

# Electronic Design 22

VOL. 21 NO.

FOR ENGINEERS AND ENGINEERING MANAGERS

OCT. 25, 1973

Combine a spectrum of inputs with a programmable logic array, or PLA — an IC system building block. It simplifies logic design, with more efficiency and fewer

parts than a ROM. Application areas range from low-speed traffic controllers to high-speed digital processors. How do you design with a PLA? Start on page 66.

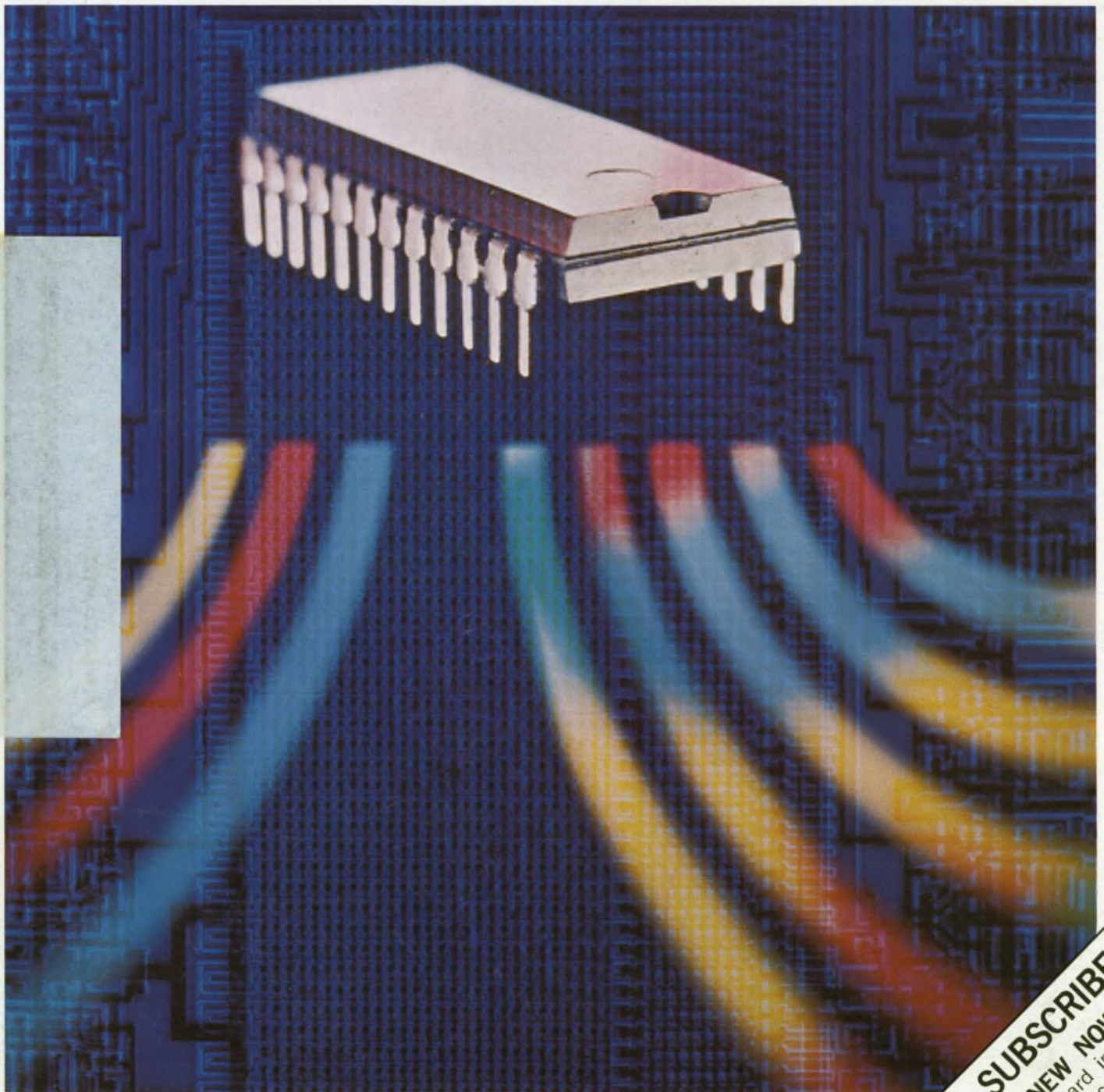

**ALL SUBSCRIBERS  
RENEW NOW!**  
Use card inside  
front cover.

# The GI book club



Here's a book club for capacitor guys. Almost everything you want to know about capacitors. Types. Specifications. Cross references. A real "how to" manual in an easy-to-use three ring binder. A binder we register in your name and periodically update. It's not a club for everybody, but if you're a qualified capacitor guy, membership is yours for the asking. From General Instrument . . . the people who wrote the book on capacitors. Capacitor Division, General Instrument Corporation, 165 Front Street, Chicopee, MA 01014. Phone (413) 594-4781.



**General  
Instrument**  
the capacitor company

Off the shelf delivery from Miconics/G.I. distributors coast to coast.  
Call (N.Y.) 212/361-2266 or (Calif.) 213/769-6782 for the name of the distributor nearest you.

**THE NEW XR-2207 IS A PRECISION VOLTAGE CONTROLLED OSCILLATOR WITH SIMULTANEOUS SQUARE AND TRIANGULAR WAVE OUTPUTS, EXCELLENT FREQUENCY STABILITY, SUPER-WIDE SWEEP RANGE, MINIMAL FREQUENCY DRIFT, AND ULTRA-LINEAR SWEEP DRIVE.**



By providing 30 ppm/°C frequency stability, 3000:1 sweep range, and 0.15%/V frequency drift in the XR-2207, Exar produced a precision VCO that can easily do those tough FSK, FM generation jobs. With a minimum of external circuitry, you can use the XR-2207 in applications such as two-channel FSK generation for modems, as the VCO portion of phase-locked loop systems, and voltage to frequency conversion that formerly required crystal controlled oscillators.

With only one capacitor and four resistors, four discrete precision frequencies are generated; two TTL keying inputs enable selection between frequencies. You can also sweep your frequency over a wide 3000:1 range with the use of one extra resistor and a little voltage.

So, if you've been putting together lots of parts

for tough waveform generation, the XR-2207 can save you time and money. It's the easy way to generate variable-frequency square and triangular waves (pulse and sawtooth too!) for every application.

The XR-2207 operates with either single or dual supplies from  $\pm 4V$  to  $\pm 13V$  over a 0.1 to 1 MHz frequency range. Seven device types are available in 14 pin ceramic and plastic packages for both commercial and military applications. Call or write for the XR-2207 data sheet and application notes.

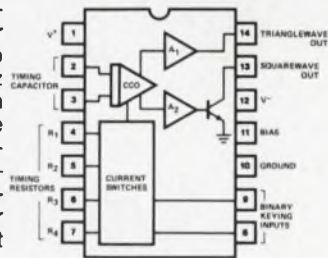

**EXAR SPEAKS YOUR LANGUAGE**



**EXAR INTEGRATED SYSTEMS**

750 Palomar Sunnyvale, California 94086 (408) 732-7970 TWX 910-339-9233

**EXAR DISTRIBUTORS** Semiconductor Concepts: Woodland Hills: (213) 884-4560 Hauppauge, L. I.: (516) 273-1234 **EFP Corporation:** Culver City: (213) 838-1912 **Intermark Electronics:** San Carlos: (415) 592-1641 San Diego: (714) 279-5200 Santa Ana: (714) 279-1322 Denver: (303) 963-8284 Seattle: (206) 767-3160 **Graham Electronics:** Indianapolis: (317) 634-8202 Lafayette: (317) 742-4006 Ft. Wayne: (219) 742-4346 Cincinnati: (513) 733-1661 **Radio Electric Service Co.:** Baltimore: (301) 823-0070 **Gerber Electronics:** Dedham: (617) 329-2400 **Yankee Electronics Supply:** Londonderry: (603) 625-9746

INFORMATION RETRIEVAL NUMBER 2

# SURPRISE!



## A quality LED for just 9¢\*.

Now you can get HP quality in an LED lamp for only 9¢\*  
That's your price when you order one million. If you only need  
one thousand, the price is a low 17¢\*. And HP is ready to  
deliver that kind of volume to meet your schedule.

This T-1 size lamp features a new low profile lens for  
high density application in calculators, cameras, computers, appliances  
and automobiles. The 5082-4487 and 5082-4488 both  
have a clear lens and a 0.8 mcd at 20 mA typical light output.  
Get the full story from your nearby HP distributor  
or, write Hewlett-Packard directly.

01333

\*US Domestic only

INFORMATION RETRIEVAL NUMBER 3

HEWLETT  PACKARD

Sales, service and support in 172 centers in 65 countries.  
Palo Alto, California 94304. Offices in principal cities throughout the U.S.

---

## NEWS

- 27 **News Scope**
- 32 **A new graphic display method** draws curves not vectors and with a lot less data.
- 34 **Connector and semiconductor manufacturers** are weighing alternatives to the high price of gold.
- 38 **Researchers see laser fusion as safe**, cheap power of the future.
- 43 **Fiber-optic modules** pave way for data and control systems.
- 47 **Washington Report**

---

## TECHNOLOGY

- 54 **FOCUS on high-temperature materials:** A special report on insulating materials that can handle tough high-temperature applications. Both mechanical and electrical characteristics are important.
- 66 **PLAs replace ROMs for logic designs.** IC programmable logic arrays simplify controllers by more efficient use of memory arrays and use of fewer parts.
- 74 **Simplify small-lamp selection** by matching design requirements to the lamps available with the help of these comparison charts.
- 84 **Fast BCD/binary conversions:** They once were a formidable task, but modern ROMs and MSI circuits have reduced part counts and speeded performance.
- 92 **Integrate with a DMM?** Yes, and you can also count, detect pulses and measure ratio—among other things. First, check the internal circuitry.
- 100 **When d/a converter glitches rear** their heads, check the application. A de-glitcher circuit added to the required DAC may solve your problem.
- 104 **Time-managed meetings are a must!** To make your get-togethers efficient and worth calling, brush up on your chairmanship, a veteran chairman advises.
- 110 **Ideas for Design:** One-shot timing circuit blocks EMI pulses that cause counting errors . . . Black-white display terminals adapted for color by controller . . . Unijunction oscillator helps increase range of monolithic timer without use of big capacitors . . . Precision resistance-ratio detector gives 0.5% accuracy for less than \$3 . . . SCR turn-off problem eliminated in rapid-fire stroboscope trigger.
- 118 **International Technology**

---

## PRODUCTS

- 121 **Modules & Subassemblies:** Successive-approximation a/d converters fit 40-pin DIPs and offer many options.
- 128 **ICs & Semiconductors:** IC op amp slew rate soars to 320 V/ $\mu$ s.
- |                     |                           |
|---------------------|---------------------------|
| 134 Power Sources   | 146 Packaging & Materials |
| 138 Instrumentation | 149 Microwaves & Lasers   |
| 142 Components      | 155 Data Processing       |

---

## Departments

- 51 **Editorial:** Let's not become another auto industry.
- |                    |                                |
|--------------------|--------------------------------|
| 7 Across the Desk  | 176 Advertisers' Index         |
| 162 New Literature | 178 Product Index              |
| 166 Bulletin Board | 180 Information Retrieval Card |

**Cover:** Photo by Patrick Tchraikian, courtesy of National Semiconductor.

# Tektronix' new programmable calculators: Natural. Powerful. Significantly less expensive.

## Natural

The new Tek 21 and 31 programmable calculators are designed for easy interaction between you and the machine. There are no machine rules or languages to learn. The new calculators have English-like programming keys and a simple keyboard that does math the way you write it.

Both machines have over 30 math functions built in. There are no extras or options to purchase: the math functions commonly used are standard.

## Powerful

With one of our calculators, you can solve problems directly from the keyboard. Data can be stored in the calculator's memory and recalled by keystrokes. Or, you can put an entire routine into the program memory and have your calculator run programs,



Tek 21

Silent alphanumeric thermal printer

Easy-to-read display: 12 digits, 2 signs

6 status messages: radians, degrees, learn, busy, stop, address incomplete  
10 error messages

Complete editing capability — insert, delete, step forward, step back

English-like programming keys

24 user-definable keys  
Built-in math ROM with 35 math functions

Register arithmetic keys



execute key commands, and recall data automatically for you.

Memory capacity needs vary from one discipline to another. The data storage and program memories of our calculators are more than sufficient to meet most needs. However, the machines can be adapted to meet the needs for large capacities (up to 8,192 program steps, 1,010 data registers, or a combination of both on the Tek 31). Magnetic cards, cartridge tapes and plug-in PROMs (programmable read-only memory) can be added to expand memory or to perform specific functions. Input and output peripherals can be interfaced to provide more power.

### Less Expensive

Through advanced design, based on unique concepts and unfettered by

unnecessary computer-based technology, Tektronix is able to offer more problem-solving performance per dollar. The Tek 21 is only \$1,850, and the Tek 31 only \$2,850. Compare those prices, and all the features of Tektronix calculators, with any other scientific programmable calculators.

### Programming

With both the Tek 21 and 31, you instruct the machine in simple English, plus common math symbols. The Tek 21 has eight keys for functions you define yourself. In your own language. The Tek 31 has 24 user-definable keys. In addition to conditional and unconditional branching, the 31 has full editing capabilities, symbolic addressing and nesting of sub-routines. Plus alphanumerics, so the calculator actually can communicate with you.

### Output

Operations and results are simple to read on both the Tek 21 and Tek 31. A large, bright display flashes to indicate that the machine has exceeded its range or that it has been asked to perform an illegal math operation. In addition, a silent thermal printer, with alphanumerics on the Tek 31, gives a hard copy of results.

We invite you to try one of our calculators. We are confident that, when you experience the ease of operation plus the overall performance, you will choose a Tek 21 or 31 programmable calculator.

For a free, full-color brochure on Tek 21 and 31 programmable calculators, please fill in and mail the coupon.



Tape cartridge for program entry

Programmable flag

-----  
Via first class mail, send me your 16-page brochure on the Tek 21 and 31 programmable calculators.

- Please add me to your mailing list.  
I am in the market for a calculator within  
 30 days     60 days  
 90 days or more

I would like to have a sales engineer call  
 Yes     No  
My area of professional activity is

Other calculators I am considering are

-----  
Name

-----  
Title

-----  
Firm

-----  
Address

-----  
City

-----  
State

-----  
Zip  
-----

Tektronix, Inc.  
P.O. Box 500  
Beaverton, Oregon 97005

Attn: Colin Barton



Prices do not include silent alphanumeric printer (\$700)  
—TEK 31: \$450—TEK 21)  
and additional memory.

INFORMATION RETRIEVAL NUMBER 4  
FOR DEMONSTRATION, CIRCLE 248

# Get the designer's edge

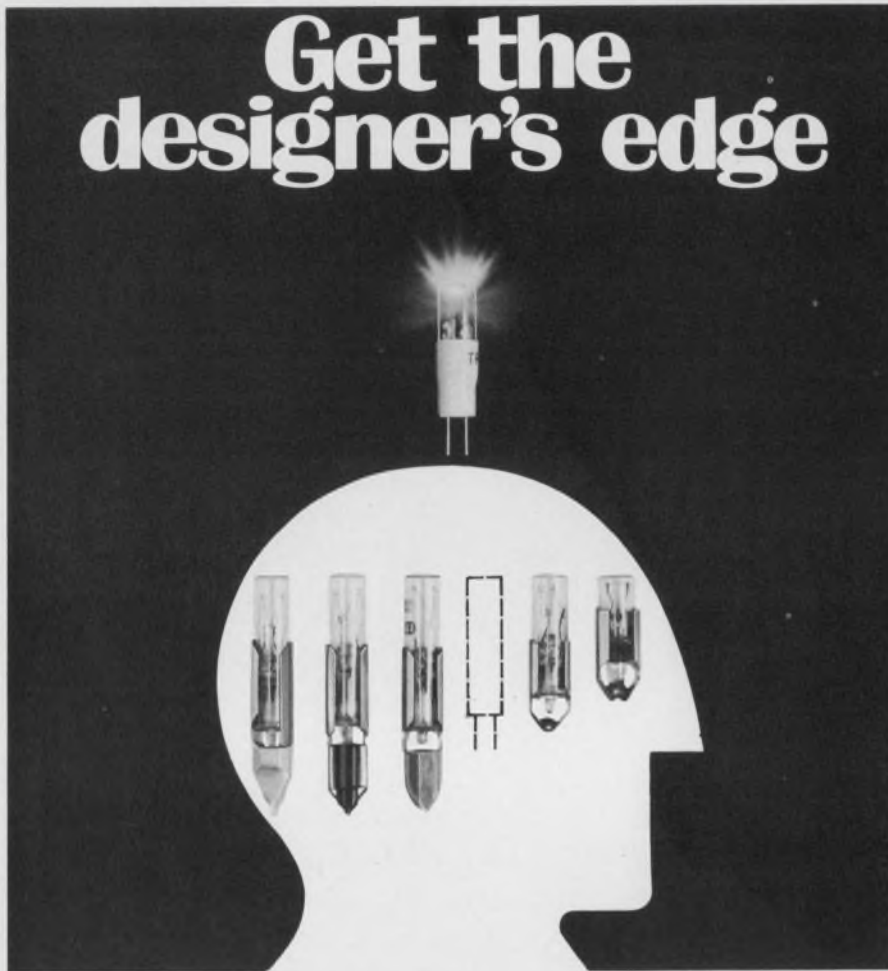

## with the industry's broadest line of subminiature T-2 lamps.

*Specify A lamp with the light output at the business end of the bulb. Maximum end viewing in signalling applications is assured with our T-2 flat top bulb construction.*

*Specify Simplicity A .250 O.D. lamp in over one hundred types assures design continuity and consistency.*

*Specify Versatility You can trade off design economy, light output, voltage, current and size with a choice of pilot, indicator and telephone lamps in up to 5 base styles.*

*Specify the Total Package We have the hardware to match the light source — a complete line of pilot and indicator sockets and lenses.*

*Specify Reliability The most widely used light source in telephone industry signalling applications. Specify telecommunications reliability.*

*Get the designer's edge — write for specification data.*



**ONE SOURCE, ONE CATALOG. GET THE EDGE.**

Send for our new 28-page catalog.  
Sylvania Miniature Lighting Products Inc.,  
West Main St., Hillsboro, N. H. 03244 (603) 464-5533

**GTE SYLVANIA**

INFORMATION RETRIEVAL NUMBER 5

**Vice President, Publisher**  
Peter Coley

### Editors

Editorial Offices  
50 Essex St.

Rochelle Park, N.J. 07662

(201) 843-0550

TWX: 710-990 5071

Cable: Haydenpubs Rochellepark

**Editor-in-Chief** George Rostky

### Managing Editors:

Ralph Dobriner

Michael Elphick

### Associate Editors:

Dave Bursky

Jules H. Gilder

Morris Grossman

Seymour T. Levine

John F. Mason

Stanley Runyon

Edward A. Torrero

Richard L. Turmail

### Contributing Editors:

Peter N. Budzilovich

Steven A. Erenburg

### Editorial Field Offices

#### East

Jim McDermott, Eastern Editor

P.O. Box 272

Easthampton, Mass. 01027

(413) 527-0183

#### West

David N. Kaye, Senior Western Editor

2930 West Imperial Highway

Inglewood, Calif. 90303

(213) 757-0183

Northe K. Osbrink, Western Editor

112 Coloma St.

Santa Cruz, Calif. 95060

(408) 426-3211

#### Washington

Heather M. David, Bureau Chief

2506 Eye St., N.W.

Washington, D.C. 20037

(202) 338-3470

### Editorial Production

Marjorie A. Duffy

### Art

**Art Director**, William Kelly

Richard Luce

Anthony J. Fishetto

### Production

**Manager**, Dollie S. Viebig

Helen De Polo

Anne Molfetas

Christopher G. Hill

### Circulation

**Manager**, Nancy L. Merritt

### Information Retrieval

Peggy Long

### Promotion

**Manager**, Jeffrey A. Welner

Karen Kerrigan



## across the desk

### German firsts? Yes, but how about these

While I agree with our German colleague that Americans tend to be a little myopic (see Hans Wilhemy's comments in *Across the Desk*, ED No. 15, July 19, 1973, p. 8), may I add the following to his list of German firsts before the world rushes to rewrite the history books:

*Television*—John L. Baird, Scotland, 1926.

*Electron microscope*—Vladimir Kosme Zworykin, United States, 1932.

*Radar*—Although the principle was first demonstrated by Hertz in 1886, it lay on the shelf until Appleton and Barnett (Cambridge University, Britain) put it to use in 1924. Later the principle was applied to the detection of aircraft by Watson-Watt (Britain) in 1935.

*Submarines*—David Bushnell, United States, 1776.

*Jet Engines*—Sir Frank Whittle, Britain, 1937.

*Rockets*—German scientists used the textbooks of Robert H. Goddard, United States.

*FM*—Edwin H. Armstrong, United States, 1933.

*Electronic Computers*—Howard Aiken, United States, 1937, and before that the Babylonians, who played with the abacus 3500 years ago.

*Rotary Engine*—Its principles were well known during the late 1800s, long before the Japanese bought the rights.

In closing, let me add that the famous Volkswagen had to wait

for a British Army captain and American machinery to make the German dream come true.

H. C. Thomas

Lyndonville, Vt. 05851

### And furthermore . . .

Mr. Wilhemy's point about German leadership in some technical areas is well taken; however, I would like to point out a fact commonly overlooked by our friends overseas—at least I found it to be so, having lived in many parts of the world in the last 10 years. That fact is that while Germany, or any other nation, was introducing technological firsts, the U.S.A. was only 150 years old!

Another point that is rarely appreciated is the American ability to "carry through" on technological introductions. For example, it was only in 1972 that the Volkswagen factory finally equaled the total output of Henry Ford's Model T!

Frank R. Bean

14 Shady Vista Rd.  
Rolling Hills Estates, Calif. 90274

Electronic Design's recruitment and classified section begins on page 168.

### Added starters for Focus article

I wish to compliment you on your article "Focus On Pulse and Word Generators" (ED No. 11, May 24, 1973, p. 128). I certainly

(continued on page 13)

Electronic Design welcomes the opinions of its readers on the issues raised in the magazine's editorial columns. Address letters to Managing Editor, Electronic Design, 50 Essex St. Rochelle Park, N.J. 07662. Try to keep letters under 200 words. Letters must be signed. Names will be withheld on request.

# THIN-TRIM<sup>®</sup> CAPACITORS FOR HYBRID-CIRCUIT DESIGNERS



ACTUAL SIZE



**THIN-TRIM** capacitors are a new development in miniaturized variable capacitors for application in circuits where size and performance is critical. The Thin-Trim concept provides a variable device to hybrid circuit designers which replaces fixed tuning techniques and cut and try methods of adjustment.

#### FEATURES

- Low profile for HYBRID CIRCUIT applications.
- High capacity values for BROADBAND applications.
- High Q - low capacity values for MICROWAVE applications.

U.S. Patent 3,701,932

*Johanson*

MANUFACTURING CORPORATION

ROCKAWAY VALLEY ROAD  
BOONTON, N.J. 07005  
PHONE (201) 334-2676  
TWX 710-987-8367





# We make components for guys who can't stand failures.

By the time they find the problem, the entire factory will be buried under ping pong balls. And there'll be a few thousand more applicants for advanced membership in the can't-stand-electronic-failures club.

If Corning had only been there in time. You see, we make components for guys who can't stand failures. Reliable components like our metal film resistors—both standard and flameproofs. Components like our glass, ceramic and glass/ceramic capacitors. Like our solid tantalum capacitors—hermetic and non-hermetic, polar and non-polar, miniature and microminiature. And like our discrete component networks—available with custom combinations of discrete microminiature resistors, capacitor chips and diodes in a dual in-line package.

## Consider tantalums:

Take our tantalum capacitors, for example. We make a wide range of extra reliability solid tantalum capacitors in a wide variety of shapes, sizes, and styles to fit virtually every packaging requirement:

Our miniminiature MINI-TANS<sup>®</sup>, encased in polyester sleeves

and sealed with special moisture resistant epoxy resin, are for use where space is at a premium. Both the cylindrical Cordwood Series and the rectangular Modular Series are available with either axial or radial leads.

Our ECONOTAN<sup>®</sup> CC Series features metal case construction and is sealed with moisture resistant epoxy resin. Polyester insulating sleeves are standard. This series finds wide application in high volume commercial and industrial equipment. Since the epoxy end seal construction makes a package extremely resistant to shock and vibration, these parts are frequently used in artillery and rocket fuses and in air-dropped anti-infiltration devices.

Corning also supplies a complete line of government approved, Established Reliability, solid tantalum capacitors. Our MILITAN<sup>®</sup> series includes the CSR13 and CSR91 which meet or exceed the requirements of MIL-C-39003. The commercial equivalents of these Series are the TS and TN Series. Miniature size, established reliability, and excellent electrical char-

acteristics make these units the most widely applied of all solid tantalum capacitors.

Our DIPATAN<sup>®</sup> TD Series capacitors feature rectangular anode construction sealed with a high stability epoxy resin. Intended specifically for commercial and industrial applications, this series has long shelf life, superior electrical performance, and radial lead construction for use in miniature printed circuit applications.

## We'd like to show you more:

But this is only a small part of our extra reliability components story. Get it all by writing for our new "General Design Guide" to: Corning Glass Works, Electronic Products Division, Corning, New York 14830.

And for information on availabilities, call your local authorized Corning distributor or D.I.A.L. EEM: (800) 645-9200, toll free. Or in New York state, call collect: (516) 294-0990.

**CORNING**  
E L E C T R O N I C S



# MECL 10,000 or...Schottky TTL?

Competition is great... as long as you keep winning.

The choice of logic for your next design may well determine the competitive status for your company. With all the claims being made, it's pretty hard to know which logic form offers the best performance per dollar. We understand your problem because we hear it daily — and that is why we have made an objective study of MECL 10,000 and Schottky TTL. Here are a few items from that comparison.

### Propagation delay

MECL 10,000 circuits are faster than comparable Schottky parts.

PART	SPEC.	MECL	TTL-S	RATIO
Gate	Typ.	2.0	8.0	1.5
	Max.	1.8	5.0	1.7
Flip-Flop	Typ.	1.0	5.0	1.2
	Max.	0.8	7.0	1.2
MSI	Typ.	4.0	8.0	2.0
	Max.	4.0	12.0	2.0
LSI ALU	Typ.	1.0	35.0	3.5
	Max.	0.8	25.0	3.2

**Conclusion:** MECL 10,000 circuits offer a more competitive design.

### Toggle rates

MECL 10,000 flip-flops are faster than Schottky TTL equivalents.

CIRCUIT	SPEC.	MECL	TTL-S
Dual 'D' Flip-Flop	Min.	175	90
	Typ.	140	75
Dual J-K Flip-Flop	Min.	175	80
	Typ.	140	125
4 Bit Shift Register	Min.	175	110
	Typ.	140	110

**Conclusion:** MECL 10,000 circuits offer a more competitive design.

### Circuit power vs. frequency

MECL 10,000 power dissipation is constant with frequency.

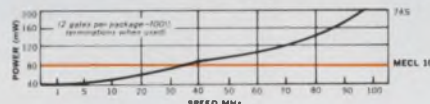

**Conclusion:** MECL 10,000 circuits offer a more competitive design.

### Additional design considerations

High speed, high performance systems involve dealing with signals containing a large content of high-frequency components. MECL 10,000 was designed for a high speed environment and provides advantages that are not available from any kind of TTL. Advantages such as:

- Lower logic swings to cut crosstalk between lines; result: the ratio of noise margin to total logic swing is markedly improved — smaller swings reduce noise on signal lines.

- Complementary outputs eliminate the usual necessity for additional inverter devices and their associated propagation delays.
- Wired-OR connections further cut back on propagation delays and device count.
- Open-emitter outputs enable the designer to match the characteristic impedance of the signal line, while keeping system power dissipation to a minimum.
- Capable of driving transmission lines, no auxiliary line drivers are needed.

**Conclusion:** MECL 10,000 circuits offer a more competitive design.

### Competition — today and next year

There are other factors you must consider. In addition to engineering merits, the marketing potential of a system is paramount. To recover development cost, the system must be competitive within the market place for several years. The product life cycle must have cost-performance advantages over present competitive equipment and future competitive designs. And, the system must be easily updated with future technologies offering greater performance.

MECL 10,000 is an open-ended technology. Significantly faster than Schottky TTL today and open-ended to apply MECL III as needed and latest state-of-the-art circuits such as 1 GHz flip-flops and sub-nanosecond gates.

### The choice is yours!

To help you make that important decision, we offer MECL Design File #4 detailing the MECL 10,000/Schottky TTL Comparison Study. For your copy, write to Motorola Semiconductor Products Inc., P.O. Box 20912, Phoenix, Arizona 85036. Better yet, call your local Motorola distributor for immediate evaluation devices. You'll find out firsthand why MECL 10,000 is specified for new designs... and upgrading of present systems.

MECL, MECL 10,000, and MECL III are trademarks of Motorola Inc.



**MOTOROLA MECL**  
... new logic capabilities for the 70's!

INFORMATION RETRIEVAL NUMBER 8

**To surround her with safety,  
at no extra cost...**



## use Sylgard 170 silicone elastomer to help make appliances flame retardant.



Appliance malfunction and even fire hazards can be minimized with Sylgard® 170 elastomer. For example, television manufacturers are using it on high voltage flyback transformers as shown above (left).

Unlike conventional insulating materials, Sylgard 170 elastomer doesn't crack or melt under 40,000-volt surges or long-term exposure to 150 C. That's well above UL requirements.

Its competitive price makes it perfect for low-cost, high-volume products.

It can also be used for potting, encapsulating and conformal coatings on hundreds of products. It's nonvolatile, nontoxic and resists ozone, x-ray and gamma radiation.

If you want the safety advantages of silicone and flame retardancy too, use competitively priced Sylgard 170 silicone elastomer.

For our Flame Retardant Sylgard® 170 silicone elastomer brochure and case histories, write Dow Corning Corporation, Dept. A-3326, Midland, Michigan 48640.

Silicone elastomers from

# DOW CORNING

DOW CORNING

## ACROSS THE DESK

(continued from page 7)

appreciate your reviewing and pointing out the various snags in the specmanship of current pulse-generator literature.

But I wish to balance my compliment with a critical question as to why my company, which today is the third or fourth largest supplier of pulse generators in the world, finds itself excluded from all but the brief listing at the end of the article. Certainly our line of pulse generators offers something to your public that should not be ignored: a 50-MHz, \$395 instrument with plus or minus 15-V output and a rise time of better than 4 ns, on up through more sophisticated instruments, including up to 100 MHz. We believe this is the most versatile general-purpose pulse-generator line on the market.

Our line is sold nationally in the United States, with representatives in almost all of the major market areas as well as in Europe, Japan and Australia through agents, with a factory-equipped sales and service office in Geneva, Switzerland.

Sid Gordon  
President

Chronetics, Inc.  
500 Nuber Ave.  
Mount Vernon, N.Y.

*Ed. Note: Electronic Design's records show that two letters were sent and two phone calls made to Chronetics, requesting information about its product line before the Focus article was published. No information was supplied.*

The word generators manufactured by Moxon Inc./SRC Div. were completely omitted from the editorial and specifications in your article "Focus on Pulse and Word Generators." Discussing word generators in this article, you mentioned that "some generators offer a fixed length of, say, 16 bits while others provide a variable bit length of 3 to 10 bits." The SRC generators are completely programmable with up to 960 bits available. The front panel is not cluttered with 960 messy toggle switches. Programming is by a unique linear octal pin, with the octal equivalent of the program-

med bits stamped on the face of the pin. This unique programming keeps the front panel small and yet maintains a flexibility that is otherwise not available in the word generator market.

You mention that word generators have one or two serial outputs. The SRC generators have been designed for both parallel and serial testing. Parallel outputs of 9, 12 and 16 bits are available with up to 100 bits per parallel stream. In addition two or more generators can be connected in parallel or serial to expand the capability further.

For production testing applications, where it is desirable to change the complete 960-bit program, SRC has the Model 912CR, which is programmed with an IBM card. This generator has a parallel capability of 80, 12 bit words.

J. E. Heyer

Vice President/Marketing  
Moxon Inc./SRC Div.  
2222 Michelson Dr.  
Irvine, Calif. 92664

*ED Note: Our records show that one letter was sent and a follow-up phone call made to SRC for product information. None was supplied.*

Don't miss an issue  
of ELECTRONIC DESIGN:  
Return your renewal  
card today.

## Manufacturer cites own s/d converters

In your June 7 issue a New Products article entitled "Monolithic s/d converter boasts high reliability" described the features of the new s/d and d/s converters produced by Analog Devices, North Atlantic Industries, and ILC Data Device Corp.

Our standard line of Synchronous-Digital Converter Modules is also directly competitive. But, in addition to the single-channel conversion modules offered by our competitors, AstroSystem's synchro modules provide:

1. 2-ms conversion rate multiplexing with a single converter

(continued on page 21)



# ULTRA-MATCHED TRANSISTORS... *made easy!*

$$V_{OS} - 100\mu V$$

$$TCV_{OS} - 0.5\mu V/^{\circ}C$$

$$\Delta h_{FE} - 3.0\%$$



## Max!

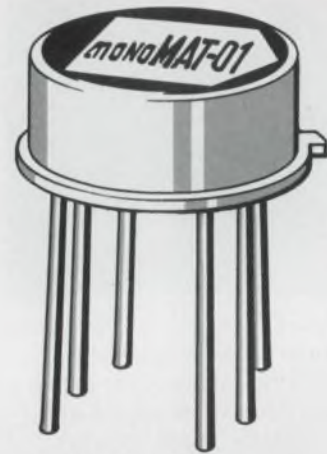

## YOUR TOUGHEST APPLICATION HAS MET ITS MATCH!

Unparalleled matching at a price you can afford — and with off-the-shelf delivery too! The monoMAT-01 makes it easy to realize your toughest-spec special purpose amplifier designs! And super-matching isn't the only feature monoMAT-01's got — the extremely linear  $V_{be}$  vs  $\log I_c$  is ideal for current sources, log-antilog and multiplier circuits. Micro-power circuitry will love the extremely low noise and high beta at very low collector currents ( $h_{FE} = 590$

typ at  $I_c = 10nA$ !). Of course, the monoMAT-01 receives Precision Monolithics' famous "Triple-Passivation Process" for the ultimate in reliability and long term stability.

*Try one and see! (It's easy! — the 6 pin TO-99 type package directly replaces most popular duals.) You'll find the monoMAT-01 is more than a match for your toughest dual transistor application! Get 'em off-the-shelf from your Precision Monolithics distributor!*

### GUARANTEED MIN/MAX SPECIFICATIONS

	monoMAT-01AH	monoMAT-01H	monoMAT-01FH	monoMAT-01GH	
$V_{OS} @ 25^{\circ}C$	0.1	0.1	0.5	0.5	mV
$TCV_{OS} (-55^{\circ} \text{ to } +125^{\circ}C)$	0.5	0.5	1.8	1.8	$\mu V/^{\circ}C$
$h_{FE} @ I_c = 10\mu A$	500	330	250	250	•
$I_{OS} @ I_c = 10\mu A$	0.6	0.8	3.2	3.2	nA
$TCI_{OS} (-55^{\circ} \text{ to } +125^{\circ}C)$	90	110	150	150	$pA/^{\circ}C$
$I_B @ I_c = 10\mu A$	20	30	40	40	nA
$BV_{CEO}$	45	60	60	45	V
Price @ 100 pcs.	\$6.00	\$5.00	\$3.75	\$2.50	•



1500 SPACE PARK DRIVE, SANTA CLARA, CALIFORNIA 95050  
TEL. (408) 246-9225 • TWX 910-338-0528 • CABLE MONO

#### AUTHORIZED DISTRIBUTORS

NEW YORK METROPOLITAN AREA Harvey Radio, Woodbury, N.Y.: (516) 921-8700 • NEW ENGLAND AREA Gerber Electronics, Dedham, Mass.: (617) 329-2400 • UPSTATE NEW YORK Harvey Federal Electronics, Binghamton, N.Y.: (607) 748-8211 • NORTHEAST Newark Electronics, Malden, Mass.: (617) 321-3930 • BALTIMORE-WASHINGTON Whitney Distributors, Baltimore, Md.: (301) 944-8080 • PHILADELPHIA Hallmark Electronics, Huntingdon Valley, Pa.: (215) 355-7300 • MICHIGAN RS Electronics, Detroit, Mich.: (313) 491-1000 • SOUTHEAST Kirkman Electronics, Winston-Salem, N.C.: (919) 724-0541 • EAST CENTRAL Pioneer/Cleveland, Cleveland, Ohio: (216) 587-3600 • Pioneer/Dayton, Dayton, Ohio: (513) 236-9900 • CENTRAL Hallmark Electronics, Elk Grove Village, Ill.: (312) 437-8800 • Minneapolis, Minn.: (612) 925-2944 • St. Louis, Mo.: (314) 521-3800 • TEXAS-OKLAHOMA Sterling Electronics, Houston, Texas: (713) 623-6600 • Dallas, Texas (214) 357-9131 • SOUTHWEST Sterling Electronics, Albuquerque, N.M.: (505) 247-2486 • Phoenix, Ariz.: (602) 258-4531 • WEST Westates Electronics Corp., Chatsworth, Calif.: (213) 341-4411 • Sterling Electronics, San Carlos, Calif.: (415) 592-2353 • Intermark Electronics, San Carlos, Calif.: (415) 592-1641 • Denver, Colo.: (303) 936-8284 • Salt Lake City, Utah: (801) 359-0531 • San Diego, Calif.: (714) 279-5200 • Santa Ana, Calif.: (714) 540-1322 • Almac-Stroum, Seattle, Wash.: (206) 763-2300 • Portland, Ore.: (503) 292-3534.

## Another FIRST from DDC...

The smallest glitchless DAC is also the fastest! . . . 13 bit resolution, settling time 50 ns per bit . . . in the first hybrid glitchless DAC. From DDC, of course. DDC, the leader in data conversion, has done it again! This time with the first hybrid deglitched digital-to-analog converter. So you could have the benefits of high speed plus compact size for critical CRT displays and precise testing applications.

The new Model DDAC hybrid features a 13 bit monotonic output, with programmable output of  $\pm 2.5V$ ,  $\pm 5V$ , or  $\pm 10V$  and 300mA coax drive capability. Other features include internal or external reference, 150 mV $\cdot$ ns glitch, and short circuit protected output. It's available as a complete two channel P.C. card assembly, a set of 3 hybrid modules or individual DAC, deglitcher, and coax driver.

And it's from DDC. The data conversion people who have made a habit of being first.

For product or technical applications information, write or call Steve Muth or Jim Sheahan. They're engineers, so they talk your language.

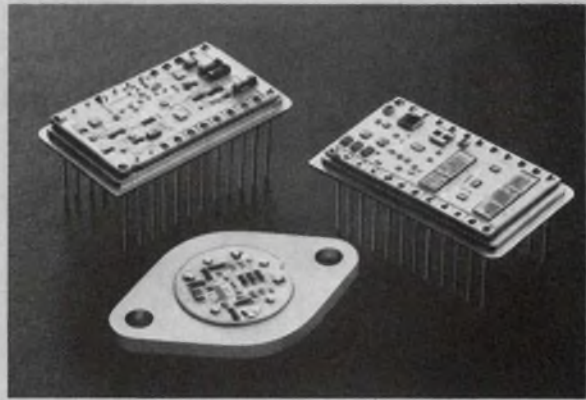

# DDC

A subsidiary of ILC Industries, Inc.

## ILC DATA DEVICE CORPORATION

100 TEC STREET, HICKSVILLE, N. Y. 11801 • PHONE: (516) 433-5330

Shaping the future of data conversion.

### APPLICATION CENTERS

Long Beach, Calif.  
(213) 597-5744

Washington, D. C.  
(703) 536-2212

Bruxelles, Belgium  
Tel. 62.01.59

# Shaping the future of Display DACs

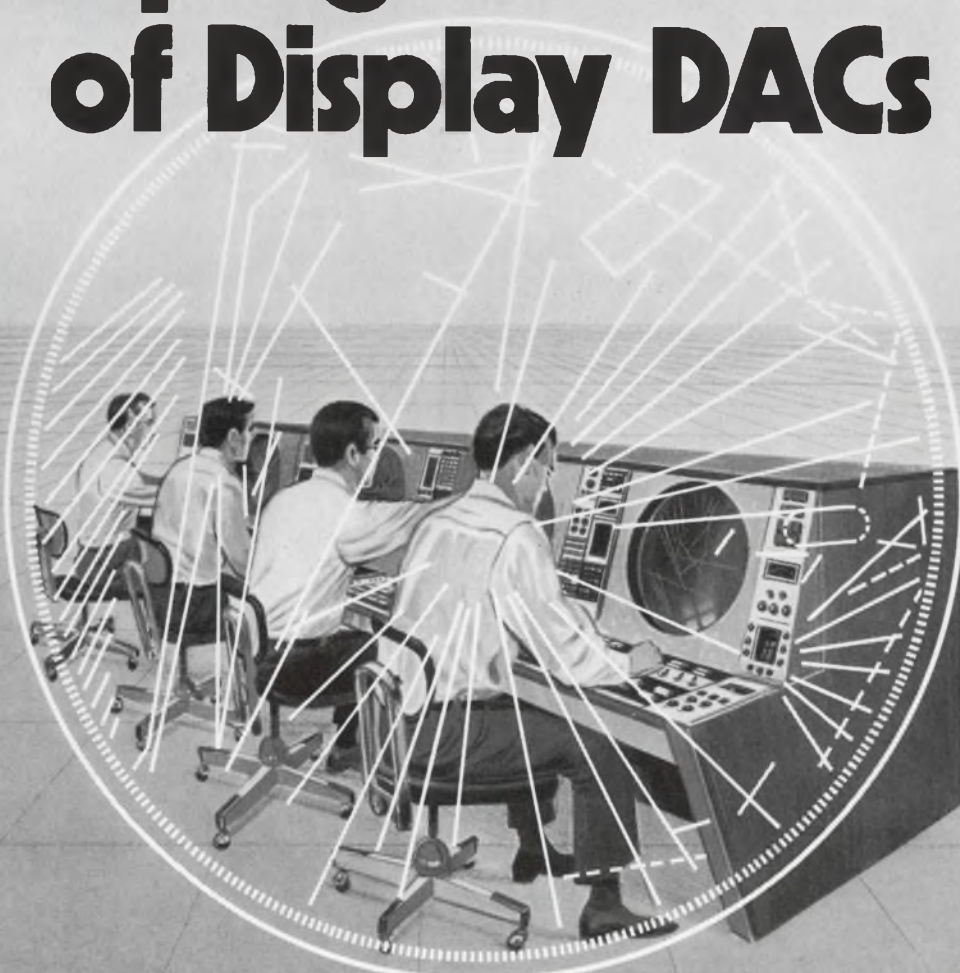

# ENI

## The world's leader in solid state rf power amplifiers

Once upon a time if you wanted broadband RF power, you had to settle for bulky tube-type power amplifiers. No more. Because ENI has developed a full line of all-solid-state Class A power amplifiers, covering the frequency spectrum of 10 kHz to 560 MHz, with power outputs ranging from 300 milliwatts to over 1000 watts. And there's more to come.

Driven by any signal generator, frequency synthesizer or sweeper, ENI's compact portable amplifiers, like the ones shown below, are versatile sources of power for general laboratory work, RFI/EMI testing, signal distribution, RF transmission, laser modulation, data transmission, NMR, ENDOR, ultrasonics and more.

Completely broadband and untuned, our highly linear units will amplify inputs of AM, FM, SSB, TV and pulse modulations with minimum

distortion. Although all power amplifiers deliver their rated power output to a matched load, only ENI power amplifiers will deliver their rated power to any load regardless of match.

We also designed our amplifiers to be unconditionally stable and failsafe—you need never fear damage or oscillation due to severe load conditions (including open or short circuit loads).

ENI instrumentation amplifiers come complete with an integral AC power supply and an RF output meter. Ruggedized amplifiers capable of operating under severe environmental conditions are available.

For a **complete** catalog of power amplifiers and multicouplers, write: ENI, 3000 Winton Road South, Rochester, New York 14623. Call 716-473-6900. TELEX 97-8283 ENI ROC.

### 40 WATT/ MODEL 240L

- 20KHz to 10MHz coverage
- More than 40w linear power output
- Up to 150w CW & pulse output
- Works into any load impedance
- Metered output

Extraordinary performance in a wide range of transducer drive applications. Deliver up to 150w into any load regardless of its impedance. Compatible with all signal and function generators, the 240L is a high quality laboratory instrument for ultrasonics, biological research & electro-optic modulation.

### 100 WATT/ MODEL 3100L

- 250 KHz to 105MHz coverage
- More than 100w linear output
- Up to 180w CW & pulse
- Works into any load
- Unconditionally stable

Designed to replace bulkier and less efficient tube type amplifiers, the Model 3100L will provide reliable and maintenance free operation. NMR, ENDOR, ultrasonics and laser modulation are just a few of the applications for this versatile source of RF energy.

### 20 WATT/ MODEL 420L

- 150KHz to 250MHz coverage
- 20 Watts power output
- Low noise figure
- 45dB +1.5dB gain
- Class A linearity

The widest band solid state power amplifier available at its 20w power level, the ENI 420L is a truly state-of-the-art instrument. As a drive source for high resolution acousto-optic modulators and deflectors the Model 420L is invaluable. Its Class A linearity will amplify AM, FM, TV and pulse signals with minimum distortion.

### .3 WATT/ MODEL 500L

- Flat 27dB gain 2MHz to 500 MHz
- 1.7MHz to 560MHz usable coverage
- Thin film construction
- 8dB noise figure
- Failsafe

This compact unit can deliver more than 300 milliwatts from 1.7MHz to 560MHz at low distortion. A thin film microelectronic circuit is the heart of this general utility laboratory amplifier. Extremely wide band response at a very modest price.





# Connector or IC panel— we can give you exactly what you need.

Single-, double- or multilayer. Mother/daughter board connectors, IC receptacle packaging, feedthrough posts, low-profile DIP headers, or cable-to-board connectors. Prewired or ready to wire by automatic techniques.

# Panels with high reliability, competitive cost and ease of repairability.

We built our reputation for quality and low applied cost in the connector field. And carried it over into back panels—the very heart of modern electronic systems. To give you the kinds of connectors, manufacturing techniques and equipment which ensure reliability, performance and repairability—at a competitive cost.

## High reliability.

We eliminate plated through-hole distortion and possible damage caused by force fit insertion. This is done by selectively pre-depositing bands of solder on posts and receptacles before inserting and reflow-soldering them into panels. This process also greatly increases the reliability and performance of our panels by eliminating wicking, bridging, peaks, icicles and board delamination.

Fillets are more uniform and complete, with full solder top to bottom. And posts are left clean and solder-free for automatic wiring. AMP has also developed connector housings which snap on over the contacts *after* contacts are flow soldered, so there's better use of printed circuit real estate. For information on our panels circle Reader Service Number 150.

## Ease of repair.

When snap-on connector housings are used, individual contacts can be exposed for quick, easy removal and replacement, without the need to desolder *all* contacts.

## Competitive cost.

There are several important ways in which we keep the cost of our panels competitive. First, by inserting contact posts with high-speed, automated machines. Second, by soldering *all* contacts simultaneously instead of individually. And third, by conducting rigorous electrical and mechanical quality checks on *every single panel* we make, eliminating the cost and burden of incoming inspection for our customers. Additional economies can be achieved by using snap-on housings which do not require time-consuming individual contact loading.





*Presoldered contact is inserted into plated panel through-hole.*



*Solder band is pulled into through-hole with just enough force to retain it during reflow.*



*Contact is flow soldered in place, producing uniform fillet with full solder, top to bottom, and clean, solder-free posts.*

## **We can design with you or for you.**

If you customarily design your own panels, we can assist in optimizing your circuit patterns. Or, we can take your parameters and complete the entire panel-making operation, sparing you considerable investment. Using computer-driven plotters, we "pack" the greatest number of circuit paths into the smallest possible board space, consistent with other design parameters.

## **We'll set you up to wire or do your wiring for you.**

Give us your parameters. We'll give you assembled connector or IC panels, pre-wired or ready for your automatic wiring. If you choose the TERMI-POINT clip system, you'll get highly-reliable, spring-action terminations that are easier to test, maintain and service.



# Panel construction is AMP-engineered and manufactured.

One main reason we can control the quality and cost of our panels so well is the fact that we design, engineer and manufacture literally everything that goes into them.

## DIP headers are ideal for low-cost, high-density packaging.

Our low-profile DIP headers provide some of the industry's lowest-cost, highest-density packaging for 14- and 16-lead IC's. Standard headers accept a full range of lead sizes—round, rectangular or both, and are compatible with high-speed, automated wiring methods. Low-profile headers (.150-inch high) accept rectangular leads up to .015 x .030-inch.

## Low-profile miniature spring socket offers maximum retention and conductivity.

Designed specifically for electronic and wiring applications that require low profile miniature sockets, this product has an inner spring member and a body with either a .022 x .036-inch or .025" post configuration. The inner spring member maintains consistent pressure against the lead, providing excellent retention and conductivity. A "barbed" design allows the socket to be self-retained in the panel and, at the same time, prevents socket "pullout."

## IC receptacles have unique anti-overstress design.

The unique, built-in anti-overstress stop on our IC receptacles assures tight, constant contact. The receptacle will accommodate any known IC configuration or package with round or flat leads up to .022-inch diameter or .022 x .040-inch dimensions.

Removable gold-over-nickel-plated contact springs provide excellent performance.

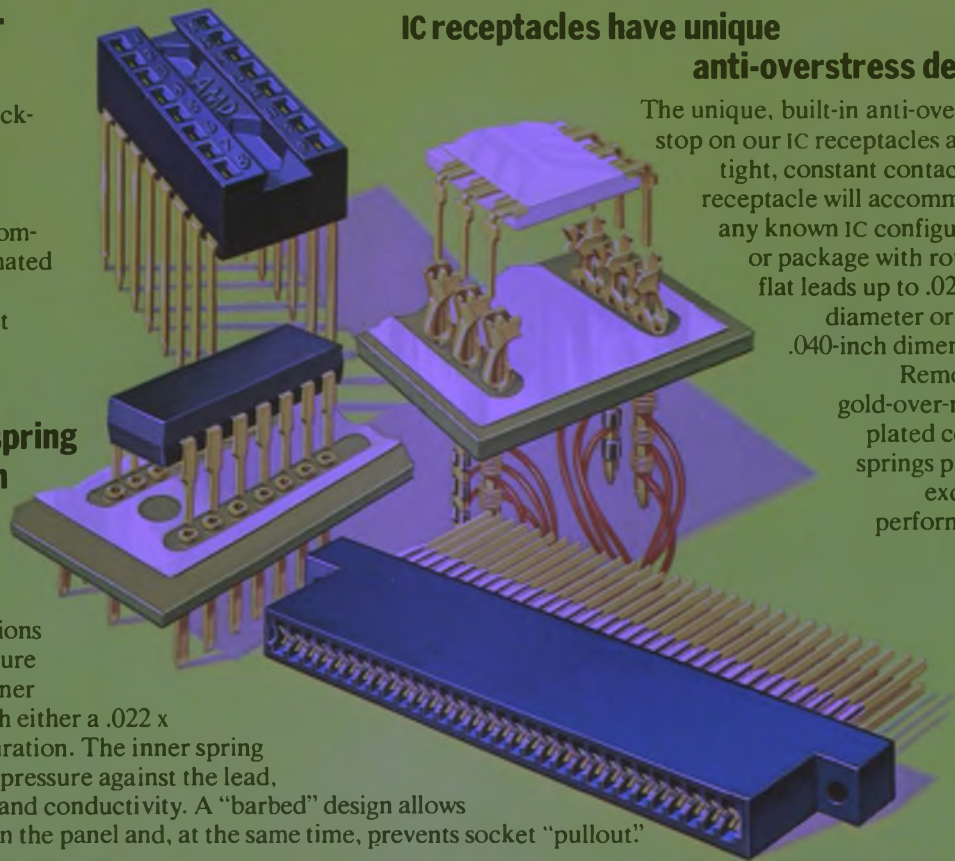

## Posted card connectors offer great versatility in panel design.

Our TERMI-TWIST Connectors are available in a variety of configurations, depending on your requirements for post size, number of positions and center-line spacing. Board area contacts are bifurcated for redundancy. Connectors can all be wired by high-speed, automatic techniques.

## Engineering backup...worldwide.

At AMP, nearly 900 application, service and sales engineers are prepared to assist you with every phase of panel-making, connectors and programming systems. At your domestic manufacturing plant, or wherever you use AMP products and machines throughout the world. You'll find AMP manufacturing and service facilities in most major international markets. In the United States, district offices are located in California, Georgia, Illinois, Massachusetts, Michigan, Minnesota, New Jersey, Ohio, Pennsylvania, Texas, and the District of Columbia.

## Write for Panel Packaging Folder

Find out how we're able to give you exactly the panel you need. Write on your company letterhead for our Panel Packaging Folder. It contains full documentation of our various processes, with suggestions of how they can work best for you. AMP Industrial Division, Harrisburg, Pa. 17105.

# RF and Switching: Win Big with D-MOS FETs



## Your own application could win a FREE VEGA in the bargain.

You really went for our first 1 GHz D-MOS FETs. So we've expanded the line! Three more RF devices. Plus two D-MOS FETs for switching. The only FETs ever produced to combine bipolar speed, noise figure and inter-electrode capacitance, with MOS linearity and input leakage.

TO IMPROVE RF PERFORMANCE—Typical Values						
D-MOS FET Device	Freq. (GHz)	NF (dB)	Power Gain (dB)	C <sub>iss</sub> /C <sub>oss</sub> /C <sub>rss</sub> (pF)	100-up price	
SD200*/201	1.0	4.5	10.0	2.0/1.0/0.13	\$4.00	
SD202*/203	1.8	5.0	6.0	3.0/1.0/0.2	\$5.25	
SD300	1.0	8.0	13.0	2.0/1.0/0.02	\$3.00	
SD301	1.0	6.0	14.0	2.0/0.6/0.02	\$3.35	
SD304	0.5	5.0	16.0	2.0/1.0/0.03	\$1.00	

TO IMPROVE SWITCHING PERFORMANCE—Typical Values						
D-MOS FET Device	<sup>t</sup> DS (On)Ω	t <sub>d</sub> (On) (ns)	t <sub>r</sub>	Analog Swing	C <sub>iss</sub> /C <sub>oss</sub> /C <sub>rss</sub> (pF)	100-up Price
SD210*	30	0.6/0.7		±10V	2.6/1.3/0.2	\$1.50
SD211	30	0.7/0.8		± 5V	2.6/1.3/0.2	\$1.50

\*Unprotected inputs: all others diode-protected

Check the chart, and match specs with your system requirements. RF? Apply yourself to low noise, lower cross mod and inter mod, for front end amplifiers and mixers. Switching? Think what you'll do with the speed: 600 picosecond turn-on time, with on-resistance of 30Ω.



With so many new user-opportunities, there'll be no stopping you. So we've designed a fabulous Application Contest, just to reward your genius with D-MOS FETs. And your application could win.

**First Prize:** 1974 VEGA Hatchback with all the extras. Automatic, power steering, air, radio & heater, white sidewalls. Delivered free anywhere in the continental USA, for the best application submitted.

**Two Second Prizes:** HP-45 Scientific Pocket Calculators. 25 Third Prizes: mini-calculators to pocket.

Idea starters for applications: mixers & amplifiers in VHF-TV, FM, CATV. Mobiles, aircraft, marine radios. A & D function modules, instrumentation & test equipment, computer peripherals.

ATTACH THIS TO YOUR LETTERHEAD — TRY FOR A BIG WIN!

Signetics—D-MOS FETs  
811 E. Arques Ave., Sunnyvale, Calif. 94086

Show me how D-MOS FETs in RF and Switching help me win system improvements and new product designs. Rush data sheets! And don't forget my contest kit with rules, entry blank, etc. Contest closes January 15, 1974. Prizes awarded March 15, 1974.

Name \_\_\_\_\_

Title \_\_\_\_\_

Special! Send a sample to work with: #SD\_\_\_\_\_.

Signetics Corporation. A subsidiary of Corning Glass Works.

## signetics



Now you can design a *true* shirt-pocket size calculator. Or handheld calculator with 30 or more functions. All with the same snap-through feel and sound that have made Klixon® low profile keyboards the number one sellers.

The new 3KS keyboards retain all the characteristics of the original 1KS model. They are available with selectively gold plated disc construction or TI's new lower cost Alloy A material system. TI engineered snap-acting discs provide uniform feel and over 1 million reliable operations. But the new discs are 25% smaller.

The design of the switch array provides complete flexibility for custom configurations. The entire switch area is sealed with Mylar™, so contacts are both lint-proof and spill-proof. The keyboards are available with or without keytops.

If your plans include shirt-pocket size or advanced-function handheld calculator models, be sure to look over our new literature. Which you can get by sending us the coupon.

## Texas Instruments expands your keyboard options:

ORIGINAL 1KS LOW PROFILE KEYBOARD  
used on most pocket calculators, only .150" thick.  
(Complete 6KS keyboard shown.)

## more functions...

NEW 3KS KEYBOARD design can provide  
up to 30 switching functions in the same  
2½" x 3" areas as the 6KS.

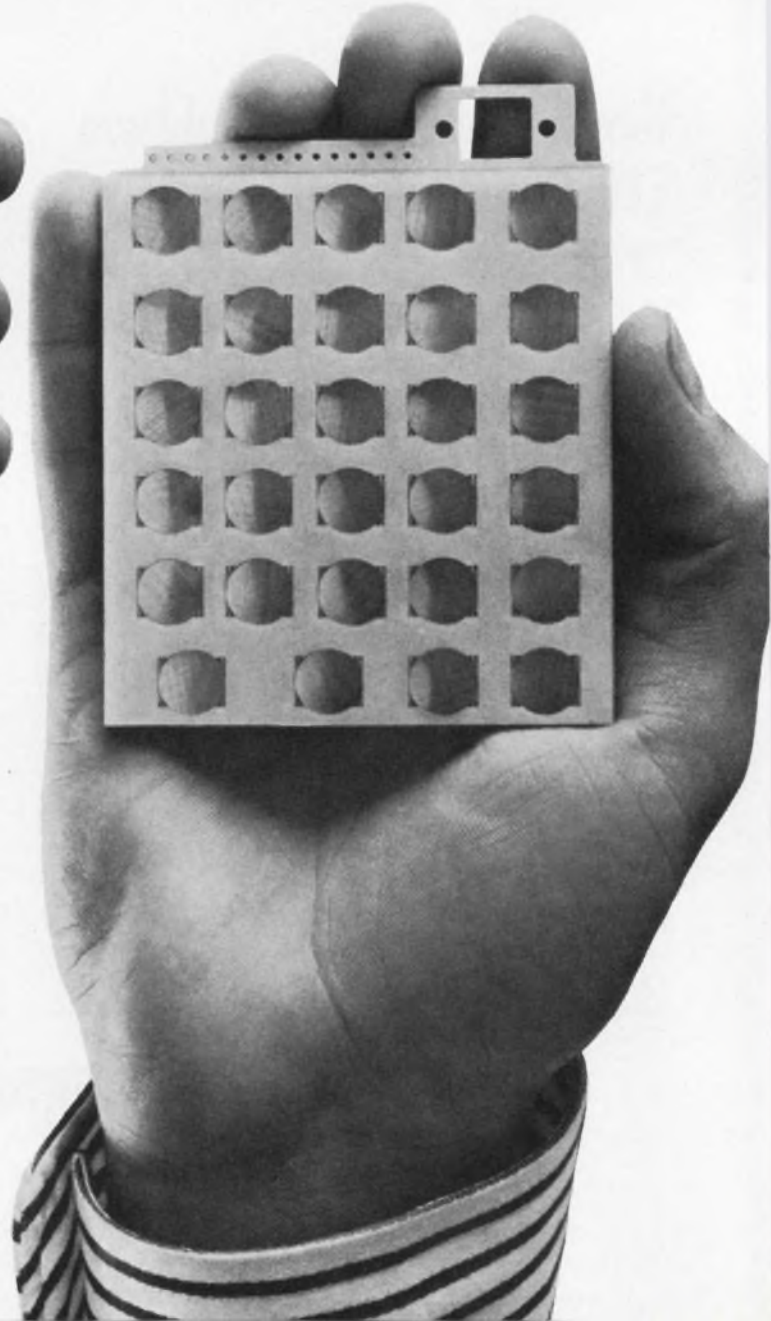

Texas Instruments Incorporated  
Keyboard Products Marketing  
MS 12-33  
Attleboro, Mass. 02703

Name \_\_\_\_\_

Title \_\_\_\_\_

Company \_\_\_\_\_

Address \_\_\_\_\_

City \_\_\_\_\_ State \_\_\_\_\_ Zip \_\_\_\_\_

Keyboard application:

- Pocket Calculator       Computer Terminal  
 Desk-top Calculator     TV Controls

Other \_\_\_\_\_

- Application is new     or existing

Approx. annual usage \_\_\_\_\_ units

Application requires:

- Basic 1KS or 3KS keyboard array  
 Complete keyboard assembly  
 Please have a TI Sales Engineer call



**TEXAS INSTRUMENTS**  
INCORPORATED

## smaller size...

OR 3KS KEYBOARDS can shrink  
20 switching functions into 2¼" x 2½"  
shirt-pocket size array.

## thinner.

NEW 2KS KEYBOARD  
is only .050" thick.



# TRI-STATE AND CMOS, TOGETHER AT LAST.

Tri-State® Logic comes to CMOS.

For all you designers of bus organized systems who know and love Tri-State, now you can have your heart's desire in CMOS, too.

## Fast-Acting Buffers

Introducing two new CMOS buffers that convert standard CMOS outputs to Tri-State outputs.

They incorporate all the mouth-watering features of 54C/74C. Not to brag, but this includes a wide supply voltage range (3v to 15v), high noise immunity (typically 45% of VDD), and guaranteed noise margin of 1.0v (which is 2½ times that of TTL).

And in addition they can drive one TTL load *directly*. So you can mix TTL and CMOS on the same board as well as on a board-to-board basis.

The numbers (get your pen out) are MM70C95/MM80C95, which has common output controls for all six buffers... and MM70C97/MM80C97, which has two controls (one for two buffers, one for the other four) in case that's the kind of thing that turns you on.

Not to mention the four additional Tri-State buffers we have on the drawing boards.

## Fascinating Flip-Flops

And, as if that weren't enough to make your day, we've also enhanced our already illustrious 54C/74C line with a Tri-State Flip-Flop. MM54C173/MM74C173 Tri-State Quad D Flip-Flop, to be exact. It also

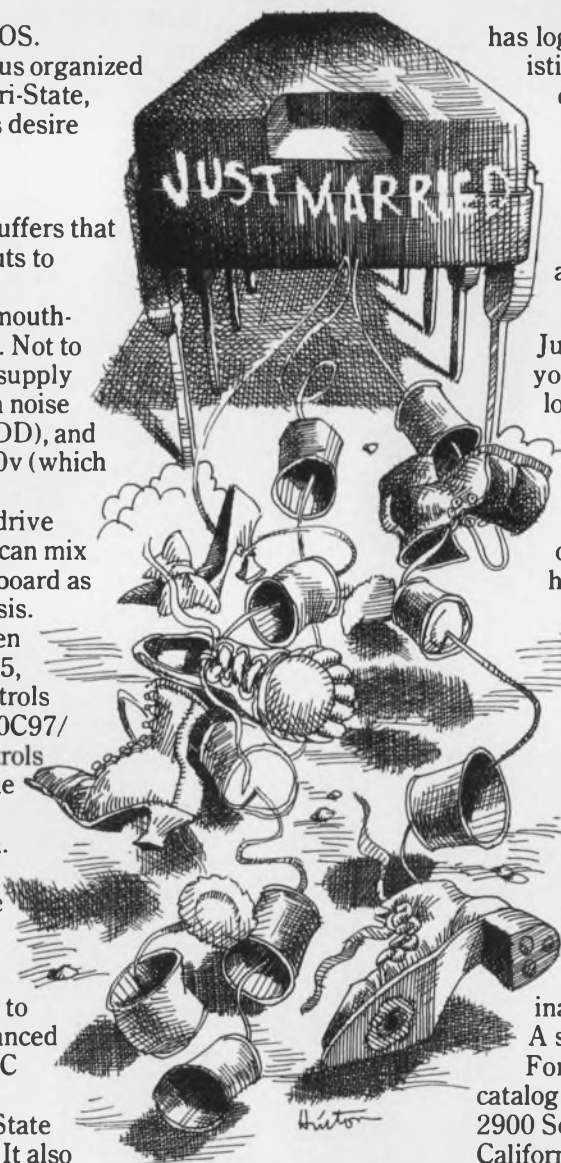

has logically controllable gated D characteristics, which greatly simplifies control circuitry.

It operates synchronously from a common clock, with a Tri-State output that allows it to be used in a bus organized system.

Ask for it wherever Flip-Flops are sold.

## Tri-State Revisited

Just in case it slipped your mind or you've been living in a cave, Tri-State logic devices give you the ability to interconnect outputs of similar devices to a common bus line.

This lets you do data bussing without the huge current transients on the line, because, cleverly, Tri-State has a third impedance state.

Fewer packages are needed to effect the same logical solution.

And noise susceptibility is improved 3-to-1 compared to a transmission gate.

## CMOS Revisited

The 54C/74C bandwagon keeps rolling.

New products (27 now available, with more on the way).

Volume production (on your distributors' shelves now).

A highly successful program of seminars all over the country just completed. A standard of the industry in the making. For the whole story write for our CMOS catalog. National Semiconductor Corporation, 2900 Semiconductor Drive, Santa Clara, California 95051.

# NATIONAL

National Semiconductor Corp., 2900 Semiconductor Drive, Santa Clara, Calif. 95051; Scottsdale, Ariz. (602) 945-8473; Mountain View, Calif. (415) 961-4740; Sherman Oaks, Calif. (213) 783-8272; Tustin, Calif. (714) 832-8113; Miami, Fla. (305) 446-8309; Chicago, Ill. (312) 693-2660; Indianapolis, Ind. (317) 255-5822; Lenexa, Kan. (816) 358-8102; Glen Burnie, Md. (301) 760-5220; Burlington, Mass. (617) 273-1350; Farmington, Mich. (313) 477-0400; Minneapolis, Minn. (612) 888-4666; Englewood Cliffs, N. J. (201) 871-4410; Syracuse, N. Y. (315) 455-5858; Dayton, Ohio (513) 434-0097; Dallas, Tex. (214) 233-6801

# Quick appearing ROMs



## Before your eyes in 6 to 8 weeks

Electronic Arrays can deliver your custom ROMs to you in 6 to 8 weeks. That's because we're organized for the job. We've already made a quarter million of these MOS ROMs for people who demand fast deliveries.

Take your pick:

**The big one, EA4800,** stores 16K bits in a 2048 x 8 or 4096 x 4 format in a 24-pin package. It's a favorite for microprocessors. Has a maximum access time of 1.2  $\mu$ secs. Uses .032 mW/bit power. Requires +5v and -12v supplies. No clocks needed - it's static. No ad-

dress decoding required - it's on the chip. No input pull-up resistors needed - they're on the chip. Price is \$28 in quantities of 100.

**The fast one, EA4000,** has a 725-nanosecond guaranteed worst-case access time. Stores 512 10-bit words in a 24-pin package. Uses .04 mW



**The big one,  
16K bits**

**The fast one,  
725 ns**

**The low-power  
one, .02 mW/bit**

per bit power. Requires +12v and -12v supplies. Price is \$13 in quantities of 100.

**The low-power one, EA3800,** uses only .02 mW per bit. Stores 1024 12-bit words in a 28-pin package. Has a maximum access time of 3.3  $\mu$ secs. Requires +12v and -12v supplies. Price is \$22.50 in quantities of 100.

If you want ROMs fast and sure, get in touch with us right now. Electronic Arrays, Inc., 550 Middlefield Road, Mountain View, Calif. 94043. Phone (415) 964-4321.

Cramer Electronics is our distributor nationwide.

electronic arrays 

---

# Raytheon Semiconductor Update 3

---

## **Straight talk about today's hi-rel semiconductor shortages. And why it pays military and other hi-rel users to specify Raytheon Semiconductor.**

There's no question about it. Semiconductor shortages are really here. Demand is exceeding supply by twenty-five percent. And there's no relief in sight.

Those who feel the pinch most are the military/government and high-reliability commercial users. Who above all cannot accept standard grade semiconductors as substitutes.

Most other suppliers would prefer to fill orders from the high volume commercial, industrial, and computer markets. And let the military and hi-rel commercial business take what's left. Or simply go without.

Not at Raytheon Semiconductor. We've built our standard commercial business around our basic military and hi-rel nucleus. Instead of the other way around.

Sure. We have a going commercial market. And we are pursuing it vigorously. But not at the expense of our military and hi-rel commercial business.

The other suppliers would rather handle these more "glamorous" burgeoning markets—the calculator,

automobile, home electronics — because the volume is great and the design specifications relatively inexpensive on a cost-per-run basis. And because today's commercial contract isn't tomorrow's military cancellation.

**We think this attitude is myopic.**



Contrary to the current trend, Raytheon Semiconductor's management is dedicated to continue its pursuit of military and hi-rel business. Not half-heartedly. But with

a firm commitment. Just because there's larger volume in more standard commercial designs doesn't mean that it's a more attractive business. Not at Raytheon Semiconductor. Not the way we manage and discipline our military and hi-rel business. Furthermore, this competency becomes well known and establishes a strong loyalty.

**Why should there be anything taboo about the military business?**

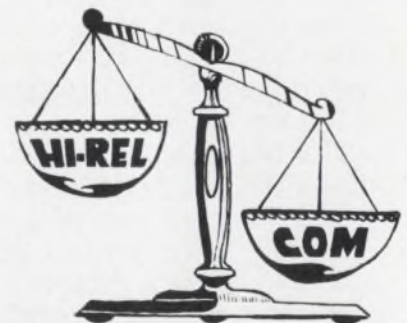

Every day, more and more military requisitioners are asking: "But where am I going to get parts?" And most semiconductor suppliers don't seem to care. Their long-term

marketing directions and the military business are at odds. They will tell you a variety of things. To design away from your special packages and custom devices. Or not to use your own unique specifications. But switch to standards. Consolidate your designs into fewer types so that volume will increase. In other words, stick to the industry standard of off-the-shelf components — popular, high volume, standard packages. Or else.

**We have always reacted quickly to military and hi-rel needs.**

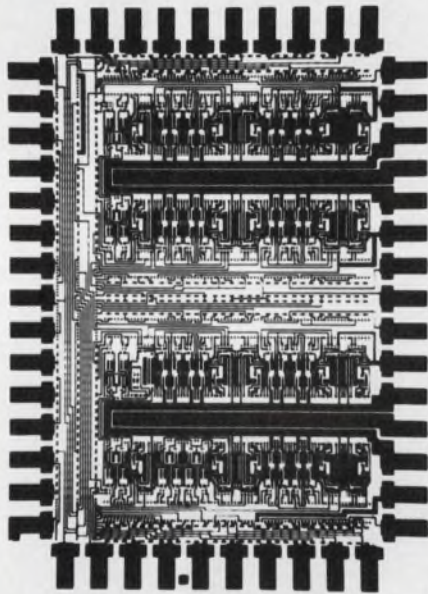

When you need linear or digital IC's, beam-lead chips or JAN TXV transistors for very hi-rel programs of a custom nature, you want them now. Raytheon Semiconductor caters to these very sophisticated requirements. Now. And doesn't ask you to stand in line 12 to 24 months to get them.

**We are totally dedicated to the long-term needs of military and other hi-rel customers.**

Our track record speaks for itself. We're still delivering a variety of linear and digital IC's and transistors for the Hawk, Sidewinder,

Maverick, Sparrow, and Minuteman missile programs. That's why we're not giving up the old just for the sake of the new. We're committed to products such as 930 Series DTL

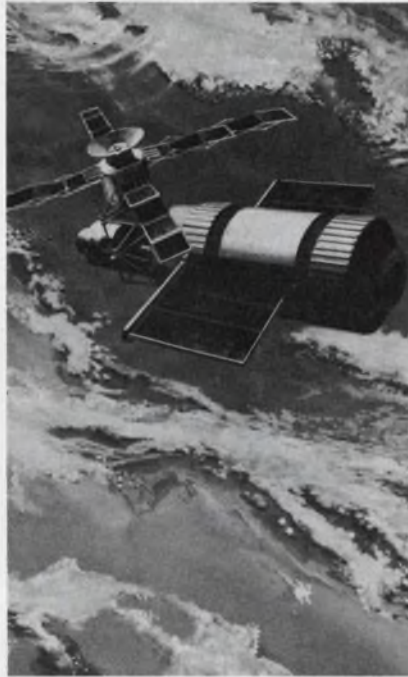

ROCKWELL INTERNATIONAL SPACE DIV

and SUHL that many suppliers are phasing out. After all, why should we give up a good profit maker.

In several space programs we've been a major semiconductor source. Apollo used our 101, 709, and 741 op amps. More than three thousand of our 709's went into Skylab. And we still furnish Agena with transistors and the 930 Series.

The Viking Mars mission scheduled for 1975 will use our transistors, IC op amps, multivibrators and voltage regulators.

And, because of our leadership in beam-lead technology, we're heavily involved with development programs for the SAM-D, Trident C-4, and the B-1.

**When it comes to reliability, there's none better than Raytheon Semiconductor.**

Let others base their future semiconductor growth on glamorous new products for standard commercial

needs. We're building our commercial market around our basic military and hi-rel nucleus. Which explains why Raytheon Semiconductor products are integral to a heart pacer, hearing aids, a solid-state digital watch, and an antiskid

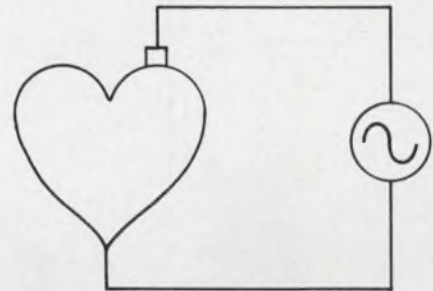

mechanism for the automotive industry. Examples of the hi-rel and advanced beam-lead technology that enhanced the reliability of these exotic new commercial products.

**We'll always give you straight answers.**

To help solve your military and hi-rel commercial problems contact our Hi-Rel Marketing Manager.

For a copy of Raytheon Semiconductor's hi-rel brochure, called *RayRel*, write us on your company's letterhead. And if you want copies of our Update 1 and 2, we'll be glad to send them along too.



Raytheon Semiconductor, 350 Ellis Street, Mountain View, CA 94042, (415) 968-9211.



# Fujitsu Quality on Sale in Reed Switch

Fujitsu reed switches combine ultra-small size with reliability and superior performance.

**FUJITSU**

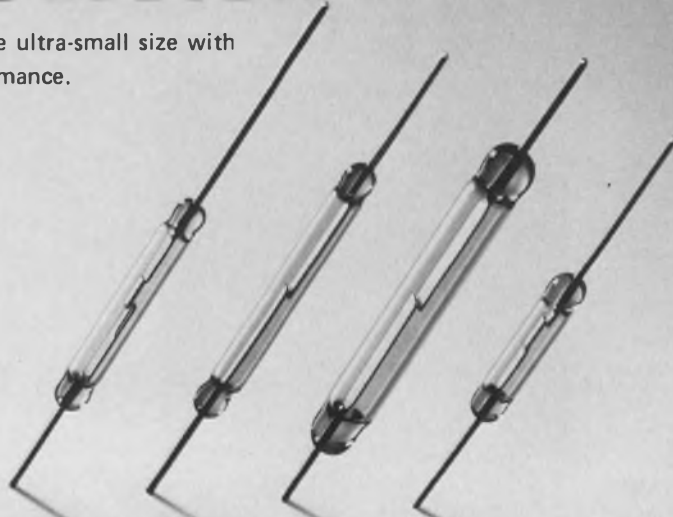

Select the most suitable reed switch for your requirements from the following:

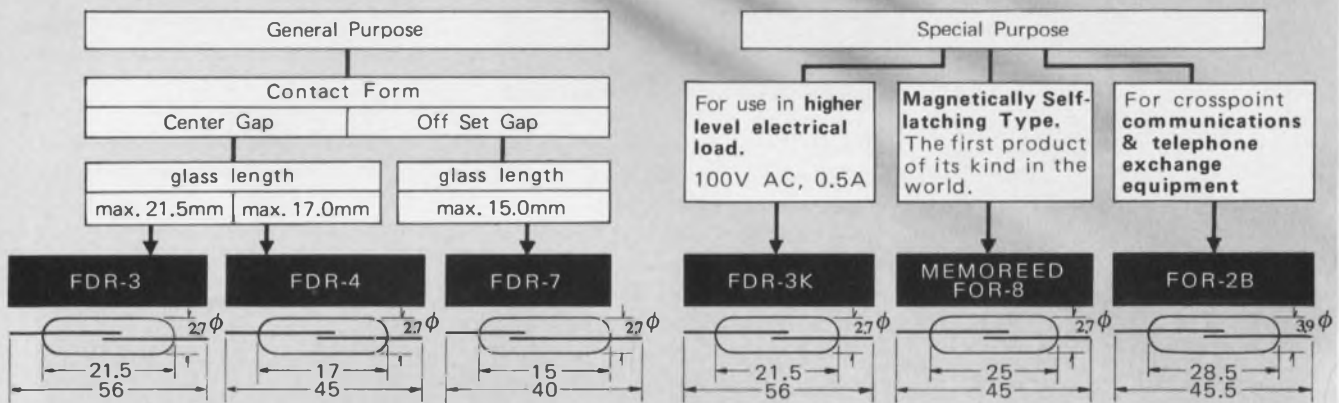

Reed Switch	Contact Form	Contact Rating	Pull-in Ampere-turns	Drop-Out Ampere-turns	Operate Time	Release Time	Initial Contact Resistance	Dielectric Withstanding Voltage
FOR-3	A(make) Center Gap	10VA DC	20 ~ 60	8 min.	800μS max. (including contact bounce)	50μS max.	150mΩ max.	250/500V DC (1min.)
FDR-4	A(make) Center Gap	(0.5A DC max.) (100V DC max.)						20 ~ 52
FDR-7	A(make) Off Set Gap		250/500V DC (1min.)					
FDR-3K	A(make) Center Gap	30VA DC (1A max.) 50VA AC (1A max.)	20 ~ 60	8 min				250/500V DC (1min.)
FDR-8	Self-latching Type	5VA DC (0.5A max.)	85 ± 10	-28 ± 6	1.5mS max. (including contact bounce)	0.1mS max.	100mΩ max.	600V DC (1min.)
			110 ± 15	-24 ± 10				800V DC (1min.)
FDR-2B	A(make) Center Gap	10VA DC (0.5A max.)	40 ~ 60	15 ~ 25				800V DC (1min.)

**FUJITSU LIMITED**  
*Communications and Electronics*  
 Marunouchi, Tokyo, Japan

For further information, please contact:  
 Head Office: 6-1, Marunouchi 2-chome, Chiyoda-ku, Tokyo 100, Japan Telex: J22833  
 New York Office: 680 Fifth Avenue, New York, N.Y. 10019, U.S.A. Phone: (212) 265-5360  
 Fujitsu California Inc.: 1135 East Janis Street, Carson, California 90746, U.S.A. Phone: (213) 636-0858, (213) 537-8930

MAIN PRODUCTS □ Telephone Exchange Equipment □ Carrier Transmission Equipment □ Radio Communication Equipment □ Space Electronics Systems □ Electronic Computers & Peripheral Equipment (FACOM) □ Telegraph & Data Communication Equipment □ Remote Control & Telemetering Equipment □ Electronic Components



# VLEDs

## Turn on. With TI's improved TIL 209A. Or the larger TIL 220 or TIL 221.

Three years ago we introduced an industry standard—the TIL 209. Now Texas Instruments announces the 209A with everything its predecessor has and more. Plus, you get fast, off-the-shelf delivery.

Designed for high volume low cost consumer applications—appliances, TVs, stereos, cameras—the TIL 209A (1/8-inch diameter) is also used in a wide variety of industrial and computer applications.

And to offer even more design flexibility, TI introduces the larger TIL 220 and TIL 221 (1/4-inch diameter).

All three VLEDs have sturdy lead frame packages for better wire wrapping and lead forming.

Rugged .020-inch square leads permit fast installation in sockets, printed circuit boards

or 1/16-inch panel mounts.

Filled-epoxy lenses provide diffused red light for a wide viewing angle in the TIL 209A and TIL 220.

The TIL 221 has a clear epoxy lens, and is a high intensity source for back-lighting applications.

Contact your nearest TI sales office or local distributor for our new low prices.

For data sheets, indicate by type number and write:

Texas Instruments  
Incorporated, P. O.  
Box 5012, M/S 308,  
Dallas, Texas 75222.

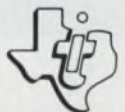

TEXAS INSTRUMENTS  
INCORPORATED



# 5 books that should be in your personal library... order now for 15-day free examination!



## DURABILITY AND RELIABILITY IN ENGINEERING DESIGN

by Gilbert Kivenson

A unique combination of materials science, reliability, and design. Examines crucial concepts of material strength, service longevity, and reliability and describes the fundamentals of breakdown analysis. Covers new materials, design techniques and fabricating methods. 200 pp., #5851-9, cloth, \$9.95.

## PRACTICAL VALUE ANALYSIS METHODS

By John H. Fasal



An applications-oriented guide offering a working knowledge of the latest methods and techniques in value engineering and value analysis. Provides ways of evaluating and supplementing the internal cost reduction techniques that enable a company to keep pace with competition. 272 pp., #5845-4, cloth, \$11.95.



## PRACTICAL RELAY CIRCUITS

by Frank J. Oliver

Logically groups relay circuits according to the functions they perform, to help you quickly select the best circuit for your purposes. Covers the whole gamut of relay circuits and is illustrated with many circuit diagrams. 363 pp., #5802-0, cloth, \$14.95.

## ELECTRICAL/ ELECTRONIC CHECKLISTS

Written and edited by W. B. Rossnagel



Twenty-two detailed checklists on subjects including cables and connectors, communication radios, multi-coders, GSE/AGE/TSE, EMI/RFI, lasers, radar, systems, transmitters and transponders, as well as other subjects. 172 pp., #9181, cloth, \$14.00.



## PRACTICAL DESIGN FOR ELECTROMAGNETIC COMPATIBILITY

Edited by Rocco F. Ficchi

A convenient manual giving electronic designers techniques for analyzing, predicting, controlling, and reducing unwanted signals. Gives advantages and disadvantages of latest methods for reduction and control. Provides ways of selecting equipment for interference reduction. 272 pp., #5685-0, cloth, \$13.95.



### HAYDEN BOOK COMPANY, INC. 50 Essex St., Rochelle Park, N.J. 07662

Please send the book(s) checked on 15-day free examination. At the end of that time, I will remit payment plus postage, or return the book(s) with no further obligation.

5851-9    5802-0    5685-0    5845-4    9181

**\$10.00 minimum for free exam orders.**

Because of higher billing and collection costs, we must ask for payment in full with any order for less than \$10.00. Books will be shipped postpaid. Same 15-day return privilege for full refund if not satisfied.

**Save Money!** On all prepaid orders Hayden pays postage — same return privilege.

Name \_\_\_\_\_

Firm \_\_\_\_\_

Address \_\_\_\_\_

City/State \_\_\_\_\_ Zip \_\_\_\_\_

ISBN Prefix 0-8104

73-65b

# GE-MOV™ VARISTORS

## CLAMP VOLTAGE TRANSIENTS

GE-MOV™ Varistors are voltage dependent resistors employing new zinc oxide technology.

At rated voltage, impedance is high, dissipation is negligible, and circuit performance unaffected.

Under surge conditions, impedance falls abruptly, surge energy is absorbed and destructive voltage transients eliminated by the conducting GE-MOV™ Varistor.

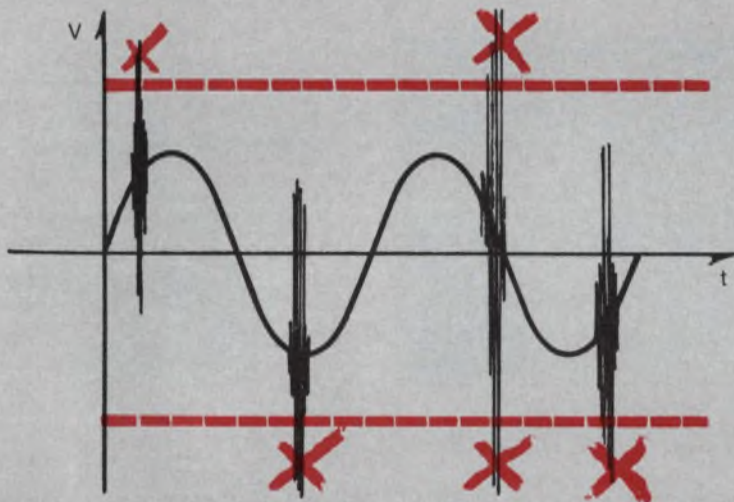

#### 98 MODELS OFFER:

- Operating voltages 40 to 1000 V RMS.
- Pk. clamping voltages 286 to 2,500 V at 10A.
- Pk. current ratings to 2000A.
- 50 nanosecond response time.
- Energy absorption 1 to 160 joules.
- Average power dissipation .25 to 15 watts.

Economical for new designs; improved protection for designs now using selenium, silicon carbide, spark gap or zener diodes.

Free GE-MOV™ DESIGN KIT available from any authorized General Electric Electronic Components distributor, or writing on company letterhead to:

General Electric Semiconductor  
Building #7, Electronics Park, Mail Drop #49  
Syracuse, New York 13201

GENERAL  ELECTRIC

yes,  
yes,  
no,  
yes,  
no.

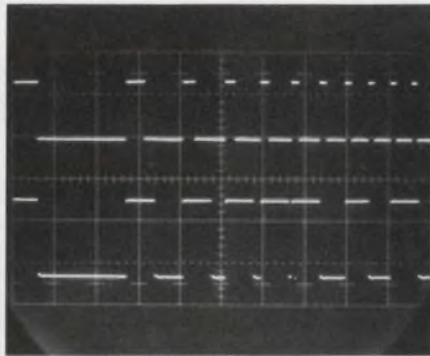

Upper trace: Constant Duty Cycle pulses over a 10:1 frequency range.  
Lower trace: Normal pulses over same range.

"Standard pulses with predetermined width are fine for most requirements, but when I'm changing repetition rates I have to fiddle with the width control to make sure that I don't lose the pulse. Does your 'Constant Duty Cycle' mode let me set width as a percent of pulse period so I can change rep rates *without* tweaking the other controls?" (YES)

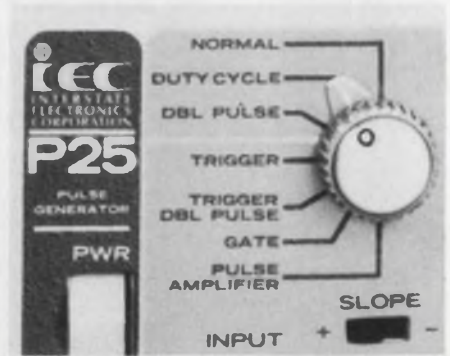

A single control selects all 7 modes.

"That Duty Cycle mode could come in handy, but I also want the regular pulses that I'm used to, and double pulses, and 50% squarewaves to 50 MHz. How about trigger, gate, triggered double pulse, and pulse shaping? (And all of these modes better be easy to set!)" (YES)



All components are fully accessible.

"Reliability and maintainability count, too. I want a generator that works! But in case it needs service I'd like to specify plug-in sockets for dual in-line IC's, and a parts list minus factory widgets. If I put my money on your model, will my QC man hate me?" (NO)

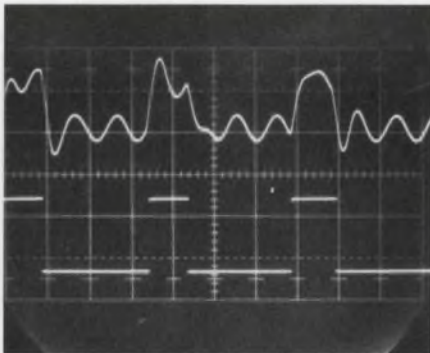

Upper trace: distorted, noisy input.  
Lower trace: pulse generator output (Pulse Amplifier Mode).

"My application calls for pure pulses with a bare minimum of overshoot and squiggles. And I need to clean up distorted signals — you know, send in a crummy pulse train and get out a nice squared-up pulse with the offset, amplitude, and rise/fall times I've set up on the generator. Can do?" (YES)



Four SERIES 20 models are available from \$575.

"Your \$1095 P25 Pulse Generator has it all, including simultaneous positive and negative outputs, each with adjustable d-c offset and variable rise/fall times from 5 nanoseconds. But if I only need a single output or faster, fixed rise times, am I out of luck?" (NO)

## ask a 50-MHz pulse generator these 5 questions if the answers are yes, yes, no, yes, no, it's INTERSTATE

the Interstate man with all the answers is John Norburg—call collect (714) 772-2811



**INTERSTATE ELECTRONICS CORPORATION**  
Subsidiary of A-T-O Inc.

U.S. HEADQUARTERS: Dept. 7000, Box 3117, Anaheim, CA. 92803; OVERSEAS SALES OFFICES: AUSTRALIA, Parameters Pty., Ltd.; BELGIUM-LUXEMBOURG, Regulation-Mesure S.P.R.L.; FINLAND, Havulinno Oy; FRANCE, Tekelec Airtronic, S.A.; ITALY, Tekelec Airtronic; ISRAEL, Radat International Company Ltd.; JAPAN, Asahi & Co., Ltd.; NETHERLANDS, Tekelec Airtronic, N.V.; NEW ZEALAND, David J. Reid, Ltd.; REPUBLIC OF CHINA, Bons International Co., Ltd.; SPAIN, Telco, S.L.; SWEDEN, M. Stenhardt AB.; SWITZERLAND, Traco Trading Co., Ltd.; UNITED KINGDOM, Euro Electronic Instruments, Ltd.; WEST GERMANY, Tekelec Airtronic GMBH; CANADA, Radionics, Limited. TWX U.S.A. 910-591-1197 TELEX U.S.A. 655443 & 655419

INFORMATION RETRIEVAL NUMBER 128

## ACROSS THE DESK

(continued from page 13)

module. A 2-ms step-function response and built-in switches make it possible to have a 10-channel multiplexing system for less than \$170 per channel.

2. Thirty-six speed, dual-speed conversion, in addition to all commonly used binary ratios—the result of Astrosystems' unique design. The price for a typical 1:36 dual-speed converter is \$1350, including BCD outputs.

*Gilbert H. Steinberg*  
Vice President

Astrosystems, Inc.  
6 Nevada Dr.  
Lake Success, N.Y. 11040

Don't miss an issue of **ELECTRONIC DESIGN**: Return your renewal card today.

## He improves an improvement

I read with interest the article concerning commutative filters ("Unusual Filter Concept Promises High-Q, Low-Frequency IC Devices, ED No. 17, Aug. 16, 1973, p. 22). I have built several such filters—using discrete devices, of course. By using an additional "switch" per section, returning the emitters to a positive potential and making  $R_i$  very high by use of an FET emitter follower, as shown in Fig. 1 in the article. I have been able to obtain a dynamic range of 60 dB with a bandwidth of 0.01 Hz at 400 Hz.  $Q_{16}$  through  $Q_{16}$  are carefully matched 2N3904's.

The clock pulses, which are negative, are generated by a NE565 phase-locked loop, a 7493 (divided by 16) and a 74154 (4-line to 16-line decoder). The phase-locked loop is used to allow frequency control by a synthesizer, which is necessary for such narrow bandwidth.

*George E. DeVilbiss*  
Technical Manager

Naval Underwater Systems Center  
Bermuda Research Detachment  
Fleet Post Office, N.Y. 09560

From out of the West . . .

## Switchlight combinations that just don't quit!

In the old days, the Western general store seemed to handle everything, and the price was right. When it comes to modern, reliable switchlights, think of us the same way. Gang switch assemblies . . . snap in adapters . . . special military switchlights . . . Monoform . . . switchlights so compact you could mistake them for shucked peas . . . some others so new they aren't on the shelf yet. But, unlike the general store, we deliver . . . and in a hurry! Just tell us what you need, and depend on Clare-Pendar.

 **CLARE-PENDAR™**  
Phone 208-773-4541

P.O. Box 785 Post Falls, Idaho 83854  
Telex 32-6448



# When it comes to breadth of product line, certain names are standouts.

In growing numbers, electronic designers are realizing they needn't look further than the Beckman catalog for thousands of standard, highest-quality components.

They look to us for more than 1,000 standard trimmers. Or our full line of precision potentiometers delivered in literally millions of versions since 1943. Or our array of turns-counting dials. And hundreds of basic microcircuit products—everything from D/A and A/D converters to ladder networks, hybrid amplifiers and regulators, ECL terminators and more.

Standards aren't the whole story, either. What backs up our catalog is as important as the hardware: excellence of custom service.

In custom microcircuit hybrids, for example, we produce on time schedules few others could meet. We build to customer design and specifications, or we supply the design help when needed. And practically any of our products can be custom-altered and produced fast.

So extensive is our entire line, in fact, that we're the second largest user of semiconductor chips in the nation.

Then, Beckman distributors across the country are kept stockpiled with the full standard line. So that delivery is as fast as any in the industry, and usually faster. We even maintain an express system that gets

requested literature to customers in a few days—not weeks, or months. Call toll-free (800) 437-4677.

Yet with all the broad line, top quality, fast delivery and thorough service, there's no catch to the cost. Our prices are definitely competitive.

As we see it, it's no wonder the Beckman catalog is something of a standard itself.



**ELECTRON**

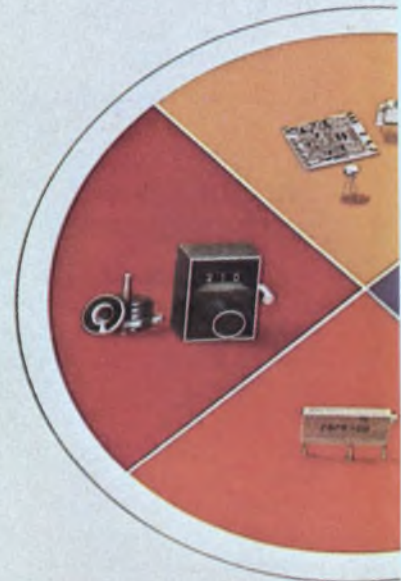

**Beckman®**

HELIPOT DIVISION

Sears  
fall and  
winter  
1973

Beckman®

## COMPONENTS

PRECISION  
POTENTIOMETERS

DIALS

TRIMMERS

VOLTAGE  
REGULATORS

AMPLIFIERS

D-TO-A, A-TO-D  
CONVERTERS

RESISTOR  
NETWORKS

ECL  
TERMINATORS

MOTOR-POTS

SWITCHES

CUSTOM HYBRID  
MICROCIRCUITS



### Beckman Electronic Component Distributors

#### EASTERN REGION

##### Arrow/Angus

P.O. Box 126  
Moorestown, N.J.  
(609) 235-1900  
(215) 928-1800

##### Arrow Electronics, Inc.

5207 East Dr.  
Baltimore, Md.  
(202) 737-1700  
(301) 247-5200

##### Arrow Electronics, Inc.

900 Route 110  
Farmingdale, N.Y.  
(516) 694-6800

##### Arrow Electronics, Inc.

295 Treadwell St.  
Hamden, Conn.  
(203) 248-3801

##### Arrow Electronics, Inc.

No. 15 A Street  
Burlington, Mass.  
(617) 273-0100

##### Arrow Electronics, Inc.

285 Midland Ave.  
Saddle Brook, N.J.  
(201) 797-5800

##### Harvey R & D Electronics

44 Hartwell Ave.  
Lexington, Mass.  
(617) 861-9200

##### Kierulff Electronics, Inc.

5 Industrial Dr.  
Rutherford, N.J.  
(201) 935-2120

##### Lynch-Gentry Associates, Inc.

1932 Draw Street  
Clearwater, Fla.  
(813) 443-2697

##### Lynch-Gentry Associates, Inc.

3470 Bowman Dr.  
Winter Park, Fla.  
(305) 671-7649

##### Marshall Industries

G.S. Marshall Products Group  
88 Needham St.  
Newton Highlands, Mass.  
(617) 965-5115

##### M & C Sales

500 Plasamour Drive, N.E.  
Atlanta, Ga.  
(404) 875-2525

##### M & C Sales

1106 Burke St.  
Winston-Salem, N.C.  
(919) 723-1001

##### M & C Sales

904 Bob Wallace Ave.  
Huntsville, Ala.  
(205) 539-8476

##### Ossmann Component Sales Corp.

395 Cleveland Dr.  
Buffalo, N.Y.  
(716) 832-4271

##### Ossmann Component Sales Corp.

411 Washington Ave.  
Kingston, N.Y.  
(914) 338-5505

##### Ossmann Component Sales Corp.

280 Metro Park  
Rochester, N.Y.  
(716) 442-3290

##### Ossmann Component Sales Corp.

132 Pickard Building  
Syracuse, N.Y.  
(315) 454-4477

##### Ossmann Component Sales Corp.

1911 Vestal Parkway East  
Vestal, N.Y.  
(607) 785-9949

#### CENTRAL REGION

##### Magnuson Electronics

2420 Oakton St.  
P.O. Box 130  
Mount Prospect, Ill.  
(312) 956-0700

##### Magnuson Electronics

1246 West 7th St.  
St. Paul, Minn.  
(612) 227-8495

##### Norvell Electronics

10210 Monroe Dr.  
Dallas, Tex.  
(214) 350-6771

##### Norvell Electronics

6440 Hillcroft Ave.  
Houston, Tex.  
(713) 774-2568

##### Norvell Electronics

3340 S. Memorial Dr.  
Tulsa, Okla.  
(918) 663-1247

##### Sheridan Sales Co.

Box 37826  
Cincinnati, Ohio  
(513) 761-5432

##### Sheridan Sales Co.

Box 4457  
Cleveland, Ohio  
(216) 524-8120

##### Sheridan Sales Co.

Box 423  
Dayton, Ohio  
(513) 277-8911

##### Sheridan Sales Co.

33708 Grand River Ave.  
Farmington, Mich.  
(313) 477-3800

##### Sheridan Sales Co.

P.O. Box 677  
Florissant, Mo.  
(314) 837-5200

##### Sheridan Sales Co.

Suite 5009  
1717 Penn Ave.  
Wilkinsburg, Penn.  
(412) 244-1640

#### WESTERN REGION

##### Almac/Stroom Electronics

8888 S.W. Canyon Rd.  
Portland, Ore.  
(503) 292-3534

##### Almac/Stroom Electronics

5811 Sixth Ave. South  
Seattle, Wash.  
(206) 763-2300

##### Barnhill Five, Inc.

1410-D Wyoming N.E.  
Albuquerque, N.M.  
(505) 299-7658

##### Barnhill Five, Inc.

1170 S. Sheridan Blvd.  
Denver, Colo.  
(303) 934-5505

##### Barnhill Five, Inc.

7329 E. Stetson Rd.  
Scottsdale, Ariz.  
(602) 947-7841

##### Marshall Industries

G.S. Marshall Products Group  
9674 Teistar Ave.  
El Monte, Ca.  
(213) 686-0141

##### Marshall Industries

G.S. Marshall Products Group  
8057 Raytheon Rd.  
San Diego, Ca.  
(714) 278-6350

##### Marshall Industries

G.S. Marshall Products Group  
788 Palomar Ave.  
Sunnyvale, Ca.  
(408) 732-1100



# Component Orders Up? Shipments Down?

HP's new LCR meter helps you get your orders out fast. If you're testing diodes, capacitors—or trimming IC capacitors or resistors—you need fast, precise, automatic LCR and loss measurements. You need the most *reliable* LCR meter you can get—one with solid state circuits and LED display. Now you can have it for only \$4295\*—less than you've had to pay for this kind of capability. When you plug our new Model 4271A 1 MHz Digital LCR Meter into your system you get fast-reading digital measurements, 10,000 an hour or more. You get four-pair measurement and offset adjustments that eliminate most fixture problems. And you get an instrument that's compatible with many HP programmable calculators and computers.

But the 4271A's accuracy and versatility make it just as great an asset to your design lab as to your pro-

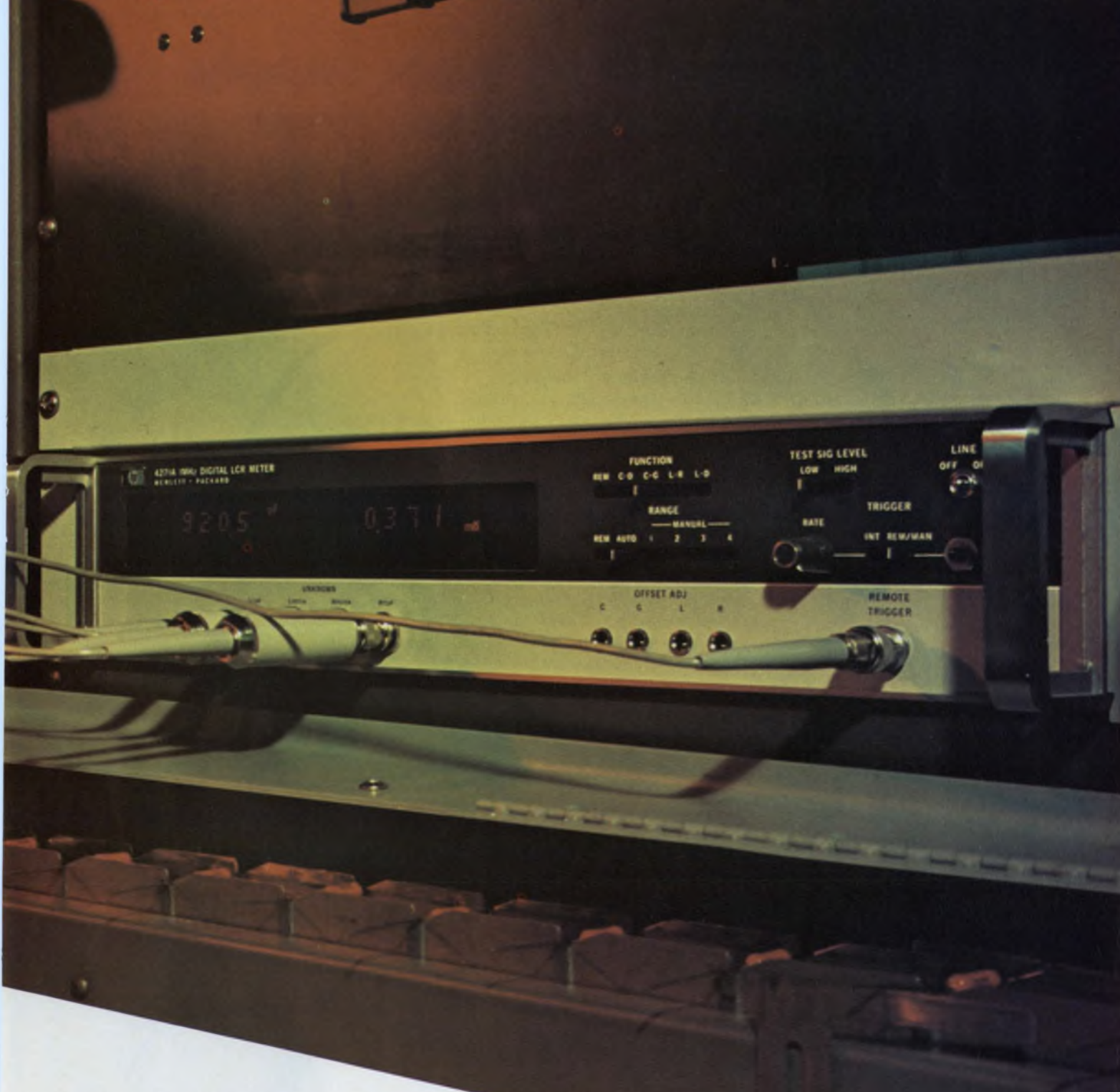

duction line. It's a snap to measure capacitance from 10.000 pF to 19.000 nF, and to measure inductance from 1000.0 nH to 1900.0  $\mu$ H. You'll also find that you can greatly simplify varicap diode testing and other kinds of micro-circuit design measurements with the 4271A and its optional DC Bias Controller. This lets you vary DC bias from 00.0V to 39.9V in 0.1V increments.

Remember that this new addition comes to you at a new low price, \$4295\*. Inexpensive options are also available: Program Code for Calculator/Computer Interface or BCD Output, DC Bias Controller —and DC Power Supply. And they're all backed by HP's time-tested reputation for reliability and service.

For more information contact your local HP field engineer.

\*Domestic USA prices only.

### The Useables — new standards in component testing.



Universal Bridge, High Resistance Meter, LCR Meter, Analog Comparator  
Universal Bridge, Milliohmeter, Q Meter, Automatic Capacitance Bridge, High-Capacitance Meter

**HEWLETT  PACKARD**

Sales, service and support in 172 centers in 65 countries.  
Palo Alto, California 94303. Offices in principal cities throughout the U.S.

093/93



# What would a power supply designer want to know about TRW's new Darlington family?

We asked our sales and applications engineers. And they said we should tell you 5 things:

1. It operates up to 450 Volts.
2. It offers fast switching — 250 Nsec.
3. It operates up to 25 Amps continuously.
4. It costs under \$5.00 (in quantity).
5. It is immediately available, in quantity, right off the distributors' shelves.

They assured us those five facts were enough to get any power supply designer pretty excited about our new Darlington. Were they right? Signify in the usual manner—casting your vote at the nearest office of any authorized TRW distributor. Or call John Powers, collect, at (213) 679-4561; or write TRW Semiconductors, an Electronic Components Division of TRW, Inc., 14520 Aviation Blvd., Lawndale, California 90260.

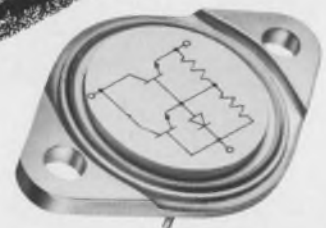

## **TRW** SEMICONDUCTORS

These products are available through the following authorized distributors:

Almo Electronics  
Bell Industries  
Cramer Electronics Inc.  
De Mambro Electronics

Eastern Radio Corp.  
Electronics Marketing Corp.  
Elmar Electronics Inc.  
Hall-Mark Electronics Corp.

Harvey-Michigan Inc.  
Liberty Electronics  
Powell Electronics  
Pytronics

Semiconductor Concepts Inc.  
Summit Distributor  
R. V. Weatherford Co.  
Westates Electronics Corp.

INFORMATION RETRIEVAL NUMBER 17

OCTOBER 25, 1973

## Advances in MIC design reported at conference

Recent advances in the newest area of microwave technology—microwave integrated circuits—were discussed at the Canadian IEEE Conference held in Toronto earlier this month.

A solution to one major problem—the inability to tune MIC diode oscillators over a range of frequencies—was described by Vassilios Makios, associate professor at Carleton University, Ottawa, and W. J. Chudobiak, staff member at the Canadian Communications Research Center in the same city.

“Present microstrip oscillators using IMPATT and Gunn diodes cannot be tuned mechanically because the oscillating frequency is fixed by mechanical circuit dimensions,” says Makios. “Varactor diodes—available as unpackaged chips—cannot be used because of unpredictable reactive characteristics when bonded into the circuits,” Makios noted.

The solution? A commercially available packaged silicon varactor diode with a cutoff frequency of 80 GHz and with predictable characteristics.

The packaged varactor acts like a variable inductor or capacitor, depending upon where you place it in the microstrip structure, Makios says. For a 10-GHz IMPATT-varactor oscillator, Makios has experimentally obtained a frequency tunable range of about 280 MHz. Both amplitude and frequency modulation was produced using different configurations of the same oscillator.

Makios sees the principle use of the new circuit in short-haul microwave communication systems.

A method of substantially reducing transmission losses in MIC structures by properly tailoring the 90-degree bends in the microstrip lines was reported by R. J. P. Douville and D. S. James, research

engineers at the Canadian Communications Research Center in Ottawa.

To conserve space in MIC microstrip design, Douville points out, the microstrip line is traditionally bent back and forth using 90-degree bends. To reduce losses and reflections from these bends, removal of a 45-degree mitered slice of 50% of the corner has been standard practice. But with a 50% corner, X-band VSWRs range from 1.2 to 1.4 per bend which produces excessive transmission loss.

Douville points out, however, that an experimental program has shown that for a 50- $\Omega$  microstrip line, a VSWR of 1 is obtained with 70% of the corner removed. And for an 80- $\Omega$  line, the optimum percentage of corner removal turned out to be better than 93%.

Douville reports that with the new experimental approach the VSWR of the structures can be reduced to 1 for a frequency range of dc to 30 GHz.

### Desk-top computer cuts price by nearly 50%

A new desk-top computer, the only one available to use the powerful APL language, is selling for only \$3500—almost half the price of competitive computers.

Introduced by Micro Computer Machines, Inc., of Toronto, the machine—called the MCM/70—weighs but 20 pounds and can operate from batteries as well as an ac line. It has 16 kilobytes of memory.

The closest competitor is the Hewlett-Packard 9830 programmable calculator. The HP device uses Basic, has 4 kilobytes of random-access memory—expandable to 8 k—and costs about \$6000.

Until now, APL has been available only to users of large time-

sharing computer systems. Because the file capabilities on these systems are often primitive or nonexistent, APL has traditionally been a very expensive language to use. Micro Computer Machines, however, says it has overcome this by offering “easy-to-use file capability.” The company declined to spell out details of the capability.

The new computer has a central-



The MCM/70 desk-top computer is the first portable one capable of using the powerful APL language.

processing unit with 16,000 8-bit bytes. The usable random-access memory of the machine is only 2000 bytes, but because of the efficiency of APL, the 2 k is equal to 10 or 20 k of memory in Fortran or Basic machines, according to Peter Wolfe, the company's marketing manager. In addition the memory can be expanded to 8 k.

The basic unit also contains a typewriter keyboard and a 32-character plasma display that shows one program line at a time.

Wolfe notes that peripherals can be added to the basic unit, including impact printers, data-communications adapters, CRT displays, card readers, diskettes and tape cassettes. The tape-cassette option is available as a 150-k virtual memory system.

### Charge-transfer camera designed for home TV

A charge-transfer device TV camera, the first to be compatible with home television receivers, will be introduced in December by General Electric, Syracuse, N.Y.

The GE announcement comes hot on the heels of Fairchild's introduction last month of the first

CCD TV camera—the MV 100.

The GE unit, which uses a 250 by 250 charge-injection device array, contrasts with the Fairchild camera which uses a 100 by 100 charge-coupled device array and is not compatible with unmodified TV receivers.

Compatibility is accomplished, notes Fred Sachs, marketing manager of GE's Optoelectronic Systems Div. by forming two 250 by 250 picture fields and interlacing them to form a 500 by 250 picture frame.

The GE photo array is fabricated on a 330 by 440-mil chip and is compatible with standard 16-mm C-mount lenses, reports Sachs. "The size of the individual array elements is fairly large," he continues, "and consequently we get very good sensitivity." As the resolution, and hence the number of array elements increases in future devices, the chip size will remain the same, while the individual elements get smaller.

The charge injection scheme chosen by GE differs in many respects from the charge-coupled device approach taken by Fairchild and RCA. Instead of using one photodiode per picture element as the charge coupled approach does, the charge-injection imager uses two photocapacitors per element. Also, instead of the serial readout scheme of CCDs, the GE device uses an xy addressing scheme (see "TV Cameras Employing Charge-Coupled Devices Being Readied for Market," ED No. 17, August 16, 1973, p. 26).

Sachs notes that at first GE will be offering subassemblies in order to open up the OEM market. The device will be available in sample quantities during the second quarter of 1974.

## 'Super disc' can store over six billion bytes

A disc storage subsystem with a capacity of up to 6.4 billion bytes and which is plug compatible with the IBM 370 has been announced by Storage Technology Corp. of Louisville, Colo.

Called "Super Disc," the subsystem is designed to compete with IBM's recently announced 3300-11 disc memory unit but will sell for

"over 35% less," according to a company spokesman.

The complete STC subsystem consists of their Model 8000 disc control unit and up to eight disc modules. Two modules are available: the Model 8800 (800-million byte capacity per spindle) or the Model 8400 (400 million bytes capacity for two spindles).

In addition to the lower cost, the system uses much less power, radiates less heat and takes up less floor space than the comparable IBM unit, an STC spokesman says. Only four boxes are required compared to the 32 boxes for a 3300-11 memory with equivalent storage capacity.

Such high-storage density is possible because of special heads and a rotary-actuator mechanism, which, according to the spokesman, "allows the 116 heads in our big module to be driven with less force than a linear actuator would take to drive 20 heads."

Because of their high byte capacity, the disc packs need never be changed. This feature is said to result in less surface contamination of the disc and less head crashing. The disc file measures 30 by 44 by 38 inches, and average access time is 27 milliseconds for either.

Both the IBM and STC systems are due for shipment in 1974.

## 'Underground' radar resolves to one inch

A new addition to the growing family of radar systems that can peer below ground offers resolution to within one inch. Developed by Calspan Corp., Buffalo, N.Y., the system can be used to locate buried objects, such as plastic mines, underground conduits and even human bodies.

The ground-penetrating radar was built in association with the Mine Detection Div. of the Army Mobility Equipment Research and Development Center at Ft. Belvoir, Va. Previous underground systems were developed by NASA for Apollo 17 and by Geophysical Survey Systems, North Billerica, Mass., for the Navy.

Although only the military version of the newest device is currently available, Calspan says that



**High-resolution radar** developed by Calspan weighs less than 20 pounds and sees below the ground up to two feet.

civilian units will be on the market by next spring.

One major use of the civilian units, according to Anthony V. Alongi, staff scientist at Calspan, would be to map the exact site and depth of underground conduits, sewers and water lines.

The radar uses nanosecond pulses and has a bandwidth of more than 1000 MHz at low frequencies. Penetration is from one to two feet for the military unit, but civilian models will be able to go deeper than that, Calspan says.

## Postal modernization problems are reported

Electronics companies were well represented in exhibits at the U.S. Postal Forum held in Washington, D.C., earlier this month, displaying a host of new technological developments in optical-code readers, computerized postal service accounting systems, automated letter sorters and other equipment.

But manufacturers often reported frustration at the Postal Service's handling of new technology projects. Plans for modernizing the Postal Service three years ago no longer seem to apply, some companies contended, and the service seems to be working with a piecemeal approach to new developments.

The industry sources expressed a need for a master plan for guidance. One problem apparently plaguing the Postal Service is difficulty in training postal workers with no technical background to operate and maintain the new, highly sophisticated equipment industry is capable of producing.

**Monsanto has red displays  
that cost \$2.70\***

**Monsanto has yellow displays  
that cost \$2.70\***

**Monsanto has green displays  
that cost \$2.70\***

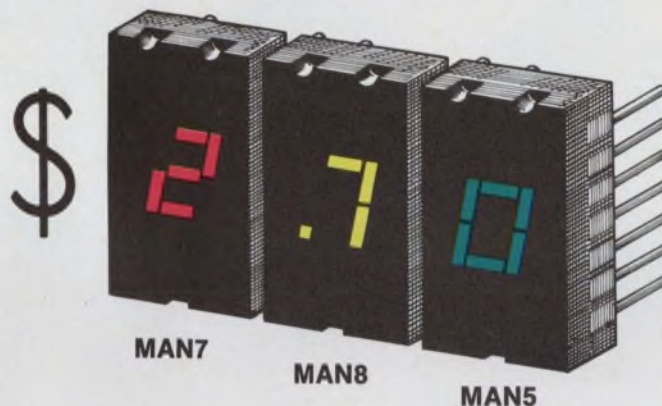

Another price breakthrough!  
Now you can design solid-state color into your readouts without paying a premium.  
Our materials technology has taken an important step forward, and we are able to pass the savings along to you.  
Now let your creativity range across the red barrier and see what yellow and green 0.27" GaAsLITE displays can do to make your readouts whisper, cajole, or yell!

For data sheets or parts, contact your Monsanto distributor.

For applications assistance, call or drop us a note.

**Monsanto Commercial Products Company**  
Electronic Special Products  
3400 Hillview Avenue  
Palo Alto, CA 94304  
(415) 493-3300

\*All prices quoted are suggested distribution prices for OEM orders.

**Putting innovation to work.**

# Monsanto

INFORMATION RETRIEVAL NUMBER 18

surround it  
with something special





Safety. Reliability. Long-haul performance. Cost. They all have an effect on your product's design parameters and capabilities.

Belden has a custom design capability in wire, cable, and cord that can help you meet the most demanding performance for your products. We've helped solve some extraordinary problems. Can provide definitive data and answers on flex life, oil resistance, electrical characteristics, aging that can cope with practically any environment your specific job criteria calls for.

Talk to your Belden specialist about it. He understands design requirements. Can give you straight answers on cable or cord design feasibility. What modifications are possible. What the trade-offs are. The costs involved. We haven't perfected that "fancy" jacketing yet, but can improve the wire, cable, or cord package you need to meet the most challenging electrical, physical and thermal applications you might be faced with.

If you need answers right now, phone:  
(312) 887-1800, Transportation Division  
(312) 681-8920, Electrical Division  
(317) 966-6681, Electronic Division  
Or write Belden Corporation, P. O. Box 386, Geneva, Illinois 60134.

H-2-3

**BELDEN** 

INFORMATION RETRIEVAL NUMBER 234



# Display method draws curves, not vectors, and with less data

A new graphic display technique makes it possible to draw complex curves on a standard CRT video monitor with a minimum of data.

Data compression of up to 100:1 is possible for a variety of different graphic forms with the technology, called Conographics by its developer, Hughes Aircraft Co.'s Industrial Products Div., Ocean-side, Calif.

In the technique, curves are generated directly rather than by multiple vectors. For example, only 4 bytes (8 bits) of data are required to draw a 10-inch ellipse on a standard CRT monitor. With vectors, it would require about 300 8-bit bytes to draw the same

ellipse.

Hughes has incorporated the technology in a display called the Conographic-12.

Luis Villalobos, manager of Conographic products at Hughes, reports: "We can generate any conic curve with a minimum of data. If the curve has a gradual variation in curvature and has no inflection point, we can draw it in a single smooth curve. Using a vector generator technique, a curve is approximated by a series of straight lines, each of which must be specified by input data."

## Variety of specifying methods

Any open curve can be drawn by the Conographic generator if certain points and slopes are fed into

it. Methods of specifying a curve include the following:

- Beginning point, beginning slope, end point and end slope.
- Beginning point, beginning slope, an intermediate point and end point.
- Beginning point, relative maximum point and end point.
- Beginning point, an intermediate point, the slope at the intermediate point and the end point.
- Beginning point, an intermediate point, end point and end slope.

The point and slope information are fed into the generator, and the generator puts out two signals. One represents the X coordinate of the curve as a function of time and the other the Y coordinate as a function of time. These signals then go to a scan-conversion memory. From the converter, the curve can be drawn and refreshed on a standard video monitor.

## Display duration is 25 minutes

Because the curve is stored in the scan-converter memory, a single curve can be displayed for up to 25 minutes without recalculation of the parameters. Once the parameters have been calculated, the curve can be rotated to any of four quadrature orientations and displayed as a real or mirror image. Thus eight different orientations can be displayed without need for additional data. Villalobos notes that a conventional vector generator must have a new set of data for each orientation of the curve on the display.

He adds: "One additional point on the subject of curve rotation is that the curve, with one additional data point—the angle of rotation—can be drawn at any angle with no variation in the shape."

David N. Kaye  
Senior Western Editor

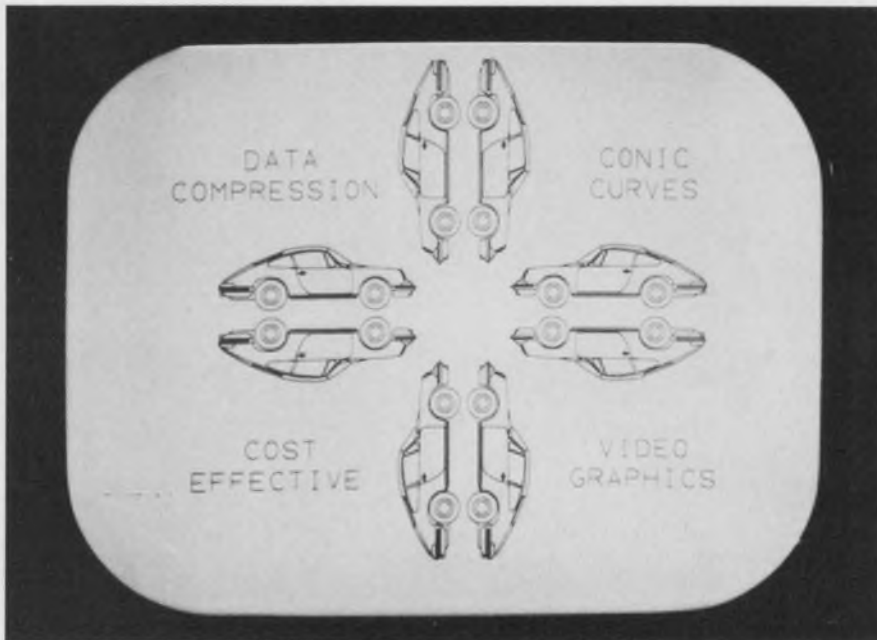

All eight orientations of a curve are demonstrated in this photo, taken from the screen of a Conographic-12 terminal. The image required only 475, 8-bit bytes of information to generate. With current vector generation technology, the same image would have required 38,000 bytes.

**“When we were evaluating Augat panels, we had to be absolutely sure they would withstand the shock and vibration of a hard-working storage system.**

**“Now we’re sure.”**

Chuck Bates  
Senior Development Engineer  
Clark Equipment Company, Storage Systems

“Clark automated storage systems utilize a computer directed stacker crane. The heart of the system is a Clark-designed electronic logic package, built around Augat plug-in socket panels.

“When we were designing the system, we of course looked for density and design flexibility. And at the same time we found the cost of wire-wrap panels attractive.

“What concerned us was if the socket panel concept could withstand shock and vibration with a high degree of reliability. Clark storage systems often work 24 hours a day. We found that Augat’s unique machined socket contact stood up very well in test

Testing control box featuring Augat panels.

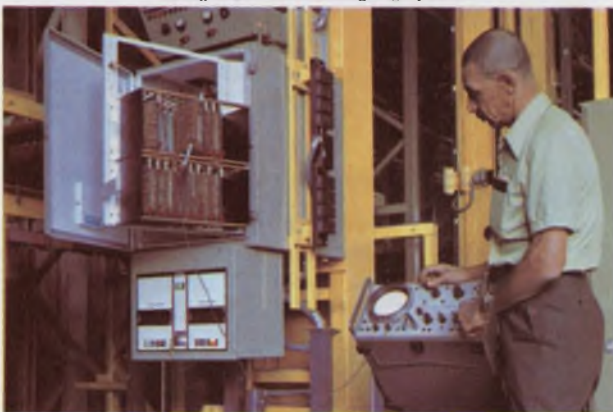

Chuck Bates

and in the field as well.

“Augat gave us an interconnection system which met our requirements from a cost, reliability and design standpoint.”

All of which just might tell you why Augat has become the world’s leading producer of wire-wrapped socket panels and other IC interconnection products. But Augat has more to offer than just hardware. Augat’s technical experience is ready to help you meet your interconnection requirements.

Call or write to us today. We’ll send you our free brochure and complete product information. Augat, Inc., 33 Perry Avenue, Attleboro, Massachusetts 02703. Represented and distributed internationally.

**Plug into Augat. Clark Equipment did.**

**AUGAT**

INFORMATION RETRIEVAL NUMBER 20



The graphic display in the Hughes Conographic-12 consists of an interface, display processor, curve generator, scan-conversion memory and video monitor. In addition to the data-compression property of Conographics, the display provides up to 10 levels of gray scale and a windowing capability. Windowing is the ability to pick out an area on the screen and to magnify and compress it at will. The Conographic-12 can window an image from 1/8 scale up to 7-7/8 scale.

The price of the basic terminal is \$10,900. To this must be added the cost of the interface to a computer, additional memory, special fonts and a variety of other options.

### Transmits graphics fast

Villalobos sees an active future for Conographics. He notes: "As graphics are required to be trans-

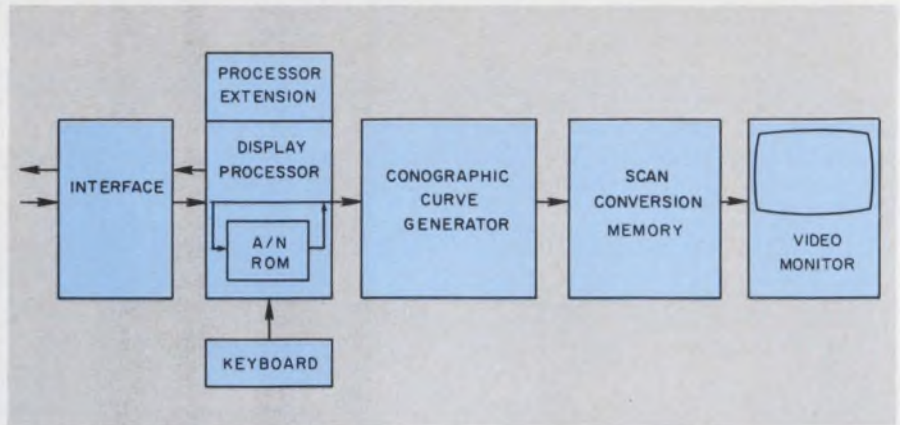

The Conographic-12 terminal can be interfaced to computers of all sizes. The display processor feeds point and slope information to the curve generator, which in turn represents the curve to the scan-conversion memory as a pair of signals. One represents X(t) and the other Y(t). It's available from Hughes Industrial Products Div.

mitted in greater and greater quantities over data-communications lines, a premium will be placed on transmitting the required information in a minimum

amount of time. This means that data compression will become necessary to cut down the load on the data-communication system," Villalobos notes. ■■

## Connector and semi makers weigh alternatives of high-priced gold

For a metal that's valued by the electronics industry because of its inertness, gold is certainly having a galvanic effect on the makers of connectors and semiconductors this year. Producers are being forced to consider how they can offset the explosive rises in the price of the metal by asking: Should we pass along the price hike to customers or absorb the loss? Should we use less gold in products where it's now being used unstintingly? Should we switch to a substitute metal, such as bright tin lead and aluminum?

Answers to all of these questions are being explored.

Gold is used in a variety of applications in electronic components and subassemblies. It is used in

connector pins, relay contacts, chip and wire assemblies, in transistors and integrated circuits, as a dopant in power semiconductors and inside microwave cavities, just to name a few uses.

If other readily available metals could withstand 100 insertions without wearing out and without oxidizing, electronic producers would buy them and forget that the price of an ounce of gold peaked at \$126.45 last June—a 200% rise since the first of the year. Since then it has fallen to around \$96 an ounce. As it is, electronics companies across the land are in a holding pattern and are grappling with the gold-price problem as best they can. Some have asked the Government for permission to raise product prices to compensate for the added gold cost. Most appear to be bearing it, if not grinning.

The problem is considerable. At \$35 an ounce, the cost of using gold in a TO-5 package came to just under 2 cents. With the price rises, there's the possibility of paying as much as 8 cents for gold in some packages. If the average selling price for a device in a TO-5 package is in the 50-cent range, with the actual cost to the manufacturer at about 25 cents, at 8 cents, gold would account for one-third of the cost of the device.

### Gold use being held down

Jim Dykes, marketing vice president at Harris Semiconductor, Melbourne, Fla., says: "Our gold suppliers have been adding a surcharge and passing it along to us. We have not passed on the surcharge to our customers. We've increased our package price, but

Richard L. Turmail  
Associate Editor

**For years,  
people thought  
Teletype<sup>®</sup>  
machines only  
talked to  
themselves.**



Teletype is a trademark registered in the United States Patent Office.

Fact is, Teletype machines have been carrying on intelligent conversations for years with some of the fastest information movers in the world. Computers.

We've earned a good, solid name for ourselves in computer communications because our equipment is compatible with practically any computer-based system.

Our product line proves the point.

The number one standard-duty data terminal in the industry is our model 33 series. And our

new wide-platen model 38 offers big system features at economy system prices.

Heavy-duty operation with minimum maintenance? Check out our model 35. And our model 37 series delivers the utmost in flexibility and vocabulary for complex data systems.

We also build equipment for paper tape systems, as well as a magnetic tape terminal for greater on-line savings. As you can see, our reputation in point-to-point communications has served us well in computer terminals. No one comes close to us in reliability, flexibility and economy.

It takes more than manufacturing facilities to build the machines Teletype Corporation offers. It also takes commitment. From people who think service is as important as sales. In terminals for computers and point-to-point communications.

That's why we invented a new name for who we are and what we make. The computer-communications people.



For more information about any Teletype product, write or call: **TERMINAL CENTRAL**, Teletype Corporation, Dept. 89F, 5555 Touhy Avenue, Skokie, Illinois 60076. Phone 312/982-2500

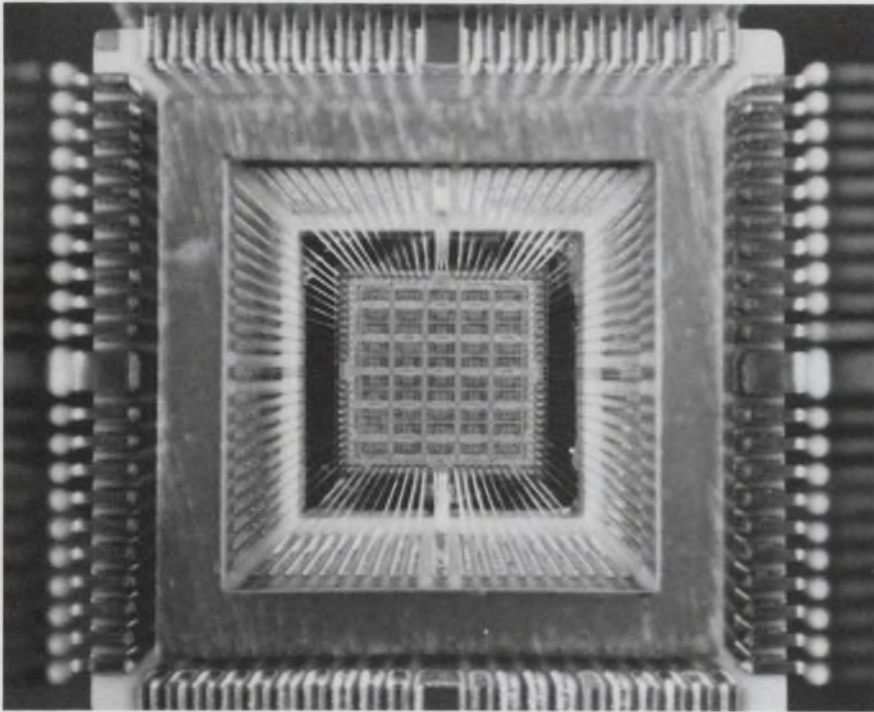

**Mounted LSI array** used in the central processing unit of the model 470 computer now under development by Amdahl Corp., Sunnyvale, Calif., contains gold in the wire bonds to the chip terminal, the chip carrier and the substrate terminals. The array uses ECL, contains 100 gates and measures 150 mils on a side.

not because of the rise in price of gold. We've discussed eliminating gold for certain uses—for example, we've considered using tin plate on the external part of the product, like the lids and leads."

Dykes notes that costs become significant in Government contracts, where the specs call for more of the precious metal than commercial contracts usually do.

Paul Feisthamel, manager of materials for Signetics, Sunnyvale, Calif., reports: "We've formed a corporate committee composed of R&D and manufacturing people to look for ways to use less gold. We're also trying to find a suitable substitute for wire leads."

Pierre Lamond, v.p. of microcircuits for National Semiconductor, Santa Clara, Calif., says: "The rise in the price of gold has affected our cost, and we're absorbing it—but I can't tell you how much." He says his company has been working to reduce the gold in its parts ever since gold was pegged at \$35 an ounce.

"We're putting the gold where it's necessary, and we're still tinning the exposed leads," Lamond says. "With the TO-5 and other packages, we're looking for

alternatives to gold; I'm not at liberty to tell you what elements we've tested, but I can say that we haven't found anything suitable yet."

Chuck Sloane, director of marketing for the ITT Cannon Electric Div. of ITT Corp., Santa Clara, Calif., reports his company has applied to the Federal Cost of Living Council for permission to pass along to customers the extra expense for gold.

"We're saying that 10% of the connector cost is gold," he reports. "That's what we're using to make it easy to administrate the price increase, but the figure is not factual—we have printed-circuit connectors that are 40% gold. In contacts alone, about 35% of the cost is gold. Some of the military items that have only one or two contacts bring down the average."

Amphenol is another company that has applied to the Government for price boosts on its products. It has been hit hard by the gold price rise because it is a major supplier to the telephone industry, which consumes gold in its interconnections far in excess of most industrial requirements. Ed Lehmann, division v.p. of marketing for the

Amphenol Industrial Div., Chicago, says: "We've discussed the use of bright tin as a gold substitute, but we haven't used it widely; we're still testing it."

Lehmann says that because of the gold situation, Amphenol is shipping some connectors with significant gold content to major customers at prices that are less than cost. "We owe it to our customers, for their loyalty, to keep them supplied with gold, even though it's costing us money," he explains.

Carl Turner, director of power transistor operations for RCA, Somerville, N.J., says that his company has found ways in the laboratory to cut the gold in its products or to eliminate it but that it always ends up with a somewhat inferior prototype. This is less true in signal-oriented devices, where power and integrity of the contact is not as important.

#### Shaving of plating specs noted

One side effect of the gold price rise, Turner notes, is shaving on gold-plating specs by some vendors. "We generally have a reliable set of vendors," he says. "We don't beat the pants off them when they fail to give us what we asked for. If we have a gold-spec range of 50 millionths to 65 millionths of an inch, our vendors are always within that area. But now they're operating on the ragged edge, and some of them ship stuff that's below 50 millionths. Unless we 100% evaluate, which is very expensive, we don't know we have a transistor under the 50-millionth range until we've made the transistor and tested it."

What about gold refiners? Do they fear a drift away from gold to other metals? Philip G. Deuchler, vice president of marketing for Handy & Harmon, a major gold refiner and supplier in New York City, says confidently: "When you need the corrosion resistance and the conductivity of gold and silver and your alloys, you don't find substitutes; they may change alloys and compositions a little bit, but we haven't seen any rush away from the use of gold." ■■

---

Don't miss an issue  
of **ELECTRONIC DESIGN**:  
Return your renewal  
card today.



# MCM'S

## Each GE Planar Ceramic Triode Delivers Acknowledged\* Excellence ...

## And You'll Find The Same Quality in Every GE Microwave Circuit Module (MCM)!

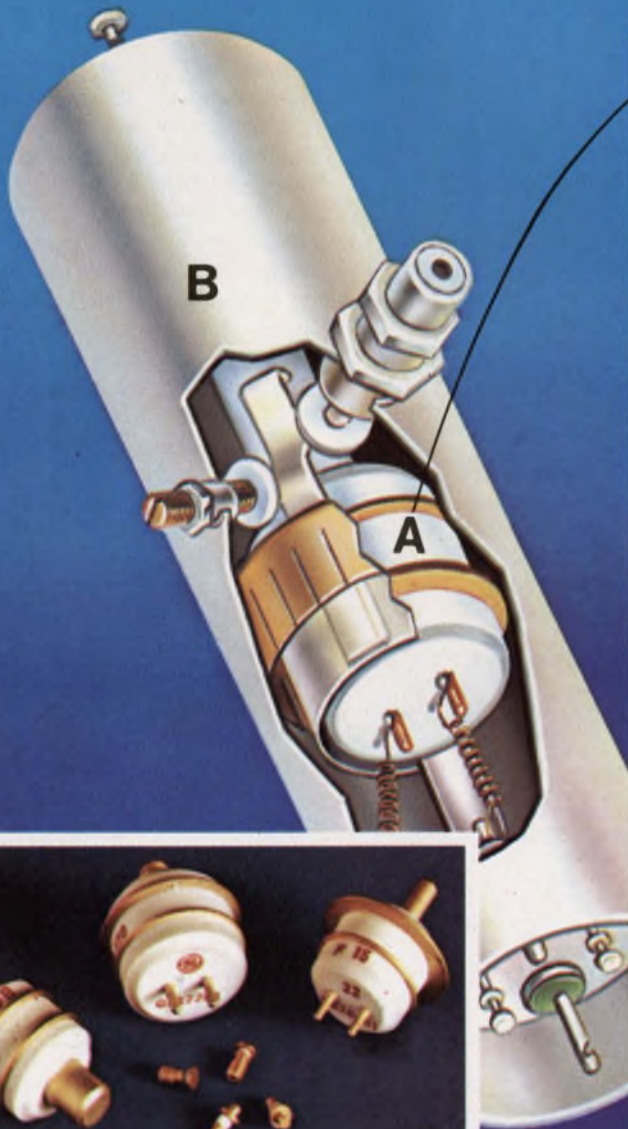

**A** GE Planar Ceramic Triodes deliver acknowledged state-of-the-art performance: thirty years' GE tube research with triodes has resulted in exceptional tolerance to the most adverse thermal, shock and vibration environments; very high ratio of power, efficiency, reliability and gain bandwidth to product size and weight; fast warmup; lower noise levels; and more efficient operation at higher frequencies.

And we've put our extensive knowledge of triode technology to work developing a family of pre-packaged microwave circuits called General Electric MCM's (Microwave Circuit Modules) **B**—each built around a GE triode or solid-state diode. And each MCM is built with such care and precision that it, too, is fast becoming a recognized standard of excellence.

Functioning as an oscillator, an amplifier, or as a complete assembly (with a power supply, and/or integrated isolator/circulator, and/or modulator), GE MCM's solve five of your toughest problems:

- circuit-active component interfaces
- reproducibility       on-time delivery
- in-line rejects       field failures.

Chances are there's a GE MCM already available for your microwave system. If not, we'll design and build the exact module you need. And we'll get it to you fast.

Contact: Microwave Devices, General Electric Company, 316 East 9th Street, Owensboro, Kentucky 42301. Or use the reader service card.

\*In a recent Brand Recognition Study by a leading business publication, more designers expressed a preference for General Electric Planar Ceramic Triodes... 11% more chose GE over the next leading brand. (Copies of the Study are available upon request.)

360-09

# Researchers see laser fusion as safe, cheap power of future

With prospects for an energy crisis on the rise in the United States, researchers are seriously considering laser fusion as a safe, economical source of power.

The basic concept requires that a nuclear fuel—such as a mixture of deuterium and tritium—be compressed to  $1000 \text{ gm/cm}^3$  and heated to 30-to-40-million centigrade by concentrated laser radiation. Under these conditions fusion occurs and heat is produced. The heat is then converted to electricity.

Ralph S. Cooper, a researcher at the University of California's Los Alamos Scientific Laboratory in New Mexico, says that pilot laser-fusion power plants could be operating by 1982 and commercial plants by 1990.

**Jules H. Gilder**  
Associate Editor

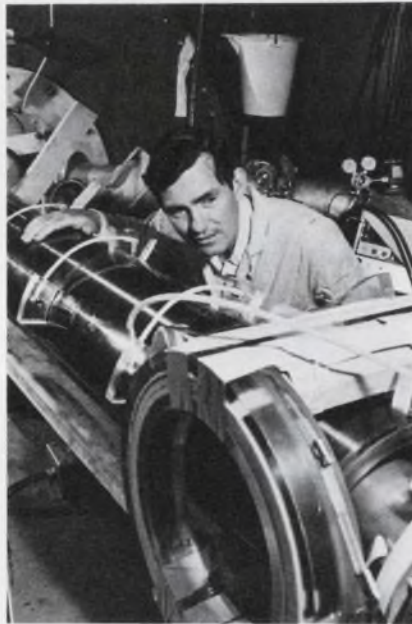

**Hydrogen-fluoride laser** developed by Sandia will be used to explore the possibility of producing electrical power through laser fusion.

Such plants would be safe, proponents note, because no radioactive by-products would be produced.

## Laser development under way

Most of the present work in laser fusion is in the development of high-power lasers that can heat and compress nuclear fuel. A new hydrogen-fluoride laser, for example, has been developed by Sandia Laboratories in Albuquerque, N.M.

The Sandia laser, notes Edward L. Patterson, a principal investigator on the project, is excited by a 55-kA, 2-MV electron beam and produces a 228-J laser beam in a 55-ns pulse. This is equivalent to a power output of about 4 billion watts.

Patterson believes that the 228 J can be increased to 1000 J by use of a larger electron-beam machine and the addition of optical resonators. At present it is thought that 1000 to 10,000 J of energy, applied to a pellet of nuclear fuel in a pulse of 1 ns or less, would be sufficient not only to produce laser fusion but to achieve laboratory "breakeven power" as well. Breakeven power is when the energy required to produce fusion is equal to the energy produced by the fusion.

Although Patterson believes that the breakeven point is still five to 10 years away, Cooper of Los Alamos Scientific Laboratory sees it coming in three to five years. Cooper predicts further that a substantial net energy gain should be achievable by 1979.

In contrast to the hydrogen-fluoride laser developed by Sandia, work at Los Alamos is centered on a carbon-dioxide laser. A 1-kJ device has been built and an eight-beam, 10-kJ laser is expected to be completed by 1975. A 10-beam, 100-

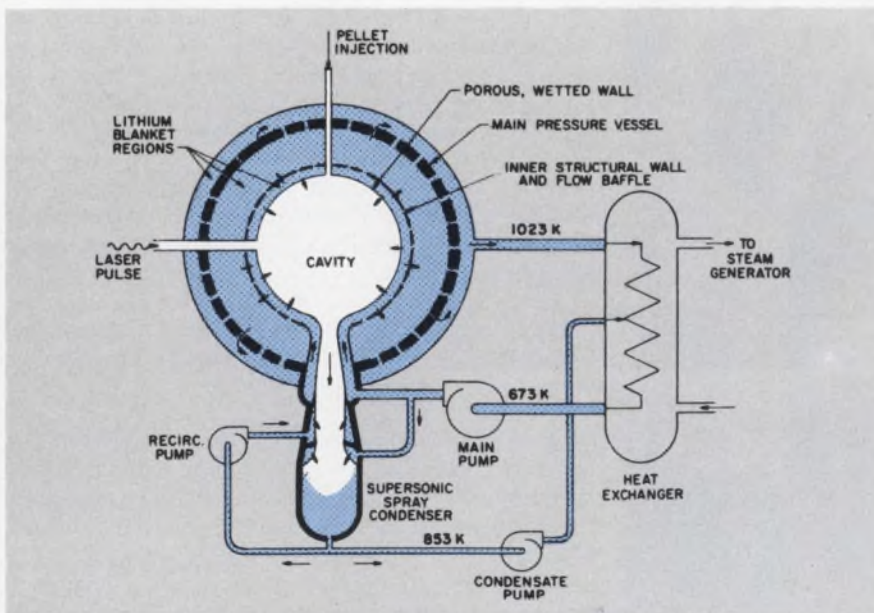

A proposed fusion power plant uses a lithium blanket to absorb the high energy neutrons. The lithium heats up, and transfers the energy to water which in turn produces steam to drive a generator.

Fluke problem solvers

# Plug in true rms... at the lowest price available!



These new Fluke plug-in options let you add true rms capability to Fluke 8200A and 8400A DVMs. Take the measure of non-sinusoidal waveforms in 500 ms. Get accurate readings from 1 mv to 1000V rms.

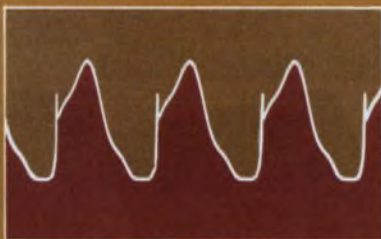

A crest factor of seven takes care of waveforms with a duty cycle as low as 2%. Common mode rejection from DC to 60 Hz is greater than 120 dB.

Now you can put true rms to work in your Fluke 8200A for just \$595, and for only \$750 in the 8400A. These are the lowest prices offered for true rms in 4½ and 5½ digit DVMs. But pride is only part of our story. Even at an unexcelled low price, we offer performance the others don't even begin to match... for instance, ac or ac plus dc coupled measurement capability.

Now look at low level accuracy. We measure low levels that competitive units can't touch. Why? because we use an exclusive converter technique which doesn't have square law response limitations of thermal rms converters.

This same technique allows us to measure waveforms that quasi-rms or distortion insensitive converters can't handle. And, we can do it up to five times faster than thermal converters. Mid-band accuracy (50 Hz to 10 kHz) is 0.1%.

auto ranging on all functions. It features switched input filter, full 1000 volt guarding. Full multimeter and systems options are available. Base price is \$995.

Fluke's Model 8400A is the ultimate bench and systems DVM. It features an accuracy of 0.002%, 1 microvolt resolution, resistance measurements down to 100 micro ohms, auto polarity and auto ranging. For \$2450 you get five ranges of DC from 0.1V full scale to 1000 volts with 20% overrange. The switched filter provides better than 65 dB noise rejection for DC, AC, resistance and ratio.

Both DVMs feature 1500V peak overload protection and the ability to meet tough environmental specs.

For full details, call your nearby Fluke sales engineer or contact us directly.

For details call your local Fluke sales engineer. In the continental U.S., dial our toll free number, 800-426-0361 for his name and address. Abroad and in Canada, call or write the office nearest you listed below. John Fluke Mfg. Co., Inc., P.O. Box 7428, Seattle, Washington 98133. Phone (206) 774-2211. TWX: 910-449-2850. In Europe, address Fluke Nederland (B.V.), P.O. Box 5053, Tilburg, Holland. Phone 13-673973. Telex: 844-52237. In the U.K. address Fluke International Corp., Garnett Close, Watford, WD2 4TT. Phone, Watford, 33066. Telex: 934583. In Canada, address ACA, Ltd., 6427 Northam Drive, Mississauga, Ontario. Phone 416-678-1500. TWX: 610-492-2119



# FIRST

## AGAIN IN SOLID STATE IMAGE SENSING

Our new *RL-1024* self-scanned array contains 1024 photodiodes on 1 mil centers and offers aperture widths from 1 mil to 24 mils. Contained within the same monolithic chip are the shift registers and multiplex switches to allow serial readout. Standard two-phase clock drive will generate data rates up to 40 MHz. The high speed, low power (4 mW) on-chip shift register is just one of the many new outstanding features.



The *RL-512*, another first of nearly two years ago, is still only surpassed by the *RL-1024*. Both arrays are designed for OCR, facsimile, page/document reader, point-of-sale terminal, real time spectroscopy and non-contact industrial measurement applications. Both devices are in gold/ceramic packages sealed with optical quality quartz windows. They fit into standard DIP sockets.

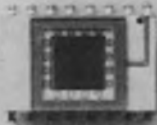

The *RA-50x50A*, introduced about a year ago, is still the only 2500 element commercially available area array. Here the 50x50 matrix of photodiodes are spaced on 4 mil centers. Designed for optical memories, guidance, surveillance applications, it also is self-scanned and operates in the charge storage mode for high sensitivity.

These and more than a dozen other photodiode array types are available from inventory.

## RETICON®

450 E. Middlefield Road  
Mountain View, CA 94040  
(415) 964-6800 TWX: 910-379-6552

NOTE: All products are shown actual size

kJ laser system that could be used for power plants should be ready by 1978, Cooper says.

Work on high-power lasers for fusion is not confined to gas lasers. Researchers at Lawrence Radiation Laboratories, Livermore, Calif., are building a large neodymium-glass laser that is designed to produce 10,000 to 100,000 J of energy, depending on the output pulse width. John H. Nuckolls, division leader, reports that the laser system should be completed by 1976 or 1977. The system is to consist of 10 or more beams and have a pulse width from 100 ps to 5 ns.

Although Nuckolls admits that the 0.1% efficiency of glass lasers makes them economically unattractive for power plants, problems such as optics and fuel-pellet design for laser-fusion reactors can be solved with them. The xenon laser, which is proposed for commercial plants, is at a very low stage of development and thus not being used at present.

### Power-plant designs proposed

A number of power-plant concepts have been proposed in which nuclear-fuel pellets are exploded by laser energy in a small vessel at a repetition rate of several times per second. High-energy neutrons released by the explosion are absorbed by a lithium blanket, which transforms the energy, in the form of heat, to water. The water forms steam, which runs a generator.

Since the circulating power of the plant will be about 30%, to be economical a reactor that supplies 50 times more energy than the breakeven energy is necessary.

The energy produced by the complete burning of nuclear fuel is about 1000 times the energy required to cause fuel ignition, and, in theory, amplification factors in excess of 100 should be possible, according to Nuckolls.

The shape of the nuclear fuel pellet is also under consideration. With a proper design, it will be possible to reduce by an order of magnitude in some cases, the laser energy to initiate fusion.

Another major design problem is the maintenance of the system's optical integrity. The optical surfaces must be protected from X-rays and the debris that results from the pellet explosions. ■■

**Quality  
resistor networks  
now available  
off-the-shelf.**

**Pull ups or  
terminators,  
in popular  
values.**

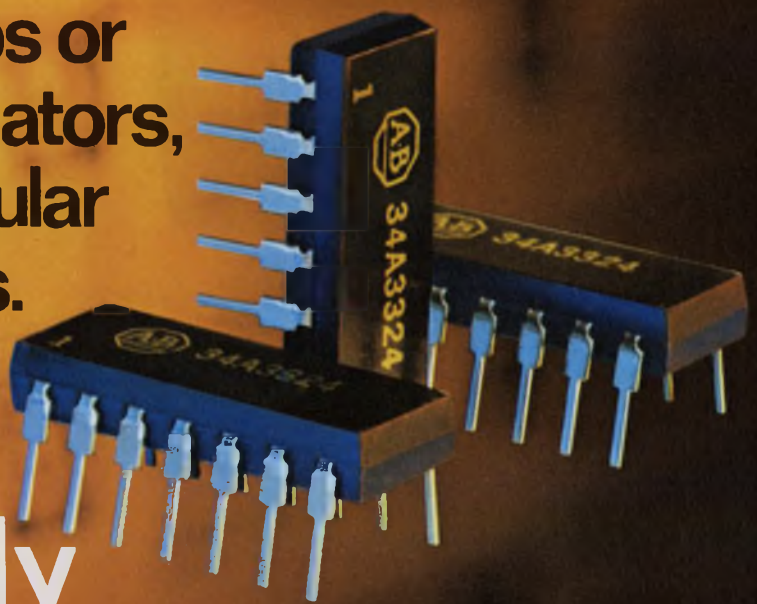

**If you're really  
serious about cost,  
be serious about quality.**

Now our most popular thick-film resistor networks are ready and waiting, in quantity, at your A-B electronics distributor. Pull-up networks and terminator networks with tolerances of  $\pm 2\%$  in popular values from 68 ohms to 22K ohms. All in compatible

14 lead .300 series DIP's. Or if you need something special we'll quickly custom design any circuit that'll fit into a 14 or 16 lead DIP. And we mean quickly. Overall specs include: absolute tolerances to  $\pm .5\%$ . Tracking  $\pm 50$  ppm/ $^{\circ}\text{C}$  (and lower). TCR to

$\pm 100$  ppm/ $^{\circ}\text{C}$ . Write for free technical publications 5850 and 5851. Allen-Bradley Electronics Division, 1201 S. Second St., Milwaukee, WI 53204. Export: Bloomfield, NJ 07003. Canada: Cambridge, Ontario. United Kingdom: Jarrow, Co. Durham NE32 3EN.



Actual Size



**Allen-Bradley**  
Milwaukee, Wisconsin 53204

INFORMATION RETRIEVAL NUMBER 25



# Oak presents a short course in keyboard switch selection you can't afford to miss.

Our course could be called "Basic Economics in Keyboard Switch Design." It sums up more than 40 years of leadership in switch design and manufacture at Oak. Take a look at our course:



At the top: the Oak Series 400 Standard Keyboard Switch. It's what you're looking for if you want economy plus reliability. Millions are in use today in every kind of keyboard application.

And our Series 475 Compact Keyboard Switches (bottom) are about the shortest premium quality units you can buy. And, like the Series 400, they're ultra-reliable and economical.



We make so many types and sizes, you can specify Oak across the keyboard. Call on us for complete assemblies to your specifications or standard keypads. The most frequently used 10, 12 or 16 button arrays are stocked in quantity by Oak distributors.



Next subject: Oak Series 415 Low-Profile Keyboard Switches designed for calculators, security devices and data entry equipment. Note the streamlined silhouette. Select colors, custom caps and legends,  $\frac{1}{2}$ " or  $\frac{3}{4}$ ", single and double keys to fit your needs exactly.



We can say that because our automated manufacturing and test equipment ensures quality. And we design our keyboard switches with the operator feel, reliability, and economy it takes for such applications as data terminals, calculators, business machines, and more.

That's it. Just be sure to follow up on what you've learned. Write for Oak Keyboard Bulletins. Class dismissed.

**OAK Industries Inc.**

SWITCH DIVISION / CRYSTAL LAKE, ILLINOIS 60014  
TELEPHONE: 815-459-5000 • TWX 910-634-3353 • TELEX 72-2447

INFORMATION RETRIEVAL NUMBER 26

## Who to call for fast delivery on Oak Keyboard Switches



Oak Series 400 and Series 415 Keyboard Switches are available from a distributor near you. He'll supply your desired quantities and ship standard 10, 12 and 16-button keypads as well. It's the way to get Oak quality switches fast!

**DEMAMBRO ELECTRONICS**  
MASSACHUSETTS, Boston.....(617) 787-1200

**DRW**  
MASSACHUSETTS, Watertown.....(617) 923-1900  
NEW YORK, Farmingdale.....(516) 249-2660

**EDMAR ELECTRONICS**  
ILLINOIS, DesPlaines.....(312) 298-8580

**FEDERATED PURCHASER**  
NEW JERSEY, Springfield.....(201) 376-8900

**GRAHAM ELECTRONICS**  
INDIANA, Indianapolis.....(317) 634-8486

**G. S. MARSHALL**  
ALL BRANCH LOCATIONS—HOME OFFICE:  
CALIFORNIA, El Monte.....(213-686-1500)

**HALL-MARK**  
ALL BRANCH LOCATIONS—HOME OFFICE:  
TEXAS, Dallas.....(214-231-6111)

**HERBACH & RADEMAN**  
PENNSYLVANIA, Philadelphia.....(215) 426-1700

**INDUSTRIAL COMPONENTS**  
MINNESOTA, Minneapolis.....(612) 831-2666

**MILGRAY/WASHINGTON**  
MARYLAND, Hyattsville.....(301) 864-1111

**OHM/ELECTRONICS**  
ILLINOIS, Palatine.....(312) 359-5500

**RADAR ELECTRIC CO.**  
WASHINGTON, Seattle.....(206) 282-2511

**SCHOMBURG SALES**  
NEW YORK, Rochester.....(716) 244-0920

**SOLID STATE ELECTRONICS**  
TEXAS, Dallas.....(214) 352-2601

**OAK Industries Inc.**  
SWITCH DIVISION / CRYSTAL LAKE, ILLINOIS 60014

## Fiber-optic modules pave way for data and control systems

A solution appears at hand to a major problem inhibiting widespread design of fiber-optic systems to carry information and to provide control—the lack of standardized components to interface between the optical fibers and the electronic circuitry. Modular building blocks, under development by General Optimization, Inc., of Southport, Conn., will be incorporated directly into the optical-to-electronic and electronic-to-optical signal paths to perform intelligent switching control and amplifying functions.

A prototype control system, using a 40-mil plastic optical fiber and capable of transmitting some 1000 separate switching commands, has demonstrated the feasibility of component standardization, according to Daniel E. Speers, director of research at the company and inventor of the system.

The building blocks accept light or infrared radiation and emit an electrical signal, or they accept an electrical signal and emit radiation, depending upon the type of module. Modules that have been produced and tested include AND, NAND and OR gates, logic inverters and flip-flops.

An optical amplifier has also been developed. It senses weak

radiation from an optical fiber and regenerates it, producing a new, higher-level optical signal suitable for further transmission along a second optical fiber.

### Modules channel data

These modules, Speers says, can perform elementary logic functions—from simple decision-making to signal routing and signal coding—to ensure acceptance of optical or electrical data at the proper terminal.

As an example of how the modules work, Speers points to an AND gate device that has two fiber input ports, a fiber output port and power leads. Optical fibers are inserted and clamped into each of the ports. When power is applied—typically 5 V dc at 250 mA—the module ignores an input optical signal unless both inputs are present. In this case the module produces an optical signal in the output fiber.

The OR gates, Speers explains, will pass either input independently but will not pass coincidental input signals.

The basic flip-flop is both a pulse-response device and a memory unit, Speers says, with a zero light output a function of the last

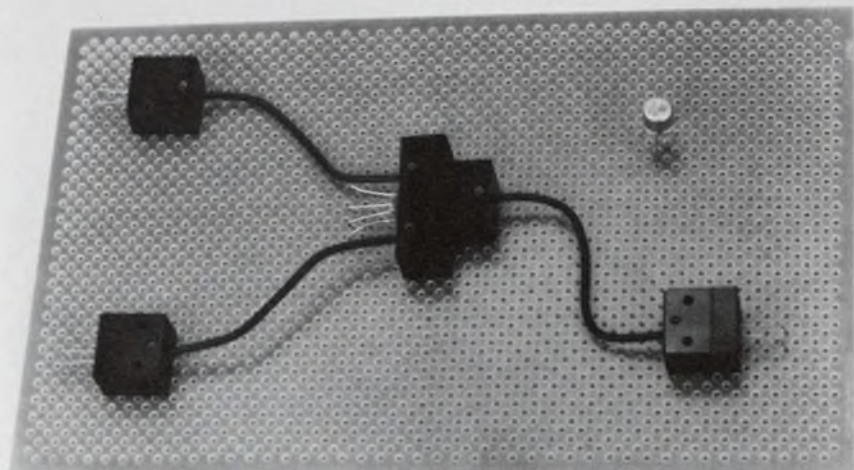

The electrical input from two emitter modules (left) is summed in the optical AND gate (center). Output is decoded by detector module (right).

# Dialight sees a need:

(**Need:** The right switch for the right price.)

## See Dialight.

For the switch buyer, choice of function and esthetics, reliability, ease of mounting, and low cost are his prime concerns. He may need a pushbutton switch for panel, sub-panel or snap-in mounting. He may need a choice of bezels with or without barriers in black, gray, dark gray or white. He may need a legend that's positive, negative, or hidden until energized... one that's white when "off" and red, green, amber, blue or light yellow when "on"... or colored both "on" and "off." He may need a highly



reliable switch proven in thousands of installations... available in momentary or alternate action... N.O., N.C. or two circuit (one N.O., one N.C.) or for low level, low voltage and current applications... that accommodates a T-1 1/4 bulb with midget flanged base, incandescent, in voltages from 6 to 28 V. Matching indicators with same front-of-panel appearance are also available. These are some custom needs he may face, and these switches are some off-the-shelf answers from Dialight.



Conservatively speaking, Dialight offers well over 1,879,698 switch possibilities. Dialight is a company that looks for needs... and develops solutions. That's how we developed the industry's broadest line of switches, indicator lights and readouts. No other company offers you one-stop shopping in these product areas. And no one has more experience in the visual display field. Dialight can help you do more with switches than anyone else because we have done more with them. Talk to the specialists at Dialight first. You won't have to talk to anyone else.

Here are a few products in this family: **1.** Thumbwheel switches—miniature and standard sizes **2.** Contactless solid state switch **3.** Keyboard reed switch **4.** Double pole, double throw snap action switch **5.** LED lighted momentary action switch **6.** Matching indicators **7.** Momentary snap, nonsnap, and alternate action switches **8.** Transistorized indicator with momentary switch **9.** Incandescent or neon lighted switch.

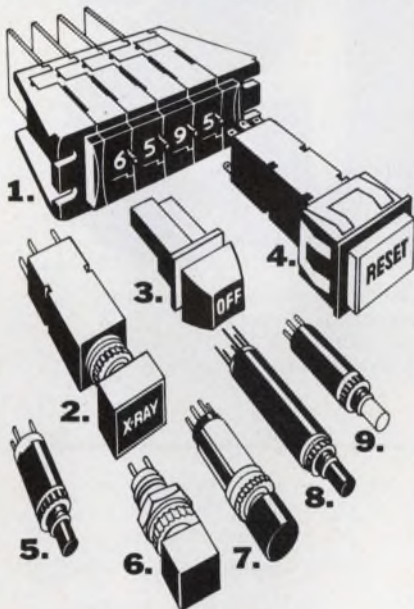

Please send data on your switches.

NAME \_\_\_\_\_

TITLE \_\_\_\_\_

COMPANY \_\_\_\_\_

ADDRESS \_\_\_\_\_

CITY \_\_\_\_\_

STATE \_\_\_\_\_

# DIALIGHT

Dialight Corporation, A North American Philips Company  
60 Stewart Avenue, Brooklyn, N.Y. 11237 (212) 497-7600

INFORMATION RETRIEVAL NUMBER 27

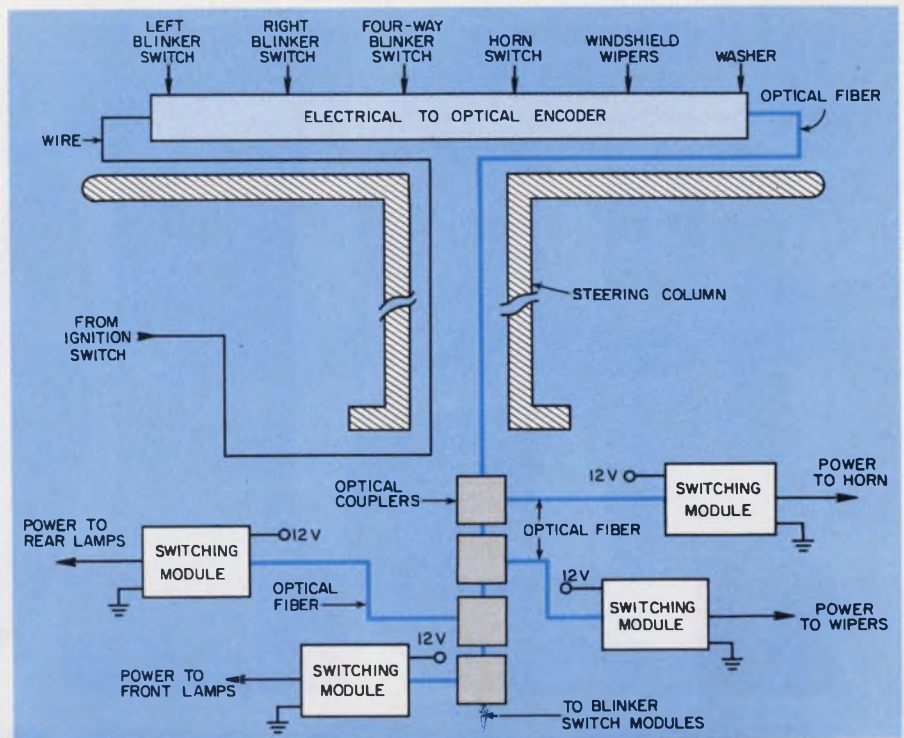

**Fiber optics for control of automotive electrical equipment** has the electrical-to-optical signal encoder in the steering wheel. Optical fiber carries control signals to switching modules for decoding and device switching.

pulse in a series of pulses.

The operating principle of the devices is simple, Speers reports. When visible or near IR radiation is applied to one (or more) of the optical inputs, the energy falls on a silicon detector. As a result, the input radiation can be visible—from a regular light-emitting diode, say, or a small tungsten lamp—or it can be invisible, as from gallium-arsenide diodes.

The detector changes the optical signal to an electrical one that can be then amplified to drive a gallium-arsenide diode, thus producing a new output that is a copy of the input signal.

The type of modular element is thus determined by the number of input and output fibers as well as the configuration of the internal circuitry.

The spectral response of the silicon detectors ranges from 0.3 to 1.1  $\mu\text{m}$ , with a responsivity of 100 mA/mW at 0.85  $\mu\text{m}$ . Typical switching power is 50 mW/cm<sup>2</sup>—equivalent to the power needed to switch a 7400 series TTL gate from 0 to 1—and the switching time is 25 ns.

Optical outputs of modular units are GaAs radiation, with a peak optical bandwidth of 0.89 to 0.8  $\mu\text{m}$ . Experimental models have

been fabricated with visible light emitters.

The bandwidth of photodetector-preamplifier units—they may be silicon diodes feeding Darlington amplifiers—is on the order of 50 MHz.

Speers sees a principal application of these modules in the data transmission between a computer and adjacent terminals. The biggest advantage of the new system, he says, is that the data can be multiplexed optically over the fiber carrier. One optical fiber can eliminate some 60 wire pairs, he says. Another advantage: The control signals for the electronic or electromechanical switching system at the terminal can be sent through the light pipe along with the transmitted data.

A further application that General Optimization has been working on is the use of fiber-optic systems for control of automobile lights, horns and other switched units. An electronic encoder, actuated by the switch inputs, produces coded optical pulses that are carried to the local switching modules by a small plastic light pipe.

The electronics for an encoder for a 32-switch assembly could be put on a single chip, Speers notes, at a cost of \$2 per car. ■■

# BIG TTL ROMS

MMI is producing high volume quantities of the world's broadest family of big bipolar monolithic ROMs.

What's good about BIG? Lower system cost, greater system reliability, plus significant savings on both power and p.c. board space. You can't find all these benefits anywhere else, even with MOS. So whether you need

large microprogramming ROMs or character generators with up to 128 9x9 characters, you can get them immediately from MMI, the industry leader and biggest supplier of ROMs and P.ROMs. Get the competitive edge: specify MMI.

Bit Capacity	Part No. Commercial/Mil	Organization	Power/Bit	Max. Access Time	100-999 (Commercial) Price	Big ROM Benefits
10K	6255/5255	1024 x 10	48 $\mu$ W	140ns	565.00	• Reduce system cost
10K	6299/5299	1152 x 9	43 $\mu$ W	175ns	60.00	• Maximum character density
9K	6260/5260	1024 x 9	48 $\mu$ W	140ns	60.00	• Simplify system design
8K	6280/5280	1024 x 8	55 $\mu$ W	150ns	45.00	• Enhance system reliability
4K	H6240/H5240	512 x 8	164 $\mu$ W	80ns	35.00	• Improve system speed
4K	6240/5240	512 x 8	110 $\mu$ W	150ns	30.00	• Reduce board count

Hear what our customers say about our big monolithic ROMs! Call, write or TWX Dale Williams today:  
Monolithic Memories, Inc., 1165 East Arques Avenue, Sunnyvale, CA 94086,  
(408) 739-3535/TWX 910-339-9229.

## Monolithic Memories, Inc.

EASTERN AREA SALES OFFICE: (617) 653-3158 • NEW ENGLAND REGION: (617) 653-3158 • NEW YORK REGION: (607) 748-3211 • CENTRAL AREA SALES OFFICE: (317) 844-3241 • WESTERN AREA SALES OFFICE: (714) 556-1216

Representing your best buy in memories: ALABAMA, Huntsville (205) 539-1771; ARIZONA, Phoenix (602) 264-7971; CALIFORNIA, San Diego (714) 747-3015; Palo Alto (415) 369-4671; COLORADO, Denver (303) 623-8713; CONNECTICUT, North Haven (203) 239-9762; FLORIDA, Orlando (305) 423-7615; ILLINOIS, Chicago (312) 593-0200; INDIANA, Ft. Wayne (219) 744-4331; KENTUCKY, Louisville (502) 893-7303; MARYLAND, Baltimore (301) 825-3330; MASSACHUSETTS, Boston (617) 444-2484; MICHIGAN, Detroit (313) 358-2020; Grand Rapids (616) 451-8901; MINNESOTA, Minneapolis (612) 929-6721; NEW JERSEY, Teaneck (201) 692-0200; NEW MEXICO, Albuquerque (505) 298-1875; NEW YORK, N.Y.C./L.I. (201) 692-0200; NORTH CAROLINA, Raleigh (919) 834-6591; OHIO, Cincinnati (513) 521-2290; DAYTON (513) 298-9546; CLEVELAND (216) 228-7525; OKLAHOMA, Tulsa (918) 627-4159; OREGON, Portland (503) 292-5656; PENNSYLVANIA, Willow Grove (215) 674-3850; PITTSBURGH (412) 242-0100; TEXAS, Dallas (214) 239-9148; Houston (713) 721-1054; WASHINGTON, Seattle (206) 455-2778.

# washington report



Heather M. David  
Washington Bureau

## **A civilian role for NASA sought**

Most Congressmen agree that Government achievements in defense and space technology should be applied to the civilian sector as well. The problem has been in finding an appropriate mechanic for that transfer. Now an idea has been introduced that stands a chance of getting Congressional approval. Sen. Warren G. Magnuson (D-Wash.), chairman of the Commerce Committee, Sen. Frank E. Moss (D-Utah), chairman of the Aeronautical and Space Sciences Committee, and Sen. John V. Tunney (D-Calif.) have proposed an amendment to the National Aeronautics and Space Act to apply the space agency's scientific and technological expertise to domestic problems. NASA's name would be changed to the National Applications of Science Foundation. The bill also would provide for a new National Technological Research Council in the office of the President, to be charged with preparing a comprehensive resource survey and to plan the application of technological resources to critical problems. NASA would get \$200-million in fiscal 1974 to carry out such projects.

Magnuson says the move is a logical one, since NASA technology already has been applied to such fields as medical instrumentation, electronic aids for paralytics and amputees, and the measurement of pollution.

## **Texas keeps A-7 production rolling**

A strong Texas lobby scored a mighty victory in the Senate, convincing it to add \$72-million to the defense authorization bill to keep A-7 aircraft production lines open at LTV Aerospace, Inc., in Dallas. The pressure by the Texas delegation almost caused a wipeout of the Fairchild Industries A-10 close-support aircraft program, termed necessary by the A-7 group. The Air Force has agreed to a flyoff competition between the two aircraft for the close-support role. The A-10, designed specifically to aid ground troops, has a simple avionics suite based on visual acquisition of targets. It is heavily armored and can loiter in one area for a long time. The A-7 is more a conventional air-to-ground aircraft, with radar and electro-optical systems.

## **Navy testing procedure drawing protests**

In what seems to be an increasing trend, the Navy is asking electronic equipment developers to lend it equipment for testing in a program aimed at finding new approaches to airborne surveillance of submarines

and ships. Electronics companies with developments in airborne sensor systems, airborne wideband data link for sensor, navigation and equipment-status data transmission, tactical and large-screen displays, uhf relay equipment and airborne inertial navigation systems are being asked to provide equipment, together with maintenance and technical assistance at company expense. The Navy is looking toward new equipment development for surveillance aircraft such as the P-3 Orion, S-3 anti-submarine warfare plane and the E-2C Hawkeye. Small electronics companies are beginning to complain that they will be frozen out of future procurements, since they cannot afford to participate at their own cost in such evaluation programs.

## Rise in aerospace unemployment forecast

Some 6000 scientists and engineers are expected to lose their jobs by June, 1974, as a result of continued constraints in Government spending and increased competition in the aerospace field. The Aerospace Industries Association predicts a total 32,000 job losses in the aerospace field between June, 1973, and June, 1974, with the most significant decline in missiles and space-hardware companies. Reports of potential unemployment are being sent to Congress, particularly to the House and Senate Appropriations Committees, which is now considering large cuts in the defense budget.

**Capital Capsules:** Details of the Army, Navy and Air Force programs for remotely piloted vehicles and air targets will be given Oct. 31 and Nov. 1 at a meeting of the American Defense Preparedness Association at the Naval Air Station, Point Mugu, Calif. The program will include discussions of electronic requirements, including guidance, control and component technology. . . . The Air Force Space and Missile Systems Organization plans to issue requests for proposals for a conceptual study of electronic systems for the reusable upper stage of the space shuttle. . . . Rockwell International has reported an estimated \$9-million underrun on its contract to build and support flights to the Skylab command and service modules. . . . A delegation on computer sciences will be among four technical teams from the People's Republic of China that will visit the U.S. this fall. Another team expected later will study laser research. The visits are sponsored by the Committee on Scholarly Communications with the PRC, National Academy of Sciences. . . . NASA is asking for bids for two aircraft to simulate space-shuttle operations. The vehicles will be equipped with functional controls to simulate orbiter displays and controls, and a special simulation engineer's station will have electronics to monitor the training system. . . . IBM's Federal Systems Div. has won a NASA contract to design, implement and maintain avionics software for the space-shuttle orbiter data system. The company previously was selected by the prime shuttle contractor, Rockwell International, to design and produce the shuttle's general-purpose avionics computer and input/output unit. . . . The Air Force's Rome (N.Y.) Air Development Center is planning to contract for design of a digital communications transceiver that will contain and LSI digital processor and process signals digitally rather than in the conventional analog manner. . . . The first Space Shuttle Spacelab may have a European astronaut and European experiments as a result of an agreement signed by the U.S. and the European Space Research Organization. Nine European nations will cooperate to design and build the laboratory, which will operate with NASA's space shuttle.

**“Interfacing the computer with my process is tough. The severe noise, high loads, long lines and high ambient magnetic**

**field give us nothing but problems. Add to that the rotten environment with high temperature and awful dust, and it's almost impossible.**



**I need help with my relays. Right now!”**

From signal switching to power switching—under truly bad environmental conditions—Clare's reliable mercury-wetted relays and the new solid state relays solve your problems.

The inherent design of Clare's mercury-wetted relays stands up to the extreme demands of a severe environment and provides nearly infinite life. And it makes these relays flexible. They can switch low level analog data into an A/D converter, or configured into the

access matrix, perform in severe environments. When designed into control matrix they can drive your heavy industrial loads.

If a high magnetic environment is your problem, Clare's new solid state 10 Amp and DIP (3/4 Amp) relays are another way to go. They're not position sensitive. Shock and vibration can't affect them. And they also last nearly forever.

Our expertise lies in the advanced design and manufacture of relays. But our energy lies in the application

of relays to help you solve specific problems. We specialize in getting down to work.

If you need help with your interfacing problem—or just some good information—get in touch with us right now. The “right now bunch” is ready to go to work for you.

Contact your local Clare Distributor or Sales Engineer. C. P. Clare & Co., 3101 Pratt Avenue, Chicago, Ill. 60645 312/262-7700.

**QUALITY/SERVICE/RELIABILITY**

**we help. get in touch with us. CLARE the “right now” bunch.**

a GENERAL INSTRUMENT company

GENERAL PURPOSE RELAYS    MERCURY-WETTED RELAYS    REED RELAYS    SOLID STATE RELAYS    TELEPHONE RELAYS    STEPPING SWITCHES

INFORMATION RETRIEVAL NUMBER 29



Meet our new series of  
high-frequency problem solvers . . .

# High-Performance VHF/UHF FET Family

Remember the U310? Some people call it the SuperFET. We introduced it a year ago: worst-case 75Ω input match VSWR of 1.25:1. Figure of merit  $2.35 \times 10^9$  typical. Third order intercept point of +29 dBm.

Now we've extended the U310 technology to produce an entire family of high-performance N-channel junction FETs. They're ideal for VHF/UHF applications such as the two circuits shown below:

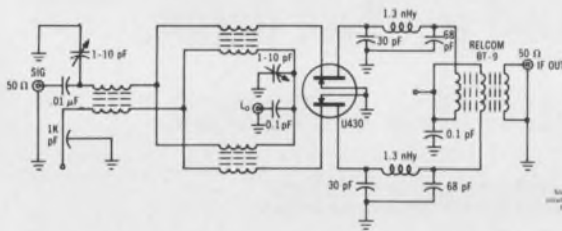

Single-balanced active mixer — 100 dB dynamic range,  
+2.5 dB conversion gain, +32 dBm intercept point, 50-250 MHz.

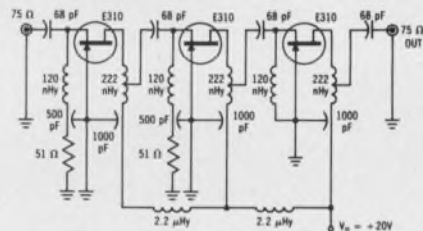

Wideband amplifier — 225 MHz center frequency,  
1 dB bandwidth of 50 MHz, 24 dB gain.

U310 family characteristics include:

- High power gain (common gate) — 16 dB at 100 MHz, 11 dB at 450 MHz.
- Noise figure = 3 dB typical at 450 MHz.
- High transconductance = 10,000 to 20,000 μmhos.

Select the right FET for your application from this array:

Type	Package	Feature	Applications	Price (\$1K units)
E308	Epoxy TO-106	$V_p = -1.0$ to $-6.0$ V $I_{Dmax} = 12$ to 60 mA	High-frequency, small signal VHF or UHF source followers, amplifiers, mixers, or oscillators	\$ 0.57
U308	Metal TO-52			\$ 3.70
E309	Epoxy TO-106	$V_p = -1.0$ to $-4.0$ V $I_{Dmax} = 12$ to 30 mA		\$ 0.75
U309	Metal TO-52			\$ 4.45
E310	Epoxy TO-106	$V_p = -2.0$ to $-6.0$ V $I_{Dmax} = 24$ to 60 mA		\$ 0.75
U310	Metal TO-52			\$ 4.45
U310 family dual FETs have $V_p$ , $I_{Dmax}$ , and $g_m$ parameters matched to 10% Packages designed for easy insertion into printed circuit boards				
E430	Epoxy Si-105	$V_p = -1.0$ to $-4.0$ V $I_{Dmax} = 12$ to 30 mA $g_m = 10$ to 20 mmho	VHF/UHF balanced mixers and cascade amplifiers	\$ 1.70
U430	Metal TO-99			\$ 9.95
E431	Epoxy Si-105	$V_p = -2.0$ to $-6.0$ V $I_{Dmax} = 24$ to 60 mA $g_m = 10$ to 20 mmho		\$ 1.70
U431	Metal TO-99			\$ 9.95

Get the complete story on this advanced high-frequency FET family.  
For application notes and technical information

## write for data

Applications Engineering: (408) 246-8000 Ext. 802



### Siliconix incorporated

2201 Laurelwood Road, Santa Clara, California 95054

## Let's not become another auto industry

The public is largely down on technology. And seemingly for good cause: consumer products that don't work, the crisis in energy and pollution, shortages in almost everything. And now another problem—fire hazards in TV sets.

In New Jersey alone this year, 14 lives were destroyed by three fires that began spontaneously in color TV sets. And at least 635 TV-caused fires in 214 cities were documented last year. No one knows how many others were started by TVs but not directly traced to them. Although the TV industry vehemently challenged the figures, the now-defunct National Commission on Product Safety has estimated that 10,000 sets caught fire in 1969.

When an 18-month-old girl, her mother and grandmother get burned to death; when three young children die along with their parents and two young cousins, does it really matter whether there were 10,000 fires or just one? One fire in a TV set is one too many.

Who's to blame? Not a vague, impersonal "TV industry" certainly. The blame rests squarely with those who design, build, inspect and test TVs and the components that go into them. TV sets, like any product, are designed and built by people. It's their responsibility to deliver a hazard-free product.

Naturally the manufacturer of any product wants to maximize his profits. The man who designs, the man who assembles, the man who inspects, the QC man—all are restrained by economics to turn out the cheapest product in the shortest time. But regardless of such pressures, designers and builders have a greater responsibility than that dictated by the profit motive. Enough lives have been lost.

The people who design and test the instant-on circuit must ensure that the heat caused by the continuously drawn current isn't dangerous. The people who design high-voltage and other circuits must guarantee that components aren't excessively heated or dangerously close to breakdown. The assemblers and QC men must be sure all components are in the right place. And the people on the bench must be certain that excessive X-rays don't emanate from CRTs and other high-voltage devices.

For the safety of all of us, the buck must stop on the assembly line.



*Stanley Runyon*

STANLEY RUNYON  
Associate Editor

Renew your ELECTRONIC DESIGN subscription today! Turn to inside the front cover, fill out card completely, affix peel-off label and mail. Do it now—don't miss a fact-packed issue of ELECTRONIC DESIGN.

# Centralab perspectives

FOR USERS OF ELECTRONIC COMPONENTS



CENTRALAB

Electronics Division  
GLOBE-UNION INC.

5757 NORTH GREEN BAY AVENUE  
MILWAUKEE, WISCONSIN 53201

## Even if 1975 circuit designs are frozen it's not too late for thick film hybrids.

Centralab can help designers meet the challenge of today's technology changes with two thick film systems. Supplying custom requirements, from quick design to volume production, is a matter of weeks.

Quick turn-around time is only one reason thick film circuits have gained such a strong foothold in many product designs. IC's require longer design lead time. Discretes can't match hybrids for size or reliability.

A case in point. Late in the design cycle for the 1974 passenger cars, governmental safety regulations called for changes in seat belt warning systems. A new seat-belt-ignition interlock would be required on all 1974 models. One major automotive firm brought their problem to Centralab. Hybrids could be the answer. Within two weeks, 8 packages had been designed by Centralab and samples shipped. Both active hybrid and passive circuits were included in the Centralab modules that were a major part of the interlock system. Two weeks later, prototype quantities were furnished and volume production quantities were shipped five weeks after that. From inquiry to mass production took a total of just 9 weeks! Tight scheduling. Exacting specs. Volume orders for millions of pieces. That's the kind of challenge Centralab meets best and the kind of service customers have come to rely upon.

Centralab, a pioneer in thick film circuits, is supplying the needs of automotive, computer, data processing, business machine, point-of-sale,

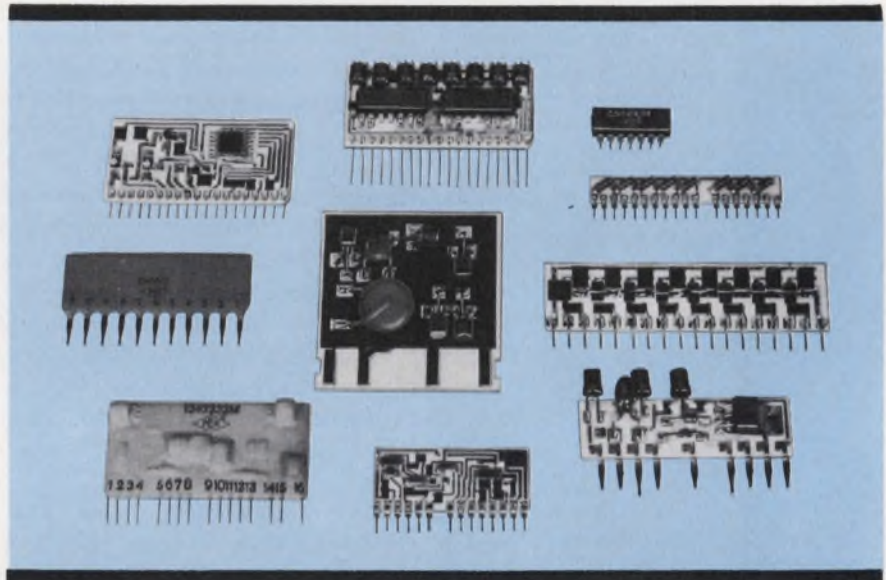

Backed by the experience of designing more than 50,000 custom hybrids, Centralab can supply a wide variety of circuit combinations and package configurations.

consumer and industrial product manufacturers. And they've proven, time and time again, that they can meet the needs for reliable circuits faster.

The two thick film systems Centralab offers means broad flexibility to accommodate custom requirements. Their silver/carbon  $\langle \text{PEC} \rangle$  system offers an economical approach for consumer and industrial applications where tight resistance tolerances are not critical. Used to produce resistor, capacitor or RC networks in a variety of values and package configurations, it also makes possible complete discrete hybrid circuits by adding encapsulated semiconductors to the basic thick film network.

The noble metal/cermet MEC system is ideally suited to commercial and industrial applications — for high stability under extreme environ-

mental conditions, for high voltage and high power applications as well. It is the system used for stable resistor banks and complex hybrid circuits. It meets the need for high-density packaging and is supplied in conformally coated single in-line or plastic molded dual in-line packages.

Customized circuitry is a Centralab specialty. Whether it's staircase networks, passive filters, frequency dividers, pull-up networks, clock drivers, video amplifiers, solid state switches, motor speed control or other special applications for hybrids. Why not consider them for your product?

You can get complete information and our latest thick film catalog by writing A. R. Wartchow, Manager Electroceramic Marketing or calling 414/228-1200.

## Centralab perspective:

### Ultra-Kap™ capacitors. Low dissipation. High insulation.



A dissipation factor as low as 3 percent maximum and high insulation resistance up to 1,000 megohms are only two critical design parameters met by Centralab Ultra-Kap capacitors. Also important is Y5F stability which is a maximum capacitance change of  $\pm 7.5\%$  from  $+25^\circ\text{C}$  over a temperature range of  $-30^\circ\text{C}$  to  $+85^\circ\text{C}$ .

Centralab Ultra-Kap capacitors cost far less than Mylar® and multi-layer monolithic types. With all the function you want. In substantially smaller space, too. For example, you can get a  $.05\ \mu\text{FD}$ , 16 V capacitor in a .375 diameter disc.

Ultra-Kap capacitors are available in voltage ratings of 3, 12, 16, 25, and 50 V, with a choice of lead size and configuration, and in a selection of coating controls. Ask about the ratings, sizes and shapes you need.

Call Bob Michaels,  
915/779-3964 or write  
Centralab for Bulletin 1106CA



## Centralab perspective:

### Ceramic Trimmer Resistors. Double the wattage of phenolics.

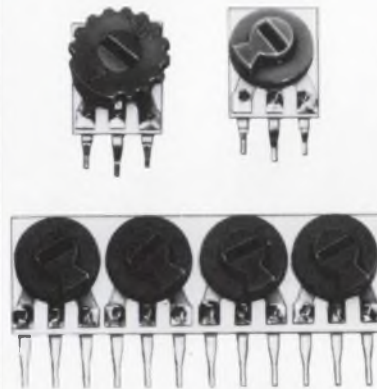

Centralab Slim-Trim carbon and Centrim cermet trimmer resistors give twice the wattage capability of phenolics, yet cost no more. Ceramic substrates mean higher wattage in a smaller space. Plus the ability to withstand high operating temperatures without shrinkage. No flux migration during flow soldering either.

Centralab design and smooth positive adjustment eliminate erratic "slip-stick" effect in setting. Choose from single or multiple sections;  $\frac{1}{2}$  to  $\frac{3}{4}$  watt; TC low as 150 PPM/ $^\circ\text{C}$ . And if you want we can add fixed resistors to any of our standard trimmers. Easy.

See your Centralab Distributor or write Centralab for Bulletin No. 1096.



## Centralab perspective:

### Push button switches. Now in 5 spacing options.

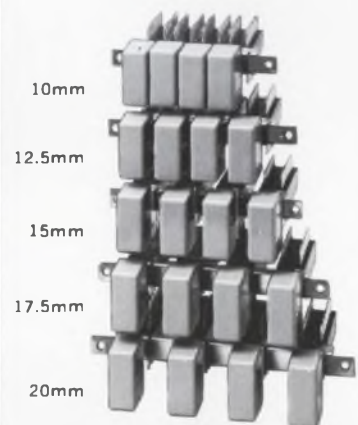

Center-to-center push button module spacings of 10, 12.5, 15, 17.5 and 20 mm are now available standards from Centralab. This, plus a choice of 2 to 8 pole switching functions, coupling arrangements and 26 standard button styles in 18 colors present added dimensions of design flexibility. Other features:

- Optional epoxy sealed terminals
- Interlock/lockout variations
- Lighted push button options
- Modular LINE SWITCH (mounts in any station)

Write Centralab for  
push button switch\*  
Bulletin No. ELC2.

\*Isostat licensed



**Reliability is six things we do  
that nobody else does.**

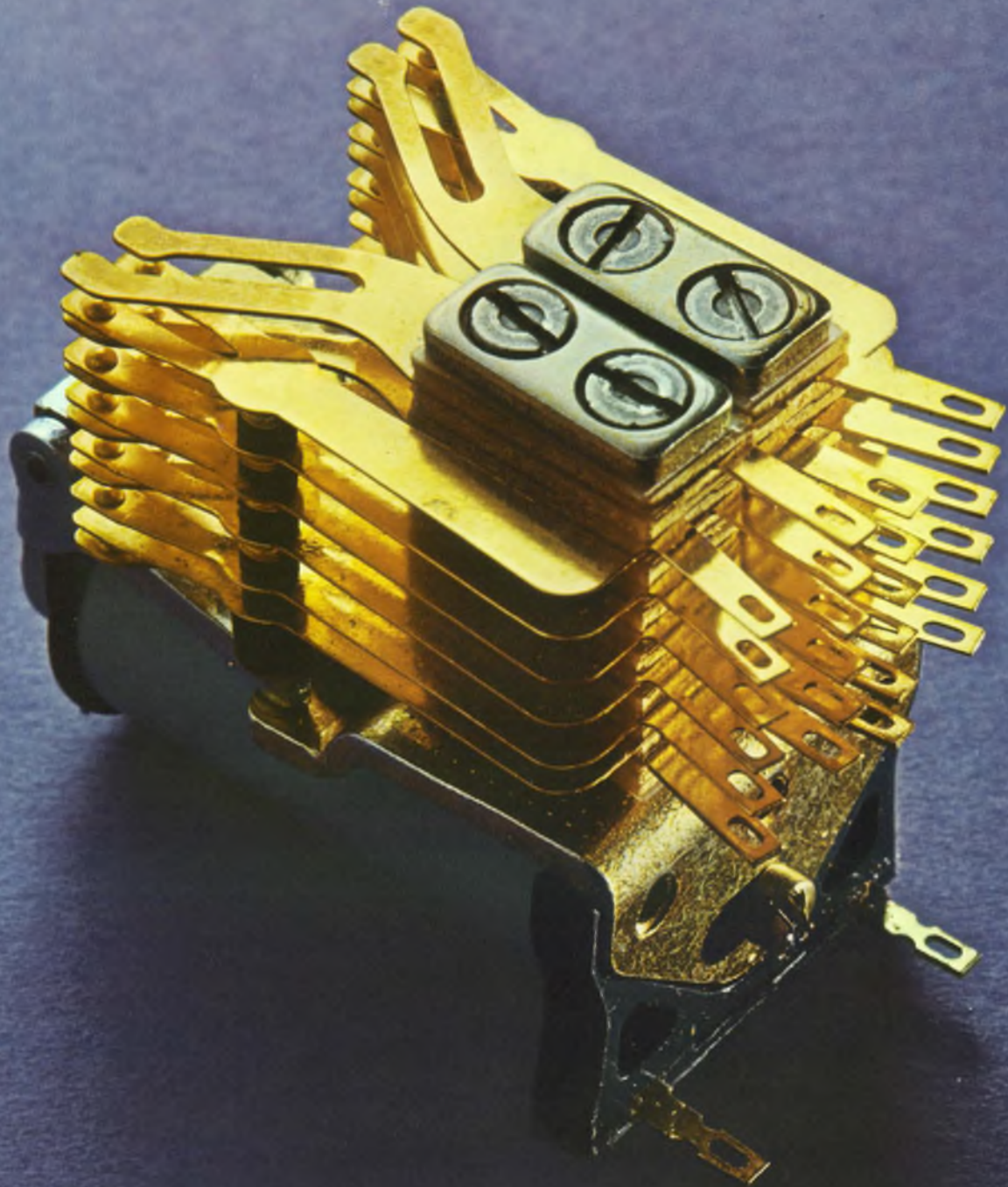



### **We're fanatics.**

We build our relays stronger than we have to. That way, they last lots longer than they ever have to. Our Class E relay (shown on the opposite page) is a good example of our way of thinking.

### **The industry's strongest heelpiece.**

We make the strongest heelpiece in the industry. A gigantic machine bangs them out extra fat and extra flat.

Extra fat to carry a maximum of flux. To handle big loads. Extra flat so that once an AE relay is adjusted, it stays adjusted.

Since our backstop is part of the heelpiece, it's just as thick and flat. But, tough as it is, the slightest wear here would throw the entire contact assembly out of whack. So, to be safe, we weld two tiny, non-magnetic pads where the armature arms meet the backstop. You might say we created the no-stop backstop.

### **Three parts that'll wear like crazy.**

When you build a relay like a small tank, you have to think of everything. We try. Right down to the tiniest part. For example, we make our armature arms and bearing yoke extra thick.



Thicker than years of testing and use say they have to be. Then, to make sure they don't cause wear problems, we insert a hardened shim between the hinge pin and the frame. The pin rides on the shim, instead of wearing into the heelpiece. (You can forget the bearing, it's permanently lubricated.)

### **Buffers with lots of muscle.**

We make our buffers of a special tough phenolic material that lasts. And lasts. And lasts. All without wear or distortion. Another reason why our relays stay in whack.

To make sure our buffers stay in place, we weld the buffer cups to the armature arms. We weld, instead of using rivets, because our lab found that rivets have a habit of falling out.

For the very same reason, we weld buffer cups to the contact springs. And also use the same special tough phenolic buffers.



### **No, we didn't forget the contact springs.**

We have some strong feelings as to what makes a contact spring reliable. Our sentiment is that two contacts are better than one. So, we bifurcate all the springs, not just the make and break. This slotting and the addition of another contact to each spring means you get a completed circuit every time.

We make each set of contact points self-cleaning. The bad stuff doesn't have a chance to build up.

### **Now, what's different about our bobbin?**

Our bobbin is one piece—molded of glass-filled nylon. This provides the maximum in insulation resistance.

Because our bobbin is nylon, we don't have to impregnate with varnish. Moisture and humidity have no effect on the stubborn nylon material. No effect means no malfunctions for you to worry about.



### **What all this means to you.**

What this all adds up to is reliability. The kind of toughness no one else can give you. It means an AE relay works when it's supposed to, longer than it has to. Isn't this the kind of reliability you really need? GTE Automatic Electric, Industrial Sales Division, Northlake, Illinois 60164.

# **GTE AUTOMATIC ELECTRIC**

# CLOCKWATCHERS



Assign your "clockwatching" to specialists:  
the Guardian Angel and

## GUARDIAN TIME DELAY RELAYS

Need a time delay relay that counts parts of a second . . . or one that counts half an hour? From 25 milliseconds to 2,000 seconds, Guardian's got them all. In your choice of electromechanical, hybrid or pure solid state. In standards that come right off the shelf or in custom designs. In just about any size, shape, form, or delay range your application can demand. Isn't it time you get all the facts on Guardian Time Delay Relays? Send today for specs and application data.



### GUARDIAN<sup>®</sup>

GUARDIAN ELECTRIC MANUFACTURING CO.  
1572 West Carroll Avenue, Chicago, Illinois 60607

*In a hurry? Call your Guardian Distributor.*



# Timefax® and Timemark® are the best recording papers for transmitting a picture of your plant baseball team. (Or almost anything else you can record.)

**Sonar Recorders** Timefax and Timemark electro-sensitive recording papers give instant access to the recorded information. You get an immediate dry copy. The fish won't get away or you won't run aground because you lost time processing the image.



**Photo Facsimiles and Voice Characteristic Sonagrams** Only the full range of neutral grey tones provided by Timefax and Timemark electro-sensitive recording papers will give you this recording ability.

**Facsimile Receivers** Timefax and Timemark papers give a dense black image on a white background. With Timefax and Timemark you get the highest quality copy in the industry.

**Computer Print Out** Using Timefax or Timemark papers you can record up to 60,000 characters per

second on an impactless computer printer or 30 characters per second on the simplest strip printer.

**Industrial Event Recorders** You can record a few inches per hour or hundreds of inches per second with maximum reliability because it's electro-sensitive recording.

**Non-destructive Testing** Very high resolution images will give you all the detail you need for flaw detection, surface profiling and spectrum analysis.

**Electrical Writing** Essentially that's what you do with Timefax and Timemark recording papers. You simply amplify the electrical output of your measuring transducer and this signal writes directly on our electro-sensitive recording paper. Couple this with the fact that the electro-sensitive recording process is completely dry and permanent. And it's hard to justify recording any other way.

We have a technical manual entitled "The Dry Electro-sensitive Recording Process". It was written to give design engineers a better understanding of the technical aspects of the electro-sensitive recording process. We would be happy to send you a free copy upon request.



**FITCHBURG COATED PRODUCTS**

Box 1106, Scranton, Pa. 18501 Phone: 717-347-2035

INFORMATION RETRIEVAL NUMBER 36



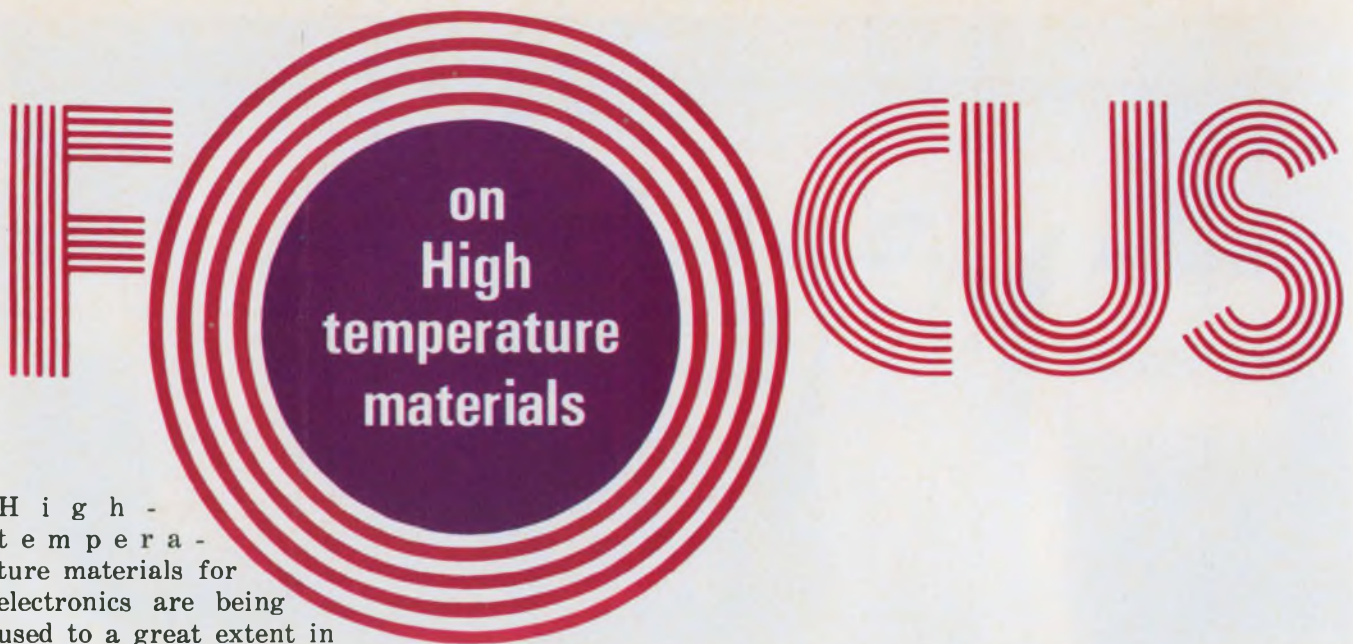

# F on High temperature materials CUS

High-temperature materials for electronics are being used to a great extent in applications in which their principal advantage—their ability to operate at elevated temperatures over extended periods of time—is not required.

One reason for such out-of-character use is that the electrical and mechanical characteristics of high-temperature materials are much better than those of low-temperature materials. This is particularly true at the higher frequencies and also at very low temperatures.

Another reason for selecting high-temperature materials—even if your application doesn't need all of the temperature protection—is to eliminate production losses caused by excessive heat during soldering. Untrained or careless personnel can ruin thin, flexible laminates with poor soldering; high-temp materials are insurance against this.

But whatever the end-use of these materials, by far the biggest problem lies in making the initial selection. Choosing a high-temperature material is substantially more involved than picking an electronic component—and for many reasons.

## A multitude of variables

Before any material can be considered suited for an application, it must meet requirements in six areas: fabricating, mechanical, electrical, thermal, environmental and chemical. All six must be met, or product failure is possible.

Within these five broad areas, the materials user's "bible"—"Modern Plastics Encyclopedia," published by McGraw-Hill—lists 46 line items for each material in a "Standard Plastic Properties Chart." And the chart is not exhaustive, by any means. Further information must be obtained from manufacturers' published specifications,

personal inquiries to manufacturers and in-house tests.

At what temperature does a material qualify for listing as a high-temperature type? The consensus in the industry is that the high-temperature class starts in the region of 250 to 300 F and extends upward to some 1000 or 1500 F. Materials that withstand such heat include the thermoplastic and thermosetting plastics at the lower end of the temperature scale, silicones and a few plastics in the middle and inorganic materials, like the ceramics, at the top.

It is universally recognized that no single material has all the best qualities for any application. As a result, extensive tradeoffs are a must. This gets complicated when mechanical, electrical, thermal and fabrication properties—plus the adverse effects of environmental factors, including moisture, sunlight, fluids and solvents—must be weighed against one another for each material.

To complicate the selection further, the pressure of Government safety programs has been instrumental in increasing the use of flame-proof or self-extinguishing materials in the electronic industry.

And, on top of that, while manufacturers' specifications are helpful in outlining the intrinsic properties of high-temperature materials, almost no manufacturers offer meaningful applications data.

Richard Kirkland, an electrical engineer and heat-transfer specialist at the Beechcraft Missile System Engineering Div., Wichita, Kan., says he has trouble finding manufacturers' specs that list the heat-transfer parameters needed to do a thermal analysis of material in an application. These parameters include density, specific heat and thermal conductivity. Many times, he points out, manufacturers state only the limiting temperatures to which the material may be exposed.

Jim McDermott  
Eastern Editor



**Tough, high-temperature plastic materials are used in fire wall connectors, like these from ITT Cannon. They**

**are tested by exposure to a 2000-F flame, and they must withstand the flame for 20 minutes.**

Robert Brush, project engineer at the Bendix Electrical Components Div., Sidney, N.Y., agrees that detailed applications information in materials specs is sorely needed.

"For the most part, the manufacturers literature is valid in what they're reporting," he says. "If they're reporting tensile stress, they're probably right. But if you want to use the elasticity of the material to make a part that snaps in place and, for example, holds connector pins, tensile strength can't be used for such evaluation."

#### **Comparative tests advised**

Kirkland at Beechcraft points to another problem: "The biggest trouble I've run into is that the manufacturer states his material is directly interchangeable with that of competitors. But

that isn't true." These remarks are typical.

Take materials for radomes. Here, Kirkland says, the only solution is to get material from everybody and make your own comparative tests.

"You need to make two tests of just about every material you're using," says Kirkland. "Many times we ask for samples to check, and if we decide on that material, we check it again when we get the first production run. Many times there is a difference between the prototype and production materials."

Kermit Van Leuven, project engineer at Beechcraft's Cryogenic Div., Boulder, Colo., says that manufacturers, in an effort to please, frequently send samples that are not representative of their usual product. His solution to the problem:

"We go outside and buy materials rather than solicit or accept free samples. We buy them very low key and try not to tip our hand. In this

## Don't get burned

The use of flame retardants in materials adds still another tradeoff factor for the designer to consider—and consider it he had better do, because flame retardants are growing in popularity.

Bart R. Comiskey, technical service engineer at the 3M Dielectric Materials and Systems Div., St. Paul, Minn., projects a 35 to 45% increase in the industry's production of fire-retardant materials through 1975.

At Hewlett-Packard headquarters in Palo Alto, Calif., a spokesman has told *ELECTRONIC DESIGN*: "Our corporate management has decided upon a product-safety program. We want flame retardancy in our materials and Underwriters' Laboratories approval on all of our instrumentation."

From the designer's standpoint, the following must be considered when the fire retardants are mixed with materials: Because they are essentially unstable compounds that break down near flame temperatures, the retardants change the material's physical and electrical properties, the aging characteristics and fabrication-process compatibility. These adverse effects are not described in manufacturers' specifications and must be determined by test or experiment.

way we get a realistic cross-section of the materials a manufacturer really does supply."

### Watch those temp ratings!

Temperature data furnished by manufacturers usually include a continuous operating maximum that may or may not agree with an Underwriters' Laboratories listing. While this is useful for a general comparison of materials, it isn't, for actual application of a material, because much more must be known. For example, under continuous, elevated-temperature operation, the properties may change gradually. And not all properties are degraded to the same degree. For some materials, the electrical properties are the first to suffer; with others it's the mechanical.

The temperature ratings of manufacturers are almost invariably stated in Fahrenheit—which are higher figures than the standards—AIEEE, ASTM, UL. They list the limits in Celsius. Naturally the Fahrenheit figures appear to give substantially better-looking temperature ranges.

The words "high temperature," "elevated temperatures" and their equivalents are frequently used by manufacturers without too close an eye on the relationship to real applications. This is guaranteed to confuse the designer. For example, literature from a leading U.S. materials manufacturer claimed recently: ". . . has heat resistance to over 400 F." There was no detailed

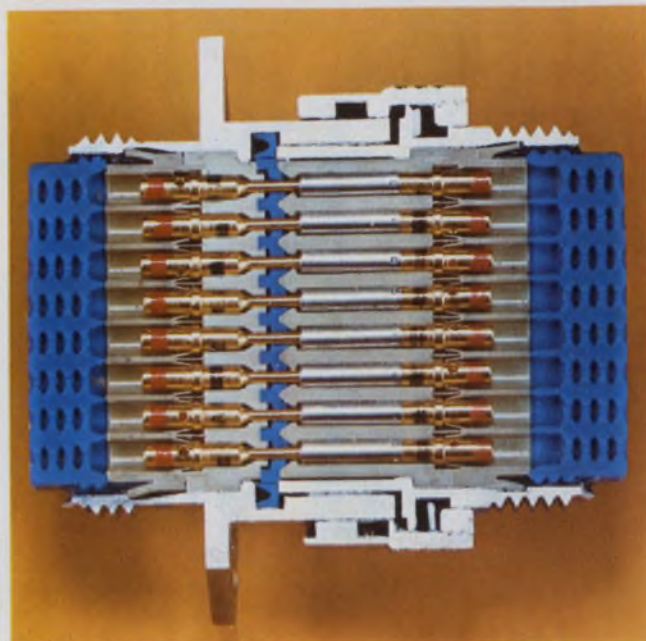

Astel 360 polyarylsulfone end inserts (in brown) hold the contacts without use of metal inserts in this connector by Amphenol. Astel 360, a 3M product, is an exceedingly tough and springy thermoplastic material.

backup information. The result among most prospective users was confusion—particularly when the UL listing showed the material to have a maximum of 240 C, or 284 F.

How good the heat resistance of a material is on a short-term basis is frequently important. But these facts are seldom found in any manufacturers' specs. An example of such short-term, elevated-temperature requirements is in fire-wall connectors used in aircraft and other engine-compartment applications. The inserts of these connectors are tough plastics with continuous-duty ratings of 350 or 400 F. Yet these connectors must pass a test (MIL-C-5015, Class K) in which a 2000-F flame placed 1/4-inch from the connector must not pass through the connector for a minimum of 20 minutes. During this time the connector is shaken at 33 Hz, with an excursion of 1/4-inch. The mated connector contacts must carry dc current without interruption for the first five minutes of the test.

### Test before you use

Since there are so many unknowns in materials specifications, how do you determine how good the materials are for a given application? Stringent in-house testing is your best bet.

Ray Gaynes, materials-engineering manager for Amphenol Connector, Broadview, Ill., tells what his company does for materials used in its environmental-resistant circular connectors. They are used by the military for aircraft and other transportation systems. The application calls for the qualities inherent in such materials as the

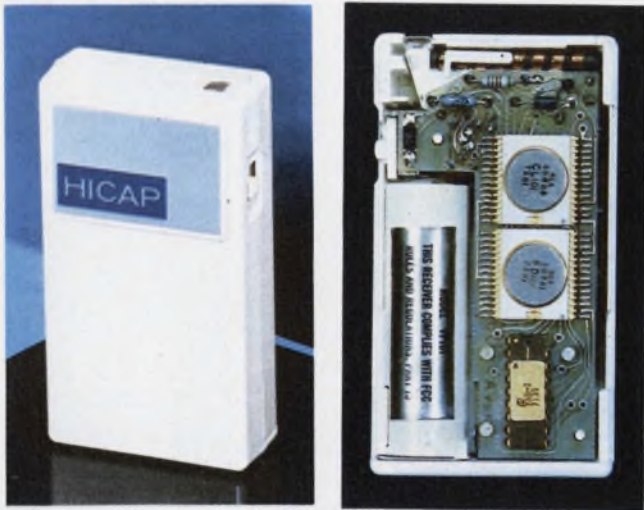

Polycarbonate was chosen for the case and the parts in this pocket pager by Martin Marietta, because of its very high impact strength and ability to withstand over 270 F. The material, made by General Electric, has stable properties and is also rated as self-extinguishing.

Teflons, silicones and some polymers, like 3M's Astrel 360 polyarylsulfone. While resistance to elevated temperatures is essential, the materials must also withstand adverse fluid environments.

Gaynes points out that MIL specs now being written call for resistance to such fluids as petroleum-based fuels and oils, synthetic hydraulic fluids, lubricants and cleaning fluids.

"Teflon is probably the best general fluid-resistant material," Gaynes notes. "The rest of the materials have a weakness in one or more classes. Silicones are very good for elevated temperatures, and they perform well in some of the synthetic lubricants. But some of the hydraulic fluids attack them."

The stability of connector dielectric materials at high temperatures is also of major concern, Gaynes points out. Silicone and fluorocarbon rubbers can withstand temperatures to 500 F, he says, and a hard dielectric, like the thermoplastic Astrel 360, can tolerate 500 F.

"Teflon is good for 500 F," Gaynes says, "but it has a weakness. It creeps under the combined influence of elevated temperatures and pressure. There aren't any good molding techniques that will hold dimensional tolerances of plus or minus one or two-thousandths for Teflon.

"And while you can machine Teflon to those dimensions, areas that may be under machining stress—after setting for a day or two—will distort out of shape, which relieves the stress.

"To evaluate connector materials, we heat-age them at the temperature of interest for 1000 hours. Then we check the weight loss and the change in mechanical properties, such as flexural strength, tensile strength and elasticity in the case of Astrel 360."

The elastic quality of the 360 material allows

it to grip connector contacts, and thus permits elimination of contact-metal retention clips that perform the same function. Amphenol, Bendix and Deutsch use polyarylsulfone inserts for connector contact retention.

#### Weight loss: a tipoff of trouble

"We also check electrical properties, such as dielectric strength and arc resistance, after the aging cycle," Gaynes continues. "Where a connector will be in high-frequency service, we also check the dissipation or loss factor.

"Weight loss is one of the first things we look at. If a material loses a significant amount of weight, the resin is decomposing and evaporating. And when a material breaks down at elevated temperatures, it may give off gases or vapors that attack the metal contacts, corroding them. Also, such breakdown can reach the point where the electrical properties are downgraded.

"Materials can lose up to 4 or 5% weight, but beyond that we start losing too much in the properties."

For some materials, Gaynes says, the volatile elements in the material attack silicone rubbers, causing them to revert from a rubbery state to an inelastic one. You wind up eventually with a hard-ash-like material, Gaynes says. And when you reach this condition, moisture can seep in and cause electrical failures."

The hard dielectrics, Gaynes points out, revert to a porous state when they lose resin. In this condition moisture can also seep in.

The compatibility of connector materials at high temperature is important, because the outgassing can have a damaging effect on other polymeric materials in the connector.

The use of 20 to 40% of glass fibers as fillers in some molding compounds for connectors—like epoxies and diallylphtalates—improves the mechanical properties significantly. But if the resin isn't stable and breaks down at high temperatures, the glass fibers become exposed at the surface. Where humidity is high and temperature low, moisture condenses and penetrates the fibers by capillary action. The moisture may travel from one contact to the other, degrading the electrical characteristics seriously.

There are no fillers in the Astrel 360 that Amphenol uses. It is a unique thermoplastic material that has a toughness not found in thermo-setting materials like diallylphtalate or the polyesters, Gaynes explains. The thermosets tend to be brittle and chip.

#### Ceramics can be rough

Of the high-temperature connectors, those at the fire wall have to withstand the toughest test—the 2000-F flame for 20 minutes. Oddly enough,

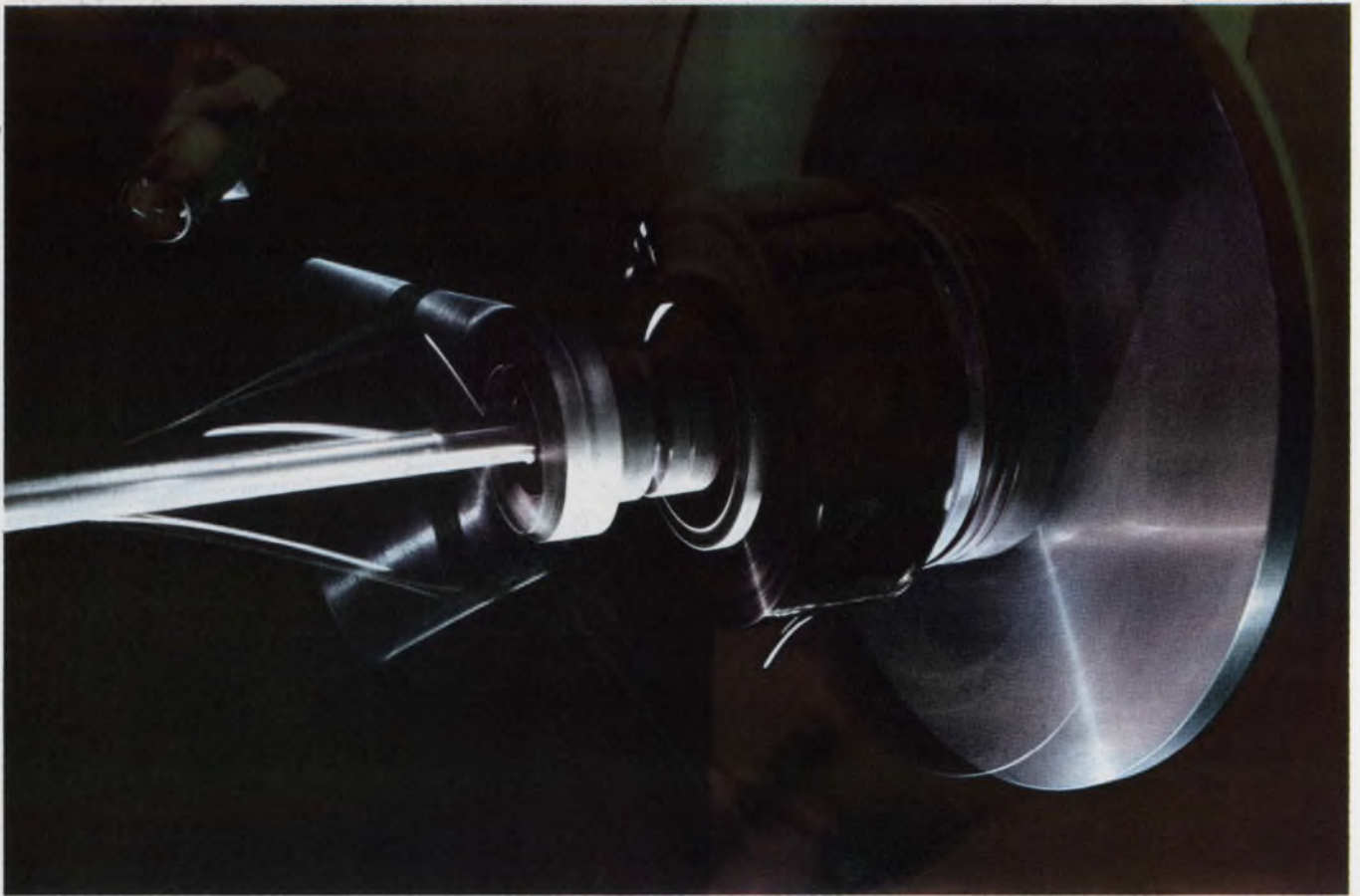

High-speed wire-wrapping machine insulates several thousand feet of cable a minute with DuPont's Kapton

polyimide film. The film is a light, tough insulation that has been used at temperatures from  $-450$  to  $750$  F.

ceramic materials are not used for fire-wall connectors. Jerry Selvin, vice president, engineering, ITT Cannon Electric, Santa Ana, Calif., explains why.

Connector contacts under high vibration wear against the insulator. With conventional plastics, abrasion is minimal. But with ceramics, Selvin says, abrasion occurs, because the ceramics that could be used have a hard rough surface. In special cases—for connectors that must withstand  $1000$  F continuously—ceramic is used, but it is custom-engineered.

Low-cost materials that have some of the desirable performance characteristics of high-temperature materials have been developed. One is irradiated, cross-linked polyvinyl chloride (PVC). The cross-linking produces a thermosetting PVC that, unlike conventional thermoplastic PVC, will not soften or melt when heat is applied, according to George Graeber, marketing manager of Brand-Rex Co., Willimantic, Conn., manufacturer of irradiated PVC insulation.

Used as a wire insulation, irradiated PVC is a tough, scuff-resistant material whose resistance to elevated soldering temperatures ( $600$  F at 5 minutes minimum) approaches that of Teflon. Beech Aircraft uses the MIL-W-81044/9 version of irradiated PVC to wire aircraft fuselages and areas other than the engine compartment.

Irving Moody, senior electrical engineer in Beech's R&D department, says the irradiated PVC has better cold-flow characteristics than Teflon. It also resists scuffing when the wires are pulled through various holes in the aircraft frame. With Teflon the insulation would be shaved, Moody notes.

#### Rigid and flexible PC laminates

Laminates for printed circuits—both rigid and flexible—use materials rated at about  $265$  F on the lower end to over  $750$  F at the high end. The laminate used in 80 to 90% of applications today is NEMA Grade G-10 or its flame-retardant equivalent, FR-4. These PC boards consist of a glass cloth, bonded in an epoxy. The copper cladding is bonded to the laminate surfaces. The UL temperature rating is  $130$  C continuous.

For higher temperatures and better loss characteristics at the higher frequencies, glass laminates are made with resins, such as the melamines, Teflons, polyimides and silicones. For flexible-film circuits—reinforced or unreinforced—the higher-temperature materials are used. The materials include: polyamide epoxy ( $150$  C); FEP Teflon film ( $200$  C); polyamide-imide film ( $240$  C); TFE Teflon film ( $260$  C); and polyimide film ( $300$  C).



The good electrical characteristics and dimensional stability of this flexible circuit, by Rogers Corp., are due to the use of polyimide film. Its resistance to elevated temperatures protects the circuit during soldering.

The adhesives used to bond the conductors to the thin-film laminates or single layers usually have lower temperature capabilities than the film itself, says Herman Gordon, design engineering manager of Rogers Corp., Chandler, Ariz. But it is possible to eliminate the adhesive and fusion-bond FEP and TFE Teflons directly to the conductor material. The polyamide-imide film, on the other hand, can be continuously cast directly onto electro-deposited copper.

The electrical properties of G-10 materials, particularly the dielectric constant and the dissipation factor, varies substantially with both variations in temperature and frequency. Where the electrical properties must remain constant over a wide range of temperatures and frequency, silicone-glass laminates are stable. The silicone-glass laminates retain good dielectric properties storage periods, environmental aging, thermal cycling and mechanical shock (Fig. 1).

Bob Perricone, corporate materials engineer at Hewlett-Packard, Palo Alto, Calif., feels that manufacturers have not devoted enough effort to improving the electrical properties of the epoxy-glass laminates.

"We don't need any improvement in the mechanical or physical properties of the G-10/FR-4 laminates," he says, "but we can use better dielectric properties. In fact, I say, 'Pick up any G-10 electrical characteristic and improve it.'"

"We're getting more and more rotary and slide switches on PC laminates today. And in this area the dielectric quality plays a very important part. This is one area in which we can use some new materials."

Perricone points out that it has been some 10 or 12 years since G-10 replaced the phenolic laminates, yet today the epoxy-glass laminate—which accounts for 80 to 90% of all electronic designs—remains essentially unimproved. It has

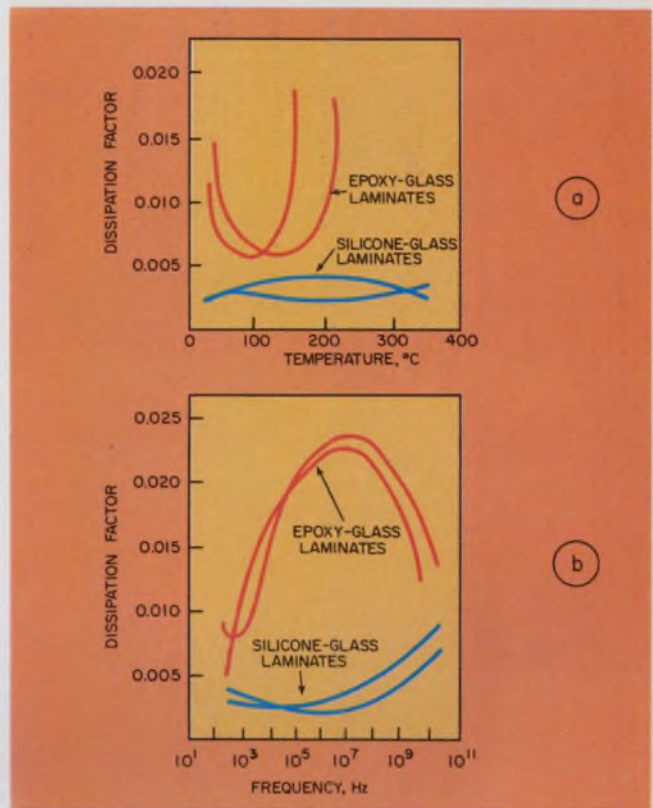

1. Glass laminates made with silicone resins are stable, low-loss materials with low dielectric constants and dissipation factors. They are better than epoxy-glass laminates over a range of temperature and frequency.

not kept up with the state of the art of the components used on those boards.

### Silicones or epoxies for ICs?

An industry controversy exists today among IC manufacturers as to whether the silicones or epoxies are the best materials to encapsulate integrated circuits. Epoxy compounds are strong and are also basically chemically stable. But harmful, ionic-contamination by-products tend to appear when the material is molded and cured.

A contamination-free "Epoxy B" developed by National Semiconductor—it has been picked up by Signetics under the name Epoxy Novalac—is being used for IC sealing. An advantage of the material is that it has a high mold-shrinkage rate that secures the IC wire bonds and wires in compression. Proponents of this epoxy report that wide-bond failure is minimized by the compressive stress of the plastic. Also, good moisture and salt-spray resistance is produced by the tight grip of the epoxy on the IC leads.

On the other hand, silicones have the fewest impurities, are resistant to heat and harsh chemicals and have good flame-retardant qualities. However, the combination of low thermal conductivity, relatively low mechanical strength and insufficiently tightened seals around the IC leads does not give the device as much protec-

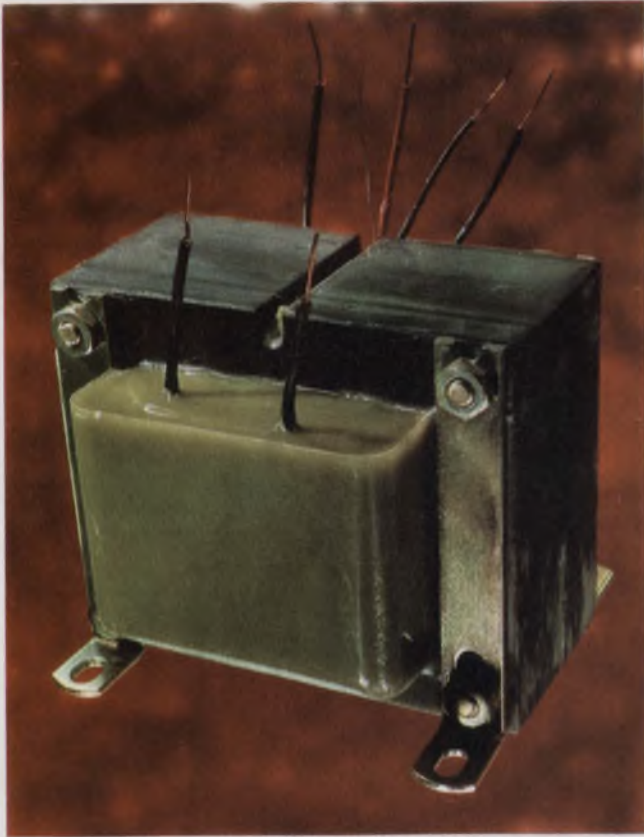

Control transformer is used in a high-temperature environment with intermittent current overloads. It's potted in a filled Scotchcast 28 semiflexible resin, which meets NEMA's Class F rating (155 C).

tion against a salt-spray environment as epoxy does. Proponents of both systems will probably be around for some time to come.

### Test-instrument potting

For potting components in test instruments, Tom Marisky, project engineer at Tektronix, Beaverton, Ore., looks for flexibility and for such stable electric properties as dielectric constant, dissipation factor and resistivity throughout the range of expected environments.

As for mechanical characteristics, he feels that the material should be flexible enough so it doesn't apply excessive pressure to the components being potted or embedded. For this reason, he leans towards silicones.

"We're using silicones where formerly we used epoxies," he says. "But where we can still use epoxy for transfer molding, we do."

The compatibility of a potting compound with the elements and devices it covers is a prime consideration, according to Marisky. Epoxies are good, he notes, for potting different kinds of conductors and wire insulations and also for potting epoxy and silicone components. The epoxy cures readily in these applications.

For elevated-temperature and high-voltage applications in instruments like oscilloscopes, Ma-

risky observes that silicones are used because of their good temperature capability and corona resistance at both normal and elevated temperatures. This is not true of epoxies and urethanes, he points out. To reduce the cost of silicone in potting, Marisky says that inert fillers—like powdered alumina—may be advantageous.

Use of a filler like powdered alumina can also serve to improve the heat transfer in a silicone-potted device. David Baker, chief engineer of the Electronic and Test Laboratory in the Bendix Electrical Components Div., Sidney, N.Y., uses an alumina-filled, Dow Corning silicone potting compound for heat transfer of a 3000-V silicon-rectifier stack that operates in a continuous environment of 480 to 500 F.

Another form of alumina-filled silicone is produced by Chomerics, Woburn, Mass., as cured pieces of rubber shaped to fit the base profiles of power transistors, triacs, SCRs and other semiconductor devices. These components provide a good heat transfer between the device and the heat sink.

"What we have," says Bob Rothenberg, marketing manager of Chomerics, "is essentially a heat-conducting, rubber-washer material that replaces the usual dielectric washer and the silicone heat-transfer grease. These silicone rubber components are used in place of beryllium oxide.

"The filling in the silicone gives you a combination of the properties of the rubber matrix and the filler you use. You reach a point, depending upon the particle sizes used, where you're limited as to how much filler you can put in. For silicone elastomers, this is typically 50%."

Alumina and boron nitride produce the best systems, Rothenberg says. "Boron nitride produces the best thermal properties," he notes, "but it's a costly material—like 5 to 1 for alumina."

As for filled materials, "it's a lot more difficult to make them than it appears," he warns. "It's difficult to get good batch-to-batch repeatability."

### Silicone plays dual role in watch

The versatility of silicones is demonstrated by their use in two places in the Pulsar Time Computer—the electronic watch with the LED display, produced by the Pulsar Time Computer Center Div. of Hamilton Watch Co.

"We use silicone to encapsulate and to give some shock support to the crystal," says John M. Bergey, president of the Pulsar Div. "The substrate that contains the crystal is floated in silicone so that heavy mechanical shocks will be partially absorbed by the silicone mounting.

"We also use it on top of the substrate on which we mount the LEDs with a black Dow Corning RTV, to give the LEDs more contrast.

It provides a shock mounting for the LEDs and at the same time—although it is not a hermetic seal—protects the LEDs from moisture. The silicone also has a good dielectric strength, which is of importance here.”

Of the high-temperature materials, the inorganics—ceramics, ceramoplastics (glass-bonded mica) and glasses—have the highest heat endurance. Beryllium oxide ceramic can safely withstand 4000 F, while the endurance point of the aluminas ranges from 2500 to 2900 F. A safe, continuous temperature for glass-bonded mica is 750 F, according to Mykroy Ceramics Corp.

But, like higher-temperature organic materials, the inorganics are used mainly for qualities that make them useful as insulating components and as structures for semiconductor packaging rather than for their heat resistance.

Beryllia ceramic is unique, in that its thermal conductivity is as high as that of brass (Fig. 2). But it costs three to four times as much as the widely used alumina ceramics, which have about one-sixth the thermal conductivity. A principal application of the beryllia is in heat sinks for power semiconductors. Like the alumina ceramics, however, the beryllias are difficult to mold in complex configurations, and their tolerances are wide. For complex configurations, costly machining is required.

For both high-temperature capability and high-radiation resistance in complex shapes, parts molded of glass-bonded mica can be molded to close tolerances. This ceramoplastic material has the dimensional stability and thermal expansion of stainless steel, and, for this reason, stainless-steel inserts are used. The dielectric strength and loss factors of glass-bonded mica are good, and the material is useful for low-loss, high frequency components. With the use of beryllia fillers, high thermal conductivity can be obtained.

The alumina ceramics are in widespread use as substrates and packages for ICs and hybrid devices. Manufacturers' specifications indicate that these ceramics are available in a number of grades, ranging from 85% alumina to high-purity 99.8%. They are supplied principally as natural white ceramics, but dark types are available to protect light-sensitive IC packages and to enhance the contrast of LED display elements.

#### Ask for essential ceramic data

George Riley, administrator of new-product planning and responsible for the use of alumina CMOS packages at the RCA Semiconductor Div., Somerville, N.J., says ceramic manufacturers don't supply essential information.

“For example,” he says, “a selection of lead-frame materials are available to use. We'd like



A clear Dow Corning silicone gives this Pulsar watch crystal protection against shock, while black silicone mounts the LED display. The black silicone protects the display against shock and also gives higher contrast.

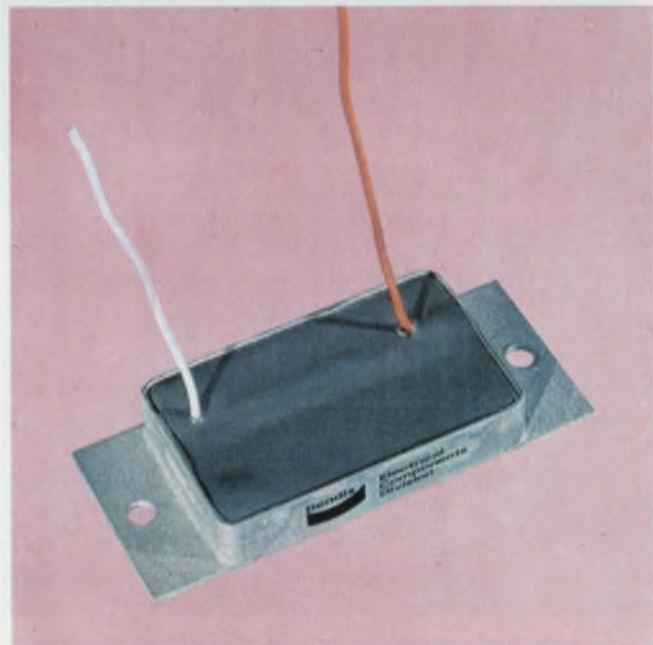

Good heat-transfer and environmental protection is provided by this silicone potting for a Bendix 3000-V silicone rectifier used in a 500-F ambient. The silicone is filled with alumina to improve heat transfer.



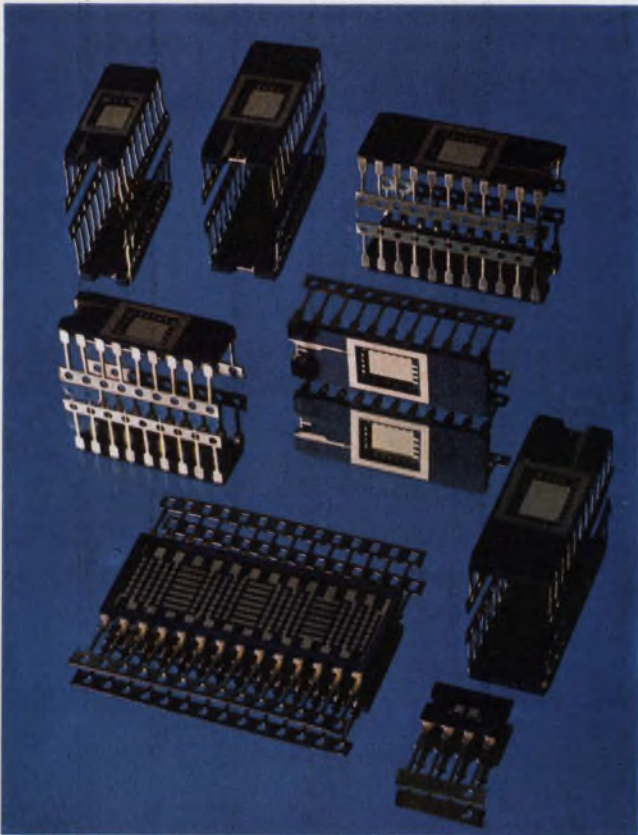

To protect light-sensitive integrated circuits and to enhance the contrast of LED displays, these black alumina ceramic packages, by American Lava, have a dark, opaque filling. The packages have multilayer interconnections. They also provide a good heat sink.

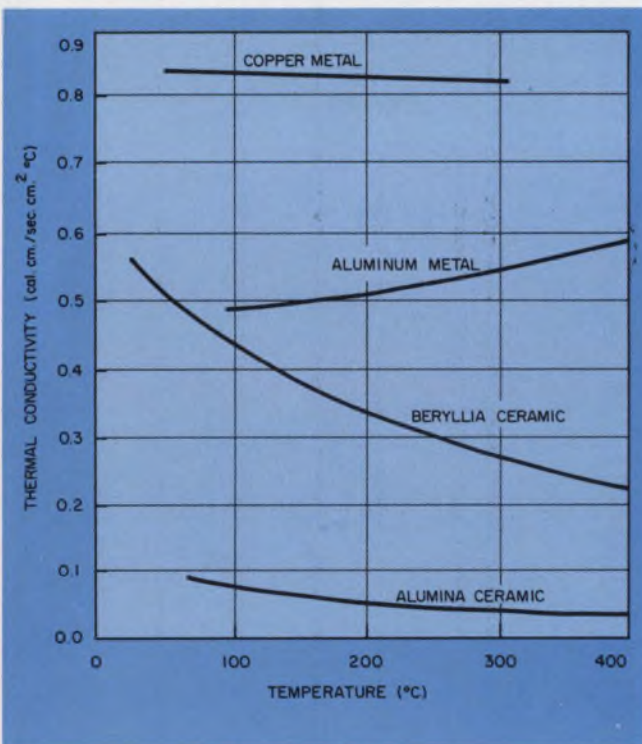

2. The thermal conductivity of beryllia ceramic is about six times that of the alumina ceramics at room temperatures. This advantage decreases at elevated temperatures. The curves shown are for a 99.5% beryllia and alumina. A major use of beryllia is in heat sinks.

the ceramic supplier to provide us with information as to how well his ceramics interface with the various electronic materials.

"We'd like to know more about the details of the compositions being supplied. Because the manufacturers give us a package that meets our specifications, they seem to consider that what the package is constituted of is their own business.

"Also, physical properties of interest to us, like roughness and porosity, are not divulged by the manufacturer unless he is pressed for the information."

Bob Du Fresne, manager of Tektronix's in-house ceramic plant, which supplies about 30% of Tektronix's requirements, sheds some light on the differences between the various alumina grades.

"The purer the material and the more organized and uniform the crystal structure, the more stable the dielectric behavior," he says. This means that there will be minimal change of the dielectric constant with frequency. This is a reversible phenomena.

"If you were fabricating a vhf attenuator and you needed stable ratios over a wide frequency range, you'd probably use relatively pure alumina," Du Fresne advises.

"However, if you had to bond to the attenuator structure, you'd have to make a compromise, because 99% aluminas are difficult to use as a substrate for metal applications."

Du Fresne explains why.

"The lower the percentage of alumina," he notes, "the more glass there is in the alumina mixture. Most of the resistive or conductive-

### Write to UL for advice

Puzzled about selection of a material? Underwriters' Laboratories invites inquiries from designers.

"We encourage a dialogue between designers and our engineers in the development stage of a product, so that any hangups can be uncovered before the item is put into production," says Howard Reymers, managing engineer at UL. "It is possible to select nonapproved materials, put a product into production and then find out that it cannot be passed by the Underwriters' Laboratories. In this case production may have to be stopped and an acceptable material chosen.

"We've embarked on a plastics testing program specifically at the request of product manufacturers, in order to develop information that would accelerate their end-product acceptance."

Inquiries about materials should be addressed to Underwriters' Laboratories, 1285 Walt Whitman Rd., Melville, N.Y. 11746. (516) 271-6200.

paste systems used for pattern bonding have a glassy matrix in them, something like 4%. The higher the glass content of the ceramic, the better the bond, while the converse is also true. So if bonding is a major criterion, you might want to go as low as an 85% alumina—provided you could tolerate the dielectric instability.

"We've had to face these different compromises, so we make an 80, 90, 95 and 99% alumina. But there is no single material that will optimize everything."

### A surface problem with thin films

Du Fresne points to another problem:

"With thin-film substrates, most of the deposition processes give good thin-film adherence to either glassy or crystalline ceramics. But with thin films, you want an extremely good surface. Depending on the geometry and requirements of the circuit, a 2-to-4-microinch surface may be required—which is very smooth for a fired ceramic.

"Ground surfaces are not very satisfactory for smooth-surface requirements, because grinding pulls out crystals of alumina and leaves voids,

which may adversely affect the thin-film circuit.

"Thin film, high-quality, high-frequency circuits require a very smooth film—as smooth as you can get. This, in turn, demands a high-purity alumina substrate of small and controlled crystal size. For circuits with wide tolerances, such as for a radio, an 85% alumina body can be used, so long as you can put a film on it."

Du Fresne has some suggestions for dealing with alumina-substrate suppliers:

"Tell the supplier what your primary requirements are. Is it dielectric stability or is it bondability? You must give him the order of your priorities, before he can make recommendations."

As a final word of advice, Du Fresne says that where incoming substrates are to be used for the deposition of metal films, they should be carefully checked from any supplier.

"It pays to cull out or reject the bad material before you ever start," he says, "because the investment beyond that point is terrific by comparison. The precious metals for the conductor patterns cost \$300 to \$400 an ounce. And labor is expensive. You can wind up with a \$3 circuit, for example, that has only 25 cents worth of ceramic." ■■

## Need more information?

The companies and products cited in this report have, of necessity, received only brief coverage. They've been selected for their illustrative qualities. Many companies not mentioned may offer similar products. Readers may wish to consult manufacturers from this partial listing for further details.

### Dielectric Materials - Thermoplastic

- Atlantic Laminates, 174 N. Main St., Franklin, N.H. 03235. (603) 934-5736. (Ray Johnson). **Circle No. 400**
- Brand-Rex Co., P.O. Box 498, Willimantic, Conn. 06226. (203) 423-7771. (George Graeber). **Circle No. 401**
- Celanese Plastics Co., 550 Broad St., Newark, N.J. 07102. (201) 877-2300. (J.E. Giordano). **Circle No. 402**
- Eastman Chemical Products Inc., Box 431, Kingsport, Tenn. 37662. (615) 247-0411. (Jane McKenzie). **Circle No. 403**
- General Electric, Plastics Business Dept., One Plastics Ave., Pittsfield, Mass. 01021. (413) 494-1110. (Gregg Bronk). **Circle No. 405**
- Hercules, Inc., 910 Market St., Wilmington, Del. 19899. (302) 656-9811. (W.C. Brown). **Circle No. 406**
- Mica Corp., Box 2578, Culver City, Calif. 90230. (213) 870-6861. (Lee Eggert). **Circle No. 407**
- Minnesota Mining & Manufacturing Co., 3M Center, St. Paul, Minn. 55101. (612) 733-1673. (Robert J. Modersohn). **Circle No. 408**
- Mobay Chemical Corp., Pkwy. W. Rte 22 & 30, Pittsburgh, Pa. 15205. (412) 923-2700. (D.H. Bryan). **Circle No. 409**
- Monsanto Co., 800 N. Lindberg Blvd., St. Louis, Mo. 63166. (314) 0X-4-1000. (Jerry Ingenthron). **Circle No. 410**
- Polymer Corp., 2120 Fairmont Ave., Reading, Pa. 19603. (215) 929-5858. (R.F. Barthold). **Circle No. 411**
- Synthane-Taylor Corp., Valley Forge, Pa. 19481. (215) 666-0300. (Joseph McGloughlin). **Circle No. 412**
- U.S. Industrial Chemicals Co., 99 Park Ave., New York, N.Y. 10016. (212) 697-0700. **Circle No. 413**
- Union Carbide Corp., 270 Park Ave., New York, N.Y. 10017. (212) 551-2345. (M. H. Jellinek). **Circle No. 414**

### Dielectric Materials - Thermosetting

- Allied Chemical Corp., P.O. Box 70, Morristown, N.J. 07960. (201) 538-8000. **Circle No. 415**
- American Cyanamid Co., Industrial Chemicals and Plastics Div., Wayne, N.J. 07470. (201) 831-1234. **Circle No. 416**

- Chomerics, 77 Dragon Ct., Woburn, Mass. 01801. (617) 935-4850. (Bob Rothenberg). **Circle No. 417**
- Ciba-Geigy Corp., Resins Dept., Ardsley, N.Y. 10502. (914) 478-3131. (Gary Arbach). **Circle No. 418**
- Dow Corning Corp., Midland, Mich. 48640. (517) 636-8000. (Phillip K. Blumer). **Circle No. 419**
- Emerson & Cuming Inc., 869 Washington St., Taunton, Mass. 02021. (617) 823-3300. (Eino Luoma). **Circle No. 420**
- General Electric, Plastics Dept., One Plastics Ave., Pittsfield, Mass. 01021. (413) 494-1110. (Gregg Bronk). **Circle No. 421**
- Hooker Chemical Corp., 1940 Ward St., Niagara Falls, N.Y. 14302. (716) 285-6655. **Circle No. 422**
- Monsanto Co., 800 N. Lindberg Blvd., St. Louis, Mo. 63166. (413) 788-6911. **Circle No. 423**
- Rohm & Hass Co., Independence Mall W., Philadelphia, Pa. 19105. (215) 592-3000. **Circle No. 424**
- Shell Chemical Co., One Shell Plaza, Houston, Tex. 77002. (713) 220-4867. **Circle No. 425**
- Union Carbide Corp., 270 Park Ave., New York, N.Y. 10017. (212) 551-2345. (M. H. Jellinek). **Circle No. 426**

### Silicones

- Chomerics, Inc., 77 Dragon Ct., Woburn, Mass. 01801. (617) 935-4850. (Bob Rothenberg). **Circle No. 439**
- Dow Corning Corp., Midland, Mich. 48640. (517) 636-8000. (Phillip K. Blumer). **Circle No. 427**
- Emerson & Cuming Inc., 869 Washington St., Taunton, Mass. 02021. (617) 823-3300. (Eino Luoma). **Circle No. 404**
- General Electric, Silicone Products Dept., Waterford, N.Y. 12188. (518) 237-3330. (Jim Crawford). **Circle No. 428**
- Union Carbide Corp., 270 Park Ave., New York, N.Y. 10017. (212) 551-2345. (M. H. Jellinek). **Circle No. 429**

### Ceramics

- American Lava Corp., Cherokee Blvd. and Manufacturers Rd., Chattanooga, Tenn. 37405. (651) 265-3411. (Jim Wade). **Circle No. 430**
- Coors Porcelain Co., 600 9th St., Golden, Colo. 80401. (303) 279-6565. **Circle No. 431**
- Corning Glass Works, Corning, N.Y. 14830. (607) 962-4444. (Allan F. Donnelly). **Circle No. 432**
- Krohn Ceramics Corp., 221 Seventh Ave., Hawthorne, N.J. 07507. (201) 427-4211. (John McManus). **Circle No. 433**
- Metalized Ceramic Corp., 100 Niantic Ave., Providence, R.I. 02907. (401) 943-2200. (Joe Feeley). **Circle No. 434**
- National Beryllia Corp., Greenwood Ave., Haskell, N.J. 07420. (201) 839-1600. (Roy Dernworth). **Circle No. 435**
- Plessey Frenchtown, 8th and Harrison St., Frenchtown, N.J. 08825. (201) 996-2121. (Walt Ripple). **Circle No. 436**
- Radio Materials Co., E. Park Ave., Attica, Ind. 47918. (317) 762-2491. (Joe Riley, Jr.). **Circle No. 437**
- SCS Corp., Electronics Packages Div., 601 Walnut Circle E., Garland, Tex. 75044. (214) 272-5481. **Circle No. 438**

## Tektronix TM 500 Series puts it all together

Tektronix has taken a new approach to test and measurement instruments. The TM 500 Series is modular, multifunctional, synergistic, cost effective, and more. It includes the features you've been looking for.

Presently, the TM 500 Series includes 24 general purpose plug-in test instruments. All new ways to think of Tektronix. Digital counters to 550 MHz. Signal sources ranging from below 1 mHz to above 1 GHz. Pulse generators to 250 MHz. Digital multimeters with 4½ digit LED readout and temperature measurements from -55° C to +150° C. Plus signal processors, power supplies, and CRT monitors.

All the modules are interchangeable. So you can make combina-

tions of instruments to meet your particular needs. When new instruments are introduced (and many will be soon), you simply plug them into the power unit. You can use a single compartment (TM 501), a triple compartment power unit (TM 503), or two 503's combined for a standard rackmount installation.

Connections between modules and/or external equipment are made through the power unit rear interface board and optional rear panel connectors. Approximately 30 input-output lines are available in each compartment for special set-ups you might want to make. This intracompartiment interface feature also permits multifunction applications resulting in a synergistic effect. Instruments working

together perform more functions than the same instruments working independently. Many modules include serial BCD so information can be transferred directly to a computer or calculator.

The TM 500 is compact too. A three-compartment power unit is only 6"x8.7"x15.3". That means the TM 500 is two to six times smaller than comparable instruments. So you save bench space. And it's light weight, easy to carry. A package including a general purpose counter, multimeter, and power supply weighs 14 to 18 pounds!

Cost? All TM 500 plug-in modules are competitively priced with instruments of comparable capabilities. Because TM 500 instruments share the fixed costs of

**Modular, compact, synergistic,  
multifunctional, versatile,  
cost effective and more.**

power supplies, cabinets, etc., they consistently provide the lowest cost per test/measurement function. And, because the instruments are modular, cost of maintenance is lower too.

For complete details, contact your Tektronix Field Engineer. Or write or phone for our new 12 page, full color brochure and 24 data sheets. They show why the TM 500 is the finest test and measurement series available today. Tektronix, Inc. P.O. Box 500, Beaverton, Oregon 97005. In Europe, write Tektronix Ltd., Guernsey, C. I., U.K.



FOR DEMONSTRATION, CIRCLE 242

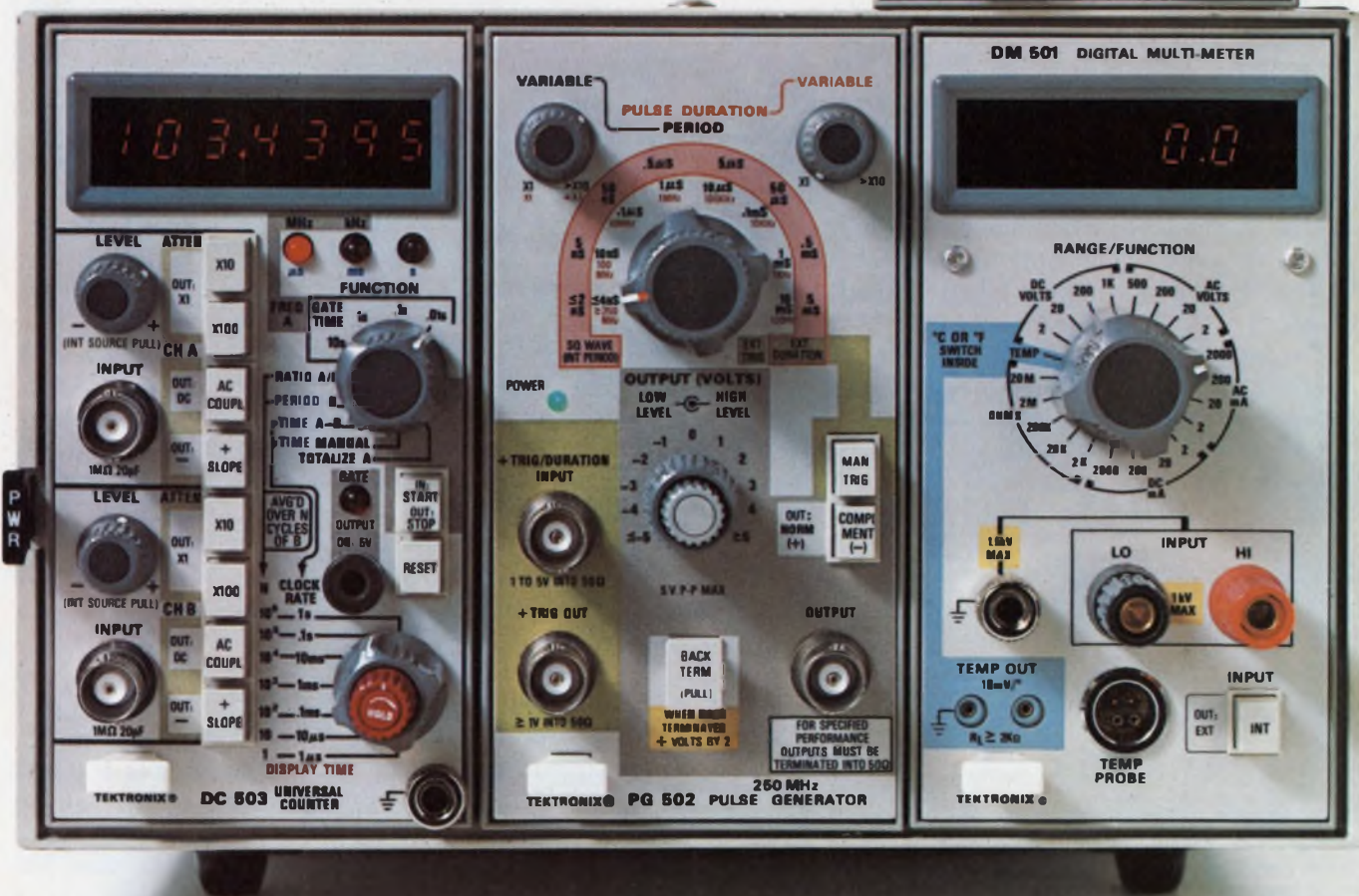
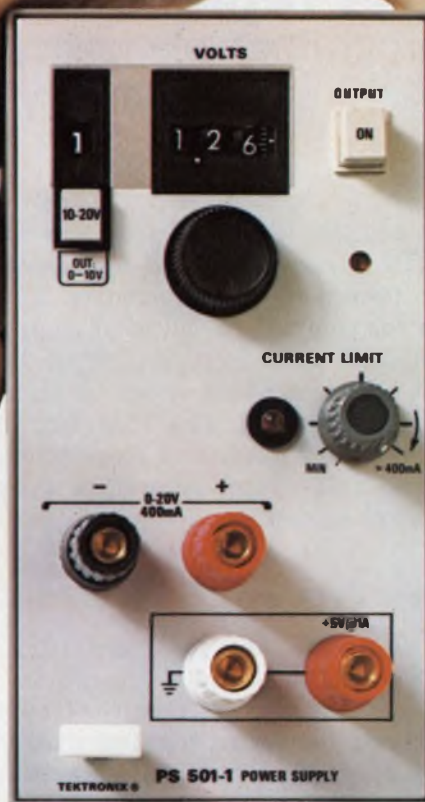

# PLAs replace ROMs for logic designs.

IC programmable logic arrays simplify controllers by more efficient use of memory arrays and use of fewer parts.

The availability of IC programmable logic arrays (PLA), in both MOS and bipolar versions, offers designers an alternative to the use of ROMs for complex decoding of control functions.

Compared to other types of logic, the use of a PLA requires fewer levels of logic to provide the same functions. The PLA can handle large memory arrays easily and more efficiently. Moreover, the LSI circuit cuts costs associated with component assemblies, PC boards and connectors.

## How does a PLA work?

PLAs are capable of translating any input code into any output code, though not all possible input combinations are possible from a single IC. The circuit generates outputs that are sums of partial products. These have the data inputs as variables. Product terms consist of logic AND functions, and these are ORed together to form the output.

The number of possible inputs to a PLA is much higher than the number generally available with ROMs. Hence an equivalent ROM would need many more words. For example, one commercially available PLA has 14 input and eight output terminals. The equivalent ROM has  $2^{14}$  or 16,384 words, as compared to 96 words for the PLA.

The number of variations possible in the partial-product terms is quite large (Fig. 1). With a maximum number of input variables (I) of 14, the 96 partial-product terms (P) can have the following form:

$$\begin{aligned}
 P_1 &= I_1 I_6 I_7 \bar{I}_{10} I_{14} \\
 P_2 &= I_4 I_5 I_7 I_{12} \bar{I}_{13} I_{14} \\
 P_3 &= I_6 I_{12} \\
 P_4 &= I_8 I_9 I_{10} I_{11} \\
 &\vdots \\
 P_{96} &= I_1 I_2 I_3 I_{13} I_{14}.
 \end{aligned}$$

Dale Mrazek, Digital Systems Applications Manager, and Melvin Morris, Field Application Engineer, National Semiconductor, 2900 Semiconductor Dr., Santa Clara, Calif. 95051.

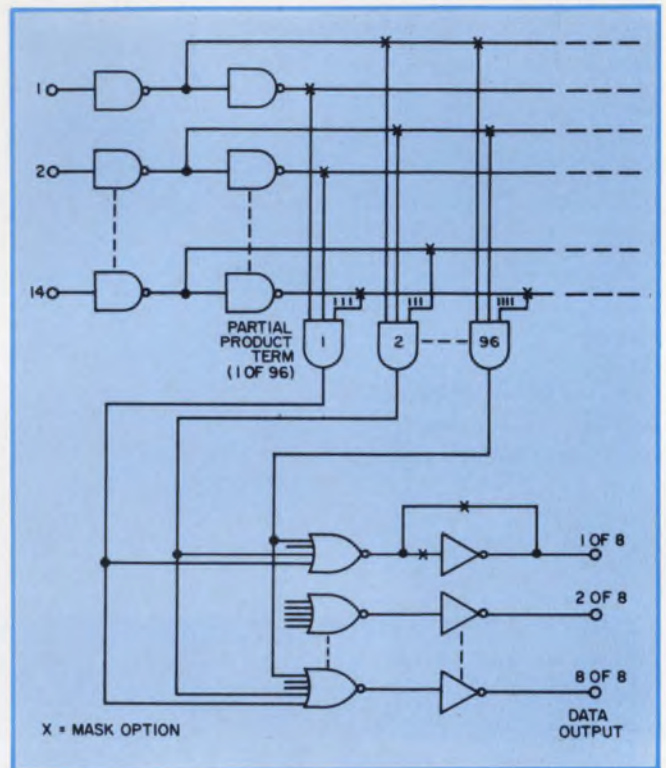

1. A PLA generates a sum of partial product terms that have the inputs as variables. The DM 8575/8576 PLA can accommodate up to 96 such terms.

Mask-programming combines or collects any of the product terms for any of the several outputs. Any or all of the partial-product (AND) terms can be combined (ORed) at each output. The specific mask connections depend on the required output code.

The PLA generates an output group with the following form:

$$\begin{aligned}
 O_1 &= P_1 + P_{16} + P_{20} + P_{42} + \dots + P_{70} \\
 O_2 &= P_6 + P_{16} + P_{17} + P_{42} + \dots + P_{52} \\
 O_3 &= P_1 + P_{20} + P_{36} + \dots + P_{90}.
 \end{aligned}$$

Note that the same product term can appear in several outputs. The first product term,  $P_1$ , appears in outputs one and three, while  $P_{16}$  and  $P_{17}$  occur in outputs one and two. PLAs can be masked with outputs in either a positive or negative TRUE state, which eliminates the need for external inverters.

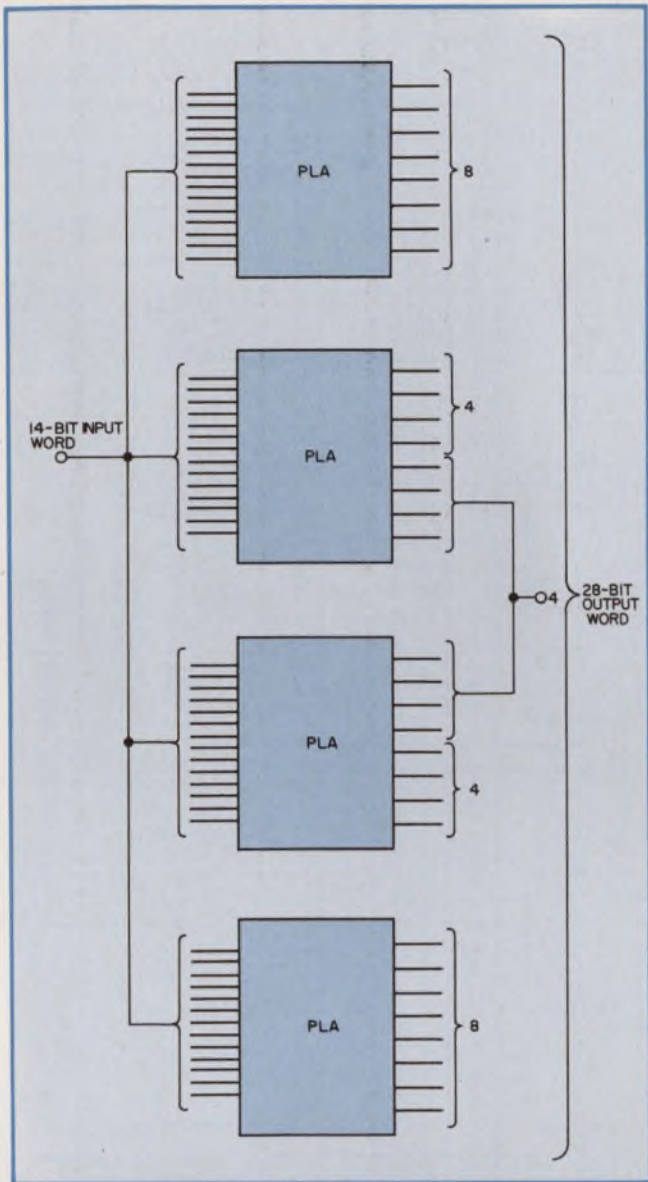

2. Common control codes can be grouped together to simplify mask-programming of partial product terms. Negative-TRUE logic permits wired-OR connections.

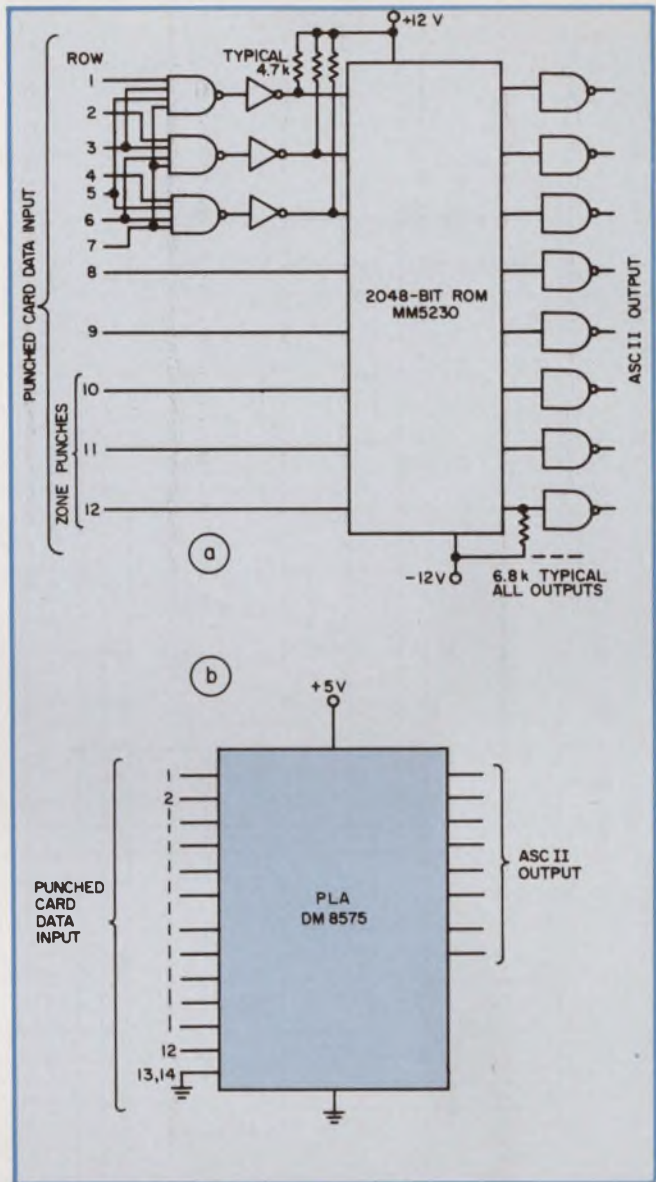

3. A Hollerith-to-ASCII conversion requires external components when using a ROM (a). But with a PLA (b), such conversions can be performed directly.

An orderly approach to the problem can simplify designs, especially when control words are long and complex. The following steps provide the essentials of such a procedure:

- List all input-control codes that are required for each output.
- Reduce the list logically to minimize the number of partial-product terms.
- Combine similar terms that can be used on more than one output terminal.
- Group outputs that can share the largest percentage of the same partial-product terms.

### PLAs expand more simply than ROMs

The last two design steps reflect the different method of memory expansion for the PLA as contrasted with that for other memory elements.

Standard ROMs and RAMs have chip-select inputs that must be decoded and selected before the circuit can be activated. An expansion of these memories requires additional decode-logic elements to select the right memory array. And with more than one output terminal, the entire package group must be activated. This requires the use of an entire memory word for the address.

Neither of these limitations applies to the PLA. Any one or combination of outputs can be selected from different but mutually connected PLA packages. Two or more PLAs can be connected with common inputs and common outputs. Hence, common control codes may be grouped together to simplify a design.

For example, assume that an input-control code of 14 bits and an output-control word of 28

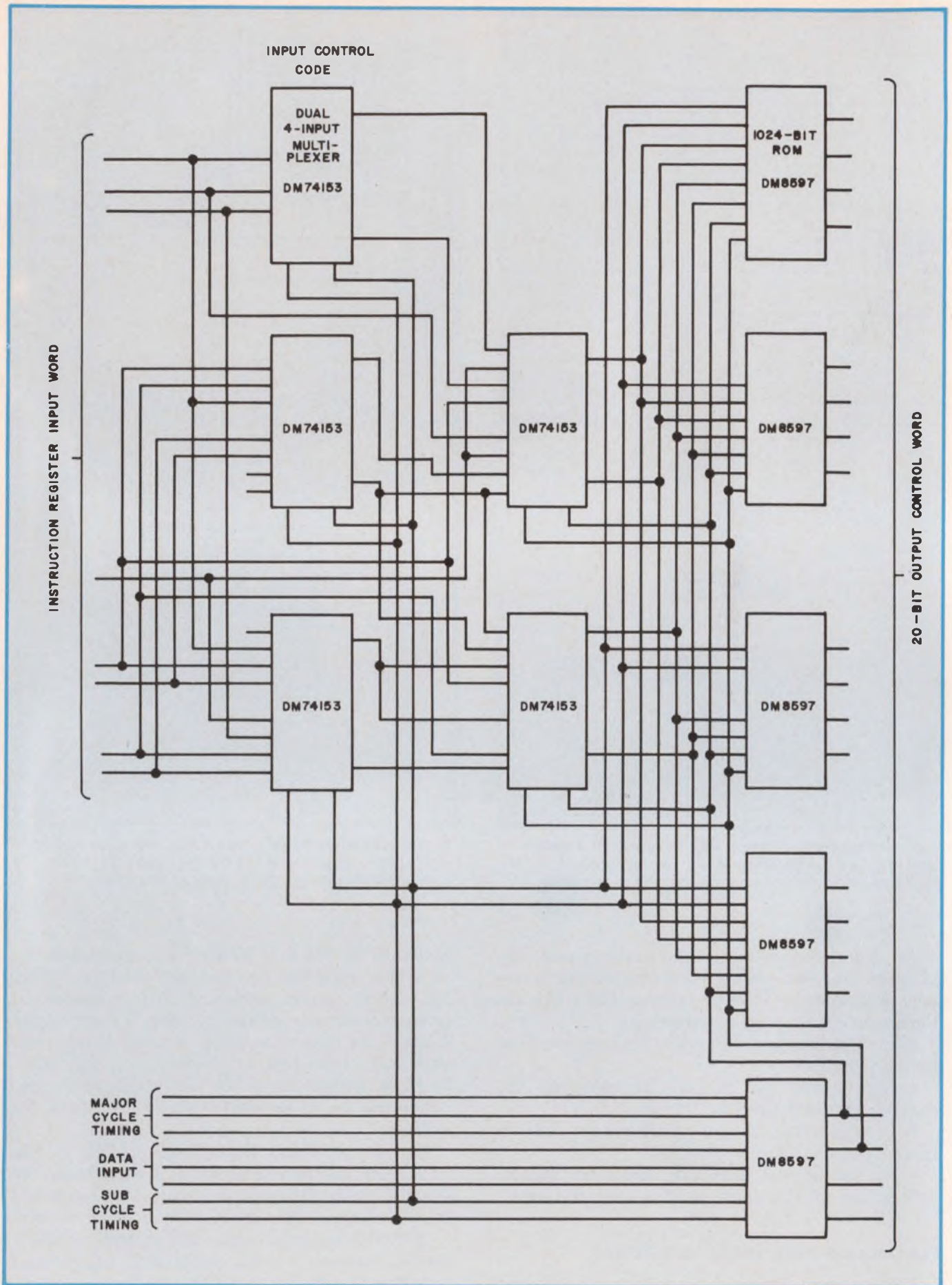

4. A multiplexer data decoder routes data to the appropriate ROM group. Two levels of multiplexing reduce

the total number of ROM packages required but add throughput delays.

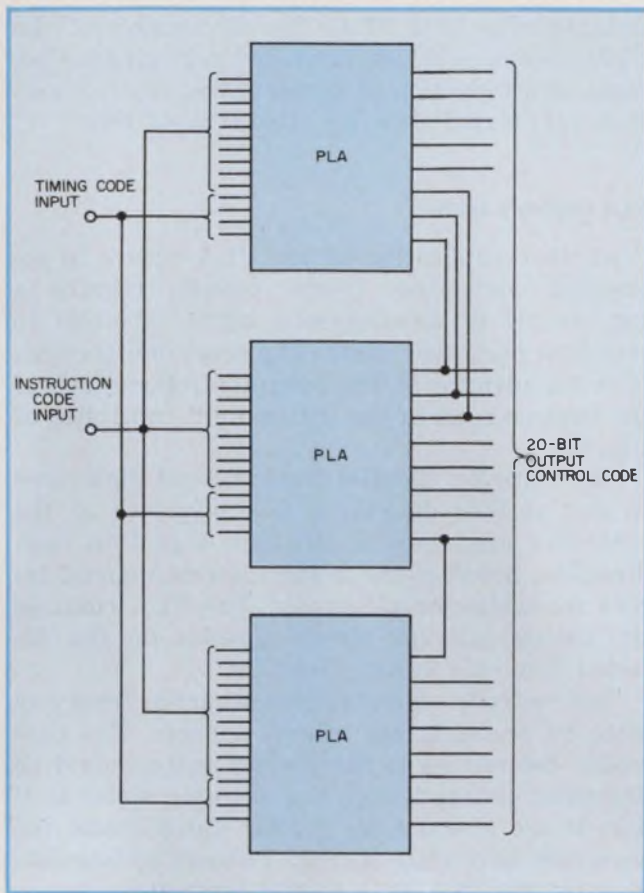

5. Three PLAs can replace a multiplexer data decoder that uses ROMs. The advantages of the PLA approach include higher speed and fewer components.

bits are required in a PLA design. Assume also that four output words require a partial-product-term maximum of 90.

A solution can be obtained by use of four DM 8575/8576 PLAs—each has 14-bit inputs, 8-bit outputs, and a maximum of 96 partial-product terms (Fig. 2). The four PLAs provide a total of 32 outputs, of which only 28 are required. However, the four additional outputs can be used to simplify the programming of partial-product terms.

A common connection of four outputs of two PLAs generates the 90 product terms. The connection allows half of the partial-product terms to be placed in each of two separate PLAs.

With this technique, the output code for the common terms must be programmed with negative TRUE logic to permit a wired-OR connection of the outputs. The technique would not have been possible using standard ROMs.

### PLA converts codes

The PLA can simplify many traditional ROM applications—for example, code conversion. In such an application, the number of partial-product terms available at the output forms the main limitation. Each output-product term, which con-

sists of a combination of input variables, represents a character of the required code.

To illustrate the simplification possible with a PLA, take the case of 12-line Hollerith to 8-line ASCII conversion (Fig. 3). If a ROM were used, it might appear that one with a 12-line input—implying a capacity of 4-k words—would be required. But seven of the 12 Hollerith lines are not binary-coded; they are ordinary decimal-coded lines.

As a result, a standard 8-input ROM could be used. However, external logic elements would be needed to convert the seven decimal-coded lines to three binary lines. Also, the 12-input ROM would have to decode all the nonexistent input possibilities into “don’t care” or error, output states.

Using a PLA rather than a ROM, you can apply all 12 inputs directly to the input terminals. No external components are needed. Since a PLA features selective decoding, no provision need be made to pre-encode the inputs. And an invalid input produces an all-high output state because it is not a recognizable product term.

### PLA vs ROM decoder for processors

A PLA code converter for a digital processor, or other similarly organized system, offers several advantages over the ROM equivalent. In digital processors, control-instruction codes require too large a number of input bits to be handled easily by ROMs.

Such applications involve 9 to 11 logic control-code inputs. To these must be added a timing code that AND-connects the input code to form output-control signals. Thus the total input-control group becomes 11 to 13 bits.

System costs can be high if ROMs are used. Two levels of logic would be required to decode the proper ROM group and transmit the input word to output terminals. A complete input-to-output decoding generally requires many ROMs.

However, in many systems, not all code combinations of instruction and timing data are required. Thus data-compression techniques can be used to reduce the number of ROMs needed to store output data. The usual technique multiplexes the required codes into the ROM elements. The input timing or instruction code determines the multiplex sequence.

An example of such a data decoder uses two levels of multiplexers to route the data to the ROM group (Fig. 4). However, while multiplexers reduce the number of ROMs, they add to the propagation delay for correct output levels.

The same functions can be performed with only three PLAs (Fig. 5). The design involves generation of the logic equations for the outputs, isolation of common product terms and mask-



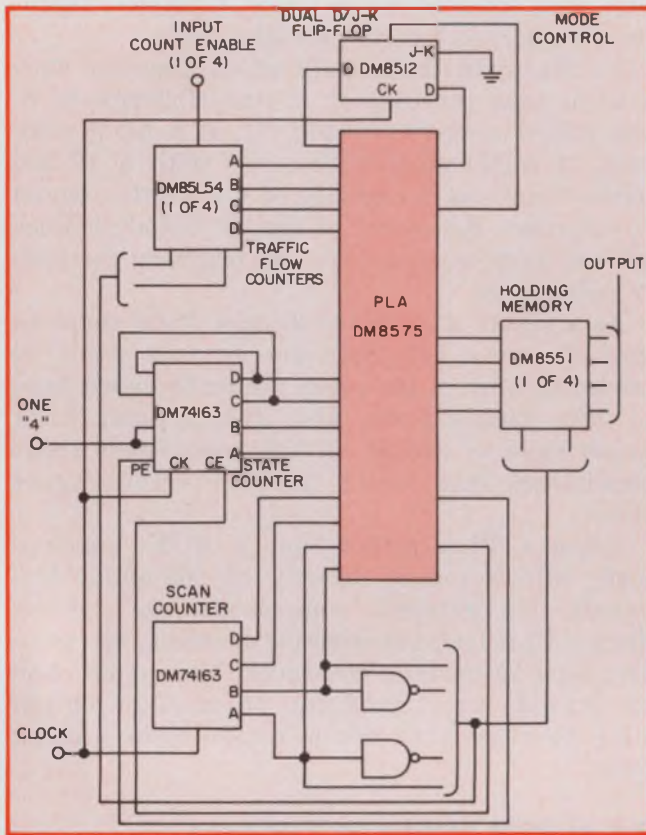

6. The PLA controls the timing interval in this traffic-light controller. The controller handles traffic flow in any of four directions and can start the control sequence from any state.

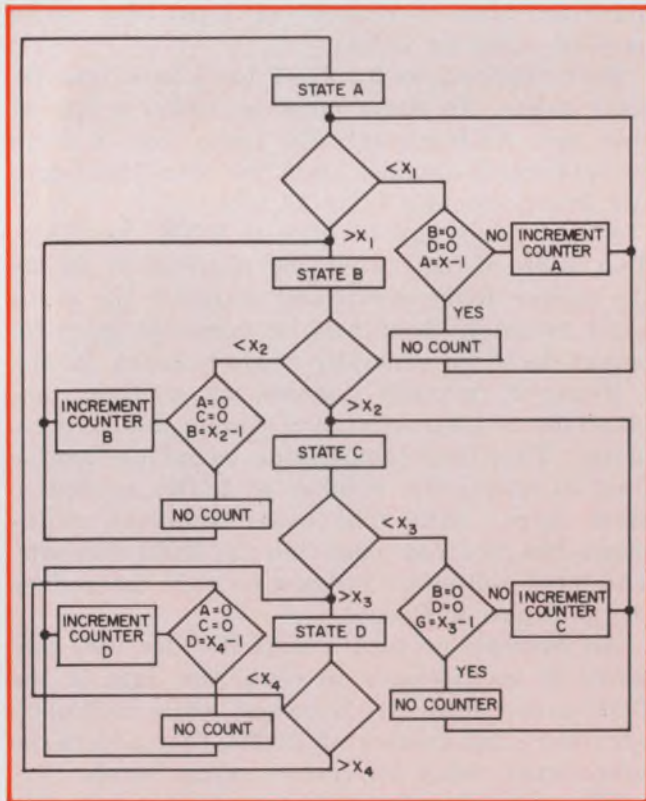

7. The state diagram for the traffic controller illustrates the functions performed. While in any state, the controller checks the others possible to obtain the timing interval of the present state.

programming of a PLA. The advantages of the PLA approach include improved performance because of a reduction of signal paths, interconnections and signal skewing. Also it costs less.

### PLA controls traffic

Another application of the PLA occurs in sequential controllers. These usually require a random set of simultaneous input variables to satisfy a particular state. The condition then allows an advance to the next controller state of the sequencer, as in the traffic-light controller of Fig. 6.

The controller handles traffic flow at high rates in any of four directions. The sequence of the controller associates a left-turn signal to each direction, however the system allows manual inputs for walk-control signals. The PLA controls the timing interval, which depends on the detected flow rate in any direction.

The controller can start the sequence from any state by scanning the others possible. The controller determines if the present state should be shortened or lengthened. For example, states B, C and D are checked for traffic status while the sequencer is in state A. Fig. 7 shows a state diagram of the PLA as a traffic controller.

Note the changes when the maximum time interval,  $X$ , becomes greater than  $X_1$ , the present value of counter A: The state counter indexes to the next machine state, in this case, B. For each state change, the holding memory stores the control information for the traffic indicators. The same scan decoder that provides a multiplex decode of remote traffic counters also updates the memories sequentially.

The control code shortens a state interval when a cross street detects oncoming traffic. Alternatively, the state interval can be lengthened in cases of no-cross or left-turn traffic. As the sequencer steps from state to state, other state conditions are tested. While in state B, states A, C and D are checked for the necessary conditions to modify the timing of state B.

The four traffic counters are multiplexed sequentially into the PLA, where they are AND-connected with present-state timing. This information modulates the sequencer period, as determined by the state equations.

### Sequence disorder can improve design

Some kind of disorder in the sequence of states can yield design advantages. For example, the sequence might have repeat intervals or jump commands. These could occur in any step within the loop. Such variations can be used for a performance improvement, or a reduction in the number of components. ■■

# WE'LL SELL YOU A KEYBOARD SWITCH FOR 30¢



## ...and give you A PENNY CHANGE



**How to save silver when buying gold:** Spec Cherry Gold "Crosspoint" Contact keyboard switches. With a momentary Form A (SPST/NO) price tag of just 29¢ in 250,000 quantity . . . lower prices in higher quantities.

What do you get besides low price? Unique, proven Cherry Gold "Crosspoint" contact configuration that enhances reliability. Tested beyond 50,000,000 operations. (Test Report No. TK 10071 available on request.) You get Cherry's low profile Keyboard switch featuring rugged construction, 2½ ounce operating force and stable contact resistance (typically 25 milliohms over life). Made by the people who pioneered the Gold "Crosspoint" Contact in snap-action switches.

The result? Cherry keyboard switches are your ideal choice for computer terminals, electronic calculators and credit card validators.

**TEST A FREE SAMPLE.** Choose the 29¢ Form A switch . . . or any of Cherry's complete line of keyboard switch modules. Just TWX 910-235-1572 . . . or PHONE 312/689-7704 and ask Frank to give you facts on Keyboard Switches . . . or circle appropriate reader service number.



ACTUAL SIZE

**FORM A, MOMENTARY  
(SPST/NO)**

Circle No. 231 for Free Sample

**ALTERNATE ACTION (SPST)**

Circle No. 232 for Free Sample

**DUAL FORM A, MOMENTARY  
(DPST/NO)**

Circle No. 233 for Free Sample

# CHERRY



**CHERRY ELECTRICAL PRODUCTS CORP.**  
3609 Sunset Avenue, Waukegan, Illinois 60085



Cherry affiliates worldwide • Hirose Cherry Precision Co., Ltd., Tokyo • G. W. Engineering Pty. Ltd., Sydney  
Cherry Electrical Products (U.K.) Ltd., St. Albans, Herts • Cherry Mikroschalter GmbH, Bayreuth, Germany



Next time you're in town



## drop by the plant.

That gives you a lot of towns to choose from. TRW Electronic Components has 30 plants in 28 towns in four countries. As of today.

Tomorrow? Well, let's just say that 30 plants are none too many. We make well over 300 distinctly different kinds of components. For the major OEMs in all major industries that use electronics. And the demand keeps growing. What's more, as one of the few companies mak-

ing both high-technology and high-volume components, we are often called on to apply our know-how in one area to the other. That sometimes means building still another plant.

In any case, we keep having to make ourselves at home—in new home towns.

So please don't write in those four blank squares, above. We may be needing them pretty soon. Because we are TRW.

**TRW**® **ELECTRONIC COMPONENTS**

10880 Wilshire Blvd., Los Angeles, CA 90024

# Simplify small-lamp selection

by matching design requirements to the lamps available with the help of these comparison charts.

There was a time when electronic equipment designers could choose any kind of small lamp so long as it was incandescent. The selection was fairly limited. But in recent years the designer's choice has broadened to include other types, like solid-state lamps—commonly called light-emitting diodes (LEDs)—and neon-glow lamps in a range of colors. And the variety of incandescents themselves has widened with miniature, sub-miniature and halogen-cycle types.

The problem now is: Which lamp do you specify for the different applications you encounter? Sometimes even a single piece of equipment requires more than one type of lamp.

## Tables compare lamps

You could become an expert on small lamps, of course, but this isn't practical for most designers. The four tables presented here are a handy alternative. They provide a comparison of the physical, electrical and performance characteristics of many small lamps (Tables 1, 2 and 3) and how they rank with respect to specific design factors (Table 4).

Careful use of the tables may indicate that more than one type of lamp should be investigated for a given application. For instance, if a low-current indicator lamp, subject to substantial shock and vibration, is needed, Table 4 indicates that a neon-glow lamp or a solid-state lamp are better choices than incandescents. Or if panel floodlighting is required, miniature and sub-miniature incandescent lamps are best choices.

For a better idea of how to use Table 4, let's examine a specific application—a portable, hand-held, 6-V battery-operated test instrument with multicolor indicator lights. The key requirements are "multicolor" and "6-V battery." Note in Design Factor 4 (light color/radiation wavelength) of Table 4 that miniature, subminiature,

halogen-cycle and glow lamps can provide the four basic indicator colors of red, yellow, green and blue. Yellow and green LEDs, just arriving on the market in quantity, along with the red LEDs now available from many sources, make solid-state lamps a possibility if blue is not needed.

Recognizing that 6 V is at the minimum end of the voltage scale and noting Design Factor 6 (power requirements), we can exclude neon-glow lamps because they require high voltage. Halogen-cycle lamps can also be eliminated because they require higher power than that generally available for indicators in a hand-held, battery-operated device. Therefore the logical lamp choices are miniature and subminiature incandescent lamps.

The next considerations are light output, available space (which might exclude miniature lamps), environment and cost. At this point detailed catalog material on miniature and sub-miniature lamps will pinpoint the desired choice. Table 4 has eliminated a futile search through neon glow, halogen-cycle and possibly LED catalogs and swiftly narrowed the selection.

Part numbers for the different types of lamps given in Tables 1, 2 and 3 are ANSI designations for all but the solid-state lamps. For the latter, manufacturers' parts numbers are provided.

## Solid-state lamps lack standardization

Because of the newness of solid-state lamps, no standard types have yet evolved. However, various manufacturers make both visible and infrared types that are similar, differing only slightly in dimensions, output and electrical ratings.

Different basic light-source material—such as gallium phosphide and gallium arsenide phosphide for visible lamps—may also be used by different manufacturers. In the initial design phase of a project these differences can be accommodated, but care should be taken in selecting a second source once the equipment is in production. ■■

---

**Kenneth R. Dean**, Operational Planner, Miniature Lamp Products Dept., General Electric Co., Nela Park, Cleveland, Ohio 44112.

# Lamp types

**Incandescent**—a lamp having a glass envelope and containing a tungsten filament. It emits light when sufficient current is passed through the filament to raise it to incandescence. The atmosphere in the lamp may be either a vacuum or an inert gas. Miniature incandescents range from 3/8 to 2-1/16 inches in bulb diameter, and subminiature are 1/4 inch and smaller.

**Halogen-cycle**—an incandescent lamp containing halogen vapor that combines with particles of evaporated tungsten from the filament and then redeposits the tungsten continuously back onto the filament. This cycling practically eliminates bulb blackening. The bulbs used for halogen-cycle lamps are high-temperature materials,

typically quartz. Halogen-cycle lamps generally fall within the miniature range of incandescents.

**Solid state**—a semiconductor lamp with a suitably doped crystal containing a p-n junction. Solid-state lamps emit visible or infrared radiation, depending upon the light-emitting crystal material. Three materials are commonly used: gallium phosphide or gallium arsenide phosphide for visible lamps, and gallium arsenide for infrared lamps.

**Glow**—a lamp having two electrodes that are sealed within a bulb containing a gas, typically neon. When sufficient voltage is applied, current flows through the gas, and the ionized gas glows near the negative electrode.



1. A sample of the wide variety of small lamps available include the 48C1 and 10C5 telephone slide base subminiature incandescents; 387, 334 and 1768 subminiature incandescents with different bases; C2A and G2B neon-glow lamps with 30-k $\Omega$  resistors attached; 3AG-F and 5AH neons, used as circuit components; SSL-22L

and SSL-22 panel indicators; SSL-55C and SSL-55CF IR LEDs; 1240 single-contact, prefocused miniature incandescent, used in microfilm readers; 211-2 miniature auto interior dome light; 1958 halogen-cycle miniature lamp, used on aircraft; and 1962 and 3026 halogen-cycle miniatures, used for instrument applications.

# Table 1. Physical characteristics

Lamp type	Physical characteristics	Design advantages	Typical lamps
LED	Very small size— 0.25 to 0.05 in. dia.	Less space; allows more room for other components	Visible: SSL-12, SSL-212 TIL-201, MV-50, 5082- 4480 IR: SSL-65, SSL-66 SSL-55B, SSL-55C TIL-31, ME-5
	Point light source	Easy to focus; increased efficiency	
	Variety of lens shapes	Moldable to fit appli- cation requirements	SSL-22, SSL-22L, SSL-12, SSL-212, 5082-4980, TIL-209, MV-5054, OSL-3
Neon glow	Bayonet, screw, telephone- slide and wire-terminal bases	Broad flexibility, easy accessibility and removal	B1A, B2A, C7A, C9A based types. A9A, C2A, D2A, A1C wire terminal types.
	Attached resistor on T-2 lamps	Complete assembly, fewer parts, lower cost instal- lation	All attached-resistor types
	Small size—down to 0.25-in. dia.	Less space; cost savings	A1B, A1C, A9A, C2A
Miniature and halo- gen-cycle incandes- cent	Wide size range— 3/8 to 2-1/16-in. dia.	Wide choice from mature product lines	112 (3/8 in.) 1240 (2-1/16 in.)
	Optically clear bulb	Minimum light distortion; uniformity of projected light	1630, 1493 instrument lamps
	Screw base	Available from many sources	112
	Wedge base	Known filament orienta- tion; range of voltages; simple socket offers cost savings	159, 259, 194, 557, 657
	Prefocused base	Precise filament loca- tion with simple inter- changeability	PR-2, 1501, 1240, 1962
	Double-ended lamps	Slim shape, space sav- ings	211-2, 212-2, 214-2, 561, 562, 563
Subminiature incan- descent	Very small size—1/4 to 1/8-in. dia.	Space savings	683, 583D
	Glass wedge Bi-pin Telephone slide Midget grooved Midget flanged Midget screw Wire terminal	Broad flexibility to fit most applications; cost savings	37, 73, 74 7327, 7381, 7387 24E1, 48C1, 10C5 253, 334 327, 328, 330, 387 1767, 1768 1762D, 1784D, 2187D
	Wedge base	Small space; simple socket; cost savings	37, 73, 74

## Table 2. Electrical characteristics

Lamp type	Electrical characteristics	Design advantages	Typical lamps
LED	Very low operating voltage—1.1 to 2.8 V	Compatibility with ICs; cost savings	Visible: 1.6 to 2.8 V SSL-22L, MV-5054, OSL-6L IR: 1.1 to 1.7 V SSL-55B, SSL-55C TIL-31 ME-5
	Very low power consumption—0.01 to 0.135 W	Less heat; no effect on other components	Visible: 0.01 W, SSL-12 IR: 0.135 W, SSL-55B, SSL-55C, TIL-31, ME-5
	No surge current	Compatibility with transistors and ICs; cost savings	SSL-222, ME-5, TIL-31
	Fast response time—10 nsec	Can be modulated; usable in high-frequency applications	SSL-4, SSL-34, SSL-54 ME-4
Neon glow	120-V power-source operation	Usable with readily available power source; cost savings	C2A, G2B, C9A with proper resistor on 120-V ac. High-brightness types need 150 V dc minimum.
	Higher than 120 V operation	No special power source needed	G2B, B7A, D2A with proper resistor, (480 V: C2A with 200 k $\Omega$ , 1 W resistor)
	ac or dc operation	Usable with any type of power source of sufficient voltage; no special power supply needed	C9A, B2A
	Very low current—2 mA or less	Compatibility with some semiconductors; cost savings	1.9 mA: C2A 1.2 mA: B2A 0.7 mA: A9A 0.3 mA: B1A
	Low power—0.25 W or less	Little heat; no effect on other components; cool to touch	0.25 W: C2A 0.14 W: B2A 0.08 W: A9A 0.04 W: B1A
	Glow-discharge operation	Useful in indicator light and circuit functions, such as memory, isolation, oscillation, switching; open circuit when off; breakdown point; two-level voltage operation; unique in small lamps; fast	3AG-F, 5AH
Miniature and halogen-cycle incandescent	High leakage resistance—100 to 1000 M $\Omega$	Low microcurrent drain; minimum current leakage when off	Above 1000 M $\Omega$ : 3AG-F Above 100 M $\Omega$ : 5AB-B
	Wide voltage range	Capability to match power supply	1.2 V: 114 55 V: 1835
	Wide current range—0.022 to 6.6 A High current—2.63 to 7.3 A	Capability to meet application needs Regulated light output; no flicker or ripple; no strobe effect	0.022 A: 1843 6.6 A: 1731 7.3 A: 1962 4.5 A: 1724 2.63 A: 1129
Subminiature incandescent	Wide voltage range—1.3 to 60 V	Wide selection in matching other components	1.3 V: 2184D 60 V: 60A1
	ac or dc operation Wide current range 0.014 to 0.400 A	Usable with any power source; no special power source required Capability to meet application need	48C1, 387, 1768, 37 (dc may affect life) 0.014 A: 344 0.400 A: 329



### Table 3. Performance characteristics

Lamp type	Performance characteristics	Design advantages	Typical lamps
LED	<p>Long life—projected 100,000+ hr average</p> <p>Gradual reduction in light output</p> <p>Rugged construction</p> <p>Dimmable</p> <p>Gallium phosphide red</p> <p>Narrow bandwidth (infrared)—70% of peak; 920 to 960 nm</p>	<p>Little or no lamp replacement time and costs</p> <p>No sudden catastrophic failure; safety; planned replacement (End of life is at 50% light output)</p> <p>Resistant to shock and vibration; minimized maintenance costs</p> <p>Setting of light level for any application up to maximum design output</p> <p>More light at lower current</p> <p>Closely matched to silicon detectors; full utilization of maximum output</p>	<p>SSL-22, SSL-30 SSL-315, TIL-31</p> <p>SSL-30, SSL-12 SSL-65, OSL-3</p> <p>MV-504, 5082-4980, SSL-212</p> <p>ME-5, MV-50 TIL-201, SSL-212</p> <p>SSL-22, SSL-22L, SSL-12, SSL-212, OSL-3, OSL-6</p> <p>SSL-55B, SSL-55C, TIL-31, ME-5</p>
Neon glow	<p>Series resistance—22 to 56 k<math>\Omega</math></p> <p>Variable brightness</p> <p>All colors</p> <p>Dc indication</p> <p>Long life—25,000 hr average</p> <p>Gradual light failure</p> <p>Rugged construction</p> <p>Relatively fast response time</p> <p>Low-cost UV output</p>	<p>Variable light output</p> <p>More light with high-brightness lamps</p> <p>Standard brightness lamps</p> <p>Color flexibility</p> <p>Low-cost technique to detect dc or ac</p> <p>Few replacements; cost savings</p> <p>No sudden catastrophic failure; safety; planned replacement</p> <p>Shock and vibration resistance, usable in almost any environment</p> <p>Can be oscillated at 10 kHz</p> <p>Cost saving for modest black-light effects</p>	<p>CZA with 22-k<math>\Omega</math> resistor CZA with 56-k<math>\Omega</math> resistor</p> <p>C2A, D2A, A1C</p> <p>A9A, A1B</p> <p>C2A—red, yellow G2B—green, blue</p> <p>A9A, C2A, D2A (only one electrode glows)</p> <p>A9A with 100-k<math>\Omega</math> resistor C2A with 30-k<math>\Omega</math> resistor</p> <p>A9A, standard brightness types</p> <p>A9A, C2A, D2A, A1C, A1B</p> <p>Circuit component types: 5AB, 5AG-A</p> <p>W1A, J2A, J3A, K4A</p>
Miniature and halogen-cycle incandescent	<p>Wide light range—0.04 to 250 cd</p> <p>High-intensity light source</p>	<p>Flexibility to fit application</p> <p>Small size for amount of light output; plenty of light for illumination</p>	<p>0.04 cd: 48 250 cd: 1240</p> <p>Halogen-cycle incandescent types 1958, 1962, 3026</p>

(continued)

Lamp type	Performance characteristics	Design advantages	Typical lamps
Miniature and halogen-cycle incandescent	Continuous visible spectrum	Available in all colors with filters plus IR & some UV (blacklight) low-cost IR and UV sources	112, PR-2, 44, 159, 906
	Dimmable	Any light level up to maximum output available	906, 562, PR2-2, 1958 (Check halogen-cycle lamps for satisfactory operation of cycle)
	Concentrated light source	Efficient use of light through focusing with lens, reflectors	PR-2, 1240, 1630
	Low cost	Cost savings	High-volume flashlight, indicator, auto types
	Hermeticity	Not affected by moisture, temperature, moderate pressure	112, PR-2, 44, 906
	High-temperature contacts	Operable in high ambient temperatures and under vibration; offers longer service life and eliminates socket failure	1631X, 6X
	Integral flasher	No need for external flasher	401, 406, 256, 257, 557
	Flashlight-prefocused filament	Good control of light with focused beam	PR types
	Lens-end designs	Control of light with fewer parts	112, 222, 114, 224
	Strong lamp type in low voltage, high current	Long service life; fewer replacements; lower maintenance	43, 44, 1129, 1680X
Tightly clamped filaments	No intermittent operation, low radio interference	44, 1847	
Subminiature incandescent	Continuous visible spectrum	Produces white light and all colors	48C1, 10C5, 683
	Dimmable	Any light level up to maximum	37, 1768, 387
	Lens-end designs	Control of light with fewer parts	253, 253X, 261, 2136D
	Long life—up to 25,000 hr	Fewer replacements and lower maintenance costs	381, 387, 683
	Aged and selected	Lamp-to-lamp lighting uniformity	683AS15, 685AS15, 715AS1
	Hermeticity	Not affected by moisture, temperature, moderate pressure	387, 10C5, 683

# Table 4. Design rankings

Design factors	Ranking of small lamps*					
	LED		Incandescent		Halogen cycle	Neon glow
	Visible	Infrared	Sub-miniature	Miniature		
1. Function indication (on-off, yes-no, go-no go)	2	–	2	1	4	2
Illumination (front panel, back panel, edge light, floodlight, backlight)	3	–	1	1	4	3
Communication (modulated code, voice, music, data)	3	1	4	4	4	3
Isolation (inputs, between circuits, electrical shock avoidance)	2	1	2	3	4	2
Detection (interruption, reflection)	2	1	2	2	3	2
2. Light output	3	–	1	1	1	3
3. Radiant-energy output for photodetector applications	2	1	2	2	3	2
4. Light color/radiation wavelength						
Red	1	–	1	1	1	1
Yellow	3	–	1	1	1	1
Green	3	–	1	1	1	1
Blue	–	–	1	1	1	1
White	–	–	1	1	1	–
Infrared	4	1	1	1	1	4
Ultraviolet	–	–	4	3	3	1
5. Minimum space requirement	1	1	1	3	3	2
6. Power requirements						
Minimum wattage	1	2	1	3	4	2
Minimum voltage						
ac	4	4	1	1	4	4
dc	1	1	1	1	4	4
Pulsed	1	1	4	4	4	2
7. Life expectancy	1	1	2	2	3	1
8. Functional environment						
Temperature extremes						
High	3	3	1	1	3	1
Low	3	3	1	1	3	1
Vibration	1	1	3	2	2	1
Shock	1	1	3	3	3	1
9. Cost (initial and replacement)	2	2	2	1	3	1
10. Availability						
Initial	2	2	2	1	2	1
Replacement	3	3	2	1	3	2

\*Lamps are ranked as follows: 1. Best choice; 2. Normally acceptable; 3. May be acceptable; 4. Not usually recommended except under special circumstances.

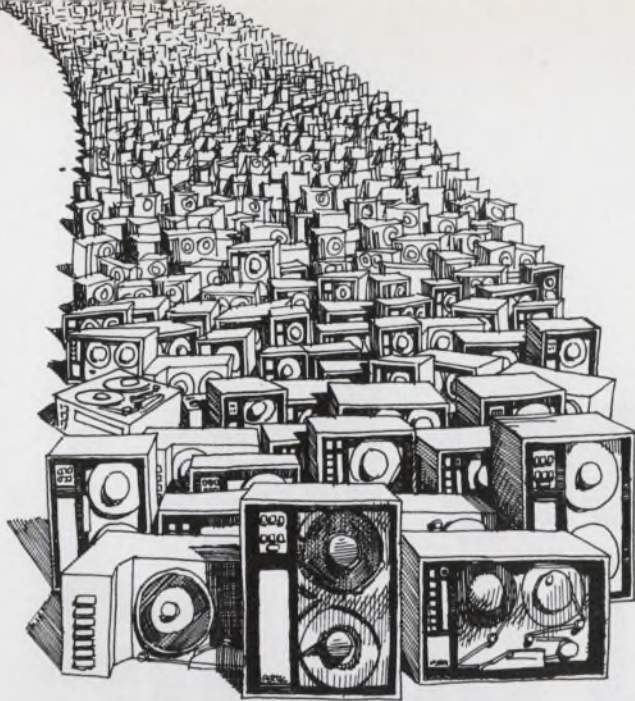

# Will a Perotec tape transport fit your application? 400 times yes!

In fact, you're likely to find a Perotec transport that will work as if it were expressly designed for your system.

You can choose from more than 400 model variations, with speeds ranging from 6¼ to 75 ips, four densities, three reel sizes and buffer and formatter options.

You get interfaces which have become the standard of the industry. (Even our competitors describe their components as "Perotec-compatible".)

You enjoy personal and professional assistance in the design, development and maintenance of your system. Factory training for your sales people. Back-up by a service and support network in 30 U.S. cities and 20 foreign countries.

And all at surprisingly low prices.

Whatever you need in a tape drive, look into Perotec. We pioneered low-cost transports, we developed the first cost-effective phase encoding capability, and we continue to keep and often set the pace in industry advancement.

Today Perotec transports are in more than 20,000 systems around the world. They should be in yours.

Find out more. Call us collect in the area nearest you: Boston (617) 890-6230; Chicago (312) 696-2460; Los Angeles (213) 996-1333; London (Reading) 582-115. Or write us at 9600 Irondale Avenue, Chatsworth, California 91311.



The best values in  
computer peripherals  
come from

## PERTEC

Already the world's  
largest independent  
manufacturer  
of tape transports.

# Memory lag got you down?

## Relief is 4 easy steps away.

### Step 1.

Think about  
the company.

### Step 2.

Pick exactly  
what you need.

### Step 3.

Know what to expect.

### Step 4.

Call for Intersil.

## Think about the company.

You know us. Technology leader in bipolar RAMs. A top supplier in P/ROMs. The company with a wider range of memory performance, and more production techniques—bipolar TTL, CMOS, N-channel and P-channel MOS—than any independent solid-state memory manufacturer.

Look here:

## Pick exactly what you need.

	Memory Type	Description	Read Access Time, Max. (nSec)	Power Dissipation, Max. (mW)
RAMs	IM5501	16x4 TTL Static	60	500
	IM5503	256x1 TTL Static, 1 C/S	80	625
	IM5503A	256x1 TTL Static, 1 C/S	60	625
	IM5508	1024x1 TTL Static, 1 C/S	85	625
	IM5523	256x1 TTL Static, 3 C/S, Tri/St	80	625
	IM5523A	256x1 TTL Static, 3 C/S, Tri/St	60	625
	IM5533	256x1 TTL Static, 3 C/S	80	625
	IM5533A	256x1 TTL Static, 3 C/S	60	625
	IM7501	256x1 P-Ch MOS Static	1000	300
	IM7511	256x1 P-Ch MOS Static	750	250
	IM7512	256x1 P-Ch MOS Static	1200	160
	IM7552	1024x1 N-Ch MOS Static	1000	300
	IM7552-1	1024x1 N-Ch MOS Static	500	300
	P/ROMs	IM5600	32x8 TTL Static	50
IM5603A		256x4 TTL Static	60	500
IM5610		32x8 TTL Static, Tri/St	50	500
IM5623A		256x4 TTL Static, Tri/St	60	500
Shift Registers	IM7712	1024x1 P-Ch MOS Dynamic	3MHz	200
	IM7722	1024x1 P-Ch MOS Dynamic	3MHz	200
	IM7780	80x4 P-Ch MOS Dynamic	2.5MHz	355

## Know what to expect.

### Coming Up

IM7733	1024-bit N-Ch MOS Static S/R, 4MHz Freq.
IM6523	256-bit CMOS RAM, 20mW Active Pwr, .25mW Stby
IM5604	2048-bit TTL P/ROM, 80nS Access
IM6508	1024-bit CMOS RAM, 60mW Active Pwr, .30mW Stby
IM5605	4096-bit TTL Static P/ROM, 90nS Access
IM7507	4096-bit N-Ch MOS Dynamic RAM, 400nS Access

## Call for Intersil.

Intersil stocking distributors.. Elmar/Liberty Electronics. Schweber Electronics. Semiconductor Specialists. Weatherford.

Intersil area sales offices. Boston (617) 861-7380. Chicago (312) 371-1440. Los Angeles (213) 370-5766. Minneapolis (612) 925-1844. New York (201) 567-5585. San Diego (714) 278-6053. San Francisco Bay Area (home office) (408) 257-5450.

Representatives in all major cities.

# Intersil



# Fast BCD/binary conversions:

They once were a formidable task, but modern ROMs and MSI circuits have reduced part counts and speeded performance.

Computers "think" in binary arithmetic, but people understand decimal numbers. Thus binary-coded-decimal (BCD) numbers must be converted to binary, and vice versa, wherever such a man/machine interface exists.

But this is not a trivial task. In fact, where the interfacing occurs frequently and the computational cycles are short, as in calculators, the device may have more over-all efficiency by working directly in BCD and thus avoid the need for conversions. Where the computational cycles are likely to be long and complex, however—as in computers—the best trade-off is to design the machine to operate with binary numbers and provide the needed conversions.

## Conversion by counting

Fortunately there is a choice of techniques. They range from relatively simple, but slow, serial counting to a fast, parallel approach that uses the latest in MSI and ROMs.

The easiest conversion method to understand is serial counting. It uses an n-bit, up/down binary counter and any equally large cascaded bi-directional BCD counter (Fig. 1). In BCD-to-binary conversion, the BCD number is parallel-loaded into the BCD counter. The binary counter is cleared to zero. The BCD counter counts down. And for each unit decrease of the BCD counter, the binary counter is increased by one count. Counting continues until the BCD counter reaches zero. The binary number in the binary counter is then the converted BCD number.

Binary-to-BCD conversion, of course, requires a reverse procedure, and it starts with the binary number parallel-loaded into the binary counter and the BCD counter set to zero. Now the binary counter counts down, while the BCD counts up, until the binary counter's most-significant bit turns zero.

This technique requires few IC packages to implement, if the latest MSI is used. However,

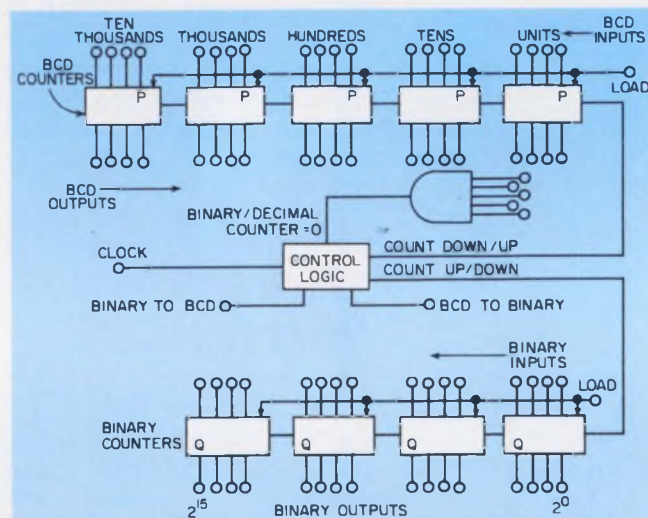

1. Serial counting is the easiest BCD/binary conversion method to understand. It can be done with few MSI packages, but it is slow.

it is slow. Even with a 10-MHz clock, it takes about 6.5 ms to convert a 16-bit binary number to BCD.

## Conversion by divide-by-two

A more sophisticated and faster serial technique traces its origin to a popular pencil-and-paper method for converting a decimal to a binary number. The decimal number is repeatedly divided by two. Each time a remainder of one is obtained, a binary ONE is entered in the appropriate order of the equivalent binary number. For example:

Decimal Number	Binary Equivalent	Binary Bit Location
242	0	2 <sup>0</sup>
121	1 0	2 <sup>1</sup>
60	0 1 0	2 <sup>2</sup>
30	0 0 1 0	2 <sup>3</sup>
15	1 0 0 1 0	2 <sup>4</sup>
7	1 1 0 0 1 0	2 <sup>5</sup>
3	1 1 1 0 0 1 0	2 <sup>6</sup>
1	1 1 1 1 0 0 1 0	2 <sup>7</sup>

Thus 242 converts to 11110010. This can be done for any integral decimal number.

Howard A. Raphael, Project Manager, Singer Business Machines, San Leandro, Calif. 94577.

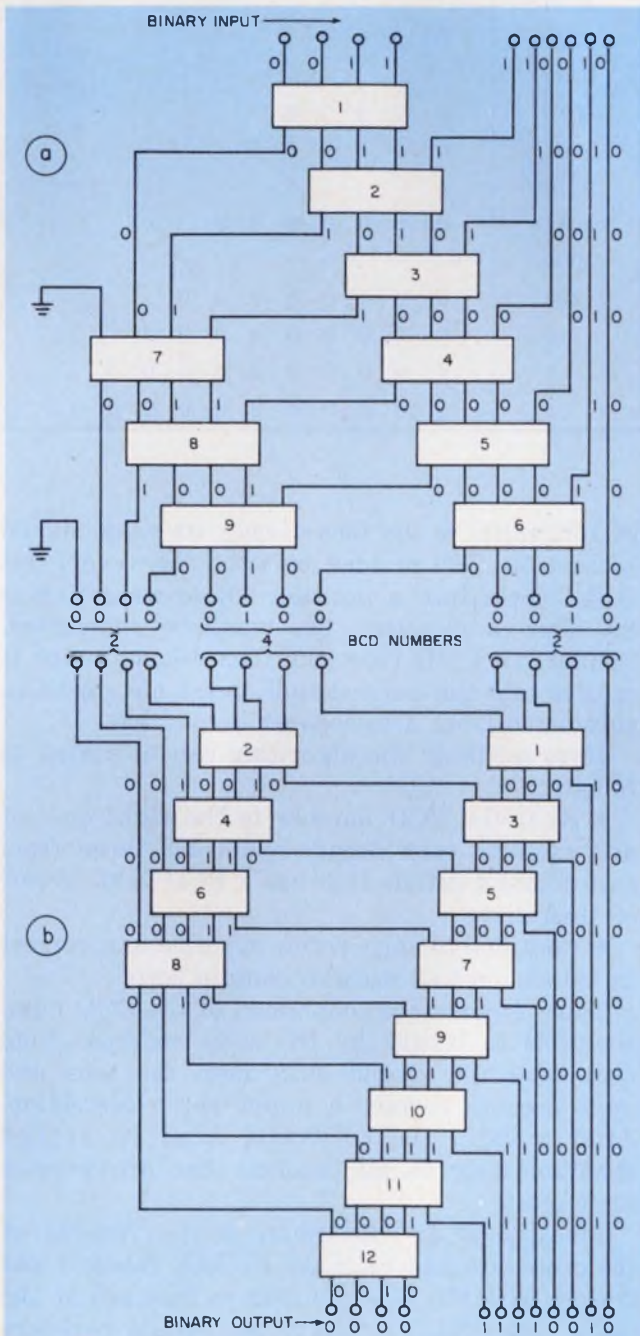

2. Binary-to-BCD (a) and BCD-to-binary (b) converters of any size can be assembled from building blocks of the logic modules shown in Tables 3 and 4. Building blocks made of specially programmed ROMs, such as the MC 4001, provide identical conversion functions with fewer packages and operate at higher speeds.

In the example, the first division by two has no remainder. Thus a binary ZERO is entered as the least-significant binary bit. This is easily explained; the first division determines whether the number is odd or even. The least-significant binary bit is a ONE only if the number is odd.

Similarly the remaining divisions determine if the decimal number contains odd or even quantities of 2s, 4s, 8s, etc. Since the number 121 indicates that an odd quantity of 2s is in 242, a binary ONE becomes the next-significant number, and so on.

To help understand this odd/even correspondence to binary bits, note in the example that there are a maximum of 15 units of the quantity  $2^4 = 16$  in 242, or  $15 \times 16 = 240$ . But seven quantities of  $2^5 = 32$ , or  $7 \times 32 = 224$ , are already included because of the first three sig-

Table 1. Add/Subtract-three technique  
242 = 11110010

Operations	Decades			Binary Bits
	Hundreds	Tens	Units	$2^7 2^6 2^5 2^4 2^3 2^2 2^1 2^0$
load-242	0 0 1 0	0 1 0 0	0 0 1 0	
shift-121	0 0 1	0 0 1 0	0 0 0 1	0
shift				
tens > 7	0 0	1 0 0 1	0 0 0 0	1 0
subtract 3		- 1 1		
obtain - 60	0 0	0 1 1 0	0 0 0 0	1 0
shift - 30	0	0 0 1 1	0 0 0 0	0 1 0
shift-unit > 7		0 0 0 1	1 0 0 0	0 0 1 0
subtract 3		- 1 1		
obtain - 15		0 0 0 1	0 1 0 1	0 0 1 0
shift-unit > 7		0 0 0 0	1 0 1 0	1 0 0 1 0
subtract 3		- 1 1		
obtain - 7	0 0 0 0	0 1 1 1	1 0 0 1 0	
shift - 3		0 0 0	0 1 1	1 1 0 0 1 0
shift - 1		0 0	0 0 0 1	1 1 1 0 0 1 0
shift - 0		0	0 0 0 0	1 1 1 1 0 0 1 0



**Table 2. Add/subtract-three technique 1024 = 10000000000**

Operations	Decades				Binary bits										
	Thousands	Hundreds	Tens	Units	2 <sup>10</sup>	2 <sup>9</sup>	2 <sup>8</sup>	2 <sup>7</sup>	2 <sup>6</sup>	2 <sup>5</sup>	2 <sup>4</sup>	2 <sup>3</sup>	2 <sup>2</sup>	2 <sup>1</sup>	2 <sup>0</sup>
Load—1024	0001	0000	0010	0100											
Shift—		1000	0001	0010	0										
Sub 3 (Hundreds)		101	0001	0010											
Shift		10	1000	1001	0	0									
Sub 3 (Tens & Units)		10	0101	0110											
Shift		1	0010	1011	0	0	0								
Sub 3 (Units)		1	0010	1000											
Shift			1001	0100	0	0	0	0							
Sub 3 (Tens)			110	0100											
Shift			11	0010	0	0	0	0	0						
Shift			1	1001	0	0	0	0	0	0					
Sub 3 (Units)			1	0110											
Shift				1011	0	0	0	0	0	0	0				
Sub 3 (Units)				1000											
Shift				100	0	0	0	0	0	0	0	0			
Shift				10	0	0	0	0	0	0	0	0	0		
Shift				1	0	0	0	0	0	0	0	0	0	0	
Shift					1	0	0	0	0	0	0	0	0	0	0

nificant bits of the binary number. Since seven quantities of 32 are the same as 14 quantities of 16, the odd, or fifteenth, quantity of 16 is provided by a binary ONE that corresponds to the 2<sup>4</sup> bit location. Thus we arrive at the quantity 240 = 224 + 16. Since 15 units of 16 are the same as 30 units (an even number) of eight, no 2<sup>3</sup> bit is needed and a binary ZERO is entered. The same applies for bits with the weight of 2<sup>2</sup> (4 × 60 = 240). But the need for an odd two is provided by a binary ONE in the 2<sup>1</sup> location, and 240 + 2 equals 242 then.

**Add/subtract three converts BCD**

With the decimal number in BCD form the same divide-by-two algorithm can convert the BCD number to binary. However, after a division by two, a correctional step may be needed.

For instance, enter the BCD number—say 242—into a shift register whose stages are arranged in decades of four bits each as in Table 1. A shift to the right of the register's contents is the equivalent of a divide-by-two in BCD, as it is in binary, as long as a ONE does not cross into the next decade. But when a binary ONE is shifted from a decade into a lower decade, the weighting of the value of the ONE must be adjusted. In Table 1 these decade-crossing shifts are noted with an arrow. When, say, a ONE in the hundreds decade, which in BCD has a weighting

of 100, shifts to the tens decade, its value should become 50 (100 divided by two). However, this ONE moves into a position whose weighting is 80. Thus a quantity, 30, must be subtracted. Similarly a ONE from the tens decade, when it crosses into the units decade, must have a three subtracted from it to convert it to a five.

More concisely the algorithm can be stated as follows:

- Shift the BCD number to the right one bit and examine each decade. Subtract three from each four-bit decade that has a BCD value greater than seven.
- Continue to shift right, examine and correct as before until all decades contain zero.

Table 2 shows the conversion of the BCD number 1024 to binary by the same method. Note that after the second shift both the tens and units decades require a minus three correction. After a shift, the correction must be applied simultaneously to all decades that are greater than seven.

Binary-to-BCD conversion is the reverse of the procedure just outlined. In both Tables 1 and 2 start with the binary numbers that are at the lower right. Shift left into the decade registers and follow the same steps from the bottom to the top of the tables. However, after every shift each decade is checked now for values greater than four. Where the BCD value is greater than four, add three—the reverse of the previous procedure

—and continue the steps. After all binary bits have been shifted and processed into the register, the register contains the BCD equivalent of the binary number.

Conversion of a 16-bit word would take about 5  $\mu$ s with a 10-MHz clock, if the worst case of 16 add/subtracts that need two clock times each is assumed. The amount of hardware required is not much greater than for the counting method.

### Conversion by combinational logic

Combinational logic can provide conversions without the need for clocks, counters or shift registers, and can do it at much greater speeds. The speed is determined by the propagation rate of the gates used. With TTL gate speeds of about 10 ns, 16 bits can be converted in less than 700 ns. However, with conventional gate clusters, the package count is high.

The easiest way to derive the logic for a static BCD/binary conversion system is to refer to the add/subtract 3 method. A complete truth table for a decade of binary-to-BCD conversion that follows the add/subtract 3 algorithm is shown in Table 3. The least-significant bits of both the binary and BCD sequences,  $B_1$  and  $D_1$ , are identical and are therefore directly connected. The next four binary bits,  $B_2$  to  $B_{10}$ , which are equivalent to a decade, as in Table 1, are converted by the combinational logic. Table 3 shows that the input sequences of  $B_2$  to  $B_{10}$ —which have binary values of greater than four—produce outputs whose values have been increased by three. This is in accordance with the add/subtract 3 algorithm. Repeated use of the combinational logic decades, as shown in Fig. 2a, can provide conversion for almost any number of binary bits.

The steps from a truth table to a logic implementation via a Karnaugh map and then Boolean equations is routine, and Table 3 also shows a NAND gate solution for the combinational logic.

A similar approach results in Table 4, the truth table for BCD-to-binary conversion and a NAND implementation. Fig. 2b shows how the logic modules can be iterated to convert almost any number of decades.

### Reducing the part count

But today's ROMs can greatly simplify the implementation of combinational logic, such as in Tables 3 and 4, and reduce the over-all package count. Motorola's MC4001 and Texas Instruments' SN74184/74185A converters use this approach with the information in the truth tables programmed onto special versions of their custom ROMs. Motorola derives the converters from its XC170/171, 128-bit ROM, and Texas Instru-

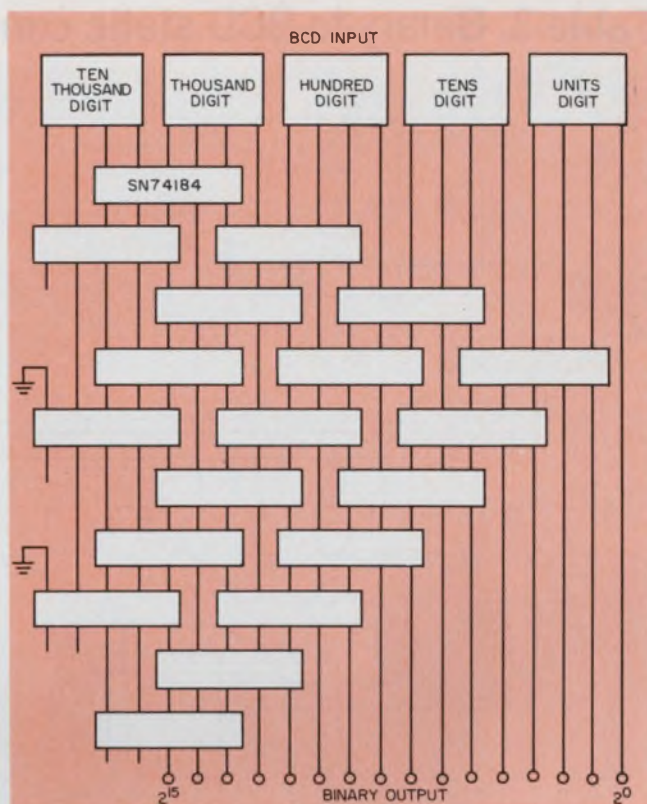

3. A five-decade BCD number can be converted to a 16-bit binary number with 19 SN74184 ROM packages. Conversion time is only 400 ns.

ments from its SN7488, 256-bit unit. Besides simplifying the logic and reducing package count, ROMs can convert a 16-bit binary number in approximately 400 ns—almost half the time that ordinary TTL logic would take (Fig. 3).

A still further reduction in both package count and conversion speed is attainable with a configuration of ROMs and adders, as in Fig. 4, for BCD-to-binary conversion.

This arrangement converts a number like 512 to binary by summing the binary equivalents of the decade parts: 500, 10 and 2, or 111110100, 1010 and 0010. The sum of these binary partial numbers equals the whole number. Thus:

$$\begin{array}{r}
 111110100 \\
 \phantom{11111}1010 \\
 \phantom{11111}\phantom{1}0010 \\
 \hline
 100000000 = 2^9 = 512
 \end{array}$$

The units decade requires no ROM conversion. The other conversion ROMs are appropriately programmed for their respective decade positions. The tens and hundreds and the thousands and ten-thousands decades are each combined into two decades per ROM to minimize hardware and use available 2048-bit ROMs. The ROMs are organized into 256-by-8-bit words, such as in Signetics' 8204. Binary adders can be of the SN7483 type.

The number of logic elements required to implement a five-decade-to-16-bit converter is 11

### Table 3. Binary-to-BCD static conversion

LOGIC MODULE

NAND IMPLEMENTATION

TRUTH TABLE

B <sub>16</sub>	B <sub>8</sub>	B <sub>4</sub>	B <sub>2</sub>	D <sub>1</sub>		D <sub>2</sub>	D <sub>4</sub>	D <sub>8</sub>	D <sub>16</sub>
				B <sub>1</sub>	D <sub>10</sub>				
0	0	0	0	0	0	0	0	0	0
0	0	0	1	0	0	0	0	0	0
0	0	0	1	1	0	0	0	0	0
0	0	1	0	0	0	0	0	0	0
0	0	1	0	1	0	0	0	0	0
0	0	1	1	0	0	0	0	0	0
0	0	1	1	1	0	0	0	0	0
0	1	0	0	0	0	0	0	0	0
0	1	0	0	1	0	0	0	0	0
0	1	0	1	0	0	0	0	0	0
0	1	0	1	1	0	0	0	0	0
0	1	1	0	0	0	0	0	0	0
0	1	1	0	1	0	0	0	0	0
0	1	1	1	0	0	0	0	0	0
0	1	1	1	1	0	0	0	0	0
1	0	0	0	0	0	0	0	0	0
1	0	0	0	1	0	0	0	0	0
1	0	0	1	0	0	0	0	0	0
1	0	0	1	1	0	0	0	0	0
1	0	1	0	0	0	0	0	0	0
1	0	1	0	1	0	0	0	0	0
1	0	1	1	0	0	0	0	0	0
1	0	1	1	1	0	0	0	0	0
1	1	0	0	0	0	0	0	0	0
1	1	0	0	1	0	0	0	0	0
1	1	0	1	0	0	0	0	0	0
1	1	0	1	1	0	0	0	0	0
1	1	1	0	0	0	0	0	0	0
1	1	1	0	1	0	0	0	0	0
1	1	1	1	0	0	0	0	0	0
1	1	1	1	1	0	0	0	0	0

EQUATIONS

$$D_1 = B_1$$

$$D_2 = \overline{B_8}B_2 + B_8\overline{B_2} + \overline{B_{16}}B_8B_4\overline{B_2} = D_{10}\overline{B_2} + B_2\overline{D_{10}}$$

$$D_4 = B_8\overline{B_4} + B_{16}\overline{B_2} + B_8B_2$$

$$D_8 = \overline{B_8}B_4\overline{B_2} + B_{16}B_2$$

$$D_{10} = B_{16} + B_8B_4 + B_4B_2$$

### Table 4. BCD-to-binary static conversion

LOGIC MODULE

NAND IMPLEMENTATION

TRUTH TABLE

D <sub>10</sub>	D <sub>8</sub>	D <sub>4</sub>	D <sub>2</sub>	B <sub>1</sub>		B <sub>2</sub>	B <sub>4</sub>	B <sub>8</sub>	B <sub>16</sub>
				D <sub>1</sub>	D <sub>2</sub>				
0	0	0	0	0	0	0	0	0	0
0	0	0	0	1	0	0	0	0	0
0	0	0	1	0	0	0	0	0	0
0	0	0	1	1	0	0	0	0	0
0	0	1	0	0	0	0	0	0	0
0	0	1	0	1	0	0	0	0	0
0	0	1	1	0	0	0	0	0	0
0	0	1	1	1	0	0	0	0	0
0	1	0	0	0	0	0	0	0	0
0	1	0	0	1	0	0	0	0	0
0	1	0	1	0	0	0	0	0	0
0	1	0	1	1	0	0	0	0	0
0	1	1	0	0	0	0	0	0	0
0	1	1	0	1	0	0	0	0	0
0	1	1	1	0	0	0	0	0	0
0	1	1	1	1	0	0	0	0	0
1	0	0	0	0	0	0	0	0	0
1	0	0	0	1	0	0	0	0	0
1	0	0	1	0	0	0	0	0	0
1	0	0	1	1	0	0	0	0	0
1	0	1	0	0	0	0	0	0	0
1	0	1	0	1	0	0	0	0	0
1	0	1	1	0	0	0	0	0	0
1	0	1	1	1	0	0	0	0	0
1	1	0	0	0	0	0	0	0	0
1	1	0	0	1	0	0	0	0	0
1	1	0	1	0	0	0	0	0	0
1	1	0	1	1	0	0	0	0	0
1	1	1	0	0	0	0	0	0	0
1	1	1	0	1	0	0	0	0	0
1	1	1	1	0	0	0	0	0	0
1	1	1	1	1	0	0	0	0	0

EQUATIONS

$$B_1 = D_1$$

$$B_2 = \overline{D_{10}}D_1 + D_{10}\overline{D_2}$$

$$B_4 = \overline{D_{10}}D_4 + D_4\overline{D_2} + D_{10}\overline{D_4}D_2$$

$$B_8 = \overline{D_{10}}D_8 + D_{10}\overline{D_8}\overline{D_2} + D_{10}\overline{D_4}D_2$$

$$B_{16} = D_{10}D_8 + D_{10}D_4D_2$$

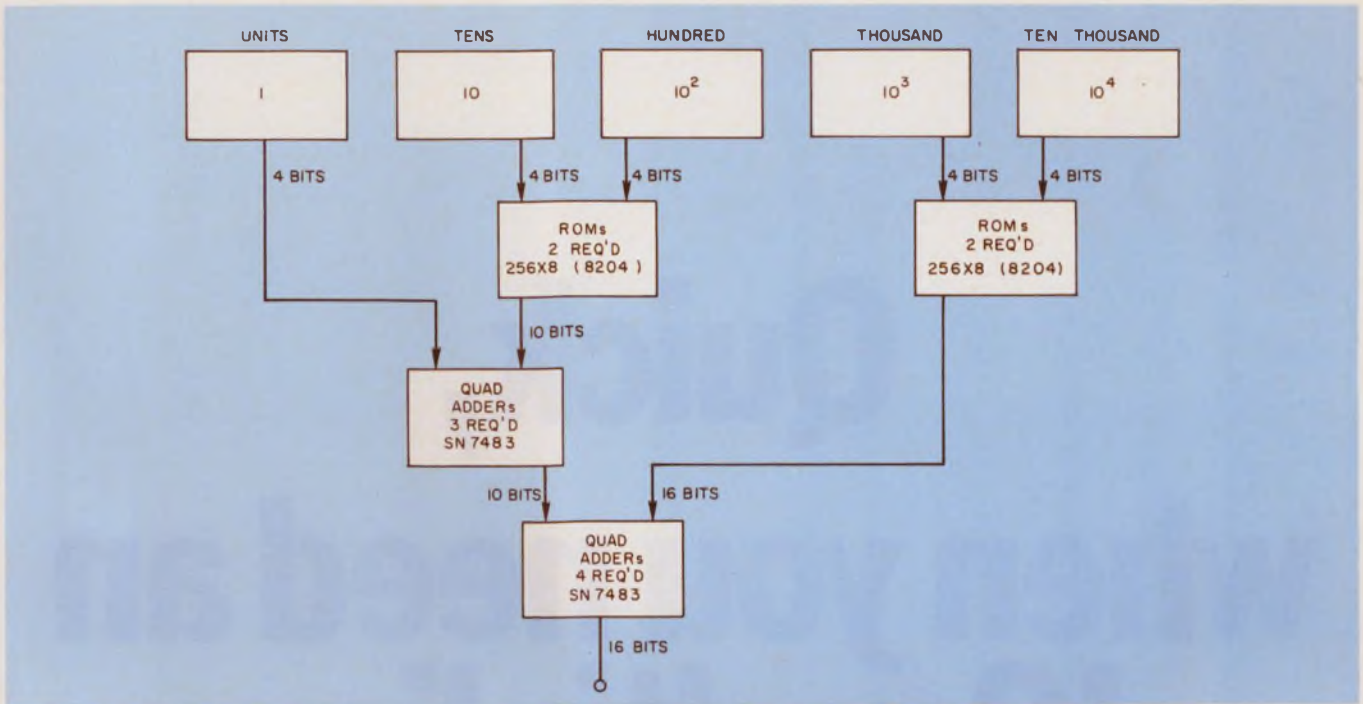

4. Reduced part count and increased speed result when the outputs of specially programmed ROMs are com-

bined in quad adders. Only 11 packages can convert five BCD numbers with a conversion time of 150 ns.

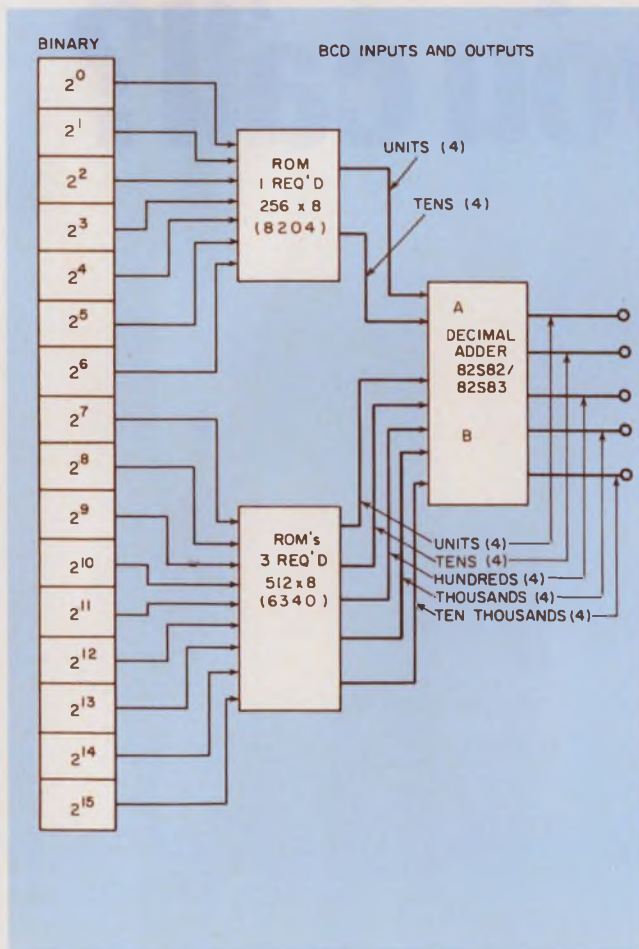

5. Binary numbers can be converted to BCD by the use of BCD decimal adders. This approach reduces part count and increases conversion speed. A 16-bit binary number converts to a five-digit BCD number in about 220 ns and uses approximately nine circuit packages.

devices (less input storage). The time required to perform the conversion through the three levels of MSI is estimated at less than 150 ns. This conversion scheme can be expanded by the addition of more ROMs and adders. For each additional increase of two decades, the level of gating increases by one, and the package count increases by an average of 4.5 packages.

Conversion from binary to decimal can also be accomplished by this technique. However, the method requires decimal addition.

In Fig. 5 a 16-bit binary number is broken into convenient subsets. The first seven bits provide all numbers to 127. The converter ROM, which these seven bits address, yields only the units and tens digits (eight BCD bits) from 0 to 99. These are added to the next subgroup, which provides the hundreds, thousands and ten-thousands positions.

Subset grouping is done to minimize the number of ROMs or adder stages. Fewer subsets require fewer adder stages and also fewer delay paths are thus needed. The partial conversions from each subset can be added with BCD adders such as Signetics 82S82/82S83 packages. ■■

#### References

- Schmid, Hermann, "BCD: Logic of many uses," *ELECTRONIC DESIGN*, June 21, 1973, pp. 90-95.
- Couleur, J. F., "BIDEC-A Binary-to-Decimal or Decimal to Binary Converter," *IRE Transactions on Electronic Computers*, Dec., 1958, pp. 313-316.
- Linford, J. R., "Binary-to-BCD Conversion with Complex IC Functions," *Computer Design*, Sept., 1970, pp. 53-61.
- Kintner, P. M., "High-Speed Decimal to Binary and Binary to Decimal Conversion," *Control Engineering*, August, 1971, pp. 61-63.

**Quick,  
when you need an  
IC multiplier,  
who do you call?**

Most people call Analog Devices. Here's why.

First we brought you the AD530. The first IC multiplier to include the transconductance multiplying element, stable reference and output amp on a monolithic chip. With guaranteed high accuracy over temperature. \$15.00 in 100's.

But nobody matched it.

Then we came out with the AD531, the first monolithic programmable multiplier/divider to provide the three variable transfer function  $V_o = (V_{x1} - V_{x2}) (V_y) / V_z$  without the need for an external output op amp. It's easier for you to use for AGC, true rms-dc and vector computation. \$20.00 in 100's.

We immediately followed it with the AD532, the first internally laser-trimmed single chip monolithic multiplier. No external trims for errors below 1.0%. This one is by far the easiest to use and the most flexible.  $V_o = (V_{x1} - V_{x2}) (V_{y1} - V_{y2}) / 10$ . \$16.00 in 100's.

Nobody equalled that one either.

Now we give you the AD533, the lowest cost IC multiplier comprised of a transconductance multiplying element, stable reference, and output amp on a monolithic chip. With high accuracy over temperature. It saves you money. \$5.95 in 100's.

And there's still little sign of competition in the IC multiplier field. Maybe no one else cares enough about you to try. Or maybe they just don't know how to make great IC multipliers.

But don't worry. We'll continue to provide unique circuit designs for you in our IC multipliers, IC FET op amps and IC converters.

Because at Analog Devices, we intend to stay ahead of the competition—if it ever arrives.

Analog Devices, Inc., Norwood, Mass. 02062

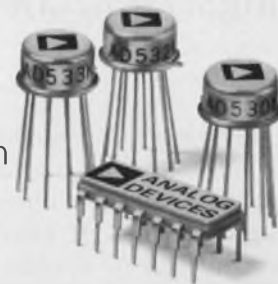

**Call 617-329-4700**  
for everything you need to know about IC multipliers.

# Integrate with a DMM? Yes, and you can also count, detect pulses and measure ratio—among other things. First, check your meter's internal circuitry.

By taking advantage of a modern digital multi-meter's internal analog-to-digital or other circuitry, you can use the instrument for a number of unusual applications. Of course, internal circuitry—thus, the type of applications—will vary with the DMM. Thorough knowledge of the internal operations of your instrument is a prerequisite. Let's lift the lid and look inside a representative meter.

## Dual slope predominates

Nearly every \$100-and-up DMM uses a variation of the dual slope integration method of analog-to-digital conversion. Here's how it works (Fig. 1):

The input signal is applied to an integrator through switch A at the start of each conversion cycle, called phase one. This causes the integrator output to swing negative, the comparator output to go positive and the AND gate to be enabled. Thus pulses are applied from the pulse generator to the counter. When the counter reaches maximum count and returns to zero—in this example, at a count of 2000—the overflow output causes control to switch to phase two.

The input signal is now disconnected from the integrator and a reference signal of opposite polarity is connected in its place. In the illustration, the reference is  $-2\text{ V}$ . The pulse generator is still connected to the counter, which again begins counting from zero. When the integrator output reaches zero volts, the pulses are disconnected from the counter; the contents of the counter are latched and displayed; and the reference is disconnected from the integrator.

At the end of phase two the following condition is true:

$$\int_0^T V_{in} dt = \int_0^\tau V_{REF} dt,$$

where  $T$  = time to reach maximum count (2000)  
 $\tau$  = time duration of phase two.

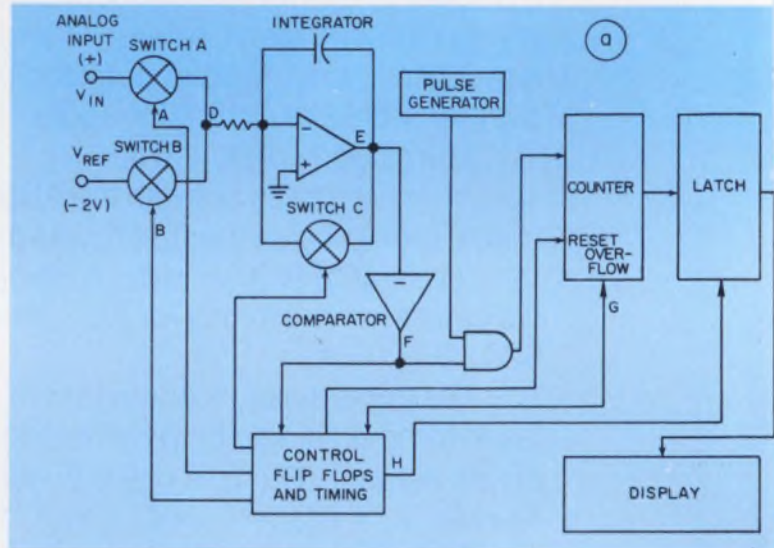

If the pulse generator produces  $p$  pulses per second, we may rewrite the integral in terms of counts:

$$\int_0^{C_{max}} V_{in} dp = \int_0^C V_{REF} dp,$$

where  $C_{max}$  = maximum count (2000), and  $C$  = counts accumulated during phase two. For  $V_{in}$  and  $V_{REF}$  constant during the integration,

$$V_{in} C_{max} = V_{REF} C,$$

or

$$C = C_{max} V_{in} / V_{REF} = 1000 V_{in},$$

for values in Fig. 1. Thus  $C$ , the count strobed to the display, is a correct measure of applied signal voltage.

Most meters have another waiting period in the cycle, denoted as phase three. During that time some meters automatically compensate for drift and offset; others discharge the integrator capacitor (as shown in Fig. 1); still others eliminate this phase.

## Construct an integrator

The power of the dual-slope scheme lies in the integrator's ability to reject noise riding on the input signal, while still allowing quick response to changes in applied voltage. It is also popular

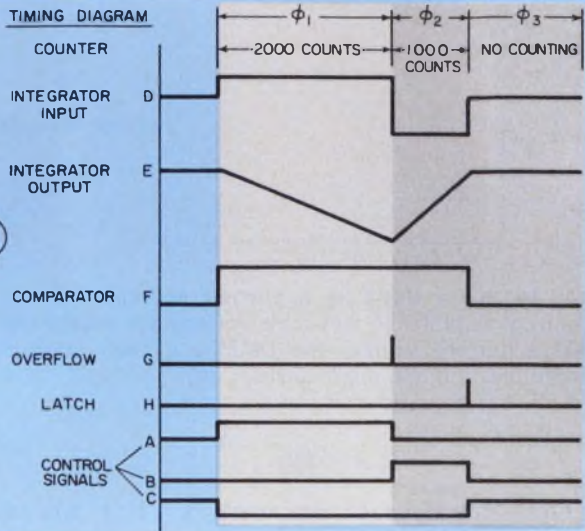

1. Most DMMs use dual-slope integration (a) to convert the analog input to a digital number. The method averages out noise riding on the input signal. Timing diagram (b) shows events during each phase of conversion.

because less parts are required than for most other a/d conversion methods.

You can use your understanding of dual-slope to construct an integrator with a digital display. The only limitation is that the time interval of integration is set by the meter, rather than by the user. The equations are:

$$\int_0^T V_{in} dt = \int_0^{\tau} V_{REF} dt =$$

$$\int_0^C V_{REF} dp = V_{REF} C.$$

System DMMs usually have the gate signal or a "start-conversion" input available at the output connector, making this type of DMM ideal for use as an integrator.

On other DMMs it will be necessary to monitor the gate signal that connects the input to the integrator, and to use this signal to sync the circuit being tested. This application is especially useful in analog computer experiments, where the computer is started by external control, and the internal time scale may be adjusted to coincide with the gate-time of the DMM.

The dual-slope principle can also be used to measure ratio. While some more expensive DMMs have built-in provision for this, others require

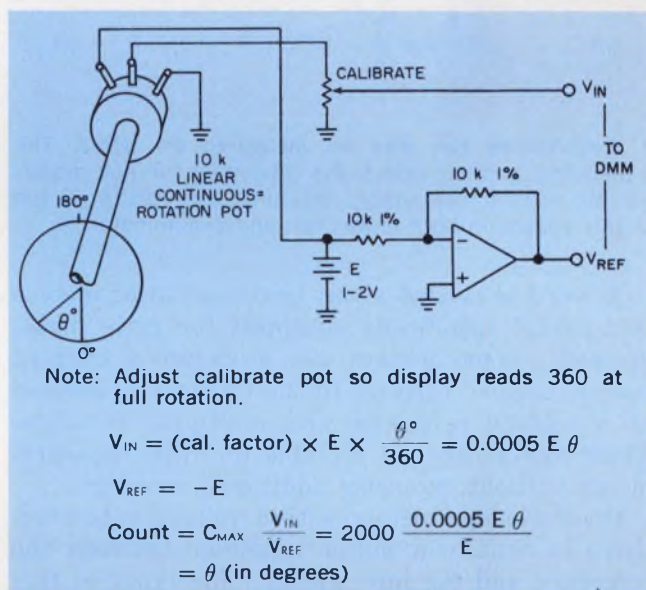

2. In a typical ratio measurement, a DMM directly displays the angular position of a potentiometer shaft.

tapping into the circuitry. Here's how ratioing works:

Since, for constant input,  $C = C_{max} V_{in}/V_{REF}$ , if you substitute an external signal for  $V_{REF}$ , you can measure the ratio of the input to the substitute reference. For example, ratios can be used to display the position of a shaft (Fig. 2).

Of course, the advantage of a ratio measurement in this application is that the voltage source, E, need not be particularly stable or precise. The only limitation is that E must be less than the DMM's internal reference to avoid saturating sensitive circuitry.

In some measurements, you can use the ratio method to monitor values computed by arithmetic division, without requiring precise analog multipliers. For example, if  $V_{in}$  is connected to a reference voltage, the value displayed is the inverse of that applied as  $V_{REF}$ .



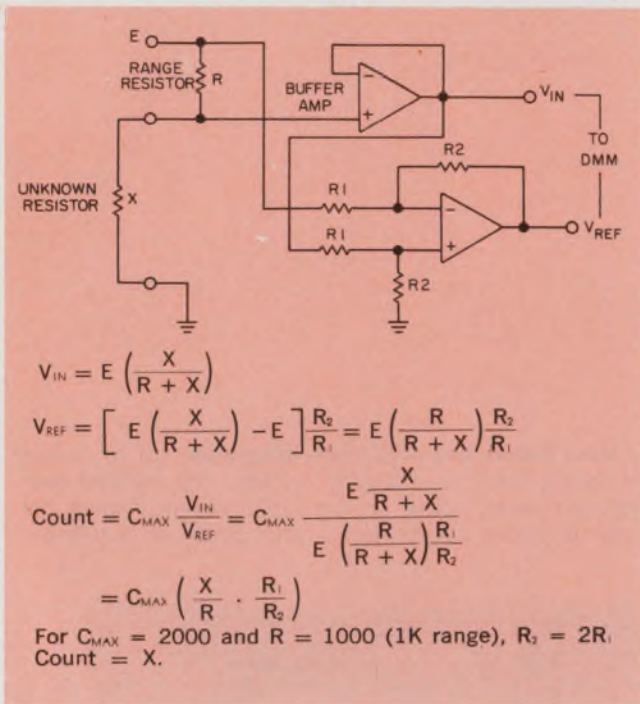

3. Resistances can also be measured as ratios. The ratiometric method offers the advantage of not requiring an extra-stable supply (e) since any drifts in the supply appear in both numerator and denominator.

A word is needed about modification of meters that aren't specifically equipped for ratio measurement. Some meters use a switched current source, applied directly to the integrator, instead of a voltage reference and multiplex switches. These meters are not suitable for ratio measurements without extensive additional circuitry.

On dual-slope meters with a voltage reference, there is usually a buffer amplifier between the reference and the mpx switch. The input to this buffer is the best place to apply the external ratio input. Suitable circuitry should be added to limit the externally-applied voltage to that of the internal reference.

Naturally, modification of the equipment will void a manufacturer's warranty. In any case, modification should be attempted only by technically-skilled personnel.

### Measure resistance and offset by ratio

Various manufacturers have their own names for measuring the resistance of DMMs by ratio; for example, Ratiometric™ and Ratiomic™. The method takes advantage of the dual-slope integrator's ability to measure a ratio (Fig. 3).

If you apply a suitably-buffered external signal to the input of the ratio circuit, the function displayed is:

$$C = C_{max} \frac{V_{in}}{E_{ref} - V_{in}}$$

For our typical 3-1/2-digit meter,  $T = 2000$  and  $E_{ref}$  is 2 V. This results in:

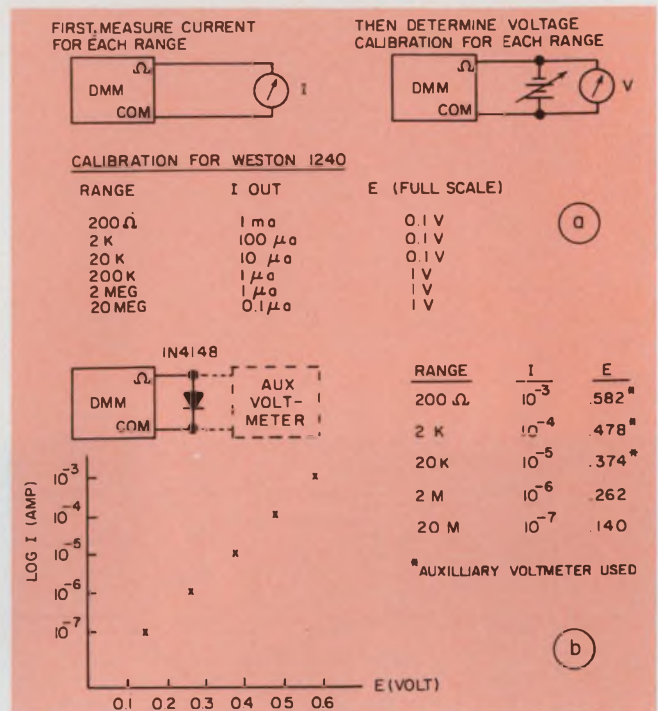

4. To use a DMM as a current source, first measure current output and full-scale voltage for each range (a). As a current source, the DMM can then measure, for example, a diode characteristic (b).

$$C = 1000 \frac{V_{in}}{1 - V_{in}}$$

Thus functions of the type,  $x/(1 + x)$ , can be displayed.

The noise-integrating feature of dual-slope allows you to measure dc offset on ac signals, even when the ac voltage is much greater than the dc offset. As long as the ac frequency is much faster than the sample rate, a clean reading of dc offset should be possible by putting the meter on dc and by applying the ac signal to the input. You must use a range that can accommodate the full ac signal, even when the dc offset is small.

This method works easily. Suppose the input signal is

$$V_{in} = A \cos \omega t + B.$$

Dual slope averages the signal over several cycles giving

$$\begin{aligned}
 C &= \frac{C_{max}}{V_{REF}} \frac{1}{2\pi} \int_0^{2\pi} \frac{2\pi}{\omega} (A \cos \omega t + B) dt \\
 &= \frac{C_{max}}{V_{REF}} \cdot B.
 \end{aligned}$$

To measure offset on low-frequency signals, an external RC filter can be used to give a steady reading after sufficient settling time.

### Using a meter's internal reference

Most DMMs have an internal precision voltage reference—usually a temperature-compensated zener diode operating in a constant-current or self-regulating circuit. Occasionally, this refer-

## Typical systems application: DMM resistor sorting system

This system sorts precision resistors into tolerance categories—necessary when a resistor must be close to a multiple of another. For example, to make an exact divider, a resistor whose value is 0.3% high with respect to its nominal would be paired with one 0.3% above its nominal value.

The user enters the lowest acceptable value on thumbwheel switches (same format as the DMM display), and also the range of values that may be lumped together (a tolerance "bin").

A row of boxes is set up; each box is marked with a tolerance; and each has a light bulb mounted above it. The user connects a resistor to the DMM and then throws the resistor into the box whose lamp lights.

There is also a reject box for resistors not within acceptable tolerance. For example, to sort 1-k $\Omega$  resistors into 0.1% categories, set the low-value thumbwheel switches to 997 and the bin-size thumbwheel to one. The boxes are marked 997, 998, 999, 1000, 1001, 1002 and 1003.

The system operates according to the flow chart. First, a register "C," is loaded with the lowest value. If the DMM reads below that value, the reject light comes on. If not, the bin size is repeatedly added to the "C" register until the contents of the register are greater than the DMM reading. The number of times the bin size is added is then latched, and displayed by one of the bin lamps. Provision is also made to reject resistors that are sorted into the 8th—or greater—bin. ■■

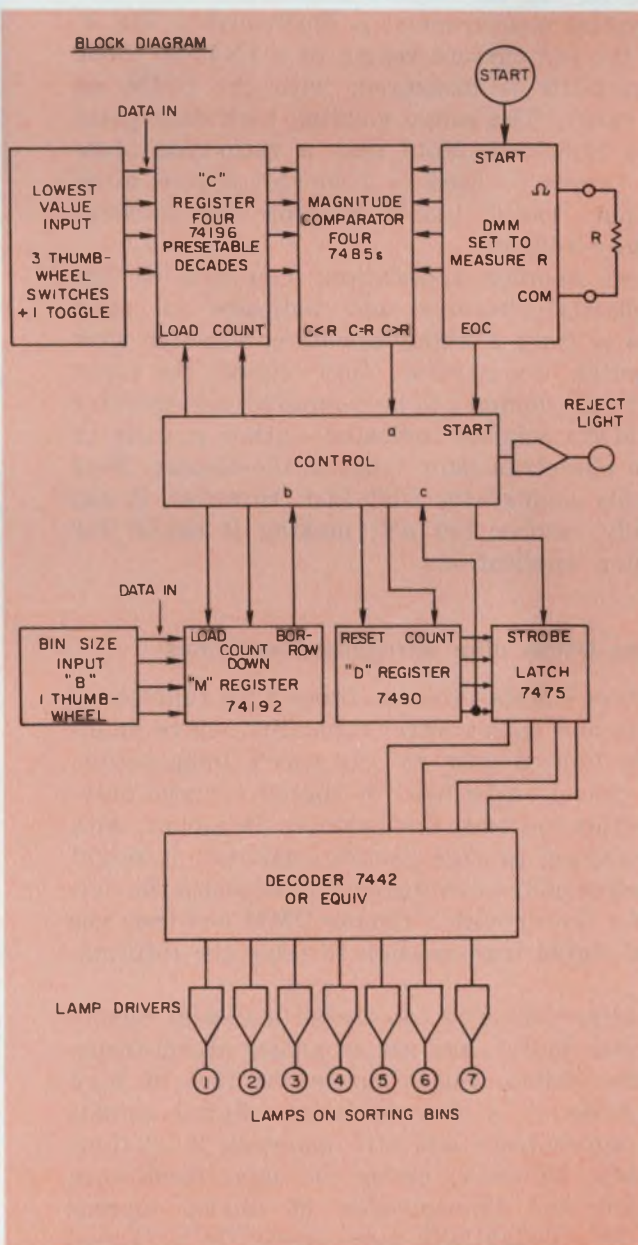
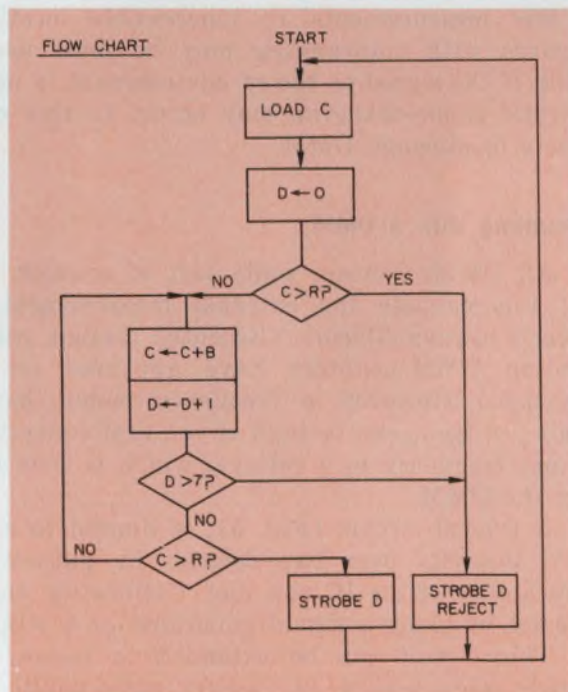
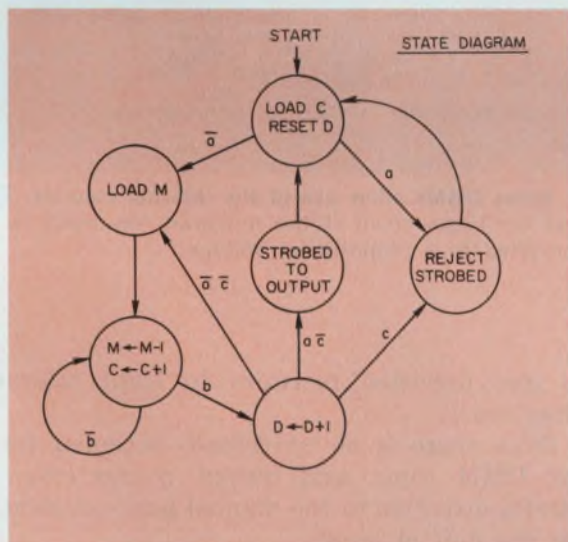

ence voltage is externally available for use in calibration. If not, you can modify the meter to bring it out. Care should be taken to apply only high-impedance apparatus to this output.

DMMs with constant-current-source resistance ranges (Specs should indicate this.) can be used as wide range, precision current sources. Simply switch to the ohms function and connect the input leads to the circuit under test. When this is done, the meter's display monitors the applied voltage.

A displayed overrange or underrange condition indicates that the current source is saturated, and a different range should be used. Caution: on high-resistance ranges (low current) the input is sometimes shunted by a capacitor so that the technique may be used with dc circuits only.

Before you use a DMM as a current source, measure the current and voltage output of each range with an auxiliary meter (if such data is not already in the owners manual).

A typical measurement is illustrated in Fig. 4. Here, the low-current region of a 1N4148-diode characteristic is measured, with the DMM on ohms range. The range yielding each data point is also indicated. Note that a ratio-type ohmmeter cannot be used as a current source, since its input "looks" like a resistor tied to some reference voltage.

Here's another application. You can use the autopolarity circuitry and indicator of most DMMs to form a highly-sensitive, although slow responding, comparator. Just connect the input leads to the voltages to be compared, and monitor the DMM's polarity indicator—either visually or with a phototransistor taped to the display. Note that this comparator isn't fast. However, it can typically resolve 100  $\mu$ V, making it useful for precision applications.

### Systems DMMs offer intriguing possibilities

System DMMs—that is, those with fully-coded outputs and with control capability—have applications limited only by the user's imagination. They can often be used in special-purpose data-acquisition systems. For example, in a plant with a centralized process-control computer, it might be economically advantageous to measure the output of a sensor with a remote DMM and then use digital signal transmission to relay the information.

Alternatively, you can install a special remote converter/buffer, and use an analog signal-transmission system. But, even in the face of high buss noise, it is easy to isolate digital signals with optocouplers and still maintain 3-1/2-digit accuracy. However, under the same conditions, isolation and transmission of analog signals could be substantially more costly. In a typical application of this type, a systems DMM is used

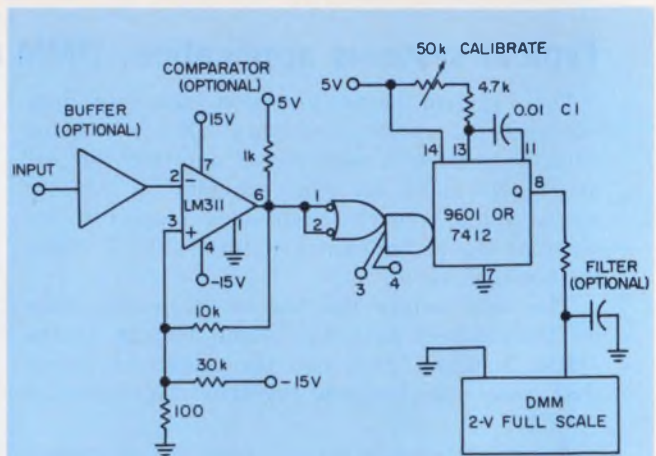

Note: Set calibrate pot for approx. pulse width = 25  $\mu$ s. Trim setting for correct reading.

Other values of  $C_1$  may be used for other frequency ranges.

The DMM reads  $V_o = \text{amplitude} \times \text{pulse width} \times \text{freq.}$   
 For values given here:  
 $V_o = (4)(25 \times 10^{-6})(\text{freq.})$   
 $= \text{freq.} \times 10^{-4}$

Input sensitivity = 100 mV peak-to-peak

5. Some DMMs allow use of the internal counter. Those that don't can count if the unknown frequency is first converted to a proportional voltage.

to sort precision resistors to tight tolerances (See box.).

Since there is no universally-accepted format for DMM input and output connections, pay careful attention to the manual and specifications for the unit at hand.

For measurements in inaccessible locations, meters with autoranging may be most useful. But, if the signal or the rf environment is noisy, erratic range-changing may occur. In this case, use a fixed-range DMM.

### Counting with a DMM

All DMMs contain some sort of counter. Use of this counter for external measurements is nearly always difficult. (Recently, though, combination DMM/counters have appeared on the market.) However, a frequency meter, having fair precision, can be built if you first convert the input frequency to a voltage, which is then read by the DMM.

A typical circuit (Fig. 5), is limited to about 1% linearity over two decades by pulse-width instability of the IC one shot. Calibration should be set by using a signal generator or a scope.

This circuit can be extended in range, and made more precise by careful pulse-width control. But its purpose as a quick-and-dirty meter

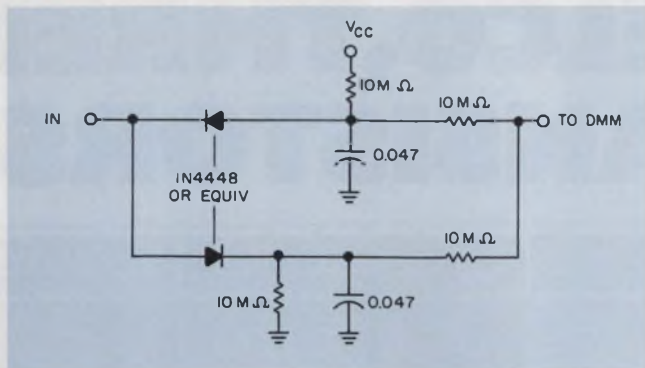

6. Need a logic checker? With this pulse stretcher, a DMM can indicate a HIGH, LOW or pulse train.

is then defeated. The frequency range over which the meter is useful can be extended to 10 MHz by using a faster comparator, such as the Signetics 527. The lower end of the frequency response is limited by the DMM's noise-rejection ability—typically 60 Hz—but can be substantially extended by adding an RC filter, as indicated in the diagram.

Alternatively, a pulse generator with an external trigger input can be used to generate the constant pulse-width. In this case, the pulse-width and amplitude controls are used to set the range and calibration.

Many other applications exist. You can use a

DMM to check digital logic for HIGH, LOW or a pulsing state. Fig. 6 illustrates an RC network that stretches short, bipolar pulses enough to be detected as a mad fluttering of the display.

This application requires a high-input-impedance DMM so that reasonably-sized capacitors can be used. Even so, capacitive loading may cause some circuit degradation. If this is not acceptable, a gate package may be used as a buffer and pulse shaper. Note that the displayed voltages will be increased above the input because of diode drops for both high and low states. An intermediate voltage between high and low on the DMM indicates a pulsing condition. The intermediate voltage is not directly related to duty cycle.

#### Other meters offer other uses

Not all meters are of the dual-slope type. For instance, one low-cost DMM uses a single-slope conversion method, which has insufficient noise rejection for some of the applications described in this article. Another popular model uses a voltage-to-frequency converter scheme, implemented in LSI. Still another DMM uses a triple-slope integration scheme to achieve high resolution, while it maintains a reasonable sample rate. Each of these units should have its own unique applications. ■■

## Two-for-One Money Saver New from Monsanto.

### 1. It's A Function Generator!!

- Frequency Range 10Hz to 1MHz
- Setability and Resolution to 0.1Hz with digital display
- Low Distortion—typically 0.1%
- Functions: Sine, Square and Offset Square Waves
- Attenuator—3,20db sections plus vernier to 4VRMS

### 2. It's A Counter!!

- Frequency Range 5Hz to 15MHz
- Six gate times for resolution to 0.1Hz
- 4 Digit LED display with memory
- Input sensitivity, 50mV RMS
- Crystal Controlled Time Base





It's A Function Generator/Counter!! Only \$445.

United Systems Corporation, 918 Woodley Road, Dayton, Ohio 45403 (513) 254-6251

A Subsidiary of

# Monsanto

# FROM DELCO, THREE POWER TRANSISTORS.

	TYPE	V <sub>CEO</sub>	V <sub>CEV</sub>
	DTS-708	900V	900V
	DTS-709	900V	900V
	DTS-710	900V	—

We'd like to simplify your life while you simplify your high energy circuits.

These three new devices are all NPN,

triple diffused and packaged in Delco's solid copper TO-204MA packages (TO-3 to you old-timers) for man-sized power handling.

DTS-708 and 709 are designed for use in high voltage switching applications—where inductive loads or fault conditions may be giving you problems now. The DTS-710 is ideal for linear regulators and power amplifiers.

Safe Operating Curves on the data sheets let you know where it's at. And our applications engineering assistance is available, too.

You probably know about our reputation for making really tough transistors—for high peak energy handling. You'll find we can deliver, too.

All of the Delco distributors listed have the DTS-700 series in stock.

Give yours a call now for the prices you'll like and the data you'll need.

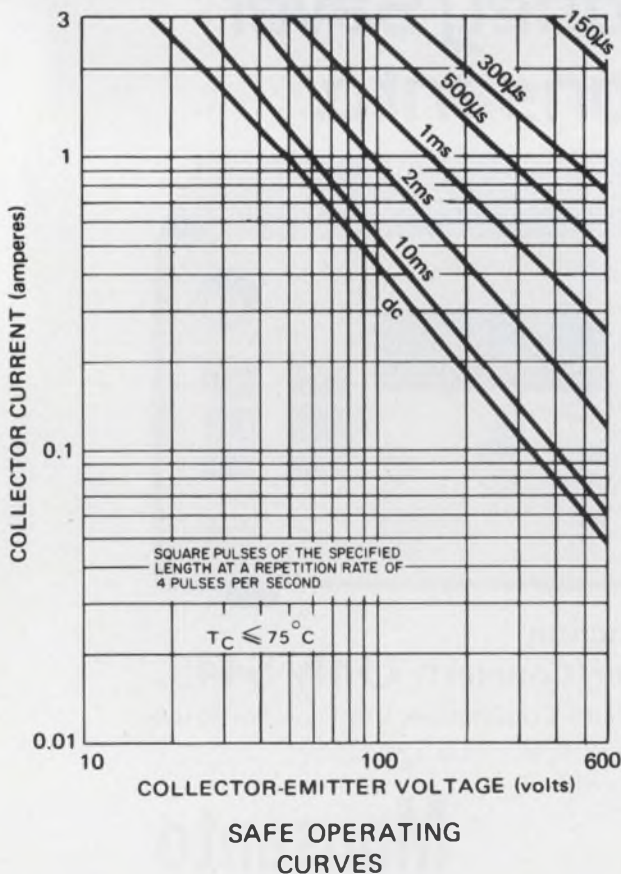

## NOW AVAILABLE FROM THESE DISTRIBUTORS IN PRODUCTION QUANTITIES.

**ALABAMA, Birmingham**  
Forbes Distributing Co., Inc.  
(205) 251-4104

**ALABAMA, Huntsville**  
Powell Electronics  
(205) 539-2731

**ARIZONA, Phoenix**  
Sterling Electronics, Inc.  
(602) 258-4531

**CALIFORNIA, Goleta**  
Radio Products Sales, Inc.  
(805) 964-4764

**CALIFORNIA, Los Angeles**  
Kierulff Electronics, Inc.  
(213) 685-5511

**CALIFORNIA, Los Angeles**  
Radio Products Sales, Inc.  
(213) 748-1271

# NEW 900-VOLT SILICON

V <sub>CEO</sub> (sus) I <sub>C</sub> = 1 A	V <sub>CE</sub> (sat)	hFE Min/Max	I <sub>C</sub>
600V	2.0V (I <sub>C</sub> = 1 A, I <sub>B</sub> = 250mA)	—	3A
600V	1.0V (I <sub>C</sub> = 2A, I <sub>B</sub> = 800mA)	—	3A
600V	—	10/50	3A

**CALIFORNIA, Palo Alto**  
Kierulff Electronics, Inc.  
(415) 968-6292

**CALIFORNIA, Sunnyvale**  
Cramer/San Francisco  
(408) 739-3011

**CALIFORNIA, San Diego**  
Kierulff Electronics, Inc.  
(714) 278-2112

**CALIFORNIA, San Diego**  
Radio Products Sales, Inc.  
(714) 292-5611

**COLORADO, Denver**  
Cramer/Denver  
(303) 758-2100

**CONNECTICUT, Norwalk**  
Harvey/Connecticut  
(203) 853-1515

**FLORIDA, Miami Springs**  
Powell Electronics/Florida  
(305) 592-3260

**FLORIDA, Orlando**  
Powell Electronics/Florida  
(305) 859-1450

**ILLINOIS, Rosemont**  
Kierulff Electronics, Inc.  
(312) 678-8560

**ILLINOIS, Skokie**  
Bell Industries  
Electronics Distributors Div.  
(312) 282-5400

**INDIANA, Indianapolis**  
Graham Electronics Supply, Inc.  
(317) 634-8202

**MARYLAND, Baltimore**  
Radio Electric Service Co.  
(301) 823-0070

**MASSACHUSETTS, Needham Heights**  
Kierulff Electronics, Inc.  
(617) 449-3600

**MASSACHUSETTS, Newton**  
The Greene-Shaw Co., Inc.  
(617) 969-8900

**MICHIGAN, Farmington**  
Harvey/Michigan  
(313) 477-1650

**MINNESOTA, Minneapolis**  
Stark Electronics Supply Co.  
(612) 332-1325

**MISSOURI, Kansas City**  
Walters Radio Supply, Inc.  
(816) 531-7015

**MISSOURI, North Kansas City**  
LCOMP-Kansas City  
(816) 221-2400

**MISSOURI, St. Louis**  
LCOMP-St. Louis  
(314) 647-5505

**NEW JERSEY, Clifton**  
Wilshire Electronics/New Jersey  
(201) 365-2600 (212) 244-8930

**NEW YORK, Binghamton**  
Harvey/Federal  
(607) 748-8211

**NEW YORK, East Syracuse**  
Cramer/Syracuse  
(315) 437-6671

**NEW YORK, Rochester**  
Cramer/Rochester  
(716) 275-0300

**NEW YORK, Woodbury**  
Harvey/New York  
(516) 921-8700 (212) 895-9260

**OHIO, Cincinnati**  
United Radio, Inc.  
(513) 761-4030

**OHIO, Cleveland**  
Pattison Supply Co.  
Industrial Electronics Division  
(216) 441-3000

**OHIO, Dayton**  
Kierulff Electronics, Inc.  
(513) 278-9411

**PENNSYLVANIA, Philadelphia**  
Almo Electronics  
(215) 676-6000

**PENNSYLVANIA, Pittsburgh**  
RPC Electronics  
(412) 782-3770

**SOUTH CAROLINA, Columbia**  
Dixie Radio Supply Co., Inc.  
(803) 253-5333

**TEXAS, Dallas**  
Adleta Electronics Company  
(214) 741-3151

**TEXAS, Fort Worth**  
Adleta Electronics Company  
(817) 336-7446

**TEXAS, Garland**  
Kierulff Electronics, Inc.  
(214) 271-2471

**TEXAS, Houston**  
Harrison Equipment Co., Inc.  
(713) 224-9131

**UTAH, Salt Lake City**  
Cramer/Utah  
(801) 487-3681

**VIRGINIA, Richmond**  
Meridian Electronics, Inc.  
(703) 353-6648

**WASHINGTON, Seattle**  
Kierulff Electronics, Inc.  
(206) 763-1550

**IN CANADA**  
**ONTARIO, Scarborough**  
Lake Engineering Co., Ltd.  
(416) 751-5980

**ALL OVERSEAS INQUIRIES:**  
General Motors Overseas Operations  
Power and Industrial Products Dept.,  
767 Fifth Avenue, New York, N.Y.  
10022. Phone: (212)-486-3723.

**Delco Electronics**  
**Regional Sales Offices**  
Union, New Jersey 07083  
Box 1018 Chestnut Station  
(201) 687-3770

El Segundo, California 90245  
354 Coral Circle  
(213) 640-0443  
General Sales Office  
700 E. Firmin, Kokomo, Ind. 46901  
(317) 459-2175  
Operator (317) 457-8461



Delco Electronics, Division of General Motors.

# When d/a converter glitches rear their heads, check the application. A deglitcher circuit added to the required DAC may solve your problem.

All simple digital-to-analog converters have an inherent limitation that causes troublesome transients, or glitches. One solution is to buy a DAC with circuitry that minimizes the output glitches. But it could cost you up to 10 times more than the simpler DAC, and it's possible that the corrective circuits will cause more problems than they solve.

A wiser way is to analyze your application carefully. It may be that you can correct the problem by adding a deglitcher circuit to the DAC—at relatively modest cost.

DAC switching circuits and their digital drive signals almost always have different turn-on and turn-off times, and because of this, an ambiguous code region inevitably results. During the time when logic inputs are changing (skew time), the analog portion of the DAC will produce a transient error, or glitch.

The glitch will be most severe at the time of the major carry—when all the logic inputs are changing. For a DAC whose analog output is always positive, the single-count transition between 011...111 and 100...000 could produce an intermediate logic state of 000...000 or 111...111 during the skew interval. This momentary logic input will force the analog output of the DAC to slew towards either voltage extreme for the duration of the skew time (Fig. 1).

Thus fast-slewing DACs can produce large transients if corrective measures are not taken.

In high-speed automatic test equipment, process-control systems and interactive displays, transients from DACs can cause such headaches as damage to components under test, overloading of the sensing circuits or even averaged errors in high-inertia electrical and mechanical systems.

In CRT displays the use of DACs to generate sweeps, characters, vectors, and for positioning and intensification of displays has increased. Glitches on CRT displays give one result—distortion. Straight-line vectors will have intensity and position nonuniformity, characters will be

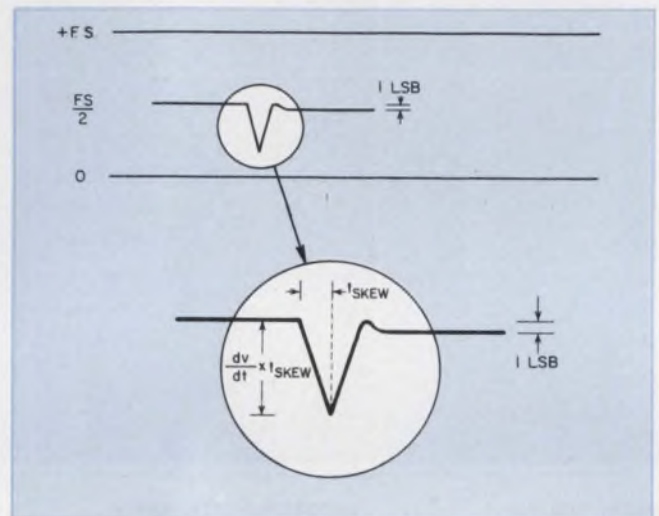

1. The major carry transition at the DAC half-scale shows the glitch caused by skewed data on the inputs and a high op-amp slew rate.

distorted and TV rasters will have erroneous vertical lines.

## What can be done?

The basic voltage-output DAC is shown in Fig. 2a. This unit has direct access to all its switches and its current reference source. The amplitude of a glitch depends to a large degree on input-logic skew time. This skew time (caused by unequal turn-on/off times and bit transmission delays) can be minimized if all logic bits are loaded into a storage register before transfer to the DAC (Fig. 2b). The simultaneous transfer of all bits into the DAC will limit skew times to those of the register and DAC switches. Selection and matching of storage registers and DACs for minimum bit switching time differences can optimize the system for many applications.

Fast-slewing DACs tend to generate the largest glitches. For these and other applications, the storage-register solution will not suffice. For example, with use of the formula shown in Fig. 1, an amplifier slewing at  $30 \text{ V}/\mu\text{s}$  for a skew time of 5 ns will have a 150-mV glitch amplitude.

By incorporating a "blanking window" around

Dave Pinkowitz, Project Manager, ILC Data Device Corp., 100 Tec St., Hicksville, N. Y. 11801.

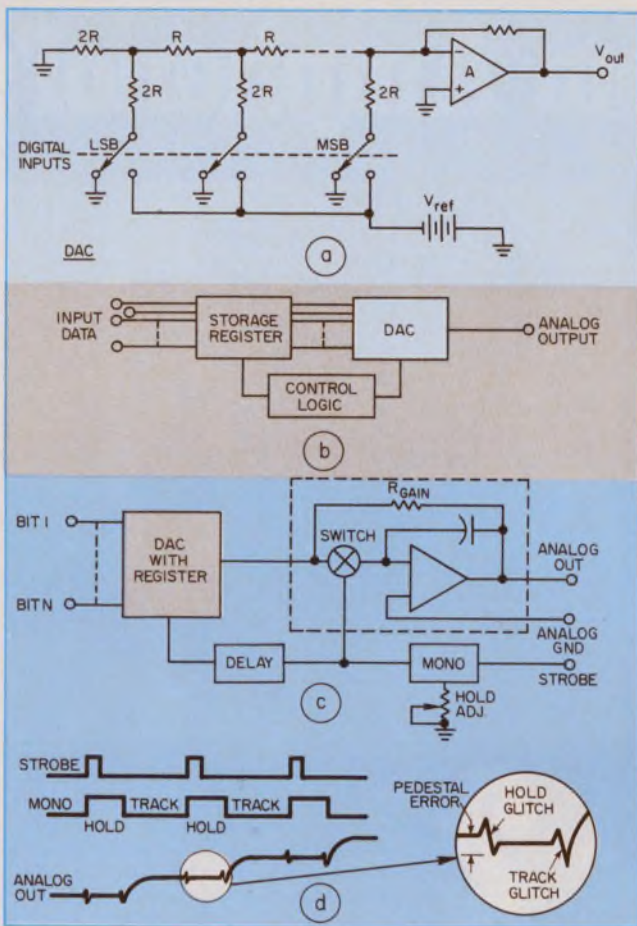

2. The basic DAC (a) can be improved by adding a storage register (b) and then a track-and-hold amplifier (c) to eliminate some of the major glitches that would otherwise appear in the output (d).

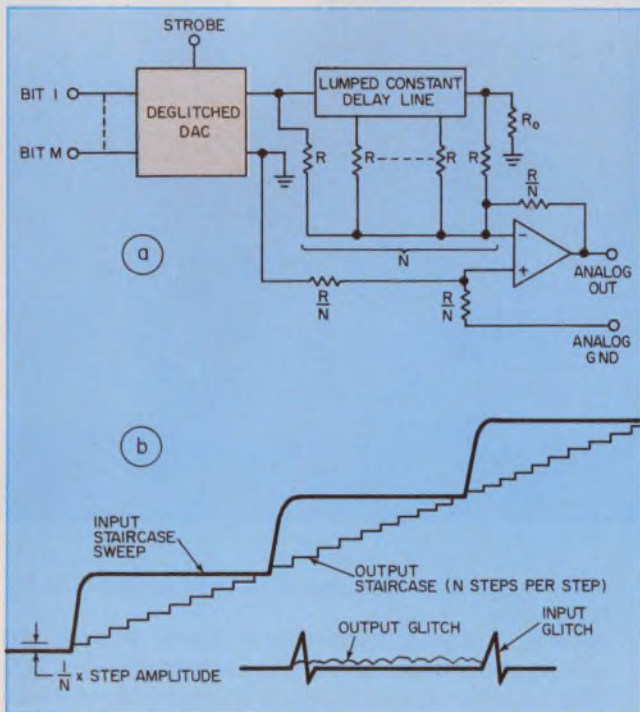

3. The addition of a multitapped delay line (a) to the deglitched DAC lets the boxcar integrator average glitches over the conversion cycle (b) to reduce the quantization error in a staircase sweep.

the glitch, in addition to the storage registers, you can get a further order-of-magnitude improvement in the glitch height. A logical choice for generation of the blanking window is a track-and-hold amplifier. Its design is relatively simple, and it eliminates the need for another output amplifier in the DAC. Fig. 2c shows a block diagram of this deglitched DAC. Proper selection of the track-and-hold amplifier hold time will eliminate nearly all traces of the DAC glitch at the output by deactivating the amplifier circuit during the DAC switching time.

Unfortunately that's not all there is to it. Track-and-hold amplifiers have their own transient problems, as can be seen in Fig. 2d. The signal required to open the switch (hold mode) will also cause both glitch and pedestal errors. This is due to capacitive transfer of residual charge across the turned-off semiconductor switch onto the holding capacitor. The same switch signal will cause a glitch during switch closure (track mode). Careful circuit design and care in component selection and design symmetry can reduce the glitch height to 10 mV or less with essentially zero pedestal error.

### Get even higher accuracy

There are even applications, particularly in high-resolution displays, where the track-and-hold amplifier doesn't give sufficient glitch suppression. For the best linearity, a boxcar integrator can be added to the deglitched DAC.

Fig. 3a shows the deglitched DAC output driving a multitapped delay line. The taps on the line are weighted and summed by a fast operational amplifier. Any glitch present at the DAC output will be reduced in amplitude by a scale factor of N and then reproduced N times during the full delay time, where N is the number of taps in the delay line. Since the amplitude of the deglitched DAC spike depends only on the characteristics of the track-and-hold amplifier, careful circuit design can yield identical repetitive glitches that are independent of the DAC input codes. These identical glitches are then averaged every conversion cycle by the boxcar integrator, and they produce a small, transient-free dc offset (Fig. 3b). Now the offset adjust can eliminate the dc offset.

The quantized nature of the DAC outputs has so far been overlooked. The number of bits present in the DAC determine the number of discrete output levels it can attain, and therefore its resolution. A digitally generated sweep can approximate a straight line no more closely than its resolution allows. In this case the boxcar integrator provides an additional feature. A digitally generated sweep (Fig. 3b) driving a boxcar integrator, will produce a sweep with an N-times reduction in quantizing error. ■■



# More ideas from Amphenol's

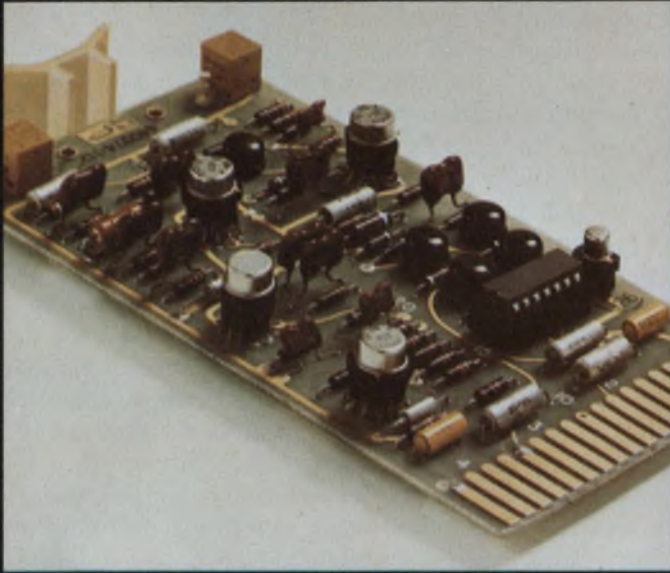

**level 1** Low-cost sockets for transistors in TO packages (above) allow easy replacement and service. ■ New IC sockets are end and side stackable for maximum single board density. Low profile design also allows maximum multi-board density.

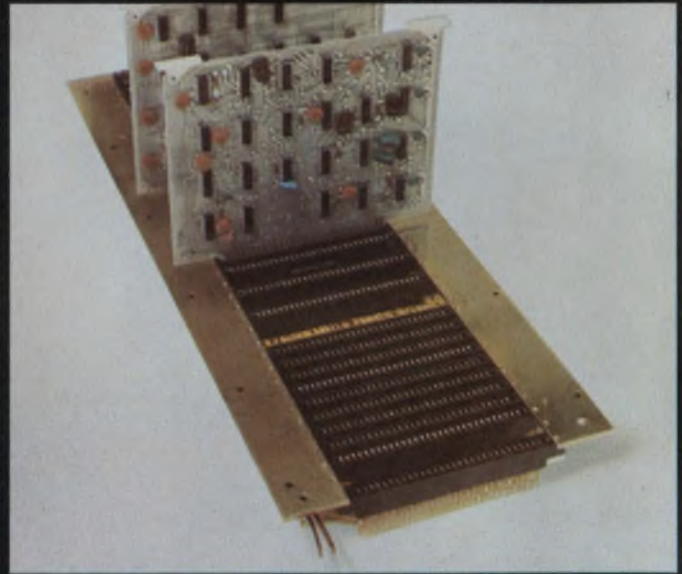

**level 2** Back panel edge board connectors with bifurcated contacts (above) can be wire wrapped or clip-terminated. ■ Bellows contact PC connectors (below) cut interconnection costs without sacrificing performance.

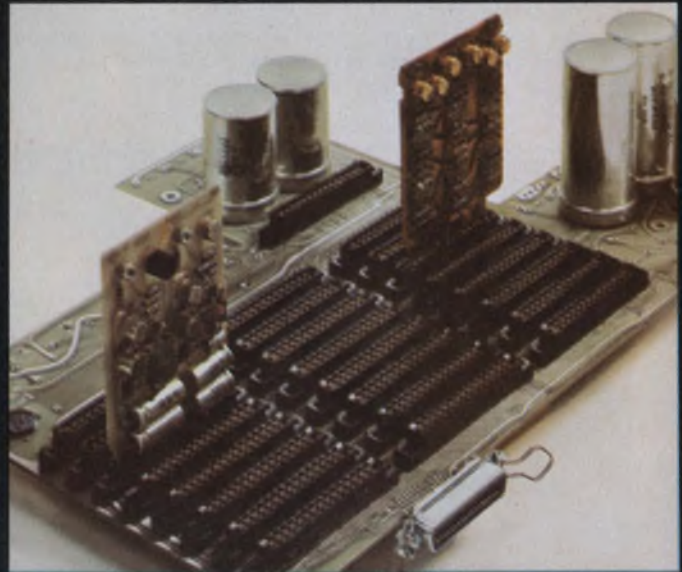
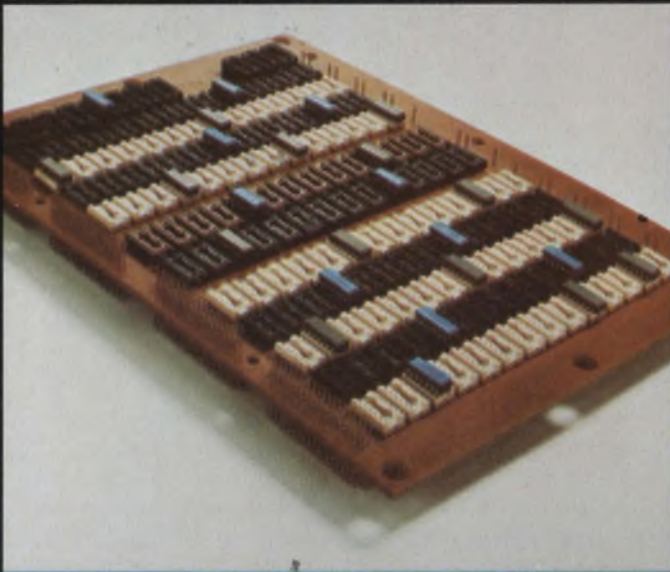

Above are seven new ideas from Amphenol Industrial Division's Spectrum of interconnection capability.

Amphenol's SPECTRUM offers you *all four* levels of interconnections from our unmatched breadth of product line:

**Level 1 . . . DEVICE TO BOARD OR CHASSIS.** We offer interconnections for components such as tubes, relays, transistors, IC packages, trimmers, resistors or capacitors to a PC board or chassis.

**Level 2 . . . BOARD TO MOTHERBOARD OR BACK PLANE.** We offer interconnections for PC boards or

other sub-circuit modules to a motherboard or to a back plane.

**Level 3 . . . MOTHERBOARD OR BACK PLANE WIRING.** We offer interconnections for levels to each other and to other sub-circuits with multi-layer circuit boards, wire wrapping, clip terminations, jumper techniques and dip-soldering.

**Level 4 . . . INPUT/OUTPUT CONNECTIONS.** We offer interconnections for power and signals to and from a system. This interface may be between sub-assemblies within the same enclosure or between individual units.

# Spectrum of interconnections.

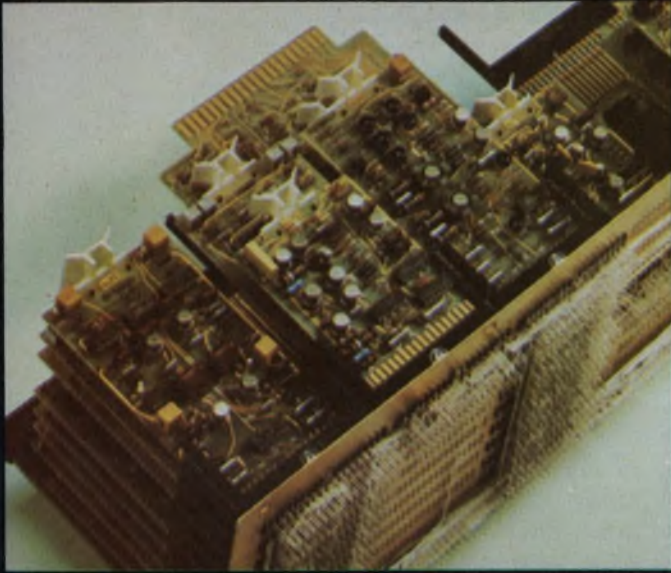

**level 3** Direct entry plate assembly offers modular packaging flexibility. Custom designed plates accommodate any size or style PC board with no tooling cost to you. Rectangular posts are true positioned for automatic wire-wrapping.

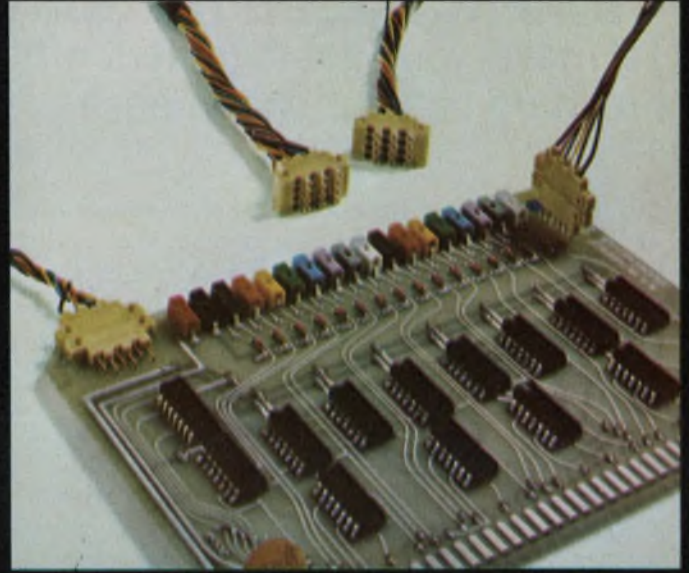

**level 4** Miniature contact (3 input, 3 output) hermaphroditic connectors can be snapped together to connect as many circuits as required. ■ Single finger-tip mounting of low cost connector saves assembly time. Available in UL Class SE-1 flammability rated material.

Write for our Spectrum brochure covering all levels of interconnections.

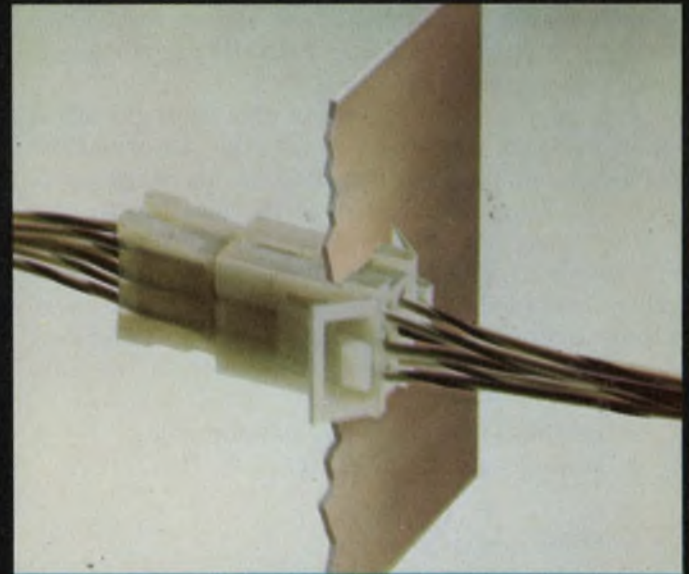

From the simple tube socket—to a myriad of electrical/electronic connectors—to complete and complex termination systems . . . SPECTRUM.

But SPECTRUM is far more than products. It is a depth of capability in engineering, manufacturing and quality control. Amphenol's SPECTRUM is a new height of service, availability and distribution backed by seven Amphenol interconnection-oriented divisions.

Amphenol can fulfill your total interconnection requirements because we are not limited to specifics such as one or two product lines, one or two levels.

Therefore we approach your interconnection needs with complete open-mindedness.

For more new ideas and specific information, write for your copy of "SPECTRUM." Amphenol Industrial Division, Bunker Ramo Corp., 1830 South 54th Ave., Chicago, Illinois 60650.

**BUNKER RAMO** AMPHENOL

## Time-managed meetings are a must!

To make your get-togethers efficient and worth calling, brush up on your chairmanship, a veteran chairman advises.

Considering that time-wasteful conferences are so universally condemned, it's strange that many managers still don't try to plan concise, efficient meetings. Most of the meetings that I've attended, including a good many that I chaired, have been far too long, and many were not even worth calling.

There are only two basic reasons for calling people together: first, to inform or coordinate by interchange of information; second, to present a problem for solution by the group. (Infrequently a meeting is called to spread responsibility for a bad decision, but I won't discuss that here.)

A group of more than six people is unlikely to do any worthwhile original thinking; nor can it seriously analyze a complex situation. If you want new ideas, send two or three congenial thinkers to a clean blackboard. If you want penetrating analysis, put one man in an office and close the door.

Call people together only to give or to get information—and remember that the information-givers must be forewarned to be prepared properly. Post the agenda before the meeting to give those attending a chance to refresh themselves. If you've chaired a few meetings, you've probably concluded, as I have, that their conduct generally boils down to these three basic challenges:

- Keeping the discussion focused on the subject.
- Letting everyone have his moment.
- Making it your meeting.

### A real-time display of talent

As a manager, or manager-to-be, you cannot afford to conduct meetings that waste the participant's time or that accomplish little. In most things the performance of a manager is judged in the aftermath. The new product stands up in the field, departmental operations are held within the budget for the quarter, or the company

shows a profit at the end of the fiscal year. Success or failure is uncertain until the summing up. But as the leader of a group discussion—large or small—your effectiveness is on display in real time and subject to instant evaluation by your associates.

It's easy for all to see if the leader is firm in keeping the discussion on the proper track, skillful in encouraging the reticent, tactful in discouraging the long-winded and intent upon useful results. At the head of the table, your visibility is at a maximum.

As everyone who has ever led a conference knows, the most difficult challenge is to keep the discussion focused on the subject. I've found that, on the average, only about three people comment on a question before a fourth introduces an extraneous topic that leads the pack astray. This can frustrate conscientious young chairmen. Older hands know that it is inevitable, and they either persist in bringing the discussion back on course, or—if they sense that little useful material remains to be found in the original subject—they let the group take a more productive new direction.

The best suggestion I can offer to keep those at a conference from wandering off the subject is to stop the wanderers promptly—before they can complete their points. Once a participant has got in his licks, his comments are usually interesting to others in the meeting, and they'll follow his lead quite eagerly, often forgetting the purpose of the meeting.

Except in particularly hurried circumstances, it's unwise to try to channel the entire course of a meeting too closely. Individuals vary too much in their experience, reactions and modes of thought to reason in single file for very long. Each participant is also working toward a different set of personal goals, quite aside from those of the assembly. These personal goals may be subconscious or unacknowledged, but they are there. One person may consider the meeting a success, for example, if he has been able to make a telling point against a rival; others may feel that much has been accomplished if their attempts at humor have won laughter. And, of course, none of us is good at distinguishing be-

---

Robert P. Owen, Manager of Mechanical Design, Medium Systems Plant, Burroughs Corp., Pasadena, Calif. 91109.

## Robert P. Owen

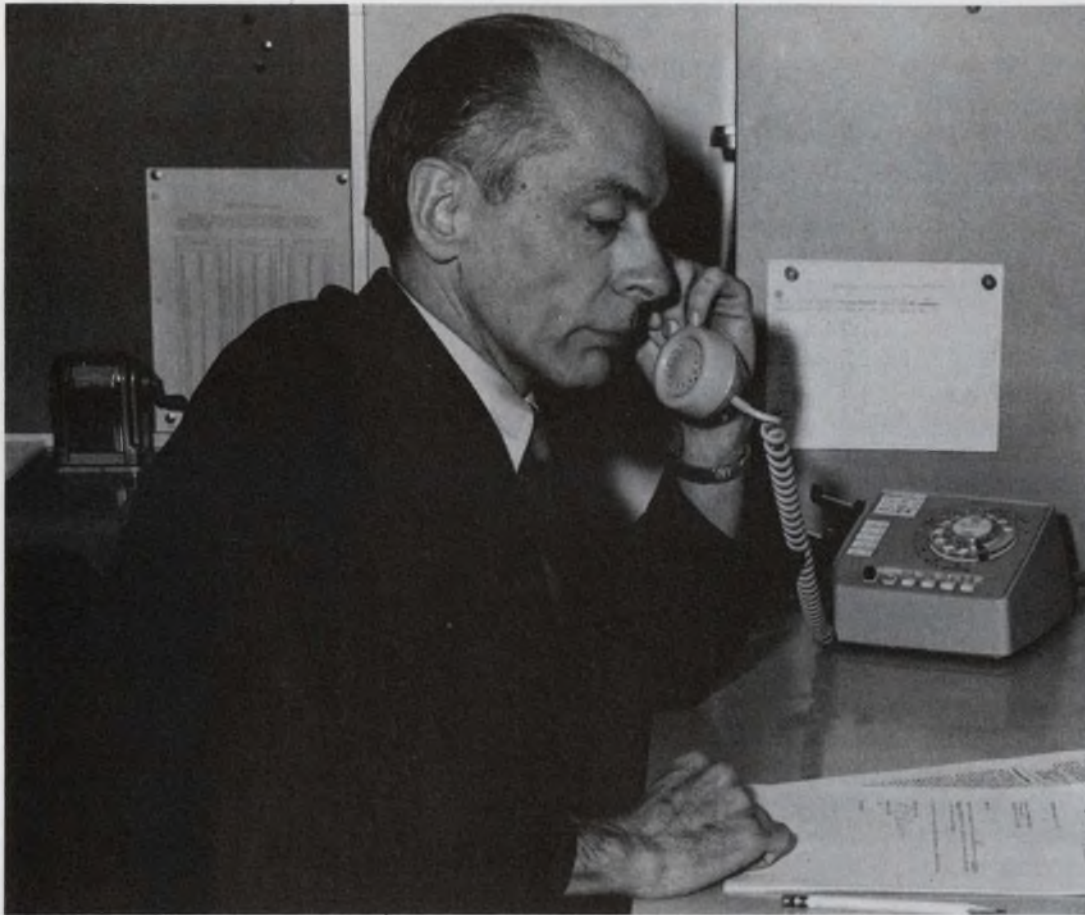

**Education:** BSEE and ME, University of Louisville.

**Responsibility:** Manager of mechanical design, medium systems plant, Burroughs Corp.

**Experience:** Electronic engineer, Allen B. DuMont Laboratories, Bendix Aviation Corp., and Consolidated Electrodynamics; directed own company, Owen Laboratories, Inc., for 15 years and upon selling this to Berklenics, Inc., went with the latter as division manager and R&D V-P. With Burroughs since 1970.

**Publications, patents:** Articles on circuit design and acoustics; five patents covering electronic and optical instruments.

**Affiliations:** Senior member of IEEE; registered professional engineer in California.

**Activities:** President of educational foundation, and director of industrial workshop.

**Personal:** Married, three sons, one daughter; hobbies include: machine and wood shop, shooting, writing, history.

**Employer:** The Medium Systems Plant of Burroughs Corporation, Pasadena, designs and produces the central systems of medium-scale digital computers. Among these are well-known B3500, B3700, and B4700 computers. Systems developed here have pioneered many advanced concepts, including that of virtual memory. The mechanical design section of this plant is responsible for all system hardware other than the electronic circuitry, including semiconductor packages, etched boards, cables and connectors, displays, cabinets, acoustics, and cooling.

tween true accomplishment and the glow that comes from having been listened to with rapt attention by our corporate betters.

Keep in mind, as the conference progresses, that the quietest members may possibly have the most pertinent and worthwhile contributions to make. Perhaps they are the types who feel that

the intelligent man waits for a pause in the conversation before stating his reasoned conclusions.

This pause never comes, of course; so it is up to you, as chairman, to see to it that everyone has his moment. Otherwise you may not only miss something of value; you may also send



**Ansley**

**Blue Streak™**  
**CABLE/CONNECTOR SYSTEM**



Here's Ansley's new cable for your wiring needs. It's rated for 105°C... flame retardant... 50 conductors or less... .050" centers... choice of 28 AWG stranded or solid or 30 AWG solid... cable on 100' reels from stock! Want more features? It's color coded every fifth conductor... separates by hand for breakouts... connectors to match from stock.

And there's more... plus a SHURE-STAKE® hand tool for the field installation.

Write for complete brochure and sample.



**Ansley**

**ANSLEY ELECTRONICS CORP.**

Subsidiary of Thomas & Betts Corporation

3208 Humboldt St., Los Angeles, Ca. 90031  
Tel. (213)223-2331, TWX 910-321-3938

some good men back to their offices feeling that these get-togethers are for the birds.

### The chairman as catalyst

If your meeting is to be both effective and efficient, you must make it *your* meeting. This doesn't mean that you should conduct business with a shape-up-or-ship-out attitude. But you should accept responsibility for the results and for the time taken to arrive at them.

The best chairman is demanding, alert and good-humored in keeping the discussion directed to the question; active in drawing out each participant; and careful not to slight anyone's contribution. If the purpose of the meeting is to inform, the chairman presents the information, allows time for it to be understood clearly and then adjourns the session. If the purpose is to solve a problem, he states it and encourages questions and discussion. If a solution does not appear after a relatively short time, he will usually adjourn the meeting until afternoon or the following day—perhaps with the request that certain people think intensively about specific aspects of the problem.

There's a tendency these days to avoid structuring meetings, even a meeting of half a dozen people. I think the purpose of many meetings is lost by the failure to organize them. I don't think many participants object to a direct, forceful leader, if it means that they'll get out of the meeting 30 minutes to an hour earlier.

### In defense of the direct approach

What techniques can the chairman use?

One thing that may puzzle a chairman of a meeting of 10 to 15 people is how to get their attention. If there are two or three groups of people in private conversation around the room and you want to bring the meeting to order without clearing your throat or tapping on the table with a coin, you can do it with tact and dignity simply by standing up. That usually creates a stir, and people's eyes turn toward you; they hesitate in their talking. Then when you start speaking in a normal voice, you have their attention without having made any great stir.

Another technique I employ is the direct approach. I have a personal aversion to trying to start a meeting with a witticism. There's no opening like a direct approach to a problem, with no preliminary remarks. I'm not against humor at meetings, but not at the beginning—it seems to set a false note.

On the whole, short but productive meetings result not from mystical management skills but from the chairman's commitment to brevity and accomplishment, and his unmistakable projection of these goals to the participants. ■■

# Strength where it's needed!



A broken line when you're interconnecting p.c. boards can be disastrous too.

Sure you can catch a 12 pounder on light line. It takes skill. But there's more to it than that. That lightweight, flexible rod is made to take the stress over its entire length. And that is just what you get in Ansley FLEX STRIP® Jumpers. When you flex an Ansley Jumper the pins don't bend . . . the Jumper does.



The secret is round pins and flat conductors. Round pins to fit p.c. board hole patterns. Flat conductors for flexibility . . . to take the bends.

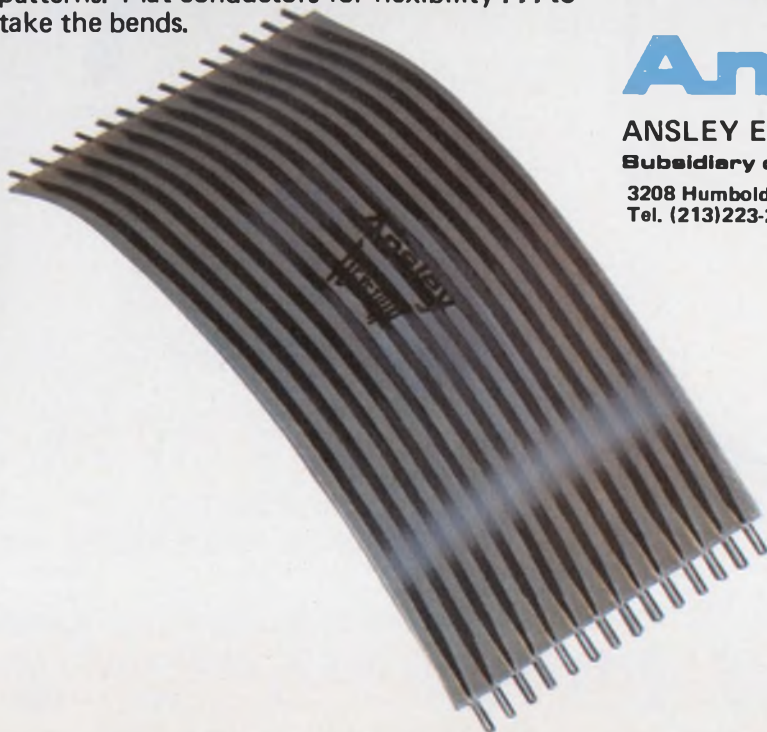

Four insulating materials are available to cover a wide range of temperature (and cost requirements). Nomex\*, Mylar\*, Teflon\*, Kapton\* are available. Standard lengths are 1", 2" and 3". Conductor pin spacing can be .050, .100, .125, .150 or .200.

\* Dupont Trademark

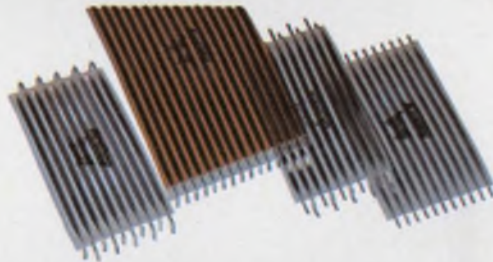

Four pin configurations are also options. Straight, 90° bend, straight or 90° staggered and you have a complete line of the best Jumpers money can buy.

## Ansley

ANSLEY ELECTRONICS CORP.

Subsidiary of Thomas & Betts Corporation

3208 Humboldt St., Los Angeles, Ca. 90031  
Tel. (213)223-2331, TWX 910-321-3938



Get a sample and see for yourself.

INFORMATION RETRIEVAL NUMBER 46

# Here's how we help jumbo jets get off the ground.

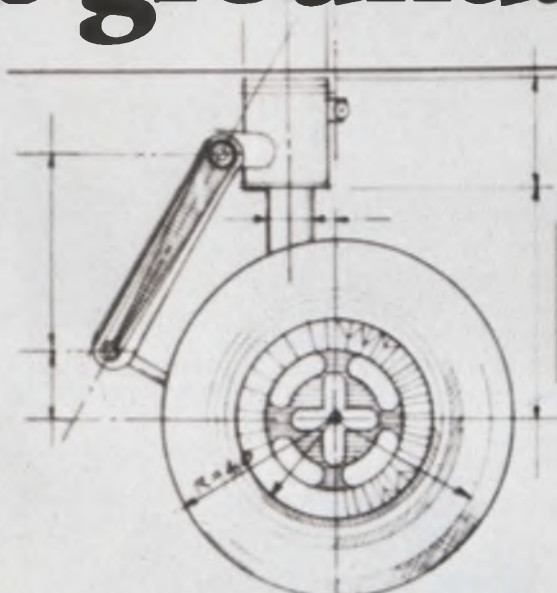

SOLID-STATE FW PROXIMITY HAS SWITCHING & SENSING ELEMENTS SEALED IN SINGLE UNIT. PROVIDES RELIABLE, NO-TOUCH SWITCHING FOR LANDING GEAR AND CONTROL SURFACE POSITION DETECTION. VARIATIONS OFFER SURFACE OR THRU-PANEL MOUNTING, HIGH-SPEED SENSING AND CIRCUITRY OUTPUT OPTIONS.

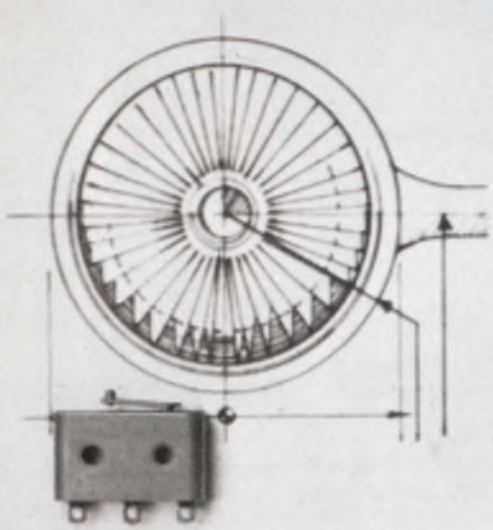

HERMETICALLY-SEALED HM FUNCTIONS IN PRESSURE SWITCH CONTROLS AND CONTROL VALVES. LARGER, HERMETICALLY-SEALED HS OPERATES IN TEMPERATURE RANGE FROM  $-100^{\circ}$  TO  $+500^{\circ}$  F AND TO 25 AMP DC.

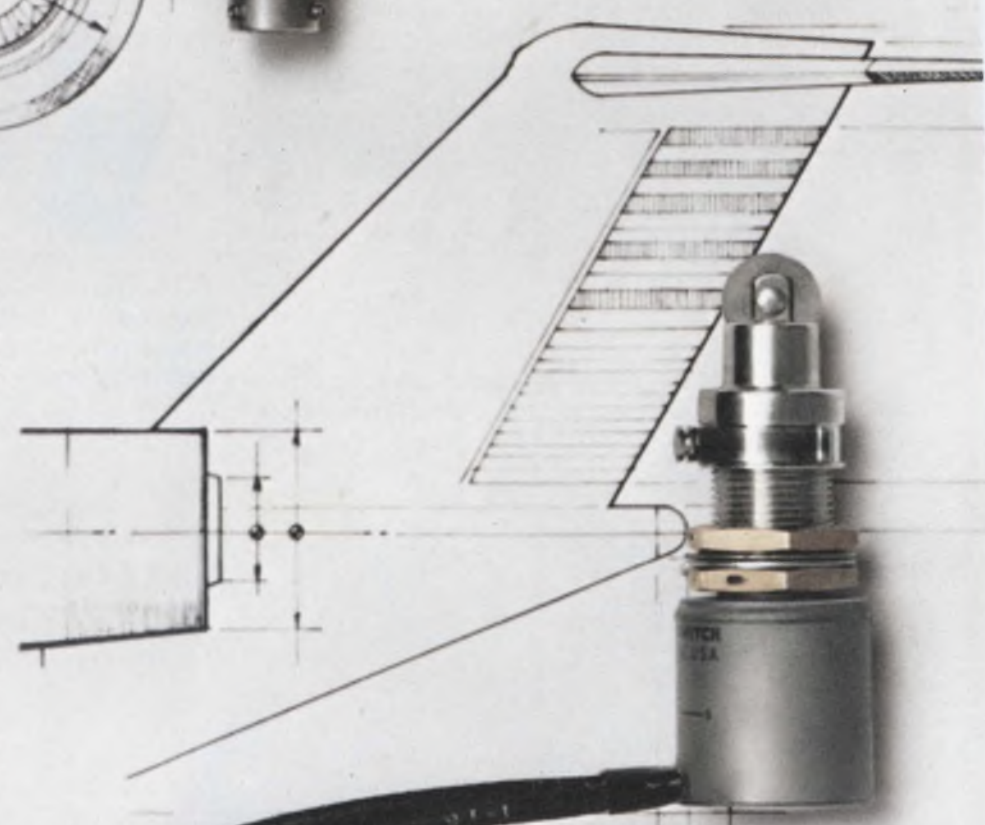

ENVIRONMENTALLY-SEALED EN'S CAN SENSE POSITION OF DOORS & CONTROL SURFACES, INDICATE STATUS OR INITIATE ACTUATOR CONTROL. OFFER WIDE ELECTRICAL RANGE, CHOICE OF TERMINATIONS & OPERATING CHARACTERISTICS. COMPLEMENTARY PRODUCTS OFFER HERMETIC SEALING AND TEMPERATURE RANGES TO  $+600^{\circ}$  F.

TL TOGGLES WORK AS COCK-  
 PIT CONTROLS AND IN MANUAL  
 INPUT PANELS. MEET MIL-S-3950.  
 AVAILABLE WITH UP TO FOUR SPDT  
 CIRCUITS & WITH  
 SCREW, SOLDER,  
 OR INTEGRATED  
 WIRING TERMINA-  
 TIONS. COMPLE-  
 MENTARY TOGGLES  
 OFFER VARIETY  
 OF ACTUATORS,  
 HERMETIC SEAL-  
 ING, UP TO 10  
 POLES, SPECIAL  
 CIRCUITRY AND  
 ROCKER ACTION.

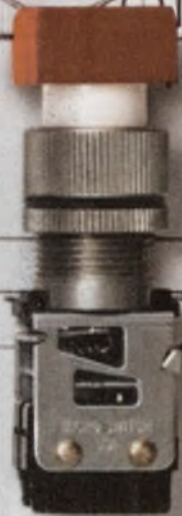
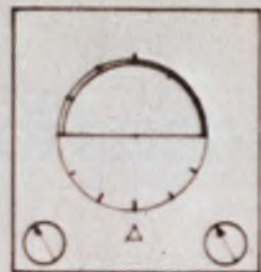
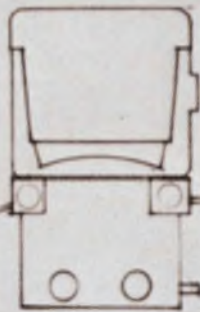

A SPECIAL PANEL SEAL MAKES SERIES 1 LIGHTED  
 PUSHBUTTON PERFECT FOR COCKPIT USE. KEEPS  
 WATER, COFFEE AND OTHER CONTAMINANTS FROM GETTING  
 THROUGH PANEL. MIL APPROVED UNDER M-22885-81. OTHER MIL  
 APPROVED PUSHBUTTONS OFFER MULTI-POLE,  
 MULTI-LAMP OPTIONS.

EXIT



ENVIRONMENTALLY-  
 SEALED SE AND  
 SE SWITCHES  
 HANDLE SENSING AND  
 MONITORING FUNCTIONS  
 AT LOW COST. APPLICA-  
 TIONS INCLUDE VALVE  
 MONITORING AND EMER-  
 GENCY EXIT CONTROL.  
 UNSEALED SM AND SX  
 OFFER GREATER COST  
 SAVINGS. UNSEALED  
 HT OPERATES TO  
 1000°F. IDEAL FOR  
 THRUST REVERSERS  
 AND VALVE CONTROL  
 MONITORING.

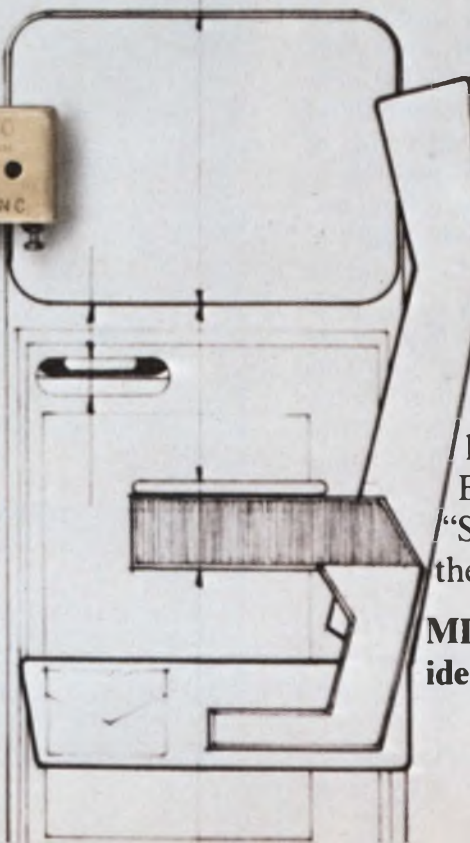

Aerospace applications present  
 special problems.

So MICRO SWITCH has  
 designed entire families of special  
 switches to handle them.

The result is one of  
 industry's most complete lines of  
 rugged high-performance  
 switches for both military and  
 civilian use.

A few examples are shown  
 here. But your MICRO SWITCH  
 Branch Office (Yellow Pages,  
 "Switches, Electric") can provide  
 the full story. Contact them today.

**MICRO SWITCH** makes your  
 ideas work.

**MICRO SWITCH**

FREEPORT, ILLINOIS 61032  
 A DIVISION OF HONEYWELL



## One-shot timing circuit blocks EMI pulses that cause counting errors

Time-interval measurements made with an electronic clock frequently require that you gate the clock from a signal source outside of the clock's shielded enclosure. Intermittent electromagnetic interference (EMI) often accompanies the gating signal with this setup (Fig. a), and can cause either false counts or the loss of true counts.

Interposition of the one-shot timing circuit ameliorates the problem (Fig. b). Monostable  $MM_1$  generates the gate signal and also isolates the clock timing/display circuits from the EMI. When the gating signal arrives, the Schmitt-trigger output of  $A_1$  goes low, which enables the astable output of  $MM_2$  to trigger  $MM_1$ . Because  $MM_1$  is retriggerable, its output,  $Q_1$ , remains high until the gating signal terminates.

Once the gating signal terminates,  $Q_1$  goes low and shuts off  $G_1$ . Simultaneously,  $Q_1$  goes high and trips  $FF_1$  to make  $Q_{FF}$  a logic ZERO. The logic ZERO presented at the clear terminals of  $MM_1$  and  $MM_2$  prevents further triggering of the monostable multivibrator. The flip-flop is reset manually—for further tests—once the displayed time has been observed and recorded.

Astable  $MM_2$  can be eliminated if the gating signal originates from an ac rather than a dc source—provided that the period of  $MM_1$  is set to exceed that of the signal. Time constants  $R_1C_1$  and  $R_2C_2$  determine the maximum timing error introduced by the two multivibrators. For best accuracy the period of  $MM_1$  should be only slightly longer than the maximum duration of the EMI. The component values shown result in an error on the order of 100  $\mu$ s.

Gerald R. Harris, Staff Engineer, U.S. Public Health Service, MS. TR-34, 5600 Fisher's Lane, Rockville, Md. 20852.

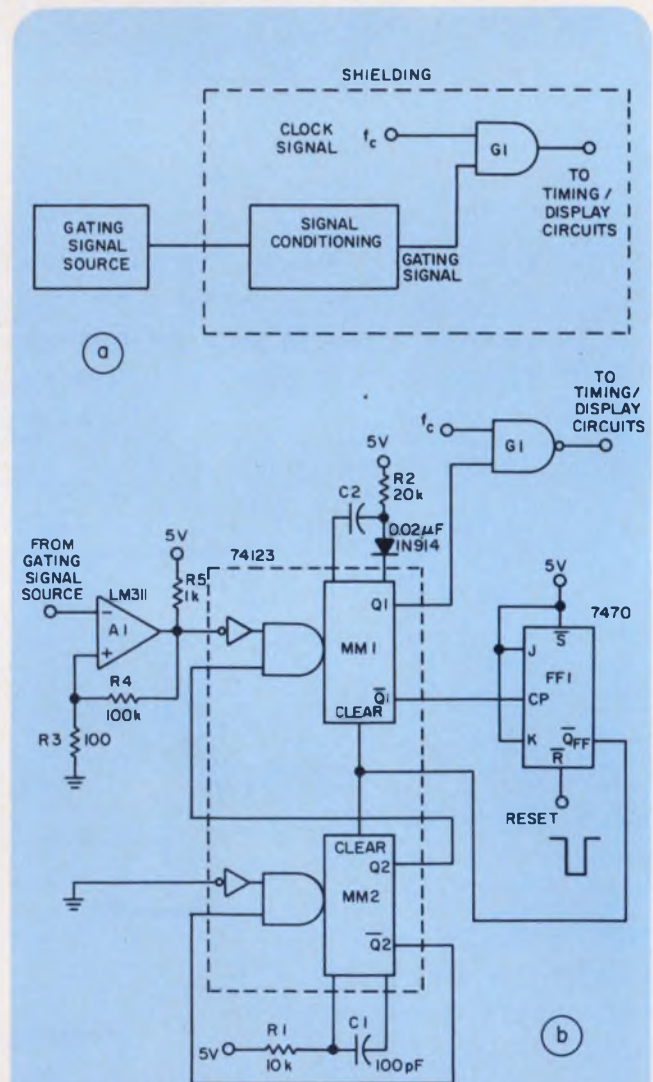

Electromagnetic interference on unshielded signal lines often causes counting errors (a) in electronic clock circuits. Insertion of the one-shot circuit (b) generates a clean timing pulse. One-shot  $MM_1$  isolates the timing circuits from the EMI but is not triggered by it.

# VACTEC PHOTODETECTORS

VACTEC adds one lobster and two new detectors  
(NPN phototransistors & silicon cells)  
to make the broadest line of  
photodetectors in the World.



New NPN silicon phototransistors and  
DIP package opto-isolators.

New complete line silicon P on N  
photovoltaic (solar) cells. N on P Blue  
sensitive also available.

Vactrols (opto-isolators) incandescent  
or LED drivers with photoconductors  
in new low cost packages.

Photoconductive Cells. Six different  
materials and nine packages.

Selenium photovoltaic cells, custom detector or array designs and a portable photometer complete the line.  
Contact VACTEC for any photodetector application.

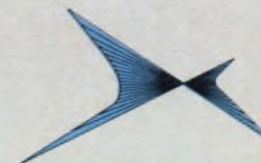

**VACTEC, INC.**  
2423 Northline Industrial Blvd.  
Maryland Heights, Mo. 63043  
Phone (314) 872-8300

# Black-white display terminals adapted for color by controller

A simple circuit lets monochromatic CRT terminals with a raster scan generate four-color displays on commercial color-TV receivers.

Alphanumerics in red, green, blue or white are formed when the output of the terminal—an Infoton Vista Standard—is switched onto one of three lines or all of them. The colors are selected by the state of the 7493 counter—which is stepped by two reserved characters whenever a change in color is desired.

One-shot MM1 transforms the video data from the shift register in the terminal to 50-ns pulses. These pulses are supplied to the color gates. A sync signal from the terminal synchronizes the color TV receiver and resets the counter to the green position. In this way each TV scan line starts in a defined color. Receipt of the "blink" and "blink stop" commands in sequence from the keyboard or computer results in a color change.

A loss of two character spaces occurs with

each command for color change (the reserved characters each occupy one memory space in the terminal). The loss is tolerable, especially when the text format contains 64 or more characters per line. And adjacent characters cannot be generated in different colors, since two blank character spaces are required before each color change.

The color monitor can be a standard RGB model or, for economy, a commercial shadow-mask or Trinitron TV receiver. All three color signals are connected to the final color amplifier of the receiver. Normal video input is terminated at a suitable point with a large capacitor. The sync signal is introduced before the sync-separator stage after similarly terminating the normal sync input.

*S. Summerhill, CERN, European Organization for Nuclear Research, Geneva 23, Switzerland.*

CIRCLE NO. 312

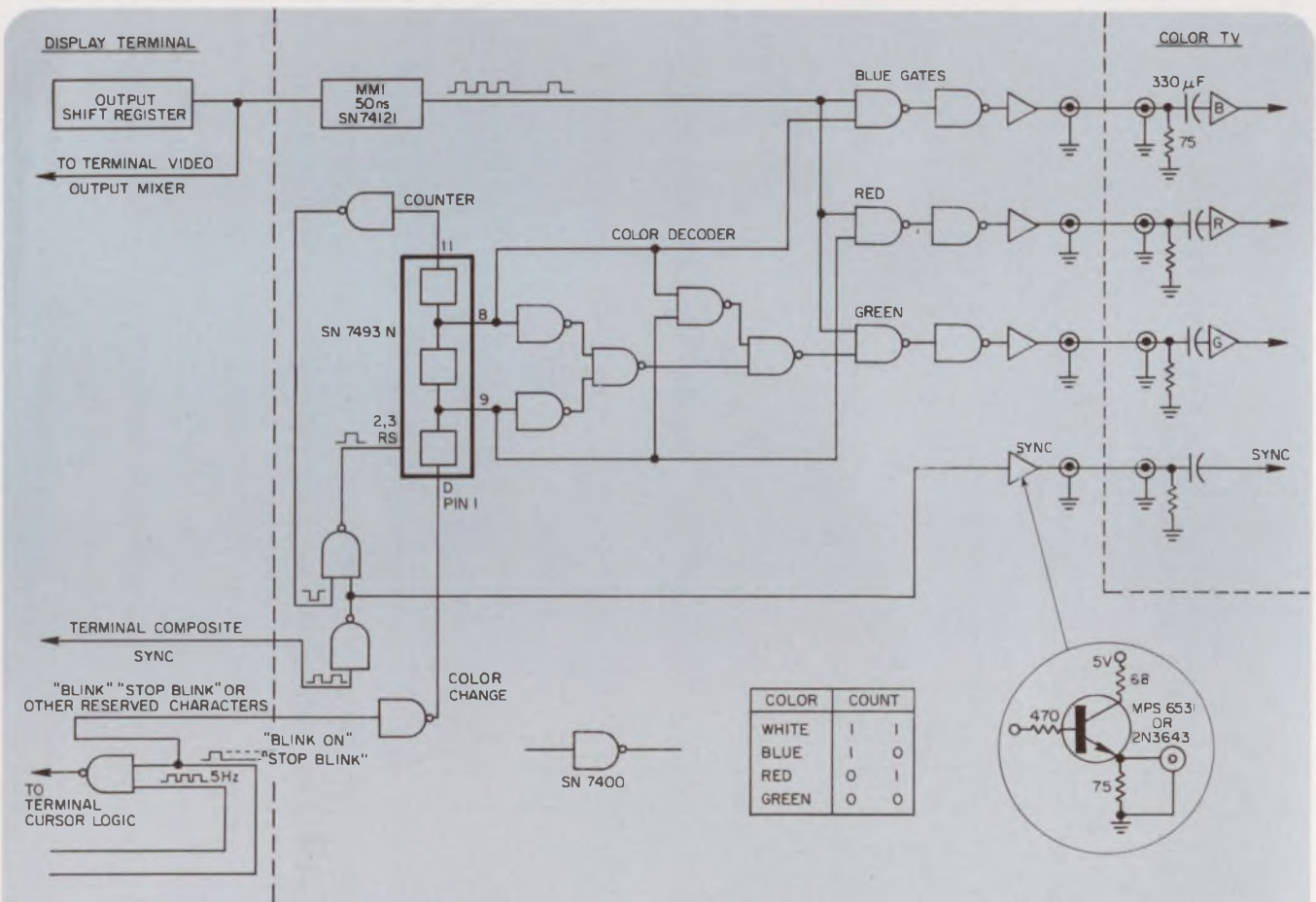

Raster type CRT terminals also display data on a color-TV screen. The terminal sync signal synchronizes the TV set and resets the counter-decoder to

green for each scan line. The presence of reserved characters prior to display steps the counter to the desired color.

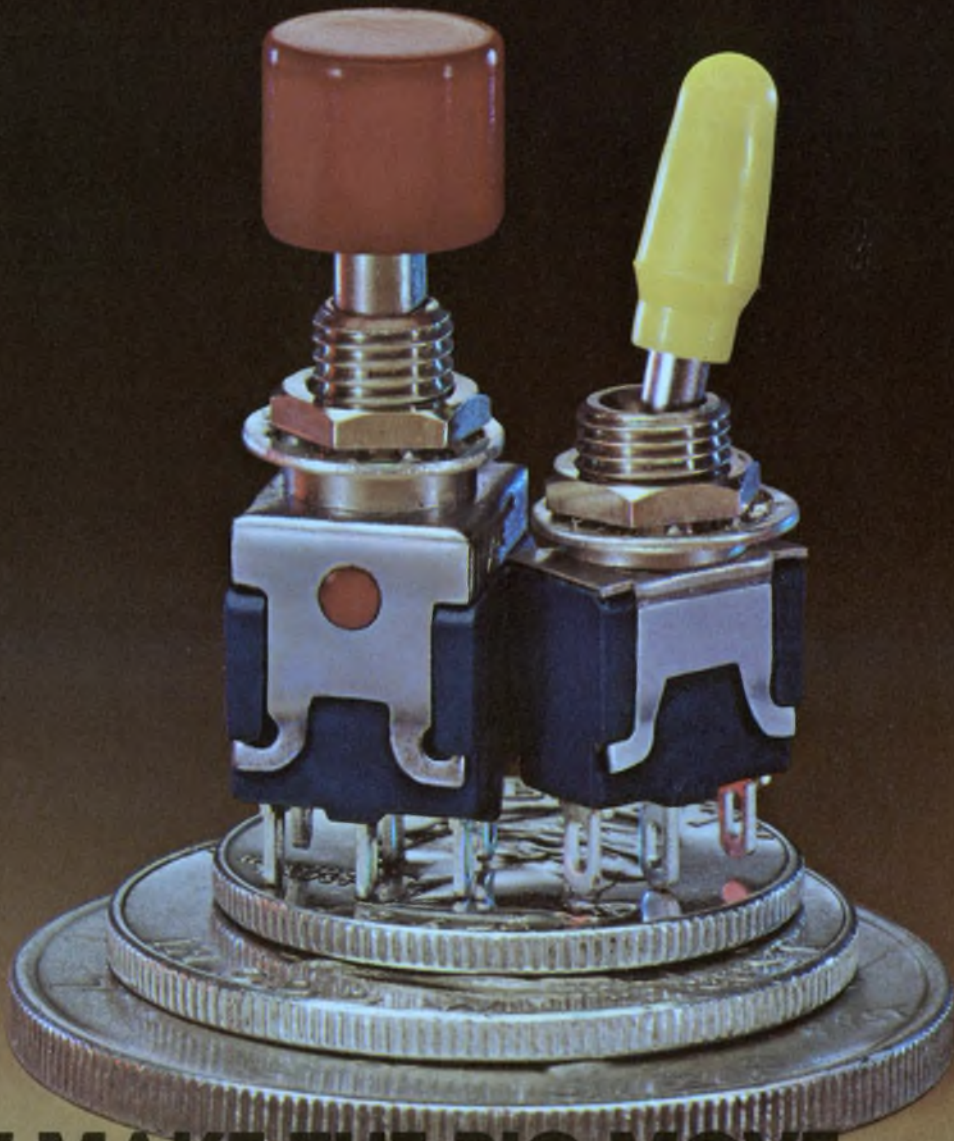

## NOW MAKE THE BIG MOVE TO MINIATURIZATION WITH CUTLER-HAMMER.

As you miniaturize your products, rely on these space-saving new Cutler-Hammer ultra-miniature switches. They deliver additional quality, together with a full choice of style, color, and shape.

You get full current-carrying capacity at 115 V.A-c in toggles or pushbuttons. One or two poles in 5 different circuits.

Superior construction details include: a 1/4-inch bushing for con-

venient one-hole mounting, silver-alloy contacts with initial contact resistance of only 0.010 ohm maximum, a polyester base partially jacketed in steel for extra switch-mechanism protection, and either solder-lug or PC terminals.

Cutler-Hammer's remarkable application flexibility continues externally with a wide range of decorator caps, buttons, and bezels in many colors.

And all circuits are in stock for fast delivery.

To learn more about how this highly adaptable new line can add function and style to your products, check with your nearest Cutler-Hammer Sales Office, or Authorized Stocking Distributor.



Cutler-Hammer ultra-miniature switches are available in a variety of designs and colors. In both toggles and pushbuttons.

Switch  
to No. 1

More than just switches;  
prompt availability,  
field help, innovation,  
quality assurance, too.

INFORMATION RETRIEVAL NUMBER 49



**CUTLER-HAMMER**  
SPECIALTY PRODUCTS DIVISION, Milwaukee, Wis. 53201

# Unijunction oscillator helps increase range of monolithic timer without use of big capacitors

The 555 IC replaces thermal relays and mechanical devices in a variety of timing applications. But achieving time constants of many minutes without large capacitors leads to a latch-up problem. Small values of  $C$  mean large values of  $R$ . When the voltage across  $C$  reaches the trip point, two-thirds  $V_{CC}$ , the current flowing through  $R$  is less than  $0.25 \mu\text{A}$  needed to trip comparator  $A_2$ . The addition of four components (dotted lines) eliminates the hangup.

The programmable unijunction transistor oscillates at about 1 Hz, which superimposes 0.1-V negative spikes on the dc level of pin 5. As the voltage across  $C$  reaches the trip point, the threshold appears 0.1 V lower each time a pulse arrives at pin 5. Capacitor  $C$ , now charged 0.1 V above threshold, supplies the necessary current to switch the IC.

The negative spikes, with their short duty cycle, have little effect on the charging current. And values of  $R$  up to  $200 \text{ M}\Omega$  can be used. Turning on transistor  $Q_1$  resets the circuit.

Bruce C. Roe, Bell Laboratories, Naperville, Ill. 60540. CIRCLE No. 313

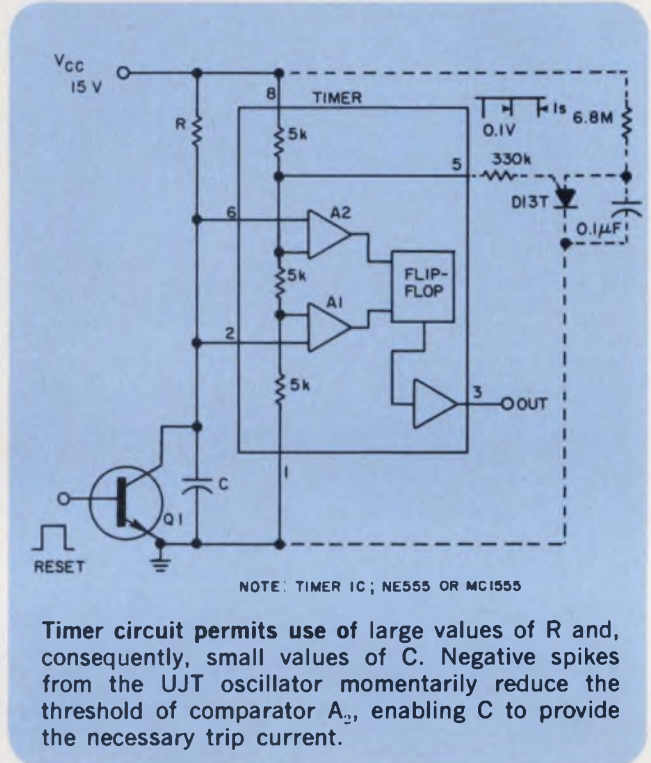

# Precision resistance-ratio detector gives 0.5% accuracy for less than \$3

Applications such as photoelectric control, temperature detection and moisture sensing require a circuit that can accurately detect a given resistance ratio. A simple technique that uses an op amp as a sensing element can provide 0.5% accuracy with a parts cost of less than \$3. In this circuit the reed-relay contacts close when the resistance of the sensor  $R_p$  equals 47% of the standard  $R_s$ . Adjusting either  $R_1$  or  $R_2$  provides a variable threshold; the threshold is con-

trolled by varying  $R_3$ .

For the most part, the type of resistors used for  $R_1$  and  $R_2$  determines the accuracy and stability of the circuit. With metal-film resistors, less than 0.5% change in ratio sensing occurs over the commercial temperature range (0 to 70 C) with ac input variations from 105 to 135 V.

Shalabh Kumar, Senior Project Engineer, National Controls Corp., 30 W. Fay Ave., Addison, Ill. 60101. CIRCLE No. 314

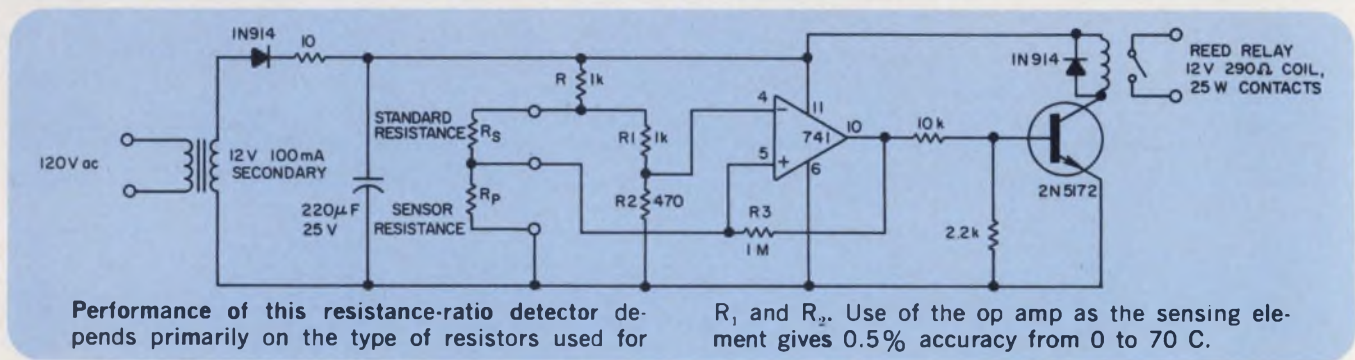

*A flexcircuit to fit new camera technology.*

# We did it for Polaroid.

Polaroid's SX-70 Land camera. More revolutionary than the first camera marketed by Polaroid. And more demanding in terms of technology.

Just distributing battery power to electronics, switches, film roller motor and shutter solenoid requires connecting 30 points. And in a camera housing measuring  $4\frac{1}{2} \times 7 \times 1\frac{1}{8}$  inches you can bet that space is at a premium.

Polaroid engineers needed a wiring harness that almost didn't have a third dimension. And they got it in a Schjeldahl flexcircuit only eight mils thick. Fully insulated both sides with Kapton® polyimide film. Fused solder on all pads for clean reflow soldering. Flexes into 5 planes. Fits the space available. Designed for volume production. That's using flex-circuitry as it should be used.

Schjeldahl did it for Polaroid.



**Schjeldahl Company**

Electrical Products Division  
Northfield, Minnesota 55057  
Phone: (507) 645-5633

*The state of the art people in volume flexible circuits*

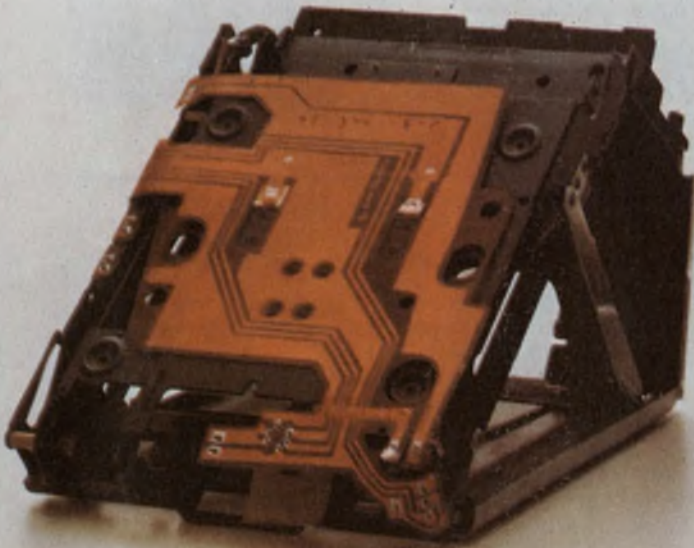

## And we can do it for you.

# SCR turn-off problem eliminated in rapid-fire stroboscope trigger

Engineers often face a problem when they design rapid-fire triggering systems that use SCRs, as in stroboscopic flash systems. The required capacitor-charging current is greater than the holding current of the SCR, so the SCR won't turn off. The circuit shown eliminates the problem with an inexpensive high-voltage transistor and a low-voltage rectifier, both of which allow pulse rates of greater than 1 kHz or 60 k/min.

During the capacitor's charging period the SCR is off and charging current flows through the transistor. The voltage across the capacitor increases to the value of the supply voltage and remains at this value until the SCR is triggered.

Once the SCR is triggered, the capacitor-discharge current flows through the diode, SCR and transformer primary. The transistor base-emitter junction is reverse-biased, which turns the transistor off. This occurs even if the capacitor was not fully charged at the time the SCR was triggered.

Discharge current flows until the SCR-turnoff current level is reached. Since only the transistor base-current is superimposed on the discharge current, no problem is encountered in making the SCR turn off. After the SCR turns off, base current is restored to the transistor and the charging cycle repeats.

The diode size must be sufficient to carry the peak pulse current of the capacitor discharge; the transistor power capability is determined by

the peak charging current of the capacitor. The transistor base resistor must allow sufficient drive current to have the capacitor charge within the required time limit.

*Dave Zinder, Senior Engineer, Motorola Semiconductor Products, Inc., 5005 E. McDowell Rd., Phoenix, Ariz. 85008.*

CIRCLE NO. 315

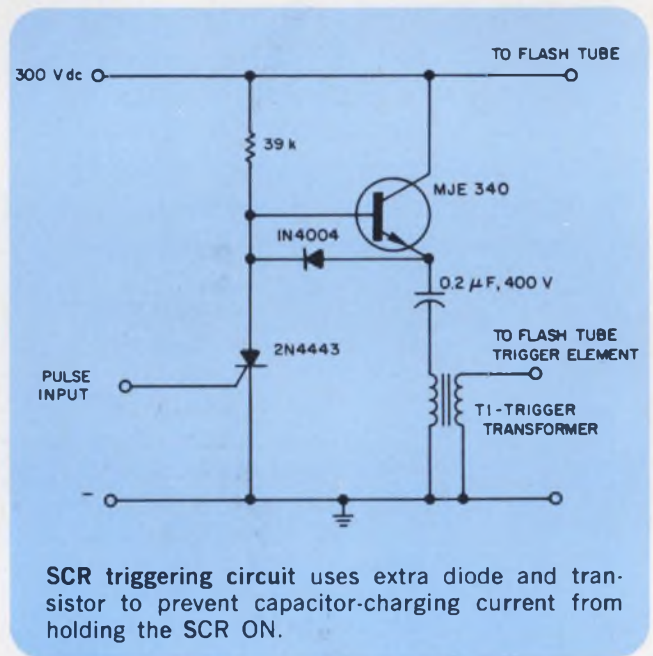

**IFD Winner of June 21, 1973**

**Chaim Klement**, Project Engineer, Electronics for Medicine, White Plains, N.Y. His idea "Voltage-to-frequency converter constructed with few components is accurate to 0.2%" has been voted the Most Valuable of Issue Award.

**Vote for the Best Idea in this issue** by circling the number for your selection on the Information Retrieval Card at the back of this issue.

**SEND US YOUR IDEAS FOR DESIGN.** You may win a grand total of \$1050 (cash)! Here's how. Submit your IFD describing a new or important circuit or design technique, the clever use of a new component or test equipment, packaging tips, cost-saving ideas to our Ideas for Design editor. Ideas can only be considered for publication if they are submitted exclusively to ELECTRONIC DESIGN. You will receive \$20 for each published idea, \$30 more if it is voted best of issue by our readers. The best-of-issue winners become eligible for the Idea of the Year award of \$1000.

ELECTRONIC DESIGN cannot assume responsibility for circuits shown nor represent freedom from patent infringement.

Don't miss an issue of ELECTRONIC DESIGN; Return your renewal card today.

Do you face  
a make or buy  
decision on  
power supplies?

# BUY LAMBDA'S LT SERIES 25 MODELS, 3 PACKAGE SIZES, ALL 5-YEAR GUARANTEED.

Line regulation: 0.02%; Load regulation: 0.15%;  
Ripple and noise: 1.5 mV RMS;  
Temp. coef.: 0.01%/°C; AC input: 105-132Vac.

### LTS-CA SINGLE OUTPUT MODELS

4<sup>29</sup>/<sub>32</sub>" x 4<sup>15</sup>/<sub>16</sub>" x 9<sup>5</sup>/<sub>16</sub>"

MODEL	FIXED VOLT. RANGE VDC	MAX. AMPS AT AMBIENT OF:				PRICE
		40 C	50 C	60 C	71 °C	
LTS-CA-5-OV*	5±1%	7.0	6.5	5.8	4.8	\$80
LTS-CA-6	6±1%	6.6	6.2	5.5	4.6	80
LTS-CA-12	12±1%	4.4	4.1	3.8	3.2	80
LTS-CA-15	15±1%	4.0	3.7	3.4	3.1	80
LTS-CA-20	20±1%	3.1	2.9	2.7	2.4	80
LTS-CA-24	24±1%	2.6	2.4	2.2	2.0	80
LTS-CA-28	28±1%	2.2	2.2	2.0	1.8	80

\*Includes fixed overvoltage protection at 6.8V ± 10%

### LTS-DC SINGLE OUTPUT MODELS

4<sup>29</sup>/<sub>32</sub>" x 7<sup>1</sup>/<sub>2</sub>" x 10<sup>1</sup>/<sub>2</sub>"

MODEL	FIXED VOLT. RANGE VDC	MAX. AMPS AT AMBIENT OF:			PRICE
		40 C	50 C	60 C	
LTS-DC-5-OV*	5±1%	17.0	14.5	12.0	\$150
LTS-DC-6	6±1%	16.0	14.0	12.0	150
LTS-DC-12	12±1%	11.0	9.7	8.6	150
LTS-DC-15	15±1%	10.0	8.8	7.7	150
LTS-DC-20	20±1%	8.0	7.1	6.0	150
LTS-DC-24	24±1%	7.1	6.4	5.4	150
LTS-DC-28	28±1%	6.0	6.0	5.0	150

\*Includes fixed overvoltage protection at 6.8V ± 10%

### LTD-CA DUAL OUTPUT MODELS

4<sup>29</sup>/<sub>32</sub>" x 4<sup>15</sup>/<sub>16</sub>" x 9<sup>5</sup>/<sub>16</sub>"

MODEL	FIXED VOLT. RANGE VDC	MAX. AMPS AT AMBIENT OF:				PRICE
		40 C	50 C	60 C	71 °C	
LTD-CA-152	±15±1%	2.0	1.8	1.7	1.5	\$110
LTD-CA-122	±12±1%	2.0	1.8	1.7	1.5	110

### LTS-DB SINGLE OUTPUT MODELS

4<sup>29</sup>/<sub>32</sub>" x 7<sup>1</sup>/<sub>2</sub>" x 10<sup>1</sup>/<sub>2</sub>"

MODEL	FIXED VOLT. RANGE VDC	MAX. AMPS AT AMBIENT OF:			PRICE
		40 C	50 C	60 C	
LTS-DB-5-OV*	5±1%	12.0	10.8	9.0	\$130
LTS-DB-6	6±1%	11.0	9.9	8.2	130
LTS-DB-12	12±1%	7.6	6.7	5.7	130
LTS-DB-15	15±1%	7.2	6.4	5.4	130
LTS-DB-20	20±1%	6.0	5.3	4.5	130
LTS-DB-24	24±1%	5.5	4.9	4.1	130
LTS-DB-28	28±1%	4.0	4.0	3.7	130

\*Includes fixed overvoltage protection at 6.8V ± 10%

### LTD-DB DUAL OUTPUT MODELS

4<sup>29</sup>/<sub>32</sub>" x 7<sup>1</sup>/<sub>2</sub>" x 10<sup>1</sup>/<sub>2</sub>"

MODEL	FIXED VOLT. RANGE VDC	MAX. AMPS AT AMBIENT OF:			PRICE
		40 C	50 C	60 C	
LTD-DB-152	±15±1%	3.8	3.2	2.6	\$160
LTD-DB-122	±12±1%	4.0	3.4	2.8	160

## 1-DAY DELIVERY



Send for free  
LAMBDA POWER SUPPLY  
APPLICATION HANDBOOK  
& CATALOG

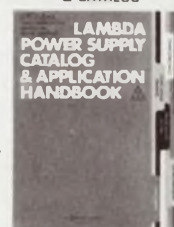

**\$80**                      **\$130**                      **\$150**  
LTS-CA-5-OV      LTS-DB-5-OV      LTS-DC-5-OV  
5V, 7A                      5V, 12A                      5V, 17A

**△ LAMBDA**  
ELECTRONICS CORP.

A  Company

MELVILLE, NEW YORK 11746 515 Broad Hollow Road Tel. 516-694-4200  
ARLINGTON HEIGHTS, ILL. 60005 2420 East Oakton St., Unit Q Tel. 312-593-2550  
NORTH HOLLYWOOD, CALIF. 91605 7316 Varna Ave. Tel. 213-875-2744  
MONTREAL, QUEBEC 100C Hymus Blvd., Pointe Claire, Quebec 730 Tel. 514-697-6520  
PORTSMOUTH, HANTS, ENG. Marshlands Road, Farlington Tel. Cosham 73221  
VERSAILLES, FRANCE 64a 70 rue des Chantiers 78004 Tel. 950-2224



## Ultra-stable i-f source built for attenuation measuring

Attenuation measurements that require an amplitude-stable source with short-term stability of better than 0.0001 dB over a 10-minute period can be handled by a solid-state source developed by the Electrical Quality Assurance Directorate in Bromley, England.

The crystal-controlled output frequencies of the source are those normally used for intermediate frequencies in attenuation-measuring receivers—namely, 1, 30 and 60 MHz. The techniques used in the design will give optimum results for any of these frequencies.

The dc supply of the rf oscillator is fed through a series-control transistor from a stabilized power-supply unit. To attenuate transients, the power-supply unit is fed through a composite filter, which consists of a multiple-section rf filter and a toroidal-inductance filter.

Rf output from the oscillator is nominally 1 V and is transformed into about 10 V to feed to the rf detector. This is a hot-carrier diode with a peak inverse voltage of 60

V. Operation at such an rf level minimizes the effect of temperature on the diode output.

Dc output from the rf detector goes to a high-stability differential amplifier and is compared with a reference voltage. Output from the amplifier controls the series transistor, and a feedback loop is formed.

Source stability is governed primarily by stability of the reference voltage. So a precision voltage-reference supply is used, which has an output voltage of 6.3 V and a stability of  $\pm 1$  ppm. The dc supply comes from the stabilized power-supply unit.

Output voltage from the precision reference is fed to a resistive chain that has four external controls to adjust the rf output level up to 1.1 dB. At the end of the chain is a temperature-compensating hot-carrier diode that is housed in the same aluminum block as the rf detector. This modifies the effective reference voltage as its resistance changes with temperature.

---

## Diode responds to starlight

A photodiode with sufficient response to starlight on a moonless night to make it suitable for use in a photographic exposure meter has been introduced by Siemens of West Germany. The device's sensitivity is 10 nA/lux.

The threshold sensitivity is such that an output voltage of more than 0.5 mV is produced at an illuminance of 1/100ths of a lux without excessive interference with useful current by thermally generated charge carriers.

Called the BPX3, the device has

a phosphorus-doped, n-type substrate, in which a thin, p-conducting region is formed by implanted boron ions. The depth of penetration is limited to  $0.8\mu$ , so the photodiode exhibits a blue response.

After diffusion, various tempering processes eliminate any crystal defects, so that noise current is kept low, in the range  $-30$  to  $+50$  C. The diode's working area measures one square millimeter, but larger areas with the same characteristics can also be made.

CIRCLE NO. 319

## X-ray image intensifier covers a large field

A large-field X-ray image intensifier, having variable electron-optic image reduction, has been developed at the Tesla Vacuum Electronics Research Institute in Czechoslovakia. The tube was produced for examination of the human lung and gastrointestinal areas, both kidneys and the complete skull and heart areas.

Of all-glass construction, the tube has an input diameter of 270 mm and an image diameter of 170 mm. Work on improving image brightness and resolution has shown that the input screen critically affects the intensifier's efficiency.

The use of sodium-activated caesium iodide as a luminescent material has shown promising results. A new technique of vacuum deposition has been developed that minimizes the contrast loss caused by light scatter in the screen grain structure.

CIRCLE NO. 318

---

## Feasibility study seeks 2000-MW generator

The feasibility of very large superconducting electrical generators is being investigated by the Electrical Research Association of Britain. Superconducting field windings, it is thought, would permit production of 2000 MW from a generator the size of a conventional 660-MW unit and at a lower cost per megawatt.

---

## Remote fire-fighting planned in Germany

Fire-fighting with the aid of radar, IR sensing and rockets is being studied at Frankfurt International Airport in West Germany. It is planned to fire missiles containing 50 kg of fire-quenching chemicals at 0.5-sec intervals on burning planes. Remote-control fire fighting will be guided by a computer connected to IR sensors and radar equipment.

# NEW FAST ANSWER FOR ELECTRONIC NOISE PROBLEMS...



## Ceramag® Ferrite Beads on Lead Tape

Stackpole Ceramag® ferrite beads provide a simple, inexpensive means of obtaining RF decoupling, shielding and parasitic suppression without sacrificing low frequency power or signal level.

Now beads are available with leads, cut and formed or on lead tape. Most equipment that is capable of automatic insertion of lead tape components can be modified to accept this special Stackpole bead.

No other filtering method is as inexpensive . . . and now as fast to insert in your circuit. Starting with a simple ferrite bead (a frequency-sensitive impedance element) which slips over the appropriate conductor, Stackpole has available a variety of materials and shapes providing impedances from 1 MHz to over 200 MHz. The higher the permeability, the lower the frequency at which the bead becomes effective.

### CERAMAG® FERRITE BEAD CHARACTERISTICS

GRADE NUMBER	24	7D	5N	11
Initial Permeability	2500	850	500	125
Volume Resistivity @ 25°C	1.0x10 <sup>2</sup>	1.4x10 <sup>5</sup>	1.0x10 <sup>3</sup>	2.0x10 <sup>7</sup>
*Effective Suppression At:	1 MHz	20 MHz	50 MHz	100 MHz
Curie Temperature	205	140	200	385

\*A tutorial guide on how these passive components behave with frequency and geometry is available from the Electronic Components Div.

Impedance varies directly with the bead length and log [O.D./I.D.]. Beads are available in sleeve form in a range of sizes starting at .020" I.D., .038" O.D., and .050" long. The bead on lead tape is .138" O.D. and .175" long. Where quantities warrant, other beads on leads and/or lead tape are a design possibility. Tight mechanical tolerances are held in sizes and shapes as varied as the pair of giant, mating channels shown on the left which are used to eliminate the effect of transient noise in computers.

Sample quantities of beads are available for testing. Consult Stackpole Carbon Company, Electronic Components Div., St. Marys, Pa. 15857. Phone: 814-781-8521. TWX: 510-693-4511.



# ★ SIMPLIFY PROCUREMENT ★

**BOURNS**  
NOW OFFERS

**16 MIL SPEC**

Save paperwork, money and time by ordering all your Mil Spec potentiometers from Bourns, the most complete single source in the industry. It's sound logistics — one purchase order, one approved source. At the same time you're protected by Bourns tradition of excellence. Each Bourns potentiometer is designed and manufactured to consistently exceed Mil Spec requirements.

FOR INSTANT  
INFORMATION  
DIAL E E M  
800-645-9200



## POTENTIOMETERS/VARIABLE RESISTORS

### ★ NON-WIREWOUND - MIL-R-22097

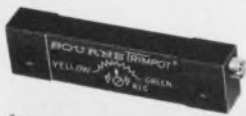

\*RJ12 C-F



\*RJ22 C-F

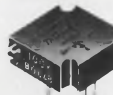

\*RJ24 C-F



\*RJ26 C-F



\*RJ50 C-F

### ★ WIREWOUND - MIL-R-27208



RT10

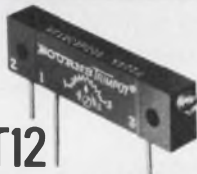

\*RT12

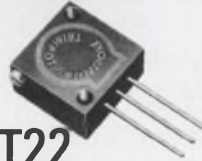

\*RT22



\*RT24



\*RT26

### ★ ESTABLISHED RELIABILITY - MIL-R-39015



RTR12

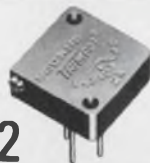

RTR22



RTR24 (NEW)



RJRI2  
C-F (NEW)

MIL-R-39035

### ★ MIL-R-94



\*RV6

BOURNS HAS MORE  
POTENTIOMETERS  
ON QPL THAN ANY  
OTHER MANUFACTURER!

MIL-R-23285



RVC6 (NEW)



BOURNS, INC., TRIMPOT PRODUCTS DIVISION • 1200 COLUMBIA AVE., RIVERSIDE, CALIF. 92507

\* AVAILABLE FROM STOCK AT YOUR LOCAL BOURNS DISTRIBUTOR

## Successive-approximation a/d converters fit 40-pin DIPs and offer many options

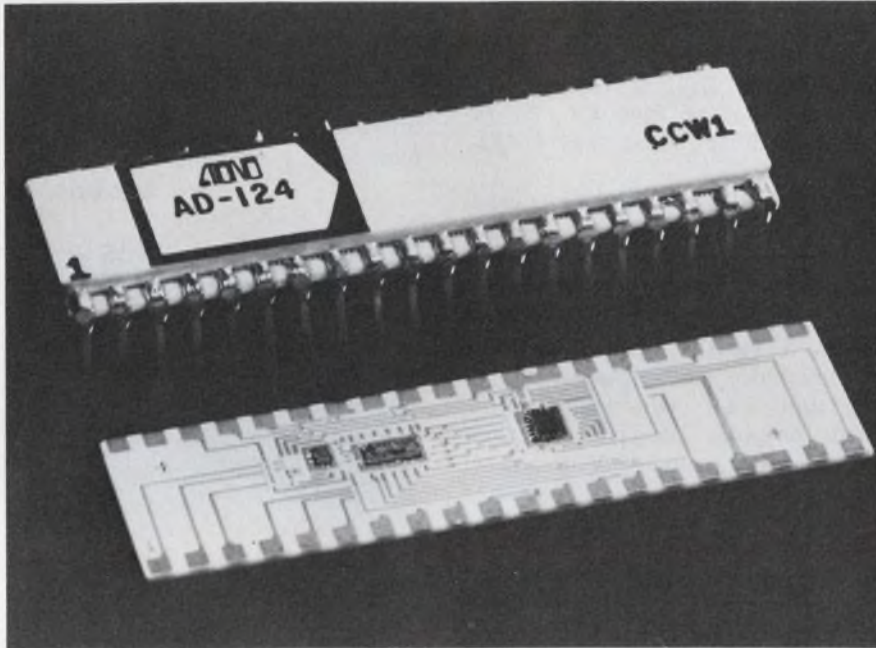

*Precision Monolithics, Inc., 1500 Space Park Dr., Santa Clara, Calif. 95050. (408) 246-9222. P&A: See text.*

Converter sizes are being shrunk by Precision Monolithics with its hybrid a/d models, Mono-AD-124-10CW3, 09CW3, 08CW3 and 08DW3. These units are successive-approximation analog-to-digital converters that fit in a 40-pin hermetic double-DIP and deliver 12-bit resolution.

Accuracies are better than 0.05%—which is equivalent to 10-bit accuracy, even though 12 bits are output. For 12-bit encoding, the converters require 24  $\mu$ s. If they are short-cycled by connecting the appropriate pins, the six-bit encoding time is 8  $\mu$ s, while for 10 bits it takes 15  $\mu$ s.

Linearity of the 10CW3 stays below 0.05% and 0.1% for the 09CW3, while for the 08CW3 or 08DW3 it is relaxed to 0.2%—all over the operating temperature range of 0 to 70 C. The temperature coefficient of the 10, 09 and 08CW3 is 60 ppm/ $^{\circ}$ C, and it is double that for the 08DW3. This is valid only when

the internal reference voltage is used.

All units require dual dc supplies of  $\pm 12$  to  $\pm 18$  V and dissipate only 800 mW. Internal scaling networks permit full-scale voltage inputs of 5, 10 or 20 V pk-pk. Aside from the scale input, the user can select one of three output codes: binary, offset binary or two's complement binary—and in either serial or parallel format. Provisions are also available to disconnect the internal reference source and use an external reference. This permits ratio-metric measurements, where the ratio of two voltages is read directly.

If an external reference is used, the necessary information is the reference input bias current. This is 100 nA for a 6-V reference, with an offset voltage of typically 1% of full scale.

The converters can be connected to either continuously-encode or encode-on-command, although for rapidly changing signals a sample-and-hold circuit is required. Inputs can be either unipolar or bipolar on the selected ranges—0 to +5, 0 to +10,

$\pm 2.5$ ,  $\pm 5$  and  $\pm 10$  V. The digital output is held in a register, and an end-of-count signal indicates when the encoding is complete.

Internally the converters consist of a logic comparator chip, d/a converter chip and a separate digital logic chip—all connected via a multilayer ceramic substrate. The d/a chip includes a diffused resistor ladder network and npn/pnp Schottky-barrier-diode circuitry. Analog and digital grounds are kept separate in all the a/d converters, to provide good isolation and noise immunity.

All units have a typical turnon delay of 60 ns and turnoff delays of 80 ns. The input impedance of the input amplifier varies from 2.44 to 9.76 k $\Omega$  and is dependent upon the voltage range selected.

Units from Micro-Networks compete with PMI devices. The closest of the Micro-Networks circuits is the MN-520—a 12-bit successive approximation a/d converter. It delivers 12-bit accuracy and resolution and requires no external adjustments to deliver specified performance over the full temperature range. There are both commercial and MIL versions available, with the commercial units selling for about \$250 in under 100 piece quantities. Conversion time for the 520 is roughly 40  $\mu$ s for the full 12-bit output. The unit is housed in a 24-pin DIP and doesn't offer as many features as the AD-124 series from Precision Monolithics.

Although many modules have the same features, the small size of the Precision Monolithics units saves both space and weight.

The a/d converters are available from stock, and the 25 to 99 unit prices are: Mono-AD-124-10CW3, \$215; -09-CW3, \$175; -08CW3, \$150 and -08DW3, \$135.

Precision Monolithics

Micro-Networks

CIRCLE NO. 250

CIRCLE NO. 252

### DAC offers 12-bits over full MIL temp range

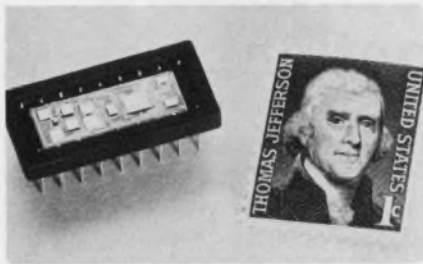

Micro Networks Corp., 5 Barbara Lane, Worcester, Mass. 01604. (617) 756-4635. \$285 (MIL Temp), \$149 (commercial temp); stock to 3 wk.

The MN 360 Series of hermetic DIP packaged 12-bit d/a converters guarantee linearity and accuracy over the full MIL range of -55 to +125 C. These specifications guarantee that without adjustment or initial zeroing, linearity is  $\pm 1/2$  LSB from -25 to +85 C and  $\pm 1$  LSB from -55 to +125 C. No additions of TC error or drift need be incorporated. The series is available in four model types. For voltage output, the MN 360 provides bipolar output of +10 to -10 V, and the MN 362 provides unipolar output of 0 to +10 V. The MN 364 provides current output of +1 to -1 mA and the MN 366 a unipolar current output of 0 to -2 mA. Another feature of this series is the power consumption—a low 630 mW—which is about one-half that of modulator d/a's. This series also provides fast settling time, which is specified as 5  $\mu$ s to  $\pm 0.012\%$ .

CIRCLE NO. 253

### Logic interface card mates with many families

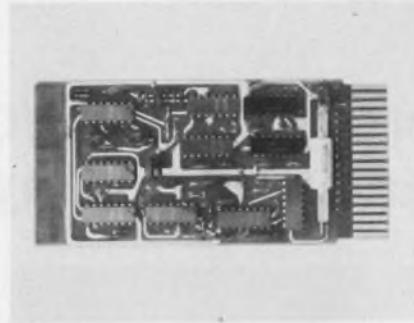

Trump-Ross, Div. of Datametrix Inc., 265 Boston Post Rd., North Billerica, Mass. 01887. (617) 663-3451.

An interface-decoder logic card can interface between incremental encoder square wave quadrature outputs and external DTL/TTL, HTL and MOS circuits. This card offers a variety of features including pulse multiplications ( $\times 1$ ,  $\times 2$ , and  $\times 4$ ), complemented line drive outputs, polarity direction and operates from +5 V dc power source.

CIRCLE NO. 254

### Get sine and square waves from oscillator

Conner-Winfield Corp., West Chicago, Ill. 60185. (312) 231-5270.

Model L220BH provides simultaneous 5 V rms sine wave and 100 V pk-pk square wave outputs into 10 k $\Omega$  loads. Outputs are available for any fixed multiple frequency from 200 Hz to 500 kHz with a frequency tolerance of  $\pm 0.005\%$  from 0 to +50 C. Frequency can be adjusted to  $\pm 0.003\%$  while the supply is 15 V dc  $\pm 10\%$  at 15 to 100 mA depending on frequency.

CIRCLE NO. 255

### Crystal oscillators cover 10 to 27 MHz

CTS Knights, Inc., 400 Reimann Ave., Sandwich, Ill. 60548. (815) 786-8411.

The JKTO-87 crystal oscillator is manufactured to specific customer specifications. Case size measures only 2.25 by 2 by 0.8 in. and is available in either oven or voltage controlled versions. Versions are available for frequencies from 10 to 27 MHz with a frequency deviation of  $\pm 1000$  ppm. Linearity is  $\pm 5\%$  of best straight line and frequency stability is  $\pm 5$  ppm from 0 to +55 C.

CIRCLE NO. 256

### Photo control uses pulsed infrared LED



Control Craft Corp., 213 Main St., West Chicago, Ill. 60185. \$110; stock.

The Mod-U-LED-I uses a modulated infrared LED as a retro-reflective scanner to give a 12 ft. range in full daylight. The miniature scanner has a 3/4 in. diameter and is 2 in. long. Reflectors of 1/2 in. to 3 in. diameters return the beam to the scanner on the same axis. Solid-state construction eliminates a fragile incandescent lamp. Circuit cards hold the pulsed power for the LED, a telltale to indicate beam break and a light-dark switch.

CIRCLE NO. 257

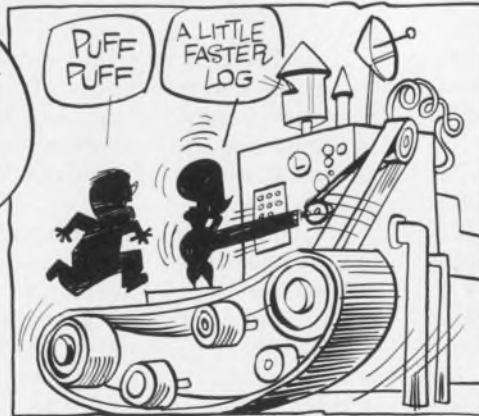

**ANALOGY**  
 WHEN YOU WANT DIRECT CONVERSION FROM DC LEVEL TO A SERIES OF TTL COMPATIBLE PULSES ACCURATELY AND CONVENIENTLY, USE AN A-847. OUTPUT IS 0 TO 10 KHZ. INPUT IS 0 TO 10V. 0.008% LINEARITY AND 10% OVER-RANGE. ADJUSTABLE FROM 9.900 TO 10.000V AT 10 KHZ. OUT. CONVERT NOW, WRITE ANA-

**ie. intech** INCORPORATED  
 (408) 244-0500  
 1220 COLEMAN, SANTA CLARA CA 95050

# innovation today

The broadest line of Digital Input Rotary Switches in the world. A switch for any digital input requirement.

## DIGISWITCH®



Developed in 1959, this is the original Thumbwheel switch.

**Features:**

- 8, 10, 12, 16 dial positions
- Front or back panel mounting
- Sealed version QPL approved
- Dozens of codes available
- Modular construction
- Dial lighting available

## MINISWITCH®

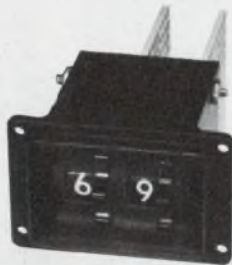

The original miniature Thumbwheel switch.

**Features:**

- 8, 10, 16 dial positions
- Sealed versions QPL approved
- Dozens of codes available
- Modular construction
- Miniature in size
- Dial lighting available

## MINILEVER



Fast action, lever actuated, switch for rapid setting.

**Features:**

- 10, 12 dial positions
- Rapid setting and resetting
- Modular construction
- Numerous codes available
- Miniature

## ECONOMY THUMBWHEEL



New, low cost, miniature Thumbwheel switch.

**Features:**

- 10 dial positions
- Sealed construction
- Modular construction
- Miniature
- Numerous codes available

Ask about our new low prices.

## 'SNAP-IN' THUMBWHEEL



New Thumbwheel that snaps into panel.

**Features:**

- Snaps in single or multiple panel cut-outs
- Eliminates end flanges and hardware
- May be grouped in one panel cut-out
- Front panel mounting
- Easily removeable

## TOGGLE SWITCH



New bi-directional toggle switch.

**Features:**

- 10 dial positions
- Fast action
- Bi-directional
- Front face sealed
- May be grouped in single or multiple panel cut-outs

## DIGIVIDER DIGIDECADE & PURE BINARY



Voltage dividers, Resistance decades and Pure Binary Thumbwheel switches produced to standard or special customer specifications. As with all Digitran switches, additional electronics can be provided as an integral part of the switch.

Write for our new catalog on all of these and other Digitran products.

## DIGIDIP

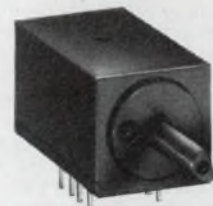

New P/C board mounted switch for I.C. socket or flow solder applications.

**Features:**

- 10 detent positions
- Plugs into standard 14 or 16 pin I.C. socket
- Dip or flow solder P/C boards
- Miniature
- Low cost

See us in  
EEM 1972-73  
Vol. 2 Pages  
2116-2117

# THE DIGITRAN® COMPANY

A Division of Becton, Dickinson and Company **B-D**

855 So. Arroyo Parkway / Pasadena, Ca. 91105 / Tel. (213) 449-3110 / TWX 910-588-3794

# GENERAL ELECTRIC'S 92F ADVANCED CAPABILITY COMPUTER-GRADE CAPACITOR...



Now! A highly reliable long life capacitor designed for applications requiring large amounts of ripple current at operating temperatures of 85 C and above. Ideal for power supplies, particularly the new switching mode types, energy storage and discharge, input filters for SCR power supplies . . . anywhere large amounts of ripple current are needed. Features include:

- 3,000 hour life rating at 85 C
- Ratings to maximum volt-microfarads per case size
- Capable of operating up to 125 C
- Standard screw-type terminal inserts
- Standard units available in 21 case sizes — over two hundred ratings

For more information on these, or any of General Electric's wide range of capacitors, call your nearest GE sales office today, or write Section 430-53, Schenectady, N. Y. 12345.

## MAKE SOMETHING OUT OF IT!

GENERAL  ELECTRIC

INFORMATION RETRIEVAL NUMBER 56

## MODULES & SUBASSEMBLIES

### Time delay relays offer axial or plug-in cases

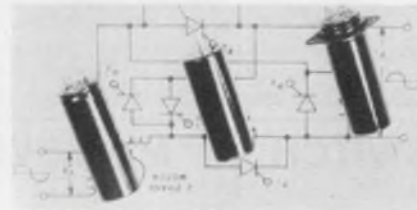

*TDR Electronics, Inc., Foot of John St., Lowell, Mass. 01852. (617) 459-0151.*

Solid-state time delay relays can be ordered preset at the factory with delays from 0.1 to 300 s. They are also available with an adjustable delay. Most units feature immediate reset to eliminate the need for additional control circuitry and also offer total isolation between control and output circuits. The units are packaged either in an axial lead case or for plug-in or printed circuit mounting. Timing is accurate to  $\pm 10\%$  for voltage and temperature changes; repeatability is  $\pm 3\%$ . Off state resistance is 20 k $\Omega$  and operating temp range is  $-55$  to  $+85$  C.

CIRCLE NO. 258

### Data break board is made for PDP-8

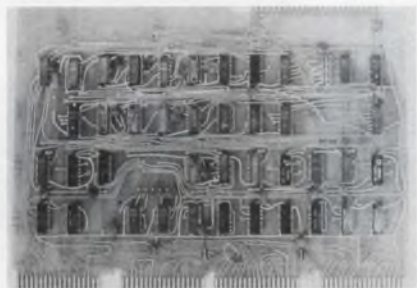

*Douglas Electronics, 718 Marina Blvd., San Leandro, Calif. 94577. (415) 483-8770. \$200; stock.*

The 27-DE-8, a single cycle data break board for interfacing with the PDP-8/e, f, and m computer systems, provides word count, memory address, skip, flags and priority selection. The unit is designed for internal OMNIBUS interfaces. A jumper connector on the 27-DE-8 handles the connection to the corresponding I/O device control board. Operational details and a schematic are available on request.

CIRCLE NO. 259

### Magnetic pulse encoders include all electronics

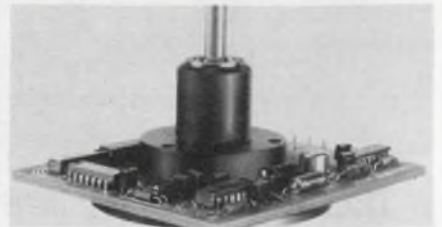

*Singer, Librascope Div., 833 Sonora Ave., Glendale, Calif. 91201. (713) 245-8711. Under \$200 (qty).*

The MPE series of magnetic pulse digital tachometer/encoders are solid-state magnetic, zero-speed tachometers and digital shaft encoders with integral electronics. The electronics package in each MPE device includes a driver, squaring circuitry and direction sense logic with TTL compatible output and input voltages. Customers are offered a selection of up to 256 quadrature square-wave cycles per shaft revolution, plus multiplying pulse-forming circuitry with a selection of up to 1024 direction sensed pulses.

CIRCLE NO. 260

### Set point comparator has three current outputs



*Pioneer/Instrumentation, 4880 E. 131st St., Cleveland, Ohio 44105. (216) 587-3600.*

A dual set-point differential-voltage window comparator, Model 34/35, has up to three current sinking outputs. The comparator is available in two electrically equivalent but differently packaged versions. The Model 34 uses open PC card construction with an etched edge connector, while circuitry of the Model 35 is fully enclosed in a relay-type aluminum enclosure with an octal plug base. Designed to operate from a power supply of  $\pm 12$  to  $\pm 18$  V dc, the new Model 34/35 provides true differential input with common-mode rejection of 60 dB, minimum.

CIRCLE NO. 261

# Burr-Brown brings it all together in data conversion products

Yes, Burr-Brown has brought it all together with a data conversion product line that will satisfy virtually any design need. These units offer a wide variety of the latest technologies including IC current switches and amplifiers, thin film ladder networks, laser trimming, chip resistors and capacitors, and Burr-Brown's quality design. We offer a wide range of:

- A/D CONVERTERS
- D/A CONVERTERS
- SAMPLE/HOLD AMPLIFIERS
- ANALOG MULTIPLEXERS
- COMPARATORS
- PEAK DETECTORS

Here are a few examples to whet your appetite.

## NEW HYBRID DAC85 D/A CONVERTER

This complete hybrid IC 12-bit D/A converter not only provides laser trimmed linearity to  $\pm\frac{1}{2}$  LSB, but it has its own internal reference and output amplifier. Voltage output models settle to  $\pm 0.01\%$  in 5  $\mu$ seconds, and current output models settle to  $\pm 0.01\%$  in just 300 nseconds, permitting throughput rates as high as 3MHz for full scale range changes.

And, they are hermetically sealed in a tiny 24-pin dual-in-line package. Prices start at \$56.00 in 100's.



## NEW DAC60 D/A CONVERTER

Available in 10 and 12-bit versions, these high speed D/A converters settle to 0.05% in only 25 nseconds for one LSB step. Full scale settling time is 40 nseconds to 0.05% and 150 nseconds to 0.01%. Linearity error and differential linearity error are both guaranteed at  $\pm\frac{1}{2}$  LSB. The units are also guaranteed to be monotonic from 0 to 70°C and are user programmable to obtain unipolar or bipolar output signals. Prices start at \$89.00 in 100's.



## NEW SHC23 SAMPLE/HOLD AMPLIFIER

This versatile hybrid sample/hold amplifier allows you to select the acquisition and droop time to best fit your needs. For example, the selection of 0.005 $\mu$ F capacitor provides acquisition time (to 0.01%) of about 25  $\mu$ seconds. Hold time, too, can be selected from 1 msecond to more than 15 minutes in the same way. TO-8 hybrid packaging, a guaranteed non-linearity of  $\pm 0.01\%$ , its versatility and low cost make the SHC23 one of



the industry's smallest and most popular sample/hold amplifiers. The SHC23 has an operating temperature of 0 to 70°C and a maximum droop rate of 0.1mV/ms over the entire range. The maximum droop rate of the SHC23ET is only 2mV/ms over its entire -55°C to 125°C operating temperature range. Prices start at \$31.00 in 100's.

## GET THE ENTIRE PICTURE

**DATA CONVERSION PRODUCTS**

Burr-Brown data conversion products deliver what they promise

All these products and many more are listed in our new Data Conversion Product Catalog. For your copy, use this publication's reader service card or contact your Burr-Brown Representative.

**WHO SAID BURR-BROWN ONLY MAKES OP AMPS?**



**BURR-BROWN RESEARCH CORPORATION**  
 International Airport Industrial Park • Tucson, Arizona 85734  
 Telephone: (602) 294-1431 • TWX: 910-952-1111 • CABLE: BBRCORP  
 Chicago Office: (312) 832-6250  
 United Kingdom Office: Watford WD1 8BT Phone: 33837  
 French Office: Le Chesnay Phone: 954 35 58

amplifiers / DAC-ADC / multipliers-dividers  
 analog functions/modular power supplies  
 active filters/data conversion products



## Thermocouple Xmitter offers 0.1% accuracy



Moore Industries, 8158 Orion Ave., Van Nuys, Calif. 91406. (213) 787-5559. \$215; 4 to 6 wk.

Model TCT-ST-SC thermocouple transmitter can accurately reference four types (J, K, E, T) of thermocouples and provide any standard process current output signal. Selections can be made in the field. The unit includes complete isolation and may be specified for operation from 24 V dc or 117 V ac. Specifications of the TCT include: Input impedance of greater than 10 M $\Omega$ ; common-mode limit of 500 V rms and rejection at 60 Hz of 120 dB and calibrated accuracy is  $\pm 0.1\%$  of full scale. Upscale or downscale T.C. burnout protection is available.

CIRCLE NO. 262

## Logic oscillator allows for zero-beat trimming

Scarpa Laboratories, Inc., 46 Liberty St., Braintree Station, Metuchen, N.J. 08840. (201) 549-4260. \$50; stock to 2 wk.

A 10-MHz crystal oscillator module designed for TTL/DTL logic has 0.002% stability and an aging rate of only 0.5 ppm per month. Power requirements are 8 mA at 5 V dc. The unit is designed for easy PC board mounting and has only three pin connections for power supply, ground and clock output. Zero beat adjustment via a trimmer capacitor is provided. High speed logic and precision film resistors are used in the design. Mounting size is 1.5 in. square by 0.8 in. high.

CIRCLE NO. 263

## Thermocouple amplifier linearizes signals

Hy-Cal Engineering, 12105 Los Nietos Rd., Santa Fe Springs, Calif. 90670. (213) 698-7785.

The Model ESD-9030 thermocouple linearizing amplifier incorporates an automatic cold junction reference, a high quality thermocouple amplifier, and a well-regulated power supply. The output is 0 to 10 V where 10 V equals the maximum temperature and 0 V equals 0 C or 0 F. Thermocouple input wire is selected and tested to match the NBS curve, carrying the accuracy through the circuit to the input terminals. Circuits are nondeteriorating, resulting in low maintenance requirements. The thermocouple input amplifier is highly stable, with better than 1  $\mu\text{V}/^\circ\text{C}$  drift. The Model ESD-9030 is available for ISA types J, K, T, E, R and S thermocouples.

CIRCLE NO. 264

## Solid-state controls offer four basic modules

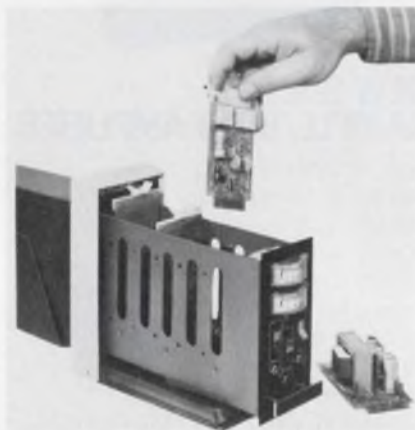

Hills-McCanna Co., 400 Maple Ave., Carpentersville, Ill. 60110. (312) 426-4851.

The Auto-Amp C servo amplifier systems include four basic modules: input interface, bipolar control amplifier, dual static switches, and dual power supply. A fifth dynamic brake module also is available. The compact servo amplifier packages are available in two basic models. The Keyboard model is panel-mounted in a NEMA V enclosure or chassis-mounted in a "card-file" arrangement. The Keyblock model is chassis-mounted with each module plastic encapsulated.

CIRCLE NO. 265

## Carrier demodulator has built-in active filter

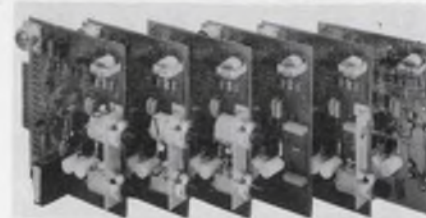

Validyne Engineering Corp., 19414 Londelius St., Northridge, Calif. 91324. (213) 886-8488.

The CD101 carrier demodulator supplies a 5 V, 5 kHz carrier excitation signal for variable reluctance and variable differential transformer transducers. It demodulates their output and provides a  $\pm 10$  V dc signal for static and dynamic pressure measurements. An active filter circuit provides the CD101 with a flat frequency response from dc to 1000 Hz. Both input and output are protected against short-circuits. Low input impedance allows operation with transducers at a distance of over a thousand feet from the CD101 with no degradation of signal. Operation is field selectable from 110 or 220 V ac, 50 to 400 Hz, or  $\pm 15$  V dc power.

CIRCLE NO. 266

## Isolation amplifier has gain and high CMRR

Analog Devices, Rt. 1 Industrial Park, P.O. Box 280, Norwood, Mass. 02062. (617) 329-4700. \$125 (1 to 9); stock.

The Model 274J isolation amplifier offers a full  $\pm 10$  V output swing and a gain that can be adjusted from 1 to 100 V/V. The unit has a 5 kV common-mode voltage and a 115 dB minimum CMRR. It also has a full 5 kV differential input and input to output defibrillator protection with 12  $\mu\text{A}$  rms maximum input fault current limiting. With a 2 M $\Omega$  input resistance for the defibrillator protection, the amplifiers noise varies from approximately 16  $\mu\text{V}$  pk-pk at a gain of 1 V/V to 12  $\mu\text{V}$  pk-pk at a gain of 20 V/V over a 100 Hz bandwidth. The 274J operates from a single +15 V dc supply at a current of 65 mA and is specified over a 0 to 70 C temperature range. It is packaged in a 3.5 by 2.5 by 1.25 in. module.

CIRCLE NO. 267

# Get it out of your system:

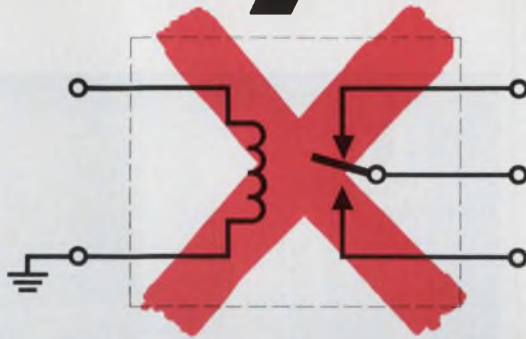

## Replace it with a Monsanto solid-state relay.

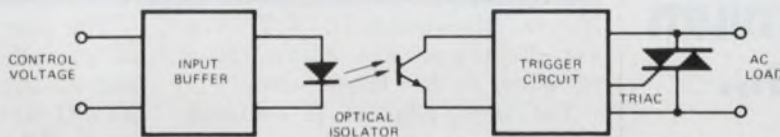

Our MSR series of solid-state relays have a lot of sex appeal. No contact bounce, because there are no contacts. No coil. No reed. No transformer. Many models are available: compatible with TTL or 110-220 VAC inputs; switching 10 Amps at 120 or 240 volts.

	Output	
	120 VAC	240 VAC
N.O. Contacts, DC input	MSR100B	MSR200B
N.C. Contacts, DC input	MSR101B	
N.O. Contacts, AC input	MSR102B	MSR202B
N.C. Contacts, AC input	MSR103B	

They turn on at zero voltage, and off at zero current. By reducing inrush currents, they will lengthen the life expectancy of lamps they turn on.

Because they are completely solid-state, they take severe mechanical shock and vibration without blinking.

### What kind of a system do you have?

There are obvious applications for our relays where noise caused by switching transients is a problem, as it is with computer peripherals. But if you're designing systems for machine control, packaging equipment, copy machines or power line transmission, there are good reasons—some you may not have thought of—why these \$13 relays (100-lot price) will be a lot cheaper than their mechanical counterparts over the long run. Write or call us for our data sheets; they'll give you all the important information you need to make an intelligent design decision.

**Monsanto Commercial Products Company**  
Electronic Special Products  
3400 Hillview Avenue  
Palo Alto, CA 94304  
(415) 493-3300.

*Putting innovation to work.*

# Monsanto

INFORMATION RETRIEVAL NUMBER 58



**everything  
you've wanted  
to know  
about extended  
capability  
nickel-cadmium  
batteries...**

Here's a book with more information on nickel-cadmium batteries. This new handbook supplements the first Nickel-Cadmium Battery Application Engineering Handbook with new application information on extended capability batteries. To find out how you can order this comprehensive engineering handbook circle the number below on the reader service card, or write: General Electric Company, P. O. Box 114, Gainesville, Florida 32601. 453-25

**But didn't  
know where  
to look**

GENERAL  ELECTRIC

INFORMATION RETRIEVAL NUMBER 59

## IC op amp slew rate soars to 320 V/ $\mu$ s

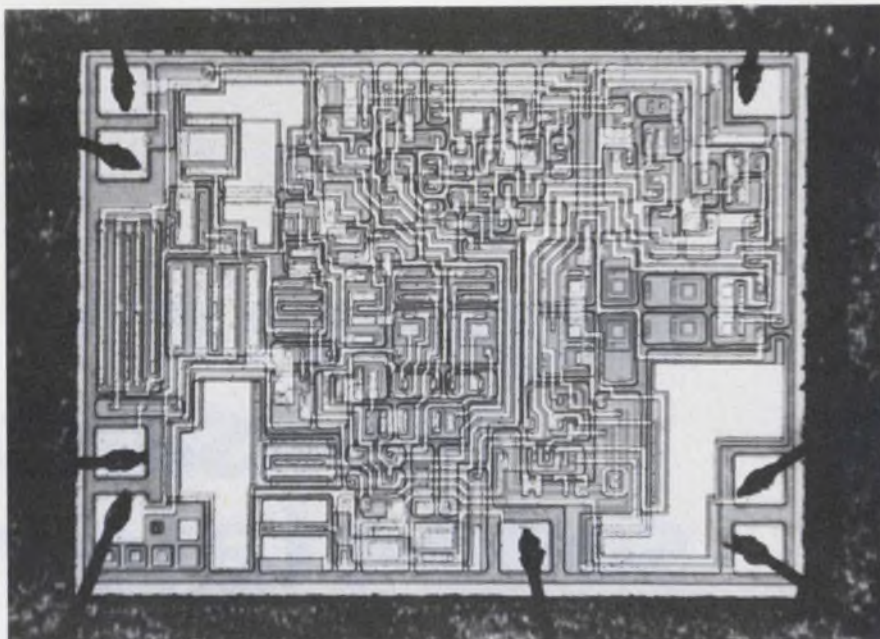

Harris Semiconductor, P.O. Box 883, Melbourne, Fla. 32901. (305) 727-5400. P: See below; stock.

The latest addition to available monolithic op amps—Harris Semiconductor's HA2530/2535—sets the pace for slew rates. The new IC boasts a typical value of  $\pm 320$  V/ $\mu$ s, or nearly three times the highest typical slew rate of previously available monolithic op amps. The minimum slew rate is  $\pm 250$  to  $\pm 280$  V/ $\mu$ s—at least double the minimum rate of any other IC.

An inverting-only amplifier, the HA2530/2535, also offers a full-power bandwidth of typically 5 MHz and a typical settling time of 500 ns to 0.1% of final output voltage. All three parameters are spec'd at 25 C.

The HA2530/2535 uses the company's high-frequency linear process to combine npn and pnp devices with Schottky transistors and MOSFETs on the same chip. As a result the chip's high-frequency performance has not required a sacrifice in dc parameters.

The new op amp lists a typical offset voltage of 0.8 mV at 25 C and an average offset drift of 5  $\mu$ V/ $^{\circ}$ C over the rated temperature range. When operating from standard  $\pm 15$ -V supplies, the IC typically draws only 3.5 mA at 25 C.

Other features of the op amp include an open-loop gain of  $2 \times 10^6$ , with a gain-bandwidth product of 70 MHz. The IC typically requires a bias current of 15 nA, has a power-supply rejection ratio of 100 dB and outputs a pulsed current of  $\pm 50$  mA.

The new op amp extends the company's HA2500 series of high slewrate op amps. Previous models in the series covered the 30-to-120-V/ $\mu$ s range.

Harris Semiconductor offers two versions of the new op amp. The HA2535 covers the 0-to-70-C temperature range and costs \$14.30 (100 to 999). The HA2530 operates over the -55-to-125-C range and sells for \$33.00 (100 to 999). Both versions come in standard 8-pin TO-99 packages. **CIRCLE NO. 251**

# One part in 10 million from 0° to 55°C. Without an oven.

Unlike an oven oscillator, it's smaller, more reliable, uses less power, needs no warm-up time, and it's not as expensive. The K1098A TCXO has TTL compatible output,  $\pm 1 \times 10^{-9}$ /sec. rms short term stability, operates from 5 and 12VDC. Prototype quantities available at 10MHz for immediate delivery. Full details from Motorola Component Products Dept., 2553 No. Edgington, Franklin Park, Ill. 60131.



## TTL comparators boast 6-ns delay

Signetics, 811 E. Arques Ave., Sunnyvale, Calif. 94086. (408) 739-7700. \$3.50 (100); stock.

Two dual high-speed comparator ICs feature a typical propagation delay as low as 6 ns. Called the 521 and 522, the new comparators maintain a  $\pm 3$ -V common-mode range, 7.5-mV input offset voltage and a 5- $\mu$ A offset current. The 521 has the 6-ns delay and TTL-compatible output levels that can source or sink up to 10 Schottky-TTL gates. The 522 has a typical delay of 10 ns and open-collector outputs that permit wired-OR connections.

INQUIRE DIRECT

## Core driver sinks up to 400 mA

National Semiconductor, 2900 Semiconductor Dr., Santa Clara, Calif. 95051. (408) 732-5000. LM-75324N: \$4.02 (100); stock.

A core memory-driver circuit, the LM75324, can provide source or sink currents up to 400 mA at 14 V in a single DIP. A bipolar IC, the LM75324 has a propagation-delay of 40 ns maximum for the delay to logic ZERO at the sink output, and 110 ns maximum for the delay to logic ONE. The driver contains two 400-mA source/sink switch pairs along with four address gates and one 3-input timing gate.

INQUIRE DIRECT

## COS/MOS IC contains 4-bit ALU

RCA Solid State Div., Route 202, Somerville, N.J. 08876. (201) 722-3200. CD4057AD: \$26 (1000).

The COS/MOS CD4057A ALU provides 4-bit arithmetic operations, time sharing of data terminals and full functional decoding for all control lines. The distributed control system allows a hard-wired connection of N-unit CD4057As in  $4^N$  unique combinations. Four control lines provide 16 instructions that include addition, subtraction, bidirectional and cycle shifts, up/down counting, AND, OR and exclusive-OR operations.

CIRCLE NO. 268

## TTL gate offers symmetrical delays

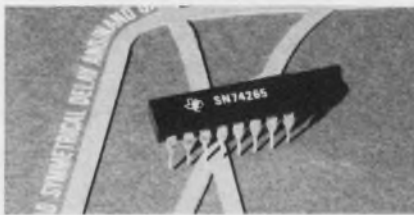

Texas Instruments, P.O. Box 5012, M/S 308, Dallas, Tex. 75222. (214) 238-3741. SN74265: 74¢ to 92¢ (100 up).

A quadruple TTL AND/NAND gate features complementary outputs from each gate for a virtual symmetry of switching time delays. Called the SN54/74265, the IC has a switching time differential or skew of the complementary outputs of typically 0.7 ns. It is guaranteed to be no more than 3 ns at rated loading. The IC features full fan-out to 20 high-level and 10 low-level 54/74 loads.

CIRCLE NO. 269

## SOS/PLA achieves 15-MHz clock rates

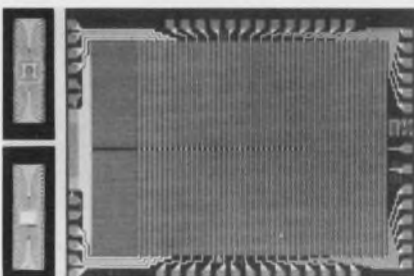

Rockwell International, P.O. Box 3669, Anaheim, Calif. 92803. (714) 632-2321. \$32 (100 up).

A programmable logic array (PLA) using silicon-on-sapphire (SOS) technology can easily achieve 15-MHz clock rates in digital control systems. The PLA contains diodes arranged in 128 rows by 46 columns. Equations are written as sums of products and each product term occupies one row. Terms to be ORed are diode-coupled in the same column, and each row is effectively an AND gate of 45 potential input terms. In addition to logic implementation, the SOS/PLA can be used as a variable word length ROM with up to 4096-bit storage, or as a character generator capable of storing complex designs such as Japanese symbols.

CIRCLE NO. 270

## Power devices rated up to 250 W and 50 A



TRW Capacitor Div., Solid State Operation, Box 1000, Ogallala, Neb. 69153. (308) 284-3611. \$1.00 to \$4.05 (prod. qty.).

A high-power family of silicon npn single-diffused mesa power transistors feature high power and current characteristics with ratings up to 250 W and 50 A. Breakdown voltages range up to 160 V BVCEO. The device structure includes a molybdenum pedestal mounted on a copper base within a hermetically sealed TO-3 case. Basic types include 2N3771, 3772 and 3773 series, and such standard types as the 2N5629 and the 2N6254 series.

CIRCLE NO. 271

## LED drivers interface MOS logic circuits



Motorola, P.O. Box 20924, Phoenix, Ariz. 85036. (602) 244-3466. MC-75491: \$1.60; MC75492: \$1.85 (100 up); stock.

Two interface devices—the MC-75491 quad-segment driver and the MC75492 hex driver—allow LED displays to be driven directly from MOS calculator chips and other MOS logic circuits. The MC-75491 has both collector and emitter outputs and can sink or source up to 50 mA. The MC75492, with collector outputs only, sinks up to 250 mA.

CIRCLE NO. 272

**attenuator-  
rated™**

quiet!

**Ferramic® components  
guarantee circuit  
performance.**

*Attenuator-Rated* components are new—and they're processed specifically for highest interference suppression.

#### **End guesswork**

This new breed of slip-on Ferramic components puts an end to cut-and-try selection. Now you can choose from a full line of our *Attenuator-Rated* components and get known attenuation properties.

Our complete specifications include the data you need to get dependable attenuation characteristics matched to your circuit requirements. And we back our specs with our own testing program.

#### **Highest attenuation**

An ordered series of nine components give you total flexibility in optimizing

attenuation to your specific circuit.

With each of these components you can select the attenuation properties you require. The highest suppression in the industry from 10 KHz to 10 Mhz or maximum attenuation from 10 to 250 Mhz.

#### **New design guide**

Selection of optimum noise attenuation couldn't be easier. Our complete design guide gives you the facts you need. You get typical attenuation and impedance curves, application data and specs that relate directly to your circuit requirements.

If your circuit impedance is known, you can determine attenuation characteristics directly from our graphs. And once your problem is

solved—it stays solved. Our testing program insures that each *Attenuator-Rated* component will meet its attenuation specs.

For complete design information and the answers to your attenuation requirements, use the reader service card for your copy of our design guide. Or call (201) 826-5100 and talk to the men who wrote it. Either way, if you're talking attenuation, talk to the ferrite experts.

That's us.

Indiana General  
Electronic Products  
Keasbey, N.J. 08832

*National distribution  
through eight  
Permag locations.*

**indiana general** 

a division of Electronic Memories & Magnetics Corp.

INFORMATION RETRIEVAL NUMBER 61

# Pistoncap™ TUBULAR TRIMMER Capacitors

OFFER SUPERIOR  
PERFORMANCE



A new series of moderate cost, precision trimmer capacitors developed by Sprague-Goodman Electronics features a simplified more reliable adjust mechanism for long life and reliability. These improved designs are form, fit and functionally interchangeable with competitive devices. Sprague-Goodman capacitors are highly stable, meet or exceed MIL-C-14409C requirements, and are furnished in glass, hi-range glass, and quartz dielectric.

Panel mounting and printed circuit board mounting designs are available in 14 standard capacitance ranges from 0.8–4.5 pF to 1.0–38.0 pF.

For full technical information call Sprague Electric district office or sales representative nearest you.

PISTONCAP trimmer capacitors are available for immediate delivery from stocking Sprague distributors.

**SPRAGUE  
GOODMAN**

**Sprague-Goodman  
Electronics, Inc.**

(An Affiliate of the Sprague Electric Company)  
371 Willis Ave., Mineola, N.Y. 11501  
516/746-1385

## ICs & SEMICONDUCTORS

### Differential comparator includes strobe

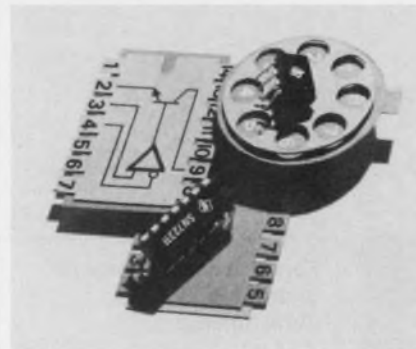

Texas Instruments, P.O. Box 5012, M/S 308, Dallas, Tex. 75222. (214) 238-3741. SN72311P: \$1.80 (100); stock to 8 wk.

A differential comparator with strobe—the SN52111/SN72311—is interchangeable with the LM-111/LM311. Maximum input bias current is 250 nA with a 50-nA maximum input offset current. Response times, low-to-high-level output and high-to-low-level output, are 170 and 190 ns, respectively. The comparator can operate from a range of supply voltages, including  $\pm 15$ -V and 5-V supplies. The circuit can switch voltages up to 50 V at 50 mA. Outputs can be wire-OR connected.

CIRCLE NO. 273

### LED drivers sink up to 500 mA

National Semiconductor, 2900 Semiconductor Dr., Santa Clara, Calif. 95051. (408) 732-5000. \$1.85 to \$3.70 (100 up); stock.

A family of LED digit and segment drivers interface MOS devices with common-cathode displays. Two of the new devices, called the DM8861 and the DM75491, are segment drivers that source or sink up to 50 mA. The DM8861 contains five segment drivers in an 18-pin Epoxy B DIP and the DM75491 contains four drivers in a 14-pin Epoxy B DIP. The other two devices in the series are digit drivers. The DM8863 contains eight digit drivers in an 18-pin Epoxy B DIP, each of which can sink up to 500 mA. The DM75492 contains six digit drivers in a 14-pin Epoxy B DIP each of which can sink up to 250 mA.

INQUIRE DIRECT

### Low-power ALU includes latch

Advanced Micro Devices, 901 Thompson Pl., Sunnyvale, Calif. 94086. (408) 732-2400. AM25L06-PC: \$7.15; (100 up).

The Am25L06 arithmetic logic unit, with built-in latch, offers maximum power dissipation of only 210 mW at guaranteed addition speed of 72 ns. The 4-bit ALU has an internal 4-bit latch for the temporary storage of data. The latch portion offers essentially "zero" propagation delay as well as "zero" power dissipation.

CIRCLE NO. 274

### Linear IC has transistors, thyristors

RCA Solid State Div., Route 202, Somerville, N.J. 08876. (201) 722-3200. CA3097E: \$1.50 (100-999).

A linear IC thyristor/transistor array—the CA3097E—consists of five independent and completely isolated elements on one chip: a programmable unijunction (PUT), a zener diode, a sensitive-gate SCR, a pnp/npn transistor pair, and an npn transistor. The CA3097E features 30-V operation for all elements. Zener impedance at 10 mA is 15  $\Omega$ , and the SCR has a forward current rating of 150 mA. Typical peak-point current for the PUT is 0.15  $\mu$ A max with a gate-resistance of 1 M $\Omega$ .

CIRCLE NO. 275

### Bipolar IC drives displays

Fairchild Semiconductor, 464 Ellis St., Mountain View, Calif. 94040. (415) 962-3816. \$2.30 (100-999).

A monolithic TTL/MSI IC—the 9370—can drive most common-anode LEDs as well as 5-V incandescent displays. It combines the function of a seven-segment decoder with high drive capability and a four-bit latch. The 9370 can drive all popular types of common-anode LED displays using only seven external resistors. It can sink up to 25 mA of current, has an active low latch enable for easy interfacing with other MSI circuits, and includes automatic ripple blanking for leading or trailing edge zeros.

CIRCLE NO. 276

#### Distributors

**Arizona:** Hamilton/Avnet,  
Phoenix (602) 269-1391  
Kierulff, Phoenix  
(602) 273-7331

**California:** Hamilton/Avnet,  
Mountain View  
(415) 961-7000  
San Diego (714) 279-2421  
Hamilton Electro,  
Culver City (213) 870-7171  
Kierulff, Palo Alto  
(415) 968-6292  
San Diego (714) 278-2112

Wesco Electronics,  
Los Angeles (213) 685-9525  
**Colorado:** Hamilton/Avnet,  
Denver (303) 534-1212  
Kierulff, Denver  
(303) 343-7090

**Florida:** Hamilton/Avnet,  
Hollywood (305) 925-5401

**Georgia:** Hamilton/Avnet,  
Norcross (404) 448-0800  
**Illinois:** Allied, Chicago  
(312) 421-2400  
Hamilton/Avnet, Schiller  
Park (Chicago)  
(312) 678-6310  
Kierulff, Rosemont  
(Chicago) (312) 678-8560

**Kansas:** Hamilton/Avnet,  
Prairie Village (Kansas City)  
(913) 362-3250

**Maryland:** Hamilton/Avnet,  
Hanover (Baltimore)  
(301) 796-5000  
Pioneer, Rockville  
(301) 427-3300

**Massachusetts:**  
Electrical Supply,  
Cambridge (617) 491-3300  
Gerber, Dedham  
(617) 329-2400  
Hamilton/Avnet, Burlington  
(617) 273-2120  
Kierulff, Needham Heights  
(617) 449-3600

**Michigan:** Hamilton/Avnet,  
Livonia (313) 522-4700

**Minnesota:** Hamilton/Avnet,  
Bloomington  
(612) 854-4800

**Missouri:** Hamilton/Avnet,  
Hazelwood (St. Louis)  
(314) 731-1144

**New Jersey:** Arrow,  
Saddlebrook (201) 256-7331  
Hamilton/Avnet, Cherry Hill  
(609) 662-9337  
Cedar Grove (201) 239-0800  
Haddonfield (609) 429-1526

**New Mexico:**  
Century, Albuquerque  
(505) 265-7837  
Kierulff, Albuquerque  
(505) 247-1055

**New York:** Semiconductor  
Concepts, Hauppauge  
(516) 273-1234  
Hamilton/Avnet, Syracuse  
(315) 437-2642  
Westbury, L.I.  
(516) 333-5812

Arrow, Farmingdale  
(516) 694-6800  
Summit, Buffalo  
(716) 884-3450

**North Carolina:** Pioneer,  
Greensboro (919) 273-4441

**Ohio:** Arrow, Dayton  
(513) 253-9176  
Kierulff, Dayton  
(513) 278-9411

**Texas:** Hamilton/Avnet,  
Dallas (214) 638-2850  
Houston (713) 526-4661  
Kierulff, Garland (Dallas)  
(214) 271-2471

**Utah:** Hamilton/Avnet,  
Salt Lake City (801) 262-8451

**Washington:**  
Hamilton/Avnet,  
Seattle (206) 624-5930  
Kierulff, Seattle  
(206) 763-1550

**Canada:** Prelco, Montreal  
(514) 389-8051  
Ottawa (613) 237-6150  
Electro Sonic Ind. Sales,  
Toronto (416) 924-9301  
Hamilton/Avnet, Montreal  
(514) 735-6393

Toronto (416) 677-7432  
Ottawa (613) 725-3071  
L. A. Varah, Vancouver, B.C.  
(604) 736-6411  
Future Electronics  
Montreal (514) 735-5775  
Ottawa (613) 232-7757  
Toronto (416) 677-7820

## OUR NEW 0.6" DL-747 DIGIT

# HIGH GLOW, LOW DOUGH



The Bright Guys are proud to announce the new 0.6" Data Lit-747—the Jumbo Digit with the Midget Price. It's the latest addition to the Bright Guys' DL-700 series of light pipe displays constructed with Litronix' Encapsulated Light Diffusion (ELD) process. It's without doubt the best digit buy of the year.

**High Glow:** The DL-747 is a 0.6" high digit with a brightness spec of 5 mcd at 20 mA.

**Low Dough:** In 1K quantities, the DL-747 costs only \$3.60, making it the lowest

cost LED of its size on the market. Now doesn't that warm your heart?

The DL-747 is a left decimal, common anode display with standard double DIP pin spacing. It's pin-for-pin compatible with the Litronix DL-62.

Not only that, its solid, mitered corner segments make it the jazziest looking digit in town. So to High Glow and Low Dough, add Good Show.

Want to know more? Write or call the Bright Guys.

the  
bright  
guys

# litronix

Litronix, Inc. • 19000 Homestead Road • Cupertino, California 95014 • (408) 257-7910 TWX: 910-338-0022

European Headquarters: Litronix, Inc. • Bevan House, Bancroft Court • Hitchin, Hertfordshire SG5 1LW England • Tel: Hitchin 2676 Telex: 825 497

INFORMATION RETRIEVAL NUMBER 63



## POWER SOURCES

### Complete power supply fits on 4-1/2 in. PC card

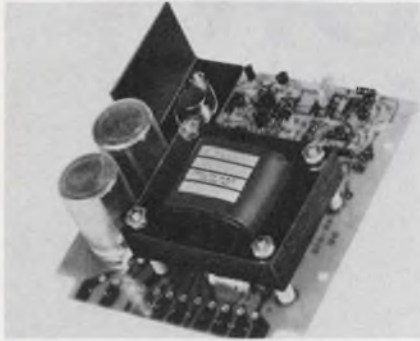

ACDC Electronics, Oceanside Industrial Center, Oceanside, Calif. 92054. (714) 757-1880. \$28.50; stock.

There are 17 single output models in the CD series of printed-circuit card power supplies. They range from 4 V at 1.5 A to 32 V at 0.4 A and include two dual output models,  $\pm 12$  V at 0.42 A and  $\pm 15$  V at 0.37 A. Designed for card-edge plug in, the 4-1/2 in. cards can be mounted right in a card file—or wherever the power is needed. Barrier strip termination can also be provided. The CD units operate from 105 to 125 V ac, 47 to 63 Hz. Regulation is 0.1%. Overload protection and remote sensing are standard. Overvoltage protection is optional.

CIRCLE NO. 277

### Lithium batteries now come in 'AA' size



Power Conversion, 70 MacQuesten Pkwy. S., Mount Vernon, N.Y. 10550. (914) 699-7333.

The Model 400 "AA" lithium primary battery exhibits a nominal voltage of 2.8 V, twice that of ordinary primary cells. It also has a rated capacity of 1.2 ampere-hours (at a 24 mA current drain). Weight is 0.44 oz. Eternacell batteries are now available in seven off-the-shelf configurations, ranging in capacities from 1 to 10 ampere-hours; all yield a nominal voltage of 2.8 V.

CIRCLE NO. 278

### Adjustable output supply provides up to 3 A



Alpha Components, P.O. Box 947, El Segundo, Calif. 90245. (213) 322-7780. \$22 (large qty.); stock.

Model 3AS12VFM dc power supply provides an adjustable dc output from 0 to 12 V at currents to 3 A. Filtered output ripple is maintained at less than 0.34 V pk-pk. Front panel controls and indicators include an ac power switch, voltage adjust control, "on" indicator light and dc voltmeter. Also included is an internal automatic resetting circuit breaker which protects the power supply from overloads and short-circuits, and automatically clears when overload is removed. The supply operates from a standard 115 V single-phase, 50/60 Hz line.

CIRCLE NO. 279

### Single and dual output supplies save space

Standard Power, 1400 S. Village Way, Santa Ana, Calif. 92705. (714) 558-8512. \$65, (5-1000), \$48 (15D-100).

Single and dual-output supplies offer continuous short-circuit protection through "fold-back" current limiting, all solid-state construction, and epoxy encapsulation for ruggedness. Nominal input voltage for each unit is 115 V ac, 50 to 400 Hz. Operational temperature range is from  $-20$  to  $+71$  C, with a temperature coefficient of  $0.1\%/^{\circ}\text{C}$ . Single output series-regulated Model ESP-5-1000 provides 5 V dc at 1 A. It measures 2.5 by 3.5 by 1.25 in. The dual-output unit, Model ESP-15D-100, provides  $\pm 15$  V dc at 100 mA and measures 2.5 by 3.5 by 0.88 in. Mounting kit accessories include: a PC board and either a 22 or 15-pin connector or PC board with an eight-terminal barrier strip.

CIRCLE NO. 280

### Modular supply offers triple power outputs

Intronics, 57 Chapel St., Newton, Mass. 02158. (617) 332-7350. \$69 (1 to 9); stock.

The SM300/5-150/15 modular power supply has  $\pm 15$  V dc outputs and a single 5 V dc logic output. The supply is contained in a compact encapsulated module measuring only 3.5 by 2.5 by 1.25 in. It provides a high input/output isolation of 50 M $\Omega$ , line regulation of 0.01%, and load regulation of 0.05%. Input regulation works over an ac input of 105 to 125 V ac, with optional input voltages from 90 to 252 V ac. The dual  $\pm 15$  V outputs provide up to 150 mA, while the single 5 V output is rated for 300 mA. All three outputs are preset to 0.5% accuracy and are fully short-circuit protected. In addition, the 5 V output is overvoltage protected.

CIRCLE NO. 281

### Brownout proof power supply delivers 1800 W



Pioneer Magnetics, 1745 Berkeley St., Santa Monica, Calif. 90404. (213) 829-3305.

The Model PM 2462 is a computer mainframe power supply. It provides 1800 W of precisely regulated power in an 80 lb package. The unit is insensitive to input frequency variations and delivers specified power over wide input voltage swings. The standard unit has four output channels: 5 V at 200 A,  $-2$  V at 200 A and 12 V at 15 A. Overload and short-circuit protection are built-in and extended output hold-up in excess of 20 ms is provided to protect against utility power dropouts. The unit is designed to meet UL-478 and the RFI requirements of VDE 08.75. Optional features including overvoltage protection, DTL and TTL compatible interface signals overtemperature cutout and output power sequencing.

CIRCLE NO. 282

# The best things always come in small packages.



## Like our new 10 Amp control circuits in the TO-3 case.

These complete 10-Amp control functions in a TO-3 package are the newest breakthrough in our line of PACE/pak™ power hybrids.

We think they are one of the best things to come along for people who build fractional HP motors and controls, low current power supplies, inverters, home air conditioners and heaters . . . you name it.

By packaging just the chips of SCRs and diodes we save you 40% in total space. What's more, the TO-3 PACE/pak can probably pay for itself by cutting out the need for a separate, electrically isolated heat-sink. How can we put so much power control in a TO-3? Partly because we can take so much heat out. We get 40% greater thermal efficiency by using a better method than you can afford with discretes.



The cooler-running junctions also give you more reliability. And by using this complete, hermetically sealed control function you don't have to worry over — or pay for — connecting up five discrete devices. Assembly time is cut by 70%. So

is inspection, inventory and purchasing time. TO-3 PACE/paks are available now in seven standard circuits, in both 120 and 240 Volt RMS ratings. The complete PACE/pak line includes ratings to 50 Amps, in configurations such as AC switches, center tap assemblies, and both single and 3-phase SCR and diode bridges. And now it's time for another old saying: Seeing is believing. Call your IR sales office, rep or distributor and get the full story. *International Rectifier, 233 Kansas St., El Segundo, CA. 90245 (213) 678-6281*

# International Rectifier

... the innovative power people





**our products  
are more fully  
developed...**

Standard Condenser capacitors are indeed fully developed to produce the optimum in performance and durability. Standard is in one business only, the design and manufacture of the world's finest capacitors. We have designed and delivered thousands of specialized capacitors for industry. In fact, what you think of as "special" may be among the many designs already available from stock at Standard. However, if you require capacitors of unusual shape, size, value and material, our engineering department will help you design and produce them to your exact specifications at stock prices. For immediate action, send us a sketch and complete details.

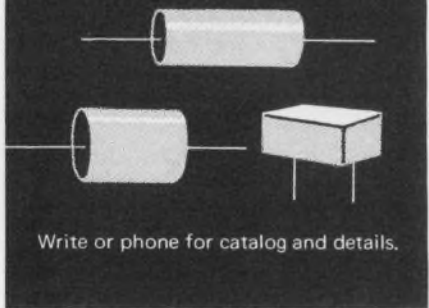

Write or phone for catalog and details.

**Standard**

**CONDENSER CORPORATION**

Dept. ED-10 1065 West Addison Street  
Chicago, Illinois 60613 • (312) 327-5440

INFORMATION RETRIEVAL NUMBER 65

**POWER SOURCES**

**Dc regulated supplies  
come minus transformer**

*ERA Transpac, 311 E. Park St., Moonachie, N.J. 07074. (201) 239-3000. From \$33.*

The CR regulator series requires the output from a simple center-tap transformer for operation. Permitted ac input variation is  $\pm 10\%$ , 47 to 63 Hz, or 380 to 410 Hz. Regulation is better than 0.05% and ripple is less than 1 mV rms. The operating temperature range is  $-20$  to  $+71$  C with a temperature coefficient of less than 0.01%/°C. Transient response is less than 50  $\mu$ s for a full-load change and protective circuits include built-in adjustable overcurrent and overvoltage protection, and automatic thermal cut-out. Supplies are available in current ranges of 3, 6, 12 or 20 A and voltage ranges of 4.7 to 7, 7 to 10, 10 to 16, 16 to 22 and 22 to 30 V dc. Size of a typical unit is 1-1/2 by 4-3/4 by 5-1/2 in.

CIRCLE NO. 283

**Power supplies deliver  
0.15 A for wide voltages**

*Abbott Transistor, 5200 W. Jefferson Blvd., Los Angeles, Calif. 90016. (213) 936-8185. From \$66 (1 to 4); stock.*

The RNO.15 family of dc power supplies provides 0.15 A at various voltages between 4.5 and 37 V dc. Line and load regulation are 0.1% and ripple is less than 0.02%. Standard features include short-circuit protection, input transient protection and remote error sensing. Anodized aluminum case construction permits sustained full-load operation at an ambient temperature of  $+160$  F ( $71$  C) without the need for heat sinking or forced air cooling. A temperature coefficient of 0.03%/°C guarantees stability in a fluctuating thermal environment. Optional features such as overvoltage protection and remote voltage adjustment are available. In addition these units can be modified to operate with an input voltage of 210 to 250 V rms at 50 to 420 Hz.

CIRCLE NO. 284

**UPS can deliver 1.1 A  
for 30 min. from Ni-Cads**



*Moxon Inc., 2222 Michelson Dr., Irvine, Calif. 92664. (714) 833-2000.*

The Model 583 uninterruptible power source delivers up to 160 VA with power factors of 0.7. It is a rack-mounted unit that includes a 24 V dc nickel-cadmium battery, internal ac-to-dc-to-ac converter and all required front panel controls. The UPS accepts 105 to 225 V ac, 50 to 400 Hz at 250 VA. This is converted to 24 V dc which "float" charges the nickel-cadmium battery. Operating temperature is 0 to 50 C at up to 95% humidity. The unit can deliver 105 to 120 V ac at 60 Hz  $\pm 5\%$  at a full load of 1.1 A. It will continue to operate for up to 30 min. or until the battery supply reaches 22 V. Physically, the unit measures 5-1/2 by 19 by 20 in. and weighs 80 lb. including the battery.

CIRCLE NO. 285

**Precision power supplies  
offer high power outputs**

*Christie Electric Corp., 3410 W. 67 St., Los Angeles, Calif. 90060. (213) 750-1151.*

The EE series of high-current dc power supplies offers  $\pm 0.1\%$  voltage and current regulation as standard features. There are models available with ratings up to 700 A or 125 V. Other standard features of the EE series include 0.1% ripple, continuous output adjustment over the entire dc voltage range by means of a 10-turn potentiometer, units may be operated in series or in parallel, provisions for selecting local sensing at the power supply terminals or remote sensing at the load terminals, all solid state design including hermetically sealed SCRs and plug-in cards for easy servicing. Optional features include varied cabinet styles, sizes, and militarizing against humidity, salt spray, sand, dust and fungus.

CIRCLE NO. 286

## Polarity reversing option works at high V



Spellman High Voltage Electronics, 1930 Adeo Ave., Bronx, N.Y. 10469. (212) 671-0300. EPS option: \$200; 6 wk.

A rack-mounted RHSR line of high voltage power supplies offers an externally situated polarity reversal switching option. This switching option enables an operator to easily reverse the output polarity. All RHSR models are rated for 60 W with output voltages ranging from 5 to 25 kV and can be ordered with the new polarity reversal system. For example, Model RHSR20PN60/EPS is a 0 to 20 kV, 3 mA power supply with 0.001% regulation, 0.001% ripple and the new reversal system.

CIRCLE NO. 287

## Digitally controlled source resolves 1 $\mu$ A



Hewlett-Packard, 1501 Page Mill Rd., Palo Alto, Calif. 94304. \$2900; 8 wk.

The Model 6145A digitally programmable current source provides current outputs from  $-9.999$  to  $+9.999$  mA (X1 range) to  $-99.99$  to  $+99.99$  mA (X10 range) at compliance voltages up to 100 V dc. In the X1 range ( $\pm 9.999$  mA), resolution is 1  $\mu$ A, accuracy is 1  $\mu$ A, and programming speed is 300  $\mu$ s. An active guard circuit eliminates internal leakage currents so that output voltage can be measured without drawing current from the load. The 6145A can be programmed from a remote four-digit 8421-BCD source or locally using front-panel thumb wheel switches.

CIRCLE NO. 288

# We've pulled a switch. DC input to drive an AC airmover. We call it, "The DC Boxer."

An integrally mounted solid state converter does it. Eliminates brush wear, arcing and attendant noise problems and adds years to service life.

Fan mounts with all the ease of a standard Boxer (4-11/16" sq., 1-1/2" deep), no extra connections or fasteners required. Eight models deliver up to 120 cfm cooling output.

Available with patented Grand Prix sleeve, or rugged ball bearings, both rated at 10 or more years operating life.

Other airmovers? Of course!

Send for our full-line catalog No. ND4r. It's free, and contains performance data, electrical and mechanical specifications on more than 100 units.

And valuable application information too.



For immediate service, contact us at IMC Magnetics Corp., New Hampshire Division, Route 16B, Rochester, N.H. 03867, tel. 603-332-5300. Or the IMC stocking distributor in your area. There are more than 50 nationwide and overseas.



INFORMATION RETRIEVAL NUMBER 235

# The Answer Fan. Low-profile installation? It's a mere 3-5/8" sq., 1-1/2" deep. High output vs back pressure? It packs a 46 cfm cooling wallop. We call it, "The Mini Boxer."

MiniBoxer fights the damaging effects of heat in rack panels, tape decks, main frames and similar space-critical applications.

10 high performance models, ball or new Grand Prix sleeve bearing types, provide 10 or more years normal operating life. Also available in rugged Mil Spec versions.

Other airmovers? Of course!

Send for our full-line catalog No. ND4r. It's free, and contains performance data, electrical and mechanical specifications on more than 100 units.

And valuable application information too.



For immediate service, contact us at IMC Magnetics Corp., New Hampshire Division, Route 16B, Rochester, N.H. 03867, tel. 603-332-5300. Or the IMC stocking distributor in your area. There are more than 50 nationwide and overseas.

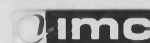

INFORMATION RETRIEVAL NUMBER 236

## Sweep function gen sells for \$450



Datapulse Div., Systron-Donner, 10150 W. Jefferson Blvd., Culver City, Calif. 90230. (213) 871-0410. \$450; 45 days.

With the Model 411 2-MHz sweep function generator, you can set the upper swept-frequency limit to 2% of full scale. The lower limit is controlled by a sweep width adjustment. Frequency is specified in 6 decade ranges from 0.02 Hz to 2 MHz and the dial accuracy is  $\pm 2\%$  of full scale. The unit may be frequency modulated over 1000 to 1 ratio either internally or externally up to a rate of 10 kHz.

CIRCLE NO. 289

## \$299 buys 40-MHz counter



John Fluke Manufacturing Co., Inc., P.O. Box 7428, Seattle, Wash. 98133. (206) 774-2211. \$299; stock to 30 days.

Model 1941A Digital Counter has a frequency range of 5 Hz to 40 MHz and can be used for frequency measurement, totalizing, events-per-unit time and time-interval measurements. Featured are a six-digit Nixie display and a low-pass filter and attenuator that can be switched into the circuit. Weight is 6 lb and size is 3  $\times$  7-1/2  $\times$  9-1/4 in.

CIRCLE NO. 290

## Waveform generator doubles as counter

MTS, Inc., 6328 Linn Ave. N.E., Albuquerque, N.M. 87108. (505) 265-7553. Kit: \$139.95; Assembled: \$199.95; 4-6 wk.

The 1700A Waveform Generator/Frequency Counter generates six carrier waveforms including sine, triangle, square, ramp, sawtooth and pulse. Frequency span is 1 Hz to 1.5 MHz in 12 overlapping ranges. Included are three internal AM or FM modulator waveforms—sine, triangle, and square, ranging from 100 Hz to 150 kHz in six overlapping ranges. The four-digit Frequency Counter measures the frequency of the Waveform Generator output or frequency of external signals from 1 Hz to over 10 MHz.

CIRCLE NO. 291

## Digital tester diagnosis ICs

PRD Electronics Div., 1200 Prospect Ave., Westbury, L.I., N.Y. 11590. (516) 334-7810. Approx. \$60,000; 5 mo.

The 949 Automatic Digital Tester is a computer-controlled system that performs functional, parametric and dynamic response time measurements on digital ICs, PC-boards, modules and systems. It can also perform both end-to-end and diagnostic testing. The maintenance features of modular design are enhanced by a highly effective self-check procedure which isolates faults in both the computer and digital subsystems.

CIRCLE NO. 292

## Comparator allows fast capacitor sorting

Electro Scientific Industries, 13900 N.W. Science Park Dr., Portland, Ore. 97229. (503) 646-4141. \$700; stock to 60 days.

Model 1412A Limits Comparator joins the Model 275 Digital Capacitance Meter. With both instruments, the user can sort capacitors by deviation and dissipation factor simultaneously, at speeds up to five capacitors per second. Nominal capacitance value, deviation upper and lower limits, and dissipation factor upper limit are set on the comparator front panel controls.

CIRCLE NO. 293

## Function generator programs in 100 $\mu$ s

Krohn-Hite, 580 Massachusetts Ave., Cambridge, Mass. 02139. (617) 491-3211. \$1995; 20 wk.

Model 5500R programmable function generator uses FET switching instead of the normally used mechanical relays. The unit provides full remote selection, with programming response time of less than 100  $\mu$ s, of frequency from 0.0001 Hz to 5 MHz; amplitude up to 30 V pk-pk open circuit with 10-mV resolution, and fixed position and negative dc offset.

CIRCLE NO. 294

## Event counter combines MOS/LSI & liquid crystal



Digilin Inc., 1007 Air Way, Glendale, Calif. 91201. (213) 240-1200. Reflective: \$52; Transmissive: \$68; stock to 6 wk.

This event counter combines a liquid-crystal display with large-scale MOS. Only 20 mW of power is required. Features include a 0.65-in. digital display and a 500-kHz counting rate. TTL logic inputs are standard, and a variety of models are available, powered from  $\pm 12$  V dc (reflective) to line-powered transmissive units.

CIRCLE NO. 295

## Universal potentiometer measures to 0.0005%

Julie Research Labs, 211 W. 61st St., New York, N.Y. 10023. (212) 245-2727. \$920; 3-4 wk.

This universal potentiometer/bridge system, the Model UPB-100T, features a 5 ppm (0.0005%) six-dial Kelvin-Varley Divider with taps at 1.0 (100K) and 1.2 (120K). The self-contained null detector has a max. sensitivity of 0.2  $\mu$ V and ranges to 1000 V. Input resistance is 120 k $\Omega$ , accuracy is 0.0005%, and resolution is 0.0001%. The unit is housed in a 17  $\times$  7  $\times$  7-1/2 in. metal cabinet and is powered by mercury batteries.

CIRCLE NO. 296

# The Dual Gap Head Piece, with a gap width of 0.000125 inch! Made possible by TDK's glass bonding and precision processing techniques.

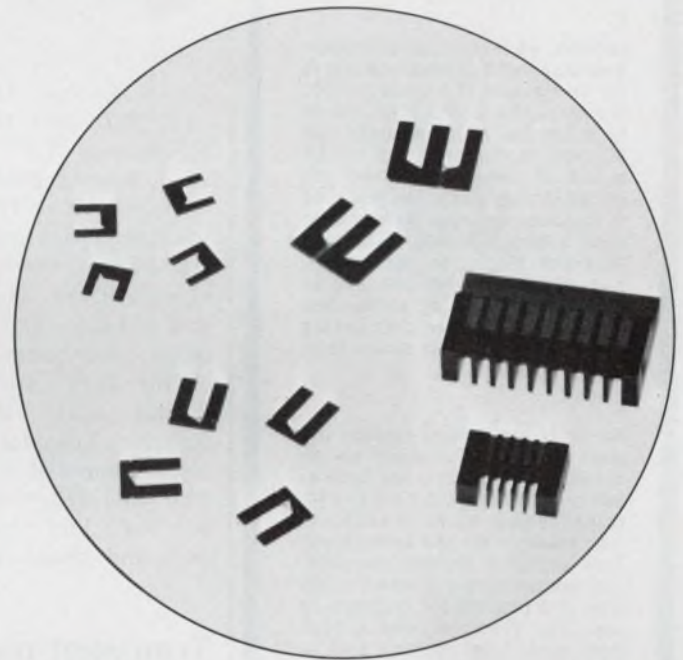

**TDK technology also presents  
IBM-2314 and IBM-3330 types,  
in addition to Dual Gap  
and Multi-Track types.**

TDK makes use of the world's top level techniques for ferrite manufacturing, techniques that are the outcome of many years of specialized application. In addition to the high-density ferrites, including hot-pressed ferrites, already produced, new glass bonding and precision processing techniques are resulting in finer products. With these improvements in quality, head pieces of highest precision are available from TDK.

TDK welcomes any inquiries concerning ferrite head pieces.

	Initial permeability	Flux density (at 15 Oe)	Coercive force	Specific density	Material composition
HR3S	18,000±20%	>3,700 gauss	<0.05 Oe	>5.10 g/cm <sup>3</sup>	Mn-Zn
HR5-2	3,000±15%	>4,900 gauss	<0.1 Oe	>5.05 g/cm <sup>3</sup>	Mn-Zn (Hot pressed ferrite)
KR4	1,500±15%	>3,200 gauss	<0.2 Oe	>5.30 g/cm <sup>3</sup>	Ni-Zn
KR6	2,000±15%	>3,200 gauss	<0.15 Oe	>5.30 g/cm <sup>3</sup>	Ni-Zn
KRZ	2 max.	-	-	>5.30 g/cm	-



TDK ELECTRONICS CO., LTD.

14-6 2-chome, Uchikanda, Chiyoda-ku, Tokyo 101, Japan

TDK ELECTRONICS CORP.

LOS ANGELES BRANCH 931 South Douglas Street, El Segundo, California 90245 Phone: (213) 644-8625 Telex: 230653456 (TODENKA ELSI)

CHICAGO BRANCH 2906 West Peterson Avenue, Chicago, Illinois 60645 Phone: (312) 973-1222 Telex: 25910221421 (TDK CHGO)

INFORMATION RETRIEVAL NUMBER 67

MONOLITHIC CRYSTAL FILTERS

THE  
STATE  
OF THE  
ART

#### THE X-Y EFFECT

X.

Recently, we received an assignment from customer X to work with him in the development of his new product. Our monolithic crystal filter was to be a key part of his product's system. We started with him on his project at earliest breadboard and carried through over a two year span to final manufacturing. We worked in close collaboration with X, tailoring filter and product to one another. The result is a product unique in its field, which, based on performance and cost, has gained outstanding market acceptance. Our custom monolithics helped.

Y.

Not every new product requires two years to develop. Customer Y saw an immediate market for a new application of radio control. But his existing control receiver would be subject to interference in the new environment. Time was short. We were consulted, and recommended a standard model filter that provided the necessary i-f selectivity. Prototypes were shipped from stock. Later we were able to speed his first production run by supplying several hundred of the same standard model filter in less than four weeks. In addition to saving time, customer Y was able to take advantage of standard model engineering and pricing for his requirement, which eventually totaled a very modest, but highly successful, 1500 units for Y.

And success is the name of the game. Whether it's a brand-new project or a fast reread of an old standby we've got the filters to make your design successful. First there's the industry's largest selection of standard model monolithic and tandem monolithic crystal filters. And when it comes to custom modes, our unmatched experience assures you of the sound engineering advice you need. Last but not least, our unequalled capacity gets you your production units on time. We've proved it for X and Y and we'd like to add you to our alphabet. Drop us a line or call us.

**Pi**

**Piezo Technology Inc.**

2400 Diversified Way  
Orlando, Florida 32804  
305-425-1574

The Standard in monolithic  
crystal filters.

## INSTRUMENTATION

### Fourier Xform analyzers are fully digital



*Signal Analysis Operation, Honeywell, TID, 595 Old Willets Path, Hauppauge, N.Y. 11787. (516) 234-5700. Approx. \$5000; 90 days.*

Models SAI-472 and SAI-473 Fourier Transform Analyzers are stand-alone devices that accept signals from the company's 100 and 400-point Correlation & Probability Analyzers. The company claims they are the first fully digital units to calculate the Fourier Transform of the functions computed by the Correlator. The SAI-472/473 output consists of real and imaginary magnitude and phase components.

CIRCLE NO. 297

### Transient recorder handles 3- $\phi$ lines



*Micro Instrument Co., Power Instrument Div., 580 Opper St., Escondido, Calif. 92025. (714) 746-2010. \$2995; 6 wk.*

With three differential-input circuits capable of either line-to-line or line-to-ground measurements, this new instrument, Model 5205-CR, features peak transient and surge measurements from dc to 100 ns. Signals are preconditioned through memory circuits and presented on a four-channel strip-chart recorder having speeds for 1, 7 or 30 days continuous monitoring. Voltage range is 10 V to 100 kV and accuracy is  $\pm 3\%$ .

CIRCLE NO. 298

### 10-MHz scope offered for \$475



*Tektronix, P.O. Box 500, Beaverton, Ore. 97005. (503) 644-0161. \$475; 2 wk.*

The Telequipment D61 is said to be one of the lowest priced 10-MHz, dual-trace scopes now available. The unit features 10-mV sensitivity at 10 MHz, dual-trace and x-y operation, calibrated vertical and horizontal deflection factors, a special TV signal triggering mode, and simple operation. The two vertical channels feature deflection factors from 10 mV/div, at accuracies within 5%. Sweep rates range from 500 ms/div to 0.5  $\mu$ s/div at 5% accuracy.

CIRCLE NO. 299

### Lock-in amplifier penetrates 100-dB noise



*Evans Associates, P.O. Box 5055, Berkeley, Calif. 94705. (415) 848-6839. \$1350; 30 days.*

Model 4103 Lock-in Amplifier is a synchronous ac-detection instrument covering 1 Hz to 100 kHz. Features include expanded signal/noise processing capability as well as a digital LED display with an optional BCD output. Input sensitivity extends down to 1  $\mu$ V fs, with 1-nV resolution and 100% overrange. CMRR is greater than 100 dB at power line frequencies and above. Inherent dynamic range for noncoherent signals and interference is greater than 100 dB.

CIRCLE NO. 300

## Programmable DMM measures to 1 ppm



Julie Research Labs, 211 W. 61st St., New York, N.Y. 10023. (212) 245-2727. \$7050; 2 to 12 wk.

Model DM-1030 Precision Digital Multimeter adds a 1 ppm resistance mode to 1 ppm dc-voltage measurement and 1 ppm dc-ratio measurement, obtainable in the Model DM-1010. This completely digital, programmable, 6-1/2-digit multimeter allows 1 ppm type measurements to be automated, in addition to having a manual mode of operation.

CIRCLE NO. 301

## Unit measures digital logic parameters

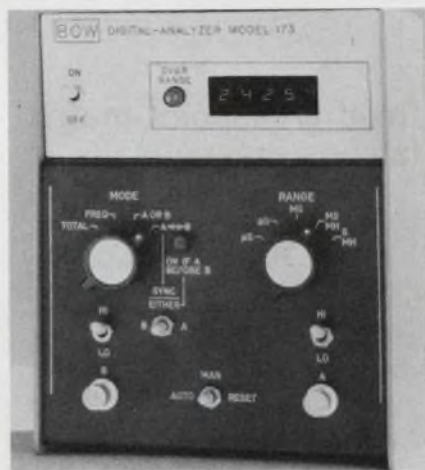

BOW Industries, 5819 Seminary Rd., Bailey's Crossroads, Va. 22041. (703) 671-4357. 3-digit: \$329.95; up to 5 digits: \$369.95; stock to 45 days.

Designated the Model 174 Digital Analyzer, this new type of instrument fills the broad gap between logic probes and scopes to serve as the digital technician's general purpose "logic multimeter." Not to be confused with a digital voltmeter, the Model 173 measures digital logic parameters, such as pulse width, timing accuracy, pulse spacing and frequency, to an accuracy of 0.02%. The unit is portable, battery-operated and hand-held.

CIRCLE NO. 302



Who said a  
digital-readout  
signal generator has  
to be hard to handle,  
hot and heavy,  
and cost \$4,450?

## Not us!

Our Model 102A, at \$2,975, has everything you need for just about any AM/FM application — plus seven performance and convenience features you won't get in the \$4,450 design.

*What did we leave out?*

Phase-lock synchronization, for one (but our dc-coupled FM channel can be externally locked if you need better stability than our typical 4 ppm); and narrow-pulse modulation (belongs in a different class of generators).

*What did we add?*

Four different signal-generation techniques — for optimum performance in each band, from 4.3 to 520 MHz, without the usual compromises in noise, stability, or residual-distortion characteristics.

The most logical panel layout and convenient control setup you've ever seen. And a unique adjustable "feel" main drive mechanism for narrow-band receiver setting with ease — even without our electrical vernier.

Separate meters for modulation and output — no annoying auto-ranging or out-of-range annunciators . . . we don't need them.

15 minute warmup to typically

meet 10 ppm/10 minute stability — made possible by low internal dissipation (only 30 watts; no fan!)

Wider FM deviation at low carrier frequencies than any other design in this class (how does 2 MHz peak-to-peak grab you?)

A detected-AM-output option, to verify our negligible phase-shift for VHF-omni testing.

Versatile modulation features — like five internal frequencies, 30% and 100% AM scales, and true-peak-responding AM and FM metering.

All these performance pluses are coupled with low spurious and close-in noise, excellent low-frequency phase integrity, really effective leveling, a low and flat VSWR curve, accurate wide-range attenuation, high output power . . . all of it buttoned up tight for low leakage in a lightweight 30 pound package.

. . . and it's all yours for \$2,975. Get the full specs today — before you spend 50% more .

For complete data or a demonstration write or call Boonton Electronics Corp., Rt. 287 at Smith Road, Parsippany, N. J. 07054, (201) 887-5110.

# BOONTON



## COMPONENTS

### Buzzer operates on alternating current

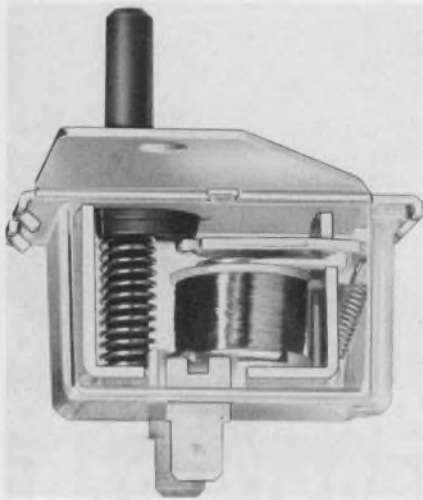

U.S. Controls Corp., 16608 W. Rogers Dr., New Berlin, Wis. 53151. (414) 782-0340.

This adjustable ac buzzer features a continuous-duty UL listing. Detents insure positive settings when the shaft is rotated to adjust the sound level. A compression spring loads the detents. The buzzer is offered with a 5-W coil and operating voltages to 240 V ac, 50/60 Hz. A fail-safe, self-fusing coil design eliminates buzzer fire hazard. It has a black, nonburning Noryl case for dust-tight protection.

CIRCLE NO. 303

### Light source requires no power supply



American Atomics Corp., 425 S. Plumer, Tucson, Ariz. 85619. (602) 622-4881.

Carbon-14 activated I-Lite is a luminous source that requires no power supply. Standard and special configurations use phosphors that are selected for optimum conversion efficiency and temperature stability. These long-lived light sources are used in applications that require reliable, low-level light emission, such as in photometric calibration, night vision studies and celestial observations. Standard emission colors are white, blue, green, yellow, orange and red.

CIRCLE NO. 304

### Pushbutton switches mount on PC cards

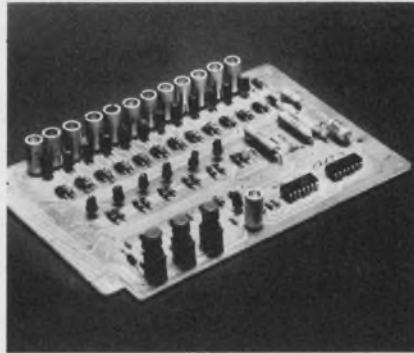

Control Switch Inc., 1420 Delmar Dr., Folcroft, Pa. 19032. (215) 586-7500. \$1.04 (500 up); stock.

Series B8700 miniature pushbutton switches are designed to mount vertically on a PC board to facilitate through-the-panel operation. These SPDT switches feature a minimum of 500,000 mechanical and 100,000 electrical operations, 0.025  $\Omega$  maximum contact resistance, a 1000 V rms dielectric rating, -20 to 70 C ambient temperature range, 4 to 8 oz operating force and they weight 0.06 oz. They are available in 28-V dc or 120-V ac at 0.5-A and 12-V dc at 1-A resistive-load ratings.

CHECK NO. 305

### Thermocouple reference mounts on PC boards

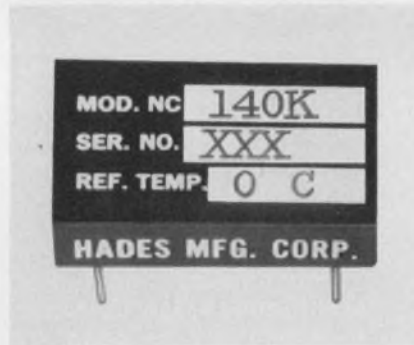

Hades Manufacturing Corp., 151A Verdi St., Farmingdale, N.Y. 11735. (516) 249-4244. \$48 (1-9); stock to 3 wks.

Model NC140K is a full-bridge, thermocouple, reference-junction compensator for PC mounting. The module electronically replaces ice-bath and electromechanical references. This unit is externally dc powered and is available for any desired reference temperature (0 C standard). It is designed to meet or exceed applicable MIL standards.

CIRCLE NO. 306

### Pushbutton switch has slide-switch style

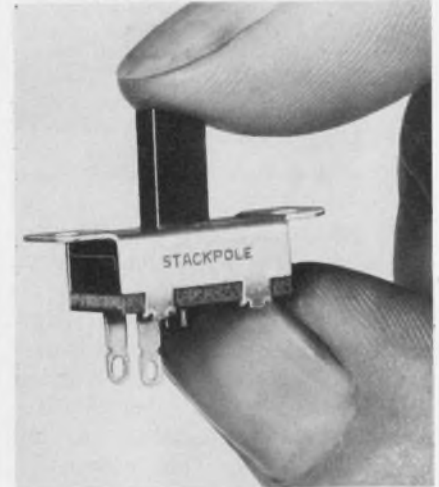

Stackpole Components Co., P.O. Box 14466, Raleigh, N.C. 27610. (919) 828-6201.

A new momentary miniature switch has the size and configuration of Stackpole's conventional miniature slide-switch line. It also has the same options on terminals. The switch is SPST, normally open.

CIRCLE NO. 307

### Reed crosspoint matrix latches magnetically

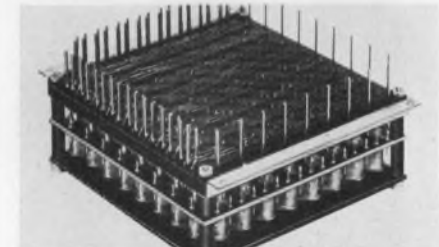

C.P. Clare & Co., 3101 W. Pratt Ave., Chicago, Ill. 60645. (312) 262-7700.

A memory matrix, built around magnetically self-latching reed relays, provides a small, fast and reliable switching package. It measures 5 x 5 x 3 in. and contains 64 crosspoint paths with either two or four poles per crosspoint. Crosspoints are addressed by a minimum 500- $\mu$ s, 1-A pulse, and thus retain their contact positions magnetically, without continuous power. Life expectancy approaches hundreds of millions of operations for signal level switching. Hermetically sealed, reed switch contacts are the only moving parts. Individual switch capsules can be removed and replaced.

CIRCLE NO. 308

# Missiles with brains use TRW/Globe motors for their brawn



Maximum performance in minimum space. Stress-proof repeatability and reliability. Combined functions. Sophisticated testing facilities.

Those are demands which these TRW/Globe "motion packages" meet for missile builders like General Dynamics, Honeywell, and Hughes Aircraft.

**1.** Torquer for the Maverick "super-smart bomb" positions each axis of the vidicon camera platform. Optimized design achieves exceptional torque (17.5 oz. in. at 1 amp 5 watts). Four-pound package combines motor, damper, AC pot, and brake-slip-clutch to gain maximum mechanical precision and eliminate assembly and interfacing problems. TRW/Globe developed a computerized program which tests 30 parameters and prints out results.

**2.** Fin control motor for the Standard and Standard Arm missiles must keep the fins fluttering. This places sudden, large surges of stress on the output gear, which TRW/Globe solved with a unique sus-

pension. At the same time, TRW/Globe re-designed the motor from 4 poles to 2 poles, reduced the number of components, and cut the cost 15%-20% under the next bidder.

**3.** Fin control motor for the Mark 46 torpedo operates in a "bang bang" mode, and must go from full speed to full speed in less than 50 milliseconds. Such rapid current reversal will demagnetize a normal motor. Integral planetary gears were designed to carry 10 times the normal load. The motor must start under low voltage after long storage in sea duty. TRW/Globe's environmental testing includes 100% inspection of hermetic sealing. This motor today costs less than the originals produced in the early '60's.

When your motion requirements are demanding, demand TRW/Globe Motors, an Electronic Components Division of TRW Inc., Dayton, Ohio 45404 (513-228-3171)

## **TRW** GLOBE MOTORS

INFORMATION RETRIEVAL NUMBER 70

## Lampless pushbutton shows bright legends

*International Electro Exchange Corp., 8081 Wallace Rd., Eden Prairie, Minn. 55343.*

Push the button once and a clear bright legend appears. Push it again and a different legend ap-

pears. That's the principle of this new lampless two-legend pushbutton that mechanically switches from one legend to the other with normal pushbutton action. The indicator needs no power supply. The button fits a large number of modular switches—from 2 PDT to 10 PDT—with individual spring-loaded sliding contacts. The contacts handle up to 4 A, 250 V ac.

CIRCLE NO. 309

## Infrared detector needs no bias voltage



*Barnes Engineering, 44 Commerce Rd., Stamford, Conn. 06904. (203) 348-5381. \$425: sealed, \$125: TO-5 header.*

Designated Series L-400 pyroelectric detectors, these units are uniformly sensitive to radiation at wavelengths from the ultraviolet to beyond 300 microns. No cooling is required by these detectors, and Barnes says that they have better detectivity at frequencies up to 2 kHz than any other type of thermal detector. Bias voltage is not required. Consequently they display little low frequency noise and provide signal-to-noise ratios that remain nearly constant for a frequency range of several thousand hertz. For high-sensitivity applications the detectors are packaged in a hermetically sealed, flanged housing, with an internally mounted FET preamplifier and an anti-reflection coated germanium window. For high power applications such as laser radiation monitoring and detection, the detectors are supplied in a TO-5 transistor header, without a window and without the internal preamplifier.

CIRCLE NO. 310

## Infrared LED claims smallest package ever

*General Electric, Nela Park, Cleveland, Ohio 44112. (216) 266-2258. \$1.58 (1000 up); stock.*

The SSL65, an infrared gallium arsenide, light-emitting diode is only 1/20th of an inch in diameter. It has a tiny metal and ceramic cylindrical case and is topped by a dome-like glass lens. The lamp is only 0.125 in. long and has an estimated half-life in excess of 100,000 hours.

CIRCLE NO. 320

# Here's HOW to choose the right ROTARY SWITCH for your needs!

FREE!  
11" x 17" WALL CHART

With this handy new guide, you can cross-check over 50 basic specifications against each of our 15 switch "families". In just a few minutes, you can narrow your applications down to a few possibilities...save hours of catalog search and research! Covers our Rotary Switch lines from 10A-240V to 200A-600V. Send for your free copy today.



**ELECTRO SWITCH**  
CORP.

Weymouth, Massachusetts 02188

Telephone: 617/335/5200 TWX: 710/388/0377

## Coded linear switch slides into positions

Standard Grigsby, 920 Rathbone Ave., Aurora, Ill. 60507. (312) 897-8417. Under \$2 (OEM qty).

The MCS-100 switches with a capacity to 13 switch positions are positively detented and have a 0.150 in. travel from one circuit to another. The detent force can be supplied with a setting from a minimum of 10 oz to suit customer requirements. The voltage capacity of the switches is 20 V dc max at a current to 10 mA and the capacitance between the common and any other switching circuit is 60-pF max. Minimum switch life is 25,000 cycles.

CIRCLE NO. 321

## Keyswitch set provides 20-million-cycle life

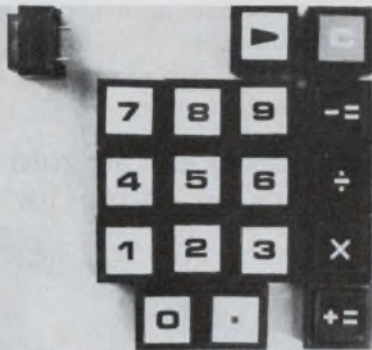

Mechanical Enterprise Inc., 5249 Duke St., Alexandria, Va. 22304. (703) 751-3030. \$2.50 per set (100,000 up); stock.

A set of 17 keyswitches, for hand-held calculators, includes the usual 11 numerical entry keys and also six function keys. The set uses the company's LM series, gold, V-bar, miniature mechanical switches which feature low bounce and an operating life of 20-million cycles. The legends are made of aluminum, Mylar-laminated plates set into the recessed key tops. The keyswitches have a plunger travel of 0.06 in. and their total height above the printed-circuit board is only 0.35 in. Low bounce is achieved by moving a gold-wire beam spring into the vee formed by two gold-plated contact rods. This is a spring-on-spring design which provides the high hysteresis that is desired in keyboard switching. Introductory sets at \$17 each are available and limited to one per customer.

CIRCLE NO. 322

# OSHA OVERCURRENT PROTECTION REQUIREMENTS

... could render your  
equipment substandard  
for industrial use!

## AIRPAX<sup>TM</sup> CIRCUIT PROTECTORS



## PROVIDE THE PROTECTION REQUIRED!

(and save you money)

Contact the factory for literature and/or assistance in selecting the proper protection for your application.

### AIRPAX ELECTRONICS CAMBRIDGE DIVISION

Cambridge, Maryland 21613  
Phone (301) 228-4600



#### § 1910.312 Overcurrent protection.

(a) *Protection of equipment.* Equipment shall be protected against overcurrent.

(b) *Interrupting capacity.* Devices intended to break current shall have an interrupting capacity sufficient for the voltage employed and for the current which must be interrupted.

(c) *Circuit impedance and other characteristics.* The overcurrent protective devices, the total impedance, and other characteristics of the circuit to be protected shall be so selected and coordinated as to permit the circuit protective devices used to clear a fault without the occurrence of extensive damage to the electrical components of the circuit. This fault may be assumed to be between two or more of the circuit conductors; or between any circuit conductor and the grounding conductor or enclosing metal raceway.

(d) *Location in premises.* Overcurrent devices shall be located where they will be not exposed to physical damage and not in the vicinity of easily ignitable material.

(e) *Enclosures for overcurrent devices—(1) General.* Overcurrent devices shall be enclosed in cutout boxes or cabinets, unless a part of a specially approved assembly which affords equivalent protection, or unless mounted on switchboards, panelboards or controllers located in rooms or enclosures free from easily ignitable material and dampness. The operating handle of a circuit breaker may be accessible without opening a door or cover.

(2) *Damp or wet locations.* Enclosures for overcurrent devices in damp or wet locations shall be of a type approved for such locations and shall be mounted so there is at least one-fourth inch air space between the enclosure and the wall or other supporting surface.

### How AIRPAX Circuit Protectors help you meet OSHA requirements:

(a) *Protection of equipment.* Airpax magnetic circuit protectors offer the most effective equipment overcurrent protection available. Fuses and thermal breakers are not as reliable.

(b) *Interrupting capacity.* Airpax magnetic circuit protectors have U.L. recognized interrupting capacities for voltage ranges up to 480 volts—sufficient for most equipment applications.

(c) *Circuit Impedance and other characteristics.* Airpax magnetic protectors operate more accurately than thermal breakers and ordinary fuses. This factor, plus close coordination with load conditions, possible only with a magnetic device, provide fault clearing without excessive damage to components and associated circuitry.

(d) *Location on premises.* Airpax protectors are also designed for front panel mounting for maximum accessibility. Front panel mounting permits use of the breaker as a power switch, as well as the protective device.

(e) *Enclosures—(1)* Airpax protectors are also designed for internal mounting.

(2) *Airpax UP Series protectors* are U.L. approved sealed magnetic circuit protectors designed for use in adverse environments. Other Airpax protectors (UPL, UPG, 205, 203) are constructed using inherently corrosion-proof and moisture resistant materials. Airpax manufactures special circuit breakers for Panel Seal (watertight integrity) as well as for dust and explosive environments.

## Wrought-porous metals make heat-pipe wicks

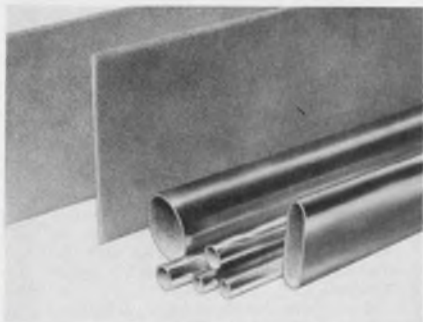

Gould Inc., 540 E. 105th St., Cleveland, Ohio 44108. (216) 851-5500.

Laminates made from metallurgically bonded, wrought-porous metal are fabricated into shapes suitable for heat pipes. Heat pipes made from these materials are claimed to exhibit high permeability, superior wicking action, high heat flux, and low temperature gradient. Gould can produce these laminates from a number of materials including copper, iron, stainless steel, aluminum, nickel and titanium. The available materials can operate over a wide temperature range—from cryogenic to very-high temperatures—and with a variety of working fluids. Close control over thickness and porosity is required to provide just the right wicking action for each application.

CIRCLE NO. 323

## Liquid masks contacts when soldering

Lancer Chemical Industries, 91 Highland Ave., Barrington, R.I. 02806. (401) 245-5493. \$25 per gallon; stock.

Solder masking tapes can now be replaced with the water-based masking liquid, Lancer RR675. The mask coating, when cured, withstands solder temperatures to 550 F for the periods required by solder-wave or dip-solder processes. The liquid can be applied by dip, brush, spray or silk-screen methods. It can be cured at room temperature or with forced hot air. A short bake cycle, though, provides longer protection. The mask can be removed with Trichlor, safety solvents, strippers and agitation.

CIRCLE NO. 324

## Kit speeds hole drilling in ceramics



Aremco Products Inc., P.O. Box 429, Ossining, N.Y. 10562. (914) 762-0685. \$380.

The Accu-Drill 3300 kit includes all the equipment and materials necessary to drill holes from 0.005 to 0.113 in. diameter in fired ceramic substrates used in microcircuits. This kit can speed the development of new microcircuits. The microcircuit engineer is often delayed while waiting for expensive tooling. The kit can drill precision holes in substrates such as 96% alumina in a matter of seconds.

CIRCLE NO. 325

## Latching pushbutton can't be teased



Marco-Oak, Inc., 207 S. Helena, Anaheim, Calif. 92803. (714) 535-6037.

Marco-Oak's new 10.5-A addition to its Rainbow switch line features a latch mechanism that cannot be teased. The new latching mechanism complements the Rainbow switch's ability to change pushbutton color and legend when depressed. The change in color and legend takes place without lamps or any other electrical connection. The latching mechanism makes it impossible for the switch to make contact without also latching.

CIRCLE NO. 326

## Potting forms from open stock need no tooling



Stevens Tubing Corp., 128 N. Park St., East Orange, N.J. 07019. (201) 672-2140.

Tooling costs often keep a hot new item from getting off the drawing board. Electronic engineers who are looking for a potting form, can use one of these glass-epoxy potting forms. Thousands of sizes of epoxy cases are available. Cases are cut from molded, fiberglass, laminated epoxy tubes and fitted with header plates. The material meets MIL-C-9084 and MIL-R-9300 and it has a 0.03-in. wall thickness.

CIRCLE NO. 327

## Contacts good as gold on stacking connector



Teledyne Kinetics, 410 S. Cedros Ave., P.O. Box 427, Solana Beach, Calif. 92075. (714) 755-1181.

An equal-to-gold connection at a tin price is provided by the new Series "T" TKC solderless stacking connectors. Low contact resistance and high reliability, even in hostile environments, is claimed for the combination of tin plating and a special cone point that is formed into each contact. The cone point penetrates a matching solder pad on the circuit. The connectors are available in a bolt-on model with double-side, spring contacts and either throughholes or threaded inserts for stack mounting, and a solder-post model for through-board flow solder mounting on one side. Contact centers are 0.050, 0.075 or 0.1 in.

CIRCLE NO. 328

FOR THE UTMOST IN RELIABILITY

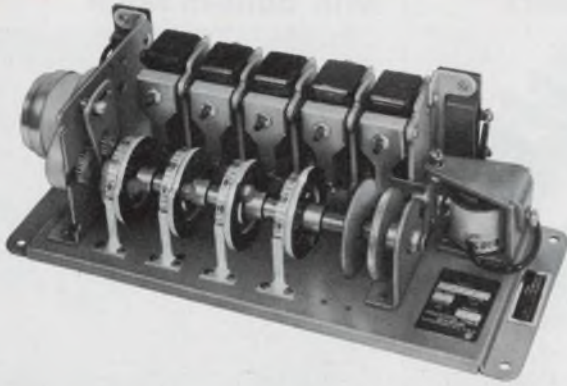

## RECYCLING TIMERS Series RC

This multi-cam timer is one of a family of very versatile recycling timers that are available in single or recycling types with up to 20 control circuits. Control cams are independently adjustable from 2% to 98% of the total time cycles enabling the timer to be used as a programming device. And with supplied interchangeable gear and rack assemblies you can select from 700 time cycles ranging from 2/3 second up to 72 hours. All our timers are made to give you service far beyond what you'd reason-

ably expect. Our line consists of 17 basic types, each available in various mountings, voltages, cycles, circuits and load ratings . . . and with whatever special wrinkles you may need. Bulletin #206 tells all about our line of reliable Recycling Timers. Write for it or a catalogue of our entire line. If you have an immediate timer requirement, send us your specifications. Or for fastest service, call (201) 867-2200.



Industrial Timer Corporation, U.S. Highway 287, Parsippany, N.J. 07054

INFORMATION RETRIEVAL NUMBER 74

**ATLAS** *positively guarantees . . .*



fastest  
delivery  
unsurpassed  
accuracy  
lowest  
prices

on Turned and Precision-Ground

# PHENOLIC RODS

EPOXY

BAKELITE

Glass Supported TEFLON

- Stock sizes in any diameter from 3/32" to 3/8"
- Increments of .001 at no extra charge
- Most sizes available for immediate delivery
- Accuracy guaranteed to  $\pm .001$ "

Plus . . . the largest inventory in the world!

SEND FOR  
COMPLETE  
PRICE LIST

## ATLAS FIBRE COMPANY

6980 N. Central Pk. Ave. Chicago, Ill. 60645  
(312) 465 1234

INFORMATION RETRIEVAL NUMBER 75

ELECTRONIC DESIGN 22, October 25, 1973

**SERMETEL**® Science  
is another way of saying:

# CUSTOMIZED METALIZING

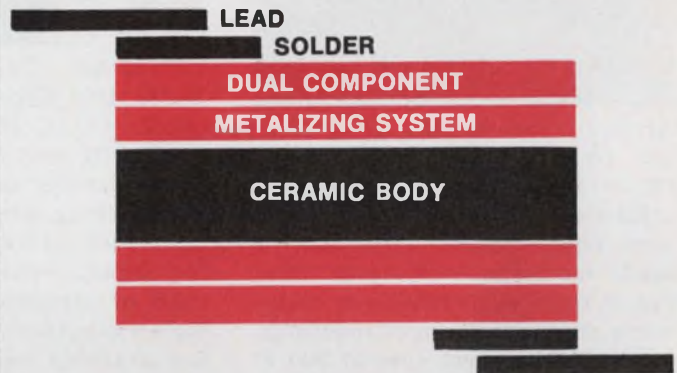

Custom applications are "routine" with SermeTel and now our new HCG process offers unique advantages for metalizing electronic ceramic and glass components utilizing aluminum microspheres and other suitable metals in a dual component system. Check these features:

### \*EXCELLENT . . .

- \* Electrical conductivity
- \* Thermal conductivity
- \* Resistance to solder attack
- \* Ceramic and glass to metal assemblies
- \* Q value on capacitors

### \*SUPERIOR BOND STRENGTH . . .

- \* Low temperature cure in air
- \* Not frit bonded
- \* Makes ohmic contact

Let us process your electronic components with our advanced metalizing system. One source for metalizing and assembly service! Send us a sketch . . . or a sample . . . we'll furnish a quotation at no cost to you. Current applications include processing of thermistors, resistors, capacitors and piezo electrics.

For a review of SermeTel's entire family of proven electronic products and their money-saving advantages, write on your firm letterhead for a copy of "The HCG Processes", P.O. Box 187, North Wales, Pa. 19454.



A DIVISION OF Teleflex® INCORPORATED

INFORMATION RETRIEVAL NUMBER 76

HCG-1

147

### Liquid compound cures to form flexible mold



Aremco Products Inc., P.O. Box 429, Ossining, N.Y. 10562. (914) 762-0685. \$30 per gallon; stock.

EZ-Cast 521 is a single-component, liquid compound for making molds for ceramic or plastic casting. It requires no mixing or measuring and has an almost indefinite pot life. After heat cure at 300 F it hardens into a tough pliable rubber-like composition that is an exact duplicate of the original pattern. The compound is inexpensive for casting ceramics, wax, gypsum, plastics or even low melting-point metals.

CIRCLE NO. 329

### Barrier terminal blocks use captive washers

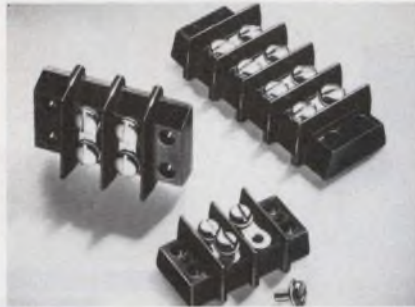

TRW/Cinch Connectors, 1501 Morse Ave., Elk Grove Village, Ill. 60007. (312) 439-8800. \$0.19 to \$1.53 (100 up); stock.

New barrier terminal blocks use Sems locking screws that have captive, internal-tooth lock washers for rapid, secure attachment of solid or stranded wire, or spade lug terminations. The Sems screws are available on blocks with terminal spacing of 3/8 in. (Series 140-E), 7/16 in. (Series 141-E) and 9/16 in. (Series 142-E). The blocks have 2 to 25 terminal positions for the Series 140-E, 2 to 20 for the Series 141-E and 2 to 17 for the Series 142-E.

CIRCLE NO. 330

### Plugs snap together with built-in latch

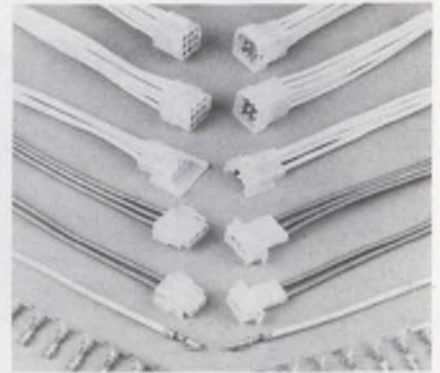

Amp Inc., Harrisburg, Pa. 17105. (717) 564-0101.

Rated up to 25-A per contact, this Mate-N-Lok connector family includes 2 to 9-position sizes with polarized nylon housings and built-in locking devices to prevent accidental unmating. The crimp-on, pre-tinned brass contacts accept solid or stranded wire from AWG 20 to 10 with insulation diameters from 0.10 to .18 in. Panel-mount versions simply snap into cutouts in 0.04 to 0.07 in. thick panels without mounting hardware.

CIRCLE NO. 331

## The Non-forgettable Memory

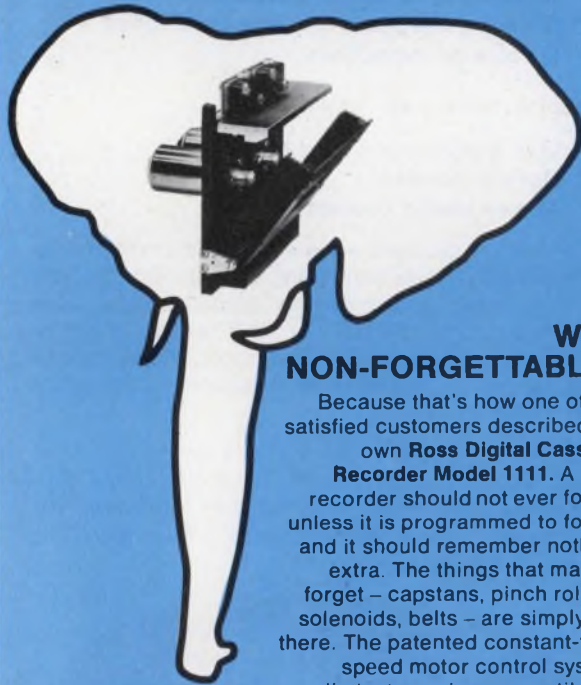

### WHY NON-FORGETTABLE?

Because that's how one of our satisfied customers described his own **Ross Digital Cassette Recorder Model 1111**. A tape recorder should not ever forget unless it is programmed to forget and it should remember nothing extra. The things that make it forget - capstans, pinch rollers, solenoids, belts - are simply not there. The patented constant-tape speed motor control system eliminates noise susceptibility.

Why not send for complete information and see what he meant.



**ROSS CONTROLS CORPORATION**  
257 Crescent Street, Waltham, Massachusetts 02154. Tel. (617) 891-9600  
An Affiliate of American Research & Development Corp. (ARD)

INFORMATION RETRIEVAL NUMBER 77



### ganged switches

flexible, with up to 5 circuits per button and interrelated switching logic...



### push buttons

all shapes and sizes, single or split lens, non-illuminated, built-in or replaceable lamps...

### indicator lights

from 1/4" diameter indicators to 2" x 3" display panels...



Licensed by Rafal of W. Germany

To really appreciate the variety, beauty, and workmanship in the complete line of Leduc push buttons and indicators, it's best to see them. We'll be glad to arrange a personal demonstration. Just call this toll free number for the name of your Leduc representative: 800-645-9200.

INFORMATION RETRIEVAL NUMBER 78

ELECTRONIC DESIGN 22, October 25, 1973

### 4-way combiner/splitter contained in mini pack



Technical Research and Manufacturing, Grenier Field, RFD #3, Manchester, N.H. 03103. (603) 668-0120. \$87 (1-4); stock.

The DL 430 series of 4-way power dividers comes in a miniature metal case measuring 1/2 × 3/8 × 1/8 inch. Frequency coverage extends from 0.2 to 200 MHz and 5 to 500 MHz. Other features include an impedance of 50 Ω, insertion loss of 0.7 dB max, isolation of 26 dB min and amplitude balance of 0.3 dB max. Input power can reach 1.5 W cw.

CIRCLE NO. 332

### Airborne L-band Xmtrs deliver up to 20 W



Emhiser Rand Industries, 7721 Convoy Ct., San Diego, Calif. 92111. (714) 278-5080. 8 wk.

Efficiencies of about 25% and power outputs of 10, 15 or 20 W minimum can be obtained from a family of L-band video transmitters. Called the Series VT-4900L, the 40-ounce airborne transmitters come with a peak deviation capability of ±6 MHz. Deviations of up to ±16 MHz are available as options. The devices are set to any frequency in the range of 1435-to-1540 or 1710-to-1850 MHz with a frequency stability of ±0.03% under all combinations of input voltage variations and environmental conditions. All models offer 3% harmonic distortion over the modulation bandwidth and operate from 28-V-dc sources with a maximum current drain of 2.5 to 4.0 A.

CIRCLE NO. 333



## Type LS8 Metalized Polystyrene Capacitors are Smaller and Lighter with No Sacrifice in Performance

Dearborn® Type LS8 Metalized Polystyrene Capacitors are 1/3 the size and 1/4 the weight of their "non-metalized" foil-electrode counterparts. Yet their performance characteristics (low negative temperature coefficient of capacitance, extremely high insulation resistance, freedom from dielectric absorption) are every bit as good, making them ideally suited for applications such as low-frequency tuned circuits, analog and digital computer refer-

ence, timing and integrating circuits, and high-Q tuned circuits.

Capacitance values range from .0027 μF to 2.2 μF. Voltage ratings are 50, 100, and 150 WVDC. Capacitance tolerances as close as ±1% are available. Operating temperature range is -65C to +85C.

For complete data, write for Engineering Bulletin 401.

SPRAGUE ELECTRIC COMPANY

Dearborn electronics division



P.O. BOX 1076, LONGWOOD, FLORIDA 32750  
INFORMATION RETRIEVAL NUMBER 79



## Vhf MOSFETs include amps, mixers

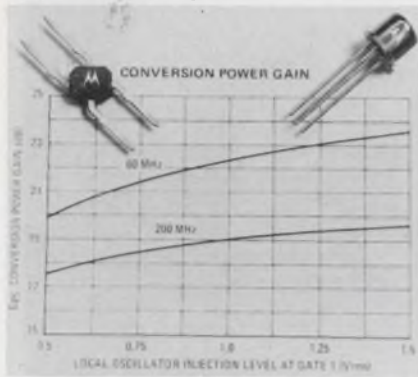

Motorola, P.O. Box 20924, Phoenix, Ariz. 85036. (602) 244-3466. 83¢ to \$1.10 (100-999); stock.

Three silicon-nitride MOSFETs provide 60 to 200 MHz operation. The devices are the MPF130/MFE-130, a 105-MHz amplifier; the MPF131/MFE131, a 60-to-200-MHz amplifier; and the MPF132/MFE132, a 60-to-200-MHz oscillator/mixer. They are available in TO-72 metal packages (MFE series) and in the Micro-H plastic package. Reverse transfer capacitance of 0.05 pF maximum is guaranteed. Noise figures are 5.0 dB max for all devices.

CIRCLE NO. 334

## Bi-phase modulator operates to 1 GHz

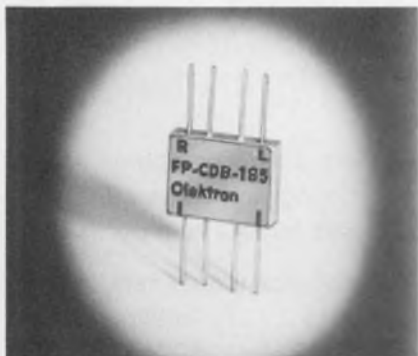

Olektron Corp., 6 Chase Ave., Dudley, Mass. 01570. (617) 943-7440. \$26.10 (25-99); stock to 6 wk.

The Model FP-CDB-185 bi-phase modulator operates over the frequency range of 0.5 to 1000 MHz and can be modulated at frequencies from dc to 500 MHz. Both i-f junctions of the double-balanced device are externally available to permit a balanced modulator drive. The modulator comes in flatpack and standard packages.

CIRCLE NO. 335

## Isolators measure only 4 inches



Systron-Donner Corp., 14844 Oxnard St., Van Nuys, Calif. 91409. (213) 786-1760. DBG-480B: \$210; DBG-480 B-1: \$235.

Operating over the frequency band from 8.2 to 12.4 GHz, the Model DBG-480B isolator measures only 4 inches long over-all. It features a minimum isolation of 30 dB, maximum insertion loss of 1 dB and maximum bilateral VSWR of 1.15. A B-1 version comes in the same small size with an extended frequency range of 7.6 to 12.4 GHz.

CIRCLE NO. 336

## Logic-controlled TWTAs cover 2-to-18-GHz range

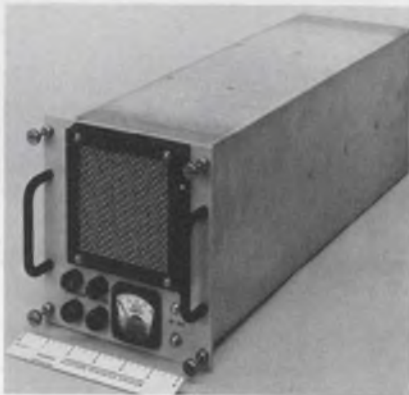

Hughes Electron Dynamics Div., 3100 W. Lomita Blvd., Torrance, Calif. 90509. (213) 534-2121. \$5300 to \$6500; 60-90 days.

A series of logic-controlled traveling-wave tube amplifiers cover the frequency range from 2 to 18 GHz, with power outputs up to 20 W. The amplifiers, Models 1233H through 1236H, feature remotely programmed and TTL-compatible controls with logic for remote indication of amplifier status. Typical amplifier gain is 35 dB (minimum) at rated power output. The amplifier series is adaptable to 28 V dc and 115 V ac, 400-Hz operation. Each amplifier consists of a PPM metal-ceramic traveling-wave tube, regulated solid-state power supply, complete air cooling system and logic control/protection circuitry.

CIRCLE NO. 337

## V-band Impatts come quartz packaged

Hughes Aircraft, P.O. Box 90515, Los Angeles, Calif. 90009. (213) 670-1515. \$100 to \$500; 30 day.

A series of V-band—50 to 75 GHz—Impatt diodes features quartz packaging for improved bandwidth and output powers. The diodes are available with up to 100 mW of output power, and are supplied either unmounted or on a copper-mounting post. Operating over the full 50-to-75-GHz frequency range, the Model A6102P-H lists an output of 25 mW and 1% minimum efficiency. For the 50-to-60-GHz range, the Model A5503P-H offers 100 mW and 1.75% minimum efficiency.

CIRCLE NO. 338

## VCOs withstand severe environments



Watkins-Johnson, 3333 Hillview Ave., Palo Alto, Calif. 94304. (415) 493-4141.

The WJ-2835 series of varactor-tuned transistor oscillators are designed for space and other severe environmental applications. Each unit contains two doubling-type oscillators combined through an SPDT switch to give a single rf output that covers the entire 8.0-to-12.4-GHz frequency range. Power output is +10 dBm minimum. A typical unit measures 8.0 × 4.2 × 1.0 in. and weighs 26 oz.

CIRCLE NO. 339

## Transistor multiplies frequencies to 175 MHz

RCA Solid State Div., Route 202, Somerville, N.J. 08876. (201) 722-3200. \$1.30 (100-999); stock.

A frequency-multiplier transistor can be used in mobile applications up to 175 MHz. Called the 40637A, the device is a silicon npn planar transistor in the JEDEC TO-18 package. A multiplier chain consisting of three 40637As can deliver 100 mW at 156 MHz from a 5-mW, 13-MHz input and a 12-V supply.

CIRCLE NO. 340

# OUR CASSETTE RECORDER WAS JUST TOO GOOD TO KEEP TO OURSELVES.



We designed the Sycor Model 135 cassette recorder to stand up to the toughest standards in the world.

Our own. For use in our own Sycor terminals.

But when we finished, we knew we had a cassette recorder capable of meeting a world of OEM and other users' needs.

The 135, for instance, has a unique capacity for record overwrite. You can edit a complete data block without disturbing the data on either side of the new record.

The 135 reads/writes at a fast 12.5 ips with quick starts and stops for high throughput. A dual-gap head gives it the capacity for Read-After-Write verification. And when you need quick access to specific data, it'll search through a cassette at a rapid 60 ips.

Every day, in 34 countries around the globe, over 20,000 Sycor cassette recorders prove their reliability. Look into our Sycor 135 yourself. You'll find why we found it too good to keep to ourselves.

## SYCOR

For complete product information—or for assistance with any design or application problem you may have—contact OEM Department, Sycor, Inc., Ann Arbor, Michigan 48104. Telephone (313) 971-0900.

*Internationally represented by Munzig International in London, Paris, Munich, and Geneva, and by STG International in Tel Aviv.*

INFORMATION RETRIEVAL NUMBER 80

## Mm receiver operates at 94 GHz

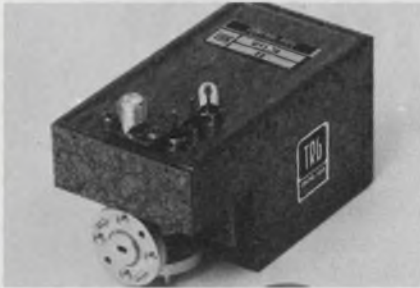

Control Data Corp., Boston Microwave Products Div., 400 Border St., E. Boston, Mass. 02128. (617) 569-2110. 60-90 days.

A millimeter receiver—the TRG Series 9120—operates at 94 GHz with an instantaneous bandwidth of 1 GHz. It has a double sideband noise figure of 10 dB and an i-f amplifier frequency of 100 to 600 MHz. Rf-to-i-f gain is 20 dB minimum and i-f impedance is 50  $\Omega$ . The LO requires a maximum power of 4 mW. The rf VSWR is 1.4:1 maximum.

CIRCLE NO. 341

## Micro-H package contains uhf amp

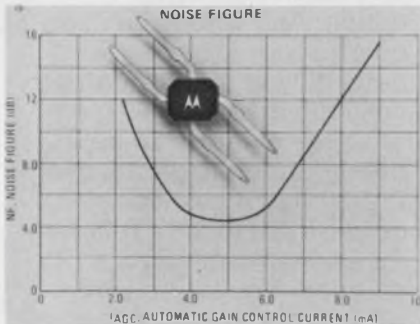

Motorola, P.O. Box 20924, Phoenix, Ariz. 85036. (602) 244-3466. 88¢ (100-999); stock.

A low-noise, high-gain transistor, called the MPS-M83, comes in a small Micro-H flat-lead plastic package for high-density mounting. The silicon uhf transistor offers a guaranteed power gain of 10 dB at 850 MHz, and a low 6.5-dB noise figure at 850 MHz. Total power dissipation is 350 mW, while current-gain-bandwidth ( $f_t$ ) is 950 MHz with a low collector-emitter capacitance of 0.3 pF. Double base leads in the Micro-H package provide stable unshielded operation since the transistor is grounded twice.

CIRCLE NO. 342

## Plug-in modules enhance oscillator system



Ailtech, 19535 E. Walnut Dr., City of Industry, Calif. 91748. (213) 965-4911. M187A-5: \$2000; M188A-5: \$2100; 10 days.

Two plug-in modules complement the company's M445 power oscillator system. The M187A-5 covers the 400-to-600-MHz range with a power output of 35 W. This unit is specifically designed for development work or production testing in the command-control band. The M188A-5 covers the 900-to-1300-MHz band with 25 W of output power and is designed for applications in the IFF/TACAN frequency range.

CIRCLE NO. 343

## Vhf transistors deliver up to 40 W



TRW Inc., 14520 Aviation Blvd., Lawndale, Calif. 90260. (213) 679-4561. JO 4040: \$27.75 (100 up).

A series of 12-V power transistors deliver up to 40 W in the 136-to-175-MHz frequency range. The JO 4020, 4030 and 4040 series offer the greatest combination of gain, bandwidth and power output available, according to the firm. They can withstand an infinite load VSWR at full output rating without degradation. The JO 4020 is rated for a power output of 20 W; the 4030 for 30 W, and the 4040 for 40 W.

CIRCLE NO. 344

## Laser receiver responds in 8 ns

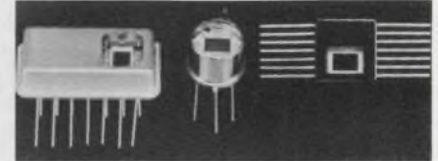

Meret Inc., 1815 - 24th St., Santa Monica, Calif. 90404. (213) 828-7496. \$150 (2-4); 2 wk.

A single-package receiver for GaAs and Nd:YAG lasers features high sensitivity and fast response at 905 and 1060 nm. The receiver includes a silicon p-i-n photodiode with special anti-reflection coatings on a special substrate. In the fully depleted condition the transit time of the carriers is less than 5 ns. A matching transimpedance amplifier in the same package provides current-to-voltage conversion over a bandwidth from dc to 60 MHz. Responsivities of 5 mV/ $\mu$ W at 905 nm and 2 mV/ $\mu$ W at 1060 nm are achieved with rise times less than 8 ns. Rms noise voltage levels over this bandwidth are less than 100  $\mu$ V, thus achieving a signal-to-noise ratio better than 5:1 with 100 nW incident on the detector.

CIRCLE NO. 345

## 1.5-to-2-GHz transistor outputs 20 W

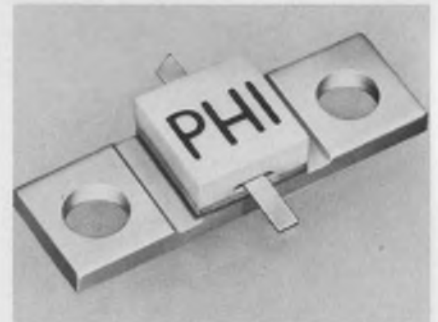

Power Hybrids, 1742 Crenshaw Blvd., Torrance, Calif. 90501. (213) 320-6160. \$245 (1-24); stock to 3 wk.

The PH2020C delivers 20 W (typical) in the 1.5-to-2-GHz frequency range. The emitter-ballasted device provides 18 W across the 1.7-to-2.0-GHz band with a broadband gain and efficiency of 6 dB and 40%, respectively. Narrowband performance is 23 W at 1.7 GHz with 7 dB gain. Typical input impedance is 7+j1  $\Omega$  at 2 GHz with an input load impedance of 1.8+j3.5  $\Omega$ .

CIRCLE NO. 346

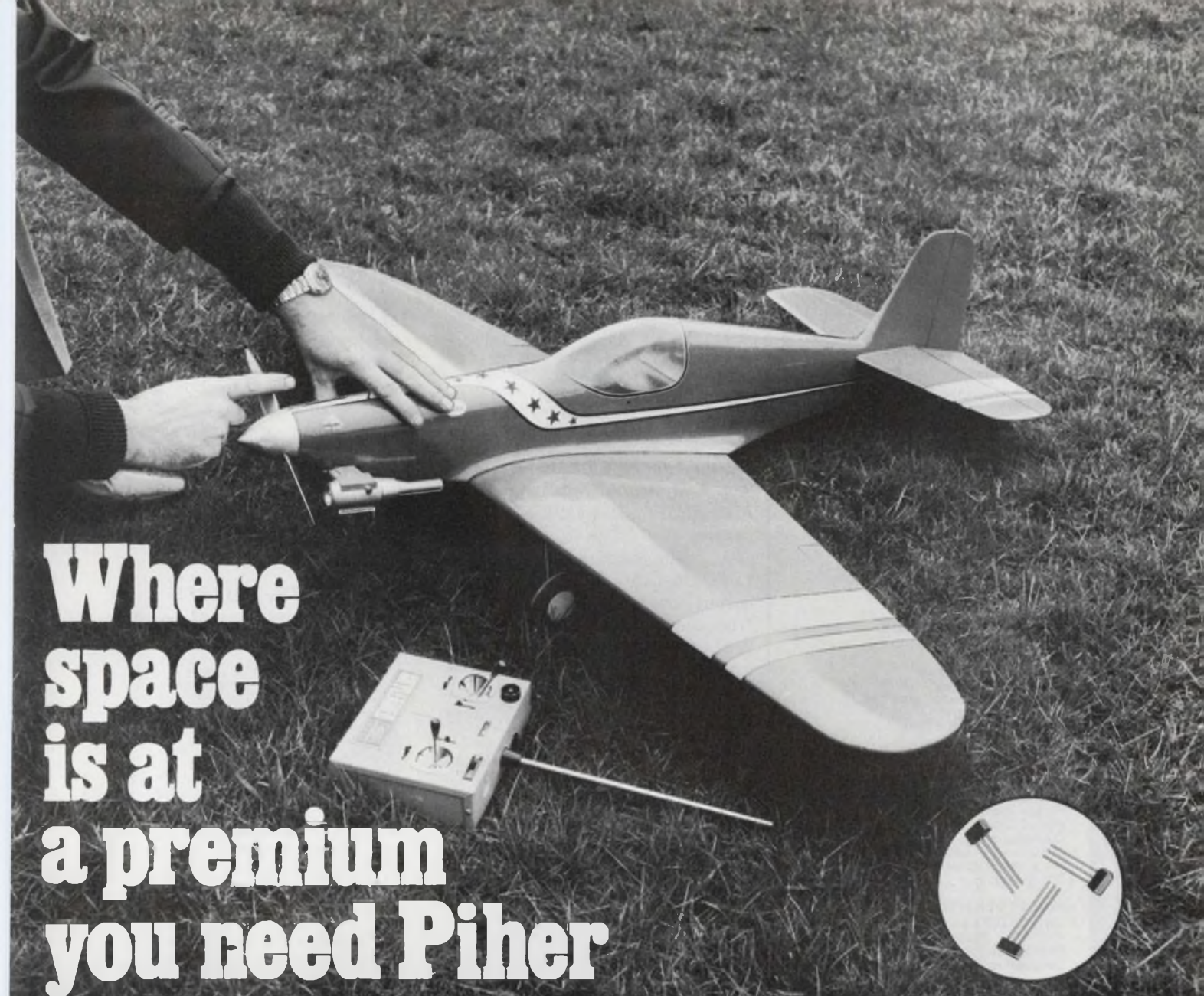

# Where space is at a premium you need Piher

We're experts in the design and manufacture of small signal, silicon epitaxial plastic encapsulated transistors. Every transistor in our 40 product range is ideal when high density packaging is essential – and the range is three times greater than that from any competitor.

When you select from Piher you not only know what you're getting, but where it came from. From the most modern semiconductor plant in Europe. You will have noticed more than once that an efficient, reliable back-up service from a European source is sometimes worth its weight in gold.

Piher is a high technology company. You will appreciate that when you look at our work in carbon film resistors and trimming potentiometers. And now, when you think of small signal, silicon epitaxial transistors, think of the name Piher.

Find out more about us. It pays.

*A Typical Selection From the Piher Range*

Part No	Type	Application/Feature
2N 3794	PNP	High Gain
2N 4286	NPN	High Gain
2N 4288	PNP	Low Leakage
2N 4289	PNP	Low Leakage
2N 4290	PNP	General Purpose
2N 4291	PNP	General Purpose
SF 173	NPN	TV IF Amplifiers
SF 115	NPN	RF Amplifiers & Oscillators

*Head Office—Spain* – Riera Cañado, s.n. Apartado de Correos, 53 Badalona (Barcelona) Spain. Tel: 389 03 00. Telex: 59521



CIRCUIT-STIK Introduces

# GP BOARDS

**GENERAL PURPOSE  
CIRCUIT BOARDS**  
Plug-in & Chassis Mounting  
and **ELECTRONIC  
PACKAGING MATERIALS**



## GP CIRCUIT BOARDS

### HIGH QUALITY

- FR-4 Blue Epoxy Glass
- Computer "DRILLED", High Accuracy Holes (not punched)
- Mil-Spec Plating
- Precision Routed Edges

### VERSATILITY

- Mix All Types of DIP Sockets (8 to 40 Leads)
- Low, Medium and High Profile Interconnections
- Hybrid Designs for Mixing Discretes and Sockets
- Designed for Edge Connector "Plug-in" or Chassis Mounting
- RFI Shielding

### HIGHEST DENSITY

- Up to 50 DIP's on one 4 1/2" x 6 1/2" Plug-In Card
- Plus Space for 50 Decoupling Capacitors

### COMPLETENESS of STANDARD DESIGNS

- Choose from 74 Off-the-Shelf Boards
- 4 Sizes of Boards available

### APPEARANCE

- Beautiful Gold, Blue and Bright Tin

### FULL LINE of ACCESSORIES (HIGH QUANTITY PRICING AVAILABLE)

- Sockets - Low and Standard Profile, P.C. and Wire Wrap - Molded Nylon and Highest Quality Gold Contacts
- Adapterplugs
- Connectors
- Card Pull Handles

### EPOXY GLASS BOARD MATERIALS

- 76 Standard off-the-Shelf Boards
- Including Unclad, Copper Clad, Cut & Peel Copper Clad, Pre-etched "X-Y" Pattern and Plated thru Hole Copper Clad
- .100" Grid Hole Pattern or Undrilled

SEND FOR YOUR FREE CATALOG

**circuit-stik**

P.O. BOX 3396  
Torrance, California 90510  
Phone (213) 530-5530

MICROWAVES & LASERS

## 50-mW VCO operates from 4 to 8 GHz



Watkins-Johnson, 3333 Hillview Ave., Stanford Industrial Park, Palo Alto, Calif. 94304. (415) 493-4141.

A voltage-controlled oscillator (VCO) delivers 50 mW guaranteed output over the full 4-to-8-GHz frequency range. Called the WJ-2844-50, the VCO has an integral isolator that permits operation into a 3:1 VSWR. In addition, an integral filter provides 20-dB guaranteed harmonic rejection.

CIRCLE NO. 347

## Digital phase shifters feature TTL control



Merrimac Industries, 41 Fairfield Pl., West Caldwell, N.J. 07006. (201) 228-3890. \$525.

A family of digital phase shifters can be controlled directly from TTL logic circuits. Called the PSD series, the new phase shifters have center frequencies from 21.4 MHz to 160 MHz. Phase may be shifted in binary increments from the least-significant to the most-significant bit. The least-significant bit, for example, is 3° for Model PSD-63-30 and 5.75° for Model PSD-64-30; the most-significant bit for these two models is 96° and 354.25°, respectively. Bit count for both models is 6.

CIRCLE NO. 348

## High-gain transistor supplies 1 W at 1 GHz

RCA Solid State Div., Route 202, Somerville, N.J. 08876. (201) 722-3200. \$4.80 (100-999); stock.

A 1-W, 1-GHz rf transistor, the 41024, provides a gain of 5 dB. The device features a typical output of 0.3 W at 1.68 GHz, with a  $V_{CC}$  of 20 V. Intended for use as a high-power amplifier, frequency multiplier or fundamental-frequency oscillator up to 1.68 GHz, the new transistor may be used in final, driver and predriver amplifier stages in uhf equipment. It is provided in the JEDEC TO-39 package.

CIRCLE NO. 349

## Detectors, mixers cover mm-wavelengths



Hughes Aircraft, P.O. Box 90515, Los Angeles, Calif. 90009. (213) 670-1515. Detectors: \$750 to \$840; mixers: \$1000 to \$1300; 60 days.

A line of tunable millimeter-wave detectors and mixers features high sensitivity and broad bandwidth. The units consist of Schottky-barrier diodes mounted in a Sharpless wafer and tunable reduced height cavity. The detectors are tunable across full waveguide bandwidths and are available from 40 to 90 GHz. Instantaneous 3-dB bandwidths of 5 GHz are typical. Model numbers, frequency ranges and peak sensitivities are as follows: Model 44803H—40 to 60 GHz and 200 mV/mW (min); Model 44801H—50 to 75 GHz, and 200 mV/mW (min); and Model 44804H—60 to 90 GHz and 100 mV/mW (min). These models have positive polarity. The mixers—Models 44909H, 44902H and 44903H—are available from 26.5 to 75 GHz in units that tune over a 6 GHz minimum bandwidth centered at a customer-specified frequency. These are single-ended mixers, and are self-biased when driven at +3 to +10 dBm input power.

CIRCLE NO. 350

## Hand-held instrument debugs CPU-chip system



Applied Computer Technology, 17815 Sky Park Circle, Irvine, Calif. 92664. (714) 549-3123. \$395; 15 days.

A hand-held test instrument called the MicroVue 4 performs operational testing of Intel's 4004 CPU. The unit generates a sync pulse when (and if) the CPU reaches a switch-selected address. Four indicators display the five bytes of data ( $M_1$ ,  $M_2$ ,  $X_1$ ,  $X_2$ ,  $X_3$ ) sequentially. The next 12 address bits can also be observed. Observation of the sync pulse with an oscilloscope enables checkout of other portions of the microcomputer system.

CIRCLE NO. 351

## Calculator operates in three number bases

Texas Instruments Inc., P.O. Box 5012, Dallas, Tex. 75222. (214) 238-7141. \$350.

Capable of converting numbers between octal, decimal and hexadecimal bases, the SR-22 calculator replaces cumbersome charts, tables and long-hand methods. The calculator performs the four standard functions—addition, subtraction, multiplication and division—in three number bases. The 14-character display—10-digit mantissa, two signs, 2-digit exponent—shows all numbers, decimal point and sign. Results of over 10 digits are displayed in scientific notation. The SR-22 operates in the hexadecimal system and performs its calculations with 13 significant figures. The calculator's memory can store, recall and sum numbers.

CIRCLE NO. 352

# A photoelectric tape reader for the same price as a mechanical one!

**Solid State**  
LED reliability  
**Low Maintenance**  
Stepping Motor — single moving part  
**Speed**

120 CPS asynchronously

Write for literature regarding our new family of complementary OEM products — printers, punches, keyboards and readers manufactured in the Addmaster tradition. To gain an important competitive edge, contact

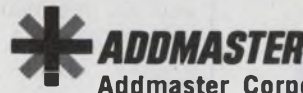

Addmaster Corporation

416 Junipero Serra Drive, San Gabriel, California 91776



INFORMATION RETRIEVAL NUMBER 83

# Vero Produces Cases for All Applications

- Slim line.
- Integral front trim, with or without handles.
- Retractable tilt feet.
- Removable bottom and rear panels incorporating ventilation slots.
- 8½", 12½" or 17½" deep.
- 10½" and 19" wide.
- 1¾" to 10½" heights.
- Side handles - standard on 17½" deep version, extra on other sizes.
- Chassis runners and front panels also available.

DETAILED LITERATURE ON REQUEST ON OUR COMPLETE PACKAGING SYSTEMS

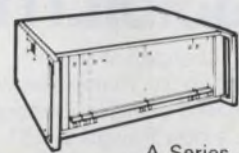

A Series

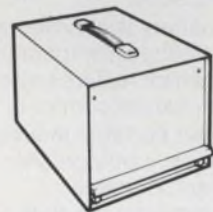

C Series with modules

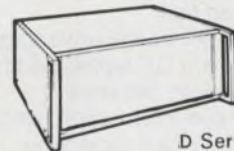

D Series

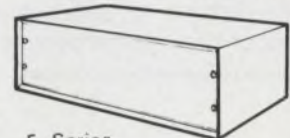

E Series



**VERO ELECTRONICS INC.**

171 BRIDGE ROAD, HAUPPAUGE, NEW YORK 11787  
516 234-0400

INFORMATION RETRIEVAL NUMBER 84



General Electric's New  
PowerUp-15\* Battery

**RECHARGES  
IN 15 MINUTES**



**THINK  
OF THE  
POSSIBILITIES**

When charged at room temperature for 15 minutes with an approved charger, General Electric's new PowerUp-15\* battery delivers 90 percent of its rated capacity.

The battery is charged with a unique Voltage/Temperature Cutoff system which features straight forward charger control circuitry.

Ideal for portable industrial power tools, photographic equipment, portable communications devices . . . anywhere portable electric power is needed fast.

And you get all the advantages of time-proved GE nickel-cadmium rechargeable batteries.

For more information, write General Electric Company, Section 452-04, Schenectady, N. Y. 12345, or circle reader service card.

\*Trademark of General Electric Company

**GENERAL  ELECTRIC**

INFORMATION RETRIEVAL NUMBER 86

156

DATA PROCESSING

**Hand-held electronic camera reads documents**



*Data Copy Corp., 550 Hamilton Ave., Palo Alto, Calif. 94301. (415) 327-3485.*

Built around a photodiode array and an internal light source, the SCANTRAC 1 camera converts graphic images to electronic signals. In addition to the data output, the compact hand-held unit also generates a positional signal to show the location of the information. Data and location signals are independent of the rate at which the camera is moved across the subject matter. The camera, used in conjunction with a control unit, is said to be very useful for document copying and optical character recognition.

CIRCLE NO. 358

**Scanner-printer helps spot equipment trouble**

*Rochester Instrument Systems, 275 N. Union St., Rochester, N.Y. 14605. (716) 325-5120.*

Designated the RA-800N, the recorder senses, stores and transmits data related to a series of events. Changes in electrical-contact status are sensed, retained in proper time relationship and then forwarded to a digital printer. The printer lists each event by time of occurrence; the point number on which the event occurred and the status change causing the event—e.g. a new alarm or return-to-normal condition. Each input is interrogated once each ms. The unit is supplied with 10 input points and is easily expandable.

CIRCLE NO. 359

**Data-terminal display viewed on video monitor**

*Digi-Log Systems Inc., 666 Davisville Rd., Willow Grove, Pa. 19090. (215) OL 9-5400. \$1295 (unity qty).*

The Digi-Log Model 33 is a portable, interactive terminal designed to replace or operate in conjunction with Model 33 teletypewriters. Weighing less than 10 lb, it can be carried in a briefcase and plugged into any video monitor or network of monitors. It can be acoustically coupled or hard-wired. TTL current loop or EIA RS 232 interfaces are provided as standard. The unit has a display format of 80 characters by 16 lines, 1280 characters in all. Standard data rates are 110 and 300 baud, when using the optional built-in acoustic coupler, or 9600 baud when hard-wired.

CIRCLE NO. 360

**Calculator lets user define 24 key functions**



*Tektronix Inc., P.O. Box 500, Beaverton, Ore. 97005. (503) 644-0161. Tek 21: \$1850; Tek 31: \$2850; 4 wk.*

According to the manufacturer, the Tek 21 and Tek 31 programmable calculators are designed for easy interaction between user and machine. Both units feature built-in math functions (with corresponding function keys) and PROM storage that allows 24 additional user-defined keys. Alpha capability allows the Tek 31 to communicate with the operator. The unit can print instructions, ask for input and label results. The Tek 21 holds 128 program steps—expandable to 512. The Tek 31 can be expanded to 8192 program steps with 266 registers or 2048 steps and 1010 registers or a combination of both. Compatible peripherals include an X-Y plotter and the 4010 family of computer-display terminals.

CIRCLE NO. 361

# Introducing the expensive digital multimeter that doesn't cost a lot.

The B&K Precision Model 281.

This 2½-digit unit is so versatile, its range covers 99% of your measurements. And its DC accuracy is 1%. The stable 281 also gives you positive over-range and wrong-polarity indications.

It's easy to use and easy to read across all 32 ranges, 100mV to 1000V.

Naturally, we're enthused about our Model 281. You will be, too, when you see our complete specs.

Call your B&K distributor. Or write Dynascan Corporation.

Very good equipment at a very good price.

**B&K** **\$169<sup>95</sup>**



Product of Dynascan Corporation  
1801 West Belle Plaine Avenue, Chicago, Illinois 60613

INFORMATION RETRIEVAL NUMBER 88

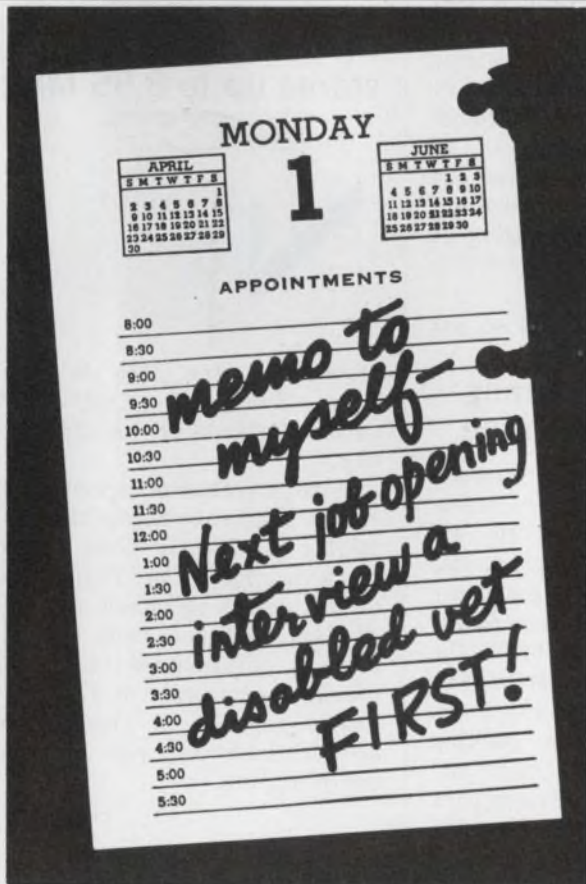

The President's Committee on Employment of the Handicapped  
Washington, D.C. 20210

## OSHINO SUBMINIATURE LAMP OVER 600 ITEMS ARE AVAILABLE DETAILS IN CATALOG SML-008

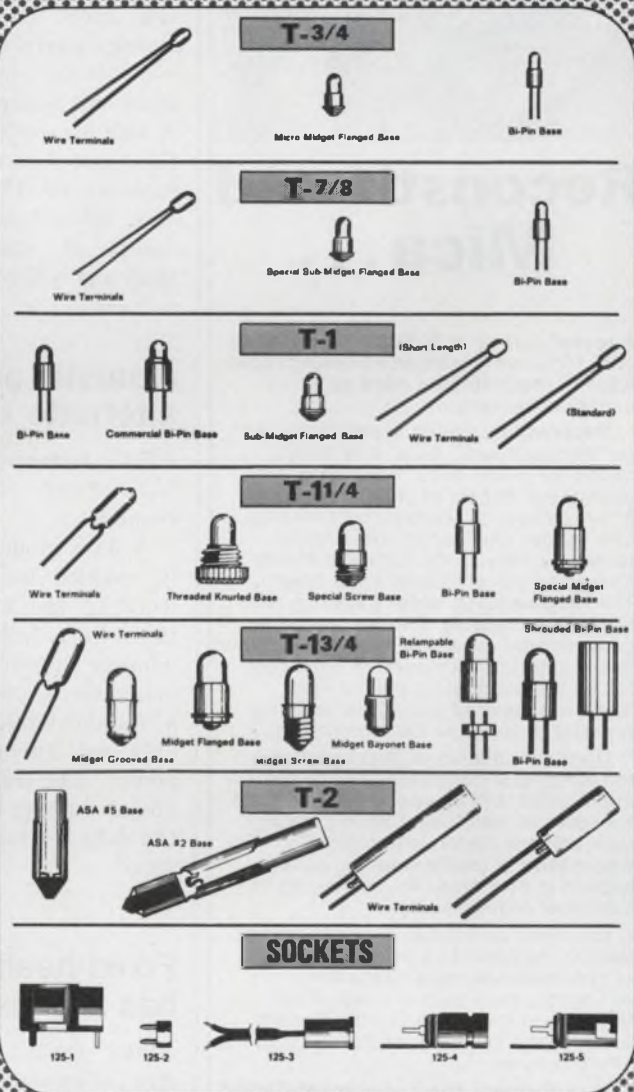

A leading manufacturer of Sub-Miniature Lamps for the Electronics Industry.



**OSHINO ELECTRIC LAMP WORKS, LTD.**  
TOKYO, JAPAN

• For catalog please write to:

**WAMCO Technical Sales, Inc.**

705 W. 16th Street, Costa Mesa, California 92627

Tel: (714) 642-5100 Telex: 678459

Mid-West 12 states only

**CIMCO International, Inc.**

201 North Wells St. (Rm. 1920) Chicago, Illinois 60606

Tel: (312) 782-5621 Telex: 724426

INFORMATION RETRIEVAL NUMBER 89



# What you should know about



## Reconstituted Mica...

A recent survey of 10,000 EEs indicated only 10% demonstrated a working knowledge of **reconstituted mica** as a capacitor dielectric.

**Reconstituted mica** is not "recycled" or "second-hand" mica. It is natural capacitor grade mica formulated into continuous sheets of uniform thickness. After removal of soluble contaminants, this "paper like" structure is maintained by the natural cohesive forces characteristic of natural mica itself. The **reconstituted mica** "paper" dielectric is then capable of being wound on conventional capacitor winding machines in conjunction with purified aluminum foil as the conducting media. Flag leads are inserted during the winding process to serve as the terminations.

Upon completion of impregnation, the winding is compressed while the impregnant is in an unpolymerized state. Pressure is maintained during curing until polymerization is complete, whereupon, a totally solid capacitor section is now ready for packaging to customer requirements.

Excellent performance under environmental extremes is a prime advantage of **reconstituted mica** capacitors. At Custom each step of production begins and ends with Quality Control because we know our customers can not afford failures.

Now that you know what **reconstituted mica** capacitors are, let us show how we can meet your requirements. See our page in EEM and write for **FREE** product sheets today.



**CUSTOM ELECTRONICS, Inc.**

4 Browne St., Oneonta, N. Y. 13820  
PH: 607-432-3880 TWX 510-241-8292

*P. S. Oil exploration personnel; Custom can help you with your logging tool problems.*

## DATA PROCESSING

### Disc drive units provide 232-Mbyte data capacity

*Century Data Systems, Inc., 1270 N. Century Blvd., Anaheim, Calif. 92806. (714) 632-7041. From \$9000; 6 mo.*

Priced at \$9000 per spindle (quantity), the CDS 225 disc drive has a total capacity of 232 Mbytes—on two spindles. Storage density is 200 tracks/in. at 4400 bits/in. and each disc pack provides 20 storage surfaces. The transfer rate—5 Mbits/s—can be handled by most minicomputers in use today. A smaller model, the CDS 125, contains one disc drive with a storage capacity of 116 Mbytes. Dual access, offered as an option, permits access of stored data by more than one controller.

CIRCLE NO. 353

### Acoustic adapter affords alternate data route

*RFL Industries, Inc., Boonton, N.J. 07005. (201) 334-3100. \$60; immediate.*

A data modem can be acoustically coupled to the direct-dial network in the event of communication line failures. The acoustic adapter provides the necessary magnetic/acoustic coupling through a standard telephone handset. The data set furnishes the necessary power. The adapter can provide a visual carrier-detect indication if the data set has a carrier detection stage.

CIRCLE NO. 354

### Fixed-head disc family has 2.1-ms access time

*Alpha Data, Inc., 8759 Remmet Ave., Canoga Park, Calif. 91304. (213) 882-6500. See text; 10 wks.*

This family of fixed-head disc drives offers average access times as low as 2.1 ms and storage capacities from 1 to 16 Mbits. The I/O transfer rate is 4 MHz. The machines feature noncontact recording heads, 4-kbit/in. packing density, multiple-access tracks and a sealed disc chamber. Prices vary with capacity and access time. For example, a 4-Mbit, 4.2-ms memory costs \$5000; an 8-Mbit, 2.1-ms memory costs \$10,000.

CIRCLE NO. 355

### Process control I/O unit handles up to 16k points



*Media 111, 2454 E. Fender Ave., Fullerton, Calif. 92631. (714) 870-7660.*

Series 1510 I/O equipment provides a modular bus-structured approach to the problem of interfacing a computer with process variables and control points. The equipment accommodates inputs in the form of low-level analog signals (down to  $\pm 10$  mV, full scale), discrete-point inputs (contact and voltage level) and digital-instrument signals. Available outputs include digitally programmable voltages, contact closures, solid-state switches or voltage levels. Up to 16,384 points can be handled. I/O capability is added by plugging cards into a rack-mounted chassis. The systems are offered for use with most of the popular minicomputers.

CIRCLE NO. 356

### Disc memory stores up to 8.95 Mbits

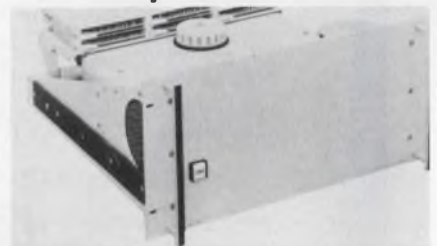

*Data Disc, Inc., 686 W. Maude Ave., Sunnyvale, Calif. 94086. (408) 732-7330. From \$5000; 90 day.*

With a rotational speed of 3600 rpm, the average access time is 8.4 ms for the 7230-L series head-per-track disc memories. Data capacity of this series, selectable in five increments, ranges from 560 k to 8.96 M unformatted bits, with a maximum data rate of 4.2 Mbits/s. Sealed versions of these systems are available for use in adverse environments.

CIRCLE NO. 357

Don't miss an issue of **ELECTRONIC DESIGN**. Return your renewal card today.

## RELIABLE SPACE SAVERS...



*NEW IMPROVED DESIGN*  
provides longer life and greater dependability.

*SNAP ACTION* feature permits a high 6 Amp rating.

*GOLD FINISH* on contacts and terminals for easier soldering and longer shelf life.

*ISOLATION BARRIERS* between poles and terminals, inside and out.

*CASE MATERIAL* of DAP for strength, better arc and flame resistance, lower leakage.

*WIDE CHOICE* of 1, 2, 3 and 4 pole models in Momentary and Push On/Off.

*OPTIONS*  
Waterproof seals, PC or Wire Wrap terminals.

*NEW FRAME DESIGN*  
allows use on 250VAC circuits.

Ask for our illustrated "New Product Selection Guide" — containing a detailed listing of all series, options and pricing.

INVESTIGATE & COMPARE

# ALCOSWITCH

Mfg. by ALCO ELECTRONIC PRODUCTS, INC. NORTH ANDOVER, MASS.



Call Sandy collect at (201) 542-1902 to get all the information (prices, delivery, specs) on our popular 2N4998 through 2N5005 (2N5006-9 on special request) series. We make them all. High quality 5 Amp NPN-PNP Planar devices for hi-voltage, hi-current and hi-speed applications. Excellent gain stability, power dissipation (50W), switching times and Safe Energy Area specified.

If you need more power (140W, 20A) ask about our 2N5038 & 2N5039 devices. If you're really serious call Sandy now, or, circle the reader service number to obtain a data sheet.

**Power Physics —  
Specialists in Power  
Semiconductor  
Technology**

Industrial Way West,  
Eatontown,  
N. J. 07724



INFORMATION RETRIEVAL NUMBER 91

INFORMATION RETRIEVAL NUMBER 92

# COMING NOV. 22

## A MAJOR, IN-DEPTH ISSUE OF YEAR-LONG REFERENCE VALUE

# INSTRUMENTATION '73

On November 22, **Electronic Design's** editors will go all out to provide readers with an exceptional issue: INSTRUMENTATION '73. Emphasis will be both on the **design** and **use** of test and measuring instruments. The report covers both **conventional instruments**—oscilloscopes, spectrum analyzers, voltage-current-resistance measuring instruments, time and frequency measuring instruments, signal sources, recording instruments, and circuit testers, and **newer unconventional instruments**—such as logic analyzers, logic probes and clips, digital memory oscilloscopes, etc. You'll find latest state of the art information, latest advances in component and circuit design that have made new performance levels both possible and practical. New approaches to packaging are also covered.

The user will be given tips on the problems that surround buying and using test and measuring instruments. Special attention is given to systems and computer compatibility. Trade-offs, and details on manufacturers' specs are included. It's an issue that will be extremely valuable for months to come.

Note: If your company has made significant new developments in instrumentation, be sure our editors know about it. (You may also want to tip off your own ad department if you are involved in this field. It's going to be a red hot issue!)

# Electronic Design

# ANALOG - TO - DIGITAL CONVERTER

## 15 BINARY BITS - 1.0 MICROSECOND



**SERIES 2000** — from 8 bits in 100 nanoseconds to 15 bits in 1.0 microsecond.

**SERIES 2100** — from 8 bits in 500 nanoseconds to 15 bits in 3.0 microseconds.

Complete data systems featuring multiplexers and sample and hold amplifiers are available. Up to 256 channels may be provided in one 5¼" high by 19" wide cabinet. High level, low level and simultaneous sample and hold systems are available.



**TUSTIN ELECTRONICS CO.**  
1656 South Minnie Street  
Santa Ana, Calif. 92707  
(714) 835-0677

INFORMATION RETRIEVAL NUMBER 93

# LOOK

to

# erc

electronic research co. • a hughes div.

THE PEOPLE DOING  
THINGS THAT MATTER...  
IMAGINATIVELY

**IN FREQUENCY CONTROL PRODUCTS:**  
Quartz Crystals, TCXO's, VCXO's,  
TCVCXO's, Hybrid Oscillators,  
and Frequency Standards • **DIGITAL  
INSTRUMENTS:** Clocks, Timers, Com-  
parators, Counters, Panel Meters,  
Thermometers, Scanners, and Sys-  
tems Components •

**IN FACT:** For anything concerned with  
time, temperature or frequency... CALL,  
WRITE, or TWX your SOUL SOURCE at:

Telephone (913) 631-6700  
7618 Wedd  
Overland Park, Kansas 66204  
Mail to: P.O. Box 913, Dept. 835  
Shawnee Mission • Kansas 66201  
TWX: (910) 749-6477

## The pollution problem.

### Maybe your engineers deserve a little help.

The engineers will be the ones to find the technical solutions to pollution problems. There's no doubt about it.

But pollution is a people problem, too. And the engineers' technological approach to pollution isn't going to solve people problems.

Maybe this booklet can help. It lists some of the things all people can do to fight pollution. And with all the people supporting your engineers we'll have a better chance of winning the fight.

For a free copy or a list of bulk rates write to Keep America Beautiful, Inc., Box 1771, Radio City Station, New York, New York 10020.

### Keep America Beautiful

Advertising contributed for the public good

## DATA PROCESSING

### Modular tape deck handles 3M cartridge

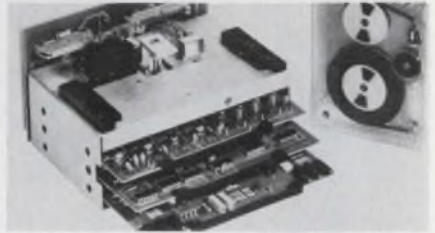

Gould Inc., Instrument Systems Div., 3631 Perkins Ave., Cleveland, Ohio 44114. (216) 361-3315.

The Gould tape deck handles the 3M DC300A 0.25-in. tape cartridge yet requires no more space than a cassette deck. The deck uses a 1600 bit/in. phase encoded format and is ANSI/ECMA compatible. Drive speeds, regulated within  $\pm 2\%$  are: read/write—20 in/s; read/search—60 in/s and forward/rewind—90 in/s. The unit accepts parallel or serial data entry; output is a phase-encoded, single-ended, TTL level. The tape deck is available with one, two or four-track, single or dual-gap, tape heads. With dual-gap heads, the unit provides a read-after-write capability that has a worst-case SNR of 26 dB.

CIRCLE NO. 362

### Core memories come in 4k and 8k capacities



Electronics Memories & Magnetics Corp., 12621 Chadron Ave., Hawthorne, Calif. 90250. (213) 644-9881. See text; 120 days.

The Micromemory 9000, a 2.5 D, 3-wire core memory fits on a 9 x 13-in. PC board. It is available in 4k x 1 or 8k x 1 configurations. The nonvolatile storage unit features 1.2  $\mu$ s cycle time, 500 ns access time, and TTL compatibility. The memories operate over a temperature range of 0 to 70 C and require 5 V, -10 V and 12 V dc supply voltages. Prices vary from 2.5 to 5¢/bit depending on the quantity ordered.

CIRCLE NO. 363

## Optical-mark readers have two output options

Wyle Computer Products, 128 Maryland St., El Segundo, Calif. 90245. (213) 678-4251. From \$995; 90 days.

Capable of sensing pencil marks, punched holes or a combination of both, the series 700 reader contains a card transport mechanism, optical read head and electronics in a single enclosure. Cards are inserted in the front loading chute and ejected from the top after being read. Model 710, designed for OEMs, provides 12 parallel channels at TTL logic levels; Model 720 provides a series ASCII interface capable of operating at data rates of 110, 300 and 1200 bits/s. The Model 720 stores up to 80 characters during the card reading sequence then transmits the data serially.

CIRCLE NO. 364

## Disc memory plugs into PDP-11 minicomputer



Engineered Data Peripherals Corp., 1701 Colorado Ave., Santa Monica, Calif. 90404. (213) 829-3696. \$8845: 256-k work system; 45 to 60 day.

A plug-compatible disc memory for the PDP-11 minicomputer has storage capacities that range from 65-k to 2-million words. Access times of 8.5 or 17 ms are available. The memory system consists of a disc drive, formatter and I/O controller. The disc drive is a fixed-head-per-track disc memory. The functions provided by the formatter are disc addressing, error detection and data formatting.

CIRCLE NO. 365

## Portable digital tester furnishes 4-M patterns/s



Fluke Trendar Corp., 500 Clyde Ave., Mountain View, Calif. 94040. (415) 965-0350. \$5975; 3 day.

The TRENDAR 1000, a portable logic tester, generates signals at rates up to 4-M patterns/s. Settings of test length can range from 40 k to 40 M patterns. Two fault-isolation tools are included: A high-impedance probe permits the operator to test and troubleshoot on the basis of node behavior and transition counts. And a form of in-circuit IC testing handles more complex boards. The unit interfaces directly with TTL/DTL boards; interface circuits handle CMOS and discrete logic.

CIRCLE NO. 366

## Display controller adds alphanumeric to TV pix



Ann Arbor Terminals, Inc., 6107 Jackson Rd., Ann Arbor, Mich. 48103. (313) 769-0926. From \$930; 15 days.

The Series 204 controllers provide a 16-line  $\times$  32-character display from a repertoire of 64 alphanumeric characters. All 16 lines can be shown at once or, for tilting applications, just one, two or three lines near the bottom of the picture. The unit accepts either picture video or composite video and offers a choice of outputs: alphanumeric added to the picture; alphanumeric added to the composite sync; or synchronized non-composite characters.

CIRCLE NO. 367

## POWER SPLITTERS-COMBINERS

Great Value at

**\$7<sup>95</sup>**  
500 piece quantities.

\$9.95 in 6-piece quantities.

0.1-400MHz  
0.5dB insertion loss  
40dB isolation  
EMI shielded case



A breakthrough in technology and high production volume enables Mini-Circuits Laboratory to offer these new products at an unprecedented low price.

In today's tough competitive market can you afford not to use these remarkably low priced and high performance units?

Ruggedness and durability are built in the PSC2-1. Packaged within an EMI shielded metal enclosure and hermetically sealed header. This new unit uses a broadband hybrid junction and uniquely designed matched transmission line transformers.

We invite you to convince yourself. Place your order now and check our delivery, product performance and reliability.

## Mini-Circuits Laboratory

2913 Quentin Rd., Brooklyn, N.Y. 11229  
(212) 252-5252, Int'l Telex 620156  
A Division Scientific Components Corp.

FRANCE: S.C.I.E., \*31, rue George-Sand, Palaiseau 91, France. GERMANY, AUSTRIA, SWITZERLAND: Industrial Electronics GMBH, \*Klüberstrasse 14, 6000 Frankfurt/Main, Germany \*UNITS IN STOCK

INFORMATION RETRIEVAL NUMBER 94

# new literature



## Switches

A short-form catalog contains more than 4000 switch product listings, any one of which can be located through a numerical-alphabetical index. Switchcraft, Chicago, Ill.

CIRCLE NO. 368

## Zip-on jacketing

A six-page bulletin covers patented zip-on jacketing for wire, cable and other applications. Jackets of various material and construction are described, including standard, high-temperature, shielded and special types. Three different closure tracks are illustrated and specifications including MIL-specs are listed. Zippertubing, Los Angeles, Calif.

CIRCLE NO. 369

## Lasers

State of the art in laser technology is now published quarterly in a four-page format. The latest advances in industrial applications, electro-optics, solid-state physics, construction alignment instrumentation, noncontact laser read systems and high-power resistant optical coatings are presented in detail. Coherent Radiation, Palo Alto, Calif.

CIRCLE NO. 370

## Oscillators

High-stability frequency standards, miniature crystal oscillators, amplifiers and multipliers are described in an 83-page catalog. Greenray Industries, Mechanicsburg, Pa.

CIRCLE NO. 371

## Key data terminal options

A data-communications option that provides remote batch communications capabilities, an external device adapter option for external input-output devices, and an input device adapter option for automatic data receiving are described in a series of brochures. Pertec, Santa Ana, Calif.

CIRCLE NO. 372

## Optical system components

A 60-page catalog and designer's handbook includes specifications and prices for optical benches, diffraction gratings, optical filters, thermopile detectors, Pockels cells, lead-sulfide and lead-selenide detectors, prisms, lenses and night-vision system components. Baird-Atomic, Bedford, Mass.

CIRCLE NO. 373

## Microwave components

Microwave components are described in a 24-page catalog. Pictures and diagrams of circulators and isolators, microwave filters, multiplexers, waveguide filters, coaxial switches, waveguide switches and integrated components are included. Teledyne Microwave, Mountain View, Calif.

CIRCLE NO. 374

## Thermistors

An eight-page bulletin details types, sizes and resistances of negative temperature thermistors plus a series of thermistor probes. The thermistor types are rod, cryogenic, glass bead, molded-in-lead bead and rod, as well as disc and disc with crossed leads. Thermistor Div., St. Marys, Pa.

CIRCLE NO. 375

## A/d and d/a converters

A 36-page catalog contains electrical and mechanical information on a/d and d/a converters, sample/hold amplifiers, wideband dc amplifiers, instrumentation amplifiers, analog multiplexers, dc-dc converters and data-acquisition systems. Datel Systems, Canton, Mass.

CIRCLE NO. 376

## Instrument tubing

An eight-page color brochure describes and illustrates Dekoron instrument wire and tubing and Dekatrace heat traced lines. Included are 32 product photos. Dekoron Div., Aurora, Ohio.

CIRCLE NO. 377

## Data-acquisition system

The VIDAC IV data-acquisition system that needs no application software to monitor temperature, strain, flow and other voltage signals is described in a data sheet. Vidar, Mountain View, Calif.

CIRCLE NO. 378

## Convertible action switches

A four-page, four-color catalog gives operational characteristics and specifications for dual-action pushbutton switches. Available options, sizes, colors, mountings, terminals and contacts are given as well as ordering information. Licon, Chicago, Ill.

CIRCLE NO. 379

## Transducers and instruments

A short-form catalog describes precision transducers and instrumentation for sensing, measuring and analyzing all aspects of sound, noise and vibration. B & K Instruments, Cleveland, Ohio.

CIRCLE NO. 380

## Ceramic capacitors

A 37-page catalog describes West-Cap monolithic ceramic capacitors and contains the latest revisions to MIL-C-39014, MIL-C-55681 and MIL-C-39014. San Fernando Electric, San Fernando, Calif.

CIRCLE NO. 381

## Lasers and accessories

Carbon-dioxide and neodymium lasers and accessories are covered in a short-form catalog. GTEylvania, Electro-Optics Organization, Mountain View, Calif.

CIRCLE NO. 382

## Butterfly packages

Metal butterfly microelectronic packages, both single piece and modular versions, are described in a 10-page bulletin. Tekform Products, Anaheim, Calif.

CIRCLE NO. 383

# When RFI problems get sticky, try *stickn* fingers®

Attaches faster, shields better than anything else!

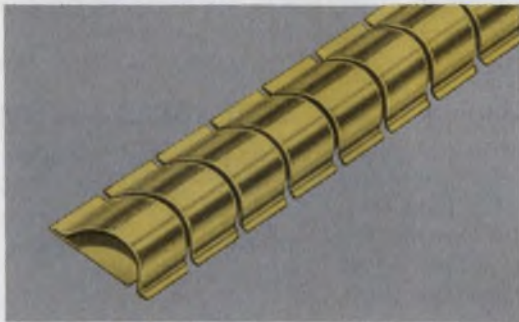

**SERIES 97-500** The original Sticky Fingers with superior shielding effectiveness.

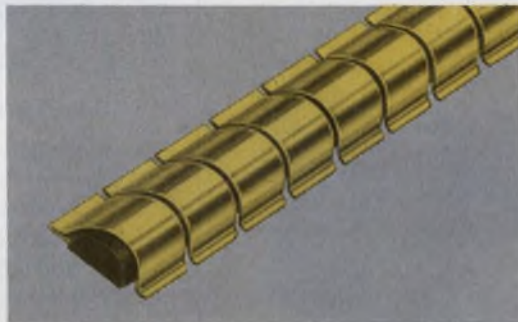

**SERIES 97-510** Provides even better magnetic shielding with Magnefil® insert strips.

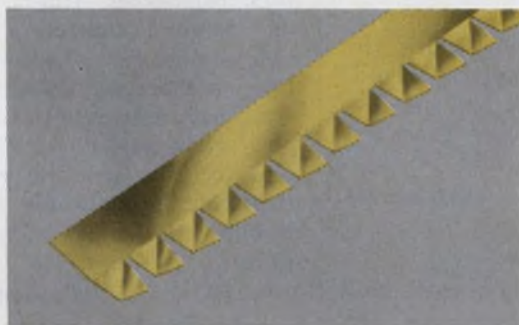

**SERIES 97-555** New Single-Twist Series for use when space is at a premium. Measures a scant  $\frac{3}{8}$ " wide.



**SERIES 97-560** New  $\frac{1}{2}$ " wide Double-Twist Series, ideal for panel divider bar cabinets.

Now you can specify the exact type beryllium copper gasket that solves just about every RFI/EMI problem. Perfect for quick, simple installation; ideal for retro-fitting. Self-adhesive eliminates need for special tools or fasteners. Write for free samples and catalog.

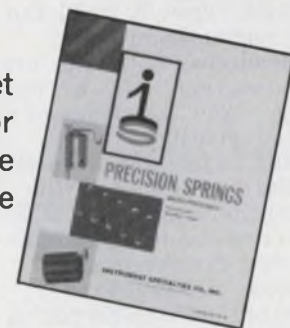

**INSTRUMENT SPECIALTIES COMPANY,** Dept. ED-65

Little Falls, N.J. 07424

Phone—201-256-3500 • TWX—710-988-5732

# 5 Remarkable Little Ovens from Texas Instruments, \$15.

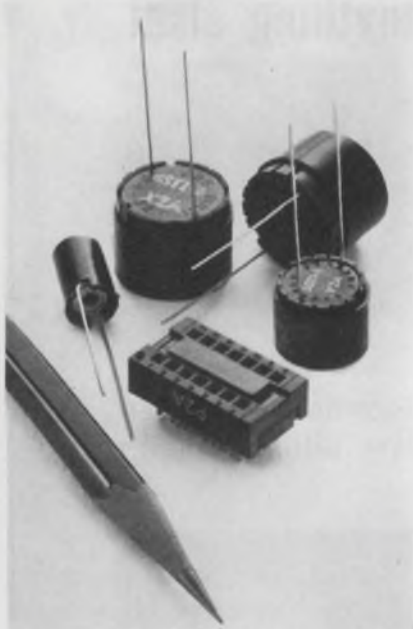

These self-regulating solid-state component temperature stabilizers provide a low cost means of controlling the environment of a wide variety of transistors, diodes, and ICs. Application of these component ovens permits the use of less expensive semiconductor devices by improving their thermal characteristics as much as 30:1. See how much less you get for your money.

**Less Bulk.** Typically 1/10th the size of conventional ovens.

**Less Headaches.** Solid state ovens have no moving parts — are more reliable — aren't handicapped by a limited cycle life.

**Less RFI.** In fact, there's no RFI since the ovens eliminate the need for thermostats and SCR's which create undesirable radio frequency interference.

**Less Money.** Costs \$3 to \$5 instead of the \$5 to \$250 you're paying now.

Send \$15 for your 5-piece Oven Sampler to Commercial Controls Marketing, MS 12-33, Attleboro, Mass. 02703. Or write for the literature.

**TEXAS INSTRUMENTS**  
INCORPORATED

INFORMATION RETRIEVAL NUMBER 96

## NEW LITERATURE



### PC board production aids

A four-page bulletin describes products for use in the production of PC boards. Each product is clearly described with options for sizes, materials and colors called out. Diameters for masking discs are referenced in fractions, decimals and millimeters. Webtek, Los Angeles, Calif.

CIRCLE NO. 384

### Recorders

Series R intermediate-size circular scale and strip chart, recorders/controllers/indicators are described in a six-page brochure. Barber-Colman, Rockford, Ill.

CIRCLE NO. 385

### SCRs

A product summary sheet describes 12 series of SCRs and six series of low-power silicon rectifiers. A specification chart and photographs are shown. International Rectifier, El Segundo, Calif.

CIRCLE NO. 386

### Power supplies

Features, specifications and prices for a line of power supplies are detailed in a four-page brochure. Calnex, Alamo, Calif.

CIRCLE NO. 387

### Hard-copy output devices

A 12-page catalog describes Matrix hard-copy output devices, software and controllers. Sample printouts of the 5 × 7, 7 × 9 and 16 × 16 Versatec Roman fonts are shown in the catalog. Versatec, Cupertino, Calif.

CIRCLE NO. 388

### Rear-projection readout

A data sheet describes the 64 Mark II rear-projection readout, detailing "slip-chip" replacement of 64, 32 or 16-message sets. Major Data Corp., Costa Mesa, Calif.

CIRCLE NO. 389

### Motorgram

General noise sources in fractional-hp motors and recommendations on how to control them highlight the July/August issue of the company's Motorgram (Vol. 53, No. 4). Bodine Electric Co., Chicago, Ill.

CIRCLE NO. 390

### WIRE IDEAS newsletter

A bimonthly newsletter, *WIRE IDEAS*, highlights specific ideas on how to solve wire handling problems. Acrometal Products, Minneapolis, Minn.

CIRCLE NO. 391

### Electronic components

A 408-page catalog covers electronic components such as capacitors, connectors, filters, hardware and motors, indicators, ICs and semiconductors, potentiometers, relays, switches and terminals. Specifications, application information and prices are given. The catalog also includes cross-references and features all applicable MIL-specs. Powell Electronics, Philadelphia, Pa.

CIRCLE NO. 392

### Step attenuators

A specification sheet covers a series of broadband manual step attenuators. Midwest Microwaves, Ann Arbor, Mich.

CIRCLE NO. 393

### Desk-top calculators

A 12-page booklet shows how design problems, which normally take days or weeks, can be solved in a few hours with the series 9800 calculator systems and HP developed software. The booklet suggests hardware/software solutions to problems in network analysis, microwave circuit design, magnetics and control-system design. Advantages of an alphanumeric printer and an X-Y plotter are shown. Hewlett-Packard, Palo Alto, Calif.

CIRCLE NO. 394

## Small tools

A catalog contains photos, descriptive copy and stock numbers for small tools for the telephone, communications and electronic industries. P.K. Neuses, Arlington Heights, Ill.

CHECK NO. 395

## Film or ceramic capacitors

Specifications and ordering information for wrap-and-fill, epoxy-cased, tubular and rectangular metal-cased film capacitors and for ceramic-chip and epoxy-cased ceramic capacitors are contained in a 16-page catalog. ITT Jennings, Monrovia, Calif.

CIRCLE NO. 396

## Micro VCOs

Descriptions, features and application information for the company's line of thick-film hybrid voltage-controlled oscillators (micro VCOs) are provided in a six-page brochure. Each model's input and output, stability, power line and environmental performance characteristics are listed. The brochure includes standard frequency tables for IRIG proportional bandwidth subcarrier bands, as well as IRIG and AIA constant-bandwidth subcarrier bands. American Electronics Laboratories, Lansdale, Pa.

CIRCLE NO. 397

## Test system

A 16-page brochure describes the J272 computer-operated system for testing, evaluating and providing data on resistor/capacitor networks for both discrete and hybrid circuits. Teradyne, Boston, Mass.

CIRCLE NO. 398

## Meter relay and controller

A 16-page brochure contains application information, specifications and diagrams of meter relays and controllers. The brochure offers such options as photocells, amplifier, solid-state and relay outputs. Simpson Electric, Elgin, Ill.

CIRCLE NO. 399

## Time-delay relays

Operational modes, dimensions and wiring of time-delays are shown in a catalog. Vanguard Relay Corp., Lindenhurst, N.Y.

CIRCLE NO. 439

# PRINTED CIRCUIT JACKS/PINS

STANDARD & CUSTOM

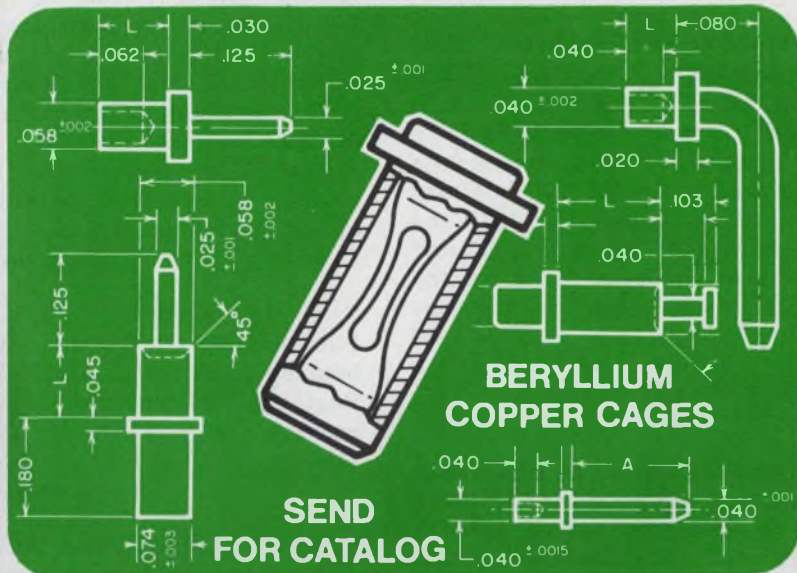

SEND FOR CATALOG

**CONCORD ELECTRONICS CORPORATION**

37 GREAT JONES STREET, NEW YORK, N. Y. 10012  
(212) 777-6571 TWX 710-581-4930

INFORMATION RETRIEVAL NUMBER 97

# dip clip

T.M.

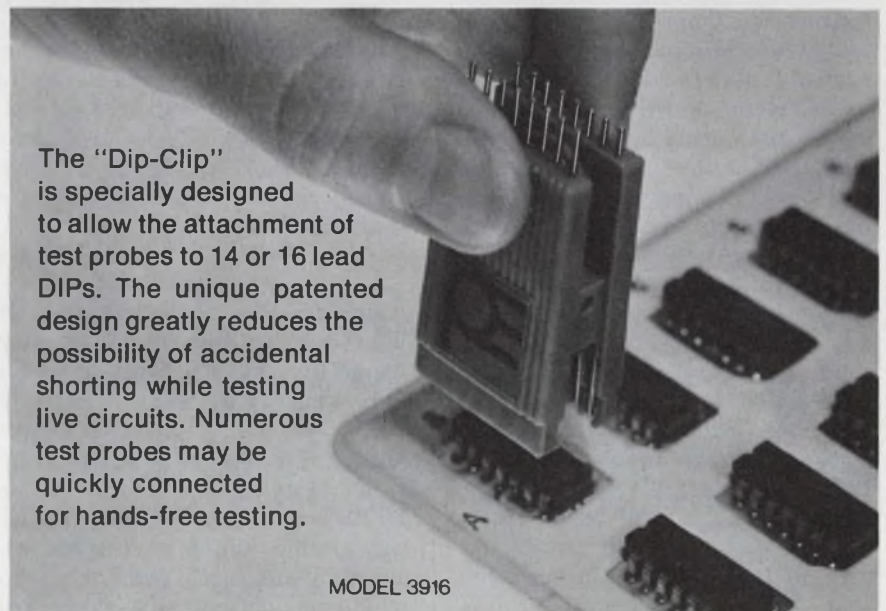

MODEL 3916



**POMONA ELECTRONICS**

A Subsidiary of ITT

1500 E. Ninth St., Pomona, Calif. 91766 • Telephone: (714) 623-3463

INFORMATION RETRIEVAL NUMBER 98



# bulletin board

**National Semiconductor**, 2900 Semiconductor Dr., Santa Clara, Calif. 95051, has developed a small ceramic flatpack suitable for relatively high-power circuits operating over the full military temperature range. Virtually the entire line of military TTL and Tri-State products made by the company are going into the new flatpack—with the exception of TTL memories, which are too large for small flatpacks.

**Fairchild Camera & Instrument Corp.** has announced it will serve as an alternate source for the 1558 and 1458 dual operational amplifier circuits. Fairchild is supplying the dual op amps in all electrical grades and in two package options, either a TO-99 metal can package or an eight-pin molded mini-DIP package. Prices in 100-999 quantities are \$4.95 for the 1558 (metal can only), \$1.35 for the 1458 metal can, \$1.20 for the 1458 C metal can, \$1.15 for the 1458 in a mini-DIP and \$1 for the 1458 C in a mini-DIP.

CIRCLE NO. 440

Four new videotape instructional courses encompassing the latest technological developments in linear and interface ICs as well as optoelectronics will be presented across the nation by **Texas Instruments**. Classroom presentation will begin September 17 and continue through April 5, 1974, with sessions being conducted at 22 major US and Canadian locations. Engineers may enroll in all or any combination of courses by sending a check or money order for \$495 for the four courses, \$395 for three, \$295 for two, or \$195 for one to Texas Instruments Inc., P.O. Box 3640, M/S 84, Dallas, Tex. 75221 (214) 238-3894. Reservations will be confirmed by return mail. Published information that will include details on the courses, locations, and arrangements will be forwarded as well.

CIRCLE NO. 441

The **RCA Model 38 ASR teleprinter** prints the 88 APL character set, as well as three new APL characters (diamond, right tack, left tack) and three new ASCII characters (opening brace, closing brace, dollar sign). It features an on-line backspace that allows it to print the APL overstrike characters. The Model 38 ASR is available as a private line or with optional data set. The private line version with APL coding can be leased for \$75 per month, including service.

CIRCLE NO. 442

Production quantities of LM 108/108A/208/208A/308/308A **super beta op amps** are available from **Raytheon Semiconductor** at prices ranging from \$1.85 to \$23.70 (100-up).

CIRCLE NO. 443

**Sprague Products Co.** has announced the addition of 96 **multiple thick-film resistors and resistor networks** to the Metanet line. Metanet resistor networks include a full complement of individual terminating, dual-terminating, pull-up/pull-down, interface and multiple isolated resistors. Standard resistance tolerance is  $\pm 5\%$ . Total power dissipation ranges from 1.5 to 3.5 W at 25 C. Typical tempco is within 350 ppm/ $^{\circ}$ C. Tracking between resistors is  $\pm 50$  ppm/ $^{\circ}$ C. Operating temperature is  $-55$  C to  $+70$  C.

CIRCLE NO. 444

**Advanced Micro Devices** has introduced the first of a series of **MOS static-shift registers**—a dual 128-bit device. This p-channel silicon gate circuit is a high-speed, pin-for-pin replacement for the Mostek 1002P.

CIRCLE NO. 445

**American Electronic Laboratories** is offering an **incoming inspection capability** by its **Semiconductor Screening Laboratory**. AEL will 100% screen a company's components, or use a statistically accurate sampling program to an LTPD or AQL specified. Quick turnaround and low cost are assured by automatic test equipment which is periodically calibrated against standards traceable to the National Bureau of Standards.

CIRCLE NO. 446

A new version of the **Model 70 general-purpose processor**, made possible by a 16-k byte main memory board, has been announced by **Interdata, Inc.** The Model 70-Twin Chassis is configured with 11 expansion slots and a bulk power supply. The minicomputer is priced in single-unit quantities at \$9200.

CIRCLE NO. 447

**Optical Associates Inc.**, a newly formed organization, is manufacturing and marketing a line of **opto-electronic components and subsystems**. Initial products include optical photodetectors, calibrated sensors, detector-preamplifier subsystems, laser-pulsers, optical filters and filter-detector combinations, scientific glasses and replica optics. OAI is offering an optical calibration service covering the spectral range of 300 nm to 1200 nm.

CIRCLE NO. 448

**Opcoa, Inc.**, has introduced the first in its line of **yellow LED lamps**. The gallium phosphide products are 0.1-in. diameter, extra-wide viewing angle lamps, designated OSL-21 and 21S, and high forward intensity 0.200 in. diameter lamps, OSL-26 and 26L for the long dome versions.

CIRCLE NO. 449

**Intel Corp.** has announced a new **high-level computer language** developed for use with its MCS-8 microcomputer. Called PL/M, it is structurally similar to IBM's PL/I.

CIRCLE NO. 450

**Decision Data Computer Corp.** has announced the availability of a **five-year leasing plan** for all four of its 96-column data preparation products.

CIRCLE NO. 246

Seven new **blow-out proof spot voltage regulators** are available from **Silicon General** in two hermetically sealed, three-terminal packages. Each device in the family—the SG7800/140 series—can supply in excess of 1 A at nominal voltages of 5, 6, 8, 12, 15, 18 and 24 V. Maximum input voltage is 35 V, except for the 24-V version which will accept inputs to 40 V. The devices are electrical and pin-for-pin equivalents to the Fairchild  $\mu$ A7800 series and to National's LM140/340 series.

CIRCLE NO. 247

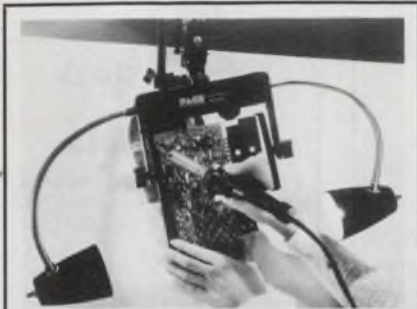

**POL-15 and POL-12 systems** provide full-field, distortion-free stereoscopic viewing of small objects within a fully illuminated field up to 14" deep. The POL-15 provides total manipulation and a reach up to 45" for fixed installations. The POL-12 is a portable, lightweight version. Pace, Incorporated, 9329 Fraser St., Silver Spring, Md. 20910. (301) 587-1696.

INFORMATION RETRIEVAL NUMBER 181



**Design as you order modular power supplies.** Complete, fully tested high efficiency power supply in a miniature package. Available with AC or DC inputs with up to 6 isolated and regulated DC outputs to 150 watts. No engineering charges! Arnold Magnetics, 11520 W. Jefferson Blvd., Culver City, Ca. 90230. Phone (213) 870-7014.

INFORMATION RETRIEVAL NUMBER 182

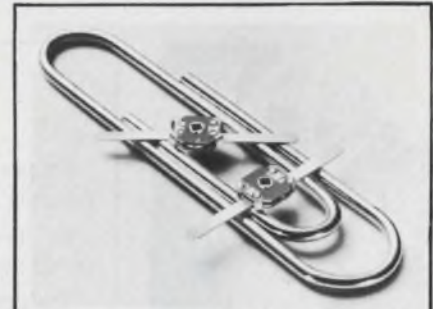

**Thin-Trim variable capacitors** provide a reliable means of adjusting capacitance without abrasive trimming or interchange of fixed capacitors. Series 9401 has high Q's and a range of capacitance values from 0.2-0.6 pf to 3.0-12.0 pf and 250 WVDC working voltage. Johanson Manufacturing Corporation, Boonton, New Jersey (201) 334-2676.

INFORMATION RETRIEVAL NUMBER 183



**Model IL700 Radiometer/Photometer** for the precise measurement of dc and pulsed optical radiation from the ultraviolet to near infrared. For studies in pollution, underwater spectroradiometry, densitometry and curing of U.V. sensitive polymers. International Light, Inc., Dexter Industrial Green, Newburyport, Mass. 01950. (617) 465-5923.

INFORMATION RETRIEVAL NUMBER 184

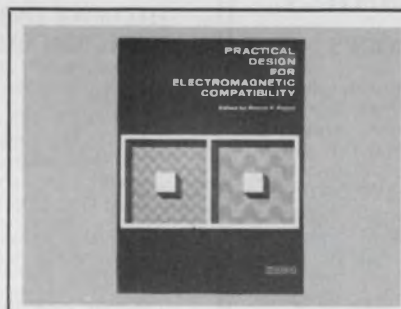

**Practical Design for Electromagnetic Compatibility**, edited by Rocco Fichici. An on-the-job manual giving designers practical techniques for analyzing, predicting, controlling, and reducing unwanted signals. 272 pp., 7-1/8 x 9-3/4, illus., cloth, \$13.95. Circle number for 15-day examination copy. Hayden Book Company, Rochelle Park, N.J. 07662.

INFORMATION RETRIEVAL NUMBER 185



**Advance through continuing education.** 5 complete design courses in Digital Circuits, IC Logic, Power Supplies, MOS/FET & J/FET Ckts and UJT Ckts. Programmed testing, instructor aided courses help you perform better on the job. Write Gene Presta, V. P., Academic Affairs, The Center For Technical Development, 2876 Culver Ave., Dayton, Oh. 45429.

INFORMATION RETRIEVAL NUMBER 186

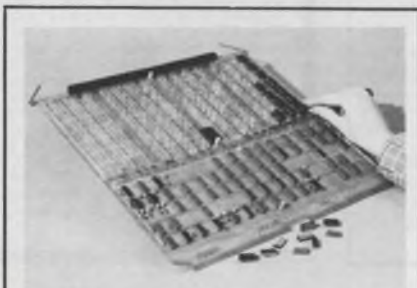

**NOVA/DCC-116 General purpose interface board** provides multiple device selection, 4 I/O registers, DMA zero word count detect, 105 socket positions for 14, 16, 24 and 40 PIN ICS. Basic board (all features of data general 4040 plus multiple device select) \$350.00. MDB Systems, Inc., 981 N. Main, Orange, CA 92667. (714) 639-7238.

INFORMATION RETRIEVAL NUMBER 187



TI type  
package

GREEN LED  
(also available  
in red, of course!)

**NEW**—the popular RED 209 LED is now available in GREEN at 46¢ (500 pcs). Identical to TI, Litronix and EEP 209's, except bright green. Specify TIL-209G, RL-209G or ED-209G—1-24: 75¢; 25 up: 65¢; 100 up: 52¢; 500 up: 46¢. Immediate delivery: Energy Electronic Products, 10180 Jefferson Blvd., Culver City, CA. 90230. 213/839-4306.

INFORMATION RETRIEVAL NUMBER 188

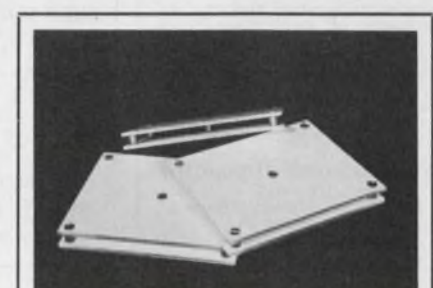

**A sure fire cost cutter.** Utilizing a base of moly, stainless or nickel and an aluminum oxide surface, HiTemCo repairable composite boats withstand hundreds more cycles than ceramic boats. Lower production costs, improved quality in sintering, firing, brazing. HITEMCO, 70 Cantiague Road, Hicksville, New York 11801. (516) 931-3500

INFORMATION RETRIEVAL NUMBER 189

# recruitment and classified ads



## SENIOR Electronic Engineer

Rapidly expanding manufacturer of crystal oscillators has an opening which offers excellent long-term growth opportunity for a Senior EE. 5-10 years of r.f. circuit design experience required; crystal oscillator design experience desired.

Send resume to  
**Mr. S. Tulgan, V.P./Engr.**  
**VECTRON**  
**LABORATORIES, INC.**  
 121 Water Street  
 Norwalk, CT 06854  
 Phone: 203/853-4433



## INSTRUMENT CIRCUIT DESIGNER

We have a place for you!

Be part of one of the largest electronic instrument houses and still enjoy a creative "small company" atmosphere.

We offer that kind of decentralized environment and challenging project opportunities to the right instrument-oriented circuit designer.

The right person must have a solid analog background (digital experience also desirable) and be capable of taking his designs from prototype through production release. Citizenship not required. Send resume and request for appointment to:

SYSTRON-DONNER CORPORATION

10150 W. Jefferson Blvd.  
 Culver City, CA 90230  
 (213) 836-6100



Equal Opportunity Employer

## dunhill search talks ELECTRONICS

**No Charge To Applicants**  
**100% Employer Retained**  
**\$13,000-24,000**

We are the National Professional Recruiting service especially active in bringing together leading nationwide electronic manufacturers and talented electronic design and project engineers. We have the contacts which add up to ideal placements and satisfied employees.

Current electronic design opportunities call for expertise in any of the following:

**CIRCUITS:** Amplifier, Relay MOS, CMOS, RAM/ROM, TTL/CML/ECL, Digital IC, Linear IC, MIC, Hybrid, and RF.

**SYSTEMS:** TV Information Systems, Digital Filters, Analog/Digital Signal Processing, Avionics, Data Transmission, Digital Systems, Control Systems, Communication Systems, MOS Calculator, Memory Sub Systems, Test Instruments, Test Equipment, Test System, HF/VHF/UHF Receivers, Antenna, ECM, EW, Radar, Loran, Tacan, Omega, Minicomputer, and Computer Peripheral.

**COMPONENTS:** Ferrite Devices, Microstrip, Waveguide Components, Power Modules, RF Microwave Transistors, and Power Transistors.

Clients offer excellent growth in technically managed environments. For instant confidential consideration, call Allan Bart COLLECT at (602) 264-1166 or (408) 244-9100; or rush your resume including current salary to:

## dunhill search

Division of Dunhill  
 of Phoenix/San Jose Agencies, Inc.  
 22 E. Mitchell Dr., Phoenix, Az. 85012  
 1922 The Alameda, San Jose, Ca. 95126

## MEMORIES

IC's CORES

for R&D Computer division of leading Fortune 500 firm located in Central New Jersey. Experience in Digital Circuit design. They offer salaries to \$20,000. All fees & relocation expenses paid. We have been exclusively retained to locate candidates for this top flight opportunity. Rush resume to Phil Phillips at

**BEST EMPLOYMENT AGENCY**  
 40 Journal Sq., Jersey City, NJ 07306

## ELECTRONIC ENGINEERS CONNECTICUT OPENINGS

Our Connecticut clients are seeking experienced, degreed, engineers for:

**CIRCUIT DESIGN**  
**SYSTEMS DESIGN**  
**PACKAGING**  
**PRODUCTION**

**QUALITY CONTROL**  
 Non-defense industries. Relocation paid. Mail resumes stating present & desired salary. Other positions also available out-of-state.

**FANNING CONSULTANTS**  
 4695 Main St.  
 Bridgeport, Conn. 06606

## IT'S A TECHNOLOGICAL SOCIETY

Industry expansion and the development of new manufacturing processes have opened new avenues of career positions. We specialize in Technical, Engineering, Design, and Management. Send your resume in confidence, or call Wayne Palmer, Mgr., 312-368-8542

**Professional Division**  
 SUITE 615  
 Business Men's Clearing House  
 150 S. Wacker Dr.  
 Chicago, Ill., 60606

## NATIONWIDE PROFESSIONAL ENGINEERING PLACEMENT

**CABLE TV/VIDEO ENGRS**

Design & Development \$15-22K  
 TACON EQUIP. \$14-18K  
 DISPLAY DEVICES TO \$16K  
 ANALOG/DIGITAL

Design & Field \$13-18K  
 All these positions are fully fee paid with all relocation expenses paid. We have many others in all locations.

Contact Mr. S. M. Brenner  
**PLACE MART - PASSAIC**  
 663 Main Av Passaic, NJ 07055

## DESIGN ENGINEERS DIGITAL OR ANALOG

Register with the Specialists in electronic recruiting. Comprehensive nationwide listings. Fee/reloc. paid. Please include current salary and reloc. information. All inquiries will be immediately acknowledged. Send resume or call

**TECHNOLOGY  
 RECRUITERS — 2000**  
**Employment Consultants**  
 3100 Richmond Ave.  
 Houston, Texas 77006  
 713/522-5191

## MOS/DIGITAL/MIC POWER TRANSISTORS LIQUID CRYSTALS

Our client, a Fortune 500 firm, situated in a rural suburban setting, (50 miles from NYC) is expanding their semicon/IC's facility. If you have exp in any of the above (Design, applications, or processing) we welcome your inquiry. To attract top Engrs they offer salaries above the industry norms. \$13-25,000. All fees & relocation expenses paid. In confidence call or write Bill Airone, 201-265-5885, Executive Recruiter, 270 Spring Valley Road, Paramus, NJ 07652.

## SAN DIEGO

Specializing in recruitment & placement of engineers, scientists and managers in electronics, optical, electro-mechanical and physics. Openings in Calif. & nationwide. No fee to applicant. Contact Jerry Halloran in confidence. (714) 299-7820.

**RAFTERY & KING, INC.**  
 Agency, 2384 San Diego Ave., San Diego, Ca. 92110

## FREE CAREER BROCHURE GROWTH POSITIONS

**\$12,000-\$30,000**

Request free details including career hints and sample resume.  
**Longberry Employment Service, Inc.**  
 913 Niles Bank Bldg., Niles, O. 44446

## WIRE-HOOK UP 24 to 16 Ga.

PVC & Some TEFLON Asstd Colors  
 Solid & Stranded Part out rolls  
 Priced at appx 50% card.  
**Surplus Research Instr. Co., Inc.**  
 643 Stewart Av.,  
 Garden City, N. Y.  
 516-248-1001

# Some Of The Industry's Finest Talent Works At National. We Won't Be Satisfied Until You're All Here.



As an engineer you know that your education will never stop. And what better way to continue this learning process than working side by side with the top talent in the semiconductor field. At National you work closely with the entire staff from the first day you walk into the place. And, our staff includes some of the finest technical minds in the business. Some came to us from competitors because they saw something happening here that they didn't see where they were. They saw that same atmosphere of freedom and creativity that you will find, and they saw a company that recognizes and rewards ideas and innovations, now.

You'll find that your enthusiasm for new ideas, new products is matched by an aggressive engineering team that is more interested in the challenge than chain-of-command regimentation.

You'll find that section and department heads and product managers are ready to discuss your ideas, and available with advice and assistance when you need it. This whole arrangement, this atmosphere of creativity, makes for a better exchange of thoughts; a better flow of ideas.

Unconventional? Not at National. Here it works.



National Semiconductor

Sound like your kind of place? Check us out. Forward your resume in complete confidence to Professional Employment Supervisor, Dept. PB, 2900 Semiconductor Way, Santa Clara, California 95051. We are an equal opportunity employer male and female.

**BOEING**

# Electronics Engineers.

**Career opportunities are great in Washington State.**

Boeing Aerospace Company has career opportunities for qualified Electronics Engineers in the Seattle area . . . where clean air is abundant. And you may work only minutes from your home.

These positions require three or more years of experience either in the activities described below or related fields. An engineering degree also is required, preferably a B.S., M.S. or Ph.D. in Electrical Engineering. These openings are for U.S. citizens only.

Present opportunities are in the following areas:

## Process Automation

Experienced engineers for assignments in Industrial Instrumentation and Control for *commercial product applications*. Experience is required in communications/multiplexer systems, instrumentation, computer interface design, panel/console design, systems integration test simulators, and diagnostics/maintenance design. Applications software experience desired.

## Electronic Parts/Components

Engineers with experience in electrical and/or electronic parts test evaluation, specifications, selection and technical parts control are needed. Emphasis is on semiconductor component—transistors, hybrids, LSI arrays, diodes and microwave devices. A knowledge of military and/or NASA specifications would be helpful. Capability to interface effectively with circuit designers and devise suppliers is required. The function provides support to major Boeing DOD, NASA and commercial programs. Experience in planning, estimating and implementing support to such programs would be useful.

## Computer Software

Real Time operational computing systems requirements analysis and design. Includes definition of computer software requirements, developing plans and specifications, performance of trade and design studies of hardware / software systems.

Real Time operational systems computational analysis and algorithm development. Develop and evaluate numerical algorithms to satisfy specific requirements for aerospace systems.

Real Time operational systems computer program development and implementation. Development and implementation of computer programs for operational systems, simulators and other Real Time applications and for programs to assist in debugging and testing of operational software systems.

## Communications

Radio and telecommunications, both narrow and wide-band transmissions.

Definition and evaluation of communications performance, interface, integration, modulation techniques, modem, multiplexers, encryption, teletype or high-quality audio distribution systems.

## Computer/Displays

Real Time operational systems requirements, analysis, design and checkout. Includes definition of computer and display hardware requirements, developing plans and specifications, performance of design, and trade studies of hardware/software systems.

Design, development and integration of computer systems, subsystems and components for both general purposes and special purpose applications.

Definition of functional and physical interfaces between the computer systems and all interacting display, sensor and communication systems.

These openings exist in several of the Boeing Aerospace Company's projects. Primarily they're in the following product areas: information and avionics systems, strategic and technical systems, personnel rapid transit, and commercial hydrofoils.

You'll enjoy the Pacific Northwest. Living is relaxed. Outdoor sports are plentiful. It's great family country!

Please send you résumé to The Boeing Company, Box 3707-ECR, Seattle, WA 98124. An equal opportunity employer.

**BOEING**  
Getting people together.

## Semiconductor Products Managers

Schweber Electronics has openings for qualified people as products managers and assistant products managers in all Schweber locations.

Call or write:

**Mr. Ben Schwartz,**  
Semiconductor Products Mgr.



**SCHWEBER ELECTRONICS**

Westbury, N. Y. 11590  
(516) 334-7474

## Printed Circuit Board Engineer \$15,000-\$20,000

Unique and challenging opportunity to guide the development of a new printed circuit board facility and determine the most technically advanced and most economical ways of producing the highest quality P. C. boards. This individual must also have the ability and potential to progress into a management position. Experience must include 3-5 years of P. C. board fabrication. This person must be especially strong in the chemical processes area of P. C. board fabrication as well as knowledge in all other process areas. Large Midwest Manufacturer. If interested please reply to P. O. Box 297, Park Ridge, IL 60068.

# Flight Control & Inertial Navigation engineers

Is your career becoming just a job?  
Discover how rewarding life on the  
Honeywell-in-Florida Aerospace Team can be!

- Be involved in the creation of some of the world's most sophisticated Flight Control and Precise Inertial Navigation Systems (Electrically Suspended Gyro).
- Freedom to make truly significant contributions to the state of the art.
- Multiple major contracts enhance job security.
- Creative ingenuity recognized and rewarded.

- Nationally competitive salary schedule.
- Beautiful campus-like grounds with lake, tall palm trees, and wide open spaces.
- Stimulating environment on and off the job (Gulf of Mexico just 8 minutes away, breakfast-off-a-tree, 361 days of sunshine yearly, 73.4° F average winter high temperatures, pure air, minimum traffic.)

#### Immediate career opportunities:

##### Analysts & Programmers

Analysis and conceptual design of Aircraft and Space Flight Control and Inertial Navigation Systems (Electrically Suspended Gyros). Involves computer simulation and paper-and-pencil analysis of systems and vehicle performance. Must be capable of Digital Computer Programming (FORTRAN.)

##### Mechanical Design

Perform studies to select packaging approach tailored for components of Space and Avionic Flight Control Systems. Activity involves thermal and stress analysis.

##### Electrical Design

Electronic Circuit Design which includes layout, packaging, breadboard and test of analog flight control circuitry and digital circuitry.

##### Systems

Systems design for Aircraft and Space Flight Control Systems and Precise Inertial Navigation Systems (Electrically Suspended Gyros). Involves conversion of analytical design into hardware mechanization including defining interfaces and developing specification and system tests.

##### Products Assurance Engineers

Quality: Knowledge of MIL-Q-9858A. Develop instructions for inspection of procured material. Review production layouts, acceptance test procedures, component specifications.

Reliability: Failure analysis of Analog & Digital Circuits. Failure analysis of test results. Evaluation of components & sub-assemblies. Advanced circuit analysis. Specification of integrated circuits. Vendor baselining.

##### Test Equipment Design Engineers

Design, production, and check-out of test equipment for Flight Control System components. Must have experience in design of automated test systems using TTL & CMOS type logic.

##### Diagnostic Programmers

Experienced in design of programming for computer-controlled test equipment for test and fault isolation of electronic modules and sub-assemblies.

##### Other Career Opportunities Available

Even if your talent and experience don't match our immediate openings, our constantly changing technology is creating new needs for engineers in practically every discipline.

Does Honeywell Aerospace Division in Florida sound like your kind of company with your kind of career opportunity and your kind of creative challenge?

#### MAIL US YOUR RESUME IN STRICTEST CONFIDENCE . . .

. . . Honeywell-in-Florida's Aerospace Division is looking for both Junior and Senior level engineers for design activity on numerous contracts, including Space Shuttle Flight Controls and ESG Inertial Navigation Systems.

#### send your resume to:

Mr. David X. Larson  
13350 U.S. Highway 19  
St. Petersburg, Florida 33733

Aerospace Division  
**Honeywell** in Florida — a place in the sun for you!  
An equal opportunity employer — male or female

## MICROWAVE DESIGN

Minimum of 5 years' microwave component design experience extending into the millimeter frequency range. Will be involved in accelerating the state-of-the-art across the full electromagnetic spectrum. BSEE required.

## ELECTRONIC DESIGN

Will design state-of-the-art electronic subsystems for space and airborne applications. Able to design, breadboard, perform laboratory testing of electronic circuits and subsystems. Emphasis on low-noise audio amplifiers and analog and digital signal processing. Four years' experience and BSEE.

## ELECTRONIC PACKAGING

Work entails product design of high density electronic equipment for space and airborne applications. Complete familiarity with hybrid, integrated packaging techniques and materials. BSEE plus 5 years' experience.

Send resume to: **D. H. JONES**



**ELECTROSYSTEMS COMPANY**  
P. O. Box 296 ED . . . Azusa, Calif. 91702

an Equal Opportunity Employer  
u.s. citizenship required

# NCR

## ELECTRICAL ENGINEER

We are looking for an Electrical Engineer to support our Human Factors Engineering function. You would be required to design and develop electronic interface and software as required for simulation of actual products and other laboratory experiments. You should have mini-computer experience and interface design plus a BSEE degree.

## PROGRAM MANAGER (Communications equipment)

Do you have product development program management experience with communications equipment? If so, we have the challenge you are seeking. Primary emphasis is in the area of planning with program management for existing products which would be domestic and international. BSEE/MSEE and 7-10 years of relevant experience with a computer equipment manufacturer will qualify you for this challenging assignment.

Please forward your resume and salary requirements to:

**Mr. Vernon L. Mirre**  
Corporate, Executive & Professional Placement  
**NCR**  
Dayton, Ohio 45479

An Equal Opportunity Employer M/F

## CRYSTAL OSCILLATOR ENGINEER

TCXO-VCXO

Challenging opportunity with young expanding company established as a leader in the crystal oscillator industry and with a reputation for quality products in TCXO, Logic Clocks, Timing Pulse & Frequency Generating systems.

Our continued growth has created opportunities for experienced design engineers. Substantial background in oscillator design and packaging with emphasis on state-of-the-art VCXO design techniques is required. TCXO experience also very desirable.

If you are interested in contributing to and sharing in this growth in the beautiful Santa Barbara research community—submit your resume in complete confidence outlining salary history and requirements to Fred Little, V-P Engineering.



Santa Barbara Airport  
P. O. BOX 948, GOLETA, CA 93017

## WANTED SENIOR ENGINEER

Job description:

Design, develop, and release products in the circuit module area, requiring creative and innovative techniques. Provide innovative approaches to new products and will have total responsibility for design projects assigned with regard to carrying them from study phase through release. Keep abreast of all new circuit design techniques, as may be unveiled as new competitive units, written articles, or lectures, maintain a constant work load for the technicians, as well as training them in circuit design to increase their value to the company. Work requires a broad knowledge of precedents in circuit design area and a good knowledge of principles and practices of related specialties. Maintain constant direct working relationship with the following areas: marketing, drafting, layout, components, transistor test, plant instrumentation, and production line.

Over 7 years experience needed.

**TELEDYNE PHILBRICK**  
Allied Drive

Dedham, Ma. 02026

Tel: (617) 329-1600 Ext. 356

Please send resume or call.

## CAREERS in FLORIDA

For experienced engineers, who are serious about relocating to Florida, there are unlimited opportunities to join growing and profitable firms. All fees paid by our clients. Listed below are only a few of these selected positions.

### ENGINEERS

Mgmt or Customer computer systems	\$21,000
Sr. digital Commo. systems	\$25,000
Consulting & HVAC design	\$16,000
Pn & Hy interface w/ bio-medical electr. instr's	\$18,000
Hi-density P.C., 3 yrs	\$15,000
Hardware & micro-wave	\$18,000
Radio/tel., UHF/VHF circuitry	\$18,000
Sr., commo. planning	\$19,000
Sr., data acquis. systems thru sensing devices & interface w/IBM3200	\$18,000

Send confidential resume to:  
Engineering/Technical  
Placement

**EXECUTIVE PLACEMENT**  
**Ott, Hertner,**  
**Associates**  
2650 Biscayne Blvd., Miami

**GIVE...  
HEART  
FUND**



## CAPACITORS

ChEngr Powr Capctrs—22-25M  
Asst ChEngr Des & Dev Capctrs 18-22M

**NO FEE  
HARPER**

Agency 22 W. 48 St., N. Y. City  
212-582-1700

# A VIEW OF THE TOP.



You are viewing the world's top team of semiconductor memory specialists. Their achievements established Intel as the leader in technology and sales of semiconductor memories.

From its inception in 1968 to 1972, Intel's revenues have grown to over \$23 million. Design and manufacturing operations extend to 5 countries, with 10 plants comprising over 300,000 square feet. Intel has grown to over 1,200 employees in four years.

Intel dominates the semiconductor memory market because of its innovations in technology, product development, and its ability to produce those products in volume. In 1969, it was Intel which introduced the first Schottky bipolar LSI integrated circuit making possible a very high speed Random Access Memory (RAM). That same year, Intel introduced the first silicon gate p-channel MOS circuit which produced the largest selling semiconductor memory component in the world today—the 1103 RAM.

In 1971, Intel engineers developed the first Read Only Memory which can be programmed, erased and reprogrammed in a

matter of minutes by the customers.

And in 1971, it was Intel which introduced the first economically mass-producible "computer on a chip." The Intel microcomputer brings the capability of the general purpose computer down to a size and cost for implementation into a vast number of applications.

By the end of 1972, Intel was shipping 80 percent of the world's n-channel MOS products. It took less than one year to establish this position.

Through its Memory Systems Division, Intel is building sub-systems and memories up to 9 mega bits in size. Thus, Intel spans the full breadth of the semiconductor memory business.

There is much more to our history of accomplishments and our plans for the future. From where we stand, the view is great.

## **COME JOIN US.**

Send your résumé to the Personnel Department, Intel Corporation, 3065 Bowers Avenue, Santa Clara, California 95051.

**intel  
delivers.**

*An Equal Opportunity Employer*



**SR. DESIGN  
AND  
DEV. ENGINEER**

**R. F.  
AND  
MICROWAVE**

Minimum 5 years experience in design of coaxial components and other passive devices. Familiar with low pass and high pass filter design utilizing both distributed and lumped components. Strong background in network synthesis and microwave techniques plus ability to reduce designs to hardware in commercially oriented product line. Experience in military specifications and FORTRAN programming helpful. M.S.E.E. desirable B.S.E.E. required.

**OUTSTANDING  
WORKING  
CONDITIONS IN BEACH  
RESORT COMMUNITY  
WITH EXCELLENT  
OPPORTUNITY FOR  
ADVANCEMENT.**

Send resume in confidence to:

**TELONIC  
INDUSTRIES  
INC.**

P.O. Box 277  
LAGUNA BEACH,  
CALIFORNIA 92652

**Inside  
Telephone  
Salesmen**

Schweber Electronics  
has openings for  
inside telephone  
salesmen.

Experience necessary.

Call or write:

**Mr. Arnold Katz,  
National Sales Manager**



Westbury, N.Y. 11590  
(516) 334-7474



**seeking  
new career  
opportunities?**

- Circuit Design
- Computer Systems
- Digital Systems
- Systems Simulation
- Signal Processing
- Radar Systems
- ASW Systems
- Pattern Recognition
- Weapons Systems
- Command/Control
- Electro-Optical
- Reliability/Test
- Avionics Systems
- Electronic Warfare
- Communications
- Mini-Computers

We are a Professional Search Firm representing a number of prestigious employers throughout the United States. Our clients include research and development laboratories, defense contractors, government contract research centers, major commercial and industrial corporations and leading management consulting firms. Starting salaries range from \$12,000 to \$40,000 with our fees, and all interview and relocation expenses fully paid by our clients.

If you wish to be considered for current and future opportunities, please send your resume, including current salary and technical strengths, to Donald M. Wallach, President . . . today!

**WALLACH  
associates, inc.**

1010 Rockville Pike  
Rockville, Maryland 20852  
(301) 762-1100

A licensed recruitment organization

**Recruitment Advertising gets READ  
. . . in Electronic Design**

**RATES**

1 page . . . . .	\$2,040.
3/4 page (3 cols.) . . . . .	1,530.
1/2 page (2 cols.) . . . . .	1,020.
1/4 page (1 col.) . . . . .	510.
1/8 page (1/2 col.) . . . . .	255.
1/16 page (1/4 col.) . . . . .	127.50
One column inch . . . . .	51.

**DATA**

Four column make-up. Column width: 1-3/4". Each issue mails two weeks prior to the issue date. Closing dates for camera-ready mechanicals or film is one week before mailing date. If desired, Electronic Design will set type at no charge (closing date is 2 weeks prior to mailing date).

**84,000 DESIGN ENGINEERS AND ENGINEERING MANAGERS**

Call the Recruitment Hotline: (201) 843-0550 X209 or clip & mail this coupon to: Recruitment Manager, Electronic Design, 50 Essex St., Rochelle Park, N.J. 07662.

I'm interested in placing recruitment  
advertising in electronic design.

Issue \_\_\_\_\_ Size of ad \_\_\_\_\_

My copy is enclosed  I need more information

Name \_\_\_\_\_ Title \_\_\_\_\_

Company \_\_\_\_\_ Telephone \_\_\_\_\_

Address \_\_\_\_\_

City \_\_\_\_\_ State \_\_\_\_\_ Zip \_\_\_\_\_

These positions provide immediate opportunities for career development, promotions and a long term association with an expanding, innovative manufacturer of mini computers and peripherals. All interviewing and relocation costs are paid by Datapoint.

**Project  
Electrical  
Engineer**

Project responsibility for new product development. Design responsibility and coordination of M.E., draftsmen and technicians. Position requires B.S.E.E. with 3 to 5 years experience in design/project management.

**Mechanical  
Engineer**

Design and implementation of mechanical portion of new electromechanical product development. Generate mechanical layouts, coordinate draftsmen and work in conjunction with Project Engineer. Prefer B.S.M.E. with 2-4 years electromechanical design experience.

**Electrical  
Engineer**

Design experience in the computer, computer peripheral, CRT terminal or communications fields desired. Must be experienced in both analog and digital circuit design. B.S.E.E. or equivalent experience.

Send resume and complete salary history to  
Personnel Department

**Datapoint  
Corporation**

9725 Datapoint Drive  
San Antonio, Texas 78284

An equal opportunity  
employer

# SOLID STATE ENGINEERS

RCA SOMERVILLE, N.J.

Due to our rapid growth, our modern solid state research and development facility in Somerville, N. J., has a number of openings for solid state engineers. Our facility is located just 40 miles from New York City and 70 miles from Philadelphia. RCA is a world leader in solid state devices and can offer degreed professionals rapid growth in a highly creative environment. The following openings for qualified engineers now exist:

**IC APPLICATION** — experience on digital or linear IC types required. Will work on applications, customer specs, characterization and data sheet preparations.

**POWER APPLICATION** — for a growing Power Transistor product line. Previous experience in applications, design, product or circuit development desirable.

**MICROWAVE CIRCUIT DESIGN** — experience in circuit design of microwave power transistors or integrated circuits. Experience in the micro-strip design required.

**CMOS, DIGITAL CIRCUIT DESIGN** — a rapidly expanding product line for individuals who have experience in the design of circuits for CMOS integrated circuits.

**IC AND POWER PROCESS** — experience in the layout, design and process development of solid state devices. Openings exist in both the IC and Power device engineering activities.

**LIQUID CRYSTALS** — experience in product design, materials development and applications engineering.

**DESIGN AUTOMATION** — experience in logic design and computer aided layout of integrated circuits.

If you are interested in any of these opportunities, call P. R. Sardella, collect, at (201) 722-3200, extension 2038. Or send resume to RCA Solid State Division, Dept. ED-10, Route 202, Somerville, N.J. 08876. We are an equal opportunity employer M/F.

# RCA

## SPACECRAFT ENGINEERS

# Join Hughes' Technology Division

**Our Technology Division offers career opportunities to well-qualified engineers in our modern facilities adjacent to Los Angeles International Airport.**

## RF Circuits Engineers

Assignments involve responsibility for design, development, and test of solid-state communications circuits that advance the state-of-the-art in the frequency range from HF through VHF. MSEE preferred, with 3-12 years of recent design experience in solid-state RF circuits, such as modulators, demodulators, frequency multipliers or mixers, plus a thorough theoretical knowledge of communications and active and passive networks.

## Microwave Technician

Breadboard development, evaluation, and test of flight hardware for communication satellite applications. Requires background in solid-state circuits and RF design from the VHF to X-band frequency range. Should have experience in filters, oscillators, multipliers, power supplies, power and video amplifiers, DC and digital circuits.

**Please call Mr. D. L. Rossier, (213) 648-4785, or send your resume to:  
Professional Placement  
Hughes Aircraft Company  
P.O. Box 92919  
Los Angeles, CA 90009**

# HUGHES

HUGHES AIRCRAFT COMPANY

U.S. citizenship required • Equal opportunity M/F employer

## WINTER'S COMING FLORIDA OPPORTUNITIES

Digital, Analog Design	13-20K	Telemetry Systems	13-20K
MOS, Memory Specialists	12-20K	Modems, Data Comm.	14-20K
Silicon Gate Specialists	12-20K	Real Time Programmers	12-17K
RF Design	24-24K	Computer Design	13-20K

Please direct resume and earning's history in confidence to:

**R. W. Marsh**

**Professional Management Search**

7370 N. W. 36th Street Suite 241 Miami, Florida 33166  
Miami (305) 592-3610 Broward (305) 925-4568

## ENGINEERING MANAGER

Join a rapidly growing Electronics Company manufacturing "state of the art" Analog-to-Digital Converters.

Your duties will include: Analog Design; Computer Interface Design; Manufacturing Engineering; Test Department Supervision, Sales Support.

Excellent Fringe Benefits. Stock Options available. E. E. Degree and five years' experience required. Send resume and salary history to the attention of:

**W. H. Buchanan**

Tustin Electronics Company  
1656 South Minnie Street  
Santa Ana, California 92707

**MBH**

**HAS THE OPENINGS!**

Specializing in Engineering, Hardware, EDP Software, Manufacturing Management, Financial and Administrative people.

We have a licensed Professional Engineer, a former college recruitment specialist and a financial expert on our staff who will seek positions for you. Never a Fee—No Contracts to sign. Simply send resume and current salary information to:

**MBH ASSOCIATES, INC.**

1616 Walnut St., Suite 809  
Philadelphia, Pa. 19105

## ENGINEERS

Current and continuing openings in design, project and maintenance work for good electrical or mechanical engineers with leading Southern industrial concerns. Opportunities with both large and medium sized companies include locations in major metro areas or smaller towns. Salaries range from \$12,000 to \$19,000. All fees paid by employer. For professional personal and confidential handling mail your resume including salary information to L. S. Livingston, Atlantic States Personnel, 31 W. Congress St., Savannah, Ga. 31401.

## URGENTLY NEEDED!

**FIELD ENGINEERS**—3 years experience in maintenance and test of complex electronics systems.

**ENGINEER**—2 years experience in analog, digital or display equipment design.

**ASSOCIATE ENGINEER**—Perform analysis and tradeoffs of avionics systems.

**APPLICATIONS ENGINEERS**—Knowledge of linear circuits, etc.

**SENIOR ENGINEER**—Design of microwave components using waveguide, stripline and coax.

For immediate consideration, please send resume to:

*Charles A. Davies, Inc.*

332 So. MICHIGAN AVENUE  
CHICAGO, ILLINOIS 60604

## E. B. HENDRICK ASSOCIATES, INC.

Over 13 years of Engineering and Professional placement coast to coast. Our current requirements cut the spectrum of the E.E. disciplines, entry level to management in the North-east and Nationally. Member of National Personnel Consultants with affiliates operating in every major market.

"The Village Mall," Vine Street

Liverpool, NY 13088  
Phone: 315-451-0121

## equipment for sale

IMMEDIATE DELIVERY

Minis & Peripherals  
DEC-HIS

SEL-HP-MOHAWK

CPU, Card Printer, Tape, Disk

NEW MOHAWK

4320 PRINTERS

DATA PRINTER V132

CENTRONICS 101A

\$750 MINIS

TELETYPE 35 & 37

For Sale Rent  
617/261-1100

Send for Free Report  
"Maintenance of Computers"  
AMERICAN USED COMPUTER CORP.  
P. O. Box 68, Kenmore Station  
Boston, MA 02215

## INDUSTRIAL EMPORIUM

New & Refurbished  
Manufacturing & Processing  
Equipment serving the  
Microelectronic, Hybrid, &  
Semi Conductor Industries  
1717 S. Boyd, Santa Ana, Calif.  
558-8641

## FOR SALE 5,000,000 FEET WIRE AND CABLE

Standard U.S. Manufacturers  
New - Original Package  
OFFERED AS A LOT! !

**GENERAL DYNAMICS**

Electronics & Test Equipment  
All New

**SINGER - FRIDEN**

Justwriter - Flexowriter  
Components  
15,000 Line Items  
15 Trailer Loads  
Detailed Listings Upon  
Request

Call - Contact  
**M.D.A., INC.**

1025 Chili Avenue  
Rochester, New York 14603  
(Box 854) 716-328-7870

**FOR SALE**  
NEW SYLVANIA SUHL TTL ICs  
As low as 15¢ each  
**Goode Sales Co.**

325 W. Huron St.  
Chicago, Ill. 60610  
(312) 642 2022

Write for our latest surplus list

**SCOPES UNLIMITED**  
IS NOT  
**LIMITED TO SCOPES**  
Complete line of new and used  
electronic test equipment.  
**SCOPES UNLIMITED, INC.**

1938 S. Anaheim Blvd.  
Anaheim, Ca. 92805  
(714) 772-0330  
East Coast Office (6 7) 891-5670

**ALPHA TORR INC.**

Vacuum Science &  
Technology for Industry  
Custom Systems—  
New & Refurbished  
200 Pumps in Stock  
Sales-Service-Lease-Rental  
1717 S. Boyd, Santa Ana, Calif.  
542-1913

Large inventory TTL I.C.'s in stock. Having trouble finding I.C.'s semis, or other components? Call Billy Gage or Jim Tanner, 214/271-2455.

**VIKON, INC.**

3429 West Kingsley Road  
Garland, Texas 75041  
TWX 510-860-5160

College dollars need  
time to grow.



**Take stock in America.**

With higher paying U.S. Savings Bonds.

# advertiser's index

Advertiser	Page
AMP, Incorporated	17, 18, 19, 20
Addmaster Corporation	155
Airpax Electronics, Cambridge Division	145
Alco Electronic Products, Inc.	159
Allen Bradley Co.	41
Amphenol Industrial Division, Bunker-Ramo Co.	102, 103
Analog Devices, Inc.	90, 91
Ansley Electronics Corp.	106, 107
Arnold Magnetics Corp.	167
Atlas Fibre Co.	147
Augat, Inc.	33
Beckman Instruments, Inc., Helipot Division	22, 23
Belden Corporation	30, 31
Boonton Electronics Corporation	141
Bourns, Inc. Trimpot Products Division	120
Burr-Brown Research Corporation	125
Centralab, The Electronics Division of Globe-Union, Inc.	52, 52A
Cherry Electrical Products Corp.	71
Circuit Stik, Inc.	154
Clare & Co., C. P.	49
Clare-Pendar	21
Concord Electronic Corporation	165
Corning Glass Works, Electronic Products Division	8, 9
Custom Electronics, Inc.	158
Cutler-Hammer, Specialty Products Division	113
Delco Electronics, Division of General Motors Corporation	98, 99
Dialight Corporation	44, 45
Digitran Company, The	123
Dow Corning Corporation	12, 13
Dynascan Corporation	157
E.E.P.	167
Electro Switch Corp.	144
Electronic Arrays, Inc.	20E
Electronic Design	159
Electronic Navigation Industries	16
Electronic Research Co.	160
Exar Integrated Systems	1
Federal Scientific Corporation	177
Fitchburg Coated Products, Division of Litton Industries	53
Fluke Mfg. Co., Inc., John	39
Fujitsu Limited	20H
GTE Automatic Electric	52B, 52C
General Electric Company	124, 128, 156
General Electric Company Microwave Devices	37
General Instrument Corporation	Cover II
Guardian Electric Manufacturing Company	52D
Hayden Book Company, Inc.	20J, 22, 167
Hewlett-Packard	2, 24, 25
HiTemCo.	167
ILC Data Devices, Inc.	15
IMC Magnetics Corporation	137
Indiana General, Electronic Products	131
Industrial Timer, A Unit of Esterline Corporation	147

Advertiser	Page
Instrument Specialties Company, Inc.	163
Intech, Incorporated	122
International Light, Inc.	167
International Rectifier	135
Intersil	82, 83
Interstate Electronics Corporation	20L
Johanson Manufacturing Corp.	7, 167
Kurz-Kasch, Inc.	167
Lambda Electronics Corp.	117
Ledex, Inc.	148
Litronix, Inc.	133
MDB Systems	167
Magnecraft Electric Company	180
Microswitch, A Division of Honeywell	108, 109
Mini-Circuits Laboratory	161
Molex, Incorporated	Cover III
Monolithic Memories, Inc.	46
Monsanto Commercial Products Company	29, 127
Motorola Components Products Dept.	129
Motorola Semiconductor Products, Inc.	10, 11
National Semiconductor Corporation	20D
Oak Industries, Inc.	42, 43
Pace, Inc.	167
Pertec Corporation, Peripheral Equipment Division	81
Philips Industries, Electronic Components and Materials Division	23
Piezo Technology, Inc.	140
Piher International Corp.	153

Advertiser	Page
Pomona Electronics Co., Inc.	165
Power Physics Corporation	159
Precision Monolithics Incorporated	14
Premier Metal Products Company	179
RCA Solid State Division	Cover IV
Raytheon Semiconductor	20F, 20G
Reticon	42
Rogan	179
Ross Controls Corporation	148
Schjeldahl Co., G. T.	115
Sermetal, A Division of Teleflex, Incorporated	147
Signetics Corporation	20A
Siliconix, Incorporated	50
Sprague Electric Company, Dearborn Electronics Division	149
Sprague-Goodman Electronics, Inc.	132
Stackpole Carbon Company	119
Standard Condenser Corporation	136
Sylvania Miniature Lighting Products, Inc.	26
Sycor, Inc.	151
TDK Electronics	139
TRW, Electronic Components	72, 73
TRW/Globe, An Electronic Components Division of TRW, Inc.	143
TRW Semiconductors, An Electronic Components Division of TRW Inc.	26
Tektronix, Inc.	4, 5, 64, 65
Teletype Corporation	35
Texas Instruments, Incorporated	20B, 20C, 20I, 164
Tustin Electronics Co.	160
United Systems Corporation	97
United Technical Publications	179
Vactec, Inc.	111
Vero Electronics, Inc.	155

## Design Data from Manufacturers

Advertisements of booklets, brochures, catalogs and data sheets. To order use Reader-Service Card (Advertisement)

### The First 500-Line Real-Time Spectrum Analyzer-Averager

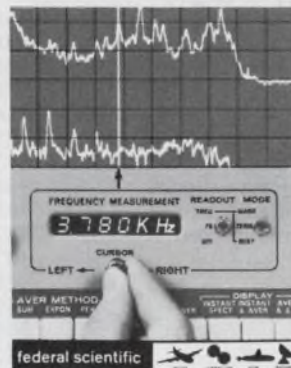

New UA-500, the most powerful analyzer of its type, offers the only standard built-in dual memory averager. Unique digital cursor reads directly in Hz. Portable, small (8-3/4"), for field and lab. Fastest speed minimizes test time, presents flicker-free display: real-time to 10 KHz, max. range of 100 KHz, 20 sweeps/sec display rate. Best possible resolution: sharpest analysis filter (proprietary 24dB/octave slope) so that 500-line analyzer has effective 650 lines. Dual memory averager allows simultaneous display of continually updated exponential average & previously stored average. To verify quality of data, instantaneous spectra can be viewed on the same CRT as average . . . input time function can also be displayed. Plus other standard features: transient capture, exponential & peak averaging, lin-log scales both vertical & horizontal, complete plotter set-up & recording, computer compatibility with remote sensing or control.

### Federal Scientific Corporation

An Affiliate of Nicolet Instrument

615 West 131st St., New York, N.Y. 10027 (212) 286-4400

# product index

**Information Retrieval Service.** New Products, Evaluation Samples (ES), Design Aids (DA), Application Notes (AN), and New Literature (NL) in this issue are listed here with page and Information Retrieval numbers. Reader requests will be promptly processed by computer and mailed to the manufacturer within three days.

Category	Page	IRN	Category	Page	IRN	Category	Page	IRN
<b>Components</b>			scanner, data	156	<b>358</b>	<b>Modules &amp; Subassemblies</b>		
beads, ferrite	119	<b>52</b>	storage, disc	158	<b>353</b>	amplifier, isolation	126	<b>267</b>
buzzer, ac	142	<b>303</b>	tape transport	81	<b>39</b>	amplifier, thermocouple	126	<b>264</b>
capacitors	7	<b>6</b>	test set, CPU	155	<b>351</b>	amplifiers	16	<b>13</b>
capacitors	132	<b>62</b>	test set, logic	161	<b>366</b>	board, data break	124	<b>259</b>
capacitors	136	<b>65</b>				card, logic interface	122	<b>254</b>
capacitors	158	<b>90</b>	<b>ICs &amp; Semiconductors</b>			comparator	128	<b>261</b>
capacitors, components	9	<b>7</b>	arithmetic logic unit	132	<b>274</b>	controls, servo	126	<b>265</b>
capacitors, polystyrene	149	<b>79</b>	comparator, differential	132	<b>273</b>	converter, a/d	121	<b>250</b>
circuit boards	154	<b>82</b>	drivers, LED	130	<b>272</b>	converter, d/a	122	<b>253</b>
circuit protectors	145	<b>72</b>	IC, bipolar	132	<b>276</b>	converters	122	<b>54</b>
components	131	<b>61</b>	IC, COS/MOS	130	<b>268</b>	converters	125	<b>57</b>
components, electronic	72	<b>38</b>	IC, linear	132	<b>275</b>	converters, a/d	160	<b>93</b>
DIP clip	165	<b>98</b>	ICs	179	<b>101</b>	DACs, display	15	<b>12</b>
detector, infrared	144	<b>310</b>	multipliers, IC	90	<b>41</b>	demodulator, carrier	126	<b>266</b>
diode, light-emitting	144	<b>320</b>	op amp, IC	128	<b>251</b>	encoder, pulse	128	<b>260</b>
fan	141	<b>236</b>	PLA, SOS	130	<b>270</b>	filters, monolithic		
keyswitch set	145	<b>322</b>	ROMs	46	<b>167</b>	crystal	140	<b>68</b>
LEDs	29	<b>18</b>	semiconductors	26	<b>165</b>	hybrids, power	135	<b>64</b>
lamps, miniature	6	<b>5</b>	TTL AND/NAND gate	130	<b>269</b>	oscillator	122	<b>255</b>
light source, low-level	142	<b>304</b>	transistors	14	<b>11</b>	oscillator, crystal	122	<b>256</b>
motors	143	<b>70</b>	transistors, power	98	<b>43</b>	oscillator, TTL	126	<b>263</b>
photodetectors	111	<b>48</b>	transistors, power	130	<b>271</b>	oscillators	129	<b>60</b>
potentiometers	120	<b>53</b>	transistors, silicon	20H	<b>20</b>	photocontrol, LED	122	<b>257</b>
relays	180	<b>102</b>				relay, time-delay	124	<b>258</b>
relays	49	<b>29</b>	<b>Instrumentation</b>			transmitter, thermal	126	<b>262</b>
relays, solid-state	127	<b>58</b>	amplifier, lock-in	140	<b>300</b>			
relays, time-delay	52D	<b>35</b>	analyzer, digital	141	<b>302</b>	<b>Packaging &amp; Materials</b>		
resistor networks	41	<b>25</b>	analyzer, Fourier trans.	140	<b>297</b>	cabinets	155	<b>84</b>
rods, phenolic	147	<b>75</b>	comparator, limits	138	<b>293</b>	cabinets	179	<b>99</b>
switch	141	<b>235</b>	counter	138	<b>290</b>	connector, IC panel	18	<b>150</b>
switch, crosspoint	142	<b>308</b>	counter	138	<b>295</b>	connector, stacking	146	<b>328</b>
switch, pushbutton	144	<b>309</b>	DMM	141	<b>301</b>	connectors	148	<b>331</b>
switch, rotary	144	<b>71</b>	DMM	157	<b>88</b>	connectors, cable	106	<b>107</b>
switches	44	<b>27</b>	generator/counter	138	<b>291</b>	drill kit, ceramics	146	<b>325</b>
switches	108	<b>109</b>	generator, function	138	<b>289</b>	interconnectors	III	<b>244</b>
switches	148	<b>78</b>	generator, function	138	<b>294</b>	interconnectors	102	<b>44</b>
switches, keyboard	42	<b>26</b>	generator, signal	137	<b>66</b>	jacks/pins	165	<b>97</b>
switches, miniature	113	<b>49</b>	IC tester	138	<b>292</b>	knobs	179	<b>100</b>
switches, rotary	123	<b>55</b>	measurement instruments	64	<b>37</b>	masking liquid	146	<b>324</b>
thermocouple reference	142	<b>306</b>	multimeter, rms	39	<b>23</b>	metalizing system	147	<b>76</b>
timers	147	<b>74</b>	potentiometer	138	<b>296</b>	molding compound	148	<b>329</b>
transformers	161	<b>94</b>	recorder, transient	140	<b>298</b>	ovens	164	<b>96</b>
triodes, ceramic	37	<b>22</b>	scope	140	<b>299</b>	potting forms	146	<b>327</b>
						pushbutton latching	146	<b>326</b>
<b>Data Processing</b>			<b>Microwaves &amp; Lasers</b>			recording papers	53	<b>36</b>
calculator	155	<b>352</b>	detectors, mixers	154	<b>350</b>	storage systems	33	<b>20</b>
calculator,			diodes, Impatt	150	<b>338</b>	terminal blocks	148	<b>330</b>
programmable	156	<b>361</b>	dividers, power	149	<b>332</b>	wicking material	146	<b>323</b>
calculators,			isolators	150	<b>336</b>	wire	30	<b>234</b>
programmable	4	<b>4</b>	MOSFETs, vhf	150	<b>334</b>			
computers	35	<b>21</b>	modulator, bi-phase	150	<b>335</b>	<b>Power Sources</b>		
controller, CRT	161	<b>367</b>	modules, plug-in	152	<b>343</b>	battery, lithium	134	<b>278</b>
coupler, acoustic	158	<b>354</b>	phase shifters, digital	154	<b>348</b>	regulators, dc	136	<b>283</b>
display, data terminal	156	<b>360</b>	receiver, laser	152	<b>345</b>	source, current	137	<b>288</b>
interface, process	158	<b>356</b>	receiver, millimeter	152	<b>341</b>	source, uninterrupt	136	<b>285</b>
memories	148	<b>77</b>	TWTAs	150	<b>337</b>	supplies, modular	134	<b>280</b>
memory, cartridge	160	<b>362</b>	transistor	150	<b>340</b>	supplies, power	117	<b>51</b>
memory, core	160	<b>363</b>	transistor	152	<b>346</b>	supply, dc card	134	<b>277</b>
memory, disc	158	<b>355</b>	transistor	154	<b>349</b>	supply, heavy duty	134	<b>282</b>
memory, disc	161	<b>365</b>	transistor, uhf	152	<b>342</b>	supply, high voltage	137	<b>287</b>
reader, optical	161	<b>364</b>	transistors, vhf	152	<b>344</b>	supply, metered dc	134	<b>279</b>
reader, tape	155	<b>83</b>	transmitters, L-band	149	<b>333</b>	supply, precision, dc	136	<b>286</b>
recorder, cassette	151	<b>80</b>	VCO	154	<b>347</b>	supply, preset dc	136	<b>284</b>
recorder, event	156	<b>359</b>	VCOs	150	<b>339</b>	supply, triple-output	134	<b>281</b>

# OUR CLAIM TO FAME... TRIMLINE ENCLOSURES

- RUGGED—FUNCTIONAL CONSTRUCTION ■ ESTHETICS KEYED TO MODERN SYSTEMS
- PROMPT SERVICE & AVAILABILITY ■ ECONOMICAL PRICING



Complete catalog  
and prices on request . . .

**PREMIER METAL PRODUCTS COMPANY**

337 Manida Street, Bronx, New York 10474 (212) 991-6600

### Assorted rear panel accessory options

1. Side Hinged Door Panel (SHP Series)
2. Formed Panel (FP Series)
3. Perforated Formed Panel, 1/16" dia. holes on 1/8" staggered centers (PFP Series)
4. Formed Louvered Panel (FPL Series)

Standard 1/4" & 3/16" flat panels also available (ARP, MAP, RP Series)

### TIC Series Construction Details (front and rear identical)

5. Trim: Extruded, anodized aluminum with black vinyl inlay
6. Chassis/Shelf Support (accessory)
7. Welded stiffener channel and hand grip support
8. Full extension slides with mounting hardware (accessory)
9. Recessed panel mounting channels and structural supports (4 per case) Standard EIA & WE hole spacing provide for frontal mounting and internal equipment mounting. Hardware supplied
10. Carrying Grip with vinyl inlay
11. Case Body, welded, formed steel (20 ga.) with welded 16 ga. channel gusseting and channel stiffeners
12. Non-marring feet

Standard Finishes: Textured Vinyls, 13 colors

Semi-gloss Enamels, 10 colors



INFORMATION RETRIEVAL NUMBER 99

## Design award winners

Rogan's "Alpha Series" Knobs . . . A winner in INDUSTRIAL DESIGN<sup>®</sup> MAGAZINE'S ANNUAL DESIGN REVIEW. Affirming our opinion that front panel components should be attractive. Our brochure will be sent upon request.



**ROGAN**  
CORPORATION

3455 Woodhead Drive, Northbrook, Ill. 60062  
(312) 498-2300 • TWX 910-686-0008

INFORMATION RETRIEVAL NUMBER 100

ELECTRONIC DESIGN 22, October 25, 1973

# integrated circuits

NEED INFORMATION ON  
**integrated circuits?**

Who makes them?

Where to get them?

PICK UP YOUR PHONE

AND DIAL TOLL FREE

**800-645-9200**

(or, in New York State, call collect (516) 294-0990)

**this service is  
FREE**

use it whenever you're about to specify  
any electronic product

**eem**

645 Stewart Ave., Garden City, N. Y. 11530

INFORMATION RETRIEVAL NUMBER 101

179

# MDR

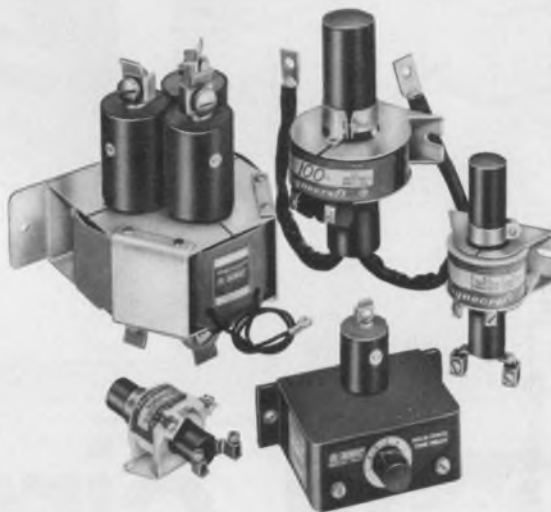

## MERCURY DISPLACEMENT POWER RELAYS

Where sealed contact protection is required for explosive, corrosive, dirty or moist ambient conditions; where the use of contactors does not permit contact maintenance; where noiseless operation is required; where weight, size, and cost must be a minimum for contact ratings up to 100 amps,

Mercury Displacement Relays are unsurpassed.

This unique design, which incorporates broad cross-sections of liquid mercury for switching, is what makes the Mercury Displacement relay a high current, high voltage, high power device. Whereas conventional relays, which use hard contacts are destroyed by pitting and sticking under high load conditions, the perpetually self-renewing, mercury-to-mercury contacts insure maximum contact life and in-rush capabilities up to 15 times rated loads.

In a highly competitive business, delivery can be a deciding factor. If delivery is important to you, be aware that Magnecraft ships better than 90% of all incoming orders for stock relays, received before noon, THE SAME DAY (substantiated by an independent auditing firm). In addition to our shipping record, most stock items are available off-the-shelf from our local distributor.

# FREE!



# MDR CATALOG

The purpose of this 16-page catalog is to assist the design engineer in specifying the proper relay for a given application. The book completely describes 20, 35, 60, and 100 amp versions with one, two, or three poles as well as Time Delay models of Mercury Displacement Power Relays.

**Magnecraft** ELECTRIC COMPANY

5575 NORTH LYNCH AVENUE • CHICAGO, ILLINOIS 60630 • 312 • 282-5500 • TWX 910 221 5221



## This is Konektcon

**No other printed circuit interconnection system on the market can match it for cost reduction! Four features make Konektcon so economical:**

1. You make use of .025 or .045-inch rigid square pin terminals that permit stacking of multiple boards to the same circuits.
  2. Only nine basic modules handle all your interconnection needs: cable-to-board; board-to-board, parallel and perpendicular; board-to-chassis; board-to-component.
  3. All components are value-engineered to cut your costs without sacrificing performance or reliability.
  4. Choice of crimp or solder tail female terminals for added flexibility with hand or high-speed automatic crimping.
- Konektcon does so many interconnection jobs so well,

we'll make you this promise: No matter what you now pay for printed circuit interconnections, we will lower your cost. And it takes only a few minutes of your time to find out if we're right. Just mail this coupon.

**Molex Incorporated, Lisle, Illinois 60532**

I'll take you up on the Molex promise. Please send me more details on the Konektcon system.

Name \_\_\_\_\_ Title \_\_\_\_\_

Company name \_\_\_\_\_

Address \_\_\_\_\_

City \_\_\_\_\_ State \_\_\_\_\_ Zip \_\_\_\_\_





# Save design time and cost with an RCA Hybrid Regulator.

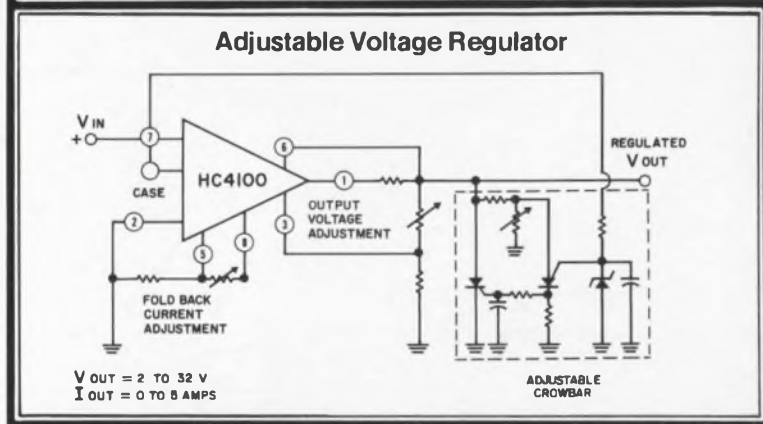
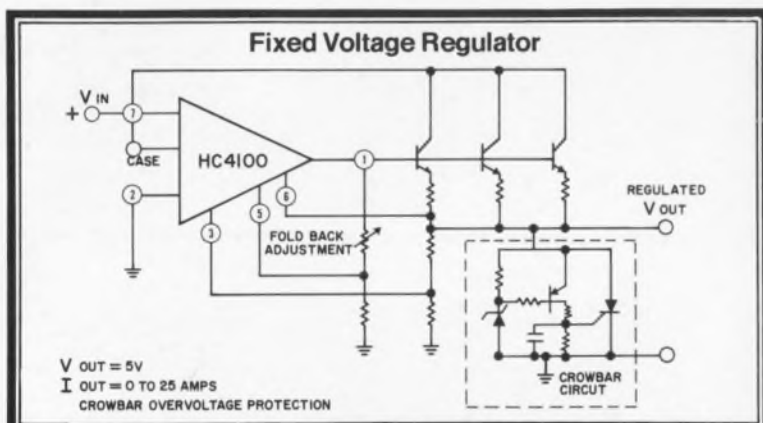

line. 2 to 32 volts with up to 5 amp current rating. Remote sensing capability. 43 volt input voltage capability. Adjustable current foldback protection circuit, features that have been designed in, developed, tested and manufactured by RCA. So, you can save cost in inventory, sourcing, qualification, and incoming parts inspection and proceed to other aspects of your system design.

Add to these advantages, compact size. The entire regulator is contained in a single, standard 8 lead TO-3 package. This can significantly reduce system size.

Oh yes! There's one other great feature... immediate availability and at a very attractive price, \$7.35 (1,000

quantity). You can get the HC4100 from your local distributor or directly from RCA Solid State.

So instead of designing a regulator, regulate your system's design. Put the RCA HC4100 to work for you.

Want more data? Write: RCA Solid State, Section 57J-25, Box 3200, Somerville, N.J. 08876. Or phone: (201) 722-3200.

That's right! You can cut your system design cost by utilizing an RCA designed and tested hybrid voltage regulator. The HC4100 is a versatile adjustable regulator which can handle up to 100 amps with external pass elements working in the Darlington drive mode.

And it has all the right features too. Regulation at 0.2% (typ) load or

**RCA Solid State**  
products that make products pay off