

# Electronic Design 22

VOL. 20 NO.

FOR ENGINEERS AND ENGINEERING MANAGERS

OCT. 26, 1972

New industrial test systems give sophisticated acquisition, display and analysis of data. The demand for such complex performance has been stimulated by Federal

crackdowns on pollution, noise and hazardous product defects. A new generation of rugged test equipment is emerging in plants around the country. See page 26.



**RENEW NOW!**  
Use card inside  
front cover.

Do you face a make or buy decision on power supplies?

# BUY LAMBDA LX SERIES

Choose from 7 packages, 39 models  
All 1-day delivery. All guaranteed 5 years

## "3" PACKAGE

DUAL OUTPUT . . . \$85  
 $\pm 15$  TO  $\pm 12$  VOLTS 0.4 AMPS



## "A" PACKAGE

SINGLE OUTPUT . . . \$85  
5 VOLTS 4 AMPS (with O.V.)

DUAL OUTPUT . . . \$125  
 $\pm 15$  TO  $\pm 12$  VOLTS 1 AMP

## "B" PACKAGE

SINGLE OUTPUT . . . \$125  
5 VOLTS 5.8 AMPS (with O.V.)

DUAL OUTPUT . . . \$150  
 $\pm 15$  TO  $\pm 12$  VOLTS 1.6 AMPS

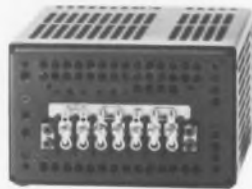

## "4" PACKAGE

SINGLE OUTPUT . . . \$135  
5 VOLTS 7.4 AMPS (with O.V.)

## "C" PACKAGE

SINGLE OUTPUT . . . \$150  
5 VOLTS 9 AMPS (with O.V.)

DUAL OUTPUT . . . \$160  
 $\pm 15$  TO  $\pm 12$  VOLTS 2.5 AMPS



## "CC" PACKAGE

SINGLE OUTPUT . . . \$200  
5 VOLTS 16 AMPS (with O.V.)

DUAL OUTPUT . . . \$235  
 $\pm 15$  TO  $\pm 12$  VOLTS 4.0 AMPS

## "D" PACKAGE

SINGLE OUTPUT . . . \$235  
5 VOLTS 27.5 AMPS (with O.V.)

DUAL OUTPUT . . . \$280  
 $\pm 15$  TO  $\pm 12$  VOLTS 6.2 AMPS

TRIPLE OUTPUT . . . \$375  
 $\pm 15$  TO  $\pm 12$  VOLTS 3.1 AMPS  
5  $\pm$  5% VOLTS 12 AMPS  
(with O.V.)

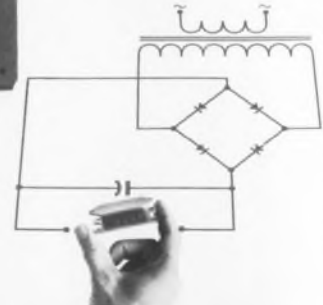
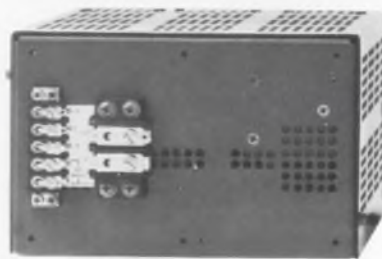

**WHETHER  
YOU MAKE  
OR BUY...**

**LAMBDA**  
ELECTRONICS CORP.

A  Company

Line regulation 0.1% Load regulation 0.1%  
Ripple and noise 1.5 mV RMS, 5 mV P-P with either positive or negative terminal grounded  
AC input 105-132 VAC; 47-440 Hz  
All 5-volt models include built-in overvoltage protection.  
For information on other models up to 28 VDC, send for catalog.

MELVILLE, NEW YORK 11746 515 Broad Hollow Road Tel. 516-694-4200 ARLINGTON HEIGHTS, (CHICAGO) ILL. 60005 2420 East Oakton St., Unit Q Tel. 312-593-2550  
NORTH HOLLYWOOD, CALIF. 91605 7316 Varna Ave. Tel. 213-875-2744 MONTREAL, QUEBEC 100C Hymus Blvd., Pointe-Claire, Quebec-730 Tel. 514-697-6520

INFORMATION RETRIEVAL NUMBER 241

# First we made them easy to use. Now we've made them easy to get.

Yes, we now have distributors. The best there are around the world. These distributors have in stock our complete line of LED displays, LED lamps, isolators and photo-detectors.

**Easy to use.** All these products are solid-state and directly DTL-TTL compatible. And they are all designed for ease of application.

**A complete LED lamp family.** Our LED lamp family offers a complete selection of lens, lead and light output combinations. Our new T-1 Mini-LED is just 0.125" in diameter. This device offers high brightness over a wide viewing angle. And you have a choice of lenses: red diffused, clear, or clear diffused. This little gem, known as the 5082-4480, costs just 45¢ in 1,000 quantities. The T-1 3/4 long lead wire wrappable 5082-4880 lamps start at 55¢ each in 1,000 quantities; the short or bent lead 5082-4440 LEDs start at 49¢ in 1,000 quantities. Higher volume prices on all these devices are even more attractive.



**A new low-cost isolator.** At 5 MHz bandwidth, it's 25 times faster than any other isolator on the market. It has a high DC isolation voltage of 2500 volts, and a high common mode rejection of 10 volts at 2 MHz, making the 5082-4350 ideal for eliminating ground loops in digital or analog line receivers, floating power supply and feedback networks. Prices start at \$2 each in 1,000 quantities.

**A low-cost LED display.** Our numeric and hexadecimal displays have simplified your designs with on-board electronics, standard package configuration, and categorized light outputs. Best of all, the 5082-7300 numeric has a new low price of \$8.25 in 1,000 quantities.

**A new 1.5" LED numeric.** This new LED display, visible from 60 feet, has on-board electronics, wide viewing angle, and is designed for edge mounting in a standard PC.

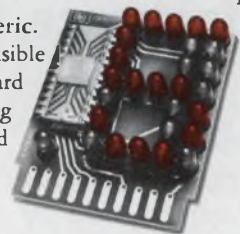

board socket. Solid-state reliability makes the 5082-7500 ideal where dependability is important. The price is \$23.50 each in 500 quantities.

**Small character LED displays.**

The 5082-7405 is a 5 digit end stackable display. It minimizes power consumption and offers ease of implementation with a standard 14 PIN DIP package. At only 7 mW per digit, this display is ideal for calculators, portable instruments and anywhere that low power and high brightness are important. The 5082-7405 is priced at \$3.20 per digit in 1,000 quantities.

**Easy to get.** Call the distributor nearest you for immediate delivery. Or write us for more information. Hewlett-Packard, Palo Alto, California 94304.



HEWLETT  PACKARD

COMPONENTS

## The Light Source



### Distributor Stocking Locations:

#### SCHWEBER ELECTRONICS

Hollywood, Florida  
(305) 927-0511  
Rockville, Maryland  
(301) 881-2970  
Waltham, Massachusetts  
(617) 890-8484  
Rochester, New York  
(716) 328-4180  
Westbury, New York  
(516) 334-7474

#### WYLE DISTRIBUTION GROUP

Liberty Electronics/Arizona  
Phoenix, Arizona (602) 264-4438  
Liberty Electronics  
El Segundo, California (213) 322-8100  
Elmar Electronics  
Mt. View, California (415) 961-3611  
Western Radio  
San Diego, California (714) 235-6571  
Elmar Electronics  
Commerce City, Colorado (303) 287-9611  
Liberty Electronics/Northwest  
Seattle, Washington (206) 763-8200

#### HALL-MARK ELECTRONICS

Huntsville, Alabama  
(205) 539-0691  
Tulsa, Oklahoma  
(918) 835-8458  
Dallas, Texas  
(214) 231-6111  
Houston, Texas  
(713) 781-6100

#### EUROPE

**Celdis Ltd.**  
37-39 Loverock Road, READING, Berks, England  
Tel.: READING 58 22 11  
**I.S.C. France**  
20, rue Gambetta, 92-Boulogne, France  
Tel.: 604.52.75  
**Ingenieurbüro Dreyer**  
238 Schleswig, Flensburger Strasse 3, Germany  
Tel.: (04621) 2 31 21  
**EBV Elektronik**  
8 Munich 2, Augustenstrasse 79, Germany  
Tel.: (0811) 52 43 40/48  
6 Frankfurt 1, Myliusstrasse 54, Germany  
Tel.: (0611) 72 04 16/8

INFORMATION RETRIEVAL NUMBER 2

# Now you can have a brush contact in whatever trimming potentiometer you may order.



For improved performance, specify MICROBRUSH® contact.

Regardless of brand name or type required, you can add a brush type contact to the variable resistor of your choice by specifying the new wire-form MICROBRUSH® contact (Patent No. 3,579,822).

You get **maximum contact** and **improved CRV** because MICROBRUSH® contact is a **multi-fingered** wire form that **conforms**

**totally** to the irregularities of the conductive surface.

MICROBRUSH® contact is available to and through all manufacturers of trimming potentiometers. We can supply it in any configuration, and you can specify it now.

For more information, write today.



## CHRONOMATIC

DIVISION ILLINOIS TOOL WORKS INC.

110 West Providencia Avenue, Burbank, Calif. 91502

(213) 849-4216

*“INNOVATORS in Precision Miniature Manufacturing”™*

INFORMATION RETRIEVAL NUMBER 3

---

## NEWS

- 23 **News Scope**
- 26 **Automated assembly-line test systems** stop the defects before they are built into products.
- 30 **President Nixon and Senator McGovern present their views** on the key issues affecting engineers and the industry.
- 34 **Optical communications** spurred by two video demonstrations.
- 37 **Technology Abroad**
- 39 **Washington Report**

---

## TECHNOLOGY

- 52 **Focus on Comparator ICs:** A special report on the application pitfalls, specification problems and some significant devices in this increasingly important IC category.
- 62 **Expand programmable-calculators** by adding peripherals. You can often top a minicomputer's performance in straight calculating and in automating systems. Part 3.
- 68 **Eliminate spikes in dc-to-dc converter** by adding a second transformer. There is no sacrifice in either efficiency or high-speed performance.
- 76 **Reduce numeric LED-display errors** with an easily expandable octal decoder circuit that locks onto one—and only one—input signal.
- 80 **Ideas for Design:** Line-voltage fluctuation indicator detects single-cycle variations . . . Op-amp current source achieves wide voltage compliance . . . Pulse stretcher indicates presence and polarity of TTL pulses to 20 MHz.

---

## PRODUCTS

- 87 **ICs & Semiconductors:** CMOS line uses dielectric isolation for fastest CMOS ICs on silicon.
- 88 **ICs & Semiconductors:** Versatile multiplier chip extends bandwidth while reducing design complexity.
- 96 Modules & Subassemblies
- 100 Packaging & Materials
- 104 Instrumentation
- 106 Data Processing
- 110 Components

---

## Departments

- 49 **Editorial:** When the competition isn't the problem.
- 7 Across the Desk
- 114 Evaluation Samples
- 116 Application Notes
- 118 New Literature
- 122 Bulletin Board
- 122 Vendors Report
- 126 Advertisers' Index
- 128 Product Index
- 128 Information Retrieval Card

**Cover:** Photo by Mike Ketchum, Courtesy of Tektronix, Inc.

### 1. Simultaneous high-level output waveforms

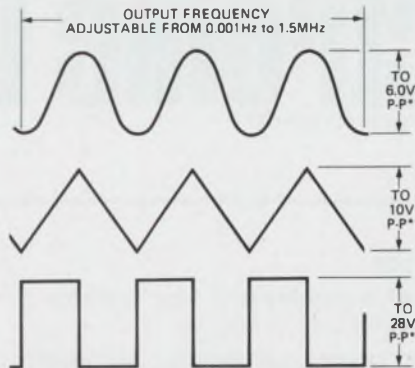

\* MINIMUM LEVELS WITH  $V_{CC} = 30V$   
ALL OUTPUTS MAY BE TTL COMPATIBLE

### 2. Frequency drift with temperature

DEVICE	TYPICAL DRIFT	MAXIMUM DRIFT
8038AC	10ppm/°C	50ppm/°C
8038BC	20ppm/°C	100ppm/°C
8038CC	50ppm/°C	Not guaranteed
NE562	600ppm/°C	Not guaranteed
NE565	100ppm/°C	Not guaranteed
HA2800	250ppm/°C	Not guaranteed
HA2820	250ppm/°C	Not guaranteed
XR205	300ppm/°C	Not guaranteed
XR215	300ppm/°C	Not guaranteed
MC4024	N/A	Not guaranteed
MC4324	N/A	Not guaranteed
CD4046	500ppm/°C	Not guaranteed

# A versatile, stable, priced-right VCO.

### 3. Pricing

DEVICE	STABILITY	PRICE (100 pcs)
* 8038CC*	50ppm/°C typ.	2.50
8038BC*	100ppm/°C max.	4.00
8038AC*	50ppm/°C max.	9.00
8038BM*	100ppm/°C max.	7.00
8038AM*	50ppm/°C max.	18.00

\*C = 0 to +70°C temperature range.  
M = -55 to +125°C temperature range.

### 4. The 8038 Waveform Generator/ Voltage Controlled Oscillator from Intersil

# Sample\* anyone?!

## It's new and different.

The Intersil 8038 is an IC waveform generator and VCO with high-level sine, square and triangular-wave outputs tunable from 0.001Hz to 1.5MHz. The outputs can be swept or FM modulated up to 100kHz, or the frequency can be digitally programmed with resistors or capacitors. The square wave duty cycle is adjustable from 2% to 98%.

## Stable, accurate, easy to use.

It's uniquely stable. Guaranteed temperature drift (8038A version) is 50ppm/°C maximum. Linearity is 0.1%; total harmonic distortion (THD) no more than 1%.

The 8038 can be TTL compatible. It works with any 10V to 30V or  $\pm 5V$  to  $\pm 15V$  power supply. Practically all vital components — including thin-film resistors and Schottky-barrier diodes — are on-chip, so the external part count is reduced at least 50%. It's available in military ( $-55$  to  $+125^{\circ}\text{C}$ ) or commercial ( $0$  to  $+70^{\circ}\text{C}$ ) temperature ranges, packaged in ceramic or plastic DIPs.

## A low temperature-drift phased-lock loop.

An ideal application. Use the phase detector and amplifier from another IC (MC4344, NE562, HA2800, etc.). You'll get a clean 6V sinewave output with frequency identical to that of the input, and with the low temperature drift of the 8038. Send for application notes and complete specs. From Intersil, 10900 No. Tantau Avenue, Cupertino, CA 95014.

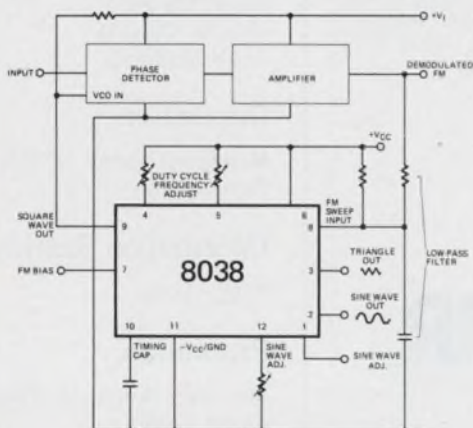

## Get a sample here.

Intersil stocking distributors. Schweber Electronics. Semiconductor Specialists. R. V. Weatherford Co.

Intersil area sales offices. Boston (617) 359-7188. Chicago (312) 371-1440. Los Angeles (213) 370-5766. Minneapolis (612) 925-1844. New York (201) 567-5585. San Diego (714) 278-6053. San Francisco Bay Area (408) 257-5450.

Overseas representatives. Copenhagen: E. V. Johanssen A/S. Helsinki: Digelius Electronics Finland OY. London: Tranchant Electronics (UK) Ltd. Milan: Auriema Italia SRL. Munich: Spezial Electronic. Paris: Tranchant Electronique. Stockholm: Elektrohlm. Tel Aviv: Schweber Electronics. Tokyo: Internix. Zurich: Laser- & Electronic-Equipment.

U.S. Representatives in all major cities.

# Intersil



# One "no" and your power supply doesn't go.

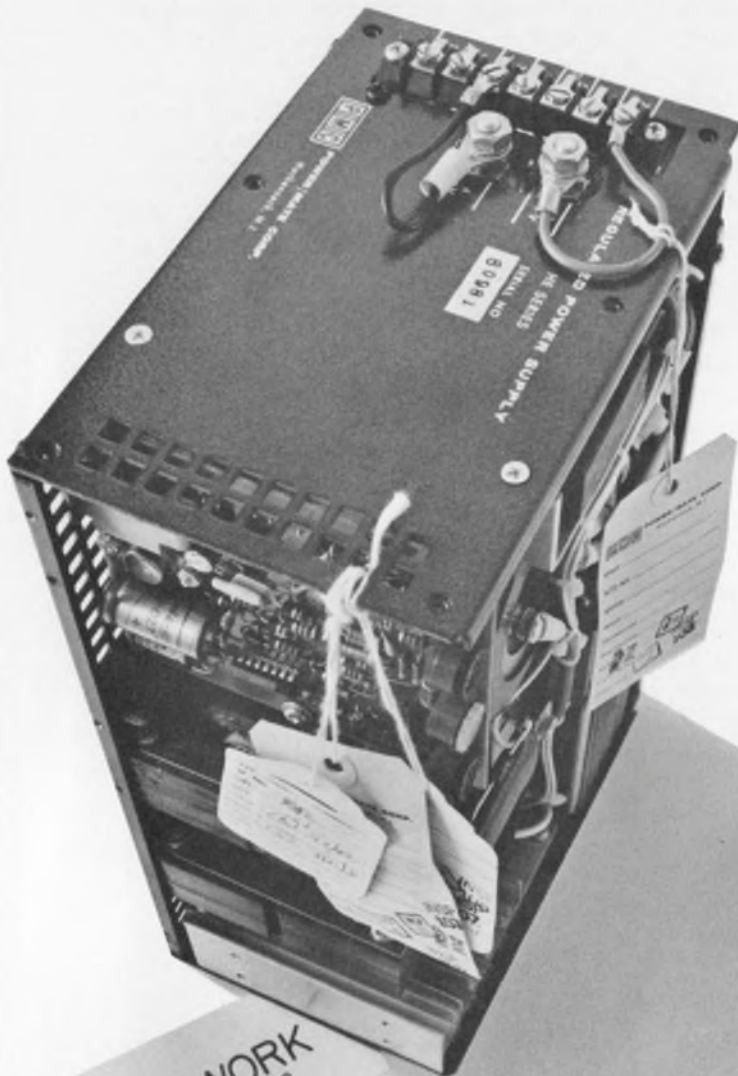

Did you know that each and every Power/Mate power supply gets 42 separate inspections?

A "no" in any one means that your power supply doesn't go out the door.

That's the insistence and emphasis that the new Power/Mate puts on quality. Sure, it costs us more, but that's how Power/Mate makes friends . . . and why Power/Mate is the world's largest producer of quality power supplies.

Send for the Power/Mate catalog . . . 32,500 models . . . most available for same-day shipment.



THE NEW

## POWER/MATE CORP.

514 S. River Street, Hackensack, N. J. 07601 / Phone (201) 343-6294  
TWX 710-990-5023

### Vice President, Publisher

Peter Coley

### Editors

Editorial Offices

50 Essex St.

Rochelle Park, N.J. 07662

(201) 843-0550

TWX: 710-990 5071

Cable: Haydenpubs Rochellepark

Editor-in-Chief: George Rostky

### Managing Editors:

Ralph Dobriner

Michael Elphick

### Associate Editors:

Jules H. Gilder

Richard Lee Goldberg

Morris Grossman

John F. Mason

Stanley Runyon

Edward A. Torrero

Richard L. Turmail

### Contributing Editor:

Peter N. Budzilovich

### Editorial Field Offices

#### East

Jim McDermott, Eastern Editor

P.O. Box 272

Easthampton, Mass. 01027

(413) 527-3632

#### West

David N. Kaye, Senior Western Editor

2930 West Imperial Highway

Inglewood, Calif. 90303

(213) 757-0183

### Editorial Production

Marjorie A. Duffy

### Art

Art Director, William Kelly

Richard Luce

Anthony J. Fischetto

### Production

Manager, Dollie S. Viebig

Helen De Polo

Maxine Correal

Anne Molfetas

### Circulation

Manager, Nancy L. Merritt

Ron Deramo

### Information Retrieval

Peggy Long

### Promotion

Manager, Jeffrey A. Weiner

Karen Costa



## Relaying a complaint on reed-relay article

I have read "Focus on Reed Relays," by Morris Grossman, in the July 6 edition (ED 14, p. 50) and believe that it may have deluded the uninitiated into believing that reeds are the answer to a "maiden's prayer." Having been intimately involved with this relay type for many years, I feel that certain facts must be brought to the forefront.

First, you don't decide on the relay type and then prepare the detailed performance specification. Actually the reverse should be the road to reliable application; first look over your characteristic requirements, noting those that are critical, and then decide on the relay type.

Second, Table 1 indicates a reliability status of the three relay types. I believe this number assignment is meaningless without the statement of what is required. If you are talking about the reliability of relays requiring a life in excess of one million cycles, your estimate may be correct. But for applications in the tens or hundreds of thousands, I question the rating. The table indicates reed relays superior to the electromechanical type, and yet in the second column of your article you mention the susceptibility of reed to vibration. With regard to coil power, a reed relay has yet to be produced that is equivalent in contact configuration to the every-day sensitive electromechanicals. There are other questionable categories, and I therefore would give that table a thorough examination before using it as a selection tool.

The fact that reed plating has been the greatest factor of uncer-

tainty in reeds, the fact that the iron bars have gold and silver migration problems, the fact that the magnetic materials contain encapsulated oil (from the working processes) that find their way to the contact interface and are a contaminating influence are all important detriments but seemed to have been overlooked.

Arthur Siegel

Senior Applications Engineer

Deutsch Relays, Inc.

65 Daly Rd.

E. Northport, N.Y. 11731.

## The author replies

Though Mr. Siegel's tone suggests argument with the essence of the article, the content of his letter contains rather little disagreement. He says the reed relay is not the answer to a "maiden's prayer;" the article says essentially the same thing. He says "you don't decide on the relay type and then prepare the detail performance specification;" the article says repeatedly that the engineer should first check the special requirements of his application before picking a relay type, and only worry about detailed relay specifications.

Table 1 is not a reliability rating but includes reliability as only one of 13 parameters for consideration. The table represents the weighting offered by one manufacturer, as the text points out. The article also makes it clear that other observers might place different ratings on some of the items. Mr. Siegel's conclusion that the table should receive thorough examination before use as a selection tool is therefore valid and is in accordance with the intent of the article.

(continued on page 10)

## giga-trim capacitors for microcircuit designers

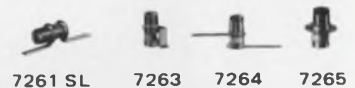
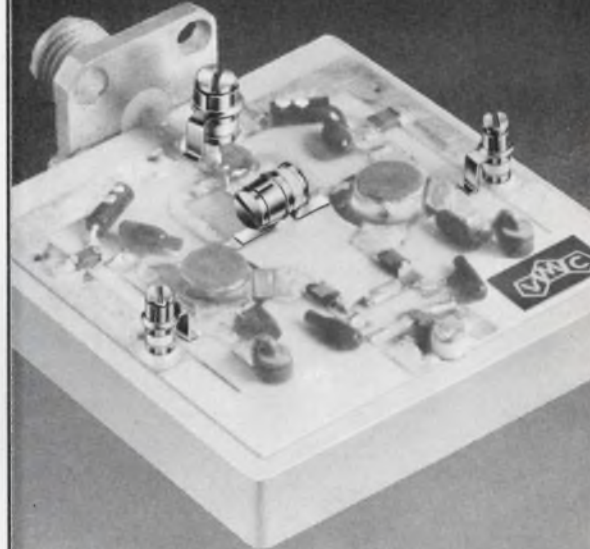

Giga-Trim® (gigahertz-trimmers) are tiny variable capacitors which provide a beautifully straight forward technique to fine tune RF hybrid circuits and MIC's into proper behavior. They replace time consuming cut-and-try adjustment techniques and trimming by interchange of fixed capacitors.

Applications include impedance matching of GHz transistor circuits, series or shunt "gap-trimming" of microstrips, external tweaking of cavities, and fine tuning of crystal oscillators.

*Johanson*

MANUFACTURING CORPORATION

BOONTON, NEW JERSEY 07005

201 / 334-2676

Electronic Design welcomes the opinions of its readers on the issues raised in the magazine's editorial columns. Address letters to Managing Editor, Electronic Design, 50 Essex St. Rochelle Park, N. J. 07662. Try to keep letters under 200 words. Letters must be signed. Names will be withheld on request.

# Announcing a remarkable for 3-year-old

There's a whole group of us at Digital whose only job is supporting people who already have our computers.

We couldn't help but notice how many people with our PDP-8's, 8/I's, and 8/L's really wanted to do more.

So we thought about all those

sixty beautiful peripherals that had been made for the PDP-8/E. Discs. Magtape units. Line printers. Paper tape punch/readers. Communications equipment, A/D converters, cassettes, DECwriters, CRT displays,

and on and on and on.

And their new low prices, many as much as 50% less than before.

So we've come up with a way to get everybody together. A \$1500 interface that'll turn PDP-8's, 8/I's and 8/L's into 8/E's. It's called DW8E.

It makes them act just like they had

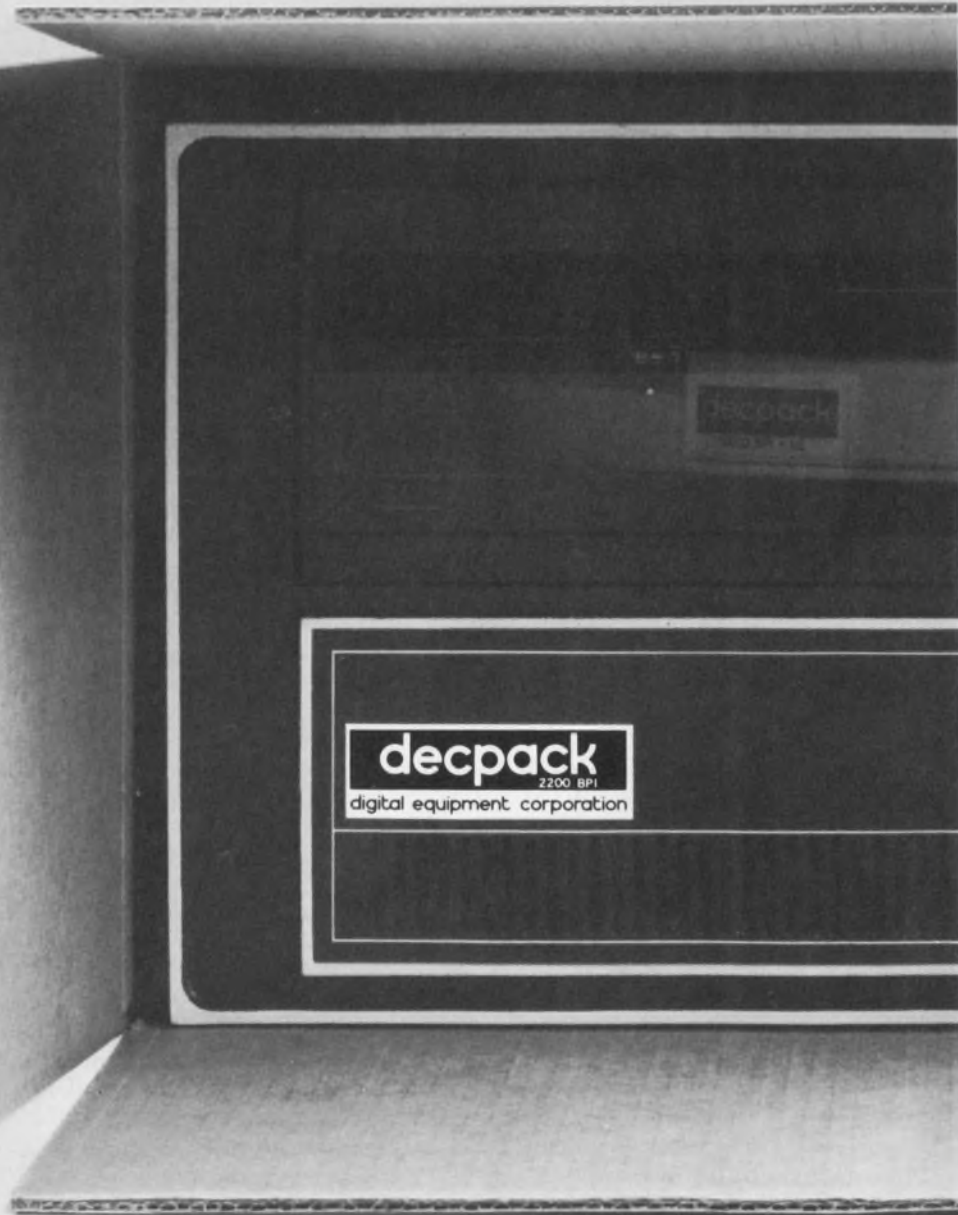

# new source of peripherals PDP-8's: Digital.

an OMNIBUS™. Which means that almost all those PDP-8/E peripherals will just plug in.

And we'll furnish all the power supplies, cables, modules, prints, bits and pieces you need.

And don't worry about delivery, support, installation and warranty,

because you'll get the same good service that brought you to Digital in the first place.

Return this coupon or call us at (617) 897-5111, Ext. 2787 or 2058, and ask for Bob Reed.

Digital Equipment Corporation, 146 Main Street, Maynard, Mass. 01754. European headquarters: 81 route de l'Aire, 1211 Geneva 26. Tel: 42 79 50.

**digital**

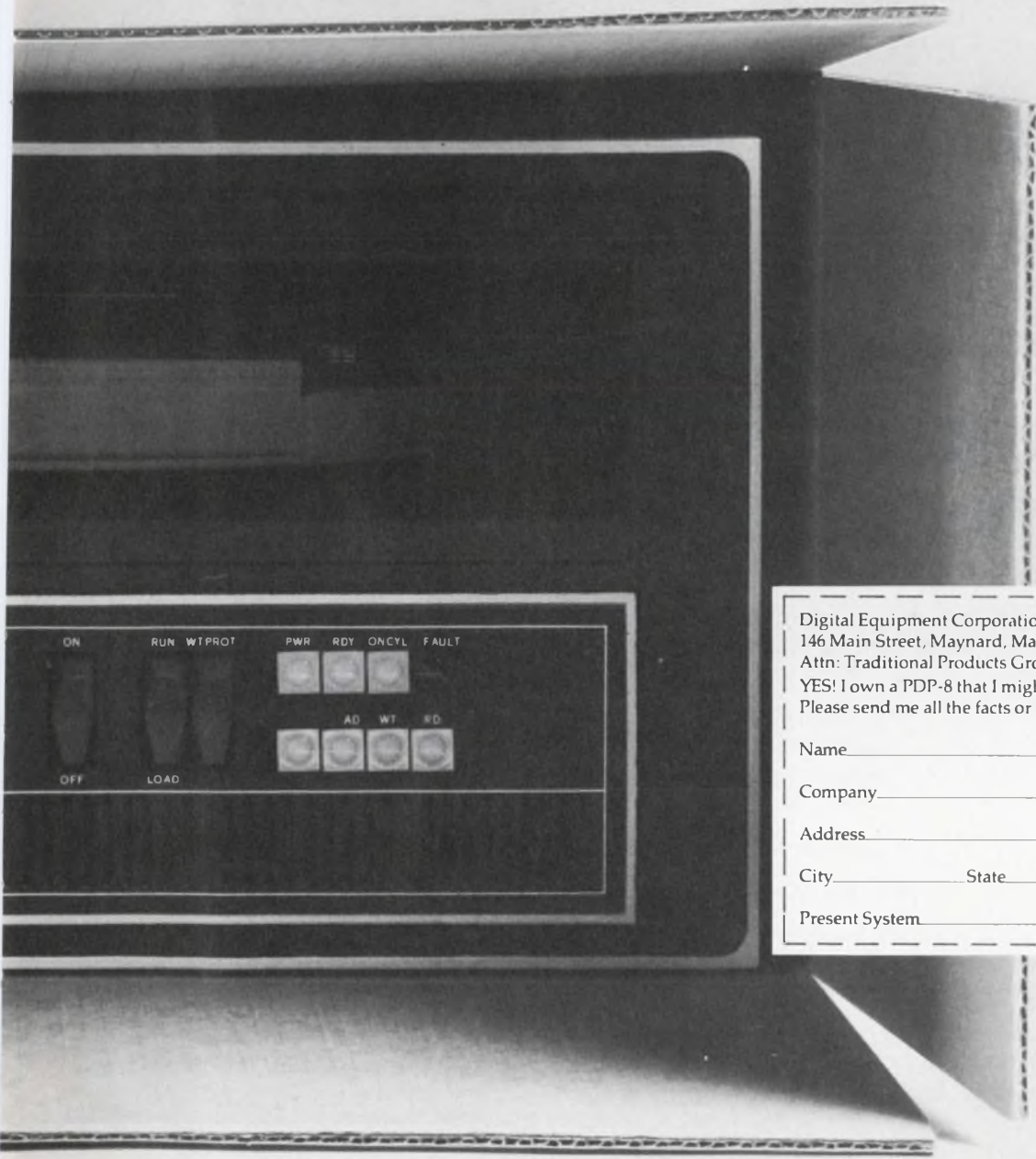

Digital Equipment Corporation  
146 Main Street, Maynard, Mass. 01754  
Attn: Traditional Products Group  
YES! I own a PDP-8 that I might consider expanding.  
Please send me all the facts or call me at:

Name \_\_\_\_\_ Title \_\_\_\_\_

Company \_\_\_\_\_ Phone \_\_\_\_\_

Address \_\_\_\_\_

City \_\_\_\_\_ State \_\_\_\_\_ Zip \_\_\_\_\_

Present System \_\_\_\_\_

## Another Sprague Breakthrough!

ACROSS THE DESK

(continued from p. 7)

### And, now, a word from Phoenix Data

The Aug. 3 issue ran an article under New Products titled "Almost 16-Bit D/A Converter Is Industry's Fastest, Most Stable, Least Expensive" (ED 16, p. 65). At Phoenix Data we were slightly offended at not being considered a part of the industry.

The article discusses the Analogic 16-bit d/a converter (MP-1916A) and compares its performance and price with that of the Analog Device Model DAC-16QM. We feel that any discussion of 16-bit d/a converters would not be complete without including the Phoenix Data Model DAC167OR.

On price and full-scale settling time, we would agree the MP-1916A is at least equal to the DAC-167OR. They both sell for \$595, with storage register and settling time specified at 20  $\mu$ s to 1 LSB.

We can readily understand the writer's reluctance to claim a 16-bit d/a converter when one examines the "fully" specified temperature coefficient of the MP-1916A. We further appreciate the reluctance to specify the total temperature coefficient for a bipolar voltage mode converter. If one is pessimistic (we always are on our converters), the sum total of the specified temperature coefficient of gain, linearity, reference and offset is 15 ppm/ $^{\circ}$ C, or 0.0015%/ $^{\circ}$ C. The discussion of long-term stability becomes somewhat academic when one considers that one degree C can cause an output error of 1 LSB (1 LSB in a 16-bit d/a = 0.0015%).

We made no claims to being the industry's most stable 16-bit d/a converter (there are probably some around we haven't heard of). However, the DAC167OR has a specified maximum "total" temperature coefficient of 5 ppm/ $^{\circ}$ C. For the moment, that makes the DAC-167OR three times as stable with temperature as the MP1916A.

Robert Nelson  
V.P. Marketing

Phoenix Data, Inc.  
3384 W. Osborn Rd.  
Phoenix, Ariz. 85017

## PRODUCTION-ORIENTED SOLID TANTALUM CAPACITORS

Solid flame-retardant epoxy with precise dimensions for automatic insertion. Completely shock and vibration resistant.

Flat surface permits clear easy-to-read marking.

No rundown to interfere with seating of capacitors on printed wiring board.

Rugged 0.025" dia. tinned leads maintain alignment. 0.100" lead spacing for standard PWB grids.

Top flat for easy identification of positive lead either visually or by touch.

Standoff feet on base to eliminate moisture entrapment and facilitate cleaning of wiring boards.

Formed leads with either 0.200" or 0.250" spacing to permit interchangeability with dipped capacitors.

ACTUAL SIZE

# Type 198D Low-cost Econoline\* Tantalum Capacitors Lead in Performance!

When it comes to low-cost solid tantalum capacitors, the new Sprague Type 198D Econoline Capacitors outperform all other designs. Here are some additional advantages:

- Low d-c leakage
- Low dissipation factor
- Wide voltage range, 4 to 50 VDC
- Capacitance range from 0.1 to 100  $\mu$ F
- Withstand severe temperature cycling and temperature shock over  $-55^{\circ}$ C to  $+85^{\circ}$ C
- Speedier handling for insertion
- Easier-to-read markings

The new Sprague Type 198D epoxy-encased Econoline Capacitor is tooled for mass production and priced competitively with imported dipped units. Investigate this new Sprague breakthrough without delay.

Call your nearest Sprague district office or sales representative, or write for Engineering Bulletin 3546 to: Technical Literature Service, Sprague Electric Co., 347 Marshall Street, North Adams, Mass. 01247.

\*Trademark

THE BROAD-LINE PRODUCER OF ELECTRONIC PARTS



INFORMATION RETRIEVAL NUMBER 8

CIRCLE NO. 280

Fluke problem solvers

# Introducing the Fluke 8100B. At \$595, you'll wonder how we did so much in a 4½ Digit Multimeter.



The new version of Fluke's most successful DMM, Model 8100B, gives you the most value for your money ever offered in a quality digital voltmeter.

With a basic dc accuracy of 0.02%, the Fluke 8100B measures ac and dc volts in four ranges from 100 microvolts to 1200 volts and resistance from 100 milliohms to 12 megohms. With an optional ac/dc current shunt accessory, it measures from 10 nanoamperes to 12 amps in six switched ranges.

Features include an active 2-pole switchable filter and automatic polarity indicator. All functions are push-button selectable.

For \$100 extra, a rechargeable battery pack can be

added to give the user complete portability with up to eight hours continuous operation. Other options include RF and high voltage probes, switched ac/dc current shunts, data output and a ruggedized case.

Demonstrated MTBF is over 10,000 hours, to make the instrument the most reliable available. The 8100B has tough environmental specs to ease your workload. Fully backed by Fluke's no-nonsense 12-month guarantee and service policy, here's an instrument that will meet your greatest expectations.

Call your local Fluke sales engineer for a demo and details. In the contiguous U.S., get his location by dialing our toll free number, 800-426-0361. Otherwise, address one of the locations listed below.

Fluke, P. O. Box 7428, Seattle, Washington 98133. Phone (206) 774-2211. TWX: 910-449-2850.  
In Europe, address Fluke Nederland (N.V.), P. O. Box 5053, Tilburg, Holland. Phone 13-670130.  
Telex: 884-55237. In the U. K., address Fluke International Corp., Garnett Close, Watford,  
WD2, 4TT. Phone, Watford, 33066. Telex: 934583.





We're the power  
semiconductor  
specialists.

Good for us.

SCRs • SILICON RECTIFIERS • ZENER DIODES • SEMICONDUCTOR FUSES  
POWER CIRCUITS / ASSEMBLIES • OPTOELECTRONICS • HEAT EXCHANGERS

# Better for you.

That's right, better for you. And for more reasons than one.

When a company has specialized for 25 years in rectifiers and thyristors, it can come up with better new products to answer almost any design requirement.

**New products. Better design alternatives.** One good example is our Schottky Power Rectifier, which makes great increases in power conversion efficiency. Another is the PACE/pak™ molded assembled circuits, which reduce costs many ways.

Now, we are far along in the development of some exciting new products. Like new series of faster recovery rectifiers, low-cost, high performance SCRs, and high-frequency SCRs, including what we believe is the best 125 Amp device ever built.

But the present and future products are just one of the reasons you'll do better with IR.

**100% testing. Quality assurance programs.** Since rectifiers and thyristors are our only business, we've grown by solving problems for our customers. Our products have to be tops. Our service has to be exceptional. We can't afford anything less, because you can't.

That's why we maintain a highly effective QC program, and do extensive testing... still 100% on both high and low power devices. Some companies may have abandoned this practice in the face of today's high costs. But for us, abandonment is too high a price to pay.

**25 years of applications know-how.** We also know it takes more than a good data sheet to help equipment designers arrive at the best circuit design with the best device. That's why we've continued to expand our Applications Engineering group.

When you need an applications

engineer with a strong background in your product field, that's what we send.

**Leadership. International strength.** When you consider a source, it is always good to know its standing in the field. And in the field of power semiconductors, IR builds and sells more devices world-wide than any other company.

However, as good as specialization has been for us, it can be even better for you.

If our better design alternatives improve your product, you win new customers.

If we can help you lower costs, your profit grows.

And if we provide higher reliability, it helps you keep your customers.

We've done these things for other companies. We'd like to do the same for you. Write International Rectifier, 233 Kansas Street, El Segundo, CA, 90245.

# International Rectifier

...the innovative power people



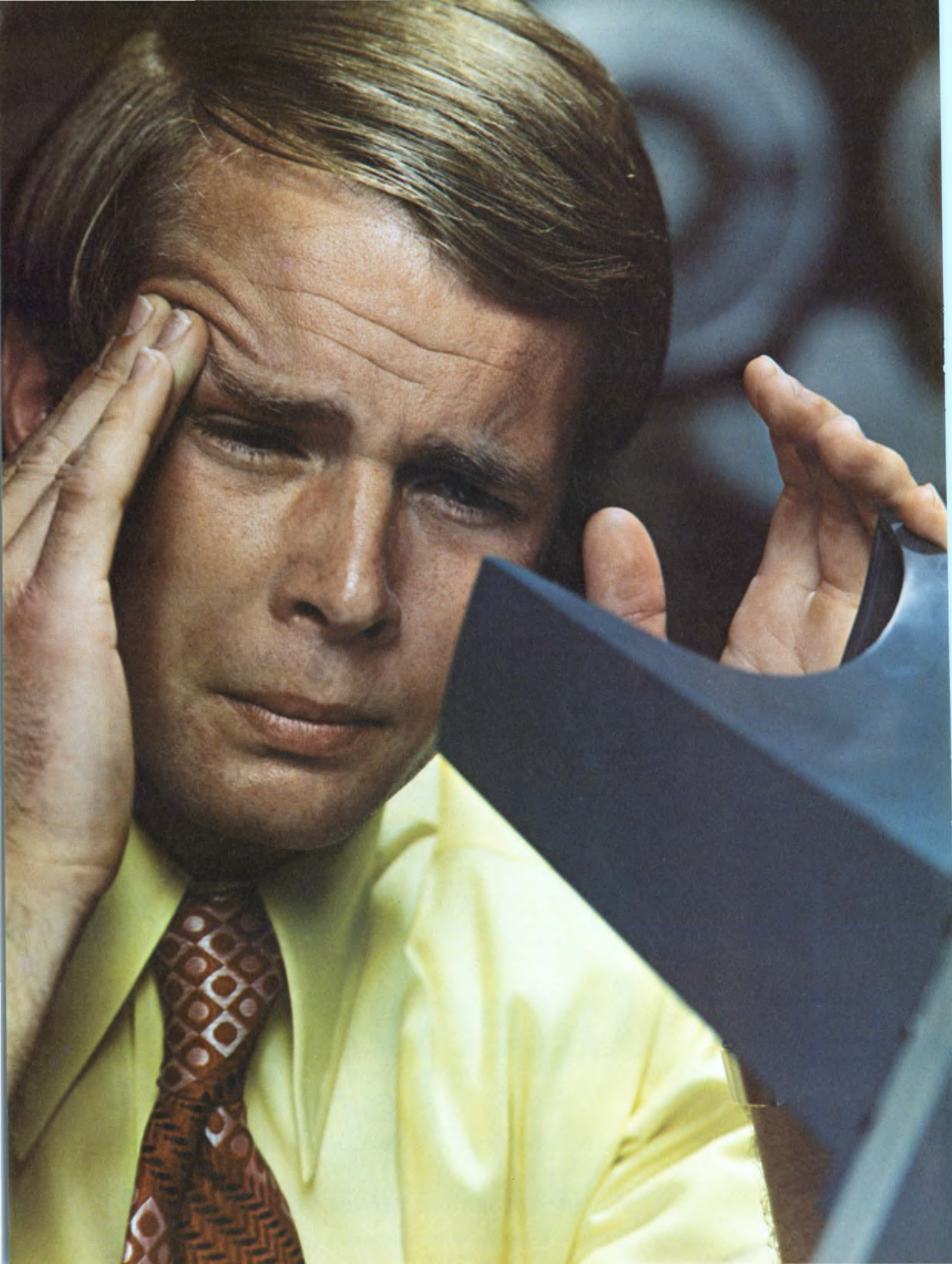



# Think Twice:

## What's one of the biggest measurement problems in the computer industry today?

### Low Duty-Cycle Measurements—

Making timing-pulse adjustments, and finding noise pulses in, or locating missing bits from low duty-cycle digital signals. Countless lost hours and eye-strain have resulted from this problem—trying to view low rep-rate signals like those found in disc, tape, or drum peripheral units. But with your refresh cycle occurring at such long intervals, coupled with short phosphor persistence, it's no wonder that you've spent an inordinate amount of time making such measurements. And it's no wonder that you often came out from under your scope hood rubbing your eyes. Well, no more!

**Storage CRT With Unmatched 400 cm/μs Writing Speed.** Hewlett-Packard just made it possible for you to throw away your scope hood by developing a new bright, burn-resistant, high-speed, variable-persistence CRT—available in either 100 cm/μs or 400 cm/μs writing speeds. Placing these new CRT's into an all new mainframe that's optimized for high-writing-speed storage measurements, HP now gives you a new dimension in storage scopes—the HP 184A. This unique combination offers the highest writing speed available, and a display with brightness as great as you can find anywhere. For the first time you can find those elusive transients that before were too fast for your storage scope to follow—like nanosecond noise pulses.

**Display True Replicas of Your Waveforms.** You'll appreciate being able to adjust persistence down to 0.2 seconds; that's 75 times lower than a major competitive unit. For those measurements that require faster sweep times, you'll know you are displaying true replicas of your waveforms when you're using an HP 184A. Capture low duty-cycle pulse trains, through repetitive sweeps, simply by adjusting the persistence to

"maximum," to build up the intensity of dim traces. This feature in the new 184A oscilloscope lets you do many jobs you previously allocated to expensive, single-shot scope/camera systems.

**Variable-Persistence Storage and Standard in One Scope.** Further, you'll find that your 184A is a true general purpose scope that offers you the capability to choose, by way of plug-ins, all the functional features of the HP 180 Series of oscilloscopes, including such items as selectable-input impedance, and sampling to 18 GHz. And for simplicity of operation, we think you're in for a pleasant surprise when you compare the 184A against the competitive unit.

**Superior Technology.** HP believes the most important part of a scope system is the CRT—the interface between you and your measurement. As the pioneer in practical applications of dome-mesh magnification, HP was first to expand the size of high-frequency CRT's to 6 x 10 cm; first to 8 x 10 cm; and first to 10.4 x 13 cm—all in high-frequency mainframes. HP was also the first to use dome-mesh technology to substantially lower power requirements for CRT deflection (making possible the only line of 35 and 75 MHz portable scopes with built-in battery packs—scopes that really are portable).

**From The Storage Leader.** HP was first with variable-persistence mesh storage for commercial applications—to give you a stored trace many times brighter than bi-stable tubes, and without annoying flicker. Variable-persistence, with its ability to build up waveform brightness, was the first CRT innovation that gave you a trace bright enough to let you tackle most single-shot or low rep-rate measurements problems. All you do is adjust persistence until the integrating storage effect brings your waveform up to a bright, clear display.

**Burn-Resistant CRT's.** HP placed variable-persistence in many of its scopes including the 181A, 1702A, and 1703A storage units. And now HP has developed, for its current line of storage instruments, carefree CRT's so highly burn resistant they require little more care than conventional CRT's. The new 184A high-writing-speed scope also has unprecedented inherent resistance to burns.

**Yes, Scopes Are Changing.** How many times have you wished for a scope that could display a low rep-rate digital signal brightly and clearly, and one that could also be used for a variety of general purpose measurements. That scope is here now in HP's 184A storage mainframe, \$2200 (for only \$500 more, you can boost your 184A's writing speed to 400 cm/μs), with plug-in capability to 100 MHz real time, or 18 GHz sampling. Think twice; put away your scope viewing hood and call your local HP field engineer for a demo today. Or write for our "No Nonsense Guide to Oscilloscope Selection." It covers the other members of HP's variable-persistence storage scopes. Hewlett-Packard, Palo Alto, California 94304. In Europe: P.O. Box 85, CH-1217 Meyrin 2, Geneva, Switzerland. In Japan: YHP, 1-59-1, Yoyogi, Shibuya-Ku, Tokyo, 151.

**Scopes Are Changing;  
Think Twice.**

HEWLETT  PACKARD

OSCILLOSCOPE SYSTEMS

# Sorensen has a bargain for you: DCR power supplies selling for \$360-\$4200.



Sorensen's DCR power supplies offer you the lowest cost per watt in the industry. More power output for each dollar you invest.

And DCR's comprise the broadest lab/systems line available anywhere: 37 models in 10 voltage ranges, 7 power levels.

Features? All silicon solid-state electronics. Precision regulation. Remote voltage, current or resistance programming — and remote sensing at distances to 200 feet. Operation in either voltage or current modes.

For complete data and prices, write Sorensen, a unit of Raytheon Company, 676 Island Pond Road, Manchester, N.H. 03103. Telephone (603) 668-1600. Or TWX 710-220-1339.

**Sorensen**  
**POWER SUPPLIES**

## Key Data

- 37 models available.
- 10 voltage ranges from 20 to 30,000 Vdc.
- 7 power levels from 400 to 20,000 W.
- Low output ripple.
- Voltage and current regulation with automatic crossover.
- Typical efficiencies to over 80%.
- Fits standard 19" rack (except 20 kW models).
- Optional overvoltage protection for all models (except 20 kW).
- Series or parallel operation.
- MTBF greater than 25,000 hours.

# OUR ANGLE: High Speed Accurate and Automatic Angle Position Indicators

## WHAT'S YOUR ANGLE?



MODEL 545/100

If you're converting synchro/resolver data to digital format, you need both speed *and* accuracy to keep pace with today's data explosion. Only one converter meets both these requirements without compromise. And for under \$4K. . . North Atlantic's Model 545/100.

The solid-state Model 545/100 converts both resolver and synchro data with  $0.01^\circ$  accuracy and resolution. And continuously digitizes input angle data at  $20,000^\circ$  per second in the face of real-life noise, harmonics and quadrature levels. BCD output is available at the rear connector. Conversion can be stopped by a data freeze command. If multiplexed signals are your bag, acquisition time is less than 30 ms.

Options? Other models offer many options, including  $0.001^\circ$  resolution with 10 arc-second accuracy; data frequencies from 60Hz to 2.4kHz, binary output, small size.

No matter what your conversion problem, if you require ultra-fast, ultra-accurate tracking, contact your North Atlantic sales engineering representative today. He'll show you a better angle.

**NT  
A**

**NORTH ATLANTIC**  
*industries, inc.*

200 TERMINAL DRIVE, PLAINVIEW, NEW YORK 11803  
cable: noatlantic / twx: 510-221-1879 / phone: (516) 681-8600

INFORMATION RETRIEVAL NUMBER 101

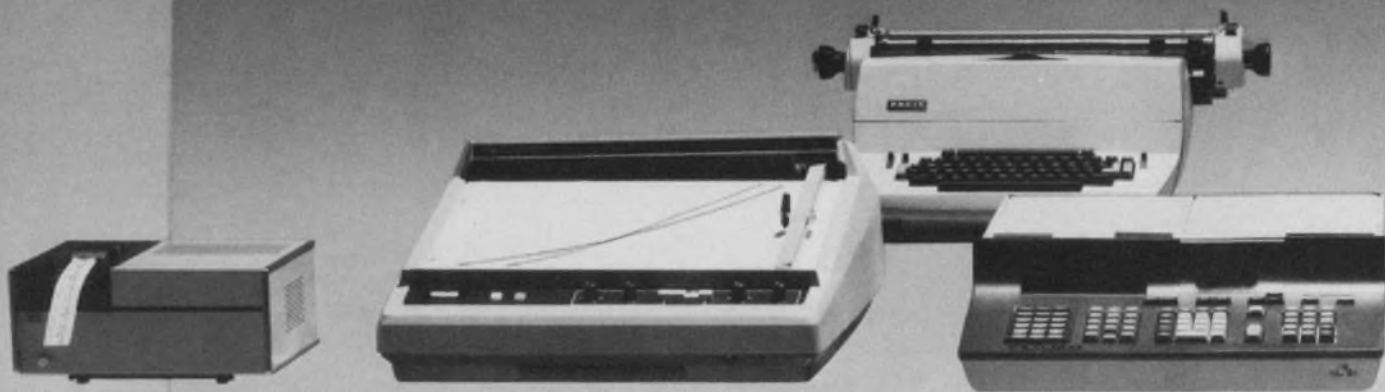

# Hewlett-Packard Series 9800. The Name And Number Mean More Than Calculators.

## Computing Power Is One Thing.

The most striking example of computing power, that we know about, is our HP-35 Calculator. At nine ounces, this *shirt-pocket powerhouse* marvelously challenges a computer in handling problems from simple arithmetic to complex mathematics. And costs \$395.



If we can package that much power in a shirt-pocket, imagine what our Series 9800 Model 10 and 20 can do:

Model 10. The one for doing repetitive problems (statistics, quality assurance, or surveying, to name a few). It comes with an LED Display, 50 registers *and* 500 program steps of memory. Coming in at under \$3,000, the Model 10 can both perform a complete regression analysis, and solve 10 simultaneous equations. You can add

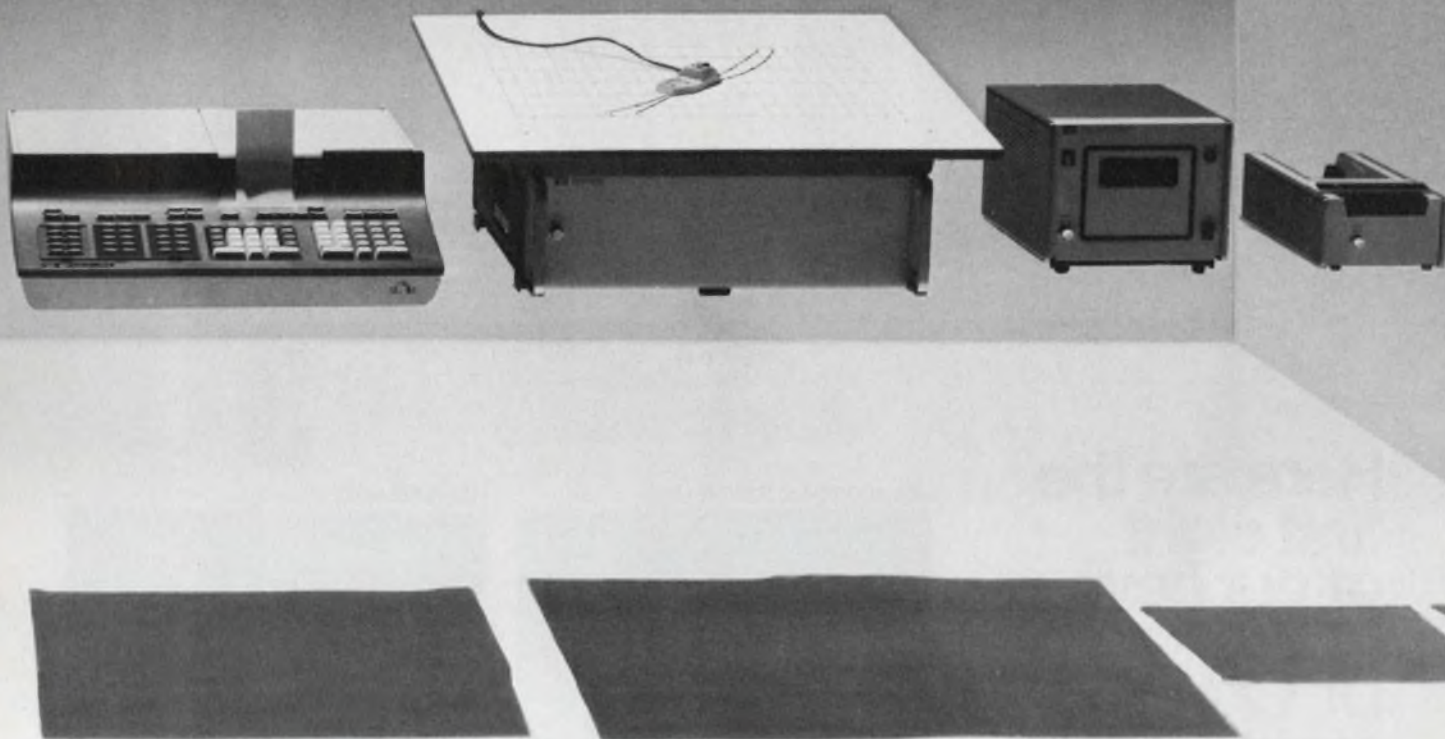

special functions, memory and printer with or without alphanumerics.

**Model 20.** The one for a lot of on-the-spot programming of complex problems. You get the best of both worlds: Very fast operation internally, with direct communication between you and the calculator. You key in your problem just as you'd write it—in Algebra and English. It gives you instructions and labeled solutions that you readily understand through its unique alphanumeric display and printer. Add to this Model 20's extensive error detecting and correcting features and its whopping memory—and you'll quickly find that it'll take you from concept to solution faster than any other system around.

What's more, with the Series 9800, you're not limited to the data formats of the Calculator. For input, you have your choice of Marked Card Reader, Paper Tape Reader, or Digitizer; for storage, the Tape Cassette; and for out-

put, a Typewriter, or our X-Y Plotter that both draws and writes.

**Support Is Another Thing.**

We're in a unique position to help you. It's the aggregate of our experience in virtually every discipline of science and engineering that does it for us. Not just with products but with people. People like your HP Field Engineer. Chances are, he'll bring the solution to your problems with him. If not, he'll put you in touch with someone who will. The point is, he can talk your language. So you do get the most from your investment. Save time in the beginning. And money in the end.

**Service Is A Third.** With over 170 field service centers in 65 countries, service is available regardless of where you are. For most, it takes only a phone call.

**Product Line Is A Fourth.**

You probably already know us as one of the world's leading designers and manufacturers of precision electronic measurement equipment. To that end we build over 2,000 products for scientists, engineers, doctors, and businessmen.

Today we're a leader in computing equipment as well. Our line runs from the Model 35 Calculator, right on up to the System 3000, a multi-lingual, multi-programming computer. Between those, and all that goes between, we can help you find the most cost-effective solution to your problems.

For more information or a demonstration of the HP Series 9800, write: Hewlett-Packard, P.O. Box 301, Loveland, Colorado 80537.

For more information or a demonstration of the HP Series 9800, write: Hewlett-Packard, P.O. Box 301, Loveland, Colorado 80537.

**HEWLETT  PACKARD**  
**CALCULATOR PRODUCTS**

HP sales, service and support in 172 cities in 65 countries.

INFORMATION RETRIEVAL NUMBER 102

# Harris

Here are the first eight of our new growing DI/CMOS family—the fastest low-power devices of their kind available today.

If you're joining the big move to CMOS, we've got your device. Or soon will have. Because we've committed ourselves to dielectrically isolated CMOS (DI/CMOS) development on a major scale. The first eight are available now. These devices offer speeds twice as fast as any comparable ICs, typically 10ns with 10-volt power supplies. They also offer a wide power supply range (3VDC to 18VDC), while providing large noise immunity, typically 45% of supply voltage. In terms of chip reliability, our engineers currently report more than 230,000 device hours at +125°C without failure.

All of the new devices are available in 14-pin dual in-line packages except the HD-4009 and HD-4010, which come in 16-pin packages. Because of their compatible pin-out configurations these circuits will replace or interface with the CD 4000A series. For details see your Harris distributor or representative.

## 1

HD-4000 Dual 3 NOR Gate

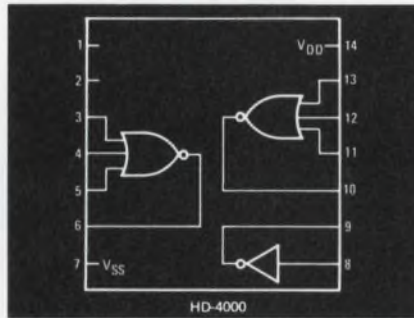

Pin for pin compatible with CD 4000A.

High speed 10ns  
Low power 1nW

100-999 units  
-40°C to +85°C \$1.00  
-55°C to +125°C \$3.10

## 3

HD-4009 HEX Inverter

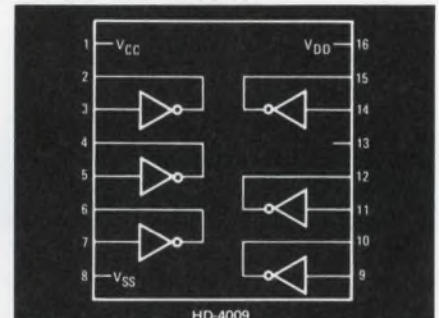

Pin for pin compatible with CD 4009A.

High speed 10ns  
Low power 50nW

100-999 units  
-40°C to +85°C \$2.20  
-55°C to +125°C \$5.25

## 2

HD-4001 Quad 2 NOR Gate

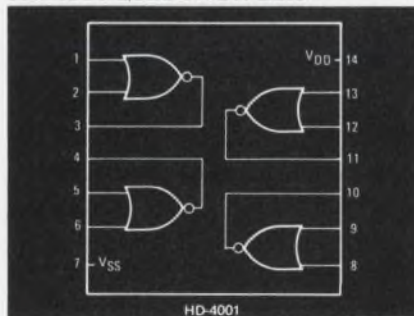

Pin for pin compatible with CD 4001A.

High speed 10ns  
Low power 1nW

100-999 units  
-40°C to +85°C \$1.00  
-55°C to +125°C \$3.30

## 4

HD-4010 HEX Buffer

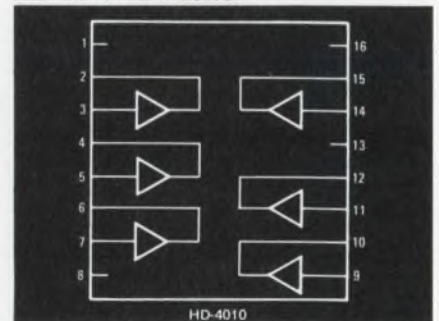

Pin for pin compatible with CD 4010A.

High speed 10ns  
Low power 50nW

100-999 units  
-40°C to +85°C \$2.20  
-55°C to +125°C \$5.25

# CMOS:

## 5

**HD-4011 Quad 2 NAND Gate**

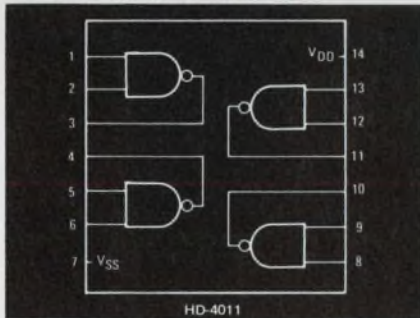

Pin for pin compatible with CD 4011A.

High speed 10ns  
Low power 1nW

100-999 units  
-40°C to +85°C \$1.00  
-55°C to +125°C \$3.30

## 7

**HD-4013 Dual "D" Flip Flop**

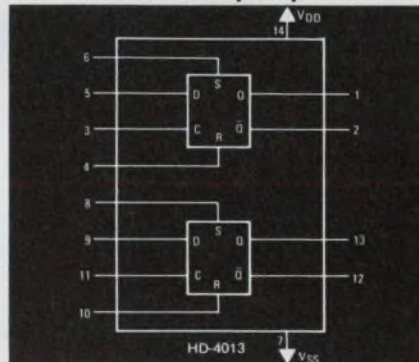

Pin for pin compatible with CD 4013A.

High speed 18MHz typical toggle rate  
Low power 50nW

100-999 units  
-40°C to +85°C \$2.10  
-55°C to +125°C \$4.75

## 6

**HD-4012 Dual 4 NAND Gate**

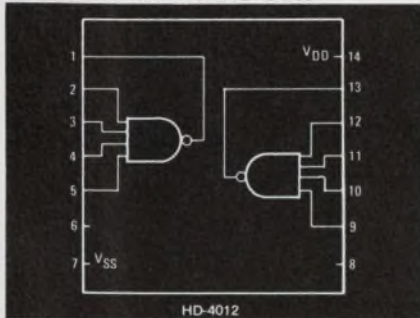

Pin for pin compatible with CD 4012A.

High speed 10ns  
Low power 1nW

100-999 units  
-40°C to +85°C \$1.00  
-55°C to +125°C \$3.45

## 8

**HD-4809 Triple/True Complement Buffer**

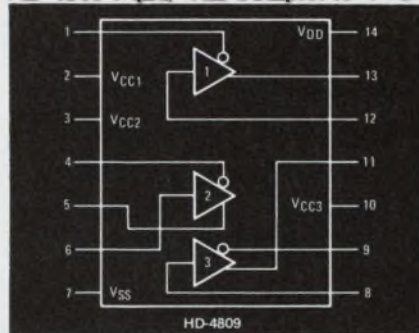

A Harris proprietary device.

High speed 10ns  
Low power 50nW

100-999 units  
-40°C to +85°C \$2.25  
-55°C to +125°C \$5.30



**HARRIS  
SEMICONDUCTOR**

A DIVISION OF HARRIS-INTERTYPE CORPORATION

P.O. Box 883, Melbourne, Fla. 32901  
(305) 727-5430

**WHERE TO BUY THEM:** ARIZONA: Phoenix—Liberty, Weatherford; Scottsdale—HAR (602) 946-3556  
CALIFORNIA: Anaheim—Weatherford; El Segundo—Liberty; Glendale—Weatherford; Long Beach—HAR (213) 426-7687; Mountain View—Elmar; Palo Alto—Weatherford; HAR (415) 321-2280; Pomona—Weatherford; San Diego—Weatherford; Western  
COLORADO: Denver—Elmar; Weatherford  
WASHINGTON, D.C.: HAR (202) 337-3170  
FLORIDA: Hollywood—Schweber; Melbourne—HAR (305) 727-5430  
ILLINOIS: Chicago—Semi-Specs; Schweber; Palos Heights—HAR (312) 597-7510  
INDIANA: Indianapolis—Semi-Specs  
MARYLAND: Rockville—Schweber  
MASSACHUSETTS: Lexington—R&D; Waltham—Schweber; Wellesley—HAR (617) 237-5430  
MICHIGAN: Detroit—Semi-Specs  
MINNESOTA: Minneapolis—Semi-Specs  
MISSOURI: Kansas City—Semi-Specs; St. Louis—Semi-Specs  
NEW MEXICO: Albuquerque—Weatherford  
NEW YORK: Melville—HAR (516) 249-4500; Syracuse—HAR (315) 463-3373; Rochester—Schweber; Westbury—Schweber  
OHIO: Beachwood—Schweber; Dayton—Semi-Specs  
PENNSYLVANIA: Pittsburgh—Semi-Specs; Wayne—HAR (215) 687-6680  
TEXAS: Dallas—Weatherford; Semi-Specs; HAR (214) 231-9031  
WASHINGTON: Seattle—Liberty, Weatherford.

**LEGEND FOR HARRIS SALES OFFICES & DISTRIBUTORS:** Harris Semiconductor (HAR); Elmar Electronics (Elmar); Harvey/R&D Electronics (R&D); Liberty Electronics (Liberty); Schweber Electronics (Schweber); Semiconductor Specialists, Inc. (Semi-Specs); R. V. Weatherford Co. (Weatherford); Western Radio (Western).

# YOUR IN-HOUSE POWER SUPPLY IS ON OUR SHELF

# 25 WAYS

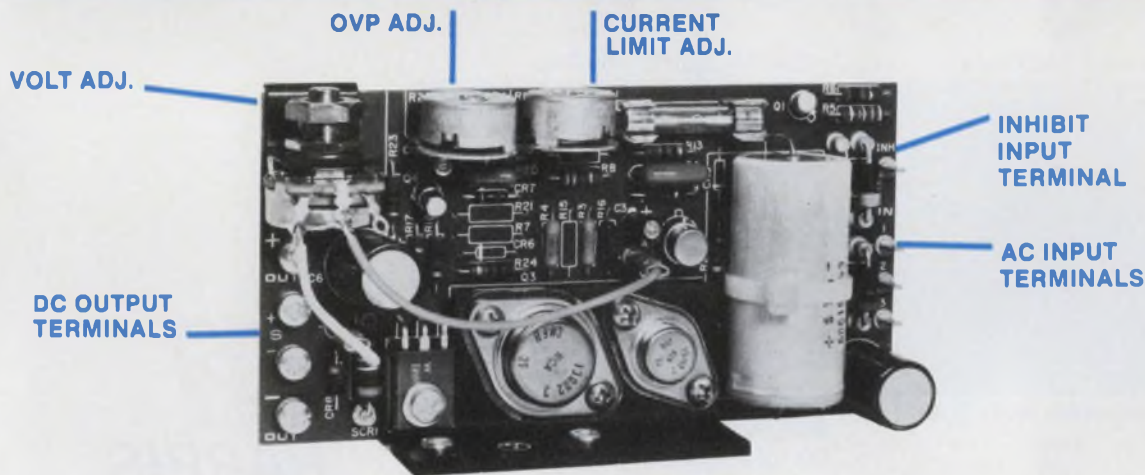

## NEW, UNIQUE LOW COST BUILDING BLOCKS WITH BUILT-IN RECTIFIER, FILTER, REGULATOR AND OVP.

25 models, 5 power packages, up to 30v, up to 18a. Direct electrical connection to a transformer and mounting to a heat sink completes a quality d.c. power supply that meets your specific needs at the lowest possible cost.

### OTHER EXCLUSIVE FEATURES:

- Regulation: Line/Load  $\pm 0.075\%$
- Logic Inhibit Function
- Hermetic Transistors
- Remote Sensing
- Computer Grade Capacitors

No need to add external components.

No bag of parts: Everything you need for In-House use is already built-in. **Write for new 8 page Sub-Modular Power Supply brochure with do-it-yourself specifier** for In-House applications.

### CUSTOM DESIGNS

Also these new standard sub-modules are ideally suited for custom designs at low costs and fast delivery.

Custom designs are standard practice at Powertec.

### SUB-MODULES OUTPUT RATING CHART AND PRICES.

MODEL	- 100		- 200		- 300		- 400		- 500		PRICES*
	5V to 6V	875A	725A	625A	575A	500A	475A	450A	425A	400A	
22A	1.0A	875A	.725A	.625A	.575A	.500A	.475A	450A	425A	400A	\$15.00
22B	3.0A	2.5A	2.2A	1.9A	1.7A	1.5A	1.4A	1.3A	1.2A	1.1A	18.00
22C	6.0A	5.2A	4.4A	3.8A	3.4A	3.0A	2.8A	2.6A	2.5A	2.3A	25.00
22D	12.0A	10.4A	8.8A	7.6A	6.8A	6.0A	5.6A	5.2A	5.0A	4.7A	35.00
22E	18.0A	15.6A	13.2A	11.4A	10.2A	9.0A	8.4A	7.8A	7.5A	7.1A	40.00

Typical ordering information for 5V, 1.0A, Model 22A-100; and 12V, 6.8A, Model 22D-300, etc.

\*Consult factory for prices at other quantities.

**POWERTEC INC.** an Airtronics Subsidiary

9168 DeSoto Ave., Chatsworth, California 91311 • (213) 882-0004 • TWX (910) 494-2092

# POWERTEC



# FREE BUYER'S GUIDE TO LOGIC CARDS

This manual will make you more efficient and productive, and help you design highly reliable, effectively performing systems. It contains specs on a complete, field-proven, reliable and economical line of Blue Chip logic modules. It includes digital, analog, power and electromechanical interface cards, with associated power supplies, chassis and other accessories. Also design aids, and essential application data for basic DTL and TTL integrated circuits. Mail this coupon today!

**FREE  
COPY**



Complete data on over 250 logic cards **immediately** available from Data Technology. Mail this coupon to Data Technology Corp., 2700 S. Fairview Rd., Santa Ana, Calif. 92704.

Name \_\_\_\_\_

Title \_\_\_\_\_

Company \_\_\_\_\_

Address \_\_\_\_\_

City \_\_\_\_\_ State \_\_\_\_\_ Zip \_\_\_\_\_



the new **Data**Technology corp.

2700 S. Fairview Rd.,  
Santa Ana, Calif. 92704.

# Candidate for the PE license this year?

Use these up-to-date guides...  
specifically tailored for  
your study campaign

## HAYDEN PROFESSIONAL ENGINEERING EXAMINATION SERIES

LAWRENCE J. HOLLANDER, Editor-in-Chief,  
Professional Engineer, New York State

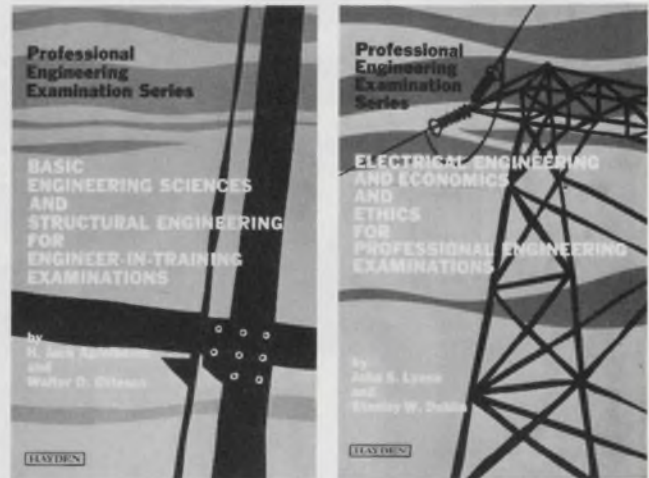

Written with your needs kept foremost,  
these study guides offer . . .

- a wide selection of actual, realistic problems from recent state examinations arranged by subject for convenient study
- detailed step-by-step solutions that bring out underlying principles to equip you to handle the unexpected
- concise background discussions precede the problems, presenting you with a mini-review of theory, principles, terminology
- separate tables of contents for subjects and problems quickly pinpoint the specifics for rapid review or "open book" examinations
- numerous schematic diagrams and detailed drawings to insure in-depth understanding

Review the books that concern you for  
15 full days—FREE!

### FOR 15-DAY FREE EXAMINATION

Please send the book(s) circled below on a 15-day examination basis. At the end of that time, I will remit payment, plus postage, or return the book(s) without further obligation.

5712-1      5715-6      5716-4

(For those ordering by ISBN, the Hayden Prefix is: 0-8104)

Save money! On all prepaid orders Hayden pays postage —  
same 15-day return guarantee!

72-29 ED

Name \_\_\_\_\_

Firm \_\_\_\_\_

Address \_\_\_\_\_

City/State \_\_\_\_\_ Zip \_\_\_\_\_



HAYDEN BOOK COMPANY, INC.  
116 West 14th St., New York, N.Y. 10011

### BASIC ENGINEERING SCIENCES AND STRUCTURAL ENGINEERING FOR ENGINEER-IN-TRAINING EXAMINATIONS

H. JACK APFELBAUM, P.E., Department of Mechanical Engineering, Lowell  
Technological Institute; and WALTER O. OTTESEN, P.E., Patent Counsel

Nearly 200 solved problems selected from a nationwide survey of recent E-I-T examinations offer you a complete, well organized review of the concepts and techniques that must be understood to successfully pass the preliminary exam. Unlike other study guides that stress one aspect of the field while shortchanging others, this volume provides balanced coverage of the three broad engineering areas: *the basic sciences*: mathematics, physics, and chemistry; *the engineering sciences*: statics, dynamics, fluid mechanics, thermodynamics, electricity, and engineering economy; and *structural engineering*. More than 300 detailed illustrations pinpoint key concepts and problem-solving techniques.

408 pp., 6 x 9, illus., cloth, #5712-1, \$13.95

### ELECTRICAL ENGINEERING AND ECONOMICS AND ETHICS FOR PROFESSIONAL ENGINEERING EXAMINATIONS

JOHN S. LYONS, P.E., and STANLEY W. DUBLIN, Institute of Environmental  
Medicine, New York University Medical Center

Concentrating on the subjects and topics that form the foundation of this rapidly changing technology, this book analyzes and solves for you almost 100 problems from a nationwide sampling of recent PE examinations. Its comprehensive, up-to-date coverage includes materials and problems not found in other guides of this type, such as electrical-magnetic-thermal analogs, semiconductors, and power system short circuits. More than 170 detailed illustrations are included. The separate section devoted to economics and ethics features an unusual approach to such topics as interest, costs, valuation, and others—the summarized use of formulas in solving nearly 50 typical problems.

302 pp., 6 x 9, illus., cloth, #5715-6, \$12.95

also available

### MECHANICAL ENGINEERING AND ECONOMICS AND ETHICS FOR PROFESSIONAL ENGINEERING EXAMINATIONS

EUGENE STAMPER, P.E., and STANLEY DUBLIN

Over 200 solved problems in mechanical engineering, along with the same thorough coverage of economics and ethics.

392 pp., 6 x 9, illus., cloth, #5716-4, \$14.95

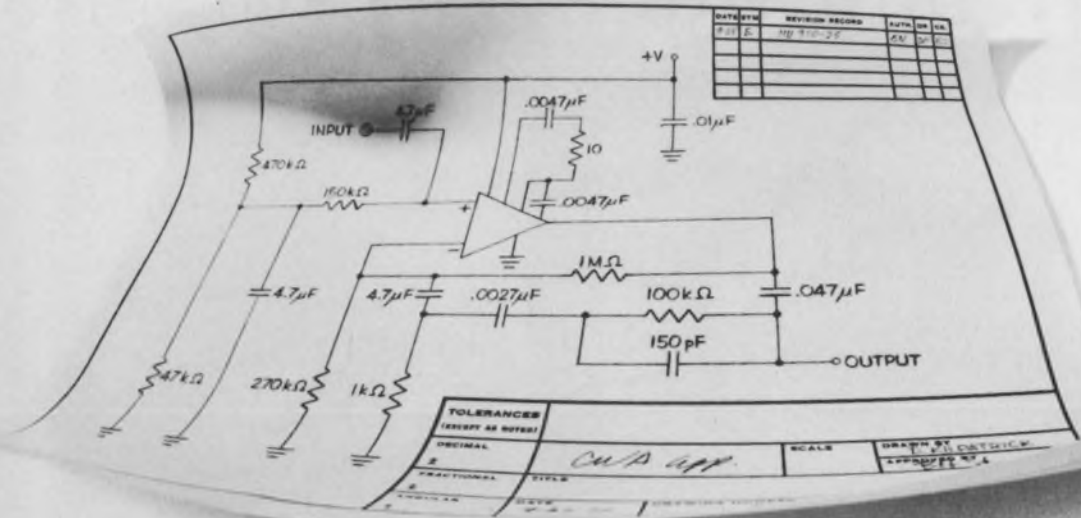

# Designing a hybrid circuit shouldn't be all work and no play.

If you want to make sure the circuit you've designed really plays, you need to do more than see a schematic of it.

You need to see the real thing.

And that's what the new KEMET® Hybrid Circuit Chip Kit allows you to do.

Containing 280 tantalum and ceramic chip capacitors with high temperature capabilities, plus supporting technical literature, it's the industry's first kit covering the complete capacitance range used in hybrid circuits.

All of which gives you the freedom you need to build a prototype of the schematic you've been working on.

So fill out the coupon and order your Chip Kit today. Or, for more information, get in touch with us at Union Carbide, Components Department, Box 5928, Greenville, S.C. 29606. Phone (803) 963-7421.

All work and no play makes a dull career.

I want to play. Enclosed is \$99.00 in check or money order for your KEMET Hybrid Circuit Chip Capacitor Kit.

I do not wish to play right now. But please send me more information on your Chip Kit anyway.

Name \_\_\_\_\_

Title \_\_\_\_\_

Company \_\_\_\_\_

Street \_\_\_\_\_

City \_\_\_\_\_

State \_\_\_\_\_ Zip \_\_\_\_\_



UNION CARBIDE

COMPONENTS DEPARTMENT

Available through your KEMET distributor

# New from Amphenol's Spectrum

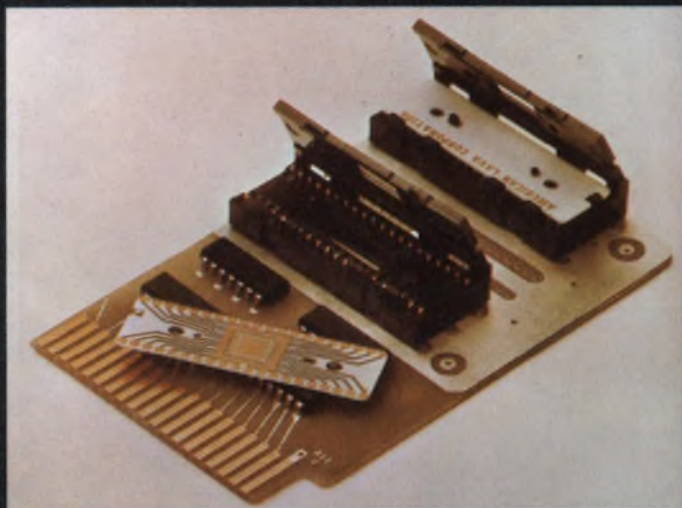

**level 1** MOS/LSI Planar Plug-In connectors (above) for leadless, flat mount ceramic substrates. Permits fast, easy replacement of IC package, no screws, has snap-down lid. ■ Free-standing terminal (below) terminates IC's to PC boards for lowest total systems cost.

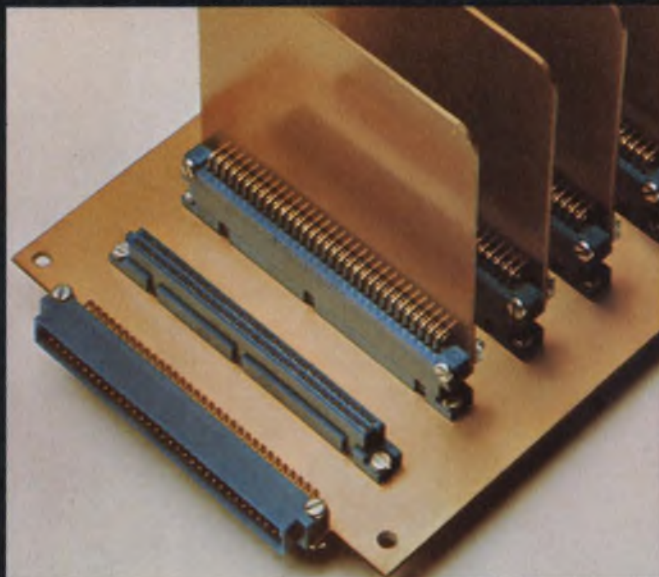
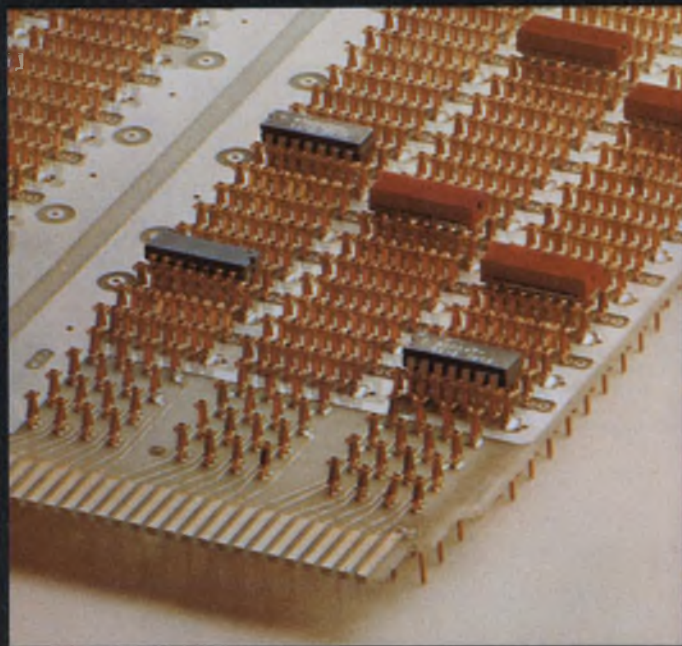

**level 2** Box contact connectors (above) intermate with .025" square or round contacts. Low insertion force. Terminations for crimp, wire wrapping or wave solder. ■ Zero insertion force connectors (below) improve PC board and connector life by eliminating strain and wear.

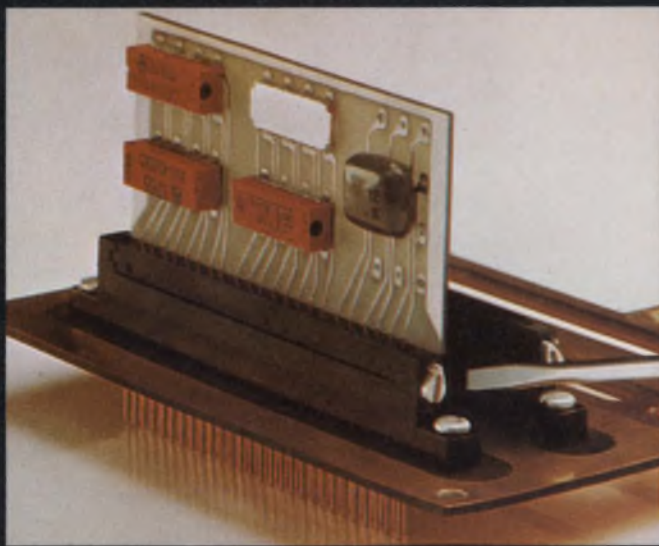

Above are seven new ideas from Amphenol Industrial Division's Spectrum of interconnection capability.

Amphenol's SPECTRUM offers you *all four* levels of interconnections from our unmatched breadth of product line:

**Level 1 . . . DEVICE TO BOARD OR CHASSIS.** We offer interconnections for components such as tubes, relays, transistors, IC packages, trimmers, resistors or capacitors to a PC board or chassis.

**Level 2 . . . BOARD TO MOTHERBOARD OR BACK PLANE.** We offer interconnections for PC boards or

other sub-circuit modules to a motherboard or to a back plane.

**Level 3 . . . MOTHERBOARD OR BACK PLANE WIRING.** We offer interconnections for levels to each other and to other sub-circuits with multi-layer circuit boards, wire wrapping, clip terminations, jumper techniques and dip-soldering.

**Level 4 . . . INPUT/OUTPUT CONNECTIONS.** We offer interconnections for power and signals to and from a system. This interface may be between sub-assemblies within the same enclosure or between individual units.

# of interconnections.

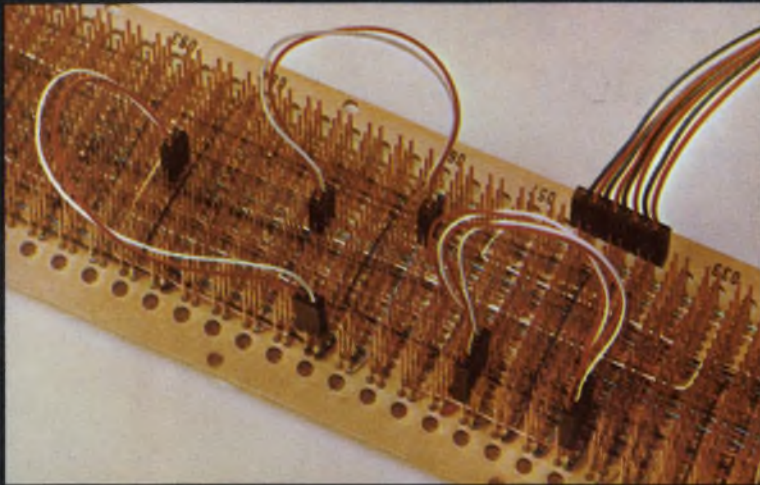

level **3**

Low cost strip connectors (above) are used as jumpers in back plane wiring. Intermates with .025" square or round posts. ■ Circuit Concentration Bay (below) consists of wire wrappable panels that are five times as compact as the telephone distribution frames they replace.

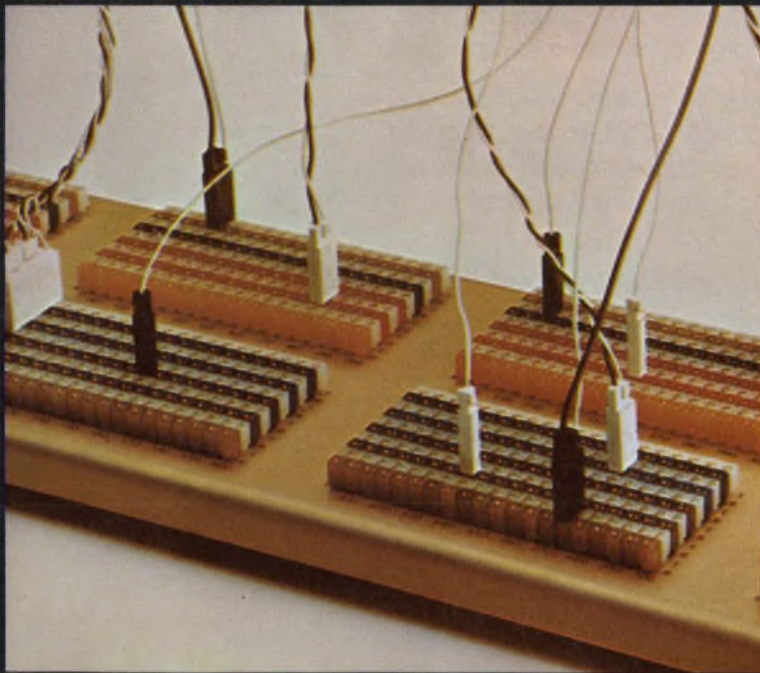

level **4**

Modular Integral Connector concept lets you make your own pin & socket connector to fit your needs. Five contact sizes, thousands of combinations. Sufficient components for six connectors in handy MIC-KIT. Design and assemble your own prototypes.



From the simple tube socket—to a myriad of electrical/electronic connectors—to complete and complex termination systems . . . SPECTRUM.

But SPECTRUM is far more than products. It is a depth of capability in engineering, manufacturing and quality control. Amphenol's SPECTRUM is a new height of service, availability and distribution backed by seven Amphenol interconnection-oriented divisions.

Amphenol can fulfill your total interconnection requirements because we are not limited to specifics such as one or two product lines, one or two levels.

Therefore we approach your interconnection needs with complete open-mindedness.

For more new ideas and specific information, write for your copy of "SPECTRUM." Amphenol Industrial Division, Bunker Ramo Corp., 1830 South 54th Ave., Chicago, Illinois 60650.

**BUNKER  
RAMO**

**AMPHENOL**

**60 watt  
signal generator**

**10 to 2,500 MHz  
with six heads**

**solid state for  
high reliability**

**frequency stability  
 $\pm 0.003\%/10$  minutes**

**power stability  
 $\pm 0.2$  db/hour**

Pick a frequency between 10 and 2,500 MHz and the Model 15022 will deliver the reliable power you need for amplifier drive, component testing, calibration, and antenna pattern measurements.

Reliability is built in with conservative design and all solid state components (except osc. tube). So you get frequency and power stability at low cost. Easy servicing. And full protection against mismatch or loss of load.

Front panel meter reads forward power in 15 and 75 watt scales. Single control tuning to 1% of actual frequency can be read directly for rapid setup.

Model 15022 has an internal and external modulation capability. An isolated RF output 20 db down is available for error-free monitoring. Meets MIL specs for RFI shielding.

For complete specifications on today's newest RF power source, call (312) 354-4350 or write:  
MCL, Inc., 10 North Beach Avenue,  
La Grange, Illinois 60525.

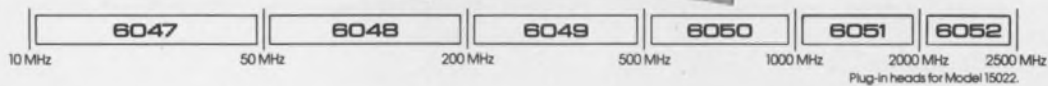

*Opportunities developing now for RF engineers at MCL, Inc. —  
an equal opportunity employer.*

INFORMATION RETRIEVAL NUMBER 15



# CUTLER-HAMMER SNAPS INTO ACTION WHEN YOU NEED PROTOTYPES.

Just watch our action when you call for service! The old-fashioned, dependable kind that just could be brand new to you. With fast application help, fast action on prototypes, and delivery dates you can count on.

Fact is, we snapped into action in a big way. Coming up with new lines of precision snap-action switches, designed and manufactured

in the Cutler-Hammer quality tradition. We have samples in stock for immediate inspection.

But remember. If we don't have exactly what you want already, tell us and we'll snap into action to get you a prototype promptly.

Call your Cutler-Hammer Sales Engineer or Switch Distributor and ask him how our snap-action switches (and service) can help you meet your product development schedules on time.

**Miniature**—Five different types with U.L. rating up to 15 amps. Four terminal styles. Choice of actuators—straight lever, roller lever, simulated roller lever.  
**Sub-miniature**—Four basic types with U.L. rating up to 10 amps. Four terminal styles. Same actuator choice as above.  
**Sub-subminiature**—Four basic types with U.L. rating up to 7 amps. Four terminal types. Actuators—a variety of lever, leaf and roller lever types.

Switch  
to No.1

More than just switches;  
prompt availability,  
field help, innovation,  
quality assurance, too.

INFORMATION RETRIEVAL NUMBER 16

Action you want.  
Action you'll get!



**CUTLER-HAMMER**  
SPECIALTY PRODUCTS DIVISION, Milwaukee, Wis. 53201

# Ampex memory power. Core modules at stack prices.

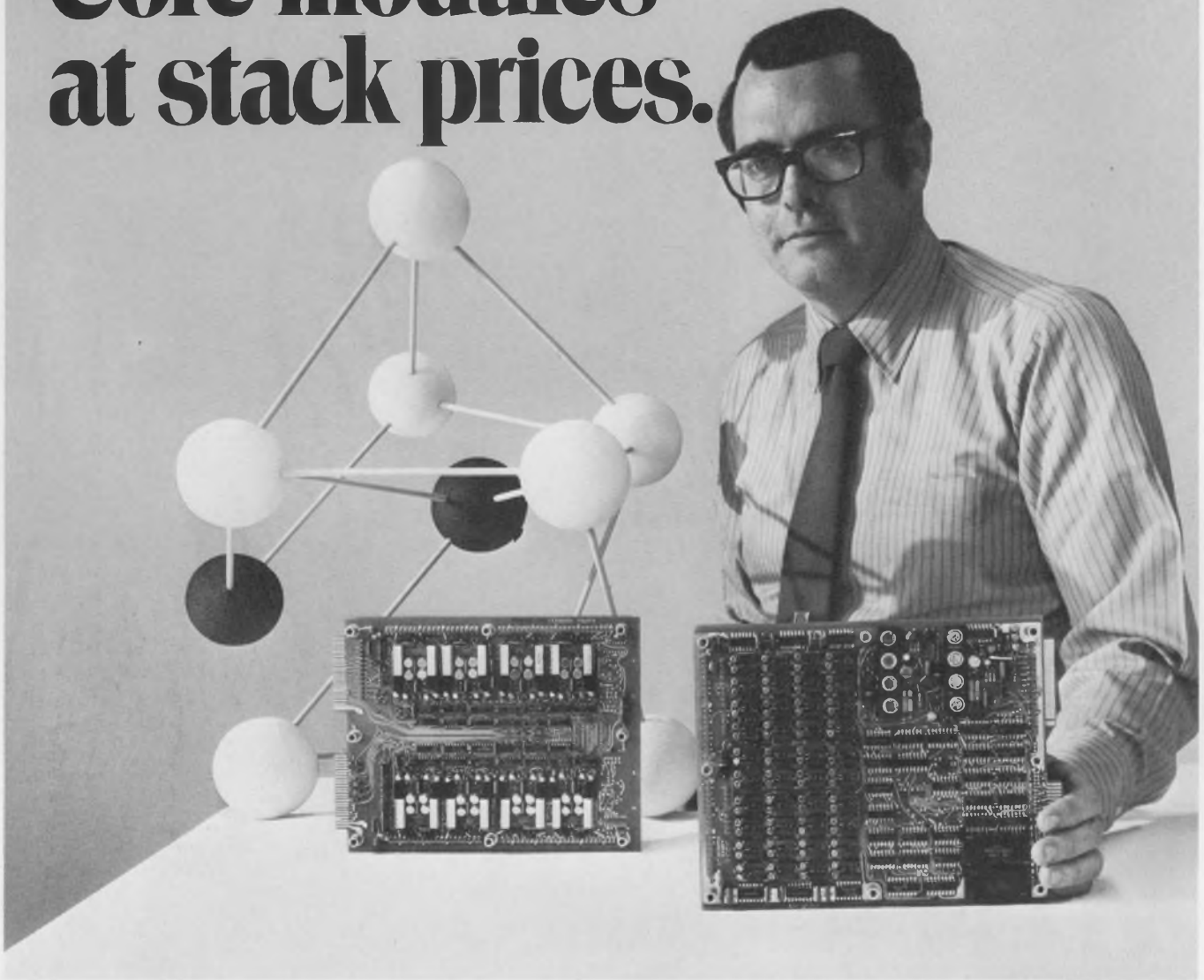

## So why design your own memory?

Ampex 1800 memory modules make real economic sense in both performance and design. No longer any need to design around purchased stacks.

The compact 1800 series modules give you twice the memory in half the space. Up to eight thousand 18 bit words in just 170 cubic inches. Combine any number of modules for the capacity and word length you need. High performance, too: access times of 250 and 340 nano-seconds.

For effortless design, all 1800 modules have decoding circuits, buffered data outputs, require only two voltages, need no temperature compensation or power sequencing. In other words, no external logic required.

Ampex 1800 modules were the first of their kind . . .

and are still the best, and, of course, they come with Ampex worldwide service.

For details on how to get best memory module performance with least design effort, call your Ampex computer expert. He can fill you in on Ampex tape and disk drives, too. Or write.

# AMPEX

**Ampex Computer Products Division**  
13031 West Jefferson Boulevard  
Marina del Rey, CA 90291. (213) 821-8933



## 5 kW in S band achieved by Navy lab's helix TWT

A broadband power output of 5 kW, continuous-wave in the S band—about twice that of other octave-bandwidth microwave tube amplifiers under development—has been demonstrated in a fluid-cooled helix-type traveling-wave tube.

A variation of the design can also operate as a high-power microwave attenuator.

The tube was designed at the Naval Research Laboratories in Washington, D.C. Its prime advantages, according to Lester Winslow, head of the laboratories' TWT section, include these:

- The tube can produce a high average or peak power output because of efficient cooling.
- The tube can deliver high peak-power outputs without oscillation—unlike competing designs—because of its unique characteristics.

The design, Winslow explains, is basically that of a hollow helix structure. Each turn of the helix is supported by two hollow ceramic tubes, each brazed to holes in opposites of each turn. There are 80 ceramic tubes.

The coolant, which was water in most of the Navy tests, is pumped into 40 inlet tubes and removed from the corresponding outlets. As a result, Winslow points out, each turn of the helix is cooled by flow of the coolant across the turn—at right angles to the helix axis.

The large volume of coolant flow across the helix turns provides highly efficient cooling of the design. But this feature is also responsible for the introduction of rf circuit losses in the water—a factor that permits outputs of high average and peak powers without oscillations in the tube.

James Burgess, head of TWT research and development for Varian, Inc., Palo Alto, Calif., calls the new tube "an impressive develop-

ment." But he does not see the design adapted to civilian use in the near future.

At present high-power tubes are used in communications systems, he notes, and the klystrons and coupled-cavity tubes now available have enough bandwidth for present needs.

## Low-cost sensor made for industrial controls

By improving barium titanate—a compound developed at Bell Telephone Laboratories in the mid-1950s—Texas Instruments has come up with an inexpensive positive-temperature-coefficient ceramic element that appears headed for broad application in industrial-control systems.

The potential applications include these:

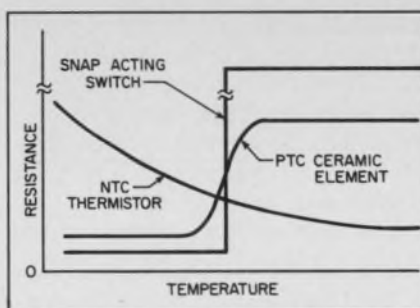

The new ceramic element's resistance-temperature characteristic is compared with a thermostatic snap acting switch and a negative temperature coefficient (NTC) thermistor.

- A self-limiting heater.
- Motor overheating protection.
- Current limiting.
- Time-delay relays.
- Detection of loss of fluid or cooling air.

The new device, developed at TI's plant in Attleboro, Mass., is made from doped barium titanate that can be formulated to change its conductivity abruptly from very high to very low levels at a predetermined (Curie or anomaly) temperature anywhere from 60 to 180 C.

The advantages of the new device, according to Andrew Loughlin, senior product specialist for TI, include its versatility and low cost—less than a dollar for each device in volume. The barium-titanate element can be used both as a heating element and as a thermal switch whose resistance changes four to six orders of magnitude at the anomaly temperature. The anomaly temperature is determined by the impurities added to the ceramic.

As a low-power, self-limiting heater, the new device can be used to replace wire-wound heating coils. In operation, the ceramic element starts out in its low resistance state, passes a high current and heats up. When the element reaches its anomaly temperature, it switches from the low to the high resistance state, limiting the current—and thus controlling the temperature. When the temperature goes below the anomaly point, the device heats up again, and a constant temperature is maintained.

Overheating protection and current-limiting applications require that the element operate in its low-resistance mode normally and switch to its high-resistance mode when too much heat is being produced and too much current drawn.

According to Loughlin, the new element can be manufactured in a wide variety of shapes and sizes.

## New CMOS offering 4-to-1 area reduction

Two-layer microcircuit technology, a high-density CMOS, will supplant TTL and conventional PMOS and CMOS logic, one of its developers predicts.

Now used primarily for 1-V electronic watch circuits, the high-density technique gives at least a 4-to-1 reduction in area compared with conventional CMOS circuits, according to John H. Hall, presi-

dent of Micropower Systems, Inc., Santa Clara, Calif. Hall collaborated with John Marshall, a vice president of the company, in developing two-layer microcircuit technology.

The high-density technique uses two layers of active devices, both having nitride passivation. In addition an outer layer of soft glass further protects the circuit against handling.

The secret of the new technique, Hall says, lies in two factors: the method used to deposit a two-layer metal interconnect and the use of high-value, thin-film resistors from 1000 to 100,000  $\Omega$  per square.

These resistors, Hall notes, can be deposited with a ratio match as close as 0.05% for a 10-bit a/d ladder network. The circuit densities, he says, are comparable to those of PMOS but show an improvement in speed-power performance. Parasitic capacitances associated with the conventional type of P-well diffusion interconnects are much less with the metal interconnect, Hall points out.

The speed of the high-density CMOS is high, with 5-V propagation delays of less than 40 ns and 10-V delays of less than 20 ns.

The unit cost per logic function approaches that of PMOS, Hall says, but the power-supply requirements are down by as much as a factor of 10 compared with those for TTL and PMOS.

## RCA endows 2 chairs at MIT and Harvard

Two chairs for the teaching and research of modern technology management will be endowed by RCA in the Sloan School of Management at the Massachusetts Institute of Technology and in the Harvard School of Business. The data resulting from the research are to be made available to all corporations and other potential users.

The grant, totaling \$2-million over 10 years, is a tribute to the late David Sarnoff, long-time chairman of RCA.

Announcement of the joint program was made by Robert W. Sarnoff, RCA's present chairman, at an MIT luncheon in Cambridge, Mass. Dr. Jerome B. Wiesner,

president of MIT, said that the teaching would focus on "the assessment of technological processes and transfer, the management of innovation, the creation of complex yet reliable systems, and the interaction of technology, business and society."

The two professorships will be held by Dr. Richard S. Rosenbloom of Harvard, whose specialty is "the management implications of social and technological change," and Dr. Donald G. Marquis of MIT, who has headed the school's research program in science and technology management.

## Hall-effect transducer replaces resolvers

A new Hall-effect gimbal angle transducer described by a Raytheon project manager may replace conventional resolvers assemblies in some applications.

Described at the recent National Electronics Conference and Exhibition in Chicago, the device is said to offer a 7-to-1 cost advantage over conventional resolvers and a 3-to-1 decrease in size.

In a paper entitled "The Hegat (Hall-effect gimbal angle transducer)—A New Concept in Angular Measurement," Barry N. Levitt, project manager at Raytheon's Missile Systems Div., Bedford, Mass., presented details of the transducer. He said it could provide all the functions of electromechanical resolvers with an accuracy of 10 minutes of arc over a range of 360 degrees. Until now Hall devices have been used in gyro pick-offs, and a range of only about  $\pm 1$  degree was required.

The Hall-effect gimbal angle

transducer was developed for the Air Force for use in low-cost inertial platforms, Levitt said, but it should also find application in gimbal antennas and missile-control systems. It may also replace potentiometers in many applications, he added, because it is much more reliable.

## Further research due on organic solar cells

Solar cells are the prime power source for many spacecraft, but their high cost so far has made them impractical for general use. Scientists at the University of Pennsylvania's Energy Management and Power Center in Philadelphia hope to change that. They have received a grant from the Air Force Cambridge Research Laboratories to conduct further research into the potential of solar cells made of organic materials.

The concept is not new. In the last decade the Cambridge Research Laboratories, RCA, Esso Research and others have investigated the possibility of using organic semiconductor materials as solar cells. The idea was to make them as easy to manufacture as plastic films—and as cheap as the films. But although such devices have been made, their performance has been poor.

In describing the goals of the new research, Martin Wolf, associate professor at Penn's Energy Management and Power Center says: "Many organic materials are cheaply available now and can be easily rolled out in films. The hope is that maybe we can make a solar cell just about like we make a cheap polyethylene film."

## News Briefs

**Agreement on terms for a jointly owned company to provide nationwide satellite communication services** has been announced by the Communications Satellite Corp., Lockheed Aircraft and MCI Communications Corp. Each of the three corporations will have a one-third interest in the new company. Copies of the agreement have been filed with the Federal Communications Commission. The agreement is subject to the com-

mission's approval. According to industry sources, **Texas Instruments is getting ready to introduce a line of CMOS integrated circuits.** It is not yet clear what approach TI will take, but speculation is that the company will produce devices that are compatible with the RCA CD 4000, Motorola 14500 and National 54/74 C series. Questioned about the CMOS rumor, TI officials refused to comment.



# Better system protection against transient voltages

## ... Better than selenium

Both DC and AC models now available.

GE-MOV™ metal oxide varistors make use of a new technology. They provide tight voltage clamping and high energy absorption . . . better than selenium. Present models offer AC voltage ratings from 100 to 1000V. Energy absorption ratings range from 10 to 160 watt-seconds (joules).

Prices are as low as \$.70 in quantity lots. For more information, including a FREE EVALUATION KIT, call your local authorized GE semiconductor distributor . . . or write to General Electric Company, Semiconductor Products Department, Building 7, Mail Drop 49, Electronics Park, Syracuse, N. Y., U.S.A.

### GE-MOV SUPERIOR FEATURES:

- Clamping Ratio
- Size
- Peak Current
- Energy Density

### COMPETING SELENIUM SUPPRESSORS

Mfrs.	Commercial or Trade Names	Device Nomenclature			
		Selenium Suppressors			
		1 inch Square	2 inches Square	4 inches Square	5" x 6"
IR (W)	Klip-Sel Volt-Trap	KSA ----	KSL ----	KSP ----	KSF ----
		SO1. 2AA --	SO3AA ----	SO6AA ----	SO9AA ----
			SO4AA ----		
Syntron Sarkes Tarzian	Surge Stop Klip Volt	SD1544 --	SD2650 --	SD2411 --	SD2452 --
		2KV26 ---	5KV26 ---	7KV26 ---	10KV26



OUR NO. 1 GOAL:  
TO MAKE  
GENERAL ELECTRIC  
YOUR BEST BUY

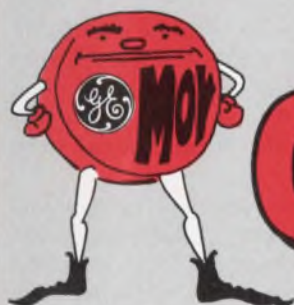

# GE-MOV™ VARISTORS

## ASSURE YOUR EQUIPMENT WILL ENDURE

# Assembly-line test systems stop the defects before they're built in

Industrial electronic test systems—for product design, machine-tool controls and process controls—are making increasing use of digital techniques and sophisticated computer-controlled acquisition, display and analysis of test data.

The reason? A rising need for systems that can conduct multiple tests simultaneously and provide test results of greater accuracy, unbiased by human evaluation. Among the factors that have created this need are these:

- Crackdowns by governmental bodies on air and water pollution, noise and product-defect hazards.

- The rapidly rising cost of labor, forcing manufacturers to reduce labor and yet increase productivity.

- Consumerism and its demands that manufacturers make good on any shortcomings in their products.

From kitchen appliances to automobiles, manufacturers are resorting to exhaustive testing to spot potential trouble before it leads to governmental curbs or excessive warranty costs.

## Auto industry automates

Many of the new computerized test systems are emerging in the automotive industry, some with partial computer control of the tests, others with fully automatic control. Tests that formerly took days to conduct and evaluate manually are now being done in minutes.

Both automotive manufacturers and testing services for the auto industry are using complex, multiple-sensor computer-controlled systems, like those produced by Process Computer Systems, Inc., of

**Jim McDermott**  
Eastern Editor



**Multiple test stands** at Ford's Allen Park facilities use computers and magnetic tape storage to acquire and process test results. Each of the test stalls is operated and monitored from its own control console.

Flint, Mich. This company's systems, which are controlled by Hewlett-Packard 2100 computers, perform government and state certification tests on auto bodies, transmission and drive trains, and engines.

One type of installation is being used for exhaust-gas analysis during engine development. The computer, according to Gary Johnson, marketing manager for Process Computer Systems, provides programmed instruction for the test.

The exhaust-monitoring system automatically calibrates, averages and linearizes the digitized analog outputs of the gas analyzer system used to detect the pollutants. A test report is provided by computer readout as soon as the test cycle is completed.

The advantage of this type of system, Johnson says, is that it not only provides test-passing or test-failing data, but also reduces the data to a form that permits the engineers to analyze the reasons for failure.

The rapid growth in application of these systems can be judged from the fact that Process Computer installed its first three test systems—which range in cost from \$40,000 to \$200,000—in 1968. Last year the company set up 20 new installations, and this year it expects to install 25 more.

## Portable testers developed

The Ford Motor Co., according to Paul Brenton, senior research engineer at Emission Test Laboratories, Allen Park, Mich., is developing a new concept in portable exhaust-analysis equipment. Individual analyzer systems are being mounted in upright consoles that can be readily moved—or altered, or assembled in a group—at a test site. Previous installations were fixed.

Ford's new emission test systems use the latest chemiluminescent detectors to measure nitrous oxides and ionization detectors to measure hydrocarbons, says Brenton.



**Portable on-board instrumentation** is used for tractor testing. This Honeywell multiple-channel Visicorder is recording cylinder-head temperature, exhaust temperature and tractor-frame dynamics to check the suspension.

Previous analysis equipment was fully manually controlled, Brenton points out. The newest systems have sufficient computer control to reduce test-stand labor, requiring only limited manual control (see photo).

"We're designing our latest equipment so that it can all be computer-interfaced," Brenton reports, "and our trend is to eventual total computer operation. We're about three-quarters of the way there and expect to see computer operation within a year."

At present, Brenton explains, Ford has two multiple-station test laboratories—one in Dearborn and the other in Allen Park—about two miles apart.

The outputs from exhaust analyzers at each laboratory are fed into a Xerox Sigma 3 computer for central processing.

I. David Long Jr., manager of technical process systems planning for the Chrysler Corp., Detroit, says:

"Our big interest here is in test-

ing to reduce both in-plant and warranty costs. We use the computer-controlled test systems because they do a better job of testing with less manpower."

A good example, he points out, is a computer-controlled test for automatic transmissions at the Chrysler transmission plant in Kokomo, Ind. This system, he says, uses twin General Electric 420 computers as redundant systems to avoid shutdowns.

Growing interest in fatigue analysis for equipment is demanding new portable test equipment, says William A. Buck, marketing manager for EMR-Instruments, Sarasota, Fla., not only for private and sporting vehicles but also for tractors and earth moving equipment. The high cost of vehicle recall, Buck says, makes it attractive for major manufacturers to make sophisticated multichannel fatigue studies of such components as rear axles, engine mounts and other vehicle elements.

These tests require programmed



**Hewlett-Packard airport monitor** checks jet noise levels fast enough to warn pilots of excessive levels.

shaking, pushing and twisting actions. For this purpose, EMR test systems can generate a digital fatigue profile—a punched tape that represents a road surface or other dynamic forces that a vehicle will encounter. From the digital tape, analog signals are generated for driving the load frames on which the equipment is tested.

Another trend, Buck notes, is replacement of the umbilical cord in vehicle test-track work with a telemetry system. Particular interest is being shown by manufacturers of recreation vehicles, such as minibikes, motorcycles and snowmobiles. The problems of monitoring the dynamics of strain, torque, vibration, temperature and other functions with a test vehicle bounding over rough terrain and through woodlands can't very well be done any other way than by telemetry, Buck notes.

EMR vehicle telemetry systems, he says, can transmit multiple channels of data over distances up to 1.5 miles, leaving the vehicle

free to maneuver without restriction. These systems apply the analog outputs of the on-board transducers to voltage-controlled oscillators, which generate frequency-modulated, multiplexed signals for transmission from the vehicle to a mobile receiving station (see photo).

For the 1.5-mile system, up to 14 data channels are available, Buck says, each with a maximum data response of 1000 Hz. These signals are transmitted in the 215-to-220-MHz band.

In water-pollution monitoring, Buck notes, there is an increasing need for reliable telemetry to link remote stations, where the sensing is done, to a central station, where there are display, recording and data-processing facilities.

### On-board monitoring, too

Allen Tucker, director of marketing for the Honeywell Test Instrument Div. in Denver, describes another approach. Honeywell provides a complete on-board monitoring and recording system that produces a visual record of the tests without the need for telemetering. It has produced a generation of rugged instruments called Visi-corder Data Systems.

These instruments are of light weight with durable frames and shock-mounting of sensitive components to protect against vibrations from the vehicle or device under test. Typical applications, says Tucker, have been in monitoring outboard-motor performance and in recording test data on garden tractors (see photo).

To study and evaluate noise—from the loud sounds of jetports to the smaller sounds of car fans or windshield-wiper motors—new generations of computer-operated spectral-analysis equipment are being produced. For example, a system by Hewlett-Packard—the Model 80500A Aircraft Noise Monitor (see photo)—measures the noise level of jet engines at several points around an airport. The sound is picked up and its intensity measured by monitoring terminals controlled by an HP 2114A or 2115A digital computer. The evaluation is a complex function of the sonic frequencies present, as well as of the bandwidths and frequency separation of the sound com-



Measurement of waste-water pH with Leeds & Northrup tester gives a check for water-treatment operation.



EMR telemetering system on board the minibike transmits field test data to the portable station at left.

ponents.

The system works fast enough for airport personnel to communicate with a pilot as soon as excess noise is detected.

Without the computer system, Honeywell estimates that a six-terminal monitoring system requiring perhaps six to eight people would be needed to collect and analyze the same data over extended periods of time.

Some five or ten years ago, says Henry J. Bickel, president of Federal Scientific Corp., New York, noise produced by consumer prod-

ucts such as vacuum cleaners, fans and blenders was considered to indicate their power and also of the fact that they were in good working order. Not so today, he insists.

Noise is now recognized, Bickel says, as a source of lost power. But more important, analysis of the noise can provide an indication of immediate or potential failure.

The use of spectral analysis instruments to measure noise is increasing at the rate of some 20% to 25% per year, Bickel says. This, he points out, is considerably greater than that of the electronic instrument field in general, which is about 10% per year.

### Verification of machine-tool tapes

Many of the newer electronic industrial test systems are designed for highly specialized applications. One is the Tektronix 1791 Numerical Control Program Verifier (see cover photo). This machine verifies whether or not a numerical-control tape has been programmed with the correct machine-tool motions along the various axes.

While the concept of numerical control for machines is sound, Glen Dower, marketing manager of the machine-tool group at Tektronix, says that considerable human error exists in the computer programming. It is not unusual, he says, for a tape to be sent back and forth from four to six times between the programmer and the production department while the tape is verified on the machine tool. This is time-consuming, he notes, and the machine tool is unproductive in this interval. Even more important, he adds, there is the possibility of costly damage to the machine during the verification like this, if the tool tears into the machine table or the side of a part because of tape error.

To verify a numerical-control tape, the Tektronix 1791 shows the path of the tool on a storage-tube display. The tape can be read at 500 characters per second or at a slower rate. The operator watches for errors and identifies the portions of the tape that must be reprogrammed. The tool path plot can be displayed in any of five formats: three-dimensional oblique, plan views in the X-Y plane, in the X-Z plane, in the Y-Z plane, or lathe. ■■

# Press here to save on lighted pushbutton switches.



**buys all  
the switch  
you need.**

Oak's Series 300 gives you good looks and a small price-tag in lighted pushbutton switches. Plenty of switching performance for most jobs, without paying a premium. Even the Series 300 Split-Legend/4 Lamp Switch is less than \$1.60 (normal latch, 2P2T, glass alkyd insulation, no engraving, less lamps.)



## Built to take it.

Series 300 is built for reliable performance and long life. Applications galore — bank terminals, calculators, and copy equipment.

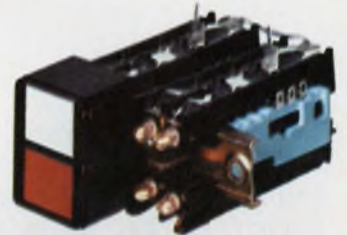

## Modular design.

Single-legend/single-lamp, split-legend/4-lamp, and single-legend/redundant lamp switches have snap-on lamp holders. Plus replaceable legend plates, lens caps, and button assemblies. Front-panel relamping, too, without special tools on all types.

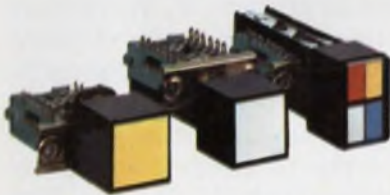

## Three versions with switching up to 4P2T.

Choose from single, dual, or four lamp display as well as non-lighted type. One to twelve station, momentary, interlock, alternate action, or any combination available on the same switch bank. Lockout feature available for all types. Power Module 3A125VAC. Lighted indicators are identical in size and appearance, but without switching.

## Gang them up by the dozen.

Order up to 12 switching stations on a single channel, any switching mix, with convenient panel-mounting studs. Color selection: white, lunar white, yellow, amber, orange, red, green, blue. Choose silk-screened, hot-stamped, or engraved-and-filled legends. Split-legend switches can be specified with any two, three, or four colors on insertable legend plates.



**Write for our Series 300 Brochure**

**OAK Industries Inc.**

SWITCH DIVISION / CRYSTAL LAKE, ILLINOIS 60014  
TELEPHONE: 815 • 459 • 5000 • TWX: 910 • 634 • 3353 • TELEX: 72 • 2447

INFORMATION RETRIEVAL NUMBER 19



## Nixon vs McGovern



# Two views of engineering issues

In this election year electronics engineers want to know how the candidates stand on issues that affect the engineer's welfare, his career and his profession. *ELECTRONIC DESIGN* wrote to both President Nixon and Senator George McGovern, inviting their views on a number of questions that concern the electronics engineer and the industry. Both responded with lengthy position papers. Here are questions that were asked and key excerpts from the candidates' responses.

**If elected, what steps will your Administration take to stabilize, once and for all, the cyclical unemployment in major sectors of the electronics industry? What can be done with the thousands of unemployed and underemployed electronics engineers as a result of the recent recession?**

**NIXON:** The actions taken to reorient and re-employ displaced aerospace and defense-industry engineers, scientists and technicians—including specialists in electronics—include the following:

1. Assistance and retraining programs were authorized in such fields as pollution control, city and urban management, and transportation technology.

2. The Civil Service Commission established a program to assist individuals being terminated from government as a result of the defense and aerospace cutbacks; the Defense Dept. took similar action to assist displaced civilian employees.

3. The Dept. of Labor set up job information banks throughout the country to match local job opportunities with available labor.

4. In April, 1971, Labor Secretary James Hodgson announced a multimillion-dollar Technology Mobilization and Re-employment Program specifically to assist in the re-employment of scientists, engineers and technicians.

**McGOVERN:** The unemployment crisis among

electronics engineers arose from a failure to plan realistically for the impact of the present recession, the decline in aerospace and military spending, and the huge number of technically trained people that our colleges and universities have been producing. In order to solve this crisis, it is necessary to vastly increase Federal spending on research and development directed toward civilian needs. We should promote an atmosphere more favorable to independent enterprises launched by individual electronics engineers. Similarly we should be prepared to subsidize the trial employment of unemployed engineers and scientists by private firms in order to bridge the gap between the unemployed technologist and the firm that could use his talents.

**What can be done to make the electronics industry less dependent upon fluctuations in defense spending?**

**NIXON:** The electronics industry today is considerably less dependent on defense spending than in the past. For instance, the electronic components industry, which manufactures the building blocks of all electronics products, has shown a marked increase in the dollar volume of these components going to the nondefense sector. In 1961 nearly 39% of the \$2.4-billion in components



# Nylon. A new twist in cutting circular connector costs.

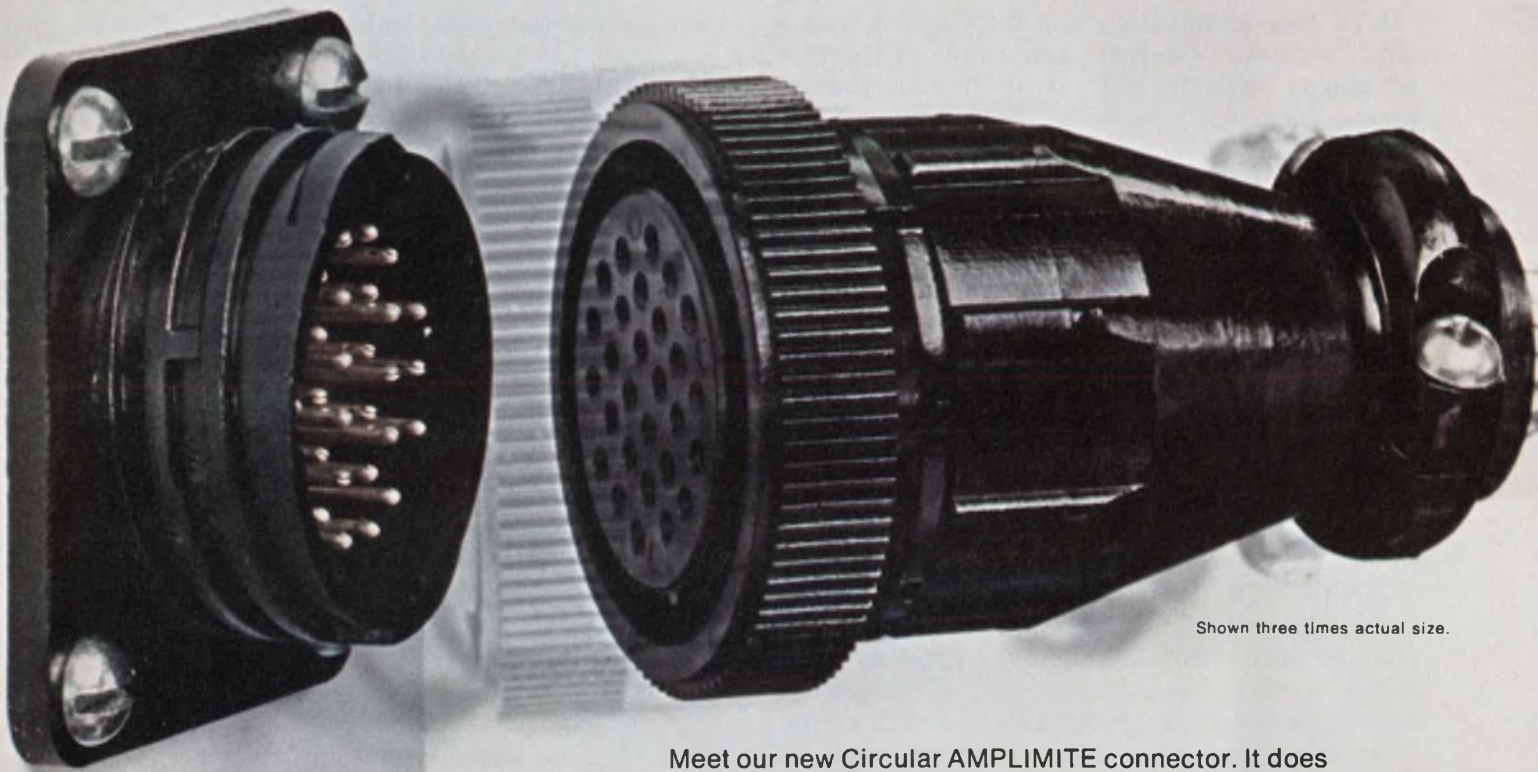

Shown three times actual size.

Meet our new Circular AMPLIMITE connector. It does everything a metal-shell connector will do. Except cost lots of money. We make it of high-strength, glass-filled nylon. So it's just as rugged . . . but lighter, nonconducting and less expensive.

Circular AMPLIMITE connectors cost less to buy. And less to use . . . because you can terminate their pin and socket contacts on our high-speed, automated, customer-provided machines. And load only the contacts you need.

We make this new nylon connector in most popular sizes, including 63-position,  $1\frac{1}{8}$ -inch O.D.; 28-position,  $1\frac{1}{8}$ -inch O.D.; and 8-position,  $1\frac{1}{8}$ -inch O.D. Mountable or free-hanging. Standard or splashproof. Rated 7.5 to 15 amp.

Ready for a new twist in circular connectors? Write for details to **AMP Incorporated, Industrial Division, Harrisburg, Pa. 17105.**

AMPLIMITE is a trademark of AMP Incorporated.

**AMP**  
INCORPORATED

Manufacturing and direct sales facilities worldwide: Barcelona, Brussels, Buenos Aires, Frankfurt, London, Mexico City, Paris, Puerto Rico, Sao Paulo, s'Hertogenbosch (Holland), Sydney, Stockholm, Tokyo, Toronto, Turin, Vienna.

151 PLEASE SEND LITERATURE—IMMEDIATE INTEREST.

152 PLEASE SEND LITERATURE—POSSIBLE FUTURE INTEREST.

manufactured were shipped for defense use. By 1971 the defense share was only 18% of the nearly \$5.4-billion of such shipments.

**McGOVERN:** By trimming the defense budget as I have proposed—eliminating needless waste and overkill, while maintaining a credible and lean attack force—our nation can better use its financial and technical resources toward meeting its domestic needs. Thus electronics workers and others will no longer be dependent on fluctuations of defense spending but rather will earn their livelihood through work directed at social progress. There will always be new frontiers to explore and greater social problems to solve.

**What do you intend to do about the import imbalance in consumer electronics? In fact, what can be done to make it easier for U.S. electronics manufacturers to export their wares in the face of import obstacles set up by foreign governments, particularly Japan?**

**NIXON:** In 1971, exports of all electronic products exceeded imports by \$434-million. Yet in consumer electronics there are problems, and the Administration is doing something about them:

- We are attempting to expand our trade opportunities overseas and stop unfair foreign competition, such as dumping, in domestic markets.

- We are working with other nations to prevent the erection of nontariff barriers.

- At the moment the U.S. is negotiating with Japan to lift quotas on imports of integrated circuits—a move that could open a sizable market to the American electronics industry.

**McGOVERN:** Trade between Japan and the United States in consumer electronics is biased and one-sided. While we allow the Japanese total access to our domestic markets on almost all commodities, our exporters are faced with an unbelievably complicated maze of controls and administrative restrictions in attempting to sell in Japanese markets. Moreover the administrative collusion between the Japanese Government and Japanese industry redoubles the difficulty faced by American exporters.

There are several things we can do. First, we can insist that if trade is going to be open, it will also have to be fair. This means compelling the Japanese to give American exporters more equal access to Japanese markets. Second, we can enforce vigorously the antidumping provisions of current laws so as to prevent American markets from being flooded illegally with foreign commodities at prices below their costs.

**Since research is the key to maintenance of technical superiority, what are your plans to keep the U.S. on top via consistent Government support of research and development?**

**NIXON:** The nation will spend about \$28-billion this year in goods and services associated with R&D. The FY '73 Federal budget calls for R&D expenditures of \$17.8-billion an 8% increase from last year. Defense Dept. and NASA research contracts account for more than half of the Federal outlays.

It should be pointed out that the character of the Federal budget has been changed over the past few years, signaling a change of priorities in our nation. In 1970, for the first time in two decades, spending for human resources exceeded defense spending in the Federal budget. Human resources spending received 42% of the 1971 Federal budget; defense, 35%.

**McGOVERN:** If we are to finally meet some of our unmet domestic needs—in areas of housing, mass transportation, medical care, pollution abatement, and public safety, to mention only a very few—we must dramatically increase our Federal commitment to civilian research and development. At present the United States spends only 1.1% of its Gross National Product on research and development directed toward economic growth. This is literally one-half of the commitment made by the major Western European nations and Japan—presently at an average of 2.2%. Moreover our export of technology-intensive products is presently only 50% greater than our import. In 1960 it was four times as great.

**Do you have any plans to modify the winner-take-all method of awarding Government contracts, with its disastrous effects upon both the losing company and its geographic region?**

**NIXON:** First, let's establish the fact that when there are competing bidders, whether Government or industry is calling for bids, somebody has to lose out as prime contractor. But the practice of "winner-take-all," as you call it, particularly in large Government contracts, is rare.

For example, North American Rockwell, the prime contractor in NASA's space shuttle orbiter program has indicated that more than 50% of the multibillion-dollar contract will go to some 10,000 subcontractors, possibly including Grumman, McDonnell Douglas and Lockheed Aircraft Corporation, losers in the contract bidding to read-contract bidding.

**McGOVERN:** In awarding contracts, the Federal Government must take several criterion into consideration. For example, the industry which possesses the best means of producing a given product should normally receive the contract. However, with conversion as an added problem, contracts may have to be awarded on the basis of geographical location, at least initially. Areas hard hit by military cutbacks would receive assistance through civilian contract awards and aid to displaced workers. ■■

Type EJ, the pot  
with rotational life  
in excess of  
1 MILLION CYCLES.

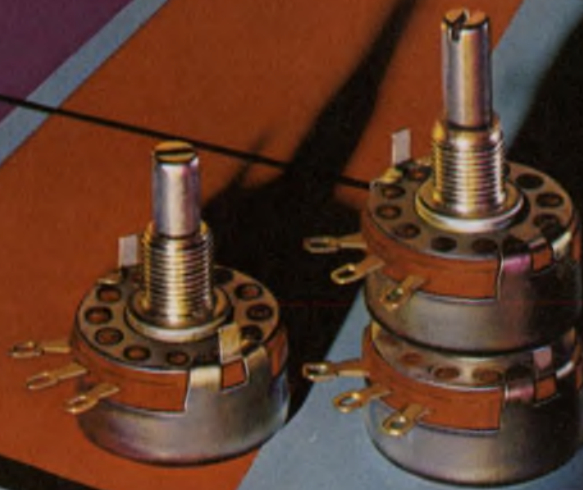

If you're really  
serious about cost,  
be serious about quality.

This is the EJ, an extended life version of our famous "J" pot. Same dependable performance. Same power handling capability. Same quality throughout, but with a tremendous difference in rotational life. One good turn after another for more than 1,000,000 cycles (under normal use

within ratings per Publication 5230). Specify the EJ for electronic organs, lift trucks, automotive and process control applications. Hot molded composition, 2.25 watts. Resistances from 50 ohms to 5.0 megs. Usable from  $-55^{\circ}\text{C}$  to  $+120^{\circ}\text{C}$ . Five standard tapers. Single or dual sections.

Request Publication 5230. Allen-Bradley Electronics Division, 1201 South Second Street, Milwaukee, Wisconsin 53204. Export: Bloomfield, New Jersey 07003. Canada: Allen-Bradley Canada Limited, Galt, Ontario. United Kingdom: Jarrow, County Durham NE32 3EN.



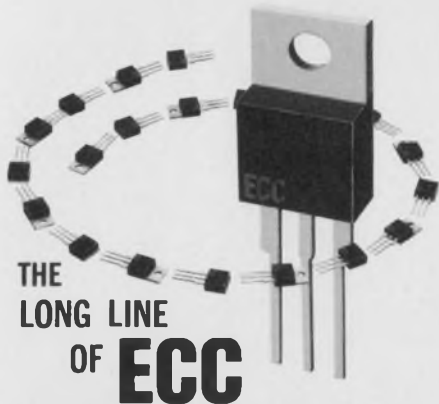

THE  
LONG LINE  
OF **ECC**

THERMOTAB® & THERMOPAK\*  
**TRIACS**

World's leading  
Triac producer offers  
fast delivery,  
electrical isolation  
and competitive pricing.

**THERMOTAB and THERMOPAK TRIACS**  
(Electrically isolated tab)

- Wide current range  
 $I_{T(RMS)}$  0.8 - 16 amps
- High voltage capability  
 $V_{DROM}$  200 - 800 volts
- High surge current ratings  
 $I_{TSM}$  20 - 150 amps
- Sensitive gate triggering  
 $I_{GT}$  1, 111 3, 5, 10, 25, 50 ma

All ECC triacs feature heavily glass passivated junctions for high reliability. They are available from your nearest ECC Sales Representative or Authorized Distributor.

\* trademark of ECC



**NEW CONDENSED CATALOG** contains technical data on these and other ECC semiconductors.

To receive your copy, circle No. 246.

**ECC**  
CORPORATION

P. O. Box 669 • Euless, Texas 76039  
817/267-2601

## Optical communications links are successfully demonstrated

The promise of optical communications has brightened with two major demonstrations in New York City.

In one a color television picture was beamed over a three-quarter-mile zigzag link between the Columbia Broadcasting System Building and the New York Coliseum. It was the first public demonstration of laser transmission of color TV signals.

In the other demonstration, closed-circuit monochrome signals were transmitted over a 15-foot fiber-optics link. It was a successful test of the feasibility of sending broadband vhf signals optically.

The TV color pictures, which were of high quality, drew standing crowds at an exhibit put on by Laser Communications, Inc., at the Electro-Optical Systems Conference in the Coliseum. The pictures shown were those of regular CBS-TV programming.

CBS provided the video and

audio signals that were fed to a laser transmitter—the LCI-203, developed by Laser Communications—atop the CBS Building. Because buildings blocked a direct view to the Coliseum, the laser signals were relayed to a nearby receiver and from there to the Coliseum.

The transmitter, according to David M. LaFleur, general manager of Laser Communications, was a 1-mW helium neon laser radiating at 6328Å. Modulation was provided by a Pockels type of crystal with a bandwidth of 10 MHz.

Jonathan Freeman, marketing manager of Laser Communications, says the reliability of the system has been demonstrated to be better than 99% over four miles. "We've successfully maintained transmission through rain and heavy snow," he reports, "but heavy fog is our worst enemy." However, he points out, where poor weather conditions are known to exist, the laser beam can be expanded to pro-



Two-way TV communications system carrying pictures and voices between surgery in one hospital and anaesthesia department in other, by Laser Communications, Inc., provides facilities for sharing professional skills.

vide spatial diversity. Although snowflakes, raindrops or fog particles interfere with part of the beam, the remainder will carry redundant information, resulting in no loss of signal, Freeman says. Further reliability, he adds, is guaranteed by the fact that the links have a fade margin of greater than 40 dB.

### Fiber optics replaces coax

In the fiber optics demonstration a 56-mil Crofon optical fiber substituted for coaxial cable in carrying the broadband information. The bandwidth of the optical signal was that of Channel 2—54 to 60 MHz. The immunity of the system to electrical noise was demonstrated by running a spark tester alongside the fiber.

The demonstration, which also took place at the Electro-Optical Systems Conference was sponsored jointly by DuPont of Wilmington, Del., maker of Crofon, and Electro Fiberoptics, Inc., Boylston, Mass., designers of the optoelectronics system. The system used the modulated output of a 2-mW power helium-neon laser to transmit the Channel 2 optical signal down the fiber.

The output of the TV camera was applied to a video-carrier generator, according to Paul Dobson, project engineer at Electro Fiberoptics. The generator produced a 3-W rf carrier at a frequency of 55.25 MHz.

The sound signal was used to modulate a sound carrier at 59.75 MHz. The two signals were then combined and applied to the laser modulator. The modulator was a 45° Y-cut, four-element ADP crystal. It produced a low-level modulation index of about 2% for the demonstration setup.

The modulated output of the laser was applied to one end of the Crofon fiber. At the opposite end, the optical signal was demodulated with a low-noise pin diode and applied to a broadband amplifier with a gain of 40 dB.

The demodulated Channel-2 signal was connected to a standard 17-inch black-and-white monitor. ■■



If you could save up to 30% without losing anything by using this new 10mm ceramic trimmer capacitor, wouldn't you want to know it?

That's exactly what we can promise you for many applications. All the performance you need for about a third less than you've been spending.

These new trimmers have five capacity ranges from 3.0pF min. to 30.0pF max. Their operating temperature range is -30° C. to +125° C. And they mount interchangeably with other ceramic trimmers for PC applications. Four dielectric types available.

But check them out for yourself. Get the coupon in the mail today.

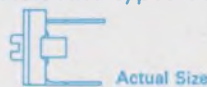

E. F. JOHNSON COMPANY/Waseca, Minnesota 56093. Dept. 3310  
You bet I'd like literature and a free test sample of your new low cost trimmer capacitor if it can do what you say!

Check capacitance (pF) range needed:

- 3.0 to 8.0       3.0 to 12.0       5.0 to 13.0  
 5.0 to 20.0       5.0 to 30.0

\_\_\_\_\_ Please send them directly.

\_\_\_\_\_ Please call me at: \_\_\_\_\_

Name \_\_\_\_\_

Firm \_\_\_\_\_ Title \_\_\_\_\_

Address \_\_\_\_\_

City \_\_\_\_\_ State \_\_\_\_\_ Zip \_\_\_\_\_



**E. F. JOHNSON COMPANY**

INFORMATION RETRIEVAL NUMBER 23

# THE HUGHES CONNECTION.

**It's a breakthrough, instead of a breakdown.  
With C-21 connectors, the greater the  
pressure change, the tighter the seal.**

Today's environmental connectors often begin to fail at pressures as low as 5 psi. The new C-21 keeps sealing even at 250 psi.

That's because we make atmospheric pressure changes work for you, not against you.

First, we got rid of the interfacial rubber seal commonly used today. It can take only low pressure changes before it starts leaking. Also, risk of leakage rises as the connector is coupled and uncoupled. And you can't change individual contacts without

endangering the whole seal.

Not good enough. So we developed a true environmental connector with individual pressure seals in front of and behind each contact.

They block out moisture, dust and other contaminants. As pressure rises, these small cup-shape seals, within their own special cavities in the connector body, only grip tighter.

Finger pressure is enough for connector mating. You can change contacts individually. And seals on

individual contacts.

The C-21 is designed for airborne, deep space, shipboard, and undersea applications in a wide range of sizes.

No other connectors with crimp-removable size 16 contacts approach the C-21 in sealing capabilities, versatility, or long life. Yet prices are competitive.

More information? Write: Hughes Connecting Devices, 500 Superior Ave., Newport Beach, CA 92663. Or call (714) 548-0671



**CONNECTORS, CABLES, CIRCUITS...ONLY HUGHES PUTS IT ALL TOGETHER.**



## technology abroad

An acidity/alkalinity meter and control system that can be used in all types of effluent-treatment systems has been designed by a Finnish company. The low-voltage output from pH electrodes is connected to a high-impedance preamp, amplifier and chopper. The transmitter output is a 44-to-20-mA current proportional to an input value of  $\pm 1400$  mA. Current ranges of 10 to 50 mA and 0 to 20 mA are also available, each corresponding to pH measuring ranges of 0-14. The design is by Ulmaelektro Oy of Helsinki.

CIRCLE NO. 441

A quick inspection system for printed-circuit boards and other complicated work pieces has been produced by Temco Tools of Bucks, England. Called the Mirror Viewer, the system has a glass screen that is partly covered with mirror strips through which the operator sees the work-piece reflection and the master diagram simultaneously. A special light-table arrangement permits the printed-circuit boards to be inspected for missing, partly obscured, wrong-sized or incorrectly placed holes. Bad holes appear to wink at the inspector as the work piece is compared with the diagram.

CIRCLE NO. 442

Improved methods of protection for 1-MV high-voltage transmission lines are under study by the French Electricity Board, Montroy, France. One solution, by Compteurs Schlumberger, consists of making measurements at the very-high-voltage line level and transmitting the results to the ground by means of optical fibers and infrared-emitting diodes. The ground data are processed by a computer that is programmed to indicate the nature and the position of the fault. Further research is being carried out to

improve the accuracy of the protection system. An accuracy of 0.5% at rated currents of 50 and 1300 A is expected. To achieve this, the company is studying a Faraday-effect magneto-optical current transformer that uses rotation of the polarization plane of a light beam by transmission-line current.

CIRCLE NO. 443

A two-dimensional array of semiconductor cells in the form of a toroid promises to give much larger semiconductor memories than are currently available, according to K. J. Dean of South East London Technical College, London, England. The toroid configuration, he says, will allow recirculation of data in either a circular or helical path around the device. In concept, the memory can be expanded to any size, because every memory cell can be connected iteratively to its neighbors. In practice, some additional cells could be connected to a rim for use as a solid-state disc storage. Several of these rims might be used to reduce the data reading time.

CIRCLE NO. 444

A rugged, high-capacity disc memory with a storage capacity of 93-Mbits is being developed under a contract awarded to Process Peripherals, Ltd., Berkshire, England. The project calls for a disc memory that can operate in hazardous environments. It is expected that the memory will incorporate a single disc with 400 tracks of information written by two independently controlled servos, one on each side of the disc. The second stage of the project is expected to be completed in 1973 and will be aimed at increasing the storage capacity of the disc to some 370 Mbits of data.

CIRCLE NO. 445

# Circuit Components? Call Hughes (714) 548-0671...

Ext. 305  
MOS integrated circuits (RS 222)

Ext. 204  
Bipolar/LSI technology and Hybrid circuits (RS 221)

Ext. 522  
Electrical connectors (RS 223)

Ext. 535  
Flat Flexible Cable and etched circuits (RS 224)

Ext. 207  
Quartz crystals, crystal filters and crystal oscillators (RS 227)

Ext. 204  
Special assemblies (RS 225)

Telephone the extension numbers shown for immediate information. For product literature, circle reader service (RS) numbers, or write to 500 Superior Ave., Newport Beach, CA 92663.

## HUGHES

HUGHES AIRCRAFT COMPANY

Industrial Electronic Products

# Amphenol sets your contacts straight



## for 30% faster terminations.

With Amphenol 97 Series connectors, the contacts *don't rotate* within the insert. They're pre-aligned—to stay aligned—so the solder cups are uniformly positioned for quick, easy soldering.

Test ours against the competition's. You'll find the soldering 30% faster, with less wasted motion, giving you lower termination costs. Our inserts are thicker, too. For extra strength and reliability. These benefits mean fewer scrapped parts during assembly, longer product life.

The 97 Series is basically the same connector as our original "Old Vet" AN (MIL-C-5015). In com-

mercial applications such as computers, traffic controls, dynamometers and welding controls, 97 Series connectors are lowering costs.

On-the-shelf inventory at your Amphenol distributor's means fast delivery, less for you to stock. Of all the orders we ship, 90% are straight from stock. Another good reason to specify Amphenol "97 Series" right on your drawings.

Get the "straight" story from our salesman or your Amphenol Industrial Distributor (AID). Amphenol Connector Division, 2801 South 25th Avenue, Broadview, Illinois 60153.



# AMPHENOL



# washington report

## **IBM antitrust suit reported near settlement**

The Justice Dept.'s three-and-a-half-year antitrust suit against International Business Machines charging monopolization of the computer market reportedly is near settlement, although the terms of an agreement probably will not be disclosed until after the Nov. 7 election to avoid accusations that the Administration is playing politics with its antitrust actions.

Justice Dept. lawyers reportedly would like to take the giant computer company into court and force it to divest itself of some of its operations, but top-level administrators in the Government indicate they may settle out of court, which probably would mean a more favorable outcome for IBM.

## **East-West trade barriers lifted further**

Trade barriers between the Communist blocs and the Western world are diminishing rapidly, the latest movement being a liberalization of export controls set by nations in the NATO Coordinating Committee. A number of electronic items have been struck off the committee's list, State Dept. officials report, but the nations involved are still hassling over computer standards. Meanwhile the Commerce Dept., under Congressional direction, is weeding out items from its own even more restrictive list, and it will give industry the word soon.

## **Defense budget heads for Senate-House conference**

The Senate had some good news and some bad news for the Defense Dept. as it voted the fiscal 1973 defense appropriations preparatory to final conference action on Capitol Hill.

On the good-news side the Senate restored these funds cut by the House: \$127-million for procurement for the advanced airborne national command post program; \$132-million so the Navy can buy Lockheed S-3A antisubmarine-warfare aircraft; \$25-million for the Navy's F model Sparrow Air-to-Air missile; \$20-million of a House reduction of \$36-million for the F-15 fighter aircraft, built by McDonnell Douglas; \$42.5-million for the Minuteman command-data buffer electronics program, and \$33.5-million for a new Army helicopter program to replace the canceled Lockheed Cheyenne.

As for the bad news, the Senate voted to make these reductions in the budget: \$104-million from the Navy's request to buy P-3C land-based

ASW aircraft from Lockheed; \$83.2-million from the A-7D aircraft program made by LTV, and \$30-million from the General Dynamics F-111 aircraft fund.

The Senate also agreed to House reductions in the Vietnam electronics sensor program; the DD-963 destroyer program; the Trident missile program, and the airborne warning-and-control program (AWACS). The Senate's concurrence in these cuts spells the end of any appeal on them from the Pentagon, but the other points of difference in the bill must be settled in a Senate-House conference before the Pentagon gets any money.

## **Laser standards under review**

The Dept. of Health, Education and Welfare's Bureau of Radiological Health will ask some 40 to 60 experts in laser engineering and biology for advice about wide differences in proposed laser-power safety standards between the bureau and the American National Standards Institute. The Bureau recently came up with power standards which in some cases would be some 1000 (one thousand) times lower than that ANSI would permit. BRH officials say industry representatives have expressed disagreement with both extremes. A meeting is planned in December.

## **U.S. to open antidumping hearings**

The Federal Tariff Commission will hold hearings beginning Nov. 28 on alleged Japanese dumping in the United States of color TV tubes. The FTC must determine whether domestic industry is being hurt by the lower prices charged by some Japanese suppliers. The issue is complicated by the fact that some American manufacturers use Japanese tubes, so that higher duties would drive up prices for that segment of the U.S. industry.

## **Airline anti-hijack sensors demanded by Congress**

Pressure for better anti-hijack screening devices is being generated by both houses of Congress in a bill (S 2280) calling on the administrator of the Federal Aviation Administration to see that all passengers and all property intended to be carried in aircraft cabins be screened by weapon-detecting devices. The bill says the FAA must furnish devices within the U.S. and would provide \$5.5-million for their purchase.

**Capital Capsules:** The Federal Communications Commission has proposed a rule to permit **splitting of channels in the aeronautical radio navigation band** because of frequency shortages in congested areas. Most aircraft avionics would work in a 50-kHz environment under the new rule, the Federal Aviation Administration says, except for glide-scope receivers, which would have to be replaced. . . . The House Committee on Science and Astronautics has issued a new report on **spinoff dividends from space**. It's available from the committee, Rayburn Building, Washington, D.C., 20515. . . . The Pentagon says no decision has yet been reached on whether to **accelerate the Trident-missile submarine program**, despite charges by Sen. William Proxmire (D-Wis.) that the planned number has been increased from 10 to 16.

**TEKTRONIX**  
committed to  
technical excellence

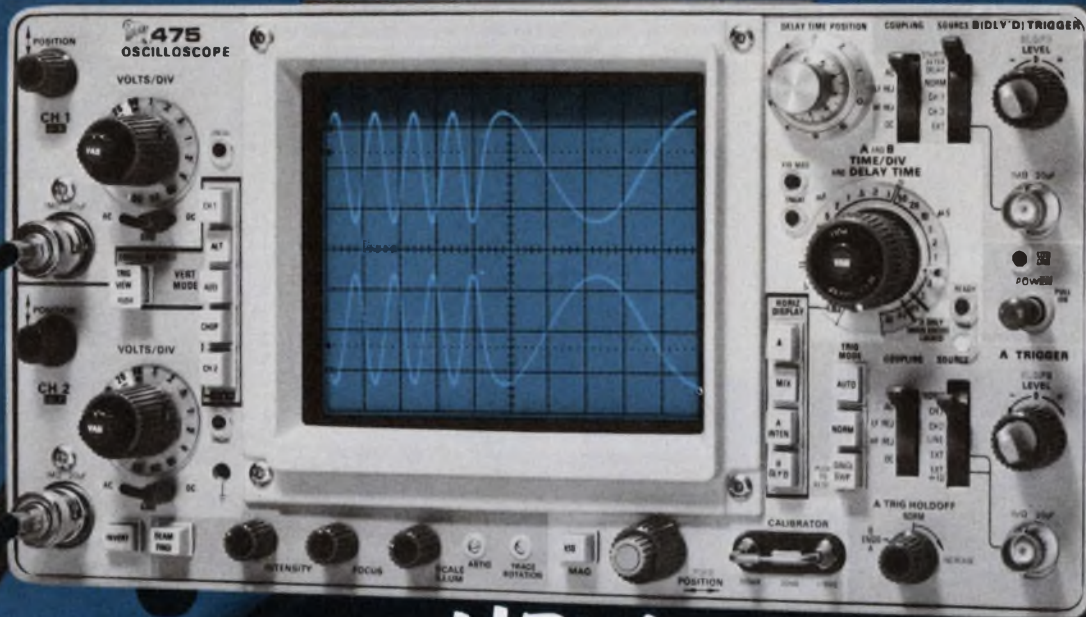

**NEW**

**value leaders =** higher bandwidths + lower prices  
faster sweep speeds + new operation conveniences + better sensitivities

The **NEW dual-trace TEKTRONIX 475 and 465 Oscilloscopes** supersede the world's most traveled and widely used general-purpose oscilloscopes . . . the TEKTRONIX 453A and 454A. They have significantly more bandwidth, twice the sweep speed, a bright 25% larger (full 8 x 10 cm) display and additional user conveniences. And all of this in a shorter, thinner, lighter and much lower-priced package.

The **200 MHz TEKTRONIX 475 Oscilloscope** at 2 mV/div and 1 ns/div sweep speed contains the highest gain bandwidth and sweep speed now available in a general-purpose portable oscilloscope and for only \$2500. Add to this many user conveniences including: push-button trigger view, knob-skirt sensitivity readout, ground reference button on the probe tip, simple to interpret vertical and horizontal mode push buttons and many more . . .

The new **TEKTRONIX 465** with 100 MHz at 5 mV/div and 5 ns/div sweep speed has all of the same user conveniences and service features as the 475 and is an outstanding price/performance package for only \$1725.

This outstanding performance and versatility with TEKTRONIX quality and laboratory accuracy makes these not only the finest field scopes available but also top contenders for use by development and design engineers. Optional DC or battery operation gives you a portable scope (25 lbs with panel cover and accessories) ready to travel and ready to make measurements at remote locations.

For complete information or to arrange a demonstration, contact any TEKTRONIX Field Office. Our offices are located in or near major cities and industrial centers—world wide. If you prefer, write Tektronix, Inc., P.O. Box 500, Beaverton, Oregon 97005.



200 MHz @ 2 mV \$2500

**value leaders**



100 MHz @ 5 mV \$1725

U.S. Sales Prices FOB Beaverton, Oregon

INFORMATION RETRIEVAL NUMBER 26

# Endangered Species

(Watch out punched tape, here comes a better alternate)

Building OEM or other data systems with punched tape? Now's the time to look into a better alternate: the PROVEN CartriFile® 20 magnetic tape subsystem.

CartriFile 20 makes better use of a minicomputer's speed capability: it reads 8.5 times faster, writes 50 times faster than high-speed paper tape units. It loads with compact, easily handled tape cartridges (a single CartriFile cartridge can hold as much data as 3,857 feet of punched tape). CartriFile 20 also has TWO independently controllable tape drives for truly efficient data handling, editing, formatting, and revision.

To system builders, CartriFile 20 is a new way of life. It's plug-compatible and supplied WITH: read/write electronics, controller, interface (available for ALL popular minicomputers), integral power supply, interconnecting cables, and basic software.

More good news. CartriFile costs less than most high-speed paper tape units. A typical system is only \$3650 with interface, \$2025 in small OEM quantities (without interface). There's even a "drive only" OEM version (the PD 20) for a mere \$795 in quantity.

Save yourself from the slow, noisy, messy punched tape bird today. Go CartriFile.



**TRI-DATA**

800 Maude Avenue/Mountain View/CA 94040  
Phone (415) 969-3700/TWX 910-379-6978

INFORMATION RETRIEVAL NUMBER 27

# “Scotchflex” Flat Cable Connector System makes 50 connections at a time.

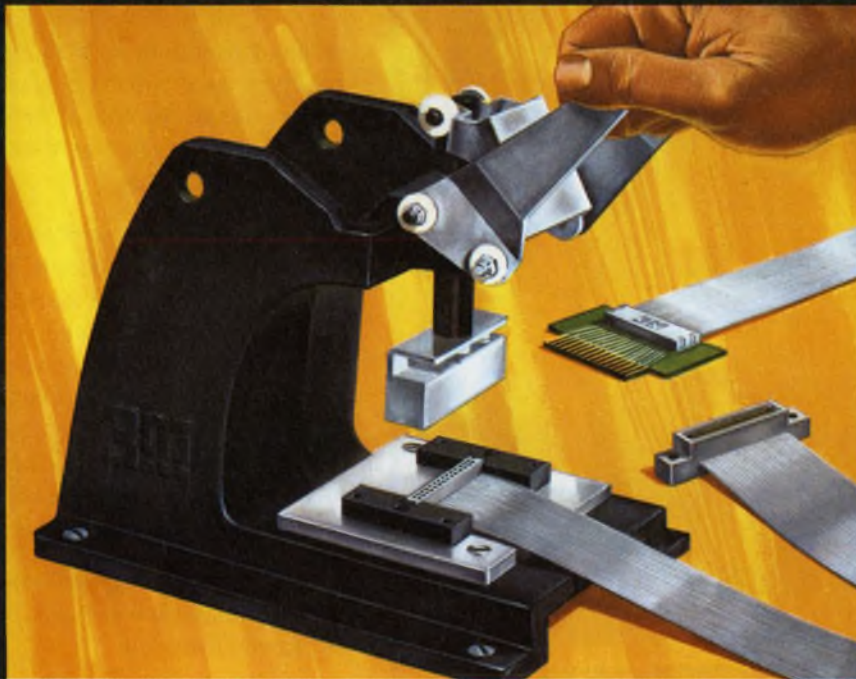

“SCOTCHFLEX” IS A REGISTERED TRADEMARK OF 3M CO.

Build assembly cost savings into your electronics package with “Scotchflex” flat cable and connectors. These fast, simple systems make simultaneous multiple connections in seconds without stripping or soldering. Equipment investment is minimal; there’s no need for special training. The inexpensive assembly press, shown above, crimps connections tightly, operates easily and assures error free wiring.

Reliability is built in, too, with “Scotchflex” interconnects. Inside of connector bodies, unique U-contacts strip through flat cable insulation, grip each conductor for dependable gas-tight connections.

“Scotchflex” offers you design freedom, with a wide choice of cable and connectors. From off-the-shelf stock you can choose: 14 to 50-conductor cables. Connectors to interface with standard DIP sockets, wrap posts on standard grid patterns, printed circuit boards. Headers for de-pluggable connection between cable jumpers and PCB. Custom assemblies are also available on request.

For more information, write Dept. EAH-1, 3M Center, St. Paul, Minn. 55101.



**“Scotchflex”.**  
**Your systems approach  
to circuitry.**

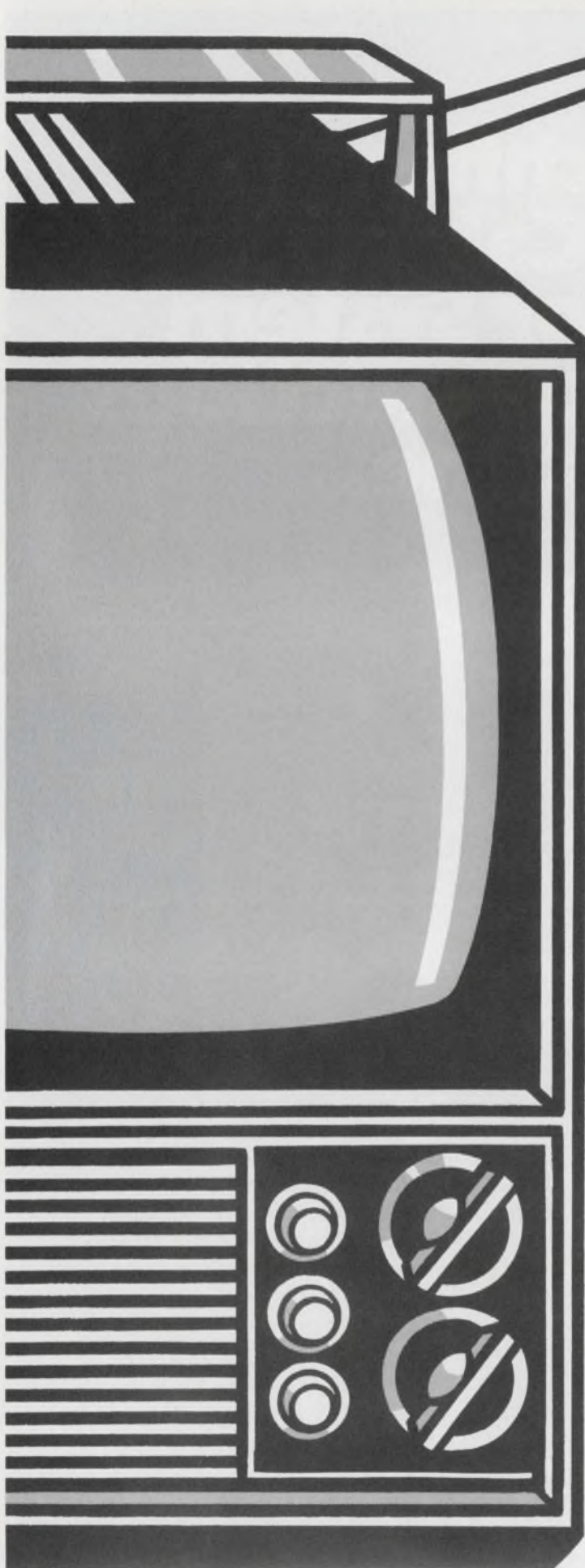

## **WE HELPED MAKE IT POSSIBLE!**

Remember those old television sets. They were bulky, heavy, used lots of electricity and had small screens.

Electronics technology has changed all that. Today's tv sets are small with large screens, portable and can work from batteries.

While Monsanto is not in the television business, we are in the business of making advancements like this possible through research and development of new electronic materials.

Take for example the silicon we produce for the semiconductor industry. The transistors and integrated circuits that replaced vacuum tubes in television sets are made from silicon. For over 13 years we have been researching every avenue to improve our production capabilities and the final quality of our material. And even though we believe that the material we produce today is the best available, we will continue to look for other ways to make it better.

Monsanto has the highest quality material available anywhere and our production is increasing every day.

**Monsanto materials  
make it happen.**

# **Monsanto**

*Advancements in electronics through  
materials technology.*

P. O. BOX 8 ST. PETERS, MO. 63376  
(314) 272-6281



## Introducing the little counter that can.

It can become four different systems.

It can go anywhere you do.

It can protect you against obsolescence.

It can make buying and maintaining a counter less expensive than ever before.

Meet the Hewlett-Packard 5300, the snap-together counter that's not much bigger than the palm of your hand. It has six digit accuracy, solid-state display and autoranging. It'll make period, frequency, time interval and ratio measurements, operate on its optional snap-on battery pack and drive a printer. Rugged dust-proof aluminum case resists almost any bumps it might get in the field. Prices start at only \$540 for one of the most amazing counters you've ever owned.

Start with the basic mainframe

(\$395). Then snap on any of the following modules (more on the way) to make just the counter you need, and avoid obsolescence, too:

10 MHz frequency module. Model 5301A, \$145.

50 MHz all-purpose module includes period, time interval. Model 5302A, \$275.

525 MHz module with both 50 $\Omega$  and 1 M $\Omega$  inputs. Model 5303B, \$800.

100 ns time interval module with: unique "time holdoff" feature, dc coupling, slope and trigger level controls, and period and frequency measurements to 10 MHz. All the functions you'd pay \$1200 for in a universal counter. Model 5304A, \$325.

Rechargeable battery pack module works with any of the other modules for

cord-free operation. Model 5310A, \$195.

The 5300 is one system you have to use to appreciate. If you've ever needed to accurately measure frequency or time interval, you owe it to yourself to call your nearby HP field engineer for further information. Or write Hewlett-Packard, Palo Alto, California 94304; Europe: P.O. Box 85, CH-1217 Meyrin 2, Geneva, Switzerland; Japan, Yokogawa—Hewlett-Packard, 1-59-1, Yoyogi, Shibuya-Ku, Tokyo, 151.

02109B

**HEWLETT**  **PACKARD**

ELECTRONIC COUNTERS

# STARK\*

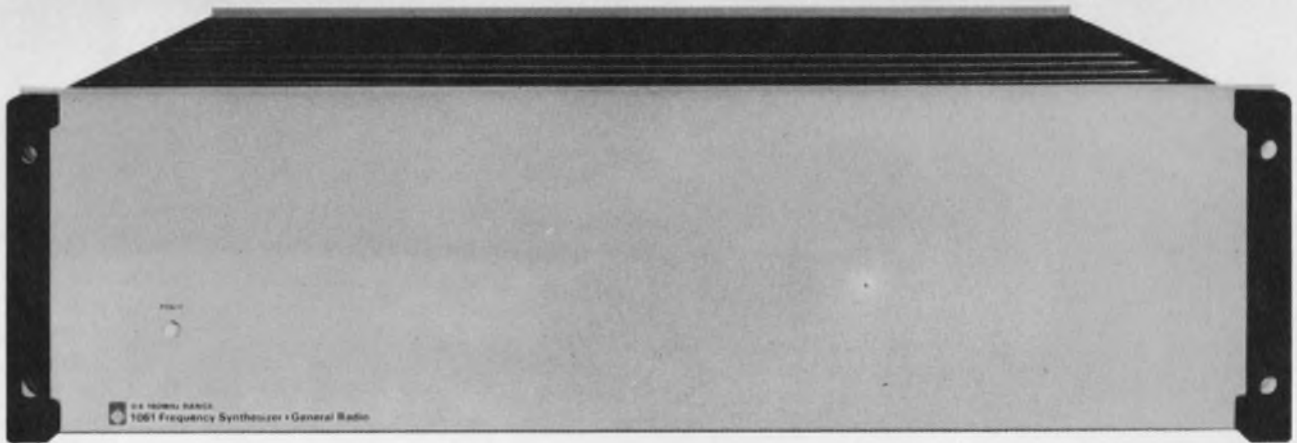

**... but bristling with performance — total performance that is unexcelled by any other frequency synthesizer:**

	GR 1061	Runner-up A	Runner-up B
Frequency	dc to 160 MHz	1 MHz to 160 MHz	10 kHz to 110 MHz
Switching Speed	< 100 $\mu$ s	1 ms	5 to 100 ms
Output Level	+ 20 dBm	+ 13 dBm	+ 13 dBm
Spurious	-80 dB	-70 to -100 dB	-80 dB
Phase Noise	-63 dB	-60 dB	-50 dB
A-M, FM Capability	standard	no	optional
Search-Sweep	standard	no	optional

Data current as of August, 1972



**General Radio**

NEW YORK (N.Y.) 212-964-2722, (N.J.) 201-791-8990 • BOSTON 617-646-0550  
 CHICAGO 312-992-0800 • WASHINGTON, D.C. 301-881-5333 • LOS ANGELES 714-540-9830  
 TORONTO 416-252-3395 • ZURICH (01) 55 24 20

GR COMPANIES • GRASON-STADLER • TIME/DATA • TECHWARE COMPUTING CORP.  
 GR ASSOCIATE • MICRONETIC SYSTEMS INC.

\* *stark* \stärk\ *adj* ... STRONG, ROBUST ... having few or no ornaments.

For computer-controlled systems or in applications that require special controls, often remote from the instrument, who needs a panel full of knobs? In systems that already include a standard reference oscillator, why buy another one? Where a resolution of only 5 digits is required, why pay for 10?

Of course one man's ornament may be an other man's necessity, so we offer an array of options to tailor the 1061 to **your** needs: a full control panel, two different internal reference oscillators, resolution to 10 digits, and phase-modulation capability. We don't offer, as options, search-sweep, a-m and fm capability, wide frequency range, fast switching speed, complete programmability, high output, and low spurious and phase-noise levels — they're all standard, starting at \$4700.





# Built better. Performs longer. Costs less.

Wire windings are *OUT*, conductive plastic is *IN* for high performance audio controls. With its new Series 300 SLIDELINE™, Duncan Electronics replaces noisy, rough and "grainy" wire elements with smooth, noise-free RESOLON® conductive plastic which actually improves with use!

RESOLON elements and precious metal wipers used in all Series 300 controls bring consistent low-noise operation and superior performance to linear motion faders for broadcast and recording. And, the cost is less than many high grade wirewound controls of the past!

Series 300 is offered in 6 different stroke lengths and features longer life of 10 million traverses minimum, infinite resolution and linear, audio and constant impedance outputs for every audio need!

Dual channels can be contained in a standard single housing only 1<sup>3</sup>/<sub>16</sub>" wide — the most compact dual attenuator available to the industry. Two dual units can be coupled and driven by a common knob to create 4 channels for master controls or quadrasonics.

For complete specifications, call or write for our FREE brochure.

## Duncan Series 300 A sound idea



### Series 220 Slideline™

Similar to our Series 200, but internal design and construction are totally new for vastly improved performance. Features the same Resolon element as the professional grade Series 300. This results in far lower noise, longer life (5 million strokes minimum), infinite resolution and smoother "feel."



**DUNCAN ELECTRONICS**  
SUBSIDIARY

SYSTRON  DONNER

2865 Fairview Road Costa Mesa, California 92626

Phone: (714) 545-8261 TWX 910-595-1128



P-channel  
J FET



N-channel  
J FET

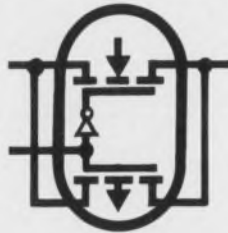

CMOS  
FETs



P-channel  
MOS FET



N-channel  
MOS FET

Since 1962, Siliconix has evolved FET technology and applied it to a complete line of singles, duals, arrays, and IC's. So what's new?

# Switch 16 channels with CMOS DG506.

Here is a single-pole 16-channel multiplexer using paired CMOS FETs, with drivers controlled by a 4-bit binary word input plus an Enable-Inhibit input — all on one chip! Check the functional diagram and then refer to the decode truth table to see what binary word input selects which switch.

### The DG506 features:

- $\pm 15$  V Analog signal range
- Break-before-make switches
- ON resistance < 500 ohms
- TTL, DTL, and CMOS direct control interface
- 36 mW standby power

DG506 Function Diagram

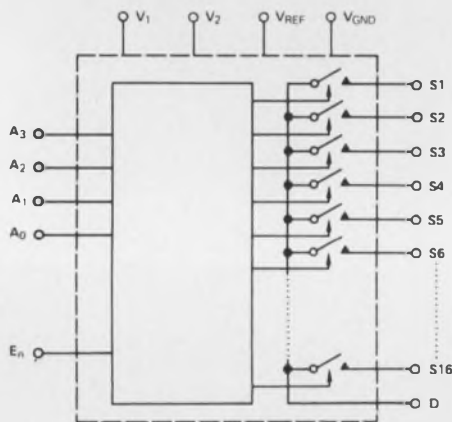

Decode Truth Table

A <sub>3</sub>	A <sub>2</sub>	A <sub>1</sub>	A <sub>0</sub>	E <sub>n</sub>	ON SWITCH
X	X	X	X	0	NONE
0	0	0	0	1	1
0	0	0	1	1	2
0	0	1	0	1	3
0	0	1	1	1	4
0	1	0	0	1	5
0	1	0	1	1	6
0	1	1	0	1	7
0	1	1	1	1	8
1	0	0	0	1	9
1	0	0	1	1	10
1	0	1	0	1	11
1	0	1	1	1	12
1	1	0	0	1	13
1	1	0	1	1	14
1	1	1	0	1	15
1	1	1	1	1	16

Our catalog line of drivers and switches will cover most applications. If your switching problems are unique — and whose aren't — call our applications people. They're eager to help. For complete information,

## write for data

Applications Engineering: (408) 246-8905



Siliconix incorporated

2201 Laurelwood Road, Santa Clara, California 95054

INFORMATION RETRIEVAL NUMBER 33

## When the competition isn't the problem

One of the ironies of business is that companies often get themselves in more trouble than any their competition can cause. Internal bickering and poor planning have probably hurt some electronics companies more in the marketplace than the other fellow's product.

No company, of course, is going to operate indefinitely without a hitch. But a few problems common to electronics companies are open to solution if management will take the time to assess their potential danger. They include these:

- **Unbending company tradition that alienates engineers and dissipates their contribution.** Broad solution: Flexible company procedures that complement employees' abilities.
- **Engineers who work independently of company goal's.** Broad solution: The setting of company priorities, with guidelines for engineers.
- **Allowing a project to continue past the point of profitability.** Broad solution: Development by manager and the marketer of the art of knowing when to kill a project. And recognition by the engineer that he is not a scientist, whose function is to push forward the frontiers of knowledge; he makes things that people can use and that will sell.
- **Manufacturing departments that accept designs as gospel.** Broad solution: A requirement that designers prove the worth of their designs instead of imposing them on manufacturing.
- **Managers who feel they must be technically superior to their staff.** Broad solution: Recognition that the manager's main function is that of a catalyst to stimulate project members. He brings to the project more over-all experience than any other staffer. He need not feel that to motivate his people he must be more technically competent than they are.
- **The assumption that a company merger will solve all major problems.** Broad solution if it doesn't: Recognition that the merged companies may have different goals. Selling a capability and selling a product, for example, require totally different approaches to marketing, project management and engineering. Use of a management committee to air grievances can be helpful in this case.

There are many more problems certainly, but you get the idea. Usually the key to their solution is taking the time to talk it over, to see if company policy is keeping pace with the times. One of the managers interviewed by ELECTRONIC DESIGN put it this way: "You can waste a lot of time doing things right, when you should be looking for the right things to do."

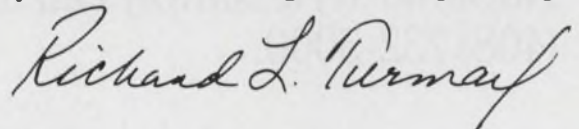

RICHARD L. TURMAIL  
Management Editor

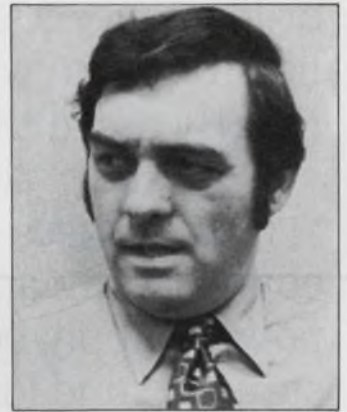

We know you have more important things to do with your time than filling out forms. But once a year we're required to re-verify the qualifications of everyone who wants to continue his free subscription. Please take a moment now to fill out the form tucked inside the front cover. We promise we won't bother you again until next year.

# INTRODUCING 54C/74C. CMOS, SIMPLIFIED.

If you've been designing with 54/74 series TTL (standard or low-power) and would now like to design with CMOS, we've greatly eased the procedure.

Our new MM54C and MM74C devices are functionally equivalent to and pin-and-power-supply-compatible with standard and low-power 54/74. Noise immunity is typically *45% of supply voltage* (which can be anywhere from 3 to 15 volts). And power dissipation is typically *10 nanowatts per gate*. All this with the kind of functions you've come to know and love with 54/74 TTL.

In addition to our new full temperature range MM54C/74C series and our intermediate temperature range MM64C series, we are also second-sourcing many of the other popular CMOS devices on the market.

For full particulars on CMOS, National style, simply call us at (408) 732-5000.

Or drop us a line. National Semiconductor Corporation, 2900 Semiconductor Drive, Santa Clara, California 95051.

## CMOS, NATIONAL STYLE

Part Number	Function	Availability
MM74C00/MM64C00/MM54C00	Quad 2-input NAND Gate	Now
MM74C02/MM64C02/MM54C02	Quad 2-input NOR Gate	Now
MM74C04/MM64C04/MM54C04	Hex Inverter	November
MM74C10/MM64C10/MM54C10	Triple 3-input NAND Gate	Now
MM74C20/MM64C20/MM54C20	Dual 4-input NAND Gate	Now
MM74C74/MM64C74/MM54C74	Dual "D" Flip-Flop	Now
MM74C73/MM64C73/MM54C73	Dual J-K Master-Slave Flip-Flop	October
MM74C76/MM64C76/MM54C76	Dual J-K Master-Slave Flip-Flop	October
MM74C107/MM64C107/MM54C107	Dual J-K Master-Slave Flip-Flop	October
MM74C95/MM64C95/MM54C95	4-Bit Parallel-In/Parallel-Out Shift Register	December
MM74C160/MM64C160/MM54C160	Synchronous Decade Counter	November
MM74C161/MM64C161/MM54C161	Synchronous 4-Bit Binary Counter	November
MM74C162/MM64C162/MM54C162	Fully Synchronous Decade Counter	November
MM74C163/MM64C163/MM54C163	Fully Synchronous 4-Bit Binary Counter	November
MM74C195/MM64C195/MM54C195	4-Bit Parallel-Access Shift Registers	November
MM74C173/MM64C173/MM54C173	Quad Latch	December
MM74C151/MM64C151/MM54C151	8-Bit Data Selections/MUX with Strobe	December
MM74C157/MM64C157/MM54C157	Quad 2 Line to 1 Line MUX	February
MM74C42/MM64C42/MM54C42	BCD-to-Decimal Decoder	December
MM74C154/MM64C154/MM54C154	4 to 16 Line Decoder Demultiplexer	January
MM74C192/MM64C192/MM54C192	Synchronous Up/Down Decade Counter	February
MM74C193/MM64C193/MM54C193	Synchronous Up/Down 4-Bit Binary Counter	February
MM74C164/MM64C164/MM54C164	8-Bit Parallel-Out Shift Register	January
MM74C165/MM64C165/MM54C165	Parallel-Load 8-Bit Shift Register	February
MM74C123/MM64C123/MM54C123	Retriggerable Monostable Multivibrator	January
MM74C200/MM64C200/MM54C200	256 Bit RAM	2nd Qtr 1973
MM4601A/MM5601A	Quad 2-input NOR Gate	Now
MM4602A/MM5602A	Dual 4-input NOR Gate	Now
MM4609A/MM5609A	Hex Inverter Buffer	Now
MM4610A/MM5610A	Hex Non-inverter Buffer	Now
MM4611A/MM5611A	Quad 2-input NAND Gate	Now
MM4612A/MM5612A	Dual 4-input NAND Gate	Now
MM4613A/MM5613A	Dual "D" Flip-Flop	Now
MM4623A/MM5623A	Triple 3-input NAND Gate	Now

# NATIONAL

# Here's one for the road.

Our new Model 4440 mini-multimeter is the smallest battery operated digital multimeter on the market.

A true portable in every sense of the word, it's shock-proofed, fully overload-protected, and usable at up to 122°F. Fuses are externally replaceable. (We even throw in an extra set, on the house.)

You get eight to twelve hours of continuous field operation before you have to recharge. In an emergency, you can run it five hours or more on ordinary flashlight batteries!

For all its littleness, this rugged portable features a new 3½-digit LED display with automatic polarity, the latest LSI circuitry for more reliability than ever, and 17 full scale ranges that cover



**(A cordless DMM for only \$285.)**

200 MV to 1000 volts AC/DC, 200 ohms to 2 megohms, plus AC and DC current.

Your local distributor will set you up with a Weston 4440 for \$285—complete with leads, batteries and recharger. Grab one. Weston Instruments Division, Weston Instruments, Inc., Newark, N.J. 07114. **WESTON®**

# on Comparator ICs

A halfway IC—linear at its input and digital at its output—the voltage comparator (not to be confused with the digital comparator) shares problems with both worlds. In its simplest form it accepts two analog inputs and delivers a ZERO or ONE output, depending on which input is larger. It can be regarded as a basic, one-bit, analog-to-digital converter, and thus finds itself in a broad range of circuits.

It appears, for example, in a/d converters, sense amplifiers, pulse shapers, line receivers, lamp and relay drivers, logic converters and—in the analog world—peak, zero-crossing, threshold and other level detectors, discriminators and oscillators.

It's almost as universal as the operational amplifier. And therein lies one of its problems. The choice between the two may not be simple. In low-speed applications, the op amp, generally a lower-cost component, can replace the comparator. But cost savings are often wiped out by additional components needed to interface with logic circuits.

## Op amps vs comparators

In some cases the op amp, often frequency-compensated for stability, is a better choice, because comparators—which are generally wide-band, high-gain devices designed for speed—have an unpleasant tendency to produce rf oscillations. A tiny stray capacitance can cause instability.

So the op amp is sometimes a better choice, sometimes worse. There are some key differences between the two devices:

- Comparators are designed primarily for open-loop operation. Op amps are usually internally compensated for operation with various

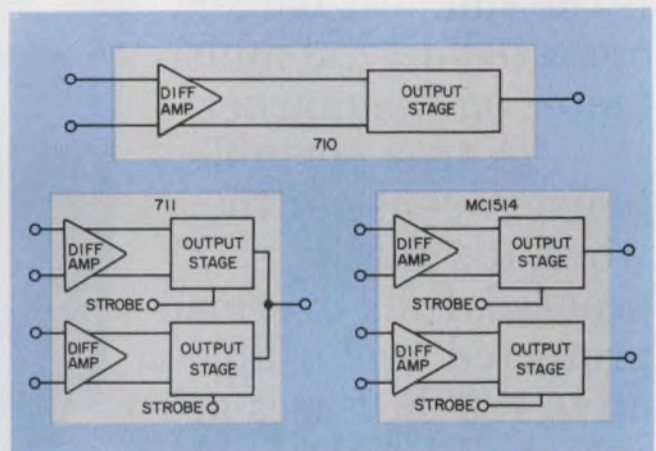

Dual versions of the popular 710 comparator can be strobed on either channel independently. The 711 has a wired-OR output, while Motorola's MC1514 is a true dual with separate outputs for each channel.

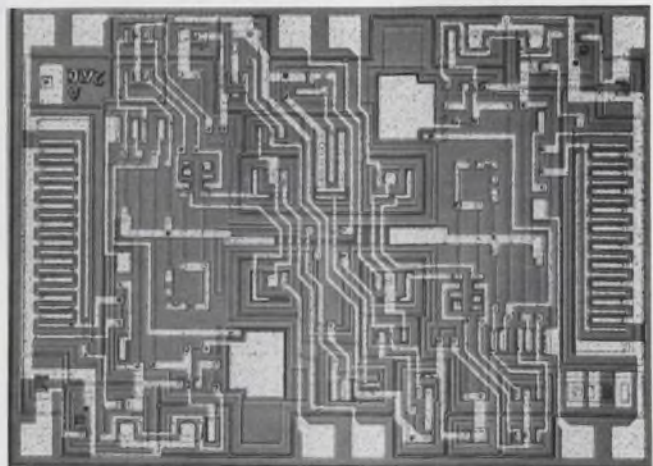

National Semiconductor's new LM119 is a dual precision comparator. It has faster response than the LM111 and lower input currents than the  $\mu$ A710. Unlike other dual comparators, it can operate from a single +5-V supply or from symmetrical positive and negative lines.

Michael Elphick  
Managing Editor

amounts of negative feedback.

- Comparators usually have larger bandwidths and smaller propagation delays than op amps.

- Comparators have output stages designed for logic compatibility or, in some cases, for driving single-ended loads, such as relays and lamps. Op amps provide large linear and bipolar output swings.

- Comparators usually have greater input dynamic range than op amps.

- Comparators frequently have larger input-offset voltage and current drifts than op amps do.

- Comparators, especially the very fast ones, usually have lower input impedances and higher bias currents than op amps do.

- Comparators often require awkward, asymmetrical, power-supply voltages and, in some cases, a third voltage to power the output stage.

### Understanding comparator specifications

Not only are comparators and op amps designed for different applications, they are also specified differently, posing several problems.

First, the specs don't always have the same definitions as they do for other devices. "Offset voltage," for example means one thing in an op amp and something else in a comparator. Comparator specs often use digital, rather than analog, terminology. Thus one is more likely to know a comparator's "propagation delay" than its "bandwidth" or "slew rate."

Second, comparator characteristics often interact in unexpected ways. Gain can affect offset voltage; load current can affect input impedance; input overdrive can affect response time. Most data sheets include about a dozen graphs to characterize a comparator.

Third, different manufacturers have different ways of measuring some characteristics.

In choosing a comparator, an engineer usually has two major factors to consider: accuracy and speed. He will also have to consider other factors such as logic compatibility, power-supply requirements and price. Let's look first at those comparator characteristics that determine accuracy.

### What are the accuracy factors?

It would be convenient if data sheets listed a single figure of merit for accuracy. It would tell us the minimum differential input voltage that a comparator detects reliably. But there is no such specification. The characteristic that comes closest to fulfilling this need is input offset voltage. Most companies list offset voltage on their data sheets, and, usually, the comparators with the lowest offset voltages have the best

resolution—though not necessarily the best stability.

Offset voltage doesn't have quite the same meaning for comparators as it does for op amps. For op amps offset voltage is usually the differential input voltage that must be applied to produce zero output. For comparators, it's commonly the differential input voltage that produces some nonzero output voltage—usually one of the two logic levels.

A comparator's accuracy is primarily controlled by two factors—the true offset-voltage error and the gain error (the amount of signal required to cause the comparator to switch). As defined by most manufacturers today, "input-offset error" accounts for both of these error terms—not just offset.

When IC comparators were first introduced about six years ago, offset and gain error were specified separately by manufacturers in much

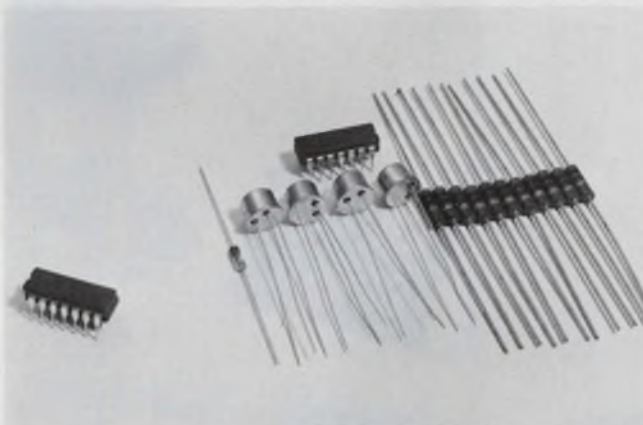

Fairchild's  $\mu A750$  dual-comparator subsystem (left) can replace (right) a conventional dual comparator, 11 resistors, four transistors and one zener diode. The monolithic circuit includes two independent high-current comparators, a voltage reference and circuitry for hysteresis control and overload protection.

the same way as for op amps. But as manufacturers produced newer comparators with higher gains, gain became a negligible source of error and offset voltage was redefined to include the limitations on resolution caused by finite gain. Note, however, that not all manufacturers measure offset voltage in the same way. If a manufacturer's comparator has low offset error but low gain, he may choose to define the two error terms separately in the hope that the gain error will be overlooked. Thus it pays to read the definitions of offset voltage and to ask manufacturers how they measure it.

A few trial calculations can usually put the various error sources in perspective and determine their effect in a specific application. For example, Robert Dobkin, director of advanced circuit development for National Semiconductor, argues that gain is a relatively unimportant spec,

because comparators are normally operated with some overdrive. He assumes an application that requires monitoring a level of 3 V and producing a logic output if the signal exceeds 3.1 V. If one then assumes very large gain and  $\pm 5$  mV offset, the comparison can occur anywhere between 3.095 and 3.105 V. Yet if the gain were, say, only 2000 (with a 4-V output swing) there would be an additional error of only  $\pm 2$  mV. The total error would still be less than 0.3%.

An opposing argument is presented by Jerry Zis, product marketing manager for Precision Monolithics. He considers an example where a comparator has an input resolution (gain error)

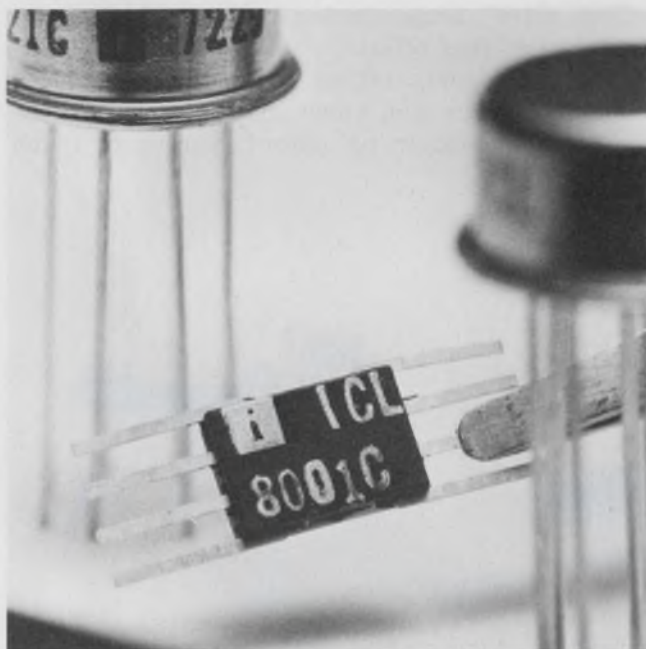

**Intersil's 8001 precision comparator** is now available in the company's tiny Pico Pak case, which is half the size of the smallest flat packages. Analog Devices also sells this comparator—as type AD351—but not in the miniature flat package.

of 0.5 mV and an offset voltage of 2 mV. Then the effective error band amounts to 2.5 mV, which Zis says would not be adequate for a precision application, such as a 12-bit  $a/d$  converter. Zis concludes that a separate "input-resolution" spec is often a coverup for poor gain in some so-called "precision" comparators.

As with op amps, it is possible externally to null out a comparator's offset voltage. This technique isn't as useful as might appear, however, because comparators with high offset voltages tend also to have high offset-voltage drifts. Nulling the voltage won't null the drift. Also one should be aware of unspecified interactions. For example, with some comparators, input offsets and their drifts depend on the output load.

Another application pitfall that can cause a deterioration in accuracy is exceeding a compara-

tor's common-mode voltage range. The common-mode limits are specified on most data sheets, but they are often overlooked by comparator users. If the input voltages exceed the specified range, a comparator won't work correctly. The offset voltage and input bias current may be much higher than expected.

Perhaps one reason why engineers sometimes exceed the common-mode range is that they confuse it with the absolute input-voltage limits. Surprisingly, however, there are also frequent instances where the absolute maximum ratings are exceeded. In industrial applications, it is not unusual for comparators to be subjected to high-voltage spikes or leakage from a 115-V ac line under fault conditions. Comparator manufacturers could help here by designing circuits with internal overload protection or by specifying suitable protection circuits in their data sheets.

Another application pitfall involves input impedance. At high frequencies, the input impedance won't be the same as at low frequencies. If it turns out to be substantially lower than expected, serious errors will result due to input currents. Most manufacturers specify input resistance rather than input impedance. Those who do specify impedance sometimes fail to mention the frequency at which it is measured.

#### Does it have the required speed?

One of the most serious areas of confusion is speed. Most data sheets define speed in the form of a "response time" or "propagation delay." The problem is that not all companies measure this in the same way, so it becomes difficult to compare the speeds of different comparators.

There can be large variations in response time when it is measured differently. So this area is fertile ground for possible specsmanship. Because comparators are designed like linear amplifiers—not like trigger circuits—response time depends heavily on the amount of overdrive applied to the input. Also, the response time won't be the same for a step input voltage, as it will for a sine-wave input.

The most common way of measuring response time is to use a 100-mV step with a 5-mV overdrive. What this means is that the comparator is initially held off in its saturated state by application of a 100-mV reference voltage at the input. Then a 105-mV signal of the opposite polarity is applied at the input. The output then switches to its other logic state, and the propagation delay is measured from input to output. Usually the test is made with the comparator's offset error externally nulled. Some manufacturers use 95 mV instead of 100 mV for the reference voltage. The effect of this probably isn't too significant. But if a comparator is saturated with a very



high voltage—say, 5 V—it will probably take longer to recover. One comparator has typical response times of 90 ns for a 100-mV step and 135 ns for a 5-V step—both with 5-mV overdrive.

This testing method has the advantage that it's fairly well standardized among comparator manufacturers, so it does allow one to judge the relative speeds of different types of comparators. But the method has the serious disadvantage that it doesn't accurately represent the actual conditions under which comparators will be operated. It's not likely that comparators will always be operated with stepped inputs, nor is it likely that they will be operated with exactly 5 mV of overdrive.

Because response time varies with overdrive, and with other variables such as temperature and load current, most manufacturers now include curves in their data sheets to show the effects of these interactions.

### Questions about speed measurement

Another method for testing response time is to apply a sinusoidal differential input—for example, a 10-MHz signal with a peak-to-peak amplitude of 30 mV. This method is especially popular with manufacturers whose comparators have such poor resolution that they can't show their paces under the usual test conditions. These manufacturers can legitimately argue, however, that their test method is more representative of the actual operating conditions for high-speed comparators. The best way to resolve these arguments, and to give the user all the information he needs, would be for manufacturers to list response times for both test methods. One company, Fairchild, is already doing this, so others may soon follow suit.

Often comparators have different response times for positive and negative step inputs. Most manufacturers list only one of the two response times, but some are now listing both. Usually the difference in propagation delay for positive and negative steps is quite small—less than 20%—but in such applications as zero-crossing detectors the resulting asymmetry could cause errors.

Another question regarding response-time measurements is this: Which parts of the input and output pulses does the manufacturer use for his time measurements? Some vendors don't tell you, others use the 50% amplitude points, while others use the 10% and 90% points. Also the output logic levels themselves are often poorly defined. Some companies claim TTL levels, but they don't guarantee the voltage and current limits that one would expect for true TTL compatibility. Furthermore you should see if a

comparator needs external pull-up resistors to achieve its specified response time and fanout. Because these resistors dissipate a lot of power, many comparator designers leave them off the chip. But this isn't always clearly spelled out on the data sheet.

To overcome the limitations of existing comparator specs, industry specialists have proposed some new specs. Zis of Precision Monolithics advocates a spec called "input slew rate," pioneered by his company. This is defined as the maximum rate of change in differential and/or common-mode voltage that the input stage can follow. Zis says this characteristic is important because fast comparators are often called upon to handle widely varying voltages—like those at the input of a multiplexed a/d converter.

In a tacit admission that most comparators are unstable at least part of the time, Joel Scheinberg, Fairchild's marketing manager for analog products, says that manufacturers should define frequency stability. This, he says, could be done by specifying an input range over which the comparator's output is unstable.

### Tradeoffs between performance characteristics

Fundamental design tradeoffs make it extremely difficult to produce a comparator that is fast while offering simultaneously good input characteristics and versatility—such as the ability to operate from a single supply line over a wide range of supply voltages or with diverse output loads. While some companies have circumvented many of the tradeoffs to produce devices with impressive all-around performance, these comparators still can't match the speed of the front runners.

From the viewpoint of the user, however, a universal comparator may not be desirable. It would probably be more expensive than a comparator that has less performance in some areas. And, more important, it may not work as well as a comparator that's optimized for a specific application. For example, precision comparators are designed to work from high source impedances. But if you needed speed, you would drive the comparator from a low source impedance. Also, fast comparators easily burst into oscillation. So it doesn't pay to use a comparator that's faster than necessary for a given application.

Another reason why comparators tend to fall into two well-defined groups is that different fabrication processes are used for fast comparators and other types. Fast comparators are usually gold doped while other types are not. And recently Schottky-barrier devices have been used in some high-speed comparators.

Gold doping produces faster transistors. But it causes lower breakdown voltages, lower gain

and higher input bias current. And it prevents the use of pnp devices, which could simplify the design of comparators that must operate from a single supply line.

Zener diodes are needed for level shifting to avoid the use of saturating stages in high-speed comparators. But because monolithic zeners have 7-V breakdown, this again complicates the design of a high-speed comparator that can operate from a single 5-V supply line. Yet another problem in the design of high-speed comparators is that higher currents are needed to charge the load and various internal capacitances rapidly. But these higher currents boost the internal power dissipation. Dissipation can be reduced and low-voltage operation achieved, while speed is preserved, by a reduction in the amplitude of internal voltage swings in the comparator. But this restriction also limits the input voltage range of the circuit.

Some new comparator designs have circumvented some of the problems by employing Schottky devices for clamping and by reorganizing the circuitry to get away from the "op-amp" approach to comparator design. The Signetics NE529, for example, has essentially three stages—a video amplifier, a high-speed level shifter and a digital output gate. Transistors are Schottky clamped rather than gold doped.

Even the newer design techniques, however, don't avoid all the tradeoffs between speed and other features. There is no panacea. Basically a user must evaluate comparators in terms of speed, accuracy or in combination with other features.

### Some important high-speed comparators

About six years ago Fairchild introduced the first monolithic comparator—the  $\mu$ A710. Even by today's standards, the 710 has an impressive combination of specs. Because of its competitive performance and low cost, it remains the workhorse of the industry. Its strong point is speed—it has a typical response time of 40 ns. Its weak point is fanout—it can only drive one TTL gate. Another disadvantage is that it operates from asymmetrical supply lines, +14 V and -7 V. Other specs stack up fairly well against competing devices. Its maximum offset voltage is a low 2 mV, while the offset current is 3  $\mu$ A. In quantities of 100 up, the 710 costs \$2.34, while a commercial version ( $\mu$ A710C) costs only \$1.05.

Because of its popularity, the 710 is extensively second-sourced. Other companies offering versions of the 710 include ITT, Motorola, National Semiconductor, Nucleonic Products, Raytheon, Signetics, Silicon General, Solitron, Texas Instruments and Transitron.

Fairchild's dual version of the 710 is the

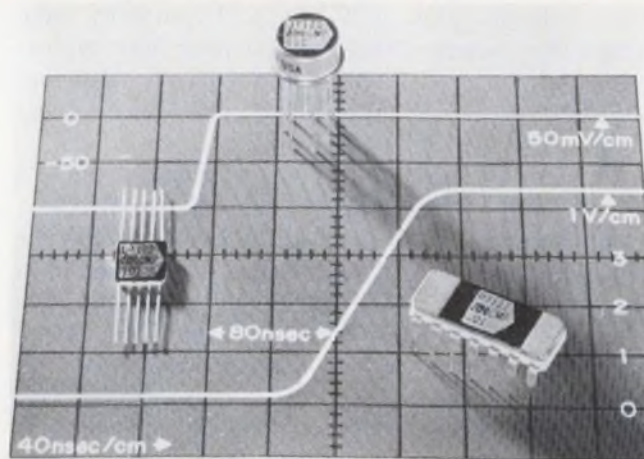

Precision Monolithics' monoCMP-01 combines precision with speed. As shown in these waveform drawings, the response time with 5-mV overdrive is typically about 80 ns. (The specified maximum is 150 ns.)

$\mu$ A711. This has the same 40-ns response time as the 710, but some of its other specs are slightly worse. For example, the maximum offset voltage is 5 mV, while the maximum offset current is 10  $\mu$ A. The major disadvantage of the 711—in addition to poor fanout—is that it's not a true dual comparator. Though there are two sets of inputs, there is only one output terminal. However, unlike the 710, the 711 can be strobed. Its price is about the same as that of the 710. In 100-up quantities the 711 costs \$2.70 for the military version and \$1.05 for the commercial.

Because of the limitations of Fairchild's  $\mu$ A711, other companies, such as Motorola and Texas Instruments, have introduced their own dual versions of the 710. Motorola's MC1514, for example, is a truly dual device with separate output stages for each of the two comparators. Also, it has the same offset specs as the basic 710—not the inferior specs of the 711. In yet another improvement, Motorola has boosted the output sink-current capability so that, unlike the 710, the MC1514 provides true TTL compatibility under worst-case conditions. The price of the 1514 is slightly higher than for the 711. In 100-up quantities, the military version sells for \$3.25 while the commercial version (MC1414) goes for \$1.17.

National Semiconductor's LM106 retains the 40-ns response time and the input characteristics of the 710, while overcoming most of the disadvantages of the earlier circuit. Unlike the 710, the 106 can operate from symmetrical,  $\pm 15$  V, power supplies and it can be strobed. It also has a fanout of 10 instead of one. Not only is the 106 compatible with RTL, DTL or TTL logic, it can also drive other loads by switching up to 18 V at currents as high as 100 mA. Thus it is a plug-in replacement for the 710, and it offers greater versatility. In 100-up quantities the LM-106 costs \$18, while a commercial version (LM-

306) costs \$6.80.

Other comparators offer faster response than the 40 ns of these devices—but at the expense of other features. For example, Fairchild's  $\mu$ A760 was designed specifically for high-speed operation. Its typical response time is 16 ns, but its maximum voltage offset of 6 mV and its current offset of 7.5  $\mu$ A are both worse than those of the 710. In 100-up quantities, the  $\mu$ A760 costs \$8.83, and the commercial version costs \$3.28.

Two very popular high-speed comparators are the Signetics SE527 and SE529. With average response times of 15 and 11 ns, respectively, these comparators were until recently the fastest available. The two ICs are identical, except that the 527 has an emitter-follower input stage to reduce input currents. The 527 and 529 have maximum offset currents of 0.5 and 3  $\mu$ A, respectively, while the corresponding bias currents are 2 and 12  $\mu$ A. Both have a maximum offset of 4 mV, and Signetics guarantees the offset to be less than 6 mV over the operating temperature range. Unlike the  $\mu$ A760, the 527 and 529 have strobe capability and can drive ECL logic as well as TTL—though pull-up resistors are needed for ECL. In 100 quantities, the 527 and 529 both cost \$4.60, while commercial versions (NE527/529) are available at \$2.

The fastest comparator on the market at present is Advanced Micro Devices' Am685. This has a *maximum* propagation delay of 7.5 ns (delays for the other units cited are typical). Unlike other high-speed comparators, the 685 was designed to drive directly 50- $\Omega$  ECL lines rather than TTL. Also the 685 has latching rather than

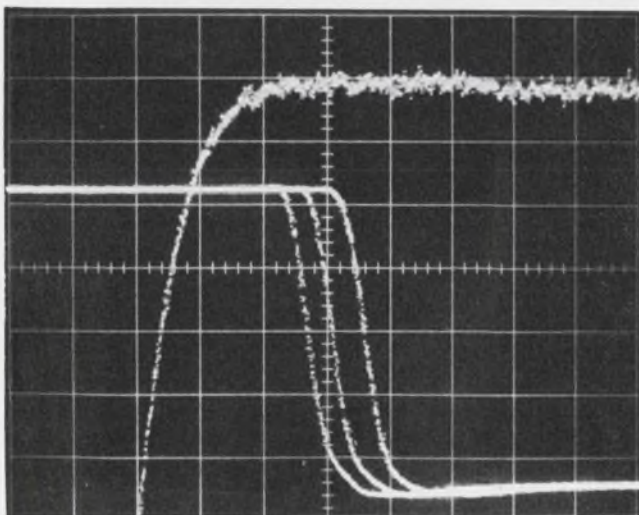

Propagation delay depends on input overdrive, as shown in this scope picture for the Advanced Micro Devices Am685. The picture shows transitions to a ZERO output, and the input is a 100-mV step with overdrives of 5, 10 and 20 mV—with the largest overdrive yielding the shortest delay. The horizontal scale is 2 ns/div, and the vertical scales are 5 mV/div for the input and 200 mV/div for the outputs.

strobing capability. Though these features suggest the 685 was tailored for ultra-fast applications, it still has quite good input characteristics. The maximum offset voltage is specified as 2 mV, and the offset current is only 1  $\mu$ A. Its offset voltage drift of 10  $\mu$ V/ $^{\circ}$ C, however, is somewhat higher than for most other comparators. In 100-up, the military version costs \$20 and the commercial version \$8.95.

Soon there may be other, even faster comparators. Motorola, for example, intends to announce its new MC1650 dual comparator during the first quarter of 1973. This IC is already available in sample quantities. Though it hasn't yet been fully characterized, preliminary indications are that it will have a typical response time of around 3.5 ns and an offset voltage of under 5 mV. In sample quantities, the MC1650 costs \$30. Production quantities aren't yet available, but the initial 100-up price will be around \$20.

### Some significant precision comparators

Precision Monolithics calls its monoCMP-01 "the industry's fastest precision comparator." With a typical response time of 90 ns, it falls outside our arbitrary 50-ns cutoff point for *high-speed* comparators, but it is much faster than other *precision* comparators. It has maximum offset voltages and currents of 2.8 mV and 80 nA, and a typical unnullled offset-voltage drift of only 2.2  $\mu$ V/ $^{\circ}$ C. Its power-supply requirements are extremely flexible. It operates from bipolar supplies (from  $\pm 5$  to  $\pm 18$  V) or from a single +5-V supply. The commercial version costs \$3.25 in 100-up quantities.

Another Precision Monolithics circuit, the monoCMP-02, trades off speed for precision. It has a typical response time of 160 ns. Though worse than the monoCMP-01, this is still better than other precision comparators, which typically have response times of 200 ns or more. But the input characteristics of the CMP-02 are about the best combination you can get in a monolithic comparator. The maximum offset voltage is a spectacular 0.8 mV, the offset current is only 3 nA (note this is nA not  $\mu$ A), and offset voltage drift is typically only 1  $\mu$ V/ $^{\circ}$ C. Like the CMP-01, the -02 can operate from a single +5-V supply, and is pin-compatible with other popular comparators, like the LM111. In 100-up, the military version sells for \$12 (metal can), and a commercial version goes for \$3.25.

The most widely used precision comparator IC is the LM111, originally introduced by National Semiconductor and now extensively second-sourced. The 111 is the workhorse of precision comparators, just as the 710 is the workhorse of high-speed comparators. When it was introduced a couple of years ago, it represented a break-

through in comparator performance and versatility. Since then, however, newer devices, such as those from Precision Monolithics, have achieved superior performance in many areas. Nevertheless the specs for the 111 tend to be the yardstick against which the performance of other precision comparators is evaluated.

Perhaps the chief reason the 111 gained popularity so rapidly was because of its versatility. It was the first comparator that could be operated from a single 5-V supply—or from  $\pm 15$  V. This means that it's compatible with analog systems that use op amps or digital systems that use TTL. Other features include a maximum offset voltage of 3 mV, a maximum offset current of 10 nA and a maximum bias current of 100 nA.

### What is the offset-voltage drift?

There is some controversy regarding the 111's drift, however. National doesn't specify offset-voltage drift on the data sheet. According to National's applications engineers, the drift is typically  $\pm 5 \mu\text{V}/^\circ\text{C}$ . But manufacturers of competing devices cite drift values of anything from 16 to 40  $\mu\text{V}/^\circ\text{C}$  for the 111. Jack Gifford, Intersil's director for analog products, says that the LM111 has fundamental design weaknesses that cause excessive drift and also offset uncertainty when the output is loaded. These problems, he says, were eliminated in Intersil's version of the 111. Dobkin of National replies that though there was a design weakness in the first version of the LM111, the problems were eliminated in a redesign a few weeks after the initial introduction. He points out, however, that some companies may have copied the original design, so he can't vouch for the drift performance of second-source

versions.

In 100-up quantities, the LM111 costs \$12. A commercial version (LM311) costs \$3.25. Companies second-sourcing the 111 include Advanced Micro Devices, Fairchild, Harris Semiconductor, Intersil, Microsystems International, Motorola, Raytheon, Silicon General and Texas Instruments.

In addition to the monoCMP-01 and -02, two other precision comparators compete with the 111—though they're not pin-compatible with it. These are Fairchild's  $\mu\text{A}734$  and Intersil's 8001M (also offered by Analog Devices under the type number AD351). They have comparable input specs but lower (and specified) drift. Input-offset drift is typically  $2.5 \mu\text{V}/^\circ\text{C}$  for the 734 and  $2 \mu\text{V}/^\circ\text{C}$  for the 8001M. In quantities of 100-up, military versions of the  $\mu\text{A}734$  and 8001M cost \$8.83 and \$11.50, respectively. Corresponding prices for commercial versions are \$3.28 and \$3.00.

With the newest comparators, there seems to be a trend toward including more circuitry on the chip. There are several dual comparators, and more recently a couple of quad comparators—National's recently announced LM3901 and Motorola's soon-to-be announced MC3302. Also additional circuit features are being added. Fairchild's  $\mu\text{A}750$ , for example, includes such on-chip features as a voltage reference, overload protection and hysteresis control.

We can expect continuous gradual improvements in the performance of monolithic voltage comparators. Meanwhile engineers who need better performance should consider the many hybrid microelectronic and discrete-component comparator modules available from companies not surveyed in this report. ■■

## Need more information?

This report highlights several important voltage-comparator ICs, but the types and specifications not included may be more significant in some applications. Readers who need more information may wish to consult the manufacturers. ELECTRONIC DESIGN is grateful to the following for their help in furnishing information for this report:

Advanced Micro Devices, Inc., 901 Thompson Pl., Sunnyvale, Calif. 94086. (408) 732-2400. (Leonard Brown, Linear IC Marketing Manager) **Circle 401**

Analog Devices, Inc., Route 1 Industrial Park, Norwood, Mass. 02062. (617) 329-4700. (Stan Harris, Product Marketing Manager) **Circle 402**

Burr-Brown Research Corp., International Airport Industrial Park, Tucson, Ariz. 85706. (602) 294-1431. (C. R. Teeple, Product Specialist) **Circle 403**

Exar Integrated Systems Inc., 733 N. Pastoria Ave., Sunnyvale, Calif. 94086. (408) 732-7970. (James Shales, Vice President of Marketing) **Circle 404**

Fairchild Semiconductor, 313 Fairchild Dr., Mountain View, Calif. 94040. (415) 962-5011. (Joel Scheinberg, Marketing Manager, Analog Products) **Circle 405**

Harris Semiconductor, P.O. Box 883, Melbourne, Fla. 32901. (305) 727-5400. (Jack S. Kompan, Marketing Communications Manager) **Circle 406**

Intersil Inc., 10900 N. Tantau Ave., Cupertino, Calif. 95014. (408) 257-5450. (Jack Gifford, Director of Analog Products) **Circle 407**

ITT Semiconductors, 3301 Electronics Way, W. Palm Beach, Fla. 33407. (305) 842-2411. **Circle 408**

Microsystems International Ltd., 800 Dorchester Blvd., Montreal 101, Quebec, Canada. (514) 875-2814. **Circle 409**

Motorola Semiconductor Products Inc., 5005 E. McDowell Rd., Phoenix, Ariz. 85036. (602) 273-3465. (Karl Huehne, Linear IC Applications Manager) **Circle 410**

National Semiconductor Corp., 2900 Semiconductor Dr., Santa Clara, Calif. 95051. (408) 732-5000. (Robert Dobkin, Director Advanced Circuit Development) **Circle 411**

Nucleonic Products Co., Inc., 6660 Varlel Ave., Canoga Park, Calif. 91303. (213) 887-1010. **Circle 420**

Optical Electronics Inc., P.O. Box 11140, Tucson, Ariz. 85706. (602) 624-8358. (Richard Gerdes, President) **Circle 412**

Precision Monolithics Inc., 1500 Space Park Dr., Santa Clara, Calif. 95050. (408) 246-9222. (Jerry Zis, Product Marketing Manager) **Circle 413**

Raytheon Co., Semiconductor Div., 350 Ellis St., Mountain View, Calif. 94040. (415) 968-9211. (Al Borken, Linear Product Marketing Manager) **Circle 414**

Signetics Corp., 811 E. Arques Ave., Sunnyvale, Calif. 94086. (408) 739-7700. (J. Daniel McCranie, Linear Product Marketing Manager) **Circle 415**

Silicon General Inc., 7382 Bolsa Ave., Westminster, Calif. 92683. (714) 892-5531. (Steve Thompson, Product Marketing Manager) **Circle 416**

Solitron Devices Inc., 8808 Balboa Ave., San Diego, Calif. 92123. (714) 278-8780. **Circle 417**

Texas Instruments Inc., 13500 North Central Expwy., Dallas, Tex. 75222. (214) 238-3741. **Circle 418**

Transitron Electronic Corp., 168 Albion St., Wakefield, Mass. 01880. (617) 245-4500. **Circle 419**

# WE'LL SELL YOU A KEYBOARD SWITCH FOR 30¢

...and give you  
**A PENNY CHANGE**

**How to save silver when buying gold:** Spec Cherry Gold "Crosspoint" Contact keyboard switches. With a momentary Form A (SPST/NO) price tag of just 29¢ in 250,000 quantity . . . lower prices in higher quantities.

What do you get besides low price? Unique, proven Cherry Gold "Crosspoint" contact configuration that enhances reliability. Tested beyond 50,000,000 operations. (Test Report No. TK 10071 available on request.) You get Cherry's low profile Keyboard switch featuring rugged construction, 2½ ounce operating force and stable contact resistance (typically 25 milliohms over life). Made by the people who pioneered the Gold "Crosspoint" Contact in snap-action switches.

The result? Cherry keyboard switches are your ideal choice for computer terminals, electronic calculators and credit card validators.

**TEST A FREE SAMPLE.** Choose the 29¢ Form A switch . . . or any of Cherry's complete line of keyboard switch modules. Just TWX 910-235-1572 . . . or PHONE 312/689-7703 and ask Walt to give you facts on Keyboard Switches . . . or circle appropriate reader service number.



ACTUAL SIZE

**FORM A, MOMENTARY  
(SPST/NO)**

Circle No. 211 for Free Sample

**ALTERNATE ACTION (SPST)**

Circle No. 212 for Free Sample

**DUAL FORM A, MOMENTARY  
(DPST/NO)**

Circle No. 213 for Free Sample

# CHERRY



**CHERRY ELECTRICAL PRODUCTS CORP.**  
3609 Sunset Avenue, Waukegan, Illinois 60085

*Makers of patented Leverwheel/Thumbwheel Switches, Matrix Selector Switches, Snap-Action Switches and Keyboards.*



# DOOPS!

## The Heavy-Duty DMM Bounces Back.

Don't worry about missing with the rugged Hickok 3300A Digital Multimeter. Its tough ABS case and shock-mounted components will take plenty of hard bounces.

Besides being tough, this 3½-digit Multimeter is versatile. It measures:

- DC/AC voltage from 100  $\mu$ V to 1.5 kV;
- DC/AC current from 100 nA to 2 A;
- Resistance from 100 m $\Omega$  to 200 M $\Omega$ .

And accuracy is good for 12 months.

The \$435 price includes real portability. The 3300A operates continuously 20 hours off its internal rechargeable battery. You can make measurements while recharging the battery. And the battery's good for 1000 recharges.

Notice the handy form factor — unique among digitals. It's made to carry around or to hang from a convenient spot by its handle.

You'll also like the automatic polarity and decimal point position, the out-of-range indication, 1500 volts off ground operation, and the continuous automatic zeroing. But you expect these from the company which was first with LSI circuits in digital multimeters.

Test it yourself. Call Hickok for a demonstration or for complete specifications.

## HICKOK

the value innovator

Instrumentation & Controls Division

The Hickok Electrical Instrument Co.

10514 Dupont Ave. • Cleveland, Ohio 44108

(216) 541-8060

# HICKOK

# all in the family

ONE CLOCK  
TOTALLY TTL COMPATIBLE  
SILICON GATE  
STATIC OR DYNAMIC  
SHIFT REGISTERS

General Instrument announces the availability of the industry's first family of both static and dynamic silicon gate shift registers in single, dual and quad configurations, each with its one clock and all inputs and outputs totally TTL compatible.

Other Features:

- Recirculation with Data Select
- Push-Pull outputs
- +5V and -5V to -12V supply voltage range
- 4 MHz operation
- Availability in 14 lead Plastic or Ceramic DIP, 10 lead TO-100

## the family

GENERAL INSTRUMENT'S SILICON GATE S/R's

SL-9-1512	Single 512 bit Static
SL-9-2256	Dual 256 bit Static
SL-9-4128	Quad 128 bit Static
DL-9-1024	Single 1024 bit Dynamic
DL-9-2512	Dual 512 bit Dynamic
DL-9-4256	Quad 256 bit Dynamic

### YOUR "FAMILY MAN" AT GI



Dr. Ed Sack is manager of General Instrument's Computer Products program. He joined GI in 1969 as a Vice President in the Semiconductor Products Group. Since that time he has held the positions of Director of Operations for the Microelectronics Division and Manager of the Hybrid Division. He is a Fellow of the IEEE, winner of the Eta Kappa Nu Outstanding Young EE Award and author of over thirty papers and fifteen patents.

Earlier this year Ed assumed responsibility for GI's Computer Products business. So, if it's answers you want on silicon gate shift registers, or for that matter, any other MOS computer product, Ed's the man to talk to. You can call him, toll free, at the number below.

# 800-645-9247

TOLL  
FREE



GENERAL INSTRUMENT CORPORATION • 600 WEST JOHN STREET, HICKSVILLE, L. I., NEW YORK

The "First Family" of Static and Dynamic Silicon Gate Shift Registers is immediately available from these authorized General Instrument distributors:

**ALABAMA:** Cramer/E. W., Huntsville (205) 539-5722; **ARIZONA:** Cramer Electronics, Phoenix (602) 263-1112, TWX: 910-951-1382; Liberty Electronics, Phoenix (602) 264-4438; **CALIFORNIA - NORTHERN:** Elmar Electronics, Mountain View (415) 961-3611, TWX: 910-379-6437; Intermark Electronics, Palo Alto (415) 961-6437, TWX: 010-373-1195-910; **CALIFORNIA - SOUTHERN:** Avnet, Culver City (213) 836-7200, TWX: 910-340-6753; Kierulff Electronics, Los Angeles (213) 685-5511; Liberty Electronics, El Segundo (213) 322-8100, TWX: 910-348-7111; **COLORADO:** Cramer Electronics, Denver (303) 758-2100, TWX: 910-431-0440; **FLORIDA:** Cramer/E. W., Orlando (305) 841-1550; Cramer/E. W., Hollywood (305) 923-8181; **ILLINOIS:** Semiconductor Specialists, Elmhurst (312) 279-1000, TWX: 910-254-0169; **INDIANA:** Semiconductor Specialists, Indianapolis (317) 243-8271; **IOWA:** Deeco, Cedar Rapids (319) 365-7551; **KANSAS:** Hall-Mark Electronics, Kansas City (913) 236-4343; **MARYLAND - WASHINGTON, D.C.:** Cramer/E. W., Gaithersburg (301) 948-0110, TWX: 710-828-9745; **Milgray/Washington,** Hyattsville (301) 864-1111, TWX: 710-826-1127; **Radio Electric Service of Baltimore** (301) 823-0070; **MASSACHUSETTS:** Greene-Shaw, Newton (617) 969-8900; **MICHIGAN:** Harvey/Michigan, Romulus (313) 729-5500; Semiconductor Specialists, Detroit (313) 255-0300; **MINNESOTA:** Hall-Mark Electronics, Minneapolis (612) 925-2944; Semiconductor Specialists, Minneapolis (612) 854-8841; **MISSOURI:** Semiconductor Specialists, St. Louis (314) 428-6100; **NEW MEXICO:** Cramer Electronics, Albuquerque (505) 265-5767; **NEW YORK (METROPOLITAN AREA):** Milgray Electronics, Freeport (516) 546-6000, TWX: 510-225-3673; Semiconductor Concepts, Hauppauge (516) 273-1234; **NEW YORK STATE:** Summit Distributors, Buffalo (716) 884-3450; **NORTH CAROLINA:** Cramer/E. W., Winston Salem (919) 725-8711; **OHIO:** Newark-Herrlinger, Cincinnati (513) 421-5282, TWX: 810-461-2662; Semiconductor Specialists, Dayton (513) 278-9455; **PENNSYLVANIA - SOUTH JERSEY:** Herbach & Rademan, Philadelphia (215) 426-1700, TWX: 710-670-9760; Milgray Delaware Valley, Cherry Hill (609) 424-1300, (215) 228-2000; Philadelphia Electronics, Philadelphia (215) LO 8-8288, (215) EM 5-6704; Semiconductor Specialists, Pittsburgh (412) 781-8120; **TEXAS:** Computer Components, Addison (214) 239-0271, TWX: 910-860-5006; Lenert Company, Houston (713) 225-1465; Semiconductor Specialists, Dallas (214) 358-5211; **UTAH:** Cramer Electronics, Salt Lake City (801) 487-3681; Alta Electronics, Salt Lake City (801) 486-7227; **WASHINGTON-OREGON:** Liberty Electronics/Northwest, Seattle (206) 763-8200, TWX: 910-444-1379.

INFORMATION RETRIEVAL NUMBER 37

## The Calculator and the Engineer—Part 3

**Expand programmable-calculators** by adding peripherals. You can often top a minicomputer's performance in straight calculating and in automating systems.

Peripherals can overcome many limitations of the manual, stand-alone calculator (Fig. 1). They can reduce dependence on manually keyed inputs. They can overcome the limitation in electronic-display calculators of a single-number output, if many numbers are needed for data evaluation. And they can extend memory size.

Manual input in a stand-alone calculator can cause operator fatigue, with resulting data-entry errors in lengthy calculations. And it consumes lots of time. The operator is forced to watch the display to determine when he must enter more data. Even under program direction, the calculator stops every time data are needed and transfers control to the keyboard. The operator must enter the data and transfer control back to the program by pressing a GO key.

Large amounts of data make the chances of error high. Finding an erroneous or missing entry can be difficult, and correcting it can be burdensome.

Single-number visual output, another limitation, often forces an operator to write down a number, return control to the calculator, write down another number—and continue this slow process.

But a wide variety of peripherals (Figs. 2 and 3) are available to cope with both the input and output limitations and with the small memories that are soon overloaded as auxiliary devices are added.

### Devices that feed data to calculators

Card readers and punched-paper-tape readers are among the more popular input peripherals. Either can supply program instructions or numerical data.

Two types of card readers are commonly used—a mark-sense reader and a punched-card reader. For either marked or punched cards, many readers use a 40-column format with the information in an octal code. The 80-column tab card with a Hollerith code (or other codes) is

also very popular. A card reader may either transfer data into the memory of the calculator or operate the calculator directly without intervention of the memory. Many calculators have a built-in I/O connector wired to tie a card reader directly to the calculator's bus.

A two-step instruction is usually required to activate the card reader. The first step selects the appropriate I/O circuit, and the second sets the mode of operation. The card reader directs program control in the run mode, or loads data into memory in the learn mode. In either mode the last reader instruction must be a GO command to return control to the calculator. Then the internal program takes over, or if the original card-reader address was keyboard-generated, control is resumed by the keyboard.

Often it is more convenient to record data on punched paper tape. Most modern tape readers handle eight-level ASCII code. As in the case of the card reader, the tape reader can also often be plugged directly into the I/O bus of the calculator. But first the ASCII code must be converted to the calculator code, and the tape reader must supply its own sequential control circuitry and the means for subsequent return of control to the calculator.

Like the card reader, the tape reader requires a two-step command from either the calculator keyboard or a program stored in the calculator's memory. The first step selects the I/O circuit, and the second causes the tape reader to transfer the information on the tape to the calculator for a learn or run mode. The tape inter-record separator code is often translated into a GO command for the calculator. Control is returned either to the calculator keyboard or program, whichever initiated the tape-reader operation. The calculator's ability automatically to transfer control from calculator to tape and back, permits a user to design programs with iterative loop routines for data entry.

### Devices that read data from calculators

In some applications that produce a large amount of output, only a small amount of input

---

Lowell W. Smith, Market Development Specialist, Wang Laboratories, Inc., Tewksbury, Mass. 01876.



is needed. Manual entry of the data is therefore not always the important limiting factor. In interactive applications, manual entry is a necessity. The operator directly and continually modifies the data or assumptions, and changes, stops or restarts the program.

In fact, the need to display much output data is probably the first roadblock a calculator user encounters. The first peripheral to be added is most often a hard-copy output device. These come in three categories: column printers, typewriters and teletypewriters, and line printers.

Since a hard-copy unit is so frequently the first peripheral, many machines come with a column printer already built in, because it is the easiest and cheapest to add. It not only can list input data for verification and print the output results, but often it also prints the step number, instruction code number and symbol. A disadvantage of the column printer is that its formatting ability is severely restricted. It is confined to printing in columns, and the repertoire of available symbols is limited. Except for a few applications, the column printer is mostly a working tool. Data must be transferred manually to prepared forms if a special format is required.

On the other hand, the output typewriter can format in an immediately usable form. The calculator can direct the full complement of typewriter controls and functions, including space, tab, line feed, carriage return, upper and lower case and a programmed quantity of numbers to the left and right of the decimal point.

The basic interfacing for a typewriter consists of the following:

- A micro-programmer that can sequence the typewriter functions.
- A code translator that converts the calculator code into a code (ASCII, Selectric, etc.) that is compatible with the typewriter.
- A coupling circuit for voltage-level matching between the typewriter and the calculator.

In operation, unless a buffer is used in the calculator output, data are temporarily stored in the display registers of the calculator until the printing is complete. A WRITE command in the program activates the typewriter.

When the typewriter is printing numbers, the WRITE command is followed by a format command that designates the number of digits to be placed to the left and right of the decimal. A busy line is also energized to prevent changing the data in the display registers while the typewriter is performing a positioning function, such as carriage return or line index. This signal remains on until all the digits are printed. At the completion of printing, as signaled by a counter in the interface, the busy signal is dropped and control is returned to the calculator for keyboard or further program control. The data in the dis-

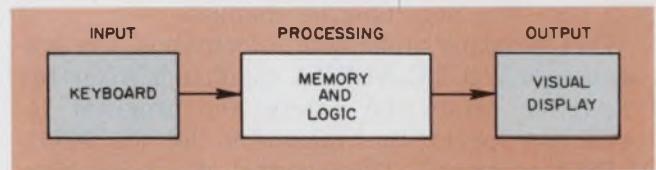

1. The stand-alone calculator is made up of three major sections. Peripherals can be used to supplement or expand the functions of each section.

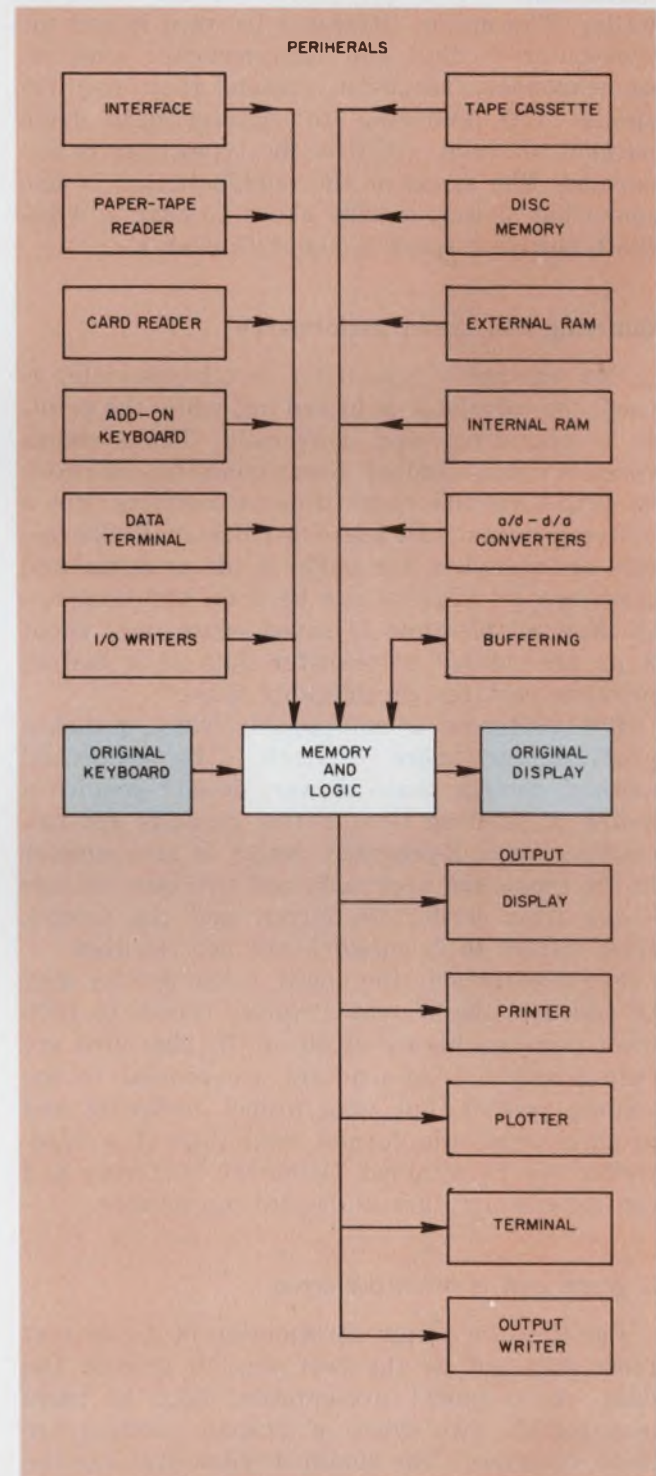

2. An expanded calculator system competes very effectively with a minicomputer or a data terminal not only in straight computation but also in data processing and logging and dedicated system controls.

play registers may now be changed.

When printing alphabetic information, the system uses a WRITE-ALPHA command. After the typewriter prints the letters, the program returns control to the calculator by an END-ALPHA command. Thus control of a typewriter requires very few additions to a program. And the computation portion of the program, of course, remains unchanged.

Another useful peripheral is the teletypewriter. The major difference between it and the typewriter is that the teletypewriter uses an asynchronous, serial-bit stream that requires special I/O buffering to convert data from parallel to serial, whereas the typewriter is bit-parallel. The speed of the teletypewriter is also somewhat slower, usually about 10 char/s, while the typewriter speed is about 15 char/s.

### **Buffering can speed performance**

But whether a typewriter or teletypewriter is used, the calculator is locked out while the printer is operating—and conversely. The system's speed is output-limited. Great quantities of printed output require much time to complete. But a buffered output can speed performance. Characters are stored in the buffer while printing, and therefore calculations can be done simultaneously. Appreciable time is saved, since only about 8  $\mu$ s are needed to transfer data to a buffer; printing requires considerably more.

But buffering is not popular, since it makes programming more difficult. The sequential method, though much slower, doesn't require a match of printing time, buffer capacity and calculating time. Equipment design is also simpler in the sequential approach, and two busy signals—one from writer to buffer, and the second, from buffer to calculator—are not required.

For greater printing speed, a line printer may be added to the system. Printing speeds to 1000 lines/min and higher at 80 or 132 char/line are then possible. Line printers are cousins to the column printer, but with proper buffering and programming, the format flexibility of a typewriter can be attained. Often the buffering and control circuitry are built into the printer.

### **A graph plot is often preferred**

Printing the output information in list or text form may not be the best way to present the data. A graphical presentation may be more meaningful. Two types of graphic plotters are most often used: the modified typewriter and the pen plotter.

The modified typewriter, with stepping motors added to position the typing head, is the more versatile—but also more expensive. The X-Y

digital locations generated by the calculator are converted to pulses to drive the stepping motors. After the type head reaches its position, a PRINT command activates it to print the desired character. As in the case of typewriter units, a busy signal locks the calculator and keyboard until the positioning and printing operation is completed. Since this system requires a point-to-point incremental signal, the calculator software must include a routine to compute the difference between plotting points from the absolute X-Y location data that the calculator normally provides. The incremental values are then converted to equivalent pulse quantities. Such an incremental plotter can also serve as a conventional output typewriter.

The more popular and more economical device is the analog, single-pen, flat-bed plotter. Here the calculator X-Y digital signals must be converted to analog signals. This d/a conversion circuitry and the necessary scaling adjustments are usually in the plotter. As with other peripherals, a busy signal locks the calculator and keyboard during plotting. The analog plotter can also be programmed to trace out alphanumeric characters, but this is a rather slow process.

For applications such as statistical analysis, where a combined graphic and tabulated output is frequently required, the modified typewriter plotter is the best choice. But where alphanumeric data-output requirements are minimal, the analog plotter can serve well. A still better choice might be to combine an analog plotter and typewriter. Each can then be used to attain the greatest efficiency for a specific application, without need for compromise.

### **Memory is also expandable**

Because calculators use a machine language, they require very specific detailing of each program step instead of the general statements of an assembly language. This means that there are a great many steps in a calculator program, and this is further complicated by the addition of peripherals, since each function of the peripheral must be exactly planned and programmed. The result is that the 500-to-2000-byte calculator memory is soon full. With peripherals, more memory almost always becomes necessary. It can be added internally in many calculators, or it can be added externally in the form of random-access core or semiconductor modules, a tape-cassette unit or a magnetic-disc device.

The addition of an internal memory increases the number of operational storage registers and therefore the number of program steps that can be handled by direct addressing. Added internal memory does not require special programming, because it functions in exactly the same way as

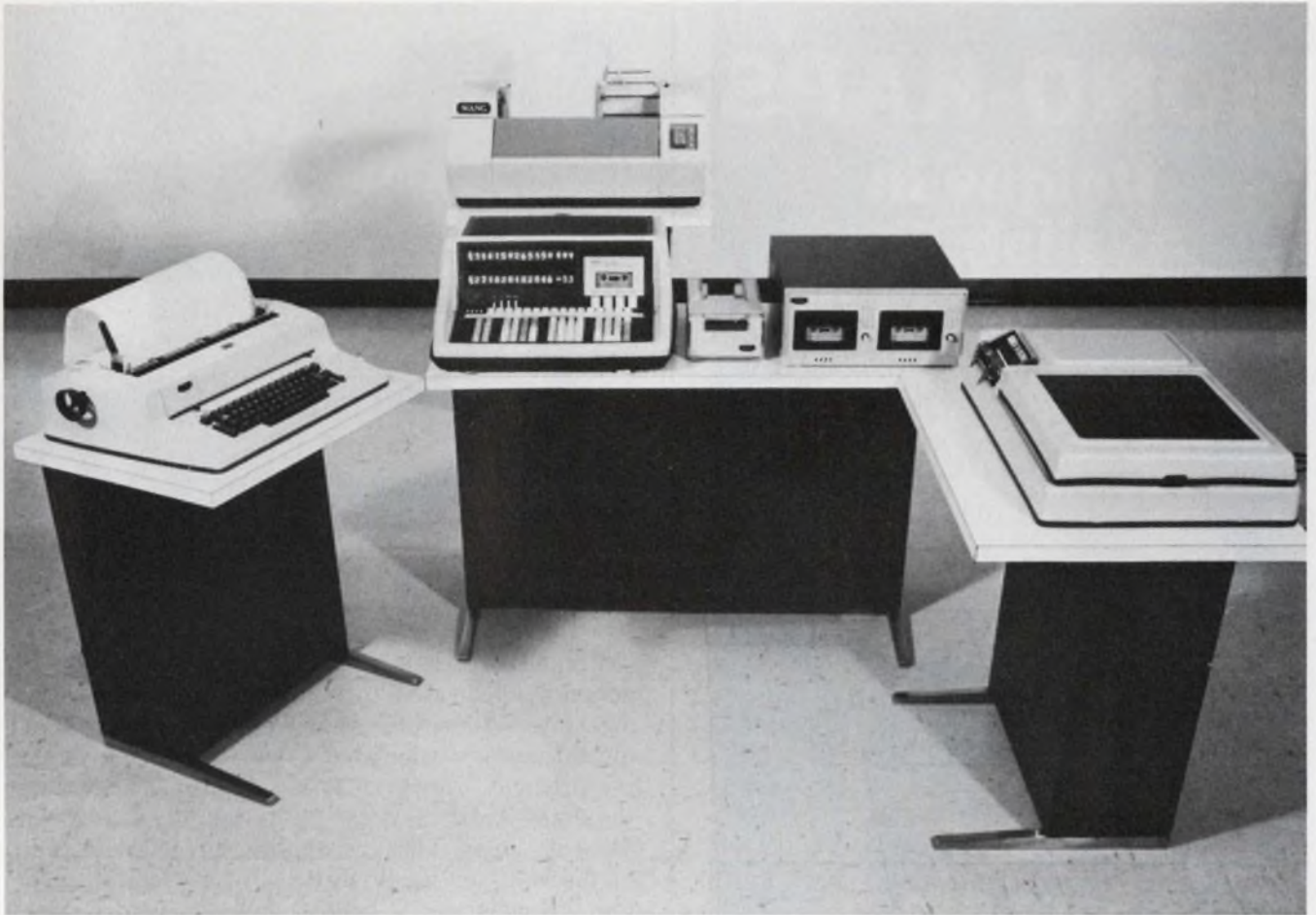

Peripherals such as (left to right) plotting typewriter, line printer (above calculator), mark-sense card reader, dual tape cassette and disc memory—and almost all

the peripherals that can be used with a computer—can be used with a calculator. Measuring instruments can supply inputs for data processing and system control.

the original calculator memory. But an external memory, attached to the calculator through the I/O bus, requires the assignment of extra addressing commands and keys. Furthermore external memory can function only as storage. Therefore, for processing, blocks of information must be transferred to the internal calculator memory.

#### Tapes and discs have long memories

Though slower than core or semiconductor memories, a tape-cassette unit can be added to the calculator for long-term storage of large amounts of data. Long, complex programs can be preserved for future use. The data are organized on the tape in blocks, so that each block is handled in its entirety. When the instructions on a block are completed, the calculator signals an ADVANCE command to the tape to load the next block into the internal memory.

In this way very long programs are broken down and handled in small units. Even so, there are limitations to program length. First, the number of steps in a single block can't exceed the number of steps that the working memory

of the calculator can employ at one time. Second, the length of tape on a cassette is limited, though several cassettes can be used successfully. Finally, the operating time for a long program can become excessive, and errors tend to increase with length of programs on many tapes.

Though a single tape cassette serving simply as a source of information is a powerful adjunct to a calculator, the addition of a multitape unit is an even greater asset. It vastly expands flexibility. For instance, a three-tape cassette unit can store the master program on one of the tapes, allow numerical data to be transferred from the second tape into the calculator working memory, as required for arithmetic processing, and record results on the third tape.

The magnetic-disc memory, however, can do this in a single unit with greater data-access speed and greater freedom in data manipulation. Blocks of data can be read or recorded in random order, thus overcoming the sequential constraints imposed by a tape unit. This imposes less of a need for careful planning in program preparation. Many units have replaceable discs. Such units can thus store as much data as tape units can.

# MONO-KAPS<sup>TM</sup>

Unique in  
Availability,  
Price and Quality



\* **FREE  
Samples**

USCC/Centralab Mono-Kap Ceramic Capacitors have availability, price and quality inherent in every part.

**AVAILABILITY.** Immediately available from over 150 distributors are stock units in six sizes from .100 x .100 to .500 x .500. Our four dielectrics are NPO, W5R, Z5U and Y5V, with capacitance values from 4.7 pF to 10 Mfd in 50, 100 and 200 VDC ratings.

**PRICE.** \$.09 average in production quantities. This low price is due to USCC's development of highly automated assembly techniques resulting in large volume production of Mono-Kaps.

**QUALITY.** USCC is currently under contract to produce chip capacitors (the heart of Mono-Kaps) at the rate of 25,000 per hour, with a failure rate level of only .001% per 1000 hrs.



\*Want FREE evaluation samples? Write on company letterhead to USCC/Centralab. For complete technical data on MONO-KAPS and other quality USCC components, circle the information retrieval number below.

USCC

USCC/Centralab

Electronics Division • Globe-Union, Inc.



2151 North Lincoln Street • Burbank, California 91504  
(213) 843-4222 • TWX: 910-498-2222

INFORMATION RETRIEVAL NUMBER 38



Calculators serve as data processing systems in many dedicated applications.

Because a programmable calculator system is generally dedicated to a single, specific task at any given time, the sharing of peripherals by more than one calculator is not usually a system requirement. However it is sometimes desirable to share a large data base that is stored on discs or tapes. Two calculators can share a tape or disc unit by using a special Tee coupling system. If calculator A addresses the memory unit, the circuitry in the Tee sends a busy signal to calculator B, and vice versa. This system of sharing is particularly satisfactory for problems that call for infrequent reference to the memory unit.

## Calculators for on-line use

Many users couple a programmable calculator directly to instruments to process and record data while an operation or experiment is in process. Such on-line use is made possible by the calculator's I/O architecture. However, special interface circuits for the instruments are usually necessary. They may often be obtained from the calculator manufacturer, or in some cases the user can design and build his own. Also custom-designed and prepackaged interface systems are available for some classes of instrumentation.

No matter what the source, the interface circuit must perform the following general functions:

- Match the voltage levels to and from the I/O bus of the calculator.
- Translate codes acceptable to both the calculator and the instruments.
- Provide a GO signal to return control to the calculator after data have been transferred. Also, by multiplexing techniques, the interface can greatly increase the number of available input ports for data-scanning applications. ■■

# SUPERDIGIT\*

## The new LED Display that Obsoletes Conventional Displays

Now available as a 1/4" LED display for instrument, terminal and industrial control applications, the Fairchild FND 70 represents a three-way breakthrough that enables you to design tomorrow's displays today.

### SUPERIOR PRICES

\$3.95 (100 up)—A low price made possible by a breakthrough in manufacturing technology which uses low cost plastic package assembly techniques.

Inherent high costs of conventional displays, which require extensive hand fabrication and large amounts of gallium arsenide phosphide materials, have been eliminated. The small-quantity price is also indicative of the low prices that will accompany large-scale production.



### SUPERIOR STACKING DENSITY

More Packages Per Inch—The FND 70 has the smallest ratio (2:1) of total package to digit size. Four digits, each 300 mils wide  $\times$  500 mils, occupy less space than three conventional units, and, because of the straight leads, can be stacked both vertically and horizontally.

### SUPERIOR APPEARANCE

Advanced Optics Technology—Provides bright, bold digits with a pleasing uniform appearance for viewing up to a full 140°. No masks required.

Seeing is Believing—You only have to see the Superdigit to realize why it is so superior to any other display on the market, whether it be Nixie tubes, LEDs or what have you. Your Fairchild Semiconductor sales engineer or distributor salesman can give you a visual demonstration.

\*SUPERDIGIT is a trademark of Fairchild Camera & Instrument Corp.

**MADE IN  
FAIRCHILD**

**FAIRCHILD SEMICONDUCTOR/MICROWAVE AND OPTOELECTRONICS**

A Division of Fairchild Camera & Instrument Corp., 4001 Miranda Avenue, Palo Alto, Ca 94304. (415) 493-3100. TWX: 910-373-1278

INFORMATION RETRIEVAL NUMBER 39

# Eliminate spikes in dc-to-dc converter

by adding a second transformer. There is no sacrifice in either efficiency or high-speed performance.

High collector-current spikes, always present in conventional dc-to-dc converters that use a single saturable transformer, damage switching transistors, generate electromagnetic interference and keep the conversion efficiency at a low 80%. Reducing the spikes with the usual brute-force method—by addition of a capacitor or a diode across the switching transistors—results in a further decrease in efficiency. But the spikes can be virtually eliminated if a second transformer is added to the dc-to-dc converter.

A look at several two-transformer circuits and examination of the design procedure for a simple two-transformer dc-to-dc converter will show how this can be done.

## Nonsaturable transformer eliminates spiking

Collector-current spikes are caused by the saturation of the output transformer (see box). Consequently they can be eliminated if the output transformer is not permitted to saturate.

Referring to Fig. 1a, we see that the output transformer,  $T_1$ , does not saturate, so that collector spiking is almost eliminated. The transistors are driven, and the oscillation frequency is determined, by a separate, small, saturable transformer,  $T_2$ . The output-transformer design is less critical now, since the transformer never saturates. Also, its efficiency will increase, raising the over-all efficiency of the converter. As is illustrated in Figs. 1b through 1h, both voltage and current spikes are practically eliminated.

Another way to build a converter with a nonsaturable output transformer is to insert a saturating inductor into the switching-transistor base circuit (Fig. 2). Square-loop material is used for the inductor,  $L_1$ , and linear magnetic material for the output transformer,  $T_1$ .

The design of  $T_1$  and  $L_1$  is such that  $L_1$  saturates before  $T_1$  does. When  $L_1$  saturates, it turns off the conducting transistor, simultaneously turning on the nonconducting transistor.

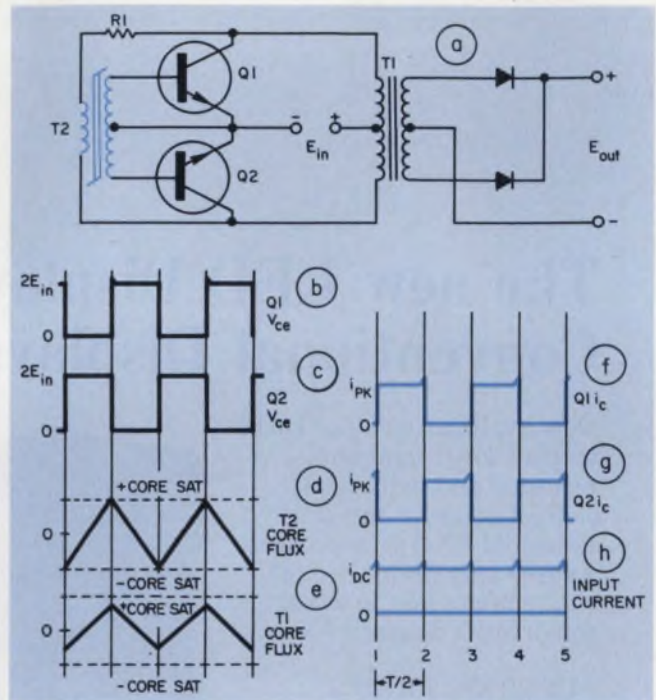

1. Collector-current spikes are eliminated when, instead of the output transformer, a second, small transformer,  $T_2$ , is driven into saturation.

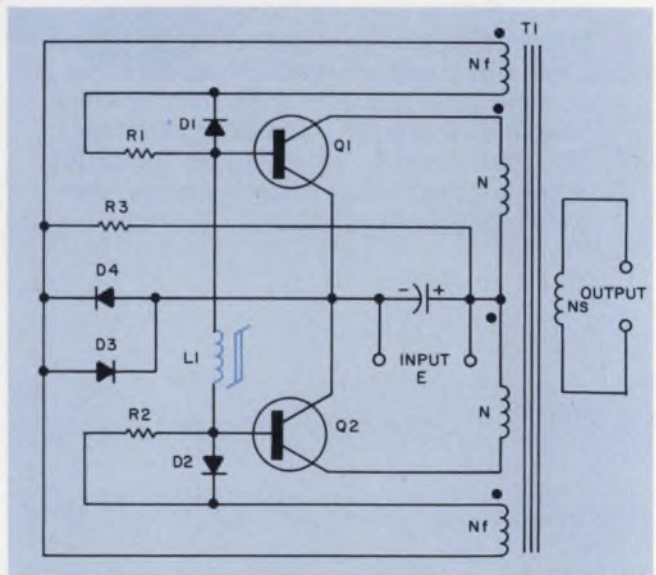

2. Another way to eliminate spikes is by inserting a saturable inductor,  $L_1$ , into the base circuit.

Eugene R. Hnatek, Military/Aerospace Product Marketing Manager, National Semiconductor Corp., Santa Clara, Calif. 95051.

Diodes  $D_1$  and  $D_2$  insure fast turn-off times for  $Q_1$  and  $Q_2$ , and diodes  $D_3$  and  $D_4$  proper operation of  $L_1$ . Converter frequency can be set at any desired value by adding or subtracting turns of the  $L_1$  winding.

Another circuit that reduces spiking is called a pseudosaturating converter<sup>1</sup> (Fig. 3). In this circuit, inductor  $L_1$  and Zener diode  $CR_1$  prevent the output transformer from going too deeply into saturation—that is, when the transformer core (a high-permeability material) begins to saturate, the current through  $L_1$  increases rapidly, thus raising the voltage level at the emitters of  $Q_1$  and  $Q_2$ . Because of base-emitter capacitances, the bases of  $Q_1$  and  $Q_2$  will follow the emitter until the base voltages are clamped by  $CR_1$ . The transistors will then turn off and limit the current into  $T_1$ .

Note that  $L_1$  is now in the emitter circuit

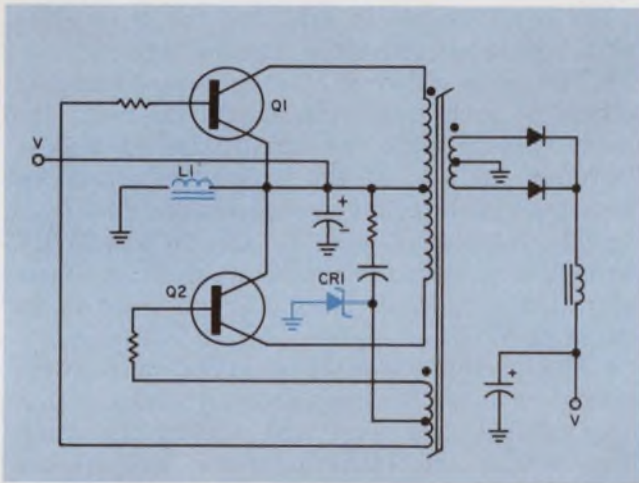

3. Spikes are reduced when the output transformer is permitted to saturate only partly by combined action of  $L_1$  and the zener diode  $CR_1$ .

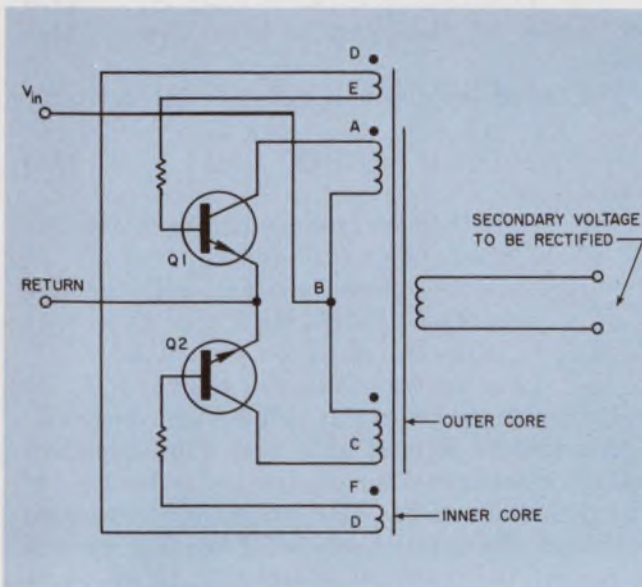

4. A unique two-core transformer reduces spikes by switching the transistors before the outer core saturates.

rather than, as in Fig. 2, the base circuit.

Finally a totally new two-transformer converter circuit is shown in Fig. 4. It uses two cores, one within another. The feedback winding is placed on the inner core, while the primary and secondary windings are on both cores. This converter operates as follows:

If it is assumed that  $Q_1$  is on, a positive voltage will be applied from B to A, and the induced voltage at E will—before saturation of the outer core—collapse as the inner core saturates. As voltage E decreases,  $Q_1$  turns off, and the flux in the inner core begins to change in the other direction, turning on  $Q_2$ . The latter transistor will remain on until the inner core saturates in this direction.

The inner core saturates before the outer because its mean circumference is smaller, while the magnetizing ampere turns are the same. Thus the switching is accomplished without excess magnetizing current and associated losses, thereby raising over-all converter efficiency and greatly reducing electromagnetic interference.

### Designing a two-transformer converter

Let's consider now the design procedure for a two-transformer converter (Fig. 5). This procedure can be adapted, if the designer chooses, to build other two-transformer converter circuits<sup>2</sup>.

The design of a converter is usually based on the available dc supply voltage, the required output voltage and power, and the ambient temperature that the unit will be subjected to. In addition other requirements might include efficiency, size, weight, operating frequency and stability. The procedure is as follows:

*Step 1.* Calculate the power delivered to the

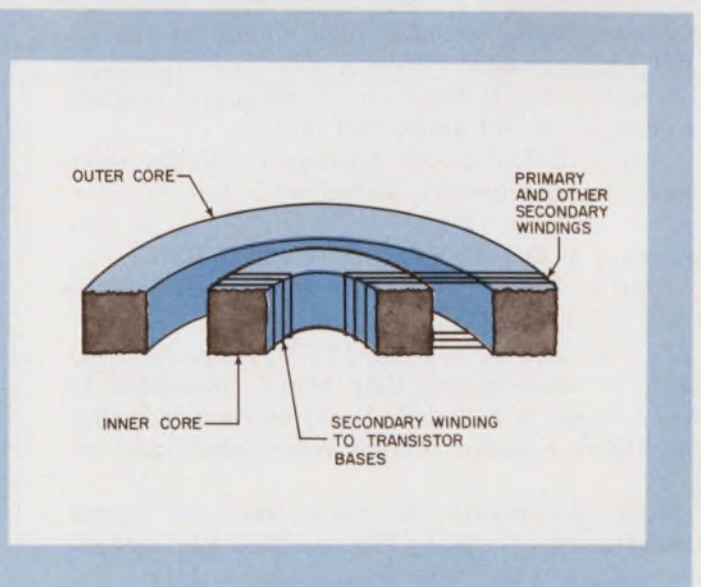

The technique improves conversion efficiency and reduces electromagnetic interference.

output transformer,  $T_1$ , from

$$P'_{out} = P_{out}/\eta_1, \quad (1)$$

where  $P_{out}$  is the specified converter power output and  $\eta_1$  is the transformer efficiency (90 to 95%).

**Step 2.** Estimate transistor collector current for a square wave,  $I'_c$ :

$$I'_c = P'_{out}/V_s, \quad (2)$$

where  $V_s$  is the supply voltage.

**Step 3.** Using the manufacturer's value of transistor saturation voltage,  $V_{CE(sat)}$ —which corresponds to the collector current  $I'_c$ , and case temperature,  $T_c$ —recompute the collector current as follows:

$$I''_c = P'_{out}/(V_s - V_{CE(sat)}). \quad (3)$$

**Step 4.** Compute base-circuit power input as follows:

$$P_{in} = V_{BE}(I''_c/h'_{fe}) + R_B(I''_c/h'_{fe})^2, \quad (4)$$

where  $V_{BE}$  (base-to-emitter voltage) and  $h'_{fe}$  are

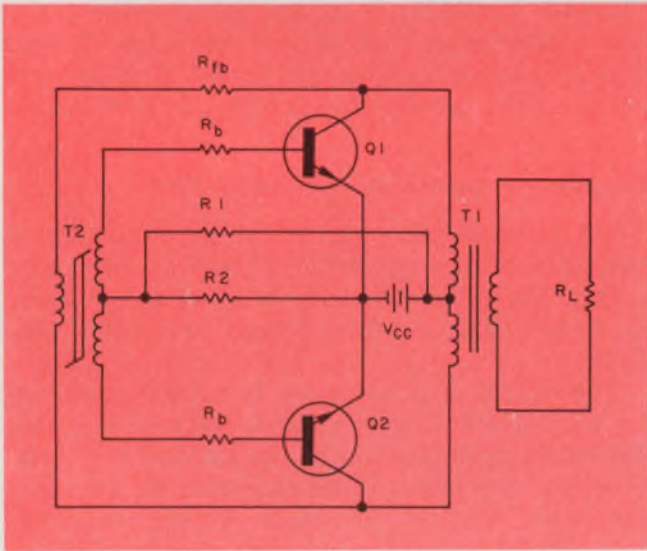

5. Design equations are developed for this basic two-transformer circuit. Note that  $T_2$  uses a rectangular-loop core material, while  $T_1$  has a linear core.

obtained from transistor data sheets for the  $I''_c$  and  $V_{CE(sat)}$  used in Step 3. The base stabilizing resistance,  $R_b$ , is small and is chosen to produce a voltage drop of about half of  $V_{BE}$ .

**Step 5.** Calculate the input power to the base-drive transformer,  $T_2$ , as follows:

$$P'_{in} = P_{in}/\eta_2, \quad (5)$$

where  $\eta_2$  is the efficiency of  $T_2$  (90 to 95%).

**Step 6.** Compute the collector current on the basis of the total power:

$$I_c = (P'_{out} + P'_{in})/(V_s - V_{CE(sat)}). \quad (6)$$

If  $I_c$  is much higher than the  $I'_c$  computed in Eq. 3, steps 4, 5 and 6 should be repeated, with the higher collector-current value substituted for  $I''_c$ .

**Step 7.** Compute the turns ratio of output transformer,  $T_1$ , using the specified load impedance,  $Z_L$ , and the reflected impedance,  $Z'_L$ :

$$Z'_L = (V_s - V_{CE(sat)})/I_c, \quad (7)$$

so that the turns ratio for  $T_1$  becomes

$$n^2 = Z_L/Z'_L. \quad (8)$$

**Step 8.** In determining the turns ratio of the base-drive transformer,  $T_2$ , keep in mind that its primary voltage,  $V_{pri}$ , is

$$V_{pri} = V_s - V_{CE(sat)}, \quad (9)$$

since the value of the feedback resistor,  $R_{fb}$ , is usually chosen to drop half of the available voltage. The corresponding primary current is

$$I_{pri} = P'_{in}/V_{pri}. \quad (10)$$

**Step 9.** Obtain the turns ratio of  $T_2$  from

$$n = (V_{BE} + I_B R_B)/V_{pri} \quad (11)$$

where

$$I_B = I_c/h'_{fe}. \quad (12)$$

This generalized design procedure is deceptively simple. It works—but only if the designer knows how to select the right transistors and the best transformer type for the job, and provided a suitable starting network is included.

### Choosing the right transistors

The requirements in selecting the transistors for a high-speed converter include these:

- The peak value of the collector-to-emitter voltage at each transistor should be twice the supply voltage plus the amplitudes of spikes. Therefore the  $V_{CEO}$  of the transistors should be twice the supply voltage plus another 20%.

- The transistors must be able to handle the currents to produce the specified power, and their saturation voltages at these currents must be as low as possible for higher over-all efficiency.

- The junction-to-case thermal resistance of the transistors must be low enough to insure that the available heat sink and cooling maintain them within the manufacturer's temperature ratings.

The maximum collector current of the transistors is

$$I_c = (P_{out}/\eta_1)/(V_s - V_{CE(sat)}), \quad (13)$$

for which all the symbols have already been defined.

The transistor dissipation is calculated from

$$P_D = (T_1/T) \{ V_{CE(sat)} I_c + 2I_{cEX} V_s + [(t_{on} + t_f)/T] (V_s I_c/3) \}, \quad (14)$$

where

$T$  is the converter switching period,

$T_1 = (1/2)[T - (t_{on} + t_f)]$ ,

$I_{cEX}$  is the collector current, with the base reverse-biased (for  $V_{CE} = 2V_s$ ),

$t_{on}$  is the transistor on time at  $I_c$ ,

$t_f$  is the transistor fall time at  $I_c$ ,

and all other terms are as defined previously.

Equation 14 is used as a first approximation, and the exact transistor dissipation is determined experimentally later. The transistor saturated switching characteristics should be fast enough to neglect the transient dissipation terms.

The required heat-sink thermal resistance is given by



$$\theta_{ca} = (\Delta T / P_D) - \theta_{jc}, \quad (15)$$

where  $\Delta T$  is the permissible junction temperature rise and  $\theta_{ca}$  is the case-to-air thermal resistance, including mounting, any insulation and heat sink.

### Selecting output and base-drive transformers

For a high-speed converter, a ferrite core is best for both the output and the base-drive transformers. The base-drive transformer,  $T_2$ , should have a rectangular-loop ferrite core (because it must saturate), while the output transformer,  $T_1$ , should use a linear ferrite core. In general, at higher frequencies iron cores cannot compete with ferrite either in performance or cost. Even at lower frequencies, ferrite cores are less costly, because iron must be in the form of very thin laminations. In addition ferrites have fairly constant losses up to about 40 kHz, increasing as

$f^{0.1}$ , where  $f$  is the operating frequency. At frequencies higher than 40 kHz, the losses go up as  $f^{0.6}$ . Both the rates are much higher for iron cores.

The core of a transformer is selected on the basis of power-handling requirements, frequency and temperature of operation. Temperature is an important consideration, since Curie temperature for many ferrites is low. (Magnetization is zero above the Curie temperature.) Core manufacturer's data sheets usually contain most design information and should be consulted closely.

The basic equation for designing the output transformer is

$$N_p = (V_p \times 10^8) / (4fAB), \quad (16)$$

where

$N_p$  is the number of turns on the primary,  
 $V_p$  is the primary voltage in volts,  
 $f$  is the operating frequency in Hz,

## The basic saturable-transformer, dc-to-dc converter:

The operation of a self-oscillating converter (see schematic) is as follows: A dc input is chopped by the oscillator into complementary square waves, which are transformed and then rectified to produce the desired dc output. The efficiency of such a unit generally runs at around 80%.

The alternate saturation and cutoff of push-pull transistors  $Q_1$  and  $Q_2$  produces the collector voltages shown in the top waveforms (a and b). The feedback windings of the saturable transformer provide positive feedback to drive the transistors. The voltage drop across the saturated (or ON) transistor is small—typically 0.2 V—so that the voltage across the corresponding half of the primary is nearly equal to the supply voltage.

The primary's voltage remains constant for a half a cycle (c), during which time magnetizing flux builds up steadily. When the core saturates, it tries to maintain its same rate of flux change, causing the magnetizing current to rise suddenly to its peak value. Then the flux-change rate decays to zero, and the voltage across the winding collapses, removing the base drive and

turning off the transistor.

The collector-current peaks (d and e), caused by the saturation of the transformer, occur shortly before the transistor turns off. Although short in duration, these spikes produce instantaneous power peaks that are many times the steady-state dissipation. Thus they can cause transistor breakdowns and interference.

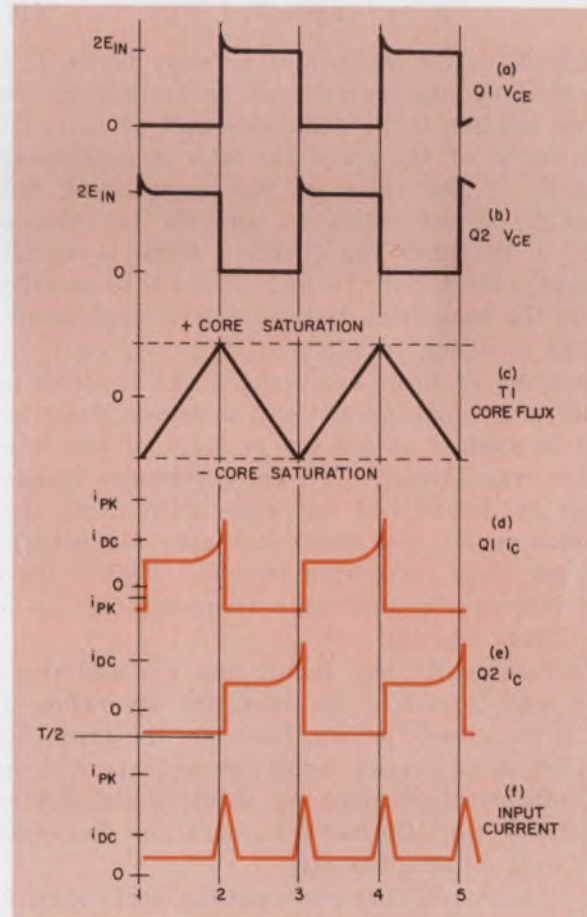
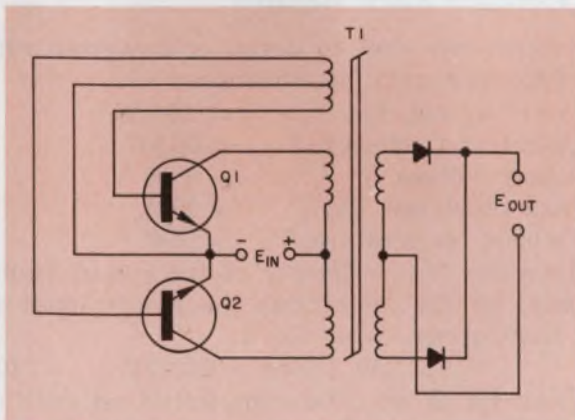

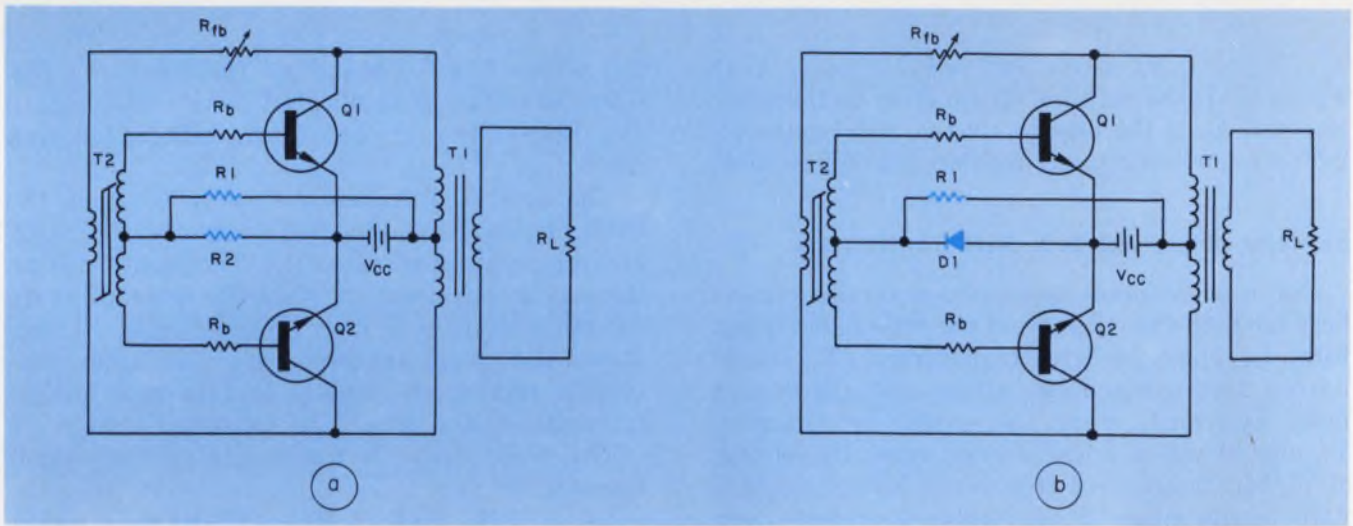

6. Reliable converter starting is insured either by a resistive divider network (a) or a resistor-diode network.

A is the transformer core area in  $\text{cm}^2$  and B is the flux density in gauss.

The design of the saturable base-drive transformer is a bit more involved than that of the output transformer, because when the transformer saturates, a sharp drop in the applied primary voltage must be produced. Thus the magnetizing current must increase considerably from a small value to one that is comparable to the primary current given by Eq. 10. Because of the saturation requirement, the following equation must be used in addition to Eq. 16 to determine the number of primary turns:

$$H_s = [(1.26) N_p I_m] / l, \quad (17)$$

where  $N_p$  is the number of primary turns,  $I_m$  is the magnetizing current at saturation in amperes (chosen to be about one-half of  $I_{pri}$ ),  $l$  is the length of the magnetic path in centimeters and  $H_s$  is the value of the magnetizing field strength at saturation in oersteds (a value of five to 10 times the coercive force is usually chosen). Both Eqs. 16 and 17 must be satisfied when the base-drive transformer is designated.

The feedback resistor,  $R_{fb}$ , for a given  $I_{pri}$  is computed to drop one-half of the collector-to-collector voltage across the transistors. The other half is applied across the primary of the base-drive transformer,  $T_2$ . The optimum resistor value is determined experimentally. Note that decreasing  $R_{fb}$  will result in higher magnetizing current, thus increasing the  $V_{pri}$ . This in turn will increase the operating frequency, as can be seen from Eq. 16.

Increasing  $R_{fb}$  will reduce the  $V_{pri}$  and therefore tend to reduce the operating frequency. If  $R_{fb}$  is increased further, however, the frequency will begin to increase again, since there will not be sufficient base drive to saturate transistors. Thus  $R_{fb}$  can control the operating frequency only over a limited range.

To insure reliable self-starting, some kind of bias network must be provided to produce the

current. There are many possible circuits. Let's discuss two—one with a resistive divider network and the other with a diode-resistor circuit.

Referring to Fig. 6a, we see a resistive starting circuit,  $R_1$  and  $R_2$ . The resistor values can be found from

$$R_1 = V_s / I_s \\ = V_s / \{2I_B + [(V_{BE} + I_B R_B) / R_2]\} \quad (18)$$

Since the denominator in Eq. 18 is equal to the starting current,  $I_s$ ,  $R_2$  can be determined readily if a starting-current value is assumed.  $R_1$  can then be computed also. Final determination of the starting current is best done experimentally.

Figure 6b depicts a diode-resistor starting circuit. The value of  $R_1$  is found from

$$R_1 = V_s / (2I_B + I_D), \quad (19)$$

where  $I_D$  is the diode current.

As the converter begins to oscillate, the base current flows through the base-emitter junction and through the starting-network diode. To compensate for the diode voltage drop, more voltage should be provided by the  $T_2$  secondary winding. Low-voltage silicon diodes, capable of carrying base current continuously, should be used.

### Let's design a 250-W converter

Suppose we want to design a converter with the following major specifications:

- Power output,  $P_{out}$  = 250 W.
- Operating frequency,  $f$  = 50 kHz.
- Supply voltage,  $V_s$  = +28 V.
- Load resistance,  $R_L$  = 25  $\Omega$ .
- Ambient temperature,  $T_A$  = 25 C.

Assuming 95% efficiency of the output transformer, we first determine the power input to the transformer, using Eq. 1:

$$P'_{out} = 250 / (0.95) = 262.5 \text{ W.} \quad (20)$$

From Eq. 2, we obtain the initial estimate of the collector current:

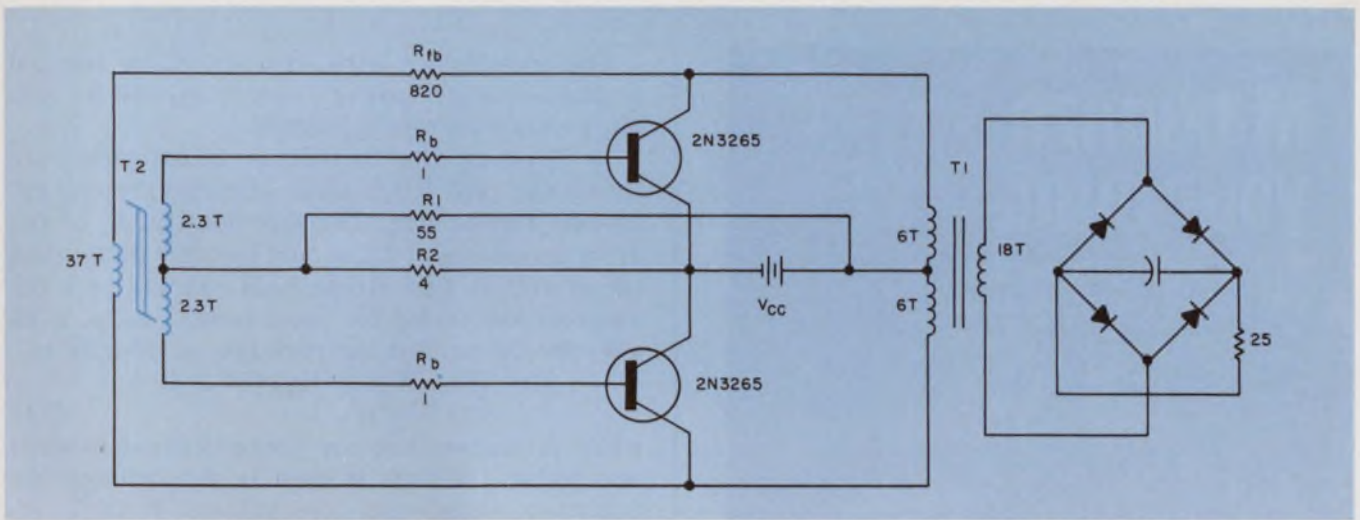

7. The complete schematic of a 250-W converter shows component values calculated in the example.

$$I'_c = (262.5) / 28 = 9.4 \text{ A.} \quad (21)$$

The transistor collector-to-emitter breakdown voltage,  $V_{CEO}$ , should be at least twice the supply voltage plus 20%, to allow for spikes. Thus the minimum  $V_{CEO}$  should be 67 V. Looking at the specifications for a 2N3265 power transistor, we find that it has a  $V_{CEO}$  of 90 V and a  $V_{CE(sat)}$  of 0.75 V (at  $I_c = 15 \text{ A}$ ). The 2N3265 also has very short switching times—both the fall time,  $t_f$ , and the on time,  $t_{on}$ , are 500 ns, which is short compared with the 20- $\mu\text{s}$  period of the converter.

Thus the second estimate of the collector current becomes (from Eq. 3):

$$I''_c = (262.5) (28 - 0.75) = 9.62 \text{ A.} \quad (22)$$

Data sheets give  $h_{FE}$  of 40 at 10 A. Thus the forced value of  $h'_{fe} = 20$  is chosen to make sure that the transistors will saturate. The  $V_{BE(sat)}$  at the collector current of 10 A is given as 1.3 V.

To determine the value of  $R_B$ , we must have an idea of the required base current, which can be obtained from

$$I_B = I''_c / h'_{fe} = (9.62) / 20 = 0.481 \text{ A.} \quad (23)$$

Thus the  $R_B$  of 1  $\Omega$  will produce a drop of about half a volt, which is sufficient. The base-circuit power input (Eq. 4) is

$$P_{in} = (1.3) (9.62 / 20) + (9.92 / 20)^2 = 0.86 \text{ W.} \quad (24)$$

Again, if we assume 95% efficiency for the base-drive transformer,  $T_2$ , the power input to  $T_2$  becomes (from Eq. 5):

$$P'_{in} = (0.86) / (0.95) = 0.902 \text{ W.} \quad (25)$$

From Eq. 6, the collector current is

$I_c = (262.5 + 0.902) / (27.25) = 9.65 \text{ A}$ , which is sufficiently close to the previously calculated estimates of  $I_c$ .

From Eq. 7, the impedance reflected into the primary of the output transformer is

$$R'_L = (27.25) / (9.65) = 2.84 \Omega, \quad (26)$$

so that the  $T_1$  turns ratio is

$$n^2 = 25 / (2.84) = 8.85$$

$$n = 2.98. \quad (27)$$

Continuing the output-transformer calcula-

tions, we get, on the basis of 95% efficiency, the following magnetically dissipated power in  $T_1$ :

$$P_M = P_{out} (100\% - 95\%) = 12.5 \text{ W.} \quad (28)$$

For an operating frequency of 50 kHz, Allen-Bradley WO-3 ferrite-core material, or its equivalent, is suitable. Its maximum usable temperature is 125 C. The flux density,  $B$ , for linear operation should be 1000 gauss, and the core-loss factor,  $\rho$ , for these conditions is 3.2  $\mu\text{W}/\text{cm}^3\text{-Hz}$ .

Thus the frequency-dependent core loss becomes

$$\rho' = (3.2 \mu\text{W}/\text{cm}^3\text{-Hz}) (50 \times 10^3) = 160 \text{ mW}/\text{cm}^3. \quad (29)$$

Since the specified temperature rise for the converter is 100 C, the maximum temperature core loss (if we assume a loss factor of 3.2  $\text{mW}/\text{cm}^3 - ^\circ\text{C}$ ) is

$$\rho'' = (3.2 \text{ mW}/\text{cm}^3 - ^\circ\text{C}) 100 = 320 \text{ mW}/\text{cm}^3. \quad (30)$$

The minimum core volume is determined on the basis of the temperature core loss, since this loss is larger than that due to frequency. Thus

$$\text{Volume} = P_M / \rho'' = (12.5 \text{ W}) / (320 \text{ mW}/\text{cm}^3) = 39 \text{ cm}^3. \quad (31)$$

A pair of "C" cores, type U2625C133A (Allen-Bradley), give a transformer core with the following dimensions: area—2.04  $\text{cm}^2$ ; length—16.4 cm; volume—40  $\text{cm}^3$ .

The number of primary turns for  $T_1$  can now be determined from Eq. 16 as follows:

$$N_p = (27.25 \times 10^3) / (4) (50 \times 10^3) (2.04) (1000) = 6.55 \text{ turns.} \quad (32)$$

If we approximate the number of primary turns to be six and the turns ratio (Eq. 27) to be three, the number of secondary turns becomes  $6 \times 3 = 18$ .

From the data sheet for the core, we see that for linear operation the value of the magnetizing field strength,  $H$ , equal to 0.189 Oe should not be exceeded. Thus the magnetizing current becomes (from Eq. 17):

$$I_m = [(16.4) (0.189)] / [(1.26) (6.55)] = 0.376 \text{ A.} \quad (33)$$

# Maximize your mini.

Heath/Schlumberger's new Computer Interface brings the inside of your PDP-8 outside to the real world



The new EU-801E Mini-Computer Interface allows owners of any PDP-8 family computer (with positive I/O bus) to take full advantage of their mini's capabilities...by allowing direct input of measurement data and output of processed data and control information. The 801E is ideal for interfacing a variety of digital instruments...designing complex dedicated interfaces...or just learning about interfacing. All connection points necessary for a functioning interface are readily available outside the computer: all signals required for any given data transfer operation are legibly and logically presented on the top of a plug-in card in the 801E ADD unit. Connection points on the card top include 12-bit digital inputs and outputs (Accumulator In, Accumulator Out and Buffered Memory Bus), three control lines, five timing lines and two status lines. And because the 801E is a patch system using positive-contact connectors and ordinary hook-up wire, there is no soldering. Simple data transfer circuits can be patched and tested in a few minutes. Signal modification and device control circuits can be quickly developed and refined. For detailed information on the new Heath/Schlumberger EU-801E Mini-Computer Interface, send coupon below for free brochure...and learn how you can turn your PDP-8 into a maxi-mini.

EU-801E System, 42 lbs. .... \$1250.00\*

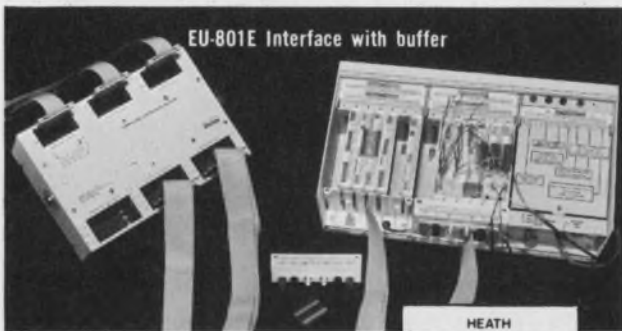

Heath/Schlumberger Scientific Instruments  
Department 541-264  
Benton Harbor, Michigan 49022

- I'm convinced and I need a maxi-mini now. Enclosed is \$\_\_\_\_\_ plus shipping for \_\_\_\_\_ EU-801E(s).
- I'm interested but not convinced. Please send EU-801E brochure.
- Please send 1972 Instrumentation Catalog.

Name \_\_\_\_\_

Title \_\_\_\_\_

Company/Institution \_\_\_\_\_

Address \_\_\_\_\_

City \_\_\_\_\_ State \_\_\_\_\_ Zip \_\_\_\_\_

\*Mail Order price; F.O.B. Benton Harbor, Michigan EK-329

INFORMATION RETRIEVAL NUMBER 40

The transformer wire sizes should be selected to avoid excessive power dissipation, and the primary should be wound bifilarly.

In selecting the base-drive transformer, we choose the type RO 3 (Allen-Bradley) rectangular-loop ferrite core. The flux density,  $B$ , of the drive transformer,  $T_2$ , should be 3000 gauss, and the saturation field strength,  $H_s$ , should be 1 Oe. The core-less factor for these conditions,  $\rho$ , is  $63 \mu\text{W}/\text{cm}^3\text{-Hz}$ , so that the core loss at 50 kHz is

$$\rho' = (63 \mu\text{W}/\text{cm}^3\text{-Hz}) (50 \times 10^3) = 3.15 \text{ W}/\text{cm}^3, \quad (34)$$

which is higher than the temperature-dependent loss factor and thus is used in determining the minimum transformer-core volume. With  $T_2$  efficiency of 95%, the magnetically dissipated power becomes

$$P_M = P_{in} (100\% - 95\%) = (0.86) (0.05) = 0.043 \text{ W}, \quad (35)$$

where the value for  $P_{in}$  was derived from Eq. 24. Thus the minimum volume is

$$\text{Volume} = P_M / \rho' = (0.043) / 3.15 = 0.0136 \text{ cm}^3. \quad (36)$$

Thus the core type TO620H101a (Allen-Bradley) is chosen with these dimensions: area— $0.119 \text{ cm}^2$ ; length— $1.53 \text{ cm}$ ; volume— $0.182 \text{ cm}^3$ .

The number of primary turns is (from Eq. 16):

$$N_p = (27.25 \times 10^4) / (4) (50 \times 10^3) (0.119) (3000) = 37.5 \text{ turns}. \quad (37)$$

From Eq. 11, the turns ratio is found to be

$$n = (27.25) / (1.3 + 0.481) = 16, \quad (38)$$

so that the number of secondary turns is 2.3.

The transformer parameters should now be checked (from Eq. 17) against their ability to produce the required magnetic field strength of 1 Oe. Prior to this, the value of magnetizing current,  $I_m$ , should be calculated from Eq. 10:

$$I_m = I_{pri} = (0.902) / (27.25) = 0.0332 \text{ A}, \quad (39)$$

so that

$$H_s = [(1.26) (37) (0.033)] / (1.53) = 1.01 \text{ Oe}. \quad (40)$$

The remaining circuit components that need to be calculated are the feedback resistor,  $R_{fb}$ , and the values for the starting network. The feedback resistor is calculated to produce the desired magnetizing current, or

$$R_{fb} = V_{pri} / I_{pri} = (27.25) / (0.0332) = 820 \Omega.$$

From Eq. 18,  $R_1$  is found to be  $55 \Omega$ , and  $R_2$  becomes  $4 \Omega$ .

The final circuit diagram of the 250-W converter is in Fig. 7. ■■

## References

1. Radys, R. G., and Agnew, C. V., "Pseudo-Saturating Power Converter," NASA Tech Brief B72-10042.
2. Hnatek, Eugene R., "Design of Solid State Power Supplies," Van Nostrand Reinhold Co., New York, 1971.

# Singer is here to Servo you.

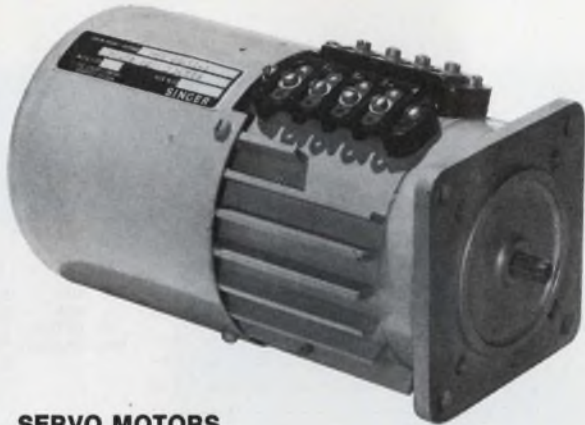

## SERVO MOTORS.

Kearfott offers you a complete line to fit just about any application. From a 3/4" diameter motor with an acceleration of 150,300 rad/sec<sup>2</sup> to units such as the 7" diameter 1 HP Servo Motor shown above.

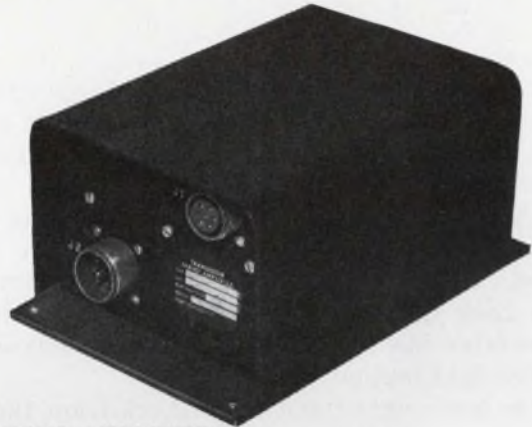

## SERVO AMPLIFIERS.

Choose from 1.4 watt output amplifiers to the new 2200 watt unit above. Only 10" long and weighing just 7 lbs., the XA-2200 is a highly-efficient solid-state amplifier that furnishes output required by 1 HP motors.

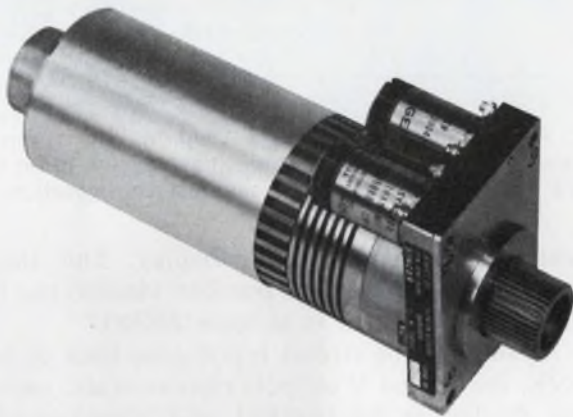

## PRECISION POWER SERVO DRIVES.

Our broad line of Servo Motors (to 1 HP) are the primary drive source for our Power Servo Drives. Typical units give you: accurate positional feedback information; low backlash; highest performance/pound.



## SERVO PACKAGES.

We can give you the "tightest" job, the lowest price and meet your delivery dates. How? We make thousands of Servo components, from motors to clutches. We design and build all associated electronics, from Servo amplifiers to switching networks.

We can meet almost any Servo requirement you may have from a single source—Singer's Kearfott Division.

For nearly 30 years Kearfott has been a pacesetter in the development of small motors and their associated electronics. Today we can offer you a wider variety of Servo components than any other single supplier.

All components are built to the highest order of precision, both in concept and construction. In

addition, we'll design and produce units to your special requirements.

To learn more about Kearfott Servos and capabilities, mail the coupon now, for our information-packed 24-page brochure "Servo Motors". We'll rush it to you. The Singer Company, Kearfott Division, 1150 McBride Avenue, Little Falls, New Jersey 07424.

**SINGER**  
AEROSPACE & MARINE SYSTEMS

INFORMATION RETRIEVAL NUMBER 41

The Singer Company, Kearfott Division  
1150 McBride Avenue  
Little Falls, New Jersey 07424 ED-10

### Gentlemen:

Please send me your 24-page booklet on Servo Motors.

Name \_\_\_\_\_

Title \_\_\_\_\_

Company \_\_\_\_\_

Address \_\_\_\_\_

City \_\_\_\_\_ State \_\_\_\_\_ Zip \_\_\_\_\_

# Reduce numeric LED-display errors

with an easily expandable octal decoder circuit that locks onto one—and only one—input signal.

Octal decoder/driver circuits for seven-segment LED readouts can be built simply and easily with decode logic only. But these circuits are prone to errors or unwanted displays, and often they require a doubling of the number of components when the number of inputs are increased. These problems are eliminated with a Count Lock Loop—a circuit that displays a decimal number identifiable with one—and only one—of its eight mutual inputs.

In the basic eight-input Count Lock Loop, three gates are connected to form a free-running 10-kHz clock (Fig. 1). At a fourth gate, the clock pulses are gated with the Y output from a data selector/multiplexer. As long as Y remains at logic ONE, clock pulses drive the binary counter.

The counter's outputs are connected in parallel to the multiplexer and to the decoder/driver. The counter's eight binary states are decoded so that each of the eight circuit inputs is sampled once during every complete counter cycle—that's once every 800  $\mu$ s, or eight clock cycles.

As long as all eight circuit inputs are either floating (open-circuited) or at logic ONE, the multiplexer's W output remains at logic ZERO and the Y output (its complement) at logic ONE. Output W's logic ZERO, applied at the BI/RBO terminal of the decoder/driver, forces all seven of its outputs to logic ONE, and the display is blanked.

## Response if one input is at ZERO

If one circuit input switches to logic ZERO, the W and Y outputs change state as soon as that circuit input is sampled. This occurs when the binary counter reaches the appropriate state.

The Y output going to logic ZERO keeps clock pulses from reaching the counter, thus preventing it from changing state. The W output going to logic ONE removes the blanking condition from the decoder/driver, allowing it to decode the state of the counter outputs and to drive ap-

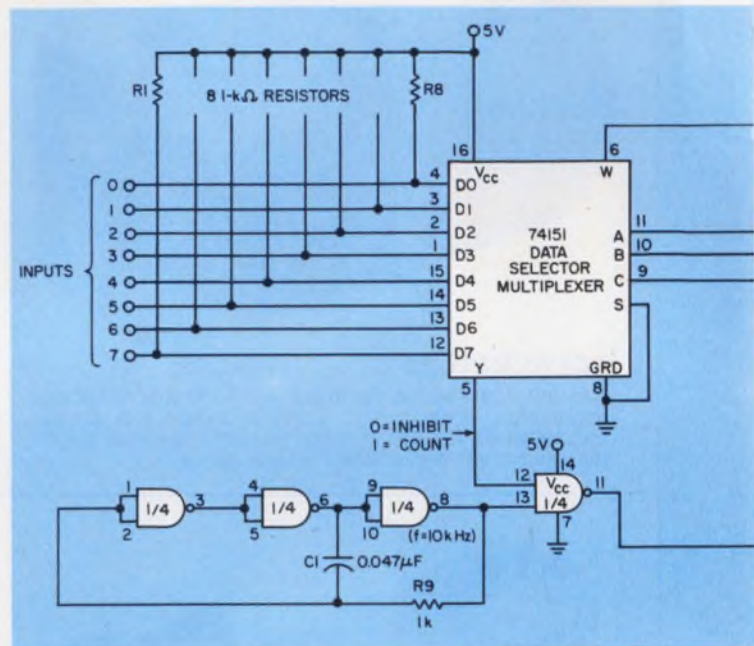

1. An eight-input Count Lock Loop for any seven-segment LED readout that does not have a built-in decoder. It's more involved than the simplest configuration with

appropriate segments of the display. The display then presents a decimal number identifying that circuit input, which is at logic ZERO.

As soon as the circuit input goes back to logic ONE, the W and Y outputs change state, causing the display to be blanked and allowing clock pulses to resume driving the binary counter. The sampling of each circuit input once during every counter cycle is resumed.

## What happens in the simpler circuit

A circuit that uses decode logic only (Fig. 2) can cause an erroneous display. While its general function is similar, its operation is not equivalent to that of the Count Lock Loop. Consider this circuit's response if certain combinations of inputs simultaneously are at logic ZERO.

If circuit inputs 4 and 7 are simultaneously at logic ZERO and all other inputs are at logic ONE, this circuit causes numeral 1 to be displayed (even though circuit input 1 is actually at logic ONE). Another example is the ambiguous

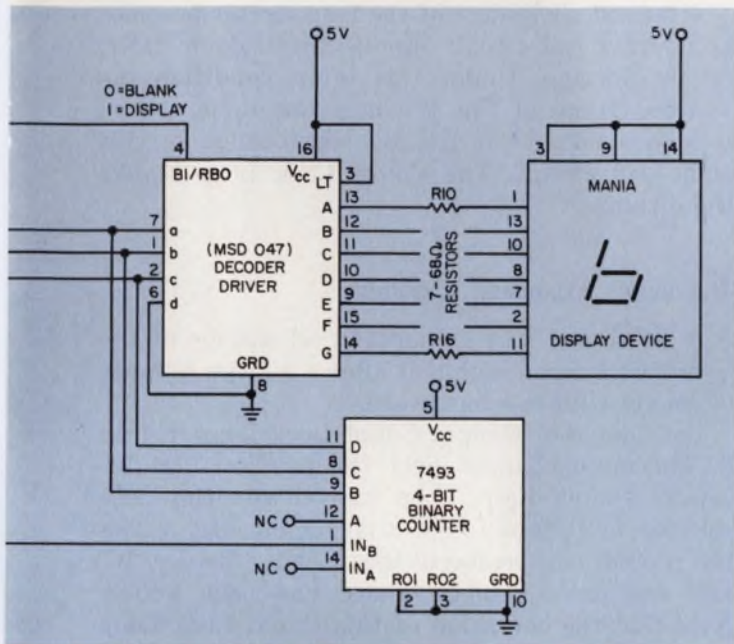

decode logic only, but the octal configuration insures that only one input determines the numeral displayed. And it can be easily expanded for more inputs.

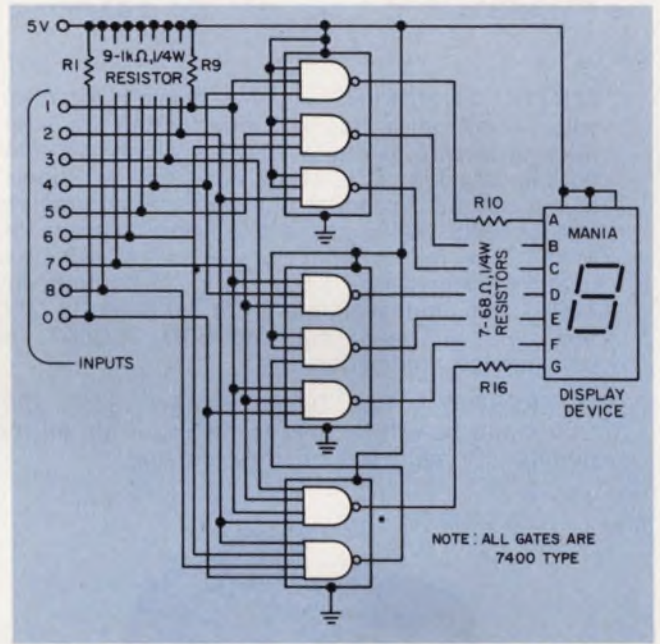

2. **With decode logic only**, you can build this circuit. But the disadvantages include erroneous displays, non-significant numerals and limited expandability.

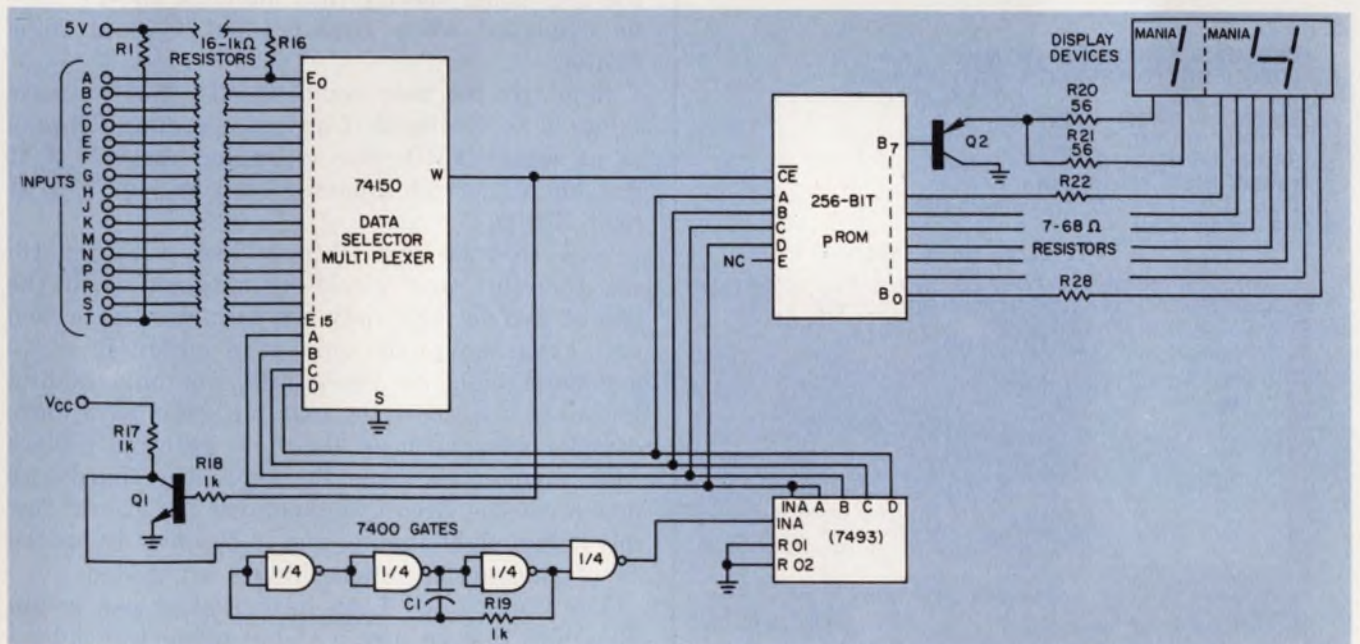

3. A 16-input Count Lock Loop requires only a larger data selector/multiplexer, a pROM instead of a decoder/

driver IC and one more display. The operation of this larger loop is essentially that of the octal circuit.

# OSCILLATORS

1 Hz to 250 MHz



**ANALOG                      DIGITAL**

**ANALOG ENGINEERS** — We haven't forgotten you. Accutronics has not devoted all its engineering talents to digital devices which are compatible with TTL, ECL, MECL and COS/MOS logic. In our standard product line we carry a complete line of SINE WAVE oscillators from 1 Hz to 250 MHz. Take for example our Series 110 which is neatly packaged in a 1.5 x 1.5 x 1.5 hermetically sealed can and available from 10 MHz to 250 MHz with +10dbm out into 50Ω. GREAT for your analog application.

**INTERESTING?** Call Dennis Griffin (312) 232-2600, and he will be glad to fill you in on all the details and send you our new catalog.



Series 110

FREQUENCY: 10 MHz to 250 MHz  
FREQUENCY TOLERANCE:  $\pm 0.001\%$  from  
 $0^{\circ}\text{C}$  to  $60^{\circ}\text{C}$   
SUPPLY VOLTAGE: +12V DC  
OUTPUT VOLTAGE: +10dbm  $\pm 3\text{db}$  into 50Ω  
SPURIOUS RESPONSE: >70db down  
HARMONICS: >20 db down  
SIZE: 1.5 x 1.5 x 1.5" typical with OSM  
connector

SEE 1972-73 EEM Pg 1571

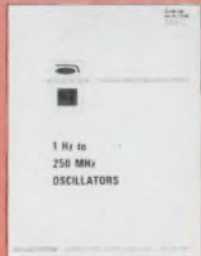

**Please write or  
call for**

**NEW 1973 CATALOG**

Our new catalog covers various types of oscillators: VCXO, LCXCO, RCXCO, high stability, computer clocks, high output power, Navy standard hardware modules and low current drain oscillators from 1 Hz to 250 MHz. We'll even send you three neat conversion charts (3) to hang on your wall and impress your friends.

**accutronics**

A HAMMOND CORPORATION COMPANY

628 NORTH STREET • GENEVA, ILLINOIS 60134

character that this circuit displays if inputs 2 and 7 are simultaneously at logic ZERO.

Now consider the response of the Count Lock Loop of Fig. 1. As soon as it detects a circuit input at logic ZERO, the loop causes the input's identifying number to be displayed. Any other circuit input or inputs simultaneously at logic ZERO are not allowed to change the display because the binary counter's state is "frozen." Other inputs continue to be ignored until the displayed circuit input goes back to logic ONE or floats. The Count Lock Loop circuit insures an error-free display.

A second advantage of the loop circuit becomes apparent if all circuit inputs are at logic ONE or are floating. Under this input condition the simpler circuit of Fig. 2 causes the numeral 9 to be displayed, but it has no significance in this eight-lead circuit. The Count Lock Loop blanks the display.

### The loop's expansion capability

A third, and very important, advantage of the Count Lock Loop is that it allows a large number of inputs with less hardware.

Consider the 16-input Count Lock Loop in Fig. 3. The main changes over the previous (eight-input) Count Lock Loop are these: the data selector/multiplexer is of a larger bit size, a 256-bit pROM has replaced the decoder/driver IC, and one more display device has been added. Note that the operation of this Count Lock Loop is an extension of that already described.

Also, in the Count Lock Loop with the pROM the user is allowed to specify the code for numerals that designate circuit inputs. For example, the user could specify that numeral 16—or 15—be displayed when circuit input t is at logic ZERO.

Similarly the user could specify that a single numeral be displayed if any of a group of inputs is at logic ZERO—for example, numeral 3 if any one of circuit inputs g or h or j or k is at logic ZERO.

Now contrast this 16-input loop with the 16-input circuit that would be obtained with the use of decode logic only. In the latter approach each expansion of the number of circuit inputs—say from eight to 10—entails not only adding gates but also replacing existing gates with more complex ones, such as five-input gates to replace four-input gates. Thus the amount of hardware doubles if the circuit is expanded for even a few more than eight inputs, and it becomes impractical if substantially more inputs are added.

The Count Lock Loop has greatest use in applications that require a visual numerical indication of OPEN or GROUNDED in a large number of inputs. ■■



# We made it because there wasn't a high performance digital panel meter at this price. Now there is.

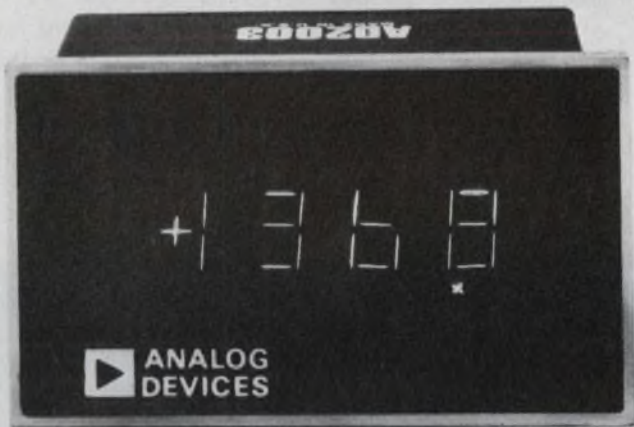

## Our AD2003 3½-digit DPM. Only \$93 in 100's.

When we introduced our first 3½-digit panel meter it was the world's smallest and least expensive DPM.

We made it primarily for high accuracy display applications.

And it cost only \$89 in 100's.

Now for only \$4 more, our 5VDC powered AD2003 has the kind of performance you need for complex system interfacing and data processing.

That's because we designed it with a true differential instrumentation input amplifier and fully latched DTL/TTL compatible BCD outputs.

You can count on high common mode rejection of 80dB minimum at  $\pm 2.5V$ . Good normal mode rejection of 40dB. And you'll get a conversion

time of 60ms max.

A few other things that make our panel meter a lot better are green filtered RCA Numitron display tubes with optional color filters you can choose for color-coding.

Polarity and overload indicators.

A seven segment filament test.

And all this performance comes neatly and reliably packaged in a 1.8" H x 3" W x 2"D rugged aluminum case which easily snaps into your panel from the front.

Think of it as a component.

We burn-in each AD2003 for 7 days before shipping.

Something we do with all our panel meters.

Like our first 3½-digit meter — perfect for display.

Our second meter — an economical 2½-digit snap-in replacement for analog meters.

And now this new high performance 3½-digit DPM.

And a soon-to-be high performance 4½-digit model.

You can get evaluation samples of our AD2003 right now. As well as our Product Guide which shows all the other things we make to solve more of your problems better than anyone else.

Analog Devices, Inc., Norwood, Mass. 02062  
(617) 329-4700.



## Line-voltage fluctuation indicator detects single-cycle variations

A line-voltage monitor reacts to voltage fluctuations of one-cycle duration. If, in any cycle of line voltage, the negative or positive peak becomes high or low by more than 10% of its normal peak value, an indicator lamp lights.

The diode bridge (CR<sub>1</sub> through CR<sub>4</sub> in Fig. 1), rectifies the line voltage, producing a full-wave rectified output at points A and B. Potentiometer R<sub>1</sub> should be adjusted, so that when the peak value of line voltage is kept within 10% (maximum tolerance) of its normal value, SCR<sub>1</sub> is triggered via zener diode CR<sub>15</sub>. When SCR<sub>1</sub> turns on, it turns on transistor Q<sub>1</sub>, discharging capacitor C<sub>1</sub>. With capacitor C<sub>1</sub> discharged, transistor Q<sub>2</sub>, SCR<sub>2</sub>, and the undervoltage indicator lamp all remain off.

When SCR<sub>1</sub> is turned off, transistor Q<sub>1</sub> also turns off and capacitor C<sub>1</sub> charges. But before

capacitor C<sub>1</sub> charges to the triggering level of unijunction transistor Q<sub>2</sub>, the peak of the new cycle of line voltage causes it to discharge. As long as the peak value of each cycle of line voltage is not lower than 90% of its normal value, the voltage across C<sub>1</sub> will not exceed the triggering level of unijunction transistor Q<sub>2</sub>.

If the peak value of the line voltage fluctuates to less than 90% of its regular value, SCR<sub>1</sub> and transistor Q<sub>1</sub> will not turn on. This allows capacitor C<sub>1</sub> to charge up to the triggering level of unijunction transistor Q<sub>2</sub>. When Q<sub>2</sub> turns on, the voltage at point C will rise to the triggering level of SCR<sub>2</sub>, thus turning on the undervoltage indicating lamp.

Potentiometer R<sub>2</sub> is similarly adjusted, so that when the peak value of the line voltage is kept at its regular value or 10% higher, SCR<sub>2</sub> remains

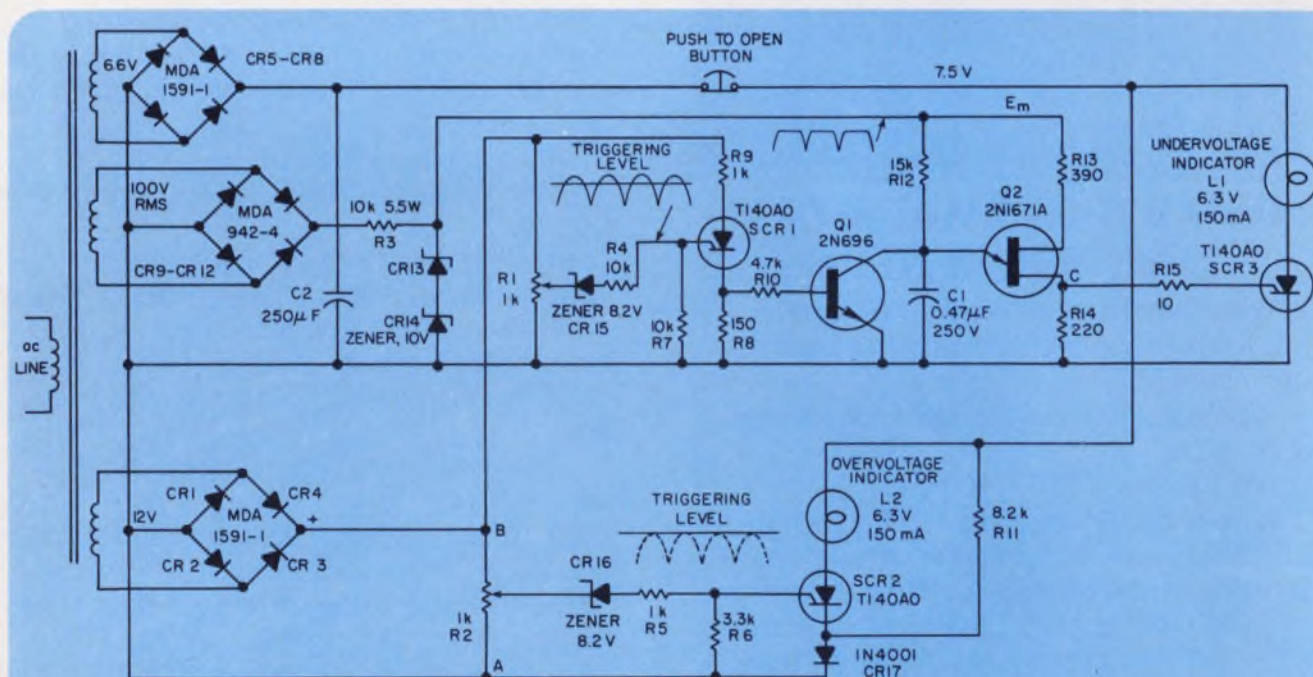

1. Fluctuations in line voltage 10% above normal trigger SCR<sub>2</sub> and fluctuations 10% below normal,

SCR<sub>1</sub>. The triggering turns on either the over-voltage or undervoltage indicating lamp.

# What do you get when you cross a signal source with a calculator?

Automatic testing with HP's new 3330B AUTOMATIC SYNTHESIZER. In this one outstanding instrument, you get a flexible synthesizer, a top-performing sweep generator, and a precision level generator—all under digital control. Its built-in controller adds computer flexibility—you can forget about tying up an external computer for your automatic testing on the production line, and for the first time make this level of testing economically feasible in your lab.

For man-machine interfacing, 3330B's convenient swing-out keyboard, coupled with 9-digits of frequency and 4-digits of amplitude readout, gives you complete flexibility for setting up your test routines.

As a frequency synthesizer spectral purity is exceptional. Spurious is down 70 dB, and harmonics at least 40 dB below the carrier. Through its easy-to-use keyboard, you can, with 0.1 Hz resolution, set in any frequency between 0.1 Hz and 13 MHz, then automatically or manually increment (tune) that frequency by any amount. Each point has the synthesizer stability of  $\pm 1$  part in  $10^8$ /day.

You can repeat the same automatic or manual sweeping operation with amplitude level. Its 100 dB range, 0.01 dB resolution and flatness of  $\pm 0.05$  dB make the 3330B a precision level generator.

Call on Model 3330B for your sweep generator needs, and you'll get performance levels of accuracy, linearity, and resolution never before available. That's because the internal serial microprocessor controls digital sweeping of synthesized frequencies or precise amplitudes. Through its keyboard and front-panel controls, you enter all sweep parameters—your 3330B takes it from there.

Systems Designers will find the standard 3330B fully programmable—ready for low-cost interfacing to other ASCII instruments and controllers, like marked card programmers, calculators, and computers.

Price? If you think about it, you would have bought a synthesizer, a sweeper, a marker generator, a counter, a programmable attenuator, and some computer time to come anywhere close to solving the same problems now done by the 3330B. At \$6000 for a complete frequency lab, we think you'll agree that the price-performance ratio of the 3330B is great. (Model 3330A, priced at \$5100, performs identically to the 3330B but has manual amplitude control and 13 dB range.)

For further information on the 3330A/B, contact your local HP field engineer. Or, write Hewlett-Packard, Palo Alto, California 94304. In Europe: 1217 Meyrin-Geneva, Switzerland.

A092/1



off. When the peak value exceeds its regular value by more than 10%, SCR<sub>2</sub> conducts and the overvoltage lamp lights.

SCR<sub>1</sub> is biased to trigger when the value of the full-wave rectified line voltage exceeds E<sub>1</sub>, where E<sub>1</sub> is 90% of the regular peak value. The voltage (Fig. 2) across capacitor C<sub>1</sub> is given by the expression

$$E_c = E_m (1 - e^{-t/RC_1})$$

where E<sub>c</sub> is the voltage across capacitor C<sub>1</sub>

E<sub>m</sub> is the maximum voltage across unijunction transistor Q<sub>2</sub>

C<sub>1</sub> is capacitance of C<sub>1</sub>

R is the 15-kΩ resistance of R<sub>11</sub>.

If SCR<sub>1</sub> is turned off, voltage E<sub>c</sub> rises to the triggering level of unijunction transistor Q<sub>2</sub>. Different values for C<sub>1</sub> vary the number of undervoltage cycles that will trigger Q<sub>2</sub> and turn on the lamp.

A. Spetsakis and A. Milas, *Electronic Div., N.R.C. Democritos, Aghia Paraskevi, Attikis, Athens, Greece.*

CIRCLE NO. 311

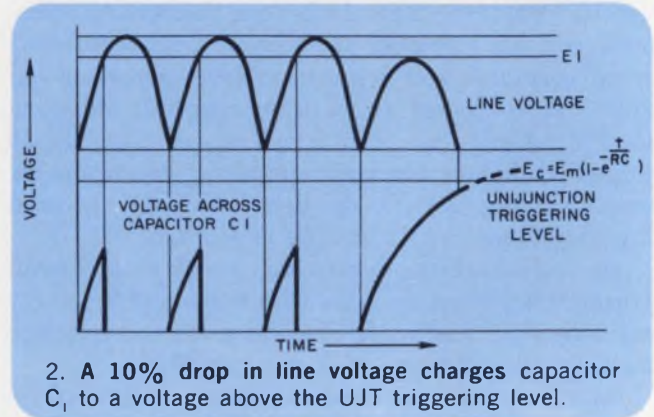

## Op-amp current source achieves wide voltage compliance

An elaboration of the simple op-amp current source overcomes the conventional limits of maximum op-amp output current and maximum output voltage swing. The circuit shown provides a constant current, variable from 0 to 10 mA, with a voltage compliance of 28 V. Current and voltage capability are limited only by the op amp, driver transistor Q<sub>1</sub>, output transistor Q<sub>2</sub> and the power supply.

The 741 op amp provides most of the gain required for good repeatability. Common-base driver Q<sub>1</sub> and output transistor Q<sub>2</sub> prevent the op amp from operating with its output at saturation.

To adjust the output current, measure the voltage drop across current-sense resistor R<sub>2</sub> with a short across diode CR<sub>1</sub>, which may be any zener having a 0 to 27.5 V range. Variations in the resistance of R<sub>2</sub> adjust the output current from 0 to 10 mA. Output current may be set to three decimal places if R<sub>2</sub> is a 10-turn potentiometer with good resolution. The shunting effect of R<sub>5</sub> introduces an error of 0.1% when a voltmeter with an input impedance of 1 MΩ or more is used.

This circuit is power-supply-sensitive because the voltage source generates the reference. Although a Semiconductor Circuits, Inc., Model P2.15.60 supply—which has 0.001% line and 0.01% load regulation at the required output current level—was used, any supply with similar

regulation should work.

Donald Belanger, *President, Semiconductor Circuits, Inc., 306 River St., Haverhill, Mass. 01830.*

CIRCLE NO. 312

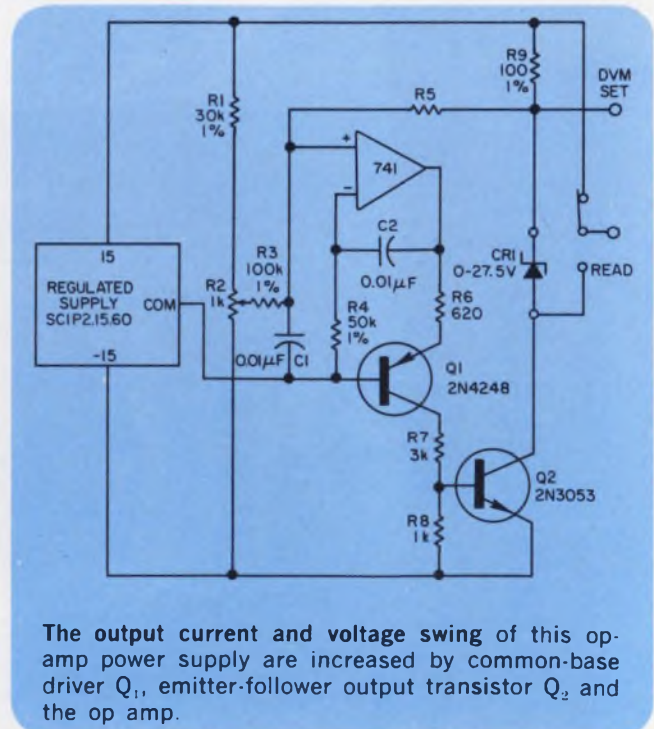



# Take Me Along!

- ❑ **New** 25 Range DMM
- ❑ 3½ Digit **.05%** Accuracy
- ❑ Rugged **All Metal** Construction
- ❑ 8 Hour **Battery & Line** Operation Standard
- ❑ **LED** Display



New Model 262C,

**\$345.00**

includes rechargeable batteries. Stock Delivery.  
Model 261C DC & Ohms only, \$289.00



**United Systems Corp.**, 918 Woodley Rd., Dayton, Ohio 45403 Phone (513) 254-6251  
All Digitec instruments are available for rental or lease through Rental Electronics, Inc.

INFORMATION RETRIEVAL NUMBER 45

# Pulse stretcher indicates presence and polarity of TTL pulses to 20 MHz

A simple pulse stretcher determines the presence and polarity of TTL-pulsed waveforms—with repetition frequencies up to 20 MHz and with pulse widths of greater than 10 ns. Unlike similar logic probes<sup>1</sup>, the circuit of Fig. 1 tracks the input pulse duty cycle.

The output signal duplicates the TTL input level. A positive pulse with less than a 50% duty cycle (Fig. 2a) produces the output in Fig. 2b. Conversely, the negative pulse in Fig. 2c produces the output in Fig. 2d. The output polarities

may be detected by either a buzzer or an indicator light.

The 9602 retriggerable monostable multivibrator is connected as a nonretriggerable constant-duration pulse generator. A positive input at pin 4 drives output pin 7 LOW for 80 ms (determined by the  $R_1C_1$  time constant). When pin 7 returns to HIGH, it triggers pin 12, driving pin 9 LOW and disabling the input for 320 ms more.

The resulting output at pin 7 is thus a positive pulse with a period of 0.4 s and a width of 80 ms (Figs. 2b, 2d). The average of the input pulse is determined by resistor  $R_1$  and capacitor  $C_1$ . Transistor  $Q_1$  acts as a buffer, and  $Q_2$  sets the pulse output polarity at pin 11 of the EXCLUSIVE-OR gate.

**Reference**

1. Sinutko, Michael, "Logic Probe Responds to TTL Pulses of Less Than 10 ns in Width," *Electronic Design* 9, April 27, 1972, p. 76.

Jeff Duerr, Hewlett-Packard Co., 1900 Garden of the Gods Rd., Colorado Springs, Colo. 80907.

CIRCLE NO. 313

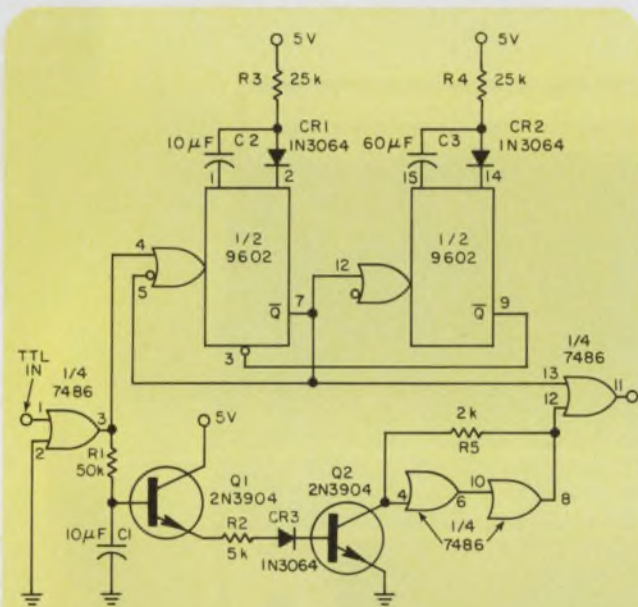

1. Monostable multivibrator 9602 tracks the duty cycle of a TTL input, generating a pulse train with the same polarity as the input.

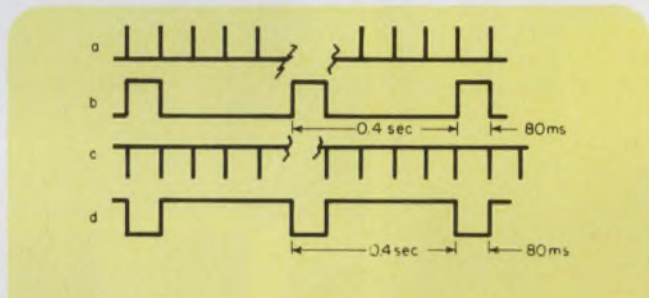

2. Positive (a) and negative (b) input pulses produce corresponding output pulse trains (b and d).

**IFD Winner of June 22, 1972**

Alphonso H. Marsh, Sr. Engineer, Raytheon Co., Sudbury, Mass. 01766. His idea "Gating scheme maximizes dc-dc converter efficiency" has been voted the Most Valuable of Issue award.

Vote for the Best Idea in this issue.

**SEND US YOUR IDEAS FOR DESIGN.** You may win a grand total of \$1050 (cash)! Here's how. Submit your IFD describing a new or important circuit or design technique, the clever use of a new component or test equipment, packaging tips, cost-saving ideas to our Ideas for Design editor. Ideas can only be considered for publication if they are submitted exclusively to ELECTRONIC DESIGN. You will receive \$20 for each published idea, \$30 more if it is voted best of issue by our readers. The best-of-issue winners become eligible for the Idea of the Year award of \$1000.

ELECTRONIC DESIGN cannot assume responsibility for circuits shown nor represent freedom from patent infringement.

# Greater RFI/EMI shielding in new, narrow-width contact strips from Instrument Specialties

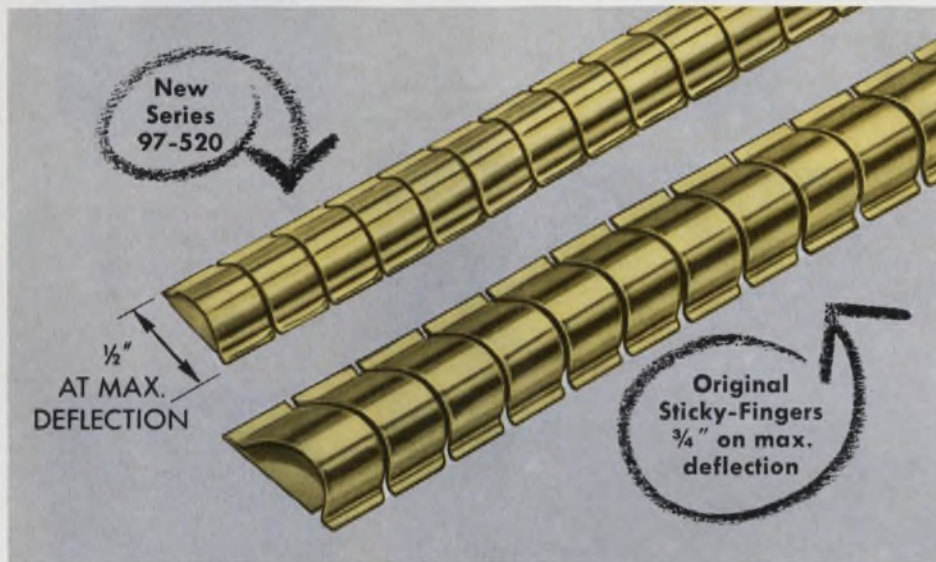

Latest addition to **sticky fingers**® line!

Instrument Specialties now offers Sticky-Fingers self-adhesive, beryllium copper contact strips in three variations to solve your most critical RFI/EMI problems.

Comparable to the shielding effectiveness of the original Sticky-Fingers, our newest series 97-520\* offers shielding effectiveness of 92 dB at 10 GHz plane wave or greater than 92 dB at 1 MHz magnetic, and has a dynamic range of 0.10". Yet, it measures a scant 3/8" wide, and 1/2" at maximum deflection.

Supplied in standard 16" lengths, series 97-520 is ideal for metal cabinets and electronic enclosures where variations exist in the space to be shielded, and where high shielding effectiveness must be maintained in narrow spaces, even with frequent opening and closing of the cabinet.

Select the exact series that fits your application best. Write today for a complete catalog, list of finishes available, and our latest Independent Shielding Evaluation Report. Address: Dept. ED-68

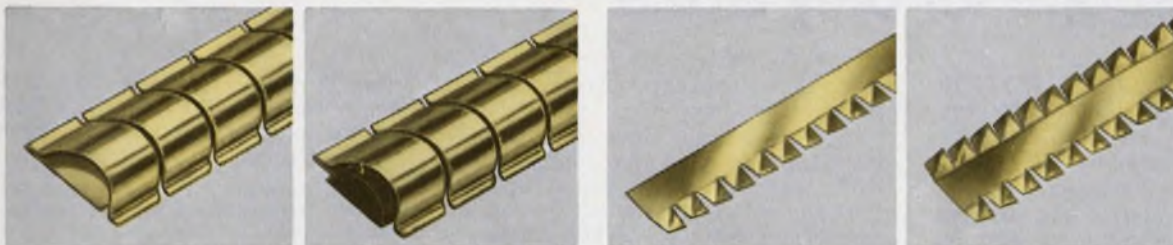

Series 97-500\*—the original 3/4" wide Sticky-Fingers. Specify when you require greatest possible shielding and where space permits. Also, supplied as 97-510 with Magnifil® for optimum magnetic shielding.

For those all-purpose applications where economy and space are both factors, specify the 3/8" wide single-twist series 97-555, or 1/2" wide double-twist series 97-560 Sticky-Fingers.

*Specialists in beryllium copper springs since 1938*

\*Patented

  
 INSTRUMENT SPECIALTIES CO., INC.  
 Little Falls, New Jersey  
 Phone 201-256-3500

INFORMATION RETRIEVAL NUMBER 46

### TRIGGERED SWEEP

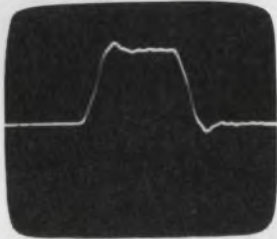

250-nanosecond (¼-microsecond) pulse demonstrates trace expansion and rise time capability of the new RCA WO-535A in Triggered Sweep Mode.

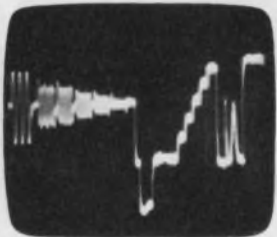

Typical TV VITS pattern on the new RCA WO-535A in Triggered Sweep Mode.

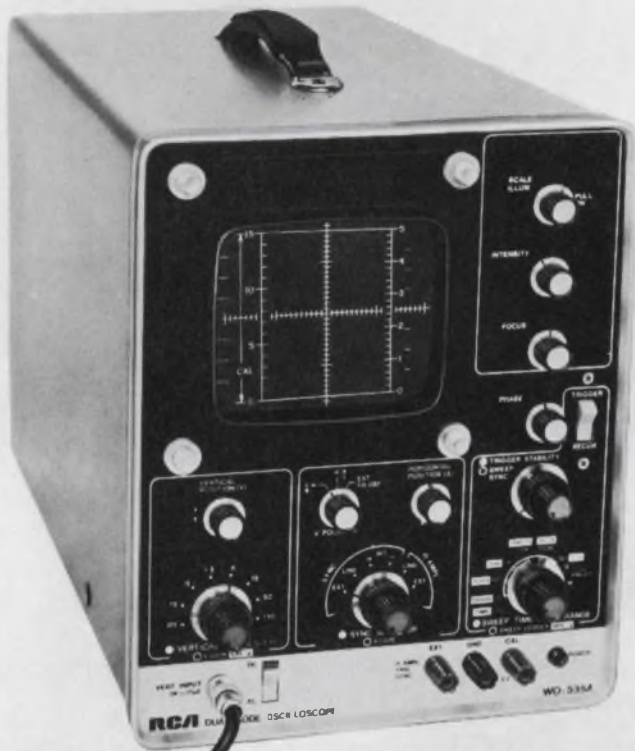

### RECURRENT SWEEP

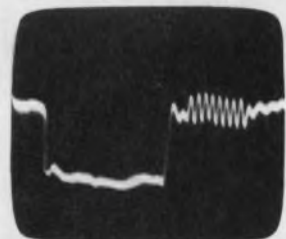

Expanded video signal on the new RCA WO-535A in Recurrent Sweep Mode shows the horizontal sync pulse and 3.58 MHz color-burst signal.

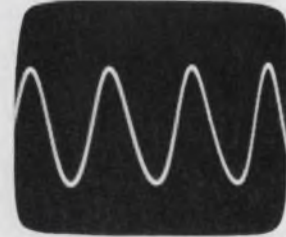

3.58 MHz sine-wave as shown on new RCA WO-535A in Recurrent Sweep Mode.

## Now...a 5-inch triggered/recurrent sweep oscilloscope for only \$329\*

It's the all solid-state RCA WO-535A featuring one-step calibration for simplified voltage measurements and usable frequency response to 10 MHz.

In the Triggered Sweep Mode, you can lock in waveforms and patterns that cannot be viewed easily using recurrent sweep. Triggered sweep with wide, variable trace expansion permits you to view small segments of complex waveforms, such as vertical-interval test signals (VITS). In the Recurrent Sweep Mode, you get all the ad-

vantages of a conventional continuous-sweep oscilloscope.

There are many other features of the WO-535A you'll like — and your RCA Distributor will be glad to supply complete information about this general-purpose oscilloscope that provides high performance in such applications as radio and TV servicing, industrial maintenance, troubleshooting, and general waveform analysis.

Also ask your RCA Distributor for the full story on the RCA WO-505A,

priced at \$299\*, and the RCA WO-33A, priced at \$180\*. Or write RCA Test Equipment Headquarters, Harrison, N.J. 07029.

\*Optional Distributor Resale Price, complete with direct/low capacitance shielded probe and cable.

RCA|Electronic Components|Harrison, N.J. 07029.

# RCA

INTERNATIONAL SALES OFFICES: ARGENTINA—Casilla de Correo 4400 Buenos Aires/BRAZIL—Caixa Postal 8460, São Paulo/CANADA—21001 No. Service Rd. Ste. Anne de Bellevue, 810 Quebec/ENGLAND—Sunbury-on-Thames, Middlesex/HONG KONG—P.O. Box 112/MEXICO—Aparlato 17-570, Mexico 17, D.F./SWITZERLAND—2-4 rue du Lièvre, 1227 Geneva

INFORMATION RETRIEVAL NUMBER 47



## new products

# CMOS line uses dielectric isolation for fastest CMOS ICs on silicon

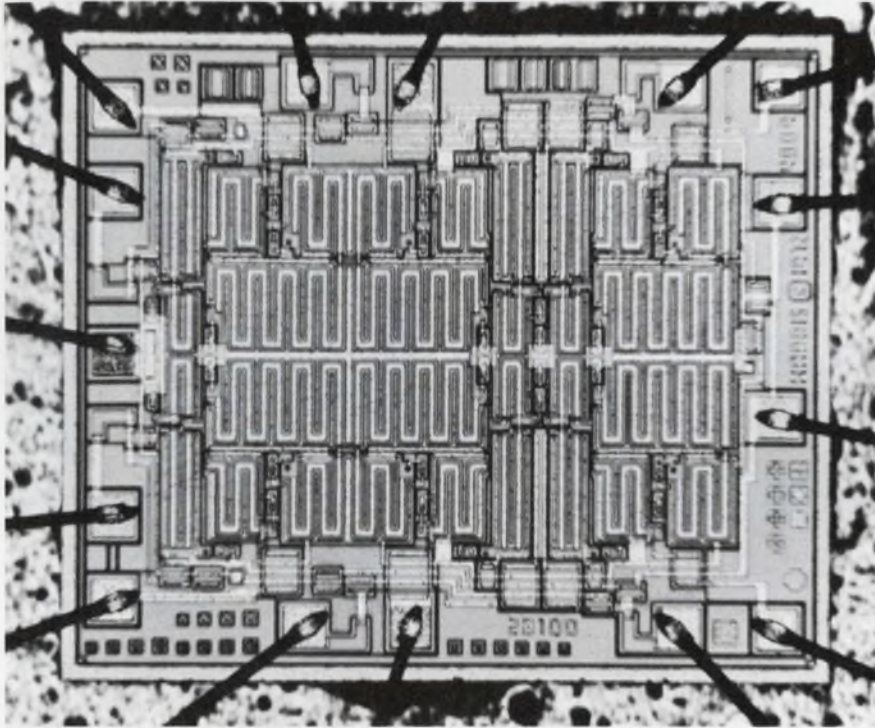

Harris Semiconductor, P.O. Box 883, Melbourne, Fla. 32901. (305) 727-5407. P&A: See below.

Standard complementary MOS (CMOS) lines, available from a number of manufacturers, have generally tended to be alternate-source devices for the industry's leading series, RCA's COS/MOS CD 4000 family. The latest entry—Harris Semiconductor's HD 4000 line—breaks the pattern with an initial offering of eight basic digital circuits that are reported to give a 2:1 improvement in speed and an order of magnitude reduction in standby power dissipation.

This improvement in performance results from the use of dielectric isolation techniques in the fabrication process. Harris thus avoids the relatively new and expensive silicon-on-sapphire (SOS) technology, now offered only by Inselek in its CMOS/SOS series. Both techniques lead to similar improvements in performance. However, the use of SOS represents a fundamental alteration in

the CMOS process: SOS, rather than the more common silicon, is used as the starting substrate.

For CMOS on silicon, National's 54C/74C series presents the major alternate direction of standard CMOS ICs. This line features TTL-pin compatibility and is primarily intended as a direct replacement for equivalent TTL functions. However the specs—especially on speed and power drain—are generally the same as those for similar RCA circuits.

The new Harris circuits have pin-out configurations that are compatible with the RCA and alternate series. Thus these circuits can replace or interface with the standard equivalent RCA series with identical input/output levels.

Compared with RCA CMOS circuits and alternate lines, Harris lists the highest CMOS speeds of any standard line. A NAND gate in the Harris CMOS series features propagation delays of 20 and 10 ns for a load capacitance of 15 pF and supplies of 5 and 10 V,

respectively. The corresponding delays of equivalent RCA circuits are 35 and 25 ns. For a 50 pF load and the same two supply voltages, the Harris gate maintains a better than 2:1 improvement in speed.

Flip-flop toggle rates, with 5 and 10-V supplies, are 6 and 15 MHz in the Harris series. Equivalent RCA circuits list 4 and 10 MHz, respectively.

All CMOS lines feature standby power dissipation in the nanowatt region. But the same Harris NAND gate has a 0.5-nW drain, as opposed to 5 nW for RCA circuits. And supply voltages can range from 3 to 18 V, as opposed to the more common 3 to 15 V.

Harris' HD-4000 series, also called DI/CMOS, includes the following seven COS/MOS-equivalent circuits—prices indicate 100-999 quantities and commercial versions (–40 to 85 C): 4000, dual 3-NOR gate (\$1); 4001, quad 2-NOR gate (\$1); 4009, hex inverter (\$2.20); 4010, 16-pin hex buffer (\$2.20); 4011, quad 2-NAND gate (\$1); 4012, dual 4-NAND gate (\$1), and 4013, dual D flip-flop (\$2.10).

Unit prices listed are generally competitive with those of other CMOS manufacturers. All devices are available only in ceramic DIPs and all, except for the 4009 and 4010 circuits (16-pin packages), come in 14-pin packages.

The eighth Harris device, the HD-4809 triple true/complement buffer, is an original Harris circuit. The commercial version sells for \$2.25 (100-999).

Other manufacturers offering standard CMOS lines are Hughes Microelectronics, Motorola Semiconductor, Solid State Scientific and Solitron Devices.

For more information on:

Harris HD-4000	CIRCLE NO. 254
Inselek CMOS/SOS	CIRCLE NO. 255
National 54C/74C	CIRCLE NO. 256
RCA CD4000	CIRCLE NO. 257

# Versatile multiplier chip extends bandwidth while reducing design complexity

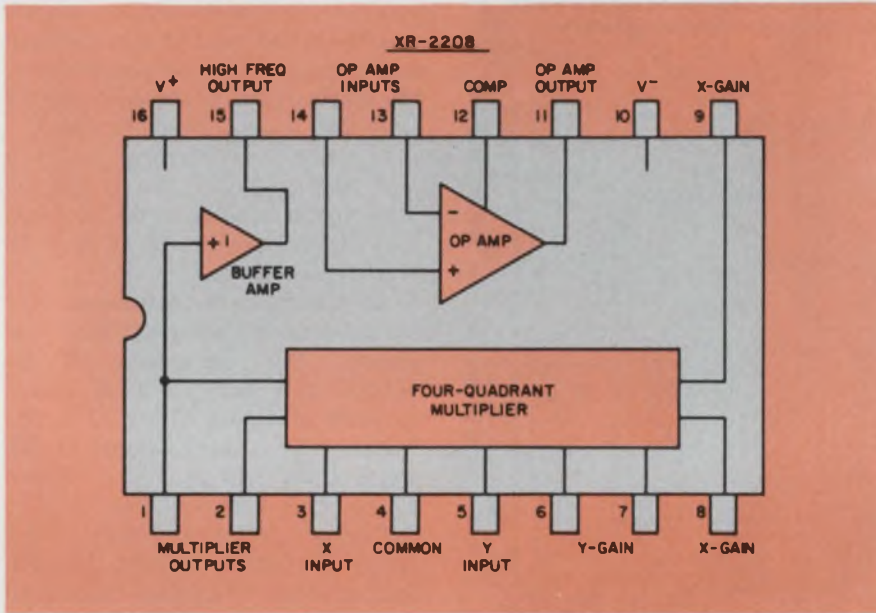

Exar Integrated Systems, Inc., 733 N. Pastoria Ave., Sunnyvale, Calif. 94086. (408) 732-7970. P&A: See below.

Before the introduction of Exar's XR-2208 Operational Multiplier, separate ICs were required for the two major application areas of four-quadrant multipliers: analog computation and signal processing. In general, an op amp or a buffer amp is essential for these applications in addition to the right multiplier. Now one XR-2208 does the job, at the same time providing increased bandwidth with fewer external passive components.

The XR-2208 contains a four-quadrant multiplier (or modulator), an op amp and a high-frequency buffer amp all on the same chip (see diagram). Both amplifiers are uncommitted. They can be used independently or interconnected to the multiplier section depending upon application.

Presently available multipliers include Motorola's fully monolithic MC1595/1495 and MC1594/1494 multipliers, with typical small-signal bandwidths of 3 and 1 MHz, respectively. Available from Mo-

torola and alternate sources, these devices don't have an op amp on the chip. And for multiplication, more than 20 external passive components plus the op amp are needed. The Exar circuit requires only about 15 passive components for the same job.

Other multipliers are Analog Devices' AD530 and Intersil's 8013. These units are monolithic with thin-film resistors, and an op amp is included on the chip. However, the use of film resistors leads to higher prices, and the op amp is connected to the multiplier section, thus limiting the number of applications.

The XR-2208, operating from split supplies ranging from  $\pm 4.5$  V to  $\pm 15$  V, has a linearity (defined as the output voltage deviation from a straight-line transfer function) of 0.3% typical and 0.5% maximum. About the same values can be obtained with other multipliers.

But the 3-dB bandwidth of the Exar circuit is 6 MHz, typical, for the X-input, compared with 800 kHz for Motorola's 1594 and 1 MHz for Intersil's 8013. The three-degree phase-shift bandwidth is

typically 1.2 MHz vs 240 kHz for the 1594.

The op-amp section of the XR-2208—a 741-type—lists input offsets under 6 mV, bias current of 100 nA, gain of 75 dB and  $\pm 12$ -V output swing for  $\pm 15$ -V supplies.

For analog computation, such as multiplication, the op amp is connected to the multiplier section. This provides a level shifting and single-ended output at pin 11. The op amp can also function as a pre-amp to the multiplier section for low-level input signals or as a post-detection amp for synchronous demodulator applications.

In a typical configuration for multiplication, potentiometers connected to pins 7, 8 and 5 are used to trim offsets and adjust the scale factor. With a scale factor of 0.1, a 10-V pk-pk output swing can be provided for X and Y voltages of 10 V.

In signal processing the unity-gain buffer amp extends the 3-dB bandwidth of the multiplier to 10 MHz. It also provides a low-impedance ( $50 \Omega$ ) output for high-frequency amplifier and modulator applications.

The XR-2208 is available in a 16-pin DIP ceramic with a temperature range of 0 to 75 C. The price for 100 quantities is \$6.90. A military version, the XR-2208M, goes for \$9.25 (100 up). And a relaxed electrical-spec version, the XR-2308, covering the industrial temperature range, is available for \$4 (100 up). Delivery is from stock.

For more information on the following multiplier circuits, circle the appropriate information retrieval number.

For Analog Devices AD530	CIRCLE NO. 250
For Exar XR-2208	CIRCLE NO. 251
For Intersil 8013	CIRCLE NO. 252
For Motorola 1595/1495, 1594/1494	CIRCLE NO. 253



DIODE-LITEs

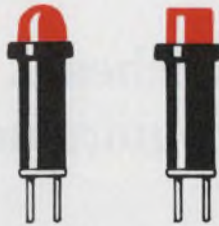

Cartridges

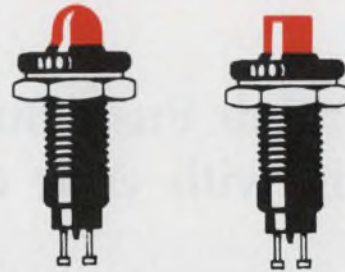

Indicator lights

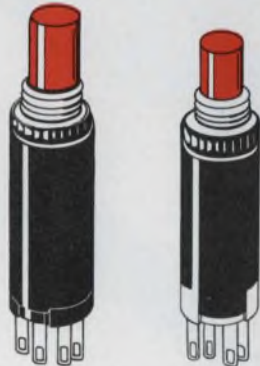

Lighted push button switches

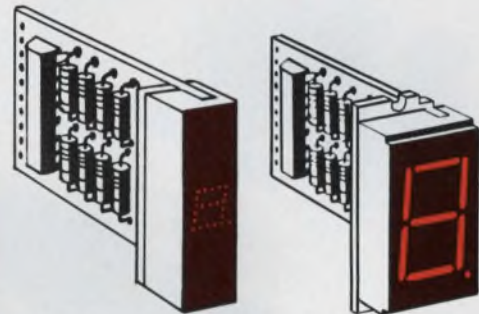
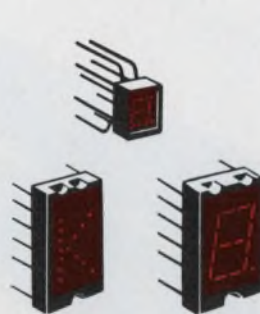

Readout modules and packages

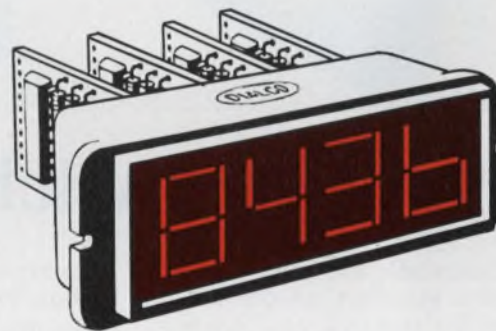
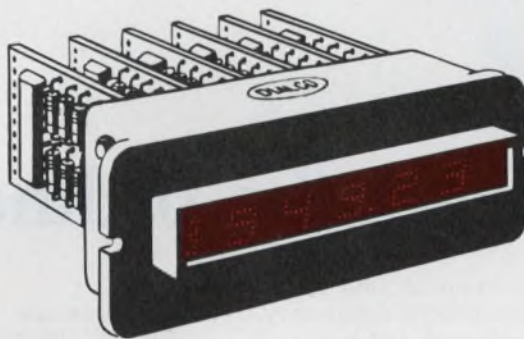

Readout assemblies

## LED displays?

**Talk to the specialists at Dialight first.  
You won't have to talk to anyone else.**

Whether you're looking for LEDs as light sources for build-your-own displays or for a variety of products that utilize LEDs, bring your requirements to us. Dialight is a major supplier of both LEDs (we call ours DIODE-LITE™) and of indicator lights, readouts and lighted push button switches that incorporate

DIODE-LITEs. We can even give you a contactless solid state switch that uses a DIODE-LITE in the circuit to provide cleaner, faster switching than any mechanical switch. Dialight can help you do more with LEDs than anyone else because we've done more with them. Write for LED Data File.



DIALIGHT CORPORATION, A NORTH AMERICAN PHILIPS COMPANY • 60 STEWART AVENUE, BROOKLYN, N.Y. 11237 • (212) 497-7600

INFORMATION RETRIEVAL NUMBER 48

# Centralab Push Button Switches... in line with your design requirements



Write  
Centralab  
for  
Bulletin  
No. ELC-3

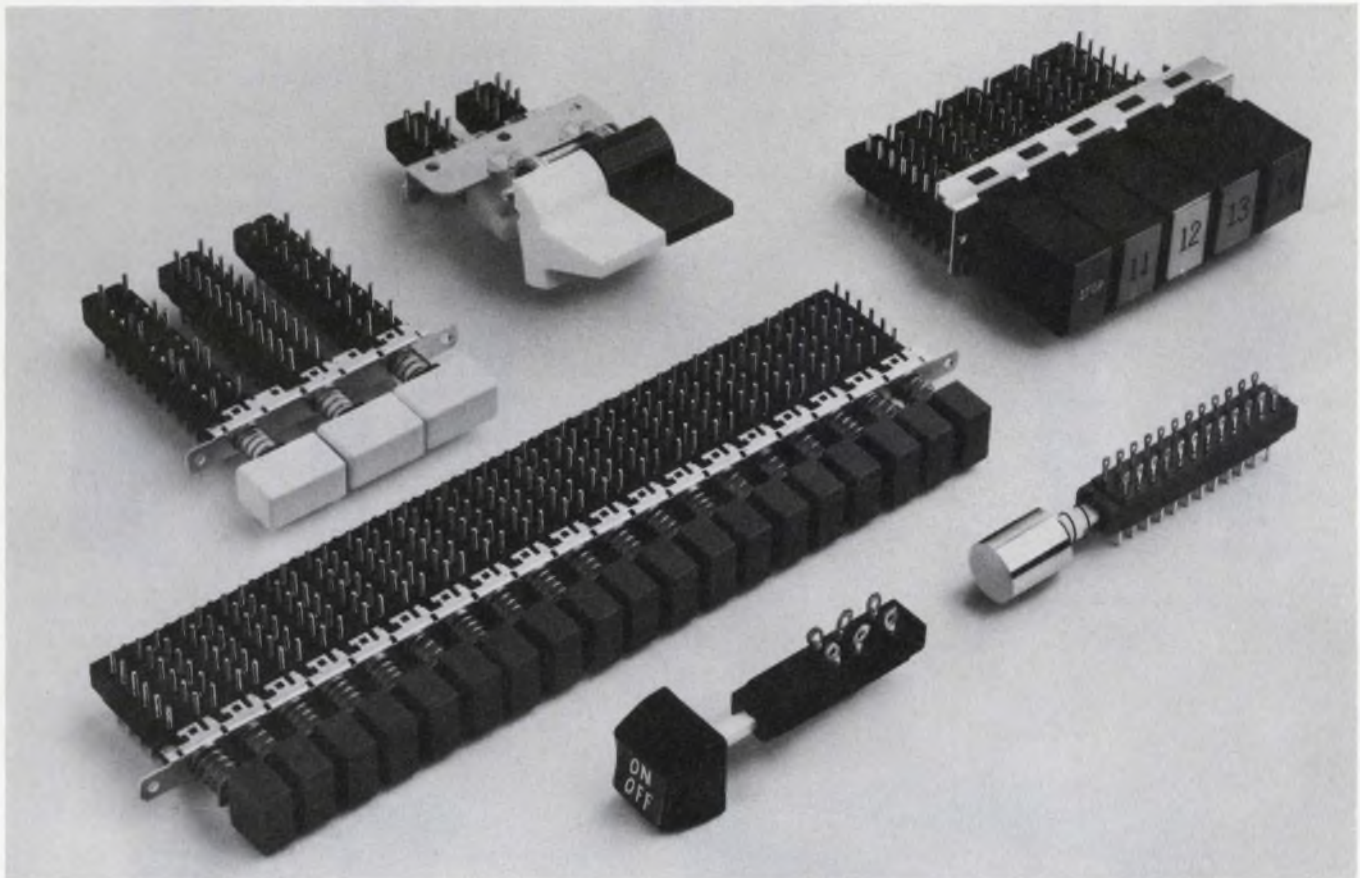

## Reasons to switch from the ordinary

Versatile Centralab push button switches\* give you more reasons to change from the ones you're using now. Our push button switch conforms to a variety of specifications for consumer products, instrumentation, and industrial applications.

Reasons? Consider these: Centralab is the only manufacturer to offer diallyl phthalate—for highest possible insulation resistance—as well as phenolic or glass alkyd. Our phenolic modules provide greater than 65 db isolation in the voice frequency range. Our modules are available with sealed terminals to avoid flux penetration and we can provide gold contacts and terminals for dry circuit applications.

To conserve space and provide compact stacking in circuit board applications, Centralab modules are adaptable to selective pin cutting or solder lug terminations. We offer three different

lockout devices to match your application. Functions include momentary, interlocking, push-push and push-pull. Up to 29 individual switch modules can be ganged on a common bracket. Other options include keyboard and row-to-row interlock. There are five center-to-center spacings with the widest variety of button colors, sizes and shapes.

Or ask for lighted push button switches that offer all the same features plus interchangeable lenses and filters in a variety of colors to provide maximum utility and appeal.

Our versatile module size line switch rated 3 amps at 120 V AC can be utilized in any position within the switch assembly.

If you need more reasons to switch to Centralab, ask for our bulletin and technical data. Write Switch Sales Manager, Centralab.

\* Isostat Licensed

### GET CENTRALAB THE "IN" LINE FOR YOUR DESIGN

Hybrid Microcircuits  
Pushbutton & Rotary Switches  
Capacitors  
Potentiometers  
Technical Ceramics  
Ceramic Packages  
Semiconductor Devices



**CENTRALAB**

Electronics Division  
GLOBE-UNION INC.

5757 NORTH GREEN BAY AVENUE  
MILWAUKEE, WISCONSIN 53201

# Centralab Distributors are another reason to switch

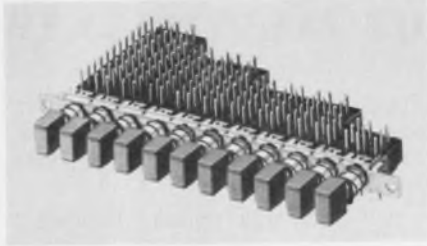

Our field assembly distributors provide a proven capability for immediate delivery of versatile, low-cost push button switches.\* These specialists offer a wide variety of lighted and non-lighted switches with custom assembly service to meet your design requirements. Three reasons to contact your Centralab push button field assembly distributor are the right switch, the right price with delivery, right now!

\*Isostat Licensed

**Almac/Stroum Electronics**  
Seattle, Washington 98109  
Phone: (206) 763-2300

**Cameradio Company**  
Pittsburgh, Pennsylvania 15222  
Phone: (412) 391-7400

**Kierulff Electronics, Inc.**  
Los Angeles, California 90022  
Phone: (213) 685-5511

**Pioneer-Standard Electronics, Inc.**  
Cleveland, Ohio 44105  
Phone: (216) 432-0010

**Radio Distributing Company, Inc.**  
South Bend, Indiana 46624  
Phone: (219) 287-2911

**Gopher Electronics Company**  
St. Paul, Minnesota 55113  
Phone: (612) 645-0241

**Fisher/Brownell**  
Santa Clara, California 95050  
Phone (408) 244-6182

**Hammond Electronics**  
Orlando, Florida 32802  
Phone: (305) 241-6601

**Herbach & Rademan, Inc.**  
Philadelphia, Pennsylvania 19134  
Phone: (215) 426-1700

**Summit Distributors, Inc.**  
Buffalo, New York 14202  
Phone (716) 884-3450

**Kirkman Electronics**  
Winston-Salem, N.C. 27108  
Phone (919) 724-0541

DISTRIBUTOR PRODUCTS



## ICs & SEMICONDUCTORS

### 4-bit priority register replaces 6-1/2 SSI ICs

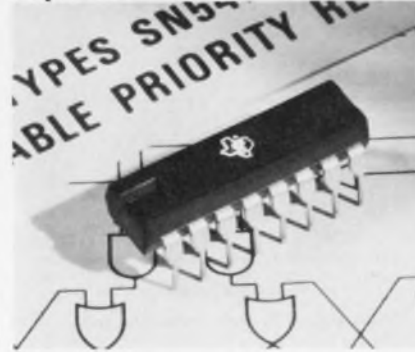

Texas Instruments Inc., P.O. Box 5012, M/S 308, Dallas, Tex. 75222. (214) 238-3741. SN74278N: \$2.70.

A four-bit priority register, capable of performing the priority-interrupt function in high-speed data transmission systems, replaces the equivalent of 6-1/2 SSI packages involving parts of a quad two NOR, a hex inverter, four dual four-expandable NORs and one quad R-S latch. Designated the SN54/74278, this IC consists of four input data latches and a five-line priority decoder in a single package.

CIRCLE NO. 258

### Silicon npn power transistors offered



Silicon Transistor Corp., KSC Way (Katrina Rd.), Chelmsford, Mass. 01824. (617) 256-3321.

Two additions to the company's line of high power transistors are the 2N5038 and the 2N5039. These are fabricated using a double epitaxial process and hard solder construction and are available in a TO-3 package. They are suitable for switching control amplifiers, switching regulators, converters and inverters.

CIRCLE NO. 259

### Transistors good for mobile applications

RCA Solid State Div., Route 202, Somerville, N.J. 08876. (201) 722-3200. 40967: \$6.60; 40968: \$8.40 (100 up).

Two rf transistors, for uhf class C amplifier service in low-voltage mobile applications, are designated types 40967 and 40968. The devices are rated for 2-W and 6-W power output at 470 MHz with a 12.5-V supply. They are the former developmental types TA8562 and TA8563, respectively, and are supplied in an RCA HF-44 package.

CIRCLE NO. 260

### Sense amps simplify 1103 memory designs

Intel Corp., 3065 Bowers Ave., Santa Clara, Calif. 95051. (408) 246-7501.

Two hex sense amps for 1103 memories simplify the operation of memory systems at high speeds. Termed the 3208A and 3408A (with latch), both devices are manufactured with Intel's Schottky bipolar process. As a result, maximum I/O delays are 20 and 25 ns over the temperature range for the 3208A and 3408A, respectively.

CIRCLE NO. 261

### Op amps deliver up to 1 A at 12 V

National Semiconductor Corp., 2900 Semiconductor Dr., Santa Clara, Calif. 95051. (408) 732-5000. LH0021CK: \$12.50; LH0041-CG: \$8.50 (100 up); stock.

The LH0021/LH0021C and LH0041/LH0041C general purpose op amps offer large output currents not usually associated with conventional IC op amps. The LH0021 provides output currents in excess of 1 A at voltage levels of  $\pm 12$  V; the LH0041 delivers currents of 200 mA at voltage levels closely approaching the available power supplies. In addition, both the inputs and outputs are protected against overload. The devices are compensated with a single external capacitor.

CIRCLE NO. 262

## Tung-Sol® 3 to 500 Amp Power Rectifiers

Tung-Sol rectifiers are conservatively rated to assure the widest possible margin of safety and reliability. Press-fit rectifiers to 44 Amps. Stud-mounted types to 420 Amps. Ratings to 500 Amps in flat-base construction.



### Modular Bridge Rectifiers 10 to 35 Amps

Highest surge ratings give designers maximum protection against voltage overloads.

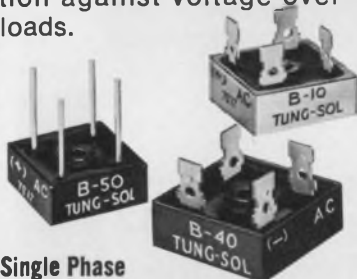

#### Single Phase

**B-50 Series**—To 10 Amps DC.  
50 to 600 PRV. 300 Amps surge.

**B-40 Series**—To 15 Amps DC.  
50 to 1,000 PRV. 300 Amps surge.

**B-10 Series**—To 30 Amps DC.  
50 to 1,000 PRV. 400 Amps surge.



#### Three Phase

**B-20 Series**—To 35 Amps DC.  
50 to 1,000 PRV. 400 Amps surge.

WRITE FOR TECHNICAL INFORMATION.  
SPECIFY BRIDGES, OR POWER RECTIFIERS

SILICON PRODUCTS SECTION  
**WAGNER ELECTRIC CORPORATION**

630 West Mt. Pleasant Ave. Livingston, N.J. 07039  
TWX: 710-994-4865 PHONE: (201) 992-1100  
(212) 732-5426

Trademark TUNG-SOL Reg. U. S. Pat. Off. and  
Marcas Registradas

## ICs & SEMICONDUCTORS

### FET input hybrid op amp cuts drift to 1 $\mu\text{V}/^\circ\text{C}$

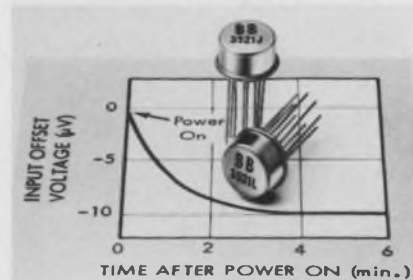

FIGURE 1. Typical Warmup Drift.

Burr-Brown Research Corp., International Airport Industrial Park, Tucson, Ariz. 85706. (602) 294-1431. 3521L: \$36 (100 up); stock (small qty.).

A FET-input op amp, in a hermetically-sealed TO-99 package, has 1- $\mu\text{V}/^\circ\text{C}$  voltage drift, 250- $\mu\text{V}$  offset voltage and 10-pA input bias current. Designated the 3521L IC, it provides FET input performance with drift equal to that of bipolar ICs. Its low drift is obtained by use of a hybrid thin-film approach using a FET monolithic-pair input stage.

CIRCLE NO. 263

### Thyristors and diodes for ac motor starters

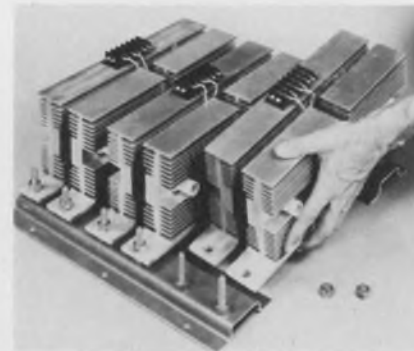

Power Semiconductors, Inc., 90 Munson St., Devon, Conn. 06460. (203) 874-6747.

A line of thyristors and diodes for use in solid state ac motor starters are rated for control of motors up to 1000 hp and line voltages of 240, 480 and 575 V. The devices feature high inrush capability. They are available either as components or in the "fast access" heat sink assembly.

CIRCLE NO. 264

### Multiplexer w/storage replaces 2 MSI ICs

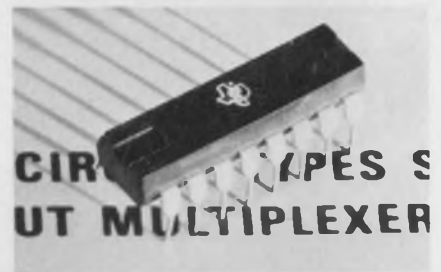

Texas Instruments Inc., P.O. Box 5012, M/S 308, Dallas, Tex. 75222. (214) 238-3741. SN74298N: \$2.16 (100-999); stock.

A TTL/MSI quad two-input multiplexer with storage replaces the equivalent of two MSI circuits. Termed the SN54/74298, this IC consists basically of the SN74157 multiplexer with a quad D-type flip-flop added to store information selected by the quad multiplexer. The circuit selects one of two 4-bit data sources and stores data synchronously with the system clock. Its multiplexing capability permits connection to operate as a shift register that can shift N-places in a single clock pulse.

CIRCLE NO. 265

### Improved counters replace existing types

Advanced Micro Devices Inc., 901 Thompson Pl., Sunnyvale, Calif. 94086. (408) 732-2400.

An improved four-device, high-speed counter series is designed to replace TI's 54/74160 and 54/74161 and Fairchild's 9310 and 9316. These four-bit up counters have built-in carry logic and provide synchronous counting and parallel entry. The Am54/74160 and Am54/74161 replace like-numbered TI devices but have typical count rates of 45 MHz compared to the 32 MHz listed for the TI circuits. The Am9310A and Am9316A also offer 45-MHz speeds and have (as do the Am54/74160 and Am54/74161) a parallel enable load requirement of one unit load as compared to two for the Fairchild units that they replace. The Am54/74160 and Am9310A are modulo ten counters; the Am54/74161 and Am9316A, hexadecimal counters.

CIRCLE NO. 266

# Need efficient cooling in a tighter-than-tight spot?



## Rotron® has the answer.

The *BISCUIT*® – Rotron's high performance centrifugal blower that is only 1 $\frac{1}{8}$ " thick. It works in really tight spots where no other can. It's the only 50-60 Hz air moving device that will fit inside a 1 $\frac{3}{4}$ " rack panel instrument.

Built around the proven features of the multi-million-installation Muffin® fan, the Biscuit is ideal where cooling air must be forced through tight passages or directed at high velocity over a hot component. It's impervious to moisture or dust, and will run reliably, quietly, and continuously for years without maintenance of any kind. It delivers up to 25 cfm for rack mounted instruments, projector lamps, power supplies, heat exchangers and sinks, core memories, computer terminals, and many office equipment applications.

Whatever your cooling or air moving need, next time you have one, take it to Rotron. As the world's leading manufacturer of precision air moving devices, Rotron has the answer to just about any problem you can pose. And at competitive prices that may surprise you. Ask and see. For more information right now, send for Biscuit Catalog Sheet H-3360.

*Why settle for less when the best costs no more?*



**ROTRON INC.**, Woodstock, N. Y. 12498 ☐ 914 • 679-2401 ☐ TWX 510-247-9033  
Pacific Div., Burbank, Cal. 91506, 213•849-7871 • Rotron N.V., Breda, Netherlands, Tel.: 49550, Telex: 844-54074

14992

INFORMATION RETRIEVAL NUMBER 51

## Hybrid decoder drivers simplify LED circuits

SCS Microsystems, Inc., 1150 N.W. 70th St., Fort Lauderdale, Fla. 33309. (305) 974-5400. 1001RL: \$6; 1004RL: \$11 (1-24).

The SCS 1000RL series, specifically designed for use with seven-segment LED readouts, offers a variety of TTL logic functions in standard DIP configurations. All outputs have series thick-film current limiting resistors eliminating the need for external limiters. Four models are available. Three of these are in 16-pin DIPs—the 1001RL with a decoder/driver plus output limiting resistors, the 1002-RL with a quad latch (memory), decoder/driver and limiters; and the 1003RL with a decade counter, decoder/driver and limiters. The 1004RL is in a 20-pin DIP and includes counter, latch, decoder/driver and output limiting resistors.

CIRCLE NO. 267

## Bus buffer offers 2 ns delay

SN54125, SN74125

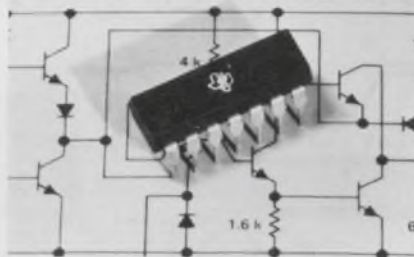

Texas Instruments Inc., P.O. Box 5012, M/S 308, Dallas, Tex. 75222. (214) 238-3741. SN74125N, SN-74126N: \$1.15; stock.

Two TTL quad bus buffer gates feature reduced propagation delays and improved output disable times. Termed the SN54/74125 and the SN54/74126 (capable of replacing the DM8093 and DM8094, respectively), the average propagation delay time is only 2 ns. The switching speed between disable and enable is improved by 4 ns, reducing the possibility of two or more outputs overlapping when they are in the low-impedance (ON) state.

CIRCLE NO. 268

## ASCII character gen has 350 ns access

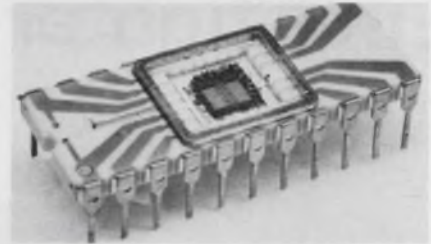

Microsystems International Ltd., Box 3529 Station C, Ottawa, Canada K1Y 4J1. (613) 828-9191. \$18.20 (100-999).

The MF7107 high-speed 4032 bit high-resolution row scan character generator, fabricated using p-channel silicon gate technology, provides 64 characters of 63 bits arranged in a 9 × 7 format. The device offers fast access and cycle times of 350 ns and operates from a +5 V, -9 V power supply. The MF7107 is directly TTL compatible, has a seven-bit parallel output, single TTL level clock, OR-tie capability and two chip select input leads. It's available in a 22-lead ceramic DIP package.

CIRCLE NO. 269

## What do you want in a push button switch?

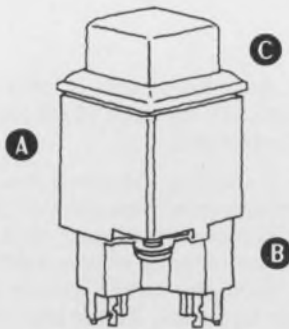

- A Actuation**—Momentary, alternate or snap action.
- B Circuitry**—From single pole, single throw to double pole, double throw; SPDT (2 circuit); make-before-break or break-before-make.
- C Styling**—Square, round, bezel, colors, lighted.

Just a few of the options possible in a wide range of push button switches available from Grayhill. If what you need isn't among them we can design one that is.

For our latest Engineering Catalog write or phone: Grayhill, Inc., 565 Hillgrove Ave., La Grange, Illinois 60525. (312) 354-1040.



INFORMATION RETRIEVAL NUMBER 52

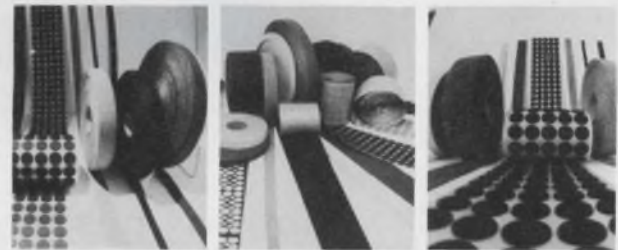

## ubiquitous

Omnipresence; being everywhere or in an indefinite number of places at the same time.

In the bulkheads of atomic submarines, inside toys, t.v. sets and electric organs, under ash trays and statues, our adhesive backed materials are found everywhere. We supply **FELT, FOAM, SPONGE, CORK, FOIL, FILM, PLASTIC** . . . in die-cut, segmented or bulk form, delivered on special quick releasing paper for whatever use you can think of — cushion, pad, protect, insulate, decorate . . .

Our brochure has samples, specifications and ideas; send for it, you'll like it.

**DECCOFELT  
CORPORATION**

500 South Vermont Avenue, Glendora Ca. 91740

INFORMATION RETRIEVAL NUMBER 53

ELECTRONIC DESIGN 22, October 26, 1972



# CANNON® CENTSIBLE CONNECTORS.

The performance you need, at a price you can afford.

## BURGUN-D

The most versatile connectors you can buy, at a price that's right... that's ITT Cannon's Burgun-D subminiatures. Look at the facts. Over one million pairs in the field. Off-the-shelf distribution with assembly facilities around the country. One stamped, crimp, snap-in pin or socket contact accommodates the entire wire range from #20 through #30 AWG stranded wire, or two #22 or smaller wires, for low cost economic applications. Also available: machined contacts and snap-in, right angle or straight printed circuit contacts. Intermateable and intermountable with existing D sub-miniature types. Five shell sizes from 9 to 50 contacts. Six different layouts. Contacts are rear insertable/removable. Complete accessories including locking devices. Semi-automatic crimping machines capable of 1,500 terminations per hour, lease or buy.

All this adds up to greater connector standardization, greater versatility in contacts and contact terminations, and smaller inventories. So if you want to save money, and your application is in business machines, computers and peripherals, medical or industrial

instrumentation, communications, vending machines, controls, or commercial aviation, it will pay you to follow the leader — Burgun-D, a Centsible connector.

For a catalog and the name of your distributor, write Dept. BD, ITT Cannon Electric, International Telephone and Telegraph Corporation, 666 E. Dyer Rd., Santa Ana, Calif. 92702. (714) 557-4700.



ABT 500 semi-automatic crimping machine.

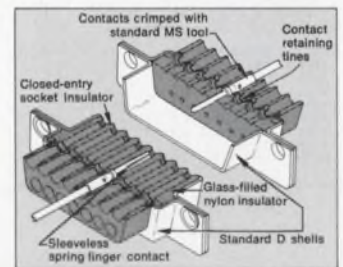

CANNON ITT



## Immediately available Pulse Transformers Delay Lines

Now you can save time and money by specifying standard Pulse transformers or delay lines from our wide range of in-stock components. We have the most commonly used designs—complete and reliable. And Pulse engineers are ready to assist you with unique designs.

### Typical Applications

1. SCR and TRIAC control
2. Small signal coupling and isolation
3. Baluns
4. Floating switches
5. Line drivers and receivers
6. DC isolation
7. Timing delays

For the broadest selection of in-stock components, available for immediate delivery in any quantity, call our catalog sales department.

### LINE DRIVE/RECEIVE TRANSFORMER SERIES

(not shown)

Catalog Number	Turns Ratio $\pm 5\%$	OCL mh MIN	ET V- $\mu$ S MIN	Cw/w pf MAX	LL ( $\mu$ h MAX)
8380	2ct:1ct:1ct	0.2	56	6.0	4.5
8381	2ct:1ct:1ct	0.5	88	6.0	10.0
8382	2ct:1ct:1ct	1.0	120	6.0	18.0
8383	2ct:2ct:1ct	0.2	58	7.5	3.0
8384	2ct:2ct:1ct	0.5	88	7.5	7.0
8385	2ct:2ct:1ct	1.0	120	7.5	18.0
8386	1ct:1ct:1ct	0.2	58	6.0	1.0
8387	1ct:1ct:1ct	0.5	88	7.5	7.0
8388	1ct:1ct:1ct	1.0	120	6.0	11.0

**Pulse  
Engineering  
Inc.**

A Varian Subsidiary  
P. O. Box 12235  
San Diego, Calif.  
92112  
(714) 279-5900  
TWX 9103351527

INFORMATION RETRIEVAL NUMBER 55

## MODULES & SUBASSEMBLIES

### 53-position keyboard costs just \$49



Controls Research Corp., 2100 S. Fairview, Santa Ana, Calif. 92704. (714) 557-7161. \$49 (5000); stock to 8 wks.

The Model 7100 is a 53-position keyboard ready for installation and operation. A dynamically-scanned MSI electronic encoding system simplifies the electronics and enables all circuitry to be housed on a single PC board complete with key-switch modules. The standard keyboard conforms to the proposed standards of the X4A9/199B committee of ANSI. Features include full ASCII coding (shifted, unshifted, control and control/shift), standard two-key rollover interlock, low-profile single PC board design, less than 300 mA power consumption and standard type-writer array.

CIRCLE NO. 270

### No contact amps sensor has ac input, dc output

American Aerospace Controls, Inc., 129 Verdi St., Farmingdale, N.Y. 11735. (516) 694-5100. \$35 (1-9); Stock to 4 wks.

The Series 1003A-M1 industrial grade sensors are designed for 60-Hz, ac-current monitoring. The new line requires no external operating power and permits sensing with complete electrical isolation. Sensing is accomplished by inserting the current-carrying conductor through a hole in the center of the device. The alternating magnetic field surrounding the conductor creates an ac signal which is rectified and filtered to produce a 0 to 5 V dc output signal. The sensors are offered in six different models ranging from 0 to 2 A to 0 to 100 A. The units measure 1 x 2 x 2 inches, with a 3/8-inch diameter pass-through hole.

CIRCLE NO. 271

### Dc/dc converters offer high isolation

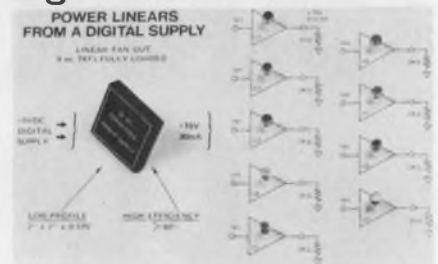

Stevens-Arnold Inc., 7 Elkins St., S. Boston, Mass. 02127. (617) 268-1170. \$39 to \$69 ea.; stock to 6 wks.

Stevens-Arnold is offering dc/dc converters having a high degree of isolation. Input voltages are 5, 12, 28 V, with dual output voltages of  $\pm 8$ ,  $\pm 12$ ,  $\pm 15$  V and current ratings from  $\pm 30$  to  $\pm 150$  mA. Medical types have isolation of 10 pF and 8 kV dc. Seated height is 0.375 to 0.5-inches. The units are shielded on six sides and between primary and secondary of the coupling transformer for negligible rfi/emi. Both input and output are filtered, reducing spikes to 10 mA. On the output, high common mode isolation reduces ripple and noise to less than 40 mV pk-pk when measured wideband from 5 Hz to 10 MHz.

CIRCLE NO. 272

### Speed controller eliminates cogging

Contronics, Inc., 2629 Johnstown Rd., Columbus, Ohio 43219. (614) 471-6466. \$89.

This Contronics motor speed controller allows precise regulation over an extremely wide speed range without cogging at low speeds. Its full-wave operation has built-in feedback sensing. Usable with either shunt wound or permanent magnet type motors, the unit gives close control, to a 3% variance, depending on motor characteristics. Unit incorporates line-voltage transient protection and can be protected with standard slow-blow fuses. Ac or dc motors, 3/4 to 1 HP, can be controlled, even under full-load start conditions. The controller weighs 20 oz., measures 7 x 4-1/4 x 3 inches and is available for 115 or 230 V, 50 or 60 Hz input (105 or 210 V dc armature and field).

CIRCLE NO. 273

# Imagination and Stackpole ferrites can cut a power supply down to size

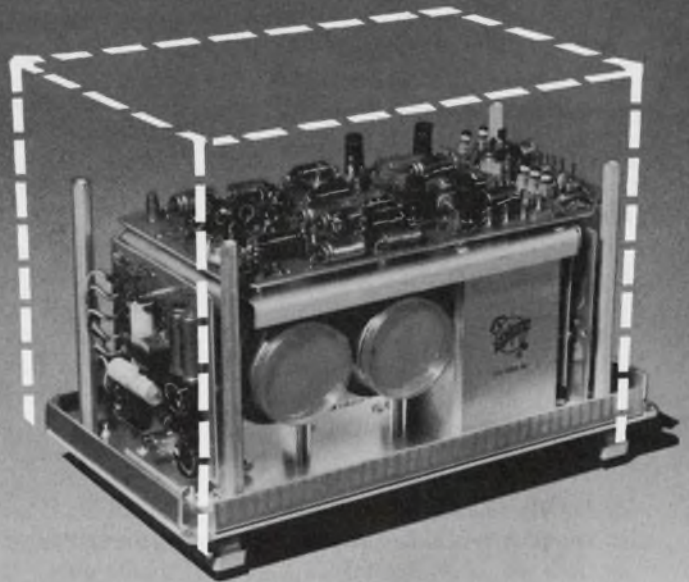

**Tektronix, Inc. uses Ceramag® ferrite materials to achieve efficiency and significant savings.**

Conventional power supplies are bulky, heavy and inefficient. Tektronix, Inc. changed all that. With ferrites and a fresh idea.

By rectifying line voltage, converting it to 25kHz and rectifying it again, Tektronix, Inc. engineers produced a power supply that was 50% lighter, over 25% smaller and consumed 1/3 less power. And the overall operating efficiency of 70% is a big improvement over the 50% typical of conventional power supplies.

Ferrites can offer the unique advantages, design freedoms and electronic characteristics that produce exciting new ideas. Stackpole Ceramag ferrites were used throughout the power supply design. Because Stackpole has a wide variety of materials and configurations, designers can unleash their imaginations.



**Ceramag 24B**

Tektronix, Inc. selected 24B for their "U" and "E" cores. This proven material has seen years of service in flybacks for television. Ideal for power applications, it can be operated at higher frequencies than laminated steel. It is cool running, due to low losses under power conditions and controlled power permeability. Tooling is available for a wide range of "U", "E" and "I" configurations.

### **Ceramag 24**



Toroids of Ceramag 24 were used by Tektronix, Inc. for transformer cores. Again, this is a proven material, widely used by the computer industry for pulse transformer cores. It has a tightly controlled initial permeability, and tooling for a variety of sizes is also available.

### **Ceramag 7D and 27A**

Multiple material selection for coil forms allowed Tektronix, Inc. maximum flexibility and design freedom. Proper inductance values could be achieved in the allotted amount of room. In addition, the high resistance of 7D

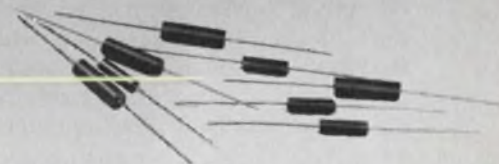

material prevents accidental shorting on printed circuit boards.

Great new designs happen when you start with the idea of ferrites. Particularly Stackpole Ceramag ferrite components. Why? Because Stackpole offers the variety of materials, numerous tooled configurations and the technical back-up you need. Twenty-four years of television and computer experience makes Stackpole one of the largest and most experienced domestic suppliers of quality ferrites.

Consider ferrites on your next prototype or redesign. But give us a call when you start. Perhaps we (and some Ceramag® ferrites) can help you cut a problem down to size. Stackpole Carbon Company, Electronic Components Division, St. Marys, Pa. 15857. Phone: 814-781-8521. TWX: 510-693-4511.



**STACKPOLE**  
ELECTRONIC COMPONENTS DIVISION

## 16-bit d/a converters are glitchless

Phoenix Data, Inc., 3384 W. Osborn, Phoenix, Ariz. 85017 (602) 278-8528. \$845 to \$1595; 30 days.

Phoenix Data has introduced a new line of 15 and 16-bit glitchless d/a converters for military and commercial-industrial applications. The DAC-G series feature accuracy within 0.005% and linearity within 0.002% of full range; switching amplitude of 600  $\mu$ V; and a switching transient duration of 200 ns, maximum. The DAC-G is completely self-contained and consists of an internal precision reference-voltage generator, the analog switches to connect the reference voltage into the precision resistor network, the precision network with temperature-matched feedback components, the output amplifier with short-circuit proofing, and a parallel holding register.

CIRCLE NO. 274

## Precision voltage source has 0.005% stability

Intech, 1220 Coleman Ave., Santa Clara, Calif. 95050. (408) 244-0500. \$85 (1-9); stock.

A precision voltage reference for accurate a/d converters and dc comparators, the A-803, features an input-voltage range of +15 to +25 V dc and an initial output-voltage of 10 V dc  $\pm$  0.01%. It has 0.005% stability over a range of 0 to 60 C. Load currents to 2 mA are handled without performance degradation.

CIRCLE NO. 275

## Scope probe features dc to 900-MHz bw

Tektronix, Inc., P.O. Box 500, Beaverton, Ore. 97005. (503) 644-0161. \$375; stock.

The P 2601 is a dc-to-900 MHz, nonattenuating FET scope probe. Full-scope sensitivity is obtained with no sacrifice in the probe rise time of 0.4 ns. Input capacitance is 3 pF and input impedance is 100 K $\Omega$ . The probe can be used for both 50  $\Omega$  sampling and 1 M $\Omega$  conventional scopes. A dc offset permits dynamic measurements of  $\pm$ 600 mV on dc voltages up to  $\pm$ 5.5 V. Plug-on 10X and 100X attenuators extend maximum voltage ranges, provide higher input resistance, and reduce input capacitance. The probe is designed for the TEK 7904 and 7704A scopes. An optional accessory power supply (Model 1101) permits the probe to be used with other scopes.

CIRCLE NO. 276

## Photodetector/amp offers 10:1 S/N ratio

Meret Inc., 1815 - 24th St., Santa Monica, Calif. 90404. (213) 828-7496. \$145 (unit qty.); stock to 2 wks.

Available in both TO-5 (MDA-325) and flat pack (FDA325) versions, the units' photodetector/transimpedance amplifiers require a single voltage supply between +9 and +15 V. The units function as complete receivers for modulated light in the range of 300 to 1100 nm. Response at 905 nm is greater than 15 mV/ $\mu$ W over a 10-MHz bandwidth. Pulse response rise time is less than 40 ns.

CIRCLE NO. 277

## Active filters cover the 0.001 Hz to 1 MHz range

Burr-Brown Research Corp., International Airport Industrial Park, Tucson, Ariz. 85706. (602) 294-1431. \$21 to \$33 (100 up); 2 wks.

Burr-Brown's ATF76-Series active filters have low-pass (Butterworth, Bessel or Chebyshev), bandpass or band-reject characteristics. Low-pass models are available with two, four, six or eight poles. Bandpass models are single-tuned (one pole-pair) or stagger-tuned (two pole-pairs) with Qs from one to 50. On standard versions cutoff or center frequencies range from 1 Hz to 20 kHz. Customized versions can be supplied for a wider range, 0.001 Hz to 1 MHz. Special packaging is also available. All types operate on  $\pm$ 15 V.

CIRCLE NO. 278

## Thick-film hybrid unit rectifies synchronously

Tadiran, Israel Electronics Industries Ltd., 3 Hashalom Rd., P.O. Box 648, Tel Aviv, Israel.

Hybrid assembly, TH-D2-1, is used to demodulate servo-system suppressed-carrier signals. Gain stability is better than 100 ppm/ $^{\circ}$ C and the output offset voltage is less than 30 mV for -55 to +125 C. The unit can also be used as a phase detector and precision full-wave synchronous rectifier. Gain and carrier-harmonic filtering can be externally trimmed. The assembly, designed to meet MIL-STD-883, is fabricated by a thick-film technique and sealed in a TO-8 package.

CIRCLE NO. 279

## ANALOGY

WITH  $\pm$ 15V AT 300 MA, THE A-906 CANNON BALL GIVES POWER OF THREE COMPETITIVE UNITS OF COMPARABLE SIZE AND PRICE. WE ABSOLUTELY GUARANTEE LINE AND LOAD REGULATIONS AS GOOD AS THE BEST YOU CAN BUY. WHY NOT USE THE BEST WHEN IT COSTS LESS? WRITE OR CALL ANA FOR DETAILS.

**intech** INCORPORATED  
(408) 244-0500  
1220 COLEMAN, SANTA CLARA, CALIF. 95050

# All you ever wanted to know about your capacitors... immediately, digitally, automatically, accurately.

The Model 275 Digital Capacitance Meter is a fast, simple, compact box that gives you automatic capacitance (both series and parallel) and dissipation measurements with the accuracy of a manually balanced instrument (approximately 0.1% plus one digit).



Designed primarily for production testing—outgoing and incoming—the 275 is simple to operate and features a brightly lit readout of  $3\frac{1}{2}$  digits with decimal point. Because of its wide range of capacitance measurements and the high resolution of its D measurements, however, it is also suited for use in developmental laboratories. Its small, half-rack size is another plus for bench work.

Normal mode of operation provides for repetitive measurements tracking at the rate of 4 per second, either C series or C parallel. When D is to be measured, the operator simply pushes the D button and the measurement is instantly displayed. The instrument's reliability is unusually high; circuitry is wholly solid state and mounted on a single, readily accessible, master PC board.

To extend the applications of the Model 275, several options are available. With the companion comparator sorting can be done, by C values and D values if desired. If bias measurements are required, an external bias supply can be connected to switch-controlled rear terminals. Holding and sorting fixtures are also available.

If you are making or buying capacitors, the Model 275 Capacitance Bridge will tell you what you need to know before you ship or wire them in. For just about \$1200—plus \$600 if you want the sorting option. Write or call for the entire story—there's nothing else quite like it.

**esi**®

**ELECTRO SCIENTIFIC INDUSTRIES**

13900 N.W. Science Park Drive • Portland, Oregon 97229 • Telephone: 503/646-4141 • Telex: 36-0273

INFORMATION RETRIEVAL NUMBER 58

High resolution,  
low cost

# SCAN CONVERTERS display any electronic information

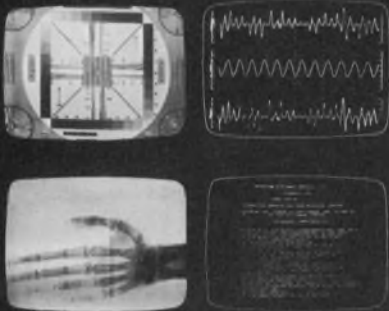

Any electronic information—from computers, lasers, TV cameras, scanners, X-ray, electron microscopes or whatever—can be displayed sharper, brighter, faster and at lower cost with PEP scan converters. Regardless of its format or speed. Even if it's only transient information. The reason: **only** PEP scan converters offer this combination of advantages:

- RESOLUTION to 3000 lines
- GRAY SCALE: 10 Logarithmic levels
- NON-DESTRUCTIVE readout
- WIDE RANGE of reading and writing speeds: video to DC
- WIDE system bandwidth: 30 MHz
- READ, write, selective erase, zoom, other functions
- LONG, trouble-free life

We're the people who developed high resolution, low cost scan conversion and image storage technology. Our Lithocon® silicon storage tube is the heart of all PEP scan converters, and makes them feasible for a whole new world of applications. Like microfilm/microfiche. Industrial process control. Facsimile. CATV systems. And X-ray, ECG and low light level detection systems. And hundreds more. We'll be happy to tell you about them. Write or call today for details. Princeton Electronic Products, Inc., P.O. Box 101, North Brunswick, New Jersey 08902; (201) 297-4448.



**PRINCETON  
ELECTRONIC  
PRODUCTS, INC.**

INFORMATION RETRIEVAL NUMBER 59

## PACKAGING & MATERIALS

### PC connectors span 5 to 50 contacts

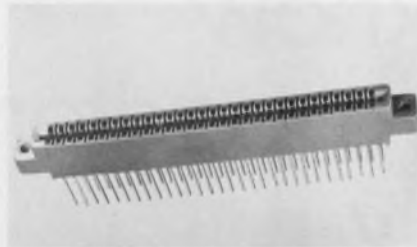

*Fabri-Tek, Inc., National Connector Div., 5901 S. County Rd. 18, Minneapolis, Minn. 55436. (612) 935-0133. \$0.02/contact; stock to 60 days.*

An innovative series of direct card connectors for PC applications, the Series 9, is available in either 100 or 125-mil centers, and with any number of contacts from five to 50 dual contact positions. The Series 9 features 25-mil square wrapped-wire tails, bifurcated contacts and five mounting hole options.

CIRCLE NO. 300

### PVC wiring duct has adhesive mounting tape

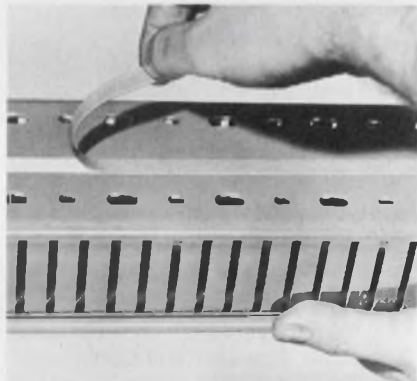

*Electrovert Inc., 86 Hartford Ave., Mount Vernon, N.Y. 10553. (914) 664-6090.*

A PVC wiring duct features pre-punched mounting slots and a temporary adhesive mounting tape as part of the standard design. The duct is positioned in place by means of the adhesive backing and the holes are then drilled in the mounting panel to coincide with selected mounting slots in the duct. This will assure perfect alignment and eliminate the need to drill through the duct. The line includes all standard sizes ranging from 1 × 1-in. to 4 × 4-in.

CIRCLE NO. 301

### Heat dissipator doubles extrusion efficiency

*W. F. Chew Enterprises, 441 E. 4th St., Long Beach, Calif. 90812. (213) 432-2704. Stock.*

MODsink, a lightweight heat dissipator for semiconductors, is 100% more efficient and yet requires only two-thirds the space of an extrusion type heat sink doing the same job. Balanced air flow distribution in a new compact modular package with increased surface area is responsible for the improved performance. Thermal resistance is 0.13 C/W to 0.23 C/W depending on air flow. Dissipation of 200 to 2000 W (4 to 40 transistors) may be accomplished with a single fan.

CIRCLE NO. 302

### Resistive pastes aimed for thick film hybrids

*Transene Co., Inc., Route One, Rowley, Mass. 01969. (617) 948-2501. \$36/oz. (small quantities); stock.*

Ohm-resist, a resistive cermet composition for thick film hybrid microelectronic circuits, is formulated as screenable resistor pastes with carefully controlled rheology. The product is applied by screening on ceramic substrates and fired to generate discrete resistors and resistor networks. Ohm-resist is available in a wide selection of sheet resistance values ranging from 10 ohms to 100 kilohms.

CIRCLE NO. 303

### Low profile DIP sockets come in 14 or 16 pins

*Vero Electronics, Inc., 171 Bridge Rd., Hauppauge, N.Y. 11787. (516) 234-0400.*

Solderless-wrap 14 and 16-pin low profile DIP sockets feature low contact resistance and high reliability of the flow solder versions. This was achieved by using the same contact form in phosphor bronze, with a 25 × 25 × 583-mil termination. Contact finish is 1 UAU over 0.8 UAG. The body material is glass-filled nylon and its design features mounting points for hexagon bolts or nuts.

CIRCLE NO. 304

# The bright new ideas are also inexpensive.



This is one of the least expensive precision lighted pushbuttons in existence. We call it our Series 4.

Precision—because our reliable SM snap-action basic does the switching. Inexpensive—because our standard price includes assembled product with lamp. In short . . . low installed cost.

You just snap the Series 4 into the front of your panel. Quick-connect terminals make wiring a snap, as well. Relamping? Just pull out the display screen and the lamp is automatically extracted from its socket.

There's a choice of low energy (1 amp, 125 vac max.) and power load (5 amps, 250 vac max.) switching—both UL listed. Bezel and barrier housings plus matching indicators are also available.

So, depending on the business you're in, you can use this new pushbutton on things like business machines, computer peripheral, instrumentation and commercial equipment.

Make it your business to call your MICRO SWITCH Branch Office or Authorized Distributor (Yellow Pages, "Switches, Electric"). Or write for Product Sheet Series 4.

In either case, we guarantee to make your life a little brighter.

**MICRO SWITCH**  
makes your ideas work.

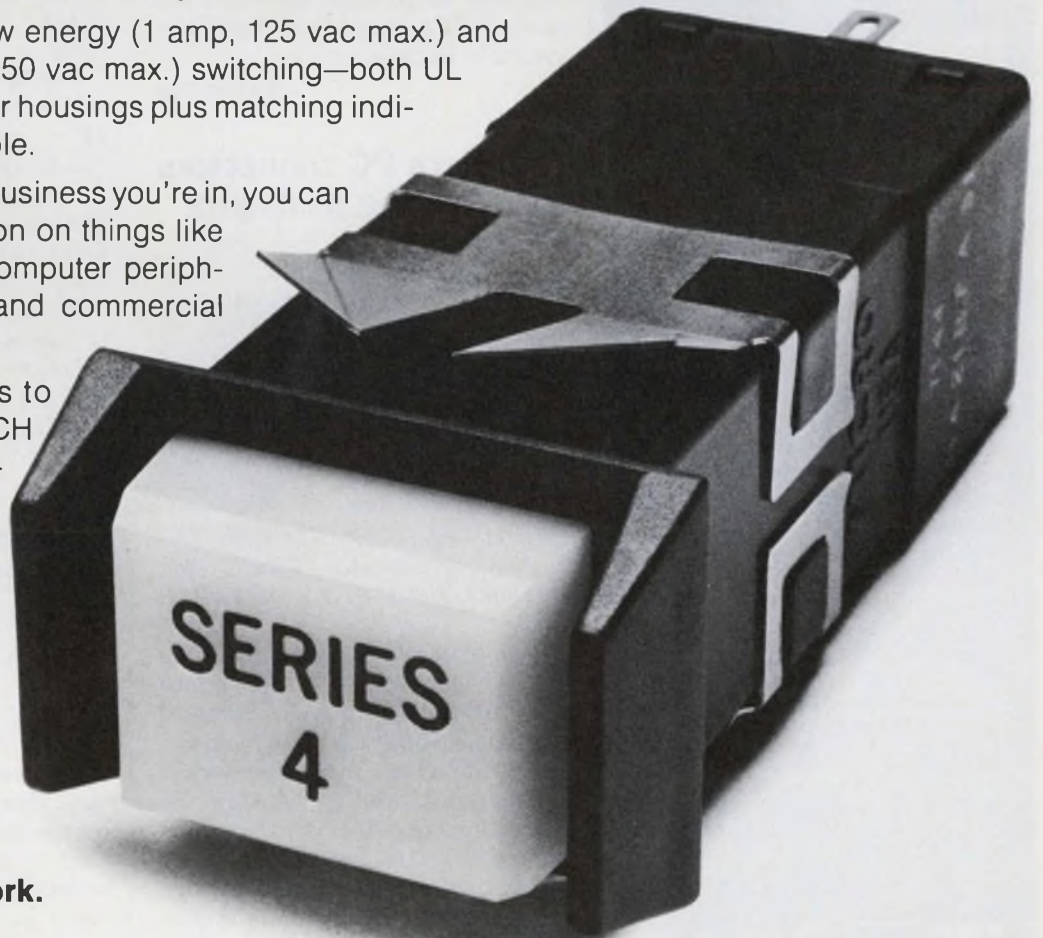

**MICRO SWITCH**  
FREEPORT, ILLINOIS 61032  
A DIVISION OF HONEYWELL

MICRO SWITCH products are available worldwide through Honeywell International.

INFORMATION RETRIEVAL NUMBER 60

# Two more solutions to tough crystal oscillator problems



The 4 cu. in. **temperature compensated TCXO-18** offers frequency stability of  $\pm 2$  ppm over a temperature range of  $-55^{\circ}\text{C}$  to  $+105^{\circ}\text{C}$ . Voltage variable capacitance diode and thermistor network maintain stability without an oven. Aging rate: 1.0 pp  $10^8$  per week. Meets aerospace/military specifications.

The **high stability PCOXO-5** has an aging of 5 pp  $10^{10}$  per day. It's a commercial, plug-in package with frequency stability of 2 pp  $10^{10}/^{\circ}\text{C}$  over a temperature range of  $0^{\circ}$  to  $+60^{\circ}\text{C}$ ; short term stability of 11 pp  $10^{10}$  per second. Specifically designed to meet frequency control and communications systems.

We've got 18 other solutions . . . and a custom engineering capability second to none. For information on crystal oscillators (or answers to any frequency control problem), call (212) 335-6000, see EEM Section 2300, or write:



**BULOVA**  
FREQUENCY CONTROL PRODUCTS

Electronics Div. of Bulova Watch Co., Inc.  
61-20 Woodside Ave., Woodside, N.Y. 11377

## PACKAGING & MATERIALS

### Connectors permit 1500 terminations/hour

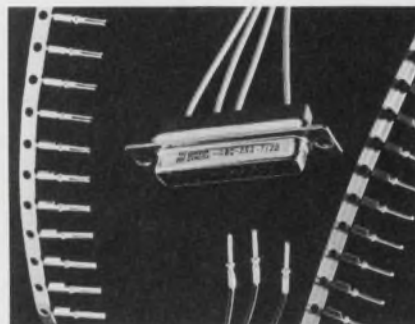

*ITT Cannon Electric, 666 E. Dyer Rd., Santa Ana, Calif. 92702. (714) 557-4700.*

Subminiature rectangular connectors with stamped contacts permit 1500 terminations per hour. Burgun-D Mark IV connectors accommodate wire gauges from 20 to 30 AWG. Contacts are on a carrier strip designed for an 18-inch-diameter reel to be used on semiautomatic crimp machines that are available for sale or lease.

CIRCLE NO. 305

### Two-piece PC connectors solve mating problems



*Control Data Corp., Connector Operation, 31829 La Tienda Rd., Westlake, Calif. 91361. (213) 889-3535.*

Two-piece PC connectors having 25-mil square post terminations with 100-mil spacing are designed for nonedgeboard PC applications, mother-daughter board designs, and intermateability between PC cards. Fourteen standard sizes are offered—10, 13, 16, 20, 23, 26, 30, 33, 36, 40, 43, 46, 50 and 53 dual row positions. Contact rows in plug and receptacle are on a  $100 \times 150$ -mil grid, and all contacts are located within a 20-mil diameter of true position to accommodate solderless-wrap equipment.

CIRCLE NO. 306

### Edge connector reduces installation time

*Reed Devices Inc., 21W183 Hill Ave., Glen Ellyn, Ill. 60137. (312) 858-2050. \$9.90 (10 up)/22 pins; stock.*

A PC board edge-connector mounting system conveniently mounts single cards and provides terminal screws for field wiring. Offering savings in time and expense in panel mounting systems where only a few cards are required, the Snaptrack system is claimed to reduce installation labor 30%. Three models are offered to handle notched and straight cards in single-sided 22-pin and double-sided 44-pin output configurations.

CIRCLE NO. 307

### Wash-away adhesive holds delicate parts

*Aremco Products, Inc., P.O. Box 145, Briarcliff Manor, N.Y. 10510. (914) 762-0685. \$25/5 sticks; stock.*

Crystalbond 509, an acetone soluble thermoplastic polymer used as a temporary bond, acts as a "wash-away" adhesive for holding delicate parts such as crystals, and ceramic substrates for slicing, grinding, dicing, or polishing operations. The adhesive has excellent adherence properties and will bond to porous or non-porous metals, glass or ceramic surfaces, and yet will not clog the cutting blades of grinding media. The Crystalbond melts at  $160^{\circ}\text{F}$ .

CIRCLE NO. 308

### Contact cleaner absorbs moisture

*WD-40 Co., 5390 Napa St., San Diego, Calif. 92110. (714) 297-4938.*

WD-40 has the ability to drive out moisture from the pores of metals and can be used as a contact cleaner that also eliminates corrosion. It quickly dries out wet electric motors and deposits a thin molecular film that inhibits re-entry of damaging moisture, preventing rust, corrosion and further malfunction. As it is a non-conductor, the product may freely be used on motors, generators, alternators, wiring and connectors.

CIRCLE NO. 309





## **Still paying for oscillator stability you don't need?**

Plug in our K1065A instead. Medium stability and price. 1 to 5 MHz range:  $3 \times 10^{-8}$  stability for  $-20^{\circ}$  to  $+55^{\circ}\text{C}$ ; less than  $5 \times 10^{-9}$  aging per day. Prototype quantities available for immediate delivery in 1.0 MHz and 5.0 MHz. Details available from Motorola Component Products Dept., 4545 W. Augusta Blvd., Chicago, Ill. 60651.  **MOTOROLA**

### 3-1/2-digit DMM uses LSI for reliability

*John Fluke Manufacturing Co., Inc., P.O. Box 7428, Seattle, Wash. 98133. (800) 426-0361. \$299; stock.*

Featuring a basic accuracy of 0.1%, the new Fluke 8000A DMM measures, in 26 ranges, ac and dc voltages from 100  $\mu$ V to 1200 V, ac and dc currents from 100 nA to 2 A and resistance from 100 milliohms to 20 M $\Omega$ . All instruments are guaranteed to meet specs for one year. According to the manufacturer, the instrument is the first to use both analog and digital LSIs. The two chips used, equivalent to over 3000 circuit elements, help reduce the parts count to about one-third that of typical 3-1/2-digit voltmeters. Because of the low parts count and LSI design the company says that it expects high reliability. The instrument is designed to withstand a fall from bench height without damage.

CIRCLE NO. 320

### Ultra-bright display uses storage CRT

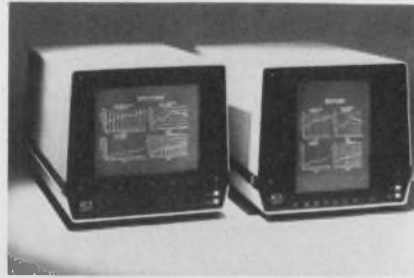

*Tektronix, Inc., P.O. Box 500, Beaverton, Ore. 97005. (503) 644-0161. \$2200.*

The "Ultra-Bright" 613 is an 11-inch, flat, direct-view storage display that is said to put out four times the brightness of other large storage CRT displays. It offers group viewing in an office where the ambient lighting is as high as 100 foot-candles. Besides being super sharp, the trace on the "Ultra-Bright" 613 has no flicker or drift characteristics. The unit doesn't use external memory devices to refresh the display. Instead, it uses a storage CRT that stores the information on the screen.

CIRCLE NO. 321

### DPMs offered for high-accuracy systems



*Newport Laboratories, Inc., 630 E. Young St., Santa Ana, Calif. 92705. (714) 540-4914. 2000A: \$385 to \$465; 2000B: \$280.*

Newport Laboratories announces their new Series 2000A and 2000B DPMs. Series 2000A has higher accuracy and resolution— $\pm 0.01\%$  of reading  $\pm 0.005\%$  of full scale and  $\pm 39,999$  counts full scale, respectively. Its reading rate is up to 20 readings/sec. The 2000A also features auto-polarity, ratio and indefinite storage of a reading, upon external command. The 2000B gives less accuracy and resolution— $\pm 0.02\%$  reading error and  $\pm 19,999$  counts—but it's smaller in size and faster at 30 readings/sec. Both series feature buffered, isolated and gated BCD outputs.

CIRCLE NO. 322

# FREE CATALOG

OVER  
26,500  
POWER  
SUPPLIES

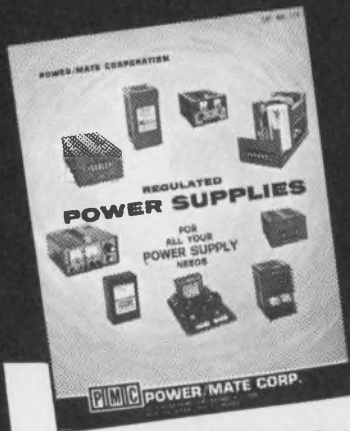

Over 26,500 models of DC Power Supplies — up to 1000VDC and 100A. Both wide and narrow range modules, plus Bench and Lab units for all applications. Quality power supplies based on industry-proven Power/Mate UniPower principles, featuring low ripple and excellent regulation. Low-cost, high reliability. 5-year warranty. Most models shipped same day.

SEND FOR YOUR FREE CATALOG

**PIMC POWER/MATE CORP.**

514 S. RIVER STREET HACKENSACK N. J. 07601  
Phone (201) 343-6294 TWX (710) 990-5023

# WANTED

THE NEWEST  
MEMBER OF THE

## SUMMIT GANG

U.H.F. Mixer alias: Double Balanced



761

U.H.F. MIXER (761) IS KNOWN TO FREQUENT THE DC TO 1000 MHz RANGE AND IS CAPABLE OF PULLING JOBS UNDER EXTREME CONDITIONS.

BECAUSE OF HIS LOW LOSS AND GREATER THAN 45db ISOLATION, U.H.F. MIXER IS DESTINED TO BECOME A LEADER IN THE SUMMIT GANG.

CAUTION: U.H.F. MIXER (761) HAS A BIG BROTHER U.H.F. MIXER (1303) WITH BNC, TNC AND SMA CONNECTIONS.

# REWARD!

PRODUCTION \$\$\$ SAVINGS!!

IF YOU DON'T KNOW HIS WHEREABOUTS:

CONTACT **SUMMIT engineering corporation**  
Box 938 Bozeman, Montana 59715 Ph. (406) 587-0638 twx (910) 975-1950

# "Our customers don't worry about delivery" 1-800-325-2595

your Toll-Free Number — to place your IC order, ask a question, or verify a rumor!

CATALOG NUMBER	ANY QUANTITY PER ITEM			MULTIPLES OF 10 PER ITEM			CATALOG NUMBER	ANY QUANTITY PER ITEM			MULTIPLES OF 10 PER ITEM		
	1-99 MIX	100-999 MIX	1000-UP MIX	100-990 MIX	1000-9990 MIX	10,000-UP MIX		1-99 MIX	100-999 MIX	1000-UP MIX	100-990 MIX	1000-9990 MIX	10,000-UP MIX
7400	.26	.25	.23	.22	.21	.20	74107	.52	.49	.47	.44	.42	.39
7401	.26	.25	.23	.22	.21	.20	74121	.56	.53	.50	.48	.45	.42
7402	.26	.25	.23	.22	.21	.20	74122	.70	.67	.63	.60	.56	.53
7403	.26	.25	.23	.22	.21	.20	74123	1.21	1.06	1.00	.94	.89	.83
7404	.28	.27	.25	.24	.22	.21	74141	1.63	1.55	1.46	1.38	1.29	1.20
7405	.28	.27	.25	.24	.22	.21	74145	1.41	1.33	1.26	1.18	1.11	1.04
7406	.52	.50	.47	.44	.42	.39	74150	1.63	1.55	1.46	1.38	1.29	1.20
7407	.52	.50	.47	.44	.42	.39	74151	1.20	1.13	1.07	1.01	.95	.88
7408	.32	.30	.29	.27	.26	.24	74153	1.63	1.55	1.46	1.38	1.29	1.20
7409	.32	.30	.29	.27	.26	.24	74154	2.43	2.30	2.16	2.03	1.89	1.76
7410	.26	.25	.23	.22	.21	.20	74155	1.46	1.39	1.31	1.23	1.16	1.08
7411	.28	.27	.25	.24	.22	.21	74156	1.46	1.39	1.31	1.23	1.16	1.08
7413	.58	.55	.52	.49	.46	.44	74157	1.56	1.48	1.39	1.31	1.23	1.15
7416	.52	.50	.47	.44	.42	.39	74158	1.56	1.48	1.39	1.31	1.23	1.15
7417	.52	.50	.47	.44	.42	.39	74160	1.89	1.79	1.68	1.58	1.47	1.37
7420	.26	.25	.23	.22	.21	.20	74164	1.89	1.79	1.68	1.58	1.47	1.37
7421	.26	.25	.23	.22	.21	.20	74166	1.98	1.87	1.76	1.65	1.54	1.43
7423	.80	.76	.72	.68	.64	.60	74176	1.62	1.53	1.45	1.36	1.28	1.19
7425	.50	.48	.45	.43	.40	.38	74177	1.62	1.53	1.45	1.36	1.28	1.19
7426	.34	.32	.31	.29	.27	.26	74180	1.20	1.13	1.07	1.01	.95	.88
7430	.26	.25	.23	.22	.21	.20	74181	5.20	4.90	4.59	4.28	3.98	3.67
7437	.56	.53	.50	.48	.45	.42	74182	1.20	1.13	1.07	1.01	.95	.88
7438	.56	.53	.50	.48	.45	.42	74192	1.98	1.87	1.76	1.65	1.54	1.43
7440	.26	.25	.23	.22	.21	.20	74193	1.98	1.87	1.76	1.65	1.54	1.43
7441	1.73	1.64	1.55	1.46	1.37	1.27	74196	1.98	1.87	1.76	1.65	1.54	1.43
7442	1.27	1.21	1.14	1.07	1.01	.94	74197	1.98	1.87	1.76	1.65	1.54	1.43
7443	1.27	1.21	1.14	1.07	1.01	.94	74198	2.81	2.65	2.50	2.34	2.18	2.03
7444	1.27	1.21	1.14	1.07	1.01	.94	74199	2.81	2.65	2.50	2.34	2.18	2.03
7445	1.71	1.62	1.53	1.44	1.35	1.26	NE501	2.99	2.82	2.66	2.49	2.32	2.16
7446	1.24	1.17	1.11	1.04	.98	.91	NE526	3.59	3.38	3.17	2.95	2.74	2.53
7447	1.16	1.10	1.04	.98	.92	.85	NE531	3.81	3.58	3.36	3.14	2.91	2.69
7448	1.44	1.37	1.29	1.22	1.14	1.06	NE533	3.81	3.58	3.36	3.14	2.91	2.69
7450	.26	.25	.23	.22	.21	.20	NE536	7.31	6.88	6.45	6.02	5.59	5.16
7451	.26	.25	.23	.22	.21	.20	NE537	7.53	7.09	6.65	6.20	5.76	5.32
7453	.26	.25	.23	.22	.21	.20	NE540	2.16	2.04	1.92	1.80	1.68	1.56
7454	.26	.25	.23	.22	.21	.20	NE555	.98	.93	.88	.83	.78	.73
7460	.26	.25	.23	.22	.21	.20	NE560	3.57	3.36	3.15	2.94	2.73	2.52
7470	.42	.40	.38	.36	.34	.32	NE561	3.57	3.36	3.15	2.94	2.73	2.52
7472	.38	.36	.34	.32	.30	.29	NE562	3.57	3.36	3.15	2.94	2.73	2.52
7473	.50	.48	.45	.43	.40	.38	NE565	3.57	3.36	3.15	2.94	2.73	2.52
7474	.50	.48	.45	.43	.40	.38	NE566	3.57	3.36	3.15	2.94	2.73	2.52
7475	.80	.76	.72	.68	.64	.60	NE567	3.57	3.36	3.15	2.94	2.73	2.52
7476	.56	.53	.50	.48	.45	.42	N5111	.90	.86	.81	.77	.72	.68
7480	.76	.72	.68	.65	.61	.57	N5556	1.87	1.77	1.66	1.56	1.46	1.35
7482	.99	.94	.88	.83	.78	.73	N5558	.80	.76	.72	.68	.64	.60
7483	1.63	1.55	1.46	1.38	1.29	1.20	N5595	3.40	3.20	3.00	2.80	2.60	2.40
7485	1.43	1.35	1.28	1.20	1.13	1.05	N5596	1.87	1.77	1.66	1.56	1.46	1.35
7486	.58	.55	.52	.49	.46	.44	709	.42	.40	.38	.36	.34	.32
7490	.80	.76	.72	.68	.64	.60	710	.42	.40	.38	.36	.34	.32
7491	1.43	1.35	1.28	1.20	1.13	1.05	711	.44	.42	.40	.37	.35	.33
7492	.80	.76	.72	.68	.64	.60	723	1.00	.95	.90	.85	.80	.75
7493	.80	.76	.72	.68	.64	.60	733	1.90	1.80	1.70	1.60	1.50	1.40
7494	1.18	1.12	1.05	.99	.93	.87	741	.44	.42	.40	.37	.35	.33
7495	1.18	1.12	1.05	.99	.93	.87	747	1.05	.99	.94	.88	.83	.77
7496	1.18	1.12	1.05	.99	.93	.87	748	.48	.46	.43	.41	.38	.36
74100	1.52	1.44	1.36	1.28	1.20	1.12							

We also stock a complete line of SCHOTTKY TTL devices, and 7-segment LED Displays.

Solid State Systems, Inc. is an independent NON FRANCHISED distributor of electronic components. All components are guaranteed to be brand new, manufacturers first run, fully tested and marked. We will ship within 24 hours or we will allow you a 10% discount.

**SOLID STATE SYSTEMS, INC.**  
P.O. BOX 773, COLUMBIA, MO. 65201  
PHONE (314) 443-3673 TWX 910-760-1453

## Your best choice in enclosures

- oil and dust tight
- EMI/RFI shielded
- rigid one-piece construction
- available from stock



CONSOLES

CONSOLETS

Consoles in versatile stock design, 50" x 24" x 23", with gasketed front and rear doors. Options include rack angles, swing-out and stationary subpanels and writing desk. Consolelets are offered in eleven stock sizes for desktop mounting of remote controls. Floorstand optional.

All units are heavy gauge steel with all-welded seams, easily shielded.



FREE-STANDING  
ENCLOSURES

NEMA 12 units in stock sizes up to 90" x 36" x 24". Rigid 12 gauge steel with all-welded seams, gasketed doors front and/or rear. Oil and dust tight. Options include several interior panel arrangements, rack angles and shielding.

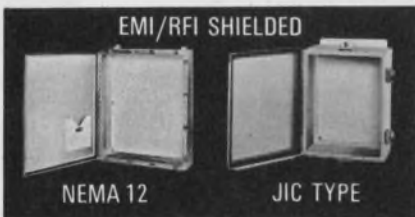

EMI/RFI SHIELDED

NEMA 12

JIC TYPE

Heavy gauge steel boxes with hinged doors, all cadmium plated. Oil and dust tight, fully shielded. Interior mounting panels and terminal block kits optional. Shipment from stock, all sizes.



NEMA 1  
ENCLOSURES

For mounting controls where oil, dust and water are not a problem. One-piece heavy gauge steel construction, finished in gray prime. Flush latches. Interior panels for mounting components. Wide size range in stock.

# Hoffman

HOFFMAN ENGINEERING COMPANY  
Division of Federal Cartridge Corporation  
Anoka, Minnesota, Dept ED-4311

## ELECTRICAL ENCLOSURES

INFORMATION RETRIEVAL NUMBER 66

## DATA PROCESSING

### Circuit converts TTY printer to data logger

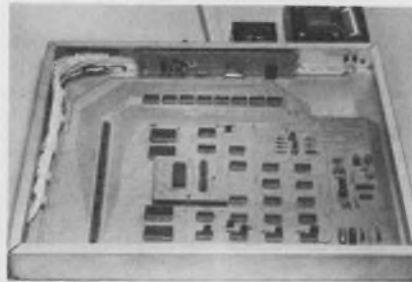

Gryczuk Electronics Co., Inc., 208 Hillcrest Ave., Millheim, Pa. 16854. (814) 349-5555. Under \$2000 including teletypewriter.

The PPSDC 1000/I, when coupled to a Teletype ASR 33, converts the printer to a data-logging terminal for data sources like DVMs and counters. Custom-designed formats, which can be changed in-the-field, are accommodated by the plug-in design. The unit will accept most binary codes with positive or negative logic. Options include parity generation and a buffered 64-bit input.

CIRCLE NO. 323

### Digital filter simulates all classical filters



Rockland Systems Corp., 230 W. Nyack Rd., W. Nyack, N.Y. 10994. (914) 623-6666. \$8500; 12 wks.

Digital-filter configurations to eight poles and eight zeros are implemented by the Model 4136 in cascade, recursive form with variable sampling rates to 80 kHz. Many classical filter types can be programmed with the unit's twelve, 16-bit filter coefficients. Types include Butterworth, Chebyshev, Bessel and Cauer (elliptic). The digital-signal input and output can have up to a 16-bit resolution; while internal computation is carried out with 24-bit accuracy. Internal 12-bit a/d and d/a converters are available as options.

CIRCLE NO. 324

### Flexible-disc memory stores 1.4 million bits



Century Data Systems, Inc., 1270 N. Kraemer Blvd., Anaheim, Calif. 92806. (714) 632-7041. \$500 (OEM qty); Under \$4 per cartridge.

The CDS-110 flexible-disc drive accepts a removable 7.5-in. four-mil mylar-jacketed disc that stores over 1.4 Mb of data on 64 tracks. Data is transferred at 33.3 kb/s and track-to-track access time is 40 ms. Units are available with read only, read/write or read-after-write capability. The disc cartridge is removable from the unit and can be mailed or stored for future use.

CIRCLE NO. 325

### FSK modem modules occupy only 2.35 in.<sup>2</sup>

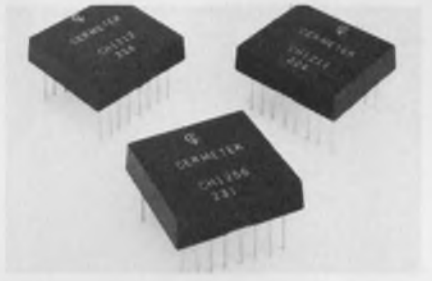

Cermetek, Inc., 660 National Ave., Mountain View, Calif. 94040. (415) 969-9433. \$33.55 (100 up) for set of three modules.

Thick-film hybrid modules for frequency-shift-keying modems use switched active resonator circuitry for modulation and demodulation. The technique eliminates many of the problems associated with phase-lock loop circuits and requires a minimum of external components. Packaged in a double-spaced, 16-pin DIP, the unit's dimensions are 0.85 x 0.92 x 0.25 in. A typical 300 b/s modem uses a CH1211 demodulator, a CH1212 modulator and a CH1256 bandpass filter, and occupies only 2.35-in. of board space.

CIRCLE NO. 326

# **STOP!**

# **GO...**

**to the inside front cover  
of this issue of  
Electronic Design . . .**

## **RENEW YOUR FREE SUBSCRIPTION TODAY**

**THIS IS A ONE-TIME RENEWAL OPPORTUNITY**

*To insure uninterrupted service, your free subscription to Electronic Design must be renewed now! Please turn to the special renewal card inside the front cover. Fill out and return the card promptly. To avoid delay, use the peel-off label from the front cover of this issue.*

**-- Do it now -- You'll be happier you did --**

# innovation yesterday

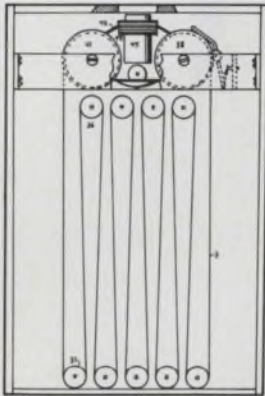

Thomas Edison's Motion Picture Machine

# innovation today



## DIGIVIDER DIGIDECADE Dial the exact voltage or resistance you want

The motion picture camera has come a long way since Edison introduced it. Thumbwheel switches have come a long way too since we developed them in 1959. Now you can buy a Thumbwheel switch that acts as a digital voltage divider, potentiometer or resistance decade. Dial the values you want, and that's what you get. Accurately with repeatability. Digivider or Digidecade. An innovation in switching. So, ask for our new catalog. We think that's a great idea too.

THE **DIGITRAN** COMPANY  
A Division of Becton, Dickinson and Co. **B-D**  
855 So. Arroyo Parkway, Pasadena, Ca. 91105  
Tel. (213) 449-3110 • TWX 910-588-3794

INFORMATION RETRIEVAL NUMBER 68

## DATA PROCESSING

### Encoder allows remote use of WATS line



Electronic Concepts Laboratories, 70 Hilliard St., Manchester, Conn. 06040. (203) 522-2171. Encoder: \$250; Base station: \$500.

Tel-Extenda-Line makes any telephone an extension of WATS, tie or trunk lines, and provides off-premise access to internal or private secondary telephone systems. The system consists of a portable pocket-size encoder, and a decoder base station that is connected to WATS or internal telephone lines and to a dedicated local line. Use of encoder audio signals and the dedicated local number ensures that only an authorized, properly equipped individual can gain access. The encoder is powered by one 9-volt transistor battery.

CIRCLE NO. 327

### Laboratory peripheral unit interfaces PDP-11

Digital Equipment Corp., 146 Main St., Maynard, Mass. 01754. (617) 897-5111. Under \$3000.

Designed to interface to the PDP-11 family of computers via the Unibus, the LPS11-S performs a variety of functions including a/d conversion (12-bit, sample and hold), multiplexing (eight-channels), measuring, display controlling and real-time clocking. This new laboratory peripheral system is suitable for applications including biomedical research, analytical instrumentation, data collection and reduction and industrial testing.

CIRCLE NO. 328

### Minicomputer uses a 4-k, 16-bit LSI memory

Texas Instruments Inc., Digital Systems Div., P.O. Box 1444, Houston, Tex. 77001. (713) 494-2186. \$3475 (1-100); 45 days.

TI's new Model 980A minicomputer includes for its \$3475 price a 4-k word, 16-bit, semiconductor memory with a 750-ns cycle time. The mini features items such as a hardware multiply/divide system, an I/O bus with four ports (expandable to 13) and a direct memory access channel (expandable to eight ports). Also, extensive software is included. A \$100 battery pack option provides standby power for two weeks.

CIRCLE NO. 329

### PCM system changes data format on command

Spacetac, Inc., Burlington Rd., Bedford, Mass. 01730. \$10,000 to \$20,000; 45 days.

Format control and frame synchronization in the Series 2100 PCM encoders are done with electrically-programmable read-only memories (EPROMS) which allow storage of up to eight formats. Selection of any format is commandable or programmable. Other features are: Handles any bit rate to 256 kb/s at 6 to 11 b/word; up to 2048 b/frame; up to 128 subframes; 6 to 10-bit analog-to-digital resolution; any of 10 output codes; and various parity options. Up to 128 analog and 320 digital inputs can be handled without restrictions on the combinations.

CIRCLE NO. 330

### Laser light used to record on 8-mm film

Laser Microfilming, Inc., 800 Shames Dr., Westbury, N.Y. 11590. (516) 334-4402.

Using laser light to photographically expose 8-mm film, the PDR-5A analog recorder/reproducer provides 36 independent channels on a 2000-ft reel. The data is recorded as varying shades of gray with a density of 2500 cycles/in. The bandwidth is flat from 0 to 150 kHz.

CIRCLE NO. 331

## "TRIMLINE MATH" 88 + 23 = 2024

Availability in **88 STANDARD SIZES**  
and **23 STANDARD FINISHES** make  
**2024 COMBINATIONS** for your  
distinctive cabinetry.

**STRONG** . . . to protect the  
heaviest load.

**ADAPTABLE** . . . to accommodate  
mounting requirements.

**ATTRACTIVE** . . . to add "Quality"  
to your product.

Starting at \$41.70 per unit, Quantity  
Discounts up to 25%.

SEND FOR OUR COMPLETE CATALOG



**PREMIER METAL  
PRODUCTS COMPANY**

A Division of Sunshine Mining Company

**337 Manida Street,  
Bronx, New York 10474  
(212) 991-6600**

## TRIMLINE INSTRUMENT CASES



**A Complete Line of over 1200 Standard Racks,  
Cabinets, Consoles and Accessories.**

INFORMATION RETRIEVAL NUMBER 69

## mi-cro-temp (mī'krō tēmp')

**A patented, positive safety thermal cutoff.**

It will interrupt a circuit when the operating temperature exceeds the rated temperature of the cutoff. Normally employed as a back-up safety protector to cut off power to electronic circuits or components that develop abnormal temperature build-up, this device is fast, reliable and accurate to  $\pm 3^\circ\text{F}$ . MICROTEMPS are UL/CSA listed and insure product safety. Costing as little as 7.5¢ each, MICROTEMPS are available in a wide range of configurations, ratings and terminations to suit your individual applications. MICROTEMPS are hermetically sealed; unaffected by vibration, shock, aging or positioning. For specific details regarding your requirements, call or write:



**MICROTEMP  
Safety Thermal  
Cutoff**



**MICRO DEVICES CORP.**

1881 Southtown Blvd. Dayton, Ohio 45439  
Ph. (513) 294-0581 Telex: 28-8087

INFORMATION RETRIEVAL NUMBER 70

ELECTRONIC DESIGN 22, October 26, 1972

## HALEX, INC.

### Second-sourcing:

0007 Clock Driver  
0009 Dual Clock Driver  
0033 High Speed Buffer  
0034 Level Shifter

For prices and data sheets  
on these or other  
high-quality thin-film  
microcircuits, please call  
or write:

Halex, Inc.  
P.O. Box 2940  
Torrance, California 90509  
(213) 772-4461, (213) 542-3555  
Telex 65-3442

INFORMATION RETRIEVAL NUMBER 71

## 27 Plug-in Modules make the

OMNIGRAPHIC®

# X-Y RECORDER

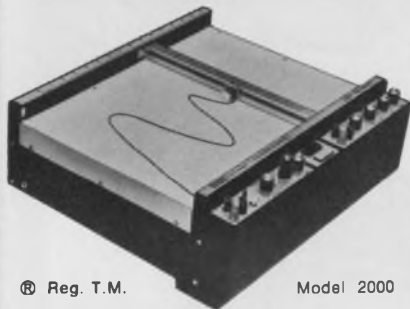

® Reg. T.M.

Model 2000

a terrific value at

**\$795** plus modules

Why? Because now there's a module for AC to DC conversions, another for both AC and DC... plus more for every function you may require. What's more, they're all interchangeable. And just look at these features:

- 30 in./sec. speed
- $\pm 0.2\%$  accuracy
- local/remote pen control
- electric pen lift
- high input resistance
- interchangeable amplifiers
- \$795 plus modules

A companion strip chart recorder, model 3000, now is available with a full span automatic integrator for gas chromatography and with modules for point plotting.

Write for brochures today.



**houston instrument** DIVISION OF BAUSCH & LOMB®

4950 Terminal Avenue, Bellaire, Texas 77401  
(713) 667-7403 Cable Hoinco

**houston instrument** European Office

Johanneskirchner Strasse 17, 8043 Unterföhring  
München, W. Germany (0811) 97-1673

INFORMATION RETRIEVAL NUMBER 72

## COMPONENTS

### Film resistors feature weldable leads

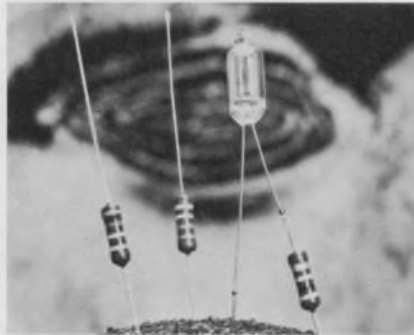

*Piher International Corp., 1239 Rand Rd., Des Plaines, Ill. 60016. (312) 297-1560.*

Piher copperply weldable-lead carbon-film resistors are ideal for neon glow lamp applications. Featuring a specially-formulated, conformally-coated encapsulant, the 1/3 W, 5 and 10% resistors are resistant to environmental conditions. A temperature coefficient of 180 ppm/°C max., a moisture resistance change of  $\pm 1.5\%$  max., and a shelf-like change of 0.15% provides stability better than carbon-composition resistors. They are available in lead-tape and reel packaging.

CIRCLE NO. 332

### Low inertia dc motor accelerates rapidly

*Magneddyne, Inc., 5580 El Camino Real, Carlsbad, Calif. 92008. (714) 729-7191.*

A low-inertia dc motor specially designed for fast computer peripheral equipment has been introduced by Magneddyne, Inc. Designated the Model 702, the new moving coil motor features an aluminum wire armature supported by resins and other lightweight, nonmagnetic materials. These features give the Model 702 high torsional resonant frequency together with high inherent damping and theoretical acceleration on the order of 600,000 radians/sec<sup>2</sup>. And armature circuit inductance is only 60  $\mu$ H maximum at 1000 Hz. Torque constant of the high-performance motor is 11.5 oz-in/amp, armature inertia is only 0.0009 oz-in-sec<sup>2</sup>, and armature circuit resistance is 0.65 ohms.

CIRCLE NO. 333

## PROTOTYPES

We'll ship them immediately—toroids and oscillators\* right out of stock—at far below competitive prices.

At Allen Electronics Division, we manufacture these, and other components, in quantity for the world's finest electronic organs. So we constantly maintain a complete stock of high quality frequency sources, and over 150 sizes of toroids. We'll send you the few you need to start your idea; the many you'll need to produce it.

All Allen components are made under the most rigid quality controls, including thorough inspection and testing, at one of the most modern and efficient plants in the country.

Send for complete information on the "Prontotypes". Then, when you have an application that requires quality components immediately, at no-penalty prices, you'll know where to get them. Pronto.

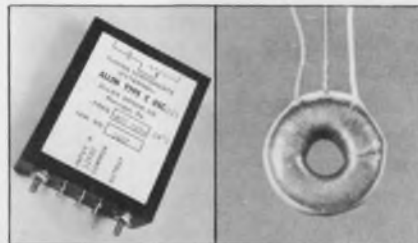

Type C Oscillator  
Range: 15 Hz to 10 kHz  
Use: Designed for applications having moderate requirements for stability in respect to temperature and frequency drift.

Toroids  
Over 150 sizes available from stock include Permalloy, Ferrite and Powdered iron types. Some no-center-tap. Inductance tolerance  $\pm 2\%$ .

\*Allow several extra days for packaging.

# ALLEN electronics division



Dept. 1072  
Macungie, Pa. 18062

INFORMATION RETRIEVAL NUMBER 73

ELECTRONIC DESIGN 22, October 26, 1972



## Hall-effect head reads magnetic stripe on cards

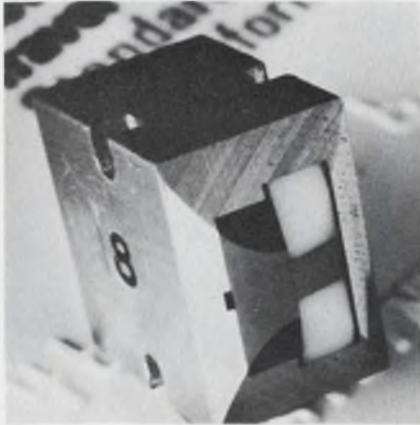

Pioneer Electronic Corp., Components & Data Products Div., 525 W. Remington Dr., Sunnyvale, Calif. 94087. (408) 245-3511.

The CRH-3101, a read-only Hall-effect head, meets ABA and IATA proposed requirements. Its primary applications are for 0.25 in. stripes on magnetically-encoded credit cards, sales tags and other hard-surface media. The head generates an output that is independent of speed and proportional to the magnetic flux. The output signal at a recording density of 210 FRPI is typically 4 mV peak to peak with a balanced load of greater than 10 k $\Omega$  at a control current of 8 mA dc.

CIRCLE NO. 334

## Semiconductor heating element regulates itself

Murata Corp. of America, 2 Westchester Plaza, Elmsford, N.Y. 10523. (914) 592-9180.

New semiconductor devices act as heating elements and provide their own inherent temperature control. They are called Posistors and have a positive temperature coefficient that tends to dissipate a constant power level (for loads under 100 W) over a range of voltages. For higher wattages, Posistors may be used to control other conventional high-power heating elements. The Posistor line includes versions for temperatures from 40 to 200 C and wattages from 2.4 to 100 W. Other units are available to control high-power heating elements in the 100 W to 2 kW range.

CIRCLE NO. 335

## Titanate ceramic has 50 k dielectric constant

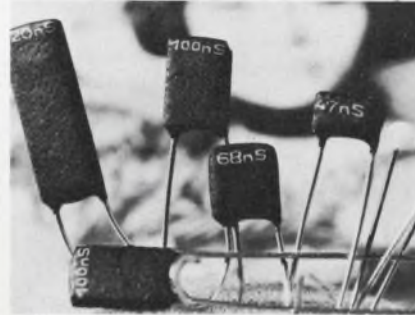

Siemens Corp., Components Div., PB Dept., 186 Wood Ave., Iselin, N.J. 08830. (201) 494-1000. \$0.10 to \$0.25 (100 up).

Capacitors with a new titanate-ceramic dielectric have a dielectric constant of 50,000. This permits a significant reduction in size. Radial leaded, flat capacitors with values to 220 nF at 40 V dc are available. Operating temperature is -25 C to 85 C with a tolerance of +50% to -20%.

CIRCLE NO. 336

## So far, we've built 132,892 types of Rotary Power Switches within these parameters.

### Your application may be number 132,893!

SWITCH SPEC	Minimum	Maximum
RATING	1/2 amp	200 amp
POSITIONS	2	16
CONTACTS (Poles)	1	72
ACTION	SNAP • DETENT • CAM	
OPTIONS	Key-operated...Key-locking...Tandem units...Gear-train units...Solenoid-locking...Push-to-turn operation...Waterproof mounting...Base & Panel mounting...Explosion-proof housing...AND MANY MORE!	

Chances are, there are several switches you can profitably choose from among our literally *hundreds* of stock units. But if you do require a special, you can have it assembled to order from a few *thousand* basic components...off-the-shelf! From simple pushbuttons to complex gear-train models...from light to heavy duty...from stock to custom...there's bound to be a perfect match to your specifications and applications.

Send for Bulletin C-1...our "Catalog of available catalogs" or give specific needs for detailed information.



1947/1972...Our 25th Year

**ELECTRO SWITCH**  
CORP.

Weymouth, Massachusetts 02188

Telephone: 617/335/5200 TWX: 710/388/0377

INFORMATION RETRIEVAL NUMBER 74

### Slide switch selects decimal-point location



OEM Mectronix, Inc., 115 E. Bethpage Rd., Plainview, N.Y. 11803. (516) 293-1530. Stock.

Five-position slide switch, ASI P/N 1577, is primarily used to control the number of digits displayed after the decimal point in electronic calculators. It has four NO contacts and one NC contact. In calculators, the switch turns the power on and then selects two, four or six digits after the decimal point. The switch is aimed at low voltage and current applications. It is capable of carrying and switching 0.5 A at 110 V ac.

CIRCLE NO. 337

### Crystal oscillator has 300,000 hours MTBF

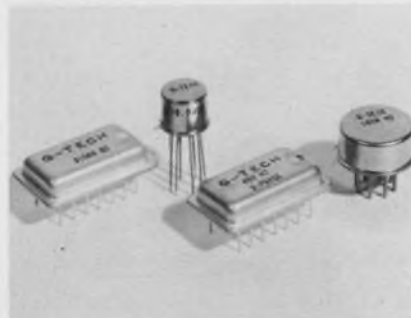

Q-Tech Corp., 11529 W. Pico Blvd., Los Angeles, Calif. 90063. (213) 473-1105. \$13 (1000 up) for 0 to 50 C, TO-5 models; stock to 6 wks.

Hybrid thin-film crystal controlled oscillators in TO-5, TO-8 or DIP have an MTBF of 300,000 hr when tested at 85 C. Frequency range is 6-25 MHz for units in TO-5 packages and 400 Hz-25 MHz for TO-8 and DIP types. They are TTL compatible and available in single, complimentary, and 3-phase (DIP only) versions. Operating temperature is from 0 to +50 C or -55 to +105 C, with the frequency stabilities of AT-cut quartz crystals.

CIRCLE NO. 338

### First practical green neon lamp is announced

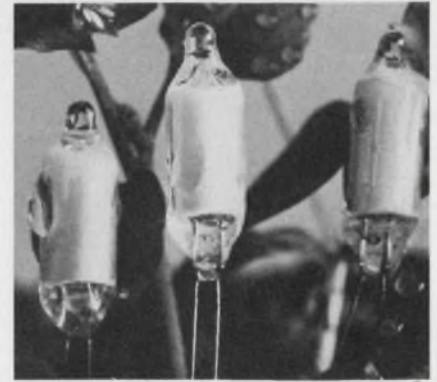

General Electric Co., Nela Park, Cleveland, Ohio 44122. (216) 266-2258; stock.

An industry first—a practical, long-life, green neon glow lamp—adds two colors—green and blue (with filter)—to the red, yellow and orange of present glow lamps. Key to the green light output is a special phosphor coating applied to the inside surface of the bulb and a new gas. Designated G2B, the new lamp is directly interchangeable electrically and physically with GE's C2A glow lamp. Average useful life is 10,000 hours.

CIRCLE NO. 339

## PERIPHERAL PERFORMANCE IMPROVERS...

Low-Inertia DC Motors from MCD!

Designed solely for the EDP market, by Control Data®'s own "inside peripheral component experts," our units all offer performance-proved, low-inertia advantages: high resonant frequency, high acceleration, high heat dissipation, and **lower** operating cost!—for the life of your products!

These MCD "Improvers" can be supplied with a performance package option, too: Motor, Capstan, Vacuum Manifold and Tachometer—ready to go—and **keep going** for the goingest peripherals in the field!

**DETAILED DATA** and performance brochures can be on their way to you fast—Write Now!

**MAGNETIC COMPONENTS DIVISION** **CONTROL DATA CORPORATION**

7801 Computer Ave. So., Minneapolis, Minn 55435  
(612) 920-8600 TWX 910-576-2978



No other conductive elastomer can shield your electronic products against EMI as effectively as Xecon®, the whole line. Xecon gasketing is made with silver deposits on a stable, lightweight substrate in a silicone matrix. Temperature range for sustained operation is -60°C to 200°C. Xecon protection is available: as die cut waveguide and connector gaskets; in sheets; and custom molded and vulcanized to your own specs. Write for free EMI Handbook today. Metex Corporation, Edison, New Jersey 08817. West Coast: Cal-Metex Corporation, Inglewood, California 90301



### Help stamp out EMI.

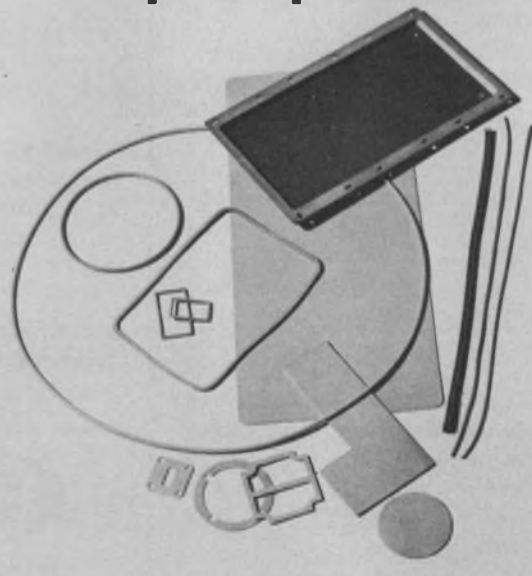

INFORMATION RETRIEVAL NUMBER 76

ELECTRONIC DESIGN 22, October 26, 1972

INFORMATION RETRIEVAL NUMBER 75

# 'BAREFOOT' VACATIONS

to exotic islands



**WINDJAMMER CRUISES**



**explore Bahamas,  
West Indies,  
Virgin Isles, Mexico.**

**Comfortable  
cabins... good  
"Grub 'n Grog".**

**10 adventurous  
days from \$200**

- Great for employee incentive programs
- Ideal for executive meetings and parties
- Wonderful for customer prizes



**WRITE CAP'N MIKE  
FOR FULL INFORMATION  
AND ADVENTURE BROCHURE  
P.O. BOX 120, DEPT. 787A  
MIAMI BEACH, FLORIDA 33139**

# FREE WITH OUR ENCAPSULATED POWER SUPPLIES

... we will send you a mating socket. That's right, Computer Products, the leading manufacturer of encapsulated power supplies, will send you a free mating socket with your order (Offer expires January 1, 1973 ... limit one per customer). It's Computer Products' way of introducing you to the most reliable power supply for your application. Reference this ad when ordering.

Contact us for our catalog describing the complete line and illustrating PIN-FOR-PIN compatibility with major OP-AMP and POWER SUPPLY manufacturers' units.



	LIST	10-24	100-249
PM505 $\pm$ 15VDC @ 100mA $\pm$ 0.02% Regulation .5mV Ripple	\$45.00	\$36.00	\$24.75
PM565 $\pm$ 15VDC @ 200mA $\pm$ 0.02% Regulation .5mV Ripple	\$65.00	\$52.00	\$35.75
PM534 5VDC @ 500mA $\pm$ 0.04% Regulation 1.0mV Ripple	\$45.00	\$36.00	\$24.75
PM542 5VDC @ 1000mA $\pm$ 0.04% Regulation 1.0mV Ripple	\$65.00	\$52.00	\$35.75

STOCKING DISTRIBUTION CENTERS: B.J. Wolfe Enterprises, North Hollywood, California (213) 877-5518; Pen Stock, Los Altos, California (415) 948-6533; and Powermart Associates, Hartford, Connecticut (203) 527-2147.



## COMPUTER PRODUCTS

(305)974-5500 • 1400 NW 70 ST. • FT. LAUDERDALE, FLA. 33307  
TWX (510) 956-9895

INFORMATION RETRIEVAL NUMBER 78

# MIIDA MODEL 6454 FULL 4 DMM with 0.01% DC ACCURACY. \$495.



- AUTOMATIC RANGING
  - Internal current shunts
  - Portable with carrying case
  - Battery operation ■ MOS-LSI
  - 9999 display ■ 1000 megohms input impedance (up to 10v range) ■ Automatic zeroing
- Other Miida multimeters in 3½ and 4½ digits

**Miida** Miida Electronics, a division of Marubeni America Corp.,  
2 Hammarskjold Plaza, New York, N.Y. 10017 / (212) 973-7152  
Distributorships available

INFORMATION RETRIEVAL NUMBER 79

## evaluation samples

### Assembly pins

A broad variety of assembly pins are made from either steel, stainless steel, copper or from any other variety of wire and materials. The pins can be pointed sharp at one end, dull ended or bullet nosed so that they may be inserted very easily during assembly operations. The pins can also be double chamfered and pointed on both ends when required. John M. Dean Inc.

CIRCLE NO. 340

### Encapsulation epoxy

Plaskon Epiall MX-3000 is an improved epoxy compound for the encapsulation of electronic devices that is designed to have excellent electrical property retention during prolonged, continuous exposure to high temperature and excessive moisture. Devices encapsulated in Plaskon Epiall MX-3000 resin have repeatedly withstood a minimum of 10 six-hour cycles in a pressure cooker with no corrosion problems or evidence of electrical breakdown. Minimum compressive strength is 30,000 psi. Allied Chemical Corp., Plastics Div.

CIRCLE NO. 341

### Ceramic insulators

A practical method of manufacturing ceramic insulators with metal members molded in place reduces costs of making electrical connections from one side of ceramic parts to the other compared to parts made by the four-step mold-metalize-fire and braze procedure presently required. Molded-in-metal components give electronic engineers considerably more latitude in component design and positioning of metal members. Also, they permit a hole pattern of much greater density than currently available and with exceptionally close member-to-member tolerances. Ceram Corp.

CIRCLE NO. 342

## Octagonal socket

A new socket is octagonal in shape to allow close packing on a 400-mil pitch. The socket body is molded in glass-loaded nylon and the contacts are gold plated phosphor bronze. The over-all height of 0.3 in. allows devices with leads up to 0.25-in. long to be fully inserted. The solder tails are suitable for boards up to 125-mils thick and are arranged on 283-mils P.C.D. These sockets are inexpensively priced at \$0.20 each for small quantities and as little as \$0.12 each for 250-499. Jermyn.

CIRCLE NO. 343

## Glass bubbles

A lightweight glass bubble is available for use in syntactic foams where minimum density must be controlled very precisely. Called the B18A type 3M brand glass bubble, it is the lightest of the high strength B—a series of bubbles that have found uses from the depths of the sea to outer space. Particle size averages 80 microns and density of a typical sample is 0.16 grams per cc. Combined with epoxy resin binders, the B18A glass bubbles can make compounds, such as adhesives, sealers and core-fillers, with a density as low as 34 lb./cu. ft. and a hydrostatic collapse strength as high as 10,000 psi. 3M Co.

CIRCLE NO. 344

## Polyethylene foam

A plastic work surface and drawer liner material for laboratories, trade-marked Clean Sheets, is a cross-linked polyethylene foam. The closed-cell construction of this material provides a smooth, nonabsorbent, nonwetting surface that is easily cleaned. The new material is resilient but not spongy. It protects glassware against breakage, cushions delicate equipment and eliminates clatter. The matte-white finish provides a bright, clean surface without glare. The cross-linked polyethylene material is unaffected by acids, bases, alcohols or titrants. The closed-cell construction holds chemicals on the surface, makes spills easy to clean. Nagle Co., Labware Div.

CIRCLE NO. 345

# Now, get more insertion loss from a smaller-volume filter.



You can get it from these RFI/EMI low-pass feedthrough filters from AMP. Because of their unique ferrite-titanate composition, they provide suppression and environmental

characteristics never before available in miniature-sized filters at an economic cost.

It's all made possible by single-piece construction which distributes inductance, capacitance and resistance over the filter, making it act like a lossy transmission line. And provides superior mechanical strength, in the bargain.

These filters are free of the usual resonance effects of conventional lumped-element filters. And, through the use of special solders, can be joined safely to bulkheads at temperatures to 260°C, without damage or change in performance. Their operating range is -55°C to +125°C. No voltage derating is required at the higher temperature.

A variety of center-conductor, terminal-type and solder- or bolt-in mounting-type filters is available in two families of filters: "55" Series—the standard maximum suppression line—and the "25" Series—miniature and subminiature filters.

For more information on AMP low-pass feedthrough filters, write to **Capitron Division, AMP Incorporated, 1595 S. Mount Joy Street, Elizabethtown, Pa. 17022.**

Capitron is a trademark of AMP Incorporated.

# AMP

INCORPORATED

Manufacturing and direct sales facilities worldwide: Barcelona, Brussels, Buenos Aires, Frankfurt, London, Mexico City, Paris, Puerto Rico, Sao Paulo, s'Herlogenbosch (Holland), Sydney, Stockholm, Tokyo, Toronto, Turin, Vienna.

INFORMATION RETRIEVAL NUMBER 80

**\$75.**(1-9)

## 5V/12A COMPUTER OEM SUPPLY



No frills, no gimmicks, no specmanship. Right. It's ugly.

But our open-frame computer-grade supplies have the prettiest price/performance ratio you've ever seen.

You get all the power we promise you over the full temperature range with no danger of overheating (and no derating, even with a 50 Hz input). You get regulation, ripple and noise specified the way you expect them to be. You get full circuit protection with foldback current-limiting and an electrostatically-shielded transformer standard, OVP optional. And deliveries are off-the-shelf for most configurations.

We've got the same story with all our other supplies, open or enclosed, single- or multiple-output.

Check it out today. Call (714) 979-4450.

OLV-60	
Output:	5V/12A to 28V/3.4A (16 models avail.)
Temp range:	0-55°C
Line & load reg:	0.1%
Ripple & noise:	0.1%

Distributed nationally by Cramer and Newark.

## ELEXON POWER SYSTEMS

3131 S. Standard St., Santa Ana, Calif. 92705

An Elpac division. 

INFORMATION RETRIEVAL NUMBER 81

## We Go All Out To Meet Your Fuse Block Requirements

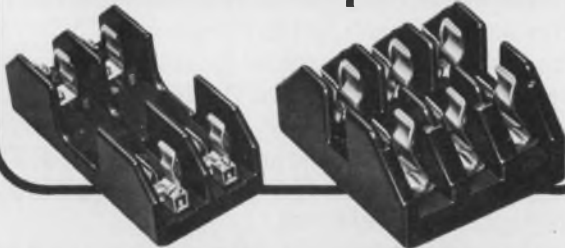

Chances are we have what you want—for prompt delivery from our constantly expanding inventory. All types and capacities: 30 to 600A, 250 and 600V. Most are UL listed and CSA certified. Heat, distortion and breakage resistant.

Request bulletin. Or, if you have a special requirement, give us the specs. We'll design one for you.



## Underwriters Safety Device Company

4332 N. Kedzie Ave., Chicago, Ill. 60618 • 312-583-4080

INFORMATION RETRIEVAL NUMBER 82

## application notes

### Computer-aided wiring

A twenty-eight page booklet describes steps used in preparing input data for computer-aided wiring of DIP sockets and panels. Three optional computer-entry points are described in detail—logic diagram, pin list, and to-to punched cards. Electronic Engineering Company of California, Electronic Products Div., Santa Ana, Calif.

CIRCLE NO. 346

### Stainless steel tubing

A 150-page three-ring binder covers stainless steel pipe and tube specifications. Included are stainless steel pipe and tubing sizes, weights, and theoretical burst pressures for products ranging from 1/8 inch O.D. to 48 inches O.D. Also shown are applications, and chemical and physical properties for 300 series stainless, Hastelloys, Inconels, Incoloy, Waspaloy, and Monel. Colt Industries, Trent Tube Div., E. Troy, Wis.

CIRCLE NO. 347

### Temperature control

A newly revised 56-page guide "How To Get Better Temperature Control" discusses the selection of a temperature controller, general operating techniques, installation and adjustment procedures, and troubleshooting tips. Fenwal, Inc., Ashland, Mass.

CIRCLE NO. 348

### Crystal polishing

An 80-page technical manual details procedures for orientation, shaping, lapping and polishing of single crystal, polycrystal, mineral and metal specimens to optical tolerances of  $\lambda/20$  flatness and 1 second of arc parallelism. Specimens may be shaped in wafers, discs, tubes, cubes, rods, etc. Hacker Instruments, Inc., Fairchild, N.J.

CIRCLE NO. 349

## Rf power supplies

A four-page engineering bulletin entitled "Applications & Advantages of the RF High-Voltage Technique" reviews the theory of operation of a new type of HV power supply, and explains its unique advantages. The advantages include safety factors, such as low stored energy and inherent safeguarding against overloads and short circuits; low initial and maintenance costs; lower weight and smaller size; increased reliability and efficiency; and much greater ease of control, regulation, programming, and interface accommodation. Spellman High-Voltage Electronics Corp., Bronx, N.Y.

CIRCLE NO. 350

## OCR concepts

Optical character recognition and video display terminal concepts with flow charts are offered in a 12-page booklet. Economic word-processing for input systems is the subject matter of this comprehensive report. Aimed at prospective users, considering OCR—with or without VDT, the report details various applications. Datatype Corp., Miami, Fla.

CIRCLE NO. 351

## Cold-heading stainless

Comparison data to help select the best stainless steels for cold-heading applications at lowest possible cost are presented in a new folder. The four-page brochure is basically a chart comparing 13 AISI stainless steel types and highlighting the four recommended by the company as most adaptable to cold-headed techniques. A simple specification change to one of these four—302 (heading quality), 305, 410, or 430—can provide a better stainless with more corrosion resistance and better welding properties. To aid in correct specification of a stainless steel for a particular product use, the chart lists for each type its chemical composition, physical and mechanical properties, heat treatment, heat resistance, welding and cold-heading properties, corrosion resistance and machinability. Elco Industries, Inc., Rockford, Ill.

CIRCLE NO. 352

# think woven

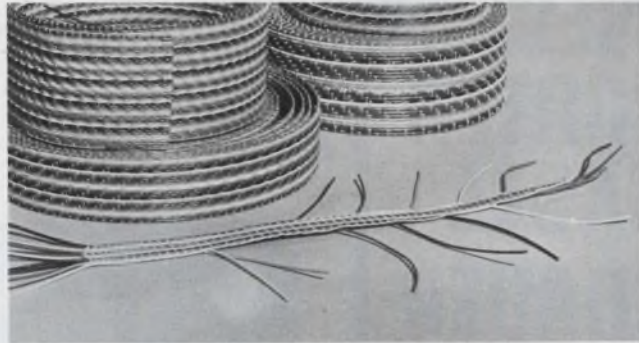

## for precision

When you don't think an interconnect can be made to do precisely what you want it to. Think again. Think Woven! Programmed lead break-outs and other exacting custom features by Woven Electronics offer cable capabilities never before available.

## WOVEN ELECTRONICS

A DIVISION OF SOUTHERN WEAVING COMPANY

P.O. Box 189, Mauldin, S.C. 29662. (803) 288-4411

INFORMATION RETRIEVAL NUMBER 83

# NEW GIANT ECONOMY CARD

Up to 70 IC's per card for more efficient functional partitioning, lower manufacturing costs.

Larger card provides easier maintenance, yet packs over 1000 IC's in a 7" H x 9 1/2" D card cage.

Delivery 1-2 weeks for hardware, just 5 weeks for wrapped, debugged and documented systems from your logic diagrams with our automatic wiring service.

14-pin to 36-pin sockets available to handle any logic up to LSI.

Discretes easily included in wire-wrap schedule.

Test points brought out to card edge for easier checkout.

**Free** We can save you time and money in design, production and maintenance with the world's largest selection of plug-in IC hardware. Our IC Packaging Package tells all. Send for it today and save a bundle.

## EECO IC PACKAGING

EECO, 1441 E. Chestnut Avenue, Santa Ana, California 92705 • Tel: (714) 547-5651

INFORMATION RETRIEVAL NUMBER 84

# NEW SHORTER CASE! SCHAUER 1-WATT ZENERS



**SAME LOW PRICES FOR  
1% TOLERANCE ZENERS  
ANY VOLTAGE  
FROM 2.0 TO 18.0**

Quantity	Price Each
1-99	\$1.07
100-499	.97
500-999	.91
1000-4999	.86
5000 up	.82

**IMMEDIATE SHIPMENT**  
Send for rating data and  
20%, 10%, 5% and 2%  
tolerance prices.

Semiconductor Division

## SCHAUER

MANUFACTURING CORP.

4511 Alpine Ave., Cincinnati, Ohio 45242  
Telephone 513/791-3030

## new literature

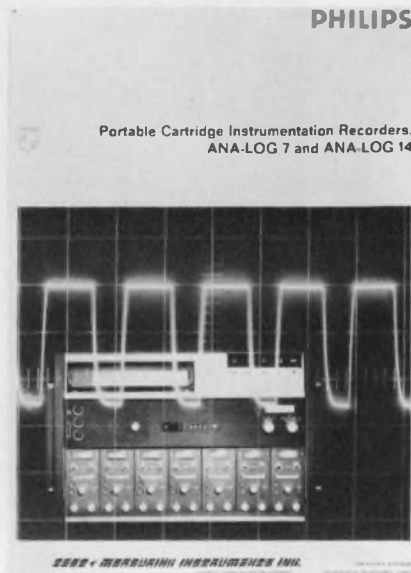

### Instrumentation recorders

The Philips ANA-LOG 7 and ANA-LOG 14 portable cartridge instrumentation recorders are described in a 36-page full-color brochure. The instruments are designed for use in fundamental and applied research. The brochure contains detailed technical descriptions of the features and functions of the recorders and their accessories and provides background information on various applications and related instrumentation requirements. Color photographs of the instruments and of the applications discussed support the text throughout the brochure. Test & Measuring Instruments Inc., Hicksville, N.Y.

CIRCLE NO. 353

### Synchro conversion guide

A Selection & Evaluation Guide describes synchro and resolver data conversion. The booklet describes some of the most advanced state-of-the-art conversion devices applicable to industrial, commercial, avionics and military ground support systems. Accompanying the guide are application notes comparing tracking, multiplexed, synchro-to-linear and synchro-to-non-variant sin/cosine converters. Data Device Corp., Hicksville, N.Y.

CIRCLE NO. 354

### LED selector guide

"LED Product Selector Guide," a 52-page catalog, details the company's broad line of light-emitting diodes, indicators, switches and related readout devices. The guide, designated SG-721, is basically divided into eight product categories—light sources; ultra-miniature indicators; 0.625" readouts; 0.125" and 0.205" readouts; 0.270" readouts; 0.300" readouts; decoder/drivers and switches. All the units described work with or contain light-emitting diodes. For each product category, the company gives complete specifications, curves, applications, and mounting details, where appropriate. Dialight Corp., Brooklyn, N.Y.

CIRCLE NO. 355

### IC reliability program

A new program for increased quality and reliability of ICs is described in a four-page pamphlet, "Rel II High Reliability Integrated Circuits from TI Supply." The brochure explains that the Rel II program is primarily intended for plastic ICs which fill the need for products more reliable than standard products, yet not as costly as military grade ceramic products. A flow diagram in the bulletin shows the various testing steps prescribed by the Rel II program. Texas Instruments Inc., Dallas, Tex.

CIRCLE NO. 356

### Lexan resin

A polycarbonate design brochure highlights Lexan resin's versatility, toughness and overall engineering properties. The 48-page brochure provides designers with a one-stop technical reference for polycarbonate applications. The brochure covers design parameters and techniques, application analysis, assembly techniques, problem analysis, typical properties and a glossary of terms. General Electric Plastics, Pittsfield, Mass.

CIRCLE NO. 357



## Communications topics

"Semiconductors For Communication Systems," a 64-page technical brochure, covers the solid state device types suggested for both radio and wire communication systems. Special emphasis is given to data communications and new industry trends such as hybrid construction, phase locked loops, monolithic voltage regulators, etc. Each section of the brochure presents a discussion of new developments and processes, as well as preferred device tables listing solid state products suggested for each particular application area. The tables are designed to aid in the selection of a proper device type from the multitude of type numbers available. New integrated circuit types are also tabulated for easy selection. Motorola Inc., Semiconductor Products Div., Phoenix, Ariz.

CIRCLE NO. 358

## IR instrumentation

A complete line of photometers, radiometers, spectroradiometers, exposure control systems, detectors, filters, fiber optics and related accessories are described in an eight-page brochure. The handbook contains over 200 spectral response curves along with theoretical and practical detector information. International Light, Inc., Newburyport, Mass.

CIRCLE NO. 359

## Power semiconductors

The Semiconductor Condensed Catalog lists the industry's widest variety of power semiconductor devices. The 16-page publication covers rectifiers, thyristors, transistors and prewired heat-sink assemblies, including the highest voltage ratings commercially available for industrial and military applications. The catalog's easy-to-use format refers the user to individual product line selector guides for more complete information on specific devices. Included are dimensioned drawings of standard packages, a brief description of manufacturing facilities and processes and a world-wide listing of facilities and sales outlets. Westinghouse Electric Corp., Semiconductor Div., Youngwood, Pa.

CIRCLE NO. 360

# Your custom resistor network is only an idea away!

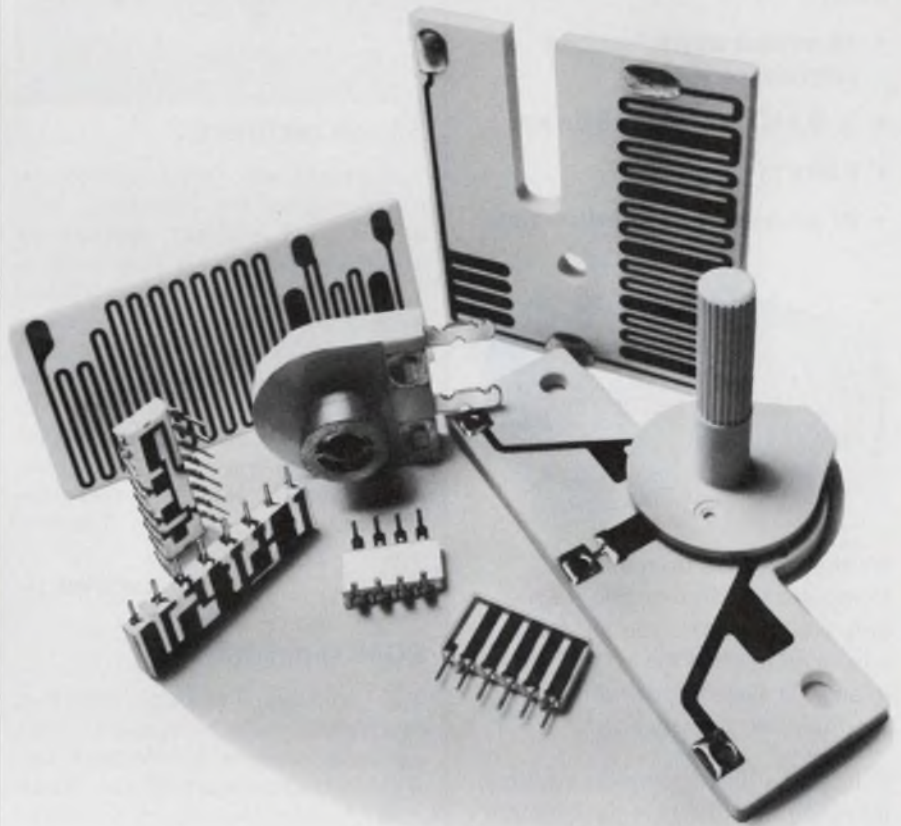

CTS CORPORATION, a pioneer in cermet network packaging, HAS WHAT YOU NEED TO SOLVE "CUSTOM" RESISTOR REQUIREMENTS! Complete thick film facilities save in-house investments: existing tools speed production—cut costs... capabilities you can't afford to overlook. Resistors and resistor networks are our business... not just a sideline.

Whatever your needs, from standard in-line and DIP networks to custom high power/high voltage packages, you can rely on CTS experience and know-how.

Unmatched field reliability, high volume mechanization, and over a decade of cermet thick film-technology make CTS resistors "the engineers' choice". We have what it takes for both standard and custom resistor packages. Call on CTS EXPERIENCE...today! CTS CORPORATION, 905 N. West Boulevard, Elkhart, Indiana 46514, Phone: (219) 293-7511.

**CTS CORPORATION**

Elkhart, Indiana



A world leader in cermet and variable resistor technology.

INFORMATION RETRIEVAL NUMBER 86

# At last... a first.

An analog-to-digital converter with just the right amount of everything to make it the best A/D converter system available today:

- 15 million words/second conversion rate.
- $\pm 0.2\% \pm \frac{1}{2}$  LSB accuracy
- 8 bits of resolution
- 67 picoseconds aperture time



It's the IAD-7108 from Inter-Computer Electronics and it's the only one that offers you the most advanced state of the art techniques in an A/D system today. And it's available for delivery now.

This ICE series of complete systems, featuring modularity in packaging, starts at just \$5,500.

Find out for yourself. Call Adolph Rosset our Advertising Manager, collect, or write for more information on ICE's new IAD-7108 analog-to-digital converter.

From Inter-Computer . . .  
the data handling company



A subsidiary of  
AMERICAN ELECTRONIC LABORATORIES, INC.  
P.O. BOX 507, LANSDALE, PA. 19446  
(215) 855-0922  
TWX 510-661-4976 • Cable: AMERLAB

INFORMATION RETRIEVAL NUMBER 87

## NEW LITERATURE



### Silicon rectifiers

Standard and fast recovery silicon rectifiers for industrial, commercial and military applications are described in a six-page catalog. The catalog devotes individual pages to ratings and electrical characteristics as well as dimensional drawings of case styles for the company's bridges, high-voltage axial lead rectifier cartridges, high-voltage rectifier assemblies and miniature axial lead rectifiers. Electronic Devices, Inc., Yonkers, N.Y.

CIRCLE NO. 361

### ROM simulator

A six-page brochure describes equipment which simulates large read-only memory subsystems. Operational advantages of the Model 1000A read-only memory simulator are discussed. Paragraphs describe the simulation modules contained in the simulator system, the data entry-and-control module, indicators and controls and the simulator's software. Signetics Memory Systems, Sunnyvale, Calif.

CIRCLE NO. 362

### Power transistors

Specifications for a line of power transistors are offered in a 75-page catalog. A comprehensive listing of all electrical and mechanical parameters are included. RSM Electron Power Inc., Sensitron Semiconductor Div., Deer Park, N.Y.

CIRCLE NO. 363

### A/d conversion handbook

The Analog-Digital Conversion Handbook has been compiled by the company's engineering dept. Converters, system components and a guide for the troubled are included. The price for a single copy is \$3.95. For larger quantities of this book, a special carton sale only discount price of \$110 has been established. Analog Devices, Inc., Rte. 1 Industrial Park, Norwood, Mass. 02062.

### Stud-mount thyristors

Three technical data sheets give full rating information, curves and order instructions for three versions of the stud-mount thyristor. Westinghouse Electric Corp., Youngwood, Pa.

CIRCLE NO. 364

### High-voltage pulser

A general-purpose high-voltage pulser suited to developing narrow high-power pulses for electro-optic modulators, photomultipliers, cavity oscillators and for triggering high energy equipment is described in a two-page data sheet. Instrument Research Co., Lincoln, Mass.

CIRCLE NO. 365

### Thick-film resistors

Data Sheet No. 3306 features the series VA-305 Cermide thick-film, vernier-adjust variable resistor—a miniature 1/2-inch diameter front panel mount multi-turn design. The series VA-305 is rated at 3/4 W at 70 C. CTS Keene, Inc., Paso Robles, Calif.

CIRCLE NO. 366

### Microwave products

High-powered microwave electronics are described in a catalog entitled "The High Power People." Included are microwave communications transmitters for earth to satellite applications; TWT microwave amplifiers for calibration and testing; microwave rf sources, industrial microwave heating equipment; microwave tube test equipment, crossfield amplifiers, and klystrons; high-voltage, highly-regulated dc power supplies; and high-power pulse modulators. Cober Electronics, Inc., Stamford, Conn.

CIRCLE NO. 367

## Power transistors

Basic features and performance capabilities of Versawatt power transistors are described in a 12-page brochure entitled "Versawatt—The Plastic Package for Power." The illustrations show the internal structure of the basic package, lead-configuration options, device performance ratings and production and testing facilities. RCA Solid State Div., Somerville, N.J.

CIRCLE NO. 368

## Industrial semiconductors

Specifications are featured in a 16-page catalog for PUTs, thyristors, SCRs, ICs, power Darlingtons, transistors, diodes, rectifiers and bridges. Outline drawings are included. Unitrode Corp., Watertown, Mass.

CIRCLE NO. 369

## Variable resistors

Complete electrical, mechanical and environmental specifications of the 450/45 Series, 15/16-inch commercial-composition variable resistors are described in a 20-page catalog. The most frequently requested constructions available to meet the majority of customer requirements are fully described. These include single, tandem, multisection and vernier-adjust types. Also included is a detailed section on the rotary, pull-push and push-push power switches used with the 450/45 series. CTS of Elkhart, Inc., Elkhart, Ind.

CIRCLE NO. 370

## Modular power supplies

An eight-page short form guide to a power supply line is complete with specifications, dimensions and prices. Rack mounting capabilities are also included. ACDC Electronics, Inc., Oceanside, Calif.

CIRCLE NO. 371

## Timing cells

Two engineering bulletins give application information on Koolometer electromechanical timing cells and operating considerations for these miniature timers. Sprague Electric Co., N. Adams, Mass.

CIRCLE NO. 372

# ENGINEERS WHO KNOW TANTALUMS SPEC DICKSON

Because Dickson is a specialist in solid tantalum capacitors! This specialization means more quality in every unit produced from MIL-C-39003 types to low-cost commercial units. With over 4,000 standard catalog items, you can always depend upon Dickson to supply the right tantalum unit at the right price. Try us! Write, today, for our 6-page Tantalum Capacitor Short Form Catalog.

"The Specialists"



"Where Quality Makes The Difference"



**DICKSON**  
ELECTRONICS CORPORATION

PHONE (602) 947-2231 TWX 910-950-1292 TELEX 667-406  
P.O. BOX 1390 • SCOTTSDALE, ARIZONA 85252

INFORMATION RETRIEVAL NUMBER 88

## If you buy our DPM's because of low price, expect some pleasant surprises.

Newport builds low-cost DPM's loaded with standard features not even possible on competitive models.

Take our new Series 2000B — 4½ digits for \$280. Reads a full 20,000-counts at 30 readings per second without sacrificing 0.01% accuracy. And only Newport gives you \*BIG-BCD outputs (\*Buffered, Isolated, Gated) to reliably drive long cables or to form a multiplexing data buss.

Plan to significantly reduce checkout time. With the Series 2000B you can ignore ground loops.

True differential inputs compensate for common-mode noise voltage and guarantees immunity up to 6 volts. All this plus so much more are protectively packaged in an extruded-aluminum shield-case.

See for yourself! Ask for some pleasant surprises with details on the Series 2000B DPM, or any of Newport's 150 matching meters. The panel instruments you install and forget.

Newport Laboratories Inc.,  
630 East Young Street, Santa Ana,  
California 92705 (714) 540-4914.



SERIES 2000B DPM: ±19,999 counts • DC voltage and current models  
30 rdgs/sec • 2½"H x 4½"W x 5"D • 0.01% accuracy • BIG-BCD output

## Newport Digital Panel Instruments

INFORMATION RETRIEVAL NUMBER 89

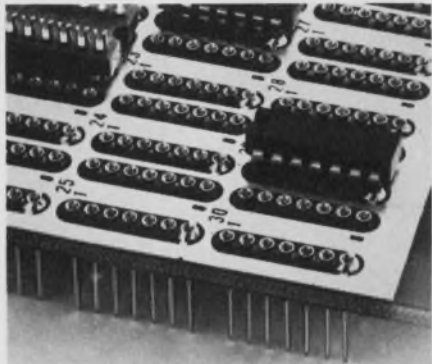

## All plug-in panels are not the same.

It's one thing to want plug-in flexibility in your circuit. It's another to get flexibility plus all the other things you'd like in a dependable point-to-point system.

Like easier IC insertion. Precision-machined contacts. Tighter contact retention. Greater reliability (we'll prove it). Unique tapered entry sockets (patent pending). Lower profile. Plus the versatility to accept 14, 16, 18, 24, 28, 36 or 40 pin IC's in a choice of panel sizes.

And we offer virtually any panel you'll need, in any number of patterns, plane-mounted or edge-connected, off the shelf or custom.

We'll also give you single-source supply for sockets, enclosures and accessories—even automatic wire wrapping whenever you need it.

The Augat way? It's a better way. Call us at (617) 222-2202. Or write for our catalog. Augat Inc., 30 Perry Ave., Attleboro, Mass. 02703. Our representation and distribution is nationwide and international.

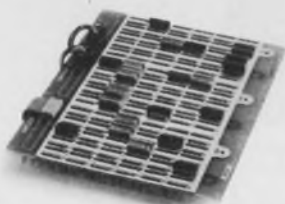

**Plug into Augat<sup>®</sup> instead.**

INFORMATION RETRIEVAL NUMBER 90

## bulletin board

Prices have been reduced to \$2060 on Digital Computer Controls D-112 12-bit minicomputer series. The price reductions reflect a minimum decrease of 15% across the product line. A 4 k D-112 1.2- $\mu$ s computer with TTY interface, programmer's console, power supply, chassis, slides and programmed I/O has been reduced \$200 to \$3490 from \$3690. The same computer with 8 k of memory is now \$4750, reduced from \$5590 with a savings of \$840. The 4 k D-112H 900-ns computer with TTY interface, programmers console, power supply, chassis, slides, and programmed I/O is \$3640 compared to \$5700, amounting to a reduction of \$2060. The D-112 H/SC 200-ns computer with 1 k of semiconductor random access memory and 4 k of core memory has been reduced \$2110 to \$7290 from \$9400.

CIRCLE NO. 373

Digital Equipment Corp. has reduced prices from 15-33% on its large-scale DECsystem-10 computer line. A new, low-cost core memory system and increased efficiencies in the production of the central processor are the reasons for the price cuts. At the same time, DEC revealed a new DECsystem-10 configuration—the DECsystem-1060—and also unveiled two new software packages and a new peripheral for the line. The company also announced that low-priced, used DECsystem-1040 systems would be marketed, and that an upgrade policy which gives substantial allowances on DECsystem-10 equipment replaced by more advanced hardware has been put into effect.

CIRCLE NO. 374

Foote Mineral Co. has restated the price of 50% ferrosilicon to be 16 cents per pound of contained silicon, F.O.B. producing plants. This rescinds a price reduction made earlier this year and restores the price to that which prevailed on January 1, 1971.

CIRCLE NO. 375

## vendors report

Annual and interim reports can provide much more than financial-position information. They often include the first public disclosure of new products, new techniques and new directions of our vendors and customers. Further, they often contain superb analyses of segments of industry that a company serves.

Selected companies with recent reports are listed here with their main electronic products or services. For a copy, circle the indicated number.

ESB Inc. Batteries.

CIRCLE NO. 376

Datacraft Corp. Scientific computers, memory systems.

CIRCLE NO. 377

L. M. Ericsson Telephone Co. Telephone systems and equipment, data communications, military systems, traffic control, radio communications, components.

CIRCLE NO. 378

Cartridge Television Inc. Cartridge television systems.

CIRCLE NO. 379

Sola Basic. Air traffic control systems, transformers, meters, switches, communication systems and electronic control systems.

CIRCLE NO. 380

Magnetic Head Corp. Read/write magnetic heads.

CIRCLE NO. 381

Gates Learjet Corp. Avionics.

CIRCLE NO. 382

Orbit Instrument Corp. Servo repeaters, optical tracking head assemblies, transformers, potentiometers, ball trackers and joysticks.

CIRCLE NO. 383

Morse Electro Products Corp. Stereophonic systems.

CIRCLE NO. 384

Ultrasonic Systems, Inc. Ultrasonic motor-converter.

CIRCLE NO. 385

Hitachi. Dry batteries, sound tapes, communications and control equipment, consumer products and computer equipment.

CIRCLE NO. 386

Medtronic, Inc. Medical electronics.

CIRCLE NO. 387

Ampex. Audio-video systems, computer products and instrumentation.

CIRCLE NO. 388

### A CAMBION® Double "QQ" Product Line

As often as you want, too. The design of the jack and the materials from which it is produced give it the strength to be cycled more than 50,000 times (we've done it) without appreciable change in contact resistance.

And we didn't just do it once "in the lab."

We have tens of millions of these jacks out, in use by customers. ID's range from .016" to .080". And are available in different shapes and types for mounting components, patching, plugging, or whatever you have in mind.

All CAMBION cage connectors are standard, immediate delivery items. You can have them fast in whatever number you want. That's the CAMBION Double "QQ" approach, the quality stands up as the quantity goes on. Ask for a sales engineer or a catalog. Cambridge Thermionic Corporation, 445 Concord Avenue, Cambridge, Mass. 02138. In Los Angeles, 8703 La Tijera Blvd. 90045.

## This cage jack was built for recycling!



Standardize on

**CAMBION®**  
the guaranteed electronic components

INFORMATION RETRIEVAL NUMBER 91

# Big Daddy ROM is here!

## The EA 16K Read Only Memory

The World's biggest MOS ROM is in town and you can get it now. The EA4800, 16,384 bit ROM is designed for custom, high density micro-programming, high resolution character generation, and other big Read Only Memory tasks.

But the EA4800 is not just BIG, it also has many big benefits and is easy to use. For example, it's static, no clocks are necessary. Full address decoding is performed on the chip. The big ROM has two output enable controls, allowing wire-OR'd outputs, for ease of memory expansion, and organization as either 2048 x 8 or 4096 x 4. Maximum access time is 1.2  $\mu$ sec and a .032 mW/bit power dissipation maximum lets your system operate at next to nothing. Works directly with TTL and operates on +5V and -12V supplies.

The EA4800 comes in either metal ceramic or low cost silicone, 24-pin Dip package. The price is a small \$52.50 in 100 quantities in the silicone package.

We'll give you fast turn-around on custom patterns. Write or call your nearest EA representative or call us direct. Ask for the Big Daddy.



**electronic arrays, inc.**

501 ELLIS STREET, MOUNTAIN VIEW, CALIFORNIA 94040. (415) 964-4321 TWX: 910-379-6985

Stacking distributors: Cramer, Computer Components, Burstein-Appelbee Company.

INFORMATION RETRIEVAL NUMBER 92

Downtime a problem?

**Monitor your hardware continually and inexpensively!**



Plug in the U9101 logic status indicators among the ICs and you have a total design check as well as an individual circuit troubleshooter — the whole design is monitored at a glance. No need to rely on good luck and time-consuming oscilloscope tests to see you through a new design or to pick up a malfunction in an existing board. The U9101 is DIL compatible and can be mounted on 0.1 inch centers and requires only 3 ma current. And their low \$99 price (1,000 units) makes them a terrific investment. Models available for a variety of applications. Fully guaranteed. Stocked for immediate delivery.

Call or write today for details.

**Unique Devices Company**

P.O. Box 70, Bountiful, Utah 84010 • (801) 295-4252

INFORMATION RETRIEVAL NUMBER 93

ELECTRONIC DESIGN 22, October 26, 1972

## Compare Mini-Mox to whatever film resistor you're using now.

Our Miniature Metal Oxide Resistors Can Give You up to 10,000 Megs and 5000 Volts in 1/10th the Space.

Compared to metal film resistors our tiny Mini-Mox can give you greater power handling capability and substantially better resistance to size or voltage to size ratios.

Mini-Mox outstrips conventional carbon film in every category: 100 ppm TCR; voltage to size ratio; stability; power handling capability; initial tolerance and reliability, particularly under extreme environmental conditions.

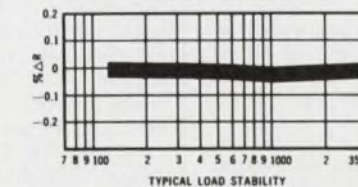
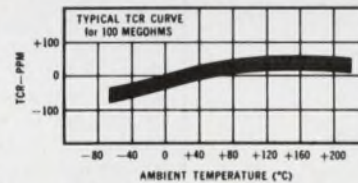

Model	Resistance	Rating @70°C	Max. Oper. Volts	Length Inches	Diameter Inches
MOX-400	1-2500 megs	25W	1000V	420	.130
MOX-750	1-5000 megs	50W	2000V	790	.130
MOX-1125	1-10,000 megs	100W	5000V	1,175	.130



For detailed specifications on Mini-Mox send for this technical bulletin. Victoreen Instrument Div. of VLN Corp., 10101 Woodland Avenue, Cleveland, Ohio 44104. Telephone: 216/795-8200.



Expertise in high voltage

DMA 684

INFORMATION RETRIEVAL NUMBER 94

123

**A precision pair...  
for tone  
signaling,  
coding and  
decoding.**

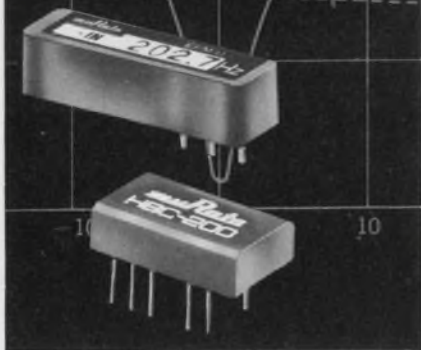

**The New Microfork  
EFM-U Tuning Fork  
and Companion  
H8C-200 Hybrid  
Amplifier.**

Murata's new EFM-U piezoelectric tuning fork — hybrid amplifier combination is designed to provide a new era in precision and flexibility for audio frequency coding and decoding applications. Designed to provide exceptional performance as a pair, these two units operate well as a transmitter for coding and as a receiver for decoding while providing outstanding reliability and accuracy over a wide range of environmental conditions.

Additional applications for these new units include:

- Traffic Signal Controllers
- Paging Systems
- Remote Control Systems
- Sound Multiplexing Devices
- Garage Door Openers
- Alarm Systems

A complete selection of standard audio frequencies, ranging from 150 to 1700 Hz, is available to meet virtually every application requirement. All E.I.A. standard frequencies in this range are also available.

Write today! We'll send along complete technical information that, we're sure, will impress you with the capabilities of our new precision pair.

**muRata**

**MURATA CORPORATION OF AMERICA**  
2 Westchester Plaza, Elmsford, New York 10523  
Telex: Murata EMFD 137332  
Phone: 914-592-9180  
Subsidiary of Murata  
Manufacturing Co., Ltd., Japan

INFORMATION RETRIEVAL NUMBER 95

**Electronic Design**

ELECTRONIC DESIGN's function is:

- To aid progress in the electronics manufacturing industry by promoting good design.
- To give the electronic design engineer concepts and ideas that make his job easier and more productive.
- To provide a central source of timely electronics information.
- To promote communication among members of the electronics engineering community.

Want a subscription? ELECTRONIC DESIGN is sent free to qualified engineers and engineering managers doing design work, supervising design or setting standards in the United States and Western Europe. For a free subscription, use the application form bound in the magazine. If none is included, write to us direct for an application form.

If you do not qualify, you may take out a paid subscription for \$30 a year in the U.S.A., \$40 a year elsewhere. Single copies are \$1.50 each.

If you change your address, send us an old mailing label and your new address; there is generally a postcard for this bound in the magazine. You will have to requalify to continue receiving ELECTRONIC DESIGN free.

The accuracy policy of ELECTRONIC DESIGN is:

- To make diligent efforts to ensure the accuracy of editorial matter.
- To publish prompt corrections whenever inaccuracies are brought to our attention. Corrections appear in "Across the Desk."
- To encourage our readers as responsible members of our business community to report to us misleading or fraudulent advertising.
- To refuse any advertisement deemed to be misleading or fraudulent.

Microfilm copies are available of complete volumes of ELECTRONIC DESIGN at \$19.00 per volume, beginning with Volume 9, 1961. Work is now in process to complete the microfilm edition of Volumes 1-8. Reprints of individual articles may be obtained for \$2.00 each, prepaid (\$.50 for each additional copy of the same article) no matter how long the article. For further details and to place orders, contact the Customer Services Department, University Microfilms, 300 North Zeeb Road, Ann Arbor, Michigan 48106 telephone (313) 761-4700.

Want to contact us? If you have any comments or wish to submit a manuscript or article outline, address your correspondence to:

Editor  
ELECTRONIC DESIGN  
50 Essex Street  
Rochelle Park, N.J. 07662

**NEW IMPROVED**  
Model L-2002



**Aqua**  
**DIGI-TEST PROBE**  
VIRTUALLY ELIMINATES NEED  
FOR OSCILLOSCOPE IN DIGITAL  
CIRCUITRY TESTING!

- ★ Visual observation of single pulses as narrow as 40 nano seconds from DC to 10 MHz. . . .
- ★ Two LED indicators show Logic states 0 to 1 RTL, DTL, TTL, MECL Compatible. . . .
- ★ Operates from +4.5V to +15V DC Electronic & Automotive Service. Reverse polarity protected, \$45.00 each. 4.75V to 5.5V — \$35.00. Money back guarantee. . . .

Also available: P-2002 Signal Injector, 100 Hz to 1MHz — \$85.00 each. For Complete Details, write TODAY to:

**AQUA SURVEY & INSTRUMENT CO.**

7041-ED Vine Street  
CINCINNATI, OHIO 45216  
Telephone: (513) 821-2514

INFORMATION RETRIEVAL NUMBER 96

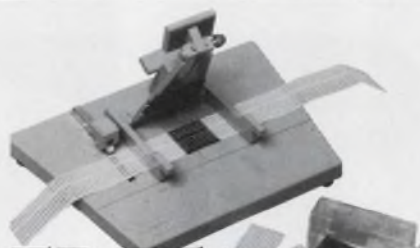

**FREE**  
**sample patches**  
**with instruction kit**

A trial supply of the world's best splicing tapes and patches — and complete instructions how to use them — are yours for the asking.

More than 70 types available for splicing, editing, repairing perforated tape — whether it's oiled, non-oiled, mylar, aluminum-mylar, or other. Find out how self-adhering Data-Links\* do the job quickly, perfectly, permanently.

Data-Links\* are great with ordinary splicers, but our DL-141 is the perfect companion for making the toughest splices or repairs perfectly every time.

\*Punched tape patches by Data-Link Corporation

**DATA-LINK CORPORATION**  
7380 Convoy Court, P.O. Box 2792  
San Diego, California 92112  
Telephone: (714) 279-5430

INFORMATION RETRIEVAL NUMBER 97  
ELECTRONIC DESIGN 22, October 26, 1972

# Electronic Design

## Advertising Sales Staff

Bryce Gray  
Sales Manager

## Rochelle Park, N.J. 07662

Robert W. Gascoigne  
Daniel J. Rowland  
50 Essex Street  
(201) 843-0550  
TWX: 710-990-5071

## Philadelphia

Thomas P. Barth  
50 Essex Street  
Rochelle Park, N. J. 07662  
(201) 843-0550

## Boston 02116

Richard L. Green  
20 Columbus Avenue  
Boston, Mass.  
(617) 482-7989

## Chicago 60611

Thomas P. Kavooras  
Berry Conner, Jr.  
200 East Ontario  
(312) 337-0588

## Cleveland

Thomas P. Kavooras  
(Chicago)  
(312) 337-0588  
(call collect)

## Los Angeles 90303

Stanley I. Ehrenclou  
Burt Underwood  
2930 Imperial Highway  
Inglewood, Calif  
(213) 757-0183

## San Francisco 94022

Jerry D. Latta  
P.O. Box 1248  
Los Altos, Calif.  
(415) 965-2636

## London W. 1

For United Kingdom and Holland  
Brayton C. Nichols

For Eastern Europe  
Peter Kehr

The American Magazine Group  
27 Maddox Street  
London, W. 1, England  
Phone: 499-0180  
Cable: Ammagnic, London

## Verviers, Belgium

For Continental Europe  
Andre Jamar  
1, Ru Mallar, 1  
(087) 253.83 Telex 41563

## Tokyo

Haruki Hirayama  
Electronic Media Service  
5th Floor, Lila Bldg.,  
4-9-8 Roppongi  
Minato-ku  
Phone: 402-4556  
Cable: Electronicmedia, Tokyo



**AMERICAN BUSINESS PRESS, INC.**

# Design Data from Manufacturers

Advertisements of booklets, brochures, catalogs and data sheets. To order use Reader-Service Card.  
(Advertisement)

## New Monograph on Real-Time Data Processing Techniques

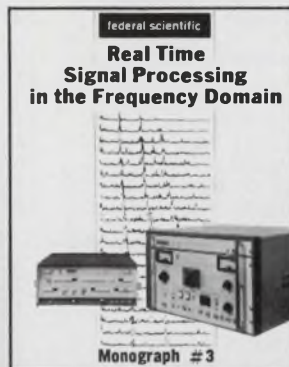

A new publication by Federal Scientific, originators of the Ubiquitous® Spectrum Analyzer, covers general and specific signal processing techniques and theoretical constraints.

- Random data processing and statistical certainty of Power Spectral Density Estimates
- Constraints in frequency analysis due to bandwidth, sampling and signal length
- Time domain weighting, with charts of theoretical performance using different weighting functions
- Theory of operation of time-compression analyzers
- Cross-property analysis and application in determining transmission and transfer functions by correlation and cross-power spectral density
- Processing of Transient data

CIRCLE NO. 171

## Federal Scientific Corporation

615 West 131st Street, New York, N. Y. 10027

## PC Drafting Aids Catalog

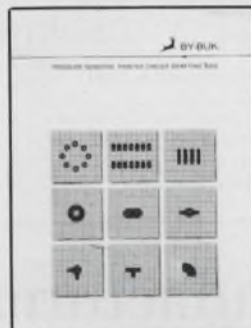

Thousands of time saving, cost saving artwork ideas are found in the By-Buk P-50 catalog of pressure sensitive printed circuit drafting aids. With the most practical artwork patterns for: TO cans, multi-pads, dual-inlines and flat packs featured. Donuts, connector strips, teardrops, ovals, tapes, tees, elbows, etc., by the hundreds are included in the most comprehensive list of sizes. Opaque black, transparent red and transparent blue materials for one and two-sided board designs. For a free copy and samples, write today.

CIRCLE NO. 172

## By-Buk Company

Subsidiary of Webtek Corp., 4326 W. Pico Blvd.  
Los Angeles, California 90019 (213) 937-3511

## Now 5VDC Microcircuitry Supplies, 12 Amp to 100 Amp



Now you can squeeze your power supply down to fit your microcircuitry with our complete line of standard 60 watt to 500 watt supplies.

New "third generation" Series 650A features 1/2 the volume, 1/4 the weight, 1/4 the heat of most contemporary 5VDC supplies. Model 650A05 delivers 5V/12A in free air convection range of -20°C to +40°C, 5V/10A at +50°C, 5V/8A at +71°C, typical efficiency 55%. Combined line & load regulation is 0.2%, changes only 0.005%/°C, output noise only ≤50MV P-P (total), fits in 94-cubic inches at 3.25 lbs — at \$200 each, delivers 18.5W/lb, 0.64W/in.<sup>3</sup>, at \$3.33 per watt.

CIRCLE NO. 173

## Trio Laboratories, Inc.

80 Dupont Street  
Plainview, L.I., N.Y. 11803

# advertiser's index

Advertiser	Page	Advertiser	Page	Advertiser	Page
AMP, Incorporated	31	Digitran Company, The	108	ITT Cannon Electric, A division of	
AMP, Incorporated, Capitron Division	115	Duncan Electronics, Subsidiary of Systron-Donner	47	International Telephone and Telegraph Corp.	95
Accutronics, Inc.	78	ECC Corporation	34	Instrument Specialties Company, Inc.	85
Allen-Bradley Co.	33	EECO	117	Intech, Incorporated	98
Allen Organ Company	110	Electro Scientific Industries	99	Inter Computer Electronics, Inc.	120
Ampex Computer Products Division	22	Electro Switch Corp.	111	Intersil	4, 5
Amphenol Connector Division, Bunker Ramo Corp.	38	Electronic Arrays, Inc.	123	International Rectifier	12, 13
Amphenol Industrial Division, Bunker Ramo Corp.	18, 19	Electronic Design	107		
Analog Devices, Inc.	79	Elxon Power Systems	116	Johanson Manufacturing Corp.	7, 127
Aqua Survey & Instrument Co.	124	Elmwood Sensors, Inc.	127	Johnson Company, E. F.	35
Arnold Magnetics Corp.	127				
Augat, Inc.	122	Fairchild Semiconductor/Microwave and Optoelectronics	67	Lambda Electronics Corp.	Cover II
		Federal Scientific Corporation	125	Larkton Scientific	127
Bishop Graphics, Inc.	126	Fluke Mfg. Co., Inc., John	11		
Bulova Frequency Control Products	102			3M Company	43
By-Buk Company	125	General Electric Company, Semiconductor Products Department	25	MCL, Inc.	20
		General Instrument Corporation	61	Metex Corporation	112
CTS Corporation	119	General Radio Company	46	Micro Devices Corp.	109
Cambridge Thermionic Corporation	123	Grayhill, Inc.	94	MicroSwitch, A Division of Honeywell	101
Centralab, the Electronics Division of Globe-Union, Inc.	90, 91			Miida Electronics, A Division of Marubeni America Corp.	114
Cherry Electrical Products Corp.	59	Halex, Inc.	109	Mini-Systems, Inc.	127
Chromatic Division, Illinois Tool Works, Inc.	2	Harris Semiconductor, A Division of Harris Intertype Corporation	16D, 16E, 127	Molex, Incorporated	Cover III
Computer Products, Inc.	114	Hayden Book Company, Inc.	16H	Monsanto Company	44
Control Data Corporation, Magnetic Components Division	112	Heath/Schlumberger Scientific Instruments	74	Motorola Component Products Dept.	103
Cutler-Hammer, Specialty Products Division	21	Hewlett-Packard	1, 14, 15, 16B.C, 45, 81	MuRata Corporation of America	124
Data Link Corporation	124	Hickok Instrumentation and Controls Division	60	National Semiconductor Corporation	50
Data Technology Corporation	16G	Hoffman Engineering Company	116	Newport Laboratories, Inc.	121
Deccofelt Corporation	94	Houston Instrument, A Division of Bausch & Lomb	110	North Atlantic Industries, Inc.	16A
Dialight Corporation	89	Hughes Aircraft Company	36, 37		
Dickson Electronics Corporation	121			Oak Industries, Inc.	29
Digital Equipment Corporation	8, 9				

## Design Data from Manufacturers

Advertisements of booklets, brochures, catalogs and data sheets. To order use Reader-Service Card. (Advertisement)

### Circuit Zaps® for Instant PC Boards



Circuit Zaps® are 1 ounce copper circuit component patterns, pads, and conductor paths, precision-etched on 5 mil (.005") glass epoxy base material, backed by a special pressure-sensitive adhesive. Circuit Zaps® completely eliminate the artwork, photography, photoprinting, touch up, etching, stripping, and other time-consuming steps in PC board development.

Write today for the FREE TECHNICAL BULLETIN 1003 with FREE SAMPLE. CIRCLE NO. 174

#### Bishop Graphics, Inc.

7300 Radford Avenue (ED)  
North Hollywood, California 91605  
(213) 982-2000 Telex 674672

RCA Electronic Components..... 86  
RCA Solid State Division..... Cover IV  
Robison Electronics, Inc.....127  
Rotron, Inc. .... 93

Schauer Manufacturing Corp. ....118  
Siliconix Incorporated ..... 48  
Singer Company, The,  
Kearfott Division ..... 75  
Solid State Systems, Inc. ....105  
Sorenson, A Unit of Raytheon  
Company ..... 16  
Sprague Products Company.....10, 128  
Stackpole Carbon Company..... 97  
Summit Engineering Corporation.....104

Tau Tron .....127  
Tektronix, Inc. .... 41  
Tri-Data ..... 42  
Trio Laboratories, Inc. ....125

USCC/Centralab ..... 66  
Underwriters Safety Device  
Company .....116  
Union Carbide, Components Dept..... 17  
Unique Devices Co. ....123  
United Systems Corporation..... 83

Victoreen Instrument, Div. of  
VLN Corp. ....123

Wagner Electric Corporation ..... 92  
Weston Instruments, Inc. .... 51  
Windjammer Cruises .....113  
Woven Electronics .....117





**Thin-Trim®** variable capacitors are designed to replace fixed tuning techniques. Applications include crystal oscillators, CATV amplifiers, communication and test equipment. Series 9410 has high Q's with five capacitance ranges from 1.0 - 4.5 pf to 10.0 - 50.0 pf. Johanson Manufacturing Corporation, Boonton, N. J. (201) 223-2676

INFORMATION RETRIEVAL NUMBER 181

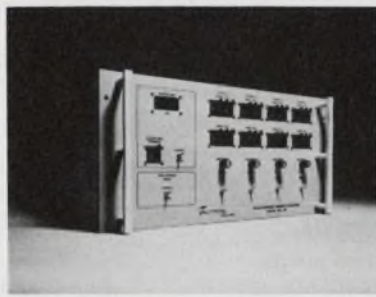

**Programmable timing unit & pulse driver** allows precise control of width & delay from 10ns to 100ns. Resolution is constant 1ns irrespective of programmed value. Front panel & remote BCD programming is for width & delay. Variable voltage & offset is also provided. \$7,995. Tau-Tron, Lowell, Ma. 01852. (617) 458-6871.

INFORMATION RETRIEVAL NUMBER 182

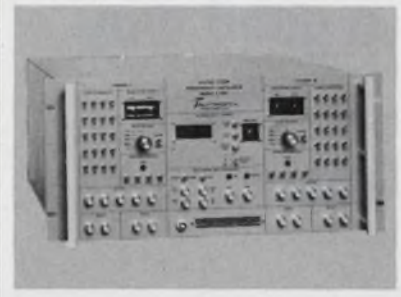

**New bit error rate detector;** fixed word + PR sequences are provided. Operates from 1Hz to 130MHz & supplies TTL signals. Variable length patterns selectable by front panel switch. Hi speed comparator & error counter/display allows reading of bit error rate + correlation of asynchronous signals. \$4,950 w/o options. Tau-Tron, Lowell.

INFORMATION RETRIEVAL NUMBER 183

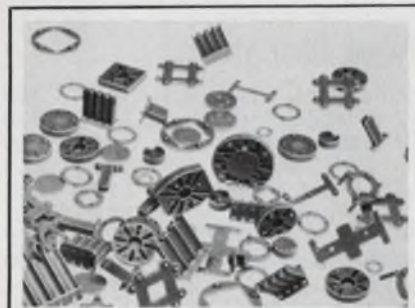

**Robison Electronics, Inc.** now offers over 100 Component Mounting Insulators, currently available and designed specifically for Capacitors, Diodes, Resistors, DIPS, Relays, and Transistors. For new 43-page free catalog write or call: Robison Electronics, Inc., 2134 W. Rosecrans Ave., Gardena, Calif. 90249. (213) 321-0080, 327-5661.

INFORMATION RETRIEVAL NUMBER 184



**Practical Relay Circuits,** by Frank J. Oliver. Time-saving guide classifies relays by function, presenting a rapid overview of the circuits that can solve the problem at hand. 384 pp., illus., cloth, \$14.95. Circle below for 15-day examination copies. Hayden Book Co., New York, N.Y. 10011.

INFORMATION RETRIEVAL NUMBER 185

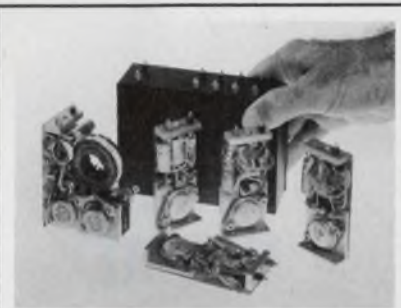

**Design as you order modular power supplies.** Complete, fully tested high efficiency power supply in a miniature package. Available with AC or DC inputs with up to 6 isolated and regulated DC outputs to 150 watts. No engineering charges! Arnold Magnetics, 11520 W. Jefferson Blvd., Culver City, Ca. 90230. Phone (213) 870-7014.

INFORMATION RETRIEVAL NUMBER 186

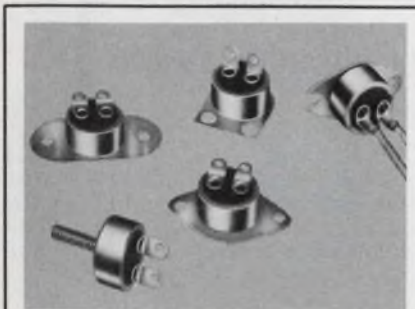

**Prototypes of precision snap-action thermostats** from Elmwood, widely specified for quick, reliable response; proven industrial and military performance record. Environ. expos. -65° to 550°F; narrow or wide diff.; rated to 15 amps. Wide choice of brackets, terminals. Elmwood Sensors, Inc. (401) 781-6500. TWX 710-381-6413.

INFORMATION RETRIEVAL NUMBER 187

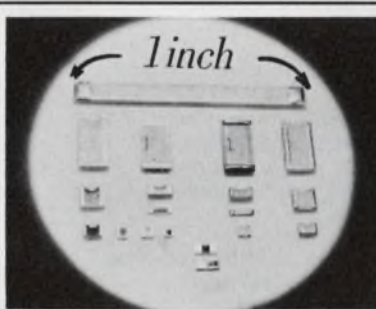

**The world's finest selection of precision thick film chip resistors.** Consistent high quality. Rapid delivery. Wide variety of types and specs. 1 ohm to 10 gigaohms. Tolerances to .1%. Special match/track and TCR specs invited. Used by Hi-Rel Mil/Aerospace industry. Lit & samples on request. Mini-Systems Inc., 20 David Rd., N. Attleboro, Ma. 02761.

INFORMATION RETRIEVAL NUMBER 188

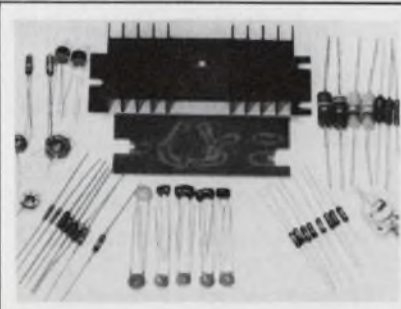

**Broad Band—No Tuning Power amplifier** in kit form. Frequency range 500 kHz to 100 MHz with 2.5 watts of cw power. It accepts inputs of AM, SSB, pulse and other complex modulation. The unit withstands a +15-dB overdrive including and open-circuit loads. Larkton Scientific, P.O. Box 302 Monroeville, Pa. Phone: (412) 731-6829

INFORMATION RETRIEVAL NUMBER 189



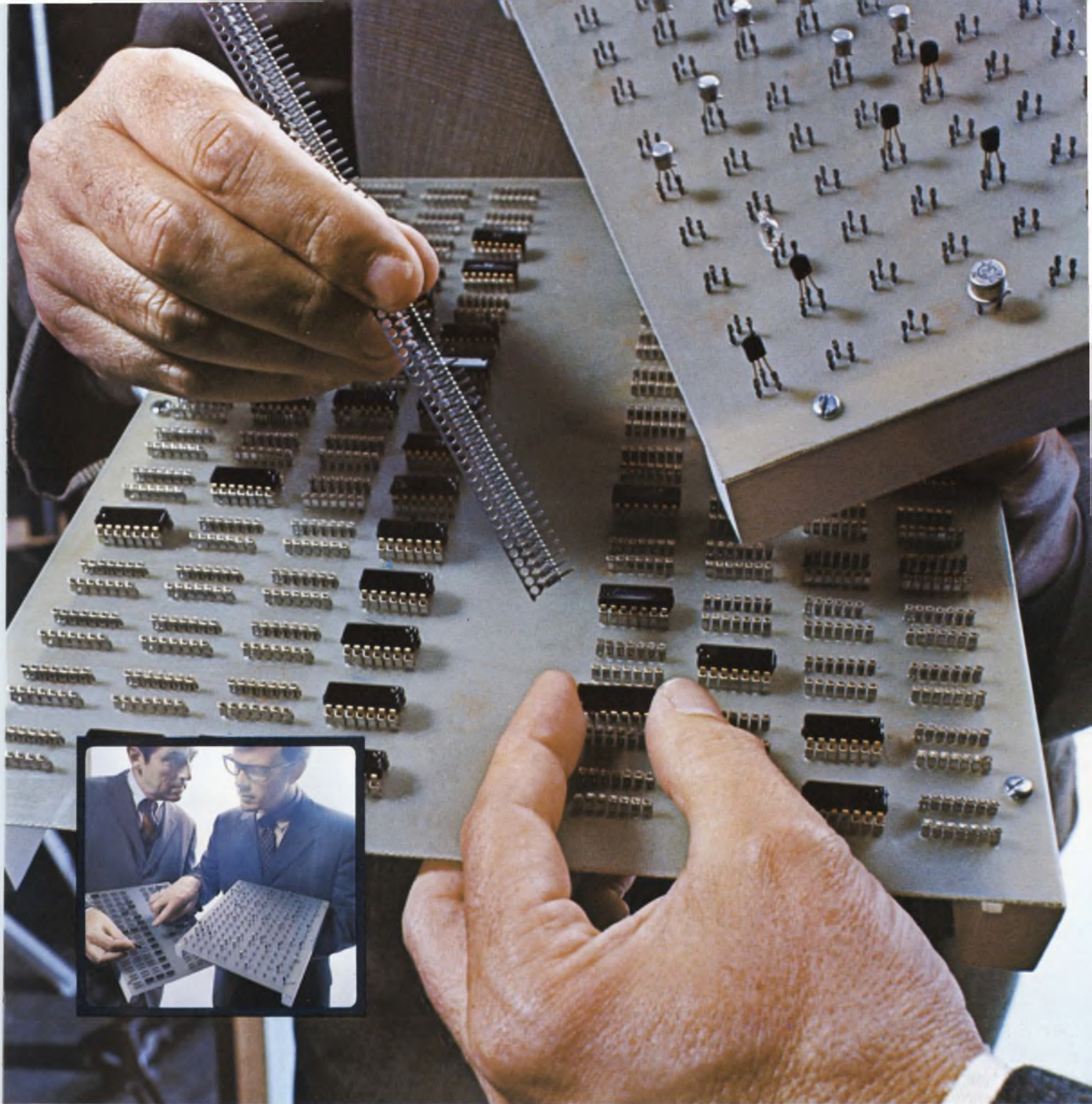

**HERE'S A NEW AND BETTER WAY: To make printed circuit board connections. Reliably. At low, low cost. They're Molex Soldercon<sup>®</sup> terminals. Integrated circuit and transistor terminals. Offering the convenience of plug-in I.C.'s and transistors *without* the cost of insulators. They fit directly on the board. And there is equipment available to do the job *automatically*. Fast! Soldercon terminals save time. Money. Speed installation. Make**

**testing easier, too. And simplify service problems. It's another example of Molex ingenuity . . . in creating components that simplify circuitry. Molex has the know-how and facilities to provide the interconnecting system you need. You can make connections by calling (312) 969-4550. Or write . . . Molex Incorporated, Lisle, Illinois 60532.**

*... creating components that simplify circuitry*

CA3118AT  
CA3118T

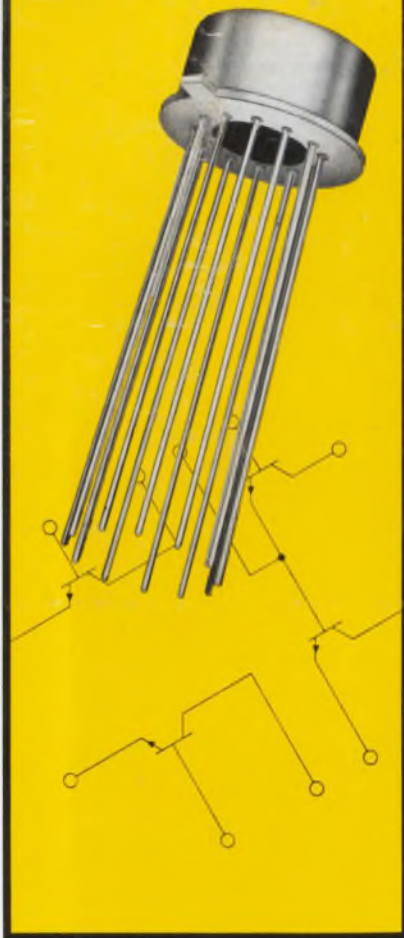

CA3146AE  
CA3146E



CA3183AE  
CA3183E



## We've UPPEd our $V_{CEO}$ to 40 volts ... to give you flexibility with extra muscle

We've taken our already popular CA3018, CA3046, CA3083 transistor arrays and upped their  $V_{CEO}$  ratings from 15 volts to 30 and 40 volts. The new CA3118AT, CA3118T, CA3146AE, CA3146E, CA3183AE, CA3183A now bring you a new level of design flexibility in our widely accepted line of monolithic transistor arrays.

They offer a broad variety of configurations — Darlington's, differential amplifiers and uncommitted transistors — for communication, control, and instrumentation equipment. High-current types CA3183E and CA3183AE offer capability up to 75 mA.

If compact, economical design

and high voltage are important to you . . . use these new RCA arrays, CA3100 Series. They're the logical choice for lamp and relay drivers, thyristor triggering, and for most signal processing and switching systems from DC to 120 MHz. (If  $V_{CEO}$  to 15 volts meets your requirements, specify the standard CA3018, CA3018A, CA3045, CA3046 or CA3083.)

If you have been using discretes, take advantage of RCA's unequalled experience in the design and manufacture of high-quality transistor arrays. If you've been voltage- or current-limited by previous arrays — check RCA's six new types now.

For more information see your

RCA Representative or your local RCA Distributor. All types are available from stock in quantity for new designs. For technical data, write RCA Solid State, Section 57J:26 Box 3200, Somerville, N.J. 08876.

Type	$V_{CEO}$	$I_C$ (max.) mA	Package	Price (1000-unit level)
CA3118AT	40	50	12L TO-5*	\$1.40
CA3118T	30	50	12L TO-5*	.98
CA3146AE	40	50	14L DIP**	1.40
CA3146E	30	50	14L DIP**	.98
CA3183AE	40	75	16L DIP**	1.50
CA3183E	30	75	16L DIP**	1.25

\*Operates over full military temperature range of  $-55^{\circ}\text{C}$  to  $125^{\circ}\text{C}$

\*\*Operates over ambient temperature range of  $-40^{\circ}\text{C}$  to  $+85^{\circ}\text{C}$

International: RCA, Sunbury-on-Thames, U.K., or Fuji Building, 7-4 Kasumigaseki, 3-Chome, Chiyoda-Ku, Tokyo, Japan. In Canada: RCA Limited, Ste. Anne de Bellevue 810, Quebec.

INFORMATION RETRIEVAL NUMBER 243

**RCA** Solid State  
products that make products pay off