

# Electronic Design 14

VOL. 20 NO.  
JULY 6, 1972

FOR ENGINEERS AND ENGINEERING MANAGERS

Storage-scope writing speed soars to 200 cm/ $\mu$ s without sacrifice of viewing time. Operating in a fast-bistable, bistable, variable persistence or normal mode, with

bandwidth to 100 MHz, the new CRT uses mesh-to-mesh charge transfer. The technique provides extreme burn resistance as well as high speed. See page 83.





# MINI BRUTES ARE HERE!

## Brute power in a mini package.

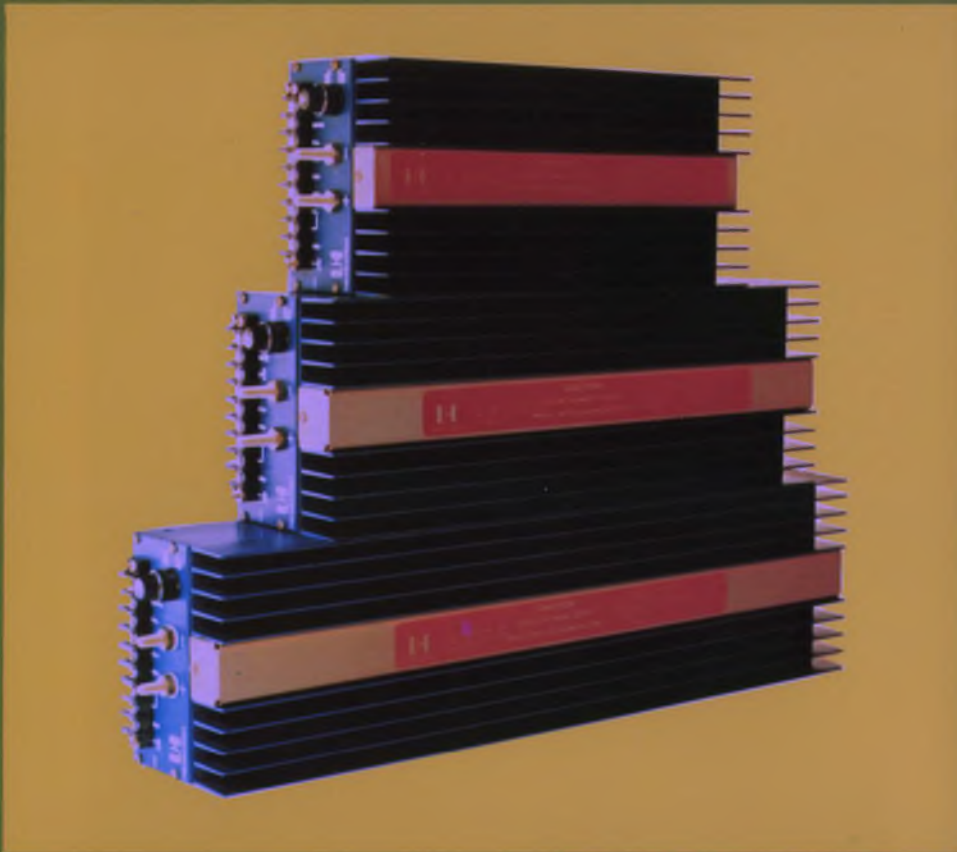

TOP TO BOTTOM:

**SINGLE OUTPUT —**

5V 50 AMPS,  
3.6" x 5.0" x 11.0".  
7 LBS.  
\$360 in Single Quantity.

**TRIPLE OUTPUT —**

5V 50 AMPS,  
 $\pm 12V$  10 AMPS (300 W. MAX.)  
3.6" x 5.0" x 15.0".  
9 LBS.  
\$460 in Single Quantity.

**SINGLE OUTPUT —**

5V 100 AMPS,  
3.6" x 5.0" x 19.0".  
12 LBS.  
\$510 in Single Quantity.

*Numerous other voltage/current  
output combinations  
are readily available.*

### FEATURES YOU CAN'T AFFORD TO BE WITHOUT—

- EFFICIENCY ; 80%
- PARALLEL OPERATION ; CURRENT SHARING OF UP TO 10 SUPPLIES WITH 'MASTER-SLAVE' CONFIGURATION.
- INPUT ; TAKE YOUR PICK — 115 VAC OR 230 VAC EXTERNALLY SELECTABLE, 3 PHASE, OR EVEN DC.
- TOTAL MODULAR CONSTRUCTION ; FIELD MAINTENANCE BECOMES A CINCH.



RESEARCH INC.

FOR COMPLETE INFORMATION AND VOLUME PRICING,  
CALL OR WRITE:

LH RESEARCH INC., 2052 SOUTH GRAND AVENUE  
SANTA ANA, CALIF. 92705 (714) 546-5279

INFORMATION RETRIEVAL NUMBER 232





## Choose. Don't compromise.

The most experienced maker of storage tubes offers you a choice: the broadest selection of devices in a wide range of sizes to meet most any display requirement you may have. There's no need to compromise. If you don't see what you need in our long line of standard models, we'll design one for you.

Write for new brochure: 2020  
Oceanside Blvd., Oceanside, CA  
92054. Or call (714) 757-1200.

**HUGHES**

HUGHES AIRCRAFT COMPANY  
INDUSTRIAL PRODUCTS DIV.

INFORMATION RETRIEVAL NUMBER 2



# Press here to save on lighted pushbutton switches.



**buys all  
the switch  
you need.**

Oak's Series 300 gives you good looks and a small price-tag in lighted pushbutton switches. Plenty of switching performance for most jobs, without paying a premium. Even the Series 300 Split-Legend/4 Lamp Switch is less than \$1.60 (normal latch, 2P2T, glass alkylid insulation, no engraving, less lamps.)



## Built to take it.

Series 300 is built for reliable performance and long life. Applications galore — bank terminals, calculators, and copy equipment.



## Modular design.

Single-legend/single-lamp, split-legend/4-lamp, and single-legend/redundant lamp switches have snap-on lamp holders. Plus replaceable legend plates, lens caps, and button assemblies. Front-panel relamping, too, without special tools on all types.

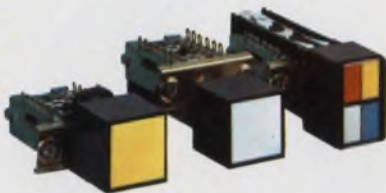

## Three versions with switching up to 4P2T.

Choose from single, dual, or four lamp display as well as non-lighted type. One to twelve station, momentary, interlock, alternate action, or any combination available on the same switch bank. Lockout feature available for all types. Power Module 3A125VAC. Lighted indicators are identical in size and appearance, but without switching.

## Gang them up by the dozen.

Order up to 12 switching stations on a single channel, any switching mix, with convenient panel-mounting studs. Color selection: white, lunar white, yellow, amber, orange, red, green, blue. Choose silk-screened, hot-stamped, or engraved-and-filled legends. Split-legend switches can be specified with any two, three, or four colors on insertable legend plates.



**Write for our Series 300 Brochure**

**OAK Industries Inc.**  
SWITCH DIVISION / CRYSTAL LAKE, ILLINOIS 60014  
TELEPHONE 815 • 459 • 5000 • TWX 910 • 634-3353 • TELEX 72 • 2447

INFORMATION RETRIEVAL NUMBER 3







**This looks like  
just another  
ordinary data  
terminal.**

**Until it goes  
to work.**





Our new model 38 eight-level data terminal is anything but ordinary.

Because it's loaded with big machine features.

Like a 132 character printing format on a 15-inch wide platen. It's designed to handle computer print-out paper so you can eliminate time-wasting reformatting procedures. And for added versatility, there's a simple modification kit that permits you to use standard friction-feed rolls, too.

More big machine features? The model 38 prints both upper and lower case, in two colors, for maximum visibility and clarity in data presentation. And the four-row keyboard generates all 128 ASCII characters.

Speed? The model 38 moves data at 100 words per minute. For on-line speeds up to 2400 words per minute, it interfaces with the Teletype® solid-state 4210 magnetic tape data terminal.

The model 38 is flexible enough to fit into practically any switched or private-line system. That's why there are three interface options available. You can select from a built-in, factory-tested modem; a current interface; or an EIA interface.

You also get a choice in receive-only, keyboard send-receive, and automatic send-receive configurations.

Finally, the model 38 was designed to offer plug-to-plug compatibility with just about anything—including the model 33.

You'd think that all these big machine features would carry a big machine price tag, right?

Wrong.

We priced the model 38 so low it can be used economically in most applications—even in low usage locations where terminals couldn't be justified before. To offer real-time system up-date,

data entry and retrieval, and inquiry response throughout your operation.

It takes more than manufacturing facilities to build the machines Teletype Corporation offers. It also takes commitment. From people who think service is as important as sales. In terminals for computers and point-to-point communications.

That's why we invented a new name for who we are and what we make. The computer-cations people.



For more information about any Teletype product, write or call TERMINAL CENTRAL: Teletype Corporation, Dept. 89A, 5555 Touhy Avenue, Skokie, Illinois 60076. Phone 312/982-2500

Teletype is a trademark registered in the United States Patent Office.



# RANGE CHANGE



**Extralytic<sup>®</sup> Aluminum 'Lytic Capacitors give you extended temperature range without sacrifice in life or leakage current.**

Type 601D Tubular Case	Type 602D Cylindrical Case
<b>-55C to +105C</b>	<b>-55C to +85C</b>
Superior performance over entire temperature range, unlike conventional 'lytics that do not operate satisfactorily at low temperatures. High volumetric efficiency, long shelf life, low leakage current. Withstand high ripple current. Write for Engineering Bulletin 3456A or; <b>CIRCLE 882 ON READER SERVICE CARD.</b>	Power supply filter capacitors specifically designed for maximum efficiency. Offer the power supply design engineer the lowest ESR and the highest ripple current capability per case size available today for long, trouble-free life. Write for Engineering Bulletin 3457 or; <b>CIRCLE 883 ON READER SERVICE CARD.</b>

## MORE FROM SPRAGUE . . . THE BROAD-LINE PRODUCER OF ELECTRONIC PARTS

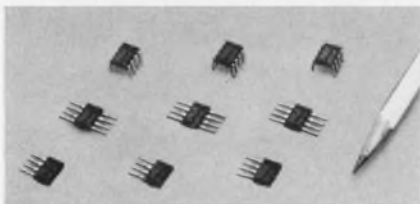

**HALL EFFECT SWITCH ICs.** Actuated magnetically, not mechanically or optically. Hall generator trigger circuit and signal amplification circuit on single silicon chip. Reliable (no moving parts). Easy interfacing with DTL/TTL/MOS logic. High speed. Low cost. Write for Engineering Bulletin 27,402A or;  
**CIRCLE 884 ON READER SERVICE CARD.**



**U.L. LISTED FILTERS.** Series JX5000 for EDP equipment and general-purpose use. Rated 125/250 VAC, 0-60 Hz, 1 thru 50 amps. 60 db @ 150 kHz, 80 db from .5 MHz thru 1 GHz. Special designs and rectangular multi-circuit units also available. Write for Engineering Bulletin 8210 or;  
**CIRCLE 885 ON READER SERVICE CARD.**

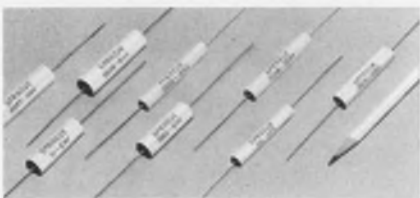

**TYPE 430P METFILM<sup>®</sup> 'E' CAPACITORS.** High-Voltage metallized polyester-film capacitors designed for voltage multiplier circuits used in electrostatic copiers, TV power supplies, etc. Working voltages from 4,000 to 15,000 V. Capacitance is stable with time, temperature, voltage. Write for Engineering Bulletin 2445.1 or;  
**CIRCLE 886 ON READER SERVICE CARD.**

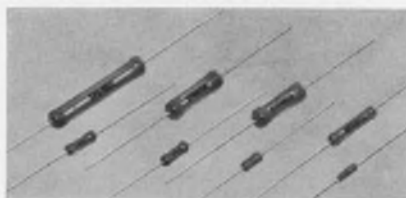

**BLUE JACKET<sup>®</sup> RESISTORS.** Vitreous-enamel power wirewound. Unique all-welded end-cap construction eliminates moisture paths along leads, anchors leads securely to resistor body. Expansion coefficients of vitreous enamel, ceramic body, and end caps are closely matched. Write for Engineering Bulletin 7410E or;  
**CIRCLE 887 ON READER SERVICE CARD.**



TECHNICAL LITERATURE SERVICE, SPRAGUE ELECTRIC CO., 347 MARSHALL ST., NORTH ADAMS, MASS. 01247

### Publisher

Peter Coley

### Editors

Editorial Offices  
50 Essex St.  
Rochelle Park, N.J. 07662  
(201) 843-0550  
TWX: 710-990 5071  
Cable: Hydenpubs Rochellepark

Editor: George Rostky

### Managing Editors:

Ralph Dobriner  
Michael Elphick

### Associate Editors:

Jules H. Gilder  
Richard Lee Goldberg  
Morris Grossman  
John F. Mason  
Stanley Runyon  
Edward A. Torrero  
Richard L. Turmail

### Contributing Editor:

Peter N. Budzilovich

### Editorial Field Offices

#### East

Jim McDermott, Eastern Editor  
P.O. Box 272  
Easthampton, Mass. 01027  
(413) 527-3632

#### West

David N. Kaye, Senior Western Editor  
2930 West Imperial Highway  
Inglewood, Calif 90303  
(213) 757-0183  
Les Brock, Western Editor  
95 Main St.  
Los Altos, Calif. 94022  
(415) 941-3084

#### Washington

Don Byrne, Washington Editor  
1111 S. Army Navy Drive  
Arlington, Va. 22202  
(202) 296-8982

### Editorial Production

Dollie S. Viebig

### Art

Art Director, William Kelly  
Richard Luce  
Anthony J. Fischetto

### Production

Manager, Thomas V. Sedita  
Helen De Polo  
Maxine Correal  
Anne Molfetas

### Circulation

Manager, Nancy L. Merritt  
Joan Licari

### Information Retrieval

Peggy Long

## An 'older' engineer supports unionism

As a regular reader of *ELECTRONIC DESIGN* as well as many other magazines and trade journals, I found the letter "Unionism Backed to Spread Work" (ED 11, May 25, 1972, p. 7) very good. But there are many other aspects to the problem that have not been cited. With 43 years' experience as a graduate engineer who has worked for private industry and the Federal Government, I would like to add the following:

Too many young engineers, brainwashed with graduation speeches of "the world is waiting for you," refuse to listen to older and experienced engineers. As a result they apple-polish and buck the system, until finally they realize they are only another expendable body. The corporations in the indoctrination program, with a self-interest, further emphasize that a union is not necessary, since "the door is always open." Heaven help the engineer who tries that open door!

Another advantage to being a union member is the matter of grievances. Every engineer, sooner or later, will encounter a grievance. As a union member, he turns the complaint over to the union, and the matter is handled by trained representatives. This frees the engineer from personal involvements.

*Name withheld on request*  
Titusville, Fla.

## A News Scope no-no

The item on Varian's multi-modular microprogrammable mid-computer in the June 8 News Scope

("Modular Midcomputer to Be Placed on Market," p. 24) contained a couple of errors. The wording "the machines will have a 16-word length" should read "16-bit word." Also American Microsystems does not make 6002 circuits; Advanced Memory Systems does.

## Cheers for editorial on metric conversion

Your editorial on the metric dilemma ("It's a Great Idea—for the Other Guy," ED 10, May 11, 1972, p. 45) was delightful. With regard to the point, the pica and the em, I'm sure you are correct when you state that these terms are universally understood. However, I also have the feeling that foreign counterparts deal with type styles that are different from ours. I doubt, for example, that all overseas printers deal with a 3.5138-mm type. What is more realistic is that they probably deal with either 3 or 3.5-mm type. What I'm alluding to is the ridiculous extremes to which nonusers of either the inch or metric system will go to make conversions.

Let me cite a specific example. Recently a major U.S. company issued a report on materials they had made that had some interesting applications overseas. The engineer-author cited the materials as being "fastened in place with 15-cm (5.905-in.) skewers." Throughout the report similar conversions appeared. What the author was describing were simply wooden sticks. Their length, over a certain minimum, was completely arbitrary. He

*(continued on p. 10)*

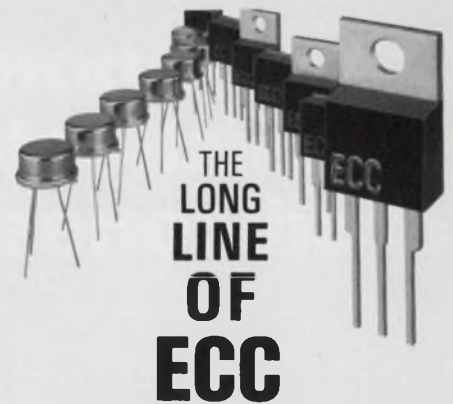

# SENSITIVE and STANDARD GATE TRIACS

World's leading triac producer offers fast delivery, electrical isolation and competitive pricing.

### SENSITIVE GATE TRIACS

TO-5 Metal and Plastic; THERMOPAK® and THERMOTAB® Packages

$I_{T(RMS)}$	0.8 - 3 amps
$I_{gt}$	3 & 10 ma (all 4 quadrants)
$I_{TSM}$	20 amps
$V_{DROM}$	200 - 400 volts

### STANDARD GATE TRIACS

THERMOTAB and THERMOPAK Packages (13 other packages available up to 40 amps)

$I_{T(RMS)}$	0.8 - 40 amps
$I_{gt}$	25 & 50 ma max.
$I_{TSM}$	20 - 300 amps
$V_{DROM}$	200 - 800 volts

All ECC triacs feature heavily glass passivated junctions for high reliability. They are available from your nearest ECC Sales Representative or Authorized Distributor.

New Condensed Catalog contains technical data on these and other ECC semiconductors. To receive your copy, circle No. 246.



# ECC

CORPORATION

P.O. Box 669 • Euless, Texas 76039  
817/267-2601

Electronic Design welcomes the opinions of its readers on the issues raised in the magazine's editorial columns. Address letters to Managing Editor, Electronic Design, 50 Essex St. Rochelle Park, N. J. 07662. Try to keep letters under 200 words. Letters must be signed. Names will be withheld on request.



# As components become more sophisticated, the versatility of silicones is more evident.

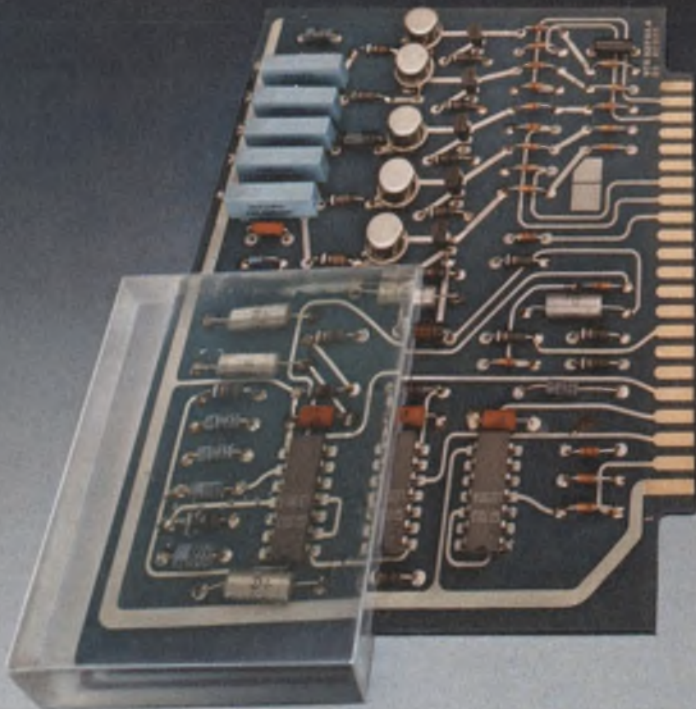

For see-through protection, encapsulate with this clear, resilient silicone resin. Self-extinguishing, it guards against humidity, heat, cold, radiation, thermal shock and vibration. Information retrieval number 221.

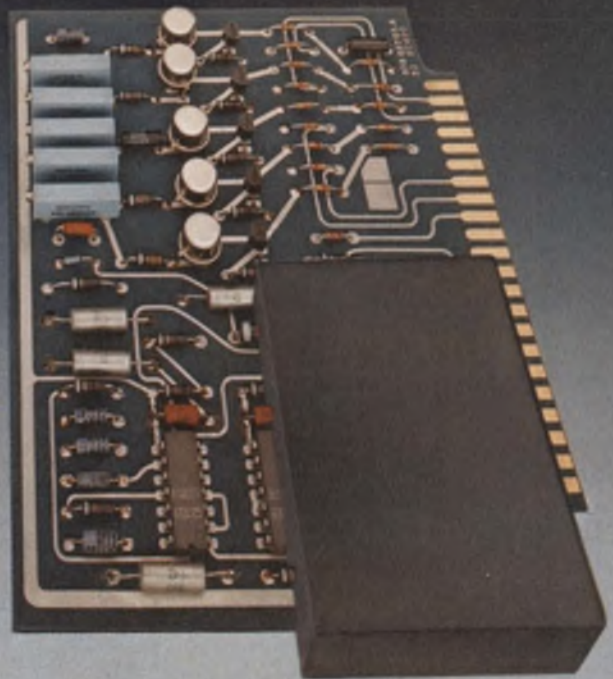

For added safety, specify this flame-retardant, pourable silicone elastomer. Uses for this low-cost packaging material include coating, potting and encapsulating. Information retrieval number 222.

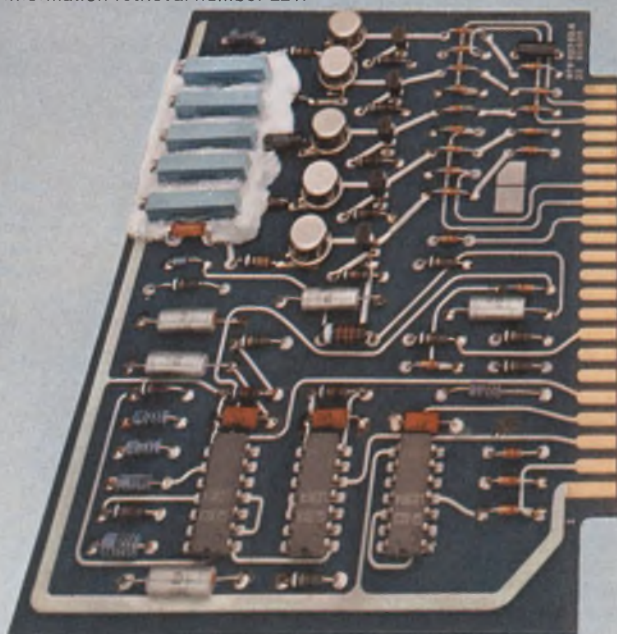

For excellent adhesion to corrosion-prone metals such as copper, use this new noncorrosive, one-part Dow Corning sealant. Cure mechanism produces no exothermic heat or acetic acid. Information retrieval number 223.

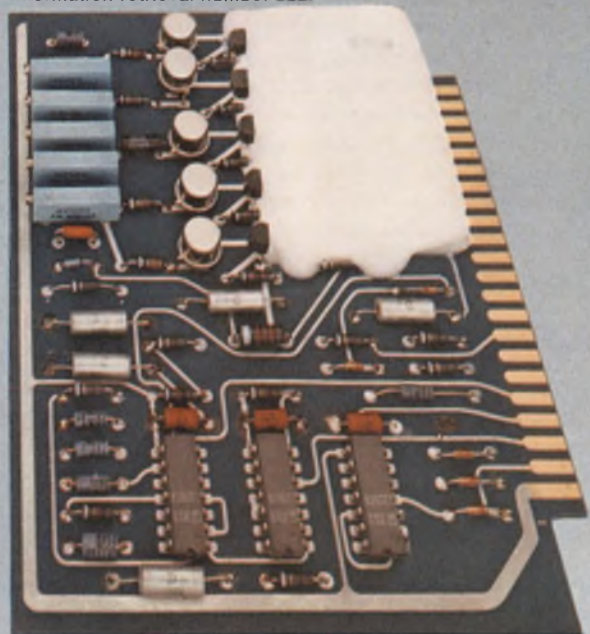

For protection against moisture, dirt, ozone, radiation and many solvents and chemicals, select this conformal coating. It flows on easily and cures at room temperature to a tough silicone rubber with excellent dielectric properties. Information retrieval number 224.



Silicones are unusual in the number of ways they protect. They resist change in hostile environments where other materials are unstable. They have excellent dielectric properties. With the electronic industry's concentration on higher performance and smaller components, the application areas where only silicone materials

can ensure design integrity have increased dramatically. Here are some of the newest examples. Many others are described in our Silicone Electronic Materials brochure available from your Dow Corning distributor. His name appears on the following page. Or write Dept. A-2202, Midland, Michigan 48640.

*Electrical/electronic materials from*

**DOW CORNING**

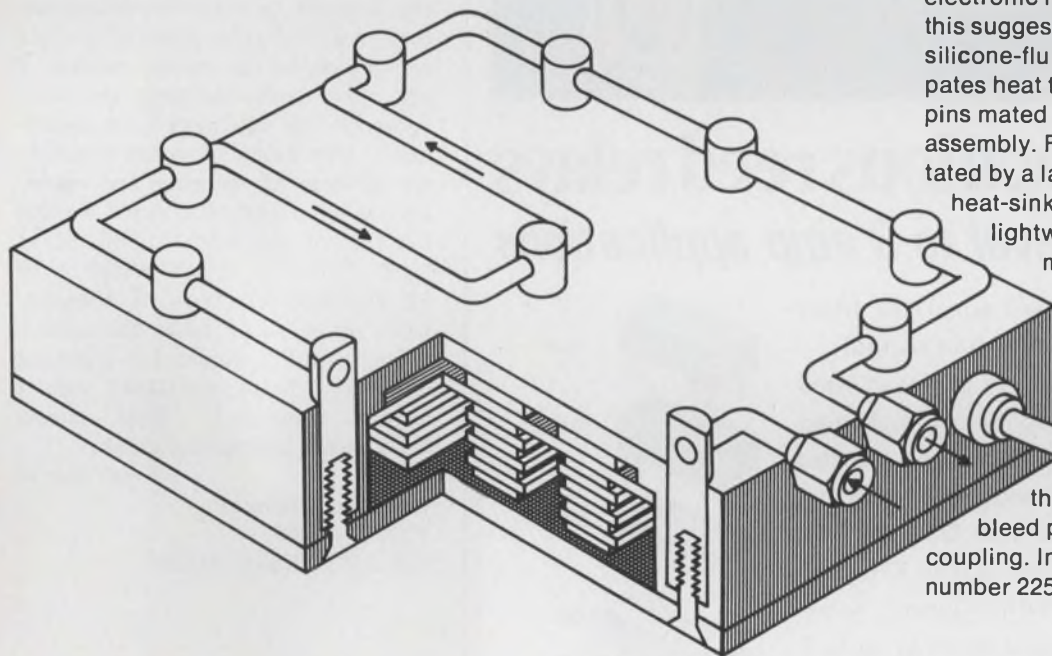

**Silicones for cooling high-density modules.** More efficient cooling of electronic modules is possible with this suggested assembly design. A silicone-fluid-filled coolant tube dissipates heat transferred to it from dowel pins mated to holes in the module assembly. Further conduction is facilitated by a layer of Dow Corning® heat-sink compound between a lightweight cold plate and module base. Silicone fluids have excellent heat-transfer properties and maintain constant viscosity over a wide temperature range. The heat-sink compound has high thermal conductivity and low bleed properties for long-term coupling. Information retrieval number 225.

**Silicones add durability to Ominimite\* transducer.** This magnetostrictive device converts electrical energy into sound for ultrasonic cleaning systems. It is insulated with Dow Corning silicones. Bendix Instruments and Life Support Division uses coil forms fabricated from a Dow Corning silicone resin bonded glass laminate. Finished coils are dipped in Dow Corning® 997 varnish and baked. Silicones help add the physical and electrical stability required for long-term performance. Information retrieval number 226.

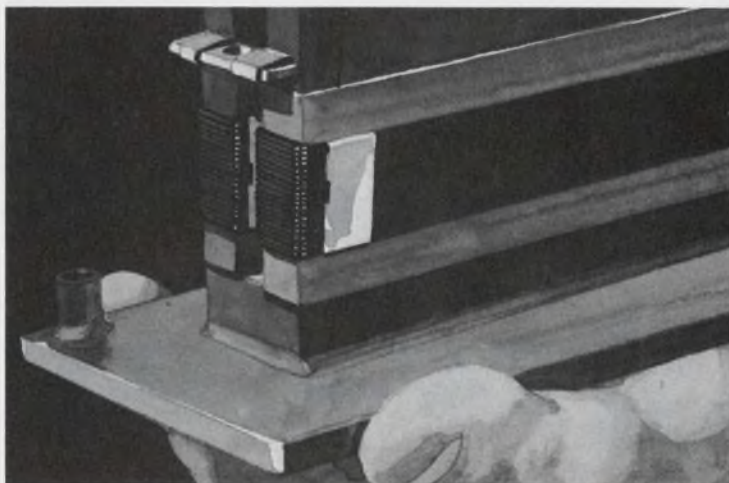

\*TM. Bendix Corporation



# up pops a miracle



## eight miraculous reed relays for your low level to 3 amp applications

Take a peek at eight small surprises from Guardian, and your Guardian Angel:

Eight series of newly-improved reed relays in your choice of 1A to multiple switching combinations. *MDR, MDX*: Mini-sized miracles that fit in same pc board spot as 14-terminal dual-in-line IC. Compatible with DTL and TTL logic families. *MRR*: Compatible with TTL logic for computer interface. *GRR*: General series sub-miniature. *SRR*: Standard series in up to 6 poles. *PRR*: Power series, switch up to 3 amp load in enclosed package. *ORR*: New open frame super-economy series. *ERR*: Economy series open frame for high quality, surprisingly low price. *Send for . . .*

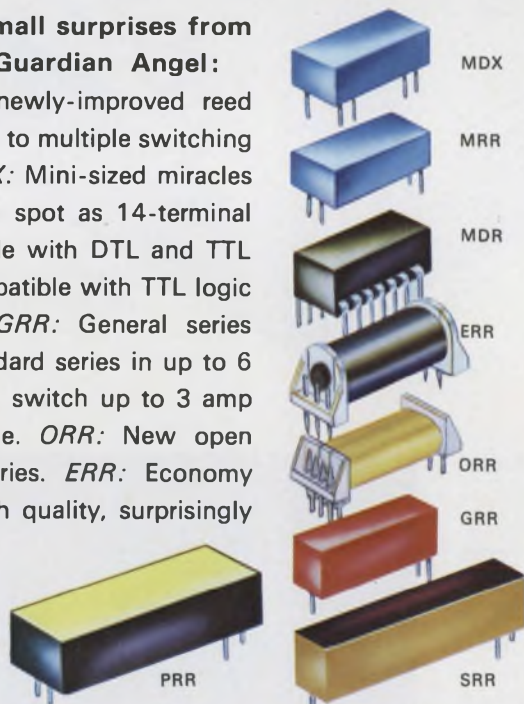

**FREE: REED RELAY LITERATURE PACKET**



# GUARDIAN®

GUARDIAN ELECTRIC MANUFACTURING COMPANY

1572 West Carroll Avenue, Chicago, Illinois 60607

INFORMATION RETRIEVAL NUMBER 7

(continued from p. 7)

could just as easily have written: "about 6 inches long."

The beauty of the metric system is its simplicity. Leave it to Americans to bungle even that up on occasion! Or, as someone recently put it, "Too many of us spend time trying to do things right instead of finding the right things to do."

*Edwin B. Bruning*  
Industrial Designer

CFC Products, Inc.  
209 E. Washington St.  
Ann Arbor, Mich. 48108

One blistering hot day last week (it was 38 or 39°, I'll swear), I was sitting on the beach watching the seagulls or other works of nature, reading your editorial on our conversion to the metric system. I was just contemplating the convenience of all metric measurement, how much it would simplify our system of weights and measures when a fantastic chick walked by. I'll bet she was 101, 66, 91 at least. Probably didn't weigh over 52 (kilograms). Wow, I thought, life's never going to be the same.

Incidentally, thanks for pointing out that a point is 0.01387 inch. I always wondered. (That means that was a 2880-point chick.)

*Fred Storke*

Nytek Electronics  
P.O. Box 358  
Los Altos, Calif. 94022

## Addition to Focus report

We goofed. In "Focus on Disc and Drum Memories" in the May 11 issue, we neglected to mention in the story, or in the vendor's listing, one important manufacturer of these memory systems, the Systematics Div. of General Instrument Corp., 13040 S. Cerise, Hawthorne, Calif.

For more information on the company's product line, circle the information retrieval number below.

CIRCLE NO. 368

# Silicone Protectors

A full line of silicone encapsulating, insulating, sealing, coating and dielectric materials is available from Dow Corning Distributors at the following warehouse locations:

## ALABAMA

**Birmingham**  
Electrical Insulation Suppliers  
205 252-9046

**Mobile**  
Brownell Electro, Inc.  
205 479-5405

## ARIZONA

**Phoenix**  
Essex International Inc.—IWI Div.  
602 278-8568

## CALIFORNIA

**Berkeley**  
C. D. LaMoree  
415 841-0601

**Culver City**  
E. V. Roberts & Associates, Inc.  
213 870-9561

**Gardena**  
Specialized Products Co.  
213 532-1230—213 770-8186

**Los Angeles**  
Essex International Inc.—IWI Div.  
213 264-7000

**C. D. LaMoree**  
213 225-5666

**Brownell Electro, Inc.**  
213 532-1150

**Mountain View**  
K. R. Anderson Company, Inc.  
415 961-6007

**San Diego**  
A. E. Yale Enterprises  
714 296-6148

**San Francisco**  
Essex International Inc.—IWI Div.  
415 626-5351

## COLORADO

**Denver**  
Waco Enterprises, Inc.  
303 322-7708

## FLORIDA

**Orlando**  
Cramer/Florida, Inc.  
305 841-1550

**Brownell Electro, Inc.**  
305 424-5634

**Electrical Insulation Suppliers, Inc.**  
305 855-7100

**Tampa**  
Essex International, Inc.—IWI Div.  
813 245-1651

## GEORGIA

**Atlanta**  
Electrical Insulation Suppliers, Inc.  
404 355-1651

**Essex International Inc.—IWI Div.**  
404 691-8520

**Chamblee**  
Prehler Electrical Insulation  
404 451-4266

**Hapeville**  
Brownell Electro, Inc.  
404 762-5181

## ILLINOIS

**Chicago**  
Prehler Electrical Insulation  
312-384-6100

**Mt. Prospect**  
Magnuson Electronics, Inc.  
312 956-0700

**Niles**  
Essex International Inc.—IMC/IWI Div.  
312 647-0044

## INDIANA

**Fort Wayne**  
Essex International Inc.—IWI Div.  
219 742-7441

**Hammond**  
Electric Supply Corp.  
219 932-8840

## IOWA

**Marion**  
Enaco Distributing Corporation  
319 377-6313

## KENTUCKY

**Louisville**  
E & H Electric Supply  
502 587-0991

## LOUISIANA

**New Orleans**  
Williamson Distributing Corp.  
504 486-5584

**Shreveport**  
Williamson Distributing Corp.  
318 424-6638

## MARYLAND

**Baltimore**  
Essex International Inc.—IWI Div.  
301 644-0140

**Pyttronic Industries, Inc.**  
301 539-6525

## MASSACHUSETTS

**Cambridge**  
Brownell Electro, Inc.  
617 864-7500

**Newton**  
Cramer Electronics, Inc.  
617 969-7700

**Peabody**  
Essex International Inc.—IWI Div.  
617 531-7100

## MICHIGAN

**Detroit**  
Essex International Inc.—IMC/IWI Div.  
313 921-6000

**Madison Heights**  
McNaughton-McKay Electric  
313 399-7500

**Southfield**  
Sheridan Sales Co.  
313 358-3333

## MINNESOTA

**St. Paul**  
Magnuson Electronics, Inc.  
612 227-8495

**Prehler Electrical Insulation**  
612 622-1541—612 622-1542

## MISSOURI

**Kansas City**  
Essex International Inc.—IWI Div.  
816 842-1613

**St. Louis**  
Enso Distributing Corp.  
314-542-3935

**Essex International Inc.—IWI Div.**  
314 371-2616

## NEW JERSEY

**Livingston**  
Robert McKeown Co., Inc.  
201 922-0700 or 212 267-9264 (NYC)

**Moonachie**  
Essex International Inc.—IWI Div.  
201 641-4400 or 212 695-7495 (NYC)

**North Bergen**  
Electrical Insulation Sales  
201 864-2376 or 212 564-6273 (NYC)

## NEW MEXICO

**Albuquerque**  
Waco Electronics, Inc.  
505 268-2409

**Williamson Distributing Corp.**  
505 344-3564

## NEW YORK

**Buffalo**  
Summit Distributors, Inc.  
716 884-3450

**New York City**  
Brownell Electro, Inc.  
212 619-7900 or 212 924-6000

## NORTH CAROLINA

**Charlotte**  
Brownell Electro, Inc.  
704 394-4341

**Electrical Insulation Suppliers, Inc.**  
704 392-2306

**Essex International Inc.—IWI Div.**  
704 394-1315

**Winston-Salem**  
Cramer/E. W. Winston-Salem  
919 725-8711

Electrical/electronic materials  
from

# DOW CORNING

DOW CORNING

## OHIO

**Cincinnati**  
Cramer/Tri States, Inc.  
513 771-6441

**Electrical Insulation Suppliers, Inc.**  
513 771-4073

**Sheridan Sales Co.**  
513 761-5432

**Essex International Inc.—IMC/IWI Div.**  
513 771-6500

**Cleveland**  
Essex International Inc.—IMC/IWI Div.  
216 781-2310

**Prehler Electrical Insulation**  
216 267-2650

**Sheridan Sales Co.**  
216 524-8210

**Columbus**  
McGraw-Edison Co.  
National Electric Coil Division  
614 488-1151

## OKLAHOMA

**Oklahoma City**  
Essex International Inc.—IWI Div.  
405 236-5411

## OREGON

**Portland**  
Essex International Inc.—IWI Div.  
503 655-0138

**C. E. Riggs, Inc.**  
503 226-3286

## PENNSYLVANIA

**Harrisburg**  
Pyttronic Industries, Inc.  
717 233-6591

**Montgomeryville**  
Pyttronic Industries, Inc.  
215 643-2850

**Philadelphia**  
Brownell Electro, Inc.  
215 632-3030

**Essex International Inc.—IWI Div.**  
215 236-7100

**Prehler Electrical Insulation**  
215 725-5014

**Pittsburgh**  
Essex International Inc.—IMC/IWI Div.  
412 244-1145

## TENNESSEE

**Memphis**  
Brownell Electro, Inc.  
901 323-8554

**Electrical Insulation Suppliers, Inc.**  
901 947-4176

## TEXAS

**Dallas**  
Essex International Inc.—IWI Div.  
214 339-8346

**Specialized Products Company**  
214 358-4663

**Williamson Distributing Corp.**  
214 741-5831

**Houston**  
Essex International Inc.—IWI Div.  
713 227-6358

**Williamson Distributing Corp.**  
713 672-1715

## UTAH

**Salt Lake City**  
Hyer/Cramer Electronics  
801 487-3681

## WASHINGTON

**Seattle**  
Atlas Packing & Rubber Co.  
206 623-4697

**Essex International Inc.—IWI Div.**  
206 763-8650

**C. E. Riggs, Inc.**  
206 623-5707

## WISCONSIN

**Milwaukee**  
Essex International Inc.—IMC/IWI Div.  
414 342-3927

9-2700



**Everyone talks  
correed reliability,**





# here's the way it looks.



## Switches under glass.

The heart of every AE correed is a reed switch consisting of two overlapping blades. For protection, we seal them inside a glass capsule. But only after we pull out all the dirty air and pump in a special, pure atmosphere. That way there's no chance of contact contamination or oxidation. Ever.

Notice our terminals are one piece. A special machine delicately forms them to precision tolerances. It's a lot of work, but one-piece terminals have distinct advantages over the two- and three-piece kind.

For one thing, there's no extra joint so you're always assured of a positive contact. Also, one piece terminals are more reliable when the correed is used to switch low-level analog signals. That's because thermal EMF is reduced to practically zero.

## A different kind of bobbin.

Since we go through so much trouble with our correed capsules, we designed a special bobbin to protect them.

It's molded of glass-filled nylon. (You know how plastic chips and cracks.) Moisture and humidity have no effect on this stubborn material. No effect means no malfunctions for you to worry about. No current leakage, either.

Running the full length of the bobbin are a series of slots. They pamper the capsules and keep them from getting damaged or jarred.

And to help you remember which terminal is which, we mold the terminal numbers into the end of the bobbin. You can read them at a glance.

## Little things mean a lot.

Reliability means that we pay attention to the little things. Like the tiny pressure rods we use in every miniature correed. They're placed at

each end of the bobbin, across the one-piece terminals. What they do is prevent stresses from being transmitted from the terminals to the reed blades. This keeps the contact gap right on the button. All the time.

The contacts are normally open. To provide them normally closed, we employ another little device—a tiny magnet. It's permanently tucked into a slot next to the reedcapsule. The magnetic action keeps the contacts normally closed.

## Coiled by computer.

Once all the parts are secure in the bobbin, we cover them with protective insulation. Around this, we wind the coil. You can be sure the coil winding is correct. It was all figured out for us by computer.

Our next step is to protect the coil. We do that with more protective insulation.

## A coat of iron.

On top of the insulation goes a layer of annealed iron. It acts as a magnetic shield and minimizes interaction between coils. Also, it improves the sensitivity of the entire unit. A coat of iron is standard on all AE correeds.

## Finally comes super wrap.

To wrap it all up, we use some very special stuff. A layer of mylar laminated material.

It's so tough we guarantee it to withstand all cleaning solvents known to man.



## Free Correed Handbook

This 60 page handbook explains advantages and disadvantages of correeds, describes the different types, and tells how to use and test them. To get your free copy, just write John D. Ashby, GTE Automatic Electric, Northlake, Illinois 60164.

**GTE AUTOMATIC ELECTRIC**

INFORMATION RETRIEVAL NUMBER 8



**Two new P&B series  
dry reed relays  
give designers  
9,627 options.**





# Now, your design work is simplified, your choice of dry reeds is broadened, with our new JRC and JRD series. And P&B Quality comes as a bonus.

With 9,627 options, these two new series of dry reed relays present printed circuit board designers new opportunities for creative engineering.

Each is miniature in size with terminals spaced on 1.0" centers.

Each offers a choice of contact arrangements and coil terminals.

Each is available now from authorized P&B electronic parts distributors.

Importantly, you get P&B quality at competitive prices in all quantities.

**JRC reeds** have terminals arranged for .100" x 1.00" grid spacing and feature a low profile (.36") to permit close stacking of pc boards. In-line termination is in keeping with the industry trend, and the JRC coil leads terminate at any of four corners. The terminals are supported by the bobbin, and any forces encountered are transmitted to the stand-off flange to prevent stressing the glass seal of the capsule.



P&B precision assembly machines make it possible to control gap variance in reeds to within 2/10,000ths of an inch. (1/10th the thickness of a human hair.)

Contact configurations are available in Form A (SPST-NO), Form B (SPST-NC) and combinations of Forms A and B. For DC restive loads, the contacts have a maximum rating of 10 watts, .5 ampere, and 200 volts. Typical operate speeds at 25°C are 1 millisecond including bounce for pick-up and .05 millisecond drop-

out. Available coil voltages range from 3 to 48VDC.

The JRC series may be ordered with 1, 2, 3, 4, 5 or 6 cavity bobbins.

**New JRD dry reed relays** offer design engineers the option of .150" x 1.00" grid spacing. Slightly larger than the JRC package, the JRD's are similar except they offer, in addition to Forms A and B, a true Form C (SPDT) contact configuration. JRD's may be ordered in 1, 2, 4 or 6 cavity bobbins.

JRC and JRD open style, dry reed relays are produced to exacting tolerances and provide design engineers with a wide selection of contact configurations for logic circuitry, instrumentation and low voltage applications. Both series are available with or without magnetic shielding.

For complete information, or advice, and for your copy of the 226 page relay catalog, write Potter & Brumfield Division, AMF Incorporated, Princeton, Indiana 47670. Or, simply call 812 385-5251.

**Replacements for IBM Reed Relays.** While not identical in all aspects, JRD Reed Relays have the same terminal spacings and electrical characteristics as those manufactured by IBM.

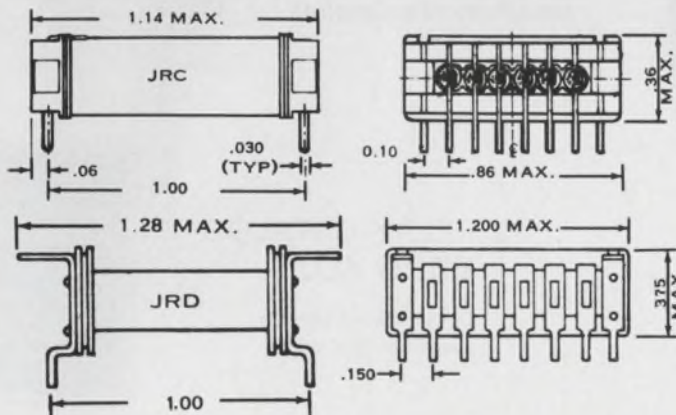

**P&B makes more of more kinds of relays  
than anybody in the business.**

**Anybody.**



# All kinds of REED RELAYS answer all kinds of Problems!

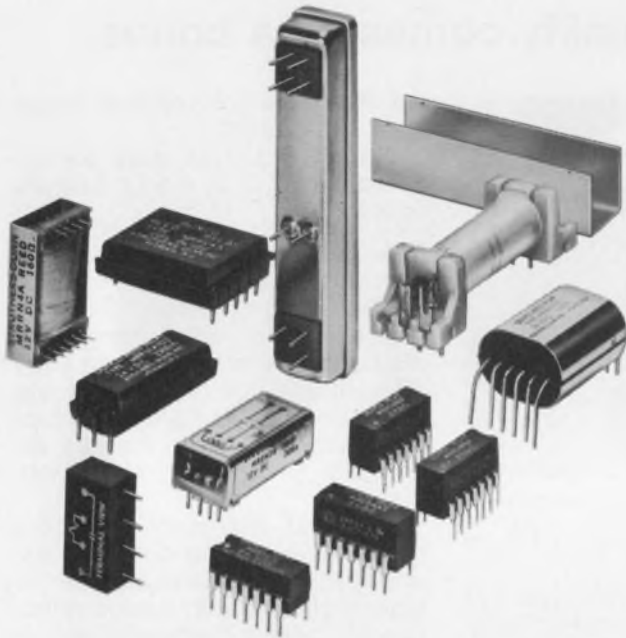

## PACKAGING PROBLEMS

DIP  Open  3 Plastic enclosed pc terminal types —inexpensive ultrasonic welded cover, metal cover, or epoxy-potted  Low profile molded  Metal clad  Axial lead encapsulated  Many specials . . . *probably more styles and sizes than anyone because S-D's been mass producing reed relays longer than anyone.*

## SWITCHING PROBLEMS

Forms A, B, C in multiples and/or combination in most types  Miniature & standard reeds  Bistable latching types  Integral logic . . . *reflecting the thinking you expect from people who really know industrial control problems.*



## SENSITIVITY PROBLEMS

Sensitak™ hybrids have solid state inputs, reed switch outputs: Sensitive types for on-off or latching on 50  $\mu$ A or 1  $\mu$ A inputs  Voltage/Current sensing  AC Null sensing relays . . . *economically combine the isolation of reed contacts with the speed and sensitivity of solid state.*

'72 RELAY CATALOG  
TELLS ALL...

Circle reader service  
card for your copy.



## STRUTHERS-DUNN, INC.

PITMAN, NEW JERSEY 08071  
Canada: Struthers-Dunn Relay Div., Renfrew Electric Co., Ltd.

INFORMATION RETRIEVAL NUMBER 10



# NEW VALOX<sup>®</sup> 310-SE0 THERMOPLASTIC POLYESTER RESIN IS OUT.

## IN ZERO SECONDS.

**With no sacrifice of dimensional stability, toughness, heat resistance or moldability.**

In UL flame tests, unreinforced VALOX 310-SE0 thermoplastic polyester surpassed the highest UL self-extinguishing ratings, SE-0 and Group 1. It flamed out in zero seconds. As a quarter second of film proves.\* But that's not all.

It's unlike SE polypropylene because it doesn't sacrifice heat resistance or toughness. It's unlike SE nylon because it has higher dimensional stability and much lower water absorption. It's unlike any acetal because no acetal is self-extinguishing. And unlike competitive thermoplastic polyesters, it's unreinforced for greater ductility and lower cost.

What's more, VALOX has built-in lubricity, unsurpassed solvent resistance, and it usually molds faster than nylon, acetal or polypropylene. At lower temperatures. And in the same molds.

In short, new VALOX 310-SE0, like other VALOX grades, including a glass-reinforced UL SE-0 grade, is a balanced thermoplastic. For complete details, write Section 148, Plastics Dept., General Electric Co., One Plastics Ave., Pittsfield, Mass. 01201.

Leader in Engineering Plastics  
LEXAN<sup>®</sup> NORYL<sup>®</sup> GENAL<sup>®</sup> PHENOLICS VALOX<sup>®</sup>

**GENERAL  ELECTRIC**

\*Unedited film. Photographed at 24 frames per second with an Arriflex 35mm camera and a 90mm Macro-Kilar lens.



# At Last! The Digital Profit Makers!

## They're "Money Makers"—

First-class appearance will sell your product, so we designed the NEW 4000 series digital panel meters with big, bright, solid displays that are "No. 1" in national user-preference surveys.

Included is a regulating AC power supply that completely blocks out line transients up to 400 volts peak-to-peak! No more jumpy readings to make you wonder "*—what was that?*"

And extra-low input bias current keeps readings accurate and super-stable, even at the highest operating temperatures.

Give your panel the quality look. Your customers will recognize it—*and buy it, too!*

## and "Money Savers," too!

We designed the 4000 series to protect you against profit-robbing failures.

The displays are more reliable (and more readable) because there are no "loose" elements inside.

High quality components, superior workmanship, and wide-safety-margin designs combine to reduce failures, too.

We're so sure we have the answer, we've extended our WARRANTY for **ONE FULL YEAR!**

It won't take you that long to find out how much money you're saving with the 4000 series on your panel.

Don't be fooled by low price tags! This time, buy quality and reliability *right from the start!*

If you have anything left from your last panel meter purchase, give us a call.

If you don't have anything left, call our sales department collect. (714) 546-7160, ext. 567.

We'll understand. That's why we built a totally new kind of DPM—

**"the Digital Profit Makers"**

**Data Technology  
Corporation**

2700 South Fairview Road  
Santa Ana, California 92704





**NOW "NO. 1"**  
 . . . in national user-  
 preference surveys.

## Compare panel meters...

## Then select the one with the good looking Sperry displays

If you think that Nixie<sup>®</sup> tubes or LED displays are the only one's you can logically use in your panel meters, you had better take a close comparison look at Sperry. The facts speak for themselves.

**COMPARE READABILITY** . . . a must requirement. Sperry displays<sup>†</sup> can be read in direct sunlight with no loss of legibility. And, continuous, "no-gap" Sperry characters make your panel meters a lot more attractive to your customers. Try the others.



**COMPARE POWER** . . . a very important factor. Under DC operation, LED's require over 500 mW — Nixie<sup>®</sup> tubes require over 400 mW as compared to Sperry 1/3" with 200 mW and 1/2" with 370 mW. Sperry can go down even further — to 85 mW under pulsed operation using a Sperry decoder/driver, without affecting readability. What about voltage? A simple, inexpensive DC/DC converter takes the battery voltage up to the 170 volts required to operate Sperry displays.

**COMPARE RELIABILITY** . . . simplicity is the key. Sperry displays have no wirebonds. They are so ruggedly built and reliable that they are used aboard the Boeing 747. Need we say more.



**COMPARE SIZE** . . . it's the housing to character size ratio that counts. Which display do you want in your equipment?



Add these Sperry advantages to greater clarity and brightness, wider viewing angle and a low cost of \$1.00<sup>\*\*</sup> per digit in large OEM quantities for either the 1/2" and 1/3" device and you can end the comparison and specify Sperry — the right displays for your panel meters. Get the whole story on Sperry displays by requesting complete technical information using this publication's reader service card or phone or write: Sperry Information Displays Division, Post Office 3579, Scottsdale, Arizona 85257, Telephone (602) 947-8371

**SPERRY**  
 INFORMATION DISPLAYS

Sperry 1/2"      Sperry 1/3"      LED 1/4"      Nixie<sup>®</sup> 1/2"

## It's a whole new ball game in displays!



<sup>†</sup>Patent Pending.  
<sup>®</sup>NIXIE is the registered trade mark of the Burroughs Corporation.  
<sup>\*\*</sup>Price is \$2.30 in 5,000 digit quantity.



# TWT amplifier line four models: 10, 20, 100 and 200 watts solid state with protective circuitry beam and helix current metering modular construction

The industry's most advanced TWT amplifier line can now provide the microwave power and stability you need for EMI/susceptibility testing, antenna pattern measurement, RF power instrumentation calibration and component testing.

Modular construction and plug-in boards allow the versatility to accommodate a wide variety of TWTs. Options include VSWR protection, harmonic filtering and variable output. Solid state components (except series regulator and TWT) and conservative design provide the reliability and performance necessary in modern electronic instruments.

Beam current and voltage protection are built in along with regulation of all power supplies.

Maximum TWT life is assured through efficient cooling: the 10 and 20 watt systems use conventional air cooling and the 100 and 200 watt are cooled with a liquid to air heat exchanger for quiet, reliable and efficient operation.

One of our twenty-six TWT amplifiers will meet your power, gain, and frequency requirements. And all have a one year warranty. For complete specifications call (312) 354-4350 or write: MCL, Inc., 10 North Beach Avenue, La Grange, Ill. 60525.



10 and 20 watt TWT

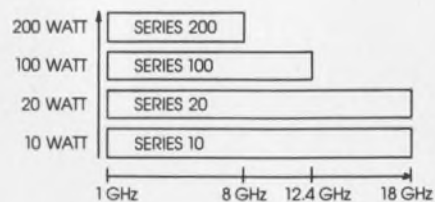

100 and 200 watt TWT



Opportunities developing now for RF engineers at MCL, Inc. — an equal opportunity employer.

INFORMATION RETRIEVAL NUMBER 14

# The timer of 1001 uses.

(Priced so low it's measured in cents.)

At last. A true standard IC timer with almost universal applications. The new low-cost 555. From Signetics-Linear, of course.

And the most extraordinary advantage of 555: it's so ordinary, and so simple to use. With designed-in flexibility that's never been matched, spec for spec.

555 functions interchangeably as a time delay, oscillator, pulse detector or power modulator. Timing from microseconds through one hour. With time delays completely resettable.

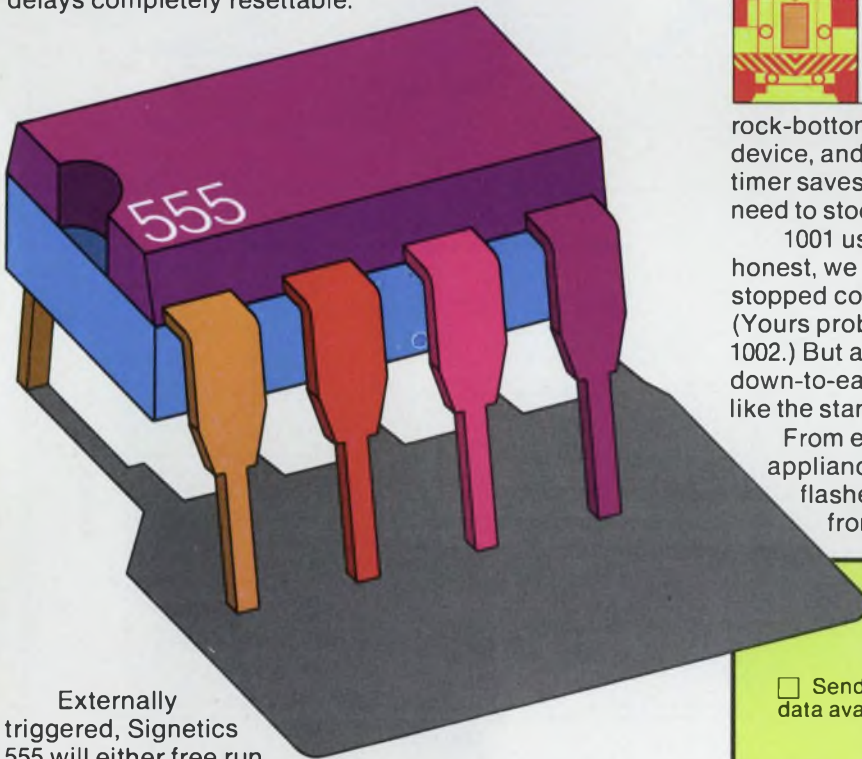

Externally triggered, Signetics 555 will either free run or latch, in adjustable duty cycles from 50% to 0.01%. Timing can be changed 10:1 with control. Operating from 5 to 15 volts with only a 1% change in timing. Output can source or sink 200mA. Temperature stability: 0.005% per °C.

And applying the adaptable 555 is practically child's play (if the kid knows basic math). Requires only a resistor and capacitor to do the job. With all kinds of options for starting the timing action. And you can operate 555 from just a single power supply.

All this, in one simple 8-pin dual in-line circuit. Available off-the-shelf now, from your distributor at



rock-bottom cost. The 100-up price is only 75¢ per device, and the multi-function capability of our 555 timer saves you still more on the parts you no longer need to stock.

1001 uses? To be honest, we haven't stopped counting yet. (Yours probably makes 1002.) But a versatile down-to-earth IC timer like the standard 555 suggests applications unlimited.

From exotic technology to household appliances... from copying machines to barricade flashers... Start thinking. And you can take it from there.

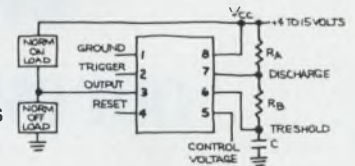

Signetics-Linear  
811 E. Arques Avenue  
Sunnyvale, California 94086

Send all the literature, specs and applications data available for the great 555 breakthrough.

Name

Title

Company

Address

City

State

Zip

Telephone

Signetics Corporation. A Subsidiary of Corning Glass Works.

**signetics**



# Our new temperature independent core obsoletes all others,

TIN core output voltages at  $-25^{\circ}\text{C}$ ,  $+25^{\circ}\text{C}$ ,  $+75^{\circ}\text{C}$ , and  $+100^{\circ}\text{C}$ . Note that the voltage output, peaking and switching times are almost identical at all four temperatures. This results in a significantly larger strobe window, placing fewer demands on sense amplifier performance. A full drive current of 475 milliamps and a disturb current of 238 milliamps were used.

# even our own.

Output voltages at  $-25^{\circ}\text{C}$ ,  $+25^{\circ}\text{C}$  and  $+75^{\circ}\text{C}$  for a typical medium-temperature ferrite core. Note that the signal amplitudes, peaking and switching times vary widely for each of the three test temperatures, resulting in an extremely small strobe window.

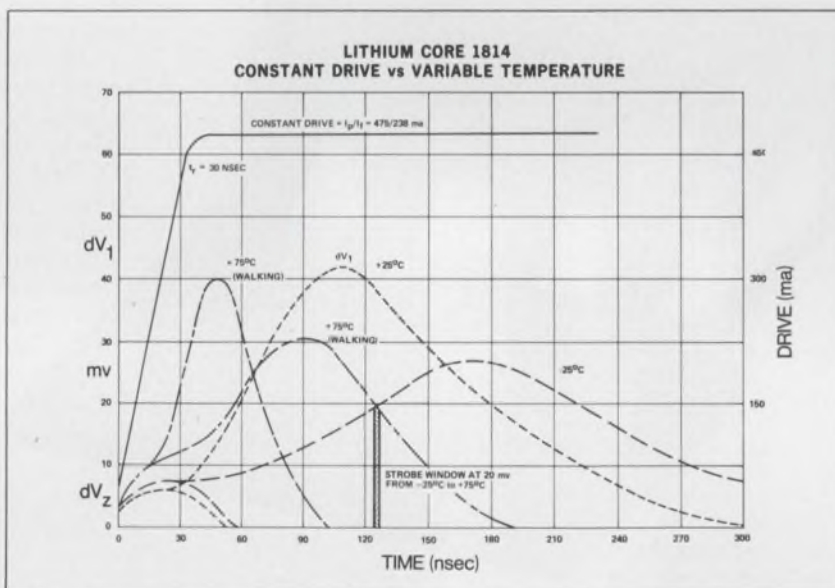
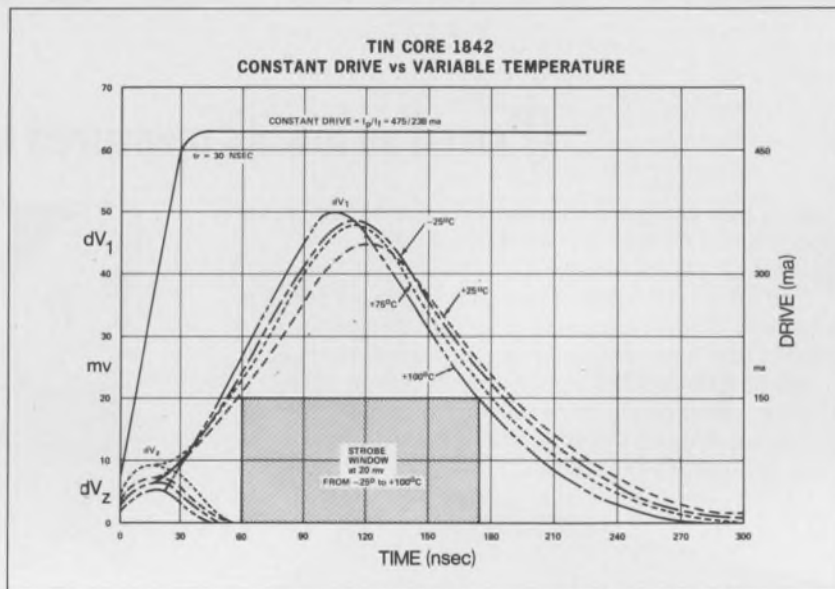

We call it TIN. You'll call it the breakthrough of the decade... the core material that will be the industry standard of the '70s. Now you can design stacks and their associated memory systems for use in any environment—offices, factories, homes, in the tropics, even in the arctic—without any costly current compensation or elaborate cooling. TIN's temperature coefficient is absolutely flat from  $-25^{\circ}$  to  $+125^{\circ}\text{C}$ . Complete freedom from thermal gradient problems. Wider margins. There's no other core material like it. Your fabrication savings will be significant.

A breakthrough? Of course. But that's what you expect from innovators like Ampex who were responsible for developing the current industry-standard medium-temperature core

in 1962, and virtually every significant advancement in core technology since... Ampex, the largest independent producer of cores, stacks and memory systems in the world.

Study these wave forms. Cores, stacks and systems are available now. Ask about TIN sample availability.



AMPEX COMPUTER PRODUCTS DIVISION  
13031 West Jefferson Boulevard  
Marina del Rey, CA 90291 (213) 821-8933

## World standards pushed for component quality

Engineers all over the industrial world may one day be able to buy components certified to the same quality standards. That's the plan of Sidney E. Goodall, president of the International Electrotechnical Commission, an organization devoted to developing electrical and electronics standards.

Developing procedures for quality certification is something new for IEC, which has devoted almost 70 years to developing definitions of units and standards for products and systems ranging from resistors to telecommunications. In an interview with *ELECTRONIC DESIGN*, Goodall pointed out that the quality-certification plan would start with passive components—resistors, capacitors and inductors—then move on to active components.

Details of how the plan will work have yet to be worked out. It's probable that a manufacturer wishing to have his components conform to a specified quality level would himself certify the components. An inspector might then buy samples in the open market and test them; there might be in-plant inspection; or there might be inspection by approved independent laboratories.

The first step would no doubt require international agreement on the characteristics to be measured, the number of different quality levels or grades to be established, and sampling requirements.

The idea of international quality certification isn't new; it started in 1965 when Britain, France and Germany decided that such a scheme would be useful in their procurement of electronic components. CENEL (a French acronym for European Coordinating Committee for Standardization—Electrical) agreed to set up the program, despite the fact that the organization had then been concerned only with harmonizing practice in

the use of standards—not preparing standards.

It wasn't long before IEC's national committee in the United States, headed by William H. McAdams, manager of industry standards for General Electric in New York City, applied to CENEL for observer status. Instead, CENEL decided to hand the operation over to IEC. An all-volunteer organization with no finances, CENEL felt it would not be the appropriate body to continue the work. IEC, with national committees in 41 nations, was the natural choice.

IEC believes that the quality-assessment plan for resistor, capacitors and inductors could begin to operate before the end of 1973.

### Moving radar helps police trap speeders

A new moving radar for use by law-enforcement authorities allows patrolmen to determine the speed of oncoming vehicles automatically.

Although the radar has been used



With a new moving radar system, police can record the speed of oncoming vehicles on a digital display.

in military aircraft for some time, the circuit complexity, size and cost have hindered civilian applications, says Fred Kittle, project engineer for Kustom Electronics, Inc., Chanute, Kans. But with MSI integrated circuits, the engineer adds, Kustom is able to produce a small radar system that can plug into the cigarette lighter of a car.

Most radar systems used by the police are stationary units. Kustom's MR-7 system can be mounted in a moving car. A signal of about 10.5 GHz is transmitted by the radar and is reflected from both oncoming vehicles and the ground. The ground return signal indicates the speed of the car containing the radar, while the signal reflected from an oncoming car indicates the closing rate of the two cars. The system subtracts the speed of the police car from the closing speed of the two cars. The speed of the oncoming car can be determined to an accuracy of plus or minus 1/2 mile an hour.

Patrolmen using the Kustom radar can set the maximum speed of the road on the device. When an approaching car as much as 2500 feet away exceeds this limit, the device emits an audible beep, and within 0.2 seconds it displays the speed of the oncoming car on a digital readout.

### New quartz wristwatch drops price below \$100

The day of the \$20 electronic wristwatch is within sight, says Victor Kiam 2d, president of the Benrus Corp., Ridgefield, Conn. What will make it possible, he predicts, is a new quartz CMOS stepper-motor watch—the Techniquartz—which Benrus will put on the market in September.

The initial retail price for the Techniquartz will be \$99 (compared with \$450 for a comparable Seiko version). But Kiam is so confident of success that he forecasts a price drop, with volume sales, to around \$20 within two to three years for such watches.

Techniquartz operates similar to quartz models made by Seiko and CEH (a 19-company Swiss combine called the Center of Electronic Horology). A quartz crystal oscillating at 32,768 Hz feeds a 16-



stage. Motorola CMOS countdown IC. A buffer amplifier generates a square-wave output, suitable for driving the stepping motor. The motor is coupled to the gearing system, which drives the hands of the watch.

A Union Carbide EXP 77 cell, rated at 176 mA/hr., supplies the 15  $\mu$ A maximum current for the watch—enough current to last a year between battery changes, including a day/date feature.

The electronics in Techniquartz are mounted to withstand shock in excess of 3000 g's. Accuracy to one minute a year is guaranteed for two years.

## Consumer show offers an expanded bill

The expansion of electronics into new consumer areas was apparent at the traditionally entertainment-oriented Consumer Electronics Show, held in Chicago.

Once almost exclusively devoted to the latest in TV, AM and FM radio, phonographs and tape recorders, the June 11-14 show featured such products as home-security systems and personal calculators.

The security systems ranged from devices in which the opening or closing of a simple contact produced an alarm to wireless-operated units. Ultrasonic motion detectors were also displayed.

The market for these systems, according to Stan Geller, president of the On-Guard Corp. of America, Carlstadt, N.J., is increasing at a rate of 50% a year. On-Guard produces battery-operated, solid-state burglar and fire alarms as well as ac-operated fire and smoke detectors.

Magnavox, the first manufacturer of home-entertainment electronics to enter the home-protection field, introduced four systems: a wireless-operated version, an ac-operated one that uses house wiring to carry the signals from some other unit to the receiver, an ultrasonic motion detector and an ionic smoke and fire detector.

A surveillance system to screen callers at the door was demonstrated by the Mitsubishi International Corp., Lincolnwood, Ill. A two-pound, 16-mm, solid-state camera,

mounted at the entrance is connected to a 13-inch monochrome TV set through a control box, with a speaker at the same site as the camera.

A press on control-box button sends a beep to the TV audio section and displays a picture of the visitor.

A seemingly endless variety of low-cost calculators included a combination electric calendar clock and digital calculator. It is being produced by the Unisonics Products Corp. of New York City.

## NASA will launch ERTS-A this month

The long-awaited Earth Resources Technology Satellite (ERTS-A) is being readied for launching later this month from the Western Test Range in California.

The NASA spacecraft is the first of two satellites that are expected to help experimenters broaden man's understanding, in a number of earth science areas, including agriculture, geology, geography, hydrology and meteorology. Some 35 nations are expected to participate in the ERTS program.

The nearly 2000-pound ERTS-A will be launched into a 500-nautical-mile, near-polar orbit. It will circle the globe every 103 minutes, surveying more than 12 million square kilometers a week.

Its three return-beam vidicon cameras and a four-channel multi-spectral scanner will send back images in the visible and near-infrared portions of the spectrum of 100-by-100-nautical-mile seg-

ments of the earth's surface. This will provide global coverage every 18 days.

A data-collection system on the satellite will receive detailed environmental information from automatic data-collection platforms at fixed sites in the United States and Canada. ERTS-A can handle data from as many as 1000 such stations.

These platforms will collect data on up to eight local environmental conditions, such as water and snow depths, stream flow, soil moisture, temperature and humidity. This information will be transmitted to the satellite and then relayed via telemetry to ground stations.

A ground data-handling system at the Goddard Space Flight Center in Greenbelt, Md., is designed to process a combination of nearly 10,000 color and black and white digital tape images of the earth's surface weekly for use by ERTS experimenters.

The prime contractor for the spacecraft is General Electric Co.'s Space Div. at Valley Forge, Pa.

## U.S. agency offers transportation data

As the electronics industry looks to civil markets, transportation looms larger and larger. To help decision-makers, the Department of Transportation in Washington has announced the availability of a report called "Summary of National Transportation Statistics."

Copies of the report can be obtained from the Information Office Dept. of Transportation, Washington, D.C. 20590.

## News Briefs

In the tests of its automatic landing system, the Concord 001 **supersonic jetliner has repeatedly flown hands off**, with the auto-pilot set to level off at heights from 50 feet down to 10 feet. The test flights at Toulouse, France, were maintained for up to 2 km along the runway.

Just-released Dept. of Commerce figures reveal that the balance of **U.S. trade in communications and electronic products continued to**

**decline in 1971**, reaching a deficit of \$570-million—more than three times the 1970 red ink of \$181-million.

Joint development by Signetics and Dolby Laboratories of London of an **integrated circuit version of the Dolby B-type noise reduction system is reported progressing well**. Production quantities of the 16-pin, dual-in-line package are expected to be available later this summer.



# ISOLATION! 6 NEW COUPLERS FROM GENERAL ELECTRIC

For **SPEED** . . . 4 models **H11A** series SSL-Phototransistor Couplers offer



- Up to 2500V Isolation
- Up to 50% min transfer ratio
- Typical  $\pm 10\%$  variation in transfer ratio — 55 to 100°C
- Typical 2  $\mu$ sec rise/fall time

For **GAIN** . . . **H11B1** and **H11B2** SSL-Photo Darlington Couplers offer



- Up to 2500V Isolation
- Up to 500% min transfer ratio

For the complete story on General Electric Optoelectronics contact your authorized General Electric distributor, General Electric Electronic Component Sales Office, or use Inquiry Card Number 248

**GENERAL**  **ELECTRIC**

Semiconductor Products Department, Syracuse, New York

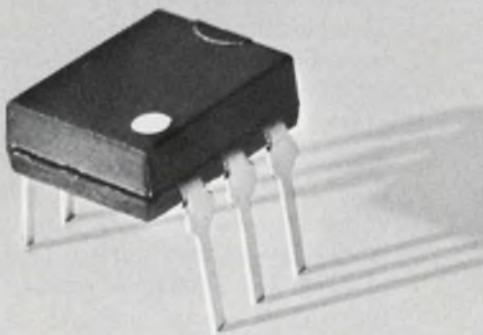

THIS SYMBOL REAFFIRMS OUR  
NO. 1 GOAL IN 1972: TO MAKE  
GENERAL ELECTRIC YOUR BEST BUY  
IN QUALITY, SERVICE, AND TOTAL VALUE





# How U.S. hopes to settle the life-on-Mars question

Jules H. Gilder, Associate Editor

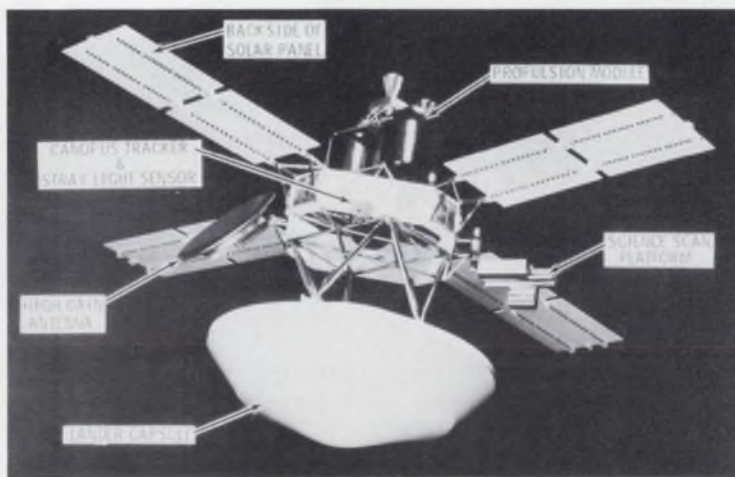
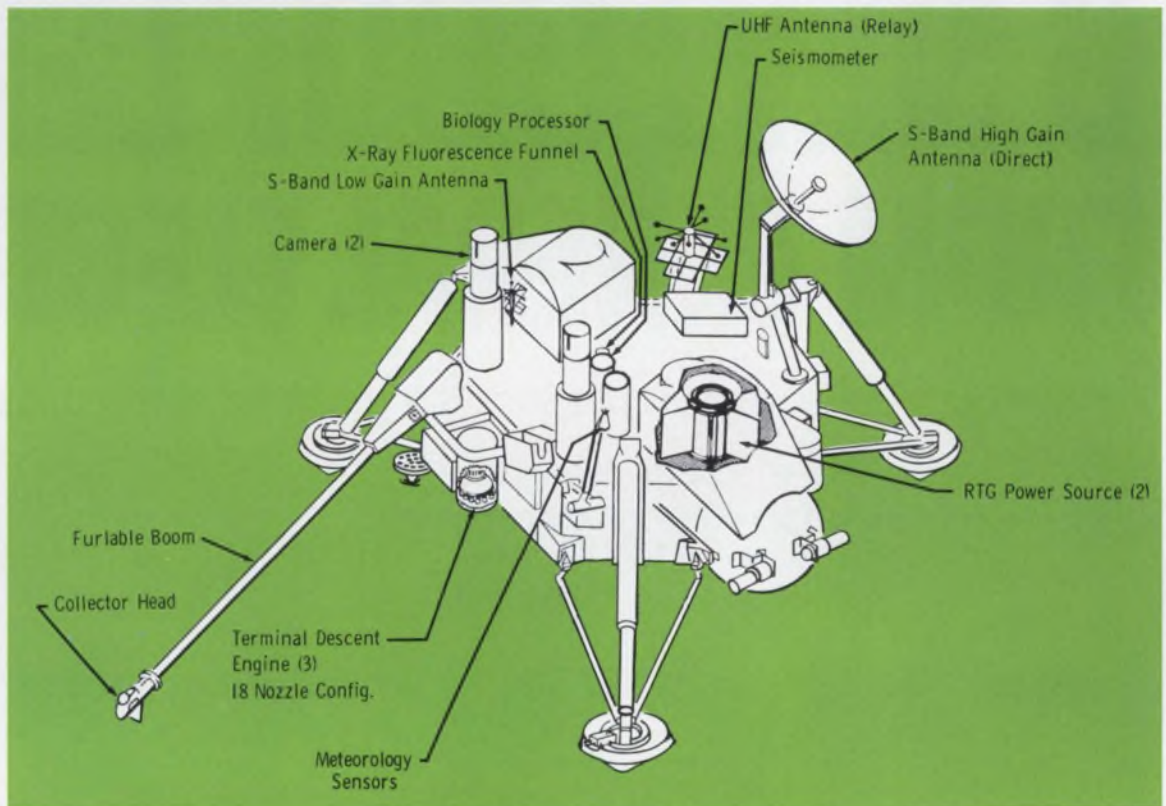

The Viking spacecraft will be launched by a Titan/Centaur rocket and will travel through space for about a year before going into orbit around Mars. The orbiter will then take high-resolution pictures and make a thermal map of the surface, as well as a map of the water in the atmosphere, to determine promising spots for exploration.

The Viking lander that will touch down on the Martian surface will be under control of an onboard computer. Once on the planet, the lander, which is essentially a miniaturized scientific laboratory, will begin its search for life. A soil sample will be picked up by a scoop mounted on a long boom. The lander will analyze the soil. In addition two facsimile cameras on board will provide 3-D pictures of the landing area. Meteorology instruments will measure local temperature, pressure, humidity and wind velocity. Data from the lander will be transmitted directly, to earth via S-band or relayed to the Viking orbiter via UHF and then to Earth via S-band.



So far there's been no evidence of humans rowing gondolas on Mars, but what about plant or animal life? By the summer of 1976, electronic and biologic instruments aboard two NASA capsules that will soft-land on the planet should give some answers.

Two spacecraft, each consisting of an orbiter and a lander, will be launched within 30 days of each other in the summer of 1975. The flight to Mars will take roughly a year. Two craft are being used to increase the chances of success and

the probability of discovering life.

Known as Viking '75, the mission will be completely automated. This is necessary because Mars will be about 225 million miles from the earth at that time and round-trip communication will take about 40 minutes.

In general, the instrumentation on the spacecraft will be improved versions of systems proved in past space efforts, although some new developments, such as the biologic instrument package and a new multibeam radar, will be employed.

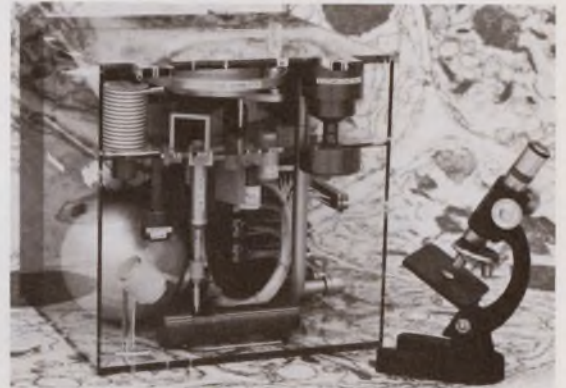
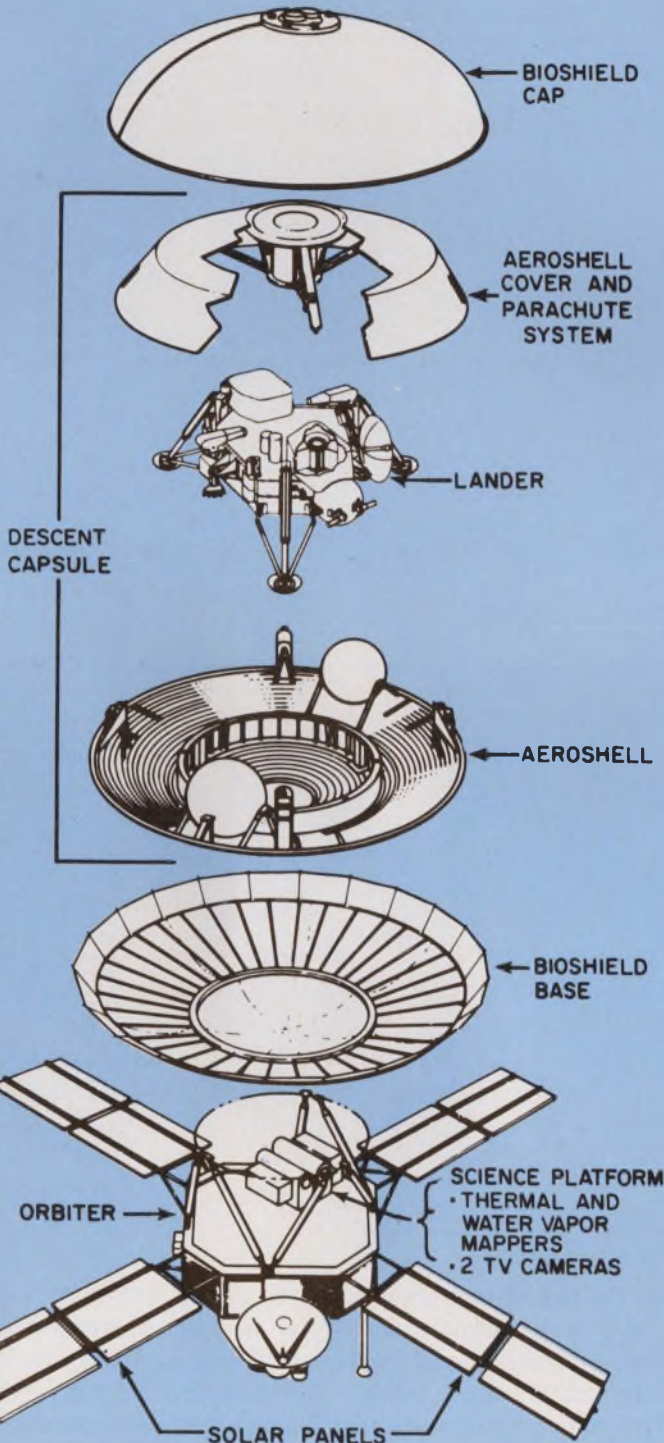

The primary experiments to be performed by the lander will be three life-determining tests that will be integrated into a fully automated instrument. The latter will have an electronics subsystem for supplying all command and control functions, data-handling capabilities and storage and power-conversion functions. The planned experiments are pyrolytic release, which will use radioactive  $\text{CO}_2$  to analyze the Martian soil for photosynthetic life; gas exchange, to monitor the environment around a soil sample for changes in gaseous makeup; and labeled release, which will provide a radioactive nutrient to a soil sample and then measure for signs of metabolic activity.

Once the spacecraft is on its way to Mars, the lander's bioshield will be jettisoned. The shield is to protect the sterile lander and assure that no earth organisms are transported to Mars. After a landing sight has been selected, the lander will be separated from the orbiter by a rocket burn, and initial deceleration will occur through aerodynamic action of the aeroshell. The lander will be slowed further by a parachute, which at the same time will jerk the lander free of the aeroshell. After the parachute is released, three retro-rockets will brake the lander to a velocity of 10 feet per second at the Martian surface. The landing energy will be absorbed by the three-legged landing gear.



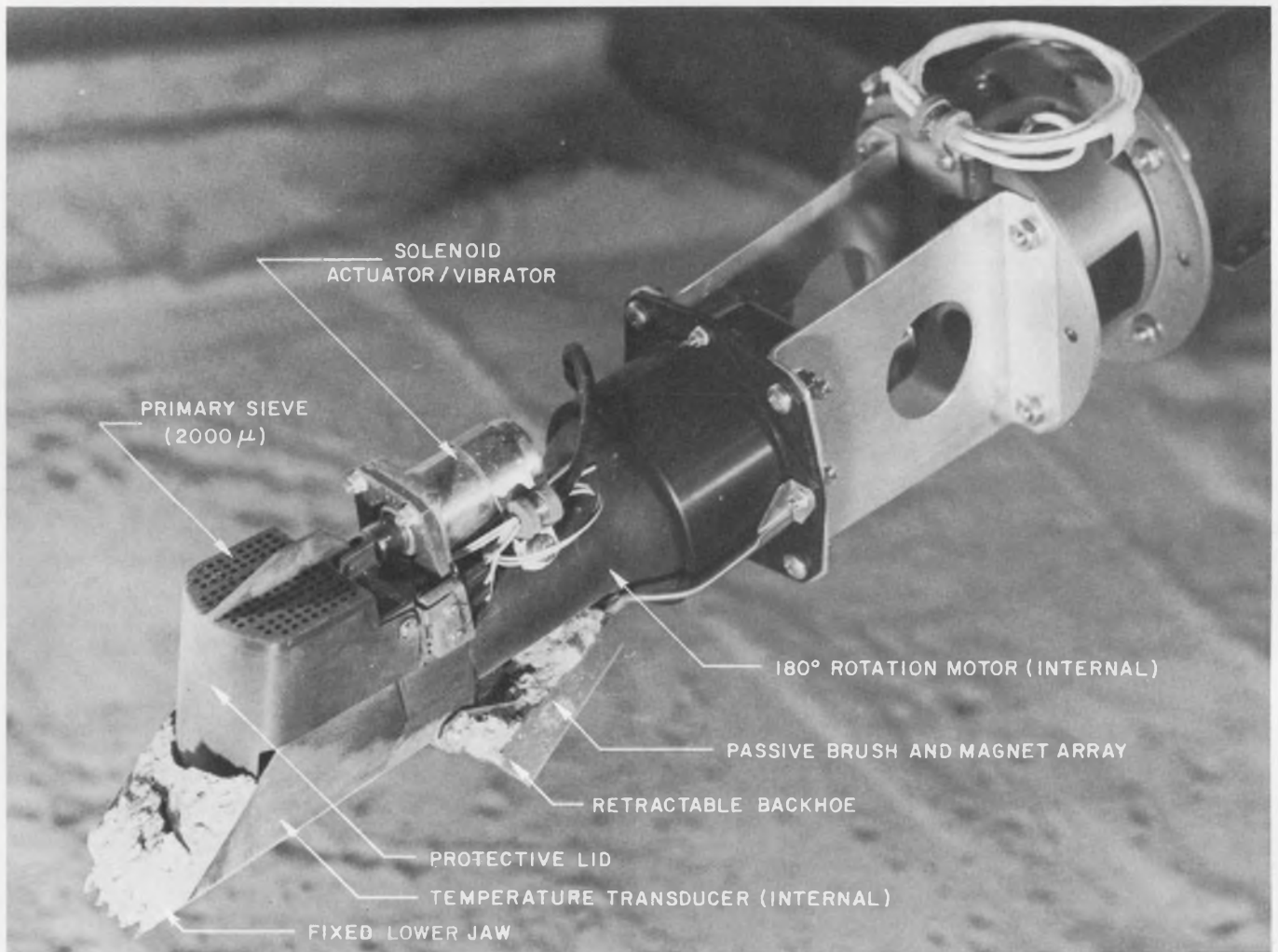

The soil samples that will be analyzed by the biology instrument package will be scooped up by a sample collector that is to be mounted on an extendable boom. The boom will be long, so that a sample of soil that has not been contaminated by the lander engines can be obtained. The sample collector will be able to rotate the scoop head 180 degrees and eliminate small particles by sifting them through a 2000- $\mu$  screen. The collector will also contain a transducer to measure the temperature of the Martian surface and a magnet to determine if magnetic material is present.

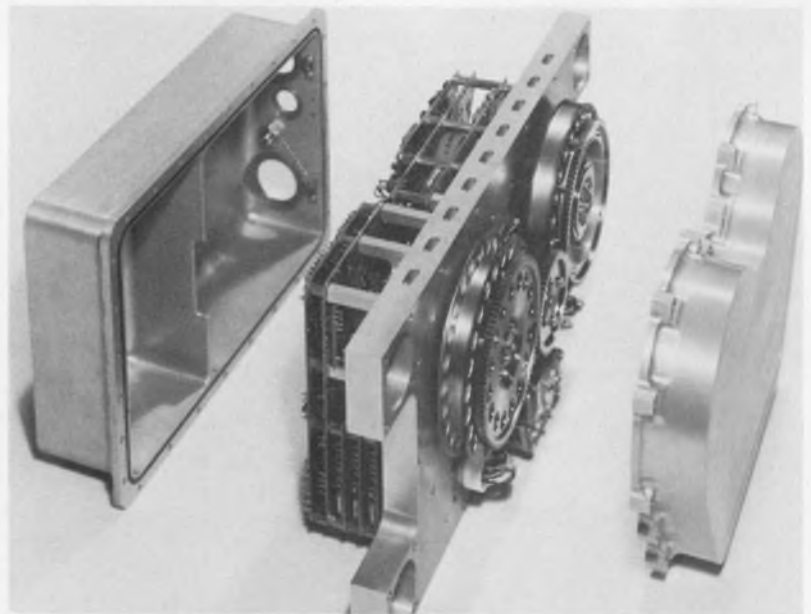

Data from the lander instruments will be stored either by a tape recorder with a 40-megabit capacity or a static memory with a 0.2-megabit capacity. To pass sterilization requirements, the tape will be a special phosphor bronze type electroplated with nickel-cobalt. The static memory will use 2-mil plated wire, as will the onboard computer.



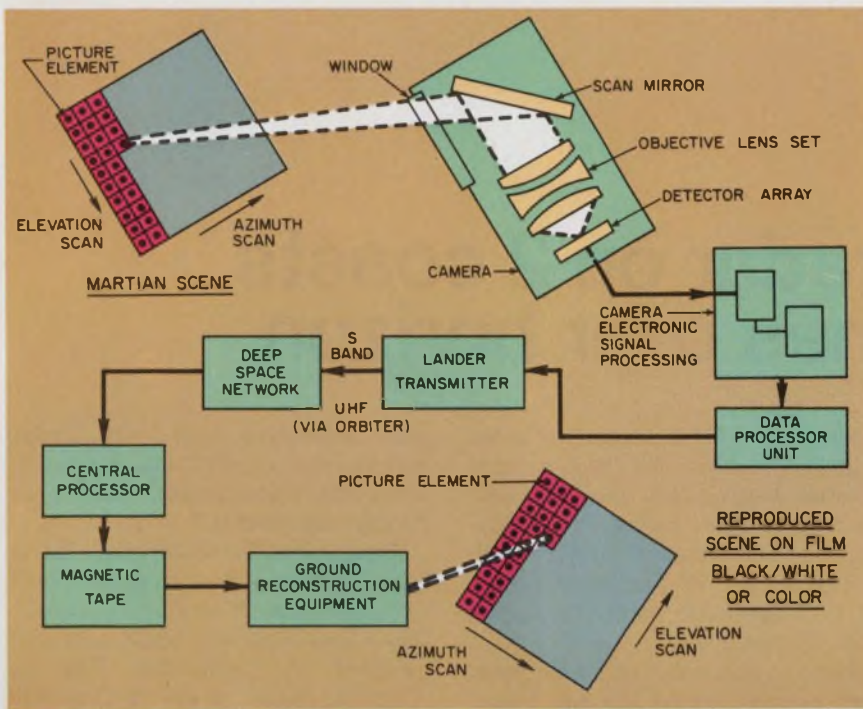

Pictures of the surface of the so-called "red" planet will be taken by two facsimile cameras capable of providing stereo color with a 360-degree field of view. The camera will have a scanning mirror and an array of photodiodes at different distances from the lens to change focus. Color information will be obtained by scanning the scene three times through red, green and blue filters. The three resulting pictures will be transmitted to Earth, where they will first be reconstructed in black and white and then combined by a color-separation process.

The UHF and S-band antennas on the lander will be of similar construction, the major difference being their physical size. Using two sets of cross dipoles over a tuned grid reflector, the novel antenna will save 50% in weight over earlier designs. In addition, there will be a high-gain dish antenna that will be used for S-band transmissions to Earth. UHF will be used to relay information to Earth via the orbiter at a data rate of about  $10^7$  bits a day. The direct Mars-Earth S-band link will be capable of transmitting about  $10^6$  bits of data a day. The S-band radio system, as with most critical systems in the project, will be completely redundant. The UHF transmitter will be a 30-W unit, while the S-band transmitter will be a 20-W device that will use a traveling-wave-tube amplifier.

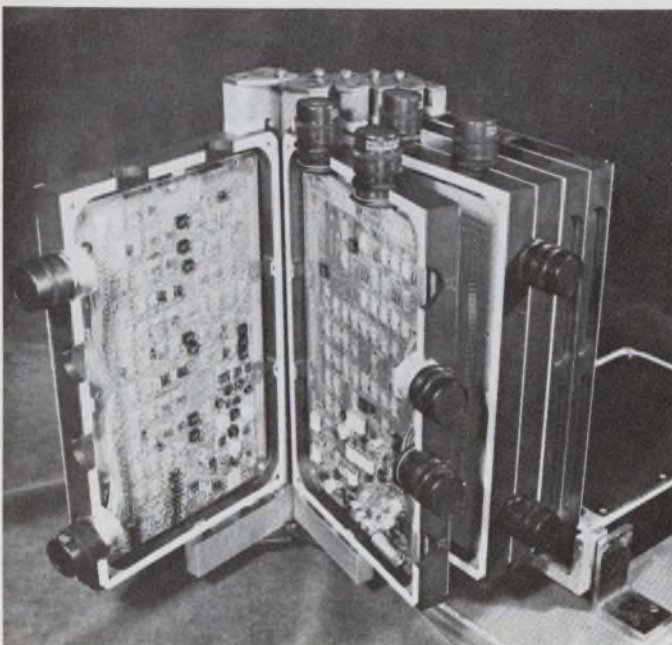
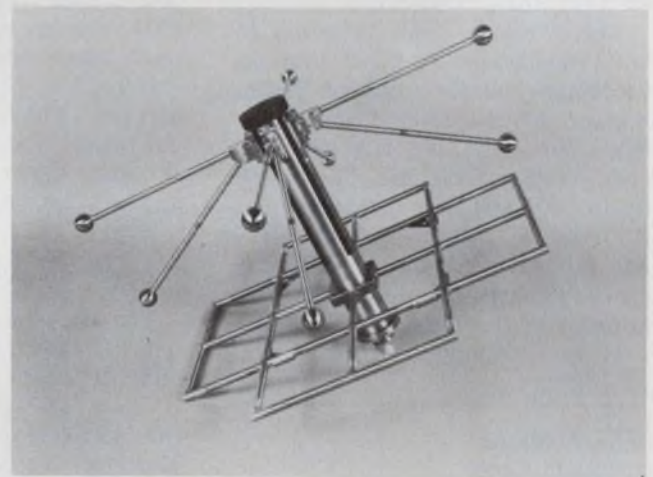

Control of data flow will be handled by the data acquisition and processing unit (DAPU). Commanded by the onboard computer, the DAPU will direct data from the various scientific instruments into tape or memory storage or will switch the information to either the direct S-band link or the UHF transmitter. The onboard computer has a capacity of 20,000 twenty-five bit words. The computer will be on-line continuously, will consume an average of 5.2 W and will be dual redundant.

*The Viking project is being carried out under the management of the Langley Research Center, Hampton, Va., and the prime contractor is the Martin Marietta Corp., Denver. Major subcontractors for the project include: TRW Inc., Lockheed Electronics Corp., Itek Inc., RCA, Honeywell, Philco-Ford and Teledyne. The orbiters are being supplied by the Jet Propulsion Laboratory, Pasadena, Calif.*



# Backscatter radar on 2 coasts to detect planes over horizon

After years of research and development and many months of highly classified tests with elaborate installations, the Air Force has proved to its satisfaction that it has a practical tool to detect enemy aircraft approaching the United States long before they get within range of conventional line-of-sight ground radar. The technique is over-the-horizon backscatter radar (OTH-B).

The Defense Dept. is going to build operational OTH-B systems in Maine and the state of Washington. At the same time, in an effort to extend detection coverage even farther, the Air Force will begin testing a new technique that it believes will outfox OTH-B's natural enemy, the electrically-charged particles in the aurora borealis in the Arctic.

If that technique is successful,

---

**John F. Mason**  
Associate Editor

operational OTH-B radars could be built in the Arctic to detect enemy aircraft long before they reached the North Pole. Called Polar Cap III, the experimental project will be carried out in Northwest Canada in cooperation with the Canadian Government.

Tests in the temperate zone have been carried out by the Air Force on one OTH-B system in Caribou, Me. These began in November, 1971, and are still going on. Tests on another system in New Kent County, Va., began in April, 1972, and were finished in May. Tests in Northwest Canada for Polar Cap III will begin in October, 1972, and will last for one year.

## A check on polar events

The experiments in Canada are to learn how well OTH-B signals will propagate over the polar cap if they are transmitted through the relatively quiet oval core of the Northern Lights. The tests will

also determine how well radar signals can survive other electromagnetic disturbances, known as "polar cap events."

Equipment for Polar Cap III is being airlifted now to Hall Beach on Canada's Melville Peninsula. The Canadians will build a second receiver at Cambridge Bay on Victoria Island to see if they will receive returns that don't get back to the U.S. site.

All three OTH-B radars are hf pulse-doppler monostatic systems operating between 6 and 30 MHz. Monostatic means that the same antenna is used for both transmitter and receiver. The radars use vertical log-periodic antenna arrays of slightly different configurations.

The Maine radar, known as Polar Fox II, is made up of 32 log-periodic array elements — four for the transmitter and 28 for the receiver. The transmitter arrays carry up to 800 kW of power. Receiving arrays have a sidelobe

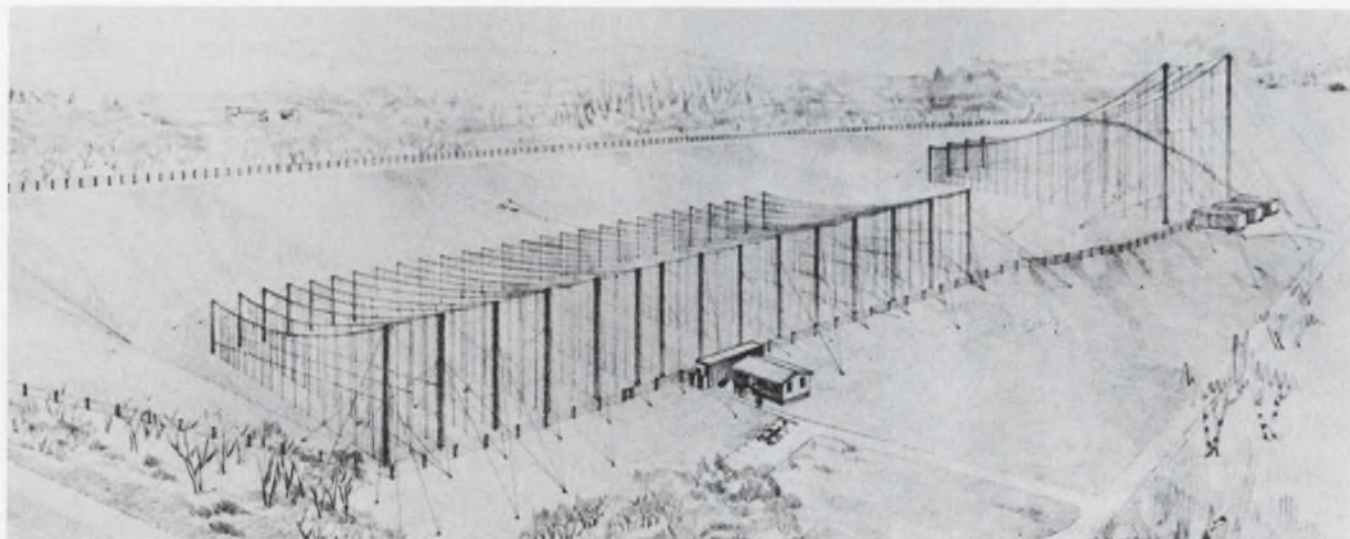

Vertical log-period antenna array for a pulse-doppler, over-the-horizon backscatter radar in Caribou, Me., is the

forerunner of a similar system being built in Canada. The latter is for the detection of aircraft over the Pole.



# 38% OFF

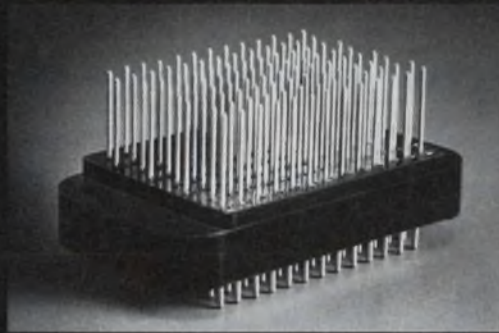

This isn't a discount sale on rack and panel connectors and it's not just a way of getting rid of old inventory.

It's just a plain and simple fact that you can save money by using our P108 rack and panel connector.

And as an even bigger advantage, the savings come on your end of the line, not ours.

You can save on installation cost, because the P108 comes completely assembled. All you need is someone to snap it into place.

In one installation, using fifty-four of our 104-pin P108 connectors, the customer was able to reduce assembly time by 18.6 hours using a combination of automatic and semiautomatic wire wrapping techniques.

This resulted in a 38% reduction in overall assembly labor.

He also got an extra measure of assured reliability, because on any GTE Sylvania connector everything is made by GTE Sylvania — from plastic body to gold-plated contacts.

The standard P108 connector comes with 104 pins. We also have a 50-pin version.

On the 50-pin version, your savings will be a little bit less than on the 104-pin design.

Sorry about that. In any event, why not contact Marv Gustafson at 814-723-2000. He'll tell you all about the P108 and our complete custom facility. GTE Sylvania, Precision Materials Group, Parts Division, Warren, Penn. 16365.

**GTE SYLVANIA**



level of -26 dB.

The radar in Virginia, which is a preliminary part of the Polar Cap III project, is much smaller, using only four elements.

The Polar Cap III system in Canada will consist of a row of 32 elements parallel to each other, 40 feet apart, making an array 1300 feet long. Each element will be 200 feet long, thereby making the array's width 200 feet.

Each element will consist of a 150-foot tower and a 50-foot pole, 200 feet apart. One sloping, sagging wire will join the tops of the structures, and another wire—the feed line for the transmitter power—will be attached to points halfway up each of these vertical supports. Twenty to 30 radiators will hang from equally spaced points along the top wire, join the feed wire and extend on to hooks in cement in the ground. Each of the 32 elements will be joined to the element next to it.

The length of the antenna acts as the antenna "dish," transmitting the radiated energy in the direction of tower to pole. In this case, the array will be "pointed" in a northwesterly direction, covering an arc of 60 degrees. The radar will have a 3-MW output.

To steer the array, a smooth phase retardation is introduced across the aperture. This is done in both receiving and transmitting by introducing increasing amounts of delay in the feed cables at each

port of the array.

To insure that the beam is formed correctly, power for each transmitter that serves an array is split into as many pieces as there are ports in the antenna. This is done through high-efficiency power-splitting hybrids. These devices divide the power and provide high port-to-port isolation, a property important in the development of a regular scanned beam.

The U. S. equipment consists of 11 40-foot trailers that contain the transmitter facilities, two intermediate power amplifiers and 16 final-stage amplifiers. A separate building houses the exciter, the processor and receiver system.

### Environment kills pulse radar

The operational radars for Maine and the state of Washington, called Conus 414-L, would have been pulse-doppler monostatic radars like their predecessors except for their high cost and the "hostile impact a pulse radar would have on the environment because of its high-peak radiated rf energy." The evaluation is contained in an Air Force environmental impact statement—a report that any agency must submit before putting in an installation that might have an effect on the environment.

Instead of pulse doppler, an FM cw bistatic type radar will be built

in Maine and in Washington. Despite its being the lesser of two hazards, the FM cw radar will nevertheless operate at "high frequencies and with high power," the Air Force report states. The statement also notes the following:

Each system will require 400 acres for the transmitter and 300 for the receiver. The two areas must be separated by at least 50 miles so that signals from the transmitter won't travel by ground waves and swamp the receiver. An operations site will be required, and it must be 10 miles from the receiver to protect it from interference by its rf noises.

Because of the system's high power, personnel must stay 180 feet from the transmitter—or if a person is wearing a pacemaker, 5100 feet. Ordinary broadcasting transmissions may be affected at distances of one to two miles, and hf and uhf as far as 100 miles. Aircraft radios may be burned out if they fly within 10 to 20 miles, the Air Force says.

Polar Fox II in Maine was sponsored by the Defense Dept.'s Advanced Research Projects Agency under supervision of the Air Force's Rome (N.Y.) Air Development Center. It was built and operated by the Raytheon Co. of Sudbury, Mass., with scientific and technical direction provided by the Lincoln Laboratory, Bedford, Mass. ■■

---

## Microwave rf detection made easy

An inexpensive, easy-to-operate microwave radiation detector has been developed by Bell Telephone Laboratories. It will be used within the Bell System to locate rf leakage in microwave radio-relay installations.

Most instrumentation currently available is either too specialized or requires a thorough understanding of antenna theory.

The new detector, with hand-held probe and an electronics package, weighs about 2-1/2 pounds, is battery operated and has five



New microwave detector is demonstrated by Ronald Petersen of Bell.

ranges of sensitivity: 0-0.3, 0-1, 0-3, 0-10 and 0-30 mW/cm<sup>2</sup>.

To survey an area, the operator simply sets the instrument to the appropriate sensitivity range. Any leakage present is displayed on the meter directly in mW/cm<sup>2</sup>.

Developed by Ronald Petersen, a member of the Environmental Health and Safety Dept. at Bell Laboratories, Murray Hill, N.J., the instrument will be used to survey rf radiation between 1 and 7 GHz. Within this band are the Bell System radio-relay frequencies. ■■



*NO MATTER WHERE YOU ARE....*

# **BOURNS®**

**ENTIRE LINE  
OF PRECISION POTENTIOMETERS  
... IS STOCKED IN DEPTH**

Bourns has 73 distributor locations; more than any other potentiometer manufacturer. One is near you... no matter where you are. Each has a complete stock of Bourns Precision Potentiometers; the industry's widest selection.

10-turns, 5-turns and 3-turns . . . in 1/2", 7/8", 1 1/16" and 1 3/16" diameters . . . with wirewound and INFINITRON® Conductive Plastic elements . . . in either bushing or servo-mount configurations.



**For complete details, or to enter your order, contact your local Bourns distributor, a Bourns sales office, representative or the factory-direct.**



**BOURNS, INC., TRIMPOT PRODUCTS DIVISION • 1200 COLUMBIA AVE., RIVERSIDE, CALIF. 92507**

**BOURNS DISTRIBUTORS —**

**ALABAMA**/Cramer/E. W. **ARIZONA**/Kierulff Elect. **CALIFORNIA**/Westates Elect. Corp. • Hamilton Electro Sales • Liberty Electronics • Elmar Elec. Inc. • Hamilton/Avnet • Electronic Supply Corp. • Western Radio **COLORADO**/Hamilton/Avnet • Kierulff **CONNECTICUT**/Conn. Electro Sales • Cramer Elect. Inc. **FLORIDA**/Cramer/E. W. • Hamilton/Avnet • Hammond Elect. Inc. **GEORGIA**/Jackson Elect. Co. **ILLINOIS**/Allied Elect. Corp. • Newark Elect. Corp. • Hamilton/Avnet **INDIANA**/Ft. Wayne Elect. Supply Inc. • Graham Elect. Supply Inc. **KANSAS**/Hall-Mark Elect. Inc. **LOUISIANA**/Southern Radio Supply Inc. **MARYLAND**/Cramer/E. W. • Pioneer/Washington Elect. Inc. **MASSACHUSETTS**/Electrical Supply Corp. • Cramer Elect. Inc. **MICHIGAN**/Harvey-Michigan **MINNESOTA**/Lew Bonn Co. • Hamilton/Avnet **MISSISSIPPI**/Ellington Electronic Supply, Inc. **MISSOURI**/Hamilton/Avnet • Hall-Mark Electronics Corp. **NEW JERSEY**/General Radio Supply Co. • Hamilton/Avnet • Eastern Radio Corp. **NEW MEXICO**/Electronic Parts Co. **NEW YORK**/Standard Electronics Inc. • Cramer/Binghamton • Cramer/Esco • Cramer/Eastern • Hamilton/Avnet • Federal Elect. Inc. • Schweber Electronics • Harvey Radio Co. **NORTH CAROLINA**/Cramer/E. W. **OHIO**/Hughes-Peters, Inc. • Pioneer **OKLAHOMA**/Hall-Mark Elect. **PENNSYLVANIA**/Pyttronics • Powell Elect. • Cameradio Co. **RHODE ISLAND**/Wm. Dandreta Co. **TEXAS**/Hall-Mark Elect. Co. • Hamilton/Avnet • Harrison Equip't Co. **UTAH**/Cramer **WASHINGTON**/Liberty Elect. **WISCONSIN**/Taylor Electric Co. **CANADA**/Varatronics • Cesco Elect. • Zentronics Ltd.

INFORMATION RETRIEVAL NUMBER 18



## technology abroad

A digital process controller designed to interface with any computer has been produced by Mimic Electronics of Kent, England. All modules of the new controller plug into a common data transfer channel. Each can be addressed individually. Also, data transfer is asynchronous so that the processor and the control module each operate at their own speed. To achieve asynchronous operation, all analog measurements are continuously available in the common data transfer channel as a 10-bit gray code. This progressive code does not pass through scattered transition states when changing in value; consequently the computer can interrogate any measurement available in the same manner that computer

memory locations are addressed and interrogated. Special large-scale integrated data-encoding circuits—a digital filter and comparator, a gray-code counter and a binary rate multiplier—were produced by Plessey for Mimic Electronics at a low cost.

CIRCLE NO. 397

The four-bit central processor unit introduced late last year by Intel has been designed into a new automatic typing system by a new English company, Dataplex. In operation, a conventional electric typewriter is driven by either of two magnetic cards on which repetitive information is stored. The

unit also serves as a low-speed data terminal when coupled through a modem to a telephone line. Using the Intel kit—which comprises a four-bit CPU with 45 instructions, an array of ROMs for storing fixed programs and an array of RAMs for storing data—Dataplex engineers added number-handling ability to their system in less than four months. This allows it to handle bookkeeping and purchase-order applications.

CIRCLE NO. 398

Seven hundred thermocouples, vapor-deposited in the form of alternate p and n-junction semiconductors on one meter of coiled plastic tape, make up the thermopile that powers Siemen's new implantable nuclear-powered pacemaker. The thermopile, developed at the Siemens' Research Center in Munich, West Germany, provides 100  $\mu$ w of electrical power from 100 mW of thermal energy. A second thermopile of the same plastic tape—polyimide—is connected in parallel with the first to provide added reliability. The pacemaker will be marketed by Elema-Schonander, a Siemens subsidiary.

CIRCLE NO. 399

A powerful laser is aiding crime detection in Austria. Even though lawbreakers leave only negligible quantities of trace material at the crime scene, particles of less than 30- $\mu$ m diameter can be evaporated by the beam of a 1-joule ruby laser combined with an aiming microscope. The sample vapor generated is fed into an electric discharge, which excites its spectrum. Further analysis is done with a fairly conventional optical spectroscope. The method has been developed by an Austrian criminologist, Dr. Heinz Neuninger. The laser system is from Optische Werke Jena.

CIRCLE NO. 400

# think woven



for economy

Save when you buy it. Save when you use it. Today's best flat cable value brings neatness and accuracy to every application. Fast, easy handling cuts your production costs, increases system quality.

## WOVEN ELECTRONICS

A DIVISION OF SOUTHERN WEAVING COMPANY

P.O. Box 189, Mauldin, S.C. 29662, (803) 288-4411

INFORMATION RETRIEVAL NUMBER 19

More TI integrated circuits are used in today's electronic systems than any other brand in the world. And for the reasons you'd expect: Technology. Volume. Price. Breadth. Dependability. Service. Quality. Weigh them all when you buy digital logic.

Someday all TTL circuits will probably be Schottky-clamped. High-speed. Low-power. Memories. Since we produced the first one, we've offered you the best and biggest choice.

---

**SCHOTTKY**



SN74LS195N



SN74LS83N



SN74LS194N



SN74LS139N

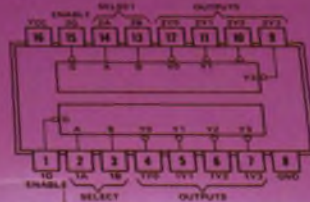

SN74LS196N

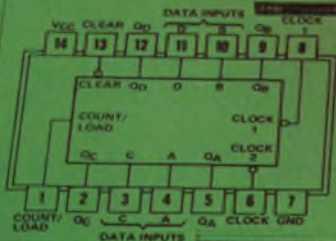

SN74LS138N

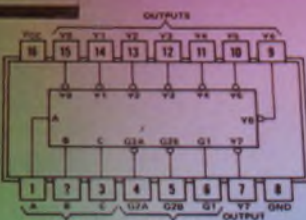

SN74LS295N

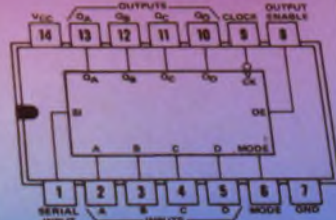

SN74LS181N

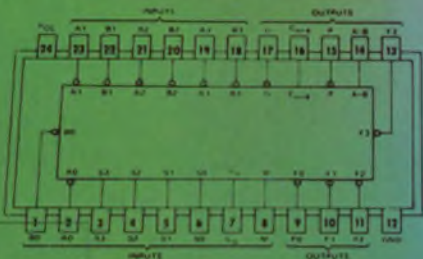

SN74LS153N

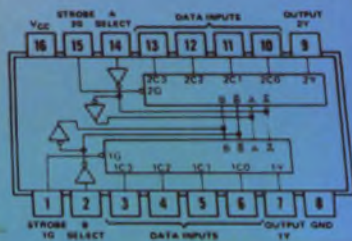

SN74LS197N

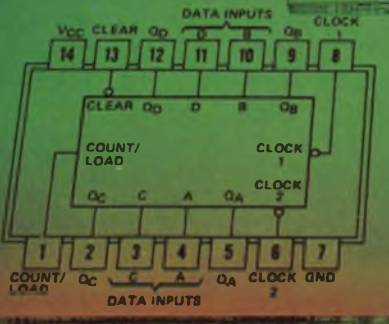

SN74LS155N

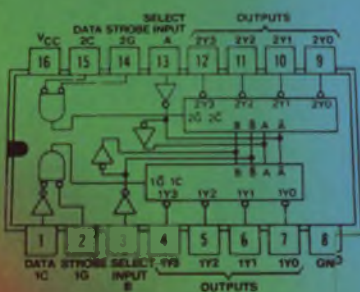

SN74LS95AN

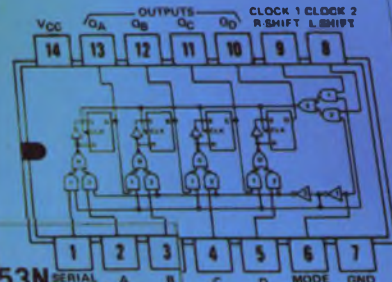

SN74LS253N

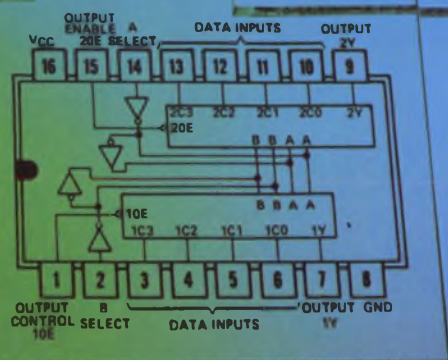

More TI integrated circuits are used in today's electronic systems than any other brand in the world. And for the reasons you'd expect: Technology. Volume. Price. Breadth. Dependability. Service. Quality. Weigh them all when you buy low-power logic.

SCHOTTKY



# TI announces low-power Schottky MSI: 10 ns at less than 2 mW.

TI's new low-power Schottky TTL line provides all the performance of low-power TTL (Series 54L/74L) with increased speed of 10-ns/gate and power dissipation of less than 2 mW.

### Improved performance in power-critical applications

Low-power Schottky offers greatly improved speeds in portable or remote systems, or in any application where minimum power is a prime consideration. Compared to their low-power TTL counterparts, low-power Schottky circuits require less than 1 mW/gate more power—but offer a three-fold increase in gate speeds.

Typical Speed/Power Performance Comparison

Family	54H/74H	54/74	54S/74S	54L/74L	54LS/74LS
Average Propagation Delay (ns)	6	10	3	33	10
Average Power Dissipation (mW)	22	10	19	1	2
Speed/Power Product (pJ)	132	100	57	33	20

### Full compatibility

TI's new low-power Schottky series is compatible with all TTL—standard, high-speed, low-power and Schottky. Together, these TI families offer more than 250 integrated circuit functions with compatible logic levels, voltage swings and noise margins. No interface circuits or level shifters are required.

### Broad MSI line available now

TI's low-power Schottky TTL line now includes 13 high-complexity functions. These circuits offer you the full benefits of MSI design—fewer packages, smaller PC boards, fewer system interconnections—all contributing to lower component and system costs per gate, plus added reliability.

And within weeks, TI will introduce a full line of

low-power Schottky SSI, including 13 gates and eight flip-flops.

Here are the MSI functions available now:

	DESCRIPTION	TYPICAL SPEED	TYPICAL POWER (mW)	100-PIECE PRICE
SN74LS83N	4-bit full adder	35 ns	80	\$ 3.51
SN74LS95AN	4-bit left-right shift register	30 MHz	52	4.78
SN74LS138N	3 to 8 line decoder. 1 to 8 line demultiplexer	20 ns	30	4.78
SN74LS139N	Dual 2 to 4 line decoder. Dual 1 to 4 line demultiplexer	20 ns	35	4.78
SN74LS153N	Dual 4 to 1 data selector/multiplexer	15 ns	35	4.78
SN74LS155N	Dual 2 to 4 line decoder	20 ns	30	4.78
SN74LS181N	Arithmetic logic unit/function generator	30 ns	105	25.85
SN74LS194N	4-bit bidirectional universal shift register	30 MHz	60	4.78
SN74LS195N	4-bit parallel-access shift register	30 MHz	52	4.78
SN74LS196N	Presettable decade counter	30 MHz	55	4.78
SN74LS197N	Presettable binary counter	30 MHz	55	4.78
SN74LS253N	3-state version of SN74LS153	20 ns	45	5.74
SN74LS295N	3-state version of SN74LS95A	30 MHz	60	5.74

### Immediate availability

Low-power Schottky circuits are available in the plastic dual-in-line package. Evaluation quantities are available immediately from your authorized TI distributor or direct from factory inventories. Production quantities are available four weeks ARO.

### Send for data sheets

For complete information on TI's new, low-power Schottky family, circle 210 on the Reader Service Card. Or write Texas Instruments Incorporated, P. O. Box 5012, M/S 308, Dallas, Texas 75222.



TEXAS INSTRUMENTS  
INCORPORATED



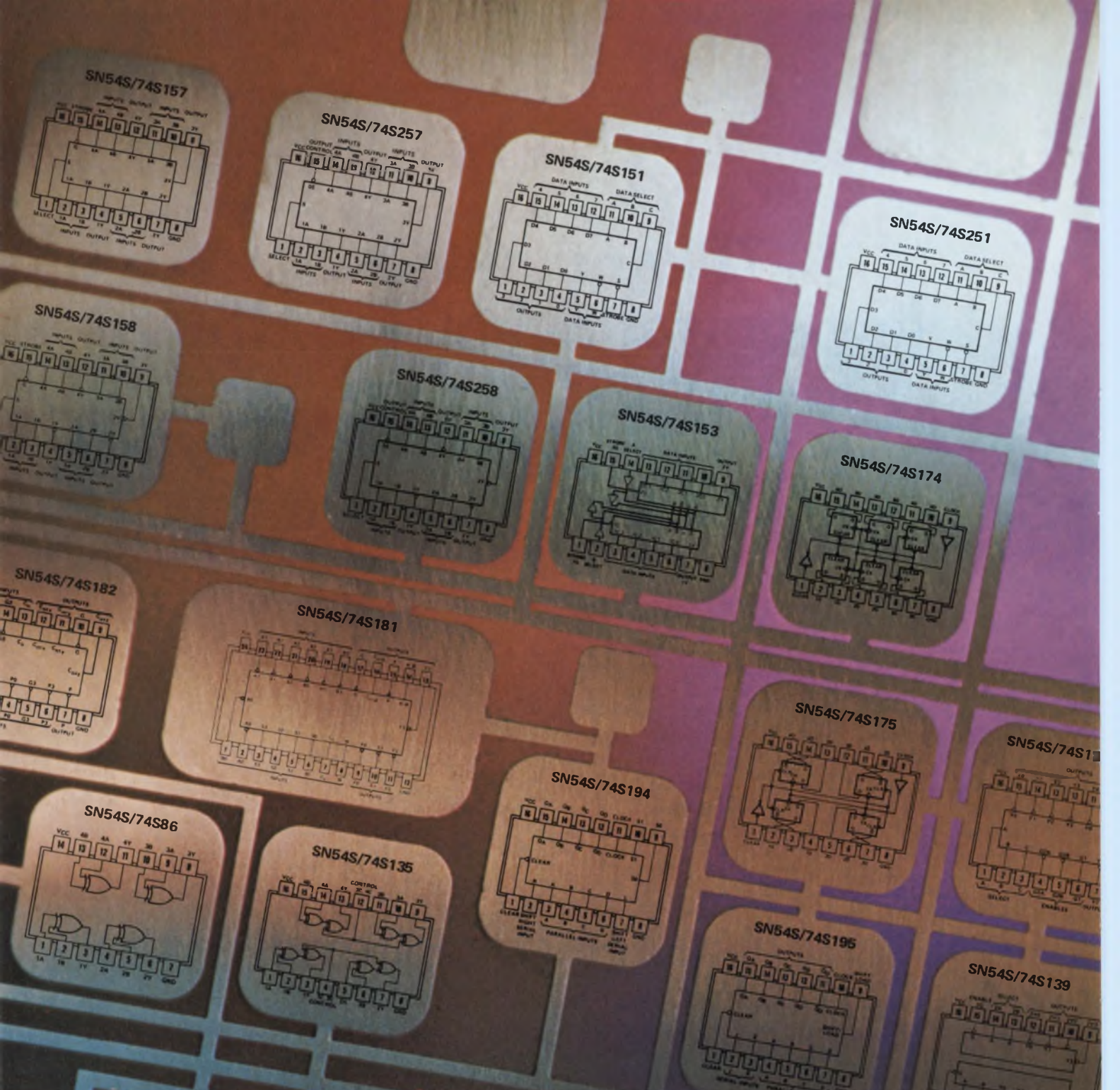

More TI integrated circuits are used in today's electronic systems than any other brand in the world. And for the reasons you'd expect: Technology. Volume. Price. Breadth. Dependability. Service. Quality. Weigh them all when you buy high-speed logic.

# SCHOTTKY



# TI announces more Schottky MSI: decoders, D-registers, shift registers, multiplexers and arithmetic elements.

In any logic form, complexity is the key to low system cost, maximum performance and reliability.

You'll find your best choice of high-complexity, high-performance Schottky TTL circuits at TI—now and in the future.

We've just added more MSI circuits to the 3-ns 54S/74S line (nearly doubled it) and all are in volume production now.

## Your best high-performance logic choice

TI's Schottky TTL reaches back through the evolution of transistor-transistor logic for reliability, design simplicity, volume availability, low cost and versatility—and combines these advantages with superior performance previously achieved only with unsaturated logics.

Here are the benefits of designing with TI Schottky MSI:

- Improved system speeds—internal-gate propagation delays as low as 1.5 ns, with an average of 2.4 ns.
- Reduced power dissipation—as low as 8 mW/gate, with an average of 13.7 mW.
- Total compatibility with all other 54/74 TTL families.
- Design rules similar to 54H/74H TTL.
- Guaranteed operation over full military (–55°C to 125°C) and industrial (0°C to 70°C) temperature ranges.
- Full package range—plastic and ceramic DIP and flat pack.
- Fewer system interconnections for increased reliability.
- Fewer packages, smaller PC boards.
- Lower component and system costs per gate.

## For new systems—or easy upgrading of existing designs

Not only can new systems incorporate the performance advantages of Schottky MSI, but existing designs can in many cases be upgraded by replacing 54/74 MSI functions with a pin-compatible, functionally identical 54S/74S version.

TI's Series 54S/74S Schottky TTL is totally compatible with all TTL...standard, high-speed, low-power and low-power Schottky. Together, these TI families offer more than 250 integrated circuit functions with compatible logic levels, voltage swings and noise margins. No interface circuits or level shifters are required. In addition, Schottky TTL will interface directly with DTL and most low-threshold MOS.

## Broad choice of functions

Series 54S/74S offers you 17 MSI functions, supported by an SSI line that includes 13 gates, a power buffer, a line driver, and 4 dual flip-flops. MSI circuits available now include:

### 100-MHz Shift Registers/Storage Registers

SN54S/74S174	Hex D-type storage register
SN54S/74S175	Quad D-type flip-flop, complementary outputs/clear
SN54S/74S194	4-bit bi-directional shift register
SN54S/74S195	4-bit parallel-access shift register

### Arithmetic Elements

SN54S/74S86	Quadruple Exclusive-OR
SN54S/74S135	Quadruple Exclusive-OR/NOR
SN54S/74S181	4-bit arithmetic logic unit and function generator
SN54S/74S182	Carry look-ahead generator for SN54S/74S181

### Data Selectors/Multiplexers

SN54S/74S151	8 to 1-line
SN54S/74S251	8 to 1-line with tri-state outputs
SN54S/74S157	Quad 2 to 1-line, true output
SN54S/74S257	Quad 2 to 1-line with tri-state true outputs
SN54S/74S158	Quad 2 to 1-line, inverting output
SN54S/74S258	Quad 2 to 1-line with tri-state inverting outputs
SN54S/74S153	Dual 4 to 1-line

### Decoders/Demultiplexers

SN54S/74S138	8 to 3-line
SN54S/74S139	Dual independent 2 to 4-line

## Send for brochure

For details on TI's TTL Schottky family, get a copy of Bulletin CB-147. Circle 211 on the Service Card or write Texas Instruments Incorporated, P. O. Box 5012, M/S 308, Dallas, Texas 75222.

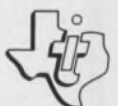



# Do you want to have the whole picture on Japan's great leap forward?

## The Japanese Miracle and Peril Willard Price

Leading the world's nations in electronics, shipbuilding, cameras, watches, literacy rate . . . gaining rapidly in other areas, Japan has risen meteorically from the ashes of World War II. Such is the Japanese miracle. Within it looms the peril, expansionism, a Japanese passion that has recurred throughout her history. Willard Price, who has been interpreting Japan to the West for more than half a century, provides a fascinating, informative account of these inter-related themes as he probes Japan's history and the Japanese character for the root explanations of her dynamism.

256 pages, #6103-x, paperback

\$3.85

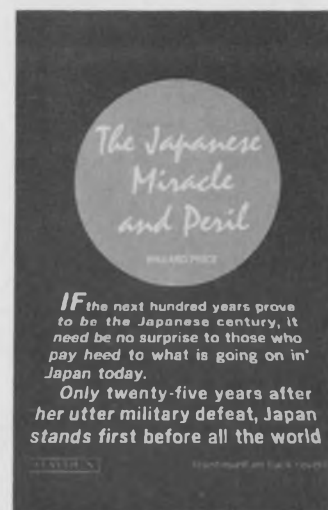

## Other New and Informative Books from Hayden

### Eight Lives in Jazz: Combo U.S.A.

RUDI BLESCH

Here are the stories behind the music, intimate portraits of the people who put their genius and dreams into a distinctly American sound. They all come alive in these pages: the late, legendary Louis "Satchmo" Armstrong; Sidney Bechet, Jack Teagarden; Lester Young; the bitter-sweet "Lady Day", Billie Holiday; Gene Krupa; Charlie Christian; and Eubie Blake.

240 pages, illustrated, #6104-8, paperback

\$3.65



### America the Vanishing: Rural Life and the Price of Progress

Edited by SAMUEL OGDEN

From paradise to pollution-riddled land, the sorry fate of the American countryside is recounted by some of our best-known writers. Audubon, Muir, Twain and others evoke the small-town and rural life that has virtually disappeared. In stark contrast, E. B. White, Rachel Carson, and other contemporaries portray the impact of progress on our environment and way of life.

256 pages, illustrated, #6105-6, paperback

\$3.95



### The Due Process Revolution: The Warren Court's Impact on Criminal Law

FRED P. GRAHAM

Demolishing the myth that the Supreme Court handcuffed the police, New York Times Supreme Court reporter Fred P. Graham reveals the background of such landmark decisions as Mapp, Escobedo, Miranda, and Wade. He places in perspective the Warren Court's courageous affirmation of the Constitution's promise of equality to all Americans.

377 pages, #6101-3, paperback

\$3.75

### The Politics of Fear:

### Joseph R. McCarthy and the Senate

ROBERT GRIFFITH

This compelling, award-winning study of a shameful episode in recent American history views McCarthyism as a political phenomenon created and sustained by politicians hungry for power or fearful of the passions aroused in a divided nation. In its eventual censure, the Senate side-stepped the real issues and assumptions upon which McCarthy built his career.

376 pages, #6100-5, paperback

\$3.75

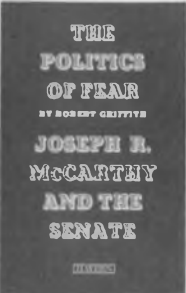

### The Electronic Invasion

ROBERT M. BROWN

Anyone concerned with Big Brother's methods will find this best-selling exposé fascinating and instructive. It details all types of snooping gadgetry, names major manufacturers and buyers. The extent of governmental and corporate bugging is surveyed, and legal strictures are fully covered.

188 pages, illustrated, #0779-5, paperback

\$4.95

### Humanizing Schools: New Directions, New Decisions

DOUGLAS H. HEATH

A disturbing analysis of today's youngsters and of where their schools are failing them. Reporting as one intimately involved as both educator and psychologist, Douglas H. Heath presents a realistic framework for deciding what must be done, and a compelling argument, why?

240 pages, #6003-3, cloth

\$6.95

At your bookstore or by mail with this convenient coupon.

 HAYDEN BOOK COMPANY, INC., 116 W. 14th St., New York, N.Y. 10011

Please send the book(s) whose code numbers I have circled below. Enclosed is my check for the total amount, plus 25¢ to cover postage and handling on my order.  
6103-X 6101-3 6105-6 6003-3 6104-8 0779-5 6100-5

If not satisfied, I may return the book(s) for full refund.

Amount enclosed: \$ \_\_\_\_\_

Send free 96-page catalog of all Hayden Books.

Name \_\_\_\_\_

Address \_\_\_\_\_

City \_\_\_\_\_

State \_\_\_\_\_ Zip \_\_\_\_\_

72-35 ED





# Interface with the special cable specialists

CALL (317) 966-6681

■ **It's Belden's Electronic Custom Design Center:** Designers, engineers, production and cost analysis people. The kind you can talk to about special cable problems. And count on for straight answers and action. ■ They can tell you if your idea is feasible. What it might cost in quantity. Even give you production and delivery data. ■ Water-blocked cable; extra-high voltage applications; medical instrumentation; low-level signal interference problems; unusual environmental conditions . . . they have tackled most of the problems that might confront you. ■ So try the direct line to special cable answers: (317) 966-6681. ■ Or send for a Custom Cable Design Kit. Write: Belden Electronic Division, Custom Design Center, P.O. Box 1100; Richmond, Indiana 47374.

B-2A-2

**BELDEN** 





N  
pdp11/05

PANEL LOCK

POWER

OFF

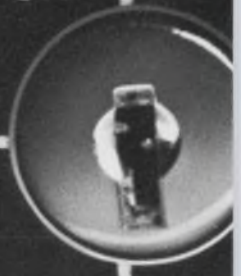

# The smallest PDP-11 just got bigger.

Bigger in performance. Not in price. Or size. It's a power package that's designed to shake up the competition.

We've given the 11/05 a real time clock.

We've replaced the standard 1.2 usec memory with one that's 0.9 usec fast.

And added our PDP-11 multi-level automatic priority interrupt.

So now you can spend less time writing programs and more time out selling

your systems.

Now the 11/05 will do your job, any job, better, more efficiently than ever before.

You can even use it for disc-based systems.

But the 11/05 still goes for the same, easy-to-take \$4,795 per. Including 4K core.

Or \$3,070 in quantities of 100.

For which you still get the same UNIBUS™ architecture, direct memory access, hardware stacking, vectored interrupts, automatic power fail protection and all the other

features that have made the PDP-11 the best-selling 16-bit computer on the market.

We've already sold a lot of 11/05's.

And we're going to sell a lot more.

Because now the 11/05 is an even bigger bargain.

Digital Equipment Corporation, Maynard, Mass. 01754. (617) 897-5111. European headquarters: 81, route de l'Aire, 1211 Geneva 26. Tel.: 42 79 50.

digital

PDP IS A REGISTERED TRADEMARK OF DIGITAL EQUIPMENT CORPORATION

INFORMATION RETRIEVAL NUMBER 22

# washington report



Don Byrne  
Washington Bureau

## **Consumer-protection bill hits electronics**

The House and Senate are expected to begin debate soon on consumer-product safety bills that could have great ramifications in the consumer-electronics industry. Both bills would establish an agency or commission with complete authority over not only the inherent safety of a manufactured product, but its labeling and content as well.

A major difference between the two bills could lead to some haggling between the Senate and House. The Senate bill would include the Food and Drug Administration in the new agency while the House bill would leave the FDA out. But whatever the fate of the FDA, most observers agree that some consumer-product safety measure will pass both houses in this session.

The only electronic consumer products exempted from control are medical devices and those, like microwave ovens and X-ray machines, that give off measurable radiation. These are already regulated by the Department of Health, Education and Welfare.

## **FCC cable-TV authority upheld**

The Federal Communications Commission's authority over cable television has been upheld by the Supreme Court but the court has warned Congress that it needs to examine existing laws in the field to handle the "explosive development" of cable television. The majority opinion of the court held that, until Congress acts to spell out the FCC authority, the court will have no choice but to allow the FCC great freedom in dealing with the CATV industry.

At issue in the case was a 1969 ruling by the FCC that CATV operators with 3500 or more subscribers must originate local programming. The dissenters in the high court's 5-4 decision held that to "entrust the Commission with the power to force some, a few, or all CATV operators into the broadcast business is to give it forbidding authority." The National Cable Television Association saw the decision as giving the FCC's authority to regulate and encourage the growth of CATV "a significant boost."

## **Space program feels impact of election year**

The election is still almost five months away but politics has already made its presence felt in the aerospace and scientific communities. Rep. George P. Miller (D-Calif.), long-time chairman of the House Science and Astronautics Committee, has been defeated in a primary race and the guessing has started on who will fill his chair.



Next in line is Rep. Olin E. Teague (D-Tex.), another strong backer of the space program, as was Miller. However, Teague is also chairman of the Veterans Affairs Committee and under House rules no member may hold two chairmanships at one time, though he may serve on two committees. Teague, a Silver Star winner in World War II, has devoted himself to veterans' matters since coming to Congress in 1946, and he may be reluctant to give up this chairmanship.

However, NASA people feel that Teague is also a very strong supporter of the space effort and for that reason will take over that committee and give up the veterans' committee. If Teague does not move up on the space committee, the head seat will go to Rep. Ken Hechler (D-W. Va.) who has been somewhat less than an ardent fan of the space program. All this, of course, assumes that the Democrats retain control of the House.

## House committee questions OTP role

The House Post Office and Civil Service Committee has taken a look at the function of the White House Office of Telecommunications Policy and did not like what it saw. The committee raised questions about the newly created White House office. For example: "Can the Office of Telecommunications Policy be used to pressure unruly networks or individuals to adopt a less critical approach to reporting administration announcements?"

The committee also questioned "Whether the White House has any business creating an office to supervise an ostensibly independent regulatory agency whose commissioners are appointed by the President." Further probing of OTP and its roles in recent FCC decisions on domestic communications satellites, microwave common-carrier competition, cable television, and aeronautical communication satellites will probably have to be performed by the Interstate and Foreign Commerce Committee or the government operation committees of the House. The Post Office and Civil Service Committee made it clear it was raising the questions but not planning any further action.

**Capital capsules:** Robert C. Wilson, president and chief executive officer of Collins Radio says a joint government/industry organization to support and foster communications in this country should be formed immediately. Wilson told the annual meeting of the Armed Forces Communications and Electronics Association that the U.S. is losing its position of world leadership in communications and the public seems to be indifferent to the trend. . . . Even with the FCC regulations on cable television pretty well squared away, don't look for a spate of new licenses. Nearly 400 applications for CATV systems are pending before the commission and of that total 90 percent are contested. FCC is looking for a way to simplify procedures in granting the franchises. . . . The Office of Telecommunications Policy is reportedly softening its stand on the overocean aeronautical satellite program. OTP blocked it originally because it wanted both the U.S. and European operations to be privately owned and leased to the government involved. It may now settle for just having the U.S. portion privately owned. . . . The Commerce Department says it expects the U.S. share of the foreign market for industrial and scientific instruments to climb to \$1-billion annually within the next three years. In 1970, which offers the latest figure available, the U.S. share was \$578-million. The growth of U.S. exports will be spurred by overseas expansion of "manufacturing and process industries, communications, research and development and pollution control."



# THE TEKTRONIX S-3260 AUTOMATED TEST SYSTEM

*...the result of years of systems experience...*

## THE S-3260 WILL TEST:

- **MOS and Bipolar Shift Registers**
- **Random Access Memories**
- **Read-Only Memories**
- **MOS and Bipolar Random Logic Arrays**
- **Circuit Boards**
- **Modules**
- **Subsystems**

## S-3260 FEATURES:

- **Advanced Test Fixturing**—Nanosecond Response Characteristics
- **128 Active Pins**—64 Input, 64 Output
- **Functional Tests**—20-MHz Data Rate; Force, Compare, Mask and Store @ 20 MHz; Individual Drive and Compare Levels at Each Pin; Programmable Loads.
- **Parametric (DC) Tests**—Functional Preconditioning, Differential Voltage Measurements; Kelvin Connections; Force V, Measure I; Force I, Measure V.
- **Dynamic (Timing) Tests**—One Shot Time Measurements; Functional Preconditioning; Dual, Strobed Comparators; Active or Passive Loads.
- **Go-No-Go or Analytical Tests**
- **Interactive Program Writing**
- **Device-Oriented Source Language**
- **Graphical Test Result Displays**
- **Data Logging and Data Reduction with Computer Graphics Displays**
- **Optional Hard Copy Output**
- **Modify Tests and Data Logging Options at Run Time**

Your TEKTRONIX Field Engineer can arrange a discussion with a Systems Specialist. Call him or write Tektronix, Inc., P. O. Box 500-A, Beaverton, Oregon 97005.



INFORMATION RETRIEVAL NUMBER 23



# to build a better VHF/UHF FET mixer:

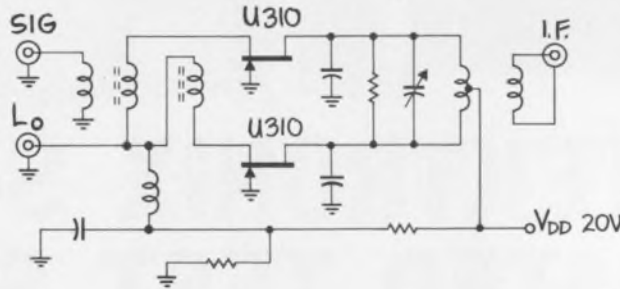

Try our U310 junction FET in this balanced mixer and make your own performance comparison. Our results are below. The inherent square-law transfer characteristic of the FET ensures high intermodulation intercept and signal desensitization. The grounded-gate connection is most stable, while source injection of both the signal and local oscillator make easy impedance matching into the FETs. Also, the balanced configuration reduces l.o. radiation from the signal port and suppresses the generation of even harmonics (which helps reduce intermodulation).

How do you select an optimum JFET for a mixer? Low gate capacitance is needed for wide bandwidth — the Siliconix U310 typically has  $C_{gs} = 4.5 \text{ pF}$  and  $C_{gd} = 1.9 \text{ pF}$ . Useful conversion gain comes from high transconductance. Our U310 has typical  $g_{fs} = 14,000 \mu\text{mhos}$ . Dynamic range is bracketed by the lowest drain current for an acceptable noise figure and the maximum drain current — typically  $I_{DSS} = 40 \text{ mA}$  for the U310. For an optimum balance, matched pairs are available.

**50-250 MHz Mixer Performance Comparison**

Characteristic	JFET	Schottky	Bipolar
Intermodulation Intercept Point	+ 32 dBm	+ 28 dBm	+ 12 dBm†
Dynamic Range	100 dB	100 dB	80 dB†
Desensitization Level (the level for an unwanted signal when the desired signal first experiences compression)	+ 8.5 dBm	+ 3 dBm	+ 1 dBm†
Conversion Gain	+ 3 dB*	- 6 dB	+ 18 dB
Single-sideband Noise Figure	6.5 dB	6.5 dB	6.0 dB

† Estimated \* Conservative minimum

There's a lot more to this, so

## write for data

and get the complete story on VHF/UHF mixing and the Siliconix U310.

Applications Engineering: (408) 246-8905



### Siliconix incorporated

2201 Laurelwood Road, Santa Clara, California 95054

## We ride herd on vendors; How about helping us

Every once in a while we get sucked in. We write about a sensational new product, and it may not exist. Or its specs may not be what the manufacturer hoped they'd be when he announced the product.

In our Product Features, we give you the significance of important new products—not a mere recitation of the specs. We evaluate a product and show how it stacks up against its competition. And if a product has a fabulous spec for one parameter and a lousy spec for another, we tell you about both.

But we can't test these products. Even if we could, we wouldn't know if the sample we tested was representative of what you may be buying. Because we're normally first to publish information about important new products, we can't use the standard procedure of checking with earlier customers; the product is too new.

So we're normally forced to start with a preliminary data sheet that may not reflect a production run. In most cases, product performance and delivery match the vendor's promises. But not always.

The vendor may make a last-minute design change because he couldn't get delivery of a critical component. Or early acceptance of the product may exceed his expectations and make him stretch delivery schedules. If he expects average orders in the 5000-piece range and you hit him with a million-piece order, you may have to wait. (Or everybody else may have to wait while your order is filled.)

These are the problems we don't master. We have a good batting average, but we're not perfect. Some of our successes go unnoticed. These are the stories we never publish because our investigation convinces us that a manufacturer can't produce and deliver the product.

But we worry about the times we think he can deliver—and it turns out he can't. You can help us. Tell us about your experiences with the products we feature. We'll keep your comments in confidence, but they'll guide us.



A handwritten signature in cursive script that reads "George Rostky".

GEORGE ROSTKY  
Editor



# Now we offer you the world's first true nonpolar wet tantalum capacitor.

We call it the ANP. And it means protection. Full protection from voltage-reversal failures. And from circuit-damaging transients.

Realizing that not every circuit needs full protection, we also came up with the AHS. Type AHS tantalum capacitors are polarized units for operation with a DC bias, including the application of a reverse voltage not exceeding 3 volts.

The new capacitors come in 32 values and 9 case sizes. Stud or PC mounting. Within specified limits, they meet requirements of MIL-C-3965.

So, if you're looking for *true* nonpolarity—or precisely limited polarity—stop looking. We've got both. And bulletin 4-608 explains the details.



**MALLORY**

**MALLORY CAPACITOR COMPANY**

a division of P. R. MALLORY & CO. INC.  
Indianapolis, Indiana 46208

Electrical and Electronic Components • Sequence Timers • Metallurgical Products • Batteries

INFORMATION RETRIEVAL NUMBER 25

# SOLID STATE REPLACEMENTS FOR REED RELAYS



## 100% SOLID STATE DIP RELAYS FOR

- Computer interfacing
- Telecommunications

Teledyne offers a broad family of SPST isolated data couplers for switching analog or digital signals and AC or DC power.

**Model 640-1** Switches bipolar analog or digital signals up to  $\pm 50V$  at  $\pm 100$  ma from logic inputs. Up to 100 KHz switching rate with a saturation resistance of 5 ohms max. Dielectric strength 1000 VAC(P-P).

**Model 641-1 & 641-2** Switches 115VAC(-1) or 230VAC(-2) loads up to 1 amp from logic inputs. Dielectric strength 2500VRMS.

**Model 643-1 & 643-2** Switches 60VDC(-1) or 250VDC(-2) loads up to 0.4 amps from logic level inputs. Up to 100 KHz switching rate with saturation resistance of 5 ohms max. Dielectric strength 1000 VAC (P-P).

Write or phone for additional information.

**TELEDYNE  
RELAYS**

3155 West El Segundo Boulevard,  
Hawthorne, California 90250  
Telephone (213) 679-2205

\*Less than \$5.00 at 1000 pcs. and \$3.00 at 10,000 pcs. for most models.





# ED on Reed relays CDS

The reed relay was the glamour device of its time when it was developed at Bell Telephone Laboratories in 1938.

Its mechanical simplicity and promise of increased reliability at reduced cost challenged traditional electromechanical relays. But traditional relays persisted; they fought back, and smaller sealed versions evolved to compete with the reeds. All the while, the solid-state relay was in the laboratory.

Now the solid-state relay is the new glamour device. It is challenging both reeds and traditional relays.

Which type of relay will prevail?

It seems likely that there will be no outright winner. Because of continuing design improvements, the distinctions between the various types is becoming somewhat blurred, leading to overlap in their capabilities. But each type has basic distinguishing qualities that allow it to dominate primary application areas at present.

Reed relay, electromechanical or solid-state—whatever the type—manufacturers' specifications need careful interpretation. This report focuses primarily on reeds, but many of the same specifying problems occur with other types.

## Which type should be used?

Before specifying detailed performance characteristics, the design engineer must first decide which type of relay is best for his application. Though the solid-state capture the headlines, the reed relay can still top it in many designs. In fact, solid-state types can't touch many applications where reeds run away with the prize.

The strength of reeds is in their excellent isolation between input and output (the coil and

contacts). Compared with solid-state relays, reeds offer the following important advantages:

- Extremely low resistance with contacts closed.
- Wide choice of multiple-contact arrangements.
- Greater tolerance of temporary overloads.
- Performance over a greater temperature range.

A minimum of mechanical parts sets the reed relay apart from traditional electromechanical types. In addition it offers these advantages over electromechanical types:

- Faster switching.
- Small packages.
- Sealed contacts.
- Longer life.
- Economical coil power.

But, of course, there are reed limitations, too. The relays suffer, as do older traditional types, from sticking, welding and erosion of contacts. In addition these limitations are inherent in the reed relay:

- The exact timing sequence for multiple-contact operation can't be guaranteed, since there is no mechanical interlock.
- Contact forces, limited by magnetic saturation of the reed, are lower than might be desired.
- Reeds are very susceptible to vibrations at their resonant frequencies because of their high mechanical "Q".
- Long time-delay operation requires external circuitry and isn't easily achieved by magnetic "slugging," as with traditional relays.

## Where does the reed relay fit?

Remember, "relay" describes an operation, not a device. Therefore a particular application needs



an in-depth study to assure a proper match.

A comparison table (Table 1), supplied by Richard Lisdero, sales manager for the Electronic Specialty Div. of Datron Systems, illustrates some of the overlapping and complex factors that must be considered.

With relay devices weighted numerically, from "most desirable" to "least desirable" (1 to 3), the table clearly shows the major strengths and weaknesses of each type. Other observers, of course, place different ratings on some of the items. Also, new developments will eventually alter the relative advantages. But at present the over-all performance of reeds falls in between that of larger electromechanical types and solid-state relays.

Unlike these other types, however, the advantages of reeds are not offset by equally important disadvantages. The worst rating for reeds is "average."

Matching the application with the correct device is an art. Vendors are usually more than eager to help an engineer, and though a seller of a single type may have an axe to grind, this is not as serious a problem as one might suspect. No vendor wants to see his product misapplied; poor performance could damage his reputation. The unwary design engineer, on the other hand, may allow himself to be mesmerized by a few outstanding advantages of a given relay. He may end up choosing a device that subsequently fails to shine in some other essential area.

One major application area for reeds is in telephone and other communication switching. The electronic switching centers of the Bell System use millions of reed relays in matrix switching arrays. Small reed-relay assemblies in molded cases simplify high-density packaging.

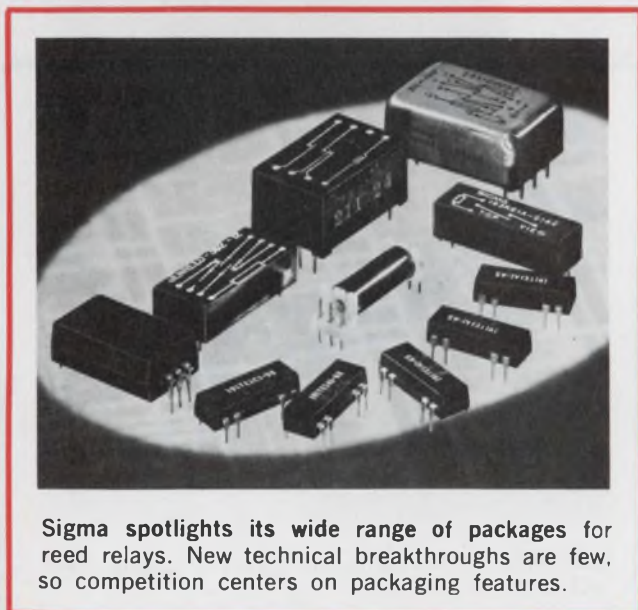
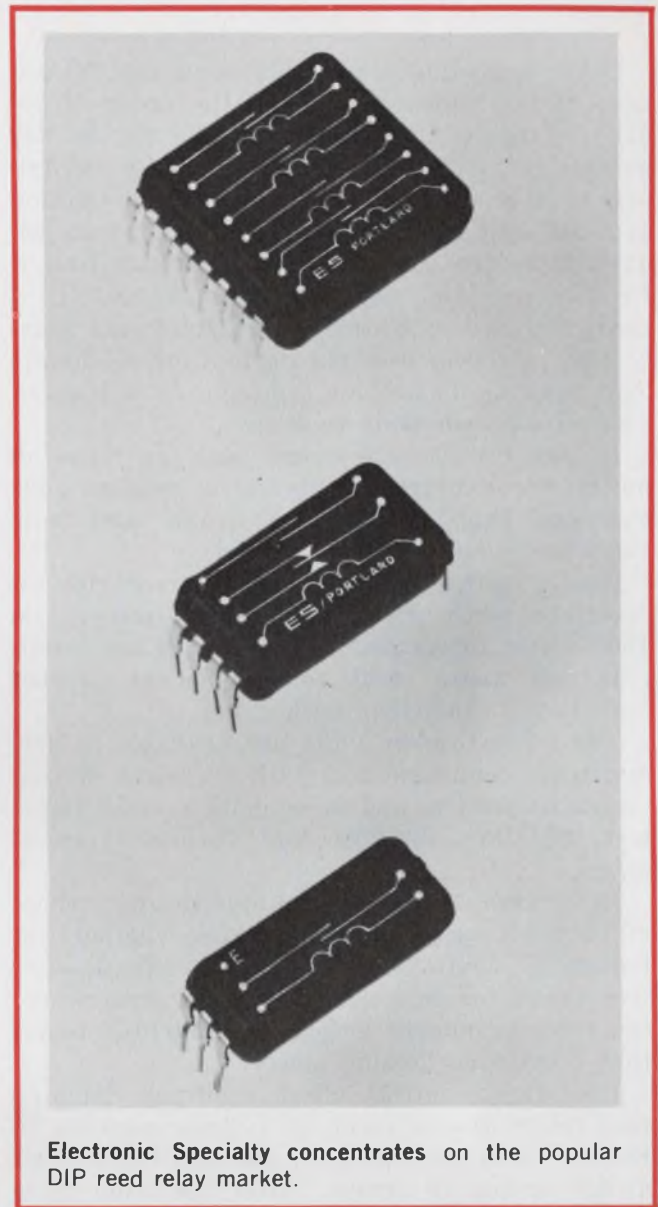

Table 1. Comparison of relay types

Characteristic:	Reed relay	Traditional electro-mechanical relay	Solid-state relay
Load switching	2	1	3
Size	2	3	1
Weight	2	3	1
Operate speed	2	3	1
Isolation	1	2	3
RF	2	3	1
Contact resistance	2	1	3
Bounce time	1	2	3
Life	2	3	1
Reliability	2	3	1
Shock/vibration	2	3	1
Coil drive power	2	3	1
Troubleshooting	1	2	3



Other important application areas take advantage of the high-isolation (on the order of  $10^3$  M $\Omega$ ) of reeds. In this respect, the devices are gaining popularity for controlling SCRs and triacs, because they offer a simple hybrid solution to a difficult isolation problem in solid-state industrial control circuits. Grisby-Barton's line of Reedacs uses' this advantageous combination of reed relay and solid-state device. Reeds are widely used moreover as input devices for solid-state logic systems, to provide isolation, noise immunity and common-mode rejection.

In small control systems, such as those in machine-tool controls, reeds can be used as logic elements, thus combining switching and logic functions to simplify the circuitry.

One company that specializes in reeds for industrial-controls circuits is Allen-Bradley. Its 1600-Series relays are packaged with tab terminals and metal cases for convenient bracket mounting in industrial enclosures.

The Allen-Bradley units are available in normal relay configurations, with a variety of contact combinations, and as logic units—shift registers, counters, flip-flops and various types of gates.

In general, logic-circuit applications where millisecond speeds are tolerable—whether for industrial controls or telephone circuits—are well-suited for reed relays. Another area where the reed is uniquely suited is in latching relays that require no holding power.

Frederick Controls offers multipole latching reed relays (to six form "A"), designated the 45 Series. These are candidates for data (or analog) switching-matrix arrays. After actuation by a 5.5-ms pulse, requiring 13 mW per pole, a relay stays ON held by its internal latching magnets. A pulse of reverse polarity, can then restore the relay to the OFF state. Other types of latching reed relays often employ a separate coil for unlatching.

The range of possible applications for reeds is enormous. Already they have been used in such dissimilar products as musical instruments and welder controls. Design engineers have a broad range of relay types and vendors to choose from—80 or so companies sell them.

### Three traps in specification

Once you've selected a suitable relay type and located the manufacturers, you're ready for the next obstacle course—choosing the right relay for the job. There are at least three booby traps: overspecification, underspecification and specmanship.

Consider overspecification. An engineer is

trained to build "safety margins" into his design. When he specifies a relay, his instincts are to ask for more than he really needs.

If his relay must pull in at 12 V, specification of an 8-V pull-in should be better, right? Wrong. With 12 V applied, an 8-V relay will bounce the contacts longer and harder, thereby wearing them out faster. And the 12 V will overheat the coil substantially, since power dissipated varies as the square of the voltage.

Also, with magnetically biased reed relays, overvoltage can result in failure to perform correctly. The effect of the bias magnet can be swamped by this overdrive, and a magnetic field can be established in the opposite direction, thus holding in a normally closed contact that was intended to be opened.

Take another example—say, when relay contacts must make and break a 5-mA current. A reed unit that is specified to handle 2 A should be fabulous—or so it seems, doesn't it? Not so. Dry-reed contacts designed for a 2-A load are generally not good for a 5-mA load. Performance will be erratic and the contacts will at times present a very high resistance to the low-load current.

Loads in the mA/mV region are usually called "dry circuits," and a suitable contact material is needed. A common solution is to use a mercury-wetted contact. Gold-alloy contacts are also frequently used for these low-level circuits.

Another common pitfall is the attempt to specify mutually opposing characteristics simultaneously. This is really another form of overspecification. Contact timing is one area where this can happen. Specify a fast pull-in time and the drop-out time will normally suffer. If both are specified for fast action, the manufacturer will have difficulty building the part. The result will be delayed

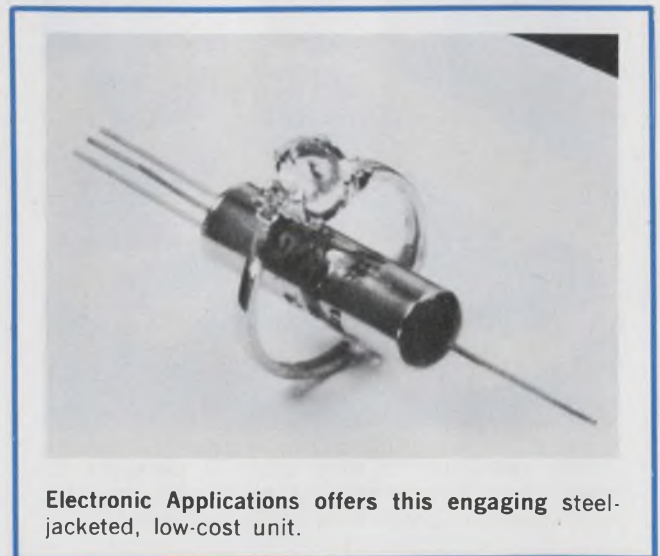

Electronic Applications offers this engaging steel-jacketed, low-cost unit.



delivery—or no delivery.

One way a relay designer can attain fast pull-in is to reduce spring tension in the reed. This slows down the speed with which the contacts will part, or drop out. And it causes other problems, such as lowered contact pressure in the normally closed state.

Remember, too, that if you request a catalog item with some minor modification of the specs, it immediately becomes a custom design. For example, you may ask for “the same relay, but with higher coil resistance.” The vendor will give you what you ask for, because “the customer’s always right.” But the relay performance may not meet the device’s other specs. Make one change and all bets are off. In this case, a higher coil resistance narrows the operating-temperature range and raises the “must-operate” voltage, necessitating tighter power-supply regulation.

Another major disadvantage of custom designs is that the manufacturer doesn’t maintain stocks of nonstandard parts. There will be lengthy delays and higher costs if you have to reorder for repair or replacement.

Underspecifying can be just as disastrous, but fortunately it tends to occur less frequently. When it does occur, it usually results from a lack of understanding of the specification subtleties. The relationships between relay parameters can be quite complex.

Load characteristics, for example, can cause confusion. If you order a “2-A relay” and fail to tell the vendor that it must control an inductive, capacitive or lamp load, no fortune-teller is needed to predict disaster.

Consider another example: If the circuit driving a relay coil doesn’t drop below the “must-release” voltage when the relay is supposed to drop out, the relay may never drop out. This type

of mistake occurs more often than it should because reed relays, in general, have quite low release voltages. In a TTL circuit, for example, the off-state logic level may be higher than the dropout voltage of a 5-V reed relay.

Underspecification problems like these could perhaps have been avoided by a careful reading of the data sheet. But some data sheets don’t list all the specs for a thorough design. This leads us to the all-important problem of specmanship.

### Analyze the specs carefully

Specmanship is no more actively practiced with reed relays than with other component lines. Do reed vendors deliberately try to mislead? Not really. In fairness to the vendors, we should recognize that relay parameters have complex interrelationships and that there is limited space on a spec sheet. So those footnotes and application notes (when available) must be carefully studied, too. Even then, can the engineer glean all the information he needs?

Let’s examine a typical spec sheet and see.

The engineer may run across a list of specs like those shown in Table 2. Is it honest? Probably. Is it adequate? Not for the average engineer. For a short spec list, it’s better than many, but still not good enough. The complete story is rarely found in a single catalog.

Consider the load-handling capabilities. Note that the ratings are maximum. The hasty designer could easily assume that these values may be simultaneously used at their maximums—a common, disastrous mistake. However, if he’s a little more observant and notes that the data sheet also lists a power specification (often stated in VA), he’d have considerably more information. But he still may have a problem.

**Table 2. Typical reed-relay spec list**

Contact ratings	Form A	Form B	Form C	General specifications
Voltage (max. switching) <sup>1,2</sup>	250 Vdc	250 Vdc	150 Vdc	Must operate voltage –80% of rated voltage (max.) Must release voltage –10% of rated voltage (min.) Over voltage –200% of rated voltage (min.)
Voltage (min. breakdown)	500 Vdc	500 Vdc	500 Vdc	
Current (max. switching) <sup>1</sup>	750 mA	750 mA	250 mA	
Current (max. gating or carry)	2 amps	2 amps	1.5 amps	
Power (resistive load)	10 watts	10 watts	4 watts	Operating parameters
Capacitance (typical)	0.2 pF	0.2 pF	0.8 pF	
Contact resistance (typical) <sup>3</sup>	0.100 ohms	0.100 ohms	0.150 ohms	Temperature . . . . . –55 to +125 C Shock . . . 200G @ 11 ms duration Vibration . . . . . 50 G @ 0-2000 Hz Insulation resistance 10 <sup>9</sup> ohms min.
Operate time (typical) <sup>4</sup>	1/2 ms	1/2 ms	1/2 ms	
Life (low load) operations	100 × 10 <sup>6</sup> min.	100 × 10 <sup>6</sup> min.	20 × 10 <sup>6</sup> min.	
Life (half load) operations	50 × 10 <sup>6</sup> min.	50 × 10 <sup>6</sup> min.	10 × 10 <sup>6</sup> min.	
Life (full load) operations	20 × 10 <sup>6</sup> min.	20 × 10 <sup>6</sup> min.	5 × 10 <sup>6</sup> min.	



Dividing 10 W by 250 V (for the form-A contact) yields 40 mA. This means that no more than 40 mA should be switched in a resistive load with a 250-V dc power source. That's a long way from the listed value of 750 mA maximum.

Similarly if an engineer uses the 750-mA rating and performs the same calculation, he gets 13.3-V—a long way from 250 V.

### What do the footnotes reveal?

Now note the footnote designations 1 through 4. The specification list didn't originally contain them; they were added by ELECTRONIC DESIGN. Here is what the footnotes refer to, based on the spec list of a second manufacturer:

Footnote 1. For loads containing inductive or capacitive components or filament-type lamp loads, see the section on contact protection.

Footnote 2. Voltages up to 250 V may be interrupted, but life expectancy will be reduced.

Footnote 3. Measured at 12-V open-contact voltage and 30 mA closed-contact current. Resistance may vary with life and may appear to be higher at very low levels of voltage and current.

Do you have all the information you need now? No.

Let's examine Footnote 3 first and see what it really means. The resistance of a pair of contacts

is not a constant, simple, ohmic value, but it depends upon such complex and difficult-to-control factors as the contact material, pressure, contaminants and area and also ambient atmosphere, temperature and past history of use. In addition, the contact resistance is not a constant with voltage and current. The variation ranges from milliohms to ohms.

In a high-voltage, low-current circuit—250 V at 40 mA—the variation in contact resistance will be relatively unimportant, since the load resistance is 6250  $\Omega$  and even a 1  $\Omega$  variation (a quite likely value) is less than 0.02%. At 13.3 V and 750 mA however, the load resistance is only 17.7  $\Omega$  and 1  $\Omega$  amounts to over 5%. Therefore the possible variation in contact resistance must be carefully evaluated if relays are to be used for switching low voltages.

As the footnote implies, the problems become even tougher at "very low levels of voltage and current."

Where voltages and current become very low, they are usually called "dry circuits." Originally the term "dry switching" was used to describe an operation where the closing or opening of a contact was done with no current flow, since other series contacts actually did the work and took the brunt of the wear. Later the term was also applied to describe direct low-level signal switching.

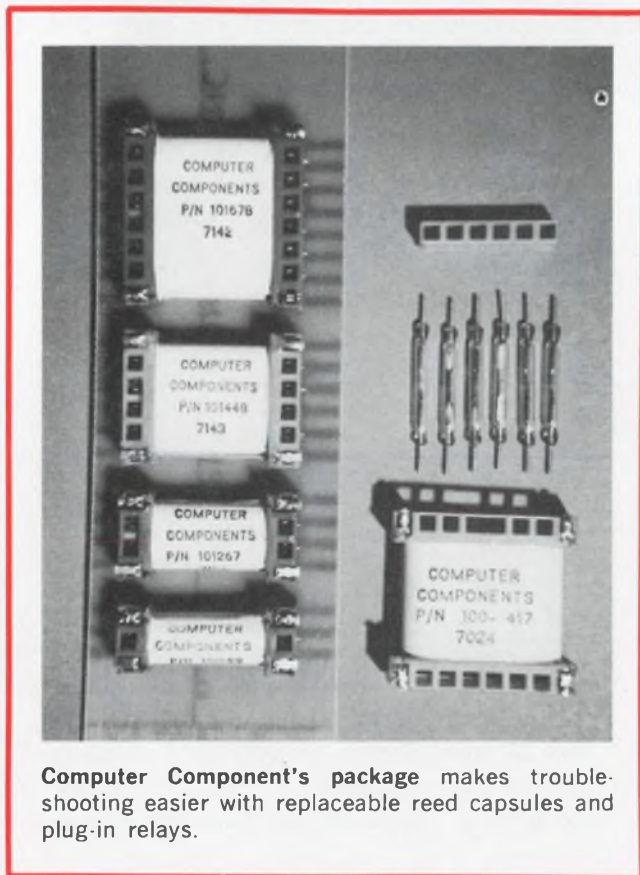

Computer Component's package makes troubleshooting easier with replaceable reed capsules and plug-in relays.

### Table 3. Reed-relay life data

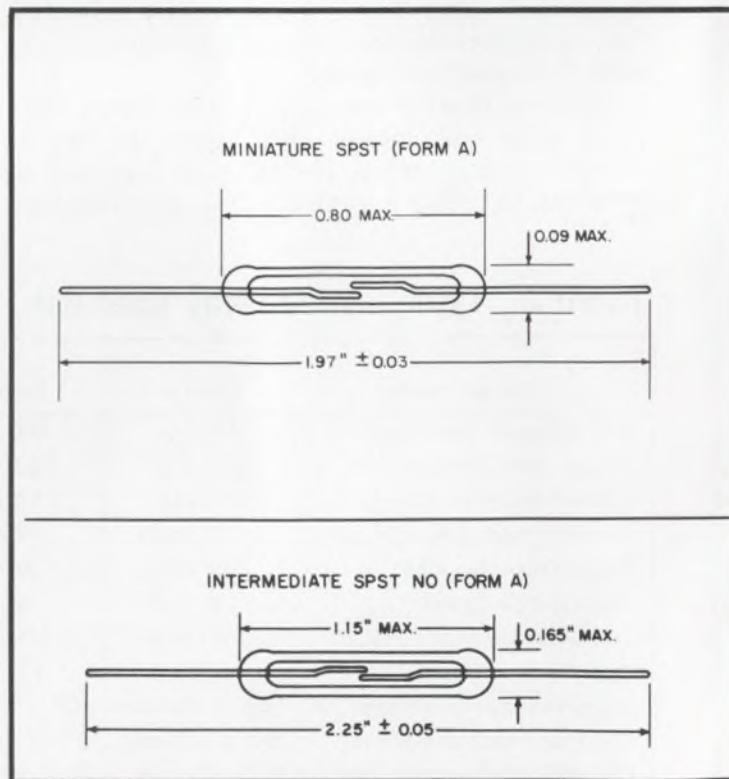

Thus the terminology can be confusing.

For direct low-level switching, there is no exact definition of the term "dry circuit." Somewhere below 1 V, 50 to 500 mV (different authorities give different values), circuit voltages can no longer readily puncture contact films. And somewhere below 10 mA the current flow will be insufficient to cause microscopic melting at the point of initial contact. Thus it becomes difficult to insure low-resistance continuity.

For such "dry circuits," contact resistance may vary not just from milliohms to ohms, but even from ohms to an open circuit. Thus the application can cause closed contacts to look like open circuits, even though the contact may be in good condition.

The data sheet of Table 2—without the added footnotes—says nothing about dry-circuit problems. The bare numbers seem to imply that any combination of voltage and current within the prescribed limits are equally good loads. As has been shown, this isn't true.

The added footnote, though helpful in alerting the engineer to a possible problem, still does not reveal the full extent of the problem.

Let's look a little more closely. The 0.1-contact resistance in the sample spec table is labeled "typical." Most other vendors however, provide a more meaningful "maximum initial-contact-re-

sistance" value. This is preferable because contact resistance is of such a complex nature that the term "typical" is almost useless.

The word "initial" implies that there will be changes. But nowhere does the manufacturer tell the user the expected extent of the deterioration. In fact, contact resistance in the majority of cases determines the ultimate life of the reed relay. With this background, perhaps we should take a close look at the "life data" given in the last three lines of the sample spec list.

Although life ratings are given at "low," "half" and "full" load, there are many unanswered questions. What is "full" load? If the full load is 250 V at 40 mA, is the life the same with 13.3 V at 750 mA, which is also "full" load? Empirical tests (Table 3) prove they aren't.

What's "half" load? And "light" load, which provides the highest life figure, is even more vague.

Many vendors add to the confusion by using the term "dry-circuit operation" instead of "light load" in arriving at this maximum life figure. But as we have seen, the term "dry circuit" here may be misinterpreted to mean that the particular relay can be used in direct dry-circuit applications, when in fact this is not true. What is really meant is that the contacts achieve this rated life provided they don't have to switch any

Guaranteed life—Rhodium		1.0 Amperes		
Volts	6 V dc	12 V dc	12 V dc	12 V dc
Amps	0.5	0.125	0.125	1.00
Miss level (dynamic)*	2.0 ohms	2.0 ohms	2.0 ohms	2.0 ohms
Mean time to first miss	5.0 × 10 <sup>6</sup> min.	100 × 10 <sup>6</sup> min.	100 × 10 <sup>6</sup> min.	1.0 × 10 <sup>6</sup> min.
Mean time to failure**	10.0 × 10 <sup>6</sup> min.	200 × 10 <sup>6</sup> min.	200 × 10 <sup>6</sup> min.	2.0 × 10 <sup>6</sup> min.
Rate of drive	100 Hz	100 Hz	100 Hz	100 Hz
Guaranteed life—Gold alloy (dry-circuit operation)		0.125 Amperes		
Volts	0.012 V dc	.05 V dc	12 V dc	28 V dc
Amps	0.00002	0.01	0.125	0.125
Miss level (dynamic)*	50.0 ohms	2.0 ohms	2.0 ohms	2.0 ohms
Mean time to first miss	500 × 10 <sup>6</sup> min.	50 × 10 <sup>6</sup> min.	5.0 × 10 <sup>6</sup> min.	2.5 × 10 <sup>6</sup> min.
Mean time to failure**	750 × 10 <sup>6</sup> min.	100 × 10 <sup>6</sup> min.	10 × 10 <sup>6</sup> min.	5.0 × 10 <sup>6</sup> min.
Rate of drive	100 Hz	100 Hz	100 Hz	100 Hz
Guaranteed life—Rhodium		2.0 Amperes		
Volts	150 V dc	12 V dc	28 V dc	12 V dc
Amps	0.100	0.125	1.0	2.0
Miss level (dynamic)*	2.0 ohms	2.0 ohms	2.0 ohms	2.0 ohms
Mean time to first miss	2.5 × 10 <sup>6</sup> min.	50.0 × 10 <sup>6</sup> min.	10.0 × 10 <sup>6</sup> min.	.5 × 10 <sup>6</sup> min.
Mean time to failure**	5.0 × 10 <sup>6</sup> min.	80.0 × 10 <sup>6</sup> min.	20.0 × 10 <sup>6</sup> min.	1.0 × 10 <sup>6</sup> min.
Rate of drive	50 Hz	50 Hz	50 Hz	50 Hz

\* Miss level is defined as a contact resistance greater than specified for any closure, or failure to open after any closure.

\*\* Failure is defined as five (5) or more misses in 100,000 consecutive operations.



current—other series contacts do the switching.

Often a larger (than switching) current is specified for this class of reed use. The sample spec lists 2 A (carry) vs 750 mA (switching) for such “dry-switching” operation.

Larger electromagnetic relays often have rating called “mechanical life.” This label is also often used as a substitute for “dry” or “light” to describe reed-relay performance. However, in most large relays a dirty contact can be cleaned or even replaced. Thus the complete relay can outlive many contacts until bearings or other relay parts fail. In this case the “mechanical life” label is fairly clear and meaningful when applied to the larger electromechanical relays. Its use for reed relays is questionable. The terms “mechanical life,” “dry circuit” and “light load” don’t convey the true picture, unless it is fully explained that current must actually be switched by other contacts, in series, to attain this life. This is seldom clear in most reed-relay spec sheets.

### How does load affect life?

Footnote 2 looks straight-forward enough. But is it supported by the test result?

The first vendor (from whom the sample spec sheet was borrowed) and the second vendor (who contributed those helpful footnotes) both provide no further life data in their catalogs. Comprehensive life data are difficult to find. However, some searching can provide such data, as in Table 3.

At first glance, the information in Table 3 appears clearly defined. Close examination reveals many areas of confusion, however.

Notice that life figures are given in “time” designations, such as “mean time to failure.” For relays, this is rather meaningless. But wait, the tables indicate that there is a “rate of drive” at which the contacts were apparently tested. Therefore multiplying the “time-life” numbers by  $6 \times 10^4$  “operations/min.” (for the 100-Hz rate) should give the answer in the more usual designation—“number of operations” to failure. But the assumption is wrong. Life values would be much too high.

If, however, “min.” means minimum rather than minutes, then the terms “mean time to failure” and “mean time to first miss” must be in error. They should read “operations to failure” and “operations to first miss.” Once this confusion is put aside, the life tables do provide some valuable insights.

It is interesting to note that gold-alloy contacts are recommended for direct “dry-circuit” operation, and the life figures are given at these low-level switch currents and voltages. Comparing the life of the gold-alloy contact with that of the 1-A rhodium contact (not recommended



Analog Digital Data Systems supplies complete reed-relay systems to customers' specifications.

for dry circuits) at a 12-V and 0.125-A load (well above the dry region), the rhodium contact has 20 times the life of the gold alloy. For the 1-A rhodium contact, 0.125 A is a “light load” but far from “dry,” while for the gold alloy this load is on the “high” side. Also note that the dimensions of both the gold and rhodium 1-A contacts are the same.

Comparing the 1-A and 2-A rhodium units, we see that at 0.125 A the 2-A unit has half the life of the 1 A (both at 12 V). The same load values don’t lead to the same life figures, even though the contacts are of the same material and made by the same manufacturer.

If any further “proof” is needed to justify the statement that specifying a reed relay for a particular load is not an easy job, examine the 2-A rhodium specs. Note that even though the load voltage is raised from 12 V at 2 A to 150 V at 0.1 A, the contact life increases fivefold. Therefore Footnote 3 is at best suspect, and at worst very misleading.

In fact, it can be said that almost any simplified or generalized pronouncement on specifications about relays must be examined with care.

Let’s examine another important area of relay performance: timing. All relay manufacturers provide timing data in one form or another. The manufacturer who supplied Table 2 lists this information under “operate time (typical).”

The first question that arises is: Typical of what? Reed relays have lively, bouncy contacts. Does the operate time include bounce time? At what coil voltage would the stated time-to-operate apply—at the “rated” value or the “must-operate” value? And what about drop-out time? This can be very important, too. Clearly the data are far from adequate.

Not in the original spec, another manufacturer however, offers a useful footnote (Footnote 4). “Operate and release values do not include bounce time, which is shown separately. The listed timing values are for rated coil voltage at



25 C.”

This information is useful, but unfortunately Table 2 lists neither the release time nor the bounce times (operate and release). Had this table included these, the engineer would have had most of the necessary timing information—but not all of it. He would also like to know the effects of external circuits, such as transient suppressors, on relay timing.

Timing data, even when comprehensive and accurate, lose their practical value if transient suppressors are connected across the relay coil. Suppression is almost always required when relays are used with semiconductor devices.

A transient-suppressing diode across the relay coil can easily boost dropout time by 100 times. Capacitor and resistor networks across the coil can easily boost both pull-in and dropout times by a factor of 10. And relay coils in parallel also greatly slow the dropout times of each other.

### Handle reeds with care

There are two potential areas of trouble in applying reed relays. They stem from the fragility and sensitivity of most reed relays and may be overlooked by engineers who are accustomed to working with the more rugged electromechanical types.

Those glass seals on reed elements are quite easily broken. Even in molded assemblies, excessive bending, twisting or heating of the leads can still damage the internal glass seal—though

the package minimizes the possibility of damage. Another possibility is that mishandling can cause distortion in performance, even though the glass seal may not actually be fractured. Therefore reed relays should always be handled with care.

Other application problems occur because reed relays can be affected by magnetic fields, even the earth's, and magnetic materials near them. Difficult-to-trace changes in timing and operate/release characteristics can result. Magnetically biased reeds and the more sensitive reed relays are especially affected.

Of course, an engineer can avoid many specification and application problems by subcontracting the design work to a relay specialist. We have already examined some disadvantages in custom designs for the basic reed elements, but the custom approach to design of reed-relay assemblies may avoid many headaches. It can be cost-effective, too, unless extremely large quantities of relays will be used. The art of working with a custom designer is to keep him fully informed of the system problems but to avoid restricting his range of possible solutions by overspecifying.

Several companies specialize in the design of custom subsystems that use reed relays. Two examples are Atuomatic Electric, which makes a broad line of relays and assemblies and, Analog Digital Data Systems, which doesn't make the actual reed relays.

### Evolutionary improvements apparent

Even though the reed-relay industry is quite mature and major breakthroughs seem unlikely, the reed relay is becoming better, smaller, faster and cheaper. Progress is evolutionary. Modest improvements are constantly chipping away at the fringes of existing reed-relay limitations. Some recent developments include these:

- The improved design of mercury-wetted contacts has made reed relays faster, less noisy and in some cases position insensitive.
- Thermal offsets have been reduced.
- The voltage rating of reed-switch capsules have been pushed higher.
- New non-reed types of relays have been developed that compete directly with reeds.
- DIP packages, with a choice of forms and contact combinations, are offered by many vendors.

Both Hamlin and Clare offer mercury-wetted reeds with dry-reed speeds—in the one-millisecond range. Hamlin is not a relay maker, but it supplies reed switches to relay manufacturers. Its MRHG-2 switch and Clare's HGQ (Clare makes the whole relay) unfortunately still suffer from position sensitivity and must be operated fairly close to the vertical position.

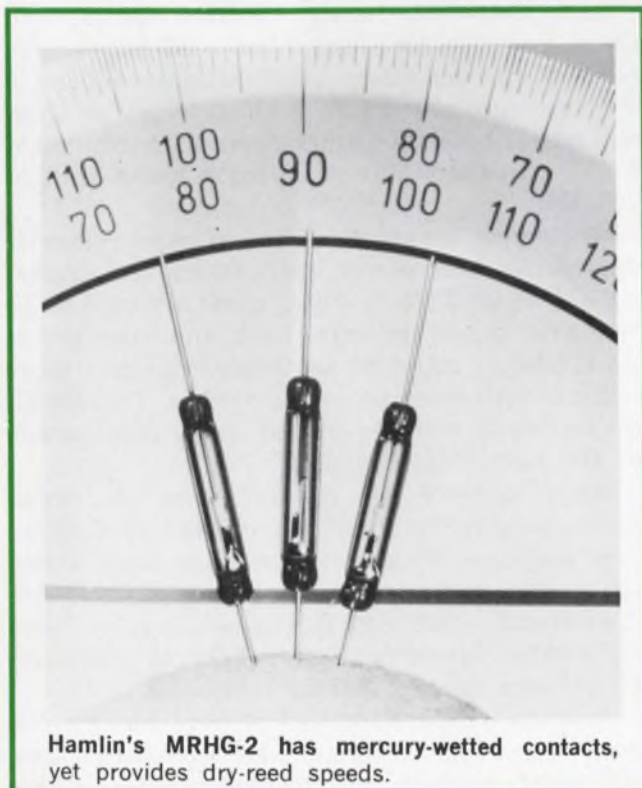



As an answer to this limitation, which may require vertical mounting as close as  $\pm 15^\circ$ , a number of today's mercury-wetted relays have been designed to be position insensitive. One type uses conventional reed construction, with the contact surfaces partly wetted by capillary action. This avoids an "open" mercury pool that could flow when the relay is tilted. An example of one such type is Magnecraft's 137MPC.

In common with older mercury-wetted types, these newer units also feature "no-bounce" performance, more stable contact resistance than dry reeds and operation into both the low-level (dry circuit) and medium-level power ranges. These characteristics are considerable improvements over dry-reed capabilities.

Interestingly Clare's high-speed, HGQ, mercury-wetted reed relay is, strictly speaking, not a reed type. By definition, a reed is rigidly fixed at one end and bends as a cantilever. The HGQ, however, sports a T-shaped, hinged armature, and its improved speed and other qualities are attributed to this non-reed construction.

Another company offering non-reed types that are even further removed from pure reed construction is Fifth Dimension. Its Logcell 3000 switch capsule does not use a reed; the moving element is a small, light rod that shuttles back and forth in its glass enclosure between two mercury-wetted, end pole pieces. To achieve position insensitivity, no mercury pool is used, but

the contact surfaces are kept wet with a thin film. The moving element's body floats in, and is not wetted by, the mercury. Suitable selection of switch element material takes advantage of the surface tension (for nonwetting) or capillary action (wetting) of mercury to provide the desired performance.

Fifth Dimension offers yet another deviant from the pure reed type, called Logcell II. Its construction differs considerably from the series 3000 switch. It is metal-enclosed. Its sandwich type of construction has a single, sturdy glass-to-metal bond that separates the fixed contact from a mercury-wetted, flexing armature that serves as the moving contact. Sharing the usual advantages of mercury-wetted construction, including position insensitivity, Fifth Dimension reports Logcell II can withstand 50 g forces without damage.

### Other recent developments

In another assault on the outer limits of reed capabilities, Hamlin has pushed its DRVT series to a 30,000-V dc breakdown maximum, where its former top was 20,000 V. The ability to handle these voltages is attributed to the use of tungsten contacts. They are said to provide a very respectable life of one million operations at rated voltage.

Another specification being nudged beyond previous limits is thermal offset. Low-level circuits (like those used for low-output transducers and front ends of sensitive amplifiers) generate offset errors because of thermally induced voltages.

Both Coto-Coil, in its CR-3200 series, and Clare, in its PR2MT line, offer reed relays with reduced thermal-offset specifications. Where a standard reed unit exhibits about  $20 \mu\text{V}$  of thermal offset, both companies claim a maximum of  $5 \mu\text{V}$ , with Coto-Coil specifying a lower limit of 200 nV.

Wheelock's Series 3000 line of reed relays is different in that power applications are emphasized. The 50-W, 2-A, 400-V units are said to be "ideal for lamps, inductive loads and small motor loads." But it might be advisable to protect those contacts with arc-suppressing devices. The Wheelock series is mercury-wetted and claims a life of 100 million operations.

Many vendors are concentrating on newer packages, with the greatest emphasis on dual in-line packages. But other packages can sometimes prove more useful. For example, Computer Components offers plug-in, low-profile relays with replaceable dry-reed (Series HP) or mercury-wetted-reed (Series MWHP) capsules.

Recently IBM announced it was halting the marketing of its reed-relay and reed-switch line, and many vendors hope to grab a slice of this

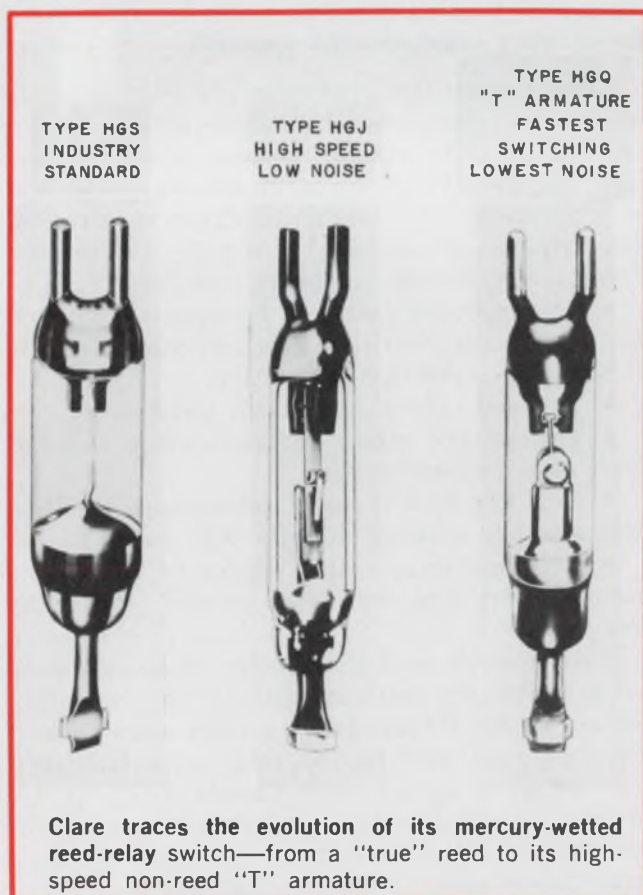

Clare traces the evolution of its mercury-wetted reed-relay switch—from a "true" reed to its high-speed non-reed "T" armature.



business. Companies like Frost, Wabash Magnetics, Computer Controls, Babcock, and Douglas Randal are all ready with compatible lines to fill the market gap left by IBM's departure. Gordos (reed-switches only) offers a line of reed switches that closely match IBM's specifications in configuration, performance and even testing procedure.

The demise of the electromechanical relay (and by inference, the reed relay), has often been predicted, but it is still here and shows strong signs

of staying. Will the solid-state relay ever fully replace electromechanical types? Probably never. But the two types may tend to merge, and it may become increasingly difficult to distinguish clearly between them.

Both the solid-state and electromechanical types (especially non-reed "reeds") will improve. The electromechanicals will become less mechanical. The solid-state relays will become "multipolar," less expensive and have improved I/O isolation—that is, they'll become more relay-like." ■■

## Need more information?

The companies and products cited in this report have, of necessity, received only cursory coverage. They've been selected for their illustrative, or in some cases, unique qualities. Companies not mentioned may offer similar products. Readers may wish to consult these manufacturers for further details:

- A D Data Systems, 830 Linden Ave., Rochester, N.Y. 14625. (716) 381-2370. (H. Turner, President) **Circle 401**
- Adams & Westlake Co., 1025 N. Michigan St., Elkhart, Ind. 46514. (219) 264-1141. **Circle 402**
- Allen Bradley Co., 1201 S. Second St., Milwaukee, Wis. 53204. (414) 671-2000. (R. A. Salzwedel, Manager of Planning Industrial Control) **Circle 403**
- Allied Control Co., Inc., 100 Relay Rd., Plantsville, Conn. 06479. (203) 628-9654. **Circle 404**
- Babcock Electronics Corp., 3501 N. Harbor Blvd., Costa Mesa, Calif. 92626. (714) 540-1234. (T. C. Schroeder) **Circle 405**
- C. P. Clare & Co., 3101 W. Pratt Ave., Chicago, Ill. 60645. (312) 262-7700. (J. E. Carlin, Marketing Development Engineer) **Circle 406**
- Compac Engineering Inc., 845 Commercial St., San Jose, Calif. 95112. (408) 286-4844. **Circle 407**
- Computer Components Inc., 88-06 Van Wyck Expwy., Jamaica, N.Y. 11418. (212) 291-3500. (J. Lemmon, Product Manager) **Circle 408**
- Computer Products Inc., P.O. Box 23849, Fort Lauderdale, Fla. 33307. (305) 974-5500. **Circle 409**
- Coto-Coil Co. Inc., 65 Pavilion Ave., Providence, R.I. 02905. (401) 941-3355. (R. L. Bellem, Sales Manager) **Circle 410**
- Cutler Hammer Inc., 4201 N. 27th St., Milwaukee, Wis. 53216. (414) 442-7800. **Circle 411**
- Datron Systems Inc., 88 Clinton Rd., Fairfield, N.J. 07006. (201) 228-4000. **Circle 412**
- Dormeyer Industries Inc., 3418 N. Milwaukee Ave., Chicago, Ill. 60641. (312) 283-4000. **Circle 413**
- Douglas Randall Div. (Walter Kidde & Co., Inc.), 6 Pawcatuck Ave., Westerly, R.I. 02891. (203) 599-1750. (E. J. Goehring) **Circle 414**
- Eaton Alarm Co. (Detector Div.), 376 Halstead Ave., Harrison, N.Y. 10528. (914) 835-4500. **Circle 415**
- Elec-Trol Inc., 26477 N. Golden Valley Rd., Saugus, Calif. 91350. (805) 252-8330. **Circle 416**
- Electrothermal Ltd., 6 Roosevelt Ave., Roslyn, N.Y. 11576. (516) 484-1444. **Circle 417**
- Electronic Applications Co., 2213 Edward Ave., S. El Monte, Calif. 91733. (213) 442-3212. (W. M. Podolece, President) **Circle 418**
- Electronic Specialty Div., 18900 Sandy Blvd., Portland, Ore. 97220. (503) 665-0121. (R. Lisdero, Product Sales Manager) **Circle 419**
- Essex International Inc., 1601 Wall St., Fort Wayne, Ind. 46804. (219) 743-0311. **Circle 420**
- Fifth Dimension Inc., P.O. Box 483, Princeton, N.J. 08540. (609) 924-5990. (Wm. Kinney) **Circle 421**
- Frederick Controls Div. (North American Phillips Controls Corp.), E. Church and Second Sts., Frederick, Md. 21701. (301) 663-5141. (L. J. Torok, Manager of Advertisement) **Circle 422**
- Frost Controls Corp., 26 Pearl St., Bellingham, Mass. 02019. (617) 966-1590. (R. Wetzal, Sales Manager) **Circle 423**
- GTE Automatic Electric, 400 N. Wolf Rd., Northlake, Ill. 60164. (312) 562-7100. **Circle 424**
- General Automatic Corp., 1055 S. East St., Anaheim, Calif. 92805. (714) 778-4800. **Circle 425**
- General Electric Co., 316 E. Ninth St., Owensboro, Ky. 42301. (502) 683-2401. **Circle 426**
- GE—Waynesboro, Waynesboro, Va. 22980. (703) 942-8161. (J. Jeffers) **Circle 427**
- Gordos Corp., 250 Glenwood Ave., Bloomfield, N.J. 07003. (201) 743-6800. (R. T. Murray, Vice President Marketing) **Circle 428**
- Grigsby-Barton Inc., 3800 Industrial Dr., Rolling Meadows, Ill. 60008. (312) 392-5900. (S. E. Wilson, Director of Sales) **Circle 429**
- Guardian Electric Manufacturing Co., 1552 W. Carroll Ave., Chicago, Ill. 60607. (312) 243-1100. **Circle 460**
- Hamlin Inc., Lake and Grove Sts., Lake Mills, Wisc. 53551. (414) 648-2361. (W. A. Bruenger) **Circle 430**
- Hathaway Instruments Inc., 5250 E. Evans Ave., Denver, Colo. 80222. (303) 756-8301. **Circle 431**
- ILC Technology, 164 Commercial St., Sunnyvale, Calif. 94086. (408) 738-2944. **Circle 432**
- Jaidinger Mfg. Co. Inc., 1921 W. Hubbard St., Chicago, Ill. 60622. (312) 421-1090. **Circle 433**
- James Electronics Inc., 4050 N. Rockwell, Chicago, Ill. 60618. (312) 463-6500. **Circle 434**
- Kahl Scientific Instrument Corp., P.O. Box 1166, El Cajon, Calif. 92022. (714) 444-5944. **Circle 435**
- Kam Corp., 845 Commercial St., San Jose, Calif. 95112. (408) 286-8603. **Circle 436**
- MKC Electronics Corp., 454 E. Donovan Rd., Kansas City, Kan. 66115. (913) 371-1351. (B. Lilly, Manager of Commercial Sales) **Circle 437**
- Magnecraft Electric Co., 5575 N. Lynch Ave., Chicago, Ill. 60630. (312) 282-5500. (R. A. Didriksen, Marketing Manager) **Circle 438**
- Micronex Reed Relay, 24248 Crenshaw Blvd., Torrance, Calif. 90505. (213) 530-0444. **Circle 439**
- Midtex Inc., Aemco Div., 10 State St., Mankato, Minn. 56001. (507) 388-6286. **Circle 440**
- New Product Engineering Inc. (Subsidiary of Wabash Magnetics), First and Webster Sts., Wabash, Ind. 46992. (219) 563-2191. (R. W. Bowers, General Sales Manager) **Circle 441**
- OKI Electronics of America, Inc., 500 SE 24th St., Fort Lauderdale, Fla. 33316. (305) 525-8201. (J. T. Webb) **Circle 442**
- PECO Corp., 450 Landess Ave., Milpitas, Calif. 95035. (415) 262-4050. **Circle 443**
- Potter & Brumfield Div. (AMF, Inc.) 1200 E. Broadway, Princeton, Ind. 47670. (812) 385-5251. **Circle 444**
- RLC Electronics Inc., 83 Radio Circle, Mt. Kisco, N.Y. 10549. (914) 241-1334. **Circle 445**
- Self Organizing Systems Inc., P.O. Box 9918, Dallas, Tex. 75214. (214) 276-9487. **Circle 446**
- Sensor Corp., 97 Indian Field Rd., Greenwich, Conn. 06830. (203) 661-5600. **Circle 447**
- Sigma Instruments Inc., 170 Pearl St., Braintree, Mass. 02185. (617) 843-5000. (W. R. Cook, Marketing Service Manager) **Circle 448**
- Singer Industrial Timer Div., U.S. Highway 287, Parsippany, N.J. 07054. (201) 887-2200. **Circle 449**
- Stromberg-Carlson Corp., 100 Carlson Rd., Rochester, N.Y. 14603. (716) 482-2200. **Circle 450**
- Struthers-Dunn Inc., Lambs Rd., Pitman, N.J. 08071. (609) 589-7500. (L. R. Davis, Advertising Manager) **Circle 451**
- Tech Serv Inc., 5451 Holland Dr., Beltsville, Md. 20705. (301) 474-3400. **Circle 452**
- Texas Instruments (Control Products Div.), 34 Forest St., Attleboro, Mass. 02703. (617) 222-2800. **Circle 453**
- Thermosen Inc., 375 Fairfield Ave., Stamford, Conn. 06904. (203) 324-6125. **Circle 454**
- Torr Laboratories Inc., 2228 Cotner Ave., Los Angeles, Calif. 90064. (213) 477-1224. **Circle 455**
- Trompeter Electronics Inc., 8936 Comanche Ave., Chatsworth, Calif. 91311. (213) 882-1020. **Circle 456**
- Universal Relay Corp., 42 White St., New York, N.Y. 10013. (212) 925-9500. **Circle 457**
- Wheelock Signals, Inc., 273 Branchport Ave., Long Branch, N.J. 07740. (201) 222-6880. (J. Klimsey) **Circle 458**
- Whistler Electronics Inc., 8613 Yolanda Ave., Northridge, Calif. 91324. (213) 349-7100. **Circle 459**



*Twice as much for your money...*

# LOOK CLOSELY AND DECIDE

1.

The multi-speed chart drive is the equal of any competitor on the market today. Further, the **OmniScribe™** is field adjustable precisely for English/Metric scaling. Quick, fast, convenient.

2.

Houston Instrument has perfected sprocket-less paper drive. It's accurate. It's self-aligning. It works!

3.

A unique operating feature is the non-contact re-balance potentiometer. It eliminates cleaning and trace "glitches" forever. It's beautiful!

4.

Did we mention the price? Just \$395 for single pen; \$595 for dual pen. With options to \$1400. What's more, all models are available off-the-shelf for immediate shipment.

## **OmniScribe™**

10" Strip Chart

# \$395

For single pen model



Write today for your complete brochure and price list.

The **OmniScribe™** is either half the cost or twice as much for your money. You decide.

**houston  
instrument**

4950 TERMINAL AVENUE, BELLAIRE, TEXAS 77401  
(713) 667-7403 CABLE HOINCO.

# DIP

## DUAL-INLINE-PACKAGED REED RELAYS



Magnecraft is proud to announce its new DIP (dual-inline-package) line of 8-pin reed relays. These new relays are designed not only to be compatible with the standard packaging developed for integrated circuits, but to offer Magnecraft quality at a low cost. This unique design gives further savings by offering the user the optimum in automated insertion and other economical installation techniques associated with printed circuit applications.

These fantastic new epoxy molded reed relays are ideal for use in circuits where high density packaging is essential. The 5VDC IC compatible versions of these relays will operate directly from TTL or DTL circuits.

Other standard coil voltages are available from stock in 6, 12, and 24VDC as well as contact configurations in 1 form A, 2 form A, 1 form B, and 1 form C. Most versions are also offered with a choice of an internal clamping diode.

**Magnecraft** ELECTRIC COMPANY

5575 NORTH LYNCH AVENUE • CHICAGO ILLINOIS 60630 • 312 • 282 5500 • TWX 910 221 5221

# FREE!



## REED RELAY HANDBOOK

The purpose of this 120-page handbook is to assist the design engineer in specifying the proper reed relay for a given application. The book contains a glossary of terms, principles of operation, applications and design requirements as well as specifying and testing data. New products include the complete line of DIP Reed Relays.

INFORMATION RETRIEVAL NUMBER 28



## DPMs—Part 1 of a series

**Pitfalls in DPM selection.** Many lie in deceptive specs, but there are traps in poor buying practices and in neglecting specs that may not appear on the data sheet.

Though it seems to be simply a high-accuracy, high-resolution replacement for the old pointer meter, with no parallax error, the digital panel meter (DPM) is far more complex. It lends itself readily to misapplication and to specsmanship. Many of the problems stem from specifications that entail more than they imply—but not all. Nevertheless, the DPM is inherently so versatile and useful that it's worth learning how to skirt the traps.

Somewhere there's probably a DPM requirement that can't be met with one of the many standard meters now on the market. Three to five years ago there were obvious applications where the meters then available could not reasonably do the job. The meters were too big and the displays too small, or the customer was in love with something other than the formed-character, gas-discharge tubes.

### Avoid 'specials,' if possible

Today the situation is different. Gas-discharge tubes, seven-filament displays, LEDs, liquid crystals and seven-lamp readouts are available. Of course, smaller meters are now being produced. So if you're going to buy DPMs, don't go to a special unit unless it's absolutely necessary—technically.

You'd have a sole source, and you'd probably want another. But I've never seen a custom-DPM requirement where it made sense (dollars-and-cents sense) to develop two suppliers. Further, the custom DPM costs too much. Specials cannot be run with the same efficiency as can a standard product. You must pay more for a special or accept the fact that something unreal is happening.

Many other problems come up with specials. There are always communications problems. For example, the manufacturer and customer test the meters differently, and there is a high reject level at both locations. Reliability is a problem. The supplier is not tooled up for volume on your item,

so temperature and life testing, normally thorough on standard products, are skimmed over because of pressure from all sides to ship.

Indirect costs are higher, too. When the product using the DPM gets to production, too much time is spent training receiving inspectors, assemblers and technicians because you and your supplier experience start-up problems. In addition the documentation and training aids available from the vendor will be meager, compared with what's available with standard products, unless you pay for something better—which indirectly increases meter cost again.

### Another trap: 'I'll make it myself'

Fearful of a bad buy, some designers resolve the decision in favor of building their own. That can be a costly mistake that's hard to track down.

Any electronics technician worthy of the name can breadboard something with a 3-1/2 digit display (but that's not true for 4-1/2 digits). What separates the amateur from the professional is whether the design can be manufactured. To be competitive, a DPM design must be clean at every step in the production process.

The circuit must not overstress any component, and normal component tolerance must be acceptable without twiddling in production. The printed-circuit layout must be simple and orderly, and the interconnect scheme between PC cards must be reliable, inexpensive and designed so that the DPM can be worked on.

At what volume does it make sense to design your own meter? First, never do it and then ask someone else to build it for you. It just won't work if you tell him how to build it part by part and at the same time tell him precisely what it should do, unless you spend an unbelievable amount of your time in production during the life of the product.

If the initial volume during the first year appears to be over 1000 units then maybe (only maybe) you should consider doing it yourself. Below that level, forget it. Remember, the cost of a DPM is not just that for materials. Besides the obvious factors of direct labor and overhead

in production, there is the cost of your salary and overhead and that of the support people needed to turn your schematic into a producible product.

Any company that gets away with a first-time total development cost of less than \$35,000 for a simple DPM is to be congratulated. If your company puts that kind of investment into reinventing the DPM when you can buy a year's supply for the same amount, it may need better management. Buy what you need from a reputable supplier for a year or two. Then if your volume has really materialized, do it yourself.

### Is accuracy really important?

On the basis of practical experience, I disagree with a statement that appeared in "Focus on Digital Panel Meters" in the Jan. 6, 1972 issue of *ELECTRONIC DESIGN* (ED 1, pp. 48-56). The statement was: "Accuracy—or rather, inaccuracy, as it should properly be called—is probably the most important parameter. . . ."

Unless you're using DPMs to monitor power-supply voltages or the ac line, the accuracy of the reading is determined by the sensor and circuitry preceding the meter, not the meter itself. I am not aware of a single scientific, analytical, engineering or industrial product now using DPMs that does not have a balance (zero) and span (full-scale) control preceding the DPM somewhere. The DPM really needs: (1) linearity; (2) temperature stability; (3) adequate adjustment range; (4) noise rejection, and (5) reliability.

Any properly designed DPM should have a maximum linearity error of no more than  $\pm 1$  digit. This should be inherent in the a/d conversion process, unless you're trying to linearize for a thermocouple or other nonlinear sensor. To be linear, the zero width of the meter cannot exceed  $\pm 1$  digit. This is a specification that few manufacturers publish and that should be checked. It's a figure of merit that gives a good indication of over-all technical quality.

Temperature stability is much more difficult for engineers to guarantee by design. There are two temperature coefficients that the DPM supplier should provide: (1) zero stability, and (2) span stability.

Another element that can have a serious effect on performance is humidity. If your meters will be exposed to humidity, do your own testing of the complete product, including the DPM. Don't rely on the DPM manufacturer.

A second figure of merit, like zero width, is commonly called "indecision." This is the ability of the meter to differentiate between one number and the next in the least-significant digit. It is a definitive way to specify how much the input must change before the meter recognizes the fact—*solidly*. A total indecision range of 0.2 digit is the

maximum that should be allowed in a properly designed and manufactured DPM. Both zero width and indecision are difficult to determine without a voltage standard.

### A little bias current can really hurt

DPMs are generally installed in equipment and left there. Therefore they are nearly always driven by a constant source impedance. The input bias current flowing through the source impedance produces a voltage that shows up as a zero offset in the meter.

However, any good panel meter can be re-zeroed or offset in some way to eliminate the zero shift caused by input bias current. So what's the problem? Simply that the current changes with temperature. If the DPM manufacturer specifies a source resistance when he gives the temperature coefficient for his meter, he should already have included the effect of bias-current drift. If not, undoubtedly he has used a voltage standard that has essentially zero output impedance to determine his temperature coefficients. It's best to simulate your source resistance, then test temperature stability yourself—with a standard.

What's the noise with fast response? *ELECTRONIC DESIGN*'s Focus report properly stated: "Some vendors will give a normal-mode spec with an input filter in the meter and a response-time spec with the filter taken out." Unless the manufacturer indicates clearly that this is what he is doing, drop him fast. If he's playing this game, he is also probably covering up other basic problems that you may not find until your production line is stopped because the panel meters won't work properly.

### BCD: What kind and how fast?

All DPMs have some kind of counting and decoding chain that drives the display. Typically there is a BCD counter and a decoder for each digit. Obviously the BCD information is generated in the meter, and the problem is to get it out. If the meter is not counting in BCD, then code conversion is necessary. This is easily accomplished in the buffer circuitry between the counter and the BCD outputs, as is done with most products that use RTL logic.

There are two reasons why buffered BCD is used with RTL: (1) The RTL is very susceptible to noise introduced at its outputs, and (2) Complex-function RTL devices are, in my opinion, notoriously unreliable and must be avoided like the plague. These are the reasons, along with lower cost at the time the products were introduced, why many RTL meters count in biquinary and then decode to BCD. The separate decoding and buffering required is why BCD outputs cost



extra in meters that use RTL. If a potential supplier offers a DPM that uses RTL with BCD output taken directly off the counter or the decoder, beware! This has been causing trouble since the day the first small low-cost, digital multimeter appeared more than six years ago.

My experience with TTL logic has been different. First, the complex-function ICs like BCD counters and high-voltage decoders, are much more reliable. TTL failure rates in production at Electro-Numerics run about 2%, while RTL has never dropped below 20% in the last four years and, at times, has been virtually 100%. Second, TTL has better apparent noise rejection in panel-meter applications, and third, it has higher fanout capabilities. Many new DPMs use TTL exclusively. BCD is generated at the output of the counters. The problem is getting it out the back, which takes some top-notch board layout when you're making a small meter.

At Electro-Numerics we have experienced no trouble driving a tape printer with a Seiko mechanism, directly off the BCD from the TTL counters. If the BCD is already generated in the panel meter, there is no reason to charge extra for it, unless you're operating on the unreal pricing philosophy that, until recently, pervaded the semiconductor industry.

The main reason why many 3-1/2-digit DPMs are limited to 60 readings per second is cost. To save the price of a storage register between the counter and the decoder, the gas-tube displays are driven from the 60-Hz power line, which is half-wave rectified. The a/d conversion takes place during the off half cycle. When the voltage pulse on the second half of the cycle comes through, the meter is just sitting there, and the display lights to whatever number the counter stopped at. This gives the effect of digital storage without the cost and should be completely acceptable. The only limitations are that all noise rejection below about 240 Hz must be provided by filtering rather than by integration, and operation on 400-Hz power may not be possible because of the higher clock rates and switching speeds required in the meter.

### Digit claims are confusing

The term "overrange" is a leftover from the early days of the digital voltmeter (the multi-range test instrument). When used with panel meters, it serves no purpose other than to confuse. The best thing that could happen would be to banish the term from our DPM vocabulary.

If you want to buy an analog meter to monitor the ac power line, you look for one that reads up to about 150 V. You don't look for a 100-V meter with 50% overrange. If a panel meter will read up to 2000 digits, let's call it 2-V full scale, or

200  $\Omega$  or 20 mA. If the display goes to 12,000 before it becomes inaccurate, then we have a 120-V full-scale meter, or 12 mV.

If we can get rid of this semantic hangup—where one man says a meter has 2000 digits and another says it has 1000 digits plus 100% overrange—we'll eliminate some confusion in accuracy and resolution specs. The last digit in all of these meters will represent 0.05% of full scale—not 0.1% from one vendor, 0.05% from another.

When the input exceeds the full-scale capability of the meter, the meter is "overloaded" and the display may be inaccurate. Therefore the input is "out-of range." If full scale refers, as I propose, to the actual capability of the DPM, then the terms "overload" and "out-of range" are meaningful by themselves. Throw in "overrange" and we have an immediate semantics problem.

### How to show off-scale

To indicate "out-of range," DPM vendors have experimented with several approaches, including blinking the entire display; blinking only the most significant digit; blanking the display, and lighting a separate "OL" indicator.

Blinking the entire display is the most obvious method and is generally preferred by users. However, there are some circuit problems in handling the 180 V necessary for gas-discharge displays. Whether you use discrete-transistor drivers or an integrated high-voltage decoder, the devices break down if you try to turn all elements in a gas tube off at the same time. When this happens, one or more segments of the display generally stay on at a lower intensity. However, for most applications this is not objectionable.

Blanking the complete display is probably the least desirable way to indicate overload. True, the operator knows something is wrong when he can't see the display. But how does he know that the unit wasn't just unplugged? More important, if he has some indication—even if it's very high and unstable—he probably has an idea of what the trouble is, which can be very helpful. Often it's significant to know if you're just a few digits over or out by a mile.

Blinking the most significant digit or lighting an indicator are the least expensive ways to indicate overload, and if properly done are generally quite acceptable. However, a separate indicator has a major potential problem. When the indicator is off, you don't want to see it through the window, any more than you want to see the minus sign when the polarity is actually positive. Look at the display carefully with the meter both on and off, and be sure you want what you see.

Another problem is how to indicate a negative input on a single-polarity, positive-reading meter. The worst solution I know of is reciprocal count-



ing. If a three-digit meter has reciprocal counting, the display counts down to 000 as the input decreases. Then it immediately switches to 999 when the input is one count negative. The meter continues to count 998, 997, 996, 995, etc. The farther away you get from zero, the closer you seem to be.

A better solution is to lock the display at 000 and light a minus sign. If the minus sign flickers while the display stays at 000, you know the meter is truly at zero.

Another way to indicate a negative input is to blank the display completely. This has all the problems associated with blanking on overload,

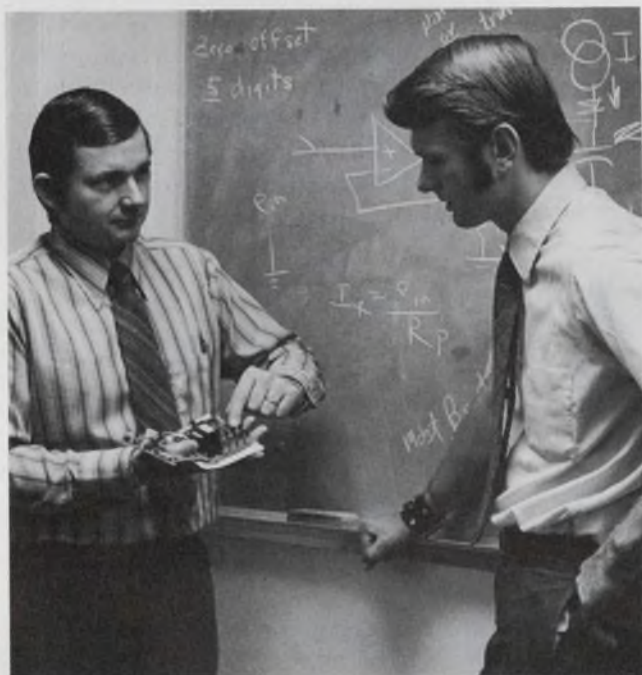

Author Walton (left) discusses some of the tradeoffs in DPM electrical specs and mechanical packaging with Electro-Numerics project engineer Robert LaFollett.

plus the additional disadvantage that if you blank below zero and above overload, and the display is out, where are you? The best solution is a bipolar DPM, which in production quantities shouldn't cost much more than a single-polarity unit. At Electro-Numerics, unless we are building a long run of meters for a particular customer who wants only single polarity, we build all meters bipolar. If we need a single polarity unit, we disable the bipolar circuitry.

#### How to change the DPM: Don't!

This leads to the question of modifying and repairing DPMs to change ranges and alter performance. I say *don't do it*. Buy it the way you want it, or return it to your supplier. If he wants your business, he should be happy to make a

change for a small, fair fee. The reasons you shouldn't do it yourself include these:

- All the new, small DPMs have very tightly packaged components and delicate printed-circuit traces that require expertise with a soldering iron that even engineers at the manufacturer's facility don't have. Try changing a component yourself, and chances are high that you will burn the board, lift pads and traces, or damage good components.
- If you do damage the unit, it's not reasonable to expect the manufacturer to repair it under warranty, even if the original problem was covered by his warranty.
- If you damage the unit, it may not even be practical for the manufacturer to repair it, and you'll have to buy another.

Of all the people who have tried to work on our panel meters, I estimate that less than one in 50 has been successful, and at least five out of 10 have created new problems that were much more severe than the one they went after.

#### Elusive reliability

I repeat Phil Wasserman's statement in the ELECTRONIC DESIGN Focus article: "High DPM failure rates are usually traceable to one or more of four causes: design, component quality, assembly workmanship and quality control." There is one more cause that I believe is the most significant of all—component reliability. I separate component reliability from component quality because you can be using the most expensive military type parts and still find they are not meeting specifications, are dying during the production cycle, or—worse yet—in the field.

I firmly believe I have valid grounds to sue a semiconductor house for the staggering number of RTL devices that have failed in our equipment and the damage that the semiconductor company's problems have done to our reputation with some customers. I am not joking or exaggerating. The major reason I haven't filed suit is that I don't think it would ultimately be worth the cost of the effort. We're now spending our time designing *out* their RTL devices.

There are two important sides to the question of whether to use sockets under gas-discharge tubes. With the larger tubes, you get stiff, wire pins that plug into a socket very well. The reasons for spending the extra 25 cents per digit are: (1) In shipping, the tubes sometimes shake out and have to be replaced, and (2) If you're buying uncased panel meters, there is always the possibility of breakage. Either way, if the tube is in a socket, it can be readily replaced at minimal cost without the possibility of damaging the unit by soldering.

When you use the smaller gas-discharge tubes, there is a different problem. They have very



small, soft, wire leads. The leads have a great tendency to fold under when the tube is plugged into the socket. Often the bent lead still makes contact with the top surface of the contact in the socket, and the panel meter works properly—until it is jarred in shipping. Then a digit goes out.

Also, if a socket pin has a small hole, it will fill with solder—which is difficult to see—and the tube's leads will bend. Experience to date indicates that the smaller tubes are actually much more rugged than the larger types internally, and they don't have the problem of elements falling apart. Therefore if you're buying small, enclosed DPMs with miniature, gas-discharge tubes, don't insist on sockets.

### The size trap

There is nothing to be gained and a lot to be lost by stuffing all the circuitry of a properly designed DPM into a box that is too small. First, there is the interconnect problem between boards. Connectors take room, so you don't use the big, reliable ones. Next is the power transformer. You make it as small as possible, which means it must run hotter than if you used a core and wire size a little larger. Third, you stand axial-lead components like resistors on end, which makes them harder to handle and more susceptible to damage.

Next you reduce the trace widths on your PC boards to the point where if they're in the etching tank an extra few minutes, there are gaps on the traces—and if they're not in long enough, the traces short together. This, of course, dramatically increases the susceptibility of the panel meter to humidity because the isolation you expect isn't there in production units, because of surface conductivity on the PC board itself between the traces. Then you have drilling registration problems, because there wasn't enough room to have reasonable-size pads under your ICs. The whole thing turns into a nightmare.

Reliability is, in my opinion, one of the major reasons a number of manufacturers have failed in the DPM business. The smaller the meter, the harder it is to make it truly reliable.

This is not to say that you shouldn't consider a number of the small panel meters now on the market. A few are excellent. However, the list of really bad designs executed in the interest of making a smaller digital panel meter is staggering. Study the guts of a meter before you buy.

### When to shop for price

In selecting a DPM, don't be overly concerned about the manufacturer's published low-quantity price. If you're buying only a few meters, the difference in price between a really good meter and a cheap one will probably be less than \$75. If

you're buying in production quantities, the initial price difference will be insignificant, but the total cost for a good meter will be substantially below that of a cheap one.

If you receive a DPM from your supplier and it doesn't work, what has it cost you? Someone has received the meter and unpacked it. Maybe you've put new meters into inventory and paid for them, because you were not quite ready to use them. Then the problem is discovered, and they have to be repacked, new paperwork written, the lot shipped back for repair, and you wait. In dollars and cents, this has to cost you at least \$25 per unit, which could be 35% of the selling price of the meter.

Evaluate two or three standard DPMs that are technically acceptable and that appear to have the best probability of being reliable. Then talk price. This way, you'll get both a good product and a good price. If you throw out a particular manufacturer because he seems to be too high-priced at the outset, you may well be eliminating your very best potential supplier.

### Watch for cheaper, smaller DPMs

Price erosion in the 3-1/2-digit segment of the market has been dramatic in the last three years. Quantity prices have dropped from over \$300 to less than \$100 for essentially the same product. Don't be deluded into believing that all of these savings have come about because of lower IC prices. That's only a small part of it. The fact is that the major portion is attributable to healthy competition, which has forced manufacturers to accept lower profit margins or to withdraw from the market. During the next two years this same thing will happen in the 4-1/2-digit market. A price tag of \$150 for a full, 4-1/2-digit meter, including power supplies and case, will be here with in that time.

The package is an important consideration, too, especially if you need a second source. Already several manufacturers offer DPMs in the same case. Digilin and United Systems have similar cases. And Data Technology, Electro-Numerics, Faratron and Weston use similar cases.

Smaller meters will come because that is one of the basic ways manufacturers compete. However, because of cost, liquid crystals may beat out LEDs as the display of the future.

On the other hand, I seriously question price prophecies of \$50, let alone \$35, within the next two years. One major requirement for much lower prices is high volume, and I don't believe it will develop in less than five years.

Certainly the digital panel meter of 1982 will make today's products as obsolete as the vacuum-tube audio amplifier. But aren't some of the latter still being sold? ■ ■



# THE MAGIC COUPLER

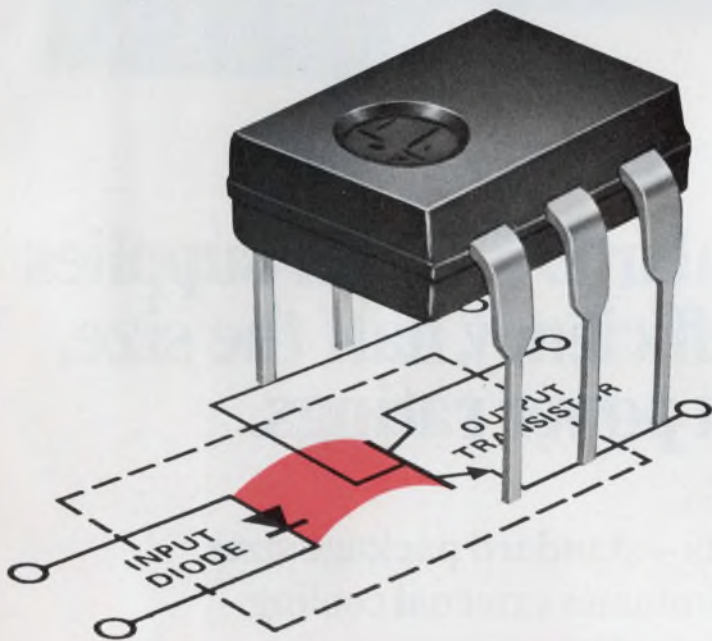

Of more than 20,000,000 phototransistors produced by Fairchild MOD, four million have been used in optical couplers.

Take a light emitting diode chip. Mount it facing a light sensitive semiconductor detector. Package these two chips in a case with input and output leads. The result is probably the most versatile solid state device available, literally a sub-system that:

- Switches on and off with a speed in the low microsecond range and faster.
- Isolates input and output with  $10^{11}$  ohms resistance and a coupling capacitance of approximately one pF.
- Relays information from DC to hundreds of KHz.
- Serves as the drive element to control equipment.
- Operates with an efficiency of up to 50% and more, producing a linear output.
- Provides unidirectional operation, with no feedback to the input.
- Interfaces such circuit devices as transistors and integrated circuits.
- Interfaces memory – CPU – I/O Logic.

## WHAT IT DOESN'T DO IS ALSO INTERESTING.

For example, it:

- Has no moving parts, no contacts to bounce or arc or erode.
- Is unaffected by magnetic fields.
- Doesn't take up much space, being about 1/3" X 1/4" X 1/3".
- Has no known failure modes to make it fail in our lifetime.
- Doesn't require much current for operation, only a few mA.
- Doesn't cost much. Economical. In fact, downright practical.

The World Beaters	Current Transfer Ratio – % (Typ)	Breakdown Voltage – V Input to Output	Description
FCD 810	25	750	Lowest cost
FCD 811	50	2500	Highest Voltage Plastic DIP
FCD 820	50	1500	The Standard

This device has been called a solid state relay, coupler, isolator and transformer. But think of it simply as the answer to many problems, whether you are in the electronics, control or processing industries; whether you are designing medical instrumentation, processing equipment, transportation systems, etc.

Data sheets describing the characteristics of these remarkable devices and how they operate are yours for the asking from your local Fairchild semiconductor sales engineer. Your stocking Fairchild semiconductor distributor can provide immediate product delivery.

**MADE IN  
FAIRCHILD**

FAIRCHILD MICROWAVE & OPTOELECTRONICS DIVISION 4001 MIRANDA AVENUE, PALO ALTO, CALIFORNIA 94304

INFORMATION RETRIEVAL NUMBER 29



# STM. Not just

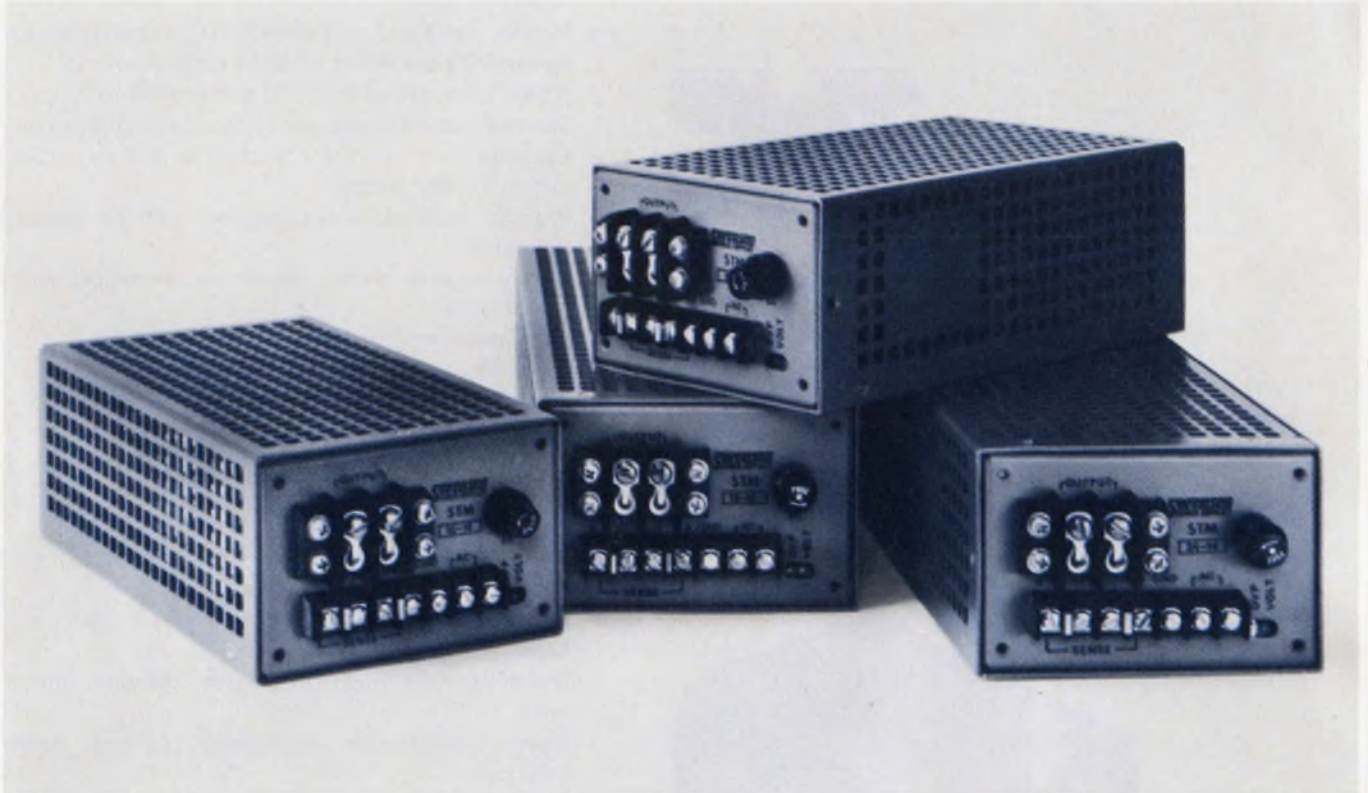

## **Sorensen's new modular DC power supplies give you twice the efficiency, half the size, for equivalent power ratings.**

- **Efficiencies as high as 75%.**
- **Unequaled power outputs — standard package sizes.**
- **Low heat dissipation — eliminates external cooling.**
- **Excellent performance — check the specs.**
- **Built-in overvoltage protection — all units.**
- **Computer optimized filtering — superior RFI and noise performance.**
- **20 models now available — 20 more to come.**

Compared with competitive series-pass power supplies, Sorensen's STM switching-transistor power supplies provide unequalled space and money-saving benefits. And, unlike competitive units, STM power supplies offer overvoltage protection as a standard rather than an optional extra-cost feature.

Sorensen STM's are backed by our world-wide reputation for excellence. For more information write Sorensen Company, a unit of the Raytheon Company, 676 Island Pond Road, Manchester, New Hampshire 03103. Telephone (603) 668-1600. Or, TWX 710-220-1339.



# another black box.

Package Size: Module III – 3-5/16" x 5-1/8" x 9-1/2" – Weight: 6.5 lbs.

Model	OUTPUT VOLTAGE Set Range		OUTPUT CURRENT (A <sub>dc</sub> )*				VOLTAGE REGULATION (comb. line and load)	RIPPLE rms p-p**		INPUT POWER					Price†
	min.	max.	40°C	50°C	60°C	71°C				AC			DC		
										Volts	Amps at 115 V	Freq. (Hz)	Volts	Amps at 150 Vdc	
STM3.5-24	3.0	4.5	24	19.4	14.9	9.6	.05%	5 mv	50 mv	105-132	1.8	50-440	150±15%	1.5	\$229
STM5-24	4.5	6.0	24	19.4	14.9	9.6	.05%	5 mv	50 mv	105-132	2.3	50-440	150±15%	1.5	229
STM9-12	6.0	10	12	9.7	7.5	4.8	.05%	3 mv	50 mv	105-132	2.1	50-440	150±15%	1.5	239
STM12-12	9.5	13.5	12	9.7	7.5	4.8	.05%	3 mv	50 mv	105-132	2.9	50-440	150±15%	1.5	249
STM15-10	13	17	10	8.1	6.2	4.0	.05%	3 mv	50 mv	105-132	2.7	50-440	150±15%	1.8	239
STM18-10	16	20	10	8.1	6.2	4.0	.05%	3 mv	50 mv	105-132	3.2	50-440	150±15%	1.8	249
STM24-8.5	19	25	8.5	6.8	5.3	3.4	.05%	3 mv	50 mv	105-132	3.3	50-440	150±15%	1.9	249
STM28-7	24	30	7.0	5.6	4.3	2.8	.05%	3 mv	50 mv	105-132	3.2	50-440	150±15%	1.9	249
STM36-4	29	43	4.0	3.2	2.5	1.6	.05%	3 mv	50 mv	105-132	4.0	50-440	150±15%	1.9	259
STM48-4	42	56	4.0	3.2	2.5	1.6	.05%	3 mv	50 mv	105-132	4.0	50-440	150±15%	1.9	269

Package Size: Module IV – 3-5/16" x 5-1/8" x 14" – Weight: 9.0 lbs.

STM3.5-36	3.0	4.5	36	29.1	22.3	14.4	.05%	5 mv	50 mv	105-132	3.8	50-440	150±15%	2.2	319
STM5-36	4.5	6.0	36	29.1	22.3	14.4	.05%	5 mv	50 mv	105-132	4.2	50-440	150±15%	2.5	324
STM9-20	6.0	10	20	16.2	12.4	8.0	.05%	3 mv	50 mv	105-132	3.8	50-440	150±15%	2.2	299
STM12-20	9.5	13.5	20	16.2	12.4	8.0	.05%	3 mv	50 mv	105-132	4.8	50-440	150±15%	2.8	289
STM15-15	13	17	15	12.1	9.3	6.0	.05%	3 mv	50 mv	105-132	4.3	50-440	150±15%	2.6	289
STM18-15	16	20	15	12.1	9.3	6.0	.05%	3 mv	50 mv	105-132	5.0	50-440	150±15%	3.0	299
STM24-13	19	25	13	10.5	8.0	5.2	.05%	3 mv	50 mv	105-132	5.5	50-440	150±15%	3.2	309
STM28-11	24	30	11	8.9	6.8	4.4	.05%	3 mv	50 mv	105-132	5.5	50-440	150±15%	3.2	309
STM36-6	29	43	6.0	4.8	3.7	2.4	.05%	3 mv	50 mv	105-132	4.5	50-440	150±15%	2.6	329
STM48-6	42	56	6.0	4.8	3.7	2.4	.05%	3 mv	50 mv	105-132	5.5	50-440	150±15%	3.2	329

\*Free – air rating – no external heatsink

\*\*Worst case. Typically less than 30 mv

†U.S.A. list prices

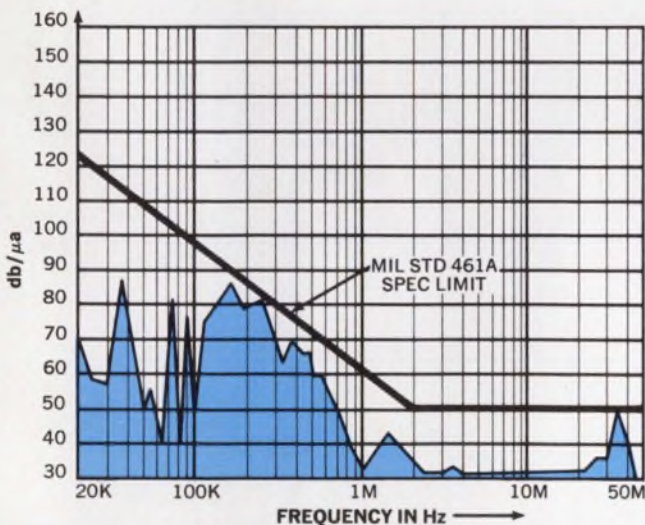

DC Load Leads. Conducted Current Level in db above a Microamp/MHz

Specification	Sorensen STM5-24	Brand "X"
Size	3 <sup>5</sup> / <sub>16</sub> x 5 <sup>1</sup> / <sub>8</sub> x 9 <sup>1</sup> / <sub>2</sub>	4 <sup>15</sup> / <sub>16</sub> x 7 <sup>1</sup> / <sub>2</sub> x 9 <sup>3</sup> / <sub>8</sub>
Volume	160 in <sup>3</sup>	344 in <sup>3</sup>
Price	\$229	\$235
Efficiency	58%	29%
Regulation (line & load combined)	0.05%	0.2%
Temperature Coefficient	0.01 % / °C	0.03% / °C
Overload Protection	Current limiting-adjustable electronic	
Overvoltage Protection	Built-in adjustable, all models	Optional @ \$30 (except built-in, fixed, on 5-volt model only)

Compare this point-by-point spec-check between Sorensen's STM5-24 and Brand "X."

## Sorensen POWER SUPPLIES



# Use three-state logic with confidence

and simplify data busing. You'll get fail-safe performance even when gates short out on a common bus.

Three-state logic (TSL) differs from standard TTL in that it has a third, high output-impedance state. Thus whenever a TSL gate is disabled, it presents very high impedance to its bus; it effectively disconnects itself from the bus. This greatly simplifies data busing by permitting the placement of up to 128 TSL gates on the same bus. The limiting factor is the accumulated leakage currents from the disabled gates.

Originally introduced by National Semiconductor under the trade name Tri-State Logic, three-state logic is now being offered by at least two other companies—Texas Instruments and Signetics. But in spite of the growing use of TSL, many designers still question its reliability. One question that often arises is: What will happen if two or more TSL gates sharing the same bus are turned on simultaneously, either through error, because of transients, or as a result of faulty timing?

Extensive tests indicate that no damage to TSL gates will occur.

## Transient overlaps: what happens

Suppose there are several TSL circuits connected to the same bus. If a timing overlap of enable lines occurs, and the enabled outputs try to put different logic levels on the bus, what are the effects? (Obviously if all the simultaneously enabled devices try to put the same logic level on the common point, timing errors will not affect the bus signal.)

There would be a current transient on the  $V_{CC}$  and ground lines, quite similar to what would occur in a conventional TTL system under the same conditions. In the TTL system (Fig. 1a) the primary cause of the transient on the  $V_{CC}$  line is that both the upper and lower transistors in the output stage conduct during a transition. The current during the transient can be as high as 30 to 50 mA. It is limited by the current-sinking capacity of the lower transistor and the magnitude of the collector resistor in the upper stage.

In the TSL system (Fig. 1b) the same transient can occur inside the gate. Its duration, however, can be extended by another activated output in the opposite state that will continue to supply current of about the same magnitude for the extended period.

The distributed capacitance in the TSL system will probably be larger than that in the TTL system, because a large number of TSL devices can be connected to the same bus, each contributing to the distributed capacitance. Furthermore the bus line itself will probably be longer than in the TTL system.

These differences between TTL and TSL will make transients in the TSL system longer in duration but similar in other respects. Good local power-supply decoupling will prevent the transients from propagating throughout the system.

Next, the resulting voltage on the bus may go to an ambiguous logic level during the overlap.

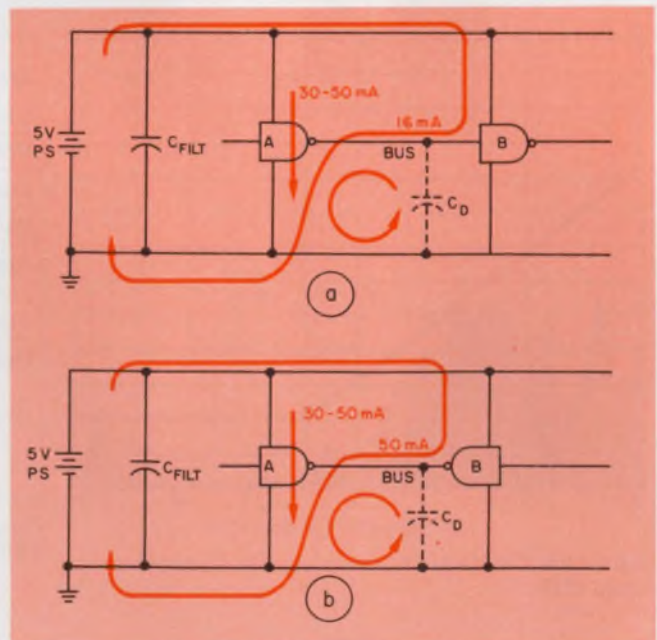

1. Very similar transient currents arise in both TTL (a) and TSL (b) when gates with opposite states turn on simultaneously on the same bus. In the TTL system, gate B represents all loads driven by gate A. In the TSL system, gate B represents all other TSL devices connected to the bus.

Stephen Calebotta, Digital Applications Engineer, National Semiconductor Corp., Santa Clara, Calif. 95051



Thus if one high and one low output are shorted together, the voltage during the overlap will be about 0.4 to 0.5 V. If, say, three highs are connected to one low, the voltage will be about 1.2 to 2.2 V, which an input device might take for ONE or ZERO, depending on noise and temperature. The final output voltage will range between a lower limit of 0.4 and an upper of  $V_{CC} - 2V_{BE}$  volts, depending on the number of devices and the combinations of ONEs and ZEROs being placed on the common bus. Logic-level recovery will take place after the multiple overlap has expired.

In a typical bus-organized system, the enable lines will probably be controlled from a bipolar ROM or a decoder. Since the access time of a ROM is somewhat content-dependent, it will vary between 35 and 50 ns. This 15-ns variation, less the differential time to enable or disable a TSL circuit, determines the overlap duration.

Now consider a case when a decoder controls the enable lines. Referring to Fig. 2, we assume that input A is low, and inputs B, C and D are high. Output ZERO is selected. As line A goes from logic ZERO to logic ONE, output ZERO goes high two gate delays later, while output 1 goes low three gate delays later. In this case, the TSL devices controlled by ZERO and ONE would be both inactive for a period of about one gate delay (5 ns) plus the differential propagation delay between disabling and enabling three-state outputs.

If A goes from a logic ONE back to a logic

ZERO, output ZERO goes low two gate delays later, while output ONE goes high three gate delays later. In this case the TSL devices controlled by ZERO and ONE could be active simultaneously for a period equal to the differential enable delay less the 5-ns gate delay.

But this overlap can be eliminated simply by letting the BCD-to-decimal decoder control eight, rather than 10, enable lines. An input code between ZERO and 7 will select one of the first eight output lines. Codes of 8 and above (simply raising the input line D) will inhibit all codes below 8, momentarily disabling all TSL devices. Such a disabling pulse need be only 10-to-15-ns wide.

### Long or short overlaps are no problem

Before we examine the effects of overlapping on TSL packages, let's see what happens to an individual circuit if multiple TSL devices are active on the same bus indefinitely, with a logic ONE shorted to ground and then a logic ZERO shorted to a power supply ( $V_{CC} - 2V_{BE}$ ).

Referring to the basic TSL schematic (see box), we see that shorting a logic ONE to ground means the 100- $\Omega$  resistor, R<sub>1</sub> limits the current. Thus power dissipation becomes 215 mW.

When a logic ZERO is shorted to  $V_{CC} - 2V_{BE}$  volts, Q<sub>5</sub> is protected only by the limitation on its base drive. Typically, Q<sub>5</sub> will sink a maximum current of 100 mA, with V<sub>CC</sub> equal to 5 V. The maximum current during actual tests was found

## How the TSL circuit operates

Three-state logic simplifies data busing because besides the TTL states—high and low—it has a third, high output-impedance state.

A typical TSL circuit works as follows:

If the enable line is at a logic ZERO, then Q<sub>6</sub> is off and either Q<sub>1</sub> or Q<sub>5</sub> is conducting, depending on the input-signal logic level. If the enable line is high (a logic ONE), Q<sub>6</sub> is on, turning off Q<sub>2</sub> via Q<sub>1</sub>. This normally would turn Q<sub>5</sub> off and Q<sub>4</sub> on, through Q<sub>3</sub>. However, the diode from the collector of Q<sub>6</sub> to the collector of Q<sub>2</sub> pulls Q<sub>2</sub>'s collector down, also removing the base drive from Q<sub>3</sub>. This keeps Q<sub>1</sub> off. Now both Q<sub>1</sub> and Q<sub>5</sub> are off. This is the high-impedance (or third) state.

The propagation delay from the enable input to the output varies, depending on whether or not the device is being enabled or disabled. In general, the disabling delay is shorter. Thus to disable the output, Q<sub>6</sub> actively pulls down the emitter of Q<sub>1</sub> and the collector of Q<sub>3</sub>, quickly discharging the base and collector capacitances of Q<sub>2</sub>. To enable the output, Q<sub>7</sub> pulls up until the disabling emitter of Q<sub>1</sub> and diode D<sub>1</sub> are both back-biased. Now the base and col-

lector capacitances of Q<sub>2</sub> must be charged via R<sub>3</sub> and R<sub>2</sub>, respectively. This difference in charging rates between enabling and disabling makes the disable propagation delay shorter.

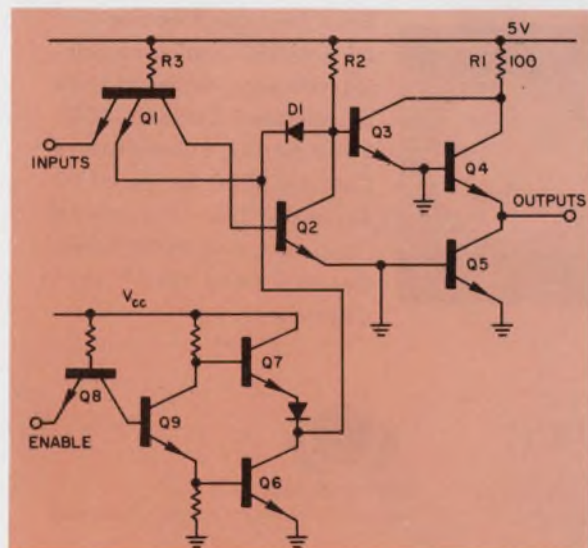



emi/rfi filters...

**STOCK  
TO  
TWO  
WEEKS**

...from USCC/Centralab

If you have an EMI/RFI problem—contact us first. That's because we've amassed an extensive distributor inventory on popular size EMI/RFI filters ready for immediate delivery. In addition, we've stocked our production shelves with all the components necessary to deliver other sizes in not more than two weeks. And if you have a custom requirement we have a staff of applications engineers whose business is solving your specific problem... and fast.

Before you buy, contact a reliable source for highest quality EMI/RFI filters—USCC/Centralab, 2151 N. Lincoln St., Burbank, California 91504 • (213) 843-4222.



Send for your free copy of our EMI/RFI Catalog containing complete technical data on: Miniature Ceramic 1000/2000 Series, Subminiature Ceramic 3000 Series, 8000 Series for Data Processing Equipment, and 9000 Series Ceramic Feed-thru Filter/Capacitors.

**USCC**

U. S. CAPACITOR  
CORPORATION



**CENTRALAB**  
Electronics Division • GLOBE-UNION INC.

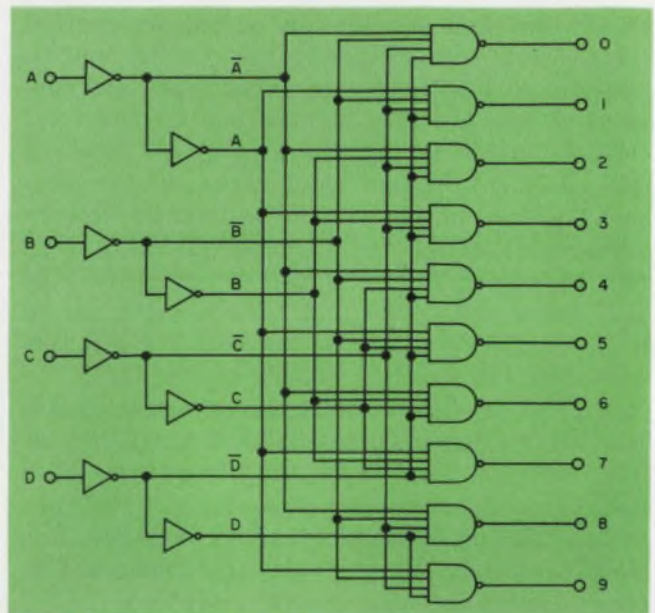

2. Transient overlaps can be eliminated simply when TSL enable lines are driven by a BCD-to-decimal decoder. Instead of driving 10 enable lines, the decoder can drive outputs 0 through 7. Pulsing the now-unused input D (for codes of 8 and above) will momentarily disable all the TSL devices.

to be 142 mA at a  $V_{CC}$  of 6.5 V, resulting in maximum power dissipation of 624 mW.

Since in both cases power dissipation is less than rated maximum, an individual TSL circuit can withstand shorting indefinitely.

How about multiple TSL circuits? Tests on packages of multiple TSL circuits have shown that no damage occurs even if all the outputs of each are shorted simultaneously to ground or to  $V_{CC} - 2V_{BE}$ , with  $V_{CC}$  varying between 4.5 to 6.0 V. Some parts dissipate almost 2 W but show no deterioration in their operation.

It has also been found that power dissipation is not necessarily N times the dissipation of N individual circuits. A self-limiting effect comes into play, reducing the current—since resistances and various device thresholds change in such a way as to choke off the high current. For instance, a device with four outputs, all shorted, dissipates about 10% less than four times the dissipation of a single circuit.

In the case of a device with eight outputs, the total power dissipation turns out to be slightly less than half the sum of individual dissipations. In general, it has been found that all devices, regardless of the number of outputs, dissipate about the same power (1 to 1.5 W for  $V_{CC}$ 's from 4.5 to 5.5 V) and that no TSL devices will be permanently damaged by shorting. At worst, the devices will heat up and may not work for 30 to 45 seconds after removing the shorts but after cooling down they will again operate to specifications. ■■



# Metal Glaze™ resistors don't drift.

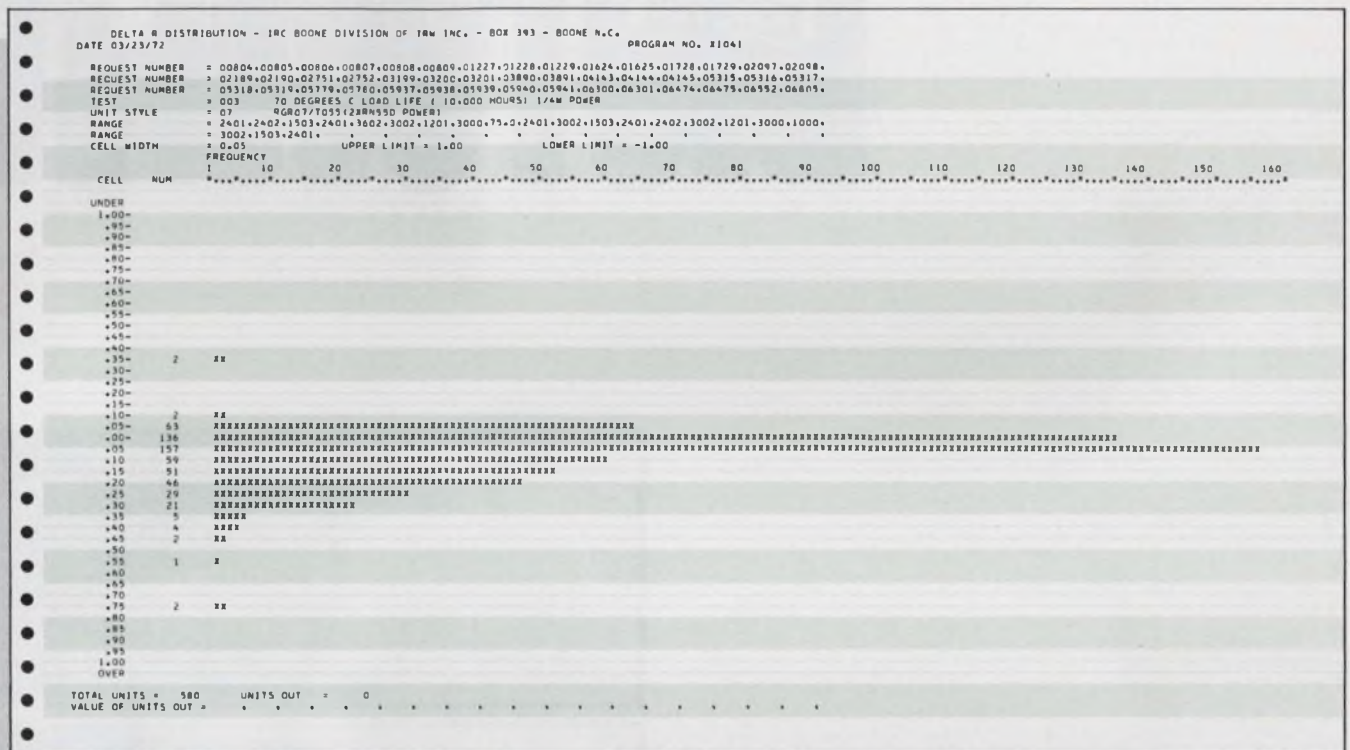

The best place to control downstream circuit drift is at the design stage. Specify IRC Metal Glaze resistors. They benefit the designer and everybody else by providing six specific kinds of protection:

1. **Load Life.** Millions of unit hours of test data and years of field usage prove it: Metal Glaze resistors change less than 1% even after 10,000 hours—as illustrated in the computer printout above.
2. **Overloads.** Metal Glaze thick film construction provides excellent overload and transient capabilities; e.g., ½ W unit can take up to 150 W for 300 μ sec.
3. **Temperature coefficient.** Because of excellent thermal conductivity, Metal Glaze T.C. Δ R is up to 50% less than other resistors with the same temperature coefficient.

4. **Storage life.** Metal Glaze inert characteristics cut shelf drift almost to zero. Drift of 1 to 3% per year is common in many other resistor types.

5. **Installation.** Insertion and assembly shocks, heat, solvent and other abuses can produce instantaneous Δ Rs beyond spec limits. But Metal Glaze sets the ruggedness standard due to solder terminated subassembly and molded protective jacket.

6. **Cost Δ \$s.** Metal Glaze resistors are most economical in universal use because they eliminate revenue drain due to field failures. Save on inventories too, due to standardizing on one resistor type.

Request Metal Glaze design data. TRW/IRC Fixed Resistors, an Operation of TRW Electronic Components, Boone, N.C. 28607. (704) 264-8861.

**TRW**  
IRC FIXED RESISTORS



**Delco's  
TO-66 silicon  
transistors for**

# BIG POWER

Now the high-energy capability of Delco's silicon power transistors is available in the TO-66 package.

Like all the Kokomoans' silicon power transistors, they're triple diffused and built to survive the most rugged applications. Their high-voltage ratings make it practical to operate them directly from rectified 117-volt or 220-volt ac line. This allows lower weight and smaller circuit size because fewer, less bulky components are required than with low-voltage higher current systems. And, their energy capability is backed by the surest rating in the business—Pulse Energy Testing.

Use the new DTS-660 series when you need the high-voltage capability of our DTS-410, DTS-423 or DTS-425 but, in TO-213MA (TO-66) size.

They're in stock at Delco distributors now. For additional information, prices, and complete data, give yours a call or contact us at our nearest regional office.

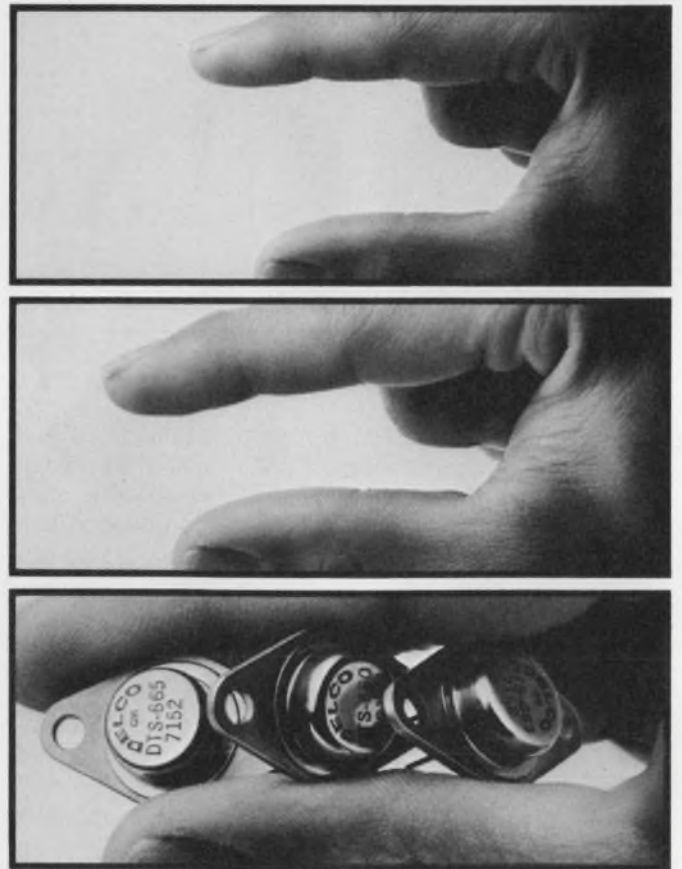

Type	$I_C$ (Cont) (Peak)	$V_{CE0}$	$h_{FE}$ @ $I_C=1.0A$ min./max.	$V_{CE0}(sus)$ min.	$P_D$ min.	Suggested resale price 1-99 quantity
DTS-660	3.5A 10.0A	200V	30 90	200V	60W	\$5.93 ea.
DTS-663	3.5A 10.0A	400V	30 90	325V	60W	\$9.57 ea.
DTS-665	3.5A 10.0A	500V	30 90	400V	60W	\$14.94 ea.

NPN triple-diffused silicon transistors in JEDEC TO-213MA (TO-66) packages.

# IN SMALL SPACES



**Delco Electronics**

DIVISION OF GENERAL MOTORS CORPORATION, KOKOMO, INDIANA

**Now available from these distributors in production quantities:**

ALA., BIRMINGHAM • Forbes Distributing Co., Inc. (205)-251-4104  
ARIZ., PHOENIX • Cramer/Arizona (602)-263-1112 • Sterling Electronics (602)-258-4531  
CAL., LOS ANGELES • Kierulff Electronics, Inc. (213)-685-5511 • Radio Products Sales, Inc. (213)-748-1271  
CAL., PALO ALTO • Kierulff Electronics, Inc. (415)-968-6292  
CAL., REDWOOD CITY • Cramer/San Francisco, (415)-365-4000  
CAL., SAN DIEGO • Radio Products Sales, Inc. (714)-292-5611  
COLO., DENVER • Cramer/Denver (303)-758-2100 • Denver Walker Electronics (303)-935-2401  
CONN., NORWALK • Harvey/Connecticut (203)-853-1515  
ILL., ROSEMONT (Chicago) • Kierulff Electronics (312)-678-8560  
ILL., SKOKIE (Chicago) • Merquip Electronics (312)-282-5400  
IND., INDIANAPOLIS • Graham Electronics Supply, Inc. (317)-634-8202  
MD., BALTIMORE • Radio Electric Service Co. (301)-823-0070  
MASS., NEEDHAM HEIGHTS • Kierulff Electronics, Inc. (617)-449-3600  
MASS., NEWTON • The Greene-Shaw Co., Inc. (617)-969-8900  
MICH., ROMULUS • Harvey/Michigan (313)-729-5500  
MINN., MINNEAPOLIS • Stark Electronics Supply Co. (612)-332-1325

MO., KANSAS CITY • Walters Radio Supply, Inc. (816)-531-7015  
MO., NO. KANSAS CITY • LCOMP-Kansas City, Inc. (816)-221-2400  
MO., ST. LOUIS • LCOMP-St. Louis, Inc. (314)-647-5505  
N.J., CLIFTON • Eastern Radio Corporation (201)-365-2600, (212)-244-8930  
N.M., ALBUQUERQUE • Cramer/New Mexico (505)-265-5767 • Sterling Electronics (505)-247-2486  
N.Y., BINGHAMTON • Harvey/Federal (607)-748-8211  
N.Y., EAST SYRACUSE • Cramer/Eastern (315)-437-6671  
N.Y., ROCHESTER • Cramer/Rochester (716)-275-0300  
N.Y., WOODBURY • Harvey/New York (516)-921-8700, (212)-582-2590  
OHIO, CINCINNATI • United Radio, Inc. (513)-761-4030  
OHIO, CLEVELAND • Pattison Supply (216)-441-3000  
OHIO, DAYTON • Kierulff Electronics (513)-278-9411  
OKLA., TULSA • Radio, Inc. (918)-587-9123  
PENN., PHILADELPHIA • Almo Electronics (215)-676-6000  
PENN., PITTSBURGH • RPC Electronics (412)-782-3770  
S.C., COLUMBIA • Dixie Radio Supply Co., Inc. (803)-253-5333

TEXAS, DALLAS • Adleta Electronics Co. (214)-741-3151  
TEXAS, FORT WORTH • Adleta Electronics Co. (817)-336-7446  
TEXAS, GARLAND • Kierulff Electronics, Inc. (214)-271-2471  
TEXAS, HOUSTON • Harrison Equipment Co., Inc. (713)-224-9131  
UTAH, SALT LAKE CITY • Cramer/Utah (801)-487-3681  
VA., RICHMOND • Meridian Electronics, Inc., a Sterling Electronics Company (703)-353-6648  
WASH., SEATTLE • Kierulff Electronics, Inc. (206)-763-1550  
WASH., TACOMA • C & G Electronics Co. (206)-272-3181  
CANADA, ONT., SCARBOROUGH • Lake Engineering Co., Ltd. (416)-751-5980  
ALL OVERSEAS INQUIRIES:  
General Motors Overseas Operations  
Power and Industrial Products Dept.,  
767 Fifth Avenue, New York, N.Y.  
10022. Phone: (212)-486-3723.

**Kokomo's Regional Headquarters.**

Union, New Jersey 07083,  
Box 1018, Chestnut Station,  
(201) 687-3770.  
El Segundo, Calif. 90245,  
354 Coral Circle, (213)  
640-0443.  
Kokomo, Ind. 46901, 700 E.  
Firmin, (317) 459-2175  
(Home Office).



INFORMATION RETRIEVAL NUMBER 33



## Modified reed switch acts as overload current sensor

If a reed relay is connected as an overload current sensor (Fig. 1), either a series pass or switching regulator can be turned off and on again continuously until the overload is removed. The duty cycle is predetermined by the circuit components. Maximum power dissipation in the series-regulating pass transistor can be limited to approximately 20% more than that for full-load operation.

A series pass regulator using a reed switch is illustrated in Fig. 2. A controlled overload current exists when the output is shorted. Unlike the widely used foldback technique, this circuit cannot exhibit two different output voltages for a given value of load/overload current. The circuit is insensitive to temperature variations between 0 and 60 C, and it lends itself to control by an external switch or by DTL/TTL logic.

The reed relay is constructed by winding copper wire around a sleeve and inserting the reed switch inside the sleeve. The winding should be connected in series with the load.

The series pass regulator of Fig. 2 consists of an LM-305 IC regulator with transistors  $Q_3$  and  $Q_4$  acting as boosters to increase the current capacity to 4 A. As the load current increases to the trip point of reed relay  $K_1$ , transistor  $Q_1$  turns on. The resulting voltage drop across  $R_1$  then turns on  $Q_2$ , which is the short-circuit limit transistor within the LM-305. Since the

base drive to transistor  $Q_1$  (through  $Q_3$ ) is cut off, the load current and voltage decay to zero.

Transistor  $Q_1$  is delayed from turning on by a period  $T_1$  (determined by the time constant  $C_2R_4$ ) thereby reducing transients. The transistor is held on for a period  $T_2$  determined by  $C_1R_6$ . When  $Q_1$  finally turns off, the output voltage returns to normal. If the load current has been reduced below the trip point of relay  $K_1$ , the regulator then returns to normal operation. If not, the complete overload cycle starts again.

*Don Gazzano, Ampex Corp., 401 Broadway, Redwood City, Calif. 94063.*

CIRCLE No. 311

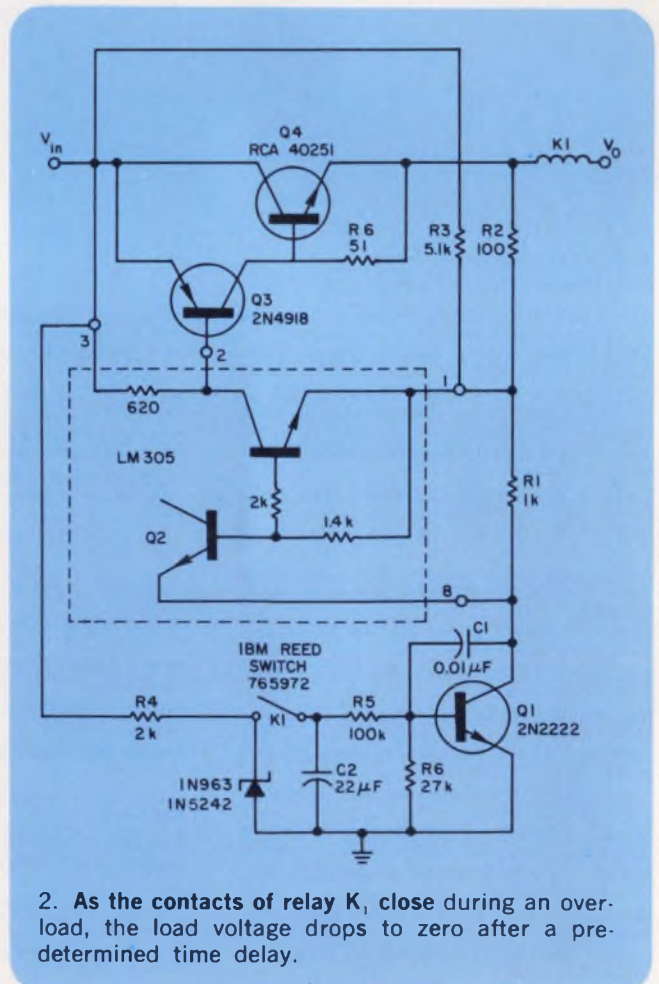
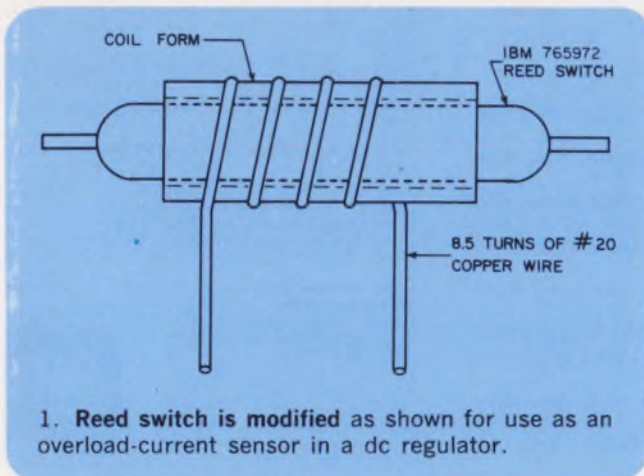



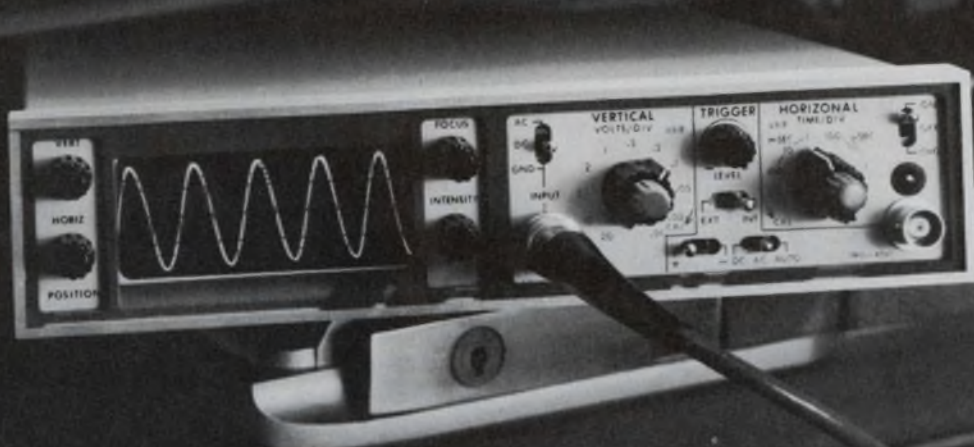

PS910A  
"FLAT-PACK"

# 20 MHz

## ...and small enough to travel with you!

- Mini-portable Oscilloscope — Battery or AC powered — DC-20 MHz bandwidth
- 10 mV/div sensitivity — Recharging circuitry — Rack mountable — Laboratory quality

The PS900's are the first mini-portable scopes to bring lab-quality to "on-site" DC to 20 MHz test and measurement applications. These are "true" portables, since they are of rugged construction, small size (will fit into your tool kit or brief case) and light weight (only 7 pounds with batteries), and since they will operate from internal batteries for up to 5 hours. Recharging circuitry is included, and standard "C" size cells can be used . . . ni-cad, alkaline or in a pinch, even common flashlight batteries!

Interested? Call Bill Kraus at (714) 279-6572, or write us at 7595 Convoy Court, San Diego, California 92111.

# \$595

AVAILABLE NOW FOR ONLY

PS920A  
"STACK-PACK"



The PS900 can be ordered in one of two different configurations, depending on your application. Both feature identical controls and are available at the same price.  
 "FLAT-PACK"—  
 1 3/4" H x 8 1/2" W x 12" D  
 "STACK-PACK"—  
 3 1/2" H x 4 1/4" W x 12" D

From the leader in Multi-Channel Monitor Oscilloscopes

**V**U-DATA  
CORPORATION





# Edge-triggered sequence generator results from Johnson counter

If a single D flip-flop is added to a standard Johnson counter, the resulting minisequencer handles both asynchronous and synchronous inputs. When the trigger is asynchronous, the sequencer provides asynchronous-to-synchronous conversion, producing three pulses in synchronism with the clock. With a synchronous trigger, the circuit acts as a one-shot, with appropriate delay and pulse-forming properties.

The two-stage Johnson counter, composed of FF<sub>2</sub> and FF<sub>3</sub> (Fig. 1) is a Gray-code type—one in which only a single stage changes for each clock input. The stages are connected as a shift register, except that the last-to-first-stage connection is inverted. A useful property of this counter is that any state may be decoded by a single two-input gate, and the decoded output (Fig. 2) will be free of timing transients. The sequence of the two-stage-counter of Fig. 1 is given in the accompanying table.

The first flip-flop, FF<sub>1</sub>, acts as a gate to the Johnson counter. In the normal state, FF<sub>1</sub> is reset—its Q output is low. This Q output holds FF<sub>2</sub> in the reset state, inhibiting FF<sub>2</sub> or FF<sub>3</sub> from counting. A positive transition at FF<sub>1</sub> releases FF<sub>2</sub> and FF<sub>3</sub>, producing the normal Johnson-counter sequence. The last non-zero state of the counter is decoded by gate G<sub>1</sub>, which resets FF<sub>1</sub>. After FF<sub>1</sub> is reset, the next clock pulse resets FF<sub>3</sub>, ending the sequence.

The Johnson counter may be as long as desired, provided the last non-zero state is decoded to reset FF<sub>1</sub>. The clock frequency depends on the speed of the logic used. With the 74 series TTL logic shown, the maximum clock frequency is approximately 8.5 MHz. The logic speed is the only limitation on the technique; changes in frequency or duty cycle of the "event" input will have no effect, and changes in state have no effect during the sequence period.

In the case of an asynchronous event, however, if the input occurs within the setup time of FF<sub>2</sub>, the flip-flop could change state but might not latch. Because of this possibility, (which doesn't occur in the 7400 series D flip-flops shown) the first state of the sequencer should not be used unless the flip-flop does latch. Setup time is the time during which the D (or J or K) inputs must be stable before the triggering edge of the clock occurs.

*T. L. Urquhart, Lead Engineer, Radiation Systems Div., Data Processing Section, P.O. Box 37, Melbourne, Fla. 32901*

CIRCLE No. 312

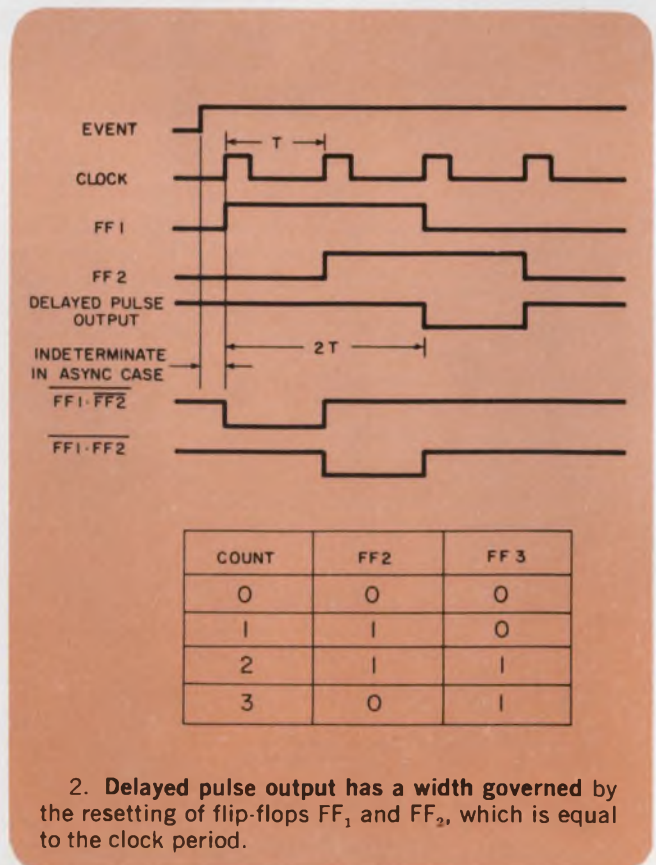
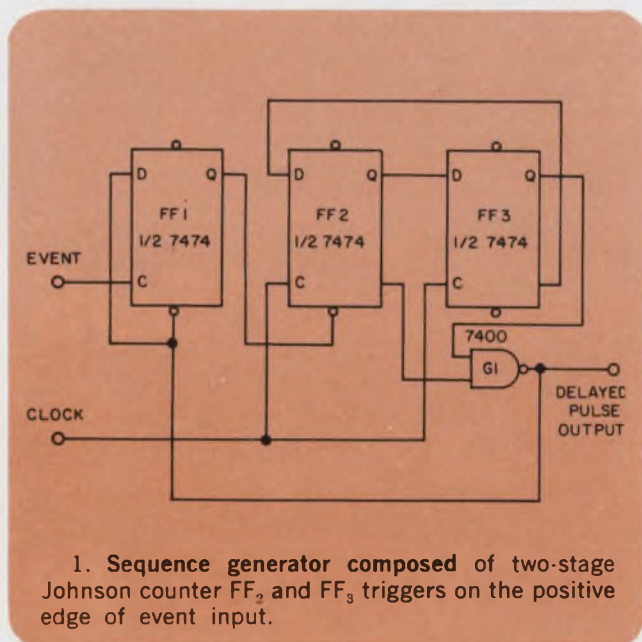



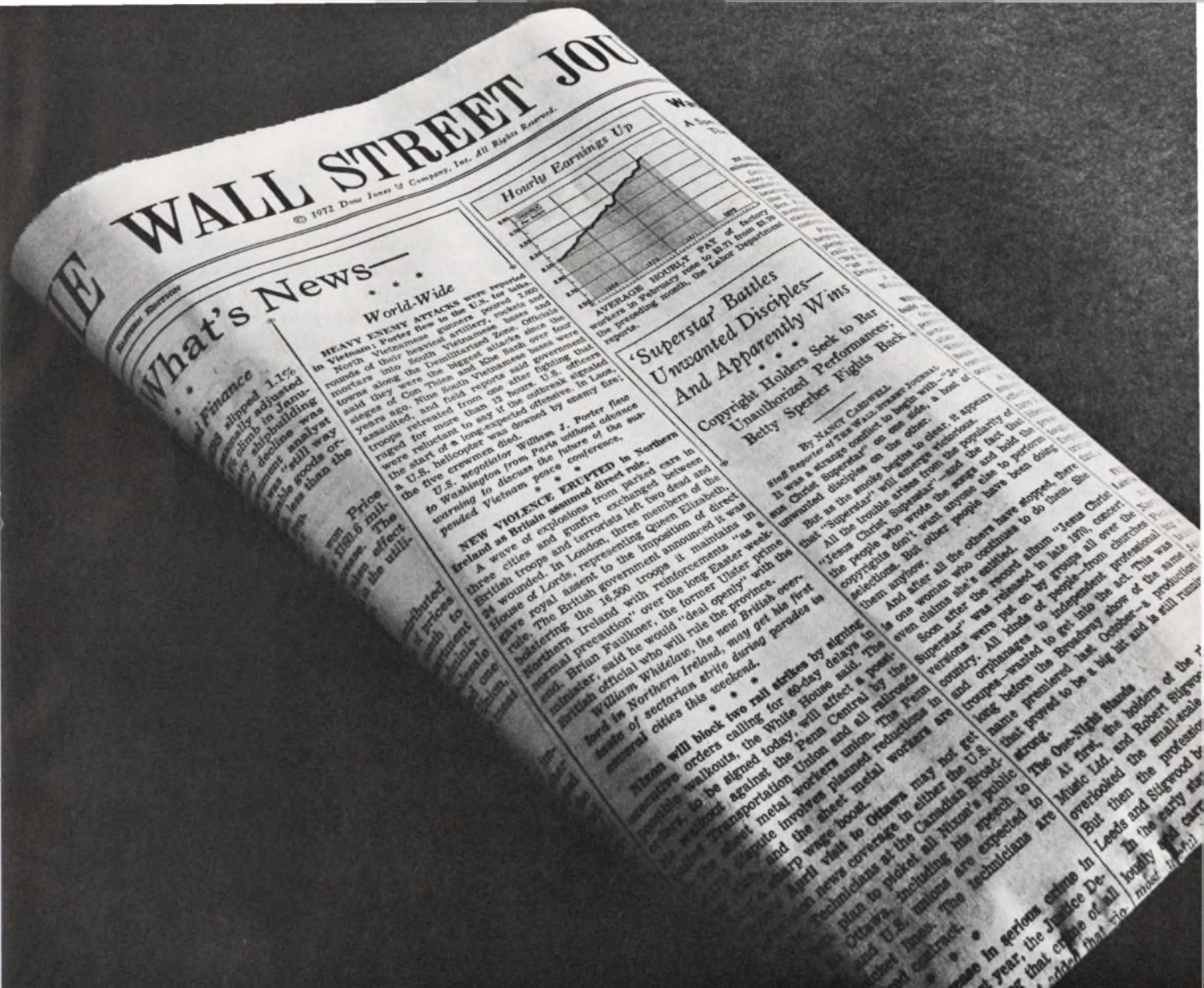

# It's as current as a PDP-8.

These days, a computer has to keep up with the times.

Like PDP-8. It's still the most popular minicomputer ever made.

Because we keep thinking about our computers long after we put them on the production line.

We keep making improvements as we go along.

Keep developing new options. And new software.

Like OS/8, a 4th generation operating system with a new set of math routines that go 4-5 times faster than the system it replaces.

And COS/300 the new data management system for the PDP-8.

And DEC/X8, a totally new concept in systems exercisers.

And RTPS, the realtime FORTRAN IV that's faster than the giant computers.

Lower cost DECtape. Lower cost DECdisplays. Low cost DECwriters. Low cost DECmagtape. Low cost DECdisks.

Of course, there are some things about the PDP-8 that naturally keep it up-to-date. Like the OMNIBUS® structure that lets you plug in every-

thing. Anywhere. In any order. At any time.

And nobody is as careful as we are. Nobody tests their computers as much as we do. Nobody uses computers to build computers like we do.

Which should help to explain why PDP-8 is the most popular minicomputer ever made.

Read all about it.

Write Digital Equipment Corporation, Maynard, Mass. 01754. (617) 897-5111. European headquarters: 81 route de l'Aire, 1211 Geneva 26 Tel.: 42 79 50.

**digital**

INFORMATION RETRIEVAL NUMBER 35

PDP is a registered trademark of Digital Equipment Corporation.



# Power-enable circuit offers variable time delay

Application of dc power can be delayed with a simple power-enable circuit that also signals when the delay period is completed. In the circuit shown, the output of transistor  $Q_2$  yields a logic signal when transistor  $Q_3$  supplies power to the load.

The length of the delay is determined by the time constant of resistor  $R_1$  and capacitor  $C_1$ . A high-level signal at its input turns on transistor  $Q_1$ , shunting the current from resistor  $R_1$  to ground and discharging capacitor  $C_1$ . As long as  $C_1$  is discharging, the turn-on of transistors  $Q_2$  and  $Q_3$  is disabled.

The time delay is determined by the time re-

quired for capacitor  $C_1$  to charge through  $R_1$  to a voltage more positive than the breakdown voltage of diode  $D_1$  plus 0.7 V ( $V_{BE}$  for  $Q_2$ ). Resistor  $R_2$  limits the discharge current from  $C_1$  into  $Q_1$ . Resistor  $R_1$  prevents the  $D_1$  leakage current from biasing on  $Q_2$ . Delays of up to  $2(R_1 \cdot C_1)$  are attainable by proper selection of  $D_1$ . The limiting factor in selecting  $R_1$  and  $D_1$  is the need to allow sufficient base-drive current to  $Q_2$  from  $R_1$ , thus limiting the current that  $Q_2$  will sink.

*James A. Haas, 132 Paoli St., Verona, Wis. 53573*

CIRCLE No. 313

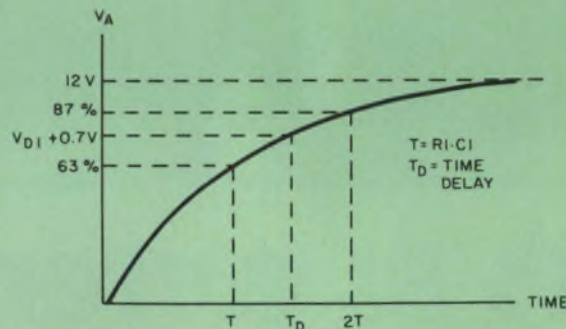
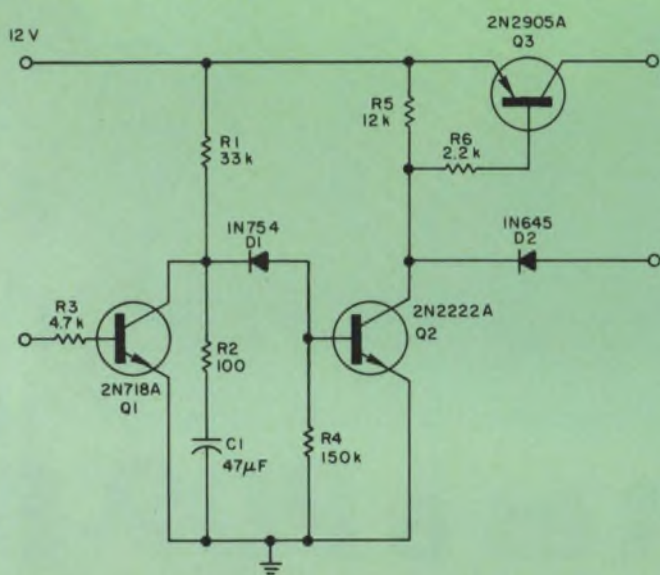

Outputs of transistors  $Q_2$  and  $Q_3$  are delayed by the charging time of capacitor  $C_1$  through resistor  $R_1$ .

## IFD Winner of March 2, 1972

**Ron Siebert**, Digital Applications Dept., Signetics Corp., 811 E. Arques Ave., Sunnyvale, Calif. 94086. His idea "Generate triangular waves with VCO" has been voted the Most Valuable of Issue award.

**Vote for the Best Idea in this issue.**

**SEND US YOUR IDEAS FOR DESIGN.** You may win a grand total of \$1050 (cash)! Here's how. Submit your IFD describing a new or important circuit or design technique, the clever use of a new component or test equipment, packaging tips, cost-saving ideas to our Ideas for Design editor. Ideas can only be considered for publication if they are submitted exclusively to ELECTRONIC DESIGN. You will receive \$20 for each published idea, \$30 more if it is voted best of issue by our readers. The best-of-issue winners become eligible for the Idea of the Year award of \$1000.



# 350 MHz

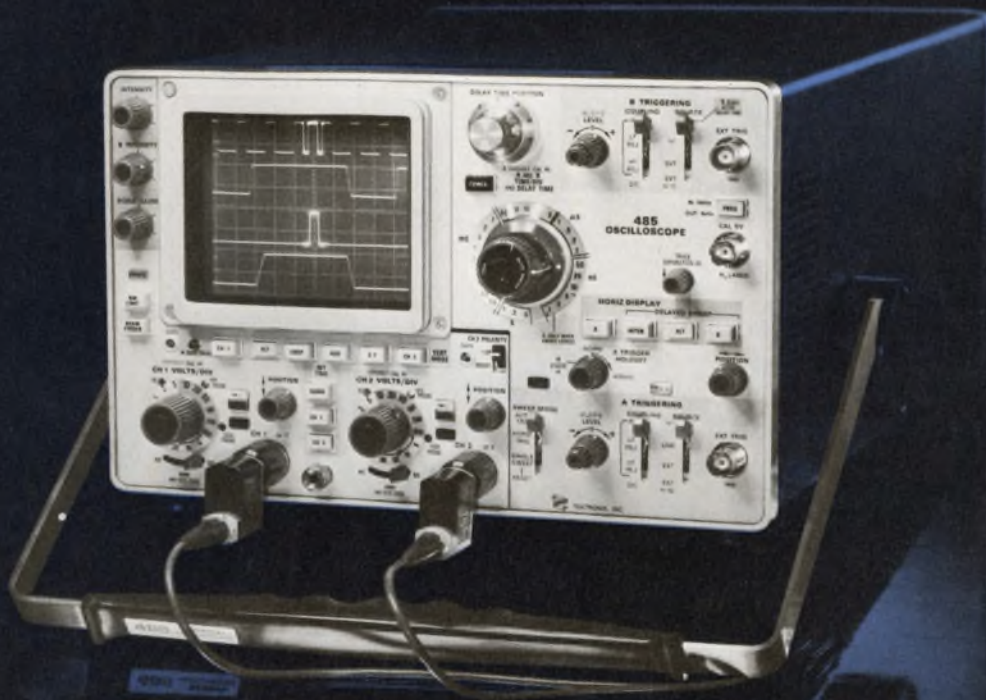

in a *portable* laboratory oscilloscope  
that weighs only 23 pounds.

The dual-trace, 350-MHz TEKTRONIX 485 Oscilloscope is the newest addition to the world's most widely used portable family. Many features of earlier TEKTRONIX portables are retained, many others are expanded and a lot of new ones are added. The result is a new product which significantly expands the performance spectrum of portable scopes. Following are some of the features of the 485, an oscilloscope which measures with laboratory precision and carries with small-package ease.

**350-MHz Bandwidth at 5 mV/Div**—More dual-trace high frequency measurement capability at 5 mV/Div than any other laboratory-quality scope—portable or cabinet.

**1-M $\Omega$  and 50- $\Omega$  Selectable Inputs**—Scope circuitry automatically disconnects the 50- $\Omega$  inputs when signals exceed 5 V RMS or 0.5 watts to protect your equipment.

**Time Resolution to 1 ns/Div**—More time resolution than any other portable. And it's direct reading.

**A-External Trigger**—Just press this button to display the external trigger signal and quickly verify your trigger source or check timing reference.

**Alternate Sweep Switching**—View intensified waveforms and delayed waveforms at the same time. When you move the intensified zone you always know precisely where you are, and still see the delayed waveform. It saves time and adds operation convenience.

Weight without accessories, just 20½ lb (23 lb with accessories). As much as 30% lighter than other portables which have only 150-MHz bandwidth.

For complete information or to arrange a demonstration, contact any TEKTRONIX Field Office. Our offices are located in or near major cities and industrial centers—worldwide. If you prefer, write Tektronix, Inc., P.O. Box 500, Beaverton, Oregon 97005.

485 Oscilloscope ..... \$4200

U.S. Sales Price FOB Beaverton, Oregon



**TEKTRONIX®**

committed to  
technical excellence



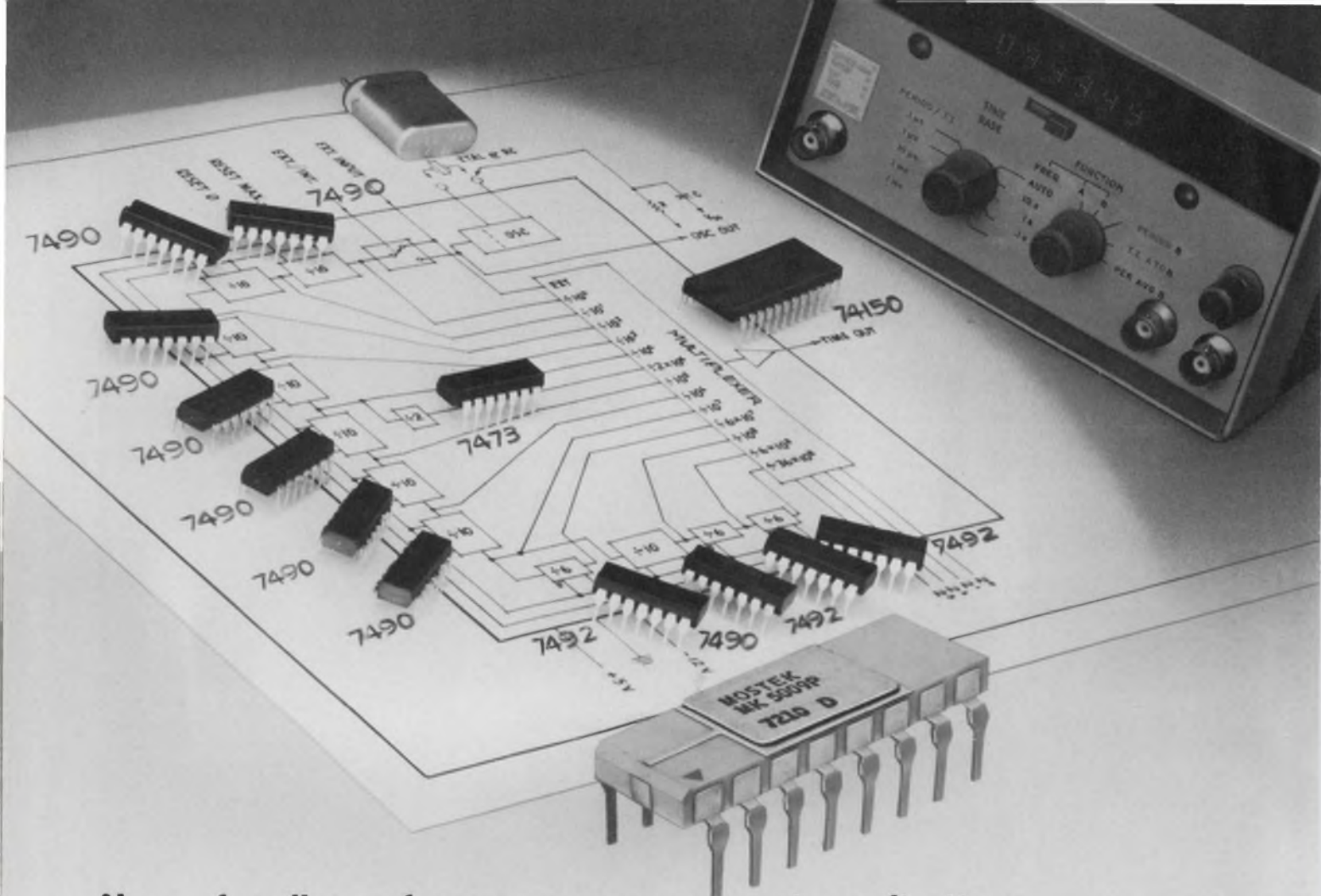

## Now... for all your frequency measurement applications the universal time-base circuit

MOSTEK is now offering a new MOS chip—the MK 5009 P—to solve a host of timing and counting applications at low cost. With this versatile new circuit you can replace seven or eight TTL packages usually employed and enjoy a 94% saving in power required (80 mW for the 5009 compared with 1.3W for eight TTL decade counters!).

For flexibility, the 5009 is designed to operate from any of three frequency sources: internal oscillator with external RC combination; internal oscillator with external crystal; or externally applied TTL signal. Other features? Check these:

- "Reset to 9" and "Reset to 0" features are included to facilitate initiation of time base periods.
- Separate oscillator output is available for use with other equipment.

- BCD selection of time base periods facilitates automatic ranging of time base with addition of simple counter.
- Inputs and time output are TTL compatible.
- Frequency division ratios of from 1 to  $36 \times 10^3$  are available.

With a 1 MHz input frequency or crystal, the 5009 provides the basic time periods necessary for most frequency measuring instruments—1  $\mu$ s through 100 secs. Also available for other applications: 1 min., 10 min., and 1 hour periods using a 1 MHz input, and 50 or 60 Hz output with a 1 or 1.2 MHz input.

Pair the 5009 with MOSTEK's MK 5002 P or new MK 5007 P counter/display circuits (the 5007 features a 16-pin package containing four decades of counting storage and BCD output) and you've got a perfect

low power "duo" for frequency counters, tachs or time interval measuring equipment.

When counting/timing are important requirements, call MOSTEK or one of the distributors or representatives listed here. We make MOS with your needs in mind!



1215 West Crosby Road  
Carrollton, Texas 75006  
(214) 242-0444

**Regional Sales Offices:** West: 11222 La Cienega Boulevard, Inglewood, Calif. 90304 (213) 649-2600 East: 60 Turner Street, Waltham, Mass. 02154 (617) 899-9107 Midwest/Southeast: 515 S. W. Avenue, Jackson, Michigan 49203 (517) 787-0508

**Representatives:** HMR Inc., Minneapolis, Minn. (612) 920-8200; W. J. Purdy Co., Burlingame, Calif. (415) 347-7701; Littleton, Colo. (303) 794-4225; KCE Corp., San Diego, Calif. (714) 278-7640; Los Angeles, Calif. (213) 391-0586; FM Associates Ltd., Greensboro, N. Carolina (919) 294-2754; Huntsville, Ala. (205) 536-9950; Orlando, Fla. (305) 851-5710; Sprague Electric Co., Wayne, New Jersey (201) 696-8200; Schiller Park, Ill. (312) 678-2262; Richardson, Texas (214) 235-1256; Tempe, Arizona (602) 966-7233; N. Seattle, Wash. (206) 632-7761; Precision Electronics, Inc., Glenside, Pa. (215) MI 6-8383; James Sample Associates, Rochester, N. Y. (716) 342-1413; Midwest Marketing, Dayton, Ohio (513) 433-2511; Chagrin Falls, Ohio (216) 247-6655; Greiner Associates, Grosse Pointe Park, Mich. (313) 499-0188; Paitline Engineering Sales Inc., St. Louis, Mo. (314) 426-7055; Overland Park, Kansas (913) 262-5643; Andover, Kansas (316) 683-7512; Nannia Associates, Orange, Conn. (203) 932-5656

**Distributors:** Cramer Electronics Inc.—Alabama: Huntsville (205) 539-5772; Arizona: Phoenix (602) 263-1112; California: San Diego (714) 279-6300; Colorado: Denver (303) 758-2100; Connecticut: North Haven (203) 239-5641; Florida: Hollywood (305) 923-8181; Orlando (305) 841-1550; Georgia: Atlanta (404) 451-5421; Illinois: Mt. Prospect (312) 593-0230; Maryland: Baltimore (301) 354-0100; Gaithersburg (301) 354-0100; Massachusetts: Newton (617) 969-7700; Minnesota: Bloomington (612) 881-8678; New Jersey: Union, (201) 687-7870; Pennsauken (215) 923-5950; New Mexico: Albuquerque (515) 265-5767; New York: Hauppauge, L. I. (516) 231-5600; Endwell (607) 754-6661; Rochester (716) 275-0300; East Syracuse (315) 437-6671; North Carolina: Raleigh (919) 876-2371; Winston-Salem (919) 725-8711; Ohio: Cleveland (216) 248-7740; Cincinnati (513) 771-6441; Oklahoma: Tulsa (918) 836-3371; Texas: Dallas (214) 350-1355; Utah: Salt Lake City (801) 487-3681; Wisconsin: Milwaukee (414) 462-8300; Canada: Ontario (416) 630-5023; Brill Electronics, Oakland, Calif. (415) 834-5888; Elmar Electronics, Mt. View, Calif. (415) 961-3611; Liberty Electronics, Inglewood, Calif. (213) 776-6252; Wesco Electronics, Los Angeles, Calif. (213) 685-9533; Merquip Electronics, Skokie, Ill. (312) 965-7500; Stark Electronics Supply, Minneapolis, Minn. (612) 333-3361; Sheridan Sales Co., Cincinnati, Ohio (513) 761-5432

**International:** MOSTEK GmbH, 7 Stuttgart 80, Waldburgstrasse 79, West Germany 0711-731305; System Marketing Inc., Center News Bldg., 1-3-11 Sotokanda, Chiyoda-ku, Tokyo, Japan; W. G. Booth Pty., Ltd., 39 Church Street, Hawthorn, Victoria 3122, Australia.

## new products

# Storage scopes leap ahead in writing rate, bandwidth, tube life

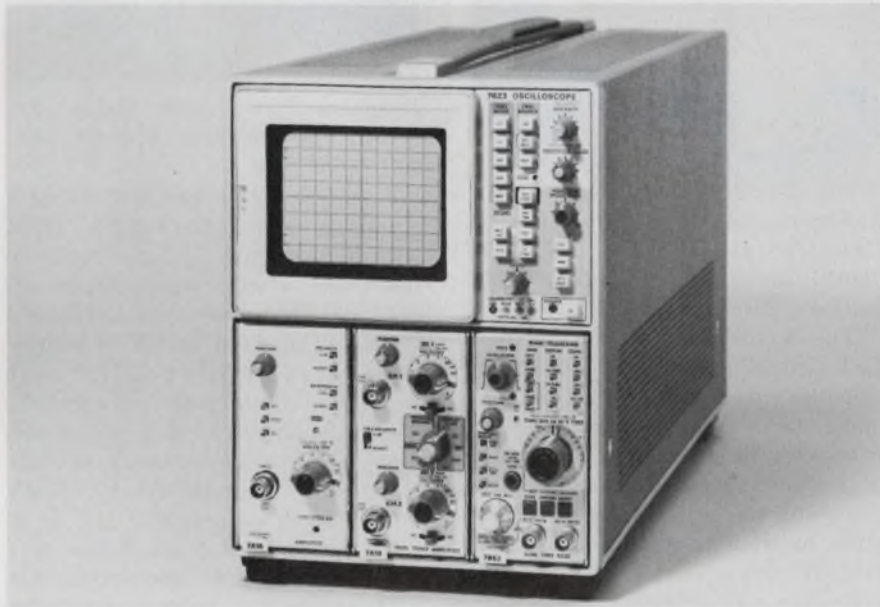

Tektronix, Inc., P.O. Box 500, Beaverton, Ore. 97055. (503) 644-0161. P & A: see text.

With a writing speed of 200 cm/ $\mu$ s, the Tektronix 7623 streaks past any other storage scope on the market. It beats Hewlett-Packard's 184 A/B by a factor of two and whips any other storage scope by at least a factor of 40. Both 7623 and 184 eliminate the problem of tube burnout, common in earlier mesh-storage CRTs, whose mesh-borne dielectric was so thin that a high-energy beam could vaporize it.

HP's 184 A/B, introduced in March, made the big jump from the former high of 5 cm/ $\mu$ s to 100 cm/ $\mu$ s at a reduced scan of  $8 \times 10$  half-size (0.475-cm) divisions. At that speed, the scope provides more than 10 seconds of viewing time at a normal intensity of about 50 foot lamberts and more than five minutes at reduced, just visible, intensity.

Tek's 7623, in contrast, writes at 200 cm/ $\mu$ s over the center  $4 \times 5$  divisions and at a somewhat slower rate over its full  $8 \times 10$ , 0.9-cm-division screen. It permits

viewing for hours, or even days at about 100 ft-L.

Tek's 200 cm/ $\mu$ s and HP's 100 cm/ $\mu$ s are provided in "Fast" modes. In addition Tek has a "Bi-stable" mode, with 0.03-div/ $\mu$ s writing speed, 100-ft-L luminance and hours of viewing. And HP has a "Standard" mode, with 0.2 div/ $\mu$ s, more than a minute at 100-ft-L and more than an hour at reduced intensity.

Both scopes have a "Variable Persistence" mode, which Tek calls "Half Tone." In that mode, Tek's viewing time, depending on intensity, ranges from 15 seconds to one minute, while HP's viewing time ranges from 0.2 s to one minute. In the "Fast" and "Variable Persistence" modes, the 184 uses its full  $8 \times 10$ -div screen with 0.95-cm divisions.

Bandwidth is 100 MHz for each main frame. The Tek main frame, a three-holer, can accept any two vertical plug-ins and any horizontal plug-in from its 7000 series. The HP main frame, a two-holer, accepts vertical and horizontal plug-ins from the 180 series.

HP already has a 100-MHz, dual-

trace plug, the 1805A. But Tek's fastest compatible dual-trace plug, thus far, is the 7A12, with 85-MHz bandwidth in the 7623. However, the 7623 can take two single-channel, 100-MHz plugs, like the 7A11, 7A16 or 7A17.

Each scope can be armed, to be triggered by a future transient. Each can integrate repetitive, fast-rise signals to boost intensity. Each can be disconnected from the power line, then reconnected—even weeks later—to display a previously stored trace. And each can be operated in the conventional, non-store mode.

HP and Tek both attribute much of the improvement in writing speed and burn resistance to new proprietary dielectrics and new methods of depositing them on the storage target. But Tek has gone beyond this and added a second target. In essence, charge from the electron beam is transferred from a high-sensitivity, high-speed, short-retention target to a less-sensitive, slower, long-retention target.

The 7623 is the high-speed star of a new storage-scope family (see cover), which includes the 100-MHz, 5-div/ $\mu$ s 7613 and the 25-MHz, 5-div/ $\mu$ s 7313. All three include direct, CRT readout of vertical and horizontal scale factors.

HP and Tek offer bench or rack-mount versions. HP's deliveries are to start in September while Tek's are due in October. HP's bench-mount 184 main frame costs \$2200. Tek's bench-mount 7623 main frame, unlike HP's unit, includes the final amplifier. This makes for a higher-cost main frame and lower-cost plug-ins, so prices should be compared on a full-system basis. At press time the 7623 had not been priced.

For more information:

From HP **CIRCLE NO. 250**

From Tektronix **CIRCLE NO. 251**



# NEW SHORTER CASE! SCHAUER 1-WATT ZENERS



**SAME LOW PRICES FOR  
1% TOLERANCE ZENERS**

**ANY VOLTAGE  
FROM 2.0 TO 18.0**

Quantity	Price Each
1-99	\$1.07
100-499	.97
500-999	.91
1000-4999	.86
5000 up	.82

## IMMEDIATE SHIPMENT

Send for rating data and 20%, 10%, 5% and 2% tolerance prices.

Semiconductor Division

# SCHAUER

MANUFACTURING CORP.

4511 Alpine Ave., Cincinnati, Ohio 45242  
Telephone 513/791-3030

## INSTRUMENTATION

### LSI memory tester offers 10 MHz rates



*Semiconductor Test Systems, 3 Computer Dr., Cherry Hill, N.J. 08002. (609) 424-2400. \$40,000 to \$60,000; 90 days.*

The Venture II is a dedicated LSI test system capable of functionally checking RAMs, ROMs, and shift-register memories at rates up to 10 MHz. The basic unit handles wafers, cards and complete memory systems 9 bits wide by 65 k words deep. Salient features are a high-speed test head for drive and comparison, a micro-programmable address generator and data format generator for bit-test sequencing and automatic margin control testing. A user-oriented console allows selection of pre-stored routines specified in English-language text. The system can be expanded to include dc parametric tests and tests of memories with up to 72 bits.

CIRCLE NO. 255

### 100 W power amplifiers give 5 kHz to 260 MHz

*RF Power Labs Inc., 924 Bellevue Way N.E., Bellevue, Wash. 98004. (206) 454-3886. See text; 4-6 wks.*

These units deliver 100 W over a bandwidth from 5 kHz to 250 MHz without tuning. Model FK250-110 has 10 dB gain and is priced at \$4450; Model FK260-110 has 10 dB gain and is priced at \$4295; Model FK250-145 has 45 dB gain and is priced at \$6695. Other features include front-panel metering; overload, overdrive and mismatch protection; 60 sec Hi volts delay; and interlocks.

CIRCLE NO. 256

### 2-3/4-digit DPM sells for \$68



*Faratron Corp., 280 Green St., S. Hackensack, N.J. 07606. (201) 488-1400. \$68.*

Faratron Corp. has introduced a standard size, 2-3/4-digit DPM with two display options designed for those whose requirements are not met by standard 3-1/2-digit DPMs. The 2700 series is dimensionally interchangeable with equivalent units made by competitors. All models in this series display a full-scale readout of 399. Ranges are available from 39.9 mV dc to 399 V dc and 39.9  $\mu$ A dc to 399 mA dc. Also available is a 2-1/2-digit DPM designated the 2500 series. Both new meters offer a 7-segment incandescent display with a choice of filter colors as standard equipment. Over/under range indicator lights are standard on the unipolar DPM. Power input options available are the standard +5 V dc; or 117 V ac; or +12, -12 V dc, +5 V dc. Ac power or +5 V power supplies are included in the price. BCD output is standard.

CIRCLE NO. 257

### Digital photometer has HV, reads to 0.1 pA

*Pacific Photometric Instruments, 5745 Peladeau St., Emeryville, Calif. 94608. (415) 654-6585. \$975; 3 wks.*

Pacific Photometric's Model 124 digital photometer incorporates a negative high voltage supply (-50 to -2000 V), current measuring circuit, dark current cancellation and scale expansion in a single rack-mounted instrument. Standard features include: 100 pA to 1 mA full scale, 0.1 pA resolution, 100% overranging and rear panel BCD output.

CIRCLE NO. 258



# What do you get when you cross a signal source with a calculator?

Automatic testing with HP's new 3330B AUTOMATIC SYNTHESIZER. In this one outstanding instrument, you get a flexible synthesizer, a top-performing sweep generator, and a precision level generator—all under digital control. Its built-in controller adds computer flexibility—you can forget about tying up an external computer for your automatic testing on the production line, and for the first time make this level of testing economically feasible in your lab.

For man-machine interfacing, 3330B's convenient swing-out keyboard, coupled with 9-digits of frequency and 4-digits of amplitude readout, gives you complete flexibility for setting up your test routines.

As a frequency synthesizer spectral purity is exceptional. Spurious is down 70 dB, and harmonics at least 40 dB below the carrier. Through its easy-to-use keyboard, you can, with 0.1 Hz resolution, set in any frequency between 0.1 Hz and 13 MHz, then automatically or manually increment (tune) that frequency by any amount. Each point has the synthesizer stability of  $\pm 1$  part in  $10^8$ /day.

You can repeat the same automatic or manual sweeping operation with amplitude level. Its 100 dB range, 0.01 dB resolution and flatness of  $\pm 0.05$  dB make the 3330B a precision level generator.

Call on Model 3330B for your sweep generator needs, and you'll get performance levels of accuracy, linearity, and resolution never before available. That's because the internal serial microprocessor controls digital sweeping of synthesized frequencies or precise amplitudes. Through its keyboard and front-panel controls, you enter all sweep parameters—your 3330B takes it from there.

Systems Designers will find the standard 3330B fully programmable—ready for low-cost interfacing to other ASCII instruments and controllers, like marked card programmers, calculators, and computers.

Price? If you think about it, you would have bought a synthesizer, a sweeper, a marker generator, a counter, a programmable attenuator, and some computer time to come anywhere close to solving the same problems now done by the 3330B. At \$6000 for a complete frequency lab, we think you'll agree that the price-performance ratio of the 3330B is great. (Model 3330A, priced at \$5100, performs identically to the 3330B but has manual amplitude control and 13 dB range.)

For further information on the 3330A/B, contact your local HP field engineer. Or, write Hewlett-Packard, Palo Alto, California 94304. In Europe: 1217 Meyrin-Geneva, Switzerland.

A092/1





# Low-cost DPM may replace conventional pointer meters

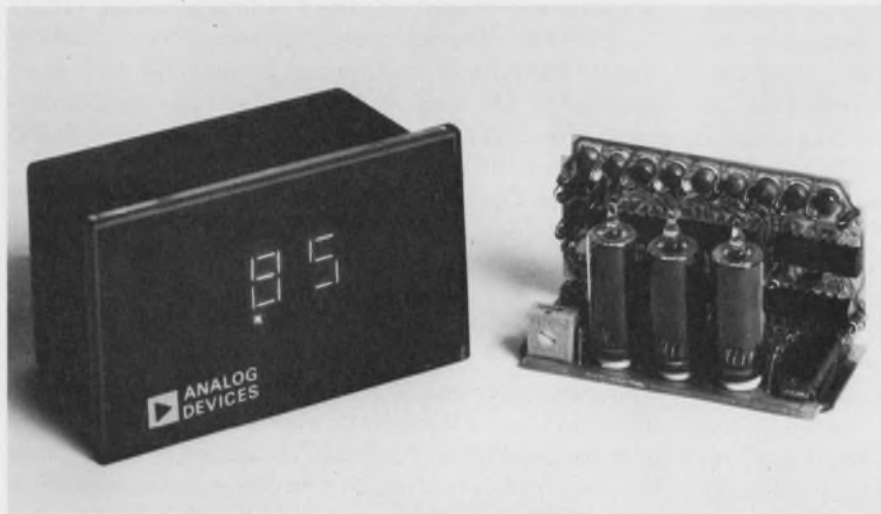

Analog Devices, Inc., Route 1 Industrial Park, Box 280, Norwood, Mass. 02062. (617) 329-4700. \$50 (100 up); stock (sample quantity).

Following successful entry into the DPM market last fall with a 3-1/2-digit unit, Analog Devices has now introduced a 2-1/2-digit version with a price tag low enough to provide serious competition for conventional analog panel meters. In quantities of 100 up, the new dc-powered AD2002 costs \$50. A version with BCD outputs, the AD2002DP, costs \$55 at the same quantity level.

The AD2002 is probably the lowest priced 2-1/2-digit DPM, though in the competitive DPM market price is pretty much a moving target. At least two companies—Faratron and Analogic—are offering units in the same price range, while a third—Gralex—is said to be preparing to introduce a lower-cost 2-1/2-digit unit. Faratron, for example, sells a 2-1/2-digit unit with BCD output and without power supply (comparable with the Analog Devices AD2002DP) for \$58 in quantities of 100 up.

With a package size of 1.8 × 3.0 × 1.5 in., the AD2002 is one of the smallest units available. Analogic, however, offers a slightly smaller 2-1/2-digit unit. Analog Devices

engineers say that they could have squeezed the AD2002 into a slightly smaller package, but they chose to use one large enough to accommodate future 3-1/2-digit and 4-1/2-digit versions, thus allowing customers to upgrade their systems without mechanical changes.

The aluminum package for the new AD2002 avoids some of the shortcomings of the company's earlier AD2001. For example, the input and output terminals now protrude from the rear instead of from the bottom. Also the new unit snaps into a rectangular panel cut-out and does not require simultaneous access to the front and rear of the panel.

Like the company's earlier 3-1/2-digit unit, the AD2002 uses RCA Numitron incandescent readouts. Light filters are available in a choice of different colors and can be imprinted with custom legends if required. The display operates at a rate of four readings per second. An optional trigger and hold allows up to 200 readings per second. Upon command, readings can be held for an indefinite period of time.

Accuracy of the AD2002 is 0.5% ±1 digit, with 10-mV resolution. The unipolar unit accepts single-ended input signals of up to 1.99 V.

Under overload conditions, the display registers two horizontal bars. The nominal input impedance of 100 MΩ drops to 10 kΩ under overload conditions. The input bias current is 70 nA, and the unit can withstand overvoltages up to ±50 V. With an operating temperature range of 0 to 60 C, the AD2002 has a temperature coefficient of 0.05 digit/°C.

The AD2002 requires +5 V dc at a total of 750 mA to power the display and the logic circuitry. Separate terminals are provided for the display and logic. This allows an unregulated supply to be used for the display while only the remaining 250 mA for the logic circuits needs to be regulated.

Both versions of the AD2002 are available from stock in evaluation quantities. Production quantities will be available in four to six weeks.

CIRCLE NO. 259

## Snap-together system is a DMM or a dc DVM

Hewlett-Packard Co., 1601 California Ave., Palo Alto, Calif. 94304. (415) 493-1311. See text; July.

The Model 3470 measurement system consists of a 4-digit, solid-state display module, Model 34740A, and a variety of plug-ons. Multimeter plug-on, Model 34702A, combined with the display module forms a \$600 DMM. It has four ranges (ac and dc) from 1 V to 1000 V FS, and six ohm ranges from 100 Ω to 10 MΩ. Also available is a dc voltmeter module, Model 34701, with the same four ranges and accuracies as the dc section of the multimeter. With the display module and the dc section plugged together, the instrument is \$475.

CIRCLE NO. 260

Now we can  
give you the  
exact shaft

and the  
exact switch  
immediately

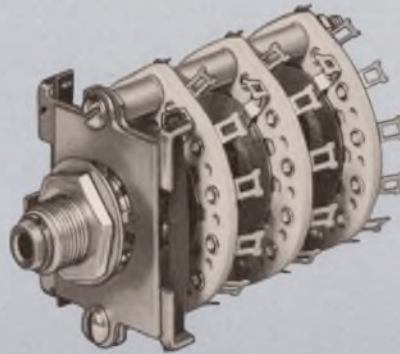
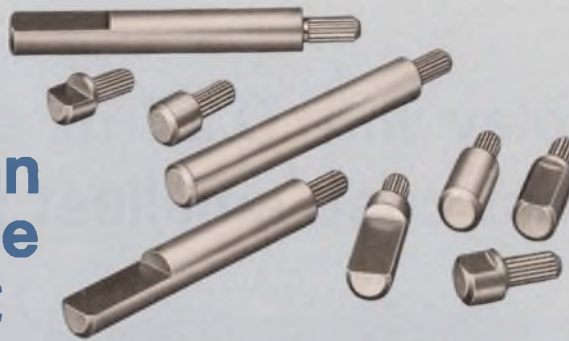

## Selectashaft™ Rotary Switches Only from Centralab Distributors

Selectashaft is your Centralab Distributor's new custom assembly program that lets you mix and match rotary switches, front shafts, shaft end details and shaft flat angles. Just order the exact custom switch assembly that fits your design requirements. It takes your Centralab Selectashaft Distributor just days to deliver. No factory delays. No setup charges.

Choose from three .250 inch diameter shaft styles: plain round, .218 inch flat or .156 inch flat configurations. Select any of 24 shaft sizes from .687 inch to 2.375 inch long from the mounting surface. Shaft flat angles are available in increments of 15°.

Selectashaft switches feature a new dual-ball sidethrust mechanism for top index performance and

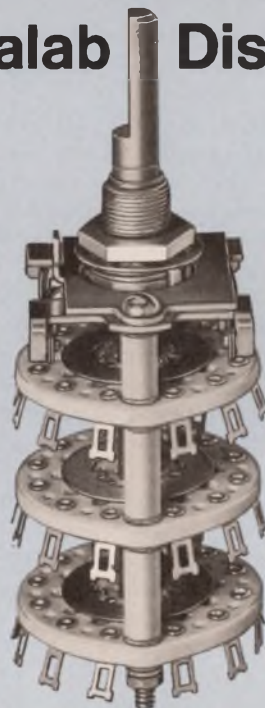

exceptionally good torque and feel. Adjustable stops allow you to easily change number of positions by varying the placement of one or two stop rings on the front plate. No disassembly or removal of stop tabs is required. To adjust torque simply remove index springs on the index mechanism. Switches are offered in miniature and sub-miniature styles with ceramic, diallyl phthalate or phenolic section material.

Don't delay. You don't have to when you order custom assembled Centralab Rotary Switches from your Centralab Selectashaft Distributor. Write Centralab Distributor Products, Department SS-1 for our complete 12 page catalog and the name of your nearest participating Distributor.

DISTRIBUTOR PRODUCTS



CENTRALAB

Electronics Division  
GLOBE-UNION INC.

5757 NORTH GREEN BAY AVENUE  
MILWAUKEE, WISCONSIN 53201

D-7222



# LED display with 0.27-in. character has lowest cost, smallest package

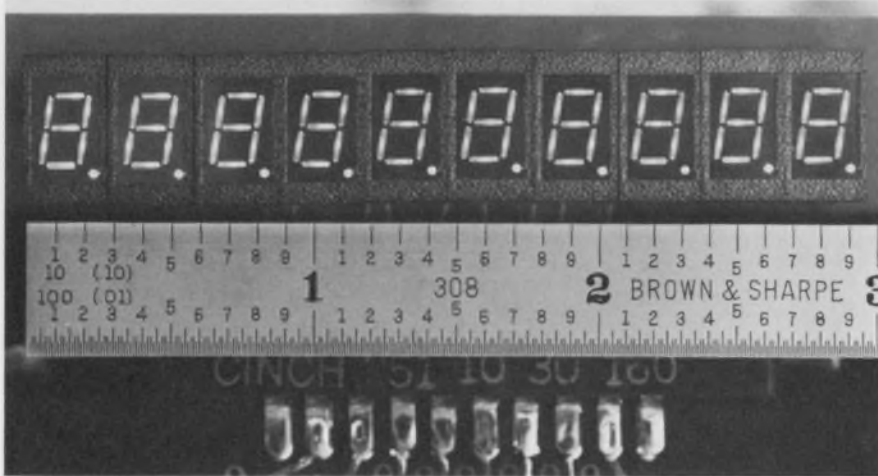

Fairchild MOD, 3500 Deer Creek Rd., Palo Alto, Calif. 94304. (415) 493-3100. P&A: See text; stock.

With the announcement of a new GaAsP common-cathode LED read-out, Fairchild MOD, Palo Alto, Calif., introduces the only seven-segment 0.27-in.-high LED digit that can be mounted on 0.3-in. centers. Pricing of the FND-70 in 1000 quantities has been set at \$3.60.

The price compares favorably with other 0.27-in. red LED displays, such as Monsanto's MAN-1A at \$7.75 and Litronix's Data-Lit 10A at \$6.75 (both common-anode devices). The Litronix Data-Lit 8 (0.245-in. high) and the Monsanto

MAN-4 (0.190-in. high) common-cathode displays sell for \$6.25 and \$4.50, respectively.

Fairchild matches all segment intensities of the same digit to within  $\pm 15\%$ . Then each digit is categorized into one of five  $\pm 15\%$  standardized classifications. While shipments will be random from any of the five categories, color-coded markings will allow the user to match the intensities of multiple-digit displays to within  $\pm 15\%$  at no additional cost. The closest match Monsanto will guarantee is  $\pm 50\%$ .

Luminous intensity in millicandelas (mcd) is not easily equated to luminance (brightness) in foot-

lamberts (ft-L). However, the FND-70's 0.15-mcd. minimum intensity at 20 mA looks about the same as the MAN-1A's 100-ft-L minimum luminance at 20 mA. The viewing angle of the FND-70 ( $\pm 35^\circ$  to 50% intensity) however, does not appear to be as large as that of the MAN-1A.

A unique feature of the FND-70 is that data for pulsed or multiplexed applications information are included in the data sheet. An example is a forward-voltage listing at 20 mA static of 1.7-V typical and at 150-mA pulsed of 1.9-V typical (2.8 V max.). No other manufacturer guarantees both multiplexed and static operation on the data sheet.

Maximum mounting flexibility is made possible by the FND-70's small size. The width of 0.295-in. reduces the minimum center-to-center digit spacing to 0.3-in., against 0.45-in. for every other 0.27-in. LED display. The package is 0.55-in. high and 0.33-in. deep.

Fairchild's unusual dual-inline pin configuration of two rows of five pins (on 0.1-in. centers) spaced 0.2-in. apart reduces the total package width by 0.1-in. over the MAN-1A type display. ■■

Fairchild                      CIRCLE NO. 252  
Litronix                         CIRCLE NO. 253  
Monsanto                       CIRCLE NO. 254

**ANA & LOG**

LOG THIS CHOPPER IS SCAREY, IT KEEPS SPIKING AND DRIFTING.

COME ON ANA, TRY MY CHOPPER IT DOESN'T HAVE THOSE PROBLEMS.

HOLD ON TIGHT, THE A-241 IS FAST, TOO!

YOU'RE AN ANGEL!

**ANALOGY**

OK GANG THERES A NEW CHOPPER KING IN TOWN-- THE A-241. IT GETS SUPER LOW DRIFT LIKE .05uV/°C AND HAS A FINE LITTLE MUFFLER THAT HOLDS THE NOISE DOWN TO 08uV P/P (TYP) CHOPPER NOISE SPIKES ARE OUT OF SIGHT. TRAVELING AT 10Hz UP TO 1 KHz, IT JUST WHISPERS ALONG AT 100 PA P/P (MAX.) TAKE A SMOOTH RIDE WITH ANA ON THE A-241

**intech** INCORPORATED  
(408) 244-0500  
1220 COLEMAN, SANTA CLARA CA 95050

INFORMATION RETRIEVAL NUMBER 41

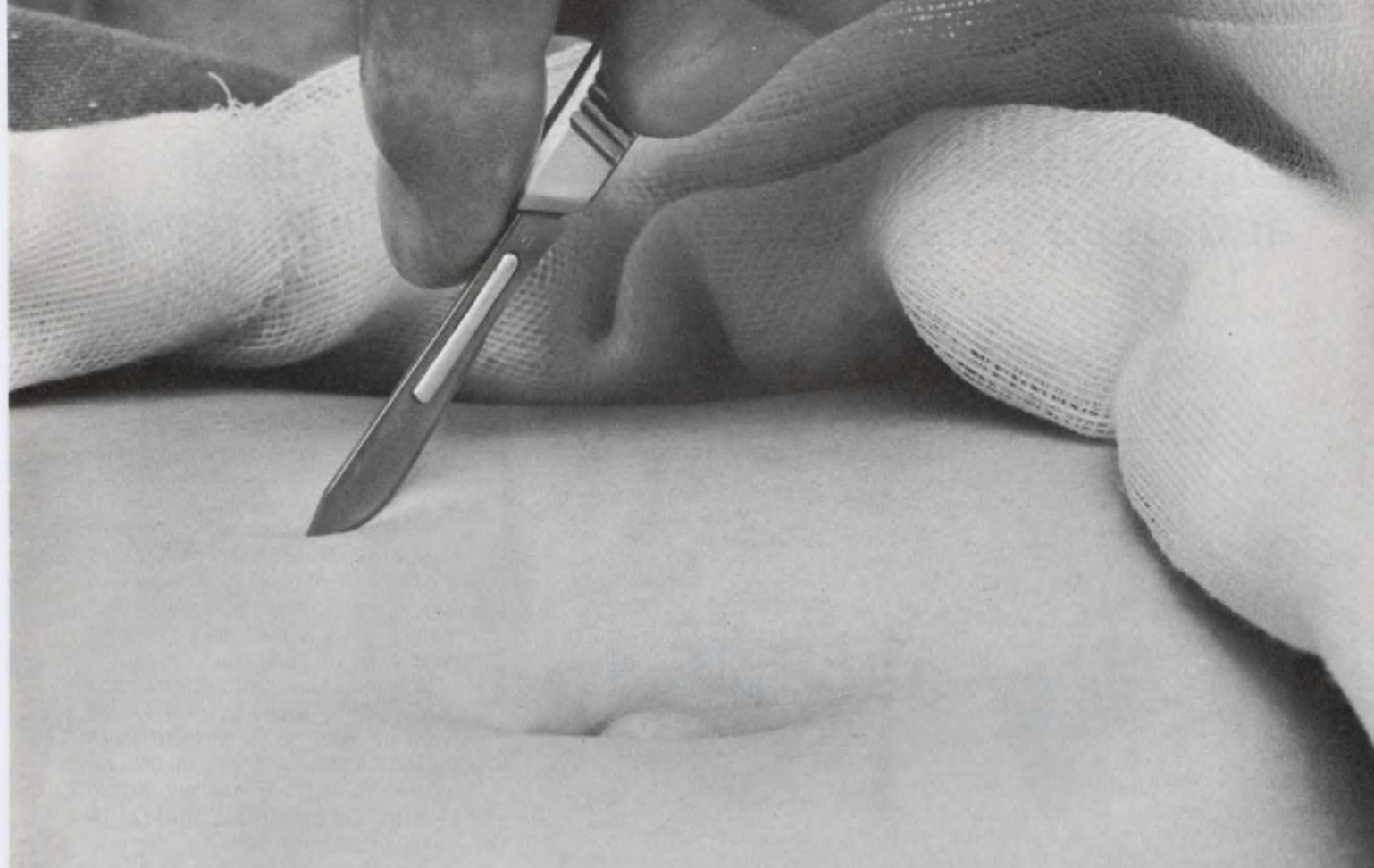

## Respiration normal. Blood pressure OK. Heart normal. Maybe.

Man's increasing dependence on electronic equipment is critical. But his confidence is dependent on the tests made on his equipment and its component parts.

New automatic testing equipment must be extremely flexible in establishing and evaluating test parameters. The programming flexibility and the interface buffering between the computer and the device under test is very complicated, very sensitive. A multiplicity of signals and reception of performance data must be totally free of distortion. Nothing can be lost in transmission. Solid state devices can't do the job because of the bilateral switching problem, signal levels, and ohmic isolation requirements.

But Clare can help. Our engineers have just expanded the horizons of

Automatic Test Equipment with our refined dry reed and mercury-wetted relays. They made it possible to increase flexibility, add data points.

Clare's new PR2MT Dry Reed relays provide low level bilateral signal switching with maximum economy. So you can add those data points. Clare's widely used HGJ2MT Mercury-wetted relays provide extreme high and low level bilateral switching. Plus unequaled life, speed and reliability. Both relays experience minimal thermal offset. This combination of relays provides ATE and other equipment with vastly improved flexibility and capabilities. Plus some practical economy.

Clare publishes a free Technical Application Reference on performance characteristics and application of dry

reed and Mercury-wetted relays. Ideas that may trigger some thoughts for you. Send the coupon for your free copy.

Or call your Clare representative directly.



All New PR2MT Dry Reed Relay

HGJM Mercury-wetted Relay

C. P. Clare & Co., 3101 Pratt Blvd., Chicago, Illinois 60645



a GENERAL INSTRUMENT company

INFORMATION RETRIEVAL NUMBER 42

Name \_\_\_\_\_ Title \_\_\_\_\_ Company \_\_\_\_\_ Address \_\_\_\_\_ City \_\_\_\_\_ Zip \_\_\_\_\_ State \_\_\_\_\_



# Digital-cassette drive is speed-controlled and uses only two moving mechanical parts



Ross Controls Corp., 381 Elliot St., Newton, Mass. 02164. (617) 969-9240. With electronics: \$575 (100-999); 8 wks.

A tape transport that is electronically speed-controlled offers the mechanical simplicity of the basic reel-to-reel drive but avoids the speed variation of fixed-rpm drives. It also eliminates the "space-waste" of a recorded clock track, since an analog servo holds tape speed constant to  $\pm 5\%$ .

The transport alone, designated Model 1000, sells for \$150 (100-999). The only moving parts are two dc-servo motors. Tape tension is held to about 3/4 ounce for forward, reverse, rewind and high-speed search.

A unit, complete with electronics, the Model 1111 embodies eight-bit parallel input/output data handling, operates on an NRZI self-clocking code and accepts any standard Philips type of cassette. It allows cassettes recorded on one Ross machine to be played on any other.

Readable signals are provided 3 ms after a start command. The unit reaches stable speed in 35 ms and stops in 50 ms. It stores 1.5 million bits on a standard 300-foot cassette. Playback and record is at

20 in./s, 500 b/in. for a data rate of 10,000 b/s.

High-speed rewind and data search is done at 120 in./s in either direction. On a statistical basis, this results in an average access time of 10 s.

The most popular way to move tape at constant velocity (as required for audio work) is to grip it between a constant-speed capstan and a pressure roller.

But for digital recording, the capstan and pressure roller are a liability. The capstan squeezes dust and oxide particles into the tape, causing data dropouts. Further, if capstan and take-up reels are inadvertently operated out of synchronism, "tape snatching," with resulting breakage or stretching, can severely degrade reliability.

Without the capstan, however, the alternate method of driving tapes—using a reel-to-reel drive—poses a basic difficulty. The changing diameters, as the tape builds up on one reel and unwinds from the other, causes a 2.5:1 tape-velocity variation.

From a purely electronic point of view, this velocity variation can be handled with careful circuit design. At a constant clock rate though, the data have a 2.5:1 varia-

tion in spacing on the tape. But all the data spacing must be determined by the slowest tape speed. This results in a major reduction in the potential storage capacity of any given cassette. Also, special speed-independent recording formats become mandatory.

To overcome this, many systems retain the mechanical simplicity of the reel-to-reel drive by using a digital servo, locked to a fixed-frequency clock signal and recorded on a separate tape track.

However, this "wastes" half the tape's data capacity, since one track is now occupied with clock pulses. Besides, the system requires an extra head and signal channel for recording this clock frequency.

The Ross system of speed control is based on determining tape velocity from the speeds of the two drive motors. Back-emf signals, proportional to motor speed, are modified by a diode function generator, then compared with a fixed voltage reference in a servo-feedback system, which maintains linear tape velocity constant to within  $\pm 5\%$ .

CIRCLE NO. 261

## Solid-state circuit breaker is self-resetting

Flight Systems, Inc., P.O. Box 25, Mechanicsburg, Pa. 17055. (717) 697-0333. \$19.75 (1 to 10); stock.

The SY Series solid-state circuit breaker is easy to install, having only four connections—two for the load and two for the programming transistor. The user can adjust the trip point of the circuit breaker to anywhere between 500 mA and 1.5 A. Inrush inhibit is also included at no extra cost. The breaker measures only 1.0 × 1.50 × .687 in. and weighs less than 3 oz. It resets automatically after momentary power interruption.

CIRCLE NO. 280



# Complete Trimmer Satisfaction

## One design...9 pin styles

Still the industry's best trimmer value  
... Less than **50¢** each in production quantities



Stability of  $\pm .03\%$  and environmental performance requirements of characteristic C of Mil-R-22097

- 1.5% average ENR noise resistance
- 0.5% average CRV
- 1/2 watt @ 70°C

You can choose from an expanded line of compact trimmers. .150" — .125" — .100" in-line terminal spacing and TO-5 pin spacing all available in top and side adjust. Plus .200" delta (.100 grid) in top adjust. All available from your CTS Distributor. **Still the best value in the industry.** CTS of Berne, Inc., Berne, Indiana 46711. Phone: (219) 589-3111.

**CTS CORPORATION**

Elkhart, Indiana



A world leader in cermet and variable resistor technology



## TEC LED LITE

### TRANSISTOR CONTROLLED LED INDICATOR SAVES PC BOARD SPACE

If you're driving LED's directly from IC outputs you're wasting valuable PC board space! TEC's new L-1017 Series LED Indicator requires 1/10th the current (only 1.6ma) of ordinary LED's (using 15ma) — lets you drive one L-1017, plus nine other loads from one IC logic circuit. Transistor driver and LED are housed in a .284 dia. x 1" long body that mounts in a  $\frac{3}{64}$ " panel hole on  $\frac{1}{2}$ " centers. Wire-wrap terminals standard. L-1017 Series turns on with "high" input, logic "1" (IC driven LED's indicate logic "0"). L-1017 signals: ON, +2.5 to +5VDC; OFF, 0 to +0.8VDC. Supply: +5VDC @ 15ma, maximum. Special lens design increases LED brilliance and side viewing — available in red or clear, spherical or flat top lens style.



2 X SIZE

Immediate Del. \$2.30 ea., 100-499 qty.

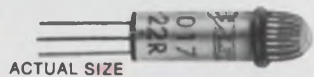

ACTUAL SIZE

### DIRECT DRIVE LED INDICATOR

L-1015 Series LED Indicator is identical to L-1017 Series above in all mechanical details. Internal resistors allow operation directly from 5.0, 6.3, 10 and 24 VDC supplies — permit LED indicator substitution for incandescents.



ACTUAL SIZE

Immediate Del. Price, \$1.30 ea., 100-499.

### TEC LED LITE INDICATOR PACKAGES



Select a rugged, long life LED indicator or switch/indicator from more than 20 TEC designs. More brilliance, easier mounting, attractive appearance are added to the various LED's packaged by TEC.

See TEC-LITE for the complete line of readouts, indicators, switches, display panels, keyboards, CRT terminals.

TEC, Incorporated; 9800 North Oracle Road, Tucson, Arizona 85704; or phone (602) 297-1111



INFORMATION RETRIEVAL NUMBER 44

## DATA PROCESSING

### Storage tube competes with refreshed types



Tektronix Inc., P.O. Box 500, Beaverton, Ore. 97005. (503) 644-0161. \$2200 (unit quantities).

The Tektronix 613 storage-display monitor, designed as a computer display, uses a direct-view storage tube that is price competitive with semiconductor memory types. The 11-in., direct-view storage CRT provides high information density with good resolution without flicker or drift. The 613 is compatible with the Tektronix 4610 hard-copy unit.

CIRCLE NO. 262

### New packaging improves performance and cost



Western Union Data Services Co., 16 McKee Dr., Mahwah, N.J. 07430. (201) 529-1170. \$195 per month (1 yr. lease).

WU Data Services has repackaged GE's TerminiNet 300 ASR into a model that, it says, "reduces the unit's size in half, improves its tape and paper handling, and rents under its own label for \$40 less per month." Called the EDT 300-ASR, the unit has a 10, 15, or 30-char/s teleprinter with switch selectable and transmission buffering capability.

CIRCLE NO. 263

### Nine-bit, time-to-digital unit measures in ns



LeCroy Research Systems Corp., 126 N. Route 303, W. Nyack, N.Y. 10994. (914) 358-7900.

The CAMAC Model 2226A quad time-to-digital converter provides four channels for measuring ns time intervals from the leading edges of a common start pulse to individual-stop signals. Each measurement is converted into a 9-bit binary number and held in a register for data readout.

CIRCLE NO. 264

### Digital synthesis gives modem narrow spectrum

Tel-Tech Corp., 11810 Parklawn Dr., Rockville, Md. 20852. (301) 770-6170.

Designated the "Thru-put" series, Tel-Tech's modems are available with data rates from 1800 to 9600 b/s. It uses an optimization technique combining digital synthesis and spectrum selection. Digital synthesis achieves a very narrow rectangular-shaped band.

CIRCLE NO. 265



## Analog plotter claims 50 in./s speed

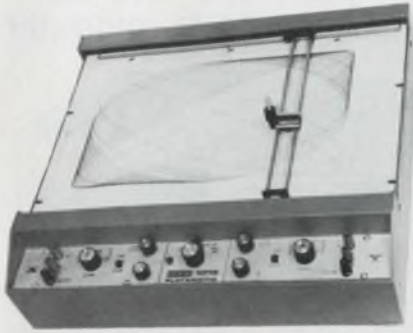

MFE Corp., 340 Fordham Rd., Wilmington, Mass. 01887. (617) 729-7760. \$1195 and up (unit).

The 11 × 17-in. 1000-Series, analog-X-Y recorders step up previous analog-plotting speeds to a 50 in./s slew rate, backed by 5000 in./s<sup>2</sup> acceleration at full slew reverse. Features include disposable fiber tip pens; paper hold down; sealed potentiometers; and over-drive protection. Three basic configurations are available with different sensitivity options from 1 to 100 mV/in.

CIRCLE NO. 266

## Keyboard-tape unit programs ROM units



Data I/O, 164 N. Cragmont Ave., San Jose, Calif. 95127. (408) 926-3813. \$3500; 30 days.

Designated the Data I/O ROM programmer, it comes with tape reader, keyboard, perforator (optional), RAM, ASCII-to-binary translation (optional), device personality cards (for any manufacturer's components), programming boards and displays. It uses keyboard data, a perforated tape or a master ROM or RAM as a data source. The system will program ROMs of the fusible link, floating gate (MOS) or avalanche-induced migration (AIM) types in a variety of pin configurations.

CIRCLE NO. 267

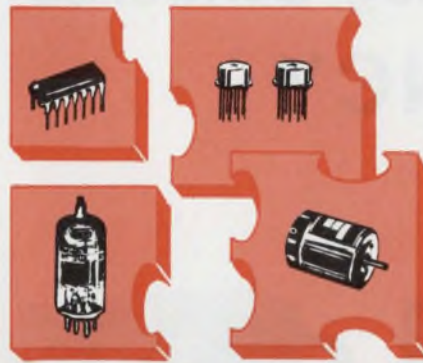

# TROUBLE?

finding components to solve your design puzzle ...  
**ADLAKE** has them!

### ADLAKE MERCURY WETTED RELAYS



Single side stable or bistable; multiple poles; sensitive form C, D, or K, or neutral form D; millions of trouble-free operations; low, stable contact resistance; plug-in or PC mountings.

### ADLAKE MERCURY DISPLACEMENT TIME DELAY RELAYS

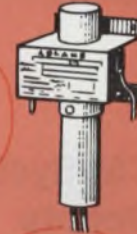

Time delays from 0 to 20 minutes; N.O. or N.C. slow "make" and N.O. slow "break" switching. AC and DC operated units, -37 to 200°F operating temperature range. 0.5-15 ampere ratings, non-inductive at 115 volts, 60Hz. Screw terminal or pigtail leads. U.L. listed types.

### ADLAKE LOAD RELAYS



Light, medium, and heavy load switching; up to 3 poles. Screw or pigtail leads. Ratings from 35 to 100 amp, non-inductive at 115 volts 60 Hz. U.L. listed types. All popular coil voltages.

### ADLAKE DRY REED RELAYS

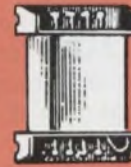

1, 2, 3, and 4-pole styles, hermetically sealed precious metal contacts, extended life, magnetic shielding, high operating speeds. Miniature, intermediate and standard sizes.

### ADLAKE HYBRID TIMERS



Highly reliable operation handles 35 amp loads. 12, 24, 32, 48 and 115 VAC or VDC inputs. Fast recycle time, fixed or adjustable timing from 100 msec. to 2+ minutes. Wide selection of N.O., N.C., On, Off, Delay, or Instant Close or Open switching.

### ADLAKE TRANSFER TIMERS, LATCHES



Transfer timers switch DC input to output with precise delay times. Close tolerance accuracy, wide operating temperature range, quick recycle, 1 amp rating. Pulse latch switches 2 amp (100% duty cycle) "off" and "on." Choice of packages.

Adlake components are ideal interface timing and switching control components for the most modern and complete systems. Fast, stable, and reliable operation are prime features. Dry circuit to heavy current loads, input/output isolation, excellent environmental features, choice of packaging, terminations.

Let ADLAKE supply the missing piece!

USE READER SERVICE NUMBER FOR COMPLETE INFORMATION

## THE ADAMS & WESTLAKE COMPANY



ELKHART, INDIANA 46514  
219 · 264 1141  
TELEX 25 8458  
CABLE ADLAKE



# Digital- or Analog-Controlled FREQUENCY SOURCE



for

**Airborne ECM Systems  
Field Test Depots  
Production Test Sets**

**The WJ-1168** is a backward-wave oscillator controller that supplies power to and controls the frequency of any standard BWO covering any band in the frequency range from 1 to 40 GHz.

Useable with nearly all Watkins-Johnson BWOs, the WJ-1168 exhibits exceptionally low noise and good frequency stability through the use of solid state components. The following power outputs are provided:

Frequency Bands	Power Output
8 to 12 GHz	100 mW
12 to 18 GHz	40 mW
18 to 26.5 GHz	20 mW
26.5 to 40 GHz	10 mW
8 to 18 GHz	10 mW

When the WJ-1168 is calibrated to the tuning curve of a BWO, the actual BWO output frequency will not deviate from the programmed value by more than  $\pm 0.15\%$  at nominal operating conditions. The unit is capable of tuning a BWO over its full frequency range in less than 1 millisecond.

Options include leveled output, 100 kHz bandwidths and operation to 50,000 feet. Low settling times and fast slew rates provide the systems engineer with an order of magnitude improvement in systems performance.



3333 HILLVIEW AVE., STANFORD INDUSTRIAL PARK, PALO ALTO, CALIF. 94304 • (415) 493-4141

INFORMATION RETRIEVAL NUMBER 46

## DATA PROCESSING

### Couplers interface lab instruments & computer



*Ambient Systems, Inc., 3020 Scott Blvd., Santa Clara, Calif. 95050. (408) 247-4400.*

These Dataspan 400 Series couplers interface laboratory instruments, providing outputs in either analog or digital form that are in computer-compatible format. The units come in six basic types and all accept an optional-keyboard input for header data. The 410 and 420 Models provide interface with digital instruments while the 430 and 440 Models interface with analog-output instruments. The 450 and 460 Models are ten-channel multiplex/converter/couplers with record-interval timers as a standard feature.

CIRCLE NO. 268

### Impactless printer make noise-free terminals



*Repco, Inc., 1940 Lockwood Way, Orlando, Fla. 32804. (305) 843-8484. \$1500; 3 wks.*

Operating speeds to 120 char/s, the Repco 120 printer becomes a terminal printer in the RO mode or an interactive printer and transmitter in the KSR mode (with the Keyboard option). This desk-top printer interfaces with a modem or acoustic coupler to provide on-line, hard-copy of 64-characters (upper case ASCII). Its use of impactless, electrosensitive paper makes it virtually noiseless.

CIRCLE NO. 269

# Sample-and-hold module settles to 0.005% in 5 $\mu$ s

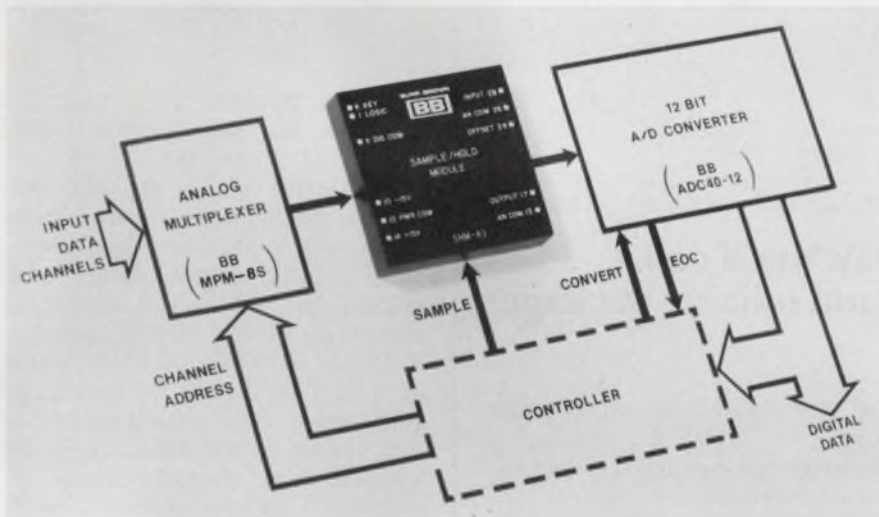

Burr-Brown Research Corp., International Industrial Park, Tucson, Ariz. 85706. (602) 294-1431. \$135.

The ideal sample-and-hold circuit follows an input without delay, holds the information indefinitely without deterioration, operates instantly, has infinite input impedance, no offsets and, finally, requires zero bias current. Though Burr-Brown's latest sample-and-hold, the SHM-41, offers improved performance, it's still a long way from the ideal.

The unit, intended to operate with 12-bit a/d converters, can acquire any input voltage from -10 to +10 V and settle to 0.005% of final value (a factor of two improvement over existing units) within 5  $\mu$ s. The final value is then maintained for a minimum of 1.0 ms.

Droop rate—or the rate at which the output decays—is specified at a maximum of 20  $\mu$ V/ms. Voltage offset is 1.0 mV but is adjustable to zero by use of an external potentiometer. And aperture time—actually a misnomer for turn-off time—is specified at 40 ns, maximum.

Input and output buffer amplifiers are used in the encapsulated 2 x 2 x 0.4-inch module to provide a minimum input impedance of 100 M $\Omega$  and a 0.1  $\Omega$  output im-

pedance. Bias current of 30 nA is required.

The operating mode is changed from sample to hold, and vice versa, by means of a TTL/DTL-compatible and COS/MOS-compatible FET switch and driver. The required logic levels are 0 to 0.8 V for a ZERO and +2 to +8 V for a ONE.

Other important specifications include maximum gain error of  $\pm 0.02\%$ , a gain drift of  $\pm 1.0$  ppm over the rated temperature range of 0 to 70 C,  $\pm 0.002\%$  feed-through of input to output in the hold mode, an offset drift of  $\pm 25$   $\mu$ V/C max. and a throughput nonlinearity of 0.5 mV.

Throughput nonlinearity refers to the combined error of gain nonlinearity and charge offset (charge coupled through the FET gate-to-source capacitance into the storage capacitance in the hold mode). The inaccuracy caused by these two errors cannot be corrected by gain and offset adjustments. The SHM-41 requires  $\pm 15$  V dc and  $\pm 15$  mA.

Another model, the SHM-40, is intended for use with 10-bit systems. It offers reduced performance for \$85. Its prime features are 5.5- $\mu$ s acquisition for a 20-V step, settling to 0.02%, a minimum hold time of 40  $\mu$ s and a droop rate of 500  $\mu$ V/ms, max.

CIRCLE NO. 270

Switch on NOISE,  
Switch off NOISE,  
Switch on NOISE,  
Switch off NOISE.



Quiet!



Ceramag<sup>®</sup> ferrite beads provide a simple, inexpensive means of obtaining RF decoupling, shielding and parasitic suppression without sacrificing low frequency power or signal level. Install beads by slipping one (or more) over appropriate conductor(s) for desired effect. Sizes from .020" ID - .038" OD - .050" L. Beads available with leads for PC boards. Send for samples.



**STACKPOLE**

Electronic Components Division  
St. Marys, Pa. 15857



# 10 amps of switching in a 1" cube!

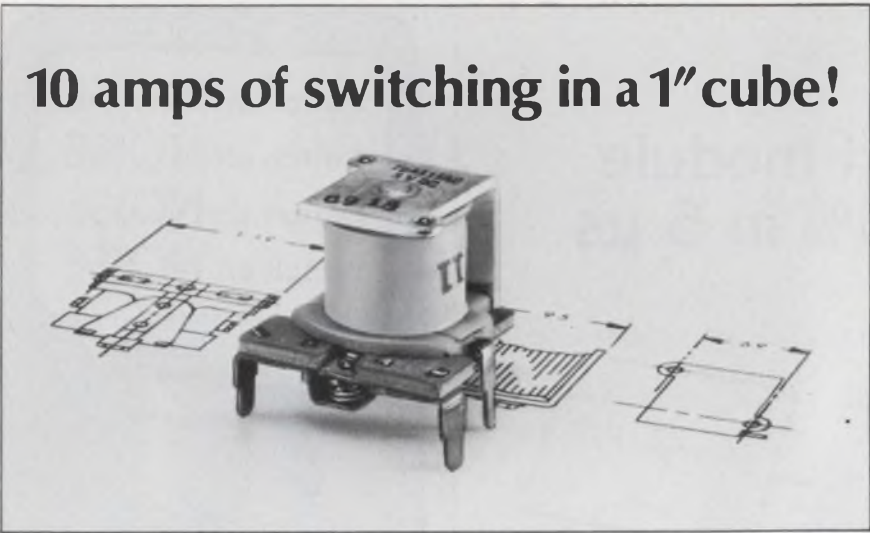

**We call it our Series 19 Relay. You'll call it one of the most compact and reliable packages you've ever used.**

Remarkable 10 amp Series 19 relay is low in cost, too — less than \$1.00 each in quantity. But price is only part of the story. The Series 19 also offers the advantages of miniaturization and the capacity to handle heavy switching loads. Result: more performance in a smaller overall package. Contact arrangement is SPDT. Rated 10 amps at 28 vdc or 115 v, 60 hz. Coil voltages available range from 3 to 24 vdc. The Series 19 is an ideal choice for a multitude of low level to 10 amp switching applications, including remote control, alarm systems and many other industrial and commercial uses.

Equally important, the Series 19 is part of a whole family of interrelated low-cost relays which will lend themselves to multiple usage in the same system. Included are:

**Series 10.** Sensitive, low cost, highly reliable SPDT relay rated at 3 amps, 28 vdc. Coil voltages 3-24 vdc. Can be used for a wide range of industrial and commercial control functions and alarm systems.



cial control functions and alarm systems.

**Series 28.** Same as Series 10, but furnished with a dust cover for use in appliance controls, remote TV tuning, industrial process controls and similar functions.



**Series 38.** DPDT, 3 amp 28 vdc contacts. Coil ratings 3-24 vdc. Applications include business machine controls, antenna rotor controls, industrial process controls, etc.



**GP.** A miniature general purpose relay with 2, 4, or 6 PDT contacts, rated 1, 2 or 5 amps, 28 vdc or 115 v, 60 hz. Coil voltages: 6-115 vdc. Consider the GP for copiers, business machines, control or alarm systems, etc. Available with single or bifurcated contacts.



**Send for information. Complete technical data on NAPCC relays available on request. Write today.**

PRICE ELECTRIC RELAYS

**NORTH AMERICAN PHILIPS CONTROLS CORP.**

A NORTH AMERICAN PHILIPS COMPANY  
E. Church & 2nd St. • Frederick, Md. 21701 • (301) 663-5141

INFORMATION RETRIEVAL NUMBER 48

## Precision multipliers give 0.02% accuracy



*Datatron Systems Inc., 7442 N. Figueroa St., Los Angeles, Calif. 90041. (213) 799-1181.*

The 00700 series are available with output voltages ranging from 10 to 100 V (external amplifier). They are the quarter-square type and can be used as two individual squaring units simultaneously. Accuracy of 0.02% for any value of X or Y represents the maximum static error. The -3-dB point for full output is 200 kHz. The total instantaneous dynamic error is 0.025% at 100 Hz and 0.2% peak at 1000 Hz. Stability is better than 25 ppm/yr.

CIRCLE NO. 271

## MOS counter time base comes in one 16-pin case

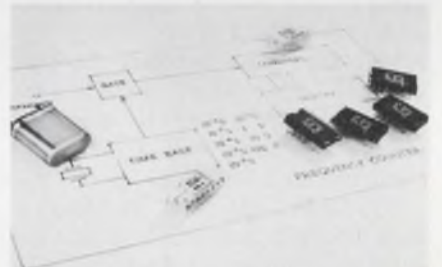

*Mostek Corp., 1215 W. Crosby Rd., Carrollton, Tex. 75006. (214) 242-0444. \$15 ea.; July.*

With the MK 5009 P counter time base only one 16-pin package is required, instead of the usual seven or eight 14-pin packages. Power requirement is 80 mW compared with the 160 mW per TTL decade counter (1.3 W for eight decades)—a saving of 94%. The 5009 operates with any of three frequency sources: the internal oscillator with an external RC combination; the internal oscillator with an external crystal; or with an external TTL signal. Frequency division ratios of from 1 to  $36 \times 10^8$  are available.

CIRCLE NO. 272



## Sample/hold amplifier gives 0.01% in 1.0 $\mu$ s

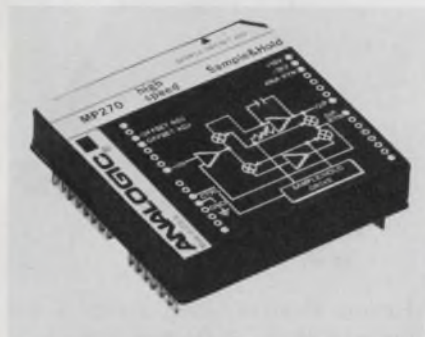

Analogic, Audubon Rd., Wakefield, Mass. 01880. (617) 246-0300. \$175.

Analogic's MP270 sample and hold amplifier, coupled with the company's new high-speed multiplexer, the MP4716, and a/d converter, the MP2912A, now provides a throughput rate of 140,000, 12-bit conversions per second. The MP270 has an aperture time of less than 2 ns. Its acquisition time (settling time) is 1.0  $\mu$ s, max, to 0.01% accuracy, for full 20 V signal excursions. Or, its acquisition time is 350 ns, max, with a 0.05% accuracy for 10 V excursions. A built-in buffer amplifier provides an input impedance of 100 M $\Omega$ . Gain is 1.0000,  $\pm 0.01\%$  and droop rate is two microvolts per microsecond.

CIRCLE NO. 273

## D/a converter offers 8-bits for \$8

Zeltex Inc., 1000 Chalmar Rd., Concord, Calif. 94520. (415) 686-6660. ZD400, \$8; 401, \$14.25; stock.

Zeltex announces two new, low cost, current d/a converters. Models ZD400 and ZD401 offer 8-bit and 10-bit resolution, 1 and 2  $\mu$ sec settling (to 1/2 LSB), respectively. Operation features  $\pm 0.2\%$  accuracy; 100 ppm/ $^{\circ}$ C tempco; 0 to 2 mA output; and standard binary-input data coding. Operating temperature range is 0 to 70 C and power required is +15 V. Both models are pin-for-pin compatible with existing Zeltex d/a converter line.

CIRCLE NO. 274

## Dc to synchro converters feature $\pm 6'$ accuracy



Computer Conversions Corp., 6 Dunton Court, E. Northport, N.Y. 11731. (516) 261-3300. \$295; stock to 4 wks.

A series of repairable, solid-state dc to synchro converters with up to  $\pm 6'$  minute accuracy, output over-current and short-circuit protection, has been introduced by Computer Conversions Corp. The new units convert any two dc inputs (from -10 to +10 V), representing the sine and cosine of the angle, into three-wire synchro outputs, which can directly drive CTs, CXs or TRs. These converters are available with 11.8 V L-L, 90 V L-L, 400 or 60 Hz outputs and require only  $\pm 15$  V dc power supplies.

CIRCLE NO. 275

## Multiplying DAC offers 11 bits

Perkin-Elmer Corp., Industrial Products Div., Main Ave., Norwalk, Conn. 06856. (203) 762-4786. \$150.

A new multiplying digital-to-analog converter is available from the Perkin-Elmer Corp. The Series 2000 provides 11-bits with accuracy of 1/2 LSB of the theoretical digital code over the full -55 to +125 C MIL temperature range. It is a true ratiometric device which exhibits a long term stability of better than 0.001% per year. It is TTL/DTL compatible. Series 2000 does not require factory trimming to compensate for accuracy or linearity errors caused by component drift or tolerances. The factory repairable unit is available in bipolar (MD/A 2111) or unipolar (MD/A 2011) versions.

CIRCLE NO. 276

Cut and formed leads reduce assembly costs.

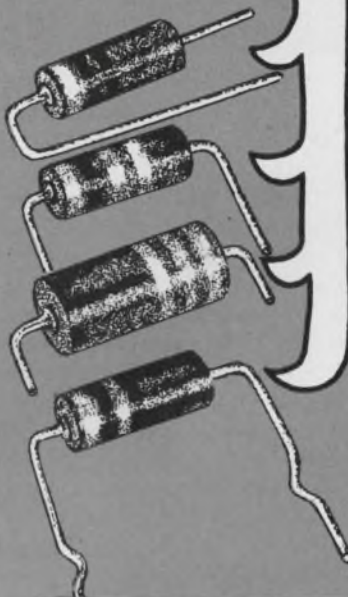

Now that's a nice twist.

Pre-shaped and trimmed resistor leads significantly reduce installation time. All Stackpole carbon composition resistors, 2, 1, 1/2, and 1/4 watts are available with cut and formed leads, to your specifications. Leads are coated for easy soldering. All resistors are 100% tested. Samples available. Send for Bulletin 80-100.



**STACKPOLE**

Electronic Components Division

Kane, Pa. 16735

INFORMATION RETRIEVAL NUMBER 49



## Dual FET gate is break-before-make type

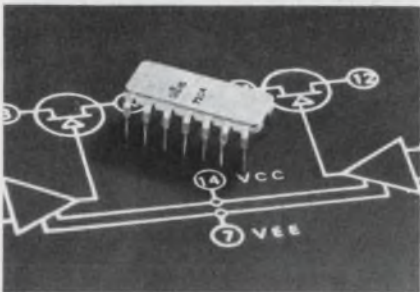

Teledyne Crystallonics, 147 Sherman St., Cambridge, Mass. 02140. (617) 491-1670. \$14.50 (100-249); stock.

The CAG45 dual FET analog gate consists of two separate FET analog switch circuits capable of switching up to  $\pm 10$  V signals with a break-before-make action. Switching can be controlled directly from most logic circuits. In addition to its inherent zero offset voltage and low on-resistance (50  $\Omega$  at normal temperatures), the circuit turns off faster than it turns on.

CIRCLE NO. 277

## Dynamic RAMs offer Wired-OR expandability

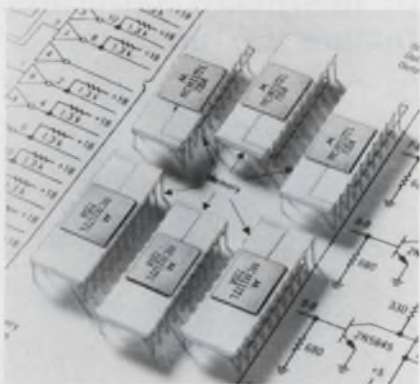

Motorola Semiconductor Products Inc., P.O. Box 20912, Phoenix, Ariz. 85036. (602) 273-3465. MCM-1172L: \$11; MCM1175L: \$12.10 (100 up).

The MCM1172L and the MCM-1175L dynamic MOS RAMs are 1024-bit memories. Both RAMs have a Wired-OR capability for memory system expansion in multiples of the  $1024 \times 1$  bit memory array. Also, a chip select input provides address expansion. Power dissipation is 75  $\mu$ W/bit, typical, with an access time of 350 ns max.

CIRCLE NO. 278

## Instrumentation amp believed IC first

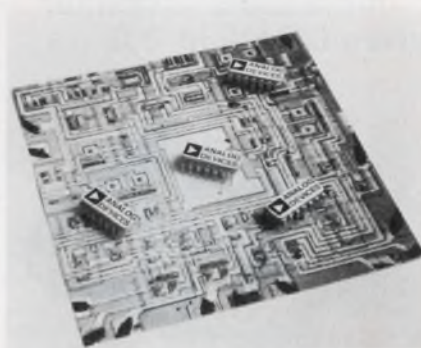

Analog Devices, Inc., Route 1 Industrial Park, P.O. Box 280, Norwood, Mass. 02062. (617) 329-4700. AD520J: \$18 (1-24); stock.

The first instrumentation amplifier on a chip, according to the company, is the AD520. It offers  $2 \times 10^9$ - $\Omega$  input impedance, 0.01%/°C drift and simple resistor adjustment of gains from 1 to 1000. The common-mode rejection is 110 dB at a gain of 1000 and with a source imbalance of 1 k $\Omega$ . These features are comparable to those of larger, discrete-component instrumentation amps.

CIRCLE NO. 279

## Eliminate relay failures.

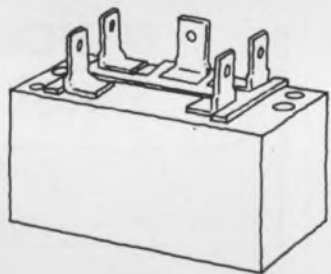

## Use Grayhill's Solid State Relays.

Grayhill Solid State Relays eliminate coil and contact sticking and burn outs because there literally are no moving parts.

Grayhill Relays are protected against transients, surges and inductive "kicks" by design—incorporating exclusive, built-in guardian circuits.

Optional features include: zero voltage crossover; logic circuit compatibility; and transformer (or LED) isolated input and output circuits.

For our latest Engineering Catalog or engineering assistance write or phone: Grayhill, Inc., 565 Hillgrove Ave., La Grange, Illinois 60525. (312) 354-1040.



INFORMATION RETRIEVAL NUMBER 50

## Designing high-speed drives?

## Consider Long-Life LTC™!



Nortronics' new LTC (Life Time Ceramic) digital heads extend head life ten times, cut replacement costs and eliminate the frequent electronic field adjustments normally required with conventional designs used in modern, high-speed tape drives.

The secret? Nortronics tough, new ceramic finish which is permanently applied to the face of digital heads. LTC is another example of Nortronics innovation—a significant breakthrough in magnetic head reliability and long-term survival. Write or call today for detailed information.



'world's leader in magnetic heads'

**NORTRONICS**  
COMPANY, INC.

8101 Tenth Avenue North  
Minneapolis, Minnesota 55427 • (612) 545-0401

INFORMATION RETRIEVAL NUMBER 51

ELECTRONIC DESIGN 14, July 6, 1972



## Wide input NAND gates now in Schottky-TTL

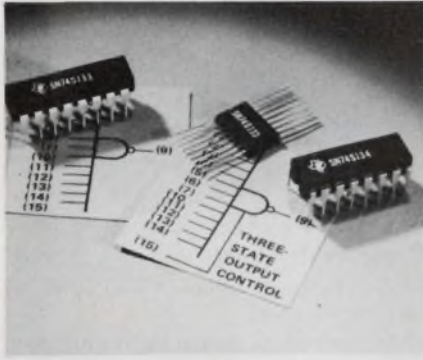

Texas Instruments Inc., P.O. Box 5012, M/S 308, Dallas, Tex. 75222. (214) 238-3741. SN74S133N: \$1.37; SN74S134N: \$1.64; stock to 4 wks.

The SN54S/74S133, with a 13-wide input section, and the SN54S/74S134, with a 12-wide input section, feature typical delay times of 4.5 to 5 ns. Both are Schottky-TTL ICs. The S133 gate has a high fan-out totem-pole output that is typical of S-TTL circuits. The S134 features a three-state output that can be put totally into a high impedance state. In this state, the output neither loads nor drives the line—an ideal condition for bus-oriented systems.

CIRCLE NO. 300

## Monolithic npn arrays match parameters

Sprague Electric Co., 347 Marshall St., North Adams, Mass. 01247. (413) 664-4411. ULS2045H: \$1.75; ULN2046A: \$1.05; ULN2054A: \$1.25; ULN2081A and ULN2082A: \$2.25 (100-999); stock.

Five npn-transistor arrays are especially useful when matched thermal and electrical parameters are required. Types ULS2045H and ULN2046A consist of five npn transistors, with two connected as a differential pair; type ULN2054A, of six npn transistors connected to form two independent differential amplifiers; and types ULN2081A and ULN2082A, each of seven npn transistors connected in the common-emitter and common-collector configuration, respectively. All types are suited for applications in low-power systems in the dc through vhf range.

CIRCLE NO. 301

## Video amp tolerates high Q inputs

Signetics, 811 E. Arques Ave., Sunnyvale, Calif. 94086. (408) 739-7700. NE592K: \$2.25 (100-999); stock.

A wideband video amplifier IC, the 592, offers fixed gains of 100 and 400 without external components, and gains that are adjustable from 0 to 400 with one external resistor. In addition, high Q circuits can be connected to the amplifier's inputs. The circuit can function as a high-pass, low-pass, or bandpass filter, with the addition of a few external reactive elements.

CIRCLE NO. 302

## Computer-on-chip can handle 16 k 8-bit bytes

Intel Corp., 3065 Bowers Ave., Santa Clara, Calif. 95051. (408) 246-7501. \$90 (100 up); stock.

An eight-bit central processor, the Type 8008 CPU, combines with RAMs, ROMs and shift registers to form the company's MCS-8 computer systems. These are capable of directly addressing and retrieving as many as 16,000 eight-bit bytes stored in the memory devices. The CPU, a p-channel silicon-gate MOS circuit, contains an 8-bit parallel adder, six 8-bit data registers, an 8-bit accumulator, two 8-bit temporary registers, four flag bits and eight 14-bit address registers.

CIRCLE NO. 303

## LM311 comparator now in mini-DIPs

National Semiconductor Corp., 2900 Semiconductor Dr., Santa Clara, Calif. 95051. (408) 732-5000. \$3.15 (100 quantities); stock.

The LM311, a popular voltage comparator, is now available in an eight-pin molded mini-DIP package. The new configuration, called the LM311N, offers the same performance as the LM311 at a lower price. The LM311N is designed to operate over a wide range of supply voltages—from a single 5-V supply (for logic circuits) to  $\pm 15$  V supplies (common in op-amp circuits). Its outputs are compatible with RTL, DTL, and TTL logic as well as MOS circuits.

CIRCLE NO. 304

For five cents, I'd start something.

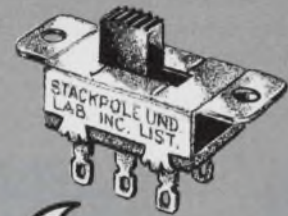
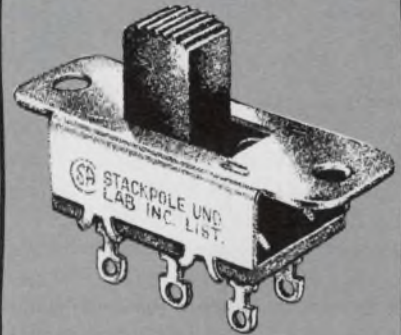

me too.

Turn on with a Stackpole slide switch. Prices start at 5¢ for this field proven standard of the industry. Available in two sizes, Regular and the new 50% smaller Miniature Series. Fully UL and CSA approved. Rated from 1 to 10 amps @ 125 and 250 volts (Miniature Series rated at 3 amps @ 125 V). Over 23 basic types, 7960 variations of slide and rocker switch adaptations. For complete details, send for Bulletin 78/79-100.



**STACKPOLE**  
COMPONENTS COMPANY  
Raleigh, N. C. 27610



### Plug-in IC sockets come in pre-cut strips

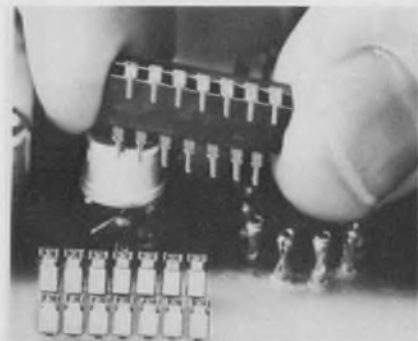

Waldom Electronics, Inc., 4625 W. 53rd St., Chicago, Ill. 60632. (312) 585-1212. \$4.94 to \$12.75/M; stock.

A new line of Soldercon IC sockets provide the speed and economy of plug-in packages. The sockets are furnished either in continuous-length reels, or in cut-to-length strips varying from 7 to 14 terminals per strip. After they are plugged into the board and soldered, the carrier is broken off and the terminal sockets are ready for instant use. Minimum spacing is 100 mil centers, 200 mil rows.

CIRCLE NO. 305

### Stripline conductor elements are adhesive

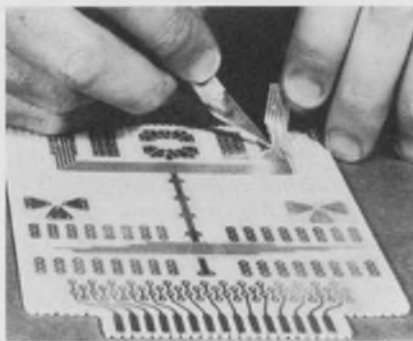

Circuit-Stik Inc., 24015 Garnier St., Torrance, Calif. 90510. (213) 530-5530.

Self-adhesive stripline parallel conductor subelements have insulated epoxy glass substrates and are designed for high density prototype applications. The stripline subelements are available in many conductor line widths from 10 mils to 250 mils. The stripline may be used for high frequency breadboarding, for making card extenders, and for repair of production circuit boards.

CIRCLE NO. 306

### IC sockets offer design flexibility

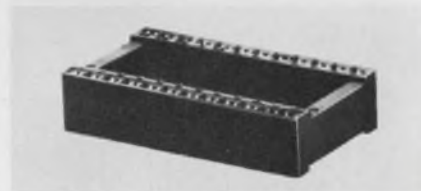

Texas Instruments Inc., 34 Forest St., Attleboro, Mass. 02703. (617) 222-2800. Stock.

A line of IC sockets features a choice of plated or bonded gold contacts, including closed or open-entry sockets in more than 200 variations. The sockets come in a wide variety of package sizes from 8 to 40 pin, and are made of precision molded glass-filled nylon with an operating temperature range of form -65 C to 150 C. Low profile, closed entry solder tail sockets project only 150 mils above the board, including standoffs. Thanks to a special contact and entrance design, users can insert IC devices without a preliminary straightening operation.

CIRCLE NO. 307

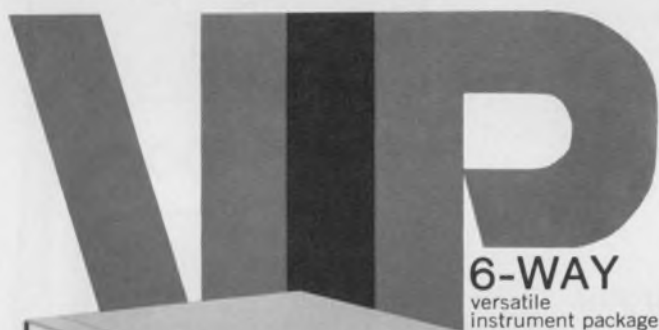

Two week delivery from stock, pre-assembled or in kit form.

**Multiple function + contemporary styling + affordable prices.**

(1) Vertical Nestable; (2) Vertical Interlockable; (3) Horizontal Interlockable; (4) Rack Mountable; (5) Briefcase Portable; (6) Tiltable... in 14 standard sizes. **Call or write for free VIP Design Guide and Prices.**

#### Zero Manufacturing Co.

Zero-West (213) 849-5521 • 1121 Chestnut St. • Burbank, Ca. 91503  
Zero-East (413) 287-5561 • 288 Main St. • Monson, Mass. 01057  
Zero-South (813) 531-8991 • Int'l Airport • St. Petersburg, Fla. 38732



10 heights from 5 1/4" to 28" with 17.9" or 25.9" depths.

Two week delivery from stock.

Accepts EIA 19"-wide panels. Positive nesting foot for vertical stacking. Single units can be fitted with tilt stands, chassis slides, fold-away cast handles, (self-retract strap available for 5 1/4" unit only). Pre-built with or without front and/or rear panels. **Ask for free VIP Design Guide, prices.**

#### Zero Manufacturing Co.

Zero-West (213) 849-5521 • 1121 Chestnut St. • Burbank, Ca. 91503  
Zero-East (413) 287-5561 • 288 Main St. • Monson, Mass. 01057  
Zero-South (813) 531-8991 • Int'l Airport • St. Petersburg, Fla. 38732

## evaluation samples

### Electroplating tape

Conformability coupled with self-sticking adhesive on XACP-447 tape establishes seepage resistant bond to PC boards in electroplate processing. Just 0.0055 in. thick, the vinyl tape hugs irregularities and curves in board surfaces. The tape removes easily, leaving a clean sharp part line without residue, thereby eliminating extra cleaning steps. Originally designed for use in nickel and gold PC board electroplating, the tape withstands common plating baths, chemicals, temperatures and current densities used in normal plating operations. Because it is transparent, the tape permits immediate visual inspection of contact to board. W. H. Brady Co.

CIRCLE NO. 321

### Closed entry sockets

Dual in-line IC Wrap-Post sockets are available in 14 or 16-pin configurations with 1 level, 2 level and 3 level wrap-posts. A closed-entry insulator (glass-filled nylon) prevents damage to contacts during IC insertion. The IC leads are gripped on ends rather than on sides to assure maximum retentive force and less vulnerability to overstressing of contacts. Jolo Industries.

CIRCLE NO. 322

### Pin header/plug

Only slightly larger than a 14-lead DIL IC package, the A23-2048 pin header/plug provides for discrete components which are soldered between terminal extensions and protected by a clip-on cover. The over-all dimensions are 0.79 in. long  $\times$  0.49 in. wide  $\times$  0.20 in. high. The contact pins are gold plated and extend 0.187 in. from the body. The cover and body are molded in glass filled nylon A190. Insulation resistance between the contacts is typically  $10^4$  megohms at 500 V dc. Jermyn.

CIRCLE NO. 323

## application notes

### Laminated plastics

"Laminated Plastic Designers Guide," a 12-page brochure, provides an easy-to-follow, step-by-step procedure for selecting and using many types of laminated plastics sheet material. The booklet describes more than 50 basic grades of laminates, with variations of resin systems and reinforcements of paper, glass, cotton, nylon, asbestos and other materials, as well as combinations of these to form composites. It lists various steps in selecting the exact laminate grade and discusses over-specification and under-specification. Synthane-Taylor Corp., Valley Forge, Pa.

CIRCLE NO. 324

### Strand annealing

A technical article entitled "Effects of Continuous Strand Annealing on the Properties of Soft Magnetic Materials" is of valued technical interest to design engineers, advanced product specialists, materials engineers and process metallurgists. The 12-page booklet presents data on the effects of annealing variables on magnetic properties, hardness and microstructure. Hamilton Watch Co., Precision Metals Div., Lancaster, Pa.

CIRCLE NO. 325

### ATR rubber spectra

Effective ATR techniques to optimize infrared spectra of rubber and rubber formulations are detailed in a 30-page booklet. Twelve spectra, reproduced full scale, show the ease and reliability of obtaining good IR spectra of various rubber compounds with minimal sample preparation. Identification of coating, fillers, and the elastomer itself can be made in a single scan. The text discusses simple sample preparation and interpretation of the resulting attenuated total reflectance spectra. Barnes Engineering Co., Stamford, Conn.

CIRCLE NO. 326

You're a penny-pinching, up-tight, li'l switch with no spark.

True.

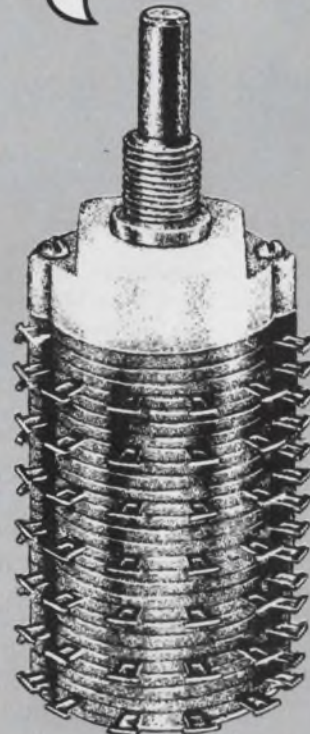

There's no better value than a Stackpole rotary switch. Fast delivery and quality features, but at a price you can afford. Unique design achieves a totally enclosed rotary, without sacrificing complex switching capability. Rigid construction and molded terminals produce a switch so tight it's explosion proof. Samples immediately. Production quantities in 1 to 2 weeks. Including switches with PC mounting. For details, send for Bulletin 73-103.

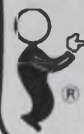

**STACKPOLE**  
COMPONENTS COMPANY  
Raleigh, N. C. 27610

INFORMATION RETRIEVAL NUMBER 55



# new literature



## General purpose relays

A complete designers reference guide to standard plug-in general purpose relays is offered in a 12-page catalog. Included is complete terminal and socket information, along with photos, dimensional drawings and schematics. Full specifications and operating characteristics are also supplied. To make your specification or selection job easier, handy how-to-order information, as well as a complete list of sales offices and distributors, is included. C. P. Clare & Co., Chicago, Ill.

CIRCLE NO. 327

## Indicator lights

A 20-page brochure details a complete line of ultra-miniature indicator lights including incandescent, neon and light-emitting diode types. In addition to general ordering information and specifications, the catalog includes data on characteristics and performance for each device, their applications, electrical and mechanical information, and clearly visible drawings. Dialight Corp., Brooklyn, N.Y.

CIRCLE NO. 328

## Relays and switches

Correeds, relays, switches, key-sets, touch-calling equipment, dials, lever keys and time delay modules are described in a 12-page catalog. GTE Automatic Electric, Northlake, Ill.

CIRCLE NO. 329

## Push-button switches

A 12-page brochure describes the Series 4 line of low-cost lighted pushbuttons and indicators. The illustrated booklet reviews features, panel-arrangement versatility, front-of-panel relamping procedures, illumination variations, housing offerings, mounting dimensions, button types and electrical ratings. It provides ordering guides for push-button switches, indicators and buttons as well as for special legending. Honeywell, Inc., Micro Switch Div., Freeport, Ill.

CIRCLE NO. 330

## Appliance switches

A new technical bulletin describing two appliance control switch lines—offering longer life and design for compact and high capacity applications—is available. The publication contains specifications, circuitry variations, line drawings and photographs of the series 240 and 390 rotary switches. Oak Electro/Netics Corp., Oak Switch Div., Crystal Lake, Ill.

CIRCLE NO. 331

## Business minicomputer

A 16-page booklet gives details on Datapoint 2200, the business minicomputer, in all its configurations, including tape, disc and line printer, and applications information on its use in data conversion and entry and in general on-line communications activity. It also describes the Databus programming language, available in six versions for varying kinds of use. Computer Terminal Corp., San Antonio, Tex.

CIRCLE NO. 332

## Minicomputer manual

A users manual describing the SS-4 minicomputer features a general description of the system, a 4-bit CPU, pROM card, RAM card, I/O card, programming examples and a detailed instruction repertoire of the SS-4. Comstar, Edina, Minn.

CIRCLE NO. 333

## Instrument transformers

ST-100, ST-200 and Scott-Tee series of instrument transformers designed for bridging, isolation and calibration application are covered in a four-page brochure. Singer Instrumentation, Los Angeles Operation, Los Angeles, Calif.

CIRCLE NO. 334

## Lafayette catalog

Stereo receivers, amplifiers, tuners, speakers, complete systems, plus the latest in four-channel stereo components, are featured in the summer sale catalog, No. 724. Car stereo tape systems, CB gear, cassette and cartridge tape recorders, ham equipment, radios, auto accessories and musical instruments are included. Lafayette Radio Electronics Corp., Syosset, L.I., N.Y.

CIRCLE NO. 335

## D/a catalog

Specifications and pinning information on 24 different models of d/a converters in DIP package and module form are described in a four-page brochure. Included are 6, 8, 10, and 12 bit DACs in DIP packages and 10 and 12-bit multiplying DACs. Operating information for bipolar, positive output and negative output units is presented. Information is also provided on types available for operation over the full military temperature range of  $-55$  to  $\pm 125$  C. Screening and processing steps for meeting Class B requirements of MIL-STD-38510 are further presented. Micro Networks Corp., Worcester, Mass.

CIRCLE NO. 336

## Core memory

A brochure describes operation and specifications of the Model ARM-30 mainframe core memory which replaces and expands IBM 360/30 mainframe memory. Ampex Corp., Marina del Rey, Calif.

CIRCLE NO. 337





**\$35.00**

## Power module for Nixie\* displays

This rugged module, designed specifically for use with high voltage display devices, provides a nominal output of 185 VDC at 25 ma . . . drives up to seven Nixies. Only 3.5" x 2.3" x 1". May be mounted directly on a p-c board. Order Model NX-25. Price: \$35.00. Shipment: Three days.



Acopian Corp., Easton, Pa. 18042  
Telephone (215) 258-5441

\*Registered trademark, Burroughs Corporation

INFORMATION RETRIEVAL NUMBER 56

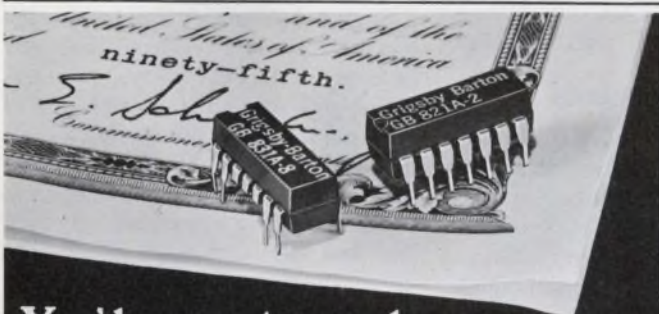

## You'd expect people who patented' DIP reed relays to offer you more

And Grigsby-Barton does. More versatility. More switching power. Advanced design. And the most expert technical help you can get.

Take our GB 820/830 Series of 14-pin and 8-pin DIP's. You can choose from 200 models in 1 Form A, B, or C, and 2 Form A. As well as all-position mercury-film Form C. 5, 12, or 24 VDC coil selection. Plus internal clamp diode and electrostatic shielding options.

All are realistically priced, and American made.

For details on our DIP reed relays, write or call; or contact your local Grigsby-Barton representative.

\*US Patent No. 3575678



**GRIGSBY-BARTON INC.**

3800 Industrial Dr., Rolling Meadows, Ill. 60008  
Phone (312) 392-5900

INFORMATION RETRIEVAL NUMBER 57

ELECTRONIC DESIGN 14, July 6, 1972

# Broadband Low Distortion RF Power Amp

- 10 watts output
- Flat response from .05 to 80 MHz



Model RF-805 is a solid-state amplifier with -30 db harmonic and intermodulation distortion. Gain is 47 db minimum, constant within 1 db for full output with less than 0.1 volt at 50 ohm input.

# Tunable 10-500 MHz RF Power Amp

- Up to 8 watts into 50 ohms
- Small and lightweight
- 35 db minimum gain



Model RF-815 is tunable in six band-switched ranges from 10 to 500 MHz. All solid state except for the one tube output stage, the unit's simple mechanical design makes maintenance easy. Output metering and overload protection are provided.

### Applications

Radio Communications • Laser Modulation • Accelerator Driver • NMR • RF Power Calibration • Ultrasonics • Transmitter Driver

**HARRIS**



**RF COMMUNICATIONS, INC.**

Electronic Instrumentation Operation  
1680 University Avenue  
Rochester, New York 14610  
Telephone: 716-244-5830 TWX: 510-253-7469  
A Subsidiary of Harris-Intertype Corporation

INFORMATION RETRIEVAL NUMBER 58





## Electronic instruments

A condensed catalog covers state-of-the-art frequency synthesizers, extremely stable signal generators, broadband and tunable power amplifiers, modular amplifiers, and accessories. These instruments are for general laboratory use, production testing, automatic test systems and communications. RF Communications, Inc., Rochester, N.Y.

CIRCLE NO. 338

## Oscilloscopes

Dc-to-200 MHz optimum pulse response, dc-to-250 MHz bandwidth option, 8 × 10-cm display, 7 cm/ns writing speed, and four-plug-in flexibility highlight many features of the 7704A oscilloscope presented in the Tektronix 7700 Family brochure. Tektronix, Inc., Beaverton, Ore.

CIRCLE NO. 339

## PC board tester

A PC board tester designed to achieve high volume testing of PC boards at minimum cost is described in a 13-page brochure. The brochure describes the three basic sections of the Model 4600—the control section, the stimulus and measurement section and the pin electronics section. Datatron, Inc., Santa Ana, Calif.

CIRCLE NO. 340

## Laser amplifier

A data sheet describes the series of high-performance, solid-state laser amplifier systems. Apollo Lasers, Inc., Los Angeles, Calif.

CIRCLE NO. 341

## Rf current probes

A 42-page book presents a brief discussion of current probe characteristics and details of fourteen different models including: applications, electrical and physical specifications and transfer impedance curves. Measurements of conducted RFI in accordance with MIL-STD 826/461, MIL-I-26600 (USAF) and MIL-I-6181D (USAF) are possible with these devices. Singer Instrumentation, Los Angeles Operation, Los Angeles, Calif.

CIRCLE NO. 342

## Pattern generator

A brochure describes a new hand-held pattern generator and data analyzer. Small and lightweight, they're packaged and priced to fit every tool box and budget. Data Products, Woodland Hills, Calif.

CIRCLE NO. 343

## EMI filters

Electromagnetic interference subminiature filters are described in a four-page brochure. Republic Electronics Corp., Paterson, N.J.

CIRCLE NO. 344

## Microwave components

A wide range of coaxial and waveguide components is described in a catalog (including attenuators, couplers, detectors, isolators, oscillators, short circuits, terminations and wave meters). A pocket inside the back cover contains a chart showing waveguide frequency ranges, dimensions and designations. Alphabetical and type-number indexes insure rapid location of components. The catalog is complementary to the booklet containing details of flexible waveguides and flanges. Marconi Instruments Ltd., Sanders Div., Stevenage Hertz, SG1 2AU. U.K.

CIRCLE NO. 345

## Thyristor rectifier

A catalog that describes thyristors and rectifiers reflects the wide selection of thyristor devices (triacs, SCRs), diacs and rectifiers. Also included is information on applications of thyristors. RCA Solid State Div., Somerville, N.J.

CIRCLE NO. 346

## MIC mixers; mixer preamps

A six-page bulletin (DM-101) describes double balanced MIC mixers, mixer preamps and image rejection mixers. Photos, specifications and prices for over 100 models are shown along with graphs noting specific performance characteristics. Additional technical information is also included on intermodulation, dynamic range, LO injection levels, upconverter performance and single sideband upconversion. RHG Electronics Laboratory, Inc., Farmingdale, N.Y.

CIRCLE NO. 347

## 3/4-inch DIP trimmer

A two-page, two-color data sheet describes a low cost, 3/4-inch trimmer, with conventional dual-in-line pin spacing. The sheet is complete with photographs, dimensional drawings, schematic cutaways showing the unique "T" slider block design, a list of detailed specifications and ordering information. Spectrol Electronics Corp., City of Industry, Calif.

CIRCLE NO. 348

## Cermet trimmers

Series 91 cermet trimming potentiometers are featured in a new catalog sheet. This four-page publication provides outline drawings of the trimmers, which are available in two different styles and six different pin spacings. Specifications, including electrical, mechanical and environmental details are given in this sheet. Beckman Instruments, Inc., Helipot Div., Fullerton, Calif.

CIRCLE NO. 349

## MOS ROM

The latest data sheet on the electrically programmable MOS ROM, the 1601, and its pin compatible metal mask MOS ROM, the 1301, contains corrections and additions to the September, 1971, data sheet. Intel Corp., Santa Clara, Calif.

CIRCLE NO. 350

## Edge connector

Data Sheet 403-1 describes the new card-edge connector with crimp-on, snap-in contacts for flat conductor flexible cable. AMP Inc., Harrisburg, Pa.

CIRCLE NO. 351



## Wire-wound resistors

A handbook on precision and power wire-wound resistors includes basic information on specialty items, such as chip resistors, high temperature resistance probes, shunt resistors and aluminum housed power resistors. All decimal and fractional equivalents appear side by side with millimeter conversions. General technical information includes cross-reference charts for MIL specs, heat distribution curves, special resistance temperature characteristics, typical circuits using TC wire-wound resistors, etc. RCL Electronics, Inc., Irvington, N.J.

CIRCLE NO. 352

## Feed-thru filters

A new family of subminiature ferrite titanate RFI/EMI filters are described in data sheet 736-1. Full electrical and physical characteristics are provided for the entire family of "25 Series" filters. The filters are available in either solder or bolt-in versions with a variety of conductor/terminal configurations. AMP Inc., Capatron Div., Elizabethtown, Pa.

CIRCLE NO. 353

## Reference diodes

A specification sheet covers all Jeduc registered temperature compensated reference diodes. Included are the specifications of 58 different Jeduc types and five high reliability Jan, Jan-Tx types. In addition to the literal specs, a variety of curves illustrating the typical characteristics of various parameters are included. Codi Semiconductor Div., Computer Diode Corp., Fair Lawn, N.J.

CIRCLE NO. 354

## Carbon resistors

Detailed data on carbon composition fixed resistors is described in a 4-page brochure. Color coding, part numbering information and a table of standard resistance values in accordance with EIA resistance values is also included. Characteristics include resistance range, standard tolerance and full temperature specifications. International Components, Farmingdale, N.Y.

CIRCLE NO. 355

# These Thinpak™ relays switch loads that would destroy a reed relay



## Yet they're in the same dimension and price ranges.

American Zettler's miniature AZ Series of THINPAK™ relays are available with 1, 2 or 5 amp contacts and coil ratings from 6 to 115 VDC. Operating power is as low as 125 mW and a sensitive version for T<sup>2</sup>L integrated circuits eliminates expensive drivers in many applications. These THINPAK relays are less than 0.450" high, allowing 0.6" center-to-center pc board or plug-in mounting.

Contact arrangements include SPDT in 1, 2 and 5 amp ratings, and DPDT rated at 1 and 2 amps. Insulation resistance is greater than 10<sup>10</sup> ohms, and contact resistance is less than 50 X 10<sup>-3</sup> ohms. Constructed without the use of phenolic insulation, AZ THINPAK's have dielectric strengths up to 2500 volts between the contacts and the coil. A SPDT 1 amp version is also available as a magnetic latching relay. Prices start at just \$1.44 each for the Model 530 SPDT, 6V coil, in 2500 piece quantity.

To obtain a free evaluation sample and complete technical information, write or phone:

**American Zettler, inc.**



697 Randolph Avenue, Costa Mesa, CA 92626 Phone: (714) 540-4190 Telex 67-8472

INFORMATION RETRIEVAL NUMBER 59



# Allochiral

The most rugged, reliable, solderless interconnect system available. Available now. (And you'll be pleased at its low cost!)

**One-piece construction** for higher reliability, substantial savings per contact, per board, per finished assembly!

**Permits extremely short lead-length** - as short as .035" below device for full contact!

**Greater contacting surface** - approximately 60% of lead perimeters!

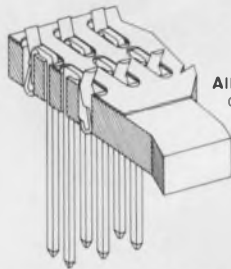

**Allows for visual inspection** of point of connection to component lead!

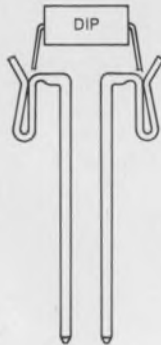

**Lowest profile available** (.025" above board) permits more packaging density!

**30° angle lead-in arms** for easier automatic or manual insertion!

Robinson-Nugent invites your attention to its new, unique one-piece contact/terminal concept. When inserted in board, the unit becomes a properly aligned, self-supporting connector/socket for ICs or a complete back panel solderless interconnection system.



800 East Eighth Street  
New Albany, Indiana 47150  
(812) 945-0211 TWX 810-540-4082

INFORMATION RETRIEVAL NUMBER 60

## bulletin board

Motorola's MECL 10,000 logic series has been enhanced by the addition of several new functions and new devices. A higher speed subset provides designers with three functions, each capable of 1.2 ns gate delays and 225 MHz toggle rates, with only 25 mW basic gate power dissipation. Four new functions have been added, bringing the total number of logic functions available in MECL 10,000 and 10,200 devices to 29. Three more MECL III devices have been added: a 4-bit binary counter, a voltage-controlled multivibrator, and a 4-bit shift register. Results of a MECL 10,000 reliability test program indicate a failure rate of 0.0035%/1000 hr. at 50 C junction temperature.

CIRCLE NO. 356

Sixteen new ECL ICs, designated the SN10000 Series, have been announced by Texas Instruments. The family includes two MSI circuits and features typical basic gate speeds of 2 ns and power dissipation of 25 mW. The MSI SN10181 circuit features 75 equivalent gates.

CIRCLE NO. 357

### Price reductions

Tyco Saphikon Div. has released pricing information for polished, single crystal sapphire substrates which reveals a 50% reduction from present market prices. As an indication of the new pricing commitment, a typical 2-inch diameter, polished sapphire substrate with 1102 crystal orientation for SOS use is priced at less than \$18 in quantity, claimed by the company to be around 50% of any price on the market today for high quality sapphire substrates. Similar price reductions apply to C axis orientation material for hybrid ICs. The sapphire is available in any popular crystal orientation and is used to host thin-film silicon application or epitaxial growth.

CIRCLE NO. 358

# dip clip

T.M.

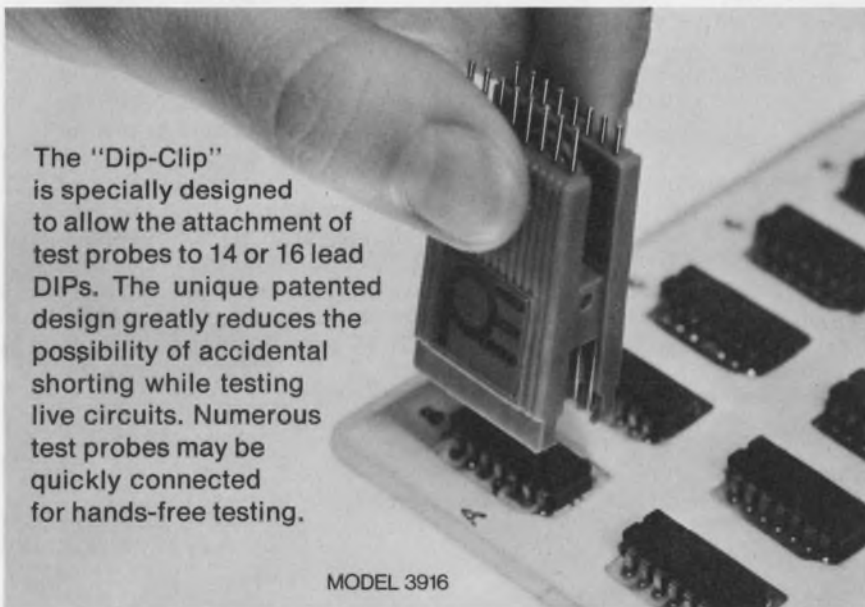

The "Dip-Clip" is specially designed to allow the attachment of test probes to 14 or 16 lead DIPs. The unique patented design greatly reduces the possibility of accidental shorting while testing live circuits. Numerous test probes may be quickly connected for hands-free testing.

MODEL 3916



**POMONA ELECTRONICS**

1500 E. Ninth St., Pomona, Calif. 91766 • Telephone: (714) 623-3463

INFORMATION RETRIEVAL NUMBER 61

## vendors report

Annual and interim reports can provide much more than financial-position information. They often include the first public disclosure of new products, new techniques and new directions of our vendors and customers. Further, they often contain superb analyses of segments of industry that a company serves.

Selected companies with recent reports are listed here with their main electronic products or services. For a copy, circle the indicated number.

**Royal Industries.** Avionics and plastics.

CIRCLE NO. 359

**Oak Electro/netics Corp.** Computers, test and measuring equipment, communications equipment, materials and switching components.

CIRCLE NO. 360

**Diebold Computer Leasing, Inc.** Computer leasing.

CIRCLE NO. 361

**American Micro-systems, Inc.** MOS/LSI, business machines and data communications.

CIRCLE NO. 362

**Technitrol, Inc.** Computers, semiconductors and automated measurement systems.

CIRCLE NO. 363

**Fifth Dimension Inc.** Switches, attenuators, multiplexers, PCM systems, commutators and rf arrays.

CIRCLE NO. 364

**Resalab, Inc.** Radar systems, antennas, communication systems, transmitters, VLF systems, energy sources, electro-optics, microwaves, avionics, test equipment and data processing.

CIRCLE NO. 365

**Siliconix Inc.** ICs, FETs.

CIRCLE NO. 366

**RCA.** Data communications, COS/MOS, ICs, semiconductors, components, aerospace and communications.

CIRCLE NO. 367



## General Purpose U. L. Relays

.. to 20 amps. 4PDT  
... to 110 VDC. 240 VAC.

Babcock offers a full line of general purpose relays, most of which are U.L. Listed—miniature DIP models to large capacity AC power versions—sealed and open frame—advanced contact systems and performance characteristics. Send today for complete information on the application of these relays to your needs—from Babcock Electronics Corp., 3501 N. Harbor Blvd., Costa Mesa, Calif. 92626: (714) 540-1234.

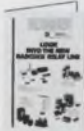

**FREE...** new industrial control products summary catalog—listing Babcock's line of industrial timers and sensors, and dry reed, mercury-wetted and general purpose relays.



**BABCOCK**

A UNIT OF ESTERLINE CORPORATION



MIL-R-6106



MIL-R-5757



TIMERS/SENSORS



MERCURY WETTED



20A INDUSTRIAL



2A INDUSTRIAL

INFORMATION RETRIEVAL NUMBER 62

# LED

## New low cost LED Vactrol photon isolator



\$2.55

as low as ~~\$9.10~~ each in 1,000 quantities

- all solid state
- 4 types of photoconductors combined with LEDs
- hermetically sealed TO-5 enclosure
- unlimited life—no filaments
- ideal for environments where shock and vibration are a problem
- applications include photochoppers, linear isolators, noiseless switching, SCR and triac turn-on, audio level controls, etc.

Write for Bulletin VTL2C



**VACTEC, INC.**

2423 Northline Ind. Blvd.  
Maryland Heights, Mo. 63043  
Phone: (314) 872-8300

Specializing in standard Cds, Cdse, and Se sells; custom engineering for every photocell need. Listed in EBG under "Semi-Conductors" and in EEM Sec. 3700

INFORMATION RETRIEVAL NUMBER 63



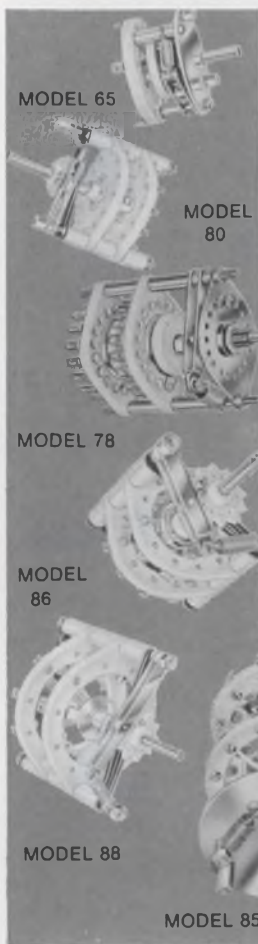

# A complete line of CUSTOMIZED ROTARY CERAMIC SWITCHES ...

For RF and POWER APPLICATIONS

RSC switches are available in a variety of switching models. RSC high precision, quality built units are designed for applications requiring long life maintenance-free service. Types include shorting and non-shorting, single and multi-deck, up to 18 pole positions. Features include, 10 to 100 amp current carrying capacity, 20° to 90° detents, 2000 to 24000 volts flashover and corrosion-proof construction.

Write for catalog no. 960  
and complete information.



## RADIO SWITCH CORPORATION

Rt. 79, Marlboro, N. J. 07746

INFORMATION RETRIEVAL NUMBER 64

# Electronic Design

ELECTRONIC DESIGN's function is:

- To aid progress in the electronics manufacturing industry by promoting good design.
- To give the electronic design engineer concepts and ideas that make his job easier and more productive.
- To provide a central source of timely electronics information.
- To promote communication among members of the electronics engineering community.

**Want a subscription?** ELECTRONIC DESIGN is sent free to qualified engineers and engineering managers doing design work, supervising design or setting standards in the United States and Western Europe. For a free subscription, use the application form bound in the magazine. If none is included, write to us direct for an application form.

If you do not qualify, you may take out a paid subscription for \$25 a year in the U.S.A., \$35 a year elsewhere. Single copies are \$1.50 each.

**If you change your address,** send us an old mailing label and your new address; there is generally a postcard for this bound in the magazine. You will have to requalify to continue receiving ELECTRONIC DESIGN free.

**The accuracy policy of ELECTRONIC DESIGN is:**

- To make diligent efforts to ensure the accuracy of editorial matter.
- To publish prompt corrections whenever inaccuracies are brought to our attention. Corrections appear in "Across the Desk."
- To encourage our readers as responsible members of our business community to report to us misleading or fraudulent advertising.
- To refuse any advertisement deemed to be misleading or fraudulent.

Microfilm copies are available of complete volumes of ELECTRONIC DESIGN at \$19.00 per volume, beginning with Volume 9, 1961. Work is now in process to complete the microfilm edition of Volumes 1-8. Reprints of individual articles may be obtained for \$2.00 each, prepaid (\$.50 for each additional copy of the same article) no matter how long the article. For further details and to place orders, contact the Customer Services Department, University Microfilms, 300 North Zeeb Road, Ann Arbor, Michigan 48106 telephone (313) 761-4700.

**Want to contact us?** If you have any comments or wish to submit a manuscript or article outline, address your correspondence to:

Editor  
ELECTRONIC DESIGN  
50 Essex Street  
Rochelle Park, N.J. 07662

# Less than 1 $\mu$ V Offset! New Ultra-Low Thermal emf Reed Relays!



- Unique new method (pat. pend.) virtually eliminates thermal offsets, permits use of almost any type reed switch... Hg wet, dry, high voltage.
- Remarkably independent of ambient temperature, environment.
- Many contact forms, pin configurations available.
- Units also available at less than 500 nanovolts per switch, or less than 1 $\mu$ V differentially between switches.
- Greater than 10<sup>11</sup> ohms isolation resistance.
- Rugged molded package. Moderate price.

Write for Complete New Catalog MR-6.1



COTO-COIL COMPANY, INC.  
59 Pavilion Avenue, Providence, R. I. 02905  
Tel: (401) 941-3355

INFORMATION RETRIEVAL NUMBER 65

## Attention Advertisers:

Could you use copies of your ad exactly as it appeared in ELECTRONIC DESIGN? Then order your reprints directly from us; the minimum unit order is 500 copies.

Please specify if you would like the reprint line omitted on your copies and mail your written order to ELECTRONIC DESIGN, Production Dept., 50 Essex Street, Rochelle Park, New Jersey 07662.

	500	1,000	Add'l M
<b>8x10 or smaller</b>			
1 color, 1 side	\$74.70	82.95	18.15
2 color, 1 side	95.47	108.00	25.28
4 color, 1 side	311.03	342.00	44.33

### Spreads

1 color	113.66	126.65	25.98
2 color	191.19	205.98	29.58
4 color	354.17	380.76	53.19

Prices FOB Waseca, Minn.

# Electronic Design

Advertising Sales Staff

Bryce Gray  
Sales Manager

Rochelle Park, N.J. 07662

Robert W. Gascoigne  
Daniel J. Rowland  
50 Essex Street  
(201) 843-0550  
TWX: 710-990-5071

Philadelphia

Thomas P. Barth  
50 Essex Street  
Rochelle Park, N. J. 07662  
(201) 843-0550

Boston 02116

Richard L. Green  
20 Columbus Avenue  
Boston, Mass.  
(617) 482-7989

Chicago 60611

Thomas P. Kavooras  
Berry Conner, Jr.  
200 East Ontario  
(312) 337-0588

Cleveland

Thomas P. Kavooras  
(Chicago)  
(312) 337-0588  
(call collect)

Los Angeles 90303

Stanley I. Ehrenclou  
Burt Underwood  
2930 Imperial Highway  
Inglewood, Calif  
(213) 757-0183

San Francisco 94022

Jerry D. Latta  
P.O. Box 1248  
Los Altos, Calif.  
(415) 965-2636

London W. 1

For United Kingdom and Holland  
Brayton C. Nichols  
For Eastern Europe  
Peter Kehr

The American Magazine Group

27 Maddox Street  
London, W. 1, England  
Phone: 499-0180  
Cable: Ammagnic, London

Verviers, Belgium

For Continental Europe  
Andre Jamar  
1, Ru Mallar, 1  
(087) 253.83 Telex 41563

Tokyo

Haruki Hirayama  
Electronic Media Service  
5th Floor, Lila Bldg.,  
4-9-8 Roppongi  
Minato-ku  
Phone: 402-4556  
Cable: Electronicmedia, Tokyo



# get less for your money

with these new Datron reed relays

## less space

Datron's new LG series reed relays, with unique coil combinations, let one relay do the work of several!



The multiple packaging of the compact LG reeds permits a choice of common or individual coils, either one a great improvement in cost and space savings.



Common Coil Individual Coils

## looking for a low-cost reed?

Check into the new LH series reed relay from the Electronic Specialty Division of Datron. For as little as 65 cents each in 5000-piece quantities, the LH does a highly reliable job in industrial and consumer circuits.



## less time

Multiple packaging saves production time!

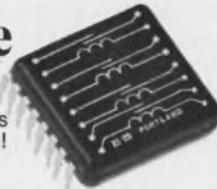

## less cost

Higher density in each relay means lower overall cost to get your job done!

The multiple packaging capability of Datron's new LG Series reed relays now lets you combine your solid state devices with the isolation and power of the reed switch.

## need MIL spec relays?

Datron's ES division is the quality military relay house. Added recently to the Qualified Products List (MIL-R-5757 Rev F) are these Datron relays:

- 50 N Series (half size) M 5757/9
- 55 N Series (half size latching) M 5757/76
- 79 N Series (full size) M 5757/10.

## DATRON SYSTEMS, INC.

Electronic Specialty Division  
18900 N.E. Sandy Blvd.  
Portland, Oregon 97220  
(503) 665-0121



INFORMATION RETRIEVAL NUMBER 66

# ENGINEERS WHO KNOW ZENER DIODES SPEC DICKSON

That's because Dickson has earned a reputation for excellence in voltage regulating (Zener) and reference (TC) diodes. Since Dickson has always been a specialist in Zeners, engineers expect the best and they get it... from a hi-rel military unit to low-cost industrial devices. Give us a try! Write, today, for our 6-page Zener Selection Guide.

"The Specialists"



"Where Quality Makes The Difference"



**DICKSON**  
ELECTRONICS CORPORATION

PHONE (602) 947-2231 TWX 910-950-1292 TELEX 667-406  
P.O. BOX 1390 • SCOTTSDALE, ARIZONA 85252

INFORMATION RETRIEVAL NUMBER 67



# Design Data from Manufacturers

Advertisements of booklets, brochures, catalogs and data sheets. To order use Reader-Service Card.  
(Advertisement)

## PC Drafting Aids Catalog

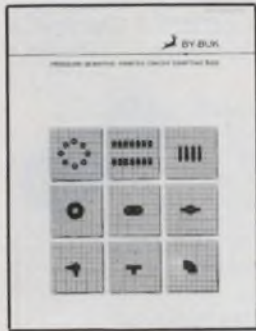

Thousands of time saving, cost saving artwork ideas are found in the By-Buk P-50 catalog of pressure sensitive printed circuit drafting aids. With the most practical artwork patterns for: TO cans, multi-pads, dual-inlines and flat packs featured. Donuts, connector strips, teardrops, ovals, tapes, tees, elbows, etc., by the hundreds are included in the most comprehensive list of sizes. Opaque black, transparent red and transparent blue materials for one and two-sided board designs. For a free copy and samples, write today.

### By-Buk Company

Subsidiary of Webtek Corp., 4326 W. Pico Blvd.  
Los Angeles, California 90019 (213) 937-3511

CIRCLE NO. 171

## Dynaload – Solid State Electrical Load



A new technical bulletin presents valuable engineering suggestions to save many dollars and hours in special or production testing of power supplies, servo systems, DC generators and similar power equipment, through the substitution of a single inexpensive test instrument to replace a multitude of specially designed test equipment. The Dynaload offers resistance current or voltage loads over wide dynamic ranges. The brochure illustrates typical setups for testing power supplies, batteries, circuit breakers, etc., and gives specifications for units ranging from 100 to 3000 watts, 0 to 400 volts and 0 to 150 Amps. For your copy, please write:

### Transistor Devices, Inc.

85 Horsehill Road, Cedar Knolls, N. J. 07927  
Tel. (201) 267-1900

CIRCLE NO. 172

## Measure Vector Angle, Magnitude And Components



The new PAR™ Model 129 Two Phase Lock-In/Vector Voltmeter, enables you to simultaneously measure the magnitude and phase angle with respect to a reference signal of virtually any low-level signal within its range of 0.5 Hz to 100 kHz—even if the signal is buried 60 dB beneath background noise. At the flip of a switch, you can also measure the in-phase and quadrature components of the vector. The Model 129 features fully automatic reference tracking, independent output expansion and filtering for each channel. Complete specifications are contained in bulletin T-314, available on request.

CIRCLE NO. 173

### PRINCETON APPLIED RESEARCH CORPORATION

P.O. Box 2565  
Princeton, New Jersey 08540

Advertiser	Page
Acopian Corp. ....	103
Adams & Westlake Company, The....	93
American Zettler, Inc. ....	105
Amplex Computer Products Division .....	22
Babcock Relays .....	107
Belden Corporation .....	41
Bourns, Inc. ....	33
By-Buk Company .....	110
CTS Corporation .....	91
Centralab, the Electronics Division of Globe-Union, Inc. ....	87
Clare & Co., C. P. ....	89
Computer Devices Corp. of America .....	111
Coto Coil Company Inc. ....	108
Data Technology Corporation .....	18
Datron Systems .....	109
Delco Electronics, Division of General Motors Corporation.....	74, 75
Dickson Electronics Corporation.....	109
Digital Equipment Corporation.....	42, 79
Dow Corning Corporation .....	8, 9, 11
ECC Corporation .....	7
Edmund Scientific Co. ....	111
Fairchild Microwave and Optoelectronics .....	67
Federal Scientific Corporation .....	112
GTE Automatic Electric .....	12, 13
GTE Sylvania, Precision Materials Group Parts Division .....	31
General Electric Company .....	17, 25
Grayhill, Inc. ....	98
Grigsby-Barton, Inc. ....	103
Guardian Electric Manufacturing Company .....	10
Hayden Book Company, Inc. ....	40
Hewlett-Packard .....	85
Houston Instrument .....	60
Hughes Aircraft Company .....	1
Intech, Incorporated .....	88
LH Research Inc. ....	Cover II
MCL, Inc. ....	20
Magnecraft Electric Company .....	61
Mallory Capacitor Company .....	48
Molex, Incorporated .....	Cover III
Monolithic Dielectrics, Inc. ....	111
Mostek Corporation .....	82
North American Philips Controls Corp. ....	96
Nortronics Company, Inc. ....	98
Oak Industries, Inc. ....	2
Philips Industries .....	40
Pomona Electronics Co., Inc. ....	106
Potter & Brumfield Division of AMF Incorporated .....	14, 15
Princeton Applied Research Corp.....	110
RCA Solid State Division .....	Cover IV
RF Communications, Inc. ....	103
Radio Switch Corporation .....	108
Robinson Nugent, Incorporated.....	106
Schauer Manufacturing Corp. ....	84
Signetics-Linear .....	21
Siliconix Incorporated .....	46
Sorenson Company, a unit of the Raytheon Company .....	68, 69
Sprague Electric Company .....	6
Sperry Information Displays .....	19
Stackpole Components Company .....	99, 101
Stackpole Carbon Company .....	95, 97
Struthers-Dunn, Inc. ....	16
TEC, Incorporated .....	92
TRW/IRC Fixed Resistors .....	73
Tektronix, Inc. ....	45, 81
Teledyne Relays, A Teledyne Company .....	49
Teletype Corporation .....	4, 5
Texas Instruments Incorporated, Components Group 35, 36, 37, 38, 39	
Transistor Devices, Inc. ....	110
U. S. Capacitor Corporation .....	72
Vactec Inc. ....	107
Vu-Data Corporation .....	77
Watkins-Johnson .....	94
Woven Electronics .....	34
Xentek Inc. ....	111
Zero Manufacturing Co. ....	100



# FREE\*

5 Vdc @ 6 Amp

## Quality Power Supply

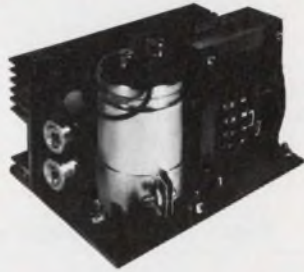

... Plus 40,000 other models with similar savings  
**compare:** .1% Reg .1% Ripple & Noise

- Input: 120-240 VAC  $\pm 10\%$  50/60 Hz
- Foldback Current Limiting
- Remote Sensing Capabilities
- Full Rated Power 0°C-55°C
- Electrostatically Shielded Transformer
- Off the Shelf Availability
- OEM Contracts
- Size 4 1/4" x 5 3/4" x 3 1/2"

1 - 9	10 - 24	25 - 49	50 - 99
\$42.95	\$40.80	\$38.40	\$36.50

\*With the purchase of any 5 Vdc @ 6 Amp Power Supply free Overvoltage Crowbar Option valued at \$6.00. Offer good until Aug. 1, 1972.

### XENTEK INC.

Call (213) 944-4417  
 10912 South Painter Avenue  
 Santa Fe Springs, California 90670

INFORMATION RETRIEVAL NUMBER 68

# RAPID SYN

## CHALLENGER PACKAGE

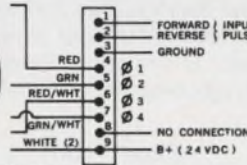

STEPPER MODEL 34H-599

DRIVER MODEL M-21

## STEPPER & DRIVER \$99<sup>00</sup>

### COMPARE QUALITY & PERFORMANCE

Stepper Model 34H-599

Driver Model M-21

Type: Bifilar, 1.8°  $\pm 2\%$  Accuracy

Type: 4 Phase, TTL Compatible

Input: 24 VDC, 20 Watts

Input: 24 VDC

Stall Torque: 150 Oz In

Pulse: Positive, 2 Volts Min.,

Dynamic Torque: 120 Oz In

Current Rating: 3 Amps Max.

Bidirectional Response: 550 PPS

Switching Rate: 10,000 Max.

Size: 3 3/8" Dia., 2 7/16" Long

Size: 4" x 2 7/8" x 1.8" High

Challenger system is offered to introduce the system designer to outstanding quality and performance of Rapid-Syn steppers and synchronous motors. Computer Devices of Calif. offers from stock a complete line of steppers in sizes 8, 11, 15, 18, 20, 23, & 34 with step angles of 1.8°, 5°, 7.5°, 15°, 45°, & 90°. Send for free catalog!

### Computer Devices Corp. of California

11901 Burke Street, Santa Fe Springs, California 90670  
 (213) 698-2595 • Telex 65-7478

72-3

INFORMATION RETRIEVAL NUMBER 69

SCIENCE · OPTICS · ELECTRONICS  
**UNUSUAL & HARD TO FIND BARGAINS**  
 NEW PRODUCTS · NEW MATERIALS · NEW METHODS



#### FLEXIBLE IMAGE TRANSMITTER

Hi-resolution image-transmitter lets you see into remote, inaccessible illuminated areas: through pipes, tubes or any 3/8" + opening no matter how intricate. Provides clear, wide sighting. 7X magnifying eyepiece focuses from less than 1/2" from subject to infinity. Ideal for monitoring hazardous processes, surveillance instrument, demonstrate fiber optics. Over 4,000 coherent glass fibers (.002"), 3/8" dia. semi-rigid gooseneck sheathing. Stock No. 60.857DA \$40.00 Ppd.



#### AMAZING NEW Wankel Engine Kit!

Build your own see-through motorized model of revolutionary pistonless type engine, rights for which GM recently paid \$50 million! Only one, engine experts think economically modifiable to meet new pollution standards. Replaces piston, cylinder, crank assemblies with rotating discs (sections removed for firing chambers). Smaller than conventional: fewer parts, greater reliability, same speed w/less horsepower. Switch. Reg. 2 — 1.5V batt. (not incl.). 519 Page Wankel Engine Book. Stock No. 9.439DA \$15.25 Ppd.



#### ULTRA LOW PRESSURE SENSOR

Big surplus bargain—tiny electrical pressure switch activated by only 0.02 psi air or 1/2" or less water pressure. Single pole, normally open, 10ma DC contact rating, 30v AC/DC (usual loads require sensitive relay or solid state control). Use as sensor, switch, control, counter, edge guide, instrument alarm. Long life (1,000,000 operations), impervious to extreme shock, vibration. 1" sq. polycarbonate case, 3/16" diameter barbed pressure ports. WT—10 grams. Original Cost \$11.50. Stock No. 41.623DA \$3.95 Ppd.



#### GIANT FREE CATALOG

Completely new 1972 edition — 148 pages. Bargains galore! New categories, items, illustrations, 1,000's of buys for Industry—Optics, Ecological and Physical Sciences, Electronics, On-the-Job helps, quality control aids. Optics for research labs, design engineers, experimenters. Instruments for checking, measuring; improve quality, cut costs. Hard-to-get surplus bargains. Write for catalog "DA".

**EDMUND SCIENTIFIC CO.** 300 EDSCORP BLDG.  
 BARRINGTON, NEW JERSEY 08007  
 TELEPHONE: 609-547-3488  
 ORDERS BY STOCK NUMBER • OPEN ACCOUNT TO CREDIT FIRMS • MONEY-BACK GUARANTEE

INFORMATION RETRIEVAL NUMBER 70

ELECTRONIC DESIGN 14, July 6, 1972

# FIXED CAPACITORS... Hermetically Sealed ...in Glass!

## FOR MAXIMUM RELIABILITY AND LONGER LIFE!

Now you can design circuit capabilities never before possible! "Glass-To-Metal" hermetic seal guarantees long-term reliability and greater strength! All potential problems are ruled out because they are sealed out... with glass! High to low temperature excursions (—100°C to +500°C or vice versa) will not affect the thermally matched components! Contact surfaces are non-oxidizing even under the most extreme conditions! Available in 4 sizes from .160 x .065 to .400 x .155 with capacitance ranges of 1 pf to .22 mfd. Write for catalog sheet.

**Monolithic Dielectrics Inc.**

Subsidiary of

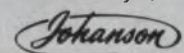

P.O. Box 647 • Burbank, Ca. 91503  
 Phone (213) 848-4465

INFORMATION RETRIEVAL NUMBER 71



# product index

**Information Retrieval Service.** New Products, Evaluation Samples (ES), Design Aids (DA), Application Notes (AN), and New Literature (NL) in this issue are listed here with page and Information Retrieval numbers. Reader requests will be promptly processed by computer and mailed to the manufacturer within three days.

Category	Page	IRN	Category	Page	IRN	Category	Page	IRN
<b>Components</b>			gate, FET analog	98	277	converters, d/a (NL)	102	336
display, LED	88	252	gates, NAND	99	300	converters, dc/synchro	97	275
lights (NL)	102	328	MOS ROM (NL)	104	350	multipliers	96	271
relays (NL)	102	327	processor, central	99	303	sample/hold	95	270
relays (NL)	102	329	RAMs, MOS	98	278	time base	96	272
resistors (NL)	105	352	transistor arrays	99	301			
switches (NL)	102	330	voltage comparator	99	304			
switches (NL)	102	331				<b>Packaging &amp; Materials</b>		
transformers (NL)	102	334	<b>Instrumentation</b>			conductors	100	306
trimmer (NL)	104	348	amplifier, power	84	256	electroplating tape (ES)	101	321
trimmers, cermet (NL)	104	349	ATR (AN)	101	326	header/plug (ES)	101	323
			digital multimeter	86	260	plastics (AN)	101	324
<b>Data Processing</b>			DPM	84	257	sockets (ES)	101	322
cassette, digital	90	261	instruments (NL)	104	338	sockets, IC	100	307
interface couplers	94	268	oscilloscopes	83	251	terminal sockets	100	305
minicomputer (NL)	102	333	oscilloscopes (NL)	104	339			
modem, digital synthesis	92	265	panel meter, digital	86	259			
plotter, analog	93	266	photometer, digital	84	258			
printer, impactless	94	269	tester, memory	84	255			
ROM, programmer	93	267	tester, PC board (NL)	104	340			
storage tube, display	92	262				<b>new literature</b>		
teleprinter, repackaged	92	263	<b>Modules &amp; Subassemblies</b>			amplifier, laser	104	341
time-to-digital unit	92	264	amplifier, sample/hold	97	273	components	102	335
			converter, d/a	97	274	connectors	104	351
<b>ICs and Semiconductors</b>			converter, d/a	97	276	converters, d/a	102	336
amp, instrumentation	98	279	converters, d/a (NL)	102	336	diodes	105	354
amplifier, video	99	302	transformers (NL)	102	334	filters	104	344
						filters	105	353
						generator	104	343
						instruments	104	338
						lights	102	328
						memory, core	102	337
						microwave components	104	345
						minicomputer	102	332
						minicomputer	102	333
						mixers	104	347
						MOS ROM	104	350
						oscilloscopes	104	339
						probes, current	104	342
						relays	102	327
						relays	102	329
						resistors	105	355
						resistors, wire-wound	105	352
						switches	102	330
						switches	102	331
						tester, PC board	104	340
						thyristor	104	346
						transformers	102	334
						trimmer	104	348
						trimmers, cermet	104	349

## Design Data from Manufacturers

Advertisements of booklets, brochures, catalogs and data sheets. To order use Reader-Service Card.  
(Advertisement)

### 500-line Real-Time Spectrum Analyzer Acts Like 650-Lines



Second generation Mini-Ubiq™ Model UA-15A low frequency real-time spectrum analyzer — smaller, lighter, easier to use and less expensive than Federal's famous Ubiquitous® 500-line analyzer — is better for on-the-spot frequency analysis, machine noise diagnosis, computer automatic systems. Incorporates a sharper, computer-designed filter for increased selectivity — can separate closely spaced components as if it had 650 frequency lines. Widest choice of range — 12 ranges from 10Hz to 50kHz; highest frequency and amplitude accuracy; computer control of input amplitude range, analysis range, and presampling filter; operation with weighting function on or off; sweep termination adjustable for high sweep rates; earphone monitor of filtered input.

### Federal Scientific Corp.

Subsidiary of Elgin National Industries, Inc.  
615 West 131st Street, New York, N. Y. 10027

CIRCLE NO. 174

### application notes

ATR	101	326
conductor annealing	101	325
plastics	101	324

### evaluation samples

electroplating tape	101	321
header/plug	101	323
sockets	101	322



**KONEKTCON® MAKES THIS EASY!** It's the Molex system that solves the most complex board-to-board, board-to-component, chassis-to-board interconnection problems. It's economical. Reliable. Quick. Versatile. Uses only four basic connectors. Unique rigid square wire male terminals permit stacking of multiple board connections to the same circuits. Molex vibration assembly method stakes up to 300 terminals per minute for wave soldering. Preassembled round male

terminal wafers also available for 2 to 18 circuits. Three female terminal assemblies provide incomparable flexibility: cable-to-board; board-to-board, parallel; board-to-board, perpendicular; and board-to-chassis. Plus a variety of options, including a 3-circuit power transistor. For technical specs call (312) 969-4550. Or write: Molex Incorporated, Lisle, Illinois 60532.

*...creating components that  
simplify circuitry*





# If your aluminum packages leak, you didn't buy RCA hermeticity—in steel.

**Aluminum Package—TO-3, soldered, preformed eyelets**  
**Thermal Cycling Test Conditions—16 W,  $\Delta T$  case = 90°C**  
**(40°C to 130°C)**  
**Typical Performance (cycles to failure)—3 K**  
**Typical Requirements (cycles)—25K**



**Steel package—TO-3, glass-to-stem, compression seal**  
**Thermal Cycling Test Conditions—16 W,  $\Delta T$  case = 90°C**  
**(40°C to 130°C)**  
**Typical Performance (cycles)—50 K (Test terminated; no failures.)**  
**Typical Requirements (cycles)—25K**



The case for RCA in popular TO-3 transistors is steel...rated from -65°C to +200°C.

The aluminum package can have an inherent weakness in the solder bond between the eyelets and the aluminum header. Under temperature cycling, fractures develop at this interface, destroying the device's hermeticity.

The RCA steel package, with

its glass-to-stem high compression seal, welded cap, and controlled solder process, offers you at least an order of magnitude improvement over aluminum in terms of hermeticity, reliability, and long-term, trouble-free performance.

Ask for RCA's Reliability Report ST6071, or conduct your own tests. Write: RCA Solid State, Section 57G-6 UTL31, P. O. Box 3200,

Somerville, N.J. 08876. International: RCA, Sunbury-on-Thames, U. K., or Fuji Building, 7-4 Kasumigaseki, 3-Chome, Chiyoda-Ku, Tokyo, Japan. In Canada: RCA Limited, Ste. Anne de Bellevue 810, Quebec.

**RCA Solid State**  
products that make products pay off