

Electronic Design

FOR ENGINEERS AND ENGINEERING MANAGERS

VOL. 20 NO.

7

APRIL 1, 1972

For a universal signal source—or one that comes close to it—a function generator is hard to beat. It provides a wide range of signal and modulation capability.

It may not equal the performance of an instrument it replaces, but it's often ideal in test setups that don't need ultimate signal purity. Check the tradeoffs. See p.36.

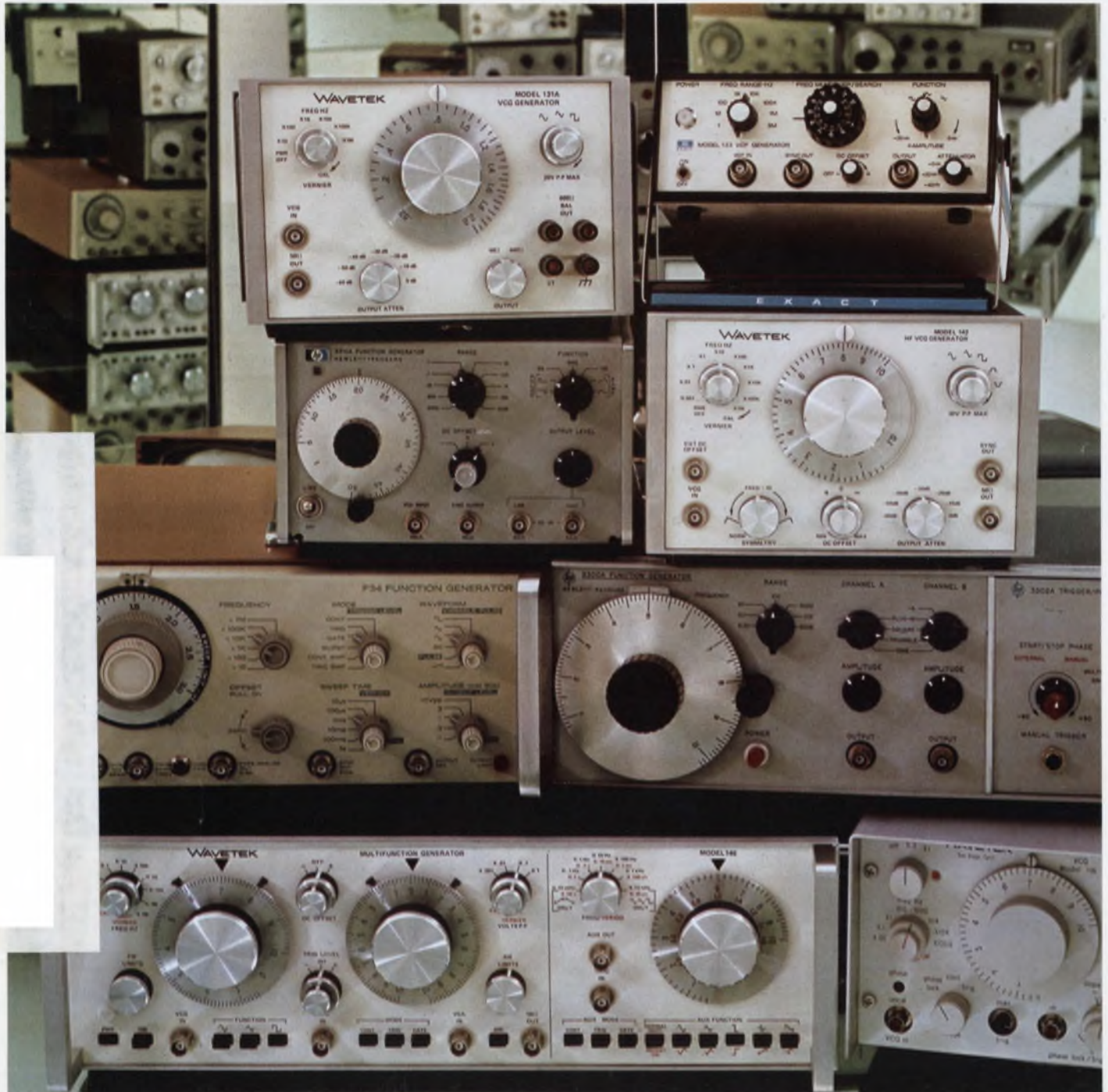

New from Dale...

Metal film performance

at a carbon comp price.



Don't settle for the loose tolerance and T.C. of commercial-grade carbon comps. Use new Dale DF metal film resistors to upgrade your circuits—without increasing your budget. Semi-precision DF's meet EIA Standard 196. They fill the performance gap between Mil-R-11 and Mil-R-22684 styles—giving you a great new source and the best resistor you can buy in the 3-cent range.

How many million shall we ship you?

Write today or phone 402-564-3131 for complete details.

DF RESISTOR SPECIFICATIONS

Power Rating: ¼, ½, 1 watt

Tolerance: ±2%, ±5%, ±10%

Temperature Coefficient: ±100, ±150, ±200 ppm/°C depending on size and resistance range

Resistance Range: 10 ohms to 1 megohm

Operating Temperature Range: -65°C to +150°C

Coating: Epoxy—specially-formulated for moisture protection and flame retardance

DALE ELECTRONICS, INC. 1300 28th Avenue, Columbus, Nebraska 68601

In Canada: Dale Electronics Canada, Ltd. A subsidiary of The Lionel Corporation

INFORMATION RETRIEVAL NUMBER 132

DALE®

Look out Mountain View, here comes Westminster.



Where?
Westminster.
What's there?
Silicon General.
Silicon Who?

Not too many years ago it was Fairchild who? Then along came National who? Now, it's Silicon who!

We're after top billing in the semiconductor business and we know what it takes to get it: performance.

What's in it for you? Right now just about the broadest selection of linear ICs ever assembled in one place. Need delivery now on a super op amp or voltage follower? It's yours. Looking for a reliable source for LM's? That's us, too.

The same goes for dual tracking regulators, or for that matter, any IC regulator. That's our trump. Want help with a linear idea? Our engineers make house calls. Processing to 883, Level A? Available. Right here in Westminster.

There's more. Here. For you.

Give us a call. Give us an order.

We want to prove who's who.

Silicon who?

Silicon General. About 400 miles due south of Silicon Gulch.

Silicon General, 7382 Bolsa Avenue, Westminster, California 92683, (714) 892-5531 TWX: 910-596-1804

Ala.: Cramer/EW, (205) 539-5722 **Ariz.:** Cramer, (602) 263-1112; Kierulff, (602) 273-7331 **Calif.:** Cramer, (415) 365-4000, (213) 243-6224, (714) 279-6300; Electronic Distributors Inc., (213) 997-7411; K-Tronics/Wesco, (213) 685-9525; Kierulff, (415) 968-6292, (714) 278-2112
Colo.: Cramer, (303) 758-2100; Kierulff, (303) 343-7090 **Conn.:** Cramer, (203) 239-5641 **Fla.:** Cramer/EW, (305) 894-1511, (305) 923-8181
Ga.: Cramer/EW, (404) 448-9050 **Ill.:** Bodelle Co., (312) 468-1016; Cramer, (312) 593-0230 **Md.:** Arrow, (301) 247-5200; Cramer/EW, (301) 354-0100 **Mass.:** Cramer, (617) 969-7700; Gerber Electronics, (617) 329-2400 **Mich.:** Bodelle Co., (313) 273-6920 **Minn.:** Cramer, (612) 881-8678; Industrial Components Inc., (612) 927-9991 **N.J.:** Cramer, (201) 687-7870 **N.Mex.:** Cramer, (505) 265-5767; Kierulff, (505) 247-1055 **New York:** Arrow, (516) 694-6800; Cramer, (516) 231-5600, (716) 275-0300, (315) 437-6671, (607) 754-6661; Ossmann Components, (716) 442-3290 **N.C.:** Cramer/EW, (919) 725-8711, (919) 876-2371 **Ohio:** Arrow, (513) 253-9176, (216) 464-2000; Cramer, (513) 771-6441, (216) 248-7740 **Okla.:** Cramer, (918) 836-3371 **Penn.:** Arrow, (215) 534-3200; Cramer, (215) 923-5950 **Texas:** Cramer, (214) 350-1355; Kierulff, (214) 271-2471; Sterling, (214) 357-9131, (713) 623-6600 **Utah:** Cramer, (810) 487-3681 **Wash.:** Kierulff, (206) 763-1550 **Wisc.:** Cramer, (414) 462-8300 **Canada:** Cramer, (416) 781-6631; Future Electronics, (514) 735-5775.

AN INFINITE VARIETY



TO-5 Relay

Every snowflake is a masterpiece of design . . . The diversity of complex geometric

patterns is limitless. In the industrial world you will find an analogy with the snowflake in the Teledyne TO-5 family of relays. The TO-5 is tiny — a testimony to our leadership in pioneering reliable miniaturization of electro-mechanical relays. Teledyne TO-5 Relays offer thousands of different relay variations for a multitude of industrial, scientific, technological and military applications.

But we don't stop with the TO-5... There is also a variety of Teledyne Solid-State relays for every requirement!

3155 West El Segundo Boulevard
Hawthorne, California 90250
Telephone (213) 679-2205



**TELEDYNE
RELAYS**

NEWS

- 19 **News Scope**
- 22 **A full-color holographic moving-map display** for aircraft pilots is reconstructed with white light.
- 23 **An analog-sensor compass** that employs a Hall-effect device gives a digital output without conversion.
- 24 **Shift register reduces the connections** in a GaP, eight-digit display developed by Bell Telephone Laboratories
- 27 **Ultrasonic technique used to set off underwater blasts.**
- 28 **Technology Abroad**
- 31 **Washington Report**

TECHNOLOGY

- 36 **Focus on Function Generators:** A special report on the most versatile signal sources and the problems engineers may have in buying them.
- 44 **Digital testing costs can be cut** with semi-automatic approach. In module quantities from 10 k to 100 k, it costs considerably less than fully automatic systems.
- 50 **Use hybrid voltage regulators,** now available from several sources, to cut power-supply design and test times and reduce inventory cost.
- 56 **Ideas for Design**
- 60 **'Top Ten' prize-winning advertisements**

PRODUCTS

- 77 **Modules & Subassemblies:** Low-cost 8-bit a/d converter completes conversion in 2 μ s.
- 80 **Instrumentation:** Conversational algebraic calculator rivals minicomputer performance.
- 82 Components
- 84 ICs & Semiconductors
- 84 Data Processing
- 84 Packaging & Materials

Departments

- 35 **Editorial:** Design or shuffle paper. Which goal?
- 7 Across the Desk
- 86 Evaluation Samples
- 86 Application Notes
- 87 New Literature
- 89 Bulletin Board
- 92 Advertisers' Index
- 92 Information Retrieval Card

Cover: Wavetek, San Diego, Calif.

**SCHOTTKY
TTL DEVICES
DELIVERABLE
IMMEDIATELY**

Our TTL Family Tree has a vigorous new Schottky branch: SSI devices now. Proprietary MSI (and more SSI) devices soon.

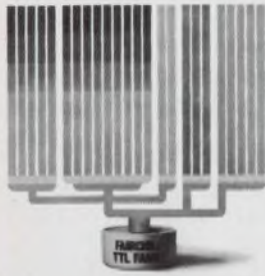

Our TTL Family Tree continues to grow. Now a new Schottky branch: SSI in volume now. MSI coming up. To give you new ways to solve your very-high-speed digital systems design problems.

Schottky TTL Devices are pin-for-pin replacements for slower, functionally

equivalent elements in existing TTL systems. An example of the speed improvement achieved is shown in the table below. These Schottky functions can be used to selectively replace devices in critical speed limiting paths within the system.

**TTL SWITCHING TIME COMPARISON
EXAMPLE: HEX INVERTER**

	T _{PLH} (turn-off delay)		T _{PHL} (turn-on delay)	
	Typ.	Max.	Typ.	Max.
9N04/7404	12.0	22.0	8.0	15.0
9H04/74H04	6.5	10.0	9.0	13.0
9S04/74S04	3.0	4.5	3.0	5.0
9S04A/74S04A	2.5	4.0	2.5	3.5

Note: All speeds listed in nanoseconds.

Important areas where speed limiting occurs are: decoder and multiplexer expansion; memory addressing and selection; general arithmetic and control functions; prescalers and counters; and elimination of skew problems in clock distribution. System speed improvements of 20 to 50% can be expected in these situations without any major redesign. Power requirements, logic levels and noise margins remain compatible with the slower, lower cost standard TTL devices which can be retained when speed is not important.

For your Schottky needs we now have 13 TTL/SSI functions, making us the only major supplier to second source these devices. And we can deliver them immediately. Our 9S and 93S series are completely interchangeable with the 54/74S series.

Just as important, these are but the first of the new Fairchild Schottky TTL family. Soon other SSI elements. Soon also, our first 93S series of proprietary MSI functions.

FAIRCHILD TTL/SSI DEVICES AND AVAILABILITY

Device	Description	Available
9S00/54S00, 74S00	Quad 2-Input NAND Gate	Now
9S03/54S03, 74S03	Quad 2-Input NAND (O.C.) Gate	Now
9S04/54S04, 74S04	Hex Inverter	Now
9S05/54S05, 74S05	Hex Inverter (O.C.)	Now
9S20/54S20, 74S20	Dual 4-Input NAND Gate	Now
9S22/54S22, 74S22	Dual 4-Input NAND (O.C.) Gate	Now
9S40/54S40, 74S40	Dual 4-Input NAND Buffer	Now
9S74/54S74, 74S74	Dual D Flip-Flop	Now
9S04A	Fast Hex Inverter	Now
9S05A	Fast Hex Inverter (O.C.)	Now
9S64/54S64, 74S64	AND-OR-Invert	Now
9S65/54S65, 74S65	AND-OR-Invert (O.C.)	Now
9S140/54S140, 74S140	Dual 4-Input NAND Line Driver	Now
9S109	Dual J-K Flip-Flop	2nd Qtr.
9S112/54S112, 74S112	Dual J-K Flip-Flop	2nd Qtr.
9S113/54S113, 74S113	Dual J-K Flip-Flop	2nd Qtr.
9S114/54S114, 74S114	Dual J-K Flip-Flop	2nd Qtr.

FAIRCHILD TTL/MSI FUNCTIONS AND AVAILABILITY

Device	Description	Available
93S41	4 Bit ALU/Function Generator	2nd Qtr.
93S05	Variable Modulo Counter	2nd Qtr.
93S39	Multiple Port Register	3rd Qtr.
93S10	Synchronous Decade Counter	3rd Qtr.
93S16	Synchronous Hexadecimal Counter	3rd Qtr.
93S12	Eight Input Multiplexer	3rd Qtr.
93S42	Carry Look Ahead Unit	3rd Qtr.
93S00	4 Bit Universal Shift Register	3rd Qtr.

Other MSI functions in development include high speed decoders and parity checkers.

Whatever your High Speed needs we have the answer. Schottky TTL for retrofitting existing systems, or our temperature compensated Easy ECL 9500 family for new high-speed systems.

Your Friendly Fairchild distributor has both our Schottky TTL and Easy ECL devices in stock, deliverable immediately. Or for more information, we have data sheets and application notes on both.



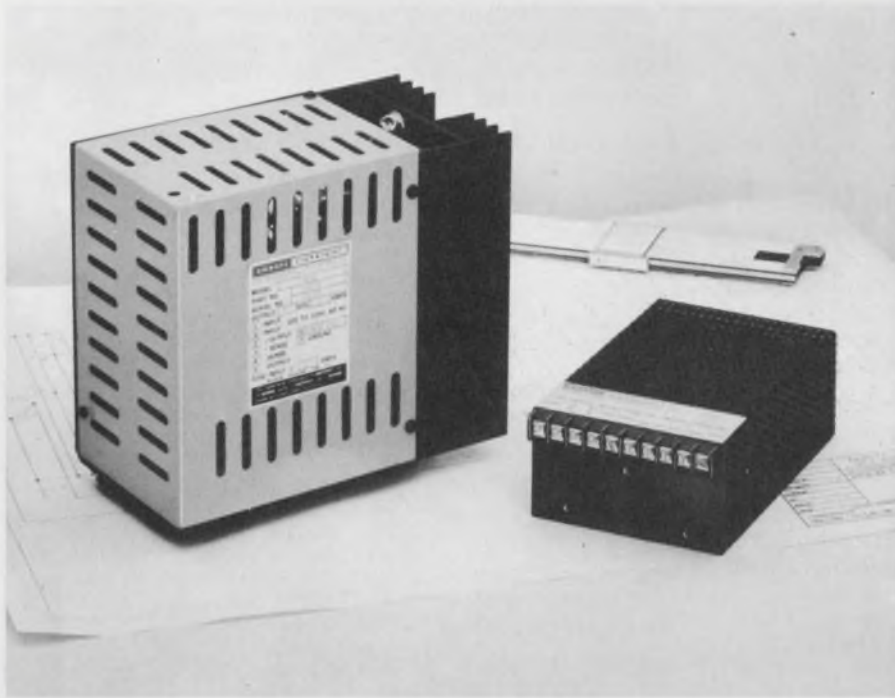

Reduce Your Power Supply Size and Weight By 70% for \$49

A new way has been found to substantially reduce power supply size and weight. Consider the large power supply shown at left in the above photo — it uses an input transformer, into a bridge rectifier, to convert 60 Hz to 5 volts DC at 5 amperes. This unit measures 6½" x 4" x 7½" and weighs 13 pounds. It sells for \$170 in small quantities. For just \$49.00 more, Abbott's new model Z5T10, shown at right, provides the same performance with 70% less weight and volume. It measures only 2½" x 4" x 6" and weighs just 3 pounds.

This size reduction in the Model Z5T10 is primarily accomplished by eliminating the large input transformer and instead using high voltage, high efficiency, DC to DC conversion circuits. Abbott engineers have been able to control the output ripple to less than 0.02% RMS or 50 millivolts peak-to-peak

maximum. This design approach also allows the unit to operate from 100 to 132 Volts RMS and 47 to 440 Hertz. Close regulation of 0.15% and a typical temperature coefficient of 0.01% per degree Centigrade are some of its many outstanding features. This new Model "Z" series is available in output voltages of 2.7 to 31 VDC in 9 days from receipt of order.

Abbott also manufactures 3,000 other models of power supplies with output voltages from 5 to 740 VDC and with output currents from 2 milliamps to 20 amps. They are all listed with prices in the new Abbott catalog with various inputs:

- 60 AC to DC, Regulated
- 400 AC to DC, Regulated
- 28 VDC to DC, Regulated
- 28 VDC to 400 AC , 1 ϕ
- 24 VDC to 60 AC , 1 ϕ

Please see pages 618 to 632 of your 1971-72 EEM (ELECTRONIC ENGINEERS MASTER Catalog) for complete information on Abbott modules.

Send for our new 56 page FREE catalog.

abbott transistor

LABORATORIES, INCORPORATED

general offices

eastern office

5200 W. Jefferson Blvd./Los Angeles 90016
(213) 936-8185 Telex: 69-1398

1224 Anderson Ave./Fort Lee, N.J. 07024
(201) 224-6900 Telex: 13-5332

INFORMATION RETRIEVAL NUMBER 5

Publisher

Peter Coley

Editors

Editorial Offices
50 Essex St.
Rochelle Park, N.J. 07662
(201) 843-0550
TWX: 710-990 5071
Cable: Hydenpubs Rochellepark

Editor: George Rostky

Managing Editors:

Ralph Dobriner
Michael Elphick

Associate Editors:

Jules H. Gilder
Richard Lee Goldberg
Morris Grossman
John F. Mason
Stanley Runyon
Edward A. Torrero
Richard L. Turmail

Contributing Editor:

Peter N. Budzilovich

Editorial Field Offices

East

Jim McDermott, Eastern Editor
P.O. Box 272
Easthampton, Mass. 01027
(413) 527-3632

West

David N. Kaye, Senior Western Editor
2930 West Imperial Highway
Inglewood, Calif 90303
(213) 757-0183
Les Brock, Western Editor
95 Main St.
Los Altos, Calif. 94022
(415) 941-3084

Washington

Don Byrne, Washington Editor
1111 S. Army Navy Drive
Arlington, Va. 22202
(202) 296-8982

Editorial Production

Dollie S. Viebig

Art

Art Director, William Kelly
Richard Luce
Anthony J. Fischetto

Production

Manager, Thomas V. Sedita
Helen De Polo
Maxine Correal
Anne Molfetas

Circulation

Manager, Nancy L. Merritt
Joan Licari

Information Retrieval

Peggy Long

across the desk

And more requests for vendor prices

I agree with the remarks of L. D. Dillard in the Jan. 6, 1972 issue concerning the lack of price information on vendor data sheets.

This condition has been such an aggravation that I recently devised a solution to the problem. Incoming literature which includes price is filed for reference. Literature with no prices is discarded. Later, when it is time to buy, only the vendors in the reference file receive consideration. Does this procedure impair my purchasing performance? Not much! There is much competition in this industry.

Salesmen must realize that engineers are economists. The price of an item is the first spec I look for. Most things are purchased in a very short time interval, so we don't have time to send for pricing before the decision is made.

Vendors, I don't care if all of you conform to this request or not. Those of you who do will get my business.

LaVar Clegg

Director of Engineering

Megadyne Industries, Inc.
1665 Buffalo Road
Richester, N.Y. 14624

I thought I was the only one fighting to get prices out of manufacturers. I thought perhaps it had to do with being a university, spending only a hundred thousand bucks a year, or being way out in Hawaii.

Now, I see another with the same frustration ("Why Can't Vendors Tell Us Their Prices," by L.D. Dillard, ED 1, Jan. 6, 1972, p. 16D), and one for whom the ex-

cuses of University or Hawaii don't apply.

I seldom use the Reader Service cards, because the response I get is usually glossy and worthless. I try with a direct letter demanding prices. If I get no prices on the first letter, I either boycott the manufacturer or, if there is no other source, write nasty letters.

Teletype Corp. is among the worst offenders. I want prices and delivery information; they give me pretty girls. HP, General Radio and Tektronix are among the best at publishing prices. I buy quite a lot of stuff from them.

Remember the first Nexus ad, with an op amp for about \$50, single unit price? I bet they sold a bunch.

Those vendors who do publish a price should also note the value of the single-unit price. They cut off tremendous amounts of impulse buying by quoting only the large-lot figure.

The man who wants 100 or 1000 units can afford to call and ask for quantity prices. The man who wants one or two, just because it looks like a good thing to have around, is not going to fight the sales department.

Noel J. Thompson, P.E.
Electronics Engineer

University of Hawaii
Hawaii Institute of Geophysics
2525 Correa Rd.
Honolulu, Hawaii 98622

Teletype Corp. replies

Something may have gone wrong in our communications with Mr. Thompson, for it certainly is our practice to communicate with any-

(continued on p. 10)

Who Put a 14 Pin DIP Clock Oscillator in 0.16 Cubic Inches?

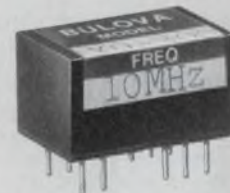

**Bulova did ...
in a package
.8"x.5"x.4"**

It's the XO-300 Series with frequency ranges from 1 MHz to 4 MHz and 4 MHz to 25 MHz, an accuracy of ± 15 PPM, the series has been specially designed to meet the requirements of medium and high speed digital applications. Outputs are directly compatible with DTL and TTL digital integrated circuits.

From Specs to Size, the Series XO-300 can be your clock oscillator answer for data handling, computing and control systems. Write for the complete data story to

BULOVA
fcp
BULOVA
Watch Company, Inc.
Electronics Division

61-20 Woodside Avenue
Woodside, N. Y. 11377
(212) DE 5-8000

Electronic Design welcomes the opinions of its readers on the issues raised in the magazine's editorial columns. Address letters to Managing Editor, Electronic Design, 50 Essex St. Rochelle Park, N. J. 07662. Try to keep letters under 200 words. Letters must be signed. Names will be withheld on request.

12 WAYS Electronic Design Leadership

CAN MAKE YOUR EOEM ADVERTISING MORE SALES-PRODUCTIVE

PINPOINT YOUR PRIME PROSPECTS

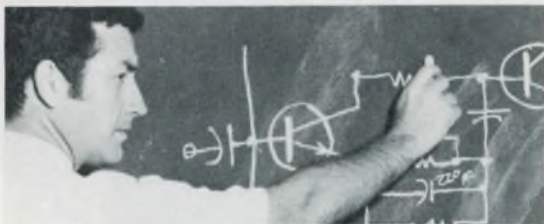

- 100% ENGINEERS AND ENGINEERING MANAGERS ● 100% DESIGN
- 100% QUALIFIED BY INDIVIDUAL REQUEST

Electronic Design goes only to your prime prospects — engineers and engineering managers. These are the "product specifiers", the men who start the life cycle of each new electronic product, device, or system; who need to know about components, devices, materials, hardware, sub-assemblies, test equipment, or systems. Study after study confirms their overwhelming importance in every step of the purchasing process, but most of all in selection and specification by brand.

GIVES YOU MORE OF THEM

Electronic Design delivers more than 74,000 known specifiers, without waste. The professionals that you value most are mostly to be found reading **Electronic Design**. Prove it for yourself — conduct a readership study over your own EOEM lists. We'll share the costs — we're that confident **Electronic Design** is best read!

A new 20 page booklet of special interest to electronics executives, sales, marketing, and advertising managers is just off press. Ask for the LEADERSHIP folder — it will help you to make better media decisions in '72.

INSURES THEY ARE LIVE AND SPECIFYING

Electronic Design makes sure that your advertising is being delivered to, and is being read by, active, on-the-job engineers and engineering managers — men who are in an immediate position to specify and buy products. In addition to one-year verification of the entire list, sampling checks are made 17 times each year. You know your audience is live in **Electronic Design**!

DELIVERS 99% IN-PLANT

Your prospects receive and read **Electronic Design** in the plant, where they work, where specifications are made. On the other hand, **Electronics** and **Electronic News** are only about 50% plant-delivered.

DEVELOPS HIGHEST READERSHIP

No. 97 1 DIGITAL EQUIPMENT CORP.	No. 96 1 E R RESEARCH LABORATORIES, INC.	No. 95 1 RODMATE CORPORATION	No. 94 1 SIGNAL ANALYSIS INDUSTRIES CORP.
No. 87 1 PARK WITFIELD	No. 86 1 PARSONS RESEARCH CORPORATION	No. 85 1 DAVITRON, INC.	No. 84 1 WELCOR ELECTRONICS CORPORATION
No. 77 1 BIL INDUSTRIES, INC.	No. 76 1 SYSTEMS DESIGN CORPORATION	No. 75 2 DAR MANUFACTURING CO.	No. 74 1 SCHWEIBER ELECTRONICS CORP.
No. 67 1 MASTER SPECIALTIES	No. 66 1 INTERNATIONAL ELECTRONIC RESEARCH CORPORATION	No. 65 1 INDIANA GENERAL CORPORATION	No. 64 1 CONU ELECTRONICS, INC.
No. 57 1 REBUS RESEARCH LABORATORY, INC.	No. 56 1 WELPOT DIV. TECHNICAL INSTRUMENTS	No. 55 1 ACCUTRONICS, INC.	No. 54 1 ELECTRONIC ENGINEERING CO. OF CAL.

No other electronics publication in the world offers you so many independent proofs of readership. We have 97 independent media readership studies to show you. **Electronic Design** is FIRST in "Read Regularly" in 89 of them!

COVERS EVERY EMERGING MARKET OPPORTUNITY



Keeping engineers knowledgeable is a mammoth task. Complexity is the norm; obsolescence a constant threat. **Electronic Design's** editors stay on the forefront of design; probe every emerging development in terms of its significance to the engineer, his company, and its competitors.

100% FOCUS ON DESIGN TECHNOLOGY

Electronic Design effectively bridges the gap between a constantly evolving technology and the needs of your customers — working engineers. They read **Electronic Design** because it is exciting . . . explores both sides . . . supplies their "total" needs. It gives them BALANCED coverage of NEWS, TECHNOLOGY, and PRODUCTS — all from the design point of view. Material is practical, immediate, solution-oriented; brought alive by color, typography and graphics. Our unique FOCUS series is typical of the extra technical emphasis in '72.

DATE	FOCUS ISSUE SUBJECT	CLOSING
Jan. 6	Digital Panel Meters	Nov. 29
Feb. 3	Resistor Trimming Equip.	Dec. 27
Mar. 2	Lighted Switches	Jan. 24
Apr. 1	Function Generators	Feb. 21
Apr. 13	ICs	Mar. 6
May 11	Disc & Drum Memories	Apr. 3
June 8	ICs	May 1
July 6	Reed Relays	May 30
Aug. 3	MSI/LSI Testers	June 26
Aug. 17	ICs	July 10
Sept. 2	Digital Cassette and Cartridge Recorders	July 24
Oct. 12	Time Delay Relays	Sept. 5
Oct. 26	ICs	Sept. 18
Nov. 9	Keyboards	Oct. 2
Dec. 7	Flat Flexible Cable & Flexible Printed Circuits	Oct. 30

PROVIDES MOST SALES LEADS

No other electronics or industrial magazine in the world can match the number of sales leads generated by **Electronic Design!** Over 1,500,000 per year! This massive influx of requests for further information is a basic proof that editorial and advertising in **Electronic Design** is seen, read, and acted upon. Ask to see copies of latest "Did You Buy?" studies.

HELPS YOU GET STARTED

Electronic Design is not just for the large advertiser . . . it's for the small company, too. Ask about our "Quick Ads". They're an easy way to get sales leads at low cost — only \$300 per insertion (and no production costs).

ACCELERATES RESULTS



Electronic Design readers not only react with requests for more information, if you give them the technical data they need, right away, in your ad, they can often be brought to the point of purchase quickly — sometimes immediately. Get the full story on our Purchase-Producing Advertising concept, then hear the cassette tape narrated by Triplett Corp.'s President. It tells how they received an avalanche of 12,000 responses from one Purchase-Producing Advertisement in **Electronic Design**. PPA insert discounts range as high as 75%!

OFFERS MORE MARKETING SERVICES

Be sure to take advantage of **Electronic Design's** arsenal of advertising and marketing aids. FAST CLOSE FORM • AUDIT OF BRAND RECOGNITION • INQUIRY FOLLOW-UP STUDIES • READER RECALL STUDIES • BUYING AUTHORITY STUDIES • READER-SHIP STUDIES • MARKETING NEWSLETTER • MERCHANDISING PROGRAM.

ENABLES PRECISION DIRECT MAIL FOLLOW-UP

Put the additional power of demographic direct mail behind your advertising program. **Electronic Design's** Precision Direct Mail Service offers 6 selections to zero-in on prospects; gives only current specifiers.

GET MOST SALES ACTION!

1971 Advertising Page Comparison

Electronic Design	1960
Electronics	1794
Electronic News	1567
Electronic Products	1096
EDN/EEE	1008
Electronic Engineer	598

The industry clearly shows its preference for **Electronic Design**, places most advertising pages in this magazine.

Electronic Design

a Hayden publication • 50 Essex Street, Rochelle Park, New Jersey 07662 • Tel: 201-843-0550

at Circuit Technology we make our customers smile

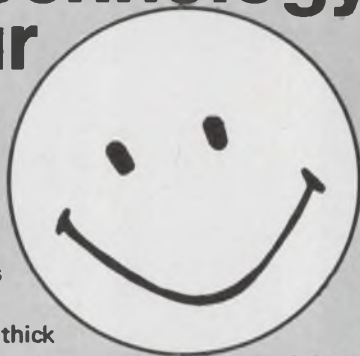

We have the know how to miniaturize complex circuit functions and subsystems without compromise in performance. We combine creative circuit design, extensive thick film hybrid manufacturing experience and unique mechanical packaging to produce quality custom devices in compliance with MIL-M-38510 and MIL-STD-883.

Illustrated below are just a few of the custom hybrid circuits we have supplied, over the years, to our satisfied customers.

- | | |
|--|---|
| A High Speed A/D Converter | E Voltage Regulator (3/8" x 3/8" Flatpack) |
| B 100 MHz Bandwidth Video Amplifier (1.25" x 1.25" plug-in) | F Active Filter (SHP) NAFI Module |
| C Two Watt Servo Amplifier (1" x 1" Flatpack) | G FET Input Operational Amplifier (Triple Deck TO5) and many, many more. |
| D Analog Multiplier (5/8" x 5/8" Flatpack) | |

Our credits include: F14 • F15 • S3A • E2C • A6E • F4 • ATS
• Apollo • Pioneer • Sea Sparrow • SRAM

For a complete description of our capabilities send for our custom hybrid circuit listing, you may find something very close to what you need. Better yet, send us your circuit requirements and we will send you a quote to make you smile.

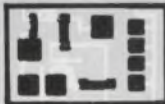

Circuit Technology Incorporated

160 Smith Street, Farmingdale, N.Y. 11735 • (516) 293-8686

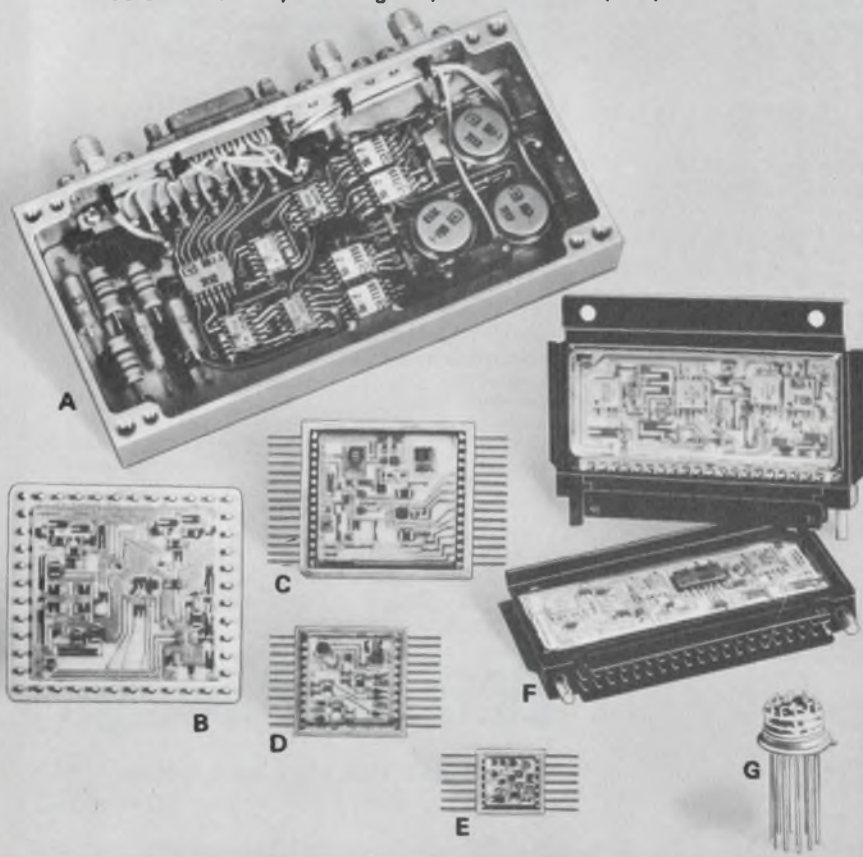

ACROSS THE DESK

(continued from p. 7)

one who requests price and delivery information. Teletype Corp. welcomes any opportunity to inform the buying public of its prices, since the low price of our equipment is one of our strongest competitive advantages. Where else can a user get a conversational input/output terminal for less than \$750? Our account managers provide prices either by formal letter quotations or telephone calls, which are usually followed by a confirming quotation.

Since there are several models of each of our lines of equipment, it is often our practice to send a variety of product description sheets to the inquirer. These sheets all include the current price and a description of the related equipment. Where the customer's specific requirements are less definite, we provide him with sheets listing a range of our equipment prices. We spend thousands of dollars every year just in printing the price information we disseminate. Our pricing policy is one price to all customers, regardless of the quantity ordered. Therefore the smaller customer is not penalized because he does not have high-volume requirements.

Since Teletype does encourage inquiries through our continuous advertising program, we have established in addition to our account managers, three full-time sales engineers who process these inquiries. This group provides on request to anyone, technical assistance, application-engineering assistance, and price and delivery information by personal phone calls, letters, etc. As you know, the main reason for Teletype's advertising is to inform the buying public of our products and to generate requests for price and delivery information.

Our system does not allow us to intentionally ignore requests of any type from potential customers. However, due to the large volume of inquiries received, it is possible (but not probable) that one might go unprocessed.

D.M. Printz
Marketing Manager

Teletype Corporation
5555 Touhy Ave.
Skokie, Ill. 60076

You can assemble our SMA connectors

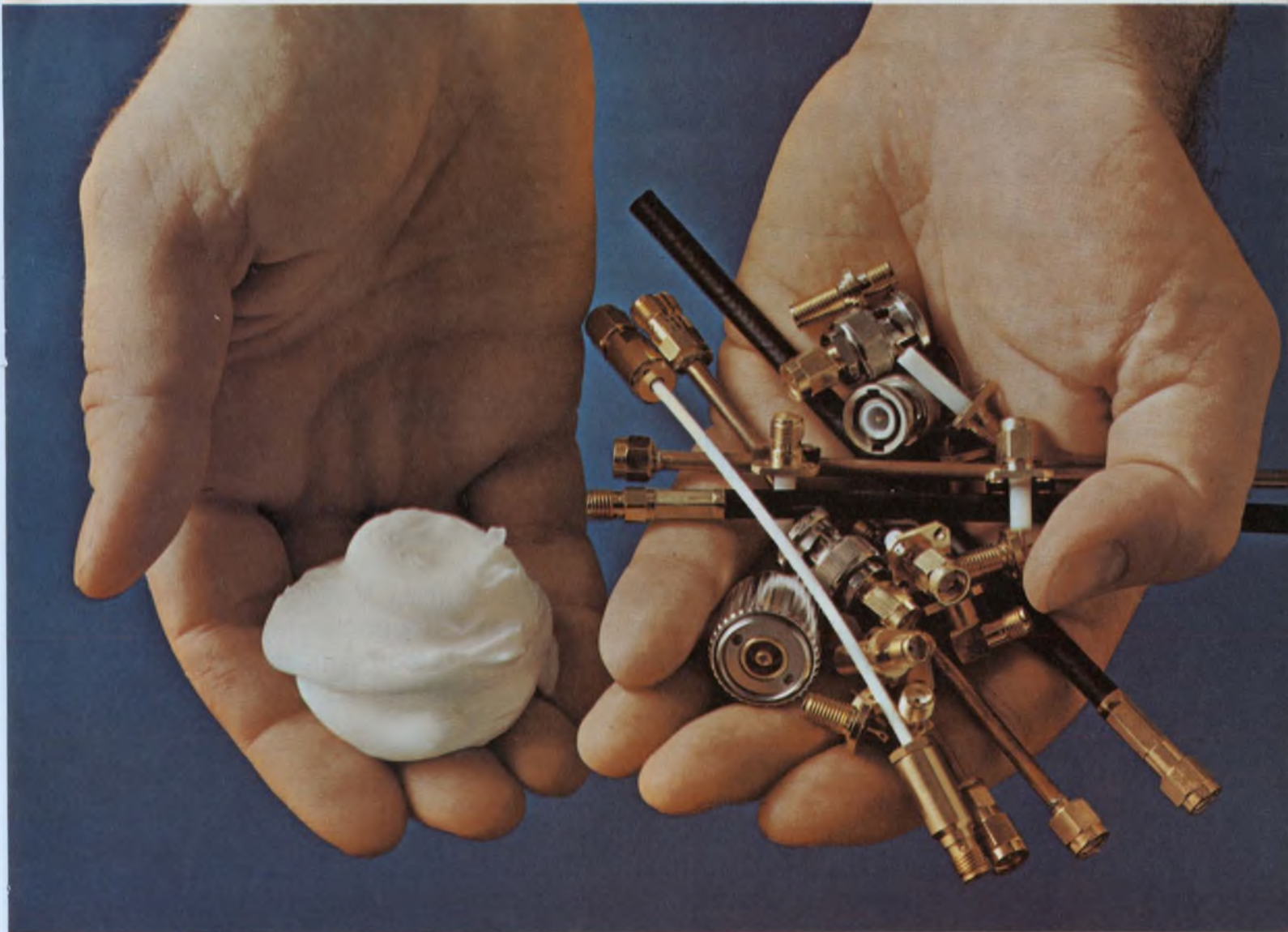

in less time than it takes to shave.

Five minutes. That's all it takes to assemble our SMA connectors for subminiature coax cables. A significant savings in production time.

You get your Amphenol SMA connectors factory preassembled, thus keeping loose parts at a minimum. And by using an inexpensive tool kit to prepare the cable, putting them all together is a snap. Parts loss is virtually eliminated.

Amphenol set the trend by making its SMA connectors of high-strength, heat-treated beryllium copper material, which is three times stronger than stainless steel. These superior connectors are, of course, completely intermatable and interchange-

able with existing stainless steel designs. Amphenol was the first source qualified for MIL-C-39012 SMA connectors.

Available in a wide variety of flexible and semi-rigid cable connectors; receptacles for strip-line, MIC packages, and numerous other microwave components. And if you need SMA specials or complete cable assemblies, come to the world's largest manufacturer of coaxial connectors.

See your authorized Amphenol distributor or write Amphenol RF Division, Bunker Ramo Corporation, 33 East Franklin Street, Danbury, Connecticut 06810.



AMPHENOL

We spent a lot of money on improved equipment and technology. So you could spend up to 35% less on miniature tantalums.

On our KEMET® Micron series, "Mylar" cased, solid-tantalum capacitors, to be specific.

Which cost less because we now turn out Microns in volume with uniform reliability.

And we turn them out in volume with uniform reliability because of our new, high-technology production lines.

You can buy KEMET subminiature tantalums off-the-shelf, from our million-unit stock. In a variety of case styles, sizes and lead configurations. From .001 through 220 uf, 2 through 50 volts dc. And they meet Mil-C-39003 where applicable.

If you want maximum electrical performance and CV product for hybrid thick-film and other applications requiring maximum packaging, do this. Check the sizes and styles on the popular rectangular and cylindrical shapes below. Then, write us at Box 5928, Greenville, S. C. 29606 for KEMET Micron Series literature and test data.

T370		T372		Polar Rectangular 3-35 VDC								
RADIAL LEAD		AXIAL LEAD		Case Dimensions—Inches				Price Each (±20%*)				
Case Size	H Case Height Max.	W Case Width Max.	T Thickness Max.	S Lead Spacing	Capacitance uf	1-24	25-49	50-99	100-499	500-999	OEM	
A	.125	.070	.040	.050	.001-1.5	.69	.55	.47	.40	.36	.26	
B	.165	.120	.070	.100	.001-10	.64	.50	.44	.37	.34	.24	
C	.225	.185	.075	.150	.68-22	.80	.63	.55	.46	.42	.30	
D	.290	.220	.110	.180	2.2-47	.90	.71	.62	.52	.48	.34	
E	.310	.230	.130	.200	6.8-68	.90	.71	.62	.52	.48	.34	
F	.475	.375	.150	.300	10-220	2.23	1.76	1.53	1.29	1.18	.84	
T374		T376		Polar Cylindrical 2-35 VDC								
RADIAL LEAD		AXIAL LEAD		Case Dimensions—Inches				Price Each (±20%*)				
Case Size	L Case Length Max.	D Case Diameter Max.	S Lead Spacing	Capacitance uf	1-24	25-49	50-99	100-499	500-999	OEM		
A	.125	.070	.050	.001-2.2	.67	.53	.46	.39	.35	.25		
B	.160	.070	.050	.001-4.7	.67	.53	.46	.39	.35	.25		
C	.200	.080	.050	.33-10	.64	.50	.44	.37	.34	.24		
D	.225	.100	.070	.68-22	.69	.55	.47	.40	.36	.26		
E	.250	.150	.120	1.5-47	.88	.69	.60	.51	.46	.33		

*For ±10% & ±5% Tolerance units use the following multipliers ±10%-1.3; ±5%-2.0



COMPONENTS DEPARTMENT

Silicone breakthrough: Flame-retardant pourable elastomer at general-purpose prices.

New Sylgard® 170 A & B silicone elastomer now offers silicone security at prices competitive with organics! This flame-retardant, low-price, two-part silicone cures, when catalyzed, to a rubber with excellent electrical insulating properties. Developed for general potting, encapsulating and conformal coating, Sylgard 170 does more. It now permits designers to utilize the superior resistive advantages of silicones on lower cost, high-volume products.

If this new material stimulates your thinking about silicones in applications where greater safety and improved flame retardance is important, we'd like to help. For a free sample of Sylgard 170, write us on your company letterhead describing your application.
Dow Corning, Dept.
A-2317, Midland,
Michigan 48640.

Encapsulants and sealants from

DOW CORNING

DOW CORNING

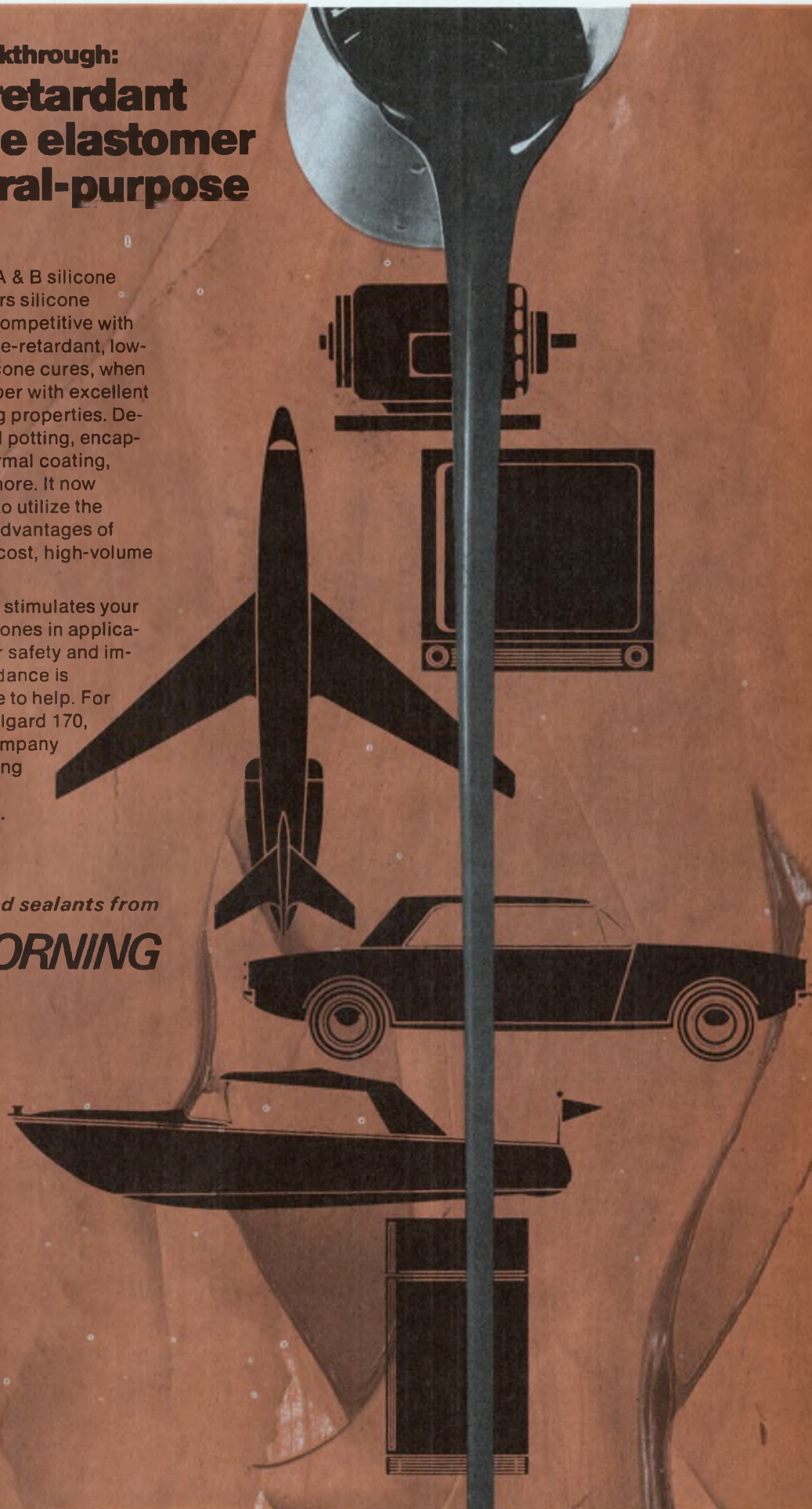



broad band-rated™



ferramic®
components
for circuits
that care

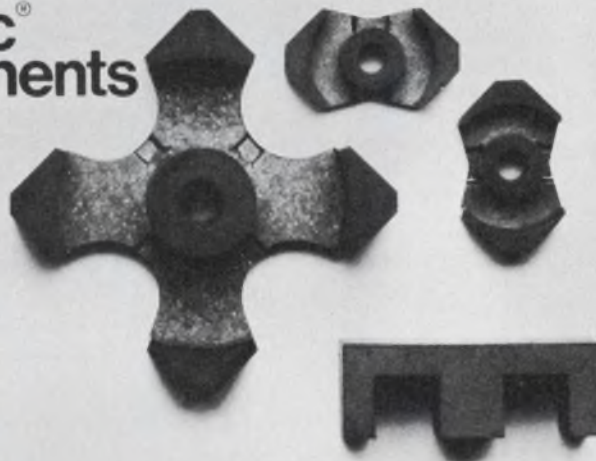

■ When bandwidth is critical, ferrite inductors and transformers must deliver electrical performance over your entire frequency spectrum. Or else your circuit is dead.

Broad Band-Rated Ferramic components guarantee the electrical performance required in critical circuits for communications, instrumentation, data transmission, telemetry, and radar applications.

First, we make this special breed of components specifically for broad band applications. So you get extra design latitude to begin with.

Then, we test our *Broad Band-Rated* components. Not as ordinary magnetic material, but as broad band components.

So we can specify bandwidth characteristics under your circuit conditions.

This testing gives you electrical data you need for precise, efficient design. You get pertinent design information, characteristic curves, response curves and applications data.

Broad Band-Rated components are part of our growing line of new ferrites designed to meet specific design needs. With guaranteed electrical specs to match their improved performance.

So get in touch with us for design samples. Or get our 24-page bulletin of applications data, performance curves, and specs that make sense. For design assistance in any ferrite problems, contact Indiana General, Electronic Products, Keasbey, N.J. 08832. Or phone (201) 826-5100.

National distribution through seven Permag locations.

indiana general 

a division of Electronic Memories & Magnetics Corp.

**Silicone breakthrough:
Noncorrosive
adhesive/sealant
at general-purpose
prices.**

The protective advantages of bonding and sealing with a noncorrosive silicone can now be extended to a wider variety of products. New Silastic® 738 RTV adhesive/sealant is offered at prices competitive to conventional silicone sealants and even to many organic materials. It will not corrode sensitive metals because it has a curing system different from that of regular silicone sealants. Also, there is no objectionable odor during cure.

Silastic 738 is a ready-to-use, durable sealant that will guard your products with all the superior resistive properties inherent in silicones.

For a free trial sample, fill out coupon:

Encapsulants and sealants from
DOW CORNING



Dow Corning Corporation
Dept. A-2318, Midland, Michigan 48640
Send me a free trial sample of
Silastic 738.

Name _____
Title _____
Company _____
Address _____
City _____ State _____
Zip _____ Phone _____

offer expires Sept. 30, 1972

INFORMATION RETRIEVAL NUMBER 14

Candidate for the PE license this year?

Use these up-to-date guides...
specifically tailored for
your study campaign

HAYDEN PROFESSIONAL ENGINEERING EXAMINATION SERIES

LAWRENCE J. HOLLANDER, Editor-in-Chief,
Professional Engineer, New York State

Written with your needs kept foremost,
these study guides offer . . .

- a wide selection of actual, realistic problems from recent state examinations arranged by subject for convenient study
- detailed step-by-step solutions that bring out underlying principles to equip you to handle the unexpected
- concise background discussions precede the problems, presenting you with a mini-review of theory, principles, terminology
- separate tables of contents for subjects and problems quickly pinpoint the specifics for rapid review or "open book" examinations
- numerous schematic diagrams and detailed drawings to insure in-depth understanding

Review the books that concern you for
15 full days—FREE!

FOR 15-DAY FREE EXAMINATION

Please send the book(s) circled below on a 15-day examination basis. At the end of that time, I will remit payment, plus postage, or return the book(s) without further obligation.

5712-1 5715-6 5716-4

(For those ordering by ISBN, the Hayden Prefix is: 0-8104)

Save money! On all prepaid orders Hayden pays postage —
same 15-day return guarantee! 72-29 ED

Name _____

Firm _____

Address _____

City/State _____ Zip _____



HAYDEN BOOK COMPANY, INC.
116 West 14th St., New York, N.Y. 10011

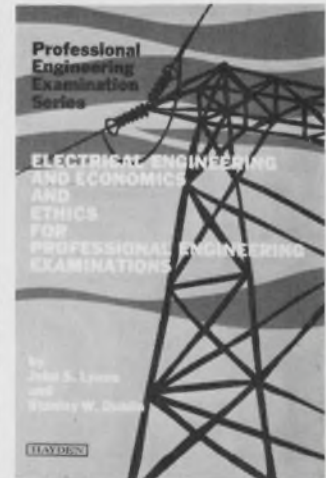
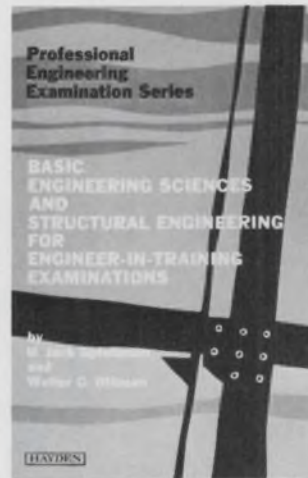

BASIC ENGINEERING SCIENCES AND STRUCTURAL ENGINEERING FOR ENGINEER-IN-TRAINING EXAMINATIONS

H. JACK APFELBAUM, P.E., Department of Mechanical Engineering, Lowell
Technological Institute; and WALTER O. OTTESEN, P.E., Patent Counsel

Nearly 200 solved problems selected from a nationwide survey of recent E-I-T examinations offer you a complete, well organized review of the concepts and techniques that must be understood to successfully pass the preliminary exam. Unlike other study guides that stress one aspect of the field while shortchanging others, this volume provides balanced coverage of the three broad engineering areas: *the basic sciences*: mathematics, physics, and chemistry; *the engineering sciences*: statics, dynamics, fluid mechanics, thermodynamics, electricity, and engineering economy; and *structural engineering*. More than 300 detailed illustrations pinpoint key concepts and problem-solving techniques.

408 pp., 6 x 9, illus., cloth, #5712-1, \$13.95

ELECTRICAL ENGINEERING AND ECONOMICS AND ETHICS FOR PROFESSIONAL ENGINEERING EXAMINATIONS

JOHN S. LYONS, P.E., and STANLEY W. DUBLIN, Institute of Environmental
Medicine, New York University Medical Center

Concentrating on the subjects and topics that form the foundation of this rapidly changing technology, this book analyzes and solves for you almost 100 problems from a nationwide sampling of recent PE examinations. Its comprehensive, up-to-date coverage includes materials and problems not found in other guides of this type, such as electrical-magnetic-thermal analogs, semiconductors, and power system short circuits. More than 170 detailed illustrations are included. The separate section devoted to economics and ethics features an unusual approach to such topics as interest, costs, valuation, and others—the summarized use of formulas in solving nearly 50 typical problems.

302 pp., 6 x 9, illus., cloth, #5715-6, \$12.95

also available

MECHANICAL ENGINEERING AND ECONOMICS AND ETHICS FOR PROFESSIONAL ENGINEERING EXAMINATIONS

EUGENE STAMPER, P.E., and STANLEY DUBLIN

Over 200 solved problems in mechanical engineering, along with the same thorough coverage of economics and ethics.

392 pp., 6 x 9, illus., cloth, #5716-4, \$14.95

Weston introduces the first truly portable 17-range, 3½-digit, 2¼-lb. mini-multimeter.

Our new Model 4440 DMM. It's the smallest battery operated digital multimeter on the market. And a truly portable unit package; with the batteries inside its rugged, compact thermoplastic case.

Yet with all its portability, the Model 4440 features 3½-digit LED readout with automatic polarity switching, LSI circuitry for more re-

liability than ever, and full range coverage from 200 mV to 1000 volts AC/DC, 200 ohms to 2 megohms, plus AC and DC current. It's shock-proofed, fully overload-protected, and usable at up to 122°F. You get up to 12 hours of continuous field operation before you have to recharge; an additional 5 or more hours with flashlight batteries in an emergency! (continued)



(actual size)

Pick up a Weston 4440. Your Weston distributor sells it for only \$285—complete with leads, batteries and recharger. Circle No. 241.



The "quiet" new face you'll love at first sight.

The new Weston 2000 series DC panel meter line leads the trend to cleaner, "quieter" design. You want your completed panel beautiful and functional, and all yours. The 2000 series feature a clear top edge, making it ideally suitable for external illumination. The sides are handsomely sculptured. Wrap-around case design provides improved dust and moisture resistance. Cover can be quickly removed to replace scale. Taut-band or pivot-and-jewel movement; 1% to 3% accuracy; four sizes. Circle No. 242.

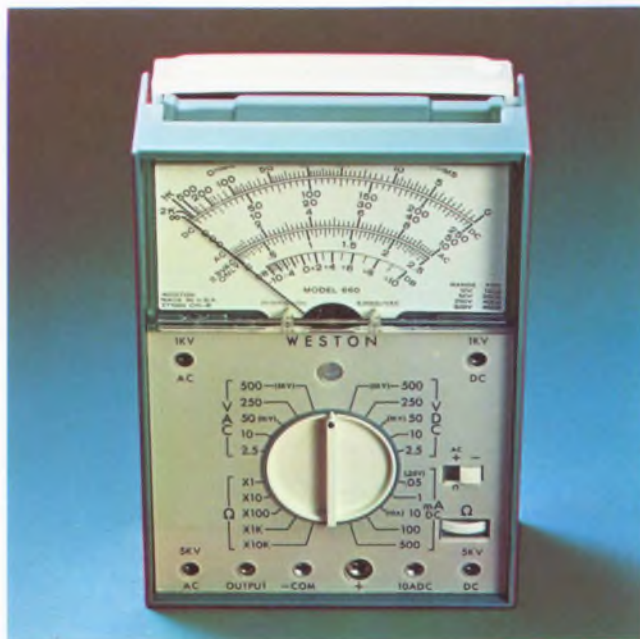

The first drop-proofed VOM.

A Weston 660 series VOM is warranted in writing to withstand a five-foot drop. They're smaller, lighter, easier to read than multitesters that don't offer a warranty. Yet they cost no more. Your Weston distributor stocks five models to choose from. Try one. Circle No. 243.

See your Weston distributor, or return the card below for more information about Weston products. Weston Instruments, Inc., Newark, New Jersey 07114.

We're either first or best. Or both.

WESTON® 

Information retrieval numbers 241, 242, 243.

(Fold card at center, seal or staple open ends)

First Class
Permit No. 392
Newark, N.J.

Business Reply Mail

Postage will be paid by addressee

Weston Instruments

614 Frelinghuysen Ave.
Newark, New Jersey 07114

Send me detailed data on these Weston products.

- No. 241. Model 4440 DMM.
- No. 242. Series 2000 Panel Meters.
- No. 243. Series 660 VOMs.
- Have salesman call. Phone _____

Name _____

Company _____

Address _____

City _____ State _____ Zip _____

13 STANDARD RESISTORS

13 STANDARD RESISTORS

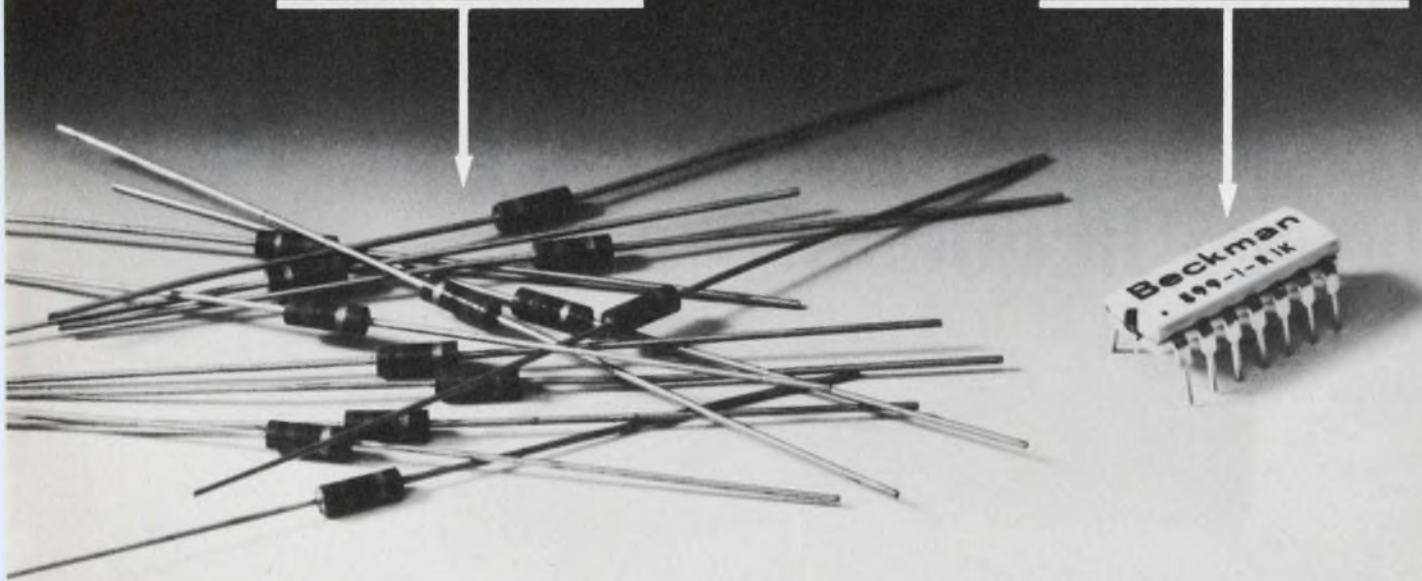

Helipot's one-piece money saver saves time and space, too.

To keep working with discrete standard resistors just isn't logical. Not when there are ceramic DIPs available that do the same jobs in less space—quicker, easier and cheaper. Whether inserted automatically or by hand.

Stocked locally for immediate delivery, too. At "on the board" cost-saving prices, in small or large quantities.

(Check the specs.) No wasted time while they're "made to order," unless you want custom modifications, which we can do fast.

And remember, ceramic. Ceramic reliability at plastic prices.

Why wait? Call your local Helipot Representative now for applications assistance or more information.



INSTRUMENTS, INC.
HELIPOT DIVISION
Fullerton, California

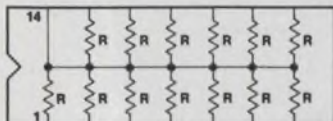

MODEL SERIES 899-1
Resistance Values (ohms): 100, 150, 220, 330, 470, 680, 1K, 1.5K, 2K, 2.2K, 3.3K, 4.7K, 6K, 6.8K, 10K, 15K, 22K.
Common Applications: Digital pulse squaring; MOS/ROM pull-up/ pull-down; "wired OR" pull-up; power driver pull-up; open collector pull-up; TTL input pull-down; TTL unused gate pull-up; high-speed parallel pull-up.
Standard Tolerance: $\pm 2.0\%$
Pricing:

1-99	\$1.45
100-499	1.12
500-999	0.97

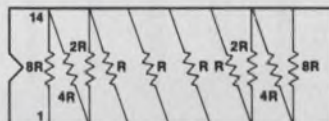

MODEL SERIES 899-2
Resistance Value (ohms): 10K
Common Applications: Inverting operational gain; potentiometric gain; differential gain; noninverting gain; gain adjustment.
Standard Tolerance: $\pm 2\%$
Pricing:

1-99	\$2.75
100-499	2.15
500-999	1.86

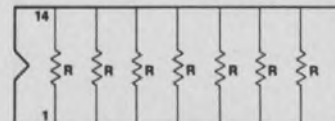

MODEL SERIES 899-3
Resistance Values (ohms): 68, 100, 110, 150, 220, 330, 470, 680, 1K, 1.5K, 2.2K, 3.3K, 4.7K, 6.8K, 10K, 15K, 22K.
Common Applications: Line termination; long-line impedance balancing; power gate pull-up; ECL output pull-down resistors; LED current limiting; power driver pull-up; "wired OR" pull-up; TTL input pull-down.
Standard Tolerance: $\pm 2\%$
Pricing:

1-99	\$1.25
100-499	0.99
500-999	0.86

If you've been looking for a miniature crystal-controlled clock oscillator in a 14 pin DIP package to fit standard PC board sockets, stop looking and start ordering. Get details on model K1091A from Motorola Component Products Dept. 4545 W. Augusta Blvd. Chicago, Ill. 60651.  *MOTOROLA*

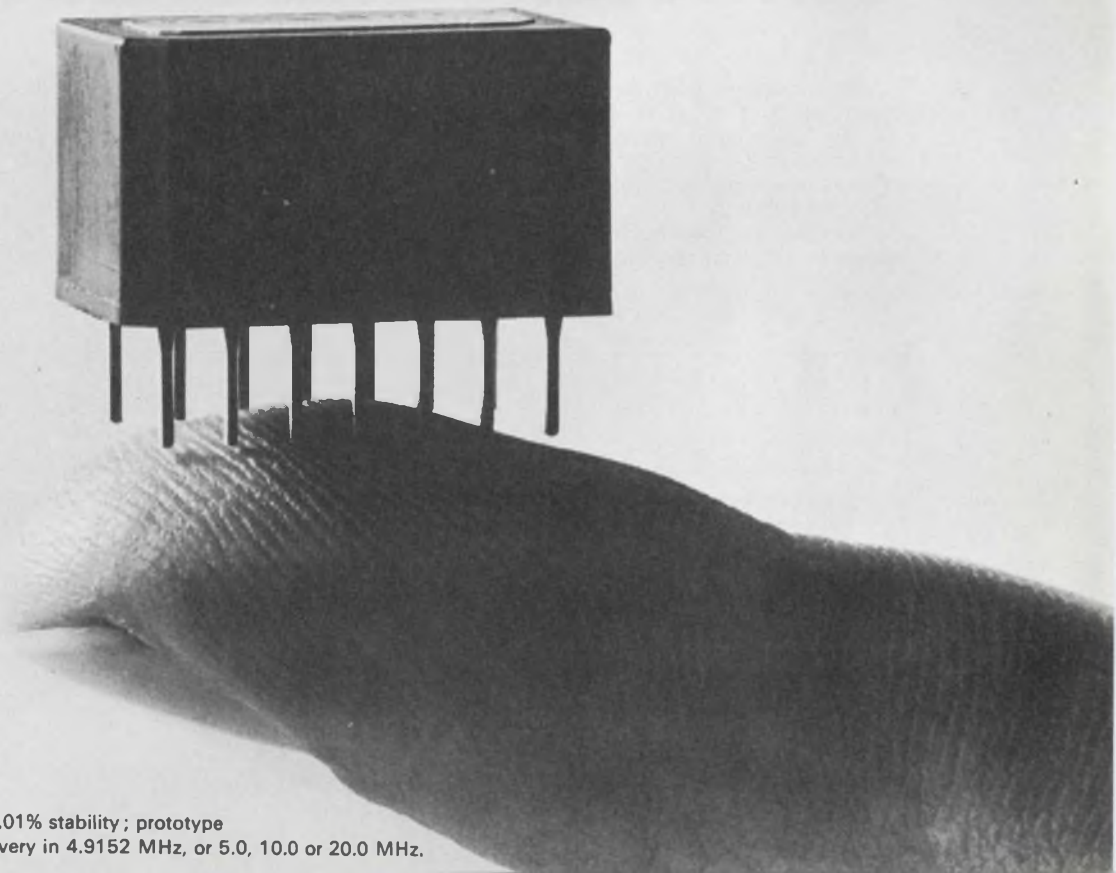

Specifications: 4 to 20 MHz range; 0.01% stability; prototype quantities available for immediate delivery in 4.9152 MHz, or 5.0, 10.0 or 20.0 MHz.

FAA calls for proposals for air-security systems

Even stronger airport security rules, expected to be issued by the Federal Aviation Administration to foil hijackers and extortionists, could be a boon to the manufacturers of electronic security systems. The FAA has just issued a new request for proposals for air-security systems. It is looking for new concepts to detect hand guns or explosives in passenger baggage and women's handbags.

According to William Richardson, the FAA's chief of aircraft systems development, there is a large market for electronic air-security systems. Such systems, he points out, could be installed in any of this country's 2600 airliners, at any of the 2500 passenger gates at airports and in any of the 2500 airline baggage counters.

An electronic security system can range from a simple magnetometer at \$300 to a sophisticated X-ray detection system in the \$35,000 price range, Richardson notes. Three basic types of detection systems are used, he reports:

- Magnetometers for detecting weapons.
- Vapor detectors for spotting explosives.
- X-ray detectors for uncovering concealed weapons.

Development in other areas includes holography and neutron imaging. Asked what kind of security system he favored, Richardson said a nonimaging X-ray system that uses pattern recognition, to eliminate the need for someone to interpret what is now shown on a screen.

son, he explains, is that the signals from the three transmitters do not necessarily have the same amplitude when they are received. This may result when the Lorets receiver is closer to one transmitter than another.

In previous design attempts, Dalbakis says, the modulation of the retransmitted signal was adjusted to give 100% modulation for the strongest signal received, and thus information in the weakest signal was sometimes lost.

To overcome this problem, Dalbakis reports, Electronics Communications designed a special network that equalizes the amplitude of the signals from the slave transmitters to that of the master transmitter. This is done by sampling the strength of the incoming signal, delaying it and automatically adjusting the gain.

After equalization, the 100-kHz Loran signal is compressed to 25 kHz and used to modulate a 238.6-MHz carrier. Both the lf receiver and the uhf transmitter use the same whip antenna.

The Lorets unit operates from a 12-V battery and has many potential applications, according to its developer, including search and rescue operations, air and harbor traffic control, missile recovery, iceberg tracking and pinpointing the location of a remote mobile unit.

Portable Loran repeater pinpoints vehicle position

An advanced repeater that receives transmissions from a standard Loran system and retransmits them in the uhf band has been developed for the U.S. Air Force by Electronic Communications, Inc., St. Petersburg, Fla.

Known as Lorets—an abbreviation for Loran retransmission system—the new unit can be placed in any vehicle or even on a person, backpack style, and send signals that pinpoint the bearer's position.

The Lorets device is about the size of a small table radio, says Eli Dalbakis, senior principal engineer for Electronic Communications and is capable of the following:

- Receiving low-frequency signals from the three transmitters associated with standard Loran (long-range aid to navigation) systems.
- Equalizing the amplitudes of

the three signals.

- Compressing the bandwidth of the received signals.
- Retransmitting them in the uhf band.

The Lorets device operates on the same principles as the regular Loran system, except that the Loran processor is at a remote location, such as aircraft, ship or ground station. Signals from the master transmitter and the two slave transmitters associated with it are received and processed, so the exact position of the receiver can be identified.

In regular Loran systems, the receiver and processor are at the same site. With Lorets, however, the Loran receiver and a uhf transmitter retransmit the Loran signal to any processor within a 200-mile range.

Several previous attempts by other manufacturers to build a system of this type were not too successful, Dalbakis reports. The rea-

EIA delays a stand on barriers to trade

The board of governors of the Electronic Industry Association has still taken no position on the growing furor over unfair international trade practices. But at its spring meeting in Washington, D.C., last month, the board did instruct the EIA's International Activities Council to develop a position paper on the subject.

The paper is likely to be made public at the EIA's annual summer conference, to be held June 16-18 in Chicago.

A position paper on foreign trade was first presented at the EIA's fall meeting last October, but it was deemed unacceptable by the board of governors, the various divisions and EIA members.

Also meeting in Washington last month, the newly formed Electronic

Industry Committee for Fair International Trade (see "Industry Group Formed to Fight Trade Barriers," ED 5, Feb. 17, 1972, p. 23) announced that it was dissatisfied with the lack of action by the EIA. It outlined its own four-point action program, which would:

- Demand the timely enforcement of antidumping laws, specifically with reference to television sets and components.

- Seek immediate and vigorous enforcement of countervailing duty laws, which would impose taxes equal to the subsidy any foreign manufacturer received from his government.

- Persuade the U.S. Government to negotiate the elimination of nontariff trade barriers that prevent American-made consumer electronic products from being sold in Japan and other foreign markets.

- Continue to make legislative and executive agencies aware of problems that have resulted from the loss of 121,000 jobs in the American electronics industry.

Although no formal votes were taken on specific trade issues, the feeling at the Washington meeting was that the liberal trade policies voiced by Senator Daniel K. Inouye (D-Hawaii) would receive wide support.

TRW proposes train suspended by magnets

A proposal for a train that is suspended from a monorail by carefully controlled electromagnetic attraction has been submitted to the U.S. Dept. of Transportation by the TRW Systems Group, Redondo Beach, Calif.

The big problem with electromagnetic suspension systems that attract has always been the need for devising a way to supply continually the right amount of electromagnetic force to keep the magnets from rushing together or getting too far apart. If the magnets rush together, the vehicle will halt; if they are too far apart, the vehicle will fall.

The required electromagnetic force varies with changes in vehicle load, speed and centrifugal force buildup on curves. TRW, according to its assistant director of transportation projects, Emanuel

S. Diamant, has designed a position-control unit to handle the problem.

TRW's suspension system, Diamant says, is highly suitable for short intercity links of 50 to 200 miles and could travel at speeds up to 300 miles an hour.

The magnetic suspension system uses the attractive forces developed between a conventional dc electromagnet on the train and a ferromagnetic plate on the guideway. The airspace, or distance, between the two magnets must be held at from 1/4 to 1/2 inch. The position-control system measures the airspace between magnets and automatically adjusts the field coil voltage that supplies the electromagnetic force.

An electromagnetic system similar to TRW's proposal is now being built in West Germany. A repulsion system—one with opposing forces built into the bottom of the vehicle and the roadbed, causing it to act somewhat like an air cushion—is being built in Japan.

Electronic air monitor to be tested for mines

The U.S. Bureau of Mines has ordered a comprehensive electronic air surveillance and monitoring system that will be installed in the bureau's demonstration mine in Bruceton, Pa.

Under a \$606,000 award, the Mine Safety Appliances Co. in Pittsburgh will design, manufacture and install the system this year. Sensors will monitor continuously eight critical environmental factors in 10

areas of the mine: methane, carbon monoxide, hydrogen, air temperature, rate of temperature change, air velocity, noise and smoke.

Data from each of the 10 stations will be transmitted to a central control room above ground, where a computer will analyze it for dangerous or potentially dangerous conditions. For example, a rising methane level or substantial decrease in air velocity might indicate insufficient ventilation and the possibility of an explosion.

A visual display terminal resembling a television set in the central control room will permit an operator to scan conditions at each station in the mine. Alarm lights on the control panel and audible alarms will alert the operator to dangerous conditions. Indicator lights will identify normal conditions, sensor malfunction and sensor calibration. Meter readouts at the stations will permit underground personnel to check air conditions.

Voice communication lines will link sensor stations with the control room, as well as with ground personnel. And the computer will automatically verify the status of the lines.

Besides voice, data communications that employ a frequency-shift-key technique will be used to transmit between sensor stations and the control room. Analog signals will be translated into digital form at each station for transmission to the computer.

The results of the experimental system at Bruceton will be studied by the bureau for applicability to commercial mines throughout the country.

News briefs

The Pioneer 10 spacecraft, launched toward Jupiter last month, is the first NASA space vehicle to draw its electrical power directly from nuclear generators. The four radioisotope generators were developed by the Atomic Energy Commission.

As expected for some time, National Semiconductor has entered the LED business. Its first product: an equivalent to the Fairchild MOD FLV 100 series.

Burroughs Corp. is reported

ready to release details on its B-3700, B-2700 and B-1700 computers. The three new series will fill the gap in the company's current line of minis and medium-scale computers.

The Federal Aviation Administration is evaluating the use of remote TV weather-monitoring systems that could be installed in mountain passes and other sites to provide improved weather service for general-aviation pilots operating under visual flight rules.

Stop wasting matches— TRW power resistors won't burn!



PGR power resistors are flameproof, not just flame retardant. You can't beat them for economy and reliability. Available in IRC's famous Metal Glaze™ thick film construction, PGR's come in 1 to 5 watt sizes, values to 100K, $\pm 2, 5$ and 10% tolerances.

PGR resistors are tough enough to withstand transients, even continuous power overloads without failure. Under severe fault conditions, these units open without flame or sufficient heat to ignite adjacent components. If your product must be certified for fire safety, it will pay you to investigate.

If non-flammability isn't enough benefit, compare the price with other power resistors — even those not designed to be flameproof! The PGR is less

than 6¢ in quantity. That's why so many appliance, TV, and industrial users specify TRW.

PGR joins IRC's type PW wirewound series which for many years has been the price and performance leader in consumer electronics. PW's are available in equivalent sizes to PGR and serve those applications where lower resistance values down to .1 ohm are required. In addition, specific fusing characteristics and positive temperature coefficients are available where the resistor is used for component or circuit protection. 2 to 50 watts.

Call us about your application. TRW/IRC Fixed Resistors, an Operation of TRW Electronic Components, Boone, N.C. 28607. (704) 264-8861.

TRW
IRC RESISTORS

Full-color holographic display reconstructed with white light

A holographic moving-map display for aircraft pilots, being developed for the Navy by RCA, is unusual in that it uses white light instead of lasers to reconstruct the projected images in full color.

The system, which is intended as a successor to current moving film displays in military planes, uses three holograms of the "quasi-focused" type, plus one of the Fraunhofer type. They are superimposed to make a single, tiny master hologram of a 12.5-inch-square navigation chart.

Five hundred of these master holograms—each displaying up to 40,000 square miles of map area—are stored in 500 12 × 12-mm frames. The frames are embossed on a 250-inch strip of transparent vinyl mounted in a special cassette.

The three quasi-focused holograms in the composite master contain the blue, green and red color separation information for the map.

Why quasi-focused hologram?

The quasi-focused type of hologram is used for these reasons:

- It permits the hologram to be reconstructed by white light.
- Its range of focus is broad, minimizing the focusing problems found in present projection displays.
- It introduces redundancy in the hologram information, providing immunity against scratches and abrasions of the holographic tape—a particularly important consideration when recording at high information densities.
- It permits the image to move in direct proportion to the tape movement—unlike the Fraunhofer

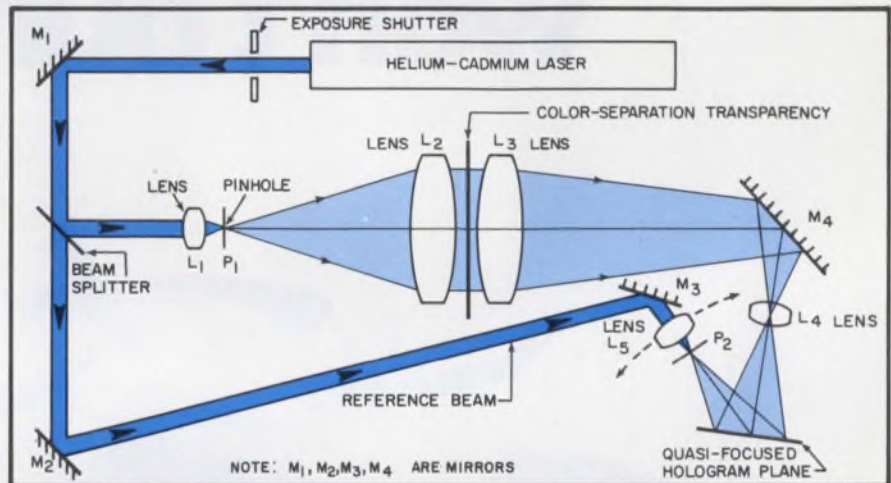

Three color-separation transparencies are recorded with this system as three overlaid holograms on a common photoresist area. Each hologram is made with the reference beam positioned at a different angle.

hologram, in which the image remains stationary despite movement of the hologram.

Use of the stationary-image characteristic is, however, made in the fourth hologram of the composite map master—a Fraunhofer hologram containing the individual-frame indexing information in an optical pattern of nine binary bits.

This bit pattern, which is used by an automatic search and retrieval system to locate a desired map, is reconstructed by the radiation from a gallium arsenide emitter. The pattern, which is not visible to the aircraft pilot, falls on and is interpreted by a photo-cell array.

The bit pattern of a single frame remains fixed on the photo-array while the hologram is stationary, or during the period it is traversing the viewing area.

Only 0.5 second is required to shift 30 frames forward or backwards from the frame being viewed. Only 6 seconds are needed to retrieve any one of the 500 maps.

The multicolor holographic sys-

tem was conceived by Jack Wolin, head of instrumentation and display systems for the Naval Air Systems Command in Washington, D.C. Its feasibility has been demonstrated by RCA's Advanced Technology Laboratory in Burlington, Mass.

In the present experimental model, the map is recreated by the light from three 350-W tungsten halide bulbs, filtered and focused to produce the blue, green and red readout beams.

The readout beams are transmitted through the original photoresist hologram, or a replica, at the proper angle to reconstruct the original object beams. These tri-color beams are collected by an imaging lens to form three superimposed images, thus providing a full-color display of the map.

Fred Shashoua, manager of RCA's Advanced Technology Laboratory, who directed the holographic development, says that in future prototype models only one 350-W lamp will be needed. RCA expects to simplify the optics.

To be able to reproduce inex-

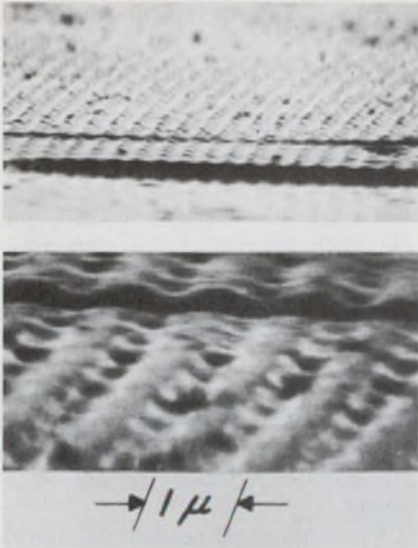

The surface of a holographic tape is shown in these photomicrographs taken with an electron microscope.

pensive tapes of the 500-map holograms on a production basis, Shashoua says, it was decided to record the holograms by using the optical phase variations produced by surface distortion of the recording medium—in this case, a

special photoresist (see photo).

This process results in a surface relief hologram that is plated with metal. The plating is then stripped to form a metallic master. The master is used in an embossing process to imprint duplicate copies on a vinyl-like storage medium, or tape.

In the display system, the three color separations for each map are recorded one on top of the other in the master hologram. The three holograms can be recovered independently, because each has been recorded with the laser reference beam aimed at a different angle when it strikes the photoresist. This produces a series of superimposed fundamental gratings—one for each color—lying at different angles with respect to each other.

How the system works

In the recording system shown in the accompanying figure, light from a helium-cadmium laser is split into a reference and an object beam. The object beam is enlarged by lens L_1 and pinhole P_1 , and is

collimated by lens L_2 .

The collimated beam from L_2 passes through the color separation transparency. Laser light passing through the transparency is collected by condensing lens L_3 and is focused to an image by L_4 . The reference beam, which is shaped to a spherical wavefront by L_5 and P_2 , interferes with the object beam on the sensitive photoresist area, which is close to but out of the image plane (quasi-focused).

The frame-indexing information is recorded as a fourth hologram over the previous three. For the 500-frame system, nine binary indexing bits are recorded over the full frame area as a Fraunhofer hologram. On playback, a stationary image is formed in space at a position that is independent of the hologram position. This image is registered on the photosensor array, which decodes the bit pattern.

In the playback system, the viewing area is a six-inch-diameter, rear-projection circle. Resolution is equivalent to that of a 3000-line TV picture or better, says RCA's Shashoua. ■■

Analog-sensor compass gives digital output without conversion

A new compass that uses an analog magnetic sensor—a Hall-effect device—provides a digital output without the use of an analog-to-digital converter. The digital output can be readily altered to correspond to degrees or fractions of a degree or to their binary equivalents.

The Hall device senses the magnetic null rather than the main flux vector. As a result, says the inventor, Joseph Star, vice president of corporate R&D for Lundy Electronics and Systems, Inc., Glen Head, N.Y., the compass is inherently more accurate than conventional types that align themselves with, or sense the direction of, the magnetic field. In laboratory tests in a uniform magnetic field, the compass proved accurate to within a fraction of a degree.

The compass is installed on a



New digital Hall-effect sensor is being used in this marine compass system. The compass assembly, at right, is hydraulically damped. The binnacle display and control unit, at left, is about 12 inches high.

vehicle—as any compass is—aligned to the longitudinal axis of the vehicle. As Star describes the basics of the system, a Hall-effect detector is rotated on a shaft in the earth's field. The Hall output is an approximately sinusoidal waveform that passes through two nulls per revolution.

One of the nulls is selected as the principal reference for magnetic north, or zero degrees on the compass. As the Hall voltage goes through the zero-degree null, it triggers a zero-crossing detector. The detector produces a pulse, which starts a count on a coded optical disc that is attached to the Hall-device shaft.

The coded disc has a transparent optical pattern. The pattern—together with a lamp (or LED) and photocell—can produce 360 pulses in each revolution, or one for each degree of the compass.

The number of counts for a single revolution can be readily increased, Star points out, simply by changing the pattern of the disc. In one prototype application, he notes, a binary-count pattern was employed.

A second photo-disc, concentric with the main-count disc, is referenced to and rotates with changes in vehicle heading.

The system is so arranged that when the zero of the rotating count-disc coincides with a zero-degree heading of the vehicle, a pulse is produced. This pulse stops the count that was begun by the Hall-device, zero-degree reference pulse.

The count thus reached is stored

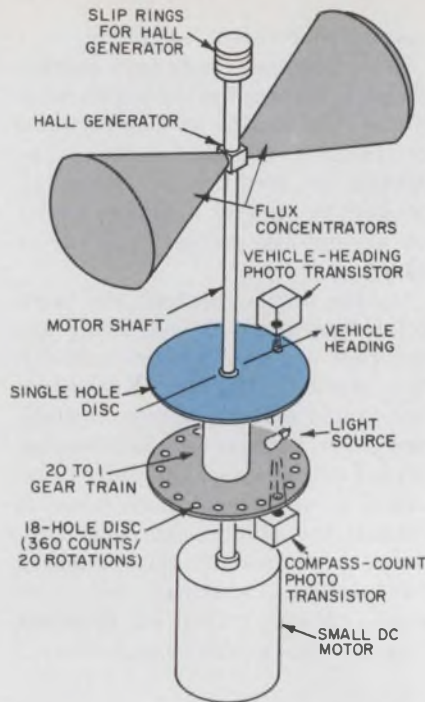

Hall sensor and photo-optical disc are spun by motor to give a direct digital readout of compass angle.

in a register and then transferred to logic and gating for the digital LED display. The display is updated once each revolution. Thus any deviation by the vehicle from magnetic north is counted in degrees.

In a production system, Star explains, the Hall generator is sandwiched between flux concentrators that are shaped to provide maximum concentration of the earth's magnetic field (see figure). This assembly is shaft-mounted and driven by a small motor.

With properly designed and heat-treated flux concentrators, as much

as 0.3-V can be produced by the Hall device from the earth's field, which is on the order of 0.5 to 0.6 gauss.

The Hall current is supplied and the Hall voltage is recovered from the generator through slip rings.

To provide a count of 360—one for each degree of the compass—a disc with 18 transparent holes is driven from the motor shaft through 20-to-1 gearing. In the figure, the light source output is directed through the two coding discs, with one producing the single vehicle-heading reference pulse and the other the 360-count pulses.

The numerical readout is obtained by converting the serial digital pulses from the counting discs to a conventional three-digit decimal display, Star explains.

The display circuitry memorizes the count and allows a change of heading between Hall-shaft spins.

In devices produced by Lundy, the speed of Hall-shaft rotation ranged from 1 to 72 revolutions per second.

The digital outputs of these systems are well within capabilities of present digital-processing circuitry, Star says. For example, a 3600-pulse-per-revolution count, corresponding to a 0.1° magnetic heading resolution—plus a display update of 2 per second—gives 7200 pulses per second.

To give the vehicle's bearing with respect to true north, the counting electronics in the system has controls for adding or subtracting the local variation of the earth's magnetic field. ■■

Memory reduces connections in a GaP, eight-digit display

By combining a shift register memory with a new photoresist technique, Bell Telephone Laboratories has come up with a low-

Jules H. Gilder
Associate Editor

power, gallium-phosphide digital display device that has fewer external connections.

The photoresist technique and bar-shaped GaP diodes are used to eliminate the need for reflectors

generally used in GaP displays and increase the legibility.

To demonstrate the feasibility of the new technique, an eight-character numeric display was constructed.

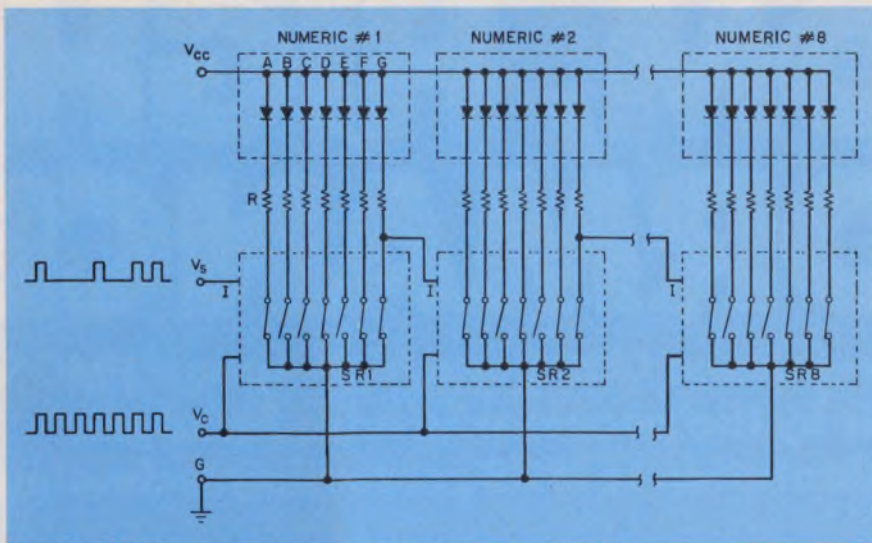

External connections are reduced by connecting the shift registers so that the last parallel output of one becomes the input for the next. The eight registers operate as a single 56-bit register.

"This is the first time that an eight-character display has been integrated onto a ceramic substrate to give a compact display package with a minimum of leads," says Matt Kuhn, supervisor of Bell's electroluminescent array group in Murray Hill, N.J.

The unit, he says, employs a basic module consisting of a seven-segment, GaP LED character, tantalum film resistors, gold conductors and a seven-bit, serial-input, parallel-output shift register. This module is repeated eight times on a 1/2-inch-by-1-1/2-inch alumina substrate.

The display, says Kuhn—who described it in a joint paper, "An Integrated Numeric Display Using a Hybrid Si-Ta-GaP Bar Technology," at the recent Solid State Circuits Conference—is the result of combining thin-film hybrid technology, originally developed for silicon circuits, with gallium-phosphide technology.

Reflectors eliminated

Gallium-phosphide display devices, until now, have used reflectors to capture light emitted from all sides of a chip. While this is fine for large displays, Kuhn says, when the displays are smaller than 0.2 inch, this approach makes it harder to fabricate them.

The display developed by Bell consists of digits—160 mils high and 90 mils wide—composed of

bar-shaped, GaP light-emitting elements. The low internal absorption and the high index of refraction of GaP provide sufficient internal scattering of the generated light to illuminate the bars almost uniformly, thus eliminating the need for a reflector.

But this approach, while eliminating one difficulty, raises another. It decreases the contrast of the display markedly, because light is reflected off the light-colored substrate and thin-film circuitry.

To overcome this problem and still eliminate the need for reflectors, an additional photoresist is applied over the entire substrate, and openings are developed to expose only those areas of the substrate required for bonding, Kuhn reports. The substrate, he continues, is then thermally annealed to convert the transparent photoresist layer into an opaque, optically absorbing one. This layer reduces reflections and thus improves the contrast and readability of the display.

External connections minimized

The reduction in external leads was accomplished with an on-board memory, which consists of the seven-bit bipolar static shift registers associated with each digit. The registers are connected so the last parallel output of one becomes the input for the next. This means that

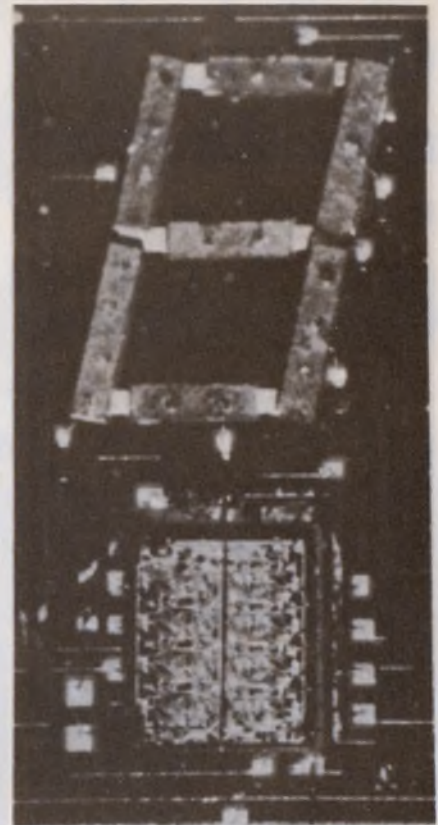

Basic display module consists of a seven-segment GaP LED and seven-bit, serial-input, parallel output shift register.

the eight registers operate essentially as a single 56-bit register.

This electrical arrangement requires only four external leads: power supply, data, clock signal and ground. It also permits the operation of an unlimited number of digits without need for strobing them.

In operation, information is serially encoded and entered into the display with a clock frequency of about 125 kHz. The information consists of seven bits for each digit and is entered, one character at a time, and then shifted from right to left. With the high clock frequency, the shifting is not visible, and characters appear to light up instantaneously.

The display has a maximum power dissipation of 1 W—all digits lighted as eights—and is clearly legible in ambient room illumination.

Although Bell isn't saying very much about future plans for the display, its compact size and low power—as well as its ability to accept serially encoded data and to shift it across the display—make it ideal for use with telephones. ■■

CUSTOM, HIGH PERFORMANCE

MOS

Low-voltage CMOS and high-speed PMOS. Built by the people who introduced ion implantation to MOS processing technology.

CMOS

- Low operating voltage—down to one volt.
- Complex, high density circuits—no channel stoppers, even at 15 volts.
- Low, matched and selectable threshold voltages—as low as 0.5 volts on both N and P channels.
- Tight threshold voltage control—within ± 0.2 volts.

PMOS

- High-speed at low power—low capacitance through zero gate overlap—example, 10 MHz shift register at 200 μ W per bit.
- Single power supply—operating voltage as low as 3 volts with ion implanted resistors.
- High circuit density—advanced photolithographic technology.

PLUS...

- Full silicon nitride passivation plus overglass protection.
- TTL/DTL compatibility.
- Full MIL STD temperature range.
- 100% screening to MIL STD 883.

If our custom capability appeals to your high performance requirements, write us. We're taking orders now.

Hughes Aircraft Company, Microelectronic Products Division, 500 Superior Avenue, Newport Beach, CA 92663
Telephone: (714) 548-0671

HUGHES

HUGHES AIRCRAFT COMPANY
MICROELECTRONIC
PRODUCTS DIVISION

Hughes Industrial Electronic Products

Ultrasonics touches off underwater explosions

An undersea blasting method that uses ultrasonic waves to detonate explosive charges has been tested by two Japanese companies: Oki Electric Industry Co., Ltd., and the Taisei Construction Co.

It is said to eliminate the need for divers to wire and plant explosives, particularly in deep ocean areas and where there are swift currents. All blasting and digging operations are carried out from a ship or a work platform.

The method employs detonation-control equipment aboard the ship or platform, a transmitter suspended beneath the surface of the water and a so-called "sono-blast-er" unit consisting of an FM receiver, amplifier, signal discriminator, switching circuitry, piezo-electric elements and batteries.

In a typical blasting situation, the holes are drilled at a maximum distance of 1 km from the vessel. One hole contains a primary sono-

blaster unit ("A" in accompanying diagram), while a number of secondary or "slave" sono-blast-er units ("Bs" in diagram) are placed in adjacent holes. The transmitter sends a 25-kHz carrier that is frequency-modulated with a 400-Hz signal to all the sono-blast-er units. This signal powers the detonators and puts them in a standby condition. A 380-Hz FM signal is then transmitted only to the primary sono-blast-er ("A"), which sets off the explosive charge. The pressure caused by this explosion activates the piezoelectric elements in the other sono-blast-ers, causing each in turn to explode.

According to Ryoji Shimizu, Oki's chief engineer: "There is no need for diving and wiring operations, and no danger of misfires due to wiring mistakes or cut wires because the blasting operations are all carried out remotely from a platform or ship." ■■

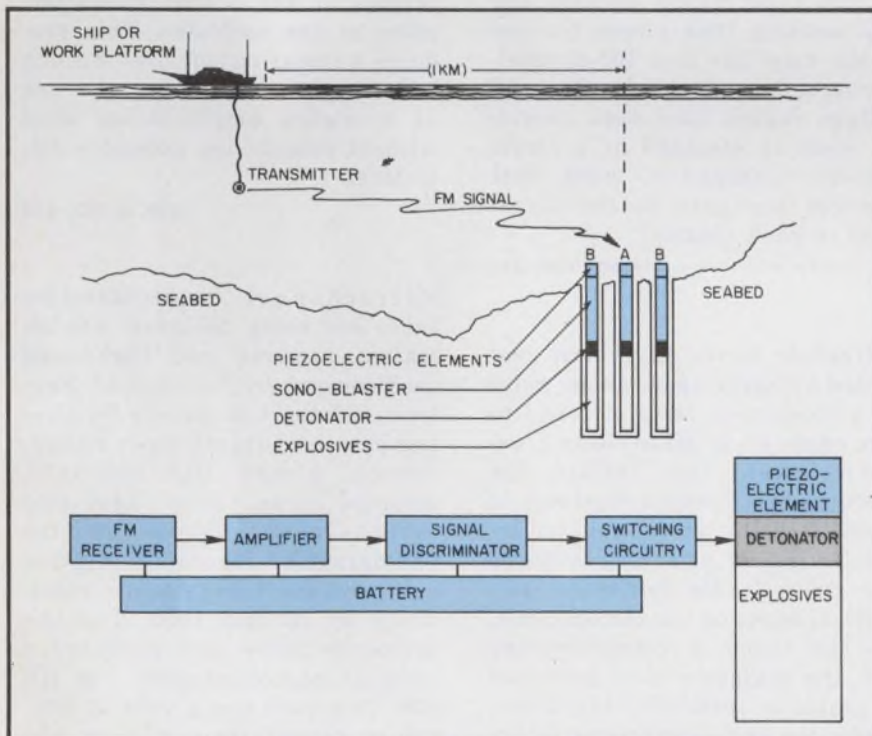

Transmitter suspended beneath surface ship sends FM signal to sono-blast-er unit A. The explosion activates piezoelectric elements in sono-blast-er units B, causing each in turn to explode.

Hughes is more than electronic components and equipment.

It's systems, too.



Numerical control systems (RS 295)



Wire terminating and harness laying systems (RS 296)



N/C positioning tables and systems (RS 297)



Multiplex systems for remote communications/control (RS 292)



FACT automatic circuit testers (RS 298)

For complete information, write Bldg. 100, Mail Station C-512, Culver City, CA 90230. Or request by Reader Service (RS) numbers.



Industrial Electronic Products



Designing with TTL ICs

A comprehensive, practical applications guide.

322 pages • 399 illustrations
hardcover

This thoroughly practical and comprehensive volume, first to explore the entire family of TTL integrated circuits, is written for electronics engineers, computer designers, systems analysts, and non-engineering managers who want information on the best uses of today's most widely used integrated circuits. Prepared by TI's IC applications staff, it covers not only design philosophy, economics, basic descriptions, and electrical performance—but also the full range of applications of TTL circuits in digital systems.

Chapter titles include: • **Introduction to digital logic** • **Series 54/74 overview** • **Circuit analysis and characteristics of Series 54/74** • **Extended-range operation** • **Noise considerations** • **Combinational logic design** • **Flip-flops** • **Decoders** • **Arithmetic elements** • **Counters** • **Shift registers** • **Other applications.**

Send coupon today for your copy.

For complete information on the many other electronic design and reference books in TI's Learning Center Library, circle 248 on the Reader Service Card.



LEARNING
CENTER

Texas Instruments Incorporated
P.O. Box 5012, M/S 84
Dallas, Texas 75222

Please send **Designing with TTL Integrated Circuits**. Enclosed is \$18.50 (check or money order only).

Name _____
Firm _____
Address _____
City _____
State _____ Zip _____

TEXAS INSTRUMENTS
INCORPORATED

technology abroad

By using a dynamic filter in a program-controlled operational amplifier, Micro Consultants, English manufacturers of d/a and a/d converters, have been able to combine noise rejection with a fast signal-settling time. Normally these two requirements are in conflict. To eliminate extraneous noise, the amplifier bandwidth should be about 30 Hz, centered on the frequency of the analog signal. But fast signal-settling time is essential when switching for example, every 10 ms from one multiplexing channel to another. And this can be attained only with adequate bandwidth. Micro's engineers solved this problem by incorporating a logic-controlled dynamic filter in the amplifier. This automatically switches to a wider bandwidth when the channels are changed, then progressively reduces the bandwidth over a 5-ms period. An improvement of more than 10 dB in the noise figure results. The fast settling time allows the use of the amplifier in a 100-channel-per-second multiplexer. Over 16 voltage ranges have been provided. Each is specified by a single four-bit computer word that matches the gain to the signal level in each channel.

CIRCLE NO. 441

Ultrasonic waves have been generated by applying a voltage pulse to a conductive strip attached to the edge of a piezo-electric ceramic sheet. This feature has been used by Siemens engineers in West Germany as a computer input device. By attaching conducting strips to the horizontal and vertical edges of the piezoceramic, and by using a voltage-sensing pen, the engineers have developed a graphics terminal that transforms the pen coordinates into a computer-compatible form. In operation, a pulse applied to the vertical edge generates an ultra-

sonic pulse that sweeps across the ceramic. Then, a pulse applied to the horizontal edge sweeps down the ceramic. The compression waves within the ceramic are sensed by the probe as a 0.2-V pulse. The transit time can then readily be measured and converted into data suitable for transmission directly to the computer or over a public telephone network.

CIRCLE NO. 442

Improvement of the linearity of TWT amplifiers in satellites and their associated earth terminals is being investigated by Marconi Communications under a contract with the British Post Office. The program is aimed at developing an add-on unit that will double the power of existing transmitters. This passive unit would modify the input signals so their amplitude envelope represents an inversion of the output characteristics of the amplifier. This produces a linear output over a much wider range, permitting the use of a higher amplification level without introducing excessive distortion.

CIRCLE NO. 443

Microchannel image-intensifier tubes are being designed into ultrafast cameras and high-speed oscilloscopes by Mullard of England and the Laboratoires d'Electronique at Limeil-Brevannes, France. A new IGF 705 tube, mounted in an optical head that contains power supplies and the photographic recording system, can increase the system's sensitivity by 10 and 1000. The two companies have also produced a compact photomultiplier, the HR 300. This tube has a gain of 100,000, a transit time of 1 ns and a half-height pulse response width of less than 0.5 ns.

CIRCLE NO. 444

THE PATH OF LEAST RESISTANCE

True 4-wire ohm measurements, fully autoranging over **9-complete ranges** (1 ohm to 200 M ohms) in only **20 msec** ... with 0.01% accuracy
... Plus, only Dana's exclusive ohms guard allows in circuit measurements.

+ 1.9544

DANA

DIGITAL VOLTMETER MODEL 4800

This is only one of the many features making Dana's 4800, premium performance DVM, a truly unique 4 digit measuring device.

Make **RMS AC measurements** of distorted signals ... and not only pure sine waves ... over a **1 MHz bandwidth** in only 350 msec with 0.03% accuracy. This outstanding performance is assured by Dana's remarkable RMS Distortion Insensitive AC Converter.

For DC measurements, 5 ranges are standard with **0.005% accuracy** ... add a plug-in preamplifier and a **10 mV range** becomes available with **1 μ V resolution**. Selectable filtering, in this mode, further extends application flexibility.

We didn't stop there, though ... the 4800 is more than just specifications. We added many features which you, the user, directly benefit from: 100% overrange in all functions and on all ranges, full autoranging, complete solid-state isolated BCD and programming ... no more troublesome slow relays ... front panel override ... protects against unauthorized and accidental tampering ... programmable front/rear input, illegal operation indicator, built in programming timeouts, plug-in IC's and accessories, and analog output.

Whether you need a basic DVM or a full multimeter, don't follow the wrong path in searching for a premium performance instrument ... let Dana guide you to the 4800.

DANA

When Test and Measurement Count

Dana Laboratories, Inc.
2401 Campus Drive, Irvine
California 92664 (714) 833-1234

First truly new function generator in years digitally synthesizes waveforms to bring you higher accuracy, greater stability plus the capability to stop- and-hold waveforms almost indefinitely.

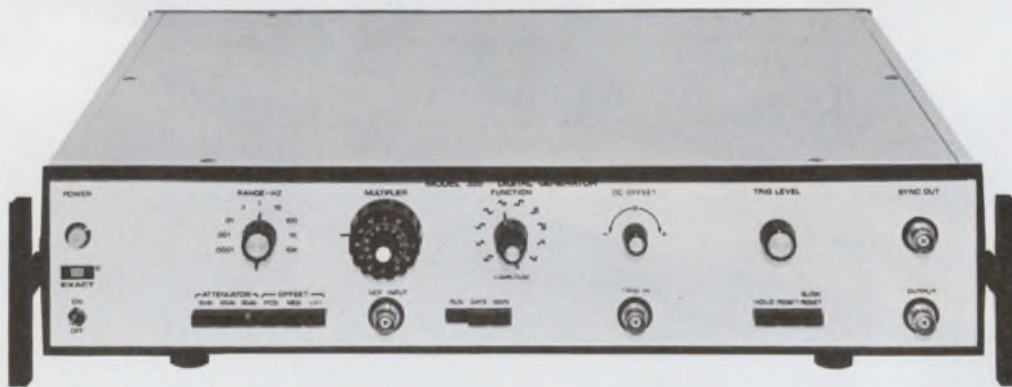

Naturally it's from EXACT

Each cycle of every waveform produced by our new Model 335 Digital Function Generator—sine, square, triangle, ramp, and pulse—is synthesized with nearly 2000 bits of digital information. This brand new but thoroughly proven approach gives you unparalleled control of frequency and amplitude—and you can stop and hold any waveform at any one of the bits (allowing ramps, for example, to be stopped and held at a given level and then allowed to continue). All the waveforms necessary to drive mechanical test systems, for geophysical and medical work, or for use as a general purpose laboratory tool—are available.

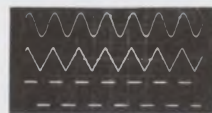

Sine, triangle and square.



Ramp caught and held twice, and allowed to complete the cycle.

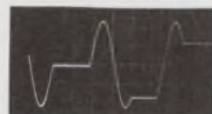

Sine wave caught and held at three different points.

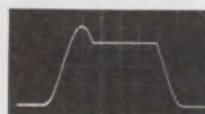

Sine square pulse held at one point.

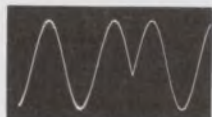

Shift quadrants, instantaneously.

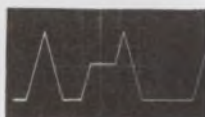

Triggered triangle started at -90° , second cycle has been held at one point.

Check These Other Features...

Voltage controlled frequency input for remote analog frequency control, frequency sweeping, or modulation.

Single shot (trigger) or burst (gated) operation by front panel push button or by external trigger or gate applied to the trigger input connector.

Fixed and variable dc offset.

80 db step attenuator in 10 db steps, with 20 db continuously variable.

Stability, 0.01% for 10 minutes, 0.02% for 24 hours.

Kelvin Varley divider frequency multiplier gives 10-turn setability and accuracy for frequency settings.

0.00001 Hz ($10\mu\text{Hz}$) to 50 KHz frequency range. Push button stop and hold; catch and hold any waveform manually from the front panel and then allow it to continue from that point to complete the cycle. Catch it again and again at any time.

Price: \$1250



P.O. Box 160, Hillsboro, Oregon 97123 • 503/648-6661

washington report



Don Byrne
Washington Bureau

Defense Dept. to try economy R&D

The new Assistant Secretary of Defense for Telecommunications, Dr. Eberhardt Rechtin, warns that the Defense Dept. will not be as free-spending on R&D as it has been in the past. The department will not be able "to support all the proposed research efforts relevant to defense" and will be "increasingly receptive only in those areas of immediate defense need," he told the spring meeting of the Electronic Industries Association here.

This selectivity, he said, will undoubtedly put off or leave unexplored "some promising avenues of inquiry." The advanced development of defense system prototypes will be increased, he indicated, but funding will explicitly omit any commitment to production. "Many prototypes will not go into production at all, and per unit cost of the end item will be set as an early and enforced criterion," Dr. Rechtin said.

He added that the Defense Dept. expected increased R&D efforts in ocean surveillance and control among naval systems, with optical systems, remote sensors, communications computers and displays being emphasized. U.S. systems of the future will have to be compatible with, or adaptive to, other systems in the non-Communist world—especially in communications, air traffic control, navigation, logistics and ammunition, Dr. Rechtin said. Suggesting that some "foreign systems may well appear in U.S. inventories," he stressed U.S. systems costs must come down.

New rules due for figuring defense profits

The Defense Dept. is expected to release early next month new guidelines for determining profits on defense contracts. The guidelines will be pegged to how much of his own capital a defense contractor uses in fulfilling the contract. Reportedly up to half of the negotiated profit will be based on the contractor's invested capital. The idea has drawn fire from industry because of the difficulty in separating defense and commercial investment funds and the fear of drawn-out accounting battles.

U.S. plans to explore the cost of CATV's future

Amid predictions of a dazzling future for CATV in American communities, the Government is posing this question: Could CATV be expanded now at realistic operating costs? The Dept. of Health, Education and Welfare and the Dept. of Housing and Urban Development are planning a study of a pilot cable-television system to determine the operating

costs. Under the plan, the agencies would select a city in the 50 to 100 largest markets and expand an existing system to cover virtually every home in the city. The Government would then study the system as it operated to attempt to pinpoint costs and profits. The Office of Telecommunications Policy is also interested in the project.

Antidumping bill drawing Senate support

An "antidumping" bill that would allow the Justice Dept. or any individual to sue in Federal Court to stop the import of the products being sold at suspected prices may get a push soon from conservative Senators on both sides of the political aisle. Charges involving dumping—a practice whereby foreign concerns sell their products in this country for less than they do in their own and sometimes for less even than their own production costs—are now handled by the Tariff Commission. But the new bill, introduced by Sen. Paul Fannin (R-Ariz.) would make dumping an antitrust action. Anyone could file suit, including corporations. The burden of the proof would be placed on the overseas manufacturer, and he would have to produce his cost records for court perusal.

Meanwhile there is still intensive lobbying in favor of the Hartke-Burke bill, which has been introduced in both houses. It would restrict the imports of all kinds of producers, including electronics.

Five companies bid on Washington subway

General Electric, Pullman Standard, the Rohr Corp., Vought Aeronautics Corp. and Toshiba, the Japanese company, are expected to bid shortly on the construction of 300 electrical subway cars for the subway now under construction in Washington, D.C. The cars are expected to cost somewhere between \$100-million and \$120-million. Bids on 256 more cars will be taken later after the subway is, in part, operational. The system will be 98 miles long when completed. The electrically powered cars will be operated by computer, although a motorman will be present. Each car will be 75 feet long and have a top speed of 75 miles an hour.

Capital Capsules: If you can lay your hands on a Feb. 25 Federal Register, you can read the guidelines for design and operation of the Worldwide Command and Control System. This is the first time that this information on the system has ever been published in one place at one time. A defense Dept. reorganization panel recommended the publishing of the material. . . . **The Hardsite Missile contract, now called the Program for Site Defense of Minuteman, has gone to McDonnell Douglas for about \$382-million. But subcontractors—General Electric, Control Data Corp., GTE Sylvania and Braddock, Dunn & McDonald, Inc.—will get almost \$220-million of that total. . . . The Navy has awarded a \$4.9-million development contract to the Avionics Div. of ITT for a miniature electronic countermeasures system for use in tactical aircraft. . . . The EIA will hold an "electronics 1985" conference in Chicago on May 18-19. The association predicts that the present \$25-billion U.S. electronics industry will have grown to \$44-billion by 1985 . . . NASA and the Air Force have signed a formal agreement for a cooperative program "to establish the technology base needed by the USAF and industry for development of military and civil transports with short takeoff and landing (STOL) capabilities."**

Subminiature tubular capacitors now offered in expanded ratings.

The latest revisions to our TT and TTX line of miniature aluminum electrolytic capacitors make expanded ratings available in $\frac{5}{8}$ " and $\frac{1}{2}$ " diameters, up to 5,000 mfd. All offer extra long life—on the job or off the shelf.

Both capacitors have the reliability of all-welded construction. They are cased in aluminum, with proven rubber end seals. PVC insulating sleeves are standard, but Mylar* insulating sleeves are available for high-temperature applications.

For more information on the expanded line write for TT Bulletin 4-104 or TTX Bulletin 4-105. Or see your authorized Mallory distributor. We'll show you how to get what you need, without paying more than you need to.

*Du Pont registered trademark.



MALLORY

MALLORY CAPACITOR COMPANY

a division of P. R. MALLORY & CO. INC.
Indianapolis, Indiana 46206

Electrical and Electronic Components • Sequence Timers • Metallurgical Products • Batteries

INFORMATION RETRIEVAL NUMBER 25



Super-performer!

A new series of exceptionally versatile Microdot waveform generators . . . at prices you won't believe.

Each Microdot Series 500 Function Generator offers the greatest performance, easiest operation, and lowest price in its class.

Like the 10MHz Model 510, for only \$495. This instrument utilizes a unique, 1000:1 voltage-control-generator with exclusive "ECL" switching, and a super-fast bipolar output amplifier. The design assures an extremely clean signal through the broad 10MHz frequency spectrum. This advanced instrument engineering permits <10ns rise and fall response, and offers variable pulses from 50ns.

Model 511 adds variable start/stop triggering to the features of the Model 510. And for lower frequency applications, the 5MHz Model 501 provides burst, gating, and special mode operation for only \$395. All Series 500 generators offer six versatile operating modes including fixed and variable DC offset, full audio range, and 5% - 95% variable symmetry control.

But these features and instruments are just the beginning. Ask about the Series 500 higher frequency and sweep models.

Contact Microdot today for complete details on how the Series 500 Waveform Generators can solve your most demanding measurement problems. You get more than your money's worth from Microdot instrumentation . . . the Super-performers.



MICRODOT INC.
INSTRUMENTATION DIVISION

19535 East Walnut Drive ■ City of Industry, California 91748
(213) 965-4911 ■ EUROPE: 102 High Street ■ North Church
Berkhamsted, Hertfordshire, England ■ 04427-71138

Design or shuffle paper. Which goal?

I was appalled at the numbers of ex-engineers I spoke to recently who will probably remain ex-engineers. They just weren't good. In interviewing them for editorial positions on the staff of ELECTRONIC DESIGN, I found almost none who could answer questions I thought insultingly simple about today's components, test equipment and design considerations.

The men I interviewed weren't kids out of school. Almost all had many years of experience in industry. But they'd fallen into the trap of becoming paper shufflers, expeditors, liaison men, contract supervisors and the like. And as they moved up in their organizations they left real engineering behind. When I asked, for example, what to look for in a scope or DVM, or what were the relative merits of TTL and ECL, I kept hearing, "Oh, one of my boys knows about that." And I was sorely tempted to say, "Send him."

This is a real tragedy and the victims are thousands of out-of-work men who spent the most productive years of their lives in an industry where they're probably no longer employable. Most of these men commanded high salaries in administrative jobs that demanded less and less of their engineering talents. When the economic crunch came, these were the men who were pitched out. Though engineering engineers were hit, too, they weren't hit as hard and they were able to find new engineering jobs more quickly.

And this is the shame of our industry. We entice men into "the excitement and intellectual stimulation of an engineering career" and "limitless personal growth." When business is booming, we "promote" them out of engineering. Sure, there are companies that encourage (with cash) growth within the ranks of engineering. But in too many companies, financial growth is limited for engineers. The "great" growth opportunities are greatest for administrators. But the layoff risks and obsolescence risks are greatest there, too.

We may be in for another period of prosperity and new "opportunities" for growth in the ranks of paper shufflers. How many men, again, will leave their engineering behind and forgotten? Will you be one?



A handwritten signature in cursive script that reads "George Rostky".

GEORGE ROSTKY
Editor

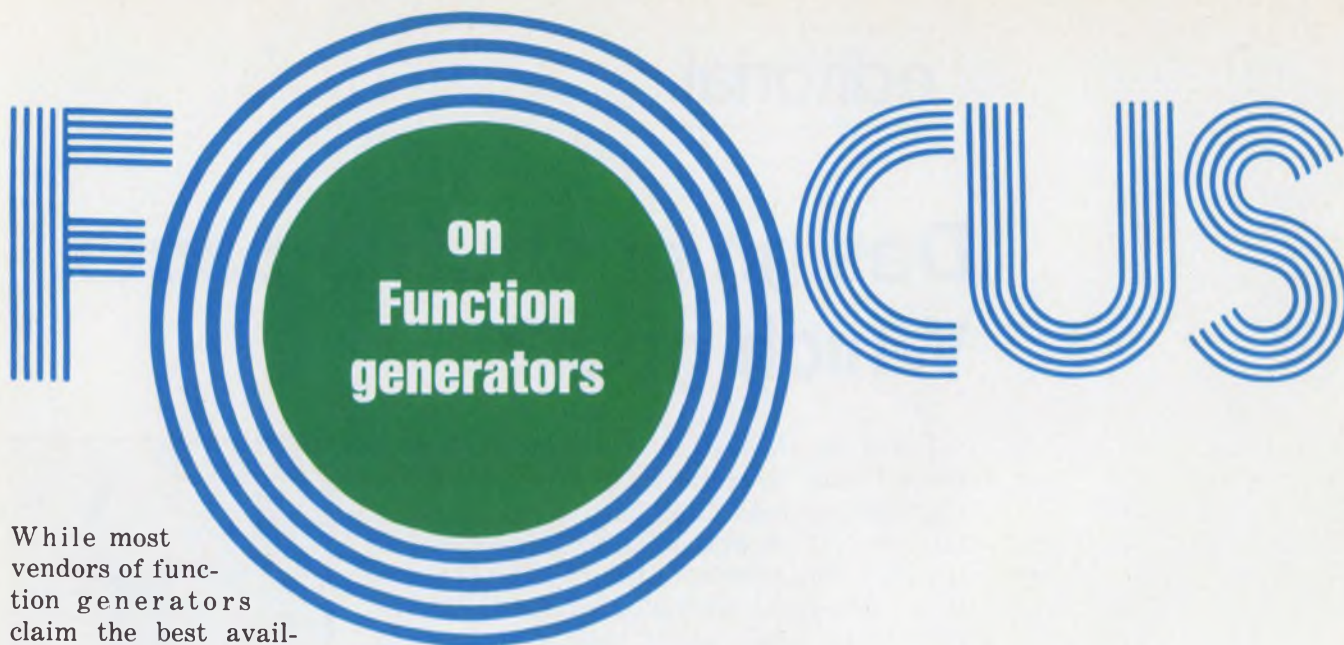

Focus on Function generators

While most vendors of function generators claim the best available cost/performance, they never assign a number to the ratio. They can't. For it's not possible to reduce performance—especially of a highly versatile instrument—to a numeral. There are so many possible applications, that its performance can be characterized only by reference to a particular set of requirements.

The term "function generator" can be used, as the EMR Div. of Weston Instruments does, to describe equipment that can synthesize an arbitrary function, dictated by holes in punched tape.

By most definitions, however, the basic function generator delivers sine waves, square waves and triangles. With the addition of a time-symmetry control, it can modify square waves to pulses and triangles to ramps. Thus even a simple function generator can replace an oscillator, a square-wave or pulse generator and a ramp generator. But not too perfectly.

Better sine waves are available from good oscillators, and better square waves from good pulse generators. And no commercial function generators deliver higher than 20 MHz.

While 10-MHz function generators have been available for more than a year, a 20-MHz generator was first made available only a few months ago when Exact introduced its Model 7230, with a frequency range of 100 μ Hz to 20 MHz. Systron-Donner's Datapulse Div. introduced the second 20-MHz generator last month: the Model 420, with a range of 2 Hz to 20 MHz. And Microdot expects to introduce a 20-MHz generator soon.

For many many applications, the function generator represents an admirable compromise. Many engineers can be quite happy with the 1% sine-wave distortion in good function generators,

0.1% in the best. They don't need the 0.01% distortion possible in the best oscillators. And they don't need frequencies higher than 20 MHz.

Unfortunately the function generator's great flexibility opens vast areas for specsmanship. It's all too easy to find partial specs, omitted specs and specs that suggest more than an instrument can deliver.

Specs problems

To characterize even the simplest function generator we need, ideally, three spec sheets—one for sine waves, one for square waves and one for triangles. Each sheet would describe permissible imperfections in the waveshape, as well as frequency range, voltage and power output, stability of amplitude and period with time and temperature, and undesirable effects of interacting controls and variations in line voltage.

And that's the problem. There's just too much to specify unless the vendor can spend as much for testing and documentation as he does for design and manufacture. So he sometimes uses wishful thinking instead of measurements. Or he may offer fragmented specs, which a user must somehow sew together in a meaningful fashion.

Since all vendors don't necessarily specify the same parameters and don't necessarily specify them the same way, and since some publish "typical" specs while others publish worst-case, paper comparisons of competitive instruments are often less than easy. It can be fruitful then to review some of the specs.

One would imagine that it should be simple to discover how much voltage a box can deliver. Not so. Though some data sheets are admirably

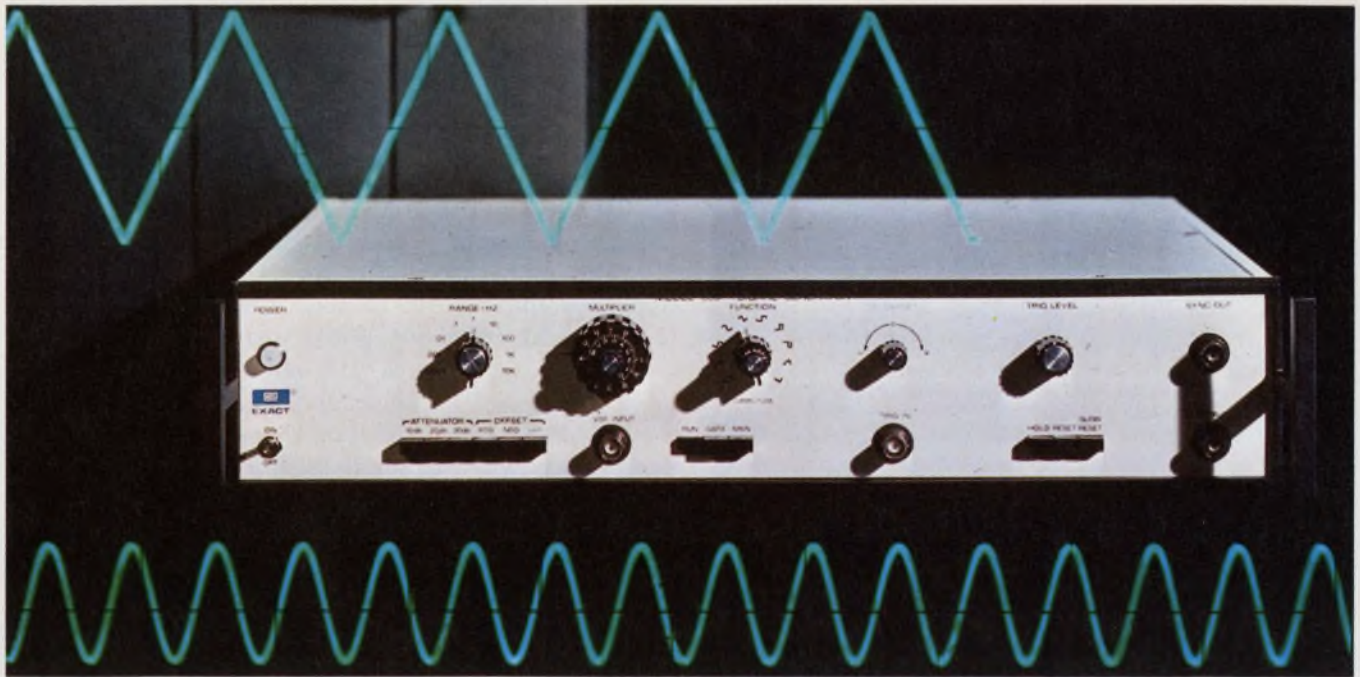

The basic triangle from which other waveforms are derived is synthesized from a 2000-bit staircase in Exact's \$1250 Model 335. Exceptional stability results over frequencies from an ultra-low 10 μ Hz to 50 kHz.

explicit, others are not. A spec sheet can promise a dynamic range of 30 dB, or 40 or 80, without indicating the magnitude of output voltage.

What's the amplitude?

One data sheet might point out quite explicitly that the unit can deliver 10 V peak-to-peak from a 50 Ω source to a 50 Ω load or 20-V peak-to-peak into an open circuit. Another sheet might indicate, on one line, that the maximum output is 10-V peak-to-peak while on another line, it points out that the source impedance is 50 Ω or 600 Ω . Does this mean that the box can deliver 10 V across 50 Ω ? Across 600 Ω ? Across an open circuit?

Or does it mean simply that 10 V is, in fact, maximum and that at some frequency—when the line voltage is high, the load current is zero, the amplitude is cranked all the way up and the moon is full—the generator delivers 10 V?

Specs are everywhere . . . or can be

Other questions can be posed. For example, what's the maximum output when the dc-offset control is used? What's the maximum output with high levels of amplitude modulation? Do distortion specs apply at maximum output? Or is there severe clipping?

Does the output-level spec apply to all waveforms over the entire frequency range of the instrument—even high-frequency pulses? In short,

do amplitude and distortion specs apply simultaneously for all waveforms across the entire frequency range? Or does a spec modestly state that "distortion is very low throughout the audio range"?

In instruments that can deliver sines, squares and triangles simultaneously, what interaction is there? Does the square wave fall apart if the triangle is loaded down? In other units, does a change in rep rate alter pulse width or symmetry of other waveforms?

How flat is the output across the specified frequency range? And how stable is it with time, temperature and line voltage? Does the amplitude-stability spec, if there is one, include dc-offset stability?

And where does the output come from? A power transistor? A calibrated attenuator? Or a cheap potentiometer? Though an attenuator at the output—or even a pot—sacrifices power and costs more than one further back in the circuitry, because it dissipates more power, it offers an important advantage. Hum and noise, which can be small in absolute terms, can be significant in a low-level output signal. If the amplitude control is on the output side of the power amplifier, it reduces hum and noise as it reduces the signal.

At low output amplitudes, there's another problem. Spec sheets don't always point out that the output cannot be varied in infinitesimal steps down to zero. They may not tell how small a voltage the instrument can deliver. And they may not tell what waveforms—especially square waves and pulses—look like below 100 mV.

Regardless of the amplitude, there can be still another problem—the load. In general, the waveshape and load voltage are specified for a resistive load. But there's an important load that

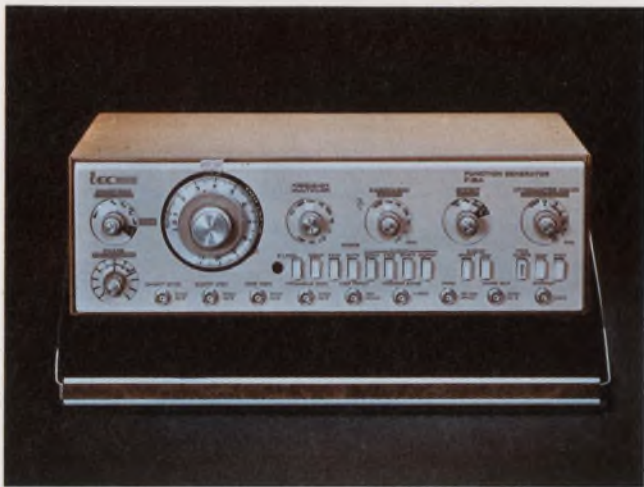

The output frequency of the F55 from Interstate Electronics Corp. can be phase-locked to an external periodic signal. This instrument—for 500 μ Hz to 10 MHz—costs \$1195.

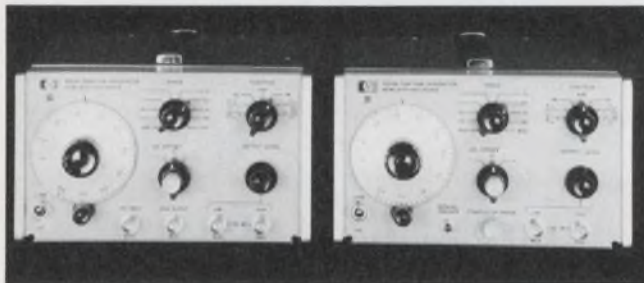

Frequencies from 500 μ Hz to 5 MHz are available in Hewlett-Packard's \$595 3310A and \$735 3310B. The latter offers single and multiple-cycle outputs.

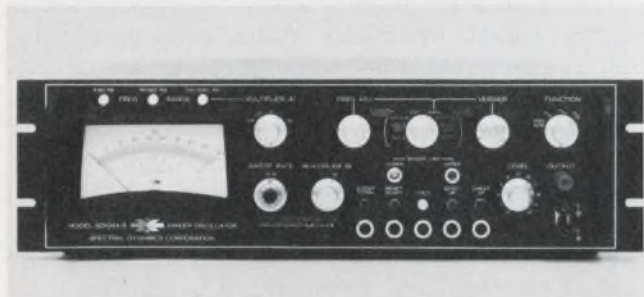

Intended mainly for sweep-generator functions, the Spectral Dynamics SD104A-5 provides linear or logarithmic sweeps of the basic sines, squares and triangles over 5 mHz to 100 kHz. Prices start at \$1965.



Independent waveforms are available at two separate outputs of the Datapulse 410, a \$995 generator with a sweep range of 1000 to 1 over 200 μ Hz to 2 MHz.

some manufacturers specify and others don't—a short-circuit. Many generators can tolerate a short without damage. Others can't.

What's the frequency?

While amplitude specs are often less complete than one might prefer, frequency specs are generally more thorough. But these, too, are not without pitfalls for the unwary.

The function generator offers an enormous range of frequencies. It's not uncommon to find 10 frequency decades. But several decades are often tucked below 1 Hz, where they're useful to a rather small segment of the engineering community. Some of those frequencies are very low indeed. Exact's new Model 335, which digitally synthesizes waveforms, delivers frequencies as low as 10 μ Hz or, as an option, 1 μ Hz.

Now 1 μ Hz is not the kind of frequency you check with a scope. One complete cycle requires 11 days, 14 hours and 24 minutes. Exact obtains low frequencies with decade dividers—not large capacitors—so there's some assurance of maintaining accuracy. But that assurance isn't always available in other generators whose frequencies extend into the millihertz range.

In many generators the region below 1 Hz is uncalibrated, so the frequency reading is merely an approximation. The lack of calibration may not be apparent from the spec sheets or from the face of the instrument.

There can be a suggestion of calibration in the fact that an instrument has lines on a dial. That's not at all conclusive. Even spec sheets that clearly spell out the dial accuracy—and there are many—merit more than casual attention.

What does the dial mean?

The dial accuracy is generally given as a percent of full scale (though a percent of setting is often added). The dial usually has a range of at least 10 to 1, and it can go as high as 50 to 1. If accuracy is specified as "1% of range," the down-range inaccuracy could be 10% or worse—which is more than one might expect in a box hailed as a precision instrument.

In some instruments, dial accuracy depends on the frequency range. It's respectable in the easy frequency ranges (up to about 100 kHz) and poor in higher ranges.

When it's practical (certainly not at 1 μ Hz) it's wise to check frequency with a counter or, at least, a scope. It's also a good idea to find out what frequencies are available outside the range of numbers on the dial—especially when low frequencies are important.

A manufacturer could number a dial down to 1 Hz, add a few lines without numbers below the

1-Hz mark then claim a bottom frequency of 0.06 or 0.07 Hz. Though the dial spacings down there are linear, the oscillator may not be.

Fortunately it's not always critical to know the exact frequency. It's often more important to know that, whatever the frequency is, it will stay there. So competitive generators should be compared—not on the accuracy of their calibration but on their stability. And that's not easy.

It almost seems as if manufacturers have agreed to disagree on the time base for stability specs. Some vendors don't publish a frequency-stability spec at all. A few give a single time base: Marconi, for example, gives eight hours; Microdot gives 10 minutes (though the company uses 10 minutes and 24 hours for amplitude stability); and Lorch-Adret uses one year. Data-pulse gives short-term stability for one hour and long-term stability for one month. And Clarke-Hess, Heath, Interstate Electronics, Krohn-Hite and Wavetek give 10 minutes and 24 hours.

Stability specs, like frequency-accuracy statements, are often qualified. A manufacturer may quote a stability figure for only what he calls the "effective" frequency range. And the stability spec invariably refers only to slow drift—never to incidental FM, which may be called jitter or cycle-to-cycle instability. That's rarely specified, regardless of terminology.

What's the waveform?

When manufacturers publish pretty waveform pictures, it's a safe bet that they shot the pictures under comfortable circumstances—moderate frequencies with appropriate amplitudes. The waveshapes may be less attractive under other conditions.

High-frequency sine waves can have glitched peaks, due to reversals in the triangles from which the sine waves are formed in most function generators. Those glitches can cause ringing. Pulses and square waves can look bad at low voltage levels, where rise and fall times are not at their best. For these signals, the best transition times occur at full output, so the vendor normally specifies rise and fall times at full output only.

In high-frequency generators, top-frequency square waves can look uncomfortably sinusoidal, since the transition times can occupy most of the period. In one series the top frequency is 2 MHz, which makes for a half-period of 250 ns. Rise and fall times are 100 ns, so the square waves don't look like those in textbooks.

What's available

Despite shortcomings in the instruments and in their published specifications, function gen-



Five sine waves, displaced from a reference by 0°, 90°, 180°, 270° or, continuously variable from -180° to +180°, are available in Feedback's TWG-500. The \$1650 instrument—for 10 mHz to 100 kHz—also has quadrature square waves and triangles.

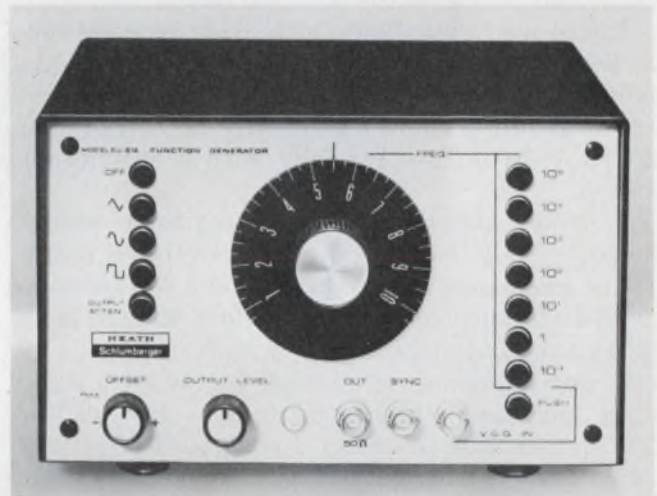

One of the lowest-priced function generators, Heath's EU-81A, delivers 100 mHz to 1 MHz and costs \$245.

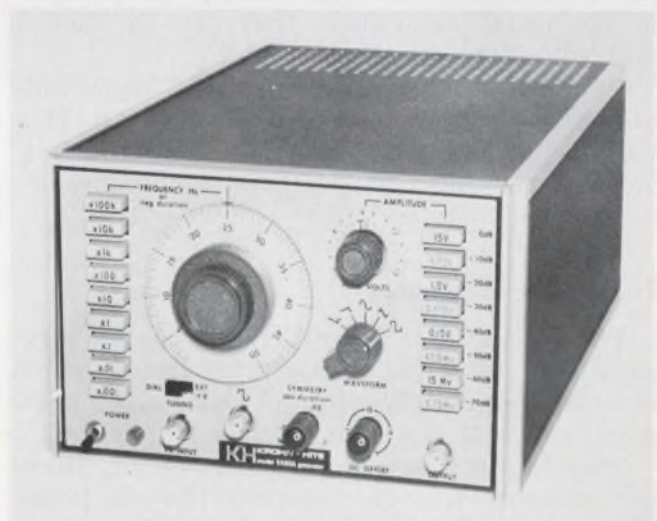

Pulse width and triangle slope can be set independently of rep rate in Krohn-Hite's 5400A, a \$575 generator for 2 mHz to 5 MHz with voltage control of frequency over a 1000-to-1 range.

Square-wave rise and fall times are only 10 ns in Microdot's Model 511, a \$695 generator for a frequency range from 100 mHz to 10 MHz.

erators are enjoying growing popularity. Their versatility, which is growing, too, often overshadows the advantages of higher frequencies, higher rep rates and better waveforms available in limited-purpose sine and pulse generators. And function generators offer features that aren't available in other instruments.

Even the least expensive function generators offer control of frequency from an external voltage. All permit frequency variation over at least the range of the dial. And several permit voltage control of frequency over a 1000-to-1 range. Most of these limit the maximum frequency to the top dial frequency, but Clarke-Hess, for one, permits excursion to twice the top dial frequency.

There are advantages to a wide, voltage-controlled frequency range, but there are limitations, too. Such a wide span, for example, is convenient for response tests over the entire audio range of 20 Hz to 20 kHz—especially with a logarithmic sweep.

A wide voltage-controlled frequency range, however, calls for a wide control-voltage range. If the maximum voltage is 10 V and the frequency span is 1000 to 1, the minimum voltage must be 10 mV. But small levels of noise riding on 10 mV can introduce significant frequency jitter.

In any case, it's a good idea to look at the waveforms at each end of a controlled frequency range and to check linearity. Frequency should be closely proportional to control voltage.

Manufacturers always indicate the maximum voltage permitted for frequency control. It might be useful if they would also indicate the amount of accidental overvoltage that can be applied without damage to the instrument.

In addition to control of frequency, many generators accept voltage control of amplitude. This permits simultaneous amplitude and frequency modulation, which simplifies testing for incidental AM and FM.

Those special features

The generators that cost the least provide little more than three basic waveforms and an input port for frequency control. Higher-priced instruments can be loaded with features.

They can include modulation sources of different waveshapes, trigger controls (for single cycles), gating controls (for multiple cycles or tone bursts in step-function tests), sweep triggers (for single-shot sweeps), phase-lock capabilities (which can make the frequency as stable as an



external source), phasing controls (which allow generation of two signals having selected or variable relative phase), logarithmic sweeps (for wideband sweep tests), sync pulses coincident with the rise of the square wave, and dc output voltages related to frequency.

In addition many generators provide simultaneous, auxiliary, fixed-amplitude outputs of several different waveshapes (sine, square, triangle, up-ramp, down-ramp, positive pulse, negative pulse). Some caution is necessary here, as some spec sheets don't clearly distinguish between main and auxiliary outputs. In one case the headlined rise time is for the auxiliary square wave. The rise time for the main square wave is double that of the auxiliary.

Further, some generators include limit lamps to warn of excessive output voltage or frequency. The amplitude-limit indicator shows when the sum of the dc offset and the signal amplitude is approaching the point where clipping and distortion would set in. The frequency-limit indi-



Thumbwheel switches set frequency to 3-digit resolution in the Clarke-Hess 745, a \$475 instrument for 10 mHz to 1.1 MHz. Frequency can be swept to twice the upper-dial frequency.



Dial calipers show the manually set limits for FM and AM in the \$1495 Wavetek 146, which includes a separate section for generating modulation waveforms.

cator shows when the frequency is swept to the point where distortion and flatness specs are exceeded.

Crowded field gives user wide choice

Though there are scarcely a dozen and a half vendors of function generators, the field is crowded in relation to the size of the market, which is estimated at less than \$12-million worldwide and less than \$8-million domestically.

So manufacturers are always striving for more features, new features, or simply more performance per dollar in their instruments. For example, Wavetek recently introduced the \$795 Model 132, which includes a wideband noise generator and a pseudo-random sequence generator with a conventional function generator for 200 mHz to 2 MHz. The 132 allows a user to select the amount of noise to be added to a signal's amplitude, or the noise can be used for random frequency modulation. The sequence generator delivers pseudo-random sequences of up to 2^{20} bits with clock rates from 160 Hz to 1.6 MHz.

In its Model 7060, Exact uses two Kelvin-Varley dividers for calibrating start and stop frequencies for its built-in sweeper. In the triggered or tone-burst modes, the start/stop phasing can be adjusted over 360 degrees. The same instrument generates pulses as narrow as 50 ns and provides independent control of pulse width and rep rate.

Feedback's TWG 5000 has 14 simultaneous auxiliary output waveforms in addition to the basic waveforms available from two main amplifiers (which can be isolated and used to amplify external signals). Reference and quadrature states are simultaneously available for all waveforms, and sine-wave phasing can be varied over 360 degrees. Marconi's TF 2120 also provides quadrature and variable-phase outputs.

Lorch-Adret offers BCD control of phase and frequency from an external source in addition to three-digit control of phase and six-digit control

of frequency from built-in rotary switches. The instrument boasts frequency stability of 30 ppm per year.

Other vendors have features that may not be unique in themselves, but may be at a particular price. Development of new features certainly won't stop in 1972. It will continue as long as competition exists in the industry. ■■

Need more information?

The function generators mentioned in this report have, of necessity, received only cursory coverage. Readers may wish to consult the manufacturers listed below for further details. You may write, telephone the individuals listed here or circle the bold face information retrieval number.

- Clarke-Hess, 43 W. 16th St., New York, N.Y., 10011 (212) 255-2940. (Kenneth K. Clarke, President) **CIRCLE 401**
- Datapulse Div. of Systron-Donner, 10150 W. Jefferson Blvd., Culver City, Calif. 90230. (213) 871-0410. (Colin S. Greenaway, Advertising Manager) **CIRCLE 402**
- EMR Div. of Weston Instruments, Box 3041, Sarasota, Fla. 33578. (813) 958-0811. (Richard N. Ridgewell, Product Manager) **CIRCLE 403**
- Esterline Angus, Box 24000, Indianapolis, Ind. 46224. (317) 244-7611. (Paul K. Lawall, Manager, Advertising and Sales Promotion) **CIRCLE 404**
- Exact Electronics, 455 S.E. Second Ave., Hillsboro, Ore. 97123. (503) 648-6661. (L. Wayne Hunter, Vice President, Engineering) **CIRCLE 405**
- Feedback, 438 Springfield Ave., Berkeley Heights, N.J. 07922. (201) 464-5181. (Colin J. Stearman, Applications Engineer) **CIRCLE 406**
- Heath, Benton Harbor, Mich. 49022. (616) YU3-3961. (Earl Brohier, Communications Manager) **CIRCLE 407**
- Hewlett-Packard, P.O. Box 301, Loveland, Colo. 80537. (303) 667-5000. (Jerry Estes, Product Engineer) **CIRCLE 408**
- Interstate Electronics Corp., 707 E. Vermont Ave., Anaheim, Calif. 92803. (714) 722-2811. (Ed Reamer, Chief Engineer; Pat O'Leary, Marketing Services Manager, Hal Stitt, Product Marketing Manager) **CIRCLE 409**
- Krohn-Hite, 580 Massachusetts Ave., Cambridge, Mass. 02139. (617) 491-3211. (E. C. Lutfy, Sales Manager) **CIRCLE 410**
- Lorch-Adret, 105 Cedar Lane, Engelwood, N.J. 07631. (201) 569-8282. (Norman A. Ellen, Marketing Manager) **CIRCLE 411**
- Marconi Instruments, 111 Cedar Lane, Englewood, N.J. 07631. (201) 567-0607. (K. Elkins, Manager) **CIRCLE 412**
- Microdot, 19535 E. Walnut Drive, City of Industry, Calif. 91744. (213) 965-4911. (Russell Burkett, Sales Manager, Test Equipment Products) **CIRCLE 413**
- Spectral Dynamics Corp. of San Diego, P.O. Box 671, San Diego, Calif. 92112. (714) 278-2501. (A. C. Keller, Manager, Technical Services) **CIRCLE 414**
- Wavetek, P.O. Box 651, San Diego, Calif. 92112. (714) 279-2200. (Tom Kurtz, Instrument Sales Manager; William Zongker, Vice President Marketing) **CIRCLE 415**

British engineers read Electronics & Power



... and the world looks on.

ELECTRONICS & POWER is a monthly wide-ranging technological magazine designed to record and report, in an easily readable way, the latest advances in electronic and electrical science and technology and their interplay with related technologies, with industrial practice, and with day-to-day life. The coverage is international with a British bias. The magazine includes feature articles specially written by accepted authorities, industrial and technical news, book reviews, editorial

comment and letters to the editor. **E & P** is read by 64 000 members of the Institution of Electrical Engineers, the recognised body for professional electrical and electronics engineers in Great Britain. It therefore accurately reflects British engineering practice. **E & P** is important to you, because it speaks for British electrical and electronics engineering. Free from commercial pressures, **E & P** speaks with authority and integrity to the professional engineer.

E & P is published monthly by the Institution of Electrical Engineers, and the annual subscription for 1972 is £13.50 (\$32.40). All subscriptions begin on the 1st January and are accepted for one year only. An annual index is given free to subscribers with every December issue of the journal.

Please send your subscription orders, with remittances to:

**The Institution of Electrical Engineers,
PO Box 8, Southgate House, Stevenage,
Herts. SG1 1HQ, England**

A more functional generator for \$495.

The new Krohn-Hite Model 5200 linear sweep/function generator gives you more versatility and performance for your money. If that's a sweeping statement, we stand ready to prove it! Model 5200 generates basic sine, square, triangle and ramp waveforms that you can manipulate with sweeps and triggers from 0.00003Hz to 3MHz. For even more versatility, the new Model 5300 adds an exponential ramp for logarithmic sweeping at only \$695. For fast action, call the Wavemakers at (617) 491-3211, TWX 710-320-6583. Krohn-Hite Corporation, 580 Massachusetts Ave., Cambridge, Mass. 02139.



KH KROHN-HITE CORPORATION

OVERSEAS SALES OFFICES: AUSTRIA, Universal Elektronik Import; AUSTRALIA, Warburton O'Donnell Limited; BELGIUM, C. N. Rood s. a.; DENMARK, SC Metric A/S; ENGLAND, Allied International Limited; FINLAND, INTO O/Y; FRANCE, Antares; GERMANY, Nucletron Vertriebs-GMBH; HOLLAND, C. N. Rood n. v.; INDIA, Bali International Agencies; ISRAEL, R. D. T. Electronics Engineering, Ltd.; ITALY, Vianello S. P. A.; JAPAN, Shosnin Shoji Kaisha, Ltd.; NEW ZEALAND, H. M. Z. Ltd.; SOUTH AFRICA, Protea Physical; SPAIN, Rema Len

Digital testing costs can be cut with this semi-automatic approach. In module quantities from 10 k to 100 k, it costs considerably less than fully automatic systems.

You're deciding how to test digital modules. If the quantity is between 10,000 and 100,000 and there's no fully automatic tester in-house, it's not necessary to invest \$25,000 or more to get one. Test costs will be lower with a semi-automatic comparison tester. And building it should cost less than \$5000.

With the semi-automatic tester, the hardware decides whether the digital modules are working properly. Pass and fail lamps tell the operator if a module is acceptable. And the choice of which tests to run isn't left to chance either. The tests are built into a programmable read-only memory (ROM). The possibility of operator error in any part of the test is almost completely eliminated, and the time required to run the test is only the time needed to insert and remove the module under test and activate a switch.

Module is tested against a good one

The module under test (hereafter called MUT) is compared with a known standard or reference—a good module of the same type (Fig. 1). The inputs for both modules are supplied from truth-table data in the ROM. The verifiers test for output voltage levels. A low-level verifier checks that a ZERO output is below the upper limit specified. Similarly, a high-level circuit verifies a ONE output above a lower limit.

Very little skill is required to operate the tester. The reference module is set in place. Then the operator merely inserts the module to be tested into a connector and turns on the start switch. This resets the ROM to address ZERO and sets the reference module and the module under test to the same initial logic states. If the MUT and reference-module outputs match exactly, the pass lamp lights, and a clock pulse steps the ROM to the next address. Any discrepancy in performance stops the sequence and lights the fail lamp.

The line from the ROM back to the clock AND-gate is programmed to supply a logic ONE for

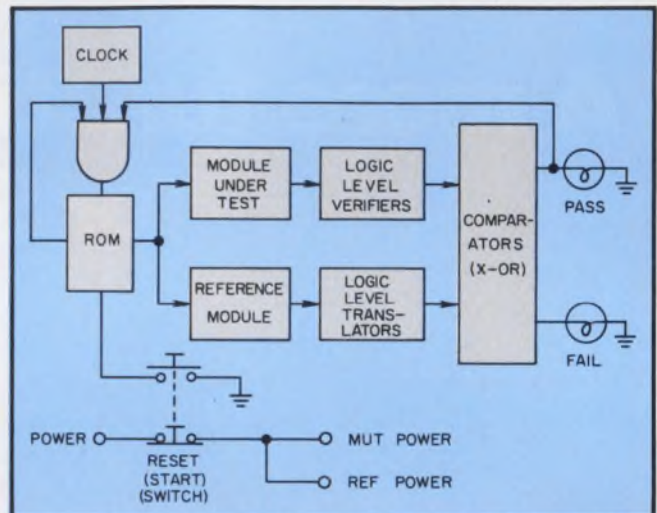

1. The essential elements of a semi-automatic module tester. The test sequence is initiated by closing the reset (or start) switch, enabling the ROM and also applying power simultaneously to the module under test (MUT) and the reference module, so they start in the same initial states.

each meaningful step in the truth table, except the last, in which a ZERO stops the test sequence. This line may also be used to indicate "test in progress" or "end of test."

The following requirements must be considered when designing the tester:

- Maintenance of stable input data.
- Provision for proper interface circuitry between the ROM and the modules (both the reference and the MUT).
- Provision for isolation between the reference-module and MUT inputs.
- Precautions to insure that the thresholds of output logic levels are correct.
- Precautions to insure that the outputs are stable before comparison.

Test program is stored in pROMS

Maintaining stable input data depends primarily on the clock-ROM decoding and interface design. Fig. 2 shows one approach. Here, four read-only memories—Harris 8256s—supply the

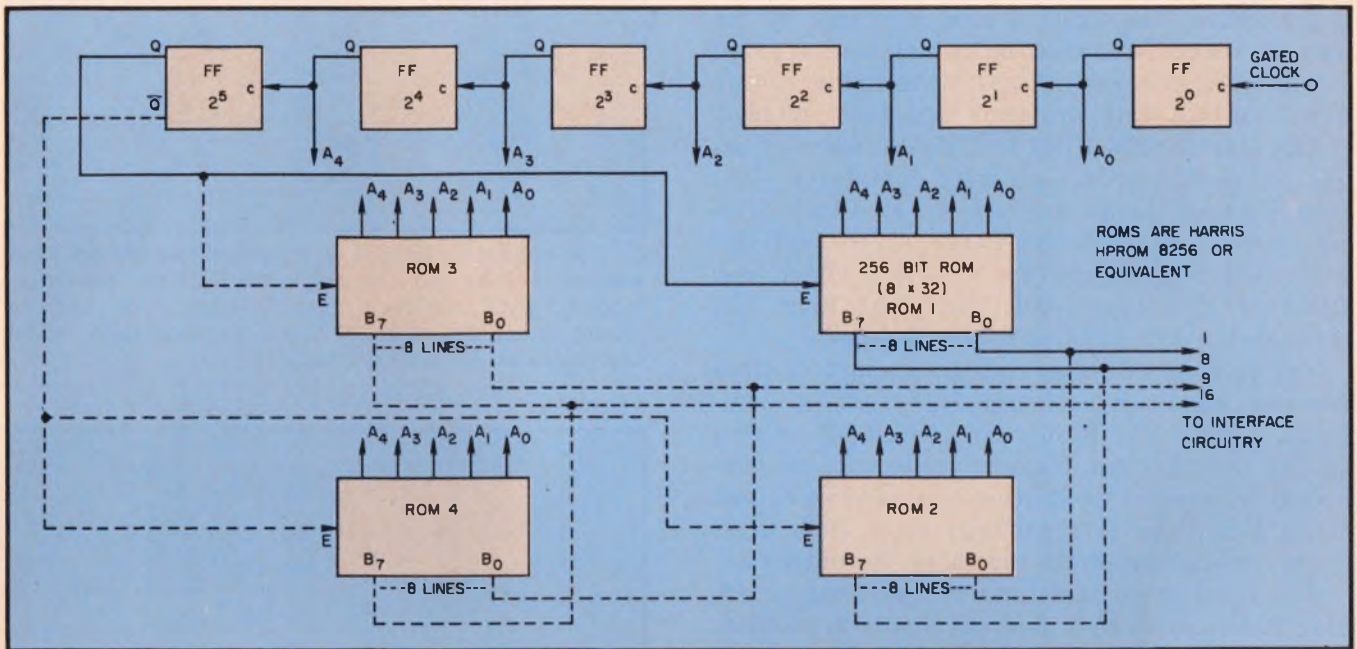

2. More ROMs increase test capacity. Also shown is a flip-flop address counter, stepped by clock pulses, which

generates the sequence. To stop on fail, the clock is applied to the counter through an AND gate (not shown).

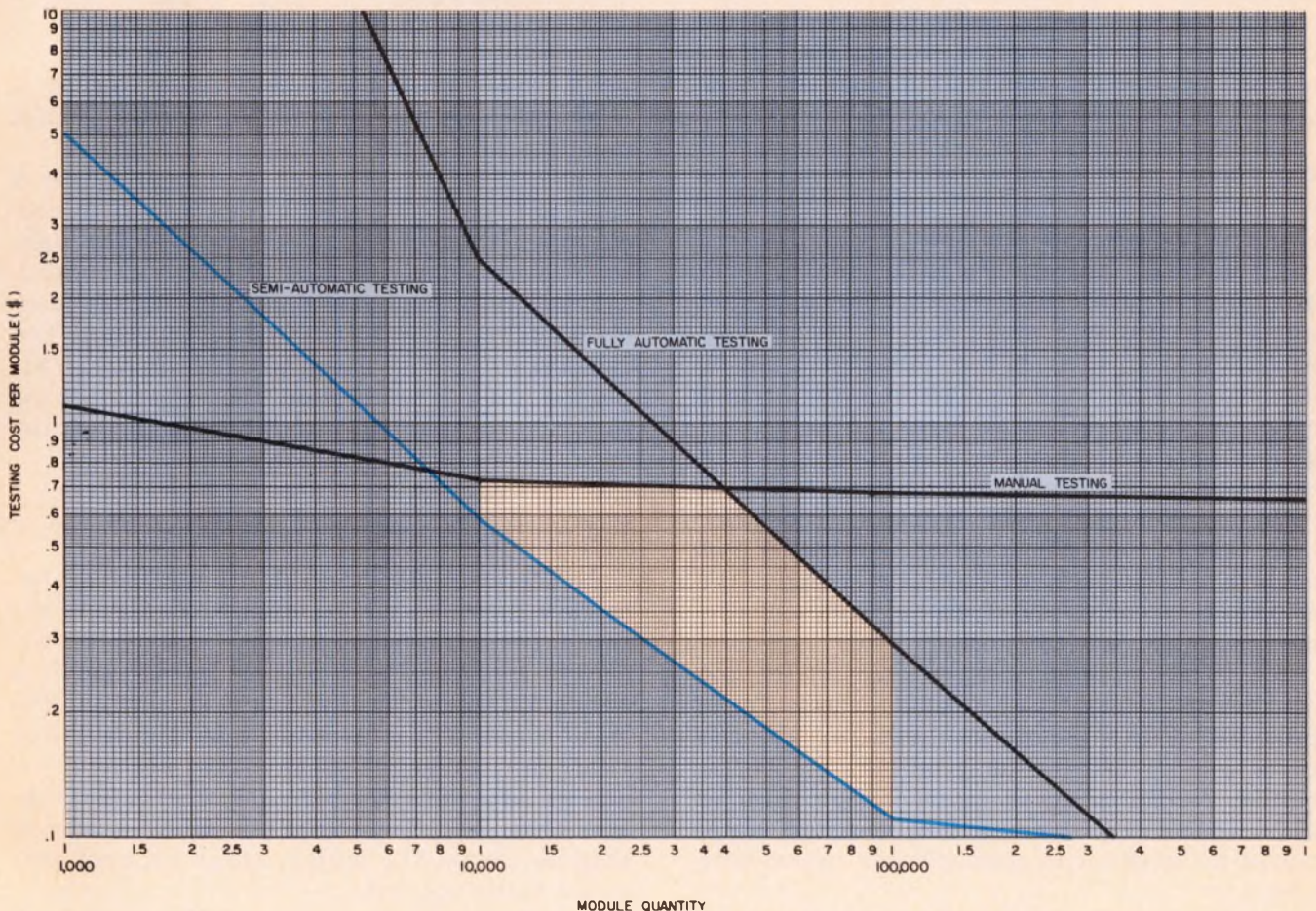

Unit test cost varies with digital-module quantity for the three approaches shown: manual, semi-automatic and

fully automatic. Semi-automatic is lower in cost for module quantities between 10,000 and 100,000.

test program and data. Only a few ROMs are used in the tester, and each memory unit must be programmed to store the special data for testing modules. The 8256 is programmable by the user, so that off-the-shelf units may be purchased at relatively low cost. A special masking charge and long-lead-time problems are thus avoided.

The Harris 8256 ROM is a 256-bit memory organized as 32 words, each word containing eight bits. Each of the 32 words is selected by a five-bit address input to the ROM, A_0 through A_4 , generated sequentially by the clock. With one ROM of this type, data for eight lines (B_0 through B_7) are supplied to the modules.

The number of tests, and the amount of lines per test, can both be increased by adding additional ROMs. The 8256 has a wired-OR output, so the output lines from a group can be connected in parallel to increase the number of test steps. When the E (enabling) input to a ROM is energized, that ROM furnishes the output.

The number of data lines is increased by adding ROMs, with their address inputs in parallel, and enabling them simultaneously. In Fig. 2, ROM pairs 1, 3 and 2, 4 are separately paralleled to produce 16 output lines. The outputs of ROM pairs 1, 2 and 3, 4 are each paralleled to produce 64 test positions. The number of addresses is increased to 64 by enabling ROMs 1 and 3 from the counter "Q" output, and ROMs 2 and 4 from its complement. The number of steps may be extended even further if more flip-flops and suitable gates are used.

The designer should select the type, number and arrangement of ROMs that best meets his requirements. Programmable ROMs with more than 256 bits are also available.

An interface between the ROM and the modules must be provided if the logic levels are not compatible. But even when they are, there must be isolation, or some failure modes will not be detected. For example, a defect in a MUT might cause the logic level at an input pin to stick at ZERO. This will cause the corresponding pin on the reference module also to hold at ZERO, if both module inputs are wired directly in parallel. Both modules would then operate incorrectly, but since they have the same output, the exclusive-OR comparators would not detect a fault, and the module would pass this test.

An isolation circuit between the ROMs and modules eliminates this possibility. Isolation is provided by two transistors (Fig. 3). The collector pull-up resistors may or may not be required, depending on the type of logic used in the modules. The input pull-up resistor is required for ROMs with open-collector (wired-OR) output.

Level verifiers are required at each MUT output where logic threshold levels must be checked.

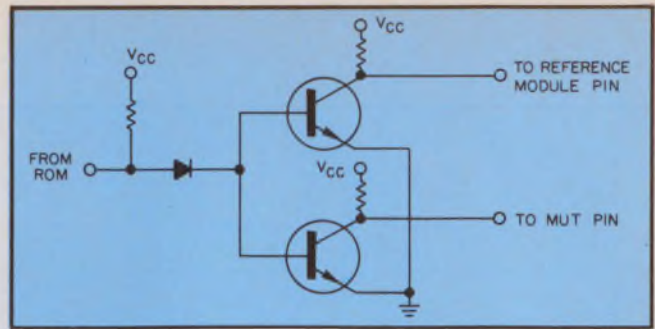

3. Two transistors provide an interface between the ROM and the modules and also isolate the MUT and reference-module inputs from each other. A failure in one module cannot affect the other. Without such isolation, some failure modes will not be detected.

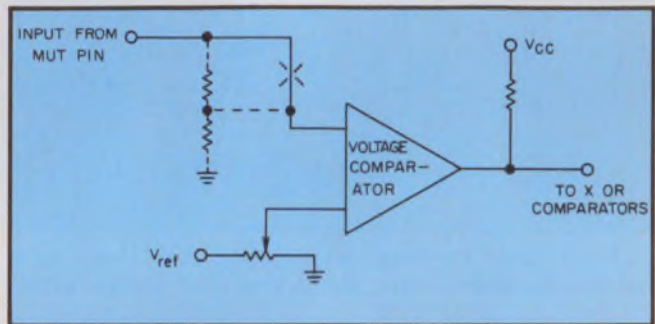

4. A voltage comparator is used to verify logic levels. Its threshold level is set by the adjustable potentiometer on the reference side.

A high-speed IC voltage comparator (Fig. 4) is a good verifier since its output is digital, thus requiring no further conditioning.

The output from the MUT is compared with a reference voltage adjusted to the desired threshold level. To modify a low-level verifier for high-level detection, the comparator inputs are scaled.

Level translators condition the reference module digital outputs to the X-OR comparator. The comparator of Fig. 4 can also be used for this purpose. In this application, the reference input threshold is adjusted to the midpoint of the logic's high and low levels.

Test comparison allows settling time

Another consideration: A comparison of the modules must be delayed, after a clock pulse advances the test sequence, to permit the test voltages to stabilize. Delay may be introduced by a simple RC time constant inserted between the X-OR comparator output and a pass-fail flip-flop (Fig. 5a). Alternately, two one-shot multivibrators generate a delayed pulse to gate the flip-flop (Fig. 5b). This circuit is more expensive than the simple RC, but its greater accuracy permits a faster sequence.

If a MUT fails the test, how do you find out where the trouble is? The semi-automatic tester

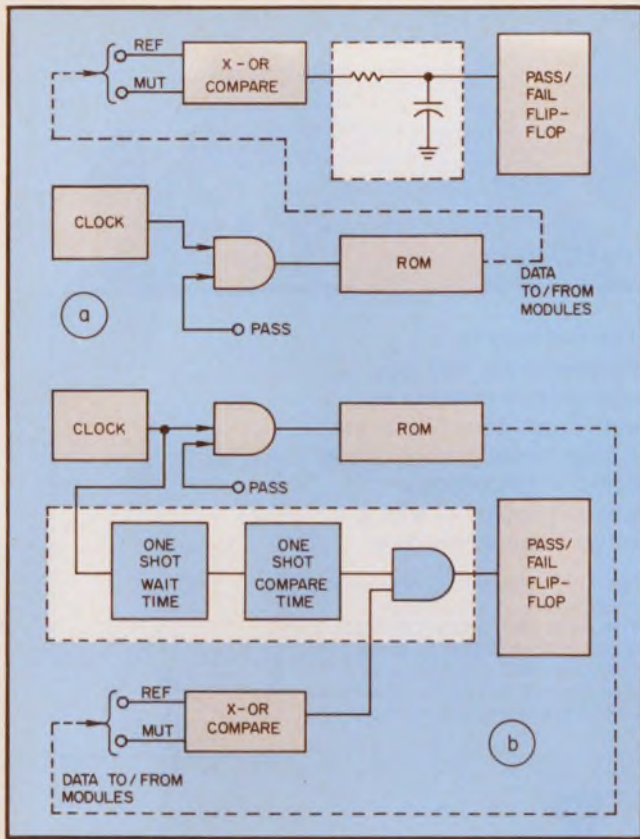

5. A simple RC circuit delays a pass/fail judgment after a test-sequence step until the voltages settle (a). The delay is generated by two one-shots (b).

has features that facilitate trouble shooting (Fig. 6). The features are:

1. Address display and stop controls. The display shows the failed-test-step address. Setting the switches returns the test sequence to this address.
2. A set of lamps to indicate logic levels on the MUT and reference modules.
3. A second reference module, placed on the front panel, and wired in parallel with the internal reference. This permits comparison of pin voltages with the MUT.
4. A pair of DIP IC sockets connected to a comparator, a display and the clock gate. This permits fault isolation on the MUT to be performed down to the chip level.

The semi-automatic tester can be further expanded to handle more than one module type by adding a switching matrix. This permits any fixture pin to be assigned to an input or an output and allows selection of the ROMs used to test each module type. A ROM can even be used to control the pin-selection matrix. This further increases the versatility of the semi-automatic test approach.

Finally, self-test capability is available at no cost. Simply plug the external reference module into the MUT connector and run it through the test sequence. ■■

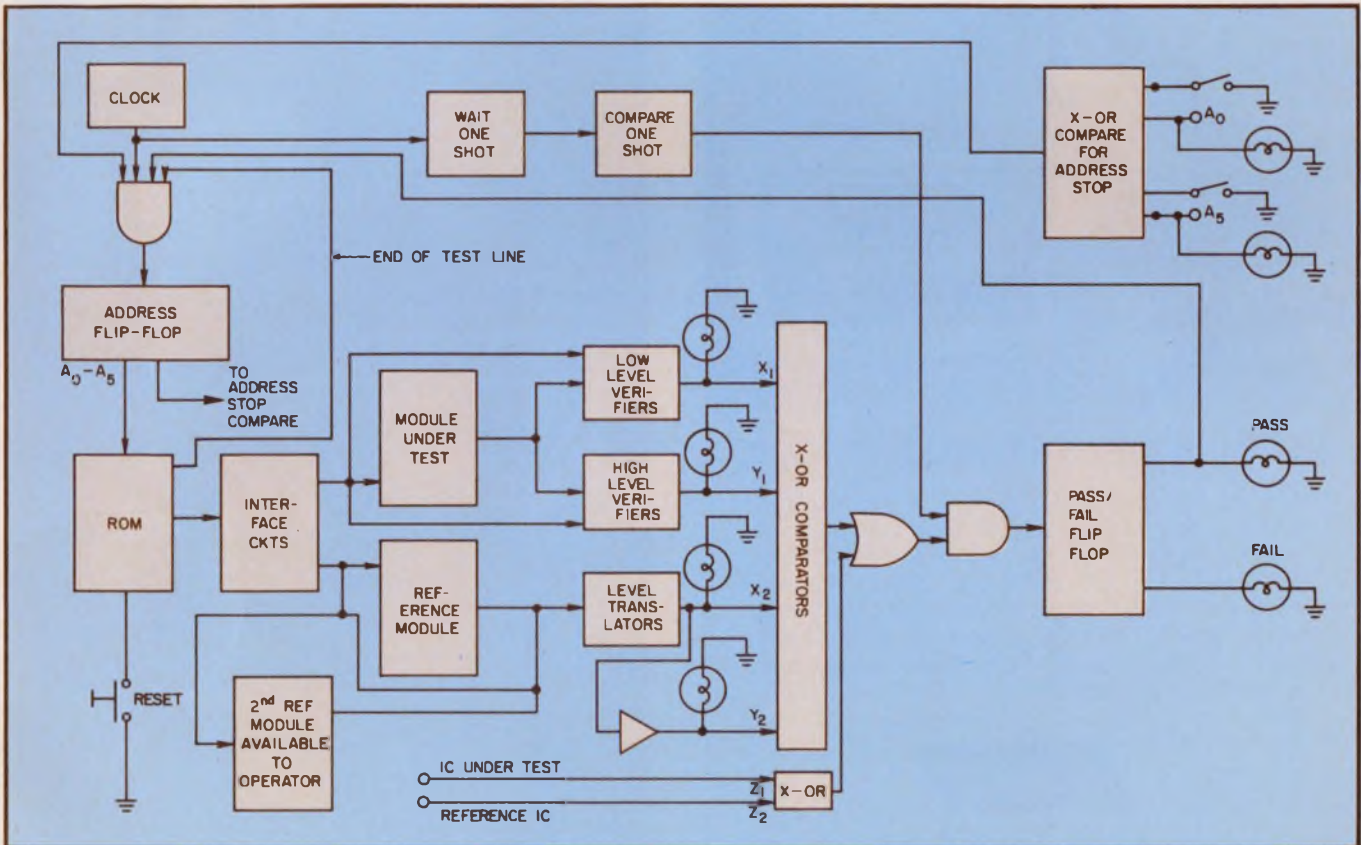

6. To aid troubleshooting, these features are included in the semi-automatic tester: lamps to indicate output

logic states; an address display and stop circuit; a front-panel reference module and an IC test comparator.



designing
Point-of-Sale?

consider DigiWand!™

Nortronics' new DigiWand is a pencil-sized, azimuth-independent magnetic reader pen designed to accurately read ABA and IATA encoding formats for Point-of-Sale (credit card) systems. Its circular gap configuration sharply reduces error rates by permitting the operator to tilt the pen 20° in any direction. Just another example of Nortronics innovation translated into product reality. Write today for detailed information.



'world's leader in magnetic heads'

NORTRONICS
COMPANY, INC.

8101 Tenth Avenue North
Minneapolis, Minnesota 55427 • (612) 545-0401

INFORMATION RETRIEVAL NUMBER 29

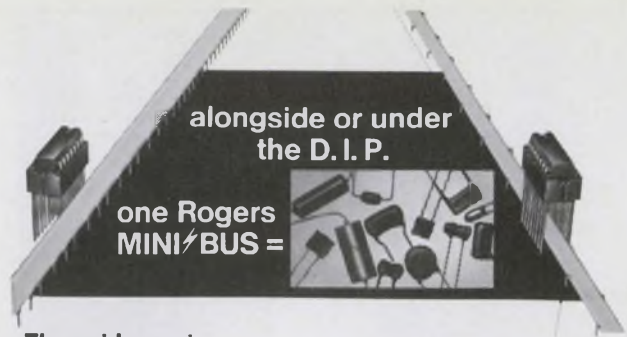

The evidence is accumulating. You may eliminate *all* discrete bypass capacitors — and get a lower-noise printed circuit board at frequencies where it counts — with a single Rogers Mini/Bus.

DELIVERY: Standard configurations are available on short notice.
Telephone EAST: (203) 774-9605;
WEST: (602) 963-4584 to know where we stand today on your requirements. Ask for our Mini/Bus brochure, showing standard parts.

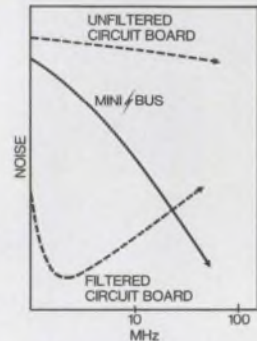

Rogers Corporation Rogers, Conn. 06263 (203) 774-9605

INFORMATION RETRIEVAL NUMBER 31



Three Output Power Supply

For Op Amps & Companion Logic

Outputs are ± 15 VDC (tracking) @ 50 ma and 5 VDC @ 250 ma. All outputs have regulation of $\pm 0.1\%$, ripple of 1.0 mv, and are short circuit protected. Only 3.5" x 2.3" x 1.0". Mounts directly on a PC board. Order Model 5E25D-D15E05. Price: \$88.00 (For ± 12 and 5 VDC, Model 5E25D-D12E05. Same price. Other voltage and current ratings also available.) Shipment: Three days.

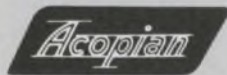

Acopian Corp., Easton, Pa. 18042
Telephone: (215) 258-5441

INFORMATION RETRIEVAL NUMBER 30

Image Intensifiers,
by Electro-Optics.
Large variety.
UV — visible — near IR.
Up to 75 mm.
Compact. Thin.
Light weight.
Small power requirement.

The Bendix Corporation,
Electro-Optics Division
Galileo Park,
Sturbridge, MA 01518
(617) 347-9191

Electro-Optics makes light work.



INFORMATION RETRIEVAL NUMBER 32

ELECTRONIC DESIGN 7, April 1, 1972



Cambion® knows a lot about thermoelectricity. So will you

after you read Cambion's new free Thermoelectric Handbook.

It's only natural that the leading producer of TE devices would produce a definitive text on the subject. Complete with background history of the theory and development of the Peltier and Seebeck Effects, their applications in today's worlds of electronics, medicine and research, this new Handbook is a first. Pocket-sized but crammed with information. Get your free copy now and catch up on this little known technique: thermoelectricity. Cambridge Thermionic Corporation, 445ED Concord Ave., Cambridge, Mass. 02138.

Standardize on

CAMBION®

The guaranteed Thermoelectrics

INFORMATION RETRIEVAL NUMBER 33



PENNTUBE[†] II-SST
(Super Shrinkable Teflon*)

1²/₃:1 SHRINKDOWN

Now, more applications including encapsulating many heat sensitive materials. Insulates, strain relieves, moisture proofs, protects. Fewer sizes need be stocked. Chemically inert with excellent electrical and mechanical properties. Will not burn or support flame. Excellent for: chafe guards—electrical terminal and splice insulation—covering over plastic, metal and wood—jacketing for cable harness assemblies, etc.

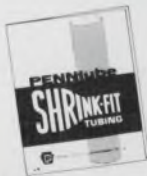

FREE! SEND FOR FOLDER.

PENNTube Plastics Co., Inc. /  **SUBSIDIARY OF DIXON INDUSTRIES**

Madison Ave. & Holley St., Clifton Heights, Pa. 19018 • (215) 622-2300



Export Div. • 5710 Empire State Bldg., N.Y. 10001
*Du Pont Reg. TM † Penntube Plastics Co. Reg. TM

INFORMATION RETRIEVAL NUMBER 34

ELECTRONIC DESIGN 7, April 1, 1972

25,000 chips per hour...mean

**LARGEST INVENTORY
FASTEST DELIVERY
LOWEST COST
FINEST QUALITY**

...from **USCC/Centralab**

Yes, it's true! Because demand for ceramic chip capacitors in hybrid microelectronics will more than double within the next two years, USCC's production capability on popular sizes will increase to 25,000 per hour by mid-1972. That's over 50 million annually, with a demonstrated failure rate level of only .001%/1000 hours.

New automation techniques and materials cost reduction mean to you as a customer: fastest delivery and lowest prices on the finest quality ceramic chip capacitor on the market.



For your free copy of our Ceramic Capacitor Catalog and Applications Manual on how to use chip capacitors more advantageously, write: USCC/Centralab, 2151 N. Lincoln Street, Burbank, California 91504 or circle the information retrieval number below.



U.S. CAPACITOR CORPORATION



CENTRALAB

Electronics Division • GLOBE-UNION INC.

INFORMATION RETRIEVAL NUMBER 36

Use hybrid voltage regulators,

now available from several sources, to cut power-supply design and test times and reduce inventory cost.

There's another choice now in power-supply design. You're no longer restricted to a supply designed by others, nor to one you have to design from scratch. You can buy the heart of the supply—the voltage regulator—in a hybrid form that offers much more power output than monolithic regulators. Then you can design the rest of the supply and the heat sink, if necessary, using a straightforward procedure.

Hybrid regulators are now available in many models with outputs to 28 V dc and to 5 A. Dissipation at 25 C can reach 85 W—a far cry from the watt or so available in monolithic regulators.

Though there are differences in circuitry, specifications and packaging among regulators available from companies like Lambda, Melville, N.Y.; Micropac, Garland, Tex.; RCA, Somerville, N.J.; and Tecnetics, Boulder, Colo.; the approaches to designing with them are basically similar.

A typical unit designed for unregulated-dc input, Fig. 1, has a power and a control section. The power section contains the series-regulator power transistor, a current-sensing resistor and a temperature-sensing element that shuts the regulator down when the safe operating temperature limit is exceeded.

The control section contains a monolithic voltage regulator, thick-film resistors, chip capacitors and, in some models, a tantalum output capacitor.

The perfect regulator

A perfect regulator would deliver a constant output voltage—but none is perfect. The output changes within specified limits as a result of dynamic factors—line voltage or load current—and temperature. Dynamic regulation, which some specs call line and load effects, can be held to acceptable levels in most cases without exotic circuitry. But it's important to remember that dynamic regulation is often given for constant

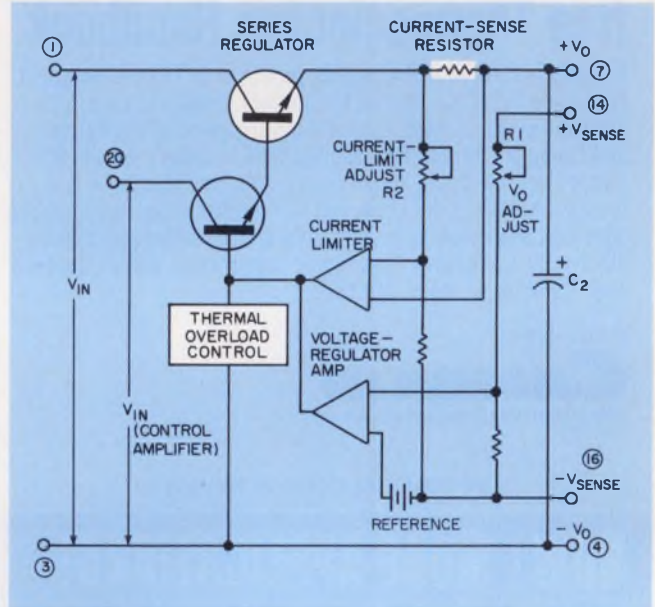

1. The basic hybrid regulator, designed for raw-dc input, has a power section (in white) and a control section. Circled numbers are package pin numbers.

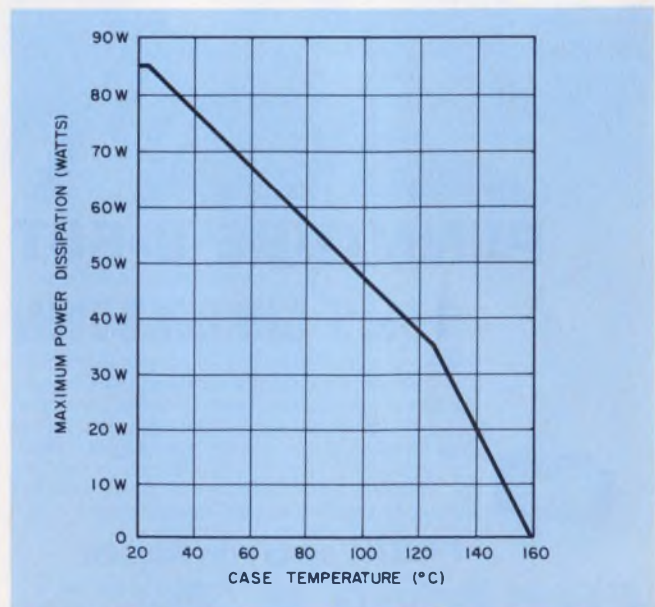

2. The maximum allowable power dissipation of the hybrid regulator goes down as a case temperature goes up, but the case can be cooled to boost dissipation.

Joshua Hauser, Director of Engineering, Lambda Electronics Corp., Melville, N.Y. 11746.

junction temperature. It's then the system designer's responsibility to consider over-all regulation and to calculate the effects of thermal changes.

However, the regulator designer can reduce thermal effects by selecting components with offsetting temperature coefficients and by reducing the temperature variation experienced by temperature-sensitive control components on a common substrate, thermally isolated from the power section. Then he can offer a regulation figure that includes dynamic and thermal factors.

That simplifies the selection and design procedures for the system designer. Any design requires, first, a statement of the performance requirements: output voltage and current, regulation, ambient-temperature range, input-voltage range and permissible output ripple. Once these requirements are defined, an engineer can select the model to be used, determine the proper heat-sink needs and select any external components that may be necessary.

Example 1: Fixed dc input

Let's assume we need a power supply for use in a vehicle with a 12-V battery. The principal specifications are:

Input voltage	10 to 14 V dc
Output voltage	5 V $\pm 2\%$ (not adjustable)
Output current	0 to 5 A
Ambient temperature	0 to 55 C
Load regulation	0.2%
Line regulation	0.1%

We start by reviewing specifications like those in Tables 1 and 2 to see that our requirements can be met by available regulators. The input range, 10 to 14 V, falls within the allowable range of 9.6 to 40 V. The input-to-output differential, 5 to 9 V (10-5 to 14-5), is within the limits of 4.6 to 37.5 V. The output voltage, 5 V $\pm 2\%$, falls between 2.5 and 28 V. And the output current of 5 A does not exceed the maximum rating of the line. So we can start.

To get 5 V at 5 A without external transistors,

we can choose Model 1 or 3. Since there's no requirement for output-voltage adjustment or remote sensing, and because our 2% tolerance requirement can be accommodated by the 1% tolerance of the 4-pin packages, we can choose Model 1.

The power dissipated in the regulator is the product of the maximum load current and the voltage differential between maximum input and minimum output. Thus,

$$P_{\max} = 5 (14-5) = 45 \text{ W.}$$

A heat sink must be selected to allow the device to dissipate 45 W safely in an ambient of 55 C. The graph of Fig. 2 shows that the maximum allowable case temperature for 45-W dissipation is 105 C. So the required thermal resistance of the heat sink is

$$\theta_{\text{HS}} = (105-55)/45 = 1.1^\circ\text{C/W.}$$

That figure calls for a rather substantial heat sink if only free-air convection and radiation are used. The size can be reduced if we use forced-air cooling.

This selection of a heat sink is based on regulator operation at maximum rating in a non-fault mode. As a safety measure, we should check the dissipation during a short circuit at the out-

Table 1. Output ratings of representative hybrid regulators.

	I_o (A)		
	Model	V_o (V) (at 40 C)	
Fixed ($\pm 1\%$) output	1	5.0	5.0
4-pin package	2	6.0	5.0
Adjustable ($\pm 5\%$) output	3	5.0	5.0
4-pin package	4	6.0	5.0
Wide-range input,	5	5.0	3.3
adjustable output	6	6.0	3.2
14-pin package			

Table 2. Key specifications for a series of hybrid regulators

Parameter	Symbol	Min.	Max.	Units
Input voltage	V_{in}	9.6	40.0	V
Output voltage ¹	V_o	2.5	28.0	V
Input-output differential ^{2,3}	$V_{in}-V_o$	4.6	37.5	V
Input-output differential ^{3,4}	$V_{in}-V_o$	2.5	37.5	V
Output current ¹	I_o	0	5.0	A
Standby current	I_b		10	mA
Power dissipation ⁵	P_d		85	W
Power dissipation ⁶	P_d		9.0	W
Thermal resistance junction—case 1	θ_{ca}		2.0	°C/W
Thermal resistance junction—free air	θ_{ra}		15.0	°C/W
Storage temperature ⁷	T_b	-55	+125	°C
Line regulation ⁸			0.01	% V_{in}
Load regulation ⁹			0.2	%
Programming resistance			1000 ¹⁰	Ω / V
Programming voltage			1/1	V/V
Temperature coefficient	TC		0.007	% / °C
Ripple attenuation ¹¹			60	dB

Notes:

1. Varies with model.
2. Single dc-input voltage.
3. Minimum input-output differential based on $T = 25$ C.
4. For separate dc-input voltages for power circuit (Pin 1) and control circuit (Pin 20), $V_{in\ min} = 9.5$ V at Pin 20.
5. Heat sink at 25 C.
6. Free air at 25 C.
7. Maximum storage temperature limited by tantalum capacitor.
8. I_o constant from $V_{in\ min}$ to $V_{in\ max}$.
9. V_{in} constant from no load to full load.
10. Nominal
11. Ripple attenuation (at $V_{in\ min}$, $I_o\ max$) is 54 dB minimum for 20-V, 24-V and 28-V models, 60 dB for others.

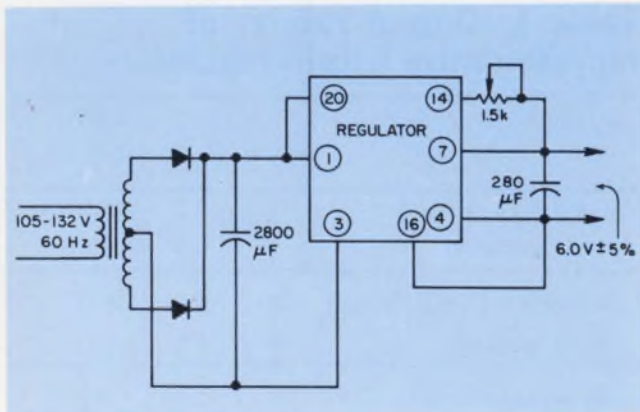

3. A simple approach to a design for wide-range ac input may not be as effective as the approach in Fig. 5.

put. The manufacturer's literature shows that the regulator's foldback current limiting cuts the maximum current during a short circuit to 60% of the full-load rating. In this case we have 60% of 5 A, or 3 A. The short-circuit power is

$$P_{sc} = 14 \text{ V} \times 3 \text{ A} = 42 \text{ W.}$$

This is less than the maximum power under normal operating conditions, so the regulator will withstand a short circuit.

If the short-circuit power were less than 40 W, the thermal-shutdown circuit could protect the regulator by turning it off before any damage is done. In this case, there is a delay from the time the short is removed to the time the output voltage returns to within the regulation band. This is because the power section must cool down before the thermal-shutdown circuit allows the regulator to return to operation.

The next step involves checking the regulation. In this example, the requirement for load regulation is 0.2%—which is that specified for the entire line, and the requirement for line regulation is 0.1%. Table 2 shows that the line regulation is 0.01% per volt of line change. The maximum line change the regulator experiences is 4 V, so the maximum line regulation is 0.04%—which is well within the 0.1% requirement.

Thus, the regulator selected for this application requires no external components and the design is complete.

Example 2: Wide-range ac input

In this example, the input is variable and we must specify the proper transformer secondary voltages, hybrid regulator and heat sink. The key requirements are:

Input voltage	to be specified based on line variation of 105-132 V at 60 Hz
Output voltage	6 V dc $\pm 5\%$ (adjustable)
Output current	0 to 2.8 A
Ambient temperature	0 to 40 C
Load regulation	0.2%
Line regulation	0.2%
Output ripple	5 mV pk-pk max.

The transformer specifications depend, in part, on the specific circuit we use external to the regulator. Let's first consider the design in Fig. 3.

According to the manufacturer's specifications, the minimum input voltage required at Pin 20, the bias input to the voltage-control amplifier, is 9.6 V. However, the spec also requires a minimum input-output differential of 4.6 V. Thus,

$$V_{in} = (1.05 \times 6 \text{ V}) + 4.6 \text{ V}$$

or 10.9 V. This is the minimum instantaneous voltage on the input filter capacitor—at low line

and full load. It's not just the minimum dc value.

To determine the minimum filter capacitance, one must consider the output-ripple requirement of 5 mV pk-pk. Since the ripple attenuation of the regulator is 60 dB (or 1000), according to Table 2, the maximum ripple that can appear on the capacitor is 5 V pk-pk. At 60 Hz, this requires a filter capacitor of about 1000 $\mu\text{F}/\text{A}$ (a good rule-of-thumb approximation) or, in this case, 2800 μF .

The exact ripple is a function of the transformer source impedance, the capacitor, and the load current. If the transformer-capacitor combination is designed to yield a maximum of 5 V pk-pk ripple at high line, the ripple at low line will be somewhat less, usually about 4.5 V. The average voltage on the capacitor at low line is the sum of the V_{in} (min) requirement and half the peak-to-peak ripple.

$$V_{in} \text{ (average)} = 10.9 + 2.25 = 13.15 \text{ V dc}$$

The maximum power dissipated depends on the input voltage at high line, which is

$$V_{in} \text{ (average)} = (132/105) \times 1.1 \times 13.5 = 18.2 \text{ V dc}$$

where the 1.1 factor accounts for the change in rectification efficiency that occurs during the transition from low (105 V) to high line (132 V). This is an approximate figure that must be calculated during the transformer design.

The dissipation of the regulator is

$$P = (18.2 - 5.7) \text{ V} \times 2.8 \text{ A} = 35.5 \text{ W}$$

The 5.7-V value is the output when it's adjusted to 5% below the nominal 6-V level. This low-output value is required for calculating the maximum dissipation.

If we go back to Fig. 2, we find that the maximum allowable case temperature with a dissipation of 35.5 W is 125 C. The thermal resistance of the heat sink is

$$\theta_{HS} = (125 - 40) / 35.5 = 2.4^\circ\text{C}/\text{W}.$$

According to Fig. 4, a 5 \times 5 \times 3/32-inch horizontal heat sink would dissipate about 28 W. Mounting the heat sink vertically and painting it should increase dissipation to about 35 W.

We can now select the regulator. Since we want external programming, we need a 14-pin model, so we're limited to Model 4 or 6. Both have output-current ratings that exceed those required in this design.

It might appear that Model 4, designed for 5 A, would give a greater safety margin than Model 6, which is rated at only 3.2 A. But a calculation of dissipation during a short circuit shows that Model 6 is the better choice. Recalling that the short-circuit current is 60% of nominal, we find, for Model 4,

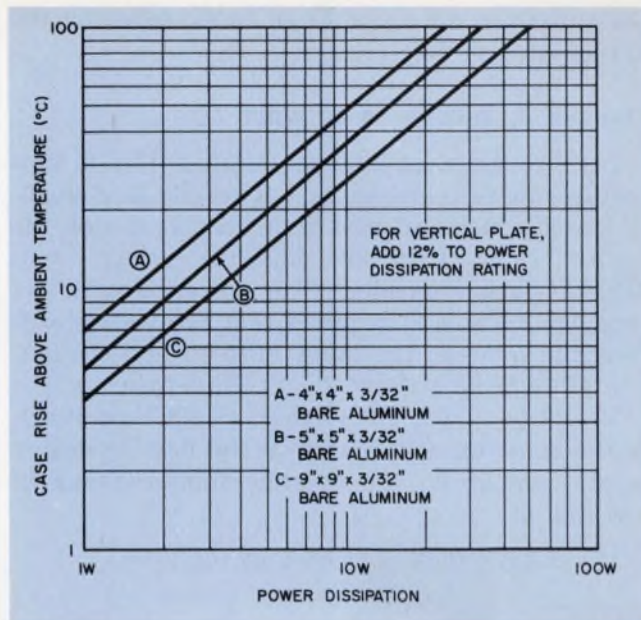

4. Typical heat-sink data for a horizontal plate. Another 12% can be added to the power-dissipation rating for a vertical plate and an additional 10% can be added if surfaces are painted.

$$P_{sc} = 18.2 \times (0.6 \times 5) = 54.6 \text{ W}.$$

For Model 6, the short-circuit power is

$$P_{sc} = 18.2 \times (0.6 \times 3.2) = 35 \text{ W}.$$

which is equal to its normal dissipation.

Now we must check the regulation. The required load regulation is 0.2%, which is that specified for all the models. A line regulation of 0.2% is required. The change in voltage across the filter capacitor when the input line is varied from 105 to 132 V is

$$\Delta V = 18.2 - 13.15 = 5.05 \text{ V}.$$

The line regulation for the regulator series is specified as 0.1%/V of line change so

$$\Delta V_o = 0.01\% / \text{V} \times 5.05 \text{ V} = 0.05\%,$$

which is well within the regulation requirement. In this case the transformer must provide 51 W (18.2 V at 2.8 A) at high line.

We must now determine the values needed for the voltage control and for the output capacitor. The voltage adjustment requires a 1.5-k Ω pot (specified by the hybrid manufacturer), which should be selected for high stability and low temperature coefficient because any variation results in an output-voltage change.

The output capacitor should be at least 100 $\mu\text{F}/\text{A}$, according to the hybrid manufacturer, or 280 μF . The part should be a high-grade aluminum or tantalum electrolytic with low equivalent series resistance. The voltage rating of the capacitor should be such that if an external sense lead opens and the output loses regulation,

the capacitor rating will not be exceeded by the unregulated output voltage.

Example 3: Wide-range ac input

Let's consider an alternate design, Fig. 5, that requires more components, but results in a smaller transformer and heat sink. In this design the control input (Pin 20) and the power input (Pin 1) are separated. The power circuit, according to Table 2, requires that the voltage differential between the input (Pin 1) and the output (Pin 7) be at least 2.5 V. Therefore,

$V_{in} (1.05 \times 6.0 \text{ V}) + 2.5 \text{ V} = 8.8 \text{ V}$ at Pin 1.
If the same capacitor used in the first ac design is still employed, the average input voltage at low line is

$$V_{in} = 8.8 + 2.25 = 11.05 \text{ V at } 105 \text{ V line.}$$

Similarly,

$$V_{in} = 1.38 \times 11.05 = 15.2 \text{ V at } 132 \text{ V line.}$$

The maximum power dissipation is then

$$P = (15.2 - 5.7) \times 2.8 \text{ A} = 26.6 \text{ W,}$$

a reduction of 25%. The transformer output is reduced to 42.5 W (15.2 V at 2.8 A), a saving of 17%.

Now consider the control circuit. The minimum differential between Pin 20 and Pin 7 (which has 6 V \pm 5%) is 4.6 V. Thus, Pin 20 must never see less than 10.9 V. In Fig. 5, the maximum voltage of the peak-detector capacitor is twice the highest voltage on the main filter capacitor. Thus, at low line, full load, when the peak voltage on the main capacitor is 13.3 V, the voltage on the peak-detector capacitor is approximately 26.6 V. This is more than adequate biasing for the control input. A resistor is required between the peak-detector capacitor and the control-circuit input. Let's now consider requirements for this resistor and the peak-detector capacitor.

The ripple attenuation of the regulator is defined as the ratio of the ripple at the control-circuit input to that at the output. Thus, to maintain no more than 5 mV at the output, the maximum ripple on the peak-detector capacitor must be 5 V pk-pk. The peak-detector capacitor is shown in a half-wave configuration to minimize the number of components. In a half-wave, 60-Hz system, the conduction time of the peak-detector rectifier is approximately 3 ms. The discharge time of the capacitor is therefore 13.6 ms—the line period, 16.6 ms, minus 3 ms. The maximum input standby current to Pin 20 is specified as 10 mA. Therefore, the minimum value of the capacitor is the product of the standby current and the discharge time divided by the maximum ripple voltage.

$$C_{min} = 10 \text{ mA} \times (13.6 \text{ ms}/5 \text{ V}) = 27.2 \mu\text{F.}$$

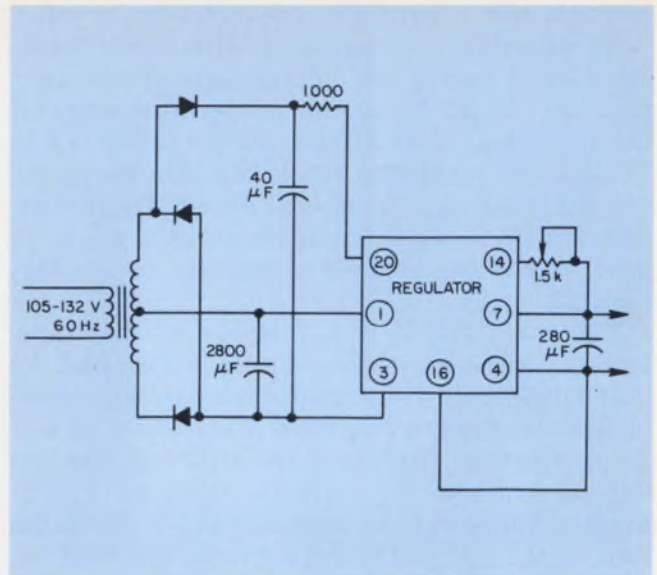

5. A more complex design for wide-range ac input calls for a smaller transformer and heat sink.

To allow for capacitor tolerances and to provide some margin above the specified requirements, we should use approximately 40 μF .

Though the voltage-doubler configuration provides a high-voltage source for the input-control regulator biasing, the amplitude of the voltage change for line variations seen by the amplifier is also greater. In this case the voltage at high line, full load is approximately $2 \times (15.2 + 2.5 \text{ V}) = 35.4 \text{ V}$. This is close to the maximum input of 40 V and limits this circuit to applications where the output voltage is less than 7 or 8 V, depending on the range of the input line swing. The maximum voltage appears when the input is maximum and the load is removed.

The change sensed by the control input in this case is $8.8 \text{ V} = (35.4 - 26.6)$, which results in a line regulation of 0.09%. That's still within the requirements.

The other component that must be considered is the resistor that limits the current into the control during turn-off. During this time, the regulator tries to provide load current from the peak-detector circuit. The control circuit cannot carry much current for even a very short time. It will be destroyed if the current is not limited to 150 mA.

When the power supply is turned off, both the peak-detector and main capacitors start to discharge. When the main capacitor discharges below the voltage required at Pin 1 to maintain the output, the load current is drawn from the peak-detector circuit.

1. Assume that the power supply is operating at high line, full load and is turned off.

2. Calculate the time required for the main capacitor to discharge to the minimum voltage

required at Pin 1.

3. Calculate the value to which the voltage on the peak-detector capacitor has decayed in the time found in Step 2.

4. The peak current in the control circuit is controlled by the external limiting resistor. The voltage that appears across the resistor is the voltage on the peak-detector capacitor at the end of the time calculated in Step 2.

In this case, it is assumed that the following voltages are present at turnoff:

Peak-Detector Cap: 36 V
Main Cap: 17.7 V

When the input capacitor discharges to 8.5 V = (6.0 + 2.5), the peak detector starts to supply the current. The time required for this to happen is

$$t = CV/I$$
$$t = 2800 \mu\text{F} (17.7 - 8.5 \text{ V})/28 \text{ A} = 9.2 \text{ ms.}$$

During this time the voltage change on the peak-detector capacitor is

$$V = It/C$$
$$= 10 \text{ mA} \times 9.2 \text{ ms}/40 \mu\text{F} = 2.3 \text{ V.}$$

The voltage remaining on the peak-detector capacitor is 35.7 V = (38.0-2.3). The voltage that can appear across the limiting resistor is 35.7 V. To limit the current to 150 mA, the resistor must be at least 240 ohms.

This sets the minimum value for this resistor. There is also a constraint on the maximum value. In normal operation, the bias requirement for the control section is 10 mA, which results in a voltage drop across the current-limiting resistor. The resistor must be selected so that under conditions of low line, maximum rated output voltage, and full load, there is enough voltage at Pin 20 for proper operation. In this case the requirement at Pin 20 is 10.9 V.

Minimum instantaneous voltage on the peak-detector capacitor is the low-line peak of 26.6 V minus the peak-to-peak ripple of the capacitor. With 40 μF , the peak-to-peak ripple is roughly 3.5 V. Therefore, the minimum instantaneous voltage is (26.6 - 3.5) or 23.1 V. Hence, the maximum value of the limiting resistance is

$$R_{\text{max}} = (23.1 - 10.9)/10 \text{ mA} = 1.2 \text{ k}\Omega.$$

The value selected for this resistor would then be somewhere between 240 and 1200 ohms; 1000 ohms is a reasonable choice.

The criteria for selection of this voltage adjustment control and the output capacitor are the same as in the first solution to this problem.

This configuration then provides a means for reducing the transformer size by about 15 to 20% and the heat sink by 25% for the price of three extra components. ■■

The Heath/Schlumberger EU-70A gives you complete dual trace capability, X-Y display, triggered sweep with full 15 MHz bandwidth capability, 50 mV sensitivity, 18 calibrated time base positions, x5 magnifier, 8x10 cm flat face CRT, sweep gate output, TTL-compatible external blanking input, all solid-state design and the lowest price in the industry for comparable features. Order now or send for free Instrumentation Catalog and get all the details.

ASSEMBLED EU-70A,
35 lbs.

\$595



New Heath/Schlumberger Instrumentation Catalog now available. Send for your free copy now and get detailed information and specifications on the expanding Heath/Schlumberger lines of digital equipment: systems, cards, modules; test and lab instrumentation: scopes, counters, generators, power supplies, strip chart recorders and accessories; analytical instrumentation: pH meters and recorders, log-linear current recording systems, polarography systems. Fill out the coupon below to get your free copy.



HEATH
Schlumberger

Heath/Schlumberger Scientific Instruments
Department 511-263
Benton Harbor, Michigan 49022

Enclosed is \$ _____, plus shipping.
Please send _____ EU-70A's.
 Please send new Instrumentation Catalog.

Name _____
Title _____
Company/Institution _____
Address _____
City _____ State _____ Zip _____

EK-330

INFORMATION RETRIEVAL NUMBER 35

Use diodes for amplitude control in 0.001-Hz Wien Bridge oscillator

If a pair of back-to-back diodes are used as a nonlinear element, a Wien Bridge oscillator will generate 0.001-Hz sine waves. Unlike other methods of amplitude stabilization, the diode approach does not introduce a long time constant. The diodes vary their equivalent dynamic resistance instantaneously.

The stabilization circuit is similar to an operational clipper, except that here the 47-k Ω resistor in series with the diodes softens their clipping action and prevents severe distortion.

The finite input impedance of the op amp in a conventional Wien Bridge oscillator, shunted across the parallel RC position of the bridge—limits the size of R at very low frequencies. With the use of two op amps, however, the bridge can be configured so the parallel RC portion is connected between the inverting input and the output of one op amp (A1). This arrangement vastly increases the impedance seen by the parallel RC portion of the bridge and allows the use of large values of R.

A FET-input op amp is thus not required in this modified Wien Bridge. The level of harmonics produced—down more than 50 dB from the fundamental—is quite comparable to the harmonics of most other Wien-Bridge oscillators.

Hank Olson, Stanford Research Institute, Menlo Park, Calif. 94205 CIRCLE NO. 311

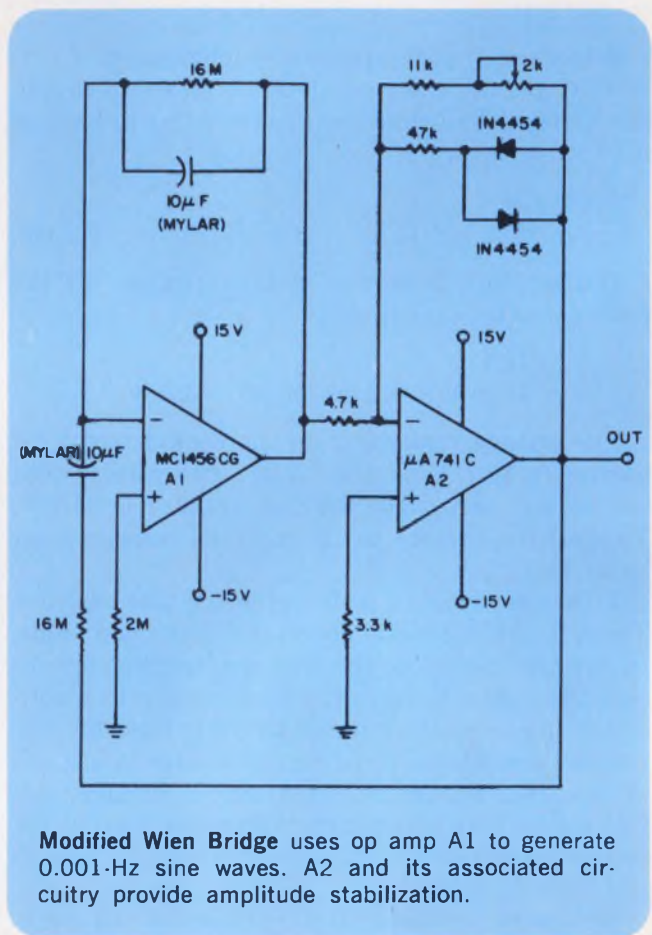

Modified Wien Bridge uses op amp A1 to generate 0.001-Hz sine waves. A2 and its associated circuitry provide amplitude stabilization.

Multivibrator uses IC one-shots

A multivibrator oscillator can be built for less than \$5 with two cross-coupled TTL monostable multivibrators—for example, the SN74121—as shown in the diagram. The IC characteristics permit a frequency range of between 2 Hz and 8 MHz, with amplitude of 3.5 to 4.0 V. The duty cycle can be adjusted, or it can be set for symmetrical operation over the frequency range. The result is a square-wave generator with excellent

stability, or a versatile VCO with a control of between 1 and 6 V.

When power is applied, one of the monostable multivibrators comes to its stable state (output: Q logic 0 and \bar{Q} logic 1) before the other, because of inherent differences in the ICs. When the second multivibrator arrives at its stable state, it triggers the first in one of two ways: Either output Q, feeding input A1A2,



Now, Helipot offers covered cermet trimmers for low-budget projects.

There's not much sense in using cheap wirewound or carbon trimmers anymore. Not when the new Helipot Series 91 Cermet Trimmers are available *off-the-shelf* for a few cents more.

These single-turn, $\frac{3}{8}$ " , covered trimmers come in 10 different mounting styles and 19 standard resistance values from 10 ohms to 2 megohms. Covered construction helps protect against moisture, corrosive atmospheres, dust, oil and other

contamination. Which means, in addition to cermet stability and better resolution, you get long-term dependable performance.

The breakthrough price is just 35¢ each in the 50,000 piece quantity, and they're equally well-priced in other quantities.

Send now for complete data on the Series 91 Trimmers... the finest of their class. We've made them for your projects where the budget may be tight, but you don't want to compromise performance.

Beckman®
INSTRUMENTS, INC.
HELIPOT DIVISION
Fullerton, California

HELPING SCIENCE AND INDUSTRY IMPROVE THE QUALITY OF LIFE

INTERNATIONAL SUBSIDIARIES AMSTERDAM CAPE TOWN GENEVA GLENROTHES SCOTLAND MEXICO CITY MUNICH PARIS STOCKHOLM TOKYO VIENNA

INFORMATION RETRIEVAL NUMBER 37

changes from logic 1 to logic 0, or output \overline{Q} , feeding input B, changes from logic 0 to logic 1, as shown in the truth table.

Equal-value capacitors (C1 and C2) on each multivibrator and a common potentiometer (R) insure a symmetrical output regardless of frequency setting. Using separate potentiometers or different capacitors will vary the on-off time.

Variations in frequency caused by varying V_{cc} are typically 1% for values of V_{cc} from 3.5 to 5.5 V. Stability with a constant V_{cc} is better than 0.01% over the entire range.

When the circuit is used as a VCO, the control voltage, rather than V_{cc} , is applied to the potentiometer. The center frequency can be set to any value between 2 Hz and 8 MHz by varying the control voltage or the resistance and capacitance values. For the frequency to vary linearly with the control voltage—as required in analog-to-digital converter applications, for example—a capacitor of at least 10 pF should be used.

Thomas R. Mitchell, 130 Lloyd Ave., Florence, Ky. 41042. CIRCLE NO. 312

TRUTH TABLE

t_n INPUT			t_{n+1} INPUT			OUTPUT
A1	A2	B	A1	A2	B	
1	1	0	1	1	1	INHIBIT
0	x	1	0	x	0	INHIBIT
x	0	1	x	0	0	INHIBIT
0	x	0	0	x	1	ONE-SHOT
x	0	0	x	0	1	ONE-SHOT
1	1	1	x	0	1	ONE-SHOT
1	1	1	0	x	1	ONE-SHOT
x	0	0	x	1	0	INHIBIT
0	x	0	1	x	0	INHIBIT
x	0	1	1	1	1	INHIBIT
0	x	1	1	1	1	INHIBIT
1	1	0	x	0	0	INHIBIT
1	1	0	0	x	0	INHIBIT

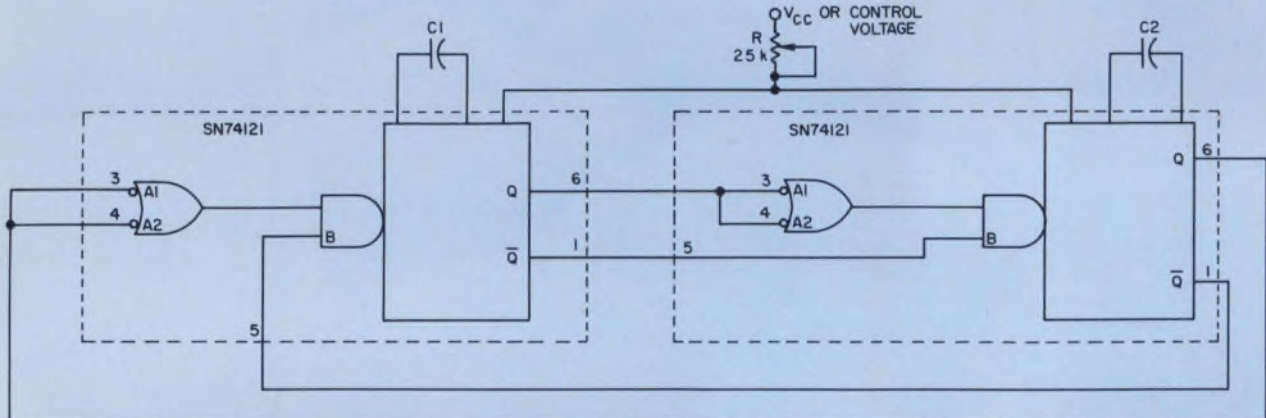

Multivibrator and truth table for logic inputs, where t_n is the time before and t_{n+1} the time after

input transition. X indicates that either a logic 0 or 1 may be present.

Generate programmable rectangular pulses

Five ICs, connected as shown in Fig. 1, generate a repeatable series of 64 individually programmable pulses. The square-wave generator can be built at a parts cost of less than \$25.

The basic circuit can be easily expanded to generate 256 pulses in increments of 64. With

extra gates and counters, it may be set to produce from 1 to 256 pulses in a series and from one series to a continuous series of the desired pulses.

To program the SN7489 16 × 4 RAM, place the desired output series of pulses on the mem-

ory's DATA-IN lines and strobe the WRITE ENABLE for a desired bit location. After these bits have been put into the memory, actuate the MANUAL switch four times to increment the SN7493 memory-address counter. This allows a new set of four bits to be strobed into the memory. It is not necessary to reset the memory-address counter to 0, since the output is cyclic.

The information is read out serially by the SN74151 multiplexer. After the first four bits are put into serial form, the memory address counter is incremented by one, and the next four bits are generated. The output may be checked manually with the MANUAL switch, and it may be helpful to use visual indicators on the DATA-OUT and memory-address line.

The memory section can be readily expanded to 256 bits by use of four SN7489 RAMs and an SN74150 multiplexer (instead of the SN74151 shown). This will allow conversion of the 16 output lines from the memory into serial form. An SN7493 counter should then be used in place of the SN7476 dual flip-flops. The MANUAL, CLOCK and WRITE switches are all bounceless types that generate the output pulses shown in Fig. 2. The output frequency is controlled by an external variable-frequency clock generator that must be capable of driving TTL circuits.

Jonathan A. Titus, Titus Labs., P.O. Box 242, Blacksburg, Va. 24060.

CIRCLE No. 313

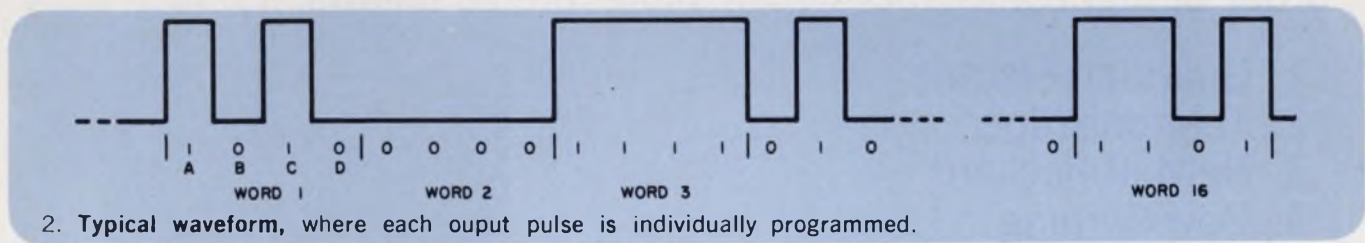
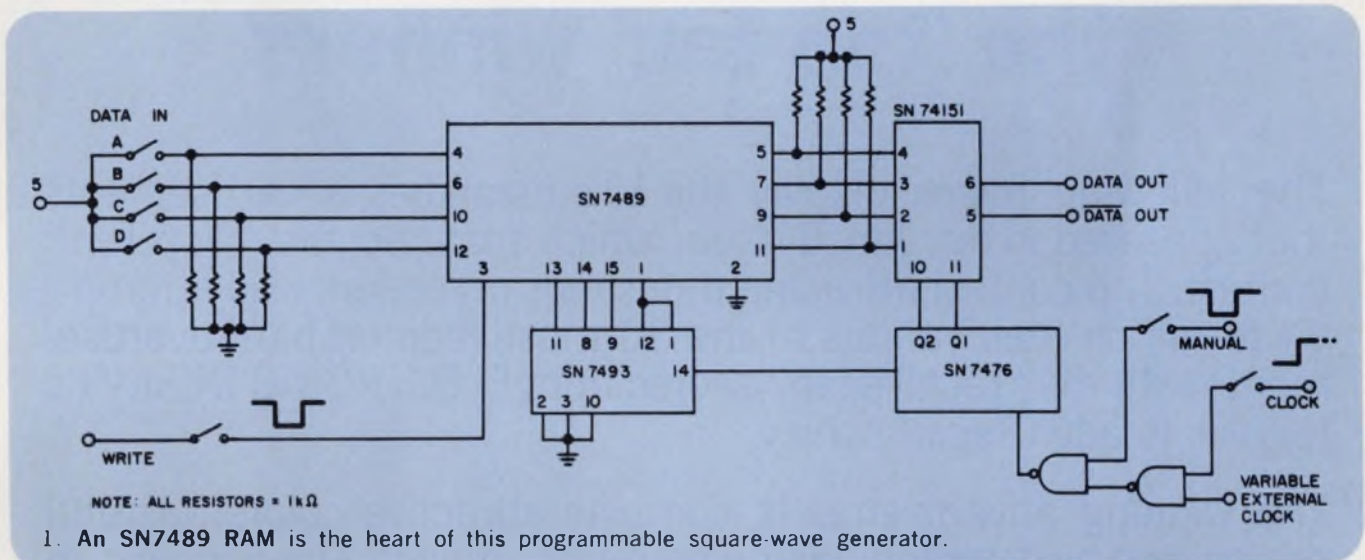

IFD Winner of November 25, 1971
R. S. Olla, Chief Engineer, Electro Dynamics Corp., 3139 Kermath Drive, San Jose, Calif. 95132. His idea, "Line regulator achieves 85% efficiency with control electronics on pcb," has been voted the Most Valuable of Issue award.
Vote for the Best Idea in this Issue

SEND US YOUR IDEAS FOR DESIGN. You may win a grand total of \$1050 (cash)! Here's how. Submit your IFD describing a new or important circuit or design technique, the clever use of a new component or test equipment, packaging tips, cost-saving ideas to our Ideas for Design editor. Ideas can only be considered for publication if they are submitted exclusively to ELECTRONIC DESIGN. You will receive \$20 for each published idea, \$30 more if it is voted best of issue by our readers. The best-of-issue winners become eligible for the Idea of the Year award of \$1000.

Electronic Design presents the 'top-ten' winners

The following pages display the 10 outstanding advertisements that appeared in our Jan. 6 issue, which featured the "Top-Ten" contest. The contest attracted thousands of readers who attempted to match their ratings of the 10 most memorable advertisements with the "recall-seen" scores from ELECTRONIC DESIGN's regular Reader-Recall survey.

The winning advertisements combine attractive colors, tasteful design and well-written copy. The result: impact. The winners, in order of highest Reader-Recall score, are as follows:

1. Guardian Electric
2. Tektronix, Inc.
3. Hewlett-Packard
4. Dow Corning
5. Hewlett-Packard
6. Oak Manufacturing Co.
7. Bourns, Inc.
8. Kurz-Kasch, Inc.
9. Siemens Corp.
10. Hewlett-Packard

a pocketful of solutions for your measurement problems



Now there's a 3-pound scope that can be carried in your tool kit, suitcase, briefcase, coat pocket, glove compartment . . . almost anywhere.

It's the **211**, our first laboratory-quality mini-scope. Size is only 3 x 5¼ x 9 inches. Bandwidth is 500 kHz. A lot of scope in a small package.

The **211** is easy to use. You spend your time solving measurement problems, not studying scope operation. Deflection factors from 1 mV/div and sweep rates from 5 μ s/div are read out from controls easily related directly to the CRT. One rotary control does all the triggering.

Ever wanted to float a scope? Here's one that floats to 500 volts RMS when operated from its internal batteries.

How many times have you misplaced a probe or power cord? There's no chance of that with the **211**. The probe and cord are attached and stored in a convenient, recessed area of the case. When you arrive on the job, both are right there, where you can find them.

And the **211** is built to take rugged trips. The double insulated high-impact plastic case takes tool kit knocks and bangs. Knobs are recessed for added protection. It's packaged in a real survival kit.

Need battery operation? The **211** operates from internal rechargeable batteries for up to 5 hours, and from AC.

Price? It's lower than many other 500-kHz scopes. Only \$545, FOB Beaverton, Oregon.

For a demo, just contact your local TEKTRONIX Field Engineer. He probably has a **211** in his briefcase. Ask him for complete information or write Tektronix, Inc., P.O. Box 500, Beaverton, Oregon 97005.

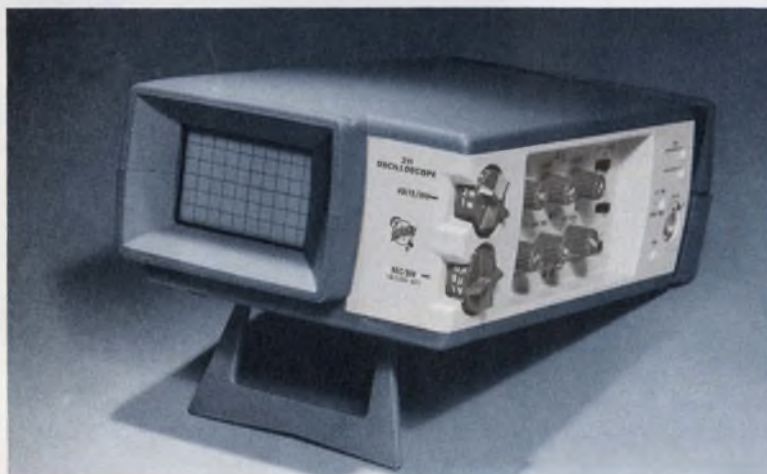

TEKTRONIX®

INFORMATION RETRIEVAL NUMBER 121

Your Guardian Angel presents a.



GUARDIAN[®]
GUARDIAN ELECTRIC MANUFACTURING COMPANY
1572 West Carroll Avenue, Chicago, Illinois 60607

In a hurry? Call your Guardian Distributor.

.LIBRARY full of MIRACLES



RELAYS 24 PAGE FACT BOOK full of dimensional drawings, specifications and application data on the comprehensive line of Guardian relays... including general purpose, special purpose, power, solid state and interlock.

INFORMATION RETRIEVAL NUMBER 211



SWITCHES A PORTFOLIO OF TECHNICAL DATA describing the complete line of Guardian switches: Molded, stacked and the miraculous lever switch with snap-in cam inserts so you change actuator functions instantly!

INFORMATION RETRIEVAL NUMBER 213

SOLENOIDS 44 PAGE MANUAL reveals everything you need to know to spec a Guardian solenoid. Includes specs, pull/stroke graphs and dimensional drawings on frame, laminated and tubular types—dozens of basic solenoids with more than 61,000 variations!

INFORMATION RETRIEVAL NUMBER 212

STEPPERS STEPPING RELAY FACT BOOK with 32 pages of catalog and application data on stepper types ranging from counting, sequence selecting and automatic resetting to pulse multiplying, slave and master, and *more*.

INFORMATION RETRIEVAL NUMBER 214





SAMPLE RATE RESET

10.0000 M Hz

OFF HOLD

5300A MEASURING SYSTEM HEWLETT - PACKARD

SENSITIVITY TIME BASE FUNCTION SENSITIVITY

PERIOD / T. I. FREQ A B PERIOD B

.1 μs AUTO T. A TO B M V B B 10 MHz

1 μs CHECK OPEN / CLOSE B

10 μs CHECK OPEN / CLOSE B

1 ms CHECK OPEN / CLOSE B

1 ms CHECK OPEN / CLOSE B

50 MHz CHECK OPEN / CLOSE B

5302A 50 MHz UNIVERSAL COUNTER

Introducing the little counter that can.

It can become four different systems.

It can go anywhere you do.

It can protect you against obsolescence.

It can make buying and maintaining a counter less expensive than ever before.

Meet the Hewlett-Packard 5300, the snap-together counter that's not much bigger than the palm of your hand. It has six digit accuracy, solid state display and autoranging. It'll make period, frequency, time interval and ratio measurements, operate on its own snap-on battery pack and drive a printer. Prices start at only \$520.

If everything sounds too good to be true, we'll tell you how we did it: snap-together construction that lets you choose the module that makes the counter you want and also avoid obsolescence. Plus the most advanced LSI circuitry ever used in a counter. That means you get

a compact instrument with high reliability, performance and versatility at a cost lower than ever before.

To make the counter you need, take the \$395 mainframe and add any of the following 4 modules (more are on the way). They lock right onto the mainframe in an instant.

- 10 MHz frequency module. Direct frequency counting to greater than 10 MHz. Model 5301A, just \$125.

- 50 MHz all-purpose module with period average, time interval,

and ratio functions. Model 5302A, \$250.

- 500 MHz frequency module, both 50 Ω and 1 M Ω impedances. DC to 500 MHz. Model 5303A, only \$750!

- Time interval module with features you'd expect to pay twice as much for: 100 ns resolution; attenuators and slope and trigger level controls on both channels; counting to better than 10 MHz; period averaging. A unique "time interval holdoff" feature lets you ignore electrical pulses between the events you want to measure. Model 5304A, \$300.

You ought to be able to take a counter as small and useful as the 5300 anywhere. And you can. All you have to do is snap on the battery pack (Model 5310A, \$175) for 4 to 8 hours worth of cord-free operation. The pack fits between the mainframe and any module. The system's rugged dust-proof aluminum case resists almost any of the bumps it might get in the field.

The 5300 is one system you have to use to appreciate; there is simply no other way. To get you started we'd like to send you more information on this amazing instrument. Just call your

nearby HP field representative or write to Hewlett-Packard, Palo Alto,

California 94304; Europe: 1217 Meyrin-Geneva, Switzerland.



HEWLETT  PACKARD

ELECTRONIC COUNTERS

INFORMATION RETRIEVAL NUMBER 122

02104

Silicone materials are unusually versatile. But whether they are used to seal, bond, insulate, impregnate, encapsulate or cool—their one basic function is to protect. And they protect better because of inherent silicone resistance to change—regardless of environment. When electronic equipment must function reliably in hostile atmospheres, look

to silicones from Dow Corning to shut out trouble. Described here are a few ways our materials can ensure the integrity of your designs. Many others are described in our Silicone Electronic Materials brochure available from your Dow Corning distributor. His name appears on the following page. Or write Dept. A-1220, Midland, Michigan 48640.

Electrical / electronic materials from

DOW CORNING

DOW CORNING

Noncorrosive silicone sealants.

For critical electronic insulating requirements on corrosion-sensitive materials. Four noncorrosive, acid-free curing silicone sealants are available from Dow Corning—two are pourable, self-leveling liquids for conformal coatings; the other two are nonslump materials for sealing, mounting and bonding. All are ready to use, cure at room temperature and are serviceable over a wide temperature range. Circle Information Retrieval Number 822.

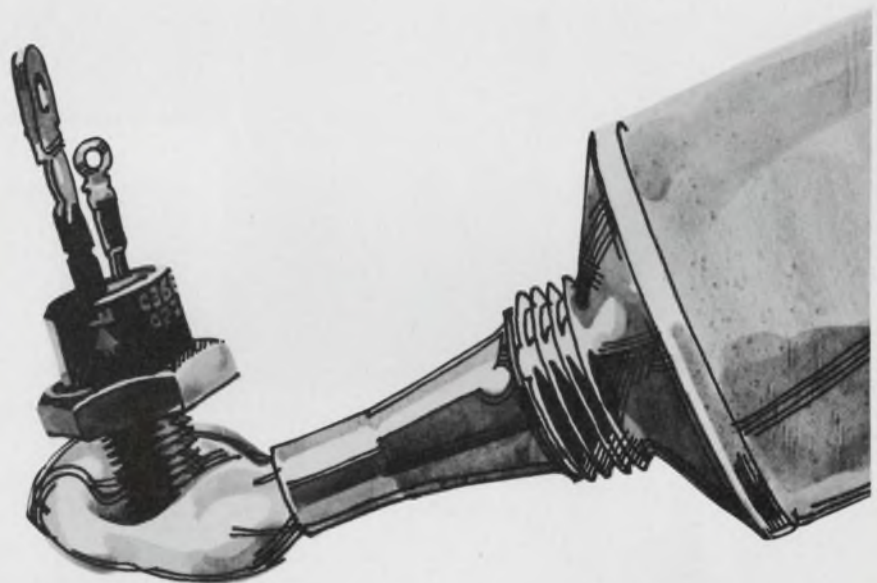
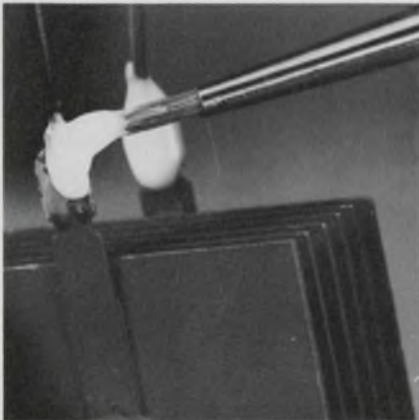

Dissipate heat fast with silicones.

You can use silicone materials to protect from heat, or to get rid of it. A Dow Corning® brand heat sink compound helps cool components such as transistors, diodes and rectifiers by transferring operating heat to heat sink or chassis. Thermal conductivity is effective as high as 200 C with this noncorrosive, metal-oxide filled silicone material. Ask about silicone fluid coolants also. Circle Information Retrieval Number 823.

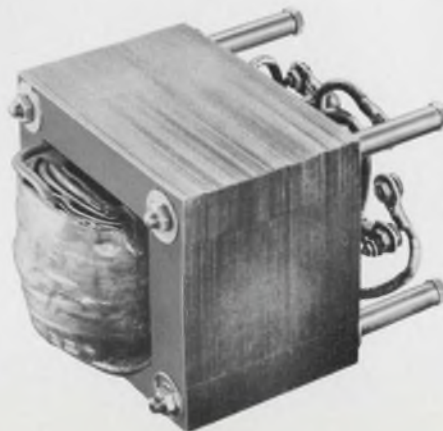

Silicone varnish aids miniaturization.

When operating temperatures of new spacesaving power supplies such as transformers hit the 200 C mark, protection with Dow Corning® brand silicone impregnating varnishes ensures performance. These materials are the most reliable insulating resins available. And they are easy to apply. Stators, chokes, coils, solenoids and other electronic equipment are protected by simply dipping, brushing, flooding or impregnating. Circle Information Retrieval Number 824.

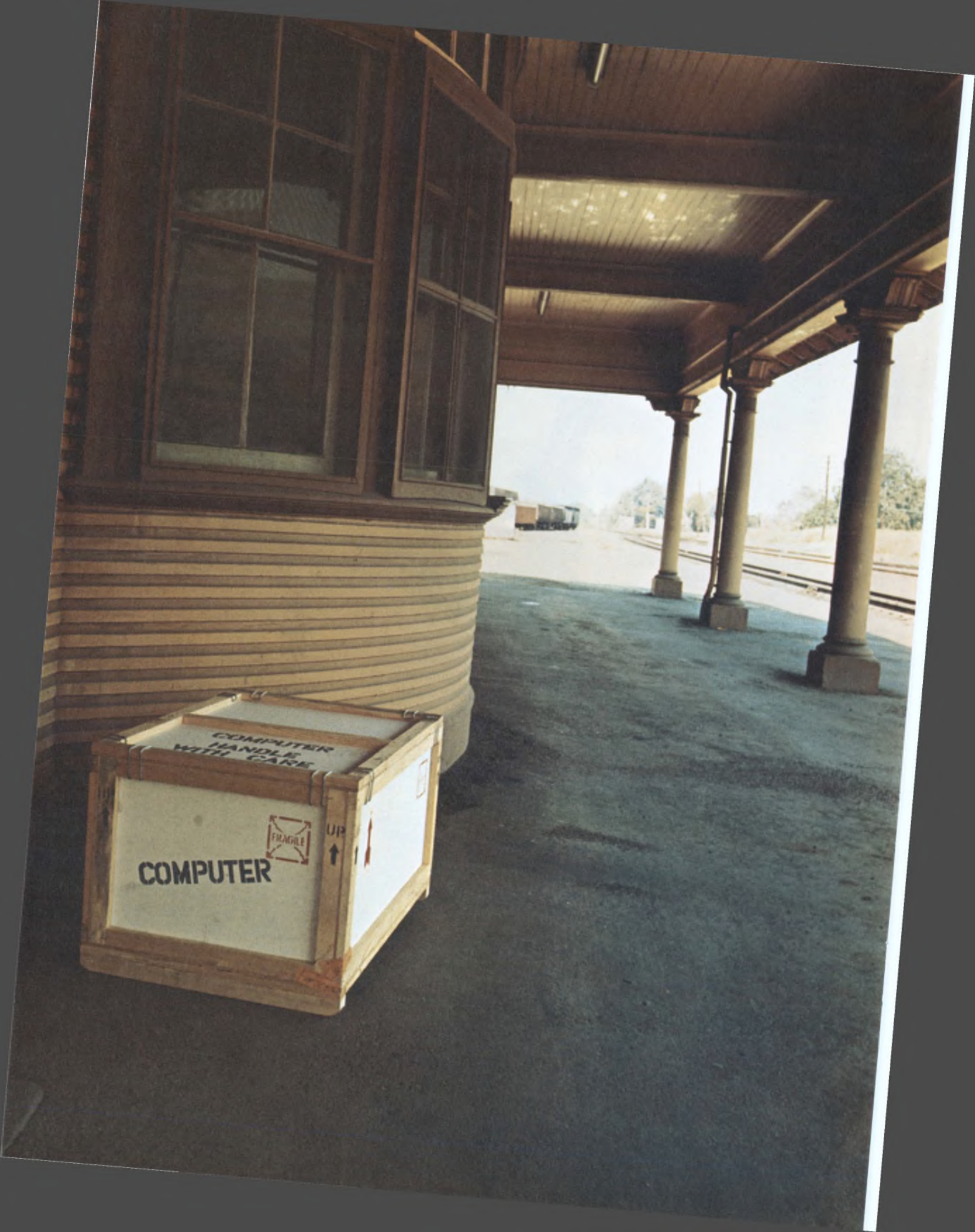

COMPUTER
HANDLE
WITH CARE



COMPUTER

UP
↑

Some small computers aren't delivered.

They're abandoned.

We believe that when you buy a small computer, you should get more than just a box of hardware. You should get the same service and support capabilities offered with the big systems.

That's the kind of support that goes along with all our small computers. We have documented training programs, including courses in preventive maintenance. And if you should need help, our parts and service are never more than a couple of hours away.

There's a good reason why we can offer this type of back-up. We're the world's largest manufacturer of test instruments. So naturally we understand the needs of engineers and scientists. In fact, we've built our reputation on understanding these needs and filling them. And we're not about to blow it.

You probably won't need much help. Our small

computers have an enviable reputation for reliability and performance in over 2500 successful installations.

And now we've taken another big step forward. Our new HP 2100 combines all three of our earlier minis in one. And its submicrosecond memory makes it almost twice as fast as any of them. It's also much smaller and you can expand from 4K to 32K in the same convenient mainframe. Using the latest in MSI/LSI technology, it also offers control Read Only Memory (ROM) plus a lot of other features usually found only in bigger systems. And it won't put a big crimp in your budget.

So if you want a good small computer, with good "big computer" support, call your local HP computer specialist. Or write: Hewlett-Packard, Palo Alto, Calif. 94304; Europe: 1217 Meyrin-Geneva, Switzerland.

22115

HEWLETT  PACKARD

DIGITAL COMPUTERS

BOURNS

BOLD NEW

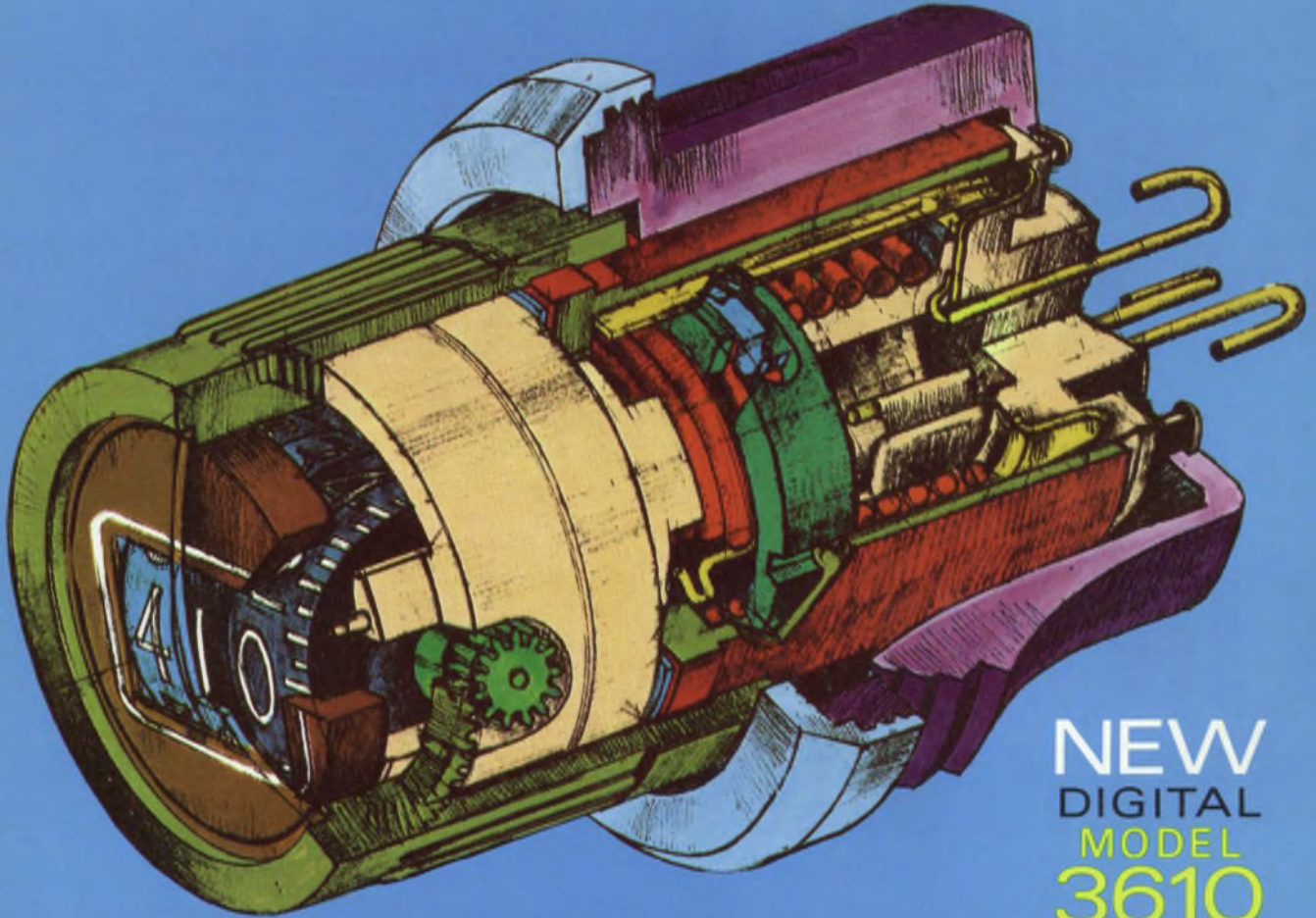

**NEW
DIGITAL
MODEL
3610**

KNOBPOT[®]
POTENTIOMETER

FACTORY - PHASED TO $\pm 0.5\%$ ACCURACY ...

**... AT LESS COST* THAN MOST SEPARATE
DIAL / POTENTIOMETER COMBINATIONS**

*SAVES HIDDEN COSTS OF PHASING AND INSTALLATION TIME NOT REFLECTED IN COMPETITIVE PRICES.

CONCEPT!

A DIAL AND POTENTIOMETER
IN A SINGLE INTEGRAL UNIT—

... AT NEW REDUCED PRICES!

NO DIALS TO ASSEMBLE!



Unlike SEPARATE Digital dial and potentiometer combinations . . . the dial and pot are INTEGRAL IN ONE, 7/8" DIAMETER UNIT. No screws, nuts, or bushing to mess with . . . JUST SNAP UNIT INTO PANEL AND CONNECT TERMINALS.

NO PHASING REQUIRED

Model 3610 is prephased at the factory to a GUARANTEED ACCURACY OF $\pm 0.5\%$ BETWEEN ELECTRICAL OUTPUT AND DIAL (This is equivalent to BETTER THAN 0.5% terminal base linearity).

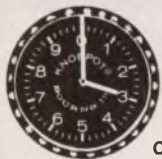

**IF YOU PREFER A
CLOCKFACE READOUT . . .**

. . . ask about the Model 3600;
clockface brother of the Model 3610.

Also an INTEGRAL DIAL/POTENTIOMETER,
it's only 3/4 inches in diameter and **PRICED EVEN
LOWER THAN MOST SEPARATE DIAL/POTEN-
TIOMETER COMBINATIONS.**

COMPARE PRICES . . .

With the labor-savings factored-in, Models 3610 and 3600 cost less than separate dial and potentiometer combinations.

Model 3610

Model 3600

\$15.30*

\$14.42*



*in 500-999 quantities.

7/8" DIAMETER

3/4" DIAMETER

TEN-TURN

NOW CHECK THE SPECS!

ACCURACY: $\pm 0.5\%$ (Maximum error between electrical output and dial reading.)

REPEATABILITY: 0.1%

POWER RATING: 1.5 watts

RESISTANCE RANGE: 100 to 250,000 ohms

RESISTANCE TOLERANCE: $\pm 5\%$

TEMPERATURE COEFFICIENT OF RESISTANCE WIRE:
20ppm/ $^{\circ}\text{C}$

TEMPERATURE RANGE

Model 3610
-25 to +85 $^{\circ}\text{C}$

Model 3600
-65 to +85 $^{\circ}\text{C}$

For details, contact your local Bourns Distributor,
Representative, or Bourns Sales Office.



Kurz-Kasch Digital Logic Instruments*



... complete logic systems analysis through the logic-probe concept

Rugged, all solid-state, Kurz-Kasch logic probes are designed for fast, accurate testing of logic levels in all types of integrated circuit systems. A simple readout system indicates "true", "zero", or "pulse" readings precisely through color-coded visual electronic readouts in the probe tip. Absence of logic levels is indicated by all readouts remaining OFF.

Applications Logic levels can be accurately tested in virtually any (DTL, TTL, RTL) IC system including desk calculators, business machines, N/C devices, computers or telephone systems. Power is derived from the unit under test allowing use in the field or in the lab.

Specifications	High input impedance prevents loading of circuit under test.
Readout Light Red=Logic "1"	Size $\frac{5}{16}$ " dia., 6" long, $2\frac{3}{4}$ " leads with pin terminals
Readout Light White=Logic "0"	
No Readout Light="infinity"	

A pulse detection feature is available on most models of logic probe. A third readout is provided to display high speed pulse trains or a single cycle pulse of less than 50 nanoseconds on the standard Model LP-520. Overload protection to +50, -20 volts DC is also available.

Standard Probes Logic probes are presently available in five standard models. MODEL LP-500 for use in testing 4.75-5.0 V DC logic systems. MODEL LP-510 for testing 4.75-5.0 V DC systems . . . includes overload protection to +50, -20 V DC. MODEL LP-520 . . . for 4.75-5.0 V DC logic systems . . . includes overload protection and pulse detection features. MODEL LP-530 for testing of 12-15 V DC logic systems . . . includes overload protection to +50, -20 V DC. MODEL LP-540 . . . for 12-15 V DC systems . . . includes overload protection and pulse detection features.

Add these options: G-S-M: Gating Feature (-G)— 3 Channel input for timing. Pulse indicator displays only when probe tip and gate/gates are in coincidence. **Memory & Stretch (-M)**— Push-pull switch for selecting stretch or latch mode. Stretch mode detects high speed pulse and displays blue "P" lamp for 200 mS. Latch mode captures high speed pulse/trains and latches blue "P" on until reset. **5 Nano-second capability (-S)**— Allows detection of pulses up to 10 x faster than standard probes. Each option \$10.00.

Special Probes As a routine service, Kurz-Kasch will custom design logic probes to user specifications. Custom designs can include: both positive and negative logic levels from 50 to 30 volts . . . special pulse detection characteristics . . . floating or grounded cases . . . custom power supply requirements . . . power lead reversal protection . . . and your choice of logic crossover parameters.

Kurz-Kasch logic probes provide all the information you need to quickly and accurately evaluate all logic systems . . . and they are the most economical logic testing instruments available. Standard Models range in price from \$39.95 to \$69.95. Write today for complete details on all standard and special logic probes.

*Patent #3,525,939 applies, others pending.



Kurz-Kasch, Inc.

Electronics Division

1421 S. Broadway

Dayton, Ohio 45401

Telephone(513)223-8161

Ring up a savings on keyboard switches.

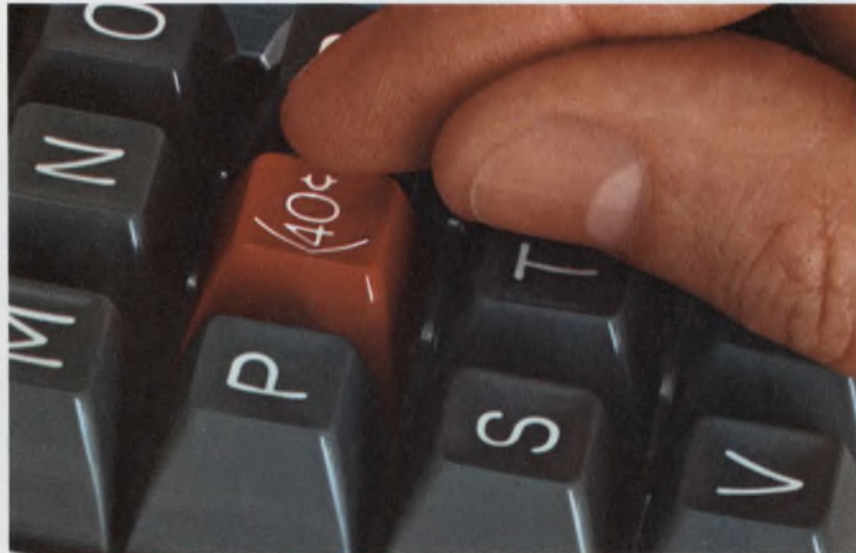

As much as **40%**
[savings per key]



The new Oak Series 400.

Get Oak-engineered quality in keyboard switches with the inherent reliability of electro-mechanical operation. Ideal for peripheral data-processing equipment. Contact bounce is less than 3 milliseconds. Long life, up to 20 million operations per key. Designed with self-cleaning crossbar-wiping contacts.



Under 40¢ each.

For SPST/NO in production quantities. Other versions comparably priced. Keytop button and snap-in mounting extra.



A feather touch.

We kept the operator in mind. Standard operating force is approximately 85 grams (3 oz.).



The configurations you want.

The Series 400 is available in limitless arrangements, including standard 10, 12, and 16-button keyboards. And you can specify any of six different contact circuitries. Choose snap-in or plug-in P.C. mounting. Compact—only 1/2" x 1/2" x 1".

Write today for our Series 400 brochure.

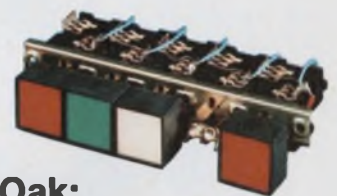

Also from Oak: Series 300 Lighted Pushbutton Switches.

Featuring Oak's exclusive twin-lamp lighting. If one lamp goes out, the other stays on. Double-wiping contact clips. Short stroke. Smooth, quiet operation. Unlimited combinations. Request our Series 300 brochure.

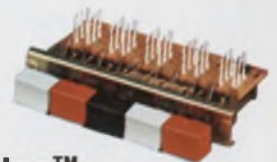

And our Series 800 Econo-Line™ Pushbutton Switches.

Compact—more buttons and more contacts in less space: 1 PST to 8 PDT per button. Your choice of mechanical actuation. Colored buttons, legend engraving to your specifications. Request our Series 800 brochure.



OAK MANUFACTURING CO.

CRYSTAL LAKE, ILLINOIS 60014 • A DIVISION OF OAK ELECTRO/NETICS CORP

Telephone: 815-459-5000

TWX: 910-634-3353

TELEX: 722-447

INFORMATION RETRIEVAL NUMBER 126



Think Twice:

How will you choose your next portable scope ...on faith, or on fact?

Forget everything you ever knew about portable scopes; today's portables are something else entirely. In the last year, both major scope manufacturers have brought out completely new lines. So, choosing a new portable on "blind faith" in your old make is about as sensible as marrying a girl you've never met, just because her second cousin was Miss America in 1967.

The only rational way to choose a new portable today is to make a head-on comparison between our scopes and our competitor's. And this means more than just a quick look at price tags and specs. It means a thorough investigation of total acquisition cost. Be sure you check these specific points:

Initial purchase price. Are you getting the best price available? HP's Portables are priced as much as \$200 below the competition, with special purchase agreements available.

Ease of Use. Are the controls simple and logical? Or are they a jungle of tightly packed knobs. Ten minutes a day, spent in needless tinkering, can add up to hundreds of

dollars a year in wasted man-hours.

Fieldworthiness. Some scopes have such high power requirements that battery operation is impossible. HP feels that a portable scope should have "go-anywhere" capabilities, so our Portables all use low-power-requirement designs which permit battery operation. Low power requirements also mean lower heat, which prolongs component life. As a result, only HP's Portables eliminate the need for fans, or dust-admitting vent holes.

Calibration and Service. Have you considered how much your scope will cost you *after* you've purchased it? For example, HP Portables are quickly calibrated — requiring approximately half the time required to calibrate our competitor's portable scope. This could save you hundreds of dollars over the life of your scope. And are you going to have to deal with one manufacturer for scope service, and another for your voltmeters, signal sources, etc.? Or can you save time and money by limiting your dealings to one company? And don't forget training aids: HP offers live

demonstrations, video tapes and literature to simplify conversion problems.

Look into all these points, and we think you'll find that you'll save a lot of time, effort, and money — and avoid a lot of frustration — by choosing HP's Portables. But don't take our word for it; make the comparisons yourself.

For a revealing package of information on HP's new Portables, send for a free copy of our "No-Nonsense Guide to Oscilloscope Selection." Or contact your local HP field engineer for a demonstration. Check before you choose. Hewlett-Packard, Palo Alto, California 94304. In Europe: 1217 Meyrin-Geneva, Switzerland.

**Scopes Are Changing;
Think Twice.**

082/2

HEWLETT  PACKARD

O S C I L L O S C O P E S

INFORMATION RETRIEVAL NUMBER 127

Siemens

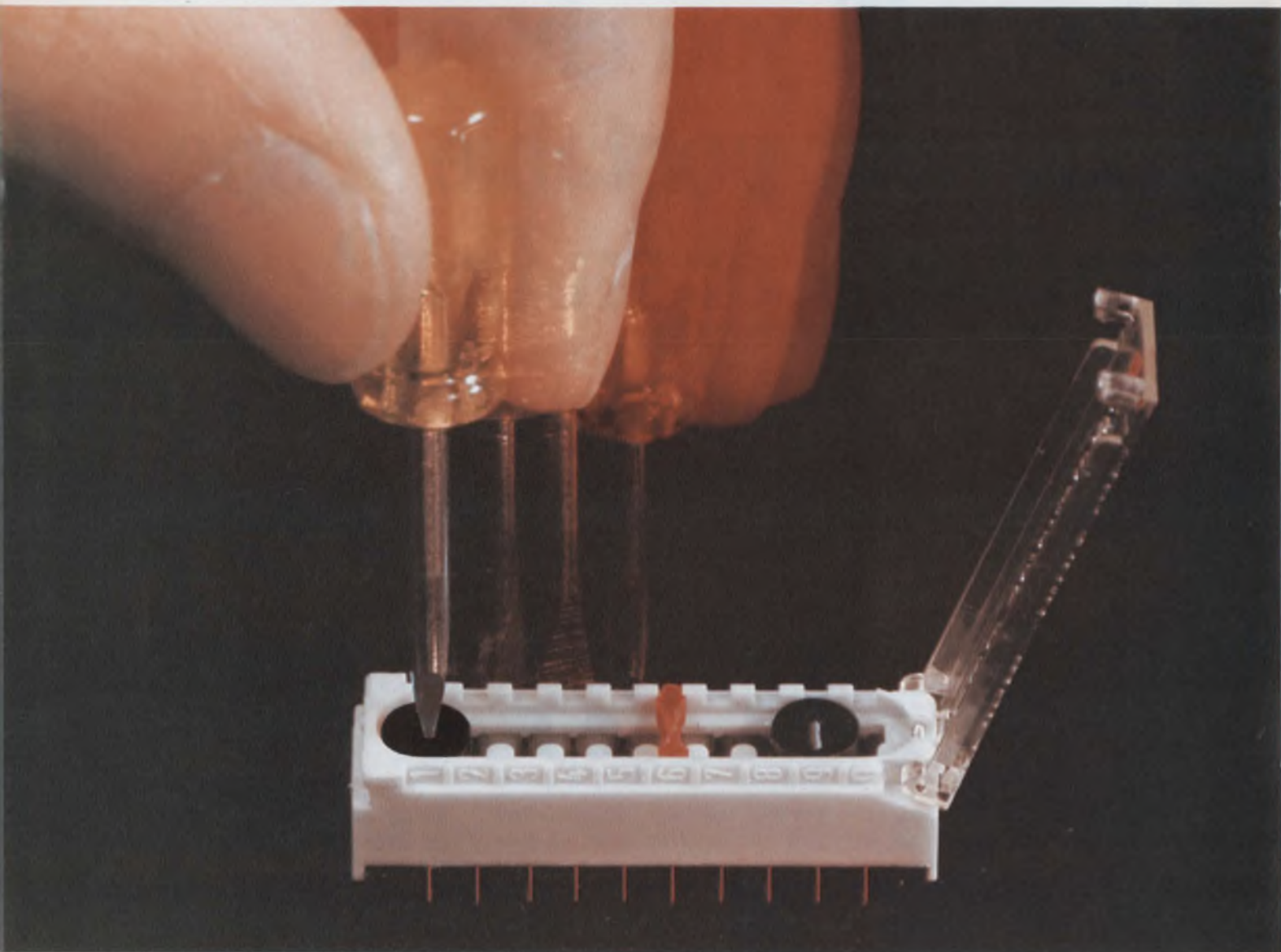

Introducing the rotary slide switch for PC boards. Ten positions. Multi-circuit switching. Low profile package.

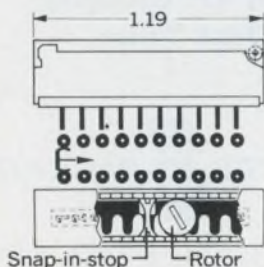

Siemens is introducing a completely new kind of programming switch for closely racked PC boards and for other tight-space applications.

To set the switch just snap open its transparent dust cover and twist the rotor with a screwdriver. This moves the switching element linearly from one of the detented positions to another.

The compact switch has ten pairs of gold-plated contacts and is available with additional rotors for independent switching of up to three circuits. Easy-to-insert snap-in stops separate circuits. Siemens Corporation, 186 Wood Ave. So., Iselin, N.J. 08830. Call 201-494-1000.



new products

Low-cost 8-bit a/d converter completes conversion in $2\mu\text{s}$



Hybrid Systems Corp., 87 Second Ave., Northwest Park, Burlington, Mass. (617) 272-1522. \$195 (1-9); stock to 2 wks.

A new analog-to-digital converter, ADC 540WB-8, from Hybrid Systems is said to be more compact and much less expensive than competing units in the same speed class. The 8-bit module has a conversion time of $2\mu\text{s}$ and sells for \$195 (1-9).

While it's not the cheapest or the fastest available, the ADC 540WB-8 has an attractive price/performance combination and fills an important market gap. One example of a competing unit with the same speed is Datel's ADC-P8B; but the Datel unit costs around \$550. Conversely, Burr-Brown offers an 8-bit a/d converter for \$195 (i.e. the same price as the Hybrid Systems unit); but Burr-Brown's ADC30-8 has a conversion time of $20\mu\text{s}$.

Hybrid Systems achieved high speed in a small package by employing a unique d/a conversion circuit in conjunction with successive-approximation logic. Because the internal d/a converter has a settling time of only 100 ns, the company's engineers were able to harness the full speed capability of the logic ICs.

With package dimensions of $2 \times 2 \times 0.4$ -in., the ADC540WB-8 is an inch shorter than Datel's ADC-M8B and half the length of Burr-Brown's ADC30-8. Of course, the new Hybrid Systems module is much smaller than PC-card units, like the Analog Devices ADC8U, though it should be recognized that card units usually offer optional features not included in modular units.

The Hybrid Systems module has DIP pin spacing and can be plugged into a standard IC socket or mounted directly on a PC card. The company points out that, because all active components are hermetically sealed (no plastic ICs or transistors are used), the module has a calculated MTBF of 50,000 h. All units are subjected to a 72-h burn-in before shipment. Use of thin-film precision resistors contributes to the circuit's long-term stability of 0.02%/yr.

Other key specifications include the following: Linearity of 1/2 LSB; accuracy drift of 50 ppm/°C; and linearity drift of 20 ppm/°C.

The unit is complete with all references, logic, clock and timing circuitry. It requires power supplies of ± 15 V and +5 V. The circuit is internally trimmed and no external components are needed.

CIRCLE NO. 250

High level mixer sells for \$16

Mini-Circuits Laboratory, 2913 Quentin Rd., Brooklyn, N.Y. (212) 252-5252. \$15.95 (5-24).

The SRA-1H double-balanced mixer is a high-level, wide-bandwidth unit that sells for approximately 1/5 the price of similar units. Features of the unit are: low conversion loss—less than 6.0 dB over its frequency range; wide bandwidth—0.5 to 500 MHz; high isolation—greater than 50 dB at 30 MHz and 35 dB at 300 MHz; linear operation at high input levels, less than 1 dB compression at +9 dBm input, and small size—only 0.128 in.³.

CIRCLE NO 251

Power supplies offer up to 6 A at 15 voltages

Elxon Power Systems, 18651 Von Karman, Irvine, Calif. (714) 833-1717. \$44 (1-9 quantities); stock.

A series of OEM regulated power supplies provides 15 different output voltages from 4 to 28 V dc with current ratings of 6 to 1.7 A. Built-in features of the new OLV-30 power supply series include: ratings of 0.1% line and load regulation with 0.1% ripple and noise; remote sensing and foldback current limiting as well as electrostatically shielded transformers. Overvoltage crowbar protection option (\$6) is available also.

CIRCLE NO. 252

Hybrid module contains three op amps

Mini-Systems, Inc., David Rd., P.O. Box 429, N. Attleboro, Mass. (617) 695-0206. \$35 (1-9 quantities); stock.

Three $\mu\text{A}741$ op amps are connected in the classical three-amplifier differential input single-ended output configuration, and a built-in premium thick-film resistance network provides an inherent closed-loop gain of 1. By adding one or more external components the gain and common mode rejection may be adjusted for optimum performance in each application. Packaged in a $3/8 \times 3/8 \times 0.067$ -in. 14-lead flat pack, the amp has a typical drift of $5\mu\text{V}/^\circ\text{C}$.

CIRCLE NO. 253

12-bit a/d converter offers 2.6-ms speed



Function Modules, Inc., 2441 Campus Dr., Irvine, Calif. (714) 833-8314. Price: See text.

A new a/d converter module is reported to be the fastest 12-bit integrating converter on the market today for less than \$100. The Model 105 features an absolute maximum conversion time of 2.6 ms (binary model) and a stability of ± 2 ppm/C max for offset drift and ± 10 ppm/C max for gain drift. Gain error is $\pm 0.05\%$ max, and initial offset ± 2 mV max. Nonlinearity is a maximum of $\pm 0.01\%$.

The full-scale input voltage of the Model 105 is 10 V, and input impedance is 100 k Ω . A BCD, 3-1/2-digit version with a faster conversion time—750 μ s, nominally—and scaled for 20-V input is available. The Model 105 sells for \$95 in quantities of 1-9.

For less stringent applications, the Model 104 is available. The conversion time is much slower—20 ms, nominally—than the Model 105, and the temperature coefficients are greater: ± 5 ppm/C for offset and ± 30 ppm/C for gain.

Gain error is $\pm 0.2\%$ max, and initial offset is ± 10 mV max. Nonlinearity is a maximum of $\pm 0.01\%$. The Model 104 costs \$85 in quantities of 1-9 and measures only 2 \times 2 \times 0.4 in. A faster, BCD, 3-1/2-digit version of the Model 104 is also available at the same price.

The binary units give better resolution than the BCD units—2.5 mV vs 10 mV—but the BCD is desirable for easier display of digital data. Gain and offset may be externally trimmed on both models. The converters are also available with input ranges of zero to -10 V (-20 V for BCD units).

CIRCLE NO. 254

IC op-amp audio card prevents overload

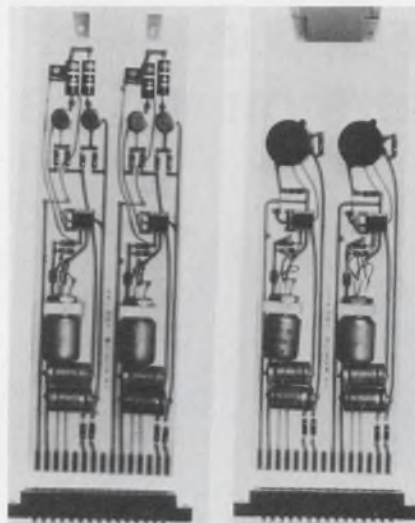

Fairchild Sound Equipment Corp., 15-58 127 St., College Point, N.Y. (212) 445-7200. \$45.

An innovative amp/preamp/limiter, the Model 725AL, automatically prevents input circuit overload, eliminating the need for pads at the preamplifier. The unit permits maximum gain of 35 dB before limiting action. The limiter, working in the feedback loop, extends the amplifier's dynamic range another 30 dB before overload takes place. Limiting slope is 40/1. The card is 2-1/2 inches high and comes with PC connector.

CIRCLE NO. 255

PC board power supplies output 5 and 7.5 W

RO Associates, Box 2163, Menlo Park, Calif. (415) 322-5321. \$99; stock.

Output for the model PC5-1 printed circuit board power supply is 5 V at 1 A, for the Model PCD-15-250 it's ± 12 to ± 15 V at 0.25 A on each side. Input is 105 to 125 V ac, 50 to 500 Hz. Regulation is 0.01% with line and 0.03% zero to full load. Peak-to-peak ripple is less than $\pm 0.03\%$ in the 15 V units; less than $\pm 0.1\%$ in the 5 V unit. Both are fully protected against short circuits and are repairable. Size is 2.63 \times 0.65 \times 4.5-in., excluding edge connector torque.

CIRCLE NO. 256

Multiplier/divider offers low drift

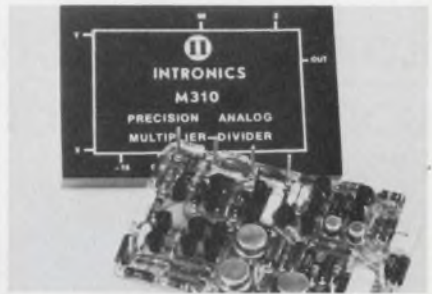

Intronics, Inc., 57 Chapel St., Newton, Mass. (617) 332-7350. \$115 (1-9); stock.

The M310 analog multiplier/divider is a pulse height-width unit with high accuracy and temperature stability. The unit achieves a 50 μ V/C max output offset drift while scale factor drift is less than 0.01%/C. Full scale accuracy for four quadrants is better than 0.15% and output offset voltage is less than ± 2 mV. The M310 is trimmed internally to its rated specs. The case size is held to a low profile 3.0 \times 2.0 \times 0.4 inches.

CIRCLE NO. 257

Synchro/digital tracker resolves 14 bits

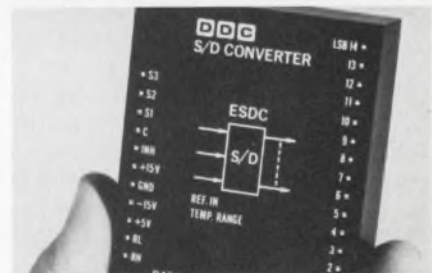

ILC Data Device Corp., 100 Tec St., Hicksville, N.Y. (516) 433-5330. \$695; stock.

The Model ESDC, is claimed to be the smallest, lightest, most accurate and least expensive of its kind. The unit converts synchro output continuously into digital form, in angle format, at 0 to 360° per second at full-scale accuracy. Resolution is 14 binary bits, or 1.3 minutes of arc. Accuracy is ± 4 minutes of arc ± 0.9 LSB. It is compatible with DTL/TTL. The unit measures about 3 by 2.5 by 0.8 in. and weighs about 7 oz.

CIRCLE NO. 258

Belden the Special "Specials" specialist

Here's what to do when cable catalog specs just won't do the job: Dial Area Code 317 ■
Then dial 966-6681 ■ You'll get action ■ From a man who devotes full time to solving
engineered cable problems ■ A Belden specialist that "lives"
with your design parameters from engineering through the
actual production run ■ Cables for underwater-under-
ground devices . . . extra-high voltage and pulse ap-
plications . . . medical instrumentation . . . low-level
signal interference problems . . . unusual environ-
mental conditions . . . he's tackled them all ■
Phone now. 850

DIAL (317) 966-6681

BELDEN



... new ideas for moving electrical energy

Conversational algebraic calculator rivals minicomputer performance



Hewlett-Packard Co., 1601 California Ave., Palo Alto, Calif. (415) 493-1501. \$5475, basic unit; stock.

A new desktop scientific calculator, the HP model 9820A, feeds information back to the user via a 16-character, alphanumeric LED display and a thermal printout. The user's equations are fed into the calculator just as they are written on paper, without need for artificial machine rules or languages. Each character is displayed as it is entered. Once the entire algebraic expression is entered, it is executed or stored with a single keystroke.

The basic 9820A comes with 173 registers, expandable to 429 internally. With the basic registers, the machine can solve up to 17 simultaneous linear equations with 17 unknowns. Fully expanded, the calculator solves as many as 36 equations with 36 unknowns. Unlimited nested parentheses, conditional and unconditional branching, and implied multiplication are among its many features—capabilities that ordinarily are found only on minicomputers.

Data and programs are fed into the calculator with the keyboard or with magnetic cards. Data and programs already in the calculator can be recorded on magnetic cards for future use. The magnetic card

reader is built into the basic machine. One 10-1/2-inch card can record all the information on the 173 registers; two cards are usually needed to record the contents of the expanded unit.

The calculator accepts up to three optional read-only memory function blocks, which are associated with three banks of keys on the keyboard. The following plug-in function blocks are now available: mathematical functions, peripheral control and user definable.

The mathematical block contains 21 different operations, each with an associated printed or displayed algebraic symbol. Included are the common trig, log and their inverses, absolute value and non-integer exponents.

The peripheral block is used to control certain peripherals and for general input/output operations. The calculator can be directly connected to up to four of these peripherals: a typewriter, X-Y plotter, card reader, tape cassette, digitizer or paper-tape reader. An I/O expander to permit use of all peripherals simultaneously is planned.

The user-definable block is custom-made for users, allowing them to tailor the keyboard to individual needs. Up to 25 functions, programs or subroutines can be assigned to keys with the addition of

this block.

The editing capability of the Model 9820A includes deleting, inserting or changing characters, lines or statements. When lines are added or deleted, the remaining program automatically adjusts to occupy minimum memory.

Diagnostic notes are displayed by the calculator to inform the user of operational or language errors, such as omission of a parenthesis. The error must be corrected before the calculator will accept further entries.

Although the LED display has 16 characters, line length is not limited to this number. Overflow characters simply move off to the left and can be recalled. The dynamic range of the Model 9820A is 10^{-99} to 10^{99} with 12 significant digits, 10 of which are displayed.

CIRCLE NO. 259

Active filter permits digital tuning



Multimetrics Industries, 120-30 Jamaica Ave., Richmond Hill, N.J. (212) 441-4240.

The Series AF-400 is a precision, digitally tuned variable active filter, having Butterworth and time domain responses of 24 and 48 dB/octave; cut-off frequency ranges of 0.001 Hz to 99.9 kHz with $\pm 2\%$ accuracy on all ranges; high pass, low pass, band pass, band reject and bypass functions; hum and noise below 100 μV rms maximum; 115/230 or battery operation. The AF-400 series offers close phase tracking between independent channels; input impedance is 100 M Ω , output impedance, 50 Ω . Attenuation is 80 dB, minimum, to 1 MHz.

CIRCLE NO. 260

Harris' Family of Op Amps. They're a different breed. By design.

Harris op amps have always been a little bit different ever since we introduced the industry's first internally compensated op amp back in 1966.

Today, we still make our op amps a little different. For example, our PNP's, or better put, our PNP — are vertical instead of lateral to give you superior AC performance without sacrificing DC characteristics.

Then take our designs. We employ a single gain stage to provide better behaved frequency response. Our bias networks are a bit more complex for uniform performance over a wide range of supply voltages and temperature ranges, and our output stages have better output current capabilities. In testing we're different too—more thorough. In fact, we were guaranteeing slew rates and rise times long before other manufacturers did. Consider just two examples:

Harris wide band general purpose op amps offer:

- Close loop bandwidth up to 100 times greater at the same gain or 100 times greater gain capability for the same bandwidth than the common 741 types.
- Much lower closed loop phase shift, lower gain error, and lower distortion at all frequencies.
- Superior response at higher gains.
- Hundreds of times better DC performance (for example, the HA-2600/2620 has a 5nA bias current, 300M Ω input resistance, and 100K minimum open loop gain).

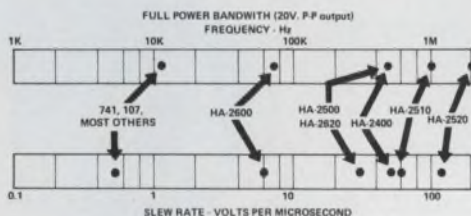
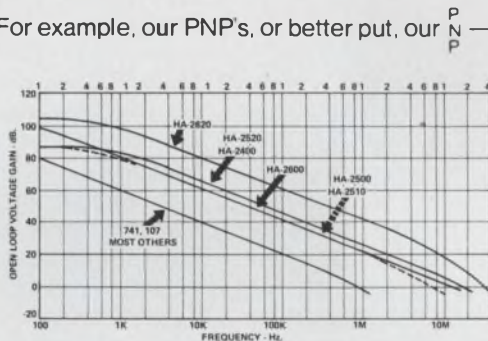

Harris high slew rate series offer:

- The only monolithic high slew rate amplifiers that are true operational amplifiers. They can be operated inverting, non-inverting, or balanced with fast settling times. In fact, they provide improved performance in virtually any standard hookup.
- The fastest settling time of any monolithic op amp. (For example, the HA-2520 settles in 250 ns to 0.1%.)
- Higher output voltage swing at high frequencies. (If you have ever tried to put a 10V peak 1MHz sine wave through a 741 type, you know what we mean.)

In summary, Harris makes a difference . . . our family of proprietary devices and popular alternate source devices can offer you the best price/performance op amp package for your system.

Full military temperature range (–55°C to +125°C):

HA-2101A	HA-2600	HA-2620	HA-2500	HA-2520	HA-2909
HA-2101	HA-2602	HA-2622	HA-2502	HA-2522	HA-2700
HA-2107			HA-2510		HA-2400
HA-2107-3			HA-2512		

Commerical/Industrial (0°C to +70°C):

HA-2301A	HA-2207	HA-2505	HA-2525	HA-2704	HA-2404
HA-2201A	HA-2605	HA-2515	HA-2911	HA-2705	HA-2405
HA-2307					

All in standard 741 pin-compatible configuration. (Except HA-2400/2404/2405 4-channel op amp.) For details see your Harris distributor, representative, or contact us direct.



HARRIS
SEMICONDUCTOR
A DIVISION OF HARRIS-INTERTYPE CORPORATION

P.O. Box 883, Melbourne, Florida 32901
(305) 727-5430

DISTRIBUTORS: Schwaber Electronics: Westbury, New York (516) 334-7474; Rockville, Maryland (301) 881-2970; Hollywood, Florida (305) 927-0511 / Harvey/R & D Electronics: Lexington, Massachusetts (617) 861-9200 / Semiconductor Specialists, Inc.: Chicago (312) 279-1000; Detroit (313) 255-0300; Minneapolis (612) 884-8132; Kansas City (816) 452-3900; St. Louis (314) 428-6100; Dallas (214) 358-5211; Indianapolis (317) 243-8271; Pittsburgh (412) 781-8120; Dayton (513) 278-9455 / R.V. Weatherford Co.: Albuquerque (505) 265-5671; Anaheim (714) 547-0891; Austin (512) Enterprise 1443; Dallas (214) 231-6051; Denver (303) 427-3736; Glendale (213) 849-3451; Houston (713) 849-3451; Palo Alto (415) 321-5373; Phoenix (602) 272-7144; Pomona (714) 623-1261; San Diego (714) 278-7400; Seattle (206) 762-4200. **HARRIS SALES OFFICES:** Wellesley, Massachusetts (617) 237-5430; Wayne, Pennsylvania (215) 687-6680; Palos Heights, Illinois (312) 597-7510; Melbourne, Florida (305) 727-5430; Palo Alto, California (415) 321-2280; Melville, New York (516) 249-4500; Syracuse, New York (315) 463-3373; Washington, D.C. (202) 337-4914; Dallas Texas (214) 231-9031; Scottsdale, Arizona (602) 946-3556; Long Beach, California (213) 426-7687.

Computerized system tests any logic module



Computer Automation, Inc., 895 W. Sixteenth St., Newport Beach, Calif. (714) 642-9630. \$39,500 approx.

A computer-driven test system performs on-line diagnostics for any digital logic module. The CAPABLE II Test System enables technicians to perform up to 100,000 functional pin tests per second, reducing test time by 80% for digital logic and IC devices. The system uses a 16-bit minicomputer, and can be interfaced to test-units having up to 319 programmable pins. Other standard features include a single cassette system for program storage; the company's Test Aids Package, a set of programs for high-speed identification of logic faults; 100 cps photoelectric paper tape reader; an ASR #3 Teletype; system interfacing; power supply; autoload and power-failure protection.

CIRCLE NO. 261

Low-price counter gives long life display

Digilin, Inc., 1007 Air Way, Glendale, Calif. (213) 240-1200. \$55; April, 1972.

The Model 4320, 3-1/2 digit counter combines a liquid crystal display and MOS counter-decoder-driver chip to provide a power consumption of less than 100 mW. The instrument is estimated to have a life of over 100 billion counts—or over 10,000 hours of continuous operation. The small power drain lowers the operating temperature, improves component life, and permits portable operation. The liquid crystal display gives good readability—even in direct sunlight—because the 7-segment, 0.65-inch characters reflect the ambient light. A back-lighting technique adapts the readout to low ambient light conditions.

CIRCLE NO. 262

20 lb oscilloscope spans dc to 15 MHz



Ballantine Labs., P.O. Box 97, Boonton, N.J. (201) 335-0900. \$845.

The Model 1066A dual-channel oscilloscope marks the entry of Ballantine Laboratories, Inc., into the oscilloscope field. The portable instrument with $\pm 3\%$ accuracy costs about half the price of oscilloscopes offering comparable specifications. Features which make the all solid-state dual-trace unit unique in its price range are its X-Y capabilities; 5 mV/cm sensitivity on both channels (amplifiers may be cascaded for 1 mV/cm max sensitivity at reduced bandwidth of 5 Hz to 5 MHz); a full-size (5-in.) CRT calibrated in centimeters; wide time-base ranges with X10 magnifier and vernier from 50 ns/cm to 25 seconds full scale; internal calibrator; comprehensive trigger controls including TV synch; and will trigger positively on as little as 2 mm peak-to-peak. The case measures 7 in. \times 11-1/2 in. \times 15-1/2 in.

CIRCLE NO. 263

Spectrum analyzer can store, vary persistence

Systron Donner Corp., Microwave Div., 14844 Oxnard St., Van Nuys, Calif. (213) 786-1760. \$2600; 30 days.

The Model 711 spectrum analyzer features storage and variable persistence capability. The unit can operate in the "standard" display mode with variable storage times up to 2 minutes without significant loss of brilliance and up to 6 hours with reduced brilliance. The rectangular CRT has a flat face area of 10 by 7 cm. The Model 711 will accept plug-in units for operation in the 10 Hz thru 1.6 MHz frequency range. For higher frequencies a converter provides coverage to nearly 200 MHz.

CIRCLE NO. 264

PC board fasteners exhibit low stresses

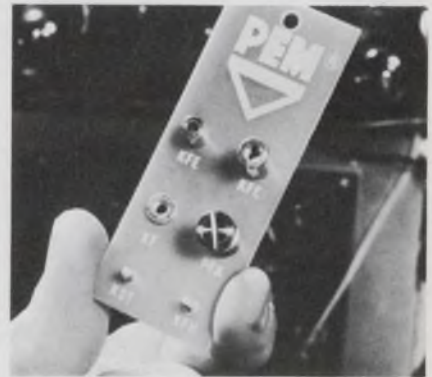

Penn Engineering & Mfg. Corp., Box 311, Doylestown, Pa. (215) 766-8853.

Broaching type fasteners for permanent mounting in PC boards include nuts, standoffs with and without internal threads, captive panel screws, studs and solder terminals. The new fasteners are installed by pressing into drilled holes. Typical torque-resistance for a 6-32 nut is 30 inch pounds with push-out resistance of 70 pounds.

CIRCLE NO. 265

Rotary attenuators use film resistors



Allen Avionics, Inc., 224 E. 2nd St., Mineola, N.Y. (516) 248-8080. Stock.

Rotary variable attenuators provide ten steps of attenuation and are offered as standards in 0.5 dB and 1-dB increments in 50, 75, and 100 ohm impedances. The units are manufactured with 1% precision film resistors and are designed in Pi networks. Frequency range is extremely flat at all settings from dc to 50 MHz. The 3.0-in. diameter black anodized case is equipped with an engraved dial and BNC connectors.

CIRCLE NO. 266

The people at
Ecole
Polytechnique
liked the
new IEC
"Générateurs
de Fonctions
Modele F31"
so well they
bought ten
of them

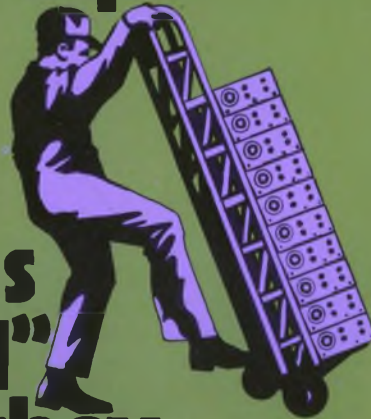

IF YOU'D LIKE TO FIND OUT WHY,
CALL JOHN NORBURG AT 714-772-2811 COLLECT

Merci, Montreal's Ecole Polytechnique. And our thanks for similar volume orders for other IEC Series 30 models from Middlesex College, the Universities of Alberta and Wyoming, Algonquin College, and other farflung educational institutions. Everywhere, decision-makers are getting the most for their money with the IEC Function Generator that exactly suits their needs. At just \$295, the F31 does what an oscillator can do, and then some! Like square waves, triangles and voltage offset. Plus better sine wave purity than comparably-priced oscillators. Meanwhile, at \$495, the F34 (illustrated) includes sweep, trigger, gate and pulse. In fact, each of the four Series 30 models has a host

of special features. And each embodies such inherent quality that we boast one of the lowest "returned for repair" rates in the industry. Ecole Polytechnique bought its IEC Function Generators after careful evaluation alongside competitive instruments. And got the most for the money. How come? Contact our John Norburg for answers and complete technical information by same-day mail.



IEC F34 Function Generator

SERIES 30 HIGHLIGHTS F34: (\$495) —
Frequency Range: 0.03 Hz to 3 MHz.
Waveforms: Sine, square, triangle, dc, pulse.
Output Amplitude: 10 mv pp to 10 v pp into 50Ω.
Sine Distortion: < 0.3% up to 30 kHz, < 0.5% to 300 kHz, < 2% to 3 MHz. *Rise/Fall Times:* < 60 ns. *Offset:* ± 5 v into 50Ω. *VCG Range:* > 1000:1. *Operating Modes:* Continuous, Triggered, Gated, Tone Burst, Continuous Sweep, Triggered Sweep. *Sweep Width:* up to 1000:1. Set width directly on tuning dial. *Sweep Time:* 10μsec to 100 sec. *Other Features:* Voltage Analog of Frequency, Sync Input, Output Limit Indicator, plug-in IC's. F33: (\$395) — Same as F34, but without Sweep, Tone Burst and Voltage Analog of Frequency. F32: (\$345) — Same as F33, but without Pulse, Trigger and Gate Modes and Sync Input. F31: (\$295) — Same as F32, but without VCG and Output Limit Indicator. Output Amplitude is 100 mv pp to 10 v pp into 50Ω.

IEC GIVES YOU THE MOST FOR YOUR MONEY
INTERSTATE ELECTRONICS CORPORATION

A Subsidiary of A-T-O Inc. Dept. 7000, Box 3117, Anaheim, Cal. 92803
(714) 772-2811 TWX 714-776-0280 TELEX 655443 & 655419

Stereo decoder uses phase-lock loop

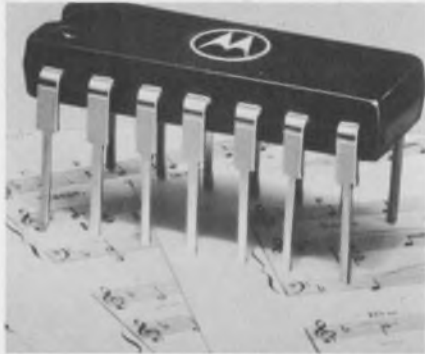

Motorola Semiconductor Products Inc., P.O. Box 20923, Phoenix, Ariz. (602) 273-6900. \$4.35 (100-up quantities).

The monolithic IC stereo decoder for multiplexed FM signals decodes without the use of tuning inductors. The new device, type MC1310, makes use of a phase-lock loop to lock onto the 19-kHz pilot signal provided by the stereo broadcaster. The loop creates a signal that is in phase with the pilot signal and of exactly double the frequency. This 38-kHz subcarrier is then used to demodulate the stereo information.

CIRCLE NO. 267

IC op amps dissipate 500 mW power

Signetics, 811 E. Arques Ave., Sunnyvale, Calif. (408) 739-7700. \$4.00 (S51A1T), \$1.10-\$1.15 (N53A1T); 100-999; stock.

Two high performance op amps feature high gain, short-circuit protection, simplified compensation, and excellent temperature stability. Designated as the S51A1 and the N53A1, the op amps are direct pin-for-pin replacements for the 101A and 301A op amps, respectively. Large-signal voltage gain for both devices is typically 160 V/mV. Input offset voltage is approximately 0.7 mV in the S51A1 version and about 2.0 mV in the N53A1 model. Both devices are capable of nulling the offset voltage, and they have large common-mode and differential voltage ranges. Typical common-mode rejection ratio in the S51A1 is 96 dB, and in the N53A1 version it is 90 dB. Maximum differential input voltage is ± 30 V.

CIRCLE NO. 268

Punched-tape reader works at many speeds



Decitek, 15 Sagamore Rd., Worcester, Mass. (617) 757-4577. \$350 (1-9 quantities); 3-4 wks.

A single universal punched-tape reader, whether the required reading speeds are 150, 300 or 600 characters per second, enables a user to cut inventory costs, speed servicing, and reduce software and training. The unit reads to 300 cps asynchronously, and synchronously to 600 cps with the ability to stop on-character. Paper, paper-polyester and metallized polyester tapes of 5, 6, 7 or 8 levels can be read interchangeably.

CIRCLE NO. 269

Punched-card terminal replaces IBM 1052/1056



Western Telematic Inc., 5507 Peck Rd., Arcadia, Calif. (213) 442-1862. Rental \$135/month; 6 weeks.

Model CTC Punched-Card Terminal and Electric printer, similar to the IBM 2741, replaces the IBM 1052/1056 with considerably simplified operating procedures. Speeds of 2 to 4 times 1050-card throughput are realized. It connects simply between the keyboard printer and the dataset, using the existing dataset cables, without hardware or software change.

CIRCLE NO. 270

Staggered finger heat sinks designed for relays

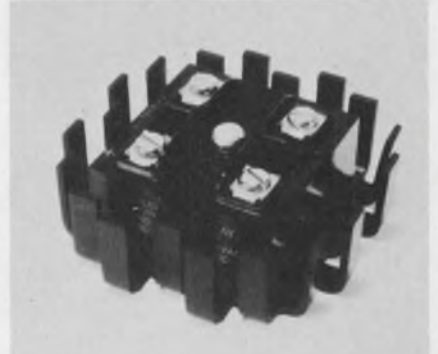

International Electronic Research Corp., 135 W. Magnolia Blvd., Burbank, Calif. (213) 849-2481.

A line of staggered finger heat dissipators—specially configured for solid-state relays—permits the current carrying capacity of solid-state relays to be increased substantially while maintaining case temperature rise above ambient to acceptable levels. The staggered finger dissipators such as the LB, UP and HP Series can be supplied for use with a variety of packaged solid-state devices as bridge rectifiers, series voltage regulators, hybrid amplifiers, as well as solid-state relays.

CIRCLE NO. 271

Jumper cables have DIP sockets attached

Ansley Electronics Corp., Old Easton Rd., Doylestown, Pa. (215) 345-1800. \$2.38 to \$2.57; stock.

A new line of ready-to-plug in DIP socket jumper cable assemblies offer high packaging density and low installed cost. The cable assemblies may be ordered to any length, using self-extinguishing flat flexible cable with current carrying capacity of 1.75 A and a continuous temperature rating of 90 C. The cable is also available with other dielectric materials. Small glass-filled, nylon connectors terminate the flat cable at the ends and may also be placed anywhere in the run of cable. The connectors can be used on 0.400-in. centers with a profile of less than 1/4-in. high. The cable can exit from either side of the connector, as well as at a 90° angle.

CIRCLE NO. 272

From Monsanto... something new for people who count.

We build counters for just about every requirement, but a lot of people who count asked for a mix of capabilities we hadn't yet packaged in a single unit. Now, here it is—the Model 113A Counter/Timer, newest addition to the Monsanto line.

Take a quick look at some of its outstanding features . . . **Frequency range: DC to 75 MHz . . . 8 operating modes: frequency, totalize, ratio, period, period average, time interval A to B, positive pulse width, negative pulse width . . . Monsanto LED display.**

The Model 113A gives you automatic selection of slope when measuring positive or negative pulse widths, so you have one less mental calculation to make, one less knob to turn. And you get Monsanto's two-year warranty. What other major instrument manufacturer offers you that? All this versatility, all this four-figure performance, sells for just \$895 for 5-digit display. For complete data or a demonstration, write Monsanto Company, Monsanto Electronic Instruments, West Caldwell, N. J. 07006.

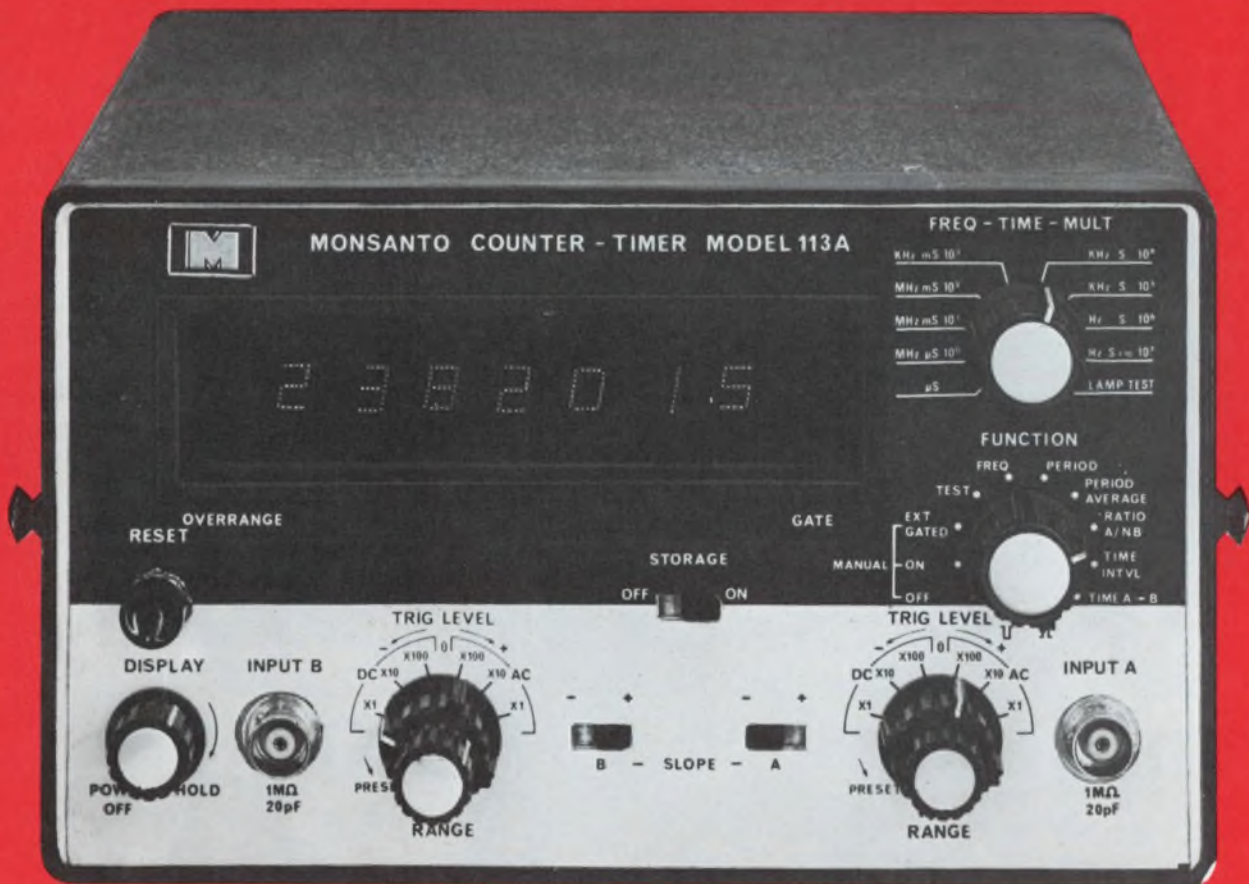

Monsanto

evaluation samples

Polysulfane capacitors

Metallized 150 C polysulfone capacitors come in more than 200 capacitance values for each of four voltage ratings—100, 200, 400, and 600 V dc. Six case styles can be furnished. Samples are offered in round wrap and fill case configuration only. Electrocube, Inc.

CIRCLE NO. 273

Micromesh screen

An ultra micromesh screen is produced by a unique single plating process that yields a smooth surface nickel wire, plated to the desired transmission width. Line counts up to 10,000 lines per inch and 90% transmission are possible. Applications include storage tubes, particle filters, thick film screens, heat exchangers, and others, Dynamics Research Corp., Metri-graphics Div.

CIRCLE NO. 274

Deburring media

A long-life alloyed plastic media deburs metal and plastic parts and cleans molds, dies, electronic connectors, and circuit boards. Called Blas-Tic, the new media is a special alloy of plastic material that has high tensile, compressive and flexural strength combined with comparatively low hardness. Media Technology Corp.

CIRCLE NO. 275

Semiconductor hardware

A range of ancillary hardware for use with subminiature electronic components and semiconductor devices includes 67 samples. Injection molded from either nylon or polypropylene, items include OBA and 2BA panel washers, two sizes of anti-vibration clips suitable for small capacitors, cable pre-forms together with mounting pads designed for transistors, diodes and multi-lead integrated circuits, plus special types of converting lead configurations to meet printed circuit board layout requirements. Jermyn.

CIRCLE NO. 276

application notes

Digital word generator

A four-page applications note on the EC-22 digital word generator contains step-by-step, procedure descriptions of several important EC-22 functions. These include quick-checking dynamic MOS shift registers, for the purpose of establishing the timing relationships between clocks and data, a computer simulator, and an arbitrary function generator—for generating arbitrary piecewise functions of great variety. Adar Associates, Inc., Cambridge, Mass.

CIRCLE NO. 277

Insertion handbook

"Design Guidelines," a handbook for the automatic insertion of electronic components into PC boards, covers today's industry standards and design parameters for automatic insertion of axial lead components, dual in-line packages (DIPs), and transistors. The 16-page bulletin contains over 30 detailed schematics. Universal Instruments Corp., Binghamton, N.Y.

CIRCLE NO. 278

Strain gage handbook

The first volume of the "SR-4 Strain Gage Handbook" covers the strain gage system generally, including sensing elements, the backings or carriers, lead wire systems, and protective coatings. The characteristics of the numerous materials used in strain gage system components are discussed and compared, enabling the user to select best suited to his particular application. The handbook opens with a description of the transducer process, discussing sensitivity and accuracy, then discusses the type of materials (metallic and semiconductor) used in sensing elements and the configuration of the elements. Carrier materials covered in this volume include both permanent and temporary types. BLH Electronics, Inc., Wal-
tham, Mass.

CIRCLE NO. 279

think woven

for speed

Instant lead exposure! No trouble. No damage. Just snip the cut line or pull the binding thread. Another emphatic advantage of woven cable and one of the biggest time-money savers ever to hit a production line.

Write for our free folder "Fast Lead Exposure."

WOVEN ELECTRONICS

A DIVISION OF SOUTHERN WEAVING COMPANY

P.O. Box 189, Mauldin, S.C. 29662 (803) 288-4411

INFORMATION RETRIEVAL NUMBER 42

new literature

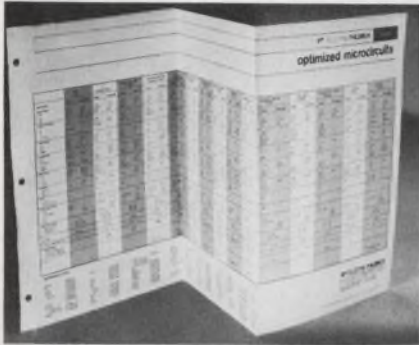

Microcircuit op amp chart

A comprehensive fold-out "optimized microcircuit" reference chart featuring detailed specifications with those of the standard 741 op amp. The chart lists both typical and guaranteed specifications for 14 such devices enabling the user to select a unit with optimum specifications where a standard 741 is not quite good enough. A current price list is attached. Teledyne Philbrick, Dedham, Mass.

CIRCLE NO. 280

Digital multimeter

A new concept in a combination systems and laboratory measuring device is described in a new four-page data sheet on the 4700 4-digit multimeter. The 4700's versatility, general features, systems performance, and reliability are all described. And, in addition, complete instrument specifications are given in detail covering dc voltage, ac voltage, resistance, and general operating requirements. Dana Laboratories, Inc., Irvine, Calif.

CIRCLE NO. 281

Multiplier photo tubes

A 10-page brochure describes multiplier phototubes and various characteristics of the different tube types. It also contains information on other related products, such as integrated photoelectric sensors, power supplies, image dissectors, scintillation detectors, aspect sensors, miniature ceramic detectors and calibration diodes. EMR Photoelectric, Princeton, N.J.

CIRCLE NO. 300



Photofabrication data book

"Photofabrication Methods With Kodak Photosensitive Resists," a 36-page publication, presents a process-oriented sequence of photofabrication methods. Topics covered include: artwork preparation photography, metal preparation for resist coating, safe practices for using resists, general working area characteristics, filtration of resists, resist viscosity and coating thickness, coating methods, prebaking the photoresist, exposure of photoresist coatings, development of photoresist coatings, postbaking the resist image, etching systems, plating, electroforming, removing the resist and process data sheets. Eastman Kodak Co., Rochester, N.Y.

CIRCLE NO. 301

Oscilloscope system

A 1-GHz via direct CRT access and 500-MHz real-time oscilloscope system is described in an 8-page brochure. Versatility of the family is afforded with 24 plug-ins, including the 525-MHz 7D14 Digital Counter. Tektronix, Inc., Beaverton, Ore.

CIRCLE NO. 302

Display system

New data sheets describe the ITT Alphascop display system features and configurations. The system has plug-to-plug compatibility with standard IBM hardware and software and requires no reprogramming. ITT Data Equipment and Systems Div., East Rutherford, N.J.

CIRCLE NO. 303

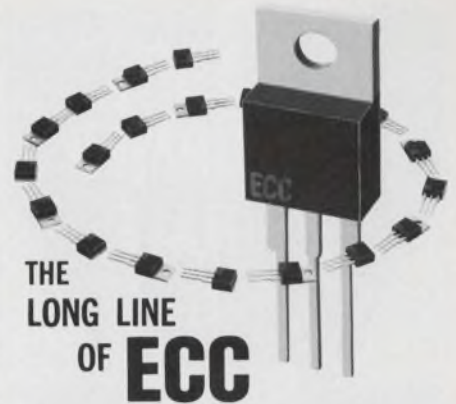

THE
LONG LINE
OF **ECC**

THERMOTAB® & THERMOPAK* TRIACS

World's leading
Triac producer offers
fast delivery,
electrical isolation
and competitive pricing.

THERMOTAB and THERMOPAK TRIACS
(Electrically isolated tab)

- Wide current range
 $I_{T(RMS)}$ 0.8 - 16 amps
- High voltage capability
 V_{DROM} 200 - 800 volts
- High surge current ratings
 I_{TSM} 20 - 150 amps
- Sensitive gate triggering
 I_{gt} 1, 111 3, 5, 10, 25, 50 ma

All ECC triacs feature heavily glass passivated junctions for high reliability. They are available from your nearest ECC Sales Representative or Authorized Distributor.

*trademark of ECC



NEW
CONDENSED
CATALOG contains technical data on these
and other ECC semiconductors.

To receive your copy, circle No. 246.

ECC
CORPORATION

P. O. Box 669 • Euless, Texas 76039
817/267-2601

**A TOP
PERFORMER
AT HALF
THE
PRICE**

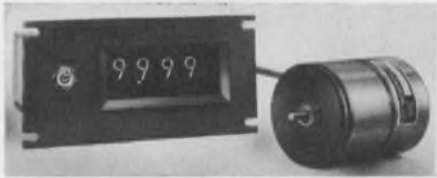

**LEM'S COMPLETE
SHAFT ENCODER
AND
DISPLAY SYSTEM**

\$995.

If you need a high reliability position measuring system that is second to none in performance and long, trouble-free life, you should consider LEM's MODEL EDS-170 SHAFT ENCODER AND DISPLAY SYSTEM. This unique absolute system, as well as complete lines of shaft encoders and digital readouts are available now from LEM Instrument Corp. All standard codes, functions and ranges as well as specials can be supplied at modest cost. Write or call us. We'll be happy to send you complete detailed literature.

Total Range: 00.00 to 99.99 revolutions
Resolution: 0.01 revolution
Encoder Starting Torque: 0.12 oz-in maximum
Power Required: 115 V, 60 Hz, 10 watts max.

LEM

INSTRUMENT CORPORATION
Subsidiary of TWIN DISC, INCORPORATED
20 Sarah Drive, Farmingdale, New York 11735
Phone (516) 293-7240

INFORMATION RETRIEVAL NUMBER 44

NEW LITERATURE



FET interchangeability guide

A field-effect transistor interchangeability guide, bulletin CRG-103, 36 pages, provides a comprehensive cross reference that simplifies the selection of the nearest electrical equivalent TI FET from hundreds of competitive types. Each of the more than 1000 device types listed is keyed with a manufacturer's code. A total of 13 different FET makers and their devices are noted. Listed in the guide in a convenient cross-checking chart are the in-house numbers used by FET suppliers. JEDEC types are given, as well. Included also are device polarities, package types used, and the basic differences between the original device and its replacement. Texas Instruments, Inc., Dallas, Tex.

CIRCLE NO. 304

Power relays

A product bulletin describes the company's Model V 23016 miniature low profile power relays. Included in the 2-page bulletin are operating data, contact data, wiring diagrams and schematic drawings. Siemens Corp., Iselin, N.J.

CIRCLE NO. 305

Switch brochure

Product Sheet 15SS describes the company's current-sinking-output solid-state switch. The 4-page brochure lists features, applications, operating principle, ratings and characteristics, construction details, mounting dimensions, magnet effectiveness and ordering instructions. It includes photographs, cut-away drawings, charts, diagrams and tables. Micro Switch, Freeport, Ill.

CIRCLE NO. 306

AM/FM modules

Data sheets for three AM and FM plug-ins for the FM-10 and FM-10C Communication Service Monitors have been issued. The plug-ins are the Oscilloscope Deviation Monitor, Model ODM-1 and the Oscilloscope Amplitude Modulation Monitor, Model OAM-1 and specifications and block diagrams are included. Singer Instrumentation, Los Angeles, Calif.

CIRCLE NO. 307

Solid-state lamps

Extra long life and high reliability are featured in three new series of solid-state indicator lights described in a 4-page brochure. The brochure includes schematic drawings for each series as well as full information on how to order by lamp number for lens shape, lens color and finish. Complete descriptions of materials and resistance are also provided. Eldema Div., Genisco Technology Corp., Compton, Calif.

CIRCLE NO. 308

Semiconductor catalog

A 24-page short form semiconductor catalog covers the company's complete line of transistors, diodes and rectifiers. Physical and electrical specifications are included for quick, easy reference. UPI Semiconductor, Paterson, N.J.

CIRCLE NO. 309

Power transistors

A 12-page brochure, No. MPT-700, provides basic design and application information on power transistors intended for use at microwave frequencies. The brochure describes significant technological developments in both the transistor pellet structure and the external package that make possible outstanding performance and exceptional reliability. It also explains current design techniques and provides design examples and performance data for practical transistor power-amplifier and oscillator circuits that operate at microwave frequencies. RCA Solid State Div., Somerville, N.J.

CIRCLE NO. 310



Thumbwheel switches

A 52-page catalog details all the many series of Digitran thumbwheel switches and devices using these switches. The catalog contains complete descriptions of the DIGISWITCH and MINISWITCH types, incorporating photographs, dimensional drawings, complete specifications and diagrams. Included also are special features and options, typical problem-solving applications, a glossary of thumbwheel switch terms, and truth tables, or output configurations for most used codes. Digitran Co., Pasadena, Calif.

CIRCLE NO. 340

Vector operator module

A product data sheet describes the operation, specifications, and applications of a wideband vector computing module. Detailed connection diagrams are shown and a number of applications including trigonometric computation, rectangular to polar coordinate conversion, CRT dynamic focus correction and sine to cosine conversion are described. Intronic Inc., Newton, Mass.

CIRCLE NO. 341

Digital multimeter

A 2-page data sheet gives complete description and specifications for the Model 3310 Universal Digital Multimeter. Ranges of the 3310 include true rms ac from 100 mV to 1 kV and current from 100 μ A to 1A, and dc ranges from 100 mV to 1 kV and from 100 μ A to 1A. Hickok Electrical Instrument Co., Cleveland, Ohio.

CIRCLE NO. 342

bulletin board

Litton Industries' Monroe division has introduced three new desktop electronic display calculator models for business, education and technical markets. Models designated 630 and 640 will be marketed to general businesses, educational institutions and government agencies. Monroe 650, which has a square root function, is for engineers, statisticians and educational institutions. The three calculators feature zero suppression, which eliminates display of all zeroes not part of the calculation, making it easier to read the significant digits. The two-digit item counter tallies the number of calculations made, a feature important in figuring averages. The Monroe 630 has a 14-digit display and one accumulating memory. List price is \$545. Monroe Models 640 and 650 have 16-digit displays and two accumulating memories. The Monroe 640 sells for \$595, and Monroe 650, with the square root function, sells for \$665.

CIRCLE NO. 343

Six new MECL 10,000 logic functions being introduced by Motorola, include five complex medium-scale-integrated (MSI) devices (>10 gates each). The six new functions being introduced at this time are: a triple line receiver, a quad latch, a 12-bit parity tree, a 1-of-8 low decoder, a 1-of-8 high decoder, and a look-ahead carry block. Prices in 1-24 quantities range from \$2.50 to \$10.10.

CIRCLE NO. 344

Price reduction

Monsanto Commercial Products Co. has reduced prices in several of its discrete light emitting diode products manufactured by the electronic special products group. Monsanto's MV50, axial lead, red LED is reduced to \$0.62 (1-99 quantity), \$0.50 (100-999), \$0.39 (1000), and \$0.33 (10,000). Previous prices were \$0.85, \$0.57, and \$0.49 respectively. The MV5020 series of red panel lights are reduced to \$1.03 (1-99), \$0.71 (100-999), \$0.65 (1000), and \$0.59 (5000). Previous prices were \$1.17, \$0.79, and \$0.71 respectively. The MV 5040, four-diode linear array, is reduced to \$4.50 (1-9), \$3.98 (10-99), \$3.18 (100-999), and \$2.50 (1000). Previous prices were \$6.30, \$5.45, \$4.70, and \$4.20, respectively.

CIRCLE NO. 345

Design Data from Manufacturers

Advertisements of booklets, brochures, catalogs and data sheets. To order use Reader-Service Card. (Advertisement)

3 NEW MINIATURE REAL-TIME SPECTRUM ANALYZERS

THREE NEW MINI-UBIQ®
PORTABLE REAL-TIME
SPECTRUM ANALYZERS



New features highlight Federal's 3 new Mini-Ubiq™ portable analyzers:

- Widest choice of ranges - 12 ranges from 10Hz to 50kHz
- Improved selectivity with 24dB/bandwidth-octave analysis filter
- Highest frequency and amplitude accuracy
- Computer control of input amplitude range, analysis range, and presampling filter
- Operation with weighting function on or off
- Sweep termination adjustable for high sweep rates
- Earphone monitor of filtered input

Write for FSC-L-522/100.

Federal Scientific Corp.

a subsidiary of Elgin National Industries, Inc.
615 West 131st Street, New York, N. Y. 10027

CIRCLE NO. 171

Design Data from Manufacturers

Advertisements of booklets, brochures, catalogs and data sheets. To order use Reader-Service Card (Advertisement)

1972 Electronic Components Drafting Aids Catalog



Free Catalog! Free Samples! Exciting innovations in pressure-sensitive electronic component drafting aids and methods are detailed in the new 1972 edition of the combined Bishop Technical Manual and Catalog 105.

84 illustrated pages of over 15,000 multi-pad configurations, symbols, tapes, sequential reference designations plus hundreds of time-and-money saving hints in making artwork for PC boards. Includes instructions for using the industry's only red and blue tape system for making two-sided boards in perfect registration.

Send now for free Catalog 105 and free samples.

Bishop Graphics, Inc.

7300 Radford Avenue, North Hollywood, California 91605
(213) 982-2000 Telex: 674672

CIRCLE NO. 172

Giant Free Catalog! 4,000 Unusual Bargains



New 148-page catalog! Packed with 1,000's of hard-to-find buys in Optics, Science, Electronics. Loaded with optical, scientific, electronic equipment available from stock. Rare surplus buys. Many "one-of-a-kinds". Ingenious scientific tools. Components galore: lenses, prisms, wedges, mirrors, mounts, accessories. 100's of instruments: pollution test equipment, lasers, comparators, magnifiers, microscopes, projectors, telescopes, binoculars, photo attachments, unique lighting. Shop, save by mail! Request free Catalog "DA".

CIRCLE NO. 173

Edmund Scientific Co.

America's Largest Science-Optics-Electronics Mart
300 Edscorp Bldg., Barrington, New Jersey 08007 (609) 547-3488

Dynaload – Solid State Electrical Load



A new technical bulletin presents valuable engineering suggestions to save many dollars and hours in special or production testing of power supplies, servo systems, DC generators and similar power equipment, through the substitution of a single inexpensive test instrument to replace a multitude of specially designed test equipment. The Dynaload offers resistance current or voltage loads over wide dynamic ranges. The brochure illustrates typical setups for testing power supplies, batteries, circuit breakers, etc., and gives specifications for units ranging from 100 to 3000 watts, 0 to 400 volts and 0 to 150 Amps. For your copy, please write:

Transistor Devices, Inc.

85 Horsehill Road, Cedar Knolls, N. J. 07927
Tel. (201) 267-1900

CIRCLE NO. 174

Electronic Design

ELECTRONIC DESIGN's function is:

- To aid progress in the electronics manufacturing industry by promoting good design.
- To give the electronic design engineer concepts and ideas that make his job easier and more productive.
- To provide a central source of timely electronics information.
- To promote communication among members of the electronics engineering community.

Want a subscription? ELECTRONIC DESIGN is sent free to qualified engineers and engineering managers doing design work, supervising design or setting standards in the United States and Western Europe. For a free subscription, use the application form bound in the magazine. If none is included, write to us direct for an application form.

If you do not qualify, you may take out a paid subscription for \$25 a year in the U.S.A., \$35 a year elsewhere. Single copies are \$1.50 each.

If you change your address, send us an old mailing label and your new address; there is generally a postcard for this bound in the magazine. You will have to requalify to continue receiving ELECTRONIC DESIGN free.

The accuracy policy of ELECTRONIC DESIGN is:

- To make diligent efforts to ensure the accuracy of editorial matter.
- To publish prompt corrections whenever inaccuracies are brought to our attention. Corrections appear in "Across the Desk."
- To encourage our readers as responsible members of our business community to report to us misleading or fraudulent advertising.
- To refuse any advertisement deemed to be misleading or fraudulent.

Microfilm copies are available of complete volumes of ELECTRONIC DESIGN at \$19.00 per volume, beginning with Volume 9, 1961. Work is now in process to complete the microfilm edition of Volumes 1-8. Reprints of individual articles may be obtained for \$2.00 each, prepaid (\$.50 for each additional copy of the same article) no matter how long the article. For further details and to place orders, contact the Customer Services Department, University Microfilms, 300 North Zeeb Road, Ann Arbor, Michigan 48106 telephone (313) 761-4700.

Want to contact us? If you have any comments or wish to submit a manuscript or article outline, address your correspondence to:

Editor
ELECTRONIC DESIGN
50 Essex Street
Rochelle Park, N.J. 07662

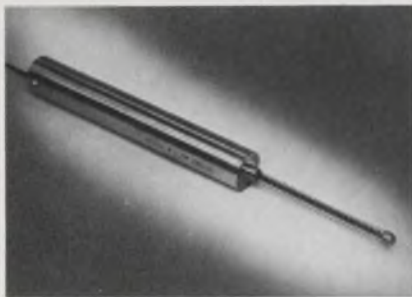

Precision DC-DC Linear Transducers.

New, first-of-a-kind series features built-in electronics for high level 0-5 VDC full scale output and 0.1% linearity. Direct input to remote DVMs or multiplexers reduces signal conditioning cost. Excitation, 6-volts, 1/4 W. Frequency response 3dB down at 20Hz.

SRC/MOXON

CIRCLE NO. 91



\$84.00 Isolated Miniature Power Supplies.

Compact Model 3564 exceeds specifications of high priced supplies. Low 0.1pF AC and 10,000 megohms DC isolation (due to fiber glass front panel, precise component placement and multi-shielded XFMR). Ripple 75uV p-p. Front panel 10-turn pot. adjusts output 0-25VDC, 0 to 200mA.

SRC/MOXON

CIRCLE NO. 92



Miniature Data Acquisition System.

Compact, 7-inch high "Astroverter" has hinged front panel for 16-channels of interchangeable plug-in cards. Design-it-yourself with system components including high speed multiplexers and ADCs, sample and hold amplifiers, DACs and high level buffer amplifiers. Throughput rates 100 kHz.

SRC/MOXON

CIRCLE NO. 93



SRC DIVISION/Moxon Inc.
2222 Michelson Drive
Newport Beach, Calif. 92664
Phone: (714) 833-2000

Electronic Design

Advertising Sales Staff

Bryce Gray
Sales Manager

Rochelle Park, N.J. 07662

Robert W. Gascoigne
Daniel J. Rowland
50 Essex Street
(201) 843-0550
TWX: 710-990-5071

Philadelphia

Thomas P. Barth
50 Essex Street
Rochelle Park, N. J. 07662
(201) 843-0550

Boston 02154

Joseph F. Palmer
1268 Main Street
Waltham, Mass.
(617) 894-2700

Chicago 60611

Thomas P. Kavooras
Berry Conner, Jr.
200 East Ontario
(312) 337-0588

Cleveland

Thomas P. Kavooras
(Chicago)
(312) 337-0588
(call collect)

Los Angeles 90303

Stanley I. Ehrenclou
Burt Underwood
2930 Imperial Highway
Inglewood, Calif
(213) 757-0183

San Francisco 94022

Jerry D. Latta
95 Main Street
Los Altos, Calif.
(415) 941-3084

London W. 1

For United Kingdom and Holland
Brayton C. Nichols

For Eastern Europe

Peter Kehr

The American Magazine Group

27 Maddox Street
London, W. 1, England
Phone: 499-0180

Cable: Ammagnic, London

Verviers, Belgium

For Continental Europe

Andre Jamar
1, Ru Mallar, 1
(087) 253.83 Telex 41563

Tokyo

Haruki Hirayama
Electronic Media Service
5th Floor, Lila Bldg.,
4-9-8 Roppongi
Minato-ku
Phone: 402-4556
Cable: Electronicmedia, Tokyo

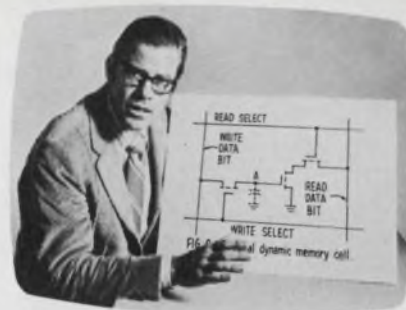

*Now available
for in-plant training...*

The MOS Course from Texas Instruments

Effectively and economically, this new 10-lesson videotape course lays the foundation for (1) evaluating the usefulness of MOS in proposed applications, (2) weighing the relative advantages of MOS options, and (3) working efficiently with MOS suppliers for cost-effective systems design.

Produced on efficient, low-cost videotape for maximum understanding and highest retention, the course includes printed workbooks and supplementary data.

The course was presented to a nationwide audience in September over a closed-circuit TV network. Hundreds of engineers in 16 cities spent three days absorbing the nine hours of concentrated instruction. It's now available for your own in-plant use.

The course covers: MOSFET characteristics • technology choices • reliability • economics • inverter and static logic • shift registers • bipolar interface • memories • PLAs.

For full details and information on obtaining a demonstration tape, circle 420 for Brochure CM-106. Or write Texas Instruments Incorporated, P.O. Box 5012, M.S. 84, Dallas, Texas 75222.



**TEXAS INSTRUMENTS
INCORPORATED**

TOGGLE SWITCH MINIATURES

Accident-proof mini switches have toggles locking in position to guard against human errors. Interchangeable colored toggles. 1-2-3-4 poles in many configurations. 6A @ 125 VAC.

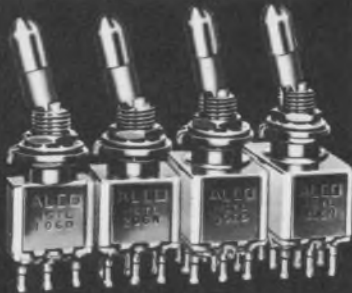

ALCOSWITCH®

ALSO AVAILABLE WITH WATERPROOF CASE

DIV. OF ALCO ELECTRONIC PRODUCTS, INC., LAWRENCE, MASS

INFORMATION RETRIEVAL NUMBER 47

TOGGLE SWITCH MINIATURES

This modified version of the original Alcoswitch has the latest improvements: double hi-voltage barriers, low-loss hi-impact hi-temp materials, silver contacts. 1-2-3-4 poles. 6A @ 125 VAC. Ask for "A" Series.

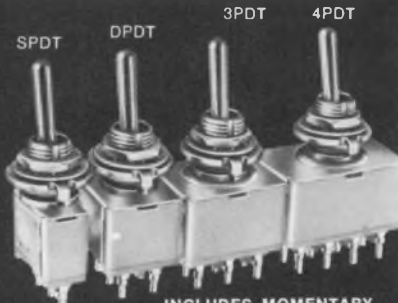

ALCOSWITCH®

INCLUDES MOMENTARY POSITIONS — SPDT, DPDT

DIV. OF ALCO ELECTRONIC PRODUCTS, INC., LAWRENCE, MASS

INFORMATION RETRIEVAL NUMBER 48

FORMATT

THIS NEW IDEA BOOK

FREE

From cover-to-cover, the all-new FORMATT Catalog No. 4 contains more information about how and where to use FORMATT cut-out acetate art aids than has ever before been available.

This, plus the widest variety of letters, arrows, borders, symbols and shading mediums offered by a single source, makes FORMATT Catalog No. 4 an indispensable tool in every creative design department.

See for yourself! Ask your art material supplier for your FREE copy of FORMATT Catalog No. 4 today, or write to:

MAIL THIS COUPON FOR YOUR FREE FORMATT CATALOG

FORMATT

GRAPHIC PRODUCTS CORPORATION
3601 Edison Place, Rolling Meadows, Illinois 60008

NAME _____ TITLE _____
COMPANY _____
ADDRESS _____
CITY _____ STATE _____ ZIP _____

INFORMATION RETRIEVAL NUMBER 49

advertiser's index

Advertiser	Page
Abbott Transistor Laboratories Incorporated.....	6
Acopian Corporation	48
Alco Electronic Products, Inc.....	92
Amphenol Components Group.....	11
Beckman Instruments, Inc., Helipot Division.....	17, 57
Belden Corporation	79
Bendix Corporation, The Electro-Optics Division.....	48
Bishop Graphics, Inc.....	90
Bulova Watch Company, Inc., Electronics Division.....	7
Burroughs Corporation	Cover IV
Cambridge Thermionic Corporation.....	49
Circuit Technology Incorporated.....	10
Dale Electronics, Inc.....	Cover II
Dana Laboratories, Inc.....	29
Dow Corning Corporation.....	13, 15
ECC Corporation	87
Edmund Scientific Company.....	90
Electronic Design	8, 9
Exact Electronics, Inc.....	30
Fairchild Semiconductor, A Division of Fairchild Camera and Instrument Corporation.....	4, 5
Federal Scientific Corporation.....	89
Graphic Products Corporation.....	92
Harris Semiconductor, A Division of Harris Intertype Corporation	81
Hayden Book Company, Inc.....	16
Heath/Schlumberger Scientific Instruments.....	55
Hughes Aircraft Company, Industrial Electronics Products	26, 27
Indiana General, A Division of Electronic Memories & Magnetics Corporation	14
Institution of Electrical Engineers, The.....	42
Interstate Electronics Corporation.....	83
Krohn-Hite Corporation	43
LEM Instrument Corporation.....	88
Lambda Electronics Corp.....	Cover III
Mallory Capacitor Company.....	33
Microdot, Inc.	34
Monsanto Company	85
Motorola Component Products Dept.....	18
Nortronics Company, Inc.....	48
Penntube Plastics Co., Inc.....	49
Rogers Corporation	48
SRC Division/Moxon, Inc.....	91
Silicon General	1
TRW/IRC Fixed Resistors, an Operation of TRW Electronic Components.....	21
Teledyne Relays, A Teledyne Company.....	2
Texas Instruments Incorporated, Components Group.....	28, 91
Transistor Devices, Inc.....	90
Union Carbide, Components Dept.....	12
U.S. Capacitor Corporation.....	49
Weston Instruments, Inc.....	16A-B
Woven Electronics	86

Do you face a make or buy decision on power supplies?

“BUY LAMBDA CUSTOM POWER SUPPLIES”

**No engineering design
charge for 15 standard
configurations**

3 weeks delivery

5 year guarantee

Low cost, full rack units provide up to 16
outputs, 3 standard package sizes, 5 stand-
ard front panel configurations.

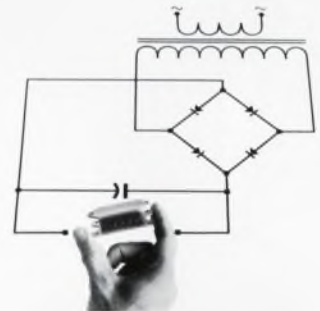

**WHETHER
YOU MAKE
OR BUY...**

**LAMBDA
ELECTRONICS CORP.**

A  Company

SELLS ON SIGHT



superior readability that competitors can't match

One look at an operating SELF-SCAN[®] panel display and you will know why you should be featuring one in your system. SELF-SCAN displays are a new solution to the operator machine interface that provides advantages to the system builder, to the system user, and to the system operator.

You can offer your customer the advantage of a custom-stylized unit that his operators can use efficiently. SELF-SCAN panels are measurably superior to CRT for operator accuracy while significantly reducing fatigue level in day in-day out high volume production applications.

The 0.2" high characters are in the popular 5x7 dot matrix format and are made up of dots on .040" centers. The unit is ASCII compatible and displays a modified 64-character ASCII character set.

256-character display subsystems are available from stock for immediate delivery. Call or write Burroughs Corporation, Electronic Components Division, Box 1226, Plainfield, New Jersey 07061, Phone: (201) 757-3400. Ask to have a Burroughs sales engineer stop by your office and show you his 256-character SELF-SCAN panel, keyboard, and power supplies packaged in a standard Samsonite[®] briefcase.

Burroughs 