

Electronic Design 5

VOL. 20 NO.

FOR ENGINEERS AND ENGINEERING MANAGERS

MARCH 2, 1972

RECEIVED
FEB 24 1972

With 350-MHz bandwidth at a sensitivity of 5mV per division, a new oscilloscope is the fastest portable. Its bandwidth passes that of all other portables and

all but one large, real-time scope with high sensitivity. Automatic sweep switching and many other sweep controls boost the scope's scope. For details, see page 67.





**DOWN WITH
UNTOLERANCE**



**UP WITH
WIREPOWER**

Dale's way with wire matches your need for precision at a price... and meets your special design needs.

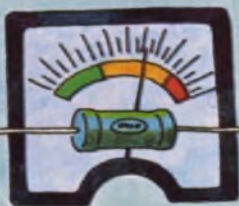

Shuntsmanship

Your meter needs Dale's new LVR. Dale has slashed shunt resistor prices as much as 66% and reduced resistance values to as low as .008 ohm. 2, 5, 10 watt styles. Circle 181



Fuse News

Two Dale styles combine precision resistance with predictable fusing times. Axial lead (CFR) has ¼ to 2½ W power. Special disc type for use in socket applications. Circle 182



Wirepower in RN50 Size

Dale's tiny new RS-1/8 dissipates up to ¼ watt in .155". Operates to +275°C. Molded body can be automatically inserted. T.C. as low as ±20 PPM. Circle 183



Networks with Muscle

WDP wirewound network handles up to 3.5 watts in standard 14-pin DIP size. Contains up to seven resistors which can have closely-matched tolerance (.1%) and T.C. (±5 PPM). Circle 184

It's all in the family. If the resistance function you need isn't in Dale's Catalog A... don't worry, we have it. No one beats our ability to mix and match resistance parameters.

DEPENDABLE DALE... comes to you with the courtesy of the best representatives and distributors in the business. There's a source of information near you... or call 402-564-3131 today.

DALE ELECTRONICS, INC.
1300 28th Ave., Columbus, Nebr. 68601
A subsidiary of The Lionel Corporation
In Canada: Dale Electronics Canada, Ltd.



**DEPENDABLE
DALE**

Why the best high frequency transistors cost less than the second best.



It doesn't happen often. But in the case of microwave transistors, you don't have to trade off performance to get the lowest price. That's because we've combined advances in silicon semiconductor technology with efficient mass-production. The result to date has been:

The workhorse: HP 21.

This small signal transistor is the backbone of any RF/microwave amplifier design. It has a 12 dB gain at 2 GHz (useable to 5 GHz), a noise figure of 4.2 dB at 2 GHz and a price of only \$19 each in small quantities. So you won't be making tradeoffs in your design.

Really low noise.

The HP 22, a significant new high frequency device, has a maximum

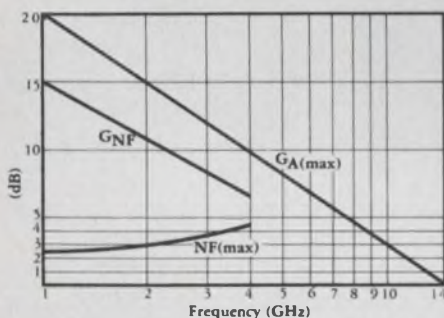

guaranteed noise figure of 4.5 dB at 4 GHz with 6.5 dB gain when biased for optimum NF (10 V, 5 mA). With 3 dB more gain across the band than the HP 21, the HP 22 is useable to 8 GHz

in its stripline packages. All for just \$75 each. No other transistor can make that statement.

More power out.

That's the function of the new HP 11. It fills the power gap between the HP 21 and high power devices. As a preamp

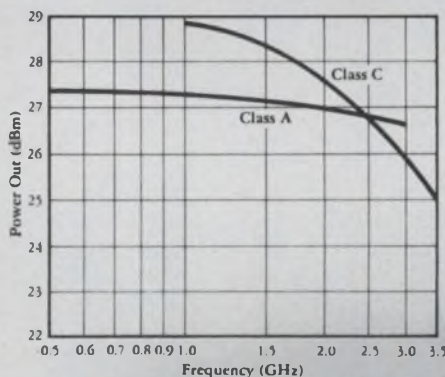

output or linear driver, it offers low distortion from 2 to 4 GHz. Yet it costs the same as the small signal HP 21.

The low price of success.

You've seen the kind of performance our transistors offer. Now let's get down to the cost factor.

Quantity	HP 21	HP 22	HP 11
1-99	\$19	\$75	\$19
100+	15	65	15

(Domestic USA prices for stripline packages.)

Can you afford not to use them?

Firm delivery and great reliability.

We can deliver most orders from stock. And you can count on device reliability. Our proven manufacturing process not only provides excellent parameter stability from batch to batch but insures healthy devices. Like 10 million hours MTBF for the HP 21.

An HP field engineer is nearby to answer your questions and handle your orders promptly. Why not give him a call for complete information about our transistors. Or write Hewlett-Packard, Palo Alto, California 94304.

Europe: 1217 Meyrin-Geneva, Switzerland.

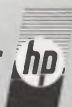

HP transistors: a small price to pay for performance.

HEWLETT  PACKARD

COMPONENTS

Now this is all the voltage you need for a 100-watt solid state SSB mobile transceiver



It's a fact. TRW's new family of 12-volt linear RF power transistors makes it possible. And the total equipment cost is comparable to tube designs.

Since they operate directly from a 12-volt DC source, these new transistors immediately eliminate the need for DC conversion in mobile designs. And they'll withstand open and short circuit VSWR at 16V in a broadband circuit at full power output. Intermodulation distortion is better than 30dB.

To make these benefits more immediately available to you, we have designed a solid state 100-watt broadband linear power amplifier using our new

transistors. It operates on 12 volts DC, covers the 1.5 to 30 MHz band, and provides superior performance and reliability in SSB applications. Our Application Note CT-113-71 describes this design in detail, including performance characteristics, parts list, P.C. board and component layout.

If you'd like a copy of this application note, as well as technical details on the SSB transistor family, call or write TRW Semiconductors, an Operation of TRW Electronic Components, 14520 Aviation Blvd., Lawndale, Calif. 90260. Phone (213) 679-4561. TWX 910-325-6206. Or contact your local TRW Sales office.



TRW
SEMICONDUCTORS

NEWS

- 19 **News Scope**
- 22 **A 'computerized' FM tuner with 0.2% output distortion features an inductorless discriminator and seven-segment frequency readout.**
- 24 **Broadband power measuring is simplified.**
- 26 **A new type of ceramic imaging device named Cerampic stores high-resolution pictures much like photographic film.**
- 28 **A new concept in high-density lighted switches**
- 31 **Technology Abroad**
- 35 **Washington Report**

TECHNOLOGY

- 40 **Focus on Lighted Switches:** A special report on relatively simple devices that may be subject to a variety of problems.
- 50 **5 W per million bits of memory are all that's needed to retain data in 1103 semiconductor arrays.** A battery can carry on if the main supply fails.
- 54 **Detect overflow errors in binary adders** by random-function generation with an IC multiplexer. The method works even with inaccessible carry bits.
- 58 **Calculate multivibrator timing** with a nomogram that also allows you to observe the effects of changing a variable.
- 62 **Ideas for Design**

PRODUCTS

- 67 **Instrumentation:** Fastest portable scope shows 350 MHz at 5mV/div
- 68 **Instrumentation:** Function generator ramp doesn't drift when held
- 70 **ICs & Semiconductors:** MOS 4-1/2-digit multimeter chip features auto ranging.
- 72 **Packaging & Materials:** Now you see it, now you don't with secret stripper
- 73 **Components**
- 74 **Data Processing**

Departments

- 39 **Editorial:** Don't be a 'don't know'
- 7 **Letters** 80 **Advertisers' Index**
- 75 **Application Notes** 80 **Information Retrieval Card**
- 76 **New Literature**

Cover: Tektronix, Inc., Beaverton, Ore.

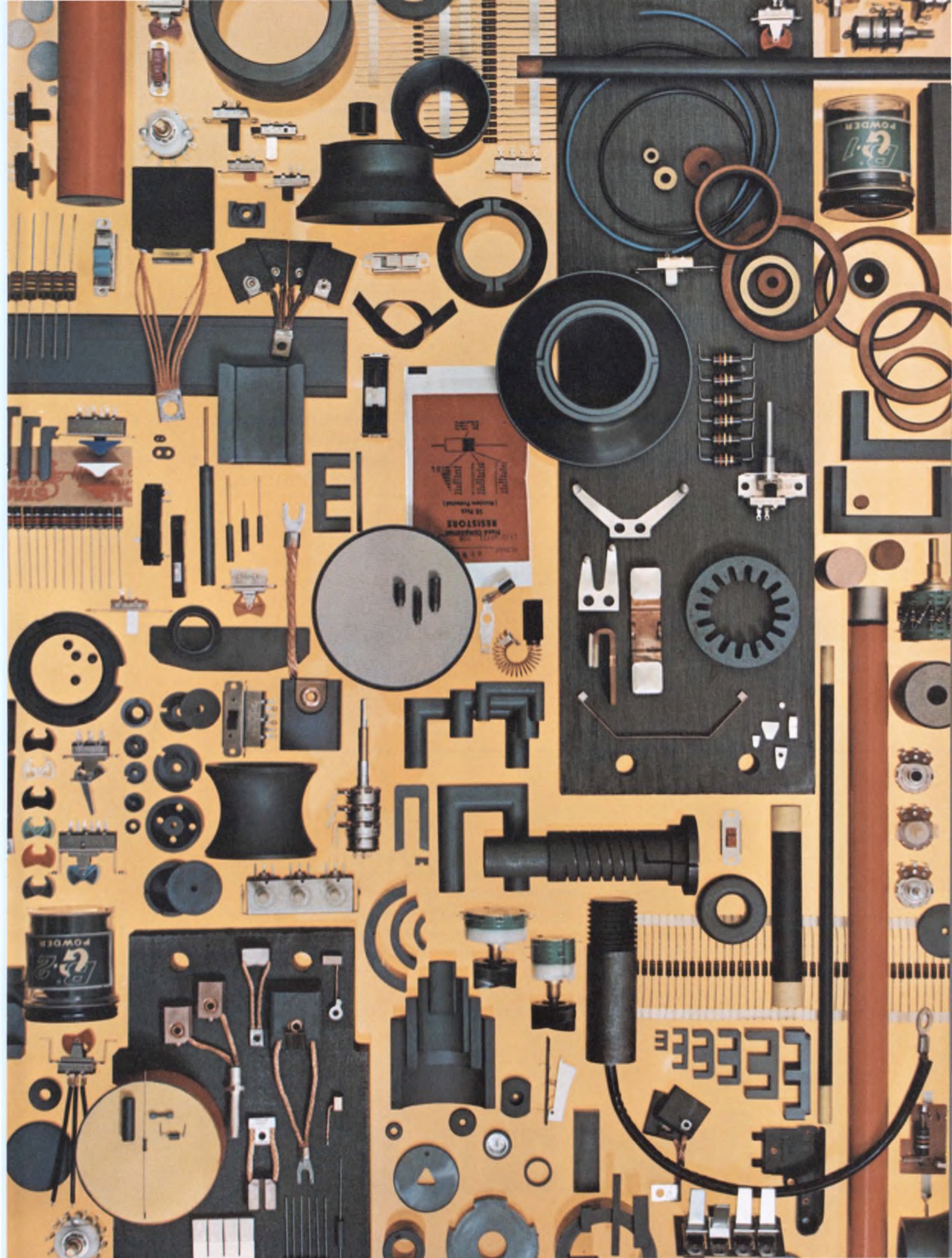

Our part in your product is value



**Carbon and
Graphite
Products**



**Electro-
Mechanical
Components**



**Hard and Soft
Ferrites**

*The items shown are produced by Stackpole's
Carbon Division, Electronic Components Division,
Magnet Division and Stackpole Components Company.*

We make a lot of things at Stackpole. Components by the millions. Materials by the ton. But what really makes us different is our philosophy.

Stackpole believes in producing the best possible product, for the lowest practical price, delivered on time and backed by service. Simple? Sure. Perhaps even old-fashioned. But true. And certainly no small task.

Ours is a manufacturing technology. A capability to produce. In volume. To your specific needs.

For sixty-five years, Stackpole has served virtually every industry. To many, we are the known, respected leader. Others in emerging technologies are coming to know the special skills, imagination, experience and quality uniquely Stackpole.

Value. It's determined in performance. For products and companies alike. Let us be a part of your production team.

Stackpole Carbon Company,
St. Marys, Pennsylvania 15857.



STACKPOLE

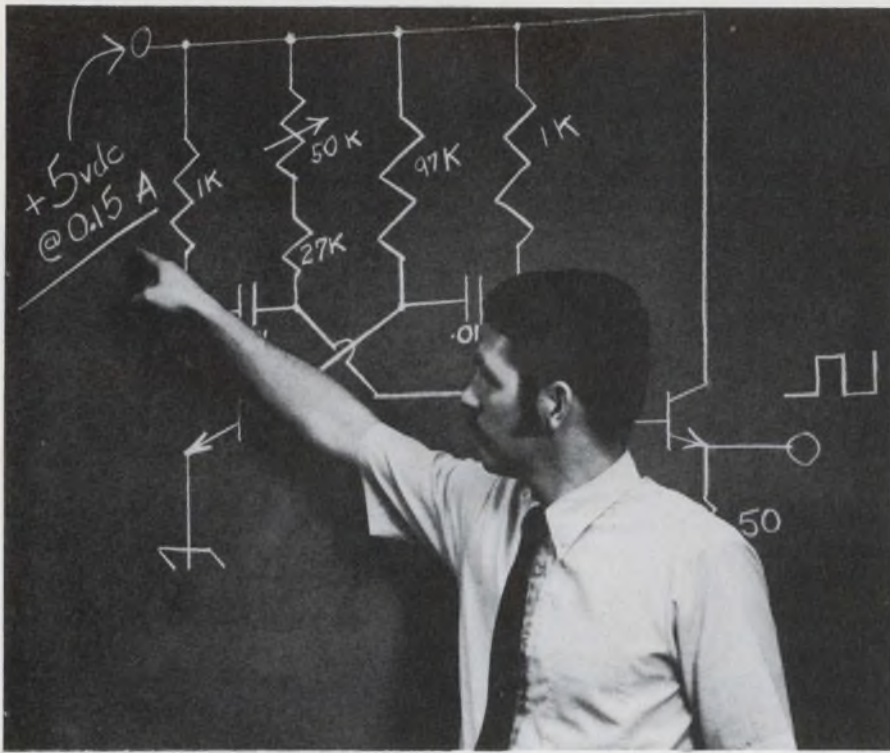

How to Design Your Power Supply for \$83

You get the **complete schematic diagram, and parts list** with operating and installation instructions when you spend \$83 for an Abbott Model "R" power supply. Two years in development, this model represents the latest state of the art in power module design. It features close regulation ($\pm 0.05\%$), low ripple (0.02%), automatic short circuit and complimentary overvoltage protection and continuous operation in a 160°F ambient.

Abbott Engineers followed specific design criteria in engineering these modules. First, the electrical design was carefully engineered to insure that all components operate well within their limits, under "worst case" operating conditions. Second, the thermal design, including case construction, was carefully made to insure that the maximum temperature limits of all components are never exceeded. Then the size and weight of these modules were controlled to a minimum, without sacrificing reliability. Finally these units were thoroughly tested to make certain that all design and performance specifications were met.

So, you can build your own power supply using our schematic diagram if you want to—but we think we can build it more

reliably and for less cost, simply because we have been doing it for ten years. Put our power supply in your system first and try it. Examine its performance. We think you will be pleasantly surprised at the quality, adherence to specifications, and the reliability you find in the Abbott Model "R".

Any output voltage from 5 to 100 volts DC with current from 0.15 to 20 amperes is available. **Many of the popular voltages are carried in stock for immediate delivery.** Please call us for attractive O.E.M. discount prices.

Abbott also manufactures 3,000 other models of power supplies with output voltages from 5.0 to 3,650 volts DC and with output currents from 2 milliamperes to 20 amperes. They are all listed **with prices** in the new Abbott catalog with various inputs:

- 60 A to DC, Hermetically Sealed
- 400 A to DC, Regulated
- 28 VDC to DC, Regulated
- 28 VDC to 400 A , 1 ϕ or 3 ϕ
- 24 VDC to 60 A , 1 ϕ

Please see pages 618 to 632 of your 1971-72 EEM (ELECTRONIC ENGINEERS MASTER Catalog) for complete information on Abbott modules.

Send for our new 56 page FREE catalog.

abbott

transistor

LABORATORIES, INCORPORATED
 5200 W. Jefferson Blvd./Los Angeles 90016 (213) 936-8185
 1224 Anderson Ave./Fort Lee, N.J. 07024 (201) 224-6900

INFORMATION RETRIEVAL NUMBER 4

Publisher

Peter Coley

Editors

Editorial Offices
 50 Essex St.
 Rochelle Park, N.J. 07662
 (201) 843-0550
 TWX: 710-990 5071
 Cable: Haydenpubs Rochellepark

Editor: George Rostky

Managing Editors:

Ralph Dobriner
 Michael Elphick

Associate Editors:

Jules H. Gilder
 Richard Lee Goldberg
 John F. Mason
 Stanley Runyon
 Edward A. Torrero
 Richard L. Turmail

Contributing Editor:

Peter N. Budzilovich

Editorial Field Offices

East

Jim McDermott, Eastern Editor
 P.O. Box 272
 Easthampton, Mass. 01027
 (413) 527-3632

West

David N. Kaye, Senior Western Editor
 2930 West Imperial Highway
 Inglewood, Calif 90303
 (213) 757-0183
 Les Brock, Western Editor
 95 Main St.
 Los Altos, Calif. 94022
 (415) 941-3084

Washington

Don Byrne, Washington Editor
 1111 S. Army Navy Drive
 Arlington, Va. 22202
 (202) 296-8982

Editorial Production

Dollie S. Viebig

Art

Art Director, William Kelly
 Richard Luce
 Anthony J. Fischetto

Production

Manager, Thomas V. Sedita
 Helen De Polo
 Maxine Correal
 Anne Molfetas

Circulation

Manager, Nancy L. Merritt
 Joan Licari

Information Retrieval

Peggy Long

across the desk

Readers to vendors: Tell us your price!

I would like to thank reader L. D. Dillard for speaking out against manufacturers who are reluctant to give prices ("Why Can't Vendors Tell Us Their Prices?" ED 1, Jan. 6, 1972, p. 16D). I think a lot of time is wasted in writing to or calling manufacturers or their reps to get this information. I wonder how such an absurd policy of withholding prices originated? Isn't the price one of the most important specifications of any product?

Stephen D. Anderson
5761 33rd Ave. S.
Minneapolis, Minn. 55417

Our thanks to L. D. Dillard for expressing his views on the vendors' reluctance to publish their prices. We have frequently been told by some vendors: "We want you to call us." Therefore we sometimes give them a call, or at least try to, around 3 a.m. on Sunday mornings, when it becomes necessary to complete important system cost estimates before 8 a.m. on the following Monday morning.

We see no earthly reason why vendors cannot issue a mimeographed price list once a year. We can always estimate a possible price increase for any other part of the year, if we are in a schedule bind. Later we can contact the vendor by mail or telephone during regular working hours for price confirmation.

W. J. Kessler, P.E.

Short circuits

In the Jan. 6, 1972 issue, the schematic for the Idea for Design entitled "Discharge Capacitors

With a MOSFET" (ED 1, p. 95) was incorrectly drawn, so that the +15 and -15 V terminals of the power supply were connected through a switch. Throwing this switch will discharge the capacitor all right, but the entire power supply will go up with it! In the correct version (shown in the accompanying Fig. 1) the switch should be connected to the gate of the MOSFET instead of to the +15 V power supply.

One reader, Bob Pease of Tele-dyne Philbrick, has suggested a JFET instead of a MOSFET, since the latter usually has a lower reset jump,

$$Q = (\Delta V_G) \times (C_{GD}),$$

if the source is connected to the output and the drain is connected to the input. This is because C_{DG} is usually smaller than C_{GS} .

The author of the Idea for Design, Glen Coers of Texas Instruments, has submitted a second drawing (Fig. 2), which he says "shows the circuit more clearly."

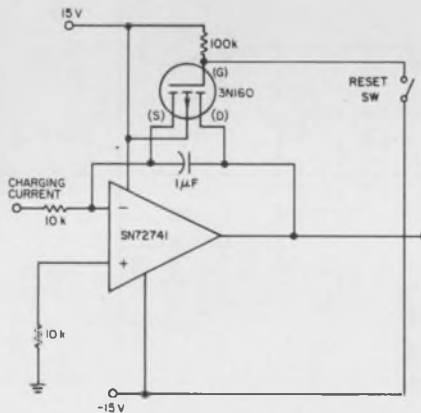

1. Corrected drawing, with reset switch tied to gate of MOSFET.

(continued on p. 12)

Electronic Design welcomes the opinions of its readers on the issues raised in the magazine's editorial columns. Address letters to Managing Editor, Electronic Design, 50 Essex St. Rochelle Park, N. J. 07662. Try to keep letters under 200 words. Letters must be signed. Names will be withheld on request.

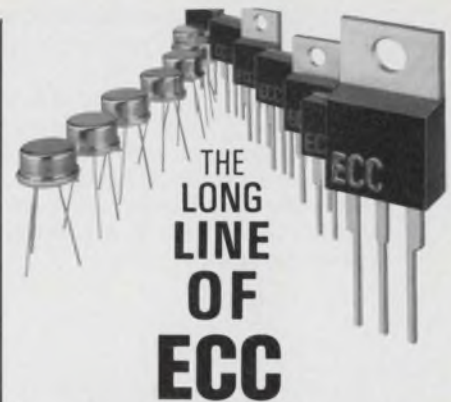

SENSITIVE and STANDARD GATE TRIACS

World's leading triac producer offers fast delivery, electrical isolation and competitive pricing.

SENSITIVE GATE TRIACS

TO-5 Metal and Plastic; THERMOPAK[®] and THERMOTAB[®] Packages

$I_{T(RMS)}$	0.8 - 3 amps
I_{GT}	3 & 10 ma (all 4 quadrants)
I_{TSM}	20 amps
V_{DROM}	200 - 400 volts

STANDARD GATE TRIACS

THERMOTAB and THERMOPAK Packages (13 other packages available up to 40 amps)

$I_{T(RMS)}$	0.8 - 40 amps
I_{GT}	25 & 50 ma max.
I_{TSM}	20 - 300 amps
V_{DROM}	200 - 800 volts

All ECC triacs feature heavily glass passivated junctions for high reliability. They are available from your nearest ECC Sales Representative or Authorized Distributor.

New Condensed Catalog contains technical data on these and other ECC semiconductors. To receive your copy, circle No. 248.



ECC

CORPORATION

P.O. Box 669 • Euless, Texas 76039
817/267-2601

INFORMATION RETRIEVAL NUMBER 5

... In Space-Limited Applications
*Hammer Driver Darlington*s are now available in compact, TO-66 packaging! The new, 2 and 4 A types offer 3,000 typical gain for space-critical switching applications such as hammer drivers. This design provides one-stage interface between MHTL logic drive and printout in minimum space.

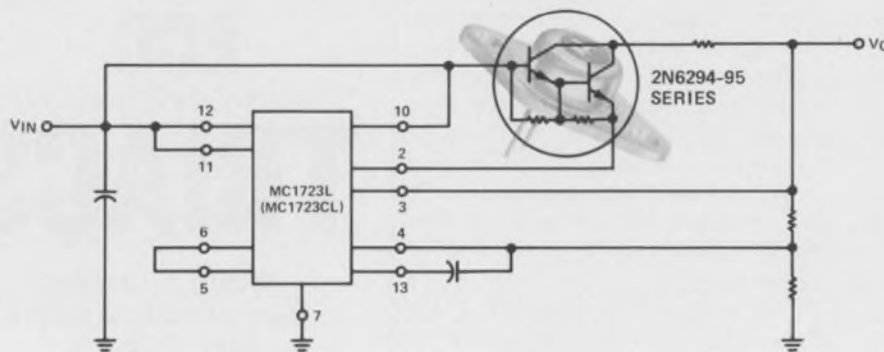
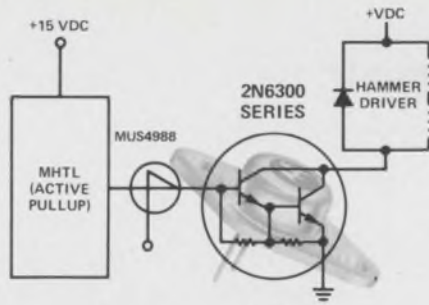

... In IC-Driven Applications
High-Performance Series Pass Regulator—Better than 0.03% performance is realized with this 2 A Darlington/MC1723 hookup. The capacitor between pins 4 and 13 provides frequency compensation for

the MC1723. The new 2N6294-95 series Darlington, with typical gain specs of 3,000 at 2 A I_c , greatly boost load current since the regulator will only source up to 150 mA. Go from milliamperes to amperes directly, compatibly, easily.

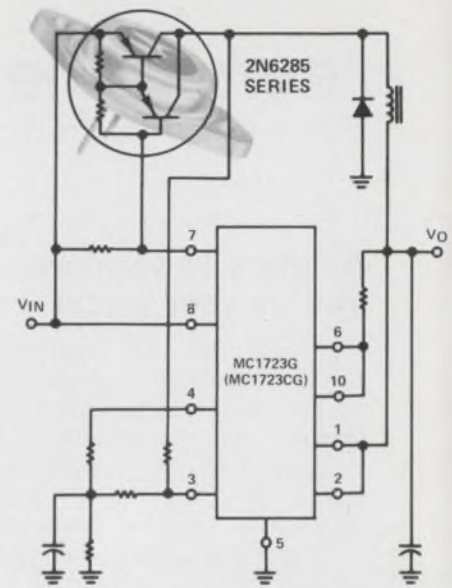

... In High-Power Applications
High-Performance Switching Regulator—The new 2N6282/6284 Darlington can be used in this regulator to furnish 2,400 typical gain at 10 A. Switching regulators are especially useful in reducing power dissipation in a circuit requiring a large input voltage and producing a small output voltage. Darlington simplify!

Gain Command With

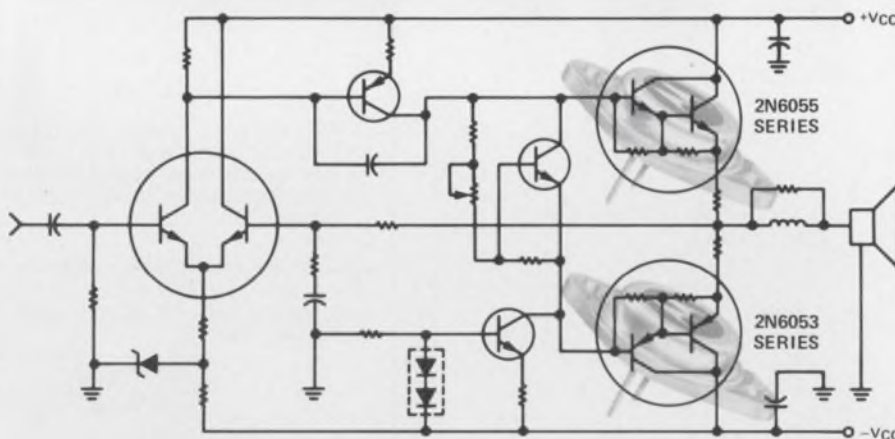

... In Complementary Applications
15 to 60 W Power Amplifier—Typical gain of 3,000 at 4 A with the new 2N6053-55 NPN/PNP Darlington complements ensures significant simplification and cost savings in complementary power amps. The

circuit features zero center voltage for maximum signal swing, 100% dc feedback, automatic offset voltage correction and noise and hum filtering. Amplify your gain specs with Darlington.

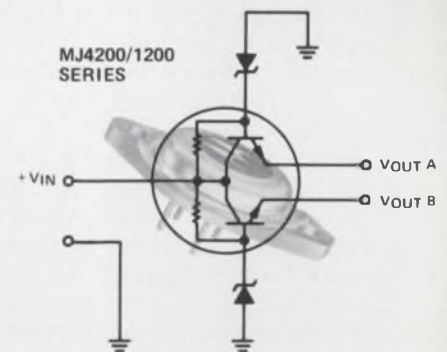

... In Dual Applications
Split Voltage Power Supply—Simpler, lower-cost, split power supplies using just one 4-lead discrete power package containing two drivers, two output devices and emitter-base resistors are easy with the new 2 and 4 A MJ4200/1200 Darlington. Providing 3,000 typical gain, the units are common-collector-connected to give 2 separate output voltages.

New Darlings . . .

NPN	PNP	Package	$V_{CEO(sus)}$ V Max.	P_D W	h_{FE} @ I_C Min	Price Range 100-999	
						NPN	PNP
2N6294-95	2N6296-97	T0-66	60-80	50	750 @ 2 A	\$1.30-\$1.65	\$1.80-\$2.25
MJ4200-01 Dual	MJ4210-11 Dual	4-Lead TO-3	60-80	50	750 @ 2 A	3.50- 4.30	3.90- 4.80
MJ1200-01 Dual	MJ920-21 Dual	4-Lead TO-3	60-80	90	750 @ 4 A	4.90- 5.80	5.90- 6.80
2N6055-56	2N6053-54	T0-3	60-80	100	750 @ 4 A	1.72- 2.07	2.43- 2.88
2N6300-01	2N6298-99	T0-66	60-80	75	750 @ 4 A	1.67- 2.02	2.38- 2.83
2N6057-9	2N6050-52	T0-3	60-100	150	750 @ 6 A	2.54- 3.54	3.25- 4.36
2N6282-84	2N6285-87	T0-3	60-100	160	750 @ 10 A	4.30- 5.20	4.55- 5.65

Darlings Introduced . . .

Complementary Series	Package	h_{FE} @ I_C Min.	Pair Price (60 V) 100-999
MJE700/800	Plastic THERMOPAD	750 @ 1.5, 2 A	\$2.62
MJ4000/4001	TO-3	1,000 @ 1.5	3.20
MJ900/1000	TO-3	1,000 @ 3 A	3.85
MJE1090/1100	Plastic THERMOPAD	750 @ 3, 4 A	3.45
MJ2500/3000	TO-3	1,000 @ 5 A	5.40
MJ4030/4033	TO-3	1,000 @ 10 A	8.50

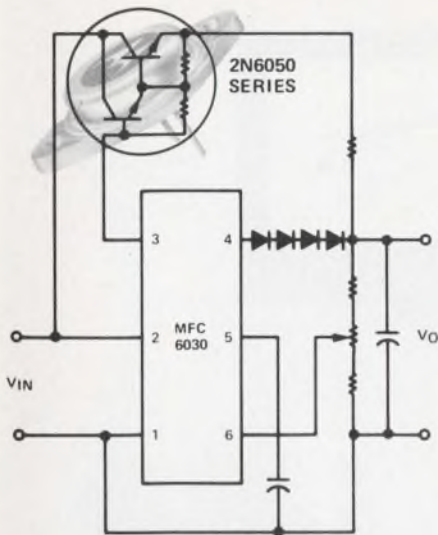

. . . In General-Purpose, "2N3055" Applications

Short-Circuit Protected Power Supply- For this economical functional circuit supply, load regulation is 0.08% when used as a 5 V regulator. The 4 and 6 A 2N6057/6059 series Darlings provide 4,000 typical gain figures and include the new 2N6055 Darlington — a direct, plug-in replacement for the industry-standard, general-purpose 2N3055 and its driver!

More Power Darlings

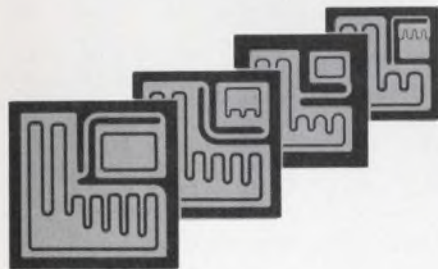

EpiBase* Makes It Possible . . .

Only EpiBase technology possesses inherent capability to yield complementary Darlings — all possessing higher gain with better linearity, more chip sizes, higher frequency, lower saturation voltages and lower

cost than other processes.

Select from 33 complementary, metal and plastic, Motorola Darlington pairs now. And write us at Box 20912, Phoenix, AZ 85036 for complete Darlington data.

Special Offer!

Get a \$1.72 2N6055 NPN Darlington for \$1.05 . . . the same 100-up price as a 2N3055! Get 750 minimum gain at 4 A . . . plus all the space, time and money-saving advantages inherent in Darlington design for your prototype relay and solenoid drivers, audio/servo amplifiers, power supply and series pass regulators. Fill in and send the coupon to your Motorola distributor . . . he'll respond with your 2N6055 Darlington in a hurry!

To: (distributor) _____

I want to gain Darlington command in my power circuits — send me a 2N6055 for the price of a 2N3055 today . . . only \$1.05!

Name _____ Title _____

Company _____

Address _____

City _____ State _____ Zip _____

(Offer expires April 30, 1972)



*Trademark of Motorola Inc.

If you need panel instruments with **custom** dials, cases, accuracy, tracking, resistance, response time, or practically any combination of unusual specs...

Buy **Triplett's** designed-for-you **Panel Instruments**

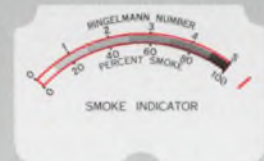
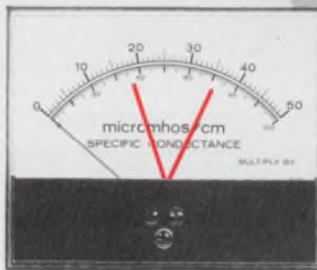

Although we stock some 1369 different styles, sizes and types of standard panel instruments, a very large proportion of our customers buy custom instruments.

Because they need:

custom dials

reading in such units as pH, roentgens, mm Hg, rpm, %, inches.

custom cases

square, round, rectangular, edge-wise (horizontal and vertical), wide, narrow, shallow.

custom accuracy

to within 1/2% with mirror scales and knife-edge pointers.

custom tracking

to match the specific needs of existing or new instrument designs.

custom resistance

for low circuit loading with tolerances as low as $\pm 1\%$.

custom damping

to meet stringent electrical and vibration requirements.

For instance, one of our customers had us design and manufacture a custom instrument to replace — in every detail of physical and electrical specifications — one which he was using on a delicate piece of medical instrumentation. Rejects from his previous source had risen to over 20%. He rejected only 3 of the first hundred we shipped — with almost negligible rejections from the many hundreds we've shipped since.

What custom panel instrument specifications do you need to make your

product more reliable, more accurate, more rugged and — in the long run — less expensive? For quick, dependable delivery of small quantities of Triplett's "designed-for-you" panel instruments, contact your Triplett Sales/Service/Modification Center. For prototypes or production quantities, contact your Triplett representative. He'll put you in touch with our Instrument Designers/Engineers who'll help you analyze the problem and suggest the optimum cost/result solution.

TRIPLETT
BLUFFTON, OHIO 45817
Manufacturers of the World's most complete line of V-O-M's

INFORMATION RETRIEVAL NUMBER 7

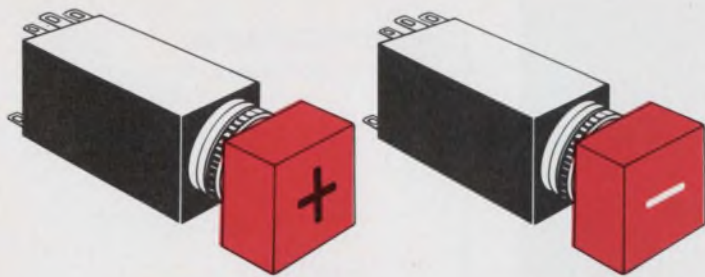

Contactless solid state switches

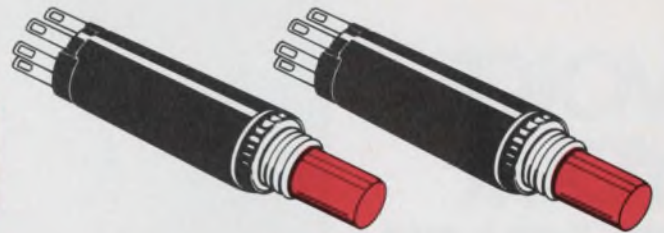

Incandescent or neon lighted switches

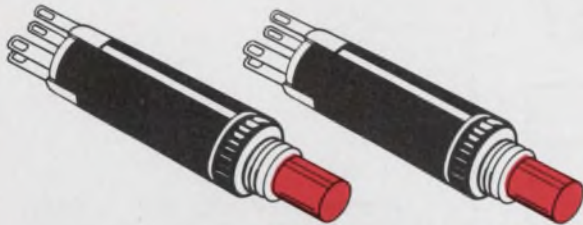

LED lighted switches... panel mounting

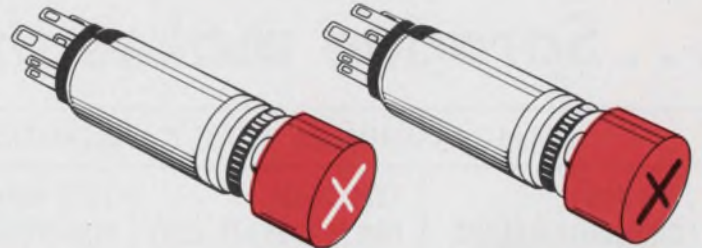

Incandescent lighted switches... panel mounting

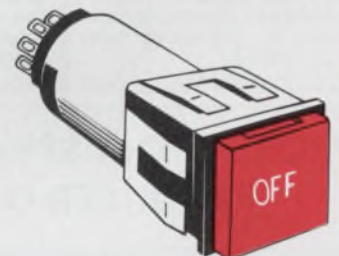
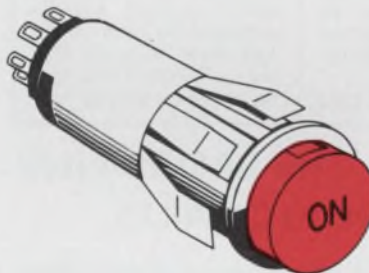
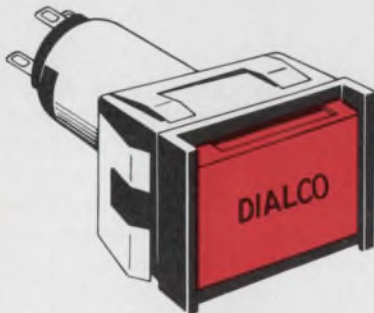

Incandescent lighted switches... snap-in mounting

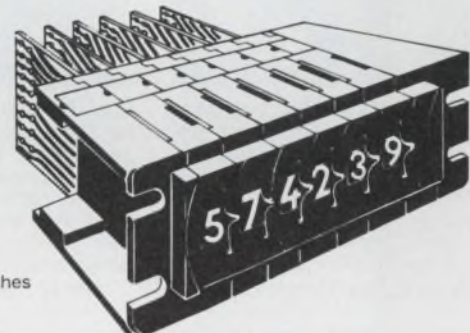
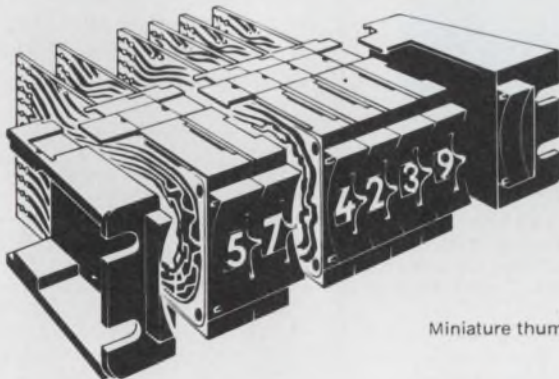

Miniature thumbwheel switches

Switches?

**Talk to the specialists at Dialight first.
You won't have to talk to anyone else.**

Dialight has a switch for virtually any application. That means complete freedom to design for the job without compromising on physical or electrical parameters. Dialight can give you push button switches with unlimited cap and bezel options...solid state switches that eliminate all mechanical switching

problems...LED lighted switches...thumbwheel switches that snap together to provide any number of decades you require... switches with transistorized indicators. If you have a special problem, tell us about it. Chances are, the specialists at Dialight have seen it before. Meanwhile, ask for our switch catalog.



DIALIGHT CORPORATION, A NORTH AMERICAN PHILIPS COMPANY • 60 STEWART AVENUE, BROOKLYN, N. Y. 11237 • (212) 497-7600

INFORMATION RETRIEVAL NUMBER 8

VOICE YOUR CHOICE

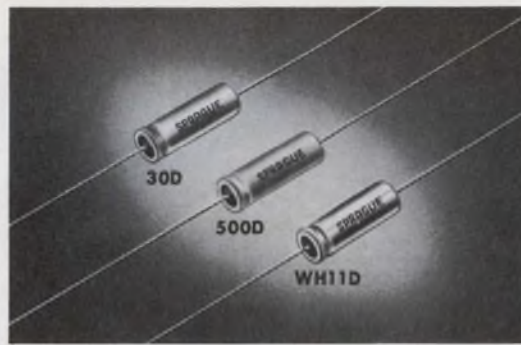

... Sprague makes three!

SMALL ALUMINUM 'LYTIC CAPACITORS

TYPE 30D FOR INDUSTRIAL USE

Will withstand 2000 hr. life test at 85C. Excellent stability, dissipation factor, leakage current. Designed for business machines, instrumentation equipment, etc. Write for Engineering Bulletin 3150A or; CIRCLE 882 ON SERVICE CARD.

TYPE 500D FOR MODERATE-COST

Good operating life characteristics, including stability, ESR, leakage current. Will withstand 1000 hr. life test at 85 C. Ideal for radio, TV, and other entertainment applications. Write for Engineering Bulletin 3149 or; CIRCLE 883 ON SERVICE CARD.

TYPE WH11D FOR ECONOMY

Welded construction, similar to higher-priced capacitors. Widely used in solid-state equipment where cost is of prime importance. Made by Sprague World Trade Corp. in Hong Kong. Write for Engineering Bulletin 3148C or; CIRCLE 884 ON SERVICE CARD.

MORE FROM SPRAGUE ... THE BROAD-LINE PRODUCER OF ELECTRONIC PARTS

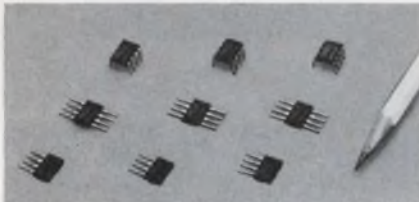

HALL EFFECT SWITCH ICs. Actuated magnetically, not mechanically or optically. Hall generator trigger circuit and signal amplification circuit on single silicon chip. Reliable (no moving parts). Easy interfacing with DTL/TTL/MOS logic. High speed. Low cost. Write for Engineering Bulletin 27,402A or;

CIRCLE 885 ON READER SERVICE CARD.



U.L. LISTED FILTERS. Series JX5000 for EDP equipment and general-purpose use. Rated 125/250 VAC, 0-60 Hz, 1 thru 50 amps. 60 db @ 150 kHz, 80 db from .5 MHz thru 1 GHz. Special designs and rectangular multi-circuit units also available. Write for Engineering Bulletin 8210 or;

CIRCLE 886 ON READER SERVICE CARD.



TYPE 36D POWERLYTIC® CAPACITORS. For use in computer power supplies, control equipment, energy storage, etc. Low impedance construction. Up to 650,000 μF at 3 V. Ratings from 3 to 450 V. Can be operated at 85 C. Tapped 10-32 terminals simplify filter bank assembly. Write for Engineering Bulletin 3431D or;

CIRCLE 887 ON READER SERVICE CARD.



BLUE JACKET® RESISTORS. Vitreous-enamel power wirewound. Unique all-welded end-cap construction eliminates moisture paths along leads, anchors leads securely to resistor body. Expansion coefficients of vitreous enamel, ceramic body, and end caps are closely matched. Write for Engineering Bulletin 7410E or;

CIRCLE 888 ON READER SERVICE CARD.



TECHNICAL LITERATURE SERVICE, SPRAGUE ELECTRIC CO., 347 MARSHALL ST., NORTH ADAMS, MASS. 01247

455-1117RZ

ACROSS THE DESK

(continued from p. 7)

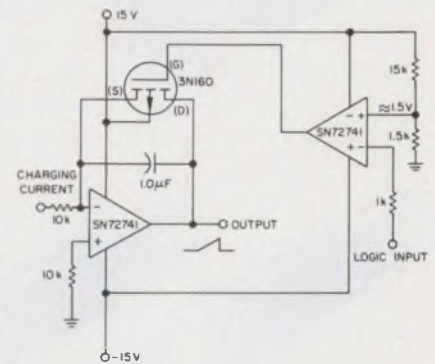

2. Alternate circuit, with another SN2741 op amp used as a differential comparator.

In the same Jan. 6 issue, Rama M. Reddy's Idea for Design, "Test One-Shots for Min, Max Widths," (ED 1, p. 96), the drawing was also incorrect. The leading edge of the clock should trigger the first one-shot of each of the four SW9602s. The second one-shot of the last SW9602 should be triggered by the trailing edge of the output pulse of the first one-shot. Here is a portion of the original drawing with corrections:

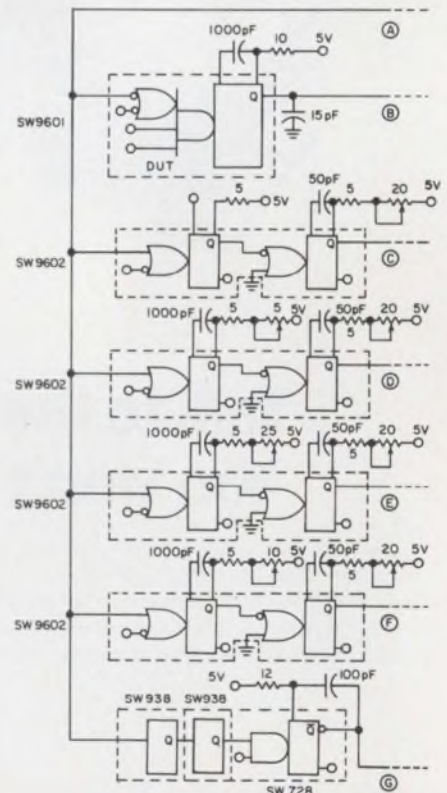

Make the simple move

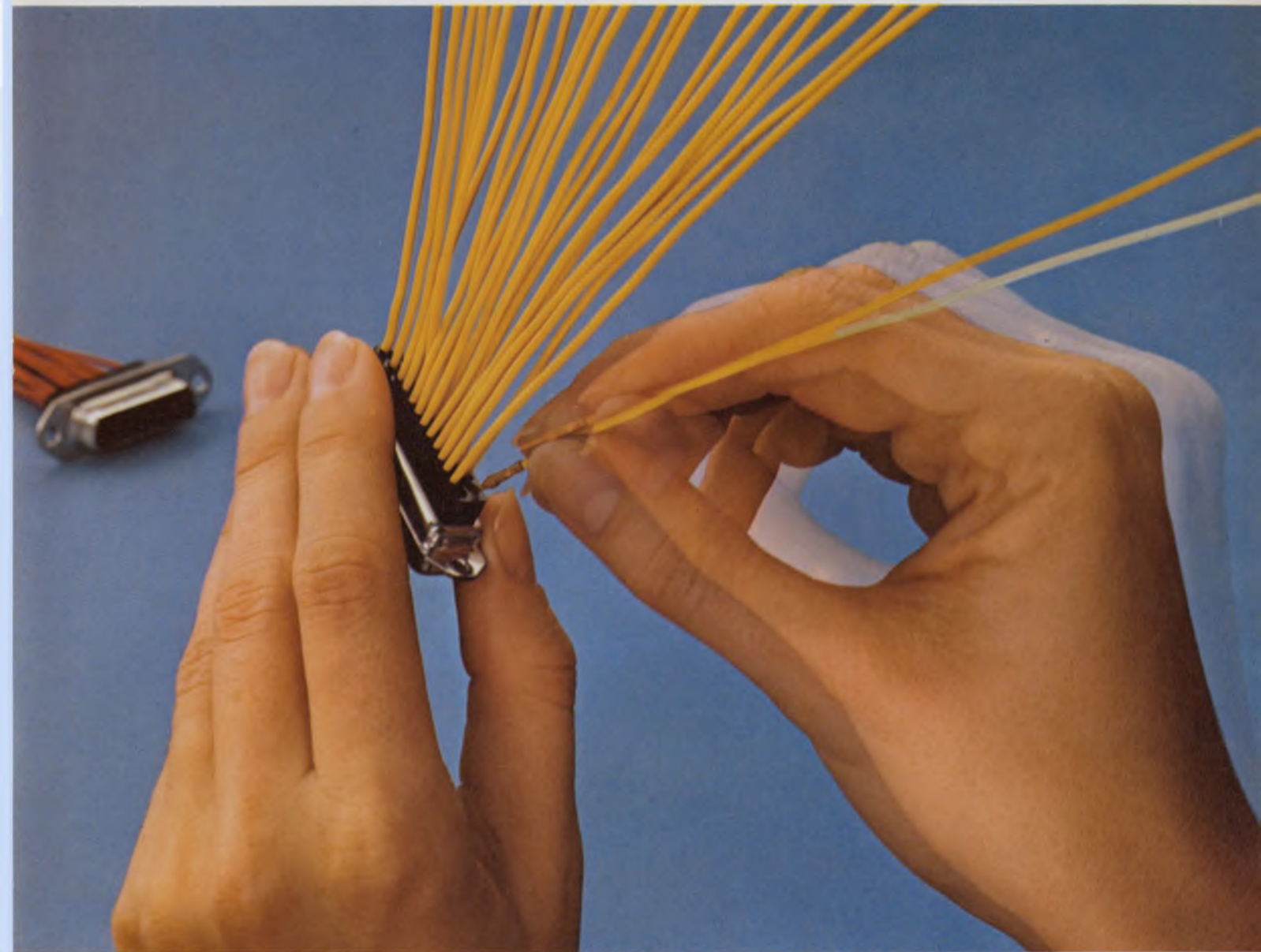

to less assembly time.

Do it the easy way with Amphenol's 17 Series miniature rear-release connectors.

A gentle push from the back of the connector and the contact snaps securely in place. No tools or broken fingernails, just easy fingertip assembly. And to remove the contact for fast-field servicing, insert a simple plastic tool in the back of the connector and out pops the contact.

You can have a choice of screw-machine contacts in bulk packaging, or stamped and formed contacts on a carrier strip. Semi-automatic crimping or hand tools available for either type of contact.

The Min-Rac® 17 Series connectors are available in 9, 15, 25, 37, and 50 contact configurations. All meet EIA Standard RS-232C for data communications input-output connectors. And all are intermountable and intermateable with other Min-Rac 17 Series connectors as well as competitive "D" type connectors.

Find out how simple it really is. Just write Dick Colt asking for the whole story on our Min-Rac 17 Series rear-release connectors. Amphenol Industrial Division, Bunker Ramo Corporation, 1830 South 54th Avenue, Chicago, Illinois 60650.



AMPHENOL

9344: A FASTER LOW-COST WAY TO MULTIPLY.



From our TTL Family Tree: A new MSI Parallel Multiplier that offers high-speed multipli- cation without using a lot of hardware and software.



Now there's a better way to perform fast multiplication: our 9344 2 x 4 special purpose multiplier.

This TTL/MSI device speeds up multiplication by using iterative logic cells in parallel, each cell generating eight partial products

and summing up carries from the adjacent cells. This contrasts with the time and space-consuming add-and-shift sequencing of conventional designs. Thus, you can include the specific multiplication function in your system with minimum hardware and programming. And compared to conventional, multi-package methods, you can do it faster, at lower cost/function, with less space required and lower overall system cost.

The 9344 is designed for hardware multiplication in both general and special-purpose computers. Its main applications are in digital filter circuits, Fast Fourier Transform processors, arithmetic function generators, minicomputers, wherever there are problems created by extensive multiplications that so greedily consume valuable time in real-time computers.

Since we announced the 9344 more than a year ago, we've been improving its performance and reducing its cost. Now it's in volume production, deliverable immediately from your friendly Fairchild distributor at these exceptionally modest prices:

9344	1-24	25-99	100-999
Flatpak Mil	\$47.50	\$42.00	\$38.00
Flatpack Ind.	26.50	23.10	21.00
DIP Mil	41.25	36.25	32.00
DIP Ind.	21.80	19.25	17.50

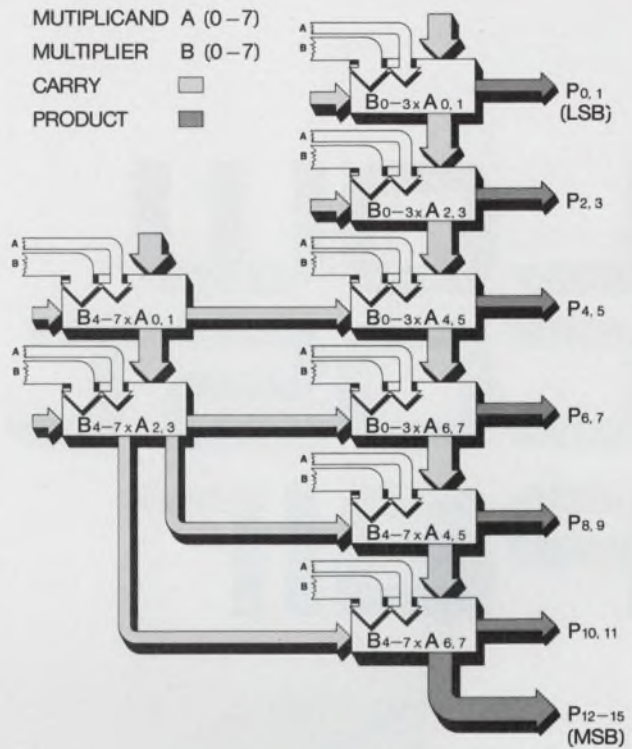

8 x 8 MULTIPLIER USING EIGHT 9344 DEVICES

The 9344 is a 2 x 4 bit combinatorial multiplier. It uses internal carry lookahead and has sufficient carry inputs to combine all equal weight outputs. This permits the design of iterative multiplication arrays without using any other components. The diagram shows the use of the 9344 to perform an 8 x 8 multiplication in 150ns. This same basic modular approach can be used for arrays ranging from 4 x 4 to 64 x 64 bits and larger.

For data sheets, applications information and samples, please call this special 9344 Hot Line number: (415) 962-3333.

**MADE IN
FAIRCHILD**

LOW COST PAIR



Two new, low-cost, 4-lamp, illuminated pushbutton switches and indicators for industrial and commercial applications.

Wide operational flexibility in either the square or rectangular unit is provided with 84 standard display options. Switching capability is from 10 micro-amps to 5 amps, in 2PDT or 4PDT configurations. Switches and indicators are off the shelf, in momentary and alternate action, or indicator display only. Designed for easy installation, these twins feature

unique integrated switch design and the exclusive "Lever Latch" which permits fast front panel pushbutton removal for relamping and legend changes.



The switch price? A low \$6.95, 100 piece quantity (2PDT Switch and Display). Get complete details today on the rectangular Model 2R and square Model 2S pushbutton switches and indicators from STACOSWITCH, Inc., 1139 Baker Street, Costa Mesa, California 92626 . . . telephone (714) 549-3041.



STACOSWITCH

INFORMATION RETRIEVAL NUMBER 11



1,500,000

KNOBS TO CHOOSE FROM...

and they're "Warranted for Life"

Kurz-Kasch has over 1½ million low cost, high quality knobs in inventory, ready to ship to you. (You save . . . no tooling cost on stock knobs, specials 4 to 6 weeks delivery.) Your local distributor's stock is available at factory prices. Select instrument and control knobs from 24 families with 367 basic sizes and shapes in general purpose phenolics, melamines and ureas. All Kurz-Kasch knobs are warranted for the life of the product on which they're used. Send now for free 20 page catalog. (Also found in THOMAS REGISTER "THOMCAT."®)



Kurz-Kasch, Inc.

1421 S. Broadway
Dayton, Ohio 45401
513/223-8161

INFORMATION RETRIEVAL NUMBER 12

Who ever heard of a line of Plug-in delay/interval Timers that is reliable, economical and interchangeable for as low as \$27.90?

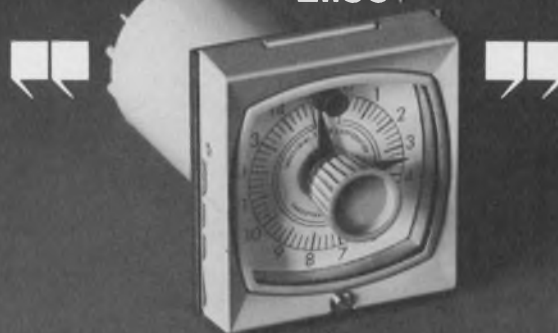

You just did.

It's our new Series GP which is completely interchangeable with over 80% of today's most widely used plug-in delay/interval timers. The GP is designed for easy installation in stan-

dard 3-inch diameter panel holes.

Delivery is stock to 6 weeks, depending upon quantity. Consult us for further information and the GP Bulletin 310. Call 201-887-2200.

SINGER
INDUSTRIAL TIMER DIV.

Industrial Timer Division, U.S. Highway 287, Parsippany, N.J. 07054 201/887-2200

INFORMATION RETRIEVAL NUMBER 13

ANOTHER MYTH DESTROYED.

Myth: National doesn't make FET op amps. And, even if they did, they probably wouldn't be as good as bipolar devices. And, besides, everybody knows that FET op amps have lousy offset voltage and drift specs. And, FET op amps are too expensive. And, anyway, why not just go to a module house in the first place...

Fact: National does make FET op amps. A "family" of five devices, to be exact. Including the super precise new LH0052 (with an offset voltage of 0.1mV, an offset voltage drift of just $5\mu\text{V}/^\circ\text{C}$, and bias current of less than 1pA); the LH0022 (high performance good general purpose FET op amp); the LH0042 (lowest cost FET op amp on the market with even better performance than cheap module designs); the LH0033 (at $1500\text{V}/\mu\text{S}$, the fastest voltage follower available anywhere); the LH0032 (a $500\text{V}/\mu\text{S}$ device); and coming soon: The precise-and-speedy new LH0062 (slew rate, $80\text{V}/\mu\text{S}$; bandwidth, 15MHz; settling rate, 800nS). Significantly, each of the above was designed and manufactured completely in-house using a special chip construction technique combining the best of J-FET and bipolar technologies. All of which goes to show that FET op amps are, indeed, alive and well at National Semiconductor Corporation, 2900 Semiconductor Drive, Santa Clara, California 95051. Phone (408) 732-5000. TWX: (910) 339-9240. Cable: NATSEMICON.

NATIONAL.

British engineers read Electronics & Power



... and the world looks on.

ELECTRONICS & POWER is a monthly wide-ranging technological magazine designed to record and report, in an easily readable way, the latest advances in electronic and electrical science and technology and their interplay with related technologies, with industrial practice, and with day-to-day life. The coverage is international with a British bias. The magazine includes feature articles specially written by accepted authorities, industrial and technical news, book reviews, editorial

comment and letters to the editor. **E & P** is read by 64 000 members of the Institution of Electrical Engineers, the recognised body for professional electrical and electronics engineers in Great Britain. It therefore accurately reflects British engineering practice. **E & P** is important to you, because it speaks for British electrical and electronics engineering. Free from commercial pressures, **E & P** speaks with authority and integrity to the professional engineer.

E & P is published monthly by the Institution of Electrical Engineers, and the annual subscription for 1972 is £13.50 (s32.40). All subscriptions begin on the 1st January and are accepted for one year only. An annual index is given free to subscribers with every December issue of the journal.

Please send your subscription orders, with remittances to:
**The Institution of Electrical Engineers,
PO Box 8, Southgate House, Stevenage,
Herts. SG1 1HQ, England**

Ring up more savings on keyboard switches.



As much as **50%**
(savings per key)

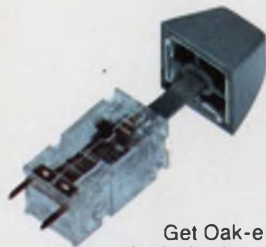

The new Oak Series 400.

Get Oak-engineered quality in keyboard switches with the inherent reliability of electro-mechanical operation. Ideal for peripheral data-processing equipment. Contact bounce is less than 3 milliseconds. Long life, up to 20 million operations per key. Designed with self-cleaning crossbar-wiping contacts.

Under 30¢ each.

For SPST/NO in production quantities. Other versions comparably priced. Keytop button and snap-in mounting extra.

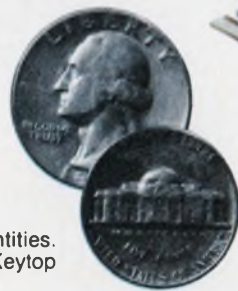

A feather touch.

We kept the operator in mind. Standard operating force is approximately 85 grams (3 oz.).



Also from Oak: Series 300 Lighted Pushbutton Switches.

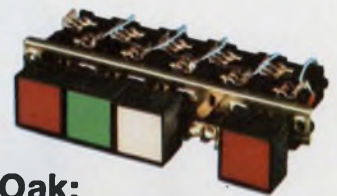

Featuring Oak's exclusive twin-lamp lighting. If one lamp goes out, the other stays on. Double-wiping contact clips. Short stroke. Smooth, quiet operation. Unlimited combinations. Request our Series 300 brochure.

The configurations you want.

The Series 400 is available in limitless arrangements, including standard 10, 12, and 16-button keyboards. And you can specify any of six different contact circuitries. Choose snap-in or plug-in P.C. mounting. Compact—only 1/2" x 1/2" x 1".

Write today for our Series 400 brochure.

OAK MANUFACTURING CO.

CRYSTAL LAKE, ILLINOIS 60014 · A DIVISION OF OAK ELECTRO/NETICS CORP.

Telephone: 815-459-5000

TWX: 910-634-3353

TELEX: 722-447

INFORMATION RETRIEVAL NUMBER 18

Heat-dissipation problems. Why tolerate them? Design in stability and reliability with the Dow Corning heat-sink system.

Forget heat, once and for all. Design in the Dow Corning heat-sink system for maximum component density, minimum heat.

Start with Dow Corning® 18 semiconductor potting compound in your solid-state, discrete components. This high-purity, greaselike material has excellent stability, low moisture content, high thermal conductivity, stable electrical properties. Protects junctions from heat failures, contaminants, mechanical and thermal shock.

Then, for maximum protection, design Dow Corning® 340 heat-sink compound between the device and the chassis or PC board. This compound combines a silicone material with metal oxides to ensure high thermal conductivity, low bleed, high temperature stability. Will not dry out, harden, or melt, even after long-term exposure to temperatures up to 392 F. It maintains a positive seal that improves heat transfer between device and chassis or PC board. Increases overall efficiency of your discrete, hybrid, or integrated components.

For complete technical data, write for our Thermal Conductors brochure. Dow Corning Corporation, Dept. A-2307, Midland, Michigan 48640.

Dielectric compounds from

DOW CORNING

DOW CORNING

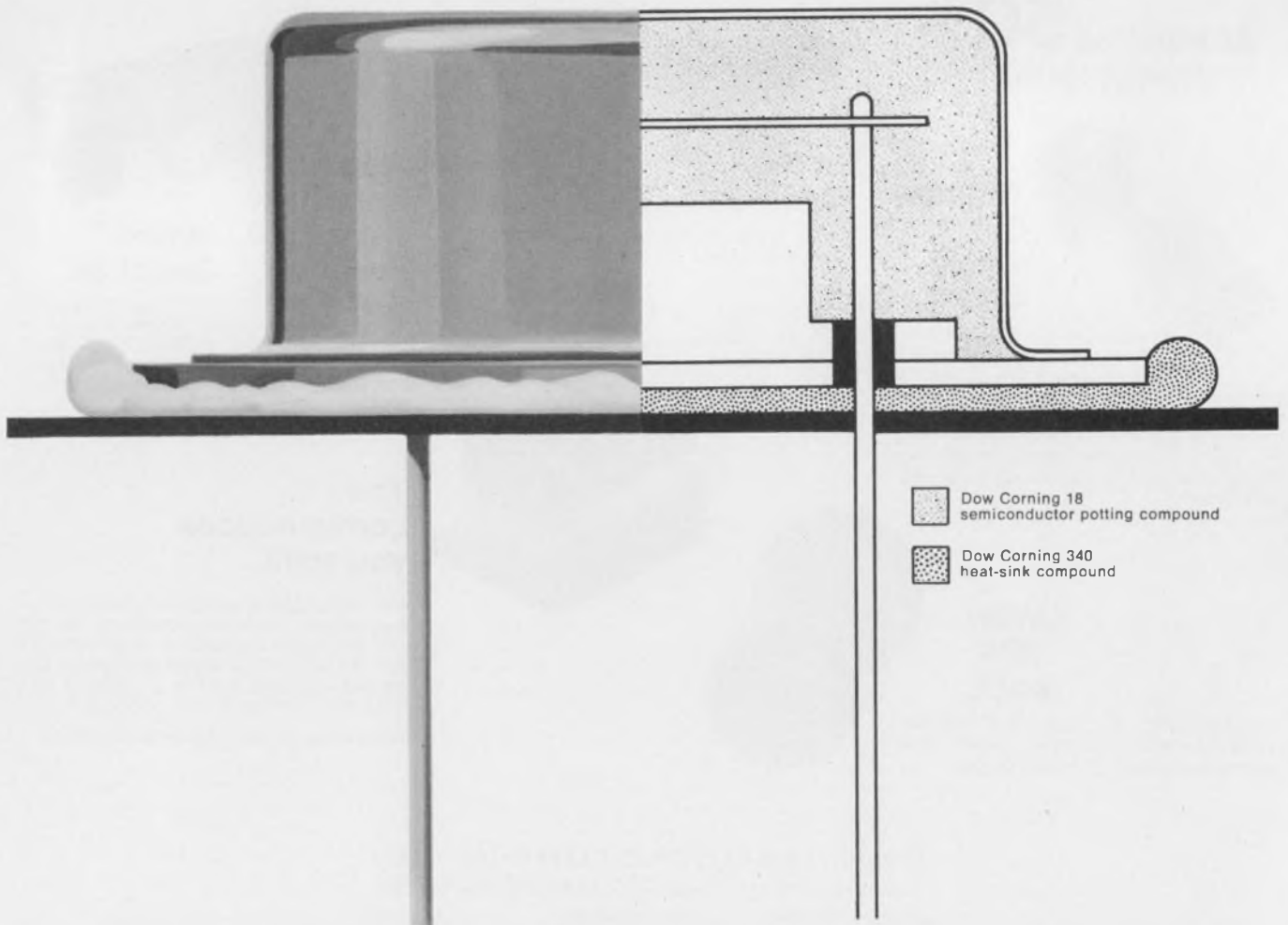

March 2, 1972

The President's pilot Talks about China's ATC

"Air-traffic-control equipment in the People's Republic of China is like U.S. equipment 20 years ago," President Nixon's pilot, Col. Ralph D. Albertazzie, says.

The 48-year-old Air Force colonel was at the controls of "The Spirit of '76" when President and Mrs. Nixon flew to China last month, and last October he flew the President's national security adviser, Henry A. Kissinger, to China. His report to ELECTRONIC DESIGN in a recent interview on the Kissinger trip suggests that Red China, if she is to emerge as a world power, will one day be in the market for millions of dollars worth of modern radio and radar equipment.

"All the air-traffic-control equipment we encountered in China was operating on the same frequency—ground control, approach control communications, ILS and radar," Colonel Albertazzie said. "But there was no problem, because there's so little air traffic. I saw one plane in the air the whole week I was there."

Indicative of the backward state of radio communications in mainland China, the colonel recalled this difficulty on his flight:

"Two hours before take-off from Guam, we were supposed to notify Shanghai control tower, 1700 miles away, by hf AM radio. The Chinese don't have single sideband. But we weren't able to get in touch with them, as it turned out. There was no hf AM radio on Guam except a Collins 1000-watt set in the President's plane, and atmospheric interference did not allow transmission from it to get through.

"Manila and Singapore towers did pick us up, and we asked them to relay the message on to Shanghai".

Shortly after takeoff, Colonel Albertazzie tried again with the AM



Colonel Ralph D. Albertazzie—the President's pilot.

set in "The Spirit of '76" and got through.

The next radio contact with the Chinese came over the boundary of Shanghai's air-defense identification zone, 150 km from Shanghai tower by vhf and proceeded to fly over a series of specified low-frequency, nondirectional beacons.

These beacons make up China's main air navigation system, Colonel Albertazzie said, "and we could easily have navigated by them with our radio compass, but we relied mainly on our inertial system."

The first beacon was 80 miles from Shanghai, where the airport radar also picked up the Presidential plane. The second beacon was 35 miles out, and the third 15 miles south of Shanghai. Here, the colonel was instructed to begin a rectangular approach to land. The approach was aided by nondirectional beacons consisting of a middle marker, and outer marker and the airport beacon itself.

Since Shanghai's airport is international, with service for scheduled stops by Air France and Pakistani airliners, it is equipped with an instrument-landing system that is compatible with international equipment. The visibility was good, the colonel said, but he landed by ILS for practice.

At Shanghai a Chinese naviga-

tor, radio operator and interpreter boarded the plane. And from Shanghai to Peking, the Chinese navigator used lf beacons.

"He wasn't interested in our inertial system," Colonel Albertazzie said. "The Chinese seem to consider it too alien."

Peking's ILS is not compatible with Western equipment, the colonel reported.

"It's probably Russian," he said, "because we have the same problem in the Soviet Union. We always have to take the boxes out of the ILS and put in something that pairs their frequencies with ours. In our ILS system, we use a vhf localizer course and a uhf glide-slope course so there is no interference."

Martin division hiring aerospace engineers

A warm employment note from Florida that may reach as far as job-blighted aerospace country in California is a drive by Martin Marietta's Orlando Div. to hire 350 to 400 engineers and several hundred other workers during 1972.

The primary need, according to Thomas P. Moran, director of professional and industrial relations, is for electronics engineers with experience in lasers, seekers, sensors and other electro-optical systems and in communications. Martin also needs engineers for systems analysis, nuclear effects, guidance and control, structural analysis, aerodynamics, thermodynamics, mechanical design and digital computer systems.

Martin Marietta says its recruiters are concentrating on areas of high aerospace unemployment and are putting particular emphasis on finding qualified blacks and other minority group members to fill technical openings.

Westinghouse 'banking' its semis to cut delays

While several large semiconductor manufacturers have withdrawn from the market in recent months, Westinghouse is out to take over a larger share of the power semiconductor market with a new man-

ufacturing system that tests the semiconductor power chips before, rather than after, assembly. The procedure cuts delays in delivery.

With the usual manufacturing methods, says Paul E. Lego, general manufacturer of the Westinghouse Semiconductor Div. in Youngwood, Pa., the devices can't be fully tested until they are fully assembled. If a batch passes its final test with few rejections, the shipment can be made on time, he notes. But if too many devices fail, only a partial shipment is made. Completing the order requires starting up the manufacturing process anew, which can mean delivery delays of four to six weeks.

To reduce delivery time to "as little as 54 hours," Westinghouse processes and tests the silicon power wafers in the unassembled state. The good wafers are placed in a special "bank," protected with a coating for indefinite storage.

When an order is received, the wafers are removed from the bank and assembled with Westinghouse's compression-bonding encapsulation technique.

High-frequency phonons to aid materials research

For the first time at power levels of 1/2 W, sharply tuned radiation of super-high-frequency sound waves, or phonons, has been generated from 150 to 400 GHz.

The achievement is reported by scientists at Bell Telephone Laboratories, Murray Hill, N.J., who generated the phonon power by applying sharp current pulses to a thin-film Constantan heater placed adjacent to a superconductor. With these elements at cryogenic temperatures, the scientists, using a magnetic field up to 1 kG, tuned the phonon radiation over more than a 100-GHz bandwidth.

An immediate application of the relatively high-power phonon radiation is in the analysis of materials.

Developed by Dr. Robert C. Dynes, a technical staff member of the Crystal Electronics Research Dept., and Dr. Venky Narayana-murti, a staffer of the Solid State and Quantum Physics Research Dept., the phonon generator con-

sists of a heater, formed of an alloyed metal film of copper and nickel. The heater is placed alongside a thin film of tin or other superconducting material, but is separated from it by a thin layer of insulation.

To vary the frequency of the phonon re-radiation, a controlled magnetic field is applied, parallel to the thin film of tin.

Super-fast teleprinter offered at cut in price

A teleprinter that prints 30 characters a second—"two to three times faster than conventional devices"—has been developed. According to its developer, Diablo Systems, Inc., Hayward, Calif., the teleprinter costs \$1000 in large quantities—"two-thirds to one-fifth the cost of competitive devices"—and instead of hundreds of individual moving parts, it uses "four electronically controlled electric motors."

The company expects the system, called HyType I, to find wide application with billing and accounting systems, computer terminals and consoles and computer output writers.

Two of the motors are high-performance servos, used for character selection and column selection. The other two are "stepper motors," used for controlling paper line feed and ribbon feed.

The electronic control also permits the carriage or printing element to move diagonally, up, down or across the paper at any time, rather than only horizontally and vertically.

HyType I's print element is called a "daisy"—a simple plastic disc about three inches in diameter, with 96 petals, each containing one of 96 print characters.

Sensitive X-ray to scan GI mail for contraband

Using X-ray surveillance systems that reportedly can detect "objects as small as a hair and as detailed as the interior of a tape cassette," the Air Force will soon begin checking packages mailed by overseas military personnel to see if they contain contraband weapons

and narcotics.

Called Dynafluor II, the X-ray system produces an immediate image of a parcel's contents on a screen, which consists of a sheet of plastic, covered with finely ground fluorescent crystals. The crystals give off visible energy and light when excited by an X-ray beam, and an image is created on the screen when the X-ray beam is intercepted by an object.

To obtain maximum screen brightness and good definition, Dynafluor II uses a self-rectified, 150-kV beryllium window X-ray tube with a 1.5-mm focal spot. This combination, Philips says, provides the contrast needed to see nonmetallic objects and also the penetration to see through 18-inch parcels.

The unit consists of a single cabinet 70 inches deep, 72 inches wide and 62 inches high. It weighs 4000 pounds.

The systems are being manufactured by the Torr- X-ray Corp. of Los Angeles and distributed by Philips Electronic Instruments, a division of Pepi, Inc., Mount Vernon, N.Y. The first system has been shipped to Vietnam. Thirty-six more will be delivered by June and sent to air bases throughout the world. The 37 units cost \$350,000.

The system has one drawback that could limit its customers: It ruins unexposed photographic film. The Air Force's solution will be to notify military personnel to mark film clearly so that it will not be examined by the machine.

A system that does not harm photographic film is now being studied, however, and when Philips finds a buyer it will be developed.

Recovery for instrument market foreseen

After two years of troubled times, U.S. electronic instrument makers are expected to make a strong recovery this year and next, according to a study made by Burnham & Co., New York City investment bankers. The upturn is based on three major forces: An increase in capital spending, an increase in Government R&D spending for space and defense electronics and Federal support of R&D in non-defense areas.

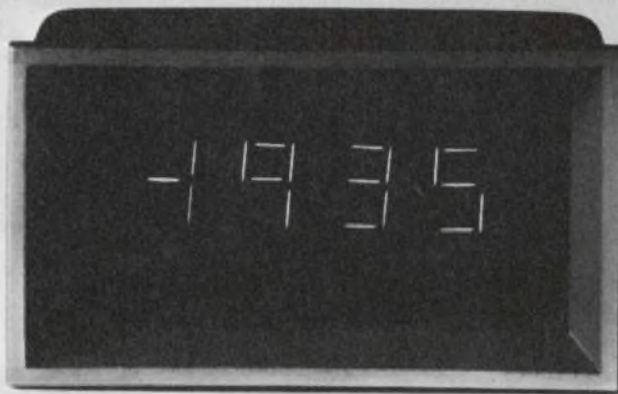

(actual size)

If we hadn't made it smaller, simpler and better we wouldn't have made it.

There was no way we could introduce a regular size digital panel meter at a regular size price.

We're the world's largest maker of analog to digital converters. With a little more experience than anyone else in the business.

That's why our AD2001 is the world's smallest and least expensive 3½-digit panel meter. It's just under 8 cubic inches in volume. \$89 in 100's. And we're delivering it now.

This is the DPM that's a component.

It's reliable because we made it with fewer parts. Eliminated multi-

level power supplies. Used long-life RCA Numitron display tubes. And built in over voltage protection.

It provides 0.05% accuracy. Has a temperature coefficient of ± 50 ppm/ $^{\circ}$ C. All the interfacing signals are standard. And we make the two critical analog components ourselves.

Each meter is burned-in for 7 days prior to shipment and warranted for one full year. You can send for our complete brochure and order an evaluation sample right now.

Watch for the appearance of our

2½ and 4½ digit DPM's. They'll be smaller, simpler and better with the same performance and reliability as this one. Or we won't make them.

Analog Devices, Inc., Norwood, Mass. 02062. Tel. (617) 329-4700.

**AD2001.
\$89 in 100's.**

 **ANALOG
DEVICES**

AD2001 DIGITAL PANEL METER. SIZE: 3" wide, 1¾" high, 1½" deep. Overall volume just under 8 cubic in. DISPLAY: Auto Polarity, Overrange, Out-of-Scale indication. Automatic zero. Programmable decimal points. DATA PROCESSING SIGNALS: External Trigger and External Hold, 3-digit BCD outputs, Overrange, Out-of-Scale, and Polarity signals are all standard. INPUT: Bias Current less than 1nA. Impedance - 1000M Ω . Over Voltage Protection. ACCURACY: 0.05% reading. Temperature Range - 0°C to 60°C operating. Temperature Coefficient - ± 50 ppm/ $^{\circ}$ C. POWER: Single power source. +5VDC input.

A 'computerized' FM tuner has 0.2% output distortion

A significant step forward in digital tuner technology has been taken in the design of a new FM tuner. Among other things, the programmable tuner has an output distortion of 0.2% and features:

- Automatic tuning, with a frequency synthesizer, by either computer keyboard, automatic scanning or computer card memory.
- An inductorless digital frequency discriminator.
- A four digit, seven-segment frequency readout.

In development for nearly three years, the new tuner—the Heathkit AJ-1510—is essentially a digital computer programmed to receive FM stereo, says David Thomas, senior engineer at the Heath Co., Benton Harbor, Mich. It contains 55 TTL and ECL integrated circuits plus discrete components.

The tuner, the first to use computer technology, has three different modes of tuning: computer

keyboard, computer sweep/scan and computer card memory.

In keyboard tuning, the user punches in the three or four-digit number representing the frequency of the desired FM station. With sweep-scan tuning, the entire FM spectrum is scanned at a variable rate. The receiver can be programmed to stop at all stations, at stereo-only stations or at stereo stations chosen by the listener through adjustable noise and automatic gain controls. The card-memory tuning has inputs for three different cards for selecting stations at the touch of a button. Cards are hidden behind a drop-down, hinged lower-front panel.

Once the station frequency has been selected by one of the three tuning methods, it is read out directly on the seven-segment readout and at the same time is used to set up a programmable divider.

The automatic tuning is accomplished by sampling a voltage-controlled oscillator. This signal is pre-scaled by a divide-by-eight cir-

cuit and then fed to the programmable divider. The output of the divider is fed to a phase detector, whose second input is a 25-kHz reference signal. If both signals are not of the same frequency, an error signal is sent back to the front end, and this simultaneously changes the bias on varactors in the front end and in the voltage-controlled oscillator. The bias is adjusted to minimize the phase-detector error and thus automatically tune the receiver to within 0.005% of the desired frequency.

Varactor diodes and FETs used

The front end of the receiver uses varactor diodes and field-effect transistors. The varactors replace the familiar mechanically ganged, variable capacitor to provide electronic tunability, while the FETs provide high sensitivity—better than $1.8 \mu\text{V}$ —and low cross-modulation, with no overload on strong-signal local stations.

FM discrimination is accomplished by means of an ultra-linear inductorless digital frequency discriminator, capable of achieving distortion levels of 0.03%, Thomas reports. The discriminator, a pulse-counting and averaging type—has a bandwidth from 10 Hz to several hundred kilohertz. Thus the linearity over the normal deviation range is far better than can be obtained with any LC tuning scheme. Further, no tuning of the discriminator is required, and the circuit is permanently aligned. According to Thomas, the AJ-1510 is the only commercially available FM tuner that uses a digital discriminator.

One drawback of the digital discriminator is that the signal at its input must have good phase linearity for minimum distortion. This is achieved by using two fixed-tun-

Jules H. Gilder
Associate Editor



The digital FM tuner uses a frequency synthesizer that automatically tunes the receiver to the desired frequency.

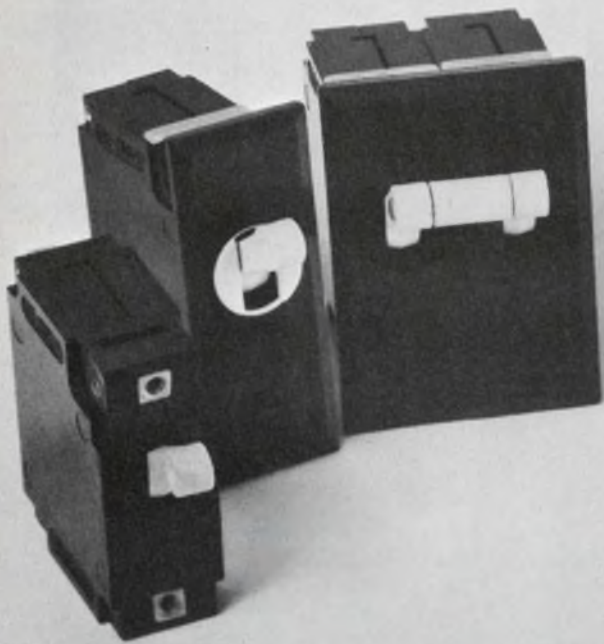

Toggle handles in white. Rocker handles in white, gray, black, or custom colors. Rectangular pushbuttons, lighted green for ON, white for OFF. Cylindrical pushbuttons, not lighted at all. An environment-protected model with a sealed bat handle. A model for fast snap-in mounting.

Our Type J line.

Circuit breakers have never looked so good before.

You don't have to settle for homely circuit breakers anymore.

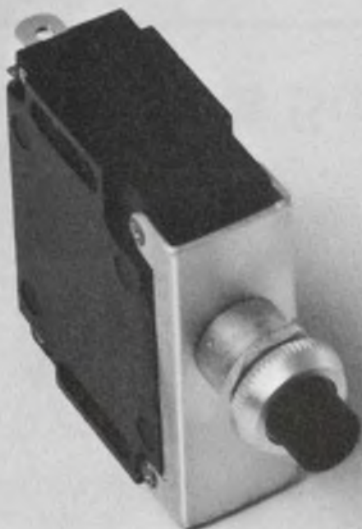

They're hydraulic-magnetic, of course, and therefore offer you exceptional performance capabilities: precise, temperature-stable current ratings and trip points; a choice of time-delay characteristics (or non-time-delay operation); the option of a half-dozen special-function internal circuits.

All are available for operation on any of the commonly used DC or AC voltages (60Hz or 400Hz). In any current rating from 0.020 to 30 amp.

All are reasonably priced. Even in modest OEM quantities.

We'll be glad to send you detailed technical literature. Just tell us to whom and to where. Heinemann Electric Co., 2616 Brunswick Pike, Trenton, N.J. 08602.



HEINEMANN

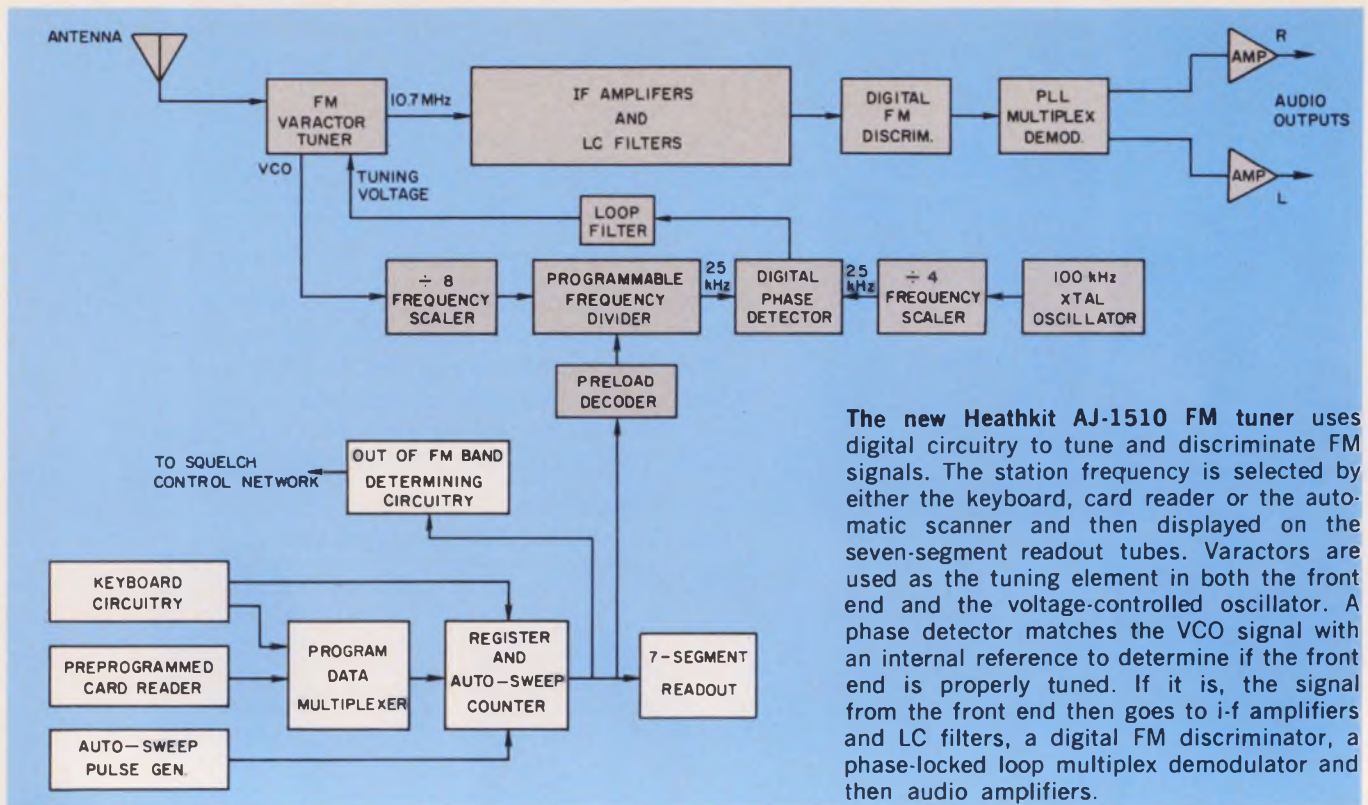

The new Heathkit AJ-1510 FM tuner uses digital circuitry to tune and discriminate FM signals. The station frequency is selected by either the keyboard, card reader or the automatic scanner and then displayed on the seven-segment readout tubes. Varactors are used as the tuning element in both the front end and the voltage-controlled oscillator. A phase detector matches the VCO signal with an internal reference to determine if the front end is properly tuned. If it is, the signal from the front end then goes to i-f amplifiers and LC filters, a digital FM discriminator, a phase-locked loop multiplex demodulator and then audio amplifiers.

ed five-pole LC i-f filters.

A phase-locked loop is used in the tuner as a multiplex demodulator. It provides higher reliability and superior stereo performance than other methods, Thomas explains. In addition alignment of the demodulator is easily accomplished by a single resistor adjustment, compared with the complex procedures of the past.

The computer-like performance of the squelch circuitry eliminates any stations with noise levels beyond any desired limit. In addition, should a fault occur within the tuner, prohibiting proper phase-locking, the squelch circuitry will lock out the audio as a fault light goes on.

The tuner also contains a front-panel meter, but contrary to those

provided in other units, it is not used for center tuning. Instead it indicates the relative strength of the received signal, and with the flip of a switch, this meter becomes a multipath indicator for antenna alignment. Output terminals are also provided for use with a multipath oscilloscope.

The Heathkit tuner is priced at \$499.95. ■■

Broadband power measuring simplified

A radically simplified method of measuring voltage, current and power from audio to millimeter wavelengths is being offered by the National Bureau of Standards Boulder, Colo. With reduced measurement time, increased accuracy and the complete elimination of radio-frequency calibration requirements, the method—which employs a device called Bolovac, for bolometric voltage and current—is described as a breakthrough in broadband measurement.

According to Myron C. Selby, senior research scientist in the bureau's Electro-Magnetic Div., Bolovac uses standard thin-film vacuum-deposition techniques to

form a 100-to-300-Å noble metal, semimetal or semiconductor film on a solid insulating disc. This coated disc, when mounted in a coaxial structure, has negligible reactance from dc to in excess of 36 GHz, while still providing high temperature coefficient of resistivity.

Accurate measurement of power in coaxial and lumped-constant systems to 0.1% or better is possible with Bolovac, the bureau reports. From 0 to 0.25 W of rf power can be measured using standard bolometric techniques.

As rf power is introduced across the bolometer, the bridge null is maintained by reduction of the audio frequency power with a cali-

brated attenuator. The amount of attenuation necessary to maintain the null determines the magnitude of the rf power introduced. Present bolometric elements have accuracies of 1% or greater and have bandwidth limitations of one octave or less.

Selby says that since Bolovac is entirely resistive to within 0.1% up to 36 GHz, the need for time-consuming, reactive reflection-loss calculations—or for maintaining several calibrated bolometers—has been eliminated.

Additional information on Bolovac is available from the National Bureau of Standards Information Office, Boulder, Colo. ■■

series 1400

illuminated push button controls

a versatile concept that gives you flexibility in designing interrelated switching combinations . . . plus prototypes in 72 hours

Momentary . . . push/push . . . reciprocal release . . . master release . . . interlock . . . one assembly does the job of several.

Mount vertically or horizontally. Up to 20 stations on a single frame. Contacts are DPDT, 2 amps, 250 VAC. Single series 1400 push buttons and indicator lights to match.

For details, or to order a custom 72-hour prototype, write or call:



the total technology people

LEDEX INC.
123 Webster Street
Dayton, Ohio 45401
(513) 224-9891

POSITIONING SWITCHING MICROELECTRONICS



Ceramic imaging device stores high-resolution pictures

A new type of ceramic imaging device, named Cerampic, has been invented by researchers at Sandia Laboratories in Albuquerque, N.M. It is said to be simpler to build, easier to operate, and will cost less, than similar devices currently un-

John F. Mason
Associate Editor

der development.

Like other imaging devices, Cerampic stores images by exposure to light, in much the same way that photographic film is exposed. The ceramic picture, however, needs no "developing," may be erased and reused, and can be viewed directly or projected like a slide.

While the device does not yet

store pictures of exceptional photographic quality, the developer believes the quality will improve with more work on the materials.

The most promising potential use, Scandia researchers say, would be to generate images of such things as documents, photographs and diagrams from signals received by telephone or radio. The facsimiles could be made in a few seconds, giving the user the opportunity to inspect them before making permanent copies.

A more far-out application is theoretically possible because of properties in the material that permit images to be formed on it and erased at rates as fast as 15,000 lines per second. Such speeds would give television-like displays.

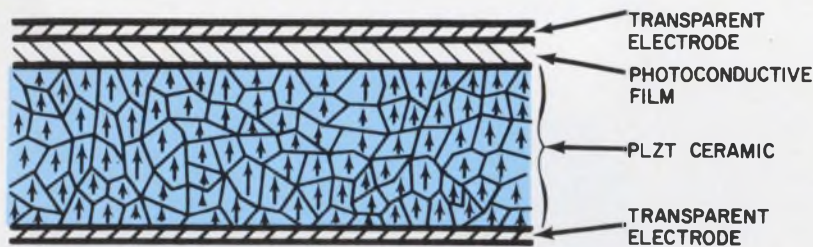

Ferroelectric domains are aligned prior to image storage when the device is flooded with light and voltage is applied.

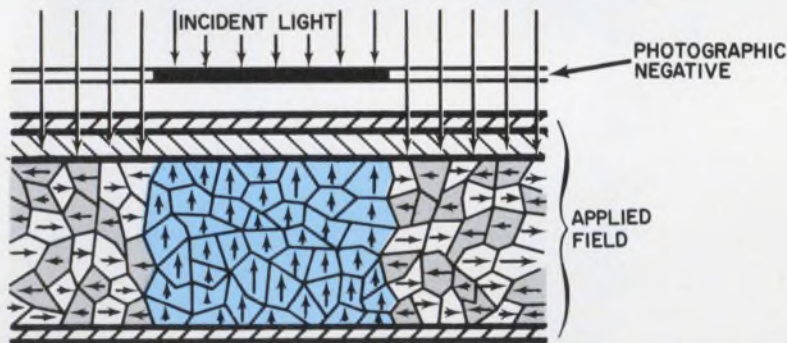

Light passing through clear areas of a photonegative increases conductivity of photoconductive film, causing ferroelectric domains to be altered by an applied field.

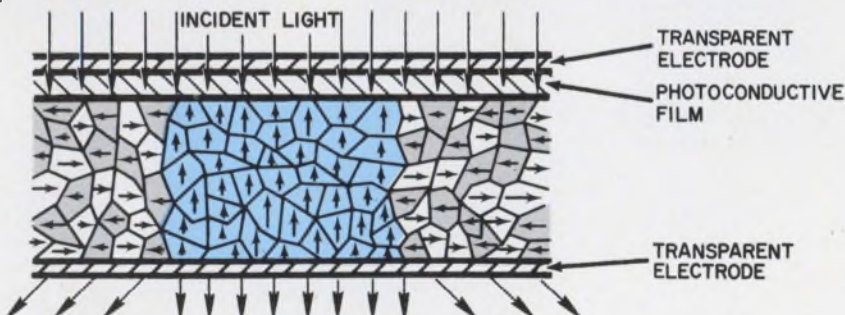

Light is scattered more by the altered domains. Thus those areas of the ceramic appear gray when projected on a screen.

No straining or flexing needed

Cerampic differs from other recently developed ceramic imaging devices in several ways: It does not have to be bonded to a substrate and then strained or flexed while the picture is being stored. And the image is formed by spatial variation of light scattering instead of by birefringence—the technique used by other ceramic image-storage devices. Avoiding birefringence simplifies the storage procedure, Sandia says, and eliminates the need for a polarizer and analyzer for viewing or projecting the storage image.

The prototype Cerampic (see diagrams) consists of a thin PLZT (lanthanum-modified lead zirconate-lead titanate) electro-optic ceramic plate with a photoconductive film (PVK polyvinyl carbazole) deposited on one surface. Transparent electrodes (tin oxide-doped indium oxide) are deposited on the PVK film and on the other surface. Terminals are provided for connec-

It doesn't cost any more for a quality connector. It could cost less.

How do we do it?

Well, first we design a totally new miniature rectangular connector that practices economy without losing sight of reliability. After all, you need both.

That's good, but we go beyond that. We offer you AMPECONOMATION—fast working automated application machinery in your own plant for high speed application of contacts. Depending on your requirements, machine capacities range from 2,000 to 12,000 finished terminations per hour with single applicator. So, whichever machine you choose, you're assured the greatest number of reliable contacts at the lowest applied cost.

Put them together—quality, low initial cost and lowest applied cost, and you've got a miniature rectangular connector that's hard to beat. Which is exactly as we planned.

Sound reasonable? It's more than that. It's downright economical, and the facts to prove it are available now. Just write **AMP Incorporated, Harrisburg, Pa. 17105**

AMP
 INCORPORATED

Manufacturing and direct sales facilities worldwide: Barcelona, Brussels, Buenos Aires, Frankfurt, London, Mexico City, Paris, Puerto Rico, Sao Paulo, s'Hertogenbosch (Holland), Sydney, Stockholm, Tokyo, Toronto, Turin, Vienna.

Accepts #26-18 AWG, solid or stranded wire in insulation diameters of .050" to .110".

Positive locking feature on housing prevents disengagement of connector halves or dislodgement from panel.

Available in 1, 2, 3, 4, 6, 9, 12, 15, 20, 24 and 36 positions.

Pin or socket crimped in same applicator.

Available in tin or gold plating on contacts.

One piece, molded "clam-shell" strain relief to facilitate wire bundling—available in 20 & 36 circuit. Strain relief grommet available to cover three ranges of cable diameter.

Egg-crate design of socket housing and extended skirt of pin housing fully protect contacts.

Cap and plug mountable in same panel cutout.

Commoning bars available for 2, 3 & 4 circuit.

Two locking lances assure positive retention.

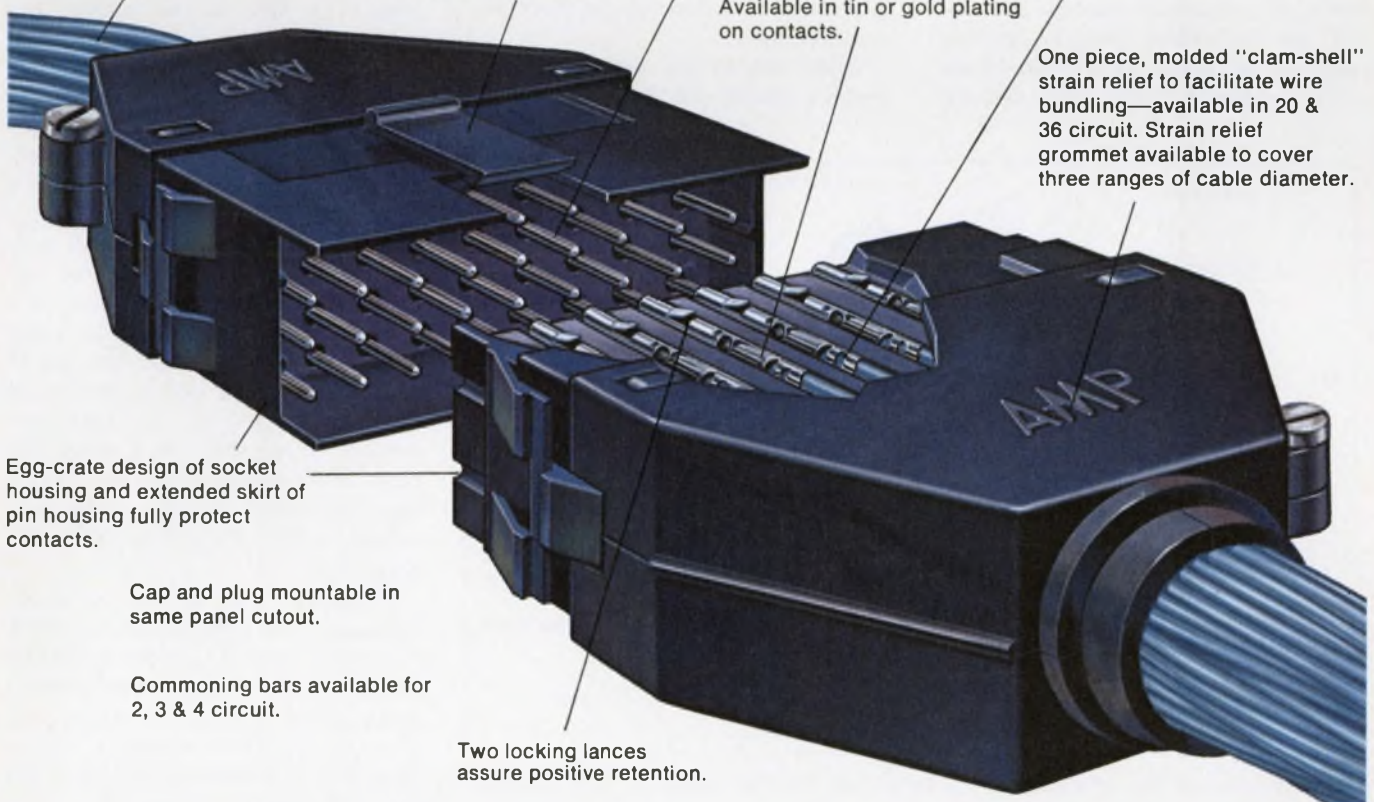

tions to each of the transparent electrodes. The ceramic plate is typically 0.0123 inch thick and 1 inch in diameter.

Ceramic stores an image by establishing a variation of ferroelectric domain orientations in the ceramic plate. These correspond to the gradations of light and dark of the image. The domain sizes and orientations, it is believed, determine the amount of light scattered by that area.

The areas, for example, that appear bright are formed by domains

aligned predominantly in the direction of the incident light. Dark areas on the other hand, result from domains oriented in directions that scatter light away from the field of view.

The procedure for storing an image involves exposing it on the photoconductive film at the same time a voltage is applied across the transparent electrodes. At any given point in Ceramic, part of the photoconductive film acts as an insulator and most of the voltage appears across the film. In the

light areas the film acts as a conductor, and nearly all the voltage appears across the ceramic. Only that part of the applied voltage that is impressed across the ceramic produces ferroelectric domain switching. Little or no domain switching occurs in the dark areas, while significantly more switching occurs in the light areas.

Once an image is stored, it remains in the ceramic permanently, or until an operator erases it by flooding the photoconductor with light and applying voltage. ■■

A new concept in high-density switches

A technique similar to that used for years in a floor switch for automatic door openers has been used to make low-cost, high-density, lighted military switches. The technique is simply that of pressing one grid of wires against another at a point in the matrix formed by horizontal and vertical wires.

John Hendricks, vice president of research engineering for Industrial Electronic Engineers, Inc., of Van Nuys, Calif., developer of the new switches, describes the advantages of the method this way:

"The number of switches possible per matrix is almost unlimited, as individual switch spacing may be as small as 3/8ths of an inch, center-to-center, and over-all

switch matrix size may be as large as 24 inches or 36 inches square. For example, a switch matrix that is 6 by 12 inches over-all size, and has switch positions on 1/2-inch centers would have a total of 288 individual switch positions."

For arrays involving a large number of switch positions, Hendricks sees arrays being sold for about 25 cents per switch position. A general guideline on cost, he says, is to use \$5 to \$10 per square inch of total switch matrix area for the complete assembly, including bezel and mounting hardware. The final cost depends on your requirements.

Since the switch matrix is completely sealed in a sandwich of

duPont Mylar polyester film, it is not affected by the severe environments that high-quality, sealed military switches are required to withstand.

Construction of the switch involves the etching of copper conductor patterns on 5-mil Mylar backing material. A 5-mil-thick Mylar spacer is then stamped with a hole pattern that requires a hole at every desired switch position. The spacer is then laminated in between the two sheets of Mylar containing the conductor patterns.

When the switch is passed in the area of a hole in the spacer, the particular horizontal and vertical conductors that short together determine the switch in the matrix that has been pressed. For a spacer hole of about 1/4 by 1/4 inch, about 2 ounces of force is required to trip the switch. Each conductor in the switch is typically 1.5 mils thick by 3 or 4 mils wide and can carry at least 30 mA of current.

Since the switch matrix is transparent, a transparent, mat-finish projection screen can be placed in front of the switch. By rear projection, a message or symbol can then be projected upon the switch face, yielding a lighted pushbutton switch with changeable message capability.

Hendricks sees the initial applications of the lighted screen switch in military control panels. However, he feels that ultimate applications will include voting machines, appliances, security systems, elevators and a wide variety of other types of control panels. ■■

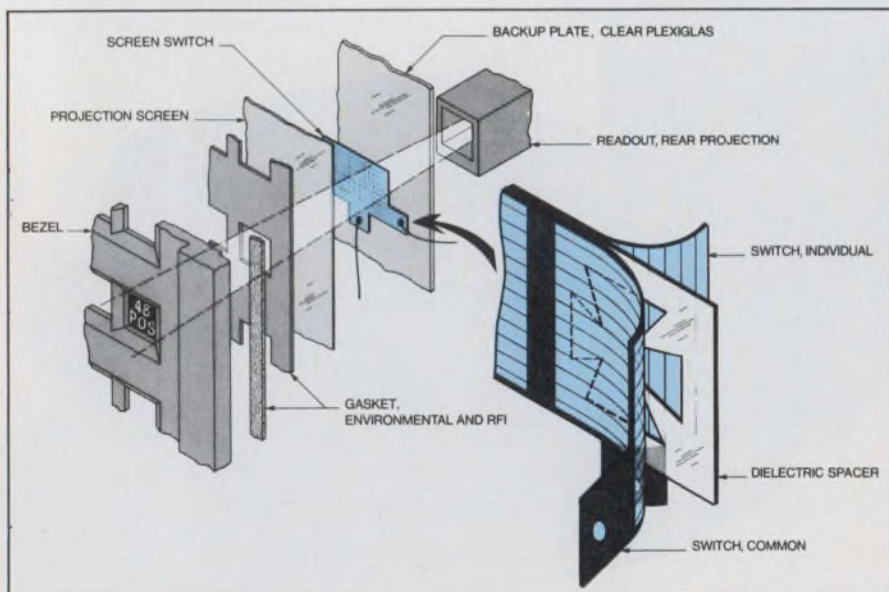

Rear projection of a message on a switch position is shown in this cutaway view of a backlit screen switch.



Coil Cords

for products that move

There's more to coil cord design than snapping back in place. Lots more. Like human, electronic, and environmental requirements. Color matching. Reliability. And cost.

Belden has the experience. Hundreds of retractile cord designs that are solving problems in communications, power and control applications. Coil cords in a wide variety of strain and stress relief configurations, special connectors, custom wire assemblies . . .

We've got a new booklet covering coil cord design parameters. It will help you determine important trade-offs between shielding, tensile strength, environmental protection, elasticity, and cost. We'll show you how Beldfoil® can eliminate noise problems that can originate in the shield itself. The advantages of thermoplastic and thermosetting jacket materials. And how to get the right elasticity for your equipment application. Just contact Electronic Sales Service Dept., Belden Corporation, Richmond, Indiana 47374. Phone (317) 966-6681.

Electronic Sales Service Dept.
Belden Corporation
Richmond, Indiana 47374
Phone (317) 966-6681



- I have an immediate coil cord design problem; please contact me.
- Please send me the new Retractable Cord Design Guide.



Name _____
Company _____
Title _____
Address _____
City _____ State _____ Zip _____
Application _____

signetics

LINEAR INTEGRATED CIRCUITS VOLUME I

signetics

811 E. Arques Avenue, Sunnyvale, California 94086
 (415) 351-7000 • Telex: 153270 • Cable: SIGNETICS

INDEX • TABLE OF CONTENTS

signetics FIVE-VOLT REGULATORS LM109 LM309

LINEAR INTEGRATED CIRCUITS

DESCRIPTION: The LM109 and LM309 are precision 5 volt regulators designed for use in portable equipment. They are designed to provide a constant 5 volt output over a wide range of load currents and input voltages. The LM109 is a monolithic integrated circuit, while the LM309 is a discrete component. Both regulators are designed to provide a maximum output current of 100 mA. The LM109 is available in a 14-pin package, while the LM309 is available in a 16-pin package. Both regulators are designed to provide a maximum output current of 100 mA.

FEATURES:

- INTERNAL THERMAL OVERLOAD PROTECTION
- INTERNAL CURRENT LIMITING
- NO EXTERNAL COMPONENTS REQUIRED

ABSOLUTE MAXIMUM RATINGS:

Supply Voltage	10V
Output Current	100 mA
Operating Temperature Range	0°C to 70°C
Storage Temperature Range	-55°C to 150°C
Lead Temperature (Soldering)	260°C

EQUIVALENT CIRCUIT:

signetics DUAL OPERATIONAL AMPLIFIER μ A747

DESCRIPTION: The μ A747 is a set of four high performance operational amplifiers designed for use in portable equipment. They are designed to provide a constant output over a wide range of load currents and input voltages. The μ A747 is a monolithic integrated circuit, while the μ A747 is a discrete component. Both amplifiers are designed to provide a maximum output current of 100 mA. The μ A747 is available in a 14-pin package, while the μ A747 is available in a 16-pin package. Both amplifiers are designed to provide a maximum output current of 100 mA.

FEATURES:

- INTERNAL THERMAL OVERLOAD PROTECTION
- INTERNAL CURRENT LIMITING
- NO EXTERNAL COMPONENTS REQUIRED

ABSOLUTE MAXIMUM RATINGS:

Supply Voltage	10V
Output Current	100 mA
Operating Temperature Range	0°C to 70°C
Storage Temperature Range	-55°C to 150°C
Lead Temperature (Soldering)	260°C

EQUIVALENT CIRCUIT:

signetics PHASE LOCKED LOOP 565

DESCRIPTION: The 565 Phase-Locked Loop (PLL) is a monolithic integrated circuit designed for use in portable equipment. It is designed to provide a constant output over a wide range of load currents and input voltages. The 565 is a monolithic integrated circuit, while the 565 is a discrete component. Both PLLs are designed to provide a maximum output current of 100 mA. The 565 is available in a 14-pin package, while the 565 is available in a 16-pin package. Both PLLs are designed to provide a maximum output current of 100 mA.

FEATURES:

- INTERNAL THERMAL OVERLOAD PROTECTION
- INTERNAL CURRENT LIMITING
- NO EXTERNAL COMPONENTS REQUIRED

ABSOLUTE MAXIMUM RATINGS:

Supply Voltage	10V
Output Current	100 mA
Operating Temperature Range	0°C to 70°C
Storage Temperature Range	-55°C to 150°C
Lead Temperature (Soldering)	260°C

EQUIVALENT CIRCUIT:

signetics MICROPOWER OPERATIONAL AMPLIFIER 533

DESCRIPTION: The 533 is a set of four high performance operational amplifiers designed for use in portable equipment. They are designed to provide a constant output over a wide range of load currents and input voltages. The 533 is a monolithic integrated circuit, while the 533 is a discrete component. Both amplifiers are designed to provide a maximum output current of 100 mA. The 533 is available in a 14-pin package, while the 533 is available in a 16-pin package. Both amplifiers are designed to provide a maximum output current of 100 mA.

FEATURES:

- INTERNAL THERMAL OVERLOAD PROTECTION
- INTERNAL CURRENT LIMITING
- NO EXTERNAL COMPONENTS REQUIRED

ABSOLUTE MAXIMUM RATINGS:

Supply Voltage	10V
Output Current	100 mA
Operating Temperature Range	0°C to 70°C
Storage Temperature Range	-55°C to 150°C
Lead Temperature (Soldering)	260°C

EQUIVALENT CIRCUIT:

signetics DUAL OPERATIONAL AMPLIFIERS 5558

DESCRIPTION: The 5558 is a set of four high performance operational amplifiers designed for use in portable equipment. They are designed to provide a constant output over a wide range of load currents and input voltages. The 5558 is a monolithic integrated circuit, while the 5558 is a discrete component. Both amplifiers are designed to provide a maximum output current of 100 mA. The 5558 is available in a 14-pin package, while the 5558 is available in a 16-pin package. Both amplifiers are designed to provide a maximum output current of 100 mA.

FEATURES:

- INTERNAL THERMAL OVERLOAD PROTECTION
- INTERNAL CURRENT LIMITING
- NO EXTERNAL COMPONENTS REQUIRED

ABSOLUTE MAXIMUM RATINGS:

Supply Voltage	10V
Output Current	100 mA
Operating Temperature Range	0°C to 70°C
Storage Temperature Range	-55°C to 150°C
Lead Temperature (Soldering)	260°C

EQUIVALENT CIRCUIT:

signetics ANALOG VOLTAGE COMPARATOR 529

DESCRIPTION: The 529 is a high speed analog voltage comparator designed for use in portable equipment. It is designed to provide a constant output over a wide range of load currents and input voltages. The 529 is a monolithic integrated circuit, while the 529 is a discrete component. Both comparators are designed to provide a maximum output current of 100 mA. The 529 is available in a 14-pin package, while the 529 is available in a 16-pin package. Both comparators are designed to provide a maximum output current of 100 mA.

FEATURES:

- INTERNAL THERMAL OVERLOAD PROTECTION
- INTERNAL CURRENT LIMITING
- NO EXTERNAL COMPONENTS REQUIRED

ABSOLUTE MAXIMUM RATINGS:

Supply Voltage	10V
Output Current	100 mA
Operating Temperature Range	0°C to 70°C
Storage Temperature Range	-55°C to 150°C
Lead Temperature (Soldering)	260°C

EQUIVALENT CIRCUIT:

signetics CHROMA REGULATOR 5072

DESCRIPTION: The 5072 is a high performance chroma regulator designed for use in portable equipment. It is designed to provide a constant output over a wide range of load currents and input voltages. The 5072 is a monolithic integrated circuit, while the 5072 is a discrete component. Both regulators are designed to provide a maximum output current of 100 mA. The 5072 is available in a 14-pin package, while the 5072 is available in a 16-pin package. Both regulators are designed to provide a maximum output current of 100 mA.

FEATURES:

- INTERNAL THERMAL OVERLOAD PROTECTION
- INTERNAL CURRENT LIMITING
- NO EXTERNAL COMPONENTS REQUIRED

ABSOLUTE MAXIMUM RATINGS:

Supply Voltage	10V
Output Current	100 mA
Operating Temperature Range	0°C to 70°C
Storage Temperature Range	-55°C to 150°C
Lead Temperature (Soldering)	260°C

EQUIVALENT CIRCUIT:

...for 230 more pages of the new **SIGNETICS LINEAR HANDBOOK Vol. 1**, call your local distributor now.

Just two bucks to your distributor gets you this invaluable collection of complete specs, diagrams and data on both proprietary and industry standard parts. Plus a big Bonus-Offet coupon, good for one FREE part — your pick from any device listed in the Handbook. To experiment with, wire in... or keep on your desk to doodle with. Linear Handbook Vol. 1, with Bonus coupon: only \$2 from your distributor.

Signetics: total capability linear.
 811 E. Arques Avenue, Sunnyvale, California 94086

SIGNETICS
Linear Handbook Vol. I,
with Bonus coupon,
\$2.00 from your distributor:

ARIZONA
Phoenix: Hamilton/Avnet Electronics
(602) 269-1391
CALIFORNIA
Burbank: Compar Corp.
(213) 843-1772
Burlingame: Compar Corp.
(415) 347-5411
Culver City: Hamilton Electro Sales
(213) 559-3311
El Monte: G. S. Marshall
(213) 686-1500
Los Angeles: KT/Wesco Electronics
(213) 685-9525
Mountain View: Hamilton/Avnet Electronics
(415) 961-7000
Palo Alto: Wesco Electronics
(415) 968-3475
San Diego: G. S. Marshall
(714) 278-6350
San Diego: Kierulff Electronics
(714) 278-2112
CANADA
Downsview: Cesco Electronics, Ltd.
(416) 638-5250
Montreal: Cesco Electronics, Ltd.
(514) 735-5511
Ottawa: Cesco Electronics, Ltd.
(613) 729-5118
Quebec: Cesco Electronics, Ltd.
(418) 524-3518
COLORADO
Denver: Hamilton/Avnet Electronics
(303) 433-8551
FLORIDA
Hollywood: Hamilton/Avnet Electronics
(305) 925-5401
Orlando: Hammond Electronics
(305) 241-6601
ILLINOIS
Elmhurst: Semiconductor Specialists, Inc.
(312) 279-1000
Schiller Park: Hamilton/Avnet Electronics
(312) 678-6310
MARYLAND
Hanover: Hamilton/Avnet Electronics
(301) 796-5000
Rockville: Pioneer Washington Electronics, Inc.
(301) 424-3300
MASSACHUSETTS
Burlington: Hamilton/Avnet Electronics
(617) 272-3060
Needham Heights: Kierulff/Schley
(617) 449-3600
MICHIGAN
Livonia: Hamilton/Avnet Electronics
(313) 522-4700
Detroit: Semiconductor Specialists, Inc.
(313) 255-0300
MINNESOTA
Minneapolis: Semiconductor Specialists, Inc.
(612) 854-8841
MISSOURI
Hazelwood: Hamilton/Avnet Electronics
(314) 731-1144
NORTHERN NEW JERSEY
Cedar Grove: Hamilton/Avnet Electronics
(201) 239-0800
SOUTHERN NEW JERSEY
AND PENNSYLVANIA
Cherry Hill: Hamilton/Avnet Electronics
(609) 662-9337
Cherry Hill: Milgray-Delaware Valley
(609) 424-1300 Phila. (215) 228-2000
NEW YORK
Buffalo: Summit Distributors, Inc.
(716) 884-3450
Hauppauge: Semiconductor Concepts, Inc.
(516) 273-1234
Woodbury: Harvey Radio
(516) 921-8700
New York: Terminal-Hudson Electronics
(212) 243-5200
OHIO
Cleveland: Pioneer Standard Electronics
(216) 587-3600
Kettering: Arrow Electronics
(513) 253-9176
TEXAS
Dallas: Hamilton/Avnet Electronics
(214) 638-2850
Dallas: Solid State Electronics Company
(214) 352-2601
Houston: Hamilton/Avnet Electronics
(713) 526-4661
WASHINGTON
Seattle: Hamilton/Avnet Electronics (206) 624-5930

technology abroad

Low-noise gallium arsenide amplifiers operated between 14 and 18 GHz are being produced by IBM Research Laboratory engineers in Zurich. A 4-stage narrow-band amplifier has a maximum gain of 16 dB at 14.9 GHz, with a 3 dB bandwidth of 150 MHz. A 3-stage broadband amplifier produces a 6 dB gain over a 380 MHz bandwidth centered at 18 GHz. A gallium arsenide oscillator output is 4 mW at 17 GHz. Engineers now believe that the maximum oscillation frequency for similar devices is about 30 GHz. Major applications for these units will be in communication systems particularly where the natural atmospheric window for radiation up to 18 GHz can be used.

CIRCLE NO. 452

Pulse-amplitude-and-phase demodulation, a new technique for satellite communications is being studied by Marconi in England under a Comsat contract. This type of modulation promises a fourfold increase in the capacity of a transmission path. A computer study will be made to evaluate the performance of various system options and to estimate the transmission characteristics of typical radio paths in the presence of noise. Related work is being done in the United States.

CIRCLE NO. 453

The full potential of gallium arsenide phosphide as a solid-state light emitter has been tapped by researchers at the Institut fur Hableitertechnik in Aachen, West Germany. They have developed a multi-layer, liquid-phase epitaxial method of growing these crystals that overcomes a principal problem—the difficulty in growing a crystal to which low ohmic contained can be made. The results obtained by the German scientists indicate that gallium alumina arse-

nide can compete with other, more commonly used materials. In the first two epitaxial layers, doping levels are chosen to attain a high internal quantum efficiency. A heavily doped third layer serves to spread the current from beneath the electrode region, thus providing a uniform light emission over the whole junction area. A GaAs top layer ensures a good ohmic contact with the electrodes. This layer is extremely thin, to minimize light absorption. The peak emission wavelength is 0.67 μm .

CIRCLE NO. 454

As part of a new Datal 400 unidirectional data-transmission telephone service, the British Post Office has placed a \$208,000 contract with EMI Electronics to develop a 600-bit-per-second analog or digital modem that draws its operating power from the telephone line. The data-transmission service will find application with large, geographically diversified organizations, such as water, gas and electricity companies. In a typical application the central computer interrogates each modem in turn, requesting that either digital or analog data be transmitted to the processing center.

CIRCLE NO. 455

A symmetrical, three-port, X-band calculator of microwave IC construction has been demonstrated by engineers at Selenia Research Laboratories, Rome. The circulator is made by photo-depositing a gold film on a transversely magnetized yttrium-iron-garnet substrate. The substrate, 22 mm in diameter, has a 3-mm hole drilled at its center. Edge-guided waves are free to circulate around the periphery of this element, the direction of circulation being determined by that of the substrate's magnetization.

CIRCLE NO. 456

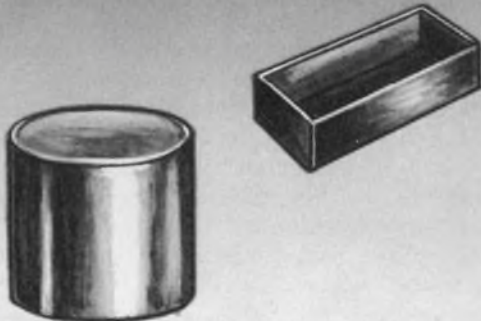

NOT ALL SHELLS ARE ALIKE!

**THAT'S WHY ROBISON ELECTRONICS
OFFERS A SELECTION OF OVER 1600
STANDARD ENCAPSULATION SHELLS!**

As a supplier to over 800 customers on a continuing basis, we are always developing new shells to satisfy specific customer and/or industry requirements.

Shells are precision molded of flame-resistant glass-fibre filled Diallyl Phthalate conforming to MIL-M-14, Type SDG-F, and are available in the following shapes: square, round, oblong, and module.

**For Free
Catalogue
Write:**



**How Can
We Be of
Assistance?**

ROBISON ELECTRONICS, INC.

2134 WEST ROSECRANS AVENUE
GARDENA, CALIFORNIA 90249
PH. (213) 321-0080, 327-5661

INFORMATION RETRIEVAL NUMBER 26

Your choice package for easier, less expensive circuit design

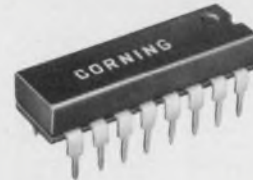

CORDIP™ COMPONENT NETWORKS

CORNING Electronics offers combinations of resistors, capacitors and diodes in standard dual in-line packages. With these CORDIP networks you can design circuit combinations of up to 20 components in a 14-pin DIP and up to 23 in a 16-pin DIP. They offer higher component densities, less complex circuit boards, reduced inventory of discretes, and significant savings in handling costs. Prototypes available in three weeks, production quantities in approximately eight weeks.

Send for our new brochure containing complete information on CORDIP component networks. Or call us. Corning Glass Works, Electronic Products Division, Corning, New York 14830. (607) 962-4444, Ext. 8684.

CORNING
ELECTRONICS

INFORMATION RETRIEVAL NUMBER 27

INTRICATE BERYLLIUM COPPER

springs

**Components,
stampings,
"Chem-Blanks"**

(Photo-etch)

**Complete production
facilities for:**

- Blanking
- Photo-etching
- Dimpling
- Bending
- Forming
- Heat treating
- Plating

Send for complete
24 page product
and application catalog

BRAUN
TOOL & INSTRUMENT CO., INC.

4200 31st Street North
St. Petersburg, Fla. 33714
Telephone: 813/526-9104



"CHEM-BLANKS"

RINGS



CUSTOMS

STRIPS

INFORMATION RETRIEVAL NUMBER 28

ELECTRONIC DESIGN 5, March 2, 1972

Centralab Technical Ceramics... in line with your design requirements



Write
Centralab
for
Bulletin
No. 1117TC3

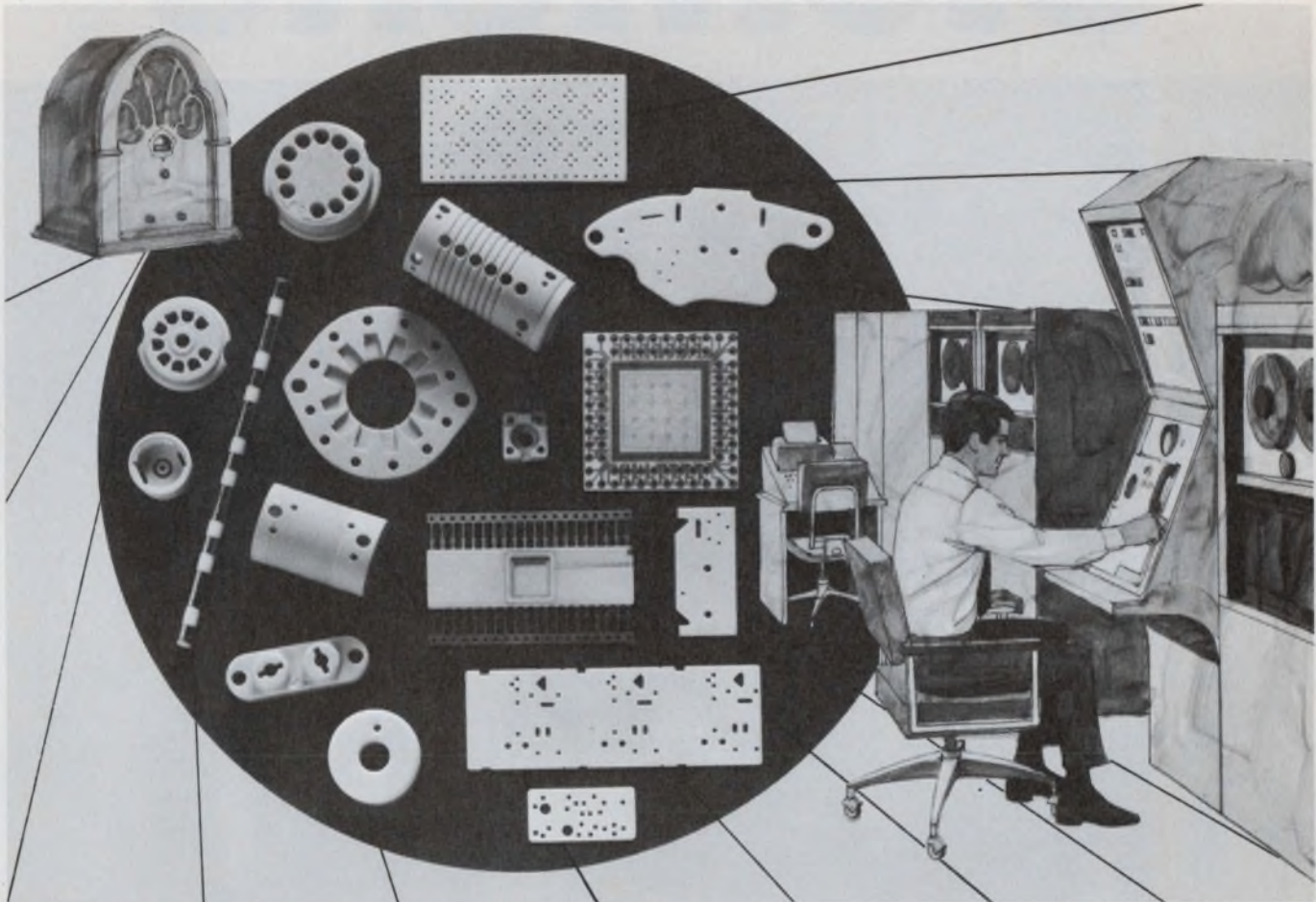

What's next for our ceramics?

We've been involved since 1928 when we built vacuum tube bases for six-tube radios.

Since then new-idea ceramics for electronics have put us in such varied applications as medical and scientific equipment, instrumentation, home and portable appliances, communications, office machines, computers and peripheral equipment. Our ceramics have found use as hybrid circuit and thin-film substrates, VHF tuner parts, LED substrates, MOS packages, LSI multilayer interconnections, SCR housings and vacuum tube parts.

So, what's next for our ceramics? Only your new design requirements will tell. You can specify aluminas, steatites, cordierites, or metallized ceramics in the configurations you need. A variety of metallizing systems is

available to insure satisfaction in your particular application. We also offer full capabilities in ceramic-to-metal assemblies and engineering service to aid you in design.

It's this kind of involvement that allows Centralab to be one of the largest manufacturers of technical ceramics. And, because we're also our own largest customer, it's important that we produce only the finest ceramics available. To us, developing better and more reliable ceramic materials for electronics means higher quality electronic components. It will mean the same to your products.

What's next for our ceramics? Whatever you need. For the complete capability story, call Centralab Technical Ceramic Sales at (414) 228-2942.

GET CENTRALAB THE "IN LINE" FOR YOUR DESIGN

Hybrid Microcircuits
Pushbutton & Rotary Switches
Capacitors
Potentiometers
Technical Ceramics
Ceramic Packages
Semiconductor Devices



CENTRALAB

Electronics Division
GLOBE-UNION INC.
5757 NORTH GREEN BAY AVENUE
MILWAUKEE, WISCONSIN 53201

INFORMATION RETRIEVAL NUMBER 29

Siemens

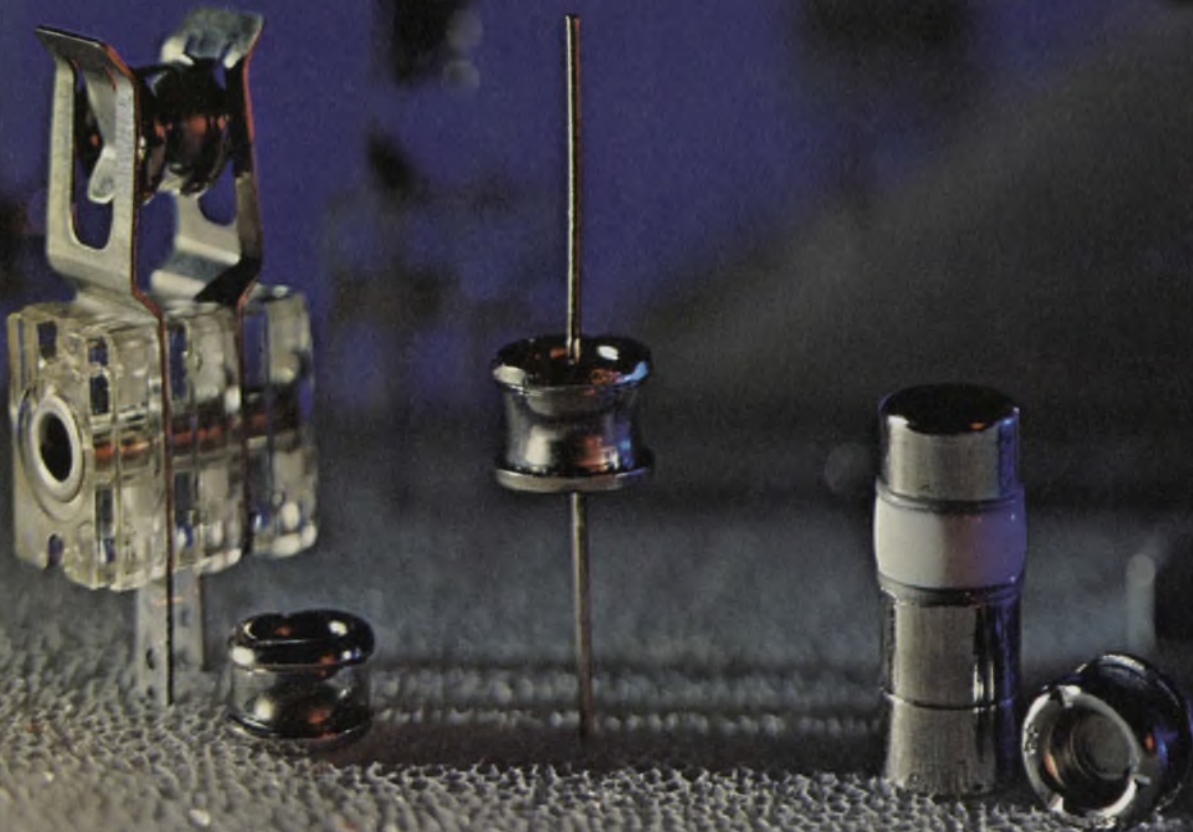

Low-cost SVP™ devices can save your valuable equipment from destruction by voltage transients.

You can no longer overlook the need for protecting your circuits. New sources of transients are cropping up every day. And any one of them might cause operational failure of your equipment.

Now there is an easy low-cost way to protect your circuitry from these transients. It's a simple little

gas-filled surge voltage protector. We call it an SVP. Only this Siemens SVP offers high-current capability (up to 50 kiloamps) in such a small package and a high impedance when not conducting (10^{10} ohms, 1 to 6.8 pF depending on model).

Siemens is the world's largest manufacturer of surge voltage

protectors. More engineers are using them every day. You can benefit by doing the same.

Siemens Corporation, 186 Wood Avenue South, Iselin, N.J., 08830. (201) 494-1000.

Siemens. A three billion dollar name in quality products.

SIEMENS

washington report



Don Byrne
Washington Bureau

Justice Dept. to screen computer pact

The Justice Dept. will be watching with interest an agreement that National Cash Register and the Control Data Corp. are drawing up to enhance their competitive position in the commercial computer market. Under the plan, the two companies intend to form a jointly owned (50-50) corporation, with net assets of about \$50-million. The new company would design and manufacture most of the peripherals for NCR and Control Data computer systems and would sell only to the two parent companies. In addition NCR and Control Data would achieve a "high degree of compatibility" in the development of computer mainframes. The question that interests the Justice Dept. is: Will the agreement violate the antitrust laws?

NCR and Control Data representatives have already met with the federal agency to make clear their intent. They see the agreement as a way to survive in a market in which one company—IBM controls 70 to 75% of the business. The difficulty in competing has led two major manufacturers—RCA and General Electric—to drop out of the market.

The decision could be a tough one for the Justice Dept. In recent years it has followed a fairly hard line on cooperative agreements between corporations, especially major corporations.

A decision nears on domestic satellite program

A final decision by the Federal Communications Commission on a domestic communications satellite program is expected in the next few weeks, and from all indications, some sort of open competition will determine who builds and operates the system or systems. Dean Burch, chairman of the FCC, has indicated that he leans toward "open entry," but he warns: "Open entry sounds wonderful, but it does not answer such questions as who it is open to, who owns the earth stations."

FAA begins work on microwave landing system

After several false starts, the Federal Aviation Administration has kicked off its microwave landing system project, which hopefully will produce an aircraft landing system for the 1980s. The first part of the program development will call for about \$100-million in contracts over five years. The FAA has awarded contracts of about \$500,000 each to AIL, a division of Cutler-Hammer, Bendix, Raytheon, Texas Instruments,

Hazeltine and ITT Gilfillan. All six will study scanning-beam techniques, with Hazeltine and ITT Gilfillan concentrating on doppler techniques and the others conventional scanners.

The FAA expects to select one company for each group to build a prototype for testing. The first part of the program will cost about \$41-million in payments to contractors, while the FAA itself will spend \$51-million more on R&D and study of the systems that evolve. Additional contracts are due shortly to companies to assist the FAA in its study work. The federal agency estimates that it will need 454 microwave units by 1981 at a cost of over \$100-million, bringing the total program to at least \$200-million. Eighty-four large instrument-landing units will be supplied to major airports, and the balance—smaller systems—will go to less heavily used airports. The smaller units will provide landing and approach guidance via C band, while the more complex units will use a Ku band to provide guidance for automatic landing systems.

New cable television decision cheers industry

The recent Federal Communications Commission's decision allowing cable television to "import" distant signals has been greeted by the industry as a "landmark." The new rules allow CATV operators to carry a limited number of out-of-town broadcast signals in competition with local broadcasters. But it offers some extensive program protection to local broadcasters in the top 50 markets. The new regulations specify that cable operators in the large 100 TV markets must provide for each broadcast signal carried—an equivalent channel that can be used for non broadcast purposes. While it is almost impossible at this point to project the effect of the new rules on the CATV industry, the National Cable Television Association says the rulings will mean "cable TV can now be brought to millions of additional people in many cities previously barred from cable's benefits."

Capital Capsules: The Fourth Communications Satellite Systems Conference, sponsored by the American Institute of Aeronautics and Astronautics will be held at the Mayflower Hotel here April 24-26. **You can get more information** from W. L. Pritchard, general chairman, Comsat Laboratories, Box 115, Clarksburg, Md. 20734 **A bill to establish a Congressional Office of Technology Assessment** has passed the House. A similar measure in the Senate is still in committee A Commerce Dept. staff study called "Policy Aspects of Foreign Investment by U.S. Multinational Corporations" **shoots holes in the arguments that overseas investments by U.S. concerns are costing American labor jobs at home.** The report says in part: "If the products in question were not produced and supplied from abroad by U.S. affiliates, they would likely be supplied by foreign competitors. The choice therefore is often not between U.S. or foreign operations but between foreign operations and no operations at all." Clay T. Whitehead, director of the Office of Telecommunications Policy, has **set up a Council for Government Communications Policy and Planning** within his agency. The council is composed of the heads of the various major federal communications users, such as the Defense Dept. and the General Services Administration. **The council will strive to integrate the various systems used by the Government into one system—hopefully with increased efficiency.**

Unimax lighted pushbutton controls offer you the broadest variety of styles in a wider choice of displays, colors, illuminations and actuations. From simple pilot light applications to the most sophisticated split face switch or circuit breaker, you'll find a Unimax LPB to meet your requirements—with Unimax quality and reliability built-in. At competitive prices.

Series 2: A high-rated (5 amps, 250 volts a-c or 28 volts d-c) lighted or unlighted pushbutton switch, available as momentary or alternate action and offering matching indicators. Small in size and price.

Series 5: A versatile two lamp double pole lighted pushbutton switch, momentary or alternate action, that can either transmit or project color in full or split display. High rating. High candlepower. Choice of front panel snap-in or sub panel hard mount. Low price.

Series 9: Highest quality 4 lamp switch meeting the requirements of MIL-S-22885. Single screw mounting, simple front of panel relamping and wide choice of lamp circuits. One to four pole switching. Features and options not available in any other switch.

Series 9C: All the advantages of the Series 9, with the switching mechanism replaced by a hydraulic-magnetic tripping action circuit breaker.

EAO Series 01, 02, 03: Just introduced, these economical products are available in round, square and rectangular styles. Up to three pole switching in momentary or alternate action or as indicators, key lock or mushroom cap models. Ratings and electrical and mechanical performance are uniformly high.



A Riker-Maxson Subsidiary/Ives Road, Wallingford, Conn. 06492

Dept. _____

Gentlemen:

I'm impressed. Please have your representative contact me for a demonstration. Please send information on the following LPB lighted pushbutton controls: Series _____

My application: _____

Name _____ Title _____

Company _____

Address _____

City _____ State _____ Zip _____

We have more LPB's going for you than anyone else.

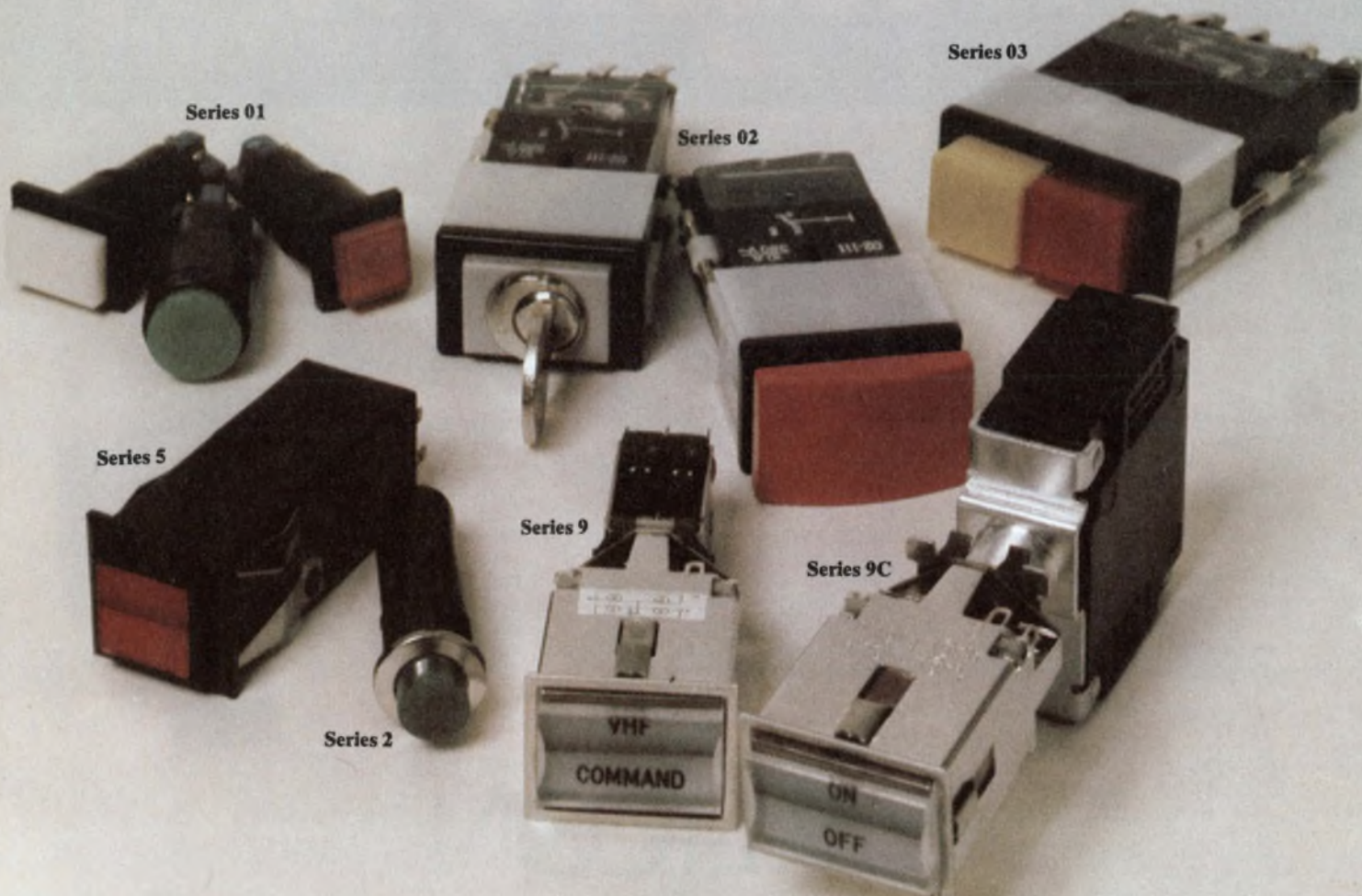

The toughest lighted switches.

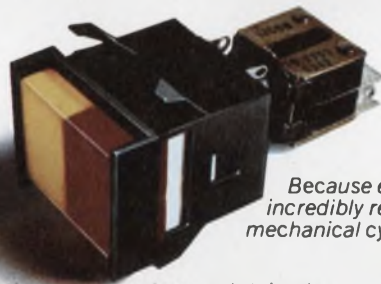
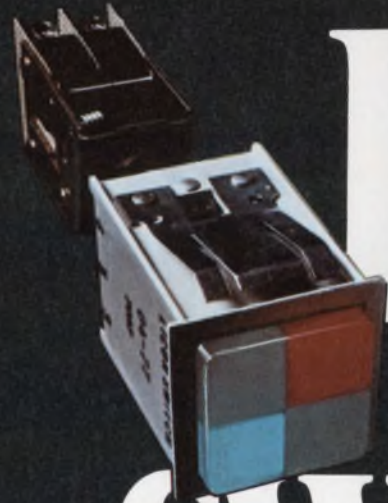

*Because every one is based on Licon's
incredibly reliable (up to 20 million
mechanical cycle) Butterfly switch.*

From the tiny inexpensive Type 01-700 to the four-lamp Type 04, every Licon® lighted switch incorporates one or more Licon Butterfly® switches. Thus the ultimate in double-break switches becomes the basis for one of the broadest lines of lighted switches available. Choose the indicating function required... one; two or four lamps... lens cap configuration... screen color and engraved legend. Name your switching

action... momentary, maintained, solenoid-held, indicator light only, or multi-circuit control. Select your mounting style... flange, barrier, bezel, bezel-barrier, horizontal or vertical, single-switch or multiple in matrix. Meet Mil Specs. In every choice, installation and servicing is fast and easy. Because ultra-reliable switching is our business. Test light the line yourself. Call your local Licon distributor or representative for a

lighted demo in your office. Or call or write for a Licon Switch Catalog. **Licon, Division Illinois Tool Works Inc., 6615 W. Irving Park Road, Chicago, Illinois 60634. Phone (312) 282-4040. TWX 910-221-0275.**



i t **LICON**

The Innovating Electronic Group of ITW... LICON ■ ELECTRO MATERIALS ■ PAKTRON

Don't be a 'don't know'

Whenever public-opinion pollsters publish their findings, a significant proportion of those polled finish up in a column headed "don't know." The designation implies that these people are either too stupid or too uninformed to have a valid opinion. But are they? Probably not.

Because of the pollster's (and his computer's) logical preference for the "excluded middle," he dumps all the awkward people—those who don't respond and those whose answers are difficult to classify—in the "don't know" column. And the world never finds out what they really think.

I was reminded of this problem, recently, when, like many of you, I received an IEEE questionnaire. The IEEE wanted straight yes/no answers to a string of questions. And the questions weren't that easy to answer.

For example, the IEEE directors asked me if some of the member services should be reduced. But they didn't say which services they had in mind. They asked how much extra I would be prepared to pay for additional services. But they didn't indicate exactly what I would get for my money.

My biggest problem, however, was the basic question of whether the IEEE should become a lobbying organization. This seemed a philosophical dilemma. What's good for engineers is not necessarily what's good for the country. To whom do I owe the greater loyalty?

If, as I believe, this country is being destroyed by powerful, greedy and hypocritical lobbying organizations—representing both labor and capital—how can the situation be improved by adding organized engineers to the roster of people waiting for handouts? Yet, why should engineers wait on unemployment lines while plumbers and physicians blackmail the public and while a farmer/politician gets a fat income for not growing cotton.

Eventually I decided, in effect, that if we couldn't beat the racket, then perhaps we should join it. But I still respect the man who decides otherwise and refuses to be as cynical or as defeatist as I was.

We've already won our first battle, though. At last, the IEEE has condescended to listen to the opinions of its members. So, whatever your viewpoint, stand up and be counted. Don't be a "don't know."



A handwritten signature in dark ink, appearing to read "Michael Elphick".

MICHAEL ELPHICK
Managing Editor

FOCUS

on
Lighted
switches

They're not as simple as they seem, lighted switches. There are two ends to such a switch, and each can cause problems.

The switch end is prey to all the problems that plague any switch—and then some. The message end shares problems with common indicators, as well as having plenty of problems of its own.

It's perhaps ironic that many of the problems stem from the apparent simplicity of the device. Especially today, when engineers are accustomed

to products with awe-inspiring complexity, it's temptingly easy to assume that something so simple as a lighted switch can't go wrong. After all, the device is merely a combination of one or more lamps, a legend plate and a switch. None of these has state-of-the-art complexity.

And yet too often a complex system breaks down, not because an LSI circuit failed but because a pair of silly switch contacts failed to make contact. Or a lamp didn't warn of danger.

Jules H. Gilder
Associate Editor

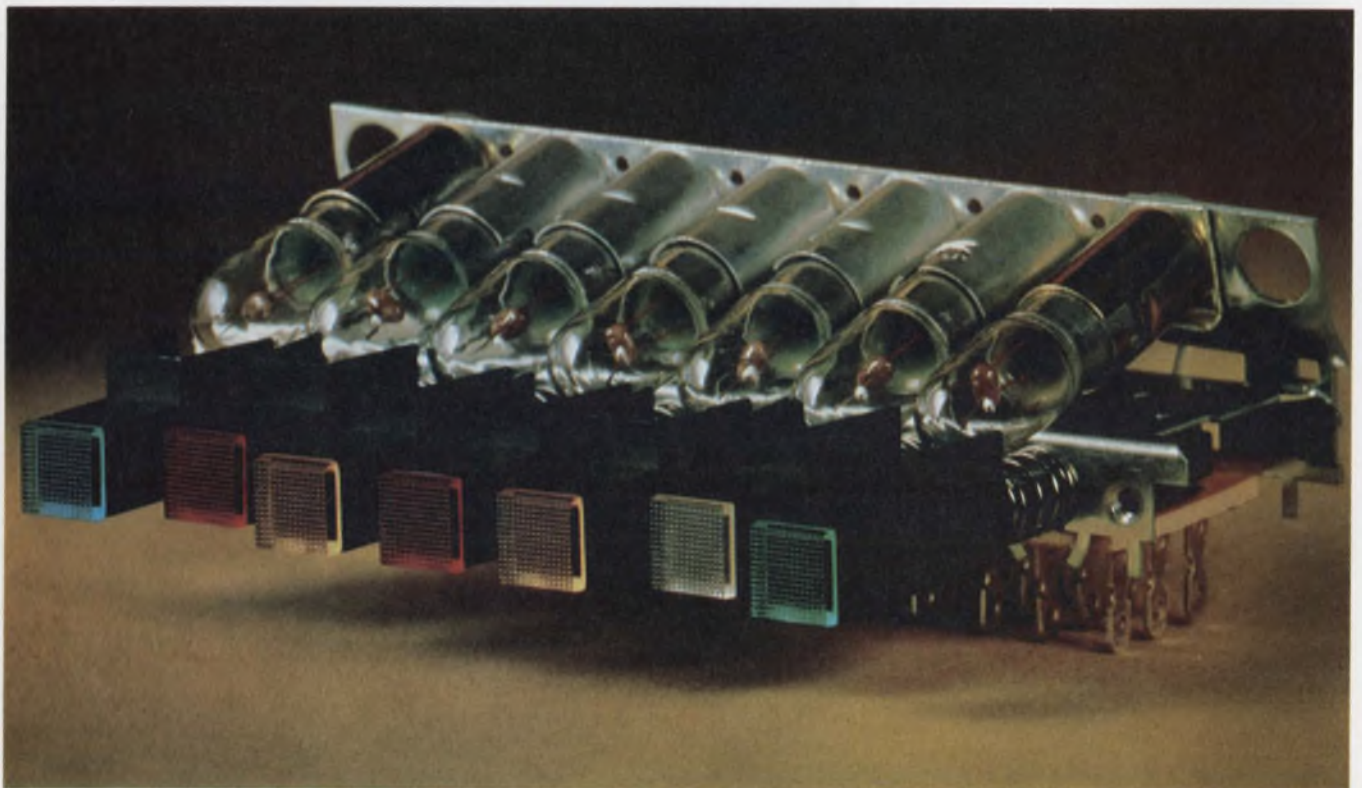

Inexpensive lamps combine with slide switches to form UID's low-cost lighted pushbutton. The pushbuttons can

be ganged to provide various switching and mechanical interlocking combinations.

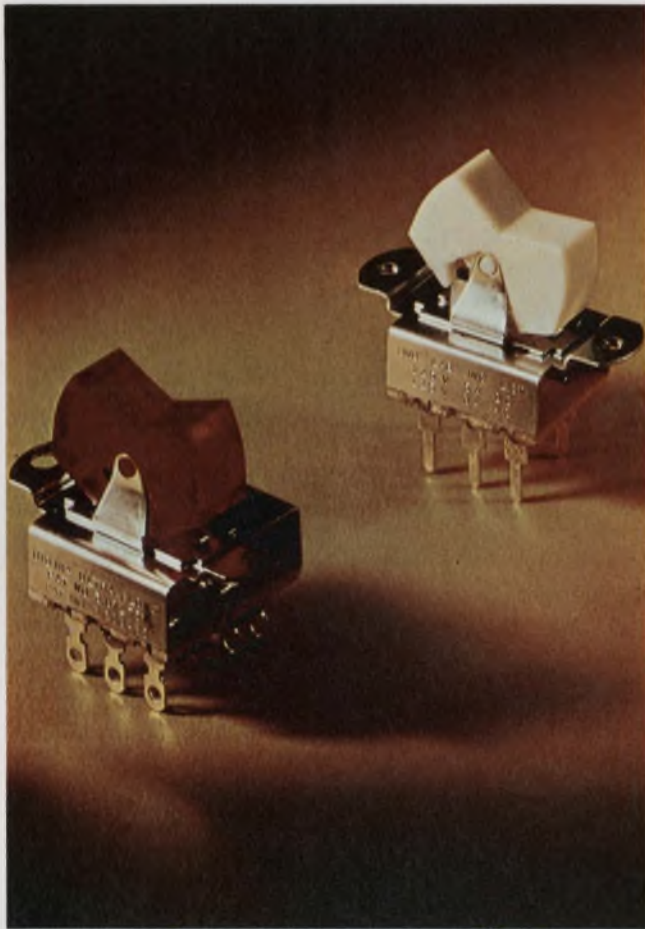

UID's lighted rocker switch can be illuminated by either neon or incandescent sources.

ally stems from electrical requirements—and these are sometimes inadequately understood.

Which resistance?

If a switch is in series with a high resistance of, say, several thousand ohms, it doesn't matter much whether the switch resistance is 50 m Ω or 10 Ω . The circuit can't tell the difference. But if the circuit resistance is small enough, the resistance of the switch can be unpleasantly significant. Unfortunately, it's not always easy to determine: It's not always specified clearly; it's not always expressed as resistance; and it's not always constant.

Before you can determine the contact resistance, you have to know what it is. Is it the resistance of the contact material itself? Is it the resistance of the contaminating film on the contacts? Is it the resistance from contacts to the terminals? Or is it all of these? If a manufacturer says his switch has a resistance of 25 m Ω , which resistance does he mean? The answer is that you don't always know. Some manufacturers specify exactly what they mean, others don't.

Moreover contact resistance is not always constant. It is a function of the voltage and current and of the number of switching cycles. It can be affected by contaminants in the atmosphere around the contacts and by the pressure applied to the contacts.

Further, contact resistance is not always indicated in units of resistance. Sometimes it is expressed as a voltage drop across the switch terminals or contacts at a particular current, but the current level isn't always specified.

Even when a manufacturer is quite precise in his definition of contact resistance, does he mean the resistance when the switch leaves the factory? Or the resistance after 10,000 operations? Contact resistance doesn't stay put; it can vary from an initial value of several milliohms to a final value of several ohms.

The open-circuit resistance of the switch may also be important. Will the switch insulation withstand a high voltage in the proposed circuit? Or will the insulation break down and cause a permanent partial short? This, in part, depends on the type of load.

What is the load?

When a spec sheet says that a switch is rated at 2 A, what does this mean? Does it mean the

Or a console operator jabbed the wrong button because he couldn't read an illegible legend. He's part of the system, too. He's part of the reason for the existence of lighted switches.

It can be fruitful, then, to examine each end of a lighted switch with some care.

THE SWITCH

In most cases, "lighted switch" means lighted pushbutton. But though the operator's action may be a push, the switch mechanism, perhaps driven by some sort of linkage behind the panel, can be of almost any type. It's often a basic snap-action switch. So the term pushbutton derives from what the operator sees, or feels, in front of the panel. Though the pushbutton holds sway as the dominant lighted switch, other types—like the rocker, slide, lever and even the toggle—are beginning to find a place on many panels.

The reason for choosing one actuator over another depends on panel-layout requirements, special needs for transmitting information between machine and human operator, and—sometimes—the whim of the design engineer. The reason for choosing a switch mechanism gener-



Solid-state lighted switches from Dialight use LEDs as the source. The two end switches incorporate photo-Darling-

ton transistors to provide Schmitt-trigger output. Snap and non-snap actions are available.

switch can carry 2 A? Or does it mean the switch can make and break 2 A? There is a big difference. A switch that is designed to carry 2 A may not be able to handle the large current surges generated by making or breaking a 2-A circuit. Is the rating for ac voltage or dc voltage? Dc loads are generally more punishing to the contacts than ac loads.

The nature of the load has a profound effect on the performance of a switch. Inductive loads tend to maintain arcs when a circuit is broken, and they can produce a voltage kickback that is high enough to destroy the switch insulation. Capacitive loads can cause a large initial surge current. Incandescent loads can, too. Typically, the current surge generated by a cold incandescent load can be 10 times the steady-state current. Thus, while the steady-state current is well within the switch rating, the transients can kill the switch.

Some engineers try to overcome switch-specification problems by overspecifying. If a switch is good at 28 V, they reason, it ought to be great at 28 mV. Right? Wrong! In addition to having a maximum voltage limit, switches also have a minimum limit. This lower voltage must be large enough to puncture and break down any film at the contact surface and thus establish good metal-to-metal contact with very low contact resistance. A minimum voltage rating is very important in dry circuits.

But what's a dry circuit? This question was asked of several switch manufacturers in a recent survey by ELECTRONIC DESIGN. The variety of answers received is illuminating. A dry circuit, it turns out, can be any of these:

- It carries up to 15 μ A at up to 25 mV.
- It has circuit parameters of less than 50 mV and 25 μ A.
- It doesn't make or break current.
- It carries milliamps at voltages up to 1 V.
- It's more frequently referred to as a low-level circuit with up to 100 mV at up to 1 mA.
- It's that power level at which no electrical effects, such as arcing, melting or softening of contacts, are associated with the switching.

The wide variety of definitions proves that terms don't always have the same meaning for different vendors.

What's the life?

How long is the switch going to last? The answer isn't as simple as you might expect. To start with, you have to define life. Is it the mechanical life or the electrical life? A spec may say the switch has a rated life of one million cycles. What the manufacturer may neglect to mention is that this is the mechanical life of the switch, and that after the first 10,000 cycles the contacts are so worn you can't get an electrical contact.

If the life has been defined as electrical life, the next thing you want to know is what constitutes the end of life? Is it the point at which the contacts weld closed permanently? Is it a point at which the contact resistance is no longer within the switch specifications? Or does it occur when the electrical contacts are worn or contaminated to the extent that they do not make a circuit when closed? How does the contact resistance at the end of life compare with contact re-

sistance at the beginning?

Every part of a switch affects its life—contact pressure, springs, housing and contact material.

Which contact material?

The switch manufacturer is usually best equipped to decide which contact material is best, assuming you tell him exactly what your requirements are. He has a variety of materials to choose from—gold, silver, copper, palladium, mercury, rhodium and others. Each has advantages and disadvantages.

Special contact materials can appear to offer remarkable flexibility. It's not uncommon, for example, to find a switch rated for either dry-circuit or heavy-current applications. While this may be true, it may be less apparent that once you use the switch to carry a heavy current, it can't be used for dry circuits. This is because the gold contact surfaces often used for dry-circuit applications melt when switching heavy currents. There is no such thing as a universal switch.

THE MESSAGE

Many considerations are involved in selecting the message indicator—light source, color source, legends, filters, lamp switching, heat, effects of ambient light and more.

A single illuminated switch can involve up to four lamps, four legends, four different insert filter colors, individual switching for each lamp and measures for coping with ambient light. It's wise to consider each parameter carefully.

Which lamp?

The light source for an illuminated switch can be either an incandescent or neon bulb or a light-emitting diode. The choice depends on the application. Do you need a high-intensity bulb? Is cost important? How about power consumption? Do you need a highly reliable lamp? Are you using high-voltage ac or low-voltage dc for your indicator power supply?

Answering these questions will help you determine which light source is best for you.

Incandescent lamps are by far the most common source of light. They have high intensity and low cost, and they can work with a wide variety of filter colors. They also come in a wide choice of filament voltages. They don't, however, come without some drawbacks. Incandescents consume a lot of power and generate much heat. Their low cost may be offset by the need to add a cooling system. Incandescents are also susceptible to shock and have a relatively high failure rate when compared with neons and LEDs.

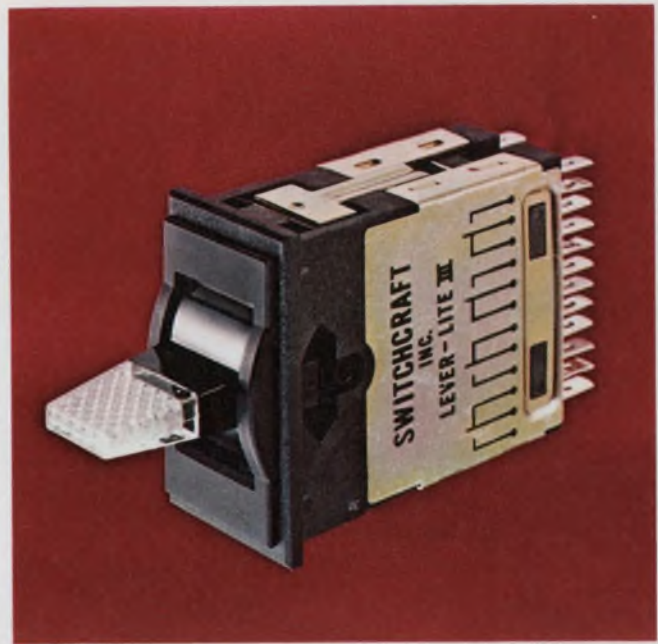

Lever-Lite III, Switchcraft's illuminated level switch features front-of-panel mounting and relamping.

What about the neon? It doesn't generate excessive heat, and it, too, is relatively inexpensive. But it lacks intensity and colors. And while it does have a relatively long life—typically 10,000 hours—the neon requires high voltage, generally ac, to operate. Dc voltage can be used, but only half the usual brightness is achieved.

Need a low-voltage, high-reliability source? Maybe a light-emitting diode is the answer. LEDs operate at low voltages and generate less heat than incandescent lamps. But the generally required series resistor consumes power, too. Because they have no filaments, LEDs are good for use in high-vibration environments. They are extremely reliable, with a typical life of 100,000 hours. And they are now available in red, green and yellow. LEDs, however, do have some disadvantages. They cost more than incandescents or neons (especially the green and yellow ones), and they produce a point source of light.

Why multiple lamps?

Do you want a high-intensity indicator with a high reliability? If cost is no factor, you can use a multiple incandescent lamp display, with the bulbs connected in parallel. Thus if one bulb fails, you'll still have a working indicator, with only a slight decrease in intensity. Indicator displays are available with up to four lamps. While they are more expensive and consume more power than single-lamp displays, they are more versatile. Some can provide up to four distinct and independent pieces of information via legends and color indication. However, care must be taken when using multiple sources. They gener-

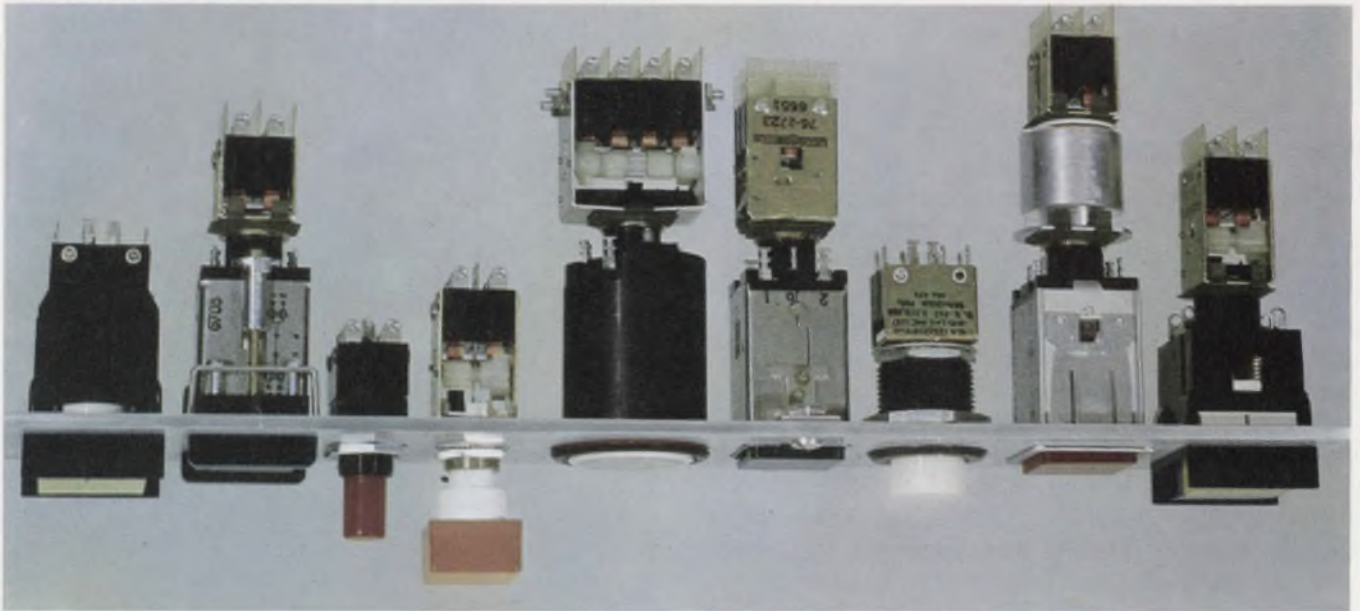

Illuminated pushbutton switches are available from Licon in a variety of shapes and sizes.

ate a lot of heat and may crack or warp the legend plate. They may also cause a filter to lose color if it is subjected to too much heat.

In some switches the lamp moves when the button is pushed. This type of arrangement can save the cost of an extra set of contacts. But what is the cost: If the lamp moves when the button is depressed, it can be subjected to high shock, which can cut filament life rapidly.

How about relamping?

Most lighted switches, especially those designed for incandescents, have provision for replacing the lamp. How big a problem can it be to change a silly little light bulb?

Lamps are mounted in switches either from the front or the back. If you use a switch whose lamp will have to be replaced from the back, you may be lucky. Chances are you'll probably know about it and will leave yourself room behind the panel to allow for this simple operation.

If, on the other hand, you use a switch that features front relamping, you could run into trouble. That doesn't mean that front relamping is no good. On the contrary, it can be most convenient. The problem is that not all switches that can be relamped from the front can be relamped from the front *panel*, and that's the trap. Some switches require removal of the panel before you can get to the front of the switch. The unwary engineer may not allow for such action in packaging the system.

Is a special tool necessary to replace the lamp? Often the lamp is recessed and out of reach. Under such conditions, it may be necessary to use a special instrument to change the bulb. What happens if you lose this tool? According to Mur-

phy's Law, that's bound to happen—just when you need it.

Which color source?

How is your switch going to indicate color? Will it be by projection or transmission? Do your switches have to be color-coded even when they are not lit? If so, then use transmission.

Transmitted color systems indicate color by way of a colored filter in the cap of the pushbutton. Since the cap is color-coded, the color remains, even when the switch is not lighted. Switches of this type do not permit changes in

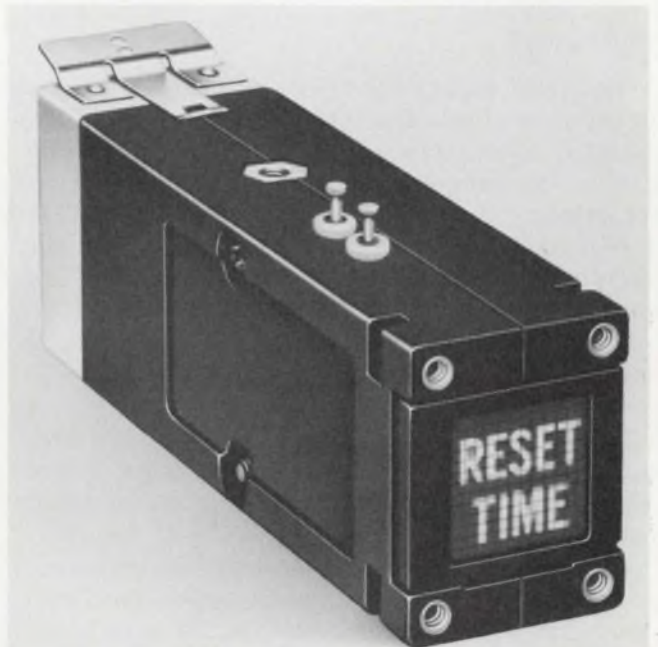

A new switch using copper-laminated Mylar squares and rear-projection display can provide up to 12 different legends on the viewing screen.

color, except by changing the color of the display screen. But the screens can be divided into smaller areas and illuminated by individual lamps.

Where is the switch going to be used? If in low ambient light, then a color projection system might be best. Color projection employs individual bulbs with color filters on them. These bulbs project the desired color on a white display screen. With this method it's easier to tell if the switch is lighted, because the color is invisible when it is off. A big disadvantage is that the color tends to wash out under high ambient light. It is best used under ambient conditions of less than 100 footcandles.

What kind of legend?

If you are going to display information on the switch, you will need to know how. Sometimes the message is just knowing if the lamp is on. Sometimes you may want a printed legend. Hot stamping of legends is fast and cheap, but only for large quantities. The initial cost of press and stamping tools is high. What about engraving? While slower and more expensive on a unit basis, it pays for short runs. Engraving templates cost much less than a set of stamping tools. But if the engraving is on the outside, it may be eroded by accumulations of finger acids in the engraving. One way of overcoming this is to use film legends instead of engraving. This method is good for rush jobs or where cost must be held to a minimum. By paying attention to these details now, you can save time and trouble later.

Of course, the best way to be sure that you are buying exactly what you need is to get several samples of the proposed switch. Several! The samples should be mounted and tested under the same conditions that it will encounter in your intended application. Only then will you know if the switch meets your needs.

THE VARIETY

The choice of lighted switches is almost endless. One manufacturer, in fact, offers more than 50,000 different switch possibilities from stock, depending on the switch, cap shape, color and panel mounting.

Do you want a low-cost lighted switch? Maybe lighted pushbuttons from UID Electronics are the answer. They are constructed from inexpensive slide switches, mechanically linked to pushbuttons. Illumination is by a T-3-1/4 lamp that cost 4 cents, instead of the more common (in switches) T-1 or T-2 bulbs at about 30 cents. Total cost per switch is about 50 cents.

How about a lever switch? If you need one that can indicate up to three different colors and has front-of-panel relamping, the Switchcraft Lever-

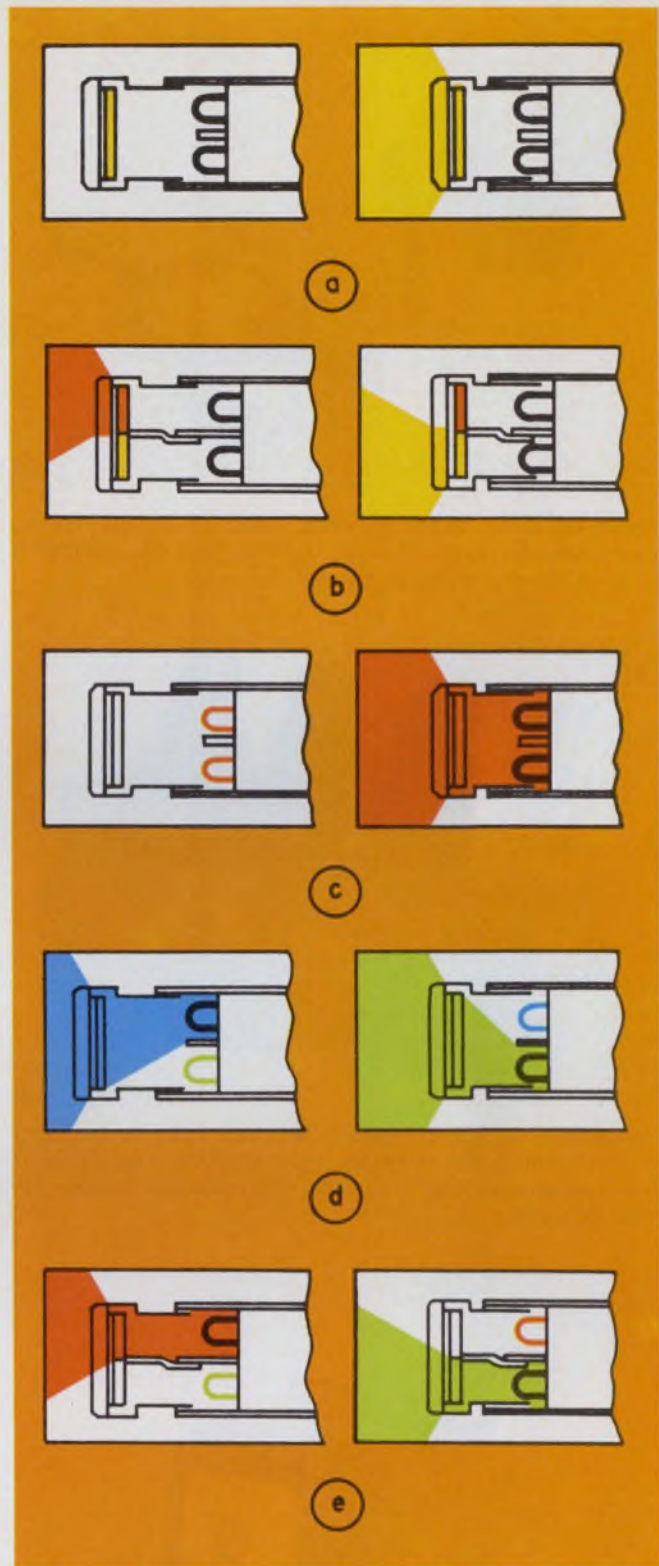

Color indication by transmission (a) is accomplished by using white bulbs and a colored filter in the cap. Multiple colors can be indicated (b) by dividing the display screen into smaller segments and using additional filters. For this method of indication, a light barrier must be used. A projection system of color indication (c) uses a white cap and either a colored bulb or a bulb with a filter over it. With projection, you can get a full-screen indication (d) of several different colors. If you want to indicate many colors at the same time, or only light up half a screen (e), light barriers must be used. The transmission system is recommended for high ambient environments, while projection is used for low ambient environments.

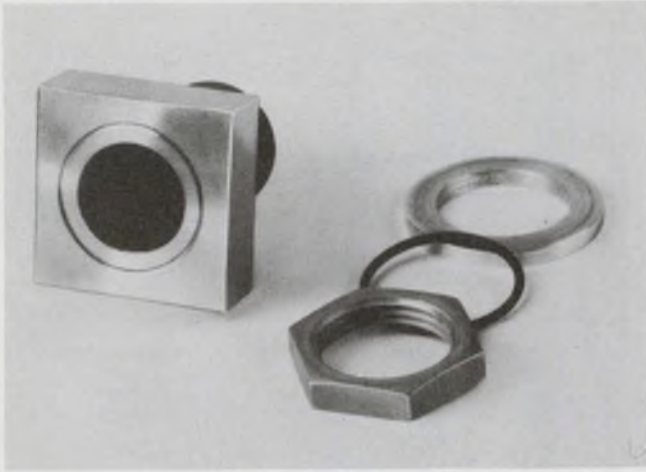

Touch-operated switch by Wild Rover Corp. features an environmental seal, multiple contacts and low profile. It is good for dry or heavy current circuits.

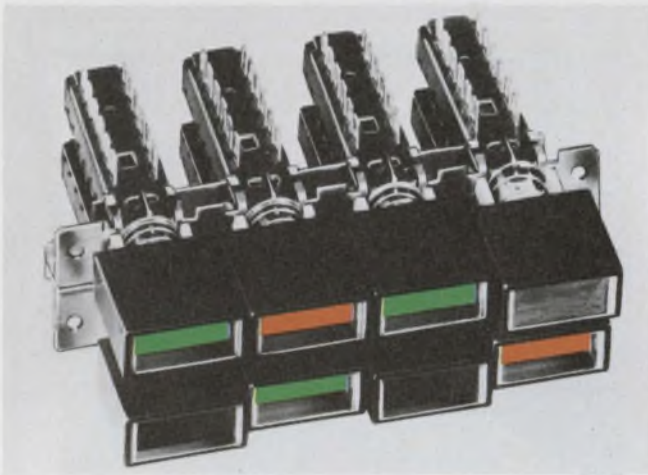

Schadow's lampless lighted switches provide indicator action without the need for light sources. The switches are available in the U.S. from International Electro Exchange Corp.

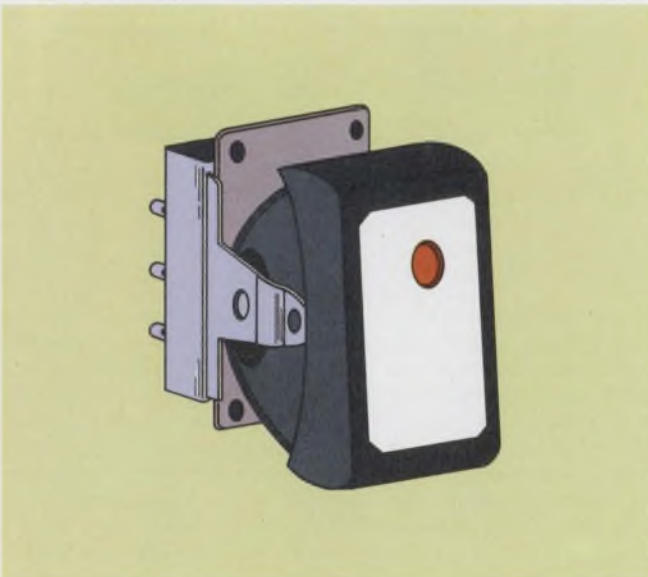

A pseudo-illuminated rocker switch, developed by General Radio, can be used to replace conventional rockers. It is good only in high ambient light.

Lite III or the lever switch made by Capital Machine and Switch might be just for you.

Have you ever seen a lighted toggle switch? Cutler-Hammer has one.

How about that special application where you want to display 12 different legends on the same switch? Impossible? Not with Industrial Electronic Engineers' new Screen Switch. It's a touch-type, momentary-contact switch that can display any one of 12 different messages by projecting light through a message film onto a front screen.

Talk about touch switches, you might want to try Wild Rover's line of TC-1 switches. They feature environmental seal, low profile and an unusual multiple-contact switching mechanism.

Do you have any keyboard installations that have to be used in a low light environment? Maybe you should consider a lighted keyboard switch from Micro Switch or Cherry.

Low-level logic circuits that need an illuminated switch can now be accommodated without

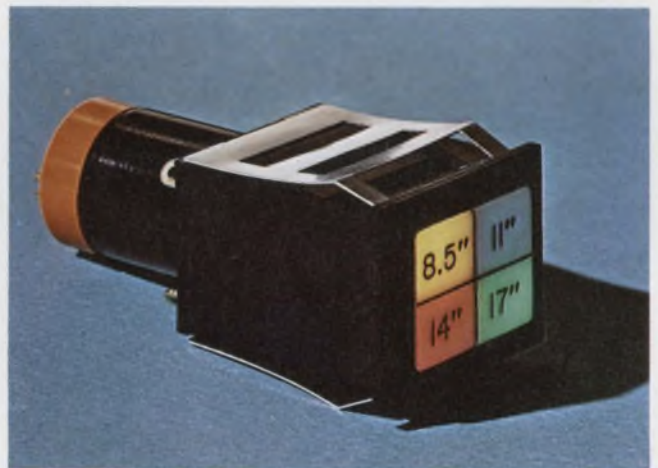

Switchcraft's Orcon switch has a multiple lamp display and uses the transmission system of color indication to provide up to four different messages.

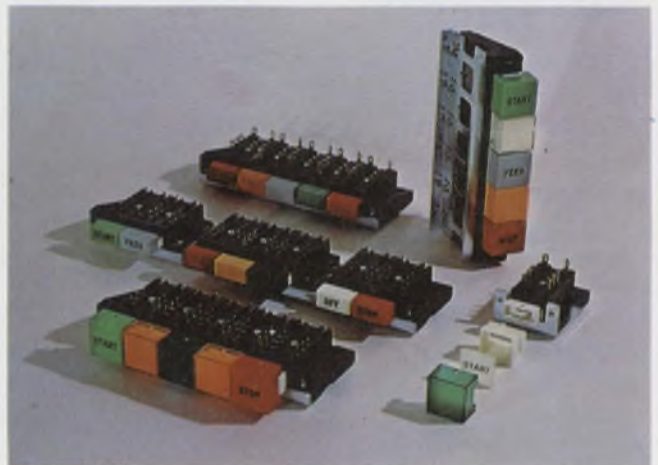

Switching assemblies by Ledex feature a wide variety of switching actions and mechanical interlocking. Matching indicators are available, too.

the need for a separate power supply. Try lighted switches that use LEDs, such as those manufactured by Dialight and TEC.

And if you want an illuminated slide switch that snaps right into your front panel, Leecraft makes one. It's called SlideLite.

Have an unlighted miniature pushbutton you'd like to convert to a lighted one? If the original is a Cutler-Hammer, you're in luck. The company offers a separate light unit that screws onto the the bushing of a standard miniature pushbutton.

Do you need a lighted switch but at the same time have to reduce wiring and power-supply

requirements? Why not try a "lampless" lighted switch. These are switches that use a "fluorescent" type of color indicator that reflects ambient light. They are insensitive to vibration, require no electrical contacts for the indicator and generate no heat. Obviously they are only good for high ambient light environments. A rocker switch of this type has been developed by General Radio, and pushbuttons using this principle are manufactured by Schadow and available from International Electro Exchange Corp. At a cost of 18 cents each in quantities of 1000, they may be just what you were looking for. ■■

Need more information?

The products cited in this report have, of necessity received only cursory coverage. Further, they don't represent vendors' full lines. Readers may wish to consult the manufacturers listed here for more details. For quick response, circle on the retrieval card the boldface numbers that are shown here.

Alco Electronic Products, Inc., 1551 Osgood St., North Andover, Mass. 01845. Phone: (617) 686-3887. (Robert Laffey, National Sales Manager). **Circle 401**

Allen-Bradley, 1201 S. Second St., Milwaukee, Wis. 53202. Phone: (414) 671-2000. (Roy Miller, Assistant Manager, Sales Dept.). **Circle 402**

American Monarch, 2801 37th Ave., Minneapolis, Minn. 55401. Phone: (612) 788-9161. (Dwayne Weaver, Switch & Relay Engineer). **Circle 403**

American Zettler, Inc., 697 Randolph Ave., Costa Mesa, Calif. 92626. Phone: (714) 540-4190. (G. Rueb, General Manager). **Circle 404**

Arrow-Hart Inc., 103 Hawthorne St., Hartford, Conn. 06101. Phone: (203) 249-8471. (Lou Wright, Product Manager Industrial Control Div.). **Circle 405**

Capitol Machine and Switch, 87 Newton Rd., Danbury, Conn. 06810. Phone: (203) 744-3300. (Michael Baldasare, Vice President, Engineering). **Circle 406**

Carling Electric, Inc., 505 New Park Ave., West Hartford, Conn. 06110. Phone: (203) 233-5551. (R. H. Smith, Sales Manager). **Circle 407**

Centralab, 900-934 E. Keefe Ave., Milwaukee, Wis. 53202. Phone: (414) 228-2963. (Lowell Mueller, Sales Manager). **Circle 408**

Cherry Electric, 3600 Sunset Ave., Waukegan, Ill. 60085. Phone: (312) 689-7600. (Pete Barthell, New Products Manager). **Circle 409**

Chicago Dynamic Industries, 1725 West Diversey Blvd., Chicago, Ill. 60607. Phone: (312) 935-4600. (Jim Early, Sales Manager). **Circle 410**

Chicago Switch Inc., 2035 West Wabansia Ave., Chicago, Ill. 60647. Phone: (312) 489-5500. (Eric Peterson, Sales Manager). **Circle 411**

Clare-Pender Co., Box 785, Post Falls, Idaho. 83854. Phone: (208) 773-4541. (Ted Neiley, Products Specialist). **Circle 412**

Computite Corp., 17795 Skypark Circle Dr., Irvine, Calif. 92664. Phone: (714) 546-9045. (Sharon Rasmussen, Sales Administrator). **Circle 413**

Control Switch, Inc., 1420 Delmar Dr., Folcroft, Pa. 19032. Phone: (215) LU6-7500. (Sam Porcelli, Manager of OEM & Distributor Sales). **Circle 414**

Co-Ord Switch Div., 102-48 43d Ave., Corona, Queens, N.Y., N.Y. 11368. Phone: (212) 899-5588. (John Villa). **Circle 415**

Cutler-Hammer, 4201 N. 27th St., Milwaukee, Wis. 53216. Phone: (414) 442-7800. (Warren G. Cudlip, Marketing Manager, Specialties Products Div.). **Circle 416**

Dialight Corp., 60 Stewart Ave., Brooklyn, N.Y. 11237. Phone: (212) 497-7600. (Harry Goodman, Sales Manager). **Circle 417**

Eldema Div., 18435 Susana Rd., Compton, Calif. 90220. Phone: (213) 774-1850. **Circle 418**

Electro Switch Corp., King Ave., Weymouth, Mass. 02188. Phone: (617) 335-5200. (Robert Eccleston, Sales Manager). **Circle 419**

Furnas Electric Co., 1197 McKee St., Batavia, Ill. 60510. Phone: (312) 879-3410. (Carl Witschonke, Manager of Advertising & Public Relations). **Circle 451**

General Control Co., 1196 Soldiers Field Rd., Boston, Mass. 02163. Phone: (617) 782-7440. (Tony Del Gaizo, Advertising Manager). **Circle 421**

General Electric, Box 913, Bloomington, Ill. 61701. Phone: (312) 325-4317. (Hal Vertun, Distribution of Sales, General

Purpose Control Dept.). **Circle 422**

General Radio, 300 Baker Ave., Concord, Mass. 01742. Phone: (617) 646-7400. (R. A. Mortenson, Engineer). **Circle 423**

Gray-Hill Inc., 569 Hillgrove Ave., La Grange, Ill. 60525. Phone: (312) 354-1040. (Al Langille, Advertising Sales Promotion Manager). **Circle 424**

Industrial Devices Inc., c/o Mohr & Co., 770 Lexington Ave., New York, N.Y. 10021. Phone: (212) PL9-7070. (John Spitzer). **Circle 425**

Industrial Electronic Engineers, 7740 Lemona, Van Nuys, Calif. 91408. Phone: (213) 787-0311. (Tom O'Gorman, Advertising Manager). **Circle 426**

International Electro Exchange Corp., 6851 Oxford St., Minneapolis, Minn. 55426. Phone: (612) 929-7875. (Dwayne Kinner, General Sales Manager). **Circle 427**

Jay-El Products Inc., 1859 W. 169th St., Gardena, Calif. 90247. Phone: (213) 323-7130. (Leo K. Miller, Sales Manager). **Circle 428**

Korry Manufacturing Co., 223 Eighth Ave. N., Seattle, Wash. 98101. Phone: (206) 624-4066. (Jack Hevly, Sales Manager). **Circle 429**

Ledex Inc., 123 Webster St., Dayton, Ohio 45401. Phone: (513) 224-9891. (Ted Ristoff, Product Marketing Manager Switching Products). **Circle 430**

Leecraft Manufacturing Co., Inc., 21-16 44th Rd., Long Island City, N.Y. 11101. Phone: (212) 392-8800. (T. J. Marine, National Sales Manager). **Circle 431**

Licon, 6615 W. Irving Park Rd., Chicago, Ill. 60634. Phone: (312) 282-4040. (Alan Steiner, Advertising Manager). **Circle 432**

Marco Oak, Box 4011, Anaheim, Calif. 92803. Phone: (714) 535-6037. (B. Scharf, Vice President, Marketing). **Circle 433**

Master Specialties Co., 1640 Monrovia Ave., Costa Mesa, Calif. 92627. Phone: (714) 642-2427. (Stuart Brown, Sales Manager). **Circle 434**

McGill Manufacturing Co., 909 N. Lafayette, Valparaiso, Ind. 46383. Phone: (219) 462-2164. (Tom Morris, Sales Supervisor). **Circle 435**

Micro Switch Div., Honeywell, Inc., 1100 Spring St., Freeport, Ill. 61032. Phone: (815) 232-1122. (Kenneth Hicks, Product Manager). **Circle 436**

Molex Products Co., 5224 Katrine Ave., Downers Grove, Ill. 60515. Phone: (312) 969-4550. (Dave Netzel). **Circle 437**

Mossman, Donald P., Inc., Box 265, Brewster, N.Y. 10509. Phone: (914) 279-3725. (Mr. Bwrist, Sales Manager). **Circle 438**

Oak Manufacturing Co., Crystal Lake, Ill. 60614. Phone: (815) 459-5000. (Ed Lortie). **Circle 439**

Seacor Inc., 598 Broadway, Norwood, N.J. 07648. Phone: (201) 768-6070. (Mel Fink). **Circle 440**

Signal Indicator Corp., 42 Stewart Ave., Brooklyn, N.Y., N.Y. 11201. Phone: (212) 497-7600. (Harry Goodman, Sales Manager). **Circle 441**

Sorenson Lighted Controls, 530 Oakwood Ave., West Hartford, Conn. 06107. Phone: (203) 236-3267. (S. C. Kundahl). **Circle 442**

Square D, Executive Plaza, Park Ridge, Ill. 60068. Phone: (312) 774-9200. (Frank Rotta). **Circle 443**

Stacoswitch, 1139 Baker St., Costa Mesa, Calif. 92626. Phone: (714) 549-3041. (G. E. Kuehn, Sales Manager). **Circle 444**

Switchcraft Inc., 5555 N. Elston Ave., Chicago, Ill. 60607. Phone: (312) 792-2700. (Clyde J. Schultz, Industrial Sales Manager). **Circle 445**

TEC, Inc., 9800 N. Oracle Rd., Tucson, Ariz. 85704. Phone: (602) 297-1111. (Bob Saffrin, Sales Manager). **Circle 446**

UID Electronic Corp., 4105 Penbroke Rd., Hollywood, Fla. 33023. Phone: (305) 981-1211. (Ron Stanish, Vice President, Marketing). **Circle 447**

Unimax Switch Corp., Ives Rd., Wallingford, Conn. 06492. Phone: (203) 269-8701. (J. M. MacKnight). **Circle 448**

Waldom Electronics, 2625 W. 53d St., Chicago, Ill. 60607. Phone: (312) 585-1212. (Mario Vescovi, V.P. Sales). **Circle 449**

Wild Rover Corp., Herbert Ave., Closter, N.J. 07624. Phone: (201) 786-8393. (William J. Allen). **Circle 450**

New from the "expensive" switchlight maker...

...an inexpensive one!

If switches turn you on, you know that our line has always been known for quality. From now on we will be recognized for quality at a startlingly low price. Call it a breakthrough, if you like, but we'd prefer you call it "the monoform family" of switchlights.

monoform I (the single lamp, momentary & alternate, rated 2 amp 120 Vac) and monoform II (two independent lamps for hori-



zontal split legends, mom. & alt., 2 amp 120 Vac) are available now. monoform III (the 10 amp, ¼ H.P. power switch version) is coming soon. And this means a new low-cost range of models... readily available, easy to mount for almost every application.

...in the \$2 range!

 **CLARE-PENDAR™**
Phone 208-773-4541

INFORMATION RETRIEVAL NUMBER 33

The "special order" gaussmeter probe may be a thing of the past.

Many manufacturers only carry a few probes in stock. The rest are special order. At Bell, we have a brand new line of probes, in stock, ready to go. You'll find standard, heavy duty, flexible, and cryogenic probes. Each available as transverse, axial, 2 or 3 axis, and magnaprobe. Write for a complete listing to: 4949 Freeway Drive East, Columbus, Ohio 43229.

F.W. Bell Inc. A subsidiary of the Arnold Engineering Company.

INFORMATION RETRIEVAL NUMBER 34

FAST, ACCURATE

computer plotted printed circuit conversion

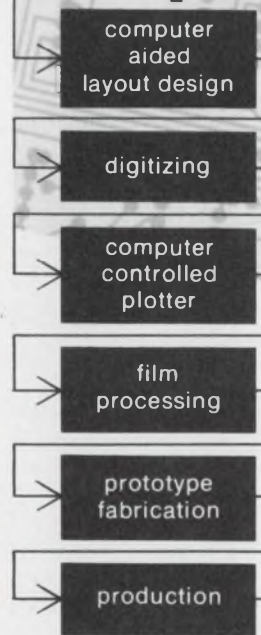

Com-Cir-Tek system converts basic electric logic into highly accurate artwork, prototypes and production run circuit boards in a matter of days. Minimizes time and expense. Accuracies to ± 0.0005 are routine. Laborious manual designs, changes and corrections are eliminated. Flexible Com-Cir-Tek capability easily adapts to your requirements. Free bulletin gives full details. Write:

com cir TEK Inc.

210 FRENCH ROAD, GARDENVILLE, NEW YORK 14227
PHONE 716 675-3800

INFORMATION RETRIEVAL NUMBER 35

Free to qualified users

We'd rather hear from you on your letterhead so we can get acquainted, but feel free to use the attached postcard to send for your sample of the first in the new "monoform" family of switches. On the other hand, pick up the phone and we'll quote you prices on your first order and then start packaging your first shipment. At Clare-Pendar, we believe in keeping things moving.

(Call your Clare Group sales engineer, our distributor or 208-773-4541.)

Yes, I'd like to receive a free sample of . . .

the inexpensive one!

A free sample of the new monoform I switchlight is available to qualifying engineers or purchasing agents returning this card.

Name _____

Title or Function _____

Company _____ Phone _____

Address _____

City _____ State _____ Zip _____

Your Product Line _____

Project(s) you are now working on requiring switchlights _____

Do you buy or specify switchlights? _____

Brand(s) presently used _____

Annual Requirements _____



Yes, I'd like to receive a free sample of . . .

the inexpensive one!

A free sample of the new monoform I switchlight is available to qualifying engineers or purchasing agents returning this card.

Name _____

Title or Function _____

Company _____ Phone _____

Address _____

City _____ State _____ Zip _____

Your Product Line _____

Project(s) you are now working on requiring switchlights _____

Do you buy or specify switchlights? _____

Brand(s) presently used _____

Annual Requirements _____



Ferramic components instead of guessing a lot

■ *Inverter-Rated* components end guesswork in your inverter designs. They're tested under actual inverter conditions to give you guaranteed, relevant electrical parameters, not just routine magnetic material data.

Inverter-Rated Ferramic components not only make your design and selection more precise—they work. Developed, tested and specified for inverter applications. So the reliability you design in—stays in.

For applications with unipolar or bipolar switching of direct currents, *Inverter-Rated* Ferramic components deliver. No trial and error selection. No rejects due to cores that only meet a material spec.

Ferrites for inverters are the latest in our growing family of application-rated components. And they're available now in Pot Cores, U Cores, Cross Cores, E Cores and Toroids.

We'd like to send you samples of our new Ferramic components that work in inverter applications. And specs that make sense. Or to consult with you about your design problems. Just contact Indiana General, Electronic Products, Keasbey, N. J. 08832. Or call (201) 826-5100.

National distribution through seven Permag locations.

indiana general 

a division of Electronic Memories & Magnetics Corp.

INFORMATION RETRIEVAL NUMBER 36

5 W per million bits of memory are all that's needed to retain data in 1103 semiconductor arrays. A battery can carry on if the main supply fails.

When 1103 MOS semiconductor packages are arranged into large-scale memory arrays, the use of space and power can mount rapidly. But it's possible to achieve high density and to reduce power considerably. Let's first examine ways to conserve power.

The 1103 arrays have an operating mode called Low-Power Data Retention (LPDR) which permits the use of batteries to retain data should the power supply fail. The power required to retain data can be reduced below 5 W per million bits of memory. LPDR makes the memory appear nonvolatile.

In the LPDR mode the data are not accessible—only enough power to retain the data is used. When normal power is restored, the memory switches back to normal mode, and the data do not require reloading. This feature is especially useful for process-control applications and small machines without disc or tape-backup storage.

The LPDR mode blocks the dc path from V_{SS} to V_{DD} when cycles are not being executed. This permits operation with very low-standby power.

The refresh cycles in the LPDR mode are conveniently executed in bursts of 32 every 2 ms—a single cycle every 60 μ s is common in normal operation. Between bursts memory for refresh-address-selection is not needed, and the timing and refresh-address circuitry can be turned off. This reduces the standby power associated with the controller logic.

Battery sustains data in LPDR mode

To retain data within the 1103s, operating voltages should be maintained on the memory throughout LPDR operation. However, the level-shift circuits should be designed for negligible power consumption between bursts. With the TTL supply turned off, the level shifter must maintain the output levels at V_{SS} . The V_{BB} supply to the level shifters may have to be dropped to the V_{SS} level between bursts to prevent V_{BB} to

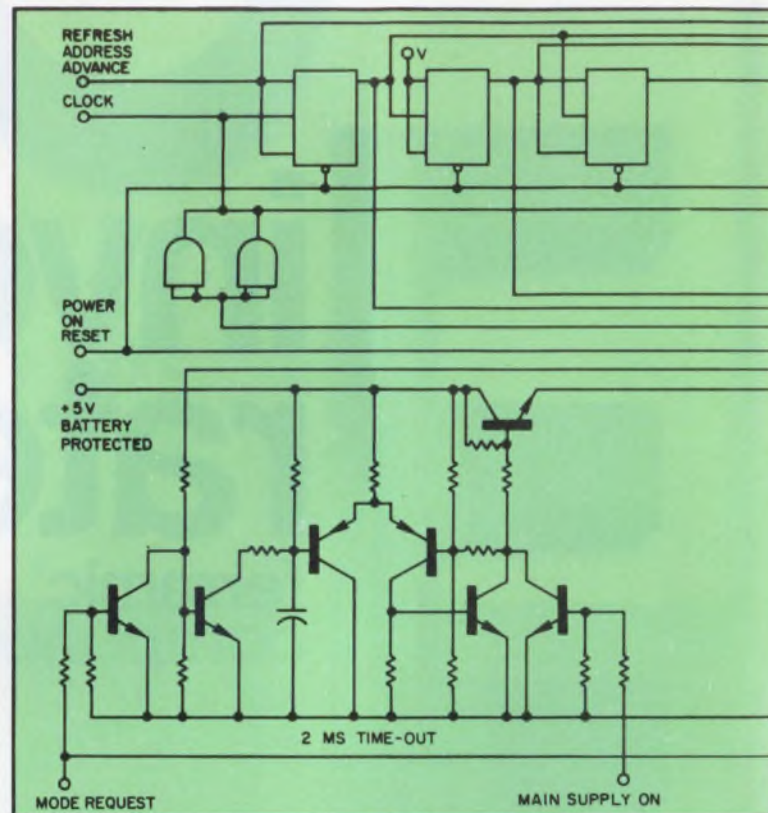

1. Low-Power Data Retention control circuit provides two modes of operation. In normal operation, one refresh cycle is executed every 60 μ s. In the data retention only mode, a burst of 32 consecutive

V_{SS} current flow.

In the LPDR mode the V_{BB} , V_{SS} and controller TTL power supplies are sustained by batteries. These are best located on the unregulated side of the supply, so that if the main power fails and the memory is switched to LPDR mode, voltages within the array do not experience switchover transients. Also, the controller TTL supply is switched on only during execution of the refresh bursts. A control circuit that implements the LPDR mode is shown in Fig. 1. The timer circuit, an RC network and a difference amplifier, establishes a 2-ms period between bursts. Controller power is switched on by the timer or by restoration of the main power. A power-on reset pulse starts the controller, resets the refresh-

Marcian E. Hoff Jr., Applications Research Manager, Intel Corp., Santa Clara, Calif. 95051

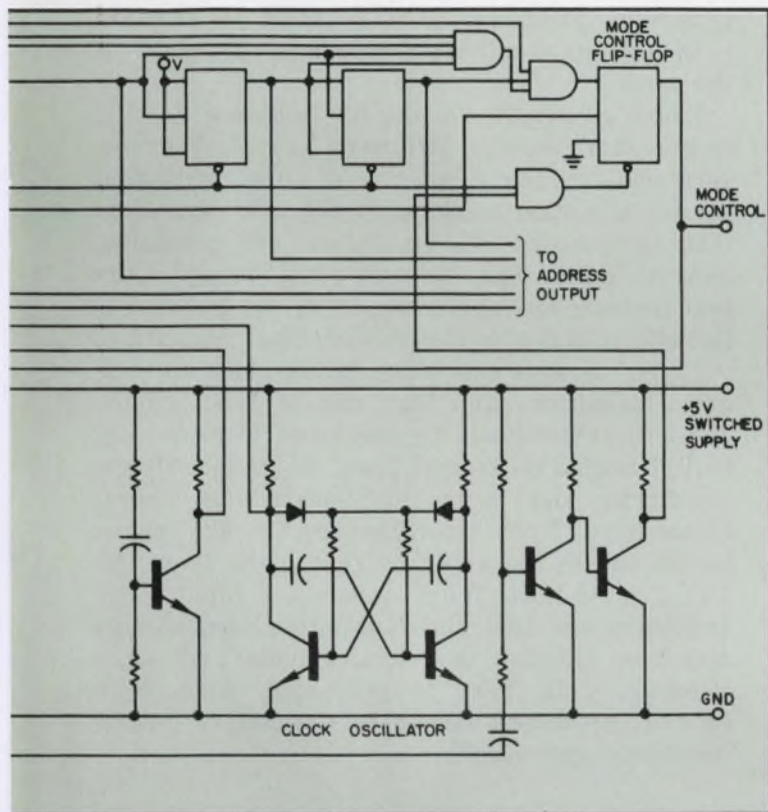

refresh cycles is executed every 2 ms. In this latter mode, power to the TTL controller logic is switched off between bursts, adding to the savings in power consumption.

address counter to zero and resets the refresh-mode control flip-flop to the burst state.

After reset is removed, the refresh-mode control flip-flop requests consecutive cycles for all refresh addresses. The carry-out from the address counter sets the refresh-mode control flip-flop to the normal mode after the 32 refresh cycles have been executed. This action returns the memory to executing refresh cycles every 60 μ s, and make it available for normal cycle requests.

However, if main power is not on, the setting of the refresh-mode control flip-flop resets the 2-ms refresh-interval timer and switches off the controller power. With controller power off, the timer again charges for 2 ms and then switches

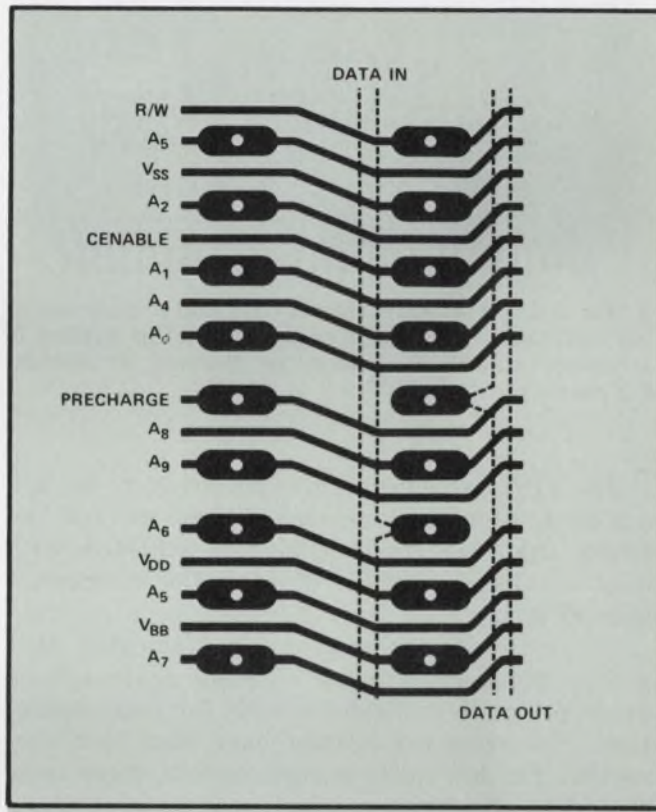

2. An array of 1103s can be laid out on 1/2-by-1-inch centers. Leads are routed between pins on the component side. On the opposite side, data-in and data-out busses interconnect the packages.

on the controller power. The turning on or off of main power also initiates a request for execution of a burst of cycles.

Power consumption in a typical 4 k x 16 system is as follows:

Supply	Power Normal Operation	Power LPDR Mode
V_{BB} (+19.5 V)	5.7	0.070
V_{BB} (+16 V)	3.2	0.145
V_{CC} (+5 V)	3.6	0.090
V_{CC2} (+5 V)	4.0	—
V_{on5} (-5 V)	0.4	—
	<u>16.9 W</u>	<u>0.305 W</u>

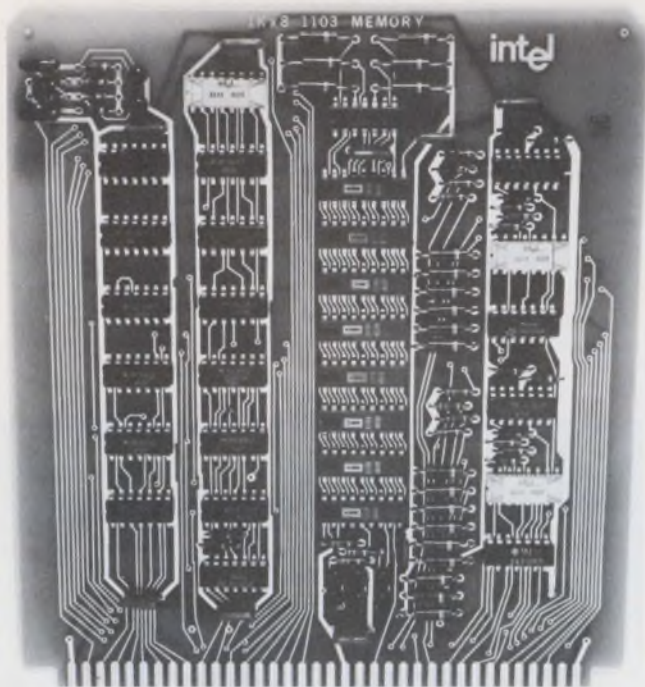

3. For a 1 k x 8 array, eight 1103s and a clock-counting controller mount on a single board. This system is synchronous, with alternate cycles reserved for refreshing memory contents.

The 1103 package permits an array to be laid out on 1/2-by-1-inch centers if leads are run between the pins. This density is achieved with only the leads between pins on the component side (Fig. 2).

Empirical evidence generally indicates that ground plane and ground/ V_{SS} plane constructions are superior to two-sided boards for noise reduction, but two-sided layouts have also been successful. For low noise in such layouts, these rules should be observed:

1. Establish occasional vertical busses on V_{SS} and V_{DD} to make the power-feed more closely approximate a grid.

Bypass capacitors reduce noise

2. Bypass the V_{SS} line to V_{DD} with at least 0.05 μF of low-inductance capacitance per device. A 0.5- μF ceramic capacitor for every eight to 10 devices in the array is usually sufficient. One such capacitor is supplied at the end of each row. These bypass capacitors maintain the V_{SS} supply level even with the large current that is drawn during cycle execution. A capacitor should be within a few inches of the furthest device that is bypassed.

3. Clock drivers and address-level shifters should be placed as close to the array as possible, and they should be connected to the array with short leads. Otherwise the array may resonate with the series lead inductance, thereby producing ringing. Excessive ringing can seriously im-

pair memory operating voltage margins. Series clamp resistors and diodes can prevent the 1103 input lines from rising more than a volt above the V_{SS} supply and can improve drive signal quality.

In the LPDR mode all array devices simultaneously execute a burst of 32 cycles. Heavy surge currents result. Very few regulators can respond to such surges, so the supply voltages must be maintained at the array by bypass capacitors. An additional 1 to 2 μF per device, usually realized as one 100- μF tantalum electrolytic capacitor in a 64-device array, provides adequate bypassing. The filtering is required in addition to the ceramic capacitors immediately adjacent to the array.

The V_{BB} supply should be bypassed to V_{SS} rather than to V_{DD} . Although the 1103 draws very small current from the V_{BB} line, bypassing insures adequate tracking of V_{BB} and V_{SS} . Now that inexpensive IC regulators are available, local regulation may be used to advantage. Current limiting and shutdown of V_{SS} when the V_{BB} line shorts is best achieved with local regulation.

Large currents may flow during clock and address transitions and they can be troublesome. These currents should be prevented from flowing in TTL signal or ground lines, or inferior drive-waveforms and, worse, oscillation may result. Connections from level shifters to the array should isolate the array current paths from the TTL ground lines. When unbalanced input sense amplifiers are used, the data-output buss signals may feed through the clock drivers and other elements. This must be prevented. Also, high ground impedances should be avoided, or circuit instability may result.

Here are typical 1103 arrays

The 1103 has been used in memories as small as 1 k x 8 to a size over a million bits. The 1 k x 8 memory board in Fig. 3 mounts eight 1103s and a clock-counting controller. The system is synchronous, with alternate cycles reserved for refresh cycles. A control line permits inhibiting refreshing. Power is saved by enabling refresh cycles for only 40 to 50 μs of the 2-ms period. Most design compromises for this memory have been made in favor of cost. The cost of peripheral parts, including the board, is less than 0.4¢ per bit in medium quantities.

Memories of this size are used in cathode-ray display terminals where random access, rather than serial memory, is required. Other applications are in buffers for peripheral equipment and calculator memories. The 1103 is also used frequently in the mainframe memories for mini-computers. Figure 4 shows a 4 k x 9 memory, complete with a delay-line controller. The board

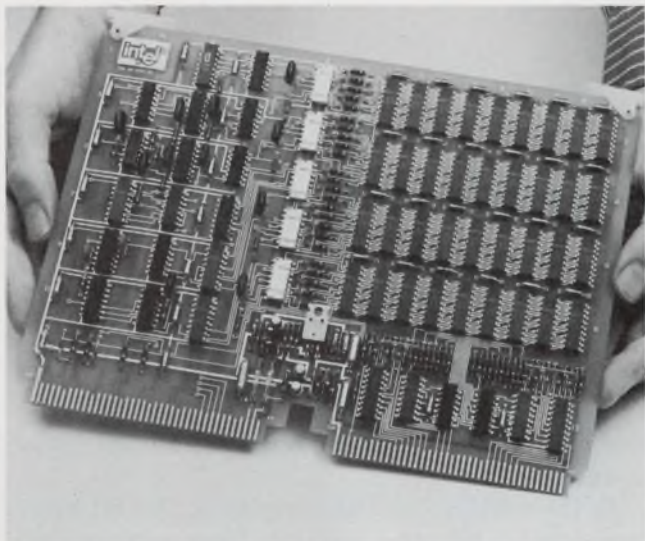

4. A 4 k x 9 memory, complete with a controller, mounts on a single board. Address and data-output latches, level shifters, clock drivers and 36 1103s are included.

includes address and data-output latches, level shifters and clock drivers (Intel 3207, an integrated quad now commercially available).

For very large memories, cost savings are achieved by using one controller for a number of modules, each consisting of a single large board with 100 to 200 1103s, IC level shifters and sense amplifiers. The overhead cost for the system approaches the cost of the individual module in large systems. Large systems also lend themselves to the power-saving methods already described.

The large 1103 memory system offers the following unusual extra features at very little additional cost: multiple simultaneous access to the memory when address and data registers are added to each module (although only one access may be made to each module); elimination of data registers and polling of modules via a strobe input to the sense amplifiers, but a slight increase in memory cycle time results; memory structuring to allow a wide data path for reading, but a variable width data path for writing, with the use of additional write clock drivers. ■■

This concludes a three-part series on the 1103 semiconductor memory. The first article, "The 1103—1024 Memory Bits on a Chip," appeared in the Jan. 20 issue of ELECTRONIC DESIGN and discussed the organization of the chip, timing and shifting input levels. The second article, "Assembling Large-Array IC Memories," appeared in the Feb. 17 issue and covered circuits to sense output, provide timing and control signals, refresh the memory and reduce power.

OSCILLATORS

1 Hz to 250 MHz

LOW
CURRENT
DRAIN / < 5
MILLI-AMPS
AT 1 Hz

YES, THAT'S RIGHT . . . less than 5 ma current drain at the frequency of 1 Hz! If your new KLOOGE can't stand a high current drain oscillator, our new Series 162 is probably the answer. Not only is the Series 162 easy on the current drain and budget, it only requires an area of 1.5 x 1.5 x .62 inches . . . much smaller than a clock plus countdown.

INTERESTING? Call Wayne Benson, (area) 312 - 232-2600, and he will be glad to fill you in on all the details and send you our new catalog.

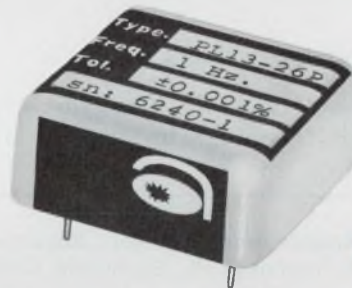

Series 162

FREQUENCY: 1 Hz to 1 MHz
 FREQUENCY TOLERANCE: $\pm 0.001\%$
 TEMPERATURE RANGE: 0°C. to 60°C. typical
 SUPPLY VOLTAGE: -20V DC, or +5V DC, or +12V DC
 OUTPUT VOLTAGE: Compatible with MOS, TTL logic,
 Sinewave also available.
 SIZE: 1.5" x 1.5" x 0.62" PC board mount,
 Chassis mount also available.

SEE 1971-72 EEM Pg. 1358

Please write or
call for

NEW 1972 CATALOG

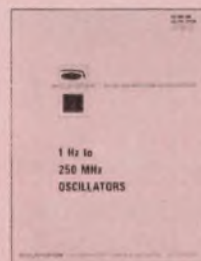

Our new catalog covers various types of oscillators: VCXO, LCVCO, RCVCO, high stability, computer clocks, high output power, Navy standard hardware modules and low current drain oscillators from 1 Hz to 250 MHz. We'll even send you three neat conversion charts (3) to hang on your wall and impress your friends.

accutronics

A HAMMOND CORPORATION COMPANY

628 NORTH STREET • GENEVA, ILLINOIS 60134

Detect overflow errors in binary adders by random-function generation with an IC multiplexer.

The method works even with inaccessible carry bits.

Errors in binary adders/subtractors can result from overflow—a condition in which the sum requires more bits than the adder can accommodate. But with additional logic, these errors can be detected.

Overflow can occur under four conditions: when two large positive numbers are added together; when two large negative numbers are added together; when a large negative number is subtracted from a large positive number; or when a large positive number is subtracted from a large negative number. Subtraction is accomplished in binary adders by forming the 2's complement of the subtrahend and adding.

How overflow produces errors

The accompanying table lists the conditions that can occur in the adder, in terms of signals at

the sign bit (which is the most significant bit of a word).

In the table, C_{in} is the carry from the bit below the sign bit into the sign bit. This carry results from the addition of the magnitude (positive) portion of the numbers. C_{out} is the carry-out of the sign bit. Sign-bit inputs A_s and B_s are the signs of A and B, respectively, before any inversion caused by subtraction—that is, they are the signs of the numbers as they are applied to the adder/subtractor.

Sign-bit output Σ_s is the result of the addition of C_{in} , A_s and B_s EXCLUSIVE-OR subtract. In the example in Fig. 1, it is the F15 output. Σ_s should be the correct sign of the result, but as can be seen in the table, there are four cases in which it does not have the proper value. These are the overflow conditions, and logic must be added to the adder/subtractor to detect these states so an error is indicated.

Examination of the table shows that all four conditions can be detected by EXCLUSIVE-ORing the carry-in and carry-out of the sign bit. This

John Springer, Applications Engineer, Advanced Micro Devices, Inc., 901 Thompson Pl., Sunnyvale, Calif. 94086

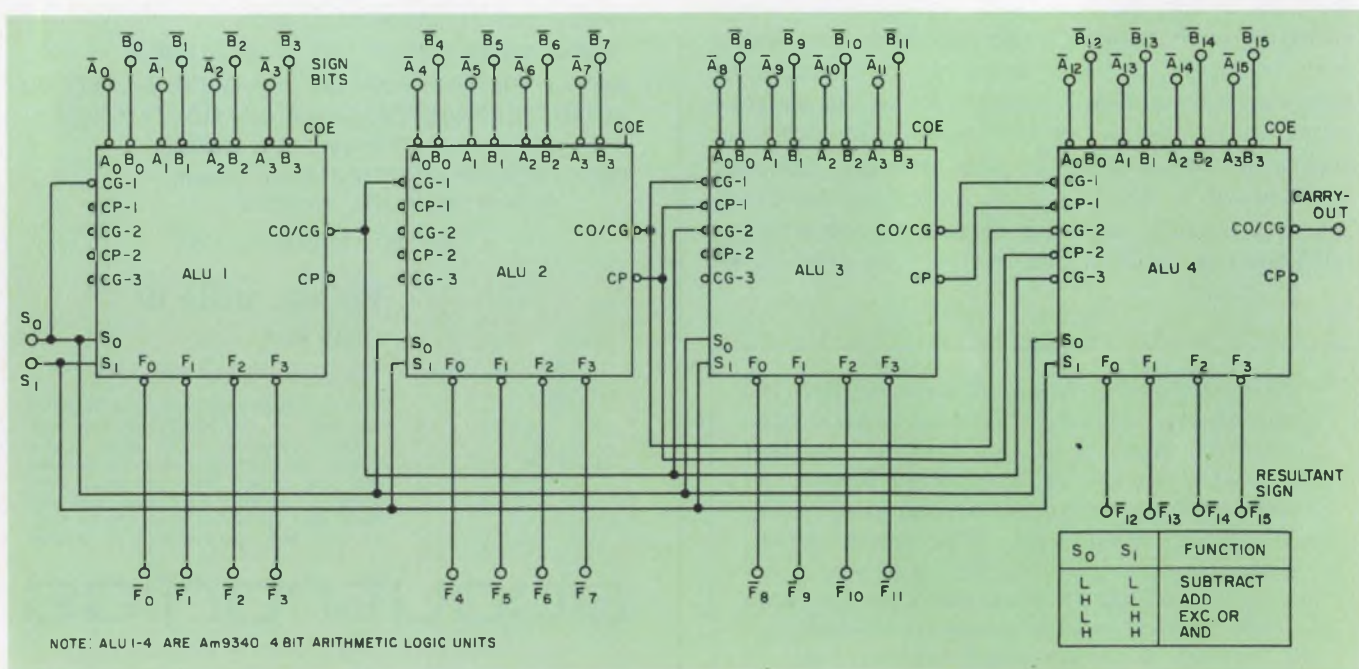

1. In this 16-bit, look-ahead adder, errors can occur because of overflow, as shown in the table.

was the method used before the advent of MSI. However, when four-bit adders are used, it is not possible to know what the carry into the sign bit is, except by reconstructing it. Instead the overflow must be detected by examining those signals that are available. Inspection shows that A_s , B_s , Σ_s and the add/subtract line must all be used. The overflow is obtained from the table:

$$\text{OVERFLOW} = \overline{\text{ADD}} \overline{A_s} \overline{B_s} \Sigma_s + \overline{\text{ADD}} A_s B_s \Sigma_s + \text{ADD} \overline{A_s} B_s \Sigma_s + \text{ADD} A_s \overline{B_s} \Sigma_s$$

The need for Σ_s is unfortunate, as this is the last signal formed during an arithmetic operation. Therefore the delay from Σ_s (F15) to the arrival of the overflow-indication output is minimized.

A convenient detection method is random-function generation with an eight-input multiplexer (Fig. 2). Two gate propagation delays (totaling

16 ns) are required from the F15 output to the overflow output. Note that because of the symmetry of the function, the detector works for both the active-HIGH and active-LOW logic equivalents of the adder. Thus an identical configuration detects overflow in either case.

An alternative method for detection

Another method for detecting overflow can be used if the sign bit is processed completely externally to the MSI adder, and this method has the advantage of producing the overflow indication output more quickly. The sign bit is removed from the MSI adder in one of two ways: (1) By shifting the operands up one bit, so that the bit below the sign bit appears in the most-significant-bit (MSB) position of the adder, or (2) By forcing a "carry propagate" condition (one input 1

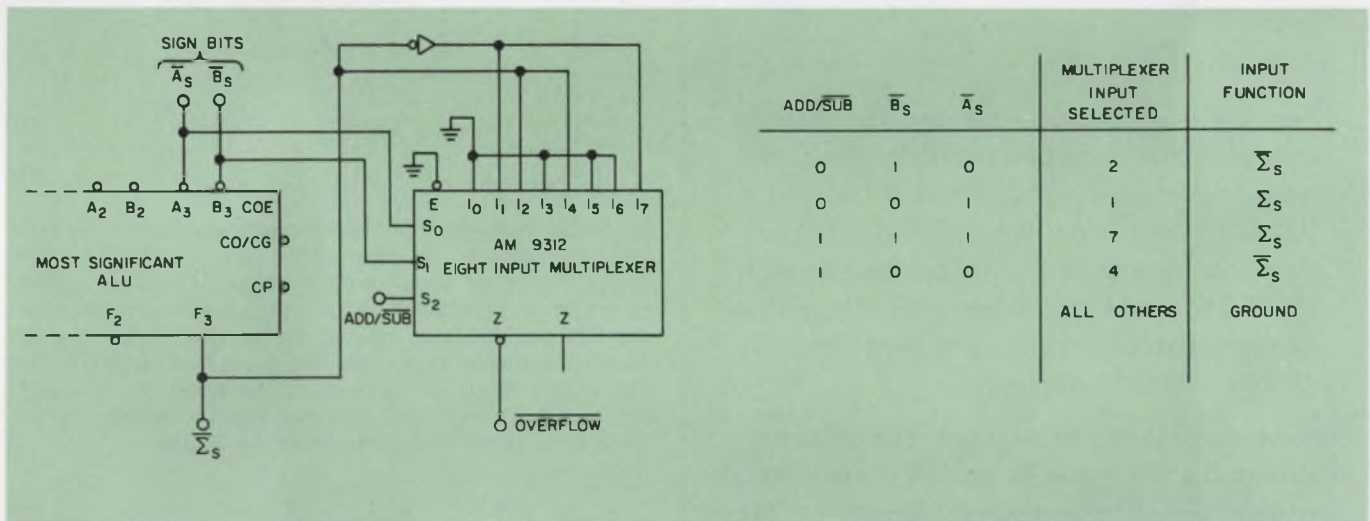

2. An eight-input multiplexer allows detection of overflow conditions in a binary adder. The delay is equivalent to

two gates. Both the sign of the result and the overflow outputs are generated by the multiplexer.

Signals at the sign bit that can produce overflow

Add/Sub	Inputs to sign bit			Outputs from sign bit		Correct sign	Over flow	Operation
	C_{in}	A_s	B_s	Σ_s	C_{out}			
Subtract	0	0	0	1	0	1		(+A) - (+B); sign depends on magnitude of A and B (-A) - (+B); result must be negative (+A) - (-B); result must be positive (-A) - (-B); sign depends on magnitude of A and B
	0	1	0	0	1	0		
	0	0	1	0	1	1	X	
	0	1	1	0	1	1		
	0	0	0	1	0	0		
	0	1	0	1	1	0	X	
	0	0	1	1	1	0		
Add	1	0	0	0	0	0		(+A) + (+B); result must be positive (-A) + (+B); sign depends on magnitude of A and B (+A) + (-B); sign depends on magnitude of A and B (-A) + (-B); result must be negative
	1	1	0	1	0	0	X	
	1	0	1	0	1	1		
	1	1	1	0	1	0		
	1	0	0	1	1	0		
	1	1	0	1	0	1		
	1	0	1	1	0	1	X	

25,000 chips per hour...mean

**LARGEST INVENTORY
FASTEST DELIVERY
LOWEST COST
FINEST QUALITY**

...from USCC/Centralab

Yes, it's true! Because demand for ceramic chip capacitors in hybrid microelectronics will more than double within the next two years, USCC's production capability on popular sizes will increase to 25,000 per hour by mid-1972. That's over 50 million annually, with a demonstrated failure rate level of only .001% / 1000 hours.

New automation techniques and materials cost reduction mean to you as a customer: fastest delivery and lowest prices on the finest quality ceramic chip capacitor on the market.



For your free copy of our Ceramic Capacitor Catalog and Applications Manual on how to use chip capacitors more advantageously, write: USCC/Centralab, 2151 N. Lincoln Street, Burbank, California 91504 or circle the information retrieval number below.

USCC

U.S. CAPACITOR CORPORATION



CENTRALAB
Electronics Division • GLOBE-UNION INC.

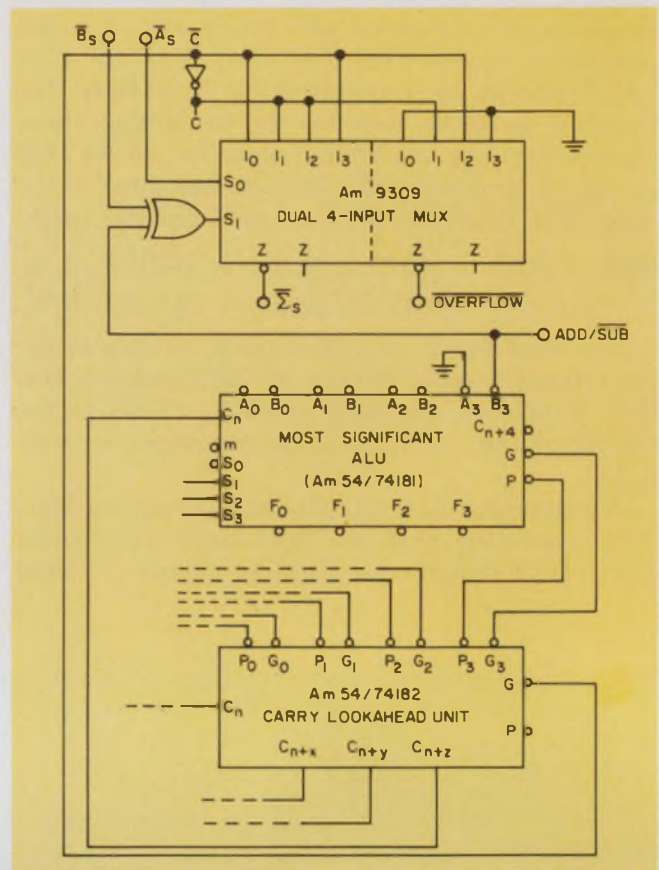

3. A dual four-input multiplexer produces both overflow and sign signals for this 16-bit arithmetic logic unit (ALU). The most significant bit of the ALU is connected to create a permanent "carry propagate" condition in the F3 position, thus making the carry-out from the F2 position available externally. The generated output of the look-ahead carry unit is used as the carry into the sign bit, and both sign and overflow signals appear at the same time as the F outputs from the ALUs.

and the other 0) at the MSB of the adder, so the carry-out of the third adder bit becomes the carry-out of the adder block. The carry-out of the adder is now the carry-in to the sign bit, which formerly was not available.

It is now necessary to generate both the sign of the result and the overflow condition. The straightforward approach is to use a full adder to process the sign bits and then to EXCLUSIVE-OR the carry-in and carry-out of the sign bit to get the overflow. However, some minimization of logic is possible, and the system in Fig. 3 shows the use of an Am9309 dual four-input multiplexer to generate both the sign and the overflow. A different arithmetic logic unit (ALU), the Am54/74181, is used in this example.

For a 16-bit adder, the carry-out can be obtained as the carry-generate (G) output of the companion look-ahead carry device for this ALU. If this is done, then the sign and overflow outputs of the multiplexer appear coincidentally with the F outputs of the adders. ■■

TWT amplifier line four models: 10, 20, 100 and 200 watts solid state with protective circuitry beam and helix current metering modular construction

The industry's most advanced TWT amplifier line can now provide the microwave power and stability you need for EMI/susceptibility testing, antenna pattern measurement, RF power instrumentation calibration and component testing.

Modular construction and plug-in boards allow the versatility to accommodate a wide variety of TWTs. Options include VSWR protection, harmonic filtering and variable output. Solid state components (except series regulator and TWT) and conservative design provide the reliability and performance necessary in modern electronic instruments.

Beam current and voltage protection are built in along with regulation of all power supplies.

Maximum TWT life is assured through efficient cooling: the 10 and 20 watt systems use conventional air cooling and the 100 and 200 watt are cooled with a liquid to air heat exchanger for quiet, reliable and efficient operation.

One of our twenty-six TWT amplifiers will meet your power, gain, and frequency requirements. And all have a one year warranty. For complete specifications call (312) 354-4350 or write: MCL, Inc., 10 North Beach Avenue, La Grange, Ill. 60525.



10 and 20 watt TWTA

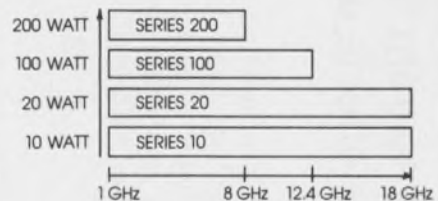

100 and 200 watt TWTA

Opportunities developing now for RF engineers at MCL, Inc. — an equal opportunity employer.

INFORMATION RETRIEVAL NUMBER 38

Calculate multivibrator timing with a nomogram that also allows you to observe the effects of changing a variable.

You're building a multivibrator, and the first thing you want to know is: How fast will it oscillate? A nomogram can give you the answer.

A standard astable multivibrator (Fig. 1) oscillates with period

$$T = \frac{2R_B C (R_B + 2R)}{R_B + R} \ln \left(2 + \frac{R}{R_B} \right)$$

The frequency is independent of supply voltage V_s within the limits of assumed parameter linearity. The oscillation period is thus controlled by the resistance and capacitance values R_B , R and C .

Maximum frequency is obtained by adjusting the potentiometer R to apply voltage V_s directly to resistors R_B . Substituting $R = 0$ in the equation gives a minimum period of

$$T_{\min} = 1.4R_B C$$

To insure that each transistor, in turn, remains turned ON, R —when fully in the circuit—should not be larger than R_B . The accompanying nomogram (Fig. 2) prevents unacceptable relative values of these resistors from being selected. Minimum adjustable frequency is then found by substituting $R = R_B$ in the equation for period

$$T_{\max} = 3.3R_B C$$

The nomogram can solve the full equation for any sets of resistors that have R greater than zero but not greater than R_B . Variables R_B , R and C can be located on the nomogram.

Starting from the point representing the value

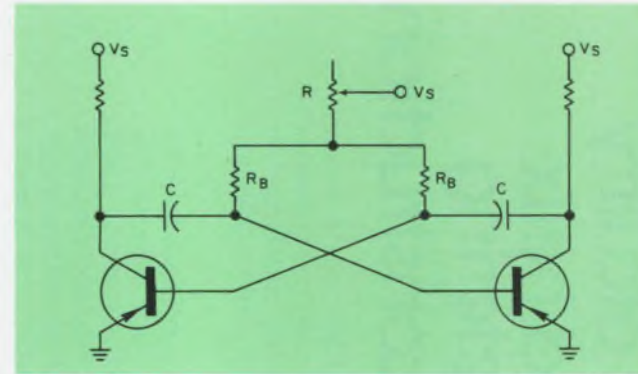

1. Astable multivibrator with self-starting abilities.

of R_B , proceed straight to the curve representing the correct value of R . Then draw a line horizontally to the right edge of the graph and, from there, through the correct value on the capacitance scale to find the correct period on the period scale.

For example, let $R_B = 150 \text{ k}\Omega$, $R = 47 \text{ k}\Omega$ and $C = 0.08 \text{ }\mu\text{F}$. Then, from 150 on the R_B scale, proceed vertically to just over $R = 40$ (where $R = 47$ is estimated). Next, proceed horizontally to the right edge of the graph. A line drawn from there through 0.08 on the capacitance scale gives an answer of 30 ms where the line intersects the last scale.

Resistance ranges can be extended by making identical moves with the decimal point on the period and all resistance scales. Conversely if the capacitance decimal point is moved, the period decimal should be moved the same number of places in the opposite direction. ■■

Donald W. Moffat, 3333 Stadium Court, San Diego, Calif. 92122

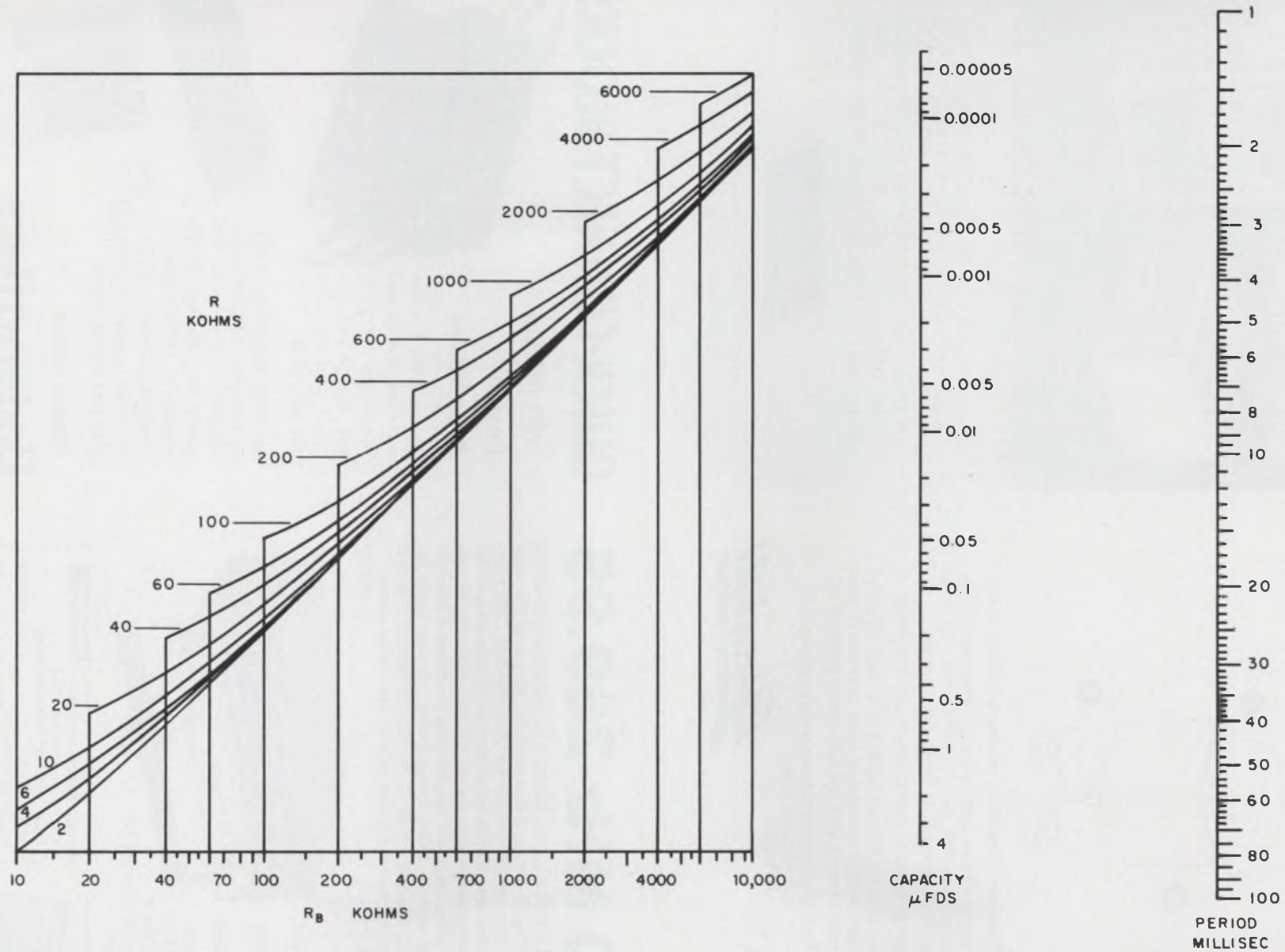

2. **Oscillation period is determined as a function of circuit variables.** From R_B at the bottom of the graph, proceed straight up the curve representing R . At the R

curve, go horizontally to the graph's right edge. Then, drawing a straight line through the selected capacitance value, find the oscillation period on the last scale.

What do you want in a push button switch?

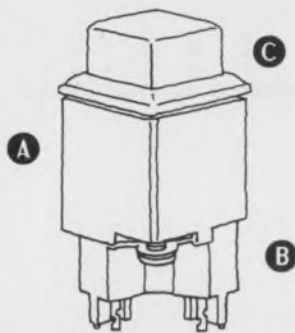

- A Actuation**—Momentary, alternate or snap action.
- B Circuitry**—From single pole, single throw to double pole, double throw; two circuit, four way; make-before-break or break-before-make.
- C Styling**—Square, round, bezel, colors, lighted.

Just a few of the options possible in a wide range of push button switches available from Grayhill. If what you need isn't among them we can design one that is.

For our latest Engineering Catalog write or phone: Grayhill, Inc., 565 Hillgrove Ave., La Grange, Illinois 60525. (312) 354-1040.

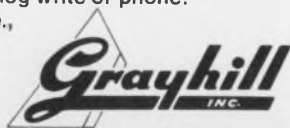

INFORMATION RETRIEVAL NUMBER 39

World's smallest

power supply for op amps... \$14

This 2.3 x 1.8 x 1-inch module has tracking outputs of ± 15 V @ 25 ma with regulation of $\pm 0.1\%$ and ripple of 1 mv. It costs \$14.00 in 1,000 lots and only \$24.00 for one. Requisition Model D15-03. (For ± 12 V @ 25 ma, order Model D12-03.) Three-day shipment guaranteed.

Acopian Corp., Easton, Pa. 18042
Telephone: (215) 258-5441

INFORMATION RETRIEVAL NUMBER 41

100 MHz-269.95

New Heathkit IB-1101 Frequency Counter is the one you've been waiting for! With full 5-digit readout, 8-digit capability when using the range selector and overrange circuitry. The exclusive solid-state circuitry accepts inputs from less than 50 mV to over 200 V, depending on frequency, without damage. And the IB-1101 has automatic decimal, overrange & gating lights, one megohm input impedance & low input capacitance to minimize circuit loading. Stable time-base crystal has better than ± 3 ppm from 17°-32° C. You get it all together in an easy 10 hours. Now that the price is right, why not get a better counter? Kit IB-1101, 8 lbs. 269.95*

Your FREE '72 Heathkit Catalog contains the world's largest selection of kit-form instrument values.

Use this coupon to order your FREE '72 Heathkit Catalog. Now there are more than 350 kits to choose from.



HEATHKIT
Schlumberger

HEATH COMPANY, Dept. 66-3
Benton Harbor, Michigan 49022

Please send FREE Heathkit Catalog.
 Enclosed is \$ _____, plus shipping.
Please send model(s) _____

Name _____
Address _____
City _____ State _____ Zip _____

Prices & specifications subject to change without notice. *Mail order prices; F.O.B. factory. TE-258

INFORMATION RETRIEVAL NUMBER 40

QUICK-CONNECT BLOCKS

With Infinite Design Possibilities

There's an Underwriters Terminal Block for virtually any design requirement you have or can conceive.

No other line offers a wider selection of blocks and variations of in-block circuitry. Any number of terminations. Wide choice of configurations. Blocks in kit form, too. Also special designs and hot-stamped coded blocks.

Request bulletin.

Underwriters Safety Device Company

4332 N. Kedzie Ave., Chicago, Ill. 60618 • 312-583-4080

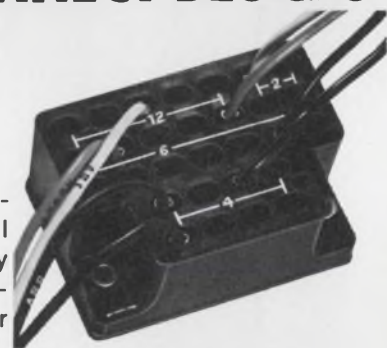

INFORMATION RETRIEVAL NUMBER 42

ELECTRONIC DESIGN 5, March 2, 1972

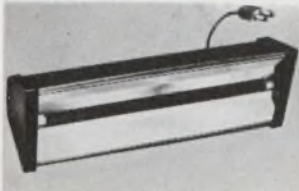

BLACK-LIGHT MIGHTY MITES
 Relatively small (12") fixtures give surprisingly bright blacklight. Mirror-finished reflector makes instant starting 8-watt, high-intensity bulb look like 40-watter. Up to 5,000 hours of safe, long-wave (3660Å) black-light to really turn-on parties, light & theatrical shows, psychedelic decors, holiday decorations. Shockproof end-caps remove for safe, easy replacement of bulb and starter. Stands upright or horizontal. Aluminum case. Stock No. 71,274DA \$14.95 Ppd. **DELUXE OUTDOOR/INDOOR** Stock No. 71,299DA ... \$19.95 Ppd.



3" ASTRONOMICAL TELESCOPE
 See moon shots, orbits—stars, phases of Venus, planets close up. 60 to 180 power. New improved, aluminized and overcoated 3" diameter f/10 primary mirror, ventilated cell. Equatorial mount with locks on both axes. Equipped with 60x finder telescope, hardwood tripod. Included FREE: "STAR CHART"—272 page "HANDBOOK OF HEAVENS"; "HOW TO USE YOUR TELESCOPE" book. Stock No. 85,050DA ... \$32.95 Ppd. **DELUXE 3"** Stock No. 80,162DA ... \$59.50 Ppd. No. 85,105DA 4 1/2" ... \$94.50 FOB Stock No. 85,086DA 6" \$239.00 FOB



50-150-300 POWER MICROSCOPE
 Amazing Value—3 Achromatic Objective Lenses on Revolving Turret! Color-corrected, cemented achromatic lenses in objective give far superior results to single lenses usually found in this microscope price range. Results are worth the difference! Fine rack and pinion focusing. Imported! Stock No. 70,008DA ... \$24.50 Ppd. **MOUNTED 500 POWER OBJECTIVE** Threaded achromatic lenses, 3mm F.L. Stock No. 30,197DA ... \$5.88 Ppd.



GIANT FREE CATALOG
 Completely new 1972 edition — 148 pages. Bargains galore! New categories. Items, illustrations, 1,000's of buys for Industry—Optics, Ecological and Physical Sciences, Electronics. On-the-job helps, quality control aids, Optics for research labs, design engineers, experimenters. Instruments for checking, measuring; improve quality, cut costs. Hard-to-get surplus bargains. Write for catalog "DA"

EDMUND SCIENTIFIC CO.



300 EDSCORP BLDG. BARRINGTON, NEW JERSEY 08007

ORDER BY STOCK NUMBER · OPEN ACCOUNT TO RATED FIRMS · MONEY-BACK GUARANTEE

INFORMATION RETRIEVAL NUMBER 43



DESIGNERS and ENGINEERS

BEFORE YOU START,

CONSIDER MANUAL PUSH BUTTON SWITCHES CAPABLE OF REMOTE CONTROL

CHANCES ARE A CAPITOL MECHANICALLY OPERATED SWITCH IS

- BETTER** *provides many more contacts and circuits in less total space
- CHEAPER** *frequently eliminates auxiliary equipment — transformers, relays, their installation and space
- MORE RELIABLE** *

Simple, quality construction. Fewer components insures greater reliability

ILLUMINATED SWITCHES CAN ELIMINATE PILOT LIGHTS

Mechanical actions: interlocking, no-two operate, accumulative lock-up, push to lock push to release, momentary. Combinations of all these are available on the same strip. Plus, many combinations of contact assemblies.

* Proven by Vending machine, communication, Computer, Recording and many other industries

CAPITOL

WRITE FOR CATALOG
 THE CAPITOL MACHINE AND SWITCH CO.
 87 Newtown Road, Danbury, Conn. 06810

Representatives in principal cities Tel: 203-744-3300 TWX: 710-456-0365

Visit us at Booth # 3522

INFORMATION RETRIEVAL NUMBER 44

dial
it in...

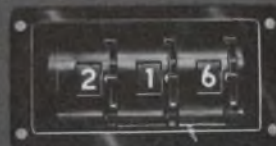

read
it out!

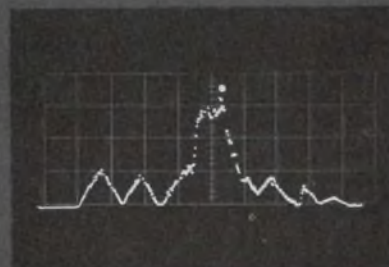

with SAICOR's new
Real time—narrow band
**SPECTRUM ANALYZERS/
DIGITAL INTEGRATORS**



An important feature of our totally new line of 200 and 400 line Analyzers/Integrators is a digital bin marker which provides accurate read-out of amplitude and frequency information.

If you're studying complex vibration problems, machinery noise, medical and speech analysis, sonar echoes, acoustics... SAICOR has the Analyzer for you.

Compare our 200 and 400 line analyzers and 200 and 400 line analyzer/integrators to all others, including 1/3 octave systems—it's your best buy! Only SAICOR builds their Spectrum Analyzers and Digital Integrators in one unit.

Write for Bulletins TB-11 "Real Time-Time Compression Spectrum Analysis"; TB-15 "Calibrated PSD Measurements" and information on Correlation & Probability Analyzers.



SIGNAL ANALYSIS INDUSTRIES CORP.

595 Old Willets Path, Hauppauge
 New York 11787 ■ (516) 234-5700

Op amp boosts phototransistor speed

Phototransistors commonly provide response speeds that are far lower than non-light-sensitive transistors. While this suggests that phototransistors have much lower gain-bandwidth, the speed limitation actually results from biasing conditions and collector base capacitance. To remove the response limit imposed by capacitive feedback, connect an op amp across the load.

Whether the phototransistor is biased as an emitter-follower or as a common-emitter amplifier (see diagram), the speed limitation is the same. In both cases the output voltage swing produces an essentially equal voltage swing on the collector-base capacitance C_c . This produces a feedback current, i_r , to base described by the equation

$$i_r = j\omega C_c e_o, \text{ for } R_L \gg r_e,$$

where r_e is the dynamic emitter resistance.

Since the base is open-circuited, this feedback

current must all flow into the base region. The result is maximum ac feedback, not generally encountered in non-light-sensitive transistor circuits, which have lower impedance base bias. Only when a non-light-sensitive transistor has a current-source base drive does it encounter this worst-case response condition.

Since the op amp feedback reduces the amplifier input signal to zero, the signal swing of the transistor is transferred to the op-amp output. Then C_c has no signal voltage and produces no shunting feedback current to the base. The frequency response is then determined primarily by the op amp.

Jerry Graeme, Monolithic Engineering Manager, Burr-Brown Research Corp., International Airport Industrial Park, Tucson, Ariz. 85706

CIRCLE NO. 311

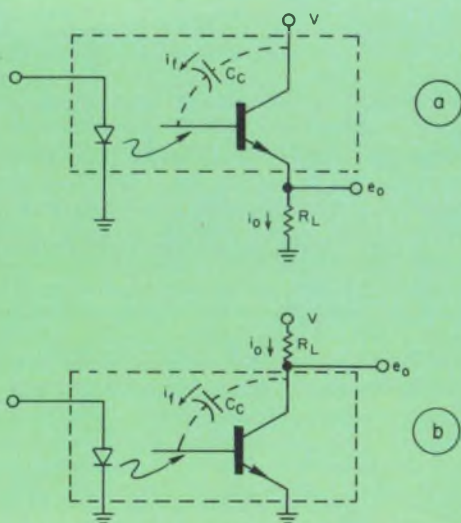

1. Internal capacitive feedback in phototransistors is shown for emitter-follower (a) and common-emitter (b) configurations.

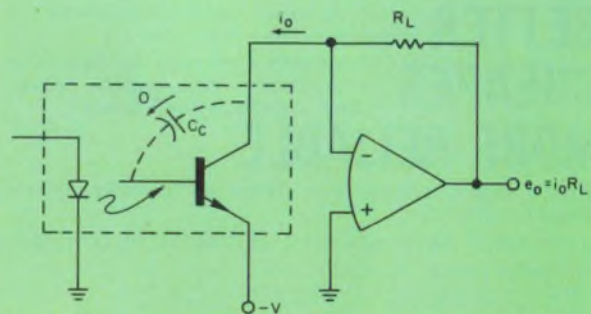

2. Capacitive feedback can be eliminated by removing the collector voltage swing with an op amp. The response is then determined by the op amp.

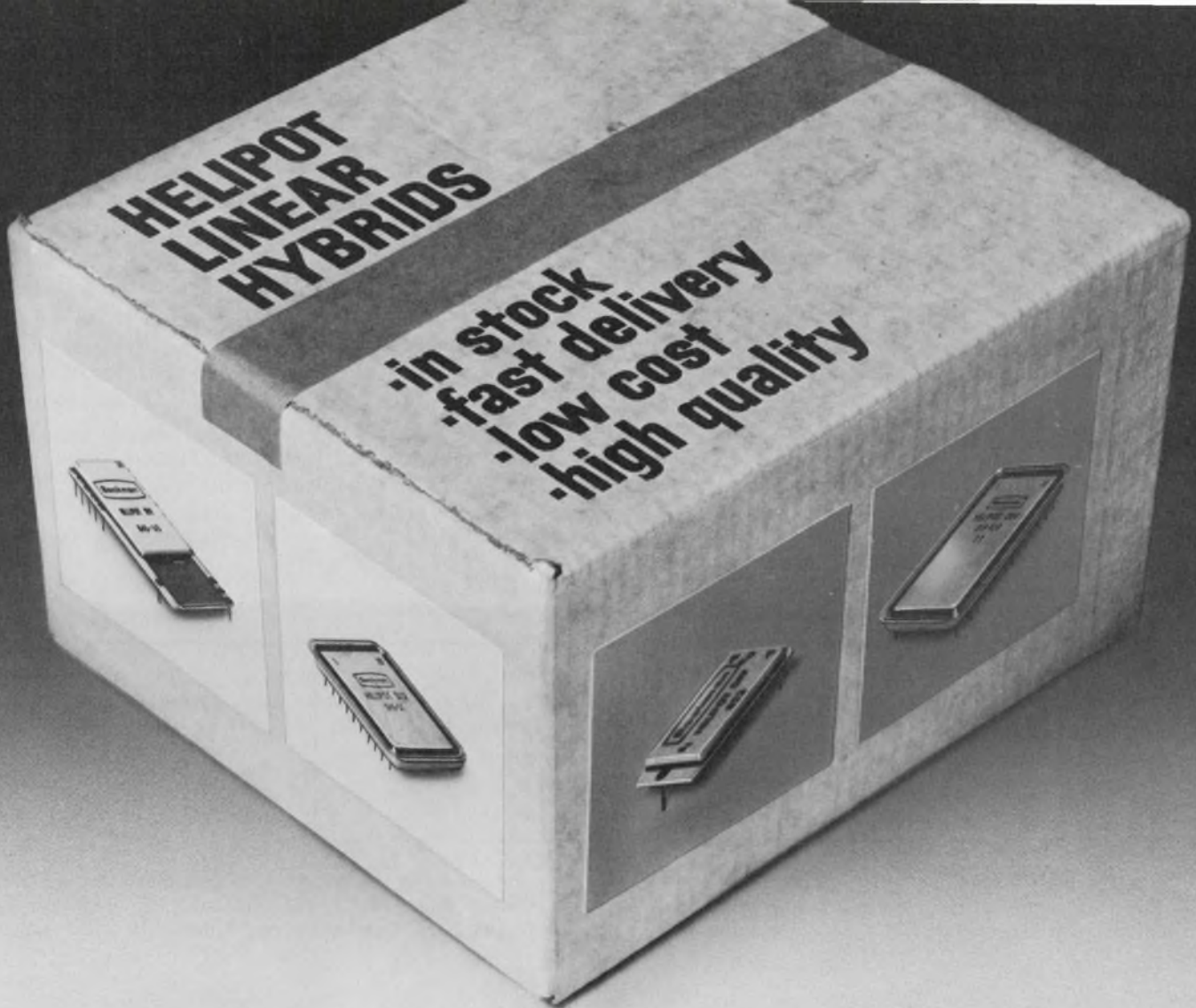

Get our problem-solving package: good products, prices, availability and design assistance—all from one source.

Digital-to-Analog Converters

Model 845: Complete 8-bit binary DAC. 4 preset output ranges. Slew rate: 0.2V/ μ sec min. Settling time: 5.0 μ sec/volt + 1 μ sec. Price (1-9) \$39.75.

Model 846: Complete 8-bit binary DAC. 4 preset output ranges. Slew rate:

4V/ μ sec min. Settling time: 0.25 μ sec/volt + 2 μ sec. Price (1-9) \$49.75.

Model 848: Complete 11-bit binary DAC. Guaranteed monotonicity and accuracy levels. 4 preset output ratings. Slew rate: 4.0V/ μ sec min. Settling time: 0.25 μ sec/

volt + 2.0 μ sec. Hermetically sealed Kovar case. MIL-STD-883. Price (1-9) \$95-\$155 depending on accuracy code.

Model 849: 13-bit resolution binary DAC. Four quadrant operation (AC reference). Accepts serial data input. MOS compatible (high threshold). Low power dissipation. Price (1-9) \$155-\$185 depending on accuracy code.

Ladder Networks

Model No.	Standard "R" Values	R _{tw} Compensation	Best Standard Accuracy	Pricing 1-9
811 (Binary)	5K, 10K, 20K	5 Ω Bits 1-4	± 122 ppm -55°C to +125°C	811-B12 \$40.00
812 (Binary)	50K, 100K	500 Ω All Bits	± 122 ppm -55°C to +125°C	812-B12 40.00
814 (Binary)	10K	5 Ω Bits 1-5	± 30 ppm @ +25°C and +61 ppm -20°C to +85°C	814-D14 90.00
815 (Binary)	10K	None	± 1952 ppm -55°C to +125°C	815 6.95
862 (BCD)	50K, 100K	500 Ω All Bits	± 300 ppm -55°C to +125°C	862-B 45.00

Miniature Power Amplifiers

Model	\pm Supply Range	Output Max. Range	Minimum Load Resistance	Price (1-9)
821	10 - 20V	± 16 V	100 Ω	\$30.00
822	10 - 20V	± 16 V	50 Ω	35.00
823	10 - 30V	± 26 V	$\frac{30 (E_o \text{ max.})}{E_{cc} - E_o \text{ max.} - 1}$	8.95
824	18 - 30V	± 27 V	140 Ω	40.00
866	10 - 20V	± 16 V	50 Ω	40.00

Model 841 Ladder Switch

Features: 0 to 2 mV switch offset. 5 (± 3) ohms "on" resistance. 200 ns rise and fall time. 0 to 5 mA load range. R_{OFF} and V_{OFFSET} independent of reference voltage used. Model 841-1 Price (1-9) \$100.



INSTRUMENTS, INC.
HELIPOT DIVISION
 2500 Harbor Blvd, Fullerton, Calif. 92634

Call your local Helipot Sales Representative today.

Single relay protects a three-phase line

The loss of a single phase in three-phase lines can lead to serious damage of equipment if a detection and control system is not used. A circuit that uses only one relay provides an economical way to obtain this safeguard (see diagram).

Generally, a delta effect—loss of a phase not causing a terminal voltage to go to zero—precludes the use of a relay on each line. But in this circuit a combination of analog and logic circuits detects the loss of a single phase. Since the logic makes use of the phase relationship between the three inputs, it is unaffected by the delta effect.

The timing circuit R_1 and C_1 is discharged by

NAND gate Z_1 each time a zero state is detected. The recharge time is much greater than one cycle. Thus the periodic zero state is stretched to a constant zero state, and the NAND gate relay driver Z_2 is turned OFF. If the voltage at the open node does not go to zero—due to a delta-connected load—its phase reversal will still cause a zero to occur for one-sixth of a cycle at point X.

The relay is used to control system power.

R. G. Durnal, Westinghouse Electric Corp., Systems Development Div., Baltimore.

CIRCLE NO. 312

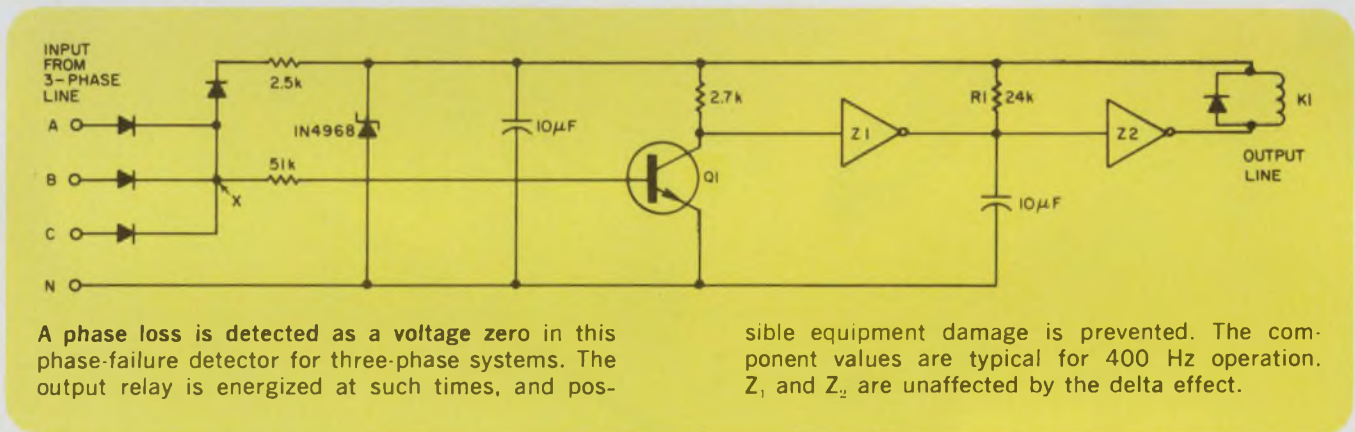

FET gain-control stage handles high-level signals

When a FET is used in the variable-resistance mode, the signal voltage (from drain to source) must be low enough to keep distortion to a minimum. As a rule of thumb, a signal voltage of 1% of pinchoff results in 1% distortion. Therefore a FET with a minimum pinchoff of 5 V can handle signals up to only 50 mV with distortion of less than 1%.

Using a T network in the feedback loop, the circuit in the diagram can accommodate signals that are considerably larger, because the signals are attenuated by the ratio R_2/R_1 before they are applied to the FET. The total gain, however, does not have to be less than unity, since subsequent gain is provided.

The transfer function of the circuit is

$$\frac{-V_o}{V_{in}} = \frac{R_2}{R_1} + \left[\frac{R_1 + \frac{R_2 R_4}{R_{DS}}}{R_1} \right]$$

Inspecting this formula, we see that R_2/R_1 is the initial attenuation and that the second term is the subsequent gain. Maximum gain is limited by the R_{DS} ON of the FET used. The dc control voltage is usually, but not necessarily, obtained by rectifying and filtering the system output and applying this voltage to the FET gate.

Leonard Accardi, Kollsman Instrument, 80-08 45th Ave., Elmhurst, N.Y. 11373

CIRCLE NO. 313

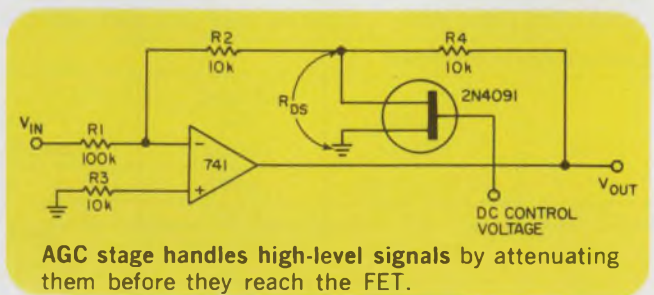



It's as dependable as a PDP-8.

We don't know anyone who's tried to drive a Mercedes-Benz non-stop, 24 hours a day, seven days a week, for two years straight.

But we do know someone who's done just that with a PDP-8. And they weren't even trying. They simply plugged it in and let it go.

Now it's possible they didn't realize their PDP-8 was going to be that dependable. They may have

selected it simply because more PDP-8's come off the production line every month than all the other minicomputers put together.

Or because of all those beautiful PDP-8 peripherals. Over sixty standards. Plus specials. Or because of all that software. The biggest library for minicomputers in the world.

And it's just possible they liked

the idea that PDP-8 comes from a big computer company. With over 1400 sales/service engineers scattered all over the world.

But we have a sneaking suspicion that what they were really looking for was something that would get them to work every day.

Digital Equipment Corporation,
Maynard, Massachusetts 01754.
(617) 897-5111.

digital

Generate triangular waves with VCO

Triangular waves with 2% linearity can be generated by a Signetics 566 voltage-controlled oscillator, used in the accompanying circuit. The VCO is variable over six decades from 0.01 Hz to 100 KHz, or it can be externally FM-modulated through J₁.

The 511 is a triangular-to-sine wave converter with less than 2% distortion. All three wave-

shapes—sine, triangular and square—are coupled to an output driver that consists of a 531 high-slew op amp driving power transistors. Amplitude and offset controls are also provided.

Ron Siebert, Digital Applications Dept., Signetics Corp., 811 East Arques Ave., Sunnyvale, Calif. 94086.

CIRCLE No. 314

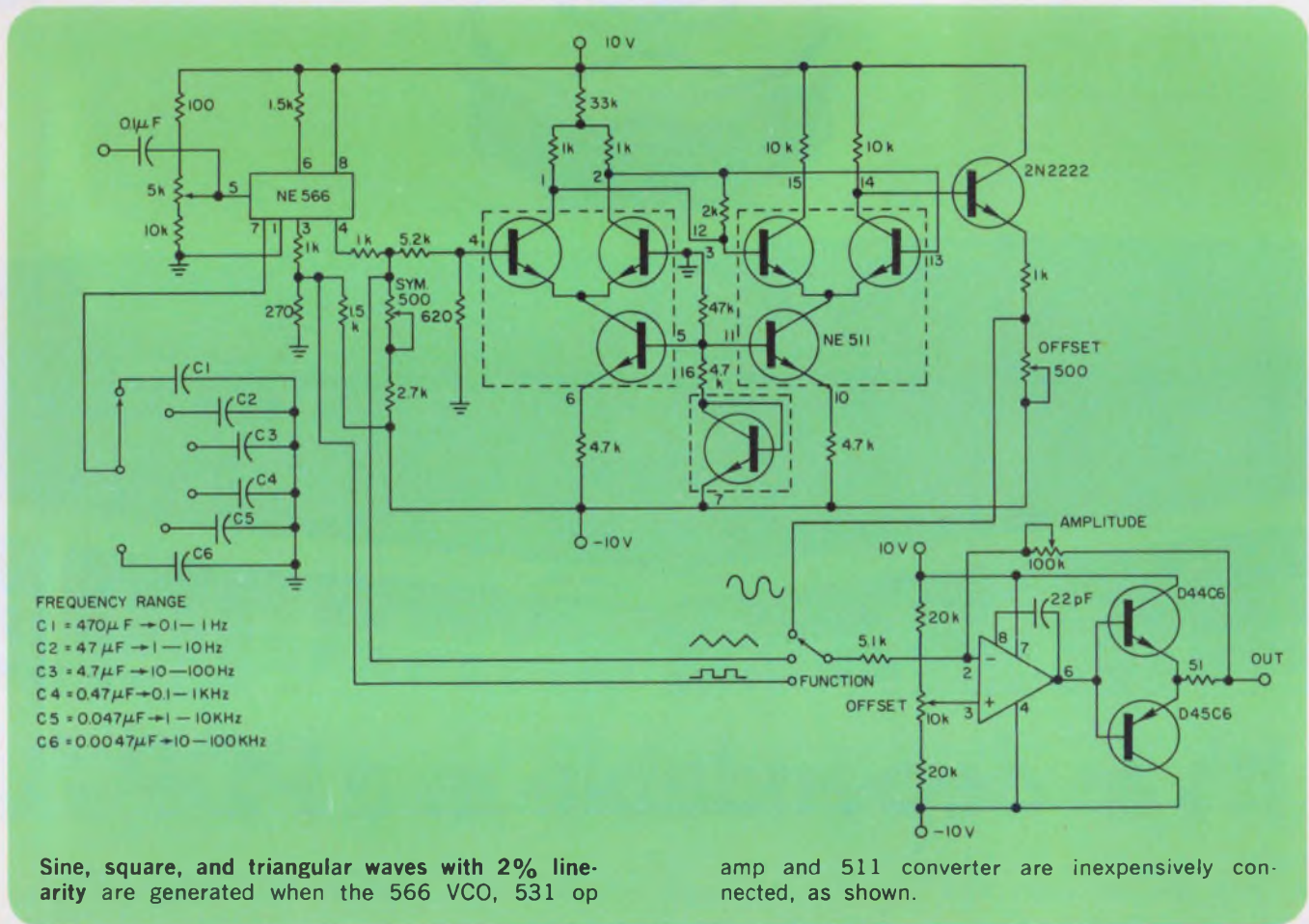

IFD Winner for October 28, 1971

Leonard F. Halio, Group Supervisor, Digital Equipment Corp., 146 Main St., Maynard, Mass. 01754. His idea, "Indicator checks relative frequencies," has been voted the Most Valuable of Issue award.

Vote for the Best Idea in this issue.

SEND US YOUR IDEAS FOR DESIGN. You may win a grand total of \$1050 (cash)! Here's how. Submit your IFD describing a new or important circuit or design technique, the clever use of a new component or test equipment, packaging tips, cost-saving ideas to our Ideas for Design editor. Ideas can only be considered for publication if they are submitted exclusively to ELECTRONIC DESIGN. You will receive \$20 for each published idea, \$30 more if it is voted best of issue by our readers. The best-of-issue winners become eligible for the Idea of the Year award of \$1000.

new products

Fastest portable scope shows 350 MHz at 5 mV/div



Tektronix, Inc., Box 500, Beaverton, Ore. (503) 644-0161. \$4100; June, 1972.

With bandwidth approaching that of the world's fastest real-time, high-sensitivity scope (the 500-MHz, 10-mV/cm Tektronix 7904, a full-size, four plug-in scope), a new portable, the Tektronix 485, streaks past any other. At the same time it neatly dodges the input-impedance controversy in wideband scopes by offering pushbutton selection of either 50 Ω or 1 M Ω shunted by 20 pF.

A similar input-impedance choice appears in Hewlett-Packard's just-introduced 1710A, a 31-lb, 150-MHz, 5 mV/cm portable that goes for \$3200. In this scope the 1-M Ω input is shunted by a remarkably low 12 pF.

In the Tektronix scope, choice of the high impedance limits the full-sensitivity bandwidth to 250 MHz,

while the 50- Ω input permits a display of 350 MHz at 5 mV per 0.8-cm div on the 8 \times 10-div. screen. That gives the 485 the highest gain-bandwidth product of any scope—large or small.

Hewlett-Packard's year-old, 24-lb 1707, which sells for \$1925 and has 750 MHz bandwidth and 10 mV/cm sensitivity on a 6 \times 10-cm screen, still holds the bandwidth crown in portables that can operate from internal batteries. So the Tek 485, which can not, raises again that old question: What is a portable?

The Army seems to define a portable as anything with a handle. Some industry sages suggest that a portable is anything IBM wants to call a portable. And others say that a portable is a scope that takes no plug-ins.

By at least two of these definitions, Tek's 485 is a portable. With-

out accessories, it weighs only 21-1/2 lb. That's 28% lighter than the year-old, 30 lb, 150-MHz, 10 mV/0.8-cm div Tek 454A (successor to the five-year-old 454).

The dual-trace 485 has a high writing rate—7.2 div/ns typical with a P11 phosphor. A beam-current limiter protects the 21-kV CRT. There's also protection against overload at the 50- Ω input.

The scope is the first portable with automatic sweep switching for alternate display of delayed and normal sweep—with trace separation and intensification of the part of the main sweep to be expanded in the delayed sweep. There are other features unique in portables. The scope has a 20-ns delay for showing a triggering event on the delayed sweep, a selectable 20-MHz bandwidth limit on signal and trigger inputs to cut noise effects in lower-frequency operation, and phase compensation to 5 MHz for X-Y displays.

Main and delayed sweeps have direct-reading time bases from 1 ns/div to 500 ms/div—without magnification. Coding on the BNC connector at the scope end of the probe cable actuates one of three panel lamps to show whether a X1, X10 or X100 probe is in use—offsetting an engineer's tendency to forget which probe he's using.

Depressing a button on a probe deflects the trace for easy identification. Single-knob triggering to the full bandwidth capability of the scope eliminates the need to diddle high-frequency stability and sync controls. And adjustable sweep holdoff allows stabilization of repetitive pulse trains with irregular periods.

For more information:
From Tektronix CIRCLE NO. 250
From Hewlett-Packard CIRCLE NO. 251

TEC LED LITE

TRANSISTOR CONTROLLED LED INDICATOR SAVES PC BOARD SPACE

If you're driving LED's directly from IC outputs you're wasting valuable PC board space! TEC's new L-1017 Series LED Indicator requires 1/10th the current (only 1.6ma) of ordinary LED's (using 15ma)—lets you drive one L-1017, plus nine other loads from one IC logic circuit. Transistor driver and LED are housed in a .284 dia. x 1" long body that mounts in a 1/4" panel hole on 1/2" centers. Wire-wrap terminals standard. L-1017 Series turns on with "high" input, logic "1" (IC driven LED's indicate logic "0"). L-1017 signals: ON, +2.5 to +5VDC; OFF, 0 to +0.8VDC. Supply: +5VDC @ 15ma, maximum. Special lens design increases LED brilliance and side viewing—available in red or clear, spherical or flat top lens style.



2 X SIZE

Immediate Del. \$2.30 ea., 100-499 qty.

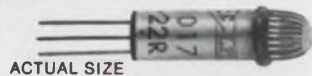

ACTUAL SIZE

DIRECT DRIVE LED INDICATOR

L-1015 Series LED Indicator is identical to L-1017 Series above in all mechanical details. Internal resistors allow operation directly from 5.0, 6.3, 10 and 24 VDC supplies—permit LED indicator substitution for incandescents.



ACTUAL SIZE

Immediate Del. Price, \$1.30 ea., 100-499.

TEC LED LITE INDICATOR PACKAGES



Select a rugged, long life LED indicator or switch/indicator from more than 20 TEC designs. More brilliance, easier mounting, attractive appearance are added to the various LED's packaged by TEC.

See TEC-LITE for the complete line of readouts, indicators, switches, display panels, keyboards, CRT terminals.

TEC, Incorporated; 9800 North Oracle Road, Tucson, Arizona 85704; or phone (602) 297-1111



INFORMATION RETRIEVAL NUMBER 51

INSTRUMENTATION

Function generator ramp doesn't drift when held

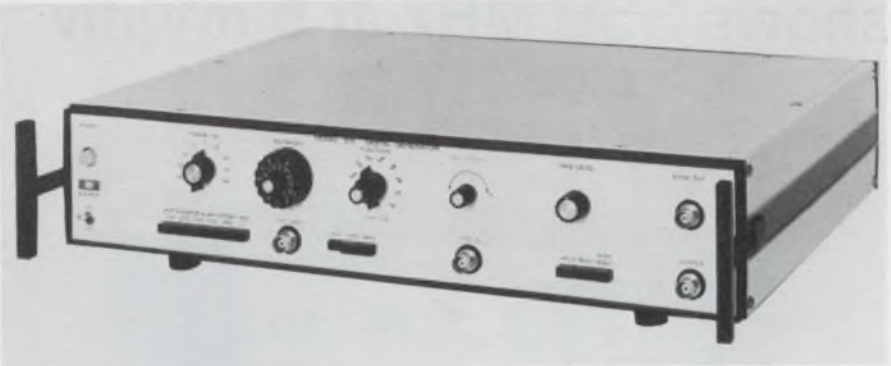

Exact Electronics Inc., 455 S.E. 2nd Ave., Hillsboro, Ore. (503) 648-6661. \$1250; 2-4 wks.

The function generator is an extremely versatile instrument: With AM, FM, external-synchronization, phase-lock and tone-burst capabilities all available for modulating the basic square, triangle, sine, saw-tooth and pulse-wave forms, it's not easy to add a new twist. Yet Exact Electronics has done just that in its new Model 335 digital function generator. It synthesizes the triangle with the staircase output of a d/a converter. So there's no drift when the user wants to stop the ramp and hold the output. This capability is important in testing materials used in bridges and other structures. When the conventional integrator-generated ramp is held, the output drifts at the rate of 0.1% of the ramp slope. This is more than many applications can tolerate. In the Model

335, the output stays put—a digital register retains the last count, and the d/a converter furnishes the corresponding fixed output.

Amplitude stability in the conventional running modes is also improved. It is generally given as 0.05% for 10 minutes and 0.25% a day for function generators. In the 335, stability is better by a factor of five. The digital approach has to trade off something, of course: The counting speed limits frequency. The upper limit is 50 kHz, with 200 digital steps per period. On the lower ranges, there are 2000 steps. And Exact claims the lowest low frequency ever—10 μ Hz. That's a period longer than a day.

The Model 335 also has features generally found on function generators: VCF input, output attenuator, dc offset and gate or trigger modes.

CIRCLE NO. 252

Amplifier delivers 20 W (typical) at 2 MHz

Microdot, Inc., 19535 E. Walnut Dr., City of Industry, Calif. (213) 965-4911. \$1150; 3 weeks.

Standard signal generators with milliwatt output levels in the range from 10 kHz to 2 MHz can be converted into a 20 to 50 W (typical output) source by power

amplifier model 3201. The instrument amplifies AM, FM, pulse or square wave signals. Applications are in susceptibility testing to MIL-STD-462, wattmeter and attenuator calibration and testing of power transistors. Input power of 500 mW will develop 10 W minimum at 2 MHz and 40 W minimum at 10 kHz.

CIRCLE NO. 253

Semiconductor tests are nondestructive

Faratron, 290 Lodi St., Hackensack, N.J. (201) 488-1440. \$6475.

A new thermal resistance analyzer for transistors and diodes provides nondestructive, high speed testing for bonding deficiencies or inadequate thermal paths. The instrument imposes a selected known amount of power on a unit and measures thermal resistance in the range of $1/4^{\circ}\text{C/W}$ to 500°C/W as well as the thermal time constant. Limits on the units tested are not exceeded. Test rates to 1000/hr are possible.

CIRCLE NO. 254

Linear amplifier tests are rapid go-no-go

Quan-Tech, Div. of KMS Industries, Inc., 43 S. Jefferson Rd., Whippany, N.J. (201) 887-5508.

Model 2414 is a dynamic test system for rapid accept-reject measurements of linear amplifiers including ICs. Measurements of harmonic distortion, noise and output voltage are made simultaneously. The test signal is supplied from a low distortion 2 kHz calibrated output. Automatic testing rates can reach 20,000 devices per hour when interfaced with automatic component handling equipment.

CIRCLE NO. 255

Correlation analyzer resolves 400 points

Signal Analysis Industries Corp., 595 Old Willets Path, Hauppauge, N.Y. (516) 234-5700.

Saicor Model SAI-43A is a 400-point, $0.2 \mu\text{s}$ real time digital correlation and probability analyzer. The unit operates in three modes; correlation (auto and cross), probability (density and distribution) and signal enhancement. Applications include noise source location, power spectral density calculations, ocean profiling and turbulence. Operating in real time, the analyzer outputs can be displayed or read out on analog or digital devices.

CIRCLE NO. 258

Now IR power technology shrinks both the size and cost of premium 20-Amp rectifiers!

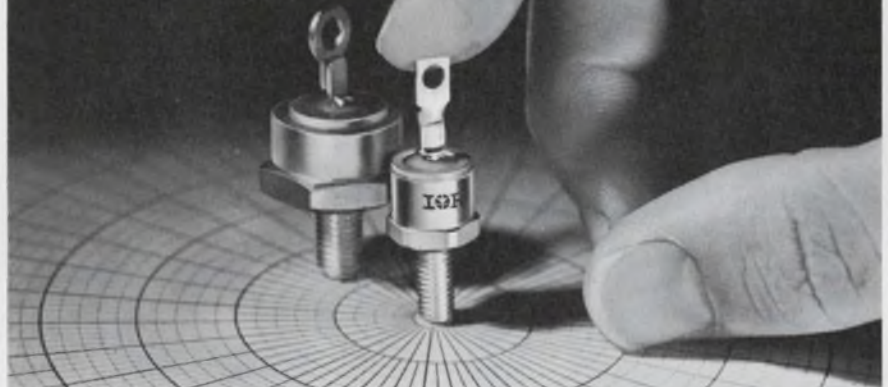

With its new 20F series that's priced and packaged like a DO-4, yet provides the peak performance and power you'd only expect from DO-5 case devices.

Another power semiconductor first from International Rectifier, the DO-4 sized and priced 20F silicon rectifier series now frees you from having to use bulky and expensive DO-5 packaged units to handle 20 Amps (avg.) requirements! They offer a great deal more than just their small-size-to-high-current handling capability and low cost. Highlighting just a few: They can handle peak one-cycle surges to 400 Amps and have an unusually high I^2t rating of $650 \text{ A}^2\text{sec}$. They display low leakage currents (I_{r}) of only 2.0mA, average, at $+150^{\circ}\text{C}$ junction temperature.

Their economy and performance make them ideal for a broad range of commercial, consumer and industrial applications such as battery chargers, motor controls, power supplies, transmitters and transceivers.

They're available in a choice of forward or reverse polarity, in seven peak reverse voltage versions (50V, 100V, 200V, 300V, 400V, 500V and 600V), from your International Rectifier Industrial Distributor. For production requirements and/or applications aid, contact your local IR sales office or call the factory.

INTERNATIONAL RECTIFIER 

Semiconductor Div., 233 Kansas St., El Segundo, CA 90245 • (213) 678-6281

A customer asked us to design a washer that would improve: joint reliability, installation control, spring return, and load distribution.

We did!

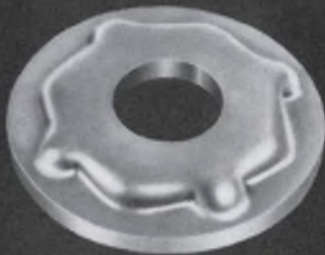

The Square Cone™ Controlled Tension Fastening system.

The unique Square Cone "dual action" provides adequate joint tension at minimum torque and has strength to support maximum torque tolerance. The "cushioned" installation effect improves consistency of joint tension — yet the Square Cone uses less material than an equivalent conical washer — better value engineering.

IT'S AVAILABLE RIGHT NOW!
The Square Cone™ Controlled Tension Fastening System.

Send for samples and Technical Report #118.

U. S. Patent No. 3,628,584

SHAKEPROOF
DIVISION ILLINOIS TOOL WORKS INC.
ST. CHARLES ROAD • ELGIN, ILLINOIS 60120

Copyright Illinois Tool Works Inc., 1972

MOS 4-1/2-digit multimeter chip features auto ranging

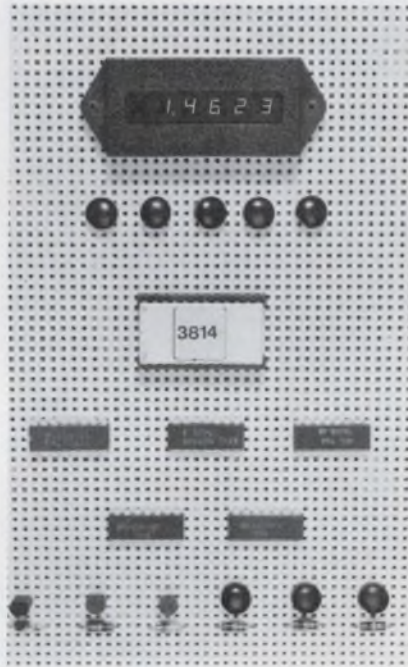

Fairchild Semiconductor, 464 Ellis St., Mountain View, Calif. (415) 962-5011. P&A: See text; stock to 2 wks.

A 4-1/2-digit, silicon-gate, MOS/LSI multimeter/counter/display building block, with complete TTL compatibility, has been announced by Fairchild Semiconductor. The 3814 Digital Voltmeter Logic Array features the basic digital functions for implementing a multiplexed 4-1/2-digit multimeter/counter display.

With a clocking frequency up to 600 kHz, the 3814 is the fastest LSI multidigit counter/display chip on the market. Mostek Corp. of Carrollton, Tex., produces the only other commercially available multidigit device—the 4 digit MK5002P, with a maximum 250 kHz operation (see "MOS, 4-Digit Counter/Display Chip Works From a +5-V Line," ED 13, June 24, 1971, p. 92). The maximum frequency of operation determines the settling time of the digital readout.

In multimeters that have four or more digits and that cost over

\$1000, fast analog-to-digital conversion is aesthetically appealing.

The high-frequency capability of the Fairchild chip is accompanied by a tenfold increase in power over the Mostek device—250 mW vs 25 mW. However, power dissipation is usually only a problem in battery-operated equipment and is of minor importance in bench-operated laboratory instrumentation.

All outputs of the 3814 can handle at least one TTL, 1.6-mA load. The five outputs, all multiplex, require transistor outputs to drive LED or incandescent displays. Liquid-crystal displays can be strobed directly by the 3814. Other features include:

- Auto-ranging control logic, usually available only in more expensive multimeters.

- Ten-count delay to eliminate errors due to switching transients.

- Strobe-synchronized BCD outputs capable of driving any TTL display decoder/driver.

Decoding of the display information—seven-segment or decimal—is integrated into the Mostek chip by metal mask variations. However, all outputs, including the strobe lines, must be buffered to interface with TTL and display devices.

Pricing at the 100-to-999-unit level is \$16.25 for the Fairchild 3814, compared with Mostek's \$19 tag for the MK5002P. The price/performance per digit would definitely favor the Fairchild chip in most multimeter and panel meter designs, which in the future will consider devices of this type.

Fairchild will soon have a complete five-digit mask variation of the 3814—the 3815.

Mostek will soon announce the MK5007P, a ceramic 16-pin, lower-cost version of the MK5002P, at \$13 in quantities of 100.

FOR FAIRCHILD:
FOR MOSTEK CORP.:

CIRCLE NO. 256
CIRCLE NO. 257

FET has 0.6 μ V input noise over 10 Hz-20 kHz

Teledyne Crystalonics, 147 Sherman St., Cambridge, Mass. (617) 491-1670. \$35; stock.

The C413N FET, claimed to be the lowest noise active device on the market, is designed for low level amplifier use in applications such as professional microphone amplifiers, instrumentation inputs, and phonograph and tape playback amplifiers. In addition to ultra-low noise, the C413N offers dramatically increased transconductance, typically 40,000 micromhos, compared to the 600 micromhos of earlier low noise FETs. This means a typically higher gain of about 40. Other key characteristics of the C413N include a gate leakage of only 3.0 nA, and a pinch-off of only 1.5 V.

CIRCLE NO. 262

Audio amp boasts 0.2% THD at 2 W output

National Semiconductor Corp., 2900 Semiconductor Dr., Santa Clara, Calif. (408) 732-5000.

The LM380 generates 2 W with a fixed voltage gain of 50. The quiescent output voltage is half the 22 V supply voltage. Input resistance is 150 k Ω ; bandwidth is 85 kHz. The output has both short circuit and thermal overload current limiting.

CIRCLE NO. 263

MOS RAMs have access time under 1 μ s

Solitron, 8808 Balboa Ave., San Diego, Calif. (714) 278-8780.

Six 64 \times 4-bit static and dynamic random access memories feature regenerative inputs which guarantee worst case TTL and DTL input/output capability, field inversion protection that allows stable performance at 125 C and circuit voltage over 20 V, and zener input protection. The combination of wired OR and multiple chip select lines provides for maximum expansion versatility. Average power dissipation is 250 μ W/bit at 5% duty cycle. Total input lockout simplifies timing requirements.

CIRCLE NO. 264

Econoline transistor line expanded

Sprague Electric Co., 347 Marshall St., North Adams, Mass. (413) 664-4411.

A variety of 22 low-noise, switching and general purpose transistors have been added to the family of ECONOLINE silicon planar transistors. The npn type 2N3903 and 2N3904, and their pnp complements—type 2N3905 and 2N3906—feature breakdown

voltages of better than 40 V, collector currents of 200 mA and power dissipation of 360 mW. Type 2N4123 and 2N4124 (nnp) and the similar type 2N4125 and 2N4126 (pnp) feature breakdown voltages of better than 25 V, collector current rating of 200 mA and a power dissipation of 360 mW. Minimum small-signal forward current transfer ratios of 2 to 3 are specified at 100 MHz.

CIRCLE NO. 265

FOR YOUR PRECISE REGULATION CONSTANT CURRENT/ VOLTAGE REQUIREMENTS

To age aluminum electrolytic capacitors, General Electric in their Irmo, South Carolina, plant required a 5 KW power supply with precise, constant current/voltage regulation.

By using these constant current/constant voltage power supplies, the power and, hence, the process can be closely controlled. Previously, power supplies in these ratings would take up several times the space without affording the same degree of regulation.

IF YOU NEED PRECISE CONTROL, SMALL SIZE, WELL-REGULATED KILOWATT CONSTANT CURRENT AND VOLTAGE POWER SUPPLIES . . . CALL TOLL FREE 800-631-4298, OR WRITE FOR OUR LATEST CATALOG.



Five of E/M's 5 KW SCR Power Supplies are used in General Electric's electrolytic capacitor aging system.



ELECTRONIC MEASUREMENTS INC.
405 Essex Road, Neptune, New Jersey 07753

INFORMATION RETRIEVAL NUMBER 53

Now you see it, now you don't with secret stripper

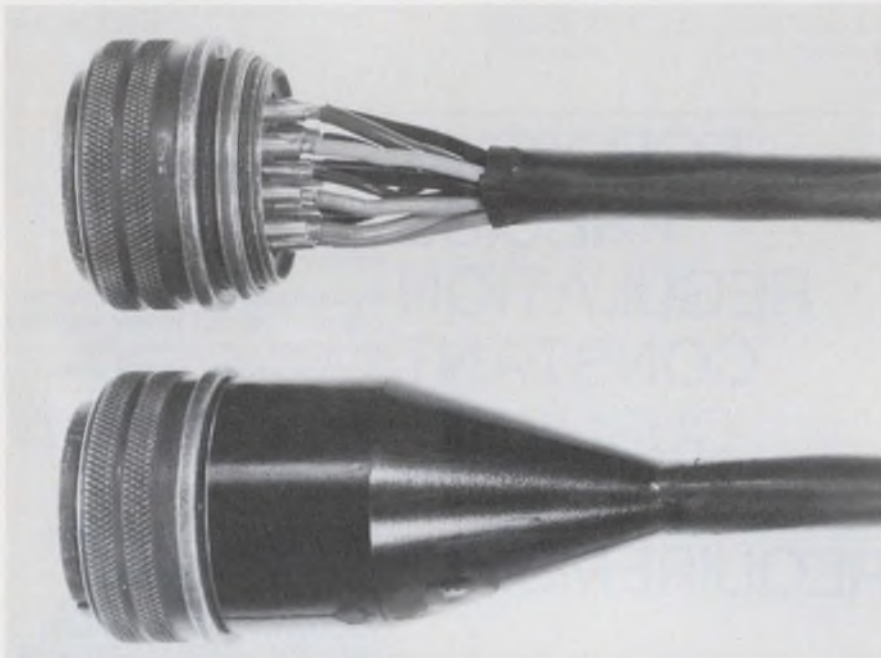

Amphenol SAMS Div., 9201 Independence Ave., Chatsworth, Calif. (213) 341-0710. P&A: see text.

With a recently acquired decapsulation process, Amphenol hopes to save customers millions of dollars by salvaging products that might have been scrapped. The process, called Access, selectively strips away almost any known encapsulant or potting compound without damaging components or insulation.

Conventional chemical strippers, in contrast, are often inadequately effective. They may be fine in one application, terrible in another.

Though Access can remove compounds like polyurethanes, polysulfides, silicone and neoprene rubbers, epoxies, foams and room-temperature vulcanizers, it leaves no residue. That's important—not only because some stripper residues can damage components—but because residues can be analyzed chemically. And Amphenol wants to keep the Access process proprietary and secret. Very secret.

Pressed for even a cursory explanation, an Amphenol spokesman

would not reveal if the process involved chemicals, heat, vacuum, any form of radiation, surgery or a small man with very sharp teeth. He would say, only, that it was a multi-step process.

The company, did, however, show samples of products stripped—beautifully. An expensive cable assembly, with the connector back-end molding stripped to expose a damaged contact to be replaced, looked as if it had never been potted. A decapsulated subassembly showed clean components with their factory markings and colors.

The advantages of the process are many. Potted assemblies can be repaired instead of discarded. In one case a \$1200 computer, which would have been scrapped, was stripped for \$480. The saving here was more than the 50% average cited by Amphenol. In other cases assemblies no longer being manufactured can be repaired economically. New products that may need future entry for design changes can be designed for encapsulation rather than costly mechanical protection.

Still another application, not mentioned by Amphenol, is engineering analysis of competitive products that have been potted for security. But the company did mention engineering failure analysis of potted assemblies.

The process is not quite universal. In removing an epoxy encapsulant from an assembly with an epoxy-glass PC board, for example, Access could chew up the board if its composition is too similar to that of the encapsulant.

Before applying the process (at its plant in Chatsworth, Calif., or on site—even in an aircraft—if security can be maintained) Amphenol performs a feasibility analysis for \$300. That fee is returned if stripping isn't feasible. The fee is credited against follow-on orders if the unit can safely be stripped. Evaluation typically requires two weeks. Stripping takes several days.

CIRCLE NO. 266

Solvent removes ionic and organic soils

Alpha Metals, Inc., 56 Water St., Jersey City, N.J. Phone: (201) 434-6778.

Cleaner and rosin flux remover Type 563 removes organic and ionic soils without damaging markings on most commercially available components and PC boards. The chlorinated solvent cleaner is applied before or after soldering of electronic parts. A blend of electronic grade organic solvents, it removes rosin flux residues and other organic contaminants. The cleaner is also used prior to etching, coating and fluxing for room or elevated temperature immersion, vapor phase or ultrasonic cleaning.

CIRCLE NO. 267

Seven-segment LED features larger digits



Monsanto Commercial Products Co., 10131 Bubb Rd., Cupertino, Calif. (408) 257-2140. \$2.95/digit (1000 quantities); Stock.

A seven-segment light-emitting diode display, Model MAN3M, features an improved font and larger digit size, in the same package size as Monsanto's MAN3A. The MAN3M character is 0.127-inch high and 0.08-inch wide, amounting to an increase of 32% in digit area. The ratio of length to width has been selected through human factors studies to give maximum readability and eye appeal. The new display is packaged compactly to permit mounting of five digits per inch.

CIRCLE NO. 268

Fixed RF inductors span 0.1 to 1000 μ H

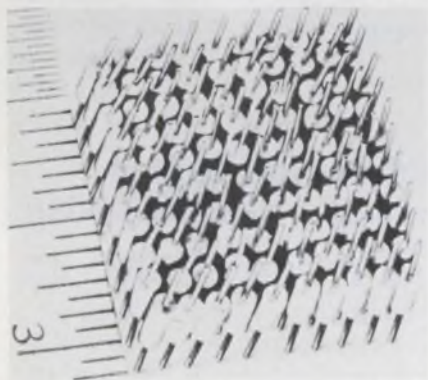

Nytronics, Inc., Orange St., Darlington, S.C. Phone: (803) 393-5421. Availability: stock.

The Deci-Ductor, a subminiature fixed inductor designed to meet all environmental specifications of MIL-C-15305C, Grade 1, Class B, has an inductance tolerance of +10% and a dielectric strength of 700 V rms at sea level. The size of the Deci-Ductor is 0.100 by 0.250-in. with #24AWG leads 1.25-in. long.

CIRCLE NO. 269

Light kits illuminate lab built equipment

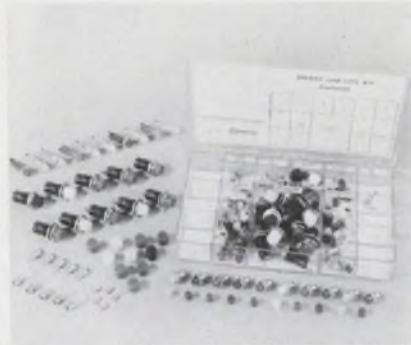

Drake Mfg. Co., 4626 N. Olcott Ave., Harwood Heights, Ill. (312) 867-7227.

Three Lab-Lite kits are intended specifically for laboratory-built equipment. Each kit contains generous quantities of incandescent and neon indicator lights, spare lamps, and lens caps housed in an attractive, transparent, compartmented case. No time is wasted in ordering (and waiting for) small quantities of indicator lights. Each kit contains 10 each miniature bayonet (Standard), midget screw (Tynylite), and neon glow (Glo-lite) indicator lights, plus spare lamps and lens caps.

CIRCLE NO. 270

Rotary BCD switches for logic functions

AMP, Inc., Harrisburg, Pa. (717) 564-0101.

Specifically designed for pc board mounting, compact (0.24-in. high \times 0.75-in. dia.) rotary BCD switches are fully enclosed for protection from dust and other atmospheric contaminants. With a contact life expectancy in excess of 10,000 cross point operations and a current rating of 250 mA, these switches are readily suited for programming logic functions in machine tools, vending machines, test equipment, computers and input data terminals. Three available styles include screw driver (or coin) actuated plus bar-type knob or thumbwheel versions for hand rotation.

CIRCLE NO. 271

New from General Electric



Rechargeable
Nickel-cadmium
Batteries
for elevated
temperature
applications



Here's the rechargeable battery for your tough, high-temperature design applications. General Electric's new Goldtop nickel-cadmium batteries have a maximum sustained temperature capability of 65°C—permitting their use in spots previously too hot for nickel-cadmium batteries. And, at 65°C cell temperature, Goldtop batteries have a longer life expectancy than conventional units at 50°C cell temperature. Goldtop batteries are also available in a quick-charge version that can be recharged in 3½ to 4 hours using a standard charger. These cylindrical cell batteries are available in a wide variety of sizes and ratings.

For more information, write Section 452-02, General Electric Co., Schenectady, New York 12345, or circle reader service card.

452-02

GENERAL ELECTRIC

INFORMATION RETRIEVAL NUMBER 54

Microprogram a mini for 256 bytes/instruction



Cincinnati Milacron, Process Controls, Div., Lebanon, Ohio. (513) 494-5451.

Decimal arithmetic is accomplished easily on the new, more powerful CIP/2200. Decimal numbers appear in memory as byte strings up to 16 digits in length. Decimal numbers may be manipulated as input, eliminating packing and code conversion. The CIP/2200 I/O structure consists of a microprogrammed serial I/O interface, a byte I/O facility, firmware support for direct memory channel concurrent transfers, and the capability of attaching up to two independent direct memory access (DMA) processors. The CIP/2200 includes memory addressing 32K bytes, 4K and 8K byte memory modules, 1.1 μ s full cycle memory speed, 8- or 9-bit memory bytes, 16 general-purpose 8-bit file registers plus many other features for advanced minicomputer technological applications.

CIRCLE NO. 272

Interface replaces HP 5050 printer

Data Graphics Corp., 8402 Speedway Dr., San Antonio, Tex. (512) 342-9486. \$1400; 30 days.

Any system now using an HP printer can be interfaced to a teletype, paper tape punch, small computer, cassette tape or calculator with the Datas 305-5050 plug-to-plug replacement. The Datas 305-5050 is a fully programmable interface that will generate data in any sequence with any character desired.

CIRCLE NO. 273

Data acquisition system stresses modularity

Hewlett-Packard, 1501 Page Mill Rd., Palo Alto, Calif. (415) 493-1501. \$32,000 to \$60,000; April, 1972.

The 9600-Series computer-based systems can be configured as stand-alone or distributed systems to automate single processes or entire factories. Modularity of both hardware and software has been given particular emphasis, so a user can start with a minimum low-cost system and later expand at reasonable cost without system redesign and without scrapping any equipment. 9600-Series systems acquire and process data from multitudes of analog and digital sources such as strain gages, pressure transducers, thermocouples, relays, instruments, and the like.

Central to all 9600 systems is a general-purpose microprogrammed mini with a memory capacity of 8192 to 32,768 16-bit words. For multiplexing and digitizing analog signals corresponding to temperatures, pressures, strains, and other physical quantities, 9600-Series systems are equipped with a high-speed analog subsystem. An optional digital subsystem provides 15 to 240 12-bit digital input/output channels. Peripherals included with 9600-Series systems are a teleprinter, a punched-tape reader, and a tape punch.

CIRCLE NO. 274

Cassette memory features dual-gap head

Teac Corp. of America, 7733 Telegraph Rd., Montebello, Calif. (213) 726-0303. \$1025.

A cassette-type digital magnetic tape memory system, the MT-6, features a dual-gap head for both read and write in a single instrument; it also permits read-after-write checks of any recorded data. The two-channel MT-6 utilizes phase encoding recording with a packing density of 800 bpi and a memory capacity of two-million bits.

CIRCLE NO. 275

Core memory stack said to be world's smallest

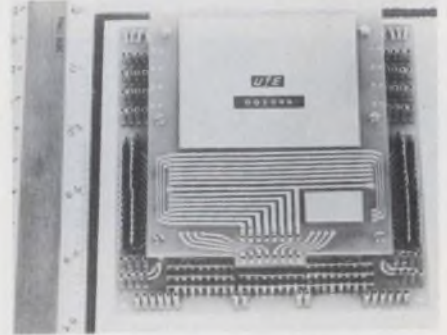

United Telecontrol Electronics, Inc., Asbury Park, N.J. (201) 922-1000.

A palm-size core memory stack is less than half the size of the previously smallest known commercial stack, built by Electronic Memories & Magnetics Corp. It is slightly more than one-fourth the size of the next smallest stack which is produced by Ampex. Actual dimensions of the UTE mini-stack are 0.4-in. high, 4-in. wide and 4.5-in. deep. Total area of the UTE stack is 18 square inches, compared with approximately 39 square inches for the EMI stack and 60 square inches for the Ampex mini-stack. The UTE stack provides 4K \times 12 to 18 bits of core storage, and will operate at a speed of 650 ns, with 18 mil cores.

CIRCLE NO. 276

Printer has built-in vacuum cleaning system

IBM, Systems Development Div., P.O. Box 6, Endicott, N.Y. (607) 755-3430.

Anything that prints 2000 lines a minute on paper is bound to stir up a little dust. The IBM 3211, solves the problem with a built-in vacuum cleaning system. Jets of air are directed at the type where it makes a turn, dislodging the paper dust, lint and other foreign matter; located right after the air jets is a cavity where all the dislodged particles are vacuumed into a disposable bag. The result is a built-in vacuum cleaner designed to help keep the IBM 3211 as maintenance-free as possible.

CIRCLE NO. 277

application notes

Solid-state choppers

An application sheet is available on electronic choppers. The transistor chopper (or modulator) is a solidly encapsulated unit which is designed to alternately connect and disconnect a load from a signal source. These choppers may also be used as synchronous demodulators to convert an ac signal to dc. They are capable of linearly switching or chopping voltages over a wide dynamic range which extends down to a fraction of a millivolt and up to ± 150 V in one model. Unlike mechanical choppers which can only be designed to operate over a narrow and comparatively low frequency range due to mechanical limitations, these transistorized choppers are inertialess devices that can be driven from dc to a hundred kilocycles in most of the basic models. Solid State Electronics Corp., Sepulveda, Calif.

CIRCLE NO. 278

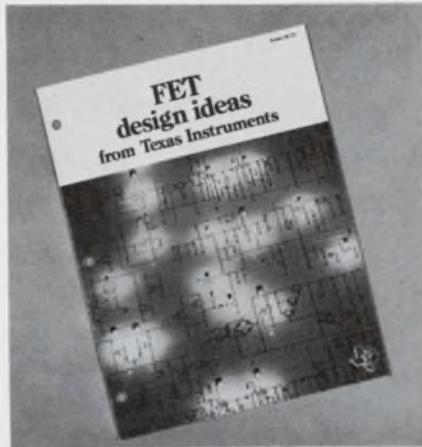

FET design

A brochure on designing with field-effect transistors (FETs), titled "FET Design Ideas," Bulletin CB-145, 17 pages, covers how to properly bias FETs, describes 26 different FET applications, and provides a listing of the most popular FETs in the industry. Among the illustrated circuits shown are amplifiers, oscillators, a MOS-to-TTL/DTL interface circuit, an FM tuner, and a chroma demodulator. Texas Instruments Inc., Dallas, Tex.

CIRCLE NO. 279

Cleaning equipment

A 12-page booklet entitled "The Whys and Hows of Cleaning Electronic Equipment" reviews some of the effects of dirt and air pollution on electronic equipment performance together with cleaning methods and systems. This basic information is especially useful to those responsible for the operation, maintenance and calibration of all types of electronic equipment and controls. M. P. Odell Co., Cleveland, Ohio.

CIRCLE NO. 280

Soldering fluxes

Non-patented formulations for new water-soluble fluxes used in electronics assembly line soldering are available without charge. License patented flux compounds can be obtained at normal royalty rates. Such fluxes are virtually pollution-free. The fluxes are chemically synthesized, giving improved uniformity and quality of solder joints. The fluxes use glycols and glycerines. IBM Components Div., White Plains, N.Y.

CIRCLE NO. 281

PUSH BUTTON MINIATURES
MSPN SERIES

Lighted snap-action DPDT models handle 6A @ 125 VAC & features separate connections to T-1 $\frac{3}{4}$ lamp. $\frac{1}{2}$ " , $\frac{3}{8}$ " , $\frac{3}{4}$ " round or square buttons; transparent or translucent colors. P.C. side terminals.

ALCOSWITCH® ILLUMINATED
DIV. OF ALCO ELECTRONIC PRODUCTS, INC., LAWRENCE, MASS.

INFORMATION RETRIEVAL NUMBER 55

ALCO LITE OFFERS MORE

PANEL INDICATORS

Miniature incandescent lamp assemblies have 5V 60 ma. rating, and 100,000-hr. life. Its sealed plastic assembly contains a T-1 #680 lamp. Mounting ring is included. Choice of 5 colors, pins or leads.

MC-680 6" INSULATED LEADS
ME-680
PIN CONTACTS

ALCO ELECTRONIC PRODUCTS, LAWRENCE, MASS.

INFORMATION RETRIEVAL NUMBER 56

Designing high-speed drives?

Consider
Long-Life
LTC™!



Nortronics' new LTC (Life Time Ceramic) digital heads extend head life ten times, cut replacement costs and eliminate the frequent electronic field adjustments normally required with conventional designs used in modern, high-speed tape drives. The secret? Nortronics tough, new ceramic finish which is permanently applied to the face of digital heads. LTC is another example of Nortronics innovation—a significant breakthrough in magnetic head reliability and long-term survival. Write or call today for detailed information.



'world's leader in magnetic heads'

NORTRONICS
COMPANY, INC.

8101 Tenth Avenue North
Minneapolis, Minnesota 55427 • (612) 545-0401

INFORMATION RETRIEVAL NUMBER 57

new literature



Information displays

A six-page, fold-out "Product Selection Guide" covers highlight parameters on all of the company's standard lighted pushbutton switches and indicators, fiberoptic readouts, illuminated word indicators and unlighted switch assemblies. The key selection criteria are organized in easy-to-use tables and each product category is referenced to specific catalog numbers which can provide complete details. Master Specialties Co., Costa Mesa, Calif.

CIRCLE NO. 340

Glass-bonded mica

"Total Dimensional Stability with Mykroy Glass-Bonded Mica," a 16-page booklet, describes eight grades of Mykroy and illustrates a representative group of parts injection-molded and machined from the material. A page of tables lists the general, electrical, and mechanical properties of four Mykroy sheet and rod grades and four molding grades. Mykroy Ceramics, Synthane-Taylor Corp., Ledgerwood, N.J.

CIRCLE NO. 341

Instrument enclosures

Catalogs 310 and 310-A offer a combined, easy to read, presentation of basic semi-custom and custom modular enclosures. New additions to Interface 33 styling system are low silhouette consoles, sloped frames and a family of modular small instrument cabinets, BC/33. Amco Engineering Co., Chicago, Ill.

CIRCLE NO. 342

Components

An 135-page Catalog No. 72F contains over 90 pages devoted to 45 categories of switches including toggle, push, rotary, trigger and power tool, micro limit and snap-action, illuminated, gasoline pump and motor, selector, miniature and military types. Circuitry, electrical ratings, terminal configurations and dimensions are furnished, as well as engineering and descriptive information. LCOMP-St. Louis, Inc., St. Louis, Mo.

CIRCLE NO. 343

Industrial testing methods

"Testing Methods and Techniques" contains 34 abstracts of innovative processes and devices used in quality control and nondestructive testing, with emphasis on internal flaw detection. Small Business Administration, Washington, D.C.

CIRCLE NO. 344

Surveillance receivers

A 16-page, two-color short form product catalog describes salient engineering features of surveillance receivers (lf through shf), auxiliary equipment, MIL-type and special purpose receivers, telemetry and test equipment. It also discusses vlf/lf receivers and demodulators, rf amplifiers and switches and vlf-hf-vhf multi-couplers. Astro Communications Laboratory, Gaithersburg, Md.

CIRCLE NO. 345

Omnephase phase control

A postage stamp sized ac phase control called Omnephase is described in a two-page data sheet. It is capable of governing load power up to 3000 W at 220 V. Applications cover a wide range and include lamp dimming, temperature control, blender/mixer control, heater element control, and universal and induction motor control. The device occupies less than one-quarter-cubic-inch of space. Omnetics, Inc., Syracuse, N.Y.

CIRCLE NO. 346



High-voltage capacitors

A 20-page catalog on precision and high-voltage capacitors provides detailed performance specifications on high precision, wrap and fill, and hermetic sealed film capacitors, including the new reconstituted mica and metallized polypropylene. It also includes high-voltage units up to 200 kV, including the parallel plate hf power capacitors and energy storage capacitors. Del Electronics Corp., Mt. Vernon, N.Y.

CIRCLE NO. 347

Infrared products

Santa Barbara Research Center has made available a 54-page brochure describing its infrared products and systems. The new brochure gives technical descriptions and specifications of various types of IR detectors and detector arrays, glass and metal dewars, components, special systems and instrumentation. Santa Barbara Research Center, Goleta, Calif.

CIRCLE NO. 348

Information systems

A 16-page brochure describes and illustrates the company's total information systems, products, and services. Each of the computer/communication systems and products discussed is accompanied by a general description of the equipment together with pictures, diagrams and specifications. Computer Communications, Inc., Culver City, Calif.

CIRCLE NO. 349

10-bit d/a converters

The aimDAC-100 "T" series 10-bit miniature d/a converter, at new low prices, is described in a five-page brochure. The complete current output d/a converter is comprised of two monolithic chips housed in a single 16-pin silicone dual-in-line package and operates over the full 0-70 C commercial temperature range. The small size and new low prices make the devices attractive for a wide variety of converter applications, including very low cost single-channel a/d converters, CRT display and servo drivers, with additional uses in data acquisition systems, modems, radar, direct digital control systems and digital filters. Precision Monolithics, Inc., Santa Clara, Calif.

CIRCLE NO. 350

Read/write amplifier

A four-page data sheet describes the MA 360 read/write NRZI amplifier. Function descriptions of the modules, input/output lines and specifications are outlined. Potter Instrument Co., Inc., Melville, N.Y.

CIRCLE NO. 351

X-Y recorder

A four-page, illustrated brochure describes the 500 high-performance analog x-y recorder for portable use or rack mounting. Specifications and ordering information for standard recorders, accessories and supplies are given and a block diagram explains the operation of the unique servo pen positioning system. Gould Inc., Cleveland, Ohio.

CIRCLE NO. 352

FSK multiplex system

A four-page brochure describes the DataPak FSK multiplex system. The system features maximum efficiency in voice circuit use and offers the most flexible systems and interface configurations available. Data Products, Woodland Hills, Calif.

CIRCLE NO. 353



Micro 1600 reference manual

An 88-page reference manual for the Micro 1600 minicomputers contains Micro 1600 design features, system description, microcommand repertoire, control panel operation, micro assembler program, input/output information, physical characteristics and system power. The manual has seven chapters and an appendix with a microcommand reference table. Microdata Corp., Santa Ana, Calif.

CIRCLE NO. 354

P-i-n diode switch

Bulletin M190 describes a new absorptive p-i-n diode attenuator/modulator/switch operating over the frequency range from 200 MHz through 10 GHz. The unit features a dynamic range of 35 dB, and flatness of ± 0.5 dB. General Microwave Corp., Farmingdale, N.Y.

CIRCLE NO. 355

Burn-in technology

A "Guideline to Component Burn-in Technology" covering economics, techniques, systems & procedures and equipment selection takes the quality control engineer through sections on burn-in and life testing of semiconductors. It includes data on high temperature reverse bias, power aging, thermal fatigue, ambient (free air) burn-in, ac blocking, etc. The information is directed towards the component manufacturer, OEM and user. Wakefield Engineering, Inc., Wakefield, Mass.

CIRCLE NO. 356

If upset pins figure in your component costs write for this free bulletin.



If you'd like to see what ART WIRE's forty-five years of know-how can do for your component costs, send for this free bulletin entitled, "UPSET PINS AND HEADED LEADS." See how experience has taught us to combine volume production with uniformity and accuracy.

It will tell you how ART WIRE mass produces precision upset pins and headed leads from wire .008" in diameter to .125" in diameter, with the upsets spaced as close as .025"

This bulletin may point the way for you to cut component costs, or solve a part problem.



Write For Free Bulletin.
ART WIRE & STAMPING COMPANY

116 Wing Drive
Cedar Knolls, New Jersey 07927

INFORMATION RETRIEVAL NUMBER 58

Advertisements of booklets, brochures, catalogs and data sheets. To order use Reader-Service Card.
(Advertisement)

King of Korrelators[®] Conquers Fuzziness

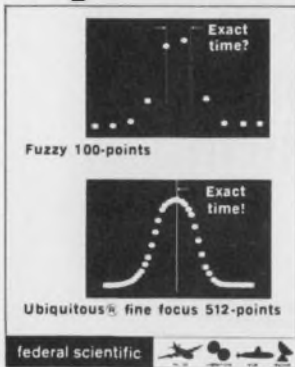

UC-201B is the world's fastest, most sensitive, has finest time resolution. A complete time-domain measurement lab for real-time auto/cross correlation, signal enhancement, probability. For underwater acoustics, fluid dynamics, medical, noise/vibration analysis. Exact time measurements with digital dial; computes integral & differential of any stored function; pre-computational delay built-in (up to 8192 samples optional); zero time can be at center of display; sampling increments 1/2 usec to 2 sec; complete ext. (computer) control plus digital outputs; built-in test signals check all modes; small, portable, easy to use. Many options.

CIRCLE NO. 171

Federal Scientific Corporation

a subsidiary of Elgin National Industries, Inc.
615 West 131st Street, New York, N. Y. 10027

Create Your Own Power Supply Sub-Systems



New T. D. I. brochure offers designers complete details in grouping its famous line of adjustable range TDM (single output) and TDMD (dual output) power supply modules in a single package to meet exact requirements, without expensive cabling, racks or accessories. All modules feature front panel voltage and current limit adjustment, test points and indicator lamps. OV crowbar protection is built in. Outputs available 1.0 to 305 VDC and 0.06 to 60.0 AMPS.

CIRCLE NO. 172

Transistor Devices, Inc.

85 Horsehill Road, Cedar Knolls, N. J. 07927
Tel. (201) 267-1900

FUNDAMENTALS OF INTEGRATED CIRCUITS

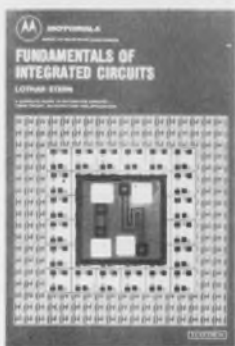

A practical guide to integrated circuits, their theory, manufacture, and applications. This new guide by Lothar Stern offers complete, highly readable coverage of the various techniques of circuit fabrication, and their effect on circuit design and performance. As to marketing considerations, it compares the characteristics of the numerous IC structures devised to date in terms of economics and logistics. A volume in the **Motorola Series in Solid-State Electronics**. 198 pages, 7 x 10, illustrated. \$8.95, clothbound. Circle the reader-service number below for 15-day examination copies.

CIRCLE NO. 173

Hayden Book Company, Inc.

116 West 14th Street
New York, N.Y. 10011

ELECTRONIC DESIGN's function is:

- To aid progress in the electronics manufacturing industry by promoting good design.
- To give the electronic design engineer concepts and ideas that make his job easier and more productive.
- To provide a central source of timely electronics information.
- To promote communication among members of the electronics engineering community.

Want a subscription? ELECTRONIC DESIGN is sent free to qualified engineers and engineering managers doing design work, supervising design or setting standards in the United States and Western Europe. For a free subscription, use the application form bound in the magazine. If none is included, write to us direct for an application form.

If you do not qualify, you may take out a paid subscription for \$25 a year in the U.S.A., \$35 a year elsewhere. Single copies are \$1.50 each.

If you change your address, send us an old mailing label and your new address; there is generally a postcard for this bound in the magazine. You will have to requalify to continue receiving ELECTRONIC DESIGN free.

The accuracy policy of ELECTRONIC DESIGN is:

- To make diligent efforts to ensure the accuracy of editorial matter.
- To publish prompt corrections whenever inaccuracies are brought to our attention. Corrections appear in "Across the Desk."
- To encourage our readers as responsible members of our business community to report to us misleading or fraudulent advertising.
- To refuse any advertisement deemed to be misleading or fraudulent.

Microfilm copies are available of complete volumes of ELECTRONIC DESIGN at \$19.00 per volume, beginning with Volume 9, 1961. Work is now in process to complete the microfilm edition of Volumes 1-8. Reprints of individual articles may be obtained for \$2.00 each, prepaid (\$.50 for each additional copy of the same article) no matter how long the article. For further details and to place orders, contact the Customer Services Department, University Microfilms, 300 North Zeeb Road, Ann Arbor, Michigan 48106 telephone (313) 761-4700.

Want to contact us? If you have any comments or wish to submit a manuscript or article outline, address your correspondence to:

Editor
ELECTRONIC DESIGN
50 Essex Street
Rochelle Park, N.J. 07662

Less than 1 μ V Offset!

New Ultra-Low Thermal emf Reed Relays!



- Unique new method (pat. pend.) virtually eliminates thermal offsets, permits use of almost any type reed switch... Hg wet, dry, high voltage.
- Remarkably independent of ambient temperature, environment.
- Many contact forms, pin configurations available.
- Units also available at less than 500 nanovolts per switch, or less than 1 μ V differentially between switches.
- Greater than 10¹¹ ohms isolation resistance.
- Rugged molded package. Moderate price.

Write for Complete New Catalog MR-6.1



COTO-COIL COMPANY, INC.
59 Pavilion Avenue, Providence, R. I. 02905
Tel: (401) 941-3355

INFORMATION RETRIEVAL NUMBER 59

HIGH RELIABILITY

MORIRICA

PHOTOCELL-LAMP

QUALITY OF
THE FIRST ORDER

Type: MCL-703C

- Input (Lamp)
 - Voltage: 10V
 - Current: 16mA
- Output (CdS cell)
 - ON-resistance: 400 Ω \pm 50%
 - OFF-resistance: 5M Ω (after 10sec.)
 - Max. power dissipation 80mW

* For catalog, please write to:
MORIRICA ELECTRONICS, LTD.
205, Tozuka-machi, Tozuka-ku, Yokohama, Japan
Tel: 045-881-2331 Cable Address: MORIRICA YOKOHAMA

INFORMATION RETRIEVAL NUMBER 60

ELECTRONIC DESIGN 5, March 2, 1972

Electronic Design

Advertising Sales Staff

Bryce Gray

Sales Manager

Rochelle Park, N.J. 07662

Robert W. Gascoigne

Daniel J. Rowland

50 Essex Street

(201) 843-0550

TWX: 710-990-5071

Philadelphia

Thomas P. Barth

50 Essex Street

Rochelle Park, N. J. 07662

(201) 843-0550

Boston 02154

Joseph F. Palmer

1268 Main Street

Waltham, Mass.

(617) 894-2700

Chicago 60611

Thomas P. Kavooras

Berry Conner, Jr.

200 East Ontario

(312) 337-0588

Cleveland

Thomas P. Kavooras

(Chicago)

(312) 337-0588

(call collect)

Los Angeles 90303

Stanley I. Ehrenclou

Burt Underwood

2930 Imperial Highway

Inglewood, Calif

(213) 757-0183

San Francisco 94022

Jerry D. Latta

95 Main Street

Los Altos, Calif.

(415) 941-3084

London W. 1

For United Kingdom and Holland

Brayton C. Nichols

For Eastern Europe

Peter Kehr

The American Magazine Group

27 Maddox Street

London, W. 1, England

Phone: 499-0180

Cable: Ammagnic, London

Verviers, Belgium

For Continental Europe

Andre Jamar

1, Ru Mallar, 1

(087) 253.83 Telex 41563

Tokyo

Haruki Hirayama

Electronic Media Service

5th Floor, Lila Bldg.,

4-9-8 Roppongi

Minato-ku

Phone: 402-4556

Cable: Electronicmedia, Tokyo



*Now available
for in-plant training...*

The MOS Course from Texas Instruments

Effectively and economically, this new 10-lesson videotape course lays the foundation for (1) evaluating the usefulness of MOS in proposed applications, (2) weighing the relative advantages of MOS options, and (3) working efficiently with MOS suppliers for cost-effective systems design.

Produced on efficient, low-cost videotape for maximum understanding and highest retention, the course includes printed workbooks and supplementary data.

The course was presented to a nationwide audience in September over a closed-circuit TV network. Hundreds of engineers in 16 cities spent three days absorbing the nine hours of concentrated instruction. It's now available for your own in-plant use.

The course covers: MOSFET characteristics • technology choices • reliability • economics • inverter and static logic • shift registers • bipolar interface • memories • PLAs.

For full details and information on obtaining a demonstration tape, circle 420 for Brochure CM-106. Or write Texas Instruments Incorporated, P.O. Box 5012, M.S. 84, Dallas, Texas 75222.



TEXAS INSTRUMENTS
INCORPORATED

NEW Low Cost, 8-Bit D/A Converters

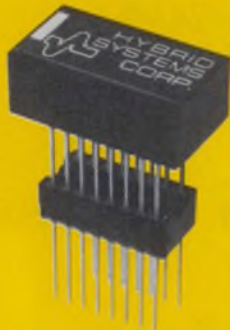

DAC
371-8

- Plugs into a Single 16 Pin IC Socket
- All Hermetically Sealed Active Components — No Plastic Devices
- Thin Film Precision Resistors for Extra Stability
- 8-Bit, Current Output

\$9.90

in singles

The DAC 371-8 D/A Converter is a new complete 8-bit, fine performance unit, economically priced at \$9.90 in singles. It incorporates all the standard features — built-in reference, DTL and TTL compatibility, and ready to use operation — plus several additional ones for high reliability and long term stability.



HYBRID SYSTEMS CORPORATION

87 Second Ave., Northwest Industrial Park, Burlington, Mass. 01803
Telephone: 617-272-1522 TWX: 710-332-7584

INFORMATION RETRIEVAL NUMBER 62

\$66. (1-9)

5V/5A COMPUTER OEM SUPPLY



Hard to believe? Then read on. Our ELV Series supplies (available in ratings of 25W, 75W, 125W and 250W) reduce your power costs with no reduction in quality.

Every supply is put together under stringent QC with American-made transformers, capacitors, semiconductors, IC's and G-10 quality boards.

Every supply delivers all the power we promise

with no temperature derating, even with 50 Hz input.

Regulation, ripple and noise are specified by the book. Spike-suppression and short-circuit protection are standard, OVP optional. And deliveries are off-the-shelf for most configurations.

And the same is true for all our other supplies, open or enclosed, single- or multiple-output.

Check it out today. Call (714) 833-2950.

ELV-25	
Output:	3V/5A to 28V/1.3A (16 models avail.)
Temp range:	0-55°C
Line & load reg:	0.1%
Ripple & noise:	0.1%

ELEXON POWER SYSTEMS

18651 Von Karman, Irvine, Calif. 92664

An Elpac division.

INFORMATION RETRIEVAL NUMBER 63

advertiser's index

Advertiser	Page
AMP, Incorporated	27
Abbott Transistor Laboratories Incorporated	6
Accutronics, Inc.	53
Acopian Corporation	60
Alco Electronic Products, Inc.	75
Amphenol Components Group	13
Analogic Corporation	21
Art Wire & Stamping Co.	77
Beckman Instruments, Inc., Helipot Division	63
Belden Corporation	29
Bell, Inc., F. W.	48
Braun Tool & Instrument Co. Inc.	32
Burroughs Corporation	Cover IV
Capitol Machine & Switch Co.	61
Centralab, the Electronics Division of Globe-Union, Inc.	33
Clare-Pendar	48, 48A-B
Com-cir-tek	48
Corning Glass Works, Electronic Products Division	32
Coto Coil Company, Inc.	79
Dale Electronics, Inc.	Cover II
Dialight Corporation	11
Digital Equipment Corporation	65
Dow Corning Corporation	18
ECC Corporation	7
Edmund Scientific Company	61
Electronic Measurements, Inc.	71
Elexon Power Systems	80
Fairchild Semiconductor, A Division Fairchild Camera and Instrument Corporation	14, 15
Federal Scientific Corporation	78
General Electric Company	73
Grayhill, Inc.	60
Hayden Book Company, Inc.	78
Heath Company	60
Heinemann Electric Company	23
Hewlett-Packard	1
Hybrid Systems Corporation	80
Indiana General	49
International Rectifier	69
Institution of Electrical Engineers, The	16B
Kurz-Kasch, Inc.	16
Lambda Electronics Corp.	Cover III
Ledex, Inc.	25
Licon, Division Illinois Tool Works, Inc.	38
MCL, Inc.	57
Moricca Electronics, Inc.	79
Motorola Semiconductor Products, Inc.	8, 9
National Semiconductor Corporation	16A
Nortronics Company, Inc.	75
Oak Manufacturing Co.	17
Robison Electronics, Inc.	32
Shakeproof Division of Illinois Tool Works Inc.	79
Siemens Corporation	34
Signal Analysis Industries Corp.	61
Signetics Corporation	30, 31
Singer, Industrial Timer Division	16
Sprague Electric Company	12
Stacoswitch Inc.	16
Stackpole Carbon Company	4, 5
TEC, Incorporated	68
TRW Electronic Components, Semiconductor Division	2
Transistor Devices, Inc.	78
Triplet Corporation	10
Underwriters Safety Device Co.	60
Unimax Switch Corporation	37
U. S. Capacitor Corporation	56

Do you face a make or buy decision on power supplies?

BUY LAMBDA LX SERIES

Choose from 7 packages, 36 models
All 1-day delivery. All guaranteed 5 years

"3" PACKAGE

DUAL OUTPUT
12 TO 15 VOLTS 0.4 AMPS...\$85



"A" PACKAGE

SINGLE OUTPUT
5 VOLTS 4 AMPS...\$85
DUAL OUTPUT
12 TO 15 VOLTS 1 AMP...\$125

"B" PACKAGE

SINGLE OUTPUT
5 VOLTS 5.8 AMPS...\$125
DUAL OUTPUT
12 TO 15 VOLTS 1.6 AMPS...\$150



"4" PACKAGE

SINGLE OUTPUT
5 VOLTS 7.4 AMPS...\$135

"C" PACKAGE

SINGLE OUTPUT
5 VOLTS 9 AMPS...\$150
DUAL OUTPUT
12 TO 15 VOLTS 2.5 AMPS...\$160

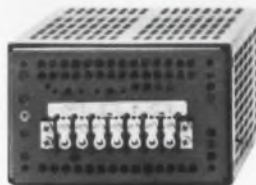

"CC" PACKAGE

SINGLE OUTPUT
5 VOLTS 16 AMPS...\$200

"D" PACKAGE

SINGLE OUTPUT
5 VOLTS 27.5 AMPS...\$235

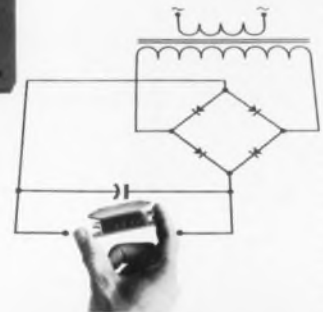
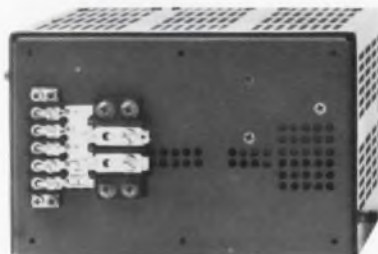

Line regulation 0.1% Load regulation 0.1%
Ripple and noise 1.5 mV RMS, 5 mV P-P with either positive or negative terminal grounded
AC input 105-132 VAC; 47-440 Hz
All 5-volt models include built-in overvoltage protection.
For information on other models up to 28 VDC, send for catalog.

**WHETHER
YOU MAKE
OR BUY...**

LAMBDA
ELECTRONICS CORP.
A  Company

MELVILLE, NEW YORK 11746 515 Broad Hollow Road Tel. 516-694-4200 ARLINGTON HEIGHTS, (CHICAGO) ILL. 60005 2420 East Oakton St., Unit Q Tel. 312-593-2550
NORTH HOLLYWOOD, CALIF. 91605 7316 Varna Ave. Tel. 213-875-2744 MONTREAL, QUEBEC 100C Hymus Blvd., Pointe-Claire, Quebec-730 Tel. 514-697-6520

We've turned the world of displays upside down

NEW PANAPLEX IITM PANEL DISPLAY

lowest cost... lowest power MOS compatibility

- Lowest power—average power less than 5 milliwatts per segment
- Lowest cost—\$1.00 per digit*
- MOS compatibility—cathodes and anodes can be driven from MOS circuits

There is a lot of talk about displays—new technologies, new innovations, a lot of good new things just "over the horizon." But the fact is that the PANAPLEX II panel display, representing a technology that grew from the NIXIE[®] tube, is the best numeric display available now.

Only PANAPLEX II panels switch on voltage and current low enough for direct MOS compatibility Cut power requirements to milliwatts And cut costs down to \$1.00 per digit.* Characters are bright and readable and can be custom-tailored for numerous applications . . . including annunciators requiring special fonts. We've packed 8 to 16 digits into a 0.2" thick (not including tubulation) in-plane display panel for calculators, cash registers, special instruments, you name it.

PANAPLEX II PANEL DISPLAY — More than another new readout, a whole new way of looking at numeric displays.

For additional information write:
Burroughs Corporation,
Electronic Components Division,
P.O. Box 1226, Plainfield, N.J. 07061;
or call our special applications
assistance number, (201) 757-3400.

*50,000 tube quantity.

Leader in the World of Displays

Burroughs



INFORMATION RETRIEVAL NUMBER 244