

Electronic Design

FOR ENGINEERS AND ENGINEERING MANAGERS

VOL. 20 NO.

4

FEB. 17, 1972

Fiber-optic systems are creating a new era in photoelectronics. Combinations of LEDs and fiber bundles and photosensors are now appearing in new computer card

readers and in alterable ROMs. Optical communications over fiber optic light pipes offer promising new solutions to old problems. We shed more light on page 26.





Try our straightforward method of reducing fixed resistor costs.

You can't blame engineers or purchasing agents for trying to save every last penny on resistors these days. But lowest price doesn't necessarily mean lowest cost. For example, most manufacturer's color bands won't stand up to the cleaning methods used to remove excess flux. Or they darken and become illegible from the heat

produced in normal usage. This can mean costly identification errors on your production line. The unnecessary expense of rework. Our solution? A-B quality. Bright, crisp identification of Allen-Bradley's specially formulated paints. Baked on to stay on. Designed to resist aging. Discover the other ways to save money. Ask your nearest

A-B distributor for our free booklet "7 ways to tell the difference in fixed resistors." Or write Allen-Bradley Electronics Division, 1201 South Second Street, Milwaukee, Wisconsin 53204. Export: Bloomfield, New Jersey 07003. Canada: Galt, Ontario. United Kingdom: Bletchley, Bucks.

NEW DIMENSION ELECTRONICS
ALLEN-BRADLEY



Complete RF Network Analysis

115 dB

400 kHz to 500 MHz with 115-dB dynamic range and 0.005-dB resolution. Precise measurements of transmission and reflection properties — magnitude, phase, group delay, and S-parameters — all direct reading and neatly displayed on a built-in scope. Complete characterization of filters, amplifiers, cables, antennas, delay lines, transistors, or most anything else that comes to mind — all at the push of a button.

115 dB! A full 115-dB dynamic range with 80 dB displayed and the ability to measure absolute as well as relative levels — at the twist of a knob. There's more, of course, including computer-controlled systems or other versions tailored to your needs. Look into it. Better yet, see it — in action — in your application.

For a demonstration of this remarkable system, call your local GR center. The price for the basic 1710 RF Network Analyzer? Only \$6850 (*truly remarkable*).

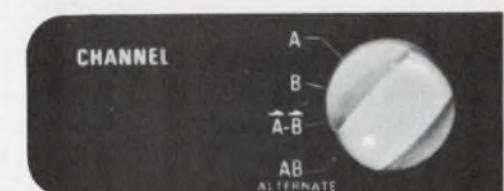
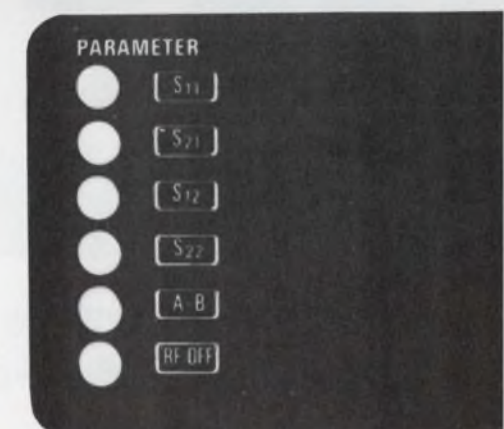
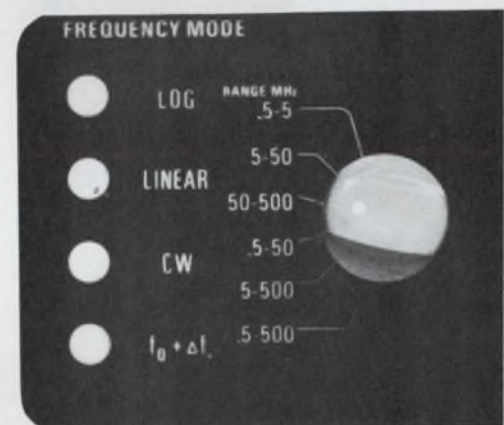
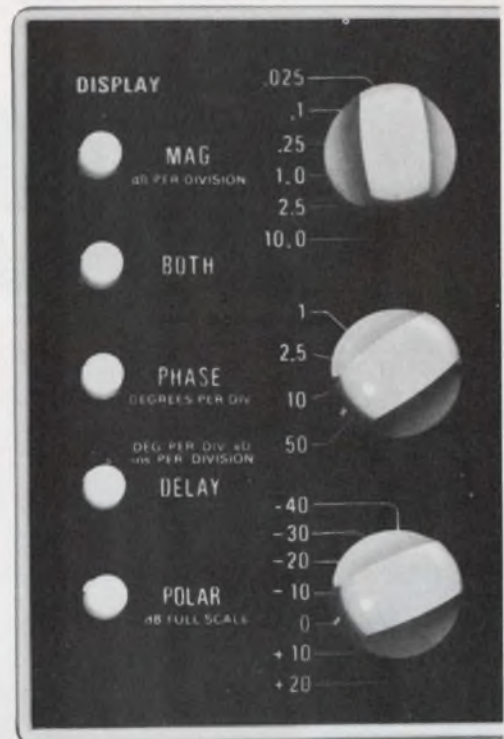

For High-Frequency Measurements



General Radio

300 BAKER AVENUE, CONCORD, MASSACHUSETTS 01742
 NEW YORK (N.Y.) 212 984-2722 (N.J.) 201 791-8990 • BOSTON 817 648-0550
 CHICAGO 312 992-0800 • WASHINGTON, D.C. 301 681-5333 • LOS ANGELES 714 540-9830
 TORONTO 416 252-3395 • ZURICH (01) 55 24 20
 GRASON-STADLER 817 369-3787 • TIME/DATA 415 327-8322

INFORMATION RETRIEVAL NUMBER 2

Siemens

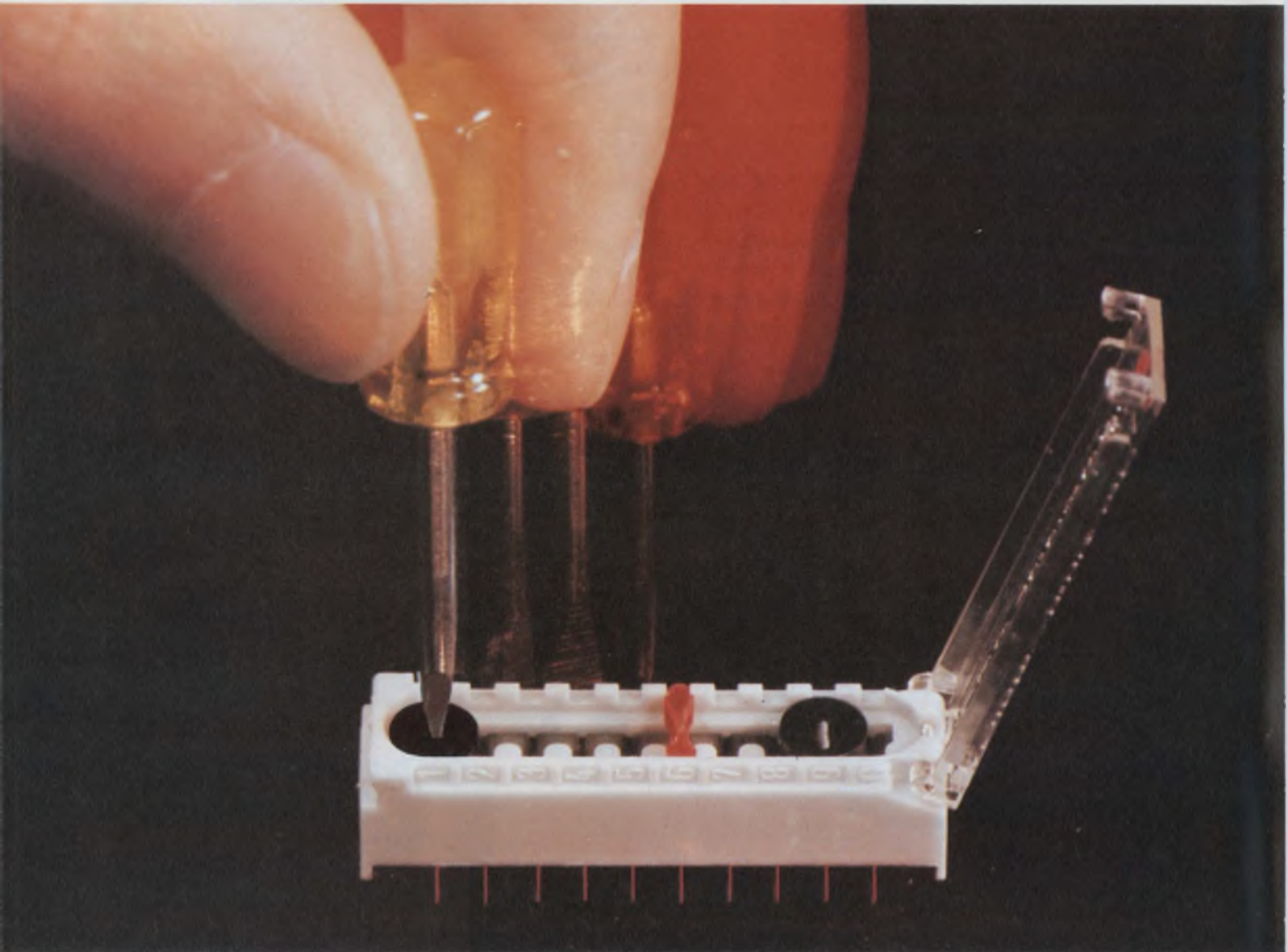

**Introducing the rotary slide switch for PC boards.
Ten positions. Multi-circuit switching. Low profile package.**

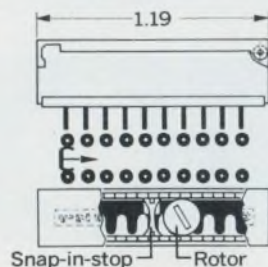

Siemens is introducing a completely new kind of programming switch for closely racked PC boards and for other tight-space applications.

To set the switch just snap open its transparent dust cover and twist the rotor with a screwdriver. This moves the switching element linearly from one of the detented positions to another.

The compact switch has ten pairs of gold-plated contacts and is available with additional rotors for independent switching of up to three circuits. Easy-to-insert snap-in stops separate circuits. Siemens Corporation, 186 Wood Ave. So., Iselin, N.J. 08830. Call 201-494-1000. **SIEMENS**

Electronic Design

FOR ENGINEERS AND ENGINEERING MANAGERS

VOL 20 NO.

4

FEB. 17, 1972

NEWS

- 23 **News Scope**
- 26 **Fiber optics is finding growing use in data transmission—**
and it is beginning to pay handsomely.
- 30 **Ulms (Undersea Long-range Missile System)—**the submarine that
will bristle with new electronics.
- 32 **The single-transistor memory cell** will lead to very small, high density
memory structures at relatively low cost.
- 40 **Technology Abroad**
- 51 **Washington Report**

TECHNOLOGY

- 60 **Israel: The brainy 'Taiwan' of electronics in the Mideast—**A special
report on one of the fastest growing electronics industries in the world.
- 70 **Optimize second-order active filters** by matching the circuit to the required
sensitivity and the filter parameters to in-circuit specifications.
- 76 **Assembling large-array IC memories** calls for these circuits to sense output,
provide timing and control signals, refresh the memory and reduce power.
- 84 **Reduce errors in data transmission** between computer and peripheral input/
output devices using properly designed I/O bus circuits.
- 90 **No design is sacred: It must be sold** to the marketing and manufacturing
sections, says this manager. He does it by organizing his men for 'the
right things to do'.
- 94 **Ideas for Design**

PRODUCTS

- 105 **Instrumentation:** First digital joystick has high rate at low cost.
- 122 **Modules & Subassemblies:** Data acquisition module is cheaper, smaller &
slower.
- 140 **Packaging & Materials:** Dry-transfer method gives fine PC prototype details.
- 118 Data Processing
- 128 ICs & Semiconductors
- 136 Microwaves & Lasers
- 139 Packaging & Materials

Departments

- 59 **Editorial:** Design for price and ride the devaluation
- 7 Letters
- 144 Design Aids
- 145 Application Notes
- 146 New Literature
- 150 Bulletin Board
- 154 Advertisers' Index
- 156 Information Retrieval Card

Cover: Plastic Fiberoptics from the duPont Co., Wilmington, Del.

ELECTRONIC DESIGN is published biweekly by Hayden Publishing Company, Inc., 50 Essex St., Rochelle Park, N.J. 07662 James S. Mulholland, Jr., President. Printed at Brown Printing Co., Inc., Waseca, Minn. Controlled circulation postage paid at Waseca Minn., and New York, N. Y., postage pending Rochelle Park, N. J. Copyright © 1972. Hayden Publishing Company, Inc. 82501 copies this issue.

New Technology Provides Improved System



**Now! Better System
Protection Against
Voltage Transients**

Reliability, Lower Costs With...

MOV™ METAL OXIDE VARISTORS

Are you an electronic equipment designer or manufacturer? You probably have a voltage transient problem . . . and we have the answer — MOV™ varistors which will protect your equipment and absorb dangerous transients. MOV™ varistors provide tight clamping and high energy absorption overcoming many of the limitations of other solutions.

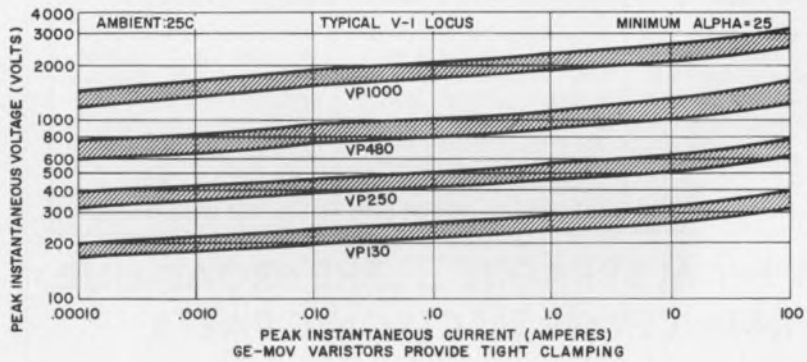

FREE EVALUATION KIT!

MOV™ metal oxide varistors may provide you with a competitive edge. To better evaluate this new answer to greater system reliability, clip and mail the coupon below.

For **FREE SAMPLE** and Evaluation Kit return this coupon to:

General Electric Semiconductor
Electronics Park
Syracuse, N.Y. 13201

IF YOUR HI-LINE AC (RMS) VOLTAGE IS	MAX. PEAK CURRENT AMPS	MAX. ENERGY WATT-SEC	MODEL	CHECK ONE
130V	1000	10	VP130A10	<input type="checkbox"/>
250V	1000	20	VP250A20	<input type="checkbox"/>
420V*	1000	40	VP420B40	<input type="checkbox"/>
460V*	1000	40	VP460B40	<input type="checkbox"/>
480V	1000	40	VP480B40	<input type="checkbox"/>

*Designed for European applications.

Name _____

Company _____

Street _____

City _____ State _____ Zip _____

Applications _____

GENERAL  ELECTRIC

VOICE YOUR CHOICE

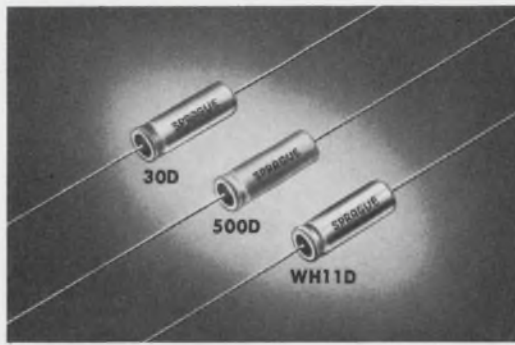

... Sprague makes three!

SMALL ALUMINUM 'LYTIC CAPACITORS

TYPE 30D FOR INDUSTRIAL APPLICATIONS

Will withstand 2000 hr. life test at 85C. Excellent stability, dissipation factor, leakage current. Designed for business machines, instrumentation equipment, etc. Write for Engineering Bulletin 3150A or;

CIRCLE 882 ON SERVICE CARD.

TYPE 500D FOR MODERATE-COST APPLICATIONS

Good operating life characteristics, including stability, ESR, leakage current. Will withstand 1000 hr. life test at 85 C. Ideal for radio, TV, and other entertainment applications. Write for Engineering Bulletin 3149 or;

CIRCLE 883 ON SERVICE CARD.

TYPE WH11D FOR ECONOMY APPLICATIONS

Welded construction, similar to higher-priced capacitors. Widely used in solid-state equipment where cost is of prime importance. Made by Sprague World Trade Corp. in Hong Kong. Write for Engineering Bulletin 3148C or;

CIRCLE 884 ON SERVICE CARD.

MORE FROM SPRAGUE ... THE BROAD-LINE PRODUCER OF ELECTRONIC PARTS

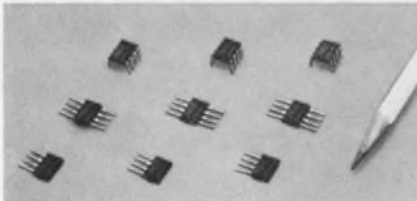

HALL EFFECT SWITCH ICs. Actuated magnetically, not mechanically or optically. Hall generator trigger circuit and signal amplification circuit on single silicon chip. Reliable (no moving parts). Easy interfacing with DTL/TTL/MOS logic. High speed. Low cost. Write for Engineering Bulletin 27,402A or;

CIRCLE 885 ON READER SERVICE CARD.



U.L. LISTED FILTERS. Series JX5000 for EDP equipment and general-purpose use. Rated 125/250 VAC, 0-60 Hz, 1 thru 50 amps. 60 db @ 150 kHz, 80 db from .5 MHz thru 1 GHz. Special designs and rectangular multi-circuit units also available. Write for Engineering Bulletin 8210 or;

CIRCLE 886 ON READER SERVICE CARD.



TYPE 36D POWERLYTIC® CAPACITORS. For use in computer power supplies, control equipment, energy storage, etc. Low impedance construction. Up to 650,000 μ F at 3 V. Ratings from 3 to 450 V. Can be operated at 85 C. Tapped 10-32 terminals simplify filter bank assembly. Write for Engineering Bulletin 3431D or;

CIRCLE 887 ON READER SERVICE CARD.



BLUE JACKET® RESISTORS. Vitreous-enamel power wirewound. Unique all-welded end-cap construction eliminates moisture paths along leads, anchors leads securely to resistor body. Expansion coefficients of vitreous enamel, ceramic body, and end caps are closely matched. Write for Engineering Bulletin 7410E or;

CIRCLE 888 ON READER SERVICE CARD.



TECHNICAL LITERATURE SERVICE, SPRAGUE ELECTRIC CO., 347 MARSHALL ST., NORTH ADAMS, MASS. 01247

48-1117R1

Publisher

Peter Coley

Editors

Editorial Offices
50 Essex St.
Rochelle Park, N.J. 07662
(201) 843-0550
TWX: 710-990 5071
Cable: Haydenpubs Richellepark

Editor: George Rostky

Managing Editors:

Ralph Dobriner
Michael Elphick

Associate Editors:

Jules H. Gilder
Richard Lee Goldberg
John F. Mason
Nathan Sussman
Edward A. Torrero
Richard L. Turmail

Contributing Editor:

Peter N. Budzilovich

Editorial Field Offices

East

Jim McDermott, Eastern Editor
P.O. Box 272
Easthampton, Mass. 01027
(413) 527-3632

West

David N. Kaye, Senior Western Editor
2930 West Imperial Highway
Inglewood, Calif 90303
(213) 757-0183
Les Brock, Western Editor
95 Main St.
Los Altos, Calif. 94022
(415) 941-3084

Washington

Don Byrne, Washington Editor
1111 S. Army Navy Drive
Arlington, Va. 22202
(202) 296-8982

Editorial Production

Dollie S. Viebig

Art

Art Director, William Kelly
Richard Luce
Anthony J. Fischetto

Production

Manager, Thomas V. Sedita
Helen De Polo
Maxine Correal
Anne Molfetas

Circulation

Manager, Nancy L. Merritt
Joan Licari

Information Retrieval

Peggy Long

across the desk

AML concept defended for CATV transmitting

News Scope of Sept. 30, 1971 ("MW System Increases Transmissions to CATV," ED 20, p. 19) contains a number of incorrect comparisons between equipment manufactured by Laser Link Corp. and AML equipment, which our company manufactures.

The article quotes figures to indicate that the price of an AML system is significantly higher than that of a Laser Link system. Actually the total cost of a typical multi-receiver, 12-channel system, including required accessories and antennas, is virtually identical for both Laser Link and AML. For a lesser number of channels, the AML system is actually significantly less expensive. The comparison is based on the published price lists of Laser Link and Theta-Com, dated July 1, 1971, as distributed at the most recent National Cable Television Association convention.

The article refers to a Laser Link claim that its equipment has a significantly longer range than the AML equipment. While Laser Link claims a higher power output, most of this nominal energy is wasted in an unmodulated carrier. Little energy is in the signal-bearing sidebands, because Laser Link must severely limit the modulation index and keep the frequency deviation very low, to stay within the bandwidth allotted by the FCC and to keep the interchannel cross-modulation and intermodulation products tolerable. These undesirable products result from uncontrollable phase nonlinearities and similar distortion in the circuitry and/or the propagation path. As a

result of these problems, we have verified from field measurements that the AML equipment actually has greater range and greater fading margins than does the low-modulation-index Laser Link equipment, despite the latter's supposed higher nominal power output.

The article mentions further that the Laser Link equipment can handle 18 TV channels but that it could handle 32 channels, given a wider bandwidth. This is a complete irrelevancy; no such wider bandwidth is available. With single polarization, AML can handle up to 38 channels within the allotted band, whereas Laser Link's theoretical upper limit is only 18.

Another point mentioned in the article is that AML supposedly transmits in only four directions, whereas Laser Link can transmit in as many as 21 directions. This is not correct. The power output of AML is always split into as many directions as is necessary for the application, whether it be four or 40. What counts is the total amount of useful signal power per channel available.

The article further states that AML "is limited to a single TV channel for each rf carrier." This is not correct, inasmuch as all the channels (up to 38) that can be transmitted by AML employ the same carrier. In actual practice, even that single common carrier is suppressed and not radiated, thus avoiding useless spectrum pollution and radiation of power.

A. H. Sonnenschein

Assistant to the President

Theta-Com

9320 Lincoln Blvd.

Los Angeles, Calif. 90045

(continued on p. 10)

giga-trim capacitors for microcircuit designers



Actual size

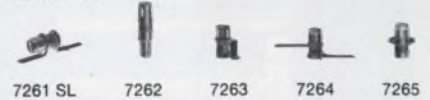

Giga-Trim® (gigahertz-trimmers) are tiny variable capacitors which provide a beautifully straight forward technique to fine tune RF hybrid circuits and MIC's into proper behavior. They replace time consuming cut-and-try adjustment techniques and trimming by interchange of fixed capacitors.

Applications include impedance matching of GHz transistor circuits, series or shunt "gap-trimming" of microstrips, external tweaking of cavities, and fine tuning of crystal oscillators.

Johanson

MANUFACTURING CORPORATION

ROCKAWAY VALLEY ROAD
BOONTON, NEW JERSEY 07005

(201) 334-2676

Electronic Design welcomes the opinions of its readers on the issues raised in the magazine's editorial columns. Address letters to Managing Editor, Electronic Design, 50 Essex St., Rochelle Park, N. J. 07662. Try to keep letters under 200 words. Letters must be signed. Names will be withheld on request.

INFORMATION RETRIEVAL NUMBER 5 ►

(continued from p. 7)

Crabby calculator

It isn't every day that a calculator takes a bath in muddy water and comes out smelling like a rose. But in Jan., 1971, someone swiped a Hewlett-Packard 9100 from the high school in Petaluma, Calif., and, perhaps in fear, pitched it into the muddy waters of the local slough. When it was recovered, HP service technicians flushed away the sand and muck and found one small crab in the logic board.

While not recommending long-term immersion as a standard test for HP equipment, president Bill Hewlett said in the May, 1971, issue of *Measure*, HP's house organ: "Getting the bugs out is one thing; getting the crabs out is another."



The calculator was restored to perfect working condition by replacement of a single transistor. Even the keyboard switches, which one might expect to suffer the most damage, were fine. Not a single one of the 63 gold-cross-point-contact switches (made by Cherry, Waukegan, Ill.) was damaged.

(continued on p. 16)



Everybody's talking about DDC's SR-102 Angle Indicator. And no wonder. It's versatile, accepts synchro or resolver data input with the change of a single pin connector, has broadband capabilities 47 to 1000 Hz, it's DTL and TTL compatible. Tracking accuracy and freedom from drift are guaranteed for the life of the instrument, with no calibration — ever. It's all solid state, of MIL quality parts.

- Accuracy to 0.03°, or about 1.8 minutes of arc in worst-case. Resolution is 0.01°. Frequency range from 47 Hz to 1000 Hz.
- Bright LED readout, fully legible in daylight.
- Tracking to 1080° (3 revolutions) per second without error.
- Built-in test (BITE) circuit detects internal malfunction.
- Model HSR-102 is a high-accuracy version with all the features of the SR-102, but *guaranteed* accurate to 0.01° worst case.

How can DDC do it? Because we make more S/D converters than anyone — which means we have the design capabilities, plus the production facilities to build 'em fast, build 'em good.

Please let us tell you more about the SR 102. And about the rest of our data conversion and signal conditioning devices. Write us, or phone direct to either Steve Muth or Jim Sheahan. (516) 433-5330.



Dual rack mount unit

SYNCHRO CONVERTERS**DDC****ILC DATA DEVICE CORPORATION**

100 TEC STREET, HICKSVILLE, N.Y. 11801 DEPT. ED2-72

INFORMATION RETRIEVAL NUMBER 7

Make the simple move

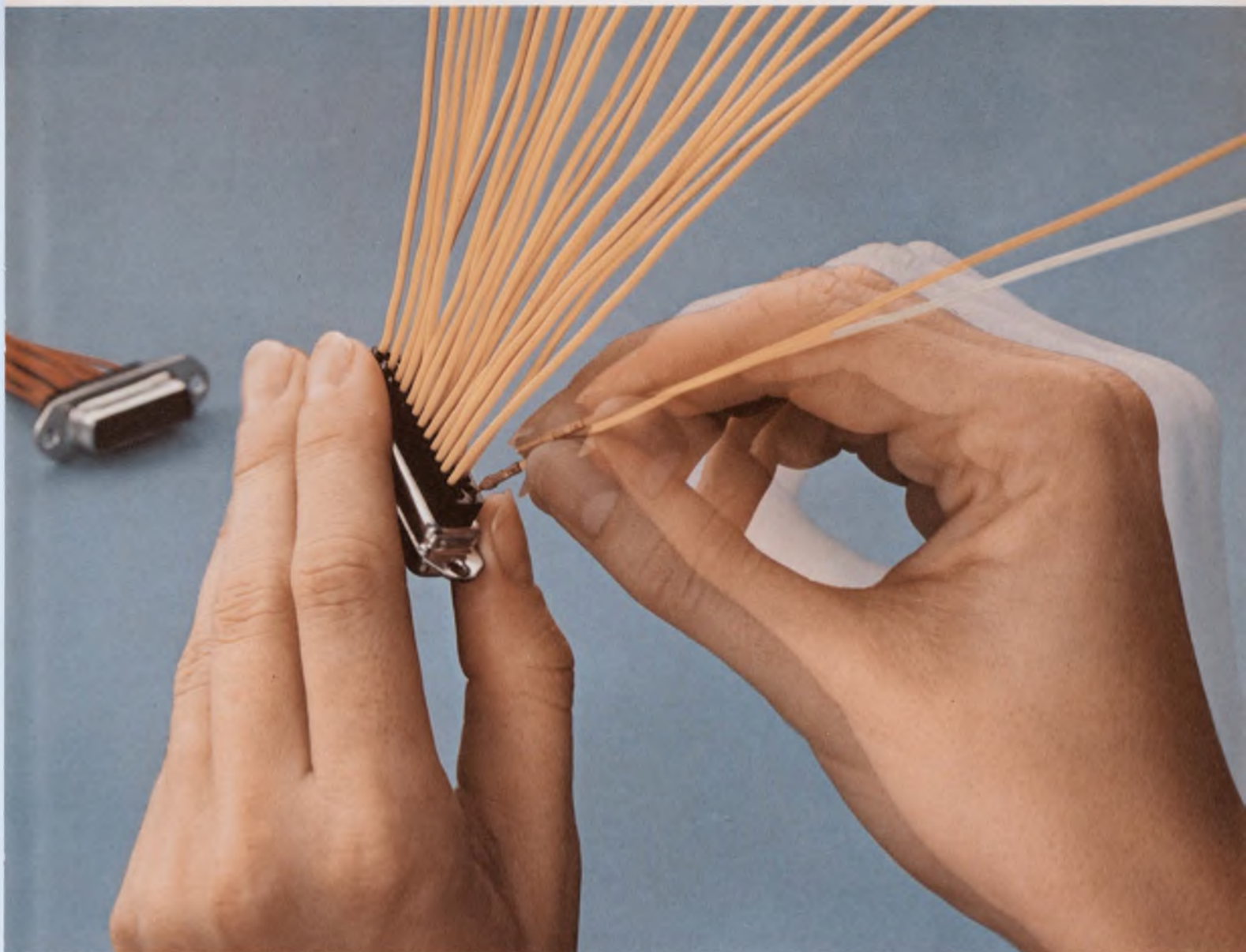

to less assembly time.

Do it the easy way with Amphenol's 17 Series miniature rear-release connectors.

A gentle push from the back of the connector and the contact snaps securely in place. No tools or broken fingernails, just easy fingertip assembly. And to remove the contact for fast-field servicing, insert a simple plastic tool in the back of the connector and out pops the contact.

You can have a choice of screw-machine contacts in bulk packaging, or stamped and formed contacts on a carrier strip. Semi-automatic crimping or hand tools available for either type of contact.

The Min-Rac® 17 Series connectors are available in 9, 15, 25, 37, and 50 contact configurations. All meet EIA Standard RS-232C for data communications input-output connectors. And all are intermountable and intermateable with other Min-Rac 17 Series connectors as well as competitive "D" type connectors.

Find out how simple it really is. Just write Dick Colt asking for the whole story on our Min-Rac 17 Series rear-release connectors. Amphenol Industrial Division, Bunker Ramo Corporation, 1830 South 54th Avenue, Chicago, Illinois 60650.



AMPHENOL

NPE/New Product Engineering, Inc.

wabash

RELIABLE

Right Now



DIP REED RELAY

Our new 814 series 14-pin dual-in-line relay for high density packaging. It is an epoxy molded unit that is automatically insertable and fits IC sockets. Comes as standard product in 1A with nominal coil voltage of 5, 6, 12 or 24 volts. Options available in 2A, 1B and 1C (true form) packages.

SPECIFICATIONS

Current (switch)	0.110 amps
Voltage	28v D.C.
Power (D.C.)	3 watts
Life	up to 50 x 10 ⁴ Operations
Configuration	.100 x .300 pin centers



MERCURY WETTED CONTACT RELAYS

Our expanded 5100 and 5500 series offer a greater variety of P.C. mount and plug-in types. They range from miniature to large 2-switch versions (3-switch version in plug-in) available in sensitive C and D or neutral D contact forms, single-sided or bi-stable coils. Typical applications: isolated power supplies driven from DTL and TTL logic; switching microvolt analog signals; 250 VA equipment requiring speeds up to 100 Hz; and digital circuits needing bounce-free operation.

SPECIFICATIONS

Contact Resistance	50 milliohms max.
Contact Rating	2 amps peak max. 500v peak max. 100 VA peak w/proper contact protection (up to 5A peak max. & 250 VA peak in neutral Form D switches)
Bounce	None
Life	Up to 1 x 10 ⁶ Operations

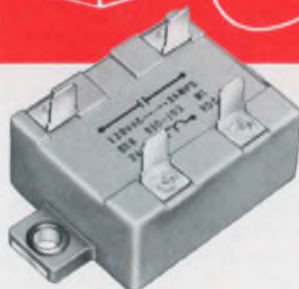
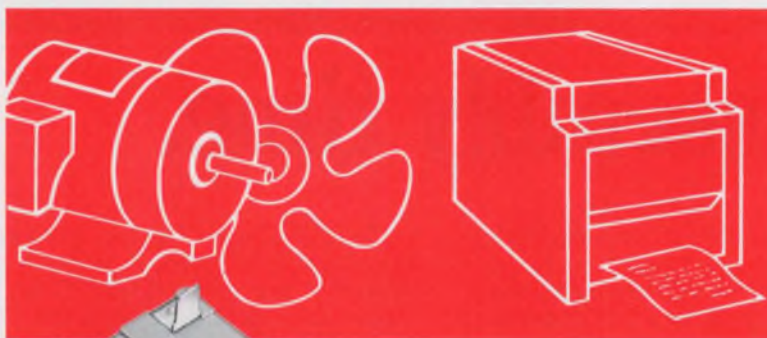

SSR MODULE

The 930 series semi-solid state, standard on-off relay module comes in this low profile package. Provides complete isolation between a low control power input and a high power load. The unit has exceptional switching reliability and is compatible with TTL logic. It can be used to switch inductive, capacitive, tungsten or resistive loads, as in lamps and transformers of office copiers and duplicators; motors, blowers, fans of heating and air conditioning systems; and in valves, solenoids and actuators.

SPECIFICATIONS

Control Voltage (nominal)	5 — 48v D.C.
Load Voltage (maximum)	200 or 400v (peak)
Load Current (maximum)	10 amps A.C.
Life	up to 500 x 10 ⁴ Operations
Size	2.63"L x 1.52"W x .850"H





EXPANDING

... and Right Soon

NOW, OR SOON... ALWAYS RIGHT

Reliability, here and now, is our continuing pledge as we expand to meet new markets. Check the new products we've engineered for delivery **right now**. And look over the ones coming **right soon**. Be certain that because they're from Wabash they come with assurance of best pricing, quality and delivery.

You'll be ordering not from an assembler, but a manufacturer with complete control of **all** components and performing over **3 billion daily** reliability test cycles.

Combined purchases of key materials by all Wabash operating divisions, and proprietary manufacturing efficiencies achieved by NPE during our 10 years of business have resulted in our providing quality products at substantial savings, which we share with you.

We recognize that high quality and competitive pricing have little merit unless you get parts when you need them. We have a reputation for fast delivery — typically 3 weeks lead time.

Call us for **PDQ** service: **Price, Delivery and Quality** — now.

RF REED SWITCHES

The 69-2721 switch is one of the latest additions to our growing family of dry reed switches. Its special switching capability is packaged in the .100" x .750" miniature size capsule. Capable of switching RF signals in multiplexing and video applications, it is used extensively in radio, TV and mobile communications equipment.

SPECIFICATIONS

Current (switch)	0.010 amps
Voltage	28v D.C.
Peak breakdown voltage	300 volts
Power (D.C.)	0.3 watts
Resistance (Initial)	200 milliohms

ALSO READY NOW



SUBMINIATURE REED SWITCHES

The 69-2821 space saver miniature (SSM) is another addition to our family of switches. The .070" x .500" capsule makes it ideal for switching functions where space is at a premium, such as in DIP reed relays, keyboard switches or any other high-density control or switching package.



RF SWITCHING RELAYS

A miniature size package with .100" or .150" x 1.00" pin configuration for switching of RF signals, such as antenna switching where it is necessary to keep talk and receive transmission separated. Applications for this relay include: multiplex, base station, mobile or portable communications equipment.



COMMERCIAL MINIATURE REED RELAY

This miniature size package with .100" x 1.00" pin configuration is tailored to meet commercial requirements at lowest cost.

COMING SOON



ECONOMY REED RELAY

A miniature size relay package specifically designed for consumer goods and commercial OEM users who require low cost electrical switching devices.



HIGH VOLTAGE RELAY

A relay capable of switching loads thru 15 KV. May be used to reverse the polarity of the high voltage source in D.C. power supplies used in office copiers or duplicators, CRT displays and electrostatic air cleaners.



MULTIPLEX REED RELAY

An intermediate size open-frame package with .150" x 1.35" pin configuration for use in multiple switching sequencing operations. Typically used in telephone PBX or intercommunications equipment or video switching in security systems.

wabash

NPE/New Product Engineering, Inc.

a subsidiary of Wabash Magnetics, Inc.

First and Webster Streets, Wabash, Indiana 46992

telephone (219) 563-2191

TWX 810-290-2722

INFORMATION RETRIEVAL NUMBER 9

**Everyone talks
correed reliability,**

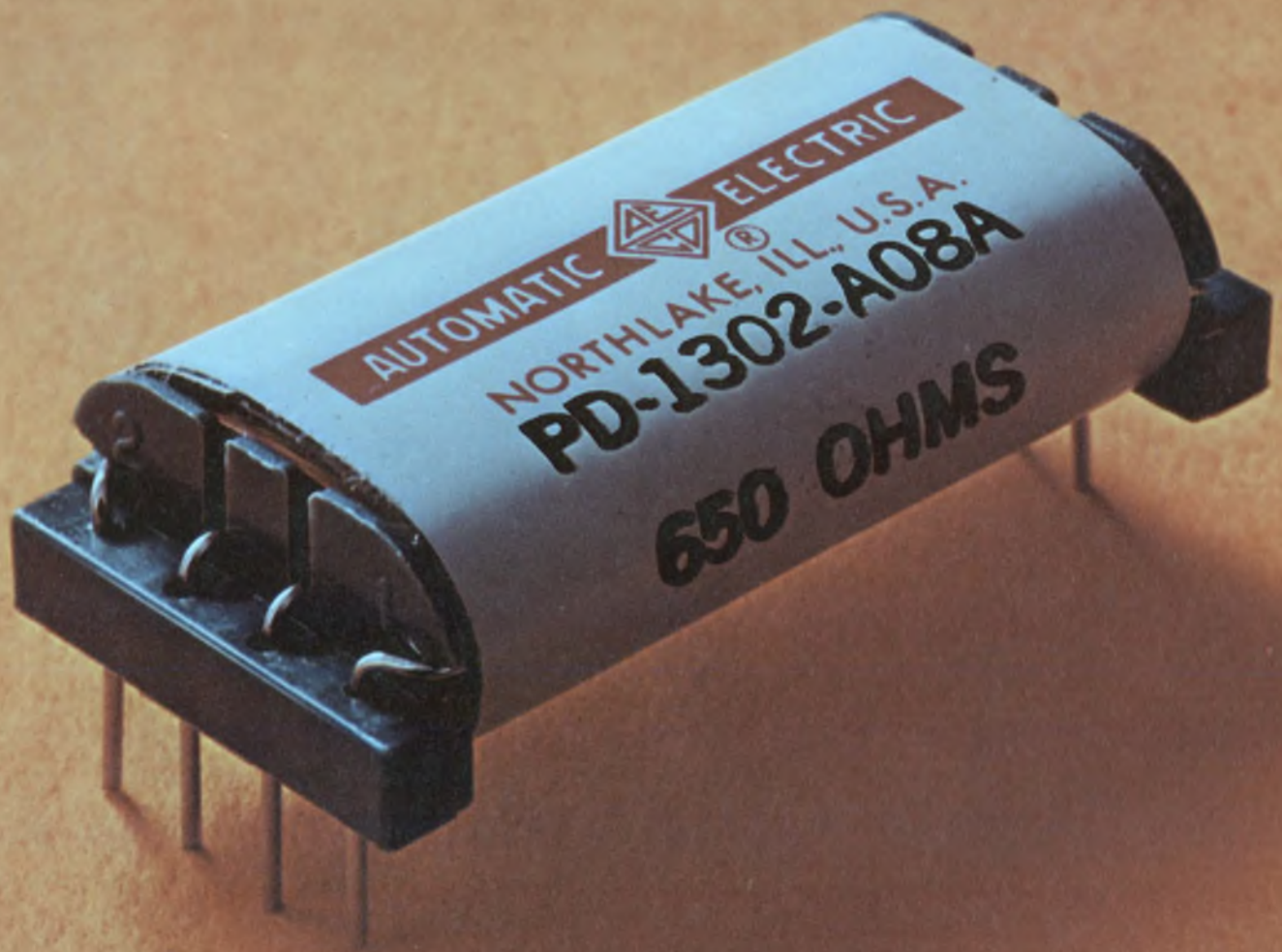

here's the way it looks.



Switches under glass.

The heart of every AE correed is a reed switch consisting of two overlapping blades. For protection, we seal them inside a glass capsule. But only after we pull out all the dirty air and pump in a special, pure atmosphere. That way there's no chance of contact contamination or oxidation. Ever.

Notice our terminals are one piece. A special machine delicately forms them to precision tolerances. It's a lot of work, but one-piece terminals have distinct advantages over the two- and three-piece kind.

For one thing, there's no extra joint so you're always assured of a positive contact. Also, one piece terminals are more reliable when the correed is used to switch low-level analog signals. That's because thermal EMF is reduced to practically zero.

A different kind of bobbin.

Since we go through so much trouble with our correed capsules, we designed a special bobbin to protect them.

It's molded of glass-filled nylon. (You know how plastic chips and cracks.) Moisture and humidity have no effect on this stubborn material. No effect means no malfunctions for you to worry about. No current leakage, either.

Running the full length of the bobbin are a series of slots. They pamper the capsules and keep them from getting damaged or jarred.

And to help you remember which terminal is which, we mold the terminal numbers into the end of the bobbin. You can read them at a glance.

Little things mean a lot.

Reliability means that we pay attention to the little things. Like the tiny pressure rods we use in every miniature correed. They're placed at

each end of the bobbin, across the one-piece terminals. What they do is prevent stresses from being transmitted from the terminals to the reed blades. This keeps the contact gap right on the button. All the time.

The contacts are normally open. To provide them normally closed, we employ another little device—a tiny magnet. It's permanently tucked into a slot next to the reedcapsule. The magnetic action keeps the contacts normally closed.

Coiled by computer.

Once all the parts are secure in the bobbin, we cover them with protective insulation. Around this, we wind the coil. You can be sure the coil winding is correct. It was all figured out for us by computer.

Our next step is to protect the coil. We do that with more protective insulation.

A coat of iron.

On top of the insulation goes a layer of annealed iron. It acts as a magnetic shield and minimizes interaction between coils. Also, it improves the sensitivity of the entire unit. A coat of iron is standard on all AE correeds.

Finally comes super wrap.

To wrap it all up, we use some very special stuff. A layer of mylar laminated material.

It's so tough we guarantee it to withstand all cleaning solvents known to man.



Free Correed Handbook

This 60 page handbook explains advantages and disadvantages of correeds, describes the different types, and tells how to use and test them. To get your free copy, just write John D. Ashby, GTE Automatic Electric, Northlake, Illinois 60164.

GTE AUTOMATIC ELECTRIC

INFORMATION RETRIEVAL NUMBER 10

Rotron's New Vanguard™ Blowers

Have a Lot of GUTS

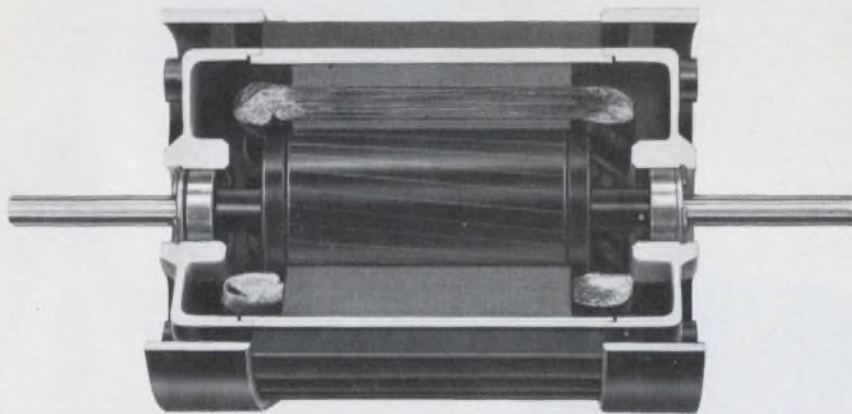

THE ROTRON®-BUILT MULTI-SLOT PSC MOTOR

- PERMANENT SPLIT-CAPACITOR DESIGN
- PERMANENTLY LUBRICATED BALL-BEARINGS
- PRECISION MACHINED ALUMINUM MOTOR HOUSING INSURES LONGER BEARING LIFE
- FINISHED AIR-GAP SURFACES PREVENT CORROSION
- EPOXY GROUND INSULATION

Vanguard blowers provide high volume cooling air for electronic systems and other commercial applications. Their advanced design and rugged construction assure performance and reliability at the lowest noise levels in the industry... at commercial blower prices.

11 models: 5 Simplex, delivering up to 310 cfm; 6 Duplex, delivering over 600 cfm. Configurations and mounting options available to meet a wide variety of installation requirements.

Write today for detailed information. Specify catalog H-3380.

Why settle for less when the best costs no more?



Woodstock, New York 12498 Phone 914 • 679-2401 TWX 510-247-9033

PACIFIC DIVISION, Burbank, California 91506, Phone 213 • 849-7871

ROTRON N.V., Breda, The Netherlands, Phone: 49550, Telex 844-54074

14890

INFORMATION RETRIEVAL NUMBER 11

ACROSS THE DESK

(continued from p. 10)

Editorial stirs thoughts on job obsolescence

I read your editorial in the Nov. 11 issue ("Wanted: 20 Years' Experience; Older Men Need Not Apply") and the *Harvard Business Review* article on which it was based. Both accept the reality of technical obsolescence, which is something that gets worse the longer an engineer is out of school.

To gain a better understanding of the problem, I compared a recent college catalog with a 20-year-old one. I found that over 90% of the course work remained essentially unchanged through the comparison period. The 10% of the new work—semiconductors, digital systems, mostly—should be known to the practicing engineer in 20 years of reading IEEE publications, your magazine and other readily available material.

I conclude that although time since graduation may be a measure of obsolescence, the act of graduating is not a cause of it. This is borne out by an interesting finding in the *Harvard* article: taking courses after graduation does not slow obsolescence.

I observed in the college catalog that the school still is graduating one principal product—the electrical engineer. But in the classified ads, I find that what is wanted is the sales engineer, uhf engineer, audio/visual engineer, attack console engineer, radar systems engineer and so on. Obsolescence lies in the difference between the generalist who graduates from college and the specialist employed in the commercial world. Somewhere along this road the engineer becomes a technician, or at least is thought to become a technician able to work only in his speciality.

One way to stay ahead in this game is to specialize in the newest technology, as suggested in your editorial. But this approach extends and compounds the present problem, for the day will come when the new technology becomes obsolete.

Jack Althouse

Palomar Engineers
Box 455
Escondido, Calif. 92025

THE PRAM™

The first 4-channel programmable op amp. With more application possibilities than we could possibly list on this page.

HA-2400/2404/2405

Take a good look at this new linear building block. It's unique and so versatile we keep discovering more and more applications for it.

Each PRAM contains four preamplifier sections, one of which is selected through the DTL/TTL compatible inputs and connected to the output amplifier. The selected analog input terminals and the output terminal form a high performance operational amplifier for just about any use you can dream up. And we hope you'll dream up some. If you do, send them along to us and we'll see what we can dream up by way of a reward.

Features.

Offset current 5nA

Voltage gain 150K

Slew rate

$A_v = +1 \pm 15V/\mu s$

$A_v = +10 \pm 50V/\mu s$

Gain Bandwidth Product

$A_v = +1 \quad 8MHz$

$A_v = +10 \quad 40MHz$

DTL/TTL compatible

0° to +75°C

-25°C to +85°C

-55°C to +125°C

100-999 units

\$10.45

\$15.95

\$23.65

For more details on the PRAM contact your Harris representative or distributor.

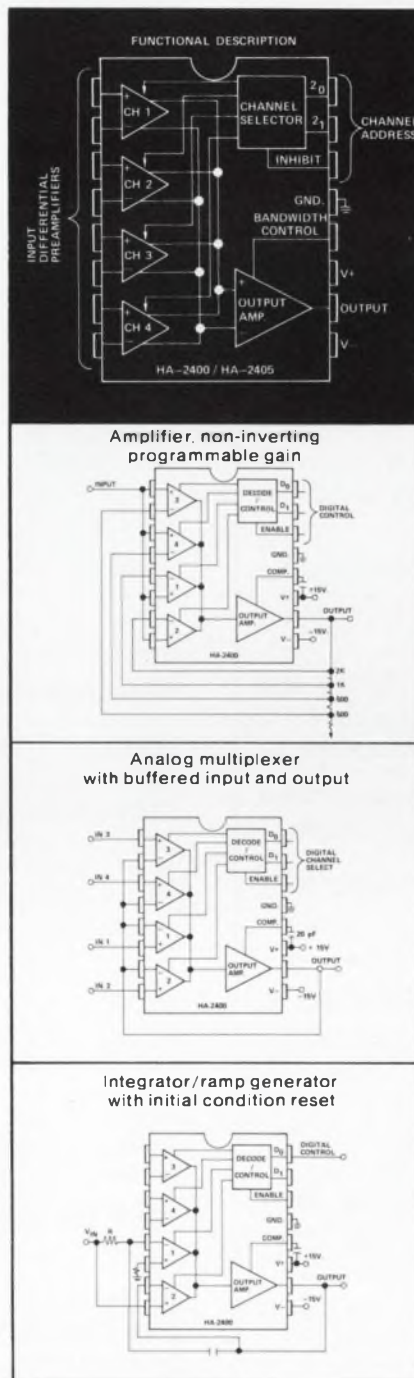

More challenges:

The foregoing diagrams show just three of many applications we've designed using the PRAM. The following lists other possibilities we haven't had time yet to prove out. Why don't you try your hand at designing them or any other ideas you come up with, and send them to:

E. Fernandez
P.O. Box 883
Melbourne, Florida 32901.

A to D converter, Dual Slope Integrating

Active Filter, State Variable Type with Programmable Frequency and/or Programmable "Q"

Amplifier with Programmable D.C. Level Shift

Chopper Amplifiers

Crossbar Switches

Current Source, Programmable

F.M. Stereo Modulator

F.S.K. Modem

Function Generators, Programmable

Gyrator, Programmable

Monostable Multivibrator, Programmable

Multiplier, Pulse Averaging

Peak Detector with Reset

Resistance Bridge Amplifier/Comparator with Programmable Range

Sense Amp/Line Receiver with Programmable Threshold

Spectrum Analyzer, Scanning Type



HARRIS SEMICONDUCTOR
A DIVISION OF HARRIS-INTERTYPE CORPORATION
P.O. Box 883, Melbourne, Florida 32901
(305) 727-5430

DISTRIBUTORS: Schwaber Electronics: Westbury, New York (516) 334-7474; Rockville, Maryland (301) 881-2970; Hollywood, Florida (305) 927-0511 / Harvey/R & D Electronics: Lexington, Massachusetts (617) 861-9200 / Semiconductor Specialists, Inc.: Chicago (312) 279-1000; Detroit (313) 255-0300; Minneapolis (612) 884-8132; Kansas City (816) 452-3900; St. Louis (314) 428-6100; Dallas (214) 358-5211; Indianapolis (317) 243-8271; Pittsburgh (412) 781-8120; Dayton (513) 278-9455 / R.V. Weatherford Co.: Albuquerque (505) 265-5671; Anaheim (714) 547-0891; Austin (512) Enterprise 1443; Dallas (214) 231-6051; Denver (303) 427-3736; Glendale (213) 849-3451; Houston (713) Enterprise 1443; Palo Alto (415) 321-5373; Phoenix (602) 272-7144; Pomona (714) 623-1261; San Diego (714) 278-7400; Seattle (206) 762-4200 **HARRIS SALES OFFICES:** Wellesley, Massachusetts (617) 237-5430; Wayne, Pennsylvania (215) 687-6680; Palos Heights, Illinois (312) 597-7510; Melbourne, Florida (305) 727-5430; Palo Alto, California (415) 321-2280; Norwalk, Connecticut (203) 853-3646; Washington, D.C. (202) 337-4914; Dallas, Texas (214) 231-9031; Scottsdale, Arizona (602) 946-3556; Long Beach, California (213) 426-7687

INFORMATION RETRIEVAL NUMBER 121

Candidate for the PE license this year?

Use these up-to-date guides...
specifically tailored for
your study campaign

HAYDEN PROFESSIONAL ENGINEERING EXAMINATION SERIES

LAWRENCE J. HOLLANDER, Editor-in-Chief,
Professional Engineer, New York State

Written with your needs kept foremost,
these study guides offer . . .

- a wide selection of actual, realistic problems from recent state examinations arranged by subject for convenient study
- detailed step-by-step solutions that bring out underlying principles to equip you to handle the unexpected
- concise background discussions precede the problems, presenting you with a mini-review of theory, principles, terminology
- separate tables of contents for subjects and problems quickly pinpoint the specifics for rapid review or "open book" examinations
- numerous schematic diagrams and detailed drawings to insure in-depth understanding

Review the books that concern you for
15 full days—FREE!

FOR 15-DAY FREE EXAMINATION

Please send the book(s) circled below on a 15-day examination basis. At the end of that time, I will remit payment, plus postage, or return the book(s) without further obligation.

5712-1 5715-6 5716-4

(For those ordering by ISBN, the Hayden Prefix is: 0-8104)

Save money! On all prepaid orders Hayden pays postage —
same 15-day return guarantee! 72-29 ED

Name _____

Firm _____

Address _____

City/State _____ Zip _____



HAYDEN BOOK COMPANY, INC.
116 West 14th St., New York, N.Y. 10011

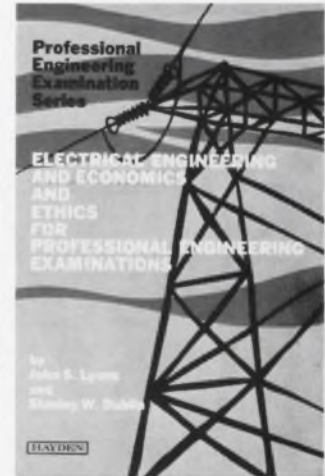
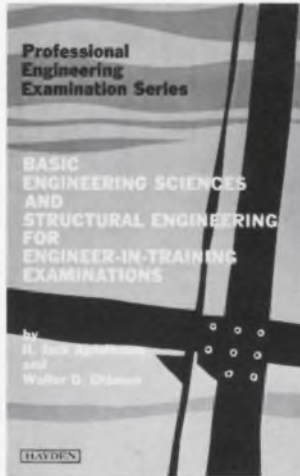

BASIC ENGINEERING SCIENCES AND STRUCTURAL ENGINEERING FOR ENGINEER-IN-TRAINING EXAMINATIONS

H. JACK APFELBAUM, P.E., Department of Mechanical Engineering, Lowell
Technological Institute; and WALTER O. OTTESEN, P.E., Patent Counsel

Nearly 200 solved problems selected from a nationwide survey of recent E-I-T examinations offer you a complete, well organized review of the concepts and techniques that must be understood to successfully pass the preliminary exam. Unlike other study guides that stress one aspect of the field while shortchanging others, this volume provides balanced coverage of the three broad engineering areas: *the basic sciences*: mathematics, physics, and chemistry; *the engineering sciences*: statics, dynamics, fluid mechanics, thermodynamics, electricity, and engineering economy; and *structural engineering*. More than 300 detailed illustrations pinpoint key concepts and problem-solving techniques.

408 pp., 6 x 9, illus., cloth, #5712-1, \$13.95

ELECTRICAL ENGINEERING AND ECONOMICS AND ETHICS FOR PROFESSIONAL ENGINEERING EXAMINATIONS

JOHN S. LYONS, P.E., and STANLEY W. DUBLIN, Institute of Environmental
Medicine, New York University Medical Center

Concentrating on the subjects and topics that form the foundation of this rapidly changing technology, this book analyzes and solves for you almost 100 problems from a nationwide sampling of recent PE examinations. Its comprehensive, up-to-date coverage includes materials and problems not found in other guides of this type, such as electrical-magnetic-thermal analogs, semiconductors, and power system short circuits. More than 170 detailed illustrations are included. The separate section devoted to economics and ethics features an unusual approach to such topics as interest, costs, valuation, and others—the summarized use of formulas in solving nearly 50 typical problems.

302 pp., 6 x 9, illus., cloth, #5715-6, \$12.95

also available

MECHANICAL ENGINEERING AND ECONOMICS AND ETHICS FOR PROFESSIONAL ENGINEERING EXAMINATIONS

EUGENE STAMPER, P.E., and STANLEY DUBLIN

Over 200 solved problems in mechanical engineering, along with the same thorough coverage of economics and ethics.

392 pp., 6 x 9, illus., cloth, #5716-4, \$14.95



Module assembly carriers minimize handling and speed material flow in "high speed assembly/solder line."

Not just another line of converters!

No other converter line gives you:

- Three built-in analog voltage ranges
- Slaveable precision internal reference
- Actively trimmed resistors
- Full monotonicity
- Stabilization bake

And no one else "systems designs" their converters to simplify your design problems. Here's real product designing:

- Dip Socket compatibility
- Pin selectable analog voltages
- External reference input
- Short circuit proof output
- Package compatibility

It's no wonder engineers are asking about our line . . . 32 versions to choose from!

What other conversion line can claim:

- "Stabilization bake" from 16-48 hr. @ 85°C
- MTBF ratings of over 1,000,000 hr. (@ 70°C) for DAC's, and over 500,000 hr. for ADC's.

When you match performance with price, you'll agree we have a winning line. And if you need complete data acquisition systems, we have those too! Both standard and custom.

Call or send for complete catalog and applications brochures today. (415) 686-6660, TWX (910) 481-9477.

Conversion Products Specialists



1000 Chalomar Road
Concord, CA 94520

**P&B solid state
hybrid relays work
up to 100 times longer
than conventional relays.
More than 10^7 operations.**

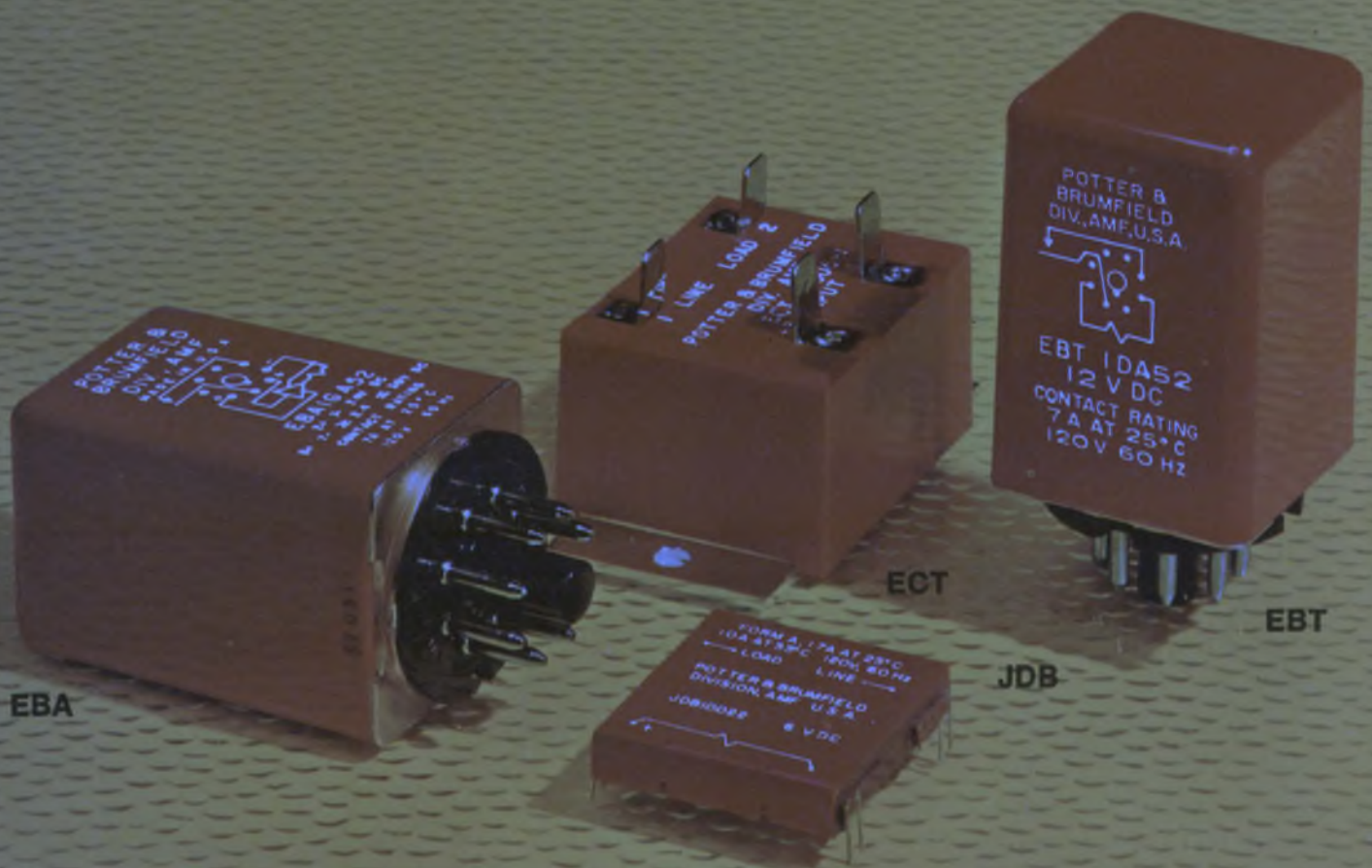

The expected minimum life of P&B Solid State Hybrid Relays is in excess of 10 million operations for standard load current and ambient temperature combinations.

This uncommon longevity, plus exceptional reliability and a wide range of switching options, offers solutions to many critical switching problems. For example, you can interface semiconductor logic circuits with inductive loads like motors, solenoids and contactors.

P&B Solid State Hybrids will switch up to 7 ampere loads with input control signals as low as 60 microwatts. And they come in a variety of package sizes and terminal styles.

Special triac, special reed

P&B Hybrids owe much of their reliability and outstanding performance to the combining of a reed relay and triac, each having characteristics specially selected to complement the other. This careful mating of semiconductor and relay greatly enhances the reliability of each and, in combination, produces a switching function of consistently superior performance.

Special snubber network

The internal RC network across the "contact" is tailored to the

triac specifications and "contact" load ratings to limit sporadic, transient-induced conduction, to provide reliable turn-off of inductive loads, yet to minimize the off-state 60 Hz leakage current.

EBT Series switches

7 amps, 60 Hz @ 25° C ambient with normal load voltage of 120 V. Rated 5 amps. rms 60 Hz @ 55° C ambient. Operate time, 2 msec. Release time, 10 msec. Coil voltages from 6 to 48 VDC at nominal power of 290 mW. Has conventional octal-type plug-in terminals for mounting convenience. Fits P&B KR Series 8-pin sockets for conversion to screw terminals.



EBA Series has the same switching characteristics, package and mounting of EBT, but with control signal amplifier. Standard sensitivity is 60 microwatts. Requires 12, 18, or 24 VDC supply.



ECT Series has similar specifications as EBT but with a special

package designed for direct to chassis mounting. Widely used in business machines and appliances. The ECT has quick-connect terminals. Screw-terminal adapters available.



JDB Series is a Dual Thin-Line reed-triggered triac for use on printed circuit boards. Designed for interfacing solid state circuits to 120 V 60 Hz loads such as contactors, fractional HP motors and solenoids. Form A contacts will switch 1.7 amps. at 25° C ambient or 1.0 A rms 60 Hz at 55° C ambient.



Potter & Brumfield Solid State Hybrid relays are available from leading electronic parts distributors. For complete information call or write your nearest P&B representative or Potter & Brumfield Division of AMF Incorporated, Princeton, Indiana 47670. Telephone 812 385-5251. In Europe, AMF International Limited, Oxford, Oxon, England and AMF Elettica, S.p.A., Milan, Italy.



P&B makes more of more kinds of relays than anybody in the business.

Anybody.

POWERTEC'S THE NAME WINNING'S THE GAME

4 NEW DC POWER SUPPLIES

ALL MODELS DELIVERABLE FROM STOCK IN 24 HOURS

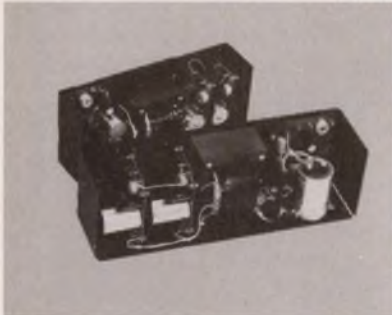
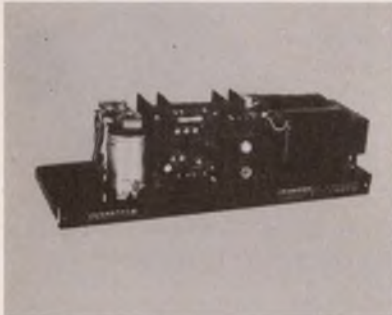
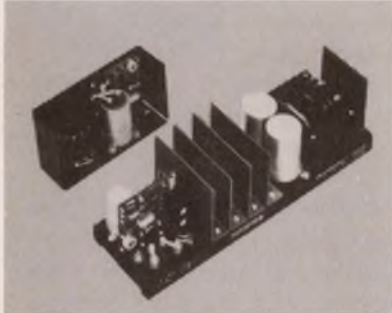

OEM Power Supplies

Model Number	*(5)		*(16)		*(24)			Unit Price
	5V	6V	12V	15V	18V	20V	24V	
2B(*)	3A	2.5A	1.5A	1.3A	1.0A	1.0A	1.0A	\$ 24.95
2C(*)	6A	5A	3.0A	2.8A	2.0A	2.3A	2.3A	\$ 44.00
2D(*)	12A	10A	6.5A	6.0A	4.5A	5.0A	5.0A	\$ 76.00
2E(*)	25A	23A	15A	14A	10A	12A	11A	\$129.00
2F(*)	50A	46A	30A	28A	20A	24A	22A	\$219.00
2G(*)	75A	68A	45A	42A	30A	36A	33A	\$299.00

Specifications REGULATION: Line $\pm 0.5\%$; Load $\pm 0.5\%$; INPUT: 115 VAC $\pm 10V$ 47-63 Hz; RIPPLE: 1 mV RMS (5 & 15V), 3 mV RMS (24V); O.L. PROTECTION: current limit foldback; RESPONSE: 50 usec typical; TEMPERATURE: 0°C to 40°C derated to 71°C; OVP: optional

CR Power Supplies

Model Number	Output Power		Unit Price
	12 to 25V	24 to 50V	
10B300	12A	6A	\$129.00
10C600	24A	12A	\$187.00

Specifications INPUT: 115 VAC $\pm 10V$, 47-63 Hz; REGULATION: Line $\pm 1\%$, Load $\pm 1\%$; TEMPERATURE: 0°C to 40°C - derated to 71°C; O.L. PROTECTION: circuit breaker; RIPPLE: 300 mV/25V, 600 mV/50V (150 mV/25V, 300 mV/50V with ORR module).

Multiple Output OEM Power Supplies

Model Number	Output Power			Unit Price
	+12V or +15V		5V	
2K15D-1.3	1.5A	1.3A	NA	\$ 46.00
2L15D-2.8	3.0A	2.8A	NA	\$ 81.00
2R-70T	1.5A	1.3A	6.0A	\$ 86.00
2S-140T	3.0A	2.8A	12.0A	\$149.00

Specifications REGULATION: Line $\pm 0.25\%$, Load $\pm 0.25\%$; INPUT: 115 VAC $\pm 10V$ 47-63 Hz; RIPPLE: 1 mV RMS (5 & 15V); RESPONSE: 50 usec typical; TEMPERATURE: 0°C to 40°C derated to 71°C; O.L. PROTECTION: current limit/foldback; OVP: optional.

DC Power Regulators (2 7/8" x 2 3/4" x 1 3/16")

90 WATT MODEL	DC OUTPUT		180 WATT MODEL	DC OUTPUT	
	VOLTS	AMPS		VOLTS	AMPS
1B5-6	4.5-6.5	6.0	1C5-12	4.5-6.5	12.0
1B15-6	11.5-15.5	6.0	1C15-12	11.5-15.5	12.0
1B24-4.5	17.5-24.5	4.5	1C24-8	17.5-24.5	8.0
Unit price	\$15.00		Unit price	\$22.00	

Specifications INPUT VOLTAGE (MAX.): 40 VDC; REGULATION: Line $\pm 0.75\%$, Load $\pm 0.75\%$; INPUT-OUTPUT DIFFERENTIAL (MIN.): 4.5 VDC; OUTPUT RIPPLE (MAX.): 4 mV P-P (2.0V P-P input ripple); OPERATION AMBIENT TEMP.: -5° to +75°C; TRANSIENT RESPONSE: 25 usec. (50% load change).

Request free application data and catalog.

POWERTEC INC. an Airtronics subsidiary
9168 De Soto Ave., Chatsworth, California 91311 (213) 882-0004 TWX 910-494-2092

AZ. Scottsdale, Hamilton (602) 948-3661
CAL. Los Angeles, Burtis (213) 670-5863
CAL. Santa Clara, Richards (408) 246-5860
COLO. Denver, D.E. Bond (303) 756-1234
FLA. Miami Beach, Geartner (305) 531-0200
FLA. Orlando, Geartner (305) 299-1000

IND. Indianapolis, Holsapple (317) 894-0513
MD. Annapolis, Hayden (202) 296-6059
MASS. Needham, Garrettson (617) 449-2640
MINN. Minneapolis, Comstrand (612) 560-5300
MO. St. Louis, P.A.C. (314) 426-2331
N.M. Albuquerque, D.E. Bond (505) 296-9111

N.Y. White Plains, Garrettson (914) 946-3001
N.Y. Williston Park, Garrettson (516) 747-6610
PA. Philadelphia, Garrettson (215) 464-2275
TEX. Dallas, Reese (214) 638-6575
TEX. Houston, Reese (713) 621-3134
WASH. Bellevue, A. Smith (206) 746-6770

Who's into back planes? You are. Cinch is.

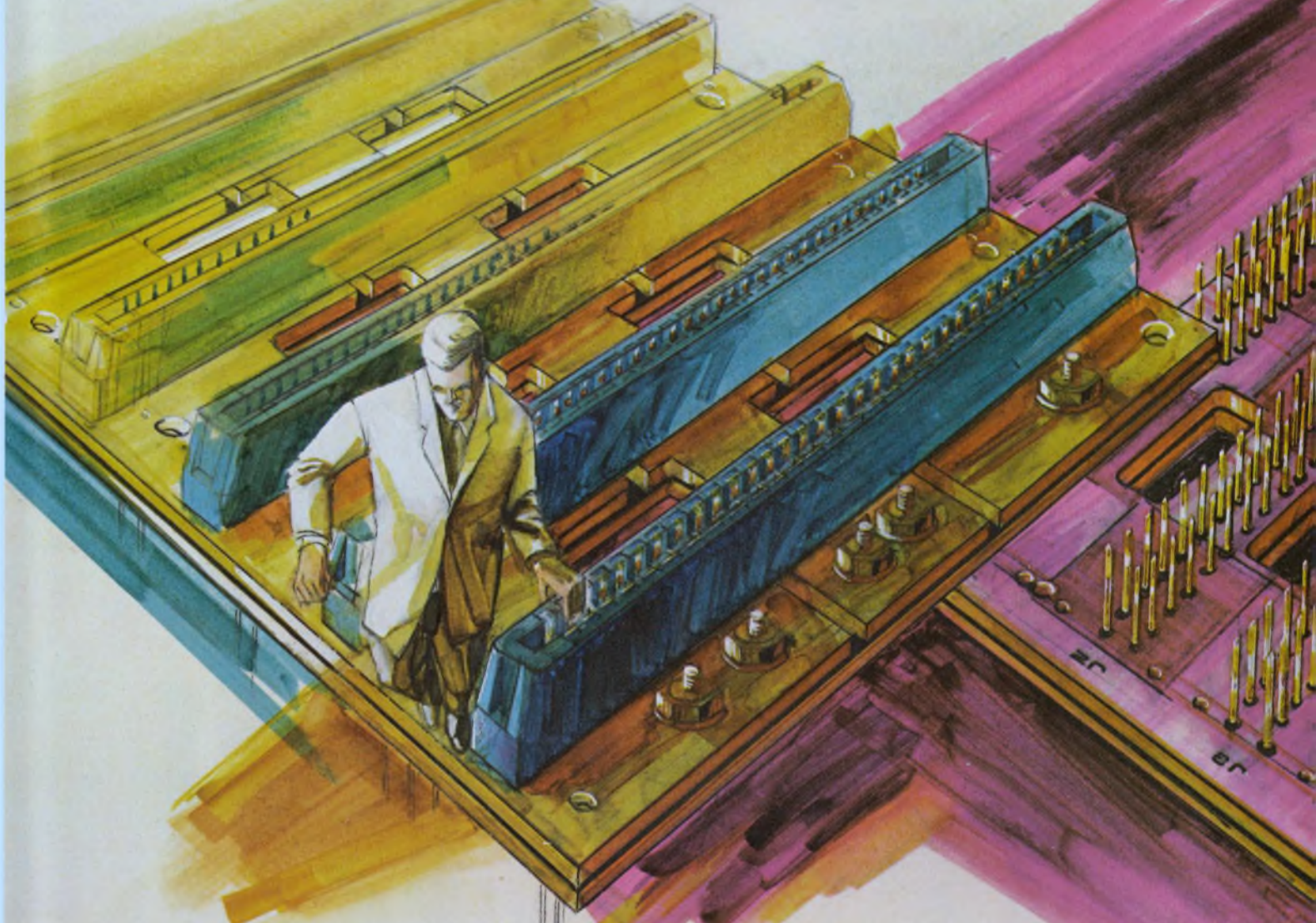

For high density packaging, back plane connector systems are the way to go, especially in producing computers and peripherals.

Cinch can tell you all about back plane connector systems . . . because we wrote the book on them (Our Catalog C-164). Cinch back plane connector systems offer seven important efficiency and economy features:

1. *Replaceable buss bars that permit removal and replacement of individual bussing contacts.*
2. *Easily replaceable individual voltage plane and ground plane contacts.*
3. *Preloaded cantilevered or tuning fork contacts on .100", .125", .150" or .200" centers.*
4. *Uniform contact alignment and closely con-*

trolled insertion forces through simultaneous insertion of entire contact rows.

5. *Selectively gold-plated contacts to reduce costs.*
6. *Precision monoblock or modular connector bodies.*
7. *Specially designed molded styrofoam carriers that eliminate damage in transit.*

If you're into back planes already, you've probably talked to Cinch. If you're not into them yet, you ought to talk to us. Call us at (312) 439-8800, and we'll fly out to see you. Incidentally the book—Catalog C-164—is free, from your Cinch sales office or Cinch Connectors, an Operation of TRW Electronic Components, 1501 Morse Avenue, Elk Grove Village, Illinois 60007.

C -7200

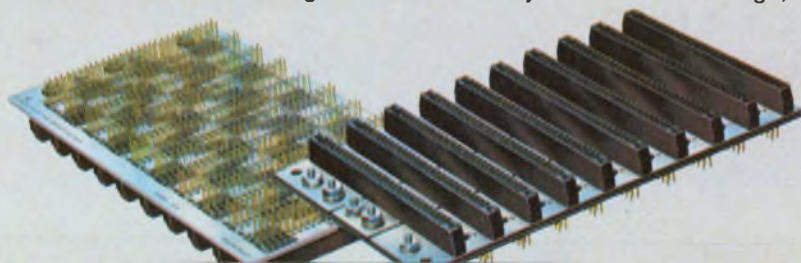

TRW[®]
CINCH CONNECTORS

VACTEC PHOTOCELLS *in the rocks*

The finest imported gin, ice and vermouth mixture can't penetrate Vactec's positive hermetic seals. Even the plastic passivated types are exceptionally stable. Other environmental extremes are just as routinely endured by Vactec Photocells. Capable of storage from -55°C to 85°C . Continuing to operate at liquid nitrogen cold (-196°C), and up to boiling water (100°C).

You simply can't buy a better photocell *anywhere*, and Vactec is competitive with import prices because of automated processing, assembling, and testing. Take advantage of Vactec engineering, research, and manufacturing in the heart of America. Because Vactec has 249 different types of cells in stock, we can ship before your order reaches an overseas supplier. Included is a complete line of visible detectors: photoconductors (CdS and CdSe); photo-voltaic cells (Se and Si); couplers of LED's or lamps and photoconductors called Vactrols. Vactec also has a photometer which measures from .0002 to 10,000 fc, for as little as \$300.00.

You needn't compromise. Vactec has it all. Quality, economy, and service.

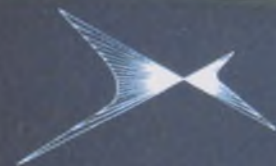

VACTEC, INC.

2423 Northline Industrial Blvd.
Maryland Heights, Mo. 63043
Phone (314) 872 8300

Industry group formed to fight trade barriers

Five electronics manufacturers have banded together in an attempt to rally industry and Government action against international trade barriers, especially Japanese restraints.

The five—Magnavox, GTE Sylvania, Zenith Radio, Corning Glass Works and Stackpole Carbon—have formed the Electronic Industry Committee for Fair International Trade and are seeking support from the more than 120 producers of electronic parts, components and materials. They decided on a joint approach after years of unsuccessful individual efforts to remove trade barriers.

The committee contends:

- About 121,000 jobs were lost in this country from 1965 to 1970 because of foreign competition.

- The U.S. balance-of-trade deficit in consumer electronic products and components exceeded \$1-billion in 1970 and promises to rise to \$3.5-billion by 1976.

- Imports captured 96% of the U.S. tape-recorder market, 92% of the radio market and almost 40% of the television receiver market.

- President Nixon's new economic policy and the recent devaluation of the dollar in foreign markets is of some help, but is still ineffective in halting the rising tide of imports.

A basic problem, according to Robert H. Platt, president of Magnavox, is that when the U.S. gave Japan technical expertise and reduced import duties on electronic components in the 1940s and '50s—all to support Japan's fledgling electronics industry—the Japanese exploited the assistance. Now Japan has a favored position in the U.S. consumer market; while not granting reciprocal access to her market, Platt says.

This inequity, the Magnavox president asserts, has continued

long beyond the time when it should have been remedied.

In a position paper, the committee notes that in addition to high Japanese tariffs on American consumer electronic products, there are also such barriers as border taxes and export rebates for Japanese manufacturers. The net effect, the committee says, is that U.S. manufacturers of consumer products and components pay an average of 23.3% in Japanese duties, compared with an average of 5% that the Japanese pay in the U.S.

What action is the committee planning?

"Firstly," says Henry Frailey, vice president of Corning Glass and general manager of its Television Products Div., "we're going to explain our position to everyone we can, from Congressmen to people from the Departments of State, Commerce and Treasury. We're going to try and get them to enforce trade laws that are already on the books. These include the antidumping regulations and the countervailing duty law, which will impose taxes equal to the amount a foreign manufacturer receives as a subsidy from his government."

Finally, Frailey reports, the committee is going to try to get the U.S. Government to negotiate with Japan to eliminate trade barriers.

Wire technicians aided by voice of a computer

Technicians who wire electronic modules in Western Electric Co.'s Oklahoma City plant are getting their instructions orally, step by step, from a friendly computer. The computer first works out the most efficient work sequence for

a particular job and "speaks" the wiring instructions directly to an automatic recorder.

The recording is then put into a cassette tape player equipped with a foot pedal for control. The technician can start and stop the recorded voice, according to need.

Using computers to calculate efficient wiring instructions isn't new. But formerly the instructions were printed out and then read by a human announcer to a recorder. These recordings had to be checked by a technician to see if the announcer had made a mistake. Because of the frequent changes that can be expected in hand-wiring operations, remaking these recordings is tedious and time-consuming. Letting the computer do the talking, however, is faster and eliminates human error.



Taped "voice" of a computer gives technician step-by-step instructions.

Despite the machine's accent, the technician had no difficulty in understanding synthetic speech, reports J. L. Flanagan, head of the Acoustics Research Dept. of Bell Telephone Laboratories, Murray Hill, N.J., where the technique was developed. "In fact," Flanagan said, "the technician remarked that the 'caricatured' nature of the computer speech made it easier to understand in competition with typical plant noises."

The wire-instruction system in Oklahoma City is an outgrowth of previously announced computer techniques for synthesizing speech from stored digital data, with the latter representing the characteristic formants (or resonances) in human speech.

With these techniques, individually spoken words are analyzed for characteristic formants and

stored in the disc of a PDP-516 computer. When a particular answer-word sequence is needed, the required formants are accessed and linked together. Finally the formant, pitch and timing data are sent to a digital filter, which simulates the resonances of the human vocal tract. The filter output is converted from digital to analog form to produce synthetic speech.

For the Oklahoma City operation, the wire-list information was generated originally as a deck of punched cards. The card deck was then put into the card reader of the PDP-516 computer and the spoken wiring instructions were synthesized. The output of the digital-to-analog converter was recorded by a computer-controlled analog tape recorder. The tape was put into a cassette for playback by the technician.

While the large storage capacity and flexibility of this system are not required for the limited vocabulary of a wire list, the speed of the automatic system facilitates frequent changes made in the wiring specifications.

New military computer introduced by RCA

Even though it has pulled out of the general-purpose commercial computer field, RCA has no intention of dropping its military and government computer lines. To prove it, the company has introduced the first in a new series of military computers.

Built by the RCA Aerospace Systems Div. in Burlington, Mass., the new machine, called Model 195 of Series 200, is designed for command and control operations. It has a one-million-byte memory, a main memory cycle time of 1.5 μ s and a read-only memory time of 300 ns.

The read-only memory is micro-programmed with elementary orders that are mechanically alterable. On request, RCA will provide special sets of instructions.

A key feature of the Model 195 and Model 215—the latter a large multi-processor in the 200 series scheduled to be introduced soon—is their compatibility with commercial computers that the Government already has. "We were

able to incorporate all the capabilities of the Spectra 70/45 general-purpose computer in this militarized series," RCA says, a feature the company believes gives it an edge on its competitors.

Because MSI is used extensively in the processor of the 195, the computer is smaller than an office desk.

U.S. offers 7 volumes to access technology

Advances in technology aren't always all good. Often there are unexpected, detrimental side effects. Consider DDT or the recent furor over the SST. How do you find out how technology will react with today's social/economic environment?

The answer, according to Gabor Strasser, formerly executive secretary of President Nixon's Science and Policy Panel and now director of planning for Batelle Laboratories, Columbus, Ohio, lies in seven basic steps to technology assessment. The steps are described in a new, seven-volume report available to the public.

The seven volumes, available from the National Technical Information Service of the Dept. of Commerce, Springfield, Va. 22151, are: "Some Basic Propositions," PB 202778-01; "Automotive Emission Controls," PB 202778-02; "Computers-Communication Networks," PB 202778-03; "Enzymes, Industrial," PB 202778-04; "Sea Farming," PB 202778-06"; "Water Pollution: Domestic Wastes," PB 202778-06, and "A Summary," PB 202778-07.

Each volume sells for \$6 separately. The complete set of seven volumes is available for \$31.50. In microfiche, the set costs \$9.

New air command post sought to counter A-peril

The Atomic Energy Commission's large, underground nuclear explosion on Amchitka Island in November is having a chain reaction in the Pentagon that may lead to a more survivable airborne command post. The post, which would be made up of seven Boeing-747 aircraft, would contain improved

communications equipment.

While it has been known for years that the electromagnetic pulse (EMP) from nuclear explosions could black out communications circuits in radars, or even in the guidance systems of ICBMs in silos on the ground, the Amchitka tests have proved, Pentagon officials indicate, that the problem is greater than previously believed.

To counter the EMP threat, Defense Secretary Melvin S. Laird has asked the House Armed Services Committee for approximately \$114-million in extra appropriations for 1972.

The airborne command system now in use is built around three KC-135 aircraft, which, Laird says, are "severely deficient in survivability and capacity and cannot fulfill our essential needs in the event of a nuclear attack on our country."

It lacks the survivable secure communications needed for control and execution of the forces, the space for sufficient high-level staff to support the President, and the space for battle staff and equipments which provide the information needed to make decisions," Laird says.

Breakthrough reported in measurement science

By making the highest absolute frequency measurement to date—88,376,245 MHz of a helium-neon laser—scientists at the Boulder Colorado Laboratories of the National Bureau of Standards have opened a new era in standards linking both frequency and wavelength, to accuracy heretofore unattainable.

The measurement of the laser frequency represents a hundred-fold improvement in frequency measurements over the last four years. It surpasses the recent record achievement of a team of Massachusetts Institute of Technology scientists. Prior to the new development, frequencies of these lasers had to be measured by dividing the speed of light by the measured wavelength. However, the National Bureau scientists say that the frequency-measuring technique is 10,000 times more accurate than wavelength measuring.



A line-up of input-output rack and panel and cable-to-cable connectors with contact spacing on .100" centers. Elco's solution to the burgeoning packaging squeeze in electronic circuitry.

Let's take muster. First, the Series 8026 R/P and cable-to-cable connector that's equipped with the Elco high-reliability crimp-and-insert mini Varilok™ contact. Team a Series 8026 117-contact plug with its corresponding receptacle, and you have a 117-contact connector that's in the same envelope as a 56-contact connector on .150" spacing. But packing more than twice the contacts in the same space.

Then, by the numbers. The 75-contact 8026 connector will fit in the same space as a 38-contact connector on .150" spacing. And the 8026 33-contact connector is one of the smallest 33-contact R/P

connectors you've ever seen. And for back-up, we offer Series 8026 connector with 55 and 79 contacts on .125" square grid.

For your I/O back-panel applications, Elco Series 5540 connectors are available in the same sizes as the 8026, but use the field-proven Varicon™ contact with .025" square wire wrappable posts. They incorporate—as do the 8026's—a new female turnable jackscrew that eliminates any possibility of damage to plate contacts in difficult or blind mating situations. Both series use standardized polarizing and keying hardware to prevent unmatched plugs and receptacles from being mated.

And by no small coincidence, hardware standardization lets you minimize your in-house and field

stocking requirements, and allows you to use the same manufacturing set-up to assemble all sizes.

Besides helping you cope with your close-order circuits, this roster of connectors will help you effect other cost economies. Like using your existing 8016 panel punches. Reducing inventory because they can do duty in R/P and cable-to-cable applications as well as be used as an I/O. On a performance/price basis, these high density connectors are your best buy because quality is equal to or better than, and published prices are much less than those of their pin-and-socket counterparts.

There's one more bonus. Immediate availability. Both Series. All sizes. Another service in keeping with CONNECTRONICS, Elco's Total Connector Capability.

100-MIL CLOSE-ORDER DRILL

For full details on these new connectors from Elco, contact:

Elco, Willow Grove Division,
Willow Grove, Pa. 19090
(215) 659-7000

Elco, Pacific Division,
2200 Park Place,
El Segundo, Calif. 90245
(213) 675-3311



Operations in USA, Australia, Belgium, Canada, Denmark, England, France, Germany, Israel and Japan. Sales offices throughout the world. In Europe, Elco Belge, 77 Blancefloerlaan, Antwerp, Belgium, Tel. 03-190064. In the Far East, Elco International, TBR Building, 2-10-2 Nagata-cho, Chiyoda-ku, Tokyo 100, Japan, Tel. 580-2711/5.

Copyright © 1971 Elco Corp. All rights reserved.



Fiber optics finding growing use in data systems—and it pays handsomely

Jim McDermott
East Coast Editor

Fiber optics, a laboratory method of piping light and images around a corner 10 years ago, is giving designers new ways to carry signals and data today, and the advantages are substantial.

Now a growing industry, with sales estimated by leading manufacturers in the multimillions, fiber-optics technology—in the form of bundles of transparent fibers—is being used increasingly in these fields:

- Military equipment.
- Biomedical equipment.
- Optical computer keyboards.
- Optical computer memory.
- Computer microfilm printer.
- Digital and analog shortrange communication links.

Designers are finding new uses and advantages for fiber optics the more they use the technology. Already such gains as these have

resulted from the advances:

- Fiber optics is making possible faster computer printout rates.

- It is simplifying the design of optical memories and eliminating time-consuming mechanical alignment problems encountered with complex lens systems.

- It is replacing copper cable for data transmission at appreciable savings in size and weight.

- It is eliminating crosstalk between channels in data systems.

- It is preventing ground loops and common-mode signals between different equipment in both data and measurement systems.

Fiber optics—all except a special type made by Nippon Electric Co. in Tokyo—transmit light efficiently along the length of each fiber by means of multiple internal reflections—that is, the light rays



The image scope, above, by Bendix Electro Optics has its protective housing removed to demonstrate the path of the light rays in the bundle.

bounce back and forth along the inside of a fiber, with a relatively low loss at each reflection (Fig. 1, left).

These fibers act like waveguides for the optical radiation. The fibers are comprised of a core, which is coated with a cladding of the same type of material as the core but one that has an index of refraction that is less than that of the core.

It is this difference in the indexes that produces the phenomena of internal reflections. It is also characteristic of these fibers that they have a broad light-gathering power that is generally equivalent to very fast lenses.

Plastic fibers have become competitive with glass primarily because their cost is about a tenth that of the glass. Also, the plastic fibers are softer and can be bent into substantially smaller radii without breaking the individual fibers.

But plastic fiber can't withstand the abrasion that glass can. And the plastic is not suitable at elevated temperatures.

For guiding light along a fiber bundle, the arrangement of the fibers with relation to one another is ordinarily ignored. However, to transmit images, the fibers at the output end must be arranged in exactly the same fashion as those at the input end. The largest use, by and large, is in light guides.

The newest type of glass fiber, developed by the Nippon Electric (Fig. 1, right) and called Selfoc, has no discrete cladding; instead it has a refractive index that varies in a continuous fashion from a maximum at the center of the fiber to a minimum at the circumference.

If an incident ray is applied in parallel to the optical axis, it passes along this axis. Off-axis rays advance down the fiber in a sinusoidal path (Fig. 1).

The optical attenuation of plastic fibers is much greater than that for regular glass in the near-infrared, at $9 \mu\text{m}$, where the radiation of gallium arsenide light-emitting diodes is centered (Fig. 2).

To compete with the glass, duPont has developed Crofon "IRX" fiber, with substantially less attenuation at $9 \mu\text{m}$. At the present state of the art, the glass fibers remain the better carriers of IR light-emitting diode (LED) radiation.

While fiber optics is produced in many forms, the most dramatic advance in the last two years has been the marriage of fiber-optic bundles and light-emitting devices (both visible and infrared) to produce a variety of new devices.

One example is the Memorex 1603 Microfilm Printer, with a printout rate of 10,000 132-character lines per minute. This is nearly 10 times the speed of the IBM 1403 or 1445 impact printers, with which it was designed to be used.

The Memorex 1603, says Laurence L. Spitters, president of

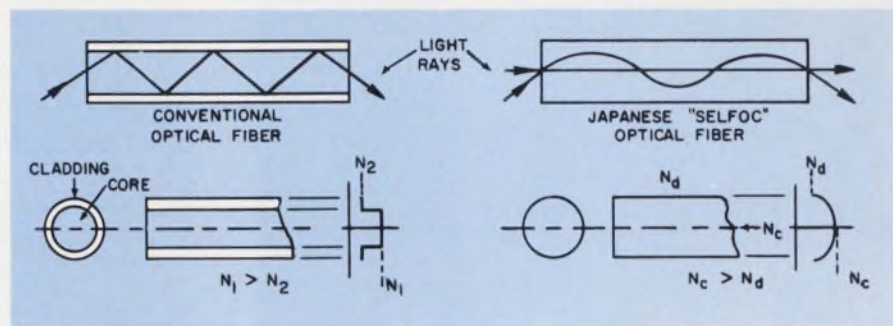

1. The conventional optical fiber has a core surrounded by a cladding of lower refractive index. The Selfoc fiber has a refractive index of continuous variation, with a maximum at the center and minimum on the outside.

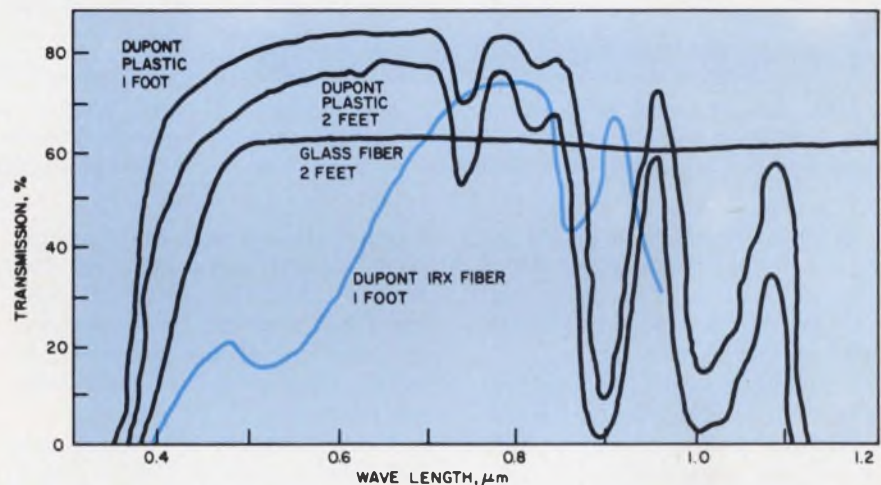

2. Plastic fibers have higher transmission than glass in the visible range. But attenuation in the plastic increases sharply in the near infrared. A new plastic duPont IRX fiber is improved at $9 \mu\text{m}$.

Memorex, uses fiber optics with two other elements—a bank of LEDs and an electronic translation matrix—to convert digital signals to optical characters.

Digital signals are applied to the proper combinations of diodes by the matrix. Light from the pulsed diodes is transmitted, through the fiber-optic strands to produce a display of alphanumeric characters on the face of the fiber-optic assembly. This exposes the film.

The duPont IRX plastic fiber is used in a unique optical alterable computer memory produced by the Quadri Corp. of Phoenix, Ariz. (Fig. 3), another development using LED-fiber optics.

The basic memory unit, or block, is 256×256 bits, or a total of 65,536-bit storage capacity. Access time is 100 ns, with a full cycle time of 200 ns. A random-access addressing mode is used.

David A. LeFebre, director of optical development for Quadri, ex-

plains some of the problems involved in this new development:

The bit pattern was stored as clear spaces on the photographic mask. There are 256 emitters, each identified with a word line. Each emitter is associated with certain fibers, which go to a specific site on the mask. Opposite each of the bit regions on the mask is another fiber bundle leading to the bit detectors.

Glass was originally chosen for the fibers, but assembly and routing problems required the use of the more flexible plastic fibers.

By using the fibers to route the LED energy, crosstalk between adjacent bit sites was eliminated.

Any alignment problems between the transmitting and receiving blocks were minimized by making the receiving fiber larger than the transmitting fiber.

Perhaps the area of keenest interest in LED-fiber optics-detector system development lies in commu-

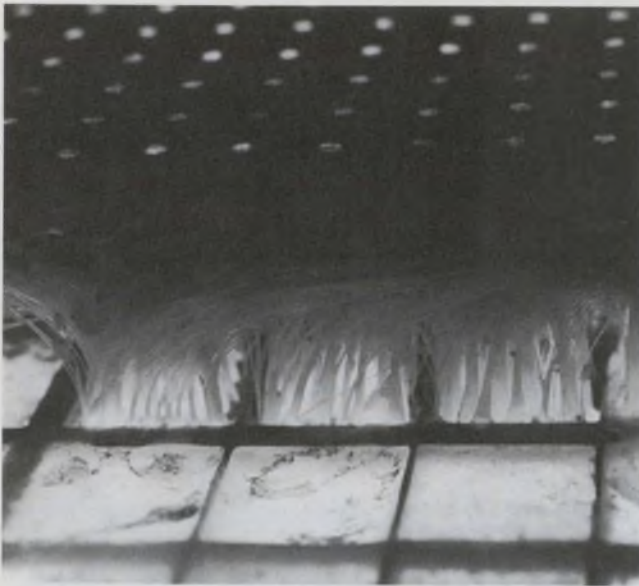

3. Fiber optic bundles in Quadri Corp.'s new memory carry light from gallium arsenide LEDs to photosensors exposed to the bit pattern in a photographic mask. The

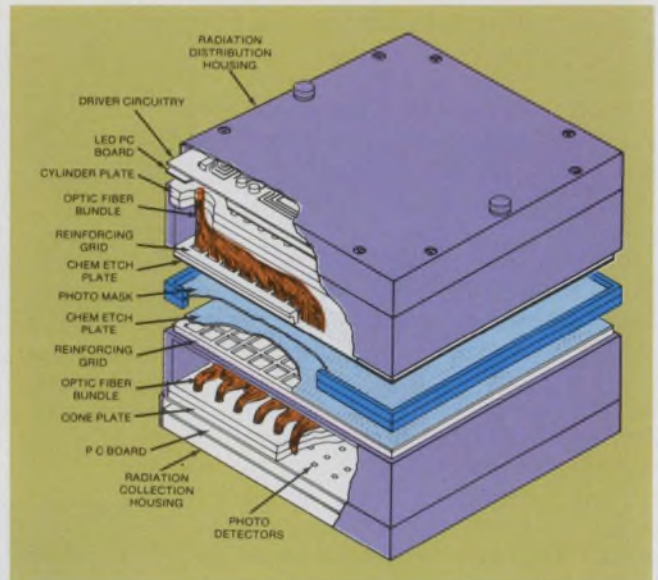

fiber bundles, left, are potted in position over photosensors. The basic mask area is about 5 x 5 inches with a storage density of about 4000 bits per square inch.

nications systems, both short and long-range. The military and others are interested in the use of systems in which fiber-optic cables would replace copper cables.

Don Williams, project engineer at the Naval Electronics Laboratory in San Diego, points out that substituting glass cables for copper gives a reduction in weight on the order of 4 to 1.

Quadri has explored the area of short-range computer-data transfer and is now producing what it calls an Opticable, a fiber-optic system for transmitting signals from one computer site to another. The cable system, which can be supplied with 6, 12 or 24 channels on regular order and 48 on special, can package up to 48 fiber channels in a 0.35-inch diameter bundle.

Each of the fiber channels is driven by a LED, which Quadri's

David LeFebre says can transmit up to 10-MHz data rate over 100 feet of cable. For up to 200 feet, the LED must be driven harder, and consequently its maximum response time is reduced to 1 MHz maximum.

The advantages of the link, LeFebre points out, are these: There is no pickup or radiation susceptibility, no crosstalk between fiber channels, and the system is TTL-compatible, requiring a 5-V supply.

Fiber-optic data systems for instrumentation in high-intensity magnetic and electric fields, which can make difficult or impossible measurements easy, have been developed by the Emtel Systems Div. of Develco, Inc., Mountain View, Calif.

One example is an electric radiation field (E-field) sensor with a data-transmission band width of

500 kHz to 100 MHz. (Fig. 4).

With a conventional measuring system and coaxial instrument cables, Emtel points out that the outer shield of the signal cables can, under the influence of high-intensity magnetic fields, reach potentials of several hundred volts.

Fiber optics communications systems—both broad band and narrow band and short distance and long distance—have attracted the attention of researchers at Bell Telephone Laboratories as replacements for twisted-wire pairs and coaxial cables (Fig. 5).

But Enrique A. J. Marcatili, head of the Bell Laboratories Component Research Department at Holmdel, N.J., says that the use of long stretches of fiber optics cables are still some way off because of a number of practical difficulties, such as interconnections between systems.

One of the problems yet to be licked is the joining of fibers. Another is suitably matching the LEDs to the ends of the fibers for maximum energy transfer (Fig. 6).

The most obvious limitation is the high attenuation (1000 dB/km) of most optical fibers to multimode transmission of energy, which is characteristic of the gallium arsenide LED now emerging in the short range systems previously described.

Studies have shown, however that the fundamental loss mecha-

Common fiber optic materials

Material	Core Index	Cladding Index	Numerical Aperture	Applications
Glass	1.52	1.48	0.35	Faceplates, light guides for near ultra violet General purpose light guides, fiberscopes CRT faceplates
	1.62	1.52	0.56	
	1.66	1.52	0.67	
	1.81	1.48	1.04	Image-tube faceplates
Arsenic trisulfide	2.47	2.37	0.50	Faceplates, light guides for infrared
Plastic	1.49	1.37	0.58	Light guides
	1.59	1.49	0.56	

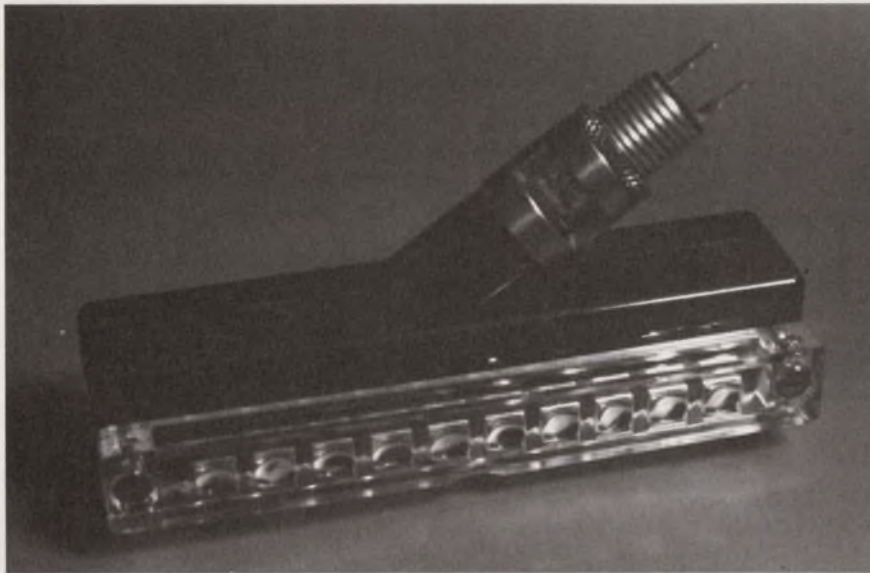

3. A fiber optics light distributor for an optical keyboard by Electro Fiberoptics Corp. uses plastic lenses to focus light from the fiber bundles down 11-inch channels. Key-operated shutters pass the beams to photosensors.

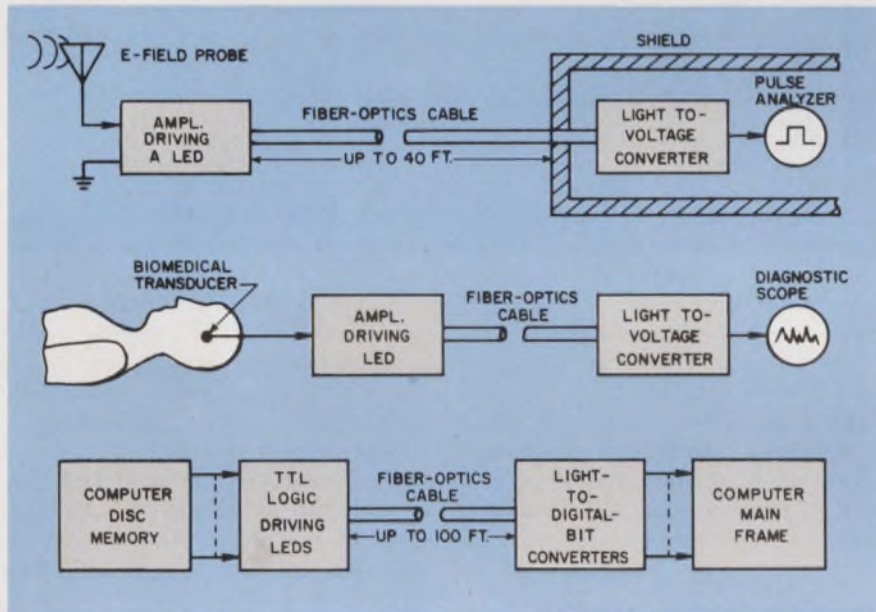

4. Representative applications of instrumentation and data transmission systems using fiber optics cables for information carriers. The two top applications are by Emtel Systems, the bottom by Quadri Corp.

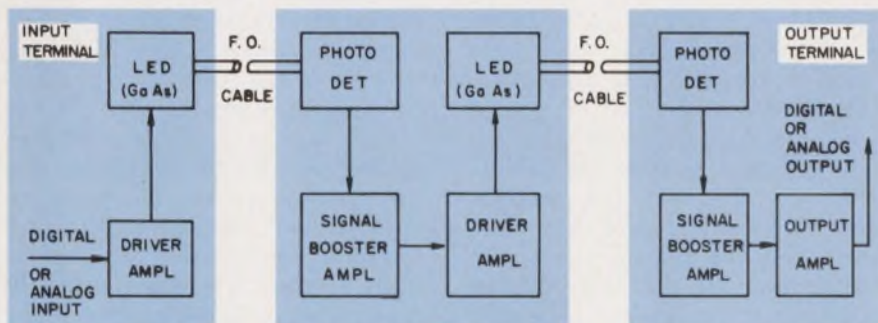

5. A proposed fiber optics communication system using repeaters to overcome losses in the fibers. The data or analog signals are applied to a modulator-driver amplifier feeding a gallium-arsenide LED.

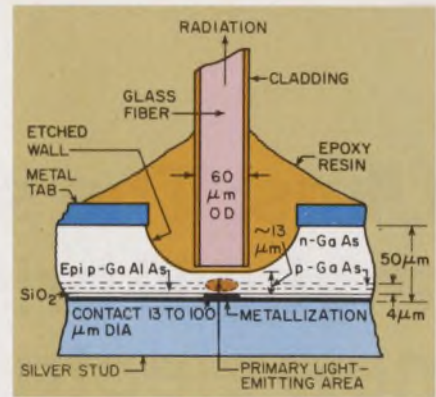

6. Fiber optics transmission lines will require emitter diodes, like the one above, fabricated by Bell Labs.

nism in glass is only a few dB/km. The loss in a single-mode fiber is considerably less than that for the multi-mode one. But, Bell's Marcatili points out that this requires lasers for the energy source in order to obtain the single mode propagation.

However, he notes the potential is there because systems calculations have shown that for 1 mW of LED power into a fiber cable for analog signals like the 4 kHz telephone or 1 MHz Picturephone signal attenuations of up to 30 dB over short interoffice distances could be overcome.

And with digitally modulated signals, twice that loss could be compensated for in a LED-fiber system with a bandwidth of several MHz.

In the search for lower loss fibers, samples with liquid cores have been studied at Bell Laboratories. The lowest measured loss in a multimode liquid core fiber was about 14 dB/km.

Burt Bielawski, senior marketing specialist of Corning Glass told ELECTRONIC DESIGN that within the past few months Corning has succeeded in making fibers suitable for single mode transmission in lengths of kilometers. Attenuation has consistently been around 20 dB/km. And he emphasizes that these now have been made by the glass engineers as opposed to the scientists.

But Bell's Marcatili emphasizes that because of problems that remain to be resolved it will be several years before the broadband fiber optics long-distance system is a practical reality. ■■

Ulms: The submarine that will bristle with new electronics

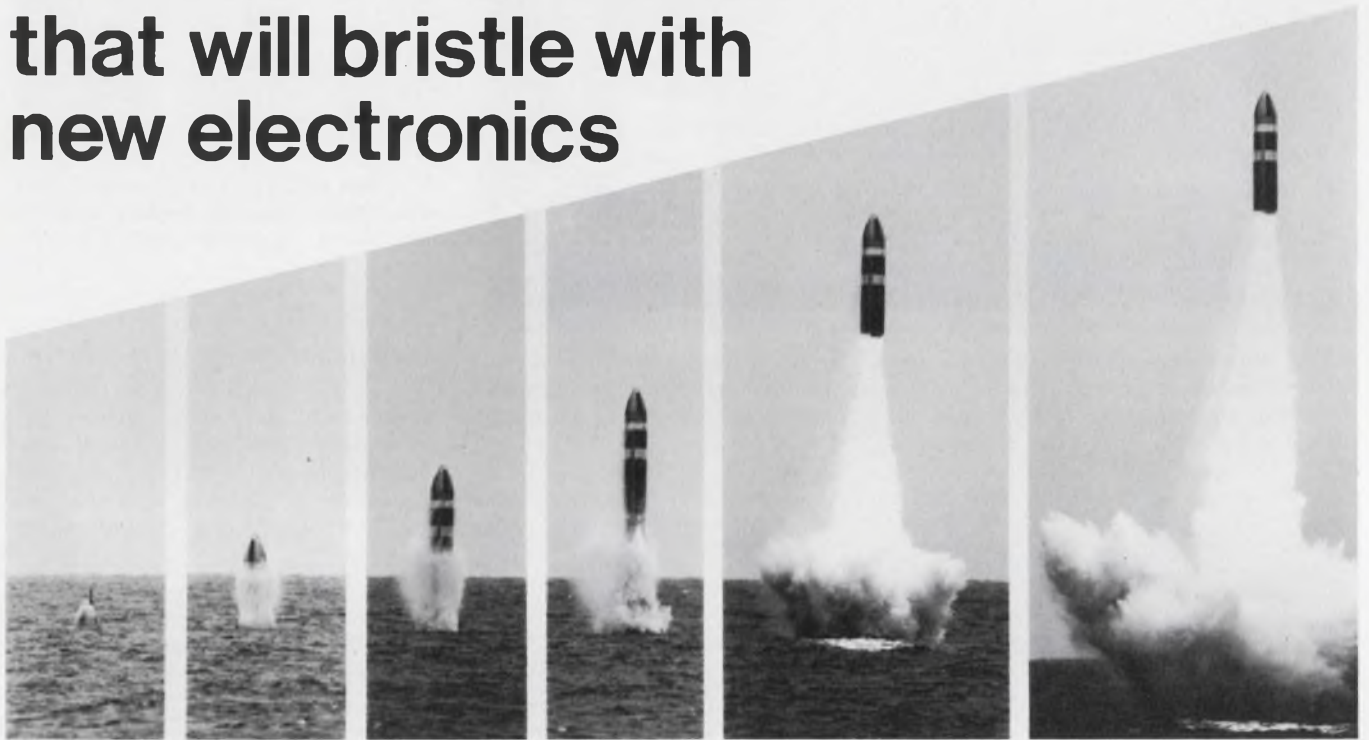

If the U.S. suddenly found itself in a nuclear war, could an enemy knock out all its Minuteman missiles as they sat in their silos in this country? And could the same enemy, using highly sophisticated techniques, find and destroy all of the U.S. Polaris and Poseidon missile-launching submarines in the waters of the world?

There are specialists in the Pentagon who believe that the Soviet Union either has this capability now or will have it shortly. To counter the potential threat, the Defense Dept. plans to spend close to a billion dollars in the next year alone to begin the hardware development of Ulms (Undersea Long-Range Missile System).

Ulms will be a quiet, high-speed submarine that would launch intercontinental ballistic missiles rather than the medium-range missiles now deployed. It would be capable of such increased range that an enemy's chances of finding and

knocking it out would be "nearly impossible," the Navy says.

The General Dynamics Electric Boat Div. in Groton, Conn., is designing the Ulms submarine and coordinating the entire program, which also includes the development of new missiles. Subcontracts have yet to be let.

Innovative design is the goal

Electronic innovations will abound in the Ulms sub. They will include the following:

- Equipment that operates super-quietly.
- Modular and standardized equipment throughout.
- Decentralized data processing.
- Integrated displays.
- Integrated communications.
- Improved inertial navigation.

Within the next few months, Rear Admiral Harvey E. Lyon, the Ulms program manager, has told ELECTRONIC DESIGN, the baseline design of the submarine should be ready. "Then," he says, "the subsystem tradeoffs begin, such as which subsystems get their own

data processing equipment and which use a central computer complex, and which subsystems share displays?" When problems of this nature are resolved, subcontracts will be awarded.

Two tradeoffs, however, will not be debated. It is already decided that all equipment must be as silent as possible to eliminate the dangerous acoustic signature that conventional submarines emit. And the equipment must be modular and standardized to simplify both training and maintenance.

Tremendous design progress will be sought in data processing, information transfer, displays and monitoring, says James Coleman, director of the Ships System Engineering Management Div. in the Navy's Bureau of Ships. "We plan to work along with the people who are providing the hardware in these areas," Coleman adds.

The old problem of whether to build a computer into every subsystem or to provide one central computer complex for all will be decided for each subsystem individually, according to Coleman.

John F. Mason
Associate Editor

Bendix ARINC's join the mating game.

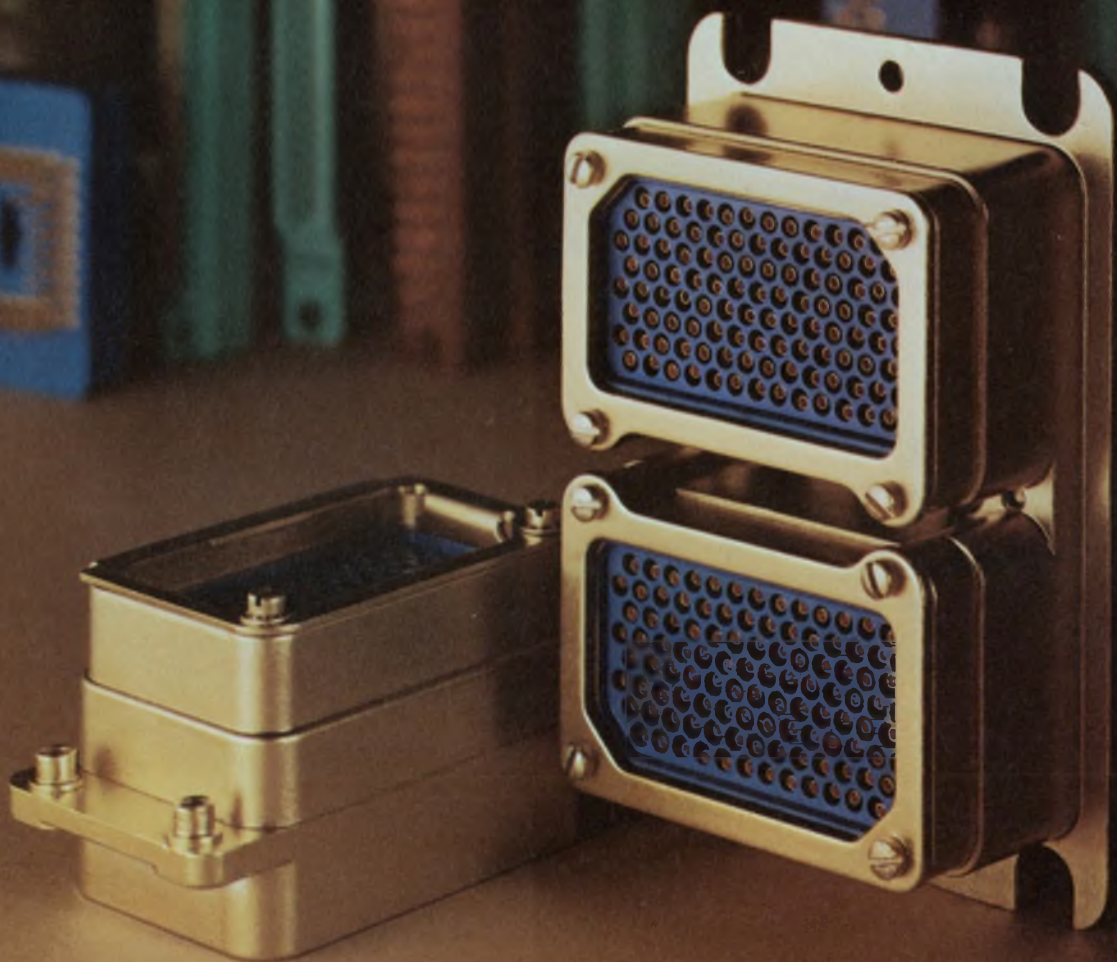

Real togetherness. Now Bendix makes ARINC connectors, too. Completely intermountable. Completely intermateable. And they have all the advantages. Solid aluminum shell. Hard dielectric. Crimp contacts. Rear-removable. Environmental. Non-environmental.

The one-piece aluminum die-cast shell comes in both double- and single-shell configurations. With the standard three polarizing posts. The aluminum shell is designed to give you maximum strength with minimum weight.

Bendix crimp, rear-removable contacts elim-

inate logistic and stocking problems. Utilize standard insertion and removal tools, too. The environmental version prevents moisture creepage along the individual wires and seals around each individual contact.

Other design modifications in shell styles, mounting, plating and contact plating are available. Bendix ARINC connectors. Just the thing you need to help win the mating game. For additional information write: The Bendix Corporation, Electrical Components Division, Sidney, New York 13838.



"Sonar, for example, will definitely have its own preprocessor," Admiral Lyon says. "All of our sonar work involves digital free-form beams, which have to be converted to positional data by a preprocessor, which can then go as processed information to an information transfer system."

The trend, the admiral notes, is an about-face from the Navy's former centralized data-processing philosophy. When data processors first went aboard ships, they were big computers tied into weapon systems that were for the most part analog. When weapons and radars became digital, the software burden on the big computer became more than it could handle, and the software often became more expensive than the hardware.

Now, fourth-generation minicomputers with high speed and good memories seem to be the answer. "We can have a family of small, individual processors with software provided by the manufacturer," Admiral Lyon explains. "The processed data can then be sent to a central computer where it is stored and sent on to the proper display."

Standardized displays sought

The design of displays on a submarine is a complicated problem, Coleman notes, since almost every subsystem has a display—sonar, communications, fire control, navigation. "We will," he says, "look at the possibility of designing integrated displays."

Admiral Lyon, who says that "the trend has been toward digital displays in recent years, so we have ended up with a combination of digital and analog," would like to go to a standard system to reduce training programs. This has been done to some extent in the SSN 688 attack submarine.

"For the first time," the admiral says, "we expect to integrate the master command and control system aboard a submarine, as has been done with missile systems."

The plan is to have common modules, consoles, information-transfer systems and displays for the sonar, radio room, defensive systems, ship's control, atmosphere control and other subsystems. The commanding officer would have a

single digital display that would enable him to call up any kind of information he wanted.

Computerizing the radios

The Navy is particularly enthusiastic over prospects for building an integrated communications system for the Ulms submarine. "We've never really gone to a computer-controlled radio system, where the radio room is put together by a series of modules that can be selected each time a radio is used," Admiral Lyon says.

Such a system would consist of receivers for elf, vlf, lf, hf, vhf, uhf and shf, and of high-power, compact transmitters for hf, vhf, uhf and shf. Modules that could be used in common would include the audio amplifier, a preamplifier, filter band and antennas. A computer-driven control console would assemble the right components when needed.

"This would require," Admiral Lyon says, "fewer modules, less cost—we hope—and better performance."

A computer would receive all messages, decode them and check them for validity and accuracy and print them out on teleprinters. One reason for this is that the information comes in at such high speeds that an operator can no longer be expected to determine its accuracy. One data processor and one teleprinter could handle several receivers. At present there are no data processors in the radio rooms of missile-carrying subs.

A similar computerized system is being developed for the Navy's surface ship, the LHA, but Ulms will get the first integrated communications system designed for a submarine, Admiral Lyon says.

A request for proposals for bids on a study effort for this aspect of the program has gone out. It is to be followed early next month by a development contract.

One of the Navy's goals is for the Ulms submarine to be able to travel at great depths, stay at sea longer and surface less frequently than existing missile subs. But maintaining precise positional data without surfacing to correct the errors that accumulate in the inertial navigation system calls for tremendously improved inertial

components. Studies are under way, Admiral Lyon says, on a ring laser gyro, a device that corrects its own drift, and on electromagnetic suspended gyros.

A Mini Sins (ships inertial navigation system) is under development by North American's Autonetics Div. in Los Angeles for the attack submarine SSN 688. This system will be considered for the Ulms. The Mini Sins has greatly improved maintenance capability Admiral Lyon says. Built originally for airborne use, the system is so small that it can simply be taken out and replaced.

Besides the submarines, the Ulms program will include new missile developments. A missile, to be known as the C-4, is to have twice the range of the Poseidon (the C-3) but be the same size. The C-4 would be usable in the Poseidon submarines as well as in the new Ulms. Under a Navy contract, the Lockheed Missiles and Space Div. in Sunnyvale, Calif., is examining the deficiencies of the Poseidon C-3 missile and defining the characteristics of the C-4.

The C-4 is to have a 5000 to 6000-mile range, compared with the 2500 to 3000 miles for the C-3 and 1500 to 2500 miles for the Polaris missile. The Ulms missile could reach any part of the Soviet Union from United States ports. Besides this strategic advantage, such a range would permit the crew to be based in the United States.

The increased range would also provide more ocean for the submarine to hide in—55 million square miles of sea, compared with the Poseidon's 3.5-million.

Some years off are plans for yet another Ulms missile, one with a still longer range that would be compatible only with the Ulms submarine.

In his State of the Union address in January, President Nixon asked for \$942-million for Ulms for fiscal 1973. Before that money would be available the Pentagon is planning to ask for a supplemental request for fiscal 1972 of from \$300-million to \$400-million. Whatever Congress eventually approves, it is expected to be a big jump over the \$170-million or so that has been spent on the program so far, since studies on Ulms began in 1968. ■■

LET'S START AT THE
BEGINNING. WITH TELEVISION.
STACKPOLE DID.

SINCE 1947, STACKPOLE
HAS BEEN A LEADING
SUPPLIER OF CRT YOKE
CORES TO THE TELEVISION
INDUSTRY. FIRST
AND WHITE

At the core of yoke technology

cores to the television industry. First, black and white. Now color. This makes us the oldest ferrite yoke core manufacturer in the U.S.

Now this knowledge and experience have been applied to the precision components necessary for CRT information displays. Whole rings. Quarter segments. Stator yokes.

What you get is a greater choice. First, tooling. Many configurations are already available. If not, Stackpole can develop precision tooling for you. Secondly, a family of ferrite materials permits greater flexibility in design, tighter control over results.

Stackpole also offers machining facilities for grinding to close tolerances.

TYPICAL CERAMAG® MATERIALS FOR INFORMATION DISPLAY YOKES

	7B	11	12	24
Initial Permeability	450	125	35	2500
Saturation Flux Density	2600	2550	2400	4500
Residual Flux Density	1650	1420	750	1700
Coercive Force	0.48	2.8	4.7	0.25
Curie Temperature	160	385	450	205

We've been around cathode ray tubes for a long time. Why not take advantage of the technology that can be yours at Stackpole. We may have the answer you've been looking for, or know how to get it. Simply contact: Stackpole Carbon Company, Electronic Components Division, St. Marys, Pa. 15857. Phone: 814-781-8521. TWX: 510-693-4511.

Stackpole Ceramag® Ferrite Yoke Cores for CRT Displays

Let's start at the beginning. With television. Stackpole did.

Since 1947, Stackpole has been a leading supplier of CRT yoke



Single-transistor memory cell: A promise with many problems

It's widely conceded that semiconductor random-access memories will be a major force in the bulk-memory market in the next two years. But which cell structure will predominate?

There are serious doubts in the semiconductor industry whether two-cell or three-cell arrays, in general use today, will remain the favorite. Most semiconductor manufacturers are investigating a more radical approach: a single transis-

tor for each memory cell.

Why a single-transistor cell? For one thing, it's possible to crowd many more cells onto a single chip, leading to very small, high-density memory structures. Hence the cost per bit of such a memory could be substantially reduced—perhaps to as little as 0.1¢ to 0.2¢ per bit for large-scale memories, according to some estimates. Most companies working on these memories now are looking at 4096-bit-per-chip densities and up.

On the minus side is somewhat slower speed with a single-transis-

tor cell and, in some cases, increased power dissipation. These constraints depend largely on the design approach—MOS or bipolar.

Among the companies that are investigating single-cell technology are General Instrument, Litton, Motorola, American Micro-systems, Advanced Memory Systems and Mostek. But only four companies have produced single-transistor cell memories so far.

General Instrument Corp., of Hicksville, N.Y., has a single-cell product on the market: a 2048-bit RAM. And the Guidance and Control Div. of Litton Industries, Woodland Hills, Calif., has been manufacturing a military version of a single-transistor-per-cell static RAM for over a year.

Engineers agree that many more design problems need to be ironed out before these memories come into wider use.

MOS is farthest along

Most straight-forward of the approaches to design of single-transistor cells is the path being followed by most MOS manufacturers. They are following General Instrument's lead and using a single MOS transistor in series with a storage capacitor, one side being grounded. The transistor is then merely a switch (Fig. 1) that either lets charge flow into and out of the capacitor or holds the charge. Several of these cells are hung in parallel off a bus called the bit sense line (read/write data); which terminates in a sense amplifier that detects the signal to be read out. Among those looking at this technique are Motorola in Phoenix, Ariz.; American Micro-systems, Inc., in Santa Clara, Calif.; Advanced Memory Systems in Sunnyvale, Calif., and Mostek Corp., lo-

David N. Kaye
Senior Western Editor

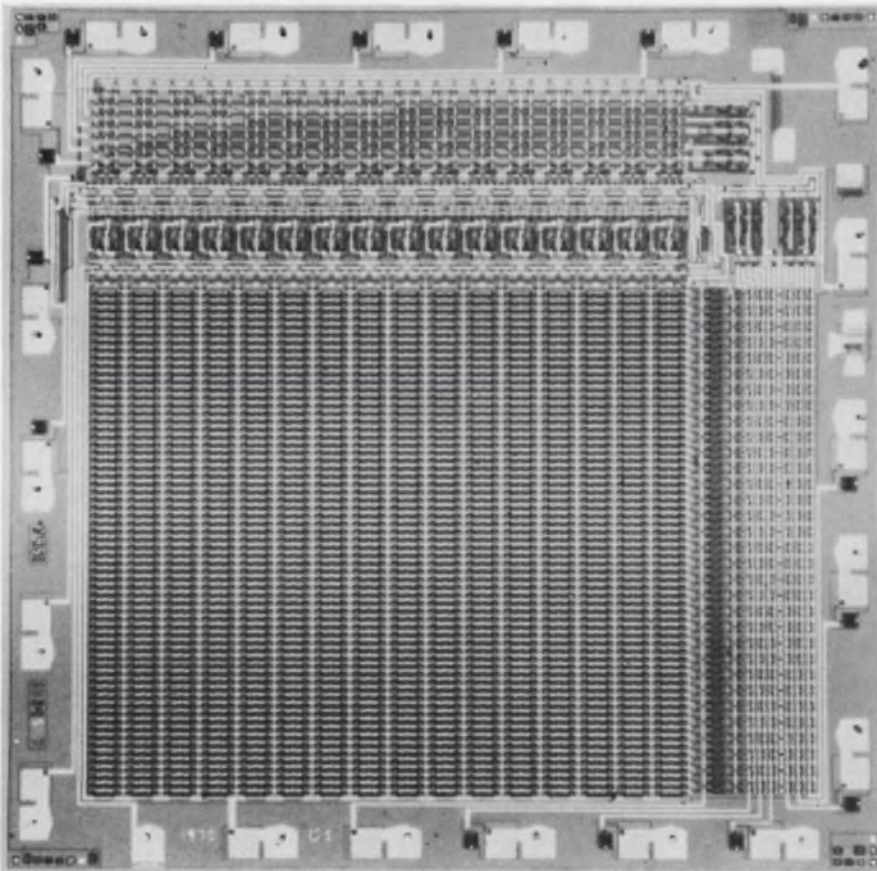

The only single-transistor-per-cell memory array to reach the commercial market so far is General Instrument's RA92048 dynamic, MOS, 2048-bit RAM. Other MOS firms are using a similar design approach.

The Fluke problem solver

The DVM you put together an option at a time, anytime



Because we use single main frame construction with all options field installable, you can configure the Fluke 8200A anyway you want when you buy it or anytime you want to change it. It's Fluke's way of giving you total flexibility for minimum money. It's one of the reasons Fluke has moved to DVM leadership in a scant two years.

Here's what you get for just \$995: 4½ digits with 60% overranging for ±16000 count resolution Auto-ranging and autopolarity on all functions Switched input filter Full 1000 volt guarding ±0.01% accuracy Fluke's unique recirculating remainder* A to D conversion which combines low parts count and low power consumption to provide higher reliability.

To the basic unit you can add: Two ranges of millivolts, giving you autoranging from 1 microvolt resolution up to 1200 volts input Six ranges of ohms measurement, providing autoranging from 10 milliohms to 16 megohms Four ranges of ac volts Four ranges

of true rms ac volts Isolated 4-terminal, real-time ratio measurement.

A real systems DVM too: Speeds up to 400 readings per second with full accuracy after only a 500 micro-second look at the input Isolated and buffered data output for digits, range, functions and polarity—with status flags Isolated remote control for continuous or buffered input commands Isolated and buffered printer output.

Ask for Fluke's 8200A Application Bulletin No. AB-10 for systems designers.

The 8200A's single main frame and field-installed options let you configure the most cost-effective 4½ digit DVM on the market.

To arrange a demonstration or get complete information, call your nearby Fluke Sales Engineer or contact us directly.

*Patent pending

Fluke, Box 7428, Seattle, Washington 98133. Phone: (206) 774-2211. TWX: 910-449-2850/In Europe, address Fluke Nederland (N.V.), P. O. Box 5053, Tilburg, Holland. Phone: (04250) 70130. Telex: 884-52337/In the U. K., address Fluke International Corp., Garnett Close, Watford, WD2, 4TT. Phone: Watford, 33066. Telex: 934583.



State-of-the-art in memory cells

Company	Type of cell	Area (mil ²)	Status
Fairchild	Two-transistor bipolar (Isoplanar technology)	12	Product
Raytheon	Two-transistor bipolar (V-ATE technology)	5.0	Under development
Intel	(1103) Three-transistor MOS	4.23	Product
Intel	Three-transistor, n-channel, silicon-gate MOS	2.0	Under development
General Instrument	Single-transistor MOS	3.16	Product
General Instrument	Single-transistor MOS	1.7	Under development

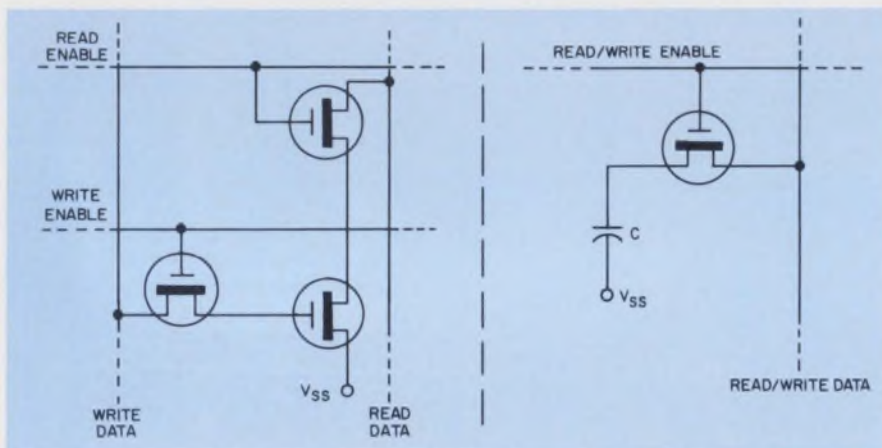

1. A comparison of the design of the Intel 1103 memory cell and the single-transistor cell shows that not only is there one transistor vs three but also only one I/O line instead of the two in the 1103 cell.

cated in Carrollton, Tex.

This approach has one major problem: getting a large enough voltage swing out of the memory cell to be able to read information out of the cell. William W. Lattin, manager of advanced MOS memory development at Motorola, notes the three possible paths to a solution:

"The problem is caused because the ratio of the capacitance along the bit sense line is too large, relative to the storage capacity of the cell, to generate much voltage swing for the sense amplifier to respond. Therefore the alternative approaches are: reduce the capacitance on the bit sense line; increase the size of the storage capacitor in the cell; or increase the sensitivity of the sense amplifier."

In fact, to achieve a successful design all of the alternatives must be used, says Lattin. If the signal at the sense amplifier is too close to the noise, the memory will have very low noise immunity and will not be too reliable. Therefore, the

first step is to consider the various ways to design a sensitive sense amplifier.

Designing a proper amplifier

Most designers who are familiar with the problem agree that the amplifier must be a differential rather than a single-ended design. Leo Cohen, manager of advanced development at General Instrument, says further that it would be useful to use ion implantation to adjust the threshold levels of the devices in the sense amplifier. Others agree that this would allow for very accurate setting and balancing of the transistor parameters in the two halves of a differential amplifier. Although used by such companies as Hughes Aircraft and Mostek, ion implantation is not being used more widely because of a lack of experience in achieving high-yield, low-cost devices.

Carroll Perkins, MOS product manager at Solitron Devices in San

Diego, points out that the sense amplifier might well be designed with CMOS techniques because of their high-noise immunity and low-power dissipation. Most designers agree that more than 50% and perhaps as much as 90%, of the total power dissipation on the chip occurs in the peripheral circuits, such as sense amplifiers and counters.

Dr. Robert Proebsting, senior design engineer at Mostek, says that the sense amplifier must be able to handle at least a 10:1 ratio of sense-line capacitance to cell capacitance and that, for a 4096-bit memory, this will come to something under a volt of sensitivity. Many feel that for adequate noise immunity, the goal in that size memory should be 500 mV.

Less capacitance wanted

A second concern involves reducing the capacitance on the bit-sense line. This capacitance is made up primarily of three ingredients:

- Gate overlap capacitance in the transistors that make up the cells.
- Junction capacitance of a p-diffused bus to an n-substrate.
- Side-wall capacitance from cell structure to cell structure.

Proebsting of Mostek notes that when a standard process is used, the gate overlap capacitance is about half of the total bit-sense-line or bus capacitance. If a self-aligned gate process, such as silicon gate, is used, the gate overlap capacitance is reduced by about half. If an ion-implanted, self-aligned gate process is used, the gate overlap capacitance goes practically to zero.

In the case of bus-to-substrate junction capacitance, Proebsting says it can be reduced by application of substrate bias. The latter can also be used to prevent injection leakage (from storage node to storage node). However, according to Proebsting, that problem can be solved by other means.

Lattin of Motorola points to two main possibilities for reducing side-wall capacitance. One involves oxide isolation between cells, similar to Fairchild's Isoplanar technique. The other is construction of the circuit on a silicon-on-sapphire substrate.

(continued on p. 39)

CUTLER-HAMMER'S BIG NEW LINE OF COMMERCIAL MINIATURES.

Toggles. Pushbuttons. Rockers. Rotaries. Available in a vast array of operator styles, colors, and shapes. Including illuminated pushbuttons and rockers. Many featuring snap-in mounting. And all in stock for fast delivery!

Now the same great quality, service and availability you've come to expect from Cutler-Hammer is available in miniature size—at a competitive price!

Make your selection. Standard or watertight. Single or multiple pole. A wide range of decorator caps, buttons, bezels that extend application flexibility. And for their size, hefty electrical/mechanical ratings.

Before you place that next order, check with your new source for commercial miniature switches—your nearest Cutler-Hammer Sales Office or Authorized Stocking Distributor.



CUTLER-HAMMER

SPECIALTY PRODUCTS DIVISION, Milwaukee, Wis. 53201



Switch
to No.1

More than just switches...
prompt availability,
field help, innovation,
quality assurance, too.

SCIENCE/SCOPE

The U.S. Army's M-60A1 main battle tank will have a new fire-control system built around a ruby laser rangefinder and a solid-state ballistic computer, both developed by Hughes. It will enable the crew to fire its first round more quickly and will greatly increase the probability of scoring a first round hit. The laser rangefinder will utilize hardware assemblies developed earlier for the Army's M60A1E2 tank and M551 Sheridan armored reconnaissance airborne assault vehicle.

A long-life solar cell power supply system for orbiting satellites, now being developed for the U.S. Air Force by Hughes, will be capable of operating at altitudes between 200 and 22,300 nautical miles, or higher, for at least seven years. It will incorporate technology which Hughes developed for USAF's FRUSA (Flexible Rolled-Up Solar Array) program, a system of extendible solar cell panels unfurled like windowshades in space to convert the sun's energy into electrical power.

The first of five U.S. Navy F-14A Tomcat air superiority fighters has been flown to the Pacific Missile Range, Pt. Mugu, Calif. for installation of the AWG-9 weapon-control system and testing of the Phoenix missile, both developed by Hughes. When the twin-engine F-14A becomes operational it will be the Navy's most sophisticated fighter for both offensive and defensive missions. It will carry a 20mm cannon and various combinations of Phoenix, Sidewinder, Sparrow, and Agile missiles.

Two new series of lightweight digital computers have been developed by Hughes for central avionics, ECM, missile guidance, RPV, and other military applications. The HCM-230, latest of a line of Hughes airborne computers spanning 20 years, is a 24-bit, 92-instruction, truly modular computer with a throughput of 400,000 operations per second. The Mini-HDP is a low-cost minimal unit. Though very small (20 cu. in. including 8K of memory), it is a 19-instruction, 16-bit-word-length LSI computer of about 600,000 operations per second.

Hughes needs electro-optical system analysts to work on surveillance and precision tracking systems. Requirements: MS or PhD in Physics or EE and 3-8 years experience with E-O sensor systems, infrared physics, and computer techniques for analysis. Also mechanical engineers for conceptual design of complex E-O systems. Requirements: BS or MS in EE or Physics, 5-10 years experience. Please send your resume to: Mr. Robert A. Martin, Hughes Aerospace Engineering Divisions, 11940 W. Jefferson Blvd., Culver City, CA 90230. An equal opportunity M/F employer.

Digital display systems for the U.S. Navy's future fleet of 30 Spruance-class destroyers are now in production at Hughes under a subcontract from Litton Industries. They will be part of the Naval Tactical Data Systems (NTDS) which provide instantaneous presentation of the action within tactical combat zones. Within seconds, NTDS can evaluate a potential threat, assign and control countering weapons, and perform other command functions. The Spruance class will be the backbone of the Navy's destroyer forces in the mid-1970s and beyond.

Creating a new world with electronics



Increasing the cell storage capacitance can be done in three ways:

1. By increasing the plate size.
2. By decreasing plate spacing.
3. By using an insulator between the plates with a higher dielectric constant.

The first two methods are not too desirable by themselves. But a combination of the second and third should yield a solution.

A nonvolatile memory

Litton's work on MNOS (metal-nitride-oxide semiconductor) memories yields some intriguing possibilities for single-transistor-cell design. The most serious drawback to semiconductor memories is the fact that conventional RAMs are volatile—that is, if the power is turned off, they lose their stored memory. MNOS is a technology that utilizes a charge storage and transfer phenomenon. Memory function is achieved by threshold shifting rather than capacitive storage. MNOS is nonvolatile.

The company is also making single-transistor-per-cell static RAMs and has been shipping them to the military for over a year. Yukun Hsia, a member of the technical staff at Litton, says that the company is building a 2048-bit MNOS memory and is looking toward larger sizes. The memory, to be completed by April, is to have less than 500-ns access time and to dissipate 300 to 400 mW in the operating state. The chip size will be 0.160 x 0.160 inch. Since a capacitor is not necessary in this type of memory, each cell will consist of a single MOS transistor.

Bipolar has several approaches

In the bipolar world several approaches are being considered in the design of single-transistor memory cells. These include dynamic cells with storage capacitors, as in the MOS case, single transistors that use avalanche breakdown and internal capacitance, shared structures that could almost be called 1-1/2 transistor cells, and multilayer charge storage devices like npn transistors or SCRs.

Jerry Mar, a member of the technical staff at Bell Telephone Laboratories in Murray Hill, N. J., has been working on a single-

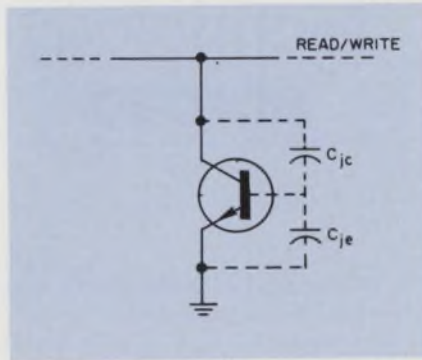

2. The Bell Laboratories bipolar cell is the simplest of all in basic design.

transistor bipolar cell that uses the internal base-emitter and base-collector junction capacitances as a storage medium. The transistor is an npn with an open base and grounded emitter that is tied to a sense line. Reading into and writing out of this cell requires that the junction be avalanched to create a large charge flow within the device. The output of the cell is quite large, because the output is beta times the charge stored rather than just the charge stored, as in a normal capacitor. If a high-gain transistor is used, a healthy signal can be outputted along the sense line. The cell size is about 2 mils,² and the ratio of the effective capacitance of an uncharged cell to a charged cell is about 250:1. The cell is dynamic and therefore must be refreshed periodically.

Monolithic Memories, Inc. of Sunnyvale, Calif., is working on a single-transistor cell of the SCR type. Since an SCR is really two transistors on a shared structure, this falls better into the 1-1/2 transistor category. According to Deryl Foster, the company's vice president of marketing, "Our memory will be static, and we are looking for a dissipation on the order of 10 to 15 μ W per bit." Foster also believes that the power can be held down by shutting down the peripheral circuits on the chip when they are not in use.

One of the most advanced in development of bipolar single-transistor memory cells is Intersil Corp. of Cupertino, Calif. Joseph Rizzi, vice president of digital operations, reports: "We're making a static cell. We hope to introduce it this year, and it will be of the 1-1/2 transistor shared-geometry variety. It will be a 4k chip." ■■

Hughes is in industrial electronics, too: components, equipment and systems.



Bipolar and hybrid circuits (RS 284)



Microcircuit production equipment (RS 294)



Flat flexible cable and circuit assemblies (RS 288)



Thermal energy transfer devices (RS 299)



Frequency control devices (RS 285)



Numerical control systems (RS 295)

For complete information, write Bldg. 100, Mail Station C-512, Culver City, CA 90230. Or request by Reader Service (RS) numbers.

HUGHES

HUGHES AIRCRAFT COMPANY

Industrial Electronic Products

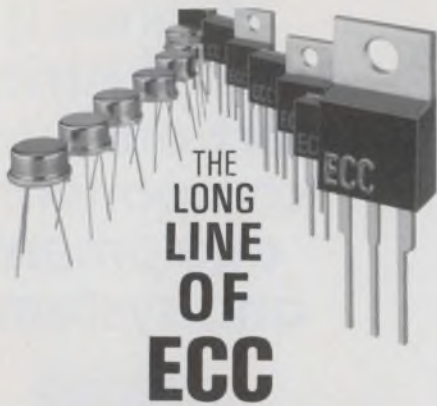

SENSITIVE and STANDARD GATE
TRIACS

World's leading triac producer offers fast delivery, electrical isolation and competitive pricing.

SENSITIVE GATE TRIACS

TO-5 Metal and Plastic; THERMOPAK® and THERMOTAB® Packages

$I_{T(RMS)}$	0.8 - 3 amps
I_{gt}	3 & 10 ma (all 4 quadrants)
I_{TSM}	20 amps
V_{DROM}	200 - 400 volts

STANDARD GATE TRIACS

THERMOTAB and THERMOPAK Packages (13 other packages available up to 40 amps)

$I_{T(RMS)}$	0.8 - 40 amps
I_{gt}	25 & 50 ma max.
I_{TSM}	20 - 300 amps
V_{DROM}	200 - 800 volts

All ECC triacs feature heavily glass passivated junctions for high reliability. They are available from your nearest ECC Sales Representative or Authorized Distributor.

New Condensed Catalog contains technical data on these and other ECC semiconductors. To receive your copy, circle No. 248.



ECC
CORPORATION

P.O. Box 669 • Euless, Texas 76039
817/267-2601

**technology
abroad**

A \$65 ac digital panel meter with instantaneous response—in contrast with the few seconds delay that many such meters require to reach the true rms level—has been designed by Excel Electronics of England. Instead of rectifying the measured signal and then applying the dc signal to charge a sampling capacitor, the Excel circuit samples the voltage over a 20-ms period. This corresponds to a full cycle of a 50-Hz supply. The signal is then integrated to obtain an average current that can be converted to an rms reading.

CIRCLE NO. 441

A transistorized microwave-beam antenna system for point-to-point relays on the receiving antenna in a cable television system has been developed by a French communication company, Wisi. Two transmitters, operating in the 11.8-to-12.1-GHz range, have power of 0.2 mW and 2 mW, respectively. The system's parabolic antenna has a gain of either 35 dB or 41 dB, depending upon aperture size. The antenna has a capacity of 12 television channels.

CIRCLE NO. 442

Extensive trials of push-button telephones that use MOS large-scale integrated circuits will be conducted by the British Post Office. Each MOS circuit incorporates its own tone generator and a small memory. Numbers keyed into the memory are transformed into 15 impulses-per-second coded tone, so that, unlike the systems adopted in the United States, no special equipment is needed to interface the phone to conventional exchange equipment. GEC-AEI Telecommunications of Coventry, England, is to supply several thousand of these phones under a large contract. Until

now, the British Post Office has been cautious about the ability of MOS devices to meet its stringent reliability requirements. The first orders were for a number of push-button key senders for telephone operators.

CIRCLE NO. 443

A new method for letting two subscribers use a telephone party line simultaneously has been devised by Siemens of West Germany. Interference and cross-talk between the two subscribers is prevented by modulating the speech, the dialing, the meter and the meter information for the second party by three high-frequency carrier channels. These channels operate at 10, 24 and 36 kHz between the subscriber and the telephone exchange. Low-pass filters at the subscribers and the exchange ends of the line remove the high-frequency carriers from the first party's line. The second party is assigned a demodulation and selection unit at the local exchange, which extracts the voice frequency that operates the local line selector.

CIRCLE NO. 444

What's the best way to cool an underground cable whose power reaches 1 billion VA per circuit? British Insulated Collendar's Cables of London has produced a superconductor cooling design in which coaxial aluminum-backed niobium or lead conductors are maintained at 4 to 5 K by liquid helium. Heat leaks are reduced by a radiation shield that is cooled to 75 K by liquid helium. The insulation is both a vacuum and alternating layers of aluminum foil and paper or glass cloth. The initial cost is about twice that of a 275-kV, oil-filled cable, but the running costs are reported to be about the same.

CIRCLE NO. 445

hp MEASUREMENT NEWS

information for better measurement



in this issue

An economical VHF signal generator

HP's new data acquisition system

At last: an X-Y recorder for OEMs

Counter intelligence for demanding buyers

These HP counters have so many well-planned features and options that you get out-of-this-world performance at down-to-earth prices.

Select the electronic counter/timer capability that you need without paying for unwanted extras. HP 5300 and 5326/5327 counters fill the bill at bare-bones prices, \$520 to \$2150. That includes capability to 550 MHz and many features you could never get before.

Take the 5300A six-digit main-frame, snap-on any of four function-determining modules in less than 15 seconds, and you have a 10 MHz or 500 MHz counter, 10 MHz/100 ns counter/timer, or 50 MHz multifunction counter. Snap-on a battery pack for portable use with any module. You can hold any 5300A in one hand; it's that compact.

(Continued on next page)

High-performance signal generator: small in size, small in price



Looking for a small, solid-state calibrated signal generator? One as easy on the budget as it is to operate? The 8654A VHF Signal Generator gives leveled and calibrated output over a 10 to 512 MHz frequency range. Stability is 20 ppm and residual FM is 5×10^{-7} .

The power level is variable from +3 dBm to -120 dBm, calibrated, and is leveled automatically over the whole frequency range. Modulate it externally or internally: continuously variable amplitude modulation, 0 to 80% (metered); and FM peak deviation 0 to 0.1%.

Its compactness fits the 8654A easily into production, mobile,

HP's easy-to-use 10-512 MHz signal generator is versatile enough for almost every job.

airborne, and shipboard test locations. Its rugged solid-state construction recommends the 8654A for field maintenance and service applications. And its economy commends it for use everywhere—testing receivers, amplifiers, antennas, filter networks, etc.

The price? Only \$1,135.

Perhaps you could use a high performance "economy" generator. For more information, return the HP Reply Card.

(continued from page 1)

For more capability, step up to the 5326/5327 Series. Select seven or eight-digit readout, total remote programming, economical computer interface, time-interval averaging down to 150 picoseconds, a built-in DVM for dc voltage, or max-accuracy time interval measurement via digital trigger level setting, new ultrastable time bases or 10-25 mV sensitivity.

It's a six counter family: 5326 A/B/C (50 MHz) and 5327

A/B/C (550 MHz). The A and B models are universal timer-counters; the B models have a built-in DVM. The C models measure frequency, period, ratio, and totalize input.

For the least costly counters that will serve all your needs, discover the 5300 and 5326/5327 line of electronic counters.

Need more details? Just send the HP Reply Card.

True RMS goes digital at a reasonable price



Only 4½ by 7¾ by 9½ inches, the Model 3403A/B fits in any corner of your laboratory. Attach it to a calibration microphone or a semiconductor test system with equal ease.

The new digital 3403A/B True RMS Voltmeters offer combined capabilities never before available in one instrument:

- Wide voltage range—measures ac voltage from 10 mV to 1000 V full scale.
- Wide frequency range—from 1 Hz to 100 MHz.
- True rms accuracy—measures both simple and complex signals $\pm 0.2\%$ reading $\pm 0.2\%$ of range.
- Versatility—measures ac, dc, ac and dc, low frequency, RF levels, and complex signals.
- LED display—three digits with fourth digit for overrange.
- Volt or decibel readout—an option automatically converts measurements to decibels and reads dBV from -48 to +60 with a resolution of 0.1 dB.
- Economy—an eight-decade bandwidth and six-decade ac voltage range in one instrument, not two or three.

The 3403A True RMS Voltmeter sells for \$1400 plus options; the 3403B (ac only) version starts at \$1150. Six options, including BCD output, are available.

Interested? For more information, check the HP Reply Card.

Do IC troubleshooting ten times faster

The new 5010A Logic Troubleshooting Kit saves time, aggravation, and money. Use the Probe separately for pulse activity problems; the Clip, for logic state; and the Comparator, for logic fault. They analyze digital IC problems ten times faster than conventional techniques.

In design applications, the Probe can be a replacement for expensive oscilloscopes; it indicates logic

The 10529A Logic Comparator finds the faulty pin in 5–10 seconds per IC; tests ICs dynamically in the circuit. Price: \$295.

The 10525A Logic Probe detects static logic highs and lows, the presence or absence of pulse activity. Price: \$95.

The 10528A Logic Clip "looks inside" the suspect IC. LEDs on the clip correspond to 16 IC pins so that each one is monitored. Price: \$125.

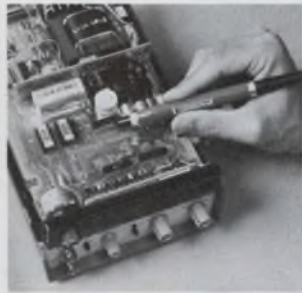

Microwave power meter for automatic systems



The 432C inputs and outputs are fully compatible with HP computers and digital recorders.

Now the HP 432 Power Meter family has a programmable member. The new 432C is a systems-oriented precision power meter with 1 μ W to 10 mW range. Frequency coverage is 1 MHz to 40 GHz using HP's temperature-compensated thermistor mounts.

The 432C features include digital readout, autoranging and auto-zeroing (these can be accomplished with remote programming), BCD and analog outputs of measured power, and 0.5% f.s. accuracy. Price of the 432C is \$1375.

Check the Reply Card for full information about all the 432 series power meters.

A digital multimeter with multi-features



The 3469B is a multimeter, milliohmmeter, dc ammeter, and dc voltmeter—all in one low-cost digital instrument.

Now you can choose 26 different combinations of range and function to make *digital* measurements of ac/dc voltage, dc current, and resistance.

The HP 3469B Digital Multimeter gives you five dc voltage ranges, six dc current ranges, seven ac voltage ranges with 10 MHz bandwidth, eight ohm ranges—all for \$595.

The multimeter measures ac from 1 mV full scale to 500 V over a frequency range of 20 Hz to 10 MHz—particularly useful in communications, broadcasting, and audio applications.

On its most sensitive resistance range, it is a milliohmmeter—one ohm full scale. Use it for contact resistance, components, and plated-through circuit board hole resistances.

The digital dc ammeter measures dc current from 1 microampere to 100 mA full scale.

The dc voltmeter measures from 100 mV to 1000 V full scale with an accuracy of $\pm 0.2\%$ to $\pm 0.3\%$, depending on the range.

For more information, check the HP Reply Card.

Three new computer systems for low-cost batch, time-sharing or real time . . .

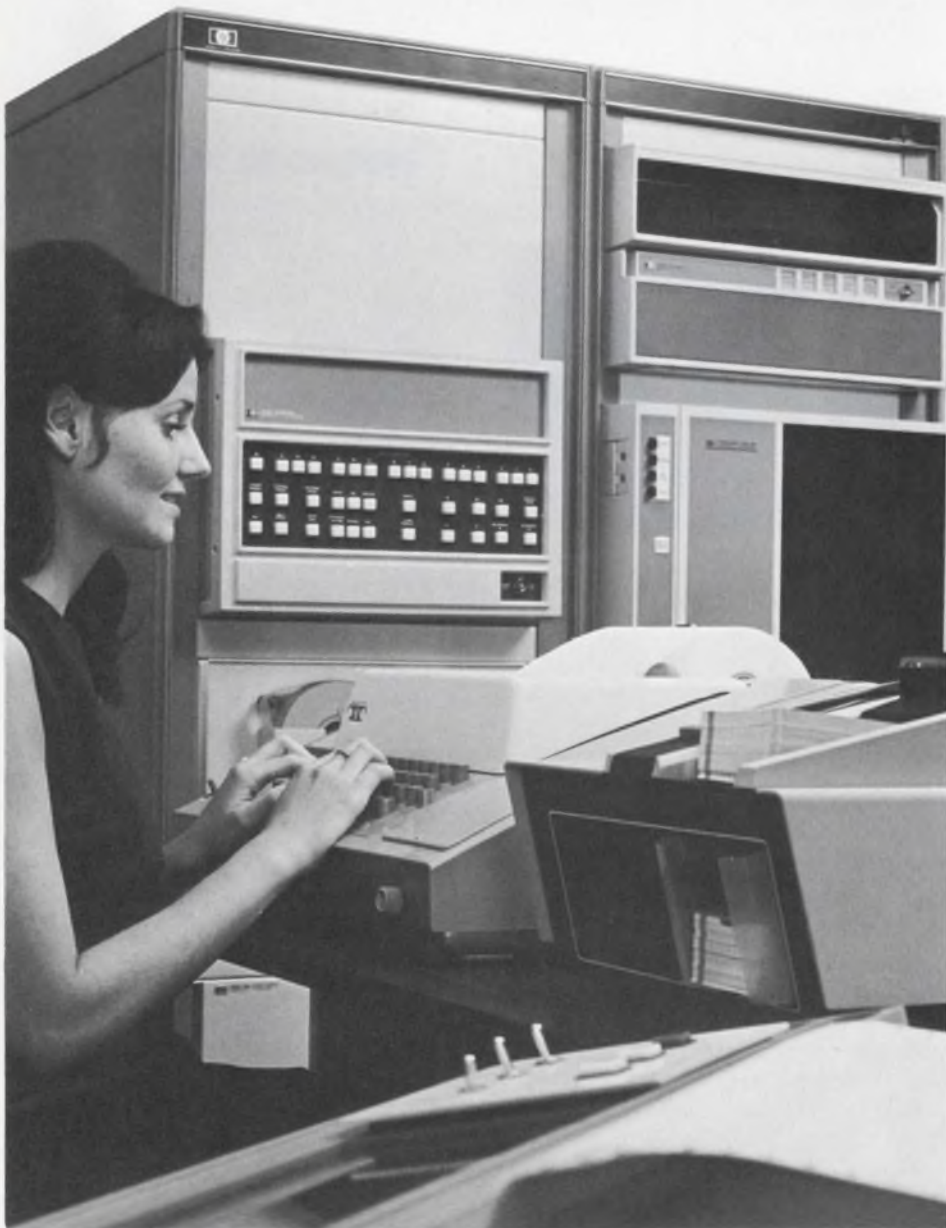

Dedicating a computer system to a specific processing task is now much easier, and costs less to do, with HP's new family of small disc-based systems. These systems can be applied to:

- Batch processing—for uninterrupted job processing with maximum throughput;
- Time-sharing—for direct man-machine interaction; and
- Real-time processing—for response to and control of external events while executing.

The fundamental system is the versatile new 2100A computer with a fast 7900A five-megabyte disc. Other mass storage devices provide up to 47 million bytes of disc storage. Each HP system interfaces with more than a dozen peripherals and plugs in to more than 50 HP instruments.

The reliable software is fully supported. The 2120 Disc Operating System features program chaining, extended file management, and a job processor that handles assembly language, ALGOL, and FORTRAN IV. It executes machine instructions or complex mathematical and logical operations with equal ease.

Just add 16 terminals, some hardware, and our easy-to-learn conversational programming language, HP BASIC, and you have the new 2000E time-sharing system. It can be expanded further to the new 2000F system with a dual processor and another 16 terminals.

With additional equipment and Real-Time Executive software, the disc system becomes a real-time system with priority interrupt and multi-programming capabilities.

Batch systems begin at \$33,000, time-sharing and real-time from \$50,000.

To learn more, check the HP Reply Card.

Batch, time-sharing, or real-time—HP's disc-based computer systems are particularly suitable when there's a need to access large data banks, and where ease of I/O interface is required.

... And a versatile new HP system family for sensor-based data acquisition

The new 9600 Series of modular data acquisition systems satisfies the need to handle multitudes of analog and digital inputs and outputs, all simultaneously. This new HP family of automated systems is specifically designed for applications in research, development, sensor-monitoring, and industrial control. The 9600 is based on the 2100A computer and features two new "plug-in" analog and digital subsystems, as well as three different software operating systems (RTE, DACE, and BCS).

The new **analog subsystem** is capable of scanning and digitizing both low and high level analog signals, and also outputting analog information, for purposes such as driving graphic displays and plotters. The unique feature is that all functional elements are contained on plug-in cards for greater flexibility with less cost and easier maintenance.

The main component is an analog-digital interface. Functional modules plug into the backplane and communicate with each other via analog and digital busses. The subsystem is controlled from the computer, through a control card in the interface. This card uses micro-programming and ROMs to generate the control and timing signals for various system functions. Depending on system needs, more than one interface can be used.

The **digital subsystem** includes the new HP 6940 multiprogrammer with 15 channels of 12-bit digital I/O and expansion capability up to 240 channels. Various plug-in cards let you monitor TTL, DTL, RTL, or contact-closure logic, and output TTL/DTL logic levels and contact-closures with read-back capability. The digital subsystem can also provide analog outputs (voltages and resistances) for controlling devices, such as power supplies.

Software for 9600 systems includes three different operating systems:

Fully integrated—rather than the all-too-familiar piecemeal assembly of data acquisition systems—is HP's 9600 Series. It features the 2100A computer, 7900A disc drive, 7970 magnetic tape unit, 2440A A-D interface, and the 6940 multiprogrammer.



- **Real-Time Executive**—Multi-programming allows real-time programs to run concurrently with general-purpose background programs. Priority scheduling/interrupt controls your programs on the basis of time, event and critical need.
- **Data Acquisition and Control Executive (DACE)**—Schedules multiple tasks (measurement, computation and output) in real-time.
- **Basic Control System**—Features

relocation and linking of user's programs, interrupt processing, input/output control, and a library of arithmetic, logic, and utility subroutines.

Configure a 9600 system to control a single test or experiment, or to automate a whole laboratory or factory. Systems start at approximately \$22,000 and typical systems cost between \$32,000 and \$60,000.

To learn all the facts and features, check the HP Reply Card.

A laser device for computer or IC guys?

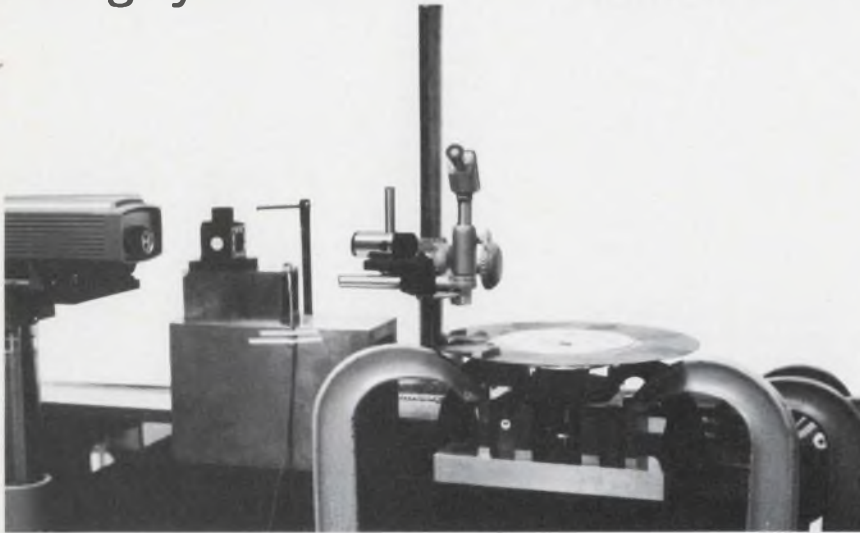

Use lasers in IC production or memory disc positioning? Why not? HP's 5525B Laser Interferometer measures displacements down to one microinch or, with the new K02-5525B Resolution Extender, down to one angstrom. This accessory electronically extends the laser's resolution by a factor of 10. The resolution extension is real-time, giving one microinch resolution at a high update rate, or 0.1 microinch at a lower rate. With two extenders cascaded together, resolution is 0.1 microinch in real-time; or .01 microinch, 10^{-10} meters, or one angstrom with the lower update rate.

The integrated circuit industry uses the Model 5525B both for

This laser interferometer is being used in HP's Gage Lab to measure spacing between the tracks of a memory disc.

calibration and for feedback control of artwork generators, step and repeat cameras, and mask inspection machines. For computer memory discs, the interferometer makes closer track spacing possible—thus improving the disc packing densities. It also calibrates the scales and actuator systems.

The 5525B costs \$11,500. For the K02-5525B Resolution Extender, add \$800.

Interested? Just send the HP Reply Card.

Fast yet precise RF measurements with high resolution

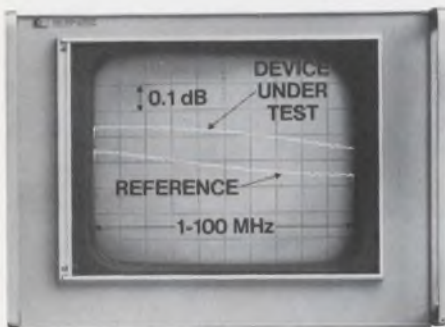

Comparisons over a 100 dB range, differences as small as 0.01 dB and 0.2° can be resolved.

Production-testing RF components normally calls for *swept-frequency* tests, but high precision and high resolution usually require *fixed frequency* tests. End the conflict. Use the new HP 8728A Network Comparator with the HP 8407A 0.1 to 110 MHz Network Analyzer, and make quick yet precise swept-frequency comparative measurements.

The 8728A is \$2950. A typical complete system is approximately \$12,000.

Discover many other features; check the HP Reply Card.

Low-cost displays come with onboard IC

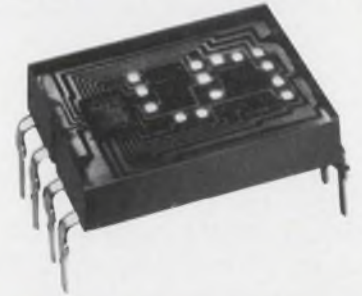

The 5082-7300 numeric display is completely TTL-compatible.

We've built both the decoder/driver and the memory into our new 5082-7300 solid-state numeric display. All you do is address them directly with four-line BCD input. You can store data or have a real-time display at your fingertips.

The characters are .290 in. high for better readability over a wide viewing angle. Yet, it's a compact .6 by .4 inch package.

The displays cost \$10 each in 1 K quantities, and are available from stock.

For more information, please check the HP Reply Card.

Increased sensitivity for 7100 recorders

One small input module increases the sensitivity of the 7100 Series recorders to 100 μ V full scale. Just plug in the 17505A High Sensitivity Input Module; it measures input signal variations as low as 1 μ V at maximum sensitivity. Your strip-chart recorder acquires a variable voltage span from 100 μ V to 100 V full scale. There is even an optional calibrated offset capability in increments from one to ten, full scale. The 17505A costs \$400.

Interested? Just send your HP Reply Card.



HP 17505A plug-in for 7100 recorders.

OEM's get an x-y recorder of their very own

Forty OEM options include several X-Y range calibrations, metric scaling, a time base, an event marker that records in the top margin, rear connectors, and TTL logic control.

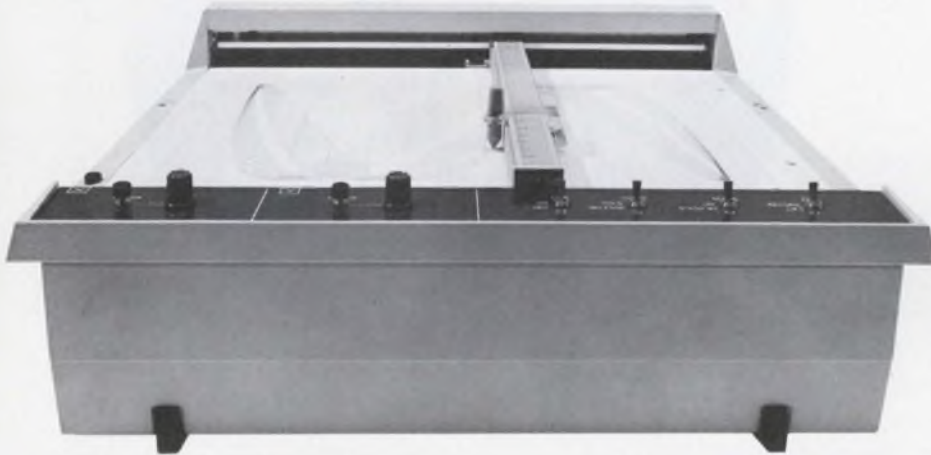

X-Y recorders used to be designed principally for laboratories; now, there is one designed specifically for original equipment manufacturers. The new 7040 does not require any special paper, calibration adjustment, or expensive maintenance.

The one-piece mainframe is die-cast aluminum—durable yet shock-resistant. The circuitry contains only ten hand-soldered connections—reliable and maintenance-free. The writing area is 10 by 15 inches (25 by 38 cm.) with an autogrip that holds 11 by 17 in. or international A3 size paper.

Accuracy is $\pm 0.2\%$ of full scale; linearity, $\pm 0.1\%$ of full scale. Standard features include a newly-developed hybrid potentiometer, disposable pens, 1 megohm input resistance, and 20 in./sec. minimum slewing speed. A new motor design on both axes lets the OEM recorder pen be driven offscale for an indefinite period of time without noise or damage.

The price, sans options, is \$890.

For more information, check the HP Reply Card.

Set scope time bases as easy as 1-2-5



The HP 226A Time Mark Generator

When you need precise timing, the new HP 226A Time Mark Generator makes it easy to calibrate your oscilloscope and recorder time bases. With a room-temperature crystal that needs only 1/2-hour warm-up to give you 20 ppm accuracy (at 25°), the 226A generates one-volt markers (into 50 ohms) at 30 intervals ranging from

2 nanoseconds to 10 seconds and in a 1-2-5 sequence.

It's programmable, too, with an option that makes it operable in automatic systems.

The 226A costs \$670. (For the programming option 003, add \$150.)

To learn more about the 226A, just check the HP Reply Card.

18-40 GHz measurements with network analyzer

Now you can measure reflection and transmission coefficients—magnitude and phase—in the 18–26.5 and 26.5–40 GHz bands, using the new K8747A and R8747A waveguide test units for the 8410 Network Analyzer.

For full details on this much-needed high-frequency measurement capability, use the HP Reply Card.

OOPS!

That was some thermal recorder described in the last issue of MEASUREMENT NEWS. Unfortunately, its impressive specifications resulted from a typographic error. (We should have said 50 Hz and 100 Hz, instead of 50 MHz and 100 MHz.) Meanwhile, the HP 7414A is still a nifty performer.

"The Portables" add two scopes, including a 75 MHz model with delayed sweep

Two new scopes have been added to HP's 1700 Series of high-performance "portables"—the 1707A, with a 75 MHz bandwidth and delayed sweep; and the 1703A, the first variable persistence/storage oscilloscope operated on batteries.

Both scopes incorporate all the 1700 Series' best features: low power requirements, only 24 lbs. in weight, bright display, no dust-collecting ventilator holes, solid triggering with a minimum of signal, and reliable thermally-stable ECL trigger circuits instead of conventional tunnel diodes.

Both scopes also have a 10 mV/div deflection factor over the full bandwidth, 10 ns/div sweep speed, and a rise time of less than 4.7 ns. There are improved divider probes, delayed sweep, and a large cathode-ray tube display. They can readily measure T²L or some ECL pulse timing and propagation delay. The sweep and trigger circuits were designed especially for digital field service applications.

Their low power requirements mean you can use an internal, rechargeable battery pack for up to four hours operation; or use an 11.5 Vdc to 36 Vdc source, or any standard ac outlet.

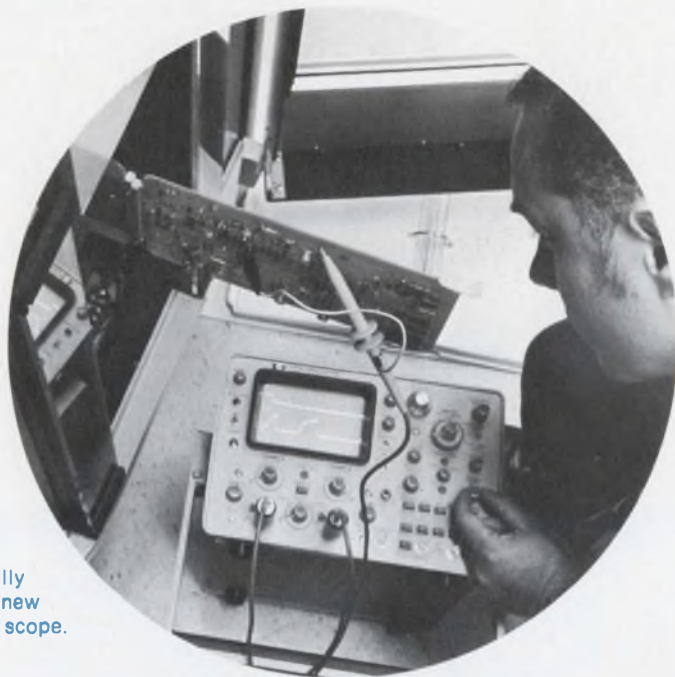

Servicing computers and peripherals can be less costly, especially if you use HP's new 1707A portable scope.

The new 35 MHz 1703A with delayed sweep is an HP exclusive—the only portable variable persistence/storage oscilloscope that can be battery-powered. Variable persistence allows you to control the rate at which the trace fades; the storage capability lets you hold a particular pattern on the scope.

Actual customer experience verifies that the 1700 Series requires roughly half the calibration time of competitive portables due to the low number of internal adjustments.

This means substantial savings over the lifetime of each instrument.

The 1700 portable scopes begin as low as \$1680 for the nondelayed-sweep, dual-channel 35 MHz version. The 35 MHz variable persistence/storage scopes sell for \$2,725 (1703A, with delayed sweep) and \$2,375 (1702A, nondelayed). The 75 MHz scopes cost \$1,925 (1707A, with delayed sweep) and \$1,775 (1706A, nondelayed).

For more facts and features, please check the HP Reply Card.

HEWLETT  **PACKARD**

Measurement, Analysis, Computation

East—W 120 Century Road, Paramus, N.J. 07652.

Ph. (201) 265-5000.

South—P.O. Box 2834, Atlanta, Ga. 30328.

Ph. (404) 436-6181

Midwest—5500 Howard Street, Skokie, Ill. 60076.

Ph. (312) 677-0400.

West—3939 Lankershim Boulevard, North Hollywood, Calif. 91604. Ph. (213) 877-1282.

Europe—Rue du Bois-du-Lan 7, CH-1217 Meyrin 2.

Geneva, Switzerland, Ph. (022) 41 54 00.

Canada—275 Hymus Boulevard, Pointe Claire.

Quebec, Canada, Ph. (518) 561-6520.

Japan—Ohashi Building, 59-1, Yoyogi 1-chrome,

Shibuya-ku, Tokyo 151, Japan.

Ph. 03-370-2281/92.

For built-in reliability, design with "Scotchflex" Flat Cable/Connector Systems.

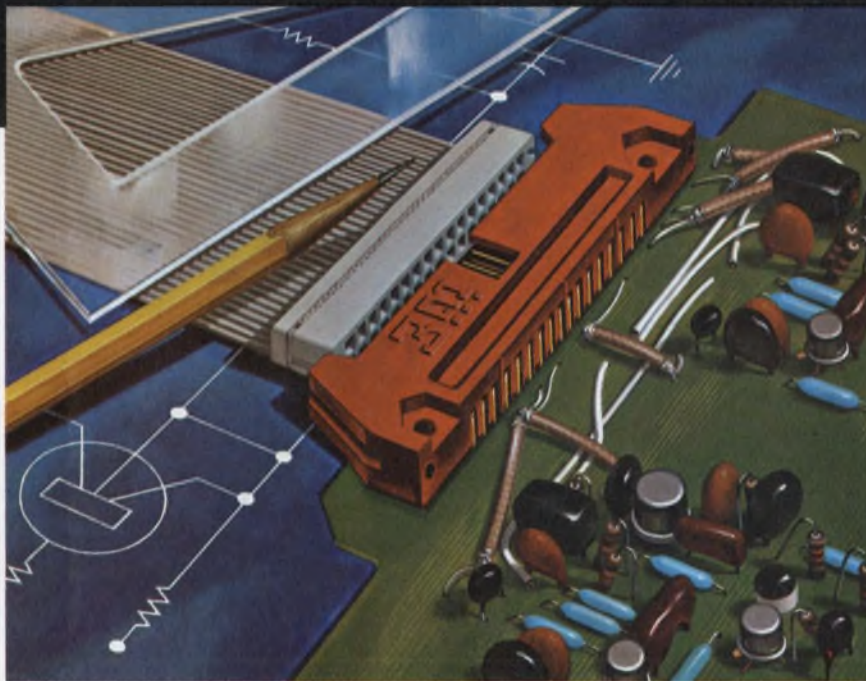

"SCOTCHFLEX" IS A REGISTERED TRADEMARK OF 3M CO.

"Scotchflex" Flat Cable and Connectors can offer you trouble-free packaging for your next generation equipment.

There's built-in reliability for your circuit inter-connects. Our flat, flexible PVC Cable has up to 50 precisely spaced conductors. The gold plated U-contacts are set into a plastic body to provide positive alignment. They strip through the insulation, capture the conductor, and provide a gas-tight pressure connection.

Assembly cost reductions are built-in, too. "Scotchflex" Connectors make up to 50 simultaneous connections without stripping or soldering. No special training or

costly assembly equipment is needed.

Off-the-shelf stock offers you flat cable in a choice of lengths and number of conductors from 14 to 50. Connector models interface with standard DIP sockets, wrap posts on .100 x .100 in. grid, or printed circuit boards. Headers are available to provide a de-pluggable inter-connection between cable jumpers and printed circuit boards (as shown). Custom assemblies are also available on request.

For full information on the "Scotchflex" systems approach to circuitry, write to Dept. EAH-1, 3M Center, St. Paul, Minn. 55101.



TWO OF MAN'S OUTSTANDING INVENTIONS



TO-5 Relay

Where would man be in the evolution of progress if through his reasoning and ingenuity he had failed to invent the wheel . . . or the TO-5? The wheel is basic. So is the TO-5 Transistor Case Relay developed by Teledyne Relays! Like the wheel, the TO-5 didn't just happen . . . It evolved from a need. From its initial beginning as a totally reliable 2-pole double throw relay, the TO-5 has grown to a broad family of configurations — the most advanced and reliable general purpose relays available.

3155 West El Segundo Boulevard
Hawthorne, California 90250
Telephone (213) 679-2205

67 Ludwigshafen (Rhein)
Altripper Strasse 27-31, Germany
Telephone 0621-576431
Telex 464760



**TELEDYNE
RELAYS**

washington report



Don Byrne
Washington Bureau

Bulk of defense budget expected to be approved

As expected, the proposed \$83.4-billion defense budget request, an increase of \$6.3-billion over fiscal 1972, is drawing protests from liberal Democrats and Republicans, Congressional tax writers and Presidential candidates. But in this election year, Defense Dept. sources feel they can get the bulk of the appropriation request approved, because of the jobs involved and a need to bolster the economy. Defense expenditures for the coming fiscal year are pegged at \$76-billion, a climb of only \$700-million over the current year.

The political implications in the defense budget are inescapable, since the spending has been linked directly to the arms-limitation talks. The Ulms (undersea long-range missile system), a major factor in the arms talks, will receive \$942.2-million in fiscal 1973, up from \$139.8-million in the current year (see p. 30). Defense R&D has been increased by \$838-million, standing at \$8.5-billion for fiscal 1973. Other programs due to receive a major shot in the arm will be the B-1 bomber—a rise to \$444.5-million from \$370.3-million in the current fiscal year—and Awacs (airborne warning and control system)—\$469.9-million, compared with \$139.3-million. The Navy's proposed CVAN 70 nuclear-carrier program, chopped from the budget last year, is slated to get \$299-million for long-lead-time items, but its future is uncertain.

Even while the President was submitting his budget, Secretary of Defense Melvin Laird was testifying before Congress on a request for a \$2.9-billion supplemental appropriation for fiscal 1972. Only \$254-million of that total is earmarked for items other than salary increases. The Pentagon is asking \$113.8-million for four 747 jetliners for Presidential airborne command posts, \$35-million for initial R&D speedup of Ulms and about \$100-million for projects which, according to Defense Controller R. C. Moot, "are designed to give us greatest immediate lift in response to the growing Soviet challenge." Moot says the projects include development of cruise missiles, sensors for ocean surveillance and protection against electromagnetic pulses from nuclear explosions.

Millions for space shuttle, but nothing for the 'grand tour'

NASA's budget of \$3,379,000,000 for fiscal 1973, an increase of about \$83-million over last year, contains \$228-million for space-shuttle development but no money for the proposed "grand tour" mission to explore the outer planets. In place of the grand tour, the space agency has proposed a flyby inspector of Jupiter, and maybe Saturn. NASA expenditures in fiscal 1973 are expected to hit \$3.19-billion, an increase of \$100-million over fiscal 1972.

Only two Apollo missions remain—Nos. 16 and 17—and Apollo costs will drop from about \$600-million this year to \$130-million in the coming year. Skylab will remain pretty much at this year's \$540-million. Some \$28-million has been slated for facilities construction for the shuttle, but, as yet, NASA will not say where the base will be. Most signs point to Cape Kennedy. NASA's budget is expected to climb about \$100-million, to \$2.6-billion, in fiscal 1973. Expenditures for R&D are expected to rise about \$15-million, to \$2.42-billion.

The cost of the shuttle, pegged now at about \$5.5-billion, compared with the originally planned \$10-billion, will peak in 1976, when the space agency will need about \$1-billion to proceed. NASA expects about 80% of the shuttle payloads to be unmanned satellites.

New budget bolsters faltering FCC probe of AT&T

The Federal Communications Commission, which announced a short time ago that it was dropping its continuing investigation of American Telephone & Telegraph because it didn't have the staff or money to pursue the chase, may get the money to carry on, after all. Included in the \$32.5-million budget that President Nixon requested for the FCC in fiscal 1973 is an unspecified amount to hire "additional staff to augment the commission's program of surveillance of Bell System operations." The FCC's initial decision to drop the inquiry drew sharp fire from Congress, state regulatory bodies and, inevitably, Ralph Nader. The agency is to get \$1.8-million more under the new budget.

Trade deficit spurs labor in imports fight

The announcement by the Dept. of Commerce that the U.S. suffered its first trade deficit in 83 years last year—\$2-billion—is fueling a drive by organized labor for legislation this year to restrict imports, including electronics of all kinds. A bill introduced in both houses by Sen. Vance Hartke (D-Ind.) and Rep. James Burke (D-Mass.) would limit imports and activities of U.S. corporations with plants and investments overseas. The bill would enact some of the toughest trade legislation since the 1930s (see News Scope, p. 23).

Capital Capsules: Total R&D commitments for the Government for the coming fiscal year are \$17.8-billion, up from \$16.4-billion this fiscal year. After the Defense Dept. and NASA agencies spending the most will be the Health, Education and Welfare Dept., Atomic Energy Commission, National Science Foundation and Dept. of Transportation. . . . The Federal Aviation Administration plans to allocate \$250-million in the coming fiscal year for facilities and equipment, of which more than half is to be spent for such electronic hardware as radars, Loran, Tacan and other navigation devices. . . . The Government may be proud of its R&D effort, but the Aerospace Industries Association says that "within the decade of the 1970s the U.S. can lose technological superiority to the Soviet Union in the fields of space and national security." Government spending on R&D the association notes, has been almost static and is, in fact, declining because of inflation. The R&D funding growth rate has dropped from 9% in 1966 to less than 1%, according to the association.



YOUR KEYS

to more calculator power!

Today, there are only two programmable calculators with mathematical keyboards. Both are TEKTRONIX Calculators.

Our keyboard is uniquely different from keyboards of other programmable calculators. With it you solve even the most complex expressions in a universal language you know and use daily—mathematics. For instance, to solve the expression:

$\ln\left(\frac{\sin x}{x}\right)^2 + \frac{x(x^2 - 1)}{2} \times \sqrt{3^2 + 4^2}$ for $x = 2$ just press the following keys:

(2	sin x	+	2)	x ²	ln x
+	2	x ²	(2	x ²	-	
+	2	x	3	$\sqrt{x^2 + y^2}$	4	=	18.42353957.

Whatever your discipline, you solve any expression involving as many as 256 programmable keystrokes (5120 with the optional programmer) using the same natural, direct mathematical procedure. You never spend valuable time learning and using an artificial machine language.

Some day all calculators will have mathematical keyboards. User preference demands it.

For complete information or to arrange a demonstration, contact any TEKTRONIX Field Office. Our offices are located in or near major cities and industrial centers—worldwide. If you prefer, write Tektronix, Inc., P. O. Box 500, Beaverton, Oregon 97005.



- Scientist 909 Calculator \$3200
- Statistician 911 Calculator \$3200

U.S. Sales Prices FOB Beaverton, Oregon

INFORMATION RETRIEVAL NUMBER 26

How to live within your budget!

Money for new test equipment is tight. Every dollar has to stretch as far as possible without hurting performance.

If you're looking for a 15 to 50-MHz scope—like the 422, 453A or 1700—you owe it to your company to try Hickok. Because, with a Hickok scope, you get quality performance while saving money.

With Hickok, you receive:

- dual and single channel models
- 25-MHz bandwidth
- stable triggering beyond 50 MHz
- 10-mV sensitivity
- built-in delay line

The value-priced 5000A and 5002A are the results of Hickok's experience in producing more than 20,000 scopes for reliable operation in rugged military environments. These performance-packed scopes are ideal for lab applications: clean pulse response; 4 screen width horizontal and 3 screen height vertical deflection; sharp, bright trace. And for field use, lightweight, compact design.

These are features usually found on models costing up to \$2100. And this brings us back to economy—the 5000A single channel scope is \$595 and the 5002A dual channel is \$845. Call Hickok to take a look at these scopes in your lab.

HICKOK
the value leader

Instrumentation and Controls Division
10514 Dupont Ave. • Cleveland, Ohio 44108
(216) 541-8060

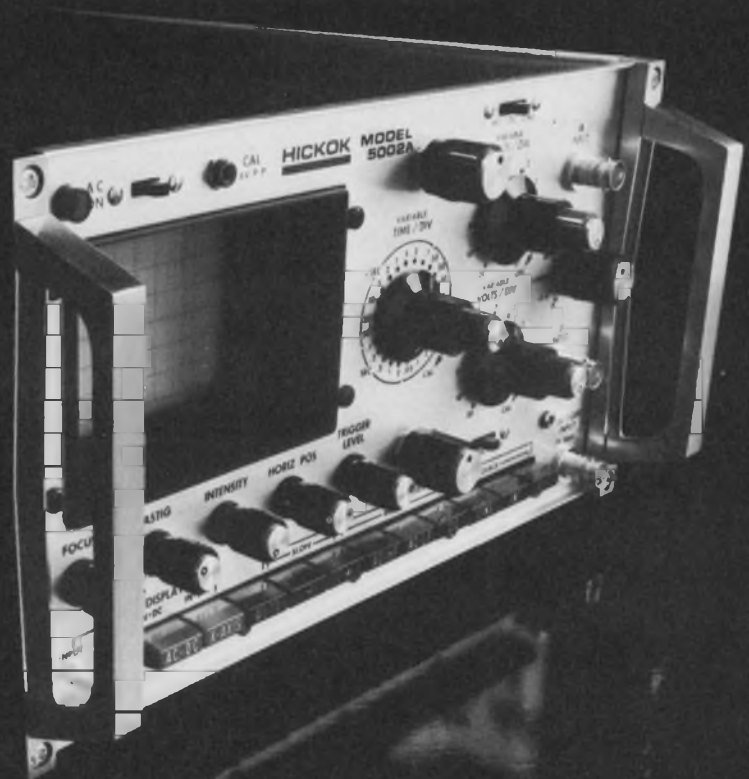

HICKOK

Announcing a reliable way to come in under budget.

Our new commercial Series 8 miniature manual switches provide quality construction and reliable performance at a low cost.

The positive detent action is a good example of our quality construction. It assures you of excellent tactile feedback.

For safer operation, there's maximum separation between the terminals and the metal mounting and operating elements. And our case, using superior arc-resistant materials, has excellent compartmentation to isolate individual internal circuits.

There's a choice of toggles (select from lever styles and colored, slip-on caps), paddles and rockers (snap-in mounting and choice of colored buttons), and lighted rockers. Also select from pushbuttons with colored buttons in two sizes.

All this makes the Series 8 perfect for jobs where money and space are limited, but performance standards aren't. Communications equipment, test and measuring devices, computer peripheral and business equipment are examples. Series 8 switches are rated 6 amps, 125 VAC.

For additional information, see your MICRO SWITCH Branch Office or Authorized Distributor (Yellow Pages, "Switches, Electric"). Or write for our Series 8 Product Brochure.

MICRO SWITCH makes your ideas work.

MICRO SWITCH

FREEPORT, ILLINOIS 61032
A DIVISION OF HONEYWELL

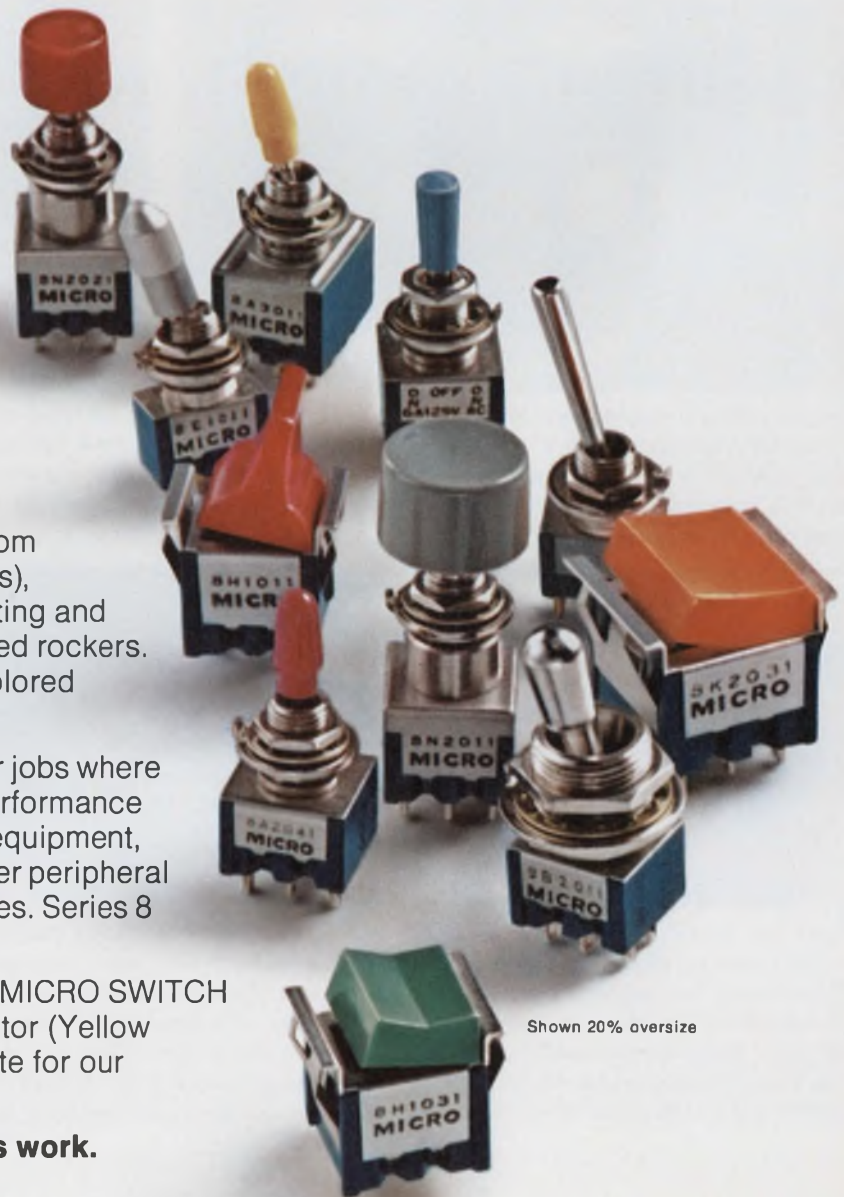

Shown 20% oversize

Tips on cooling off hot semiconductors

As power levels go up and up and package size shrinks, circuit designers are keeping semiconductors cool with IERC Heat Sinks/Dissipators. Reducing junction temperature gives many benefits: faster rise and fall times, faster switching speed and beta, fewer circuit loading effects and longer transistor life and circuit reliability.

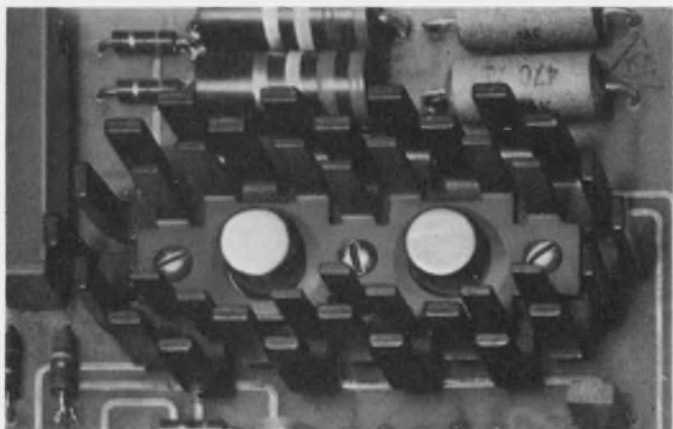

Thermal mating of matched transistors, such as these TO5's shown on a dual LP, maintains matched operating characteristics. The LP's unique multiple staggered-finger design (both single and dual models) maximizes radiation and convection cooling, results in a high efficiency-to-weight and -volume ratio.

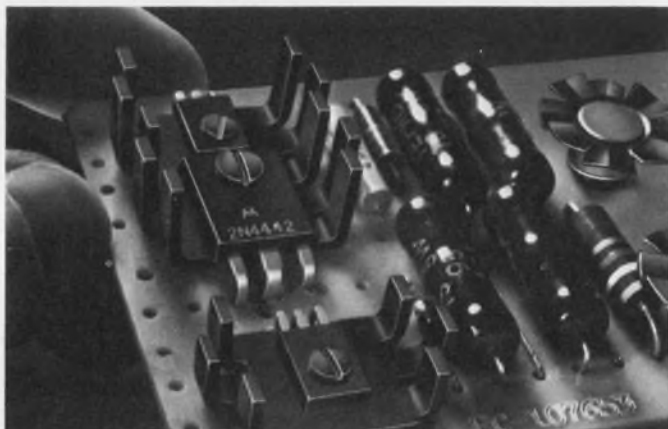

Power levels of plastic power devices such as X58's, MS9's, and M386's can be increased up to 80% in natural convection and 500% in forced air when used with PA and PB Dissipators. PA's need only .65 sq. in. to mount; PB's 1.17 sq. in. Staggered finger design gives these light-weight dissipators their high efficiency.

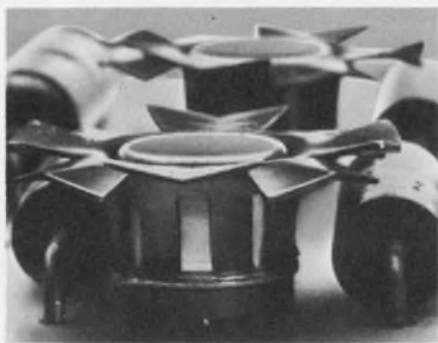

TO5's and TO18's in high density packages can be cooled off with efficient push-on Fan Tops that cost only pennies. T-shaped, need no board room, let other components snuggle close. Spring fingers accommodate wide case diameter variations. Models for RO97's, RO97A and D-style plastic devices also.

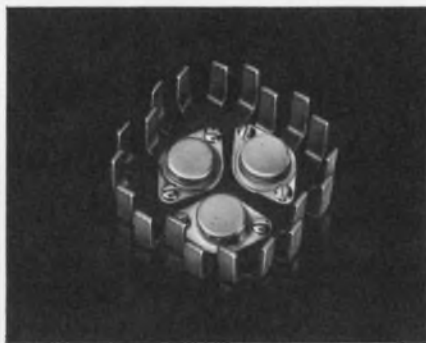

High power TO3's, TO66's, TO6's, TO15's, etc. can be operated with much more power when used with HP's. These compact, light-weight staggered finger devices accommodate from one to four TO3's. Provide the same heat dissipation as an extrusion that's three times heavier and one-third larger.

Heat problems? IERC engineers welcome the opportunity to help solve your heat dissipation problems. As the world's largest manufacturer of heat sinks/dissipators for lead and case mounted semiconductors, they can come up with a practical, low cost solution.

Free four-page Short Form Catalog. Send for your copy today.



Heat Sinks/Dissipators

IERC



Now..practical pluggability for leadless LSI and LED packages.

AMP pluggable connector for substrates with top- or bottom-contact pads

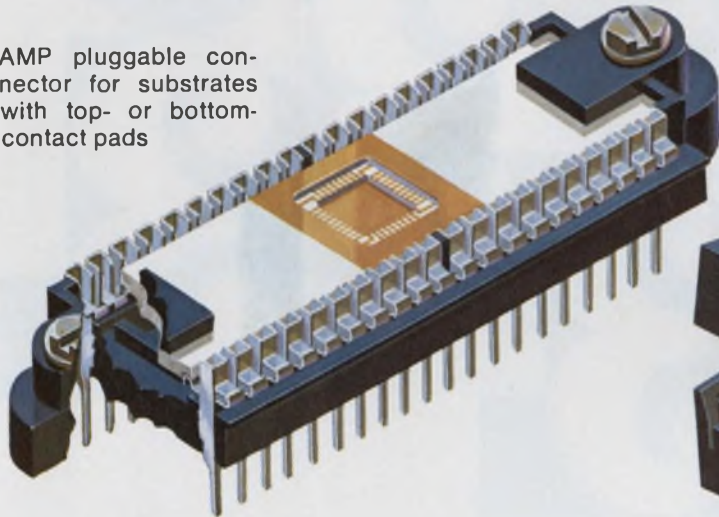

AMP pluggable connector for substrates with edge-contact pads

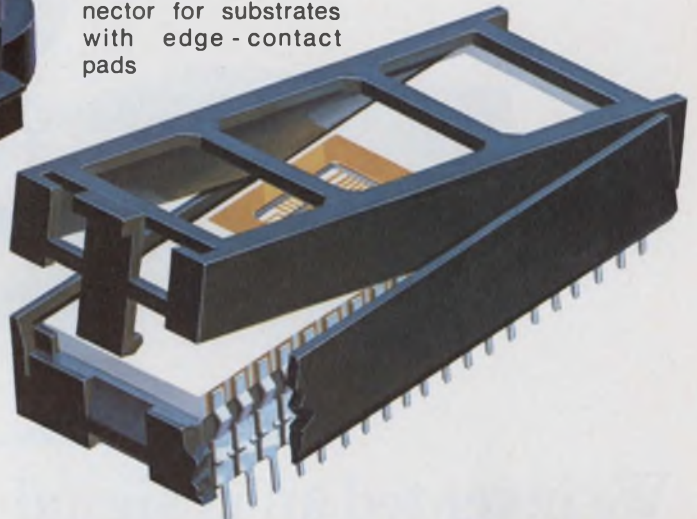

You've been hearing about the new leadless substrate LSI packages that will eliminate the handling problems of delicate leads and allow field replacement without mind-blowing soldering.

AMP now has a line of special connectors designed to make pluggability of these leadless substrates practical and reliable. The AMP connectors feature zero entry force insertion, a contact design with stored spring energy to maintain reliable contact pressure, and a low profile.

We have two types of these connectors for leadless LSI packages. One to mate with either top or bottom surface metalization, the other accepts the new packages with contact pads on the edge of the substrate.

Get the latest word on the latest in LSI/LED pluggability, by writing **Industrial Division, AMP Incorporated, Harrisburg, Pa. 17105.**

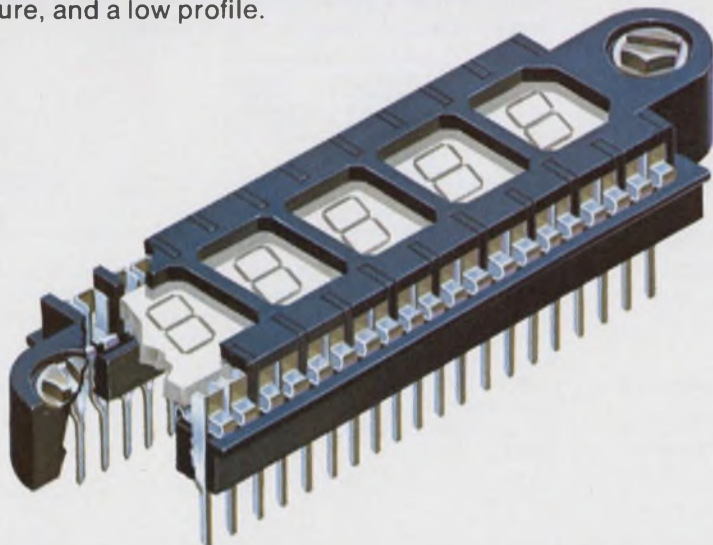

We also have a new version of this leadless connector that is designed to accept modular LED seven-segment displays. We can modify length and width to accommodate your complete LED display unit.

AMP
 INCORPORATED

Manufacturing and direct sales facilities worldwide: Barcelona, Brussels, Buenos Aires, Frankfurt, London, Mexico City, Paris, Puerto Rico, Sao Paulo, 's Hertogenbosch (Holland), Sydney, Stockholm, Tokyo, Toronto, Turin, Vienna.

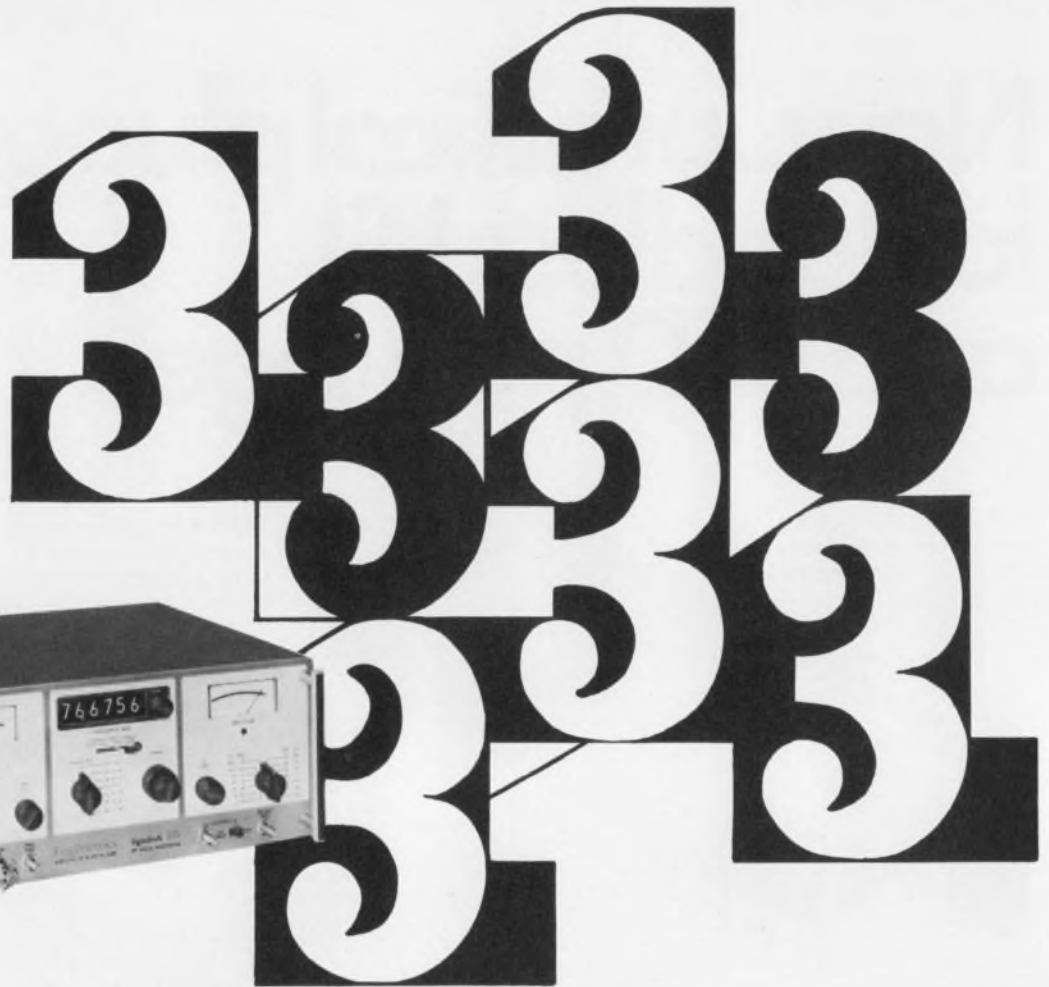

We invented an rf signal generator for people with a 3-instrument need and a one-instrument budget It contains a generator, a frequency stabilizer and a counter, all in one instrument

What a joy it is to have that six digit counter built right into Logimetrics' Model 925 generator!

The counter's primary purpose is to display the generator frequency. But the counter can be used independently. It has variable resolution to 100 Hz, a frequency range that's the same as the generator — 50 kHz to 80MHz — and a maximum sensitivity to 50 mV rms. A counter with similar specifications is worth about \$995, but you get this one as a bonus with the model 925.

The built-in frequency stabilizer helps the generator produce the most remarkable result of all: a frequency stability of ± 10 Hz. This synthesizer-like stability was simply not available before the Signallock™ circuit was invented.

Whether it's the economy of getting three instruments in one, or the idea of having that amazing frequency stability, and accuracy at your fingertips, or simply the instrument's

wide range of 50 kHz to 80 MHz that appeals most to you, it's best to get all the details now. Use the Readers Service Card, or write or call us directly.

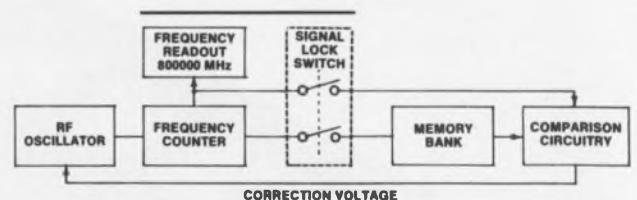

"Signallock" is a patented circuit which enables the output of the built-in rf oscillator to be locked into the crystal time base of the built-in counter. When the Signallock mode is switched in, the digital readout is stored in a memory, and then continuously compared to the generator's output frequency. If an error exists between the output frequency and the memory frequency, a correction voltage is fed back to the oscillator, causing frequency to return to the original setting.

LogiMetrics INC. 100 Forest Drive, Greenvale, New York 11548 • Phone (516) 484-2222 • Telex 96-1371

INFORMATION RETRIEVAL NUMBER 31

Design for price and ride the devaluation

If we work it right we should be able to get tremendous mileage out of the dollar's devaluation. Now that our government has stopped kidding itself into thinking the dollar is worth more than it really is, we have a chance to compete effectively with engineers from other countries—if we don't blow the deal by letting our prices climb.

Over the years, we've become increasingly noncompetitive. In earlier days our electronics technology—even on the simpler levels—led the world's. We pioneered mass-consumption products like radio and TV sets and were the undisputed leader in more sophisticated electronics. Then we watched Japan take over.

To many of us who were brought up with the idea of American leadership in technology and price, the Japanese ascendancy came as a shock. Before World War II, "Made in Japan" meant cheap imitations of American products. Today the Japanese design and produce some of the most impressive equipment in the world—and not just consumer electronics.

Japan didn't advance unaided. We helped. We prevented the Japanese from building a war-centered economy—thus forcing them into producing consumer and industrial goods. And we kept the price of the dollar high. The world's people had to spend too many francs, or pesos, or pounds, or guilder, or Deutsche mark or lira to buy a dollar's worth of American goods. The yen was cheaper.

Now that we've priced the dollar more realistically in terms of other currencies, we stand a better chance to compete. It still won't be easy for our labor-intensive products to outsell those made by underpaid workers in impoverished nations. But our higher-technology products can get a fresh start—if we don't overprice them and throw away the advantage we gain from devaluation.

At the same time we can reverse the flow of capital. Devaluation can discourage U.S. investments abroad and encourage foreign investments here. The advantages—more jobs and new engineering challenges—are obvious.



A handwritten signature in cursive script that reads "George Rostky".

GEORGE ROSTKY
Editor



“In two or three years we’ll become the Taiwan of sophisticated electronic equipment.”

The prediction is made by Oded Vered, manager of the Technical Products Dept. in the Israel Export Institute, Tel Aviv. The Government agency is dedicated to the promotion of Israeli products in other countries, but Vered’s forecast is echoed by engineers and engineering managers nearly everywhere in Israel.

While most sectors of the Israeli economy have advanced in recent years, none can rival the growth

rate of its electronics industry—about 20 to 30% annually. In 1961 electronics companies produced only about \$3-million worth of goods; in 1971 the figure was about \$130-million. The output by 1975, according to the Israeli Minister of Commerce and Industry, will reach \$300-million to \$500-million.

Most of this extraordinary spurt has taken place since the French embargo on arms shipments to Israel. President Charles de Gaulle’s precipitous decision proved to Israel the danger



Israel: The brainy 'Taiwan' of electronics in the Mideast

Ralph Dobriner, Managing Editor

of depending on other countries for military supplies. In June, 1967, Israeli policymakers decided that self-sufficiency had to be promoted at all costs. Millions of dollars were poured into research and development, and local concerns began to receive orders that formerly were placed with overseas concerns.

By world standards, the Israeli electronics industry is still small. But the ingredients to insure success are present: relatively cheap, reliable labor and a reservoir of engineering brainpower that is probably unmatched in any of the world's small nations.

With this combination, Israel could develop its own electronics hardware in time, and some, in fact, is being developed. But faced with the need to expand exports rapidly while at the same time supplying its military, Israel leans heavily toward licensing and technical agreements with foreign companies, especially American.

Foreign companies that foster electronics operations in Israel find they can cut costs. An Israeli engineer makes the equivalent of about \$450 a month, while a good salary for a technician is about \$300 monthly. A girl on the production line gets about \$150 a month.

Eliezer Grunwald, deputy director of the investment authority in the Israeli Ministry of

Finance, sums up the advantages this way: "An American firm can manufacture a tailor-made piece of electronic hardware in Israel cheaper and with as high a quality content as in the United States. I don't believe we can compete with General Electric or General Motors in terms of mass-produced items, but for small series production, it pays to manufacture it in Israel."

Wide range of hardware

The Israeli electronics industry is now producing a wide range of high-quality hardware, including military communications equipment, radar fire-control systems, advanced circuitry and microminiature electronics. A variety of instrumentation is also being produced: nuclear, industrial, medical, optical and scientific. In addition there is manufacturing of control equipment for the telephone network, batch-fabrication systems, and so on. A number of consumer products are being produced for the domestic market, including television sets and car radios. There are at present some 80 manufacturers of electronics in Israel, with an average of 10 new companies being formed each year.

Most of the output of Israel's electronics industry goes for domestic needs, particularly to the military. But with the country also embarked on a campaign to reduce imports and increase exports, because of a critical balance-of-payments problem, exports are increasing rapidly. Exports brought \$16.5-million into Israel in 1970, a six-fold increase since 1967.

The boom in housing and factory construction in sparsely populated regions of Israel makes "instant" communications a must. Here a construction foreman employs a two-way FM radio manufactured by Motorola Israel Ltd.

Ten leading companies employ 93% of the manpower and produce 95% of the output of the Israeli electronics industry. The biggest by far—the “General Electric” of the Mideast—is Tadiran Israel Electronics Industries Ltd.

Tadiran is owned 50% by Koor Industries Ltd.—the largest industrial concern in Israel—35% by General Telephone and Electronics International and 15% by the Israeli Defense Ministry. In the early 1960s the company was little more than a manufacturer of flashlight batteries. This year it expects to turn out nearly \$60-million worth of electronics, including communications equipment for military and civilian use, car radios, tape recorders, television sets and a line of integrated circuits and hybrids. Tadiran employs about 3500 workers—more than all other electronic companies in Israel combined—and of the total, about 180 are electronic engineers.

The company considers itself the largest manufacturer of military communications equipment outside the U.S. “And as far as wide range is concerned, I think we’re the No. 1 company in the world,” says Itzhak Toledano, administration manager. Most of the military equipment that Tadiran manufactures flows from license agreements with U.S. companies, including Magnavox, Sylvania Electric Products and Lenkurt Electric. A considerable amount of the licensed production is modified for the particular requirements of the Israeli military.

Toledano says that 50% of Tadiran’s military production is being exported to nations around the world. But it’s practically impossible to break into the U.S. market, he observes. “We have to be 50% lower than the lowest bidder,” he explains. “We once got down to 40% but didn’t make it.”

Tadiran’s line of hf, vhf and uhf military communications equipment ranges from hand-carried, two-way FM radios to single-sideband long-range transceivers. Military radios—manpack, vehicular and airborne—are of modular construction and completely solid-state, many employing thick-film hybrids and ICs.

The digitally controlled synthesizers in one military radio set provide a frequency range of 7000 vhf/uhf channels, and in another there are 16,000 hf channels for ssb operation. Most of the sets come with auxiliary equipment, such as range boosters or intercom control boxes.

Innovation in a small package

An example of a very simple, but innovative, modification to a standard line of military products is Tadiran’s LSA-100T loudspeaker-amplifier assembly. The two-pound unit, which is about the width of two packs of cigarettes, plugs into AN/PRC-24 and AN/PRC-77 backpack radio

Managing editor Ralph Dobriner spent two weeks touring Israel’s electronics industry. His report is based on interviews with engineers and executives from more than 25 companies and Government agencies.

sets, whose audio outputs are insufficient to drive a normal loudspeaker. Thus while the radio operator remains in full communication, a commander can simultaneously listen in on the conversation if the amplifier assembly is used.

The company recently finished development of a small military switchboard that will eventually replace its manual 12-line field version. Tadiran is also working on a line of fully electronic switchboards that will be both exported and adopted as standard by the Israeli Army.

Besides being the major producer of television receivers in Israel, under a licensing agreement with Voxson of Rome, Tadiran is designing an electronic voting machine.

According to Toledano, the machine will probably first be tried out in Israel and then offered for sale in the U.S. “One thing is clear, however,” the manager observes, “we cannot afford to make a \$2000-to-\$3000 machine, such as exists in the States. To bring the costs down, our designers are now working to put all of the machine’s logic on an LSI chip.”

In the components area, Tadiran produces a line of 1-to-150-MHz quartz crystals, crystal filters and discriminators for military and civil communications equipment. It also plans to introduce a line of monolithic crystal filters. It produces a variety of thick-film hybrid circuits, which it is widely incorporating in military communications equipment and now plans to design into car radios and other consumer products. And finally, Tadiran produces a broad line of linear ICs, including op amps, differential amplifiers and voltage regulators.

Toledano says that ICs are widely used in Israeli products. The use of MSI and LSI circuitry is also growing rapidly, but Israel has no manufacturing capability at present. Most of the circuits are purchased from the U.S.

Probably second in size to Tadiran is Elta Electronics Industries Ltd., a subsidiary of Israel Aircraft Industries Ltd. Employing about 1450 people, of which about 500 are engineers (145 EEs), Elta turns out a variety of hardware for the Defense Ministry.

One of the company’s “most promising” developments is the TS1-ARC-51 portable transceiver test set. This 25-pound unit, which replaces a raft of bulky test gear, pinpoints defects as it performs a go-no-go check of the airborne transceiver. The transceiver, manufactured by



Color video scan of human head was made with an automated digital scanning system developed by Elscint Ltd., a major Israeli manufacturer of scientific instruments.



Israeli engineers check logic diagram and printed-circuit board preparation at Monsel Electronic Instruments Ltd. in Haifa, a subsidiary of Monsanto Co.

Collins Radio and Admiral, is installed in some 50,000 aircraft around the world, according to Jacob Paz, Elta's director of sales and marketing. The test unit is being evaluated by the Israeli Air Force on its fleet of Skyhawks and will eventually, Paz hopes, be sold to the U.S. military.

Paz says that Elta and Microwave Associates of Burlington, Me., are planning a joint venture to develop other sophisticated aircraft maintenance and checkout equipment. Fast servicing and checkout are extremely important to the Israeli Air Force. "With distances as relatively short as they are in the Middle East," Paz notes, "military aircraft must have a turnaround time on the ground of no more than seven minutes."

Elta has also developed what it calls a "unique" S-band radar for civilian and military airfields. The system incorporates a small, special-purpose computer that allows detection of low-flying aircraft against a high level of ground clutter. The radar is modularized for easy servicing and contains built-in test equipment. Test points are brought out on the front panel, adjacent to a metal plaque that shows the waveshapes that should be displayed on the scope. The first unit will be installed at Lod Airport, Tel Aviv, and Elta is now bidding against major radar manufacturers for installation of the system at two international airfields.

According to Paz, the company intends to diversify into nonmilitary areas and have a 50-50 split within five years. Elta now manufactures coronary-care equipment, including a central nursing station with a plug-in electrocardiogram display unit, heart-rate alarm and rectilinear recorder. Also in production is a line of defibrillators and an rf-coupled pacemaker in which an externally located transmitter sends pacing energy to an internally implanted receiver. In addition Elta has manufactured a batch-fabrication control system for a textile plant, an alarm system for the automated engine rooms of ships and a bridge maneuvering system (electronic instead of electro-mechanical).

The Israeli minicomputer

Another flourishing member of Israel's "top 10" in electronics is Elbit Computers Ltd., with headquarters at Haifa. The company manufactures its own Elbit-100 minicomputer and mini-computer systems, as well as custom industrial process-control and military equipment. It is owned 51% by Control Data Corp. and 49% by Elron Electronic Industries Ltd., a major Israeli industrial holding company.

Anticipating future trends, Elbit introduced in 1967 what was probably the first of the small computers to hit the market. Ahead of its time

U.S. helping to train Israeli engineers

A considerable manpower resource for Israel is 7000 Israeli scientists and engineers who have been studying in the United States, many for as long as six years. Of these, about 850 are in electronics. Originally they came to the U.S. because technical employment was limited at home. But with the growth of the Israeli electronics industry, an increasing number of engineers are beginning to return for jobs with Israeli companies and U.S.-owned subsidiaries.

To help expand engineering opportunities, the Government of Israel encourages manufacturers to set up science-based industrial parks near the country's research institutes. It offers liberal land-development loans and grants. In addition approved science-based ventures are also entitled to the following Government assistance:

- A grant of about \$1000 a year for the training of each graduate employe.
- 50% reimbursement of all industrial research expenses for a five-year period, provided that the product resulting from the research is manufactured for export.

and pretty much alone in the mini derby, the computer never really caught on in the U.S. Uzia Galil, the company's managing director, attributes this to a lack of maintenance capability as well as a poor marketing effort.

The Elbit Model 100 computer, which sells for about \$4900, is a 12-bit, single address, fixed-word length machine with typical add time of 8.1 μ s. It can operate with up to 256 channels of input/output equipment. The computer features a two-level core memory system, with one memory a standard read-write core store with 2- μ s cycle time and the other a fixed micro-programmable read-only store with 450-ns cycle time. It incorporates DTL monolithic ICs mounted on fiberglass printed-circuit cards. Elbit is currently developing a 16-bit minicomputer to complement the Model 100.

Galil points out that for the future the company has decided to emphasize total systems based either on the Elbit minicomputer line or the more powerful CDC-1700 computer. One example is the Elbit Validata key-to-tape dedicated system, which has been installed in a number of Israeli banks. Another is a data-acquisition system completed some time ago for the Faculty of Agriculture at the Technion. Trailer-mounted, the acquisition system scans meteorological data, such as temperature, humidity and wind velocity, and provides data for agricultural experiments.

A major reason for the dramatic increase in exports of Israeli electronics is a well-known name—Motorola Israel Ltd., a subsidiary of Motorola, U.S.A. The company is the fourth largest in the Israeli electronics industry, with 1971 sales close to \$15-million, of which one-third was exports. It employs over 1000 workers, including 91 engineers, of which 34 are designers.

Situated in Tel Aviv, Motorola Israel has two major operating divisions. The communications division has a licensing agreement to manufacture two-way radio equipment, base stations, mobile radios, walkie-talkies, FM radios and a variety of other communications systems.

Currently under development at Motorola Israel and intended for the world market is a mobile 100-W ssb communications transceiver. According to Skiva Mayer, assistant general manager, it was developed with the close cooperation of the Motorola Group in Chicago. Also under development is a Citizens Band receiver for the local market.

The supervisory control and data communications division at Motorola Israel designs, develops and manufactures frequency-shift keying systems, high-speed data transmission modems and supervisory and remote control systems. All of these are for the local market.

The company exports a great deal of its radio communications products to developing countries, particularly Africa.

Monsanto instruments by Monsel

Another familiar name, Monsanto, is represented in Israel by its subsidiary, Monsel Electronic Instruments Ltd., now responsible for the instrument line formerly manufactured at West Caldwell, N.J. The output includes frequency counters, counter-timers and digital voltmeters.

Before Monsanto's divestment of its instrument lines in 1970, Monsel's contribution to the American company was segmental, says Mark Shavit, general manager of the Israeli concern. "We took care of relatively inexpensive, small counters within a limited price and frequency range," he notes. "Now we probably have the second most complete line of counters."

Monsel exports about 80% of its product lines. Out of this, about 70% goes to the U.S. and the remainder to the European market. Shavit predicts a 15% sales increase in 1972, mostly in programmable instruments and low-cost counter-timers.

Generally considered the forerunner of today's electronics industry in Israel is Elron Electronic Industries Ltd. of Haifa. The company was founded in 1962 with initial capital provided by the Israel Discount Bank and a small group of American investors. It was the first company to develop



Technician inspects hybrid thin-film module produced at Elta Electronics Industries Ltd. in Ashdod. Thin and

thick-film circuits are finding wide use in Israeli-made military communications equipment.

and manufacture sophisticated professional equipment on a commercial basis. The products included a limited range of nuclear, medical and laboratory instruments.

As the company grew, it set up several subsidiaries and joint ventures with U.S. companies. Gradually all of its industrial operations were transferred to subsidiaries, and today Elron itself operates as a holding company.

The company has joint ventures with Monsanto (Monsel Ltd.), Control Data Corp. (Elbit Computers Ltd.) and Xerox Data Systems (Scientific Data Systems Israel Ltd.—a producer of rapid-access disc memories). Wholly owned subsidiaries include Eltek Ltd. (printed circuits) and Elscint (scientific instrumentation).

A major factor in the specialized laboratory instrumentation market is Elscint Ltd. of Haifa. The company has developed a line of some 50 instruments for nuclear research, including high-gain pulse amplifiers, spectrometers, scintillation detectors, pulse-shape detectors, radiation monitors and scientific systems in conjunction with computers.

Elscint is placing its export hopes on its radioisotope digital video scanner with a full-color display, first introduced in the U.S. last summer. Menachem Matza, the company's marketing manager, notes that other U.S. manufacturers have made automated digital scanning systems but that in these, the computer is in a separate package. "Our videoscanner contains a wired-in computer [the Elbit-100] and costs half as much," he says.

This spring the company expects to introduce an advanced version of the scanner and associated EDP for use in hospitals.

Elscint also manufactures a line of standard power supplies for the domestic market under license from Lambda Electronics Corp. of Melville, N.Y.

Microwave equipment, too

A major supplier of custom-made microwave communications systems and components for the armed forces, AEL Israel Ltd., a wholly owned subsidiary of American Electronic Laboratories of Colmar, Pa., is now gearing to reduce its dependence on military contracts. The four-year-old company, which had sales of about \$2.8-million last year, expects to triple its exports by next year.

Most of the products it sells are spin-offs from its military work. These include a variety of solid-state microwave components and functional assemblies, including antenna systems, ruggedized stationary and mobile communications equipment, and systems with wide-band power amplifiers, transmitters, filters, splitters and attenuators. The company also maintains a laboratory for the manufacture of thin and thick-film hybrid and stripline circuits.

Others in the running

In addition to the 10 or so major electronics companies in Israel, there is a host of smaller



Israeli soldier carries an AN/PRC-77 back-pack radio manufactured by Tadiran Israel Electronics Industries Ltd. The unit includes a loudspeaker-assembly that enables a commander to listen in on the conversation.



A line of frequency counters undergo inspection and "burn-in" at Monsel's final test department.

concerns, with product lines ranging from precision components to semiconductor production equipment. Many have been around for a number of years, and their economic viability seems assured. Others are in a more precarious position, their existence dependent upon finding an export market for some specialized device or system.

One of the more successful and growing component manufacturers is Vishay Israel Ltd., a subsidiary of Vishay Intertechnology Corp. of Malvern, Pa. Vishay makes a line of customized, high-precision flat-pack resistors (0.1% tolerance and temperature coefficient of ± 1 ppm/ $^{\circ}$ C). The company expects to have sales of over \$2-million this year, compared with less than \$1-million in 1971. It exports 95% of its products to the U.S. and Europe.

Another newcomer, founded in 1970, is Meeda Scientific Instrumentation Ltd. in Ramat Gan. The company's first product line was a balloon-borne pulsed radar altimeter for meteorological applications. Operating at 403 MHz, it is designed to measure heights between 0.5 km and 35 km with an accuracy of ± 10 meters. NASA bought 15 of the altimeters for experimental purposes, and the company is looking to market another version of the device in the U.S. for use as a low-cost radar altimeter for light aircraft.

A relatively new manufacturer of multi-layer and flexible printed circuits is Koor Systems, Research, Development and Engineering Ltd. of Petach Tikva. Until a few months ago all of its production went for military use. Now Koor is trying to break into the U.S. market with a line of multilayer PCs that would sell for half the price of multilayer PCs made in the U.S.

Other successful ventures include Mamash Applied Science Laboratories in Ramat Aviv, a manufacturer of specialized acoustic and electromagnetic instrumentation; Tabor Electronics of Haifa—a spinoff from Monsel—which makes its own line of automatic counter-timers and signal generators; Eljim—a subsidiary of KMS Industries in the U.S.—which is doing R&D on radar and communications systems for the military; Microelectronics Ltd. of Holon, a manufacturer of precision capacitors, and R.D.T. Electronics Engineering Ltd. of Tel Aviv—a supplier of test equipment to the Israeli Air Force and a major importer of U.S. electronic products. ■■

For additional information on Israeli industries and products, write to P. Zvi Rosner, manager, Science-Based Industries Div., Government of Israel Investment Authority, 850 Third Ave., New York, N.Y. 10022.

Profile of the Israeli engineer

There's more freedom to design in Israel but less means to achieve the goal.

That, in substance, is how many Israeli electronics engineers compare their job with that of American engineers. The American designer has at his disposal very sophisticated means—fast access to data, superb equipment, highly experienced senior engineers. But engineering aids that are common-place in the U.S. may be nonexistent in Israel.

"There is never enough equipment, there is never enough access to data fast enough," says Mark Shavit, general manager of Monsel Electronic Instruments in Haifa. "Sometimes the Israeli designer has to invent the wheel from scratch."

Israeli engineers rely heavily on data from trade publications; company libraries are usually not as well organized as they are in the U.S. The Israeli engineer also spends considerable time getting parts to make his prototype, because parts procurement is a very severe problem. He often doesn't know what part he really wants, because vendor catalogues are scarce.

He often has to learn to specify a screw by four different names, in German, in French, in English and in Hebrew. The little things that come so easy for an American engineer often come hard for the Israeli designer. Therefore he works harder, and very often he doesn't have the time to do things that he should do, like worst-case design.

But the average Israeli engineer has almost full authority on the job. His boss gives him the work, often doesn't define the objective precisely enough, and tells him to come up with the answer. It's a tough school.

"When you don't have enough means and you don't have enough time, you've got to find a solution, which, almost by definition, is never the optimum technical solution," says Shavit. "The average Israeli designer is more efficient than his U.S. counterpart, but he's certainly less meticulous. He's more resourceful, because he has so few resources."

Another quality of the Israeli engineer is that he assimilates new information very fast—new ideas and new designs. But he has shortcomings on the business side of engineering.

"What you have in Israel," Shavit says, "is a high percentage of innovative engi-

neers with a not very well developed management ability."

Designers in the U.S. are much more cost-conscious. On the other hand, the Israeli designer is much more of a "generalist." He can be given a wide range of projects, and he learns to adapt.

"There is no doubt that American engineers are more marketing-oriented, while many of the Israelis are more scientifically oriented," says Uzia Galil, managing director of Elbit Computers, Haifa.

The good, experienced engineers in Israeli industry today come from scientific research institutions, like the Weitzmann or Technion Institutes or the scientific department of the Ministry of Defense, where cost isn't an overriding factor in design.

The pay scale for experienced engineers in Israel ranges from \$400 to \$500 a month. An outstanding engineer may make slightly more, but income taxes soak up most of the differential. So money isn't the top incentive for attracting competent engineers.

"There is the technical satisfaction of doing a very interesting job," says Itzhak Toledano, administration manager of Tadiran Israel Electronics Ltd. in Tel Aviv. "The greatest difficulty a designer has here is the lack of components to solve a particular design problem. When I worked in the States, I used to pick up the phone, and the next day I had a circuit component. This problem has not been solved in Israel."

Many American electronic designers are too specialized, observes Uri Fehr, a physicist at Mamash Applied Science Laboratories in Ramat Aviv.

Israeli engineers," he says, "work in companies where they have to adapt themselves to work on virtually anything—low-frequency circuits, analog or digital, and so on. It's not a matter of education. Such U.S. engineering schools as MIT, Columbia and so on are in some cases better than the Technion. It's the experience the Israeli engineer gets if he works in the right places, where his capability is utilized to the fullest."

Because of the enormous size of the U.S. electronics industry, many American engineers are working below their educational or skill level, Fehr contends. In Israel the opposite holds true: The engineer has to work above his level, and those who are successful at it advance very quickly. ■■

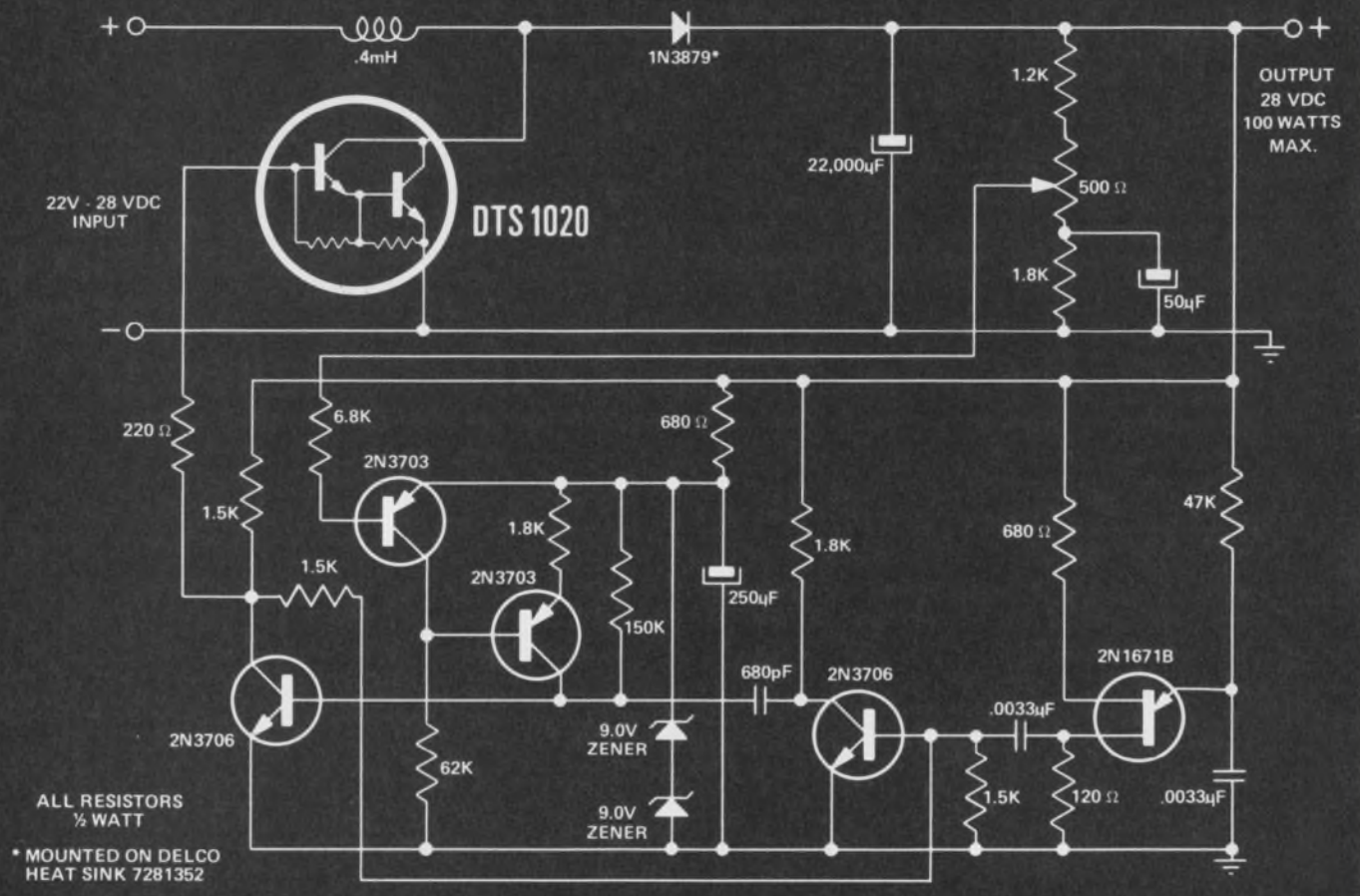

SWITCHING REGULATOR

	V_{CEO} @ 0.1 mA	V_{EBO} @ 50 mA	$V_{CE(SUS)}$ @ 500 mA	h_{fe} @ 1 MHz ($V_{CE} = 10V,$ $I_C = 200 mA$)	h_{FE} ($V_{CE} = 5V,$ $I_C = 10A$)	$V_{CE(SAT)}$ @ 5.0 A	I_C	P_T @ 75°C
DTS-1010	120V	7V	80V	12	200	1.8V	10A	100W*
DTS-1020	120V	7V	80V	12	500	1.5V	10A	100W*

*100 percent tested at 2.5A, 40V.

The Kokomoans now give you Darlington Switching Power.



Use a Darlington in place of an ordinary transistor, and you'll realize an additional magnitude of gain plus increased switching power. Use a Delco silicon power Darlington (DTS-1010 or DTS-1020) and you'll also realize a gain in dependability.

Delco's Darlington's are triple diffused mesa units housed in copper TO204MA cases and built for ruggedness. The design gives them high energy capability—the ability to handle surges of current and voltage simultaneously. They are ideal for switching inductive loads in circuits subject to transients or fault conditions.

Design a switching regulator circuit around a Delco Darlington or use it in any 60-100 volt

application to reduce circuit size, weight, and cost. In addition, the Darlington space saving feature allows you more design flexibility. Unlike an ordinary transistor, it's only energy-limited, not beta-limited. You can exploit its full energy capability in your circuit.

Call your nearest Delco distributor. He has them in stock and he's got the data on high energy switching for small spaces.

For details on the switching regulator circuit, ask for Application Note 49.



Delco Electronics

DIVISION OF GENERAL MOTORS CORPORATION.
KOKOMO, INDIANA

Now available from these distributors in production quantities.

ALA., BIRMINGHAM • Forbes Distributing Co., Inc. (205)-251-4104

ARIZ., PHOENIX • Cramer/Arizona (602)-263-1112 • Sterling Electronics (602)-258-4531

CAL., LOS ANGELES • Kierulff Electronics, Inc. (213)-685-5511 • Radio Products Sales, Inc. (213)-748-1271

CAL., PALO ALTO • Kierulff Electronics, Inc. (415)-968-6292

CAL., REDWOOD CITY • Cramer/San Francisco, (415)-365-4000

CAL., SAN DIEGO • Milo of California, Inc. (714)-232-8951

CAL., SAN DIEGO • Radio Products Sales, Inc. (714)-292-5611

COLO., COLORADO SPRINGS • Walker Electronics (303)-636-1661

COLO., DENVER • Cramer/Denver (303)-758-2100 • Denver Walker Electronics (303)-935-2401

ILL., ROSEMONT (Chicago) • Kierulff/F-J-R (312)-678-8560

ILL., SKOKIE (Chicago) • Merquip Electronics (312)-282-5400

IND., INDIANAPOLIS • Graham Electronics Supply, Inc. (317)-634-8202

MD., BALTIMORE • Radio Electric Service Co. (301)-823-0070

MASS., NEEDHAM HEIGHTS • Kierulff Electronics, Inc. (617)-449-3600

MASS., NEWTON • The Greene-Shaw Co., Inc. (617)-969-8900

MICH., ROMULUS • Harvey/Detroit (313)-729-5500

MINN., MINNEAPOLIS • Stark Electronics Supply Co. (612)-332-1325

MO., KANSAS CITY • Walters Radio Supply, Inc. (816)-531-7015

MO., NO. KANSAS CITY • LCOMP-Kansas City, Inc. (816)-221-2400

MO., ST. LOUIS • LCOMP-St. Louis, Inc. (314)-647-5505

N.J., CLIFTON • Eastern Radio Corporation (201)-471-6600

N.M., ALBUQUERQUE • Cramer/New Mexico (505)-265-5767 • Sterling Electronics (505)-247-2486

N.Y., BINGHAMTON • Harvey/Federal (607)-748-8211

N.Y., EAST SYRACUSE • Cramer/Eastern (315)-437-6671

N.Y., ROCHESTER • Cramer/Rochester (716)-275-0300

N.Y., WOODBURY • Harvey/New York (516)-921-8700

OHIO, CINCINNATI • United Radio, Inc. (513)-761-4030

OHIO, CLEVELAND • Pattison Supply (216)-441-3000

OHIO, DAYTON • Kierulff/F-J-R (513)-278-9411

OKLA., OKLAHOMA CITY • Radio, Inc. (405)-235-1551

OKLA., TULSA • Radio, Inc. (918)-587-9123

PENN., PHILADELPHIA • Almo Electronics (215)-676-6000

PENN., PITTSBURGH • RPC Electronics (412)-782-3770

S.C., COLUMBIA • Dixie Radio Supply Co., Inc. (803)-253-5333

TEXAS, DALLAS • Adleta Electronics Co. (214)-741-3151

TEXAS, FORT WORTH • Adleta Electronics Co. (817)-336-7446

TEXAS, GARLAND • Kierulff Electronics, Inc. (214)-271-2471

TEXAS, HOUSTON • Harrison Equipment Co., Inc. (713)-224-9131

UTAH, SALT LAKE CITY • Cramer/Utah (801)-487-3681

VA., RICHMOND • Meridian Electronics, Inc., a Sterling Electronics Company (703)-353-6648

WASH., SEATTLE • Kierulff Electronics, Inc. (206)-763-1550

WASH., TACOMA • C & G Electronics Co. (206)-272-3181

CANADA, ONT., SCARBOROUGH • Lake Engineering Co., Ltd. (416)-751-5980

ALL OVERSEAS INQUIRIES:
General Motors Overseas Operations
Power and Industrial Products Dept.,
767 Fifth Avenue, New York, N.Y.
10022. Phone: (212)-486-3723.

Kokomoans' Regional Headquarters.

Union, New Jersey 07083,
Box 1018, Chestnut Station,
(201) 687-3770.

El Segundo, Calif. 90245,
354 Coral Circle, (213)
640-0443.

Kokomo, Ind. 46901, 700 E.
Firmin, (317) 459-2175
(Home Office).



MARK OF EXCELLENCE

Optimize second-order active filters

by matching the circuit to the required sensitivity and the filter parameters to in-circuit specifications.

The design of active filters usually begins with the often arbitrary selection of a suitable filter configuration and the calculation of parameters based on incomplete specifications. A better way is to choose the filter configuration on the basis of relative performance and to determine filter parameters by taking all relevant in-circuit characteristics into account.

The low-pass filter is one of the most general types, but many others can be built on this foundation. The five most common second-order (two-pole) active implementations of the low-pass filter are shown in Table 1.

The circuits differ in number and cost of the components required, of course. But an additional and important difference is the respective sensitivity—the percentage change of a characteristic caused by an equal percentage change of component value.

The most common sensitivities are those of the cutoff frequency, ω_c , and the damping characteristic, Q . In notch and bandpass filters these are very important. For low-pass and high-pass applications, however, passband gain sensitivity and voltage offset (output voltage with the input grounded) are often much more important.

Calculate the sensitivities

The various sensitivities can be obtained by allowing a worst-case 1% change in each of the passive components and observing the effect on e_o/e_m (gain), ω_c , and Q . Passband gain can be found by making the Laplace variable $s \rightarrow 0$ (low-pass) or $s \rightarrow \infty$ (high-pass).

In Table 2 the chief differences are tabulated. In general, for bandpass filters these results differ, in that the gain sensitivities are linear with the Q sensitivity.

Let's take a closer look at each configuration.

The *noninverting* circuit is the most often used in low-pass and high-pass applications. It has the minimum number of active elements, the

minimum number of passive elements, the minimum voltage offset with temperature and the best passband gain accuracy of all configurations.

The *INIC* (ideal-current-inversion negative admittance converter) is similar to the noninverting or follower circuit. It has the same sensitivities and is also noninverting. However, to achieve a low impedance output, an output buffer must be employed. This results, of course, in higher cost and greater voltage offsets. An advantage is the ability to achieve voltage amplification, but at the cost of passband accuracy and sensitivity.

The *multiple feedback* circuit uses only one op amp and only one more component than the noninverting circuit. The disadvantages are an inverting voltage-transfer characteristic and highly sensitive passband gain.

The *gyrator* configuration is so-called because of the active element of the same name: It is a nonreciprocal device that is characterized by an output impedance that's the complex-conjugate inverse of the input impedance.

This circuit is the least sensitive to component tolerance. This makes it often seem attractive. What is often overlooked, however, is that the gyrator, an active element, appears in the transfer function under the guise of a passive component (L). Voltage offset and device cost are increased by the addition of each gyrator.

The *state variable*, also known as the *universal* or *biquadratic*, circuit is unique in several respects. It permits independent adjustment of ω_c and Q . It has simultaneous low-pass, high-pass and bandpass outputs, and it can achieve the highest Q of any circuit (up to 100). Typical applications for the state-variable filter are circuits with high- Q bandpass and those where the filter parameters are subject to continual optimization.

Watch those specs

Once the filter configuration is selected, the design can proceed with the choice of circuit components. Standard tables can be used to

C. Peter Zicko, Analog Devices, Inc., 221 Fifth St., Cambridge, Mass. 02142

1. Select the filter configuration

<p>Noninverting</p> $e_o/e_{in} = \frac{1}{R_1 R_2 C_1 C_2 S^2 + S \left(\frac{1}{R_1 C_1} + \frac{1}{C_2 R_2} \right) + \frac{1}{R_1 R_2 C_1 C_2}}$ $\omega_o = (R_1 R_2 C_1 C_2)^{-1/2} \quad Q = \frac{(R_1 C_1 R_2 C_2)^{1/2}}{C_2 (R_1 + R_2)}$	
<p>INIC</p> $e_o/e_{in} = \frac{1}{R_1 R_2 C_1 C_2 S^2 + S \left(\frac{1}{R_1 C_1} - \frac{1}{C_2 R_3} \right) + \frac{1}{R_1 R_2 C_1 C_2} \left(K - \frac{R_2}{R_3} \right)}$ <p>letting $R_3 = \infty$ $\omega_o = (R_1 R_2 C_1 C_2)^{-1/2}$ $K = 1$ $Q = \left(\frac{R_1 C_1}{R_2 C_2} \right)^{1/2}$</p>	
<p>Multiple Feedback</p> $e_o/e_{in} = \frac{-1}{R_1 R_2 C_1 C_2 S^2 + S \left(\frac{2}{R_1 C_1} + \frac{1}{R_2 C_1} \right) + \frac{1}{R_1 R_2 C_1 C_2}}$ $\omega_o = (R_1 R_2 C_1 C_2)^{-1/2} \quad Q = \frac{(R_1 C_1 R_2 C_2)^{1/2}}{C_2 (R_1 + 2R_2)}$	
<p>Gyrator</p> $e_o/e_{in} = \frac{1/LC}{S^2 + S \left(\frac{1}{CR_2} + \frac{R_1}{L} \right) + \frac{1}{LCR_2} (R_1 + R_2)}$ $\omega_o = \left(\frac{R_1 + R_2}{LCR_2} \right)^{1/2} \quad Q = \frac{(R_1 + R_2)^{1/2}}{(L/CR_2)^{1/2} + (CR_1/L)^{1/2}}$ <p>$L = \text{Effect of Gyrator}$</p>	
<p>State Variable</p> $e_o/e_{in} = \frac{K(1 + A_2 + A_3)/R_1 R_2 C_1 C_2}{S^2 + S \frac{A_1}{R_1 C_1} (1 + A_2 + A_3) + \frac{A_2}{R_1 R_2 C_1 C_2}}$ <p>where $K = R_O / (R_6 + R_O)$ $A_2 = R_5 / R_3$ $A_1 = R_O / (R_7 + R_O)$ $A_3 = R_5 / R_G$ if: $K = 1/2$ $A_2 = 1$ $A_1 = 1/2$ $A_3 = 0$ then:</p> $e_o/e_{in} = \frac{1}{R_1 R_2 C_1 C_2 S^2 + \frac{S}{R_1 C_1} + \frac{1}{R_1 R_2 C_1 C_2}}$ $\omega_o = (R_1 R_2 C_1 C_2)^{-1/2} \quad Q = \left(\frac{R_1 C_1}{R_2 C_2} \right)^{1/2}$	

2. Compare the circuits

	Follower or Noninverting	INIC	Multiple Feedback	Gyrator	State Variable
Number of R and C components	4	7	5	Gyrator + 4	11
Number of op amps for Low Z_{out}	1	2	1	2	3
V_{offset} vs Temp (# of op amps)	1	2	1	2	2
* Sensitivity of ω_0	2%	2%	2%	2%	2%
Sensitivity of Q	2%	2%	2%	1%	3%
** Sensitivity of Passband Gain	1 0%	$\frac{1}{1 - KR_2/R_3}$ 0%	R'_1/R_1 2%	$\frac{R_2}{R_1 + R_2}$ 1%	$\left(\frac{R_0}{R_6 + R_0}\right) \left(1 + \frac{R_3}{R_5}\right)$ 2%

*Sensitivity defined as % change $\Delta\omega_0/\omega_0$ for a worst case 1% change of Rs and Cs.

**Passband defined as $f=0$, Low-pass; $f=\infty$, High-pass. For Bandpass center frequency gain sensitivity, multiply by Q.

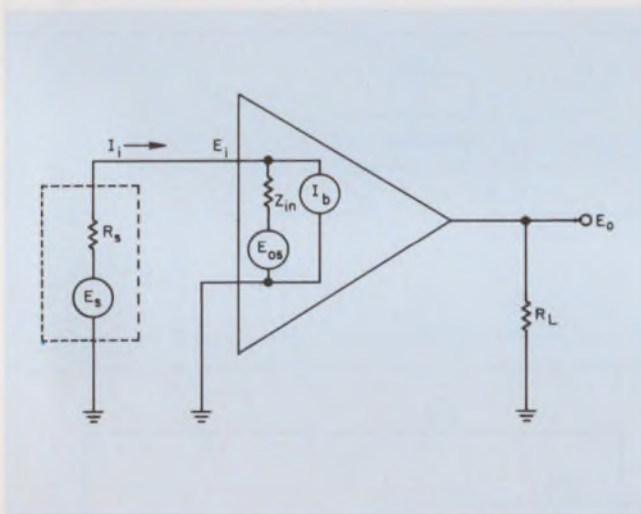

1. **Amplifier-related characteristics** pose special problems to the filter designer. The value of Z_{in} , for example, may not be the in-circuit value, since the impedance is often used to adjust frequency characteristics.

speed this phase of the design.

The problem now is ensuring that the filter meets its application specs. Toward this end, the designer should be aware of several important filter parameters, the limits of the technology of each and the effect each has on end cost.

The relevant filter parameters are grouped as amplifier-related, (Fig. 1) and network-related (Fig. 2) characteristics.

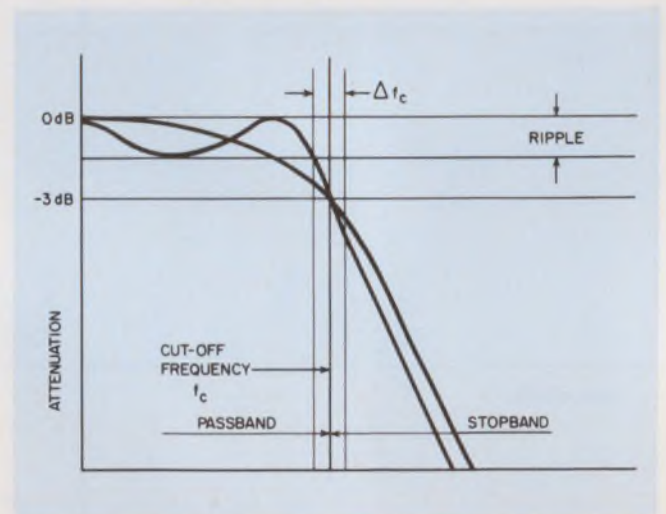

2. **Network-related characteristics** provide the theoretical basis for a filter design. But component tolerances, temperature effects and physical limitations restrict the filters that can be realized.

For the amplifier-related parameters, the input impedance, Z_{in} , is the ratio of a change in input voltage, ΔE_i , to the resulting change of input current, ΔI_i . In circuits with input buffers, this impedance can easily be $10^{11}\Omega$. With no input buffer, the minimum input impedance is the resistance of the RC network to ground as seen from the input.

This impedance is most often varied to achieve

the frequency characteristics within a given model. The use of a typical Z_{in} is therefore misleading, since the actual value may be an order of magnitude lower. Loading of the input RC network by source impedances may significantly change the filter frequency characteristics unless $Z_{source} \ll Z_{in}$. The addition of an input buffer is a low-cost factor.

Full-power response—not to be confused with the filter cutoff frequency—is the frequency at which the amplifier response is down 3 dB with respect to related input sinusoidal voltage swing. It is of concern only in high-pass and band-reject filters, since the low-pass and bandpass filter network attenuations completely mask amplifier rolloff. Increasing full power response is a low-cost factor up to about 1000 Hz.

Output offset voltage, E_{os} , is the voltage appearing at the output with the input grounded. The offset voltage of low-pass and bandpass active filters is the sum of all the op-amp offset voltages plus the sum of all the bias currents times their respective network source resistances. In high-pass and bandpass filters, the only offsets are those generated by the last pole-pair stage. To achieve very low cutoff frequencies in a reasonable module size, network resistances may run into megohms. Therefore small, very-low-frequency low-pass and band-reject filters with small offset voltages require op amps with both low E_{os} and low I_{bias} vs temperature—a relatively high cost factor. For the additional cost, however, active filters can have offsets nearly as low as those in the best op amps.

Input bias current, I_b , is the current flowing into a grounded input. The output offset voltage resulting from I_b through the filter network is already included in E_{os} . However, additional E_{os} will be generated by I_b flowing through the source resistance. Low I_b may be achieved through the use of a FET or super-beta input buffer—a relatively high-cost factor at present.

The *output noise* of an active filter consists of the sum of the input noise voltage of its op amps plus the input noise currents times the respective network source resistances. In a multipole high-pass or band-reject filter, all such noise above the cutoff frequency is passed. In low-pass and bandpass filters, however, the noise of all preceding stages is attenuated by the output stage at frequencies above the cutoff. Output noise of active filters tends to be high with respect to the average op amp.

For the network related parameters, the *cutoff frequency, f_c* , is the frequency at which the network attenuation becomes -3 dB. The practical upper limit is set by the fact that passive RLC circuits are smaller and cheaper below 10 kHz.

The lower limit is set by a combination of capacitor size, high-resistance values and consequent large voltage offsets. A practical lower limit with op-amp size modules is $10^{-3} - 10^{-1}$ Hz. The requirement for larger capacitors and better op amps results in a significantly higher cost.

Another important parameter is the *cutoff frequency tolerance* (at 25 C). The use of $\pm 1\%$ resistors and capacitors in the filter network allows prediction of the actual cutoff frequency to $\pm 2\%$. An f_c tolerance of $\pm 1\%$ requires sorting and/or trimming of Rs and Cs to $\pm 0.5\%$, and so on. The cost associated with sorting and trimming to achieve better tolerance is relatively low—down to about $\pm 0.5\%$. Beyond this point the curing effects and aging of components, especially capacitors, become significant. To improve stability, relatively expensive NPO capacitors may be used. A practical limit for f_c tolerance, even with the NPO capacitors, is about 0.1%.

If the filter is to be used over a wide temperature range, *f_c drift with temperature* may be important. A drift of $\pm 0.05\%/^{\circ}\text{C}$ is easily achieved with low-cost capacitors. Polycarbonate or polystyrene capacitors may be substituted to achieve $\pm 0.01\%/^{\circ}\text{C}$ at a relatively low cost. A practical limit of $\pm 0.003\%/^{\circ}\text{C}$ is achieved with NPO capacitors and E-characteristic metal-film resistors.

Passband gain tolerance is the deviation from the theoretical network attenuation response in the passband. The gain in inverting active-filter circuits is controlled by ratios of Rs and Cs. A specification of $\pm 1\%$ (± 0.1 dB) therefore requires trimming and good component stability for good retrace vs temperature. The passband gain, but not ripple, of the noninverting, or follower, configuration is independent of Rs and Cs. Typical passband gain tolerance at frequencies well within the full power band for this type of circuit is ± 0.01 to 0.05 dB. The use of very high gain op amps in a follower configuration allows specification of dc gain in low-pass and band-reject filters to ± 0.001 dB at a moderate cost.

The *number of poles* is generally limited because higher-order filters are difficult to implement. An exception is the RC filter, but this is rarely used because of its poor rolloff characteristic.

Implementation is difficult because increasingly higher Qs are required to peak the amplitude response near the cutoff frequency. The effect of component tolerance and amplifier gain on amplitude tolerance is multiplied directly by the circuit Q. Practical limits are about ± 0.2 -dB amplitude response tolerance up to eight poles. The relative cost vs number of poles for active filters increases at a greater than linear rate. ■■

Systematic savings through...

Up to this point we have stressed the increased system performance offered by MECL 10,000. Now let's consider system savings. As data

processing systems become smaller and faster it is necessary to evaluate the effect of MSI approaches that will reduce package count and

shorten processing times. Here are four new MECL 10,000 MSI functions that illustrate savings that can be expected.

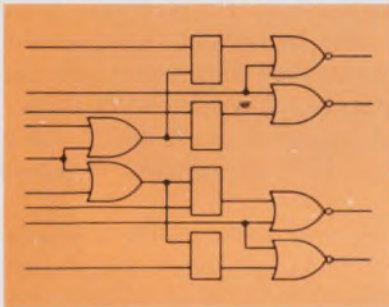

MC10133 Quad Latch — Consists of four bistable latch circuits with D type inputs and gated Q outputs. Latch outputs are gated, allowing direct wiring to a bus. All four latches may be clocked at one time with the common clock, or each half clocked separately with its own clock. Useful as a temporary storage element in high speed central processors, accumulators, register files, digital communication systems and instrumentation.

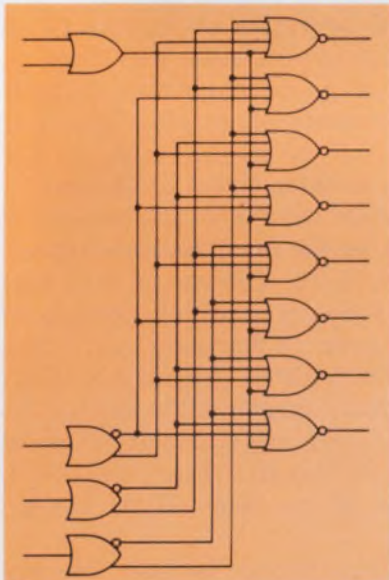

MC10162 Binary To One-Of-Eight Decoder — Decodes a three bit input word to a one-of-eight output. A high level on either enable forces the outputs low. Features true parallel operation; ie, propagation delay from every input to any given output is the same, eliminating unequal delay times found in other decoders. Allows easy expansion of memories or other computer addressable functions, and can be used as a data distributor.

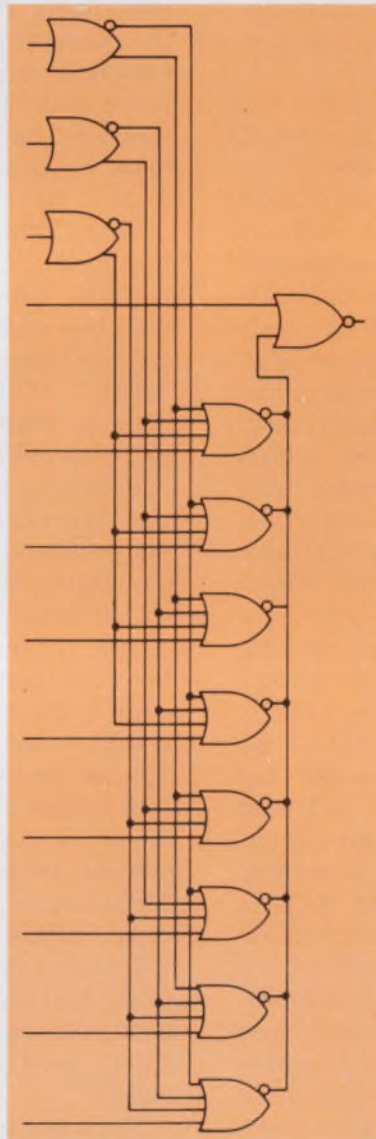

MC10164 8-Line Multiplexer — For use wherever data multiplexing or parallel to serial conversion is desirable. Full parallel gating permits equal delays through any data path. The output incorporates a buffer gate with eight data inputs and an enable. A high level on the enable forces the output low. The MC10164 can be connected directly to a data bus due to its open emitter output and output enable.

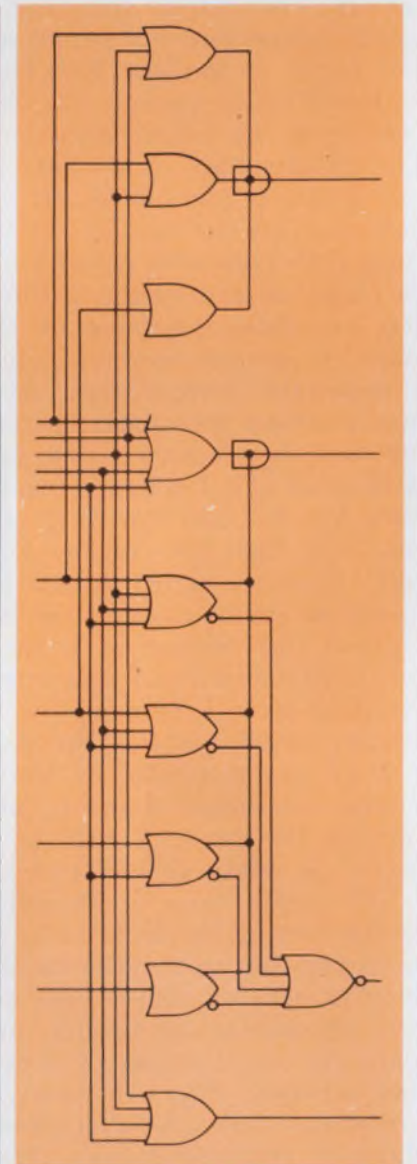

MC10179 Lock-Ahead Carry Block — A powerful MSI function consisting of 10 low power gates internally connected for the look-ahead carry function. Recommended for use with the MC10181 4-Bit ALU, or the MC10180 Dual Arithmetic Unit, to accomplish high speed arithmetic operations on long words. Highly useful for reducing system package count for the function generation of several variables.

MECL 10,000 designs

Let's look at typical applications; for example, this 16 line multiplex system utilizing the MC10164 and MC10162. Two MC10164's are used to multiplex 16 lines in to 1 total data line out. A counter using MC10131 flip-flops generates an address

code to step through the 16 data lines. The data line and clock signal are sent to a demultiplexing system at the receiving point. MC10162 decoders are used to demultiplex the serial data to 16 lines out. A counter using MC10131's produces the

decode address and a reset line is provided to synchronize the counters to the proper initialization state.

The system utilizes twisted pair transmission lines to send data. The MC10105 Triple OR/NOR Gate generates complementary output signals which are received by the MC10116 Triple Line Receiver. This system is capable of 150 megabit operation resulting from MSI advantages of less circuit delays and fewer circuit interconnects.

The adjacent illustration shows a typical 32-bit arithmetic processing subsystem comprised of a dual rank 32-bit storage register using the MC10133 Quad Latch with gated outputs. The clock to output delay is typically 3.5 ns with the gate or strobe delay of only 2 ns. With this approach, addition of two 32-bit words is improved from 30 ns with ripple-carry techniques, to 18 ns by using two MC10179 Look-Ahead Carry Units. Arithmetic operation times may be significantly reduced for words with larger bit counts by the simple addition of the MC10179 to the arithmetic operation.

These are a few ways that MECL 10,000 can offer systematic savings through new MSI techniques. For further specifications write to Motorola Semiconductor Products Inc., P.O. Box 20912, Phoenix, Arizona 85036. And for immediate evaluation call your nearby Motorola distributor.

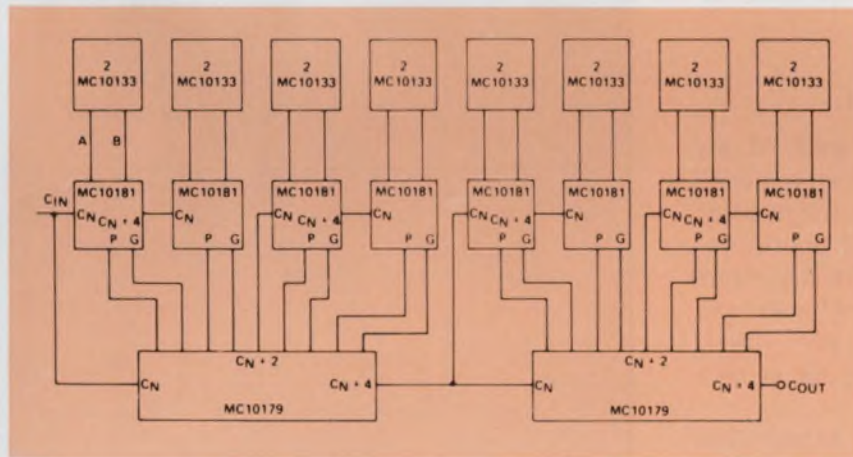
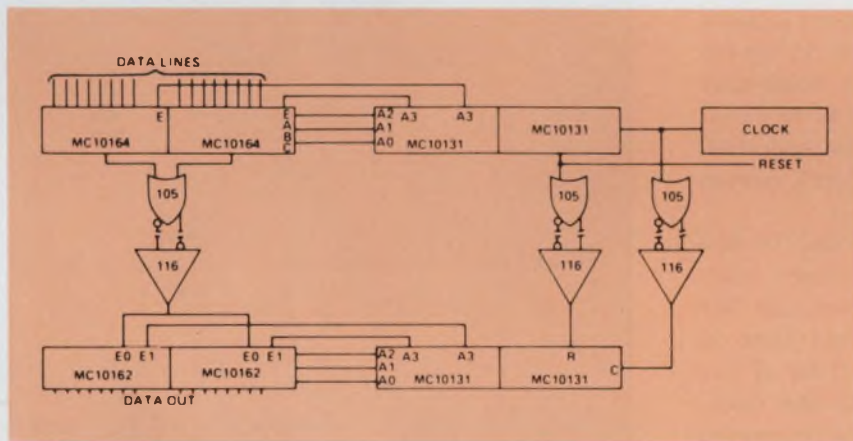

MECL and MECL 10,000 are trademarks of Motorola Inc.

MECL 10,000 eliminates the alternatives. Evaluate and compare!

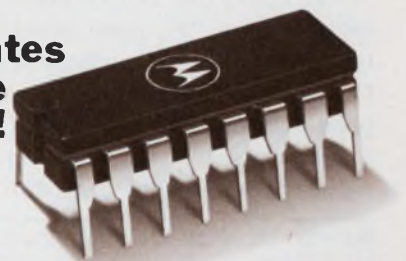

MOTOROLA MECL
... for faster computers & systems

INFORMATION RETRIEVAL NUMBER 33

Assembling large-array IC memories

calls for these circuits to sense output, provide timing and control signals, refresh the memory and reduce power.

Second of three articles

The 1103 read/write random-access memory supplies a current output ranging from $500 \mu\text{A}$ to 4 mA for a "1" (a negative charge on the cell storage capacitor or a low level on the data line). For an output "0" (uncharged cell or V_{SS} level on the data line), the output current is essentially zero, although in a system, some noise may be observed on the data-output line due to capacitive coupling from other signals. The specified access time is based on developing 40 mV across a 100Ω resistor, or $400 \mu\text{A}$.

The voltage developed is proportional to the value of the load resistor. However, higher load-resistor values cause longer time constants for the data-output line. The actual access time is approximately the sum of the access time of the 1103 itself and the time constant of the data-output line. The 1103 current output is converted to a voltage output for driving logic circuits by sense amplifiers (Fig. 1).

Sense amplifiers convert current output

The circuit in Fig. 1a uses one half of an SN75107 or SN75108 line receiver as a sense amplifier. The SN75108 requires a differential signal input of 25 mV for guaranteed operation. The high input side may draw up to $75 \mu\text{A}$ input current. A balanced-input arrangement is shown, but unbalanced configurations are also used. Current output from the 1103 array is sensed across resistor R_1 in Fig. 1a.

The reference threshold voltage is established by the resistor divider R_2, R_3 . R_2 is usually equal to R_1 . For the minimum "1" level of $500 \mu\text{A}$, and, given the 25 mV and $75 \mu\text{A}$ values characteristic of the SN75108, the reference voltage level for detection of a "1" level must be less than $[(0.50-0.075)R_1 - 25] \text{ mV}$, where R_1 is in ohms. However, the reference level must be greater than 25 mV for proper detection of zeros. To meet these two requirements, R_1 must be larger than 100Ω . A value between 200 and 400Ω is generally used

Marcian E. Hoff Jr., Applications Research Manager, Intel Corp., Santa Clara, Calif. 95051.

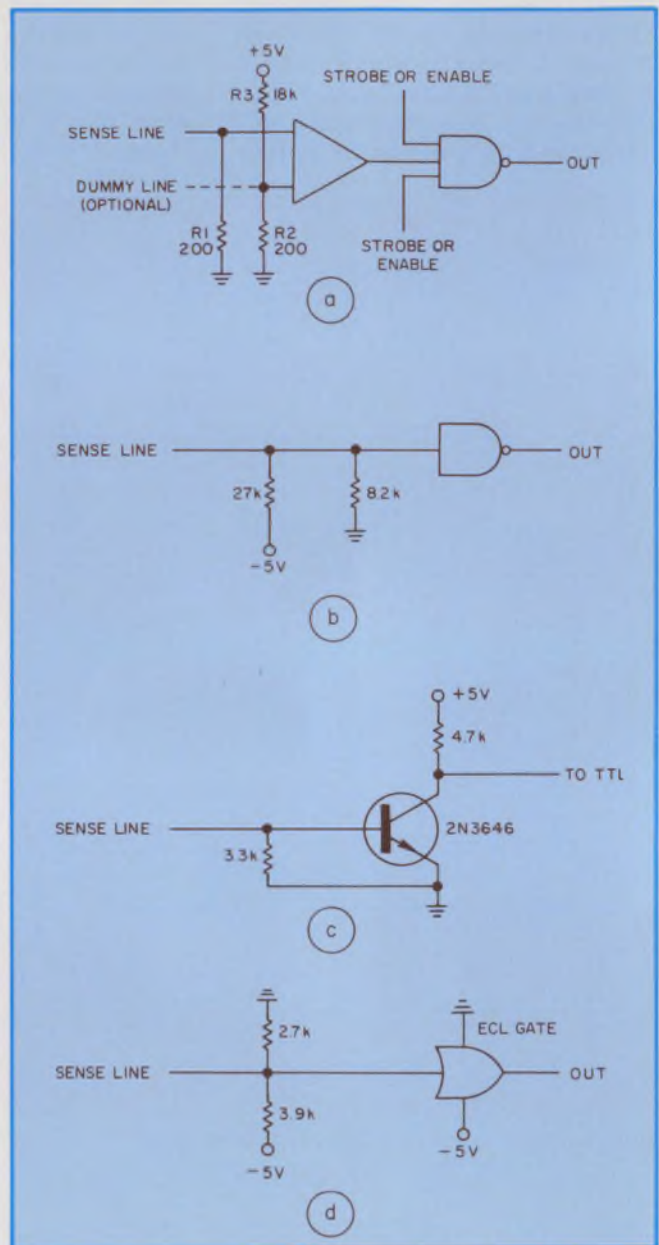

1. A balanced-input sense amplifier converts the 1103 current output to TTL logic levels. R_2 and R_3 provide threshold bias. The optional dummy line return reduces noise coupled into the data-output line (a). The lower-power TTL element is biased for direct sensing of output (b), and here a discrete transistor does the sensing (c). The circuit converts to ECL levels (d). Note that the higher impedance inputs in b, c and d increase system delays.

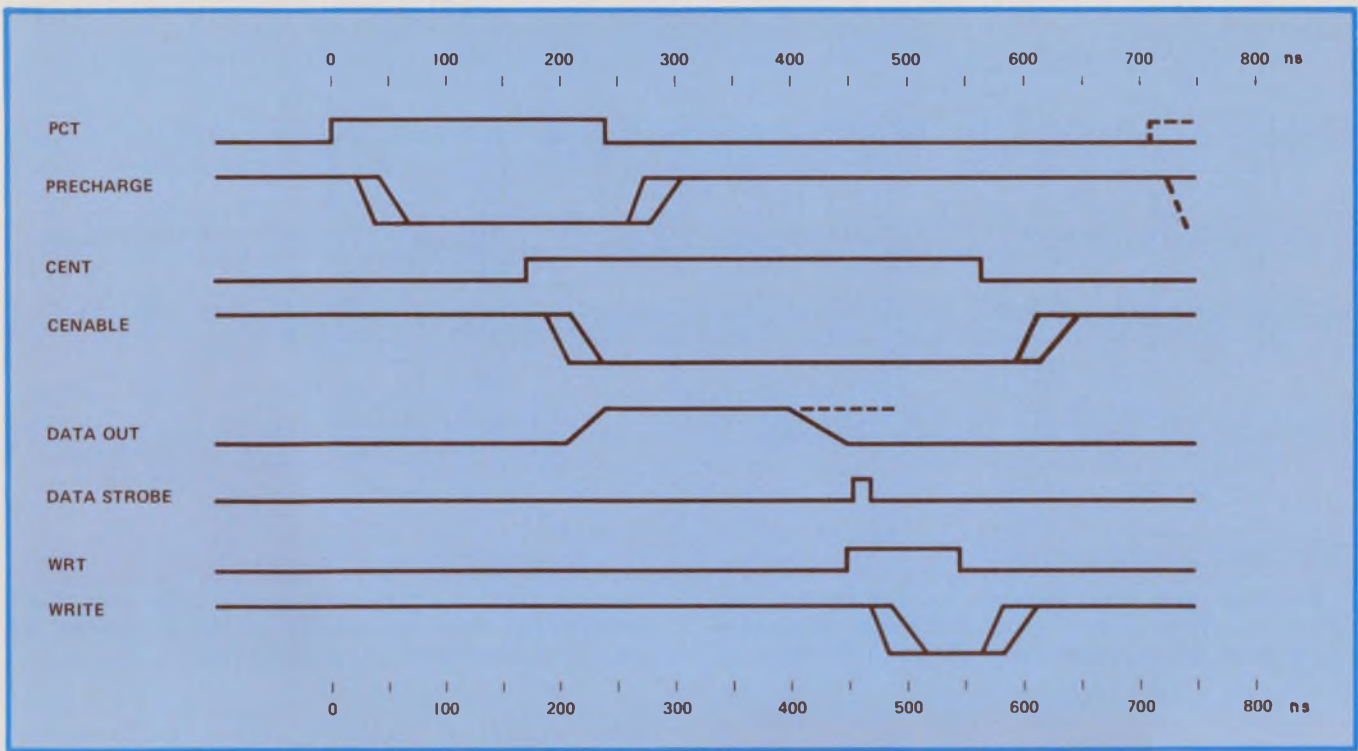

2. Gates and drivers in the timing path introduce delays and add to rise time. They also make relative timing of signal transitions more critical and increase access

and cycle time. Double-line transitions show the effects. The system timing here has been adjusted for these effects and meets system requirements.

with the SN75108.

The effects of capacitively-coupled noise on the data-output line may be reduced by adding a dummy line in the array. This line runs parallel to the sense line, and is connected to the low side of the sense-amplifier input. Noise signals then couple into both sides and some common-mode rejection of noise signals occurs. The output currents from the 1103s couple into one line only and develop a differential voltage between the lines.

In unbalanced operation, the low amplifier input line is grounded and a negative bias current is added to the sense-line input. This current may be supplied through a resistor returned to a negative supply voltage. The SN75107 has a totem-pole TTL output, while the SN75108 has an open-collector output, a feature used to advantage in large systems, where several memory modules may share a common data bus.

Comparators, like the μ A710 or MC1710, are also used as sense amplifiers. They have a smaller differential voltage tolerance (3 mV vs 25 mV) and lower bias current (45 μ A vs 75 μ A) so that lower input-resistor values may be used. However, they lack a strobe-signal input, and/or open-collector output, and require power-supply voltages not generally used in the system. An amplifier is therefore generally preferred.

The SN75108 amplifier requires an additional negative supply. The circuits of Figs. 1b and c do not, but sacrifice speed. In Fig. 1b a low-

power TTL element is biased to sense output current directly. In Fig. 1c a discrete transistor circuit is used.

However, both circuits increase system access time significantly; they require high input-resistance values. Figure 1d shows a possible arrangement for converting to ECL levels. The 1103 output terminals are biased approximately 1.5 V negative with respect to V_{DD} . Here too, high input impedance adds to system delay. Another approach in conversion to ECL levels uses a discrete pnp-transistor difference amplifier between the 1103 sense line and the ECL gate.

Gates and drivers affect timing

In generating timing signals for an 1103 memory system, we must consider the variations in the delays of gates and driver in the timing path. Consider a system in which driver delay (to start rise or fall) is 15 ± 5 ns and rise time is 20 ± 5 ns. In addition, let each timing signal pass through two gates, each with a delay from 5 to 10 ns. For each timing signal, a delay of 30 ± 10 ns and a rise time of 20 ± 5 ns occur. In Fig. 2, the timing signals include the effects of these skews, but still maintain the required timing.

All signal skews are assumed independent, but the actual delay spread for gates within a single package will typically be much less than the spread for the logic family. It may be possible to take advantage of this reduced spread in

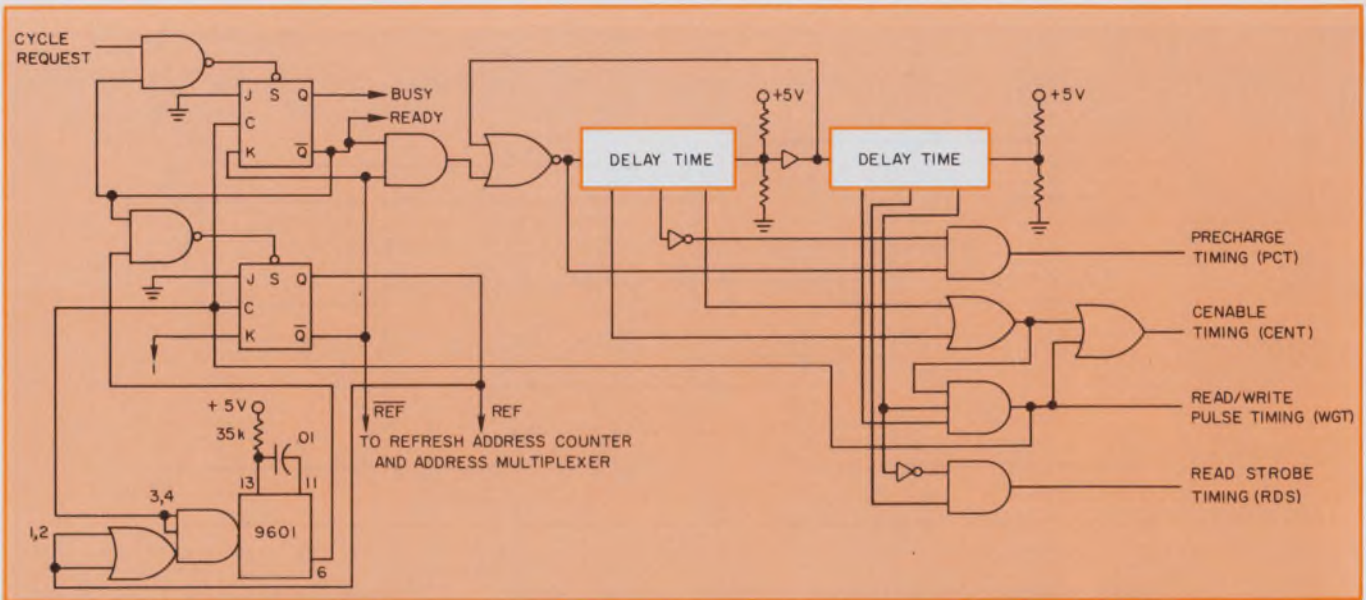

3. Controller uses delay lines to produce cycle timing signals. A refresh cycle generated by a single-shot multivibrator is requested every 60 μ s. The timing of

control signals is set by taps on the delay lines. Each refresh cycle steps an address counter to change the memory row refreshed on the next cycle.

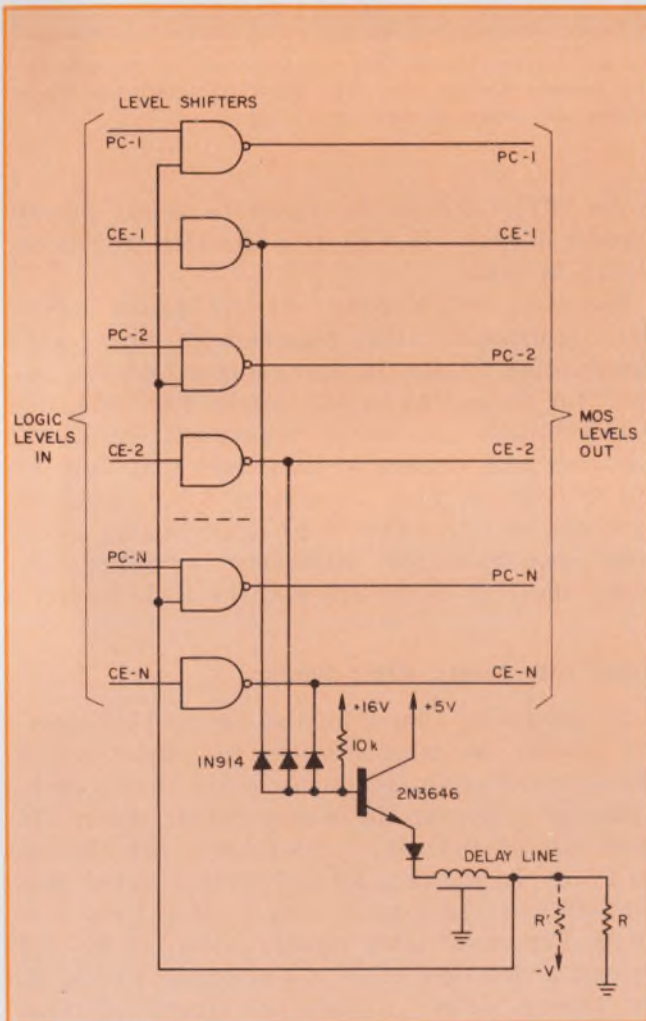

4. Timing generator reduces the number of gates in the path. The "c" enable (CE) turn-on pulses at the 1103 output are delayed and used to turn off the precharge (PC). All CE and PC pulses in the array connect to an OR circuit to actuate the PC timing from the actual CE pulse in operation.

some system to achieve higher performance. With these figures, the shortest read/write cycle requires 705 ns, a read-only cycle, 580 ns. Of course, each system designer must use values characteristic of his own system.

Delay line controller generates timing

Timing inputs to a memory system must be generated. Fig. 3 shows a delay line and controller approach. This circuit also includes control for refresh cycles and generates a ready/busy signal. At the end of each normal (non-refresh) cycle, the memory goes "ready," indicating readiness to accept another memory-cycle request.

A single-shot multivibrator controls refresh-cycle request timing—a cycle is requested every 60 μ s. When the memory is "ready," if such a request is pending it is accepted and a refresh cycle executed. However, the memory control continues to indicate "ready." Normal requests received during the execution of the refresh cycle are acknowledged by the controller indicating "busy," and are not executed until after completion of the refresh cycle. Thus, refresh cycles are visible to the normal requestor only as occasionally longer access and cycle times.

Cycle timing in the circuit of Fig. 3 is established by launching a signal, a square pulse of one-half-cycle length, down the delay line. The various timing signals are derived from logic circuits at the output of the taps on the delay line. The most critical timing is associated with the overlap interval—the time between turn-on of "c" enable and turn-off of precharge. With the skews shown, the tolerance for these events is used up and they must occur exactly 70 ns

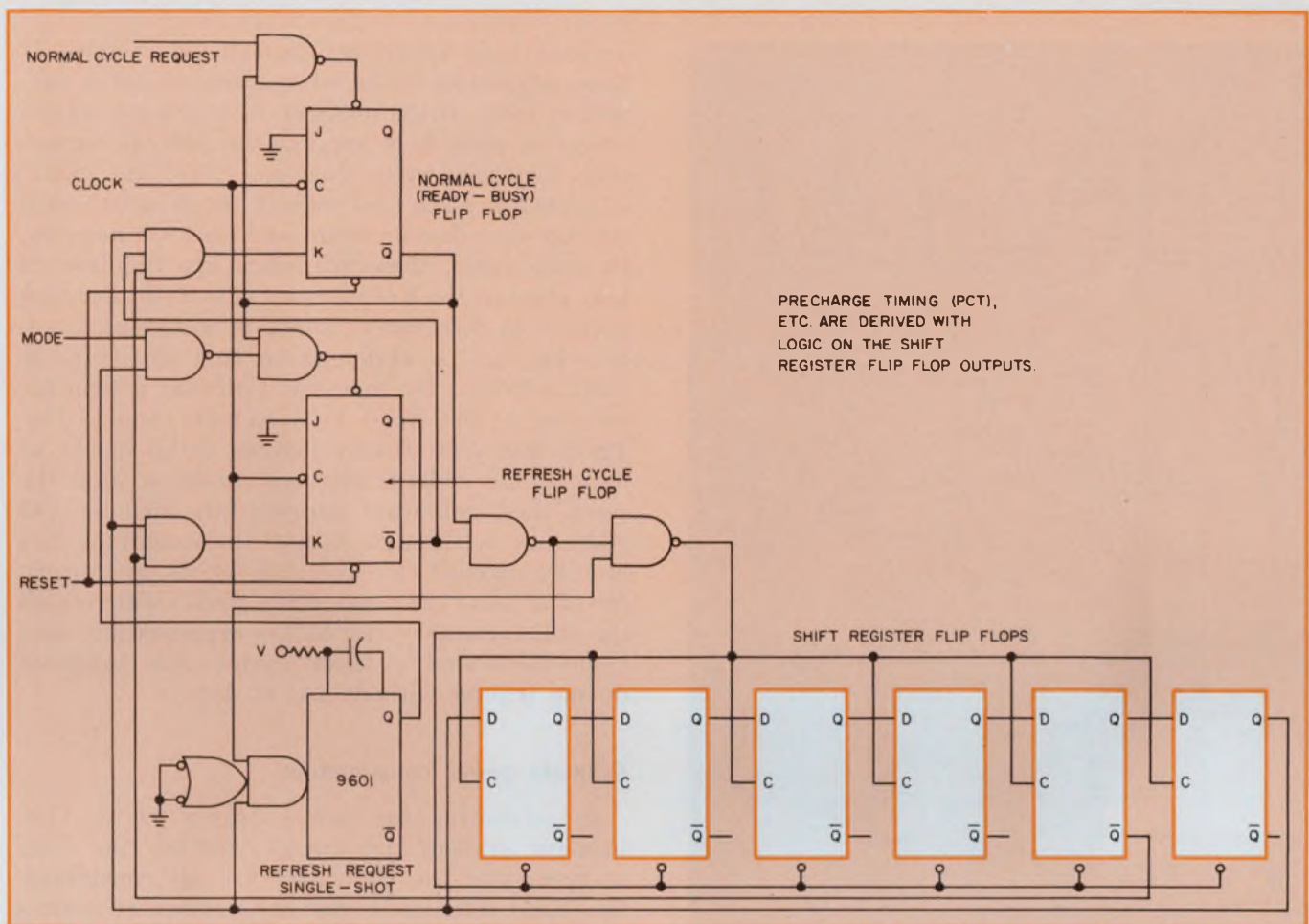

5. Controller uses a shift register instead of delay lines to generate timing signals, but access time is increased by the interval from cycle request to the next clock

pulse. The trade-off for the lower cost is speed. Timing pulses are derived from logic operations on the output of the clocked J-K flip-flops that make up the register.

apart. To make the system design requirements more realistic, the designer has the following choices:

1. To provide several delay-line taps for timing precharge turn-off and "c" enable turn-on. The appropriate tap is selected for best overlap.
2. To generate the overlap timing pulses at (or closer to) the drivers so as to reduce the number of gates in the timing path. A signal derived from "c" enable turn-on, suitably delayed, is used to control precharge turn-off. Figure 4 shows such a circuit. A discrete circuit detects "c" enable turn-off directly at the 1103s. The output of this circuit controls precharge turn-off.
3. To match skews more closely in the path from the timing generator to the "c" enable and precharge drivers by using gates located in a common package. If IC drivers are used, the corresponding precharge and "c" enable drivers should be located in the same package.
4. To use faster logic, such as Schottky TTL,

in critical timing control paths.

The access time for a system with timing as shown in Fig. 2 is at least 450 ns plus additional delays associated with starting the cycle and propagating the data to the memory output.

Shift register develops timing

The circuit of Fig. 5 uses clocked J-K flip-flops connected as a shift register instead of delay lines to generate timing for an 1103 memory. Operation is similar to that of the controller in Fig. 3. However, access time is increased by the time elapsing from the occurrence of the cycle request until the next clock pulse arrives. If timing similar to that in Fig. 2 is used, the clock must operate with a 70-ns period. All other requirements can be met by using an 840-ns read/write cycle.

The shift-register controller approach results in a longer memory cycle than does the delay line controller, since timing cannot be optimized with the shift register. When cost is more important than speed, the shift register may be favored since flip-flops typically cost less than delay lines.

In all of the systems described, the address is

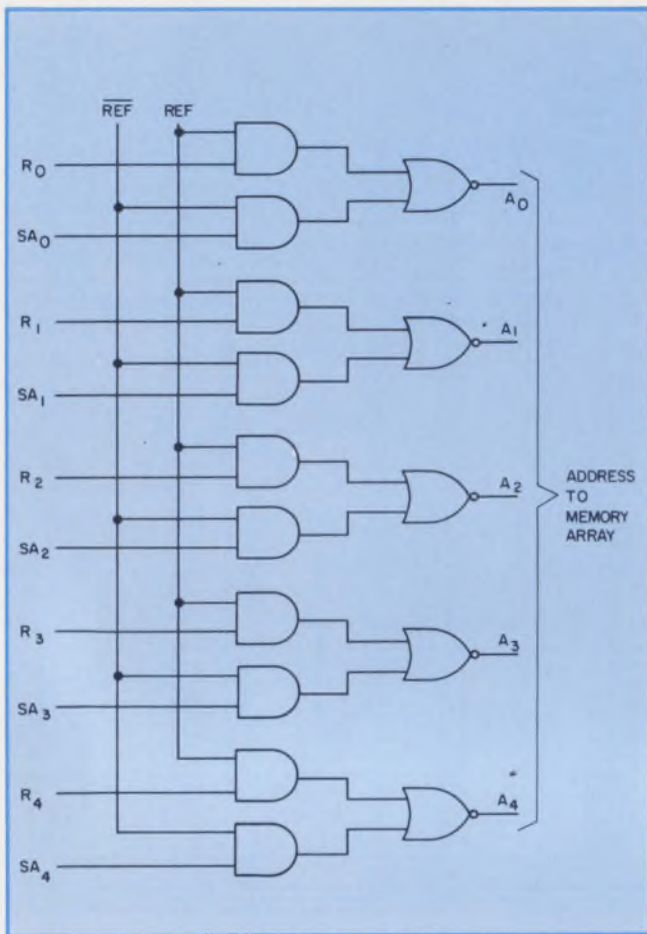

6. Refresh address switching circuit selects a five-bit address (R_0 through R_4) from an address counter for refresh cycles, or from a memory address register (SA_0 through SA_4) for normal requests. REF line selects the input. Only the row-address lines A_0 through A_4 are switched during refresh cycles.

derived from a refresh address source during refresh cycles, rather than from the normal address counter. Fig. 6 shows how address generation and switching can be accomplished. Only the five bits controlling address lines A_0 through A_4 need to be switched during refresh cycles. In larger memories where "c" enable (and sometimes precharge) are decoded to act as a chip-select signal, the decoding may be overridden during refresh cycles. In this way, the entire memory is refreshed by executing only 32 cycles.

The two controllers described each execute a refresh cycle every $60 \mu\text{s}$ so that 32 cycles are executed within 2 ms. Refresh cycles are also read cycles. The user can take advantage of the short cycle time for reading only.

In small memories and in applications with slow cycles, it is sometimes convenient to use every other cycle as a refresh cycle. For some applications, normal addressing may be used to achieve the refreshing requirement. Thus, random-access memories maintaining CRT displays may be used in a mostly sequential access mode,

or may have recurring sequential accesses. If these sequential cycles have access to three percent or more of the memory in any 2-ms period, it may be possible to arrange the address connections for these cycles alone to refresh the data.

Normal use can also refresh the data in transfers between disc or drum and an 1103 memory. In some cases, these transfers are required to take place at the full memory rate with no cycles devoted to refreshing. Then, in most cases, addressing can be arranged so that the transfer itself refreshes the memory. Consider a transfer between a 4096-word 1103 memory and a disc. These transfers usually involve serial blocks of data. If the address bits are chosen so that the seven least-significant address bits include 1103 addresses A_0 through A_6 and the remaining two bits are decoded to drive chip-selects, any transfer of at least 128 consecutive words will refresh the entire memory. With this organization, controller-generated refresh cycles are inhibited during transfer without loss of data.

Estimate power consumption

In estimating the power drawn by an 1103 memory system, the memory array, the level shifters, and the controller are all considered. Precharge duty cycles and the number of devices activated are most important in determining power dissipation.

One 1103 operating with a cycle time of 580 ns and a precharge duration of 190 ns at 25 C draws a maximum of 24 mA average current. Those devices not executing memory cycles draw 4 mA maximum. These figures apply unless duty cycles of the various clocks are significantly altered. Consider a $4 \text{ k} \times 16$ (4 rows of 16 1103s each) memory, with only the selected row driven by precharge. Maximum average power-supply current for the array is then $(16 \times 0.025) + (3 \times 16 \times 0.004) = 0.567 \text{ A}$.

When executing a memory cycle, an 1103's dissipation can approach 400 mW. Between cycles, dissipation is less than 64 mW. A significant amount of power is saved by applying precharge only to those rows of 1103s to be accessed. The circuits used to decode address bits to drive "c" enable are also used to select the precharge drivers operated. In systems using decoded precharge but undecoded "write," system noise effects may occur. A "sliver" (about 50 ns) of precharge, applied to all devices at the beginning of each memory cycle, should eliminate the problem.

Arrays of 1103s draw large surges of current during normal operation. Power supplies must be adequately regulated and bypassed at the memory array to ensure proper maintenance of the required voltages. Distribution of bypass capacitors

is discussed in more detail in the section on printed-circuit layout (to appear in Part 3).

Level shifters make major contribution to power dissipation. The level shifters described in Part 1 dissipate some 400 mW each in the low output state ($V_{SS} = 16 \text{ V}$, $V_{BB} - V_{SS} = 4 \text{ V}$). A typical $4 \text{ k} \times 16$ memory requires ten address level shifters, 16 data level shifters, and from 6 to 12 clock level shifters depending on the clock decoding scheme used.

Because the clock level shifters have relatively low effective duty cycles, their dc dissipation is relatively small, 300-400 mW total. However, worst-case dissipation for the 26 address and data level shifters can exceed 10 W. Some reduction in power may be achieved by gating the data level shifters to deliver low outputs only during the "c" enable period of write cycles.

In large systems, addresses may be held high on all but selected memory modules to conserve power. In level shifters driving large capacitive loads, the power associated with charging and discharging the capacitances must also be considered. This power, $p = f C V^2$ (see Part 1) is most significant in clock-driver circuits.

However, in high-performance heavily loaded address drivers, switching transients must be prevented from effectively increasing the frequency and, correspondingly, the dissipation. For example, in a $4 \text{ k} \times 16$ memory with a 700-ns cycle, addresses would typically change at most once per cycle, equivalent to a maximum frequency of half the cycle rate. To charge 488 pF at 16 V, we get a dissipation of about 84 mW. If glitches cause two or three address transitions prior to starting a cycle, this number may double or triple.

In larger systems, total system power may be reduced by placing data and address level shifters in unaccessed modules in a low-dissipation condition. In some cases, a further power reduction may be achieved by blocking dc current paths in unaccessed modules. This may be done when a module is not accessed for several cycles. If the A_1 address line is held low in the unaccessed module for the first non-accessed cycle, and then raised for subsequent non-accessed cycles, dc currents are significantly reduced until the module is again accessed. ■■

This is the second of three articles on the 1103 semiconductor memory. The first article, "The 1103—1024 Memory Bits on a Chip," appeared in the Jan. 20 issue of ELECTRONIC DESIGN and discussed chip organization, timing and shifting input levels. The final article on the 1103 will cover low-power operation of memory arrays.

Two Top Choices

Frequency Synthesizer



- 1 kHz to 80 MHz in 1 kHz Steps
- 1 Hz Resolution Optional
- Fully Programmable

Model RF-828 is offered with 1 kHz phase-locked steps. An optional vernier provides 1 Hz resolution. The RF-828 is fully programmable with contact closures, RTL, DTL or TTL logic.

Or

Synthesized Signal Generator



- AM/FM/Pulse Modulation
- Manual and Automatic Sweep
- 160 db Output Level Range

Model RF-808 is three instruments in one: signal generator and frequency synthesizer and sweeper. Frequency range is 0.05 to 80 MHz in 1 kHz phase-locked steps with a vernier for 1 Hz resolution. Frequency, modulation and attenuation are programmable.

Applications

Automated Test Systems • General Lab Use • Computer-Controlled Signal Sources • Semi-Automatic Test Systems • Receiver and Transmitter Systems • Nuclear Magnetic Resonance • Crystal Calibration and Resonance



HARRIS RF COMMUNICATIONS, INC.

Electronic Instrumentation Sales
1680 University Avenue
Rochester, New York 14610
Telephone: 716-244-5830; TWX: 510-253-7469
A subsidiary of Harris-Interbyte Corporation

To get
 "hooked" on
 our
 "bellowform"
 connector,
 you've
 got to see
 their
 connector.

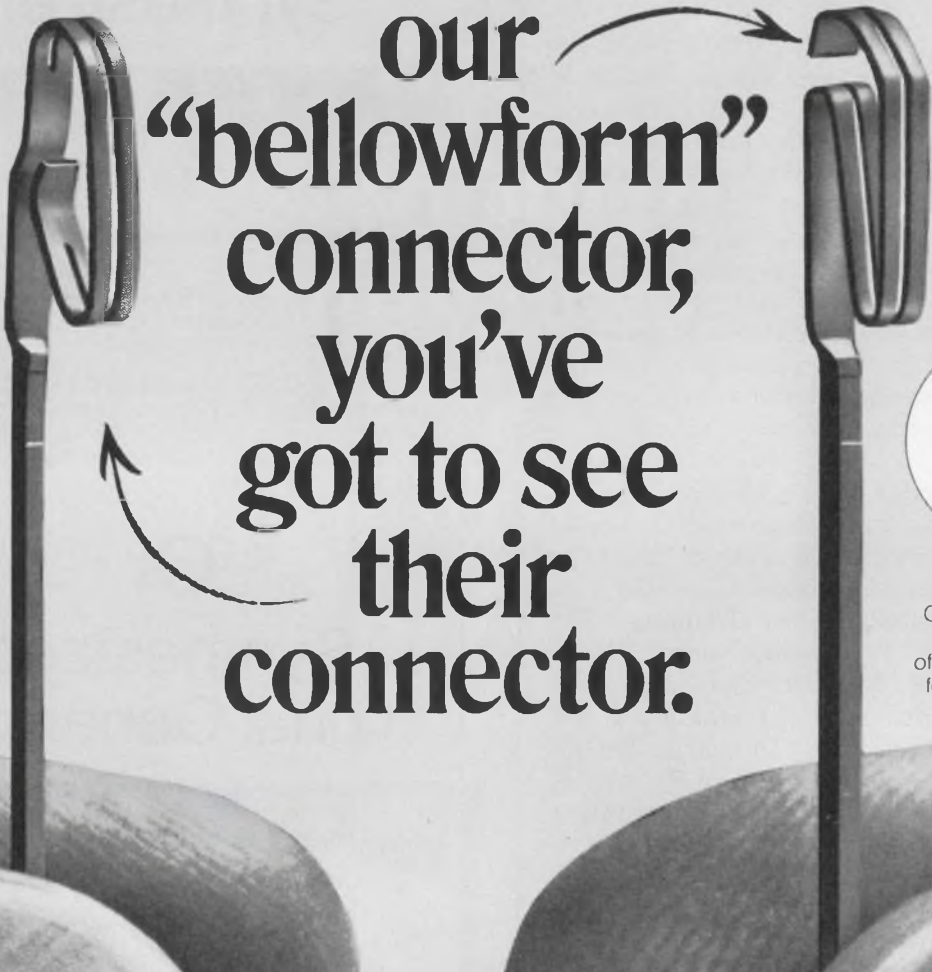

Cross Section Shows How a Continental Contact Hooks on Top of Connector Molding for Permanent Grip.

.100", .125", .156" AND .200" CONTACT CENTERS



PATENT NO. 2,875,425

Nothing holds more firmly than Continental's "Bellowform" contacts... because they hook on top for a permanent grip on the molding. The absolute end to loose connections. Choose from a wide variety of printed circuit connectors with .025" square terminations on .100" or .125" contact spacing; and .045" square terminations with .156" or .200" contact spacing. For connector contacts that can't loosen - because they're "hooked" in - call or write for our free 80-page Printed Circuit Connector Manual.



See EEM and VSMF Directories for Distributor or Sales Representative Nearest You

CONTINENTAL CONNECTORS

Continental Connector Corporation, / Woodside, New York 11377 / 212-899-4422

INFORMATION RETRIEVAL NUMBER 35

Simpson® has the world's largest selection of

PANEL METERS and METER RELAYS

OVER 1500 RANGES, SIZES AND TYPES IN STOCK AT ELECTRONIC DISTRIBUTORS NATIONWIDE



WIDE-VUE
1½", 2½", 3½", 4½", 8"



DESIGNER SERIES
3½", 4½"



NEW CENTURY SERIES
1½", 2½", 3½", 4½"



BOLD-VUE
2½", 3½"



RECTANGULAR
2½", 3½"
round style available



RUGGED SEAL
3½", 4½", 4" x 6"

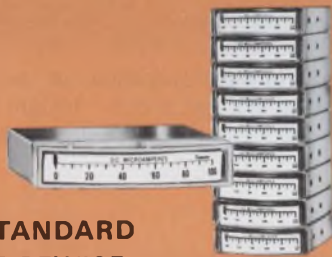

STANDARD EDGEWISE
1½", 2½"

STACKABLE EDGEWISE
1½", 2½"

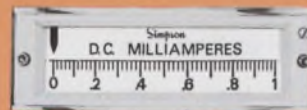

NEW 3½" STACKABLE EDGEWISE METER



RECTANGULAR
4½"



DIGITAL
Model 2800



PYROMETERS
4½"



METER RELAYS
3½", 4½", 4" x 6"



NEW 3½" EDGEWISE CONTROLLER
Many features.
Request Bulletin C1206

- THE ABOVE PANEL METERS ARE AVAILABLE IN AC/DC VOLTMETERS, AMMETERS, MILLIAMMETERS, MICROAMMETERS . . . DC MILLIVOLTMETERS AND GALVANOMETERS . . . RF AMMETERS AND MILLIAMMETERS.
- METER RELAYS AVAILABLE IN DC MICROAMPERES, MILLIAMPERES AND MILLIVOLTS . . . AC AMPERES

- MATCHING WATTMETERS, RADIO FREQUENCY, SEGMENTAL, VU AND DB, RECTIFIER AND ELAPSED TIME METERS ALSO AVAILABLE.

- SIMPSON CAN MAKE CUSTOM PANEL METERS AND METER RELAYS TO YOUR SPECIFICATIONS. ANY PRACTICAL RANGE CAN BE SUPPLIED. SEND US YOUR REQUIREMENTS.

GET "OFF-THE-SHELF" DELIVERY FROM YOUR LOCAL ELECTRONIC DISTRIBUTOR. WRITE FOR NEW CATALOG 4100.



SIMPSON ELECTRIC COMPANY

5200 W. Kinzie St., Chicago, Ill. 60644 • (312) 379-1121 • Cable: SIMELCO

IN CANADA: Bach-Simpson Ltd., London, Ontario

IN INDIA: Ruttonsha-Simpson Private Ltd., International House, Bombay-Agra Road, Vikhroli, Bombay



MANUFACTURERS OF THE WORLD FAMOUS SIMPSON 260®

Reduce errors in data transmission

between computer and peripheral input/output devices
using properly designed I/O bus circuits

Because small, low-cost computers are readily available, a variety of digital systems can now be designed by, essentially, "non-computer" engineers. Since the existing hardware is generally reliable, the largest problem a designer faces is possible data-transmission errors, or how to interconnect the system elements for "errorless" operation.

We are concerned here only with hardware error-reducing techniques, since most software (coding) approaches are fairly well known. The solution lies in ways to terminate the required transmission lines, whether in medium or high-speed systems. In addition attention must be paid to the sending and receiving circuits.

Getting on and off the unified bus

A transmission line that interconnects digital system elements is generally referred to as a bus. A current trend in minicomputer-based systems is toward the unified bus, where processor, memories and I/O devices can be plugged into the bus in any configuration (Fig. 1).

Each piece of equipment is connected to the bus by sending and receiving gates. The sending, or driver gates place the digital information on the bus for reception by the addressed components.

From a hardware point of view, errorless data transmission implies that sent and received information be distortion-free. Major factors affecting the signal quality in a given bus include:

- Bus loading.
- Crosstalk.
- Signal propagation speed.

An ideal pair of sending/receiving circuits would present as small an ac and dc load as possible to the bus. In addition it should be possible to tie the outputs of several sending circuits to the bus and let them send different logic information. (This operation is commonly called a "wired OR/AND.") But the basic T²L gate used in new computers cannot operate in this mode. And while the new logic form, three-state T²L, will simulate the "wired AND" mode, to the to-

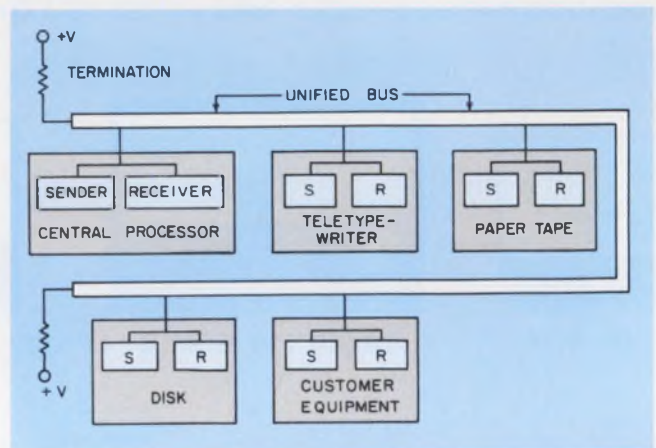

1. Error-free operation of a digital system depends heavily on the proper design of a "unified bus" that interconnects the various system components.

tem-pole outputs of these circuits are far from optimum transmission-line drivers.

Bus crosstalk is defined as the coupling of signals from one conductor to another. Mechanically a typical bus is a pattern containing a number of parallel conductors on a printed-circuit board. Since many of these parallel paths carry signals that are switching while others are not, the danger of crosstalk is very high. Thus if the crosstalk amplitude is large enough, a line that acts as an antenna will receive it as logic information, and the system will commit an error.

A circuit's ability to reject this crosstalk and other extraneous signals is determined by its noise immunity. (Additional noise sources are external, such as chopper-regulated power supplies and noisy relays. This external noise is normally common-mode in nature—that is, it may be present at both the circuit input and at the circuit ground or power supplies. A receiver circuit with high common-mode noise rejection is strongly recommended in bus design.)

For a given bus, crosstalk amplitude will be directly proportional to the amplitude of the noise-generation signal, or the driver's output-voltage swing. Thus the relative crosstalk performance of a bus driver and receiver is expressed in the following crosstalk figure of merit:

$$F_{ct} = 100\% (N_r/S_d),$$

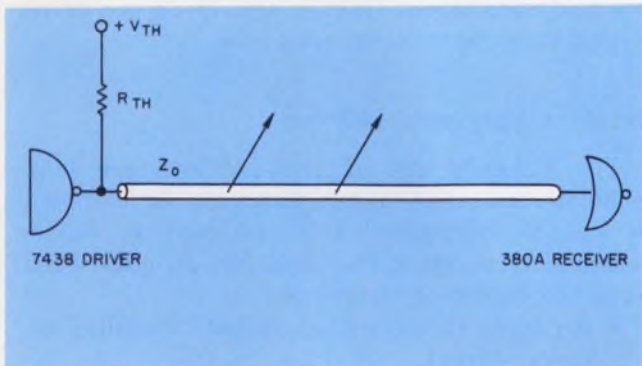

2. **Medium-speed bus circuits** use open-collector T²L logic, so several circuits can be tied together by the bus. Furthermore a collector pull-up resistor is used to terminate the bus line. The figure of merit for this circuit is 28%. This system is most used in minicomputer-based configurations.

where:

F_{ct} is the crosstalk figure of merit.

N_i is receiver noise immunity, in volts.

S_d is driver signal swing, in volts.

A higher F_{ct} means a better ability to reject the crosstalk.

Signal-propagation speed within a bus is another important consideration. A worst-case delay introduced by the bus is about 10 ns per foot or more; thus the bus circuits should be as fast as possible. If the total bus delay is smaller, the entire system will operate faster.

Choose I/O bus circuits

Figure 2 depicts a bus-driving system most often used in minicomputer-based configurations. The driver (sender) is a T²L open-collector NAND gate. An open-collector device permits the outputs of several circuits to be tied by the bus while, as mentioned previously, normal totem-pole T²L devices cannot be connected in this manner. The open-collector device also permits you to terminate the transmission line, using the collector pull-up resistor as the line termination.

The choice of the driver depends largely on its ability to sink the current that may be present in the bus. The primary source of this current is line-termination current. In Fig. 2, R_{TH} and V_{TH} are Thevenin-equivalent line-terminating resist-

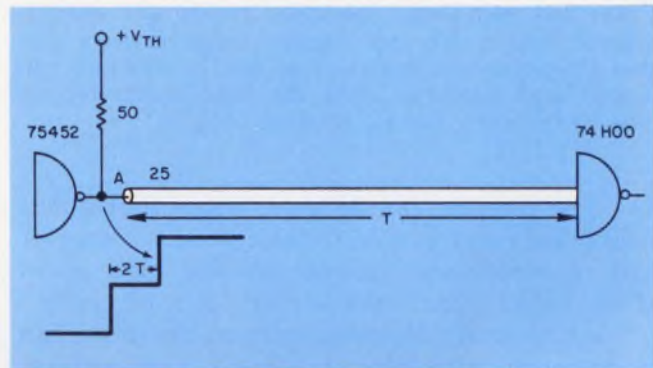

3. **The degree of mismatch** between the line and the terminating resistance depends on the noise immunity of the bus circuits. Gate switching time is delayed by the line in each direction. The height of the pedestal, for a $V_{TH} = 3.5$ V, is equal to $3.5(25/75) = 1.2$ V. The f_{ct} is about 12%.

ance and voltage, respectively. The line-termination current is given by:

$$I_{lt} = (V_{THmax} - V_{CESat}) / R_{TH}$$

The V_{CESat} is specified at a particular current. For a commonly used driver, such as the 7438, the V_{CESat} is 0.4 V at a current of 48 mA. A typical bus characteristic impedance, Z_0 , is 100 ohms, which calls for $R_{TH} = 100$ ohms. Since a typical V_{TH} is about 3.5 V, the line-termination current for a 7438 driver is

$$I_{lt} = (3.5 - 0.4) / 100 = 31 \text{ mA},$$

which requires 17 mA of current-sinking capability.

The second source of current is the input load current of the receiver circuits. For conventional logic circuits, this current is about 2 mA per circuit. Thus a 7438 can drive about eight loads on the bus, since it can sink only 17 mA of additional bus current.

Since a typical computer system might use many more components, eight circuits is not enough, and a circuit with a lower load current is normally used. For example, the 380-type, high-impedance receiver presents currents of a few microamperes to the bus.

The current-sinking ability of bus drivers and receivers is not the only consideration in bus design. Conventional logic circuits have smaller propagation delays—6 ns vs 30 to 40 ns for 380-type circuits. If the bus can be relatively slow, a

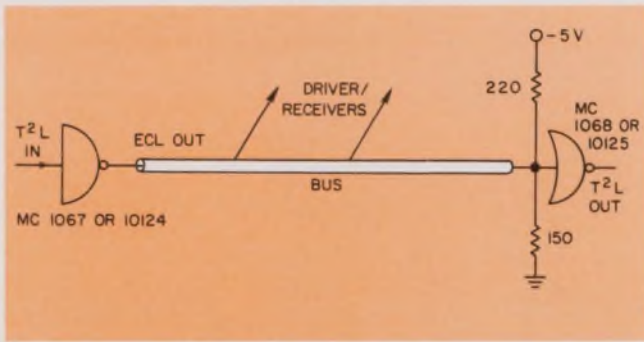

4. For very high-speed operation, drivers with emitter-follower outputs are used together with receivers that have transistor-base inputs. The emitter followers can supply large currents, while the base inputs require very little current. The F_{ct} is about 16%.

380-type receiver can be used, but if higher bus speeds are required—as in the case of a computer with semiconductor memories—the high speed of the conventional logic circuits is a necessity.

The previously described current limitation can be overcome with new high-speed, high-current-sinking peripheral drivers (75451 and 75452). These can sink about 100 mA at 0.4 V, so they can drive about 35 logic receivers compared with only eight. This increased current-sinking ability makes the design of a computer bus much easier, by doing away with the requirement for special high-impedance receivers. The receiver can be any logic gate. This bus system can operate very fast, but the high-current drivers present certain difficulties.

To sink the large amounts of current, the output transistor has a large collector area. This results in an output capacitance of about 17 pF, which is distributed along the bus transmission line. In addition to the driver capacitance, every receiver has an input capacitance of about 3 pF. Allowing another 5 pF for the connector pins of the printed-circuit board, every driver/receiver pair connected to the bus will load the bus with about 25 pF. If circuits are spaced every 0.5 inch, the line capacitance is increased by 50 pF/inch, or 600 pF/foot.

If the original line impedance were 100 ohms, with a typical delay of 1.8 ns/ft, the high capacitive loading of 600 pF/ft will reduce the line impedance to about 17 ohms and also increase the delay to about 10.5 ns/ft. Even if the driver/receiver pairs were spaced an inch apart on the bus, the line impedance would still be reduced to about 24 ohms with a delay of 7.6 ns/ft.

Thus to terminate the bus properly, a much smaller R_{TH} must be used. This, however, requires the driver circuit to sink more current. For example, if R_{TH} is selected as 50 ohms, then

$$I_{it} = (3.5 - 0.4)/50 = 62 \text{ mA},$$

leaving only 38 mA for receiver circuits, or sufficient for about 19 loads.

Note that the actual line impedance could be 25 ohms or even less. The important consideration in deciding how badly a line can be mismatched without introducing errors into the transmitted data is the receiver noise immunity—that is, when a line is mismatched, reflected voltages develop. These reflections can cause severe wave shape pedestals to occur because of the voltage division between the line impedance and the terminating resistor (Fig. 3). Obviously a careful trade-off between a properly terminated bus and the current-sinking ability of the driver circuit must be made in each case.

Design a high-speed I/O bus

The widening use of high-performance semiconductor memories necessitates the development of suitable high-speed I/O and memory busing schemes. In addition the ideal bus circuits would have the following properties:

- An ideal receiver that neither supplies nor sinks current.
- An ideal driver that is not disturbed by the line termination. An optimum driver would supply current to the termination, rather than sink the termination current.

A very high-speed I/O bus configuration is shown in Fig. 4. Its driver has an emitter-follower output that is capable of supplying large amounts of current without disturbing its performance. The receiver inputs are the transistor base input, which neither load nor supply the bus.

The driver is a T²L-to-ECL translator that can drive loads with impedances of less than 50 ohms. Its typical delay is about 5 ns, and it delivers an ECL level signal of 800 mV.

The receiver converts the ECL signal applied to its input into a T²L level signal to interface with the rest of the machine. The receiver, typically, has a delay of 7 ns.

Very little capacitive loading is added in this case, since the driver's emitter is connected to the bus rather than to the large collector substrate. In this way the bus transmission line can be almost perfectly terminated, resulting in high-speed operation without any reflections.

The ECL-to-T²L translator has less absolute noise immunity than a T²L gate, but its corresponding driver has a much smaller signal swing. Thus the higher speed ECL-T²L system permits high-speed operation with less crosstalk than the T²L systems. For operation in environments with high common-mode noise caused by external sources, a differential receiver, such as the MC 10115, can be used before an ECL-to-T²L translator. This receiver has more than 1 V of common-mode noise rejection, which will result in greater absolute noise immunity than conventional T²L receivers. ■■

Maybe the guy who knows the most about power supply modules is the guy to buy from.

With everyone saying the same things about their products, who do you listen to?

Us. Analog Devices.

We first popularized the packaged circuit "module" concept. Which gave you the convenience and economy of "plug-in" encapsulated power supplies.

In fact, we're the reason all the other guys have something to talk about.

Our performance, reliability, price and delivery could be the reason we're the leader in power supply module sales.

We can tell you all the things you have to know about our complete line. Which offers dual 15VDC for op amps and single 5VDC for logic circuits. With quantity discounts for OEM customers.

After all, we've been telling you longer than anyone else. Let us tell you again

with our 1972 Product & Application Guidebook.

Analog Devices, Inc., Norwood, Mass. 02062. Tel. (617) 329-4700.





All toroids look alike.

Our PULSE-RATEDTM toroids really are alike.

We developed the concept of *pulse rated* toroids to eliminate tedious selection problems. Now we've developed new materials. Fully proven. Component tested. So you get guaranteed performance over a temperature range of 0° to 60° C.

Pulse-rated toroids not only simplify your selection process, they practically eliminate scrap. So you get 100% yield in your pulse transformer production.

Specifications provided for every *pulse-rated* toroid include pulse in-

ductance, volt-microsecond product, and temperature behavior under pulse conditions.

Parylene-coated *pulse-rated* toroids in sizes and specifications to suit your design requirements are now available for off-the-shelf delivery. Want some? We welcome the opportunity to send you samples. And hot-off-the-press spec sheets. And to consult with you about your design problems. Write Indiana General, Electronic Products, Keasbey, N. J. 08832.

indiana general 

a division of Electronic Memories & Magnetics Corporation

"National distribution through seven Permag locations"

NEW ...

*A complete family
of low-cost,
high performance
packaged AC-DC
regulated power supplies*

"THE PRACTICALS™"

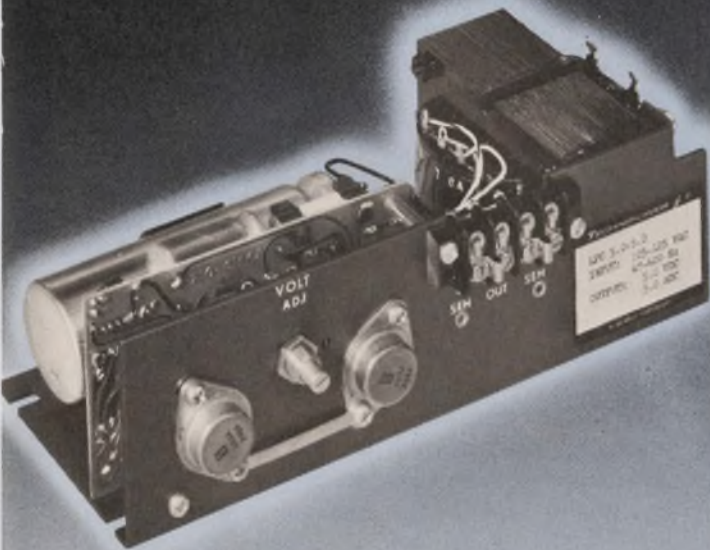

They make systems engineers
cost efficiency experts

Today's OEM Engineer must assume many responsibilities beyond the pure design of systems.

He must realistically specify the components and sub-systems; buy the required performance specifications at competitive prices; package the system in its most compact form. In short, he must achieve the greatest cost-efficiency and reliability per dollar invested.

Just compare the basic specifications and prices of "The Practicals" with other open construction power supplies. Then consider that we give "The Practicals" the identical 5-Year Warranty as our premium mil-spec units.

Standard output voltages and power availabilities satisfy the most popular circuits. Custom specification can easily be adapted to order.

"The Practicals" are an OEM Engineer's most realistic answer to any power supply need. Call, wire or write today for immediate delivery.

**U.L. APPROVED. BACKED BY TECHNIPOWER
5-YEAR WARRANTY**



Benrus Center, Ridgefield, Ct. 06877
203-438-0333 TWX: 710-467-0666

TECHNIPOWER "PRACTICALS" STANDARD SPECIFICATIONS

Single, Dual, Triple, and Quadruple Output Models

Input voltage range: 105-125 volts
Input frequency range: 47-420 Hz.
Regulation-Line and Load Combined: $\pm 0.5\%$
Ripple (RMS): (with either positive or negative terminal grounded): 10mv.
Temperature Coefficient: (TYP.) 0.05%/°C or 5 mv/°C whichever is greater.
Polarity: May be used positive or negative.
Output voltage and current: See model listing.
Short circuit protection: Automatic circuit protects the power supply if the output is shorted continuously. Automatic return upon removal of short circuit.
Remote sensing: Provisions are made for remote sensing to eliminate effects of lead resistance on dc regulation.
Ambient Operating Temperature: 0°C to +55°C for current ratings specified in model listings.
Storage temperature: -20°C to +85°C.
Recovery time: (TYP.) Less than 50 usec, 1/2 L to FL.
Fixed output voltage: Can be pre-set at the factory with a setting accuracy of $\pm 2\%$ of nominal output for any or all of the outputs at slight additional cost.
OEM quantity and less than 10 unit prices quoted upon request.
Custom specifications easily adapted to order.

Single Output Series designed for logic, op-amp, signal and other commercial applications



Length 8 1/2"
Width 3 1/8"
Height 2 5/8"

Adjustable Output Voltage	Output Current Amperes	Standard Model No.
5.0 $\pm 5\%$	5.0	LP5.0-5.0
6.0 $\pm 5\%$	4.5	LP6.0-4.5
12.0 $\pm 5\%$	2.5	LP12.0-2.5
15.0 $\pm 5\%$	2.0	LP15.0-2.0
24.0 $\pm 5\%$	1.5	LP24.0-1.5
28.0 $\pm 5\%$	1.2	LP28.0-1.2

\$39⁷⁵

10 or more combined units

Overvoltage protection available on all models, add \$5.00.

Dual Output Tracking Series designed for op-amp and other commercial applications



Length 8 1/2"
Width 3 1/8"
Height 2 5/8"

Adjustable Output Voltage	Output Current Amperes	Standard Model No.
$\pm 12.0 \pm 5\%$	1.2	LPDT-12.0-1.2
$\pm 15.0 \pm 5\%$	1.0	LPDT-15.0-1.0

\$74⁷⁵

10 or more combined units

Overvoltage Protection available on all models, add \$10.00. Independent output adjustment (non-tracking) provided at slight additional cost. Modification of standard output voltages can be provided over the range of ± 5 to ± 28 volts at slight additional cost. Voltages below ± 7 volts not available in Tracking models.

Triple Output Series combines single and dual output functions



Length 8 1/2"
Width 7 1/2"
Height 3 3/8"

Adjustable Output Voltage	Output Current Amperes	Standard Model No.
+5.0 $\pm 5\%$	5.0	LPM-1
+12.0 $\pm 5\%$	1.2	
-12.0 $\pm 5\%$	1.2	
+5.0 $\pm 5\%$	5.0	LPM-2
+15.0 $\pm 5\%$	1.0	
-15.0 $\pm 5\%$	1.0	

\$142⁷⁵

10 or more combined units

Overvoltage Protection is standard on 5 Volt Output at no additional cost. Available on the ± 12 or ± 15 volt output, add \$10.00. Modification of standard output voltages can be provided at slight additional cost.

Quadruple Output Series combines triple output functions plus output for indicator or drive voltage



Length 14"
Width 8 1/2"
Height 5"

Adjustable Output Voltage	Output Current Amperes	Standard Model No.
+5.0 $\pm 5\%$	10.0	LPQ-1
+15.0 $\pm 5\%$	2.0	
-15.0 $\pm 5\%$	2.0	
+28.0 $\pm 5\%$	1.0	
+5.0 $\pm 5\%$	7.5	LPQ-2
+15.0 $\pm 5\%$	4.0	
-15.0 $\pm 5\%$	4.0	
+28.0 $\pm 5\%$	1.0	
+5.0 $\pm 5\%$	5.0	LPQ-3
+15.0 $\pm 5\%$	6.0	
-15.0 $\pm 5\%$	6.0	
+28.0 $\pm 5\%$	1.0	

FROM
\$229⁷⁵

10 or more combined units

Overvoltage Protection is standard on 5 Volt Output at no additional cost. Overvoltage Protection is available on the ± 12 or ± 15 volt output, add \$10.00. Modification of standard output voltages can be provided at slight additional cost.

No design is sacred. It must be sold to the marketing and manufacturing sections, says this manager. He does it by organizing his men for 'the right things to do'.

Robert W. Gress, Manager, Resistor Product Development, Corning Glass Works, Electronics Products Div., Bradford, Pa.

Selling a new design to my division has been my toughest challenge since I was promoted to manager of resistor product development at Corning Glass Works two and a half years ago. Because we're a staff group, we have to sell everything we design to our manufacturing department. Before it can accept our new products for processing, we have to provide both the design and a manufacturing method. We must also sell our new programs to our marketing force, which in turn guides us as to what will sell in the marketplace.

We found that we had expected both departments to accept as gospel the designs that we had been working on for months, sometimes years, without really trying to sell them on the idea, and without really giving them the opportunity to understand our point of view. In other words, we'd been trying to impose our ideas on them without trying to teach them what the ideas meant.

When I first realized that to sell our designs we had to sell ourselves, I took a course on selling. After that, I hired a sales consultant to teach the rest of my group. He was a little apprehensive because he'd never taught a group comprised exclusively of technical people.

My people went to class convinced that all salesmen were villains; that all they wanted was to get the customers' money. They learned there's much more to selling than that. They learned that selling requires a good product, a willingness to sell and knowing how your customer looks at your product.

To sell our designs, we decided to go face-to-face—individuals confronting one another in the different departments within the plant and the division.

Five years ago, people in the other departments in my plant felt they were being hoodwinked into accepting products. Communications were not at their best, and when something went wrong, everyone assumed that it was someone

else who caused the problem.

A key factor in selling our designs was to sell the other departments involved on the idea that they wouldn't interfere with their objectives. We had to build confidence in what we'd done. We conducted face-to-face test labs using our development test facility and their manufacturing test facility. We correlated the data together and ran studies between the two facilities. Through statistical manipulation, we proved to the satisfaction of both groups that the facilities were equal and compatible.

The second part of the challenge of selling new designs was to inspire my own people to do the jobs that were ahead of us. We had to re-group and start thinking in new directions. I re-organized my own people into three nearly equal groups: a mechanical processing group to design the equipment and the process for working it; a product testing group; and a material processing group to check out the materials from which we make our products. Responsibilities, including the planning functions, were delegated to the group leaders. Before, they were getting task assignments that weren't objectively assigned. Now they were "masters of their own destinies."

The groups serviced each other. One that was strong mechanically would help the others, and they in turn would share their strengths. We organized so that no walls of conflict were allowed to be built between groups. If one group's program was of key importance for a time, the two other groups would shift people around among themselves to accommodate that program. The idea behind the reorganization was to make my people feel more a part of the total job and to make them understand more completely what they were going to be doing.

But I think, personally, the toughest adjustment of all for me, in my new role as a manager, has been in allowing something to happen without doing it myself. It's hard to train a new subordinate and plan his projects. It's difficult to tell him what the objective is and how to accomplish it. It's easier to do it yourself.

So I teach them that they *can* commit themselves to an action or a design. It's neither Corn-

Robert W. Gress

Education: BSME, Indiana Institute of Technology; PERT and PERT Cost at A.M.A.; sensitivity training; Managerial Grids I and II; manager development program, Syracuse.

Experience: Design engineer; senior development engineer; supervisor of process development; manager product development—resistors.

Paper: "Characteristics of Antimony Doped Tin Oxide Films," published and presented at 1968 Electronic Components Conference.

Community Affairs: Kiwanis, Scouting.

Personal: Married; three sons; interests include camping, swimming and weight-lifting.

Employer: Founded in 1851 and incorporated as Corning Glass Works in 1877. Long a supplier of glass parts for electrical items such as light bulbs, lighting refractors, and vacuum and television tubes, Corning entered the electronics market in the 1950's with glass capacitors and resistors. Later, the company added such electronics-oriented products as encapsulating and sealing glasses, photomask substrates and glass and glass-ceramic parts. With the acquisition of Signetics Corp., Corning moved into the integrated circuits market.



ing's policy nor mine to punish for errors. We learn by them. It's important for my people to realize that if they get into trouble, I'm right there to help. The ticklish part is knowing when to jump in and help and when to let the engineer work things out himself. Factors that enter into consideration on this score include project timing and the relative importance of the project. For example, is there time for the engineer to pull a lagging job out of the fire? Or, how important is the project? If it's small, more might be gained by allowing the engineer to work it out completely on his own, even if it drags a bit.

There are times, however, when we could hurt ourselves in the marketplace by letting something lag behind schedule. When that happens, the

manager has no choice. He must take control and retain control until the project is completed or until the engineer is capable of resuming control.

I think I can sum up my operating philosophy as a manager in this way: Years ago, when I was a machinist in the service, I remember we used to polish the surfaces of all our machine parts because that was doing things right. But you can waste a lot of time doing things right when you should be looking for the right things to do. Rather than polishing parts, perhaps we should have been looking for that next piece of equipment to build. In other words, new and better products are more important than polishing up the ones we have. ■■

Don't be shocked.

EXAR can give you superior wire performance at no increase in price.

EXAR™ Wire—an entirely new class of cross-linked polymeric insulation that outperforms the hook-up wires and motor lead wires in use today is available now at no increase in cost over the wire you are using. Shocked? Read more.

As a hook-up wire: EXAR exceeds all the performance requirements of UL Styles 1429 and 1430 and passes the "FR-1" vertical flame test. It can be certified to MIL-W-16878D Type B with the additional bonus to the user of a continuous 125°C rating.

As a motor lead/transformer wire: EXAR does not yield the corrosive gases present in chlorinated polymers at elevated temperatures. It prevents the pos-

sibility of permanent damage in totally enclosed motors. It passes accelerated aging tests at 230°C and easily withstands varnish bake temperatures as high as 185°C. You can take advantage of its greater current-carrying capacity to reduce gauge size and lower wire costs. You can save on inventory cost by using EXAR in wider range applications which formerly required two or more wire types.

EXAR is ready to take on the major insulations in use today in hook-up and motor lead application. Now that the shock has worn off, for more information about how EXAR can give you added value for your wire dollar write: Haveg Industries, Inc., Super Temp Wire Division, P.O. Box 7E, Winooski, Vermont 05404. Telephone (802) 655-2121. TWX 510-229-0018.

SUPER TEMP WIRE DIVISION
HAVEG INDUSTRIES INC

Winooski, Vermont 05404



HW 72-1

We
 put eight
 IEC F34
 Function
 Generators
 aboard
 this
 747.
 Tagged for
 Paris, France,
 with
 one-way tickets.



**IF YOU'D LIKE TO FIND OUT WHY,
 CALL JOHN NORBURG AT 714-772-2811 COLLECT**

It's nothing unusual. Our various agents overseas, including Tekelec Airtronic of France, represent a very interesting line of Function Generators. The IEC Series 30. Four of the most advanced-concept test instruments available in the Free World. Designed to fit the exact needs of our customers, whether here or abroad. And priced from \$295 to \$495 to provide the most for the money. Take the IEC F34 (illustrated) for example. At \$495, it does everything an oscillator can do and then some! Square waves and triangles, voltage offset, sweep, trigger, gate and pulse. Plus better sine wave purity than comparably-priced oscillators. The F34, like all Series 30 models, provides extra-special features that make it a

bargain. Together with such inherent quality that we boast one of the industry's lowest "returned for repair" rates.

It may not require a 747 delivery to fulfill your need, but you can depend on IEC to deliver your new Series 30 Function Generator on time. Our John Norburg is ready to answer your questions. Contact him now. Get complete technical data by same-day mail.



IEC F34 Function Generator

SERIES 30 HIGHLIGHTS F34: (\$495) —
Frequency Range: 0.03 Hz to 3 MHz.
Waveforms: Sine, square, triangle, dc, pulse.
Output Amplitude: 10 mv pp to 10 v pp into 50Ω.
Sine Distortion: < 0.3% up to 30 kHz, < 0.5% to 300 kHz, < 2% to 3 MHz. *Rise/Fall Times:* < 60 ns. *Offset:* ± 5 v into 50Ω. *VCG Range:* > 1000:1. *Operating Modes:* Continuous, Triggered, Gated, Tone Burst, Continuous Sweep, Triggered Sweep. *Sweep Width:* up to 1000:1. Set width directly on tuning dial. *Sweep Time:* 10μsec to 100 sec. *Other Features:* Voltage Analog of Frequency, Sync Input, Output Limit Indicator, plug-in IC's. **F33: (\$395)** — Same as F34, but without Sweep, Tone Burst and Voltage Analog of Frequency. **F32: (\$345)** — Same as F33, but without Pulse, Trigger and Gate Modes and Sync Input. **F31: (\$295)** — Same as F32, but without VCG and Output Limit Indicator. Output Amplitude is 100 mv pp to 10 v pp into 50Ω.

IEC GIVES YOU THE MOST FOR YOUR MONEY

INTERSTATE ELECTRONICS CORPORATION A Subsidiary of A-T-O Inc. Dept. 7000, Box 3117, Anaheim, Cal. 92803 (714) 772-2811 TWX 714-776-0280 TELEX 655443 & 655419

Adjustable couplings improve interdigital bandpass filters

Input/output couplings are important in the design of interdigital bandpass filters. The usual design equations do not permit analysis of these couplings with sufficient accuracy for many applications, so it's necessary to use cumbersome cut-and-try techniques.

Optimizing passband response in production units often requires very tight mechanical tolerances. If adjustable input/output coupling mechanisms are used instead of fixed ones, the filter response shape can be optimized without machining. The response shape can also be improved when the couplings are interfaced with mismatched source/load impedances encountered in practical equipment configurations.

The basic interdigital filter structure uses round rods or rectangular bars as resonator center conductors, located midway between two metallic ground planes. Input/output couplings are implemented by electromagnetic coupling between an auxiliary resonator (attached to a coaxial connector) and the first resonator (see figure). The filter employs adjacent resonators with alternating short-circuit reference planes so that electric and magnetic couplings between adjacent resonators are in phase. This means that the effective input/output couplings can be

altered by changing inductive and/or capacitive coupling.

A practical adjustable input/output coupling mechanism uses a capacitive probe mounted on a screw. The screw is threaded into the auxiliary resonator center conductor parallel to the ground planes. A small hole in the filter end plate permits accessibility for screwdriver adjustment of the coupling. The first resonator is equipped with a small Teflon disc that provides enhanced capacitive coupling and a mechanical stop for the adjustable probe. The spacing between the auxiliary resonator and the first resonator is made slightly larger than required for the desired input coupling. Tighter coupling is realized by screwing the probe closer to the first resonator.

The adjustable probe is applicable to L band and S band filters using 3/16 to 1/4-inch diameter center conductors and 1/2 to 5/8-inch ground-plane spacings. Typical probe designs employ probe-head diameters comparable to the center conductor diameters and 2-56 screw threads.

Richard M. Kurzrok, P.E., Consulting Engineer, 545 West End Ave., New York, N.Y. 10024

CIRCLE NO. 311

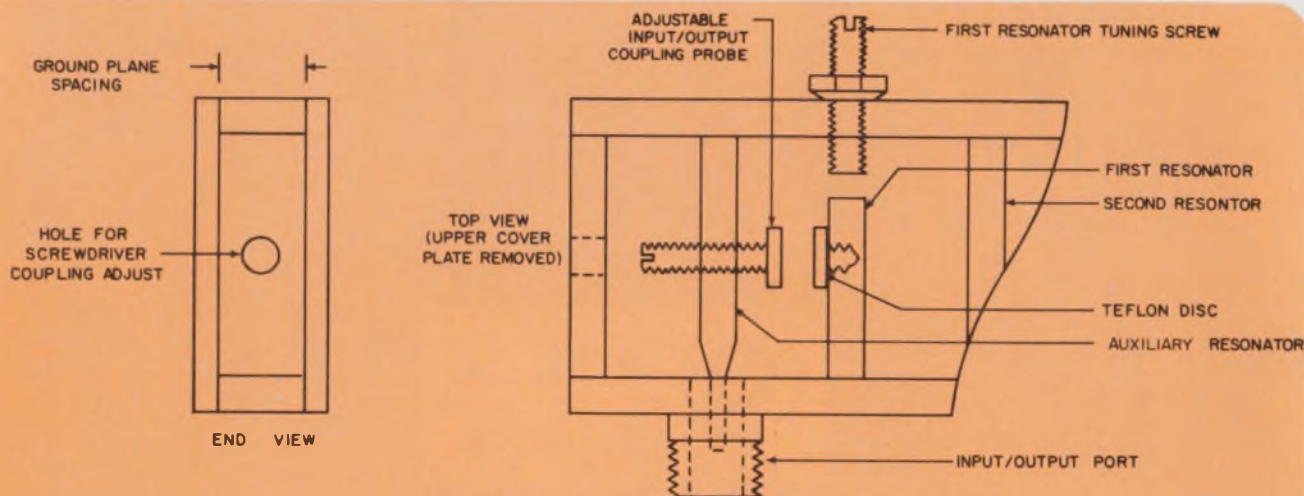

Capacitive probe allows fine adjustment of input/output coupling in interdigital bandpass filter.

13 STANDARD RESISTORS

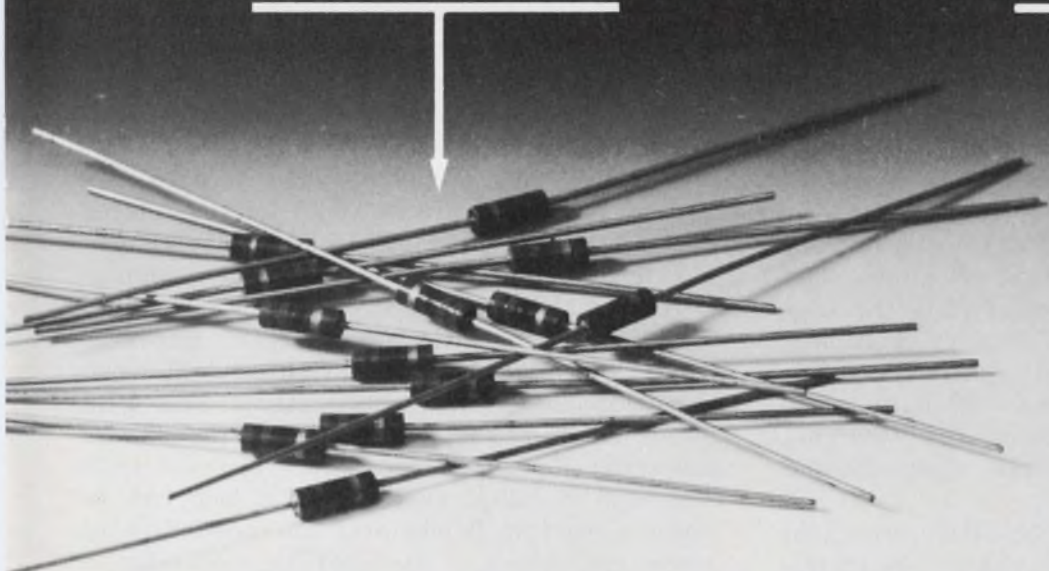

13 STANDARD RESISTORS



Helipot's one-piece money saver saves time and space, too.

To keep working with discrete standard resistors just isn't logical. Not when there are ceramic DIPs available that do the same jobs in less space—quicker, easier and cheaper. Whether inserted automatically or by hand.

Stocked locally for immediate delivery, too. At "on the board" cost-saving prices, in small or large quantities.

(Check the specs.) No wasted time while they're "made to order," unless you want custom modifications, which we can do fast.

And remember, ceramic. Ceramic reliability at plastic prices.

Why wait? Call your local Helipot Representative now for applications assistance or more information.

Beckman
INSTRUMENTS, INC.
HELIPOT DIVISION
Fullerton, California

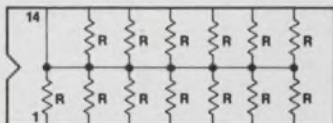

MODEL SERIES 899-1

Resistance Values (ohms): 100, 150, 220, 330, 470, 680, 1K, 1.5K, 2K, 2.2K, 3.3K, 4.7K, 6K, 6.8K, 10K, 15K, 22K.
Common Applications: Digital pulse squaring; MOS/ROM pull-up/ pull-down; "wired OR" pull-up; power driver pull-up; open collector pull-up; TTL input pull-down; TTL unused gate pull-up; high-speed parallel pull-up.

Standard Tolerance: $\pm 2.0\%$

Pricing:	1-99	\$1.45
	100-499	1.12
	500-999	0.97

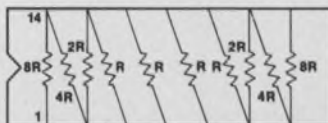

MODEL SERIES 899-2

Resistance Value (ohms): 10K
Common Applications: Inverting operational gain; potentiometric gain; differential gain; noninverting gain; gain adjustment.

Standard Tolerance: $\pm 2\%$

Pricing:	1-99	\$2.75
	100-499	2.15
	500-999	1.86

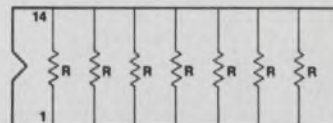

MODEL SERIES 899-3

Resistance Values (ohms): 68, 100, 110, 150, 220, 330, 470, 680, 1K, 1.5K, 2.2K, 3.3K, 4.7K, 6.8K, 10K, 15K, 22K.
Common Applications: Line termination; long-line impedance balancing; power gate pull-up; ECL output pull-down resistors; LED current limiting; power driver pull-up; "wired OR" pull-up; TTL input pull-down.

Standard Tolerance: $\pm 2\%$

Pricing:	1-99	\$1.25
	100-499	0.99
	500-999	0.86

Phase-locked loop generates stereo multiplex switching source

Stereo multiplex generators are usually based on the principle of time-division multiplexing. The composite signal is formed from the addition of a 19-kHz pilot tone with the two audio channels, which are alternately switched to the summing amplifier at a frequency of 38 kHz. A phase-shift network inserted after the selective amplifier has to be adjusted to insure that the pilot tone has the right phase relationship with the 38-kHz subcarrier. A different and better way to generate the 19 and 38-kHz signals in the correct phase relationship uses a phase-locked loop (PLL).

The output of a 19-kHz crystal oscillator (see diagram) is used directly as the pilot tone. The same signal drives an integrated PLL, the LM565CM, which is used as a frequency multiplier with the VCO free-running at 76 kHz. Two flip-flops are inserted between the VCO output and the phase-detector input, dividing the VCO output by 4 to arrive at the 19-kHz signal for the phase detector.

The first flip-flop runs at 38 kHz to give two out-of-phase switching signals. These are amplified to the value needed to drive the two series FET switches. Transistor Q is a level-shifting transistor between the output of the PLL and the flip-flop.

With the timing resistor R set so that the VCO

free-runs at 76 kHz, the PLL automatically locks itself with the correct phase relationship to the 19-kHz sine wave. Additional phase adjustment of the 19-kHz pilot tone is therefore not required. Also, since the 38-kHz phase-locked oscillator is a closed-loop system, changes in component value due to aging, temperature, etc., are automatically corrected, with good long-term system stability resulting.

The same arrangement with a modified low-pass filter can also be used for decoding stereo multiplex signals. Popular stereo decoders are switching types, where the pilot tone is filtered by high-Q tuned circuits, the frequency is doubled to 38 kHz and used to switch the complex stereo signals. But high-Q circuits require careful alignment, and the phase of the recovered 38-kHz subcarrier becomes extremely drift sensitive, reducing channel separation. The PLL avoids all of this when recovering the 38-kHz subcarrier. Its closed-loop nature provides good long-term stability, and since the loop can be given a narrow bandwidth, the possibility of phase modulation of the 38-kHz subcarrier is very much reduced.

*Erno Borbely, Design Engineer, Dynaco, Inc.,
3060 Jefferson St., Philadelphia, Pa. 19121*

CIRCLE NO. 312

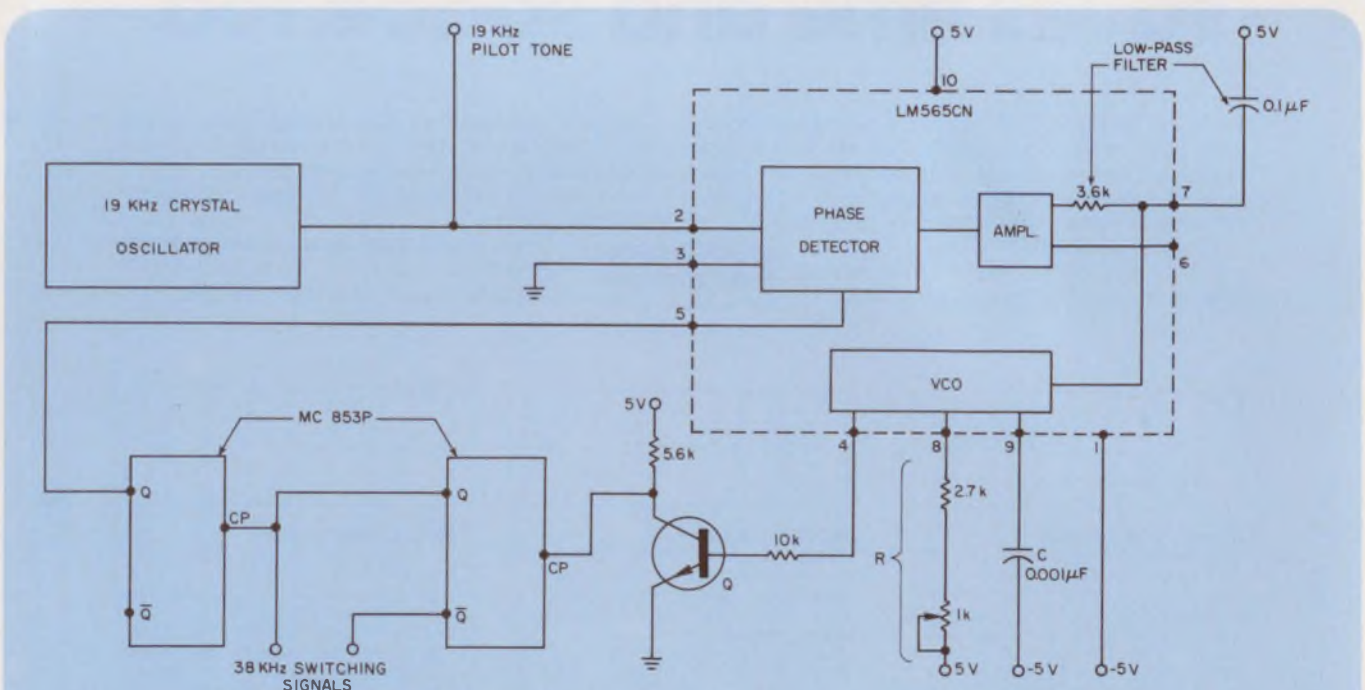

An integrated PLL, the LM565CN, driven by a 19-kHz crystal oscillator, is used as a frequency multiplier. Use of the PLL insures that the 38-kHz

switching signal will have the correct phase relationship with the 19-kHz pilot tone. This eliminates the need for a phase-shift network.

¢-LINE MICROWAVE PIN DIODES

**Choose the best
and still pay less for your
microwave switching needs**

¢-LINE MICROWAVE PIN DIODES — SPECIFICATIONS

Type	Maximum Total Capacitance (0V, 1GHz)	Maximum Series Resistance (100mA, 1GHz)	Minimum Carrier Lifetime ($I_f = 10\text{mA}$)
	C_T	R_s	τ
	pF	Ω	us
UM4001B	3.0	0.5	5.0
UM7001B	0.9	1.0	2.5
UM7101B	1.2	0.6	2.0
UM7201B	2.2	0.2	1.5
UM6001B	0.5	1.7	1.0
UM6101B	0.7	1.0	1.0
UM6201B	1.1	0.4	1.0
UM6601B	0.4	2.5	1.0

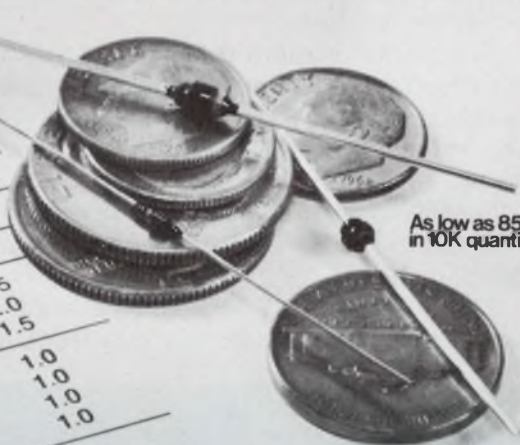

As low as 85¢
in 10K quantities

You can now select capacitance, resistance and carrier lifetime and get circuit optimization at the industry's lowest prices. These new 100V PIN diodes from Unitrode all feature low distortion and low insertion loss for microwave applications such as TR switches, antenna selectors, receiver channel selectors, switching matrices and attenuators in AGC circuits. They're available off the shelf at your local Unitrode distributor. Samples on request.

For fast action, call Sales Engineering collect at (617) 926-0404, Unitrode Corporation, Dept. 2 X, 580 Pleasant Street, Watertown, Mass. 02172



UNITRODE quality takes the worry out of paying less.

Ramp generator has 20-ns settling time

A major limitation on the bandwidth of instruments with sweep generators is the finite settling time of the ramp generator, which is a function of the speed of the trigger. This disadvantage can be minimized by adding a comparator circuit to the ramp generator, which generates the trigger pulse. (see figure). The modified generator has a settling time of 20 ns and an output with a rise time of less than 10 ns.

When the positive-going trigger input (0 to +5 V) is received, Q_1 —normally in saturation—turns OFF, resulting in -23 V at the junction of R_4 , R_5 and R_{11} , which turns emitter-follower Q_2 ON. The negative voltage is transmitted with a small drop to the output of Q_2 , forward-biasing D_2 and back-biasing D_3 at -21 V. At this instant the constant current starts to flow through R_{11} , discharging C_2 toward -21 V until D_7 , D_8 and D_9 stay back-biased, which depends on the reference voltage.

The negative ramp output is generated at the junction of D_3 , D_4 and D_7 , and the negative slope is determined by the constant current rate and the value of C_2 . The constant current is generated by the D_5 and D_6 current regulating diodes. The constant current is kept at 9 mA with a linearity of $\pm 0.2\%$, which causes the ramp to be linear.

The lowest C_2 (47 pF) will generate the fastest ramp, with a maximum amplitude of 12.5 V

during a time span of 100 ns. For the highest C_2 (500 pF), a ramp is obtained with the same maximum amplitude, but it has a 1- μ s duration.

Comparison occurs when the particular ramp generated becomes more negative than the reference voltage, causing D_7 , D_8 and D_9 to be forward-biased. D_8 , D_{10} and D_{11} are tunnel diodes with very fast response. When the peak voltage -55 mV between anode and cathode—of the D_8 tunnel diode is reached, the diode conducts and generates a very fast negative spike of ~ 500 mV across the primary of the T_1 pulse-transformer and R_{11} , which is in parallel with C_3 .

The negative spike is transmitted and attenuated 2:1 to the secondary of T_1 , where it triggers tunnel diode D_{10} , which drives Q_3 almost to saturation. The output of Q_3 generates a positive-going pulse of 9 V. During the build-up of this pulse, when the peak voltage of tunnel diode D_{11} is reached, the diode conducts and pushes an excess current into the base of emitter-follower Q_4 . This results in an even faster rise time of the output trigger pulse, which can be used as a sweep generator.

Andrew A. Kiss, *Electronic Engineer, FBM S/E Comp. Engineering, Room#2674, Electronic Systems Div., General Electric Co., 100 Plastics Ave., Pittsfield, Mass 01201*

CIRCLE NO. 313

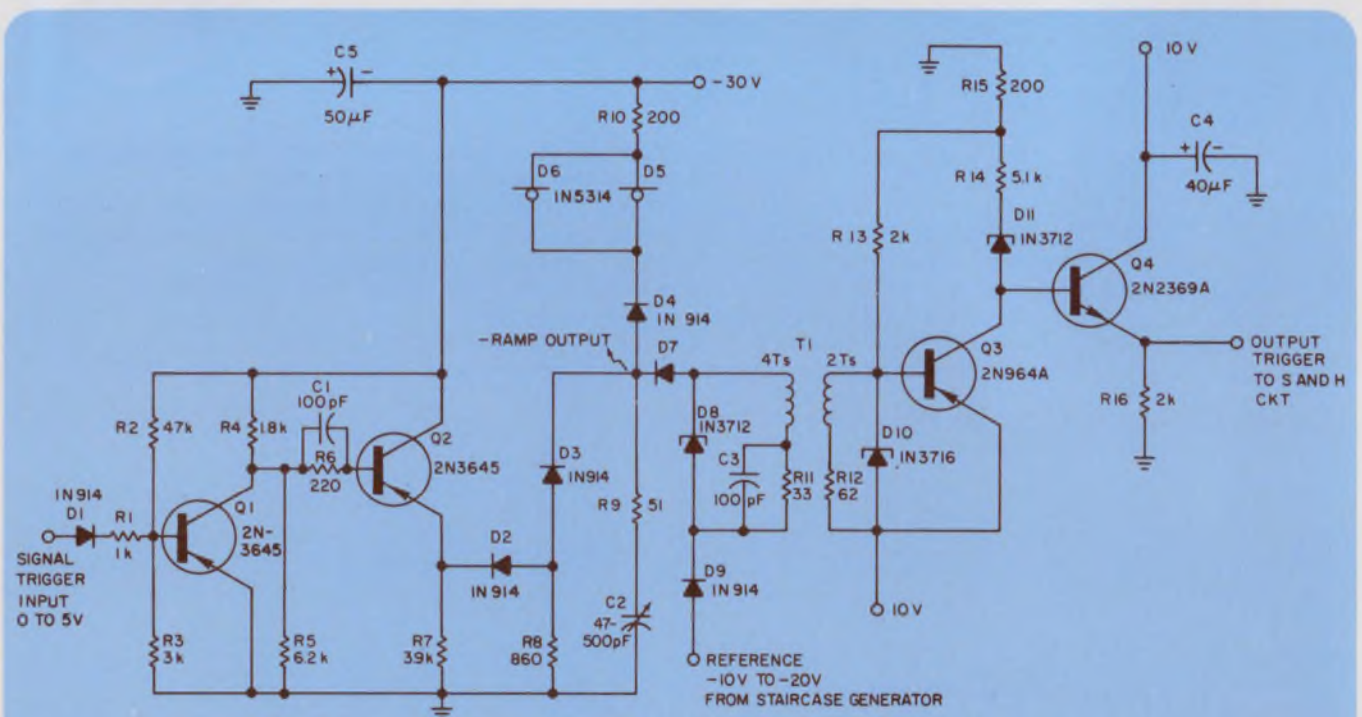

Ramps of 100-ns to 1- μ s time duration are generated and the comparator circuit is triggered into ac-

tion when the reference voltage agrees with the ramp. This results in a ramp settling time of 20 ns.

ANOTHER MYTH DESTROYED.

Myth: National doesn't make FET op amps. And, even if they did, they probably wouldn't be as good as bipolar devices. And, besides, everybody knows that FET op amps have lousy offset voltage and drift specs. And, FET op amps are too expensive. And, anyway, why not just go to a module house in the first place...

Fact: National does make FET op amps. A "family" of five devices, to be exact. Including the super precise new LH0052 (with an offset voltage of 0.1mV, an offset voltage drift of just $5\mu\text{V}/^\circ\text{C}$, and bias current of less than 1pA); the LH0022 (high performance good general purpose FET op amp); the LH0042 (lowest cost FET op amp on the market with even better performance than cheap module designs); the LH0033 (at $1500\text{V}/\mu\text{S}$, the fastest voltage follower available anywhere); the LH0032 (a $500\text{V}/\mu\text{S}$ device); and coming soon: The precise-and-speedy new LH0062 (slew rate, $80\text{V}/\mu\text{S}$; bandwidth, 15MHz; settling rate, 800nS). Significantly, each of the above was designed and manufactured completely in-house using a special chip construction technique combining the best of J-FET and bipolar technologies. All of which goes to show that FET op amps are, indeed, alive and well at National Semiconductor Corporation, 2900 Semiconductor Drive, Santa Clara, California 95051. Phone (408) 732-5000. TWX: (910) 339-9240. Cable: NATSEMICON.

NATIONAL.

Analog polarity reversed by CMOS switch

A common requirement in analog signal instrumentation is an electronically controlled polarity-reversal switch. This function can be accomplished by a CMOS integrated circuit equivalent of a double-pole double-throw polarity-reversal switch. The CMOS IC offers advantages over discrete components in that the transistor geometries are arranged to minimize the effects of control-to-signal-transients arising from capacitance-coupling effects.

The circuit shown consists of an SCL4016A quad bilateral switch connected with a portion of an SCL4007A used as a control signal inverter.

An SCL4016A quad bilateral switch is used because it is designed for digitally controlled switching of analog signals. It is connected with a portion of an SCL4007A which is used as a control signal inverter. The SCL4007A can be replaced by Q/\bar{Q} when the switch is driven by a flip-flop as in dual-slope integrators.

Constraints on the switched signal are that its envelope be within the bounds of the supply voltages $+V_{DD}$ and $-V_{SS}$. For example, the circuit will transmit a 10-V, zero-average-value sine wave with $V_{DD} = +5$ V and $V_{SS} = -5$ V. The switch can also handle millivolt signals with the magnitude of control voltage anywhere between 3 and 15 V. On-resistance is approximately 200 ohms per switch, while off-resistance is of the order of 10^{12} ohms. Switching speed can be as fast as 10 MHz.

Walter F. Kalin, CMOS Logic Product Manager, Solid State Scientific Inc., Montgomeryville, Pa. 18936

CIRCLE No. 314

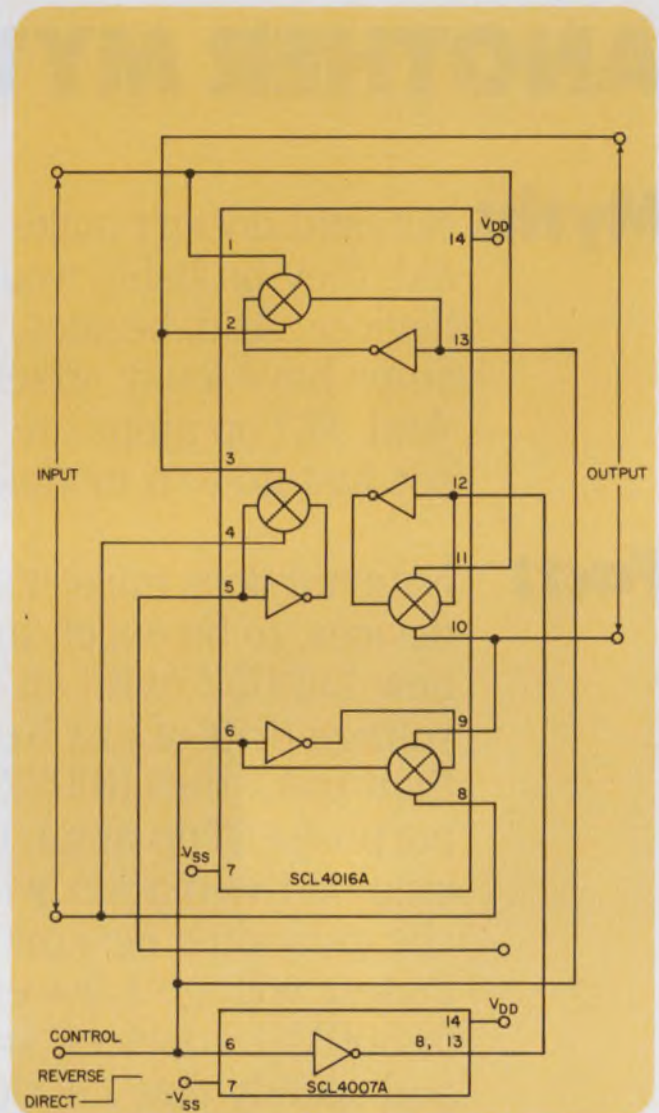

An SCL4016A quad bilateral switch reverses the polarity of analog signal inputs, with an SCL4007A acting as a control-signal inverter.

IFD Winner for October 14, 1971

R. W. Johnson, Consulting Engineer, R. W. Johnson Co., 7511 Clay Ave., Huntington Beach, Calif. 92648. His idea, "Inexpensive circuit extends low-cost unijunction range," has been voted the Most Valuable of Issue award.

Vote for the Best Idea in this issue.

SEND US YOUR IDEAS FOR DESIGN. You may win a grand total of \$1050 (cash)! Here's how. Submit your IFD describing a new or important circuit or design technique, the clever use of a new component or test equipment, packaging tips, cost-savings ideas to our Ideas for Design editor. Ideas can only be considered for publication if they are submitted exclusively to ELECTRONIC DESIGN. You will receive \$20 for each published idea, \$30 more if it is voted best of issue by our readers. The best-of-issue winners become eligible for the Idea of the Year award of \$1000.

no ifs ands or buts...

General Instrument will deliver, on time, its silicon gate 1024 bit shift registers, the pin-for-pin replacements for the 1402A's, 1403A's and 1404A's:

DL-9-1402A	(1-99—\$12.00 ea.; 100-999—\$9.00 ea.)
DL-9-1403A	(1-99—\$10.75 ea.; 100-999—\$8.00 ea.)
DL-9-1404A	(1-99—\$10.75 ea.; 100-999—\$8.00 ea.)

In stock and immediately available from authorized General Instrument distributors

For complete information call 516-733-3138 or write: Marketing Services Manager, General Instrument Corporation, 600 West John Street, Hicksville, N.Y. 11802, or call, in New York: 516-733-3333; in Chicago: 312-774-7800; in Los Angeles: 213-641-7411. In Canada, call or write: General Instrument Canada, Ltd., 61 Industry Street, Toronto 337, Ontario, Canada, Tel: 416-763-4133. In Europe, write: General Instrument Europe S.P.A., Piazza Amendola 9, 20149 Milano, Italy. In the U.K., write General Instrument U.K. Ltd., Stonefield Way, Victoria Rd., South Ruislip, Middlesex, England. In the Far East, write General Instrument of Taiwan Ltd., P.O. Box 22226, Taipei, Taiwan.

THE WORLD'S MOS EXPERIENCED COMPANY



GENERAL INSTRUMENT CORPORATION • 600 WEST JOHN STREET, HICKSVILLE, L. I., NEW YORK

INFORMATION RETRIEVAL NUMBER 45

How you can become your own IC designer; reduce turnaround time and cost by as much as 80%...it's as easy as 1,2,3!

MEET THE MONOCHIP

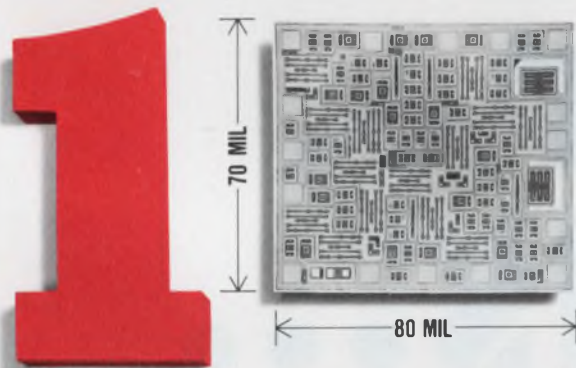

It's a chip that's almost finished for you . . . just sketch in your design on a drawing supplied with our kit and the job is 80% finished.

Here is how it works: We inventory the basic wafer with hundreds of integrated active and passive components already diffused. We supply you with a design kit having an enlarged drawing of our chip. You decide what your schematic will be and draw in your interconnection pattern . . . simple as a PC board layout. Send us your drawing and we'll supply the first 100 prototypes within only a few days.

The kit helps you do it.

The design kit has a handbook, 64 integrated transistors (NPN and PNP) and 8 diodes in sixteen 14-pin DIP's, and three large scale drawings. It contains everything you need to design and breadboard your own custom IC, and costs just \$85.00.

You need not divulge any proprietary secrets. It's not even necessary for us to know what your circuit does. And we'll produce the 100 prototypes at an unusually low cost; about 20% of a normal custom IC program.



The Monochip can be delivered in just about any IC package, or in chip form for hybrids.

You'll be surprised about the low price in production quantities too, even if your volume is small. In the majority of cases, it's way below the cost of discrete components.

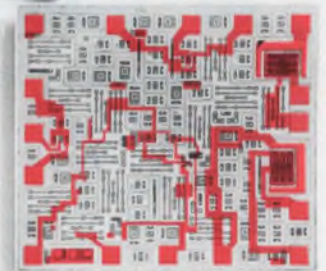

INTERDESIGN

165 South Murphy Avenue
Sunnyvale, California 94086 ☐ (408) 732-4171

We also design custom integrated circuits. We'll be happy to evaluate your requirements . . . free of charge.

GTE Sylvania and Hudson Lamp have joined forces so our salesmen are coming on twice as strong.

Now that Hudson is part of the GTE Sylvania miniature lamp family you can say goodbye to multi-source buying, hello, single-salesman convenience. With GTE Sylvania T-2 slide base lamps and Hudson Lamp Company miniature incandescent lamps together in one product line, one call does it all. And fast.

Just name your application, and the lighting product you need is here in one of the industry's broadest lines of lighting products. But seeing is believing. So ask your Sylvania/Hudson salesman to show you the Hudson miniature,

sub-miniature, micro-miniature and automotive lamps that have just joined the Sylvania family of T-2 slide base lamps and associated hardware.

And don't be surprised if he boasts a little. With all the more quality to sell, our network of representatives is coming on proud.

Check the list below for name of your nearest representative.



GTE SYLVANIA

West Main Street
Hillsboro, N. H. 03244
(603) 464-5533

LAMP COMPANY
Hudson

A SUBSIDIARY OF
GTE SYLVANIA INCORPORATED
526 Elm Street
Kearny, N. J. 07032
(201) 997-1850

ARIZONA, Hamilton Rep., Tucson (602) 297-2279 • **CALIF. (Northern)**, W. W. Posey Company, Los Altos (415) 948-7771 • **CALIF. (Southern)**, WESTREP, Pico Rivera (213) 949-2551 • **COLORADO**, Arrowhead Sales Corp., Broomfield (303) 222-6462 • **CONNECTICUT**, Coakley, Boyd & Abbett, Waterbury (203) 756-8766 • **FLORIDA**, Hutto, Hawkins, Peregoy, Maitland (305) 831-2474 • Hutto, Hawkins, Peregoy, Pompano Beach (305) 943-9593 • Hutto, Hawkins, Peregoy, Tampa (813) 932-1800 • **ILLINOIS**, George E. Finnegan, Oak Park (312) 383-9098 • **INDIANA**, Southern Sales Corp., Indianapolis (317) 253-3359 • **KANSAS**, L. R. Harry & Assoc., Grandview, Mo. (816) 763-3634 • **MASSACHUSETTS**, Coakley, Boyd & Abbett, Needham (617) 444-5470 • **MICHIGAN (Western)**, R. O. Whitesell & Assoc., St. Joseph (616) 983-7337 • **MICHIGAN (Eastern)**, R. O. Whitesell & Assoc., Southfield (313) 358-2020 • **MICHIGAN (Central)**, R. O. Whitesell & Assoc., Grand Rapids (616) 451-8901 • **MINNESOTA**, Erv Stoss Assoc., Inc., Minneapolis (612) 925-2757 • **MISSOURI**, L. R. Harry & Assoc., St. Louis (314) 872-3183 • **NEW YORK (Upstate)**, Fowler Beach Corp., Rochester (716) 586-0468 • **NEW YORK (Metro)**, Hudson Lamp Company, Kearny, N. J. (201) 997-1850 • **OHIO (Southern)**, R. O. Whitesell & Assoc., Cincinnati (513) 521-2290 • **OHIO (Northern)**, R. O. Whitesell & Assoc., Cleveland (216) 333-2585 • **OHIO (Central)**, R. O. Whitesell & Assoc., Dayton (513) 298-9546 • **PENNSYLVANIA (Eastern)**, Shelmar Electronics Corp., Glenside (215) 885-0800 • **PENNSYLVANIA (Western)**, R. O. Whitesell & Assoc., Pittsburgh (412) 242-0100 • **TENNESSEE**, R. O. Whitesell & Assoc., Bristol (615) 968-4195 • **TEXAS**, Jack Yount Company, Dallas (214) 391-4125 • **UTAH**, Arrowhead Sales Corp., Salt Lake City (801) 487-3444 • **WASHINGTON**, Blum & Associates, Seattle (206) 782-1600 • **WISCONSIN**, F. C. Du Bois & Assoc., Milwaukee (414) 774-3100

INFORMATION RETRIEVAL NUMBER 47

If your problem is **measuring μV , μA and milliohms** in transistorized and integrated circuits . . . Solve it with **Triplett's 801**



Model 801
\$210

1. Lower power ohms — 8 ranges with 35 mV power source and 1 ohm center scale.
2. High sensitivity — 5 mV AC full scale at 10 megohm input impedance; 50 mV DC at 11 megohm input resistance.
3. Simplified scale — 8" meter with only 4 arcs for all 73 ranges.

It offers 73 measurement ranges including 8 low-power resistance ranges that apply only 35 mV to the device under test . . . does not activate or damage solid-state components. With full-scale readings as low as 50 mV DC and 5 mV AC, 5 μA DC and 100 Ohms (1 Ohm center-scale) — plus a 10 megohm input impedance on the AC scales and 11 megohm input resistance on DC — Triplett's Model 801

V-O-M is ideally suited to in-circuit testing. When you add 2% DC and 3% AC accuracy on the voltage ranges (current: 3% DC and 4% AC) and a 25 μA suspension-type meter with a nearly 7½" scale length, there's no doubt that the Model 801 has no equal among analog V-O-M's in terms of sensitivity and versatility. And there's an optional **Leakage Adapter (\$30)** that measures leakage currents

as low as 1 μA .

See the remarkable **Model 801 V-O-M** — priced at **\$210** — at your Triplett distributor. For more information—or for a free demonstration—call him or your Triplett sales representative right away. Triplett Corporation, Bluffton, Ohio 45817.

TRIPLETT

The World's most complete line of V-O-M's... choose the one that's just right for you

new products

First digital joystick has high rate at low cost

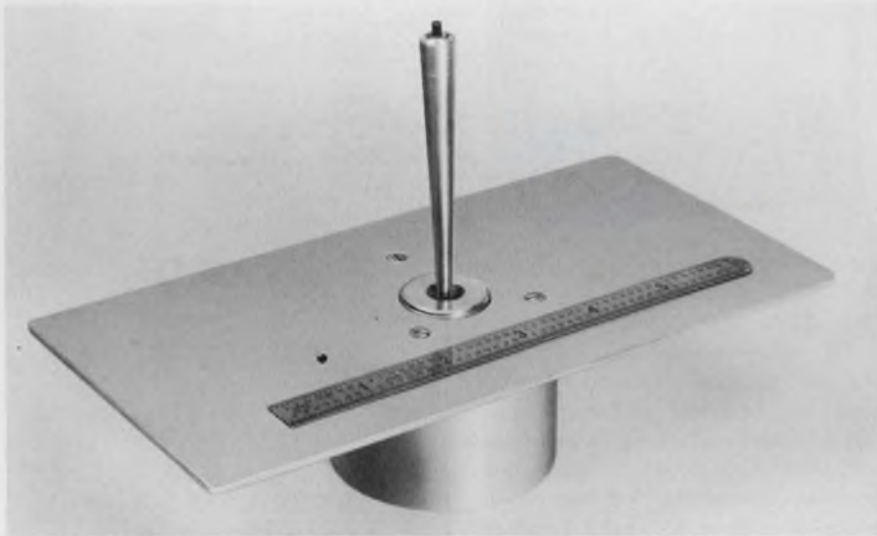

Singer Librascope, 808 Western Ave., Glendale, Calif. (213) 245-8711. Less than \$500 in production quantities; 90 days.

Till now joystick position control was only available through the use of analog joysticks. If digital outputs were desired, an analog-to-digital converter was placed on the output at considerable cost. The first direct digital joystick to hit the market is the model DJ-100 from Singer Librascope.

Most common of the applications of a joystick control is the positioning of a dot on a CRT display. Movement of a joystick determines the direction and rate of movement of the dot on the screen. When the joystick returns to its center position, the dot stops moving and remains in place wherever it has been positioned.

A range of rate of 20:1 is standard on the model DJ-100. Common analog joysticks have a 4:1 range of rate. Using the same design procedure, Librascope could provide up to a 1000:1 range of rate. The 20:1 range was selected through human engineering as the range most easily handled by the

average operator.

Two basic oscillators are contained within the housing. One provides 240 pulses per second, and the other 340 pps. From these two basic oscillators, ten discrete frequencies are formed ranging from 15 pps to 340 pps. These 10 frequencies are represented in the device as positions on an x-position commutator and a y-position commutator. The joystick wipes a contact across the commutator to select frequencies. At any position an x frequency and a y frequency are selected. These two frequencies represent the direction and rate desired. The wiping contact can overlap two adjacent positions on the commutator. When that happens the two frequencies selected by the wiper are combined in an AND-gate to create a new frequency dubbed the overlap frequency. Nine overlap frequencies can be created to give a total of 19 discrete possible output frequencies for both x and y position.

In order to get a direct digital representation of the x and y frequencies, a pair of up/down counters are offered as an option.

Electronics and commutator are

contained within a sealed housing 1.5 inches deep and 2.5 inches in diameter. More than one handle design will be available, if a custom look is desired.

A push-button is available as an option in the top of the handle if desired. This can be used for such operations as data dump, lock-on to target, ready switch or call for help.

Output signals are temperature independent over an operating range of -25°C to 75°C . The nominal power requirement of the joystick is 5 V dc at 100 mA, unloaded. Output circuits are TTL type with active drive of both leading and trailing edges. Rise and fall times are less than 30 ns when outputs are shunted with 15 pF and one TTL load.

CIRCLE NO. 250

512-point correlator samples in $1/2 \mu\text{s}$



Federal Scientific Corp., 615 W. 131 St., New York, N.Y. (212) 286-4400.

Federal Scientific claims its new 512-point correlator for real-time auto- and cross correlation is the world's fastest and has the finest time resolution. Accuracy in time-locating signals increases with the number of sampling points. Applications are in underwater acoustic noise-source identification and radio astronomy. Sampling time ranges from $1/2 \mu\text{s}$ to 2 s. Exact time measurements are made with a digital dial.

CIRCLE NO. 251



the safe
operating area
required for
TRUE
reliability!

2N3055 SINGLE-DIFFUSED 15-AMPERE NPN POWER TRANSISTORS

Hermetically sealed, passivated surface devices designed for industrial and military switching and amplifier applications. Extremely low saturation resistance, uniformly high gain across collector current spectrum, low leakage currents. You can plug it in anywhere Brand 'R' is specified without secondary breakdown problems.

For complete technical data, write today for Engineering Bulletin 31,631 to Pirgo Electronics Inc., Pembroke Road, Concord, N.H. 03301



A Sprague Electric Co. Subsidiary
INFORMATION RETRIEVAL NUMBER 49

INSTRUMENTATION

Recorder works on rechargeable batteries



Gould Inc., Instrument System Div., 3631 Perkins Ave., Cleveland, Ohio. (216) 696-0330.

The new Brush 222 is a two-channel general purpose recorder with an internal battery supply and a battery charger. Two sealed lead-lead dioxide cells allow continuous operation for up to 12 hours and have a total life of up to 6000 hours when recycled by the charger. Measurement range is from 1 mV to 10 V per division, with 50 divisions full scale. Frequency response is flat within 2% FS from dc to 30 Hz at 50 divisions but to 70 Hz at 10 divisions.

CIRCLE NO. 252

Modem tester provides calibrated test signal

Novation, Inc., 18664 Oxnard St., Tarzana, Calif. Phone: (213) 344-7191. P&A: \$2500; stock to 30 days.

Model SG-103 Modem Tester provides calibrated test signal and parameter measurements for all acoustic and the DAA 101, 103 and 113 Series Bell compatible modems. Unlike conventional testers which use phone lines for a distortion source, the SG-103 simulates worst-case telephone line conditions. The unit checks modem sensitivity under distorted conditions and with logic signals, loading and jitter in both answer and originate modes. Use is in engineering evaluation or as a semi-automatic incoming inspection station.

CIRCLE NO. 253

Raytheon Semiconductor Regional Sales Offices

CALIFORNIA
INGLEWOOD (213) 757-0251
MOUNTAIN VIEW (415) 568-9211
ILLINOIS
DES PLAINES (312) 297-5540
MASSACHUSETTS
BURLINGTON (617) 272-6400
MINNESOTA
MINNEAPOLIS (612) 920-8710
NEW JERSEY
ENGLEWOOD (201) 567-4911
VIRGINIA
ARLINGTON (703) 979-6100
U. S. A. & Canada Sales Representatives
ALABAMA
HUNTSVILLE, Rep. Inc., (205) 881-9270
ARIZONA
SCOTTSDALE, Mercury Eng Sales (602) 945-1927
CALIFORNIA
SAN DIEGO, Fred Nagle Co., (714) 298-4850
SAN MATEO, Jack Pyle Co., (415) 347-1401
CONNECTICUT
TRUMBULL, Ray Perron Co., (203) 268-9631
FARMINGTON, Ray Perron Co., (203) 673-4825
FLORIDA
ORLANDO, Parrott Assoc., Inc., (305) 275-1132
GEORGIA
ATLANTA, Rep. Inc., (404) 876-1591
INDIANA
FORT WAYNE, Scott Elec., Inc., (219) 743-1586
INDIANAPOLIS, Scott Elec., Inc. (317) 535-8951
KENTUCKY
LOUISVILLE, Scott Elec., Inc., (502) 583-3220
MASSACHUSETTS
NORWOOD, Ray Perron Co., (617) 762-8114
NEW HAMPSHIRE
DOVER, Ray Perron Co., (603) 742-2321
NEW MEXICO
ALBUQUERQUE, Electronic Marketing, Inc. (505) 265-7837
NEW YORK
ALBANY, COMPAR (518) 489-7408
BINGHAMTON, COMPAR (607) 723-8743
ROCHESTER, COMPAR (716) 271-2230
SYRACUSE, COMPAR (315) 471-3356
OHIO
CINCINNATI, Scott Elec., Inc., (513) 791-2513
CLEVELAND, Scott Elec., Inc., (216) 291-2600
COLUMBUS, Scott Elec., Inc., (614) 236-8619
DAYTON, Scott Elec., Inc., (513) 223-2652
PENNSYLVANIA
PITTSBURGH, Scott Elec., Inc., (412) 781-3112
TEXAS
DALLAS, J. B. Guenther, Inc., (214) 528-6286
HOUSTON, J. B. Guenther, Inc., (713) 486-0232
WASHINGTON
SEATTLE, Underwood & Underwood (206) 243-2133
CANADA
ONTARIO
REXDALE, Aero Sales Eng. Co., (416) 249-9139
U. S. A. & Canada Franchised Distributors
ALABAMA
HUNTSVILLE, Cramer, (205) 536-4493
HUNTSVILLE, Hallmark, (205) 539-0691
ARIZONA
PHOENIX, Kierulff Elec., (602) 273-7331
TEMPE, Intermark, (602) 968-3489
CALIFORNIA
CULVER CITY, Avnet Elec., (213) 870-0111
GLENDALE, Cramer, (213) 245-7121
LOS ANGELES, Kierulff Elec., (213) 685-5511
MENLO PARK, Bell Elec. Corp., (415) 323-9431
REDWOOD CITY, Cramer, (415) 365-4000
SAN CARLOS, Intermark Elec., (415) 592-1641
SAN DIEGO, Intermark Elec., (714) 279-5200
SAN DIEGO, Kierulff Elec., (714) 278-2110
SANTA ANA, Intermark Elec., (714) 540-1322
VAN NUYS, Intermark Elec., (213) 782-0362
COLORADO
DENVER, Cramer, (303) 758-2100
DENVER, Intermark Elec., (303) 936-8284
CONNECTICUT
NORTH HAVEN, Cramer, (203) 239-5641
FLORIDA
HOLLYWOOD, Cramer, (305) 923-8181
ORLANDO, Cramer, (305) 841-1550
PALM BEACH GARDENS, Industrial Electronics Associates, (305) 622-2626
GEORGIA
ATLANTA, Cramer, (404) 451-5421
ILLINOIS
ELK GROVE VILLAGE, Hallmark Electronics (312) 437-8800
MT. PROSPECT, Cramer, (312) 593-0230
INDIANA
INDIANAPOLIS, Graham Elec., (317) 635-5453
MARYLAND
BALTIMORE, Cramer, (301) 354-0100
BALTIMORE, Radio Electric Service Co. (301) 823-0070
GAITHERSBURG, Cramer, (301) 948-0110
ROCKVILLE, Pioneer Washington Electronics (301) 427-3300
MASSACHUSETTS
NEWTON, Cramer, (617) 969-7700
MICHIGAN
FARMINGTON, Northland Elec., (313) 477-3200
MINNESOTA
BLOOMINGTON, Cramer, (612) 881-8678
MINNEAPOLIS, Hallmark Elec., (612) 925-2944
MISSOURI
ST. LOUIS, Hallmark Elec., (314) 521-3800
NEW JERSEY
PENNSAUKEN, Cramer, (215) 923-5950
UNION, Cramer, (201) 687-7870
NEW MEXICO
ALBUQUERQUE, Century Elec (505) 265-7839
ALBUQUERQUE, Cramer, (505) 265-5767
NEW YORK
ENDWELL, Cramer, (607) 754-6651
HAUPPAUGE, Cramer, (516) 231-5600
HAUPPAUGE, Time Elec. Sales, (516) 273-0100
NEW YORK CITY, Terminal-Hudson Electronics, (212) 243-5200
PLAINVIEW, A.C.I. Elec. Corp., (516) 293-6630
ROCHESTER, Cramer, (716) 275-0300
SYRACUSE, Cramer, (315) 437-6671
NORTH CAROLINA
RALEIGH, Cramer, (919) 876-2371
WINSTON/SALEM, Cramer, (919) 725-8711
OHIO
CINCINNATI, Cramer, (513) 771-6441
CLEVELAND, Cramer, (216) 248-7740
OKLAHOMA
TULSA, Cramer, (918) 836-3371
PENNSYLVANIA
PITTSBURGH, Cameradio Co., (412) 391-4000
TEXAS
DALLAS, Cramer, (214) 350-1355
UTAH
SALT LAKE CITY, Cramer, (801) 487-3681
WASHINGTON
SEATTLE, Intermark Elec., (206) 767-3160
WISCONSIN
MILWAUKEE, Cramer, (414) 462-8300
MILWAUKEE, Hallmark Elec., (414) 462-1270
CANADA
MONTREAL, Prelco Electronics, (514) 389-8051
OTTAWA, Wackid Radio & TV Lab Ltd. (613) 728-1821
TORONTO, Cramer, (416) 781-6631

MORE TOUGH LINEARS. WE PROMISED. WE DELIVERED. NOW IT'S UP TO YOU.

OP AMPS

1556A Beyond Super Beta

1556 Super Beta

108/108A Super Beta

725 Precision

VOLTAGE REGULATOR

109 +5 Volts

COMPARATOR

1514 Dual 710 with Strobes

VIDEO AMPLIFIER

733 Wide Band

LINE DRIVERS & RECEIVERS

1489 Quad Line Receiver
/EIA Compatible

8T13 Dual Line Driver (high
current applications)

8T14 Triple Line Receiver
(high input impedance
with hysteresis)

8T23 Dual Line Driver*

8T24 Triple Line Receiver*

9621 Dual Line Driver

9622 Dual Line Receiver

*Only available line driver/
receiver compatible with IBM
360 I/O interface specs,
channel-to-control unit.

Contact your nearest Ray-
theon Semiconductor sales
office, representative, or fran-
chised distributor. Or stop by
Raytheon Semiconductor, 350
Ellis St., Mountain View, Cali-
fornia 94040. (415) 968-9211.

INFORMATION RETRIEVAL NUMBER 50

RAYTHEON



Raytheon Semiconductor
makes tough linears.

INSTRUMENTATION

Digital counter goes 0.6 in. behind panel



Durgin & Browne Inc., 80 Allen Rd., S. Burlington, Vt. (802) 863-6873. \$55 to \$96 (100 quantities).

This slim digital panel counter requires less than 0.6 in. of rear panel space and fits a standard 2.8 in. by 4.32 in. cutout. Series DPC-200, counting TTL logic inputs at rates up to 18 MHz, is available in models with readouts of 2 to 5-1/2 digits. Display is flat pack segmented, viewed through a polarized front filter.

CIRCLE NO. 254

Mark generator calibrates sweeps

Hewlett-Packard, 1601 California Ave., Palo Alto, Calif. (415) 493-1501. \$670; 6 weeks.

A new time mark generator, model 226A, supplies narrow one-volt pulses at precise time intervals for calibrating time bases of oscilloscopes and recorders. A single front-panel control selects 30 time intervals ranging from 2 ns to 10 s in a 1,2,5 sequence corresponding to the sweep timing on most oscilloscopes. A crystal-controlled clock assures 0.002% interval accuracy after 1/2-hour warmup. The marker output impedance is 50 Ω .

CIRCLE NO. 255

**RF Coils
Chokes
Transformers**

**In Stock for
Immediate Delivery**

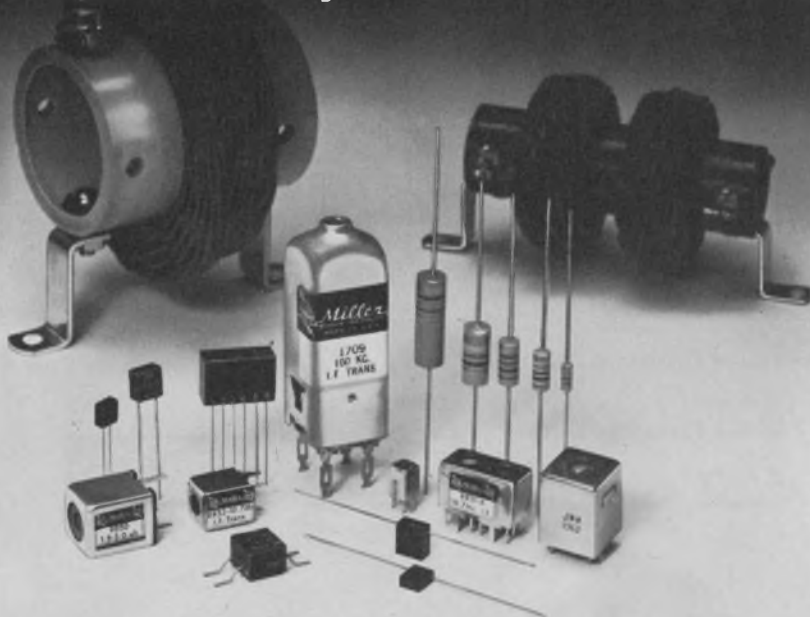

Write for your copy of the 80-page full line Catalog 72.



- Custom Winding
- MIL SPEC Testing
- Samples — 10 days
- Shipments start within 3 weeks after sample approval



J.W. MILLER COMPANY

19070 REYES AVE. ■ P.O. BOX 5825 ■ COMPTON, CALIF. 90224

Memory cores tested at 75000 per hour

Horex Electronics, Inc., 1729 21st Street, Santa Monica, Calif. (213) 451-0211.

Ferrite memory cores are go-no-go tested at a rate up to 75,000 per hour by Model 501 automatic tester. Electrical parameters programmed into the unit are dV_z high, μV_i or dV_i high or low, and t_s short and long. The amounts of accepted and total tested cores are each indicated on a 6-digit LED display. Min-max yields may be set with decimal thumbwheel switches in sample sizes of 100, 1000 and 10,000 and the results continuously displayed.

CIRCLE NO. 256

4-1/2-digit DPM has standard BCD output

Electro-Numerics Corp., 2961 Corvin Dr., Santa Clara, Calif. (408) 738-1840. \$195 to \$375; stock.

BCD output is a standard feature in model 305 4-1/2-digit DPM. Features still optional are bipolarity, ratio, zero offset, analog output, differential input and current or resistance measurement. The unit can make up to 20 measurements per second or be commanded to take and hold one reading until retriggered. Decimal points and polarity signs are programmable from the rear connector.

CIRCLE NO. 257

If you've been looking for a miniature crystal-controlled clock oscillator in a 14 pin DIP package to fit standard PC board sockets, stop looking and start ordering. Get details on model K1091A from Motorola Component Products Dept. 4545 W. Augusta Blvd. Chicago, Ill. 60651.  *MOTOROLA*

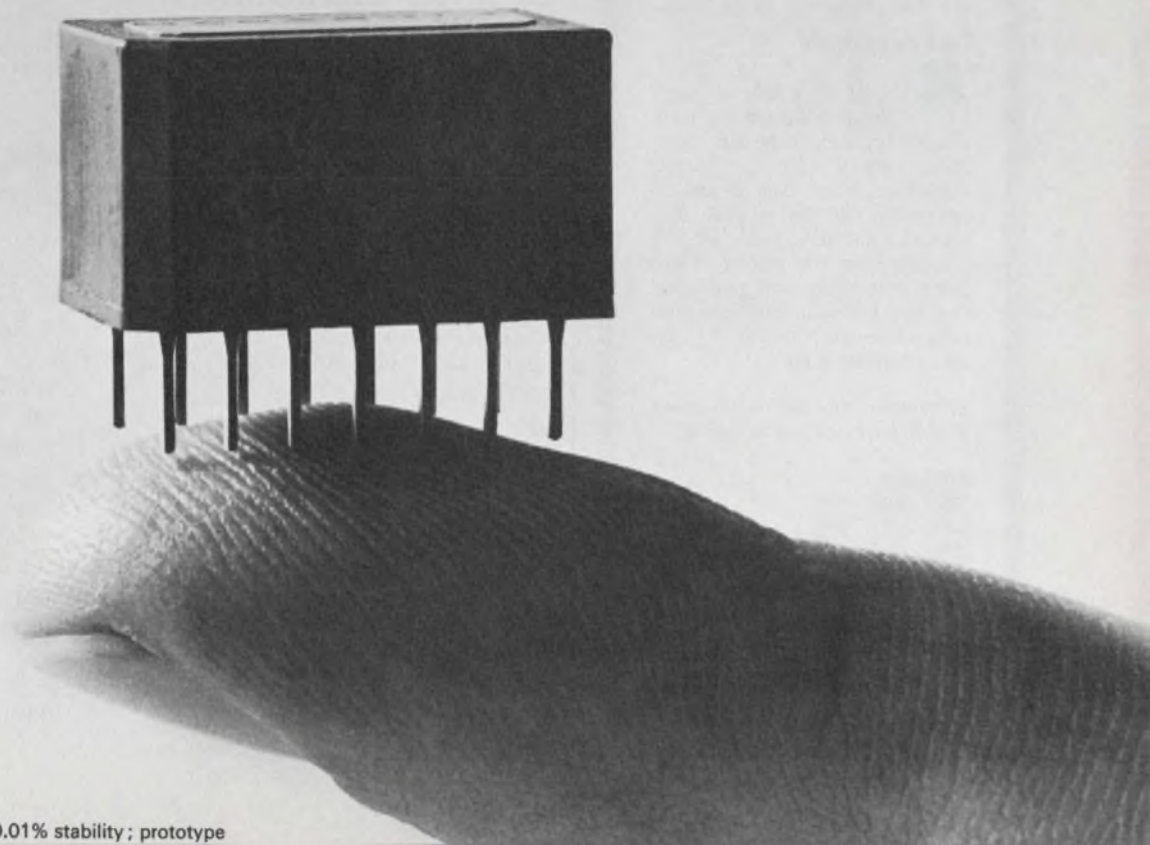

MONOLITHICS:

THE STATE OF THE ART

Specifying tips

 The next time you order monolithics, here's a helpful hint. It's usually best to specify attenuation boundaries rather than bandwidth, since these are easily related to information transmission and selectivity requirements. We have a sheet filled with all the details that's yours for the asking. We'll also be glad to discuss design trade-offs.

Our new 21.4's

 We've just come up with an off-the-shelf line of low cost monolithic and tandem monolithic crystal filters at 21.4 MHz. Here's the story — twenty-one standard models in 2, 4, 6 and 8 poles with 13, 15 and 30 kHz bandwidths. Available in flatpack or upright packages. We'll be happy to mail you our new data sheets with all the specs.

The Bare Essentials

 A lot for a little — that's the idea behind the do-it-yourself approach to tandem monolithics. Take a set of our tandem monolithics. Mount them on your circuit board. Add two or three fixed capacitors and voila, you've got a 6- or 8-pole filter. Why bother? To save space, save money and gain layout flexibility. Whatever your filter problem, we can help reduce it to the bare essentials. Write us.

Like more information on monolithics? Drop us a line or call us.

Pi

Piezo Technology Inc.

2400 Diversified Way
Orlando, Florida 32804
305-425-1574

The standard in monolithic
crystal filters.

INSTRUMENTATION

Digital multimeter works on battery



Hickok Electrical Instrument Co., 10514 Dupont Ave., Cleveland, Ohio. (216) 541-8060. \$435; 45 days.

Model 3300A is a portable DMM which operates for 24 consecutive hours from its internal nickel-cadmium battery. The battery recharges when the meter operates from the ac power line. The device has five ac and five dc voltage ranges, each from 100 mV to 1 kV, with 100 mV resolution. Ac bandwidth is to 100 kHz. Seven resistance ranges from 100 Ω to 100 M Ω , and five ranges each, for ac and dc current, from 100 μ A to 1 A, are also included. Resolution for current is 100 nA and 100 m Ω for resistance.

CIRCLE NO. 258

Electrical thermometer has ± 1.5 C accuracy



RFL Industries, Inc., Thermocontrol Div., Boonton, N.J. Phone: (201) 344-3100. P&A: \$120 plus \$20 to \$30 for a probe; 10 days.

A new portable electrical thermometer, model 290, spans -60 to +130 C in three ranges with an accuracy of ± 1.5 C over the entire range. Power for the instrument is derived from a 9-V snap-in transistor type battery. The ranges are selectable by means of color-coded pushbuttons that coincide with colored arcs on the multiple-scale taut-band meter.

CIRCLE NO. 259

Tester covers simple gates through MOS/LSI

Systems Technology Div. of Fairchild Camera & Instrument Corp., 974 East Arques Ave., Sunnyvale, Calif. Phone: (408) 735-5221. P&A: \$70,000 to \$180,000.

A modular family of six semiconductor test systems, the Sentry series, tests all levels of digital integrated circuit complexity from simple gates through the most complex MOS/LSI. The user can upgrade or alter testing capability in the field in response to changing technological or production requirements without obsoleting his existing equipment. Sentry 600 is capable of testing MOS/LSI parts at rates up to 10 million tests per second.

CIRCLE NO. 260

Temperature meter calibrates irons

Edsyn Inc., 15954 Arminta St., Van Nuys, Calif. Phone: (213) 989-2324.

Loner is a portable thermocouple-type temperature meter which measures and calibrates both conventional and variable-range soldering irons, solder pots and ovens. The meter features an expanded mirror scale with a range between 400 F and 900 F, spaced at 10° increments. A centigrade scale with 5° increments is also provided. A general-purpose five-foot probe is standard equipment with the meter.

CIRCLE NO. 261

Exerciser checks fast magnetic memories

Technitrol, Inc., 1952 E. Allegheny Ave., Philadelphia, Pa. (215) 426-9105. \$21,950; 4 weeks.

Magnetic memories with access time to 40 ns are tested in model 4602 memory exerciser. Up to 65,536 addresses of a 40-bit word and 192 data patterns can be selected from the front panel. Error checking is performed by comparing the data generated in the exerciser with that read from the memory during the unload cycle. During the load cycle, data generated in the exerciser are compared with data received from the memory data register.

CIRCLE NO. 262

**WE'VE
COMBINED
THREE
SEMI
CONDUCTOR
PROCESSES
INTO
ONE
POWER
TRANSISTOR!**

Each process is usually found only in an individual device. However, by combining these processes into a single unit, a unique one-of-a-kind transistor is created. The result? The most efficient silicon power transistor series developed in years: Solitron's "3-in-1" 2N6216 and 2N6217. Only Solitron's state-of-the-art technology delivers the advantages of these three processes into one transistor family.

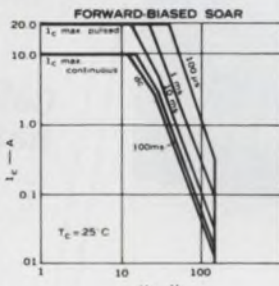
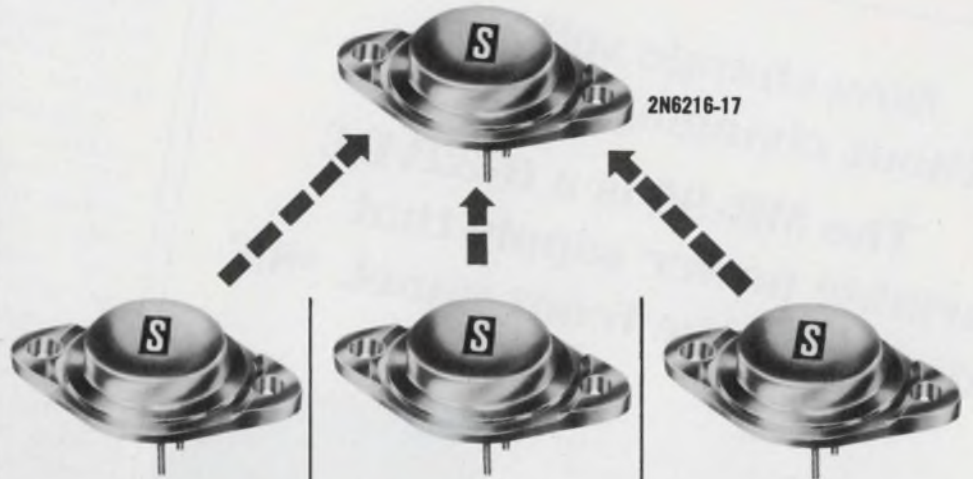

**1. SINGLE
DIFFUSED MESA**
(linear SOAR $I_{s/b}$)

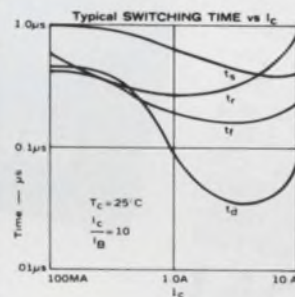

**2. DOUBLE
DIFFUSED EPITAXIAL**
(highest speed)

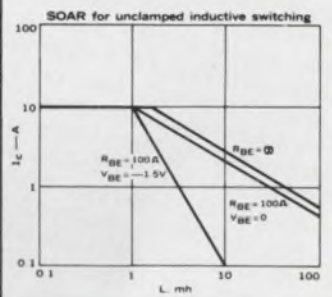

**3. TRIPLE
DIFFUSED PLANAR**
(excellent inductive
switching $E_{s/b}$)

Solitron's 3-in-1

20 AMP, 200 VOLT NPN SILICON POWER TRANSISTORS

For complete information, prices and engineering application assistance, dial toll-free 1-800-327-3243. Or write:

**Solitron
DEVICES, INC.**

1177 BLUE HERON BLVD. / RIVIERA BEACH, FLORIDA / (305) 848-4311
TWX: (510) 952-7610

SAN DIEGO, CAL.
8808 Balboa Avenue
FET & Dual FET
Transistors
MOS/FET Devices
MOS Memory Arrays
Shift Registers
Monolithic IC's
Small Signal
Transistors

RIVIERA BEACH, FLA.
1177 Blue Heron Blvd.
Hi-Rel Power Transistors
Si & Ge. Power
Transistors
Hi-Rel Power Hybrids
PNP-NPN Industrial
Transistors

PORT SALERNO, FLA.
Cove Road
Microwave Connectors
Plaxial (R) Cable
Precision RF Coaxial

JUPITER, FLA.
1440 W. indiantown Rd
Microwave Stripline
Components
Microwave Semiconductor
RF Semiconductor
Microwave Integrated
Circuits

TAPPAN, N. Y.
256 Oak Tree Road
Diodes & Rectifiers
Zeners
High Voltage
Assemblies
Power Rectifiers
Thick Film Hybrid
Circuits
Ferrite & Ferrite Devices
Film Resistors

KENT, ENGLAND
Tubbs Hill House
London Road,
Sevenoaks
Solidev, Ltd.
Full line of
Solitron devices

BEN BARAQ, ISRAEL
51 Hayarkon Street
AEL Israel, Ltd.
Full line of
Solitron devices

TOKYO 105, JAPAN
No. 5, 3-Chome
Shibahamamatsu-Cho
Minato-Ku
Matsushita Electric
Trading
Full line of
Solitron devices

**Now, change voltage
without changing taps.**

**The MR-95 is a 0-32VDC
variable power supply that
adjusts on the front panel. \$85***

No terminal de-soldering and cover removal required, just flip a switch and adjust to the desired voltage. Rating stays put at 1.75 amps regardless of position. And, constant current limiting makes the MR-95 ideal for operating lamp loads, relays, etc. Specs: input, 105-132 vac; freq., 47-420 Hz; line reg., $\pm 0.005\%$; load reg., $\pm 0.005\%$; ripple, < 0.5 mv RMS. Write or call: 290 Lodi Street, Hackensack, N.J. 07601 / 201-488-1440



*in OEM quantities

FARATRON

INFORMATION RETRIEVAL NUMBER 55



Information, room reservation forms, admission tickets:
GERMAN AMERICAN CHAMBER OF COMMERCE
666 5th Avenue, New York, N.Y. 10019
77 E. Monroe Street, Chicago, Ill. 60603
465 California St. San Francisco, Cal. 94104

INFORMATION RETRIEVAL NUMBER 56

INSTRUMENTATION

Precision calibrator is pocket-size

Pioneer Magnetics, Inc., 1745 Berkeley St., Santa Monica, Calif. (213) 829-3305.

A pocket-sized precision voltage calibrator, Model PM2330 has a LED readout indicating when a voltage is within 0.05% of preset values. Standard units have up to four calibrated voltage sources preset between 3 and 500 V dc. A slide switch feature may be used to determine if an unknown voltage is within an error band, which is specified by the user in a range from $\pm 0.5\%$ to $\pm 5\%$. In many applications, the unit may replace a 4-digit DVM.

CIRCLE NO. 263

Calibration standard has ac current output

Yewtec Corp., 1995 Palmer Ave., Larchmont, N.Y. (914) 843-3550.

Model 2858 ac voltage/current calibration standard provides a voltage output from 1 to 1000 V and current from 10 mA to 50 A with an accuracy of 0.1% and stability of 0.02%/3 hr. Discrete frequencies of 50, 60 and 400 Hz or variable frequencies between 50 and 500 Hz may be selected. Readout is an in-line 4-digit display with a fifth window indicating mA, V or A. Calibration is rms.

CIRCLE NO. 264

Function generator has trip and gate modes

Exact Electronics Inc., 455 S.E. 2nd Ave., Hillsboro, Ore. (503) 648-6661. Stock.

Model 7050 voltage-controlled function generator covers 0.0001 Hz to 11 MHz frequency range and has trigger and gate capabilities for single shot and burst waveforms. In the trig mode, one cycle is generated for each trigger with the start and stop points variable through 360°. In the gate mode the signal is generated for the duration of the external gate but completes the last cycle after the gate is removed. Output is normally 15 V pk-pk into 50 Ω but half that for fixed offset operation.

CIRCLE NO. 265

15 reasons why Monsanto counts with people who count.

Here are 15 Monsanto counters. Their capabilities are as varied as the requirements of you who read this ad. Frequencies range from DC to 12.5 GHz, prices from \$250 to \$3590.

1.

5 Hz-5 MHz \$250



2.

5 Hz-32 MHz \$475



3.

5 Hz-20 MHz \$350



4.

5 Hz-40 MHz \$575



5.

5 Hz-50 MHz \$695



6.

5 Hz-5 MHz \$795



7.

10 Hz-8 MHz \$815



8.

DC-75 MHz \$895



9.

DC-2.5 MHz \$995



10.

0.1 Hz-20 MHz \$995



11.

5 Hz-150 MHz \$995



12.

5 Hz-512 MHz \$1550



13.

DC-150 MHz \$1285



14.

DC-512 MHz \$1795

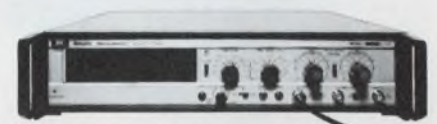

15.

DC-12.5 GHz \$3590



According to an independent, nationwide brand preference survey, we're No. 2 (of 67 counter manufacturers mentioned). Not bad. But not good enough. In the year ahead, we plan to give you even more reasons to specify Monsanto for anything you want to count. Meanwhile, one of the 15 shown here will probably do the job. Write for our catalog and see. Monsanto Company, Monsanto Electronic Instruments, West Caldwell, N. J. 07006.

Monsanto

Centralab Push Button Switches... in line with your design requirements



Write
Centralab
for
Bulletin
No. ELC-3

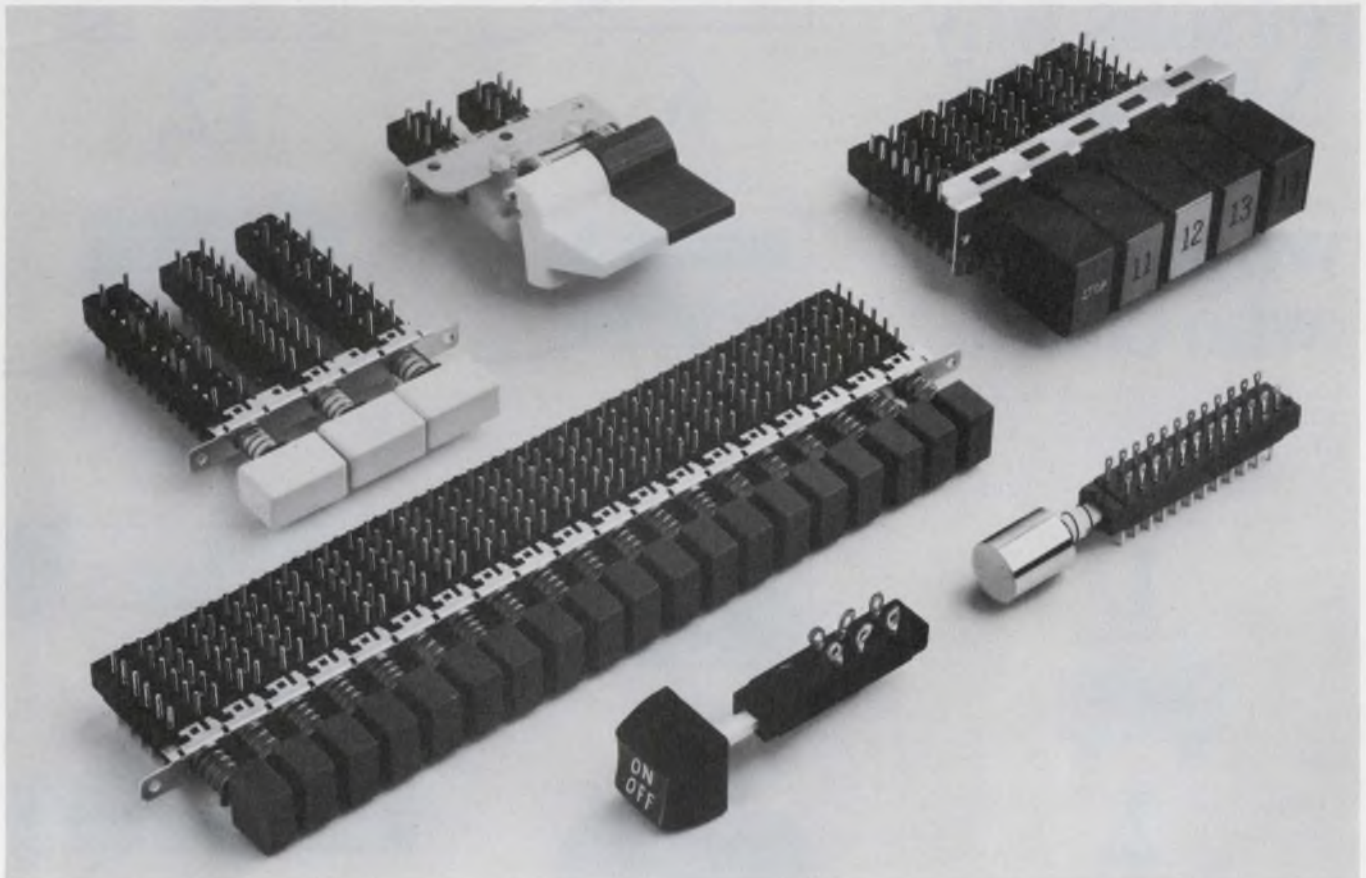

Reasons to switch from the ordinary

Versatile Centralab push button switches* give you more reasons to change from the ones you're using now. Our push button switch conforms to a variety of specifications for consumer products, instrumentation, and industrial applications.

Reasons? Consider these: Centralab is the only manufacturer to offer diallyl phthalate—for highest possible insulation resistance—as well as phenolic or glass alkyd. Our phenolic modules provide greater than 65 db isolation in the voice frequency range. Our modules are available with sealed terminals to avoid flux penetration and we can provide gold contacts and terminals for dry circuit applications.

To conserve space and provide compact stacking in circuit board applications, Centralab modules are adaptable to selective pin cutting or solder lug terminations. We offer three different

lockout devices to match your application. Functions include momentary, interlocking, push-push and push-pull. Up to 29 individual switch modules can be ganged on a common bracket. Other options include keyboard and row-to-row interlock. There are five center-to-center spacings with the widest variety of button colors, sizes and shapes.

Or ask for lighted push button switches that offer all the same features plus interchangeable lenses and filters in a variety of colors to provide maximum utility and appeal.

Our versatile module size line switch rated 3 amps at 120 V AC can be utilized in any position within the switch assembly.

If you need more reasons to switch to Centralab, ask for our bulletin and technical data. Write Switch Sales Manager, Centralab.

GET CENTRALAB THE "IN" LINE FOR YOUR DESIGN

Hybrid Microcircuits
Pushbutton & Rotary Switches
Capacitors
Potentiometers
Technical Ceramics
Ceramic Packages
Semiconductor Devices



CENTRALAB

Electronics Division
GLOBE-UNION INC.

5757 NORTH GREEN BAY AVENUE
MILWAUKEE, WISCONSIN 53201

* Isostat Licensed

INFORMATION RETRIEVAL NUMBER 58

Centralab Distributors are another reason to switch

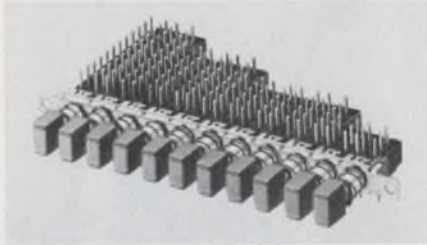

Our field assembly distributors provide a proven capability for immediate delivery of versatile, low-cost push button switches.* These specialists offer a wide variety of lighted and non-lighted switches with custom assembly service to meet your design requirements. Three reasons to contact your Centralab push button field assembly distributor are the right switch, the right price with delivery, right now!

*Isostat Licensed

Almac/Strom Electronics
Seattle, Washington 98109
Phone: (206) 763-2300

Cameradio Company
Pittsburgh, Pennsylvania 15222
Phone: (412) 391-7400

Kierulff Electronics, Inc.
Los Angeles, California 90022
Phone: (213) 685-5511

Pioneer-Standard Electronics, Inc.
Cleveland, Ohio 44105
Phone: (216) 432-0010

Radio Distributing Company, Inc.
South Bend, Indiana 46624
Phone: (219) 287-2911

Gopher Electronics Company
St. Paul, Minnesota 55113
Phone: (612) 645-0241

Fisher/Brownell
Santa Clara, California 95050
Phone (408) 244-6182

Hammond Electronics
Orlando, Florida 32802
Phone: (305) 241-6601

Herbach & Rademan, Inc.
Philadelphia, Pennsylvania 19134
Phone: (215) 426-1700

Summit Distributors, Inc.
Buffalo, New York 14202
Phone (716) 884-3450

Kirkman Electronics
Winston-Salem, N.C. 27108
Phone (919) 724-0541

DISTRIBUTOR PRODUCTS



CENTRALAB
Electronics Division
GLOBE-UNION INC.

COMPONENTS

Lighted switch meets Navy high-shock specs

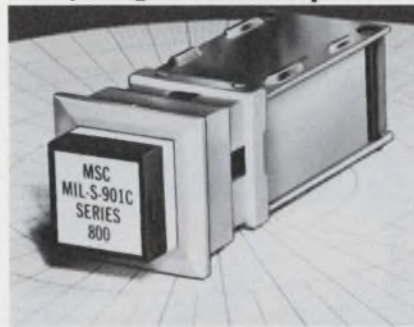

Master Specialties Co., 1640 Monrovia, Costa Mesa, Calif. (714) 642-2427.

A modified version of the series 800 Tellite lighted pushbutton line meets the stringent high-impact shock test requirements of the Navy's MIL-S-901C spec. The unit is mounted on a test panel and a 400-pound weight is dropped from various heights ranging from one-to-five feet at a resultant hammer force of 400,000 lbs. and an acceleration of 1000 gs on the panel mounting.

CIRCLE NO. 266

35-LED display has 0.35-in. character height

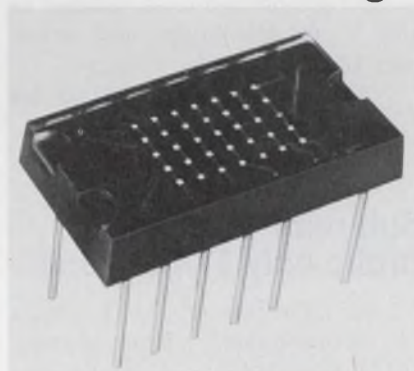

Litronix, Inc., 19000 Homestead, Cupertino, Calif. (408) 257-7910. \$11 (1000 quantities); stock.

The Data-Lit 57, a 5 by 7 light-emitting diode array, is a 35-LED alphanumeric display with a decimal point. It is made of diffused planar GaAsP LEDs mounted on a dual inline substrate with a clear epoxy lens. The Data-Lit 57 can display the complete 64 character set ASCII code. The diodes produce an output of 300 foot-Lamberts at 10 mA per diode on a 1.7 volt supply.

CIRCLE NO. 267

MODULAR HIGH VOLTAGE POWER SUPPLIES



For breadboarding and production systems

Tecnetics introduces the new HV Modular High Voltage power supplies to fill system designers' needs for a greater selection of voltage ranges and outputs.

HV Modular High Voltage power supplies can be used in initial breadboarding and production systems.

HV output modules are available in nine adjustable ranges from -300 VDC to 25,000 VDC with standard or precision regulation. (A precision regulator module improves regulation by a factor of 10 to 1.)

Four standard frames offer up to four output voltages. Custom frame lengths available.

HV Modular High Voltage power supplies are ideally suited to systems, labs and production lines.

HV Modular High Voltage power supplies are priced from \$250.

(See EEM Cat., pp. 880-885 vol.1)

For complete data write:

tecnetics inc.

P.O.Box 910, Boulder Industrial
Park, Boulder, Colorado 80302
(303) 442-3837 TWX 910-940-3246

INFORMATION RETRIEVAL NUMBER 59

**New
from
General
Electric**



Goldtop
Rechargeable
Nickel-cadmium
Batteries
for elevated
temperature
applications



Here's the rechargeable battery for your tough, high-temperature design applications. General Electric's new Goldtop nickel-cadmium batteries have a maximum sustained temperature capability of 65°C — permitting their use in spots previously too hot for nickel-cadmium batteries. And, at 65°C cell temperature, Goldtop batteries have a longer life expectancy than conventional units at 50°C cell temperature. Goldtop batteries are also available in a quick-charge version that can be recharged in 3½ to 4 hours using a standard charger. These cylindrical cell batteries are available in a wide variety of sizes and ratings.

For more information, write Section 452-02, General Electric Co., Schenectady, New York 12345, or circle reader service card.

452-02

GENERAL ELECTRIC

INFORMATION RETRIEVAL NUMBER 60

COMPONENTS

Neon lamp replaces digital displays



Signalite, 1933 Heck Ave., Neptune, N.J. (201) 775-2490. Stock.

The high brightness model A261 neon lamp may be used to replace tubes in the over-range position of a digital voltmeter, or the plus and minus displays in other digital readout equipment. The 14-mm lighted electrode length is compatible with commonly used readout tubes including the multi-character tube. The visual electrode measures 0.55 inches in length when illuminated, and will last a minimum of 2000 hours continuously. The lamp glass envelope measures 1-3/16-in. in length by 0.255-in. in diameter, and has 1-in. wire leads. The lamp is designed to operate on a circuit voltage of 150 V dc minimum, and draws only 1.5 mA current.

CIRCLE NO. 268

Sub-mini thermistor probe only 1/4-in. long

Fenwal Electronics, 63 Fountain St., Framingham, Mass. Phone: (617) 872-8841.

The sub-mini-probe consists of a miniature thermistor bead sealed in the tip of a shock-resistant, thin-wall glass tube, with corrosion-resistant platinum-iridium leads. An extremely short time constant (of order of 25 ms in moving water) makes the unit particularly well-suited to dynamic temperature measurements in liquids and gases. Standard probes offered are available in nominal resistances of 500 Ω to 300,000 Ω, and can be used at temperatures up to 300 C.

CIRCLE NO. 269

Test clamps use minute gripper jaw



Hunter Associates, 792 Partridge Dr., Somerville, N.J. Phone: (201) 526-8440. P&A: \$2.50-\$2.85; stock.

The Hunter universal test clamps consist of a narrow, insulated, flexible metal sheath, with a minute gripper jaw which is advanced and retracted through the sheath by means of a hyperdermic action. The solid head is terminated in a standard banana jack for ease of interconnection. The unique construction permits their use in the most dense types of circuitry, and the positive gripping action insures no loosening under shock or vibration. Three different types of gripper jaws are available; Type H-2 two hook wire gripper, Type H-3 three hook wire gripper, and Type P-1 two hook flat gripper with detachable pin probe included.

CIRCLE NO. 270

Capacitors for high impedance handle 10 A

Potter Co., 500 W. Florence Ave., Inglewood, Calif. (213) 678-2651. \$2.

A line of herm-sealed, feed-thru capacitors, rated for 10 A continuous duty, is designed for use on circuits which have high source and load impedances. The units range in capacitance from 0.5 to 5.0 μF, with voltages of 50, 100, 400 and 600 V dc. Comparable devices, intended for ac operation, are rated at 125 and 250 V ac, 60 Hz.

CIRCLE NO. 271



1 MHz to 1400 MHz.



Calibrated output system provides precise power outputs from +10 to -80 dBm.



Complete marker system allows accurate frequency measurements of $\pm 0.005\%$.



Solid-state, varactor-tuned and swept oscillator permits zero to full-band sweep width and FM modulation.



P.I.N. diode attenuation and leveling allow amplitude and pulse modulation.



P.I.N. diode band switching.



Programmability and/or remote control of frequency, bandwidth and output level.



Compact and lightweight: 5 1/4" x 8" x 12".



Model 2001 Sweep/Signal Generator: \$1695

**The more you know
about the 2001,
the smaller the price looks.**

WAVETEK®

INDIANA INCORPORATED
P.O. Box 190, 66 North First Avenue
Beech Grove, Indiana 46107
Tel. (317) 783-3221 TWX 810-341-3226

Plotter interfaces with MDS 2400 terminals



Houston Instrument, 4950 Terminal Ave., Bellaire, Tex. (713) 667-7403. \$2445; 30 days.

The BTC-7/2400 Batch Terminal Controller provides an interface to use the Complot incremental plotters with the MDS 2400 series terminals. Completely automatic plotting up to speeds of 300 steps per second using a Complot DP-1 or DP-3 plotter is possible.

CIRCLE NO. 272

Disc storage for HP minicomputers

Daconics Corp., 925 Thompson Place, Sunnyvale, Calif. (408) 732-2634.

A new subsystem provides economical random access storage for any Hewlett Packard 2100 series computer equipped with DMA (Direct Memory Access). The new Model 2923 disc memory subsystem utilizes the IBM 2315 type disc cartridge in single or multiple disc drive configurations. Each disc provides 1.22M words of storage.

CIRCLE NO. 273

So far, we've built 132,892 types of Rotary Power Switches within these parameters.

Your application may be number 132,893!

SWITCH SPEC	Minimum	Maximum
RATING	1/2 amp	200 amp
POSITIONS	2	16
CONTACTS (Poles)	1	72
ACTION	SNAP • DETENT • CAM	
OPTIONS	Key-operated...Key-locking...Tandem units...Gear-train units...Solenoid-locking...Push-to-turn operation...Waterproof mounting...Base & Panel mounting...Explosion-proof housing...AND MANY MORE!	

Chances are, there are several switches you can profitably choose from among our literally *hundreds* of stock units. But if you do require a special, you can have it assembled to order from a few *thousand* basic components...off-the-shelf! From simple pushbuttons to complex gear-train models...from light to heavy duty...from stock to custom...there's bound to be a perfect match to your specifications and applications.

Send for Bulletin C-1...our "Catalog of available catalogs" or give specific needs for detailed information.



ELECTRO SWITCH
CORP.

Weymouth, Massachusetts 02188

1947/1972...Our 25th Year

Telephone: 617/335/5200 TWX: 710/388/0377

INFORMATION RETRIEVAL NUMBER 62

Planar 8K x 18 core array on one card

Datacraft, P.O. Box 23550, Ft. Lauderdale, Fla. (305) 974-1700. 1¢ per bit; 60 days.

An 8K magnetic core memory system doubles the storage capacity of Datacraft's 4K single board memory. The new 8K single card can be obtained in two basic configurations: as a single card memory system, up to eight cards can be connected to give a 64K memory, or in a two-card approach a single timing and control card can drive up to eight 8K x 18 digital stack boards. Expansion in banks of 64K x 18 is possible.

CIRCLE NO. 274

Cassette memory weighs only 4-1/2 lbs.

Teac Corp., 7733 Telegraph Rd., Monte Bello, Calif. (213) 726-0303. \$595.

The Teac two-channel MT-5 provides a memory capacity of two-million bits with a packing density of 800 bpi. A capstan drive system provides a tape speed of 7.5 ips with start and stop times of less than 25 ms. The compact, light-weight design—5 3/4-in. wide, 3 1/2 in.-high and 7 3/8-in. deep and weight only 4 1/2 pounds—makes the MT-5 easily adaptable to a wide range of OEM applications. Two models are available: the MT-5W for "write only" and the MT-5R for "read only" applications.

CIRCLE NO. 275



A mercury switch that's tough as nails

and operates in any mounting position.

We've used this demonstration to prove a point: new Logcell® II mercury-film switches are almost indestructible. They eliminate the dangers of mercury leakage, the handling problems of glass switches, the need for protective encapsulation, and switch failures caused by rugged environments. Yet these advantages, and more, come to you at costs lower than most mercury capsules, and about the same as many dry reed switches.

Logcell II switches are magnetically actuated. They operate in any mounting position without contact bounce. And they provide up to a billion operations.

Because of their size, ruggedness, reliability and performance, Logcell II switches lend themselves to a whole world of imaginative packaging ideas. Use them in relays, in switching matrices, in pushbuttons for truly low-profile keyboards (switch shafts may be shortened), in stepping, rotary, limit and proximity switches. And who knows what else.

For detailed specifications on Logcell II, plus some applications ideas to get you started, write Fifth Dimension Inc., Box 483, Princeton, New Jersey 08540. Or call (609) 924-5990.

Logcell II mercury-film switches offer:

- Low cost
- Reliability, long life
- 50g shock rating
- No contact bounce—self healing contacts
- Operation in any mounting position
- High temperature capability to 125° C
- Freedom from mercury leakage
- Hundreds of new applications where cost, ruggedness, performance or reliability prohibited the use of fragile mercury capsules or dry reed switches

This is Logcell II



FIFTH DIMENSION INC.

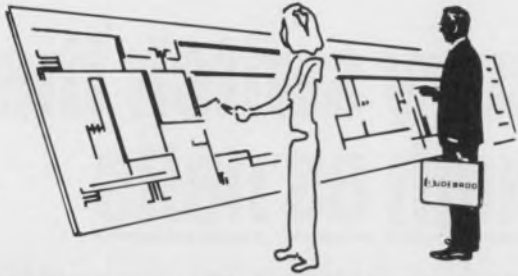

Talk to Gudebrod about your tying operation this month...

And about Lacing Tapes, harness rooms and systems. About temperature and vibration . . . speed and rejects! About Nylon, Dacron, Teflon, Nomex, Glass tapes and cords—treated and untreated . . . that meet *or exceed* military and industrial specifications, about cost comparisons with other methods . . . and *all* backed up with one hundred years of manufacturing knowledge.

Dacron, Teflon, Nomex—Du Pont Registered Trade Marks

Talk to Gudebrod this month!

Write to this address for prompt return of our
Product Data Catalog.

Electronics Division
Dept. 452

Gudebrod Bros. Silk Co., Inc. 12 South 12th Street, Philadelphia, Pa. 19107
INFORMATION RETRIEVAL NUMBER 64

think woven



for economy

Save when you buy it. Save when you use it. Today's best flat cable value brings neatness and accuracy to every application. Fast, easy handling cuts your production costs, increases system quality.

WOVEN ELECTRONICS

A DIVISION OF SOUTHERN WEAVING COMPANY

P.O. Box 189, Mauldin, S.C. 29662, (803) 288-4411

INFORMATION RETRIEVAL NUMBER 65

DATA PROCESSING

Lockheed has a mini named Sue



*Lockheed Electronics Co., Inc.,
6201 E. Randolph St., Los Angeles,
Calif. (213) 722-6810. \$4295 (4K
memory).*

The 'System User Engineered' minicomputer, Sue, permits selection of required system functions by the user engineer. The Sue minicomputer is configured from a series of independently operating system modules each on a plug-gable circuit card. Modules are inserted into a multilayer printed circuit board that provides a common high speed communications bus. System users have a choice of four memory modules—two core and two LSI—intermixed in any combination. Core modules are 4K or 8K x 16 with a system capacity of 30K words. LSI modules are 1K x 16; one is a user customized ROM, the other a RAM memory with 160-nanosecond access time.

CIRCLE NO. 276

Paper tape reader has only one moving part

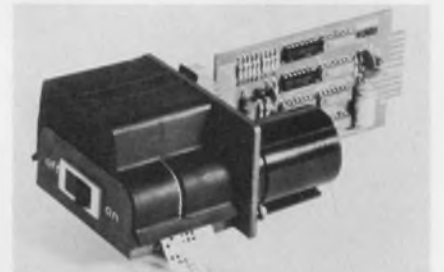

*Addmaster Corp., 416 Junipero
Serra, San Gabriel, Calif. (213)
285-1121.*

The Addmaster 601 paper tape reader is a photoelectric solid-state reader which operates with only one moving part. Data and control functions are at TTL levels. The 601 operates asynchronously at 10, 15, 30 and up to 120 characters per second.

CIRCLE NO. 277

OUR ANGLE: Modular D/S and S/D Converters



IN

A

Do Low Cost Repairable Circuit Cards Make Sense from Your Angle?

North Atlantic's new 701 D/S and 711 S/D Converters offer unmatched advantages for the digital/analog interface at low-low cost . . . typically \$1000. Open-card construction is easily and economically maintained. Adaptable to systems needs, interchangeable converter cards are compatible with your automatic test, simulation or digital control systems.

Compared to 19" panel designs, these units provide a choice of accuracy, frequency, resolution, and systems customization without the extra bulk and expense of unnecessary power supplies and other panel controls. They are ideal for multi-channel applications where a converter is assigned to a specific function.

These new converters are available to meet a wide range of systems needs. The 701 D/S has selectable accuracies of 9 or 12 bits with resolution of 8 through 14 bits, transformer output isolation and short circuit protection, operation at 60 Hz or 400 Hz with 1VA or 10VA output. The 711 S/D has 0.05° accuracy, 13 bit resolution with input transformer isolation, and continuously tracks 400 Hz synchro data to 1000°/second.

Don't these converters make sense from any angle? Talk it over with your North Atlantic sales engineering representative today.

NORTH ATLANTIC
industries, inc.

200 TERMINAL DRIVE, PLAINVIEW, NEW YORK 11803
cable: noatlantic / twx: 510-221-1879 / phone: (516) 681-8600

INFORMATION RETRIEVAL NUMBER 66

A customer asked us to design a screw for fastening plastics that would: hold better, drive easier, strip harder, not crack bosses.

We did!



The Hi-Lo[®] Screw

The unique thread design offers up to 42% greater pull-out strength, 33% less driving torque and 26% better stripping torque as compared to an equivalent Type B screw. Reduced radial pressure minimizes boss cracking — or — can allow a significant reduction in boss diameter.

IT'S AVAILABLE RIGHT NOW!
The Hi-Lo[®] Screw

Send for samples and Technical Report #132.

Product covered by one or more of the following method, apparatus and article patents: 3,207,023; 3,260,100; 3,204,442.

SHAKEPROOF
DIVISION ILLINOIS TOOL WORKS INC.
ST. CHARLES ROAD • ELGIN, ILLINOIS 60120

Copyright Illinois Tool Works Inc., 1972

Data acquisition module is cheaper, smaller & slower

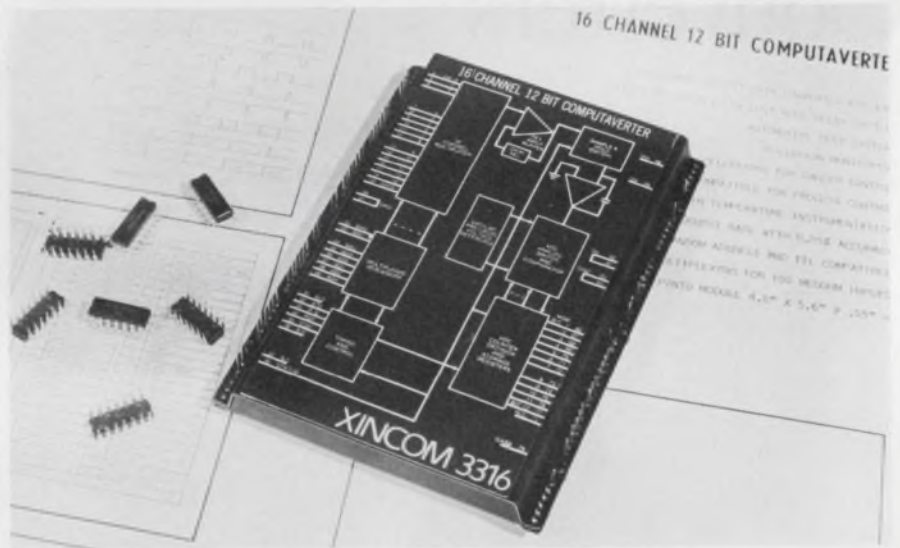

Xincom, 20931 Nordhoff St., Chatsworth, Calif. (213) 341-5040. P&A: see text; stock to 30 days.

Price and size plus a buffered output distinguish the new Xincom 3316 series 16-channel Computaverter. These are data acquisition system front ends packaged in a module. For the last year only one other company has been producing a similar type of product. Datel Systems, Inc. of Canton, Mass. has its DAS-16 series 16-channel Data Acquisition System modules.

Whereas the Datel units measure 4.5 in. x 5.0 in. x 1.5 in. or 33.75 cubic inches of volume, the Xintel units measure 4.0 in. x 5.6 in. x 0.55 in. or 12.3 cubic inches of volume. Therefore, the Xintel unit only takes up 36.5% of the space of the Datel unit. In addition, the Xintel unit only weighs 12 oz. versus 18 oz. for the Datel unit.

Size of course means nothing if the data acquisition front end isn't fast enough to do the job. Xintel offers three accuracies derived from the number of bits of word length of the analog-to-digital converter built into the module. They

are 8, 10 and 12 bits. The system throughput rates corresponding to those word lengths are: 30 kHz, 25 kHz and 20 kHz. Datel, on the other hand is much faster. In the DAS-16-L series the corresponding speeds are: 50 kHz, 30 kHz and 25 kHz. In the DAS-16-M series the corresponding speeds are: 100 kHz, 60 kHz and 50 kHz.

Where speed is not the determining factor, price usually is. Xintel quotes single quantity pricing for the 8, 10 and 12 bit versions at \$648, \$695 and \$760 respectively. The Datel L series is quoted at \$790, \$890 and \$990 respectively. And the Datel M series is \$990, \$1090 and \$1190 respectively.

Contained within the Xintel unit are: a 16-channel analog multiplexer; a sample and hold switch and amplifier; an analog-to-digital converter; a buffer memory on the output; and accessory circuitry such as precision voltage reference, a multiplexer sequencer and timing and control circuitry. The unit is packaged in Xintel's PINTO package. This package has wire wrap posts along two edges as contacts.

Maximum aperture uncertainty

time of the system is 40 ns. Maximum power dissipation is 5.0 W. All of the following analog inputs are offered: 1.0 V, 2.5 V, 5.0 V and 10.0 V unipolar; ± 1.0 V, ± 2.5 V, ± 5 V and ± 10.0 V bipolar. Digital coding available on the output includes: bipolar 1's or 2's complement and unipolar straight binary.

Input current is 5 nA max at 25 C ON or OFF. Source resistance is 1 kilohm max for specified performance.

Accuracy is quoted at up to 0.05% full scale ($\pm 1/2$ least significant bit) on the 12 bit unit with analog input full scale range of 5 V and 10 V.

FOR XINTEL:
FOR DATEL:

CIRCLE NO. 278
CIRCLE NO. 279

Magnetic protector has SPDT switch

Airpax Electronics, Woods Road, Cambridge, Md. Phone: (301) 228-4600.

The APL-RS is a magnetic circuit protector line with an auxiliary SPDT switch that only operates in the event of electrical trip of the protector. A typical application would utilize this switch to operate a light to indicate circuit Safe and a second light to indicate circuit Unsafe condition. The APL-RS protector line is available in single or multipole assemblies with series, shunt, and relay internal circuit construction. Standard current ratings from 0.02 to 100 amperes, voltages to 277 Vac and 65 Vdc and inverse time delays from instantaneous to 1 second at 600% of rated load are available.

CIRCLE NO. 280

How you profit from our



APTITUDE

Magnetics has been a special talent of ours for more than two decades. The devices and systems to magnetize, demagnetize, stabilize, measure—in the lab, in production, in the product—we have consistently engineered the most complete line available anywhere. And the top-value line.

RFL's gaussmeters cover every requirement—from the low cost and portability of the Model 505, to the unparalleled precision of the 3265. Then there's the 101 flux-gate type Magnetometer for measuring extremely low level flux densities... five different types of Magnet chargers for every requirement ranging from the economical, rugged 107A Magnet Charger to the Model 942 that takes on any shape or type of permanent magnet... the Magnetreater® for precisely controlled stabilization... and many more. Where needed, we can integrate standard RFL equipment to make a custom system, too.

Write or phone for our 16 page catalog of
Magnetics Instruments and Systems.
Descriptions, specs, prices.



RFL Industries, Inc.

Instrumentation Division • Boonton, New Jersey 07005

Tel: 201-334-3100/TWX: 710-987-8352/CABLE: RADAIRCO, N.J.



Strip chart with 9 pushbutton selectable speeds

from 20 to 0.05 in./min.

For your particular application, the model 3000 strip chart recorder is an outstanding unit. The chart paper is a full 10 inches wide and the rolls are 100 feet long. Nine Y axis plug-in modules permit ease in customizing or obtaining any desired function from the basic unit. An event marker is standard. Inputs, pen, event marker, chart on/off can all be controlled or inserted from rear terminals. And the price? A competitive \$835. plus economical modules. OEM discounts available.

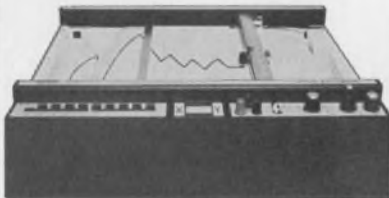

Model 3200-50
\$835
+ Y Axis Module



- Accuracy of $\pm 0.2\%$
- 30 in./sec slewing speed (also 40 in./sec available)
- English/Metric scaling at the flick of a switch
- Snap-in disposable pen
- Left to right chart presentation to read a graph properly
- Electric pen lift
- Every feature and function you will find in any other recorder on the market—at a price less than competition.

OMNIGRAPHICTM
ANTI-WORK
MACHINES

write for bulletin.

**houston
instrument**

DIVISION OF BAUSCH & LOMB

4950 Terminal Avenue, Bellaire, Texas
77401 (713) 667-7403

**houston
instrument** | **European Office**

Johanneskirchner Strasse 17, 8043 Unterföhring,
München, W. Germany (0811) 97-1673

MODULES & SUBASSEMBLIES

4 k × 9 MOS memory goes on one board

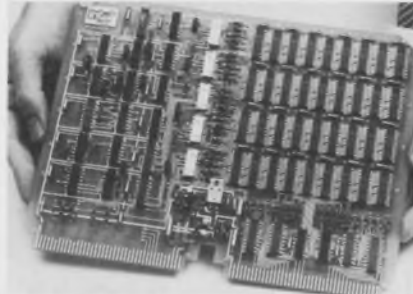

Intel Corp., 3065 Bowers Ave.,
Santa Clara, Calif. (408) 246-7501.
1¢/bit OEM.

A complete 4 k × 9 memory system built with 1103 MOS RAMs, in-16, comes on one 7 in. by 10 in. PC board. Ready for connection to TTL logic, the board contains all clock drivers, decoders and level shifters. Address and data registers, automatic refresh, and low power standby operation are standard features. The system has a maximum cycle time of 950 ns with access in 600 ns maximum. Only +5 V and +16.2 V nominal supplies are required.

CIRCLE NO. 300

Industrial modules are photo-isolated

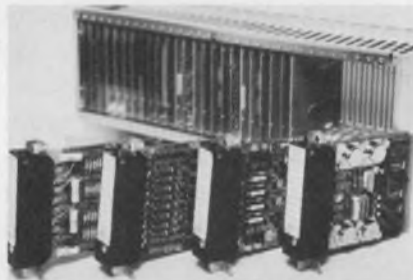

Xerox Data Systems, El Segundo,
Calif. (213) 679-4511. \$82 to \$120;
stock.

NJ series industrial logic modules use photo-isolation for extremely high noise rejection and up to 1500 V of ground isolation. They link monitoring and control devices to standard DTL/TTL logic. The first four modules in the line are a sensor converter, input detector, ac switch and dc switch. Typical applications include voltage comparison (photo cells, thermistors and tachometers), and closing contacts. Light-emitting and sensing semiconductor devices are used to achieve isolation.

CIRCLE NO. 301

Regulators rated at 180 W weigh only 3 oz.

Powertec Inc., 9168 DeSoto Ave.,
Chatsworth, Calif. (213) 882-0004.
\$22; stock.

The DC series power regulators, rated to 180 W, regulate voltages to 24 V dc and currents to 12 A. Input voltage is 40 V dc maximum, regulation is $\pm 0.075\%$ for line and also for load, the input ripple is 4 mV pk-pk for a 2 V pk-pk input. Typical 120 Hz ripple reduction is 60 dB. Response to a 50% load change is 25 μ s. Package size is 2-7/8 in. by 2-3/4 in. by 1-3/16 in., while weight is 3 oz. The unit operates from -5 C to +75 C. Also available are 90 W units at \$15.

CIRCLE NO. 302

Braided ROM system stores 1.6 million bits

Memory Technology Inc., 83 Boston Post Rd., Sudbury, Mass.
(617) 443-9911. 3/4¢ to 1-1/2¢/bit.

This braid ROM system is capable of accessing 1.6 million bits of storage—200,000 per board. The entire memory is altered by unplugging and replacing the braid. Individual bits or words are modified by the user in 30 seconds by disconnecting the appropriate wire and laying a new one on the braid. A board is 12.9 in. by 11 in. Access time is 255 ns and dissipation 0.5 mW/bit.

CIRCLE NO. 303

10-channel multiplexer occupies only 3-1/2 in.³

Sonex, Inc., 2337 Philmont Ave.,
Huntingdon Valley, Pa. (215) 947-6100.

This 10-channel FM multiplexed telemetry system occupies only 3-1/2 in.³. Ten voltage-controlled oscillators and a mixer amplifier, all plug-in, are included. Subcarrier frequencies between 400 Hz and 300 kHz with peak deviations of 1 to 40% can be provided. Temperature stability of the oscillators is within 1.5% dBW of the best reference over -20 C to +85 C. Application is for data acquisition, and the device can withstand aircraft and missile environments.

CIRCLE NO. 304



DIGITEC

DVMs & DMMs

Nowhere can you find the selection of value designed Voltmeters and Multimeters as with DigiTec. You could spend much more and not receive the advantages of our outstanding specifications and features. Budget minded engineers have become increasingly aware of DigiTec's accuracy and performance uniquely designed for both bench and system applications.

If your requirements call for an inexpensive VOM which measures 10 ranges of DC volts and resistance, you need a **DIGITEC MODEL 261** for only **\$279**. Capable of measuring AC and DC volts and current and resistance, **THE MODEL 262A** is a "must" . . . value priced at **\$375**. Both of these instruments are in a rugged metal case and may be equipped with a battery pack for complete portability.

We have developed a new family of 4½ digit instruments which offer the very finest performance in their class. A few of the many features are: .02% accuracy, LED displays, guarded input and isolated BCD output. **THE BASIC DVM** is priced at a low **\$525** and is available from stock. An **AUTO-RANGING DVM** is offered at only **\$625**. **THE MODEL 269** is a **FULL MULTIMETER**, unmatched in value at **\$695** (including internal current shunts and isolated BCD . . . no add on prices). A **6 RANGE MILLIVOLTMETER**, with 1µVolt resolution, is available at **\$795**.

Write or call for assistance in selecting the most suitable instrument for your application.

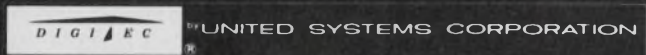

918 Woodley Road • Dayton, Ohio 45403 • (513) 254-6251
Representatives throughout the world
For complete specifications, request new catalog

INFORMATION RETRIEVAL NUMBER 70

ELECTRONIC GLASS

The way you want it



Highest quality General Electric 012 electronic glass tubing — in long lengths, cut rings, or cut to your exact specifications — a General Electric specialty. Its high-lead composition provides the high resistivity vital for electronic applications. Electronic bulbs, TV neck repair parts and electronic flares are among the products made with General Electric 012 glass and produced to standard specifications or to your specific print by General Electric. Glass tubing, available for

Send for technical literature.

quick delivery, can be weight-sorted for your convenience. Other glasses available from General Electric include low lead, lime, iron sealing, borosilicate, very high resistance, and others. Whatever your glass needs may be, General Electric stands ready to serve you.

Lamp Glass Department, General Electric Company,
24400 Highland Road, Richmond Heights, Ohio 44143



INFORMATION RETRIEVAL NUMBER 71

ELECTRONIC DESIGN 4, February 17, 1972



FREE

LAFAYETTE 1972 Catalog

Our 51st Year



468 PAGES

Your 1st Guide To Everything in Electronics

- Stereo/Hi-Fi Components • Musical Instruments and Amplifiers
- Photography Equipment • Ham and CB Gear
- Public Address Systems • Tools and Test Equipment
- Educational and Optical Equipment • Black and White/Color Televisions
- Police and Fire Monitor Receivers
- Books and Parts • Plus Thousands of Additional Items

Lafayette Radio Electronics, Dept. 45022
P.O. Box 10, Syosset, L.I., N.Y. 11791

Send me the FREE 1972 LAFAYETTE Catalog 45022

Name

Address

City State

Zip

(please include your Zip Code No.)

INFORMATION RETRIEVAL NUMBER 72

Par-Metal

ENCLOSURES



engineered efficiency



modular flexibility



ruggedly functional

**SEND FOR YOUR
NEW PAR-METAL
CATALOG NOW!**

Just off the press,
it's your shopping
center and planning
guide. Send for yours
now — FREE!



Par.Metal Products
DIVISION OF EON CORPORATION
1260 Atlantic Ave., Brooklyn, N.Y. 11216

INFORMATION RETRIEVAL NUMBER 73

126

MODULES & SUBASSEMBLIES

**Regulated dc supply
delivers 6 A at 50 W**



Abbott Transistor Laboratories, Inc., 5200 W. Jefferson Blvd., Los Angeles, Calif. (213) 936-8185. \$219; 7 days.

Model Z6 dc power supply furnishes 50 W of regulated power in a package measuring only 4 in. by 6 in. by 2-1/2 in. with 6 A output. Dc voltages between 9.5 and 12.5 V are regulated to within 0.15% total for changes of the ac line input from 100 to 132 V rms and from no load to full load. The circuit accepts an input frequency between 47 to 440 Hz. Ripple is less than 0.2% rms or 5 mV pk-pk. Weight is just 3 lbs.

CIRCLE NO. 320

**Dc instrument amplifier
has 600 V pk-pk CMR**



Ectron Corp., 8133 Engineer Rd., San Diego, Calif. (714) 278-0600.

Model 751 wideband dc differential instrumentation amplifier operates with 300 V dc or 600 peak to peak ac common mode potentials. These voltages are encountered in process control, atomic reactor and many industrial applications. Accuracy at a fixed gain from 1 to 1000 is 0.01%, output is 10 V peak, 3 dB bandwidth is 100 kHz, common mode rejection to 60 Hz is up to 126 dB, stability is 2 μ V referred to the input for 200 hours, and input resistance is 30 M Ω .

CIRCLE NO. 321

Photo Multiplier Power Supplies



- Variable DC to DC Converters
- Output to 3000V. proportional to input
- Efficiency > 50% at Full Load
- M.T.B.F. = 105,000 hours @ 71°C
- Shielded, Encapsulated
- Short Circuit Reverse Polarity Protection
- Immediate Delivery

MODEL	INPUT	OUTPUT	RIPPLE (P/P)	PRICE (1-9)
K15	3V. to 15V.	300V. to 1500V. @ 1 ma	0.1%	\$149
K30	3V. to 15V.	600V. to 3000V. @ 0.5 ma	0.5%	\$158
Q30*	2V. to 12V.	500V. to 3000V. @ 0.2 ma	0.25%	\$168

*Designed for battery applications — Idling current only 8 ma.

Both output and input floating. Separate case ground lead provided. Meets MIL STD810 where applicable. Operates at -55°C to +71°C. Dimension: 1" Dia. x 2 1/4" Long.

Venus Scientific Inc.

399 SMITH STREET
FARMINGDALE, N.Y. 11735
Telephone (516) 293-4100
TWX: 510-224-6492

INFORMATION RETRIEVAL NUMBER 74

ELECTRONIC DESIGN 4, February 17, 1972

Analog multiplexer has 16 channels on a board

Phoenix Data, Inc., 3384 W. Osborn Rd., Phoenix, Ariz. (602) 278-8528. \$225; 2 weeks.

MUX1670 multiplexer has 16 channels divided into two sections. Each eight-channel section has three binary-coded address lines and an inhibit line. Address decoding, drive circuitry accepting TTL input levels, MOSFET analog switches, two optional input buffer amplifiers and over-voltage protection are all included on one plug-in board, 4.5 in. by 3.33 in. A complete 128-channel analog commutator is readily constructed from eight cards plus a control card. Input voltage range is ± 10 V.

CIRCLE NO. 322

SCR circuit protects against overvoltage

ERA Transpac Corp., 67 Sand Park Rd., Cedar Grove, N.J. (201) 239-3000. \$65 to \$110; stock to 30 days.

These silicon SCR overvoltage protectors, OV448 series, incorporate "crowbar" circuitry to short circuit terminals within microseconds. Protection is provided for all types of solid-state components. The trip range is adjustable over 4.5 to 40 V to a point 5% less than the line voltage. Response is within 10 μ s after the trip voltage is exceeded. With a tripped shunt impedance less than 10 m Ω , current capabilities exceed 200 A for 16 ms, 10 A continuous duty.

CIRCLE NO. 323

Proportional controller supplies 2000 W load

Jewell Electrical Instruments, Inc., Grenier Field, Manchester, N. H. (603) 669-6400.

This solid-state device operates as a relay or proportional controller. An external resistance controls the phase conduction angle from 10% to the full 100% duty cycle characteristic of other relays. Transient protection has been incorporated for operation in adverse industrial environments. A thermal-conductive epoxy container and encapsulation permit the control of up to 2000 W without heat sinking. The operating frequency range is 50 to 500 Hz.

CIRCLE NO. 324

MECANORMA Symbols. Because thinner layouts print better circuits.

Most electronic symbols used in preparing printed circuit layouts are die-cut from crepe paper and mounted on large sheets or rolls.

Now K&E offers you something new and measurably better.

The MECANORMA System. Symbols that are *printed* on transparent strips of carrier film, only 20 microns thin. So thin you can barely feel the film with your finger, once you press it on the layout. So thin there's no parallax, no distortion, no rough edges—just a sharp, opaque symbol that's ready for the camera. Unaffected by the heat of your copying equipment. And accurate to within 1/1000 of an inch!

The convenient size of MECANORMA'S carrier strips, and their transparency, allow rapid, precise positioning, application and correction (with adhesive tape or blade)...a remarkable 40 to 50% more rapid than other methods! There are more than 800 symbols available, and packaged so you order only those you need. Others can be printed to your specifications.

Why not write us today for free samples and our catalog: Keuffel & Esser Co., 20 Whippany Road, Morristown, N.J. 07960.

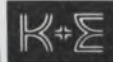

KEUFFEL & ESSER CO.

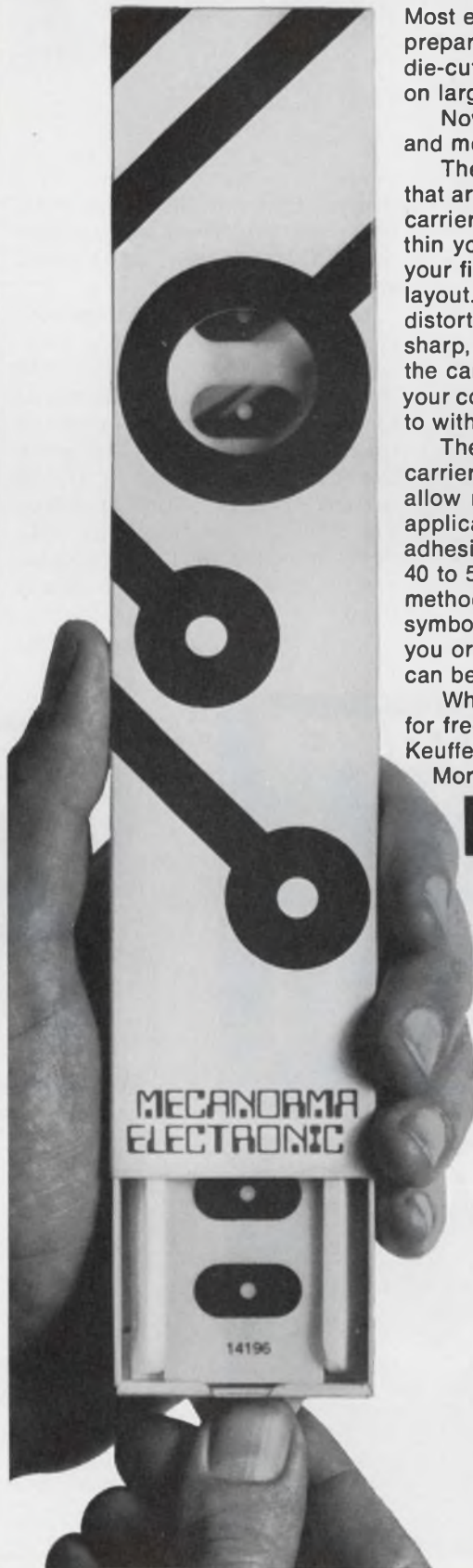

INFORMATION RETRIEVAL NUMBER 75

Microchopper features transformer isolation

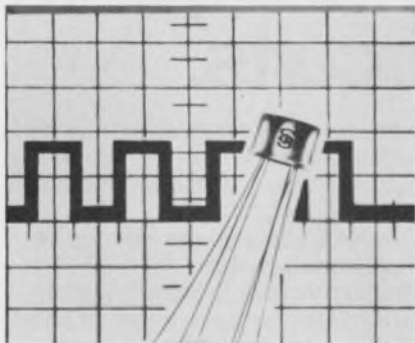

Solid State Electronics Corp., 15321 Rayen St., Sepulveda, Calif. (213) 894-2271.

The NS8000A is a transformer-isolated solid-state chopper using stabilized integrated silicon semiconductors in a TO-5 type enclosure. The range of operation is dc to 1.5 MHz. This unit has a maximum offset voltage of $\pm 100 \mu V$, a maximum leakage current of 5.0 nA and a maximum saturated dynamic impedance of 100Ω ; all values are given for a temperature of 25 C.

CIRCLE NO. 325

Optoelectronic photon couplers

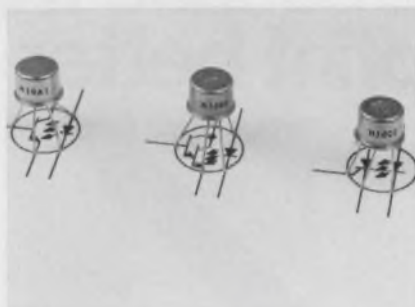

General Electric, Electronics Park, Bldg. #7, Mail Drop 49, Syracuse, N.Y. (315) 456-2021. \$3.95 (1000 quantities).

Three optoelectronic photon couplers in hermetically sealed packages feature 1000-V isolation. The H10A1, an SSL-phototransistor coupler, has a $3\text{-}\mu s$ typical turn ON time. The H10B1, an SSL-photo Darlington coupler, offers typical current transfer ratios of 500%. The H10C1, consisting of an SSL-light activated SCR combination gives a 1-A output with a 15-mA input.

CIRCLE NO. 326

Infrared light source may be smallest yet

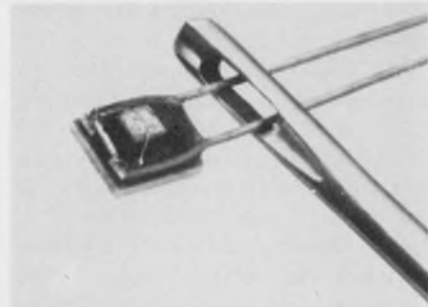

HEI Inc., Jonathan Industrial Center, Chaska, Minn. (612) 448-3510. \$1.25 (1000 quantities); stock.

A LED light source, designated the He-500, is small enough to pass through the eye of a needle. According to the company, the LED may be the smallest discrete LED package available as a standard product. The package consists of an infrared LED bonded to a ceramic substrate with two attached leads. A typical application would be tape sensing in a cassette deck.

CIRCLE NO. 327

PUSH BUTTON MINIATURES

Unusual momentary magnetic repulsion Alco push button switches have ceramic magnets that eliminate springs. Glass reeds, $\frac{1}{2}$ " dia. metal case, 100 mA @ 50 VDC. SPST, N.O. or N.C. .110" flat or .058" round terminals.

MAGNETIC ACTION

ALCOSWITCH®
DIV. OF ALCO ELECTRONIC PRODUCTS, INC., LAWRENCE, MASS.

INFORMATION RETRIEVAL NUMBER 76

SLIDE SWITCH MINIATURES

The world's best mini slide switch with a compact $\frac{1}{2}$ " case and new anti-tease design. Available in 1 and 2 pole, double throw models. 2 amps @ 120 VAC. MIL-Grade.

MSS-22 SHOWN ACTUAL SIZE

ALCOSWITCH®
DIV. OF ALCO ELECTRONIC PRODUCTS, INC., LAWRENCE, MASS.

INFORMATION RETRIEVAL NUMBER 77

UP TIGHT 50% SHRINKDOWN AT ONLY 160°F with PENNTUBE† VII-B

SHRINKABLE TUBING Neoprene*

Tough! Flexible! Protective! Inexpensive! Shrinks down in hot water above 140°F. Good electrical and mechanical strength. Resists corrosion and chemicals and will not support a flame. Used for electrical insulation on wires, mechanical protection for pipes and fittings. Effective as scuff resistant jacketing for electrical cables and harness... and much more. Sizes $\frac{1}{4}$ " to 4". Black only.

PENNTube Plastics Co., Inc.
SUBSIDIARY OF DIXON INDUSTRIES
Madison Ave. & Holley St. Clifton Heights, Pa. 19018 (215) 622-2300
Export Div. • 5710 Empire State Bldg., N.Y. 10001
*Du Pont Reg. TM. †Penntube Plastics Co. Reg. TM.

SEND FOR FREE SAMPLE and Bulletin #71SN-B

INFORMATION RETRIEVAL NUMBER 78

Intersil dollar-a-channel analog gates.

Try one for free.

The price is right.

Weatherford offers you new low prices and a free sample on analog gates from Intersil. 100-piece prices on the four-channel gates lower costs to one dollar per channel for the first time ever:

	Number of channels			
	4	3	2	1
5009 type gate	\$4.00	3.30	2.40	1.30
5011 type gate	4.00	3.30	2.40	1.30

And the gate is great.

They're usable with logic inputs of either +5 or +15 volts with no external driver. Typical $I_{D(OFF)}$ is 100 pA (@ $V_{DS} = 1V$). Suitable for single-pole or double-pole use, gates come with from 1 to 4 channels per device, packaged in silicone (standard) or ceramic DIPs.

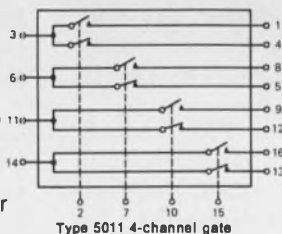

How to get 5 to 50 ohms Effective ON Resistance.

The 5009 analog gate design utilizes a "Compensating FET" in series with the common output (pin 4) of the ORed switch channels. When pin 4 is connected into the feedback loop of a "virtual ground" inverting amplifier, this provides "Effective ON Resistance" ($R_{ON(MATCH)}$) guaranteed 50 ohms maximum. 25, 10 and 5 ohm matched versions are also available. This low $R_{ON(MATCH)}$ is the difference between the precision-matched R_{ON} of the Compensating FET and each switching FET.

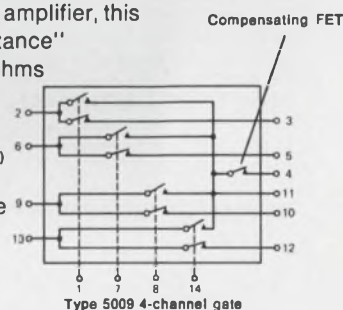

Ask for a free sample.

Get the feel of these gates with this special offer: To every qualified respondent in the next thirty days, Weatherford will give one free sample gate and a set of detailed application notes. Call today.

Albuquerque: (505) 265-5671
 Anaheim: (714) 547-0891
 Austin: Enterprise 1443
 Dallas: (214) 231-7141
 Denver: (303) 427-3736
 Glendale: (213) 849-3451
 Houston: Enterprise 1443
 Palo Alto: (415) 321-5373
 Phoenix: (602) 272-7144
 Pomona: (714) 623-1261
 San Diego: (714) 278-7400
 Seattle: (206) 762-4200

WEATHERFORD



We'll save your space.

The way we make subminiatures, they're more subminiature. More fully packed. Same contact size and spacing, only we get 110 contacts to the inch. Socket to 'em!

HUGHES
HUGHES AIRCRAFT COMPANY
CONNECTING DEVICES

INFORMATION RETRIEVAL NUMBER 131



We've got your number

Show us a spec, and we'll show you miniature and subminiature printed circuit connectors in 10 sizes with 10 to 96 contacts. We're good at the numbers game.

HUGHES
HUGHES AIRCRAFT COMPANY
CONNECTING DEVICES

Newport Beach, Calif. 92663
(714) 548-0671

INFORMATION RETRIEVAL NUMBER 132

ICs & SEMICONDUCTORS

Transmitter transfers data for peripherals

Motorola Semiconductor, P.O. Box 20912, Phoenix, Ariz. (602) 273-3466. \$13.60 (100 quantities) stock.

The MC2257L terminal transmitter provides a conversion of parallel binary input data to serial output form. At the same time, the MC2257L internally provides timing and control functions, an odd or an even parity bit, one character of buffer storage, and error detection. Words ranging from 5 to 8 bits in length can be selected for entry into a buffer storage register.

CIRCLE NO. 328

Schottky TTL product line introduced

Fairchild Semiconductor, 464 Ellis St., Mountain View, Calif. (415) 962-3816. \$1.47-\$3.26 (100 quantities).

The first Schottky TTL products to be announced by the company is designated the 9S series. Designed as pin-for-pin replacements for 54/74 and 9N series standard TTL/SSI units, the eight-product line includes gates, inverters and a D flip-flop. The Schottky TTL circuits have typical gate propagation delays of 3 ns and typical power dissipation of 22 mW per gate.

CIRCLE NO. 329

FET features 140-dB dynamic range

Teledyne Crystalonics, 147 Sherman St., Cambridge, Mass. (617) 491-1670. \$9 (500-999); stock.

The CP640 FET has a dynamic range of 140 dB, as compared with normal ranges of 110 dB for other FETs and 90 dB for bipolar transistors, according to the company. Transconductance is typically 75,000 micromhos at a drain current of 50 mA. The input impedance is about 25 Ω ; the CP640 can be used as a front end without matching for 50- Ω and 75- Ω antennas. Using 3 MHz and 5 MHz signals, third-order harmonics are 80 dB down for a 250-mV input. The CP640 is operable through 400 MHz.

CIRCLE NO. 330

Power hybrid contains high-gain current amps

RCA Solid State Div., Route 202, Somerville, N.J. (201) 722-3200. \$4.25 (1000 up); stock.

A power hybrid circuit, designated the HC3000, consists of two Darlington-pair high-gain current amps in an eight-lead TO-3 hermetic package. Each Darlington circuit has a load-current rating of 10 A and a dissipation rating of 20 W (at a case temperature of 25°C). The minimum current gain is 600 for a 3 A load, or 500 for a 5 A load. The hybrid circuit can be operated from supplies up to 70 V.

CIRCLE NO. 331

Monolithic op amp has 1.0 $\mu\text{V}/^\circ\text{C}$ max drift

Burr-Brown Corp., Tucson, Ariz. (602) 294-1431. \$20 (100 quantities); stock.

The maximum voltage drift of the 3500E a monolithic op amp, is 1.0 $\mu\text{V}/^\circ\text{C}$. Although the 3500E is the only ultra low drift IC op amp with internal compensation for unity gain operation, according to the company, unity gain full power bandwidth is 15 kHz compared to about 100 Hz for 725 types. The low drift spec is achieved without nulling the initial offset voltage of 500 μV .

CIRCLE NO. 332

Magnetic, flux sensitive diodes

European Electronic Products, 10150 W. Jefferson Blvd., Culver City, Calif. (213) 838-1912.

Two specially diffused germanium diodes, models AHY10A and AHY10B, are sensitive to external transverse magnetic fields. Changes in this field produce an electrical signal as a result of changes in the internal resistance values. The AHY10A has a magnetic sensitivity of 0.75 to 1.0 V per kilogauss. The AHY10B has a higher sensitivity of 1.0 V to 1.5 V per kilogauss. Applications include contactless pushbuttons, speed controls and vacuum chamber altimeters.

CIRCLE NO. 333

The heart of our gaussmeter is so good, even our competitors use it.

The Hall generators that we make for our own gaussmeters are so accurate and dependable, our competitors even use them. But that's where the similarity ends. We have other special features like internal calibration, temperature stable probes, and many more items that are covered in our gaussmeter brochure. Write to: 4949 Freeway Drive East, Columbus, Ohio 43229.

F.W. Bell Inc.

A subsidiary of The Arnold Engineering Co.

INFORMATION RETRIEVAL NUMBER 81

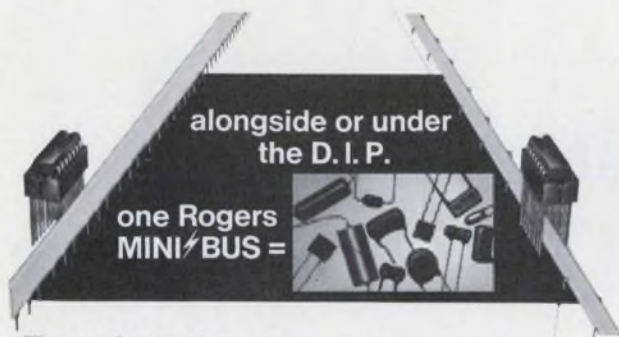

The evidence is accumulating. You may eliminate all discrete bypass capacitors — and get a lower-noise printed circuit board at frequencies where it counts — with a single Rogers Mini/Bus.

DELIVERY: Standard configurations are available on short notice.
Telephone EAST: (203) 774-9605;
WEST: (602) 963-4584 to know where we stand today on your requirements. Ask for our Mini/Bus brochure, showing standard parts.

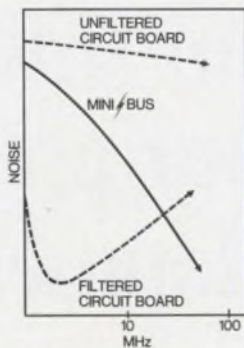

Rogers Corporation Rogers, Conn. 06263 (203) 774-9605

INFORMATION RETRIEVAL NUMBER 82

ELECTRONIC DESIGN 4, February 17, 1972

Rotron Power Conversion Devices

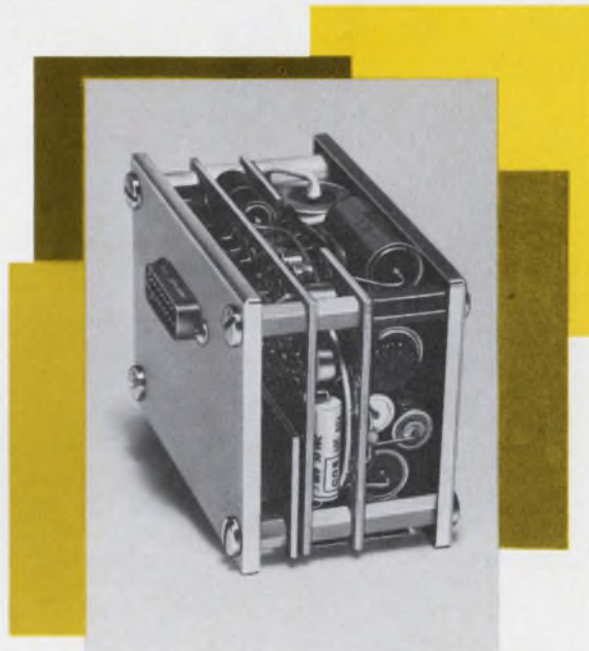

Custom-built to match your own voltage/frequency requirements.

What you need is what you get from Rotron. Because Rotron® will build a solid state converter to meet your most specific requirements — of size, weight, configuration, environmental conditions, and, of course, output. And, with many years experience in matching solid state converters to specific loads, Rotron will do it at reasonable cost.

For computer, aerospace, medicine, marine, instrument, tele-communications, and avionic equipment. AC to AC frequency converters, AC to DC converters (regulated or unregulated) with single or multiple voltage outputs. DC to AC inverters, with optional reverse polarity protection, high voltage protection and RF suppression to MIL specifications.

Before you compromise your system power requirements, learn how the power conditioning pros at Rotron can give you exactly what you do need, at a price you can afford. Contact Wes Riley at Rotron today.



POWER CONVERSION PRODUCTS DIVISION
ROTRON INC., Woodstock, N. Y. 12498
 914-679-2401 TWX 510-247-9033

Pacific Div., Burbank, Cal. 91506 213-849-7871
 Breda, Netherlands, Tel: 49550, Telex: 844-54074

INFORMATION RETRIEVAL NUMBER 83

131

**Triacs rated to 40 A,
take surges to 400 A**

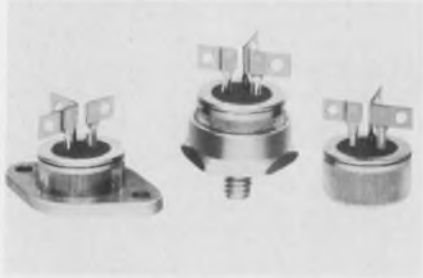

Hutson Ind., 2019 W. Valley View Lane, Dallas, Tex. (214) 241-3511.

The 3/4-in. press-fit series of 30-A and 40-A electrically isolated triacs incorporates center-gate geometry and glass passivated, dual-mesa construction for improved thermal characteristics and current-carrying capabilities. These devices can withstand surges up to 400 A. Shorted emitter and center-gate construction improve both critical and commutating dv/dt ratings and di/dt capabilities.

CIRCLE NO. 334

**FET op amp has
25 V/ μ s slew rate**



Bell & Howell, 706 Bostwick Ave., Bridgeport, Conn. (203) 368-6751. \$41 (1 to 9); stock.

A FET-input hybrid op amp, the C-228, features a slew rate of 25 V/ μ s minimum either inverting or noninverting. The full power output at ± 10 V is available at a minimum rate of 500 kHz. The C-228 also offers 5 pA bias current and $10^{11} \Omega$ input impedance. The op amp operates over the temperature range of -55 to $+125$ C. Settling time is less than 1 μ s.

CIRCLE NO. 335

**Overvoltage protectors
use thick-film SCR's**

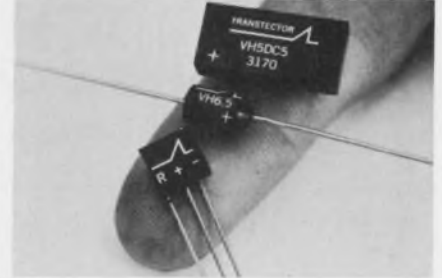

Transtector Systems, 532 Monterey Pass Road, Monterey Park, Calif. (213) 281-3633. \$5-\$12; stock.

A family of hybrid overvoltage protectors use thick-film SCR crowbars. Capable of deflecting overvoltage transients in 50 ns or less, the hybrid protectors are designed for dc circuits carrying up to 5 A nominal line current. They can handle surges of up to 40 A for 100 ms and draw less than 1 mW/V in the standby mode. Standby trip points are 5 to 50 V dc.

CIRCLE NO. 336

Introducing the new Pertec Disk Formatter.

**It lowers your system cost,
simplifies your interface,
and saves your precious
design & development time.**

Wide range of double balanced mixers

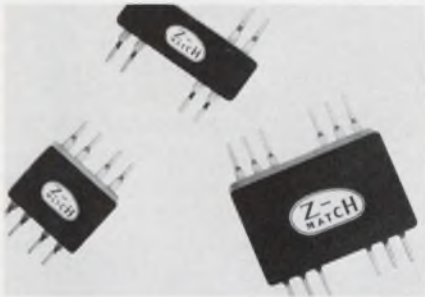

Vari-L Co., Inc., 3883 Monaco Parkway, Denver, Colo. (302) 321-1511.

A series of Z-Match DIP packaged doubly balanced mixers offer both small signal and high level types. The frequency range is from 0.05 to 1500 MHz. Some additional features are the following: low conversion loss—5-6 dB typically; high interport isolations—40 dB typically; superior harmonic suppression; and suitability for military environments.

CIRCLE NO. 337

Solid-state relay with 1-kV ac isolation

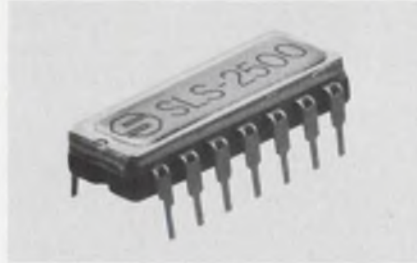

Sterer Engineering and Manufacturing Co., 4690 Colorado Blvd., Los Angeles, Calif. (213) 245-7161.

The SLS-2500, a solid-state relay, features SPST normally open contacts rated at 1 A, 8 to 32 V dc with 1000 V ac pk-pk isolation between input and output. The drive coil is directly compatible with all logic gates operating at 1.6 mA max and 2.4 V dc max through the temperature range of -55 to +125 C. The drive may be subjected to continuous 32 V dc without damage.

CIRCLE NO. 338

Multiplexer has low ON resistance

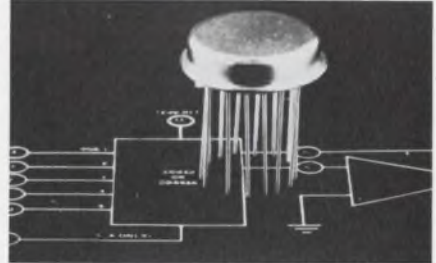

Teledyne Crystalonics, 147 Sherman St., Cambridge, Mass. (617) 526-7351.

The Model CAM601 is a 6-channel FET multiplexer featuring a 60-Ω maximum ON resistance and break-before-make action. OFF-channel isolation is enhanced by ac grounding of the FET gates. Internal reference resistors assure tracking of ±10 V ac signals without clipping or ON-resistance modulation. Operating temperature range for the CAM601 is -25 to +85 C.

CIRCLE NO. 339

So you can concentrate on more exciting things.



Pertec Peripheral Equipment has a new disk formatter that's going to make life easier for you.

The new Pertec disk formatter greatly simplifies your interface design because we include all the formatting electronics, error checking and timing functions which you would normally

have to provide. The formatter handles up to four Pertec 5000-Series disk drives. It's available now, so you'll save precious development time and free yourself for more important things.

Pertec 5000-Series disk drives feature an exclusive voice-coil with elec-

tronic detent head positioner for continuing accuracy and proven reliability. You'll also get high speed access — 15 msec track-to-track, 60 msec average. Standard data rates are 720 KHz at 1100 bpi and 1.562 MHz at 2200 bpi.

You can choose single or dual-disk drives with one removable IBM 2315-type cartridge and one fixed disk. There are four new models which store from 12 million to 50 million bits.

Pertec Peripheral Equipment is the largest independent supplier of digital magnetic tape transports in the world. And we're getting bigger fast in disk drives. We offer complete applications assistance and sales and service in 30 U.S. cities and 15 foreign countries.

Write or call for more information on our new disk formatter and our disk drives. We'll make life easier for you. Pertec Peripheral Equipment, 9600 Irondale Avenue, Chatsworth, California 91311. (213) 882-0030.

PEC has outgrown its name. Our new name is...

PERTEC
PERIPHERAL EQUIPMENT

Boston (617) 899-6230 • Washington, D.C. (703) 573-7887 • New York (203) 966-3453 • Detroit (313) 769-4376 • London Reading 582115

INFORMATION RETRIEVAL NUMBER 84

Now you need
only ONE reader
for 150/300/600 CPS



DECITEK'S NEW UNIVERSAL READER

**cuts inventory costs
saves on spare parts
speeds servicing
simplifies your designs
reduces documentation,
software and training**

Think of the money, time and trouble you can save by standardizing on *one*, proven-reliable punched-tape reader for *all* your applications. Decitek's evolutionary new "Universal Reader" reads to 300 CPS step-at-a-time truly asynchronously . . . to 600 CPS stop-on-character.

Combines refined electromechanical design and improved electronics with all original Decitek advantages that avoid edge guides, capstans, pinch rolls, brakes, lenses . . . stepping motor/dual sprocket bi-directional drive . . . interchangeable reading of 5, 6, 7 or 8-level paper, metallized polyester or paper-polyester tapes having up to 70% transmissivity. Basic reader with or without electronics, fanfold or spooler. Call or write DECITEK, 15 Sagamore Rd., Worcester, Mass. 01605. Tel. (617) 757-4577.

DECITEK
A DIVISION OF JAMESBURY CORP.

INFORMATION RETRIEVAL NUMBER 85

ICs & SEMICONDUCTORS

Power pnp transistors rated at 125 W

RCA Solid State Div., Route 202, Somerville, N.J. (201) 722-3200. \$2.25, 2N6246, \$2.50, 2N6247; \$2.95; 2N6248 (1000 quantities); stock.

Three new silicon pnp transistors are capable of 125-W dissipation at 25 C. Designated 2N6246, 2N6247 and 2N6248 (formerly RCA Dev. Nos TA7281, TA7280 and TA7279), these devices operate with a continuous collector current of -15 A, with maximum V_{CEO} ratings of -60 V for 2N6246, -80 V for 2N6247 and -100 V for 2N6248.

CIRCLE NO. 340

Small ROM features infinite alterability

Quadri Corp., 2950 W. Fairmont, Phoenix, Ariz. (602) 263-9555.

The model 816 "mini ROM", according to Quadri Corp., is ideally suited for applications requiring a small, nondestructive and electrically alterable read out store. With a maximum storage of 256 bits, the 816 features infinite alterability, full TTL compatibility, 5 V only operation and 36-pin dual-in-line packaging. The ROM utilizes a low threshold, square loop core arrayed in the 2-core per bit mode.

CIRCLE NO. 341

Voltage regulators ease power-supply design

Fairchild Semiconductor, 464 Ellis St., Mountain View, Calif. (415) 962-3816. \$1.75 (100-999).

A family of seven IC voltage regulators, designated the 7800 series, is less expensive and easier to use than other types of voltage regulators, according to the manufacturer. The devices, available in three-terminal plastic packages, provide seven regulated voltages: 5, 6, 8, 12, 15, 18 and 24 V. Output voltage tolerance is $\pm 5\%$. The units provide 0.01%/V line regulation and 30 m Ω output impedance for load regulation. Rated output current is 1 A.

CIRCLE NO. 342

LED-phototransistors feature fast responses

Clairex Corp., 560 S. Third Ave., Mt. Vernon, N.Y. (914) 664-6602.

A line of six-lead DIP LED-phototransistor isolators have minimum transfer ratios from 20% to 600%. The Model CLI-5 has a maximum rise or fall time of 2 μ s into a 1000- Ω resistor—the highest speed in the industry, according to the company. The Model CLI-10 is a photo-darlington isolator with transfer ratio between 800 to 1000%. The Model CLI-2 is a general purpose opto-isolator with a max rise or fall time into a 100- Ω resistor of 5 μ s.

CIRCLE NO. 343

High-voltage transistor chips for hybrids use

Dionics, Inc., 65 Rushmore St., Westbury, N.Y. (516) 997-7474. 17¢ to 22¢ (100,000 quantities); stock.

Silicon pnp and npn complementary transistor chips for hybrid applications are rated as high as 225 V. Only 19 mils square over-all and 6 mils ± 1 mil thick, the chips have a minimum operational frequency of 50 MHz. Designated in a DN and DP series, the model 200 has a $V_{CBO} = 225$ V; h_{FE} at $I_c = 10$ mA and $V_{CE} = 10$ V is 20 (minimum). The corresponding values for the 201 are $V_{CBO} = 200$ h $_{FE}$, 50. And for the 202, its $V_{CBO} = 175$ and $h_{FE} = 75$.

CIRCLE NO. 344

Tighter controls make low burst-noise op amp

RCA Solid State Div., Route 202, Somerville, N.J. (201) 722-3200. \$3.30 (1000 quantities).

A new version of the CA3741T, designated the CA6741T, is virtually free from burst, or "popcorn," noise. The improvement is a result of processing development and burst-noise inspection criteria. A highly selective test circuit with a 1-kHz bandwidth rejects a device if its "total" input noise-voltage amplitude—burst noise + 1/f noise—exceeds 20 μ V (peak) during a 30-second test period.

CIRCLE NO. 345



Power module for Nixie* displays

This rugged module, designed specifically for use with high voltage display devices, provides a nominal output of 185 VDC at 25 ma . . . drives up to seven Nixies. Only 3.5" x 2.3" x 1". May be mounted directly on a p-c board. Order Model NX-25. Price: \$35.00. Shipment: Three days.

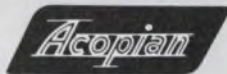

Acopian Corp., Easton, Pa. 18042
Telephone (215) 258-5441

*Registered trademark, Burroughs Corporation

INFORMATION RETRIEVAL NUMBER 86



FREE YOKE SELECTION KIT

Information you need to know about selecting and specifying a precision yoke for your CRT display. Indicates the interaction between circuitry, CRT and yoke. Includes an application checklist to simplify your work. Send for your kit.

SYNTRONIC INSTRUMENTS, INC.
100 Industrial Road Addison, Ill. 60101 (312) 543-6444

syntronics



INFORMATION RETRIEVAL NUMBER 88

now...you
can test
digital
IC's...
economically...
to manufacturer's specs



New Kurz-Kasch Model IC-590 is the first economically priced digital IC analyzer for accurate testing in the lab, shop, inspection, production, field or any other location.

The Model IC-590 is a completely portable, battery powered digital IC tester for use in conjunction with published IC specification sheets for static and dynamic testing of all 14 and 16 pin dual in-line IC modules of the DTL and TTL, 5 and 15 volt families. Flat pack and TO-5 modules may also be tested by using appropriate adapters. Price \$169.95.

A unique sister Model IC-591 is also available. It comes complete, as IC-590 above, internal power supply for highly regulated 5 volt, 1 amp operation and adapter cable for firing-up complete card units containing as many as 15 or more mounted IC's. Price \$295.00.

For complete technical data, write or call now: Tom Barth, Marketing Manager



ELECTRONICS DIVISION
Kurz-Kasch, Inc.
1421 S. Broadway,
Dayton, Ohio 45401

(513) 223-8161

INFORMATION RETRIEVAL NUMBER 87

ELECTRONIC DESIGN 4, February 17, 1972

Compare Mox to whatever resistor you're using now.

Our Metal Oxide Resistors offer you:

- Small Size ■ Maximum Reliability
- 100 ppm TCR ■ High Stability
- High Voltage Capability

Set a comparable MOX Resistor beside the wire wound or metal film resistor you're using now. Chances are you'll find ours smaller, giving you greater design possibilities for ultra-critical applications.

We offer you a complete MOX Series to choose from, and we keep them stocked for prompt delivery.



Mini-Mox—Miniature high voltage resistors with ratings as high as 5 Kv and dissipations to 1 watt.

Maxi-Mox—Rated at 2.5 watts and 7.5 Kv per lineal inch. Available in 1-5" lengths in 1" increments.

Divider-Mox—Single units with one or more taps. Ratios as high as 10,000:1. Input voltages to 37.5 Kv; .5% output voltage stability.

Power-Mox—High voltage, high power resistors. Voltages to 45 Kv. 45 watts in 70°C air ambient.

MOX FACTS and Technical Data Sheets are available from: Victoreen Instrument Div. of VLN Corp. 10101 Woodland Avenue, Cleveland, Ohio 44104. Telephone: 216/795-8200.

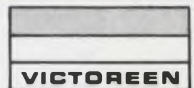

DMA 682

Expertise in high voltage.

INFORMATION RETRIEVAL NUMBER 89

135

Fast waveguide switch covers 3.7 to 4.2 GHz



Waveline, Inc., P.O. Box 718, West Caldwell, N.J. Phone: (201) 226-9100.

The Model 90828 transfer switch with removable drive section helps cut system down time. In WR-229 waveguide, the unit has an insertion loss less than 0.01 dB, isolation greater than 80 dB, VSWR less than 1.05:1, and power handling of 10 kW cw. Switching time is 90 ms.

CIRCLE NO. 346

Varactors tune wide C swing with low V



MSI Electronics, Inc., 34-32 57th St., Woodside, N.Y. Phone: (212) 672-6500. P&A: \$33 (1-99); 2 wks.

Hyperabrupt junction design allows a new line of varactors, the HA1702 through HA1717, to provide the same capacitance-tuning ratio with a 30-V bias swing that an earlier line, the GC, provided with a 60-V swing. Capacitance ratings are available up to 22 pF at 4 V for vhf through 4 GHz.

CIRCLE NO. 347

Vhf crystal oscillator with low noise density



Vectron Laboratories, Inc., 121 Water St., Norwalk, Conn. (203) 853-4433. 6 to 10 wks.

The crystal oscillator model CO-224 provides an output signal-to-noise of better than 110 dB/Hz, 100 Hz from the carrier and 130 dB/Hz, 1 kHz from the carrier. Power available at the output is 20 mW, or +13 dBm, with a stability of 1×10^{-8} per day at any fixed frequency in the 25 to 150 MHz frequency range. Options include operation from -55 to +85 C.

CIRCLE NO. 348

General Radio Introduces Two New

GR874[®] (75 Ω)- General Purpose

Now you can add a new degree of confidence and flexibility to your 75- Ω work with this broad new line of GR874 (75- Ω) components. Confidence because you'll be using components with known 75- Ω characteristic impedance and low SWR to 2000 MHz. Flexibility because of the broad selection of components plus their hermaphroditic design which permits easy interconnection among a variety of connector types with a minimum number of GR874 adaptors.

The GR874 quick-connect/disconnect design has proven reliable electrically and mechanically since the introduction of GR874 50- Ω components almost 25 years ago. Now you can have this same reliability in 75- Ω .

The GR874 (75- Ω) series includes:

- GR874 75- Ω Basic Connector (\$3.60* in lots of 100)
- Cable and Panel Connectors for: RG/11U, RG/59U, RG/187U
- Adaptors to jack and plug types: BNC, N, F, Western Electric small and large, and GR900[®] (50- Ω)
- Terminations: matched, open-circuit, short-circuit
- Fixed Attenuators: 6 dB, 10 dB
- Matching Pad: 50- Ω to 75- Ω
- Air Line and Inner Conductor Rod

*Net FOB Concord, Mass.

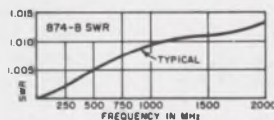

SWR curve for basic connector



Dye cassettes drop into tunable lasers



Avco Everett Research Laboratory, 2385 Revere Beach Parkway, Everett, Mass. Phone: (617) 389-3000.

Interchangeable dye cassettes drop into the company's pulsed nitrogen lasers or tunable lasers, allowing a user to select wavelength and output power. Each of 10 cassettes allows tuning over about 30 nm in the 360 to 670-nm range. Power outputs and rep rates extend to 50 mW and 500 pulses per second, respectively.

CIRCLE NO. 349

Double-balanced mixers give 35-dB isolation



Relcom, 3333 Hillview Ave., Palo Alto, Calif. (415) 961-6265. \$199; stock.

Three double-balanced mixers offer higher isolation, lower noise figure, wider bandwidth, smaller size, and better environmental performance—all at a lower price. The Model M1H, M5H and M11H mixers feature 35-dB isolation, 6-dB noise figure, 1.8 to 6.2 GHz input range and dc to 2 GHz i-f range. The mixers come in stripline and miniature models and operate in MIL environments.

CIRCLE NO. 350

6-kW coax termination is 1.75 in. long



Weinschel Engineering, Gaithersburg, Md. (301) 948-3434. \$95-\$145; 30 days.

A series of power terminations, the models 1420 through 1422, feature a peak power rating of 6 kW and average power ratings of 5, 10 and 20 W. The model 1421, with an SMA connector and 5 W average power rating, has an overall length of 1.75 inches. For all models the maximum SWR is 1.35 over a 3.5 to 18 GHz frequency range. Typical SWR, from 4 to 18 GHz, is less than 1.25.

CIRCLE NO. 351

Lines of 75-Ω Coaxial Components

GR900[®] (75Ω)- Precision

GR900 (75-Ω) coaxial components deliver the precision and repeatability needed for confidence in calibration and standards lab work. This new series of standards is specified to 1000 MHz and useable to 8.5 GHz. SWR for the precision connector is less than $1.0015 \pm 0.0015f_{\text{GHz}}$ and repeatability is better than $\pm .002 \text{ dB}$, $\pm 0.01^\circ$.

The GR900(75-Ω) series includes:

- Precision Coaxial Connectors
- Precision Standard Terminations
- Precision Matching Pads — 50-Ω to 75-Ω
- Precision Adaptors to types: GR900 (50-Ω), F, and Western Electric small and large

Complete specifications and prices on GR's new 75-Ω coaxial components are available from your GR sales engineer or from GR, Concord, Mass. 01742. In Europe write Postfach, 124, CH 8034, Zurich, Switzerland.



General Radio

NEW YORK (N.Y.) 212 964-2722 (N.J.) 201 781-8990 • BOSTON 617 646-0550
CHICAGO 312 992-0806 • WASHINGTON, D.C. 301 881-5333 • LOS ANGELES 714 540-9830
TORONTO 416 252-3395 • ZÜRICH (01) 55 24 20
GRASON-STADLER 617 389-3787 • TIME/DATA 415 327-8322

INFORMATION RETRIEVAL NUMBER 90

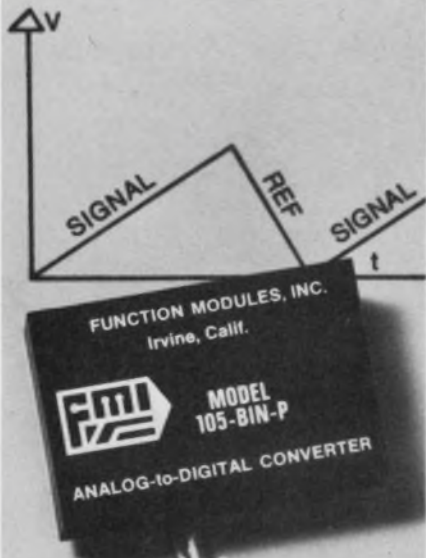

NEW

12 Bit ADC

\$95

(1-9 Quantity)

Model 105 Dual-Slope ADC

- Resolution of 12-Bits . . . Binary or 3½ Digit BCD
- ±0.01% Max Nonlinearity
- Low Drift . . . ±2ppm/°C Offset TC ±10ppm/°C Gain TC
- Fast Conversion . . . 2msec for Binary Units 750µsec for BCD Units

And this new analog-to-digital converter is versatile . . . you can connect it to automatically recycle or to convert on external command. We're shipping the 105's from stock, so order several today!



FUNCTION MODULES, INC.
2441 Campus Drive
Irvine, California 92664
(714) 833-8314

MICROWAVES & LASERS

10.6-µ beam monitor responds in 1 ns



Oriel Corp. of America, 1 Market St., Stamford, Conn. (203) 348-4247.

The model 7440, a photon drag monitor of CO₂ laser pulses, achieves a response time of 1 ns with response of 0.6 mV/kW; the beam aperture is 1/2 inch. The monitor absorbs approximately 25% of the beam in a bar of crystal germanium. The remaining 75% of the beam passes straight through unchanged. The 7440 is particularly useful for monitoring mode locked, Q-switched or TEA CO₂ lasers.

CIRCLE NO. 352

Ferrite absorbs cover 50 MHz to 15 GHz range

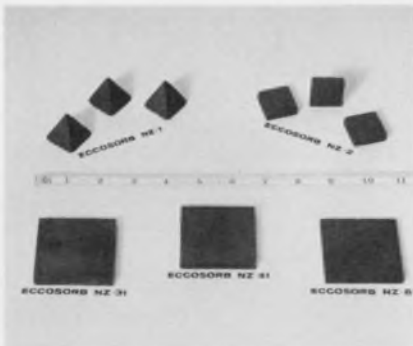

Emerson & Cuming, Inc., Canton, Mass. (617) 828-3300. \$60-\$100 per ft².

Eccosorb NZ-31, 41 and 51 are added to the NZ line for increased absorption in the lower frequency range. In the case of NZ-31, a reflectivity level of 30 dB down from a metal plate at 250 MHz rises to a level of 10 dB down at 50 MHz. Similarly, NZ-41 provides a reflectivity of 35 dB down at 400 MHz. Eccosorb NZ-51 has a reflectivity of 27 dB down at 800 MHz.

CIRCLE NO. 353

1%
AMERICAN MADE

Tolerance
SCHAUER
1-Watt
ZENERS

Immediate Shipment
Low Prices

ANY voltage from 2.0 to 18.0

Quantity Price each

1-99	\$1.07
100-499	.97
500-999	.91
1000-4999	.86
5000 up	.82



Gold plated leads

All welded and brazed assembly

No fragile nail heads

Write for complete rating data and other tolerance prices.

Buy the kit-
Save a lot



Kit contains a 51-piece assortment of SCHAUER 1% tolerance 1-watt zeners covering the voltage range of 2.7 to 16.0. Three diodes of each voltage packaged in reusable poly bags. Stored in a handy file box. Contact your distributor or order direct.

A \$54.57 value for

ONLY \$24⁵⁰

Semiconductor Division

SCHAUER
Manufacturing Corp.

4511 Alpine Ave. Cincinnati, Ohio 45242
Telephone: 513/791-3030

Microwave dissipating material casts readily

Transene Co., Inc., Route 1, Rowley, Mass. (617) 948-2501. Stock.

Liquid micropoxy, a strong microwave energy absorber material, readily casts into many shapes and forms in fabricating loads, attenuators, stripline structures and other dissipative parts for microwave frequencies. At 10 GHz, attenuation is 85 dB/inch, decreasing to 6.5 dB at 1 GHz. Power dissipation is better than 1 W/in.³ and volume resistivity is better than 10¹⁴ ohm-cm. Dielectric strength is 400 V/mil.

CIRCLE NO. 354

Terminal block rotates ±45° for easy access

ADC Products, Div. Magnetic Controls, Inc., 4900 W. 78 St., Minneapolis, Minn. (612) 929-7881.

A new "swinger" 26-pin terminal block rotates at full 45° in either direction for easy access to the terminals during installation and maintenance. With the block mounted in a distribution frame, installers or maintenance personnel can pivot the block to expose either side. The block can be mounted on both horizontal and vertical distributor frames. The block is available up to 12 rows high, with 26 terminals per row.

CIRCLE NO. 355

IC kit speeds up custom chip packaging

Exar Integrated Systems Inc., 733 N. Pastoria Ave., Sunnyvale, Calif. (408) 732-7970. \$80; stock.

Exar's IC design kit allows a breadboard circuit to be converted into a custom-tailored IC in two to four weeks; a lower cost per circuit than the price of many standard ICs is claimed. The XR-C100 kit provides more than 200 independent components, plus such sub-functions as current sources and balanced modulators in 22 individual IC packages. Exar furnishes custom packaged chips from a circuit schematic and a kit part interconnection diagram supplied by the user.

CIRCLE NO. 356

A photoelectric tape reader for the same price as a mechanical one!

- Speed**
1-120 CPS asynchronously
- Solid State**
LED reliability
- Low Maintenance**
Stepping Motor — single moving part



See us at fjcc

Write for literature regarding our new family of complementary OEM products — printers, punches, keyboards and readers manufactured in the Addmaster tradition. To gain an important competitive edge, contact



416 Junipero Serra Drive, San Gabriel, California 91776

INFORMATION RETRIEVAL NUMBER 93

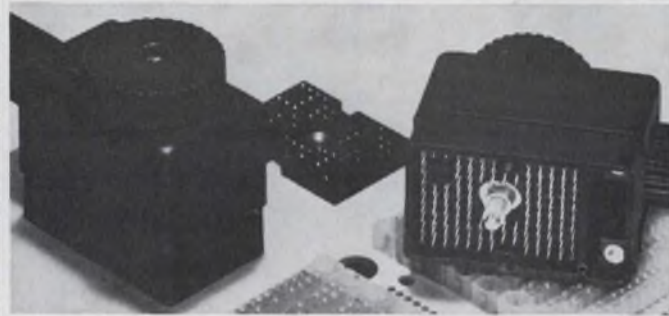

At last. An I/O connector designed exclusively for back panel assemblies.

Here it is. An input/output connector that features up to 120 crimp-removal contacts on a .100" grid which accepts #22 to #26 gage stranded wire.

The receptacle contacts, fixed to the panel half, can be supplied in numerous .025² wrap post lengths. The receptacle contacts are as precisely located as the rest of the back panel contacts, and automatic wiring presents no problem.

Get all the facts, write for free Bulletin No. I/O 100.

Gentlemen:
Please send me Bulletin No. I/O 100.



Name _____
 Company _____ Street _____
 City _____ State _____ Zip _____

Teradyne Components, Inc., 900 Lawrence Street, Lowell, Mass. 01852

INFORMATION RETRIEVAL NUMBER 94

A TOTAL CAPABILITY
FROM ADVANCED
THYRISTOR TECHNOLOGY

TRIAC's & SCR's

FOR MOTOR HEATING
COOLING AND LIGHTING
CONTROLS AND
SPECIAL APPLICATIONS

ALL POPULAR PACKAGE
CONFIGURATIONS WITH
VOID-FREE
GLASS-PASSIVATED CHIPS

Included are *electrically isolated* 6, 8, 10 & 15 Amp *center-gate* plastic (ISOTAB*) and 30 and 40 Amp *electrically isolated, center-gate* press-fit TRIAC's. All feature improved critical and commutating dv/dt ratings and di/dt capabilities with low switching losses.

Hutson thyristors are available in a wide range of current and voltage ratings from 3A and 4A sensitive-gate to 35 and 40 Amp standard gate devices; and from 30V and 50V to 600V (V_{DROM}).

PATENTED DI-MESA* CONSTRUCTION

This chip construction provides a dual mesa barrier to prevent minute fractures, caused by the dicing operation in glass-passivated chips, from spreading and causing an eventual device failure from repeated operational cycling.



*T.M. HUTSON INDUSTRIES

HUTSON INDUSTRIES

2019 W. VALLEY VIEW LANE
DALLAS, TEXAS 75234 (214) 241-3511
TWX 910-860-5537

Distributed by:

BODELLE COMPANY, Chicago, Ill.
312/468-1016 ■ NEWARK ELECTRONICS
CORP., Inglewood, Cal. 213/678-0441
THOR ELECTRONICS, Elizabeth, N.J.
201/354-2420

Canada: WEBER-SEMAD ELECTRONICS, Downsview, Ont.

European Marketing Director:

30 Rue Pierre Semard, Yverres, 91 France
Tel: Paris 925-8258 TELEX 21-311

Distributed in Europe by:

Switzerland: D. LEITGEB, Dubendorf
Sweden: ELEKTROFLEX, Sundbyberg
Spain: BELPORT, Madrid
Holland: RODELCO, Den Haag

Dry-transfer method gives fine PC prototype details

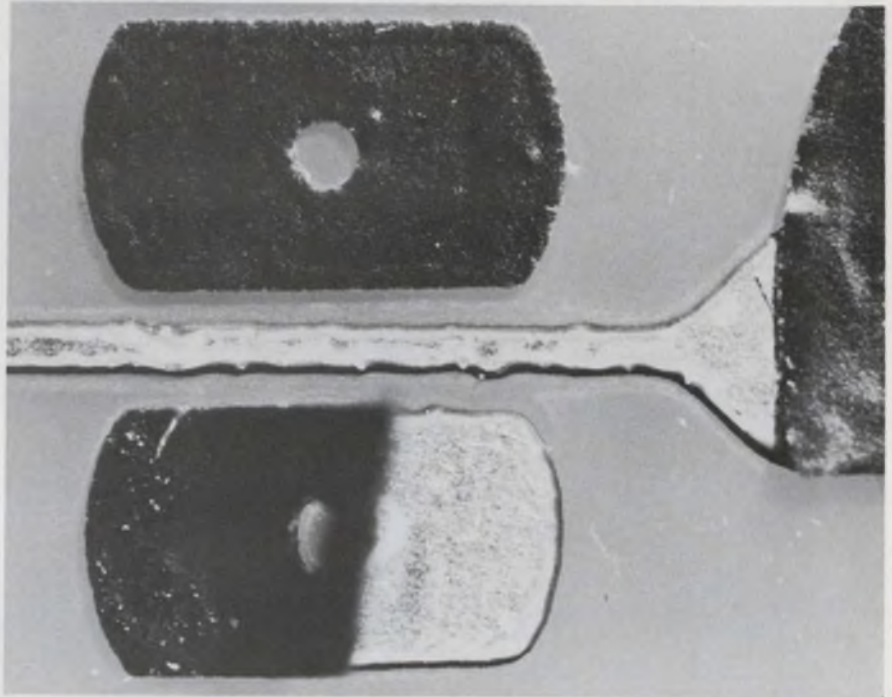

Datak Corp., 85 Highland Ave.,
Passaic, N.J. (201) 773-3399.
P&A: \$2.75; stock.

Making just one printed circuit economically has always been a problem. Datak has a new solution: a dry transfer resist made with a plastic ink that's tough, yet capable of printing the fine detail in DIP, flatpack and round TO-5 patterns.

The transfer patterns are supplied in a kit, ER-2, at \$2.75 each. Each kit contains eight sheets, including 1/16-inch lines, universal flatpack and dual inline patterns, round-can and plastic transfer pads and a roll each of 1/16-inch and 1/32-inch tape. The patterns rub off directly onto copper. The board is then etched; ferric chloride, ammonium persulphate or peroxide type etchants can be used. Afterward the resist is peeled off with a knife or scoured off with a wire brush and solvent.

The photograph shows a PC board after etching, with the resist partially removed to facilitate examination. Clearances from the pads to the line are seven to eight

thousands of an inch. The undercut on the 15-thousands line is only about 1.5 thousands.

Vector also has a dry resist that rubs directly onto copper. If you happen to need more than one board, then either company's resist is transferred onto clear Mylar, which is then used as a film positive with direct photo resist. There are other methods for making prototype boards. Instead of rubbing the resist onto a master, transfer can be made by cutting out or lifting off preprinted patterns from a sheet. Datak and Vector supply these also. And so do Bishop and By-Buk.

There are also pre-etched copper patterns, backed with a pressure-sensitive adhesive, which press directly onto a blank board and are connected with adhesive foil or wire. The PC board is thus fabricated directly without etching. Bishop and Circuit-Stik supply the material required.

FOR DATAK:
FOR BISHOP:
FOR BP-BUK:
FOR CIRCUIT-STIK:
FOR VECTOR:

CIRCLE NO. 357
CIRCLE NO. 358
CIRCLE NO. 359
CIRCLE NO. 360
CIRCLE NO. 361

ON THE MOST WANTED LIST

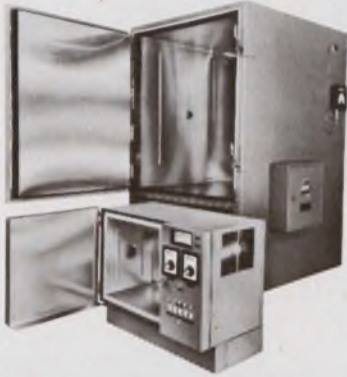

ALIAS MINI & MAXI

Real names: **TH-Jr. and TH-65.** Smallest and largest members of the "Tenney Gang" of reach-in, temperature-humidity chambers. Easily identified by the Tenney Vapor-Flo® humidity generation system and the fully hermetic, all-welded Hermeticool® refrigeration system.

Known to cover a temperature range of 0°F to 200°F and a humidity range of 20% to 95% RH. Noted for responsive performance. Praised for ease of operation and high reliability.

Can be found serving in evaluation or manufacturing of products sensitive to temperature and humidity environments. For details on Mini, Maxi and all the Gang in-between, call or write today:



1090 Springfield Rd., Union, New Jersey 07083 • (201) 686-7870
Western Division: 15721 Texaco St., Paramount, Calif. 90723



INFORMATION RETRIEVAL NUMBER 96

our tape heads sell computer tape drives!

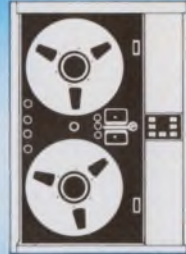

Nortronics' comprehensive line of 7 and 9 channel, IBM-compatible heads for 1/2" tape are specified by leading manufacturers all over the world.

Maybe that's because of extra features such as our terminal connector which provides rapid head pluggability. But we also think it's due to Nortronics' unique ability to design the right head and deliver it in prototype or production quantities—anywhere in this world! Write for detailed technical information on Nortronics digital heads today!



8101 Tenth Ave. North • Minneapolis, Minn. 55427 • Tel: 612-545-0401

INFORMATION RETRIEVAL NUMBER 98

PANEL LIGHTS

Best buy in the field!

TEC-LITE volume production pays off for you —with quality replaceable cartridge lites priced as low as 49¢ in 500 quantities.

Your choice of three lens styles, ten lens colors, three cartridge holders (one for PCB), a full range of voltages and either neon or incandescent lamps. The RCL Series can be clip-mounted on the panel or plugged into matching RCLH Series lite holders.

For more information on RCL Series Panel Lites — or any part of our complete line of display/control products and systems — write: **TEC, Incorporated, 9800 N. Oracle Road, Tucson, Arizona 85704. (602) 297-1111.**

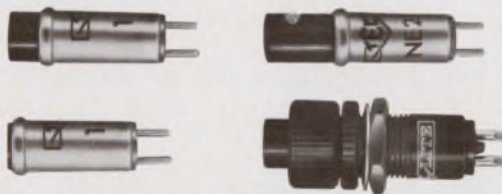

INFORMATION RETRIEVAL NUMBER 97

ELECTRONIC DESIGN 4, February 17, 1972

The "Ideal" Unity-Gain Follower Amplifier

PRICE BREAK THRU!
\$35
(O.E.M. Qties.)



MODEL AF2

UNI-AMP™

- ▶ High Input Resistance >10¹² ohms
- ▶ Low Input Capacitance <0.1 pF
 - ▶ Fast Rise Time, 30 nS
- ▶ Excellent Linearity, ±0.1% FS.
- ▶ High Dynamic Range, 120 dB, 10 μV to 10 V

TYPICAL APPLICATIONS

Photo Amplifiers & Transducers • Wide-Band Electrometer & Charge Amplifiers • Fast Pulse Instrumentation • A/D-D/A Converters • Sample & Hold Amplifiers • High Speed Comparators & Multiplexors • High Impedance Wideband Probes



Send for complete UNI-AMP data

BIOELECTRICS INSTRUMENTS

DIVISION OF GENERAL MICROWAVE CORPORATION
155 MARINE ST., FARMINGDALE, N. Y. 11735 • 516-694-3600

INFORMATION RETRIEVAL NUMBER 99



New Approach To Capacitive Measurements!

Digital Capacitance Meter Converters

New capacitance measuring techniques give results unaffected by capacitance of long cables to the point of measurement or stray capacitance to ground

- Accuracy of an automatic capacitance bridge at a fraction of the cost
- Analog and BCD (optional) outputs
- Two- or three-terminal measurements—with up to 25' of cable. Grounded guard.
- Capacitor testing and sorting up to 2000 pF
- Capacitance difference and deviation (bipolar)
- Signal conditioning with display for capacitive probes, cells and transducers for measuring, recording or controlling moisture in solids, ingredient ratio, level, flow, shaft position, micro-displacements, thickness, torque, etc.

Write for FREE series 2000 bulletins today!

SPEARHEAD
inc.

1401A Cedar Post Lane Houston Texas 77055 (713) 464-4882

INFORMATION RETRIEVAL NUMBER 100

THAT'S UP TO YOU!

LESS SPACE WITH THE MINIPULSE MOTOR. USING THE LSI DRIVING CIRCUIT!! DIVERSIFY YOUR PRODUCTS RANGE WITH THE MINIPULSE MOTOR. THE GUARANTEED PERFORMANCE. THE ECONOMICAL PRICE!!



MODEL PF1-20

Diameter 12 mm.
Max. Pull-out torque... 0.5 gr-cm.
Max. Pull-in rate..... 400 pps.
Step Angle 18°

Other six models for the higher torque are available. The diameter from 20 mm. to 51 mm. The maximum torque from 3.25 gr-cm. to 150 gr-cm. The stepping angle from 7.5°, 10° and up to 18°. You can use those models as well as the synchronous motors and the servomotors.

Please write your demand to us immediately

NIPPON PULSE MOTOR CO., LTD.

International Department

No. 13-16, 2 chome, Hongo, Bunkyo-ku, Tokyo, Japan. Cable: NIPULSEMOTOR TOKYO

Attention Advertisers:

Could you use copies of your ad exactly as it appeared in ELECTRONIC DESIGN? Then order your reprints directly from us; the minimum unit order is 500 copies.

Please specify if you would like the reprint line omitted on your copies and mail your written order to ELECTRONIC DESIGN, Production Dept., 50 Essex Street, Rochelle Park, New Jersey 07662.

500 1,000 Add'l M
8x10 or smaller

1 color, 1 side	\$74.70	82.95	18.15
2 color, 1 side	95.47	108.00	25.28
4 color, 1 side	311.03	342.00	44.33

Spreads

1 color	113.66	126.65	25.98
2 color	191.19	205.98	29.58
4 color	354.17	380.76	53.19

Prices FOB Waseca, Minn.

CIRCLE NO. 363

PACKAGING & MATERIALS

Miniature hook-up wire resists cut-through

Alpha Wire Corp., Div. Loral Corp., 711 Lidgerwood Ave., Elizabeth, N.J. (201) 925-8000.

Alpha's miniature hook-up wire with extreme cut-through resistance and small outer diameter (0.020-in. for #30 wire to 0.030-in. for #24) is widely used in computer and related industries employing wire-wrap techniques. The wire is packaged on especially-designed 1000-ft. spools with extra-large diameter cores to minimize the tendency to set when bent to small radii. The polyvinylidene fluoride insulation is rated for 300 V.

CIRCLE NO. 362

Tie mount is used on 6-in. diameter bundles

Panduit Corp., 17301 Ridgeland Ave., Tinley Park, Ill. (312) 532-1800. Stock.

New TMEH extra-heavy tie mount is used to mount large cables and bundles up to 6 in. diameter. A choice of #8, #10 or 1/4 in. screw holes is offered. The tie mount mates with releasable and self-locking type lashing ties also available from Panduit. The mount accommodates intermediate standard and heavy cross-section cable ties in addition to the lashing type. Standard packages contain 100 pieces, bulk packages 500.

CIRCLE NO. 363

Epoxy adhesive bonds large capacitor chips

Epoxy Technology, Inc., 65 Grove St., Watertown, Mass. (617) 926-0136. \$15; stock.

An insulating epoxy adhesive, H-55's great strength makes it suitable for bonding large capacitor chips. It's also used to bond chip resistors over transmission lines where an insulating film makes wire bonding difficult. No film is formed during H-55 curing. The epoxy can be used in the 300 C to 400 C wire-bonding temperature range and is virtually impervious to solvents, chemicals and moisture.

CIRCLE NO. 364

INFORMATION RETRIEVAL NUMBER 101

Bonding tape adheres to crinkle finishes

Neltape Div. of New England Laminates Co. Inc., 25 Crescent St., Glenbrook, Conn. Phone: (203) 359-0429. Availability: stock.

A new solid, dry film bonding tape provides high adhesion to crinkle finishes and other uneven surfaces with resistance to 400 F heat and to solvents. Neltape/400 is used with a variety of metals in nameplate and graphic arts applications. A choice of heat or solvent activation is offered. In both cases, the film softens and flows to make good surface contact. Width starts from 1/4 in. in 1/8 in. increments. The tape is delivered in 60-yard rolls.

CIRCLE NO. 365

Ribbon conductor cable woven to specifications

Atlas Asbestos Co., 488 Walnut St., North Wales, Pa. (215) 699-9266. 4 wks.

Product 6288, a new, flat ribbon conductor cable is woven to the user's individual specifications of number of wires, wire size, alloy and insulation. The ribbon cable is used in computers and other equipment requiring flexible and compact cabling. The cable takes virtually the same space as the conductors alone. Cable width to 6 in. is standard, but larger widths can be woven. Individual wires, of copper, aluminum or nichrome, have a 1/16-in. diameter limit.

CIRCLE NO. 366

Two-contact connector mates are very small

Microtech, Inc., 777 Henderson Blvd., Folcroft, Pa. (215) 532-3388. \$0.65; stock to 2 wks.

The tiny G-Series two-contact connectors consist of a male plug and female receptacle, each with dimensions less than 1/16 in. thick by 1/8 in. wide. The plug is 1/8 in. long and the receptacle 1/4 in. In medical instruments, hearing aids and similar microminiature applications, the connectors are cemented directly to the mating parts of an assembly to provide an electrical interconnection. Pins and sockets are gold-plated brass.

CIRCLE NO. 367

We've got TRW's number: Their entire X463UW capacitor series.



If you need their ultraminiature X463UW's but need them fast, ask for Elpac's HSA-7700 Series instead.

We'll give you the same capacitance values and voltage ratings. The same tolerances and stability. The same sizes and form factors: full interchangeability with no deviations. At more-than-competitive prices.

If that's not good enough, we've got a range of capacitors all our own. Instrument-grade wound-dielectrics from 0.001-20.00 μ F with tolerances as good as $\pm 1\%$ for voltages up to 600 Vdc. With polycarbonate, polysulfone, polyester or polystyrene dielectrics. All backed by our 100% testing, national distribution and delivery that's usually off-the-shelf.

What more could you ask for?

For free samples, call (714) 833-1717.

ELPAC COMPONENTS

18651 Von Karman, Irvine, Calif. 92664

An Elpac division. 

INFORMATION RETRIEVAL NUMBER 102

NO SOCKETS • NO SOLDERING

PRINTACT RELAY
24 VDC

MAGNETIC RELAY
with
Custom Features

- Low Thermal EMF
- 45-60db Isolation
- Low Contact Bounce
- Encapsulated Coil
- Bifurcated Contacts

At No Extra Cost!

Printact®

Plugs into your PC board... mates with plated conductors

The unique design concept of the Printact magnetic latching and non-latching relays provides $< 5.0\mu$ v thermal EMF, 45-65 db cross talk isolation, < 0.5 ms contact bounce and other custom features as standard at no extra cost. The single moving part is the pivoting armature with series break contacts held by a permanent magnet eliminating return springs, mechanical linkage and pigtail connections thus assuring reliable performance for many millions of cycles.

Available with 6, 12 or 24 VDC coils (0.5 watt G series, 1.0 watt LD series) in 2, 3 and 4 pole configuration. Series break swingers permit each pair of fixed contacts to be etched with common (Form C) or isolated (Form A plus Form B) switching between make and break circuits.

Send for catalog, 2X and 4X artwork stick-on contact patterns and Technical Notes PR262-D, which assist in simplifying PC board artwork, fabrication and procurement.

For a sample and/or data, write or call 212-EX 2-4800

Printact Relay Division, Executone, Inc., Box 1430ED, Long Island City, N.Y. 11101

INFORMATION RETRIEVAL NUMBER 103

USING ACTIVE FILTERS OR PASSIVE FILTERS ?

Are size, shape or weight considerations important? Special mechanical configurations offered—Hermetically sealed or encapsulations for pcb installations
Low, high, band pass and reject designs—Butterworth, Chebishev, Bessel or elliptic response characteristics—wide range of source and load impedances
Low frequency actives, stable toroidal LC's, RC twin-T's
No EXTERNAL components required
Unbiased recommendations on active or passive filter selections for maximum economy



instruments, incorporated

PHONE AREA 512/892-0752 • P.O. Box 698 AUSTIN TEXAS 78767

INFORMATION RETRIEVAL NUMBER 104

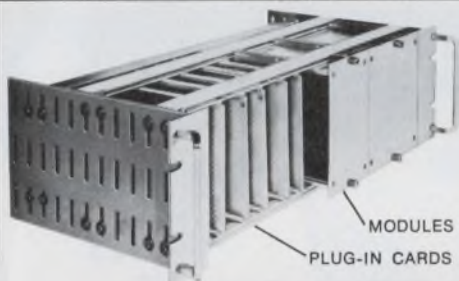

Vector-strut Cages Have Universal Adjustability

- STRENGTH
- HANDSOME APPEARANCE
- QUICK ASSEMBLY
- LOW COST

CHECK THE SPECS AND SEE:

THE VECTOR-STRUT CAGE provides an adjustable aluminum frame which through customer test has proven to be more versatile than other competitive units on the market.

- Mountable on 10", 19" or 24" racks.
- Three standard heights - 3 1/2", 7 1/2", 8 3/4".
- Three standard depths - 8.975", 11.975", 15.725".
- Prototype quantities shipped from stock. Production quantities in minimum time.
- Vertically slotted side walls and adjustable cross member end brackets allow universal height and depth adjustability for cards and module cases.
- Infinite adjacent positioning capability for modules, cards and connectors with extruded fastener holding ducts.

"EFP" ALUMINUM MODULE CASES" to fit Vector-Strut Cages

- Sixty (60) standard sizes for circuit cards, featuring 1/16" extruded grooves on .150" centers across case width for easy card mounting — no holes required in circuit board.
- Slide out side covers for quick access to cards.
- Front panels with captive thumb screws and rear panels either slotted or closed for user's connector design.

FOR HIGH FREQUENCY Vector Pak plug-in cases provide 90 to 100 DB of shielding with optional side panel gasketing.



Patented Features

Write the factory for specification data and prices.



Vector ELECTRONIC COMPANY, INC.
 12460 Gladstone Ave., Sylmar, Calif. 91342

INFORMATION RETRIEVAL NUMBER 105

design aids

Ceramic capacitor chart

A ten-page ceramic capacitor conversion chart cross references the military part number designations and dash numbers between MIL-C-39014B and MIL-C-39014A established reliability capacitors. Also included is a cross reference to equivalent MIL-C-11015D capacitors and a conversion table to equivalent Kemet Ceramic Capacitors. Union Carbide Corp.

CIRCLE NO. 368

Connector selection guide

A two sided 14-in. x 22-in. Elco wall plaque is a complete guide for selecting needed connector information at a glance. The guide has information on insulator materials, contact and plating materials, termination methods, Mil Specs, and a glossary of connector terms. Elco Corp.

CIRCLE NO. 369

Drill bushing terms

A comprehensive glossary of drill bushing terms contains five pages of terms used in selection. Welch Drill Bushing Co.

CIRCLE NO. 370

Computer graphics glossary

A list of terms frequently used in computer graphics defines much of the jargon of display systems. The ten-page guide is fully cross-referenced. Univac Div.

CIRCLE NO. 371

Soldering kits

A series of Paste Kits contains several types of brazing and soldering pastes which are compounds of filler, metal, flux and neutral binders. Applicators and an instruction sheet are included. According to the manufacturer, the kits are excellent tools for the engineer in developing metal joining techniques for automatic brazing and soldering production. Fusion Inc.

CIRCLE NO. 372

application notes

Heating in rf transistors

Hotshot effects in rf power transistors and the use of safe-operating-area curves to avoid performance degradation caused by these localized thermal phenomena are discussed in a new four-page application note. "Hotspotting in RF Power Transistors," application note AN4774, discusses the concentration of current in some areas of rf transistors during linear operation (Class A or AB) or operation with high collector supply voltage or high load VSWR. A design technique that minimizes hot-spot effects by use of emitter-ballasting resistors is explained and its effectiveness is demonstrated by comparative thermographs. RCA Solid State Div., Somerville, N.J.

CIRCLE NO. 373

How to select a yoke

Yoke selection involves consideration of the display system requirements, the CRT used, and the circuitry conceived. A guide to these factors and an application checklist simplify the decision-making. Syntronic Instruments Inc., Addison, Ill.

CIRCLE NO. 374

Teflon cables

Problem-solving information on the use of flat cables and flexible circuits of Teflon FEP film in computer wiring is contained in an eight-page booklet. It describes typical applications which utilize many of the properties of "Teflon," including high dielectric strength, superior reliability and retention of properties, bondability, no electrical tracking, nonwetting, nonflammability, and very low power factor and dielectric constant—only slight change over wide ranges of temperature and frequency. Du Pont Co., Wilmington, Del.

CIRCLE NO. 375

This?

or This?

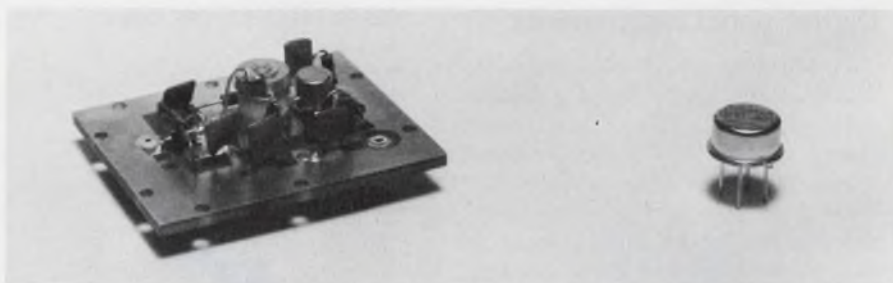

Avantek's GPD replaces up to 15 different components (and as many as 50 engineering manhours) at any frequency from 5 to 400 MHz... and it's cascadable.*

Avantek's inexpensive GPD (General Purpose Device) is packaged in a miniature TO-12 transistor can and serves as a completely cascadable thin film amplifier without bandwidth shrinkage.

The GPD consolidates all the functions of multiple resistors, capacitors, RF coils and a silicon transistor chip into a highly reliable unit of gain that minimizes assembly time as well as inventory requirements.

Avantek offers a series of three GPD models, featuring either 9 or 13 dB minimum gain and typical power outputs ranging from -2 to +15 dBm. Send for full performance specifications or, better yet, fill in the coupon below to order a sample set of three GPD's at more than 1/3 off the list price.

*U.S. Patent No. 3493882

Avantek ... Years Ahead Today

2981 Copper Road, Santa Clara, CA 95051

- Send full information on your new GPD amplifier series.
- Rush a sample set of your three GPD amplifier models for only \$99.95 (list price \$160.00).

NAME _____

TITLE _____

COMPANY _____

P.O. # _____

ADDRESS _____

ZIP _____

INFORMATION RETRIEVAL NUMBER 106

new literature

Digital panel instruments

A ten-page pocket-size guide to digital panel instrument selection entitled "Digital Panel Instrument Guide," lists specifications and prices for more than seventy-five individual Newport models. Cross referencing of all instruments in easy-to-read tabular form permits rapid evaluation and comparison to the user's requirements. Newport Laboratories, Inc., Santa Ana, Calif.

CIRCLE NO. 376

A/d encoders

A short-form catalog describes in detail the company's complete line of ultra-high-speed analog-to-digital converters, analog-to-digital encoder modules, fast settling digital-to-analog converters, and sample-and-hold modules. The firm's analog-to-digital converters offer conversion rates up to 320 megabits, with aperture time of less than 200 picoseconds, and word sizes ranging from 4 to 12 bits. Inter-Computer Electronics, Inc., Lansdale, Pa.

CIRCLE NO. 377

Rf connectors

An extensive line of 3mm miniature rf connectors is described in a new 72-page SRM catalog which features two-color connector photos, dimensional drawings and complete technical specifications. Seaelectro Corp., Mamaroneck, N.Y.

CIRCLE NO. 378

Dual-in-line hardware

Seventy-eight different types of panels, including socket boards, connector boards and special boards are shown in a new 28-page EECO Dual-In-Line Socket Board and Packaging Hardware Catalog. The catalog also includes 49 standard drawers and frame assemblies including fixed, swing-out, double level and front panel models. Electronic Engineering Co. of Calif., Santa Ana, Calif.

CIRCLE NO. 379

RELAYS, TRANSFORMERS, COILS

solid state relays
reed relays
power relays
latching relays
light controlled relays
frequency sensitive relays
time delay relays
transformers
toroidal inductors



Relays and coils

A 48-page catalog describes a line of relays and coils including optoelectronic relays, reed relays, and miniature transistor transformers. All units utilize a miniaturized, ruggedized design and are recommended for military and industrial application. Solid State Electronics Corp., Sepulveda, Calif.

CIRCLE NO. 380

Electromechanical devices

A 120-page catalog of bargain buys in instruments, transducers, recorders, gives specifications on thousands of terminated inventory electronic and mechanical instruments and equipment—all priced at a fraction of OEM cost. Lee Lab Supply Div., of Datacraft, Inc., Gardena, Calif.

CIRCLE NO. 381

Magnox iron oxides

A technical data bulletin about Magnox iron oxides is available. Magnox brown oxides are used in the preparation of magnetic tapes for audio, video, instrumentation, and computer applications, as well as for discs, drums, magnetic ticket coatings, and movie film striping. Magnox black oxide meets the special requirements of magnetic inks for printing and transfer media. Hercules Inc., Wilmington, Del.

CIRCLE NO. 382

Solid tantalum capacitors

A product catalog describes Kemet Epoxy Molded T310 Series axial lead solid tantalum capacitors. The T310 Series are available in four case sizes in capacitance ratings that correspond with the popular Military A, B, C, and D CS/CSRi3 metal cases up through 50 V. They are available in a capacitance range from 1 through 330 μ F with voltage ratings of 6 to 50 Vdc in ± 20 , ± 10 , and $\pm 5\%$ capacitance tolerances. Union Carbide Corp., Components Dept., Greenville, S.C.

CIRCLE NO. 383

A/d converter system

The Analogic AN5800 series multichannel multiplexing a/d converter system which provides up to 64 multiplexed 8 to 15-bit ADC channels in the master control/display chassis, and expansion capability without limit on compatible expansion chassis, is described in a new brochure. Analogic, Wakefield, Mass.

CIRCLE NO. 384

Schottky TTL ICs

A brochure describes the company's line of Series 54S/74S Schottky-clamped TTL ICs. Bulletin CB-147, 26 pages, provides aids for designing high-performance digital systems using state-of-the-art Schottky TTL ICs. Texas Instruments, Dallas, Texas.

CIRCLE NO. 385

Linear IC tester

A 12-page brochure on Sitek's Model 1420 Linear IC Tester and accessories gives comprehensive component test specifications augmented with a technical description on large signal measurement techniques. Information on transfer function characteristics, their relation to test specifications, and how the 1420 may be used to generate these characteristics is also included. Sitek, Inc., Sunnyvale, Calif.

CIRCLE NO. 386

When RFI problems get sticky, try *stickn* *fingers*®

Attaches faster, shields better than anything else!

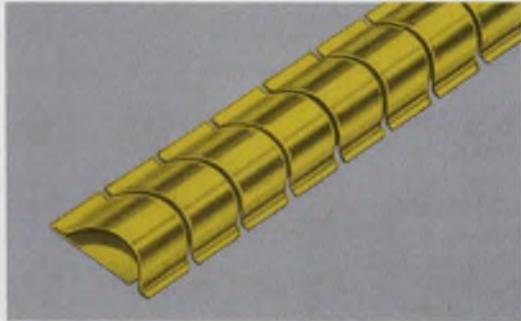

SERIES 97-500 The original Sticky Fingers with superior shielding effectiveness.

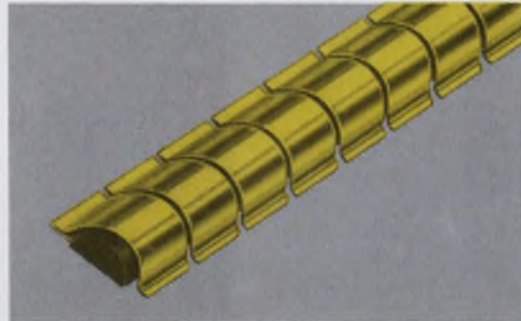

SERIES 97-510 Provides even better magnetic shielding with Magnefil® insert strips.



SERIES 97-555 New Single-Twist Series for use when space is at a premium. Measures a scant $\frac{3}{8}$ " wide.



SERIES 97-560 New $\frac{1}{2}$ " wide Double-Twist Series, ideal for panel divider bar cabinets.

Now you can specify the exact type beryllium copper gasket that solves just about every RFI/EMI problem. Perfect for quick, simple installation; ideal for retro-fitting. Self-adhesive eliminates need for special tools or fasteners. Write for free samples and catalog.



INSTRUMENT SPECIALTIES COMPANY, Dept. ED-65

Little Falls, N.J. 07424

Phone—201-256-3500 • TWX—710-988-5732

Reliability and Service

Two important reasons to discuss your power rectifier requirements with Tung-Sol.



Complete Line of Power Rectifiers

If your current requirements are in the 3 to 420A range, let us send you specifications and operational data on Tung-Sol DO-4, 5, 8, 9 and 21 types. Ratings up to 500A in flat base construction.

Higher Ratings in Standard Bridge Rectifier Packages

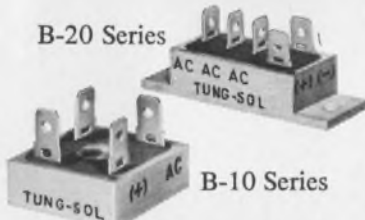

Single phase B-10 Series – 30A DC @ 55°C. Forward surge rating – 400A @ rated load. Replace similar bridges rated from 8 to 25A and from 50 to 1,000 PRV per leg.

Three phase B-20 Series – 35A DC @ 55°C. Forward surge rating – 400A @ rated load. Replace similar bridges rated up to 25A and from 50 to 1,000 PRV per leg.

WRITE FOR TECHNICAL INFORMATION. SPECIFY BRIDGES, OR POWER RECTIFIERS.

SILICON PRODUCTS SECTION
TUNG-SOL DIVISION
WAGNER ELECTRIC CORPORATION

630 West Mt. Pleasant Ave. Livingston, N.J. 07039
TWX: 710-994-4865 PHONE: (201) 952-1100
(212) 732-5426

Trademark TUNG-SOL Reg. U. S. Pat. Off. and Marcas Registradas

INFORMATION RETRIEVAL NUMBER 108

NEW LITERATURE



A/d—d/a converters

A 12-page catalog contains detailed electrical and mechanical information on a line of ultra-miniature analog-to-digital and digital-to-analog converters, plus accessories, sample and hold, analog multiplexers, and miniature dc power supplies. There are 71 models of 17 series described in detail in this new catalog. Datel Systems Inc., Canton, Mass.

CIRCLE NO. 387

Wires and cords

A 100-page catalog, "Wires and Cords for Electrical Appliance and Equipment Manufacturers," contains complete product and specification listings on GE's lines of flexible service and heater cords, appliance, fixture, motor, apparatus and transformer leads, switchboard wires, hookup and other electronic wires, aircraft wires, and computer and business machine wires. General Electric Co., Wire and Cable Department, Bridgeport, Conn.

CIRCLE NO. 388

Inductive components

An updated version of its brochure covering LC-filters, balun transformers and toroidal coils includes 20 pages of useful design advice on the selection of filter types and a modern glossary of filter terms, in addition to detailed specifications of each component. Cambridge Thermionic Corp., Cambridge, Mass.

CIRCLE NO. 389

GE semiconductors

A new 1250-page semiconductor data handbook contains an index and interchangeability guide, product selector guides, and product specification sheets. The selector guide section offers summary product information on all General Electric semiconductors including optoelectronics, SCRs, triacs, uni-junctions, rectifiers, transistors and circuit assemblies. The specification sheet section contains detailed product specifications. Copies are available for \$3.95. General Electric Co., Syracuse, N.Y.

11-bit DAC

A complete, binary, digital-to-analog converter that includes a current summing ladder network, analog switching, a precision voltage reference, an output operational amplifier and preset scaling and offset resistors, is featured in a six-page catalog sheet which provides complete specifications, applications information, diagrams, tables and photographs of the Model 848 D-to-A Converter. The new unit, featuring 11-bit resolution and a 4.0 V/ μ s minimum slew rate, is designed for direct "design-in" usage with a minimum of external components. Beckman Instruments Inc., Helipot Div., Fullerton, Calif.

CIRCLE NO. 391

Transformers

Transformers and related components are described with a considerable amount of general technical information in a brochure which engineers who specify transformers and people who buy transformers will both find useful. Northlake Engineering Inc., Antioch, Ill.

CIRCLE NO. 392

Scope applications

A 24-page booklet describes how an oscilloscope can be used for measuring pressure, force, acceleration vibration, temperature, displacement or strain, or can be an engine analyzer. Tektronix, Inc., Beaverton, Ore.

CIRCLE NO. 393

AC Voltage Control

VERSATILE — control up to 480 V, up to 300 A, 50 to 1200 Hz, single or three phase; and control it quietly without SCR-generated noise. Choose from hundreds of standard models or, as one out of five does, order a custom-tailored special.

RELIABLE — specify a device of uncompromising quality, so ruggedly built that only 1 out of 1000 is ever returned for repair during a two-year warranty period.

ECONOMICAL — compare; then use economical units, made even more attractive by generous quantity discounts.

FAST — receive prompt delivery on standard models off-the-shelf; wait only slightly longer for special units.

VARIAC® — of course! Great when introduced as the first commercial adjustable autotransformers, now they're 39 years better.

NEW! — A 2-amp unit for only \$13.00 — single-hole mountings, 140-volt output. Catalog and applications handbook for full line FREE on request.



for Line-Voltage Control



General Radio CONCORD, MASSACHUSETTS 01742

NEW YORK (N.Y.) 212 864-2722 (N.J.) 201 791-8990 BOSTON 617 646-0550 CHICAGO 312 892-0800
WASHINGTON, D.C. 301 881-5333 LOS ANGELES 714 540-9830 TORONTO 416 252-3395 ZURICH (01) 53 24 20

INFORMATION RETRIEVAL NUMBER 109

EDITOR

Tired of your present job? Looking for new opportunities to meet people, travel, to attend conferences on the latest microwave technology?

MicroWaves is seeking a graduate electronics engineer to add to its editorial staff. If interested and have writing ability, send resume to:

Hayden Publishing Co./MicroWaves
50 Essex Street
Rochelle Park, New Jersey 07662
(201) 843-0550
Richard T. Davis, Managing Editor

TEST CLIPS
After 100,000 wire insertions and removals contact resistance registered less than .001 ohms.



BI-PIN LAMP SOCKETS
Features 4 point PC mount for stability.



TRANSISTOR SOCKETS
Minimum insulation resistance of 500,000 meg-ohms at 100 VDC.



BINDING POSTS
Caps won't melt at soldering temperature.



Even hardware can be different

Grayhill is in termination hardware because our customers wanted something different.

And products and features shown above reveal only part of the picture.

Grayhill makes 100 other items of termination hardware — developed for superior insulation, dielectric strength, minimum contact resistance. And if what you need isn't in our line now, we can design and make it for you.

For our latest Engineering Catalog write or phone: Grayhill, Inc., 565 Hillgrove Ave., La Grange, Illinois 60525. (312) 354-1040.



INFORMATION RETRIEVAL NUMBER 110

FREE TEST



shows you how to save costs
SUPERIOR NO. 30 FLUX
prevents corrosion when soldering
Ideal for printed circuit boards

Why take chances that corrosion from soldering will cause rejects and unnecessary expense? Use the same flux that hundreds of our customers all over the world are using — Superior No. 30 NON-CORROSIVE SOFT SOLDER LIQUID FLUX. We'll sample it to you at no cost to prove that it will end corrosion problems! It's positively non-corrosive. No zinc, ammonium chloride, resin or gum. Non-hygroscopic, non-conductive... no fumes or disagreeable odors. Residue is water soluble. Makes soldering easier and faster!

Send coupon below or check reader service card for free sample now. After you've tested it, you'll be mighty glad you did.

SO SUPERIOR THAT IT IS PATENTED
Meets U.S. Army Sat. Com. Agency Spec. SM-A-571678

send for
FREE
sample
TODAY!

SUPERIOR FLUX COMPANY • Est. 1932
1530 St. Clair Ave., Cleveland, Ohio 44114

Send free sample No. 30 FLUX

Send prices and details

FIRM _____

ATTN. OF _____

ADDRESS _____

CITY _____

STATE _____

ZIP _____

INFORMATION RETRIEVAL NUMBER 111

OPCOA

lamps and displays

with

SOLID-LITE

Gallium Phosphide LED's..

THE HIGH-EFFICIENCY DIODES FOR BRIGHT LIGHT AT LOW CURRENT.

New SOLID-LITE SLA-3 Numeric Display with 0.8-in. character

- Largest available solid state numeric display
- Low voltage operation compatible with TTL and DTL IC's
- Single-plane wide viewing angle
- High reliability—200,000-hr. half life
- Excellent shock and vibration resistance
- Thin package—0.100-in. lead spacing

New SOLID-LITE OSL-3 and -3L Lamps with exceptionally wide viewing angle

- Large 0.200-in. diameter lens with long or short dome
- Red or clear lens available
- Low voltage, low power operation
- Area light source—not a pinpoint
- IC compatible
- Excellent shock and vibration resistance
- High reliability—200,000-hr. half life
- Socket or soldered mounting—0.100-in. lead spacing
- Low cost

For technical information or applications assistance, contact OPCOA, Inc., 330 Talmadge Road, Edison, New Jersey 08817; (201) 287-0355; TWX 710-998-0555.

OPCOA

bulletin board

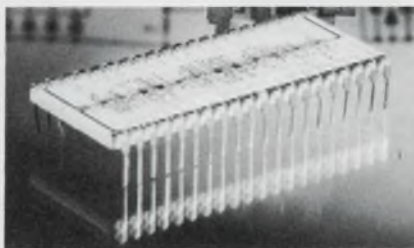

Texas Instruments has introduced seven new beam-lead low-power TTL chips; the only known low-power TTL beamlead chips currently on the market. They include a quadruple 2-input positive-NAND gate, dual 4-input positive-NAND gate, 8-input positive-NAND gate, 2-wide 4-input AND-OR-INVERT gate, single J-K edge-triggered flip-flop, and two dual J-K edge triggered flip-flops. These Series 54L/74L chips feature the same electrical characteristics as their standard Series 54L/74L counterparts, such as typical power dissipation per gate of 1 mW at a 50% duty cycle; a propagation delay of only 33 ns; high noise margin, typically 1 V at 25 C; and a fan-out of 10 Series 54L/74L loads. Prices range from \$1.97 to \$2.57 each in 1000-up quantities.

CIRCLE NO. 394

A family of seven IC voltage regulators introduced by Fairchild Semiconductor's Analog Products Div. provides seven voltages from 5 to 24 V. Output voltage tolerance of the 7800 series is $\pm 5\%$, and the units provide 0.01%/V line regulation and 30 M Ω output impedance for load regulation. Rated output current is one amp, but 7800 devices can be used with output currents up to 1.5 amps, depending on the regulation range, input voltage and heat sinking used. The 100-999 price is \$1.75.

CIRCLE NO. 395

The Signetics 8280, 8281 and 8288 counters have been redesigned using level sensitive (dc) flip-flops for each stage, thereby eliminating the maximum fall

time requirements for the clock signal. In addition, the logic circuit was modified to minimize the strobe and reset hold times. The new counters are pin-for-pin compatible with the stored-charge version (original design) and can replace those devices in existing circuits without requiring any design modifications. To minimize hold times, the logic circuitry was modified so that each J-K flip-flop is disabled for the duration of the strobe or reset signal. This prevents high-to-low output transitions from toggling the next bit during reset or strobe. This means that the strobe and reset hold times are determined solely by the propagation delay through the basic flip-flop, and not by the number of counters in a series string. The 8280/81 (dc) counters will accept a clocking transition typically 30 ns following the entry of parallel data or 50 ns following the activation of reset. These parameters are defined as Data Strobe Release Time and Reset Release Time respectively.

CIRCLE NO. 396

Integrated Circuit Engineering Corp., Phoenix, is offering to electronic manufacturers and semiconductor suppliers requiring custom monolithic chips—a free bipolar wafer processed from the customer's mask set. Wafers will be processed with guaranteed transistor parameters where the design specified falls within the range of ICE's standard process and electrical parameter range. The offer is based on ICE acceptance of a commercial grade mask set and expires March 1, 1972.

CIRCLE NO. 397

Price reductions

North American Rockwell Microelectronics Company (NRMEC) has announced reductions by as much as 42% in prices for its

silicon-on-sapphire (SOS) diode arrays. The firm is now quoting \$26 each for its 40 by 128 SOS diode array (p/n 15900NA) custom encoded as a read-only memory (ROM) or as a character generator in 500 to 999 quantities. The former price for this quantity range was \$45. The 25 to 99 quantity range is now quoted at \$45 each for custom coded devices, a 30% drop. The 100 to 499 range was reduced by 33% to \$30 each. With approximately 3200 bits available for encoding on each array, custom-encoded SOS/ROMs with 20 ns access time will cost only seven-tenths of a cent per bit at the 1000 to 4999 quantity price of \$23.

CIRCLE NO. 398

Trygon Electronics, subsidiary of Systron-Donner Corp., has achieved price reductions of up to 30% on its line of Super-Mercury lab and systems rack or bench mounted power supplies. Lower selling prices are available on models from 5 V dc at 130 amps up to 160 V dc at 5 amps. These price reductions are attributed to the addition of an overvoltage protection option at no extra cost and certain costs savings realized through high volume production. Typical prices are: 0.15 V dc @ 30 A with overvoltage protection standard, \$750; 0-8 V dc @ 50 A 0 V standard, \$595; 0-60 V dc @ 10 A, 0 V standard, \$645.

CIRCLE NO. 399

Cal-R Thermonetics Div., has announced price reductions of up to 60% off published prices on 0.055-in. and 0.75-in. disc type thermistors. Miniature disc thermistors were originally used in small temperature sensing probes. Increased demand for circuit package miniaturization, however, has resulted in their primary use being temperature compensation of systems and other components. They are also used

extensively for temperature control in the computer and instrumentation industries. Standard thermistors having a $\pm 10\%$ resistance tolerance at 25 C are now priced from \$1.50 to \$0.13 each depending upon quantity purchased. Delivery is stock to four weeks.

CIRCLE NO. 400

Information Control Corp. has announced a new CorPak-8 pricing package which allows PDP-8I minicomputer users to save up to 38% in add-on core memory costs. For a PDP-8I with 8K memory, the computer manufacturer normally charges \$10,600 for each additional 8K of memory. ICC's price for the first 8K of add-on is \$6400—and \$3132 for each 4K after that—up to the computer's limit of 28K of add-on. At manufacturers listed prices, a PDP-8I user with the basic 4K memory would pay the computer manufacturer \$35,800 for 28K of additional memory. ICC's new pricing package would furnish the same memory for \$22,060. One reason for the lower cost is that the ICC design calls for the addition of only one add-on core memory chassis, in which the customer can purchase, in 4K increments, whatever amounts of memory he wishes.

CIRCLE NO. 401

Relcom has reduced prices up to 26% on Models M6D and M6E double balanced mixers from \$50 to \$37 each in quantities up to four pieces. The frequency range for the M6D is from 0.05 MHz to 200 MHz, while the M6E frequency range is 5 MHz to 500 MHz. Both mixers are guaranteed to meet their specifications during and after environmental stressing per MIL-STD-202D. Uses include up-down frequency conversion, amplitude and pulse modulation, phase detection, switching and current-controlled attenuation.

CIRCLE NO. 402

SPECIAL PURPOSE TELEVISION CAMERAS

1270 SERIES



- General Purpose
- Low Cost
- 800 Line Horizontal Resolution
- Environmental Proofed
- Rugged
- Remote Control

1400 SERIES



- Miniature Size
- Low Cost
- 800 Line Horizontal Resolution
- Low Power Requirement

1500 SERIES



- Subminiature Size
- Extra Rugged
- 800 Line Horizontal Resolution
- Battery or Line Operated

2800 SERIES



- Self-Contained
- General Purpose
- 800 Line Horizontal Resolution
- RS 170 Synch Generator
- Power Line Operation

MODEL V1000



- Ultra High Resolution (30 MHz bandwidth)
- Photographic Quality
- Flat Field
- Multiple Scanning Rates (525-1225)

MONITORS • SWITCHERS
PAN & TILTS
VIDEO TAPE RECORDERS
REMOTE CONTROLS
ACCESSORIES



Edo Western CORP.

GENERAL OFFICES: 2645 South 2nd West, Salt Lake City, Utah 84115
(801) 486-7401 • Telex: 300 315

INFORMATION RETRIEVAL NUMBER 114

Design Data from Manufacturers

Advertisements of booklets, brochures, catalogs and data sheets. To order use Reader-Service Card.
(Advertisement)

PC Drafting Aids Catalog



Thousands of time saving, cost saving artwork ideas are found in the By-Buk P-50 catalog of pressure sensitive printed circuit drafting aids. With the most practical artwork patterns for: TO cans, multi-pads, dual-inlines and flat packs featured. Donuts, connector strips, teardrops, ovals, tapes, tees, elbows, etc., by the hundreds are included in the most comprehensive list of sizes. Opaque black, transparent red and transparent blue materials for one and two-sided board designs. For a free copy and samples, write today.

By-Buk Company

Subsidiary of Webtek Corp., 4326 W. Pico Blvd.
Los Angeles, California 90019 (213) 937-3511

CIRCLE NO. 171

WORLD'S SMALLEST 5VDC/100 AMP POWER SUPPLY

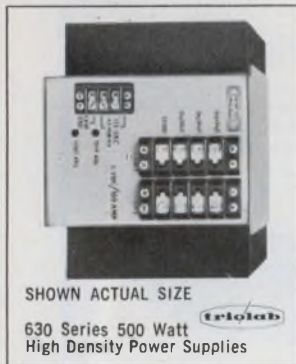

Now you can squeeze your power supply down to fit your microcircuitry with our complete line of off-the-shelf 100 watt to 500 watt supplies. All offer small size, lightweight, high efficiency, cool operation, low cost.

630 Series 5V/100 Amp supply has volume under 500 cubic inches! ($8\frac{1}{2}'' \times 6\frac{3}{4}'' \times 8\frac{3}{4}''$); weighs under 20 lbs; 65% efficiency even with light load conditions; no forced air or external cooling for full rated output to 55°C; priced lower than large conventional supplies. Quantity 1-9 \$695 ea.

The 100 watt series come in single, dual, triple outputs; 5VDC to 30VDC; commercial, Military, and export models available.

Trio Laboratories, Inc.

80 Dupont Street
Plainview, Long Island, N. Y. 11803

CIRCLE NO. 172

Free Nomograph Simplifies PSD Calibration

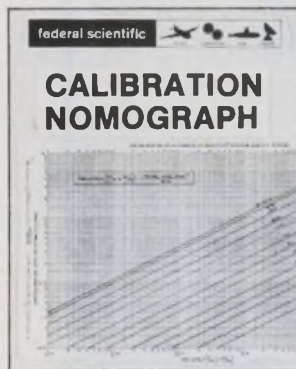

A new unique tool, Federal Scientific's Nomograph provides a fast means of calibrating a real-time power spectral density system in terms of PSD level using a sine wave calibration signal. It makes it possible for the user of a Ubiquitous® Spectrum Analysis System to easily scale the output data in terms of g^2/Hz and V^2/Hz . Printed on $8\frac{1}{2} \times 11$ heavy glossy stock for durability, it is useful for all those who analyze random data such as noise, vibration, or underwater acoustic signals. It applies expressly to Federal's Ubiquitous series of Real-Time Spectrum Analyzers with 200, 400, 500, 1000, or 2000-line resolution. It allows a non-technical operator to take into account the bandwidth of analyzers and gain settings of the system when performing calibration. Write to Federal for your copy.

CIRCLE NO. 173

Federal Scientific Corporation

a subsidiary of Elgin National Industries, Inc.
615 West 131st Street, New York, N. Y. 10027

Electronic Design

ELECTRONIC DESIGN's function is:

- To aid progress in the electronics manufacturing industry by promoting good design.
- To give the electronic design engineer concepts and ideas that make his job easier and more productive.
- To provide a central source of timely electronics information.
- To promote communication among members of the electronics engineering community.

Want a subscription? ELECTRONIC DESIGN is sent free to qualified engineers and engineering managers doing design work, supervising design or setting standards in the United States and Western Europe. For a free subscription, use the application form bound in the magazine. If none is included, write to us direct for an application form.

If you do not qualify, you may take out a paid subscription for \$25 a year in the U.S.A., \$35 a year elsewhere. Single copies are \$1.50 each.

If you change your address, send us an old mailing label and your new address; there is generally a postcard for this bound in the magazine. You will have to requalify to continue receiving ELECTRONIC DESIGN free.

The accuracy policy of ELECTRONIC DESIGN is:

- To make diligent efforts to ensure the accuracy of editorial matter.
- To publish prompt corrections whenever inaccuracies are brought to our attention. Corrections appear in "Across the Desk."
- To encourage our readers as responsible members of our business community to report to us misleading or fraudulent advertising.
- To refuse any advertisement deemed to be misleading or fraudulent.

Microfilm copies are available of complete volumes of ELECTRONIC DESIGN at \$19.00 per volume, beginning with Volume 9, 1961. Work is now in process to complete the microfilm edition of Volumes 1-8. Reprints of individual articles may be obtained for \$2.00 each, prepaid (\$.50 for each additional copy of the same article) no matter how long the article. For further details and to place orders, contact the Customer Services Department, University Microfilms, 300 North Zeeb Road, Ann Arbor, Michigan 48106 telephone (313) 761-4700.

Want to contact us? If you have any comments or wish to submit a manuscript or article outline, address your correspondence to:

Editor
ELECTRONIC DESIGN
50 Essex Street
Rochelle Park, N.J. 07662

Electronic Design

Advertising Sales Staff

Bryce Gray
Sales Manager

Rochelle Park, N.J. 07662

Robert W. Gascoigne
Daniel J. Rowland
50 Essex Street
(201) 843-0550
TWX: 710-990-5071

Philadelphia

Thomas P. Barth
50 Essex Street
Rochelle Park, N. J. 07662
(201) 843-0550

Boston 02154

Joseph F. Palmer
1268 Main Street
Waltham, Mass.
(617) 894-2700

Chicago 60611

Thomas P. Kavooras
Berry Conner, Jr.
200 East Ontario
(312) 337-0588

Cleveland

Thomas P. Kavooras
(Chicago)
(312) 337-0588
(call collect)

Los Angeles 90303

Stanley I. Ehrenclou
Burt Underwood
2930 Imperial Highway
Inglewood, Calif
(213) 757-0183

San Francisco 94022

Jerry D. Latta
95 Main Street
Los Altos, Calif.
(415) 941-3084

London W. 1

For United Kingdom and Holland
Brayton C. Nichols

For Eastern Europe

Peter Kehr

The American Magazine Group

27 Maddox Street
London, W. 1, England
Phone: 499-0180
Cable: Ammagnic, London

Verviers, Belgium

For Continental Europe

Andre Jamar
1, Ru Mallar, 1
087) 253.83 Telex 41563

Tokyo

Haruki Hirayama
Electronic Media Service
5th Floor, Lila Bldg.,
4-9-8 Roppongi
Minato-ku
Phone: 402-4556
Cable: Electronicmedia, Tokyo



AMERICAN BUSINESS PRESS, INC.

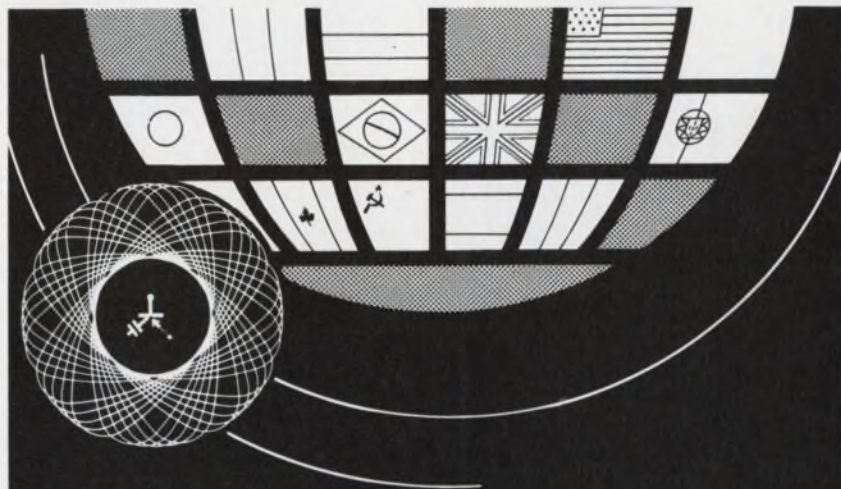

PARIS, APRIL 6, 7, 8, 10 AND 11, 1972
PORTE DE VERSAILLES

15th INTERNATIONAL ELECTRONIC COMPONENTS EXHIBITION

The world's most important event
in the electronic field.

Organized by the S.D.S.A.

For further information and complimentary entrance card please contact :
French Trade Shows, 1350 Avenue of the Americas,
New York, N.Y. 10019. Tel. (212) 582.4960



Detach here

I would like to receive information on the 15th Paris International Electronic Components Exhibition, as well as an entrance card.

Name _____ Title _____

Company _____

Address _____

Zip code _____

ED

Please send this coupon to : FRENCH TRADE SHOWS, 1350 Avenue of the Americas,
New York, N. Y. 10019.

PUBL-SERVICE

Now...from
AMPERITE-

**UTMOST
RELIABILITY in
SOLID STATE
(HYBRID)
TIME DELAY
RELAYS**

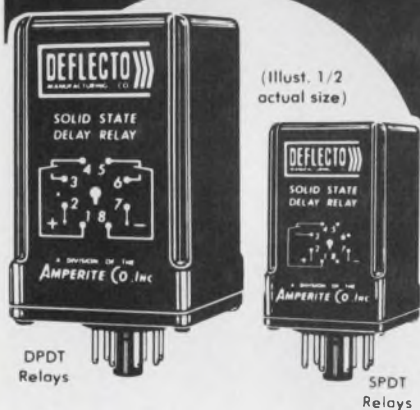

Maximum Dependability
at **LOW COST**
--backed by over 30 years
of Relay experience.

FEATURES:

**CONTACTS: SPDT, 3 Amps;
DPDT, 10 Amps.**
**VOLTAGES: 24V AC or DC;
28V AC or DC; 115V AC or DC.**

**5 TIMING RANGES:
From .1 to 300 Seconds.**

- Repeat accuracy of $\pm 5\%$; screwdriver adjustable time delays.
- Recycle time of 100 milliseconds. Transient and polarity protected.
- Relays plug into standard octal socket.

PRICES:

SPDT Relays: \$8.45 in 100 lots; wt. 2 ozs.
DPDT Relays: \$13.65 in 100 lots; wt. 6 ozs.

Write for Bulletin No. DSR-1

DEFLECTO Mfg. Co.

Div. of Amperite Co., Inc.

600 Palisade Ave., Union City, N.J. 07087
(201) 865-5648

**advertiser's
index**

Advertiser	Page	Advertiser	Page
AMP, Incorporated	57	Molex, Incorporated	Cover III
Acopian Corporation	135	Monsanto Company	113
Addmaster Corporation	139	Motorola Communications & Electronics, Inc.	109
Alan Industries	155	Motorola Semiconductor Products, Inc.	8, 9, 74, 75
Alco Electronic Products, Inc.	128	National Semiconductor Corporation	99
Allen-Bradley Co.	Cover II	New Product Engineering, Inc.	12, 13
Amphenol Components Group	11	Nippon Electric Company, Ltd.	142
Analog Devices, Inc.	87	North Atlantic Industries, Inc.	121
Avantek, Inc.	145	Nortronics Company, Inc.	141
Beckman Instruments, Inc., Helipot Division	95	OPCOA, Inc.	150
Bell, Inc., F. W.	131	Par-Metal Products	126
Bendix Corporation, The Electrical Components Division	31	Penntube Plastics Co., Inc.	128
Bioelectric Instruments	141	Pertec Peripheral Equipment	132, 133
Centralab, the Electronics Division of Globe Union, Inc.	114, 115	Philips Electronic Components and Materials	96A
Cinch Connectors, an Operation of TRW, Inc.	21	Piezo Technology, Inc.	110
Continental Connector Corporation	82	Pirgo Electronics, Inc.	106
Cutler-Hammer	37	Potter & Brumfield, Division of AMF Incorporated	18, 19
Data Precision Company	155	Power-Tec, Inc.	20
Decitek, Division of Jamesbury Corp.	134	Printact Relay Division Executone, Inc.	143
Deflecto Mfg. Co.	154	RCA Solid State Division	Cover IV
Delco Electronics, Division of General Motors Corporation	68, 69	RF Communications, Inc.	81
ECC Corporation	40	RFL Industries, Inc.	123
Edo Western Corp.	151	Raytheon Company	106, 107
Elco Corporation	25	Rectifier Components	155
Electro Switch Corp.	118	Requested Data Delivery Service	Cover II A-B
Elpac Components	143	Rotron, Incorporated	16, 131
Faratron	112	Rogers Corporation	131
Federal Scientific Corporation	152	S.D.S.A.	153
Fifth Dimension, Inc.	119	Schauer Manufacturing Corp.	138
Fluke Mfg. Co., Inc., John	35	Schweber Electronics	128 A-B
Fork Standards, Inc.	155	Shakeproof Division Illinois Tool Works, Inc.	122
Function Modules, Inc.	138	Siemens Corporation	2
GTE Automatic Electric	14, 15	Siliconix Incorporated	32A, A1-A6.B
General Electric Company	4, 5, 116, 125	Simpson Electric Company	83
General Instrument Corporation	101	Solitron Devices, Inc.	111
General Radio Company	1, 136, 137, 149, 156	Sprague Electric Company	6
German Chamber of Commerce	112	Spearhead Inc.	142
Grayhill, Inc.	149	Stackpole Carbon Company	33
Gudebrod Bros. Silk Co., Inc.	120	Superior Flux Company	149
Harris Semiconductor, A Division of Harris Intertype Corporation	16A	Syntronic Instruments, Inc.	135
Haveg Industries, Inc.	92	TEC, Incorporated	141
Hayden Book Company, Inc.	16B, 129	Tecnetics, Inc.	115
Hewlett-Packard	41, 42, 43, 44, 45, 46, 47, 48, 48A-B	Technipower, Inc.	89
Hickok Instrumentation and Controls Division	54	Tekelec Airtronic	96B
Houston Instrument, A Division of Bausch & Lomb	124	Tektronix, Inc.	53
Hudson Lamp Company	103	Teledyne Relays, A Teledyne Corporation	50
Hughes Aircraft Company	38, 39, 130	Tenney Engineering, Inc.	141
Hutson Industries	140	Teradyne	139
I.L.C. Data Device Corporation	10	Thomas Electronics, Inc.	155
Indiana General, A Division of Electronic Memories & Magnetics Corporation	88	Trio Laboratories, Inc.	152
Instrument Specialties Company	147	Triplett Corporation	104
Interdesign	102	Tucker Electronics	155
International Electronic Research Corporation	56	Tung Sol Division, Wagner Electric Corporation	148
Interstate Electronics Corporation	93	United Systems Corporation	125
Johanson Manufacturing Corp.	7	Unitrode Corporation	97
Keuffel & Esser Co.	127	Vactec Inc.	22
Kurz-Kasch, Inc.	135	Vector Electronic Company, Inc.	144
Lafayette Radio Electronics	125	Venus Scientific, Inc.	126
LogiMetrics, Inc.	58	Victoreen Instrument, Div. of VLN Corp.	135
3M Company	49	Wavetek Indiana Incorporated	117
MicroSwitch, A Division of Honeywell	55	Weatherford	129
Miller Company, J. W.	108	Webtek Corporation	152
		White Instruments, Incorporated	144
		Woven Electronics	120
		Zeltex, Inc.	17

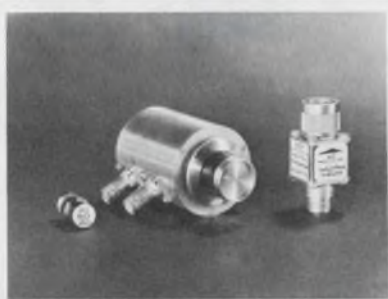

RF attenuators and RF components. Low cost and off-the-shelf Variable-Step Attenuators, Fixed Attenuators, Minimum Loss Matching Pads, RF Detectors, and Terminations covering the frequency range of DC-2GHz. All units are available with a wide choice of connectors in 50 and 75 ohm impedances. Alan Industries, Inc., Columbus, Ind. (812) 372-8860

INFORMATION RETRIEVAL NUMBER 181



New PDM Cathode Ray Tube. 12" rectangular electrostatic deflection crt incorporating post deflection magnification for high sensitivity and low distortion. Write for full details of PDM line up to 23" diam. size. Contact Thomas Electronics, Inc., Wayne, N.J. (201) 696-5200 for design application assistance.

INFORMATION RETRIEVAL NUMBER 182



L & N Type "W" 24 pt. recorders. Choice of paper speeds and t/c or MV range cards. Many features. Full warrantee. \$1295. ea. Send for '72 instrument catalog! Tucker Electronics Co. Box 435 Edison, N.J. (201) 225-2900

INFORMATION RETRIEVAL NUMBER 183

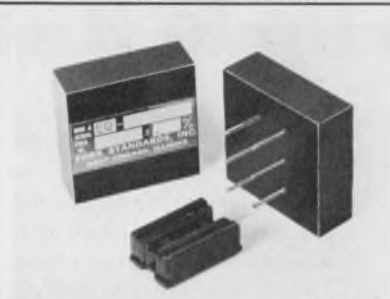

DIP-compatible model EQ oscillator combines crystal-controlled accuracy and stability with physical and electrical IC compatibility. Frequency range 1 Hz to 20 MHz at .002% accuracy. TTL compatible square wave output. Priced from \$50 singly. Fork Standards, Inc., 217 Main St., West Chicago, IL 60185. (312) 231-3511

INFORMATION RETRIEVAL NUMBER 184



Best Buy: 5 1/2 DMM, \$1195, delivers outstanding performance, 50% saving. Model 2540 gives DVC, ACV, resistance, voltg. ratio, auto-ranging, auto-polarity, isolated BCD outputs, remote triggering and ranging. $\pm 0.001\%$ f.s., $\pm 0.007\%$ rdg., ± 1 digit. guaranteed 6 mos. certf. of conformance. Eights models. Data Precision, Audubon Rd., Wakefield, Ma.

INFORMATION RETRIEVAL NUMBER 185

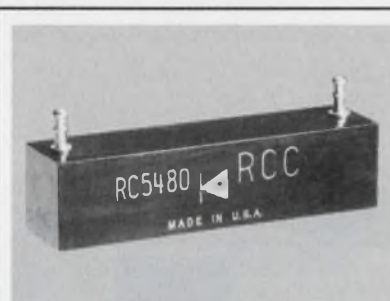

RC477 series HV silicon rectifiers - Val. Eng. version of JEDEC IN5477-IN5481. All ratings of the "IN" counterpart types are matched or exceeded. Has non-cavity, fully glassivated, controlled avalanche diodes interconnected via welding. 1-99—\$5.70 to \$8.50 dep. on voltage types. Rectifier Components Corp., Freeport, N.Y., Tel: 516 868-0470.

INFORMATION RETRIEVAL NUMBER 186

Advertisers wishing to reserve Quick Ad units should note the following mechanical requirements: Specs—Supply glossy photo of product and approximately 40 words which will set no more than 10 lines of 34 characters each. AFTER SUBMISSION NO COPY CHANGES CAN BE ACCEPTED. Quick Ads cost only \$300 per insertion, less for frequency advertisers.

RATES:

1x
\$300

7x
\$280

13x
\$255

19x
\$250

26x
\$245

39x
\$240

52x
\$235

104x
\$230

Clock Us!



Frequency-Response Recordings Up to 3 Times Faster

GR's new 1523 sweep oscillator/recorder can give you accurate frequency-response plots in 1/2 to 1/3 the time you've been accustomed to. And it gives you 1 Hz-to-500 kHz wide-range capability for only \$3800. You can sweep the full range, or selected portions of it, at output levels continuously adjustable from 500 μV to 5 V behind 600 Ω .

Speed

The 1523 features a "Constant-Q" mode that sweeps slowly at low frequencies and increases the sweep speed automatically as frequency increases. Many devices require slow sweep speed at low frequencies; Constant-Q lets you take advantage of the fact that, as the exciting frequency increases, the sweep speed can be increased without sacrificing measurement accuracy.

Only GR offers Constant-Q to increase sweep speed automatically for accurate answers in minimum time. An example of time savings is a three-decade analysis starting at a rate of 100 seconds/decade. Measurement time is 300 seconds with constant sweep speed but only 115 seconds with the Constant-Q mode.

Stability

The 1523 output frequency is stable within 0.05% stability (short term) over the entire measurement range through use of the frequency-synthesizer technique. With this method of signal generation, stability is always a constant percentage of output frequency, a considerable improvement over the older beat-frequency-oscillator technique.

Recorder Reliability

A stepper motor drives the chart (no gears or clutches to fail or jam) and the disposable cartridge pens deliver easy-to-read, skip-free traces at all writing speeds.

And for \$400 more . . . Our 1523-P1 Pre-amplifier plug-in converts the instrument to a 1 Hz-to-500 kHz high-performance level recorder with 100- μV sensitivity and chart speeds from 20 hours/inch to 0.5 second/inch. The -P1 plug-in module includes a continuously adjustable 0-to-70 dB attenuator for maximum resolution.

Write or Call Today

Do it now! Request complete specifications on GR's 1523 sweep oscillator/recorder from your nearest GR office or from GR at 300 Baker Avenue, Concord, Mass. 01742; in Europe write Postfach 124, CH 8034, Zurich, Switzerland.

Prices net, FOB Concord, Mass.

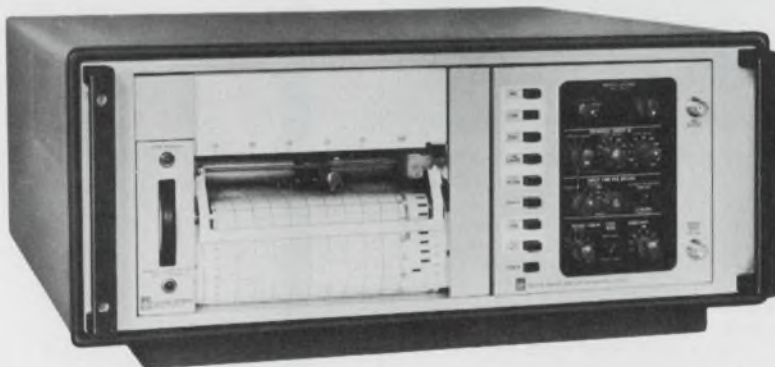

General Radio

NEW YORK (N.Y.) 212 964-2722 (N.J.) 201 781-8990 • BOSTON 617 846-0550
CHICAGO 312 992-0800 • WASHINGTON, D.C. 301 881-5333
LOS ANGELES 714 540-9830
TORONTO 416 252-3395 • ZURICH (01) 55 24 20
GRASON-STADLER 617 369-3787 • TIME/DATA 415 327-8322



THEY'RE MOLEX EDGE CONNECTORS. "Straight-on" or "right-angle" types for printed circuit boards. Terminals crimped to wires automatically. Reliable? And how! Connector terminals are bifurcated. Provide a really solid contact. Yet you can slip the connector on and off time after time without any damage to the printed circuits. And it's not a preload unit. Carries only contacts required. From six to twenty-four. Comes in white or six other colors. Terminals available in tin-plated brass with gold plating or selec-

tive gold plating. ■ A good example of how Molex helps create high-speed low-cost devices that simplify circuitry. If you want to save assembly time, steps and money, take a close look at these Molex edge connectors. For *free* samples write: Molex Incorporated, Downers Grove, Illinois 60515. Or you can make connections by calling (312) 969-4550.

*... creating components that
simplify circuitry*



RCA's thyristor line continues to expand— in plastic.

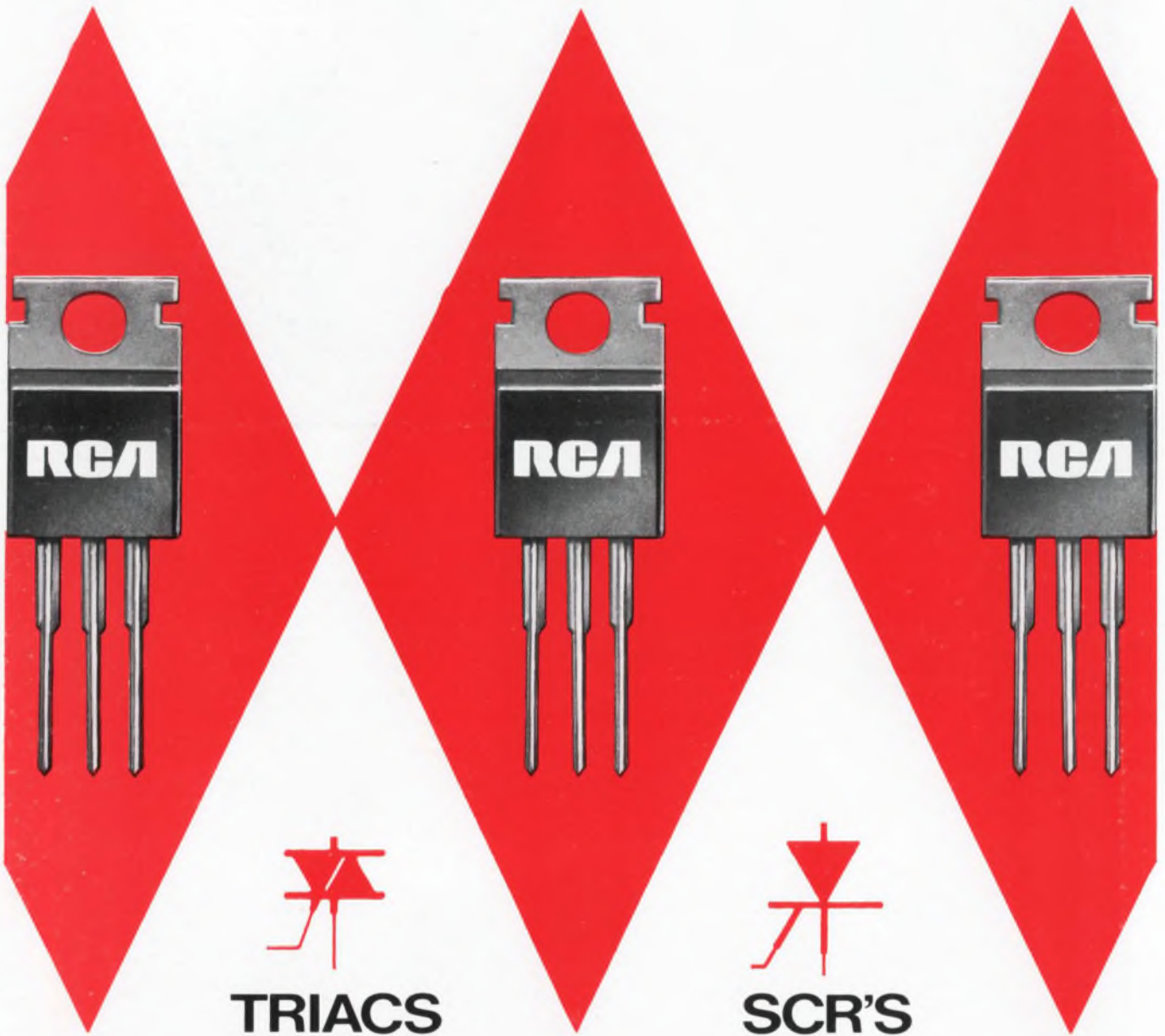

TRIACS

SCR'S

To its popular 40668/40669 triacs and 40868/40869 SCR's, RCA now adds 8 A ISOWATT triacs and 4 A SCR's—all available now—in the industry-accepted VERSAWATT package. Leads are custom-formed to your requirements, of course.

- ISOWATT triacs, 40900, 40901, 40902. These 8 A units are ceramic isolated versions of 40668/40669, providing great flexibility in chassis mounting.

- RCA-106 and 107. Here are 4 A SCR's that fill your needs for low-cost circuit areas that require triggering at 200 and 500 μ A. These RCA microamp gate SCR's

have extended voltage ratings to 500 V and 600 V.

- 40668/40669. Use these 8 A triacs for control of AC loads for power control and industrial lighting applications.

- 40868/40869. Select these 8 A SCR's for applications in power switching and motor speed controls.

RCA triacs are gate-controlled in all four modes.

RCA VERSAWATT thyristors employ glass-passivated chips for quality performance. When you design circuits using the RCA VERSAWATT thyristor, you get ease of mounting, low thermal impedance

for operation at elevated temperatures, and minimum heat sink requirements—all at excellent cost-effective levels.

With RCA's full plastic capability, you can cover full- and half-wave applications with currents from 1 to 15 A and voltages from 15 to 600 V.

See your local RCA Representative for details. For technical data, write: RCA Solid State Division, Section 57B-17/UR14, Box 3200, Somerville, N.J. 08876. International: RCA, Sunbury-on-Thames, U.K. or P.O. Box 112, Hong Kong. In Canada: RCA Limited, Ste. Anne de Bellevue 810, Quebec.

RCA Solid State
products that make products pay off

INFORMATION RETRIEVAL NUMBER 244