

# Electronic Design 26

FOR ENGINEERS AND ENGINEERING MANAGERS

VOL. 19 NO.

DEC. 23, 1971

**Japan at the crossroads:** With the latest technology and highly efficient production, the Japanese electronics industry challenges competition the world over. But

growth is slowing, labor getting scarce, and foreign capital and imports are gaining a foothold. For business trends, products and technology, see page 52.



**RENEW NOW!**  
CARD INSIDE  
FRONT  
COVER

# Ring up a savings on keyboard switches.



As much as **40%**  
[savings per key]

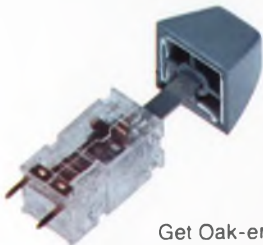

## The new Oak Series 400.

Get Oak-engineered quality in keyboard switches with the inherent reliability of electro-mechanical operation. Ideal for peripheral data-processing equipment. Contact bounce is less than 3 milliseconds. Long life, up to 20 million operations per key. Designed with self-cleaning crossbar-wiping contacts.



## A feather touch.

We kept the operator in mind. Standard operating force is approximately 85 grams (3 oz.).

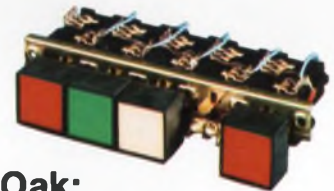

## Also from Oak: Series 300 Lighted Pushbutton Switches.

Featuring Oak's exclusive twin-lamp lighting. If one lamp goes out, the other stays on. Double-wiping contact clips. Short stroke. Smooth, quiet operation. Unlimited combinations. Request our Series 300 brochure.



## The configurations you want.

The Series 400 is available in limitless arrangements, including standard 10, 12, and 16-button keyboards. And you can specify any of six different contact circuitries. Choose snap-in or plug-in P.C. mounting. Compact—only 1/2" x 1/2" x 1".

Write today for our Series 400 brochure.

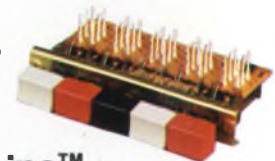

## And our Series 800 Econo-Line™ Pushbutton Switches.

Compact—more buttons and more contacts in less space: 1 PST to 8 PDT per button. Your choice of mechanical actuation. Colored buttons, legend engraving to your specifications. Request our Series 800 brochure.



## Under 40¢ each.

For SPST/NO in production quantities. Other versions comparably priced. Keypoint button and snap-in mounting extra.



**OAK MANUFACTURING CO.**

CRYSTAL LAKE, ILLINOIS 60014 · A DIVISION OF OAK ELECTRO/NETICS CORP

Telephone: 815-459-5000

TWX: 910-634-3353

TELEX: 722-447

INFORMATION RETRIEVAL NUMBER 101

# ARRAY OF HOPE

## For Low-Cost, Bipolar LSI

*Introducing a whole new concept in design flexibility — Motorola's 112-gate TTL array — the realization of economical custom LSI.*

### ARRAY CONCEPT PROVIDES MAJOR DESIGN ADVANTAGES

1. The design has already been proven except for the interconnections whose logical integrity can be established. Through Computer Aided Design probability of a successful part from the initial design is high.

2. Turn-around time is low for production quantities. And the array's predesigned cells make the use of Computer Aided Design easy.

3. Custom design costs are cut to a minimum since only metalization paths need be determined.

Besides yielding customized circuits in minimum time at low cost, the array concept provides a better speed/power product, lowers power consumption, and offers an overall reduction in system cost.

### 112 GATES AWAITING YOUR INSTRUCTIONS

Basically the device is a matrix array of 8 x 14 TTL NAND gates completely processed except for metalization. The designer has only to specify interconnection of the 14 8-input gates and 98 4-input gates to meet his overall function requirement. The array is then transformed into a custom circuit by designing metalization patterns which connect the gates into the desired functions.

Each cell can be used as a high-level, low-level or buss gate by connections made on the first layer metal. Signal wiring is done on second and third layers with power and ground runs on first and third layers. And AOI and totem pole configurations can be implemented by a simple combination of cells.

### HOW SOON AND HOW MUCH?

Using the array design, prototype samples can be available within three months ARO, with limited production quantities following six weeks later. And non-recurring design costs range from \$6 - \$12,000 depending on extent of computer analysis required. Unit cost of finished parts ranges from \$45.00 (1K) to \$23.00 (25K). Design cycles are shortened by months and costs by one-third through application of the array concept.

### START SAVING NOW

For further information on the 112-gate array write to Motorola Semiconductor Products Inc., P.O. Box 20912, Phoenix, Arizona 85036. Or for immediate assistance, call Larry Bradfield, collect, at (602) 962-2151. Larry will show you how to translate bipolar customizing into savings.



**MOTOROLA LSI Arrays**  
— New Concepts in System Design

# OUR ANGLE: High Speed Accurate and Automatic Angle Position Indicators

## WHAT'S YOUR ANGLE?



MODEL 545/100

If you're converting synchro/resolver data to digital format, you need both speed *and* accuracy to keep pace with today's data explosion. Only one converter meets both these requirements without compromise. And for under \$4K. . . . North Atlantic's Model 545/100.

The solid-state Model 545/100 converts both resolver and synchro data with  $0.01^\circ$  accuracy and resolution. And continuously digitizes input angle data at  $20,000^\circ$  per second in the face of real-life noise, harmonics and quadrature levels. BCD output is available at the rear connector. Conversion can be stopped by a data freeze command. If multiplexed signals are your bag, acquisition time is less than 30 ms.

Options? Other models offer many options, including  $0.001^\circ$  resolution with 10 arc-second accuracy; data frequencies from 60Hz to 2.4kHz, binary output, small size.

No matter what your conversion problem, if you require ultra-fast, ultra-accurate tracking, contact your North Atlantic sales engineering representative today. He'll show you a better angle.

**IN  
A**

**NORTH ATLANTIC**  
*industries, inc.*

200 TERMINAL DRIVE, PLAINVIEW, NEW YORK 11803  
cable: noatlantic / twx: 510-221-1879 / phone: (516) 681-8600

INFORMATION RETRIEVAL NUMBER 3

ELECTRONIC DESIGN 26, December 23, 1971

# Electronic Design 26

VOL. 19 NO.

FOR ENGINEERS AND ENGINEERING MANAGERS

DEC. 23, 1971

---

## NEWS

- 19 **News Scope**
- 22 **Computer researchers achieve their fastest switching so far** with measurements on Josephson superconducting junctions.
- 24 **Finally, a low-cost linear MIL package** has been developed for the linear IC user.
- 26 **A LED display replaces dial on new ADF tuning indicator.**
- 28 **New family of rugged switches promised.**
- 28 **Holograms reproduced faster and better.**
- 30 **And now, PC boards with built-in resistors.**
- 32 **Technology Abroad**
- 37 **Washington Report**

---

## TECHNOLOGY

- 52 **There's anxiety in Japan** with Japanese electronics executives reporting business problems and faltering markets.
- 60 **Use statistics in your logic design.** You'll find it easier to evaluate propagation delays, and optimization of Boolean equations is enhanced with this method.
- 64 **Use your oscilloscope for numeric display.** You can generate a line of seven-segment characters with standard components and up to 400 characters in a 'page.'
- 68 **Ideas for Design**

---

## PRODUCTS

- 75 **Instrumentation:** A 3-1/2-digit 5-V DPM is lowest in cost and size.
- 76 **Components:** Up to 50 g's of shock withstood by a mercury wetted switch.
- 78 **Modules & Subassemblies:** A tiny 8-bit d/a converter costs only \$9.95.
- 79 ICs & Semiconductors 82 Packaging & Materials
- 80 Data Processing 82 Microwaves & Lasers

---

## Departments

- 51 **Editorial.** Engineering without shame
- 7 Letters 85 Bulletin Board
- 13 Designer's Calendar 88 Advertisers' Index
- 83 Application Notes 88 Information Retrieval Card
- 84 New Literature

**Cover:** Cover photo from Matsushita Electric Industrial Co., Ltd., Kadoma, Osaka, Japan

---

ELECTRONIC DESIGN is published biweekly by Hayden Publishing Company, Inc., 50 Essex St., Rochelle Park, N.J. 07662. James S. Mulholland, Jr., President. Printed at Brown Printing Co., Inc., Waseca, Minn. Controlled circulation postage paid at Waseca, Minn., and New York, N. Y., postage pending Rochelle Park, N. J. Copyright © 1971, Hayden Publishing Company, Inc. 82501 copies this issue.

# Now... strip coax better,

Our new semiautomatic machine does the cleanest job yet of preparing coax cable for termination. It strips without nicking the braid or center conductor. It trims clean; no pulled outer jacket, no fraying of braid. Dielectric, braid and insulation are stripped to exact dimensions, all in one operation.

It can completely strip coaxial cable in about 5 seconds, a fraction of the time required for hand opera-

tions. Interchangeable tooling lets you handle a full range of cable sizes for the many AMP RF connectors and coaxial contacts. Available from AMP on our unique no-capital-investment arrangement.

It's the ideal working partner for AMP crimp-type connectors . . . the connectors that go on quickly, simply, cleanly and uniformly, with no possibility of heat damage to dielectric.



# connect it faster.

## A high-performance line of solderless, full-crimp coax connectors.

*Quick application . . .* labor-saving one- or two-crimp assembly cuts termination time as much as 90%.

*Superior RF characteristics . . .* broadband performance, low VSWR impedance-matching crimp.

*High reliability . . .* cable retention well in excess of MIL Spec values. Characteristics are repeatable even with unskilled operators, because of precision

crimping tools. Fully intermateable with their solder-type counterparts.

After the cable has been properly prepared by the stripping machine, it can be terminated very quickly with any one of a variety of high-performance AMP COAXICON\* connectors or contacts. This is readily accomplished by one or two crimps of the AMP hand or power crimping tools.

### Two-crimp assembly for single line COAXICON Connectors



1. To terminate the prepared coaxial cable with an RF connector, first crimp on the center contact.

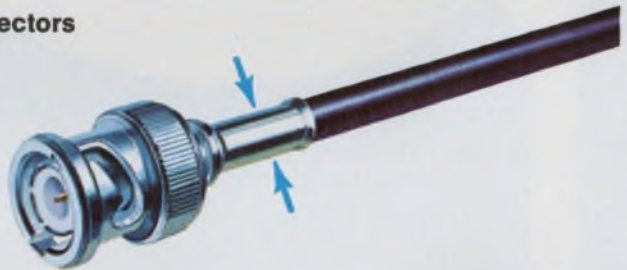

2. Then, install the connector body and crimp the ferrule. Both simple operations accomplished with the same tool.

### One-crimp assembly for multiple connector COAXICON Contacts

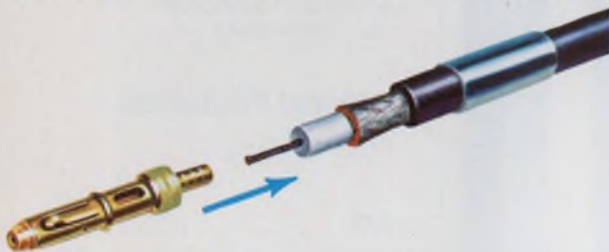

1. To terminate the prepared coaxial cable with a COAXICON contact, (Standard, Miniature or Sub-miniature,) first install the contact and ferrule in place on the cable.

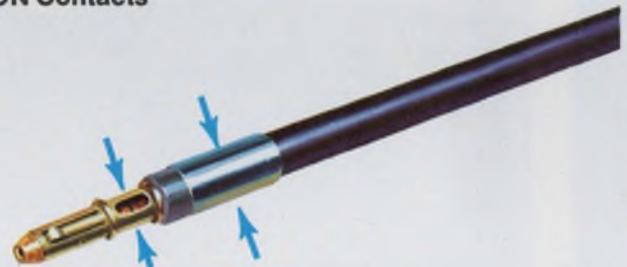

2. Then, with a single closure of the hand or power-assist tooling, the contact and ferrule are crimped simultaneously.

Stripping head sets are available to prepare RG/U type cables for terminating with a wide variety of AMP Connectors and COAXICON Contacts, including the following:

SMA • BNC • TNC • N Series • C Series • AMP Threaded Series • SMC • Subminiature COAXICON • Miniature COAXICON • Standard COAXICON •

When you're looking for a faster, better way to strip and connect coax, write **AMP INCORPORATED, Industrial Division, Harrisburg, Pa. 17105.**

**AMP**  
INCORPORATED

Manufacturing and Direct Sales Facilities in: Australia, Canada, France, Great Britain, Holland, Italy, Japan, Mexico, Puerto Rico, Spain, Sweden, United States and West Germany.

★Trademark of AMP Incorporated

INFORMATION RETRIEVAL NUMBER 4

# RMC DISCAPS

## *the complete Ceramic Disc line*

Over the years Radio Materials Company has maintained its leadership in the production of ceramic disc capacitors. A complete line offering outstanding quality has been the key to continuing growth.

### STANDARD

Type C, B, BA, JF, JL and JE

### SUBMINIATURE

Type SM, BT, TA and Magnacaps

### GREENCAPS

Type CG, JG, and BG

### SPECIAL

U.L. Listed Discaps, T.C. High Voltage, High K High Voltage and Dual Section By-Pass

#### SOLDER-IN T.C. DISCAPS

For application in equipment where lead inductance effects must be reduced to an absolute minimum.

If your application requires special physical or electrical characteristics, contact RMC's Engineering Department.

#### U.L. LISTED T.C. DISCAPS

Should be specified when the use is an integral part of an antenna coupling network where compliance with Underwriters' Laboratories specifications are required.

RMC  
.0039

DISCAP  
CERAMIC  
CAPACITORS

RMC

### RADIO MATERIALS COMPANY

A DIVISION OF P. R. MALLORY & CO., INC.  
GENERAL OFFICE: 4242 W. Bryn Mawr Ave., Chicago 46, Ill.  
Two RMC Plants Devoted Exclusively to Ceramic Capacitors  
FACTORIES AT CHICAGO, ILL. AND ATTICA, IND.

## Publisher

Peter Coley

## Editors

Editorial Offices  
50 Essex St.  
Rochelle Park, N.J. 07662  
(201) 843-0550  
TWX: 710-990 5071  
Cable: Haydenpubs Rochellepark

Editor: George Rostky  
Managing Editor: Ralph Dobriner  
Managing Editor: Raymond D. Speer

### Associate Editors:

Roger Allan  
Jules H. Gilder  
Richard Lee Goldberg  
John F. Mason  
Nathan Sussman  
Edward A. Torrero  
Richard L. Turmail

## Field Offices

### Massachusetts

Jim McDermott  
P.O. Box 272  
Easthampton, Mass. 01027  
(413) 527-3632

### West Coast

David Kaye  
2930 Imperial Highway  
Inglewood, Calif. 90303  
(213) 757-0183

### Washington

Don Byrne  
1111 S. Army Navy Drive  
Arlington, Va. 22202  
(202) 296-8982

## Editorial Production

Dollie S. Viebig

## Art

Art Director, William Kelly  
Richard Luce  
Anthony J. Fischetto

## Production

Manager, Thomas V. Sedita  
Helen De Polo  
Maxine Correal  
Anne Molfetas

## Circulation

Manager, Nancy L. Merritt  
Joan Licari

## Information Retrieval

Peggy Long



## across the desk

### Manager is optimistic about U.S. economy

Howard G. Melick's letter in ED 21, Oct. 14, 1971, p. 7 ("U.S. Is In Trouble, Manufacturer Says") while it is, in his words, "somewhat disjointed," raises questions that are bothering people in our industry. Here are some comments:

1. The fact that foreign products are increasingly available in our markets should not be distressing. The concept of comparative advantage works to the benefit of everyone involved in free trade. In terms of the traditional factors of production, we are at a disadvantage because of higher labor costs, but we enjoy the benefits of greater capital and more skillful management. This translates into our being able to make use of large-volume, high efficiency production facilities in competition with the foreigners' greater use of manpower. Our standard of living is improved by virtue of our ability to acquire goods with high labor content that might be prohibitively expensive if made here. What seems to be growing protectionism feeds on misunderstanding and on the cries of narrow, special-interest groups. The benefits of free trade must be recognized because a trade war at this time would mean a serious worldwide depression. The Japanese have been a special case, but the concessions they have had are being terminated. We should welcome direct fair competition from them in the same sense that Massachusetts welcomes competition from California.

2. The longer period for receivables is symptomatic of the general recession of policies deliberately initiated by the Federal Government. Diminishing profits are part

of the same syndrome. National economic advisors have recognized that these policies didn't work and have abandoned them. It is now reasonable to expect a gradual return to prosperity.

3. The problem of Big Labor is enormous, but it is not clear that labor's behavior is always to the detriment of the economy. It has been argued that labor represents a balance to the power of Big Business. Although this point of view is flawed, I doubt that labor's actions are so unruly as to threaten the economic ruin of the country.

4. Big Business is often accused of monopolistic practices, but when its detractors are called on to cite specific examples, with the exception of those sanctioned by the Government—for example, A.T.&T.—we find stiff competition is the rule. Further development of foreign trade will increase competition. Hence we want our Big Business to be strong to meet this challenge.

5. The demise of small business has been forecast for decades, even centuries. Nevertheless in the last few months new incorporations have trended sharply upward, the number of entrepreneurs is growing and big businesses are complaining they can't compete with the flexibility of small, efficient operations (like, I presume, Mr. Melick's). The Phase II game plan is geared to stimulate business profits to a greater percentage of GNP, reversing a trend that, if true, should add further impetus to the rate of new business formation.

*Anthony J. DeBerardis*  
*Quality Engineering Manager*  
*Sanders Associates, Inc.*

Crosby Road  
Bedford, Mass. 01730

Electronic Design welcomes the opinions of its readers on the issues raised in the magazine's editorial columns. Address letters to Managing Editor, Electronic Design, 50 Essex St., Rochelle Park, N. J. 07662. Try to keep letters under 200 words. Letters must be signed. Names will be withheld on request.

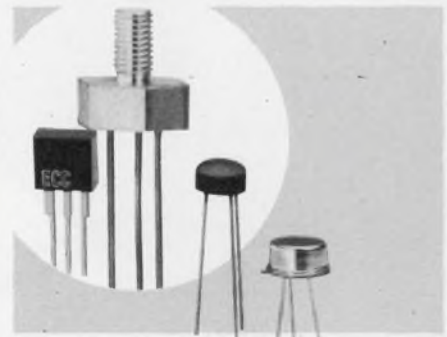

## THE LONG LINE OF ECC Sensitive Gate TRIACS and SCR's

**Fast delivery and competitive pricing make ECC Triacs and SCR's your best buy.**

### SENSITIVE GATE TRIACS

TO-5 Metal and Plastic; THERMOPAK® and THERMOTAB® Packages

$I_{T(RMS)}$  0.8 - 3 amps

$I_{gt}$  3, 10, 25 ma (all 4 quadrants)

$I_{TSM}$  20 amps

$V_{DROM}$  200 - 600 volts

For more information, circle No. 221

### SENSITIVE GATE SCR's

TO-5 Metal; 5/8" Hex Stud; THERMOPAK and THERMOTAB Packages

$I_{T(RMS)}$  0.8 - 10 amps

$I_{gt}$  50, 200, 1500  $\mu$ amps

$I_{TSM}$  50, 100 amps

$V_{DROM}$  30 - 600 volts

For more information, circle No. 222

All ECC Triacs and SCR's feature heavily glass passivated junctions for high reliability.

Detailed technical data on the complete line of ECC Triacs and SCR's is available from your nearest Sales Representative or Authorized Distributor. \*trademark of ECC

**ECC**  
CORPORATION

P. O. Box 669 • Euless, Texas 76039

817/267-2601

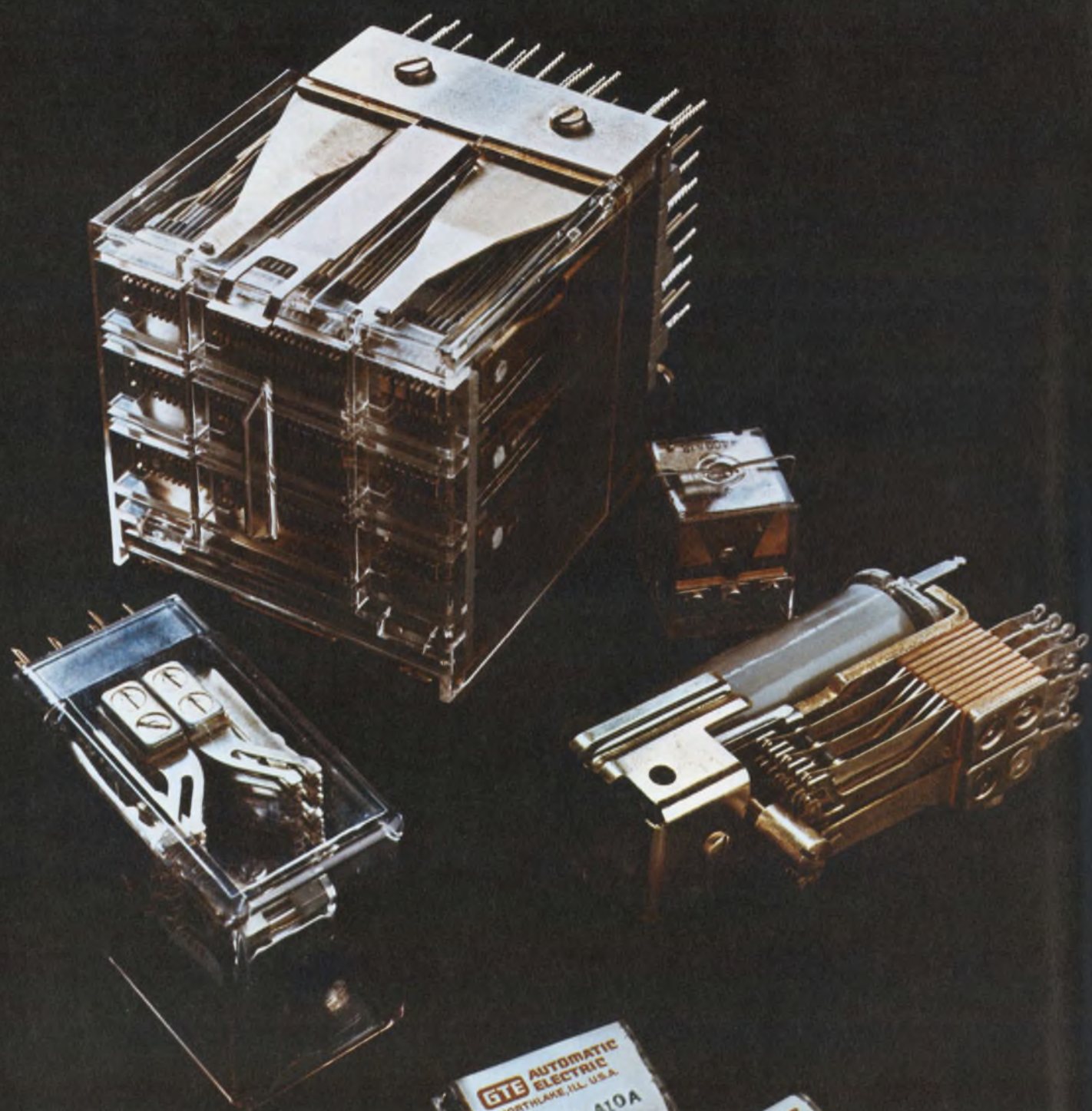

**GTE** AUTOMATIC ELECTRIC  
NORTHLAKE, ILL. U.S.A.

PD1311 A10A  
1930 OHMS

**GTE** AUTOMATIC ELECTRIC  
NORTHLAKE, ILL. U.S.A.

PD1308 A11A  
2600 OHMS

# Announcing the rediscovery of the relay.

In an age when most people think solid state is the only way to go, some designers have rediscovered the good old electro-mechanical relay. They found relays still can't be beat when it comes to certain jobs. And when they're dealing with tight fisted cost control committees. Maybe you can save some effort and expense by rediscovering the relay whenever you need these things:

## **1. Simple logic:**

Relays let you combine both power switching and logic functions economically. Memory can usually be retained, even after a power loss. And you don't need special power supplies or noise suppression techniques.

## **2. Easy troubleshooting:**

Most relay failures (and they do occur occasionally) can be identified visually. You can see what's wrong. And fix it easily.

## **3. Heat resistance:**

A relay shrugs off a short dose of overheating. Give a solid state device the same treatment while it's functioning near capacity and it's ruined forever. The amount of heat a solid state device can take is usually dependent on the heat sink used. It can take up all the room you expected to save with solid state in the first place. And finding the right heat sink design can become very involved.

## **4. Electrical isolation:**

Relays have a natural isolation between input

circuits, between output circuits, and between output and input control circuits. You can't get that with junction type semiconductors.

## **5. High insulation resistance:**

Open relay contacts have an insignificant amount of leakage ( $10^{10}$  ohms or more). Semiconductors can't match this. And, their leakage rates vary greatly with temperature changes.

## **6. Wide operating power range:**

Relays work with operating power anywhere from milliwatts to watts. And they usually don't require regulated power. Semiconductors do.

## **7. Transient voltage immunity:**

Transient voltage doesn't bother a relay. But high voltage, short duration transients can be sure death to semiconductors.

## **8. Forgiveness:**

Relays give you a little margin of safety should you want to change your mind. Maybe you find you need more contacts, or uncover a timing problem, or discover a need for absolute input-output isolation. You can change your circuit design a lot easier with relays.

If your project or product needs any of these things, just ask our salesman to help you rediscover relays. GTE Automatic Electric, Industrial Sales Division, Northlake, Illinois 60164.

**GTE AUTOMATIC ELECTRIC**

**EASY ECL  
EVEN EASIER  
WITH 12  
NEW DEVICES**



## 9500 Easy ECL Family offers designers lower power, higher speed, lower cost systems.

The addition of 4 new MSI circuits — along with 8 new SSI devices — gives our *temperature compensated* ECL family the breadth, depth, variety and flexibility that makes designing with ECL/MSI functions easy as using TTL/MSI.

Since MSI is even more significant in ECL systems design than in TTL, our Easy ECL 9500 series is essentially an MSI family. That's why we now offer 7 key MSI functions — 22 circuits in all. Why all 9500 Series devices are fully temperature compensated for adequate noise immunity to allow problem-free SSI-to-MSI interfacing. Why MSI design in ECL systems is practical for the first time.

### ECL/MSI ASSURES LOWEST SYSTEM POWER DISSIPATION

Comparison of unloaded and system power dissipation per gate of 9500 Easy ECL functions. With an MSI function, the termination power is amortized over many gates thereby assuring lowest system power dissipation.

Device	Description	Gates/ Function*	Power Dissipation (mW/Gate)										
			0	15	30	45	60	75	90	105	120		
SSI — Gates													
9502	General Purpose Dual OR-NOR	2											
95H02	High Speed Dual OR-NOR	2											
95L22	Low Power, High Speed Dual OR-NOR	2											
9503	General Purpose Triple OR-NOR	3											
95H03	High Speed Triple OR-NOR	3											
95L23	Low Power, High Speed Triple OR-NOR	3											
9582	Triple Line Receiver/Amplifier	3											
9504	General Purpose Quad NOR	4											
95H04	High Speed Quad NOR	4											
95L24	Low Power, High Speed Quad NOR	4											
9505	Four Wide OR-AND	5											
9507	Quad AND-NAND	5											
9595	Dual ECL-TTL Converter	2	not applicable										
SSI — Flip-Flops													
95H29	250MHz J-K	9											
9528	Dual 160MHz D-Type	12											
MSI Elements													
9538	1-of-8 Decoder	12											
9581	8-Input Multiplexer	12											
9578	Quad EX-OR/Comparator	16											
9579	Quad 2-Input Multiplexer	16											
9534	Quad Latch	24											
95H84	High Speed Adder/Subtractor	29											
95H90	250MHz VHF Prescaler	29											

\*Number of on-chip ECL Gates not discrete TTL equivalents.

Typical Device Dissipation Additional Dissipation in system due to termination scheme.

### MSI + SSI = EASIEST ECL.

Key to easiest ECL design is the lower power dissipation afforded by maximum use of MSI functions — with ancillary SSI low power gates and flip-flops. That way you get the speed and performance of ECL with economic and reliability advantages of MSI design. You get the most favorable speed/power trade-offs.

For example, basic ECL/SSI gates are approximately two times faster than TTL; but with the design advantages of ECL, the MSI functions are four to eight times faster at similar power dissipation.

### NOW NEW IN EASY ECL.

#### Four new MSI Circuits:

**95H84 adder-subtractor** with full on-chip carry lookahead that permits addition or subtraction of two 64-bit words in 22nS. Fastest adder function on smallest board area available.

**9534 quad latch** with gated input and output enable features. Buffering of outputs insures glitch-free operation with approximately 4nS delay. Applications: register, ALU, parallel-serial conversion.

**9578 quad exclusive-OR** function also for use as 4-bit comparator or dual differential line driver. 3nS delay.

**9579 quad 2-input multiplexer** with 2.6nS delay. Common select line reduces external wiring for variety of function-generation and multiplexing applications.

#### Low-Power SSI

**New 95L22, 23, 24 low-power gates** are pin-identical with standard and high-speed gates. 20mW power dissipation (20% lower than any other available ECL gates), and 2nS propagation delay at no price premium. 60K ohm on-chip pulldown resistors.

For use in an area of high-power density (e.g., memory arrays), and as receiving element at end of long data bus lines.

#### High-Speed SSI

Three new high-speed gates and a new high-speed flip-flop:

**95H02, 03, 04 gates**, pin-identical with standard and low-power gates. 1.6nS delays at similar power as standards. For clock-driving with flip-flops, registers, large synchronous arrays, where maximum speed required. Also as high-speed logic function where multiple gate decisions must be made within short clock period (e.g., loading a universal shift register within a narrow clock pulse).

**95H29 J-K flip-flop** with 250 MHz toggle frequency features non-ones catching master-slave circuit with multiple gating on inputs. For high-speed counting, register, data storage.

#### Low-Cost Standard SSI

**9507 quad and 2-input AND, 8-input NAND gate.** Eliminates a number of external connections in computing and general logic applications. 2.3nS delays without deterioration in rise-and-fall performance under heavy loading conditions.

#### AVAILABLE NOW

All 12 new members (and their 10 older relatives, of course) of our Easy ECL family are now available in production quantities from your friendly Fairchild distributor. Additional sources: N. V. Philips/Amperex and Raytheon.

**MADE IN  
FAIRCHILD**

# Make the simple move

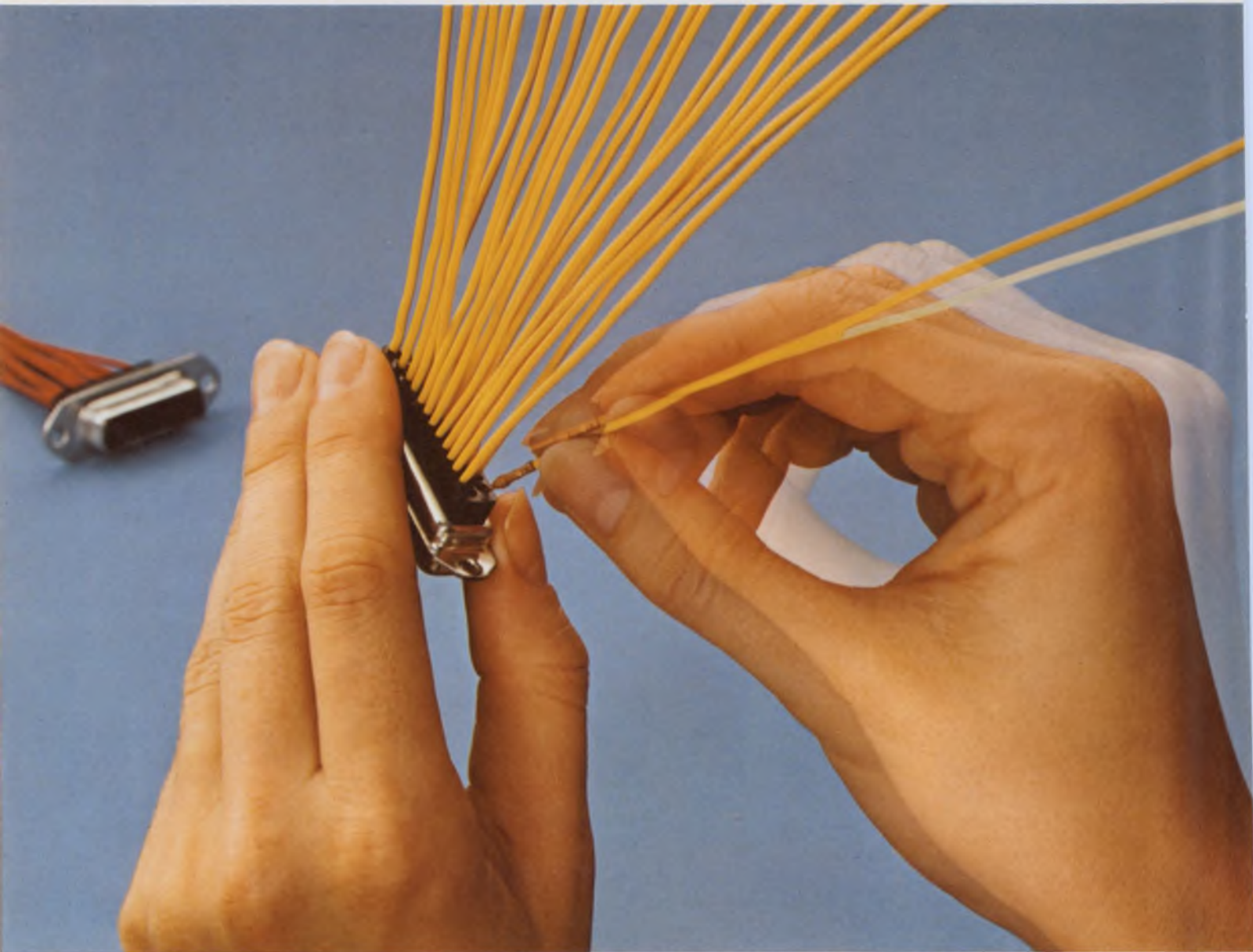

## to less assembly time.

Do it the easy way with Amphenol's 17 Series miniature rear-release connectors.

A gentle push from the back of the connector and the contact snaps securely in place. No tools or broken fingernails, just easy fingertip assembly. And to remove the contact for fast field servicing, insert a simple plastic tool in the back of the connector and out pops the contact.

You can have a choice of screw-machine contacts in bulk packaging, or stamped and formed contacts on a carrier strip. Semi-automatic crimping or hand tools available for either type of contact.

The Min-Rac® 17 Series connectors are available in 9, 15, 25, 37, and 50 contact configurations. All meet EIA Standard RS-232C for data communications input-output connectors. And all are interchangeable and intermateable with other Min-Rac 17 Series connectors as well as competitive "D" type connectors.

Find out how simple it really is. Just write Dick Colt asking for the whole story on our Min-Rac 17 Series rear-release connectors. Amphenol Industrial Division, Bunker Ramo Corporation, 1830 South 54th Avenue, Chicago, Illinois 60650.

**BUNKER  
RAMO**

**AMPHENOL**

# designer's calendar

## JANUARY 1972

S	M	T	W	T	F	S
						1
2	3	4	5	6	7	8
9	10	11	12	13	14	15
16	17	18	19	20	21	22
23	24	25	26	27	28	29
30	31					

### Jan. 25-27

Symposium on Reliability, (San Francisco), Sponsor: IEEE, J. H. Simm, Beckman Inst. Inc., 2200 Wright Ave., Richmond, Calif. 94804

CIRCLE NO. 422

### Jan. 30-Feb. 4

Power Engineering Meeting, (New York City), Sponsor: IEEE, J. W. Bean, AEP Service Corp., 2 Broadway, New York, N. Y. 10004

CIRCLE NO. 423

## FEBRUARY 1972

S	M	T	W	T	F	S
		1	2	3	4	5
6	7	8	9	10	11	12
13	14	15	16	17	18	19
20	21	22	23	24	25	26
27	28	29				

### Feb. 8-10

Aerospace & Electronic Systems Winter Convention (WINCON), Los Angeles), Sponsor: IEEE, Gerry Goldenstern, L.A. Council Office, 3600 Wilshire Blvd., Los Angeles, 90010

CIRCLE NO. 424

### Feb. 16-18

International Solid-State Circuits Conference (Philadelphia), Sponsor: IEEE, A. V. Brown, T. J. Watson Res. Ctr., Box 218, Yorktown Heights, N.Y. 10598

CIRCLE NO. 425

Capacitors, designed for operation at UHF/Microwave<sup>\*1</sup> frequencies, with reliable power handling<sup>\*2</sup> capability, with fast delivery from stock<sup>\*3</sup>!



\*1 - ATC 150 Case A to 12 GHz

\*2 - 15 KW pulse operation at 500 MHz

\*3 - Typically less than TWO WEEKS

Need application information? Circle the retrieval number listed below.



## UHF/MICROWAVE CAPACITORS

american technical ceramics

1 NORDEN LANE, HUNTINGTON STATION, N. Y. 11746  
516/271-9600 • TWX-510-226-6993

INFORMATION RETRIEVAL NUMBER 10

**Our one-two punch knocks  
heat problems cold.  
It delivers up to 125 cfm against  
the toughest opposition.  
We call it, "The Tandem Boxer."**

Synergistic. Push-pull operation of the Tandem's impellers moves volumes of air through systems where high density component packaging would otherwise impede air flow. Nearly twice the output of two equivalent fans working independently.

Parallel redundancy. Wiring and fusing the fan motors in parallel adds an extra measure of protection.

Interchangeable with all standard Boxers (or the other contenders). Only depth dimension is increased.

Eliminates the problem of premature air-mover specification.

Other airmovers? Of course!

Send for our full-line catalog No. ND4r. It's free, and contains performance data, electrical and mechanical specifications on more than 100 units.

And valuable application information too.



For immediate service, contact us at IMC Magnetics Corp., New Hampshire Division, Route 16B, Rochester, N.H. 03867, tel. 603-332-5300. Or the IMC stocking distributor in your area. There are more than 50 nationwide and overseas.



INFORMATION RETRIEVAL NUMBER 11

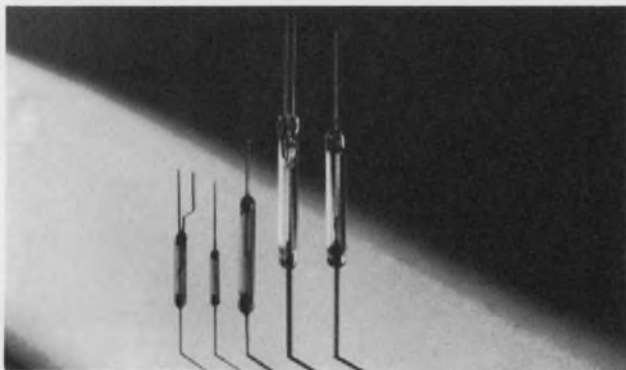

## Star Performers

### Hathaway Drireed Switches

The most advanced production techniques, rugged testing and quality control helps assure you that the Hathaway Drireed Switch you specify meets the standards you need. Hathaway has the broadest line of dry reed switches, one to fit most any application. Form A and Form C, in Micro Subminiature, Miniature, Intermediate, Compact and Standard sizes, have off-the-shelf availability. **Write to Hathaway for our new Drireed Switch Handbook and free samples.**



**HATHAWAY**  
instruments, inc.

5250 EAST EVANS AVENUE DENVER COLORADO 80222  
(303) 756-8301 TWX 910 931 0568

INFORMATION RETRIEVAL NUMBER 12



## Touch It!

### Hathaway's Low Profile Keyboard Switches

Hathaway's Low Profile Drireed Pushbutton Switch is designed to allow you to build more compact, smaller instruments with greater reliability at a lower cost. Our knowledge of dry reeds enables us to design the best.

The Hathaway Switches have other unique advantages to offer you even more. A unique switching design totally eliminates interference between switches with positive action and no teasing. Standard units can be screw base mounted on the standard  $\frac{3}{4}$ " or  $\frac{5}{8}$ " centers. The switches interlock for mounting rigidity. Operating force is 50 to 60 grams at the beginning of displacement and 80 to 90 at the end, no matter which plane the switch is in. The switch and pushbuttons are both produced by Hathaway for total single source control from design through manufacturing.

For complete information write to:

**HATHAWAY**  
instruments, inc.

5250 EAST EVANS AVENUE DENVER COLORADO 80222  
(303) 756-8301 TWX 910 931 0568



INFORMATION RETRIEVAL NUMBER 13

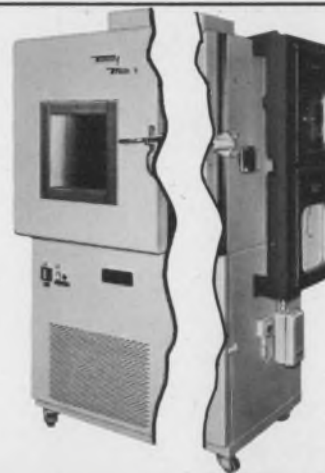

## THE SCHIZOPHRENIC.

I'm a temperature test chamber. No, I'm a temperature-humidity test chamber. No, I'm both, in one compact unit. My Dr. Jekyll side has a dry bulb temperature testing range of  $-100^{\circ}\text{F}$  to  $+350^{\circ}\text{F}$ . My Mr. Hyde personality combines temperature testing with a humidity range of 20% to 95%. I'm a five cubic foot automated test chamber with  $2^{\circ}$  control tolerances, but I have bigger brothers up to 64 cu. ft. (with other features) who can also help you. For full information write my keepers, Tenney Engineering, Inc.

**Tenney**  
ENGINEERING, INC.

1090 Springfield Rd., Union, New Jersey 07083 • (201) 686-7870  
807 Western Division: 15721 Texaco St., Paramount, Calif. 90723



INFORMATION RETRIEVAL NUMBER 14

## COMAR CR-2



### Still up front in the miniature relay race.

Easily the winner at the poles, Comar's CR-2 miniature relays offer a 1, 2 or 3 PDT AC or DC bundle of precision in one tiny package. Save precious space and money by buying only the number of poles

you actually need. CR-2 relays combine in series for additional poles. UL recognized (File #29163), CR-2 relays are only  $1\frac{1}{4}$ " x  $\frac{3}{4}$ " x  $\frac{3}{4}$ ", complete with Lexan dust cover.

**Ingraham COMAR**  
a division of McGraw-Edison Company

3349 ADDISON STREET / CHICAGO, ILL. 60618  
(312) 588-2410 / TWX 910-221-5198

INFORMATION RETRIEVAL NUMBER 15

ELECTRONIC DESIGN 26, December 23, 1971



# a new breed

of digital  
cassette recorders

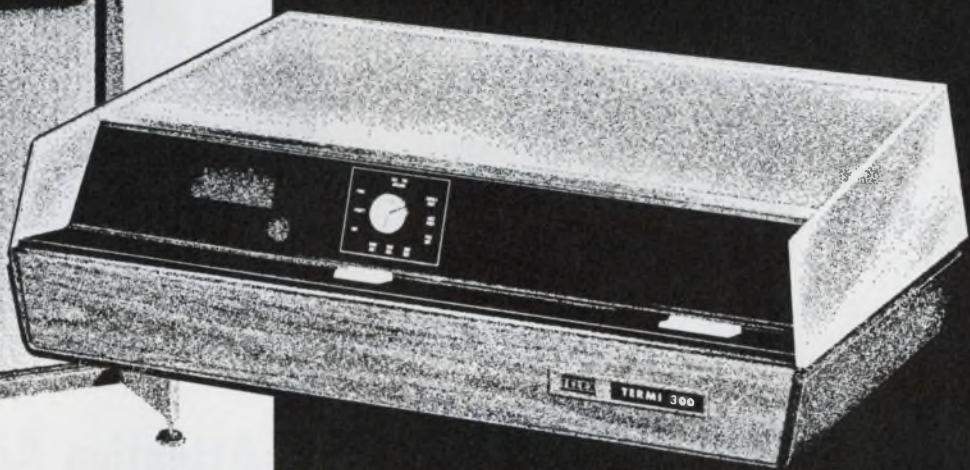
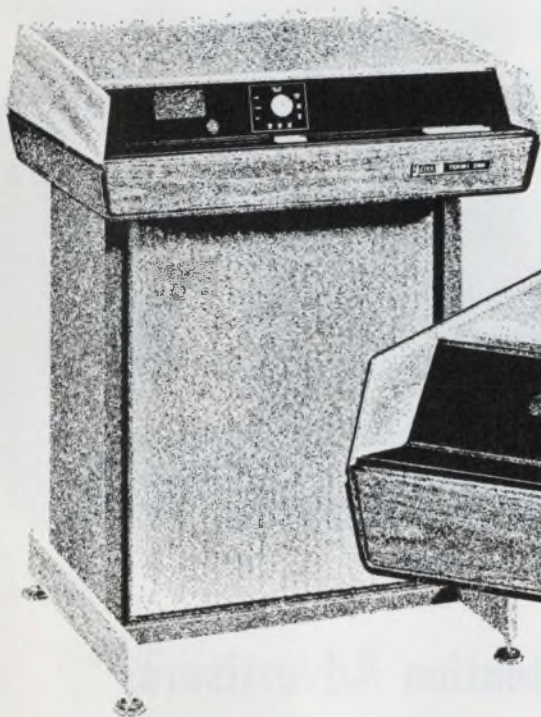

TELEX — world's leading manufacturer of recording equipment — has drawn on thirty-five years of expertise to create industry's most comprehensive line of field-proven digital cassette memories — recorders which are pre-engineered for virtually every modern application.

TELEX provides everything from basic cassette transports to complete systems designed expressly for point-of-sale equipment, data capture, peripheral storage, data communications and a wide range of other digital data handling missions.

TELEX offers important mechanical enhancements and read/write deck including electronics, power supply, digital control interface and serial or parallel converters to supplement our basic transports. Or, you can specify the buffer memory and electronics for a complete system that operates incrementally to 250 characters per second.

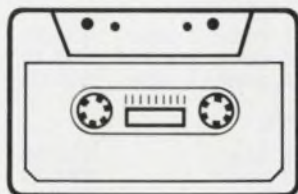

**new breed**<sup>™</sup>  
digital recorders

Contact **TELEX** today for detailed information on our new, competitively-priced digital cassette products.

**TELEX**<sup>®</sup>  
COMMUNICATIONS DIVISION

9600 Aldrich Avenue South  
Minneapolis, Minnesota 55420

## Don't let your new PM motor design die on the production line.

The performance, reliability and cost of a new permanent magnet motor could depend on the magnet processing equipment you use. We supply equipment for fully automated operations that magnetize, stabilize and test PM stators and assemblies. We've got success stories from tape drive motor manufacturers, appliance companies and car makers. Write for detailed brochure to: 4949 Freeway Drive, East, Columbus, Ohio 43229.

**F.W. Bell Inc.** A subsidiary of The Arnold Engineering Company

INFORMATION RETRIEVAL NUMBER 17

## DC-AC INVERTERS

- 12 VDC and 28 VDC input
- 28 or 115 Vrms sine wave 400 Hz regulated output
- 20, 40, 50 and 100 watt models
- Small size and weight



### ARNOLD MAGNETICS CORPORATION

11520 W. JEFFERSON BLVD · CULVER CITY, CA 90230 · (213) 870-7014  
VSK/51

INFORMATION RETRIEVAL NUMBER 18

## DISPLAY AND LOGIC POWER CONVERTER

The PHU-180-5 provides regulated 180 VDC @ 100 ma for display tubes and 5 VDC @ 3 amps for logic power in a miniature 1 7/8 x 3 3/8 x 3 1/2 case with a weight of 21 oz. Ideal for small portable terminals. Input: 115 Vrms, 50-500 Hz



### ARNOLD MAGNETICS CORPORATION

11520 W. JEFFERSON BLVD · CULVER CITY, CA 90230 · (213) 870-7014  
VDL/51

INFORMATION RETRIEVAL NUMBER 19

now...you  
can test  
digital  
IC's...  
economically...  
to manufacturer's specs



New Kurz-Kasch Model IC-590 is the first economically priced digital IC analyzer for accurate testing in the lab, shop, inspection, production, field or any other location.

The Model IC-590 is a completely portable, battery powered digital IC tester for use in conjunction with published IC specification sheets for static and dynamic testing of all 14 and 16 pin dual in-line IC modules of the DTL and TTL, 5 and 15 volt families. Flat pack and TO-5 modules may also be tested by using appropriate adapters. Price \$169.95.

A unique sister Model IC-591 is also available. It comes complete, as IC-590 above, internal power supply for highly regulated 5 volt, 1 amp operation and adapter cable for firing-up complete card units containing as many as 15 or more mounted IC's. Price \$295.00.

For complete technical data, write or call now: Tom Barth, Marketing Manager



ELECTRONICS DIVISION  
**Kurz-Kasch, Inc.**  
1421 S. Broadway,  
Dayton, Ohio 45401

(513) 223-8161

INFORMATION RETRIEVAL NUMBER 20

## Attention Advertisers:

Could you use copies of your ad exactly as it appeared in ELECTRONIC DESIGN? Then order your reprints directly from us; the minimum unit order is 500 copies.

Please specify if you would like the reprint line omitted on your copies and mail your/written order to:

Production Dept.  
ELECTRONIC DESIGN  
50 Essex St.  
Rochelle Park, N.J. 07662

	500	1,000	Add'l M
<b>8x10 or smaller</b>			
1 color, 1 side	\$74.70	82.95	18.15
2 color, 1 side	95.47	108.00	25.28
4 color, 1 side	311.03	342.00	44.33
<b>Spreads</b>			
1 color	113.66	126.65	25.98
2 color	191.19	205.98	29.58
4 color	354.17	380.76	53.19

Prices FOB Waseca, Minn.

# The 'anti' vacation vacation.

The Queen Elizabeth we're not. Not even a luxury liner. No gold door knobs or velvet wall coverings.

We're a beautiful schooner under white sail that meets adventure head on in the West Indies. Dominica, Montserrat, St. Lucia, Guadeloupe. Then there's English Antigua, Dutch St. Maarten and French Martinique.

You'll awake to the smell of fresh coffee and iridescent sunrises. Discover great native shops, scale a volcano, prowl old forts and coves.

No olympic pools on deck. Dive over the side and swim, skindive in our backyard...the sometime turquoise, sometime emerald, sometime red gold Caribbean sea.

There's no ballroom but wait 'till you step out to our steel band. Limbo and calypso rock. Watch the sky give birth to a golden moon. Then fall asleep under a star spangled sky (or your cabin). Share 10 days from \$250. Then there's tomorrow... write for your free Windjammin' adventure brochure in Caribbean color.

 **Windjammer Cruises.**

Post Office Box 120, Department 788, Miami Beach, Florida 33139



**50 watt  
signal generator**

**10 to 2,500 MHz  
with six heads**

**solid state for  
high reliability**

**frequency stability  
 $\pm 0.003\%/10$  minutes**

**power stability  
 $\pm 0.2$  db/hour**

Model 15022 is the first state-of-the-art Signal Source in ten years. Provides highest reliable power currently available. The instrument is solid state except for Planar Triode Oscillator. The System provides direct frequency adjustment from 10 to 2500 MHz.

The 15022 is designed for standard 19" rack mounting, only 7" high, complete with power supply, cooling, and protective circuitry. Plug-in Cavity Oscillator is protected against output load mismatch.

**FEATURES:**

50 watts CW 10 to 1000 MHz.  
35 watts CW 1000 to 2000 MHz.  
15 watts CW 2000 to 2500 MHz.  
Forward/reflected panel power meter.  
RF Sample output.  
Meets MIL-STD-462 RFI.  
Meets MIL-STD 810B Environmental.  
Residual FM < 0.005% CW operation.  
Residual AM < 2.0% CW operation.  
Power output adjustable .05 to 50 watts.  
Automatic protection against high load VSWR.  
Internal Modulation 1 KHz  $\pm$  1% square wave.  
External Pulse Modulation capability.  
Spurious output > 30 db down.

For complete specifications on the newest RF power source today, call (312) 354-4350 or write: Microwave Cavity Laboratories, 10 North Beach Avenue, La Grange, Illinois 60525.



**MCL**

**MICROWAVE  
CAVITY LABORATORIES**

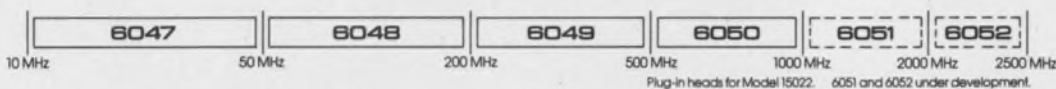

## Low-light camera advance increases sensitivity tenfold

A new low-light-level camera said to be 10 times more sensitive to light than previous ones, fills but a tenth the volume and uses half or less the power. It has been introduced by RCA as one of a series of four new low-light-level television systems.

Designed primarily for airborne military applications, these cameras employ RCA's Silicon Intensifier Target tube, which was used in the color TV cameras that transmitted live pictures from the moon during the Apollo 15 mission. The camera has a range gating capability not incorporated in previous similar systems.

According to James Gilday, leader of the technical staff for image devices and systems at the RCA Aerospace Systems Div., Burlington, Mass., the new camera is substantially more sensitive than those using Secondary Electron Conduction or Isocon tubes. It can produce pictures on a cloudy, overcast moonless night.

The design emphasis for the new series is on miniaturization, Gilday notes. The new camera uses the same type of Silicon Intensifier Target tubes employed in the low-light-level system for the Huey Cobra aircraft. But the camera has been scaled down from about 2500 cubic inches for previous systems to 250 to 350 cubic inches. While former systems were constructed in two pieces, with a head assembly and optics in one enclosure and the electronics in the other, the new RCA unit houses both the electronics and the optic head in one unit that is 4.5 by 5.6 by 14 inches.

The power consumed by older systems was about 90 W for passive viewing. The new unit uses only 30 W for the same function. With range gating, about 50-W input is required for the new camera.

In addition to its low-light

capabilities, the new camera can also operate in sunlight. It is relatively immune to damage, even when pointed directly at the sun.

The vertical resolution is 525 scan lines at 30 frames per second, while the horizontal resolution exceeds 650 lines on most models.

Ground versions of the new cameras are self-contained for tripod operation, while the airborne configuration is designed for operation on a gimbel, with controls mounted on a remote box.

### IC sets camera opening at very low light levels

A new integrated circuit to set the exposure time of cameras automatically at very low light levels has been developed by Philips Laboratories, Eindhoven, the Netherlands.

It could find use in low-light-level military photo reconnaissance missions or in television camera work.

The circuit, which consists of a silicon chip combined with a silicon photodiode, operates by measuring the short-circuit current of the photodiode instead of its open-circuit voltage. By this method, it is possible to obtain a much greater sensitivity and temperature stability than has previously been possible, Philips engineers report.

In earlier arrangements, to ensure sufficient sensitivity to light, the photodiode required an area of several square millimeters. In silicon diodes with such a large area, the leakage current of the diode limits the open-circuit voltage that the diode delivers when weakly illuminated. In addition the value of this leakage current—and thus the open-circuit voltage—depends largely on the ambient temperature.

In the new method, however, the

short-circuit current of the photodiode is used as the input signal to the measurement circuitry. Limitation of the sensitivity by leakage current is no longer a problem, because the voltage difference across the diode, even in the illuminated condition, is negligibly small. Moreover the short-circuit current is practically independent of ambient temperature.

In tests by Philips engineers, it was found that the minimum level of illumination necessary for proper operation of a camera shutter was 0.01 lux—in other words, 25 times less than the level of illumination at night with a full moon and a clear sky.

### Monsanto offers LEDs in yellow and green

While light-emitting diode (LED) numeric displays have been in use for some time, they have been available only in red. Now, however, yellow and green displays are being introduced by Monsanto.

Clarence Bruce, director of marketing at the Monsanto Electronic Products and Controls Div. in Cupertino, Calif., says: "In applications where more than one color is required or where red implies danger, the new displays offer the designer a workable alternative in LED technology."

Meanwhile RCA is carrying out Navy-supported research aimed at developing the technology for fabricating light-emitting diodes in a wide choice of colors and three times more efficient than presently available LEDs.

Monsanto's green is achieved by use of gallium phosphide material that emits at 5650 Å. At that wavelength the color is actually a greenish yellow, but the frequency of emission can be tuned by adding a nitrogen impurity to the gallium phosphide.

Raymond Brown, technical director and manager of display products at Monsanto, says: "We would like the emission to be at 5555 Å, or emerald green [which is at the peak of the eye's spectral response]. However, when we tune to 5555 Å, we lose about 70% of our efficiency."

Monsanto's yellow is achieved by use of gallium arsenide phosphide

material that emits at 5890 Å. At that wavelength the color is actually an orange-yellow, similar to the color of Burroughs' Nixie tubes. According to Kenneth Lawley, manager of R&D at Monsanto: "Tunability of gallium arsenide phosphide is achieved by varying the amount of phosphorous in the mix. Tunability of the material is on the order of 40 Å per 1% change in phosphorous level."

Forward voltage for 20 mA of current per segment is 2.2 V for the Monsanto yellow display and 2.5 V for the green display. This compares with 1.8 V for the conventional red display. The forward voltage corresponds to the band-gap of the material.

The RCA research, being done at the company's David Sarnoff Research Center in Princeton, N.J., has resulted in the formation of light-emitting diodes from alloys of the semiconductor materials gallium phosphide and indium phosphide. Such a LED can be made to emit any color from red to yellow-green without increasing the power requirements. This is done by regulating the fraction of gallium phosphide used in the alloy, says Dr. David Richman, head of semiconductor materials research at RCA.

A major feature of these LEDs is that they can be made by the commonly used vapor epitaxy fabrication technique. This means that the entire device can be grown in a single operation, making production economically feasible.

## NASA seeks solution's to problems on earth

NASA is examining proposals from industry on how to adapt space technology to solve major problems on earth: air pollution, water pollution, solid-waste management, and clinical medicine.

A team of experts at four NASA installations is scanning the most promising ideas, and when its work is finished, the space agency says, contracts may be negotiated up to \$75,000 to start developmental work.

The screening is taking place at the Amcs Research Center, Moffett Field, Calif. (for air-pollution ideas); Langley Research Center, Hampton, Va. (for water-pollution

and solid-waste management proposals); and the Manned Spacecraft Center, Houston, Tex. (for clinical-medicine suggestions).

## 3 U.S. concerns bid for Mexican contract

Three United States companies—General Electric, Westinghouse and Combustion Engineering—are contenders for a contract to build a \$160-million nuclear power plant for the Mexican Government in the state of Veracruz.

Foreign companies to be considered include Mitsubishi of Japan, Siemens of West Germany, the Canadian Atomic Energy Group and the British Atomic Energy Authority. Work is expected to begin in mid-1972 on the 650,000-kilowatt plant and to be completed in 1977. It will be Mexico's first nuclear power plant.

A decision on the principal contractor for the nuclear steam supply and the turbo-generator is expected in the spring.

## Weather forecasters to get better technique

A satellite weather research system that will use a new meteorological technique—it will look out to the edge of the earth's atmosphere instead down at the surface—is expected to provide substantial improvement in global weather forecasting.

The new system, called the Limb Radiance Inversion Experiment, is being developed by the Honeywell Aerospace Div., St. Petersburg, Fla., under a \$2,730,000 contract with NASA's Goddard Research Center in Greenbelt, Md. It will fly with Nimbus F in 1974 some 600 miles above the earth, and it is expected to provide new information on temperature distribution in the stratospheric and mesospheric regions, as well as on water vapor and ozone density at those heights.

Conceived by Jerry C. Bates, Honeywell's manager of surveillance systems, the system will consist of a four-channel radiometer. Two of the channels are in the 15-micron rotational band of carbon dioxide, one is in the 9.6- $\mu$  ozone band, and one is in the 18-to-24- $\mu$

water vapor band. The unit will have a much smaller field of view than the infrared sensors now used to look straight down.

A prime advantage of this system, Bates explains, is that much longer optical paths are used to look out over the edge of the atmosphere than to look down at the earth. Consequently signal measurements can be made to much higher altitudes—in this case, up to 70 km in the stratosphere-mesosphere region, as contrasted with up to 35 km with present weather satellites.

Because the limb type of instrument looks only at a background of space, it is possible to derive more precise altitude information than with other systems, Bates says. In addition the need to separate the noisy infrared background radiation of the earth from that of the lower atmosphere is eliminated.

## Computer Conferences to shift their emphasis

Joint Computer Conferences of the future will be more directed to buyers and users of data-processing machines than to the engineers who design them, according to Walter L. Anderson, vice president of the American Federation of Information Processing Societies.

"We won't lock the original equipment manufacturers out," he says, "but we will expand end-user activities within the shows."

"We want to draw those in other businesses who now depend extensively upon EDP products," he says.

End users include nonelectronic-oriented specialists, such as bankers, officials of hospitals, chemical and plastics plants and oil refineries.

In the past the conferences have been very hardware-oriented, but with the drop in the economy, new markets are being sought. Attendance at future shows may be encouraged through joint arrangements with other societies not in the electronics field but whose members are potential users of computing equipment.

Anderson says that one scheme under consideration is to have one show devoted to the end user and one to manufacturers. But a decision on this has not been reached.



# GE PRESENTS THE NEW POWER-GLAS™ SCR.

General Electric introduced the original SCR in 1957, and now presents a new SCR series that capitalizes on the General Electric **POWER-GLAS™** process . . . the C220 series. Rated at 10 amperes with blocking voltages up to 500 volts, the C220 series SCR's are available in three standard industrial packages—press fit, stud and isolated stud. Through the use of **POWER-GLAS™** passivation, General Electric now offers the most reliable SCR's available.

**POWER-GLAS™** provides a proprietary glass formula and deposition process that improves upon normal passivation techniques. It creates an intimate void-free bond between the silicon chip and the matched glass. The resulting stable low level "off state" current significantly improves DC blocking life stability.

For the full story on **POWER-GLAS™** passivation, C220 reliability and a free sample write on company letterhead to General Electric Company, Semiconductor Products Department, Electronics Park, Bldg. #7, Mail Drop 49, Syracuse, N.Y. 13201.

GENERAL  ELECTRIC

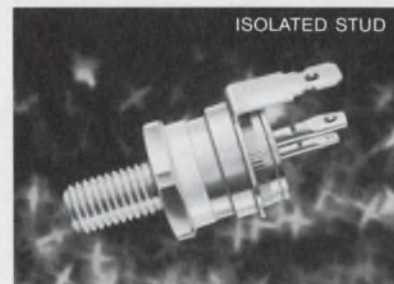
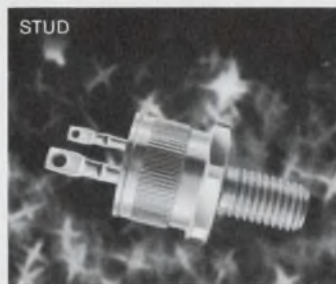
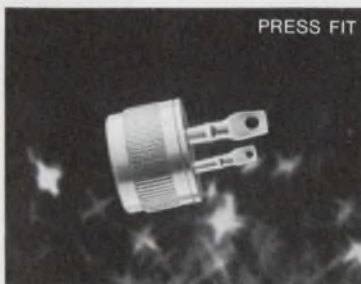

# Computer researchers achieve their fastest switching so far

The application to computer circuits of the ultra fast operating speeds and ultra low-power consumption found in superconducting Josephson devices has been brought a step nearer by IBM researchers. They have made the shortest switching-time measurements to date—85 ps for single-gate switching and 550 ps for an array cycle time of elementary Josephson memory cells.

Bell Laboratories scientists have also reported significant advances in research on "flux shuttle" Josephson shift registers. They are confident the research will result in logic elements with switching times approaching the theoretical limit for Josephson junctions—10 ps.

Josephson junction devices are superconducting, micrometer-sized elements that operate at liquid-helium temperatures of 1 to 4 K. In 1966, Juris Matisoo, a research staff member of IBM's Watson Research Center in Yorktown, N.Y., demonstrated that a Josephson junction could be switched from zero voltage to a finite voltage state in less than 1 ns and thus provide a fast, logical com-

puter element.

Matisoo also disclosed that two Josephson junctions in parallel could be switched back and forth, like a flip-flop, thus forming a memory element.

Measuring the performance of Josephson logic elements has been difficult because of the formidable problems involved in making impedance-matched connections to micrometer-sized elements. Also, the signals are low-level—a few millivolts—but they have bandwidths on the order of gigahertz, thus adding thermal noise and instrumentation instability to the problem.

But H.H. Zappe and K.R. Grebe, other research members of the IBM Watson Center, report that whereas the best previous switching-time measurements were on the order of 800 ps, they were able to reduce this to below 100 ps by designing a Josephson configuration of a complex shape (Fig. 1).

The device, as described in the September issue of *IBM Journal of Research and Development*, is essentially a fork with four short leads on one side of the junction.

The handle of the fork is a strip line with 2- $\mu\text{m}$  spacing between the lines. To form a memory loop, the line is shorted.

This configuration is made by evaporating lead alloy elements and a 2- $\mu\text{m}$  insulating layer of silicon dioxide between them on a glass substrate. The junction area is created through a window in the oxide layer.

## Strip lines make connections

Broad-band connections for applying current pulses to switch the junction and for measuring the voltage change across the junction are taken from two pairs of 25-ohm copper strip lines covered with an unconnected copper ground plane. These lines are matched in pairs to two 50-ohm cables.

The output of the voltage pair is connected to an HP 141A sampling oscilloscope having a 28-ps sampling period. The input to the current pair is a sequence of slowly rising 60-ns ramp pulses. To measure switching times, the junction voltage is observed at the time at which the current reaches the Josephson threshold current, which has previously been measured.

The signal, as it appears on the oscilloscope (Fig. 2), is distorted—because of the 30-GHz response of the measuring system—by 1 mV of thermal noise, oscilloscope baseline drift, inductive signals from the current lines, as well as the attenuation and distortion of the read cable itself.

To measure the gate switching time, the long strip line is left open at the end. The response (Fig. 2) is one of the smallest transition times so far measured.

In the memory-cell experiments, the time to transfer the current from the junction into the loop was

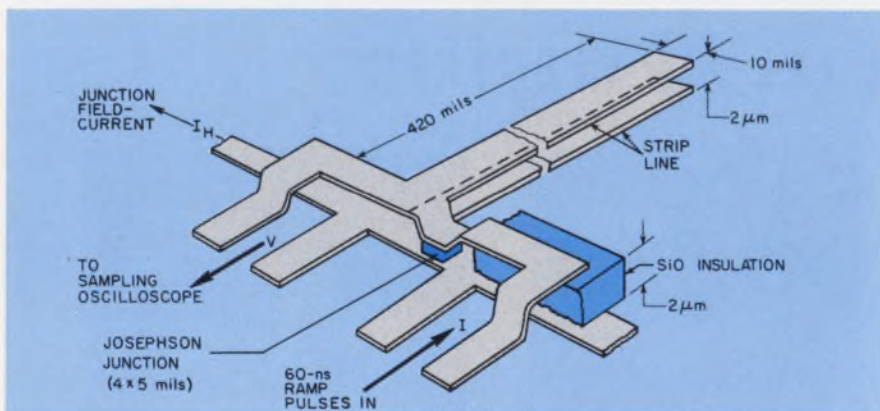

1. Resolution of millivolt signals with about 60-ps rise times is made with this special Josephson structure designed by IBM. Contact to the sample is made through two broadband pairs of 25-ohm strip lines.





ANNOUNCING A TWO-COLOR TWO-GUN SHADOWMASK  
MONITOR TUBE WITH 900 LINE RESOLUTION.

ELECTROSTATIC FOCUSING.

NO HIGH VOLTAGE SWITCHING.

SATURATED RED AND GREEN.

THE HIGH RESOLUTION LETS YOU USE  
A 14" SIZE TUBE TO DISPLAY  
UP TO 3000 CHARACTERS IN A SINGLE FRAME.

THAT'S A LOT TO SAY FOR ANY TUBE.

*Sylvania Electronic Components, Seneca Falls, N.Y. 13148*

**GTE SYLVANIA**

measured by shorting the strip line at varying distances from the junction. In this way the loop inductance was changed from 10 nH to about 100 nH.

For a superconductive loop 420 mils long with an inductance of 100 nH, a memory cycle time of about 550 ps was obtained.

Bell Laboratories in Murray Hill, N.J., is making progress on its flux shuttle, a shift register consisting of a number of Josephson junctions in parallel. These have been experimentally fabricated in a linear array with several junctions.

These flux shuttle elements, says T.A. Fulton, a member of the technical staff at Bell Laboratories, are smaller than those reported by IBM. The Bell devices consist of two superconducting metal films separated by an insulating layer of about 15 Å thickness. Through this, a supercurrent of milliamperes can flow, Fulton notes.

Single or multiple flux-shuttle junctions can support bistable con-

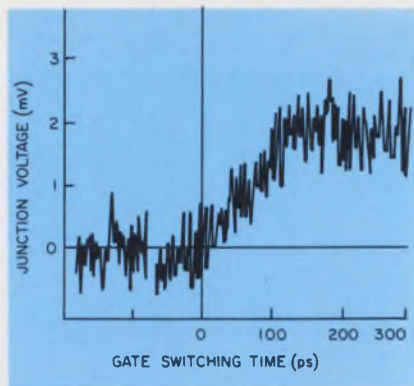

2. This recording of an 85-ps junction switching time illustrates the noise problems involved.

ditions of one or more circulating loops of supercurrent, Fulton explains. Each loop contains a single minimum unit of flux called a quantum.

The flux shuttle circuit can contain an array of these self-trapped fluxoids, each of which represents the presence of one bit of data.

Because each fluxoid can be

moved from one location to the next by applying a drive current or magnetic field, such a circuit can be used for data processing and storage, Fulton says.

The inherent switching times of these flux quanta are approximately the period of the Josephson plasma oscillation, typically 10 ps. The power dissipated per bit transfer is, in a typical case,  $10^{-18}$  joules.

In comparing the flux shuttle with the IBM device, Fulton says that the self-inductance of each loop of the flux shuttle is much smaller—so much smaller that the critical junction current is on the order of one flux quantum. This, Fulton states, is a reduction of about 50 to 100 to 1.

While Fulton says that the Bell Laboratories experimental work is still in its early stages, he maintains that the theoretical basis for the device performance is conservative, and he confidently predicts that the 10-ps speed will be realized. ■■

## Finally, a low-cost linear MIL package

Low-cost, eight-lead standard IC packages that can be inserted automatically into circuit boards were, for a long time, unavailable to the military designer. He couldn't use cheap plastic packages because of MIL temperature and humidity constraints; he put his circuits mainly into TO-99 cans and placed them in the circuit boards by hand. But now he has an alternative.

A new eight-lead ceramic package, primarily for linear IC use, has been developed for military designers. It is said to offer costs comparable to those achieved with industrial plastic packages, and it can be inserted into PC boards.

### Improved yields promised

Produced by Diacon of San Diego, these devices work over the full MIL-standard temperature

range of  $-55$  C to 125 C. And according to Bryant C. Rogers, president of Diacon: "Although the actual package costs about 50% more than a plastic package, improved yields bring package circuit costs down to a comparable level."

First user of the new mini-CER-dip, eight-lead package will be Solitron Devices of San Diego. It will use them in its UC 4250 low-power op amp. Solitron worked with Diacon in the development of the package.

Rogers notes that even in non-MIL situations, linear ICs often face 85-85 humidity environments (85 C at 85% humidity). Plastic packages won't stand that, but the hermetic ceramic package will.

According to the Diacon president, the key to the new package is the development of a graded viscosity sealing system. Diacon first puts a layer of glass on the base ceramic and embeds the leadframe in it (saving the IC manufacturer this job). This layer of glass is processed, so that it does not be-

come fluid until it reaches temperatures of 600 C. A second layer of glass, processed to melt at less than 450 C, is applied over the top of the already embedded leadframe. Use of the two glasses with different viscosities gives rise to the term graded viscosity.

### Glazed cap seals package

The IC manufacturer takes the base of the package with the already embedded leadframe, die-attaches and wire bonds and then merely seals the package with a glazed cap that can be bonded with a glass to glass seal at a temperature of only 450 C. Hence a linear IC will not degrade and a hermetic, ceramic, eight-lead package is possible.

An added feature of the system, Rogers points out, is that since there is now a smaller amount of glass to outgas during hermetic sealing, a further potential yield reducer is eliminated from the production process. ■■

David N. Kaye  
West Coast Editor



# Our filter/capacitor family takes experimentation out of circuit design.

We provide the comprehensive data you need for every one of our filter and capacitor components. Attenuation curves (by current, voltage or in combination at room temperature and maximum). Test procedures. Application aids. Specs. Dimension drawings. That's why the Allen-Bradley family is easier to work with. We also give you high volumetric efficiency and

a wide variety of styles. Backed by our famous track record for quality and improved performance. Request your personal copies of our literature. Call our nearest appointed electronics distributor, or write: Allen-Bradley Electronics Division, 1201 South Second Street, Milwaukee, Wisconsin 53204. Export: Bloomfield, New Jersey 07003. Canada: Galt, Ontario.

Publication 5409: type FA, FB, FW, SB, SS ceramic disc capacitors for VHF/UHF.  
 Publication 5410: type FCS, SMFB, SMFO filters for the 50 MHz to 10 GHz range.  
 Publication 5411: type CL multi-layer, coaxial capacitors for connectors.  
 Publication 5414: type MT, MS by-passing capacitors for 50 KHz to 1 GHz.  
 Publication 5416, 5417: type BE, SF filters for RFI/EMI suppression.  
 Publication 5418: type AB broad band filters in Pi, T and L configurations.



NEW DIMENSION ELECTRONICS  
**ALLEN-BRADLEY** 

# A LED display replaces dial on new ADF tuning indicator

Navigation errors caused by pilots flying toward the wrong radio beacon or broadcast station, because their automatic direction finder (ADF) is tuned in error, may be prevented by a new ADF digital tuning indicator unit that uses an unusual type of frequency counter. The device substitutes for the frequency-calibrated tuning dial of the ADF.

Developed by Airdata Div. of the Airtech Corp., Columbus, Ohio, the unit counts the frequency of the ADF superheterodyne local oscillator, "subtracts" the value of the intermediate frequency from the oscillator count, and then displays the difference on seven-segment LED readouts (see photo). The displayed difference is the actual frequency to which the receiver is tuned.

The Airdata unit LED display is driven by a frequency counter with a 100-kHz crystal as the master time base. This frequency is divided down to a basic 50-Hz clock signal that drives the count-

ing system. According to Lewis Knaul, operations manager of Airdata, the choice of their particular system simplified the circuitry and reduced the cost.

Both MSI and LSI are used for the counting display circuit TTL logic. Provided the receiver is properly aligned, the frequency to which it is tuned—within 1 kHz—is displayed on the four seven-segment LED readouts. The count and display capacity is from 160 to 1999 kHz, which is greater than the typical ADF range of 190 to 1750 kHz, in three bands.



This independent display unit substitutes for the tuning dial of a standard aircraft ADF receiver.

Jim McDermott  
East Coast Editor

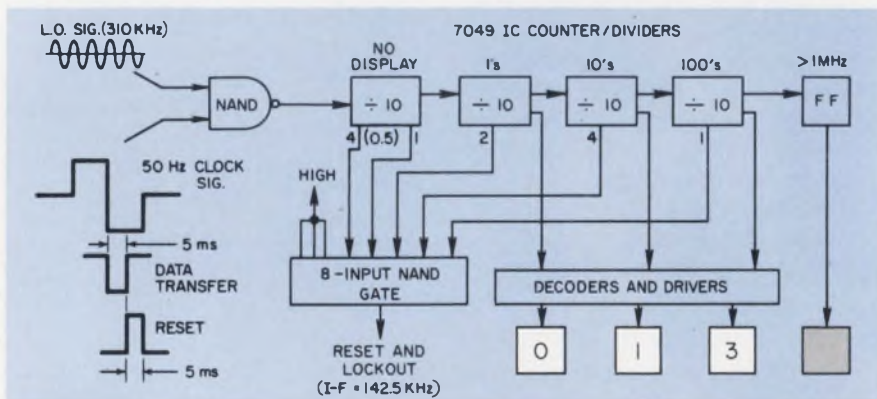

1. When the i-f count is reached in Airdata's unit, the 8-input NAND gate resets the counter. Counting resumes until the frequency to which the ADF is tuned is reached. This is transferred and displayed on the LEDs.

The manner in which the i-f frequency is subtracted from the local oscillator count is proprietary. It involves two counting periods.

First, the counter accumulates a count equal to the i-f. It then dumps the count by resetting the counter, at which point it again starts counting until the total equals that of the local oscillator frequency. This difference count is then displayed for 85% of each basic clock cycle, and it remains until the receiver is returned.

The local oscillator signal and the 50-Hz clock signal are applied to the counter through a two-input NAND gate (its output inverted). The NAND gate (Fig. 1) passes the oscillator signal during the first half of the 50-Hz clock. The latter half of the clock signal inhibits the oscillator signal.

The NAND gate output drives a chain of four divide-by-10 counters plus a flip-flop, which is set when the output of the last (hundreds) divider reaches 10.

The first counter in the string has no display. But it serves two purposes, Knaul says. First, it eliminates an annoying instability in the displayed digits. In addition it provides a means of subtracting the 0.5 kHz, of either the 142.5 or 157.5-kHz standard ADF i-f frequency, from the local oscillator frequency.

The outputs of the next three dividers drive the display latches and decoders, which illuminate the units, tens and hundreds of kilohertz digits. The fourth, or megahertz digit, remains dark unless the tuned frequency reaches 1 MHz or greater.

If the frequency exceeds 1 MHz, the output of the hundreds counter reaches 10. This triggers the flip-flop, energizing the D and C segments of the megahertz display and producing a "1." No other

# Take a hard look—

## These new cores may mean dozens of profitable new markets & products for you.

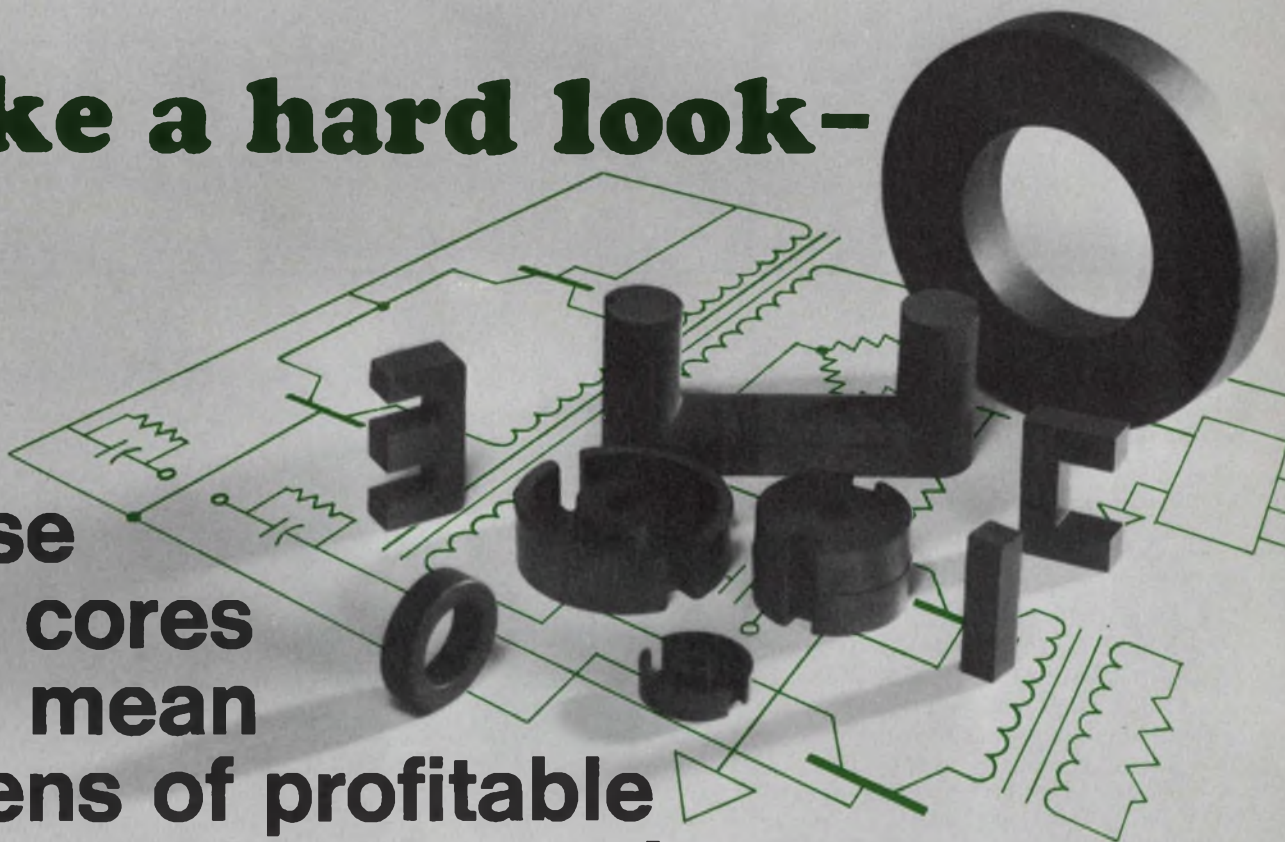

That's right, they're just ferrite cores. But they're made of Ferroxcube's new 3C8 — a material that opens up a whole new vista of applications for high-frequency circuit designs. Even if you've never designed an inverter or other high-frequency power device, you owe it to yourself and your company to read on. . .

3C8 is a remarkable advancement in the state of the ferrite art. It offers a combination of electrical, mechanical, and magnetic properties that formerly were only selective *trade-offs* among several ferrite materials. We mould it into cores of all sizes and shapes — including pot cores, E-I and U-I cores, and toroids.

For high-frequency inverters, 3C8 gives you high flux density, *even at elevated temperatures*, and low losses, *even at high excitation levels*. We'll provide 3C8 in practical-sized cores — up to kilowatt power levels. And ferrite cores cost only a small fraction of their laminated equivalents, despite lower losses and freedom from mechanical loss of permeability.

Perhaps you haven't considered the markets for a HF inverter designed around a low-loss ferrite core. Starting with DC, you can go almost anywhere, by inverting, transforming up or down, then using the AC directly or rectifying it to DC.

(In some applications, of course, you may wish to rectify and filter the power line, to get the DC.)

High-frequency AC is great stuff, by the way. . . Take fluorescent lamps, for example. They don't have to operate at 60Hz. They operate beautifully up to 3KHz. . . and, as the frequency goes up, the ballast gets much smaller, and lighter, and cheaper.

Take strobe light devices — highway warning markers; harbour buoy flashers, airport guidance systems; and the like. Using high-frequency inverters, their HV circuitry becomes much simpler and cheaper.

How about high-speed motors? Certain motor types, fed directly from a high-frequency source, shrink *startlingly* in size, and don't need gearing.

And don't forget the hundreds of devices operated from rechargeable batteries — radios, shavers, recorders, DVM's, 'scopes, etc, etc. At 5KHz, the charger circuit gets smaller than the battery.

Finally, 3C8 makes great power oscillators, power amplifiers, and ultrasonic generators. . . and don't forget induction heating applications!

Interested? Challenged? Write, or call your local Ferroxcube office today — and get started on 3C8!



**FERROXCUBE CORPORATION / SAUGERTIES, N. Y.**



Hempstead, L.I., New York, Keshan Sales Corporation, (516) 538-2300; Rochester, New York, R.P. Kennedy Co., Inc., (716) 271-6322; Hyde Park, New York, R.P. Kennedy Co., Inc., (914) 229-2269; Orlando, Fla., Cartwright & Bean, Inc., (305) 425-8284; Memphis, Tenn., Cartwright & Bean, Inc., (901) 276-4442; Metairie, La., Cartwright & Bean, Inc., (504) 887-5225; Atlanta, Ga., Cartwright & Bean, Inc., (404) 237-2273; Huntsville, Ala., Cartwright & Bean, Inc., (205) 852-7670; Charlotte, N. C., Cartwright & Bean, Inc., (704) 333-6457; Raleigh, N. C., Cartwright & Bean, Inc., (919) 832-7128; Philadelphia, Penn., Eastern Components, (215) 927-6262; Landover Hills, Maryland, Eastern Components, (301) 322-1412; Columbus, Ohio, Tom Mulligan & Assoc., (614) 457-2242; Shawnee Mission, Kansas, Thomas & Modicon Assoc., (913) 432-2131; Moline, Iowa, Thomas & Modicon Assoc., (319) 377-6261; Hazelwood, Missouri, Thomas & Modicon Assoc., (314) 838-6446; Minneapolis, Minn., Sanders Associates, (612) 533-2284; Burlingame, California, William J. Purdy Co., (415) 347-3701; Littleton, Colorado, William J. Purdy Co., (303) 794-4283; Needham Heights, Mass., Ferroxcube Corporation, (617) 449-1406; Saugerties, New York, Ferroxcube Corporation, (914) 246-2811; Addison, Illinois, Ferroxcube Corporation, (312) 832-0450; Dallas, Texas, Ferroxcube Corporation, (214) 691-2141; Tulsa, Oklahoma, T.J. Rayco, (918) 627-1515; Burbank, California, Ferroxcube Corporation, (213) 849-6631.

connections are made to this read-out, since the receiver frequency never reaches 2 MHz.

An eight-input NAND gate is used to subtract the i-f from the oscillator frequency, Knaul points out. For example, with a received beacon frequency of 310 kHz, and an i-f of 142.5 kHz, the counter

is then allowed to accumulate 142.5 kHz.

When the unique coded input derived from the five 142.5 inputs appears at the eight-input NAND gate, the latter produces an output that is used to reset the counter. The counter is reset after the first 142.5 kHz and it then con-

tinues to count for the remainder of the counting period until the data loaded in the counters are equal to the difference between the local oscillator and the i-f frequencies.

The data are transferred on the second half-period of the 50-Hz clock signal by a data-transfer pulse. ■■

## New family of rugged switches promised

A new patented concept in switch design has produced a rugged, bounce-free, position-insensitive switch capable of withstanding a shock force of 50 g's.

Called the Logcell II, the switch is manufactured by Fifth Dimension, Inc., Princeton, N.J. It is the forerunner of a whole new family of switches and is designed to be used in shipboard test and ordnance equipment, automotive applications requiring chassis mounting of switches, logic control of industrial machinery and applications where less-shock-resistant dry reeds and mercury wetted reeds are presently being used, says William D. Kinney, marketing manager of Fifth Dimension.

The reeds in use today are encased in glass and thus are very fragile. To compensate for this weakness, it is necessary to pot these switches in a protective com-

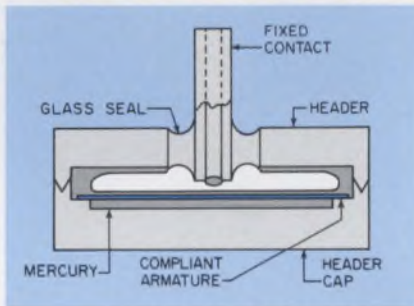

Contact bounce is eliminated in this switch by use of mercury films on the contact surfaces.

pound of some kind to reduce the amount of force applied to the glass envelope, Kinney explains.

The ruggedness of the Logcell II is achieved by using a tough metal enclosure with a single sturdy glass-to-metal bond that separates the two switch contacts.

The switch employs a mercury

system that makes use of the principle that mercury will take the shape providing the lowest free energy surface (see illustration). The armature and the inside surfaces of the header body and cap are all wetted by mercury. The volume of mercury used is controlled to provide enough to allow bounce-free operation and a self-healing contact interface.

The end surface of the fixed contact, where the armature strikes, remains unwetted by mercury. Because of the large ratio of wet to non-wet surfaces in the switch, any mercury lost because of switching or evaporation is quickly recovered. Thus no large position-sensitive pool is required.

Kinney says that in addition to the spst non-latch switch available now, spst latch and spdt latch and non-latch switches will be offered in about a year. ■■

## Holograms reproduced faster and better

A simple technique for rapid reproduction of high-quality holograms at a low cost has been devised by John H. King Jr., a staff engineer at IBM's Systems Development Laboratory, Endicott, N.Y. Capable of producing large arrays of holograms, the technique has potential application in future large-capacity, optical data-storage systems.

According to King, previous methods for duplicating holograms, such as direct contact printing and programmed plotting by computer, have been relatively

complex, costly or optically inefficient. With his new method, King has been able to reproduce holograms with diffraction efficiencies as high as when the holograms are recorded directly.

A master hologram or "holoarray," and a plate on which the reproduction is to be made, are on opposite sides of a field lens at its conjugate focal planes. A readout beam directed through the master yields a diffracted beam containing the master image. The diffracted beam then passes through the lens and interferes with a reference

beam to form interference patterns on the plate which is then processed like an ordinary hologram.

A master holoarray is constructed by shifting the object beam to a different position for each discrete hologram to be recorded. A small aperture mask and a short focal length lens behind a collimating lens provide a movable point source of light. A second movable mask is positioned in front of the holoarray itself. The masks and lens move together to control the position of each hologram in the array. ■■

# DANA



## counters with innovation



A year and a half ago we introduced the best universal counter/timer available on the market . . . the 8000. Now we have made it even better in the **8000B**, by providing the user with increased flexibility through the use of more optional capability and increased performance . . . and it's made to sell from \$1195 with features you wouldn't believe . . . 1 mV sensitivity to 500 MHz; trigger level monitoring and indicator; 8-digit display; 150 MHz direct count; 10ns time interval; 150 pico seconds time interval average; systems interface; and much more. We think it's the best counter you can buy in its price range.

Check us out before you buy. Let us send you complete information on 8000B . . . and our 8100 Automatic Counters too, if you want. We'll prove to you that we make really great counters, 11 of them. You have the budget and the decision . . . Dana has the ELECTRONIC COUNTERS.

**DANA**  
COUNTERS

Dana Laboratories, Inc.  
2401 Campus Drive, Irvine  
California 92664 (714) 833-1234

*When Test and Measurement Count*

# VARIABLE CAPACITORS FOR MICRO-CIRCUITS

7263

**VERTICAL  
STYLE**  
For series  
impedance matching  
in high frequency  
transistor  
circuits.



**MICRO-  
STRIPLINE  
STYLE**  
For stripline  
(series or shunt)  
"gap trimming".

7284



**PANEL  
MOUNT  
STYLE**  
For external  
tweaking of  
cavities  
or coaxial  
structures.

7265



**PRINTED  
CIRCUIT  
STYLE**  
For  
PC mounting  
in crystal  
oscillators or  
filter  
applications.

7271



*Johanson*

MANUFACTURING CORPORATION  
ROCKAWAY VALLEY ROAD  
BOONTON, NEW JERSEY 07005

## And now, PC boards with built-in resistors

Printed-circuit boards with "built-in" resistors are now available.

Until relatively recently, resistance could only be added to circuits on epoxy-glass printed-circuit boards by stuffing discrete resistors into holes on the board and soldering. More recently a technique was demonstrated that allowed thick-film resistors to be screened into a board to save money and space (see "Thick Films Deposited onto PC Board," ED 16, Aug. 5, 1971, p. 23). Now, the Mica Corp. of Culver City, Calif., has developed an epoxy-glass printed-circuit board that contains a layer of resistive material between the copper cladding and the epoxy-glass substrate.

According to Donald J. Loundy, manager of advanced projects at Mica, the board is a laminate of an epoxy-glass substrate, with thickness ranging from 0.0025 inch to 0.250 (depending upon the application) and surrounded on both sides by a 1000-Å layer of a proprietary resistive coating. Finally a 0.0013-inch copper layer is placed on both sides of the board to complete the sandwich.

Loundy notes that the resistive layer is in electrical contact with the conductive layer over the entire surface of the substrate, so that when the conductor is etched away, the remaining surface is in effect a thick-film resistor.

"The major problem in developing this technique," Loundy says, "was that of finding a resistive material that could be deposited uniformly ( $\pm 5\%$ ) over the entire surface of the substrate in a repeatable manner."

Although Loundy will not divulge the constituents of the resistive coating, he does say that the coating can be produced with a present sheet resistivity of 25 ohms/square. The company expects to perfect a 100 ohm-square coating soon. With conventional etching techniques, the minimum resis-

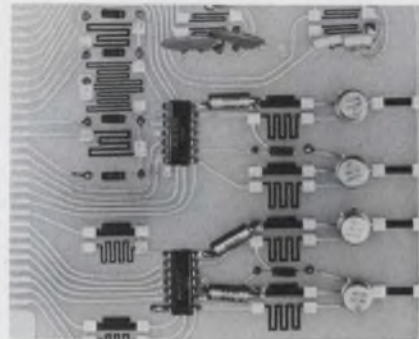

**New epoxy-glass PC boards** contain an integral resistive layer. They are called Micaply Omega Laminates by the Mica Corp.

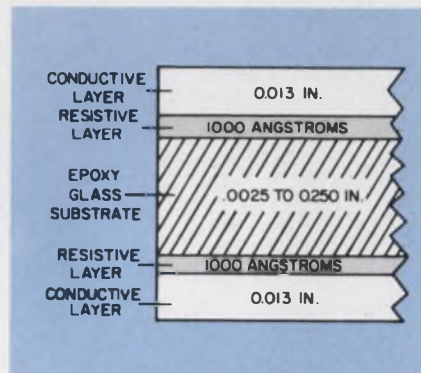

The conductor-resistor pattern is left on the epoxy-glass substrate after the copper cladding and the resistive layer of the circuit boards have been etched away.

tive line width attainable is 0.005 inch.

Loundy says the new boards can be used over a temperature range of  $-65$  to  $+125$  C with little change in characteristics. The temperature coefficient of resistivity measured over the range of 25 to 125 C is 50 ppm/ $^{\circ}$ C.

Applications for the present boards are expected in commercial or industrial systems.

"Later boards will be developed on cheaper substrates than epoxy-glass," says Loundy, "and they will find their way into consumer products." ■■



# DIP

## DUAL-INLINE-PACKAGED REED RELAYS



Magnecraft is proud to announce its new DIP (dual-inline-package) line of 8-pin reed relays. These new relays are designed not only to be compatible with the standard packaging developed for integrated circuits, but to offer Magnecraft quality at a low cost. This unique design gives further savings by offering the user the optimum in automated insertion and other economical installation techniques associated with printed circuit applications.

These fantastic new epoxy molded reed relays are ideal for use in circuits where high density packaging is essential. The 5VDC IC compatible versions of these relays will operate directly from TTL or DTL circuits.

Other standard coil voltages are available from stock in 6, 12, and 24VDC as well as contact configurations in 1 form A, 2 form A, 1 form B, and 1 form C. Most versions are also offered with a choice of an internal clamping diode.

**Magnecraft** ELECTRIC COMPANY

5575 NORTH LYNCH AVENUE • CHICAGO, ILLINOIS 60630 • 312 • 282-5500 • TWX 910 221 5221

# FREE!



## REED RELAY HANDBOOK

The purpose of this 120-page handbook is to assist the design engineer in specifying the proper reed relay for a given application. The book contains a glossary of terms, principles of operation, applications and design requirements as well as specifying and testing data. New products include the complete line of DIP Reed Relays.

INFORMATION RETRIEVAL NUMBER 27

# technology abroad

Using optical rather than micro-wave techniques, Marconi Radar Systems has developed a vehicle speed-measuring system with a range from 20 to 150 miles per hour. In operation, light from a passing vehicle falls on a set of mirror strips, which all focus on a single photo-diode. Optical irregularities on the passing vehicle, such as bright spots from the trim, windows or door handles, produce fluctuations in the light falling on the diode. The frequency of such fluctuations is a direct function of the vehicle speed. The photodiode gives a frequency output related to the speed. This output can be transformed by logic circuitry to yield a true speed indication. The unit is small and can be battery powered. A liquid crystal readout of speed is planned.

CIRCLE NO. 440

A low-cost, compact design of a multi-wafer input attenuator switch is under development by Solartron, one of England's largest oscilloscope makers. These attenuator switches reduce input signal levels and match the impedance of the input signal to that of the particular range of the attenuator in use. Conventional attenuators are comprised of resistors connected in a potential-divider fashion to reduce the incoming voltage. The capacitors are also required to provide capacitive attenuation ratios that match the resistive attenuation values, thus giving a uniform frequency response. The multiplicity of attenuator-switch wafers, resistors and capacitors creates a jungle of connections and takes up considerable space. But Solartron—working in collaboration with Diamond H Controls and EMI and Erie, hybrid manufacturers—has formed each section of the wafer as a hybrid substrate that contains the resistive and capacitive elements and

terminations. Each substrate is drilled and mounted on the common switch spindle, thus occupying no more space than a bare wafer-switch assembly.

CIRCLE NO. 441

Printed-wiring techniques that produce small but rugged tuning coils have been used by Plessey Windings of Essex, England. The coils will be used in the tuning circuits of a man-pack transceiver developed for the Clansman project—a British program to provide the armed forces with an advanced communication system. With the Plessey method, a series of interconnected coils are etched in the copper laminates on each side of a thin strip of polyester. The strip is then folded, concertina style, so all the windings are stacked, one on top of the other. Insulation is slipped between the folds, and the assembly is then bonded. At the same time a ferrite core is inserted. Representative inductance of these fingernail size coils is 100  $\mu$ H, with a Q value between 80 and 120. The coils will be fabricated for use over a frequency range of 0.5 to 30 MHz.

CIRCLE NO. 442

A simple detector that warns of ice formations on aircraft wings is being offered by England's Rosemount Engineering Co. The device, approved by Britain's Air Registration Board, is a cylindrical probe about one inch long. The probe is made to vibrate at its resonant frequency in the airstream. When ice forms on the probe, its resonant frequency changes, and a warning signal is relayed to the pilot. The frequency change with only a slight coating of ice is sufficient to give the pilot time to take corrective action before serious icing builds up.

CIRCLE NO. 443

## SALES OFFICES

### CALIFORNIA

Del Mar: (714) 453-7570  
Irvine: (714) 833-8980 (213) 437-6718  
Sunnyvale: (408) 739-7700

### FLORIDA

Boca Raton: (305) 391-8318  
Clearwater: (813) 726-3469

### ILLINOIS

Rolling Meadows: (312) 259-8300

### MARYLAND

Silver Springs: (301) 946-6030

### MASSACHUSETTS

Lexington: (617) 861-0840

### NEW JERSEY

Fort Lee: (201) 947-9870

### PENNSYLVANIA AND SOUTHERN NEW JERSEY

Medford: (609) 665-5071

### VIRGINIA

Reston: (301) 946-6030

## REPRESENTATIVES

### ALABAMA

Huntsville  
Compar Corp. (205) 539-8476

### ARIZONA

Scottsdale  
Compar Corp. (602) 947-4336

### CALIFORNIA

San Diego  
Celtec Company (714) 279-7961

### CANADA

Montreal, Quebec  
Corning Glass Works of Canada  
Toronto, Ontario  
Corning Glass Works of Canada (416) 421-1500

### COLORADO

Denver  
Elcom (303) 771-6200

### CONNECTICUT

Hamden  
Compar Corp. (203) 288-9276

### FLORIDA

Altamonte Springs  
WMM Associates, Inc.  
(305) 831-4645

Clearwater  
WMM Associates, Inc.  
(813) 446-0075

Pompano Beach  
WMM Associates, Inc.  
(305) 943-3091

### INDIANA

Indianapolis  
R. H. Newsom Associates  
(317) 849-4442

### MARYLAND

Silver Springs  
Mechtronic Sales, Inc.  
(301) 622-2420

### MASSACHUSETTS

Newton Highlands  
Compar Corp. (617) 969-7140

### MICHIGAN

Grosse Pointe Park  
Greiner Associates, Inc.  
(313) 449-0188 (313) 449-0189

### MINNESOTA

Minneapolis  
Compar Corp. (612) 922-7011

### MISSOURI

St. Louis  
Compar Corp. (314) 567-3399

### NEW MEXICO

Albuquerque  
Compar Corp. (505) 242-3633

### METROPOLITAN NEW YORK

Manhasset, Long Island  
Win-Cor Electronics Sales Corp.  
(516) 627-9474

### UPSTATE NEW YORK

TriTech Electronics, Inc.  
(315) 446-2881

### NORTH CAROLINA

Winston-Salem  
Compar Corp. (919) 723-1002

### OHIO

Dayton  
Compar Corp. (513) 890-9260  
Fairview Park  
Compar Corp. (216) 333-4120

### SOUTHERN NEW JERSEY AND PENNSYLVANIA

Haddonfield, N. J.  
Compar Corp. (609) 429-1526

### TEXAS

Richardson  
Semiconductor Sales Associates  
(214) 231-6181

### UTAH

Salt Lake City  
Elcom (801) 846-2317

### WASHINGTON

Bellevue  
Western Technical Sales  
(206) 454-3906

# Now your #1 source for digital is also your #1 source of reference.



The "can-do" champions in digital capability put it in writing. With the most complete "how-to" library available off-the-shelf. Check the coupon below, or call your local Signetics salesman or rep.

## signetics

Signetics-Digital  
811 E. Arques Avenue  
Sunnyvale, California 94086

Please rush your digital manuals, containing comprehensive logic diagrams, schematics, pin configurations, operating characteristics and application information on Signetics #1 Digital Line.

Check or money order, payable to Signetics-Digital, enclosed to cover nominal postage and handling costs. \$1.00 for entire set, 50¢ each for individual handbook.

- Complete Digital Package (6 books) \$1.00
- 54/7400 TTL Handbook, 256 pages. 50¢
- Utilogic II/600 TTL/DTL Handbook, 64 pages. 50¢
- 8000 Series TTL/MSI and Memory Handbook, 208 pages. 50¢
- DCL SSI 84/8800 TTL/DTL Handbook, 112 pages. 50¢
- MOS Silicon Gate 2500 Series Handbook, 176 pages. 50¢
- 8000/5400 Chip Catalog, 72 pages. 50¢

Name

Title

Company

Address

City

State

Zip

Telephone ( )

SIGNETICS CORPORATION — A SUBSIDIARY OF CORNING GLASS WORKS

INFORMATION RETRIEVAL NUMBER 28

# CTS *has the answer in*

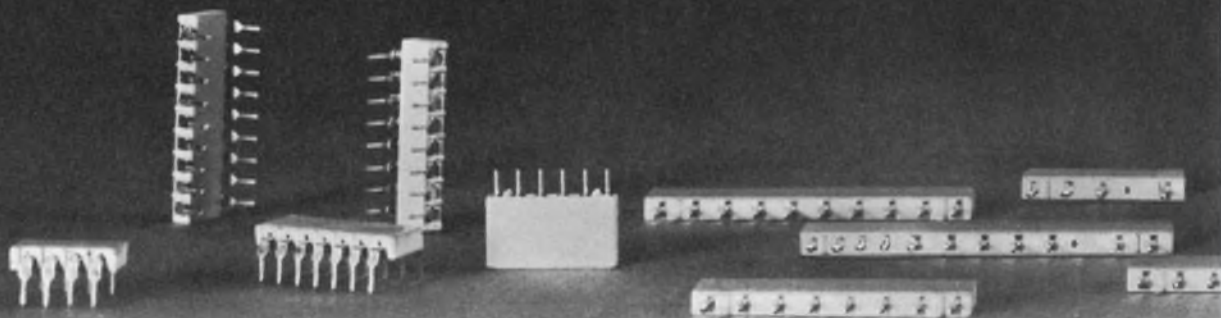

You name it—we have the exact cermet resistor network size and characteristics you need. Here's the choice you get right now: our *750 line* includes: .100" centers with 4, 6 & 8 pins; .125" centers with 2, 4, 6 & 8 pins; and .150" centers with 4 through 13 pins. And we're working on new designs right now!

All compact, extremely stable and highly reliable. Recently we packed even more circuitry into our *760 series*, giving you a choice of four popular space-saver packages: 8, 14, 16 and 18 flat lead styles. Packed with up to 17 resistors per module with flat leads standard (round leads on request).

# *cermet resistor networks.* So ask us!

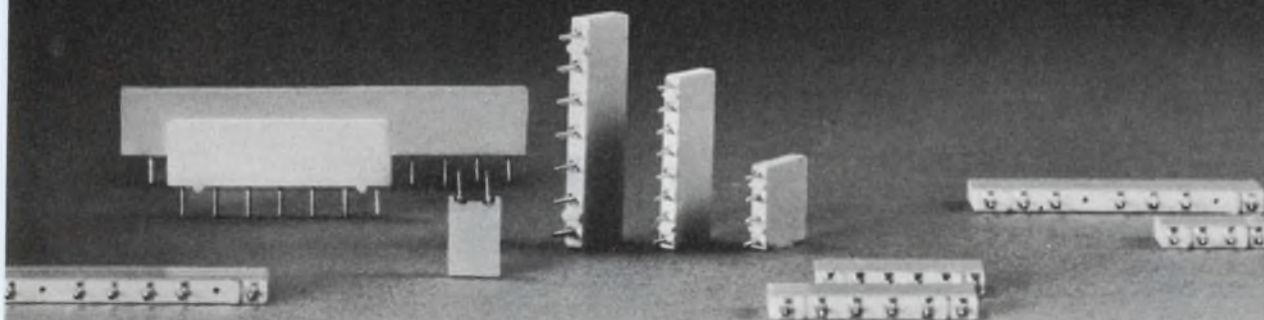

Our broad line provides an infinite number of circuit combinations, all with excellent TC, load and temperature characteristics supported by millions of hours of reliability testing. Ask your CTS sales engineer for data. Or write CTS of Berne, Inc., Berne, Indiana 46711. Phone (219) 589-3111.

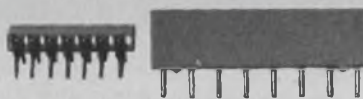

ACTUAL SIZE



**CTS CORPORATION** *Elkhart, Indiana*

A world leader in cermet and variable resistor technology.

# Everything's subminiature except their capacity.

Our subminiature switches may be tiny, but there's nothing small about their electrical capacity, long life expectancy, or application versatility.



Shown actual size.

Our SM series, for example, has a switching capability to 10 amps, bifurcated gold contacts for high reliability and a wide choice of integral or auxiliary actuators. Available are several terminal styles, including new flat quick-connects. To meet your other design needs, there's now a sealed version of the SM.

And if that's not enough, our smallest snap-action switch—the 1SX series—combines precision operation and long life in a 1 gram package. Plus it offers most of the features found in the SM.

For more information, call your MICRO SWITCH Branch Office or Authorized Distributor (Yellow Pages, "Switches, Electric"). Or write for Catalog 50.

## **MICRO SWITCH**

FREEPORT, ILLINOIS 61032  
A DIVISION OF HONEYWELL

MICRO SWITCH products are available worldwide through Honeywell International.

# washington report



Don Byrne  
Washington Bureau

## **GAO finds fault in Navy sonobuoy**

The General Accounting Office criticized the reliability of a sonobuoy AN/SSQ-53, made by Magnavox—in Navy's Difar (directional low-frequency analyzing and recording) submarine detection system. The GAO report submitted to Congress contends the item for the so-called directional Jezebel system has a mean-time-between-failures of only three hours. The contract calls for 300 hours.

The equipment is going aboard the Lockheed P-3C aircraft and is due for use on the S-3A, which will carry up to 60 of the sonobuoys. Dropped from 30,000- to 40,000-foot altitudes, the sonobuoys search a suspected submarine-infested area. The plane that made the drop can then dive to attack hostile subs with ASW torpedoes or other weapons. The Navy is also planning to install Difar equipment in 238 P-3A and P-3B patrol aircraft by next June.

## **Comsat for abolishing FAA satellite plan**

Comsat has asked the White House Office of Telecommunications Policy to kill the plan by Federal Aviation Administration to build an over-ocean satellite for airline communications and surveillance. At issue is who will own the system. The FAA's plan is to build the system with federal funds and retain ownership; Comsat would like to launch the satellites and then lease them to the Government.

The Office of Telecommunications Policy is thought to be leaning toward the Comsat approach. Meanwhile the FAA has missed its target date of November 15 for requests for proposals on the system, and the best guess now is that it will do this in early February, if at all. The airlines keep insisting that they don't want or need at this time the costly satellite system but nobody in the Government seems to be listening.

## **FCC urged to support digital microwave**

Digital microwave transmission has a bright future, but the rules for its regulation should not be so restrictive as to inhibit its use in present microwave systems, the Federal Communications Commission has been told by companies in the field. In a proposed rule-making docket for digital modulation techniques, the comments came from established carriers, like AT&T and Western Union, and also from new, specialized carriers, like Microwave Communications, Inc., and Data Transmission Corp. The U.S. Independent Telephone Association and equipment manufacturers also

filed briefs.

AT&T said the systems under development should handle inter-city traffic for the next 15 years when supplemented by high-capacity cable and waveguide. MCI asked that a separate frequency allocation be made for digital systems. The Electronic Industries Association said digital modulation should be permitted with proper regulation in all currently used microwave bands, a position some manufacturers shared.

## **PBX regulation report expected by April 1**

An industry group, called the PBX Advisory Committee, working with the Federal Communications Commission on proposed regulations for the inter-connection of private branch exchange (PBX) equipment with the telephone network hopes to have an interim report by April 1. The group has been working for several months to come up with recommendations for both equipment standards and ways to protect the telephone systems. Meanwhile Arcata Communication, Inc., a PBX supplier, is asking emergency relief from the FCC in a dispute with the New York Telephone Co., which has been affected by a strike since July 14. Arcata says the company should either make connecting arrangements available or permit others to furnish them. Arcata provides PBXs to some office buildings in New York City. A Federal Court in New York turned down an Arcata request for a preliminary injunction against the New York Telephone Co.

**Capital Capsules:** Watch for a big push by labor in the coming election year for stricter import legislation and a concerted program of "Buy American." . . . The Washington-based ICX-Intercontinental Computer Exchange, Inc., says it has completed the first IBM 360 installation in the Soviet Union. The company specializes in buying data-processing equipment for overseas sales. ICX says that the Soviet contract totaled about \$1-million and that the equipment will be used in a radio-TV factory being built in a suburb of Moscow . . . Aeronautical Radio Inc., has installed its first decentralized third-generation electronic switching system in Chicago. The system uses a pair of Control Data Corp. M1000 computers and peripheral equipment. It is part of a proposed 265-city system . . . NASA's Automated High-Energy Astronomy Observatory contract has gone to TRW Systems of Redondo Beach, Calif. The \$70-million contract will run about seven years and cover two of four planned satellites that will study space radiation . . . In the past decade the aerospace industry had sales totaling \$247.7-billion, of which \$156-billion came from defense, \$32-billion from space, \$35-billion from the commercial aircraft industry and \$24-billion from non-aerospace buyers according to an Aerospace Industries Association study. R&D, included in the sales figures, totalled \$54-billion in the 1960-1970 period. Over-all, the sales amounted to 3.2% of the Gross National Product. . . . The Government now has in its inventory 5961 computers, an increase of almost 700 over the previous year. No dollar figures have been released, but it is estimated that the inventory is worth well over \$1-billion. IBM remains the biggest supplier and the Defense Dept. the biggest user. . . . The Air Force has awarded a \$2.66-million contract to the Northrop Corp. for airborne navigational computer systems to be used in its undergraduate navigator training system.



# Centralab offers immediate delivery on functional modules

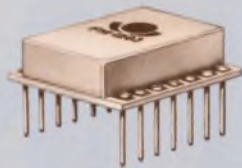

Centralab, the industry leader in thick film microcircuitry, now has combined its recent advances in packaging and chip hybrid technology to bring you five new functional modules available for immediate delivery from stock. These modules are sealed in ceramic packages with 14 swaged terminal pins universally spaced .600" row-to-row and .100" apart to facilitate printed circuit board mounting.

Module	Function	Rating	Suggested Applications
FM-1110	Power driver	1 amp @ 60v steady state	Interfacing with relay/solenoid coils, magnetic cores, lamps, etc. in computers, control consoles, test equipment, digital systems, etc.
FM-1203	Dual driver	300 ma @ 28v steady state	
FM-1403	Quad driver	300 ma @ 28v steady state	
FM-2100	MOS clock driver	200 ma with up to 30v shifts	
FM-3110	Programmable multivibrator	Output pulse widths 200 ns to 12 $\mu$ s	To drive all popular MOS circuitry in calculators, computers and other digital systems.
*FM-4110	RC clock oscillator	500 kHz to 6 MHz	Delay, timing and pulse shaping in computers, control circuits, test equipment and other digital systems.
*FM-5110	Overvoltage crowbar	Trip voltage 4.5 to 12.5v, < 1 $\mu$ sec response	Time base, square wave generators and tone signalling controls for computers, test equipment, etc.
*FM-5111	Overvoltage crowbar	Trip voltage 12.5 to 20.5v, < 1 $\mu$ sec response	
*FM-5120	Electronic fuse	Trip current 1 amp @ 40v, < 1 $\mu$ sec response	To protect voltage sensitive devices such as IC's, MOS devices, etc.
*FM-6110	Power operational amplifier	250 ma peak output current with supply voltages $\pm$ 15 vdc	DC electronic equipment and systems where precise, fast current disconnect is required.
			Servo systems, test equipment, power supplies, etc.

## DESCRIPTION

**FM-1110, 1203, 1403: Single, dual and quad drivers**  
Designed to accept standard DTL and TTL logic levels and to drive loads which require high power. Consist of single or multiple NAND/NOR gates and high gain amplifiers.

**FM-2100: MOS clock driver**  
Designed to accept standard DTL and TTL logic levels and universally drive MOS circuitry. Consists of a three input AND function followed by a power inverter.

**FM-3110: Programmable monostable multivibrator**  
A flip-flop which, when triggered by an input pulse, generates an output pulse of prescribed width, with control through interconnection of appropriate package pins.

**\*FM-4110: RC clock oscillator**  
An RC astable multivibrator and an output buffer stage capable of providing a square wave output at a predetermined fixed frequency. It can operate down to 5 Hz with the addition of external capacitors.

**\*FM-5110, 5111: Overvoltage crowbar**  
A high speed electronic voltage sensing element and switch designed to protect voltage sensitive electronic devices by shunting out the supply voltage when high transients or other overvoltage conditions are experienced on the supply line.

**\*FM-5120: Electronic fuse**  
The electronic equivalent of a fuse which features accurate threshold levels, high speed and reset capabilities. Available in a variety of current threshold levels.

**\*FM-6110: Power operational amplifier**  
An operational amplifier designed to provide output capabilities far beyond those obtainable with equivalent monolithic IC's.

**\*These modules are scheduled for introduction in 1971.**

We welcome inquiries on any variation of the above modules and can provide rapid turnaround on samples and production quantities of custom modules. For design assistance or other information, write Sales Manager, Microcircuits, Centralab. Standard modules are also available through Centralab Distributors.



**CENTRALAB**

Electronics Division  
GLOBE-UNION INC.

5757 NORTH GREEN BAY AVENUE  
MILWAUKEE, WISCONSIN 53201

M-7115

# POWER POWER!

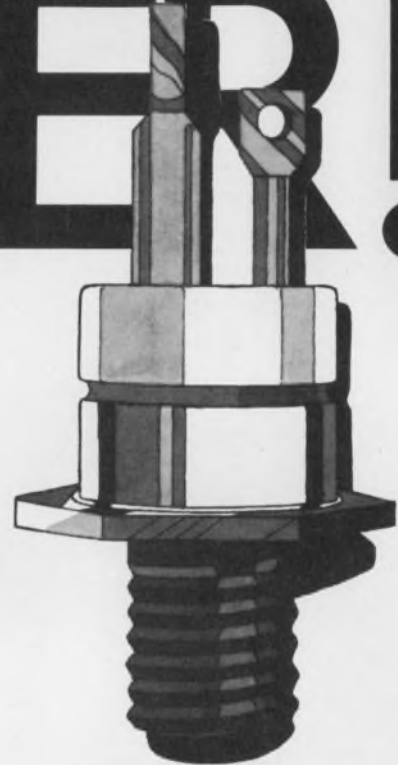

Who are the power people in Europe, in electronic power devices? Philips, of course. Where else, for example, can you obtain a triac rated at 50 A and 1200 V? A company with the development and production power to come up with this combination is able to solve most other problems too, when it comes to power devices.

The Philips triac range starts with the more conventional 500 V, 6 A and 12 A units, and includes a 25 A/1200 V device as well. You'll find just about any triac you require, somewhere in the Philips range of power devices. But there are many other things in the Philips Power Package too.

Here are some typical examples...

- Power zeners for voltage regulation or transient suppression, with ratings from 1.5 to 300 W.
- High-voltage rectifier stacks, including units rated to 150 kV, and controlled-avalanche units stacked in series for RF heating.
- Welding stacks, including the new "Ignistor" which replaces the ignitron in automatic resistance welding.
- Thyristors... 1 A to 160 A/1600 V from a single source.
- Rectifier diodes from a few milliamps to 400 A/2000 V... plus a complete selection of fast-recovery (200-300 ns) diodes.

When you need a power device for your circuit, Philips power power is always at your fingertips. Write today for full documentation and see!

N.V. Philips' Gloeilampenfabrieken  
Electronic Components and Materials  
Division, Eindhoven - The Netherlands.



electronic components  
and materials

# PHILIPS

INFORMATION RETRIEVAL NUMBER 32



# MEASUREMENT NEWS

information for better measurement

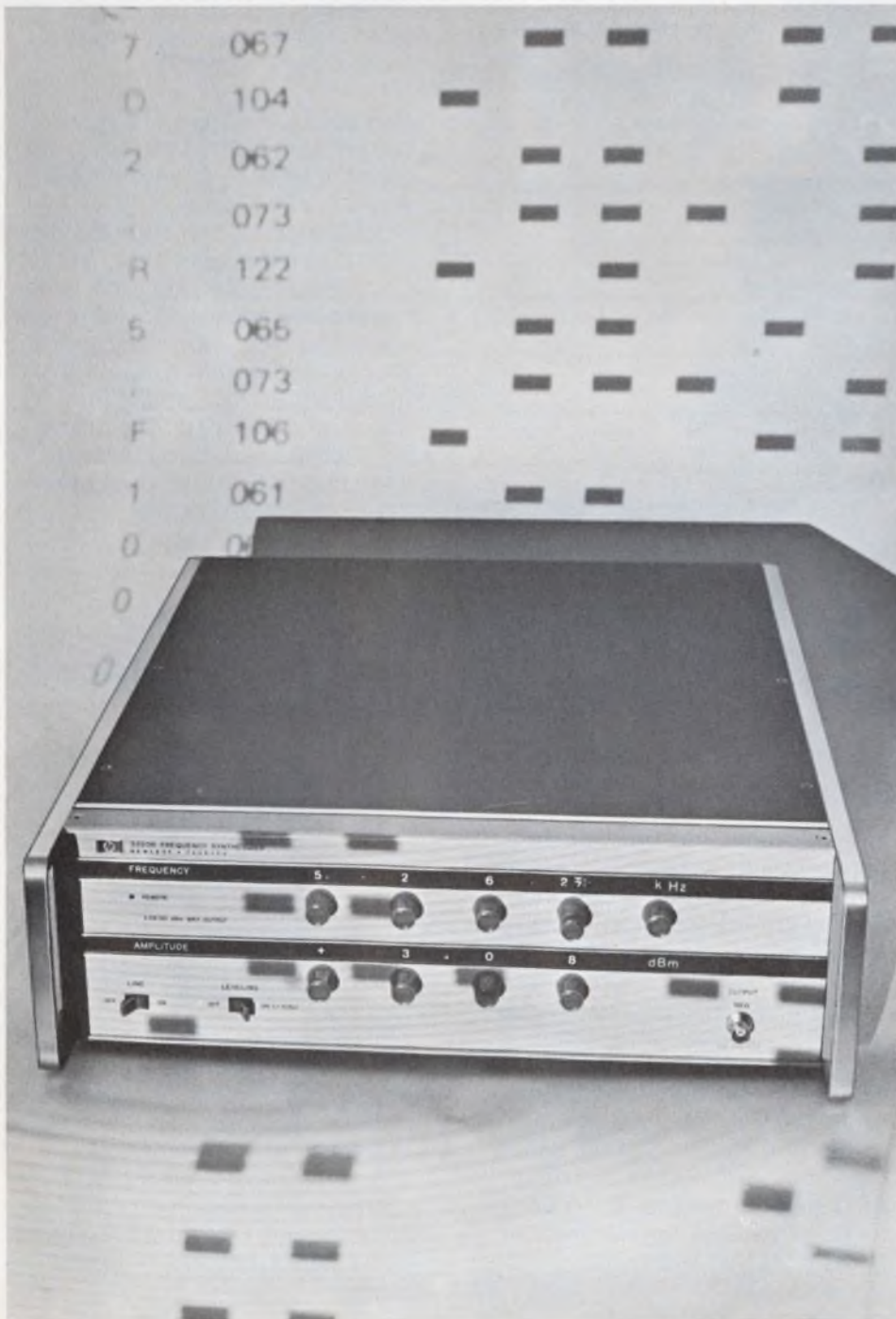

## in this issue

1300 MHz RF sweeper covers seven octaves

HP's "total solution" computing counter system

Low-cost digital 'scopes

## Finally: a synthesizer anyone can afford

Get a quality frequency synthesizer at a truly low price, without sacrificing signal purity. Its many virtues include full digital remote control.

When HP was founded in 1939 its first product was an RC Wien Bridge oscillator invented by William R. Hewlett, now the firm's chief executive. Direct descendant of those first products (the 200 series RC oscillators), the new 3320A/B Frequency Synthesizer has the frequency accuracy and stability of synthesizers, and the spectral purity of oscillators—all at a very low price.

3320A/B stability depends on a single fixed-frequency oscillator, so you can tailor your choice exactly to the job. Standard equipment is an ambient crystal with drift below  $\pm 10$  parts in  $10^6$  per year. An oven reference is op-

*(continued on page 3)*

# Sweep seven octaves of RF in 10 milliseconds flat



HP's newest RF Sweeper, the Model 8622A 10-1300MHz plug-in in an 8620B mainframe. The lap belongs to Miss Barbara Althoff of Microwave marketing.

Just some of the reasons we think you'll like our new 1300 MHz Sweep Oscillator are:

- 10-1300 MHz coverage—in one continuous sweep.
- 10 milliwatts calibrated output, leveled to  $\pm 0.5$  dB full range.
- Clean, stable CW signals—less than 5 KHz peak residual FM.
- Solid-state reliability and compactness.
- Low \$2750 price for the **complete** sweeper (RF plug-in and mainframe).

Calibrated start/stop and  $\Delta F$  sweeps commend the 86220A (RF Unit) and 8620B (Mainframe) for both broadband and narrow band

sweep testing of RF components, networks and systems. And stable CW with low spurious, plus the capability for low distortion AM and FM permit this sweeper to be used in signal simulation applications. An optional 70 dB attenuator adds more flexibility of use.

Although we're talking about the value of the 86220A/8620B just for its 10-1300 MHz coverage, don't overlook the point that the 8620B mainframe also accepts our other solid-state RF plug-ins for coverage to 12.4 GHz. *Info on the 86220A RF Unit (\$1775) and 8620B Mainframe (\$975) is yours simply by checking the Reply Card.*

## Make Z-fold recordings without ink

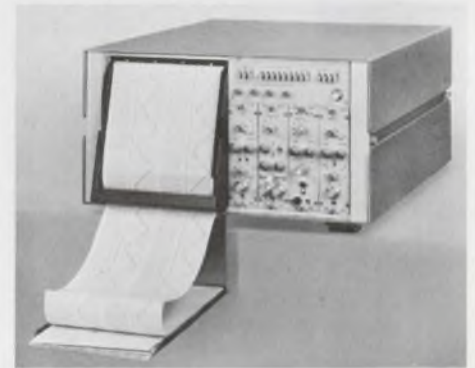

HP Model 7414A four-channel thermal tip oscillographic recorder.

Ever tried to find part of a chart recording on a 500-foot roll of chart paper? Compare with flipping the pages of a book and you'll see how much easier it is to handle the Z-fold charts from the new HP 7414A Oscillographic Recorder. It's a thermal (no ink), four-channel recorder featuring pushbutton chart speed change. Response is within  $\pm 0.5$  dB from dc to 50 MHz, and falls off less than 3 dB at 100 MHz. The full range of HP 8800 series plug-ins can be used. Price is \$4500 without plug-ins. *There's more; check the Reply Card.*

## Meet the "Value Family" of HP sweepers

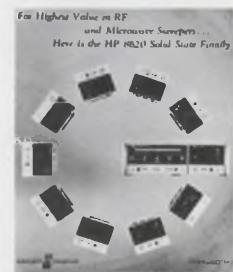

From the "simplest," low-cost sweeper to a sophisticated, multi-octave, programmable source, the 8620 family offers the highest value in solid-state RF sweepers.

And it's easy to select the precise configuration for **your** job; this attractive brochure presents the entire family in concise, logical format.

*For your copy, check the Card.*

# Need more stability? Step up to rubidium

Quartz oscillators rank high in frequency stability, but many systems need something better, like the HP 5065A Rubidium Frequency Standard. This atomic standard has 100 times the long-term stability of quartz. Besides upgrading system performance, increased stability may simplify the design of other parts of the system. In PCM communications, for example, switching from quartz to rubidium may eliminate the need for "bit stuffing" pulses needed for synchronization when less stable frequency sources are used. Navigation systems, color television systems, and calibration labs can also benefit

by upgrading to rubidium. The HP 5065A has the best guaranteed rubidium specifications available. Long-term stability is better than  $1 \times 10^{-11}$  per month. Short-term stability for a one-second averaging time is  $5 \times 10^{-12}$ . The 5065A is more rugged than a quartz oscillator, too. HP now gives an unconditional 3-year warranty on the rubidium vapor frequency reference—not just the gas cell, which hardly ever fails, but the *entire* module including oscillator, lamp, filter cell, and photo-detector. At \$7500, the 5065A offers unsurpassed price/performance. *For more information, check the Card.*



In frequency standards, the next step beyond quartz is rubidium. This one has the best guaranteed specs, plus an unmatched warranty.

*Continued from page 1*

tional and retrofittable. Or you can phase-lock to an external reference.

Both instruments have a range of 0.01 Hz to 13 MHz (the two lower ranges are optional).

3320A adds synthesizer quality to production and design work, yet keeps you out of trouble with the budgetmasters. It will put a volt rms into  $50\Omega$  and it has a continuous  $+13$  dBm-to-0-dBm vernier, so it's most useful where level control is not a critical item.

3320B is the super-synthesizer. It has a 4-digit leveling loop with 0.01 dB resolution of a calibrated output from  $+26.99$  dBm to  $-69.99$  dBm ( $-73.00$  under remote control). It's flat  $\pm 0.05$  dB from 10 Hz to 13 MHz, and level accuracy is  $\pm 0.05$  dB absolute at 10 kHz.

Because the 3320A/B is a synthesizer with ranges, its signal-to-phase noise is improved as the instrument is downranged. Its low spurious content ( $>60$  dB down) and low har-

monic distortion ( $-60$  to  $-40$  dB, depending on frequency) bespeak its high-quality spectral output.

### Programmable/Remote Control

Digital remote control is an option on both instruments, and it can be a retrofit later. On 3320A Option 003 gives you parallel BCD remote control over frequency only. There are two remote control options for 3320B. Both give you control over all functions except the last vernier digit and the line switch. Option 004 is parallel BCD. Option 005 is a unique bit-parallel/word-serial ASCII option; with it, one program device can control several 3320B's. With Option 005, 3320B interfaces directly with the HP 3260A Marked Card Programmer, a photo reader, or any other 8-bit controller.

Price: 3320A ranges from \$1900 to \$2715, depending on options. 3320B prices are from \$2400 to \$3910. The 3260A Marked Card Programmer is \$750. *For further information, check the Card.*

## Locate faulty IC's with less time and effort

HP's 10529A Logic Comparator is a clever gadget that's extremely useful in design, production testing, and servicing digital integrated-circuit equipment. The comparator locates faulty IC's in malfunctioning equipment as quickly as possible. It's simple to use, self-powered, adjustment-free, requires no tools, and costs only \$295.

The logic comparator clips onto powered TTL or DTL IC's and instantly identifies any pins where the logic states don't match those at corresponding pins of a known-good reference IC. Logic differences are indicated on the comparator's 16 light-emitting diodes. There's one diode for each pin of 14-pin or 16-pin dual in-line IC packages, and a lighted diode indicates a logic difference at the corresponding pin, therefore a faulty IC.

When the user also wants to see specific logic operation, the HP 10525A Logic Probe and 10528A Logic Clip nicely complement the comparator. The logic clip will display all the actual states of 14- or 16-pin DIP IC's at a glance. When pulses are involved, the logic probe is handy; it has pulse detecting and stretching capability. HP's 5010A IC Troubleshooting Kit consists of comparator, probe, and clip in a carrying case. Price is \$495, or \$20 less than if the three are purchased separately.

*To learn more, check the Reply Card.*

Here's a rapid, low-cost way to zero in on faulty IC's. The logic comparator simply clips onto your in-circuit IC's and lights LED's for any IC pins associated with faults.



# Scan up to 1,000 channels without a computer



High-speed data acquisition doesn't always need a computer. Two new options enable this DVM to measure fast-changing signals, scan up to 50 channels at 1,000 per second, and then print.

There are two new options that give HP's 3480 DVM and 2070A Data Logger even **more** can-do for the dollar. 2070A is the little system you form by combining a fast 3480A/B DVM (1,000 readings a second) with a plug-in scanner and a digital printer. All in 7" of rack space, for \$4475 plus options, of which two are new:

For \$500, Option 001 **Sample and Hold** gives the 3480A/B DVM's the ability to measure fast-changing signals accurately. Trigger the 3480 now, and it will remember the value of the instant long enough to digitize it. Trigger it, if you like, with the delayed sweep on your scope, and digitize a

whole LF waveform, point by point.

For \$1000, Option 005 **Data Storage** makes the 3480's speed more usable. Store up to 50 complete readings at that 1,000/s rate, then tick them out later at 10 lines/s on the printer. Scan 50 transducers in only 50 milliseconds, yet preserve every digit.

To learn about all the options open to you with the 3480 DVM's— like true rms, multi-ranges and  $\Omega$ , and to learn how a low-cost 2070A Data Logger might do the job of a \$10k or \$15k system for you, *check the Card for data sheets or three similarly relevant Application Notes.*

## Programmable DC power line grows again

The 6129B is the most recent addition to the HP line of Digitally Controlled Power Sources (DCPS's), which along with HP D/A's and Multiprogrammer/analog power supply combinations, represents an extensive digitally programmable dc power capability.

The new addition (\$2700) is rated at  $\pm 50V/5A$ , five times the output power of the existing DCPS's (6130B,  $\pm 50V/1A$ ; 6131B,  $\pm 100V/0.5A$ ). All three of these DCPS's meet all requirements for systems use.

Typical applications for these DCPS's include stressing power semiconductor devices on high-speed production lines, and establishing signal and bias parameters on electronic modules under test.

For applications requiring more than 250W, or where the DCPS's 300 $\mu$ sec programming speed and 0.01% accuracy are not required, combining the 6936A Multiprogrammer with up to 240 standard analog power supplies can provide dc power outputs to 10kW, with 0.1% accuracy and programming speeds from 10msec.

Finally, in applications where high programming speed and lower output power are required, HP DA's can provide 50 $\mu$ sec programming speed with power outputs of  $\pm 10V/5mA$  (69321A) and  $\pm 10V/20mA$  (6933B).

*For more information, check the Card.*

**The 6129B extends HP's digitally programmable dc power capability with its 250W output, 300 $\mu$ sec programming speed, and 0.01% accuracy.**



## Timer/Counter/DVM team up for unique measurements



The HP 5327B universal timer/counter measures frequency to 550MHz, sub-nanosecond time intervals, and has a built-in DVM.

A universal counter and digital voltmeter in one package? Yes, but the HP 5326B/5327B Timer/Counter/DVM's are considerably more than that. They're really an entirely new type of counter, capable of making measurements no other counter can make.

First, there's the built-in 3-range integrating DVM. It'll measure external DC voltages, but, because of unique design it can measure the counter's trigger levels. Thus you can measure things like 10%-to-90% rise times, with the start and stop levels set with DVM accuracy. It's faster and more accurate than using a scope with intensity markers to show the start and stop points. Even without the DVM these counters are special. They **average** repetitive time intervals to get improved resolution—like 100 pico-

seconds, good enough to measure propagation delays in logic circuits and other short intervals. Unique synchronizers found only in these counters permit measuring sub nanosecond intervals! Try to beat all this performance at double the price of the 5326B and 5327B.

There are two new optional high-stability time bases: aging rates are  $< 3 \times 10^{-9}$ /day and  $< 5 \times 10^{-10}$ /day. Both change  $< 1 \times 10^{-8}$  from  $-20^{\circ}\text{C}$  to  $+65^{\circ}\text{C}$ . Prices: \$300 and \$450. Another option for the 5327 is high input sensitivity: 25mV rms, 0 to  $50^{\circ}\text{C}$ ; 10 — 15mV typical at  $25^{\circ}\text{C}$ . Price \$125.

Models 5326B (\$1595) and 5327B (\$2150) are members of a six counter family. Other models omit the DVM, time interval capability, or both. Prices are \$950 to \$1795. *Check the Card for full details.*

## A computer that expands with your needs



The HP 2100A "thoroughly modern mini"

The HP 2100A minicomputer—more powerful and lower in cost than its predecessors—gives OEM's and end users new flexibility in tailoring a computer to specific needs.

Merely by plugging in more memory and adding peripherals, a 2100A can grow from an OEM controller to a multi-language stand-alone computer, or become the nucleus of time-sharing or batch processing systems.

The 2100A has a 16-bit word length and can expand from 4K to 32K of core memory within its 12-inch high mainframe. With a memory cycle time of 980ns, it is

## Low-cost, functional pulse generators

HP's budget-stretching family of pulse generators now offers repetition rates to 100MHz, amplitudes from 0.2 to 5V from a 50Ω source. These fast pulsers, with a wide range of pulse widths and transition times, are useful for testing both analog and digital circuits—including digital IC's. Newest:

- **8007A.** 100MHz max rep rate; rise and fall times controllable from 2.5ns to 250μs; \$1600.
  - **8012A.** 50MHz max rate; transition times, 10ns–500ms; \$875.
  - **8013A.** 50MHz max, 3.5ns transition times; pos, neg outputs; \$625.
- All three models have an external input for reshaping and amplifying pulses generated elsewhere.

*These generators are valuable performers; for more info, check the Card.*

Three new members of HP's budget-stretching pulse-generator family—the 8007A, the 8012A, and the 8013A.

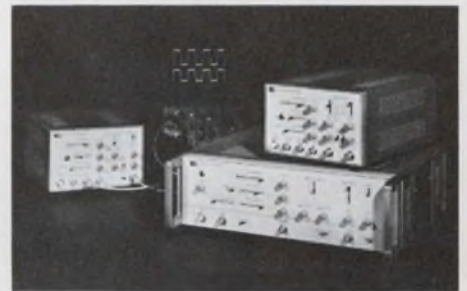

40 to 100 per cent faster than previous HP models.

It's an entirely new design except for the instruction set and I/O structure. Keeping these the same makes the 2100A compatible with HP's existing peripherals and large software library.

Other features include FORTRAN, ALGOL, BASIC and Assembly software modules; 14 I/O channels, or up to 45 with an extender; plus floating point arithmetic and micro-programming capability. Prices begin at \$6,900.

*This brief description only scratches the surface; for more information, check the Reply Card.*

# Desk-top computing counter system is versatile and economical

Programmed by punched card, keyboard or diodes, this HP system gives highest performance frequency and time interval measurements. Equations involving these measurements, or external data, are solved in real time.

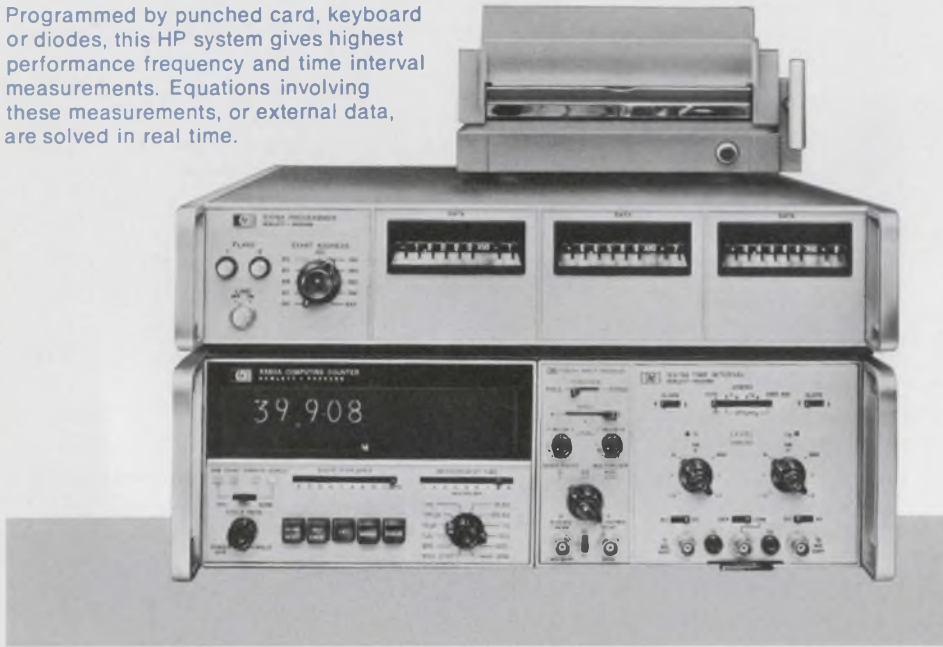

Better measurements, plus a total solution to measurement and computation problems—in seconds, and economically. That's what the HP 5360A/5376A Computing Counter System—a desktop measuring and computing center for electrical measurements—gives you. It puts unmatched frequency and time-interval measuring power *and* real-time arithmetic capability at your fingertips. To duplicate its capabilities you'd have to buy a counter and computer, interface them and write software. Cost? About \$25,000, not including software. The 5360A/5376A does it all for \$7850!

It will solve equations involving its own measured data or that from other digital sources (DVM's etc.). For example, it will linearize transducers, calculate phase differences, calculate mean, standard deviation, and fractional frequency deviation, calculate maximum access time, and generate control signals. Final solutions are displayed directly on the 5360A Computing Counter readout. The 5360A Computing Counter portion measures frequency to 320 MHz (to 18 GHz with accessories) and time interval with a resolution of 100 picoseconds. Its frequency measurements are 10 to 1000 times faster than ordinary counters.

The 5376A Programmer automatically sequences the 5360A through a predetermined series of measurements and computations. Operations include  $+$ ,  $-$ ,  $\times$ ,  $\div$ , and  $\sqrt{\quad}$ . It also provides facilities for the interchange of control signals and data between the 5360A Computing Counter and various other instruments and output devices, such as DVM's, signal generators, printers, and recorders.

Programs can have up to 200 steps, and may include branching, looping, subroutines, and constants. Programs are entered by punched card or by plug-in-diode read-only-memory.

The 5360A has 3 registers for accumulating data, 2 for storage. The 5376A can provide up to 6 additional storage registers. Program constants can be stored in up to three optional thumb-wheel switches. These are useful, for example, in production testing, for specifying upper and lower limits or nominal values and tolerances.

Optional D to A converters can provide analog outputs under program control for plotting results, or as test stimulus or feedback signals in closed-loop control systems.

5360A/5376A Systems start at \$7850. For full details, check the Card.

## Communications links get IF/RF sweeper

For fast, efficient alignment of microwave radio links, use the HP 8605A Communications Sweeper, a CW and swept signal source, covering both IF (47-100MHz) and RF (up to three communications bands can be selected from within the 1.7-13.25 GHz range). The 8605A features the excellent frequency accuracy and flat power output needed for stringent communications systems measurements. This high-performance capability comes in a rugged portable package, making the 8605A equally suitable for lab and field tests. The RF (microwave) coverage employs economical microelectronic modules, which means you can tailor the sweeper just for the band (or bands) of interest.

The 8605A is easy to use; IF and RF controls are separate and independently adjustable. The operator can shift back and forth between IF and RF measurements without readjusting any source settings or changing any cables or plug-ins.

Output power is flat within 0.01dB via internal leveling for the IF band and via external leveling for the RF bands, using the recommended 784A Directional Detector (\$625) and 11675A Leveling Cable Assembly (\$50). Price of the 8605A varies from \$3875 up, depending on frequency and number of RF bands selected.

For specifications and more information on the 8605A Communications Sweeper, check the Reply Card.

Extremely flat-output Communications Sweep Oscillator offers both 70MHz IF and multiband RF (microwave) coverage in the same all-solid-state instrument.





### A free LED is yours for the asking



Our gallium arsenide phosphide lamp is offered in both plastic and hermetic packages.

If you'd like to have one of our solid-state lamps to try, just ask. All we ask in return is that you tell us briefly about your application. You'll receive a free LED with a panel mounting clip. These HP light-emitting diodes have a 100,000 hour life with low power requirements—1.6 volts at 2 to 10 mA. They also have a wide viewing angle of 180 degrees with high brightness. For comprehensive data and order coupon, check the Reply Card. Try one, you'll like it!

### Communications kit offers new components

Now, at paltry cost, you can get a solid handle on what those premium solid-state components can do for you. For just \$19.40 you get **seventeen** high-technology components, for breadboarding, that would cost you \$34 if you bought them separately.

The kit (HP 5082-0051) contains a new transistor in a TO-72 can with 12 dB gain and a 3 dB noise figure at **1 GHz**. You also get eight fast-recovery (< 100 ps) Schottky diodes, good for low-noise UHF mixers, switches and clamps (HP 5082-2835), four high-breakdown (70 V) Schottky diodes for such uses as high-level detectors, and four 5082-3080 p-i-n diodes for low-distortion attenuation and switching at high frequencies.

For comprehensive data and order coupon, check the Card.



Here's the Communications Sample Kit that gives you a low-cost introduction to HP's high-technology semiconductors.

### Lower prices announced for alphanumeric

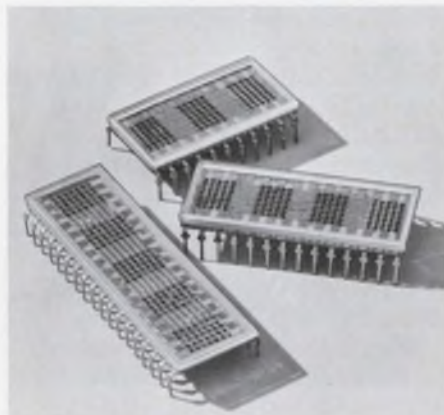

Lower prices are now in effect for HP's line of alphanumeric LED displays. For example, in quantities of 1,000, prices are cut from \$20 per digit to only \$11. These Model 5082-7100 series displays are 5 x 7 dot displays. They are IC compatible and come in dual-in-line (DIP) packages of three, four or five characters. Characters are 1/4-inch high on 1/3-inch spacings. Display packages are end stackable, thin and lightweight. Maximum voltage required is 1.6 volts.

Quantity	Price
1-9	\$22.50
10-99	18.00
100-499	15.50
500-999	13.50
1,000	11.00

For more specifics, check the Card.



The Doppler output and return signal is channeled through a single coupler in each of the packages shown here—one with X-band waveguide, the other with a miniature coaxial connector.

A mere palm-full of hardware is the heart of a microwave Doppler radar, lacking only antenna, power supply, and readout. Because it's a thin-film hybrid microcircuit (and all solid state), it's rugged and reliable. Inexpensive, too: \$200 for small quantities, significantly less in large volume.

To the designer who has the problem of detecting and measuring motion — or acceleration — the 35200 Doppler Radar module is the perfect prescription. Detect subtle movements of an unwelcome intruder, or track a diesel train. For traffic control, count passing cars and measure their speed. Build an anti-crash system to keep cars from colliding (trucks, trains or boats, too). Feed an airborne navigational system all it needs to know about landing velocity and deceleration rate.

Within the compact module is the microwave power source (i.e., transmitter); plus the circuitry to detect the return and generate an audio output containing all the motion information.

To see how 35200 can work for you, check the Card for our new 16-page engineering bulletin. Applications, system design considerations, readout needs, test procedures, options and detailed specs are presented.

# HP's low-cost 'scope team exceeds your needs for digital IC design and checkout

Designing and maintaining digital equipment doesn't **always** need \$3000+ 'scopes — a big part of all digital work is MOS and TTL, and for these uses new low-cost HP plug-ins with the fast-writing 180C/D mainframes form a neat, more than adequate package for as little as \$1950. **35 MHz—for digital applications?**

Sure. In analyzing the performance of computers and peripherals you're mainly concerned with accurate measurements of **pulse timing**, rather than risetime. (It's true, of course, that for accurate risetime tests even 100 MHz is not enough!) Fast sweep speed—like 5 ns/div—is more than enough for accurate pulse time measurements. That, plus a mainframe which can write bright while it writes fast.

Take an HP 180C mainframe (the bench version) or a 180D (the lower, wider rack-mount version). It puts out a bright, clear trace at writing speeds of 1500 cm/ns. What else it's good for is **clean, bright traces on signals that recur only once or infrequently**.

Next, plug in a new low-cost time base and sweep expander with sweep speeds up to 5 ns/div (HP

HP 180C mainframe, 1808A or 1807A dual channel amplifier, and 1824A time base and sweep expander provide low-cost digital design checkout capability.

Model 1824A, \$550) and a new 2-channel 10 mV/div, 35-MHz amplifier (HP Model 1807A, \$450). Result: a digital journeyman—for a total of only \$1950. Or add \$430 and substitute the new 75-MHz Model 1808A plug-in, providing ECL capability too.

#### **Fast-sweep, low-cost time base**

Next best thing to an elegant delayed sweep generator, to study high-frequency pulses, is the new Model 1824A sweep-expand time base. Its TIME/DIV knob shows calibrated sweeps up to 50 ns/div, and then the expander takes over. It's interlocked to the TIME/DIV



knob, so you **always** know what gear you're in. Expansions up to 100 times are available with direct readout. And accuracy, even at full expansion, is  $\pm 3\%$ . Speed limit: 5 ns/div! It triggers to 150 MHz and a trigger hold-off control makes possible stable triggering on complex waveforms or on a particular pulse in a digital word. What it doesn't give you, that a delayed generator would, is retriggering after delay and calibrated delay times. And it will save you \$250 or more.

*To find out more about HP's lower cost digital 'scopes, check the Card.*



Measurement, Analysis, Computation

**East**—W 120 Century Road, Paramus, N.J. 07652, Ph. (201) 265-5000.

**South**—P.O. Box 2834, Atlanta, Ga. 30328, Ph. (404) 436-6181.

**Midwest**—5500 Howard Street, Skokie, Ill. 60076, Ph. (312) 677-0400.

**West**—3939 Lankershim Boulevard, North Hollywood, Calif. 91604, Ph. (213) 877-1282.

**Europe**—Rue du Bois-du-Lan 7, CH-1217 Meyrin 2, Geneva, Switzerland, Ph. (022) 41 54 00.

**Canada**—275 Hymus Boulevard, Pointe Claire, Quebec, Canada, Ph. (518) 561-6520.

**Japan**—Ohashi Building, 59-1, Yoyogi 1-chrome, Shibuya-ku, Tokyo 151, Japan, Ph. 03-370-2281/92.

# DESIGN ENGINEERS—WE'VE GOT YOUR NUMBER

Whether It's Eye-easy Phosphorescent Display Tubes or Crt's and It'll Show You a Thing or Two in Quality, Performance, and Other Important Advantages That Constitute a Big Seeing-Is-Believing Difference

EXCITE  
YOUR  
CREATIVE  
APPETITE



Variety is the spice of life — and here it is on a silver platter. Legi variety comes big so you can design big, and it comes small so you can design small. The choice is yours. But the latitude in physical size isn't all you get with Legi. You also get important quality and performance advantages. Legi phosphorescent display tubes meet portable and circuit-board mounting requirements, have a readout as bright as day, and a dynamic life of 100,000 hrs; 'Multi-Legi' is our special package deal for display electronics system designers; Legi compact decoders and drivers are more designer specials in separate, composite, and Bipolar MOS types; and Legi picture perfect picture tubes let you design from 9" to 5-1/2" down to pocket-size 3" spec. There's a lot more you should know about Legi, if you don't know already. Write today for full particulars, and we'll show you how it pays to think Legi when you're thinking new systems. The spice of life is yours. Now.

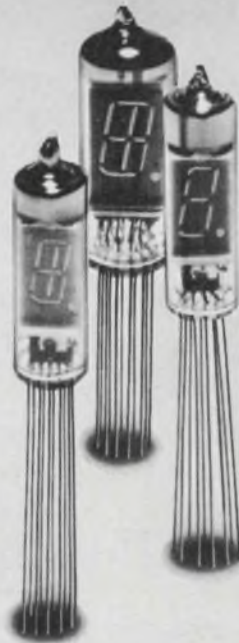

## SPECIFICATIONS (pulse operation)

TYPE	Filament Current mA	Filament Voltage V <sub>a</sub>	Phosphor Segment Voltage V <sub>d.c.</sub>	Control Grid Voltage V <sub>p-p</sub>	Phosphor Segment Current mA <sub>p-p</sub>
DG12M	85	≡ 1 0.8 : 10%	50	≡ 2 50	4
DG12H	85	≡ 1 0.8 : 10%	50	≡ 2 50	3
DG19E	95	≡ 1 1.7 : 10%	55	≡ 2 55	4
Unit	mA	V <sub>a</sub> c	V <sub>d.c.</sub>	V <sub>p-p</sub>	mA <sub>p-p</sub>

TYPE	Control Grid Current mA	Phosphor Segment Cut-off Voltage V <sub>seg</sub> (MAX.)	Control Grid Cut-off Voltage V <sub>seg</sub> (MIN.)	Brightness
DG12M	19	0	-4	150
DG12H	18	0	-4	150
DG19E	22	0	-4	150
Unit	mA <sub>p-p</sub>	V	V	Ft.-L

≡ 1 Effective Value at 50 or 60 Hz A.C.  
≡ 2 Pulse condition—Duty Factor 1/16 pulse width 60 μsec.

*Legi* Sole U.S. Agent

## LEGI ELECTRONICS CORPORATION

3118A, West Jefferson Blvd. Los Angeles, California 90018, U.S.A.  
Tel: (213) 733-9105

**ISE** The Brighter Side of Electronics

## ISE ELECTRONICS CORPORATION

P.O. Box 46, Ise City, Mie Pref., Japan  
Phone: Mie (05963) 2-4944, (05963) 5-2121



**We invented an rf signal generator for people who wanted a better way to set frequency more precisely**

**Its output is displayed on a six digit counter built into the instrument**

The days of twiddling with the dial of a signal generator just to set the frequency are gone forever. So are the days of squinting to read the frequency.

LogiMetrics' Model 925 contains a built-in six digit counter that continuously monitors and displays output frequency on large, flicker-free Nixie tubes. Anyone can see at a glance what the frequency output is, even from six or eight feet away. The counter, incidentally, can be used independently of the generator.

The instrument's frequency range is 50 kHz to 80 MHz. Throughout that range, its stability is  $\pm 10$  Hz, a characteristic of synthesizer-like proportions. This remarkable stability is achieved through the Signallock™ circuit.

This combination of features: the wide 50 kHz to 80 MHz range, the  $\pm 10$ Hz stability, the ease of calibration, the frequency display and the built-in counter provide you with

the most practical, most usable rf signal generator now available.

For details, use the Readers Service Card, or write or call us directly today.

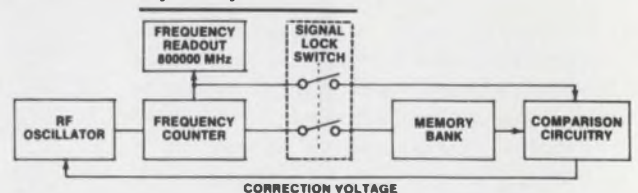

"Signallock" is a patented circuit which enables the output of the built-in rf oscillator to be locked into the crystal time base of the built-in counter. When the Signallock mode is switched in, the digital readout is stored in a memory, and then continuously compared to the generator's output frequency. If an error exists between the output frequency and the memory frequency, a correction voltage is fed back to the oscillator, causing frequency to return to the original setting.

**LogiMetrics** INC., 100 Forest Drive, Greenvale, New York 11548 • Phone (516) 484-2222 • Telex 96-1371

## Engineering without shame

If President Nixon can really get his New Technology Opportunities Program off the ground, we'll have a great new day for engineers. If the NTOP, a vast program of Federal support for non-war technology, can get going without the usual morass of red tape and boondoggling, we'll have more than lots of new jobs; we'll have new pride.

Most of us went for engineering because of its great intellectual challenge and stimulation. Many of us had second thoughts as we looked at the results of some of our efforts. If we didn't feel outright guilt, we were less than proud of developing more sophisticated techniques for directing bombloads at a few snipers in a Vietnam jungle.

We didn't boast of our role in defending "democracy" in the form of President Thieu. As we saw that our own society seemed to be crumbling, many of us had nagging doubts about our nation's wisdom in ignoring our social environment while pumping dollars and engineering brainpower into space exploration—however breathtaking that challenge might be. We buried our doubts and hid from our guilt. We had to earn a living.

If the President's new program is effective, we'll be proud again. We may be working on practical methods for predicting and modifying earthquakes—and the weather. Or we may be designing equipment for the electronic distribution of business mail. Or we may be developing computerized traffic-control systems to relieve urban congestion—or systems to help medical men wipe out disease.

These are just a few of the ideas being kicked around. The possibilities are endless. The "poets" of our industry and engineering-curriculum advisers have always talked of the great benefits electronics could heap on mankind. We've seen some. Perhaps we'll see a great deal more.

Perhaps not. It's been known to happen that election-year promises have been rosier than their fulfillment.



Hayden has a new, free, personalized and self-selected information system. We call it our Requested Data Delivery Service, and as a qualified professional you're entitled to take advantage of it. Please take a moment now to fill out the enrollment form; you'll find it facing page 16.

A handwritten signature in dark ink, which appears to read "George Rostky". The signature is fluid and cursive, written over a white background.

GEORGE ROSTKY  
Editor

Japan's marvelous production machine may be slowing down. Japanese executives report a drop in business last year, a little growth in mid-'71 and an abrupt drop after Nixon's policy announcement.

**F**or years, electronics competitors around the world have worried about the Japanese. Now the Japanese are worried.

After a decade of phenomenal growth, under the careful protection and tutelage of the Japan Ministry of International Trade and Industry (MITI), the Japanese electronics industry is beset with troubles. To counteract the problems it has begun to make changes, and the net result is a ferment in the industry and a general air of nervousness.

"Are we headed for a depression?" some Japanese electronics executives are asking as they eye the steep-climbing sales and production curves of the last 10 years.

Surprisingly, Japanese technology is forging ahead, despite the economic unrest. Electronics companies are demonstrating impressive accomplishments in such advanced and diverse areas as LSI, wire memory, computers and peripherals, and displays.

What are the problems that have caused Japanese electronics executives in December, 1971, to reassess their prospects cautiously? They include these:

- The industry is overextended, with too much inventory and too much production capacity for the available markets.

- It has been forced to rely heavily on export markets, and the countries it has exported to—irked by the unceasing competition—have begun to take protective steps. The 10% surcharge on imports imposed by the U.S. may be only the beginning, the Japanese fear.

- It has looked largely to other countries to do its R&D and is now encountering resistance in acquiring R&D from abroad. Doing your own R&D is expensive, the Japanese are learning.

- It is plagued by rising labor costs at home and, like some of its foreign competitors have been forced to do, is now looking to shift some of its manufacturing to cheaper labor areas outside of Japan.

Changes under way to correct some of the troubles include these:

- A policy of "liberalization" toward foreign investment. Foreigners are being allowed to buy into businesses in Japan with fewer strictures than before and also to sell their products in Japan without special permission.

- A widening of electronics production from almost exclusively consumer products to include industrial markets, too.

- Serious consideration of Chinese mainland as a market, particularly in light of President



# Anxiety in JAPAN

Nixon's announced intention to visit there and the admission of Red China to the United Nations.

## The economic slowdown

In a sense, the Japanese electronics industry has been "spoiled." Under the wing of MITI, it has come to expect growth that has averaged 24% a year in the last decade. Production of a wide array of consumer goods and semiconductors, instruments and computers has soared, with the upward curve faltering only briefly in 1965.



Matsushita photo

## Part 1

# After years of rapid growth: problems and uncertainties.

**Raymond Daniel Speer**  
Managing Editor

Under licensing or joint-venture agreements, the Japanese industry has acquired the very latest in American technology.

But the picture today is not as bright.

To begin with, economic growth is expected to slow. Japan entered 1971 with a Gross National Product of \$196.2-billion, roughly one-fifth that of the U.S., and it's expected to grow more slowly in 1971, at somewhat less than 10% per year, than it has in the last few years. The reasons for that slowdown include an inflation-fighting credit squeeze by the Bank of Japan from September, 1969 to October, 1970; surplus plant capacity,

caused by overexpansion in recent years; a shift in Japanese consumer spending away from durables, like TV sets and cars, to such things as travel and recreation; and successive demands by labor for higher annual wages.

Surveys of the attitudes of Japanese businessmen have revealed a good deal of pessimism, with 1971 sales reported lower than expected and production cuts not reducing excess inventories. In radio and television manufacturing, production declines of 10 to 25% have been reported, compared with 1970 figures, and last January this section of the industry reported rapidly accumulating inventories in a MITI survey.

Added to all of this was the Aug. 15 announcement of President Nixon's new economic policy. The refusal of the U.S. to redeem foreign-held dollars with gold, the 10% surcharge on imports and suggestions that Japan revalue its currency have shaken Japan's statesmen, economists and business leaders.

Called the "Nixon shock" by Japanese, the U.S. announcement has reverberated through the country, and estimates of the immediate cutback in total Japanese exports because of the surcharge have been placed at \$1.4-billion a year, with monetary uncertainties possibly increasing the slash to as much as \$3-billion.

"We are wandering like lost sheep after the Nixon shock," says Tamafusu Onoye, executive director of the Administration Dept. of the Elec-

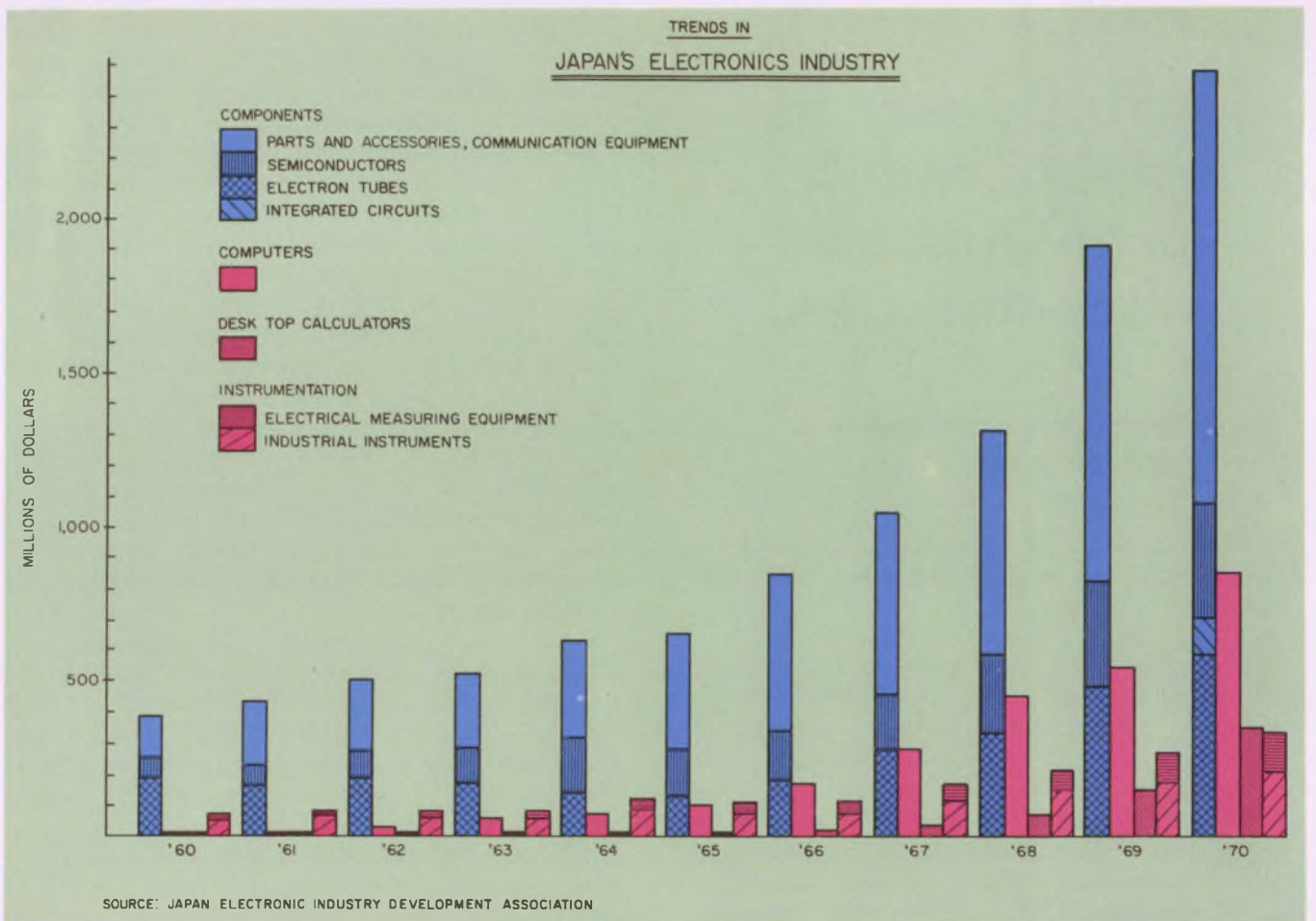
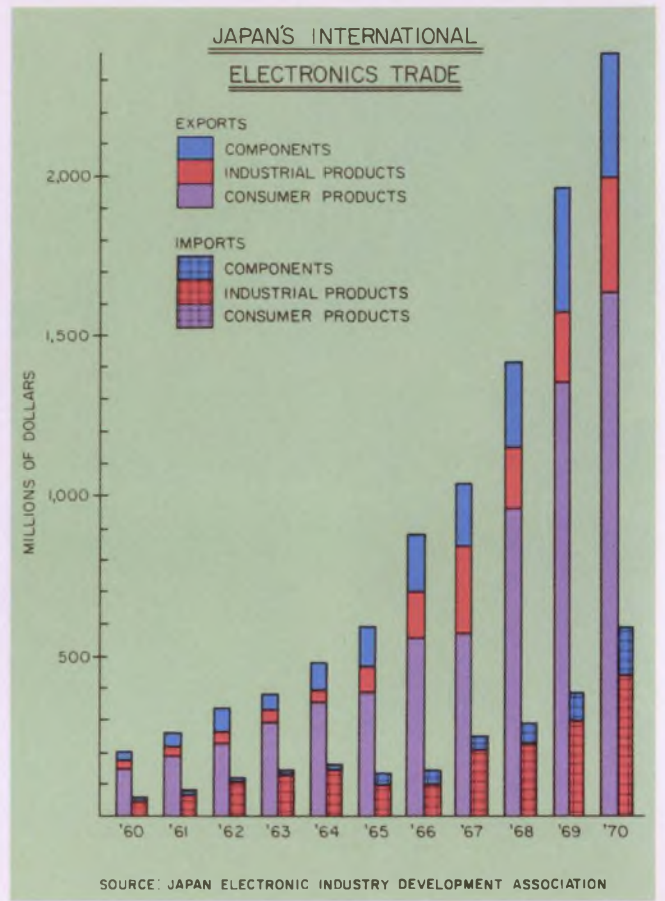
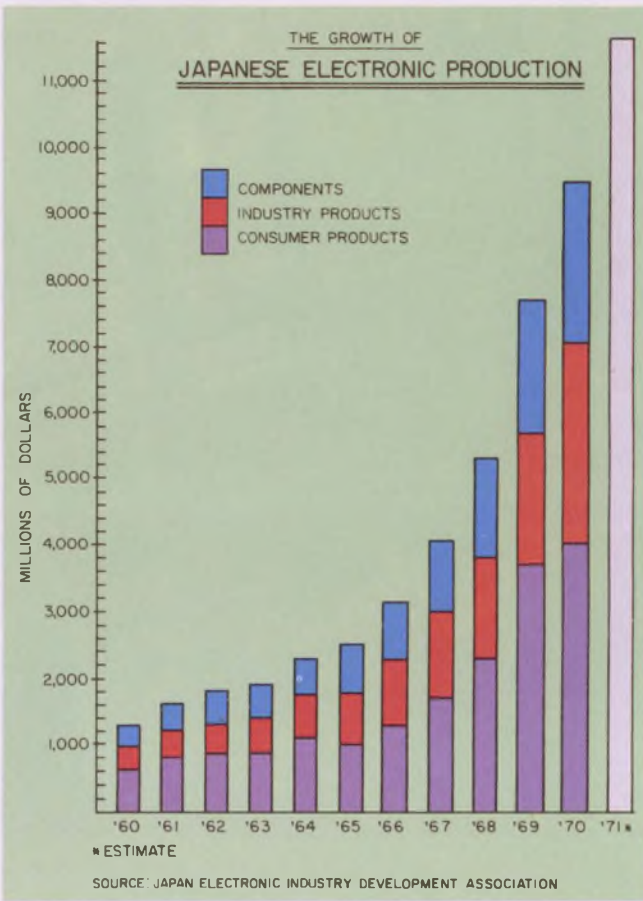



tronic Industries Association of Japan. He feels that as long as the yen is floating and the import surcharge continues, business decisions in Japan will be difficult, with a marked recession a possibility.

"Business has already slowed considerably," Onoye says.

Japanese executives, he continues, are very concerned that protectionism could be the future trend in the U.S. They feel that if this policy is pursued, it could quickly put the world into a 1930s type of depression.

The demands of labor are particularly unsettling to Japanese businessmen. The average annual wage increase in Japan's manufacturing industries over the last 10 years was 11%, but in 1970 it was 18%.

Kunio Arimori, director and manager of export operations for Tokyo Electron Laboratories, Inc., reports wages rising at 20% a year, pushed up by labor shortages. Company executives all over Japan, the Tokyo manager says, are talking about moving their operations to Korea, Taiwan and other low-cost labor areas of Southeast Asia.

"We're investigating the possibility of a factory in Singapore," Arimori says, "where we can find high quality labor at very low rates. Graduate engineers in Singapore cost as much as in the U.S., and Singapore lacks good middle management; so we'll have to take some of our people from Japan to fill this gap. Middle management is our strength."

#### **A major weakness: R&D**

The lack of a solid research base is cause for further concern. The Japanese electronics industry began with "knock-down" assembly operations, in which it used low-cost labor to assemble fairly unsophisticated gear. Then it added marketing expertise and moved up to consumer-goods production, while keeping, for a time, the advantage of low-cost assembly and engineering talent. In recent years it has used licensing agreements and joint ventures to acquire its technology. The strategy has paid off handsomely till now.

Now the Japanese are finding that the prices for licenses are climbing and that many U.S. companies are insisting on joint-venture arrangements.

Though Japan still spends less than 2% of its GNP on R&D, there are some companies in Japan that do considerably more than this. Hiroe

**Japan's fantastic growth in electronics** production may be difficult to maintain in years to come. Manufacturers complain of excess inventories and disappointing sales; 1971 production may not reach the official JEIDA estimate.

*Managing editor Raymond Speer spent three weeks touring Japan's electronics industry and talking with engineers and executives in over 40 companies, associations and Government agencies. His report is based on these interviews and on research in the U.S. and Japan.*

Osafune, general manager of the Semiconductor Div. of Nippon Electric Co., reports that his concern spends 5% of sales for R&D, and Onoye, the head of Japan's EIA, estimates that electronics manufacturers on the average spend as much as 4% of annual sales on R&D.

Taking stock of what the setbacks have done to the Japanese electronics industry, Osafune says he has no idea when business will pick up again. He sees almost no chance until 1973.

"Only the computer business is healthy," he says. "It may show 30% growth in '72."

Aritoki Murakami, manager of electronic computer sales for Tokyo Shibaura Electric Co., agrees that the computer business is where the action is, especially the minicomputer sector.

"Last year there were 10 minicomputer manufacturers in Japan," says the Toshiba manager. "This year there are 25."

The market for minicomputers in Japan is only about two years old, with some companies at the prototype stage and others in production. Forecasting over the next year is extremely difficult, Murakami says, because there's considerable confusion in the Japanese mini market. Murakami says he is sure, however, that the demand for minicomputers next year will be twice that of this year's market in Japan.

Up to now, according to the Tokyo manager, less than 2000 minicomputers have been installed in Japan: roughly 500 manufactured by Hitachi, 200 to 300 by Facom, 200 by Nippon Electric and 100 by Toshiba.

#### **Liberalization, step by step**

For most of the last 25 years Japan has protected her industry, particularly the high technology areas, with import and capital restrictions. She fought a long battle to achieve a surplus in her balance of payments and to prevent foreign takeover of her industry.

Since 1965 the Japanese balance of payments has, in fact, shown a handsome surplus, and the U.S. has stepped in, pressing very hard for investment and sales opportunities in Japan. The Japanese Government is responding—although in a slow-step-by-step fashion that some U.S. businessmen find very frustrating.

Among the most recent advances announced in Japan's liberalization policy are these: For-



Hitachi photo

Semiconductor and computer technologies are considered crucial by the Japanese for future growth. They're hard at work and showing impressive progress in memories, LSI and displays.

eign companies will be allowed, starting early next year, to invest up to 50% in joint ventures to make ICs for all except computer products; the import of data-processing equipment into Japan without special licenses will be allowed, also early next year; and in three years foreign companies will be allowed to make computers and peripheral gear in Japan.

The Japanese are quick to defend their go-slow approach to liberalization.

"Japan has tried not to cause problems in the electronics markets in the U.S.," says Onoye. "We have tried to establish new markets in the U.S. and to avoid taking existing markets away from U.S. companies."

He points to miniature radio and TV sets as Japanese innovations in the American market, and he asks the U.S. to understand that the Japanese attitude has always been to avoid direct competition by creating new markets.

Barriers to investment in Japan are exaggerated, Onoye contends. "There are," he says, "no capital investment barriers to consumer electronics in Japan, for instance. The areas in which barriers exist are limited—such areas as computers and semiconductors. Even here, 50% of the computers now used in Japan are U.S.-built, and 70% of the LSI used in desk-top calculators is imported from the U.S."

Many Japanese companies report a swift growth in importance of industrial electronics in the Japanese market.

Industrial products have always accounted for most of the electronics imported to Japan (see chart), but the Japanese, having acquired the

necessary technology, are now endeavoring to produce for themselves.

"Electronics in Japan is shifting away from consumer electronics," says S. Sugiguchi, marketing and sales manager for the Memory Div. of Toko, Inc. "We see the brightest future in the industrial area."

Sugiguchi expects annual growth of 35% to 40% for Toko in the industrial area, with 20% average annual growth over the next five years.

Kohi Sogabe, plant manager for Murata-Bournes Inc., in Kyoto, agrees. His company recently displayed its industrial components prominently at the Japan Electronics Show. "Expanded military budgets in Japan will contribute heavily to our business," Sogabe says.

Arimori of Tokyo Electron Laboratories also sees a move from consumer-oriented products to industrial components; from low-cost assembly to sophisticated technology. In nonsophisticated assembly operations, he says, Japan cannot stay competitive much longer.

Meanwhile Japan is considering a major change in her policy on Red China. A market of 800 million people appears impossible to ignore. Japan is making official overtures in an effort to open negotiations with the Red Chinese. And Japanese businessmen, suddenly taking care not to offend the Communist Government, are curbing direct investments in Taiwan.

### Progress in semiconductors

The Japanese see semiconductor and computer technology as extremely important areas for the future growth of their industry. They're hard at work in semiconductors, memories, computers and displays, and they possess an impressive technology.

Perhaps the best example of progress in semiconductors is the Nippon Electric Co., which began 72 years ago as a joint venture of the Japanese with Western Electric and now is very strong in high-frequency semiconductors and making photo diodes, emitter-coupled logic, ROMS and PROMS.

Nippon Electric is especially strong in the microwave field. It has developed a number of Gunn and Impatt diodes, and is changing from varactor diode multipliers to Gunn or Impatt diode units and to locking amplifiers that use Impatts. The new, simpler circuits, says Osafune, are being used in communications systems and radars, including collision-avoidance radar. They operate at frequencies from 6 to 80 GHz.

Nippon Electric is achieving 500 mW at X band with its Gunn diodes and 1 W at X band with Impatt diodes. At around 20 GHz, the quasimillimeter range, it achieves 150 mW with

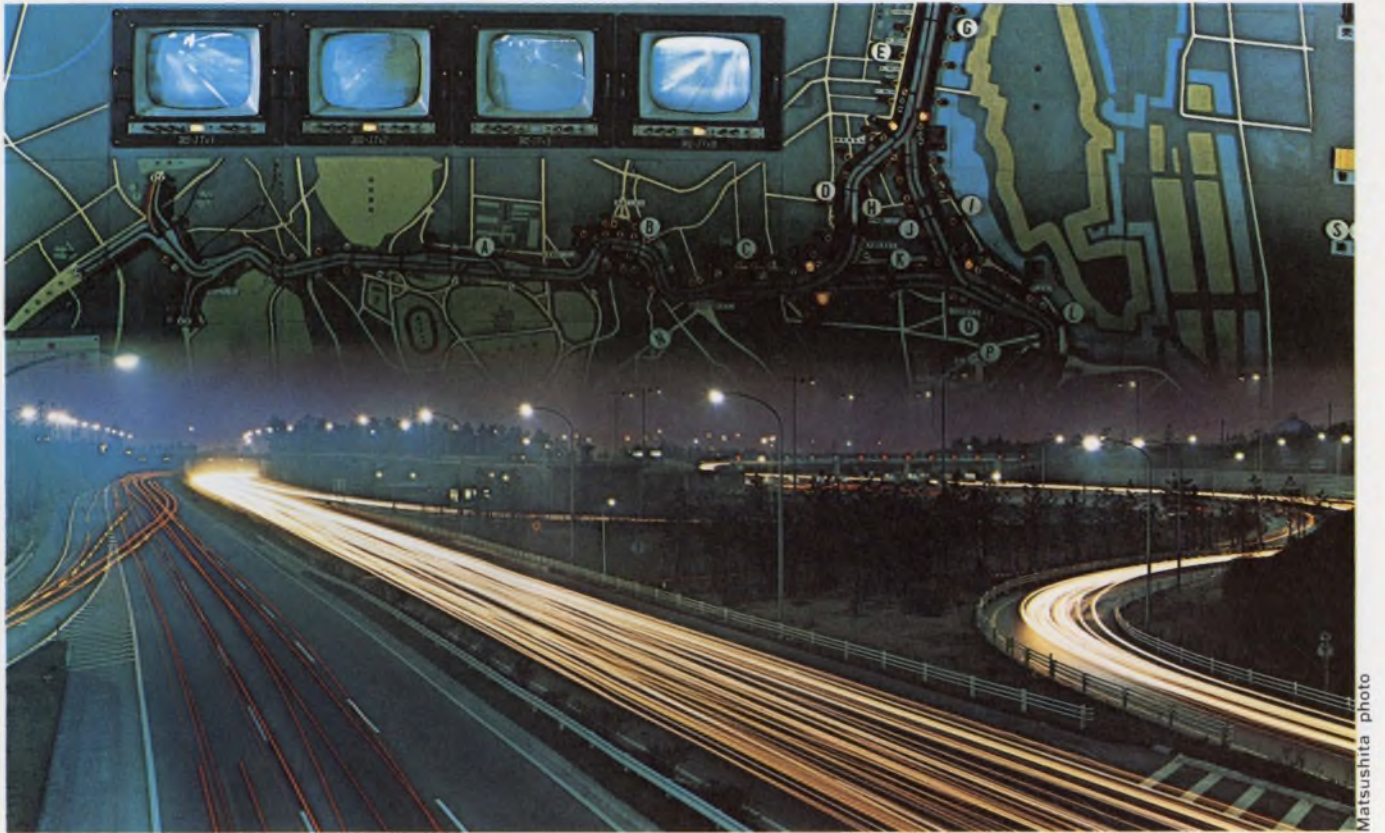

Matsushita photo

A shift toward industrial products and systems is seen by many Japanese executives. Some companies predict 20% annual growth in the industrial sector, and eye expanding Government budgets for traffic and pollution

control and for military systems. Large- and medium-size computer markets are seen growing 30 to 50% a year, and the two-year-old minicomputer market is expected to soar.

Gunns and 300 mW with Impatts.

"We've developed gallium arsenide Schottky-barrier diodes with noise figures of less than 5 dB at X band for microwave relay links," says Osafune, and we can get 7 dB at 80 GHz.

"We are also making avalanche photodiodes, hopefully intended for laser communication systems," the Nippon Electric manager says. "We'll get better signal-to-noise ratio than with photomultipliers."

Quantum efficiency of the avalanche photo diodes is around 50%, cut-off frequency is 3 GHz, multiplication factor 300, breakdown 80 V, and sensitivity is 0.3 mA per milliwatt at 30 V and 6328 Å.

"This is the highest level of performance in the world," Osafune says, "and we're achieving it with standard products."

Also heavily involved in semiconductor R&D is the Electrotechnical Laboratory of the Japanese Government. One of its most interesting projects at present is research in high-field-domain logic. This technology lends itself to building functional logic devices with a considerable advantage in speed over conventional logic.

"Delay per gate in logic circuits using transistors will probably never be less than 1 ns," says Dr. Yasuo Komamiya, head of the laboratory's

Electronic Device Div. "You can get down to a few picoseconds for a single gate, but physical limitations in practical circuits impose minimum figures of about 1 ns."

In a 40-bit, high-speed carry circuit, using the new high-field-domain technology, however, the total theoretical propagation delay is less than 2.4 ns. The fundamental research for a single gate is complete, and Dr. Komamiya is leading his R&D group in the direction of this new technology.

Devices using the new concept avoid the delay inherent in the sequential operation of gates because single devices perform complete logic functions.

"Japanese semiconductor materials technology is much behind that of the U.S.," says Komamiya. "In production technology Japan is doing very well—better than Europe, not as well as the U.S. But in Europe, materials technology is much better than in Japan, where materials technology has traditionally been weak." ■■

*For a detailed look at Japan's rapidly advancing technology, watch for Part 2 of this article in the next issue of ELECTRONIC DESIGN.*

# Electronic Design

## 1972 TOP TEN CONTEST

*More Prizes, More Excitement,  
More Fun Than Ever Before!  
It's All In The January 6th Issue.*

FOLLOW THESE EASY STEPS...IT  
COULD BE YOUR FIRST STEP TOWARD  
A CARIBBEAN CRUISE!

1. Look over the January 6, 1972 issue with extra care.
2. Pick the 10 ads that you think will be the best read in the Jan. 6 issue.
3. List your selections on the specially provided Top Ten entry blank available in the January 6, 1972 contest issue.
4. Mail to Electronic Design before midnight, March 15, 1972.

This year the Top Ten ads will again be selected on the basis of "Recall Seen" scores. This means that attractive, well-designed ads in smart form will be on a par with strong marketing ads... messages that offer dramatic news, give complete product data and features in compelling copy terms...ads that produce purchasing action for advertisers.

The judges will select winning entries based on the "seen" category of Reader Recall—Electronic Design's method of measuring readership in the contest issue. Remember, in selecting your Top Ten list of ads, be sure to watch for both the graphic form and appealing words that you think would stimulate a strong sales reaction from our 74,000 engineer subscribers.

READ THE RULES CAREFULLY, EXAMINE THE ADS, MAIL IN YOUR ENTRY BEFORE MARCH 15, 1972, AND THIS YEAR YOU MAY BE THE WINNER OF THE WINDJAMMER CRUISE OF A LIFETIME!  
ENTRY FORMS IN THE JANUARY 6TH ISSUE

### 1972 TOP TEN READER CONTEST RULES

1. Enter your Top Ten selections on the entry blank provided, or on any reasonable facsimile. Be sure to indicate the names of the advertiser and page number for each of your choices. These choices should be placed in the order you think readers will rank them. (Ads placed by Hayden Publishing Company in Electronic Design should not be considered in this contest.)
2. No more than one entry may be submitted by any one individual. Entry blank must be filled in completely, or it will not be considered. The box on the entry blank marked "Reader Contest" must be checked. Electronic Design will pay postage for official entry blanks only.
3. To enter, readers must be engaged in electronic design engineering work, either by carrying out or supervising design engineering or by setting standards for design components and materials.
4. No cash payments, or other substitutes, will be made in lieu of any prize.
5. Contest void where prohibited or taxed by law. Liability for any taxes on prizes is the sole responsibility of the winners.
6. Entries will be compared with the "Recall Seen Most" category of Reader Recall (Electronic Design's method of measuring readership). That entry which in the opinion of the judges most closely matches the "Recall Seen Most" rank will be declared the winner.
7. In case of a tie, the earliest postmark will determine the winner. Decisions of Top Ten contest judges will be final.

### THERE IS A SEPARATE CONTEST— SEPARATE PRIZES FOR ADVERTISERS

Each advertisement ranking in the Top Ten will receive a free rerun. In addition there is a separate contest, separate prizes for advertisers. The 3 winners can also receive free ad reruns. SEE THE LAST PAGE OF THE JAN. 6, 1972 ISSUE FOR RULES AND PRIZE INFORMATION.

*Come  
Aboard The  
Ad-Venture  
of the Year!*



We'll send you on the vacation cruise of a lifetime if you can choose the ten ads appearing in the January 6th, 1972 issue that get highest reader recall "seen" scores in the same ranking as selected by readers. It only takes a little time and some marketing smarts to enter. And it's fun to see if you can outsmart the experts! It may be your ticket to winning these nifty prizes:

1st PRIZE—10 unforgettable days for 2, cruising the storied Caribbean aboard the coveted Windjammer schooners. Sunshine and blue water unlimited...enough out-of-the-way beaches and tropical lagoons to last a lifetime of memories. AND round-trip luxury flights for 2.



2nd PRIZE—Heathkit 25-inch Solid State Color TV. World's most unique color TV, ultra rectangular, largest picture in the industry.

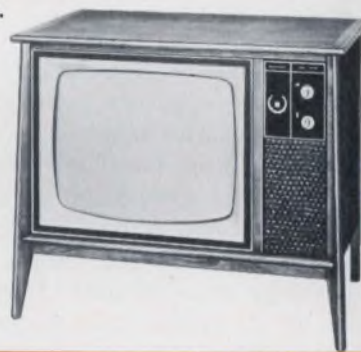

3rd PRIZE—Brother miniaturized Desk-Top Digital Calculator—and 100 other prizes.



Nothing to write, no gimmicks—all you need do is check the ads carefully and pick those you think have the most memorable information and data and will be best read by your colleagues in engineering and management. It's the one contest that tests your marketing sense. It proves, once more, that computers can't do everything.

# Use statistics in your logic design.

You'll find it easier to evaluate propagation delays, and optimization of Boolean equations is enhanced with this method.

Two goals in logic design are the evaluation of propagation delays and the optimization of the relevant Boolean equations. And each poses problems that a type of network analysis can avoid.

Propagation delays are usually calculated by assuming worst-case delays in each stage or a nominal delay per stage. The former method suffers from the real possibility of system failure, and the latter from lack of a way to measure the failure rate precisely.

As for trying to optimize the Boolean equations, you generally cannot get an optimum form without examining the logic implementation.

A technique that avoids these design hangups is basically a network analysis in which a logic diagram is constructed, with path delays assigned on a statistical basis.

## Five steps to design

The technique consists of five steps:

1. *Construct a logic diagram* (similar to that in Fig. 1) for each feasible solution.

2. *Assign turn-ON and turn-OFF delays and variances from known component statistics to each AND and OR block.* Manufacturers' specs form the basis for the assigned values.

3. *Total the delays in each path.* Comparisons are then made of all paths terminating at the same block. Intolerable differences are corrected by changing components or logic sequences.

4. *Compute the probability of meeting specs with the formula.*

$$t = \frac{T_R - T_A}{\sqrt{\sigma^2}}$$

where  $T_R$  is the time required for an output,  $T_A$  is the actual total path delay and  $\sigma^2$  is the total variance. The probability is found from the value of  $t$  and a table of the normal distribution.

The assumptions that enter into a calculation of  $t$  are as follows: First, the system is composed of switching elements and is therefore in-

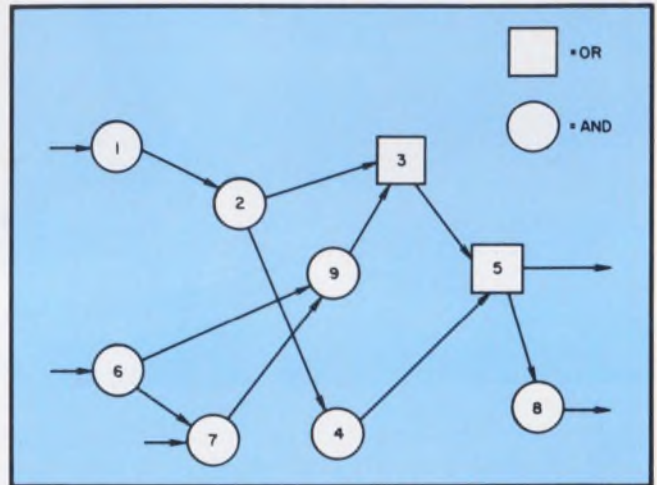

1. **Setting up a logic diagram is the first step** in a technique to evaluate propagation delays more efficiently. The component delays are assigned on a statistical basis. An important additional advantage of the technique is the optimization of the Boolean equations used.

sensitive to random-noise effects. Second, the input data include systematic environmental effects and random tolerance variations. It follows then that the total variance is found from a summation of variances caused by some finite number of independent variables. The total variance is expressed as

$$\sigma^2 (S) = \sum_{k=1}^N \sigma^2 (X_k),$$

where  $S$  represents the sum of independent random variables and  $X_k$  is the random variable. The equation for  $t$  then becomes

$$t = \frac{T_R - T_A}{\sqrt{\sigma^2 (S)}}$$

5. *Minimize the Boolean equations* by comparing the results of Step 4 for each feasible solution. The most probable solution is the optimum one.

Let's see how this technique is used.

Consider the problem of accessing the storage system in Fig. 2. The read cycle of the coincident-current core storage system begins with the selection of a particular core from the array.

Irving Dlugatch, 2330 S. Corning St., Los Angeles, Calif. 90034.

The output is then monitored to determine its state prior to selection. The X and Y select signals specify the X and Y coordinates of the desired core, and their combined value causes the selected core to be read. The timing of the X and Y select signals is important: To minimize error, the two should occur as close in time as possible.

Following the procedure outlined, you calculate component delays and variances for each block in a logic diagram (see Fig. 3a and 3b). The path configurations are different for the two

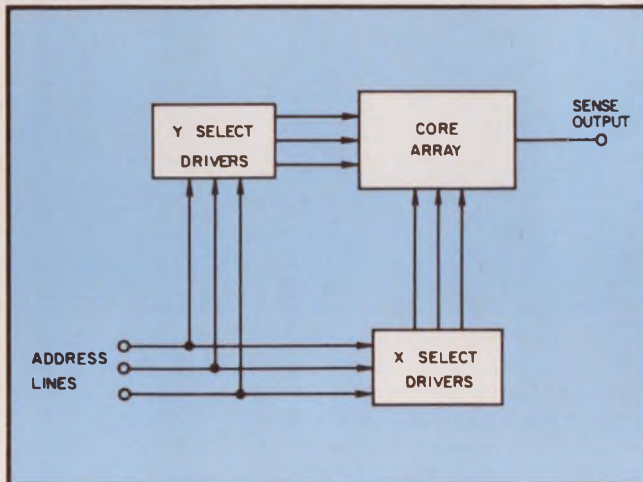

2. Accessing a logic storage system is one case where the usefulness of the logic-design technique is demonstrated. An important design criteria is to minimize the stagger—the timing of the X and Y select signals. For minimum error, the two should be as close as possible.

coordinates. This is generally the case.

Note that one OR block has zero delay. This arises from collector OR-ing, which has no delay time associated with it. Of course, where a separate logic circuit must be used, a propagation delay will occur. This indicates a design choice that can be made when it is necessary to reduce the path delay.

The timing relations for the system are shown in Fig. 3c. The objective now is to determine the feasibility of a 520-ns access time in a 2- $\mu$ s ferrite core system. Absolute worst-case calculations, because of the many components in the logic path, could indicate 520 ns is not feasible. This is because of the large variances.

The delay between the Y select current 10% point—turn-OFF—and the sense pulse is determined empirically from the averaged core-array characteristics. This relationship is maintained by the timing points determined by the X and Y drive current turn-ON times relative to the storage-select pulse. The difference between the two drive pulses is called the stagger. Efforts to reduce stagger, and thus minimize error, are concentrated on the logic diagrams.

Let's compute total path delays and variances. For the X coordinate, the total X mean delay =  $14.6 + 20.2 + 5.1 + 45.4 = 85.3$  ns, and the total X variance =  $9.0 + 5.6 + 0.1 + 47.4 = 62.1$  ns. The total Y mean delay =  $14.6 + 15.2 + 30.7 + 26.7 + 24.8 + 20.2 + 5.1 + 45.4 = 182.7$  ns, and the total Y variance =  $9.0 + 12.3 + 44.3 + 28.4 + 23.4 + 5.6 + 0.1 + 47.4 = 170.5$  ns.

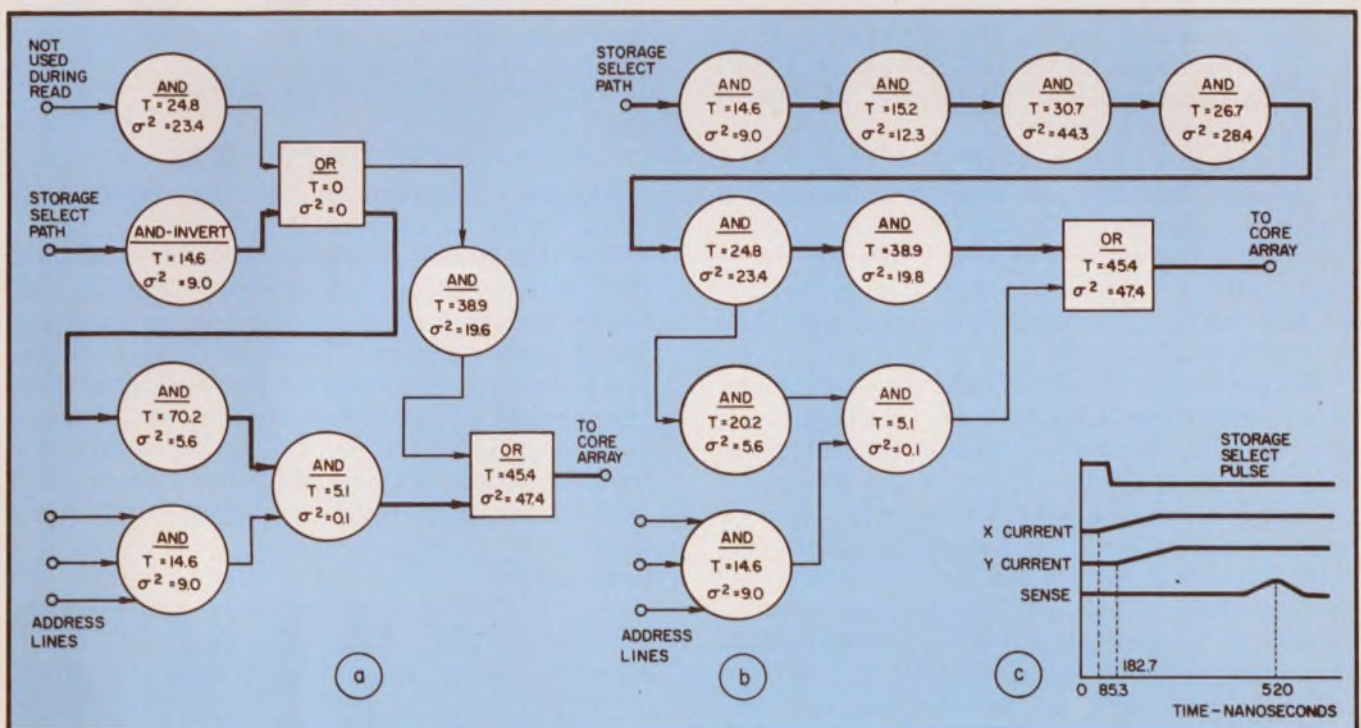

3. Typical design values are given as component delays and variances in the blocks of the logic diagrams. Storage-select paths for the X coordinate (a) and the Y co-

ordinate (b) are shown by heavy lines. A timing diagram (c) summarizes the design goal—a 520-ns access time. In the storage system, a 2- $\mu$ s ferrite core is used.

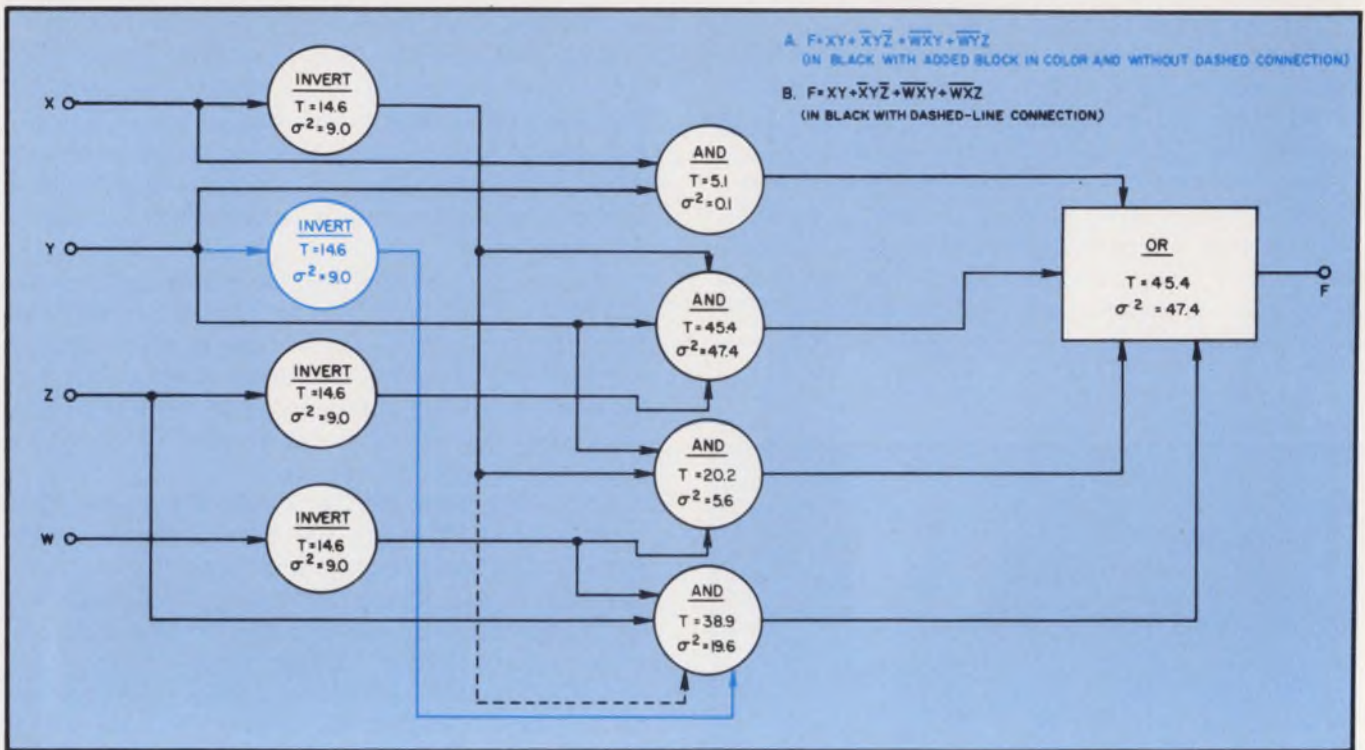

4. A Boolean equation in two minimal forms is implemented in these logic diagrams. Blocks are presented with typical values for completeness. Of course, b is the optimum implementation, and it can be determined to

be so from the equations. But the example indicates that an optimum implementation doesn't have to correspond to a minimal Boolean equation. You could get a simpler realization from a nonminimal equation.

The goal delay,  $T_A - T_B$ , and the delay if all variances were zero, is calculated as the difference between the access time and the fixed delay time between the Y 10% point and sense pulse. The delay is  $520 - 300 = 220$  ns. And  $t = (220 - 182.7) / \sqrt{170.5} = 2.85$ .

From standard tables, the probability  $P = 0.9978$ . This value means that 22 out of 10,000 units manufactured will fail to meet the 520-ns access-time requirement.

The expected stagger is  $182.7 - 85.3 = 97.4$  ns. Assume that the goal stagger is 80 ns. The variance  $\sigma^2$  (stagger) is  $62.1 + 170.5 = 232.6$ . Calculating the value of  $t$  in this case gives  $t = (80.0 - 97.4) / \sqrt{232.6} = -1.15$ . The probability for this value of  $t$  is found from standard tables to be  $P = 0.1251$ .

Therefore the probability that the stagger will be less than 80 ns is 0.1251. Note that it is necessary that the stagger be greater than 80 ns to have coincidence between the X and Y current pulses. The stagger may be tolerable since it implies that of the 10,000 units manufactured, only 12.5% will have a stagger of less than 80 ns. Conversely 87.5% will have staggers that exceed 80 ns. A worst-case analysis would conclude that a 520-ns access is not feasible.

The network analysis indicates that not only is 520 ns feasible but it will also have high reliability. The same is true for the stagger, but the reliability will be considerably lower. However,

this reliability may be acceptable, or the goal stagger can be reduced to improve the reliability.

#### Optimize Boolean equations

As an example of the technique's usefulness in optimizing Boolean functions, assume that two minimal Boolean functions are

$$F = XY + \overline{X}YZ + \overline{W}XY + \overline{W}YZ$$

and

$$F = XY + \overline{X}YZ + \overline{W}XY + \overline{W}XZ.$$

The logic diagram for the first equation is given in Fig. 4a, the second in Fig. 4b.

For this rather simple problem, it is evident that one less logic module is used in Fig. 4b, and thus it is the optimum solution for implementing the Boolean equation. This could have been accomplished by inspection of the equations. But, the example served to indicate that any minimal Boolean equation is not the optimum one for implementation. It's possible that a greater than minimal equation could be implemented more simply. ■■

#### Bibliography:

- Bartee, T. C., "Computer Design of Multiple-Output Logical Networks," *IRE Trans. on Electronic Computers*, Vol. EC-10, March, 1961, pp. 21-30.
- Petric, S. R., "A Direct Determination of the Irredundant Forms of a Boolean Function from the Set of Prime Implicants," *Mass. Techn. Report No. AFCRC-TR-56-1110*, 1956.
- Svoboda, A., "An Algorithm for Solving Boolean Equations," *Information Processing Machines*, NCSAV, Prague, Volume 9 (1963), pp. 557 to 559.



# 250A Planar

## NPN SILICON POWER TRANSISTORS

Solitron's new family of planar power transistors are the most versatile high power, high current devices now available to you. Three individual series have been developed to meet various application requirements for high current switching such as motor controls and power supplies. Identified as the SDT 5840, SDT 5850 and SDT 5860 Series, these silicon power transistors are constructed with the largest planar chip in the industry.



TO-114 CASE

### FEATURING:

- Hi-Rel Construction
- $f_t = 15$  MHz Typical
- Low Saturation Voltage (1.0V max.)  
@  $I_c = 120A, I_b = 12A$
- Power Dissipation @  $100^\circ C = 300W$
- Low Thermal Resistance,  
 $\theta_{j-c} = 0.33^\circ C/W$

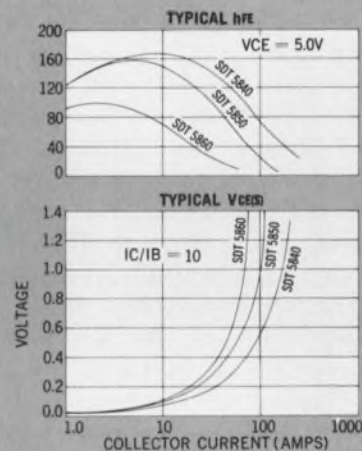
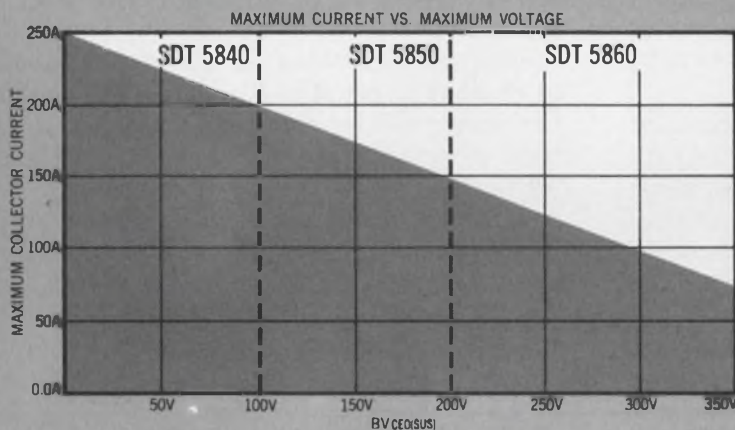

For complete information, prices and engineering application assistance, dial toll-free 1-800-327-3243. Or write:

**Solitron**  
DEVICES, INC.

1177 BLUE HERON BLVD. / RIVIERA BEACH, FLORIDA / (305) 848-4311

TWX: (510) 952-7610

SAN DIEGO, CAL  
8808 Balboa Avenue  
FET & Dual FET  
Transistors  
MOS/FET Devices  
MOS Memory Arrays  
Shift Registers  
Monolithic IC's  
Small Signal  
Transistors

RIVIERA BEACH, FLA.  
1177 Blue Heron Blvd.  
Hi-Rel Power Transistors  
Si & Ge Power  
Transistors  
Hi-Rel Power Hybrids  
PNP-NPN Industrial  
Transistors

PORT SALERNO, FLA  
Cove Road  
Microwave Connectors  
Plaxial (R) Cable  
Precision RF Coaxial

JUPITER, FLA  
1440 W. Indiantown Rd  
Microwave Stripline  
Components  
Microwave Semiconductor  
RF Semiconductor  
Microwave Integrated  
Circuits

TAPPAN, N. Y.  
256 Oak Tree Road  
Diodes & Rectifiers  
Zeners  
High Voltage  
Assemblies  
Power Rectifiers  
Thick Film Hybrid  
Circuits  
Ferrite & Ferrite Devices  
Film Resistors

KENT, ENGLAND  
Tubbs Hill House  
London Road,  
Sevenoaks  
Solidev, Ltd.  
Full line of  
Solitron devices

BEN BARAQ, ISRAEL  
51 Hayarkon Street  
AEL Israel, Ltd.  
Full line of  
Solitron devices

TOKYO 105, JAPAN  
No. 5, 3-Chome  
Shibahamamatsu-Cho  
Minato-Ku  
Matsushita Electric  
Trading  
Full line of  
Solitron devices

INFORMATION RETRIEVAL NUMBER 35

# Use your oscilloscope for numeric display.

You can generate a line of seven-segment characters with standard components and up to 400 characters in a 'page'.

It's possible to convert an ordinary oscilloscope into a seven-segment numeric display generator. You make the change with a circuit that converts an 8421 BCD coded number into the segmented display (see diagram).

The parts of the circuit are the timing generator, the stroke generator and the blanking/unblanking circuit. The timing generator consists of a decade divider, a BCD-to-decimal decoder and 10 inverters. The decade counter is synchronous to prevent spurious outputs from the decoder. The inverters are used to generate positive pulses.

In the stroke generator, time pulses T1 and T6 are OR-ed together to drive a positive-pulse amplifier. The OR of T3 and T4 drives a negative-pulse amplifier. The outputs of the two amplifiers are tied together, and the composite output is integrated by an RC network. An op amp acts as a buffer to the Y axis of the scope.

When T1 occurs, the output of the amplifier rises, causing the capacitor to charge up. During T2 both amplifiers are cutoff; no current flows into or out of the capacitor. Hence the voltage across it remains essentially constant. T3 causes the output to fall, discharging the capacitor. The same process occurs for the X-axis circuit.

The appropriate segments of the display must be either blanked or unblanked, depending on the type of oscilloscope used, to produce the desired digit. This is done by the third portion of the circuit. The BCD code of the character to be displayed is fed into the BCD-to-seven segment decoder. Each output of the circuit is fed into a two-input NAND gate. The other input of the NAND is connected to the appropriate timing pulse.

When any of the inputs of the NAND gate are low, its output is high, but when all of its inputs are high, then its output is low. Thus for the character 6, segments C, D, E, F and G are high. When T0 occurs, the output of the gate goes low. Since the gate drives another gate, the output

of the second gate goes high. Therefore a Z-axis pulse is produced to unblank the display. The same process occurs during T1, T4, T5 and T6 to produce the waveform shown. Note that since segments A and B are low, the Z-axis output will also be low during times T2 and T3. And similarly for other characters.

## Display a line of characters

This shows how a single character is generated. To generate a line of characters, we must add additional circuitry, as in Fig. 2a. The BCD characters are loaded in parallel into the shift registers. A character is displayed, as previously described. Then T8 triggers the character counter and causes the digits in the shift registers to be shifted one place to the right. The character counter should have as many states as the number of characters per line. The output of the character counter drives a d/a converter. Its output is then summed with the normal X axis of the oscilloscope.

A "page" of numerical data could be generated with another counter and d/a converter, as in Fig. 2b. The output of the character counter drives the second (line) counter. The output of the d/a converter is summed with the Y-axis signal to provide a signal to drive the Y axis of the oscilloscope.

About 400 characters can be displayed without flicker with the 100-kHz clock. The characters produced are vertical block digits that are about 2 V peak-to-peak, vertically, and 1 V peak-to-peak, horizontally.

Larger signals are obtained by giving the buffer amplifiers in the stroke generator a gain greater than 1. For smaller signals,  $R_s$  of the same circuit is increased. If a different clock frequency is used, the capacitor C should be scaled proportionally.

Slanted characters can also be obtained. All that must be done is to sum a portion of the vertical signal with the horizontal signal and to apply the resulting signal to the X axis of the oscilloscope. The signal applied to the vertical axis is left unchanged. ■■

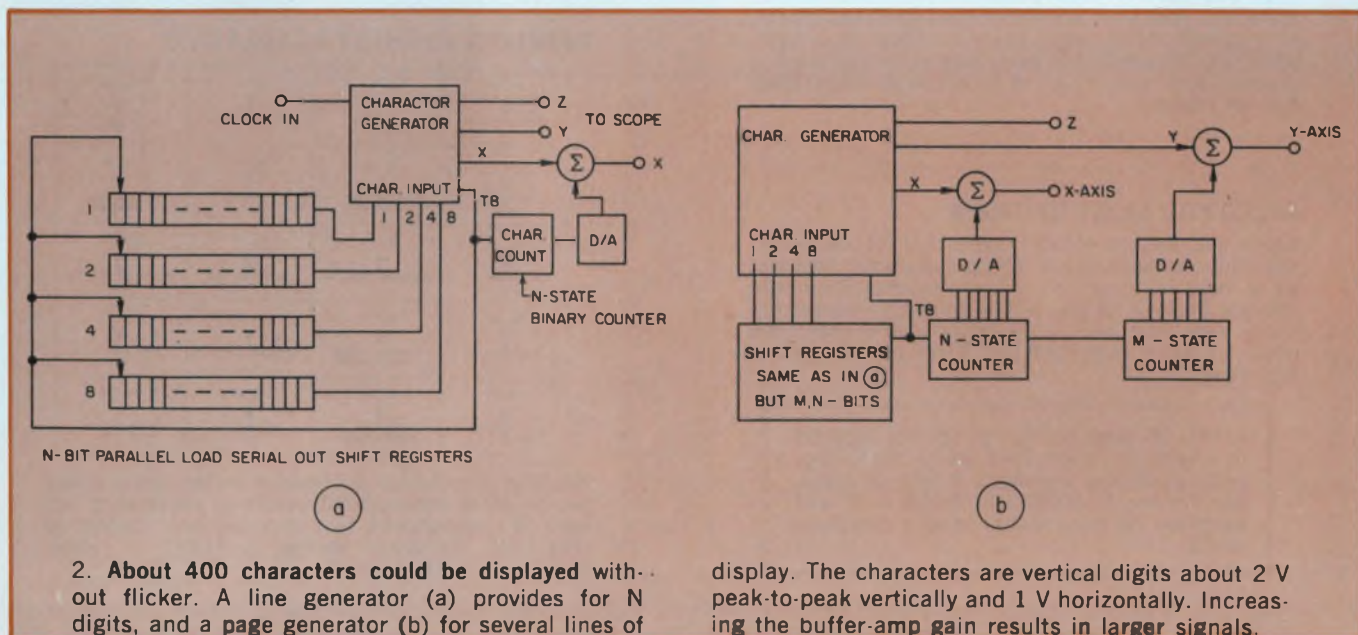
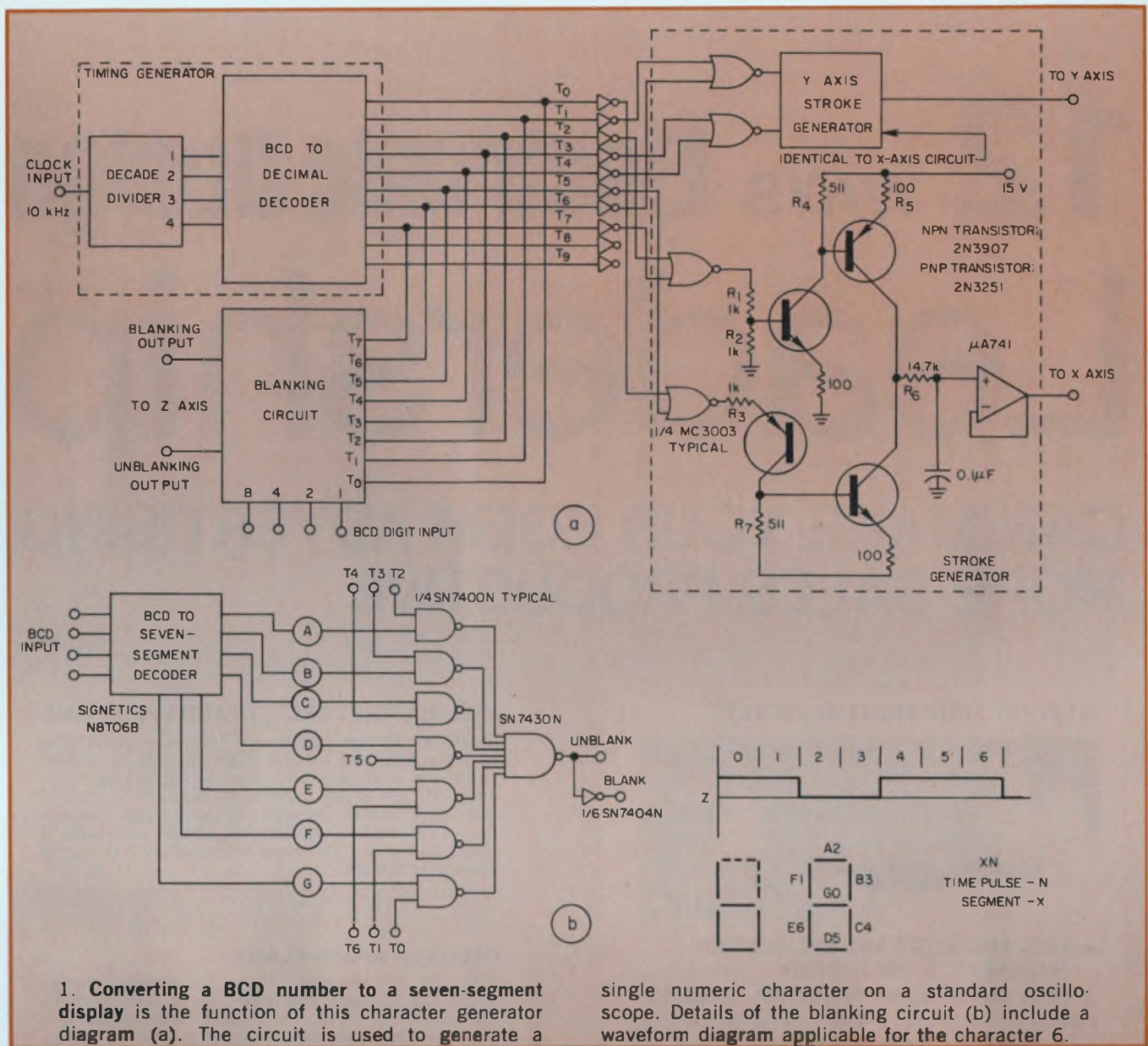

# 12 WAYS Electronic Design Leadership

## CAN MAKE YOUR EOEM ADVERTISING MORE SALES-PRODUCTIVE

### PINPOINT YOUR PRIME PROSPECTS

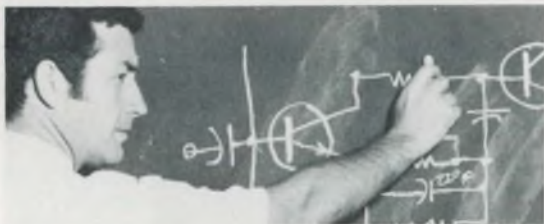

- 100% ENGINEERS AND ENGINEERING MANAGERS ● 100% DESIGN
- 100% QUALIFIED BY INDIVIDUAL REQUEST

**Electronic Design** goes only to your prime prospects — engineers and engineering managers. These are the "product specifiers", the men who start the life cycle of each new electronic product, device, or system; who need to know about components, devices, materials, hardware, sub-assemblies, test equipment, or systems. Study after study confirms their overwhelming importance in every step of the purchasing process, but most of all in selection and specification by brand.

### GIVES YOU MORE OF THEM

**Electronic Design** delivers more than 74,000 known specifiers, without waste. The professionals that you value most are mostly to be found reading **Electronic Design**. Prove it for yourself — conduct a readership study over your own EOEM lists. We'll share the costs — we're that confident **Electronic Design** is best read!

A new 20 page booklet of special interest to electronics executives, sales, marketing, and advertising managers is just off press. Ask for the LEADERSHIP folder — it will help you to make better media decisions in '72.

### INSURES THEY ARE LIVE AND SPECIFYING

**Electronic Design** makes sure that your advertising is being delivered to, and is being read by, active, on-the-job engineers and engineering managers — men who are in an immediate position to specify and buy products. In addition to one-year verification of the entire list, sampling checks are made 17 times each year. You know your audience is live in **Electronic Design**!

### DELIVERS 99% IN-PLANT

Your prospects receive, and read **Electronic Design** in the plant, where they work, where specifications are made. On the other hand, **Electronics** and **Electronic News** are only about 50% plant-delivered.

### DEVELOPS HIGHEST READERSHIP

No. 97 1 DIGITAL EQUIPMENT CORP.	No. 96 1 I & R RESEARCH LABORATORIES, INC.	No. 95 1 ARMO WIRE CORPORATION	No. 94 1 SHANGHAI ELECTRONICS INDUSTRIES CORP.
No. 87 1 RANE INSTRUMENTS	No. 86 1 PAPER INSTRUMENT CORPORATION	No. 85 1 DATAFOR INC.	No. 84 1 UNICO ELECTRONICS CORPORATION
No. 77 1 RFI INDUSTRIES INC.	No. 76 1 SYSTEMS GROUND CORPORATION	No. 75 2 DAN MANUFACTURING CO.	No. 74 1 SCHWEER ELECTRONICS CORP.
No. 67 1 WALTER SPECIALTIES	No. 66 1 INTERNATIONAL ELECTRONIC RESEARCH CORPORATION	No. 65 1 INDIANA GENERAL CORPORATION	No. 64 1 CEVA ELECTRONICS INC.
No. 57 1 NEBUS RESEARCH LABORATORY INC.	No. 56 1 NUPRO BY BICKMAN INSTRUMENTS	No. 55 1 AZCUBONICS INC.	No. 54 1 ELECTRONIC ENGINEERING CO. OF CAL.

No other electronics publication in the world offers you so many independent proofs of readership. We have 97 independent media readership studies to show you. **Electronic Design** is FIRST in "Read Regularly" in 89 of them!

## COVERS EVERY EMERGING MARKET OPPORTUNITY



Keeping engineers knowledgeable is a mammoth task. Complexity is the norm; obsolescence a constant threat. **Electronic Design's** editors stay on the forefront of design; probe every emerging development in terms of its significance to the engineer, his company, and its competitors.

## 100% FOCUS ON DESIGN TECHNOLOGY

**Electronic Design** effectively bridges the gap between a constantly evolving technology and the needs of your customers — working engineers. They read **Electronic Design** because it is exciting . . . explores both sides . . . supplies their "total" needs. It gives them **BALANCED** coverage of **NEWS, TECHNOLOGY, and PRODUCTS** — all from the design point of view. Material is practical, immediate, solution-oriented; brought alive by color, typography and graphics. Our unique **FOCUS** series is typical of the extra technical emphasis in '72.

DATE	FOCUS ISSUE SUBJECT	CLOSING
Jan. 6	Digital Panel Meters	Nov. 29
Feb. 3	Resistor Trimming Equip.	Dec. 27
Mar. 2	Lighted Switches	Jan. 24
Apr. 1	Function Generators	Feb. 21
Apr. 13	ICs	Mar. 6
May 11	Disc & Drum Memories	Apr. 3
June 8	ICs	May 1
July 6	Reed Relays	May 30
Aug. 3	MSI/LSI Testers	June 26
Aug. 17	ICs	July 10
Sept. 2	Digital Cassette and Cartridge Recorders	July 24
Oct. 12	Time Delay Relays	Sept. 5
Oct. 26	ICs	Sept. 18
Nov. 9	Keyboards	Oct. 2
Dec. 7	Fiat Flexible Cable & Flexible Printed Circuits	Oct. 30

## PROVIDES MOST SALES LEADS

No other electronics or industrial magazine in the world can match the number of sales leads generated by **Electronic Design**! Over 1,500,000 per year! This massive influx of requests for further information is a basic proof that editorial and advertising in **Electronic Design** is seen, read, and acted upon. Ask to see copies of latest "Did You Buy?" studies.

## HELPS YOU GET STARTED

**Electronic Design** is not just for the large advertiser . . . it's for the small company, too. Ask about our "Quick Ads". They're an easy way to get sales leads at low cost — only \$300 per insertion (and no production costs).

## ACCELERATES RESULTS



**Electronic Design** readers not only react with requests for more information, if you give them the technical data they need, right away, in your ad, they can often be brought to the point of purchase quickly — sometimes immediately. Get the full story on our Purchase-Producing Advertising concept, then hear the cassette tape narrated by Triplet Corp.'s President. It tells how they received an avalanche of 12,000 responses from one Purchase-Producing Advertisement in **Electronic Design**. PPA insert discounts range as high as 75%!

## OFFERS MORE MARKETING SERVICES

Be sure to take advantage of **Electronic Design's** arsenal of advertising and marketing aids. **FAST CLOSE FORM • AUDIT OF BRAND RECOGNITION • INQUIRY FOLLOW-UP STUDIES • READER RECALL STUDIES • BUYING AUTHORITY STUDIES • READERSHIP STUDIES • MARKETING NEWSLETTER • MERCHANDISING PROGRAM.**

## ENABLES PRECISION DIRECT MAIL FOLLOW-UP

Put the additional power of demographic direct mail behind your advertising program. **Electronic Design's** Precision Direct Mail Service offers 6 selections to zero-in on prospects; gives only current specifiers.

# GET MOST SALES ACTION!

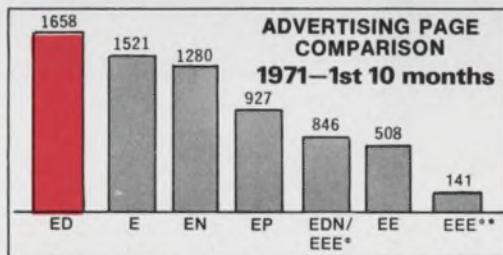

\* EEE space after merger.

\*\* EEE space prior to merger.

The industry clearly shows its preference for **Electronic Design**, places most advertising pages in this magazine.

# Electronic Design

a Hayden publication • 50 Essex Street, Rochelle Park, New Jersey 07662 • Tel: 201-843-0550

## Use the two-stage RC low-pass approximation for matched filters

Matched filters are widely used for the detection of pulses in the presence of noise, but the ideal filter is hard to build. Yet, with simple passive filters, such as the two-stage RC low-pass (Fig. 1), you can approximate the perfect matched filter to within a few tenths of a decibel if filter bandwidth pulse-length products are chosen for the optimum case. And with the curves in Fig. 2, you can design the two-stage RC low-pass for several common signal pulse shapes.

Here's an example: Suppose you must choose the components of the RC filter to provide optimum performance as a matched filter for a rectangular signal pulse of 1- $\mu$ s duration.

As a means of comparison with the ideal matched filter, let  $SNR_0$  be the relative signal-to-noise ratio of the RC filter. This is also the actual signal-to-noise ratio since the ideal matched filter ratio is unity. The  $SNR_0$  is the peak ratio at the output of the filter normalized to the input pulse energy content.

From Fig. 2a, curve 1, the lowest value of  $SNR_0$  occurs at  $T=3$ . With use of the table in Fig. 2b to obtain denormalized component values,  $a=T/T^*=3/10^{-6}=3 \times 10^6$ . A convenient value of  $b$  is  $10^6$ . Then,

$$R^* = bR = 1 \text{ M}\Omega$$

and

$$C^* = \frac{C}{ab} = \frac{1}{3} \text{ pF.}$$

### Bibliography:

Schwartz, M., *Information Transmission, Modulation and Noise*, McGraw-Hill Book Co., Inc., 1959, pp. 287-291.

Carlock, G. W., *Approximating the Matched Filter for Pulse Signals in Noise*, MSEE Thesis, University of Texas at Arlington, 1968.

Turin, G. L., "An Introduction to Matched Filters," *IRE Transactions on Information Theory*, June, 1960, Vol. IT-6, No. 3.

VanValkenburg, M. E., *Introduction to Modern Network Synthesis*, John Wiley & Sons, 1964, pp. 48-53.

Gaylord W. Carlock, *Aerosystems Engineer, Convair Aerospace Div., General Dynamics, Fort Worth, Tex. 76101*

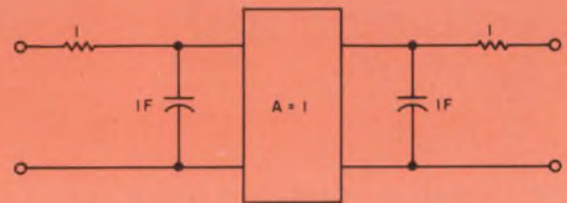

1. An excellent approximation to the ideal matched filter is the two-stage RC low-pass filter. As shown, component values are normalized. For the closest approximation, it's necessary that bandwidth pulse-length products be chosen for the optimum  $SNR_0$ .

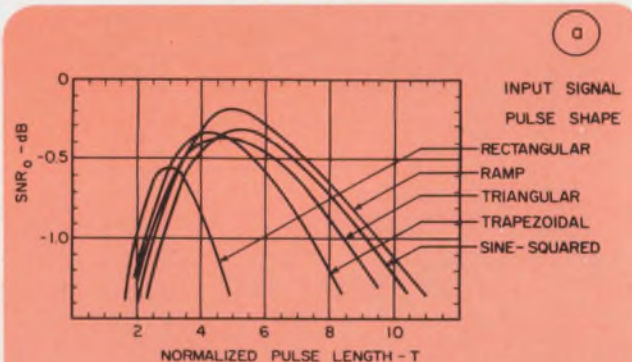

NORMALIZED		SCALED	
R		$R^* = bR$	
C		$C^* = \frac{1}{ab} C$	

2. For a given input pulse shape, read off the normalized pulse length corresponding to the optimum performance (a). Then, the RC filter components are calculated from the scaling relationships (b). The scale factor,  $a$ , is found from  $T$  and the pulse length,  $T^*$ . The factor  $b$  is chosen to obtain conveniently sized components.

CIRCLE NO. 311



# HELIPOT BREAKS THE HALF-BUCK BARRIER.

Here they are: the best buys. Our new Series 72 single-turn  $\frac{3}{8}$ " cermet trimmers at an eye-opening 49¢ each in the 1,000 quantity. They're equally well-priced in other quantities, too. One alone costs just 70¢.

But there's also that dependable Helipot quality and performance, plus things you don't get elsewhere. Like our resistance and slider stability... change is less than 0.5% in the first 1,000 operation hours, progressively less thereafter. Impressive, when the life expectancy exceeds five years' continuous duty under full-rated power. And the Series 72 sealing — compatible with wave soldering, low-viscosity potting, and board washing even with chlorinated solvents.

Add the wide range of values,  $\pm 100$  ppm/ $^{\circ}$ C tempco, and off-the-shelf availability from 17 nationwide stocking points and what have you got? The best reasons in the world for requesting complete specs and data on this breakthrough line of Helipot cermet trimmers. Do it now — it won't cost you a cent.

**Beckman®**

INSTRUMENTS, INC.  
HELIPOT DIVISION  
FULLERTON, CALIFORNIA

HELPING SCIENCE AND INDUSTRY IMPROVE THE QUALITY OF LIFE.

INFORMATION RETRIEVAL NUMBER 36

# Build a dual voltage regulator for \$11

It's possible to build a dual voltage regulator for \$11. The savings come about with the elimination of a second temperature-compensated reference diode.

The regulator circuit uses the common-mode rejection properties of the op amps to eliminate the need for a second reference diode (see diagram).

The total change in the output voltage for positive or negative input voltages from 14 V to 18 V—and for load current from 0 to 45 mA—is only

40 mV. The load current causes a 2-mV shift in the 40 mV.

Better regulation against input voltage changes can be realized with a simple, non-temperature-compensated zener preregulator (shown in dashed lines). The current through the 1N821 reference diode should then be readjusted to 7.5 mA at the design center input voltage.

*Horace T. Jones, Jr., Project Engineer, HB Engineering Corp., Silver Springs, Md. 20910*

CIRCLE No. 312

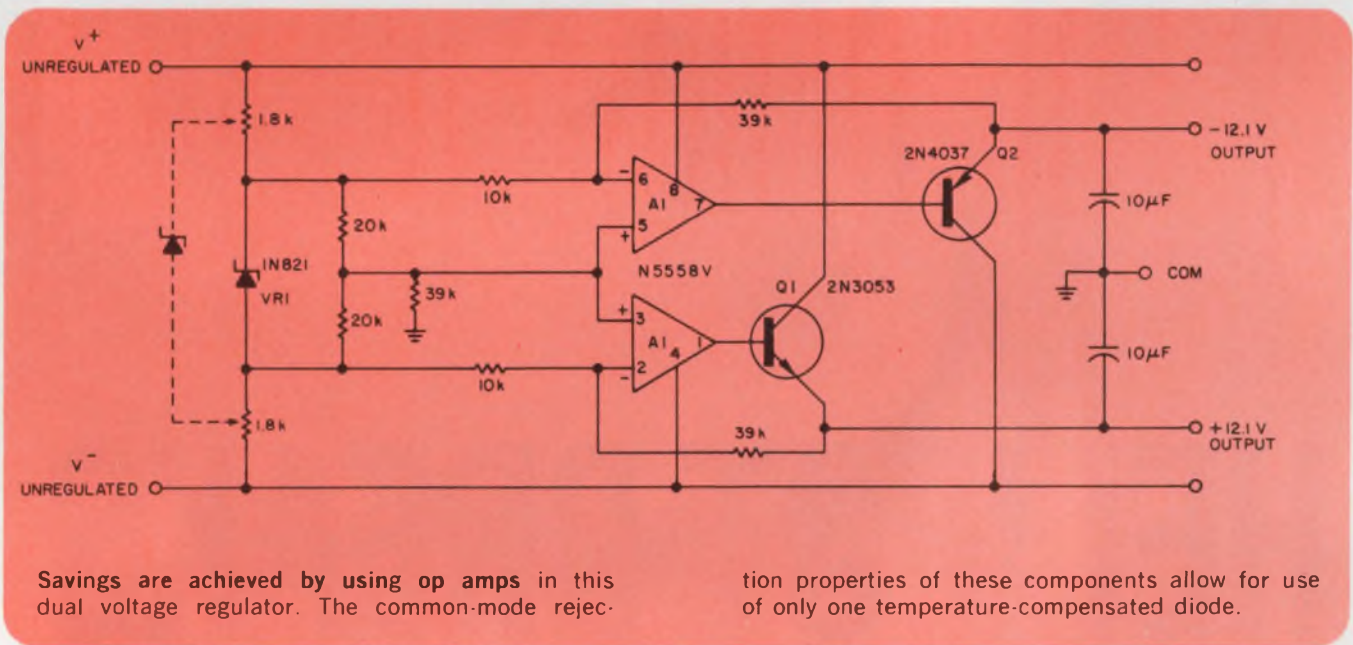

## Sure-start multivibrator offers wide output with fast rise and fall times

It's often necessary to obtain waveforms of long duration that have very fast rise and fall times. By combining the stable timing characteristics of a UJT with the fast switching of an IC flip-flop, as in the diagram, you can build an astable multivibrator with the required characteristics. Output waveforms of several seconds in duration are easily obtained, with rise and fall times of less than 100 ns.

The time duration of each half of the output waveform is independently adjusted by the time

constants formed from  $R_1C$  and  $R_2C$ . Diodes  $D_1$  and  $D_2$ , along with open-collector inverters A1 and A2, serve to enable only one resistor-capacitor combination during each portion of the output waveform. Inverter selection is alternately performed by the output state of flip-flop FF1. Since a single timing capacitor is used, variations in the value of that capacitor do not effect the duty cycle of the output.

The duration of the output waveform is given by the UJT relaxation-oscillator formula, modi-



A simultaneous, rather than a sequential, reading and writing capability makes our new second-generation miniature storage tubes outstanding. Now you can have greatly increased flexibility in design. Now you can enjoy continuously up-dated data—and ease of handling high data bits. Now your designs can be more flexible than ever before, whatever your application (zooming, selective erasure, write and read stored data at the same time).

The new tubes are an extension of our RST family, retaining all the features previously demonstrated. They

can store a full TV gray-scale image for half an hour. With power off, the storage capability is at least a month. And one TV frame is enough to erase a complete image thanks to a unique, patented, gun design.

Their flexibility, capability, and the low cost of associated electronics make these tubes ideal for a wide variety of applications. For complete information concerning them and our entire line of storage and display tubes, please circle the appropriate number on the Reader Service Card, or contact us direct.

Model	Type No.	TV Lines at 50% MF	Voltage (Mesh)
1.5" EM	TME 1239	1200	750
1.0" EM	TME 1238	800	650
1.5" ES	TME 1348	600	1100
Dual Gun 1.0" EM	TME 1496	800	650

information concerning them and our entire line of storage and display tubes, please circle the appropriate number on the Reader Service Card, or contact us direct.

The foremost family of miniature storage tubes is growing...

**Now we have tubes that read and write at the same time.**



**THOMSON-CSF**

THOMSON-CSF Electron Tubes, Inc./50 Rockefeller Plaza/ New York, N.Y. 10020/(212) 489-0400

France—THOMSON-CSF Groupement Tubes Electroniques/8, rue Chasseloup-Laubat/75/PARIS 15ème/Tel: 566 70 04

Germany—THOMSON-CSF Elektronenröhren GMBH/Am Leonhardsbrunn 10/6 FRANKFURT/Main/Tel: 0611-70 20 99

Italy—THOMSON-CSF Tubi Elettronici SRL/Viale degli Ammiragli 69/ROMA/Tel: 63 80 143

Sweden—THOMSON-CSF Elektronrör AB/Box 27080/S 10 251 STOCKHOLM 27/Tel: 08/22 58 00

fied to account for the additional diode-drop across  $D_1$  or  $D_2$ :

$$T_P = C (R_1 + R_2) \left[ \frac{1}{1 - \eta - (V_D/V_{BB})} \right]$$

where  $\eta$  = UJT standoff ratio,  $V_D$  = voltage drop

across  $D_1$  or  $D_2$  when conducting and  $V_{BB}$  = voltage supplied to the UJT circuit.

*Phil M. Salomon, Instructor in Engineering, Pasadena City College, Tujunga, Calif. 91042*

CIRCLE NO. 313

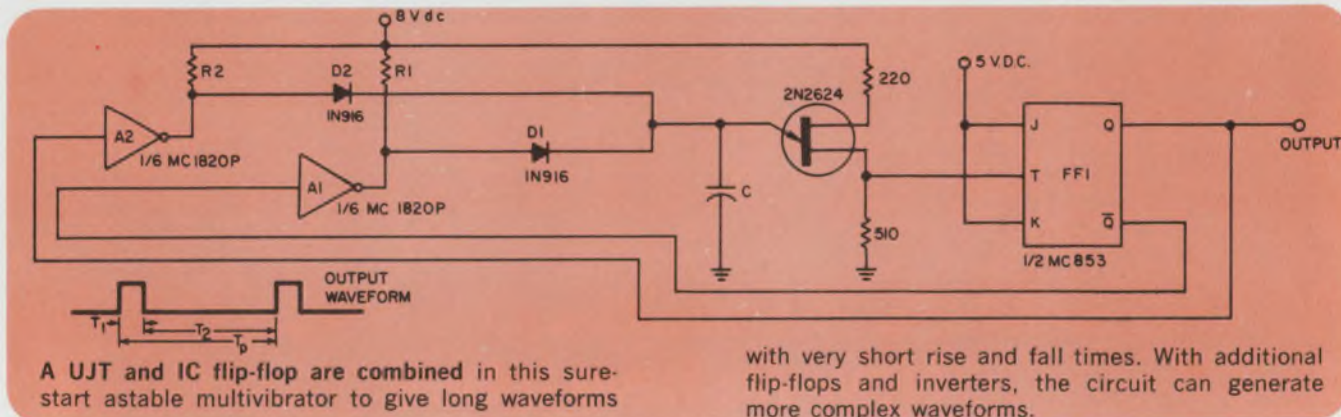

## Multivoltage monitor for power supply

When falling voltages can cause serious errors or damage to the circuits being powered, it's sometimes essential to monitor power supplies continuously. A conventional sense relay can be used. But when microsecond response is required and you want comparable precision, too, use the circuit shown in the diagram.

When power is applied to the circuit, a series of reference voltages are developed. Resistors  $R_1$  and  $R_2$  develop  $V_{ref1}$ , and zener  $Z_2$  develops  $V_{ref2}$ . Resistors  $R_6$  and  $R_7$  develop  $V_{ref3}$ , and  $R_{11}$  and  $R_{12}$  develop  $V_{ref4}$ . Each voltage is compared with its respective reference voltage by means of a differential current switch.

Comparators 1, 2 and 3 carry a common current—produced by  $R_3$ —that sinks into  $R_4$  if all voltages are safe. This produces an up level on the output. Comparator 4, carrying a current produced by current source  $R_{10}$ , sinks in  $Q_3$ .

If any voltage drops below its  $V_{ref}$ , the result is a down level at the output. Should 24-V, 12-V or 5-V inputs drop below their respective  $V_{ref}$ , the current produced by  $R_3$  is switched into ground. If the -12-V input drops below its  $V_{ref}$ , the current produced by current source  $Q_3$  is switched into  $R_4$ . Transistor  $Q_{10}$  is turned ON, and it switches the current produced by  $R_3$  into ground.

*S. F. Aldridge, International Business Machines Corp., Systems Development Div., San Jose, Calif.*

CIRCLE NO. 314

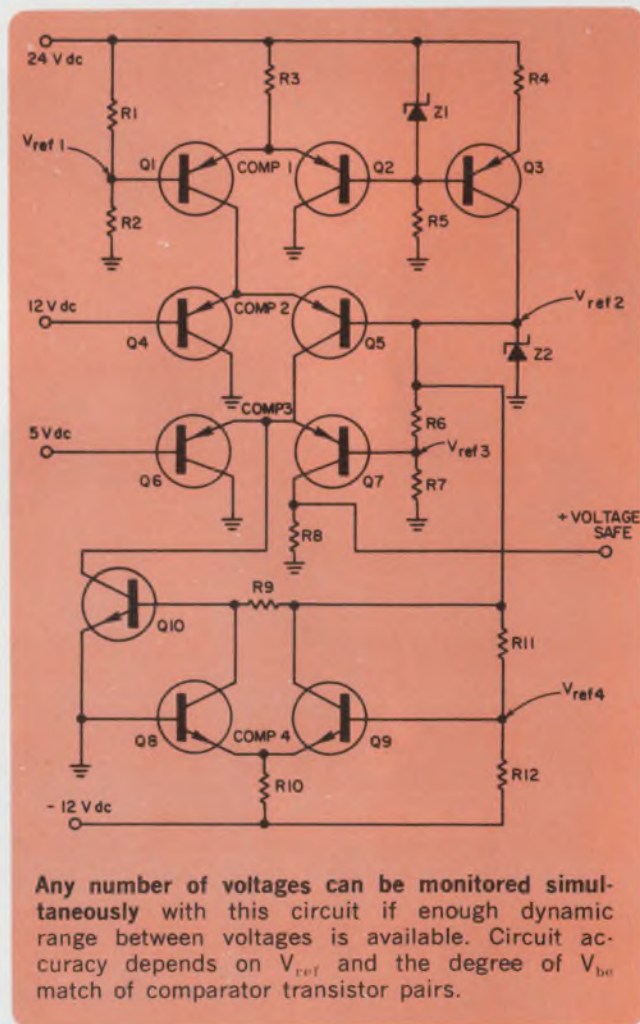

## Decorator Push Button Switches

Front panel bezel mounting

Sub-panel mounting



Their good looks are more than button-deep

Handsome is as handsome does. These push button switches represent the ultimate in engineering, materials, finishes and manufacture—Grayhill all the way.

Depending on style, momentary or alternate action, type of service, their life expectancies range from 200,000 to 1,000,000 cycles.

For an attractive front panel with the proper push button circuitry behind it specify the Grayhill Dec-

orator Line. Buttons are red, black, yellow, green, blue, or white; round or square. Square ones can be hot stamped with legend.

Like to know more? Write or phone for our latest general engineering catalog. Grayhill, Inc., 565 Hillgrove Ave., La Grange, Ill. 60525, (312) 354-1040.

### Grayhill

... the Difference Between Excellent and Adequate

INFORMATION RETRIEVAL NUMBER 38

More wafers per furnace load. Longer furnace tube life.

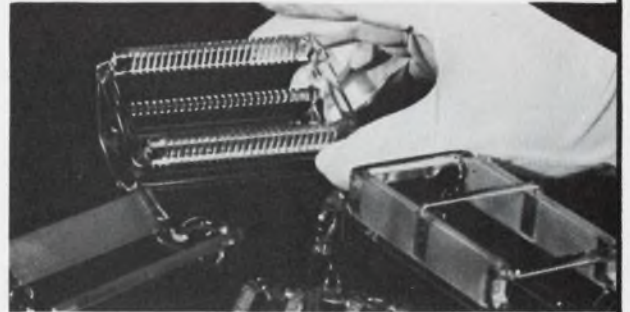

Newly designed carrier boats from Amersil are a marked improvement over slotted plate and slotted rod carriers for low and high temperature diffusion applications. This construction provides more secure wafer spacing for uniform diffusion.

For details on the above and our complete line of new spring boats and carriers to raise wafer output, write today to: Amersil, Inc., 685 Ramsey Ave., Hillside, N. J. 07205.



An Equal Opportunity Employer

207B

INFORMATION RETRIEVAL NUMBER 39

## The gaussmeter comes to the production line.

If any of the products you make include permanent magnets, you could use a Bell gaussmeter. It's the best quality control check you can use. And in addition to testing, we can even help with production. We have a complete line of magnetizers, sorters, stabilizers, and demagnetizers.

Write for our detailed brochure to: 4949 Freeway Drive East, Columbus, Ohio 43229.

**F. W. Bell Inc.**

A subsidiary of The Arnold Engineering Co.

INFORMATION RETRIEVAL NUMBER 40

ELECTRONIC DESIGN 26, December 23, 1971

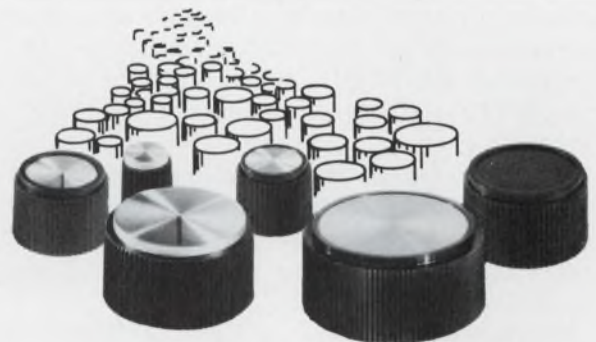

# 1,500,000

## KNOBS TO CHOOSE FROM...

and they're "Warranted for Life"

Kurz-Kasch has over 1½ million low cost, high quality knobs in inventory, ready to ship to you. (You save . . . no tooling cost on stock knobs, specials 4 to 6 weeks delivery.) Your local distributor's stock is available at factory prices. Select instrument and control knobs from 24 families with 367 basic sizes and shapes in general purpose phenolics, melamines and ureas. All Kurz-Kasch knobs are warranted for the life of the product on which they're used. Send now for free 20 page catalog. (Also found in THOMAS REGISTER "THOMCAT."®)



**Kurz-Kasch, Inc.**

1421 S. Broadway  
Dayton, Ohio 45401  
513/223-8161

INFORMATION RETRIEVAL NUMBER 41

# Compute Laplace transform and Bode response with BASIC

The calculation of the Laplace transform of an experimental waveform is long and tedious. But with the program listing shown, the equation is determined by a computer. In addition the program computes the gain-phase vs frequency spectrum for a Bode plot presentation.

To obtain the Laplace transform of a pulse waveform, the designer selects six to 12 data points on the waveform, so that a straight line segment between data points gives a good fit. These data values, along with the frequency range desired, are entered into the program according to the instructions on lines 2 to 7.

The program calculations are based on an indirect method of obtaining the Laplace transform that is essentially an application of the shifting theorem. The program computes the first two derivatives of the time function in lines 15 to 27 and forms the transform of the resulting impulse chain by a double integration (division by  $S^2$ ). Lines 28 to 42 print out the Laplace transform equation, one term for each time period. The remaining program computes the gain and phase of the transform by substituting  $JW$  for  $S$  in the expression for  $F(S)$ , where each term of the form  $\text{EXP}(-ST)$  is expressed as  $\text{COS}(WT) - J \text{SIN}(WT)$ .

The accuracy of the method is dependent on the input data accuracy, the number of data points and the closeness of the data fit to the time response waveform. In general, 12 points are sufficient to give 1-2% accuracy.

Program restrictions are listed in lines 6-7.

*C. L. Stansberry, 20521 Debbie Lane, Saratoga, Calif.*

CIRCLE NO. 315

```

11 THIS PROGRAM OUTPUTS THE LAPLACE TRANSFORM OF A TIME FUNCTION
21 AND COMPUTES THE FREQUENCY & PHASE RESPONSE OF THE TRANSFORM
31 THE TIME FUNCTION MUST BE GIVEN AS A SET OF DATA POINTS.
41 INSTRUCTIONS:ENTER TOTAL # OF DATA PTS.:ENTER LOWEST FREQ:
51 ENTER HIGHEST FREQ:ENTER FREQ STEP:ENTER DATA IN VOLT,TIME PAIRS
61 INITIAL DATA VALUES MUST BE ZEROS:TWO CONSECUTIVE TIMES WHICH
71 HAVE ZERO VALUES ARE NOT ALLOWED,INFINITE SLOPES ARE NOT ALLOWED
8 PRINT
9 COMPLEX(A(100),B(100),C(100),N5
10 DIM T(100),F(100),D(100)
11 INPUT N
12 INPUT W1,W2,S1
13 PRINT
14 INPUT T(I) FOR I=1 TO N
151 COMPUTE SLOPES AS F'=V2-V1/T2-T1
16 L=1
17 FOR K=1 TO (N-2)/2
18 F(K)=(T(L+2)-T(L))/(T(L+3)-T(L+1))
191 INCREMENT TO NEXT DATA PAIR
20 L=L+2,J=1,D(1)=F(1)
211 # OF F' VALUES ARE ONE LESS THAN # OF DATA PAIRS
22 NEXT K
231 COMPUTE F",ONE FOR EACH DATA PAIR
24 FOR M=2 TO (N-2)/2
25 D(M)=F(J+1)-F(J)
26 D(N/2)=-F((N-2)/2),J=J+1
27 NEXT M
281 PRINT F" AS AN EXPONENTIAL SERIES
29 STRING R,Z,O
30 R="EXP(-",Z=" S)",L=3
31 PRINT"F(S)=(1/S+2)I":
32 FOR J=1 TO N/2
33 IF J=1 THEN 37
34 IF D(J) <=0 THEN 41
35 IF D(J)>0 THEN 39
36 GO TO 42
37 PRINT D(1):
38 GO TO 44
39 Q="+"
40 GO TO 42
41 Q=""
42 PRINTO:D(J):R:T(L+1):Z:
43 L=L+2
44 NEXT J
45 PRINT""
46 PRINT
47 PRINT" W MAG. MAG(DB) ANGLE"
481 FORM PRODUCTS OF COEFF. & SIN,COS TERMS FOR EACH T
49 FOR W=W1 TO W2 BY S1
50 N5=CMPLX(D,O),M=2
51 FOR J=2 TO N/2
52 B(J)=CMPLX(COS(W*(M+J)),-SIN(W*(M+J)))
53 C(J)=CMPLX(D(J),O),C(1)=CMPLX(D(1),O)
54 A(J)=C(J)*B(J),N5=N5+A(J),M=M+1
55 NEXT J
56 N5=N5+C(1),R1=REAL(N5),Z1=IMAG(N5),R3=SQRT(R1*2+Z1*2)
57 A3=ATAN(Z1,R1),A1=57.296*A3-180.,R2=R3/W+2,F2=20*LOG10(R2)
58 PRINT IN IMAGE"ZZZZZ.ZZ ZZZZ.ZZZ ZZZ.ZZ ZZZZ.Z":W,R2,F2,A1
59 NEXT W

```

Just 12 data points and the frequency range desired of an experimental pulse waveform are all the input data needed for this BASIC program. The printout gives the Laplace transform and Bode response. The accuracy is usually 1 to 2%.

## IFD Winner of August 5, 1971

**Doug Clifford, Design Engineer**, Hewlett-Packard Co., 1501 Page Mill Rd., Palo Alto, Calif. His idea "Reset dividers faster with a single flip-flop" has been voted the Most Valuable of Issue award.

**Vote for the Best Idea in this Issue**

**VOTE!** Go through all Idea-for-Design entries, select the best, and circle the appropriate number on the Reader-Service-Card.

**SEND US YOUR IDEAS FOR DESIGN.** You may win a grand total of \$1050 (cash)! Here's how. Submit your IFD describing a new or important circuit or design technique, the clever use of a new component or test equipment, packaging tips, cost-saving ideas to our Ideas-for-Design editor. You will receive \$20 for each accepted idea, \$30 more if it is voted best-of-issue by our readers. The best-of-issue winners become eligible for the Idea Of the Year award of \$1000.

## new products

### Smallest-size DPM family is also the lowest in cost



Analogic Corp., Audubon Rd., Wakefield, Mass. Phone: (617) 246-0300. P&A: see text; 8 wks.

The price and size race in DPMs continues to produce many victors, with Analogic Corp. being the latest. The company has introduced a line of bipolar 2-1/2, 3-1/2 and 4-1/2-digit cased DPMs that operate from +5-V-dc  $\pm 5\%$  logic lines (no power supply is needed), and are the smallest-size and lowest-cost in the industry.

Measuring 1.4-in. high, 1.4-in. deep and 3.4-in. wide, the meters are the smallest in volume on the market. At just under 6.7 in.<sup>3</sup>, they're more than 1 in.<sup>3</sup> smaller in volume than Analog Devices' recent AN2001 3-1/2-digit DPM which had held the smallest-volume crown. Analogic's DPMs however are 3.4-in. wide compared to Analog's unit which is 3-in. wide.

Analogic has also scored another point. Its DPMs with BCD output as standard are the lowest in cost. Models AN2525, AN2535 and AN-2545 (2-1/2, 3-1/2 and 4-1/2 digits) are priced at \$69, \$78 and \$160, respectively, for 100-quantity lots. The \$78 price is \$11 under

Analog Devices' AN2001, which until recently was the lowest-cost 3-1/2-digit DPM at \$89.

Accuracy ratings for the 2-1/2, 3-1/2 and 4-1/2-digit models are  $\pm 0.25\%$  of reading  $\pm 1$  count,  $\pm 0.05\%$  of reading  $\pm 1$  count, and  $\pm 0.2\%$  of reading  $\pm 1$  count, respectively. TCs and power dissipations are 100, 50 and 20 ppm/C and 1.5, 2 and 2.5 W, respectively.

All three meters feature 1000-M $\Omega$  input impedance, less than 1 nA of bias current and use flat-plane 7-segment incandescent 1/2-in. high readouts.

Analogic's proprietary 3-Stage Integrating Converter is used in the meters' inputs. The converter provides automatic zeroing (zero correction after every measurement) and Iso-referencing which minimizes time drift and the temperature coefficient.

The DPMs use differential inputs which are fully isolated from the outputs eliminating errors due to logic-system noise. The common-mode rejection ratio is specified as 70 dB at 60 Hz. A reading rate of up to 100 measurements/s is available.

CIRCLE NO. 250

### Graphic plotter works to 30 characters/s



Hewlett-Packard Co., 1501 Page Mill Rd., Palo Alto, Calif. Phone: (415) 493-1501. P&A: \$3575; 30 days.

A new high-speed graphic plotter, the model 7202A, operates in parallel with data communications terminals and accepts ASCII code at 10, 15 and 30 characters/s. Graphs on any size paper up to 11 by 17 in. are plotted using any source language such as BASIC or FORTRAN. Each point is defined by 4-digit X and Y coordinates—from 0000 to 9999.

CIRCLE NO. 251

### 1-kV supply can be digitally programmed



Alpha Scientific, Subs. of Systron-Donner Corp., Box 2044, Oakland, Calif. Phone (415) 635-2700. P&A: \$1750; 60 days.

The model M106 precision voltage source supplies 0 to 1000 V dc in four ranges, each with six-digit resolution and readout. All functions are push-button controlled or are programmable by parallel or series DTL/TTL input. BCD output is also available. Voltage calibration accuracy is 0.003% on all ranges.

CIRCLE NO. 252

Announcing REQUESTED DATA DELIVERY, it's free—see card facing page 16.

## Portable 3-1/2-digit DMM weighs 2.5 lb



Weston Instruments, Inc., 614 Frelinghuysen Ave., Newark, N.J. Phone: (201) 243-4700. Price: \$285 (includes batteries).

A new low-cost battery-operated portable DMM features 17 ranges at 3-1/2-digit resolution and weighs less than 2-1/2 lb. Designed specifically for field use, the model 4440 can operate continuously for 8 to 12 h on four rechargeable C cells. It is housed in a high-impact Lexan case. Its dc accuracy is  $\pm 0.3\%$  of reading  $\pm 1$  digit and ac accuracy is  $\pm 0.5\%$  of reading  $\pm 3$  digits.

CIRCLE NO. 253

## $\pm 39999$ -count DPM has floating input



Analogic Corp., Audubon Rd., Wakefield, Mass. Phone: (617) 246-0300. P&A: \$350; stock to 3 wks.

The AN2544 4-3/4 digit-DPM ( $\pm 39999$ ) has an automatic polarity symbol, an externally positionable decimal point, 6 ppm stability and accuracy of  $\pm 0.01\%$  of reading  $\pm 0.0025\%$  of full scale  $\pm 1$  count. Features include a floating, guarded differential input with transformer coupling between analog and digital sections. An auto-zero circuit automatically zeroes out all offset and drift errors. Common-mode rejection is greater than 100 dB to 60 Hz. Conversion time is 100 ms.

CIRCLE NO. 254

## Mercury wetted switch withstands 50 g's



Fifth Dimension Inc., P.O. Box 483, Princeton, N.J. Phone: (609) 924-5990. P&A: \$3.00 (100 quantities); see text.

A new non-position mercury wetted switch, which is almost unbreakable, will be available in January. Known as the Logcell II, the device can withstand a worst-case shock of 50 g's. Ruggedness is achieved by encasing the switch in a hermetically sealed metal body with only one sturdy glass to metal seal.

Using a simple mercury wetted armature contact which flexes with virtually no wear or friction, the Logcell II marries the reliability of mercury with the mounting flexibility of dry reed switches.

Contact bounce and erosion are prevented by a patented process of mercury film replenishment. The rated life of the switch ranges from 100 million cycles at full load to 1 billion cycles at 1/4 load.

The switch is of the spst normally open variety. It has a contact resistance of  $0.15 \Omega$  and a 3-pF contact capacitance. Contact breakdown is 500 V dc and the maximum cycling rate is 100 Hz.

The Logcell II can be operated by a permanent magnet or by the magnetic field of a coil formed around the stud of the switch. Typical applications for the device range from pushbuttons, relays, and keyboard switches to choppers and crossbar and alarm switches.

While the switch sells for \$3 in quantities of 100, the price drops to \$1.25 in quantities of 100,000.

CIRCLE NO. 255

## 2-channel opto-isolator fits in an 8-lead DIP

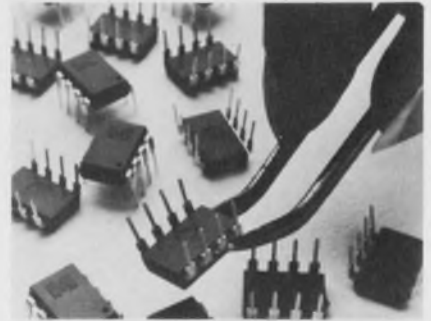

Monsanto Electronic Special Products, 10131 Bubb Rd., Cupertino, Calif. Phone: (408) 257-2140. P&A: \$5.95 (1000 quantities); stock.

A new dual-channel opto-isolator model MCT2D, combines in an eight-lead, plastic, DIP two MCT2 phototransistor coupled pairs. The device is contained in an iso-dip package only 1/16-in. longer than the single-channel model. This permits four channels of optical isolation to be incorporated in a 16-pin DIP socket. The MCT2D package is compatible with all current automatic-insertion techniques and PC-board spacing standards.

CIRCLE NO. 256

## In-line panel fuseholder twist-locks into place



Littelfuse, Inc., 800 E. Northwest Hwy., Des Plaines, Ill. Phone: (312) 824-1188. Price: less than 10¢.

A new universal, low-cost, in-line fuseholder is designed with a simple "twist lock" which permits rapid opening and positive closing of the holder for easy fuse extraction and replacement. Approximately 2-3/16-in. in dia, the 155100 fuseholder is made for holding a fuse in a cable or in a chassis. In addition to a transparent version, it is molded in seven basic colors: grey, black, red, yellow, white, green and blue.

CIRCLE NO. 257

## Solid-state relay comes in a DIP



*Sterer Engineering & Mfg. Co., 4690 Colorado Blvd., Los Angeles, Calif. Phone: (213) 245-7161. Price: \$21.75.*

Featuring solid-state construction, the new SLS-2000 2pdt relay features snap-action switching in a DIP. Hysteresis and TTL-compatible drive voltage is 2.4 V dc at 1.6 mA maximum. Operating temperature range is -55 to +125 C. The relay may be subjected to 32 V dc continuously without any damage. Contacts are rated at 250 mA. The relay can be switched at 100 kHz at maximum current.

CIRCLE NO. 258

## Low-profile PC relay has 0-5-in. height

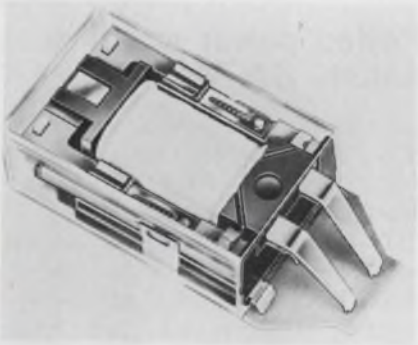

*Siemens Corp., 186 Wood Ave., S., Iselin, N.J. Phone: (201) 494-1000. P&A: approx. \$2; stock.*

To permit the lowest possible profile in direct PC-board mounting for its model V23016 miniature power relay, Siemens has introduced a new terminal configuration. Termed the "D" series, the relay features a right-angle terminal design which allows horizontal PC-board mounting. This results in a 0.511-in. height above the mounting surface. Measuring only 1.22 by 0.786 by 0.511 in., the V23016 relays' contacts are rated at 115/208 VAC and 7.5 A resistive (continuous current).

CIRCLE NO. 259

## Low-cost photocell is priced at only \$2

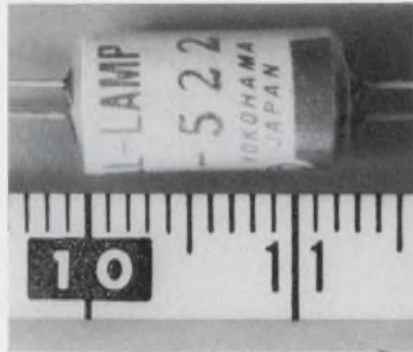

*Moririca Electronics, Ltd., 205 Tozuka-machi, Tozoka-ku, Yokohama, Japan. Price: \$2.*

A new CdSe photocell designated MCD-522 is priced at only \$2. Spectral distribution of the photocell has been accurately matched to that of a gallium LED with an output ratio of 60 dB. Temperature characteristics of the photocell vary inversely with those of a gallium LED. Dimensions are less than 1/4 those of incandescent and neon lamps.

CIRCLE NO. 260

## Fast opto-isolator is rated for 5000 V

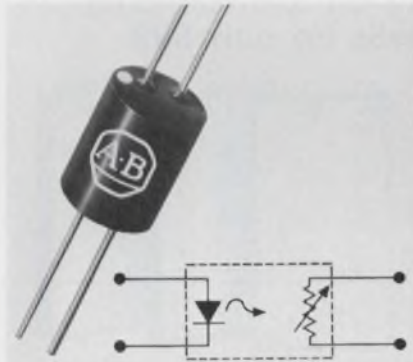

*Allen-Bradley Co., 1201 S. 2nd St., Milwaukee, Wis. Phone: (414) 671-2000.*

An opto-isolator with 5000-V isolation and a 3.5-ms rise time that blocks high-frequency transients is the PT-001 which consists of an LED and a spectrally matched photoconductive cell assembled in a light-tight tubular package. It provides less than 1 pF of coupling capacitance and less than 3 pF of cell shunt capacitance. Case operating temperature is -40 to +75°C.

CIRCLE NO. 261

Togetherness...

# DIALCO DATALITES

mount as close as  
1/2 inch center to center

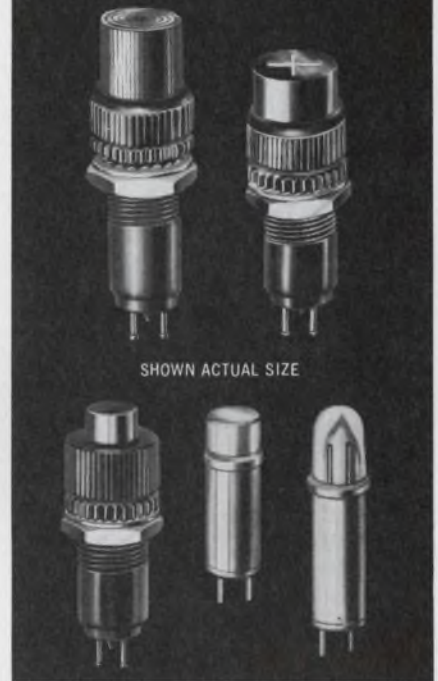

Designed to meet or exceed requirements of MIL-L-3661B.

Replaceable plug-in cartridges: Incandescent for 1.35-120V; neon—high-brightness operation 110-125V AC, and standard brightness operation 105-125V AC-DC.

Wide range of lens shapes, colors and finishes.

Broad selection of positive or negative legends.

Available off-the-shelf for prompt delivery.

**Send for free catalog**



Dialight Corporation  
60 Stewart Ave., Brooklyn, N. Y. 11237.  
(212) 497-7600



A NORTH AMERICAN PHILIPS COMPANY  
INFORMATION RETRIEVAL NUMBER 42

## Tiny 8-bit d/a converter costs \$10



Varadyne Systems, 1020 Turnpike St., Canton, Mass. Phone: (617) 828-6395. P&A: see text; 2 wks.

Model DAC-9-8B 8-bit d/a converter is small in price as well as size—it costs just \$9.95 and measures only 1 by 2 by 0.4 in. Its full-scale output is +2.6 mA with a maximum voltage compliance of 1.2 V. The output settling time to  $\pm 0.4\%$  is 1  $\mu$ s. TC is  $\pm 100$  ppm/C, linearity is  $\pm 0.2\%$  with a current resolution of 10  $\mu$ A and over-all accuracy is  $\pm 0.4\%$  of full scale. Operating temperature range is 0 to 70 C.

CIRCLE NO. 262

## Monolithic quad switches slash prices to \$1/bit

Analog Devices, Inc., Route 1 Industrial Park, Norwood, Mass. Phone: (617) 329-4700. P&A: see text; stock.

A major price break in  $\mu$ DAC quad switch components for d/a and a/d conversion has been achieved by encapsulating the basic quad-switching chip in a silicone DIP package. The new AD550N quad switches provide the same electrical performance levels of the original AD550 quad switches but compare favorably in price: for single quantities 8 and 12-bit units cost \$13 and \$30 compared with \$35 and \$60, respectively. In 100 quantities 8 and 12-bit units cost \$8 and \$21 compared with \$25 and \$42, respectively.

CIRCLE NO. 263

## Long-life keyboards feature economies

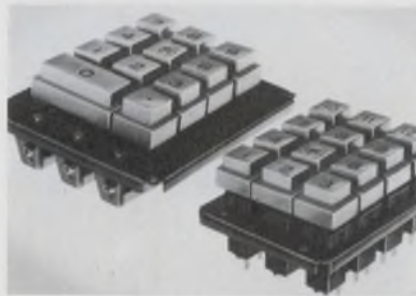

Alco Electronic Products, Inc., 1551 Osgood St., N. Andover, Mass. Phone: (617) 686-3887. Price: see text.

The CR series of economy priced mechanical keyboard switch assemblies has normally open momentary switch action and a long spring span which provides stabilized contact pressure. The gold-clad contacts provide a life of over 2 million operations. Current rating is 100 mA at 24 V dc. Size is 3.04-in.-wide by 3.75-in. long. Model CR-011 has numerals 0 to 9 and a decimal and is priced at \$9.95 each. The CR-015 has numerals 1 to 12 and is priced at \$10.85.

CIRCLE NO. 264

## 12-bit a/d converter sells for only \$99

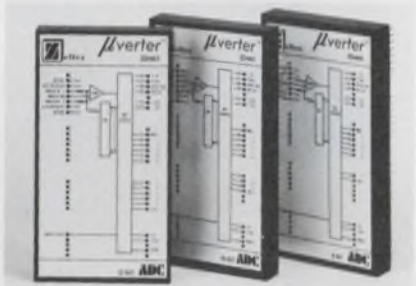

Zeltex, 1000 Chalomar Rd., Concord, Calif. Phone: (415) 686-6660. P&A: see text; stock to 2 wks.

Model ZD462 12-bit a/d converter features 100  $\mu$ s (maximum) conversion time and costs only \$99. Quantizing error is  $\pm 1/2$  LSB and full-scale input voltage ranges are  $\pm 10$  V,  $\pm 5$  V or 0 to +10 V selected by simple pin connections. Input overvoltage protection is  $\pm 50$  V. All units are DTL/TTL compatible. Operation is from  $\pm 15$  and +5 V supplies over 0 to 70 C.

CIRCLE NO. 265

## Miniature modules make building-block supplies

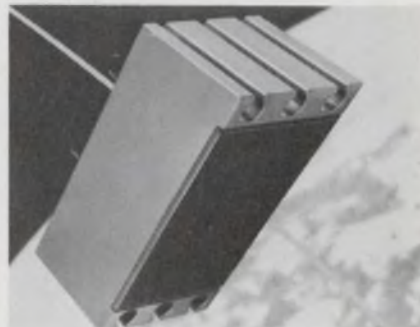

Powercube Corp., 214 Calvary St., Waltham, Mass. Phone: (617) 891-1830. P&A: \$50 to \$100/module; stock.

A new series of Cirkitblock modules allow a designer to build virtually every internal power need from "off-the-shelf" blocks. The modules include power converters (generators), pre-regulators and output units. They can supply applications up to 100 W with as few as two-cubic-inch modules. The Cirkitblock line has three basic types of pre-regulators and eight power generators.

CIRCLE NO. 266

## Potted power supplies satisfy $\mu$ A 741 needs

Semiconductor Circuits, Inc., 306 River St., Haverhill, Mass. Phone: (617) 373-9104. P&A: from \$25; stock to 1 wk.

The new P741 series of miniature encapsulated, dual output power supplies provide all the essential requirements for most  $\mu$ A741 and equivalent op amp applications. There are 8 models:  $\pm 12$ ,  $\pm 15$ ,  $\pm 18$ , and  $\pm 22$  V dc at 30 mA, designated P741-312, -315, -318 and -322 respectively;  $\pm 18$  and  $\pm 22$  V dc at 50 mA, designated P741-518 and -522; and  $\pm 12$  and  $\pm 15$  V dc at 60 mA, designated P741-612 and -615. Each module measures only 2.25 by 2.5 by 1.25 in. and may be plugged directly onto a PC board.

CIRCLE NO. 267

Have you filled out your free REQUESTED DATA DELIVERY enrollment form? See card facing page 16.



ICs & SEMICONDUCTORS

**Sense amplifier IC speeds up cycle time**

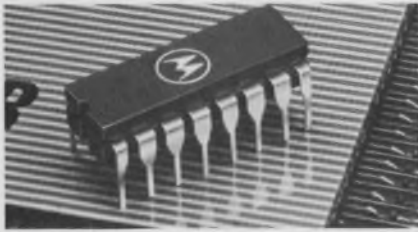

Motorola Semiconductor Products, Box 20924, Phoenix, Ariz. Phone: (602) 273-6900. P&A: \$9 (100 quantities); stock.

The MC1544 four-channel sense amplifier employs internal coupling capacitors, Schottky clamped output transistors that help achieve a propagation delay of only 18 ns and a unique dc level-restore circuit to eliminate repetition-rate problems and speed up cycle times. Other features include a decoded input, channel selection, wired-OR capability, TTL compatibility and a strobed output to inhibit undesirable signals.

CIRCLE NO. 268

**IC is an asynchronous receiver/transmitter**

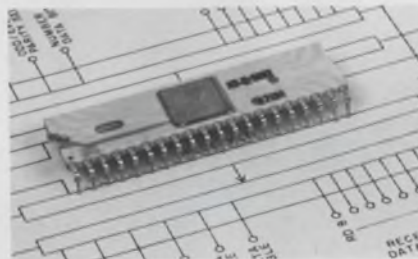

General Instrument Corp., 600 W. John St., Hicksville, N.Y. Phone: (516) 733-3000. P&A: \$22.50 (100 quantities); stock.

A new one-package MOS UAR/T (universal asynchronous receiver transmitter) identified as the AY-5-1012 is an LSI subsystem which accepts binary characters from either a terminal device or a computer and receives or transmits them with appended control and error-detecting bits. All characters contain a start bit, 5 to 8 data bits, one or two stop bits and either odd/even parity or no parity mode. Baud rate, the bits-per-word, parity mode and the number of stop bits are externally selectable.

CIRCLE NO. 269

**Dual Schmitt triggers shape TTL pulses**

Signetics, 811 E. Arques Ave., Sunnyvale, Calif. Phone: (408) 739-7700. Price: \$1.93 (25 quantities of 7413A).

Two versions of a dual NAND Schmitt trigger IC are available for use in shaping TTL pulses. Identical except for temperature range, the 5413 (military) and 7413 (commercial) contain two Schmitt-trigger circuits, each of which functions as a four-input NAND gate. The Schmitt action causes the gate to have different input threshold levels for positive and negative-going signals. Hysteresis levels are typically 800 mV.

CIRCLE NO. 270

**CMOS analog switch has multiple configurations**

Harris Semiconductor, Melbourne, Fla. Phone: (305) 727-5412. P&A: \$13.75; stock.

A new CMOS analog switching element is the HI-1800 which works over -55 to +125 C. A variety of possible configurations permits the customer to use the HI-1800 for many switching applications, such as a signal selector, multiplexer, chopper or a crosspoint switch for signals from dc to rf. The configuration is two independent dpdt switches with a TTL-compatible addressing scheme which permits connection as a dual spdt, or a single dpdt, spdt or spst switch.

CIRCLE NO. 271

**Programmable array enhances logic use**

Collins Radio Co., Newport Beach, Calif. Phone: (714) 833-0600. Price: \$26.75 (100 quantities) plus \$750 mask charge.

Collins' new MOS/LSI programmable logic array (PLA) provides an economical means to implement random logic circuits. Beginning with the advantage of an already electrically proven circuit, the designer simply programs his new requirements into the device by modification of one photomask. The TTL-compatible PLA consists of 64 20-bit words, each bit accessible by 15 (CRC3506) or 16 (CRC3507) independent inputs.

CIRCLE NO. 272

**NEED CMOS**

**LOGIC**

- SCL 4000A Dual 3 Input NOR +Inv.
- SCL 4001A Quad 2 Input NOR
- SCL 4002A Dual 4 Input NOR
- SCL 54004A 8 Stage Binary Counter
- SCL 4007A Dual Complementary Pr. + Inv.
- SCL 4009A Hex Buffer, Inverting
- SCL 4010A Hex Buffer, Non-Inverting
- SCL 4011A Quad 2 Input NAND
- SCL 4012A Dual 4 Input NAND
- SCL 4013A Dual "D" Flip Flop
- SCL 4015A Dual 4 Bit Static S.R.
- SCL 4016A Quad Bilateral Switch
- SCL 4017A Decade Counter w/Decoder
- SCL 4018A Presettable Divide by "N" Counter
- SCL 4019A Quad AND/OR Select Gate
- SCL 4020A 14 Stage Binary Ripple Counter
- SCL 4022A Octal Counter w/Decoder
- SCL 4023A Triple 3 Input NAND
- SCL 54024A 8 Stage Binary Counter
- SCL 4025A Triple 3 Input NOR
- SCL 4027A Dual J-K F.F.
- SCL 4030A Quad Ex-Or
- SCL 5206 1 of 8 Decoder
- SCL 5407 8 Bit Counter

**SHIFT REGISTERS**

- SCL 5136 64 Bit Static
- SCL 5137 128 Bit Static w/recycle (Low Power)
- SCL 5151 128 Bit Static w/recycle
- SCL 5169 100 Bit Static
- SCL 5170 128 Bit Static
- SCL 5172 Dual 128 Bit Static
- SCL 5408 8 Bit Static Parallel/Serial
- SCL 5340 64 Bit Variable Static

**WATCH CIRCUITS**

- SCL 5415 16 Stage Ripple Counter
- SCL 5423 Silicon Gate Time Base
- SCL 5424 4 Digit Decoder/Driver (For Liquid Crystal)

**CALL SOLID STATE SCIENTIFIC**

*The Solid State People...*

MONTGOMERYVILLE, PENNA.  
(215) 855-8400

Circle Bingo Number for a Personal Copy of our new short form Catalog

## 16-bit minicomputer sells for \$2850



Texas Instruments, Inc., Box 1444, Houston, Tex. Phone: (713) 494-5115. P&A: see text, late 1971.

A new 16-bit digital computer with a selling price of \$2850 was announced by Texas Instruments. Designated the model 960A, the computer has a 4k semiconductor memory with a 750-ns cycle time. The unique hardware and software design of the 960A which features a dual-mode architecture makes it especially appropriate for manufacturing automation, process-control and data-collection systems applications.

CIRCLE NO. 273

## Ceramic tape heads extend lifetimes

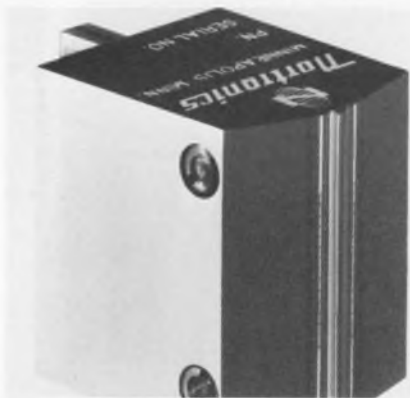

Nortronics Co., Inc., 8101 10th Ave. North, Minneapolis, Minn. Phone: (617) 545-0401.

A new series of lifetime ceramic heads for computer tape drives offer extended life times by a factor of ten. Long life is accomplished by first contouring the face of the magnetic head to within 0.01 in. of the gap on each side. The non-magnetic ceramic finish is then applied to the face to fill-in previously contoured areas. The head is then recontoured to obtain the desired surface.

CIRCLE NO. 274

## 3 new minicomputers expand Nova line

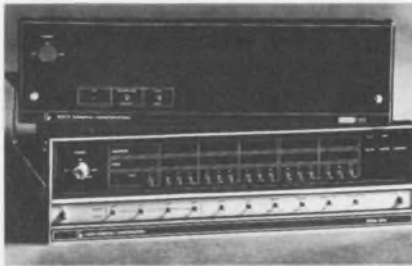

Data General Corp., Southboro, Mass. Phone: (617) 485-9100. P&A: see text; February, 1972.

Three new models of Nova computers are available. The three are: the Nova 1210 which costs \$4350 with 4k 16-bit words of core memory and \$5750 with 8k words; the Nova 1220 which costs \$5250 with 4k words of memory and \$6650 with 8k; and the Nova 820 which gives users 800-ns instruction execution for a price of \$6450 with 4k words of core memory and \$7850 with 8k.

CIRCLE NO. 275

## Portable tape recorder emphasizes ruggedness



Bell & Howell Electronics & Instruments Group, 360 Sierra Madre Villa, Pasadena, Calif. Phone: (213) 796-9381.

A new light-weight, portable instrumentation tape recorder/reproducer is easy to operate in rugged and remote applications. The CPR-4010 gathers data with the precision of a large, laboratory recorder. It records/reproduces up to seven channels on 1/2-in. or 14 channels on 1-in. tape and accepts reels up to 10-1/2 in. in dia. It has seven speeds ranging from 15/16 to 60 in./s.

CIRCLE NO. 276

## Premium tape cartridge speeds up to 180 in./s



3M Co., St. Paul, Minn. Phone: (612) 733-2925. P&A: \$8 to \$10; 1st quarter, 1972.

Designed for 1/4-in. tapes, a new cartridge is rated for speeds to 180 in./s and acceleration and deceleration of 2000 in./s<sup>2</sup>. Its precise tape motion permits recording of up to 4 tracks and 1600 bits/in. Life tests of the data cartridge components are reported to have exceeded 5000 passes. A simple, single-motor transport drives the cartridge. The band-drive eliminates the classical capstan which is common to digital cassette systems. No tape driving or tape position sensing elements penetrate the cartridge.

CIRCLE NO. 277

## 7-in.-reel transports reach 25-in./s speeds



Pertec Corp., 9600 Irondale Ave., Chatsworth, Calif. Phone: (213) 882-0030. Price: see text.

A new series of 7-in.-reel, low-cost tape transports attain tape speeds to 25 in./s. The new transports are primarily designed for data entry and terminal applications requiring synchronous digital magnetic-tape transports. Purchased in quantities of 100, the 1600-character/in. read-after-write transports sell for \$3010, and the 1600-character/in. write/read models for \$2630. The transports include all data and tape-motion control electronics.

CIRCLE NO. 278

## 325-ns modular memory system uses MOS RAMs

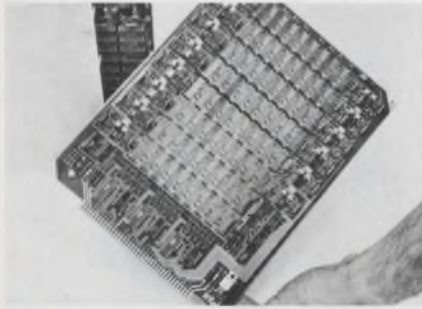

Intel Corp., 3065 Bowers Ave., Santa Clara, Calif. Phone: (408) 246-7501. P&A: 1.5¢/bit; stock.

A fast-cycling, self-contained semiconductor memory system using 1024-bit MOS RAMs is the In-10 system which has a maximum cycle time of 450 ns and a maximum access of 325 ns. In-10 systems are assembled modularly from 8-by-10-in. memory cards, each storing 4k 18-bit words or 8k 9-bit words. One 8-by-10-in. control card serves up to eight memory cards. The In-10 system is TTL compatible.

CIRCLE NO. 279

## 16-register calculator has expandable memory



Wang Laboratories, Inc., 836 North St., Tewksbury, Mass. Phone: (617) 851-7311. P&A: \$2600; 5 months.

The basic new 600 calculator offers 16 registers and 312 program steps. Other standard equipment includes log, trig, statistics and 16-user definable keys. In each register, a user can perform all arithmetic operations, including division of ten-digit numbers with exponents. Memory may be increased by as many as three increments of 512-byte RAM at \$300/increment.

CIRCLE NO. 280

## Auto-answer Teletype gets data automatically

Anderson Jacobson, Inc., 1065 Morse Ave., Sunnyvale, Calif. Phone: (408) 734-4030. Price: \$1954 (ASR model).

A versatile new Teletype terminal for data communication and time-sharing applications can receive data at any time without the assistance of an operator. The key to this unattended service capability is a newly designed auto-answer modem which connects to the Bell System automatic Data-Access-Arrangement types CBS or CBT. The modem and control panel are available as a kit (TMU 330K) for use in a Teletype 33 terminal.

CIRCLE NO. 281

## Digital heads write 100 tracks on 1-in. tape

Applied Magnetics Corp., 75 Robin Hill Rd., Goleta, Calif. Phone: (805) 964-4881.

A new series of magnetic heads write 100 in-line tracks on 1-in. tape. The heads feature a special construction technique permitting precise track alignment. Although the tracks are very closely spaced, internal shielding limits intertrack crosstalk to within 10%. Track width is 0.008 in. spaced on 0.01-in. centers. Each head is capable of writing to a linear packing density of 5000 flux reversals/in. or higher rates.

CIRCLE NO. 282

## Core-memory module has 1024 10-bit words

Fabri-Tek, Inc., 5901 S. County Rd. 18, Minneapolis, Minn. Phone: (612) 935-8811.

A new core memory, the model 620, is a 1024-word-by-10-bit module designed for small-memory requirements. It features full (read/restore clear/write), half (read-only/write-only) and split (read/modify/write) cycles. Access time is 350 ns and cycle time is 1  $\mu$ s.

CIRCLE NO. 283

**REQUESTED DATA DELIVERY SERVICE is here—see card facing page 16.**



AMERICAN MADE

**Tolerance**

# SCHAUER

**1-Watt**

# ZENERS

## Immediate Shipment Low Prices

ANY voltage from 2.0 to 18.0

Quantity	Price each
1-99	\$1.07
100-499	.97
500-999	.91
1000-4999	.86
5000 up	.82

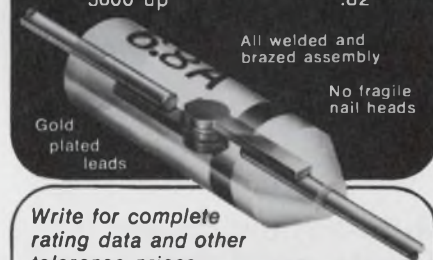

All welded and brazed assembly

No fragile nail heads

Write for complete rating data and other tolerance prices.

## Buy the kit— Save a lot



Kit contains a 51-piece assortment of SCHAUER 1% tolerance 1-watt zeners covering the voltage range of 2.7 to 16.0. Three diodes of each voltage packaged in reusable poly bags. Stored in a handy file box. Contact your distributor or order direct.

A \$54.57 value for  
**ONLY \$24<sup>50</sup>**

Semiconductor Division  
**SCHAUER**  
Manufacturing Corp.

4511 Alpine Ave. Cincinnati, Ohio 45242  
Telephone: 513/791-3030

### Component stand holds DO-7 parts vertically

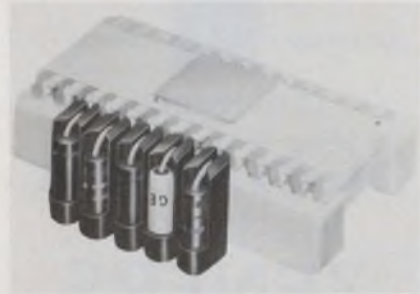

*Jermyn Industries, Vestry Estate, Sevenoaks, Kent, England.*

The A22-2010 component holder allows DO-7-sized diodes and similar-sized resistors and capacitors to be vertically mounted thus saving PC board area. Components up to 0.3-in. long and 0.125-in. in dia. with leads not exceeding 0.031 in. in dia. can be accommodated. Leads exit from the holder on 0.15 to 0.2-in. centers. The holder is molded in flame-retardant polypropylene and is suitable for continuous use at 120 C.

CIRCLE NO. 284

### Multi-airflow blower directs air 4 ways

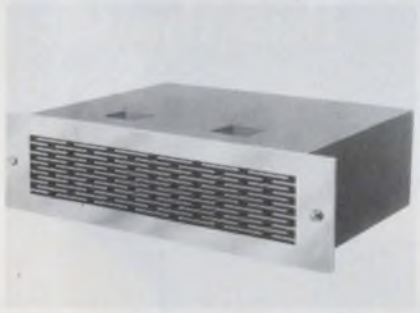

*McLean Engineering Laboratories, Princeton Junction, N.J. Phone: (609) 799-0100.*

Two vertical-top and two diagonal-rear outlets provide over-all wider and deeper filtered airflow efficiencies in the model 4EB300 air blower. The result is more uniform cabinet pressure and higher cooling levels with airflows of 250 or 450 CFM. Low audible noise levels and brushed-aluminum or stainless-steel grilles are additional features.

CIRCLE NO. 285

**A FREE new Hayden Service for you—see card facing page 16.**

### Lead-frame terminals complement ceramic ICs

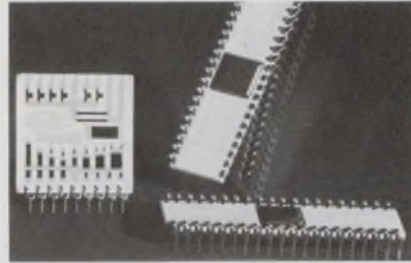

*Dupont Co., Electronic Products Div., Wilmington, Del. Phone: (302) 774-1000.*

Six new easy-to-attach Solok lead-frame terminals are designed for use as connectors for ceramic hybrid microcircuits. The six proprietary terminals are available in two basic configurations: edge-mount versions for connecting one side of a vertically inserted hybrid micro-circuit, and right or left-hand lead-frame versions for standard dual-in-line configurations. Terminals are on 100-mil centers and can be attached to substrates with thickness of 25 to 35 mils and 55 to 65 mils.

CIRCLE NO. 286

### High-temperature epoxy cures at only 50 C

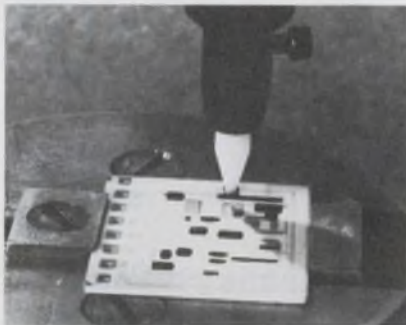

*Epoxy Technology, Inc., 65 Grove St., Watertown, Mass. Phone: (617) 926-0136. P&A: \$70 per 1/2-oz kit; stock.*

A new gold-filled epoxy requires very low-heat curing cycles yet can be utilized at extremely high temperatures. The two-component epoxy called Epo-Tek-H80 can be used in the 300-to-400-C range for wire bonding applications. Curing is accomplished in just 3 h at 50 C, and the material has a 5-h pot life. Volume resistivity is tightly held from 0.001 to 0.002 ohm/cm. Lap shear strength is 2000 psi.

CIRCLE NO. 287

### 14-GHz amplifiers have noise figure of 4.5 dB

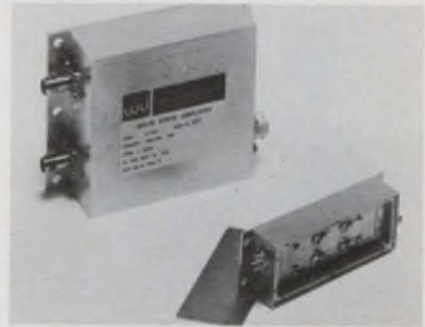

*Watkins-Johnson Co., 3333 Hillview Ave., Palo Alto, Calif. Phone: (415) 326-8830.*

A family of high-performance solid-state amplifiers includes a line of thin-film devices operating in the 1-to-4-GHz frequency range with noise figures from 4.5 to 7.5 dB. Designated the WJ-5201 series, they are 70% smaller and lighter over other Watkins-Johnson solid-state amplifiers, previously reported to be the smallest and lightest solid-state amplifiers.

CIRCLE NO. 288

### Coupler increases laser output power 7500%



*Spectra-Physics, Inc., 1250 W. Middlefield Rd., Mountain View, Calif. Phone: (415) 961-2550. P&A: \$5000; 45 to 60 days.*

The model 365 acousto-optic output coupler is a cavity dumper which increases laser output power by up to 7500%. For example, the 365 coupled with a Spectra-Physics model 164 or 165 argon laser can deliver 2 to 150 W of output at 488.0 to 514.5 nm with a pulse width varying from 10 ns to a cw mode and repetition varying from dc to 20 MHz. The lower the pulse duty cycle, the higher the power. Normal output power of the 164 is 2 W and that of the 165 is 4 W.

CIRCLE NO. 289

## Stable photomultiplier has 0.5 $\mu$ A dark current



Amperex Electronic Corp., Hicksville, N.Y. Phone: (516) 931-6200.

Employing a bi-alkali photocathode for high quantum efficiency and low-noise, type PM2106 photomultiplier tube offers jitter of less than 0.2 ns and rise time of less than 1.8 ns. Dark current is only 0.5  $\mu$ A at a gain of  $10^5$ . The PM2106 has unique front-end geometry designed to provide photo-electron collection efficiency of 88%. Since bi-alkali photocathode efficiency is typically 25%, the PM2106 reaches net over-all efficiencies of better than 20%.

CIRCLE NO. 290

## Traveling-wave tubes cover 4 to 16 GHz



RCA Electronic Components, 415 S. 5th St., Harrison, N.J. Phone: (201) 485-3900. P&A: \$2700 to \$3200; 90 to 120 days.

Five new traveling-wave tubes (TWTs) are available. Type A1440 operates from 7.6 to 16 GHz with 27 dBm of minimum saturated output. Type A1442 operates from 7 to 12.4 GHz with 5 dBm of output. Type A1444 works from 8 to 16 GHz with a 10-W output. Type A1445 4 to 8-GHz unit has 10 W of output. Type A1460 is a 13 to 14-GHz unit with 15 W of output.

CIRCLE NO. 291

## application notes

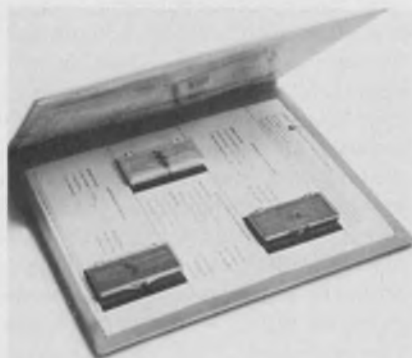

### Rf design kit

A sample kit introduces rf designers to high-technology semiconductors. The kit contains one high-gain, low-noise transistor, 12 Schottky diodes and 4 p-i-n diodes with data sheets and application notes. The devices are for use for 5 MHz to 2-GHz applications. The kit (Hewlett-Packard #5082-0051) gives the rf design engineer an economical opportunity to become acquainted with the exceptional behavior of Schottky and p-i-n diodes and computer-designed transistors—components made possible by advanced technology. Hewlett-Packard, Palo Alto, Calif.

CIRCLE NO. 292

### Using optical flats

A booklet entitled "Optical Techniques For Measuring Flatness" is available to familiarize readers with the effects of the interference of light and the necessary techniques for measuring flatness using optical standards. This instructive publication clearly explains optical-flats theory so one can devise his own techniques when faced with an unusual problem, or a situation differing slightly from those described. The 16-page booklet covers light waves and interference, contact method for testing flatness, typical interference patterns and their interpretation, non-contact methods of measurements (Twyman & Green and Fizeau interferometers) and applications. Edmund Scientific Co., Barrington, N.J.

CIRCLE NO. 293

### Encoder logic interface

A technical note entitled "Tru-Rota Encoder Logic Interfacing" gives suggestions on proper loading of encoder output channels with respect to the various control input configurations most generally used. In order to aid the system designer in the proper interface selection, schematics are provided for use with TTL, RTL and DTL IC circuits. Trump-Ross Industrial Controls, Inc., N. Billerica, Mass.

CIRCLE NO. 294

### Coaxial cable guide

A 9-by-12-in. chart which lists nominal loss characteristics and power handling capability of 234 RG/U coaxial cables is available. The convenient reference chart shows cable behavior at frequencies ranging from 10 to 10,000 MHz. B&W Cable Co., Burlington, Mass.

CIRCLE NO. 295

### Measuring tunnel diodes

Application Note T-240 describes a simple method of measuring tunnel-diode parameters through the use of phase-sensitive detection. The note shows how peak and valley voltages and the region of negative conductance may be conveniently determined. Princeton Applied Research Corp., Princeton, N.J.

CIRCLE NO. 296

### Snubber-network design

The design of snubber networks which prevent non-gated turn-on of triacs used to control inductive loads is made easy by a new six-page application note. It analyzes the operation of snubber networks and presents graphs that allow a designer to select a network to meet his requirements. RCA Solid State Div., Somerville, N.J.

CIRCLE NO. 297

**A FREE new Hayden Service for you—see card facing page 16.**

## new literature



### Relays and timers

A new 24-page catalog on relays and timers is available. Comprehensive component specifications augmented by applications data and schematics are presented. Information is given on 3 to 10-A industrial, mercury-wetted, electronic time-delay, rf coaxial, synchronous mechanical and magnetic latching relays and motor timers. Midtex, Inc., Mankato, Minn.

CIRCLE NO. 340

### Long-life solenoids

A series of nine data sheets lists specifications of a new line of tubular solenoids which feature rugged construction for long service life. Hart-Advance Relay Div. of Oak Electro/Netics Corp., Crystal Lake, Ill.

CIRCLE NO. 341

### Motor drives

A new four-page catalog describes a line of motor drives including dc and encoded motors and motor tachometers. Sequential Information Systems, Inc., Elmsford, N.Y.

CIRCLE NO. 342

### Instrumentation

A new product selection guide outlines 56 different types of measurement and control instrumentation. This short-form catalog contains data on several types of flowmeters. Brooks Instrument Div. of Emerson Electric Co., Hatfield, Pa.

CIRCLE NO. 343

### Filters

A 12-page catalog describes a new filter standardization concept and its three major advantages: five-minute filter specification, seven-day filter delivery and standard-case sizes. By taking advantage of network theory and computer-aided design, the brochure shows how low-pass, high-pass and bandpass filters are grouped into 18 basic filter family designations, ranging from the simplest single-section devices to highly complex networks. The standard filter configurations presented are estimated to cover 80% of all applications. Nytronics, Inc., Alpha, N.J.

CIRCLE NO. 344

### Thin-film resistors

A new data sheet is available on a complete line of tantalum thin-film resistors in die form. The tantalum-on-silicon resistors are intended for use in hybrid microcircuits. Teledyne Semiconductor, Mountain View, Calif.

CIRCLE NO. 345

### Temp./pressure controls

A new 32-page catalog describes temperature and pressure controls, recorders and thermometers. United Electric Controls Co., Watertown, Mass.

CIRCLE NO. 346

### Emi filters

A series of subminiature emi filters designed for cable-television, uhf, vhf and microwave applications are covered in a brochure. The Potter Co., A Div., of Pemcor, Inc., Inglewood, Calif.

CIRCLE NO. 347

### Coaxial connectors

Complete specifications on Microdot's line of standard microminature non-crimp coaxial connectors are listed in a new 28-page catalog. Hundreds of connectors shown include screw, Twinax, slide-on, quick-connect and feed-through types and BNC/TNC adapters. Microdot Inc., S., Pasadena, Calif.

CIRCLE NO. 348

### Thermocouple recorder

A new low-cost thermocouple recorder which enables 32-channel automatic data acquisition when combined with a DVM is featured in a two-page brochure. Kay Instruments, Inc., Cambridge, Mass.

CIRCLE NO. 349

### Test equipment

A short-form catalog details a complete line of test and measurement instruments and systems, including automated and programmable equipment. It also shows precision resistors and networks. Julie Research Laboratories, Inc., New York, N.Y.

CIRCLE NO. 350

### Panel plugs

A technical bulletin on low-cost easily replaceable plugs for packaging panels and Wire-Wrap applications is available. Hugh H. Eby Co., Philadelphia, Pa.

CIRCLE NO. 351

### DIP resistor

A dual-in-line resistor package consisting of 13 thick-film resistors of equal value and with a common terminal is described in a new publication. Helipot Div. of Beckman Instruments, Inc., Fullerton, Calif.

CIRCLE NO. 352

### Displays

A new display catalog contains data on 2 to 12-digit display modules that feature green-fluorescent-tube and red-LED displays. The catalog also shows bezels, test equipment and other display accessories. Star Displays, Inc., Eugene, Ore.

CIRCLE NO. 353

### Heat sinks

A new 40-page heat-sink catalog is available. Containing data on over 40 new products, it includes new designs in DIP heat sinks, plastic power, vertical and diamond heat sinks and brazed compact coolers. Thermalloy Co., Dallas, Tex.

CIRCLE NO. 354

## Instruments

"Electronic Instrumentation Digest" is the title of a new 18-page catalog that provides information on a full line of electronic test instrumentation. Included among products listed are: digital printers, frequency meters, programmable and expandable counters and timers, heterodyne frequency converters, industrial counters and controllers, IC testers, function, pulse and line-noise generators, voltage, current and frequency meters, accumulators and digital clocks and comparators. Electronic Instruments Div. of Beckman Instruments, Inc., Schiller Park, Ill.

CIRCLE NO. 355

## He-Ne lasers

A revised He-Ne laser selection guide features updated information to assist the system application designer in choosing a He-Ne laser device to meet his particular systems needs. RCA Electronic Components, Harrison, N.J.

CIRCLE NO. 356

## Linear ICs

A 20-page catalog details 24 new linear ICs. These include a wide variety of op amps, multipliers, dividers, squares, square rooters, quad switches, resistor networks, a/d and d/a converters and dual npn transistors. Analog Devices, Inc., Norwood, Mass.

CIRCLE NO. 357

## Chart recorders

A 10-page brochure describes a new line of precision laboratory chart recorders with dc servo system drives. Yewtec Corp., Larchmont, N.Y.

CIRCLE NO. 358

## Isolators/circulators

An eight-page catalog describes coaxial isolators and circulators covering up to octave bandwidths from 50 MHz to 18 GHz in miniature and subminiature sizes. Ramsey Development Labs, Sunnyvale, Calif.

CIRCLE NO. 359

## Power-conversion units

A 36-page catalog describes power-conversion and control equipment. The catalog covers dc power supplies, ac and dc line conditioners and voltage regulators and single-to-three-phase converters. Wanlass Div. of Ambac, Fort Washington, Pa.

CIRCLE NO. 360

## Transformers

A newly revised 28-page booklet provides comprehensive information on how to select and apply General Electric's wide selection of dry-type transformers. General Electric Co., Schenectady, N.Y.

CIRCLE NO. 361

## Trimmers

A condensed 12-page catalog covers wirewound and cermet trimmers in round, square, cube, rectangular and dual-in-line configurations. IRC Div. of TRW Inc., St. Petersburg, Fla.

CIRCLE NO. 362

## CRTs

A new 50-page brochure contains electrical characteristics and ratings for more than 900 color and monochrome TV CRTs. In addition to electrical data and basing diagrams, the booklet provides interchangeability information and tips on CRT installation and handling. GTE Sylvania, Inc., Electronics Components Group, Seneca Falls, N. Y.

CIRCLE NO. 363

## Grommets

An eight-page brochure lists a line of caterpillar grommets for irregular-shaped openings and various other types of split-ring self-locking and blind grommets for round openings in normal bulkhead thicknesses. Sizes, material specifications to meet military or commercial requirements and colors are given. Union Plastics Corp., Springfield, N.J.

CIRCLE NO. 364

**A new laser system for semi-automated trimming of resistors to fine tolerances on thick and thin-film hybrid circuits has been introduced by Raytheon Company's Laser Advanced Development Center, Waltham, Mass. Designated as the model SS-328, it features a neodymium-doped yttrium aluminum garnet laser operating at 5000 pulses/s or in a cw mode. The system is capable of both straight and L-trims on deposited resistor materials on a wide range of substrate materials and can be used for circuits up to 2 in. square.**

CIRCLE NO. 365

## Price reductions

Fairchild Graphic Equipment Div., of Fairchild Camera & Instrument Corp., has announced **major reductions in purchase and lease prices within its line of keyboards.** Purchase price of the Electro/Set 430 has been reduced from \$2865 to \$2365. Lease price for the same unit was reduced from \$70 to \$50 per month on a 40-month guaranteed basis. In addition, purchase prices for all models in the Fairchild line of TTS equipment were reduced by an average of 20%.

CIRCLE NO. 366

**A simultaneous price cut and speed increase for the Datacraft 6024/5 central processor has been announced by the Fort Lauderdale, Fla., company's Computer Div. Basic price of the DC 6024/5 has been reduced from \$15,500 to \$10,900. At the same time, cycle time for the computer has been cut from 1.2 to 1  $\mu$ s.**

CIRCLE NO. 367

**Price on Micro Networks' MN301 6-bit d/a converter has been cut to \$9.95 in 100 quantities from \$21. The 1 to 99 price has been reduced from \$29 to \$14.95.**

CIRCLE NO. 368

High-Accuracy

# Phase Meters

0.5 Hz to 2 MHz

Digital or meter readouts

As low as \$885



930 E. Meadow Dr. Palo Alto, Ca. 94303  
(415) 321-7428

INFORMATION RETRIEVAL NUMBER 45

## Low Frequency MECHANICAL FILTERS



- Applications:
- Paging systems
- Remote control systems
- Remote supervisory systems

Mechanical filters distributed by Seiko Instruments Inc. are derivatives of world renowned SEIKO precision, the outcome of exacting processes and production technology. With almost a decade of experience in the manufacturer of mechanical filters, DAINI SEIKOSHA is able to offer miniature types exhibiting truly high performance. Reliability?

Not questionable if you're talking about one of our products.

Many types are available. On special order, we can satisfy a wide range of specifications.

**SI** Sole distributor in the United States:  
**SEIKO INSTRUMENTS, INC.**  
14333, South Figueroa Street, Gardena,  
Calif. 90247 Phone: 213-770-0152  
Telex: No 873686

INFORMATION RETRIEVAL NUMBER 46

# Electronic Design

ELECTRONIC DESIGN's function is:

- To aid progress in the electronics manufacturing industry by promoting good design.
- To give the electronics design engineer concepts and ideas that make his job easier and more productive.
- To provide a central source of timely electronics information.
- To promote two-way communication between manufacturer and engineer.

Want a subscription? ELECTRONIC DESIGN is sent free to qualified engineers and engineering managers doing design work, supervising design or setting standards in the United States and Western Europe. For a free subscription, use the postfree application form inside the back cover. If none is included, write to us direct for an application form.

If you do not qualify, you may take out a paid subscription for \$25 a year in the U.S.A., \$35 a year elsewhere. Single copies are \$1.50 each.

If you change your address, send us an old mailing label and your new address; there is generally a prepaid postcard for this inside the back cover. You will have to requalify to continue receiving ELECTRONIC DESIGN free.

The accuracy policy of ELECTRONIC DESIGN is:

- To make reasonable efforts to ensure the accuracy of editorial matter.
- To publish prompt corrections whenever inaccuracies are brought to our attention. Corrections appear at the end of the Letters column.
- To encourage our readers as responsible members of our business community to report to us misleading or fraudulent advertising.
- To refuse any advertisement deemed to be misleading or fraudulent.

Microfilm copies are available of complete volumes of ELECTRONIC DESIGN at \$19.00 per volume, beginning with Volume 9, 1961. Work is now in process to complete the microfilm edition of Volumes 1-8. Reprints of individual articles may be obtained for \$2.00 each, prepaid (\$.50 for each additional copy of the same article) no matter how long the article. For further details and to place orders, contact the Customer Services Department, University Microfilms, 300 North Zeeb Road, Ann Arbor, Michigan 48106; telephone (313) 761-4700.

Want to contact us? If you have any comments or wish to submit a manuscript or article outline, address your correspondence to:

Editor  
ELECTRONIC DESIGN  
50 Essex Street  
Rochelle Park, N.J. 07662



QUALITY OF THE FIRST ORDER



### MAIN PRODUCTS

- CdS Photoconductive Cell
- CdSe Photoconductive Cell
- Photocell-Lamp
- Se Photovoltaic Cell

\* For catalog, please write to:  
**MORIRICA ELECTRONICS, LTD.**  
205, Tazuke-machi, Tazuke-ku, Yokohama, Japan  
Tel: 045-881-2331 Cable Address: MORIRICA YOKOHAMA

INFORMATION RETRIEVAL NUMBER 47

## A mouse has already been saved from leukemia.

## Help us save a man.

For years, you've been giving people with leukemia your sympathy. But sympathy can't cure leukemia. Money can. Give us enough of that, and maybe we'll be able to do for a man what has already been done for a mouse.



American Cancer Society



## 1MHz HIGH PRECISION PACKAGED CRYSTAL OSCILLATOR

- LOW COST
- READY SUPPLY

### TYPE:

TCO-8D...  $2 \times 10^{-8}$   
TCO-9D...  $2 \times 10^{-9}$   
TCO-9E...  $5 \times 10^{-9}$

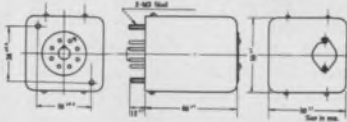

These oscillators feature a 4MHz, 3rd overtone cold-weld vacuum-sealed high-stability crystal element having a Q above 1,500,000, 4:1 frequency division by means of IC, continuously controlled constant temperature oven, new construction, and high reliability components. Extremely fine frequency adjustment to the order of  $10^{-6}$  ~  $10^{-9}$  is possible with a single trimmer.

### TOYO COM

TOYO COMMUNICATION  
EQUIPMENT CO., LTD.

EXPORT DEPARTMENT  
TOYO BUILDING, 805-16, SHIBUYA-KU,  
SHIBUYA-KU, TOKYO, JAPAN  
CABLE: EIMPTFVCOM, TOKYO  
TEL: 03-346-3282  
TELEX: 333333

INFORMATION RETRIEVAL NUMBER 48

## THAT'S UP TO YOU!

LESS SPACE WITH  
THE MINIPULSE MOTOR OR NOT!!!  
USING THE LSI DRIVING CIRCUIT,  
THE GUARANTEED PERFORMANCE,  
THE ECONOMICAL PRICE!!!



### MODEL PF1-20

Diameter ..... 12 mm.  
Max. Pull-out torque... 0.5 gr-cm.  
Max. Pull-in rate ..... 400 pps.  
Step Angle ..... 18°

Other six models for the higher torque is available. The diameter from 20 mm. to 51 mm. The maximum torque from 3.25 gr-cm to 150 gr-cm. the stepping angle from 7.5°, 10° and upto 18°

Please write your needs to us immediately.

OUR COMPANY NAME SHOWS  
YOU OUR SPECIALITY.

### NIPPON PULSE MOTOR CO., LTD.

International Department  
No. 13-16, 2-chome, Hongo, Bunkyo-ku, Tokyo,  
Japan. Cable: NIPULSEMOTOR TOKYO

INFORMATION RETRIEVAL NUMBER 49

ELECTRONIC DESIGN 26, December 23, 1971

## Electronic Design

### Advertising Sales Staff

Bryce Gray  
Sales Manager

### Rochelle Park, N.J. 07662

Robert W. Gascoigne  
Daniel J. Rowland  
50 Essex Street  
(201) 843-0550  
TWX: 710-990-5071

### Philadelphia

Thomas P. Barth  
50 Essex Street  
Rochelle Park, N. J. 07662  
(201) 843-0550

### Boston 02154

Joseph F. Palmer  
1268 Main Street  
Waltham, Mass.  
(617) 894-2700

### Chicago 60611

Thomas P. Kavooras  
Berry Conner, Jr.  
200 East Ontario  
(312) 337-0588

### Cleveland

Thomas P. Kavooras  
(Chicago)  
(312) 337-0588  
(call collect)

### Los Angeles 90303

Stanley I. Ehrenclou  
Burt Underwood  
2930 Imperial Highway  
Inglewood, Calif  
(213) 757-0183

### San Francisco 94022

Jerry D. Latta  
95 Main Street  
Los Altos, Calif.  
(415) 941-3084

### London W. 1

For United Kingdom and Holland  
Brayton C. Nichols  
For Eastern Europe  
Peter Kehr

### The American Magazine Group

27 Maddox Street  
London, W. 1, England  
Phone: 499-0180  
Cable: Ammagnic, London

### Verviers, Belgium

For Continental Europe  
Andre Jamar  
1, Ru Mallar, 1  
(087) 253.83 Telex 41563

### Tokyo

Haruki Hirayama  
Electronic Media Service  
5th Floor, Lila Bldg.,  
4-9-8 Roppongi  
Minato-ku  
Phone: 402-4556  
Cable: Electronicmedia, Tokyo



**AMERICAN BUSINESS PRESS, INC.**

## HIGH QUALITY LOW-COST THERMISTORS

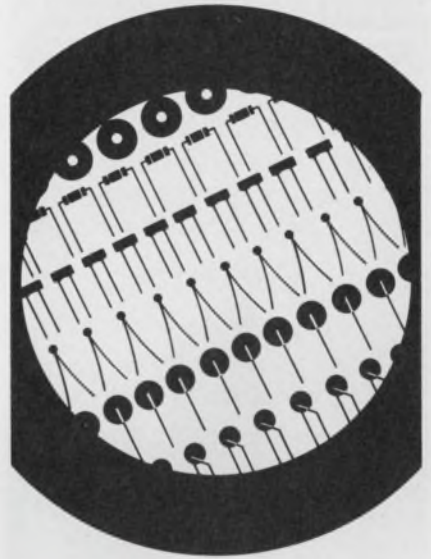

### WASHERS

To handle large amount of power

### RODS

Low/medium and high temperature coefficients

### LOW-COEFFICIENT

Discs or rectangular rods

### CRYOGENIC

For operation in liquid oxygen, nitrogen, hydrogen and helium

### DISCS

With radial, opposite or crossed leads

### MOLDED-IN-LEAD BEADS and RODS

Small size . . . low price

### GLASS BEADS

Protection from hostile environments—fast response

### PROBES AND ASSEMBLIES



Special design for temperature measurement and liquid level sensing

Write for 8-page Thermistor data bulletin T-501

**Keystone**  
CARBON COMPANY

Thermistor Division  
St. Marys, Pa. 15857  
Phone: 814/781-1591

INFORMATION RETRIEVAL NUMBER 50

Newer, Higher Quality

# NDK Products

## CRYSTAL FILTERS

455kHz—Series  
(For All Kinds of Receivers)



YF 455EF

150MHz Antenna Filter

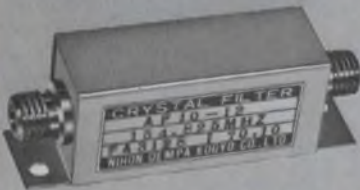

10.7MHz MCF  
(Monolithic Crystal Filters)

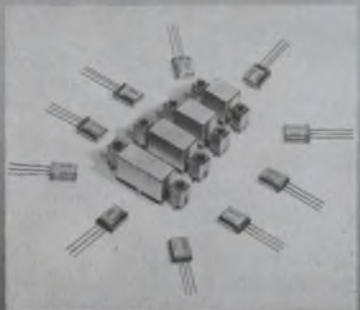

World's Leading  
Manufacturer of:

- Synthetic Quartz Crystals
- Water Soluble Crystals (LH, ADP, KDP)
- Quartz Crystal Units
- Crystal Oscillators
- Crystal Filters
- Delay Lines
- Ultrasonic Instruments

**NIHON DEMPA  
KOGYO CO., LTD.**

Since 1948

1-21 Nishihara, Shibuya-ku, Tokyo, Japan  
Tel: 460-2111

Cable: CRYSTALUNITS TOKYO TLX: TK4893

## advertiser's index

Advertiser	Page	Advertiser	Page
AMP, Incorporated .....	4, 5	Johanson Manufacturing Corp.....	30
Allen-Bradley Co. ....	25	Keystone Carbon Company.....	87
American Technical Ceramics.....	13	Kurz-Kasch, Inc. ....	16, 73
Amersil, Inc. ....	73	LogiMetrics, Inc. ....	50
Amphenol Components Group.....	12	Magnecraft Electric Company.....	31
Arnold Magnetics Corp.....	16	MicroSwitch, A Division of Honeywell .....	36
Beckman Instruments, Inc., Helipot Division .....	69	Microwave Cavity Laboratories, Inc.	18
Bell, Inc., F. W.....	16, 73	Moricca Electronics, Ltd. ....	88
CTS Corporation .....	34, 35	Motorola Semiconductor Products, Inc. ....	1
Centralab, the Electronics Division of Globe-Union, Inc. ....	39	Nihon Dempa Kogyo Co. Ltd.....	88
Comar Electric Company .....	14	Nippon Pulse Motor Co., Ltd.....	87
Dale Electronics, Inc.....	Cover III	North Atlantic Industries, Inc.....	2
Dana Laboratories, Inc.....	29	Oak Manufacturing Co. ....	Cover II
Dialight Corporation .....	77	Philips Electronic Components and Materials .....	40, 64A
ECC Corporation .....	7	RCA Solid State Division.....	Cover IV
Electronic Design.....	16, 17, 58, 59, 66, 67	Radio Materials Company.....	6
Fairchild Semiconductor, A Division Fairchild Camera and Instrument Corporation .....	10, 11	Requested Data Delivery Service.....	16 A-B
Federal Scientific Corporation.....	88	Schauer Manufacturing Corp.....	81
Ferroxcube Corporation .....	27	Seiko Instruments, Inc.....	86
GTE Automatic Electric.....	8, 9	Signetics Corporation .....	32, 33
GTE Sylvania Electronic Components .....	23	Solid State Scientific, Inc.....	79
General Electric Company.....	21	Solitron Devices, Inc.....	63
Grayhill, Inc. ....	73	Telex Communications Division.....	15
Hathaway Instruments, Inc.....	14	Tenney Engineering, Inc.....	14
Hewlett-Packard .....	41, 42, 43, 44, 45, 46, 47, 48, 48 A-B	Thomson CSF .....	71
IMC Magnetics Corporation.....	13	Toyo Communication Equipment Co. Ltd. ....	87
ISE Electronics Corporation.....	49	Wiltron Company .....	86

## Design Data from Manufacturers

Advertisements of booklets, brochures, catalogs and data sheets. To order use Reader-Service Card.  
(Advertisement)

### FREE MONOGRAPH ON REAL-TIME CORRELATION

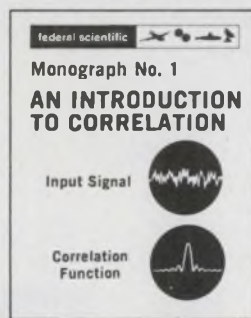

Monograph #1 explains how auto- and cross-correlation are as versatile & useful as Fourier transform. Correlation, a method for finding similarity between wave-forms & time delays, is made practical in REAL TIME through Federal's Ubiquitous® Correlation/Spectrum Analysis systems. For radar, geophysics, sonar, adaptive systems, communications, filter design, reactor control, etc. Detailed applications: reception of signals in noise, direction finding, decoding of magnetically recorded digital data, detection of a periodic signal immersed in noise.

CIRCLE NO. 171

### Federal Scientific Corp.

A subsidiary of Elgin National Industries, Inc.  
615 West 131st Street, New York, N. Y. 10027

# Circuit-Makers.

## New DIP Tools from Dale.

### DIP TRIMMERS

**2600/8600 "Fastpacks"**. Wirewound model (2600) rated at 1 watt (40°C) over 10-50K ohm range  $\pm 10\%$ . T.C. 50 ppm/°C. Film model (8600) rated .75 watt (25°C) over 10 $\Omega$ -2 Meg. range  $\pm 10\%$ ,  $\pm 20\%$ . T.C. 150 ppm/°C. Sealed cases, .75" long, machine or hand insertable.

**85/87 "Fastpacks"**. Single or multi-turn models rated at .5 watt (25°C) over 10 $\Omega$  to 1 Meg. range  $\pm 20\%$ . T.C. 150 ppm/°. Sealed cases, .265" wide x .28" long. Machine or hand insertable.

### DIP RESISTOR NETWORKS

**TKR**. Molded or coated networks with 14 (T.O. 116) 16, 18 pins. 1/8 watt max. per resistor, 3/4 watt max. at 125°C per package. 10 $\Omega$  to 1 Meg.,  $\pm 2.5\%$ , 200 ppm/°C. Available with DIP or P.C. pins on .3" x .1" or .6" x .1" grid (coated only).

**WDP/FDP**. Film (FDP) networks in 14 and 16 pin packages. Up to 15 elements, .05 watt max. with .5 watt max. per package; 10 $\Omega$  to 1 Meg. per resistor,  $\pm 1\%$ , 10-200 ppm/°C. Wirewound (WDP) networks have up to 7 elements per 14-pin package, .5 watt per element, 3.5 watts max. per package. 1 to 800 $\Omega$  per resistor, .1%-5%,  $\pm 20$ ,  $\pm 50$  ppm/°C.

### DIP PULSE TRANSFORMERS

**PT-14/PT-16** with 3 (14-pin) or 4 (16-pin) pulse transformers per package. Inductance 1  $\mu$ h to 2.0 mh over -55 to +125°C. range. Temperature stability  $\pm 10\%$ , tolerance  $\pm 20\%$ . Sealed cases with pins on .3" x .1" grid. Machine or hand insertable.

In addition to these standard DIP packages, we're ready to quote on custom RC networks and hybrids with active and passive devices to your specification. Fast turnaround on prototypes. Write for new DIP Brochure or phone our Application Engineering Department, 402-564-3131 today!

# Quiet, please...

...we're introducing RCA's PREMIUM CA6000 Series of Low-"Popcorn"-Noise Op Amps

RCA premium Op Amps are tested for noise over a 30 second period.

Popcorn noise bursts are not detected by averaging test techniques.

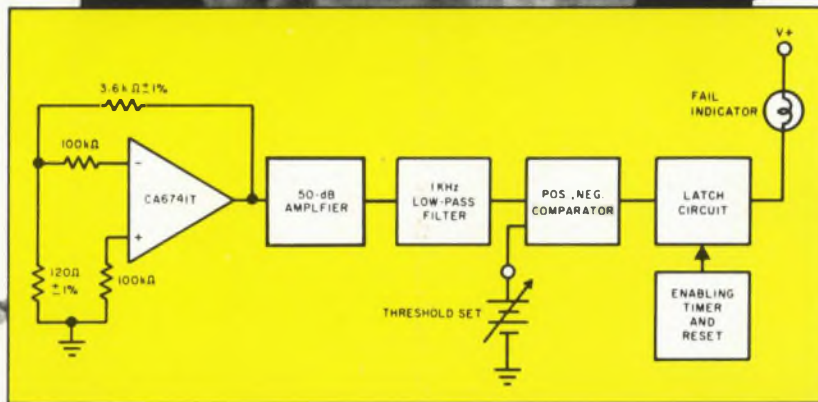
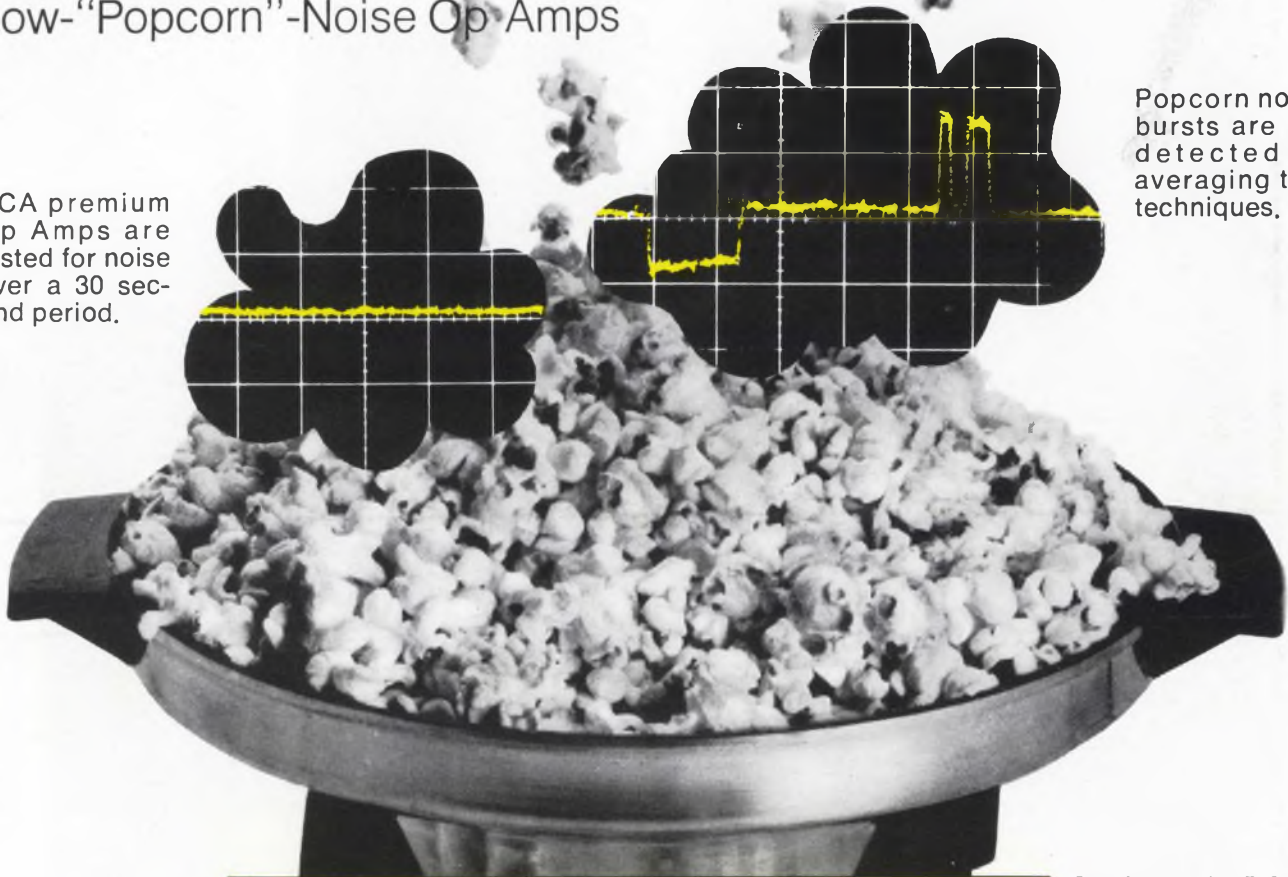

Op Amps in RCA's CA6000 Series are 100% tested for absence of "popcorn" noise. This unique test rejects any unit that produces a burst greater than 20  $\mu$ V (peak.)

...and just for starters here's our low-noise PREMIUM 741-RCA-CA6741T (\$3.30 1000-unit level\*)

Here's an important new series of circuits for the designer who's looking for extra assurance of performance in op-amp applications. RCA's new Premium CA6000 Series now offers the results of two major assurances from RCA Solid State:

- **BUILT-IN ASSURANCE**  
inherently low burst noise and 1/f noise performance, the result of processing developments.

- **TESTED-IN ASSURANCE**  
100% testing for burst noise with a 1-kHz bandwidth test circuit for 1/2 minute on each device.

Now, try RCA's low-"popcorn"-noise PREMIUM CA6741T. It offers you the same design and application features as the industry-accepted 741 PLUS the new benefits of RCA's low-noise processing and specification.

For further details, check Technical

Bulletin, File No. 530, and Application Note, ICAN 6732. Contact your RCA Representative or your RCA Distributor, or write Section 57L-23/69 CA, RCA Solid State, P.O. Box 3200, Somerville, N. J. 08876. International: RCA, Sunbury-on-Thames, U.K., or P.O. Box 112, Hong Kong, or RCA Limited, Ste. Anne de Bellevue, 810 Quebec.

**RCA** Solid State  
products that make products pay off

\*Price indicated is Original Equipment Manufacturer price in the USA only.