

# Electronic Design 16

VOL. 18 NO.

FOR ENGINEERS AND ENGINEERING MANAGERS

AUG. 2, 1970

Electronics at mid-year — a blend of pessimism and promise. The outlook continues bleak in the military-aerospace industry, while consumer electronics firms are

concerned over foreign imports. Some companies, on the other hand, are looking toward new overseas markets and a year-end upturn. For a report, see p. 26



# Today, fast, low-cost pulses with variable rise and fall — tomorrow, a system!

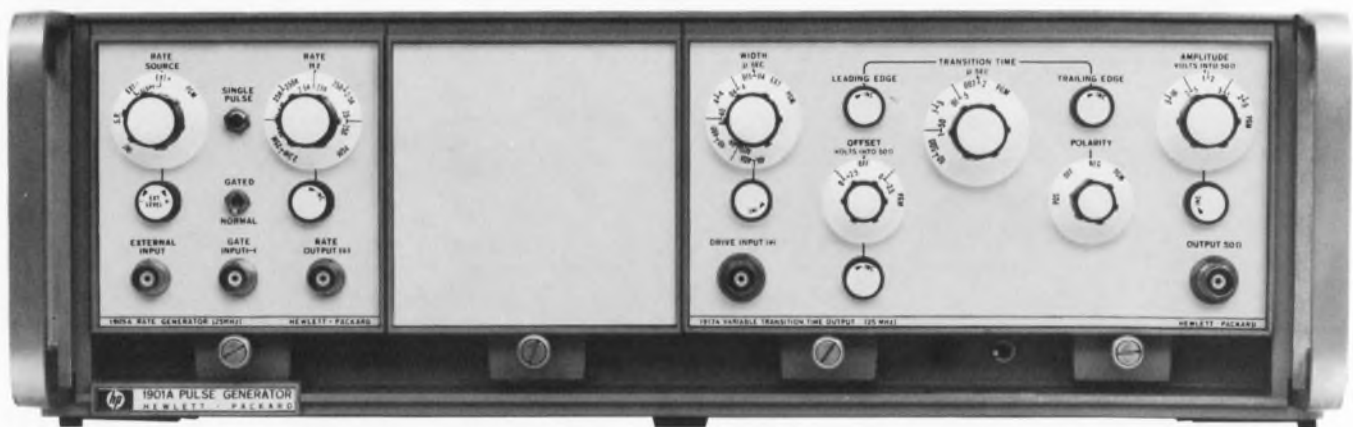

HP's new, all-solid-state 1900 Pulse System gives you the best of two worlds. For only \$1195, you can get a 7 ns variable rise and fall generator, right away. Then, as your needs and / or funds increase, plug-in capability allows you to get additional features, without having to buy a whole new generator.

Our basic package consists of a rate generator, a pulse shaping output, and a mainframe.

The 1917A pulse shaping output provides 10 V pulses with variable rise and fall times as short as 7 ns, reversible polarity, and dc offset. It takes up only half of a mainframe, and can handle rep rates of up to 25 MHz. A unique external-width function allows the 1917A to be used as a pulse amplifier, also, maintaining

width and spacing of externally-supplied pulse trains.

The 1905A Rate Generator ("clock") is a quarter-size plug-in. It provides output triggers at repetition rates from 25 Hz to 25 MHz in six decade ranges. Rep rate can be determined internally, by external triggering, or by single-pulse push-button. **Gating feature allows pulse bursts.**

The 1901A Mainframe is a standard rack size unit, and contains power supplies that can be used to power other 1900-series plug-ins. **Built-in EMI and RFI shielding are standard.**

Price of this three-part package (including a blank plug-in) is only \$1195. As your needs change, available plug-ins include a 350 ps output, a 16-bit (RZ, NRZ) word generator, variable delay generators, fan-in and

fan-out generators, and optional analog programming—plus a high power pulse-shaping output (1 A, 50 $\Omega$ ) and mainframe.

Call your local HP field office for ordering. For further information on the HP 1900 Pulse System, see pp. 254-261 in your 1970 HP catalog, or send for our new free brochure on pulse generators. Hewlett-Packard, Palo Alto, California 94304. In Europe: 1217 Meyrin-Geneva, Switzerland.

080 / 10

HEWLETT  PACKARD  
S I G N A L S O U R C E S



## THE 0.1% PORTABLE IMPEDANCE BRIDGE

# ...in the GR tradition of better measurements

GR's new 1656 Impedance Bridge rounds out the General Radio family of impedance bridges. Now there's a choice of three to suit your exact needs for accuracy and economy. All three measure broad ranges of C, L, R, G, D, and Q, while each has its own distinctions. The new portable 1656 offers 0.1% accuracy for only \$700 (price in the U.S.), the 1650 features 1% accuracy in a portable package for \$525, and the 1608 is a bench-type instrument with 0.05% accuracy for \$1550. All three are self-contained 1-kHz instruments; external oscillators and detectors will extend their ac testing capability to a 20 Hz-to-20 kHz range.

The 1656, like the other two bridges, measures C up to 1100  $\mu\text{F}$ , L up to 1100 H, and R to 1.1 M $\Omega$ . With the 1656, G can be measured up to 1.1 $\Omega$ ; D and Q cover over-all ranges of 0 to 50 and 0.02 to  $\infty$ , respectively. The 1656 resolves C down to 0.1 pF, L to 0.1  $\mu\text{H}$ , R to 0.1 m $\Omega$ , and G to 0.1 n $\Omega$ . Your best bet, anywhere, for dc measurements is the 1656: consider the 10- $\mu\text{V}/\text{mm}$  detector sensitivity and the wide resistance and conductance ranges.

Measurement of the new high-precision components demands an accurate bridge. With four-decade lever balancing, the 1656 achieves *true* 0.1% basic accuracy and a direct and easy readout of all four digits, without the need

for interpolation or vernier interpretation. A rack version of the 1656 is available for \$735; GR also makes an accessory \$35 test jig for connecting axial-lead components.

Know all the members of our impedance-bridge family by name:

1656—0.1% accuracy, portable, \$700.

1608—0.05% accuracy, bench, \$1550.

1650—1% accuracy, portable, \$525.

Whichever degree of measurement performance you require, you can get complete specifications from your nearest GR District Office or from 300 Baker Avenue, Concord, Massachusetts 01742. In Europe write to Postfach 124, CH 8034, Zurich, Switzerland.



## General Radio

ATLANTA 404 633 6183 / BOSTON 617 646 0550 / CHICAGO 312 992 0800 / CLEVELAND 216 886 0150  
DALLAS 214 637 2240 / LOS ANGELES 714 540 9830 / NEW YORK IN. Y. 212 964 2722 IN. J. 201 943 3140  
PHILADELPHIA 215 646 8030 / SAN FRANCISCO 415 948 8233 / SEATTLE 206 747 9190 / SYRACUSE 315 454 9323  
WASHINGTON D.C. 301 881 5333 / TORONTO 416 252 3395 / ZURICH (051) 47 70 30

INFORMATION RETRIEVAL NUMBER 2



**MAKE YOUR CONNECTIONS: FAST.** With Molex standard and miniature connectors. They're easier to work with. Simplify wiring. Speed production. Save assembly steps. Make installation and servicing extra easy, too. This is why circuitry idea men everywhere are making connections with Molex. From one circuit to 104 or more. Production keyed and available in a variety of colors to meet design requirements. Molex has the

connector. Plus the design and engineering capability to solve the most complex wiring problems . . . fast. For a colorful free sample of the Molex connector write: Molex Incorporated, Downers Grove, Illinois 60515. Or you can make connections by calling (312) 969-4550.

*... creating components that  
simplify circuitry*



# Electronic Design 16

VOL. 18 NO.

FOR ENGINEERS AND ENGINEERING MANAGERS

AUG. 2, 1970

---

## NEWS

- 23 **News Scope**
- 26 **Electronics at Mid-1970**—A special report
- 26 **Consumer market** beset on 2 fronts
- 27 **Semiconductor makers** throttle back
- 28 **Component houses** push innovation
- 30 **Instrument manufacturers** feeling pinch
- 32 **Microwaves:** A hunt for new buyers
- 33 **West Coast** job market getting tighter
- 34 **Computers:** It's shakeout time
- 35 **Industrial electronics** stand fast
- 36 **Aerospace-defense** firms hurt badly
- 41 **Washington Report**
- 47 **Technology Abroad**

---

## TECHNOLOGY

- 52 **Unsnarl that logic-circuit testing!** Build one pulse-shaper and driver circuit, and get the performance of several pulse generators for worst-case checking.
- 56 **Cut down signal distortion.** An active feedback filter with inverse characteristics compensates for transducer or transmission errors.
- 60 **Job hunters, be prepared to scramble!** Hires for experienced hands are down, but findings suggest a demand in small firms exists; technical hires will herald upturn.
- 66 **Ideas for Design**
- 74 **Product Source Directory:** A/D and D/A Converters

---

## PRODUCTS

- 85 **Modules & Subassemblies:** A/d 12-bit converter has 0.0125% accuracy.
- 87 **ICs & Semiconductors:** Micropower op amp needs just  $\pm 1$ -V supply voltage.
- 90 **Components:** Monolithic readouts for \$11.95 come as DIPs or flatpacks.
- 88 Data Processing
- 91 Instrumentation
- 92 Microwaves & Lasers
- 93 Packaging & Materials
- 93 Tools & Engineering Aids

---

## Departments

- 51 **Editorial:** Will a business turnaround guarantee you a job?
- 13 Designer's Calendar
- 44 Sidelights
- 94 Evaluation Samples
- 95 Design Aids
- 96 Application Notes
- 98 New Literature
- 101 Bulletin Board
- 104 Advertisers' Index

Information Retrieval Service Card inside back cover

**Cover:** Drawing by Pat Oliphant, editorial cartoonist for the Denver Post

---

ELECTRONIC DESIGN is published biweekly by Hayden Publishing Company, Inc., 850 Third Avenue, New York, N.Y. 10022. James S. Mulholland, Jr., President. Printed at Brown Printing Co., Inc., Waseca, Minn. Controlled circulation postage paid at Waseca, Minn., and New York, N.Y. Copyright © 1970, Hayden Publishing Company, Inc. 82,501 copies this issue.

# end your signal pollution problems

## Beldfoil® ISO-Shielded™ Cable

It's the cable with virtually perfect shielding. It's a Belden exclusive. Beldfoil ISO-Shield is like a continuous metal tube enclosing each pair of conductors in a cable. It locks out crosstalk or interference . . . whether from outside sources or between shielded elements in the cable.

Beldfoil is a layer of aluminum foil bonded to a tough polyester film (for insulation and added strength.) To form an ISO-Shield, we apply it in any one of several unique ways to meet the requirements of different applications. (See Figures 1 and 2, for example). Each gives more physical shield coverage than braided wire or spiral wrapped (served) shields. And greater shield effectiveness . . . even after repeated flexing.

Beldfoil ISO-Shielded Cables are small, lightweight. They terminate easily. They're modest in price. Your Belden Distributor stocks a wide variety of standard Beldfoil shielded cables as listed in the "Belden Electronic Wire and Cable Catalog" (ask him for the latest edition). And, should you have specifications no standard product can meet, ask him to quote on a specially engineered design. Or, if you choose, contact: Belden Corporation, P. O. Box 5070-A, Chicago, Ill. 60680. Phone (312) 378-1000.

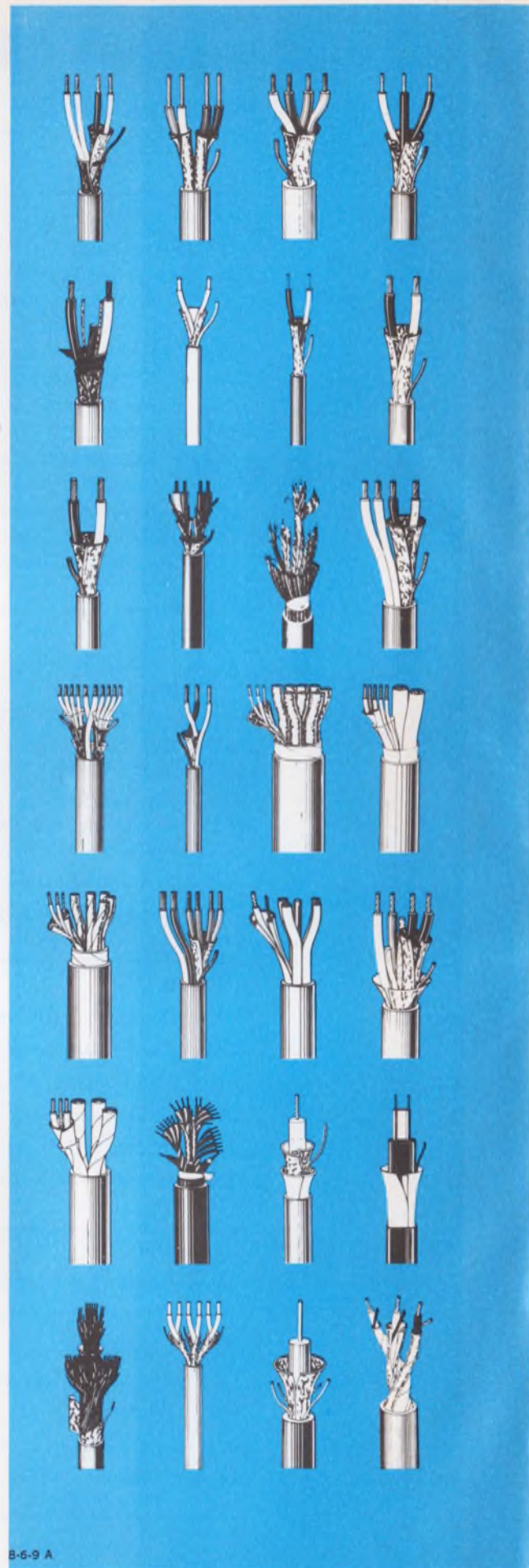

B-6-9 A



Metal (shield) foil, folded to assure metal-to-metal contact.

FIGURE 1

Polyester insulating layer folded to assure isolation between shields.

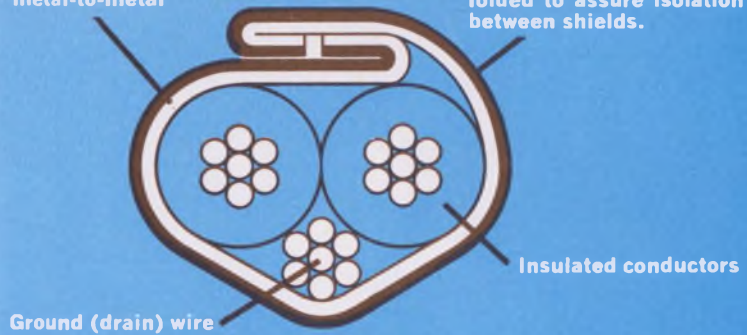

### Beldfoil Multiple Pair Individually Shielded Cable

The Figure 1 cross-section shows Belden's exclusive Z-folded Beldfoil ISO-Shield. Note the metal-to-metal contact between the two edges of the aluminum foil. In essence, you have a continuous aluminum tube. And the polyester layer on the outside of the fold assures the isolation between shields so necessary for best performance in the field.

#### Technical Data

Nominal values for multiple pair individually shielded cables containing 3 to 27 pairs (including 8769 and 8773 through 8778 Series cables)  
 Suggested working voltage: 300 volts rms max.  
 Working voltage between adjacent shields: 50 volts rms max.  
 Capacitance between conductors in a pair: 30 pf per ft. nom.  
 Capacitance between one conductor and other conductor connected to shield: 55 pf per ft. nom.  
 Capacitance between shields on adjacent pairs: 115 pf per ft. nom.  
 Insulation resistance between shields on adjacent pairs: 100 megohms per 1000 ft. nom.

Metal (shield) foil, folded to assure metal-to-metal contact.

FIGURE 2

Polyester insulation layer folded to provide bonus insulation between conductors and shield.

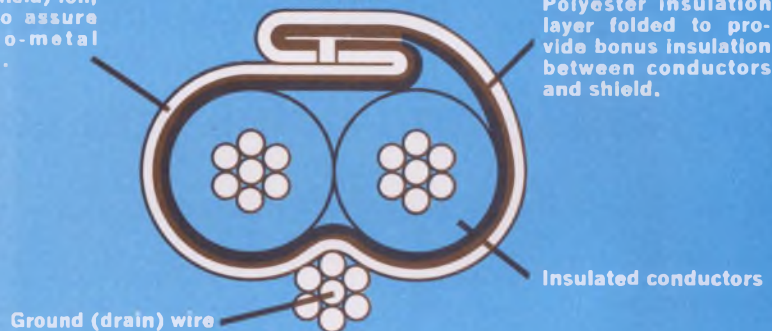

### Beldfoil Shielded Single Pair Cable

The Figure 2 cross-section shows the exclusive Belden Z-fold with the polyester insulating layer inward. This makes use of the high dielectric strength of the polyester film as bonus insulation between the conductors and the shield. (The cable jacket provides the primary insulation of the shield from outside objects or adjacent cables.)

#### Technical Data

Nominal values for 8451 Shielded Pair Cable  
 Suggested working voltage: 200 volts rms max.  
 Capacitance between conductors: 34 pf per ft. nom.  
 Capacitance between one conductor and other conductor connected to shield: 67 pf per ft. nom.



*new ideas for moving electrical energy*



## General Electric helps you solve the tough ones

GE has the broadest line of electronic components in the industry. From the tiniest integrated circuits to powerful high performance motors, GE components help you solve your tough problems . . . in design, in performance, in economy. Take a look at these GE problem solvers.

**p.s.1** New GE computer-grade capacitor offers 50% greater ripple current capability. GE's new 92F provides 30 to 50% lower ESR for better frequency capability. High efficiency permits reduction in size and weight over conventional units.

This newly-developed GE capacitor has a life expectancy of up to 3000 hours at 85C. Temperature capability up to 120C gives increased reliability or eliminates derating or additional cooling. Get complete specifications on this new GE capacitor. Circle 211.

**p.s.2** Replace 200 different SCR's with GE's versatile C103. This rugged epoxy encapsulated low-current SCR comes in the TO-18 plastic package and is ideal for tough military and industrial uses as well as many consumer applications.

The C103 is available in peak reverse voltage ratings from 30 to 200 volts. It combines an extremely sensitive gate (200  $\mu$ A) with a high surge capability (8 amp) and a low forward blocking current (1  $\mu$ A). Get full details. Circle 212.

**p.s.3** GE Sintered Alnico magnets give you high energy products with superior temperature stability and physical characteristics. And only GE can provide a complete line of Sintered Alnico materials.

Sintered Alnico has its greatest advantage in applications where mechanical work is required in small complex shapes. GE materials offer up to 12000 gauss induction and 1550 oersted coercive forces. For complete data or application help, circle 213.

**p.s.4** New Hi-TECH ceramic metal components . . . custom-designed problem solvers. GE's Hi-TECH line offers a variety of alumina, forsterite and other special ceramic materials . . . sealed to virtually any metal . . . and custom-engineered to meet your toughest operational requirements.

Use in severe environments, for example, to withstand ultra-high tempera-

tures and hyperactive chemicals. Ideal for vacuum or gas-filled devices, electrical equipment or machine parts. Find out how GE can custom design the ceramic component you need. Circle 214.

**p.s.5** Get long-life portable power with rechargeable GE nickel-cadmium batteries. Nominal ratings range from 0.1 amp-hours to 4.0 amp-hours in sealed cells and up to 160 amp-hours in vented types at the one-hour rate. And GE batteries are rechargeable for longer operating life.

Get details on how to put longer battery life into your application. Circle 215 for complete information.

**p.s.6** Get more magnetic performance per size and weight with GE cast Alnico 5-7 and 9 permanent magnets. GE's columnar grain cast Alnico 5-7 provides high inductions at 7.5 million energy products. Cast Alnico 9 couples high coercive forces with 9 million energy capabilities.

Complete directionality of grain growth permits design freedoms which were impractical before. Check with GE's application experts. Or for complete details, circle 216.





## with the broadest line of electronic components

**p.s.7** Select your indicating instruments from industry's most complete line. For measurement and control of electrical quantities, get GE Panel Meters and Meter Relays in the popular BIG LOOK® and HORIZON LINE® styles. 1½" edgewise instruments are ideal for compact display problems.

And the new BIG LOOK Frequency Meters in three ranges . . . 45-55Hz, 55-65Hz and 380-420Hz . . . are now available for engine generator sets, panel boards and inverters. For complete catalog, circle 217.

**p.s.8** New complementary power transistors are color coded for easy identification. GE's 4-amp NPN/-PNP power transistors (D44C/D45C) are molded in plastic packages to provide tough pellet protection in the most demanding applications. Three round leads fit the standard JEDEC TO-66 configuration.

These color-molded transistors feature low collector saturation voltage, excellent gain linearity and fast switching. Apply them in countless industrial and consumer circuits. For details, circle number 218.



Let General Electric help solve your component problems. Call your nearest Electronic Components Sales Operation Office. Or check with one of the many authorized GE distributors. P.S. Problems? General Electric has solutions.

285-65

GENERAL  ELECTRIC

# The IC troubleshooters.

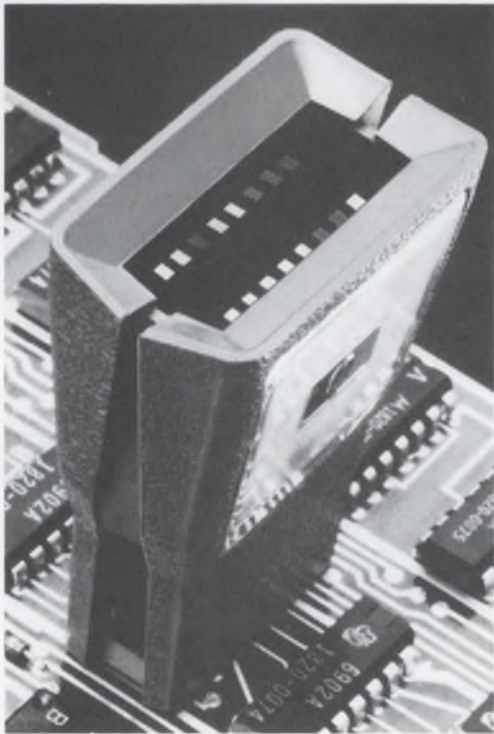

**For \$125, it lets you see logic states at a glance.**

Engineers testing the logic states of DTL or TTL IC packages no longer have to go the troublesome voltmeter route. The new HP 10528A Logic Clip shows you the state of all 16 (or 14) pins. This simple tool clips over the IC package, uses the circuit's power, is auto-seeking of Vcc and ground.

Bright LED's light up, indicating a high logic state. All this for just \$125. Or less in quantity.



**For \$95, it lets you see pulse activity at a glance.**

The HP 10525A Logic Probe makes tracing pulses through integrated circuits a painless task. Just touch the DTL or TTL circuit with the probe, and the tip flashes a signal for pulses as narrow as 25 nsec. A light in the tip indicates pulse, polarity, pulse trains, logic state.

It's almost like having an oscilloscope squeezed into a ball-point pen. And it only needs 5 volts and \$95 to start troubleshooting your circuits.

Your local HP field engineer is your source for the clips and probes to speed up your IC testing. So give him a hurry-up phone order. Or you can write for full information from Hewlett-Packard, Palo Alto, California 94304; Europe: 1217 Meyrin-Geneva, Switzerland.

HEWLETT  PACKARD



Electronic equipment is constantly running the risk of being "zapped" . . . by lightning, short circuits, switching of inductive components, etc. These ceramic gas filled arresters, from Signalite, offer maximum protection against voltage surges. They are low priced (under \$1.00) . . . reduce maintenance and down time . . . withstand shock and vibration. Some of the more vital statistics are listed, but for complete details, contact Signalite.

**this**



**protects  
equipment  
against  
voltage  
surges**

**Guaranteed 50  
discharges . . .  
200 typical**

**Fast response . . .  
40 kv/nsec. wavefront**

**High temperature  
capability with true  
follow-on capability**

**Rugged ceramic  
construction . . .  
no glass**

**Low cost...under \$1.00**



**AVAILABLE UPON  
REQUEST**

**Detailed Data Sheet . . .**  
on Signalite Subminiature  
Low Voltage Ceramic Gas  
Filled Surge Arresters.



**The Broadest Line of Spark Gaps In  
The World . . .** are described in the  
Signalite "300" Spark Gap brochure . . .  
including definition of terms,  
characteristics of gap operation and  
application information.

*Signalite*



**DIVISION OF  
GENERAL INSTRUMENT**

1933 HECK AVE., NEPTUNE, N.J. 07753  
(201) 775-2490

320

Need a fast, accurate solution to an IC problem? E-H Research Laboratories, Inc. teams up with Iwatsu Electric Company, Ltd. to offer you the ideal test instrumentation.

E-H breaks through with the **E-H 129 pulser** which is capable of driving the fastest digital logic circuits. Until this compact, all solid-state instrument came along, no practical commercial pulse generator offered repetition frequency capability beyond 200 MHz. The E-H 129 offers 500 MHz, 2-volt pulses with less than 500 ps risetime and such extras as baseline offset, pulse-top/baseline inversion function, and synchronous gating.

And the ideal mate for this instrument is the **Iwatsu 5009B sampling scope** which allows you to observe and control the waveforms you generate. The Iwatsu 5009B with 18GHz bandwidth lets you evaluate fast circuits with high accuracy—in fact, direct measurements on 100 ps edges with less than 2% display error. Features include less than 20 ps risetime, sensitivity from 10mV/cm, dual-trace performance with seven operating modes, separate miniature sampling heads, big CRT and triggering to full bandwidth for extra convenience.

If these two instruments can't solve your problems, E-H can offer you E-H and Iwatsu instrumentation that can. Contact an E-H representative and get a fast solution. Today.

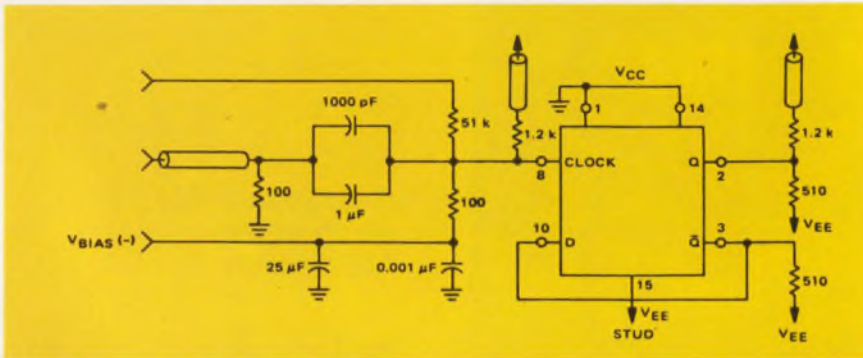

# E-H the fast solution



## **E-H** E-H RESEARCH LABORATORIES, INC.

515 Eleventh Street • Box 1289, Oakland, California 94604 • Phone: (415) 834-3030 • TWX 910-366-7258  
 In Europe: E-H Research Laboratories (Ned) N.V., Box 1018, Eindhoven, The Netherlands, Telex 51116  
 In Japan: Iwatsu Electric Company, Ltd., 7-41, 1-Chome Kugayama Sugunami-Ku, Tokyo 167, Japan



## The globetrotting 417 goes wherever the data is. (Even on a roller coaster.)

When you can't bring the data to the recorder, bring the 417 to the data. It's light (28 lbs.). Small (17" x 15" x 7"). Rugged (works under vibration and in any position). And accurate (equals large rack machines).

Made in wideband or intermediate models, it measures vibration, speed, air speed, G forces, shock, all kinds of physical data. On up to seven channels at once, IRIG compatible. Within the 417 series, direct frequency response ranges from 100 Hz to 375 KHz. FM

frequency response, DC to 100 KHz at 30 inches per second.

For power (normally 13w) the 417 can use its self-contained battery. Or, with accessories, it can use any power: 12 to 28v DC, 110 or 220v AC, 50 to 400 Hz.

You'll spend your time recording, too, not tweaking. Because the 417 is simple to use. And it needs less maintenance than any other recorder you can carry. If you should ever have a problem, there are thirty-five helpful

417 offices throughout the U.S.

You can take off with a 417 for as little as \$7,000. Around the lab, around the campus, or around the world. It's a go-getter.

For more intermediate and wide-band specs, write: Mr. Bob Mei, Dept. 413-10, Lockheed Electronics Company, Plainfield, New Jersey 07061. Or call him at (201) 757-1600.

**Lockheed Electronics**

A Division of Lockheed Aircraft Corporation

# New oscilloscopes from TELEQUIPMENT



DUAL TRACE  
TYPE D54 — \$595

The 54 Series represents a new standard of performance for low priced oscilloscopes.

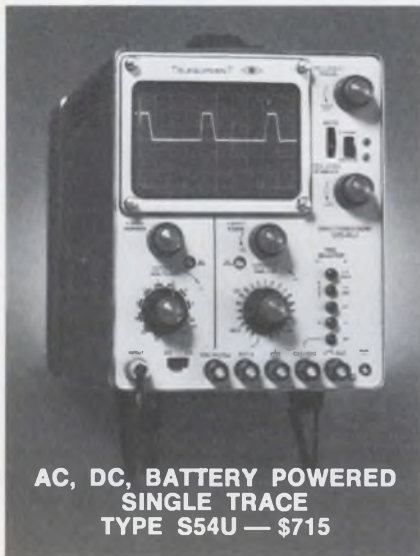

AC, DC, BATTERY POWERED  
SINGLE TRACE  
TYPE S54U — \$715



SINGLE TRACE  
TYPE S54A — \$450

Telequipment products are backed by a one year warranty, parts support and 26 Tektronix service centers; marketed through 58 Tektronix Field Offices.

For a demonstration or more information call your local Tektronix Field Engineer or write Tektronix, Inc., P.O. Box 500, Beaverton, Oregon 97005.

- **10 mV/cm DEFLECTION FACTOR** and **10 MHz BANDWIDTH** permit viewing of low level high frequency signals with good vertical resolution.
- **FET INPUTS** minimize vertical trace drift.
- **TRIGGERED SWEEP**, including TV field or line, so that signals remain stationary with changes in sweep speed.
- **22 CALIBRATED SWEEP SPEEDS** from  $0.2 \mu\text{s/cm}$  to  $2\text{s/cm}$  permit analysis of a wide range of frequencies.
- **4-kV CRT HIGH VOLTAGE** which means that the trace is bright.
- **VOLTAGE CALIBRATOR** for verification of the vertical gain.
- **SOLID STATE** for reliability.

The 54 Series are only three of the low-cost Telequipment Oscilloscopes. Many other models are available (priced from \$245), designed by Telequipment specifically for applications where price is a prime consideration.

U.S. Sales Prices FOB Beaverton, Oregon



..... a subsidiary of **Tektronix, Inc.**

See The Tektronix Display At WESCON

# Designer's Calendar

## AUGUST 1970

S	M	T	W	T	F	S
						1
2	3	4	5	6	7	8
9	10	11	12	13	14	15
16	17	18	19	20	21	22
23	24	25	26	27	28	29
30	31					

For further information on meetings, use Information Retrieval Card.

Aug. 25-28

Western Electronic Show & Convention (WESCON) (Los Angeles). Sponsors: IEEE, WEMA. WESCON Office, 600 Wilshire Blvd., Los Angeles, Calif. 90005.

CIRCLE NO. 401

## SEPTEMBER 1970

S	M	T	W	T	F	S
		1	2	3	4	5
6	7	8	9	10	11	12
13	14	15	16	17	18	19
20	21	22	23	24	25	26
27	28	29	30			

Sept. 1-3

Association for Computing Machinery Conference (New York City). Sponsor: ACM. ACM 70, 1133 Ave. of the Americas, N.Y., N.Y. 10036.

CIRCLE NO. 402

Sept. 21-24

International Conference on Engineering in the Ocean Environment (Panama City, Fla.). Sponsor: IEEE. Lewis Winner, 152 W. 42nd St., New York, N. Y. 10036.

CIRCLE NO. 403

Sept. 23-24

Electron Device Techniques Conference (New York City). Sponsor: IEEE. Mayden Gallagher, Hughes Res. Labs., 3011 Malibu Canyon Rd., Malibu, Calif. 90265.

CIRCLE NO. 404

# it's short. it's tall. it's wesco.

WESCO designs capacitors to meet demanding dimensions. *You design them. Chances are we make them.* WESCO also works wonders with capacitance — matches it exactly to the value you or your computer selects. Advanced production and testing techniques produce values from .001  $\mu\text{f}$  to 10.0  $\mu\text{f}$  to  $\pm 2\%$  tolerances (or lower).

Production quantities are shipped generally *within three weeks*... up to specification and at the quoted price. Evaluation quantities can be shipped within 48 hours. When you design in WESCO capacitors, you go from breadboard to production in less time than ever before.

And, every one we ship goes "into the circuit" and gives you the performance you expect.

WESCO manufactures a custom line of close tolerance film dielectric capacitors in Mylar, metalized Mylar, Polystyrene, Polycarbonate and metalized Polycarbonate. We make custom capacitors at "off-the-shelf" prices. Write for WESCO's new capacitor catalog today.

WESCO Electrical Company, Inc.,  
27 Olive Street, Greenfield,  
Mass. 01301. Tel: (413)  
774-4358.

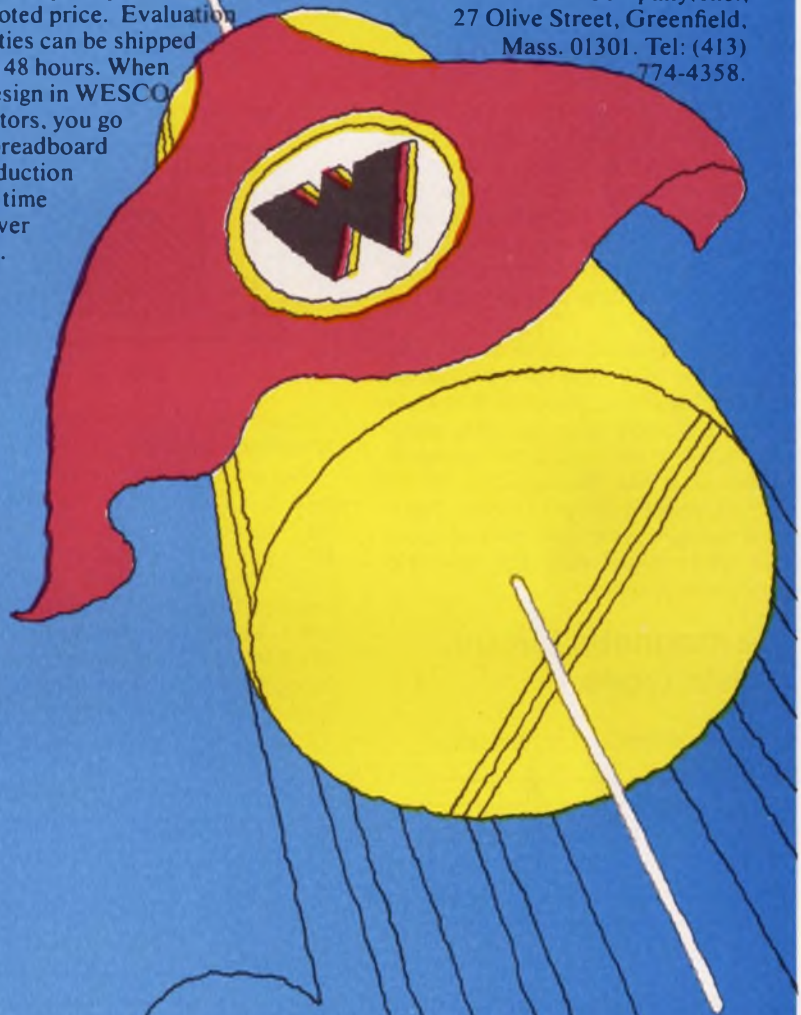

**WESCO**

INFORMATION RETRIEVAL NUMBER 10

# Linear actuators: Positioning systems that offer high speed, high resolution and positional accuracy within mils.

The drive system in a pm loud-speaker is a familiar example of the linear actuator principle. It consists of a coil mounted in the annular gap of a permanent magnet assembly. When you introduce a current, the coil moves with force proportional to the product of the current and the magnetic field.

Your particular application may require the coil to move a precise amount, apply a precise force or simply advance to a specific position. Coil travel can be several inches or a few thousandths of an inch depending on your need. Positional accuracy within mils is possible when high resolution sensing equipment is used.

## The magnetic circuit. 3 basic types.

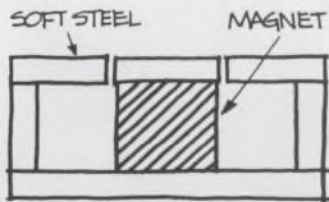

FIG. 1

Figure 1 shows the magnetic circuit with highest efficiency. The magnet forms the center pole with a soft steel plate on the gap end. Leakage is 1.5 to 1.8. Operating density of the

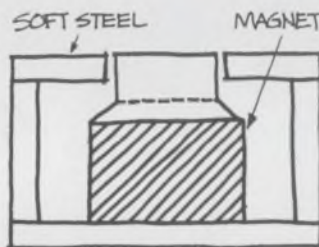

FIG. 2

magnet controls gap density. Magnet length determines coil excursion.

Greater gap density for a given gap size is possible when you design the type of circuit in figure 2. The soft steel center pole operates near magnetic saturation, which may be 50% greater than the magnet  $B_d$  in figure 1. Leakage in the figure 2 circuit is 1.8 to 2.2. Short center pole length establishes coil excursion in this type of circuit.

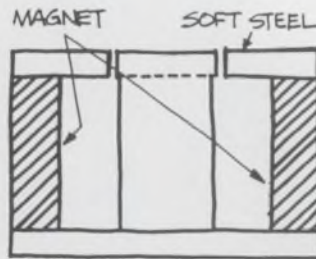

FIG. 3

The circuit in figure 3 provides long coil excursion, high gap density —

or both. Leakage ranges from approximately 2.5 to 3.0. Magnetic saturation of the center pole sets gap density.

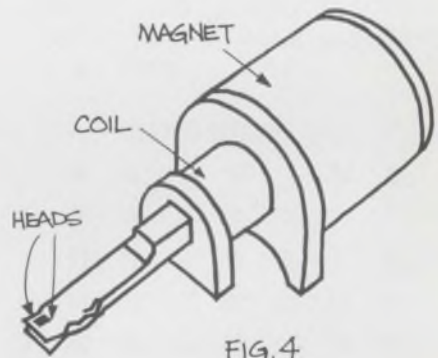

FIG. 4

The unit in figure 4 is an application of the magnetic circuit in figure 3 above. It positions magnetic heads in computer disk drive systems. Both electrical and optical position sensing are employed to achieve extremely high resolution.

## We offer design assistance.

If your design problem concerns high speed or high resolution linear motion, you can get the magnetic circuit information you need at Indiana General. Our engineers are always ready to work with you. Just write Indiana General, Magnet Products, Valparaiso, Indiana 46383.

**indiana general** 

a division of Electronic Memories & Magnetics Corporation

INFORMATION RETRIEVAL NUMBER 11



# The tin is free.

**(The chips we charge for.)**



Save yourself a lot of time and money by getting pre-tinned Fast Chip capacitors from Electro Materials. When you order in production quantities, the end terminations come pre-tinned at no extra cost.

We'll be glad to send you samples. For free.



## Electro Materials

Division Illinois Tool Works Inc.  
11620 Sorrento Valley Road, San Diego, California 92121  
Phone (714) 459-4355, TWX 910 322-1130



## IT'S TIME... TO SEE THINGS IN A NEW LIGHT

When multi-faceted display problems dictate 9 to 9 work days, it's high time you saw things in a new light, on a single plane with no "dancing" digits and with no eye strain.

Legi DG 12C numerical indicator tube segments are an eye-easy phosphor green for a readout as bright and clear as day, legible at distances over 35 feet. These tubes offer low-voltage, low current drain, and high stability advantages so definitive and pack a performance punch so large, you can't afford not to afford to examine full particulars. They fit to the "T" perfectly portable and circuit-board mounting applications and are available at mass production prices. Look at these important particulars, then write for comprehensive data

that show display tube performance in an entirely new light:

### LEGI DG 12C

Filament voltage at 95 mA ..... 0.85 volts  $\pm$  10%  
 Phosphor segments & control grid ..... 20 Vdc  
 Brightness ..... 80 foot -lamberts  
 Operating temperature .....  $-10^{\circ}$  to  $+70^{\circ}$  C  
 \* Dynamic life expectancy ..... 200,000 hrs.

U.S. PATENT 3508101

*Legi* Sole U.S. Distributor:

### Legi Electronics Corporation

3118 West Jefferson Blvd. Los Angeles, California 90018 U.S.A.  
 Phone: RE 3-4508, 733-9105

**ISE** Manufacturer:

### Ise Electronics Corporation

P.O. Box 46, Ise City Mie Pref., Japan Phone: Mie (059627)-26

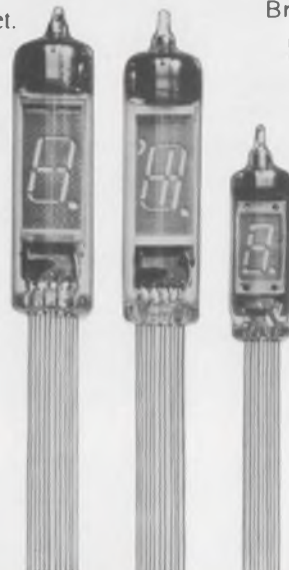

DG 12H

DG 10A

INFORMATION RETRIEVAL NUMBER 13



### AN IC VOLTAGE COMPARATOR FOR HIGH IMPEDANCE CIRCUITRY

The IC voltage comparators available in the past have been designed primarily for low voltage, high speed operation. As a result, these devices have high input error currents, which limit their usefulness in high impedance circuitry. An IC is described here that drastically reduces these error currents, with only a moderate decrease in speed.

This new comparator is considerably more flexible than the older devices. Not only will it drive RTL, DTL and TTL logic; but also it can interface with MOS logic and FET analog switches. It operates from standard  $\pm 15V$  op amp supplies and can switch 50V, 50 mA loads, making it useful as a driver for relays, lamps or light-emitting diodes. A unique output stage enables it to drive loads referred to either supply or ground and provide ground isolation between the comparator inputs and the load.

Another useful feature of the circuit is that it can be powered from a single 5V supply and drive DTL or TTL integrated circuits. This enables the designer to perform linear functions on a digital-circuit card without using extra supplies. It can, for example, be used as a low-level photodiode detector, a zero crossing detector for magnetic transducers, an interface for high-level logic or a precision multivibrator.

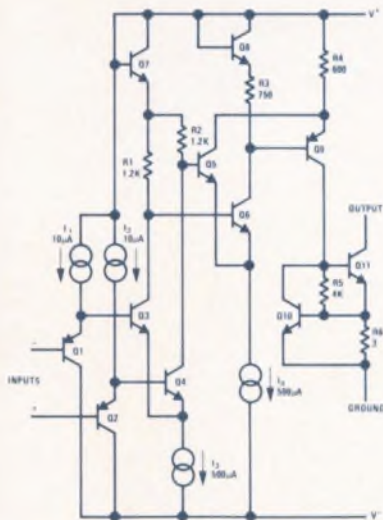

FIGURE 1. Simplified Schematic of the LM111

Figure 1 shows a simplified schematic of this versatile comparator. PNP transistors buffer the differential input stage to get low input currents without sacrificing speed. Because the emitter base breakdown voltage of these PNPs is typically 70V, they can also withstand a large differential input

voltage. The PNPs drive a standard differential stage. The output of this stage is further amplified by the  $Q_5$ - $Q_6$  pair. This feeds a lateral PNP,  $Q_9$ , that provides additional gain and drives the output stage.

The output transistor is  $Q_{11}$  which is driven by the level shifting PNP. Current limiting is provided by  $R_6$  and  $Q_{10}$  to protect the circuit from intermittent shorts. Both the output and the ground lead are isolated from other points within the circuit, so either can be used as the output. The  $V^-$  terminal can also be tied to ground to run the circuit from a single supply. The comparator will work in any configuration as long as the ground terminal is at a potential somewhere between the supply voltages. The output terminal, however, can go above the positive supply as long as the breakdown voltage of  $Q_{11}$  is not exceeded.

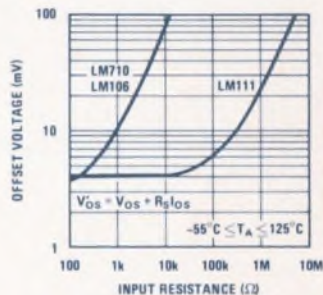

FIGURE 2. Illustrating the Influence of Source Resistance on Worst Case, Equivalent Input Offset Voltage.

Figure 2 shows how the reduced error currents of the LM111 improve circuit performance. With the LM710 or LM106, the offset voltage is degraded for source resistances above 200Ω. The LM111, however, works well with source resistances in excess of 30 kΩ. Figure 2 applies for equal source resistances on the two inputs. If they are unequal, the degradation will become pronounced at lower resistance levels.

Table I gives the important electrical characteristics of the LM111 and compares them with the specifications of older ICs.

A few, typical applications of the LM111 are illustrated in Figure 3. The first is a zero crossing detector driving a MOS analog switch. The ground terminal of the IC is connected to  $V^-$ ; hence, with  $\pm 15V$  supplies, the signal swing delivered to the gate of  $Q_1$  is also  $\pm 15V$ . This type of circuit is useful where the gain or feedback configuration of

LINEAR BRIEF 12 IS VOLUME NUMBER 12 OF THE NATIONAL SEMICONDUCTOR LINEAR BRIEF SERIES, WHICH CONTAINS ARTICLES ON THE DESIGN AND APPLICATIONS OF LINEAR IC'S.

**Table I. Comparing the LM111 with earlier IC comparators. Values given are worst case over a -55°C to 125°C temperature range, except as noted.**

Parameter	LM111	LM106	LM710	Units
Input Offset Voltage	4	3	3	mV
Input Offset Current	0.02	7	7	$\mu\text{A}$
Input Bias Current	0.15	45	45	$\mu\text{A}$
Common Mode Range	$\pm 14$	$\pm 5$	$\pm 5$	V
Differential Input Voltage Range	$\pm 30$	$\pm 5$	$\pm 5$	V
Voltage Gain†	200	40	1.7	V/mV
Response Time†	200	40	40	ns
Output Drive Voltage	50	24	2.5	V
Output Drive Current	50	100	1.6	mA
Fan Out (DTL/TTL)	8	16	1	
Power Consumption	80	145	160	mW

†Typical at 25°C.

an op amp circuit must be changed at some precisely-determined signal level. Incidentally, it is a simple matter to modify the circuit to work with junction FETs.

The second circuit is a zero crossing detector for a magnetic pickup such as a magnetometer or shaft-position pickoff. It delivers the output signal directly to DTL or TTL logic circuits and operates from the 5V logic supply. The resistive divider,  $R_1$  and  $R_2$ , biases the inputs 0.5V above ground, within the common mode range of the device. An optional offset balancing circuit,  $R_3$  and  $R_4$ , is included.

The next circuit shows a comparator for a low-level photodiode operating with MOS logic. The output changes state when the diode current reaches  $1 \mu\text{A}$ . At the switching point, the voltage across the photodiode is nearly zero, so its leakage current does not cause an error. The output switches between ground and  $-10\text{V}$ , driving the data inputs of MOS logic directly.

The last circuit shows how a ground-referred load is driven from the ground terminal of the LM111. The input polarity is reversed because the ground terminal is used as the output. An incandes-

cent lamp, which is the load here, has a cold resistance eight times lower than it is during normal operation. This produces a large inrush current, when it is switched on, that can damage the switch. However, the current limiting of the LM111 holds this current to a safe value.

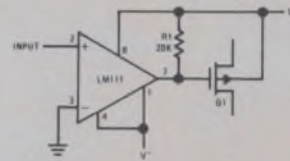

a. Zero Crossing Detector Driving Analog Switch

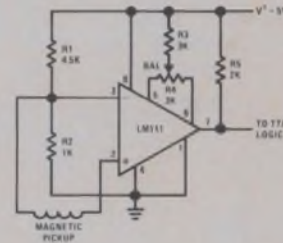

b. Detector for Magnetic Transducer

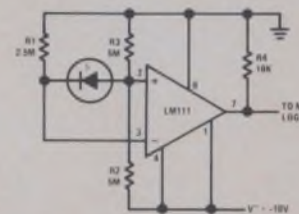

c. Comparator for Low Level Photodiode

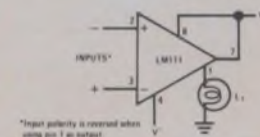

d. Driving Ground—Referred Load

**FIGURE 3. Typical Applications of the LM111.**

The applications described above show that the output-circuit flexibility and wide supply-voltage range of the LM111 opens up new fields for IC comparators. Further, its low error currents permit its use in circuits with impedance levels above  $1 \text{ k}\Omega$ . Although slower than older devices, it is more than an order of magnitude faster than op amps used as comparators.

The LM111 has the same pin configuration as the LM710 and LM106. It is interchangeable with these devices in applications where speed is not of prime concern.

**National Semiconductor Corporation**  
 2900 Semiconductor Drive, Santa Clara, California 95051  
 (408) 732-5000 / TWX (910) 339-9240



1-70 Printed in U.S.A.

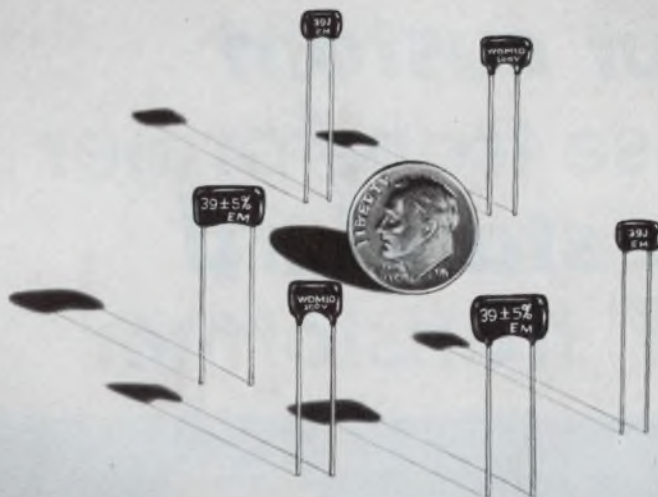

## They're Small and Reliable\*

### EL-MENCO DM5 — DM10 — DM15 — ONE COAT DIPPED MICA CAPACITORS

STYLE	WORKING VOLTAGE	CHARACTERISTIC	CAPACITANCE RANGE
DM5	50VDC	C	1pF thru 400pF
		D, E	27pF thru 400pF
		F	85pF thru 400pF
DM5	100VDC	C	1pF thru 200pF
		D, E	27pF thru 200pF
		F	85pF thru 200pF
DM10		C	1pF thru 400pF
		D, E	27pF thru 400pF
		F	85pF thru 400pF
DM15	C	1pF thru 1500pF	
	D, E	27pF thru 1500pF	
	F	85pF thru 1500pF	
DM5	300VDC	C	1pF thru 120pF
		D, E	27pF thru 120pF
		F	85pF thru 120pF
DM10		C	1pF thru 300pF
		D, E	27pF thru 300pF
		F	85pF thru 300pF
DM15		C	1pF thru 1200pF
		D, E	27pF thru 1200pF
		F	85pF thru 1200pF
DM10	500VDC	C	1pF thru 250pF
		D, E	27pF thru 250pF
		F	85pF thru 250pF
DM15		C	1pF thru 750pF
		D, E	27pF thru 750pF
		F	85pF thru 750pF

Where space and performance are critical, more and more manufacturers are finding that El-Menco miniaturized dipped mica capacitors are the reliable solution. The single coat is available in three sizes: 1-CRH, 1-CRT and 1-CE.

The 1-CRH DM "space savers" easily meet all the requirements of MIL and EIA specifications, including moisture resistance. The 1-CE and 1-CRT units also meet the requirements of MIL and EIA specifications, except that they have less moisture protection because of their thinner coating; these capacitors, therefore, are ideally suited where potting will be used. Note: DM10 and DM15 units are still available in the standard 4-CR size.

**Specify "El-Menco" and be sure . . .** the capacitors with proven reliability. Send for complete data and information.

\*Normally, El-Menco 39 pF capacitors will yield a failure rate of less than 0.001% per thousand hours at a 90% confidence level when operated with rated voltage and at a temperature of 85°C. Rating for specific applications depends on style, capacitance value, and operating conditions.

## THE ELECTRO MOTIVE MFG. CO., INC.

WILLIMANTIC, CONNECTICUT 06226

Dipped Mica • Molded Mica • Silvered Mica Films • Mica Trimmers & Padders  
Mylar-Paper Dipped • Paper Dipped • Mylar Dipped • Tubular Paper

West Coast Manufacturers contact: COLLINS & HYDE CO., 900 N. San Antonio Rd., Los Altos, California 94022  
5380 Whittier Blvd., Los Angeles, California 90022

ALSO SOLD NATIONALLY THROUGH ELECTRONIC PARTS DISTRIBUTORS  
INFORMATION RETRIEVAL NUMBER 14

# Your **custom** pulse transformer is a **standard** DST\* transformer

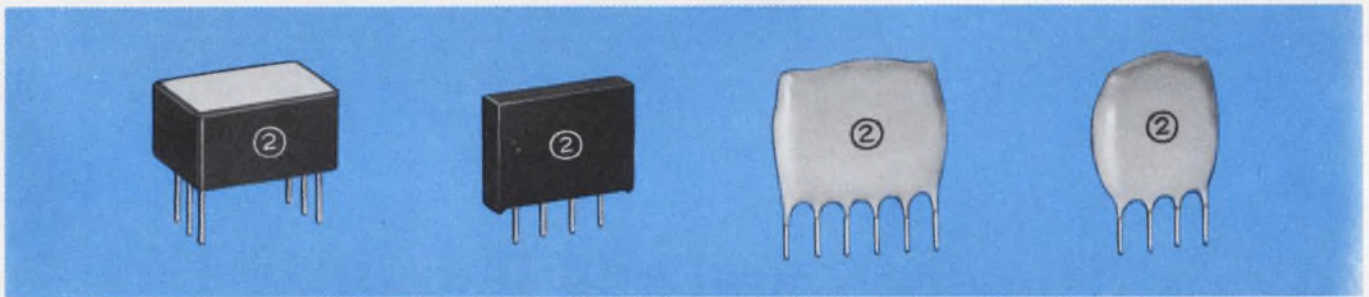

Some of the case styles in which Sprague DST Pulse Transformers are available. Note the in-line leads.

**You can select** the transformer design you need from the new Sprague DST Family, a fully-characterized series of Designer Specified Transformers which Sprague Electric has pioneered. It's easy. Start with the two basic parameters dictated by your circuit requirements: primary (magnetizing) inductance and volt-second capacity.

New Sprague engineering data gives basic information from which all nominal sine wave parameters are derived. This data allows you to specify the one transformer from thousands of possibilities which will optimize performance in your application.

**Design Style A** minimizes magnetizing inductance change as a function of temperature. Typically it's  $< \pm 10\%$  change from 0 to 60C;  $< \pm 30\%$  from -55 to +85 C.

**Design Style B and C** give you broad band-pass characteristics, and still keep magnetizing inductance change  $< \pm 15\%$  from 0 to 60 C.

**Design Style D** is **fast**. Associated leakage inductance and coupling capacitance are kept at a minimum. This style is just what you need for interstage and coupling devices in computer drive circuits.

The Sprague DST Series packs a lot of transformer into minimum volume packages — epoxy dipped for minimum cost, or pre-molded. The 100 mil in-line lead spacing is compatible with integrated circuit mounting dimensions on printed wiring boards.

To solve your pulse transformer design, start now. Write for Engineering Bulletin 40,350 to the Technical Literature Service, Sprague Electric Company, 347 Marshall St., North Adams, Massachusetts 01247.

\*Trademark

## SPRAGUE COMPONENTS

PULSE TRANSFORMERS  
THIN-FILM MICROCIRCUITS  
TRANSISTORS  
CAPACITORS  
RESISTORS

INTEGRATED CIRCUITS  
INTERFERENCE FILTERS  
PULSE-FORMING NETWORKS  
TOROIDAL INDUCTORS  
ELECTRIC WAVE FILTERS

CERAMIC-BASE PRINTED NETWORKS  
PACKAGED COMPONENT ASSEMBLIES  
BOBBIN and TAPE WOUND MAGNETIC CORES  
SILICON RECTIFIER GATE CONTROLS  
FUNCTIONAL DIGITAL CIRCUITS



Sprague and ® are registered trademarks of the Sprague Electric Co.

# Highlighting

THE ISSUE

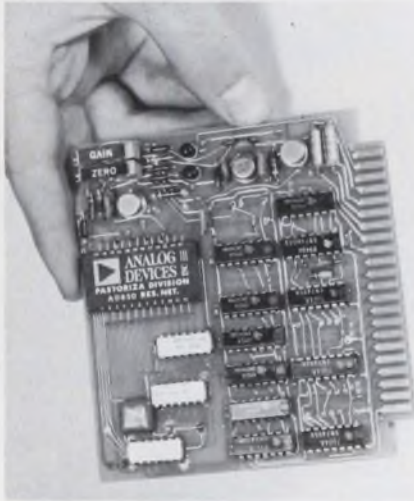

A new successive-approximation 12-bit analog-to-digital converter features a relative accuracy of 0.0125%—including buffer amplifier and comparator errors.

The key to the unit's high performance is its d/a circuitry—three four-bit monolithic weighted switches and a thin-film resistor network. An extra compensating transistor on each chip operates in an external compensating circuit to stabilize against temperature and aging errors.

**Page 85**

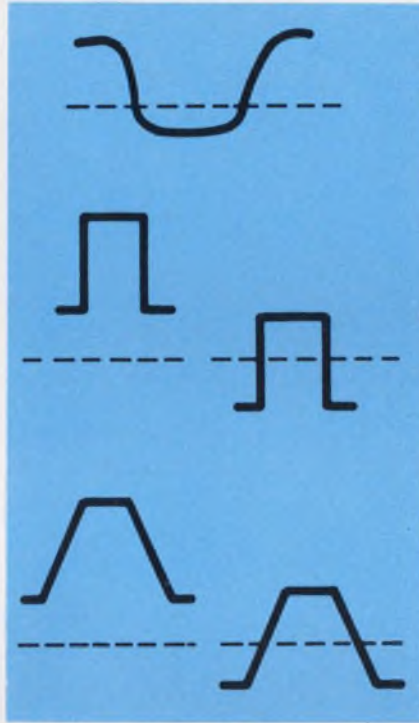

Testing complex logic circuitry at the subassembly level can be troublesome. If you want to check worst-case input conditions, with frequent changes in environment, you likely will end up with a complex testing system employing several pulse generators. But you needn't.

You can build yourself a pulse-shaper and driver circuit that offers more than any single piece of test equipment on the market today. This one circuit can independently vary pulse rise and fall times, amplitude and dc offset. It provides all pulse parameters for testing under worst-case conditions, and it's designed to be driven by any standard DTL or TTL integrated-circuit logic.

**Page 52**



The really big news in the electronics industry today has to do with economic "engineering." What good are facts about circuitry design or systems trade-offs if you're not going to have a job where you can put the findings to use?

It's no secret that the national economy is in the throes of a slowdown. Some engineers have already been hurt. Others ask: Will I be next? What are prospects in my corner of the business? The editors of *ELECTRONIC DESIGN* have canvassed companies and staffs in key electronics areas in the United States. Their findings are included in a special report.

**Page 26**

# SELF-SCAN™

## *alphanumeric panel displays*

*lowest cost readout system...  
and it's available now*

SELF-SCAN panel displays combine everything you've wanted — including low cost — in 10 to 400 character alphanumeric readouts.

- the application flexibility of either digital or ASC II code
- the readability of formed characters in a high-contrast display, coupled with an in-plane readout
- the reduced cost and clean packaging which result from designing out most of the drive circuitry and minimizing connections
- the reliability comparable to that of a NIXIE® tube (Burroughs developed and is the world's only manufacturer of NIXIE indicator tubes)
- the display flexibility needed to meet your exact readout requirements

Write today for our new brochure. Learn the detailed story behind SELF-SCAN panel displays. Burroughs Corporation, Electronic Components Division, P.O. Box 1226, Plainfield, New Jersey 07061 • Tel.: (201) 757-3400.

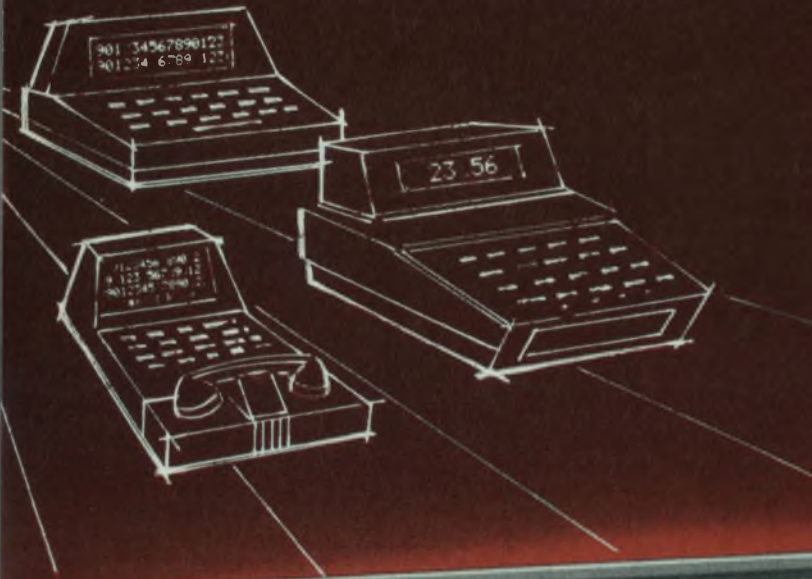

Only Burroughs manufactures NIXIE® tubes  
and SELF-SCAN™ panel displays.

**Burroughs**





## Nader calls pollution detectors "priority item"

In condemning pollution as a "subtle form of violence" consumer advocate Ralph Nader pointed to the development of detection instruments as being a priority item in the quest for clean air and water.

At the 1970 IEEE International Symposium on Electromagnetic Compatibility in Anaheim, Calif., Nader said "Detection instruments are usually not considered a priority item in the consumer movement, but they are going to be.

"The detection of hazards, of fatigue or pollutants in various consumer products is important. We desperately need instruments of detection that can be used in the food area. For example, we must be able to detect mercury in fish."

Nader noted with despair the lack of technology transfer from the military to the consumer. "In the last 25 years, while we have achieved pretty impressive practical applications in space, defense and computer-operated production systems, the basic needs of the American population have been semi-starved of these technological benefits."

Medical hazards are among Nader's greatest concerns. "Specialists have indicated that, from an accidental electrocution, there are between 1200 and 12,000 fatalities per year in hospitals. There are some very well known hospitals in this country that don't have any electrical engineers or biomedical electronics specialists in house. Of course, it's not just poor equipment, but also poorly trained personnel," he said.

Part of the solution to the question of how the engineer can help, lies in organization and status. Nader urged that professional societies take a more active role in areas of controversy.

Finally Nader pleaded that, "En-

gineers must speak out on social ills and their cures. Do not remain a part of the silent majority."

## FCC considers new plan for Microwave Licensing

If the Federal Communications Commission adopts the procedures proposed last month by its Common Carrier Bureau, small communications companies may be on the way toward exploiting the special communications services market. These include private-line communication channels customized to subscribers' needs and a switched data-transmission system.

The new proposal would obviate the need for individual hearings before licenses for special communications services are authorized. It would also permit such licenses to compete with one another in the same geographical area.

Until last August, the FCC had not permitted a company to supply private-line microwave communications in competition with regulated common carriers like the Bell System (see ED 18, Sept. 1, 1969, p. 21).

After the FCC makes its decision, which is expected by the end of the year, there could be a dog-fight among relatively small communications companies competing to supply the burgeoning needs of business and industry for specialized common carrier services.

These services would include private-line digital channels with very low error rates, a wide variety of bandwidths for analog transmission, one-way (as well as two-way) transmission, and full-time or part-time service with billing adjusted to specific needs of subscribers. (See ED 22, Oct. 25, 1969, p. 32).

Already nearly 2000 applications

from some 30 companies have been filed with the commission.

The FCC has taken no position on its staff proposal. But Microwave Communications of America, Inc. (MCI) in Washington, D. C., and Data Transmission Corp., (Datran) in Falls Church, Va., (both of which have filed a number of applications with the Commission) are optimistic that the FCC will approve the new procedures.

The Common Carrier Bureau noted that the demand for all types of communications services is growing very rapidly and data communication would probably exhibit very substantial growth in the next decade. The new carriers, according to the Bureau, disperse "the burdens, risks, and initiatives involved in supplying the rapidly growing markets for new specialized service proposals now filed with the commission."

## FCC also OKs microwave links for CATV in cities

Another decision from the FCC will permit CATV operators to use microwave relay links to span short distances where the use of cable is impractical.

One such cableless design, developed by Laser Link division of the Chromalloy American Corp., in New York City, would beam SHF signals to rooftop receivers with coaxial cable used to route signals to individual apartments.

The FCC authorized FDM/FM (frequency division multiplexed frequency modulated) systems in addition to AM VSB amplitude modulated vestigial sideband systems) now permitted.

## 90% price cut foreseen for memories by 1973

A reduction of at least 90% in the average price of semiconductor memories and shift registers by 1973 is predicted by Earl Gregory, vice president of Electronic Arrays, Inc., Mountain View, Calif. He made his forecasts at a seminar on MOS products sponsored by Electronic Arrays in Plainview, N. J.

Based on Electronic Industry Association figures, Gregory says,

the price of a random-access memory—which was 22¢ a bit in 1969 and is 10¢ this year—will fall to 0.8¢ by 1973. Gregory attributes this sharp decline in prices to increased sales and production efforts by manufacturers.

Read-only memories, which cost 2¢ a bit last year, will decline in price to 0.2¢ by 1973, Gregory says.

Using the same EIA figures, he expects the price of static shift registers to fall—from 5¢ a bit in 1969 and 2.5¢ this year—to 0.4¢ by 1973. According to Gregory, added increases in the number of bits per chip and in production volume will cause the large drop in prices for both the static shift registers and read-only memories. (See ED 15, July 19, 1970 "The Big Memory Battle," p. 70.)

## Laser light amplifies acoustic signals

Amplification of ultrasonic pulses by light in a birefringent crystal can be used to create a new class of computer storage elements. This forecast was made by Dr. Edward S. Cassedy, Polytechnic Institute of Brooklyn, N.Y., in connection with his work on laser-sound interactions.

Cassedy and his associate, Martin Piltch, accomplished the amplification by directing light from a ruby laser onto a quartz crystal into which 75-MHz acoustic energy had been injected. The amplification results from a coupling between the two types of energy in the crystal. The sound creates bands of compression and rarefaction, which act to diffract the light. The laser beam causes stresswaves that scatter the sound waves.

The interaction produces a third type of wave—Stokes-shifted light. A fixed relationship among the three waveforms must be maintained to amplify the sound. The amplification is unidirectional—both of the original waves must be propagating in the same direction.

## Laser radar measures glide-path visibility

A lightweight, portable laser radar has come to the aid of airmen in forward field areas who need to measure accurately the height of cloud bases at altitudes from 150 to 3000 feet.

Now, a relatively awkward system is used. Two arc lights are placed 300 to 400 feet apart and directed on the cloud base. The altitude must then be worked out by triangulation calculation. The laser radar is in one package, it is accurate and human interpretation is not required.

The system was built in response to a request from units in Southeast Asia by the Sperry Gyroscope Div., of Sperry Rand Corp., Great Neck, N. Y. The sponsor was the Air Force Avionics Laboratory, Wright-Patterson Air Force Base, Ohio.

The laser radar used a pulsed gallium-arsenide laser transmitter and a receiver mounted adjacent to each other. The return signal is due to scattering from particular matter in the clouds. The cloud height is conveniently read on a pixie tube numerical display. The whole operation takes about six seconds.

The system consists of a laser transmitter-receiver unit and an auxiliary battery-control unit which can be located depending upon the user's requirements. The optical unit containing the gallium arsenide laser diode array, projector optics, detector, receiver optics, and most of the signal processing circuitry is connected to the battery control unit by a cable through rain.

To detect small targets, a narrower, more concentrated beam is used—2.4 degrees in azimuth and 4 degrees in the vertical plane.

## Fast-scan radar used to detect small boats

The Coast Guard is getting a long-needed airborne radar that will detect small fiberglass boats in high seas. Fiberglass is one of the most widely used materials for civilian pleasure boats and one of the poorest reflectors of radar.

To beat the poor reflectivity

problem, the Georgia Institute of Technology designed a special radar, and the AIL Div. of Cutler-Hammer, Deer Park, N. Y., is building it. AIL's contract calls for two prototypes, the first to be delivered in July, 1971, for approximately \$1.5-million.

The specifications call for a radar capable of detecting a 16-foot fiberglass boat in five-foot seas at a distance of 10 miles in fog and rain. Radars the Coast Guard uses now are efficient only up to three miles in two-foot seas.

To play down random, moving objects, such as wave crests, and to emphasize the consistent presence of the boat, an antenna scan rate of 300 rpm is used. This is five times faster than radars ordinarily scan.

The new radar will also have higher transmitter power, 250 kW as opposed to 50 kW. This additional power, plus a circularly polarized antenna, will help it "see"

The pulse duration will be short—one ten-millionth of a second. The image persistency will be varied from three-tenths of a second to 10 seconds.

The new radar comes at a good time due to the expansion of pleasure boating. As of today, there are 8.7 million pleasure boats in the U.S., and the number is growing by at least 4000 each week. In 1969, 70% of the 48,000 total Coast Guard search and rescue operations involved pleasure craft.

## Communications link based on minicomputer

Tymshare, Inc., Palo Alto, Calif., has developed a minicomputer communications processor that acts as an interface between a time-shared computer and any commonly used terminal. The communication link is called Tymsat, and it allows an engineer to obtain a graphic plot, a CRT display or conventional teletypewriter printout from an ordinary telephone line.

The new processor also detects errors that may develop on the telephone line and automatically retransmits corrected data. Error rate is one in 10<sup>9</sup> bits transmitted.

The heart of the new system is a Varian 620/i minicomputer with added software and hardware.

# What makes this the best low-priced digital printer you can buy?

Printing wheels, not drums. Each wheel is interchangeable so you can alter any individual column and include special characters at minimal cost. Tailor your printer to your individual needs.

Prints with or without ink. Rotating ink roller means reliable ink printing. No intricate ribbon advance mechanism. If you'd rather use pressure-sensitive paper and no ink, just take out the roller.

10 lines/second printing. Prints ten columns three times faster than any other low-priced printer. Free your system from long print cycles.

Field-proven heavy-duty mechanism. It's the one used for years in our 20 lines/second printer so at 10 lines it's just coasting. Moving parts are held to a minimum. In a word, what you get is reliability.

Price: \$1150 complete. Beat that value!

For the full story on this great new economical, flexible HP 5055A Digital Recorder, call your nearby Hewlett-Packard field engineer. Or write to Hewlett-Packard, Palo Alto, California 94304; Europe: 1217 Meyrin-Geneva, Switzerland.

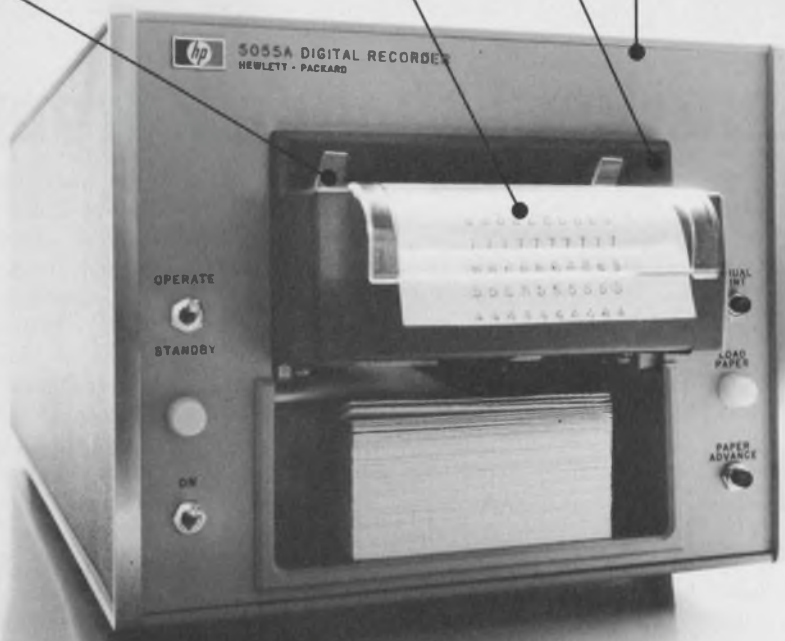

HEWLETT  PACKARD

# Beleaguered industry battles economic slide

The really big news in the electronics industry today has to do with economic "engineering." What good are facts about circuitry design or systems tradeoffs if you're not going to have a job to put the findings to use?

It's no secret that the national economy is in the throes of a slowdown. Some engineers have already been hurt. Others ask: Will I be next? What are prospects in my corner of the business? The editors of **ELECTRONIC DESIGN** have canvassed companies and their staffs in key electronic areas in the United States. Their findings include these:

- The consumer industry is seeking to combat both the slump and worrisome foreign competition by trimming production rather than engineering staffs and by emphasizing imaginative design.

- In semiconductors, it's a buyers' market. The business is there, manufacturers say, but it's more difficult to get. Engineers have more

choices of components and at better prices.

- Component sales are down slightly, but the hybrid market continues to expand. Growth in the overseas market is helping to offset any slump at home.

- In instruments, there's a mood of concern, with sales down 20%. The reason: industrial belt tightening and a drop in Government R&D spending. A bright spot is foreign sales.

- The microwave industry, though down, is looking toward foreign and non-military markets for stability in the second half of 1970. Many small companies appear ready to fail.

- In aerospace-defense, the picture is bleak. Despite the awarding of some major contracts recently, some manufacturers expect no upturn before late 1973 or early '74.

In short, there are clouds over the electronics industry, but they're scattered clouds. And there's ample hope that the economic climate will improve.

## Consumer market beset on 2 fronts

It's the golden anniversary of the United States consumer electronics industry—the market was born in 1920 with the start of radio broadcasting—but from the standpoint of sales, the prospects are leaden this year.

Deliveries of radios, television sets and phonographs are down markedly from last year. To add to the woes, foreign imports of these items are making large inroads.

Major manufacturers, a survey by **ELECTRONIC DESIGN** shows, have stabilized their positions by trimming production rather than engineering staffs, choosing to combat

both the slump and foreign competition with increased emphasis on imaginative design.

Just how bad the slump is depends upon whom you talk to. The Electronics Industries Association says that total radio and TV sales are down somewhat over 20%, compared with last year, while the phonograph market has slipped more than 34%.

"Some people call it a recession, but I think it's almost a depression," says I. L. Griffin, vice president and general manager of General Electric's TV Division, in Hampton, Va. "The total dollar sales drop is more serious than the

unit numbers published by EIA. Not only have unit sales fallen, but those sales made are in a lower-cost product mix.

"For example, the number of color TVs being sold is lower today than it was a year ago. But those purchases being made are of table models and smaller screen sizes, so that the industry dollars are down more than the units—which cuts profits."

William Boss, vice president of marketing for Sylvania Entertainment Products, Batavia, N.Y., is somewhat more optimistic. He calls the economic situation a "stage of mild stagnancy." And he considers

the situation simply a temporary part of the economic cycle. He points out that there is a direct relationship between sales in the consumer electronics industry and the automotive and consumer appliance markets.

"When the majors start going down, our business follows correspondingly," he says. "But we all eventually get ourselves out of it."

### The bottom, at last?

Boss' optimism is shared by many in the industry. There is a general feeling that the decline has "bottomed out."

"I don't see anything going down any further," says Robert O'Neil, executive vice president of sales for RCA Sales Corp., Indianapolis.

"But I think it's a little early to expect too much. We're expecting this thing to start moving back in July and August, but we're all holding our breath."

General Electric's Griffin points out that the incidence of multiple TV set ownership is bound to grow, just as it did with automobiles. Also, there's a definite swing to color TV, he believes, with a replacement market growing here—not color for monochrome, but color for color, because many early color sets are reaching the end of their life cycle.

General Electric's TV planning is based on an expected turnaround in the market in the fall, according to Griffin. "Probably the latter part of the third or early part of the fourth quarter," he says.

Another significant indicator is the fact that automobile radio sales this May were actually 13.1% higher than in May of 1969—the first consumer electronic product to surpass 1969 sales.

Two other markets are bucking the downturn: stereo modules and components, and tape-recording equipment. These both appeal essentially to buyers in the 18-to-30-year-old bracket.

### Foreign imports hurt

A major worry to U. S. manufacturers is the rise in imports of radios, television sets and phonographs. Sales of home radios produced in this country declined



from 17.4% of the market in 1969 to 7.5% in 1970, according to the EIA. And phonographs declined from 90.2% to 59.7%, with imports making commensurate gains.

The imports are also making inroads in both the black-and-white and color TV markets. Japanese television manufacturers dominated the 1970 Consumer Electronics Show, held in New York, June 28-July 1. For the first time, no American-made TV sets were exhibited at the show.

General Electric was represented at the show, but with radios and recorders from its Consumer Electronics Div. in Utica, N. Y.

"We can't compete with the foreign labor," Frank E. Murphy, manager of special consumer products at GE, told ELECTRONIC DESIGN, "particularly when it comes to the lower-priced items. Instead, we depend on new and unique features or designs from our engineering group."

He pointed to a new electronic pushbutton FM/AM clock radio with digital electroluminescent readouts. And he displayed a second FM/AM clock radio that had a proximity "snooze alarm" control. Once the alarm goes off, one need only wave a hand over the top of the set, and the alarm is silenced for seven minutes.

"It works by sensing heat from the hand," Murphy explained. ■■

## Semiconductor makers throttle back

"It's a buyer's market" is the word in the normally bullish semiconductor industry. Both semiconductor manufacturers and users agree on this, a sampling of opinion in the industry shows.

The situation is attributed to a general decline in the electronics industry plus a maturing of the rapidly growing IC field. The business is there, manufacturers say, but it's more difficult to get. Design engineers have more choices in components and at better prices.

Most semiconductor sales are still rising, but not as fast as manufacturers would like to see. There have been small declines in some

areas, primarily in discrete components. But discretely are headed down in the long run, manufacturers point out, because ICs are gaining most of this market.

"It is obvious to everyone there has been a slump in semiconductor business in the consumer, computer and automotive sectors of our market place, and this slump will probably continue through 1970," says Stephen L. Levy, vice president and general manager of Motorola Semiconductor Products div., Phoenix, Ariz.

Moses Shapiro, chairman of the board of the General Instrument Corp., Newark, N. J., confirms that

discrete semiconductor sales will be off in the industry this year—"at best, level, but I doubt it."

Frank Jaumot, director of research and engineering for Delco Radio, Kokomo, Ind., agrees with this appraisal and adds: "There is no expectation of it picking up next year."

Manufacturers of hybrid microcircuits are more optimistic than the general semiconductor industry. Leslie W. Chapin, manager of microcircuit operations for the Helipot Div. of Beckman Instruments, Buena Vista, Calif.,—which produces both custom and standard hybrids—reports a growth of about

50% in sales for the first half of this year. He expects this rate to slow somewhat in the last half year.

Floyd Kvamme, microcircuit product manager at National Semiconductor, Santa Clara, Calif., says: "TTL sales are not up to expectations." But as bad as this sounds, the semiconductor industry is still growing, and at a faster pace than the electronics industry in general. Roger W. Eck of the



Bank of New York's Electronics Group, predicts that the total U. S. semiconductor industry growth for this year will be between 3 and 6%, compared with 20% last year.

But ICs will grow 20 to 25% in the semiconductor market this year at the expense of discretely, according to Eck.

These predictions are similar to those by Levy of Motorola. "Our backlog has remained fairly constant since the first of the year and, in fact, is higher than it was a year ago," he says. "I don't anticipate there will be any significant reduction in our back-orders during the third quarter.

Earlier this year Mark Shepherd

Jr., president of Texas Instruments, predicted a 5% growth in the U. S. semiconductor market. He expects growth in total sales to Europe and Japan to continue at a 20% rate.

The brightest spot in the semiconductor picture is MOS, with sales growth of over 100% expected this year. This, more than anything else, is contributing to the increase in IC sales.

Predictions for MOS sales earlier this year ranged from a low of \$50-million to a high of \$100-million. Most observers now believe that \$50-million to \$60-million is a likely total.

How does all this affect the user who is designing new equipment? New products are still being introduced at about the same rate as in the past, but price-cutting has appeared with competition.

Some semiconductor makers have cut back on production because of the slower market, but James Quinn, engineering supervisor at the Kearfott Div., Singer-General Precision, Little Falls, N. J., says he hasn't noticed any problems in buying semiconductors he wants.

A spokesman for Tektronix, Inc., Beaverton, Ore.—a big purchaser of semiconductors—also reports no new difficulties with suppliers.

However, S. Ralph Parris, manager of the Circuits and Packaging Dept. at Burroughs, Plymouth, Mich., says he has noticed a deterioration in IC quality in some cases; he attributes it to price-cutting.

"Price hacking has to affect manufacturing procedures," he says. "You can't do a job more

efficiently forever. You have to let quality slip."

National Semiconductor's Kvamme says:

"TTL is the safest thing to design in and buy. The prices are down. The line has not grown as rapidly as predicted, and this has resulted in an overcapacity. If I were an engineer today, I'd stick with 54/74 as a base for all simple gate functions and shop for MSI."

A spokesman for Texas Instruments, Dallas, contends there really is no price war in TTL or DTL, though prices declined, on the average, 26% in 1969. He says that the reductions have followed the normal learning or experience curve and are very close to values predicted four years ago.

TTL and DTL price cuts, the TI spokesman says, are similar to those experienced by the discrete transistor industry almost a decade ago. TI expects IC prices to drop another 30% this year, he adds.

Mel Phelps, vice president of marketing at Nortec Corp., Santa Clara, Calif., does not see the effects of the semiconductor industry slowdown working its way into the design groups of IC manufacturers. He feels that most of the effect has been on the production lines, where the manufacturers started to gear up two or three years ago for a volume that has not materialized.

The customers "have pulled in their horns," Phelps says. But, he adds, custom LSI circuits are still being designed and developed. This market appears to be immune to the national economic slowdown, he says. ■■

## Component houses push innovation

Component sales, in general, are following the trend of the American economy today: The market has slowed. But it isn't all gloom.

Although sales of standard components, like resistors, potentiometers and capacitors, show a slight decline, the market for hybrids continues to grow, even if at a slower rate than previously. Hybrid microcircuits are described as "very dynamic."

The tight market has also re-

sulted in a stress on new products and the value of innovative engineering. Many component houses feel that the present small business slump is the perfect time to get a jump on the competition. Analog Devices, for example, hopes to introduce 20 new products by the end of the year.

One result of the drive for new and better products is that layoffs of engineers in the components industry are virtually nonexistent.

Most companies are intent on preserving their innovative talent.

In addition the foreign sales picture for components is bright—brighter than the domestic one, most component manufacturers report. Some say their foreign business is growing at an annual rate of 20 to 30%. For many manufacturers, this overseas growth is offsetting any slump in the market at home.

These findings have emerged

# Signetics throws design costs for a loop.

Again.

A short time back, we introduced the phase locked loop. Or, to be technical, the monolithic phase locked signal conditioner and demodulator.

Now we've gone ourselves two better.

First, with the PLL 562. This is our phase locked loop with the loop opened. It gives the designer access to the innards of the system. It also allows him to hook up the PLL to other standard parts like our 8200 series MSI. And this enables the PLL to do things like frequency multiplication and division. (If you ask us, the PLL 562's major uses will be in frequency synthesis and synchronizing data off tape and drum memories.)

Second, our low-cost PLL 565. This is a brand new design, again with the loop opened. It provides a reference on the output and operates from common power supply voltages. That's why the PLL 565 can drastically simplify modem designs.

Most important: you get the savings and benefits inherent in broader application of the PLL technique.

As we've said before, the PLL concept has many possibilities. It will be the universal building block that the op amp has become.

Our new phase locked loop devices are

available now from Signetics and Signetics distributors. Nowhere else.

In 100-up quantities, the PLL 562 goes for \$18; the PLL 565 for \$6.35.

Build yourself a better whatever. Cheaper. Write for a complete description of performance, applications and spec sheets.

Be two up on everyone.

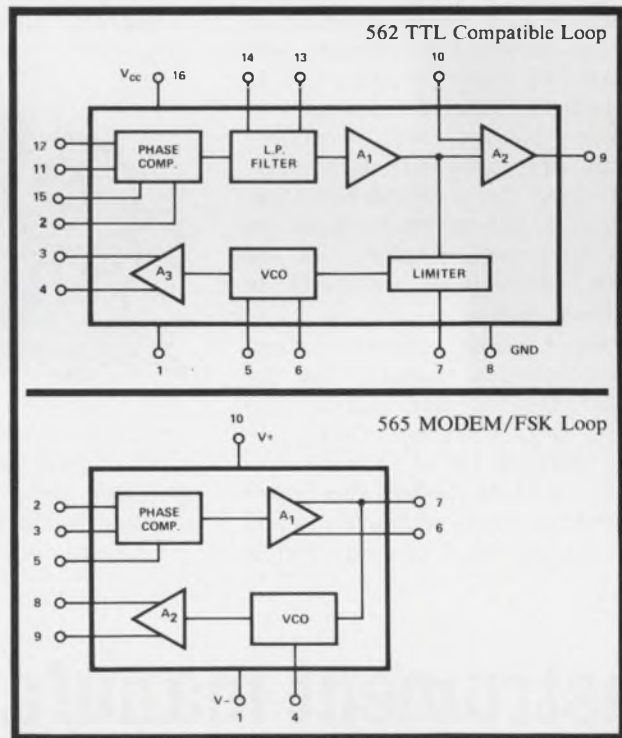

# Signetics

Signetics Corporation / 811 E. Arques Ave., Sunnyvale, California 94086 / A subsidiary of Corning Glass Works

INFORMATION RETRIEVAL NUMBER 19

from an ELECTRONIC DESIGN survey of component makers across the country. The consensus was that despite the business slowdown in this country, the economy is basically "healthy."

Ray Stata, senior vice president of Analog Devices, Inc., Cambridge, Mass., explained: "There has been a trend in the hybrid business toward a slowdown in domestic sales, primarily in large orders. However, there has not been a setback in sales. It's just that the rate of growth we have been accustomed to hasn't been there in the last couple of quarters."

Analog enjoyed practically a 50% increase in sales last year. This year it is projecting an increase of 35%.

Leroy Gray, marketing manager of the Electronics Div. at Burndy Corp., Norwalk, Conn., said:

"A large part of our business is electrical, with customers like Consolidated Edison and Pacific Gas and Electric. This power business is doing very well."

Sprague Electric Co. of North Adams, Mass., on the other hand, reported that it began to experience an across-the-board slowdown in March in hybrids, semiconductors and standard components, particularly in those products tied to the home entertainment area.

"The picture will certainly change. My guess is that the present forecast for a second-half turnaround is not going to show up until next year. I can't pick the month," Glen Foss, assistant to president, noted.

Howard Frazier, advertising and sales promotion manager for the Helipot Div. of Beckman Instruments, Inc., Fullerton, Calif., believes that the lag in finished electronic products began two years ago. "It has taken 18 months to feel it in components," he said, "but it

will take only two to three months to pick up the slack."

The Electronics Div. of Allen-Bradley Co. in Milwaukee, probably the world's largest supplier of fixed-composition resistors, expects military and consumer markets to decline slightly through 1970, while industrial sales remain relatively stable. Variable resistors, the company said, will be affected the same way.

Connectors have not escaped unscathed from the general downward trend. "On an over-all basis," says Burndy's Gray, "connector sales are probably down as far as 15% this year over last year. Although the military business is probably down as much as a third, the commercial-industrial segment is up over last year by 5 to 10%."

Burr-Brown Research Corp., Tucson, Ariz., a module manufacturer, had a growth of 10 to 20% last year and is hoping to at least meet this figure for 1970.

To increase sales, Burr-Brown is trying for a larger share of the market through new products and new customers. "Today is not like back in the early 60s, when you could do a lot of things wrong and still grow," Cate said.



Burr-Brown is not increasing its total of new products, but it is stressing the need for more significant products.

"We are developing new prod-

ucts to lower the cost of our customers' end products," Cate said.

Burndy's marketing manager reported: "There may be some re-shifting, but in total numbers our work force will remain the same. In the engineering department, we have good engineers and we aren't letting them go—in no way, no how."

Sprague intends to be relatively conservative with respect to new-product development and research. Although there have been no major cutbacks in the work force, hiring is only isolated and not concentrated in any one group.

An official statement from Allen-Bradley asserts that "the company is continuing heavy activity in both thick and thin-film resistor networks, as well as research and development in the hybrid circuit area." A company spokesman reported that no personnel cutbacks were anticipated—and, in particular, none in the engineering work force.

When will the much-talked-of business turnaround come? Component manufacturers feel that it is not far away.

Beckman looks for a pickup between September and January. Others tie the turnaround point to a tapering-off of the war in Vietnam.

Burr-Brown's product marketing engineer commented: "The business turnaround should occur when the military shifts its spending from the war to new weapon systems and into the R&D area."

Burndy's marketing manager said:

"The slowdown in military electronic components will continue until the war ends. Once it's over, I think the electronics business is going to shoot off like a skyrocket.

"The turnaround point should be sometime next January." ■■

## Instrument manufacturers feeling pinch

In the instrument segment of the electronics industry—oscilloscopes, voltmeters, frequency sources and electronic counters—the economic mood among instrument manufacturers is one of increasing concern.

A commonly heard report is that sales for the last six months have been well off projected figures—down by 20 to 25%—despite the fact that some instrument manufacturers are enjoying increases over last year.

Two reasons are given for the drop: one is a decline in federal spending for research and development; the other is a general industrial belt-tightening, leading to smaller orders for test and measurement instruments.



# New FET V-O-M features 8 Low-Power Ohms Ranges . . . 0.005 V AC Full Scale

Triplet's new Model 801 V-O-M offers 73 measurement ranges including 8 low-power resistance ranges that apply only 35 mV to the device under test. There are 22 voltage ranges—10 DC and 12 AC; 24 current ranges divided equally between DC and AC; 15 resistance ranges—including the 8 low-power ranges; and 12 ranges of output measurement.

As if such unsurpassed versatility were not enough, the Model 801 also offers 11 megohm DC and 10 megohm AC input resistances, 2% DC and 3% AC accuracy and a 25 uA suspension-type meter with a nearly 7½" long scale. There's no doubt that the new Triplet Model 801 has no equal among analog V-O-M's in terms of sensitivity and versatility.

See the remarkable new Model 801 V-O-M—priced at **\$200** suggested USA user net—at your Triplet distributor. For more information—or for a free, no-obligation demonstration—call him or your Triplet sales representative right away. Triplet Corporation, Bluffton, Ohio 45817.



The World's most complete line of V-O-M's . . .  
choose the one that's just right for you

Model 801



1. 8 ranges of low-power ohms at 35 mV with 1 ohm center scale.
2. High sensitivity (0.005 V AC full scale) at 10 megohm input resistance.
3. 8" meter has simplified scale with only 2 arcs for 46 AC/DC ranges.



One bright note is that nearly all companies queried by ELECTRONIC DESIGN report sharp increases in their international sales. Most indicate that overseas sales are up by 15 to 20%. Hewlett-Packard, Palo Alto, Calif., says a strong increase in its international sales has helped raise its total of orders by 6%, despite the fact that domestic orders alone are down by 6%.

Most spokesmen agree that unless the nation's economy picks up instrument sales in this country will, at best, remain static. Some companies have already initiated economy measures to combat the slump. Hewlett-Packard is giving its U. S. employees—including corporate officers—a day off every other week without pay.

Systron-Donner, Concord, Calif., has laid off 5 to 10% of its personnel.

Dr. Donald B. Sinclair, president of General Radio Co., West Con-

cord, Mass., blames federal pay increases, in part, for the dip in instrument sales.

"I believe that Government bureaus, such as the Dept. of Transportation and the National Science Foundation, are diverting some of the money allotted for instrument purchases into the payroll as a result of retroactive raises. This, in turn, has caused many companies whose customers deal with the Government to experience a decrease in sales orders."

Modern designs are being emphasized in an effort to hold the line. Monsanto Instruments of West Caldwell, N. J., for example—manufacturers of electronic counters and digital voltmeters—reports that its domestic sales were off projected figures by only small amounts. Thomas Odderstal, sales director, says this is probably due to the relative newness of the company's instrument designs.

"Users of instruments are now less likely to invest large sums of money in an instrument whose design might become outmoded in a short period of time," he says. "Newer designs would not become outmoded as fast."

"It is time for strong emphasis on marketing; time for the clever companies to be looking at where they are going. There are going to be some changes in the available markets for instrument sales."

"I feel that the defense sector of the electronics industry will be down in instrument sales, the aerospace sector will hold its own and non-defense Government industries, such as the Atomic Energy Commission, will probably be up in instrument sales orders."

### A big shakeout on the way?

Dr. Herman Epstein, president of Singer Instruments, Bridgeport, Conn., comments: "There are going to be many shakeouts in the instrument business. Many small companies whose sole business is test and measurement equipment are going to be out of business if this economic slump continues. We have been fortunate in that we have other divisions that deal with electronic components and systems to lean on."

Not only instrument makers but the manufacturers of instrument enclosures, or cases, have been affected by the slowdown. One of the largest enclosure manufacturers in the country says its sales this year are far below last year's as a result of a decline in business with the instrument manufacturers. Instrument makers, this company reports, are using a single enclosure design for several types of instruments, thereby eliminating the need to buy new designs for each new instrument. ■■

## Microwaves: A hunt for new buyers

With the exception of a very few large domestic programs, the microwave industry is looking towards the foreign market and certain nonmilitary areas—communications and transportation—for stability in the second half of 1970.

A survey of major manufacturers in the industry yields a consensus that employment of microwave engineers will drop to a level about 30% below that of six months ago. At that point, most industry spokesmen believe the industry should be able to maintain itself.

Many small companies appear ready to fall by the wayside. This is attributed to the tight money

market and a scarcity of orders. Several of these firms are still in business today only because of the spare parts market and the Vietnam war.

Jesse Taub, a consultant with the AIL Div. of Cutler-Hammer in Melville, N. Y., notes: "I think that there will be more of an employment shakeout, leaving only the sharper and more creative people."

Of military business, James H. Johnson, manager of marketing for the Hughes Aircraft Electron Dynamics Div. in Torrance, Calif., says: "Major new development money in the next six months will come from F-14, F-15 and B-1 programs."

Most industry sources expect the move into foreign markets to take up the slack in domestic business. Richard Orth, vice president of the Electron Tube and Device Group of Varian Associates, Palo Alto, Calif., points out: "Since the United States no longer is des-



tined to be the policeman of the world, we must furnish more and more technical assistance to our allies." This business, he believes, will be primarily in military radar and communications systems.

In the nonmilitary areas of interest, a major move is being made toward use of millimeter waves for communications in the near term and lasers at a later date. Taub of AIL says: "We can now see at least moderate amounts of power being generated from 40 GHz to 110 GHz by Impatt oscillators. Money is being spent by Bell Labs on ground-to-ground communications. With the new extra-high-cutoff varactors, it is possible to

build practical millimeter paramps for low-noise receivers."

Taub points out further: "There is some money in low L-band, special-purpose, point-to-point communications."

Included in communications is cable TV. Johnson of Hughes reports: "We're involved with microwave equipment for the cable TV industry."

In the transportation area, both air and ground equipment is important to microwave manufacturers. According to Taub, "We've seen money coming into the industry for transportation applications. Such things as aircraft landing systems, beacons and associated

microwave relay lines. Money for this comes mostly from state and federal governments."

Also mentioned by many are aircraft pilot-warning systems, collision-avoidance systems and clear-air-turbulence detection systems.

Most of the nonmilitary applications will depend upon solid-state microwave sources and microwave integrated circuits. Taub says: "Solid-state power generation has kept going at a good level, even though hard times have fallen on most other areas. With microwave integrated circuits and volume-production techniques, prices could come down to a point where commercial markets will open up." ■■

## West Coast job market getting tighter

**DESIGN ENGINEER WANTED.** 5 years' experience in CRT power supplies. High-voltage experience. BSEE. Salary \$12,000.

This request taken from the files of a professional job recruiter in San Jose, Calif., is typical of current employment prospects for engineers in California. There is hiring, but it is very selective. As one recruiter in Los Angeles puts it: "Companies are looking for 'direct plug-ins,' and they know they can get them because there are so many unemployed professional people around right now."

Salaries also have been affected. They tend to be lower than they were two or three months ago.

As for Washington and Oregon, professional recruiters there report virtually no hiring of EEs.

The West Coast has been harder hit by military/aerospace cutbacks than any other part of the country because of its heavy dependence on military contracts. Seattle has long depended on the Boeing Company to employ the greater part of the labor force.

When Boeing cut 25,000 persons from its payrolls by layoffs and attrition during the first six months of this year, the job market was flooded with over 2700 professional/technical personnel. The picture continues dark at least until the end of 1970. According to a Boeing spokesman, the work

force will be reduced to a total of not less than 45,000 by December, 1970—down from 80,400 at the beginning of the year. This will mean laying off about 10,000 more people during the last six months of the year. Even the awarding of \$170 million for a two-year developmental contract in connection with the airborne warning and control systems (AWACS) is not expected to improve the situation significantly, the spokesman said. The "bottomed-out" figure of 45,000 by December, 1970, was predicted upon receipt of the contract, he said, and most of the personnel assigned to the program will be transferred from within the company.

### Employment down 18%

The second hardest hit area on the West Coast is probably Greater Los Angeles. Robert Leventhal, secretary of the Southern California Professional Engineering Association, estimates that the employment of all types of engineers and scientists in the area is at least 18% below what it was in February of 1969.

In addition to military/aerospace cutbacks, the West Coast is a victim of the nationwide electronic downturn that began to affect the instrument business more than a year ago and has reportedly

extended even to the computer industry in the last two or three months. A recruiter in Los Angeles reports that only computer peripheral companies are hiring EEs now, and they are looking for people with specific experience—in the design of tape transports, readout devices, terminals, microfilm systems, etc.

Despite the general downturn, however, there are a few bright spots, most of them in the San Francisco Bay area. There is a base of unemployed professional people there because it is a center for Government R&D as well as aerospace contracts. However, professional recruiters report that semiconductor companies, as well as systems companies, are looking for engineers with experience in LSI—both MOS and bipolar—as well as digital logic. Salaries for these jobs are described as "reasonable." But, as one recruiter puts it, "a guy with 10 years' experience designing radar systems is out of luck unless he's also a digital man."

Elsewhere, too, the news isn't all bad. In the Greater Seattle area, the number of electronics concerns has increased 30% since 1968 to a present total of 60. According to an industry spokesman there, these companies are as healthy as electronics companies elsewhere, but they are not able to

absorb many of the EEs who have been laid off by Boeing.

Boeing's Aerospace Group at Kent, Wash., near Seattle, recently announced that its electronic manufacturing organization would aggressively seek Government contracts for the manufacture of data-processing equipment and custom microelectronics instead of functioning in these areas strictly as an in-house facility. As a result, the group hopes to increase its employment by 50% by the end of

1971 adding about 50 EEs.

One bright spot in the Los Angeles area is North American Rockwell Corp., Los Angeles, which expects to hire about 2,000 people during the last six months of 1970 to work on the air frame of the new B-1 supersonic bomber. This number may include some electronic engineers, a company spokesman said. In addition, the company expects a decision shortly on an additional contract to cover a new avionics system for the bomber, which

would be subcontracted to an electronics company.

An industry spokesman in San Diego told ELECTRONIC DESIGN that although the aerospace business in that area was flat, the presence of a number of computer and computer peripheral-equipment companies—such as National Cash Register, Honeywell's EDP and Data Products Div., and Digital Development Corp.—had helped stabilize the situation there to a great extent. ■■

## For computers, it's shakeout time

A shakeout is under way in the computer industry, but for the survivors, the prospects are far from grim: They are either consolidating gains in this year of general business slowdown, or happily ringing up new sales records.

Employment is following the overall trend. It's down among some of the manufacturers of large-scale computers, such as Control Data Corp. and Xerox Data Systems, but it's up among the more successful peripheral equipment and minicomputer houses.

Wariness is the watchword among both the giants and dwarfs as such events as the Honeywell-GE computer merger and the failures and consolidations in software and service bureaus are evaluated by management.

The two major factors on the gloomy side are the credit crunch and defense cutbacks. On the bright side is the continuing expansion of the minicomputer market. Donald P. Kenney, program manager of the Computer Technology Dept. of Mobil Oil Corp., New York City says his company will continue to install the minis as part of its continuing program of automation.

"The minis can be acquired with little cash investment, and they have performance-price ratios far in excess of big machines," Kenney says.

Reasoning like this has propelled Digital Equipment Corp., Maynard, Mass.—the largest and most integrated maker of minicomputers—to the highest point in its sales history. The nine month's report for the period ending March 31,

1970 showed sales of \$97 million and earnings of \$1.10 per share compared to \$61 million and \$0.63 per share for the same period in 1969. Other small machine manufacturers—General Automation, Inc., Anaheim, Calif., for example—are also experiencing rapid growth. Unfortunately profits have not always followed the sales curve upward because of high interest rates and inflation.

The second bright spot is the explosive growth of peripheral equipment in response to a demand for higher performance or lower price. Auxiliary memories—disc, tape and drum—are being redesigned. The star performers are digital tape-cassette recorders and head-per-track discs. Both of these have high performance and low cost—features that make them popular with minicomputer users.



Success in numerical control (assembly area shown) led Cincinnati Milling Mach. Co. to minicomputers.

The large-scale auxiliary memories have not been ignored either. IBM has announced the 3300 series disc storage, with almost twice the number of tracks, double the bit density and half the access time of earlier models.

Among the input/output peripherals, noninteractive keyboard-CRT and keyboard-cassette terminals are stimulating business. Among the major applications for this equipment are the new direct keyboard entry or key-to-tape systems for data inputs. The old punched-card systems are clumsy, slow and bulky. Cards will be around for a while because of the huge investment they represent, but new installations will be displacing them steadily. Since the direct-input systems are electronic, this will create more demand both for trained electronic personnel and components.

The proliferation of new ideas and the easy availability of risk capital that existed before the downturn in the American economy spawned a host of hardware and software companies. Now, with the economy in the doldrums, there has been a wave of failures and consolidations among computer corporations, according to Norman S. Zimbel, member of Arthur D. Little Co., Cambridge, Mass.

Zimbel predicts a continuing shakeout in the computer industry through the remainder of 1970 and into 1971. He expects that the rapid pace of technological change will continue as new types of memories demand a restructuring of mainframe architecture. ■■

(continued on page 36)

The same pricing advantage holds true for RCA's 2N5038—at \$6.25. (Prices of 2N5039 and its companion type are based on 1000-unit purchases. These prices go down as your volume requirements go up.) For the full story, call your local RCA Representa-

tive or your RCA Distributor. For technical data, write: RCA, Commercial Engineering, Section 57H-2/UT10, Harrison, New Jersey 07029. International: RCA 2-4 rue du Lièvre, 1227 Geneva, Switzerland, or P. O. Box 112, Hong Kong.

# RCA

## 2N5039... switches off 15 A in less than 250 ns at \$4.90

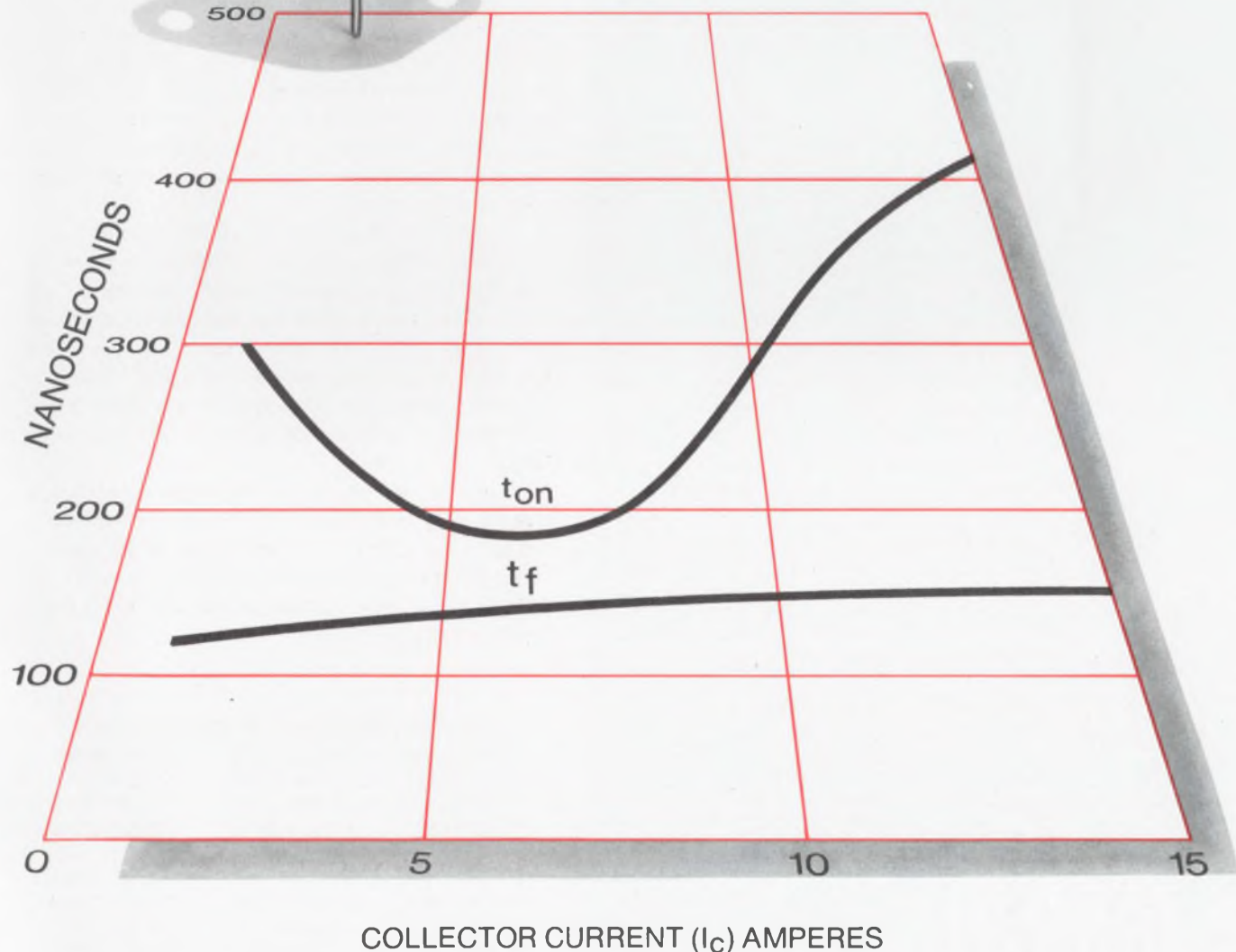

COLLECTOR CURRENT (I<sub>c</sub>) AMPERES

INFORMATION RETRIEVAL NUMBER 162

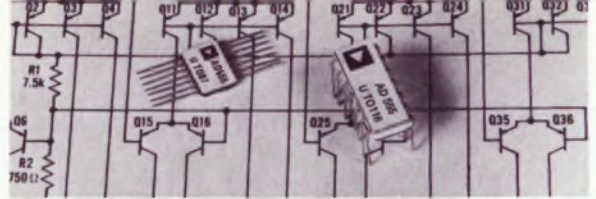

# μDAC 555

## The World's First Monolithic IC Multiplying D/A Converter

- 4 SPDT SWITCHES ON A SINGLE CHIP
- 12-BIT  $\pm\frac{1}{2}$ LSB ACCURACY
- FULL 4 QUADRANT MULTIPLICATION CAPABILITY
- $\pm 5\text{ppm}/^\circ\text{C}$  MAX TC,  $-55^\circ\text{C}$  TO  $+125^\circ\text{C}$
- IDEAL FOR DIGITAL-TO-SYNCHRO APPLICATIONS
- MEETS MIL-STD 883... FLATPACK OR DIL

EQUIVALENT CIRCUIT AD555 QUAD SWITCH

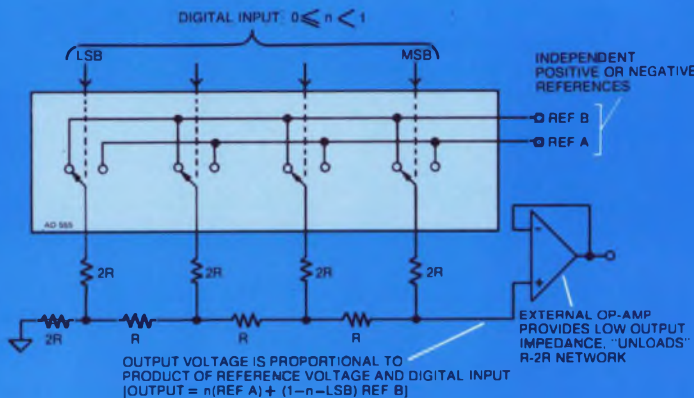

SINGLE SWITCH CELL OF 4 SWITCH QUAD

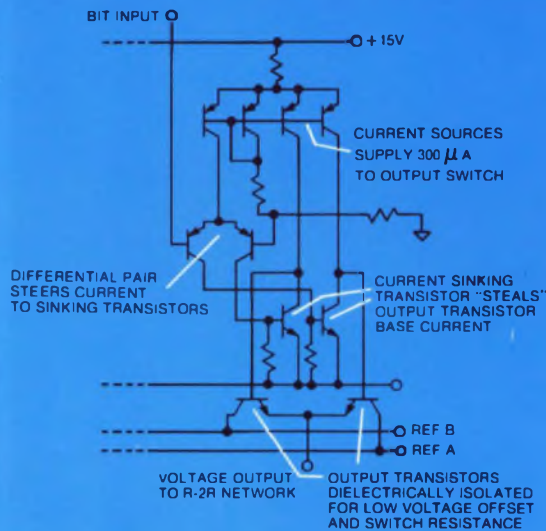

12-BIT MULTIPLYING D/A CONVERTER

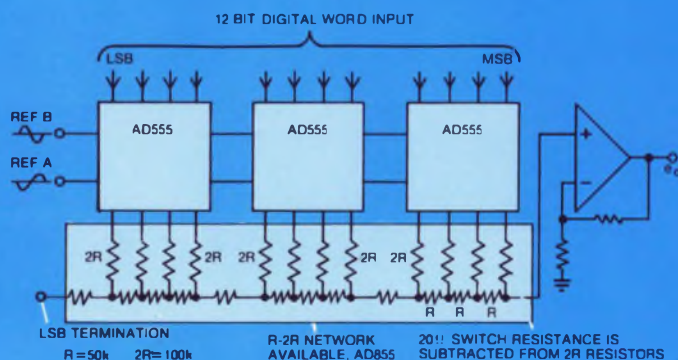

Second in a series of monolithic IC D/A converter circuits, the Analog Devices Model AD555  $\mu$ DAC is intended for applications which require variable reference inputs. This feature permits full 4 quadrant multiplication of the analog and digital inputs, useful in many avionic applications such as digital-to-synchro conversion, digital gain control, etc.

The  $\mu$ DAC AD555 is comprised of 4 dielectrically isolated voltage switches driven by logic input buffers compatible with all popular DTL or TTL logic. With the addition of an R-2R resistor network, each AD555 becomes a 4-bit D/A converter. All critical parameters are matched to permit three such  $\mu$ DAC's to be simply interconnected to form a monotonic 12-bit converter with  $\pm\frac{1}{2}$ LSB accuracy.

Proprietary design techniques yield switch performance similar to discrete-component solid state switches, but with inherently better tracking. Switch "ON" resistance is 20 ohms, matched to  $\pm 5$  ohms within each chip. Precision 12-bit thin film R-2R resistor networks, matched to switch ON resistance, are also available from Analog Devices. Voltage offset is  $1\text{mV} \pm 1\text{mV}$  max. Switching delay time is typically  $3.5\mu\text{s}$ .

For free new application notes giving complete specifications and theory of operation of this new series of monolithic D/A converters, or to request evaluation samples phone your local sales office or Mr. Richard Ferrero collect on the ANALOG HOT LINE ... (617) 969-3661.

### ANALOG DEVICES' SALES OFFICES

205/536-1969	314/725-5361	602/274-6682
206/767-3870	315/454-9314	604/926-3411
213/595-1783	317/846-2593	607/748-0509
214/231-4846	412/371-9449	612/881-6386
215/643-2440	415/941-4874	613/224-1221
216/261-5440	416/247-7454	617/492-6000
301/588-1595	512/732-7176	713/622-2820
303/781-4967	513/426-5551	716/685-4111
305/424-7932	514/683-3621	913/831-2888
312/774-1452	516/692-6100	918/622-3753
313/886-2280	518/372-6649	

221 FIFTH STREET • CAMBRIDGE, MASSACHUSETTS 02142



## Industrial electronics market standing fast

Industrial electronics—equipment used, directly or indirectly, to produce other products—is expected to hold its own in the generally declining electronics market. The reason for this exception to a largely gloomy market picture today is that manufacturers of all kinds need to compete by offering more reliable products at lower costs.

One way to achieve this is to buy minicomputers. This relatively inexpensive machine is appearing in smaller and smaller companies—some with as few as 200 employees—to serve as a controller of other machines and processes. The minicomputer runs tests at various stages of production. It keeps track of inventories, costs and the labor expended. And it supervises other computers in a hierarchical plan.

The market for minicomputers is expected to grow at a healthy pace. The Electronic Industries Association estimates that \$325-million worth of computers for industrial-control operations were sold in 1969. The estimate for 1970 is \$355-million.

Sales of industrial-control and processing equipment, which EIA says amounted to \$421-million in 1969, are also growing. In 1970 sales will climb to \$435-million, the association predicts. These instruments are used to measure, record and regulate temperature, pressure, flow, liquid level and other process variables.

The market for electronic testing and measuring instruments for industrial-commercial purposes reached an estimated \$452-million during 1969, EIA reports. This year, it forecasts, sales will hit \$490-million.

Automatic test equipment for all stages of production will be bought in increasing amounts to assure quality control and reduce personnel. The exceptions will be on-line test equipment for military products and for consumer goods—both of which are down.

Manufacturers of power semiconductors are confident of a growing market, with 1970 industry sales expected to exceed \$150-million. ■■

## PROVEN IN HIGH-SPEED ANALOG APPLICATIONS

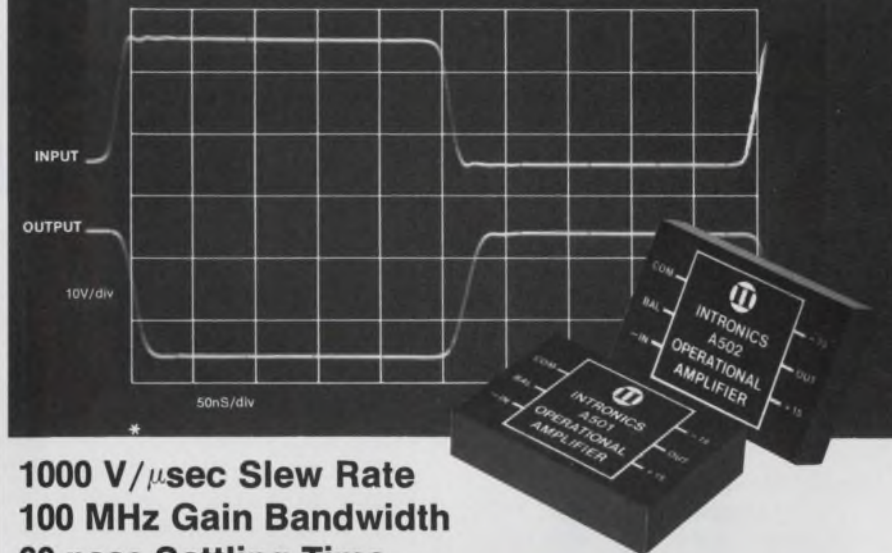

**1000 V/ $\mu$ sec Slew Rate**  
**100 MHz Gain Bandwidth**  
**60 nsec Settling Time**

Intronics' Models A501 and A502 Op Amps, specifically designed for high frequency inverting operations, drive loads up to  $\pm 50$  mA at  $\pm 10$ V while slewing at 1000 V/ $\mu$ sec — and offer 100 MHz gain bandwidth. Model A502 additionally features a 0.1% settling time of 60 nsec. Both models operate from  $-25$  to  $+85^\circ\text{C}$ , measure 1.2 x 1.8 x 0.6 inches, weigh 1 oz. installed and work off  $\pm 15$ V supplies. Standard .040-inch connecting pins are spaced on a 0.1-inch grid pattern for etched circuit board connection (or may be plugged into optional mating socket). Price (1-9): A501 — \$105, A502 — \$125.

Models A501/M and A502/M with an operating temperature range of  $-55$  to  $+125^\circ\text{C}$  are offered to meet military and space program requirements.

Models A501 and A502 are ideally suited to:

- High speed integrators
- Video summing applications
- Coaxial line drivers
- Deflection control amplifiers

Specify Model A502 for fast settling applications:

- High speed A — D or D — A conversion
- Tightly feedback on non-linear feedback requirements
- As a high-speed rectifier



### FREE 12-PAGE DESIGN GUIDE

Features theoretical and practical considerations in applying wideband amplifiers to the design of high speed analog circuitry. Send for your copy.

For further information or applications assistance, write or call INTRONICS, 57 Chapel Street, Newton, Massachusetts 02158, Tel: (617) 332-7350; TWX: 710-335-6835 — or see a demonstration at . . .

**WESCON, BOOTH 656, AUGUST 25 - 28**

\*Model A501 operating as unity gain amplifier. Scope trace reproduced from actual Polaroid scope photo.

 **intronics**

INFORMATION RETRIEVAL NUMBER 21

## New D-C generator simplifies alignment

This new design eliminates the need for a front bearing in the generator. Instead, it utilizes a drive motor shaft and bearing which simplifies alignment resulting in improved performance and longer mechanical life. Ideal for high response motor systems with fast reversals, such as are required in computer applications.

The Model ST-7258A D-C Generator is available with output ranges from 3v to 10v/1000 rpm and approximate rotor inertias of 3.5 gm-cm<sup>2</sup> to 8.5 gm-cm<sup>2</sup>.

SERVO-TEK PRODUCTS COMPANY  
1086 Goffle Road, Hawthorne  
New Jersey 07506  
Phone: 201-427-3100

**SERVO-TEK**<sup>®</sup>  
PRODUCTS COMPANY

Call or write for complete details.

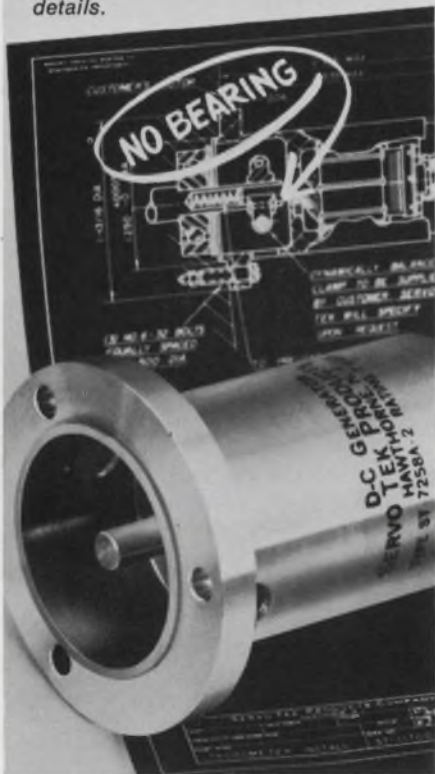

## Aerospace-defense firms hurt badly

No change is expected for the remainder of this year in the already bleak aerospace-defense economic picture. Some companies fear the gloom will linger long beyond that: They don't look for any improvement before late 1973 or early 1974.

The industry is now operating largely on contracts already under way. Congress still has not passed a defense budget for fiscal 1971, which began July 1. And when the election-conscious Congress does vote a budget into law, the total will probably be lower than that requested, rather than higher.

Forecasters in industry, the military, NASA and the Electronic Industries Association all fall back on such phrases as "up in the air" and "poorly defined." No one feels confident to read the future.

The impressive number of aircraft contracts now active—the F-14, F-15, B-1, S-3, AWACS and the SST—don't call for large-scale employment, according to a spokesman for Grumman Aerospace Corp., Bethpage, N. Y., "They are all in the early R&D, or program-definition, stages and don't need many engineers. Several years from now, production will require more personnel."

### B-1 provides a lift

The B-1 aircraft contract, however, was a big shot in the arm for North American, Downey, Calif.; it will require 1000 to 1500 engineers over the next six months, according to a company spokesman. But these will be largely systems, aerodynamics, thermodynamics and avionics engineers.

One of the largest defense-aerospace companies in the United States says it expects business to get worse through 1973. The upturn in 1974, its Washington, D.C., office says, will come from pro-

duction of military aircraft now in the R&D stage. The exception to this bad news, according to the company's market researchers, will be missiles and ships.

The Aegis missile, SRAM, Minuteman III and Poseidon will remain big business. And if the anti-ballistic missile program expands, it will provide contracts for years to come.

Money for ships is up and may go higher. The Navy plans to continue to build aircraft carriers and a new fleet of highly automated destroyers.

Litton Industries is hiring 700 electronics engineers under its \$2.1-billion contract to build 30 destroyers in the next 10 years at the Ingalls Shipbuilding Div. in Pascagoula, Miss. And makers of electronics for ships are gearing up for part of the action. These include makers of sonars—although one big manufacturer says that sonars cost so much now that the Navy will spend a lot for sonars but won't get many of them. Other companies to benefit from the big shipbuilding program include manufacturers of computers—the ships will be the most automated to date—communications equipment, radars and displays.

The next big manned space programs are the shuttle and the space base—both in the program-definition phase. The money is not impressive, nor is the employment significant. The \$8-million in studies, being carried out by North American and McDonnell Douglas, will last 11 months. North American is using 200 engineers—mainly systems and design—for its study, and many are working on materials research and thermal problems.

Significant funding and employment for these programs, NASA says, can't be expected before 1973. ■■



**Bench or System — the HP 3450A gives you maximum performance in a minimum space.**

A quick look at the unfolding dodecahedron shows each of the 12 functions the Incredible Dodecameter performs. What it doesn't show is just how well this 5-digit multifunction meter performs each function.

For instance, you not only get true rms capability—you also get value-plus features like true 4-terminal ac ratio testing and 4-terminal ohms measurements.

And, accurate, fast measurements in each of these twelve categories is

only the start. You can add digital output and directly control external equipment like a printer. Or, add remote control and get full programmability for system use.

No matter what the application, you get more for your money with the HP 3450A.

This Incredible Dodecameter lets you start with the basic dc meter and add the capability that best fits your requirements. If your needs change, any of the options (except the rear

input terminals) can be easily installed in the field.

For more information on this outstanding 12 in 1 bargain, just call your local HP field engineer. Or, write Hewlett-Packard, Palo Alto, California 94304. Europe: 1217 Meyrin-Geneva, Switzerland.

Price Basic HP 3450A, \$3300; AC Option 001, \$1250; Ohms Option 002, \$425; Limit Test Option 003 \$375; Digital Output Option 004, \$190; Remote Control Option 005, \$245; Rear Input Terminal Option 006, \$70.

090/8A

# The Incredible Dodecameter— A 12-in-1 way to better measurements!

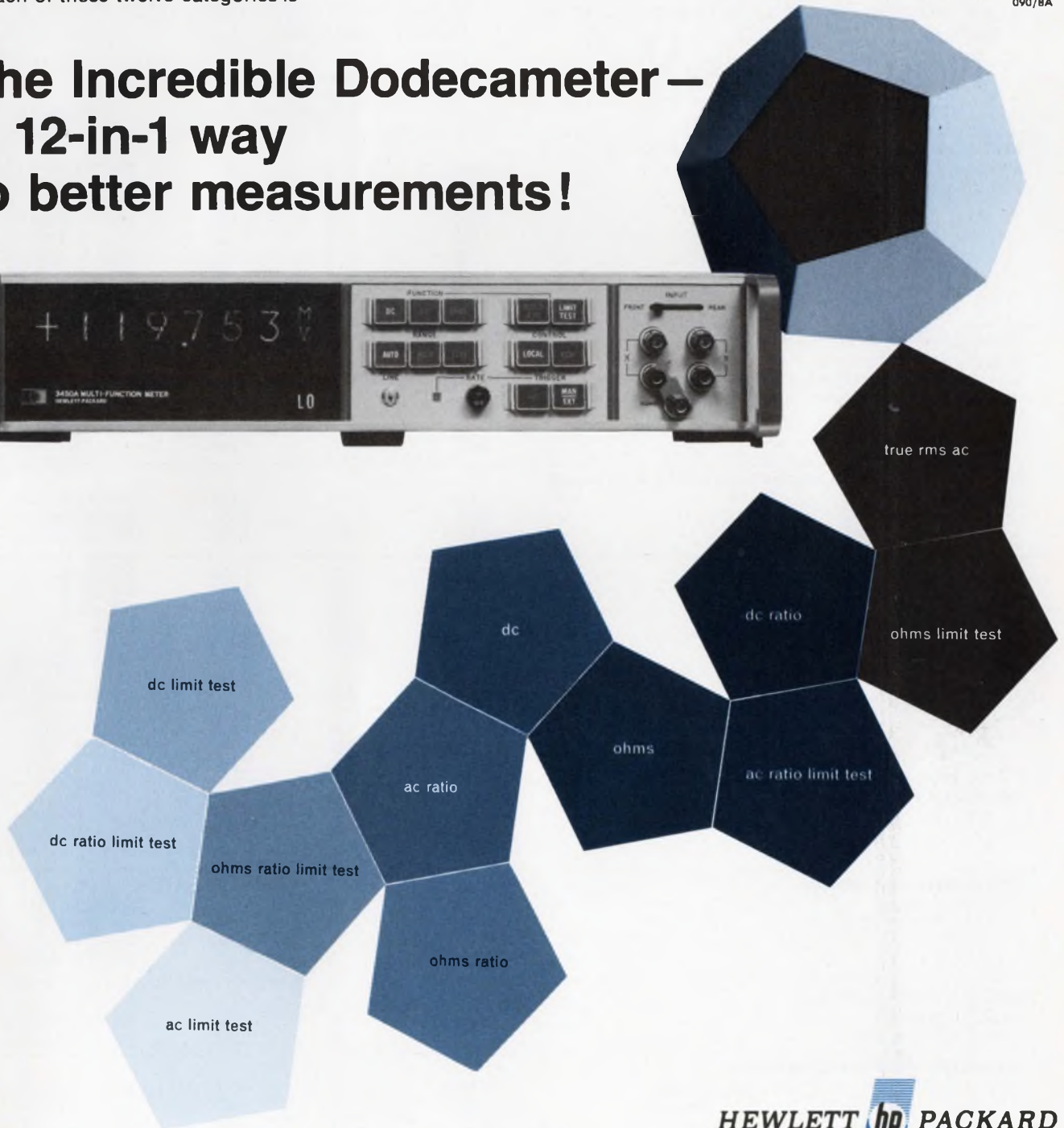

**HEWLETT  PACKARD**  
DIGITAL VOLTMETERS



V-Scan Binary Encoder

See More Complete Catalog Information in



# Norden Encoders: there's no better way to convert shaft angles to numbers.

Norden offers the broadest line: magnetic, optical and contacting. Plus reliability, verified by 100% testing. Plus competitive pricing. And fast delivery.

For more information and detailed specs, write Norden, Att: Components Dept., Helen Street, Norwalk, Conn. 06856. Phone (203) 838-4471. TWX: 710-468-0788.



	Total Count	Revolutions for Full Count	Diameter"	Model Number
<b>NEW! Rugged Industrial Grade Optical Incremental Encoders</b>				
All available with quadrature and internal squaring circuit options	4,000	1	3.500	OADC-35/4000/INC
	3,000	1	3.500	OADC-35/3000/INC
	2,500	1	3.500	OADC-35/2500/INC
	2,000	1	3.500	OADC-35/2000/INC
	1,200	1	3.500	OADC-35/1200/INC
	1,000	1	3.500	OADC-35/1000/INC
	600	1	3.500	OADC-35/600/INC
	400	1	3.500	OADC-35/400/INC
	200	1	3.500	OADC-35/200/INC
<b>Optical Incremental Encoders</b>				
All available with index marker, quadrature outputs and internal squaring circuit options. Other counts on special order.	500	1	2.250	OADC-23/500/INC
	512	1	2.250	OADC-23/512/INC
	1,000	1	2.250	OADC-23/1000/INC
	1,024	1	2.250	OADC-23/1024/INC
	2,000	1	2.250	OADC-23/2000/INC
	2,048	1	2.250	OADC-23/2048/INC
<b>IC-Compatible Encoders. For direct interface with TTL &amp; DTL circuits</b>				
Binary	128	1	1.750	ADC-ST7-BNRY-E/L
	8,192	64	1.750	ADC-13-BNRY-E/L
	524,288	4,096	1.750	ADC-19-BNRY-E/L
<b>Binary-Decimal Code</b>				
	100	1	2.250	ADC-ST2-BCD/L
	1,000	10	2.250	ADC-3-BCD/L
	10,000	100	2.250	ADC-4-BCD/L
	100,000	1,000	2.250	ADC-5-BCD/L
	1,000,000	10,000	2.250	ADC-6-BCD/L
	360	1	2.250	ADC-3-36BCD-E-360L
	3,600	10	2.250	ADC-4-36BCD-E-360L
	36,000	100	2.250	ADC-5-36BCD-E-360L
	360	1	3.250	ADC-ST3-36-BCD/L
	3,600	36	2.250	ADC-4-36-BCD/L
	36,000	360	2.250	ADC-5-36-BCD/L
	360,000	3,600	2.250	ADC-6-36-BCD/L
<b>External Logic V-Scan Binary Encoders</b>				
	128 or 256	1	1.750	ADC-7/8-BNRY-XB
	8,192 or 16,384	64	1.750	ADC-13/14-BNRY-XB
	524,288 or 1,048,576	4,096	1.750	ADC-19/20-BNRY-XB
<b>Single Turn Gray Code Encoders</b>				
Available with various levels of RFI suppression	256	1	1.066	ADC/11/8-GRAY
	256	1	1.750	ADC-ST8-GRAY
	512	1	2.250	ADC-ST9-GRAY
	1,024	1	3.062	ADC-ST10-GRAY
<b>Multiturn Gray Code Encoders</b>				
Available with various levels of RFI suppression	1,024	4	1.062	ADC-11/10GRAY256
	1,024	16	1.062	ADC-11/10GRAY 64
<b>Low-Cost Magnetic Noncontacting Encoders</b>				
Incremental	128	1	1.750	MADC-18/128/INC
Binary	128(V scan)	1	1.750	MADC-18/7/BV
Binary	8,192(V scan)	64	1.750	MADC-18/13/BV
Binary	524,288(V scan)	4,096	1.750	MADC-18/19/BV

All magnetic encoders are normally furnished with sleeved leads. Terminal header or Cannon connector options are available for all units. Non-standard counts within the capabilities of the encoder are available on special order.

TI's quiet  
revolution in  
optoelectronics



## Now, phototransistors that hang in there

Take another look at the flange. The metal can. The two leads sealed to glass and mated for standard TO-92 sockets.

You won't see rugged, easy-mount features like these in any other low-cost sensors.

TI's improved line comes priced below comparable 100% epoxy devices. As little as 67c each in 100s.

The payoff:

Smooth assembly. Obviously easy and inexpensive mounting. Staying power in the 100,000-hour league. And, the speed and economy "opto" delivers in switches, controls, indicators, displays.

TI is quietly creating new oppor-

tunities for designers with standardized devices like this new NPN line. Standardized, yet the only line in its class that gives you a choice of 5 specific light current sensitivity ranges. All off-the-shelf.

TYPE	TIL63	TIL64	TIL65	TIL66	TIL67
MIN	0.4	0.4	1	2.5	6
MAX		1.6	4	10	
UNIT	mA	mA	mA	mA	mA

There's more for you on TI's growing optoelectronics shelf.

Help yourself to over a decade of system reliability and speed improvements. Designers now enjoy devices 20 times more reliable and 1000 times faster than the costly

electromechanics they replace. Circuits get simpler, too, thanks to low voltage and current demands.

Your TI choice is the industry's broadest. From high density, ready-made arrays to standard singles. Emitters. Couplers. Isolators. Custom designs, too. The works.

Chances are, TI's "opto" can revolutionize your works.

Get the data sheet on the phototransistors that hang in there. Write Texas Instruments Incorporated, P.O. Box 5012, MS 308, Dallas, Texas 75222. Or circle reader service number 240.



TEXAS INSTRUMENTS  
INCORPORATED

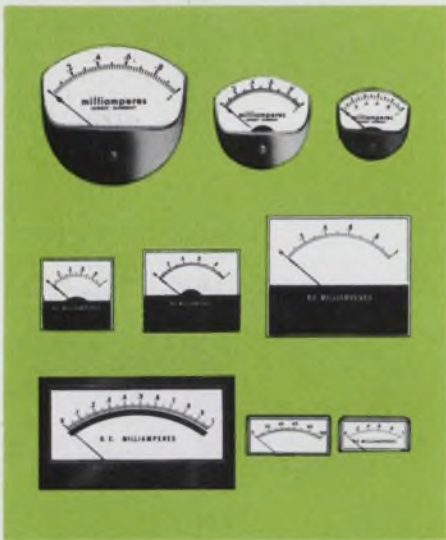

**Honeywell's versatile line of precision meters.**

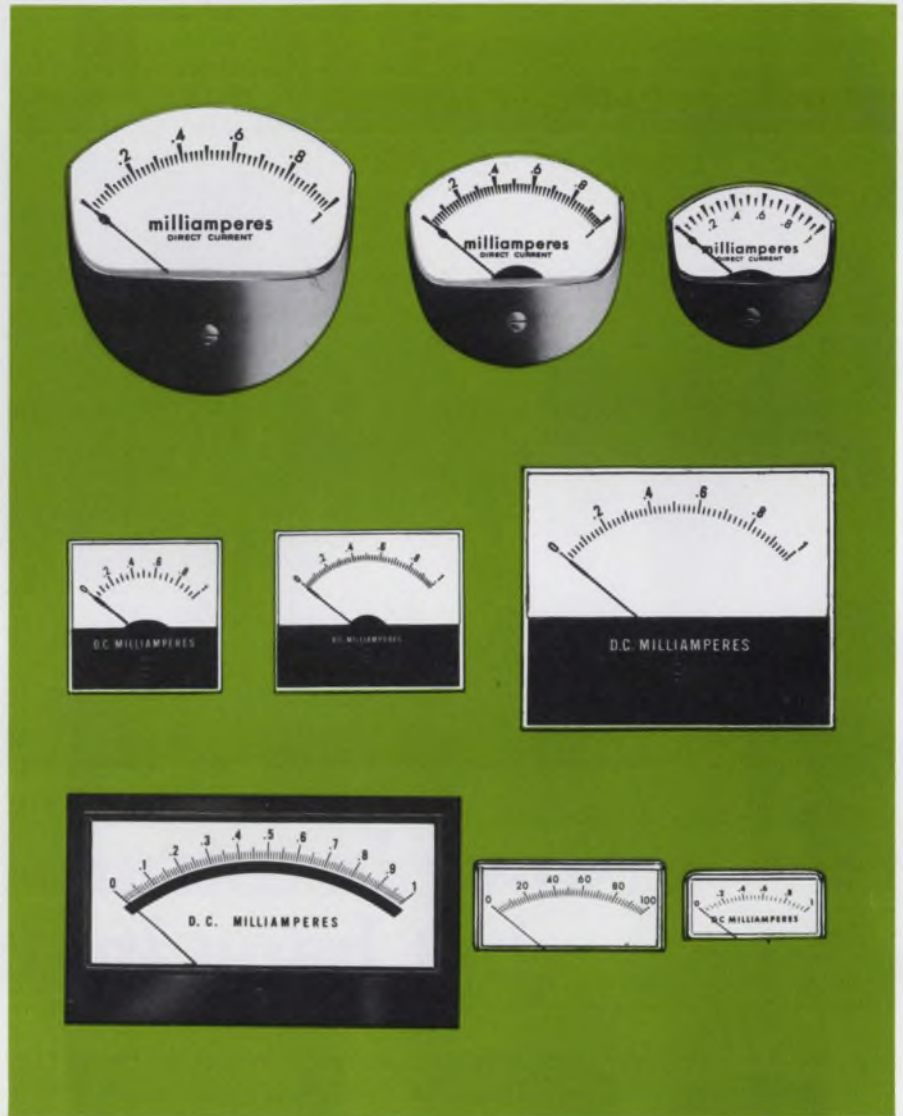

## Now that versatile line of precision meters is **Jewell**

Same plant. Same people. Same meters that were made popular by superior styling, design and quality. Only now they're Jewell. Everything else is the same—including the compact, frictionless movements and self-shielded, low-cost construction. So, when you need a meter for your application, the best place to find it is still Manchester, N.H. *Write for our spanking new catalog . . . or get in touch with our nearest sales representative, distributor or mod-center.*

See us at Wescon Booth 402

# Jewell

JEWELL ELECTRICAL INSTRUMENTS, INC.

Grenier Field, Manchester, N.H. 03105 • Phone: 603/669-6400



DIVISION

INFORMATION RETRIEVAL NUMBER 25

# Washington Report

DON BYRNE, WASHINGTON BUREAU

## AWACS radar award two years away

The winner in the radar competition for the Airborne Warning and Control System will not be decided before late 1972. Westinghouse and Hughes Aircraft are the two contestants. Boeing, the winner of the over-all \$2-billion contract, expects to take delivery on flight-ready radars from the two firms in November, 1971. Two months of ground tests will follow. The systems will then be mounted on a 707 Jetliner with the minimum modifications needed for the aircraft to fly with the 30-foot mushroom-shaped antenna aboard. Flight tests will start in January, 1972, and run through September, when a selection will be made for the contract.

The radar planned by Hughes has a moderate pulse-repetition frequency. It is not clutter-limited, and its performance generally can be improved by adding power. The Westinghouse radar is of the pulse doppler type, similar to that used by Boeing in the Bomarc target seeker. It will have a high pulse-repetition frequency. One of the major objectives of the flight-test program is to determine which type of radar is most effective at picking up low-flying targets against ground clutter.

The test phase through September, 1972, will cost \$169,982,500. The following phase will cost approximately \$1-billion and will consist of the design of the eight-engine version of the 707 for the operational AWACS and the integration of the complete avionics system. During this phase, locations will be selected for the 30 or more antennas the aircraft will require and a frequency management system will be developed.

Boeing expects to employ a maximum of 7000 people on the AWACS program. Of this number, 4000 will be involved in electronics work and 3000 in design and production of the aircraft.

## FCC's Burch sees no competition between CATV and phones

Chairman Dean Burch of the Federal Communications Commission says he doesn't see the cable TV industry competing with the telephone companies in such specialized communications services as Picturephone or even computer terminals.

The FCC has encouraged the cable TV industry to prepare for "esoteric" two-way service, which Burch interprets as facsimile newspapers, security and alarm systems and audience reaction polls.

The broadband voice, record and data communications would be left for the telephone companies.

## House committee approves import bill

The House Ways and Means Committee has given the President wide authority to limit imports on electronic equipment and other commodities. As expected, however, it has approved import quotas on textiles and shoes.

The proposed measure establishes a provision whereby any industry that feels it is being hurt by imports may file a complaint with the Tariff Commission. If the commission finds "injury or the threat of injury"

along with lower prices or greatly increased imports, it will certify the complaint as being valid. This automatically gives the President 180 days to seek trade agreements with the foreign nations. Failing in that, he may, at his discretion, set quotas or other import limitations. A date for floor action has not been set.

## North American gets new instructions on B-1 avionics

Air Force Secretary Robert Seamens has a directive on his desk calling for North American-Rockwell to take a fresh look at the B-1 bomber avionics and to estimate costs for eight separate packages of varying sophistication. Four of the packages are composed of equipment available now or scheduled to be off-the-shelf items by 1975. The simplest of these is basically the Mark II system of the F-111. The other four packages involve integrated avionics that will require additional development. Originally, North American-Rockwell as the prime contractor, was to have selected from among the systems presented only by IBM and Autonetics, but this has been abandoned to save money.

## FCC raises fees, but not as high as first proposed

Responding to adverse industry comments, the Federal Communications Commission has established a new license-application and grant-fee schedule greatly reduced from the one originally proposed (ED 10, May 10, 1970, p. 39). Under the new rules, the cost of filing to operate equipment will range from \$5 to \$200 and licenses to operate from \$15 to \$800. Originally, the agency planned to set fees on the basis of the manufacturers' selling price and the number of units produced. The new schedule, effective Aug. 1, should make the FCC virtually self-sufficient. It is expected to produce some \$25-million in revenue per year. The agency makes less than \$5-million a year now.

**Capital Capsules:** FAA and NASA have set a meeting for August 12 with the airline industry to clear up what the agencies term a "misunderstanding." The airlines are fearful that NASA and FAA are about to force them into satellite communications at least five years before they think they will need them. . . . The Administration may set up an agency to guide national policy on scientific matters. Disclosure came in Congressional hearings, which also heard charges that "Science has taken a secondary role in the Administration's thinking." . . . Congress has before it the President's plan to combine eight federal anti-pollution groups into one independent agency to be called the Environmental Protection Agency. The new agency becomes a fact if Congress does not reject the program within 90 days. . . . So that more design approaches to a space shuttle may be considered, NASA has awarded three more study contracts for preliminary studies. The new awards go to Grumman Aerospace, \$4-million; Lockheed, \$1-million; and Chrysler, \$750,000. The two earlier \$8-million contracts went to North American and McDonnell Douglas.



**portable  
from any viewpoint**

## **Tektronix 422 Oscilloscope**

The 422 isn't portable as an afterthought—it was designed that way for your convenience. It's designed to travel in your car, aboard airplanes and boats, in mobile electronic facilities—anywhere you have room for a small 22-pound package. When you reach your destination, simply remove the panel cover and the ruggedized 422 is ready to display waveforms with laboratory precision. Dual channel, 10 mV/div (ch 2 is 1 mV/div AC), 50 ns/div sweep rate with X10 mag, 15-MHz performance in a "portable designed" package. Take along a 422 when you need a truly portable, high-performance oscilloscope.

The 422 is available in AC and AC/DC models. The AC model operates from 115 or 230 VAC, 45 to 440 Hz; the AC/DC model operates from AC, an internal rechargeable battery pack or from external 11.5 to 35 VDC.

For a demonstration of the 422 in your application call your Tektronix Field Engineer or write, Tektronix, Inc., P. O. Box 500, Beaverton, Oregon 97005.

422 AC Model \$1500—422 AC/DC Model with batteries \$1900, FOB Beaverton, Oregon.

*Available in U.S. through the Tektronix lease plan*



***Tektronix, Inc.***  
*committed to technical excellence*

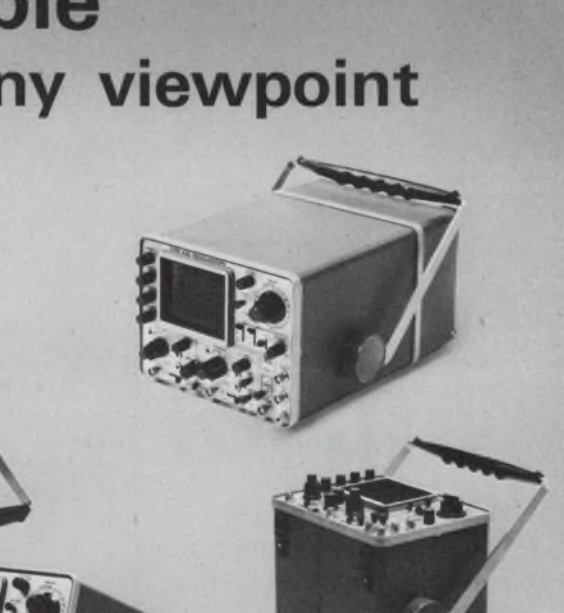

AC/DC Model

***See The Tektronix Display At WESCON***

INFORMATION RETRIEVAL NUMBER 26

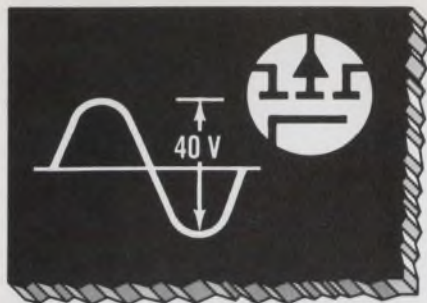

# 75 VOLT MOS FET SWITCHES

**Problem:** You need a MOS FET switch that will stand large analog signals and high overvoltages.

**Solution:** The new Siliconix M119 P-channel MOS FET with 75 volt source-drain breakdown.

These circuits show biasing for  $\pm 20$  V and 0 to  $+40$  V analog signal operation.

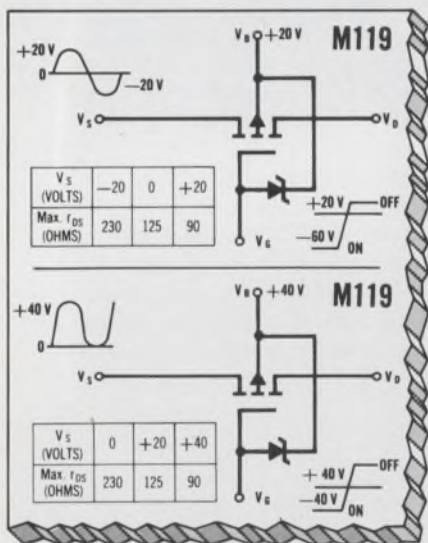

Write direct for further information and the data sheet on this newest Siliconix MOS FET!

**Siliconix**  
incorporated

2201 Laurelwood Rd. • Santa Clara, Calif. 95054  
(408) 246-8000 Ext. 201 • TWX: 910-338-0227

In Europe: Siliconix Limited, Saunders Way, Sketty, Swansea, Great Britain

## How the industry looks at mid-year

As everybody knows, the nation's economy is passing through a valley right now after years of scaling the heights. The fortunes of some electronics companies have fallen temporarily, too; others have managed to remain on high ground. Many engineers are uneasy. For years, *ELECTRONIC DESIGN* has offered its readers every January a forecast of what the upcoming year holds for engineers. This year, for the first time, the editors decided to make a mid-year report.

The staff sought the answers to questions like: How is business in a particular area? Where are engineers being sought or laid off? Is the development of electronic innovations being cut back? What is the state of the semiconductor industry—is it designing new-generation MSI and LSI devices, or merely pushing state-of-the-art technology? Why the upsurge in minicomputers, and why the downturn in mainframe systems?

For the answers and a look at how the electronics industry and engineers are surviving, turn to p. 26.

## About that cartoon on the cover. . .

The artist's style and signature for the cover drawing of this issue of *ELECTRONIC DESIGN* may look familiar to you. That's because it was done especially for us by Pat Oliphant, editorial cartoonist for the *Denver Post*, whose work now appears in over 180 newspapers throughout the world. Pat, who was born in Adelaide, Australia, and got his start as a cartoonist there, has won (so far) the Sigma Delta Chi Award, the Reuben Award of the American Cartoonists Society and the Pulitzer Prize since coming to this country. His cover drawing for *ELECTRONIC DESIGN* is intended to demonstrate that the Pentagon has been hurt by the cutback in engineering and electronic funds. If our Pentagon readers detect a note of exaggeration in the portrayal, let them rest assured—they're right. It's a caricature. And caricatures are supposed to exaggerate. Right?



Pat Oliphant



# “a real Joule”

FROM SOLITRON

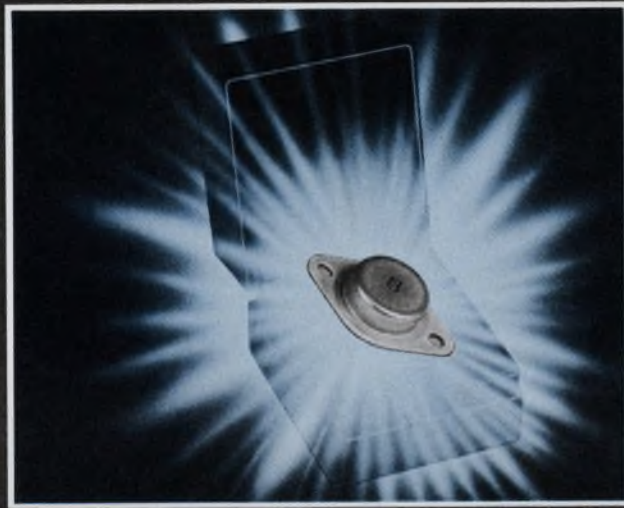

NEW, LOW COST 2N3055  
COMMERCIAL SINGLE-DIFFUSED  
NPN SILICON POWER TRANSISTOR SERIES

## E s/b = 1 Joule minimum

100% TESTED TO 125 WATT/SECOND

TYPE NUMBER TO-3 CASE	h <sub>FE</sub> @ 4.0V V <sub>CE</sub>				V <sub>CE (sat)</sub> I <sub>C</sub> =4.0A I <sub>B</sub> =4.0V	V <sub>BE (on)</sub> I <sub>C</sub> =4.0A V <sub>CE</sub> =4.0V	V <sub>CEX</sub> VOLTS	V <sub>CEO</sub> VOLTS
	I <sub>C</sub> =3.0A		I <sub>C</sub> =4.0A					
	Min	Max	Min	Max				
2N3055/1	20	—	—	70	1.5V	2.0	40V	30V
2N3055/2	10	—	—	70	1.5V	2.0	40V	30V
2N3055/3	20	70	—	—	1.5V	2.0	100V	60V
2N3055/4	30	—	70	—	1.5V	2.0	30V	20V
2N3055/5	—	—	14	—	1.5V	2.0	30V	20V
2N3055/6	—	—	15	70	1.1V	1.8V	100V	60V
2N3055/7	14	—	—	70	1.1V	1.8V	100V	60V
2N3055/8	—	—	70	—	1.1V	1.8V	100V	60V
2N3055/9	14	—	—	70	1.1V	1.8V	55V	45V
2N3055/10	—	—	70	—	1.1V	1.8V	55V	45V
SDT9201	—	—	20	70	1.1V	1.8V	55V	45V
SDT9202	—	—	20	70	1.1V	1.8V	100V	80V
SDT9203	—	—	20	70	1.1V	1.8V	120V	100V
SDT9204	—	—	20	70	1.1V	1.8V	140V	120V

Solitron's new line of 2N3055 Commercial single-diffused power transistors offer you an inexpensive solution for meeting rugged application requirements. It provides an outstanding secondary breakdown capability for high inductive loads. The TO-3 case is tin plated for easy-wave solder assembly.

Now available from stock in quantities of 10,000 or more for immediate delivery. Contact us today for details and application assistance.

Dial 1-800-327-3243 for a  
"No Charge" telephone call  
and further information.

**Solitron**  
DEVICES, INC.

1177 BLUE HERON BLVD.  
RIVIERA BEACH, FLORIDA  
(305) 848-4311 / TWX: (510) 952-6676

EUROPE: Solidev Ltd., Tubbs Hill House North Entrance, London Road, Sevenoaks, Kent, England. TEL: (0732) 57541-2-3

ISRAEL: A.E.L. Israel Ltd., 51 Hayarkon Street, Bene Baraq, TEL: 78-21-41

JAPAN: Matsushita Electric Trading, 5 Chrome Kawamachi, Hegashi - Ku, Osaka  
TEL: (06) 202-1221 or 15-17 Chrome, Minato - Ku, Tokyo. TEL: (03) 433-7211

# more than a power supply

You get more than a power supply when you specify this or any Hewlett Packard power supply. An international network of 220 sales/service offices are at your disposal . . . the most comprehensive service manuals detailing every aspect of the supply from theory and operation to troubleshooting . . . protection circuitry including an internal overvoltage "crowbar" to safeguard delicate loads, standard on this Low Voltage Rack (LVR) Series. OUTPUTS: 10V @ 20, 50, or 100A; 20V @ 10, 20, or 50A; 40V @ 3, 5, 10, 30, or 50A; 60V @ 3 or 15A. RIPPLE AND NOISE: typically 200 $\mu$ V rms, 10mV p-p. Remote Programming and lots more. Prices start at \$350.

## and you can customize it with these options...

- 10-Turn Output Voltage and Current Controls
- Chassis Slides
- 3-Digit Graduated Decadial for Voltage or Current
- 115V, 208V, or 230Vac Inputs
- 50Hz Input.

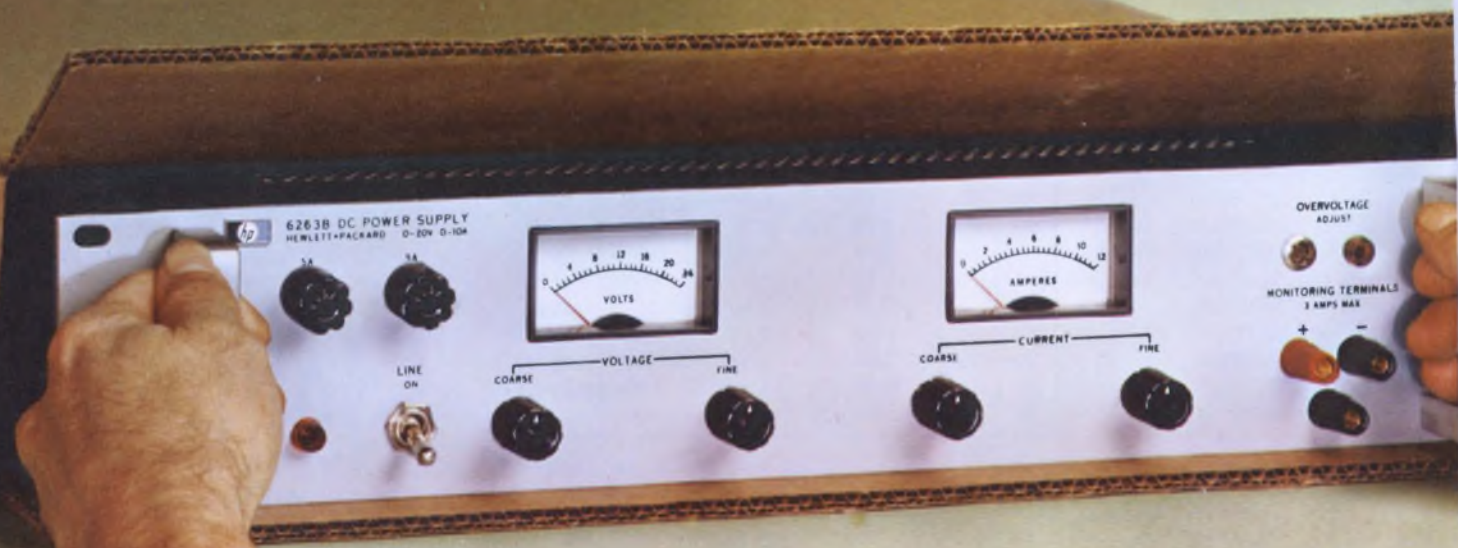

HEWLETT  PACKARD

POWER SUPPLIES

Over 100 power supplies are described in the 1970 HP Electronics Catalog. Write for your copy.

# hp DC POWER

From 10 $\mu$ V to 4000V

From 1 $\mu$ A to 2000A

From \$90 to \$3,500

From manual to computer controlled.



## LOW COST SUPPLIES

Compact laboratory power supplies can be stacked or rack mounted. Choose from 6 well-regulated models: 10V @ 1A; 25V

@ .4A; 50V @ .2A. Three Constant Voltage/Current limiting models — \$90. Three Constant Voltage/Constant Current models — \$115.

**Constant Voltage/Constant Current with Automatic Crossover, Remote Programming, Remote Sensing, Auto-Series or Parallel, Optional Internal Over-voltage "Crowbar"**



## MEDIUM POWER / TRANSISTOR REGULATED

Precisely regulated. Programming speeds as fast as 500 $\mu$ s. 20 models: 7.5V @ 3 or 5A; 10V @ 10A; 20V @ 1.5, 3, 5, or 10A; 30V @ 1A; 40V @ .75, 1.5, 3, or 5A; 60V @ 1 or 3A; 100V @ .75A; 160V @ .2A; 320V @ .1A. \$144 to \$395.



## MEDIUM POWER / SCR REGULATED

8 models: 20V @ 15 or 45A; 40V @ 10 or 25A; 60V @ 5 or 15A; 120V @ 2.5A; 600V @ 1.5A. \$360 to \$550.

## HIGH POWER/SCR REGULATED

12 Models: 4V @ 2000A; 8V @ 1000A; 18V @ 500A; 36V @ 300A; 64V @ 150A; 110V @ 100A; 220V @ 50A; 300V @ 35A; 600V @ 15A. \$1275 to \$3500.



## Technology Abroad

### Laser is frequency-stabilized by means of the Zeeman effect

Stabilizing a helium-neon laser frequency to better than 1 part in 10<sup>10</sup>, using the Zeeman effect, has been accomplished by the Siemens Co., West Germany. One beam from the 0.1-mW laser cavity is directed through a Zeeman cell, which normally absorbs all incident light at the desired laser frequency. When frequency drifts, light escapes from the cell and falls on a photodiode producing a signal proportional to frequency deviation.

The signal is amplified and applied to a piezoelectric ceramic element mounted behind one of the two laser-cavity mirrors. The element deforms slightly, moving the mirror a few microns and adjusting the length of the cavity enough to bring the laser back to the design frequency.

### Sensor net at London airport to gather aircraft landing data

A network of optical, infrared and seismic sensors at London's Heathrow airport will be able to "see" aircraft when tracking cameras are useless because of bad weather. The sensors, located under the final approach path and along the runway, will measure the flight path, speed, touch-down point and roll-out of all aircraft. Computer analysis of this data will be correlated with weather data, landing-aids performance, and other statistical details to provide information on how aircraft perform during automatic landings in poor visibility. The new system will be installed next year.

**Nuclear-powered heart pacemakers** using heat from the radioactive decay of plutonium-238 are presently undergoing trials, in England, as implants in two dogs. The heat is applied to a miniature semiconductor thermoelectric converter that produces power to operate the pacemakers. A 10-year life is predicted for the nuclear batteries, as compared to the one-to-two-year life of the batteries now used.

To help American firms enter or increase their share of Italy's \$700 million dollar electronics market, the U. S. Dept. of Commerce is sponsoring an exhibit of production and test equipment, materials and components for hybrid circuits in Milan Sept. 8-13.

# Hoffman's don't-do-it-yourself enclosures

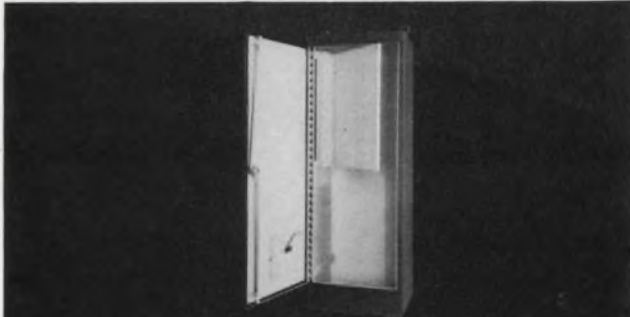

## FREE-STANDING NEMA 12

Front and rear single and dual access units up to 90" x 72" x 24". Rigidly constructed with flexible design. Versatile mounting panel and relay rack angle arrangements. Completely dust tight. EMI/RFI shielding on order.



## CONSOLES, CONSOLETS

These 14 gauge steel units have all-welded seams, gasketed doors, and are dust tight. Several configurations are available. And EMI/RFI shielding is available by special order.

Hoffman makes enclosures as only Hoffman can. So naturally, we don't leave any of the basic design or assembly work up to you. You've got other things to do. And besides, there's just no way to "assemble" an all-welded seam, a properly gasketed door, or any of the other features that have given Hoffman enclosures their reputation for excellent design and consistent high quality.

If you would like more information on our wide range of stock enclosures for electronic components, contact your Hoffman distributor or write.

# Hoffman

## ELECTRICAL ENCLOSURES

HOFFMAN ENGINEERING COMPANY  
Division of Federal Cartridge Corporation  
ANOKA, MINNESOTA DEPT. ED-42

See us at the Production Engineering Show, Booth 6158, Sept. 22-Oct. 2

INFORMATION RETRIEVAL NUMBER 29

NEW!

## SERIES 404 HEAVY DUTY ROTARY SWITCHES CAM-OPERATED

for Industrial Control  
Applications



- 5 Models — 12 to 160 Amps
- 30° — 45° — 90° Detent Indexing
- 2 to 12 Positions — Cam Actuated
- Full range of standard & custom circuits
- Wide choice of handles, plates, mountings, and options

Literally thousands of combinations (plus options!) from a few basic components to match your specific applications. Positive cam action with 2 independent poles per section to give maximum flexibility in minimum space. Ratings as high as 160A-600V (continuous) ... 120A-600VAC (interrupt) ... making current, 400A ... up to 70HP @ 600VAC. Circuitry fully customized to your applications at no extra cost! Complete specs in Condensed Catalog IND-404.



**ELECTRO SWITCH  
CORP**

Weymouth Massachusetts 02188  
Telephone: 617/335/5200 TWX: 710/388/0377

INFORMATION RETRIEVAL NUMBER 30

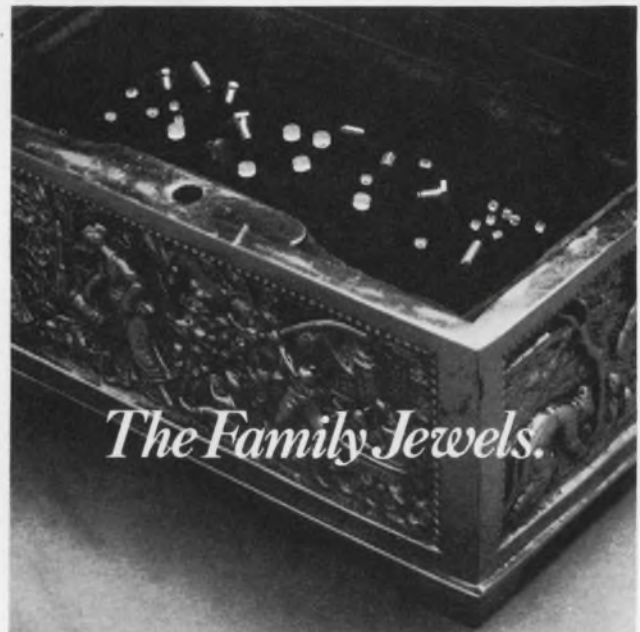

*The Family Jewels.*

Stunning, versatile Vee Jewels. Sparkling, dramatic Ring Jewels. Sensational Cup and Double-Cup Jewels. Chic, unique Orifices and Assemblies. All in a full range of shapes and sizes, set or unset, glass or sapphire.

A complete line of accessories and services, of course. Including Pins and Pivots, Prototype Development, and Engineering Services. Call or write.

*R. H. Bird Precision Jewelers*

1 Spruce Street, Waltham, Massachusetts 02154 (617) 894-0164  
Serving the crown-heads of the industrial world since 1913.

INFORMATION RETRIEVAL NUMBER 31

ELECTRONIC DESIGN 16, August 2, 1970

# Who provides 99.98% microcircuit reliability? Centralab!



Thick film microcircuit reliability depends on quality control at every stage . . . from design and manufacturing through application and use. At Centralab we have established a single Quality Assurance System that includes some 89 quality and reliability control procedures. This System, which meets MIL-STD-883 requirements, is applied to everything we produce, whether for military, consumer or industrial use. A total of 45 procedures control quality at the design and development stage; 24 during fabrication and assembly; and 20 are applied to verification during application and use. The procedures include use of our DESC-approved environmental test laboratory, one of the few such facilities in the Midwest.

By strictly adhering to these standards and procedures, we've been able to greatly minimize failures. Predicted failure rates for a typical Centralab module average 0.2 failures per million hours.

If quality and reliability aren't enough, we are the leading manufacturer of microcircuits. We've been in the thick of it for 25 years. We've produced more than 500,000,000 thick film circuits in some 5,000 designs. With this kind of manufacturing experience, we can provide product samples in three weeks; production quantities 8 weeks from prototype approval.

At Centralab, we're geared for quality and service. To find out how you can put both to work for you, write for a copy of our new Thick Film Microcircuit brochure.



**CENTRALAB**

Electronics Division  
GLOBE-UNION INC.  
5757 NORTH GREEN BAY AVENUE  
MILWAUKEE, WISCONSIN 53201



CENTRALAB PRODUCTS  
ARE MARKETED INTERNATIONALLY THROUGH  
GLOBE-UNION INC. - INTERNATIONAL DIVISION

M-7016

INFORMATION RETRIEVAL NUMBER 32

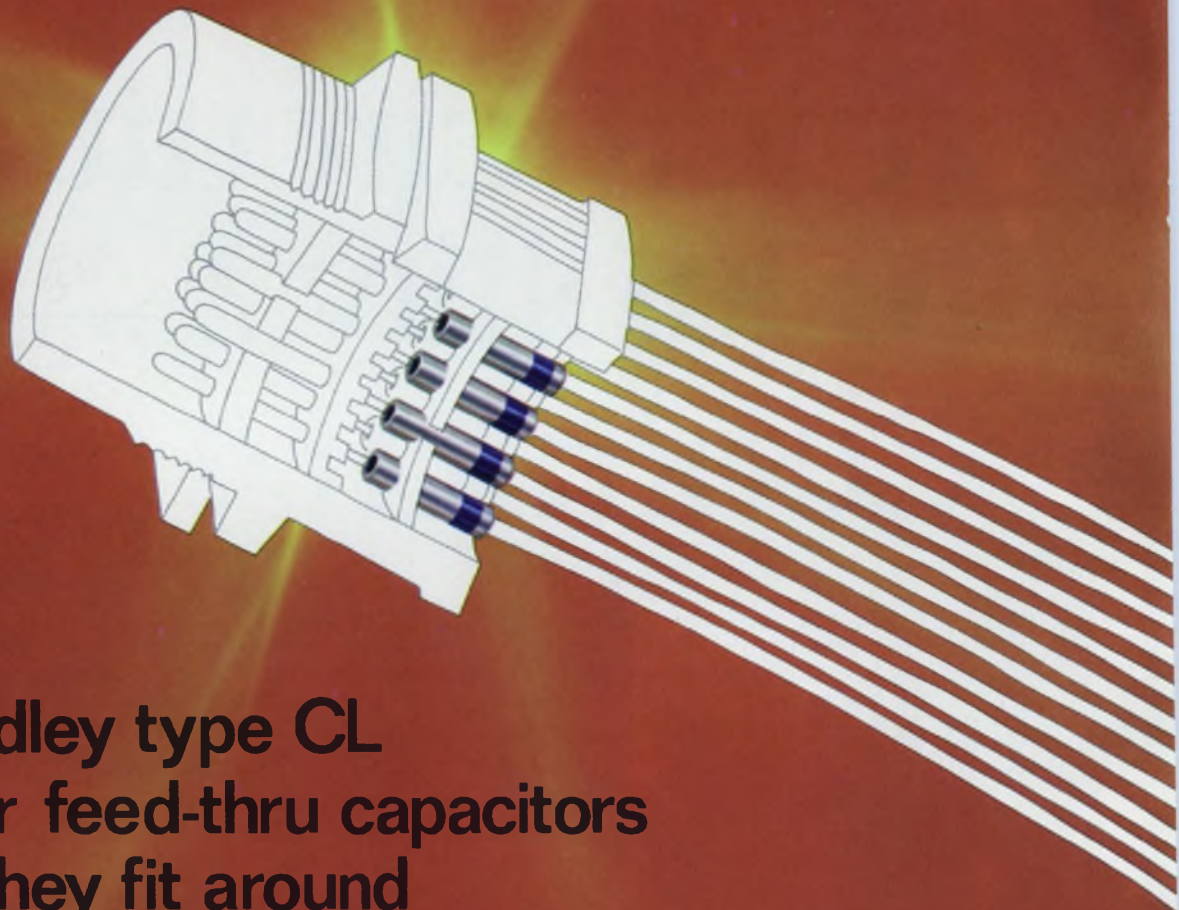

## Allen-Bradley type CL multi-layer feed-thru capacitors so small they fit around the head of a pin.

**VOLUMETRIC EFFICIENCY.** Big words that explain why Allen-Bradley type CL feed-thru capacitors are so small. Our unique multi-layer concept shaves size to a minimum, without affecting performance. It took Allen-Bradley to get filter capacitors down to their fighting weight. Now rolled capacitors are no longer a design alternative.

Concentric layers of proprietary Allen-Bradley ceramic and noble metal electrodes are fired together for unmatched protection against moisture and contamination. Rugged. Non-polar. With lower inductance and far less noise.

Voltages to 200 WVDC. Temperatures to 125°C. Capacities to 1.0  $\mu$ F. High dielectric strength and reliability.

Several styles and sizes are available through your appointed A-B industrial electronic distributors. For further information write: Marketing Department, Electronics Division, Allen-Bradley Co., 1201 South Second Street, Milwaukee,

Wisconsin 53204. Export office: 1293 Broad Street, Bloomfield, N.J. 07003 U.S.A. In Canada: Allen-Bradley Canada Ltd., 135 Dundas St., Galt, Ontario.

### **ALLEN-BRADLEY**



## Publisher

Hugh R. Roome

## Editors

New York Office  
850 Third Ave.  
New York, N.Y., 10022  
(212) 751-5530

Editor: Frank Egan  
Managing Editor: Ralph Dobriner  
Managing Editor: Raymond D. Speer  
Microelectronics, Steven A. Erenburg  
Computers, Milton J. Lowenstein  
Circuits, Don Mennie  
Microwaves, Michael J. Riezenman  
Management, Richard L. Turmail  
News, John N. Kessler  
Military-Aerospace, John F. Mason  
New Products, Roger Allan  
New Products, Lucinda Mattera  
Directory Manager, Greg Guercio  
Copy, Marion Allen

## Field Offices

**Massachusetts**  
Jim McDermott  
P.O. Box 272  
Easthampton, Mass. 01027  
(413) 527-3632

**San Francisco**  
Elizabeth de Atley  
2051 Wellesley St. (Suite 2)  
Palo Alto, Calif. 94306  
(415) 321-7348

**Los Angeles**  
David Kaye  
2930 Imperial Highway  
Inglewood, Calif. 90303  
(213) 757-0183

**Washington**  
Don Byrne  
1425 N St. NW  
Washington, D.C. 20005  
(202) 667-6568

## Editorial Production

Dollie S. Viebig  
Richard D. Grissom

## Art

Art Director, Clifford M. Gardiner  
Assistant, William Kelly  
Rita Jendrzejewski  
JoJo Miskimmon  
Jack Weissman

## Production

Manager, Thomas V. Sedlta  
Helen De Polo  
Kathleen McConkey  
Leslie Stein

## Circulation

Manager, Nancy L. Merritt

## Information Retrieval

Peggy Long

## EDITORIAL



## Will a business turnaround guarantee you a job?

As we move further into the second half of 1970, the big question in the electronics industry is: When will the general business turnaround occur?

It will come sooner or later. The nation's economy is just too strong for anything but a very temporary downturn, virtually all economists agree. Gaylord A. Freeman Jr., chairman of the board of the First National Bank of Chicago, sums up the prevailing opinion this way: "It's important to remember that there is nothing basically wrong with our economy. It did not slow down from natural causes—it was intentionally slowed down by the Government in order to overcome the inflationary pressures and to get prices under control."

But exactly when the improvement will be evident to everyone is as difficult to predict as it is easy to ask. ELECTRONIC DESIGN posed the question to a cross-section of the electronics industry (see report starting on p. 26) and found something less than unanimity in the responses. Estimates ranged from just a few months to as long as two years, and they depended heavily on the products involved (components, instruments, etc.), the segment of the industry (consumer, aerospace, etc.) and even the geographic location.

Despite the variance, however, most of those queried either implied or stated that getting back to normal was just a matter of time. But will industry normalcy end present fears about engineering employment in electronics? Will it generate continued full employment for designers who are now employed? Or will shifts in emphasis, such as from military/aerospace to the industrial or consumer areas, continue to affect some engineers adversely? It's a fact that \$10-million worth of television sets require less design effort than, say, a \$10-million aerospace navigation system.

The implications of these questions should be clear: The time is ripe for many designers to reappraise their careers. New skills may be necessary, or revised attitudes, or possibly even drastic measures, such as relocation. And the time to think about these things is now.

As for engineers now laid off and merely marking time until full prosperity returns to the country, let them ponder this: Will they be the first to be re-employed, or will they be passed over in favor of new engineering graduates?

For all engineers, it's time for soul-searching.

FRANK EGAN

# Unsnarl that logic-circuit testing!

Build one pulse-shaper and driver circuit, and get the performance of several pulse generators for worst-case checking.

Testing complex logic circuitry at the sub-assembly level can be troublesome. If you want to check worst-case input conditions, with frequent changes in environment, you likely will end up with a complex testing system employing several pulse generators. But you needn't.

You can build yourself a pulse-shaper and driver circuit that offers more than any single piece of test equipment on the market today. This one circuit can independently vary pulse rise and fall times, amplitude and dc offset. It provides all pulse parameters for testing under worst-case conditions, and it's designed to be driven by any standard DTL or TTL integrated-circuit logic.

A block diagram of the circuit is shown in Fig. 1. The input pulse width and pulse repetition rate are both determined by the external source used to drive the circuit.

The output pulse width is determined by the time transitions of the threshold level (about +1.5 V) of the DTL NAND gate used as an input buffer to the circuit, as shown at point A in Fig. 2. The input to the circuit is a Motorola MC843G dual monolithic buffer element in a hybrid configuration, with a high-performance npn silicon transistor output stage. The MC843G is used in the pulse-shaper card as an input buffer, squaring circuit and level converter. The output transistor of the MC843G is connected to +15 V through the 1-K resistor R1, thereby converting the input signal level from a nominal +5 V DTL "1" level to a "1" level of +15 V, as shown at point B. The pulse at that point is inverted from the input pulse by the MC843G. The pulse is ac-coupled through capacitor C1 and clamped symmetrically about ground by diodes CR1 and CR2. Those diodes are returned to +6.8 V and -6.8 V levels, respectively, to give the pulse a symmetrical swing of  $\pm 6.8$  V around ground.

The symmetrical pulse is buffered by A-2, a National Semiconductor NH0002C current ampli-

fier. This amplifier is a unity-gain current booster with an input impedance of 200 k $\Omega$  and an output impedance of 6 ohms, and is capable of delivering  $\pm 100$  mA. To switch the diode bridge, consisting of FR700 diodes CR3 through CR6, the pulse at this point must have rise and fall times that are very short compared with the linear rise and fall times being generated by the circuit. To maintain short rise and fall times, the low output impedance of the NH0002C is utilized to drive the capacitance of the diodes and other stray capacitances of the bridge circuitry. The waveform is shown at point C.

The NH0002C applies a symmetrical pulse to the circuitry. The portion of the pulse-shaper circuit that generates the linear rise and fall times of the output pulse consists of the following:

- The diode bridge, composed of FD700 diodes CR3 through CR6.
- A-3, an npn-pnp silicon complementary-pair dual transistor, connected as constant current generators for the rise and fall time circuits. These two transistors are packaged in a single six-lead case to lower the total package count of the assembly.
- Charging capacitor C8, which may be selected for different ranges of rise and fall times.

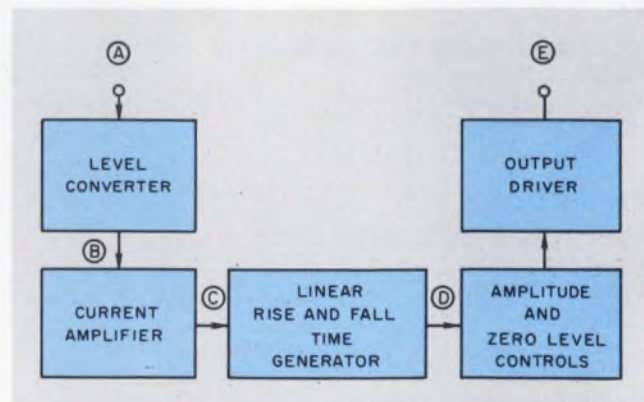

1. Circuit functions performed by the pulse shaper and driver are as shown. Various points are labeled to correspond to the waveshapes shown in Fig. 2.

**Kenneth D. Benedict**, Project Engineer and **Donald E. Richardson**, Senior Engineer, Kansas City Div., Bendix Corp., Kansas City, Mo.



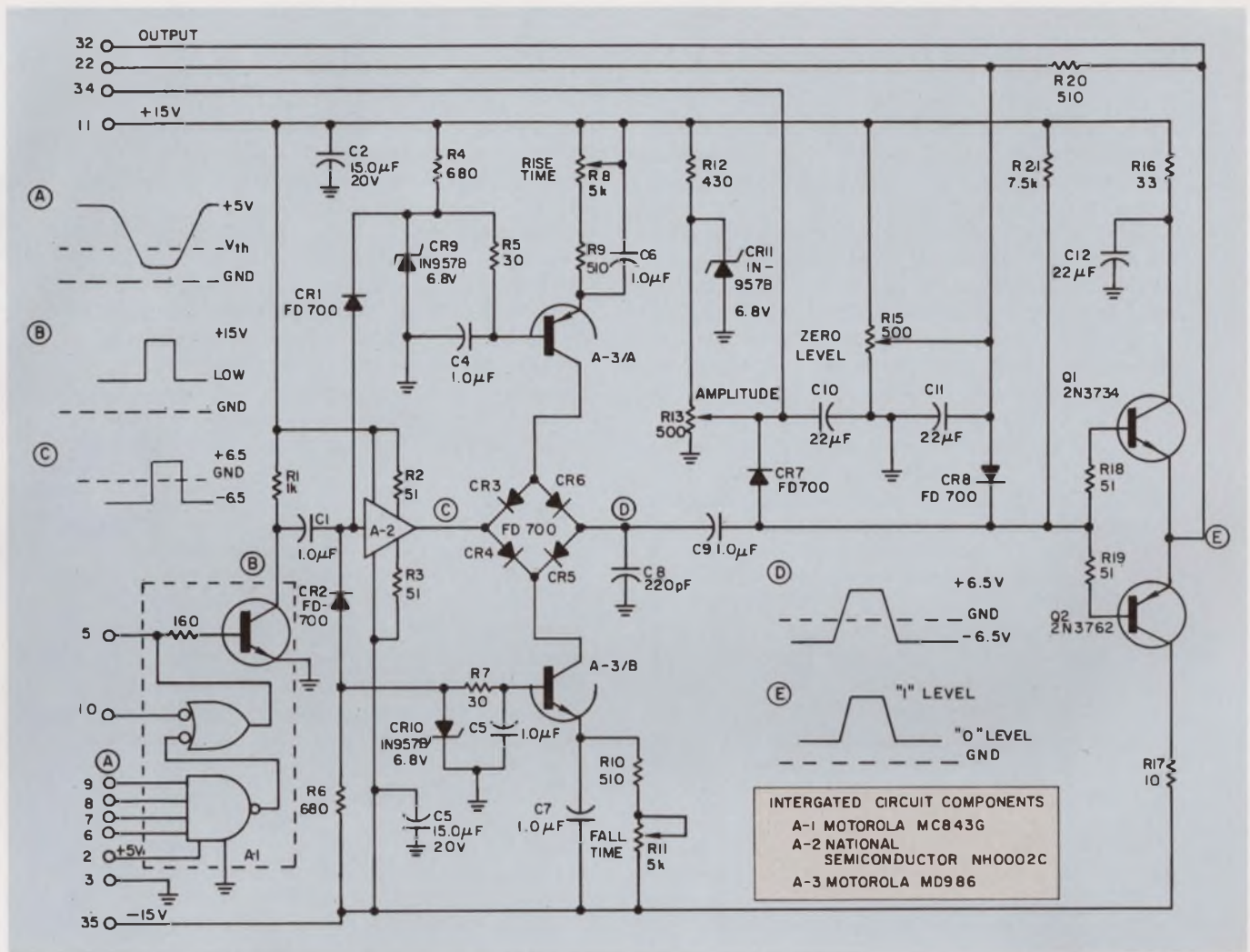

2. The complete circuit can be assembled on a standard 3-1/2-by-4-inch plug-in printed-circuit card. Rise and

fall times of 25 ns can be transmitted using a six foot length of terminated 50 ohm coaxial line.

Separate controls for linear rise and fall times are provided by potentiometers R8 and R11. The two potentiometers independently vary the magnitudes of the charging and discharging current for timing capacitor C8. When a capacitor is charged or discharged with a constant current, the voltage change with respect to time is at a linear rate.

When the input to the diode bridge switches from +6.5 V to -6.5 V, CR3 is forward-biased and CR4 and CR6 are back-biased. The current from the rise time source (A-3/A) flows through CR3 to A-2. Since CR5 is forward-biased and CR6 is back-biased, capacitor C8 discharges through CR5 through the fall-time source (A-3/B) to the -15-V supply. Current continues to flow in that direction until the charge on C8 reduces sufficiently to back-bias CR5.

When the input to the diode bridge switches from -6.5 V to +6.5 V, CR4 is forward-biased and CR3 and CR5 are back-biased. Current from A-2 flows through CR4 to the fall time circuit. CR6 is forward-biased allowing capacitor C8 to charge

from the rise-time circuit. Current continues to flow until the charge on C8 is sufficient to back-bias CR6. Since the charge and discharge paths for C8 are constant-current sources, both are linear. The rate of charge or discharge may be controlled by controlling the magnitude of the currents. The linear rise and fall times produced at C8 are shown at point D.

After the linear rise and fall times of the pulse have been generated, the pulse is ac-coupled to the output circuit through C9. At the output, the "1" level of the pulse is clipped at the level determined by setting the amplitude level control (R13). The maximum "1" level is determined by zener diode CR11. The "0" level of the output pulse is clamped to the level determined by the zero-level control (R15). In the present application of this circuit, the "1" level is clipped at +6.5 V, and the zero level is clamped at a +1.0-V level as shown at point E.

The output characteristics of the pulse can be varied considerably by slight modifications to the circuit. If a higher "1" level is desired, a zener

## Why perform worst-case testing of logic circuits?

The interface between two logic circuits in a logic assembly is normally well-defined and easily utilized with very little chance of incompatibility between the circuits in the same logic family. Under varying power supply and environmental conditions, this ease of interface may become doubtful. A typical DTL gate interface (see figure) illustrates some of the parameters that may vary.

In normal operation, when the output transistor Q2 of gate 1 is turned on, the voltage at the collector of Q2 is the  $V_{CE(sat)}$  of Q2; this is normally sufficient to forward-bias the input diode D1 of gate 2, the anode of which is returned to  $+V_{CC}$  through some resistance. This will turn off Q1 and Q2 in gate 2 and allow the output of gate 2 to switch to a high level.

If the  $V_{CE(sat)}$  of Q2 in gate 1 had been too high to forward-bias the input diode of gate 2, the switching action of gate 2 would not have occurred. When the output transistor of gate 1 Q2 is turned off, the voltage at the collector of Q2 rises to  $+V_{CC}$  through the collector resistor. This voltage reverse-biases the input diode D1 of gate 2, turning on transistors Q1 and Q2 in gate 2; therefore the output of gate 2 switches to a low level. If the voltage at the collector of Q2 in gate 1 had not risen to a high enough level to reverse bias D1 in gate 2, the output of gate 2 would not have switched to a low level.

To assure that any two subassemblies that

are mated will function requires worst-case input testing. Two of the parameters of the input stimuli that can be made worst-case are the low and high logic levels. To simulate the worst-case of the turned-on driving transistor (Q2 of gate 1 in the example), the logic level must have a low level equal to the highest predicted  $V_{CE(sat)}$  of the transistor. To simulate the worst-case of the turned off driving transistor, it is necessary to determine the maximum leakage current ( $I_{CER}$ ) that the transistor will have; this, in turn, determines the voltage drop across the collector resistor. That voltage drop, subtracted from the supply voltage, is the worst-case high logic level.

Two other parameters that must be considered in generating worst-case pulse stimuli are rise and fall times of the pulses. These parameters are important when testing certain types of integrated-circuit logic that depend on the time rate of change of the input pulse for triggering. Examples of these are certain monostable multivibrators or pulse-triggered flip-flops. The worst-case rise and fall times for testing such circuits are the longest predicted times that could occur. The long rise and fall times may also be considered worst-case for logic subassemblies where timing is critical. Long rise or fall times would add to other propagation delays in the circuitry to cause improper timing of switching actions.

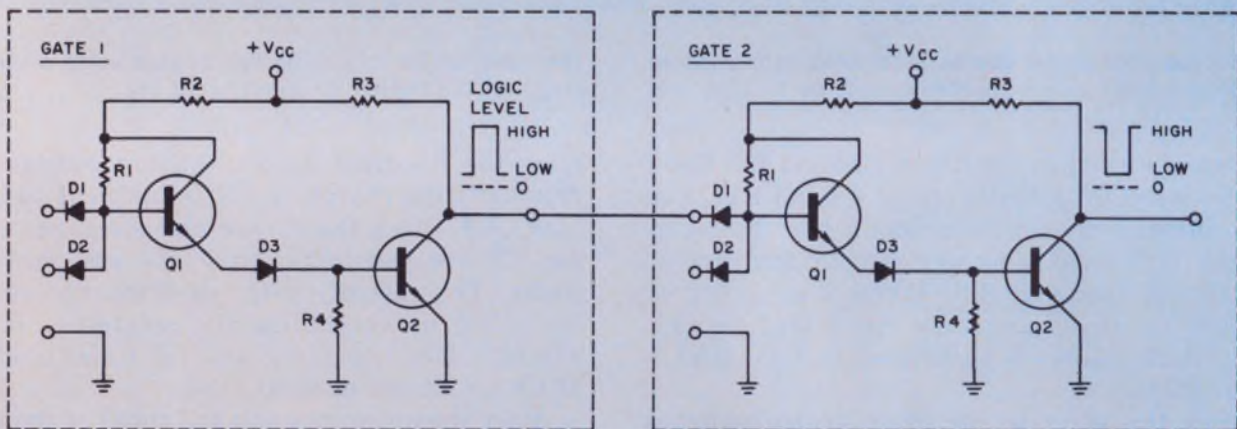

A typical DTL interface between two gating circuits.

diode with a higher breakdown level can be used in place of CR11. If a negative-going pulse is desired, the amplitude control circuit can be connected to the  $-15\text{-V}$  line, instead of to the  $+15\text{-V}$  line. That configuration would also require reversing the polarity of CR7 and CR11. The zero level can be made variable from ground to some negative level by connecting R15 to  $-15\text{ V}$ , and reversing CR8.

Remote programming of pulse amplitude and

zero level can be accomplished by connections to terminals 34 and 22 respectively.

The output driver circuit of the pulse shaper circuit is a pnp-npn complementary emitter-follower circuit. This circuit configuration has an output impedance of 4 to 6 ohms and can deliver up to 200 mA into 50 ohms. Resistors R16 and R17 in the collector of the output transistors are for current limiting in the event of a short circuit in the output load. ■■

# TOMORROW MOSINCS +5

Plus 5 years in developing and perfecting MOS technology. Plus 5 new Tomorrow MOSINCS here today. All with the same advanced features that make it the optimum line to use: Low threshold voltages, low channel resistance, and faster speeds.



#### GENERAL PURPOSE 300-OHM SWITCH

HDGP1000. A 300-ohm diode-protected general-purpose switch. Breakdown — 20 Volts, threshold — 2 Volts. For long-time delay, low-frequency circuitry. 70c each (100 up).



#### GENERAL PURPOSE 30-OHM SWITCH/ AMPLIFIER

HDGP1001. General purpose 30-ohm diode-protected P-channel enhancement mode device. For easy interface of DTL or TTL circuits to MOS levels. Ideal for low cost applications. 80c each (100 up).

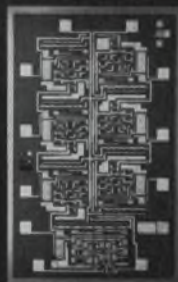

#### SIX-STAGE BINARY COUNTER

HCTR0206. Six circuits cascaded on a single chip. Buffered true outputs of each octave isolate cascading logic. Ideal for organ frequency divider applications. \$3.30 each (100 up).

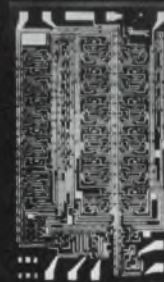

#### TV SYNC CIRCUIT

HSUB0525. The first IC for digitally controlling horizontal and vertical raster generation in TV sync circuit applications. Ideal for cable or closed circuit TV. \$15 each (100 up).

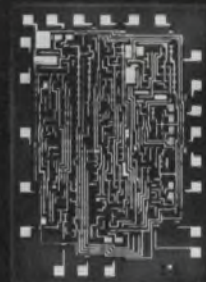

#### DIFFERENTIAL DIGITAL ANALYZER

HSUB5021. For serial operation. Applied in implementing algorithms for rectangular and trapezoidal integration, or multiplication and division. \$18.00 each (100 up).

**HUGHES**

HUGHES AIRCRAFT COMPANY  
MOS DIVISION

We'll send you data on the newest MOSINCS, plus the entire line. Just write us:  
Hughes MOS Division, 500 Superior Avenue, Newport Beach, CA 92663.

# Cut down signal distortion.

An active feedback filter with inverse characteristics compensates for transducer or transmission errors.

An ideal filter can compensate for the distortion introduced into a signal by a frequency-limited network—if it has a transfer function that is the precise reciprocal of the original network. The original network might be a transducer or a transmission line in which distortion is inherent, or it might be an amplifier with a response shaped to conserve bandwidth or attenuate noise. In any case the signal suffers and must be restored.

One way to accomplish this is to use a servo-system with a feedback function that is a duplicate of the original network.

## Use a feedback amplifier

Figure 1 shows a distorting network  $K'_H H'(s)$  whose input signal must be restored and an inverse compensating filter that consists of a feedback system. The forward element,  $G$ , of the inverse filter is a high-gain integrator. The feedback element  $K_H H(s)$  has a frequency response that should be as exact a duplicate of the transducer as  $K'_H H'(s)$  as can be achieved. The gain of the feedback element  $K_H$  may be any convenient value, but if it is different from  $K'_H$ , the output of the inverse filter will be a scaled replica of the input signal with a scale factor of  $K'_H/K_H$ .

Qualitatively, the operation of the inverse filter is as follows: When  $\alpha(s)$ , the output of  $K_H H(s)$ , is different from  $R(s)$ , the output of  $K'_H H'(s)$ , an error signal  $E(s)$  is present at the input of the integrator. The output  $C(s)$  of the integrator will then change until  $E(s)$  becomes zero. But  $H'$  and  $H$  were made identical. Therefore, their inputs must be the same; in other words,  $C(s)$  must equal  $A(s)$ .

Since a feedback system has been added, there is the possibility of instability. The stability of the inverse filter can be checked by applying the Nyquist criterion.

For example, consider an amplifier with one low-frequency and one high-frequency breakpoint. Then, ideally, both the amplifier and the feedback network have transfer functions of the form:

$$K_H H(s) = K_H \frac{sa}{s+a} \frac{b}{s+b} = \frac{K_H bas}{(s+a)(s+b)}$$

where  $a$  and  $b$  are the low and high-frequency breakpoints, respectively, and  $K_H$  is the amplifier gain. The Laplace transform of the forward loop integrator is

$$K_G G(s) = K_G \frac{1}{s}$$

Then:

$$K_G G(s) K_H H(s) = \frac{K_G K_H}{\left(\frac{s}{a} + 1\right) \left(\frac{s}{b} + 1\right)}$$

and

$$K_G G(j\omega) K_H H(j\omega) = \frac{K_G K_H}{\left(\frac{j\omega}{a} + 1\right) \left(\frac{j\omega}{b} + 1\right)}$$

Now, if the low and high-frequency breakpoint are  $a = 1$  radian and  $b = 500$  radian/second, respectively, then:

$$K_G G(j\omega) K_H H(j\omega) = \frac{K_G K_H}{(j\omega + 1)(j 0.002\omega + 1)}$$

The complex plane locus of this transfer function can never encircle the  $-1,0$  point for any value of  $K_G K_H$ ; thus, this particular case is unconditionally stable.

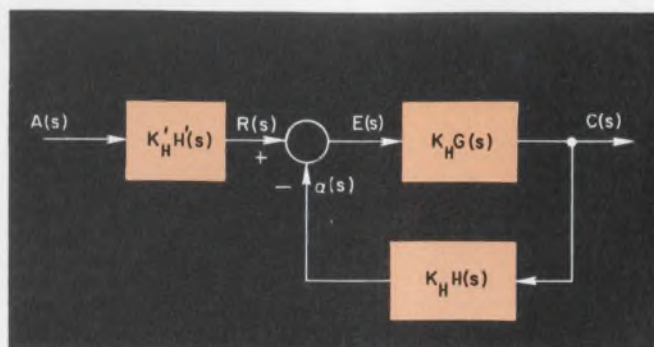

1. The distortion in signal  $R(s)$  is corrected by the inverse filter at the right. The feedback transfer function of the filter is a replica of the transducer's.

Antony Jalink, M/S 494 NASA, Langley Research Center, Hampton, Va.

Inaccuracy of the inverse filter can result from changes due to drift in the forward and feedback elements or from steady-state errors. The response<sup>1</sup> of the inverse filter to changes in the elements of the forward loop is:

$$\frac{d[C]}{C} = \left( \frac{1}{1 + K_G K_H G H} \right) \frac{d[G]}{G} \quad (1)$$

For changes in the feedback loop it is:

$$\frac{d[C]}{C} \approx - \frac{d[H]}{H} \quad (2)$$

Equation 1 shows that changes in the integra-

tor,  $G$ , have a negligible effect on the output because its denominator is very large. Equation 2 shows a variation in the feedback element of the inverse filter causes an almost proportional variation in the output. However, this element can be made entirely passive and stable because it must match only the frequency response of the original transducer and errors can be made as small as desired.

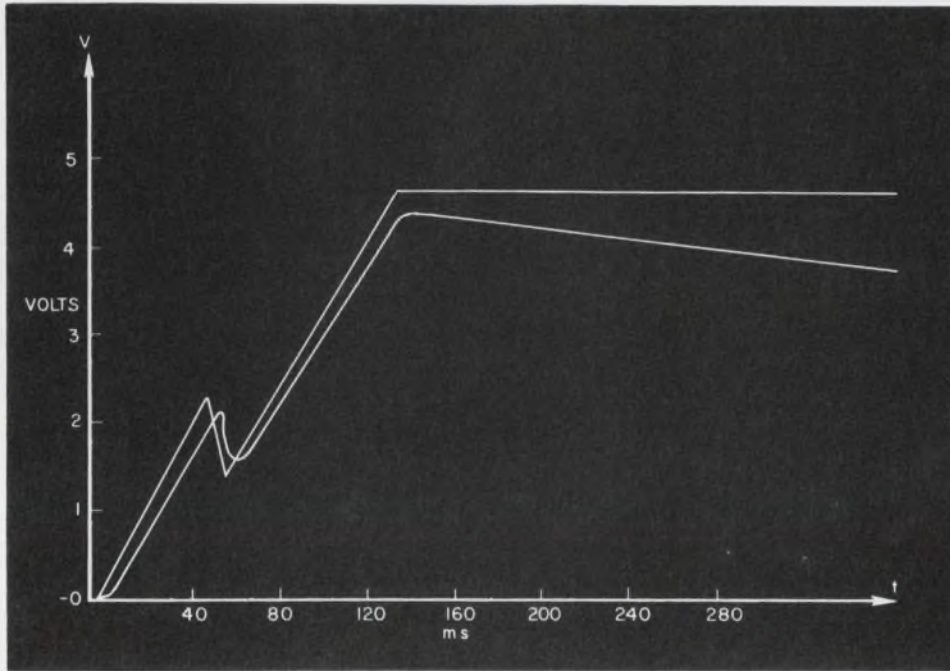

2. A simulated signal of a horizon profile is distorted by its transducer and telemetry (lower curve). The restored waveform is indistinguishable from the original signal (upper curve).

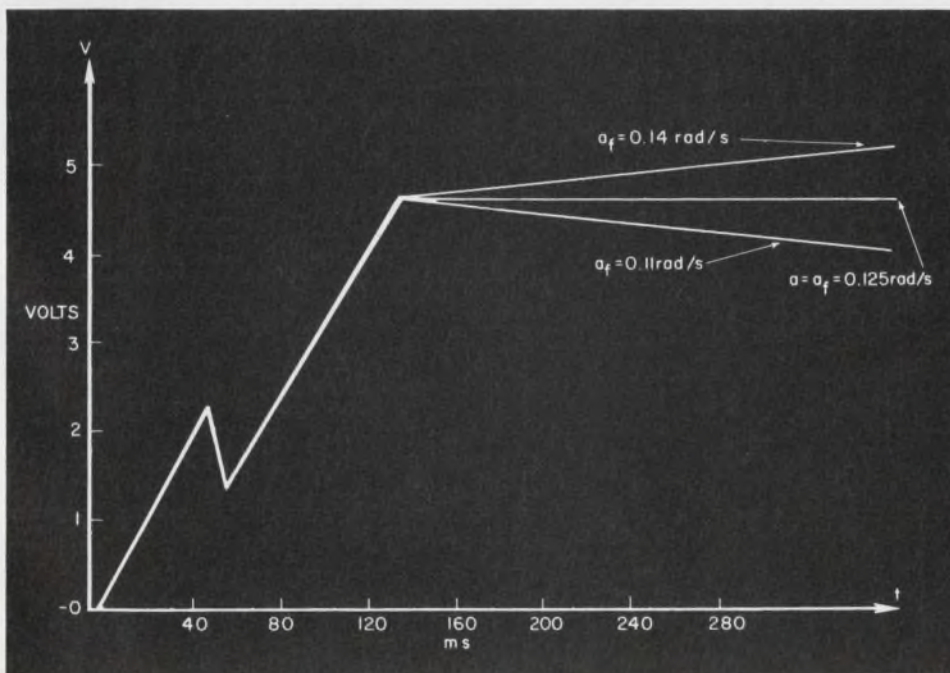

3. Incorrect choice of low-frequency breakpoint in the filter has this effect on signal restoration: The top curve shows the error resulting from too high and the bottom curve from too low a choice. The correct curve is in the center.

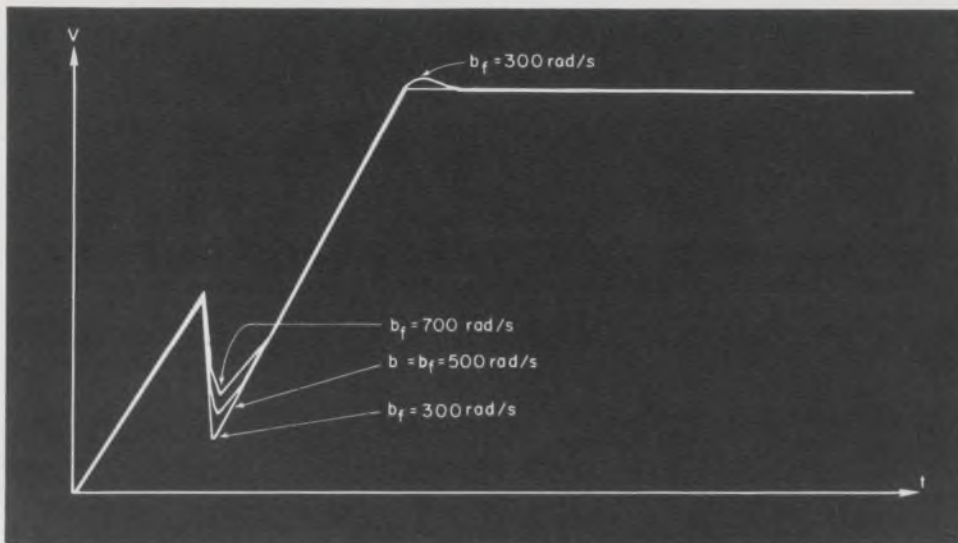

4. Inaccuracy in the high-frequency breakpoint causes errors in sharp corners in the filter output. The deviation from the correct curve is exaggerated to show the effect.

From Fig. 1 the steady-stage accuracy of the system can be found from:

$$\frac{C(s)}{R(s)} = \frac{K_G G(s)}{1 + K_G K_H G(s) H(s)}$$

and

$$R(s) = A(s) K'_H H'(s)$$

Therefore,

$$\frac{C(s)}{A(s)} = \frac{K_G K'_H G(s) H'(s)}{1 + K_G K_H G(s) H(s)}$$

Since

$$K_H H(s) \cong K'_H H'(s),$$

$$\frac{C(s)}{A(s)} \cong \frac{K_G K_H G(s) H(s)}{1 + K_G K_H G(s) H(s)}$$

If  $K_G K_H G H \gg 1$  ( $K_G K_H$  is typically  $10^4$ ),  $C(s) \cong A(s)$ , indicating a small error.

#### A test verifies the theory

The shape of a horizon profile measured by a radiometer in a spacecraft is distorted by limited-frequency bandpass in the radiometer and telemetry. It must be recovered by some form of inverse filter.

In actual cases in the past, this recovery has been performed during data reduction at a ground station. For the test of the inverse filter, a simulated horizon profile was generated by an analog computer and passed through a bandpass filter to simulate the radiometer and telemetry frequency response. The feedback system that constitutes the inverse filter was also simulated on the computer.

Figure 2 shows system performance when the horizon profile is a ramp that lasts 120 ms. Approximately halfway up the ramp there is a brief reversal of slope to simulate the presence of a cloud on the horizon. The output of the amplifier is distorted and delayed in time where the change in slope takes place. Both phenomena

are caused<sup>2</sup> by the high-frequency breakpoint "b." Also the amplifier output decays toward zero and reaches only about 96% of full amplitude because of the low-frequency break "a" in the amplifier transfer function. Neither of these effects appears in the restored output.

If the frequency response of the inverse filter feedback element is different from that of the original transducer, waveshape recovery is less accurate. An estimate of the amount of error introduced can be obtained from Figs. 3 and 4. Here "a<sub>r</sub>" and "b<sub>r</sub>" are the breakpoints in the feedback element of the inverse filter, which had different values for each run shown, while the breakpoints "a" and "b" in the transducer remained fixed.

White noise in the band from 0 to 75 Hz does not appreciably disturb the system. When noise is introduced at a 10:1 peak-signal-to-peak-noise ratio, the responses of the input and restored output are indistinguishable.

#### Digital computer simulates filter

If a distorted signal is available in digital form, and if the equation of the inverse filter is known, an input signal can be restored by a digital computer. In this case, state variables<sup>3</sup> represent the inverse filter and the distorted waveform. A state variable diagram is then used to determine an over-all transition matrix that is used to find the state variables and to reconstitute the original signal. ■■

#### References

1. Chestnut, Harold; Mayer, Robert W.; *Servomechanisms and Regulating System Design*, vol. 1, John Wiley and Sons, New York, 1959, p. 226.
2. Millman, Jacob and Taub, Herbert, *Pulse and Digital Circuits*, McGraw-Hill, New York, 1956, p. 45.
3. Tou, Julius T., *Modern Control Theory*, McGraw-Hill, New York, 1964, pp. 65-90.

# Time interval measurements like you've never seen before.

Plug the HP 5379A Time Interval Unit into the HP 5360A Computing Counter and things happen faster than they could ever happen before.

This unique combination resolves time intervals to 100 picoseconds. With absolute accuracy of 1 nanosecond. And you can measure zero, positive and negative intervals, which makes it ideal for checking coincidence.

By adding the HP 5375A Keyboard, you can enter programs to produce instantaneous answers about phenomena that you could never previously measure with a counter. Things like peak-to-peak jitter; rms jitter; phase measurements; duty cycle; and radar ranging in feet,

inches, meters or any other units you want.

Thanks to the 5379A, dozens of jobs can be handled easily and accurately. These include calibration of radar, lasers, and laboratory instruments; testing semi-conductors and computers; cable fault location; delay line adjustment; ballistic and nuclear measurements.

It does all this while saving you the cost of a computer, because the computer's built in. And you're not buying a counter that only measures time interval. You're getting the most advanced frequency measuring system available today, ideal for measuring pulses, pulse trains or any time-based events.

The cost is \$750 for the plug-in and

\$6500 for the mainframe. Your local HP field engineer will be glad to arrange a demonstration. Give him a call. Or write for complete information to Hewlett-Packard, Palo Alto, California 94304; Europe: 1217 Meyrin-Geneva, Switzerland.



**HEWLETT  PACKARD**

**ELECTRONIC COUNTERS**

02920

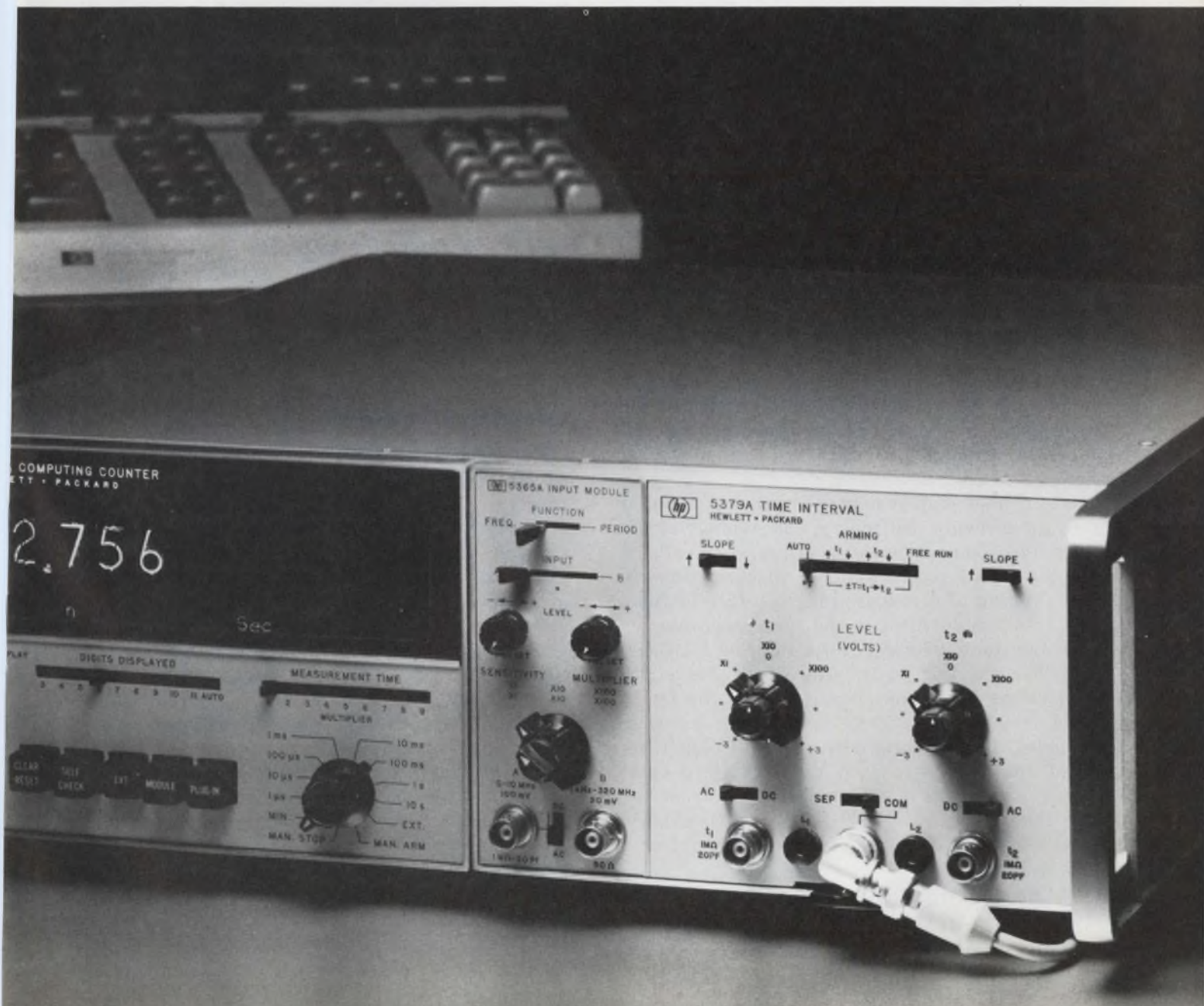

## Job hunters, be prepared to scramble!

Hires for experienced hands are down, but findings suggest: a demand in small firms exists; technical hires will herald upturn.

Richard L. Turmail, Management Editor

While experience is the best teacher, it apparently isn't teaching the seasoned engineer how to get a job. This is one of the hard facts of engineering employment that *ELECTRONIC DESIGN* found during a nationwide spot check of this year's Government and industrial hiring practices. Since planned college recruitment was not reported down as much as total hires—although it has lessened—the conclusion is that there will be a reduction in the hiring of experienced engineers.

Newspaper reports near the end of the first quarter indicated that student electronics engineers would face stiff competition from experienced engineers unemployed because of the large-scale layoffs in defense-oriented companies. Our findings, however, suggest that the reverse is true. Except for such companies as instrument manufacturers that hire only experienced engineers, most firms are loath to cut back on their recruitment commitments.

As if confirming industrial recruitment commitments, *U.S. News and World Report* recently predicted that the "biggest need for engineers in the 70's will be for new graduates trained in the latest specialties, or for those who can apply engineering principles to medical or to biological sciences."

This dismal employment picture was brought on by an economic "softening," as so many of the electronics company spokesmen prefer to call the business slump, plus a major cutback in Government funding of aerospace projects. In mid-June, 1970, total employment in the aerospace industry was down to 1,194,000 from a high of 1,418,000 in 1968, according to the Aerospace Industries Association, which also reported that the figure would drop to 1,177,000 by September. A survey conducted by the Engineers Joint Council revealed that the aerospace industry in general doesn't expect its employment to increase by more than 73% of its 1969 figure, but it expects growth to resume in 1972 and continue through 1975.

Adding to the general gloom was a recent report in the *New York Times* stating that non-

aerospace companies fear that engineers who have done business with the Government are not as cost-conscious as they should be nor so well attuned to handling simple problems after grappling with complex ones.

On the college scene, the Massachusetts Institute of Technology at Cambridge reported that only 256 companies recruited this year compared to 303 last year and 412 during 1966-67. These reasons were given by a spokesman for the MIT placement department for the change in the recruiting climate: Students are not as interested in industry; more of them are branching out into medicine, law, and teaching; firms have fewer opportunities. Boeing, for example, says it has no jobs to offer, and IBM, where many MIT grads are employed, cautioned that next winter will be tight.

Lafayette College, Easton, Pa., which has a sizable percentage of technical graduates each year, reported that total job interviews fell off in 1970 from 3638 in 1969 to 2206 this year. Although recruiters' visits rose from 222 to 224, job offers fell by nearly 50%.

### Checking out the industry

Government hiring of engineers (career civil servants) increased by 5% in 1969-70 over the previous year, according to John Alden, director of manpower programs for the Engineers Joint Council. Regardless of the present Administration's talk of economization, Government hiring of engineers has increased slightly but steadily each year. In some cases, however, a number of Government divisions report that many of the engineering jobs that have been vacated have been left unfilled. Most of the layoffs in DOD, NASA, and the Federal Power Commission have fallen to private industry.

The Government has fewer hardware programs, and the ones it has are being purposefully stretched out. More time is being taken to build a better prototype, an aerospace company spokesman reported. The Government "buy"-word is "fly before buy," meaning that every project must be thoroughly tested before it will be



accepted by the Government.

The following is a spot check, by industry area, of company hiring practices since the business slump.

**Research:** Stanford Research Institute, Menlo Park, Calif., reports that its investment is people; they can't stockpile products. Because of a loss of contract work, employment at SRI has dropped 20% from a total of 3200 last year to 2650 at present. "We're fairly typical of research organizations that are exposed to the world marketplace and must make a profit," a spokesman said.

**Components:** A large eastern components parts company said that it has experienced no layoffs and little turnover. A spokesman for the company said it is experiencing a transitional period from aerospace work to promoting and stockpiling new products to generate customer interest in the return of the construction industry. (According to Deutsch, Shea & Evans, Inc., a technical advertising agency, the construction industry plans to hire 37% more engineers than it did last year—which indicates an increase in building activity.)

Although the components company has not been able to hire any of the aerospace people, they have continued to honor their commitments with technical schools where they recruit many of their employees.

Texas Instruments said, "We are currently seeking electrical and mechanical engineers in many of our operations. Although our needs for engineers are somewhat reduced as compared to this time last year, our engineering work force is about the same as it was this time last year. TI's over-all engineering need for college recruits will be less in 1970 than in 1969, with the current college hires expected to be more than 300 graduates."

TI hired about 500 grads in 1969.

**Industrial and consumer goods:** "This is such a dynamic industry," a spokesman for Motorola said, "that we can't cut off our hiring completely. We must work in anticipation of what we may need. While our recruitment has been cut back, we haven't changed our college recruitment policy. We had a layoff in April, but we don't anticipate any more. Although we're hiring fewer engineers than last year, there have been a few openings for aerospace engineers."

**Diversified:** At Honeywell a spokesman said the company's operations are "like a piece of elastic that expands and tightens depending on business conditions." There is a surplus of technical personnel, but employment has been provided for most of them elsewhere in the organization. Although there has been some layoff due to lack of work—and hires are practically frozen—we try not to interfere with our college recruitment program," Honeywell's man said. "But

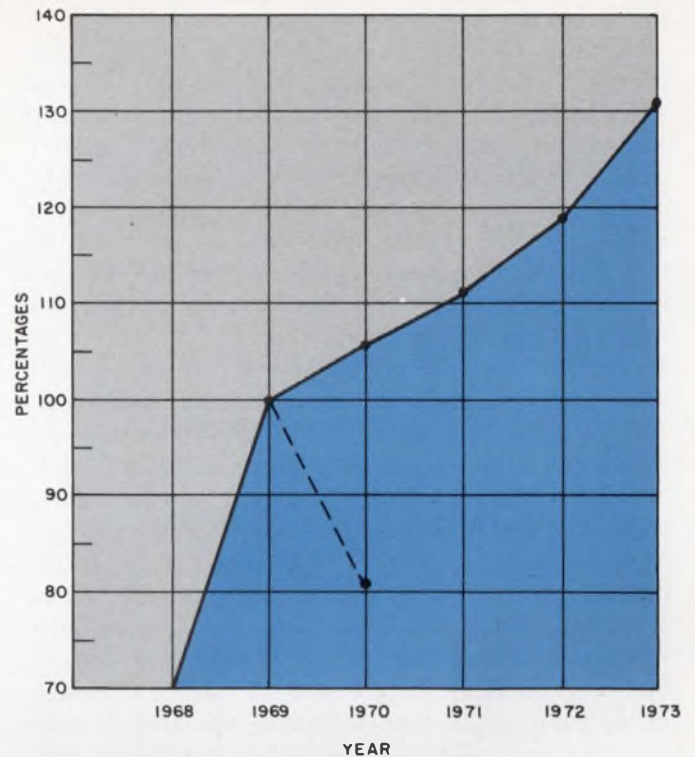

Hiring forecast indicates the future demand for engineers based on the projected growth of the economy over a five-year span. Dashed line represents the percentage of planned hires. Source: Engineers Joint Council.

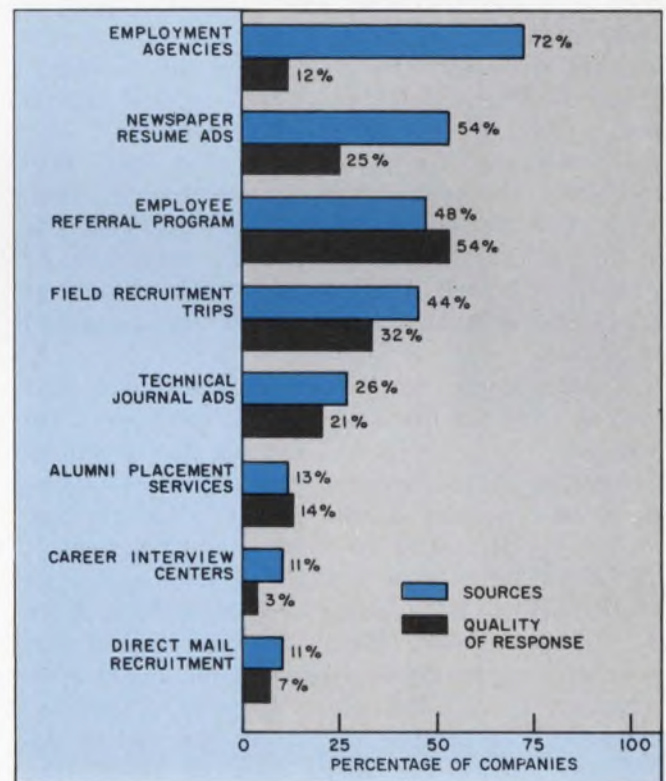

Recruiting methods that are used regularly by technical employers are shown in order of frequency, with the shaded portions representing the quality of response. The use of executive recruiters and society placement services (not shown) is reportedly infrequent, while the use of technical conventions for recruitment purposes is negligible. Source: Deutsch, Shea & Evans, Inc.

the program has been curtailed somewhat."

General Electric has a policy of hiring from within whenever possible, especially during business declines. A spokesman for the company said that it has hired fewer engineers this year than last. Since it has tried to relocate its engineers who were involved in the company's aerospace projects, layoffs have been kept at 1% of the total employment figure. Referring to employee relocation, the spokesman explained, "We've been 'force-fitting' and taken the risk. Sometimes we ask our technical people to take lesser jobs rather than be laid off." GE visits 400 colleges per year, and 800 students were hired this year—10 to 15% down from last year.

*Semiconductors:* Reporting that there's always room for good people, National Semiconductor, Santa Clara, Calif., is experiencing a fairly healthy year because of a broad customer base. European and non-U.S. sales have reportedly increased during the slump. Hiring has slowed, but the company hasn't laid off any more engineers than usual. One aspect of the slump: jobs have become more defined as an economy measure, and the company is more selective about hiring. National Semiconductor is looking for good applications and/or design engineers. It hired 10 grads last year and 25 this year.

*Test equipment:* "The door is always open for good self-starters who can innovate," said a spokesman for Teradyne of Boston. "The slump has not had any serious effect on the company. Since we are still building, we are still hiring, with no change in our recruitment policy."

*Instruments:* Systron-Donner said that, until last year, the company had never had a group layoff, but the company feels it has bottomed out in hiring and should maintain its usual level of employment soon. Right now new hires are at zero. The company rarely hires inexperienced engineers.

A spokesman for Hewlett-Packard said that the company has hired 20% fewer engineers than last year. It is currently looking for technical writers, systems engineers, and engineers experienced in computer hardware and software. The company claims the aerospace industry doesn't lay off the really experienced engineers and some years half of HP's total hires have been from the college campus. During the first half of this year, 40% of the total hires are from the campus compared to 42% last year. "Because of the cycling nature of campus recruiting, we will be doing less hiring the latter part of 1970," the spokesman said.

*Aerospace:* A spokesman in charge of the personnel needs for one division of Hughes Aircraft is pessimistic about the aerospace situation because the military-industrial complex is on the defensive in Congress. "Every project is under

attack," he said. "Hires at Hughes this year have been much less than last year at this time." Through June 1 this year, 71 were hired, including 40 campus recruits, as compared to last year when, on June 1, 457 had been hired, including 300 campus recruits. Of those hired, about 80% are electronics engineers. "We've had a mild lay-off of about 5% from 31,000 to 29,000 employees," he said, "and we expect it to drop to 28,000 by the end of the year. In all, some 200 electronics engineers will be involved. Hughes reportedly cut back on college visits by 25% this year.

There is considerably less hiring at Grumman compared to last year, and a number of engineers have been laid off, according to a company spokesman. It is still looking for design engineers and those with experience in digital-computer technology. Grumman maintained its commitment to college grads, but total hiring has been off by 50% compared to last year.

Kaye Kiddoo, corporate director of manpower resources for Lockheed Aircraft Corp., said recently that in past business slumps, major aerospace companies could usually cushion the effect on scientists and engineers by shifting them from divisions with diminishing projects to others that are expanding, often into new fields, like space ships. Kiddoo's report on his company's LEND program (Lockheed Engineers for National Deployment) appeared in an article in the Dec. 6, 1969 issue (ED 25), p. 92. The objective of LEND is to keep the engineering talent on the payroll during the times when the company has little or no work for him but expects work within a few months.

"But now the industry is sick across the board," Kiddoo says. "There are nowhere near enough new projects to occupy the talents of the legions of engineers taken on in the boom years. I fear we're going to have a surplus of engineers through the decade."

### Engineers: first fired—first hired?

The immediate question asked by the engineer now, however, is what is the demand for technical manpower in latter 1970?

It depends, according to Deutsch, Shea & Evans, Inc., on an increase in federal spending, and if the Government's anti-inflationary policies begin to get results. If the economic reins are loosened somewhat during the remainder of 1970, an improvement in the business climate may be reflected by an upturn in demand for technical people.

Placement and manpower specialists point out, however, that poor distribution of engineers—the ratio of job-hunting engineers to positions available—contribute as much as the current job

By field:	Invitation per resumes submitted	Interview per invitations received	Offer per interviews	Hire per offers
Aerospace	1 : 238	1 : 3	1 : 3	1 : 2
Business machine/EDP	1 : 116	1 : 3	1 : 4	1 : 2
Petroleum	1 : 75	1 : 1	1 : 5	1 : 2
Ordnance	1 : 721	1 : 3	1 : 3	1 : 2
Electric/Electronic	1 : 312	1 : 2	1 : 2	1 : 2
Chemical	1 : 126	1 : 2	1 : 2	1 : 2
Nuclear	1 : 36	1 : 3	1 : 2	1 : 3
R & D	1 : 85	1 : 2	1 : 3	1 : 2
Metalworking & machinery	1 : 104	1 : 2	1 : 3	1 : 2
Others	1 : 1188	1 : 2	1 : 4	1 : 2
Totals (average)	1 : 245	1 : 2	1 : 3	1 : 2

**Hiring ratios:** The table indicates the ratios between response, interviews, offers and hires as experienced by the sample companies during the past two years. Un-

tinted columns indicate the decisions that were made by prospective employees. Source: Deutsch, Shea & Evans, Inc., "Technical manpower recruitment practices."

shortage in some areas and industries to the present soft employment picture.

"Overall hiring plans for engineers in 1970 are down 1% from 1969," says EJC's John Alden, "but in the aerospace industry, planned hires are only 62% of last year while they are up as much as 137% in construction and consulting firms, public utilities and state governments. Today's demand is greater in less glamorous industries and in the smaller firms that the average engineer may not even know exist."

But even if the engineer knows of the existence of small employers, "Better distribution of jobs and engineers won't create employment where no openings exist," says Robert Herrick, executive director of the College Placement Council, Bethlehem, Pa. "A means to relate the supply more closely to the demand can help even out the peaks and valleys."

The council, which provides services in the college placement and recruitment field for about 1300 colleges and 2100 employers, offers a system called GRAD (Graduate Resume Accumulation and Distribution). EJC has entered into a cooperative arrangement that makes this resume referral system readily available to nearly 500,000 engineers on the rolls of its member societies. Although a total of 60,000 resumes is put through the system regularly, only 10,000 are on file at any one time because of the turnover. Ten per cent of the resumes on file are from engineers, as compared to a negligible number a year ago.

One encouraging note in an otherwise bleak employment picture is that engineers will prob-

ably be the first ones hired again when the economy regains its health.

Alden says that an economic upswing is usually preceded by a demand for engineering talent (technical people in general) because of the lead time necessary to prepare for projects. Recruiting will reflect that.

"However," he said, "the job-hunting engineer should be advised that when the upswing begins he won't necessarily find a surplus of employment ads in the newspapers."

The barometer of the upswing may not be increased advertising. As happened at the end of the last recession in 1964, more engineers responded to one employment ad than they did before the recession when the employer was forced to insert more ads for the same response.

Based on its study, "Engineer/Scientist Demand Index," which covers 41 publications in 20 major markets and technical journals representing a wide variety of fields, Deutsch, Shea & Evans, Inc., says: "At no time (in the past decade) has the need for technical people been a stable straight line; instead, demand has either climbed or declined. The more the technical community has been subjected to the vagaries of the demand cycle, the more difficult they are to recruit when the demand trends upward, and the more likely they are to desert the technical life when, as now, they are thrust into a depressed job market, often with bare minimum of notice and severance pay. Such cycles of demand and dismissal are inhibiting the numbers of students entering the engineering field, with potentially disastrous consequences." ■■



# KEPCO TALKS POWER SUPPLY TECHNOLOGY:

**THERMAL REGULATION IS THE REAL MEASURE OF A POWER SUPPLY**

It has long been recognized that a power supply's line and load regulation can, by feedback and very high gain, be reduced to infinitesimal proportions. With high gain, wide-band amplifiers providing nearly complete isolation from the effects of line or load variations, the limiting factor on performance becomes noise. Noise, in this context encompasses a whole spectrum of continuous or random unwanted deviations, including impulse or spike noise in the megahertz region, "ripple" in the audio-frequency band, jitter in the subcycle region, and over the longer term: drift. Filtering and shielding techniques, work at the higher frequencies, but jitter and drift being mainly thermal effects, their reduction is accomplished only by reducing the thermal sensitivity or the *thermal regulation*.

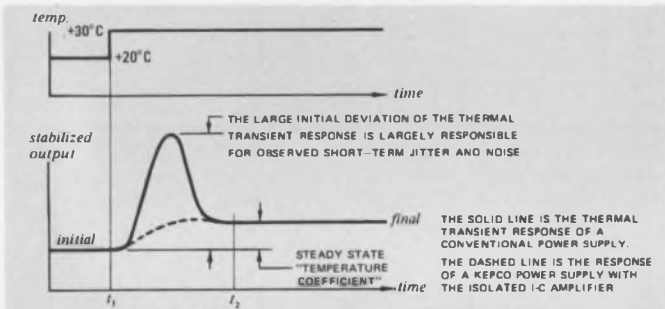

Every element in a power supply has a temperature coefficient, the reference, the sampling resistors, the amplifier. . . Their net steady-state value is reported as the "temperature coefficient" on the spec sheet. Some elements in the supply, however, also exhibit a *transient response* to temperature changes, a large initial deviation which recovers slowly to the steady-state temperature coefficient. In these elements, coefficients of change are balanced against others so that only the differential change appears in the steady-state coefficient. Unequal or localized heating or cooling - even a very small amount - will cause major perturbations which decay only as the elements regain thermal equilibrium.

Conventional, discrete construction, because of the physical separation of the elements, gives rise to the kind of thermal disequilibrium that makes the transient thermal regulation the *largest single cause* of low frequency jitter, noise and short-term drift.

By using a linear I-C control amplifier, Kepco has significantly reduced this effect. Our amplifier chips are buried in 0.8 cubic inches of thermally conductive epoxy, to form a thermal low pass filter, filtering out the sudden temperature fluctuations caused by drafts. The monolithic control amplifier sees only slow homogeneous temperature changes, affecting all parts of the chip simultaneously and eliminating differential heating as a cause of the transient thermal regulation effect. The improvement is several orders of magnitude!

We will discuss this subject in detail at the Kepco Power Supply Seminars—during WESCON at the Century Plaza Hotel. If you would like to participate in these discussions, please contact Mr. Art Rippeon at Windsor Dynamics, for complimentary tickets. Write to P.O. Box 5500, Sherman Oaks, Cal. 91413, or call (213) 989-3631. We'll see you at WESCON.

Write Dept. DF-05

## KEPCO®

KEPCO, INC. • 131-38 SANFORD AVENUE • FLUSHING, N.Y. 11352  
(212) 461-7000 • TWX # 710-582-2631

INFORMATION RETRIEVAL NUMBER 36

# Hi-Ho ASTROplate®

"UGH! Silver not take-um heat like ASTROplate!"



ASTROplate® CAN STAND THE HEAT. We've tested ASTROplate's heat handling capacity. To put it concisely, the base connector material and insulation will deteriorate long before ASTROplate will. ASTROplate's melting point is 2600° F.

YOU CAN MIX OR MATCH ASTROplate® with silver or any other finish anywhere in your system (old or new) with *no galvanic reaction*. Solderability performance meets Mil Spec. QQ-S-365.

Ask your Amphenol Distributor for ASTROplate® —the PERMANENT FINISH for RF connectors.

**AMPHENOL**  
THE BUNKER-RAMO CORPORATION

INFORMATION RETRIEVAL NUMBER 37

## Get low-cost transient protection in a microcircuit package.

Capable of deflecting overvoltage transients in 50 nano-seconds or less, the new TRANSTECTOR® Circuit Protector Hybrid Crowbar can operate in circuits carrying up to 10 Amps. Standard overvoltage trip points from 5 to 200 VDC.



Conveniently packaged in standard dual in-line integrated circuit and DO-27 diode cases — it permits you to save space on your printed circuit or multi-layer boards by 3 to 1 over the old method of using discrete components.

Find out about Transtector Systems from M&T Chemicals Inc., 532 Monterey Pass Road, Monterey Park, Calif. 91754. Tel. (213) 283-9278.

\*Trademark of M&T Chemicals Inc.

**M&T Chemicals Inc.**   
SUBSIDIARY OF AMERICAN CAN COMPANY

## M&T can make you look good.

INFORMATION RETRIEVAL NUMBER 38

INFORMATION RETRIEVAL NUMBER 39 ▶

## The new PDP-8/e: Its own mother wouldn't know it.



The PDP-8/e is a radical departure in computer design. There's no back panel wiring — everything plugs into the OMNIBUS™, even the CPU. In any order. It's completely flexible; you buy only what you need. And if you need more later, just buy it and plug it in. And the PDP-8/e is easier to interface and easier to maintain than old-style computers.

We've made a few other changes. Easier programming. 1.2  $\mu$  sec memory cycle time. 15 added instructions. 256 words of read-only memory. 256 words of read/write memory.

Yet there's no generation gap between the PDP-8/e and the rest of the PDP-8 family computers in 7500 world-wide installations. They all use the same peripherals (over 60 of them). They're all program and interface compatible, they all have extensive applications and documentation. PDP-8/e was born with a silver software package in its mouth.

The basic 4K machine sells for less than \$5000. With teletype, less than \$6500. Quantity discounts available.

**digital**  
COMPUTERS • MODULES

Digital Equipment Corporation  
Maynard, Mass. 01754 (617) 897-5111

# Ideas For Design

## SCR improves UJT oscillator circuit

The basic unijunction transistor (UJT) oscillator shown in Fig. 1 is widely used, but it has two drawbacks since the timing capacitor,  $C_T$ , is never fully discharged by the UJT:

- The period of oscillation is always abbreviated for a given timing capacitor value.
- The first cycle after initial turn-on is always longer than the following ones.

This causes timing ambiguity when the circuit is to be gated on or used in a one-shot mode as a delay element, because the exact charge on  $C_T$  is never known.

By adding an SCR and resistor to the circuit,  $C_T$  can be completely discharged every time the UJT fires (Fig. 2). Discharge current through the new resistor,  $R_s$ , produces a negative pulse at the SCR cathode, which causes it to latch since the gate is grounded.  $C_T$  completes its discharge through the shunt SCR path. The SCR will unlatch and allow a new cycle to start when the voltage across  $R_s$  reaches zero. Care should be taken to assure that the timing resistor,  $R_T$ , is large enough to prevent the flow of SCR holding current (usually about 1 mA for small devices).

*C. J. Ulrick, D. A. Kaplan, Design Engineers, Collins Radio Co., N.E. Cedar Rapids, Iowa.*

VOTE FOR 311

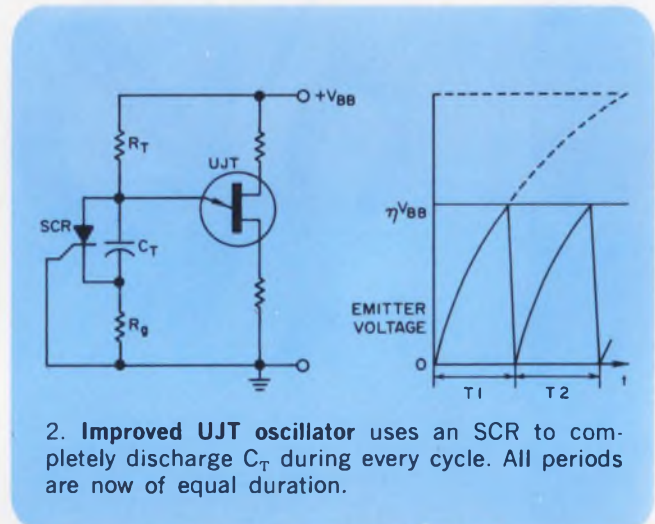
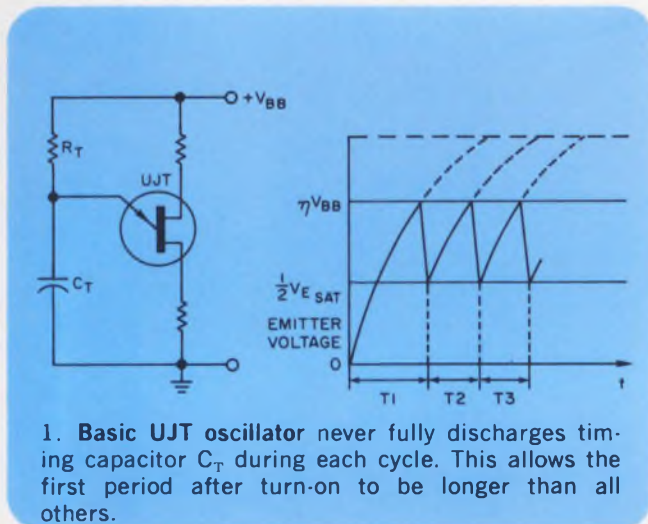

## Don't neglect cable error in high loss measurements

Precision attenuators are commonly used to measure gain, with cable shielding providing ground continuity between the oscillator and the attenuator. This ground is normally considered more than adequate for low frequency signals. However, the cable shielding must always have some resistance that affects accuracy. An equivalent circuit (Fig. 1) of a typical gain measurement setup provides the basis for error calculations. Assume all input and output impedances are 50 ohms.

This circuit can be redrawn (Fig. 2) so that  $R_4 = R_{1 \text{ shield}}$  in parallel with  $R_{2 \text{ shield}}$ . Solving for  $V_1$ ,

$$V_1 = \frac{V_{in} R_p}{R_3 + R_4}, \text{ where } R_p = \frac{R_4 R_o}{R_4 + R_o}.$$

Because  $R_4 \ll R_o$ ,

$$V_1 \cong \frac{V_{in} R_4}{R_3 + R_4}. \quad (1)$$

Expressing  $V_o$  in terms of  $V_{in}$  and  $V_1$ ,

$$V_o = (V_{in} - V_1) 10^{-1} + V_1. \quad (2)$$

Substituting Eq. 1 into Eq. 2 and dividing

## Helipot Trims Price & Profile



69PR100X

The new Helipot Series 89 industrial  
cermet trimmers feature:

**Low Cost:**

\$1.35 each in 1-9 quantities;  
less than \$1.00  
in quantities over 1,000.

**Low Profile:**

Maximum height of .250 inches  
allows for closer p-c board stacking.

Series 89 trimmers with two different pin spacings  
are available "off-the-shelf"  
from 17 locations across the country.

**Beckman®**

INSTRUMENTS, INC.  
HELIPOT DIVISION  
FULLERTON, CALIFORNIA

INTERNATIONAL SUBSIDIARIES: AMSTERDAM; CAPE TOWN; GENEVA; GLENROTHES;  
SCOTLAND; LONDON; MEXICO CITY; MUNICH; PARIS; STOCKHOLM; TOKYO; VIENNA.

through by  $V_{in}$  gives

$$\frac{V_o}{V_{in}} = \left(1 - \frac{R_4}{R_3 + R_4}\right) 10^{-4} + \frac{R_4}{R_3 + R_4}, \quad (3)$$

which is the total attenuation provided by this circuit.

To appreciate the significance of small cable shielding resistance, assume first that  $R_1 = 0 \Omega$ , then

$$V_o/V_{in} = 10^{-4} = -80 \text{ dB.}$$

Now assume  $R_4 = 0.001 \Omega$ . In this case

$$V_o/V_{in} = \left(1 - \frac{0.001}{50.001}\right) 10^{-4} + \frac{0.001}{50.001} \approx -78.4 \text{ dB.}$$

An  $R_4$  of  $0.001 \Omega$  has caused a 1.6-dB error in output voltage  $V_o$ . This effect becomes more serious with increasing attenuation. At a 100-dB attenuator setting, the error in  $V_o$  is 10 dB.

Measurement accuracy demands that  $R_4$  be very small. For example, to measure  $80 \text{ dB} \pm 0.5 \text{ dB}$ , the second term of Eq. 3 must be  $\leq (0.06) 10^{-4}$ . Solving for  $R_4$ ,

$$R_4 \approx 0.003 \Omega \text{ (maximum).}$$

This analysis has been done with the assumption  $V_1$  is in phase with  $V_{in}$  and holds for dc through hf. At vhf and above,  $V_{in}$  and  $V_1$  could have any phase relationship, because the propagation delay in the ground path might not be the same as in the signal path. The output signal would then vary in amplitude with the path length of the ground as well as the resistance of the ground.

For the circuit considered here, no measurement problem would exist if  $R_{1 \text{ shield}}$  is zero. A short, heavy ground connection between signal source and attenuator will allow high gain measurements with a fair accuracy.

*C. W. Hill, Electrical Design, Westinghouse Electric Corp., A & ESD, Baltimore, Md.*

VOTE FOR 312

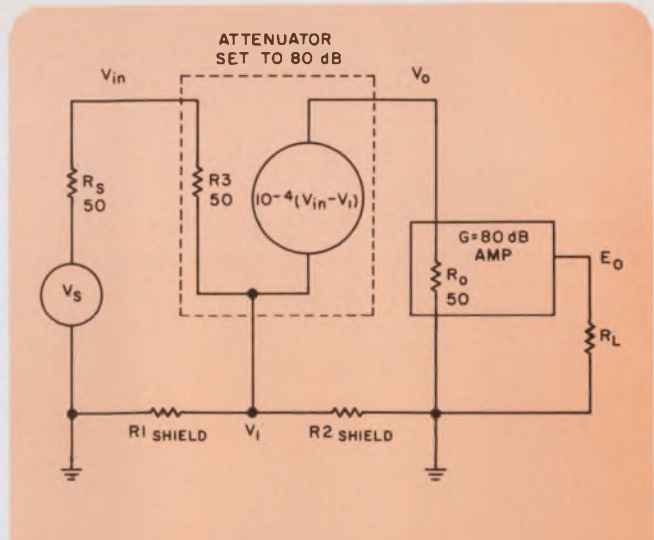

1. Gain equals attenuator setting when  $V_{in} = E_o$  in this standard test setup. The attenuator is shown in equivalent circuit form.

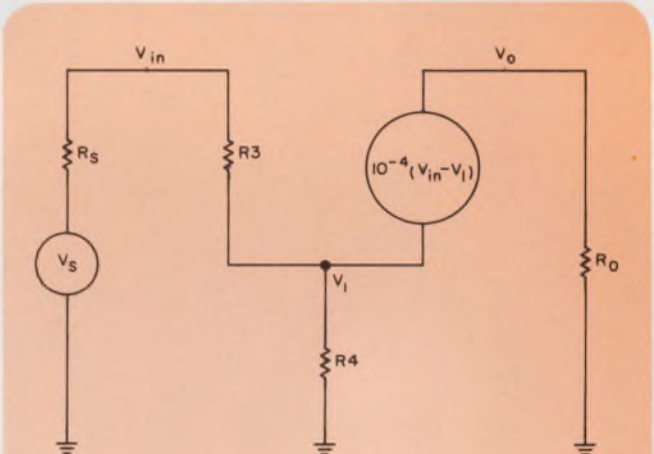

2. Parallel cable shield resistances are redrawn as  $R_4$  to simplify circuit analysis. An  $R_4$  of only  $0.001 \Omega$  can cause a 1.6-dB error when measuring 80 dB.

## Dual tracking circuit added to single regulated supply

Since both output terminals of most modern power supplies are floating, the common or ground for external circuitry may be located electrically between the positive and negative terminals. Taking advantage of this fact, dual tracking outputs can be provided from one regulated supply.

In the circuit shown, the op amp (709) compares the voltage at the  $R_1/R_2$  junction to the output voltage of complementary transistors  $Q_1$

and  $Q_2$  and drives these transistors to equate the two voltages. When  $R_1 = R_2$ , the input voltage will be divided in half. The middle output terminal common may be grounded, and two power sources will be available: for example,  $+15 \text{ V}$  and  $-15 \text{ V}$  from a  $+30\text{-V}$  supply.

Operation is such that one output transistor is always off, and the conducting transistor supplies the unbalance current of the loads. When the circuit is to divide the source into two equal voltages, dual regulation is maintained for both source and load variations. This operation is preferred over the usual system in which the voltage reference is dependent on the positive supply



# TRW Polycarbonates

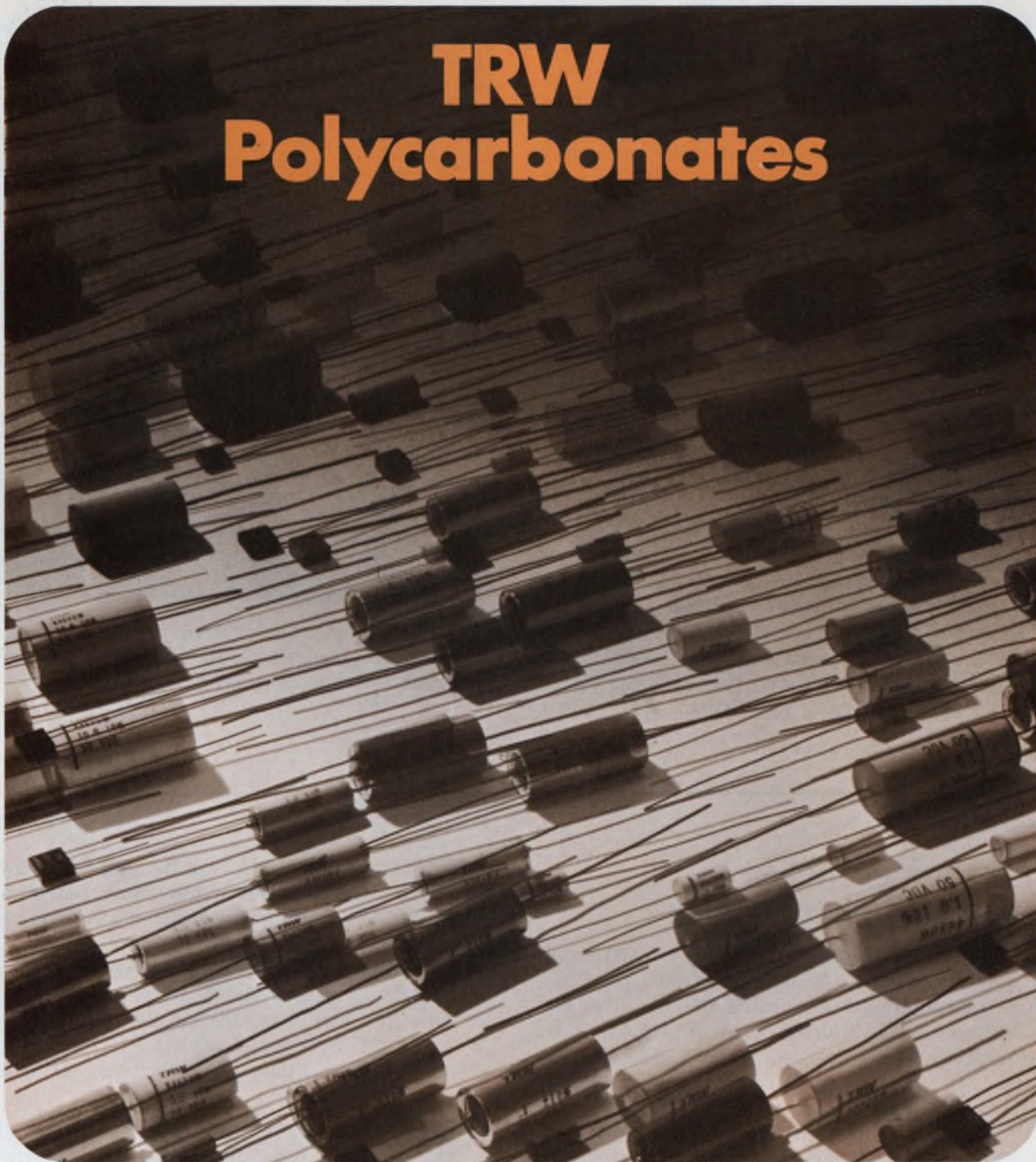

## ...small answers to big problems

Need capacitors with premium electrical and TC properties...and in the smallest possible package? Polycarbonate capacitors are your answer. And no one knows more about polycarbonates than TRW.

As the pioneer in polycarbonate capacitor development, TRW has the know-how to get that "extra

ounce of performance" out of this remarkable material. We can meet your design requirements with either metallized or foil wound polycarbonates in a wide range of capacitances, voltage ratings, shapes, and sizes. Standard types will solve most design problems...if not, let's talk about your special requirements.

For full information, contact TRW Capacitor Division, Box 1000, Ogallala, Nebraska. Phone: (308) 284-3611. TWX: 910-620-0321.

# TRW®

INFORMATION RETRIEVAL NUMBER 41

only. The output regulation will be very nearly as good as the source, if a 709 amplifier is used.

Alternatively, the  $R_1/R_2$  resistance ratio may be changed to allow unequal output voltages: for example, +12 V and +5 V, using a 17-V source with the most negative terminal grounded. A potentiometer could be substituted for  $R_1$  and  $R_2$ . The restriction here is that the input limits of the operational amplifier must be observed. It might not be possible to divide and get +25 V and -5 V from a 30-V source because of the input limitations with respect to the supply voltage.

Compensation networks may be required since the amplifier is operating at a closed-loop gain of one. Capacitors  $C_1$  and  $C_2$  reduce the ac impedance of the output circuit.

A diode between pins 6 and 8 or a pair of diodes across the op amp input will prevent latch up in the event one output is shorted. These are indicated by dashed lines on the diagram.

Resistors  $R_3$  and  $R_4$  are 100 k $\Omega$  but could possibly be eliminated if extra gain is needed.

Transistors  $Q_1$  and  $Q_2$  may be silicon and germanium-power types, respectively, and require

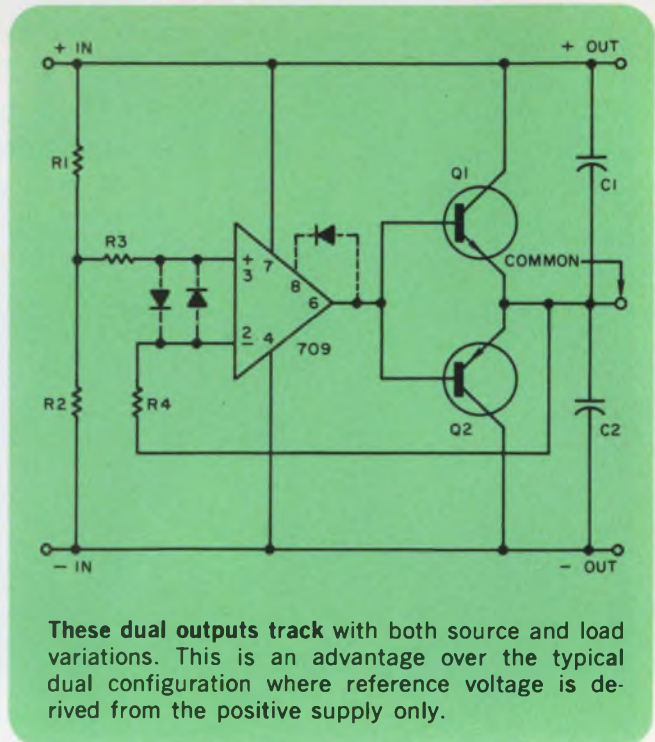

**These dual outputs track with both source and load variations. This is an advantage over the typical dual configuration where reference voltage is derived from the positive supply only.**

no heat sink for output currents up to 100 mA.

*Preston C. Rice, Associate Engineer, Southern Research Institute, Birmingham, Ala.*

VOTE FOR 313

## Transformer makes broadband phase shifter

A broadband phase shifter, linear to 60° and capable of phase shifts exceeding 150°, provides a constant-amplitude output as the signal phase is varied. With wideband transformers, this phase shifter may be used from 1 MHz to 100 MHz.

Phase shift controls  $R$  or  $C$  may be adjusted manually or electronically depending on the application.  $R$  can be varied electronically through controlled FET bias while  $C$  can be adjusted by controlling the bias on a varicap. For best phase linearity the FET approach is superior. This phase shifter may produce either lead or lag phases by interchanging the  $R$  and  $C$  circuit positions.

The schematic diagram and equivalent circuit of the phase shifter are shown in Fig. 1 for a lagging phase control. Writing equations for the equivalent circuit shows

$$i = 2cse_1 / (1 + RCs)$$

$$e_o = e_1 - iR = e_1 [1 - (2RCs) / (1 + RCs)]$$

$$e_o/e_1 = (1 - RCs) / (1 + RCs) = Ae^{-j\theta} / Ae^{j\theta} = e^{-j2\theta}$$

where  $\theta = \tan^{-1} \omega RC$ .

The magnitude of  $e_o/e_1$  is unity, and the output amplitude is independent of the phase controlling parameter  $\omega RC$ . The phase shift as a function of  $\omega RC$  is plotted in Fig. 2.

The phase plot may be used by considering  $\omega$  as a variable with a fixed  $RC$  or fixed  $\omega$  and variable  $RC$ . The phase shifter should be driven from a low source impedance (typically 50 ohms). The resistance and reactance elements

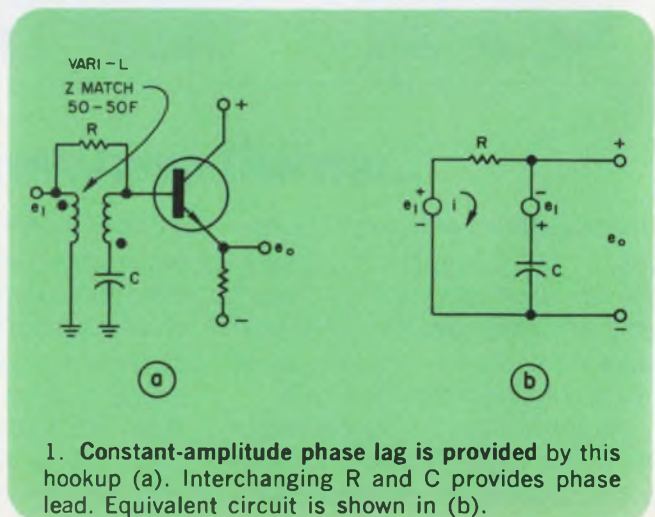

**1. Constant-amplitude phase lag is provided by this hookup (a). Interchanging  $R$  and  $C$  provides phase lead. Equivalent circuit is shown in (b).**



# CHIPS\*

**\*USCC CERAMOLITHIC® CHIP CAPACITORS FOR ANY HYBRID CIRCUIT DESIGN PROBLEM**

SPECIFICATIONS: Capacitance range: 10pF to 3.3Mfd. Voltage ratings: 50, 100 and 200 WVdc. Dielectrics: W and NPO. Sizes: start with .050" X .050" X .040". End terminations: noble metal and special combinations. Meets all applicable requirements of MIL-C-11015 and MIL-C-39014.

**USCC**

U.S. Capacitor Corporation, 2151 No. Lincoln St., Burbank, Calif. 91504, Phone (213) 843-4222 • TWX: 910-498-2222

**CERAMIC CHIP CAPACITORS, MINIATURE CERAMIC CAPACITORS, EMI/RFI FILTERS**

should be large relative to the source impedance (200 to 3000 ohms). An output emitter follower is employed for load isolation.

Applications of the phase shifter include:

- Phase modulation without AM.
- Phase shifter to develop quadrature reference signals for quadrature phase detection. In noncoherent signal detection, local oscillator reference signals are necessary (90 degrees apart) so that both the amplitude and phase of an incoming signal may be determined.

*Ronald J. Turner, Staff Engineer, General Atronics Corp., Philadelphia, Pa.*

VOTE FOR 314

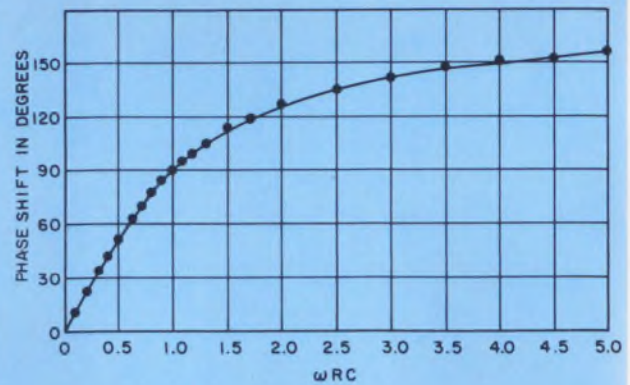

2. Linear phase shift exists over the first 60° of phase adjustment. A wideband transformer allows operation from 1 MHz to 100 MHz.

## High-voltage decoder uses common-base buffer

One-of-ten IC decoders often interface with lamps, indicator tubes or solenoids. In most cases these devices cannot be driven by the 2-V output swing of the decoder's TTL circuitry. Even special Nixie decoder-drivers (Fairchild 9960, 9315 and TI 7441A) have excessive leakage at high voltage, which may cause background glow. When used in multiplexed operation, they cannot sink enough current to maintain full brightness.

The typical solution is to place on each decoder

output a common-emitter transistor buffer, tailored to the specific voltage, current and speed requirements. Such a modification acts as an inverter and requires an additional stage for correct operation.

This extra stage can be eliminated by using the common-base configuration with the single 5-K resistor shown. It is especially attractive for high-voltage operation, since it supplies a low-impedance back-bias of about 2 V to the bases of all nonconducting transistors. The circuit is restricted to applications where the load current does not exceed 16 mA.

*Peter Alfke, Design Engineer, Fairchild Semiconductor, Mountain View, Calif.*

VOTE FOR 315

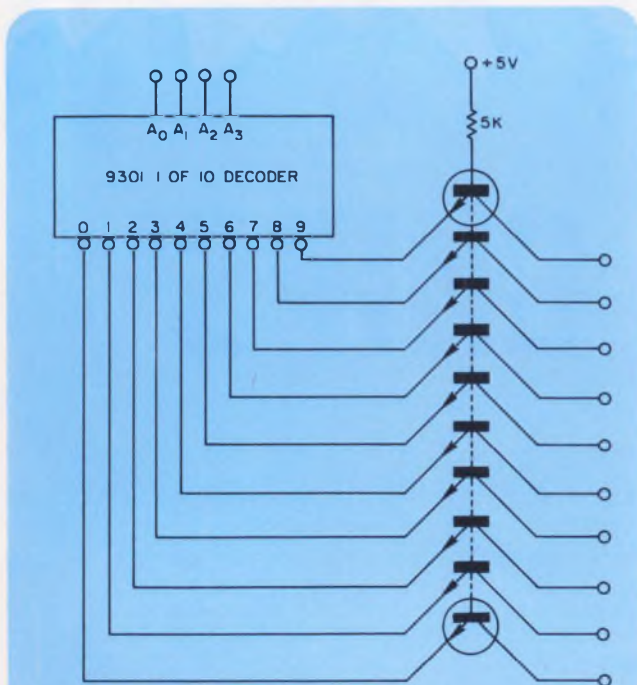

Common base buffer provides an output interface for the one-of-ten decoder.

**VOTE!** Go through all Idea-for-Design entries, select the best, and circle the appropriate number on the Reader-Service-Card.

**SEND US YOUR IDEAS FOR DESIGN.** You may win a grand total of \$1050 (cash)! Here's how. Submit your IFD describing a new or important circuit or design technique, the clever use of a new component or test equipment, packaging tips, cost-saving ideas to our Ideas-for-Design editor. You will receive \$20 for each accepted idea, \$30 more if it is voted best-of-issue by our readers. The best-of-issue winners become eligible for the Idea Of the Year award of \$1000.

### IFD Winner for April 1, 1970

**Charles A. Herbst**, Consultant Engineer, Dumont, N.J. His Idea "Solid-State Isolation Relay Has Nonpolarized Terminals" has been voted the Most Valuable of Issue award.

**Vote for the Best Idea in this Issue.**

# Isolate with light...

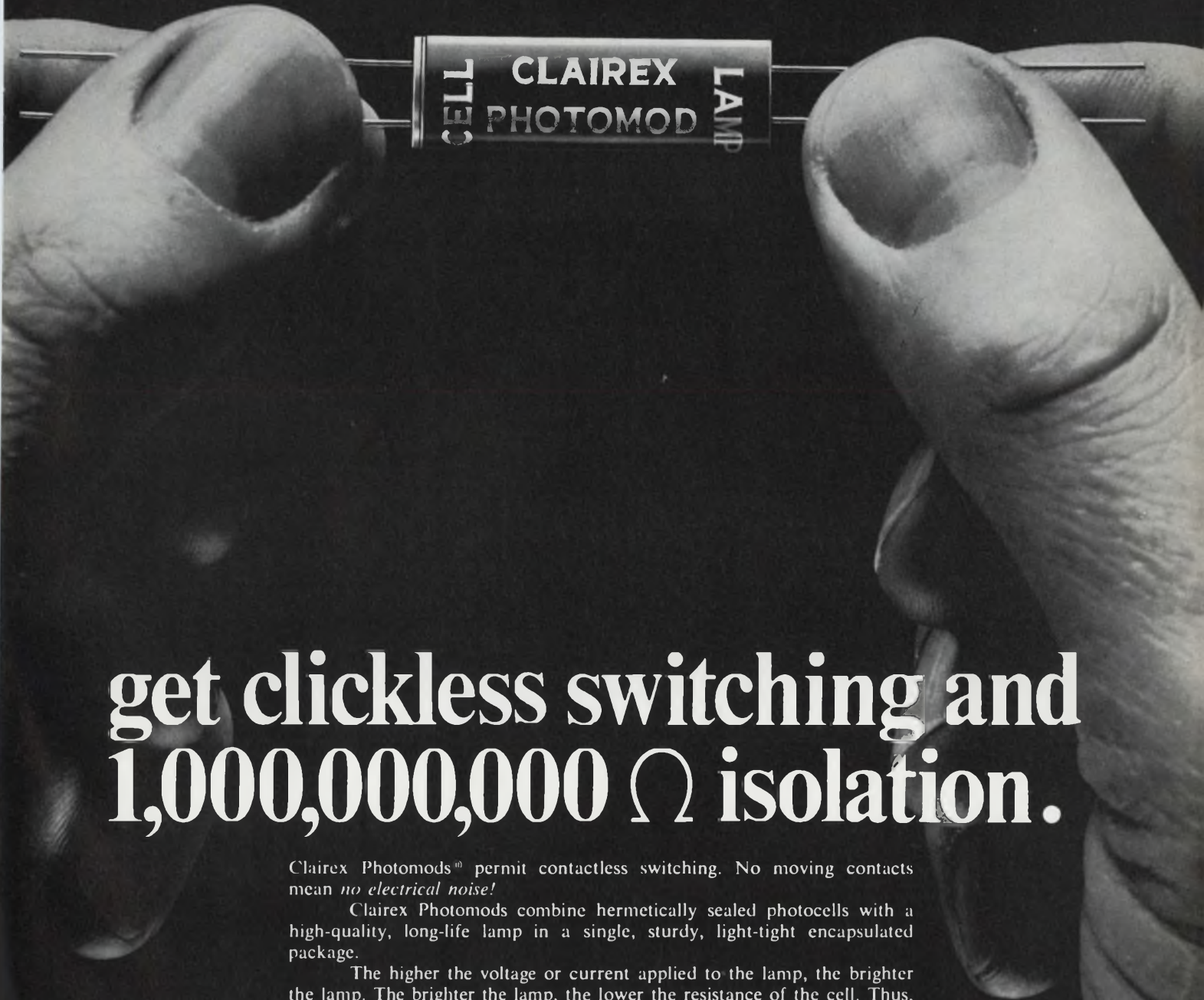

## get clickless switching and 1,000,000,000 $\Omega$ isolation.

Clairex Photomods<sup>®</sup> permit contactless switching. No moving contacts mean *no electrical noise!*

Clairex Photomods combine hermetically sealed photocells with a high-quality, long-life lamp in a single, sturdy, light-tight encapsulated package.

The higher the voltage or current applied to the lamp, the brighter the lamp. The brighter the lamp, the lower the resistance of the cell. Thus, resistance of the cell is varied without physical contact, and no noise is generated in the signal circuit.

Let us show you how the "light touch in automation and control" can provide you with noiseless switching and control. Call (914) 664-6602 or write Clairex, 560 South Third Avenue, Mount Vernon, New York 10550.

**CLAIREX ELECTRONICS<sup>®</sup>**  
A DIVISION OF CLAIREX CORPORATION

# Product Source Directory

## A/D and D/A Converters

This Product Source Directory covers a/d and d/a converters.

Units covered are separated into two categories: discrete and hybrid. Within these two categories a further breakdown was made to differentiate modular from rackmount converters.

For each table, units are listed in ascending order of one major parameter. The column con-

taining this parameter is color-coded white.

The following abbreviations apply to all converters listed: ina—information not available  
n/a—not applicable  
req—request

Manufacturers are identified by abbreviation. The complete name of each manufacturer can be found in the Master Cross Index below.

Abbrev.	Company	Information Retrieval No.	Abbrev.	Company	Information Retrieval No.	Abbrev.	Company	Information Retrieval No.
Adage	Adage, Inc. 1079 Commonwealth Ave. Boston, Mass. 02215 (617) 783-1100	425	CL	Computer Labs 1109 S. Chapman St. Greensboro, S.C. 27403 (919) 292-6427	437	EG&G	EG & G Inc. 35 Congress St. Salem, Mass. 01970 (617) 745-3200	449
ADI	Analog Devices Inc. 221 Fifth St. Cambridge, Mass. 02142 (617) 492-6000	426	Conrac	Conrac Corp. 330 Madison Ave. New York, N.Y. 10017 (212) 687-3330	438	E-H	E-H Research Laboratories Inc. Box 1289 Oakland, Calif. 94604 (415) 834-3030	450
American	American Astrionics, Inc. Technicolor Inc. 855 N. Cahuenga Blvd. Hollywood, Calif. 90038 (213) 466-9741	427	CP	Computer Products, Inc. 2801 E. Oakland Park Blvd. Ft. Lauderdale, Fla. 33306 (305) 565-9565	439	EMR	EMR Div. Box 3041 Sarasota, Fla. 33578 (813) 958-0811	451
Analogic	Analogic Corp. Autoban Rd. Wakefield, Mass. 01880 (617) 246-0300	428	Datascan	Datascan, Inc. 1111 Paulison Ave. Clifton, N.J. 07013 (201) 478-2800	440	Fairchild	Fairchild Semiconductor 313 Fairchild Dr. Mountain View, Calif. 94040 (415) 962-5011	452
Astrodata	Astrodata, Inc. 240 E. Palais Rd. Anaheim, Calif. 92803 (714) 772-1000	429	Datel	Datel Corp. 943 Turnpike St. Canton, Mass. 02021 (617) 828-1890	441	GAP	GAP Instrument Corp. 17 Brooklyn Ave. Westbury, N.Y. 11590 (516) 333-8020	453
Avco	Avco Electronics Div. 4807 Bradford Dr. Huntsville, Ala. 35805 (205) 837-6500	430	DDC	Data Device Corp. 100 Tech St. Hicksville, N.Y. 11801 (516) 433-5330	442	Helipot	Helipot Div. Beckman Instruments Inc. 2500 Harbor Blvd. Fullerton, Calif. 92634 (714) 871-4848	454
BB	Burr-Brown Research Corp. Int'l Airport Ind. Pk. Tucson, Ariz. 85706 (602) 294-1431	431	DEC	Digital Equipment Corp. 146 Main St. Maynard, Mass. 01754 (617) 897-5111	443	Hi-Tek	Hi-Tek Corp. 2220 S. Anne St. Santa Ana, Calif. 92704 (714) 540-3520	455
Beckman	Beckman Instrs. Inc. Electronic Instrs. Div. 2200 Wright Ave. Richmond, Calif. 94804 (415) 526-7730	432	Ditran	Ditran Corp. Division Clifton 25 Adams St. Burlington, Mass. 01803 (617) 272-6210	444	H-P	Hewlett-Packard Co. 1501 Page Mill Rd. Palo Alto, Calif. 94304 (415) 326-7000	Contact local sales office
Bendix	Bendix Environmental Science Div. 1400 Taylor Ave. Baltimore, Md. 21204 (301) 825-5200	433	Doric	Doric Scientific Corp. 7969 Engineer Rd. San Diego, Calif. 92111 (714) 277-8421	445	Hybrid	Hybrid Systems Corp. 95 Terrace Hall Ave. Burlington, Mass. 01803 (617) 272-1522	456
BME	Bio-Medical Electronics, Inc. 653 Lofstrand Lane Rockville, Md. 20850 (301) 762-8373	434	DSE	Dynamic System Electronics Corp. Box 780 Tempe, Ariz. 85281 (602) 967-8644	446	KDI	KDI Navcor Valley Forge Ind. Pk. Norristown, Pa. 19401 (215) 666-6531	457
C-H	Culler-Harrison Inc. 5770 Thornwood Dr. Goleta, Calif. 93017 (805) 967-0424	435	Dynalex	Dynalex, Inc. 885 Front St. Burbank, Calif. 91502 (213) 849-2221	447	Kearfott	Kearfott Div. Singer-General Precision Inc. 1150 McBride Ave. Little Falls, N.J. 07424 (201) 256-4000	458
Cimron	Cimron Div. Lear Siegler Inc. 1152 Morena Blvd. San Diego, Calif. 92110 (714) 276-3200	436	EECO	Electronic Engrg. Co. of Calif. 1441 E. Chestnut Ave. Santa Ana, Calif. 92701 (714) 547-5651	448	Lancer	Lancer Electronics Corp. 1416 W. Main St. Norristown, Pa. 19401 (215) 275-3344	459

The best power supply  
for driving 5 volt IC's  
is one specifically designed  
for driving 5 volt IC's.  
We make it.  
We call it our  
5 volt IC series.

(Catching it?)



ACDC's 5 volt IC series is a compact, rugged power supply designed specifically for driving 5 volt IC's. It features a built-in 5 volt regulator and a 5 volt output. The unit is housed in a metal case with a fan for cooling. It is available in several models with different current ratings and voltages. For more information, contact ACDC Electronics Inc. at (714) 757-1880.

**acdc electronics inc.**

Oceanside Industrial Center, Oceanside, California 92054, (714) 757-1880

The best power supply for  
driving operational amplifiers  
is one specifically built  
to drive operational amplifiers.  
We make it.  
We call it our OA series.

(In case you missed the connection,  
that's short for operational amplifier.)



ACDC's OA series is a compact, rugged power supply designed specifically for driving operational amplifiers. It features a built-in operational amplifier and a dual output. The unit is housed in a metal case with a fan for cooling. It is available in several models with different current ratings and voltages. For more information, contact ACDC Electronics Inc. at (714) 757-1880.

**acdc electronics inc.**

Oceanside Industrial Center, Oceanside, California 92054, (714) 757-1880

The best power supply  
to tuck into impossible spaces  
is the one specifically designed  
to tuck into impossible spaces.  
We make it.  
We call it our Impossible Space  
Power Supply.

(also known as the JR series)



ACDC's Impossible Space Power Supply is a compact, rugged power supply designed specifically for tucking into impossible spaces. It features a built-in regulator and a single output. The unit is housed in a metal case with a fan for cooling. It is available in several models with different current ratings and voltages. For more information, contact ACDC Electronics Inc. at (714) 757-1880.

**acdc electronics inc.**

Oceanside Industrial Center, Oceanside, California 92054, (714) 757-1880

...and the best power supply  
specifically designed  
for no specific application  
is our BX series.



If you're looking for power supplies but don't need the miniature size of our JR series . . . or the optimized characteristics of our IC series . . . or the dual output of our OA series . . .

There are over 175 models in the BX series, covering voltage ranges from 2 through 400 volts (0.01% regulation) with current ratings from 300 mA to 20 amps. 2 through 28 VDC supplies are off the shelf, however, you may have to wait a bit

for ratings up to 400 VDC. Prices start as low as \$66 with a nominal addition for overvoltage protection, and they all carry ACDC's "guaranteed forever" warranty.

But, if you're still looking, there are 178 models in our BC series (0.5% regulation), a complete line of dual output modules, digital programmables, wide range programmables, multiple output, digital readout and memory power supplies.

**acdc electronics inc.**

Oceanside Industrial Center, Oceanside, California 92054, (714) 757-1880

# BX Precision Power Supply Modules for All Applications / Specifications

Nominal Output Voltage (VDC)	Output Voltage Range (VDC)	Maximum Current Rating (Amps)	Maximum Dimensions (inches)			Weight approx. (lbs.)	Case Size	Model (Add -1 for Overvoltage Protection)	Price
			H	W	L				
2 through 28 in even voltages	±1 from nominal	0.3	1.88	3.44	4.75	1.6	M1	BX2N0.3 through BX28N0.3	76.00 Add \$20 for overvoltage protection
2 through 28 in even voltages	±1 from nominal	1.2	5.00	3.12	4.37	4	A1	BX2N1.2 through BX28N1.2	116.00 Add \$20 for overvoltage protection
2 through 28 in even voltages	±1 from nominal	2.5	5.00	4.37	6.00	8	B1	BX2N2.5 through BX28N2.5	137.00 Add \$20 for overvoltage protection
2 through 10 in even voltages	±1 from nominal	5.0	5.25	5.00	6.00	11	C1	BX2N5 through BX10N5	184.00 Add \$30 for overvoltage protection
12 through 28 in even voltages			5.00	6.87	6.00	14	D1	BX12N5 through BX28N5	
2 through 6 in even voltages	±1 from nominal	10.0	6.50	6.62	8.25	18	E3	BX2N10 through BX6N10	274.00 Add \$30 for overvoltage protection
8 through 28 in even voltages			6.50	7.75	8.25	25	F2	BX8N10 through BX28N10	
2 through 14 in even voltages	±1 from nominal	20.00	6.75	8.00	15.00	42	G1	BX2N20 through BX14N20	395.00 Add \$30 for overvoltage protection
16 through 28 in even voltages			6.75	9.75	15.00	46	H1	BX16N20 through BX28N20	

For applications requiring 0.5% regulation, see BC series, also available from stock.

Input	105-125VAC, 47-63Hz (usable also to 400Hz — consult acdc for derating). All models of 20A and greater are provided with a 105-125/210-250VAC input.
Output	Voltage range shown in table is continuously variable between limits by externally accessible screwdriver adjustment of multiterminal pot. Output is floating — either positive or negative terminal may be grounded. Current: zero to full load as shown in tables.
Regulation	0.01% or 0.001 volt for line change of 10%. 0.01% or 0.002 volt for NL to FL changes.
Ripple	0.5mV or 0.001% max. RMS (whichever is greater).
Stability	Maximum 0.1% or 10mV for eight hour period after initial warmup.
Transient Response	Output voltage returns to within regulation limits within 50μsec in response to a 50% step change in load current.
Remote Sensing	Terminals are provided to maintain regulation at the load, compensating for the DC voltage drop in the load cable.
Remote Voltage Adjustment	Terminals are provided to adjust the output voltage by means of a remote variable resistor.
Ambient Temperature	Operating: Full rated output at operating temperatures of 0° to 71°C without forced air or heatsinking. Storage: -55°C to +85°C.
Mil Specs	The listed catalog models are constructed with the highest quality components and have MTBF ratings in the neighborhood of 50,000 hours per MIL-HDBK-217. acdc will also build supplies to meet specific MIL specs such as MIL-E-4158A, MIL-E-16400, MIL-T-21200, and meet environmental requirements such as MIL-E-5400, MIL-E-5272, MIL-E-4970, and RFI specs MIL-I-26600 and MIL-I-6181. acdc's own environmental laboratory is able to perform qualification testing

	when required and is used extensively to prove out designs. In order to provide the most efficient design, customer inquiries are invited, outlining exact specifications and environmental conditions required for the end product.
Weight	See table.
Mounting	Unit can be mounted in any position on either one of two sides. Mounting faces have threaded mounting holes.
Dimensions	H-W-L dimensions for individual models are given in the table.
Overload Protection	All models are inherently protected against overload and short circuits of any duration. No fuses or reset buttons are used — automatic recovery is electronically accomplished.
Overvoltage Protection (Optional)	Any model, up to 50 volts, can be furnished with overvoltage protection which "crowbars" the output in the event of a rise in the output voltage of 10% or 2 volts (whichever is greater).
Connector	Cases A through F are supplied with a solder hook terminal header. Case M1 is furnished with an attached 10 terminal PC edge connector which may be used either as a solder connection or readily removed by the user and mounted in his equipment to provide plug-in convenience. G and H cases have barrier strip termination.
Construction	Modules are constructed of heavy gage aluminum with integral extruded heatsinks; color is black. Removable covers of perforated steel have a light gold enamel finish. Regulating circuitry is mounted on a PC board.
Output Impedance	DC — 1KHz 0.0001 R <sub>L</sub> or 0.001 ohm max. 1-10KHz 0.0003 R <sub>L</sub> or 0.01 ohm max. 10-100KHz 0.006 R <sub>L</sub> or 0.3 ohm max. (whichever is greater). R <sub>L</sub> = rated load.
Temperature Coefficient	Maximum .015% or 1mV/°C.



Abbrev.	Company	Information Retrieval No.
Micro	Micro Instrument Co 12901 Crenshaw Blvd. Hawthorne, Calif. 90250 (213) 772-1275	460
ND	Nuclear Data, Inc. 100 W. Golf Rd. Palatine, Ill. 60067 (312) 529-4600	461
NLS	Non-Linear Systems, Inc. Box N Del Mar, Calif. 92014 (714) 755-1134	462
P-E	Perkin-Elmer Corp. 131 Danbury Rd. Wilton, Conn. 06897 (203) 762-1000	463
Phoenix	Phoenix Data, Inc. 3384 W. Osborn Rd. Phoenix, Ariz. 85017 (602) 278-8528	464
PM	Precision Monolithics Inc. 1500 Space Park Dr. Santa Clara, Calif. 95050 (408) 246-9222	465
Preston	Preston Scientific Inc. 805 E. Cerritos Ave Anaheim, Calif. 92805 (714) 776-6400	466
Radiation	Radiation Microelectronics Div. Melbourne, Fla. 32901 (305) 727-5412	467
R&S	Rohde & Schwarz Sales Co. 111 Lexington Ave. Passaic, N.J. 07055 (201) 773-8010	468
Raytheon	Raytheon Computer 2700 S. Fairview St. Santa Ana, Calif. 92704 (714) 546-7160	469
Redcor	Redcor Corp. Box 1030 Canoga Park, Calif. 91304 (213) 348-5892	470
SLI	Standard Logic Inc. 1630 S. Lyon St. Santa Ana, Calif. 92705 (714) 835-5466	471
Solid State	Solid State Electronics Corp. 15321 Rayen St. Sepulveda, Calif. 91343 (213) 364-2271	472
Taft	Taft ElectroSystems, Inc. P.O. Box 43 Metuchen, N.J. 08840 (201) 549-9200	473
Zeltex	Zeltex Inc. 1000 Chalomar Rd. Concord, Calif. 94520 (415) 686-6601	474

# DISPLAY COMPONENTS

## YOKES

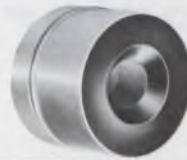

CELCO Deflection Yokes offer the most in resolution, speed and sensitivity along with low residual and low LI<sup>2</sup>. Distortion-free magnetic fields minimize spot growth from the center to the edge of the CRT.

## DEFLECTION AMPLIFIERS

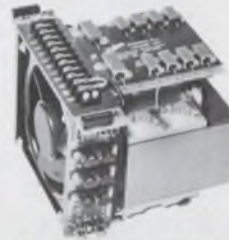

CELCO Deflection Amplifiers assure fast and accurate deflection of the electron beam in CRT or Storage Tube Displays. These all-silicon units, working at up to 120 V p-p can provide as much as 16 A p-p of output current. Features include wide bandwidth with excellent linearity and transient response.

## CIRCUIT CARDS



Plug-in cards include generators for dynamic focussing, correction circuits for linearity, regulators for static focussing and centering, and amplifiers for blanking, video, dynamic focussing and deflection.

## COIL POSITIONERS

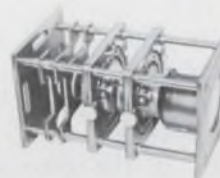

Low cost Coil and Tube positioners provide six independent degrees of freedom for yoke, focus, centering and alignment coils without jump or backlash. Tubes, such as CRTs, Scan Converters, Storage Tubes and Image Intensifiers, are firmly held and may be dismounted without removing the coil assemblies.

## DISPLAY SYSTEMS



CELCO Precision Display Systems are completely self-contained X-Y monitors with wide bandwidth to 1.0 MHz, linearity to 0.1% and fast slew rates. These flexible

systems are ideal for flying spot scanners, film and hard copy printers and recorders and most other applications where a high resolution light source is required.

**Celco** YOKES *Constantine Engineering Laboratories Company*  
Mahwah, N. J. 201-327-1123 Upland, Cal. 714-982-0215

INFORMATION RETRIEVAL NUMBER 44

# Be aware of a/d and d/a converter specifications

Today's analog/digital and digital/analog converters have moved out of the computer laboratory and into industry. Like the op amp before them, converters are finding new applications as size and price drop and performance improves. The first generations of high-performance integrated-circuit converters now coming into production are exploiting the inherent uniformity of IC manufacturing processes to achieve unprecedented levels of temperature tracking—with resultant accuracy, monotonicity and temperature range.

Key specifications that must be considered in many applications are quantizing error, resolution, relative accuracy, linearity, "glitch," differential linearity, monotonicity, repeatability, feed-through and noise.

## Quantizing error can't be avoided

Quantizing error occurs in analog a/d converters when the input signal lies midway between two different output codes. That is, the converter is equally likely to develop one of two digital outputs. For example, if the circuit is designed for 1-mV resolution and it is fed with a 5.5-mV signal, then theoretically it is equally likely to produce a digital reading of either 6-mV or 5-mV. Actually, circuit errors will bias the reading one way or another, but nonetheless, the circuit can't read closer to the actual value than  $\pm 1/2$  least significant bit (LSB).

## Resolution can be viewed in two ways

A 1-bit a/d or d/a converter provides  $2^{10}$  or 1024 different output values from zero to full scale. However, it provides one less than 1024 output steps in adjusting output over its zero-to-full-scale range. Thus, a 10-bit d/a converter with 10-V maximum output will provide 1024 different output values, including 0 and 10 V, but it will traverse between these values in 1023

increments of  $10\text{ V}/1023 = 9.775\text{ mV}$  each. Conversely, a 10-bit d/a converter designed to give 10-mV output steps will provide 10.23-V full-scale output.

Another way of viewing resolution is to consider it in terms of dynamic range. A 10-bit a/d converter provides 1024 different output levels, giving slightly more than 60-dB (1000:1) dynamic range. The dynamic range approach is often of considerable concern in optical, acoustic, vibratory, chemical and other fundamental scientific fields, where the signals span an enormous range of voltage or current values.

## Relative accuracy and linearity differ

These terms are partly synonymous, but with some second-order differences. Relative accuracy usually applies to an a/d converter, and it measures the deviation from straight-line proportionality. This is not quite the same as a d/a converter's linearity, whose specification refers to the best straight line ( $\pm 1/2$  LSB) rather than a line intersecting full scale and zero.

Further, the a/d converter's relative-accuracy figure does not include quantizing error but is simply a measure of circuit imperfection, while the d/a converter has no quantizing error so its linearity is a measure of total departure from best straight-line proportionality. Nonetheless, relative accuracy and linearity still don't provide a figure for total error, because a converter's full-scale value can drift with temperature, component aging, or supply voltage change.

## 'Glitch' critical in many applications

Because the increasing speed of today's d/a converters, the phenomenon of "glitch" grows in importance to the point of being the most critical specification in many applications. Glitch is somewhat analogous to feedthrough, since it is created by asymmetry in logic circuit turn-ON and turn-OFF times rather than capacitive coupling between digital input and analog output.

Because an IC flip-flop typically turns OFF some 20 to 100 ns faster than the same flip-flop

---

Barry Hilton, Senior Engineer, Pastoriza Division, Analog Devices, Inc., Newton Upper Falls, Mass.

turns ON, some of the digital input codes create havoc with the d/a's analog output. For example, in making the transition from 1111111111 to 1000000000, a 10-bit converter would move to an intermediate 0000000000 condition. The temporary 0000000000 condition would persist for perhaps 20 to 100 ns, and the converter would then produce an output according to the actual 1000000000 digital input code.

However, this intermediate 0000000000 state sets the output temporarily to zero—or, at least, starts the output slewing in that direction. As a result, the converter creates a short-duration output transient whose amplitude can approach half scale. For high-speed converters, where the whole updating process takes 100 ns or less, a 20-ns glitch pulse of substantial amplitude can drastically distort two successive levels of output.

### Keep differential linearity 1/2 LSB

Since a converter's output progresses in a series of discrete steps, the specification for differential linearity defines the allowable magnitude of each step. Ideally the converter's output advances in a series of accurate least-significant-bit increments. In reality, circuit imperfections may shrink one step and expand another.

Most converters give a 1/2-LSB tolerance for differential linearity for static operation. This means that no step may differ from the ideal LSB value by more than  $\pm 1/2$  LSB. In fact, should differential linearity exceed  $\pm 1/2$  LSB, the converter is nonmonotonic.

### Lack of monotonicity can cause havoc

An a/d's digital output code should increase as the analog input increases and a d/a converter's analog output should rise in accordance with larger values of digital input.

Lack of monotonicity occurs when the different weighted switching circuits don't track with temperature or long-term aging. If one weighted current value rises with temperature, for example, while the next-higher value decreases, then the point will ultimately be reached where the transition from the first code to the next higher code will reduce output instead of increasing it.

### Some applications need repeatability

Although a converter user may not be concerned with the absolute accuracy of his circuit, he often wants to reproduce its output with considerable fidelity over an extended operating period. Temperature effects and component aging are obvious sources of repeatability error.

Examples of the need for high repeatability

occur in some machine-tool applications, where a great deal of dimensional uniformity must be produced over the entire production run. Similarly, computer output microfilm equipment, using d/a converters to control CRT deflection and "writing," demand high repeatability in order to update artwork and graphics previously recorded.

### Speed defined in terms of settling time

Since a converter operates with 0.1% and better accuracy levels, the speed of operation is defined in terms of settling, rather than slew rate. For example, if a d/a converter with 10-V full scale featured a slewing rate of 10 V/ $\mu$ s, one might expect the device to respond to a transition from zero to full scale in roughly 1  $\mu$ s.

Actually, its listed specification might show a settling time for 1/2-LSB accuracy of 20  $\mu$ s, because of the additional time required for the output to traverse the few final percentages. Slewing rate merely defines the output excursion on a coarse scale to roughly 10% of final value. The last 10%, to a stated level of accuracy, takes considerably longer.

### Noise must be held below the LSB

In addition to picking up induced noise, all electronic circuits develop an irreducible minimum output noise, consisting of 1/f, Schottky, Johnson and other fundamental noise components. Noise must be held below the converter's LSB level; otherwise, the stated resolution begins to have dubious meaning.

### Feedthrough differs in a/d and d/a

Feedthrough is a measure of capacitive coupling between a d/a converter's digital input and its analog output. Because of the steep edges (fast risetimes) of the digital input codes, very little stray capacitance is required before input-to-output coupling becomes serious. Nevertheless, a good d/a converter design will hold down feedthrough transient pulses to a maximum amplitude of less than 1 LSB and a matter of nanoseconds' duration.

Feedthrough is a problem with modular a/d converter designs, too, but does not appear explicitly in the specification. However, it is inherent in the components and will add to the designer's difficulty in reducing physical size. It will also tend to cut down on conversion speed. In fact, although a modular successive approximation converter may be based on a straightforward circuit arrangement, its final success depends enormously on the designer's packaging and component placement skill. ■■

# A/D Converters (discrete, modular)

108

Manufacturer	Model	Number of Bits	Accuracy (% of fs)	Analog Input Voltage (V)	Conversion Time ( $\mu$ s)	Conversion Method	Digital Outputs (V)	Temperature Range ( $^{\circ}$ C)	Notes	Price Unit \$
Datel	ADC-E8D	2 BCD	$\pm 0.05$	$\pm 0.1, 5, 10$	312	integrating	0.4, 2.4	0 to 70		125
Datel	ADC-L8D	2 BCD	$\pm 0.025$	$\pm 1, 5, 10$	40	a	0.4, 2.4	0 to 70	a	215
Datel	ADC-M8D	2 BCD	$\pm 0.025$	$\pm 1, 5, 10$	4	a	0.4, 2.4	0 to 70	a	315
Datel	ADC-M12D	3 BCD	$\pm 0.025$	$\pm 1, 5, 10$	11.5	a	0.4, 2.4	0 to 70	a	495
Datel	ADC-E12D	3 BCD	$\pm 0.05$	$\pm 0.1, 5, 10$	5 ms	integrating	0.4, 2.4	0 to 70		155
Datel	ADC-L12D	3 BCD	$\pm 0.025$	$\pm 1, 5, 10$	60	a	0.4, 2.4	0 to 70	a	295
CL	HS-406	4	3.1	2.048	0.16	x	x	0 to 50		3200
Datel	ADC-H48	4	$\pm 0.1$	$\pm 10$	0.25	a	0.4, 2.4	0 to 70	a	595
CL	HS-505	5	1.6	2.048	0.2	x	x	0 to 50		3250
American	AD-1000-6	6	$\pm 1.6$	$\pm 2.56$	100 ps	ina	ina	0 to 50		req
Avco	AD-6	6	0.85	0-5	17.6	g	0.4, 3	-20 to +85	g	req
CL	HS-604	6	$0.8 \pm 1/2$ LSB	2.048	0.25	x	x	0 to 50		3300
CL	HS-615	6	0.8	2.048	0.066	x	x	0 to 50		7490
Datel	ADC-H68	6	$\pm 0.1$	$\pm 10$	0.4	a	0.4, 2.4	0 to 70	a	795
American	AD-1000-7	7	$\pm 0.8$	$\pm 2.56$	100 ps	ina	ina	0 to 50		req
Avco	AD-7	7	0.45	0-5	33.3	g	0.4, 3	-20 to +85	g	req
CL	HS-703	7	0.4	2.048	0.33	x	x	0 to 50		3350
CL	HS-710	7	0.4	2.048	0.1	x	x	0 to 50		7950
EG&G	AD1288/N	7	ina	0-1	12.9	ina	0-12	-15 to +60		req
American	AD-1000-8	8	$\pm 0.4$	$\pm 2.56$	100 ps	ina	ina	0 to 50		req
Avco	AD-8	8	0.25	0-5	64.5	g	0.4, 3	-20 to +85	g	req
Avco	HA-8	8	$\pm 0.23$	0-5	64.5	g	0.4, 3	-20 to +85	g	req
BB	ADC30-08N	8	$\pm 0.2$	$\pm 10$	20	a	2.6	0 to 70	as	195
CL	HS-802	8	0.2	2.048	0.5	x	x	0 to 50		3400
CL	HS-810	8	0.2	2.048	0.1	x	x	0 to 50		8750
CP	AD328A	8	$\pm 0.025$	0 to -10	50-100	a	2.4	0 to 65	az	167
CP	AD328C	8	$\pm 0.025$	0 to -4	50-100	a	2.4	0 to 65	az	167
CP	AD328D	8	$\pm 0.025$	+4 to -4	50-100	a	2.4	0 to 65	az	167
CP	AD328B	8	$\pm 0.025$	+10 to -10	50-100	a	2.4	0 to 65	az	167
Datel	ADC-H88	8	$\pm 0.1$	$\pm 10$	0.8	a	0.4, 2.4	0 to 70	a	895
Datel	ADC-E88	8	$\pm 0.05$	$\pm 0.1, 5, 10$	312	integrating	0.4, 2.4	0 to 70		119
Datel	ADC-L88	8	$\pm 0.025$	$\pm 1, 5, 10$	40	a	0.4, 2.4	0 to 70	a	195
Datel	ADC-M88	8	$\pm 0.025$	$\pm 1, 5, 10$	4	a	0.4, 2.4	0 to 70	a	295
DDC	MADC-8-3	8	$\pm 0.2$	$\pm 10$	16	a	0, +5	0 to 70		400
DDC	MADC-8-1	8	$\pm 0.2$	$\pm 10$	16	a	0, +5	-55 to +85		500
MICRO	5221-B	8	0.1	0-5	100	counter	(37)	10 to 40	(37)	195
NLS	1508	8	0.2	$\pm 10.24$	3	a	yes	0 to 50	a	575
Redcor	770-755	8	$\pm 0.4$	2	3	a	TTL/DTL	0 to 50	a	625
Redcor	770-750	8	0.4	5	20 $\pm$ 2	a	3-6	0 to 50	a	545
Redcor	770-755	8	$\pm 0.4$	5	3	a	TTL/DTL	0 to 50	a	625
Avco	AD-9	9	0.15	0-5	127	g	0.4, 3	-20 to +85	g	req
CL	HS-901	9	0.1	2.048	1.0	x	x	0 to 50		5450
CL	HS-905	9	0.1	2.048	0.2	x	x	0 to 50		9660
DDC	HADC-9-3	9	$\pm 0.1$	$\pm 10$	9	a	0, +5	0 to +70		550
DDC	HADC-9-1	9	$\pm 0.1$	$\pm 10$	9	a	0, +5	-55 to +85	a	650
DDC	MADC-9-3	9	$\pm 0.1$	$\pm 10$	18	a	0, +5	0 to +70		500
DDC	MADC-9-1	9	$\pm 0.1$	$\pm 10$	18	a	0, +5	-55 to +85		600
Kearfott	MADAC	9	$\pm 0.1$	$\pm 63$ dc	300	(44)	-15, 0	-30 to +50	(45)	req
Redcor	770-750	9	0.2	10	25 $\pm$ 2	a	3-6	0 to 50	a	625
ADI	ADC-F	8/10	0.05	+10	1	a	TTL	0 to 70		1680.
BB	ADC30-10N	10	$\pm 0.05$	$\pm 10$	30	a	2.6	0 to 70	as	225
CP	AD340A	10	$\pm 0.025$	0 to -10	50-100	a	2.4	0 to 65	az	178
CP	AD340B	10	$\pm 0.025$	$\pm 10$	50-100	a	2.4	0 to 65	az	178
CP	AD340C	10	$\pm 0.025$	0 to -4	50-100	a	2.4	0 to 65	az	178
CP	AD340D	10	$\pm 0.025$	$\pm 4$	50-100	a	2.4	0 to 65	az	178
Datel	ADC-H108	10	$\pm 0.1$	$\pm 10$	1	a	0.4, 2.4	0 to 70	a	995
Datel	ADC-E108	10	$\pm 0.05$	$\pm 0.1, 5, 10$	1.25 ms	integrating	0.4, 2.4	0 to 70		135
Datel	ADC-L108	10	$\pm 0.025$	$\pm 1, 5, 10$	50	a	0.4, 2.4	0 to 70	a	225
Datel	ADC-M108	10	$\pm 0.025$	$\pm 1, 5, 10$	11.5	a	0.4, 2.4	0 to 70	a	395
DDC	MADC-10-1	10	$\pm 0.05$	$\pm 10$	20	a	0, +5	-55 to +85		700
DDC	MADC-10-3	10	$\pm 0.05$	$\pm 10$	20	a	0, +5	0 to 70		600
DDC	HADC-10-1	10	$\pm 0.05$	$\pm 10$	10	a	0, +5	-55 to +85		750
DDC	HADC-10-3	10	$\pm 0.05$	$\pm 10$	10	a	0, +5	0 to 70		650
DEC	A811	10	0.1	0-10	10	(5)	(5)	0 to 50	(5)	450
Ditran	AD10A2	10	0.05	0 to -10	220	a	0, +5	0 to 70	a	505
Ditran	AD10A1	10	0.05	0-10	55	a	0, +5	0 to 70	a	475
Hybrid	501	10	0.1	10	30	ina	TTL	-25 to +70		195
NLS	1510	10	0.05	yes	4	a	yes	0 to 50	a	660
Redcor	770-755	10	$\pm 0.1$	10	4	a	TTL/DTL	0 to 50	a	650
Redcor	770-750	10	0.1	20	30 $\pm$ 3	a	3-6	0 to 30	a	650
DDC	HADC-11-1	11	$\pm 0.025$	$\pm 10$	11	a	0, +5	-55 to +85		850
DDC	HADC-11-3	11	$\pm 0.025$	$\pm 10$	11	a	0, +5	0 to 70		750
DDC	MADC-11-3	11	$\pm 0.025$	$\pm 10$	22	a	0, +5	0 to 70		700
DDC	MADC-11-1	11	$\pm 0.025$	$\pm 10$	22	a	0, +5	-55 to +85		800
Redcor	770-750	11	0.05	20	35 $\pm$ 4	a	3-6	0 to 50	a	625
BB	ADC30-12N	12	$\pm 0.0125$	$\pm 10$	40	a	2.6	0 to 70	as	295
CP	AD362C	12	$\pm 0.025$	0 to -4	50-100	a	2.4	0 to 65	az	219
CP	AD352A	12	$\pm 0.025$	0 to -10	50-100	a	2.4	0 to 65	az	189
CP	AD352C	12	$\pm 0.025$	0 to -4	50-100	a	2.4	0 to 65	az	189
CP	AD352B	12	$\pm 0.025$	$\pm 10$	50-100	a	2.4	0 to 65	az	189

# A/D Converters (discrete, modular)

109

Manufacturer	Model	Number of Bits	Accuracy (% of fs)	Analog Input Voltage (V)	Conversion Time ( $\mu$ s)	Conversion Method	Digital Outputs (V)	Temperature Range ( $^{\circ}$ C)	Notes	Price Unit \$
CP	AD352D	12	$\pm 0.025$	$\pm 4$	50-100	a	2.4	0 to 65	dz	189
CP	AD362A	12	$\pm 0.025$	0 to -10	50-100	a	2.4	0 to 65	az	219
Datel	ADC-E12B	12	$\pm 0.05$	$\pm 0.1, 5, 10$	5 ms	integrating	0.4, 2.4	0 to 70		149
Datel	ADC-L12B	12	$\pm 0.025$	$\pm 1, 5, 10$	60	a	0.4, 2.4	0 to 70	a	275
Datel	ADC-M12B	12	$\pm 0.025$	$\pm 1, 5, 10$	13	a	0.4, 2.4	0 to 70	a	475
Ditran	AD12C1	12	0.05	0-10	55	a	0, +5	0 to 70	a	535
Kearfott	P3C	12	$\pm 2$ dc	11.8	10000	(49)	5, 0	(48)		req
Kearfott	A-7D/E	12	$\pm 0.1$	$\pm 10$ dc	130	(46)	5, 0	(48)		req
Kearfott	F-111D	12	$\pm 0.003$	dc	100	(46)	5, 0	-55 to +71		req
MICRO	5221-12	12	0.1	0-1	300	counter	(38)	10-40	(38)	300
NLS	1512	12	0.0125	$\pm 10.24$	5	a	yes	0 to 50	a	775
Redcar	770-750	12	0.025	20	40 $\pm$ 4	a	3-6	0 to 50	a	625
Redcar	770-755	12	$\pm 0.025$	20	5	a	TTL/DTL	0 to 50	a	675
Kearfott	Micro-minac	13	0.05	11.8	2000/chan	(49)	5, 0	(48)		(22)
Redcar	770-754	13	0.015	5	50 $\pm$ 2	a	3-6	0 to 60		725
Redcar	770-754	13	0.015	10	50 $\pm$ 2	a	3-6	0 to 60	a	725
Redcar	770-754	13	0.015	20	50 $\pm$ 2	a	3-6	0 to 60	a	725
Analogic	AN2214	14	$\pm 0.01$	(58)	140	ina	(59)	0 to 70		995
Analogic	AN2317	to 14	$\pm 0.01$	$\pm 1.0000$	(60)	ina	0.3, 2.5	0 to 70	(60)	249
Analogic	AN2313	to 14	$\pm 0.01$	$\pm 1.0000$	(60)	ina	0.3, 2.5	0 to 70	(60)	199
Dynalex	ADX	14	0.05	5, $\pm 15$	10	ina	0, 5	0 to 50		req
Kearfott	FB-111	14	$\pm 0.033$	ac, dc	100	(46)	5, 0	-55 to +71		req
NLS	1515	15	0.005	$\pm 10.24$	18	a	yes	0 to 50	a	1000
Datascan	268	ina	$\pm 0.1$	ina	15	g	ina	0 to 70	g	102

# A/D Converters (hybrid, modular)

110

Datascan	DM-721	4	$\pm 0.02$	$\pm 1-100$	300 ms	w	(4)	0 to 60	(4)w	250
Fairchild	3751	8/9/12	$\pm 0.025$	-5	2/bit	a	"0" to -1 -10 to -30	-55 to +85		75
EECO	D-4078	8	$\pm 0.4$	$\pm 10$	20	a	DTL	0 to 50	a	1037
SLI	ADC	8	$\pm 1/2$ LSB	$\pm 10$	5	a	(51)	0 to 70		165
Zeltex	Z D470	8	$\pm 0.2$	$\pm 10$	500	a	staircase	0 to 70		59
ADI	ADC-10H	10	0.05	$\pm 10$	12	a	TTL	0 to 70		195
Conrac	590T4	10	0.5	5	200	a	(3)	125	a	1100
H-P	12564A	10	0.3	$\pm 1, \pm 10$	17.6, 22	a	(32)	0 to 55		1250
ND	540	10	ina	10	15	(39)	DTL	0 to 45	(39)	req
SLI	ADC	10	$\pm 1/2$ LSB	$\pm 10$	5	a	(51)	0 to 70		205
Solid State	AD6001	10	0.1	5	40	a	15	0 to 75	a	600
Taft	2600	10	$\pm 0.1$	0-5	0.5/bit	a	yes	0 to 55	a	950
Taft	2400	10	$\pm 0.1$	0-5	0.5/bit	a	yes	-35 to +100	a	1500
GAP	S3255	11	$\pm$ LSB	3	2500	(29)	0, 14	0 to 70	(30)	12, 000
P-E	A/D 011	11	0.025	3.5	10	u	+5	-55 to +125		800
P-E	A/D 111	11	$\pm 0.025$	$\pm 3.5$	10	u	5	-55 to +125		800
ADI	ADC-Q	8/12	0.01	$\pm 10$	15	a	TTL	0 to 70		250
Analogic	AN2608B	8-12	0.05	$\pm 1$	0.6-9 ms	ina	DTL/T <sup>2</sup> L	-10 to +70	(61)	(61)
Analogic	MP2212	12	0.01	(58)	0.8/bit	ina	DTL/T <sup>2</sup> L	0 to 70	(58)	495
EECO	D-4080	12	$\pm 0.025$	$\pm 10$	40	a	DTL	0 to 50		1036
Helipot	871-D3	12	$\pm 0.075$	0-10, -5 to +5	100/10 bits	a	0 to -2 9 to -30	-20 to +80	a	295
Helipot	871-D2	12	$\pm 0.05$	0-10, -5 to +5	100/10 bits	a	0 to -2 9 to -30	-20 to +80	a	295
Helipot	871-D1	12	$\pm 0.025$	0-10, -5 to +5	100/10 bits	a	0 to -2 9 to -30	-20 to +80	a	295
ND	2200	12	0.075	-5, +10	10	(39)	DTL	0 to 45	(39)	req
P-E	A/D 112	12	$\pm 0.015$	$\pm 3.5$	10	u	5	-55 to +125		900
P-E	A/D 012	12	0.015	3.5	10	u	5	-55 to +125		900
Raytheon	MADC-12F-01	12	0.05	$\pm 10$	7.5	a	0.5	0 to 70	a	850
Raytheon	MADC-12-01	12	0.065	$\pm 10$	18.5	a	0, 5	0 to 50	a	590
SLI	ADC	12	$\pm 1/2$ LSB	$\pm 10$	5	a	(51)	0 to 70	a	235
Bendix	AD5100	13	0.025	0-10, $\pm 5$	1000	a	0, +5	0 to 70	a	635
Bendix	AD4100	13	0.025	0-10, $\pm 5$	1000	a	0, +5	-54 to +71	aq	1390
DSE	860	13	$\pm 0.06$	$\pm 0.01-10$	13	a	TTL	0 to 50		req
DSE	820	13	$\pm 0.06$	$\pm 0.01-10$	13	a	TTL	0 to 50		req
ND	2200	13	0.075	10	4	(39)	DTL	0 to 45	(39)	req

# A/D Converters (discrete, rackmount)

111

Manufacturer	Model	Number of Bits	Accuracy (% of fs)	Analog Input Voltage (V)	Conversion Time ( $\mu$ s)	Conversion Method	Digital Outputs (V)	Temperature Range ( $^{\circ}$ C)	Notes	Price Unit \$
Preston	715	3,BCD	0.1	10	160	a	6	0 to 50	ab	625
CL	HS-425	4	3.1	2.048	0.04	x	x	0 to 50	bx	5800
Preston	8500HS	4,BCD	0.01	5, 10	8	(41)	$\pm 4, 12$	0 to 50	(41)b	5665
CL	HS-520	5	1.6	2.048	0.05	x	x	0 to 50	bx	6400
C-H	1608	8	0.1	-5 to +5	7	ina	0.4, 2.4	0 to 50	b	(55)
R&S	UCM 1207102/2	8	1	$\pm 100$ mV-10V	0-0.1 ms	g	0- $\pm 9.9$	0 to 45	bg	1075
H-P	5610A	9	$\pm 0.35$	$\pm 1$	10	a	5(32)(33)	20 to 80	ab	2000
Beckman	4027	10	0.1	0.1-1000	1s	h	0,+5	0 to 50	bhi	req
Preston	711	11	0.05	10	150	a	6	0 to 50	ab	625
E-H	702	12	0.1	0-1	8	a	3	ina	ab	9950
R&S	UCM 1207102	12	$\pm 0.1$	$\pm 10$ mV- $\pm 10$ V	0.1 ms	g	0- $\pm 9.99$	0 to 45	bg	1075
Beckman	4026	13	0.1	0.1-1000	1s	h	0,+5	0 to 50	bhi	395
Beckman	4025	13	0.1	0.1-1000	1s	h	0,+5	0 to 50	bhi	345
Astradata	3000	14	0.01	$\pm 10$	2.5/bit	a	0-6	0 to 55	ab	2500
EECO	762	10-14	$\pm 0.05$	$\pm 5, \pm 10$	27-32	a	0,9	0 to 50	ab	(25)
Preston	8500k	14	0.01	5, 10	100	a	$\pm 4-12$	0 to 50	ab	2045
Preston	8500MS	14	0.01	5, 10	12	(41)	$\pm 4, 12$	0 to 50	ab	3725
Preston	8500VAS	14	0.01	5, 10	5	(41)	$\pm 4, 12$	0 to 50	(41)b	5760
Preston	GMAD1	14	0.01	5, 10	1	(42)	4	0 to 55	(42)b	7800
Preston	GMAD2	14	0.01	5, 10	4	(42)	4	0 to 55	(42)b	3725
Preston	GMAD3	14	0.01	5, 10	15	(42)	4	0 to 55	(42)b	2110
Lancer	AD200	15	0.01	$\pm 10$	30	a	0,+5	0 to 50	ab	3000
C-H	1616	16	0.1	-5 to +5	7	ina	0.4, 2.4	0 to 50	b	(55)
Hi-Tek	737	16	0.01	ina	ina	ina	ina	ina	b	(57)
Lancer	AD500	18	0.01	$\pm 10$	100	(36)	0,5	0 to 50	b	5500
Cimron	6853	21	0.001, 0.01	0.1 $\mu$ V-1099.99V	40 ms	t	0-5, -12, +12	0 to 50	bt	4095

# A/D Converters (hybrid, rackmount)

112

Astradata	3902	12	0.05	$\pm 10$	5	a	0,+5	0 to 50	abc	500
BME	AD119	12	$\pm 0.05$	0.1, 1, 10, 100	14	a	r -	0 to 40	abr	1800
GAP	53314	12	$\pm$ LSB	$\pm 10$	1500	a	(27)	15 to 50	(31)	9900
GAP	53289	12	$\pm 5$ min	3	1500	a	(27)	-55 to +85	ob(28)	19,500
H-P	3480/81	13	$\pm 0.02$	$\pm 15$	950	a	5(32)(33)	0 to 50	ab	145
Adage	VH204	15	0.01	$\pm 5, 10, 100$	1	p	T <sup>2</sup> L	0 to 45	bp	req
Adage	VH202	15	0.01	$\pm 5, 10, 100$	4	p	T <sup>2</sup> L	0 to 45	b	req
Adage	VH203	15	0.01	$\pm 5, 10, 100$	2	p	T <sup>2</sup> L	0 to 45	bp	req
DSE	825	15	$\pm 0.01$	$\pm 10$	15	a	TTL	0 to 50	a	req
DSE	855	15	$\pm 0.01$	$\pm 10$	15	a	TTL	0 to 50	a	req
EECO	1200	15	$\pm 0.009$	$\pm 10$	4	a	DTL	0 to 50	ab	6150
EECO	1201	15	$\pm 0.009$	$\pm 10$	4	a	DTL	0 to 50	ab	7350
EECO	1202	15	$\pm 0.013$	$\pm 10$	5	a	DTL	0 to 50	ab	(22)
Raytheon	MADC-15-01	15	0.01	$\pm 10$	10	a	0, 5	15 to 50	a	2750
Cimron	6453	17	0.01	10 $\mu$ V-1199V	245 ms	w	5	0 to 40	bw	1125
Cimron	6653A	17	0.01	1 $\mu$ V-1099.9V	1.3 ms	a	0-5	0 to 50	bv	1740
Doric	DS-100-P2	17	0.01	1 $\mu$ V	5x10 <sup>4</sup>	(21)	(21)	0 to 50	b	1300
Doric	DS-100-k1	17	0.01	0.01	10 <sup>5</sup>	(21)	(21)	0 to 50	b	990
R&S	UCM 1207103	20	$\pm 0.007$	$\pm 1$ mV-1000V	90 ms	a	(43)	15 to 35	ab	2850
Cimron	6753	21	0.001	0.1 $\mu$ V-1099.99V	75 ms	u	0-5, -12, +12	10 to 40	bu	2990

- a. Conversion method, successive approximation
- b. Complete unit packaged in cabinet
- c. Construction: DTL/TTL
- d. Conversion method, ladder
- e. Analog accuracy at full scale
- g. Conversion method, ramp
- h. Conversion method, dual slope integration
- i. Includes BCD outputs
- j. Digital input,  $V_{in}$  "1" = 2V minimum,  $V_{in}$  "0" = 0.5V maximum. Settling time is based on output step caused by shifting from one binary input word to any other. Output will step to new level within 1% of step magnitude, at a rate of 3.3 $\mu$ s/volt of change plus 1 $\mu$ s.
- k. Digital input, serial or parallel. Slewing rate, 0.5V/ $\mu$ s
- m. Specify voltage required at no cost
- n. Conversion method, current switch
- p. Conversion method, recursive error correction
- q. Includes sample & hold, mil spec.
- r. Digital outputs, logic 0 = 0V,  $\pm 0.5$ V, logic 1 =  $\pm 0.5$ V, 5V BDC or binary
- s. These converters are available with or without an input buffer amplifier. Codes available, unipolar straight

- binary, bipolar offset binary, bipolar 2's complement, BCD
- t. Conversion method, continuous balance
- u. Conversion method, tracking logic
- v. Includes dc and ratio measurements. Includes -12 to 0 and +12 to 0 digital outputs
- w. Conversion method, dual slope
- x. Conversion method, cascade grey encoder. Digital outputs "0" = 0 to +0.5V, "1" = +3.0 to +3.5
- y. Conversion method, parallel binary. Digital inputs "0" = 0 to +5, "1" = +2.2 to +4.0. Reference and bias can be varied from external sources up to 25 MHz, making units useful as function generators, modulators or programmable attenuators
- z. IC's included
  - (1) Conversion method, current summing
  - (2) Includes input data storage with DA235, 435, 635 and 636 series at extra cost
  - (3) Input logic "0" = 0.2V, "1" = 3.5V
  - (4) Digital output, 16 line BCD
  - (5) Conversion method, monolithic IC logic. Digital outputs, logic "0" = +0.4V, logic 1 = +3.6V

(Notes continued on p. 83)

Manufacturer	Model	Number of Bits	Digital Input (V)	Settling Time ( $\mu$ s)	Conversion Method	Analog Output (V)	Analog Output (mA)	Analog Accuracy (%)	Temperature Range ( $^{\circ}$ C)	Notes	Price Unit \$
Datel	DAC-VR8D	2 BCD	0.4, 2.4	2	(1)	$\pm 10$	10	$\pm 0.01$	0 to 70	(54)	135
Datel	DAC-V8D	2 BCD	0.4, 2.4	2	(1)	$\pm 10$	10	$\pm 0.01$	0 to 70	(1)	105
Datel	DAC-V12D	3 BCD	0.4, 2.4	2	(1)	$\pm 10$	10	$\pm 0.01$	0 to 70	(1)	165
Datel	DAC-VR12D	3 BCD	0.4, 2.4	2	(1)	$\pm 10$	10	$\pm 0.01$	0 to 70	(54)	195
EECO	D-4088	3 BCD	2-5	15	(24)	10	3	$\pm 0.05$	0 to 50		171
CL	HS-2425	4	y	0.09	y	2.1	21	0.1	0 to 50		1480
CL	HS-2520	5	y	0.09	y	2.1	21	0.1	0 to 50		1530
CL	HS-2615	6	y	0.09	y	2.1	21	0.1	0 to 50		1580
Datascan	267	6	0, +5	ina	y	+5 to -5	1	1	0 to 70	d	203
CL	HS-2710	7	y	0.09	y	2.1	21	0.1	0 to 50		1630
BB	DAC20-08U	8	2.4	1.5	n	$\pm 10$	$\pm 20$	$\pm 0.2$	0 to 70	ns	95
CL	HS-2810	8	y	0.09	y	2.1	21	0.1	0 to 50		1690
CP	DA-135C	8	4	50	(1)	$\pm 10$ to 0	to 10	$\pm 0.1$	10 to 70	(2)z	69
CP	DA-135B	8	4	50	(1)	$\pm 10$	to 10	$\pm 0.1$	10 to 70	(2)z	69
CP	DA-135D	8	4	50	(1)	0 to -5	to 10	$\pm 0.1$	10 to 70	(2)z	69
CP	DA-135E	8	4	50	(1)	$\pm 5$	to 10	$\pm 0.1$	10 to 70	(2)z	69
CP	DA-135F	8	4	50	(1)	+5 to 0	to 10	$\pm 0.1$	10 to 70	(2)z	69
CP	DA-135A	8	4	50	(1)	0 to -10	to 10	$\pm 0.1$	10 to 70	(2)z	69
Datel	DAC-VR8B	8	0.4, 2.4	2	(1)	$\pm 10$	10	$\pm 0.01$	0 to 70	(54)	125
Datel	DAC-H18B	8	0.4, 2.4	0.025	(1)	$\pm 1.2$	$\pm 2.5$	$\pm 0.05$	0 to 70		195
Datel	DAC-V 8B	8	0.4, 2.4	2	(1)	$\pm 10$	10	$\pm 0.01$	0 to 70	(1)	95
DDC	NDAC-8-1	8	0, +5	0.075	d	+5	100	$\pm 0.2$	-55 to +85	d	325
DDC	NDAC-8-3	8	0, +5	0.075	d	+5	100	$\pm 0.2$	0 to +70	d	275
DDC	EDAC-8-1	8	0, +5	10	d	$\pm 10$	$\pm 5$	$\pm 0.2$	-55 to +85	d	200
DDC	EDAC-8-3	8	0, +5	10	d	$\pm 10$	$\pm 5$	$\pm 0.2$	0 to +70	d	150
EECO	D-4076	8	TTL	10	(24)	$\pm 10$ , dc	$\pm 10$	0.025	0 to 50		432
Redcor	770-712	8	2-5	10	a	$\pm 10$	$\pm 10$	0.025	0 to 50	a	245
CL	HS-2910	9	y	0.09	y	2.1	21	0.1	0 to 50		1760
DDC	EDAC-9-3	9	0, +5	10	d	$\pm 10$	$\pm 5$	$\pm 0.1$	0 to +70	d	175
DDC	EDAC-9-1	9	0, +5	10	d	$\pm 10$	$\pm 5$	$\pm 0.1$	-55 to +85	d	250
DDC	UDAC-9-3	9	0, +5	10	d	$\pm 10$	$\pm 5$	$\pm 0.1$	0 to +70	d	200
DDC	UDAC-9-1	9	0, +5	10	d	$\pm 10$	$\pm 5$	$\pm 0.1$	-55 to +85	d	300
Kearfott	MADAC	9	-15, 0	1000	(44)	$\pm 63$ dc	20	0.1	-30 to +50	(45)	req
ADI	MDA-F	8/10	TTL	0.06	n	ina	4.4	0.05	0 to 70		370
BB	DAC20-10U	10	2.4	1.5	n	$\pm 10$	$\pm 20$	$\pm 0.05$	0 to 70	ns	225
CP	DA335C	10	4	50	(1)	+10 to 0	to 10	$\pm 0.1$	10 to 70	(2)z	73
CP	DA335B	10	4	50	(1)	$\pm 10$	to 10	$\pm 0.1$	10 to 70	(2)z	73
CP	DA335A	10	4	50	(1)	0 to -10	to 10	$\pm 0.1$	10 to 70	(2)z	73
CP	DA335D	10	4	50	(1)	0 to -5	to 10	$\pm 0.1$	10 to 70	(2)z	73
CP	DA335E	10	4	50	(1)	$\pm 5$	to 10	$\pm 0.1$	10 to 70	(2)z	73
CP	DA335F	10	4	50	(1)	+5 to 0	to 10	$\pm 0.1$	10 to 70	(2)z	73
Datel	DAC-VR10B	10	0.4, 2.4	2	(1)	$\pm 10$	10	$\pm 0.01$	0 to 70	(54)	155
Datel	DAC-H110B	10	0.4, 2.4	0.025	(1)	$\pm 1.2$	$\pm 2.5$	$\pm 0.05$	0 to 70		215
Datel	DAC-V10B	10	0.4, 2.4	2	(1)	$\pm 10$	10	$\pm 0.01$	0 to 70	(1)	125
DDC	NDAC-10-1	10	0, +5	0.250	d	+5	100	$\pm 0.05$	-55 to +85	d	450
DDC	NDAC-10-3	10	0, +5	0.250	d	+5	100	$\pm 0.05$	0 to +70	d	350
DDC	EDAC-10-1	10	0, +5	10	d	$\pm 10$	$\pm 5$	$\pm 0.05$	-55 to +85	d	300
DDC	EDAC-10-3	10	0, +5	10	d	$\pm 10$	$\pm 5$	$\pm 0.05$	0 to +70	d	200
DEC	A621	10	1	5	level	0-10	10	$\pm 0.05$	0 to 50		425
DEC	A620	10	1	5	level	0-10	10	$\pm 0.05$	0 to 50	(16)	400
DEC	A618	10	(17)	5	level	0-10	10	$\pm 0.05$	0 to 50	(18)	350
DEC	A619	10	(17)	5	level	0-10	10	$\pm 0.05$	0 to 50		375
EECO	764	10	DTL	1	(23)	$\pm 10$	$\pm 5$	$\pm 0.01$	0 to 50	b	(23)
Hybrid	321	10	TTL	0.75	ina	2	8	0.05	-25 to +70	(35)	69
Hybrid	340	10	TTL	0.2	ina	2	10	0.05	-25 to +70		149
Hybrid	325	10	TTL	10	ina	10	10	0.05	-25 to +70		99
Hybrid	320	10	TTL	0.75	ina	2	15	0.05	-25 to +70	(35)	69
Hybrid	342	10	TTL	0.3	ina	2	10	0.05	-25 to +70		149
KDI	541C	10	-7	5	d	-6.9	1	$\pm 0.03$	0 to 50	d	165
DDC	UDAC-11-1	11	0, +5	10	d	$\pm 10$	$\pm 5$	$\pm 0.025$	-55 to +85	d	400
DDC	UDAC-11-3	11	0, +5	10	d	$\pm 10$	$\pm 5$	$\pm 0.025$	0 to +70	d	300
DDC	EDAC-11-1	11	0, +5	10	d	$\pm 10$	$\pm 5$	$\pm 0.025$	-55 to +85	d	400
DDC	EDAC-11-3	11	0, +5	10	d	$\pm 10$	$\pm 5$	$\pm 0.025$	0 to +70	d	300
EECO	D-4087	11	0.2-5	15	(24)	10	3	0.05	0 to 50		160
ADI	MDA-U	8/10/12	TTL	0.3	n	ina	+5	0.01	0 to 70		195
ADI	MDA-L	8/10/12	TTL	0.3	d	ina	+2	0.01	0 to 70		140
Analogic	MP1612-DA	12	DTL/T <sup>2</sup> L	10	n	(58)	$\pm 10$	$\pm 0.01$	0 to 70	d	150
Analogic	MP1012	12	DTL/T <sup>2</sup> L	5	multiply	$\pm 10$	$\pm 20$	0.01	0 to 70		200
BB	DAC20-12U	12	2.4	1.5	n	$\pm 10$	$\pm 20$	$\pm 0.0125$	0 to 70	ns	155
CP	DA536B	12	4	50	(1)	+10 to 0	to 10	$\pm 0.05$	10 to 70	(2)z	79
CP	DA536A	12	4	50	(1)	0 to -10	to 10	$\pm 0.05$	10 to 70	(2)z	79
CP	DA535F	12	4	50	(1)	+5 to 0	to 10	$\pm 0.05$	10 to 70	(2)z	79
CP	DA535E	12	4	50	(1)	$\pm 5$	to 10	$\pm 0.05$	10 to 70	(2)z	79
CP	DA535D	12	4	50	(1)	0 to -5	to 10	$\pm 0.05$	10 to 70	(2)z	79
CP	DA535C	12	4	50	(1)	+10 to 0	to 10	$\pm 0.05$	10 to 70	(2)z	79
CP	DA535B	12	4	50	(1)	$\pm 10$	to 10	$\pm 0.05$	10 to 70	(2)z	79
CP	DA535A	12	4	50	(1)	0 to -10	to 10	$\pm 0.05$	10 to 70	(2)z	79
CP	DA536C	12	4	50	(1)	$\pm 10$	to 10	$\pm 0.05$	10 to 70	(2)z	79
Datel	DAC-VR12B	12	0.4, 2.4	2	(1)	$\pm 10$	10	$\pm 0.01$	0 to 70	(54)	185
Datel	DAC-V12B	12	0.4, 2.4	2	(1)	$\pm 10$	10	$\pm 0.01$	0 to 70	(1)	155

# D/A Converters (discrete, modular)

114

Manufacturer	Model	Number of Bits	Digital Input (V)	Settling Time (µs)	Conversion Method	Analog Output (V)	Analog Output (mA)	Analog Accuracy (%)	Temperature Range (°C)	Notes	Price Unit \$
Datascan	265A	12	0, +5	ina	d	0-10	2	ina	0 to 70		255
Datascan	265	12	0, +5	ina	d	0-10	2	ina	0 to 70	d	255
DEC	A613	12	2-5	50	(19)	0, +0, +10	10	±0.05	0 to 50	(20)	250
EECO	D-4077	12	TTL	10	(24)	±10	±10	0.025	0 to 50		540
E-H	930	12	10	ina	(1)	n/a	0-10	2	ina	(1)	200
Hybrid	302	12	TTL	20	ina	±10	10	0.01	-25 to +70		350
KDI	541D	12	-7	5	d	-6.9	1	±0.03	0 to 50	d	207
KDI	541E	12	-7	5	d	-6.9	1	±0.03	0 to 50	d	195
Kearfott	A-7D/E	12	5, 0	500	(47)	±15 dc	5 dc	±0.1	(48)		req
Kearfott	P3C	12	5, 15, 26	250	d	11.8	60	ina	(48)		req
Redcar	770-712	12	2-5	10	a	±10	±10	0.025	0 to 50	a	295
DDC	UDAC-13-1	13	0, +5	10	d	±10	±5	±0.00625	-55 to +85	d	500
DDC	UDAC-13-3	13	0, +5	10	d	±10	±5	±0.00625	0 to 70	d	400
DDC	HDAC-9-1	13	0, +5	1	d	±10	±10	±0.2	-55 to +85	d	250
DDC	HDAC-9-3	13	0, +5	1	d	±10	±10	±0.2	0 to 70	d	200
DDC	HDAC-10-1	13	0, +5	1	d	±10	±10	±0.1	-55 to +85	d	300
DDC	HDAC-10-3	13	0, +5	1	d	±10	±10	±0.1	0 to 70	d	225
DDC	HDAC-11-1	13	0, +5	1	d	±10	±10	±0.05	-55 to +85	d	350
DDC	HDAC-11-3	13	0, +5	1	d	±10	±10	±0.05	0 to 70	d	250
DDC	HDAC-12-1	13	0, +5	1	d	±10	±10	±0.025	-55 to +85	d	450
DDC	HDAC-12-3	13	0, +5	1	d	±10	±10	±0.025	0 to 70	d	350
DDC	ADAC-3	13	0, +5	n/a	d	7	2.5	±0.00625	0 to 70	d	310
DDC	BDAC-1	13	0, +5	10	d	±9.990	±5	0.05	-55 to +85	d	400
DDC	BDAC-3	13	0, +5	10	d	±9.990	±5	0.05	0 to 70	d	250
DDC	BDAC-1-H	13	0, +5	10	d	±9.990	±5	0.05	-55 to +85	d	475
DDC	ADAC-1	13	0, +5	n/a	d	7	2.5	±0.00625	-55 to +85	d	360
Kearfott	F-111D	14	5, 0	480	(47)	ac, dc	ina	0.033	-55 to +71		req
Kearfott	FB111	14	5, 0	480	(47)	ac, dc	ina	±0.033	-55 to +71		req
Kearfott	Micro-minac	13	4.5	250	(50)	to 1	ina	(48)		req	
Lancer	DP200	14	0, +5	10	parallel	±100	±25	±0.01	0 to 50	b	1400
AD1	DAC-15R	15	TTL	1	n	±10	ina	0.0015	0 to 70		995
Lancer	DA50	15	0, +5	1.5	parallel	±10	10	0.01	0 to 50		350
Analogic	AN1200	to 16	DTL/T <sup>2</sup> L	2	d	±10	±20	±0.01	0 to 70	d	req

# D/A Converters (hybrid, modular)

115

Datel	DAC-1BD	2 BCD	0.4, 2.4	0.15	(1)	±1.2	1	±0.05	0 to 70	(1)	110
Datel	DAC-12D	3 BCD	0.4, 2.4	0.15	(1)	±1.2	1	±0.05	0 to 70	(1)	169
PM	DAC-01H	6	0-3	3	n	0-10	ina	±1/2LSB	0 to 70		40
PM	DAC-01F	6	0-3	3	n	0-10	ina	±1/2LSB	-55 to +125	n	60
Analogic	MP1908	8	DTL/T <sup>2</sup> L	0.15	n	±1	2	±0.01	0 to 70	n	250
Analogic	MP1808	8	DTL/T <sup>2</sup> L	5	d	(58)	±20	±0.1	0 to 70	d	59
Datel	DAC-H888	8	0.4, 2.4	5	(1)	±5	5	±0.05	0 to 70	(1)	65
Datel	DAC-188	8	0.4, 2.4	0.15	(1)	±1.2	1	±0.05	0 to 70	(1)	100
Helipot	846-85	8	i	i	ina	-5 to +5	±2.5	ina	-20 to +85	i	95
Helipot	846-1310	8	i	i	ina	-10 to +10	±2.5	ina	-20 to +85	i	95
Helipot	846-U10	8	i	i	ina	0 to +10	±2.5	ina	-20 to +85	i	95
Helipot	846-U5	8	i	i	ina	0 to +5	±2.5	ina	-20 to +85	i	95
Helipot	845-810	8	i	i	ina	-10 to +10	±2.5	ina	-20 to +85	i	75
Helipot	845-85	8	i	i	ina	-5 to +5	±2.5	ina	-20 to +85	i	75
Helipot	845-U10	8	i	i	ina	0 to +10	±2.5	ina	-20 to +85	i	75
Helipot	845-U5	8	i	i	ina	0 to +5	±2.5	ina	-20 to +85	i	75
Radiation	R1-1080	8	DTL, TTL	1	n	4-10	ina	0.5 LSB	-55 to +125	(53)	82.50
SLI	DAC	8	(51)	5	a	±10	to 5	ina	0 to 70	a	70
Zeltex	ZD430	8	(52)	30	bipolar	(52)	±5	±0.2	0 to 70	(52)	49
Fairchild	3750	8/10	-5	n/a	n	ina	ina	±0.025	-55 to +85		60
ADI	DAC-10H	8/10	TTL	25	n	±10	ina	0.05	0 to 70		75
ADI	MDA-10H	8/10	TTL	0.3	n	ina	2	0.05	0 to 70		70
Analogic	MP1810	10	DTL/T <sup>2</sup> L	5	d	(58)	±20	±0.02	0 to 70	d	75
Convac	590T5	10	(3)	15	ina	5	ina	0.5	125		900
Datel	DAC-HB108	10	0.4, 2.4	5	(1)	±5	5	±0.05	0 to 70	(1)	75
Datel	DAC-1108	10	0.4, 2.4	0.15	(1)	±1.2	1	±0.05	0 to 70	(1)	129
Helipot	847-D2	10	k	k	ina	±5	2.5	n/a	-20 to +85	k	195
Helipot	847-D1	10	k	k	ina	0 to 10	5	n/a	-20 to +85	k	195
SLI	DAC	10	(51)	5	a	±10	to 5	ina	0 to 70	a	110
P-E	D/A111	11	5	2	xformer	±3.5	ina	±0.016	-55 to +125		375
P-E	D/A011	11	+5	2	xformer	3.5	ina	±0.016	-55 to +125		375
ADI	AD550	4/8/12	TTL	1.8	n	ina	2	0.01	-55 to +125		96
ADI	AD555	4/8/12	TTL	2.0	(40)	±4	ina	0.02	-55 to +125		96
ADI	DAC-Q	8/10/12	TTL	2.5	n	±10	ina	0.01	0 to 70		135
Analogic	MP1912	12	DTL/T <sup>2</sup> L	150	n	±1	2	±0.01	0 to 70	n	400
Analogic	AN1000	8-12	DTL/T <sup>2</sup> L	2	multiply	±10	±20	0.005	-10 to +70		370
Analogic	MP1812	12	DTL/T <sup>2</sup> L	5	d	(58)	±20	±0.02	0 to 70	d	89
Bendix	DA2000	12	0, +5	40	a	±5	±5	0.05	0 to 70		605
Datel	DAC-H8128	12	0.4, 2.4	5	a	±5	5	±0.05	0 to 70	(1)	99
Datel	DAC-1128	12	0.4, 2.4	0.15	(1)	±1.2	1	±0.05	0 to 70	(1)	159



# D/A Converters (hybrid, modular)

116

Manufacturer	Model	Number of Bits	Digital Input (V)	Settling Time (μs)	Conversion Method	Analog Output (V)	Analog Output (mA)	Analog Accuracy (%)	Temperature Range (°C)	Notes	Price Unit \$
DSE	840	12	TTL	10	ina	±10, ±1000	10	0.06	15 to 45		req
P-E	D/A112	12	5	2	xformer	±3.5	ina	±0.012	-55 to +125		425
P-E	D/A012	12	5	2	xformer	3.5	ina	±0.012	-55 to +125		425
Raytheon	MADD1-06-032	12	0, 5	25	a	±10	5	0.075	0 to 50	a	6440
Raytheon	MDAC-12-04-02	12	0, 5	10	a	±10	5	0.05	0 to 50	a	805
Raytheon	MDAC-12-06-02	12	0, 5	10	a	±10	5	0.05	0 to 50	a	2305
SLI	DAC	12	(51)	5	a	±10	to 5	ina	0 to 70	a	115
Analogic	MP1614/DA	14	DTL/T <sup>2</sup> L	10	d	±5, ±10, 0-10	±10	±0.01	0 to 70	d	240
Analogic	AN7200	to 14	DTL/T <sup>2</sup> L	2	d	±10	±10	±0.01	0 to 70	d	req
GAP	773-1	14	2.7-12	15	d	0-140	7	0.01	0 to 45	d	5500
GAP	S3315	13	(27)	150	d	±10	4	±LSB	15 to 50	d	4500
Phoenix	DAC-R	8-14	0.4, 5	10	ina	±10, 0-10	±10	±0.01, 0.02	0 to 70	(56)	req
Analogic	MP1715	15	DTL/T <sup>2</sup> L	0.5	n	±1	8	±0.01	0 to 70	n	795

# D/A Converters (discrete, rackmount)

117

Manufacturer	Model	Number of Bits	Digital Input (V)	Settling Time (ms)	Conversion Method	Analog Output (V)	Analog Output (mA)	Analog Accuracy (%)	Temperature Range (°C)	Notes	Price Unit \$
H-P	580A	3	4-75	1	d, BCD	0.1	1	0.5	0 to 50	d	550
Astradata	3510	8	-18, +6	35	d	±10	±100	0.2	0 to 50	de	1500
Astradata	3510	8	-18, +6	35	d	±10	±100	0.2	0 to 50	d	1500
EMR	2750	8	(26)	ina	ina	0-10, ±5	ina	±0.1	0 to 50		req
EMR	2751	12	(26)	ina	ina	0-10, ±5	ina	±0.05	0 to 50		req
Astradata	3520	12	-18, +6	18	d	±10	±100	0.04	0 to 50	de	2100
Preston	GMDAC	14	10-100	4	a	10-100	10	0.01	0 to 50	a	1145
Astradata	3530	15	-18, +6	15	d	±10	±10	0.01	0 to 50	de	2500
Astradata	3540	15	-18, +6	40	d	±100	±50	0.01	0 to 50	de	3800

# D/A Converters (hybrid, rackmount)

118

Manufacturer	Model	Number of Bits	Digital Input (V)	Settling Time (ms)	Conversion Method	Analog Output (V)	Analog Output (mA)	Analog Accuracy (%)	Temperature Range (°C)	Notes	Price Unit \$
Adage	Y8DB	8	m	30	n	to 20	5	0.1	0 to 45	mn	req
Astradata	3902	8	0, +5	2	d	±10	±100	0.5	0 to 50	cd	225
Adage	Y120B	12	m	5-45	n	5-128	to 20	0.02	0 to 45	mn	req
Astradata	3902	12	0, +5	5	d	±10	±100	0.1	0 to 50	cd	260
Adage	Y150B	15	m	5-45	n	5-128	to 20	to 0.01	0 to 45	mn	req
Astradata	3902	15	0, +5	10	d	±10	±100	0.01	0 to 50	cd	300
H-P	6933B	16	(34)	20	d	-16.4 to +16.4	10	0.0003	0 to 55	(34)	1500
H-P	6131B	16	(34)	100	d	+100 to -100	500	0.005	0 to 55	(34)	1800
H-P	6130B	16	(34)	100	d	+50 to -50	1000	0.01	0 to 55	(34)	1800

(16) Double buffered

(17) TTL unit load

(18) Single buffered

(19) Conversion method, standard positive logic

(20) Analog accuracy for BCD, ±0.015%, binary

(21) Conversion method, guarded integration. Digital outputs, BCD, FET closures

(22) Up to 128 channels available, prices range from \$8000 to \$14,800

(23) Conversion method, weighted resistor. Configurations of 100, 250, 384, 512 channels available, price ranges from \$1800 - \$65,000

(24) Conversion method, weighted resistor

(25) Up to 256 channels available, prices range from \$3825 to \$7500

(26) Digital inputs, logic "0" = 0 to 0.45V dc, logic "1" = 3 - 5V dc

(27) Digital inputs, logic "0" = 0.2V, logic "1" = 3.7V

(28) 48 channel multiplexed

(29) Conversion method, dual phase shift

(30) 8 channel multiplexed

(31) 7 channel multiplexed

(32) Compatible with H-P 2114/15/16 computers

(33) Model 5610A, binary, model 3480/81, BCD

(34) Digital inputs, 0, +3 or 0, +5 or 0, +12 or 0, -3 or 0, -12. Includes systems functions: internal storage, analog output isolated from digital input, remote sensing

(35) Model 320, external reference; model 321, built-in reference

(36) Conversion method, series parallel with redundant checks

(37) Digital output, logic "0" = ±0.5V, logic "1" = -6V ±0.5V. Permanent storage of peak input signal

(38) Digital output, logic "0" = 0V ±0.5V, logic "1" = +6V ±0.5V. Holds peak amplitude of input signal

(39) Conversion method, Wilkenson

(40) Conversion method, voltage switch

(41) Conversion method, combination of successive approximation and parallel

(42) Conversion method, modified cyclic technique

(43) Digital outputs, logic "0" = -11V ±20%, logic "1" = -1V ±100%

(44) Conversion method, sample & hold

(45) 28 channels, a/d or 3 channels d/a converter

(46) Conversion method, linear feed forward

(47) Conversion method, time shared linear ladder/analog hold

(48) Temperature range MIL-E-5400 class 11X for model A-7D/E, MIL-E-5400 class 1 model P3C

(49) Conversion method, linear charge gated

(50) Conversion method, non linear ladder, multiplexed

(51) Digital input, logic "0" = 0 to 0.5V, logic "1" = 2.5 to 7

(52) Digital input, logic "0" = 0.8V max, 1 = 2V min (TTL, DTL levels). Analog outputs, 0-10V, 0-5V, -5 to +5V, -10 to +10V. Hermetic sealed 14 pin DIP

(53) Monolithic d/a converter, price for quantities of 100-999

(54) Includes storage register

(55) Prices range from \$1950 to \$2500

(56) Number of bits available 8, 9, 10, 11, 12, 13, 14

(57) Also available in 9 and 12 bit units, prices range from \$3000 to \$6500

(58) Analog output, 0-5V, ±5V, 0-10V, ±10V

(59) Digital output, logic "0" = 0-0.5V, logic "1" = 2.4-5V

(60) Conversion time and sample rate is a function of the size and format of the output register used with the converter, check with factory

(61) Available in 8, 9, 10, 11, 12 bit binary, 2, 3 bit BCD, prices on request

Transient; high-speed; narrow; or "one chance."  
 It doesn't matter what you call your measurement problem. And it doesn't matter whether your data are radar, color TV, medical measurements, nuclear phenomena, chemical reactions, or any of dozens of others. Data acquisition becomes an important question demanding sophisticated answers. Computer Labs has those answers in the . . .

# WORLD'S FASTEST Data Acquisition Products.



*Over 6 million analog connections/second.*

◀ The Computer Labs Model MUX-810 Multiplexer will connect eight analog inputs to a single output at a rate of 6.6 million connections every second. Channels can be connected sequentially, with any number in the sequence; random access; or manually, with a front panel push button. **Equivalent "ON" resistance is 0.2 ohm, making the Model MUX-810 an ideal choice for switching 100-ohm lines.** Price includes one-year warranty and manual.

Computer Labs HS Series A/D Converters include ▶ sample-and-hold, internal test circuits, and power supplies. **No external test equipment required.** Random or periodic word rates available from 4 bits at 25 MHz to 9 bits at 5 MHz. Digital output TTL compatible. Unipolar or bipolar input; 50, 75, or 93 ohms impedance; and regular binary or 2's Complement outputs are no-cost options. Price includes one-year warranty and manual.

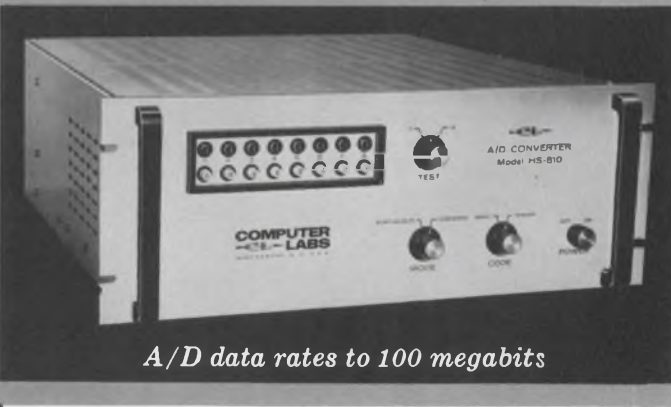

*A/D data rates to 100 megabits*



*High-speed D/A . . . and more.*

◀ Computer Labs HS-2000 Series D/A Converters convert parallel binary words into analog voltages accurate to within  $\pm 2$  mv. **No strobe signal required.** Output settles to within 0.1% of input in less than 90 nanoseconds. External bias and reference signals can be applied from dc to 25 MHz, making units useful also as programmable attenuators, function generators, or modulators. Price includes one-year warranty and manual.

**For additional information:**

**ALBUQUERQUE**  
 (505) 265-7989  
**BOSTON**  
 (617) 272-2606  
**CHICAGO**  
 (312) 283-0713  
**DALLAS**  
 (214) 235-3043

**DENVER**  
 (303) 421-0706  
**HUNTSVILLE**  
 (205) 881-3721  
**LOS ANGELES**  
 (213) 837-0123  
**NEW YORK**  
 (212) 233-4849

**ORLANDO**  
 (305) 841-2215  
**OTTAWA**  
 (613) 722-3489  
**PHILADELPHIA**  
 (215) 265-5211  
**PHOENIX**  
 (602) 279-5243

**ROCHESTER, N. Y.**  
 (716) 586-8033  
**SAN FRANCISCO**  
 (415) 344-2521  
**WASHINGTON, D. C.**  
 (301) 946-4055  
**OVERSEAS**  
 (212) 758-2790



*for tomorrow's technology today*

1109 S. Chapman / Greensboro, N. C. 27403 / (919) 292-6427 / TWX 510 922-7954

# New Products

## PC-card 12-bit a/d converter boasts accuracy of 0.0125%

Analog Devices, Inc., Pastoriga Div., 221 Fifth St., Cambridge, Mass. Phone: (617) 492-6000. P&A: \$305; stock.

Utilizing monolithic integrated circuit construction in its d/a converter section, a new successive-approximation analog-to-digital converter features a relative accuracy of 0.0125%, including buffer amplifier and comparator errors. Model ADC-12Q also offers a conversion time of 20  $\mu$ s (for 12 bits), a differential linearity of  $\pm 1/2$  the least-significant bit, and a differential linearity drift of 1.5 ppm/ $^{\circ}$ C.

Key to the unit's high performance is its d/a circuitry—three four-bit monolithic weighted switches and a thin-film resistor network. Because the switching transistors are located on a single silicon substrate, initial offsets are matched within 0.01%. In addition, an extra compensating transistor on each chip operates in an external compensating circuit to stabilize against temperature and aging errors.

Besides very high stability, the new converter guarantees a monotonic output—that is, the output will always increase over its previous value. To specify monotonicity, the differential linearity temperature coefficient of 1.5 ppm/ $^{\circ}$ C assures that the converter's output is within one least-significant bit of the correct value, even at temperature extremes. Differential linearity alone simply defines the maximum departure of the converter's output from true linearity.

The ADC-12Q can handle full-scale input voltages of  $\pm 10$  V. Its digital outputs are TTL compatible, and include such digital codes as binary, BCD, two's complement and offset binary.

Primary applications for the unit include: data acquisition, instrumentation, machine tool control, digital communications, digital recording, and one line digital control.

The new a/d converter is a plug-in PC card measuring 4.5 by 3.75 by 0.35 in.

CIRCLE NO. 250

Op amp supply for \$20 gives  $\pm 15$  V at 25 mA



Computer Products, 1400 N.W. 70th St., P.O. Box 23849, Fort Lauderdale, Fla. Phone: (305) 933-5561. P&A: \$19.95; 1 to 5 days.

Costing just \$19.95 in single-unit quantities, a new regulated dual dc power supply delivers an output of  $\pm 15$  V at 25 mA. Model PM558 operates from 115 V ac, at 50 to 400 Hz. It is an encapsulated module measuring 2.5 by 3.5 by 0.875 in. and is intended for PC-board mounting. Line and load regulation is  $\pm 0.2\%$ .

CIRCLE NO. 251

## Modular 5-W supply drives 1000 gates



Semiconductor Circuits, Inc., 163 Merrimac St., Woburn, Mass. Phone: (617) 935-5200. P&A: \$69; stock.

Designated as model PI.5.1000, a new 5-W power supply module delivers 5 V dc at 1 A to drive up to 1000 logic gates. The unit is packaged in a black anodized aluminum case measuring only 2.5 by 3.5 by 1.25 in. Regulation from zero to full load is 0.1% maximum. Maximum ripple and noise do not exceed 1 mV rms.

CIRCLE NO. 252

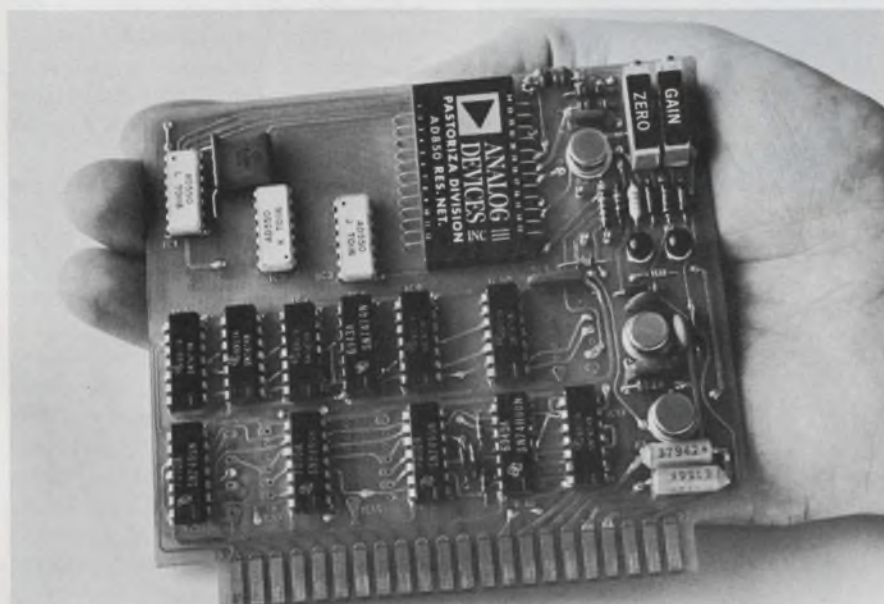

Precision 12-bit analog-to-digital converter offers a relative accuracy of 0.0125%. The unit uses monolithic weighted switches and a thin-film resistor network in its d/a section to achieve ultra-stable performance.

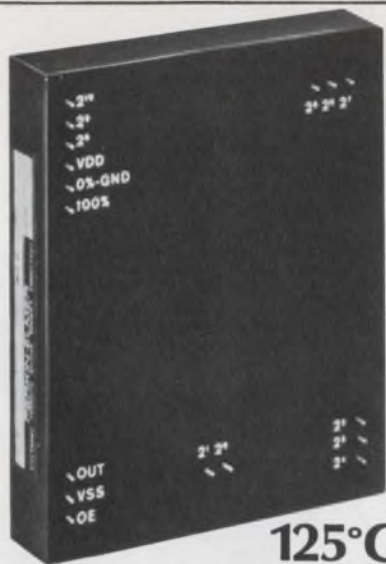

## 125°C doesn't bother our D/A Converters a bit. (not even half a bit)

Over the range of  $-55^{\circ}\text{C}$  to  $+125^{\circ}\text{C}$  you maintain half bit accuracy, as well as 11 or 12 bit resolution — a stability which spans a full  $180^{\circ}\text{C}$ . This high performance level of Perkin-Elmer precision digital to analog converters is based on the utilization of our patented principal of vernier transformer windings. There is no drift or degradation over the life of the unit.

Each D/A unit is encapsulated in a rugged package containing a series of windings switched by MOSFET IC's. The logic input lines can be used directly with 5.0 V levels and units compatible with 0.4 V and 2.4 V logic levels for TTL are available.

These precision converters have wide applications in synchro and servo controls, interfacing digital and analog systems, for shipborne or air data computers, fire control systems and drivers for analog display.

Numerous applications in the machine tool and process control industries are also possible since the frequency range is not limited to 400 Hz. For information on standard models, including bipolar or custom units for a specific application, just write or call: Electronic Products Department, Industrial Products Division, The Perkin-Elmer Corporation, 131 Danbury Road, Wilton, Conn. 06897. (203) 762-6574. Vernistat® AC pots, Scott T's and other toroidal transformers are specialties of ours too.

# PERKIN-ELMER

INFORMATION RETRIEVAL NUMBER 46

## Hexadecimal readout is non-ambiguous

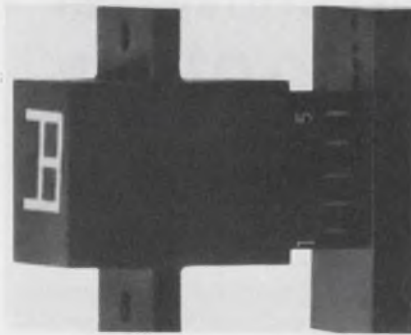

Luminetics Corp., 1150 N.W. 70th St., Fort Lauderdale, Fla. Phone: (305) 933-4551. P&A: \$21 to \$26; stock to 2 wks.

Expanding the DiGiCATOR line of display components, a new nine-bar hexadecimal readout translates 8-4-2-1 BCD format into a display of 16 non-ambiguous characters, 0 through 9 and A through F. Character height for the series 30 display is 0.32 in. and is 1 in. for the series 20 line.

CIRCLE NO. 253

## Low-cost TO-8 op amp has a \$30 price tag

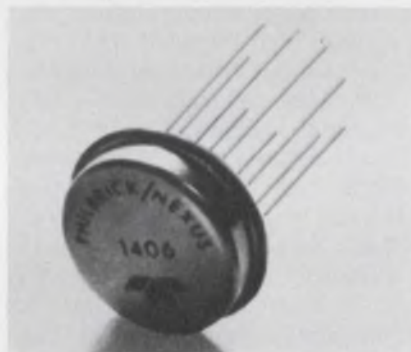

Phibrick-Nexus Research, Allied Dr. at Rte. 128, Dedham, Mass. Phone: (617) 329-1600. P&A: \$30; stock.

Designed for use where moderate specifications of voltage drift ( $\pm 10 \mu\text{V}/^{\circ}\text{C}$ ), current drift ( $\pm 1 \text{ nA}/^{\circ}\text{C}$ ), and input impedance (300 k $\Omega$  differential and 300 M $\Omega$  common-mode) are acceptable, the model 1406 low-cost operational amplifier retails at \$30. It is input and output protected, and is internally trimmed and compensated.

CIRCLE NO. 254

## Decoder/driver gives 40 V at 120 mA

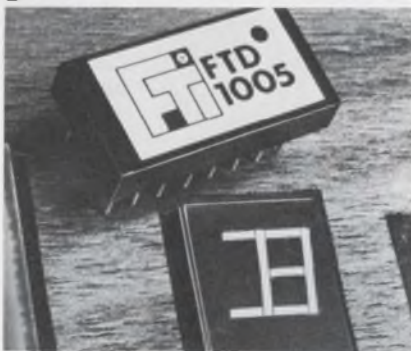

Fabri-Tek Micro-Systems, Inc., 1150 N. W. 70th St., Fort Lauderdale, Fla. Phone: (305) 933-9351.

The model FTD-1005 hexadecimal decoder/driver features a drive capability of 40 V at 120 mA (continuous) per output. The unit can handle surge currents of 500 mA per output. Sixteen output combinations are possible from a four-line BCD code, including digits 0 through 9 and characters A through F. Inputs are TTL and DTL compatible.

CIRCLE NO. 255

## D/a converter modules are self-contained

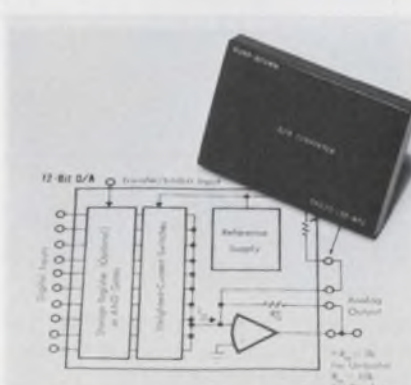

Burr-Brown Research Corp., International Airport Industrial Park, Tucson, Ariz. Phone: (602) 294-1431. Price: \$95 to \$155.

Series DAC20 self-contained d/a converters include TTL-compatible input switches, a weighted-resistor network, a precision reference, and an output amplifier. All units, which measure 3 by 2 by 0.4 in., have a relative accuracy of  $\pm 1/2$  the least-significant bit. Maximum settling time to rated accuracy is 1.5  $\mu\text{s}$  for the eight and 10-bit units.

CIRCLE NO. 256

### Micropower op amp operates with 1 V

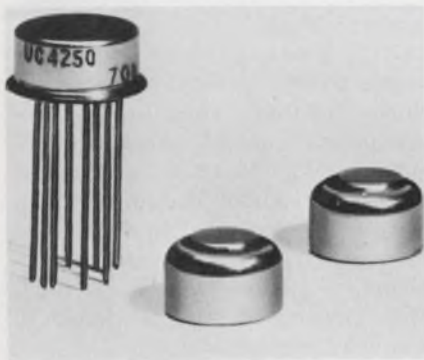

*Solitron Devices, P. O. Box 1416, San Diego, Calif. Phone: (714) 239-3471. Availability: stock.*

Besides offering a standby power consumption of only 20  $\mu$ W, a new monolithic operational amplifier needs a power supply voltage of just  $\pm 1$  V. The UC4250 is a general-purpose amplifier that can be powered by two single cells, or any other power source up to 18 V. Its typical input bias current is 3 nA with a temperature drift of less than 2 pA/ $^{\circ}$ C.

CIRCLE NO. 257

### Memory and register are just single chip

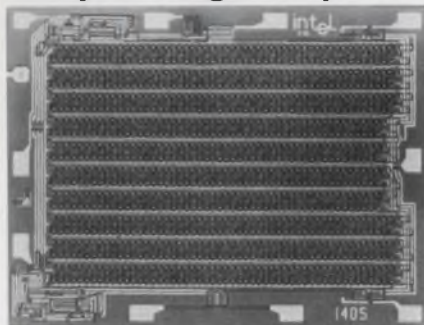

*Intel Corp., 365 Middlefield Rd., Mountain View, Calif. Phone: (415) 969-1670. P&A: \$17; stock.*

Complete with all necessary recirculating circuitry, a self-contained IC serial memory and a 512-bit shift register are now available on one silicon-gate MOS chip. Model 1405 is guaranteed to operate at data rates to 2 MHz. The unit can operate as a fully functional serial memory without the need for external logic.

CIRCLE NO. 258

### Read/write memories store up to 4096 bits

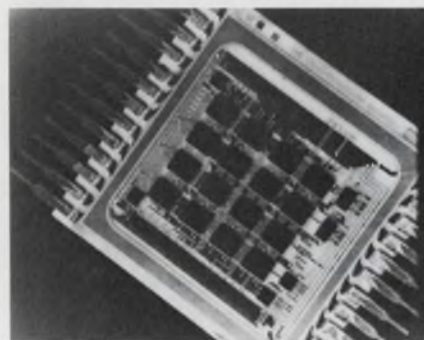

*Computer Micro Technology Inc., 610 Pastoria Ave., Sunnyvale, Calif. Phone: (408) 736-0300. P&A: \$1200; stock.*

Combining MOS and bipolar technologies, series CM2400 read/write memories offer the designer from 1024 to 4096 words organized with either one, two or four bits per word. There is a maximum of 16 MOS storage chips and six bipolar ICs for driving, sensing and output functions. Access time is 300 ns, and cycle time is 450 ns.

CIRCLE NO. 259

### 2048-bit memory has 600-ns access

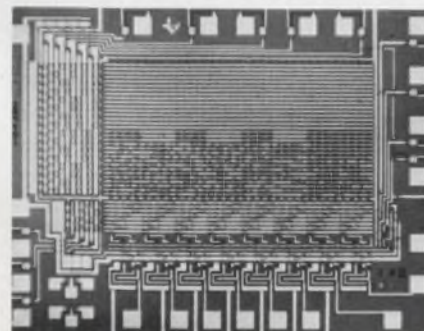

*Texas Instruments Inc., Components Group, P. O. Box 5012, Dallas, Tex. Phone: (214) 238-2011. P&A: \$21.70; 8 wks.*

An MOS LSI 2048-bit static read-only memory features a typical access time of 600 ns. Model TMS2600JC is available with two different memory organizations, allowing it to function as a 512-word by four-bit unit or a 256-word by eight-bit unit. Inputs are available for enabling the chip and for selecting memory organization.

CIRCLE NO. 260

INFORMATION RETRIEVAL NUMBER 47 ►

# Versatile reed relays

*Economical Series G Relays Offer These Features:*

- Wide switching capability—Low level to 450 VA. Voltages up to 5000 V DC.
- Low coil power to 50 mw—
- High IR—to  $10^{14}$  ohms.
- Electromagnetic and/or Electrostatic Shielding.
- Dry Reed or Hg wet switches.
- Vertical mounting available for limited board space—Series VR mounts in .4" square.

Three sizes available:  
Series MG—Miniature  
Series SG—Standard  
Series CG—Compact



New Series CG Relays.  
Top unit: Form B  
Bottom unit: Form A, will switch 5000 V DC @ 50 watts.

You're also sure of outstanding reliability with Series G relays, thanks to their rugged construction features:  
Welded switch leads.  
Unitized nylon bobbins.  
Coil leads terminated under wrap to eliminate open coils.

**DOUGLAS RANDALL, INC.**

6 Pawcatuck Ave.,  
Pawcatuck, Conn. 02891  
(203) 599-1750  
A Division of  
Walter Kidde & Co., Inc.



# SCHAUER

# 1%

tolerance

## 1 WATT ZENERS ARE A REAL BUY!

ANY voltage from 2.0 to 16.0  
at the industry's **LOWEST  
PRICES!**

Quantity	Price each
1-99	\$1.07
100-499	.97
500-999	.91
1000-4999	.86
5000 up	.82



## THE HI-RELIABLE!

No fragile nail heads.  
Silicon junction aligned between two, parallel, offset tantalum heat sinks . . . great lead tension strength.  
All welded and brazed assembly.  
High pressure molded package.  
Gold plated nickel-clad copper leads.  
Write or phone for Form 68-4 for complete rating data and other tolerance prices.

Semiconductor Division

### SCHAUER MANUFACTURING CORP.

4511 Alpine Avenue  
Cincinnati, O. 45242  
Ph. (513) 791-3030

INFORMATION RETRIEVAL NUMBER 48

## DATA PROCESSING

### 12-bit minicomputer has \$4990 price tag



Digital Equipment Corp., 146 Main St., Maynard, Mass. Phone: (617) 897-5111. P&A: from \$4990; November, 1970.

With a base price of \$4990, the model PDP-8/E minicomputer includes the basic computer, a programmer's control panel, a core memory of 4096 12-bit words, and a training course. The unit's memory can be expanded in 4096-word increments or 256-word increments to 32,768 words. A read-only memory is also available in 256-word segments.

CIRCLE NO. 261

### Graphic recorder copies CRT displays

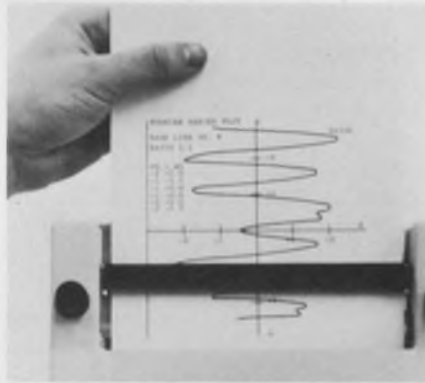

Alden Electronic & Impulse Recording Equipment Co., Inc., Alden Research Center, Westboro, Mass. Phone: (617) 366-8851. Price: \$1980.

Utilizing a flying-spot facsimile recording technique, the model 600 recorder provides instant graphic hard-copy paper records from data and graphic CRT display terminals. Clean crisp CRT recordings are generated on electrosensitive paper. Recordings are instantly visible and require no further processing.

CIRCLE NO. 262

### Graphic display sells for \$5500



Bendix Corp., Communications Div., E. Joppa Rd., Towson, Md. Phone: (301) 823-2200. P&A: \$5500.

Designed to mate with the IBM 1130 computer, a new graphic computer display speeds man-machine communications for a total cost of only \$5500. The model ICD-1100 interactive terminal is FORTRAN programmable and is compatible with digital plotter software. It provides a high-resolution 10-bit display. Program control is via a two-speed joy stick.

CIRCLE NO. 263

### Magnetic tape is 8270% tougher



Graham Magnetics Inc., Graham, Tex. Phone: (817) 549-3211.

A magnetic computer tape that is so tough it is said to be permanent is now available. Called Epoch 4, the new tape claims to offer 8270% greater toughness than competitive products. It uses a totally new tape chemistry—a binder system of alloyed high-performance polymers. The tape is free of layer-to-layer adhesion, and it minimizes dropouts.

CIRCLE NO. 264

# UNUSUAL BARGAINS

... MANY U. S. GOV'T SURPLUS

**FREE!**  
GIANT  
CATALOG



## TERRIFIC BUY! TOP QUALITY! PRICE BREAKTHROUGH IN LARGE SIZE OPAQUE PROJECTOR

"Best Opaque of its Kind Under \$200"

Projects brilliant, sharp 4 1/2 FOOT SQUARE image from 8 feet away using up to 5" x 5" color, b & w illustrations. Retains all original colors and proportions. Enlarges drawings, blueprints, watercolors, pictures, stamps, coins, other objects. Features high speed, 200mm anastigmatic projection lens (f3.5, 8" F.L.); powerful peanut-size quartz halogen lamp (50 hr. life); unique internal reflecting system. Gives maximum brightness, entire field focus. Flat stage and removable magnetic platen enable use upside down. Turbo-blower cooled. Tough plastic case. 5 1/2 ft. cord.

No. 71, 272DA (8 3/4" x 6" x 12 1/2" — 11 1/2 lbs.) \$89.75 Ppd.

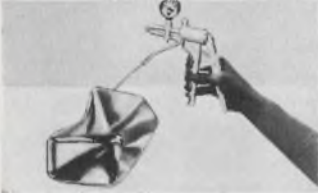

### 1st LOW-COST VACUUM PUMP!

Nothing like it! Top-quality hand-held pump produces & maintains 25" of vacuum. Has instant release tab, 1 5/8" diam. stainless gauge (0-30"). 100's of uses — siphon noxious fluids, evacuate bell jars and castings, clean, retrieve, lift sterile objects, demonstrate Magdeburg hemispheres, bleed fuel lines, check leaks, etc. Lifts 40 lbs. with included "T" Lifter (2 1/2" diam. cup) — much more w larger cup.  
Stock No. 71,301DA \$12.00 Ppd.  
No. 71,300DA (without gauge/lifter) 5.00 Ppd.



### Giant Free Catalog

Completely new 1970 edition—148 pages. Bargains galore! New categories, items, illustrations. 1,000's of buys for industry — Optics, Science, Math, On-the-job helps, quality control aids. Optics for research labs, design engineers experimenters. Instruments for checking, measuring to speed work, improve quality, cut costs. Huge selection of telescopes, microscopes, and other hard-to-get war surplus bargains. Write for Catalog DA.

ORDER BY STOCK NUMBER • OPEN ACCOUNT TO RATED FIRMS • MONEY-BACK GUARANTEE  
**EDMUND SCIENTIFIC CO. 300 EDCORP BUILDING**  
BARRINGTON, NEW JERSEY 08007

INFORMATION RETRIEVAL NUMBER 49

## PRECISION POWER WIRE WOUND AND HEAT SINK RESISTORS ON "DESIGN-CALL"

FROM

# OMTRONICS MANUFACTURING, INC.

2406 Leavenworth Street  
Phone (402) 348-9500

Omaha, Nebraska 68105  
TWX 910 622 8820

WRITE FOR OUR CATALOG AND NAME OF OUR  
LOCAL REPRESENTATIVE



**OMI**  
at the center of supply.

INFORMATION RETRIEVAL NUMBER 50

ELECTRONIC DESIGN 16, August 2, 1970



## What do you need in Multi-Conductor Cable?

# Victor

## will make it.

Get exactly what you need in multi-conductor cable. We'll design and produce multi-conductor cable to meet just about any individual requirement.

We have the plant, the equipment, the personnel and the know-how to solve your particular problem.

**Victor**  
*Electric Wire & Cable Corp.*  
WEST WARWICK, RHODE ISLAND

INFORMATION RETRIEVAL NUMBER 51

## Monolithic displays are DIPs or flatpacks



Hewlett-Packard Co., 1501 Page Mill Rd., Palo Alto, Calif. Phone: (415) 326-7000. P&A: \$11.95; 1 wk.

A new series of monolithic seven-segment displays diffused into a GaAsP single chip, are available in two package types: 14-pin dual-in-line (models 5082-7210, 11, 12), and flatpack (models 5082-7215, 16, 17). They feature small size (0.1-in. high), and require low power (1.6 V at 3 mA for 100 foot-lambert brightness).

CIRCLE NO. 265

## Short-length CRT works to 150 MHz



Thompson-CSF Electron Tubes, Inc., 50 Rockefeller Plaza, New York, N. Y. Phone: (212) 245-3900.

Measuring only 11.5-in. long, the F 8071 CRT features operation up to 150 MHz. It achieves these characteristics due to a patented deflection system that has two quadruple lenses and a special slot lens. It operates at up to 24 kV and has a 0.2-dB drop in gain at 150 MHz. A graticule placed in the same plane as the phosphor eliminates parallax errors.

CIRCLE NO. 266

## 50-mil capacitor cubes pack in 100,000 pF



American Technical Ceramics, 1 Norden Lane, Huntington Station, N. Y. Phone: (516) 271-9600. P&A: 53¢ to \$1.98; 3 to 8 wks.

The ATC-300 chip capacitors pack in from 0.012 to 0.1  $\mu$ F of capacitance in a 0.05 by 0.05 by 0.05-in. case. Available tolerances are 20 and 30%, dissipation factor is 4% at 1 MHz, and working voltage is 25 V dc. Specifications include a test voltage of three times the rated voltage for 5 s and insulation resistance of  $10^4$  M $\Omega$ .

CIRCLE NO. 267

## Tiny 1/2-W trimmer is just 0.08-in. high

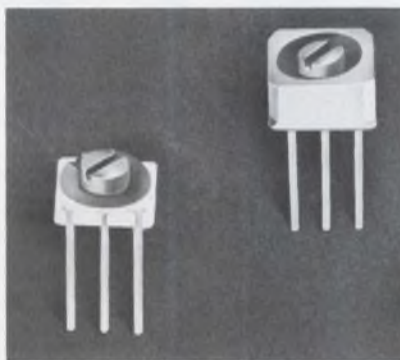

Mark Micro-Electronics Mfg. Co., Potentiometer Prod. Div., 21 Cottage St., Bayonne, N. J. Phone: (201) 339-2121. Price: \$60 to \$75.

A new ultra-miniature potentiometer rated at 0.5 W, measures only 3/16-in. square by 0.08-in. high. It incorporates a cermet element designed to meet MIL-R-22097 specifications. Operating temperature range is  $-55$  to  $+150^\circ$  C. Up to 16 resistance ranges from 0  $\Omega$  to 1 M $\Omega$  are available with tolerances of 1, 5, and 10%.

CIRCLE NO. 268

## Small cermet trimmers span 200 $\Omega$ to 1 M $\Omega$

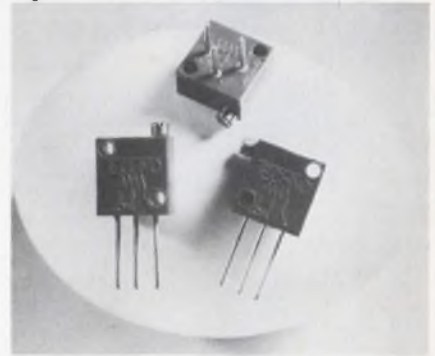

Techno-Components Corp., sub. of Oak Electro/Nectics Corp., 7803 Lemona Ave., Van Nuys, Calif. Phone: (213) 781-1642.

Besides infinite resolution, a new series of miniature cermet trimming potentiometers offer a resistance range of 200  $\Omega$  to 1 M $\Omega$ . Models 226, 251 and 276 are 3/8-in.-square RJ24-style units with differing pin configurations. Their temperature coefficient is 150 ppm/ $^\circ$ C, with 100 ppm/ $^\circ$ C available upon request.

CIRCLE NO. 269

## Hollow-rotor dc motor has 65-oz-in. torque

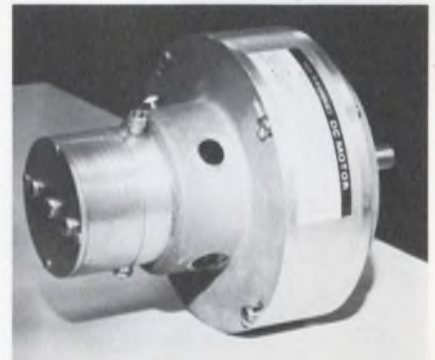

Micro Switch Div. of Honeywell, Inc., 11 W. Spring St., Freeport, Ill.

Known as the 5VMI, a new permanent-magnet moving-coil shell motor with a hollow rotor features torque of 65 oz-in. and accelerates from dead stop to 1200 rpm in 1 ms. Its rotor is made from wires wound into a cylindrical shell and reinforced with glass yarn and epoxy. The hollow-rotor principle results in low inductance and inertia, eliminates clogging and reduces brush sparking.

CIRCLE NO. 270



**Frequency sources  
build up waveforms**

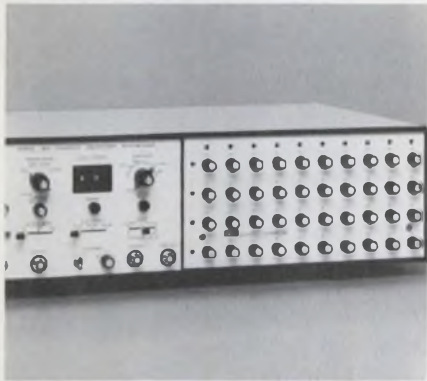

*Exact Electronics, Inc., Box 160, Hillsboro, Ore. Phone (503) 648-6661. Price: \$1995, \$2495.*

Model 201 and 202 waveform synthesizers can produce digital or analog complex waveforms piece-by-piece. These pieces or bits can be controlled in amplitude, width and slope. The 201 has 40 bits (20 bits in 20 variable-width modes); and the 202 has 0 to 40 selectable bits (0 to 20 bits in 20 variable-width modes).

CIRCLE NO. 271

**Taut-band multimeter  
works with 41 ranges**



*Medistor Instrument Co., 1443 N. Northlake Way, Seattle, Wash. Phone: (206) 633-5145. P&A: \$39.95; 5 days.*

The model N 2 is a taut-band multimeter with 41 ranges. It measures dc voltages of 0.012 to 600 V full scale, ac voltages of 1.5 to 600 V full scale, dc current from 30  $\mu$ A to 6 A full scale, and ac current from 150  $\mu$ A to 6 A full scale. It also has two resistance ranges, 5-dB level ranges, and two temperature-measuring ranges.

CIRCLE NO. 272

Now choose either

PLASTIC

or

GLASS

FIBER OPTICS

from

WELCH ALLYN

For minimum cost (as in disposable products) or for maximum bundle flexibility, check the advantages of fiber optics assemblies or systems made with Welch Allyn's newly developed *plastic* fibers.

For high precision work, where infra-red light transmission is important, or where fiber optics are exposed to high heat, our *glass* fibers are normally still preferable.

**COORDINATED FIBER OPTICS/LAMP SYSTEMS**

Glass or plastic, your fiber optics system will have maximum optical performance with custom-built, precision Welch Allyn miniature lamps.

**Ask us about your glass or plastic fiber optics assemblies or lamp/fiber optics systems.**



Welch Allyn, Inc., Skaneateles Falls, N. Y. 13153 Tel (315) 685-5788

INFORMATION RETRIEVAL NUMBER 52

LET'S DO SOMETHING EXOTIC AT THE SHOW THIS YEAR— SOMETHING CLASSY, THAT SHOWS McLEAN PRECISION INSTRUMENT MOTORS AND BLOWERS ARE REALLY BUILT!



LATER AT THE SHOW!

WE DECIDED TO EMPHASIZE OUR PERFORMANCE CURVES BOSS— AND WE'RE KNOCKIN' 'EM DEAD!



McLean's performance curves are something to get excited about just the same. A talented computer resolves Precision Instrument Motor problems that just can't be handled by ordinary motor manufacturers — plotting curves that relate motor RPM to shaft torque, power factor, and percent efficiency. Blowers and Motors are computer-matched and built for highest performance and guaranteed for 25,000 hours of operation. Write or phone for some exotic, but understandable, information.

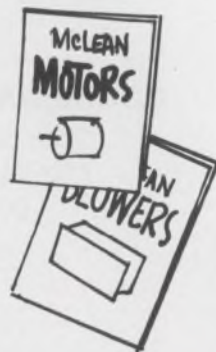

**McLEAN** ENGINEERING LABORATORIES 

Princeton Junction, New Jersey 08550 • Phone: 609-799-0100 • Telex: 84-3422

See us at WESCON SHOW Booth 567

INFORMATION RETRIEVAL NUMBER 53

MICROWAVES & LASERS

Uhf power transistor gives 40 W at 400 MHz

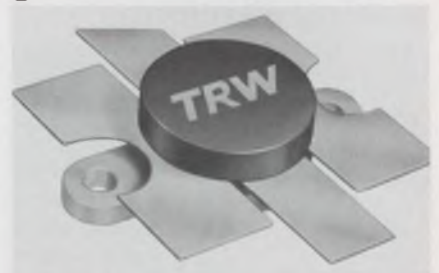

TRW Semiconductor Div., 14520 Aviation Blvd., Lawndale, Calif. Phone: (213) 679-4561. P&A: \$185; 30 to 45 days.

With internal matching circuitry that reduces input reactance to essentially zero, a new uhf power transistor delivers a 40-W output across the entire band from 225 to 400 MHz. Model JO-2001 also provides high input resistance with low input Q. The device operates from a 24-V source with a minimum efficiency of 50%.

CIRCLE NO. 273

Holography lab sells for \$99.50

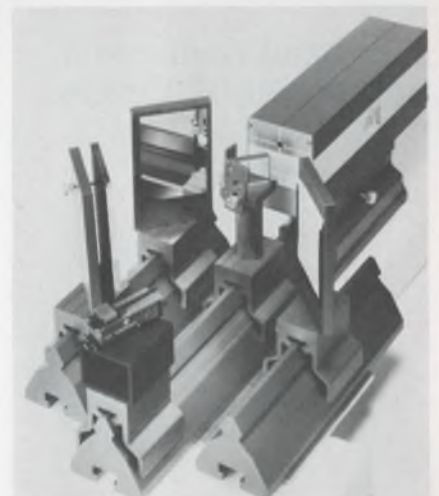

Metrologic Instruments, Inc., 143 Harding Ave., Bellmawr, N. J. Phone: (609) 933-0100. Price: \$99.50.

When accompanied by a laser, a new holographic laboratory for \$99.50 includes all the materials needed to make three-dimensional holograms. A detailed instruction book, three tracks of shock-mounted optics benches, a sample hologram, completely mounted optical components, high-resolution film, and the necessary chemicals are supplied.

CIRCLE NO. 274

### Adjustable card racks change symmetrically

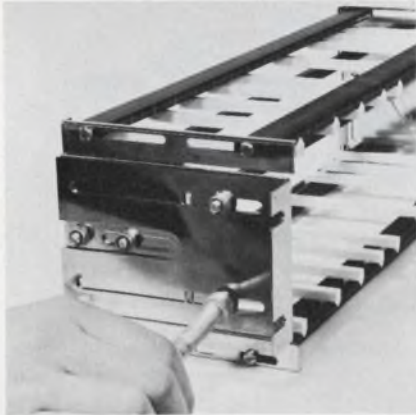

*Thermalloy Co., 8717 Diplomacy Row, Dallas, Tex. Phone: (214) 637-3333. P&A: \$24.95; stock.*

Series 5201 adjustable card racks fit practically any size cabinet, due to their complete flexibility in width, height and depth. The units have end plates that are capable of handling cards from 3-1/2 to 7 in. in height. The end plate adjustment keeps the card rack symmetrical as it is adjusted. Cards of any length up to 10 in. are easily accepted.

CIRCLE NO. 275

### Laminated buss bars are structural too

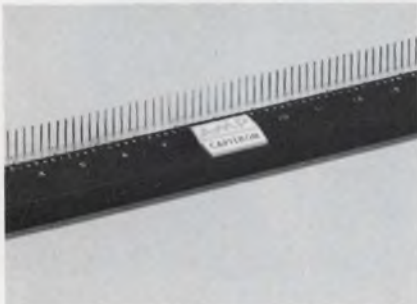

*AMP Inc., Capatron Div., 155 Park St., Elizabethtown, Pa. Phone: (717) 564-0101.*

Because it is epoxy-potted within an aluminum housing for mechanical strength, a new laminar buss-bar power distribution system can serve as a chassis structural member and as a mounting point for connectors. The system is laminated from planar conductors interleaved with thin layers of high-dielectric-constant insulating material. It provides 1000 pF/in.<sup>2</sup>

CIRCLE NO. 276

### Dual-in-line system accepts most DIPs

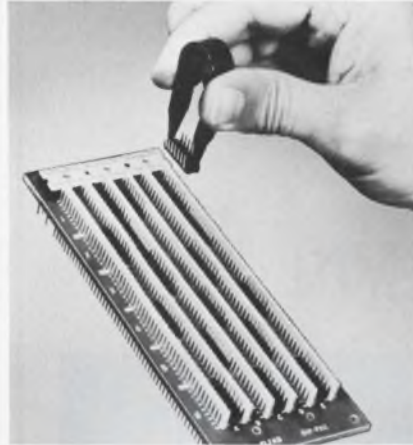

*Elfab, P. O. Box 34555, Dallas, Tex. Phone: (214) 239-7181.*

A new packaging system called DIP-PAC, designed for all variations of dual-in-line devices, permits DIPs to be inverted and plugged into the system, with the use of contacting fingers. This feature eliminates insertion problems caused by bent DIP leads. Standard sizes of 30, 60, 90, 120, 150, and 180 DIP positions are available.

CIRCLE NO. 277

### PC-board kit speeds prototypes



*Bishop Graphics, Inc., 7300 Radford Ave., N. Hollywood, Calif. Phone: (213) 982-2000.*

A new system for prototyping printed circuit boards and test circuits directly from the schematic is now available in kit form. Circuit Zap SpeedKit contains everything needed for "instant" PC boards—a complete assortment of adhesive-backed copper-circuit component patterns, plus all associated hardware, laminate boards and male and female jumper wires.

CIRCLE NO. 278

### Fiber-tip marking pen uses etch-resistant ink



*Dalomark Corp., 161 Coolidge Ave., Englewood, N. J. Phone: (201) 567-4111. Price: \$11.76/dozen.*

The model 33 fine-line fiber-tip marking pen allows the PC-board designer to draw directly on the copper surface of laminated boards. The unit's special ink, available in blue or red, serves as a mask to resist the action of various etchants. Marks, however, can be easily removed with naphthas or chlorinated solvents. A precision valve feeds ink to the tip.

CIRCLE NO. 279

### Solder-cleaner tip clears DIP mountings

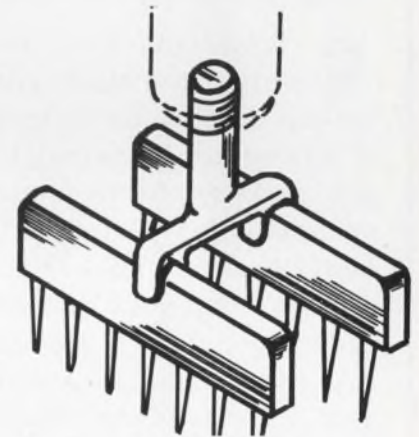

*Techni-Tool, Inc., 1216 Arch St., Philadelphia, Pa. Phone: (215) 568-4457.*

Now available is the model 4922 aperture cleaner with special tips for clearing solder-blocked holes and eyelets, which often make component re-insertion complicated. This new solder tip is intended for use with 14-pin dual-in-line packages. It fits all standard soldering irons and is constructed from long-life beryllium copper.

CIRCLE NO. 280

# THE COCKY LITTLE TRANSIENT QUENCHER FROM JOSLYN

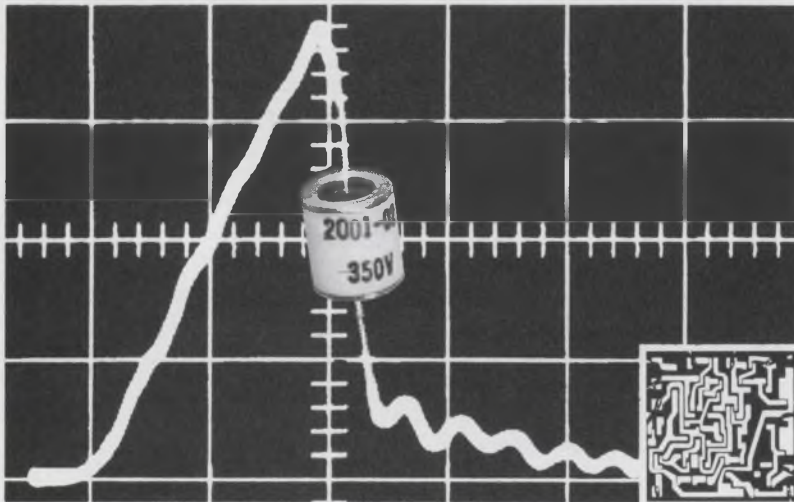

**2001-01**  
**350V**

Transients have never been able to knock off solid-state electronics when Joslyn precision protection devices are on guard duty. \*Never! They quickly extinguish damaging transients with extreme accuracy, nano-second response, and high repeatability over an unequalled period of time. Ideal for protecting AC and DC input lines, RF systems (transmitting or receiving), balanced and unbalanced transmission lines, radar modulators, traveling wave tubes, and cathode ray tubes. Contact Joslyn today for full information and delivery from stock for the field-proven cocky little spark gap that will solve your particular protection problem. Full line includes surge protectors and lightning arresters. \*when properly selected and connected



## JOSLYN

### ELECTRONIC SYSTEMS

Joslyn Electronic Systems  Santa Barbara Research Park   
P.O. Box 817  Goleta, Calif. 93017  Tel. (805) 968-3551

1813

## Evaluation Samples

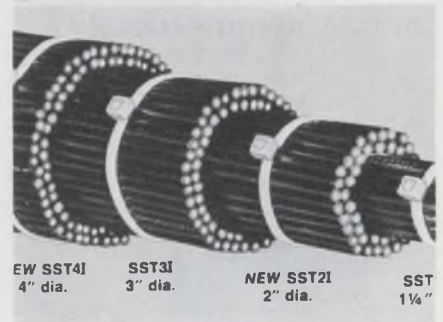

### Cable ties

Samples of four new cable ties for wire-bundle diameters from 1-1/4 to 4 in. are available. SST cable ties have a minimum loop tensile strength of 30 lbs and meet applicable military standards. They can be uniformly tensioned and cut off with a single setting of an installation tool, or a harnessing tool can be used for uniform tension control. Panduit Corp.

CIRCLE NO. 281



### Phono receptacle

A low-cost phono-receptacle that can be soldered to a printed-circuit board is available as a free sample. After installation, it remains rigidly seated. It will accept any standard phono plug, regardless of the length of the center pin. The outside shell of the receptacle is made of tinitilaplated brass. The interior contact is of tin-plated brass with a nylon insulator. Molex Inc.

CIRCLE NO. 282

# Design Aids

## Transistor reference

A four-page pamphlet contains practical reference data on general-purpose transistors that operate from the vhf through the S band. Called "Design Aids," it helps engineers solve amplifier and oscillator problems. Collector-current and frequency curves, as well as typical S parameters are featured. KMC Semiconductor Corp.

CIRCLE NO. 283

## Copper PC-board patterns

Circuit Zaps are pre-etched pressure-sensitive copper patterns, pads and conductor paths for PC-board applications. They are made of 1 oz of copper on a 3.5-mil glass epoxy film which is backed by a pressure-sensitive adhesive. With Circuit Zaps, printed wiring boards and test circuits can be made directly from the designer's schematics or component layouts, in one quick operation. Bishop Graphics, Inc.

CIRCLE NO. 284

## Varnish selector chart

A wide variety of insulating varnishes are listed along with recommended uses in a four-page selection chart. Included on the chart is such information as the varnish compatibility with magnet-wire coatings, descriptions of various characteristics, and military specifications. A brief description of the most important properties is given for each varnish type. John C. Dolph Co.

CIRCLE NO. 285

## Extrusion design guide

Design considerations for plastic profile extrusions of polyethylene and polypropylene are given in a two-page guide. It gives valuable information on material characteristics, properties, design considerations (part function, wall balance, hollows, corners and radii, tolerances), die requirements, and secondary operations for polyethylene and polypropylene. Specific details on polypropylene design are included. General, mechanical, electrical and environmental information is included. Crane Plastics, Inc.

CIRCLE NO. 286

# Now you can specify:

- Clean-cut, modern design
- Time-Tested, tough phenolic case
- Environment-Free Viewing Area



all in the new Simpson

## CENTURY SERIES

### PANEL INSTRUMENTS

- 1½", 2½", 3½" and 4½" sizes. Ranges, scales and other characteristics to meet your exact requirements.
- Variety of movements. Matching Relays, Wattmeters and Elapsed Time Meters also available.

Standards now in stock at electronic distributors everywhere. For custom specials, see your Simpson Representative . . . he's listed in the Yellow Pages. For more details, write for Bulletin 2081.



### SIMPSON ELECTRIC COMPANY

5200 W. Kinzie St., Chicago, Ill. 60644, Phone: (312) 379-1121  
Export Dept: 400 W. Madison St., Chicago, Ill. 60606, Cable SIMELCO  
IN CANADA: Bach-Simpson, Ltd., London, Ontario  
IN INDIA: Ruttonsha-Simpson Private, Ltd., International House,  
Bombay-Agra Road, Vikhroli, Bombay

the best way  
to start  
designing  
a system is to  
**SEND FOR  
THE LATEST  
CATALOG of  
PREMIER  
STANDARD  
METAL  
ENCLOSURES**

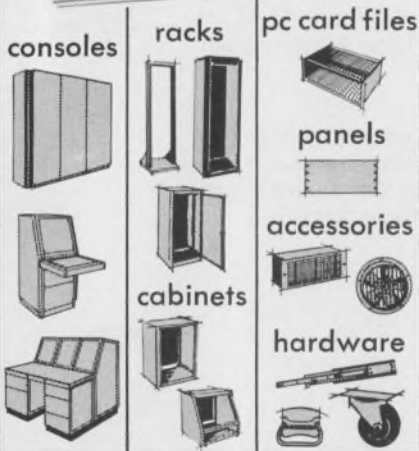
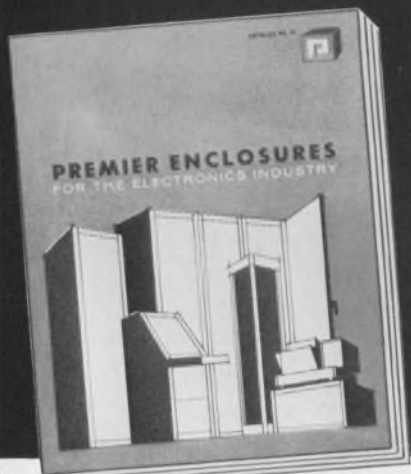

**PREMIER**

**METAL PRODUCTS CO.**

A Division of Sunshine Mining Company  
Pioneers in Metal Housings  
for the Electronics Industry Since 1946  
337 Manida Street, Bronx, N.Y. 10474  
(212) 991-6600



# Application Notes

## Spectrum analysis

A series of notes on the practical aspects of audio-frequency spectrum analyzers and their application is begun with an eight-page note. After a readable discussion on the similarities and differences between continuous (noise-like) and line spectra and the concept of degrees-of-freedom, the note concludes with a glossary and list of annotated references. Parallel-filter, swept-filter, time-compression and digital or numerical methods will be covered as the series progresses. Testronic Development Laboratory.

CIRCLE NO. 287

## Vibration testing

A practical primer on vibration testing answers such questions as: what vibration behavior may be expected when a vibration input is added to a component under test, and does a specified vibration test really simulate in-service vibration? It briefly traces vibration testing from its early beginning and shows how in-flight vibration measurements resulted in test specifications. The basic elements of vibration testing systems are discussed. Tustin Institute of Technology, Inc.

CIRCLE NO. 288

## X-ray analysis

"Instruments for X-ray Analysis" is a 12-page bulletin that presents a detailed description of the operation of a semiconductor X-ray detector, including comparisons with other types of detectors, and a discussion of some of the associated parameters. Following the detector portion are sections dealing with its application to scanning electron microscopes and electron probe microanalyzers. Photomicrographs of various types of samples are shown, along with spot or line scans made with the detector revealing the composition of a sample. Ortec Inc.

CIRCLE NO. 289

A mouse has  
already been saved  
from leukemia.

Help us save a man.

For years, you've been giving people with leukemia your sympathy. But sympathy can't cure leukemia. Money can. Give us enough of that, and maybe we'll be able to do for a man what has already been done for a mouse.



American Cancer Society

Space Contributed By  
Hayden Publishing Company, Inc.

## FREQUENCY SYNTHESIZER FOR LESS THAN \$2500.00



- ★ Dial in frequency to five significant figures.
- ★ 10 KHz to 9,999.9 KHz, in steps of 100 Hz.
- ★ Accuracy > 1 part in 10<sup>6</sup>, stability > 1 part in 10<sup>8</sup>.
- ★ Calibrated vernier frequency control, ± 50 parts in 10<sup>6</sup>, readable to 0.2 in 10<sup>6</sup>.
- ★ Output voltage 1.0 volt r.m.s., step attenuator to < 1 millivolt.
- ★ Spurious more than 30 DB down.
- ★ Price \$2,390.00.

For Complete Specifications - Mail Coupon Today

Name .....  
Address .....  
City ..... State ..... Zip .....

**LAMPKIN LABORATORIES, INC.**  
FS DIV., Bradenton, Florida 33505

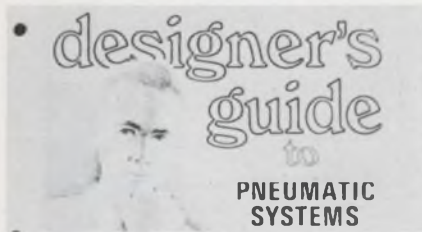

## Pneumatic systems

A 20-page illustrated guide to compressed-air systems covers the basics of factory air-power systems, including air supply, preparation and power control. All sections of the guide are illustrated with simple cutaway drawings and photos. Designers of machinery, plant systems and process lines will find this booklet a valuable summary of compressed-air basics, written in clear language by well-qualified experts. Parker Hannifin Corp.

CIRCLE NO. 290

## Crystal polishing

An article entitled "Precision Polishing Technique for Optics and Microwave Acoustics" describes a simple system for polishing crystal surfaces. These crystals have surfaces with an over-all flatness of  $1/8$  the wavelength of light and are parallel to  $6$  s of arc. The article describes how metal laps are used throughout and how materials of hardness ranging from cadmium sulphide to sapphire have been treated successfully. Hacker Instruments Inc.

CIRCLE NO. 291

## IR sampling

Silver chloride encapsulation, a new efficient approach to direct analysis of micro quantities of reactive materials or those that sublime in the heat of an IR beam, is discussed in a 16-page illustrated booklet. The technique uses a small inexpensive die to seal the solid samples between two thin layers of rolled silver chloride. The samples are then mounted in a disc retainer and placed directly in a spectrophotometer beam or mounted in a beam condenser. Resulting spectra using both methods are discussed. Barnes Engineering Co.

CIRCLE NO. 292

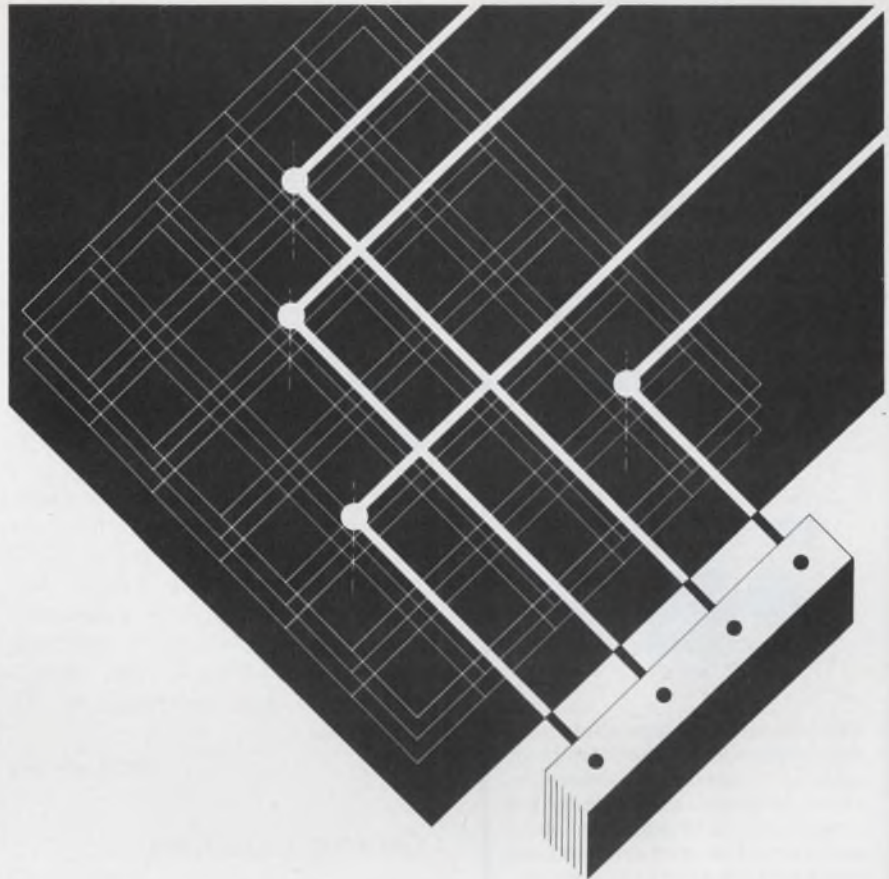

**What multi-point switch is so reliable that more than 20 million closures per crosspoint are common?**

## The Cunningham Crossbar

This high performance, electro-mechanical switch assures long life with minimum signal distortion for the full range of switching applications—from very low voltage up to 1000 volts.

A unique contact structure is the main reason for the crossbar's reliability. Twin gold contacts, high tension, low mass and friction levels, self-wiping action... all assure superb low-level switching down to micro-volt level—at high speed.

Inherent in the crossbar design is exceptional isolation of each signal path from other paths and from the control circuits. The crossbar is not susceptible to major failure from erroneous voltages or circuit breakdown—nor to chain type failures as in solid state circuitry.

Two matrix patterns: Type A for group-to-group switching; Type F for group-to-one switching. Each covers a specific segment

of data acquisition or broadband switching and is readily programmable by every control device from tape to direct computer input.

*Uses include:*

- Switching video, radar and antenna signals.
- Memory and logic functions.
- Machine tool programming.
- Data acquisition systems such as outputs from strain-gages, transducers, thermocouples, component test devices, or where signal levels are in the micro-volt range.

Write or phone for Bulletin No. 130, Cunningham Corporation, 10 Carriage Street, Honeoye Falls, New York 14472. Phone (716) 624-2000.

# Cunningham Corporation

SUBSIDIARY OF GLEASON WORKS

INFORMATION RETRIEVAL NUMBER 58

For a true record  
of temperature  
in service...

**Tempilabel**<sup>®</sup>

Easy to use . . .

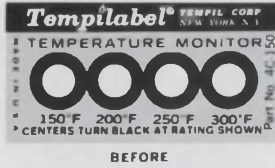

BEFORE

Easy to read



AFTER

Self-adhesive Tempilabels<sup>®</sup> assure dependable monitoring of attained temperatures. Heat-sensitive indicators, sealed under the little round windows, turn black and provide a permanent record of the temperature history. Tempilabel<sup>®</sup> can be removed easily to document a report.



AVAILABLE

Within the range 100° to 500°F Tempilabels<sup>®</sup> are available to indicate a single temperature rating each — and also in a wide choice of four-temperature combinations per Tempilabel<sup>®</sup>.

#### JUST A FEW OF THE TYPICAL APPLICATIONS

- Electrical Apparatus
- Electronic Assemblies
- Appliance Warranties
- Aircraft and Rockets
- Machinery and Equipment
- Storage and Transportation of Heat Sensitive Materials.

For descriptive literature and a sample Tempilabel<sup>®</sup> for evaluation . . . (please state temperature range of interest).

Write to: SPECIAL APPLICATIONS DIVISION



HAMILTON BLVD., SO. PLAINFIELD, N.J. 07080  
PHONE: 201 • 757-8300 • TELEX: 138662

## New Literature

### Printed circuit aids:

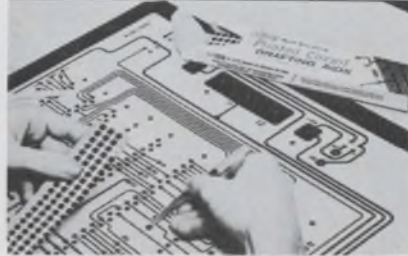

### Printed-circuit aids

A new 24-page catalog lists self-sticking printed-circuit drafting and production aids. Items listed include new drafting shapes, connector strips and pad configurations. A dry transfer lettering system for printed-circuit identification is also described. W. H. Brady Co.

CIRCLE NO. 293

### Ceramic capacitors

General characteristics of a series of ceramic capacitors are highlighted in a 24-page catalog. Details included cover rectangular-case 50, 100 and 200-V capacitors, and tubular-case 50 and 100-V capacitors. San Fernando Electric Manufacturing Co., West-Cap Div.

CIRCLE NO. 294

### Computer system

A 20-page brochure contains details on a new 16-bit computer system. It covers in detail the system's architecture, addressing and input/output structures, and instruction formats. Infotronics Corp.

CIRCLE NO. 295

### Delay switches

Applications and specifications for a line of solid-state delay switches are detailed in a new technical bulletin. Models are available with fixed delay times from 0.02 to 60 seconds. Adjustable units have a 30:1 time range; these are also offered with relay switching. The basic switch is a 1-in. cube, operating on 26 V  $\pm 30\%$ . General Time Corp.

CIRCLE NO. 296

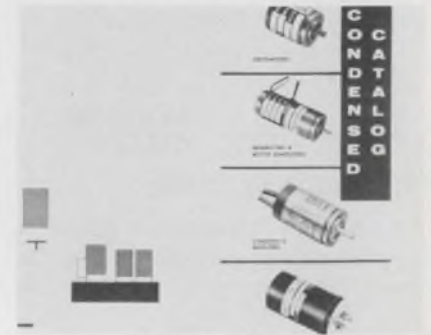

### Servo mechanisms

A 12-page condensed catalog shows electrical and mechanical specifications for servo motors, generators, synchros, resolvers, stepper motors, and servo amplifiers. Also included are pancake synchros and servo systems. Weston-Transicoil, Components Div. of Weston Instruments, Inc.

CIRCLE NO. 297

### Buyers guide

A 28-page buyers guide lists hundreds of electronic products, services and facilities. These include control systems, machine-tool controls, electron tubes, micro-electronic components, marine electronics, broadcast systems, microwave tubes and calibration and maintenance services. EMI Electronics Ltd.

CIRCLE NO. 298

### Selenium rectifiers

Selenium rectifiers, transient voltage suppressors and contact protectors are outlined in a new 40-page illustrated engineering brochure. International Rectifier.

CIRCLE NO. 299

### Servos and synchros

A broad range of components and systems for aircraft, missile and industrial use are listed in a 176-page catalog. Included are accelerometers, amplifiers, generators, gyros and precision potentiometers. Also included are pressure transducers, recorders, resolvers, synchros, servo motors and related components and systems. Ast/Servo Systems, Inc.

CIRCLE NO. 300





## Connectors and coax

Semi-flexible air-dielectric coaxial cable and connectors are described in a new catalog. Also shown are curves for attenuation and power versus frequency, and informative applications engineering data. Prodelin Inc.

CIRCLE NO. 335

## Mylar capacitors

Specifications of Mylar-dielectric capacitors in tubular, rectangular or bathtub configuration are detailed in an eight-page catalog. Detailed are hermetically sealed tubular capacitors with inserted-tab or extended-foil construction rated at 50, 100, 200, 400, 600 and 1000 V dc. San Fernando Electric Manufacturing Co.

CIRCLE NO. 336

## Time sharing

*Time-Sharing Today* is a newsletter for users of remote computing facilities. It identifies industry trends and alerts readers to changes in companies and services they offer. Special issues are devoted to analyses and evaluations of important time-sharing subjects. Time-Sharing Enterprises, Inc.

CIRCLE NO. 337

## Templates

Templates for engineers, architects, students, artists, draftsmen and technical contractors are included in a new catalog. Plasticoid Products.

CIRCLE NO. 338

# THE MOST ACCURATE RF MILLIVOLTMETER PROGRAMMABLE AVAILABLE ONLY FROM BOONTON



The Model 92A has been designed as the definitive rf millivoltmeter. Accuracy at all frequencies and voltage levels is the best ever offered by Boonton Electronics, long a leader in the rf millivoltmeter field.

Fast warm-up, high reliability, long intervals between calibrations, plug-in PC boards for ease of servicing, light weight, and no heat, are characteristics of the Model 92A's solid state design.

### STANDARD FEATURES

- Accuracy 1% full scale + 1% reading
- Programmable
- Measures 100  $\mu$ V to 3 V\* from 10 kHz to 1.2 GHz
- True RMS response to 30 mV\*\*
- Convenient push-button ranging and half-rack packaging
- Fast, high level dc output
- High input resistance, low input capacitance
- Overload protection to 400 V dc, 10 V ac
- VSWR less than 1.15 up to 1.2 GHz

Price: \$750 Standard Unit

\*To 300 V, up to 700 MHz with accessory 100:1 divider  
\*\*To 3 V, up to 700 MHz with accessory 100:1 divider

Call or Write for Details or Demonstration

**BOONTON**  
**ELECTRONICS**  
CORPORATION

ROUTE 287  
PARSIPPANY, N.J. 07054  
Telephone: 201-887-5110  
TWX: 710-986-8241

# Pulling down the cost of lighting up an instrument



For a high-reliability light source, the Tung-Sol baseless cartridge lamp is about as simple as you can get. Elimination of cemented-on bases removes two potential failure sources while lowering cost. There are no anchors to generate noise and no soldered connections. Design permits use of an inexpensive clip-type mounting bracket which achieves low silhouette. Can be supplied in 6 v. and 12 v. types. Complete information and application assistance available. Write for catalog A-21. Tung-Sol Division, Wagner Electric Corporation, 630 W. Mt. Pleasant Avenue, Livingston, N.J. 07039; TWX: 710-994-4865, Phone: (201) 992-1100; (212) 732-5426.

## TUNG-SOL® BASELESS CARTRIDGE LAMP

TUNG-SOL—WHERE BIG THINGS ARE DONE WITH SMALL LAMPS

® Trademark TUNG-SOL Reg. U.S. Pat. Off. and Marcas Registradas

INFORMATION RETRIEVAL NUMBER 61

### NEW LITERATURE



#### Infrared detectors

An easy-to-use carefully indexed 68-page book catalogs a line of infrared detectors. It contains sections on mercury-doped germanium, yttrium and cadmium-mercury-telluride infrared detectors. Mullard, Inc.

CIRCLE NO. 339

#### Rf chokes

A four-page brochure details high-temperature encapsulated rf chokes. Included are complete specifications on several series providing inductances from 0.1 to 4700  $\mu$ H. Vanguard Electronics.

CIRCLE NO. 340

#### Microwave devices

Extensive lines of microwave diodes, rf multipliers, power sources, impatt and Gunn-effect oscillators, and high-power waveguide limiters are described in a 36-page catalog. Varian, Solid State Div.

CIRCLE NO. 341

#### Counter ICs

Discussing design considerations for high-speed counters using emitter-coupled-logic (ECL) integrated circuits, an eight-page report covers the use of series ECL2500 ICs when designing four-bit synchronous binary counters, four-bit Johnson counters, pseudo-random sequence counters, and four-bit programmable counters. Included are practical considerations and suggestions for preventing unwanted signals due to reflections or inadequate power-supply decoupling. Complementing the discussion are circuit diagrams, truth tables, block diagrams, and photos. Texas Instruments Inc.

CIRCLE NO. 342

#### Digital computer

A comprehensive 67-page reference manual describes a new digital computer system. It presents detailed information on the system's design features, its organization, instruction set, memory and I/O characteristics. Computer Development Corp.

CIRCLE NO. 343

#### Computer-aided design

A new computer-aided design and layout program is described in a 20-page brochure. The program starts with the most basic design element in a system, which allows the engineer to design a truly complete integrated circuit. Integrated Circuit Engineering Corp.

CIRCLE NO. 344

#### Technical manuals

A new brochure lists various available technical publications dealing with transistors, transmitting and receiving tubes, integrated circuits, hobbyists' and experimenters' circuits, photo-conductive devices and diodes and thyristors. RCA Electronic Components.

CIRCLE NO. 345

#### Signal averaging

A complete system capable of performing signal conditioning, a/d conversion, arithmetic operations, data display, modification and readout, and direct and hard-wired interface is described in a 41-page brochure. Fabri-Tek Instruments, Inc.

CIRCLE NO. 346

#### Cradle relays

Carefully designed to simplify the selection and specifying of cradle relays, a 14-page catalog contains relay data, features, applications, dimensions, wiring diagrams and chassis layouts pertaining to each enclosure and terminal type. Allied Control Co., Inc.

CIRCLE NO. 347

# D to A A to D

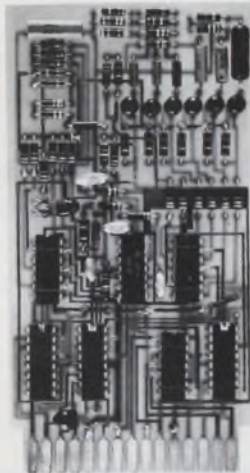

## DA 035 Series D/A Conv.

- 8, 10, 12-bit Binary, 12-bit BCD on Single Card
- With or Without Input Data Storage
- $\pm 10V$  @ 10mA Output

Price: 12-bit, w/o storage, 10 qty. **\$72**

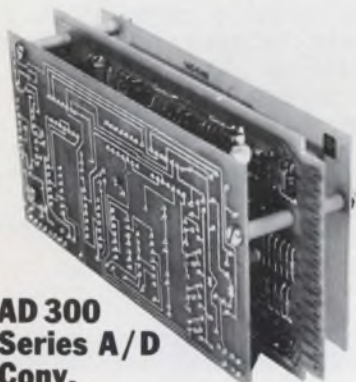

## AD 300 Series A/D Conv.

- 8, 10, 12-bit Binary, 12-bit BCD
- Accuracy . . . .  $\pm 0.025\%$   
 $\pm \frac{1}{2}$  LSB
- Speed . . . . 10KC  
(20KC available)

Price: 12-bit, 10KC, 10 qty. **\$172**

CALL: 305-933-5561  
WRITE: P.O. Box 23849  
Ft. Lauderdale, Fla. 33307



**COMPUTER  
PRODUCTS™**

FORT LAUDERDALE

## Bulletin board

of product news  
and developments

A new self-powered Flashcube called Magicube, which is activated mechanically without the use of batteries, is now available. Each lamp in the four-flash Magicube is ignited by its own torsion spring system mounted in the base of the cube. The spring is automatically triggered when the camera shutter is depressed. Cameras designed to use Flashcubes and flashbulbs cannot use Magicubes, but Kodak is offering five special Instamatic X cameras for the new flashes. Sylvania Electric Products Inc., the supplier of Magicubes, sells a sleeve of three for \$2.25.

Designed for industrial television systems, an optical kit makes it possible to pick up a scene with an ordinary television camera and see it in three dimensions on a regular television monitor. The system consists of a \$1750 Stereo-Captor (model 5002), a \$150 Stereo-Screen (model 6001) for 8-in. monitors, and \$35 Stereo-Glasses (model 7001). The Stereo-Captor is easily installed on the lens of any closed-circuit TV camera, while the Stereo-Screen replaces the monitor's glass impression plate. The picture is then viewed in three dimensions with the Stereo-Glasses. This 3-D presentation can be recorded on film or video tape and played back in stereo. The manufacturer is Stereotronics Television Co., Sherman Oaks, Calif.

CIRCLE NO. 348

Dual transistors from Fairchild Semiconductor have been lowered in cost by as much as 75%. The price reductions apply to 70 products, including npn and pnp differential amplifiers, unmatched dual amplifiers and complementary unmatched dual amplifiers. For quantities of 1 to 99, prices range from \$2.25 to \$18; in lots of 100 to 999, costs vary from \$1.50 to \$12.

CIRCLE NO. 349

Another  
unique quality  
of Electro Cube  
is to pack  
more into a  
small package  
reliably



electro cube  
capacitors

Our new 50 Volt metallized polycarbonate capacitors, with .00008 gauge film, make conventional units look like elephants. If space is a problem, ask. We'll help. Electro Cube, Inc., 1710 South Del Mar Avenue, San Gabriel, California 91776. (213) 283-0511.

ELECTRONIC DESIGN's function is:

- To aid progress in the electronics manufacturing industry by promoting good design.
- To give the electronic design engineer concepts and ideas that make his job easier and more productive.
- To provide a central source of timely electronics information.
- To promote two-way communication between manufacturer and engineer.

**Want a subscription?** ELECTRONIC DESIGN is sent free to qualified engineers and engineering managers doing design work, supervising design or setting standards in the United States and Western Europe. For a free subscription, use the postfree application form inside the back cover. If none is included, write to us direct for an application form.

If you do not qualify, you may take out a paid subscription for \$25 a year in the U.S.A., \$35 a year elsewhere. Single copies are \$1.50 each.

**If you change your address,** send us an old mailing label and your new address; there is generally a prepaid postcard for this inside the back cover. You will have to requalify to continue receiving ELECTRONIC DESIGN free.

**The accuracy policy of ELECTRONIC DESIGN is:**

- To make reasonable efforts to ensure the accuracy of editorial matter.
- To publish prompt corrections whenever inaccuracies are brought to our attention. Corrections appear at the end of the Letters column.
- To refuse any advertisement deemed to be misleading or fraudulent.

Microfilm copies are available of complete volumes of ELECTRONIC DESIGN at \$19.00 per volume, beginning with Volume 9, 1961. Work is now in process to complete the microfilm edition of Volumes 1-8. Reprints of individual articles may be obtained for \$2.00 each, prepaid (\$.50 for each additional copy of the same article) no matter how long the article. For further details and to place orders, contact the Customer Services Department, University Microfilms, 300 North Zeeb Road, Ann Arbor, Michigan 48106; telephone (313) 761-4700.

**Want to contact us?** If you have any comments or wish to submit a manuscript or article outline, address your correspondence to:

Editor  
ELECTRONIC DESIGN,  
850 Third Avenue,  
New York, N.Y. 10022.

## Terminal Block Selector



A new 24-page, completely illustrated catalog contains photos, descriptions, ratings, engineering drawings, and prices of the complete line of Curtis terminal blocks. Included are printed circuit, insulated feed-thru, quick disconnect, track type, and high current terminal blocks. Handy selection chart quickly locates the perfect block for your particular requirements. Send today for your free copy.

CIRCLE NO. 171

### Curtis Development & Mfg. Co.

3236 North 33rd Street  
Milwaukee, Wisconsin 53216

SEE US AT WESCON-BOOTH 1018 AND PE Show booth 6058

## Minimizing Capacitance Changes



Causes of capacitance value changes in wound dielectric capacitors are treated in an Electro Cube technical bulletin to aid designers in selecting and using capacitors. Graphs and formulas are used to illustrate the straight-forward discussion and to compare performance of various dielectrics with changes in operating and environmental conditions. Also available are bulletins treating the sometimes confusing considerations of capacitor dissipation factor and insulation resistance, as part of a continuing series of two and four page technical discussions by Fred L. Johnson.

CIRCLE NO. 172

**Electro Cube, Inc.**  
1710 South Del Mar Avenue  
San Gabriel, California 91776

## How To "Design-Your-Own" Precision Power Supply In Minutes.



**Trio Laboratories, Inc.**  
80 Dupont Street  
Plainview, N.Y. 11803

Super/reg® miniature, pre-packaged, precision power regulators (series and shunt types) make possible design/fabrication of custom power supplies with virtually no engineering time or effort. Data Sheets S201A, S202A, S204 show how just a front end of raw DC or a transformer with rectifying diodes and filter capacitor — and a heat sink mounting area — are all that are needed. Single or multiple outputs easily accommodated. 104 models provide wide range of voltage levels, maximum layout flexibility, low output Z(0.01% regulation), temperature compensation 0.01%/°C, 125°C operation, output adjustability ±10%, short circuit protection.

CIRCLE NO. 173

# Manufacturers

Advertisements of booklets, brochures, catalogs and data sheets. To order use Reader-ServiceCard (Advertisement)

## 146 Ready-To-Use Networks

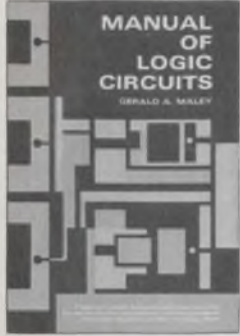

G. A. Maley of IBM Corp. presents 146 pre-designed networks for your immediate use or for building upon previously designed switching networks; be it a gated latch, a ring circuit, a counter, a shift register, or an adder. Gives you a brief description of the network and its applications, illustrates appropriate flow chart, diagrams logic network and gives operational notes relating to causes and effects. Plus, where necessary, describes additional inputs, network restrictions, timing charts, design notes and alternatives. Pub. May 1970, 256 pp., 374 illus., 6x9", \$10.95. Circle the reader-service number below for a 15-day examination copy.

CIRCLE NO. 174

**Prentice-Hall, Inc.**  
Englewood Cliffs, N. J. 07632

## Bus Bars For Noise Reduction

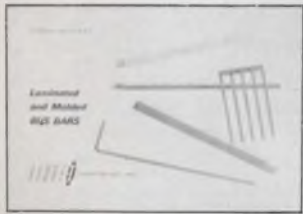

A 16 page Technical Bulletin is now available, describing a new concept in power or signal distribution. Basic mechanical and electrical design principles, along with descriptive pictures and diagrams, are included in this bulletin. These compact buses can replace bulky cable harnesses and repetitive wiring for computer or modular application. This method of construction satisfies the demanding requirements of low inductance and resistance of high speed, solid state systems, while controlling electrical noises.

Send For Free Sample CIRCLE NO. 175

**Eldre Components, Inc.**  
1239 University Avenue  
Rochester, New York 14607

## Hybrid Microelectronics Review



Now you can scan the exploding hybrid technology in just minutes through the monthly HYBRID MICROELECTRONICS REVIEW. The Review helps you fight information pollution and break the executive "time log jam" by condensing the flow of thick/thin film microcircuit information for quick analysis by administrative, marketing, engineering, and production managements involved in the hybrid field. Under the direction of a technical review board, this important tool provides a concise scanning service summarizing current technical, marketing, financial, and production information appearing in more than forty domestic and foreign technical publications. An annual subscription rate is \$36.00. Circle this number for free sample copy and special \$6.00 saving offer.

CIRCLE NO. 176

**Hybrid Microelectronics Review**  
P. O. Box 11685  
Philadelphia, Penna. 19116

# Electronic Design

## Advertising Sales Staff

Keith Aldrich  
Sales Manager

## New York 10022

Robert W. Gascoigne  
Samuel M. Deitch  
Daniel J. Rowland  
850 Third Avenue  
(212) Plaza 1-5530  
TWX: 867-7866

## Philadelphia 19066

William C. Repetto  
P. O. Box 206  
Merion Station, Pa.  
(215) MA-3-5888

## Boston 01945

Joseph F. Palmer  
14 Peter Hobart Drive  
Hingham, Mass.  
(617) 742-0252

## Chicago 60611

Thomas P. Kavooras  
Berry Conner, Jr.  
200 East Ontario  
(312) 337-0588

## Cleveland

Thomas P. Kavooras  
(Chicago)  
(312) 337-0588  
(call collect)

## Los Angeles 90303

Stanley I. Ehrenclou  
W. James Bischof  
2930 Imperial Highway  
Inglewood, Calif.  
(213) 757-0183

## San Francisco 94022

Arthur R. Shields, Jr.  
95 Main Street  
Los Altos, Calif.  
(415) 941-3084

## London W. 1

For United Kingdom and Holland  
Brayton C. Nichols  
44 Conduit Street  
Tel: REGent 4714

## Verviers, Belgium

For Continental Europe  
Andre Jamar  
1, Rue Mallar, 1  
087) 253.83 Telex 41563

## Tokyo

Haruki Hirayama  
Electronic Media Service  
5th Floor, Lila Bldg.,  
4-9-8 Roppongi  
Minato-ku  
Phone: 402-4556  
Cable: Electronicmedia, Tokyo



**AMERICAN BUSINESS PRESS, INC.**

# If your equipment calls for custom-designed protection...

Give us your out-of-the-ordinary container requirement—and we'll meet it. Precisely. In the shortest possible time. Because we have everything it takes to do the job. Sandwich construction materials. Off-the-shelf components. Standard hardware. Over 30 years of experience in the manufacture of cases and containers. The result? Complete equipment protection against shock, vibration, and environmental hazards. Built to all required MIL specifications. We also make custom molded and standard fiberglass and ABS thermoplastic containers and cases. Call or write for our standard price lists and comprehensive design manuals.

## Skydyne will "contain" it for you.

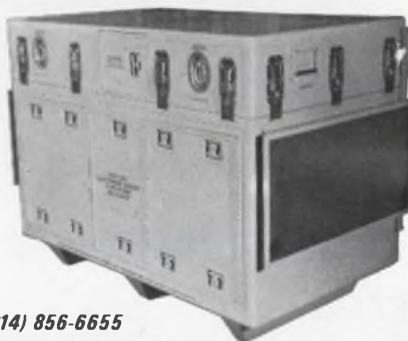

**Skydyne, Inc.**

River Road, Port Jervis, N. Y. 12771 • (914) 856-6655

Subsidiary of **b+p** Brooks & Perkins, Inc.

INFORMATION RETRIEVAL NUMBER 64

**NO SOCKETS • NO SOLDERING**

**Dust Cover PC BOARD PLUG-IN Series G RELAYS**

**\$165 EACH**  
only (IN 5000 LOTS)

**Printact®**

**Plugs into your PC board... mates with plated conductors**

The design concept of the series G non-latching and series LD dual coil magnetic latching relays is to simply mate the encapsulated motor assembly and its associated swinger blade assembly with etched and plated conductors on your PC board which become the fixed contact section.

Encapsulated coil, bifurcated gold or palladium contacts, low thermal EMF, plug-in without sockets or soldering, low bounce and chatter, series-break switching eliminates pig-

tails, permanent magnet avoids return spring and mechanical linkage—all of which assures continuous performance for many millions of cycles.

Available with 6, 12 or 24 VDC coils (0.5 watt G series, 1.0 watt LD series) in 2, 3 and 4 pole configuration. Series break swingers permit each pair of fixed contacts to be etched with common (Form C) or isolated (Form A plus Form B) switching between make and break circuits.

For data write or call 212-EX 2-4800.

Printact Relay Division, Executone, Inc., Box 1430, Long Island City, N.Y. 11101

INFORMATION RETRIEVAL NUMBER 65

# Advertisers' Index

Advertiser	Page
ACDC Electronics, Inc.	74 A-B
Allen-Bradley Co.	50
Amphenol, The Bunker-Ramo Corporation	64
Beckman Instruments, Inc.	67
Belden Corporation	4, 5
Bird Precision Jewels, R. H.	48
Boonton Electronics Corporation	99
Burroughs Corporation	22
CELCO (Contantine Engineering Laboratories Co.)	75
Centralab, the Electronics Division of Globe-Union, Inc.	49
Clairex Electronics	73
Computer Labs	84
Computer Products	101
Cunningham Corporation	97
Curtis Development & Mfg. Co.	102
Dale Electronics, Inc.	Cover III
Digital Equipment Corporation	65
Douglas Randall, Inc.	87
E-H Research Laboratories, Inc.	10
Edmund Scientific Company	89
Eldre Components, Inc.	103
Electro Cube, Inc.	101, 103
Electro Materials, A Division of Illinois Tool Works, Inc.	15
Electro-Motive Mfg. Co., Inc., The	19
Electro Switch Corp.	48
Electronic Measurements, Inc.	105
Executone, Inc.	104
General Electric Company	6, 7
General Radio Company	1
Hayden Book Company, Inc.	74D
Hewlett-Packard	Cover II, 8, 25, 37, 59
Hewlett-Packard, New Jersey	46, 47
Hoffman Engineering Company	48
Hughes Aircraft Company	55
Hybrid Microelectronics Review	103
ISE Electronics Corporation	16
Indiana General	14
Intronics, Incorporated	35
Jewell Electrical Instruments Inc.	40
Joslyn Electronic Systems	94
Keeco, Inc.	64
Lampkin Laboratories, Inc.	96
Lockheed Electronics Company	11
M & T Chemicals, Inc.	64
McLean Engineering Laboratories	92
MicroSwitch, A Division of Honeywell	106
Molex Incorporated	2
National Semiconductor Corporation	17, 18
Omnitronics Manufacturing, Inc.	89
Perkin Elmer Corporation	86
Philips Electronic Components and Materials Division	74C
Prentice-Hall, Inc.	103
Precision Metal Products Co.	105
Premier Metal Products Co., Inc.	96
Printact Relay Division Executone, Inc.	104
RCA Electronic Components and Devices	Cover IV
Schauer Manufacturing Corp.	88
Servo Tek Products Company	36
Signalite, Division of General Instrument	9
Signetics Corporation	29
Siliconix Incorporated	44
Simpson Electric Company	95
Skydyne, Inc.	104
Solitron Devices, Inc.	45
Sprague Electric Company	20
TRW Inc., Capacitor Division	69
Tektronix, Inc.	12, 43
Tempil Division of Big Three Industrial Gas and Equipment Co.	98
Texas Instruments, Incorporated, Components Group	39
Trio Laboratories, Inc.	102
Triplett Corporation	31
Tung Sol Division, Wagner Electric Corporation	100
U. S. Capacitor Corporation	71
United Aircraft Corporation	38
Victor Electric Wire & Cable Corp.	89
Welch-Allyn, Inc.	91
Wesco Electrical Company, Inc.	13

# Happy Endings...



## Precision Metal Terminals

Whether you need terminals from stock or of special design — tell us your requirements. Our free engineering assistance in terminal selection or design will provide the happy ending. We precision-machine your specials, often with no tooling charge. Or select from over 500 stock items, the most complete line in the industry. You can look to PMP for precision-made mini-pins too, for use in connectors, micro modules and every mini purpose.



Send for our latest complete catalog.

**PRECISION METAL PRODUCTS CO.**

41 ELM ST., STONEHAM, MASS. 02180  
Telephone: (Area Code 617) 438-3650

INFORMATION RETRIEVAL NUMBER 66

# Engineers and Inventors

THE KEY TO BUSINESS IS  
GOOD PRODUCT IDEAS

We are a reputable, public electronics corporation with a competent engineering staff, a modern well equipped developmental laboratory, an efficient production facility, an established marketing organization and considerable cash assets.

To assure our continued growth, we need new product ideas in which to invest our talents, facilities and capital. If you have a product idea you wish to sell or develop with us, we would like to talk to you. To protect you and your product or invention, do not send your idea in without first asking for our disclosure agreement form. See your idea become a market reality and a financial benefit to us both.

Write: Attention, President  
P. O. Box 11311  
Fort Lauderdale, Florida 33306

# LOWEST Ripple 5Mv

## EM LEADS IN 5 SIGNIFICANT SPECIFICATIONS: POWER SUPPLIES

TYPICAL EXAMPLE	MV RIPPLE	WATTS PER CU. IN.	SIZE (CU. IN.)	WEIGHT	CONSTANT CURRENT REGULATION
10-KW		2.15	4,655	365	0.2% Total
		1.07	11,221	400	1.5% Total
E/M	5	.96	10,374	485	0.4% Total
		.96	11,221	420	1.0% Total
Christie	30				
Sorensen	160				
H-P	220				

Focusing Coils for Accelerators — Burn-in & Life Testing Semiconductors — CW Lasers — Capacitor Forming & Aging — General Purpose

Write today for your free Quick-Selector Guide to our complete line of power supplies offering detailed specifications, application notes, accessories and prices.

(Data compiled from the latest available specification sheets)

Call Toll FREE (800) 631-4298



**ELECTRONIC  
MEASUREMENTS INC.**

405 Essex Road, Neptune, New Jersey 07753

INFORMATION RETRIEVAL NUMBER 67

# Air Controller.



Shown approx.  
twice actual size.

**Our new FW one piece electronic proximity switches guide the pilot by keeping him supplied with vital information about his aircraft.**

**They're solid state. Which eliminates moving parts. The result is precision monitoring of important systems or functions. As well as high reliability and long life. Even in severe atmospheres.**

**Ferromagnetic and all-metals sensing versions are available. Each conforms to MIL-STD-704 and is highly resistant to shock and vibration as well as protected from the effects of RFI.**

**Our FW proximity switches can also be used to monitor the status of aircraft entry, cargo, and landing gear doors. Or for baggage and cargo handling. They also may be just what is needed in most any tough ship, tank, missile or artillery application you have.**

**For more information, call your MICRO SWITCH Branch Office (in the Yellow Pages under "Switches, Electric"). Or write for Product Sheet FW.**

**MICRO SWITCH**

FREEPORT, ILLINOIS 61032

A DIVISION OF HONEYWELL

HONEYWELL INTERNATIONAL - Sales and Service offices in all principal cities of the world. Manufacturing in Australia, Canada, Finland, France, Germany, Japan, Mexico, Netherlands, Spain, Taiwan, U.K. and U.S.A.





## Dale takes the headaches out of hybrids

If you want to move faster in converting your hybrid circuit ideas to reality—call Dale. Our proficiency in thick and thin film chips and microcircuits enables us to take your custom hybrid project and run with it. We'll go as far as you like...starting with circuit design...prototype testing...building the film resistive-capacitive platform...adding active or passive devices...and packaging to your requirements. Turnaround time between your idea and our prototype can be as short as two weeks for simple RC circuits...and is always held to an absolute minimum. Your circuit information will, of course, be held in strictest confidence. Whether your application is commercial, industrial or military—get it moving. Our hybrid circuit specialists are waiting for your call—with action. *Call our Applications Engineering Department—402—564-3131 or write today.*



### **DALE ELECTRONICS, INC.**

1300 28th Ave., Columbus, Nebr. 68601

In Canada: Dale Electronics Canada, Ltd.

*A subsidiary of The Lionel Corporation*

INFORMATION RETRIEVAL NUMBER 203

# RCA COS/MOS MSI IC's make complex logic circuits simple... they're flexible and easy to use.

Here are two more additions to RCA's growing COS/MOS line—the CD4017D decade counter/divider with 10 decoded outputs and the CD4018D presettable divide-by-"N" counter—that give you the advantages of simple logic circuit design; micropower quiescent dissipation [ $P_T = 5 \mu\text{W}$  (typ) @  $V_{DD} = 10\text{V}$ ]; high noise immunity [4.5 V (typ) @  $V_{DD} = 10\text{V}$ ]; medium speed capability [dc to 3 MHz (typ)] and the high tolerance to supply-voltage variations and input signal-amplitude fluctuations unique to COS/MOS technology.

The CD4017D (formerly dev. #TA5684)

is priced at \$13.80 each (1000-unit level). This MSI device has clock enable, common reset, 10 decoded outputs and carry-out (decade division output) functions. Specific applications for the CD4017D are in decade counting/decimal decoding for display or data selection, divide-by-"N" counting/decoding, and decade frequency division.

The CD4018D (formerly dev. #TA5580) is available at \$15.00 each (1000-unit level). It has preset capability and 5 individual outputs that can be connected back to the data input in various ways to provide a variety of "divide-by" functions.

The CD4018D is recommended for use in implementing programmable counters, frequency synthesizers, divide-by-"N" counters, and parallel in/out holding registers.

For more information, see your local RCA Representative or your RCA Distributor. Ask for the COS/MOS application bulletin "Counters and Registers," ST-4166. Or write: RCA, Commercial Engineering, Section 57H-2/CD44, Harrison, New Jersey 07029. International: RCA, 2-4 rue du Lièvre, 1227 Geneva, Switzerland, or P.O. Box 112, Hong Kong.

INFORMATION RETRIEVAL NUMBER 204

DECADE COUNTER/DIVIDER PLUS 10 DECODED OUTPUTS

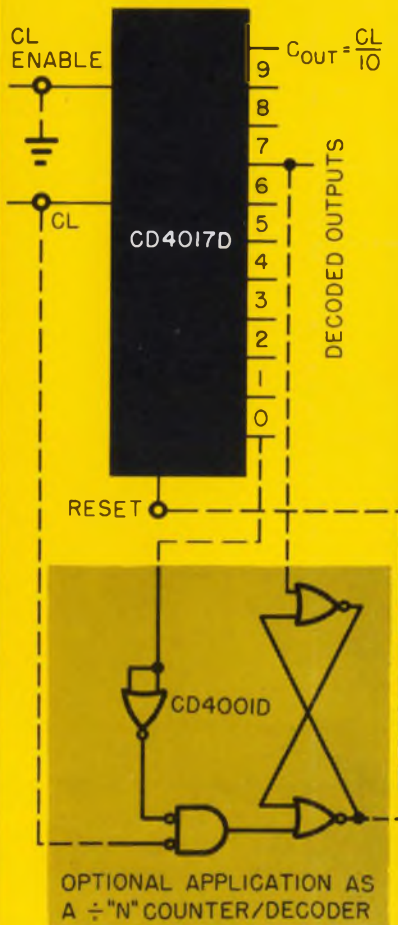

3-DECADE PROGRAMMABLE DIVIDE-BY-"N" COUNTER (N=2 TO 999)

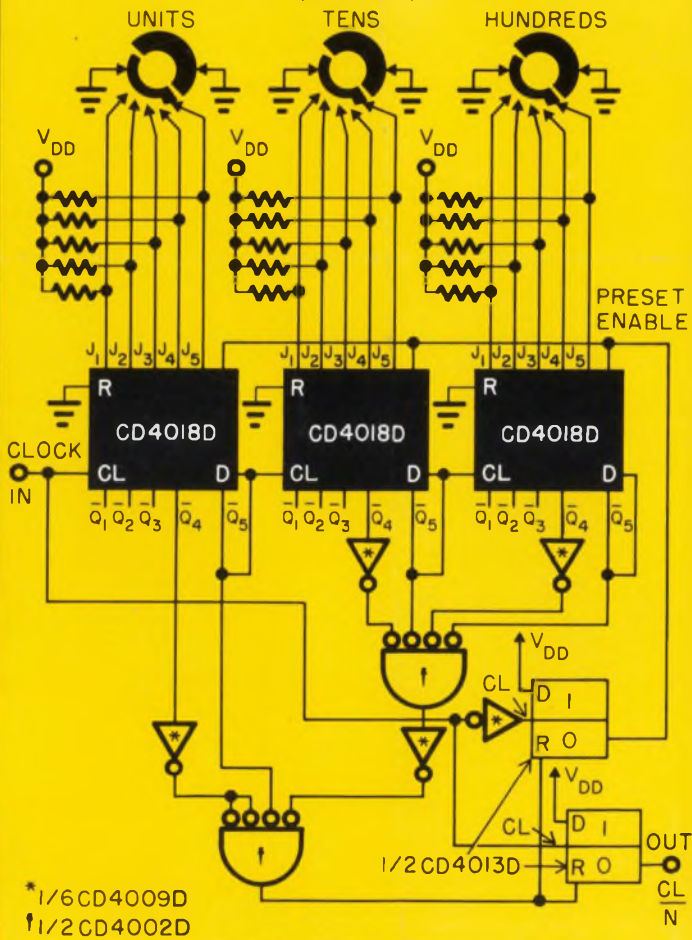

**RCA**  
Integrated Circuits