

# Electronic Design

FOR ENGINEERS AND ENGINEERING MANAGERS

VOL. 18 NO.

# 3

FEB. 1, 1970

**System designers face a decision.** If a computer fits on a few LSI chips, should the system people design the chips or should the semiconductor people design the

system? How can the two groups, working in separate companies, interface effectively? And what about wafer processing? To see what the experts say, turn to p. 44.

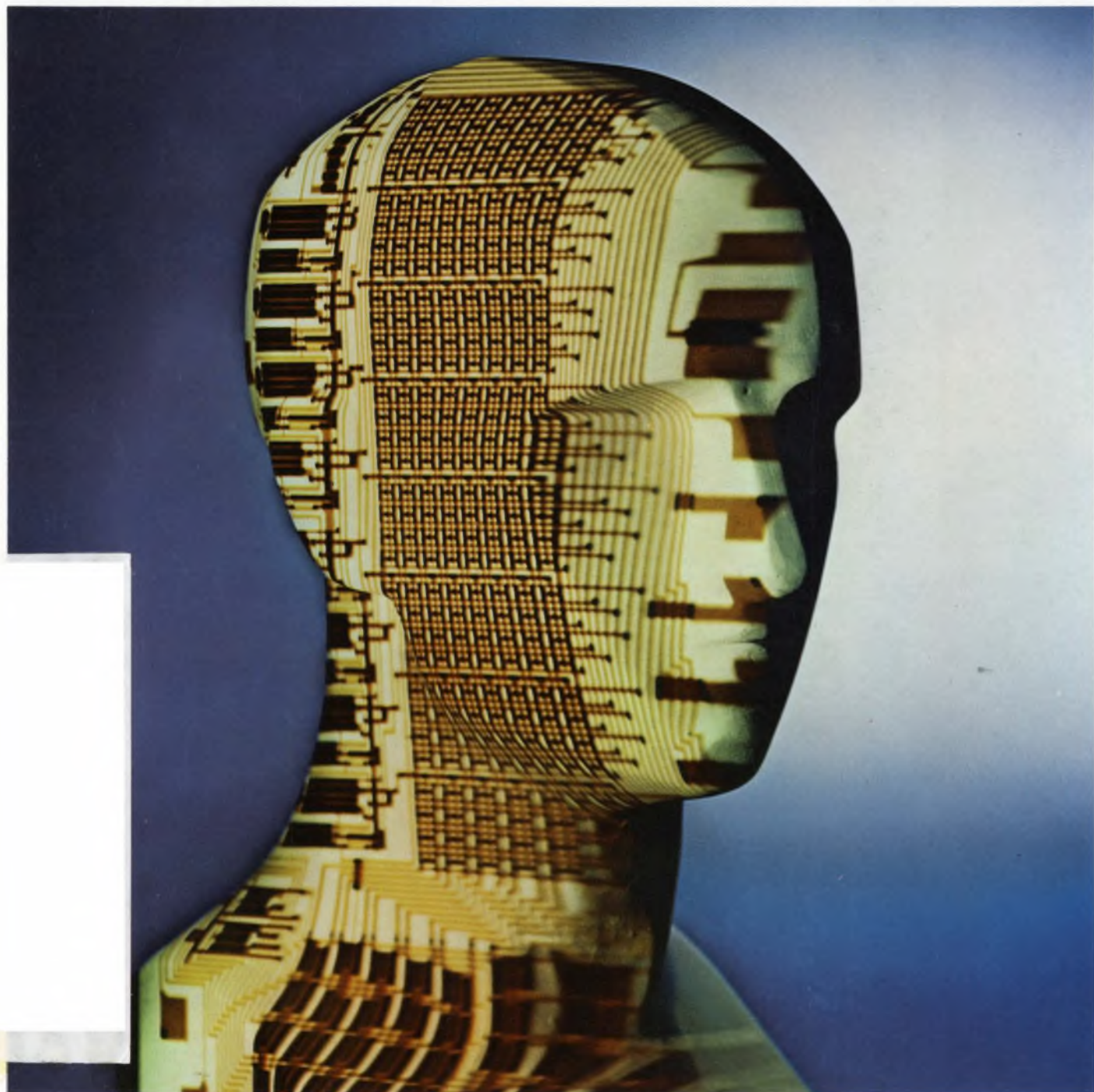

# Space-saving trimmers

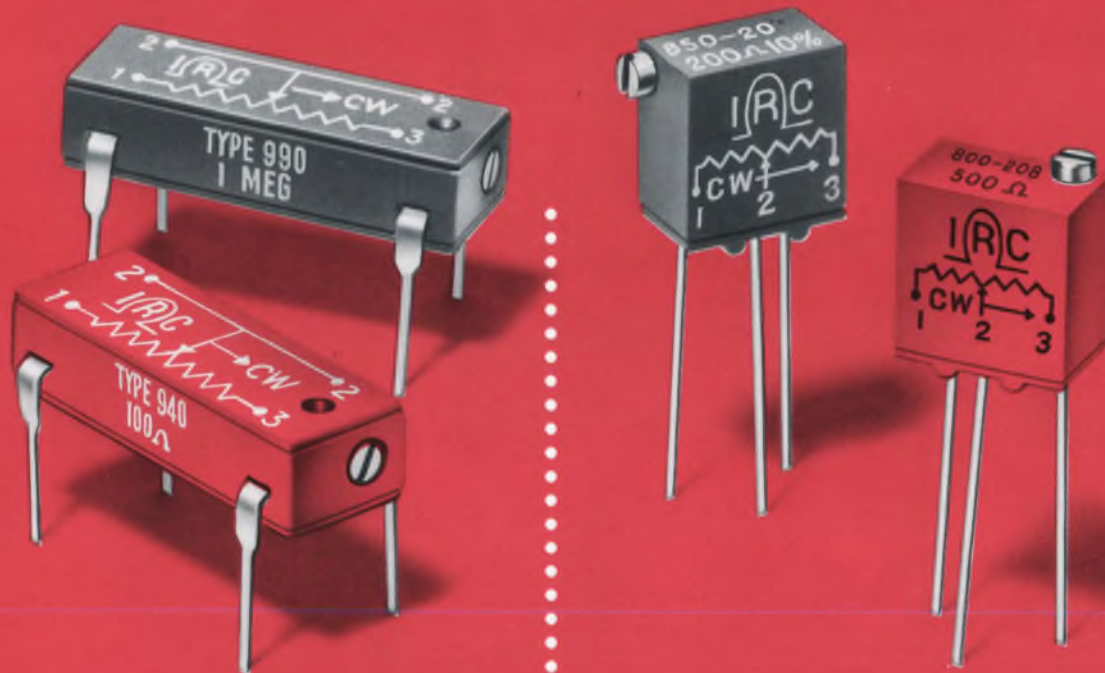

DIP construction matches IC size. Cuts assembly costs.

5/16-in. doubles performance of 1/4-in. trimmer—cuts cost almost in half.

These new IRC precision trimmers in dual-in-line packages simplify PC board layout. Only .200-in. high, their pin spacing is the same as the TO-116 size integrated circuit. It is fully compatible with high-speed automatic inserting equipment.

Pin spacing of these IRC 5/16-in. square trimmers matches the 1/4-in. square unit. Only .031-in. larger on each side, they can cut your cost almost in half and give you three times the power rating of the 1/4-in. and 40% better resolution.

Both DIP and 5/16-in. are available with precision wirewound and infinite resolution Metal Glaze elements. All units are fully sealed and impervious to common industrial solvents because of a silicone rubber shaft seal and epoxy bonding at all seams.

These units, like all IRC Metal Glaze trimmers, have a maximum guaranteed TC of  $\pm 150\text{ppm}/^\circ\text{C}$  over the entire resistance range, with typical TC being  $\pm 100\text{ppm}/^\circ\text{C}$ , and at no added cost. For complete technical information and prices, contact your IRC Industrial Distributor or write IRC St. Petersburg Division of TRW INC., 2801 72nd St., North, St. Petersburg, Florida 33733.



**DIVISION OF TRW INC.**

# Now! HP Hot Carrier Diodes

# 32¢

## for better-than-PN junction diode performance

Hewlett-Packard will deliver Hot Carrier Diodes at 32¢ each in volume quantities, less if you order more.

Instead of saving these state-of-the-art diodes for only the most advanced, critical design work, now you can use them in quantity, any place where better-than-PN junction performance will give you a product design edge. Put them into computers and other digital logic systems and use their 100 picosecond switching speed to maximum advantage. Or think of your own application, which could be mixing, detecting, switching, clipping, clamping and A to D conversion.

Move up now to state-of-the-art performance at state-of-the marketplace prices.



HEWLETT  PACKARD

SOLID STATE DEVICES

HP 2800 and 2811 Series Hot Carrier Diodes are available at prices as low as 32¢ each in 100,000 quantities. Call your HP sales office for the full story on quantity quotes and specifications. Or write to Hewlett-Packard, Palo Alto, California 94304; Europe: 1217 Meyrin-Geneva, Switzerland.

01913

INFORMATION RETRIEVAL NUMBER 2

# You're looking at 35 new digital printers!

**\$995.**



You only see one? That's because you don't see all the plug-in options and features packed into S-D's new printer . . . **including** features found only in \$3,000 printers!

The basic Model 5103 is a 5-column, asynchronous, 3-line/sec. printer, so quiet-running you can hardly hear it. It expands to a 21 column printer with 16 characters/column simply by adding economical 5-column plug-in boards. Just slide them in yourself at any time.

**Interface problems just don't exist.** For example, Model 5103 handles any 4-line BCD code with a simple IC socket change. No disassembly or rewiring ever. For only \$995, you get a printer that offers **dual source operation**, handles positive or negative logic, and features input channels that can be programmed to print in any column on the print drum. You get a printer with zero suppression, measurement units printout and two-color printing so you can use it directly with limit comparators.

**Unique options for every situation.** You have your choice of such useful options as plug-in boards for  $\pm 200$  V levels, 1 msec transfer time, digital clock, buffer storage, floating decimal point and more.

For complete details, write Data Products Division, 888 Galindo Street, Concord, California 94520. Phone: (415) 682-6161.

**SYSTRON**  **DONNER**

**Another S-D instrument first!** Electronic counters/Digital voltmeters/Pulse generators/Data generators/Time code generators / Sweep generators / Spectrum analyzers / Digital panel meters / Digital clocks / Signal generators / Oscillators Laboratory magnets / Precision Power Supplies / Analog & analog—hybrid computers / Data acquisition systems.

---

## NEWS

- 21 **News Scope**
- 25 **AF stretches work on navigation satellite**  
Advantages that could lead to new tri-service system keep proposal alive despite short money.
- 26 **Giant C-5A's instrumentation is readied for tests**
- 30 **New anemometer aids remote weather stations**  
Lightweight instruments contain solid-state sensors that give wind direction and velocity.
- 37 **Washington Report**

---

## TECHNOLOGY

- 44 **LSI poses dilemma for systems designers: shall they design their own chips or leave it to the semiconductor houses? A special report.**
- 54 **Diodes make good gain-control devices** for high-performance amplifiers. Four transfer functions are obtained with these simple techniques.
- 60 **Assemble a sequential counter** from flip-flops and gates by following this step-by-step method.
- 64 **Why use current-mode flip-flops?** Because the CML approach offers maximum speed and also has good noise immunity and stability.
- 71 **Ideas for Design**
- 79 **Product Source Directory: Slotted Lines**

---

## PRODUCTS

- 85 **Modules & Subassemblies:** D/a 15-bit converters speed settling time.
- 88 **ICs & Semiconductors:** Dynamic 20-bit MOS register clocks to 15 MHz.
- 90 **Microwaves & Lasers:** MIC noise sources boast 25-dB excess noise ratio.
- 92 Data Processing
- 93 Instrumentation
- 94 Components
- 95 Packaging & Materials
- 95 Tools & Engineering Aids

---

## Departments

- 43 **Editorial:** His IC brainchild is no baby any more.
- 13 Designer's Calendar
- 41 Sidelights
- 96 Evaluation Samples
- 97 Design Aids
- 98 Annual Reports
- 99 Application Notes
- 100 New Literature
- 106 Advertisers' Index
- 108 Information Retrieval Service

Information Retrieval Service Card inside back cover

**Cover:** Designed by Art Director Clifford Gardiner and photographed by Henry Ries.

#82

#82  
SCR Phase Control Trigger Circuit  
See Circuit Diagram on Page 86

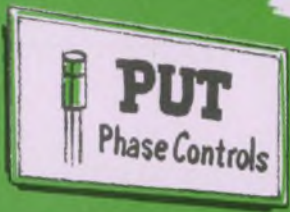

#230  
90 Minute Precision Timer  
See Circuit Diagram on Page 86

#230



# General Electric's Programmable Unijunction Transistor

#406  
Low Voltage Oscillator  
See Circuit Diagram on Page 87

#406

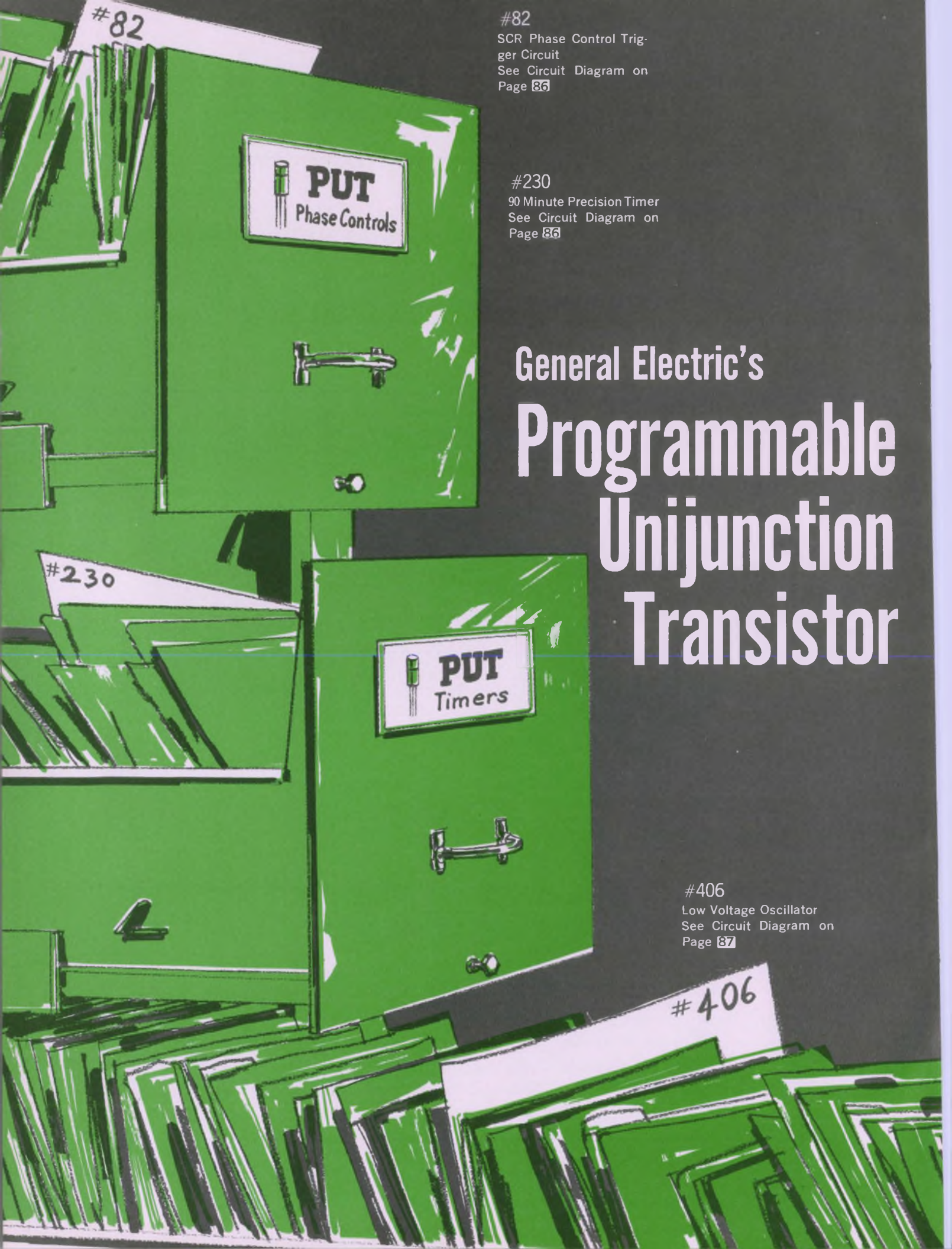



The key to PUT's versatility is what we call programmability.

General Electric's D13T programmable unijunction transistor is an extremely versatile, general-purpose triode thyristor that continues to fascinate the designer. Because it is programmable, you can make it act practically any way you like. With just two circuit resistors, you can control key parameters ( $\eta$ ,  $R_{BB}$ ,  $I_p$ , and  $I_v$ ) of the PUT. It's like being able to design the ideal component for your circuit. GE's PUT offers several other advantages as well. Its low leakage current and low peak point current permit use in long interval timer circuits. And it's an excellent SCR trigger device thanks to its fast, sure high-output pulse. Packaged in the low-cost plastic TO-98 case, GE's D13T is a three terminal, planar-passivated PNP device that just invites new applications. We've included circuit drawings on the next few pages to demonstrate PUT's versatility. If you need an oscillator, a sensing or a high gain phase control circuit, why not give the PUT a try. We'll make it easy by sending a sample. Just ask on your firm's letterhead, and we'll send the ideal component for your circuit. The programmable unijunction transistor . . . from General Electric.

# ...we're still finding new uses for it

For more information about the PUT or other General Electric semiconductor products, call or write your GE sales engineer or distributor, or write General Electric Company, Section 220-81, 1 River Road, Schenectady, N. Y. 12305. In Canada: Canadian General Electric, 189 Dufferin Street, Toronto, Ont. Export: Electronic Sales, IGE Export Division, 159 Madison Ave., New York N. Y. 10016.

#321

Variable Duty Cycle, Variable Frequency Pulse Generator  
See Circuit Diagram on Page 87

GENERAL  ELECTRIC

INFORMATION RETRIEVAL NUMBER 4

#321

 PUT  
Oscillators

# Big Jackpot in Connector Strain Relief

## GLENAIRS NEW *Qwik-Ty*

### THE BIGGEST PAYOFF YET FOR CONNECTOR USERS

#### INSTALLED COST — DOWN

A 'lode' of installed cost saving with Qwik-Ty. Reduces assembly time up to 12 to 1 over conventional cable-clamping methods.

#### WEIGHT SAVING — UP

SLIM-LINE Qwik-Ty's weigh as much as 50% less than standard MS clamps. Additional FAT TRIMMING is achieved by eliminating wrapping tape used in present cable clamp installations.

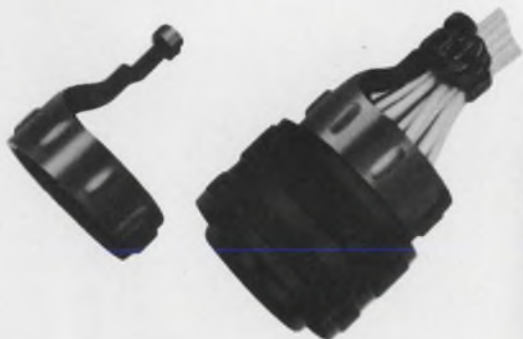

#### HOW IT WORKS

No more wrapping the wires to make the bundle fit the I.D. of the clamp. Simply wrap a tie strap or lacing cord around Qwik-Ty's arm and wires are snug and tight . . . IN SECONDS.

#### EASY MAINTENANCE TOO

For quick access to wires . . . cut the strap or cord, perform wire or connector maintenance, then tie off again. It's that easy.

Available for connectors	Qwik-Ty Series
MIL-C-26482	GTR00
MIL-C-26500	GTR01
MIL-C-27599	GTR04
MIL-C-38300	GTR01
MIL-C-38999	GTR04
MIL-C-81511	GTR03
NAS-1599	GTR02

and others

\*Patents Pending

Call or write for demonstration and literature . . . today. It'll pay off.



**GLENAIR, INC.**

1211 Air Way, Glendale, California 91201  
Phone (213) 247-6000, TWX 910-497-2066

INFORMATION RETRIEVAL NUMBER 5





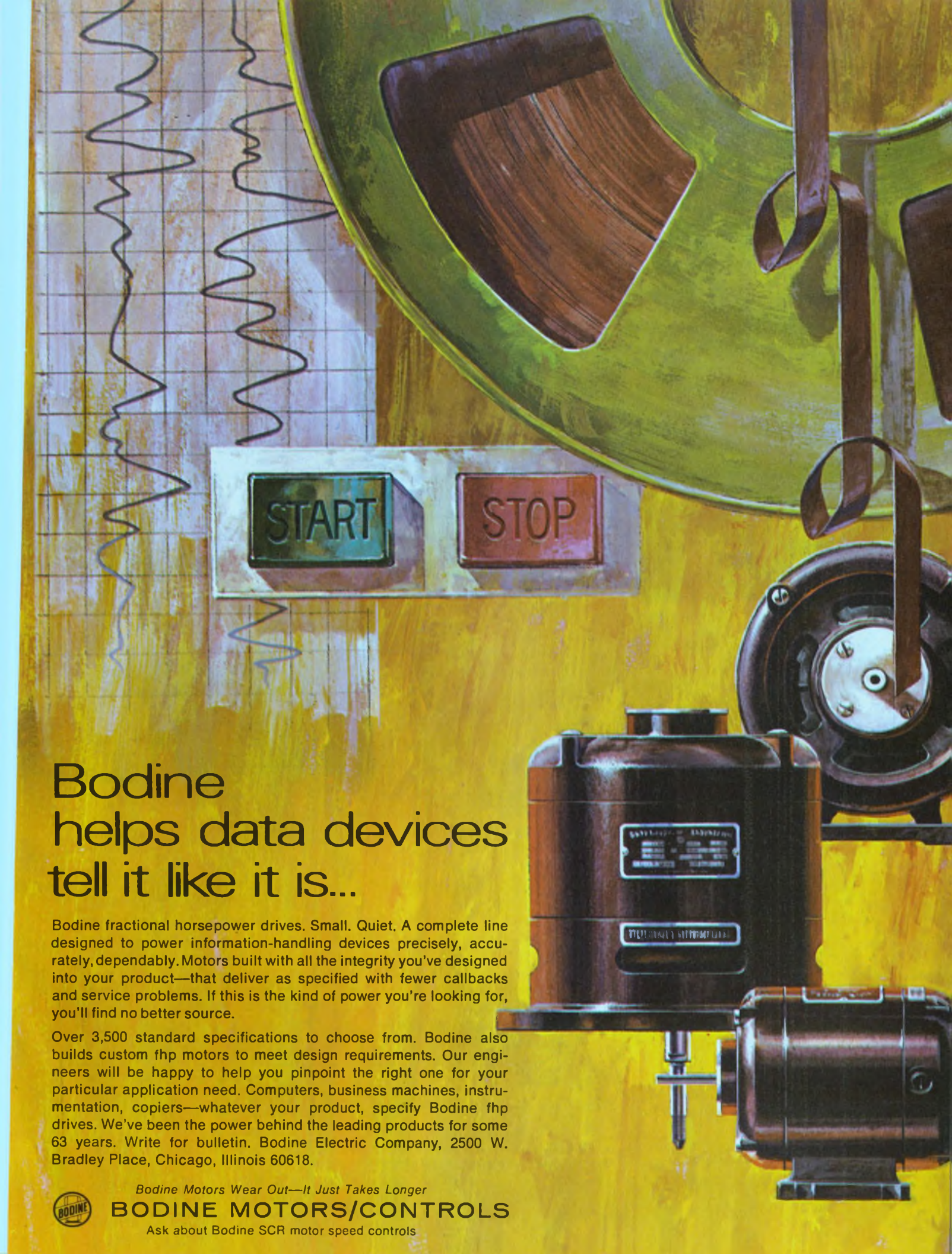

# Bodine helps data devices tell it like it is...

Bodine fractional horsepower drives. Small. Quiet. A complete line designed to power information-handling devices precisely, accurately, dependably. Motors built with all the integrity you've designed into your product—that deliver as specified with fewer callbacks and service problems. If this is the kind of power you're looking for, you'll find no better source.

Over 3,500 standard specifications to choose from. Bodine also builds custom fhp motors to meet design requirements. Our engineers will be happy to help you pinpoint the right one for your particular application need. Computers, business machines, instrumentation, copiers—whatever your product, specify Bodine fhp drives. We've been the power behind the leading products for some 63 years. Write for bulletin. Bodine Electric Company, 2500 W. Bradley Place, Chicago, Illinois 60618.

*Bodine Motors Wear Out—It Just Takes Longer*



**BODINE MOTORS/CONTROLS**

Ask about Bodine SCR motor speed controls

# Are You Going to Buy a New Scope This Year?

First, you'll want to know a scope's bandwidth and sensitivity. But beyond "horsepower," aren't there other things just as important? For example:

Does the scope have the latest technical innovations; so it's technically best now . . . and looks like it will be best in the future? **Leadership!**

Does the scope incorporate performance features that give me accurate measurements, easily? **Useability!**

Can it solve my measurement problems today, tomorrow and next year, economically? **Value!**

You're now going beyond specs and specmanship, and investigating the area of a company's design



philosophy — the "X" quantity you get in every instrument you buy.

## Let's look at HP's record.

In the general-purpose, laboratory oscilloscope area, HP announced the first 180 Series Scope over three years ago. Today, it is your best answer to high frequency measurement problems! And here's why.

## How about HP 180 leadership?

1. The HP 180 Scope was the first

all-solid-state scope to be introduced — July, 1966.

2. It is the only high-frequency scope utilizing mesh-dome technology to increase, simultaneously, CRT bandwidth and CRT viewing area (instead of shrinking the CRT display area or extending tube length).

3. It is the only solid-state scope that has a fully documented, environmentally specified military version.

4. It is the only high-frequency system that has a rack version only 5¼" high.

5. It is the only system that offers direct read-out TDR with 35 ps rise-time (1815A plug-in).

6. The HP 181A is the only mainframe that offers both variable persistence, and flicker-free storage — and it is the only storage scope in the 50 MHz and above frequency area.

7. The HP 180A and the 181A Mainframes are the only system-oriented mainframes to have field-proven, solid-state plug-ins — now 9 — that cover 50 MHz and 100 MHz real-time, as well as 12.4 GHz sampling and 35 ps TDR.

8. This year HP announced the Performance Champ — the 250 MHz, 10 mV, real-time 183A System:

- A. The only 250 MHz (<1.5 ns rise-time), general-purpose real-time system.
- B. The only real-time scope with 1 ns/cm sweep speed.
- C. The only scope with 4 cm/ns writing speed.

## How about HP 180 useability?

Some of the innovations above have contributed to useability. Here are some additional useability features:

1. Important contributions have been made in simplifying controls: Single-control triggering for the 250 MHz time base; selective use of push-buttons; exclusive HP mixed sweep control; single switch signal averaging in the sampling plug-in to reduce noise and jitter.

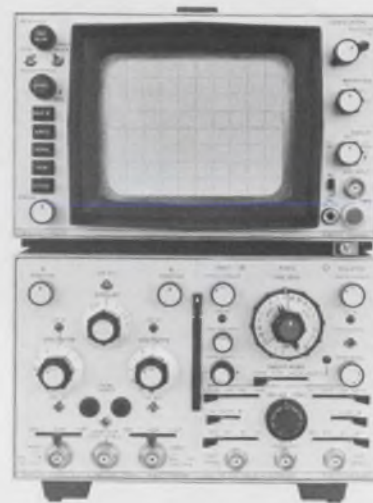

2. The calibrator built into the 183A Mainframe gives you 1 ns rise time at 2 kHz or 1 MHz, with 50 mV or 500 mV amplitude. Now you can check time, amplitude and pulse response — as well as compensate probes.

3. The 50 Ω input system has been adopted for both the 100 MHz and 250 MHz vertical amplifiers — to eliminate the bug-a-boo of capacitive distortion. If you're in these frequencies, chances are you're wanting a 50 Ω impedance match. If not, you have a choice of ultra-low capacitance passive or active probes.

4. Carry the rugged 180 Scope anywhere you need it — with plug-ins, weight is only 30 to 35 pounds. Put it

*The Performance Champs*

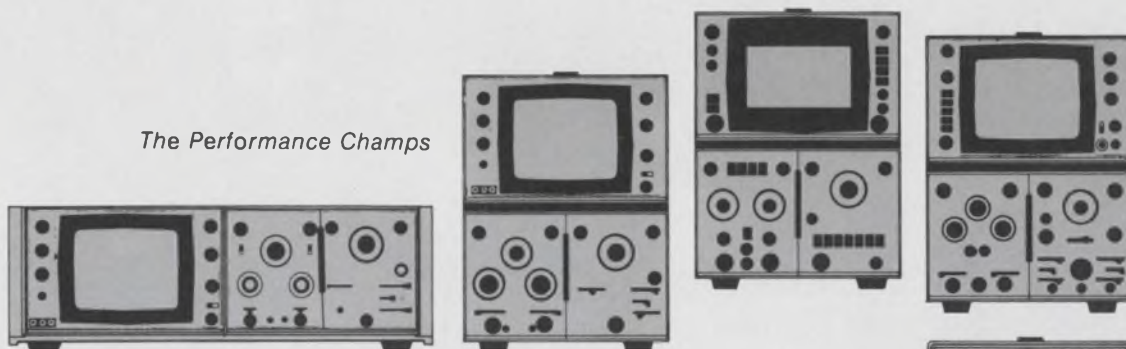

on your bench without crowding—the scope's front panel is less than the size of this page. (Like we said, the rack model is only 5¼" high.) But this mini-size doesn't mean a mini-CRT—its 8 x 10 cm area is 30% to



100% larger than most other high-frequency scopes.

**How about HP 180 value?**

Capability of solving today's and tomorrow's measurement problems is a real gauge of worth, or value. To prevent mainframe obsolescence in the 180 Series, HP has adopted a design philosophy of driving the CRT vertical plates directly from the vertical plug-in. Unlike some other scopes, the delay line and all vertical

amplifier elements are contained in the HP vertical plug-ins.

HP's design approach keeps the full capability of the CRT available to future plug-ins, so you can take advantage of tomorrow's technology in today's mainframes.

This philosophy—no built-in mainframe limitations—is illustrated by the design approach used in the new 183A Mainframe. A unique HP design provides a CRT with a real-time bandwidth beyond 500 MHz. Today, IC technology limits the vertical amplifier to only 250 MHz, real-time. Tomorrow, higher bandwidth vertical amplifiers will be available. When they are, HP will have them. And, you can use them in your 1970 183A Mainframe — because you have direct plug-in access to a 500 MHz CRT! (Compatibility with "old" plug-ins? The 183A Mainframe will take all 11 of the existing 180 Series plug-ins—and they'll meet their specs.)

Doesn't this philosophy make sense? We think so.

What other plug-in scope can offer you these values—at these prices? For example: A 50 MHz laboratory system, with plug-in versatility, complete, \$2065. A 250 MHz system, \$3150.

This is the year of the big change. Everyone seems to have come up with a new scope. You have to make a decision. Should you continue down the same old road? Or is it time you took a look at another manufacturer?

The HP road means going with the demonstrated leader, a system that's been de-bugged for three years, a scope that will let you buy tomorrow's state-of-the-art plug-ins and use them in today's mainframes.

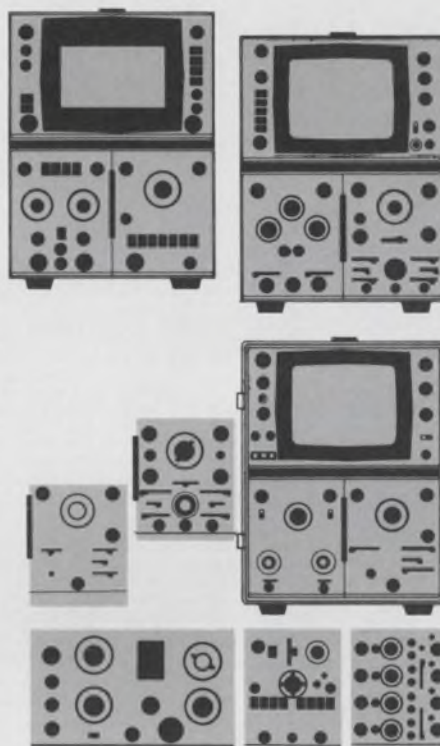

Because this is the year of the big change, your decision is important. You'll have to live with it for some time to come. If you're not convinced HP is best, try a side-by-side comparison with any scope.

Call your local HP field engineer to arrange a comparison. And remember to ask him about HP's new concept of oscilloscope service... have him show you HP's new video training tapes on the 180 System. For a complete, full-color brochure, write Hewlett-Packard, Palo Alto, California 94304. Europe: 1217 Meyrin-Geneva, Switzerland.

080/11

**HEWLETT  PACKARD**  
OSCILLOSCOPE SYSTEMS

INFORMATION RETRIEVAL NUMBER 7

# Photoconductive Cells

This listing represents less than half of the Clairex standard and special photocells available. A 16-page design manual is available on request.

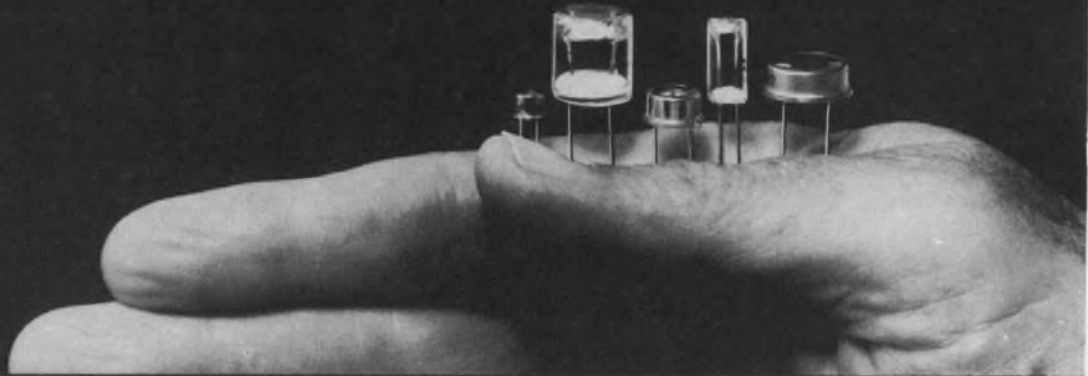

Photocell ordering abbreviation	Diam. X Length (inches)	Resistance @ 2 fc ± 33 1/3%	Minimum resistance ratio from 2 fc to Dark within 5 sec.	Maximum voltage	Power Dissipation @ 25°C (mw)
CL5M2	.55 X .18	55K	1:100	250	2000-500 <sup>1</sup>
CL602	.25 X .5	1 meg.		300	75
CL702	.36 X .18	1 meg.		300	125
CL902	.21 X .15	1 meg.		250	50

Type 2 CdS (photosensitive material designated by last number in ordering abbreviation, i.e. CL5M2). Peak spectral response 5150 angstroms, bluest response photosensitive material, high stability, lowest temperature error.

CL503	.5 X .5	7.2K	1:10,000	250	500-250 <sup>1</sup>
CL5M3	.55 X .18	7.2K		250	2000-500 <sup>1</sup>
CL603	.25 X .5	133K		300	75
CL603A	.25 X .5	75K		300	75
CL603AL	.25 X .5	3.5K		170	75
CL703	.36 X .18	133K		300	125
CL703A	.36 X .18	67K		300	125
CL703L	.36 X .18	2.7K		100	125
CL903	.21 X .15	133K		250	50
CL903A	.21 X .15	67K		250	50
CL903L	.21 X .15	6.0K		100	50

Type 3 CdSe, peak spectral response 7350 angstroms, fast response, and very high light-to-dark resistance ratio. Can be used for high speed switching or counting. Sensitive to near infra red. For use with incandescent or neon lamps.

CL504	.5 X .5	1.5K	1:1000	250	500-250 <sup>1</sup>
CL5M4	.55 X .18	1.5K		250	2000-500 <sup>1</sup>
CL504L	.5 X .5	0.25K		170	500-250 <sup>1</sup>
CL5M4L	.55 X .18	0.25K		170	2000-500 <sup>1</sup>
CL604	.25 X .5	30K		300	75
CL604L	.25 X .5	1.5K		170	75
CL704	.36 X .18	30K		300	125
CL704L	.36 X .18	0.6K		100	125
CL904	.21 X .15	30K		250	50
CL904L	.21 X .15	2K		100	50

Type 4 CdSe, peak spectral response 6900 angstroms, lowest resistance photocells available. Can be used for "on-off" applications when low resistance is desired. For use with incandescent or neon lamps.

CL505	.5 X .5	9K	1:100	250	500-250 <sup>1</sup>
CL5M5	.55 X .18	9K		250	2000-500 <sup>1</sup>
CL505L	.5 X .5	1.5K		170	500-250 <sup>1</sup>
CL5M5L	.55 X .18	1.5K		170	2000-500 <sup>1</sup>
CL605	.25 X .5	146K		300	75
CL605L	.25 X .5	7.5K		170	75
CL705	.36 X .18	146K		300	125
CL705L	.36 X .18	3.3K		100	125
CL905	.21 X .15	146K		250	50
CL905L	.21 X .15	10K		100	50

Type 5 CdS, peak spectral response 5500 angstroms (closely matches the human eye), most stable, lowest memory photocell available. Can be used in light measuring applications and precision low speed switching. For use with incandescent, fluorescent or neon lamps.

CL705HL	.36 X .18	28K	1:1000	100	125
CL905HL	.21 X .15	100K		100	50
CL905HN	.21 X .15	700K		100	50

Type 5H CdS, peak spectral response 5500 angstroms (closely matches the human eye). Combines high speed, stability, linearity, and uniform color temperature response.

Photocell ordering abbreviation	Diam. X Length (inches)	Resistance @ 2 fc ± 33 1/3%	Minimum resistance ratio from 2 fc to Dark within 5 sec.	Maximum voltage	Power Dissipation @ 25°C (mw)
CL507	.5 X .5	7.2K	1:1000	250	500-250 <sup>1</sup>
CL5M7	.55 X .18	7.2K		250	2000-500 <sup>1</sup>
CL607	.25 X .5	133K		300	75
CL707	.36 X .18	133K		300	125
CL707L	.36 X .18	2.7K		100	125
CL907	.21 X .15	133K		250	50
CL907N	.21 X .15	66K		100	50

Type 7 CdS, peak spectral response 6150 angstroms, moderate speed and ratio. Can be used in general beam breaking applications. For use with incandescent, neon or fluorescent lamps.

CL707H	.36 X .18	500K	1:1000	300	125
CL707HM	.36 X .18	100K		250	125
CL707HL	.36 X .18	10K		100	125
CL907H	.21 X .15	600K		250	50
CL907HN	.21 X .15	300K		100	50
CL907HL	.21 X .15	24K		100	50

Type 7H CdS Peak Spectral response 6200 angstroms. Very fast decay time coupled with low resistance and high linearity. Ideal for beam breaking applications.

Photocell ordering abbreviation	Diam. X Length (inches)	Resistance @ 2 fc ± 33 1/3%	Minimum resistance ratio from 2 fc to Dark within 5 sec.	Maximum voltage	Power Dissipation @ 25°C (mw)	Type
CL703/2	.36 X .18	50K	1:10,000	300	125	3 CdSe
CL703L/2	.36 X .18	6.5K	1:10,000	100	125	3 CdSe
CL704/2	.36 X .18	17K	1:1000	300	125	4 CdSe
CL704L/2	.36 X .18	1.5K	1:1000	100	125	4 CdSe
CL705/2	.36 X .18	146K	1:100	300	125	5 CdSe
CL705L/2	.36 X .18	7.5K	1:100	100	125	5 CdS

## DUAL ELEMENT

Photocells contain two separate elements with two separate leads and one common lead.



## PHOTOMOD®

### PHOTOCELL-LAMP ASSEMBLIES

Part No.	Rated Lamp Voltage	Resistance (Max. Ohms) @ Rated Lamp Voltage	Max. Allowable Cell Voltage @ Peak AC
CLM3006A	6	160	120V
CLM4006A	6	55	120V
CLM4012A	12	30	120V
CLM3012A	12	160	120V
CLM5H10A	10	3000	120V
CLM7H16A	16	550	170V
CLM3120A	120	1150	120V
CLM4120A	120	160	120V

FOOTNOTE: <sup>1</sup> With and without heat sink.

# CLAIREX ELECTRONICS®

A DIVISION OF CLAIREX CORPORATION

560 SOUTH THIRD AVE., MOUNT VERNON, N.Y. 10550 • WRITE FOR NAME OF YOUR NEAREST CLAIREX REPRESENTATIVE OR DISTRIBUTOR.

INFORMATION RETRIEVAL NUMBER 8

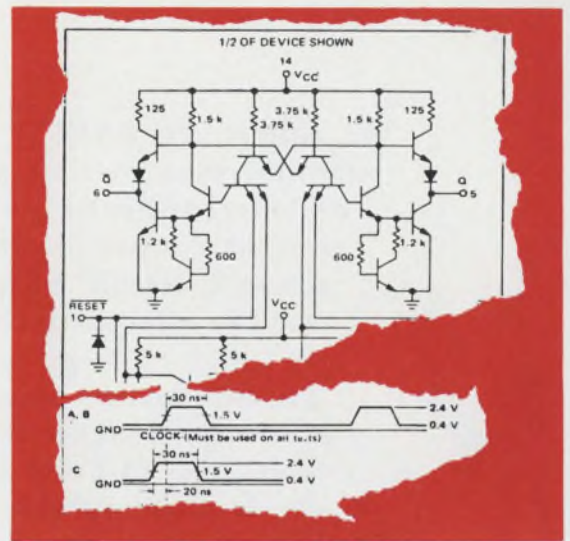

## E-H the logical solution

The E-H Research Laboratories, Inc., America's leading designer and manufacturer of pulse generators and other measurement instruments, has teamed up with the Iwatsu Electric Company, Ltd., Japan's foremost manufacturer of oscilloscopes. Together they make an ideal team to solve any of your logic problems.

For example, the **E-H 137 pulser** is an ideal stimulus source offering a source impedance of 50 ohms, fast, ultra-clean, adjustable leading and trailing edge ramps, all the output levels you need for TTL and ECL logic and 100 MHz pulse repetition frequency.

Team this up with the **Iwatsu 212 oscilloscope** and you've got a team that'll perform to your utmost satisfaction for years to come. The Iwatsu 212 is the ideal wide-band scope featuring bandwidth in excess of 200 MHz, with sweep speeds and writing rate to match. One MΩ input impedance matches directly with the impedance level of circuitry under test. This is the only 200 MHz bandwidth oscilloscope featuring 1ns/cm and delayed sweep in one instrument. Big, bright 6x10 cm display is another feature.

These are only two instruments from a broad line of E-H and Iwatsu instrumentation exclusively available from E-H. So whatever your logic problems are, contact an E-H representative today for the most logical solution.



**E-H RESEARCH LABORATORIES, INC.**

515 Eleventh Street • Box 1289, Oakland, California 94604 • Phone: (415) 834-3030 • TWX 910-366-7258  
 In Europe: E-H Research Laboratories (Ned) N.V., Box 1018, Eindhoven, The Netherlands, Telex 51116  
 In Japan: Iwatsu Electric Company, Ltd., 7-41, 1-Chome Kugayama Sugunami-Ku, Tokyo 167, Japan

INFORMATION RETRIEVAL NUMBER 9

**We call it INCONNECT®. Our new Molex modular system that provides five ways of interconnecting electrical-electronic printed circuit assemblies: Two ways to connect circuit boards to chassis, three ways to interconnect printed circuit boards. It's a giant step forward in helping speed production and assembly techniques in the area of printed circuits. Unique flexibility enables you to tailor connector components to your specific product needs. Easily. Simplifies assembly, testing, servicing and model change requirements. It's another example of the Molex creative approach to circuitry problems. One that demonstrates just how reliable and economical printed circuit connections can really be. But see for yourself. Write for details. Or you can make connections by calling (312) 969-4550.**

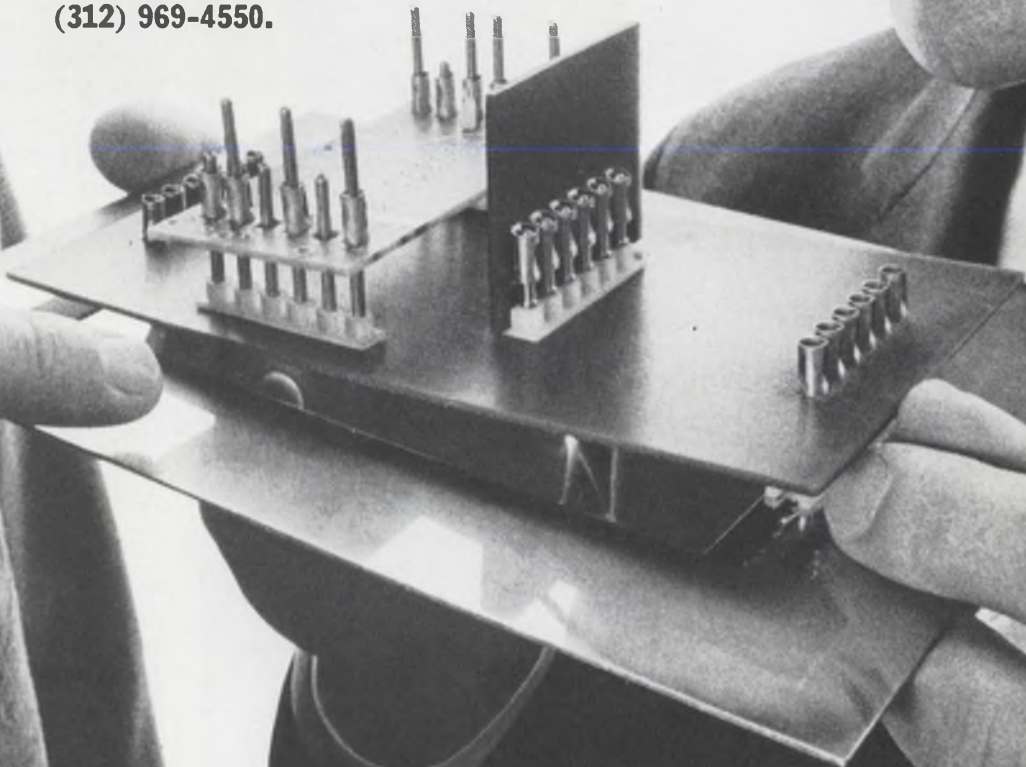

# Designer's Calendar

## FEBRUARY 1970

S	M	T	W	T	F	S
1	2	3	4	5	6	7
8	9	10	11	12	13	14
15	16	17	18	19	20	21
22	23	24	25	26	27	28

Feb. 18-19

**Instrumentation Fair** (Los Angeles) Sponsor: Instrumentation Fair Inc., Calif. L. Courtney, Larry Courtney Co., 16400 Ventura Blvd., Encino, Calif. 91316

CIRCLE NO. 458

Feb. 18-20

**International Solid-State Circuits Conference** (Philadelphia) Sponsor: IEEE, Univ. of Penna., L. Winner, 152 W. 42 St., New York, N.Y. 10036

CIRCLE NO 459

## MARCH 1970

S	M	T	W	T	F	S
1	2	3	4	5	6	7
8	9	10	11	12	13	14
15	16	17	18	19	20	21
22	23	24	25	26	27	28
29	30	31				

Mar. 11-13

**Scintillation & Semiconductor Counter Symposium** (Washington, D.C.) Sponsor: NBS, IEEE, R. Chase, Brookhaven National Laboratory, Upton, N.Y. 11973

CIRCLE NO. 460

Mar. 23-26

**IEEE Convention and Exhibition** (New York City) Sponsor: IEEE, H. L. Nicol, The Institute of Electrical and Electronics Engineers, 345 E. 47th St., New York, N.Y. 10017

CIRCLE NO. 461



## How to Buy a Good Power Supply

## Without Spending a Bundle . . .

Take a long look at the Abbott line of over three thousand standard models *with their prices listed*. The unit shown above, for instance, is the Abbott Model AL6D-27.6A, a DC to DC converter which puts out 28 volts of regulated DC at two amps and sells for only \$220.00. Other power outputs from 5 to 240 watts are available with *any output voltage from 5 volts to 10,000 volts*, all listed as standard models in our catalog. These converters feature close regulation, short circuit protection, and hermetic sealing for rugged application found in military environment.

If you really want to save money in buying your power supply, why spend many hours writing a complicated specification? And why order a special custom-built unit which will cost a bundle — and may

bring a bundle of headaches. As soon as your power requirements are firmed up, check the Abbott Catalog or EEM (see below) and you may be pleasantly surprised to find that Abbott already has standard power supplies to meet your requirements — *and the prices are listed*. Merely phone, wire, or write to Abbott for an immediate delivery quotation. Many units are carried in stock.

Abbott manufactures a wide variety of different types of power supply modules including:

60~ to DC, Regulated  
 400~ to DC, Regulated  
 28 VDC to DC, Regulated  
 28 VDC to 400~, 1ϕ or 3ϕ  
 60~ to 400~, 1ϕ or 3ϕ

Please write for your FREE copy of this new catalog or see EEM (1969-70 ELECTRONIC ENGINEERS MASTER Directory), Pages 1834-1851.

**abbott transistor**

LABORATORIES, INCORPORATED

5200 W. Jefferson Blvd./ Los Angeles 90016  
 (213) WEBster 6-8185 Cable ABTLABS

TO: Abbott Transistor Labs., Inc., Dept. 87  
 5200 West Jefferson Blvd.  
 Los Angeles, California 90016

Sir:  
 Please send me your latest catalog on power supply modules:

NAME \_\_\_\_\_ DEPT. \_\_\_\_\_

COMPANY \_\_\_\_\_

ADDRESS \_\_\_\_\_

CITY & STATE \_\_\_\_\_

**We care enough  
to send  
the very best.**



### National/TTL

54s. 74s. Low power and Hi-rel.

- Send me the TTL tally.
- Send me your new IC catalog.

Name \_\_\_\_\_  
 Title \_\_\_\_\_  
 Company \_\_\_\_\_  
 Address \_\_\_\_\_  
 City \_\_\_\_\_ State \_\_\_\_\_ Zip \_\_\_\_\_

### National/DTL

Old favorites. The whole 930 series.

- Send me the DTL data.
- Send me your new IC catalog.

Name \_\_\_\_\_  
 Title \_\_\_\_\_  
 Company \_\_\_\_\_  
 Address \_\_\_\_\_  
 City \_\_\_\_\_ State \_\_\_\_\_ Zip \_\_\_\_\_

### National/MOS

ROMs and registers, quite a bit better.

- Send me your MOS material.
- Send me your new IC catalog.

Name \_\_\_\_\_  
 Title \_\_\_\_\_  
 Company \_\_\_\_\_  
 Address \_\_\_\_\_  
 City \_\_\_\_\_ State \_\_\_\_\_ Zip \_\_\_\_\_

### National/Linear

Hands-down leaders in the linear line up.

- Send me the Linear Lit Pack.
- Send me your new IC catalog.

Name \_\_\_\_\_  
 Title \_\_\_\_\_  
 Company \_\_\_\_\_  
 Address \_\_\_\_\_  
 City \_\_\_\_\_ State \_\_\_\_\_ Zip \_\_\_\_\_

### National/Hybrids

Big performers with a chip on the shoulder.

- Send me the Hybrid hypothesis.
- Send me your new IC catalog.

Name \_\_\_\_\_  
 Title \_\_\_\_\_  
 Company \_\_\_\_\_  
 Address \_\_\_\_\_  
 City \_\_\_\_\_ State \_\_\_\_\_ Zip \_\_\_\_\_

### National/FET

Featuring the fabulous monolithic Dual.

- Send me the facts on your FETs.
- Send me your new IC catalog.

Name \_\_\_\_\_  
 Title \_\_\_\_\_  
 Company \_\_\_\_\_  
 Address \_\_\_\_\_  
 City \_\_\_\_\_ State \_\_\_\_\_ Zip \_\_\_\_\_

### National/Transistors

NPNs. PNP's. By the numbers. Buy the carload.

- Send me your Transistor tabulation.
- Send me your new IC catalog.

Name \_\_\_\_\_  
 Title \_\_\_\_\_  
 Company \_\_\_\_\_  
 Address \_\_\_\_\_  
 City \_\_\_\_\_ State \_\_\_\_\_ Zip \_\_\_\_\_

### National/Dice

The wherewithal to do your own thing.

- Send me the Chip charts.
- Send me your new IC catalog.

Name \_\_\_\_\_  
 Title \_\_\_\_\_  
 Company \_\_\_\_\_  
 Address \_\_\_\_\_  
 City \_\_\_\_\_ State \_\_\_\_\_ Zip \_\_\_\_\_

### National/883

We put put a lot of stock in hi-rel inventory.

- Send me the numbers on 883.
- Send me your new IC catalog.

Name \_\_\_\_\_  
 Title \_\_\_\_\_  
 Company \_\_\_\_\_  
 Address \_\_\_\_\_  
 City \_\_\_\_\_ State \_\_\_\_\_ Zip \_\_\_\_\_

## It's all in our new IC catalog.

Loaded with specs, schematics and design data. High-flying lowdown on circuit design, performance and reliability. Best be National.

National Semiconductor, 2900 Semiconductor Drive, Santa Clara, California 95051

Reply in confidence to

### National Semiconductor

2900 Semiconductor Drive  
Santa Clara, California 95051

The best is right for me. Send me your

- New IC catalog.
- Plus shortform material on
  - Transistors
  - FETs
  - Dice.

Name \_\_\_\_\_  
 Title \_\_\_\_\_  
 Company \_\_\_\_\_  
 Address \_\_\_\_\_  
 City \_\_\_\_\_ State \_\_\_\_\_ Zip \_\_\_\_\_

# do your own thing!

Plug standard I. C.'s into Datascan's new Wrap-X™ card and interconnect them. Then to complete the system connect to function cards (eg. to decimal converters, comparators, shift registers — there are over 100 DTL, HTL, and TTL function cards in our line.)

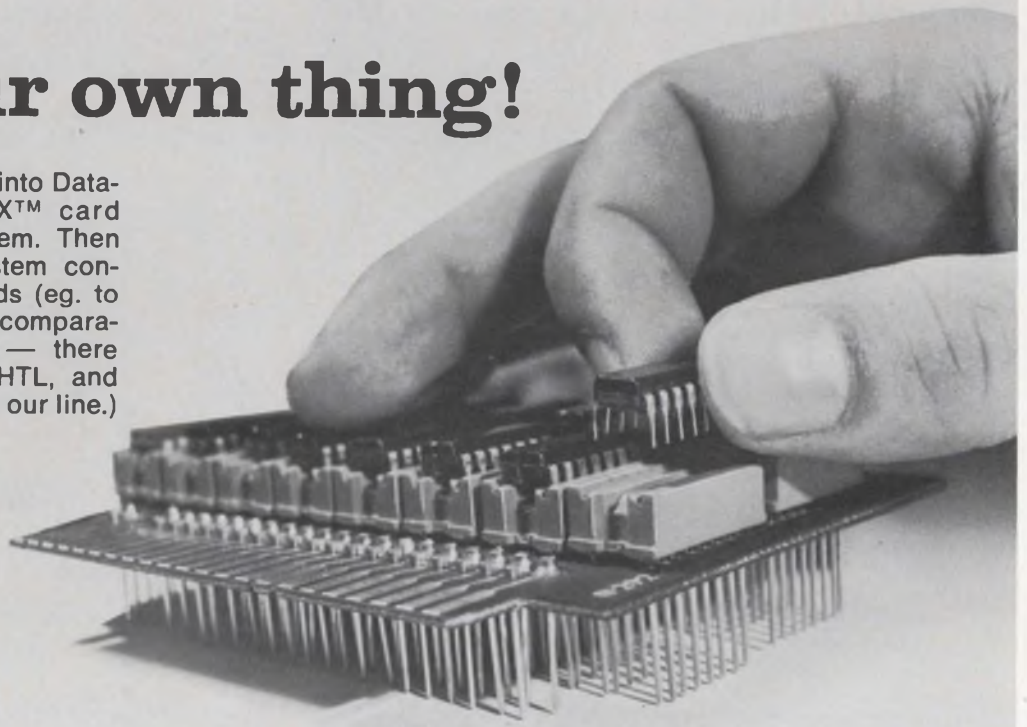

# or let us wrap it up!

We'll do the job from your schematic or block diagram, complete it with computer-aided design and automatic wire wrapping — or anywhere in between.

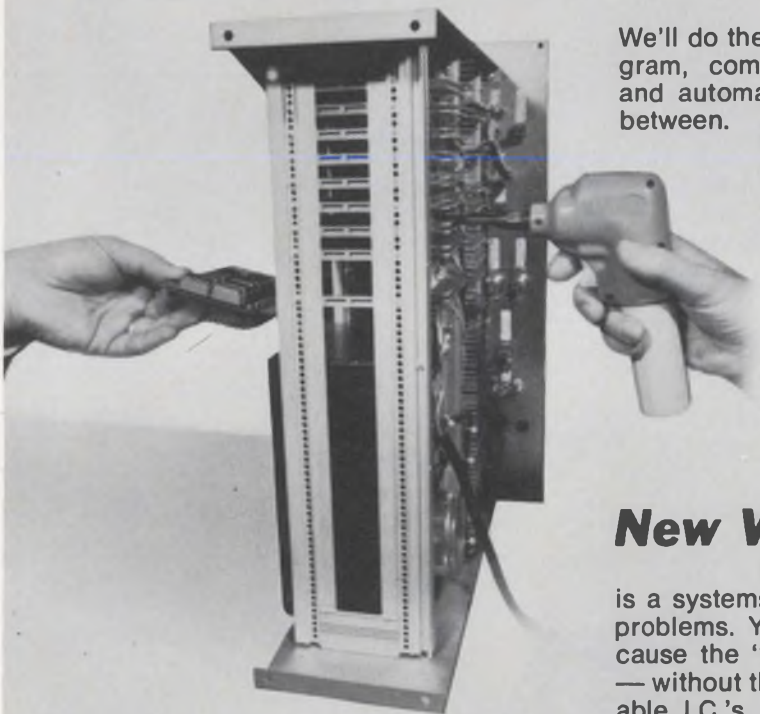

## ***New Wrap-X Concept***

is a systems approach to solving your packaging problems. You save time, money and trouble because the "X" factor is now part of your system — without the cost of customizing. Standard, available, I.C.'s, plus Datascan Wrap-X cards and function logic cards are all interconnected to give you one-company responsibility for completely wired and tested hardware, at lower installed costs.

*Start saving with Wrap-X cards, write for complete information.*

# Datascan

**DATASCAN, INC.**  
1111 Paulison Avenue, Clifton, N. J. 07013  
Telephone 201-478-2800



product report  
curve tracer

## New Type 576 Curve Tracer

### *Advanced Measurement Features for Semiconductor Testing*



**Expanded Viewing Area**—combines a 10 cm x 12 cm graticule with fiber-optic readout of scale factors, step amplitude, and Beta/div or  $g_m$ /div

**Swept or DC Collector Supply** to 1500 V

**Leakage Measurements** to 1 nA/div

**Multi-function Switching**—direct-reading power limits, polarity tracking, auto positioning, mode changes

**Calibrated Display Offset**—improved accuracy ( $\pm 2\%$ ), increased resolution

**Step Generator Range** to 2 A or 40 V

**Calibrated Step Offset**—aid or oppose Pulsed Base Operation

**Kelvin Sensing** for high-current tests

**Interlock Operator Protection**

**Provision for Future Expansion**

please turn page for additional information 

# Making the Measurement . . . with the unique performance features of the Tektronix Type 576 Curve Tracer

**EXPANDED VIEWING AREA**—The large display area (10 cm x 10 cm, 12 cm usable horizontal), internal illuminated graticule, and bright trace bear directly on viewing ease, resolution, and readability.

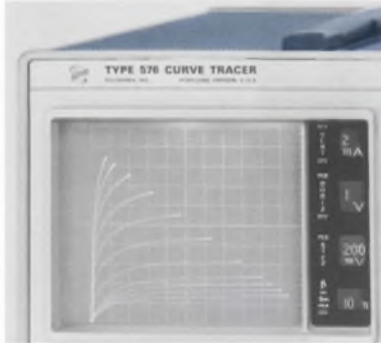

Scale-factor readout effectively labels the display parameters near the CRT for convenient reference during setup and testing. The simple, but bothersome, correction for magnifiers or multipliers is computed and displayed, as is the often used value of Beta/div or  $g_m$ /div. Calibration data recording during photography is a prime convenience factor.

**SETUP VERSATILITY FOR DIODES, TRANSISTORS, AND FET'S**—Multi-function switching makes test set-up faster and more understandable. By combining and pre-programming compatible functions, a single switch movement can select several normally-used conditions. Examples:

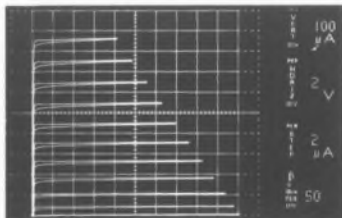

Other than the normal display functions, the NPN transistor waveform (above) required selection of collector range and percent, power limit, polarity and step amplitude. Step generator polarity and positioning is combined with the polarity switch; series resistance is determined by the voltage range and power limit switch.

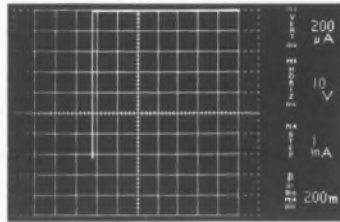

This Zener diode display required settings for collector volts, power limit, and polarity. The negative polarity selection positioned the trace-start to the upper right-hand corner. If desired, the display could be inverted with a single pushbutton. The Zener voltage at 1 mA is 72 V, accurate within 3%.

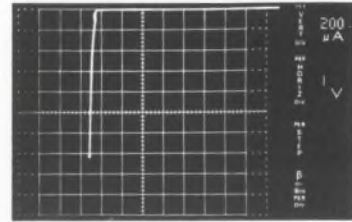

The display above is the same 72 V Zener diode test previously discussed except the display offset and magnifier are used to improve resolution and accuracy. The centerline value is now 70 V but the horizontal deflection factor is 1 V/div. The Zener voltage can now be resolved as 72.6 V within 2%, a X10 increase in resolution and improvement from 3% in absolute accuracy.

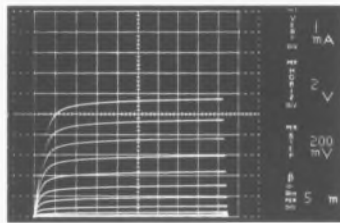

This MOSFET drain family test set-up is the same as for transistors except the step polarity was inverted for operation in the depletion region. The DC step offset could be used to view both enhancement and depletion characteristics by positioning the step-start below the zero bias level.

The calibrated DC STEP OFFSET allows the steps to start on a DC plateau up to X10 the step amplitude setting. It can either AID or OPPOSE the step polarity within the maximum current or voltage limitations of the generator, a control feature which is important to certain tests. One example is the enhancement-depletion FET display previously mentioned.

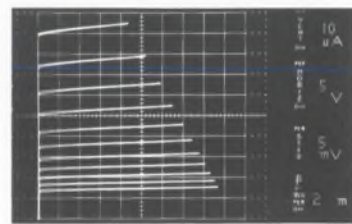

The display above shows a transistor test with voltage drive to the base. The DC STEP OFFSET permits positioning of the small voltage steps within the active region of the transistor base.

**RESOLUTION AND CONTROL** is enhanced in the Type 576 by the concept of calibrated offset. The DISPLAY OFFSET is a precision positioning control and X10 magnifier which calibrates the graticule centerline value and expands the effective measurement axis to 100 cm rather than 10 cm.

**ADAPTABILITY**—Connecting the many types of semiconductors to the instrument requires a wide range of adapters. A new line of adapters has been designed for the Type 576 which includes a universal unit for single and dual FET's and transistors, guiding long-lead adapters for untrimmed units, high-current adapters with KELVIN sensing, and clip or magnetic axial-lead diode holders.

**Your Tektronix Field Engineer will conduct a comprehensive demonstration of the Type 576 on request.**

For additional information, contact your local Tektronix Field Office, circle the Reader Service Number, or write Tektronix, Inc., P. O. Box 500, Beaverton, Oregon 97005.

**TYPE 576 CURVE TRACER . . . . . \$2250**  
U.S. Sales Price FOB Beaverton, Oregon

Measurement Concepts

**SEMICONDUCTOR DEVICE MEASUREMENTS**

This new concepts book is available through Tektronix Field Offices.





## Tektronix, Inc.

*committed to progress in waveform measurement*

# HAPPENINGS IN ELECTRONICS

February, 1970

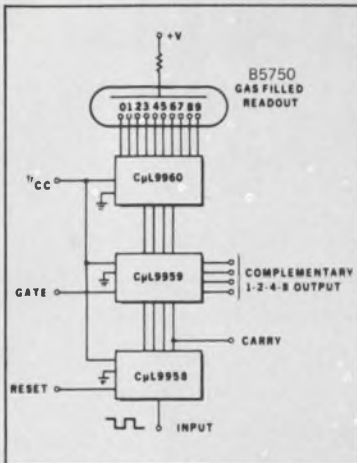

## Schweber Offers Complete Readout Package

Burroughs NIXIE® tube, B5750, is a high quality, low cost, side viewing indicator tube, which displays the numerals 0-9 and either of two internal decimal points. Mounting centers of 0.540" center to center is possible with this tube.

Fairchild's Decimal Decoder/Driver, CuL9960, is a monolithic silicon circuit which accepts 1-2-4-8 BCD inputs at integrated circuit signal levels and produces ten mutually exclusive outputs which can directly control the ionizing potentials of Burroughs NIXIE tube, B5750.

Fairchild's Buffer-Storage Element, CuL9959, consists of four gated-latch circuits and a common driver, diffused into a single silicon substrate. Information which is present at the four data inputs enters the latch thruout the interval of a load command applied to the gate input terminal. With gate high, information is stored until a subsequent load command permits a change.

Fairchild's Decade Counter, CuL9958, is a complete counter consisting of four cascaded binary triggered flip-flops modified by a feedback loop to count in the familiar 8-4-2-1 code. Provision is made for clearing and pre-setting any one of the possible decimal states.

NIXIE is a registered Burroughs trademark.

Fairchild Type	1-24	25-99	100-999
U6B996079X	15.70	12.55	10.50
U6B995979X	10.05	8.00	6.75
U6A995879X	11.20	9.00	7.50

Burroughs Type	1-24	25-99	100-499	500-999	1000-UP
B5750 NIXIE Tube	6.75	5.75	4.95	4.50	3.95

## At Schweber the Chips are Down!

Down in the warehouse, we mean. Varieties and quantities to suit most needs. We can supply Motorola zener diode chips, thin-film chip inductors, and beam-lead resistors. As made by Union Carbide, we can supply in chip form: single and dual FETS, dual bipolar transistors, op amps, and MOS devices. From General Electric, Schweber stocks forty-two different diode and transistor chips. We have ceramic chip capacitors by Vitramon and solid tantalum chip capacitors from Kemet. If the kind of chips you are interested in are not animal or vegetable, call us at one of our seven locations listed below.



CIRCUIT DESIGN BREADBOARD

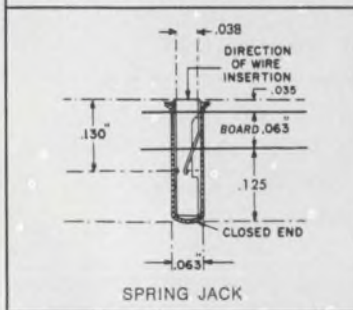

## Can You Afford to Breadboard Integrated Circuits?

Breadboarding ten discrete components having 2 to 4 leads into a circuit design can be a tiresome job, but imagine breadboarding ten integrated circuit devices with 10 to 16 leads! We can offer you an easier way to prove the feasibility of your sub-system designs, and at the same time provide you with the ability to change connections, add connections, and remove connections with the flip of a finger. The easy way to do it is to use a Barnes Circuit-Design Breadboard. A good example of this type of board is Barnes model 030-501-02-10. This model has ten 16-lead dual-in-line sockets mounted on a printed circuit board that terminates in a standard 22-contact PCB edge connector (Amphenol 143-022-01). The 22 contacts are tied to 78 individual spring jacks (see illustration) that will accept simple bus wire thus eliminating costly patch cords. Twelve of the contacts have four spring jacks per contact and ten have three. These tiepoints are not connected to the socket leads for a very important reason. Should any of the leads require protection against high frequency coupling, a single or multi-wire shielded cable may be used from the connector contacts to the socket contacts, thus reducing coupling problems. The sockets themselves are considered the world's finest dual-in-line socket with contacts designed for minimal insertion and withdrawal forces. The price is 97.00 per complete board and they are immediately available from Schweber stock. So are the Amphenol connectors and the individual sockets, model 029-275.

*We are in an age of fast turn-on time and fast reaction time. If anything on this page attracts your interest, why not satisfy your curiosity now by calling any of the seven locations listed below? They are at your service for ordering, pricing, delivery information, and technical literature.*

WESTBURY, NEW YORK: 516/334-7474 □ WALTHAM, MASS: 617/891-8484 □ ROCKVILLE, MD: 301/427-4977 □ CLEVELAND, OHIO: 216/333-7020  
HOLLYWOOD, FLA: 305/927-0511 □ HUNTSVILLE, ALA: 205/539-2756 □ TORONTO, CANADA: 416/925-2471



*...want a tantalum capacitor with proven performance?*

## Buy TYPE 150D TANTALEX<sup>®</sup> SOLID-ELECTROLYTE CAPACITORS

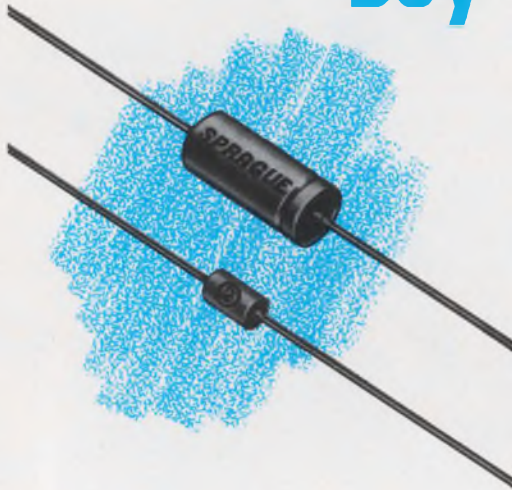

- Hermetically-sealed in metal cases
- Four case sizes, ranging from 1/4" to 3/4" length
- Value-packed performance characteristics—low impedances at high frequencies, low dissipation factor, minimal capacitance drift with temperature, practically no change in capacitance with life
- Low leakage current limits
- New higher capacitance ratings
- Request Engineering Bulletin 3520F

INFORMATION RETRIEVAL NUMBER 825

45C-9144R2

*...like more capacitance in aluminum 'lytics?*

## Get SPRAGUE Type 36D POWERLYTIC<sup>®</sup> CAPACITORS



- Large cylindrical electrolytic capacitors for use in digital computer power supplies, industrial control equipment, energy storage applications, etc
- Low impedance construction
- Largest case (3" dia. x 8 5/8" high) provides 650,000  $\mu$ F at 3 volts!
- Can be operated at +85 C
- Tapped No. 10-32 terminals simplify filter bank assembly
- Available with or without outer plastic insulating sleeves
- Request Engineering Bulletin 3431C

INFORMATION RETRIEVAL NUMBER 826

For Engineering Bulletins as noted above, write to:  
Technical Literature Service, Sprague Electric Co., 347  
Marshall Street, North Adams, Massachusetts 01247.

45C9153R1



'Sprague' and '®' are registered trademarks of the Sprague Electric Co.

**THE BROAD-LINE PRODUCER OF ELECTRONIC PARTS**

# Highlighting

THE ISSUE



"The computer-on-a-chip is no big deal," says Lee Boysel, president of Four-Phase Systems, Cupertino, Calif. "It's almost here now. We're down to nine chips, and we're not even pushing the state of the art. I've no doubt the whole computer will be on one chip within five years."

But who designs the chip—the systems company or the semiconductor manufacturer? You can find advocates for either approach in the industry today. On what do they base their decisions?

**PAGE 44**

KARNAUGH MAPS

$A_n B_n$	00	01	11	10
$C_n$	0	1	0	0
	1	0	X	X
	$A_{n+1}$			

$A_n B_n$	00	01	11	10
$C_n$	0	0	1	0
	1	0	X	X
	$B_{n+1}$			

$A_n B_n$	00	01	11	10
$C_n$	0	0	0	1
	1	0	X	X
	$C_{n+1}$			

Application equations:

$$A_{n+1} = \bar{A}_n \bar{B}_n \bar{C}_n + \bar{A}_n B_n \bar{C}_n = \bar{A}_n \bar{C}_n \text{ if all 3 Xs are zero}$$

$$B_{n+1} = \bar{A}_n B_n \bar{C}_n + A_n \bar{B}_n \bar{C}_n + \bar{A}_n B_n C_n + A_n \bar{B}_n C_n = \bar{A}_n B_n + A_n \bar{B}_n \text{ if the Xs in 011 and 101 are one and the X in 111 is zero}$$

$$C_{n+1} = A_n B_n \bar{C}_n \text{ if all 3 Xs are zero}$$

$$Q_{n+1} = Q_n J + \bar{Q}_n \bar{K} \text{ (characteristic equation)}$$

$$A_{n+1} = 0 + \bar{A}_n \bar{C}_n$$

$$B_{n+1} = B_n \bar{A}_n + \bar{B}_n A_n \quad \text{application equations from above}$$

$$C_{n+1} = 0 + \bar{C}_n (A_n B_n)$$

Resulting Boolean expressions:

For A:  $J = 0 \quad K = C_n$   
 B:  $J = \bar{A}_n \quad K = \bar{A}_n$   
 C:  $J = 0 \quad K = \bar{A}_n B_n$

It is frequently necessary for an engineer to design a sequential binary coded decimal (BCD) counter. Although these counters are obtainable as MSI devices, they are expensive and not likely to be found in stock. The engineer is then forced to fall back upon his old standbys, the flip-flop and the gate.

The J-K flip-flop is usually chosen because it is inexpensive and easily available. The engineer first determines the number of stages needed; he then formulates the characteristic equation of the flip-flop he will use.

The number of stages required is determined by converting the largest decimal number, N, to be counted into its binary equivalent.

**PAGE 60**

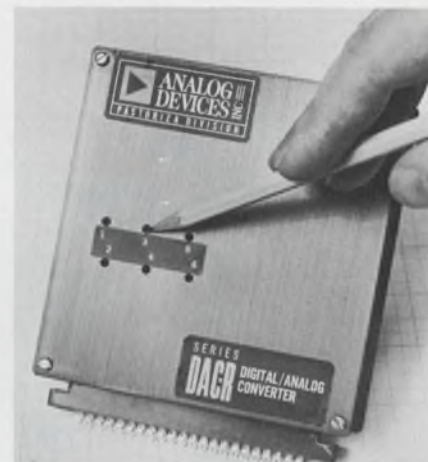

Two new modular 15-bit digital-to-analog converters establish new standards for state-of-the-art specifications for speed and resolution, stability, and freedom from output transients (glitch). Accenting different end purposes for the same price, model DAC-15RF is designed for fast operation, while model DAC-15RS stresses high stability.

The DAC-15RF combines a 15-bit resolution with a 5- $\mu$ s settling time to within one least significant bit of the final output value. This means that the unit settles in 5  $\mu$ s to 0.003% of the final value for full-scale output changes.

**PAGE 85**

## Why Intel uses Teradyne J259's to test memory devices

When we asked Intel's test supervisor, Les Vadasz, what he liked most about the Teradyne J259 computer-operated IC test system, he smiled and said: "It runs."



"Just running" is no small matter, as any IC producer can tell you. It's especially vital when you're testing 256-bit silicon-gate MOS memories like Intel's. When your devices are that exotic, you want the most unexotic test system you can find. One that doesn't go off the air once a week. One that doesn't need periodic calibration. One that "just runs."

How dependable are Intel's J259's? So dependable that Intel finds it hard to put a number on downtime, but estimates that less than *1 percent* of its test-facility downtime is attributable to the Teradyne systems.

And Intel's J259's work hard. They make as many as 10,000 functional and parametric tests on each 256-bit

MOS memory. They also test all of Intel's new Schottky-barrier bipolar memories. They test packages. They test wafers. They classify devices. They datalog test results. They generate test summary sheets and distribution tables. Since everything is done on a time-shared basis, it all adds up to an awesome test capability per J259, hour after dependable hour.

Intel's new lines of memory devices mark the company as a leader in its field. So does its choice of test equipment—equipment that, in the best Teradyne tradition, "just runs."

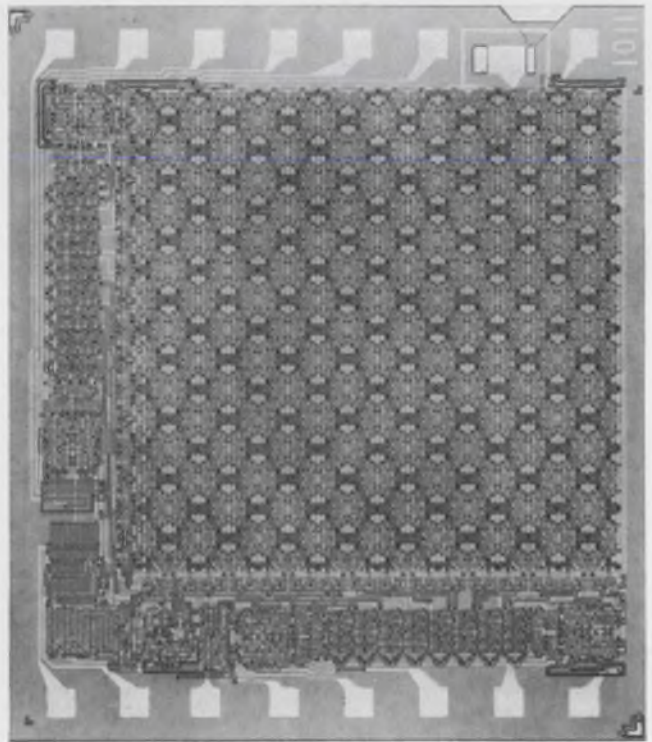

Teradyne's J259 makes sense to Intel. If you're in the business of testing circuits—integrated or otherwise—it makes sense to find out more about the J259. Just use the reader service card or write to Teradyne, 183 Essex St., Boston, Massachusetts 02111.

**Teradyne makes sense.**



## Shakeout is rattling time-sharing business

The time-sharing industry is undergoing an ordeal of survival. Rapidly rising costs and sharpened competition have stimulated price rises, retrenchment and consolidations. The current state of the business is not unexpected (see "Where Does the Designer Go From Here?" ED 23, Nov. 8, 1969, p. C19), but it is causing concern nonetheless.

Price increases this year, running from 10 to 15%, are a sharp departure from the recent past, when price cuts were the rule. The industry leader, General Electric's Information Service Dept., has announced a rise of 10%. Among others, Service Bureau Corp. has raised its prices 14%, and Tymshare, 12%.

More ominous are office closings and manpower cuts that are spreading through the industry. ITT Data Services has closed one office and consolidated two others in the New York area, and it has also reduced its sales and technical support force by 8%. Honeywell has frozen new employment, and General Electric has just completed a 20% reduction in personnel. Comnet is undergoing a reorganization.

Earnings reports, when available, indicate substantial losses for many time-sharing services. Many others are rumored to be sustaining losses that run into the millions.

Customer demand for software support is just one burden. For example, Com-Share Inc.'s monthly budget for software R&D is \$80,000. At 10% of sales, this requires a total business of \$800,000 just to keep pace.

The bad news comes at a time when all projections for the computer service segment of the data-processing field indicate a very bright future. Those companies that survive this period of adversi-

ty will undoubtedly become highly profitable in the future. The big question is: How far away is the future? Upon the answer, hinges the survival of many time-sharing services.

### Ambulance telemeters information to doctor

About 13% of all heart-attack patients die en route to the hospital, says Dr. Herman N. Uhlie, associate chief, Dept. of Medicine, at San Francisco's Mt. Zion Hospital. Some of these people might be saved if a doctor were in the ambulance, but there is a widespread shortage of medical men for this work.

Next best to a doctor's presence is a telemetry system installed by the San Francisco Ambulance Co. in six of its ambulances. It telemeters the patient's electrocardiogram to the hospital, where the doctor can monitor it on a CRT screen and instruct ambulance personnel on the treatment to give.

Designed by Electro-Biometrics of Lancaster, Calif., the system consists of a modulator in the ambulance and a demodulator in the hospital. It makes use of existing radio transmitting and receiving equipment for voice communications. The patient's EKG signal frequency-modulates an audio tone, which is transmitted by radio to the ambulance company's headquarters. There the rf component is removed, and the audio is retransmitted by telephone to the member hospital. The demodulator is displayed on a CRT and recorded on tape.

"I expect the system will have major impact," says Dr. Uhlie, "because of its very low cost and simplicity." A hospital can subscribe to the service, he points out, for a

total investment of only \$700 for the demodulator plus a small fee to the ambulance company. The modulator in each ambulance costs the ambulance company between \$1200 and \$1500, he says.

### Thick-film circuits find increasing uses

Though the "thick vs thin-film" controversy persists, thick-film hybrid microcircuits are nevertheless finding ever wider acceptance, according to Donald C. Sutherland, marketing manager of Du Pont's Electrochemical Dept., Wilmington, Del.

Speaking before a recent editorial conference in New York City, Sutherland noted that thick-film ICs are now being used in cameras, tape recorders, desk calculators and in the logic and memory sections of computers.

He pointed to one big U.S. manufacturer that has already broken ground for a large-scale plant to manufacture thick-film hybrid microcircuits for television sets. In addition General Motors is introducing thick-film microcircuitry in 10% of the radios installed in its 1970 models. The circuits are supplied by GM's Delco-Radio Corp.

Designers are now considering using these circuits in as many as 25 to 30 other automobile subsystems, such as fuel gauges, radiator gauges and speedometers, Sutherland says.

He also announced at the meeting that Du Pont is introducing—in prototype quantities—a new type of ceramic wiring structure intended for use in high-density packaging and interconnection of silicon integrated circuit chips. The primary purpose of the new structure, says Sutherland, is to facilitate packaging of multichip hybrid-LSI arrays.

The structure, called Multilox, consists of high alumina ceramic parts that contain one or more layers of buried hermetic wiring of high conductivity. Hermetic risers connect the buried wiring to the top and bottom of the assembled structure. The various layers are assembled, stacked one on top of another, and fired together as a unit.

A unique characteristic of the de-

vice, according to Sutherland, is its ability to be processed in high-temperature oxidizing or reducing environments. "This means that any one of the three metal technologies—thick film, thin film, or active metal—may be employed on top and bottom surfaces for package sealing and lead attachments."

## New-generation radar goes to White Sands

A new-generation radar has just been turned over to the Army's White Sands Missile Range in New Mexico. It is mobile and can be shuttled from one concrete pad to another over the 4000-square-mile area.

Designated the AN/MPS-36, the radar was built by RCA's Missile and Space Div., Moorestown, N. J., under a \$4.9-million contract with White Sands. It will be used to pinpoint trajectory and velocity of the 2000 rockets and missiles fired on the range every year.

The MPS-36 marks a big step forward in mobile range radar in both performance and design. It's the first instrumentation radar designed from the outset to be fully coherent—it uses doppler signal-processing techniques to measure target velocity directly.

A coherent radar is one that derives both the transmitter frequency and receiver local-oscillator frequency from the same source. Thus slight frequency shifts between the transmitted and received signals can be accurately measured and useful doppler information can be extracted from them.

Noncoherent radar transmitters simply pulse an oscillator and get only an approximate output frequency.

The MPS-36 is far more mobile than its predecessor, the MPS-25. The new radar can be moved by four men to a prepared site and set up in eight hours. The MPS-25 required three to four days to assemble.

The MPS-36's electronics are contained in a 40-foot van, and its 12-foot antenna is mounted on a 36-foot trailer. The antenna, which is constructed of foam-filled fiberglass with a metallized surface to provide electrical conductivity, is built in one piece. The antenna of the MPS-25 was in four sections and had to be assembled.

## Digital Equipment adds 16-bit minicomputer

Digital Equipment Corp., Maynard, Mass., has finally announced its PDP-11 computer. This entry into the 16-bit word-length area gives the company an opportunity to compete in a field previously invaded by all major manufacturers of minicomputers.

The PDP-11 family currently consists of two members: PDP-11/10, with 1024 words of 16-bit read-only memory and 128 words of 16-bit read-write memory, and the PDP-11/20, with 4096 words of 16-bit read-write memory. Prices of the 11/10 model start at about \$7700, while those for 11/20 start at \$1000 more.

The PDP-11/10 is intended primarily for use in the control market, while the PDP-11/20, with its greater capabilities, can compete with any of the more general minicomputer applications. The new computers, in a competitive price range to existing units, do not pose the serious threat other manufacturers had feared.

## Digital system locates vehicles in seconds

An automatic vehicle-monitoring system that can rapidly identify and locate any auto, truck, bus or police car in a fleet, regardless of course whether it is standing or moving has been demonstrated by Hazeltine Corp., Little Neck, N. Y.

As described by James Evans, vice president of the company's Industrial Products Div., the system will reduce radio voice-channel congestion through the use of digitally coded "canned messages."

A central transmitter in a metropolitan area radiates a periodic synchronizing pulse, which initiates a "roll call" of all the vehicles in

the system. A transponder in each vehicle automatically replies in a preassigned time slot, which can be as short as 1 msec.

The reply of the vehicle transponder is a coded pulse train. Part of this pulse train is used to obtain a location fix; the rest of the train contains digitally coded information, such as operational status, the number of passengers in the vehicle or the need for emergency assistance.

The entire series of replies, received in sequence by fixed receiving stations, is automatically fed back to a control station, where it is processed by a computer. A complete interrogation-response sequence for a system of 5000 vehicles for example, can be completed in five seconds, according to Evans.

## Cascading of broadband amplifiers made easy

Now you can cascade your broadband (0.1 to 2 GHz) amplifiers by soldering the output leads of one stage to the input leads of the next.

Avantek Corp., Santa Clara, Calif., offers a complete line of thin-film amplifiers in ceramic flat-packs about the size of a razor blade. Copper tabs attached to the packages can be soldered to power-supply leads and other amplifier stages. The units are reported to have a noise figure of 6.5 dB, nearly 6 dB better than that of any other thin-film amplifier in that frequency range. They are available in ceramic packages in a range of gains from 9 to 26 dB and at prices starting at \$350 for the lowest gain device.

## Private R&D supported

Sen. Alan Cranston (D-Calif.) told 150 executives at a Western Electronic Manufacturers Association Meeting in Palo Alto that he supports present Defense Dept. regulations that allow contractors to charge a certain amount of independent R&D as overhead. He urged that other federal agencies adopt similar regulations to encourage independent research by private industry.

# Allen-Bradley cuts space requirements with new sealed type Z cermet trimmers



Type Z  
1/2-watt trimmer  
shown 5 times actual size

this latest addition to the Allen-Bradley line of cermet trimmers...the type Z...affords high performance in an especially compact package

The cermet material — an exclusive formulation developed by Allen-Bradley — provides superior load life, operating life, and electrical performance. For example, the full load operation (1/2 watt) for 1000 hours at 70°C produces less than 3% total resistance change. And the temperature coefficient is less than  $\pm 250$  PPM/°C for *all* resistance values and throughout the *complete* temperature range ( $-55^{\circ}\text{C}$  to  $+125^{\circ}\text{C}$ ).

The Type Z is ruggedly constructed to withstand shock and vibration. The unique rotor design ensures smooth adjustment and complete stability under severe environments. The leads are permanently anchored and bonded. The connection exceeds the lead strength — opens cannot occur. Leads are weldable.

The enclosure is *SEALED*. It is both dust-tight as well as watertight and can be potted. Mounting pads prevent moisture migration and also post-solder washout. You can get immediate delivery at factory prices from your authorized A-B industrial electronics distributor. Or write: Marketing Dept., Electronics Div., Allen-Bradley Co., 1201 S. Second St., Milwaukee, Wis. 53204. Export Office: 1293 Broad St., Bloomfield, N. J., U. S. A. 07003. In Canada: Allen-Bradley Canada Limited.

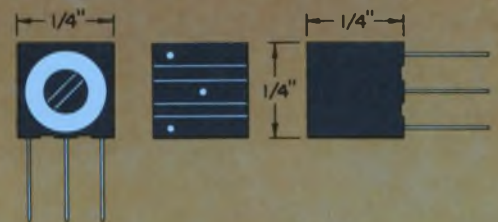

#### SPECIFICATIONS SUMMARY

- Adjustment:** Horizontal or vertical.
- Temperature Range:**  $-55^{\circ}\text{C}$  to  $+125^{\circ}\text{C}$ .
- Resistances:** 50 ohms through 1 megohm. Lower resistances available.
- Tolerances:**  $\pm 20\%$  standard,  $\pm 10\%$  available.
- Resolution:** Essentially infinite.
- Rotational Life:** Less than 2% total resistance change after 200 cycles.
- Rotation:**  $300^{\circ}$  single turn.
- End Resistance:** Less than 3 ohms.



**ALLEN-BRADLEY**  
QUALITY ELECTRONIC COMPONENTS

# DUAL TRANSISTORS

THEIRS  \$9<sup>50</sup>

OURS  \$2<sup>40</sup>

SURE A METAL CAN  
IS HERMETIC.  
BUT IS IT WORTH A  
\$7.00 PRICE DIFFERENTIAL?

Now you can get what you need; the specs. Without paying an arm and a leg for a metal can. Look over the table of types. The specs check. And the price is \$0.92 to \$2.40 at 100-999. So pick up the phone to save a pocketful of dollars.

Sprague thinks not. In 9 out of 10 industrial and instrument applications, it's beta match and  $V_{BE}$  tracking that count in a dual transistor. Not the can. That's why we package in plastic. So you can save dollars on your design. With no loss in performance. Just like with ICs, where plastic DIPs are almost the rule. It's just that simple.

Polarity	$ V_{BE1} - V_{BE2} $		$\frac{ V_{BE1} - V_{BE2} }{\Delta T_A}$			Matched Duals	Pinning	
	5mV	10mV	10 $\mu$ V/ $^{\circ}$ C	20 $\mu$ V/ $^{\circ}$ C	30 $\mu$ V/ $^{\circ}$ C		BN C E C B	BP C E C B
NPN/NPN	TD-100 TD-200 TD-250	TD-101 TD-201	TD-250	TD-100 TD-200	TD-101 TD-201	TD-2219	TD-200 TD-201 TD-202 TD-250	TD-100 TD-101 TD-102 TD-2219
PNP/PNP	TD-400 TD-500 TD-550	TD-401 TD-501	TD-550	TD-400 TD-500	TD-401 TD-501	TD-2905	TD-500 TD-501 TD-502 TD-550	TD-400 TD-401 TD-402 TD-2905
PNP/NPN	—	—	—	—	—	TD-600 TD-601 TD-602 TD-700 TD-701 TD-702	TD-700 TD-701 TD-702	TD-600 TD-601 TD-602

PRICE? DELIVERY? LOCAL DISTRIBUTORS? TECHNICAL LITERATURE?  
GET THE ANSWERS AT ANY OF THE NUMBERS LISTED BELOW.

455-9188R1

ALA. Huntsville, no charge call operator, WX4000 ARI. Phoenix (602) 279-5435 CALIF. Burlingame (415) 347-8217 Los Angeles, Bell Tel., (213) 870-0161, Gen. Tel., (213) 391-0611 San Diego (714) 278-7640 COLO. Denver (303) 756-3611 CONN. Trumbull (203) 261-2551 DC. Washington (202) 244-6006 FLA. Orlando (305) 831-3636 ILL. Schiller Park (312) 678-2262 IND. Indianapolis (317) 546-4911 MASS. Newton (617) 969-7640 North Adams (413) 664-4411 MICH. Ann Arbor (313) 761-4080 Detroit, no charge call operator, Enterprise 7498 MINN. Minneapolis (612) 335-7734 MD. St. Ann (314) 291-2500 NJ. Cherry Hill (609) 667-4444/(215) 467-5252 Wayne (201) 696-8200 NY. Melville (516) 293-6710 Upstate call (413) 664-4411 NC. Winston-Salem (919) 722-5151 OHIO Chagrin Falls (216) 247-6488 Dayton (513) 223-9187 Cincinnati, no charge call operator, Enterprise 3-8805 TEX. Richardson (214) 235-1256 WASH. Seattle (206) 632-7761.



# AF stretches work on navigation satellite

## Advantages that could lead to new tri-service system keep proposal alive despite short money

Air Force engineers, along with engineers from Aerospace Corp. in Los Angeles, have put the finishing touches on a revised version of a proposal for a navigation satellite system and shipped it off to the Air Force Systems Command in Washington, D.C.

The revision was more administrative than technical. Because of tight money, Washington asked for the development period to be stretched out.

As the only major contender for a system that goes beyond the capabilities of the Navy Navigation Satellite (sometimes known as Transit), the Air Force proposal has a good chance of becoming a new tri-service system, to be called the Defense Navigation Satellite System.

If the Systems Command is satisfied with the design—called the 621B—the proposal will go to the Air Staff for a final decision.

### Designed for variety of users

The result of independent studies made by TRW, Inc., Redondo Beach, Calif., and Hughes Aircraft Corp., El Segundo, Calif., the 621B system will have a variety of applications, says a spokesman for the Systems Command's Space and Missile Systems Organization in Los Angeles. It can be used by surface ships, aircraft—military, commercial and general aviation—and even by manned spacecraft.

"The accuracy is better than loran, Omega or the Navy Navigation Satellite," says the Los Angeles office. "Analysis has shown that we can deliver weapons precisely. We can provide a weapon with grid coordinates of its own location and that of the target, whether the system be on an aircraft, ship or artillery in the field."

It is also reported accurate enough to be used in mapping and

is much faster than the Army's Secor system. "With Secor it takes a month to put a map together, while with 621B, the job can be done in eight hours," a Systems Command engineer says.

### Signals from space

The network consists of a Y-shaped constellation of four satellites in a near-synchronous orbit. Three such constellations could cover the entire earth. But one will give a receiver-equipped vehicle its position in three dimensions, its velocity in three directions and the correct time.

The user does not transmit signals—the advantages being that radio silence can be maintained and the system is not clogged by overlapping transmissions. As many users as have receivers can use the network at the same time.

Each receiver, which is equipped with a precise clock, picks up cw pseudo-random noise signals transmitted simultaneously from each of four satellites.

The receiver compares the time of arrival and—because the satellite positions are known—can calculate its position.

The clock, which is a high-quality quartz crystal oscillator of the type commonly incorporated in high-grade field equipment, works in conjunction with a correlation detector. The detector determines the time shift between the satellite signal and the user clock.

The signals contain identifiable range codes modulated upon the carrier by biphase modulation. Satellite position information is modulated at a low data rate. The signals may be at different carrier frequencies or they may be modulated by orthogonal codes. Either way, the user is able to identify their source.

The satellite knows its position

from periodically updated information from a ground-controlled radio station. This isn't a big problem anyway, since the satellites are nearly stationary.

This is one of the system's advantages over the Navy satellite network, which is not synchronous. Transit is in a 400 to 500-mile orbit and must be tracked carefully.

Besides obtaining three-dimensional coordinates, the user can correct his clock if it's off, by the master clock in the ground station. This information is transmitted via the satellite. By measuring the frequency shift, the user determines velocity in three directions.

### Good things in small packages

The receiver, which will probably grow somewhat when it's ruggedized, is extremely small for the big job it does— $7 \times 3 \times 12$  inches. It weighs 12 pounds. Signals are received by a 0 dB hemispherical antenna providing 160 degrees of coverage. The display consists of six windows, which show coordinates, altitude and velocity, forward, lateral and vertical. A general-purpose digital computer is used with a 4000-word memory. If the vehicle has another computer on board, the receiver can use it.

For a manpack system the receiver and computer can be put in a 30-pound package.

Despite short money that precludes an immediate go-ahead from the Defense Dept., the Air Force has four contracts under way with fiscal 1969 money and hopes to continue them next year. TRW and Magnavox, in Torrance, Calif., are independently breadboarding receivers for testing in a laboratory. Boeing in Wichita, Kansas, is integrating the receiver with the other avionics ordinarily used in aircraft. And Grumman Aerospace in Bethpage, N.Y., is investigating the impact the satellite system will have on fleet aircraft-carrier operations and on aircraft. ■■

# Giant C-5A's instrumentation is readied for tests

Story and photographs by John F. Mason, Military-Aerospace Editor

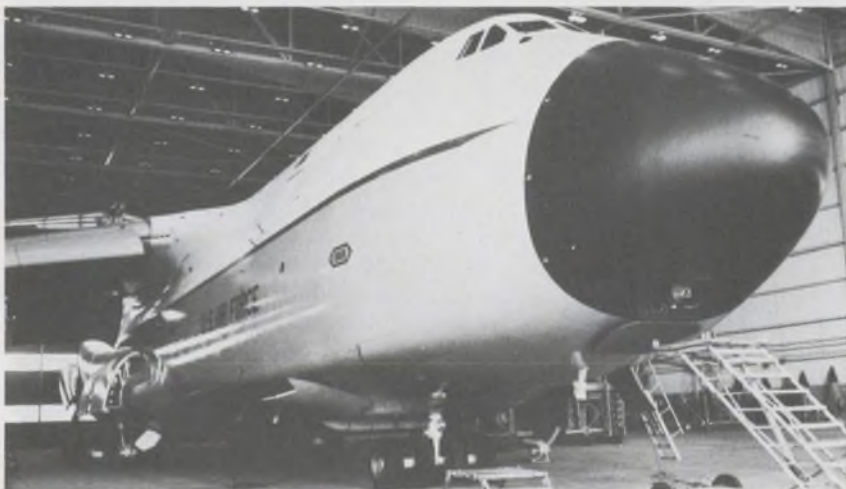
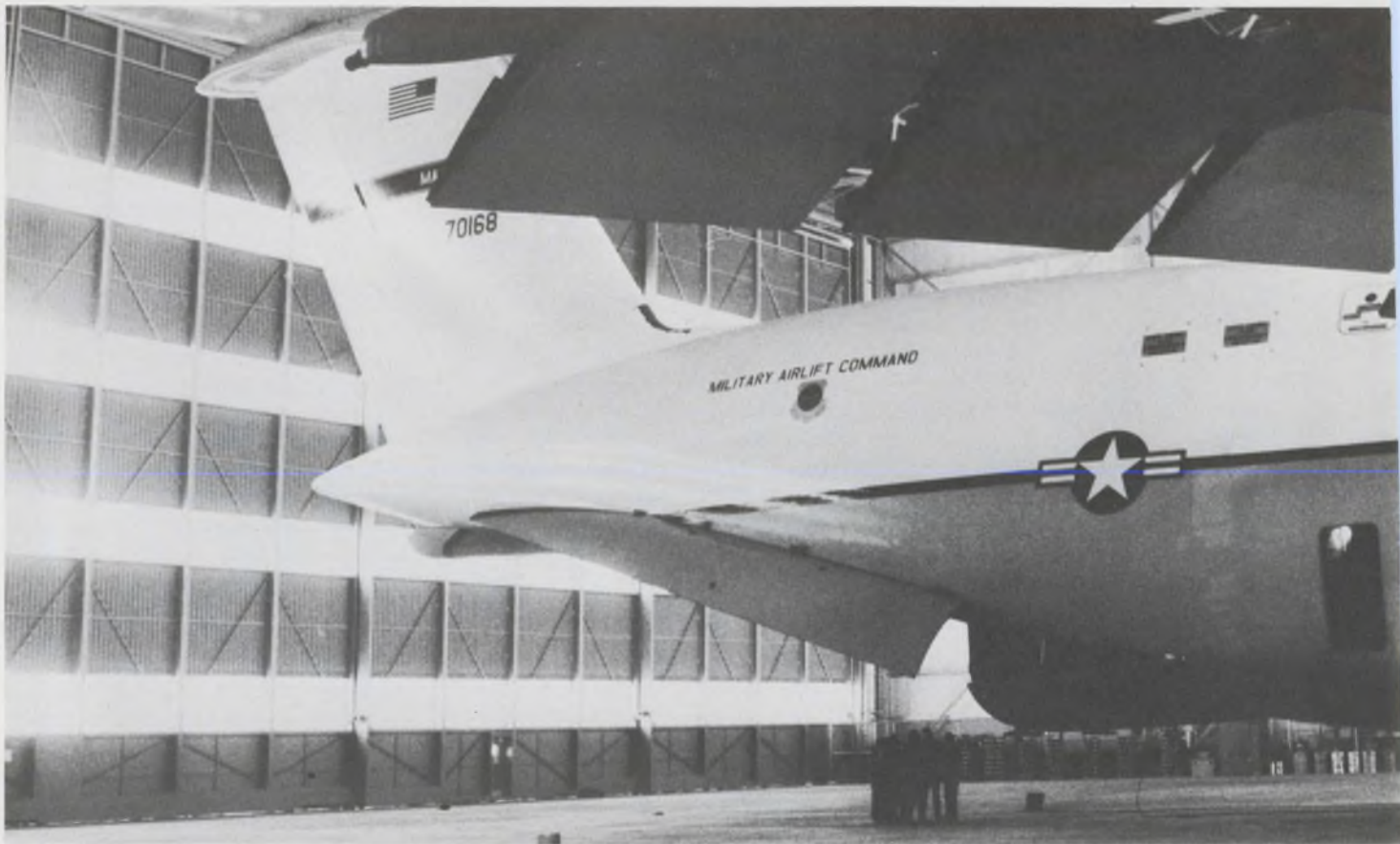

The world's largest aircraft—the Military Airlift Command's C-5A, built by Lockheed-Georgia—has equaled or surpassed all its performance specifications. It can deliver more than its required 265,000 pounds of equipment and 75 men to a rough landing spot 3050 nautical miles away, unload them and take off and return without more fuel. It can fly a 100,000-pound payload 5500 miles. And empty, it flies 7275 miles. The plane's fast cruise speed is 470 knots, but it can slow to 130 knots to make aerial equipment drops. It can take off with a medium load in 7500 feet.

Flight tests have proved that the Air Force's giant C-5A cargo aircraft is "a magnificent machine," according to Gen. Jack J. Catton, commander of the Military Airlift Command, who recently delivered the ninth C-5A from the Lockheed-Georgia factory to Altus Air Force Base, Okla.

Tests have also proved that the plane can carry 265,000 pounds of vehicles with 75 drivers, and that it can deliver this load to a rough landing field 3050 nautical miles away and fly back without taking on fuel.

Now, its instrumentation is due for a check.

At Edwards Air Force Base, Calif., on the moonlike Mojave desert flats, engineers are making preparations to flight-test the C-5A's instrument landing system, the radar altimeter, engine components during engine starts and the highly complex inertial navigation system.

Because of the tremendous amount of data these instruments will produce, two television cameras will be carried in the aircraft to provide the engineers on board

with real-time displays, as well as instant playback on video tape.

If performance is questioned, that portion of the test can be redone at once. The tape will also permit unhurried reexamination of the tests on the ground.

To monitor the landing gear and other external portions of the aircraft, a TV camera will be carried in a fighter flying close by, sending its signals to the ground.

The C-5A will also be followed from the ground by a number of the 24 TV cameras set up at Edwards on boulders, hangars and



The flight director's command post for the test missions at Edwards Air Force Base, Calif., is the Space Positioning Center. From the master control console (foreground) the director can control the radars, television cameras and optical tracking instruments scattered over the hundreds of miles of dry desert lake. He talks with operators throughout the range and the flight crews in the air. Besides the TV monitors that follow the flights, a real-time computer plotter (rear) provides a three-dimensional presentation of the test aircraft at all times.





**Tactical Acquisition and Data Control System** being installed in the Flight Vision room tells radars where to acquire incoming planes.



**Flight Vision Room** console allows test engineers to watch flights from a number of vantage points on a number of TV screens. The 80-inch lens shows planes 150 miles out.



**Flight crew compartment** seats six—two pilots, navigator, engineer, and two observers. Upcoming tests will concentrate on the instrument landing system, radar altimeter, inertial navigator and engine readings. The display for the plane's automatic test system is at the lower right of the engineer's console (above).

small stands built on the desert's dry lake bed.

Some of the ground-based cameras are bore-sighted to AN/FPS-16 radar antennas to provide two kinds of pictures of the action being watched. The radar, which has been the work horse of the missile ranges for years, can hold onto an aircraft as long as it's above the horizon. And the television cameras, with their 80-inch lenses, also have a very long range. A large aircraft, such as the B-70, for example, has been recognized on the home-size TV screens at 150 nautical miles. The cameras are produced by Cohu Electronics Inc., in San Diego.

Signals from the ground-based cameras can be transmitted to 58 monitors at Edwards Air Force Base via cable and microwave link.

One main recipient of the telecasts is the Space Positioning Center at Edwards from which the missions are directed.

From a master control console, the mission director is able to control the radars and cameras, talk with all range operators and aircraft, and respond to the Target Acquisition and Data Control System—a computerized system that accepts flight information from another range.

For example, if a plane takes off from the Navy's Pacific Mis-

sile Range, nearby, headed for Edwards, the information is microwaved to the computer, which calculates precise acquisition information for each optical and radar tracker on the base—where and when each one should look to pick up the approaching target.

Besides the Space Positioning Center there is a Flight Vision Center near the flight line that receives TV coverage of each mission.

A Target Acquisition and Data Control System console is currently being installed in the Flight Vision Center, and will be operational soon. It is built by Astrodats, Inc., Anaheim, Calif. ■■



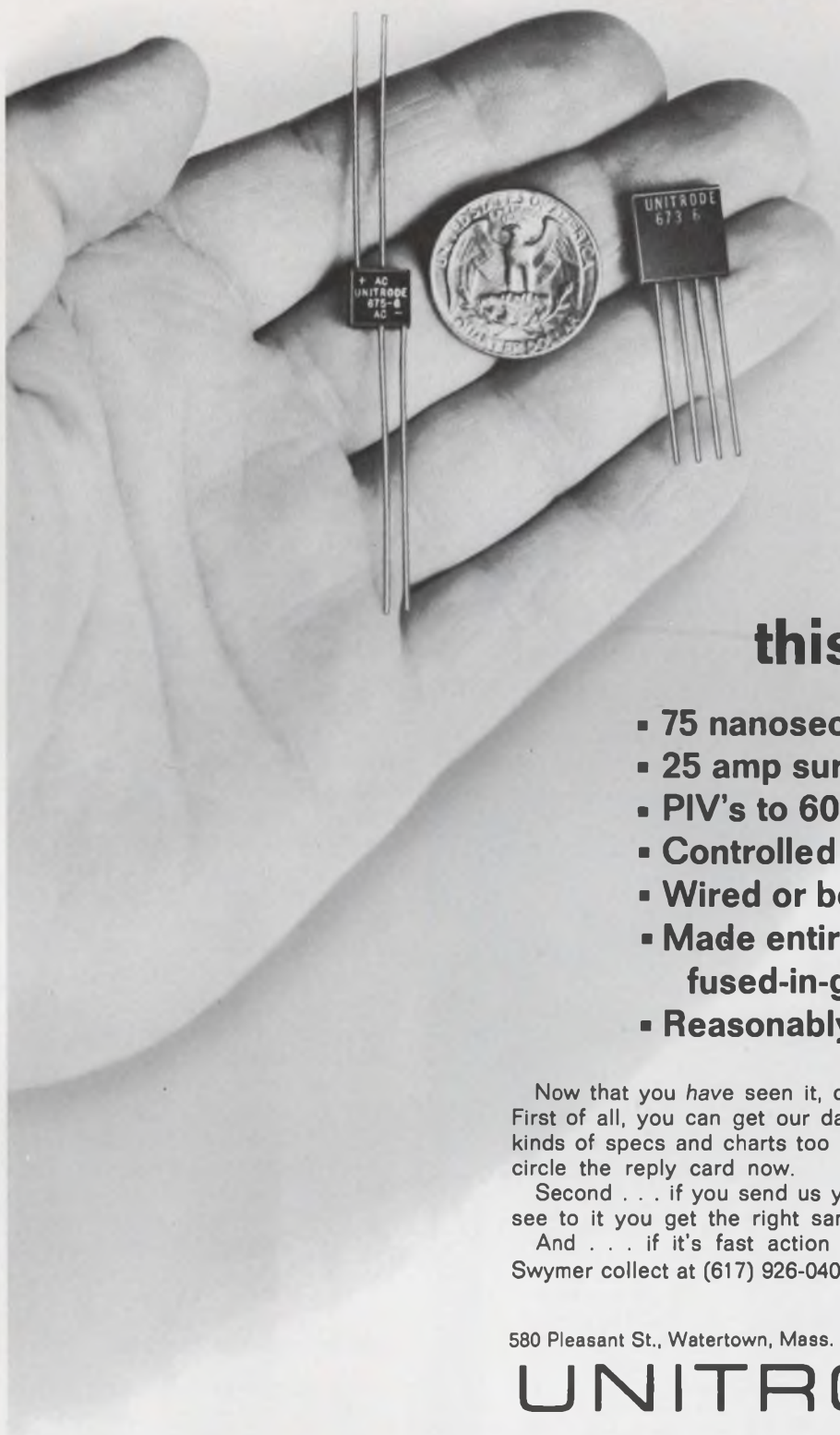

**Two bits  
says  
you've  
never seen  
a 1.5 amp  
bridge  
this small with**

- 75 nanosecond recovery
- 25 amp surge rating
- PIV's to 600V
- Controlled avalanche
- Wired or board mounted
- Made entirely with individually fused-in-glass diodes
- Reasonably priced

Now that you *have* seen it, don't you want to know more? First of all, you can get our data sheet, just packed with all kinds of specs and charts too detailed to put in this ad. Just circle the reply card now.

Second . . . if you send us your circuit requirements, we'll see to it you get the right sample for the job.

And . . . if it's fast action you want, why not call Fred Swymer collect at (617) 926-0404.

580 Pleasant St., Watertown, Mass. 02172, (617) 926-0404

**UNITRODE**



**STANDARD RECOVERY**

PIV to 600V  
Rating 1.5A  
Surge 25A

**FAST RECOVERY (500 nsec)**

PIV to 600V  
Rating 1.0A  
Surge 20A

**ULTRA-FAST RECOVERY (75 nsec)**

PIV to 200V  
Rating 1.0A  
Surge 20A

HERE'S WHAT IT LOOKS LIKE INSIDE

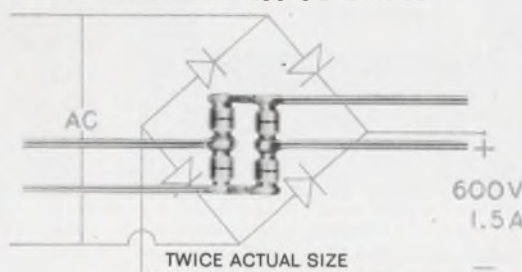

AND HERE'S WHAT IT LOOKS LIKE INSIDE THE INSIDE

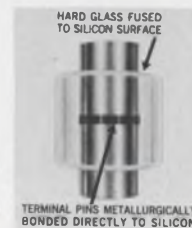

With the silicon die metallurgically bonded between terminal pins of the same thermal coefficient, the hard glass sleeve is fused to the entire outer silicon surface. Result — a voidless, monolithic structure.

INFORMATION RETRIEVAL NUMBER 17

# Anemometer aids remote weather stations

## Lightweight instruments contain solid-state sensors that give wind direction and velocity

Telemetering wind direction and velocity from some remote weather stations can be rough on the circuitry. The instruments may be bouncing around in unoriented fashion on a buoy at sea or swinging from a balloon in an arctic wasteland.

Getting wind velocity is reasonably simple. Some anemometers drive a small dc generator; others use a photocell and shutter pulse-counting arrangement. But the real problem lies in establishing an electronic reference for wind direction.

Circuitry that can do this becomes undesirably complex, and the power requirements are relatively high.

Two researchers at the University of Wisconsin have developed a lightweight, solid-state device they call Windav to solve the problem. It weighs only two ounces and consumes only a few milliwatts of power. And it measures both velocity and wind direction.

Essentially it's an anemometer. But a hole in the cylindrical sleeve of the anemometer permits the measurement of wind pressure,

thereby giving wind direction—because the pressure is highest, naturally, when the hole faces directly into the wind.

Two versions of the device have been developed by the researchers, Prof. Theodore Bernstein and a specialist, Joseph G. Miller, both affiliated with the university's Space Science and Engineering Center in Madison, Wis.

The first version was produced for the U.S. Environmental Service Administration's Barbados Oceanographic and Meteorological Experiment (Bomex) program.

In this experiment, three Windavs were mounted on vanes attached to a balloon cable at altitudes of 200, 400 and 600 meters. They were free to rotate about the cable and point into the wind. A small reed switch in the anemometer base pointed toward the head of the weather vane, and as the anemometer rotated, it produced a pulse that gave the direction of the vane with respect to the earth's magnetic field.

In the latest version, which has been suggested for use on ocean buoys, the switch is replaced by a pressure-sensitive transistor. This produces a pulse in response to wind pressure through the hole in the anemometer sleeve, and consequently gives wind direction.

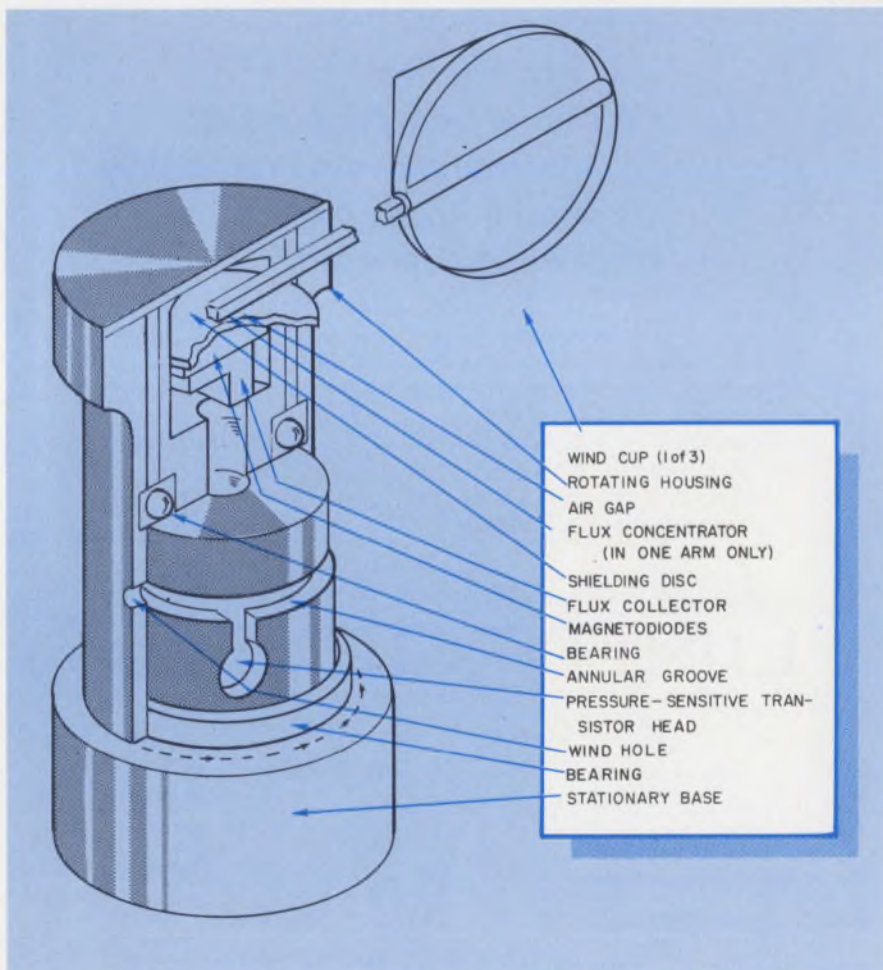

Internal details of wind direction and velocity of the anemometer/transducer unit. Only one of the three wind cups is shown, and the flux concentrator arm is located in one arm only.

### Key to systems' success

The success of these systems lies in the use of an arm that concentrates the earth's magnetic field; it is located inside one of the three anemometer arms (see figure). As the anemometer spins in the earth's field, flux is at a minimum when it points north and south, and at a maximum when it points east and west.

This flux is transferred to a Sony magnetodiode assembly, the output of which is an ac sine wave signal containing both direction and velocity information.

First, at the zero-crossing axes of the sine wave, the flux arm points directly north or south, while at 90° and 270° points, the direction is either east or west.

By design, the signal is phased so that the positive-going portion is in the easterly direction, and the negative half is westerly, thus providing a directional reference aligned with the magnetic north.

The second type of information in the magnetodiode signal is wind velocity, because as the anemometer rotates, the sine-wave frequency is a direct function of wind speed.

To provide wind direction for the solid-state system, a tiny hole is drilled in the rotating anemometer sleeve. Inside the sleeve, a path is provided to the pressure-sensitive transistor diaphragm. As the sleeve turns, wind pressure is at a maximum when the hole faces directly into the wind, thus producing a pulse from the pressure transducer. The pulse is clipped and sharpened for telemetering.

The instant at which the pulse occurs is compared with the sine wave, and by relating the pulse to the number of degrees from the north reference, the device evaluates wind direction.

### The solid-state devices used

The magnetodiodes used in the instrument are a twin, matched pair in a single case, and are Sony's MD-230A. For fields up to 500 oersteds, the output is linear, with a slope of about 1 mV per oersted. With the added concentrators, an earth's field of 0.6 oersted gives a peak-to-peak amplitude of 17 to 20 mV, with 9 V across the magnetodiodes. Reversal of the field, as the anemometer rotates, reverses the output.

The velocity signal output was determined to be  $v = 0.208 + 3.318 \omega$ , where  $v$  is the wind velocity in knots and  $\omega$  is the rotation of the anemometer in revolutions per second.

The pressure-sensitive transistor, a PT-2/3 Pitran by Stowe Laboratories, Stowe, Mass., operates over a differential pressure range of  $3.8 \times 10^{-4}$  to 1.25 psi differential, corresponding to a range of about 4 to 237 knots. Below 4 knots the signal-to-noise ratio falls below 10:1. ■■



High voltage transients caused this emitter-base short which later caused failure of several power transistors.

## And how you can prevent it.

Whether it was caused by a technician with a wayward probe, or a piece of heavy equipment starting up nearby, or "strays," the origin of a high-voltage transient is of no consequence.

In every case, the results are the same: immediate—or eventual—failure of costly semiconductors.

Even though it may not fail immediately, the punctured device is left with a path, analogous to scar tissue, along which subsequent failures take place.

Eventually, under thermal stress or load conditions, the semiconductor gives up. Often without apparent cause.

### Protection against transients

The Heinemann JA/Q™ electronics protector prevents high voltage spikes, or overvoltages of any kind, from ever reaching your semiconductors. (JA/Q undervoltage protectors are also now available.)

The JA/Q provides protection against transients and overvoltages by sensing them before they reach the vulnerable portions of the circuit. It responds to dangerous conditions

by shunting them from the line and signaling a trip mechanism to open the line.

Transient response time of the JA/Q is within 500 nanoseconds. Trip time is 10 milliseconds.

### And overcurrent protection

Transient/overvoltage protection is combined in the JA/Q with hydraulic-magnetic overcurrent protection, which may be specified with or without time delay, depending on your circuit requirements. Time delays for typical overcurrent faults have no effect on the trip time of the protector under transient or overvoltage conditions.

To learn more about the JA/Q, write for Bulletin 3370. We're as interested in preventing failures as you are. Heinemann Electric Company, 2616 Brunswick Pike, Trenton, N.J. 06802. 4440

**HEINEMANN**



# *circuit problems?*

## ***Signalite Glow Lamps have solved problems in these areas:***

- Voltage Regulation & References • Photo-Cell Drivers • SCR Triggering
- Timing • Photo Choppers • Oscillators • Indicator Lights • Counters
- Voltage Dividers • Surge Protectors • Logic Circuits • Flip-Flops
- Memory • Switching • Digital Readouts

Signalite glow lamps combine long life, close tolerance and economy, and are manufactured with a broad range of characteristics to meet individual application requirements. For a creative approach to your design problem . . . contact Signalite's Application Engineering Department.



**ULTRA HIGH LEAKAGE RESISTANCE.** Devices with leakage resistance in excess of  $10^{12}$  ohms are available for circuits requiring this property. Such applications would include sample and hold for A to D conversion, and capacitor memory systems.

SEE Signalite Application News for TYPICAL APPLICATIONS



### PHOTO-CELL APPLICATIONS

The A074 and A083 have been designed for use with Cadmium Sulfide or Cadmium Selenide photocells. Applications include photo choppers, modulators, demodulators, low noise switching devices, isolated overload protector circuits, etc. Speed of operation is limited only by the photo-cells.

SEE Signalite Application News for TYPICAL APPLICATIONS

### SIGNALITE APPLICATION NEWS



is used to communicate new and proven techniques and applications of Signalite's neon lamps and gas discharge tubes. Signalite Application News provides a forum for an exchange of ideas to keep the design engineer aware of the versatility of neon lamps and their many applications. Copies are available from your Signalite representative or by contacting Signalite.

INFORMATION RETRIEVAL NUMBER 20



**VOLTAGE REGULATORS BETTER THAN 1% ACCURACY** These subminiature voltage regulators are used in regulated power supplies, as reference sources, photomultiplier regulators, oscilloscopes calibrators, etc. They are available in voltages from 82 to 143 V. They are used in multiples as regulators in KV ranges.

See Signalite Application News for TYPICAL APPLICATIONS.



**NEON TIMERS** The bi-stable characteristics and high leakage resistance of Signalite's special glow lamps make them ideal as a component for timing circuits. The basic circuit resembles a relaxation oscillator network.

SEE Signalite Application News for TYPICAL APPLICATIONS

# Signalite

INCORPORATED

NEPTUNE, NEW JERSEY 07763

(201) 776-2490



A General Instrument Company

313



When you can't afford a "wrong number"...

Symbolic representation of the TV, voice, ranging data and biomedical telemetry signals from the moon. Photograph courtesy of NASA.

## bring ERIE in early.

Where are they? How are they? What do they see... and say? NASA and the world want to know. And, the only way to find out is over the special Motorola S-band equipment on both the Command and Lunar Modules. Once the Apollo Astronauts are over 30,000 miles out, it's their *only* communications link with Earth. It simply can't fail. That's why Motorola called on ERIE TECHNOLOGICAL to develop the EMI filters and Monobloc capacitors that would help this equipment perform flawlessly on every Apollo mission since Motorola has been involved. Proof, once again, that it pays to bring ERIE in early.

**ERIE TECHNOLOGICAL PRODUCTS, INC.**  
644 West 12th Street, Erie, Pennsylvania 16512  
(814) 456-8592

# Radar signal processing engineers:

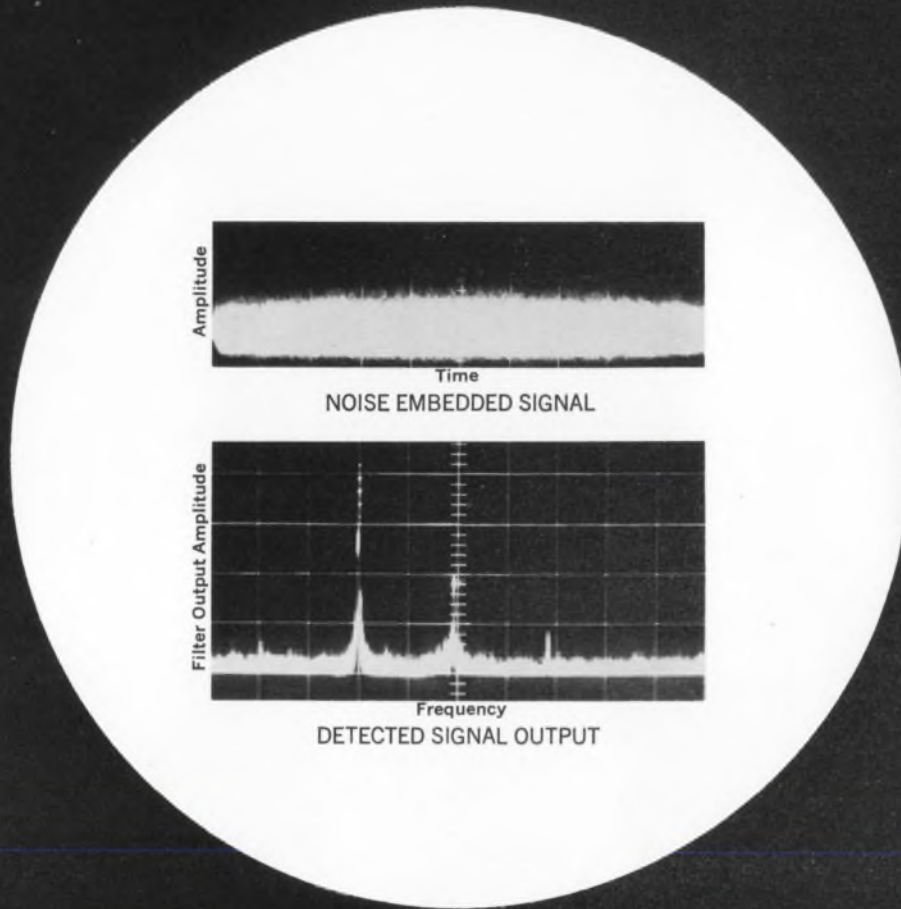

## Our expansion can be your opportunity.

Today at Hughes, we're developing digital radar signal processors for a variety of important airborne applications.

An engineering model of one of these processors has been developed for real-time operation. It uses the Cooley Tukey, or fast Fourier transform algorithm, to form a bank of 512 narrowband doppler filters, together with their associated detectors and threshold circuits.

The scope photographs show a processor input signal 12 db

below wideband input noise, and the resulting processor output signal 15 db above rms noise in one digital filter output.

Several programs are now starting to carry this technique and others further toward operational radar systems.

It's a rapidly expanding field. And Hughes wants to grow with it. That's why qualified engineers and scientists are needed now. Particularly those with digital circuit design experience, signal processing analysis and

subsystem design experience, and microelectronic circuit applications background.

Interested? Please airmail resume today to:

Mr. Robert A. Martin  
Head of Employment  
Hughes Aerospace Divisions  
Dept. 50  
11940 W. Jefferson Blvd.  
Culver City, Calif. 90230

An equal-opportunity employer  
— M & F

U.S. citizenship is required



*from Bourns*

# A DIAL T C COUNT ON



*New, High-Quality 1 $\frac{3}{8}$ " Diameter Turns-Counting Dial with Readability of a 1 $\frac{13}{16}$ " Dial*

**SEE WHAT YOU GET**

White on black set points pop right out at you. No misreading. Ten turns setable to one part in a thousand. Same readability as 1 $\frac{13}{16}$ " dial in a third less panel space.

Tough cast aluminum housing with only 4 moving parts. Newly developed dial changeover can't foul. Smooth as it looks. Zero backlash.

1 $\frac{3}{8}$ " diameter for mounting on  $\frac{1}{4}$ " and  $\frac{1}{8}$ " diameter shafts. Simple to do; no special panel holes required.

**ONLY \$3.99** in 1,000 lots

Send for data on H-510 Turns-Counting Dial or ask your nearest Bourns sales office or representative.

Available through your Bourns distributor.



# We make guys who can't





# components for stand failures.

Picture yourself in your living room in front of the TV on a quiet Sunday afternoon. The ball's on the four yard line, 24 seconds to go. Your team trails by six points but has just made a first down.

That's when your set decides to burn out. And that's when you first mutter the words that officially put you in the group of enraged guys that our components are designed to stamp out.

At Corning we make components to please guys who can't stand failures. We build an extra measure of performance into all our resistors and capacitors to help you build extra reliability into all of your systems. Like you and the guys who use your equipment, we have to admit that we can't stand failures either.

Consider our tin oxide resistors, they're the best of the metal film class. Because the resistive tin film is completely oxidized and molecularly bonded to the glass core, our tin oxide resistors are impervious to moisture and environmental degradation. No other resistor can deliver the same stability and reliability over load life. They offer guaranteed moisture resistance across all ohmic values to set a standard of

reliability that can't be matched by metal film, wire wounds, carbon comps or metal glaze resistors.

No other resistor can give the same value. Our tin oxide resistors offer long term economy over metal film, precision wire wound and metal glaze resistors. And our new C3 resistors, in addition to the benefits of small case size, compete costwise with carbon comps.

Another important Corning development for men who can't stand failures is our flame proof tin oxide resistor. Ideal for circuitry where functions, environments and duty cycles demand low power resistors with excellent frequency characteristics, our flame proof resistors can withstand overloads of up to 100 times rated power without any trace of flame. And because they open under overload, they provide protection for your other, more expensive components. For this reason, plus safety, CORNING® Flame Proof Resistors are now being widely used in Color and Monochrome TV receivers.

And consider our Glass-K™ capacitors. We developed them to give you the volumetric efficiency and economy of monolithic ceramic capacitors, but with the much

improved stability and reliability that only a glass dielectric can add. Our Glass-K™ capacitors are extremely reliable for bypass and filtering applications—the traditional capacitor failure spot.

Then consider our glass capacitors. There's only one reason why they've been designed into so many major aerospace and missile programs. Only glass capacitors could give their designers the proven stability and reliability that these important systems demand.

At Corning we make components for guys who can't stand failures. Guys like your customers. Guys like you. Next time you're designing a system, reach for your CORNING® capacitor and resistor catalogs and call your local Corning authorized distributor for off-the-shelf delivery. They'll help you design-in an extra measure of performance.

If you don't have our catalogs, ask your Corning distributor for copies or drop us a line at: Corning Glass Works, Electronic Products Division, Corning, New York 14830.

**CORNING**  
ELECTRONICS

CORNING presents "THE YOUNG AMERICANS," an entertainment special on ABC-TV, March 12, 1970, 9:00 PM EST. We invite you to watch.



## What's so special about GR's 1192 Counter?

### The answer has to be VALUE.

Where else could you get a \$575, 5-digit counter that measures frequency (dc to 32 MHz), period (single or multiple), frequency ratio, and time interval? Or 10-mV input sensitivity up to 20 MHz, a 10-MHz crystal time-base with a stability better than  $\pm 2 \times 10^{-6}$  per month, or manual attenuation up to 60 dB?

You say you want more for your money? How about automatic units-of-measurement and decimal point displays, and SPILL and COUNT indicators?

For a few more dollars we can really make it worthwhile! Get a 6-digit counter for \$675, or 7 digits for \$775; add a BCD data output for \$50 and a rack mounting for \$20. And if you have higher frequencies to look at, tack on our 500-MHz scaler for \$850.

Now that you're interested, why not get all the details from the General Radio Company, West Concord, Mass. 01781; telephone (617) 369-4400? In Europe write Postfach 124, CH 8034 Zurich, Switzerland. To sweeten the deal, we'll tell you about our quantity discounts and Annual Purchase Agreement.

Prices apply in USA.

**GENERAL RADIO** 

# Washington Report

CHARLES D. LA FOND, WASHINGTON BUREAU

## Future of Main Battle Tank hangs in balance

The role of the armored tank in U. S. land warfare plans hangs on a decision to be made by Deputy Defense Secretary David Packard—whether to cancel the high-cost Main Battle Tank (MBT-70) R&D project or to continue with a more austere design. His report to the Congress, promised by January 15, was delayed. Industry and Pentagon informants believe that his choice could go either way.

The MBT-70, which had its beginnings in 1963, was intended to encompass all the technological advancements necessary to make it the world's finest armored vehicle. R&D in the program to date totals over \$300-million. It is now believed the present system in production would cost nearly \$700,000 for each tank. Congressional opponents say the total cost of the tank program would come to \$1.5-billion during the decade.

Fiscal 1970 appropriations (\$43-million) will carry the program through component testing of six developmental prototypes. The next planned step would be for construction of essentially a second-generation design requiring eight prototypes for advanced development and engineering testing. To date, all elements of the computer-controlled firing system, stabilization system, automatic loading system and laser range-finding and electro-optical night-fighting aids have not been tested as an integrated system, according to a program spokesman.

## Crime institute seeking new scientific aids

About \$7-million will be spent in the next six months on research that hopefully will produce new ways to fight crime, says the National Institute of Law Enforcement. The institute is part of the Justice Dept.'s Law Enforcement Assistance Administration.

To meet a lack of new technological approaches by the scientific community, the institute is sending anticrime proposals to both private laboratories and universities. One-quarter of the institute's spending will be for lighter-weight radio transceivers for foot patrolmen, narcotics scent-detection instruments, electronic identification instruments and improvements in the use of computer systems for command and control.

## Air Force considers new surveillance drone

Plans for a new surveillance drone aircraft are under consideration by the Air Force Aeronautical System Div., Dayton, Ohio. The jet craft would be used for high-altitude electronic intelligence and high-resolution photographic missions over relatively long ranges, industry informants here say. Military security on the program, called Comfy Bee, is unusually tight. One air-frame manufacturer's director of public relations, asked by this column for basic information, not only did not know his company was involved in the effort but, after learning of its existence, could obtain no information from the program's participants.

The Air Force is expected to request proposals soon, and several concerns probably will be selected for a feasibility study and system-design competition. Vehicle avionics are expected to be handled on a subcontract basis for the selected primes, but surveillance equipment for pod installa-

tion will be handled under separate contracts, according to industry representatives here.

It's been reported that the design will require minimal manual flight controls, to permit piloting of the drone aircraft into unimproved landing zones. This would indicate a comparatively large aircraft. The last large high-performance jet drone program was managed by the Army in the early 1960s.

## Computerized medical checkup can cut costs

An annual checkup at a clinic can take up to several days with conventional procedures. But this spring a new automated system for medical clinics will be tested in Washington. It is expected to speed the process and nearly halve the cost. A typical checkup fee, involving some 35 tests, can come to \$150 to \$200 today.

The system is under development by Health Auto-Data, Inc., a subsidiary of Quanta Systems Corp. It will be leased to the Spring Valley Medical Center, a private clinic here. "The design will be tested for at least six months before we attempt to build and lease additional systems throughout the country," says Joseph Kennedy, executive vice president of the developer. The equipment features a Digital Equipment Corp. PDP-8I general-purpose digital computer. Kennedy says it will permit a complete checkup with a printout for the reviewing physician in about 1 hour and 40 minutes.

## Post Office will test 'Mailgram' service

The Post Office Dept. and Western Union have joined forces in a new attempt to improve the transmission and delivery of printed communications. During the two-year experiment, Western Union will make use of its Telex and Info-Com transmission services in 12 cities to send messages to 110 post offices. The Postal Service will deliver the messages, dubbed Mailgrams, as it would ordinary mail. If the joint venture proves a success postal officials estimate a return to the Government of \$12.5-million annually by 1975. Western Union will pay the Post Office Dept. 25 cents for each message handled.

## Military and industry to air progress in computer training

The use of computers for training personnel is a relatively new but growing field of increasing interest to both the military, which has pioneered the effort, and to industry, which ultimately will exploit it. Indicative of the recognition of this new field is an upcoming Government-industry conference (Feb. 10-11) to be held in Washington under the sponsorship of the National Security Industrial Association. The first Conference on Application of Computers to Training will discuss current research, says the proceedings chairman, Carl R. Vest. "The real need," says the GE engineer, "is to develop techniques rather than hardware."

# METAL FILM SOURCERY

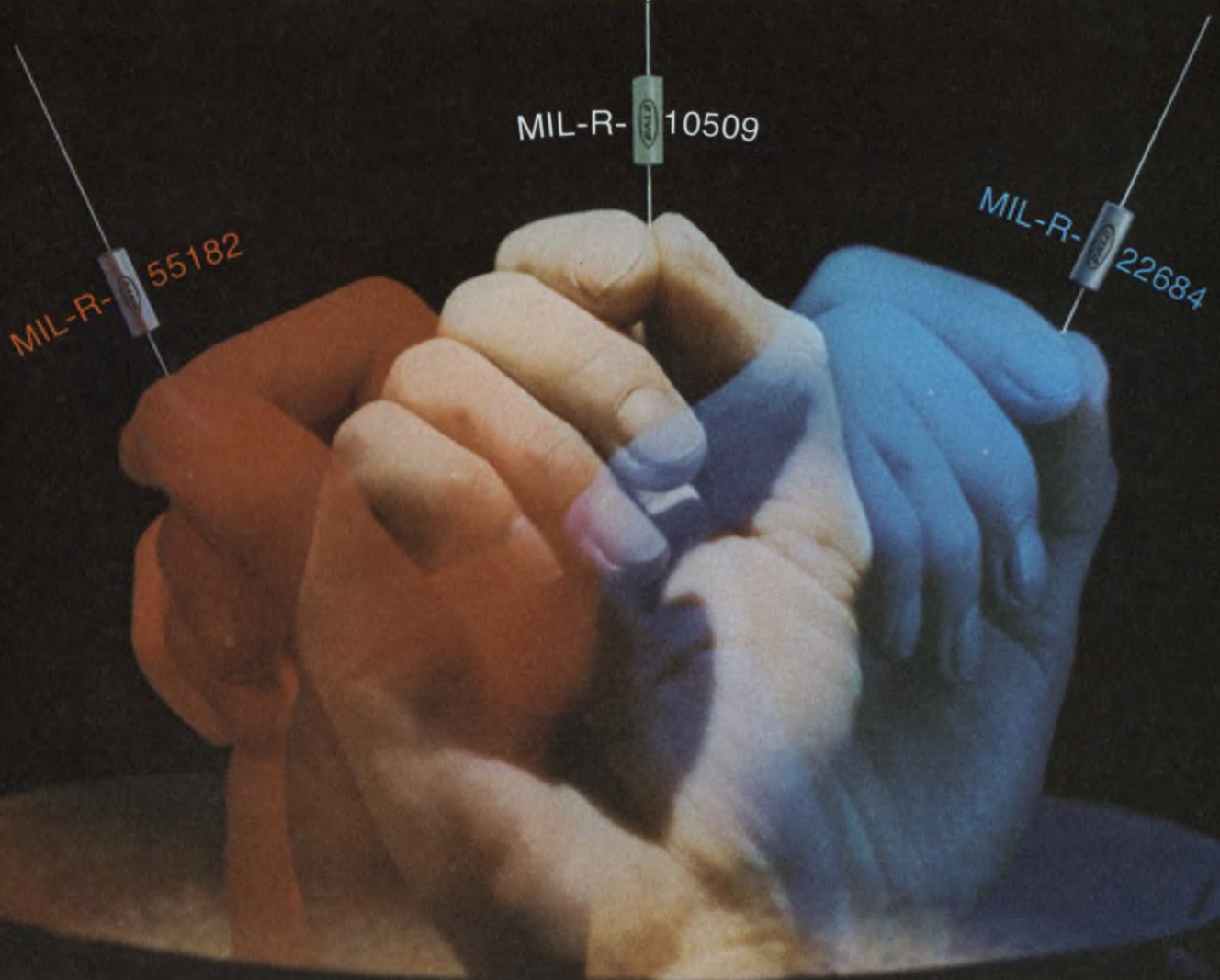

**Three performance levels—one basic source.  
No trick at all when you call Dale.**

Don't buy tin oxide resistors just to get power at a low price. Dale's molded MF styles match these needs with the precision stability and tolerance of metal film. Designers and buyers alike know it's a better deal and dozens of companies are profiting from it. Many are consolidating their MIL-R-22684, 10509 and 55182 buys at this one broad, dependable source. Whether you want established reliability or prices as low as pennies per part—Dale can give you action.

*Here's Metal Film versatility  
across the board*

Dale epoxy-molded MF resistors are available to meet the following specifications. For complete information, write for Catalog A.

<u>MIL-R-55182</u>	<u>MIL-R-10509</u>	<u>MIL-R-22684</u>
RNR 55 thru 65 RNC 55 thru 65	RN-55 thru RN-80	RL-07, RL-20

Call today 402-564-3131



**DALE ELECTRONICS, INC.**

1300 28th Ave., Columbus, Nebr. 68601  
In Canada: Dale Electronics Canada, Ltd.  
A subsidiary of the Lionel Corporation

# Phelps Dodge Communications: the company our customers started.

Before we organized Phelps Dodge Communications Company our customers were in the position of having to deal with a variety of our divisions in order to buy a related grouping of products. Different plants to contact. Different people to talk to. "Doesn't make sense," they complained. They were right (as customers always are) and we decided to do something about it.

We did. Phelps Dodge Communications Company is a new entity in our corporate structure formed through the combining of product lines previously manufactured and marketed by other Phelps Dodge organizations. The essential purpose behind the creation of our company was to provide our customers with a single source with full manufacturing and marketing responsibilities. Phelps Dodge Communications Company now manufactures a series of products allied in their applications to the many faceted field of communications. Total marketing responsibility and authority is centered at a headquarters office in North Haven, Connecticut. From this point we direct a network of District Managers and Technical Representatives backed by a Service Staff and strategically located warehouses. While we manufacture at four different plants, Phelps Dodge Communications is the unified easy-to-work-with entity it was originally organized to be.

Ask for a brand new brochure which describes us in detail. Or, better still, contact our Sales Office or Technical Representative nearest you.

**PHELPS DODGE** COMMUNICATIONS COMPANY 

**Telephone Cable / Coaxial Cable / Connectors—Standard and Miniature/Land Mobile Antennas/Broadcast Antenna Components/Microwave Components/Customized Components.**

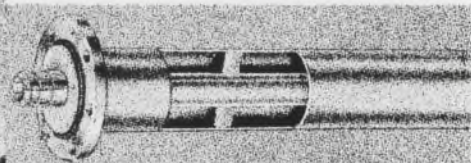
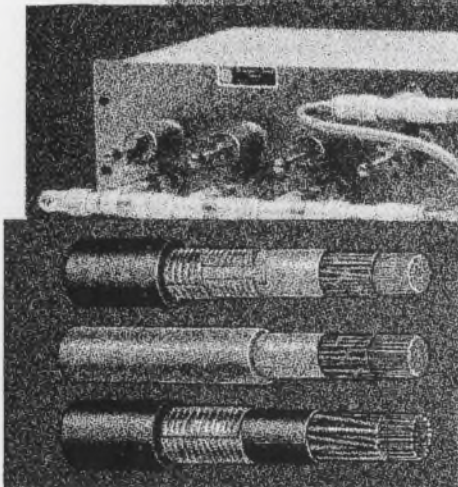
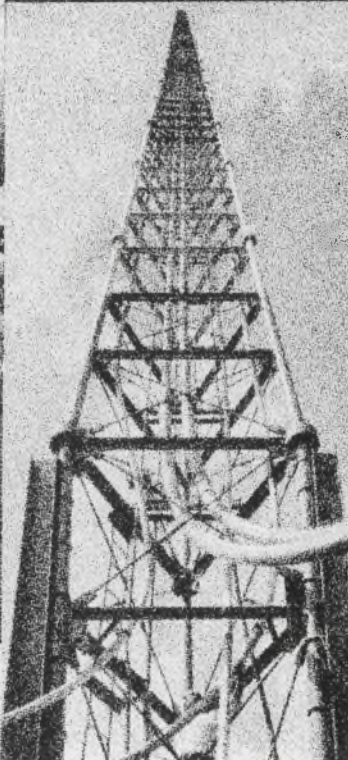
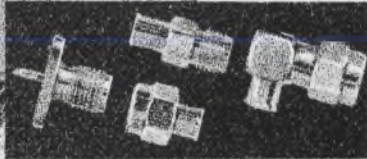
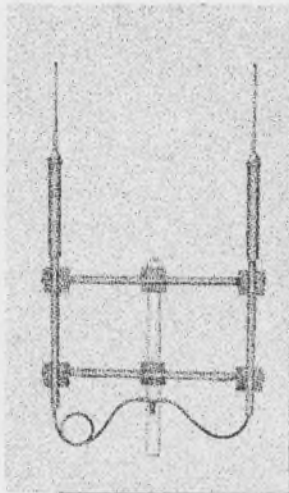



PHELPS DODGE  
COMMUNICATIONS  
SALES OFFICES:

**California 90065, Los Angeles;** Thompson L. Baker, 3043 Rosslyn Street  
**California 94010, Burlingame;** John W. Elsasser, 851 Burlway Road  
**Florida 33601, Tampa;** William D. Furr, 505 North Rome Avenue  
**Georgia 30326, Atlanta;** K. W. Atkinson, 3400 Peachtree Road, N.E.  
**Illinois 60603, Chicago;** Albert W. Gallick, 18 S. Michigan Avenue  
**New Jersey 08608, Trenton;** W. C. Youkers, 724 Broad St. Bank Bldg. 143 E. State St.  
**Virginia 23230, Richmond;** Benjamin W. Hutcheson, 3105 West Marshall Street

#### TECHNICAL REPRESENTATIVES

**Alabama 35801, Huntsville;** W. A. Brown & Associates, Inc., 1314 Buford Street, N.W.  
**Arizona 85004, Phoenix;** Hytronic Measurements, Inc., 1017 North Third Street  
**California 91803, Alhambra;** M. W. Riedel & Company, 2215 West Valley Boulevard  
**California 94061, Redwood City;** The Woodworth Company, P.O. Box 2165  
**Colorado 80207, Denver;** Hytronic Measurements, Inc., 4940 East 39th St.  
**Connecticut 06514, Hamden;** L-K Associates, Box 4104  
**D.C. 20036, Washington;** P. F. Bell, 1028 Connecticut Avenue, N.W.  
**Florida 33308, Ft. Lauderdale;** W. A. Brown & Associates, 3039 N. E. 32nd Avenue  
**Florida 32548, Ft. Walton Beach;** W. A. Brown & Associates, 18 Chelsea Drive  
**Florida 32802, Orlando;** W. A. Brown & Associates, P.O. Box 513  
**Illinois 60635, Chicago;** Claude Booth & Associates, 1921 North Harlem Avenue  
**Indiana 46809, Ft. Wayne;** McDonald Sales Company, P.O. Box 2848  
**Iowa 50314, Des Moines;** Forristal-Young Sales Company, P.O. Box 1170  
**Kansas 66205, Mission;** Forristal-Young Sales Company, P.O. Box 552  
**Massachusetts 01830, Haverhill;** L-K Associates, 359 Main Street  
**Missouri 63117, St. Louis;** Forristal-Young Sales Company, 7110 Oakland Avenue  
**New Jersey 07001, Red Bank;** Dolan-McCloskey Associates, 16 Spring St.  
**New Mexico 87108, Albuquerque;** Hytronic Measurements, Inc., 205 San Pablo, W.  
**New York 14618, Rochester;** Reed Electronics, Inc., 2815 Monroe Avenue  
**New York 13850, Vestal;** Reed Electronics, Inc., P.O. Box 187  
**North Carolina 27101, Winston-Salem;** W. A. Brown & Associates, 1108 Burke St.  
**Pennsylvania 19480, Eagle;** P. F. Bell, P.O. Box 300  
**Texas 75219, Dallas;** Hillman Enterprises, Suite 208, 3505 Turtle Creek Boulevard  
**Utah 84115, Salt Lake City;** Hytronic Measurements, Inc., 2022 S. Main St.  
**Washington 98114, Seattle;** The Thorson Company, 1767 Fifteenth Ave., South

#### MANUFACTURING PLANTS/WAREHOUSES

**Arkansas 71742, Fordyce;** P.O. Box 577  
**California 94010, Burlingame;** 30 Ingold Road  
**California 90065, Los Angeles;** 3043 Rosslyn Street  
**Connecticut 06473, North Haven;** 60 Dodge Avenue (Headquarters)  
**Florida 33601, Tampa;** 505 North Rome, P.O. Box 3009  
**Illinois 60160, Melrose Park;** 1940 North Janice Avenue  
**New Jersey 07746, Marlboro;** Freehold Road, Rte. #79  
**New York 10702, Yonkers;** P.O. Box 448  
**North Carolina 28201, Charlotte;** 919 Berryhill Road, P.O. Box 1802  
**Oregon 97210, Portland;** 2950 N. W. Yean Avenue  
**Texas 77055, Houston;** 8111 Kempwood Drive, Kempwood Park

## The tapes that didn't add up

"When I came home with material for a story on whether systems companies should design their own LSI chips or leave the design to semiconductor houses," says West Coast Editor Elizabeth deAtley, "I had visited 10 systems and 11 semiconductor companies in California, Texas, Michigan and Massachusetts. I listened to the tape-recorded interviews as I did my dishwashing, ballet and yoga. I was caught up by the force of each person's argument; then five minutes later I'd be listening to somebody else arguing just as compellingly, but 180° out of phase. So I'd phone the first person to ask him what he thought of the second person's idea—and collected 38 hours' worth of tapes but still no story. When I tried to summarize people's views on paper, it was Dullsville. All the lively crossfire of ideas was lost.

"Meantime, my husband had also been listening to the tapes. 'You know,' he remarked one day, 'these people sound as if they are talking to each other. How about writing the story in the form of a panel meeting?'"

"So I did."

It begins on p. 44.

## Testing the C-5A's instruments

On a recent tour of major military centers in California, Military-Aerospace Editor John F. Mason hit Edwards Air Force Base in the Mojave Desert just in time to watch engineers prepare for flight-testing of instruments aboard the largest aircraft in the world, the Military Air Lift Command's C-5A, built by Lockheed-Georgia. Details on how such tests are instrumented and Mason's picture story start on p. 26.



## The Competition And Us.

### More than an open and closed case.

Three fine rotary switches. Two competitors'. And ours.

The open deck rotary switch on the right is probably the most versatile type switch available today. It is simple. Functional. And very inexpensive.

However, an open switch is highly susceptible to contamination, damage, even tampering. It must be handled carefully. Both in production and in end use.

At Stackpole, we've designed a *totally enclosed* rotary for only pennies more and without sacrificing flexibility. And tough as they come.

To the left is a closed type rotary often considered as top-

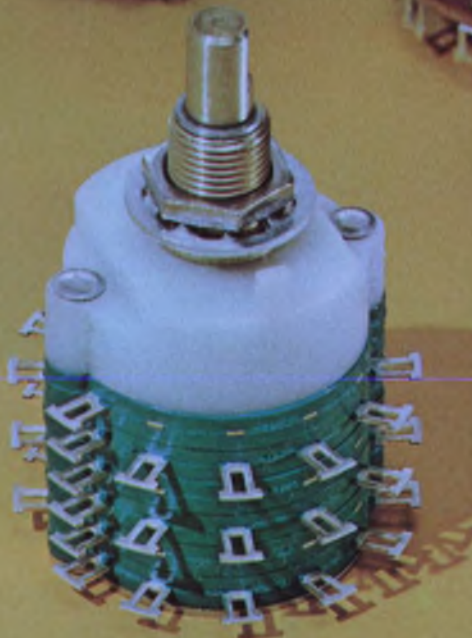
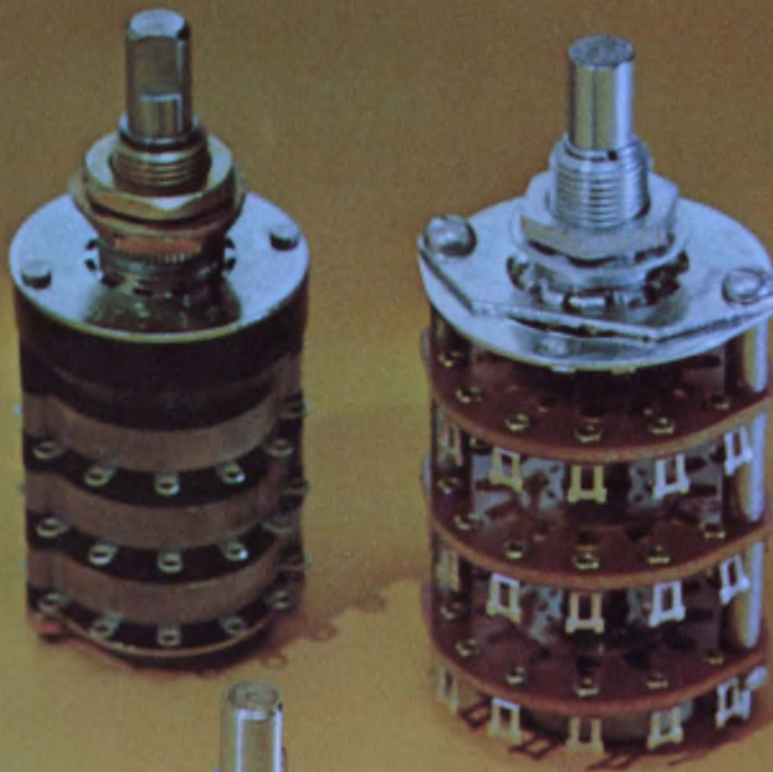

of-the-line. Rugged. Well made. Expensive.

Unfortunately it is severely limited. No interconnection of adjacent terminals or decks is possible.

The slots through which riveted terminals protrude in this so-called closed rotary prevent total enclosure. Permit looseness. Stackpole molds contacts and terminals right into the switch body. Everything's

rigid. Tight. We call it "Environment proof." And it costs a lot less.

That leaves the Stackpole Series 100 rotary switch. Front and center. A totally new concept in rotary construction. Decks interconnect internally. Adjacent terminals may be interconnected internally or externally. At no extra cost.

Another feature is compactness. Note the shorter build-up in length. Then there's the wear compensating dual-ball detent. Rotation is precise. Positive.

Compare. Send for a sample. Made to your specifications in 2 to 3 days. Production quantities in 2 to 3 weeks. For data, quotation or samples, contact: Stackpole Components Company, P.O. Box 14466, Raleigh, N.C. 27610.

Right in the middle is value. Stackpole rotary switches.

Now in two sizes

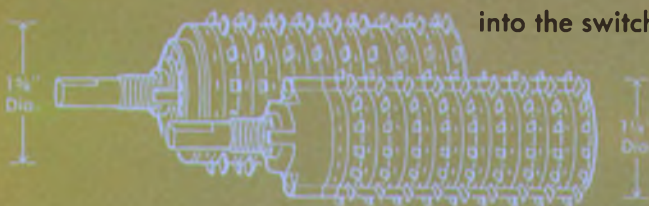

Also the leading producer of quality slide and rocker switches and linear potentiometers.

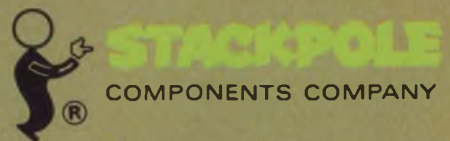



## Publisher

Hugh R. Roome

## Editors

New York Office  
850 Third Ave.  
New York, N.Y., 10022  
(212) 751-5530

**Editor**, Howard Bierman  
**Managing Editor**, Frank Egan  
**Computers**, Milton J. Lowenstein  
**Circuits**, Don Mennie  
**Microwaves**, Michael J. Riezenman  
**Microelectronics**, Raymond D. Speer  
**Management**, Richard L. Turmail  
**News Chief**, Ralph Dobriner  
**News**, John N. Kessler  
**Military-Aerospace**, John F. Mason  
**New Products**, Roger Allan  
**New Products**, Lucinda Mattera  
**Directory Manager**, Greg Guercio  
**Copy**, Marion Allen

## Field Offices

### Washington

Charles D. LaFond  
P.O. Box 138  
Burke, Va. 22015  
(702) 461-7210

### Massachusetts

Jim McDermott  
P.O. Box 470  
Easthampton, Mass. 01027  
(413) 527-3643

### San Francisco

Elizabeth de Atley  
2051 Wellesley St. (Suite D)  
Palo Alto, Calif. 94306  
(415) 321-7348

### Los Angeles

David Kaye  
2930 Imperial Highway  
Inglewood, Calif. 90303  
(213) 757-0183

## Editorial Production

Dollie S. Viebig  
Richard D. Grissom

## Art

**Art Director**, Clifford M. Gardiner  
**Assistant**, William Kelly  
Rita Jendrzewski  
Lynn Thompson  
JoJo Miskimmon

## Production

**Manager**, Thomas V. Sedita  
Helen De Polo  
Kathleen McConkey  
Leslie Stein

## Circulation

**Manager**, Nancy L. Merritt

## Information Retrieval

Genate Piccinetti

## EDITORIAL



## His IC brainchild is no baby any more

We were happy to learn recently that Jack Kilby of Texas Instruments was awarded a 1969 National Medal of Science Award by President Nixon and his science advisers. These medals are the Government's highest awards for distinguished achievements in science and engineering, and Kilby received his "for original conceptions and valuable contributions in the production and application of integrated circuits."

Announcement of the award started us thinking about the enormous influence ICs have had on the electronics industry since Jack Kilby demonstrated his first circuit in 1957-58. Today ICs are a fact of life to the engineer, and anyone who does not use—or at least consider—them in his designs is just not with it. Many older designers wonder how they ever got along before ICs moved onto the scene.

But strong as the IC influence has been to date, the coming of LSI may cause it to pale by comparison. Ordinary integrated circuits did not disrupt the conventional designer-component manufacturer relationship. They merely raised the design level so that the engineer designed on the function, instead of the component, plane.

But with LSI, and the equivalent of hundreds of gate functions on a single chip, the relationship between the designer and the semiconductor manufacturer may be in for an upheaval.

The LSI chip may represent most, if not all, of the designer's system—so who does the actual design? And if it's the semiconductor manufacturer, what does the designer do?

At this point in time it's too early to answer these questions with certainty. The viewpoints of knowledgeable people in the field, though, are given in the report on p. 44.

Another thought occurred to us upon hearing of Kilby's award: namely, that the so-called military-industrial complex—anathema to many—was in large part responsible for bringing the integrated circuit out of the laboratory and into use. It was the Avionics Laboratory at Wright Patterson Air Force Base that funded much of the early development work, and the guidance system of the Minuteman missile proved the operational feasibility of ICs on a large scale.

This doesn't mean, of course, that military spenders should be given carte blanche. Rather, it indicates that defense procurement and contracting are not universally wasteful, as some would have us believe.

FRANK EGAN

# LSI poses dilemma

By Elizabeth de Atley, West Coast Editor

"The computer-on-a-chip is no big deal," says Lee Boysel, president of Four-Phase Systems, Cupertino, Calif. "It's almost here now. We're down to nine chips, and we're not even pushing the state of the art. I've no doubt the whole computer will be on one chip within five years."

But who designs the chip—the systems company or the semiconductor manufacturer? You can find advocates for either approach in the industry today. On what do they base their decisions?

Boysel and his associates have designed an MOS mini-computer that, they say, will do 75% of the functions of a large, general-purpose computer. It consists of a nine-chip central processing unit and 100k-bytes of random-access memory made up of 1024-bit MOS chips, each with its own decoding. Boysel insists his company could never have accomplished this if it had let an outside semiconductor house do the chip design, as most systems companies do.

"You can't put that much of a system on one chip without having a good grasp of both the system *and* the technology," he says. "Either you turn over all your system secrets to a semiconductor company—and hope they care as much about your success as you do—or you do the chip design."

As LSI grows more complex, will many other systems companies conclude they must do their own chip design? If so, what will the semiconductor companies do? Straight wafer processing? Already two new plants—Nortec of Santa Clara, Calif., and Cartesian of Cupertino, Calif.—have opened their doors as specialists in wafer processing. They leave the chip design entirely to their system customers. Do they represent the beginning of a trend?

ELECTRONIC DESIGN interviewed 10 systems and semiconductor specialists on the question "Should systems companies design their own chips?"

Here is how they answered:

	Systems Companies should design own chips	Semiconductor Companies should design chips
Robert W. Ulrickson, manager, Systems and Applications Engineering Dept., Fairchild Semiconductor, Mountain View, Calif.		✓
Ralph Parris, staff engineer, Circuits and Packaging Dept., Product Engineering, Burroughs Corp., Plymouth, Mich.		✓
Laurence C. Drew, manager, Engineering Development, Viatron Computer Systems, Bedford, Mass.	✓	
Don Farina, president, Integrated Systems Technology, Inc., Santa Clara, Calif.	✓	
Daniel E. Borrer, vice president, Cartesian, Inc., Cupertino, Calif.	✓	
Robert H. Norman, president Nortec Electronics Corp., Santa Clara, Calif.	✓	
Lee Boysel, president, Four-Phase Systems, Cupertino, Calif.	✓	
William E. Ballard, manager, Tactical Communications; Len A. Gille, engineering specialist, and Vince Christmas, senior member, technical staff, all of Litton Data Systems, Van Nuys, Calif.		✓

# for systems designers

Here, in panel-discussion form, is how the 10 explained their answers:

**ULRICKSON** (Fairchild Semiconductor): The customer can do his own chip layout and send us art work or finished masks if he wants to, but we don't feel this is the best interface. He risks the possibility that his circuits won't work. We can't promise him good circuits if we haven't laid out the chips ourselves.

**BOYSEL** (Four-Phase Systems): We're willing to take that risk. And we prefer to work with the semiconductor company this way because the division of labor is clear-cut. We do the chip layout down through the ruby lith stage and send it out for working plates and wafer processing. When the wafers come back, we do the scribing, packaging and final test ourselves. The question of who is to blame if the circuit's don't work is resolved by the performance of special test chips, interspersed among the working circuits on the wafer. We set up an acceptance criterion with the semiconductor company, based on the distribution and number of good test chips. For example, if

the test chips in the four corners of a rectangle are all good, then we assume the area inside will be good too. If the estimated yield is 10% or greater, we accept the wafer. Otherwise we reject it.

**ELECTRONIC DESIGN:** What's in the test chip?

**BOYSEL:** It contains a 64-bit shift register, several MOS transistors of various sizes and a large capacitor. We use the shift register as a quick measure of functional performance. The transistors are used to test wafer parameters, like punch-through, and the capacitor to plot capacitance vs voltage at room temperature and at elevated temperature. From the resultant shift in the C-V plot, we can measure the level of contaminants in the furnaces and weed out long-term failures.

**ELECTRONIC DESIGN:** What correlation have you been getting between good test chips and good working circuits?

**BOYSEL:** Excellent.

**ELECTRONIC DESIGN:** What have your yields on working circuits been running?

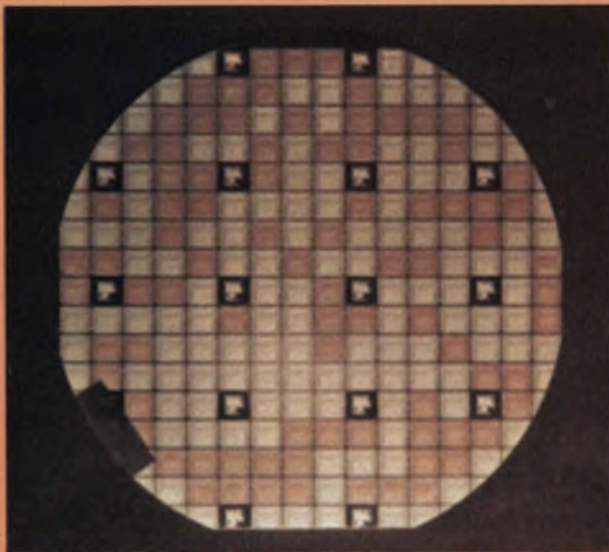

This wafer, designed by Four-Phase Systems, contains 15 test devices (dark-edged squares) interspersed among arithmetic logic circuits. The bad working circuits are marked orange.

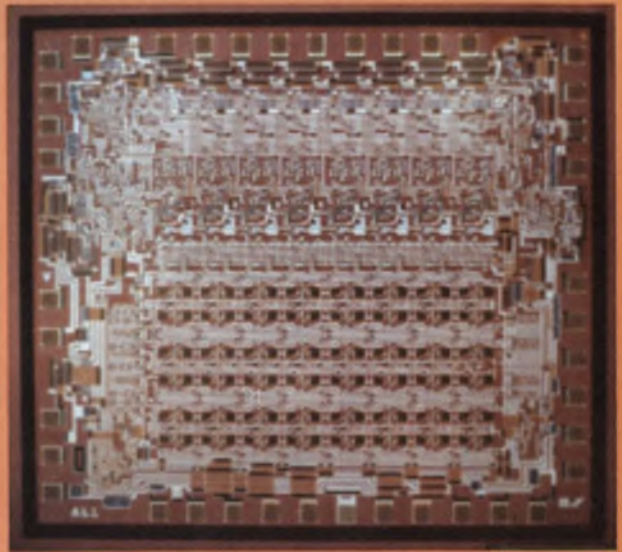

This arithmetic logic chip of Four-Phase Systems is 110 x 120 mils—about average for an LSI chip—but, instead of 100 gates, typical for a chip of that size, it contains 700—800 logic gates.



**Lee Boyssel, President, Four-Phase Systems.** "We could never have designed our computer on nine chips if we had just chunked up a logic design into pieces and given them to a semiconductor house to put on chips."

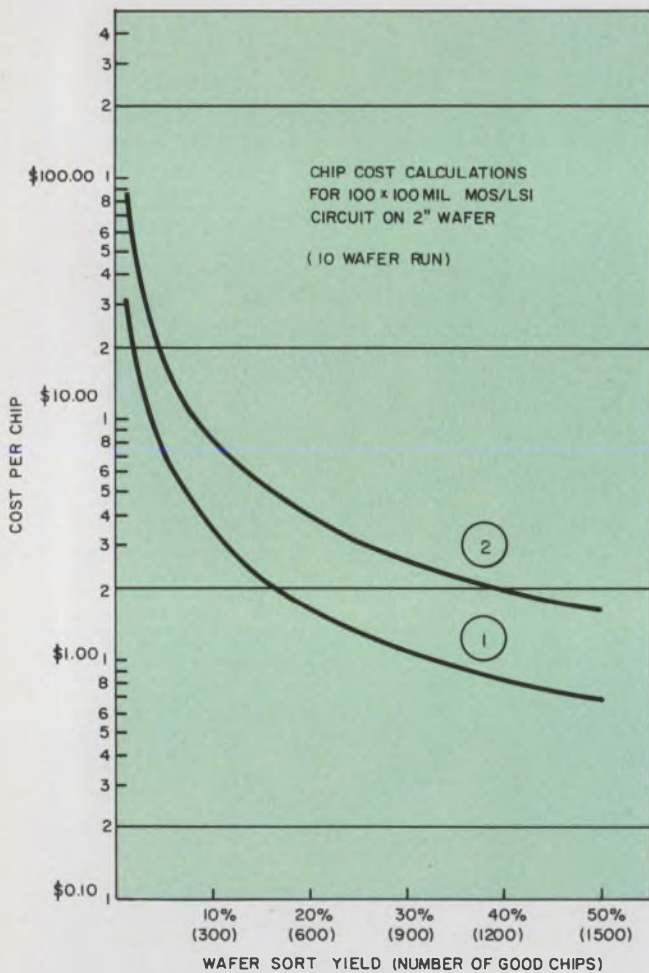

Cartesian uses these curves to show its systems customers how to estimate the cost per chip for having ten wafers processed. Curve 1 shows the cost versus yield based on Cartesian's charge of \$1000 for ten wafers. Curve 2 shows the cost versus yield based on their charge of \$1000 for processing ten wafers, plus their charge of \$2500 for making the masks. As for the yield the customer may expect, Don Borrer, Vice President of Cartesian, says 20% is not unusual. Cartesian normally intersperses test chips among the working circuits on the wafer, just as Four-Phase Systems does. Yields on these test chips have been running as high as 50%, says Borrer.

**BOYSEL:** That depends on the chip size. On the 1024-bit random-access memories, which are  $150 \times 160$  mils square, the yields have been between 10% and 20%—but you have to remember that we reject anything under 10%. On our smaller chips, the yield has been much higher—even for the most complex circuits. For example, take our arithmetic logic circuit. It's  $110 \times 120$  mils square and contains between seven and eight times as many gates as most LSI chips that size. Yields on this device have been running between 30% and 50%.

**ELECTRONIC DESIGN:** Who processes the wafers for you?

**BOYSEL:** We've used both Nortec and Cartesian, with excellent results, and we expect to work with some other companies in the future.

**BALLARD (Litton Data Systems):** If you design your own chips in-house, you must orient yourself to one company or else use a conglomeration of several people's design rules. If you use a conglomerate set of rules so several people can make your chips, then I don't think you can get the optimum device. For example, I doubt that you would get a very high-speed, random-access memory this way.

**BOYSEL:** Our memory isn't fast in the conventional sense. The system speed for 100K bytes is only around 3 to 4 microseconds cycle time, compared with 1 to 2 microseconds for cores. But ours can do several jobs at the same time. For example, the 3-to-4-microsecond cycle time includes both a memory cycle and the input/output memory access time. So actually it's faster than a core.

**ULRICKSON (Fairchild):** Few systems houses go as far as Four-Phase in chip design. A more popular approach is what I call the middle interface. The customer designs his system using our standard cells and partitions it into chips. Then we lay out the blocks with our computer-aided design techniques, make the masks and send him prototype wafers. This gives him the maximum control over his design, and it gives us the optimum chips to integrate.

**PARRIS (Burroughs Corp.):** We have found this an effective interface with the semiconductor companies. We don't pay much attention to how the chip is laid out. We find it isn't necessary to get into the act on that level. What we normally do is define the performance we want in terms of speed and power and partition the system into chips. We've worked with the technology enough to know pretty much what you can put into a chip and what are the best compromises for breaking up a system. We think about things like: How much logic complexity can go into a chip? What amount of power will the chip dissipate? We think about chip area in terms of yield. We also think about testing. Some chips with a

## ... And then there's the question of who makes the wafer

If systems companies do their own chip design, should they take over processing of the wafer, too?

Here, in essence, is how the representatives of two systems companies and one semiconductor house answer this question:

**Hewlett-Packard:** "For state-of-the-art technologies, its only good business."

**Texas Instruments:** "It's business suicide."

**The Singer Co.:** "It depends on the business you're in."

Three specialists at Hewlett-Packard's Instrumentation Div. in Santa Clara, Calif.—Merrill W. Brooksby, engineering section manager; Ed Hilton, manager of ICs, and John Hulme, manager of IC applications—explain their answers this way:

**Brooksby:** We need Fairchild, Motorola and TI far more than they need us. We buy parts from them as soon as they become standard and available throughout the industry. The same would be true of technologies, like MOS-LSI.

**Hulme:** But in the instrument business HP has to build innovative things, and it really would be a questionable practice to go shopping around among component suppliers two years before announcing something, because we would have to tell the suppliers what we wanted, why and what the specs were. And there's no reason at all why many of them wouldn't be in the same kind of business if they knew what was involved.

**Brooksby:** Yes, there's the fear of compromise—on both sides actually. If they're working on some state-of-the-art thing, they don't want to talk to us about it either.

**Hilton:** To understand how to apply any technology to instruments, we need to have an in-house facility in that technology. If we sit back and let them tell us what they want to, we won't know ahead of time that some of these things can be done. We won't even know what to ask for. But by having our own facility, we can often introduce an instrument with a new kind of device in it before anyone else does.

A Texas Instruments vice president, Glenn E. Penisten, summarizes the case against wafer processing by systems companies in these words:

"I've seen it happen time and time again when an equipment house invests in one of the semiconductor technologies. First of all, they have to choose which technology is right for them out of some 12 possible choices, including several MOS technologies—bipolar, optoelectronic and microwave. To have even a small state-of-the-art pilot line

in one of these 12 takes an initial outlay of between \$3-million and \$5-million.

"Let's take a specific example. Let's say that two years ago a calculator company had decided to build an electronic calculator with its own in-house facility. At that time bipolar DTL was the obvious choice of technologies for an electronic calculator. So our hypothetical company would have spent their \$5-million or so on a small DTL pilot line. And today they would be forced to recognize they had made a bad mistake, because only MOS is going into calculators today. And you know why they would be forced to recognize their mistake now? Because by now they would have been forced clear out of the marketplace.

To help the customer solve this problem, says Penisten, TI has set up a Customer Engineering Center as an independent department that reports to Jack Kilby, assistant vice president.

If a customer comes in with a particular requirement, TI will contract to develop his product for him on a consultant basis if he desires. Thus he need not commit himself to a production run unless he wishes to.

"If the customer pays for the engineering knowledge," Kilby says, "the Custom Engineering Center will keep the results of the program proprietary for an agreed period of time."

Finally, there is the yes-and-no approach to the question.

"You have to decide what your business is," says George Hare, acting technical director of the Singer Research Laboratory, Palo Alto, Calif. "If you're going to be in the business of buying and selling, get yourself a group of salesmen and buyers. That's what Montgomery Ward has done. But, generally speaking, systems houses are in the business of making something. And it isn't efficient to buy parts from somebody else and just assemble them.

"We have two criteria for deciding whether to make or buy a particular product. First: Is the volume of business we do in that product comparable to the size of a typical small company that specializes in it? If so, then it may be more efficient for us to make it ourselves, just because of the difficulties involved in communicating our needs to an outside company.

"Second: Is the industry mature enough so we are likely to find a viable reservoir of talent to support an operation in-house? Nowadays, thanks to the great universities of TI, Motorola and Fairchild, there are thousands of people all over the country who are knowledgeable in wafer processing."



Jerry Wozniak, Senior Staff Engineer, Lockheed Missiles & Space Co. "What's to stop the semiconductor com-

panies from going into the systems business in competition with their systems customers?"

lot of buried flip-flops can be a real mess to test. It's a big help to be able to set all the flip-flops to some known state, so when you start applying test patterns, you at least know where you're starting from. Sometimes, too, you like to put in a special test pad, so even if you don't bring it out to a package pin, you can probe to see whether a logic signal has propagated some portion of the way through the chip properly.

**ULRICKSON:** The customer can learn what he needs to know to do all this by reading our design manual carefully and talking to us. Then he can take his basic logic diagram and convert it to our cell set. That way he will get a much more powerful implementation of his system than he would if he designed it with nothing but NOR gates. That's what so many people do in MOS, and we have much more powerful logic blocks than just simple NOR gates. By converting the logic into the right form, it's often possible to use these more powerful blocks.

**NORMAN** (Nortec Electronics Corp.): This approach doesn't give the system designer the control he needs. With LSI you've got so many alternative ways to organize a system that it pays you to rethink the fundamental architecture in terms of chip layout. But to do that, you've got to do your own chip layout, because that's the tool you work with in LSI—not the packaged device.

#### Use rules of thumb for partitioning

**ULRICKSON:** The system designer does not need to know chip layout to restructure his system. That's the beauty of interfacing at the level

of partitioned logic. If he designs with our standard cells, we can give him rules of thumb for estimating chip area pretty accurately.

**BOYSEL** (Four-Phase Systems): We could never have designed our computer on nine chips if we had just chunked up a logic design into pieces and given them to a semiconductor house to put on chips. We wanted to use every available square micron, and we had to actually do the chip layout before we could know what space was available. Then we had to go back over the whole system to pull out functions and put them into the available spots. It was a tradeoff between the system organization and the chip layout.

Furthermore we had to do this by hand to get the complexities we're talking about. Look at our arithmetic logic chip, for example. It's at least seven times as dense as the average LSI chip. The computer just can't lay out something this complex. It would saturate the core immediately.

You've got to get your engineers right down in the dirt if you want to do this level of complexity. We start from the over-all architecture, logic design, circuit design, layout and art work. The guy who does the architectural partitioning does the circuit design himself. He does his own layout and follows it right through the art work down to the rubyolith stage. He designs his own test equipment and his own test program. Then we cross-check each other. Two or three different people come in and reconstruct the design and compare it with the schematics. We do this throughout the design cycle. We spend a long time in the design phase. For example, it took us six months to design the arithmetic logic chip. But this has really paid off. We've run seven



Fairchild's computer-aided design system will do the layout and generate test programs for the customer's

LSI chips. The customer designs his system using standard Fairchild cells.

different circuits now—that's all the circuits for the main computer—and every single one of them worked the first time. We just don't have any failures.

**ULRICKSON:** It's all very well to spend six months designing a single chip if you're going to produce it in very high volume. But most LSI, by its nature, is low volume. When you put 100 gates or more on a chip, there won't be too many chips that you will be able to use more than once in a system. So the total number of chips of any one type will be equal to the total number of systems you're going to build—plus spares. Now if you're building a mini-computer, your volume may be high enough to justify the time necessary to handcraft it. But a more typical example of an LSI requirement might be some complex function in a military aircraft. You wouldn't be able to afford months of engineering time to produce maybe 100 circuits plus spares. What you want then is quick turn-around, and that we can give you with standard cells and CAD (computer-aided-design). You may sacrifice some silicon area and hence yield with standard cells, but the reduced engineering cost more than compensates for this loss.

**GILLE** (Litton Data Systems): The building block approach is good for us. We don't care about the chip area, because our volume is low. Our highest volume on a custom circuit is about 5000 spread out over four or five years, so the engineering development costs are a big part of the cost per circuit. If the semiconductor houses can cut this cost significantly by using CAD, then what do we care if we only get 5% yield instead of 6? We don't need that many circuits

anyway, and the biggest cost to us is their engineering development.

#### Systems people should develop chips

**FARINA** (Integrated Systems Technology, Inc.): But the systems people can develop their own circuits as part of the total system development. The ideal approach is for the circuit-systems engineering team at the systems company to work together on the total systems problem, which may involve many chips. If they're going to optimize the total system, it's got to be an iterative process. They've got to keep reconfiguring the system to get a better chip layout. But they have the motivation to do this because they're interested in that piece of equipment. They're getting paid to do a good job on the total system. If, instead, they turn it over to a semiconductor company, those engineers are not interested in reconfiguring the system to make the total job more efficient or cheaper. They can't be. Their volume is simply too great. They're interested in making the chips as cheaply and quickly as possible, based on the input documentation they receive.

**DREW** (Viatron Computer Systems): If the systems house is really going to do something seriously, I would say it probably has to go as far as the chip layout. There aren't that many people around the country who know what they're doing. In any one semiconductor house you may find five or six people, but they're trying to do 50 jobs, and that means they can't be effective in any one of them. They tend to take shortcuts, which lead to mistakes and stretched

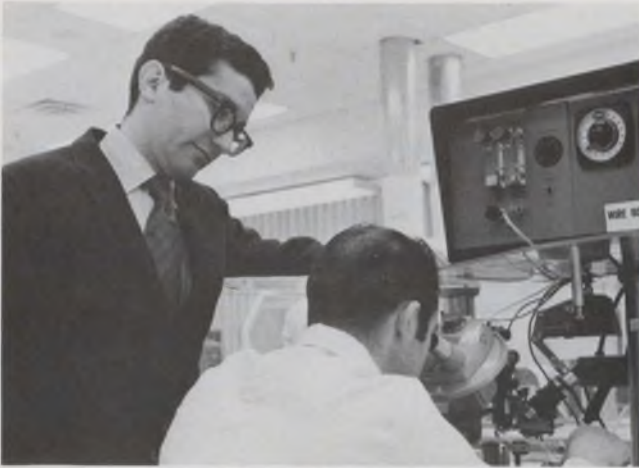

**Leonard J. Martire, Manager, Microelectronic Products, TRW Systems.** "As circuits get more complex, what do the systems houses do? Become totally dependent on an outside vendor? If we're having difficulty interfacing now on a DTL logic spec, what's going to happen when we talk about a 500-bit shift register or something more complex?"



**Laurence C. Drew, Manager, Engineering Development, Viatron Computer Systems.** "If the systems house is really going to do something seriously, I would say it probably has to go as far as the chip layout."

out schedules.

**ELECTRONIC DESIGN:** Have you found semiconductor companies willing to work with you on this basis?

**DREW:** I haven't found anybody not.

**ELECTRONIC DESIGN:** Would you make use of a small prototype shop, like Nortec?

**DREW:** I *have* used Nortec—with great success!

**ULRICKSON (Fairchild):** Sure, we're busy. We've got more customers out there who want MOS LSI than we or the whole industry can satisfy. The market has grown much faster than we thought it would. We're currently turning some customers away. The problem isn't in the factory—we have the capacity there. The problem is that we don't have enough people to talk to all the customers. If the customer hasn't followed our design handbook in designing his logic and partitioning his system, then we have to have one of our systems engineers sit down with his systems engineer, work out the problems, partition the logic and try to convert his logic diagram into our cell set. If we have to do that with a significant number of customers, we can't hire enough systems engineers to meet the need. But if he reads our design handbook and then comes here and works with us for a couple of days, he becomes fairly expert at designing in terms of our cell set, and then the problem gets solved. When he comes back a second time, it's easy to interface with him,

**FARINA (Integrated Systems Technology):** We feel that before the systems engineer ever goes to see a semiconductor company, he ought, as a minimum, to do a plan diagram of the chip showing the building blocks as blank rectangles and interconnecting them with hand-drawn lines. From this he can determine the chip size, calculate the load capacities and determine the performance.

**ULRICKSON:** Why should he do the interconnection himself? It's a very tedious process, and we'll just whip it into the computer and do it automatically.

**FARINA:** But these computer routines aren't very effective. They're really just first-order aids. The semiconductor industry has been forced to use a computer because they can't afford to assign an engineer to every chip. But the computer doesn't really organize the placement of the cells in the most desirable locations.

#### The computer doesn't do it alone

**ULRICKSON:** But the computer doesn't do the layout all by itself. We use an interactive program. The computer takes a cut at it and wires it completely, but it may not be exactly what the designer wants. Our designers may go



back to the computer five or 10 times for new routing—after moving things around and changing wires. The computer runs take only 5 or 10 minutes, so the whole process amounts to less than an hour of computer time. We have two interactive programs—placement modification and wire modification—and the designer can play with it until he's satisfied. The computer does the tedious parts. Every time the designer makes a change, the computer automatically incorporates it into the over-all design, making all the other changes that go with it.

**FARINA:** But why not have the systems guy do that to begin with? He wouldn't really have to use a computer because his volume is low. He may only have two or three chips a month, so he can afford to take the time to lay out and interconnect the cells by hand. In fact, we advocate that the customer use his own building blocks. We've generated a set of design rules that are compatible with pretty much all of the thick-oxide MOS processes, and we can make available a library of standard cells which he can use as a basic tool, designing additional cells to do specific things more efficiently.

Now, don't get me wrong. There's a place for the CAD programs of the semiconductor industry. I would guess that they might do perhaps 75% of all the chips, and it may not be important to optimize the chip area for those 75%. The more important criteria may be quick turn-around time and confidence that the devices can be made—because you assume that the cell library used by a big semiconductor company would have had a lot of shakeout and experience in its use. But there are always those chips that are weird. For example, some chips contain both logic and a little bit of read-only memory right in the chip to microprogram just that chip. And that just doesn't lend itself to a CAD library, because you need different amounts of read-only memory, different word lengths, different ways of gating in and out, different ways of decoding, and so on. In fact, decoding is a very typical example. A standard cell library might contain a 6-bit decoder. A computer would run 32 lines from this block to various parts of the chip. But if an engineer had the capability of designing his own special cells, he might distribute the decoder throughout the chip and decode only where each term is required. In one case that we had experience with, this procedure eliminated about two-thirds of the interconnect area. We feel that, given the basic ground rules, with examples of a standard cell library, it's an easy thing for the system designer to generate new cells. And, really, that's the way to minimize chip area—use standard cells where they're appropriate and customize where necessary.

**ELECTRONIC DESIGN:** How will the design-

er get working circuits?

**FARINA:** He can get prototypes made by a small prototype shop, or even by a large semiconductor company. If these work satisfactorily, he can then feel confident that the same devices can be made in production.

**ELECTRONIC DESIGN:** How should he test his chips?

**FARINA:** Well, he can follow any one of several approaches. He might generate a complete test program, either by hand or with CAD, in the early design stages. Or he might have the semiconductor company go ahead and package 100 prototype parts after testing the individual chips very superficially—perhaps just by means of a test transistor on the chip. Then when he gets the packaged prototype parts, he could test them one at a time with a superficial test sequence or assemble them into a test jig that is a prototype of the system and exercise the whole system with an input exerciser. This could be a PDP8 with a simulated keyboard stored in memory, or whatever he was using to demonstrate to management and their customers that they have a computer. He would use this test jig to prove out the chip designs. In a typical chip, most of the outputs will work, but there may be one or two consistently bad ones. Very seldom does the whole chip not work. We will then identify the errors, which may be either in the logic or in the artwork, and fix them. Now remember, he still hasn't devised a test sequence to test the chips in production. All he's done is obtain some chips, put them in a test jig and find out what the problems are. He may want to change the design. But so far he hasn't generated a long test sequence to use in production, which is a costly affair if it's done right. After he's redesigned maybe 10% or 20% of the chips and knows he has a compatible set, then he devotes the engineering time necessary to generate a more complete test sequence, either with CAD or by hand. This test sequence he then gives to the semiconductor company to use as the final acceptance criterion. Or in the case of a simple system containing no more than, say, five chips, he can, if he wishes, furnish the semiconductor people with a prototype system using the same input simulator he devised earlier, and they can use this to test the chips in production.

**ELECTRONIC DESIGN:** How would they do that?

**FARINA:** Well, suppose they're testing chip No. 5 of his system. They have a prototype system with a good chip No. 5 mounted in the test jig. When they want to test a wafer that contains chip No. 5's, they just unplug the good chip No. 5 from the board and hook up their wafer probe station in its place. The final output of the system, based on the test sequence the



**Don Farina, President, Integrated Systems Technology, Inc.** "We feel that, given the basic ground rules with examples of a standard cell library, it's an easy thing for a systems designer to generate his own new cells."

system designer has already worked out for it, constitutes the acceptance criterion.

**ULRICKSON (Fairchild):** We have one customer who will accept this functional type of test. We take the entertainment module from the Boeing 747, plug it in and if music comes out the end, it's okay. But for a complex computer system, most customers want a higher level of confidence than this can give them. People say that no computer in service today has been fully checked out, and this is probably true, because the number of sequences required to do so would take a ridiculously long time to go through. Generally the user prefers to test each chip thoroughly, as well as testing the whole system. And I think this is possible today. With CAD techniques, we can identify all the logical faults that can occur on a chip and automatically generate a test sequence that will find all those faults.

**ELECTRONIC DESIGN:** How do you feel about the user doing the layout with his own set of standard cells and designing others as he needs them?

**ULRICKSON:** He can do the layout if he wants to, and if he doesn't mind taking the risk. But I don't think there's any cost advantage to be gained. In fact, there's a distinct advantage to be *lost* if the cells he uses aren't optimized for our technology. As for designing new cells, if he's working with us and he needs something that isn't in our library, he should talk to us. We can design a new cell in a week. Then we plug it into the machine and store it forever. We've designed new cells for about half the jobs we've done. That's our bag. We know all about how to design ICs. But if he tries to take on the design of ICs and come up with an optimized cell, he's getting himself into a can of worms that he doesn't really understand that well. And if he deludes

himself into thinking he does, then chances are you've got an empire builder in that company somewhere.

**FARINA:** I agree it would be very difficult to lay out a whole chip, or even an original cell, by hand without quite a bit of training. But to take an existing standard library, such as the one we provide, and to design a few new cells using exactly the same design criteria is not difficult at all. For example, the system designer might want to take a big chunk of logic—such as a ripple-through carry gate or an adder—and put it all in one big block. He would essentially just copy the layout of the gates in the existing cells and condense them a bit.

**CHRISTMAS (Litton Data Systems):** May I interpose a remark here? We've found that the building block approach is just fine, so long as our system can be designed with the existing building blocks within their parameters. But if we need something special, like a static shift register, and the semiconductor company has to design a special building block, there aren't sophisticated enough computer design programs to take in the special criteria and incorporate them into a special part of the chip. It's a cut and patch situation, and the techniques for doing it with CAD are not well-developed at present. They can do it, but we've been surprised at the time it takes to incorporate the corrections and design the program, leaving an open space. In fact, preparing the CAD may be a bigger job than designing the chip by hand.

**ULRICKSON:** I'm sure this would be the case where you have a requirement for a different technology or a process that is incompatible with the rest of the cells. For example, if you had a static cell set and you had a requirement to do a dynamic cell, then this would require maybe as many as four phases of clock signals around the chip, as well as the three-power supply bus lines. This really throws a monkey wrench into the works because the cell library isn't set up for routing an extra four common wires. But if you're not violating any of the basic specs for the cell set and you just want a different function, then it's quite easy to create a new cell. It takes up about a week to lay the cell out by hand. Then it's a matter of one of our assistant drafting gals sitting down for a half hour or 45 minutes, writing the necessary codes and punching the cards, and the new cell is in. ■■

*In considering the question "Should systems companies design their own chips?" some engineers may raise this possibility: "Why make a custom chip at all? Why not build the logic system out of standard LSI and MSI parts?" This alternative will be considered in a forthcoming issue of ELECTRONIC DESIGN.*

# did you know?



General Electric **volt-pac**<sup>®</sup> variable transformers help you vary voltage dependably...year after year,\* after year, after year, after year, after year, after year, after year, after year...

Send in this coupon for free bulletin giving complete details on Volt-Pac transformer features, ratings and application data; or see your GE sales representative today.

\* Laboratory tested for over one million failure-free operations.

GENERAL  ELECTRIC

Section 413-34  
General Electric Company  
Schenectady, New York 12305

Please send me free bulletin GEA-8110 on Volt-Pac Variable Transformers.

NAME \_\_\_\_\_

COMPANY \_\_\_\_\_

TITLE \_\_\_\_\_

ADDRESS \_\_\_\_\_

CITY \_\_\_\_\_ STATE \_\_\_\_\_ ZIP \_\_\_\_\_

# Diodes make good gain-control devices

for high-performance amplifiers. Four different transfer functions are easily obtained with these simple techniques.

The ability to vary electronically the gain of an ac amplifier is a necessity in many systems, from simple radios and television sets to sophisticated radars and communications gear. Probably the most common way of varying the gain of, say, a transistor is to vary its operating point. But this method has two drawbacks that may become serious in high-performance systems:

- It limits the amplifier's dynamic range, because the transistor is operated near cutoff when low gain is needed.
- It changes the amplifier's frequency characteristics, and other parameters as well, since they are all functions of the operating point.

In general, there exists an optimum operating point at which a transistor exhibits its best performance. Any deviation from this point will result in a degradation of some sort: loss of dynamic range, lowering of cutoff frequency, etc.

## Use a diode

What, then, can the designer do if he wants to vary the gain of a transistor without changing its biasing? The answer, obviously, is to change something else.

In particular, if a diode is included in either the emitter or collector leg of the circuit, changing the diode voltage or current will vary its impedance and thus change the circuit's gain without affecting the transistor itself.

Furthermore, depending upon whether the diode is placed in the emitter or collector leg and whether it is controlled by a current or a voltage, four different gain vs control-signal transfer characteristics can be obtained: linear, logarithmic, hyperbolic and inverse logarithmic.

The first step in implementing this scheme is to determine the dynamic resistance of the diode as a function of its applied voltage or current. The voltage across a forward-biased diode is given by

$$V = (\eta KT/q) \ln(I/I_s) + IR_s \quad (1)$$

provided that  $\exp(qV/\eta KT) \gg 1$ . In the equa-

tions,  $I_s$  is the diode saturation current,  $R_s$  is the ohmic (bulk) resistance,  $q$  is the electronic charge,  $\eta$  is a diode constant,  $K$  is Boltzmann's constant,  $T$  is the absolute temperature, and  $V$  and  $I$  are the diode's forward voltage and current.

If Eq. 1 is differentiated with respect to  $I$ , the dynamic diode resistance is obtained. It can be presented in two forms:

$$r_d = (\eta KT/qI) + R_s \quad (2a)$$

$$r_d = (\eta KT/qI_s) \exp(-qV/\eta KT) + R_s \quad (2b)$$

For modern diodes, the bulk resistance,  $R_s$ , is on the order of 1 ohm and can be neglected in both equations.

To make use of Eqs. 2, the two constants  $I_s$  and  $\eta$  must be determined.  $I_s$  is found by examining a plot of  $\log_{10} I$  vs  $V$  (Fig. 1) and extrapolating the straight portion (logarithmic region) until it intersects the ordinate. Alternatively, the reciprocal slope,  $m$ , of the straight portion can be measured and then, using any voltage current pair,  $V_o$  and  $I_o$ ,  $I_s$  is given by:

$$\log_{10} I_s = (m \log_{10} I_o - V_o)/m \quad (3)$$

The reciprocal slope,  $m$ , is measured in volts per decade of current. It should be noted that the curve of Fig. 1 will change with temperature.

The other constant,  $\eta$ , is easily found by dividing the reciprocal slope,  $m$ , by the junction temperature,  $T$ , and then simply consulting Fig. 2.

Typical results show that  $I_s$  is a strong function of temperature while  $\eta$  is relatively unaffected by it. Furthermore, it is found that  $\eta$  is quite constant for a whole diode family although  $I_s$  may vary greatly from unit to unit.

## The four basic circuits

Most amplifier gains can be expressed in the form  $A_v = R_1/R_2$  where  $R_1$  and  $R_2$  are collector and emitter resistances, respectively. Therefore, a variable-resistance diode placed across one of these gain-determining resistors may be used to control the amplifier's gain.

The four basic configurations shown in the box illustrate the flexibility of the technique. Although simple circuits were chosen for explanatory purposes, there is no reason not to use the technique with more complicated amplifiers.

**Richard S. Hughes**, Senior Electronic Engineer, U.S. Naval Weapons Center, China Lake, Calif.

# The four basic configurations

The four circuits shown here demonstrate the flexibility of the diode gain-control approach. In all four cases, the transistor is a 2N744 and the diode is a 1N3064 (FD-100) computer diode.

The gain equations all assume a transistor alpha of unity. Deviations from the ideal response at low values of  $r_d$  are caused by diode saturation. At the other end of the scale, deviations arise as  $r_d$  approaches the value of the bypassed resistance.

For the cases of the emitter-coupled diode (linear and logarithmic functions)  $R_E'$  is the parallel combination of  $R_E$  and  $r_d$ . When the

diode is effectively across the collector resistor (hyperbolic and inverse log functions)  $R_C'$  represents the parallel combination of  $R_C$  and  $r_d$ .

A good working estimate of the gain temperature coefficient for the voltage-controlled cases is  $+2 \text{ mV}/^\circ\text{C}$ . This means that, for decreasing temperatures, increasing the applied voltage by  $2 \text{ mV}/^\circ\text{C}$  will keep the gain constant. For the current-controlled cases, the temperature coefficient is approximately  $-0.17\%/^\circ\text{C}$ . Thus, for decreasing temperatures, decreasing  $I$  by  $0.17\%/^\circ\text{C}$  will provide constant gain.

These numbers assume silicon diodes.

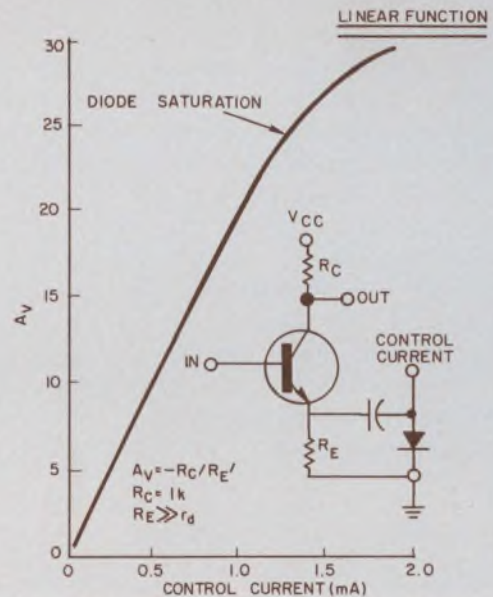
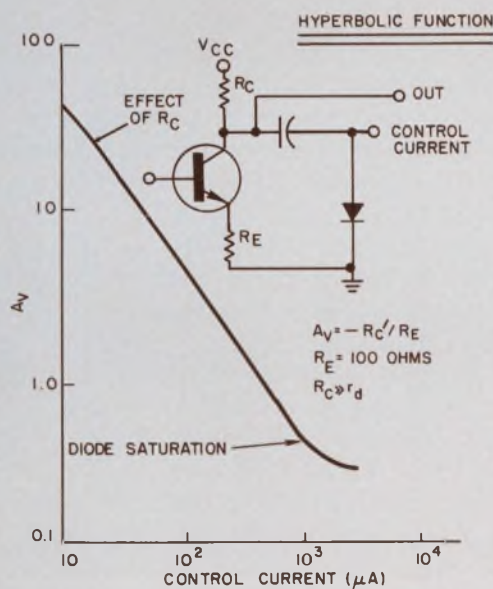
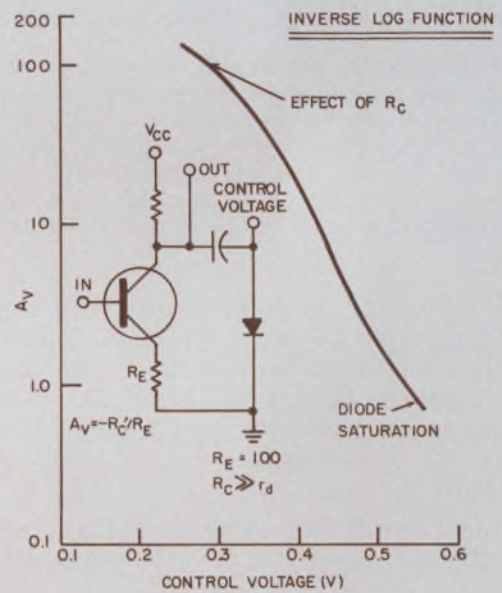
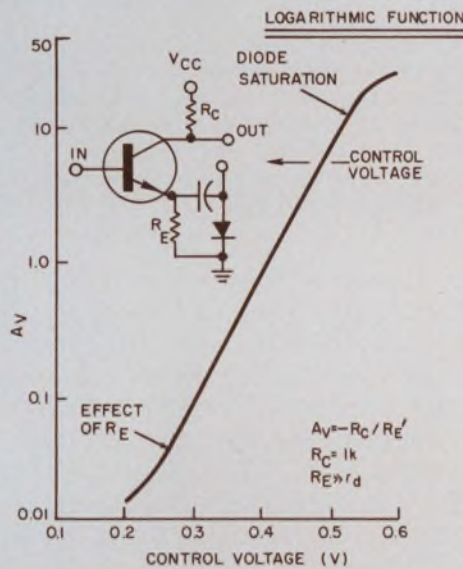

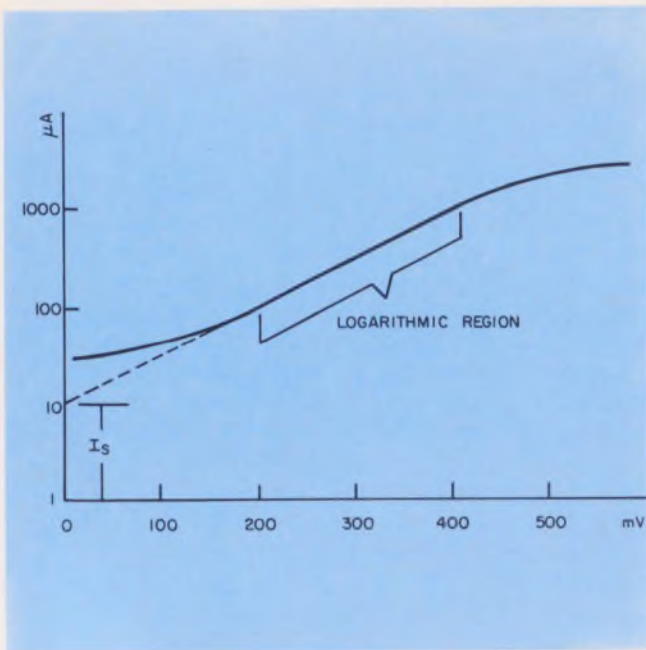

1. Here's how to calculate  $I_s$ : The reciprocal slope,  $m$ , of the straight portion of this  $\log_{10} I$  vs.  $V$  curve is seen to be 0.2 V per decade. For a  $V_o$  of, say, 0.4 V,  $I_o$  is  $10^{-3}$  A, hence  $\log_{10} I_o = -3$ . Plugging these numbers into Eq. 3, a value of  $-5$  is found for  $\log_{10} I_s$ . Hence,  $I_s = 10^{-5}$  A =  $10 \mu\text{A}$  as verified by the extrapolated (dashed) line.

One problem that this diode technique shares with more conventional methods of gain control is the undesired changing of the circuit gain by the gain-controlled signal itself. If the ac signal appearing across the gain-controlling diode is too large, it will strongly affect the circuit gain.

While this effect cannot be eliminated, it can be kept within set limits by making sure that the ac signal across the diodes does not exceed

$$v_d = m \log_{10} (A_v/A_x) \quad (4)$$

where  $v_d$  is the (instantaneous) value of the ac signal voltage across the diode,  $m$ , is the reciprocal slope discussed in Fig. 1,  $A_v$  is the desired gain of the amplifier and  $A_x$  is the minimum acceptable gain including the self-agc effect.

Consider, as an example, a gain-controlled amplifier biased to provide a voltage gain of 10 (20 dB). Suppose that loss of 2 dB due to self-agc is the maximum that can be tolerated; this would reduce the voltage gain to 8 (18 dB). If, say an FD-700 diode is used in the circuit, then  $m = 0.12$  V/decade.

Plugging this data into Eq. 4, it is seen that

$$v_d = 0.12 \log_{10} (10/8) \cong 12 \text{ mV},$$

or that the ac signal across the diode should not be allowed to exceed 12 mV.

### Gain-matching several amplifiers

Sometimes it is desired to control two or more amplifiers with one control signal. If the control signal is a current, then little problem arises

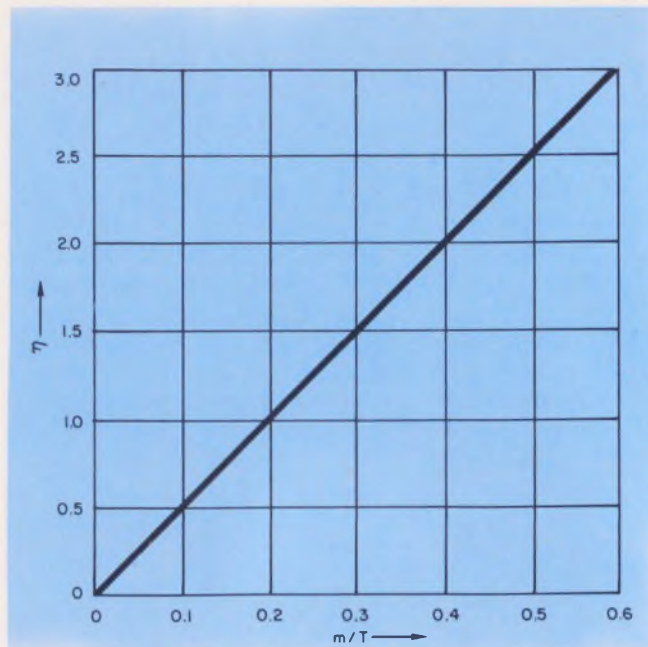

2. To find the diode constant,  $\eta$ , simply divide the reciprocal slope,  $m$ , of Fig. 1 by the junction temperature and consult this graph. Although the curve of Fig. 1 is actually a family of curves—the different curves each corresponding to a different temperature—the actual number  $\eta$  will be quite temperature independent. It also won't vary much between diodes.

in having the amplifiers track each other. As Eq. 2a indicates, the diode resistance,  $r_d$ , is a function of the current, several fundamental constants and  $\eta$ , which we have mentioned is quite constant for a given family of diodes.

If the control signal is a voltage, however, the diode resistance will depend upon  $I_s$  and hence will vary from diode to diode. To ensure acceptable gain tracking at a particular temperature, the curve of Fig. 3 may be used.

It shows the maximum permissible value of  $(\Delta V/\eta T) \times 10^{-5}$  that can be tolerated for a specified gain match. The quantity  $\Delta V$  is the difference in forward voltage drop between the diodes. These voltage drops are dc quantities measured over the complete range of current that the diodes are expected to carry in the actual circuit application. Of course,  $\Delta V$  is the difference between diode voltages at a specified current.

The curve simplifies diode selection because it's a lot easier to measure the forward dc voltage drop of a sampling of diodes than it is to measure their ac resistance.

As an example of the use of the curve, suppose that two amplifiers must track to within 1.0 dB at  $+100^\circ\text{C}$ . Assume a value of 2 for  $\eta$ . Then  $\Delta V/\eta T = 0.9 \times 10^{-5}$  and  $\Delta V = 6.7$  mV at  $100^\circ\text{C}$ . This means that for a few different values of current, covering the operating range of the diodes in the circuit, the forward voltage drops across the diodes should not differ by more than 6.7 millivolts.

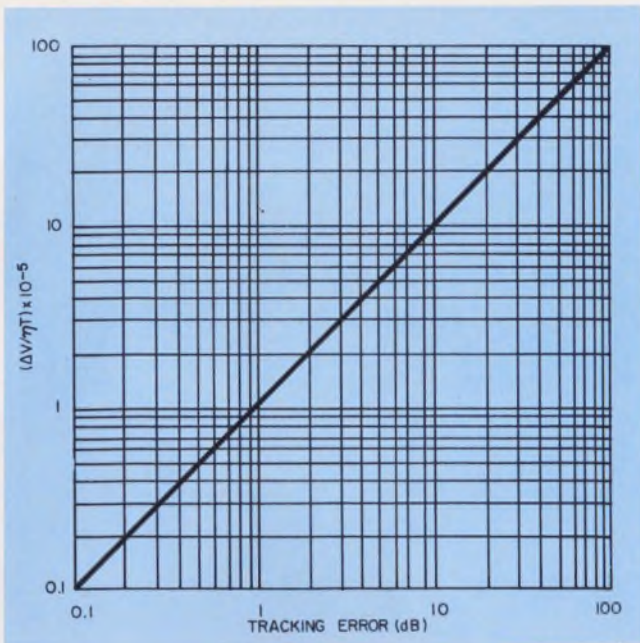

3. To ensure close gain tracking of two or more amplifiers, their gain-control diodes should be selected so that their forward voltage drops do not differ by more than  $\Delta V$  over a broad range of currents. The graph shows  $(\Delta V/\eta T) \times 10^{-5}$  vs the maximum permissible gain deviation. Each value of  $\Delta V$ , of course, is determined from voltages measured at the same current.

### Diodes make good attenuators also

Clearly, since they are being treated as variable-resistance devices, diodes can be used to make simple variable attenuators as well as gain-controlled amplifiers. Two simple circuits are shown in Fig. 4 (top).

Using the diodes as attenuators may be advantageous in certain situations, such as with feedback amplifiers, where changing the gain of an amplifier stage may lead to circuit instability. An implementation of a diode attenuator, used for this reason, is shown in Fig. 4 (bottom).

Several points of a practical nature are worth noting. Two diodes have been used, instead of just one because a single diode would have allowed the control voltage (low-impedance source) to short out the ac signal. If the amplifier had been a bandpass type, such as an i-f amplifier, only the lower diode would be needed; the rf choke would prevent loading of the signal by the voltage source. However, the broadband amplifier in the diagram goes down to a few hertz where the choke provides little protection.

Two bypass capacitors are shown. The 1.0- $\mu\text{F}$  unit is for the lower frequencies, and the 0.1- $\mu\text{F}$  one handles the high end of the band. Experience has shown that large capacitors have too much parasitic inductance to be useful for bypassing very high frequencies.

The setup provides essentially perfect loga-

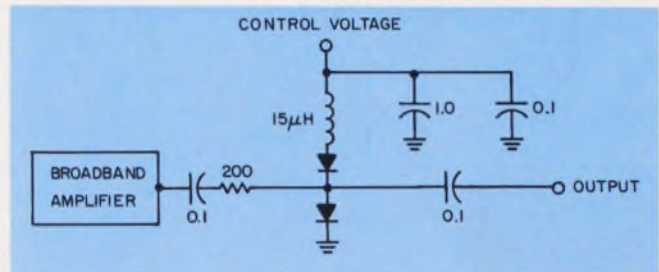
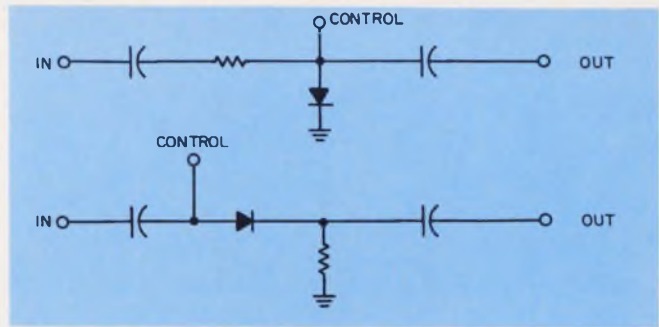

4. Diodes make good variable attenuators as these simple voltage-divider circuits (top) show. Their use is recommended with feedback amplifiers which can get unstable with gain variations. For broadband applications, two diodes are needed (bottom) to prevent loading of the ac signal by the control voltage. The diodes, both FD-700s, effectively act in parallel.

rithmic gain control over an 18-dB range with a control voltage range of about 0.9 to 1.4 V. A 3-dB bandwidth in excess of 100 MHz is maintained, and the frequency response is essentially independent of gain setting. ■■

### Bibliography:

Hughes, Richard S., *Semiconductor Variable-Gain and Logarithmic Video Amplifiers*, Tinnon-Brown Pub. Co., Los Angeles, 1967.

### Test your retention

Here are questions based on the main points of this article. Their purpose is to help you make sure you have not overlooked any important ideas. You'll find the answers in the article.

1. Where in an amplifier circuit would you place the gain control diode to get a linear gain transfer function? Would you use a current or a voltage as the control signal?
2. How can the effects of self-agc be predicted?
3. Why are two diodes sometimes needed to make a single variable-gain attenuator?
4. What type of control signal (voltage or current) works better in matched gain situations?





# Gerber original ...the system 40 p.c. artwork generator



First showing / Gerber's brand new  
low cost precision artwork generator / designed  
to produce low cost p.c. photo masters /  
features turnkey operation / complete  
software available / standard off the  
shelf / price \$55,000 / leasing  
arrangements / completely self-contained  
unit eliminates darkrooms /  
accuracy  $\pm .0015$  / call 203-644-1551  
extension 40 for quick action, quick answers /

GERBER...THE COMPANY THAT DRAWS ON YOUR IMAGINATION

THE GERBER SCIENTIFIC INSTRUMENT COMPANY  
P.O. BOX 305, HARTFORD, CONNECTICUT 06101



INFORMATION RETRIEVAL NUMBER 00

# Assemble a sequential counter

from flip-flops and gates. Proceed from the count required to the logic diagram by following this step-by-step method.

It is frequently necessary for an engineer to design a sequential binary coded decimal (BCD) counter. Although these counters are obtainable as MSI devices, they are expensive and not likely to be found in stock. The engineer is then forced to fall back upon his old standbys, the flip-flop and the gate.

The J-K flip-flop is usually chosen because it is inexpensive and easily available. The engineer first determines the number of stages needed; he then formulates the characteristic equation of the flip-flop he will use.

The number of stages required is determined by converting the largest decimal number,  $N$ , to be counted into its binary equivalent. The number of bits in this binary equivalent, from least significant to most significant, is equal to the number of stages. The characteristic equation, which usually is not given by the manufacturer, can be derived from the truth table, which generally is provided.

## Derive the characteristic equation

The process by which the characteristic equation is derived from the truth table is illustrated for two types of J-K flip-flops in Fig. 1. The first step is to expand the limited truth table given in the specification sheet to accommodate all possible variations of the output with respect to the J and K input terminals.

Both the limited and the expanded truth tables are diagrammed in Fig. 2 in three-variable OR Karnaugh maps. Since there is one square for each variable and its inverse,  $2^m$  squares, where  $m$  is the number of variables, are needed. In this case  $m = 3$ . The number of 1s entered for the  $Q_{n+1}$  state (the state of the output after the clock pulse), should equal the number of 1s entered in the Karnaugh map. Each square of the Karnaugh map represents one row of the truth table.

An unsimplified characteristic equation is obtained from the Karnaugh map as a Boolean

function. Simplification yields a second order sum of products expression with two terms and containing the  $Q_n$ , J and K variables. This is the proper form of the characteristic equation.

To organize a sequential counter for a given modulo count—say, 5—a truth table, as in Fig. 3, is again set up. Since the binary equivalent of 5 is 101, three stages are needed. These are A, B and C. First, start at the reset or initial state for all stages of the counter. This must be insured by an external reset signal when the design is implemented. Then list the sequential binary count on the left side of the truth table from binary zero to the maximum possible count from the  $N$  stages. Thus, an orderly presentation of the count will proceed with each clock pulse.

The right side of the table in Fig. 3 represents the next desired state of each of the stages after the clock pulse. This sequence continues until the final count of the modulo is reached on the left side of the table. At this point, the next state becomes the initial state since this final state represents the highest possible binary number desired from the counter. The next clock pulse must return the count to zero, completing the modulo sequence. The remaining counts appearing on the left side are to be ignored by the counter, so each of these states after the clock pulse should be marked by an X indicating a "don't care" condition. The state, of course, may have either a 0 or 1 value. Which value is chosen depends on convenience when using the application equations.

## Set up the application equation

For each stage of the counter, there exists one application equation. This equation is in the sum of products form and is second order. It applies the previously developed flip-flop characteristic equation to each particular stage. Also contained within the application equation is the interrelationship of all other stages with the J and K input of the stage of interest.

The application equation is derived by using the OR type of Karnaugh map to summarize the information contained within the modulo truth table. It is nothing more than a characteristic expression for each particular stage. It merely

J	K	Q <sub>n+1</sub>
0	0	Q <sub>n</sub>
1	0	1
0	1	0
1	1	$\bar{Q}_n$

J	K	Q <sub>n+1</sub>
0	0	$\bar{Q}_n$
1	0	1
0	1	0
1	1	Q <sub>n</sub>

(a)

J	K	Q <sub>n</sub>	Q <sub>n+1</sub>
0	0	0	0
0	0	1	1
1	0	0	1
1	0	1	1
0	1	0	0
0	1	1	0
1	1	0	1
1	1	1	0

J	K	Q <sub>n</sub>	Q <sub>n+1</sub>
0	0	0	1
0	0	1	0
1	0	0	1
1	0	1	1
0	1	0	0
0	1	1	0
1	1	0	0
1	1	1	1

(b)

1. Flip-flops differ, depending on the manufacturer. The limited truth table, which is a part of the specification sheet, is given for two J-K flip-flops in (a). The detailed truth tables for these flip-flops are derived in (b). Q<sub>n</sub> is the output prior to the clock pulse; Q<sub>n+1</sub> is the output after the clock pulse.

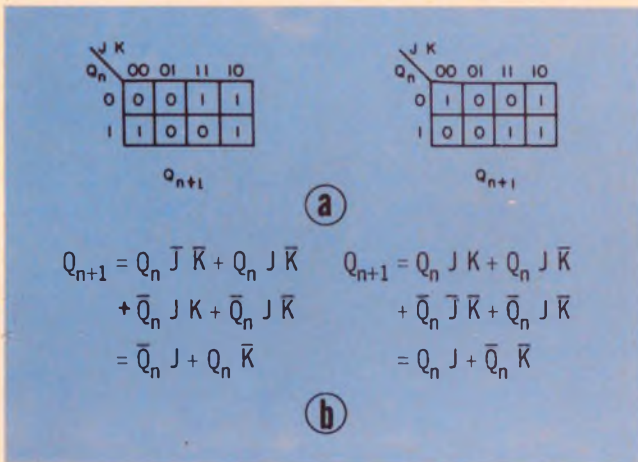

2. The expanded truth tables of Fig. 1 are summarized into Karnaugh maps in (a), and their characteristic equations are obtained in (b).

follows the form of the J-K characteristic equation, and simplification should proceed to that end. Each application equation is determined by using one Karnaugh map of M variables for each stage.

Each stage in the counter has a post clock pulse state, corresponding to Q<sub>n+1</sub> that appears on the right side of the truth table. This state of a particular stage is dependent on the previous output states, Q<sub>n</sub>, of all other stages. And the information is contained in each row of the truth table for the output of each Q<sub>n+1</sub> stage. Therefore, a Q<sub>n+1</sub> output can be summarized in

DECIMAL COUNT	BINARY COUNT FOR PRESENT STATE			BINARY COUNT AFTER CLOCK PULSE		
	C <sub>n</sub>	B <sub>n</sub>	A <sub>n</sub>	C <sub>n+1</sub>	B <sub>n+1</sub>	A <sub>n+1</sub>
0	0	0	0	0	0	1
1	0	0	1	0	1	0
2	0	1	0	0	1	1
3	0	1	1	1	0	0
4	1	0	0	0	0	0
5	1	0	1	X	X	X
6	1	1	0	X	X	X
7	1	1	1	X	X	X

X = DON'T-CARE STATE

3. A truth table is written for a modulo 5 counter. The decimal count is given on the left; the binary count for the present state is simply the binary equivalent of the decimal count. The binary count after the clock pulse is obtained by incrementing the present binary count by one. Decimal 5, 6, 7 are not needed in modulo 5; hence the X (don't-care) entries in the table.

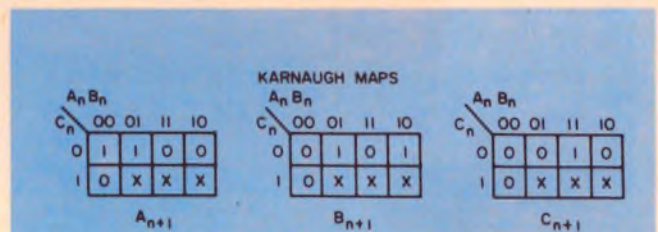

Application equations:

$$A_{n+1} = \bar{A}_n \bar{B}_n \bar{C}_n + \bar{A}_n B_n \bar{C}_n = \bar{A}_n \bar{C}_n \text{ if all 3 Xs are zero}$$

$$B_{n+1} = \bar{A}_n B_n \bar{C}_n + A_n \bar{B}_n \bar{C}_n + \bar{A}_n B_n C_n + A_n \bar{B}_n C_n = \bar{A}_n B_n + A_n \bar{B}_n \text{ if the Xs in 011 and 101 are one and the X in 111 is zero}$$

$$C_{n+1} = A_n B_n \bar{C}_n \text{ if all 3 Xs are zero}$$

$$Q_{n+1} = Q_n J + \bar{Q}_n \bar{K} \text{ (characteristic equation)}$$

$$A_{n+1} = 0 + \bar{A}_n \bar{C}_n$$

$$B_{n+1} = B_n \bar{A}_n + \bar{B}_n A_n \text{ application equations from above}$$

$$C_{n+1} = 0 + \bar{C}_n (A_n B_n)$$

Resulting Boolean expressions:

$$\text{For A: } J = 0 \quad K = C_n$$

$$B: J = \bar{A}_n \quad K = \bar{A}_n$$

$$C: J = 0 \quad K = \overline{A_n B_n}$$

4. The Karnaugh map equivalent of the truth table in Fig. 3 is written using J-K flip-flops with the characteristic equation: Q<sub>n+1</sub> = J Q<sub>n</sub> +  $\bar{K}$   $\bar{Q}_n$ . The Boolean expression for each J and K input is then obtained from the application equations.

# THE WORLD'S MOST ACCURATE FREQUENCY SWITCH

## FASTER DATA TRANSMISSION

New, GO-NO-GO Audio Switches which fire whenever the input frequency goes above, below, or is within certain definite frequency limits are now available. Accuracies as close as 1 cycle per thousand can be maintained. Maximum response time is the length of two input cycles. All units are completely solid state.

The input frequency can be in the form of a sine or square wave. Or even in pulses in which case it measures the length of time between pulses. Frequencies from 1 hz to 40,000 hz can be handled easily and directly. Higher frequencies can be handled if dividers and/or mixers are incorporated.

Highpass, lowpass, and band-pass functions are all available.

# GOSH instruments, inc

P.O. BOX 36 • WETHERSFIELD, CONNECTICUT 06109 • (203) 527-4794

NEW  
TELEMETERING  
FREQUENCY  
SWITCHES  
1 hz to 40,000 hz  
RESPONSE LIKE  
THIS

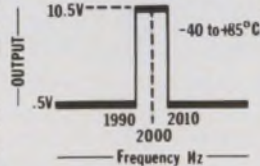

from  
**\$99<sup>50</sup>**  
Single piece

INFORMATION RETRIEVAL NUMBER 30

## YOU SET THE STOPS TO SUIT YOUR CIRCUIT

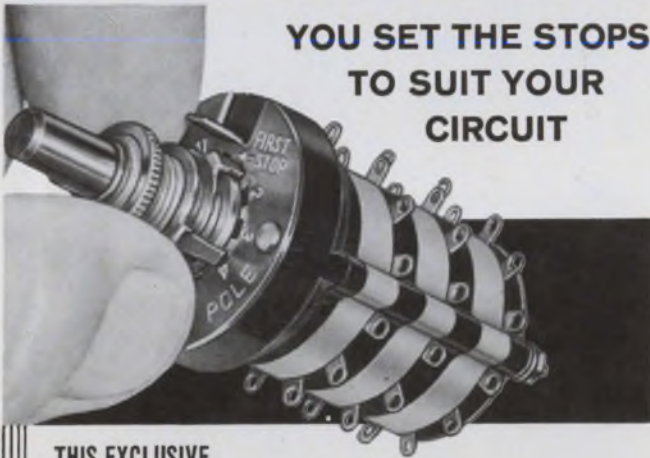

### THIS EXCLUSIVE GRAYHILL ADJUSTABLE STOP FEATURE

simplifies switch selection for prototype and small production run.

- 1 to 4 Poles Per Deck
- 2 to 12 Positions Per Pole
- 1 to 12 Decks
- Shorting Or Non-shorting Contacts
- 30°, 36°, 45° or 60° Angle Of Throw
- Concentric Shaft Switch And Potentiometer Styles Available
- Explosion Proof Design

For your Grayhill Engineering Catalog offering complete technical data—contact



565 Hillgrove Avenue  
LaGrange, Illinois 60525  
Area Code 312, Phone 354-1040

... the Difference Between Excellent and Adequate

INFORMATION RETRIEVAL NUMBER 31

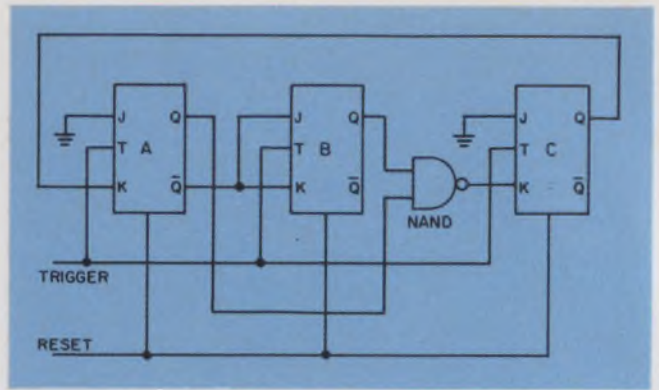

5. The counter schematic is derived directly from the Boolean expressions of Fig. 4.

terms of the  $Q_n$  states of the other stages.

Both the don't-care and the desired states are entered into the Karnaugh maps (Fig. 4). A 0 or 1 value is chosen for each X entry. This choice is dictated by convenience. The Karnaugh maps are simplified to give the application equation. The characteristic J-K flip-flop equation is  $Q_{n+1} = J Q_n + K Q_n$ .

The next step is to convert the simplified application equation into the form of the desired J-K characteristic equation. This procedure is illustrated in Fig. 4. The result of equating the coefficients of the application equation to the corresponding coefficients of the characteristic equation is a set of Boolean expressions for the J and K inputs of each stage. The Boolean expressions are then translated directly into the schematic in Fig. 5.

This technique for designing counters follows a step-by-step procedure. It is, therefore, convenient for computer solution. This becomes a significant consideration when more than six stages are used. ■■

#### Bibliography:

- Hill, F. J., and Peterson, G. R., *Introduction to Switching Theory and Logical Design*, John Wiley & Sons, New York, N. Y.
- Marcus, Mitchell P., "Single Map Method Simplifies Design," *Electronic Design*, ED 26, Dec. 20, 1969, p. 66.

#### Test your retention

Here are questions based on the main points of this article. Their purpose is to help you make sure you have not overlooked any important ideas. You'll find the answers in the article.

1. What is the characteristic equation of a flip-flop?
2. What is the application equation of a computer?
3. How are the application equation and the characteristic equation related?
4. How are the number of stages needed to build a sequential counter determined?

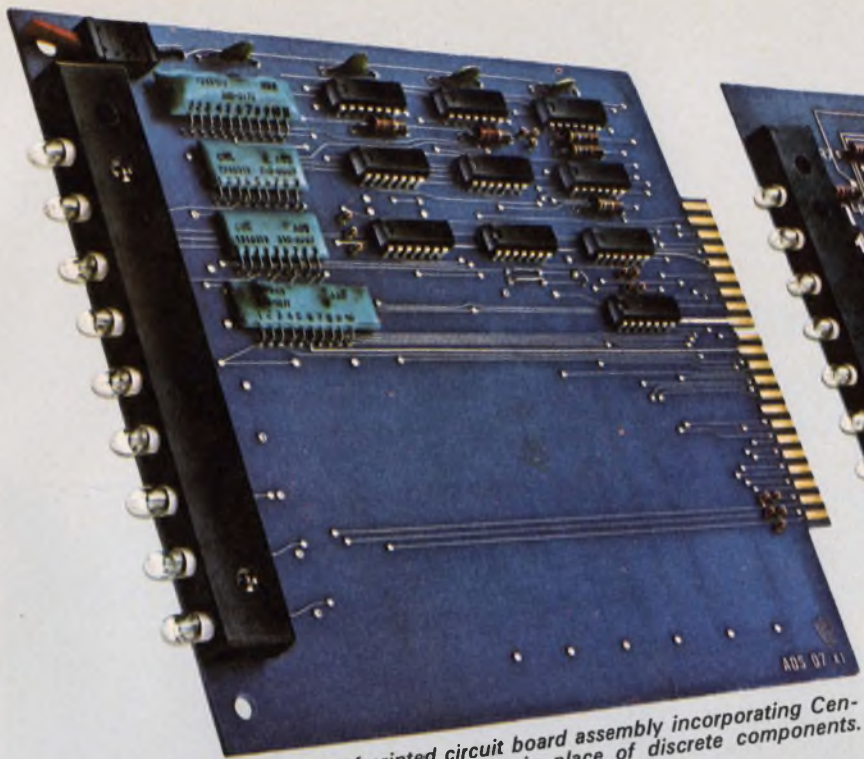

*Redesign of printed circuit board assembly incorporating Centralab hybrid microcircuits in place of discrete components.*

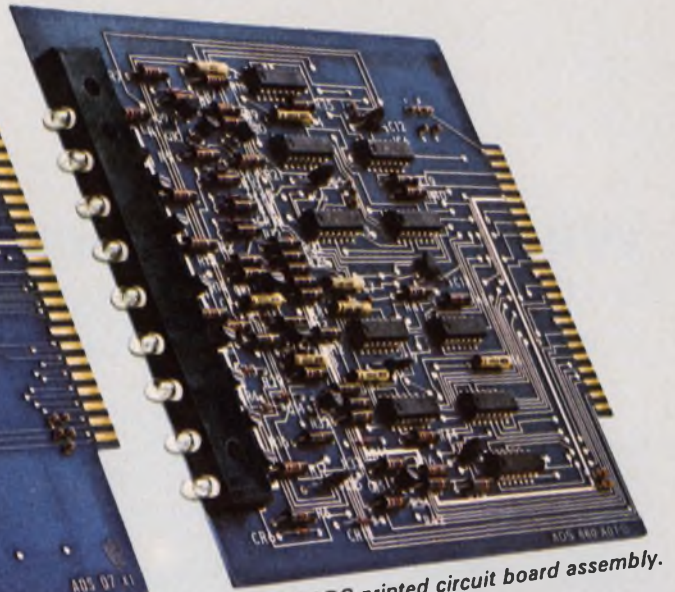

*Initial ADS printed circuit board assembly.*

# Centralab makes a difference for

## AMERICAN DATA SYSTEMS

### Microcircuitry simplifies assembly, improves performance

American Data Systems is a new company, just a little over one year old, experiencing a meteoric growth in data communications equipment. The heart of their ADS-660 Data Distribution System is a number of printed circuit board modules. These card modules are compatible with a variety of low-speed data terminal devices.

Initially, these plug-in boards were assembled as shown on the right — using discrete components. ADS, with help from Centralab Electronics Division, was able to redesign using thick-film hybrid circuits. The four blue hybrid microcircuits (shown on the board at the left) have replaced 9 diodes, 48 resistors, 16 transistors and 5 capacitors. The change resulted in lower circuit assembly time, fewer rejects due to faulty assembly, and increased the reliability of performance — all contributing to a significant cost saving for ADS.

Centralab capability in customer design-specified microcircuits has helped improve the performance and reliability of the data communications products of American Data Systems. For information on how Centralab hybrid microcircuits might benefit your products' reliability, write: Sales Manager, Centralab Electronics Division, Globe-Union Inc.

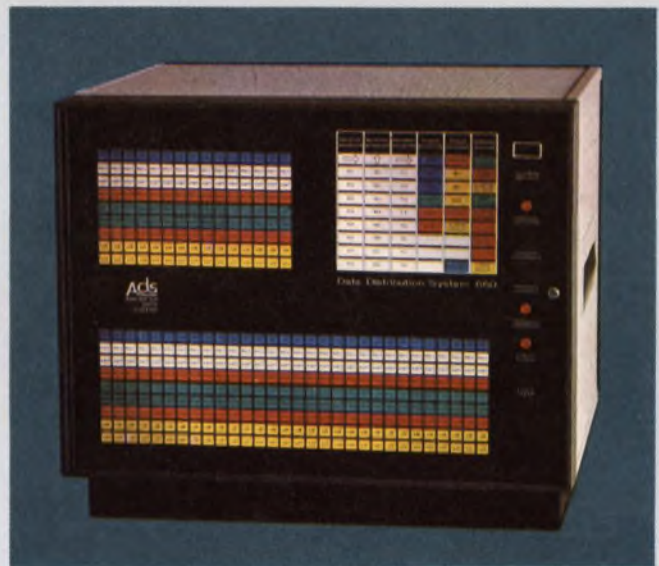

*ADS-660 time-division-multiplexer provides for the transmission of several low-speed data circuits over a single high-speed voice grade line.*



**CENTRALAB**

Electronics Division  
GLOBE-UNION INC.  
5757 NORTH GREEN BAY AVENUE  
MILWAUKEE, WISCONSIN 53201

M-6929

# Why use current-mode flip-flops?

First, because the CML approach offers maximum speed. It also has good noise immunity and stability.

Current-mode logic (CML) is gaining popularity as systems designers are searching for ways to increase the speed of computation. Past disadvantages due to the use of many transistors have been eliminated with the advent of integrated circuits. Integrated transistors are easy and cheap to make, and the CML circuits are very tolerant of parameter variations, since their transfer characteristics are determined by resistor ratios, not absolute values.

CML is worth a good look by logic designers, too. The basic circuit designs offer high dc stability, and since the signal paths are through emitter followers and grounded base stages, the propagation times of the gates can be very good. Speed is further promoted by low-impedance drive circuitry, low voltage swings and avoidance of stored charge effects—the transistors are not required to saturate.

These are not the only advantages. The low output impedance of the CML circuit enables good driving capability, and performance in general is insensitive to component parameters. The nearly constant current drain of the differential-style circuit leads to greatly reduced power-supply transients. To fully understand the advantages of this approach, let's take a good look at the CML flip-flop.

## Consider the gated R-S flip-flop

The basic building block of all CML circuits is a current switch, with the general structure shown in Fig. 1.

The logic diagram and the truth table of a gated R-S flip-flop are shown in Fig. 2. A conventional implementation of this logic element, of course, requires three separate circuits: two AND gates and a flip-flop.

The new, gated R-S flip-flop, shown in Fig. 3, eliminates the need for two-input AND gates by incorporating the gating feature in the flip-flop's structure itself. Two levels of current switches

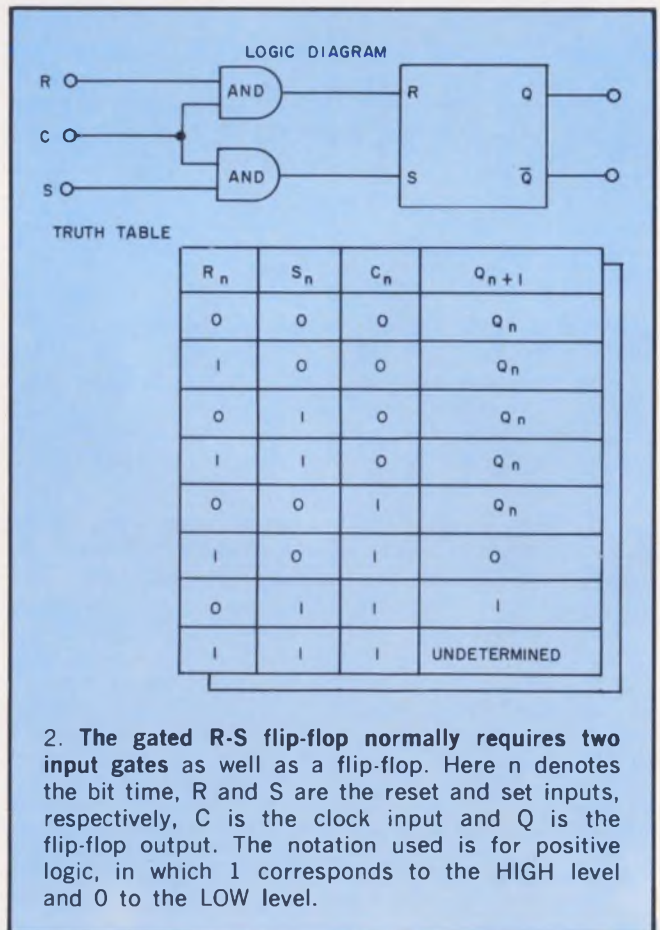
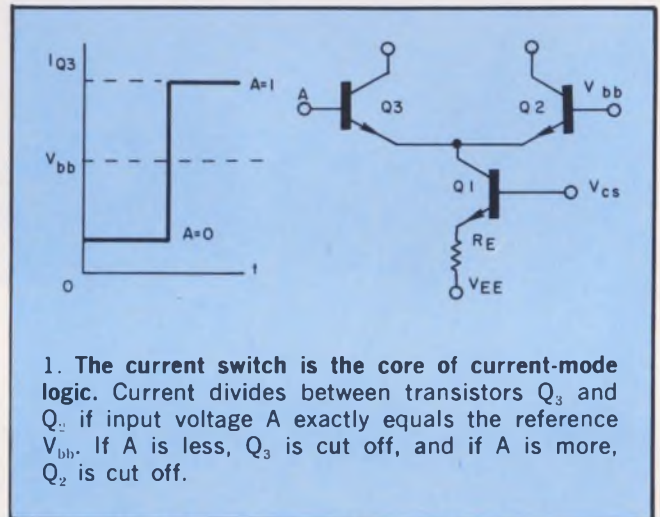

Ury Priel, Motorola Semiconductor, Phoenix, Arizona (now with National Semiconductor, Santa Clara, Calif.)

are used.

The clock is used to gate a fixed current between two groups of emitter-coupled transistors. One transistor in the first group (consisting of  $E_6$  and  $E_7$ ) is conducting when the clock is LOW, and one transistor in the second group (consisting of  $Q_4$ ,  $E_5$ ,  $E_8$  and  $Q_9$ ) is conducting when the clock is HIGH. Which device will conduct in each group is determined by the state of the flip-flop and by the external signals at the S and R inputs.

The reference voltage for the R and S inputs is established internally, by the base-emitter voltages of the cross-coupled transistors  $Q_{12}$  and  $Q_{13}$  when their emitter is at a logical ONE level, and by the resistors  $R_E$  and  $R_F$ . When the clock is HIGH, Q is ONE and  $V_{E2}$  is HIGH;  $V_{E2}$  establishes

the reference voltage for the resetting signal at the R input. Similarly, when Q is ZERO,  $V_{E1}$  becomes the reference voltage for the setting signal at the S input.

If both S and R are LOW when the clock signal is rising, the flip-flop will not change its state, as implied by the truth table of the R-S flip-flop, and the current conduction will switch from  $E_6$  to  $E_5$  or from  $E_7$  to  $E_8$ , depending on whether Q is HIGH or LOW, respectively. The logic requirement  $Q_{n+1} = Q_n$  when  $RS = \text{ZERO}$  makes necessary a dynamic type of reference, rather than a fixed reference, for the external signals. The multiple-emitter devices provide the solution to this problem.

The fixed reference network shown in Fig. 3 provides the flip-flop with the reference nodes  $V_{bb}$ ,

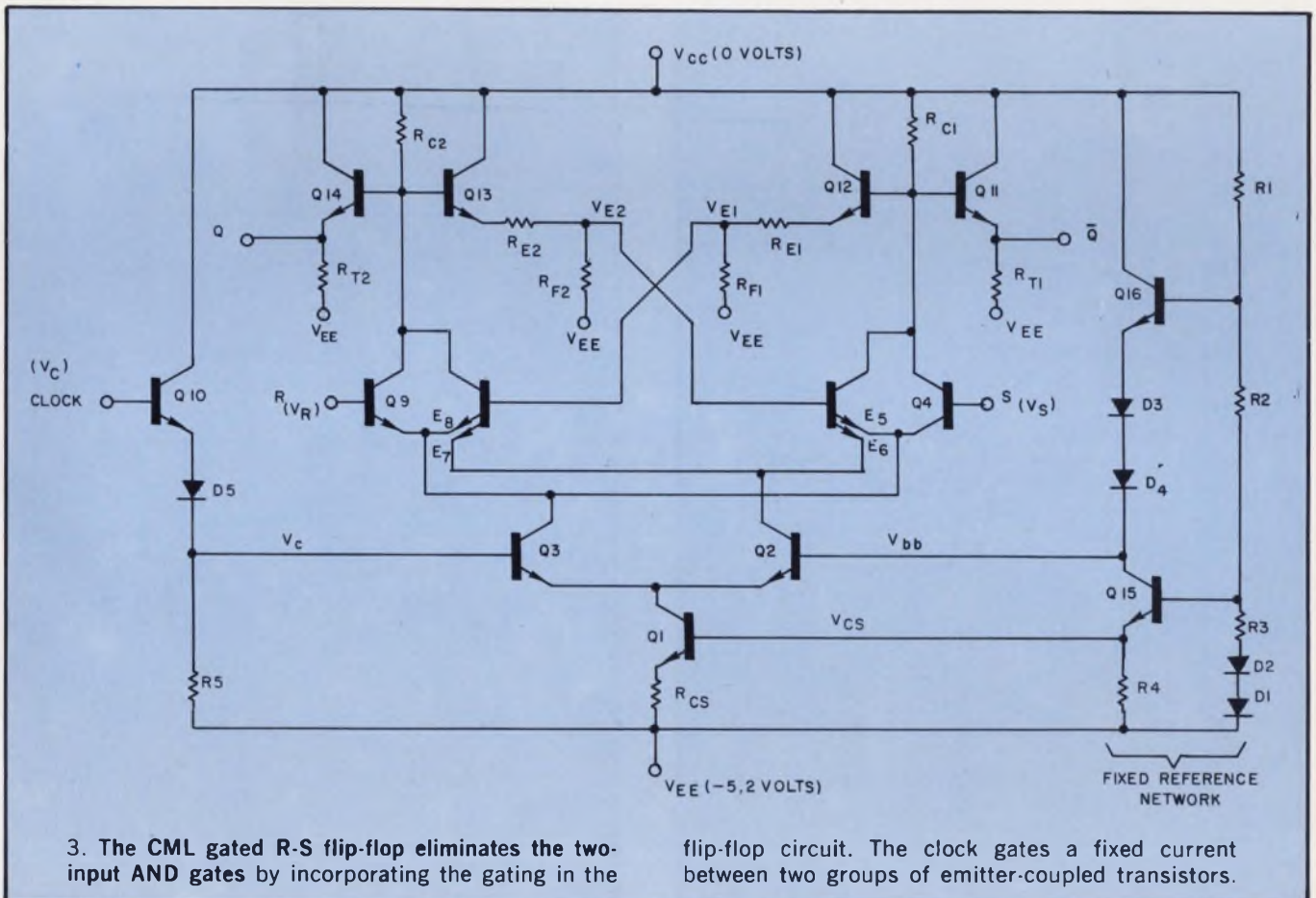

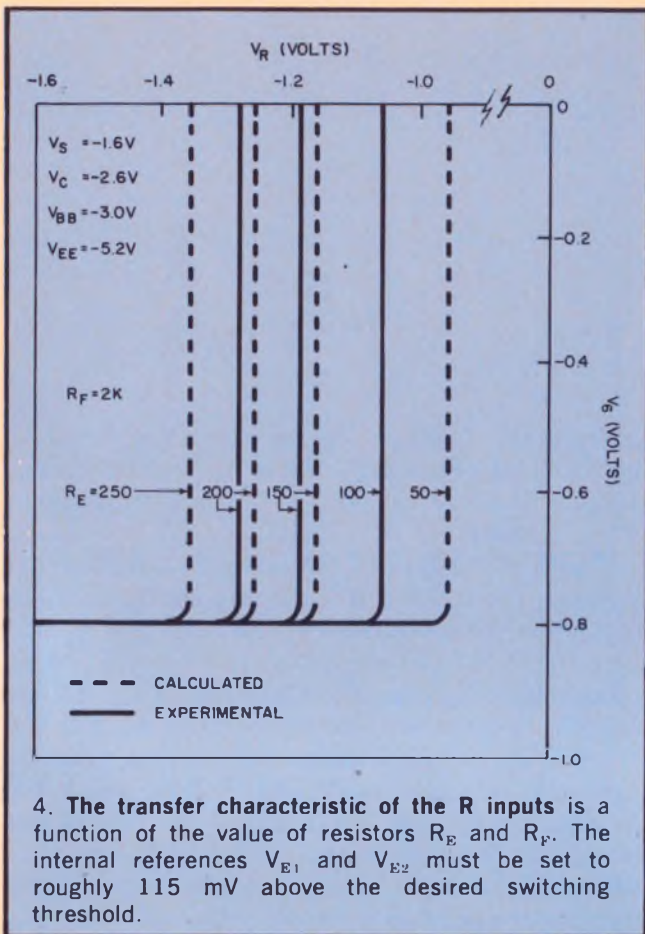

and  $V_{CS}$ , eliminates the need for additional power supplies and simplifies the interconnections. More important, this network ensures the proper dependence of these reference voltages on temperature and power-supply voltage variations, to provide the circuit with maximum noise margins and an extended range of current mode operation.

#### Analyze the dc behavior

Careful dc analysis of the R-S flip-flop determines the nominal levels of the internal references  $V_{E1}$  and  $V_{E2}$  (Fig. 3), establishes the noise margins under variations in temperature and power supply, and fixes the range of current mode operation.

Using the nonlinear transistor model in a computer analysis, the threshold in the transfer characteristics of the R-S inputs can be determined as a function of the resistors  $R_E$  and  $R_F$ . The analysis indicates that the HIGH level of  $V_{E1}$  or  $V_{E2}$  must be 115 mV above the desired switching threshold. Computed and experimentally obtained transfer characteristics between the R input,  $V_R$ , and  $V_6$  are shown in Fig. 4.

Qualitatively, the transfer mechanism is as follows: Assuming that the clock is HIGH and that Q is ONE when  $V_R$  is rising ( $S=ZERO$ ), when the base potential  $Q_b$  ( $V_R$ ) approaches that of  $E_5$ ,

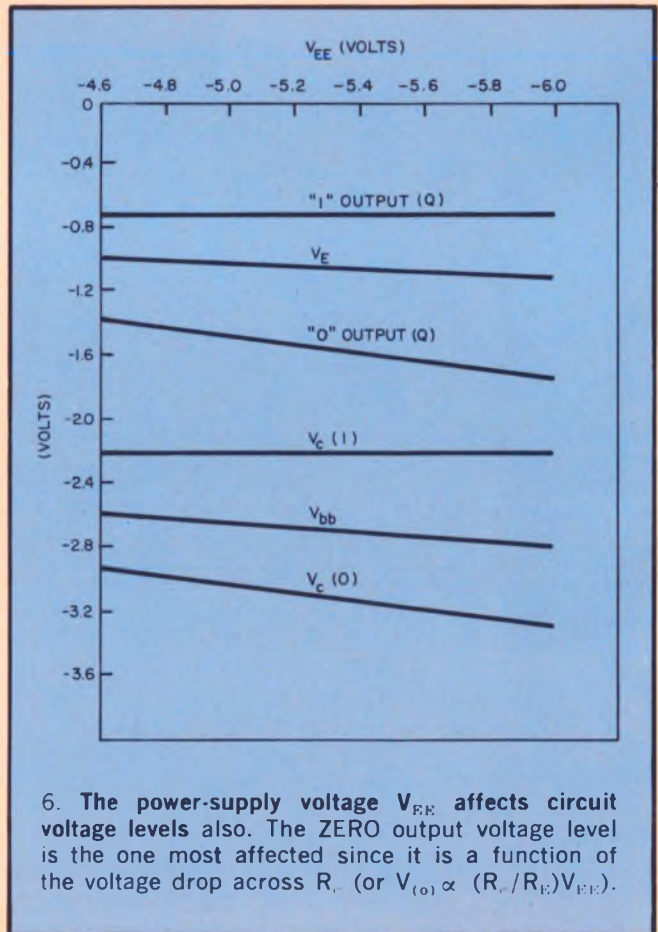
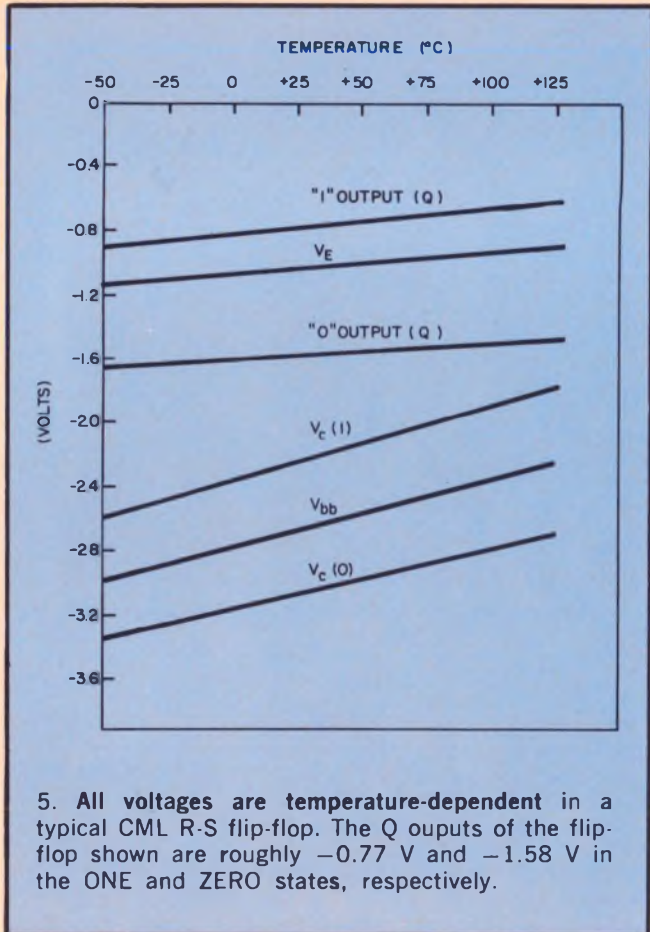



$Q_1$  will start to conduct and current will flow through  $R_{C2}$ , thus lowering  $V_{E2}$ . Simultaneously,  $V_{E1}$  will start to rise, since the current through  $R_{C1}$  is reduced. The falling potential  $V_{E2}$  will further increase the conduction of  $Q_1$  at the expense of  $Q_2$ , causing a regenerative action that results in a sharp drop in the transfer characteristics. The output levels of the flip-flop are translated down by the  $V_{BE}$  of the output emitter-follower.

The noise margins of the circuit under temperature and power-supply variations are dependent on the relative tracking of the reference node  $V_E$  and the logic levels at the R and S inputs. Similarly, the range of the current-mode operation is dependent on the variations of the base-collector voltage under the same conditions. The total variation in the pertinent node voltages are described qualitatively by the equation

$$\Delta V = \frac{\partial V}{\partial V_T} \frac{\partial V_T}{\partial T} \Delta T + \frac{\partial V}{\partial V_{EE}} \Delta V_{EE} + \sum_i \frac{\partial V}{\partial K_i} \Delta K_i + \frac{\partial V}{\partial \alpha} \Delta \alpha$$

where  $V_T$  is the average base-emitter voltage,  $T$  is the absolute temperature,  $V_{EE}$  is the power supply voltage, and  $K_i$  are resistor ratios. The common-base current gain is represented by  $\alpha$ ,

and  $\frac{\partial V_T}{\partial T}$  is approximately  $-1.5 \text{ mV}/^\circ\text{C}$ .

The ZERO and ONE logic levels and their corresponding reference nodes as functions of temperature and power-supply voltage are shown in Figs. 5 and 6. The internal reference  $V_E$  shown in these figures is approximately 115 mV above the mid-swing level, as is dictated by the regenerative action in the transfer characteristics. The base collector voltages of  $Q_1$  and  $Q_2$  (Fig. 3) as functions of temperature and power supply are shown in Fig. 7. These junctions are the limiting ones because of their sensitivity to temperature and power-supply voltage.

Transistor  $Q_2$  saturates at high temperatures and increased power-supply voltage, while  $Q_1$  saturates at the opposite extremes. The information displayed in Fig. 7 is useful in the circuit design stage, as well as in the final determination of the worst-case range of operation for optimum system performance.

The analysis shows that, as in all current-mode circuits, performance is quite insensitive to device parameters ( $\alpha$ ,  $V_{BE}$ ,  $K_i$ ). By adding the forward bias of  $Q_2$  due to temperature and power-supply variations, the range of operation can be determined under worst-case conditions of increased temperature and power-supply voltage. A similar computation can be done for  $Q_1$  to determine the worst-case conditions at low temperature and

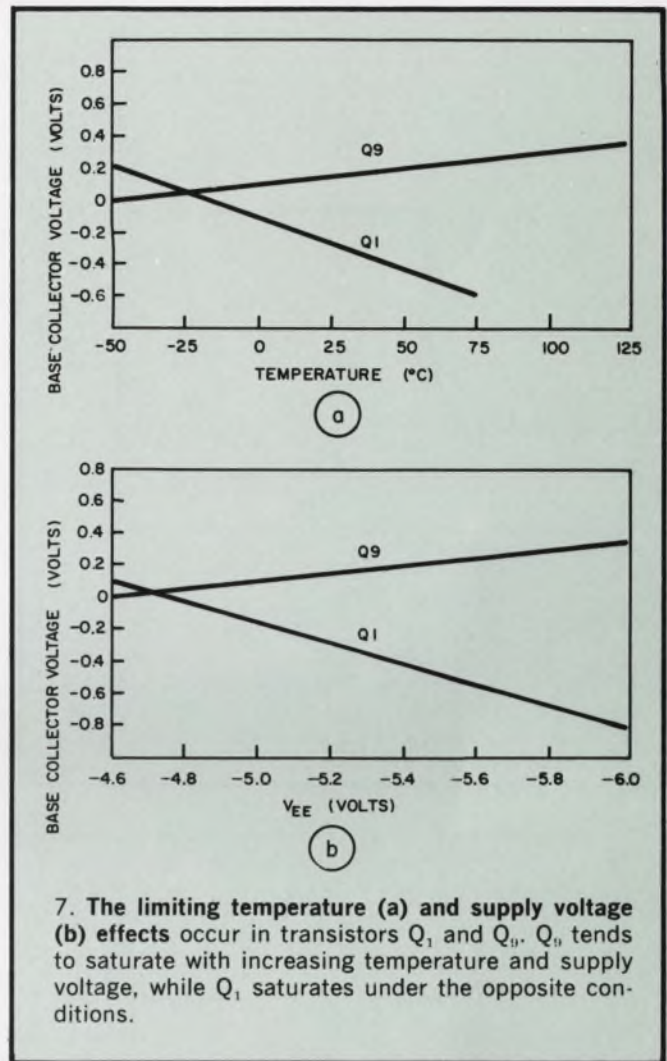

7. The limiting temperature (a) and supply voltage (b) effects occur in transistors  $Q_1$  and  $Q_2$ .  $Q_2$  tends to saturate with increasing temperature and supply voltage, while  $Q_1$  saturates under the opposite conditions.

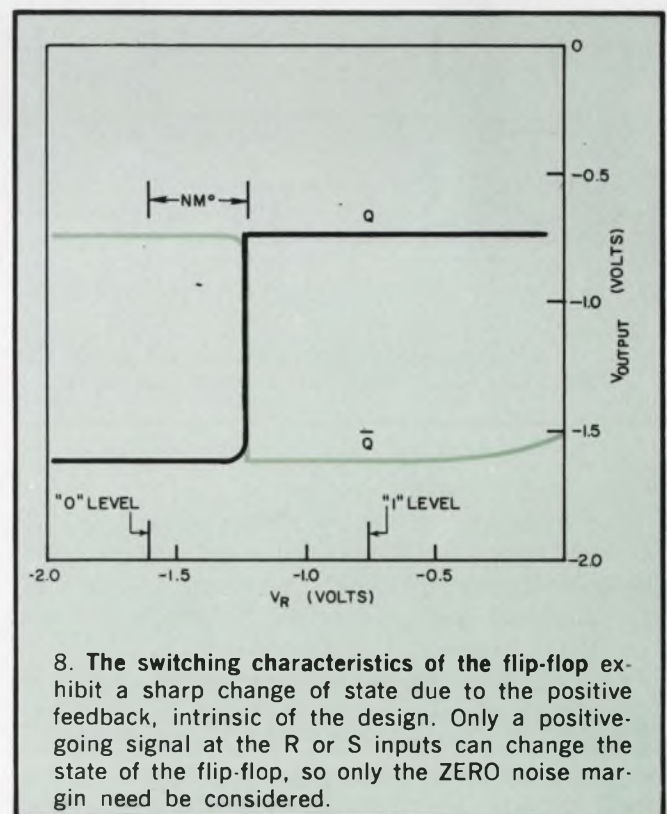

8. The switching characteristics of the flip-flop exhibit a sharp change of state due to the positive feedback, intrinsic of the design. Only a positive-going signal at the R or S inputs can change the state of the flip-flop, so only the ZERO noise margin need be considered.

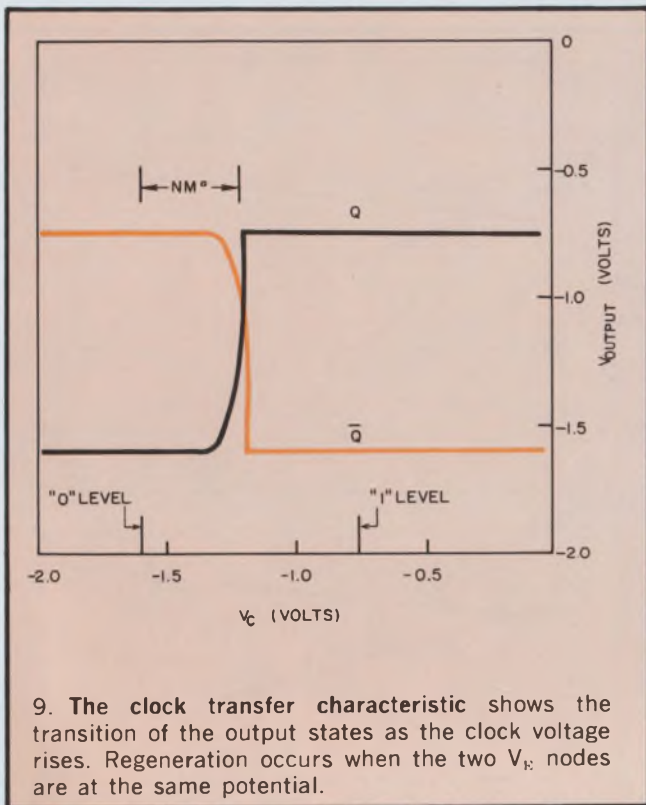

9. The clock transfer characteristic shows the transition of the output states as the clock voltage rises. Regeneration occurs when the two  $V_C$  nodes are at the same potential.

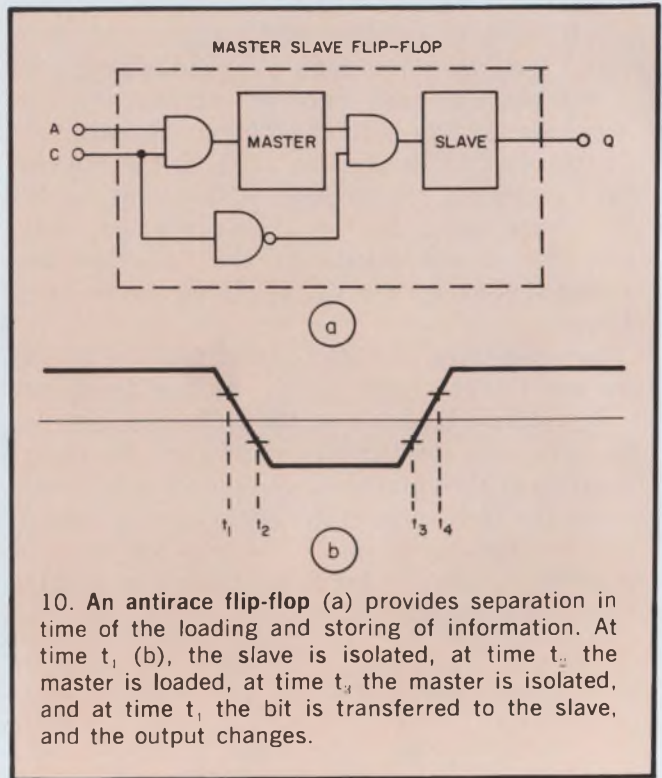

10. An antirace flip-flop (a) provides separation in time of the loading and storing of information. At time  $t_1$  (b), the slave is isolated, at time  $t_2$  the master is loaded, at time  $t_3$  the master is isolated, and at time  $t_4$  the bit is transferred to the slave, and the output changes.

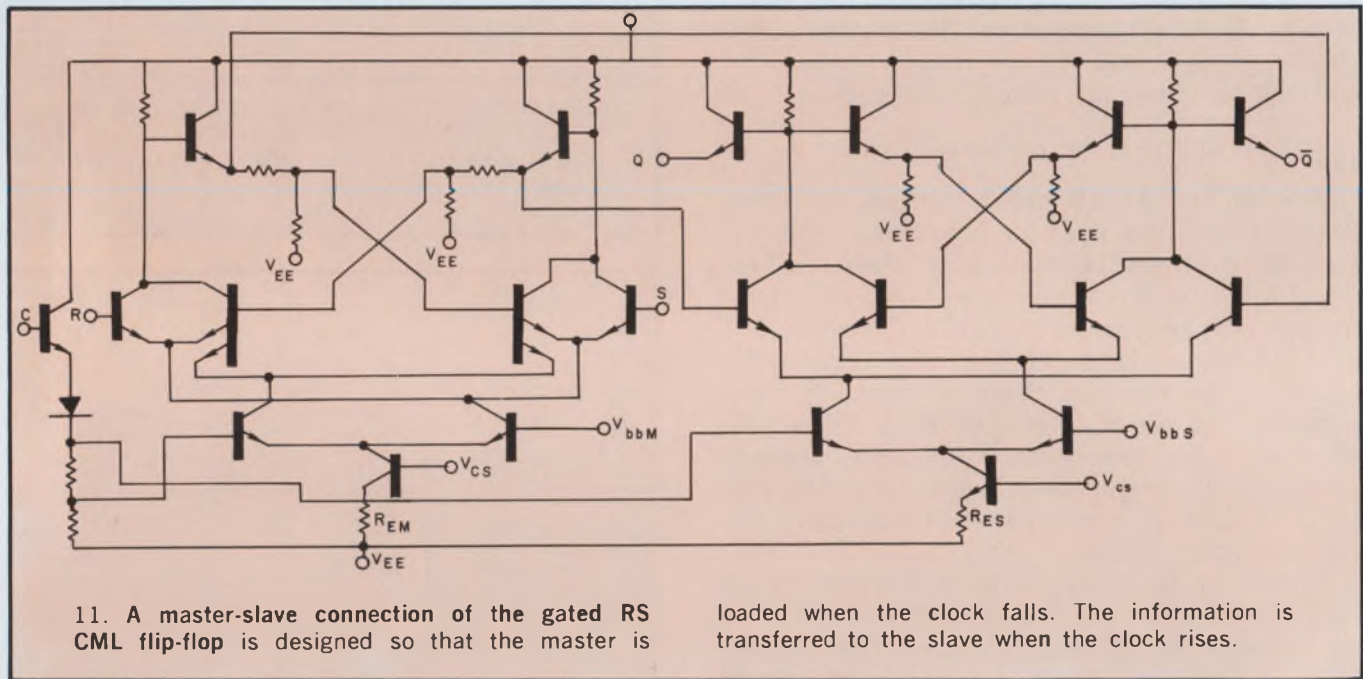

11. A master-slave connection of the gated RS CML flip-flop is designed so that the master is

loaded when the clock falls. The information is transferred to the slave when the clock rises.

reduced power supply voltage.

The most useful way to characterize a digital IC is to display its terminal characteristics. Once these are known, a system can readily be designed and analyzed and a detailed knowledge of the internal components is not needed.

The R-S transfer characteristics are shown in Fig. 8. The sharp break in the curve is due to the regenerative action caused by positive feedback encountered when the signal at the base of the input transistor rises to within 115 mV of the

corresponding  $V_E$  potential. Since only a positive-going signal at the R or S inputs can alter the state of the flip-flop, only the ZERO noise-margin,  $NM^0$ , is meaningful for these characteristics.  $NM^0$  is defined here as the maximum amplitude of a positive-going noise spike that, when superimposed on a ZERO input level, will not affect the state of the output.

The clock transfer characteristics are displayed in Fig. 9, where the ZERO and ONE noise margins and the transition region are defined. Regenera-

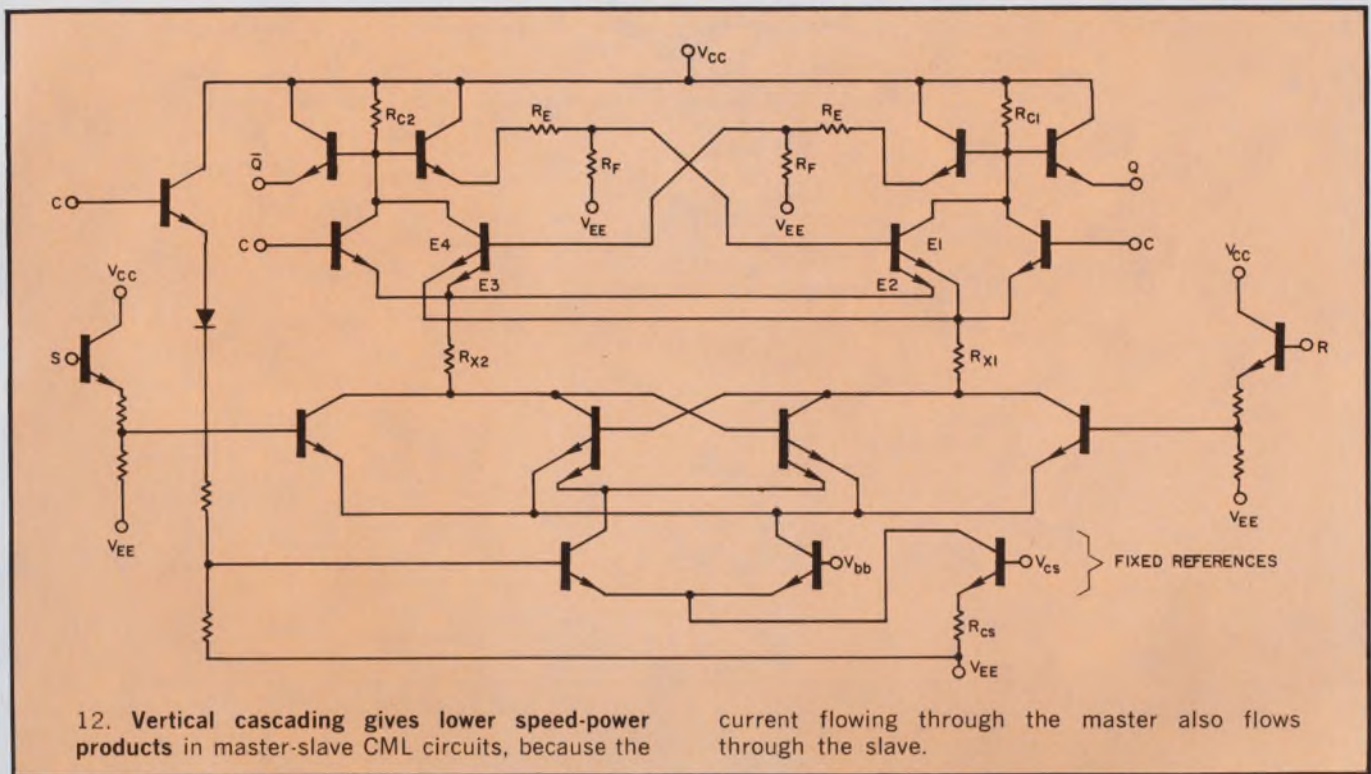

tive action occurs here when the clock has risen to the level at which the two  $V_E$  nodes are at the same potential.

Our discussion of the CML R-S flip-flop has so far been confined to its internal operation. But one important aspect of its application should be mentioned—preventing race conditions.

### Investigate race conditions

Race problems are often encountered in flip-flop applications such as counters and shift registers. During one clock transition the information fed into a flip-flop may race through it and introduce an error by changing the state of the next flip-flop in the register.

This problem is generally alleviated by using a temporary storage means and by providing a separation in time between loading of the flip-flop and displaying the information. A very effective anti-race flip-flop using both of these means, the master-slave configuration, is illustrated in Fig. 10.

A master-slave configuration of the gated R-S flip-flop of Fig. 3 is shown in Fig. 11. The master portion is loaded when the clock falls, and is transferred to the slave when the clock rises. By providing different thresholds for the isolating and loading operations, they become separated in time, as illustrated in Fig. 10, and the circuit is thus completely raceproof.

An interesting aspect of CML master-slave flip-flops is the possibility of cascading them.

A considerable improvement in the speed-power product of master-slave flip-flops has been realized

by a new design in which both portions are cascaded vertically (Fig. 12). In this circuit the logic-generating current that flows in the master is also flowing in the slave, thus realizing savings in power dissipation.

Two-level translators are used to shift the R and S levels that load the master when the clock is LOW. If R is HIGH, the current will flow in  $R_{X1}$  through either  $E_1$  or  $E_4$ , depending on whether Q is ZERO or ONE, respectively. When the clock rises, this current will flow through  $R_{C1}$  and reset the flip-flop ( $\bar{Q} = \text{ONE}$ ). The operation is symmetrical for the S input. ■ ■

### Bibliography:

1. Camenzind, Hans R., "A Guide to Integrated-Circuit Technology," *Electro Technology*, February, 1968.
2. Narud, Jan A., and Seelbach, W. C., "Advance Developments in Ultra High Speed Integrated Circuits," *Conference on Micro-Electronics in Equipment*, Sponsored by Electronic Equipment News, Nov. 9-11, 1966.

### Test your retention

Here are questions based on the main points of this article. Their purpose is to help you make sure you have not overlooked any important ideas. You'll find the answers in the article.

1. What are the principal advantages of current-mode logic?
2. How does the cascading of CML master-slave flip-flops improve the speed-power product?

Helipot slashes  
voltage regulator prices  
to

**\$5.82**

Now Models 809 and 859 Voltage Regulators are available  
at \$5.82 each (1000 quantity) or \$8.95 (1-9) from local stock.

**Beckman®**

**INSTRUMENTS, INC.**  
**HELIPOT DIVISION**  
Fullerton, California 92634

INTERNATIONAL SUBSIDIARIES: AMSTERDAM; CAPE TOWN; GENEVA; GLENROTHES,  
SCOTLAND; LONDON; MEXICO CITY; MUNICH; PARIS; STOCKHOLM; TOKYO; VIENNA

INFORMATION RETRIEVAL NUMBER 45

# Ideas For Design

## Boost discriminator performance with a differential capacitor

Discriminators are widely used as demodulators and frequency-control circuits. As such they must be both accurate and easily reproducible. Unfortunately, as the frequency increases these goals become less attainable. A modification in discriminator design can extend the frequency capability and permit ease of adjustment.

At low and moderate frequencies the operational characteristics of a Foster-Seely discriminator are quite predictable, but, in common with other rf circuitry, the problems multiply rapidly as the frequency goes up. The general result is that high-frequency discriminators are often designed on a purely empirical basis that requires on-the-line modifications to make them work properly, even over a limited range. Of all the circuit components the transformer secondary is the most troublesome since:

- There are more components with parasitic capacitances connected to the secondary than to the primary. This limits the maximum inductance that can be used. The use of a secondary that is small compared to the primary is undesirable since loss of output amplitude results.

- The inductance of both halves of the secondary must be equal. So must the distributed capacity and the capacitance to ground. Unless this is arranged, an unsymmetrical response will result. This will cause the phase relationships at the output terminals and the voltage amplitudes across each half of the secondary to be unequal. Correct output phase relationship will lead and lag the reference voltage at the center tap by 90 degrees.

Not much can be done about the first problem except to follow good physical design practices and to use components having the lowest residual capacitances. The second problem is far more serious since it not only affects initial design but severely restricts the ability to obtain reasonable tolerances in either slope or linearity on production-line units.

A conventional way of making a secondary for a frequency discriminator operating in the vicinity of 30 MHz is to wind 20 turns of #30 AWG on a quarter-inch slug-tuned coil form with a third terminal inserted at the tenth turn as a center tap. The circuit is tuned to resonance by

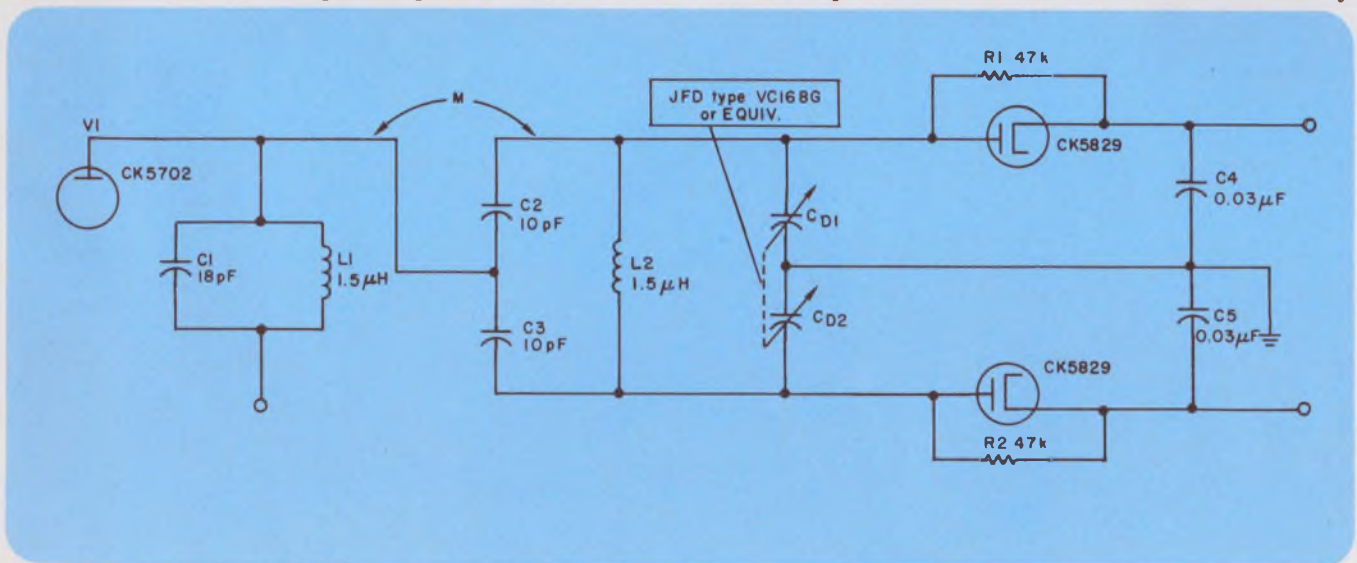

Discriminator with differential capacitor permits slope adjustment to close tolerances.

# Sylvania introduces the MSI supermarket.

FUNCTIONAL ARRAYS, TYPICAL CHARACTERISTICS (+25°C, +5.0 Volts)						
Function	Type Nos.	$t_{pd}$ (nsec)	Avg. Power (mW)	Noise Immunity +(Volts)-		Fanout
Full Adder	SM10 Series	Sum 22 Carry 10	90	1.0	1.0	These arrays are available in fanouts up to 15 and are completely compatible with SUHL I and SUHL II integrated circuits.
Dependent Carry Fast Adder	SM20 Series	Sum 22 Carry 10	125	1.0	1.0	
Independent Carry Fast Adder	SM30 Series	Sum 22 Carry 10	125	1.0	1.0	
Carry Decoder	SM40 Series	2	25	1.0	1.0	
4-Bit Storage Register	SM60 Series	20	30/bit	1.0	1.0	
Bus Transfer Output 4-Bit Storage Register	SM70 Series	20	30/bit	1.0	1.0	
Cascade Pullup Output 16-Bit Scratch Pad Memory	SM80 Series	25	250	1.0	1.0	
Decade Frequency Divider	SM90/92 Series SM91/93 Series	35MHz 30MHz	125 85	1.0	1.0	
4-Bit Shift Register	SM110 Series	25MHz	120	1.0	1.0	
Parity Generator/Checker	SM120 Series	22	125	1.0	1.0	
Comparator	SM130 Series	17	120	1.0	1.0	
Programmable Binary Divider	SM140 Series	25MHz	150	1.0	1.0	
Programmable Decade Divider	SM150 Series	25MHz	150	1.0	1.0	
Binary Counter	SM160 Series	25MHz	135	1.0	1.0	
Decade Counter	SM170 Series	25MHz	135	1.0	1.0	
Binary Up/Down Counter	SM180 Series	25MHz	205	1.0	1.0	
Decade Up/Down Counter	SM190 Series	25MHz	205	1.0	1.0	
BCD to 7-Segment Translator	SM200 Series	85	280	1.0	1.0	
Dual 4-Bit Multiplexer	SM210 Series	10-20	130	1.0	1.0	
Demultiplexer	SM220 Series	9-14	225	1.0	1.0	

Sylvania Electronic Components,  
Semiconductor Division,  
Woburn, Mass. 01801

**SYLVANIA**  
GENERAL TELEPHONE & ELECTRONICS

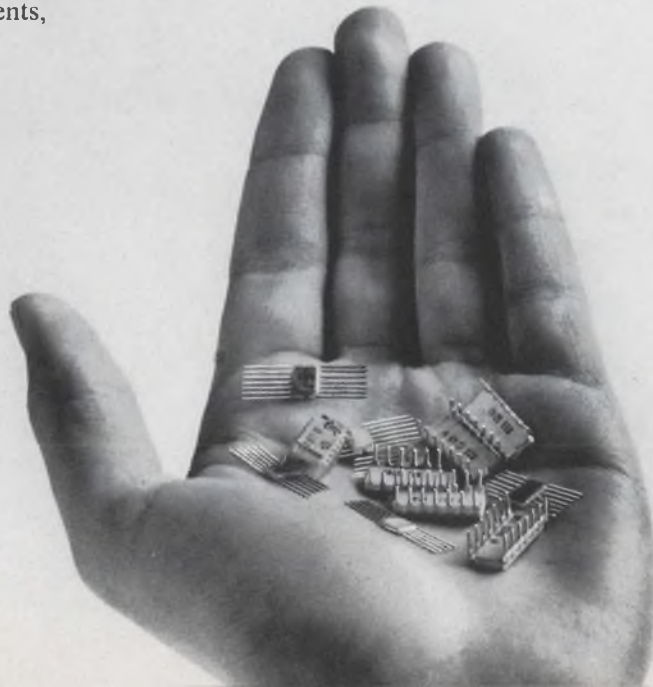

adjusting the core.

The core must be introduced at one end of the winding. This increases the effective inductance of the adjacent half of the secondary much faster than that of the more physically remote half. A transition occurs as the slug passes through the center of the coil. This is the point of maximum coil inductance as well as the point at which the inductance of the two halves is equal. Thereafter the coil halves reverse their roles.

Secondary effects result from changes in the effective shunt capacitances of the two coil halves, their stray capacity to ground and the presence of the brass screw supporting the iron core. It is clear that the shape of the response curve, as well as its crossover frequency, is a function of core location. Since there are variations in total circuit capacitance resulting from tolerances in components and slight differences in physical assembly, no two units with identical core position will tune to the same frequency. As a result, production-line units suffer from poor uniformity of response.

Although a secondary inductor of this nature is a poor choice, it has found wide acceptance. The coil is simple to make, and the response can be adjusted by adding a piece of wire to either side of the circuit and dressing it to the chassis. Another tuning method involves the use of an unsymmetrical secondary winding. But these systems are time-consuming, inaccurate, and inadequate for equipment required to meet even modest tolerances.

The only type of secondary winding capable of satisfying the symmetry requirements is a special class of bifilar construction. The winding is started at the center tap, which is located toward the base of the coil form, and wound simultaneously in both directions, crossing the two wires sequentially every 180 degrees and ending at two terminals (located symmetrically with respect to the center tap) near the upper

end of the coil form.

If properly built, both coil halves will use the same length of wire; will have the same inductance, distributed capacitance and stray capacitance, and will tune identically when a slug is introduced for frequency adjustment. The technique has two major drawbacks: It adds a considerable amount of interwinding capacitance to the coil, thus cutting down on the maximum usable inductance, and it is impractical to make on a production-line basis.

The discriminator circuit shown (patent no. 2,974,287) was designed to overcome all these problems. Reference voltage is introduced by means of a center-tapped capacitance. Since the secondary coil no longer has a center tap, it can be tuned without affecting the shape of the response. This phantom ground arrangement has been used before, but it still suffers from many of the problems mentioned previously. Dramatic changes in characteristics of the device result from adding the differential capacitor shown in the circuit diagram.

The differential capacitor provides a means of balancing the capacitances of the two sides of the circuit. By restoring an exact ground reference, it can be used to adjust the response curve slope without affecting the crossover frequency. Adjusting the differential capacitor to the other side of its crossover point inverts the output response. No switch of the discriminator output wiring is needed. Frequency deviation monitors having slopes up to 120 V per MHz with a tolerance of plus or minus 1 V per MHz operating near 30 MHz, have been turned out on a production line with little difficulty. The new circuit can be adjusted with great precision, resulting in better instrumentation accuracy than previous designs.

*Robert F. Arnesen, P.E., (formerly of Raytheon Co.), Camarillo, Calif.*

VOTE FOR 311

## EXCLUSIVE-OR gates replace choppers in phase-lock loop

A major problem in the design of phase-lock loops is the phase detector. Without the use of costly and complex techniques, it is usually the limiting factor in achieving accuracy.

The EXCLUSIVE-OR circuit shown in Fig. 1, consisting of a single quad-gate IC unit, can replace virtually all existing chopper or demodulator circuits used in phase-lock loops for input

frequencies ranging from dc to 5 MHz. Besides the obvious advantages of simplicity, size and cost, it operates relatively free from the effects of static or dynamic offsets found in conventional phase detectors. These errors are often indistinguishable from the actual phase error voltage that drives the VCO. The dc nature of the EXCLUSIVE-OR makes phase-locking insensitive to

# Lots of people have told us they could use an active filter with low power requirements and a low enough price

## How does 0.3 mW at \$10\* sound?

### Ask for carload prices or send \$12 for an evaluation sample.

You'll find there's a lot to evaluate. Like that power spec—ideal for all kinds of battery-powered gear. Plus a price/performance combination that we think will eliminate a lot of in-house filter making, even for commercial applications. Mail the coupon and a check or P.O. for \$12.00 today (please attach your company letterhead). We'll respond by air with a sample FS-60 and our brand new Filter Design Handbook. Till then, here are the basic specifications:  Delivers band-pass, high-pass and low-pass outputs simultaneously  Any desired form of the second order transfer function  Complex zeros anywhere in the S-plane  Multi-loop negative feedback for added stability  F<sub>c</sub> and Q of basic unit can be tuned by adding external resistors  Frequency range from DC to 10 kHz  Q range from 0.1 to 500  Voltage gain is adjustable to 40dB  Supply voltages from ±2V to ±15V with 0.3 mW power consumption  Dimensions: (14-pin DIP) 0.804" x 0.366" x 0.474"  IC hybrid construction.

Gentlemen at KTI:

Please send me an FS-60 evaluation sample. Our  check  P.O. is attached, in the amount \$12.00. Send me more information on:

FS-60  All active filters  Hybrid subsystems  
 Please add my name to your permanent mailing list

Name \_\_\_\_\_

Company \_\_\_\_\_

Address \_\_\_\_\_

City \_\_\_\_\_

State \_\_\_\_\_ ZIP \_\_\_\_\_

My applications are: \_\_\_\_\_

\_\_\_\_\_

\_\_\_\_\_

PRICES:	1 - 49	\$28	5,000 - 9,999	\$14
	50 - 199	\$23	10,000 - 19,999	\$12
	200 - 999	\$19	*20,000 - 49,999	\$10
	1,000 - 4,999	\$16		

# KTI

**KINETIC TECHNOLOGY, INCORPORATED**

3393 De La Cruz Boulevard  
Santa Clara, California 95051

(408) 246-8100 TWX: 910-338-0279

The name to remember for Hybrid Integrated Systems and Active Filters . . .



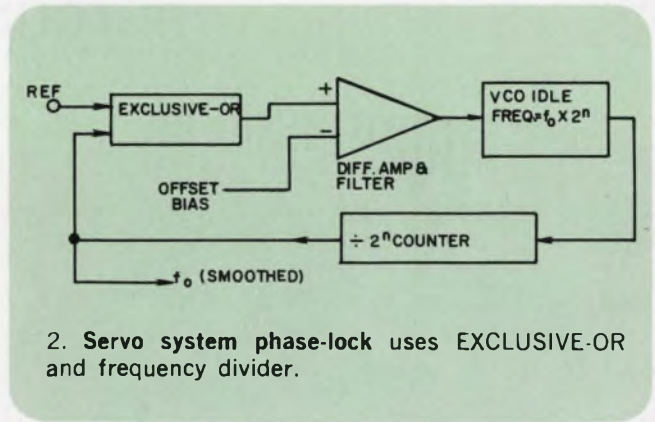
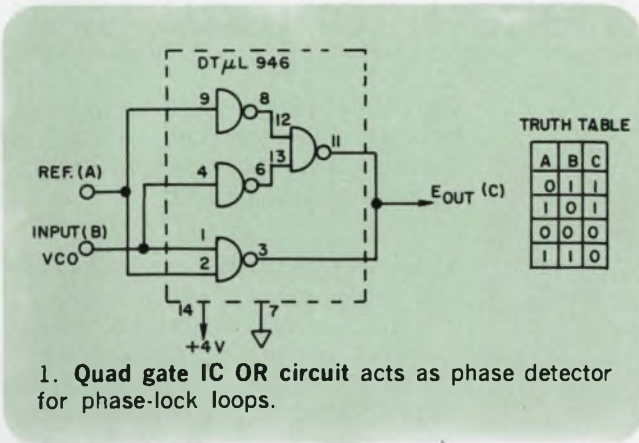

noise spikes exceeding the logic threshold. In addition, the inputs need not be symmetrical if only frequency lock is desired.

A phase-lock servo utilizing the EXCLUSIVE-OR is shown in Fig. 2. This loop, with a frequency divided chain, provides precise control of a high-frequency oscillator with a low-frequency input. (A high-frequency oscillator is much easier to design in the spectrum mentioned than a low-frequency oscillator.) Phase locking occurs when the inputs are 90° out of phase. The frequency of the phase-detector output at lock is double that of the input.

An EXCLUSIVE-OR gate coupled to two NAND gates produce a frequency divider output that is in-phase with the reference. This circuit is shown in Fig. 3. The output of the detector is essentially pure dc at lock. This condition results in a smoother output frequency than that using only an EXCLUSIVE-OR gate. Power supply variations have practically no effect, and tem-

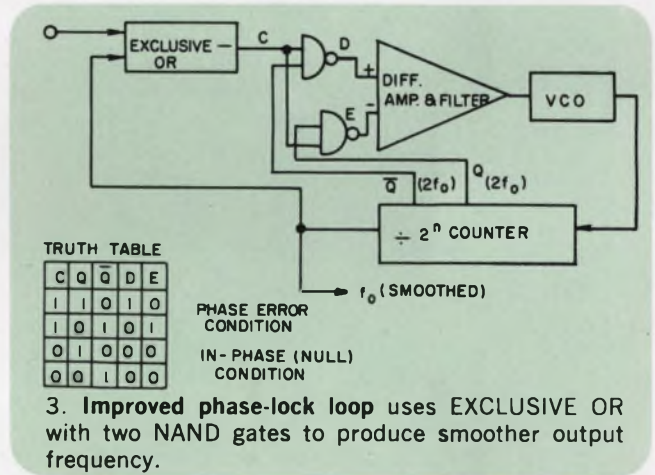

perature effects are held to a minimum by using NAND gates on the same chip.

George S. Oshiro, Design Engineer, Teledyne Systems, Los Angeles, Calif.

VOTE FOR 312

## Over/under voltage monitor is inexpensive and stable

An overvoltage or undervoltage condition is indicated by this circuit. Any potential from 1 to 15 volts can be monitored. Two lamps alert the operator to any undesirable variation. The voltage differential from lamp turn-on to turn-off is about 0.2 V at any setting. High and low set points are independent of each other, and the circuit is quite stable. In six months of use the set points on one unit did not need adjustments.

The design is inexpensive. Less than \$5 will secure all components and a rugged case.

The SCRs used in the circuit should be the sensitive gate type. R<sub>3</sub> must be experimentally

# VOTE

**VOTE!** Go through all Idea-for-Design entries, select the best, and circle the appropriate number on the Reader-Service-Card.

**SEND US YOUR IDEAS FOR DESIGN.** You may win a grand total of \$1050 (cash)! Here's how. Submit your IFD describing a new or important circuit or design technique, the clever use of a new component or test equipment, packaging tips, cost-saving ideas to our Ideas-for-Design editor. You will receive \$20 for each accepted idea, \$30 more if it is voted best-of-issue by our readers. The best-of-issue winners become eligible for the Idea Of the Year award of \$1000.

# lowest profile – smallest over-all mercury-wetted contact relay

The Clare HGSR (only .33 cu. in.) puts more switching capacity on a board than ever before possible with long life mercury-wetted contacts.

It's fast and tough—serves most process control operations . . . provides over 22 billion operations without fail or falsing. And like the widely recognized Clare HGM and half-size HGSM, it provides a combination of high speed and low contact noise generation . . . the elimination of contact bounce and chatter and resulting false signalling. Advanced circuits can be designed with power gain up to 5000 . . . sensitivities as low as 20 mw. For solid state buffering, you get built-in input/output isolation . . . for measurement circuitry, minimal contact resistance, constant over billions of operations.

For information, circle Reader Service number, or, call your Clare Sales Engineer or local Clare Distributor. Or write for Data Sheet 802. C. P. Clare & Co., Chicago, Ill. 60645 . . . and worldwide.

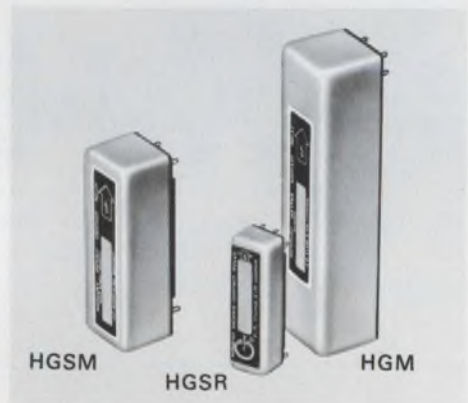
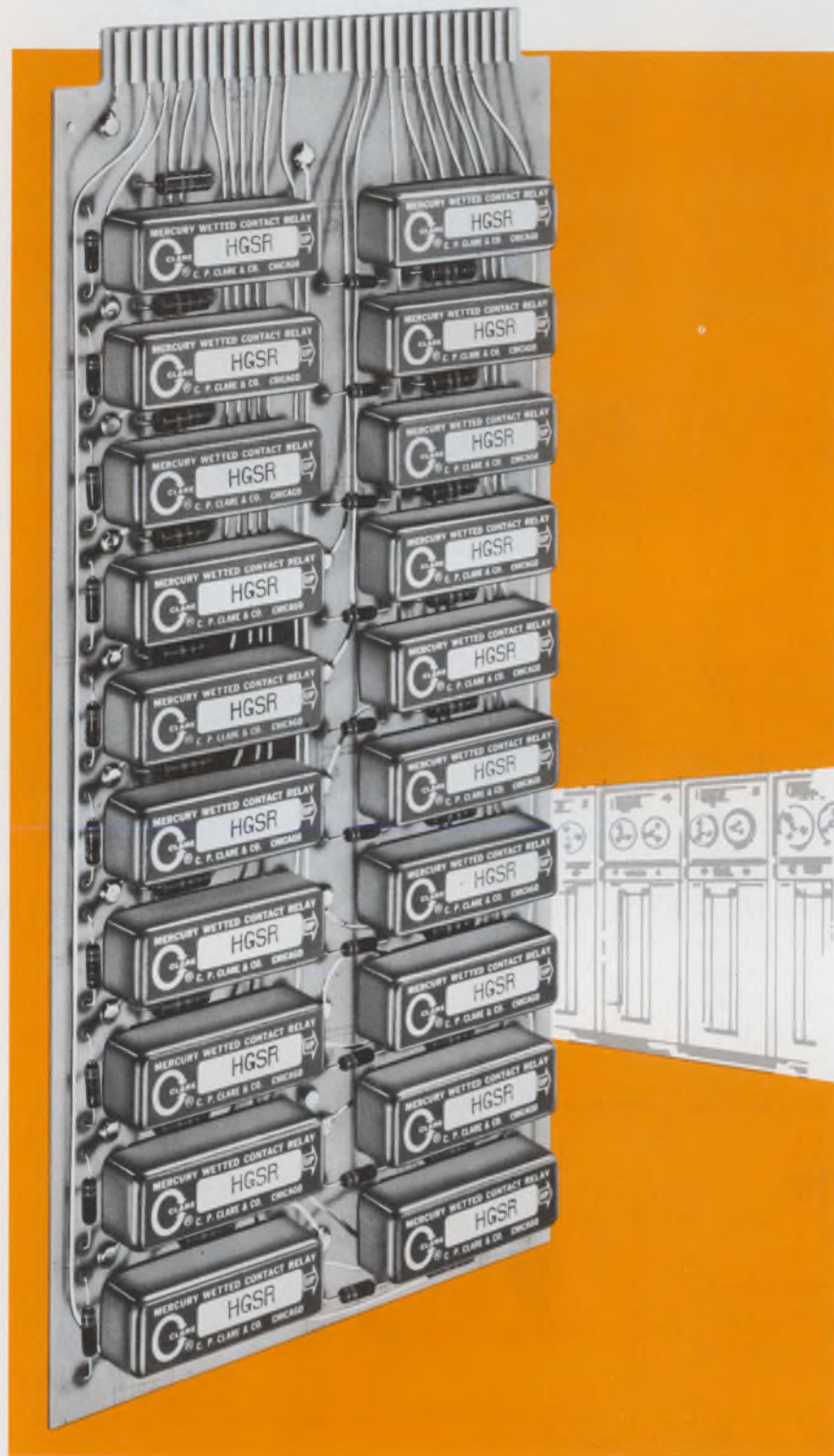

- Life:  $22 \times 10^9$  operations—with no maintenance
- Low, constant contact resistance—no mechanical wear or electrical erosion
- No contact bounce
- Switching speeds to 1 ms
- Versatile contact load capabilities—low level to 250 va
- High power gain—to 5000 with no noise sensitivity
- Sensitivities as low as 20 mw

LOOK FOR



**CLARE** ON THE RELAY

a GENERAL INSTRUMENT company

INFORMATION RETRIEVAL NUMBER 48

ELECTRONIC DESIGN 3, February 1, 1970

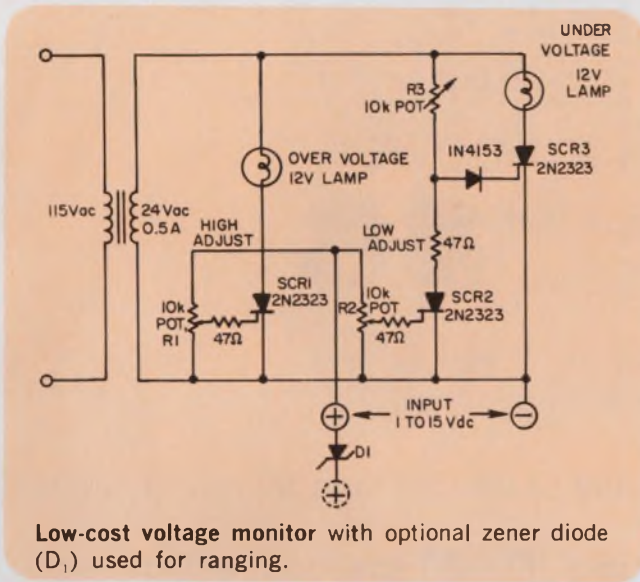

determined for the particular series of SCRs used. This is done by adjusting  $R_3$  to the point where the undervoltage lamp turns on when no signal is present at the SCR<sub>3</sub> gate.

Any 15-V segment can be monitored by putting a zener diode ( $D_1$ ) in series with the positive input lead (see figure). The low set-point voltage will then be the zener voltage plus 0.8 V. By changing  $R_1$  and  $R_2$  it is possible to adjust the voltage range monitored.

This device was first designed for monitoring electroplating cell potential. It is especially useful in a series setup, since the potential can change from cell to cell. A drop or rise from normal in cell voltage can be a sign of electrolyte problems.

*Charles L. Andrew, Control Circuitry & Electroplating Consultant, Lemont, Pa.*

VOTE FOR 313

## Frequency-shift oscillator uses DTL circuits throughout

A DTL gate, used as the basis of a frequency-shift oscillator, provides variable-frequency sine waves for many applications.

As shown in the figure, the inverter A operates as a Colpitts oscillator whose frequency is determined by the parallel resonant frequency of  $L_1$ ,  $C_1$ , and  $C_2$ , which in this particular case is approximately 1.2 MHz. Inductor  $L_1$  serves both as frequency-determining element and a bias path that linearizes the inverter by providing heavy negative dc feedback. By adding inverters B, C, and D and capacitors  $C_3$  and  $C_4$ , the oscillator becomes a frequency-shift keyer.

The introduction of the output saturation resistance of the inverters in series with the shift capacitors causes the circuit Q and the oscillator output voltage to be reduced. To keep the Q high, it is necessary that the ratio  $C_2/C_3$  and  $C_2/C_4$  be kept high (10 or more). To keep the output amplitude variations at a minimum during frequency shifting, the ratio  $C_3/C_4$  should be kept at a minimum (5 or less).

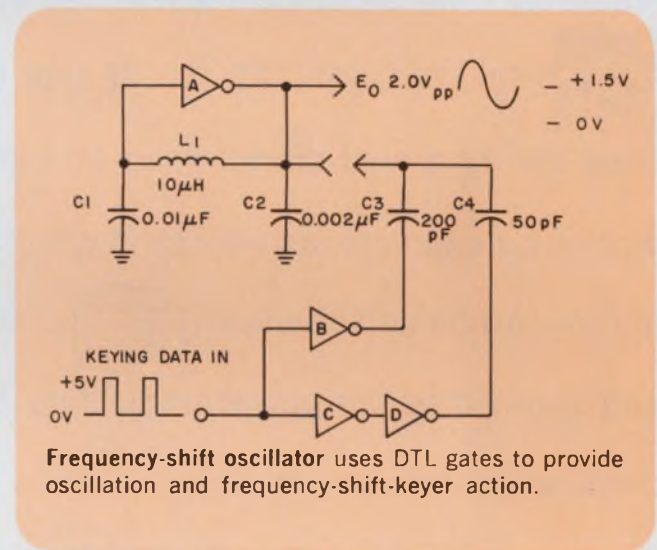

*Charles A. Herbst, Consultant, COMFAX Communications, Garden City, N.Y.*

VOTE FOR 314

### IFD Winner for September 27, 1969

**Basil Ioannou and Carl Brunnett**, Design Engineers, Picker Instruments, Cleveland, Ohio. Their Idea "Divide by 3, 5, or 10 With A Minimum of Hardware" has been voted the Most Valuable of Issue Award.

**Vote for the Best Idea in this Issue.**

### IFD Winner for October 11, 1969

**B. A. Rogers**, Senior Engineer, Bendix Corp., North Hollywood, Calif. His Idea "Dual Level Detector Uses One Active Device" has been voted the Most Valuable of Issue award.

**Vote for the Best Idea in this Issue.**

Depend on RCA  
reliability in  
complementary  
medium-power  
transistor  
pairs...

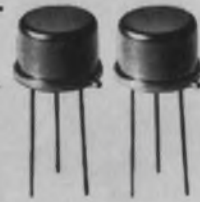

hermetically sealed for broader applications.

Now...RCA covers the industrial  spectrum with general-

purpose, p-n-p/n-p-n  transistor complements...and they're all hermetically sealed in TO-5 packaging to give you greater design flexibility and

reliability. Choose any of these broad-spectrum device families — the  p-n-p



2N5781, 2N5782, 2N5783, or the n-p-n 2N5784, 2N5785 and 2N5786.

They can fit a host of switching and amplifier  applications — in computers, for example, as well as in oscilloscopes, radar, missiles, hi-fi equipment,

marine radios and satellite  communications systems. RCA silicon p-n-p

and n-p-n medium-power transistors all feature low saturation voltages, high

breakdown voltages and high  $h_{FE}$  (min.) at  high current. And they're

beta controlled to 1.6 A, with collector-to-emitter sustaining voltages ( $V_{CE}$ ) up

to 80 V available.  $V_{CE}$  (sat.) is 1.0 V max. at 1.6 A. For complete  details,

see your local RCA representative or your RCA distributor, or write RCA Elec-

tronic Components,  Commercial Engineering, Section IG-2/UT5, Harri-

son, N.J. 07029. In Europe: RCA International Marketing S.A., 2-4 rue du Lièvre,

1227 Geneva, Switzerland.

**RCA**

# Product Source Directory

## Slotted Lines

This Product Source Directory, covering Slotted Lines, is the sixth in a continuing series of product selection data that will list comparative specifications and prices for products frequently purchased by design engineers. All categories will be arranged according to some primary parameter so that items having similar functional capabilities can be instantly compared.

### How to use the tables

The tables in this section list the specifications for coaxial and waveguide slotted lines.

The following abbreviations apply to all instruments listed:

ina—information not available.

n/a—not applicable.

An index of models by manufacturer is included at the end of the tables.

For each table, the instruments are listed in ascending order of one major parameter. The column containing this parameter is color-coded white. Manufacturers are identified by abbreviation. The complete name of the manufacturer can be found in the following Master Cross Index along with reader service numbers.

Abbrev.	Company	Reader Service No.
Alford	Alford Manufacturing Co. 120 Cross Street Winchester, Mass. 01890 (617) 729-8050	462
GR	General Radio Co. West Concord, Mass. 01781 (617) 369-4400	463
HP	Hewlett Packard Co. 1501 Page Mill Road Palo Alto, Calif. 94304 (415) 326-7000	Contact Local Sales Office
Narda	Narda Microwave Corp. Commercial St. Plainview, N.Y. 11803 (516) 433-9000	465
Omega	Omega Labs Inc. Haverhill St. Rowley, Mass. 01969 (617) 948-7757	466
Omni Spectra	Omni Spectra Inc. 24600 Hallwood Ct. Farmington, Mich. 48024 (313) 255-1400	467

Abbrev.	Company	Reader Service No.
PRD	PRD Electronics Inc. 6801 Jericho Turnpike Syosset, N.Y. 11791 (516) 364-0400	468
R-S	Rohde & Schwarz 111 Lexington Ave. Passaic, N.J. 07055 (201) 773-8010	469
Somerset	Somerset Radiation Labs. Inc. 2060 N. 14th St. Arlington, Va. 22216 (703) 525-4255	470
TRG	TRG 400 Border St. East Boston, Mass. 02128 (617) 569-2110	471
Weinschel	Weinschel Engineering Co. P.O. Box 577 Garthersburg, Md. 20760 (301) 948-3434	472

	Manufacturer	Model	Min GHz	Max GHz	Residual VSWR	Characteristic Impedance $\Omega$	Probe Travel cm	Misc. Features	Price \$
S1	PRD	2219-L	0.01	0.1	1.02	50	n/a		1025
	R-S	LMM	0.08	0.3	1.03	50, 60, 75	193		1575
	PRD	2219-M	0.1	1	1.02	50	n/a		850
	PRD	2219-K	0.01	2.3	1.02	50	na		1975
	PRD	2219-H	0.95	2.3	1.02	50	n/a		900
	Alford	1198A-16	0.0375	3	a	75	408	a	5035
	Alford	1026-13	0.05	3	a	50	318		3985
	Alford	1198A-13	0.05	3	a	75	318	a	4235
	Alford	1026-8	0.075	3	a	50	204		2550
	Alford	1198A-8	0.075	3	a	75	204	a	2800
S2	Alford	1198A-6	0.1	3	a	75	153	a	2175
	Alford	1026-6	0.1	3	a	50	153		1925
	Alford	1026-4	0.15	3	a	50	102		1550
	Alford	1198A-4	0.15	3	a	75	102	a	1800
	Alford	1026-2	0.3	3	a	50	51		1450
	R-S	LMD	0.3	3	1.02	50, 60, 75	50		1180
	Alford	1198A-2	0.3	3	a	75	51	a	1700
	Alford	1026-16	0.375	3	a	50	408	a	4785
	Alford	1300A-6	0.1	4	a	75	153	a	1590
	Alford	1300A-4	0.15	4	a	75	102	a	1375
S3	Alford	1300A-3	0.2	4	a	75	76	a	1275
	Alford	1300A-2	0.3	4	a	75	51	a	1175
	H-P	805C	0.5	4	1.04	50	40	st	750
	Alford	2181-6	0.1	4.5	a	50	153		1380
	Alford	2181-4	0.15	4.5	a	50	102	a	1140
	Alford	2181-3	0.2	4.5	a	50	76		1030
	Alford	2181-2	0.3	4.5	a	50	51		915
	Alford	3116A-1.6	0.35	6	a	50.0	40.7	a	1385
	Alford	3116A-1	0.6	6	a	50	25.4	a	1060
	R-S	LMC	1.65	7.45	1.011	50, 60, 75	16		2270
S4	Alford	2382-4	0.15	3.5	a	50	102		1140
	GR	900-LB	0.3	8.5	1.002	50±0.1%	50	hi	1300
	Alford	2382-2	0.3	8.5	a	50	51	a	915
	GR	874-LBB	0.3	9	1.1.02	50±0.5%	50	jk	475
	PRD	230/N231	4	10	1.15	50	6		475
	Alford	2288-1	0.6	12.4	a	50	28	a	900
	Alford	3028	1.2	18	a	50	12.7	a	1250
	Alford	3300	1.2	18	a	50	12.7	a	1275
	Alford	2920-05	1.2	18	a	50	12.7	ae	1050
	Alford	2852-05/APC-7	1.2	18	1.013	50	12.7	c	1140
S5	Alford	3407/APC-7	1.2	18	1.011	50	12.7	b	1340
	H-P	817A	1.8	18	1.02	50	10	mnp	925
	H-P	816A	1.8	18	1.02	50	10	mnqr	250
	Weinschel	1021	2	18	1.02	50	3	x	1145
	Omni Spectra	20010	3	18	1.05	50	10		960
	Narda	4232	4.0	26.5	1.07-1.15	50	5		1200
	Alford	3501-04	2	36	1.01	50	10	df	1700
	Alford	2400-04	2	36	1.02	50	10	dg	1300



## This little relay is new!

**It's about a third as big as the others. Costs less, too.  
Its 3PDT contacts will switch 3 amperes.**

This little relay saves money and chassis space. It measures only 1" x 1" x 1 3/8" high. It costs only \$4.60 in single lots\*. It may be mounted directly to a chassis, in a socket or on a printed circuit board.

Meet our new KNP Series . . . designed for reliable duty in appliances, vending equipment, business ma-



chines, machine tool controls and a host of other applications.

This relay has Underwriters' Laboratories component recognition (File E 22575—Magnetic Motor Controller) for 1/10 HP, 120V AC; 3 amperes, 32V

DC resistive; 3 amperes, 240V AC.

Two sockets are available. The first snaps into a metal chassis and requires no retaining spring. It has



pierced solder terminals. The second is designed for use on p.c. boards. Both sockets can be furnished with a grounding lug.

KNP relays may be ordered with printed circuit terminals for direct mounting on p.c. boards. The assembly of six relays shown above requires a board space of only 6 3/4" x 1".

### KNP SERIES SPECIFICATIONS

**Arrangements:** 1 Form C (SPDT), 2 Form C (DPDT) and 3 Form C (3PDT).

**Rating:** 3 amps @ 30V DC, resistive, or 120V AC. Also available with silver-cadmium oxide rated 3 amps @ 30V DC, inductive, or 120V AC.

**Voltages:** To 120V AC, 50/60 Hz.  
To 110V DC.

**Pick-up @ 25°C:** AC: 85% of nominal voltage.  
DC: 75% of nominal voltage.

**Expected Life:** Electrical: 100,000 operations minimum @ rated load.  
Mechanical: 10,000,000 operations minimum.

**Temperature Range:** -45° to +70°C.

Get full information today. Call your local P&B sales engineer or write directly to Potter & Brumfield Division of American Machine & Foundry Company, Princeton, Indiana 47570. Phone 812/385-5251.

\*3PDT, 24V DC model. Quantity discounts apply.

STANDARD P&B RELAYS ARE AVAILABLE FROM LEADING ELECTRONIC PARTS DISTRIBUTORS

**AMF | POTTER & BRUMFIELD**

	Manufacturer	Model	FREQUENCY		Irregularity SWR	Slope SWR	Residual VSWR	Probe Travel cm	Waveguide Size Inches	Flange Type	Misc. Features	Price \$
			Min GHz	Max GHz								
S6	Omega	1515	0.75	1.12	1.005	ina	1.01	71	9.75 x 4.85	CPR975F		2800
	Omega	1516	0.96	1.45	1.005	ina	1.01	54	7.7 x 3.85	CPR770F		1900
	Omega	510	1.12	1.7	1.005	ina	1.01	32	6.66 x 3.41	UG-417/U		1700
	Omega	2074	2.3	2.7	1.005	ina	1.01	30	3.698 x 1.849	CPR369F		1800
	Omega	511	1.7	2.6	1.005	ina	1.01	30	4.46 x 2.31	UG-435/U		1500
	Omega	512	2.6	3.95	1.005	ina	1.01	25	3 x 1-1/2	UG-53/U		1200
	Omega	523/520	3.3	4.9	1.005	ina	1.01	10	2.418 x 1.273	CMR229		505
	H-P	G810B	3.95	5.85	1.01	n/a	n/a	10	2 x 1	UG-407/U		175
	Omega	524/520	3.95	5.85	1.005	ina	1.01	10	2 x 1	UG-149A/U		500
	Omega	525/520	4.9	7.05	1.005	ina	1.01	10	1.718 x 0.923	CMR159		505
S7	H-P	S810B	5.3	8.2	1.01	n/a	n/a	10	1-1/2 x 3/4	UG-441/U	u	150
	Narda	222	5.3	8.2	1.01	1.01	1.01	9.4	1-1/2 x 3/4	UG-441/U		335
	Omega	526/520	5.85	8.2	1.005	ina	1.01	10	1-1/2 x 3/4	UG-344/U		495
	H-P	H810B	7.05	10	1.01	n/a	n/a	10	1-1/4 x 5/8	UG-138/U	u	135
	Omega	527/520	7.05	10	1.005	ina	1.01	10	1.25 x 0.625	UG-51/U		490
	H-P	X810B	8.2	12.4	1.01	n/a	n/a	10	1 x 1/2	UG-135/U	u	125
	Somerset	X103	8.2	12.4	1.01	ina	1.01	fixed	1 x 0.5	39		115
	Somerset	X102	8.2	12.4	1.01	ina	1.01	fixed	1 x 0.5	39		65
	PRD	230/X231	8.2	12.4	ina	ina	1.01	6	1 x 1/2	UG-39/U		300
	Omega	528/520	8.2	12.4	1.005	ina	1.01	10	1 x 1/2	UG-39/U		490
S8	Omega	3525/520	10	15	1.005	ina	1.01	10	0.85 x 0.475	ina	u	500
	H-P	P810B	12.4	18	1.01	n/a	n/a	10	0.702 x 0.391	UG-419/U		150
	TRG	KU740	12.4	18	1.01	1.01	ina	ina	0.622 x 0.311	UG-419/U		795
	PRD	230/U231	12.4	18	ina	ina	1.01	6	0.702 x 0.391	UG-419/U		320
	Omega	529/520	12.4	18	1.005	ina	1.01	10	0.702 x 0.391	UG-419/U		500
	Narda	219	12.4	18	1.01	1.01	1.01	8.9	0.702 x 0.391	UG-419/U		440
	Omega	3526/520	15	22	1.005	ina	1.01	10	0.59 x 0.335	WR51		500
	TRG	K740	18	26.5	1.01	1.01	ina	ina	0.42 x 0.17	UG-595/U		920
	PRD	230/K231-F1	18	26.5	ina	ina	1.01	6	0.5 x 2.5	UG-595/U		500
	H-P	K815B	18	26.5	1.01	n/a	n/a	5.4	0.42 x 0.17	UG-595/U	v	525
S9	TRG	A740	26.5	40	1.03	1.03	ina	ina	0.28 x 0.14	UG-599/U		990
	PRD	230/A231-F1	26.5	40	ina	ina	1.01	6	0.36 x 0.22	UG-599/U		500
	H-P	R815B	26.5	40	1.01	n/a	n/a	5.4	0.28 x 0.14	UG-599/U	v	525
	TRG	B740	33	50	1.03	1.03	ina	ina	0.224 x 0.112	UG-383/U		1040
	TRG	U740	40	60	1.03	1.03	ina	ina	0.188 x 0.094	UG-383/U		1050
	TRG	V740	50	75	1.03	1.03	ina	ina	0.148 x 0.074	UG-385/U		1070
	TRG	E740	60	90	1.03	1.03	ina	ina	0.122 x 0.061	UG-387/U		1120
	TRG	W740	75	110	1.03	1.03	ina	ina	0.1 x 0.05	UG-387/U		1800

- a. Depends on reducer used, check with manufacturer.
- b. Residual VSWR to 12 GHz, 1.015 to 18 GHz.
- c. Residual VSWR to 11 GHz, 1.025 to 18 GHz.
- d. 3.5 mm
- e. 7 mm
- f. Residual VSWR to 18 GHz, 1.02 to 36 GHz.
- g. Residual VSWR to 18 GHz, 1.035 to 36 GHz.
- h. Residual VSWR at 1 GHz, 1.01 at 8.5 GHz.
- i. Chart recorder for SWR 1.002 available.
- j. Residual VSWR to 1 GHz, 1.035 to 4 GHz, 1.10 to 8.5 GHz.
- k. Accessories available.
- m. APC-7 and type N connectors.
- n. Residual VSWR; to 8 GHz, 1.03 to 12.4 GHz, 1.04 to 18 GHz.
- p. Model 817A complete swept slotted line system consisting of slotted section,

- carriage, sweep adapter with matched detector probes. Slope and irregularities 0.1 dB/half wavelength, 0.2 dB max cumulative.
- q. With 809C carriage at \$225 and 447B probe at \$125.
- r. Slope and irregularities 0.1 dB/half wavelength, 0.2 dB maximum cumulative.
- s. Slope and irregularities 0.2 dB.
- t. Type N connectors
- u. Waveguide sections mounts in 809C carriage at \$225 with 444A detector probe at \$55.
- v. Waveguide section mounts in 814B carriage at \$525 with 446B detector probe at \$225.
- w. Residual VSWR, 3-8 GHz, 1.10, 8-18 GHz.
- x. Residual VSWR, 2-10GHz, 1.03, 10-18 GHz type N connector; 1.01, 2-10 GHz, 1.02, 10-18 GHz type GPA connector.

## Index by Model Numbers

Name	Model	Code	Name	Model	Code	Name	Model	Code
Alford	1026-2	S2		1198A-2	S2		1300A-2	S3
Alford Electronics	1026-4	S2		1198A-4	S2		1300A-3	S3
	1026-6	S2		1198A-6	S2		1300A-4	S2
	1026-8	S1		1198A-8	S1		1300A-6	S2
	1026-13	S1		1198A-13	S1		2181-2	S3
	1026-16	S2		1198A-16	S1		2181-3	S3



Name	Model	Code
	2181-4	S3
	2181-6	S3
	2288-1	S4
	2382-2	S4
	2382-4	S4
	2400-04	S5
	2852-05/APC-7	S4
	2920-05	S4
	3028	S4
	3116A-1	S3
	3116A-1.6	S3
	3300	S4
	3407/APC-7	S5
	3501-04	S5
GR	874-LBB	S4
General Radio	900-LB	S4
H-P	805C	S3
Hewlett Packard	816A	S5
	817A	S5
	G810B	S6
	H810B	S7
	P810B	S8
	S810B	S7
	X810B	S7
	K815B	S8
	R815B	S9
Narda	219	S8
Narda Microwave Corp.	222	S7
	4232	S5
Omega Labs	510	S6
	511	S6
	512	S6
	523/520	S6
	524/520	S6
	525/520	S6
	526/520	S7
	527/520	S7
	528/520	S7
	529/520	S8
	1515	S6
	1516	S6
	2074	S6
	3525/520	S8
	3526/520	S8
Omni-Spectra PRD	20010	S5
PRD Electronics	230/A231-F1	S9
	230/K231-F1	S8
	230/N231	S4
	230/U231	S8
	230/X231	S7
	2219-H	S1
	2219-K	S1
	2219-L	S1
	2219-M	S1
R-S	LMC	S3
Rohde & Schwarz Sales Corp.	LMD	S2
	LMM	S1
Somerset	X102	S7
Somerset Radiation Labs	X103	S7
TRG	A740	S9
TRG Inc.	B740	S9
	E740	S9
	K740	S8
	KU740	S8
	U740	S9
	V740	S9
	W740	S9
Weinschel	1021	S5
Weinschel Engineering		

# WE'VE GOT A BETTER WAY TO MAKE PRINTED CIRCUITS!

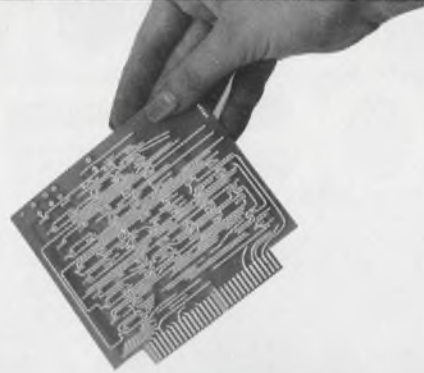

*Here's some Industrial History you should know!*



F-104

Developed new technique to produce circuit boards with more reliable plated-thru holes.



PHOENIX

Required new techniques for manufacturing heat sinks and insulation by chemical milling.



F-111

New industry technique was used to produce multilayer circuit boards with an internal heat sink.



POSEIDON

Developed new technology for sequential laminating multilayer circuit boards with aluminum backbone.



707

Reliable circuit boards in high volume at low cost were produced for this project.



MERCURY

Our company used a unique etch-back method for plated-thru holes in large quantities.



C5

We introduced circuit boards that had the highest density circuitry ever used before on a production basis.



GEMINI

Again, top reliability was required and delivery on-time was made to the customer.



OTHERS

Hundreds of projects use our circuit boards in all phases of civilian and military equipment. We've got a better way to make printed circuitry.



APOLLO

Our circuit boards were on Apollo, LEM, and seis. experiment. Sequential laminating, extra-fine line width and spacing, plated slots and edges.



*This design & production experience can give you a BIG JUMP on your next project.*  
**CALL US NOW!**

**CONTROL DATA**  
CORPORATION

CONTROL DATA CORPORATION

PRINTED CIRCUITS OPERATION  
7800 COMPUTER AVENUE  
MINNEAPOLIS, MINN. 55435  
PHONE: (612) 920-8600

# LAST YEAR THE TOMORROW MOSFETS.

The complex LSIs are Tomorrow-minded, too. These Metal Oxide Semiconductor Integrated Circuits are loaded with Tomorrow features. Low-voltage threshold and nitride passivation have been production processes for more than a year. The advanced Mosinc device pictured is our new up-down counter with seven-segment decoder, Hughes Part No. HCTR0107. It includes 512 Mosfets; performs up to 100 functions; and serves as a universal, presettable counter and a storage register. We'd like to tell you more about our total capability in microelectronics—including our custom CMOS (Complementary MOS) and IMOS (Ion-Implantation MOS) logic, shift-register and memory capability. Check pages 1606-1620 in the 1969 EEM Catalog. Or write to us at this address: Hughes MOS Division, 500 Superior Ave., Newport Beach, Calif. 92663.

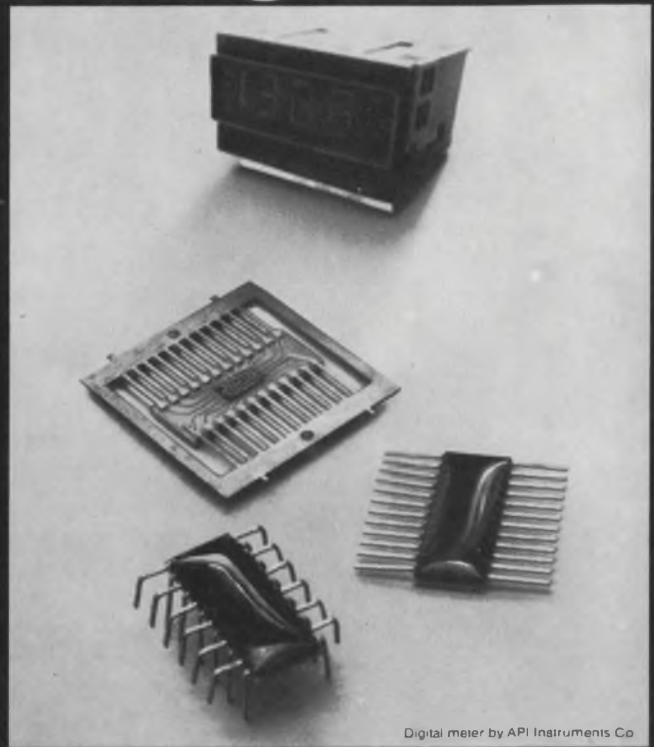

Digital meter by API Instruments Co



# THIS YEAR THE HUGHES MOSINCS.

## COUNTERS

HCTR 0107 Reversible Decade Counter with Seven-Segment Decoder and Drivers  
HCTR 0507 Seven-Stage Binary Counter, 7 Outputs  
HCTR 0102 Commercial/Entertainment Binary Divider  
HCTR 0201 RST Flip-Flop

## STATIC SHIFT REGISTERS

HSSR 2016 Dual-16 Bit  
HSSR 2064 Dual-64 Bit

## DYNAMIC SHIFT REGISTERS

HDSR 2025 Dual-25 Bit  
HDSR 2050 Dual-50 Bit

## ION-IMPLANTED MOS (IMOS)

LISR 0064 20MHz/64-Bit Dynamic Shift Register

## MULTIPLEXERS

HMUX 1756 4-Bit D-to-A Converter  
HMUX 1784 4-Bit D-to-A Converter  
HMUX 2542 Dual 2-Bit Commutator  
HMUX 2641 4-Bit Commutator

## LOGIC ELEMENTS

HLOG 2304 Triple 3, Dual 2 NOR Gates  
HLOG 2306 Dual J-K Flip-Flop

## MULTIPLES

HMUL 1441 General Purpose Quad  
HMUL 1444 General Purpose Quad

HMUL 1445 General Purpose Quad  
HMUL 1446 General Purpose Quad  
HMUL 1447 General Purpose Quad  
HMUL 1463 Quad Dual-Switch  
HMUL 1884 Quad Dual-Switch  
HMUL 2661 Six-Channel Switch  
HMUL 3362 Triple Differential Pairs  
HMUL 3551 Five-Channel Switch  
HMUL 3651 Five-Channel Switch  
HMUL 3661 Six-Channel Switch

## DUALS

HDIG 8049 Low-Level Modulator  
HDIG 8551 Amplifier  
HDSW 8050 Modulator-Demodulator  
HDSW 8550 High-Level Switch

## DISCRETE MOS TRANSISTORS

HDIG 1030 General Purpose  
HDIG 1886 Electrometer  
HDSW 2106 Low-Resistance 20 Ohm Switch, General Purpose  
HDSW 3005 Low-Leakage Switch  
HDSW 8300 30-Volt Switch  
HDSW 8318 Switch, General Purpose  
HDSW 8338 Chopper Switch  
HDSW 8346 Linear Amp  
HDSW 8348 50-Ohm Switch, General Purpose

# New Products

## Modular 15-bit d/a converters set state-of-the-art specs

Analog Devices, Inc., Pastoriga Div., 221 Fifth St., Cambridge, Mass. Phone: (617) 492-6000. P&A: \$995; stock.

Two new modular 15-bit digital-to-analog converters establish new standards for state-of-the-art specifications for speed and resolution, stability, and freedom from output transients (glitch). Accenting different end purposes for the same price, model DAC-15RF is designed for fast operation, while model DAC-15RS stresses high stability.

The DAC-15RF combines a 15-bit resolution with a 5- $\mu$ s settling time to within one least significant bit of the final output value. This means that the unit settles in 5  $\mu$ s to 0.003% of the final value for full-scale output changes.

Settling time drops to 2  $\mu$ s for output excursions of 10% full scale (100 mV or less). Model DAC-15RF slews at 100 V/ $\mu$ s, and limits output transient spikes to a 100-mV amplitude and a 100-ns duration.

Emphasizing stability rather than speed, the DAC-15RS converter settles in 100  $\mu$ s to within plus-and-minus one least significant bit of the final output. It slews at a modest rate of 0.2 V/ $\mu$ s. However, this unit restricts output transients to less than one significant bit or  $\pm 305 \mu$ V maximum.



Output transients or glitches arise from the normal and inherent asymmetry of the ON and OFF switching times for an IC logic unit. Usually, an IC flip-flop switches OFF some 20 ns faster than it switches ON.

To cure this problem, the model DAC-15RS embodies a built-in storage register that accepts and stores the incoming digital command pulses. The register feeds the command signals to the ladder network switches only when a strobe pulse signal tells it to do so.

In this way, the control of

switching times is made independent of any relative delay between incoming ON and OFF switching times. The asymmetry between the converter's internal ON and OFF switching times is then reduced to second-order effects by using cascaded complementary drivers for each bit.

Features common to both the new converters include a 10-V full-scale output, and a linearity of one-half the least significant bit or 0.0015% of full scale. In addition, both modular plug-in units measure only 4.85 inches square by 1 inch thick.

Model DAC-15RF offers a full-scale stability of  $\pm 35$  ppm/month and a maximum output noise of 500  $\mu$ V rms. For unipolar versions, zero stability is  $\pm 25$  ppm/month, and temperature coefficient is  $\pm 7$  ppm/ $^{\circ}$ C of reading plus  $\pm 6$  ppm/ $^{\circ}$ C of full scale. For bipolar versions, zero stability is  $\pm 35$  ppm/month.

Model DAC-15RS provides a full-scale stability of  $\pm 10$  ppm/month and a maximum output noise of 300  $\mu$ V rms. Unipolar versions have a zero stability of  $\pm 0.1$  ppm/month, and a temperature coefficient of  $\pm 7$  ppm/ $^{\circ}$ C of reading. Bipolar versions give a zero stability of  $\pm 10$  ppm/month.

CIRCLE NO. 250

### Also in this section:

**Dynamic 20-bit n-channel MOS shift register** clocks at rates above 15 MHz. p. 88.

**Compact MIC noise sources** feature excess noise ratio as high as 25 dB. p. 91.

**Infrared data transceiver** transfers up to 250k serial bits per second. p. 92.

**Pocket-sized multi-tester** with sensitivity of 200  $\Omega$ /V costs only \$5.95. p. 93.

**Evaluation Samples**, p. 96 . . . . . **Design Aids**, p. 97 . . . . . **Annual Reports**, p. 98.

**Application Reports**, p. 99 . . . . . **New Literature**, p. 100.





## Dynamic 20-bit shift register is 15-MHz n-channel MOS IC

Intersil Inc., 10900 N. Tantau Ave., Cupertino, Calif. Phone: (408) 257-5450. P&A: \$30; stock.

Initiating a series of n-channel MOS memory products, a new 20-bit dynamic shift register can operate at speeds above 15 MHz over the full industrial temperature range, while driving a TTL load. Model LCM6001 achieves these speeds with only a slight increase in power consumption over conventional lower-speed p-channel MOS devices.

Since it is directly compatible with both DTL and TTL bipolar logic, the ICM6001 eliminates the need for level shifting. In addition, special high-voltage clock devices are not required, as with standard p-channel MOS devices. The clock signals needed for the ICM6001 can be generated by standard bipolar logic circuits.

Model ICM6001 works at a 15-MHz rate with two two-phase 12-V clocks. Operating speed drops to 1.5 MHz when clock and drain supply voltages are 5 V. Voltage can range from -0.6 to +15 V; maximum power dissipation is only 300 mW.

For both clocks, repetition rate can vary from 10 kHz to 15 MHz, while pulse width goes from 10  $\mu$ s to 20 ns. Clock delay can be as large as 80  $\mu$ s at 10 kHz. At a 0-V condition, clock input capaci-

tance is typically 15 pF.

Data input logic levels are 0 to 1 V for an OFF state and 4 V minimum for an ON state. Data output logic levels are 0.4 V maximum for an OFF state and 4.5 V minimum for an ON state. Minimum data pulse width is 0.05  $\mu$ s.

Not limited to a maximum performance rate of 15 MHz, the oscilloscope traces below show the ICM6001 n-channel MOS dynamic shift register operating at a speed of 20 MHz. The scope displays are a simultaneous indication of both input clock signals and the data output signal. The figure on the right is a times-ten time magnification of the figure on the left.

The upper portion of both figures show the two input clock signals, while the lower portion is a display of the output data signal. The lower left display shows the two 12-V clock pulses imposed on the data output, which is directly driving a TTL load.

The magnified figure on the right displays the relationship between clock pulses when one is imposed on the other. An ON-state clock signal is always present to insure no loss of information when transferring data into the shift register, even at clock pulse rates as fast as 20 MHz.

CIRCLE NO. 255

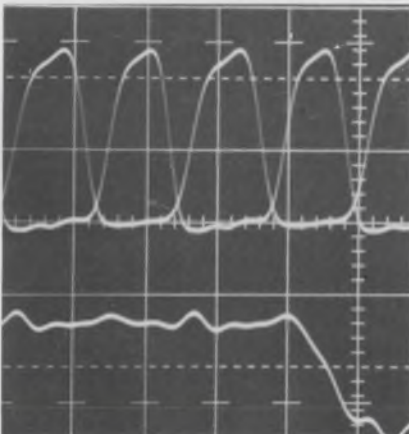
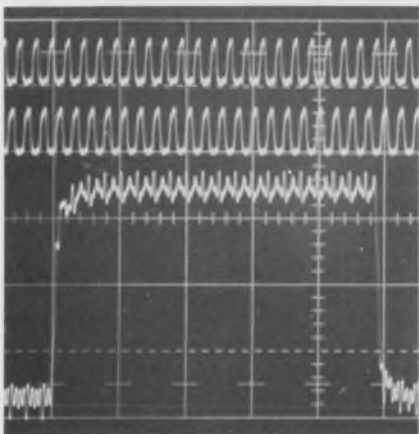

Dynamic 20-bit shift register is an n-channel MOS IC that is capable of guaranteed performance at clock rates as high as 15 MHz. Scope traces show no loss of information while directly driving a TTL load at 20 MHz.

## Plastic transistors carry 4 A at 100 V



Solitron Devices, Inc., 256 Oak Tree Rd., Tappan, N.Y. Phone: (914) 359-5050.

Npn silicon mesa plastic power transistors, which are compatible with TO-66 metal-case transistors, can carry a maximum collector current of 4 A at a maximum collector-emitter voltage of 100 V. Series B-13300-8 units offer a short-circuit forward current gain as high as 300. They are intended for a variety of medium-power applications.

CIRCLE NO. 256

## Dual pulse stretcher gives noiseless pulse

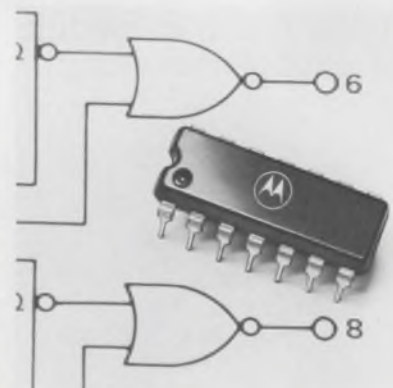

Motorola Semiconductor Products, Inc., P.O. Box 20924, Phoenix, Ariz. Phone: (602) 273-6900. P&A: \$4.95; stock.

Operating on threshold levels to make input rise and fall times unimportant, the MC-675 dual pulse stretcher can generate a noise-free pulse of virtually any width. The width of the output pulse is controlled by the input pulse, an external timing capacitor and an internal or external resistor.

CIRCLE NO. 257

## Rectifier bridges take 1000 PIV

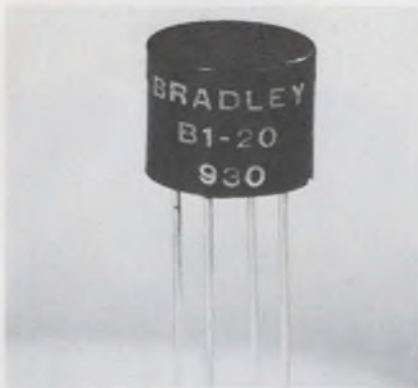

Bradley Semiconductor Corp., 275 Welton St., New Haven, Conn. Phone: (203) 787-7181. Availability: 2 to 4 wks.

A new line of encapsulated silicon bridge rectifiers is rated at 1.5 A and is available in voltage ratings of 50 to 1000 PIV. Series B1 bridges are intended for rapid insertion into printed circuit boards. In addition, the new devices save the user the time and expense of selecting and matching individual diodes.

CIRCLE NO. 258

## Economy 40-A SCRs sell for only \$24.25



International Rectifier, Semiconductor Div., 233 Kansas St., El Segundo, Calif. Phone: (213) 678-6281. P&A: \$24.25; stock.

Costing as little as \$24.25 each in single-unit quantities, a new economy series of 40-A SCRs can handle voltage levels from 600 to 1200 V. Series 40RCS units come in an epoxy package or a glass-to-metal sealed package. Applications include dc motor controls and power supplies.

CIRCLE NO. 259

# Now on the Veeder-Root label...



## Magneline® . . . the digital and data display with inherent memory

Now among the Veeder-Root product groups, Magneline® indicators clearly communicate numbers, colors, or symbols. In normal light, brilliant ambient light, or in the dark, you can easily see what's said. And you don't forget it. Because they won't. When the characters of the message are pulsed into display position, they hold that position by magnetic force after the coils are de-energized, and remain on sharp display as long as needed, without any use of external power. Extremely high reliability, wide mounting variety, low power requirement, and multiplex indication are other advantages. See it and hear it all on this record—free—entertainingly presented and playable on any hi-fi or stereo machine. Whatever your application, you'll say thanks for the, er, Magneline. Remember? For a free copy of this informative, entertaining presentation, write:

**VEEDER-ROOT**

INSTRUMENT & ELECTRONIC DIVISION  
HARTFORD, CONNECTICUT 06102—(203) 527-7201



INFORMATION RETRIEVAL NUMBER 57

### Solid-state switches vary attenuation

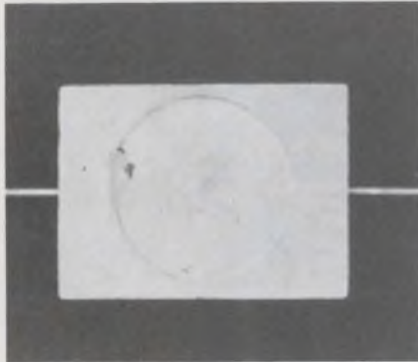

Philco-Ford Corp., Microelectronics Div., Union Meeting Road, Blue Bell, Pa. Price: \$40.

Two new solid-state microwave switch modules are tiny hermetically sealed devices that produce variable attenuation of incident signals by changes in impedance determined by direct current control bias. Model L8370 features a breakdown voltage of 120 V, while model L8380 features switching speeds of 10 ns.

CIRCLE NO. 260

### Wideband noise source gives 36 dB at 1 GHz



Microwave Semiconductor Div. of Solitron/Microwave, 37-11 47th Ave., Long Island City, N.Y. Phone: (212) 937-0400. P&A: \$375 to \$800; 2 to 4 wks.

Operating in the uhf region to X-band, a new solid-state noise source offers 36 dB of excess noise at 1 GHz and 25 dB at 12.4 GHz. The model RFN/25 unit has a VSWR of 2.5 typical (both fired and unfired), which can be reduced to 1.2 by the use of a 10-dB pad, and requires bias power of 28 V dc at 10 mA.

CIRCLE NO. 261

### IR emitting diode boasts broad angle



Fairchild Microwave and Optoelectronics, 2513 Charleston Rd., Mountain View, Calif. Phone: (415) 961-1391. P&A: \$5; 4 wks.

Ideally suited for use with silicon photosensors, a new gallium-arsenide infrared emitting diode has a wide angle at half intensity points. This increases the energy reaching the photosensor at close separations. Model FLD 100 offers a forward voltage of 1.35 V and a reverse voltage of 8.3 V.

CIRCLE NO. 262

KEEP PACE WITH SPACE AGE! SEE MOON SHOTS—LANDINGS, SPACE FLIGHTS, CLOSE-UP!

## AMAZING SCIENCE BUYS

for FUN, STUDY or PROFIT



#### Camera Holder for Telescopes

Take exciting moon pictures. Bracket attaches to any telescope. Removable rod with adjustable bracket holds camera over scope's eyepiece. White metal sun projection screen included. Just attach to holder and place behind eyepiece. Point scope at sun, move screen to focus . . . and see sunspots! Includes brackets, 28 3/4" rod, projection screen, screws, directions. Aluminum; black crinkle brackets. Stock No. 70.162DA \$9.95 Ppd.



#### Camera Body For Astrophotos

Economical 35-mm S.L.R. camera body comes with adapters for direct hookup — has unique two-motion shutter release for maximum sharpness. Rugged, easy to operate. Perfect for astrophotography, prime-focus use. Includes focal-plane shutter, waist-level finder, removable back, self-timer, direct optical viewfinder. Shutter speeds 1 to 1/1,000 sec. Excellent for general pictures with readily available lenses and accessories. Stock No. 70.857DA \$79.00 Ppd.



#### 3" Astronomical Telescope

See moon shots, orbits, stars, phases of Venus, planets close up. 60 to 180 power. Aluminized, overcoated 3"-diam. f/10 primary mirror, ventilated cell. Equatorial mount with locks on both axes. 60x eyepiece and mounted Barlow lens. 3x finder telescope, hardwood tripod. FREE: "Star Chart," "Handbook of the Heavens." Stock No. 85.050DA \$29.95 Ppd. Stock No. 85.105DA 4 1/4" \$94.50 FOB Stock No. 85.086DA 6" \$239.50 FOB



#### Giant Free Catalog

Completely new 1970 edition. 148 pages—1000's of Bargains. New items, categories, illustrations. Dozens of electrical and electromagnetic parts, accessories. Enormous selection of Astronomical Telescopes, Microscopes, Binoculars, Magnifiers, Magnets, Lenses, Prisms. Many war surplus items: for hobbyists, experimenters, workshop, factory. Write for catalog "DA."

LAUNCHING THE SPECTACULAR



IN ELECTRICAL and ELECTRONICS ENGINEERING



## 4 Floors of Exhibits

NEW YORK COLISEUM / 10 a.m.-8 p.m. 4 Days.

## 50 Technical Sessions

NEW YORK HILTON / 10:00-12:30; 2:00-4:30 5 Days.

Registration — Good all days — Technical Sessions and exhibits. In and out privileges. IEEE Members \$4.00. Non-members \$8.00. Ladies \$2.00. High School Students \$3.00 if accompanied by adult (One student per adult). Thursday only — limit of 3 students per adult.

IEEE INTERNATIONAL CONVENTION and EXHIBITION  IEEE MARCH 23-26, 1970 **70**

ORDER BY STOCK NUMBER • OPEN ACCOUNT TO RATED FIRMS • MONEY-BACK GUARANTEE  
EDMUND SCIENTIFIC CO. 300 EDSCORP BUILDING  
BARRINGTON, NEW JERSEY 08007



## Small stable MIC sources give 25-dB excess noise

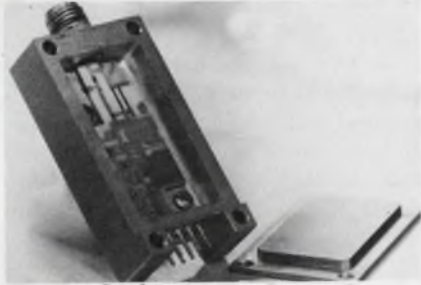

Texas Instruments Inc., Components Group, P.O. Box 5012, Dallas, Texas. Phone: (214) 238-2011. P&A: \$700 typical; 60 days.

Designed to replace bulky argon gas tubes, a new series of compact microwave integrated circuit (MIC) noise sources achieve power output levels with an excess noise ratio as high as 25 dB. All five models feature a temperature-compensated current source driver to provide constant noise power output over the temperature range of  $-55$  to  $+100^{\circ}\text{C}$ .

Model MIC-93S covers the frequency range of 2 to 4 GHz; MIC-93C1 spans 4 to 6 GHz; MIC-93C2 goes from 6 to 8 GHz; MIC-93X1 ranges over 8 to 10 GHz; and model MIC-93X2 operates from 10 to 12.4 GHz.

Functioning as the heart of each noise source is a silicon avalanche noise diode, which is biased to generate a constant noise voltage from 1 to 20 GHz. This diode is constructed with an exclusive guard ring, confining the avalanche noise generator to a well-defined area in the bulk of the diode. Combining this guard-ring design with low power dissipation gives very stable operation.

Measuring only  $1.7 \times 0.8 \times 0.4$  in. and weighing just 0.1 lb, these low-power MICs are ideal for use in airborne receiver noise-figure monitoring applications. In addition, their turn-on and turn-off times of less than  $1 \mu\text{s}$  permit them to be pulsed ON during radar deadtime intervals for continuous performance monitoring.

Due to their low-voltage triggering (5 V for OFF and 0 V for ON), these noise sources are also compatible with the outputs of low-voltage IC logic modules.

CIRCLE NO. 263

## Small TWT amplifiers range over 2 to 11 GHz

Varian, TWT Division, 611 Hansen Way, Palo Alto, Calif. Phone: (415) 326-4000.

Offering typical small-signal gain and noise figure of 30 and 7.8 dB, respectively, at C, S and X bands, a line of miniature low-noise TWT amplifiers span the frequency range of 2 to 11 GHz. The VT series of conduction-cooled units uses a double-reversal permanent magnet method of focusing and includes saturation-output power of 11 dB above 1 mW.

CIRCLE NO. 264

## Hot-carrier diode is 59¢ plastic device

Motorola Semiconductor Products, Inc., P.O. Box 20924, Phoenix, Ariz. Phone: (602) 273-6900. P&A: 59¢; stock.

Said to be an industry first, a new hot-carrier diode is now available in an injection-molded plastic package for only 59¢ in quantities of 100 to 999. Type MBD101 is supplied in a two-lead version of the TO-92 package. Capacitance is less than 1 pF at 0 V and maximum noise figure is 7 dB at 1 GHz.

CIRCLE NO. 265

## Ku-band diodes deliver 300 mW

Sylvania Electric Products, Inc., Semiconductor Div., 100 Sylvan Rd., Woburn, Mass. Phone: (617) 933-3500

Three new Ku-band avalanche oscillator diodes, which are oxide-passivated devices using flip-chip construction, provide an output power of 100 (DGA-5768), 200 (DGA-5768) or 300 mW (DGA-5768B). Depending on the model, typical operating voltage ranges from 60 to 90 V, while typical operating current is 30 to 120 mA.

CIRCLE NO. 266

# Exactly your speed.

Servo-Tek's Speed Indicating System takes the precise rotational speed of your application and displays it on an easy-to-read meter. And it tells you repeatedly and accurately even on the most delicate machinery. A temperature-compensated low torque d-c generator and a taut-band meter movement assure a maximum error of less than 1% of full scale reading. Use it as a watchdog on any industrial application where sensitive speed indication is necessary. The attractive design of our Model ST-926 modernizes any application and comes in a standard version or tailor-made with bi-directional indication, special scales and ranges, and with color coding for multiple readouts.

SERVO-TEK PRODUCTS COMPANY  
1086 Goffle Road, Hawthorne,  
New Jersey 07506.

## SERVO-TEK

PRODUCTS COMPANY

For complete specifications  
write for our colorful  
technical sheets.



INFORMATION RETRIEVAL NUMBER 60

## Isolation was the only thing preventing a high-frequency Reed Switch Matrix Until now.



The Cunningham Reed Switch Matrix reduces high-frequency crosstalk and interference to a new low. Unique "sandwich" design seals, shields and separates matrix-mounted reed switches from their controls. Offers:

- **Excellent signal characteristics:**

- 50-ohm distributed. Broadband handling with top isolation. Low thermal noise.
- **100% Random access:** Any number or combination of crosspoints can be set, any place, any direction without affecting other crosspoints.
- **Computer compatibility:** Can be directly addressed by all computers using +5 volt logic. No added interfacing needed.
- **Proven reliability:** Up to 100 million operations.
- **Easy inspection and maintenance:** Control and signal sections can be separated for easy access.
- **Applications:** Interconnecting video channels; broadband data switching; test systems for nanosecond digital pulses; telemetry equipment for multiple data channels; antenna switching; medical data monitoring.

Write or call for Data Sheet No. 603, Cunningham Corporation, 10 Carriage St., Honeoye Falls, New York 14472. Phone: (716) 624-2000.

## Cunningham Corporation

SUBSIDIARY OF GLEASON WORKS

INFORMATION RETRIEVAL NUMBER 61

## DATA PROCESSING

### Infrared transceiver zips out 250 kbits/s



Computer Transmission Corp., 1508 Cotner Ave., Los Angeles, Calif. Phone: (213) 477-5020. P&A: \$2900; 30 days.

Known as Optran, an infrared data transceiver system is a full-duplex point-to-point communications system linking high-speed data terminals with a central computer facility. Model 1815 will operate over the range of 1200 to 250,000 serial bits per second. A typical system consists of two terminal ends, and an optical and interface unit.

CIRCLE NO. 267

### Computer readouts use TV monitors

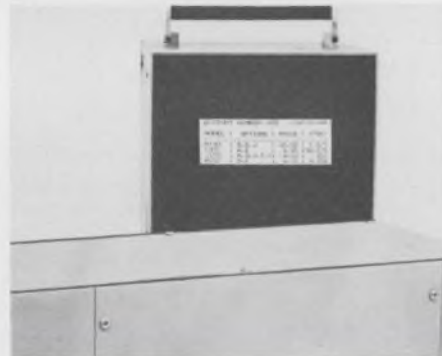

Applied Digital Data Systems, Inc., 89 Marcus Blvd., Happaugue, N.Y. Phone: (516) 273-7799. P&A: \$1250 to \$1295; 90 to 120 days.

Series MRD (Memory Raster Displays) readout devices employ standard TV monitors to display computer-generated data. These units accept data from a computer or keyboard, magnetic tape or any other sequential source, and display the data on an ordinary 525-line TV monitor at any number of remote locations.

CIRCLE NO. 268

### Computer power console is self-contained unit



Cregier Electrical Mfg. Co., sub. of Anixeter Bros., Inc., 1747 N. Milwaukee Ave., Chicago, Ill.

Said to be an industry first, a new self-contained power distribution console features voltage-regulator and circuit-breaker capabilities for power entry to computer facilities. With its solid-state sensing circuit, Cemcor II prevents operating malfunctions due to undervoltage or transient surges. Capacity is 600 V at 70 to 225 A.

CIRCLE NO. 269

### CRT display terminal simplifies operation



Monitor Displays, an Aydin Co., 401 Commerce Drive, Fort Washington, Pa. Phone: (215) 646-8100. Price: \$3750.

Engineered for a minimum of operator intervention, the model 8011 CRT display simply requires turning the display on or off and adjusting its focus and intensity. This direct-writing alphanumeric/graphic device has a writing speed of 500,000 inches per second.

CIRCLE NO. 270

**Pocket-size multimeter sells for only \$5.95**



*Mura Corp., 355 Great Neck Rd., Great Neck, N.Y. Price: \$5.95.*

A tiny pocket-sized multimeter with a 2000-ohms-per-volt sensitivity on ac and dc ranges retails for an amazing low price of only \$5.95. The NH-45 uses 1% precision resistors and can measure ac and dc voltages in three ranges of 30, 300 and 1200 V. It also measures currents up to 120 mA dc and resistances from 0 to 100 kΩ in two ranges.

CIRCLE NO. 271

**Waveform generator spans 0.01 Hz to 3 MHz**



*Exact Electronics, Inc., Box 160, Hillsboro, Ore. Phone: (503) 648-6661. P&A: \$345; stock to 30 days.*

Featuring a 1000:1 voltage-controlled frequency ratio, a new waveform generator spans the frequency range of 0.01 Hz to 3 MHz. The model 123 produces sine, square and triangular waveforms, as well as sync pulses. It can be voltage-controlled externally by dc programming or ac frequency modulation.

CIRCLE NO. 272

**High-impedance DPM has a 1000-M Ω input**

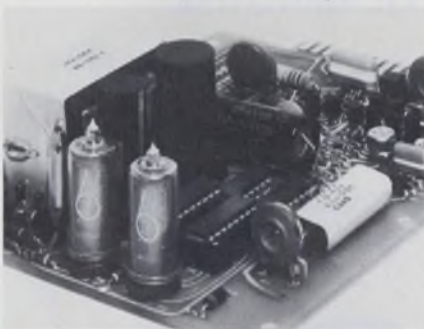

*Analogic Corp., Audubon Rd., Wakefield, Mass., Phone: (617) 246-0300. P&A: \$109.50; stock to 3 wks.*

Exhibiting a bias current of 0.1 nA, a new digital panel meter shows an input impedance greater than 1000 MΩ. The model AN2505-2C is a 2-1/2-digit meter. It converts in 3 ms and has a full-scale reading of 199 mV. Full-scale accuracy is 0.25% ±1/2 the least significant bit.

CIRCLE NO. 273

**Low-cost oscilloscope covers dc to 10 MHz**



*Leader Instruments, 37-27 27 St., Long Island City, N.Y. Phone: (212) 729-7411. P&A: \$339.50; stock. P&A: \$59; 2 wks.*

Using solid-state components, a new low-cost 5-in. oscilloscope responds from dc to 10 MHz. The model LBO-501 has triggered sweep and calibrated time base and vertical input. Its vertical sensitivity is 20 mV/cm pk-pk and its triggered-sweep range is from 0.2 μs/cm to 0.2 s/cm.

CIRCLE NO. 274

**EUTECTIC PREFORMS**  
for semiconductor assembly



**with quality service to match quality products**

CRM makes perfect preforms of eutectic alloys of Gold-Tin, Gold-Silicon, and Gold-Germanium.

CRM preforms can help you to produce perfect ICs, hybrids, transistors, and diodes. Quality is controlled from the ingot on, including not only standard tests, but also checks of foil surface finish and flow characteristics. The extensive die inventory at CRM makes most preforms available without delay and without a tooling charge.

CRM will meet your strictest specifications.

CRM delivers what it promises: CRM delivers on TIME.

*Call or write CRM for a quotation on your preforms or the CRM catalog with a list of over 300 stock dies.*

**CONSOLIDATED  
CRM REACTIVE  
METALS, INC.**

a Division of CONSOLIDATED REFINING CO. Inc.  
118 Hoyt Avenue, Mamaroneck, N.Y. 10543  
Tel: (914) 698-2300 □ TWX 710-566-1112

INFORMATION RETRIEVAL NUMBER 62

**Four pulse transformers fit into 0.825-in. DIP**

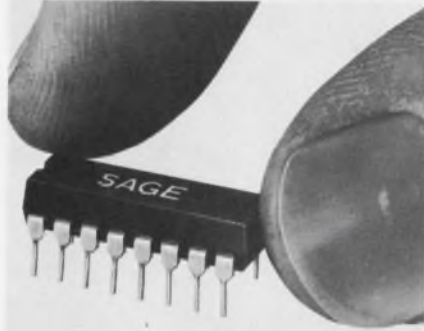

*Sage Electronics, Box 3926, Rochester, N.Y.*

Up to four pulse transformers are supplied in a 16-bit dual-in-line module measuring 0.825-in. long. These transformers can provide such uses as dc isolation, impedance matching, current/voltage gain or common-mode rejection. They are rated at an average current of 150 mA (25% duty cycle), an average power of 250 mW and a peak pulse voltage of 50 V.

CIRCLE NO. 275

**DIP 14-pin relays are IC compatible**

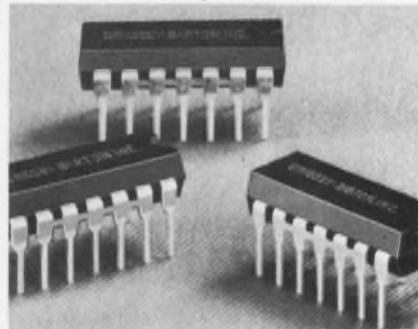

*Grigsby-Barton, Inc., 107 N. Hickory St., Arlington Heights, Ill. Phone: (312) 392-5900.*

Three new 14-pin dual-in-line reed relays compatible with DIP IC devices are the GB812A, the GB811C, and the GB813C. All can be automatically inserted and all measure 0.175-in. high. They have electrostatic shields and internal clamp diodes, and come in a variety of pin designations. All coils are designed for 5-V IC drivers at 10 or 40 mA.

CIRCLE NO. 276

**Alphanumeric readout widens viewing angle**

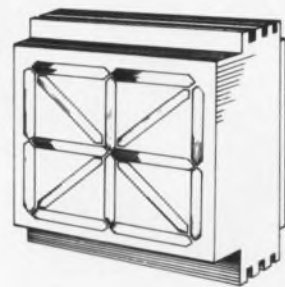

*Systems Technology, Inc., Rte 29N, Box 5387, Charlottesville, Va., Phone: (703) 973-5379.*

Designed for maximum visibility, a new 16-segment alphanumeric readout shows a wide viewing angle. Its segments do not have the commonly found halo effect yet have high brightness. Each segment has its own lamp that is rated at 50,000 h. The readout is available with character heights of 1 or 5/8 in.

CIRCLE NO. 277

**GOOD BUY, MR. CHIPS** BY MONOLITHIC DIELECTRICS



**CHIP KIT NO. 1** consists of 300 monolithic ceramic capacitor chips for hybrid circuits. Browse, examine, and test. There are 10 chips of each standard RETMA values from 1.2 pf to 330 pf in  $\pm 10\%$  tolerances at 50 VDCW.

**CHIP KIT NO. 2** consists of 300 sample chips, 10 chips each of all standard RETMA values from 390 pf to .1 MFD in  $\pm 10\%$  tolerances at 50 VDCW.

**KIT NO. 1 or KIT NO. 2—\$49.50 ea. A GOOD BUY!** Delivery from stock. Call direct and ask for Jim Waldal.

Monolithic Dielectrics Inc.

P.O. Box 647, Burbank, Calif. 91503 • (213) 848-4465

INFORMATION RETRIEVAL NUMBER 63

"IT'S GOOD BUSINESS TO HIRE THE HANDICAPPED."

ISN'T THAT A GREAT IDEA, SNOOPY?



THE PRESIDENT'S COMMITTEE ON EMPLOYMENT OF THE HANDICAPPED, WASHINGTON, D. C.

### Conductive adhesive remains flexible

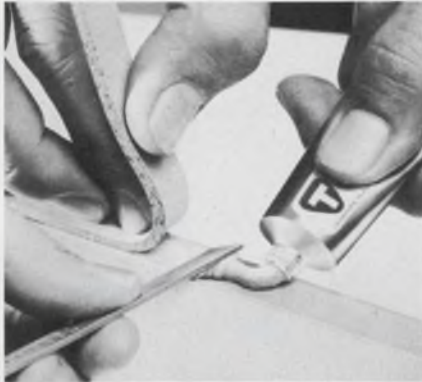

*Technical Wire Products, Inc., 129 Cermody St., Cranford, N.J. Phone: (201) 272-5500.*

Conductive System 72-00002 is a one-part pure silver-loaded silicone rubber adhesive that incorporates two important characteristics for emi/rfi shielding—high electrical conductivity and permanent flexibility. This new adhesive contains no solvents and requires no mixing or measuring. It cures in only two hours at room temperature.

CIRCLE NO. 278

### Silver-filled epoxy bonds hybrid units

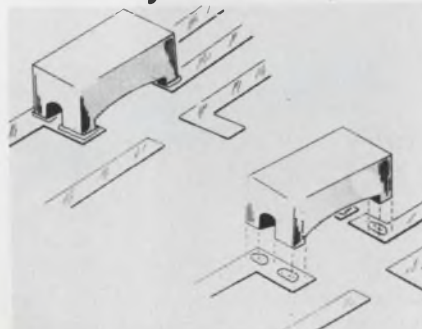

*Epoxy Technology, Inc., 65 Grove St., Watertown, Mass. Price: \$15/oz.*

A new two-component silver-filled epoxy compound is designed especially for bonding passive components and LIDs in hybrid circuit fabrication. Epo-Tek H21 is a 100% solids system with properties permitting rapid and reliable positioning of chip resistors, chip capacitors, LIDs, inductors and other devices. Volume resistivity is 0.0006 to 0.0009 ohm-cm.

CIRCLE NO. 279

### Pulse soldering system handles microcircuits



*Browne Engineering Co., 1120 Coast Village Circle, Santa Barbara, Calif. Phone: (805) 969-2268. P&A: \$175; stock.*

Designed for delicate hybrid microcircuit soldering processes, the model 150 Autopulse soldering system uses plug-in hand probes with soldering tips as small as 0.01 in. in diameter. These permit such delicate operations as solder-ball pickup and reflow, lead frame soldering, capacitor/resistor chip soldering and micro-wire soldering.

CIRCLE NO. 280

### Swivel-head plier has eight positions



*C. H. Mitchell Co., Electronic Tools Div., 18531 Ventura Blvd., Tarzana, Calif. Price: \$17.95.*

Able to go around corners and into blind spots, the SHP swivel-head plier features four interchangeable heads that can be set at eight locking positions (every 45 degrees around the full 360-degree circle). Included with the set are a long-nosed head and a short duck-bill head with serrations, a duck-bill head without serrations, and a retainer-ring head.

CIRCLE NO. 281



*When it comes to microminiaturization... we get right down to business.*

Our engineers have just completed a low-noise (2 db noise figure) IF amplifier... with an AGC range of 60 db minimum... in a package much smaller than our business card! Center frequency is 120 to 150 MHz with a 10 MHz bandwidth. □ Gain in excess of 80 db is available. Standard input impedance is either 50 or 150 ohms. And the output impedance is 50 ohms. Power requirements are 12 VDC at 35 mA. Video detectors are available upon request. □ So let's get down to business. Write or call **Scientific Research Corporation**, 4726 Eisenhower Blvd., Tampa, Florida 33614. Phone (813) 884-2989.

A subsidiary of Trak Microwave Corporation.

INFORMATION RETRIEVAL NUMBER 64

# Shock Test Microelectronic Components to 30,000 G



This new L.A.B. P4-30K shock machine tests integrated circuits and other solid state components to the high shock levels required by MIL-STD 883.

A free piston provides the carriage for the test load and impinges on a pulse device supported by a pneumatically cushioned reaction mass.

Test specimens are preassembled into piston assemblies outside the machine. Several pistons may be used so that one group of specimens can be prepared or evaluated while another is undergoing shock tests.

Write or phone for full details.

## L·A·B CORPORATION

A SUBSIDIARY OF MTI

P.O. Box H 14, Skaneateles, N.Y. 13152  
Tel. (315) 685-5781

INFORMATION RETRIEVAL NUMBER 65

# Evaluation Samples

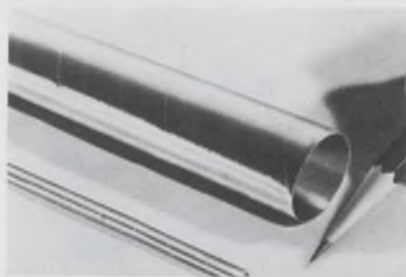

## Conductive tubing

New electrically conductive shrinkable tubing is constructed of spirally wound vacuum-metalized Mylar. It is available with inside diameters from 0.09 to 1 in. and in lengths of 36 in. An insulating layer of Mylar or any other desired film can be wound on the inside of the conducting layer, on the outside, or both. In fact, there can be any number of alternate conducting and insulating layers, which means that the tubing's capacitance can be controlled. A free evaluation sample is available. Niemand Bros., Inc.

CIRCLE NO. 282



## Drafting aids

Complete with product samples, a new 68-page technical manual and catalog describes more than 15,000 pressure-sensitive electronic component drafting aids, techniques and systems. In addition, the new manual is said to illustrate many new ways to save time and money in preparing master artwork for printed wiring boards. Pressure-sensitive patterns, symbols, tapes and multi-pad configurations are completely detailed with illustrated how to and why sections. Bishop Graphics, Inc.

CIRCLE NO. 283



## Aerosol degreaser

Now available as a free evaluation sample, a new aerosol mold cleaner removes silicone, grease, oil and wax build-ups on mold, tool and die surfaces. Called Slide, this mold cleaner-plus-degreaser makes possible fast clean-ups of electrical equipment oil build-ups on abrasive wheels and discs, and general degreasing of tools and machinery without wiping since it leaves no residue. The surface to be cleaned is sprayed until it is flooded. This dissolves the foreign matter or build-up, which then dries off to provide a clean dry surface. Percy Harms Corp.

CIRCLE NO. 284

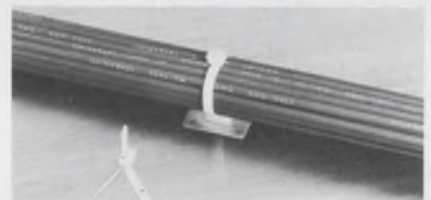

## Swivel mount

The new ASMS-A adhesive swivel mount, which is now available as a free evaluation sample, has a metal base to provide a secure bond in heavy-duty harnessing applications. The new mount incorporates a swivel that permits it to be adjusted after bonding to assure proper orientation with the harness. Holes in the four corners provide a means of quality control inspection for the presence of adhesive. The new mount overcomes the problems of attaching plastics to metals. It can support up to 50 pounds of weight when correctly installed. Panduit Corp.

CIRCLE NO. 285

# Design Aids

## Thermoplastics profile

Intended as a quick reference for design engineers is this new thermoplastics compound profile. This maximum-performance profile lists physical, mechanical, and thermal values of compounds. The compounds are fortified with the highest commercially-available percentage of dispersed glass fiber. It also contains a generalized index to chemical resistance for 17 base polymers with glass fiber fortification ranging from 25 to 50%. Liquid Nitrogen Processing Corp.

CIRCLE NO. 286

## Epoxy selector

A new epoxy compound selector chart gives initial evaluation information on sealants, potting and encapsulation compounds, adhesives and conformal coatings. The guide contains such useful information as pot life, temperature range, viscosity, color, mixing ratio, hardness and recommended uses. It can save many hours of checking individual product information sheets in search of a suitable compound for a particular application. EPD Industries, Laboratories Div.

CIRCLE NO. 287

## Plastics charts

Said to analyze all plastics materials now on the market, the eighth edition of a 16-page set of plastics properties charts includes thermoplastics and thermosets, and a special section on high-pressure industrial laminates. Judicious use of color sets-off each plastics family treated, and text and figures are in easily read bold type. In all, 34 separate properties are listed for each of the thermoplastics and thermosets, and 24 properties for the high-pressure laminates—like mechanical, electrical, physical and thermal characteristics. The charts fit conveniently into a design manual or handbook, or in a desk-drawer file folder. Commercial Plastics & Supply Co.

CIRCLE NO. 288

# Who put 500KHz-1MHz in a tiny TO-5 COLDWELD CRYSTAL PACKAGE?

(who else but BULOVA!)



Who else could offer such a broad range of low frequency output from a series of masterfully miniaturized packages? Now Bulova produces a coldweld-enclosed crystal built to an even tighter spec — in a smaller container — at a lower price!

In the TO-5 can, for example, with the frequency range of 500 KHz to 1 MHz, you get a tolerance of  $\pm 0.015\%$  (from  $-55^{\circ}\text{C}$  to  $+105^{\circ}\text{C}$ , or to specification), and aging is  $1 \times 10^{-7}$  per week ( $10^{-6}$  after four weeks), after one week stabilization at  $75^{\circ}\text{C}$ . All this with a coldweld seal to eliminate the problems from contamination and frequency shift caused by solder flux and heat.

What's more, Bulova supplies an entire line of high precision crystals in a selection of packages. Virtually the entire frequency spectrum is available, from 2 KHz to 140 MHz for oscillator and filter applications, in every type of package: glass sealed, solder-seal, metal holders, and, of course, coldweld.

For more data, call 212-335-6000, see EEM Section 2300, or write —

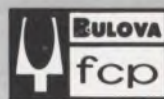

**BULOVA** FREQUENCY CONTROL PRODUCTS

Electronics Division of Bulova Watch Company, Inc.  
61-20 Woodside Ave., Woodside, N. Y. 11377 (212) 335-6000

Go Bulova, and leave the designing to us!

# Annual Reports

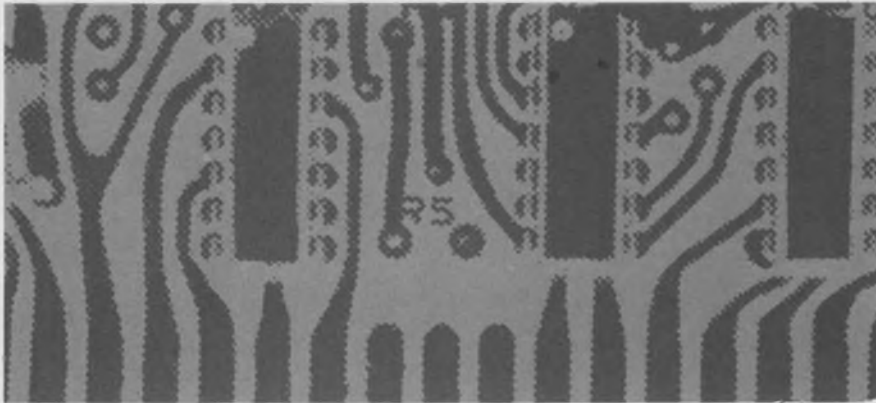

Manufacturing electronic subassemblies, printed-circuit logic cards and automatic typesetting equipment is **Datascan, Inc.**, 1111 Paulison Ave., Clifton, N.J. The company reported for fiscal 1968,

**Automation Sciences Inc.**, 215 14th St., Jersey City, N.J.

Computer software, data processing, equipment leasing, electronic desk calculators.

1969: revenues, \$2,351,312; net income, \$298,401.

1968: revenues, \$1,727,201; net income, \$197,219.

CIRCLE NO. 290

**California Computer Products, Inc.**, 305 N. Muller St., Anaheim, Calif.

Off-line and electronic/micro-film plotting systems, plot heads.

1969: net sales, \$20,474,026; net income, \$1,127,850.

1968: net sales, \$16,853,751; net income, \$1,187,447.

CIRCLE NO. 291

**Dataram Corp.**, Route 206, Princeton, N.J.

Ferrite memory cores, automatic core testers, memory plane and stack testers.

1969: net revenues, \$749,167; net income (loss), \$299,386.

1968: net revenues, \$29,867; net income (loss), \$109,874.

CIRCLE NO. 292

net sales of \$3,053,691, and net income of \$241,766. For fiscal 1967, net sales were listed to be \$2,241,321, and net income was indicated at \$127,385.

CIRCLE NO. 289

**Del Electronics Corp.**, 250 E. Sanford Blvd., Mount Vernon, N.Y.

Regulated power supplies, capacitors, power converters, angle sensors.

1969: net sales, \$2,056,952; net earnings, \$57,657.

1968: net sales, \$1,887,394; net earnings, \$53,070.

CIRCLE NO. 293

**Digital Equipment Corp.**, 146 Main St., Maynard, Mass.

Computers for time sharing, industrial control and machine-tool control, computer modules.

1969: net sales, \$87,867,000; net income, \$9,329,000.

1968: net sales, \$57,339,000; net income, \$6,856,000.

CIRCLE NO. 294

**Digital Products Corp.**, 4030 N.E. 6th Ave., Fort Lauderdale, Fla.

Tape recorder and interface systems, pulmonary-function analyzers, digital logic trainers, nuclear instrumentation.

1969: net sales, \$167,605; net income (loss), \$79,965.

1968: net sales, \$76,077.

CIRCLE NO. 295

**Gulf+Western Industries, Inc.**, 437 Madison Ave., New York, N.Y.

Wires, cables, capacitors, motion pictures, consumer products.

1969: sales, \$1,563,564,000; net earnings, \$72,050,000.

1968: sales, \$1,330,565,000; net earnings, \$70,366,000.

CIRCLE NO. 296

**Lear Siegler, Inc.**, 3171 Bundy Dr., Santa Monica, Calif.

Transportation, housing, education, automotive services.

1969: net sales, \$586,909,685; net earnings, \$22,366,322.

1968: net sales, \$518,379,774; net earnings, \$19,289,081.

CIRCLE NO. 297

**Mohawk Data Sciences Corp.**, Palisade St., Herkimer, N.Y.

Electronic data processing, paper-tape readers/punches, print stations.

1969: net sales, \$60,926,761; net income, \$6,652,786.

1968: net sales, \$44,463,022; net income, \$3,050,535.

CIRCLE NO. 298

**Narda Microwave Corp.**, Plainview, N.Y.

Microwave sweepers, attenuators, pads, coaxial couplers and survey meters, power amplifiers.

1969: net sales, \$6,110,285; net income, \$55,511.

1968: net sales, \$5,652,899; net income, \$67,714.

CIRCLE NO. 299

**Northrop Corp.**, Northrop Bldg., Beverly Hills, Calif.

Military aircraft, space electronics, pilot training, worldwide communications, missiles.

1969: net sales, \$561,200,762; net income, \$18,501,303.

1968: net sales, \$485,503,957; net income, \$15,740,235.

CIRCLE NO. 334



# Application Notes



## Thermistors

A considerable amount of design information on disc-type thermistors is presented in a new 56-page catalog. It contains 34 full-page graphs of resistance-temperature curves and tabulated charts. These curves and charts enable the determination of the resistance value of any thermistor at a specified temperature. Other data included are terminology definitions, thermistor lists, basic applications and ordering information. A section is devoted to washer, rod, probe and low-coefficient-type thermistors. Keystone Carbon Co.

CIRCLE NO. 335

## Logic review

The December issue of "Tekscope" is now available. This 16-page issue includes a discussion on a new logic for oscilloscope displays and a review of basic logic with basic logic diagrams. A service section includes an article on trouble-shooting oscilloscope amplifiers. The last page of the issue contains a list of new and used instruments for sale and instruments wanted. Tektronix, Inc.

CIRCLE NO. 336

## Signal correlation

A thorough description of auto and cross-correlation techniques is described in a new 20-page brochure. Applications are described in characterizing linear systems, vibration analysis and turbulent fluid flow. Also described are applications in crosstalk identification, electroencephalographic signal analysis and noise studies. Shown are two new signal correlators and a new Fourier analyzer with a discussion of their operational theories. Princeton Applied Research Corp.

CIRCLE NO. 337

## Computer-aided design

A publication for electronic engineers consists of a seven-page magazine reprint that introduces computer-aided design in circuit, ac, dc and transient analysis. It also describes circuit-analysis programs for engineers who are interested in computer time-sharing. Discussed are simple, practical computer analysis techniques like IBM's ECAP, which is used by design engineers who find them more accurate and economical than traditional methods. Comp/Utility, Inc.

CIRCLE NO. 338

## Voltage measurement

Application of pulse and peak voltage measurement is the subject of a new 20-page technical paper. It includes a discussion of the theory and techniques utilized in measuring peak values of waveforms. These waveforms could be one-shot pulses or repetitive pulses as several hours in width. Discussed and illustrated are methods for providing instrumentation capable of consistent and accurate recording of voltage transients with measure and hold capabilities. Micro Instrument Co.

CIRCLE NO. 339

INFORMATION RETRIEVAL NUMBER 67 ▶

# COMPARE CLOSE-UPS

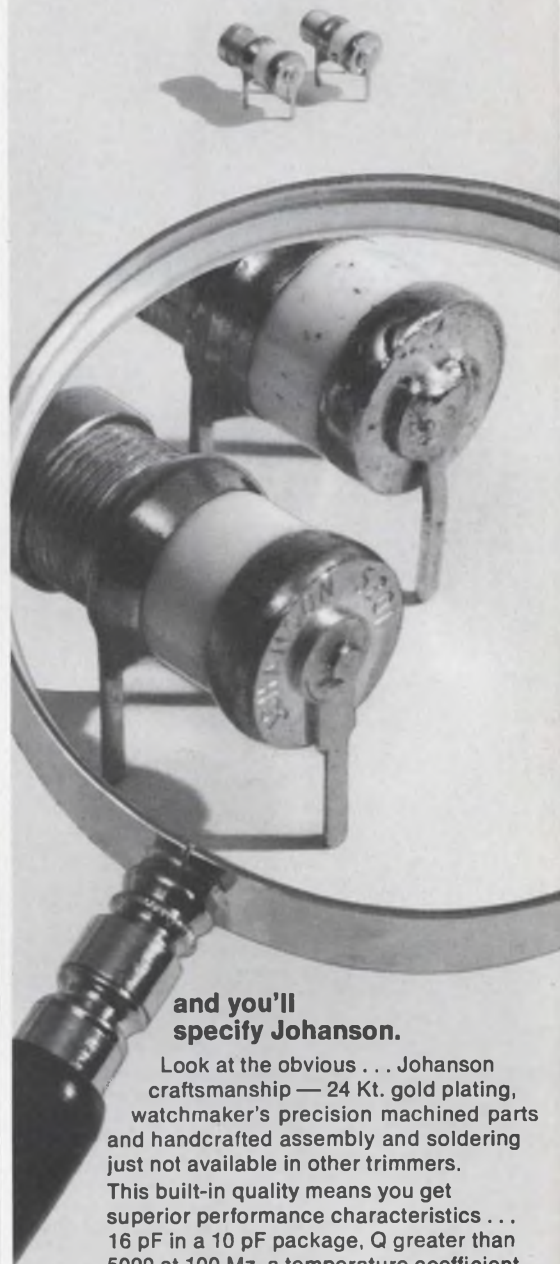

## and you'll specify Johanson.

Look at the obvious . . . Johanson craftsmanship — 24 Kt. gold plating, watchmaker's precision machined parts and handcrafted assembly and soldering just not available in other trimmers.

This built-in quality means you get superior performance characteristics . . . 16 pF in a 10 pF package, Q greater than 5000 at 100 Mz, a temperature coefficient of  $0 \pm 15$  PPM°/C, with tuning stability and long life.

Why settle for ordinary trimmers when the best is available — send today for our new catalog sheet on our 5200 series . . . and start comparing.



*Johanson*

MANUFACTURING CORPORATION

Rockaway Valley Road, Boonton, N.J. 07005  
(201) 334-2676

Electronic Accuracy Through Mechanical Precision

# New Literature



## Flexible cable

Some 26 miniature flexible cables are described in a new short-form catalog. It is arranged to allow the designer to make comparisons between the optimum choice as quickly and easily as possible. Described are cables with from one to five conductors, with or without jacketing. Conductors are #30 and #32 AWG and cables are rated at temperatures up to 220°C. Outside diameters range from 0.095 in. for one and two-conductor cables to 0.140 in. for a five-conductor configuration. Caltron Industries.

CIRCLE NO. 340

## Fasteners

Government specification types MS, NAS and AN fasteners are thoroughly detailed in a 104-page catalog. It includes part numbers and prices as well as outline drawings of thousands of fasteners and parts. Also shown are screws, bolts, nuts, washers, rivets, pins, inserts and self-locking fasteners. Century Fasteners Corp.

CIRCLE NO. 341

## Resistors

Precision and power wire-wound resistors are the subject of a new 32-page catalog. Included are new advancements in the resistor field and up-dated technical information on over 35 series of wire-wound resistors. Temperature coefficient tables as well as graphical and schematical representations of performance are also shown. RCL Electronics, Inc.

CIRCLE NO. 342

## Microwave connectors

Designated bulletin PDM-1, a new 12-page catalog includes short-form specifications and operating limits for type SMA 3-mm miniature microwave connectors. Sections are devoted to general descriptions, illustrations and dimensional sketches of straight jacks, straight plugs and bulkhead receptacles. Also covered are right-angle plugs and jacks, between-series and in-series adaptors and N, TNC and BNC-type connectors. Phelps Dodge Communications Co.

CIRCLE NO. 343

## Data acquisition systems

Entitled "Industrial Information Systems," a new brochure discusses data acquisition systems for industry. It examines the need and uses for such systems, as opposed to other means of data handling, from meters and recorders to computers. It also shows how a data acquisition system provides the preliminary information on which final selection and programming of a computer is based. Actual system installations in a variety of industries are described. Electronic Modules Corp.

CIRCLE NO. 344

## Resistive pastes

Technical data on high performance pastes is in a 16-page technical paper on thick-film resistor pastes and a four-page product catalog. Shown is such data as resistivity versus firing temperatures, temperature coefficients, effect of refiring, resistor trimming by abrasive spray or laser beams and noise and voltage coefficients. Also shown are resistor distribution and absolute values, effect of termination, and effect of geometry on resistivity. Electro-Science Laboratories, Inc.

CIRCLE NO. 345



## Non-standard resistors

Engineers whose circuit designs involve the use of non-standard resistors can obtain design and special assistance from a new guide to non-standard resistors. It details the extended performance levels available in various types of resistors. This information is matched with charts showing the range of readily available lead and packaging variations. Included are resistor examples which illustrate the departure from standard design for achieving a specific function. Dale Electronics, Inc.

CIRCLE NO. 346

## Measurement

The latest issue of the "Metricist" describes the use of a pulse generator in frequency-domain testing. Also described is a way of using a computer-controlled frequency synthesizer in a closed-loop adaptive test system. The "Metricist" shows two new plug-in modules for a series of counter/timers. Monsanto Electronic Instruments.

CIRCLE NO. 347

## Connectors

A line of high-performance microminiature connectors is described in a new catalog. These connectors are rugged and moisture-sealed. They feature 24-pin contacts and are epoxy-sealed within an aluminum shell. Detailed dimensional information as well as outline drawings is included. ITT Cannon Electric, a div. of International Telephone and Telegraph.

CIRCLE NO. 348



### Pressure transistors

The unique characteristics of a pressure-sensitive transistor are described in a new eight-page brochure. It updates the device's technical data and describes its principles of operation. Also included are circuit design notes with schematic illustrations. Typical areas of application discussed include medicine, meteorology and industrial control. Stow Laboratories.

CIRCLE NO. 349

### Thermocouple connectors

A line of thermocouple connectors and accessories is comprehensively covered in a new 12-page catalog. It is complete with photographs, dimensional drawings and temperature ratings. Covered are standard all-purpose, miniature and special-purpose connectors. Also listed are many accessories, from neoprene jackets to adapter brackets. Thermo Electric.

CIRCLE NO. 350

### Controller/plotter

A portable controller/plotter is described in a new six page brochure. The full-color literature details the unit's operation, features, specifications and applications with several examples shown of its generated graphic output. The unit is designed for high speed graphic plotting with diminished computer processing time, and may be used with virtually any computer. Time-share Devices, Inc.

CIRCLE NO. 351

**JFD**  
CAPACITORS

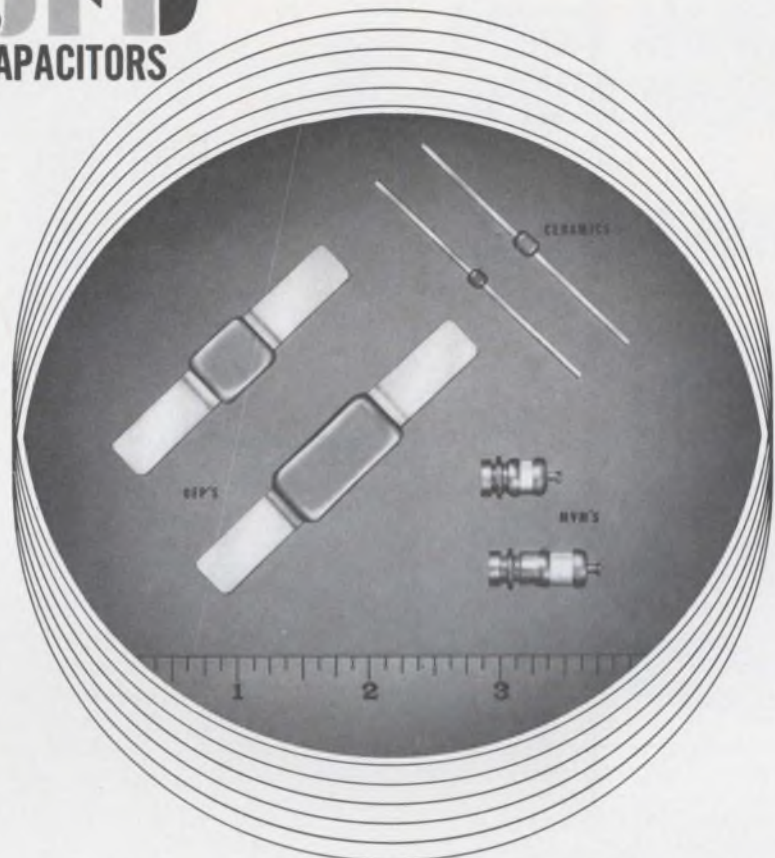

### THE ULTIMATE IN Q

JFD has developed several series of fixed and variable capacitors especially designed for Hi Q applications. Each series incorporating a variety of mounting configurations and capacitance values for a multitude of applications.

The MVM series of Air Dielectric Variable Trimmers has a Q of greater than 3,000 measured at 100 MHz. Offered in 4 basic mounting configurations these miniature units are rugged and extremely stable. Capacitance ranges measured at 1 MHz are 0.8 through 10.0 pf, and 1.0 through 20.0 pf.

The Uniceram series of microminiature ceramic fixed capacitors, glass encapsulated, has a Q measured at 1 MHz and 25°C (values 1,000pf and smaller) of 5,000 min. and features a constant ceramic dielectric that is fused into a solid monolithic structure. This construction insures complete protection from moisture and environmental stresses. JFD ceramic capacitors are available in leaded and unleaded configurations and are ideal for high speed switching and for capacitance at VHF and higher frequencies when low inductance is essential. Capacitance range 0.5 to 3,000 pf.

Also available under the Uniceram brand is a series of Hi Q capacitors with Hi RF power capabilities. Q measured at 1 MHz and +25°C (for values of 1,000 pf and smaller) is 5,000 min. Entitled UFP's, these fixed ceramic units are the smallest high RF power capacitors available and represent the state of the art in manufacturing techniques. Capacitance range 10 pf to 3,000 pf.

Write for catalogs.



"TODAY'S COMPONENTS BUILT FOR TOMORROW'S CHALLENGES"

**JFD ELECTRONICS CORP. / COMPONENTS DIVISION**

15th Avenue at 62nd Street / Brooklyn, New York 11219 / Phone 212-331-1000

SUBSIDIARY OF RIKER-MAXSON CORPORATION

INFORMATION RETRIEVAL NUMBER 68

# Tempilaq<sup>o</sup> signals rated temperature... in milliseconds!



Now you can simply and reliably monitor temperatures on smooth surfaces such as polished metal, glass or plastics, and in hard-to-reach areas—at the cost of a cent or less per application. More than 100 certified ratings to choose from. Applied by brush or aerosol spray.

Tempilaq<sup>o</sup> dries almost immediately to a dull-opaque coating, which liquefies sharply as soon as its stated rating is reached. On cooling, the melted Tempilaq<sup>o</sup> does not revert to its original appearance, but remains glossy transparent—which makes subsequent interpretation easy. Accuracy of Indication: within 1% of the stated rating of the Tempilaq<sup>o</sup>. Response delay of a thin coating is only a few milliseconds! You'll find it ideal for determining temperatures of polished metal surfaces, electronic tubes, fabrics, rubber, plastics, glass and similar items.

Technical data sheet on request.

## AVAILABLE IN THE FOLLOWING DEGREES (°F)

100	169	250	331	475	900	1400	1950
103	175	256	338	488	932	1425	2000
106	182	263	344	500	950	1450	2050
109	188	269	350	525	977	1480	2100
113	194	275	363	550	1000	1500	2150
119	200	282	375	575	1022	1550	2200
125	206	288	388	600	1050	1600	2250
131	213	294	400	625	1100	1650	2300
138	219	300	413	650	1150	1700	2350
144	225	306	425	700	1200	1750	2400
150	231	313	438	750	1250	1800	2450
156	238	319	450	800	1300	1850	2500
163	244	325	463	850	1350	1900	



132 WEST 22nd St., NEW YORK, N.Y. 10011

Phone: 212-675-6610 TWX: 212-640-5478

INFORMATION RETRIEVAL NUMBER 69

## NEW LITERATURE



### Voltage conversion

Converting single or repetitive pulses to dc or digital outputs is the subject of a six-page brochure. The conversion is provided by plug-in PC card modules which store the converted output in a memory until the memory is reset. A description of the modules along with their principles of operation is included. Also included are applications plus a table of ordering information and specifications. Micro Instrument Co.

CIRCLE NO. 352

### Nylon handbook

Various properties of nylon are indicated with charts in a new 28-page design and machine handbook. Shown are physical, thermal, electrical and chemical properties. Described are nylon machining techniques, standard shapes and sizes, and applicable specifications. Also detailed with graphs are design considerations and discussions of design factors such as elasticity, heat, stress and annealing. Cadillac Plastic and Chemical Co.

CIRCLE NO. 353

### Solderless terminations

The development of a new solderless hermetic connector is the subject of a 14-page article. In this article, the hermetic connector is treated as the last bastion of soldered terminations. Problems that have led the electronic industry away from the use of soldered terminations are explained. Advantages and cost savings between soldered and hermetic terminations are also contrasted. Deutsch Co.

CIRCLE NO. 354



### Assembly costs

A new 12-page booklet entitled "What every executive on the way up should know about bringing costs down" is meant to help in industrial management cost problems. It explains how management can achieve more efficient production assembly, resulting in a better return on investments in plants and with people. The discussion is about the proper selection of fasteners as related to product assembly costs. Shakeproof Div., Illinois Tool Works Inc.

CIRCLE NO. 355

### Filters

A series of general-purpose tubular filters are shown in a new 20-page catalog. Included are feed-thru, L-section, T-section, Pi-section and double-L-section types that conform to MIL-F-15733E specifications. The filters are available for bulk-head mounting, hermetically-sealed applications or for use as feed-thru capacitors. Eight graphs show insertion loss characteristics. Hopkins Engineering Co.

CIRCLE NO. 356

### Instrument components

Components for precision instruments are cataloged in a 24-page product brochure. Included in this brochure are standard cells, resistance coil units and galvanometer suspensions. Also discussed are helical potentiometers, battery holders and a variety of switches and instrument stands. The brochure is intended as a supplement to a recently released full-line catalog. H. Tinsley and Co.

CIRCLE NO. 357

## condensed catalog of capacitors



### Capacitors

A new six-page condensed catalog features eight porcelain capacitor styles, six ceramic styles, and a full line of chip capacitors. Each style is identified by capacitance range, voltage rating, temperature coefficient, available tolerances, dimensions, lead spacing, and wire size when applicable. General specifications and ordering instructions are included and each style is cross referenced to the pertinent data sheet. Vitramon, Inc.

CIRCLE NO. 358

### Push-button switches

A new line of lighted push-button switches is described in a 12-page catalog. The line was designed with a building block concept to enable the user to build more than 25,000 switching variations from 31 components. The catalog contains switch ratings and circuit data plus information on applications, operating characteristics and optional features. Also included are switch dimensions, mounting recommendations and lamp life. Arrow-Hart, Inc.

CIRCLE NO. 359

### Books

Over 125 current and forthcoming books are described in an illustrated 16-page catalog. It includes books with subject areas such as broadcasting, CATV, electric motors, electronic engineering, radio and television servicing, audio and high-fidelity and transistors. Tab Books.

CIRCLE NO. 360

# NEW VACTEC "PLASTIC" PHOTOCELLS

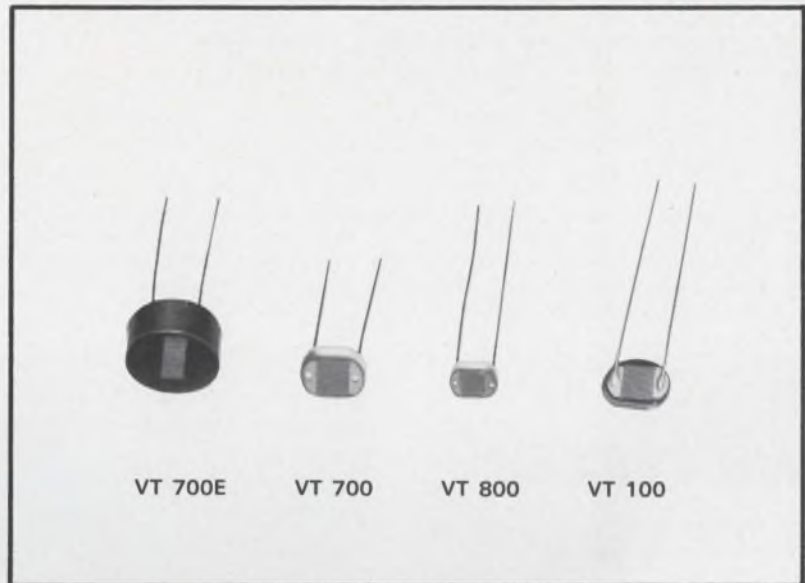

Actual size, priced as low as .25 each ( $\pm 33\%$  tolerance) in 100,000 quantities.

### Low Cost Way to Meet Most Photocell Requirements

Are you spending up to a dollar for photocells when Vactec can satisfy your needs for far less? Here's a complete line made the same, and with the same quality characteristics and precise tolerances as their metal cased counterparts. Yet they cost about *half* as much, because instead of sealing, they are protected by a thin transparent plastic coating.

Vactec "plastic" cells are conveniently controlled by ambient light, or from closely coupled low voltage lamps for remote control. Special processing provides resistance to humidity, making these devices suitable for indoor industrial and commercial applications like controlling relays in line voltage circuits; switching SCR's on or off; phase control in proportional circuits; or as feedback elements for motor speed controls in consumer appliances.

#### GENERAL SPECIFICATIONS

Material	Two Cdse and three Cds materials, including the new type 3 with exceptionally high linearity and speed.
Voltage Maximum	(dark 300V.)
Dissipation at 25°C	200 mw (VT 100) 250 mw (VT 700 and VT 700E) 125 mw (VT 800)
Ambient	-40°C up to +75°C
Resistance	Wide range as low as 600Ω at 2 F.C.

Write today for Bulletins PCD-41, 57, 57E, and 58

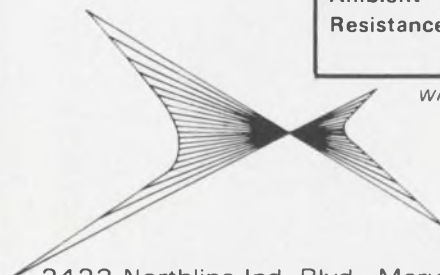

## VACTEC, INC.

2423 Northline Ind. Blvd., Maryland Heights, Missouri 63042  
(314) 872-8300

Specializing in standard Cds, Cdse, and Se cells. Custom engineering for every photocell need. Listed in EBG under "Semi-Conductors" and EEM Sec. 3700.

INFORMATION RETRIEVAL NUMBER 70

# If your equipment calls for custom-designed protection...

Give us your out-of-the-ordinary container requirement—and we'll meet it. Precisely. In the shortest possible time. Because we have everything it takes to do the job. Sandwich construction materials. Off-the-shelf components. Standard hardware. Over 30 years of experience in the manufacture of cases and containers. The result? Complete equipment protection against shock, vibration, and environmental hazards. Built to all required MIL specifications. We also make custom molded and standard fiberglass and ABS thermoplastic containers and cases. Call or write for our standard price lists and comprehensive design manuals.

## Skydyne will "contain" it for you.



**Skydyne, Inc.**

River Road, Port Jervis, N. Y. 12771 • (914) 856-5241

Subsidiary of **b-p** Brooks & Perkins, Inc.

INFORMATION RETRIEVAL NUMBER 71

# ELECTRONIC MOTOR SPEED CONTROLS

The most complete source of every type: SCR, Variac, Transistorized, Ferrite, 172 models. 1/1000 to 150 H.P. From .01 RPM to 15,000 RPM. Low-cost and feature packed models: 1000:1 range, reversing, braking, speed readout, remote control, positioning, feedback, 0.25% reg. Custom controls and systems. Thousands of motors, controls; hundreds of accessories, clutches, brakes, timers, etc.



**FREE CATALOG**

28 pages of variable speed motor controls

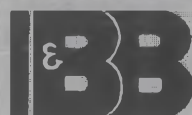

**MOTOR & CONTROL**

CORP. • 96 Spring Street, New York, N.Y. 10012  
Phone (212) 966-5777

INFORMATION RETRIEVAL NUMBER 72

# Electronic Design

ELECTRONIC DESIGN's function is:

- To aid progress in the electronics manufacturing industry by promoting good design.
- To give the electronic design engineer concepts and ideas that make his job easier and more productive.
- To provide a central source of timely electronics information.
- To promote two-way communication between manufacturer and engineer.

**Want a subscription?** ELECTRONIC DESIGN is sent free to qualified engineers and engineering managers doing design work, supervising design or setting standards in the United States and Western Europe. For a free subscription, use the postfree application form inside the back cover. If none is included, write to us direct for an application form.

If you do not qualify, you may take out a paid subscription for \$25 a year in the U.S.A., \$35 a year elsewhere. Single copies are \$1.50 each.

**If you change your address,** send us an old mailing label and your new address; there is generally a prepaid postcard for this inside the back cover. You will have to requalify to continue receiving ELECTRONIC DESIGN free.

**The accuracy policy of ELECTRONIC DESIGN is:**

- To make reasonable efforts to ensure the accuracy of editorial matter.
- To publish prompt corrections whenever inaccuracies are brought to our attention. Corrections appear at the end of the Letters column.
- To refuse any advertisement deemed to be misleading or fraudulent.

Microfilm copies are available of complete volumes of ELECTRONIC DESIGN at \$19.00 per volume, beginning with Volume 9, 1961. Work is now in process to complete the microfilm edition of Volumes 1-8. Reprints of individual articles may be obtained for \$2.00 each, prepaid (\$.50 for each additional copy of the same article) no matter how long the article. For further details and to place orders, contact the Customer Services Department, University Microfilms, 300 North Zeeb Road, Ann Arbor, Michigan 48106; telephone (313) 761-4700.

**Want to contact us?** If you have any comments or wish to submit a manuscript or article outline, address your correspondence to:

Howard Bierman, Editor,  
ELECTRONIC DESIGN,  
850 Third Avenue,  
New York, N.Y. 10022.

# Electronic Design

## Advertising Sales Staff

Keith Aldrich  
Sales Manager

## New York 10022

Robert W. Gascoigne  
Thomas P. Barth  
Samuel M. Deitch  
850 Third Avenue  
(212) Plaza 1-5530  
TWX: 867-7866

## Philadelphia 19066

William C. Repetto  
P. O. Box 206  
Merion Station, Pa.  
(215) MA-3-5888

## Boston 01945

Joseph F. Palmer  
P. O. Box 645  
Clifton Station  
Marblehead, Mass.  
(617) 742-0252

## Chicago 60611

Thomas P. Kavooras  
Berry Conner, Jr.  
200 East Ontario  
(312) 337-0588

## Cleveland

Thomas P. Kavooras  
(Chicago)  
(312) 337-0588  
(call collect)

## Los Angeles 90303

Stanley I. Ehrenclou  
W. James Bischof  
2930 Imperial Highway  
Inglewood, Calif.  
(213) 757-0183

## San Francisco 94022

Arthur R. Shields, Jr.  
175 San Antonio Rd., S 243  
Los Altos, Calif.  
(415) 941-3084

## London W. 1

For United Kingdom and Holland  
Brayton C. Nichols  
44 Conduit Street  
Tel: REGent 4714

## Verviers, Belgium

For Continental Europe  
Andre Jamar  
1, Rue Mallar, 1  
(087) 253.83 Telex 41563

## Tokyo

Haruki Hirayama  
Electronic Media Service  
Rm. 601, Daini Miyauchi Bldg.  
6-8-14, Roppongi,  
Minato-ku  
Phone: 402-4556  
Cable: Electronicmedia, Tokyo



# Printact®

**Plugs into your PC board... mates with plated conductors**

Where memory without power is a requirement in the design of control circuitry, the use of the "LD" relay results in a compact-low cost module. Reliability is assured by the unique design which includes, as standard, many features not generally available in commercial relays.

Encapsulated coil, bifurcated gold or palladium contacts, low thermal EMF, plug-in without sockets or soldering, low bounce and chatter, series-break switching eliminates pig-

tails, permanent magnet avoids return spring and mechanical linkage—all of which assures continuous performance for many millions of cycles.

Available with 6, 12 or 24 VDC 1 watt coil (AC operation with series diode) in 2, 3 and 4 pole configuration. Series break swingers permit each pair of fixed contacts to be etched with common (Form C) or isolated (Form A plus Form B) switching between make and break circuits.

For data write or call 212-EX 2-4800.

Printact Relay Division, Executone, Inc., Box 1430, Long Island City, N.Y. 11101  
INFORMATION RETRIEVAL NUMBER 73

**Double Coil  
MAGNETIC  
LATCHING  
Series LD  
RELAYS**  
**\$249**  
only EACH  
(IN LOTS OF 5,000)

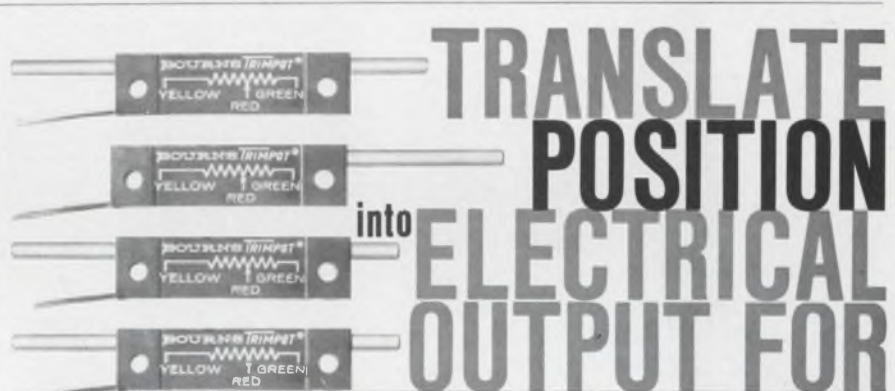

**\$4.65\*** with this new  
**RECTILINEAR POTENTIOMETER**

Call or write your nearest Trimpot Products Division sales office for more information on Model 3049, a high performance rectilinear potentiometer for industrial applications, at a price you wouldn't believe—\*\$4.65 in 500-piece quantities.



BOURNS, INC., TRIMPOT PRODUCTS DIVISION • 1200 COLUMBIA AVE. RIVERSIDE, CALIF. 92507

INFORMATION RETRIEVAL NUMBER 74

# Design Data from Manufacturers

Advertisements of booklets, brochures, catalogs and data sheets. To order use Reader-Service Card.  
(Advertisement)

## Terminal Block Selector



A new 24-page, completely illustrated catalog contains photos, descriptions, ratings, engineering drawings, and prices of the complete line of Curtis terminal blocks. Included are printed circuit, insulated feed-thru, quick disconnect, track type, and high current terminal blocks. Handy selection chart quickly locates the perfect block for your particular requirements. Send today for your free copy.

### Curtis Development & Mfg. Co.

3236 North 33rd Street  
Milwaukee, Wisconsin 53216

See us at booth 4E11 - IEEE Show

# 174

## Calibrated Frequency Domain Measurements

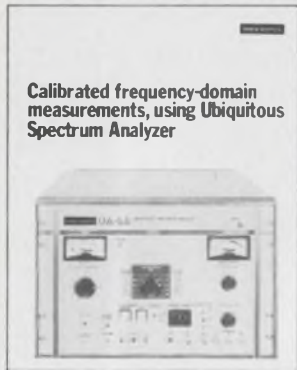

Calibrated frequency-domain measurements, using Ubiquitous Spectrum Analyzer

... in real-time, and wider coverage to 40kHz with Ubiquitous®, the newest real-time Spectrum Analyzer for high-speed on-line frequency analysis of noise, vibration, underwater signals, radar doppler, and machine diagnosis. Employs digital time-compression to perform 500-point analysis of a signal completely as it occurs. Much faster than digital computers using fast-Fourier transforms. Expandable at any time to multi-channel spectrum analysis, cross-spectrum analysis, transfer-function analysis, auto and cross-correlation, Cepstrum analysis, & shock-spectrum analysis.

### Federal Scientific Corporation

a subsidiary of Elgin National Industries, Inc.  
615 West 131st Street, New York, N. Y. 10027

# 175

## DRAFTING AIDS CATALOG



Send today for the By-Buk Printed Circuit Drafting Aids P-45 Catalog featuring the most comprehensive listings of basic pressure sensitive printed circuit drafting shapes, tapes and aids. Contains thousands of pads, tees, elbows, corners, donuts, connectors, fillets, colored tapes, multi-pads for dual in-lines, flat packs, TO cans and more. Here is your guide to better printed circuit drafting. Scores of ideas to speed master artwork preparation time and reduce drafting costs. Send for your free catalog and samples.

### By-Buk Company

4326 West Pico Blvd., Los Angeles, Calif. 90019  
Phone: (213) 937-3511

# 176

## Advertisers' Index

Advertiser	Page
Abbott Transistor Laboratories Incorporated .....	13
Allen-Bradley Co. ....	23
B & B Motor & Control Corp.....	104
Beckman Instruments, Inc., Helipot Division .....	70
Bodine Electric Company .....	7
Bourns, Inc. ....	33, 105
Bulova Frequency Control Products.....	97
By-Buk Company .....	106
Centralab, the Electronics Division of Globe-Union, Inc. ....	63
Clairex Electronics, A Division of Clairex Corporation .....	10
Clare & Co., C. P. ....	76
Consolidated Reactive Metals, Inc.....	93
Control Data Corporation .....	83
Corning Glass Works, Electronic Products Division .....	34, 35
Cunningham Corporation, Subsidiary of Gleason Corp. ....	92
Curtis Development & Mfg. Co. ....	106
Dale Electronics, Inc. ....	39
Datascan, Inc. ....	16
E-H Research Laboratories, Inc. ....	11
Edmund Scientific Company .....	90
Erie Technological Products, Inc. ....	32A
Executone, Inc., Printac Relay Division.....	105
Federal Scientific Corp. ....	106
General Electric Company .....	4, 5, 53, 86, 87
General Radio Company .....	36
Gerber Scientific Instrument Co., The .....	58, 59
Glenaire, Inc. ....	6
Gosh Instruments, Inc. ....	62
Grayhill, Inc. ....	62
Heinemann Electric Company .....	31
Hewlett-Packard .....	1, 8, 9
Hughes Aircraft Company, Mosfet Devices .....	84



# How would you like to have to get 268 OK's on every decision you make?

If the U.S. Post Office wants to get approval for a new Post Office facility, it has to get a majority of the 535 members of Congress to vote "yes."

That's 268 separate "yeses."

And it has to get them several times between concept and completion. On the average, it takes seven years. Seven years.

Why? Largely because Post Office appropriations have to compete for money with all sorts of requests that are politically more attractive.

So it's no wonder the Post Office tries to make do with inadequate facilities. With crowded buildings, antiquated equipment, almost unbelievable working conditions.

If you had to get 268 OK's in your business, maybe you'd give up. And maybe, like the Chicago Post Office in 1966, you'd break down, too. (Hardly a piece of mail moved for three whole weeks.)

You're in business, and you need the Post Office. You can help put it on a businesslike, efficient basis.

Write or phone your congressman today. Tell him you want to see HR 11750 passed soon. HR 11750. The total Postal Reform bill. The only true Postal Reform bill. The bill to establish a government authority and take the Post Office out of politics.

Write or phone today. Put the Post Office on a businesslike basis. Either you do, or nobody does.

## Citizens Committee for Postal Reform

1725 Eye Street N.W. Washington D.C. 20006  
Lawrence F. O'Brien/Thurston B. Morton  
National Co Chairmen

Space contributed by  
Hayden Publishing Co. Inc.

ELECTRONIC DESIGN 3, February 1, 1970

Advertiser	Page
IEEE .....	90
IRC, Division of TRW, Inc. ....	Cover II
JFD Electronics Corp./Components Division .....	101
Jonathan Manufacturing Company .....	99
Kinetics Technology, Incorporated .....	74
L. A. B. Corporation .....	96
Molex Products Company .....	12
Monolithic Dielectrics, Inc. ....	94
Monsanto Company .....	Cover III
National Semiconductor Corporation.....	14, 15
Phelps Dodge Communications Company .....	40, 41
Potter & Brumfield Division of American Machine & Foundry Company ..	81
RCA Electronic Components and Devices .....	78, Cover IV
Schweher Electronics .....	17
Scientific Research Corporation .....	95
Servo-Tek Product Company .....	91
Signalite, Incorporated .....	32
Skydyne, Inc. ....	104
Sprague Electric Company .....	18, 24
Stackpole Components Company .....	42
Sylvania Electric Products, Inc. ....	72
Systron-Donner Corporation .....	2
Tektronix, Inc. ....	16 A-B
Tempil Division of Big Three Industrial Gas and Equipment Co. ....	102
Teradyne .....	20
Vactec Inc. ....	103
Veeder-Root .....	89
Vector Electronic Company, Inc. ....	107

### Career Advertising

Hughes Aircraft Company, Aerospace Divisions .....	32B
--	-----

Handsome new  
**VECTOR**,  
Fixed-Panel  
**PATCHBOARDS**  
available off-the-shelf!

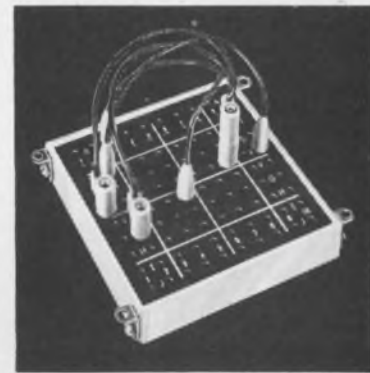

Lowest cost of any reliable patchboards... 10 cents or less per contact!

■ **7 Standard sizes**—10 to 300 receptacles; may be ganged or stacked for additional capacity.

■ **Quick delivery**—Wide range of standard sizes in stock at all times.

■ **New design**—Vector's new extruded aluminum frame gives the unit greater strength and a handsome custom look. Damage-proof entry insures reliability of beryllium copper gold-plated contacts. Standard panels are black phenolic with white alpha-numeric lettering, front and back.

■ **More contacts for your money**—Vector patchboards give far greater connection capability at much lower costs than X-Y type boards. In Vector patchboards, each contact is independent and can be connected to any other contact, providing maximum flexibility at lowest possible costs.

■ **Wide application**—Vector patchboards are used for programming machines, test set-ups, as instrument patchers, or as add-on accessories to give automatic machines greater flexibility.

■ **Specials**—Vector can provide custom units up to 15" x 36", and with special finishes, colors and printing, at moderate extra cost.

■ **Pre-programmed boards** also available. 204, 300, 450, 600 and 1200 contacts.



■ **Solderless slip-on contacts** speed backboard wiring by eliminating soldering. Leads may also be wire wrapped or soldered. Full line of stackable, multiple, and single color coded cords available.

For full information contact:

**Vector**

**ELECTRONIC COMPANY, INC.**  
12460 Gladstone Ave., Sylmar, Calif. 91342

INFORMATION RETRIEVAL NUMBER 75

107

# Information Retrieval Service

All products, design aids (DA), application notes (AN), new literature (NL), and reprints (R) in this issue are listed here with Page and Information Retrieval numbers. Reader requests will be promptly processed by computer and mailed to the manufacturer within three days.

Category	Page	IRN	Category	Page	IRN	Category	Page	IRN
<b>Components</b>			<b>Instrumentation</b>			tubing (ES)	96	282
amplifiers, TWT	91	264	book catalog (NL)	103	360	<b>Tools &amp; Engineering Aids</b>		
assembly costs (NL)	102	355	components (NL)	102	357	assembly costs (NL)	102	355
book catalog (NL)	103	360	control terminal (NL)	101	351	book catalog (NL)	103	360
cable, flexible (NL)	100	340	correlation (AN)	99	337	control terminal (NL)	101	351
capacitors (NL)	103	358	data acquisition (NL)	100	344	drafting aids (ES)	96	283
components (NL)	102	357	design, computer (AN)	99	338	plier, swivel-head	95	281
connectors (NL)	100	343	DPM, 2-1/2-digit	93	273	soldering <sup>t</sup> system,	95	280
connectors (NL)	100	348	generator, waveform	93	272			
connectors (NL)	101	350	multitester	93	271			
correlation (AN)	99	337	oscilloscope, 5-in.	93	274			
design, computer (AN)	99	338	signal measuring (NL)	100	347			
diode, hot-carrier	91	265	voltage measuring (AN)	99	339			
diode, infrared	90	262						
diodes, Ku-band	91	266	<b>Microwaves &amp; Lasers</b>			<b>New Literature</b>		
fasteners (NL)	100	341	amplifiers, TWT	91	264	assembly costs	102	355
filters (NL)	102	356	book catalog (NL)	103	360	book catalog	103	360
logic review (AN)	99	336	connectors (NL)	100	343	cable, flexible	100	340
mount, swivel (ES)	96	285	correlation (AN)	99	337	capacitors	103	358
noise source	90	261	diode, hot-carrier	91	265	components	102	357
noise sources	91	263	diode, infrared	90	262	connectors	100	343
op amps, FET	86	251	diodes, Ku-band	91	266	connectors	100	348
power console	92	269	noise source	90	261	connectors	101	350
pulse stretcher	88	257	noise sources	91	263	controller/plotter	101	351
readout	94	277	signal measuring (NL)	100	347	data acquisition	100	344
rectifier bridges	89	258	switches	90	260	fasteners	100	341
relays, DIP reed	94	276				filters	102	356
resistors (NL)	100	342	<b>Modules &amp; Subassemblies</b>			nylon handbook	102	353
resistors (NL)	100	346	amplifiers, TWT	91	264	resistive pastes	100	345
SCRs, 40-A	89	259	assembly costs (NL)	102	355	resistors	100	342
shift register	88	255	book catalog (NL)	103	360	resistors	100	346
switches, microwave	90	260	converter, d/a	87	253	signal measurement	100	347
switches, push (NL)	103	359	converters, d/a	85	250	switches, push	103	359
terminations (NL)	102	354	correlation (AN)	99	337	terminations	102	354
thermistors (AN)	99	335	design, computer (AN)	99	338	transistors, pressure	101	349
transformers, DIP	94	275	filters (NL)	102	356	voltage converters	102	352
transistors (NL)	101	349	function module	87	254			
transistors, power	88	256	logic review (AN)	99	336			
tubing (ES)	96	282	noise source	90	261			
voltage modules (NL)	102	352	noise sources	91	263			
			op amps, FET	86	251			
<b>Data Processing</b>			oscillator, thin-film	86	252	<b>Application Notes</b>		
book catalog (NL)	103	360	power console	92	269	design, computerized	99	338
control terminal (NL)	101	351	readout	94	277	logic review	99	336
CRT display	92	270	rectifier bridges	89	258	signal correlation	99	337
data acquisition (NL)	100	344	voltage modules (NL)	102	352	thermistors	99	335
data transceiver	92	267				voltage measurement	99	339
design, computer (AN)	99	338	<b>Packaging &amp; Materials</b>					
logic review (AN)	99	336	adhesive, conductive	95	278			
power console	92	269	assembly costs (NL)	102	355			
readouts, computer	92	268	book catalog (NL)	103	360	<b>Design Aids</b>		
shift register	88	255	cable, flexible (NL)	100	340	epoxy selector	97	287
			connectors (NL)	100	343	plastics charts	97	288
<b>ICs &amp; Semiconductors</b>			connectors (NL)	100	348	thermoplastics	97	286
book catalog (NL)	103	360	connectors (NL)	101	350			
diode, hot-carrier	91	265	connectors (NL)	101	350			
diode, infrared	90	262	degreaser (ES)	96	284			
diodes, Ku-band	91	266	drafting aids (ES)	96	283			
logic review (AN)	99	336	epoxy, conductive	95	279			
pulse stretcher	88	257	epoxy selector (DA)	97	287			
rectifier bridges	89	258	fasteners (NL)	100	341			
SCRs, 40-A	89	259	mount, swivel (ES)	96	285			
shift register	88	255	nylon handbook (NL)	102	353			
thermistors (AN)	99	335	plastics charts (DA)	97	288			
transistors, power	88	256	resistive pastes (NL)	100	345			
transistors (NL)	101	349	terminations (NL)	102	354			
			thermoplastics (DA)	97	286			
						<b>Evaluation Samples</b>		
						degreaser, aerosol	96	284
						drafting aids	96	283
						mount, swivel	96	285
						tubing, conductive	96	282

# From Monsanto: 130,000,000 discrete frequencies with almost perfect purity.



## Programmable, of course

**DC to 1.3 MHz**

**Resettable with 0.01 Hz resolution  
over total range**

**Less than 20  $\mu$ sec switching time from  
any frequency to any frequency**

**Calibrated output level**

**AM or FM— or both simultaneously**

Here is the sinewave source of the future . . . all the accuracy, stability and resettable-ability that only a frequency synthesizer can give you, plus such signal generator advantages as accurately calibrated output level, AM or FM modulation capability (or both), and built-in sweeps with

provision for sweeping externally.

Now add digital programmability of frequency, analog programmability of output level and the benefits of computer-aided IC design, and you see a classic example of Monsanto's "4th generation" instrumentation.

The Model 3100A-016 Programmable Frequency Synthesizer is \$4950. Our non-programmable version, Model 3100A, is \$4250. An 8-page Technical Bulletin fills out the story. For your copy write: Monsanto Company, Electronic Instruments, West Caldwell, N. J. 07006.

# Monsanto

Where do you go if you are looking for high-performance, high-reliability solid-state power sources, traveling-wave tubes, and triode cavity devices? Sure, you don't need them for any one microwave system. But can you get them from a single microwave source?

Call RCA. For more than two decades, RCA has devoted itself to design and development of product that could easily be integrated into a microwave system. A superior product line has resulted. It includes:

□ Packaged solid-state "black-boxes" such as Transferred Electron Oscillators, Microwave Integrated Circuits and Fer-

rite devices for a variety of applications which include phased array radar, navigation and communications.

- Ceramic-metal TWT's that represent significant break-throughs in size, weight, and performance for ECM applications.
- Pulsed triode cavities with improved efficiencies, longer life, and stable performance for airborne automatic traffic control and altimeter systems.

Designed into dozens of systems, from ground support equipment to satellite communications, any of these components are examples of advances made possible only through years of involvement with

system designers' problems. They could endow your system with advanced reliability and performance.

For more information, consult your local RCA Representative. For technical data, write: RCA Electronic Components, Section Q18-2-1 /ZM6, Commercial Engineering, Harrison, N. J. 07029. In Europe: RCA International Marketing S.A., 2-4 rue du Lièvre, 1227 Geneva, Switzerland.

## In Microwaves, the hot line is RCA

