

# Electronic Design 21

FOR ENGINEERS AND ENGINEERING MANAGERS

VOL. 17 NO.

OCT. 11, 1969

**Hall effect devices mushroom,** spurred by thin-film technology, lower costs, improved reliability and reduced temperature effects. Latest applications range from

solid-state computer controls to gyro pickoffs on the Boeing 747 superjet. But a new, magnetically sensitive transistor promises to give competition. See page 38.

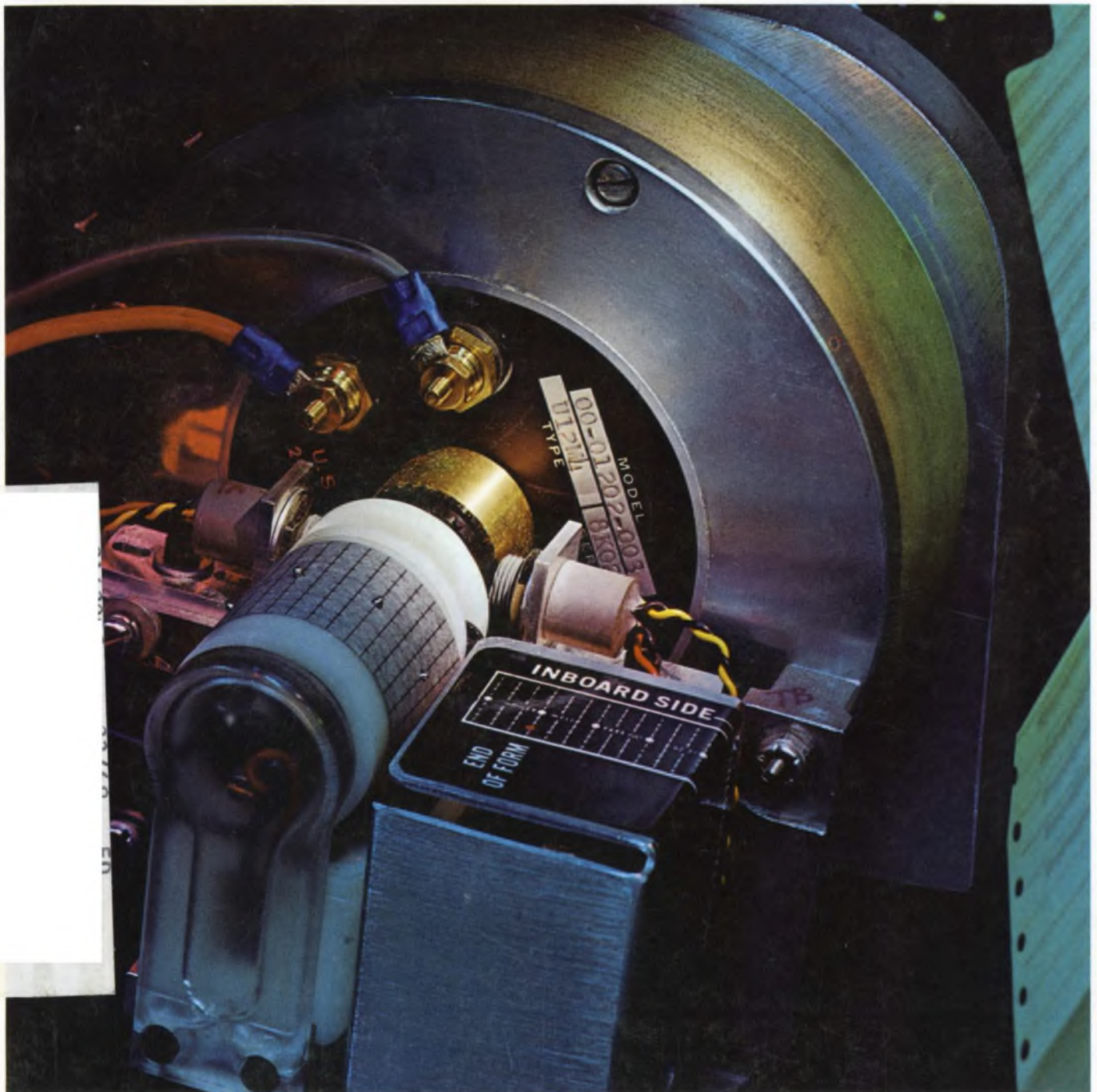

# Inductors for all temperatures



## UTC high Q coils give you better inductance stability over any temperature range

That's a tough claim to back up!

We do it by meticulously controlling every process variable that can affect temperature stability of an inductor. We pay special attention to every detail of design and manufacture—winding methods, materials compatibility, stabilization processes, assembly and impregnation—details other manufacturers ignore. Over any temperature range you specify, UTC inductors will outperform all others.

Available from our catalog are high Q inductors with guaranteed stability from  $-55^{\circ}\text{C}$  to  $+130^{\circ}\text{C}$ . Adjusted inductance

tolerances are as tight as  $\pm 1\%$  on standard inductors. Select from hundreds of inductors made to MIL-T-27B. If your specific need cannot be supplied, we'll tailor an item to your specifications.

When your designs call for better inductance stability, UTC is the answer. Check your local distributor for immediate off-the-shelf delivery or contact United Transformer Company, Division of TRW INC., 150 Varick Street, New York, New York 10013.

**TRW**  
UNITED TRANSFORMER COMPANY

X 1 0 0  
 fA pA nA nV  $\mu$ V  
 AT 1 Hz BANDWIDTH  
 + 0 10 20 30 dB



**Our singularly accurate transistor noise analyzer tells you the whole story**

The singular advantage of Hewlett-Packard's new 4470A is its inherent ability to read out transistor noise voltage ( $e_n$ ), noise current ( $i_n$ ) and noise figure (NF), accurate to better than  $\pm 1$  dB. And when you tie these factors into one neat package, you end up with the most complete noise performance story ever told. Unless you want accuracy an order of magnitude greater by calculating your measurements with  $e_n$  and  $i_n$ .

The 4470A was designed for accuracy and convenience in laboratory, for incoming device inspection and for QC testing applications on FET and bipolar transistors. Yet the analyzer is simple enough to be used by production personnel.

Measurements are made at 4 Hz bandwidths, for precise checks at 11 spot frequencies between 10 Hz and 1 MHz. Noise figure is read directly

in dB, using conveniently applied external or internal source resistances.

Since transistor gain varies between devices, an automatic gain control normalizes overall system gain to a fixed value independent of the transistor being used. And the 4470A is completely flexible for biasing transistors under test. The price is just \$4450.

Find out more about the simplicity of measuring transistor noise from your HP field engineer, or write to Hewlett-Packard, Palo Alto, Calif. 94304; Europe: 1217 Meyrin-Geneva, Switzerland.



Input filtering PLUS dual-slope integration form a unique double barrier against noise in these fast-reading DVM's. This new idea from S-D gives you more accuracy for less money than any other .01% DVM.

The portable Model 9200 and the Thin-Line, rack-mounting Model 9300 come with all the popular ranges, functions and interfacing options. Prices start at \$1175.

Send for the complete, proven specs and see for yourself. Contact Measurements Division, Systron-Donner Corporation, 888 Galindo Street, Concord, Calif. 94520. Phone (415) 682-6161.

## Newest DVM idea: double noise barrier boosts accuracy!



### More firsts. Two of 145 Systron-Donner instruments

Electronic counters	Digital voltmeters
Pulse generators	Spectrum analyzers
Microwave frequency indicators	Digital panel meters
Digital clocks	Microwave signal generators
Memory testers	Laboratory magnets
Analog computers	Data acquisition systems
Time code generators	Microwave test sets
Data generators	

SYSTRON  DONNER

---

## NEWS

- 21 **News Scope**
- 25 **Telemetry is down, but don't count it out**  
Delegates to Washington conference look for new applications in military, space and business areas
- 28 **IR device said to improve cancer detection**  
Autonetics sensor reported an order of magnitude more sensitive than other infrared instruments
- 32 **Self-renewing computers reach for the stars**  
JPL prototype points way to models that will diagnose their own failures and repair them en route
- 38 **The Hall Effect: Success at 90—a Special Report**
- 47 **Washington Report**
- 57 **Letters**
- 68 **Sidelights**
- 71 **Editorial: Let's broaden those automobile safety standards**

---

## TECHNOLOGY

- 86 **Consider dual JFET input stages** when requirements call for high input impedance, low common-mode voltage and good temperature tracking.
- 90 **Build digital models of analog systems using** a component block program. You'll find it gives analog flexibility to a digital computer.
- 98 **Feedback amplifiers are a snap for network topology.** Flow-graph methods speed analysis of these circuits without sacrificing accuracy.
- 104 **Cut binary-to-BCD conversion costs** by reducing IC package count with a nonsequential circuit, using full adders and TTL gates.
- 112 **Preparing a technical paper?** These steps will guide you in the written and oral presentation of your material.
- 117 **Ideas for Design**

---

## PRODUCTS

- 130 **Data Processing:** Multi-function desktop calculator stores 392 program steps.
- 138 **ICs & Semiconductors:** Hall-Effect chip switches two 10-mA loads.
- 158 **Instrumentation:** Digital clock uses light-emitting film display panels.
- 150 **Components**
- 166 **Microwaves & Lasers**
- 174 **Packaging & Materials**
- 182 **Modules & Subassemblies**
- 188 **Production**

---

## Departments

- |     |                     |     |                               |
|-----|---------------------|-----|-------------------------------|
| 14  | Designer's Datebook | 198 | Application Notes             |
| 192 | Evaluation Samples  | 200 | New Literature                |
| 194 | Design Aids         | 214 | Advertisers' Index            |
| 196 | Annual Reports      | 216 | Information Retrieval Service |

Information Retrieval Service Card inside back cover

**Cover Photo:** Two Hall devices pick up impulses from toothed magnetic wheels in a Honeywell computer printer.

# AMP interconnections

The inside of this black box is all AMP.

Side to side. Top to bottom. And every connector in it is right at home under MIL-E-5400 whether it be airborne or ground-based in support of aircraft.

Our connector technology has created dozens of products specifically designed for the interconnection of communications and navigational systems devoted to safe, efficient flight the world over. All of them meet the demanding criteria set by modern aircraft performance—design flexibility, lightness, compactness and reliability. No matter where in the world you build equipment to fly, and control flight, AMP offers world wide facilities to supply all connectors required in your avionics system design.

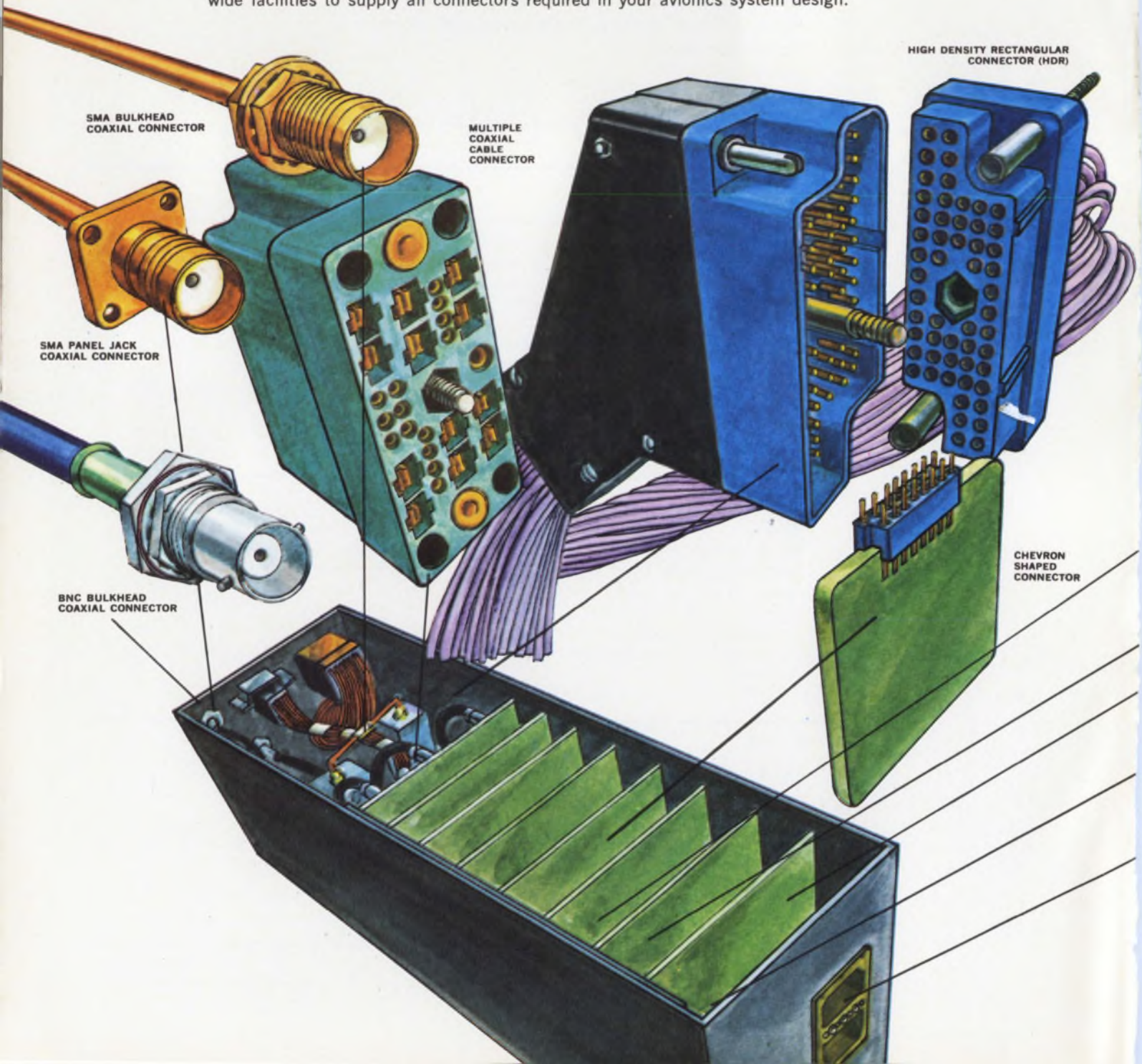

# for MIL-E-5400

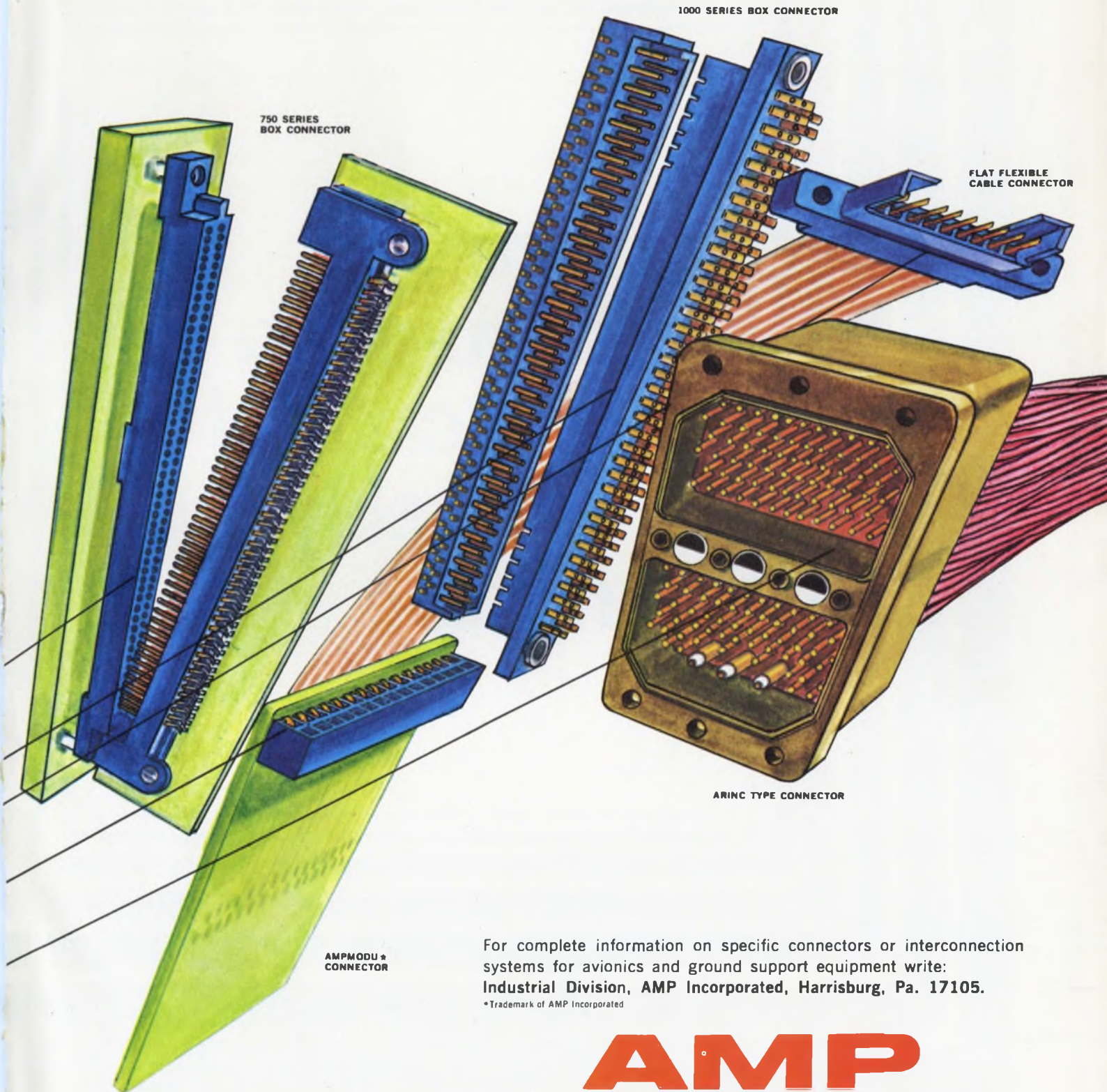

750 SERIES  
BOX CONNECTOR

1000 SERIES BOX CONNECTOR

FLAT FLEXIBLE  
CABLE CONNECTOR

AMPMODU \*  
CONNECTOR

ARINC TYPE CONNECTOR

For complete information on specific connectors or interconnection systems for avionics and ground support equipment write: Industrial Division, AMP Incorporated, Harrisburg, Pa. 17105.

\*Trademark of AMP Incorporated

**AMP**  
INCORPORATED

INFORMATION RETRIEVAL NUMBER 4









**Tired  
of running  
the crystal  
can relay  
maze?**



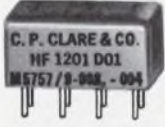

# You don't have to any more!

■ Because we've got them all. Everything from power crystal cans to TO-5 relays, from military types to industrial/commercial devices. All built to the same exacting Clare quality. And, as you'd expect from Clare, the world's greatest selection of operating characteristics and mounting styles.

**Military Relays.** Every Clare military relay is designed to meet the requirements of MIL-R-5757. All feature hermetically sealed cases to eliminate contamination under the most severe conditions. Withstand temperatures from  $-65^{\circ}\text{C}$  to  $+125^{\circ}\text{C}$ ; shock to 100 G; vibration to 30 G.

 <p><b>Type TF.</b> TO-5 transistor size; low-level to 1 amp.</p>	 <p><b>Type TF. Sensitive.</b> To 40 mw sensitivity; low-level to 1 amp.</p>	 <p><b>Type MF.</b> One-sixth size; low-level to 0.5 amp.</p>	 <p><b>Type HF &amp; HFW.</b> Low profile; low-level to 2 amp.</p>
 <p><b>Type F &amp; FW.</b> Full size; low-level to 3 amp.</p>	 <p><b>Type SF.</b> 40 mw sensitivity; low-level to 2 amp.</p>	 <p><b>Type LF &amp; LFW.</b> Magnetic latching; low-level to 2 amp.</p>	 <p><b>Type PF.</b> 10 amp. power.</p>

**Industrial/Commercial Relays.** A combination of economy and rugged construction to meet industrial/commercial requirements. Industrial/commercial versions are rated for 30 G shock and 10 G vibration.

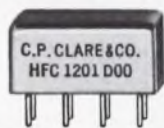
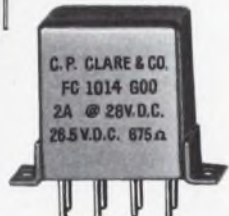
 <p><b>Type TFC.</b> TO-5 transistor size; low-level to 1 amp.</p>	 <p><b>Type MFC.</b> One-sixth size; low-level to 0.5 amp.</p>	 <p><b>Type HFC.</b> Rugged "metal" cover; low-level to 2 amp.</p>
 <p><b>Type FC.</b> Full size; low-level to 2 amp.</p>	<p>For information, circle Reader Service number, call your Clare Sales Engineer or your local Clare Distributor. Or write for data on the types you need. C. P. Clare &amp; Co., Chicago, Ill. 60645...and worldwide.</p>	

LOOK FOR



ON THE RELAY

a GENERAL INSTRUMENT company

INFORMATION RETRIEVAL NUMBER 5

# did you know?



General Electric **AC VOLTAGE STABILIZERS** respond instantly\* to give you voltage that is constant... constant, constant, constant, constant, constant, constant, constant, constant...

Send in this coupon for free bulletin giving complete details on GE AC Voltage Stabilizer features, ratings and application data; or see your GE sales representative today.

\* Output voltage is stabilized in less than 2 cycles for transient line drop of 30%.

**GENERAL  ELECTRIC**

INFORMATION RETRIEVAL NUMBER 6

Section 413-35  
General Electric Company  
Schenectady, New York 12305

Please send me free bulletin GEA-7376 on AC Line Voltage Stabilizers.

NAME \_\_\_\_\_

COMPANY \_\_\_\_\_

TITLE \_\_\_\_\_

ADDRESS \_\_\_\_\_

CITY \_\_\_\_\_ STATE \_\_\_\_\_ ZIP \_\_\_\_\_

# did you know?



General Electric **volt-pac**<sup>®</sup> variable transformers help you vary voltage dependably...year after year,\* after year, after year, after year, after year, after year, after year, after year...

Send in this coupon for free bulletin giving complete details on Volt-Pac transformer features, ratings and application data; or see your GE sales representative today.

\* Laboratory tested for over one million failure-free operations.

**GENERAL**  **ELECTRIC**

INFORMATION RETRIEVAL NUMBER 7

.....

• Section 413-34  
 • General Electric Company  
 • Schenectady, New York 12305  
 • Please send me free bulletin GEA-8110 on Volt-Pac Variable Transformers.

• NAME \_\_\_\_\_

• COMPANY \_\_\_\_\_

• TITLE \_\_\_\_\_

• ADDRESS \_\_\_\_\_

• CITY \_\_\_\_\_ STATE \_\_\_\_\_ ZIP \_\_\_\_\_

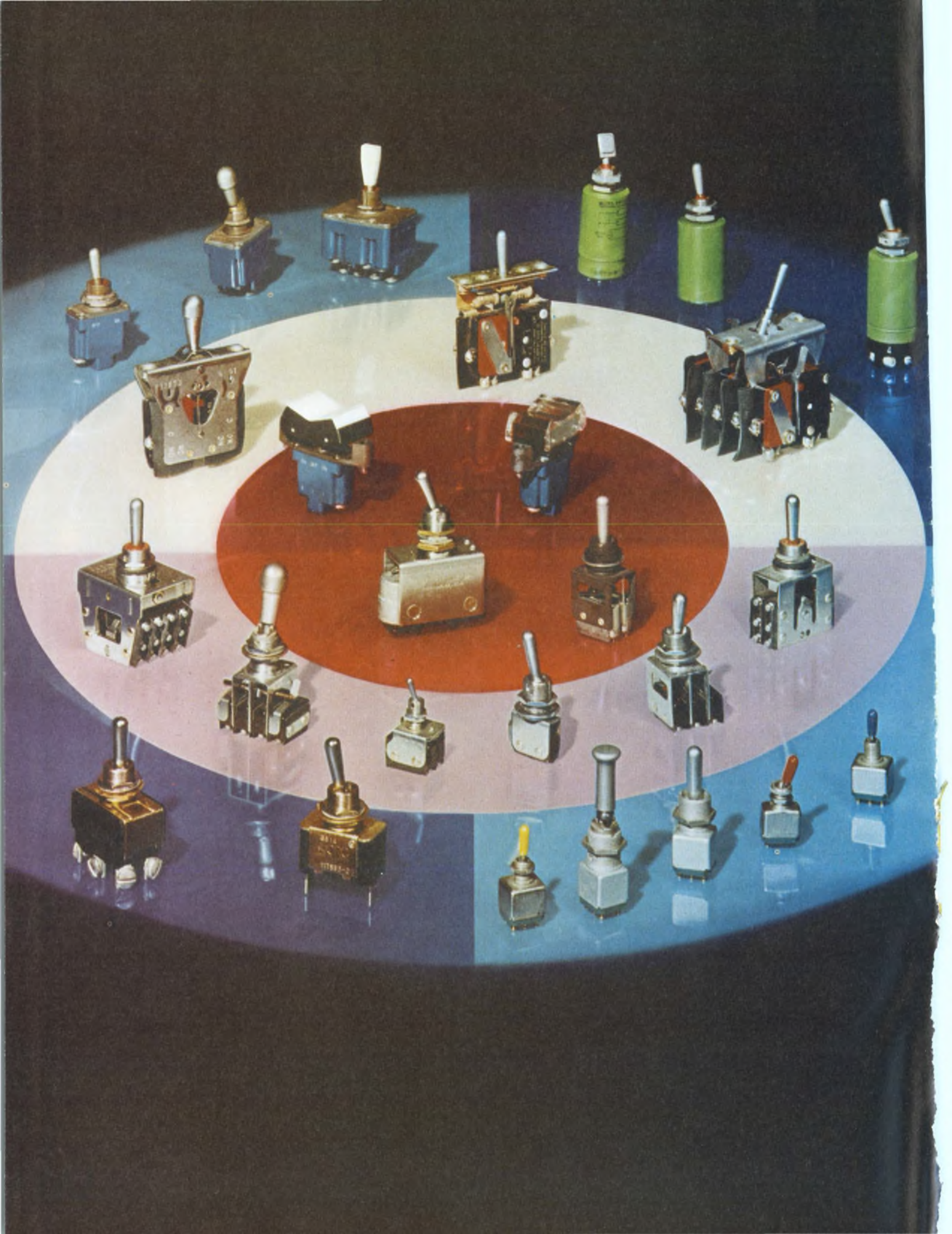

# Sure way to target in on all your toggle needs. Call MICRO SWITCH!

You'll score every time, no matter what combination of features you require. MICRO SWITCH offers the world's broadest line of toggle switches with an almost limitless selection of specifications. Such as size, circuitry, capacity and toggle action.

You can select special features, too, and get them right off the shelf. For example, environment-proof construction, magnetic hold-in, electric memory, and dry circuit capabilities.

Many in the MICRO SWITCH line are designed to meet military specifications. What's more, quality is

assured by a program that is the model of the industry.

Maybe you can use some new design ideas—ways to simplify circuit design, combine functions in fewer controls, improve operator efficiency. The most extensive field engineering staff in the industry is available to offer you help and suggestions whenever you need them.

A sampling of our thousands of toggle switches are shown at left and described below. For more details, call a Branch Office or an Authorized Distributor (Yellow Pages, "Switches, Electric"). Or write for Catalogs 51 and 52.

**1. Miniature toggle switches, Type TW**—Weight and space savers (extend only  $\frac{5}{8}$ " behind panel), yet they provide good operating feel and  $35^\circ$  toggle travel. Molded-in terminals. Lever seal and optional panel seal. Versatility, too:  $\frac{1}{4}$  or  $\frac{15}{32}$  inch bushings. 1 or 2 pole. Small, standard or large pull-to-unlock levers with 2 or 3 positions. Colored lever caps.

**2. Environment-proof toggle switches, Type TL**—Only switch of its kind which meets the complete environmental sealing requirements of MIL-S-3950. Case is of high impact, arc-resistant material. Rugged, molded-in, stepped terminals. 1, 2 or 4 pole. 2 or 3 position with momentary or maintained action, and special "on-on-on" circuitry. Standard or pull-to-unlock levers. 15 amps 115 vac, 20 amps 28 vdc.

**3. Assemblies with subminiature basic switches, Type AT**—Versatility is the keyword for these compact assemblies. Miniature, standard, or pull-to-unlock levers. Momentary or maintained contact action 2 or 3 position levers.  $\frac{1}{4}$  or  $\frac{1}{2}$  inch bushings. Up to a dozen or more precision snap-acting Type SM basic

switches, each SPDT. Silver contacts for 5 amp. rating or gold contacts for low energy reliability. Solder post, or single or double turret terminals.

**4. Assemblies with high-capacity basic switches, Type AT**—Precision snap-acting Type V3 basic switches are UL and CSA listed for 15 amps and  $\frac{1}{3}$  hp at 125-250 vac. Up to 10 individual SPDT switches can be ganged in one assembly. Rugged construction, positive 3-hole mounting. Two lever lengths. Convenient screw terminals.

**5. Magnetically-held toggle switches, Type ET**—Two or three position levers, magnetically maintained, manual or remote electrical release. Environment-

proof construction. MIL-S-3950 (immersion-proof). MIL-S-5272 (explosion-proof). SPDT or DPDT. Turret, screw or leadwire terminals. Standard, flat tab, or pull-to-unlock levers.

**6. Assemblies with hermetically sealed basic switches, Type AT**—Maximum protection for switch contacts with hermetically sealed (MIL-S-8805, Class 5) subminiature or standard size precision basic switches. MIL-S-5272 (explosion-proof). MIL-S-6743 (corrosion-resistant). For temperature extremes from  $-300^\circ$  to  $+500^\circ$  F.

**7. Rocker button toggle switches, Type TP**—Pushbutton operation with toggle switch versatility. Translucent button for edge-lighting and engraved legends, or transparent button for removable legends. Above-panel or flush-panel mounting. Same circuitry and rating as Type TL.

**8. Panel sealed toggle switches, Type TS**—Rugged construction, vibration and shock resistant. Sealed lever, plus panel seal (MIL-S-3950B). 1 or 2 pole, 2 or 3 position. UL and CSA listing: 15 amp. 125-250 vac,  $\frac{1}{2}$  hp 125 vac, 1 hp 250 vac. Solder, screw, or quick-connect terminals.

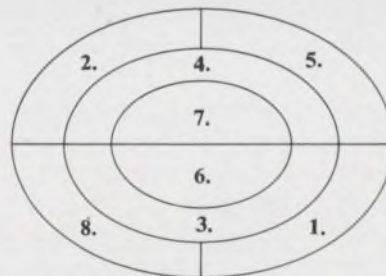

**MICRO SWITCH**  
FREEPORT, ILLINOIS 61032  
A DIVISION OF HONEYWELL

HONEYWELL INTERNATIONAL • Sales and service offices in all principal cities of the world. Manufacturing in United States, United Kingdom, Canada, Netherlands, Germany, France, Japan

INFORMATION RETRIEVAL NUMBER 8

# If these standard hybrids won't do it... we have more where they came from

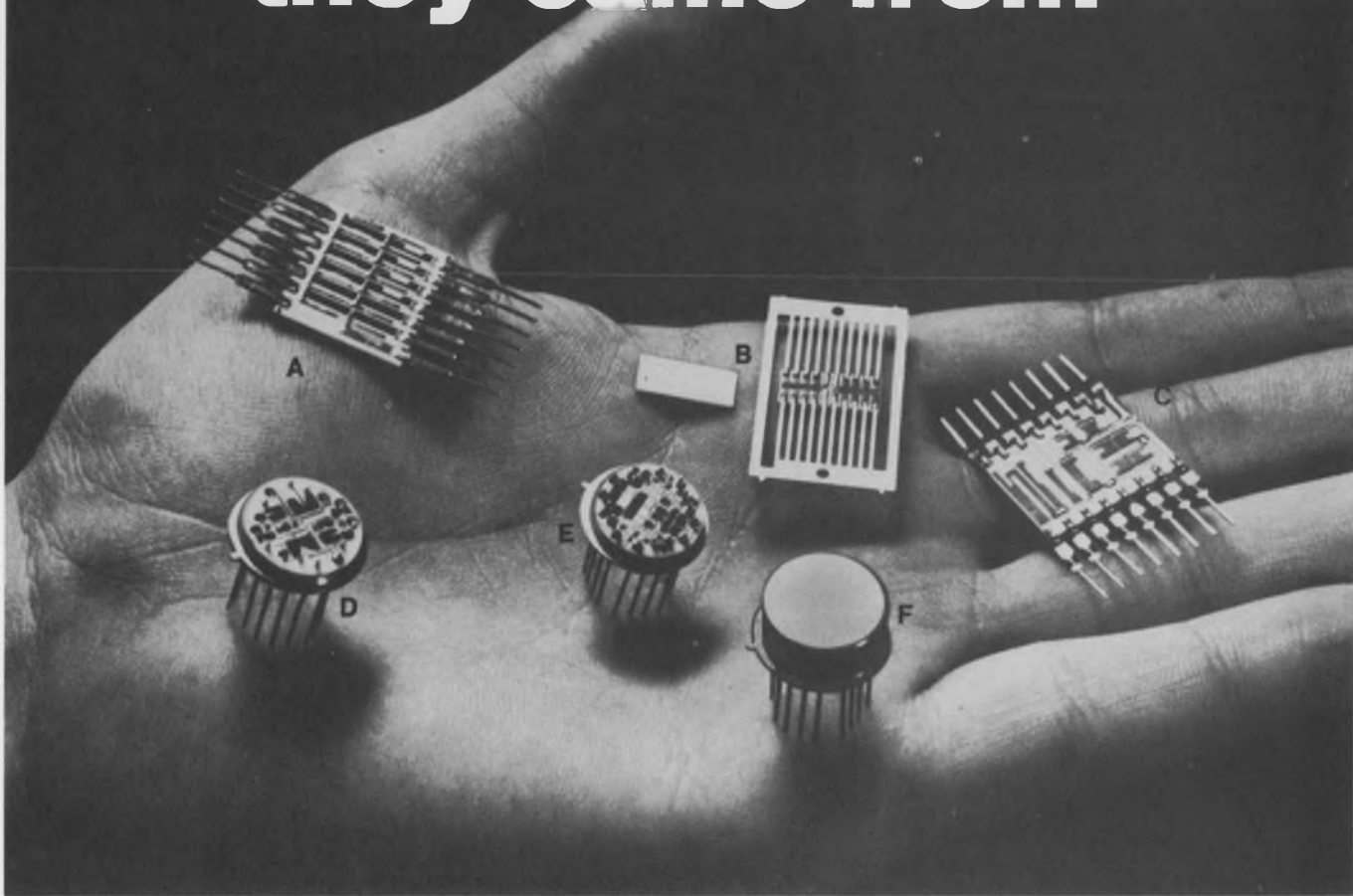

Standard hybrids featured in MEPCO "circuit of the month" program: A D/A binary voltage summing ladder; B ceramic sandwich resistor flatpack; C D/A binary current summing ladder; D DTL to MOS level shifter; E precision high speed ladder switch; F relay, lamp, core driver.

MEPCO microcircuit design engineers have perfected a good number of standard hybrid microcircuits lately. No doubt you've heard about our "standard circuit of the month" program. They're all designed to meet the most stringent high-reliability design requirements, while offering the time and cost advantages of mass production.

If we haven't yet perfected a standard circuit to meet your needs, it could very well

be that we're working on it now. Or perhaps we can find the fit among the hundreds of custom hybrids we've developed this year.

Before you look any further, ask us to show you a completely packaged hybrid integrated circuit that can outperform its counterpart. Write or call us collect for complete information, or talk to your MEPCO representative.



# New ways in digital automation with:

- Shaft Encoders, 34 types
- Synchro-to-Digital Converters, 6 types
- Analog-to-Digital Converters, 10 types
- Solid-State Digital Modules, 136 types

FREE . . . 58 Pages

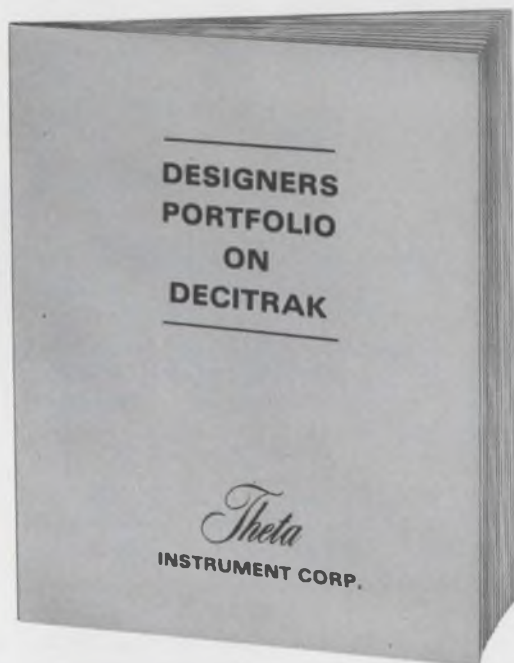

Includes copy of  
"A Primer on Shaft Encoders"

## We call it the DECITRAK<sup>®</sup> SYSTEM

Selecting from hundreds of off-the-shelf digital transducers and circuits, we assemble a remarkably low-cost, customized digital system for control/display/logging. DECITRAK can perform as simple a job as providing remote digital display of antenna pedestal position. Or, as impressive a task as the precise control of massive prime movers in response to punched-card commands.

Need a computer interface? A code converter? A typewriter driver? Set-point controls? Let a Theta Application Specialist tailor a system to your specific needs from the field-proven line of DECITRAK digital components.

More than 1,000 of these systems are now in use in nuclear installations, satellite tracking stations, wind tunnels, and aboard ships.

*Theta*

**INSTRUMENT CORPORATION**

FAIRFIELD, NEW JERSEY 07006 • PHONE: 201 - 227-1700 • TELEX: 138353

INFORMATION RETRIEVAL NUMBER 10



## How to Buy a Good Power Supply Without Spending a Bundle . . .

Take a long look at the Abbott line of over three thousand standard models *with their prices listed*. The unit shown above, for instance, is the Abbott Model AL6D-27.6A, a DC to DC converter which puts out 28 volts of regulated DC at two amps and sells for only \$220.00. Other power outputs from 5 to 240 watts are available with *any output voltage from 5 volts to 10,000 volts*, all listed as standard models in our catalog. These converters feature close regulation, short circuit protection, and hermetic sealing for rugged application found in military environment.

If you really want to save money in buying your power supply, why spend many hours writing a complicated specification? And why order a special custom-built unit which will cost a bundle — and may

Please write for your FREE copy of this new catalog or see EEM (1968-69 ELECTRONIC ENGINEERS MASTER Directory), Pages 1727 to 1740.

bring a bundle of headaches. As soon as your power requirements are firmed up, check the Abbott Catalog or EEM (see below) and you may be pleasantly surprised to find that Abbott already has standard power supplies to meet your requirements — *and the prices are listed*. Merely phone, wire, or write to Abbott for an immediate delivery quotation. Many units are carried in stock.

Abbott manufactures a wide variety of different types of power supply modules including:

- 60 $\infty$  to DC, Regulated
- 400 $\infty$  to DC, Regulated
- 28 VDC to DC, Regulated
- 28 VDC to 400 $\infty$ , 1 $\phi$  or 3 $\phi$
- 60 $\infty$  to 400 $\infty$ , 1 $\phi$  or 3 $\phi$

TO: Abbott Transistor Labs., Inc., Dept. 87  
5200 West Jefferson Blvd.  
Los Angeles, California 90016

Sir:  
Please send me your latest catalog on power supply modules:

NAME \_\_\_\_\_ DEPT. \_\_\_\_\_  
COMPANY \_\_\_\_\_  
ADDRESS \_\_\_\_\_  
CITY & STATE \_\_\_\_\_

# Designer's Datebook

OCTOBER 1968						
Sun	Mon	Tue	Wed	Thu	Fri	Sat
			1	2	3	4
5	6	7	8	9	10	11
12	13	14	15	16	17	18
19	20	21	22	23	24	25
26	27	28	29	30	31	

NOVEMBER 1968						
Sun	Mon	Tue	Wed	Thu	Fri	Sat
						1
2	3	4	5	6	7	8
9	10	11	12	13	14	15
16	17	18	19	20	21	22
23	24	25	26	27	28	29
30						

For further information on meetings, use Information Retrieval Card.

### Oct. 21-23

**Thermionic Energy Conversion Conference** (Carmel, Calif.) Sponsor: IEEE, W. E. Harbaugh, RCA, Electronic Components, Lancaster, Pa. 17604

CIRCLE NO. 432

### Oct. 26-30

**Mathematical and Computer Aids to Design Conference** (Anaheim, Calif.) Sponsor: IEEE, ACM, SIAM, J. F. Traub, Computing Science Research Center, Bell Telephone Laboratories, Murray Hill, N. J. 07974

CIRCLE NO. 433

### Oct. 27-29

**Southeastern EMC Symposium** (Atlanta, Ga.) Sponsor: IEEE, D. Vrooman, P.O. Box 331, Smyrna, Ga. 30080

CIRCLE NO. 434

### Oct. 27-29

**Electronic & Aerospace Systems Convention (EASCON)** (Washington, D.C.) Sponsor: IEEE, H. P. Gates, Jr., Sect. of Army for Southeast Asia Matters, The Pentagon, Washington, D.C. 20310

CIRCLE NO. 435

### Nov. 5-7

**Northeast Electronics Research and Engineering Meeting (NEREM)** (Boston) Sponsor: IEEE, C. J. Peters, Sylvania Electric Products, 40 Sylvan Road, Waltham, Mass. 02154

CIRCLE NO. 436

### Nov. 18-20

**Fall Joint Computer Conference** (Las Vegas) Sponsor: E. Grabbe, TRW Systems Inc., Bldg R3, Room 2070, One Space Park, Redondo Beach, Calif. 90278

CIRCLE NO. 437

**abbott transistor**

LABORATORIES, INCORPORATED

5200 W. Jefferson Blvd./ Los Angeles 90016  
(213) WEBster 6-8185 Cable ABTLABS

INFORMATION RETRIEVAL NUMBER 11

INFORMATION RETRIEVAL NUMBER 12 ►



**No tetrodes  
with higher  
linearity.**

In the power tetrode field we're defining the state of the art by demonstrating intermodulation distortion better than any other known tubes. In 1966 we introduced the 4CX1500B, a 1.5 kW tetrode with the highest linearity then known: better than  $-40$  dB 3rd order IM distortion. Since then we produced the 4CX600J, a 600 watt tube with  $-45$  dB 3rd order IM products—without feedback—and later a 5 kW tetrode with the same figure. Now the latest tetrode in our program, a 15 kW tube, exhibits  $-40$  dB 3rd order IM products. We can show IM distortion improvements from 10 to 20 dB in a practical quiescent plate current range.

Other tetrodes now under development will deliver up to 40 kW with linearity as high as  $-45$  dB IMD, according to preliminary data. Such performance advances are part of a long range program employing computer-assisted design studies to optimize internal tube geometry—all part of our plan to insure you get state of the art products every time you buy from Eimac.

Contact your nearest Varian/Eimac distributor or ask Information Operator for Varian Electron Tube and Device Group.



# Our film has the biggest cast in the business.

Just being big isn't necessarily being good, but we fixed that, too. (Had to because we aren't all that big.)

Our sales cast is made up of more electrical engineers and electrical insulation experts than you'll find in the "big name" film outfit.

And their role is to help manufacturers of motors, capacitors, wire and cable

and transformers get better performance out of the film they buy from us.

The story line is fascinating: Scotchpar® Brand polyester film gives you toughness, flexibility, indestructibility, thinnesses down to .25 mils, maximum resistance to voltage, solvents, moisture, high temperature. Every virtue a film can have, including heat-sealability if you order Scotchpak® film.

When you'd like to see our great cast in action, write to 3M Company, Film & Allied Products Division, 3M Center, St. Paul, Minnesota 55101 . . . or the Dielectric Materials Desk at the 3M Office nearest you.

**Scotchpar®** **3M**  
BRAND POLYESTER FILM COMPANY



Make your power play  
with the **SCR/triac** pros

# Go General Electric

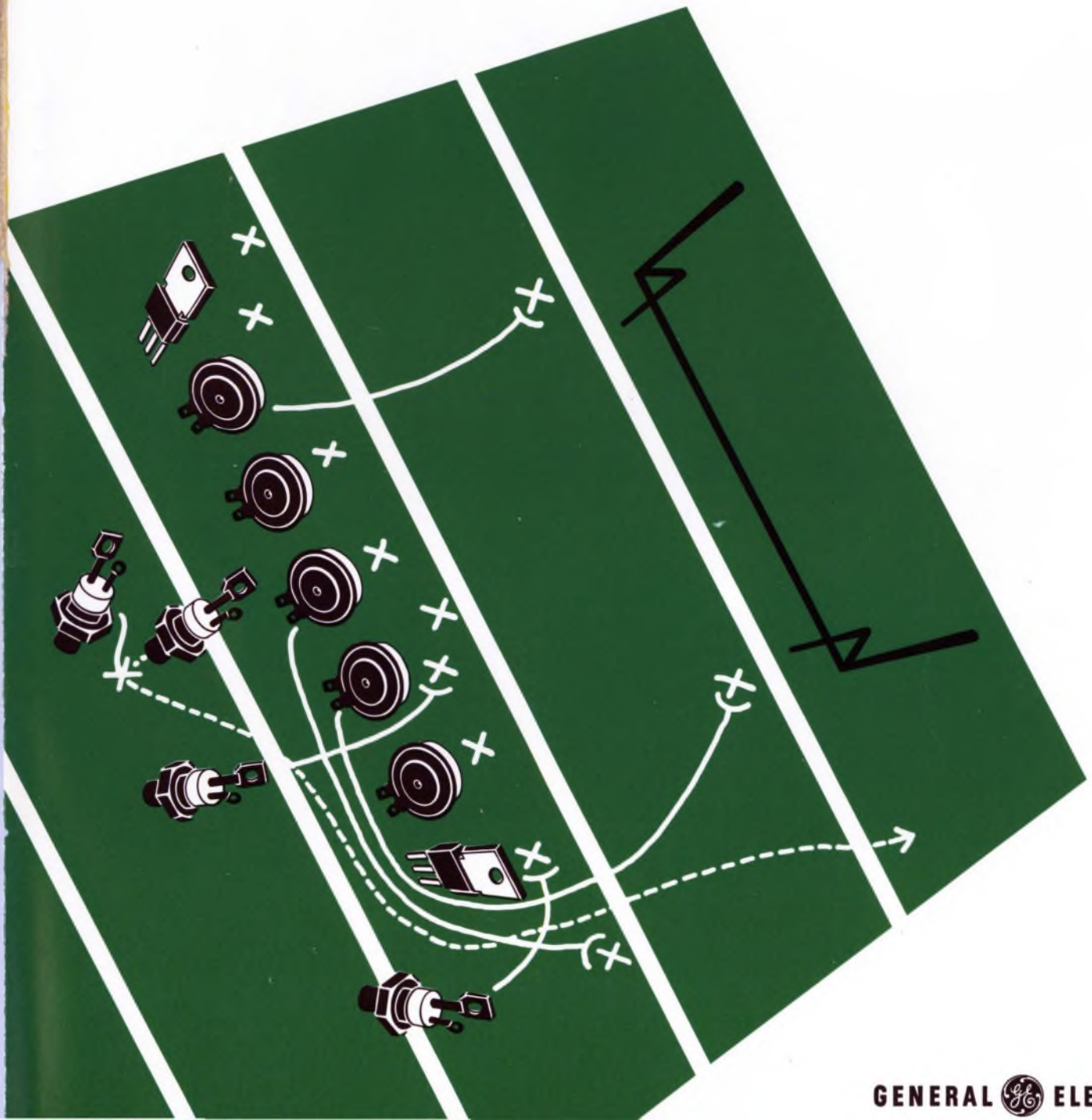

# GE's complete line of triacs and SCR's matches your price and performance needs

## THYRISTOR SELECTION GUIDE

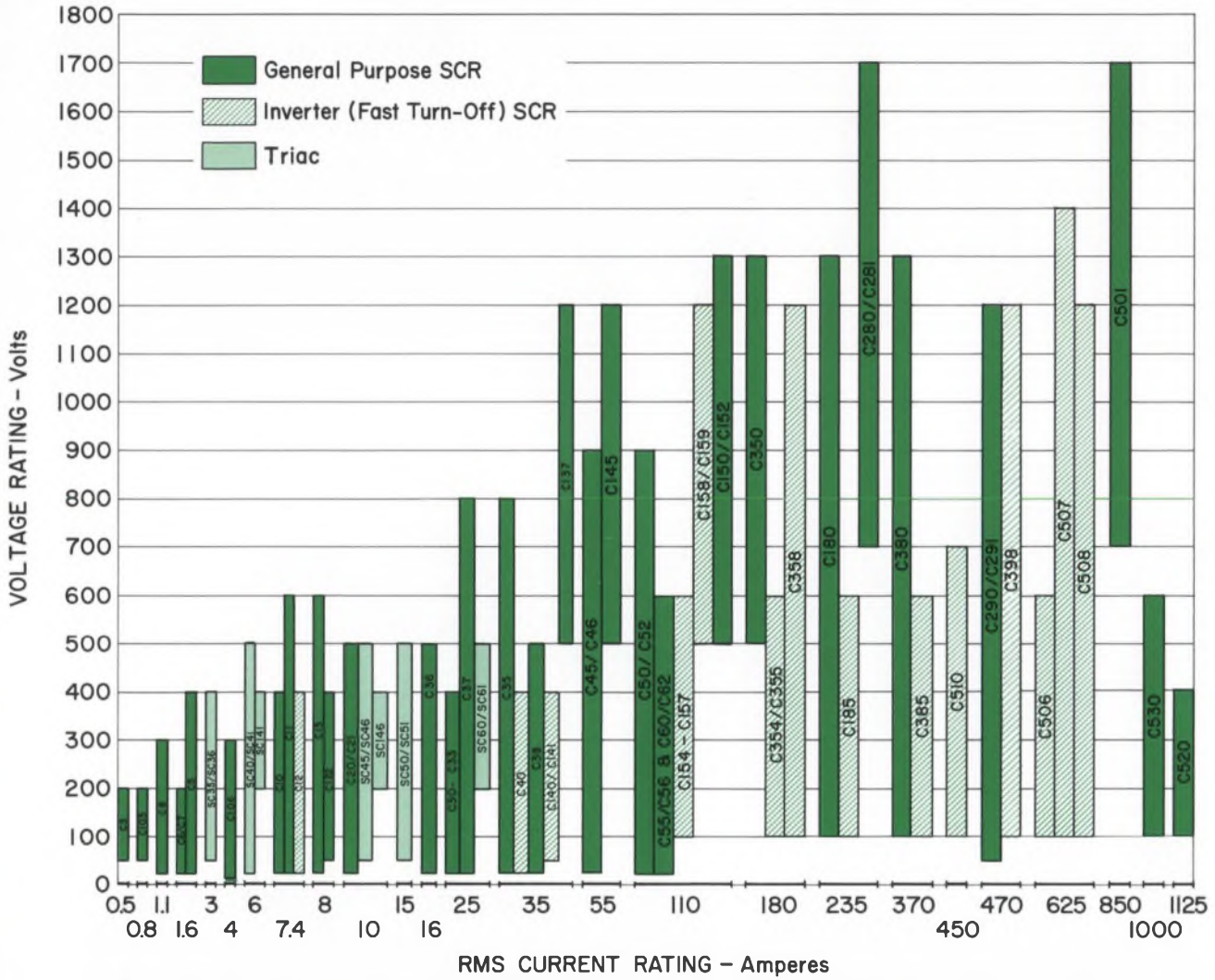

## LOW CURRENT SCR'S

Current Rating Amps. RMS Max.	Peak Voltage Range	Product Types		Package*	Significant Product Features	Temperature—°C		For Further Information Refer to Applicable Specification Sheet
		GE	JEDEC			Junction T <sub>J</sub>	Storage T <sub>STG</sub>	
0.50	30 thru 200	C3	2N877-2N881	TO-18 <sup>(1)</sup>	Small size, high sensitivity.	-65 to +150	-65 to +150	Pub. # 150.5
			2N884-2N889					
0.80		C103	None	TO-18 size <sup>(2)</sup>	Lead mounted, small size, low cost, high sensitivity.	-65 to +125	-65 to +150	Pub. # 150.7
1.10	25 thru 300	C8	2N1929-2N1935	See Pub. #150.12 <sup>(2)</sup>	Lead mounted, double ended, 30 ampere surge.	-65 to +125	-65 to +150	Pub. # 150.12
1.60	25 thru 200	C6	None	TO-5 <sup>(3)</sup>	Lead mounted, medium sensitivity.	-40 to +125	-40 to +150	Pub. # 150.8
			2N2344-2N2348		Lead mounted, very high sensitivity.			Pub. # 150.11
	25 thru 400	C5	2N2322-2N2329		Lead mounted, high sensitivity. Meets MIL-S-19500/276.	-65 to +125	-65 to +150	Pub. # 150.10
			2N2322A-2N2329A		Lead mounted, low sensitivity.			Pub. # 150.15
50 thru 400	None	2N1595-2N1599		-65 to +150		Pub. # 150.15		
4.00	15 thru 200	C106	None	Flat Pack <sup>(4)</sup>	Tab and/or lead mounted; high sensitivity, low cost.	-40 to +110	-40 to +150	Pub. # 150.9

\*Number in parentheses corresponds to outline drawing.

## MEDIUM CURRENT SCR'S

Current Rating Amps. RMS Max.	Peak Voltage Range	Product Types		Package*	Significant Product Features	Temperature—°C		For Further Information Refer to Applicable Specification Sheet	
		GE	JEDEC			Junction T <sub>J</sub>	Storage T <sub>STG</sub>		
7.40	25 thru 400	C10	2N1770A- 2N1777A	TO-64 <sup>(5)</sup>	Medium current, high temperature. Meets MIL-S-19500/108.	-65 to +150	-65 to +150	Pub. # 150.20	
	25 thru 600	C11	2N1770-2N1778 2N2619		Medium current, general purpose.	-65 to +125		Pub. # 150.21	
	25 thru 400	C12	None		Same as C11, except with 12 μsec. turn off (max).	-65 to +105		Pub. # 150.25	
25 thru 600	C15	Limited temperature range, general purpose.			Pub. # 150.22				
50 thru 400	C122	Power Pac <sup>(6)</sup>		Plastic package, round leads, glass- sealed junctions.	-40 to +100		Pub. # 150.35		
10.0	25 thru 500	C20†	None	Stud (¼-28) <sup>(7)</sup>	Limited temperature range, general purpose.	-40 to +100	-40 to +100	Pub. # 150.30	
		C22†		Press Fit <sup>(8)</sup>				Pub. # 160.19	
16.0	25 thru 500	C36	2N1842-2N1850	TO-48 <sup>(9)</sup>	Same as C30 and C32, except has 9.0 mA, IGT (max).	-40 to +100	-40 to +100	Pub. # 160.27	
25.0	25 thru 400	C30†	None	Stud (¼-28) <sup>(7)</sup>					
		C32†		Press Fit <sup>(8)</sup>					
		C31†		Stud (¼-28) <sup>(7)</sup>					
		C33†		Press Fit <sup>(8)</sup>					
25 thru 800	None	2N681-2N692	None	TO-48 <sup>(9)</sup>	Limited temperature range, general purpose.	-40 to +105	-40 to +105	Pub. # 160.23	
					C35	Medium current, general purpose.	-65 to +125	-65 to +150	Pub. # 160.22
						Similar to 2N681-92 series with specified dv/dt, di/dt, t <sub>off</sub> and I <sub>H</sub> . Meets MIL-S- 19500/108.			Pub. # 160.20
35.0	25 thru 400	C40	None	TO-48 <sup>(9)</sup>	Similar to C35, except has 12 μsec. turn off (max).	-65 to +150	-65 to +150	Pub. # 160.25	
	25 thru 500	C38			Similar to C35, except has high tempera- ture.			-65 to +150	Pub. # 160.30
	50 thru 400	2N3649-2N3653	None	TO-48 <sup>(9)</sup>	High speed for applications to 25k Hz., 15 μsec. turn off.	-40 to +120	-40 to +120	Pub. # 160.35	
					C141			2N3654-2N3658	Same as C140, except has 10 μsec. turn off.
	500 thru 1200	C137	None	High voltage, 100V/μsec., 150A/μsec., 360 amp. surge. 40 mA <sub>dc</sub> trigger I @ T <sub>C</sub> = 25°C, 75 μsec. turn off.	-40 to +125	-40 to +150	Pub. # 160.45		
	600 thru 1200	None	2N5204-2N5207	Similar to C137—For general purpose phase control applications—100A/μsec. di/dt—300A surge.	-40 to +125	-40 to +150	Pub. # 160.46		

## HIGH CURRENT SCR'S

Current Rating Amps. RMS Max.	Peak Voltage Range	Product Types		Package*	Significant Product Features	Temperature °C		For Further Information Refer to Applicable Specification Sheet	
		GE	JEDEC			Junction T <sub>J</sub>	Storage T <sub>STG</sub>		
55.0	25 thru 900	C46	None	TO-49 <sup>(10)</sup>	General purpose.	-40 to +150	-40 to +150	Pub. # 170.17	
		C45		Flag Terminal <sup>(11)</sup>					
	500 thru 1200	C145	TO-103 <sup>(12)</sup>	Compact size, high voltage, high dv/dt.	-40 to +125	Pub. # 170.18			
110.0	25 thru 900	C50	2N1909-2N1916	TO-49 <sup>(10)</sup>	General purpose, high power.	-40 to +125	-40 to +150	Pub. # 170.20	
		C52	2N1792-2N1798	Flag Terminal <sup>(11)</sup>					
	25 thru 600	None	None	None	TO-49 <sup>(10)</sup>	Same as C50 and C52, except with 20 μsec. turn off (max.).	-65 to +150	-65 to +150	Pub. # 170.21
					C56				Flag Terminal <sup>(11)</sup>
					C60				2N2023-2N2030
	100 thru 600	None	None	None	Flag Terminal <sup>(11)</sup>	High dv/dt, 10 μsec. turn off for inverter applications.	-40 to +125	-40 to +125	Pub. # 170.35
					C154				TO-49 <sup>(10)</sup>
					C156				Flag Terminal <sup>(11)</sup>
C155					TO-49 <sup>(10)</sup>				Same as C154 and C156, except has 20 μsec. turn off.
500 thru 1200	C157	Flag Terminal <sup>(11)</sup>	Amplifying gate, very high di/dt, soft fir- ing, 30 μsec. turn off time for high fre- quency applications.	-40 to +125	-40 to +125	Pub. # 170.36			
		C158		TO-49 <sup>(10)</sup>					
		C159		Flag Terminal <sup>(11)</sup>					

\* Number in parentheses corresponds to outline drawing.

† Isolated-case versions available.



## TRIACS

Current Rating Amps. RMS Max.	Peak Voltage Range	Product Types		Package*	Significant Product Features	Temperature °C		For Further Information Refer to Applicable Specification Sheet		
		GE	JEDEC			Junction T <sub>J</sub>	Storage T <sub>STG</sub>			
3.00	50 thru 400	SC35‡	None	Stud (1/4-28) <sup>(7)</sup>	Designed for 60 Hz. AC switching and control applications, such as lamp dimming, motor speed and temperature controlling, and static switching.	-40 to +100	-40 to +125	Pub. # 175.19		
		SC36‡		Press Fit <sup>(8)</sup>						
6.00	50 thru 500	SC40‡		Stud (1/4-28) <sup>(7)</sup>	Plastic package, round leads, glass-sealed junctions.				Same as SC40 & SC41.	Pub. # 175.20
		SC41‡		Press Fit <sup>(6)</sup>						
	200 thru 400	SC141		Power Pac <sup>(6)</sup>	Same as SC141.				Same as SC141.	Pub. # 175.15
		SC45‡		Stud (1/4-28) <sup>(7)</sup>						
10.0	50 thru 500	SC46‡		Press Fit <sup>(8)</sup>	Same as SC35, 36, 40 & 41.				Same as SC35, 36, 40 & 41.	Pub. # 175.20
		SC146		Power Pac <sup>(6)</sup>						
15.0	50 thru 500	SC50‡		Stud (1/4-28) <sup>(7)</sup>	Similar to SC40 & SC50 series, except with higher current rating. High dv/dt, handles 6 kW at 240 V.				Same as SC40 & SC50 series, except with higher current rating. High dv/dt, handles 6 kW at 240 V.	Pub. # 175.15
		SC51‡		Press Fit <sup>(8)</sup>						
25.0	200 thru 500	SC60‡	Stud (1/4-28) <sup>(19)</sup>			Pub. # 175.20				
		SC61‡	Press Fit <sup>(20)</sup>							

\* Number in parentheses corresponds to outline drawing.  
 ‡ Isolated-case and 400 Hz versions available.

### SILICON CONTROLLED RECTIFIERS

Voltages from 15 to 1700 volts  
 Current ratings from 1/2 to 1125 amps  
 Lead mounts, plastic power pacs, stud mounts, press fits, press paks

### TRIACS

Voltages from 50 to 500 volts  
 Current ratings from 3 to 25 amps  
 Stud mounts, press fits, plastic power pacs

General Electric also offers a complete line of switch and trigger devices to be used with these triacs and SCR's. For more information about UJT's, programmable unijunctions, silicon switches and diacs, ask for the line folder on triggers on the reply card below.

**GENERAL  ELECTRIC**

Want more information on a specific triac or SCR?  
 Would you like a salesman to call?  
 Fill out this postage-paid reply card and mail today!

Please send complete spec sheets on the following SCR's:

\_\_\_\_\_  
 \_\_\_\_\_  
 \_\_\_\_\_

Please send complete spec sheets on the following triacs:

\_\_\_\_\_  
 \_\_\_\_\_  
 \_\_\_\_\_

Please send line folder (pub. no. 60.01) on trigger devices.

Please have a salesman call.

MY GE DISTRIBUTOR IS: \_\_\_\_\_

NAME \_\_\_\_\_

FIRM \_\_\_\_\_ TITLE \_\_\_\_\_

STREET \_\_\_\_\_

CITY \_\_\_\_\_ STATE \_\_\_\_\_ ZIP \_\_\_\_\_

## HIGH CURRENT SCR'S, CONT.

Current Rating Amps. RMS Max.	Peak Voltage Range	Product Types		Package*	Significant Product Features	Temperature—°C		For Further Information Refer to Applicable Specification Sheet
		GE	JEDEC			Junction T <sub>J</sub>	Storage T <sub>STG</sub>	
110.0	500 thru 1300	C150	None	TO-49 <sup>(10)</sup>	High voltage, high dv/dt, all-diffused.	-40 to +125		Pub. # 170.23
		C152		Flag Terminal <sup>(11)</sup>				
		C350						
180.0	100 thru 600	C354	None	Press Pak <sup>(13)</sup>	Electrically similar to C150 with increased current capability. Pressure mounted.	-40 to +125		Pub. # 170.54
	100 thru 1200	C355			High dv/dt, 10 μsec. turn off for inverter applications.			Pub. # 170.37
		C358			Same as C354, except has 20 μsec. turn off			Pub. # 170.38
		C358			Amplifying gate, similar to C158 with increased current capability.			Pub. # 170.38
235.0	100 thru 1300	C180	None	TO-93 <sup>(14)</sup>	High voltage, high dv/dt, all-diffused.	-40 to +150		Pub. # 170.52
	100 thru 600	C185			Similar to C180, except with 20 μsec. turn off (max.)			Pub. # 170.53
	700 thru 1700	C280		Stud (3/4-16) <sup>(15)</sup>	Very high-voltage.			Pub. # 170.58
		C281		Flat Base <sup>(16)</sup>				
		C380		Press Pak <sup>(13)</sup>	Electrically similar to C180 with increased current capability. Pressure mounted.			Pub. # 170.56
370.0	100 thru 1300	C380	None	Press Pak <sup>(13)</sup>	High dv/dt, 20 μsec. turn off for inverter applications.	-40 to +125		Pub. # 170.57
	100 thru 600	C385						Pub. # 170.57
450.0	100 thru 700	C510	None	Press Pak <sup>(17)</sup>	High dv/dt, 15 μsec. turn off time. Very high di/dt for inverter and chopper applications.**	-40 to +125		Pub. # 170.80
470.0	50 thru 1200	C290		Stud (3/4-16) <sup>(15)</sup>	High voltage, high current.			-40 to +125
	100 thru 1200	C291	Flat Base <sup>(16)</sup>					
		C398	Press Pak <sup>(18)</sup>	Amplifying gate, very high di/dt, soft firing, 30 μsec. turn off time, pressure mounted.	Pub. # 170.45			
625.0	100 thru 600	C506	None	Press Pak <sup>(17)</sup>	High dv/dt, 35 μsec. turn off time for inverter applications.**	-40 to +150	-40 to +150	Pub. # 170.76
	100 thru 1400	C507			Same as C506, except with 100 μsec. turn off time.**			Pub. # 170.77
	100 thru 1200	C508			Same as C506, except with 60 μsec. turn off time.**			Pub. # 170.78
850.0	700 thru 1700	C501	None	Press Pak <sup>(17)</sup>	Very high voltage, high dv/dt for general purpose use.**	-40 to +150	-40 to +150	Pub. # 170.70
1000.0	100 thru 600	C530			Electrically similar to C501.**			Pub. # 170.82
1125.0	100 thru 400	C520			Electrically similar to C501, except has 150°C T <sub>J</sub> max.**			Pub. # 170.81

\*Number in parentheses corresponds to outline drawing.

\*\*Available separately, or in factory-assembled air- and water-cooled heat exchangers.

**NOTE:** For definitions of symbols and terminology used, refer to Chapter 2, 4th Edition of GE's SCR Manual (Pub. #ETR 3875 is the SCR's 10th Anniversary Issue).

FOLD and SEAL

FIRST CLASS  
PERMIT NO. 1424  
SYRACUSE  
N. Y.



**BUSINESS REPLY MAIL**  
NO POSTAGE STAMP NECESSARY IF MAILED IN THE UNITED STATES

POSTAGE WILL BE PAID BY—  
**GENERAL ELECTRIC COMPANY**  
Semiconductor Products Dept.  
Northern Concourse Office Bldg.  
Room C2  
North Syracuse, N. Y. 13212



# HAPPENINGS IN ELECTRONICS

October, 1969

## Schweber makes history with Allen-Bradley!

Allen-Bradley has selected Schweber Electronics as their first distributor of electronic components. This marks the first such appointment in the sixty years of Allen-Bradley's history. Schweber prices will be the same as the factory in specified quantities. Among the components Schweber is now privileged to sell from stock are fixed composition resistors that meet or exceed all applicable military specifications including the new Established Reliability specification MIL-R-39008A at the highest level—the S level. Other stocking items will be the A-B types J and G potentiometers to MIL-R-94C, carbon trimming potentiometers, and ceramic feed-thru capacitors. For a complete brochure on all Allen-Bradley electronic components, circle #241.

## Motorola Voltage Regulator Circuit joins LIC hit parade.

Linear integrated circuit technology takes its second great leap forward with the Voltage Regulator circuit. (The Op Amp circuit was the first.) It would seem that the microscopic size of monolithic devices offers insurmountable barriers to the creation of effective voltage regulators on a single chip. The limitations imposed on voltage and current by size would seem to relegate IC voltage regulators to marginal applications. But Motorola has changed this picture

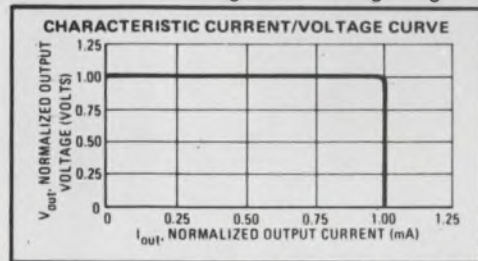

by introducing a monolithic voltage/current regulator circuit that "floats" on top of the output voltage of the power supply and thus is not subject to voltage limitation! Actually, the only restriction on the range of voltages that can be regulated is the breakdown voltage rating of the external pass transistor, and this maximum of several hundred volts can be adjusted all the way down to zero volts. Designated MC1566L (commercial version MC1466L), this exciting new circuit is immediately available from Schweber stock. The commercial version sells for 12.75 each in 1 to 24 pc. quantities, the military for 36.75 each in similar quantities. For technical literature circle #242.

## Fairchild trains big guns on Op Amps.

In the meanwhile, the monolithic Op Amp continues to proliferate in all directions. Of the last seventeen LICs to come off the drawing boards at Fairchild, ten are Op Amps: High Speed 715; Instrumentation 725; Micropower 735; Dual Low-Noise High-Gain 739; Frequency-Compensated 741; Radiation-Resistant 744; Dual Internally Compensated 747; High Performance 748; and last but not least, the plain Jane of the Op Amps, the Dual 749. But in spite of its plain name, the Dual Op Amp749 has some unusual features. The output stage is a class A common emitter PNP circuit with collectors uncommitted, features which are not usually found in OP Amps. This permits ORing of the dual outputs and makes possible such applications as a Dual Level Comparator circuit, Strobing with independently strobed outputs, and Peak Voltage Detection without external diodes. All ten devices are stocked at Schweber. To receive all ten data sheets, circle #243.

### $\mu$ A749

#### Dual Op Amp

92 dB Voltage Gain  
 $\pm$ 11V Common Mode Range  
 20 MHz Bandwidth  
 No Latch-up  
 Output Short Circuit Protected

U6A7749393		
1-24	25-99	100+
5.85	4.75	3.49
U6A7749312		
17.95	14.35	11.95

## Review of new catalogs:

1. RCA's Solid State Product Guide is now available just off the press. This 48-page catalog has a unique arrangement of characteristics by type number. Thirty-four pages of charts list parameters ranked in order of a significant rating or characteristic. The charts are grouped under three major categories (AF, RF, Switching & Pulse) which in turn are further sub-divided. Thus, this product guide serves a two-fold function:—it provides data on a specific type and provides types for a specific application. Circle #244.
2. A Master Selection Guide to Motorola semiconductor devices and a price list for an appendix is available from Schweber. The guide lists all of Motorola's many device categories including Zener diodes, Rectifiers, Thyristors, Bipolar & FET transistors, Opto-electronics, Varactors, Digital & Linear ICs. The tables include only basic specifications to permit quick comparison and preselection of semiconductors that are most suitable. Circle #245.



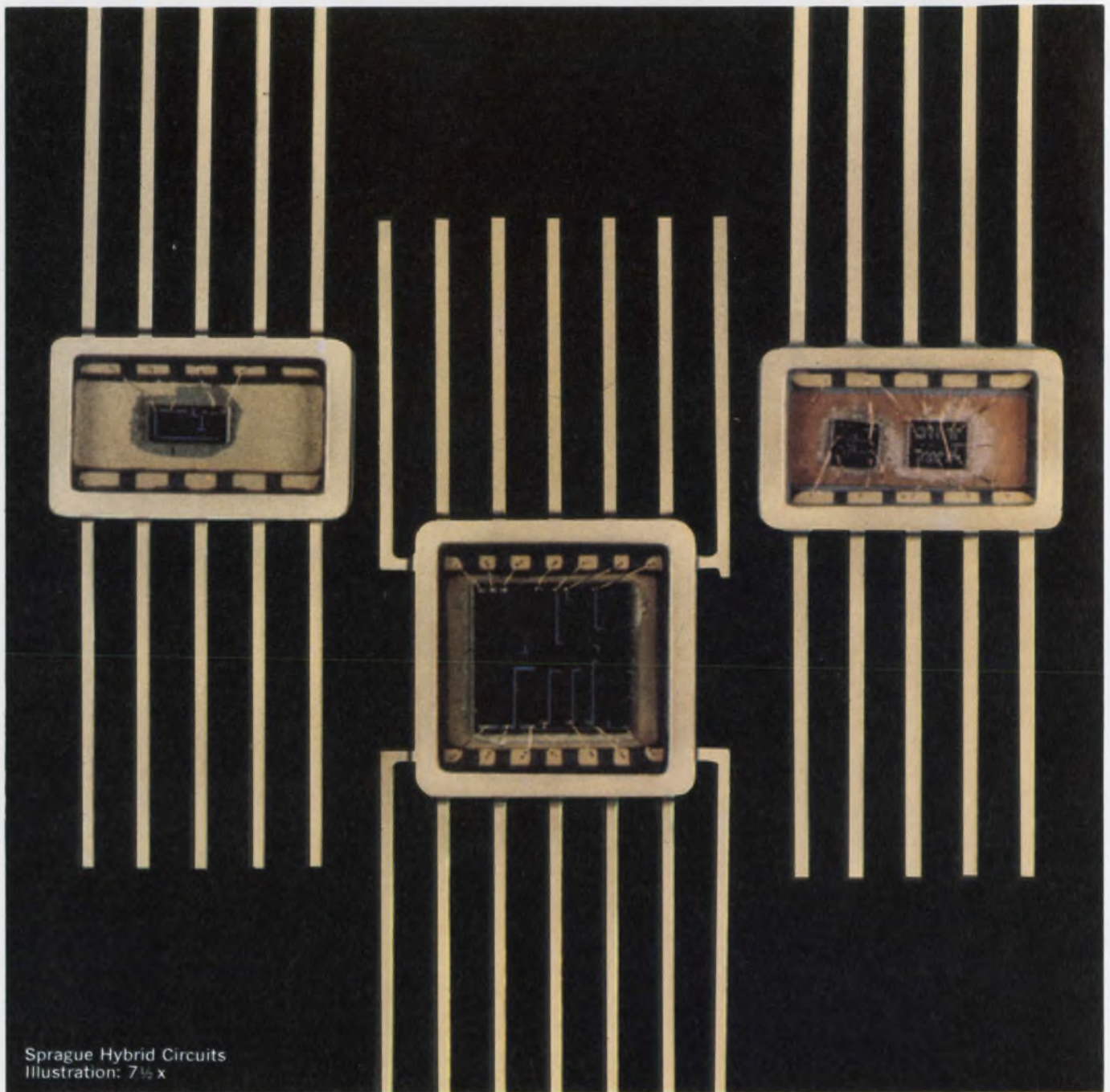

Sprague Hybrid Circuits  
Illustration: 7½ x

## Look. Look into a 10-bit D-to-A with 2.8 MHz count rate.

Get 10-bit accuracy with only eight packages. You get ladder networks, ladder switches, and buffers. Just add a PC board and the fastest Op Amp you can find. Only 240 mW total power dissipation. There's no

speed/power trade-offs with these new Sprague Hybrids. And you save space, too. The circuits are in ¼" x ¼" and ⅛" x ¼" ceramic flatpacks, for operation -55 to +100° C.

### Other D-to-A hybrids from 4 bits...

can be made from our standard line of packaged ladders, switches and buffers. Get the high accuracy tanta-

lum resistor ladder alone, or a complete kit for up to 12 bits. Start your conversion to Sprague hybrids now.

Call Sprague Info-Central (617) 853-5000 extension 1969.

Or call your Sprague industrial distributor. He has the 10-bit 2.8 MHz circuits on the shelf. For complete specification data, circle the reader service number below.



# News



The venerable Hall-effect device is finding ever wider use in a variety of industrial and aerospace applications. Here, a Hall current-

measuring system monitors up to 50,000 amperes dc, used in refining bauxite ore for aluminum production. p. 38.

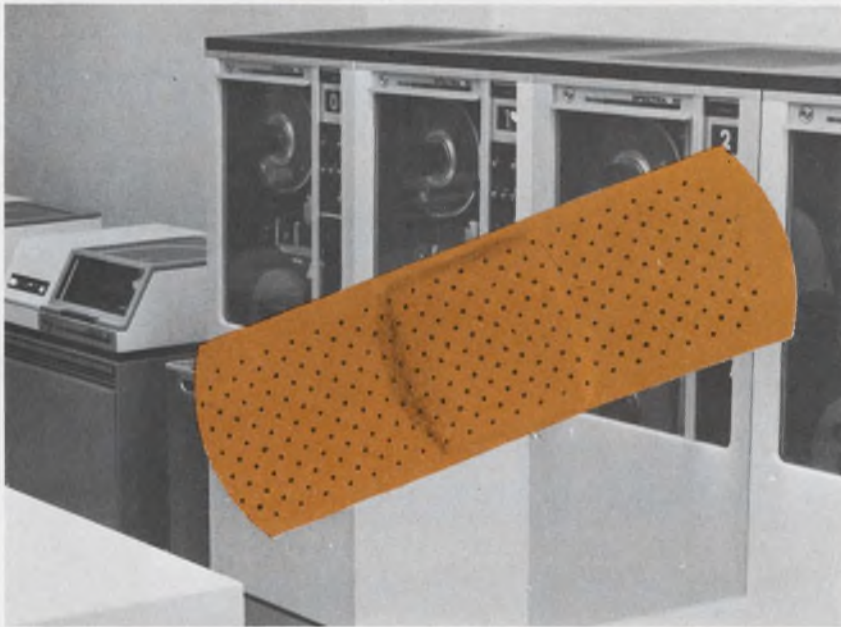

A computer that can spot its own failures and then repair itself is a necessity for long space voyages. JPL has designed a prototype. p. 32.



Telemetry manufacturers see end of two-year slack period. p. 25.

## Also in this section:

IR device said to improve cancer detection. p. 28.

LSI computer to cut time-sharing costs. p. 52.

News Scope, p. 21 . . . Washington Report, p. 47 . . . Editorial, p. 71.

**For bandpass signal control without inductors...**

# Select SERIES JF 33-2000 ACTIVE FILTERS

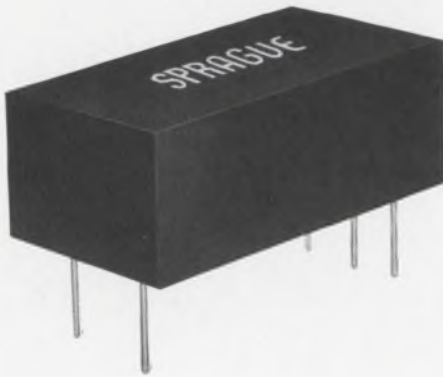

INFORMATION RETRIEVAL NUMBER 821

Developed for a variety of bandpass signal control applications. Combine both high performance and small size. Offer circuit designers a  $\pm 7.5\%$  bandwidth, 20 db gain, and center frequencies from 400 Hz to 14.5 kHz. Precise capacitor and resistor components plus integrated amplifiers provide extremely stable performance at temperatures from  $-25\text{ C}$  to  $+75\text{ C}$ . Available in encapsulated construction. Meet vibration, shock, moisture resistance, thermal shock, and immersion cycling requirements of MIL-F-18327.

48P-9103

**...want high volume efficiency in tubular 'lytics?**

# Use SPRAGUE Type 39D POWERLYTIC<sup>®</sup> CAPACITORS



INFORMATION RETRIEVAL NUMBER 822

Provide maximum capacitance in smaller cases with axial leads. No internal riveted or pressure connections. Welds at critical anode and cathode terminals. Molded end covers. Life expectancy of 10 years or more in normal service. Very low effective series resistance and leakage current.

For complete technical data on Active Filters, write for Engineering Bulletins 8700 and 8701. For information on Type 39D Capacitors, request Engineering Bulletin 3415. Write to: Technical Literature Service, Sprague Electric Co., 347 Marshall Street, North Adams, Massachusetts 01247.



'Sprague' and '®' are registered trademarks of the Sprague Electric Co.

**THE BROAD-LINE PRODUCER OF ELECTRONIC PARTS**

## Nixon approval of SST welcomed by industry

The decision by President Nixon to proceed with development of a U.S. supersonic transport is sparking high interest in the electronics industry. A number of vital on-board systems and major ground systems will have to be developed, and the market for operational systems is, as one industry source put it, "very respectable."

In addition to conventional electronics, the SST will require a myriad of warning systems, complex navigation and landing systems, advanced cockpit instruments, long-range radar, and malfunction detection and alarm equipment. At a price tag of up to \$45-million each and potential world sales of up to 1200 aircraft, avionics suppliers have an important market for exploitation.

The SST program must still be approved by Congress, but if it is (and a tough fight is expected), electronic needs for the plane are expected to fall somewhere between 10 to 15 per cent of the total cost. The Boeing Co. is prime contractor for the aircraft, and General Electric is the engine developer. Electronics supplies will be selected by Boeing over the next several years.

The Nixon Administration will seek an appropriation of \$96-million for fiscal 1970 and the release of some \$90-million in carry-over funds. This falls short of the \$212-million Boeing officials had sought to keep the program on a 1972 flight schedule.

The cost of building and developing two prototypes is estimated at \$1.6-billion, in all. Expenditures to date by U.S. industry and the federal government are estimated at nearly \$550-million.

Because of its 1800-mph speed and 70,000-ft. altitude flight design, the SST will require highly sophisticated electronics. The Air Line Pilots Association has urged

a number of system requirements to assure aircraft and passenger safety. For example, it has recommended satellite relay of VHF voice communications and a continuous data link for updating air traffic, navigation and weather information.

It proposes inertial guidance as the primary navigational subsystem, but urges a backup system, such as improved Loran or a satellite navigational system, to cross-check inertial accuracy. It also urges improved pictorial displays with pre-programmed flight direction—for example, computer-driven moving map displays.

The pilots' association proposes that all major flight systems be tri-redundant, so that a malfunction in one element can in no way cause intersystem failure.

Also, because of the operational characteristics of the craft and the unique flight environment, the pilots see a need for many warning systems. These include a positive collision-avoidance system, meteorological sensors for weather prediction, forward-looking weather radar out to 300 nautical miles, radiation detectors, equipment-malfunction monitors with a central warning system, and a means for detecting clear-air turbulence.

### Navy will switch to solid-state relays

The Navy plans to replace most of its electromechanical relays in airborne systems with solid-state devices by the mid-1970s.

Its program was outlined at a recent "think-in" seminar on relays, sponsored by the Ohmite Corp. in New York. Leonard Wendling, program manager of the Engineering Support Group, Avionics Div., Naval Air Systems

Command, Washington, D. C., explained that the work was being planned by Project Sostel (solid-state electric logic), which he manages.

Until recently, one problem in using solid-state relays has been their inability to switch currents of more than 1 ampere. But recent developments have made available solid-state relays that can switch up to 10 amperes.

Wendling said that 90 per cent of all avionic systems presently use 3 amperes or less in switching by electromechanical means.

### Airlines demonstrate anti-collision system

The pilots in two planes—the one a Martin 404 jetliner, the other a Fan Jet Falcon—flew at each other on a collision course. Suddenly alarms beeped and a panel indicator flashed the instruction "Dive" to one pilot and "Climb" to the other. The two planes passed each other safely.

It was a test flight to demonstrate to the public the airlines' progress in developing a 13-year-old concept: a cooperative type of collision-avoidance system. The demonstration, put on by Martin-Marietta from its airfield in Middle River, Md., was sponsored by the Air Transport Association as part of a program that has cost some \$2-million and required about 300 hours of flight time so far.

The collision-avoidance system is being developed by Bendix Avionics, Fort Lauderdale, Fla., McDonnell Douglas, St. Louis, and a team from Wilcox Electric, Kansas City, Mo., and Sierra Research, Buffalo, N.Y.

The system uses atomic clocks to keep precise track of time in cooperating aircraft and at two ground stations, one at the Martin field at the Federal Aviation Administration Experimental Facility in Atlantic City, N.J.

In operation, each aircraft transmits a short burst of data in digital form, giving its altitude and other information. Only one aircraft transmits at a time, with all the others listening, until their turn comes to transmit. Computers in each plane determine relative positions and rates of closure, and

also indicate to the pilots the evasive maneuvers to take.

Initial versions for the air carriers are expected to cost from \$30,000 to \$50,000. Estimates of the ultimate cost for a general-aviation (private flying) version range from \$2,000 to \$10,000.

A prime limitation of the system is that it does not detect any plane that does not have the equipment on board. To help breach this gap, much effort is being expended on low-cost proximity warning indicator systems, which only tell the pilot: "Watch out!" The main efforts here center on infra-red detection systems that are triggered by the infra-red energy of flashing Xenon lights, now in common use on all planes.

The airlines expect to complete tests on their prototype by the end of this year.

## Low-cost color TV player demonstrated by RCA

Selecto Vision players that will attach to any standard color TV set and display prerecorded programs were demonstrated by RCA at its Princeton, N.J., laboratory last week. According to Dr. James Hillier, executive vice president, RCA Research and Engineering, the player is expected to be the first consumer product to employ lasers and holography. The Selecto Vision players will play one-half and full-hour recordings made on tape of clear, inexpensive material such as is used in supermarkets to wrap and display meats.

Production will commence in 1972, according to Chase Morsey, Jr., executive vice president, RCA Operations Staff, with delivery shortly thereafter. The target price for the player, he stated would be \$400. A library of 100 original program albums in half- and full-hour lengths will be offered at the same time; project price for a half-hour program is set at \$10, Morsey added.

Robert W. Sarnoff, RCA presi-

dent, noted that this is the first time an RCA Laboratories' project has reached the demonstration stage with its own record of exhaustive market studies to define the nature and extent of the demand that can be expected.

## Wall-sized displays are 100 times brighter

A Charactron tube for projecting computer-generated text, graphics and analog information on a wall-sized screen has been stepped up to emit 100 times more light than the standard Charactron tube.

Developed by Stromberg Data-graphiX, a San-Diego-based subsidiary of General Dynamics, the Charactron process produces minute characters and lines on the tube face, which are then projected onto the screen by means of a reflective optical system. Coupled with the appropriate software, the new tube displays information at computer speeds. The company plans to market the system to both industrial and military groups.

The extra brightness was achieved by improving the efficiency of the electron gun. This was done by removing, from their normal internal location, the electron beam controlling elements and mounting them on the outside of the tube. This reduces the distortions and allows a higher percentage of the emitted beam to reach the Charactron matrix and ultimately the viewing screen.

## Semiconductor leaders discuss the market

When four presidents of the nation's leading semiconductor companies got together at a panel meeting sponsored by the IEEE Electron Devices Group in Sunnyvale, Calif., last month, what was the topic of conversation? Prices of course.

C. Lester Hogan of Fairchild, Robert R. Noyce of Intel, James Riley of Signetics and Charles Sporek of National Semiconductor agreed that the marketplace continues to be the prime factor in determining prices.

"In some applications," said Hogan, "it would be ridiculous to talk about selling semiconductor devices at \$5 apiece because there is no market at that price . . . You have to establish your price at what the market is willing to pay and then try like hell to make a buck doing it."

Noyce agreed, pointing out that in the specific market Intel is aiming for—memories—the price is set by cores at about a penny a bit.

"We can't possibly meet those prices today," he said, "but we can certainly look forward to matching them and eventually to cutting them in half."

Sporck—whose company has just announced price reductions of 60% on 17 field-effect transistors—termed price-cutting practices "terrible" and blamed them on "immature management."

Noyce countered by arguing that "if you look back at history, profitability has been almost inversely related to price."

Hogan agreed, noting that "This is an era when the price of discretes has never been lower and yet that's where most of the money is being made in our industry today. In fact, if one plots the life cycle of devices, it appears you make the most money on any device after it stabilizes into a high-volume business at low prices."

## Robot sailboat



A robot sailboat developed by RCA can navigate itself unmanned by radio command to any point on the world's seas. The craft employs movable sails and rudders plus electronic navigation to proceed to a designated point. It will hold its station until commanded to move elsewhere.

# LOW PROFILE

hot-molded trimmer for  
close circuit board stacking



Basic Type Y unit  
shown actual size



With wheel for  
side adjustment



With attachment for  
horizontal mounting and  
wheel for side adjustment



With attachment for  
horizontal mounting

**Type Y** single turn trimmer is especially designed for use on printed circuit boards. It has pin-type terminals for use on boards with a  $1/10''$  pattern. And the low profile easily fits within the commonly used  $3/8''$  space between stacked printed circuit boards.

For greater operating convenience, the Type Y can be supplied with an optional thumb wheel for side adjustment, or an optional base for horizontal mounting, or both. The Type Y enclosure is splash-proof as well as dust-tight, and the metal case is isolated to prevent accidental grounding.

While featuring a new low profile, this new Type Y trimmer retains the popular Allen-Bradley solid resistance element, which is produced by A-B's exclusive hot-molding technique. With virtually infinite resolution, adjustment is smooth at all times. Being essentially noninductive, the Type Y can be used at frequencies where wirewound units are inadequate. The Type Y is rated  $1/4$  watt at  $70^\circ\text{C}$  and is available in resistance values from 100 ohms to 5.0 megohms. Standard and special tapers are available.

For immediate delivery at factory prices, call your authorized A-B industrial electronics distributor. Or write: Marketing Dept., Electronics Div., Allen-Bradley Co., 1201 South Second Street, Milwaukee, Wis. 53204. Export Office: 1293 Broad St., Bloomfield, New Jersey, U.S.A. 07003. In Canada: Allen-Bradley Canada Ltd.

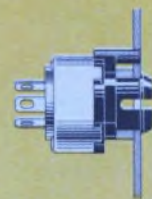

Type Y with handy  
snap-in panel mount,  
supplied with spacers for use  
on panels up to  $1/8''$  in thickness





# Damon's got 'em!

## Monolithic Crystal Filters.

IMMEDIATE DELIVERY ON "STANDARDS"

Custom designs take a little longer.

If one of the 4 "standards" in the accompanying chart meets the requirements of your communications system, you can forget the delivery problem. Damon is making immediate off-the-shelf delivery of evaluation quantities. In addition, you get all these extra advantages over conventional, multi-component filters: much smaller size, significantly lower price and practically zero failure rate.

Damon also offers a wide variety of computer-assisted custom designs but these take a little longer — 3 weeks from date of order.

For detailed technical brochure on Damon Monolithic Crystal Filters, write Electronics Division, Damon Engineering, Inc., 115 Fourth Ave., Needham, Mass. 02194. Or call (617) 449-0800.

"STANDARD" 4 POLE MONOLITHIC CRYSTAL FILTERS

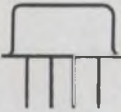
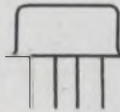
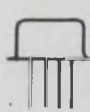
				
MODEL NO.	6347 MA	6347 MB	6348 MA	6348 MB
Center Frequency	10.7 MHz $\pm$ .5 KHz	10.7 MHz $\pm$ 1 KHz	21.4 MHz $\pm$ .5 KHz	21.4 MHz $\pm$ 1 KHz
Bandwidth, 3 dB	6 KHz min	15 KHz min	6 KHz min	15 KHz min
Bandwidth, 40 dB	24 KHz max	50 KHz max	24 KHz max	55 KHz max
Ripple, Max	1 dB	1 dB	1 dB	0.5 dB
Insertion Loss, Max	3 dB	2 dB	3 dB	2 dB
Spurious Returns	> 40 dB down	> 30 dB down	> 30 dB down	> 20 dB down
Terminations (Resistive)	1.5 kilohms	3.9 kilohms	0.38 kilohms	1.3 kilohms
Ultimate Atten.	55 dB	50 dB	50 dB	45 dB
Op. Temp Range	0°-60° C	0°-60° C	0°-60° C	0°-60° C
Case	TO-8	TO-8	TO-8	TO-5

**DAMON**



# Telemetry is down, but don't count it out

Delegates to Washington conference look for new applications in military, space and business areas

John F. Mason  
Military-Aerospace Editor

If there was one point on which everyone agreed at the International Telemetry Conference in Washington, D. C., it was that business is slow. "Most companies in our industry are fairly hungry," said Miller S. Redden, Jr., president of DEI Industries, Rockville, Md.

Mark Mougel, marketing director of Radix Telemetry Corp., Anaheim, Calif., agreed:

"The whole industry has been in the doldrums since Apollo and Saturn got out of the design and development stage and into operational hardware. This covers at least the past two years."

The main market that has slowed to the near-panic point is, of course, instrumentation of the nation's missile ranges. The ranges are relatively complete, except for replacement of equipment as it wears out.

But most of the 1100 delegates from the nation's telemetering equipment makers—200 companies were represented—also agreed on another point: better times are coming. When and from what source, however, depends on the company's specialty, marketing philosophy and how optimistic it is.

## Pentagon business expected

What if the current mood in Congress cuts defense work severely? "It won't," was the general answer.

"Some companies refuse to believe that some of their business has dried up," warned a spokesman for a big instrument house, who asked to remain anonymous. "I know people who just can't accept the fact that the Air Force's MOL [manned orbiting laboratory] and the Navy's SAM-D [surface-to-air missile] are dead. If they don't go out and find a new market, *they're* dead!"

Radix's Mougel, an articulate young observer of the Government scene, comments on what he considers a more subtle marketing blind spot: "Many companies miss the boat by spreading themselves too thin. They go out and grab any contract they can get, finally ending up with a completely diverse line of products. Our philosophy is to settle on one area in which we know we are competent and try to get as many contracts for that family of products as we can."

Radix makes modular, pulse-code-modulation, data-acquisition devices for the Navy's Poseidon missile, the Minuteman missile, re-entry warheads and other classified missiles. These systems are, needless to say, one-shot products, some costing in the neighborhood of \$10,000.

Mougel looks to a build-up in military business and explains why.

"There's been such a delay in so many Defense Dept. programs because the money's being spent in Vietnam and because of Congress' tough attitude on the military," he said, "that the state of the art has passed the military by, leaving it with obsolete equipment.

"The situation has become so bad—especially in view of how advanced Russian equipment is and the growing Chinese potential—that they've got to do something.

"They've learned a lot in Vietnam. Much of the equipment didn't operate well and has to be redesigned."

Summing up his military market forecast, Mougel said: "We're seeing, right now, a spurt of buying. I've seen more business in the last three months than I've seen in a year.

"The Defense Dept. is channeling money into areas of known practicality. We're going forward suddenly with procurement of real hardware."

Examples of the big new programs that will shoot lifeblood into the telemetering business are the Navy's F-14 carrier-based fighter,



A 10-channel alarm system built by DEI Industries warns of intruders within a 3.6-million-square-foot area. Called AIDS-10, the system employs buried geophone sensors that are linked by wire to a multiplexer.

## NEWS

(Telemetry, continued)

needed to replace the F-111B that never got off the deck; the Phoenix air-to-air-missile, which will arm the F-14; the S-3A antisubmarine warfare carrier-based aircraft; classified missiles, re-entry warheads, and now, perhaps, the Advanced Strategic Manned Aircraft, to replace the aging B-52 bomber. Also expected is a new fighter for the Air Force—the F-15 to replace the F-4.

"Taking MOL from the Air Force and giving it to NASA means a loss for telemetry equipment makers," Mougel said. "NASA will use hardware it already has, whereas the Air Force would have had to develop it. And, of course, much of our business depends on the development phase of a program."

The main roadblock, Mougel said, is the exhaustive scrutiny Congress is giving all military programs. "Although this certainly isn't all bad," he conceded, "it can aggravate one problem: The Defense Dept. has always had a tendency to procrastinate in getting on with programs. This will make them worse."

### Space contracts foreseen

What if the space program is drastically reduced? "It won't be," was the consensus.

This optimistic response was partly borne out the last day of the conference, Sept. 17, when the President's Space Task Group published its anxiously awaited report. Although it did not recommend a crash program for putting a man on Mars, it called for a substantial continuation of the nation's exploration of the moon and planets; the establishment of military space systems, and a big program for building stations to orbit the earth and the moon.

How much new ground equipment the ranges will buy to support this space work is debatable. Elie J. Baghdady, technical program chairman of the conference and president of Adcom, a Tele-dyne company in Cambridge, Mass., said that the vhf receiver market had dried up but that the uhf had not. He referred to an order to the national ranges to

shift from vhf to uhf by 1970. In cases where this has not been done, translators have been installed to convert the uhf signals received from missiles and spacecraft to the old vhf receivers. Baghdady believes, however, that these vhf receivers will be replaced. If they are, DEI's Redden said, it will mean a market of approximately \$4.5-million.

"But such a buy," Redden added, "would probably take place, piecemeal, over the next five years as vhf receivers wear out.

"The range market is not a closed door by any means," Redden continued. "We're selling our new TMR-74 receiver because it's better than anything they've got.

"It includes 9 rf amplifiers which determine the predetection bandwidth, which is selected by a front panel switch. The receiver also has an automatic frequency control feature that holds on to faded signals, waiting for them when they come back. The future for range receivers is the computer-controlled device.

"We're also selling a new bit synchronizer analyzer."

Some companies are still working for the range on contracts awarded before business dried up. "We're not hurting," said George A. Lynn of Symetrics Engineering Corp., Satellite Beach, Fla. "We were saved by a large contract, awarded three years ago, that has carried us through this slump. We're selling L- and S-band equipment to White Sands Missile Range, and L-, S- and P-band to the Pacific range. We're now looking forward to work on some of the ambitious programs lined up for space."

### Potential in communications

Predictions for exactly how much and what kind of support will be bought for future space missions differed at the conference. One of the big hopes was that NASA would move quickly to start development of a data-relay satellite system for communication with the many satellites and spacecraft expected to be operating in the solar system in the next 10 years. According to Baghdady: "This would be a \$300-million to \$400-million market. It would also

be the first step toward communications for an earth-orbiting laboratory."

ITT, New York City, is looking for its major telemetry business in satellite systems.

Mougel sees telemetry in a number of commercial applications of the future. "I see it in oil-well drilling rigs, in dams under construction, in reservoirs, in pipelines," he said. "And the more complex the operation you're monitoring, the more complex your equipment will have to be."

He cautioned, however: "But the potential here will be slower in coming than many people believe."

Baghdady believes this market will open up soon. Not only for the commercial uses that Mougel expects but for urban improvements as well: for control of water and air pollution and for street traffic.

DEI's Redden observes:

"Medical electronics is a growing market but it's hard for a small company to know where to invest its money. Communication between doctors and the electronics industry needs to be improved. The equipment must be extremely reliable, safe and cheap enough for hospitals to afford."

Industrial telemetry is another area manufacturers eye wistfully, but real research into the problems of unrelated businesses and how electronics can solve them is required.

ITT and DEI are both looking for a big market in personnel-intrusion detection devices to supplement closed-circuit television systems now used by banks, apartment houses, stores and factories.

DEI has built two seismic units, one big enough to monitor national borders and a smaller unit that military troops can carry and set up around a camp. ITT has developed an anti-intrusion device that is acoustic. In an industrial version, it works in conjunction with a seismic unit; for a military version it employs radar.

"A vast opportunity," Baghdady said, "lies in two areas: automatic checkout systems for telemetry, and multifunction receivers—receivers that by modulation can receive tracking, command and communication all on one signal, or at least on signals not too far apart in the spectrum." ■■

# Signetics was on the ball.



**We've also been to Mars.**

**And Venus.**

**And, all in all, we've taken part in 76 major space probes. So far.**

**Which really means nothing to our earthbound friends. Except for this: Here at home, you need reliability too. The highest you can get.**

**So, wherever you're heading, shouldn't Signetics integrated circuits go along for the ride?**

## Signetics

Signetics Integrated Circuits, 811 E. Arques Ave., Sunnyvale, Calif. 94086 / A subsidiary of Corning Glass Works

INFORMATION RETRIEVAL NUMBER 17

# IR device said to improve cancer detection

## Autonetics sensor reported an order of magnitude more sensitive than other infrared instruments

**Elizabeth deAtley**  
West Coast Editor

A new infrared temperature-sensing device developed to detect flaws in microcircuits may be sensitive enough to detect cancer up to a year and a half before the disease can be spotted by exploratory surgery.

So says Dr. E. F. Marriner, director of Life Sciences Operations at Autonetics, Anaheim, Calif., developer of the sensor. A research program being carried out at Autonetics, with the cooperation of specialists, is showing encouraging results, Dr. Marriner says, not only in the detection of early cancer but also of vascular disease, bone and joint disease, varicose veins and even early pregnancy. All these conditions affect the heat distribution pattern of the skin and can therefore be detected by a highly sensitive temperature-sensing device.

Medical infrared detection systems have been on the market for some years. But according to Dr. Marriner, the Autonetics thermographic device is more than an order of magnitude more sensitive than any of these systems. It can detect temperatures down to 0.02°F. Most of the instruments on the market today detect temperature differences of only 0.2°F.

The Autonetics detector is yielding results in early detection of breast cancer, Dr. Marriner says, that are comparable to mammography—the X-ray technique currently used for diagnosis.

According to R. Ward Jones, a member of the technical staff of Autonetics' Systems Div. and one of the designers of the instrument, it owes its extraordinary sensitivity to signal-processing techniques similar to the image enhancement done on lunar photos that are tele-

metered to earth from space probes. The device consists of an infrared radiometer, a minicomputer and a CRT display.

"In our system," Jones points out, "the radiometer scans the scene point by point. Each point is then converted to a digital number, which is processed by the digital computer and displayed on the CRT screen. The image is either photographed or recorded on magnetic tape."

The photos show differences in temperature as variations in shades of gray and differences in height—giving a 3D effect. Thus the cooler spots in the photo are whiter and stand above the surrounding hotter areas.

As an example of its sensitivity, Dr. Marriner points out, the device will detect subtle changes in the heat distribution of a smoker's finger before and after he smokes a cigarette, due to the effect of the nicotine on his circulatory system.

"If you take a picture of a smoker's finger four or five hours after he has had a cigarette and then take another picture just after he has had a drag, it almost scares you to death," Dr. Marriner says. "The heat pattern on the finger has changed markedly."

The changed heat pattern, he points out, is due to changes in the flow rate of the blood caused by constrictions of the blood vessels in the finger.

These local constrictions may, in turn, indicate that the smoker has some arteriosclerosis of the coronary arteries and therefore may be subject to a heart attack at some later time, according to Dr. Ashutosh Roy, a heart specialist and staff member of Life Sciences Operations at Autonetics.

Changes in the heat pattern of the skin may indicate a variety of causes besides a change in the blood flow rate in the subcutaneous veins, Dr. Roy notes. Local abnormalities, such as incipient cancer in some part of the body, will also



**IR temperature-sensing instrument**, developed at Autonetics to detect flaws in microcircuits, detects minute temperature differences on the surface of the human body and displays them on a CRT screen.

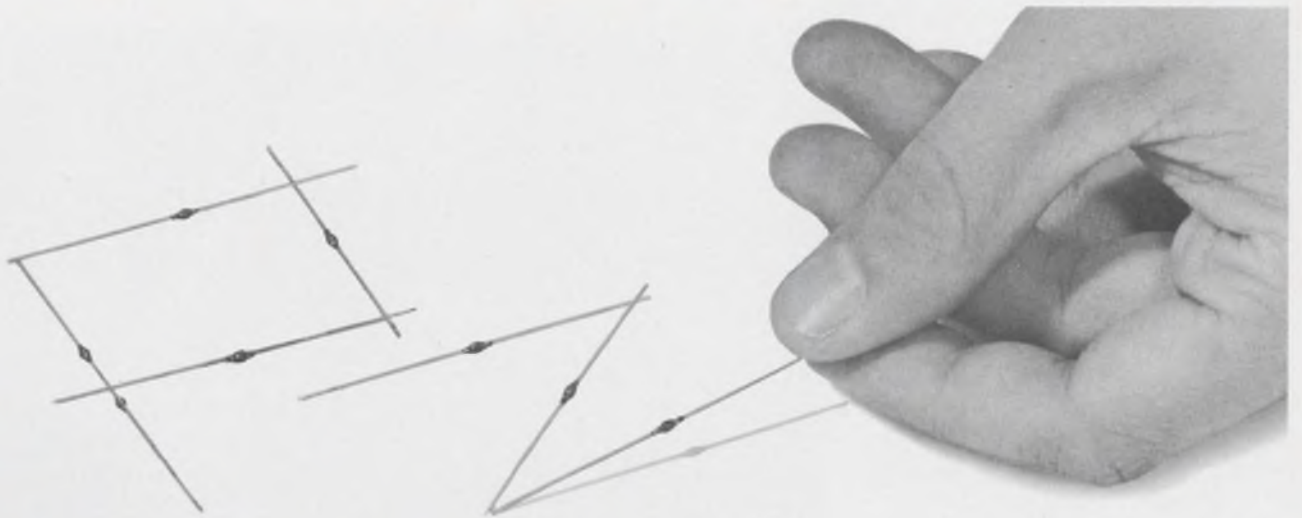

## Introducing the PZ Zener

The new fused-in-glass  
1 watt zener . . .

Typical Unitorde fused-in-glass  
stability and high-performance at  
the price of an ordinary device

Order your free samples today

- Fills the bill from 400 mw thru 1 watt
- Voltages from 6.8 to 200 V
- 8 millisecond surges to 30 watts
- Low reverse current — to 500 nA
- A quarter the size of a conventional 1 watt
- Weighs less than 1/4 gram
- No plastics, epoxies, silicones, oxides, gases, or solders are used

580 Pleasant St., Watertown, Mass. 02172 • (617) 926-0404

# UNITRODE



TOUGH AS ALL GET-OUT FROM THE INSIDE OUT

With the silicon die metallurgically bonded between terminal pins of the same thermal coefficient, the hard glass sleeve is fused to the entire outer silicon surface. Result — a voidless, monolithic structure.



#### 4 EASY WAYS TO GET FREE SAMPLES AND SPECS

1. Call Bud Anderson COLLECT, at (617) 926-0404.
2. Call your nearest Compar office.
3. Call your nearest Daniel & Co. office.
4. Check off the magazine Reply Card number.

INFORMATION RETRIEVAL NUMBER 18

**(Cancer Detector continued)**

cause a "hot spot" in the skin above it.

"A cancer of the breast, for example, shows up on a picture of the whole body as a local hot spot in that area," Dr. Roy points out. "Then if the doctor wants to examine that spot in more minute detail, we have a zoom system which allows him to zero in on that spot and determine exactly how much heat it is generating. Any of the commonly found breast cancers give a certain known amount of heat—about 8° to 10°F above the surface body temperature near the afflicted area.

"There can also be hot spots due to an inflammation of the breast—an abscess, for example. But in that case, the heat generated would be somewhat higher. So if we relate the quantity of heat generated to the type of abnormality, we can diagnose more precisely."

Although interpretation of the photos is difficult—in view of the number of possible reasons for the appearance of a hot spot—Dr. Roy

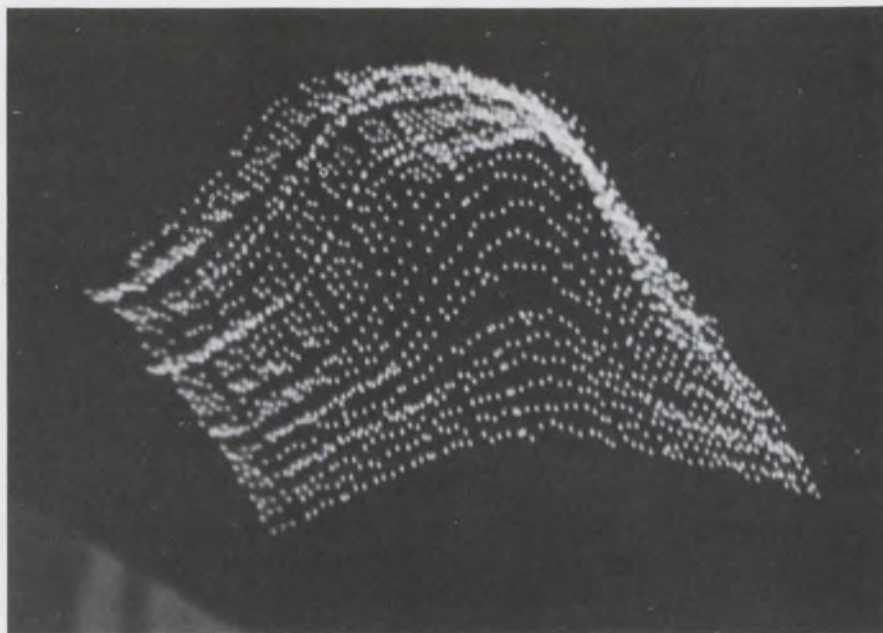

**This is what a human fingertip looks like normally to the Autonetics instrument. The warmth at the tip stands out in a 3D effect. After smoking, the hot and cold pattern would change markedly.**

indicates that specialists at Autonetics, a division of North American Rockwell, and others in the medical community feel they have a powerful diagnostic tool and that,

with practice, they can accurately interpret the photos. A research program is under way to develop nomograms to simplify the task of diagnosis. ■■

## Moon rocks analyzed for clues to human life

How did life originate? The moon rocks brought back by the Apollo 11 astronauts may help answer this question, say scientists at NASA's Ames Research Center, Mountain View, Calif., where the rocks are being pulverized, leached by organic solvents, bathed in helium, broken into molecular fragments and shot through electric fields to isolate and identify any traces of organic materials they may contain.

Electronics is playing an important role in this isolation and identification process. Tools for the search include:

- Chromatographs with electronic detection systems.
  - Mass spectrometers.
  - Microdensitometers.
- And of course the computer.

Preliminary investigation at the Houston Manned Spacecraft Center indicates that the lunar rocks, which appear to be as old as the

earth itself, contain minute traces of organic materials. The Ames scientists hope to find out whether they contain any of the basic "building blocks" of which all living organisms are composed. These include the amino acids, sugars, nucleic acid bases, fatty acids, aromatic hydrocarbons, alkalines and porphyrin. Most of them have been synthesized in the laboratory.

### The search for organics

"By analyzing the lunar samples, we are looking to see whether these same materials were formed in nature's own laboratory somewhere else than on the earth," says Dr. Cyril Ponnampuram, chief of the Ames chemical evolution branch. "The theory is that any planet should experience some outgassing at some stage in its early history. If any of various forms of energy—such as ultraviolet radiation,

electricity and others—act on this outgassing, the result is the synthesis of organic material in which will be found those molecules necessary for life. If we find such molecules in the lunar rocks, we will have pretty strong support for the hypothesis that life results naturally from the evolutionary sequence of matter."

Because of the minute quantities of organic materials in the lunar samples, extremely sensitive instrumentation is required for the analysis. Unknown organic materials are separated by some form of chromatography and then detected. When the separated substance is a liquid, it is commonly mixed with a color reagent and detected by a monochromatic photocell.

When the unknown substance is in gaseous form, flame ionization is the most sensitive detection technique. ■■



The solid state numeric  
is ready at Monsanto.

So are 19 other LED's.

Send a P.O.

MAN 1 shown 6x actual size.

You know we've been working on the MAN 1 visible diode numeric for several years. Well, now we're ready to take orders.

It offers all the good things you expect from microcircuits. Low power drain. Shock resistance. Happy interface with your solid-state circuitry. Plus it gives you design flexibility you've never had before. And the multi-segmented construction avoids the danger of a number being altered by a small circuit failure.

Send a P.O. and be the first designer on your block to give your

digital readout the look of the 70's.

The 19 other low-cost, long-lived LED's? Four are bright red light-emitting semiconductors that have ns switching time, diode reliability and million-hour\* life.

One of our LED's emits amber light, one green light. Five put out frequencies in the infrared. One is a coupled pair, with detector and emitter in the same package to give you a light-quick switch (5 ns rise and fall) with 3 kV isolation.

Six are room temperature lasers in a variety of miniaturized configurations. Number 19 is a bunch of new

CO<sub>2</sub> laser modulator components.

So there's the whole line. They're all currently available from Schweber, Kierulff, K-Tronics, or Semiconductor Specialists. Or from us: Monsanto Electronic Special Products, 10131 Bubb Road, Cupertino, California 95014. Phone (408) 257-2140.

Want more information on our new numeric, the MAN 1? Circle reader service #203.

For specs on the other 19 LED's, circle #204.

\* T<sub>A</sub> = 25°C, I<sub>f</sub> = 50ma. Result of step-stress testing with end of life projections.

Monsanto

# Self-renewing computers reach for the stars

## JPL prototype points way to models that will diagnose their own failures and repair them enroute

David N. Kaye  
West Coast Editor

Unmanned spacecraft, embarking on space trips that require several years to complete, are going to need computers that are both self-controlling and self-maintaining. One such model—the first computer able to detect its own failures and repair itself—has already passed preliminary tests at the Jet Propulsion Laboratory in Pasadena, Calif. It is considered the first breadboard model for the space-

craft guidance systems of the 1970's and 1980's.

Called the STAR—for self-testing and repairing—the computer is essentially a replacement system. Each subsystem has one or more spares available that are held in an unpowered state and used to replace operating units when a permanent fault is discovered.

Not only will later models of the STAR aid spacecraft to navigate outer space—and intergalactic space beyond—but they can cut routine

hospital work to a minimum for doctors and nurses by monitoring as many as 100 to 200 bed patients at a time. Failure of one of its parts would not interrupt the work, for within 1/100 of a heartbeat a faulty unit would be replaced by a spare, while the computer would request repair and return of the rejected unit to its spare-part bank.

This was reported on at the Aerospace Computer Systems Conference of the American Institute of Aeronautics and Astronautics held in Los Angeles last month.

Referring to the outer-space

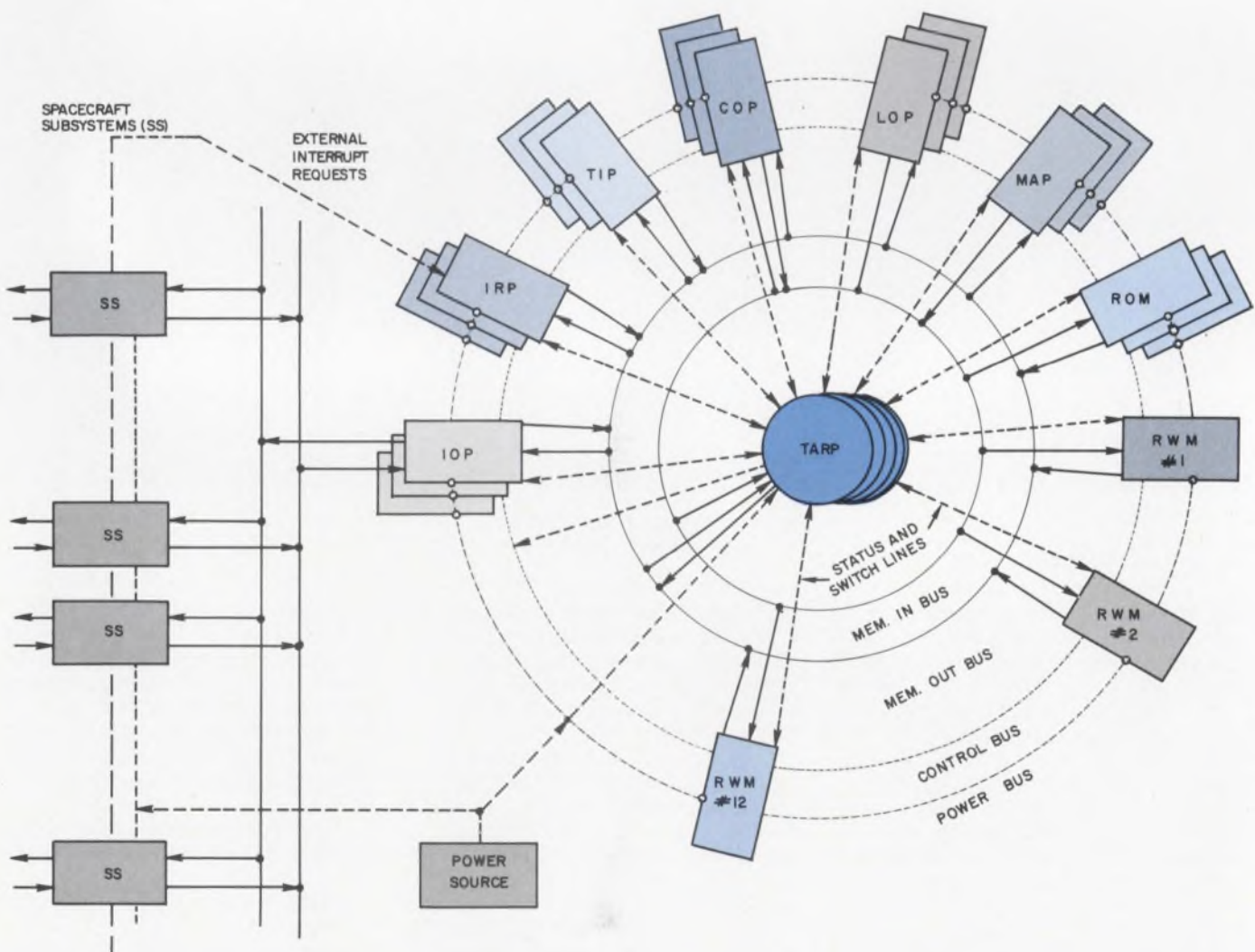

Self-testing and repairing computer (STAR) block diagram. The computer is essentially a replacement system. Test and repair processor (TARP) monitors status re-

ports from all working subsystems, and decides whether there is an error. If so, faulty unit is checked again before being replaced.



trips, Dr. Algirdas Avizienis, father of the STAR project, says "We are aiming for the 90% probability of lasting 15 years." That would be enough time to control spacecraft operations to Neptune or Pluto, outermost targets in multiplanet Grand Tours of the solar system envisioned by NASA for the late 1970's (see "Hop to Jupiter: Takeoff, 1972. Arrival, 1974," ED 10, May 10, 1969, p. 25).

A trip to Neptune, via Jupiter and Uranus, would take 7 to 9 years, and the trip to Pluto, by way of Jupiter and Saturn, up to 11 years, according to current NASA projections. On voyages such as these, self-control and self-repair would be imperative, since a radio signal from the earth to the vicinity of Neptune or Pluto would take some four hours, and four more hours would pass before a reply arrived.

### Monitor uses majority vote

The monitor that keeps an eye on the inner workings of the computer is called TARP—test and repair processor. This monitor receives status reports from all working subsystems and, in effect, decides whether behavior is normal.

Furthermore, like any good conscience, TARP also checks itself. For this, it is built like a three-lobed brain. The computer actually has three active monitors, which operate by majority vote. Whenever at least two monitors indicate an anomaly somewhere along the line, the decision is made to repair the malfunction. The suspected unit is tried once more, then replaced if it persists in its errors.

"If the vote had been two to one," according to Avizienis, "the majority members of the TARP unit would disconnect the power of the disagreeing monitor and replace it with a spare. Later, the rejected member may be tried again and re-used if the previous fault proves temporary."

### The organization chart

"The STAR computer," says Avizienis, "may be thought of as a collection of small special-purpose computers tied together by two 4-wire information buses." The buses are designated as the Mem-

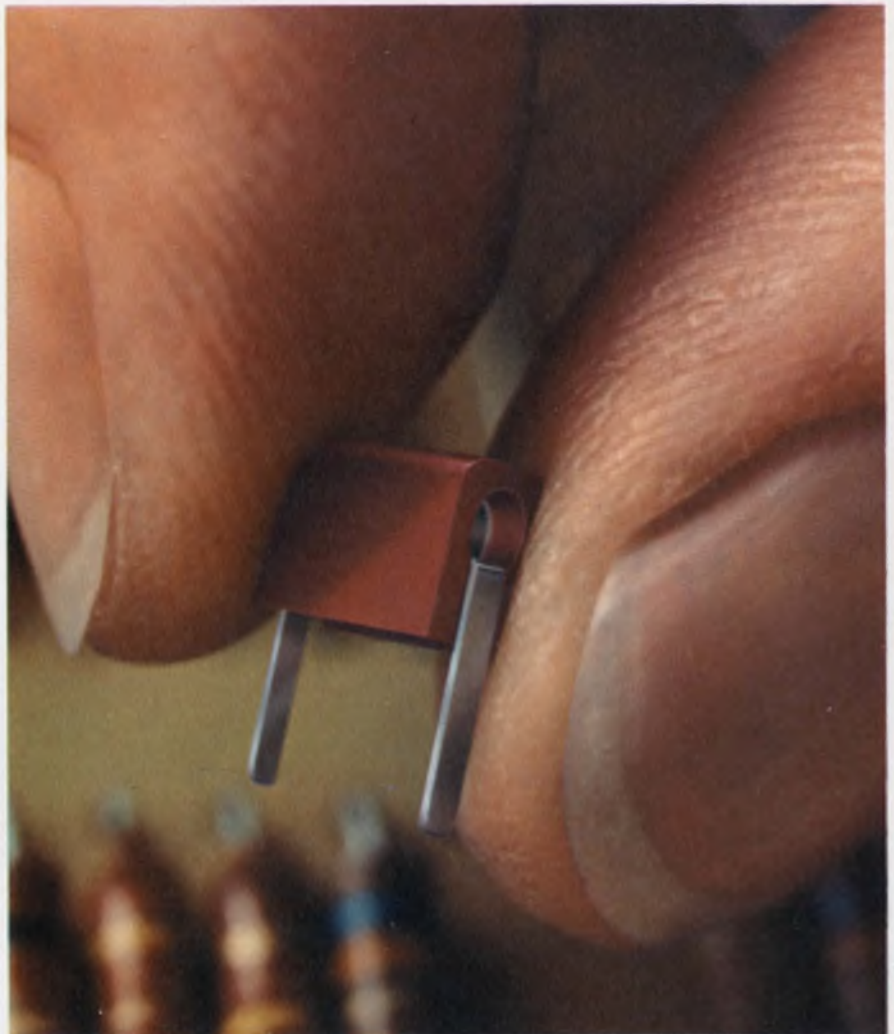

Looking for a little jack? (  )  
How's this for size? ( Actual Size )

We've been making miniature jacks for over 10 years. But this new one is half again as small as any horizontal mounting type we've offered before. It accepts a 0.080" diameter tip plug on either end and has a maximum current capacity of 5 amperes. Operating voltage is 1500 volts RMS at sea level, 350 at 50,000 feet. Contact resistance is less than 2 milliohms. Capacitance between adjacent jacks is less than 1 pF at 1 MHz. Comes in 10 colors meeting Federal Standard #595.

Johnson makes hundreds of different jacks and plugs . . . and carries most of them in stock for immediate delivery. Or perhaps you have a unique need. Our engineers will work it out for you. Just give us a call. Meanwhile, return the coupon.

E. F. JOHNSON COMPANY/3310 Tenth Ave. S.W./Waseca, Minnesota 56093

- Send me a sample of your new miniature jack and complete design details.
- Send me information on your complete connector line and other Johnson components.

NAME \_\_\_\_\_ TITLE \_\_\_\_\_

FIRM \_\_\_\_\_ ADDRESS \_\_\_\_\_

CITY \_\_\_\_\_ STATE \_\_\_\_\_ ZIP \_\_\_\_\_



**E. F. JOHNSON COMPANY**

INFORMATION RETRIEVAL NUMBER 19

(computers, continued)

ory-In Bus (MI Bus) and the Memory-Out Bus (MO Bus). Computer words of 32 bits are transmitted on these two buses in bytes of 4 bits each. As instruction words appear on the buses, each unit samples the operation code and performs the operation if required.

"For example," Avizienis points out, "if the command CLA 1000 appears on the MI Bus, the memory unit that contains the address 1000 outputs the required word onto the MO Bus. Simultaneously, the arithmetic processor unit loads the word appearing on the MO Bus into its accumulator register."

### TARP controls replacement

Three control signals are sent from TARP through the 3-wire control bus to synchronize the operations of the functional units. Otherwise, these units operate autonomously. The functional units are identified as follows in the block diagram:

COP—The control processor—contains the location counter and index registers.

LOP—The logic processor—performs logical operations on data words (two copies are powered).

MAP—The main arithmetic processor—performs arithmetic operations on data words; it contains the accumulator and M/Q registers.

ROM—The read only memory—has 16,384 permanently stored words.

RWM—A read-write memory unit—has 4096 words of storage (at least two copies always powered, 12 units directly addressable.)

IOP—The input/output processor—contains a transfer register and peripheral unit buffer registers.

IRP—The interrupt processor—provides communication links with systems outside the computer.

TIP—The timing processor—acts as an interrupt-generating interval timer.

TARP—The test and repair processor—serves as a central controller and as the diagnosis unit. (Three copies are powered, two more are spares.)

CHK—bus checker. Two are contained in each TARP to check for coding errors in words being transmitted on the MI and MO buses.

Unless otherwise noted, one copy of each unit is powered at any given time.

### Cure by replacement

According to Avizienis, the principal features of the STAR replacement system used to implement error diagnosis and repair are these:

- All machine words (data and instructions) are encoded in error-detecting codes to provide concurrent fault diagnosis. In other words, fault detection occurs at the same time as the execution of the programs.

- The computer is subdivided into a number of replaceable functional units containing their own operation code decoders and sequence generators. This decentralization of the system allows simple fault location procedures and simplifies system interfaces.

- Fault detection, recovery, and replacement are carried out primarily by special-purpose hardware. In the special case of memory damage, software is used to augment the recovery hardware.

- Transient faults are identified, and their effects are corrected by the repetition of a segment of the current program. Permanent faults are eliminated by the replacement of faulty functional units.

- The replacement is implemented by power switching; units are removed by turning the power off and connected by turning the power on. The information lines of all units are permanently connected to the buses through isolating circuits; unpowered units produce only logic "zero" outputs.

- The error-detecting codes are supplemented by monitoring circuits that serve to verify the proper synchronization and internal operation of the functional units.

- The hard core test and repair hardware is held to a small size and protected by complete replication and immediate replacement.

The Stanford Research Institute developed the magnetic power switch which disconnects faulty units, and the Massachusetts Institute of Technology Instrumenta-

tion Laboratory built the system's "read only" storage unit for permanent programs.

### When the STAR flies

In its breadboard stages, STAR is now a 10-unit computer that can diagnose and cure a failure within 1/100 second. While the STAR test model fills three 6-foot racks now, Avizienis says that its parts can be miniaturized easily to fit spacecraft requirements. The flying STAR will not exceed 2 cubic feet in volume, nor consume more than 50 watts of electrical power.

Miniaturization of the computer will come through liberal use of MSI. At a later date, the JPL group may come up with an LSI version of the STAR computer that would be even smaller.

### Medical use possibilities

On the earth, STAR could speed the development of the automated hospital. Avizienis says this computer could take routine measurements every second, look for abnormalities, and ring an alarm when something goes wrong in any bed in the ward or hospital.

Moreover, failure of one of its own parts would not cause STAR to forsake its vigil. Within 1/100 of a heartbeat, the faulty unit would be replaced by a spare. The computer would then request repair and return of the rejected unit to its spare-part bank.

Such split-second action also may save anxious moments for pilots of future supersonic passenger planes, and for astronauts on extended manned space flights in the coming decades. Avizienis explains:

"The flight-control STAR would automatically handle most malfunctions, making spare-part substitutions as needed. Only in rare cases of overwhelming fault conditions would the computer request the pilot or co-pilot to take over. And that alarm would be registered within a tenth of a second."

Copies of the proceedings of the conference can be obtained from the AIAA at \$20 for members, \$30 for non-members. Write to Preprints Dept., AIAA Subscription Service, 1290 Ave. of the Americas, New York, N. Y. 10019 ■■



## Not everyone needs a multimeter that can measure the resistance of a piece of solder.

But you may be looking for a digital multimeter that will measure relay contact resistance. Or check cable continuity. Or handle other applications that require 100  $\mu$ ohm resolution without error caused by lead resistance. If that's the case, you may be looking for our 5500/135 DMM.

And it's more than an ohmmeter. You can turn it loose on dc volts, mV, dc/dc ratios, or square, triangular, sawtooth and sine waves. It will give you the true rms of an ac waveform, so accurately and distortion-free that we call it Computing RMS™ and have a patent pending on this revolutionary new technique.

But it is possible that the 5500 is more or less multimeter than you need. If that's the case, don't buy one. Buy one of our 32 others instead. We make them for labs and production lines, for use on the bench and in systems, militarized models, 4- and 5-digit, from \$1150 to over \$8000. (Actually, with our unique plug in modules, you can create some 300 different configurations. For every imaginable application. To fit every budget).

Which one suits you best? Ask for the decision maker. Our free brochure.

Dana Laboratories, Inc., 2401 Campus Drive, Irvine, California 92664.

**DANA**®

# We make guys who can't



# components for stand failures.

Picture yourself in your living room in front of the TV on a quiet Sunday afternoon. The ball's on the four yard line, 24 seconds to go. Your team trails by six points but has just made a first down.

That's when your set decides to burn out. And that's when you first mutter the words that officially put you in the group of enraged guys that our components are designed to stamp out.

At Corning we make components to please guys who can't stand failures. We build an extra measure of performance into all our resistors and capacitors to help you build extra reliability into all of your systems. Like you and the guys who use your equipment, we have to admit that we can't stand failures either.

Consider our tin oxide resistors, they're the best of the metal film class. Because the resistive tin film is completely oxidized and molecularly bonded to the glass core, our tin oxide resistors are impervious to moisture and environmental degradation. No other resistor can deliver the same stability and reliability over load life. They offer guaranteed moisture resistance across all ohmic values to set a standard of

reliability that can't be matched by metal film, wire wounds, carbon comps or metal glaze resistors.

No other resistor can give the same value. Our tin oxide resistors offer long term economy over metal film, precision wire wound and metal glaze resistors. And our new C3 resistors, in addition to the benefits of small case size, compete costwise with carbon comps.

Another important Corning development for men who can't stand failures is our flame proof tin oxide resistor. Ideal for circuitry where functions, environments and duty cycles demand low power resistors with excellent frequency characteristics, our flame proof resistors can withstand overloads of up to 100 times rated power without any trace of flame. And because they open under overload, they provide protection for your other, more expensive components. For this reason, plus safety, CORNING® Flame Proof Resistors are now being widely used in Color and Monochrome TV receivers.

And consider our Glass-K™ capacitors. We developed them to give you the volumetric efficiency and economy of monolithic ceramic capacitors, but with the much

improved stability and reliability that only a glass dielectric can add. Our Glass-K™ capacitors are extremely reliable for bypass and filtering applications—the traditional capacitor failure spot.

Then consider our glass capacitors. There's only one reason why they've been designed into so many major aerospace and missile programs. Only glass capacitors could give their designers the proven stability and reliability that these important systems demand.

At Corning we make components for guys who can't stand failures. Guys like your customers. Guys like you. Next time you're designing a system, reach for your CORNING® capacitor and resistor catalogs and call your local Corning authorized distributor for off-the-shelf delivery. They'll help you design-in an extra measure of performance.

If you don't have our catalogs, ask your Corning distributor for copies or drop us a line at: Corning Glass Works, Electronic Products Division, Corning, New York 14830.

**CORNING**  
ELECTRONICS

# The Hall Effect: Success at 90

by Jim McDermott  
East Coast Editor

Some 90 years after the discovery of the Hall Effect, solid-state, magneto-sensitive devices are at the threshold of wide application. The emerging technology embraces not only Hall devices—generators and magneto-resistors—but two new devices: the magneto-diode and magneto-sensitive transistor.

This success follows four false starts in the development of Hall devices in this country in the last 10 years. The first premature venture was the introduction of these devices, in 1959, by Siemens of Germany. U.S. ventures included their manufacture by Ohio Semiconductor (See p. 68), Beckman Instruments, and Westinghouse five or six years ago. In general, these ventures failed to catch on in the U.S. because of four major shortcomings: The devices were too costly, too complicated to apply, unstable in changing temperatures and not especially reliable.

But with the vast strides in semiconductor technology in the last three years, a brighter picture is emerging. Thin-film devices have brought the cost down, temperature stability has been improved and reliability is substantially better. The devices are still somewhat

Arrays shown on these pages are diced into chips for the Honeywell solid-state, contactless Hall switch.



complicated to apply, but their other advantages are outweighing this drawback.

Today Hall devices are turning up in the following applications:

- In solid-state contactless switches for computer terminal and instrument keyboards.
- As a computer printer paper-feed positioning control.
- In a gyroscope pickoff for the Boeing 747 Carousel inertial navigation system.
- As an aircraft two-axis compass element for an autopilot heading control.
- In brushless motors for precision video tape drives, 150,000-rpm laser-beam scanners, lunar vehicle drives and spacecraft attitude control systems.

## New devices still unproved

The magneto-diode and magneto-sensitive transistor—called a Magnistor—are, as yet, still unproved devices. But they are competitive in both price and sensitivity with Hall devices, and potentially they have comparable applications.

Magneto-diodes, which were introduced by Sony of Japan last year are sensitive, low-level devices that change resistance under the influence of a magnetic field. They are fabricated as thin, rectangular slabs of germanium with P+

doping at one end and  $N^+$  at the other. The magneto-sensitivity is due to a change in the mean effective lifetime of injected carriers, which are deflected by the applied magnetic field.

The response is unique at room temperature, in that the resistance increases with one direction of field, while a reversal of field decreases it. However, the devices are highly temperature-sensitive, and at about  $35^\circ\text{C}$  the bidirectional effect ceases and there remains only a decrease in resistance for either direction field.

Partial compensation for temperature change is obtained by using magneto-diodes in fabricated matched pairs.

#### **Magnistor: a patented device**

The newest magneto-sensitive device to make the scene is the Magnistor, a transistor invented and patented by Edward C. Hudson Jr., president of Hudson, Inc., Manchester, N.H. The Magnistor, which is now available in sample quantities, is a twin-collector device fabricated on a microcircuit chip and sealed in glass.

According to Hudson, when in the quiescent state with zero flux incident on it, the collector current is shared equally by both collectors, and the differential voltage be-

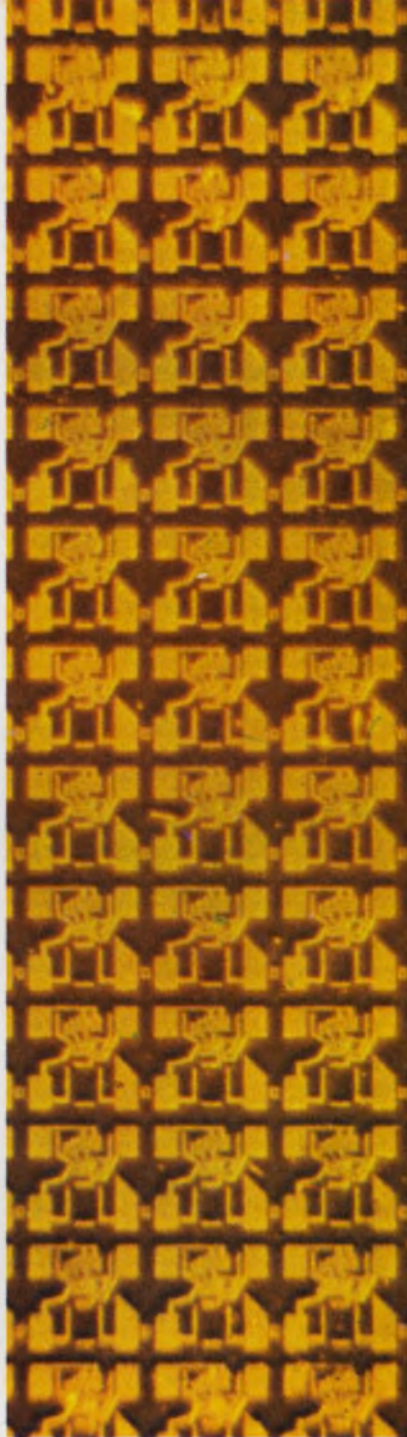

tween the collectors is zero. With application of a magnetic field, the depletion layers adjacent to the collectors are distorted, unbalancing collector currents and producing a differential voltage between collector loads.

The sensitivity of the Magnistor is high, making it well adapted for use with weak fields.

#### **Compounds form Hall devices**

In Hall devices, the current progress in materials and semiconductor technology has produced generators of micron-thin wafers or of deposited thin films with sufficient output, linearity and temperature stability for a wide range of uses—from dc to microwave

**Magneto-sensitive devices are starting to go into wide use as former obstacles of cost and stability are overcome—Two new devices join rising trend**

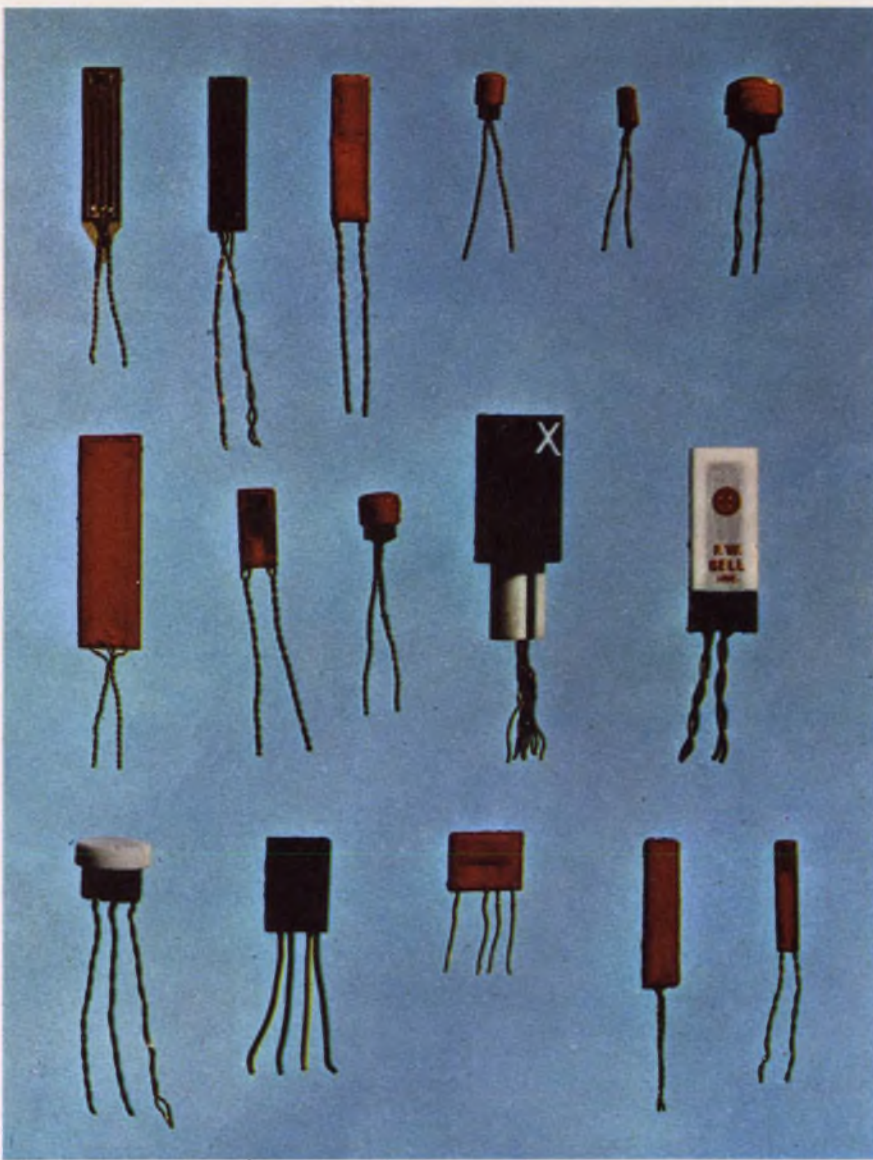

A wide variety of Hall generators is available. Those above from F. W. Bell, Inc., include devices for transverse and axial magnetic field applications, as well as a special three-axis probe. Packaging includes miniature and sub-miniature versions, as well as ferrite mountings.

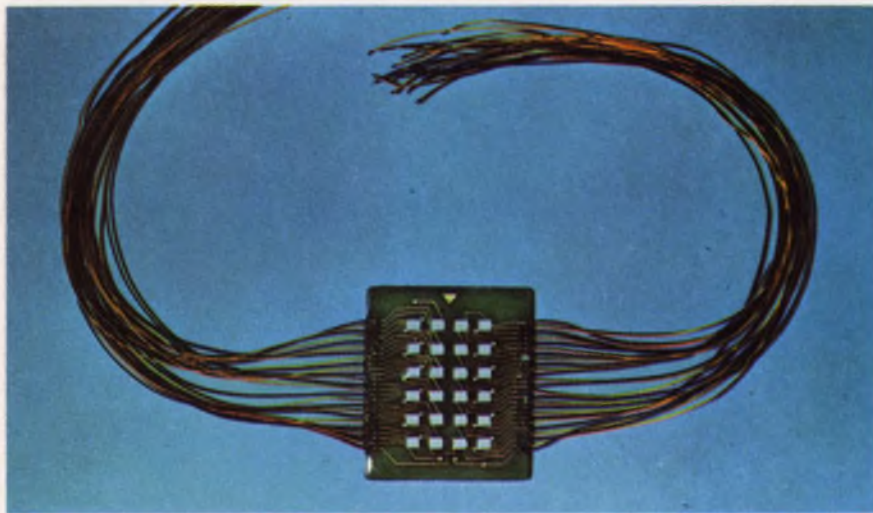

This array of 24 thin-film "flip chips" made by F. W. Bell, forms a hybrid Hall generator assembly suitable for high-density keyboards.

instrumentation.

While silicon and germanium exhibit the Hall Effect, Hall generators are made of the intermetallic compounds of indium antimonide (InSb), indium arsenide (InAs) and indium arsenide phosphide (InAsP), because these materials are orders of magnitude more sensitive.

The Hall voltage is obtained by passing a magnetic field at right angles through the generator and passing control current through it. Typical outputs for Hall generators are bounded by a lower open-circuit output of 5 mV per kilogauss, extending to an upper limit of 70 mV per kilogauss (Fig. 1).

Special, high-sensitivity probes have outputs considerably higher. The use of flux concentrators of ferrite or permalloy, attached to the Hall generator, improve the effective sensitivity several hundred fold. This is particularly useful for working with weak magnetic fields, such as the earth's.

When a Hall generator is placed in a magnetic field, the resistance increases between the terminals conveying the control current (Fig. 2). This effect is termed magneto-resistance and is the basis for two terminal magneto-resistive elements, which are fabricated to enhance the sensitivity of the effect. They can be substituted for Hall generators in many applications, and in some cases with improved sensitivity.

### Two forms of generators

Hall generators are fabricated in two forms. The first is a sub-millimeter-thin rectangular wafer—called the "Hall plate" or "Hall crystal"—which is sliced from an ingot of the bulk semiconductor material and polished to the required thickness.

The second form of Hall generator is a deposited thin film of the semiconductor material.

Hall crystals are substantially more costly than the thin-film types due in large part to the expense in fabricating the Hall crystal from the parent material. But the crystal offers superior temperature stability and output linearity.

Both the plate and thin-film generators are made of the same materials—namely one of the syn-



thetic intermetallic semiconductors of indium antimonide, indium arsenide and indium arsenide phosphide. These intermetallic compounds have a high Hall voltage output and low internal resistance. The desired Hall characteristics are obtained by doping these materials; the process is a trade secret of each manufacturer.

By far the most sensitive material is indium antimonide, but its decrease in sensitivity with a rise in temperature is marked. Both the arsenide and the arsenide phosphide are substantially more temperature-stable, but this comes at a cost of sensitivity.

The low output impedance of the Hall crystal—from less than one to a few ohms—has created problems in applying it. But thin-film fabrication has raised this value and has markedly improved sensitivity—which means that less control current is required, thus minimizing one of the greatest problems with sensitive Hall device application: compensation for temperature rise effects.

In general, sensitivity is highly dependent on the material doping, and it should be noted that with either the bulk crystal or the deposited thin film, the prime trade-off is between sensitivity, temperature stability and output linearity of the device.

Although slow, good progress has been made in producing better Hall generator characteristics, according to Robert Easley, manager of the semiconductor department of F. W. Bell, Inc., Columbus, Ohio. He is confident that future improved materials will retain the higher sensitivities and yet be more temperature-stable and have improved linear response.

The cost of certain Hall generators with potential mass application has been substantially lowered by using the thin-film-deposited Hall elements.

For example, thin-film generators with an active area of 0.125 by 0.10 inch, are available today from F. W. Bell for \$1.75 to \$2.50 in single units. They are supplied in three versions: flip chip; with long wire leads; or with a flexible printed-wire strip attached. Sensitivity ranges from 7 to 12 mV per kilogauss.

In Hall generator applications,

the sensitive crystal or thin-film elements are mounted, or deposited, on some sort of supporting substrate. Leads are attached, and the device is usually encapsulated for environmental protection. When thus assembled, the generator is called a probe.

Modern methods of lead attachment have virtually eliminated one of the principal early sources of device failure: lead detachment.

A wide variety of probes has been developed for all kinds of applications. For example, special multiplier probes are available with a small effective air gap, suitable for insertion into sensitive multiplier magnetic circuits or for measuring small, bundled magnetic fields. The control leads are attached in a special manner to cancel out errors caused by currents in the connecting wires.

Axial-field probes are shaped particularly for insertion into bore holes, such as for measurement of the long, axial fields of traveling-wave-tube magnets.

Another type of probe is especially long and thin for measurements in extremely small air gaps.

For cryogenic superconductivity measurements, both flat and cylindrical forms are made, operative down to  $-270^{\circ}\text{C}$ .

A special three-axis probe by F. W. Bell consists of three matched Hall elements mounted mutually perpendicular to each other and molded into a small epoxy package. This type of unit makes it possible to measure the magnitude and direction of the three orthogonal components of a magnetic field vector. But its cost is high—more than \$500.

### Microcircuiting spurs uses

The increasing application of Hall devices has been spurred by the development of microcircuit techniques. Hall generators are essentially low-signal devices requiring amplification. Not too long ago the electronics associated with amplifying and processing the Hall outputs occupied a sometimes intolerable volume. But today, microcircuits can readily be tucked in alongside Hall probes.

But what is of greater significance is the fact that two recent Hall developments place the elec-

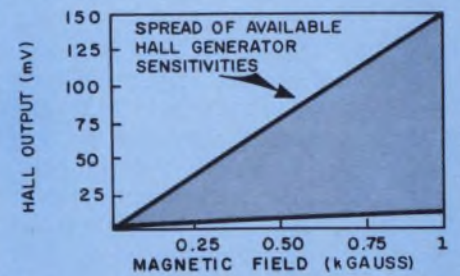

1. The maximum open-circuit Hall voltage sensitivities for available devices fall within the shaded area.

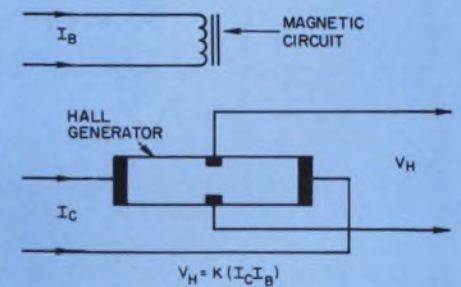

2. The value of a magnetoresistor increases with increasing flux density. Typical useful change is shown here.

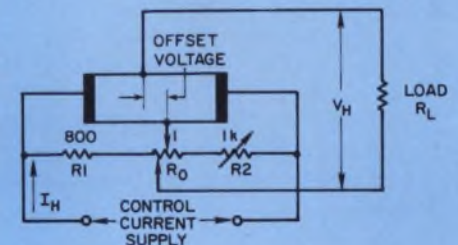

3. Hall connection misalignment is a principal problem. The circuit above compensates for the offset voltage.

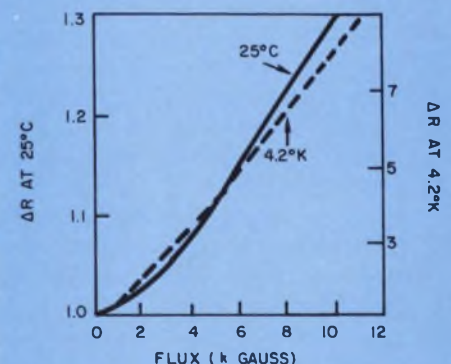

4. The basic Hall multiplier is formed by applying a controlled magnetic field to a Hall generator.

## Hall Effect gains fame at ninetieth birthday

In October of 1879, physicist Edward H. Hall discovered that, when a strong magnetic field passed through current flowing in a thin film of gold, a voltage appeared between the edges of the strip. This effect is utilized in Hall generators made of intermetallic compounds that increase this effect to useful proportions.

The Hall generator is set at right angles to a magnetic field. A control current is passed through the long dimension, and the Hall voltage appears between the center contacts.

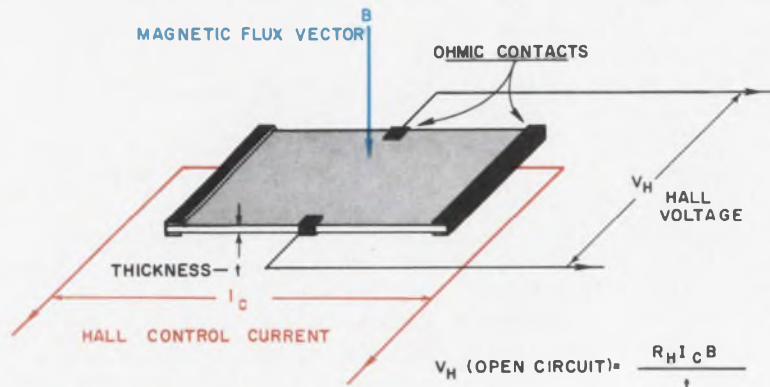

The Hall generator output is a voltage that is proportional to the product of magnetic field intensity and control current.

tronic circuits on the same substrate on which the Hall generator is deposited. This technique has been demonstrated by competitive versions of a contactless switch for computer and instrument keyboards, one by F. W. Bell and the other by the Microswitch Div. of Honeywell, Freeport, Ill.

In the contactless switch applications, the output is digital—that is, on or off. Since the Hall generator output is analog, switching circuitry is necessary for the conversion.

In F. W. Bell's unit the switching transistors are mounted on the substrate, which also contains thin-film resistors and zener diodes in chip form. The Hall generator is a low-cost, thin-film indium-arsenide device deposited on a flip chip, which is soldered to the substrate. Three leads provide power input and signal output.

The Hall microcircuit assembly produced by Honeywell, for its solid-state, contactless computer terminal keyboard, is mounted in a plastic assembly that has input and output terminals. In a significant departure from conventional Hall technology, the generator is fabricated as an integral part of the switching and output amplifier circuits through the use of conventional silicon-device technology.

Although silicon is inferior to the indium compounds as a Hall device, the Honeywell design of the switching and amplifying circuits

on the chip has more than compensated for this. An advantage in terms of reliability is the fact that the connections to the Hall element are an integral part of the microcircuit, rather than independently attached.

The Honeywell device uses a 5-volt power supply and provides a fan out of two 3.5-volt logic outputs. Triggering is effected by moving a U-shaped magnet assembly (See Fig. 6) in a pushbutton, down over the Hall device, which is secured at the bottom of the switch assembly.

The reliability and performance of this device has encouraged Honeywell to market the Hall assembly by itself and also to repackage it in single pushbutton switches (see New Products, page 138).

### New computer application

A radically different computer application is found in the new Honeywell H-112, low-cost, 300-line-per-minute computer printer. The devices used here are two magneto-resistors that pick up impulses from toothed magnetic wheels to control the advancing of paper on a roll and the alignment of the printout (see cover photo).

William Campbell, Honeywell project engineer, in demonstrating the printer operation for ELECTRONIC DESIGN, said that use of the magneto-resistors, supplied by Instrument Systems Corp., Hunting-

ton, N. Y., had simplified previous designs that used photocells and slotted wheels. The cost of the equipment has been reduced, he reported, reliability increased and maintenance simplified through easier operator access—all in line with the original design goals of producing a low-cost printer to mate with the Model 120 or Model 200 rental computer systems.

### Gyro pickoff proves superior

It was about 10 years ago that engineers at A. C. Electronics, Milwaukee, producers of the Carousel inertial navigation system, first decided that a Hall device would have substantial advantages as a gyro pickoff. But at that time, according to George Campbell, a product manager at A. C. Electronics, hardware was not available.

In contrasting the now-successful Hall pickoff with other methods with which the company has had extensive experience—such as optical and magnetic-core-and-lamination types—Campbell cites these advantages:

"To begin with, its small size [about 1/8th inch square by 0.010 inch thick] is well suited for miniature instruments. This is in contrast to relatively bulky coils and laminations required for magnetic pickoffs. But use of Hall generator wasn't possible until the development of microcircuit preamplifiers

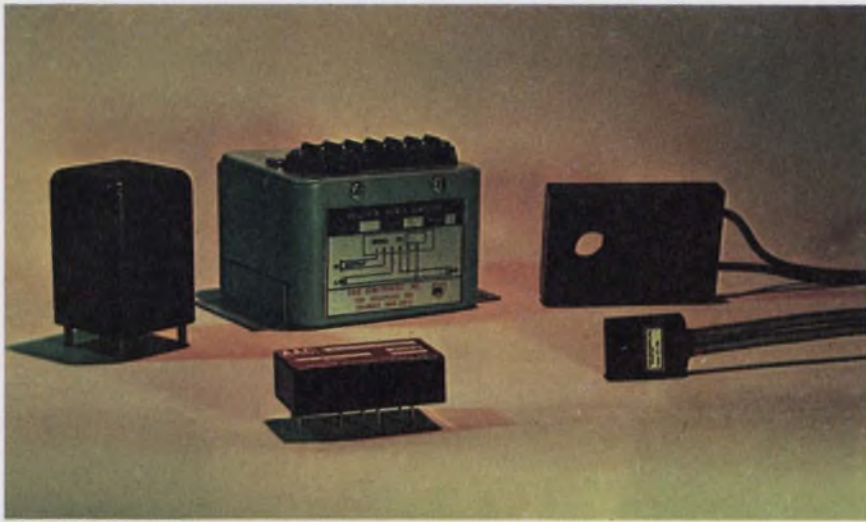

Multipliers using Hall generators (left rear, by Instrument Systems Corp.) and magneto-resistors (front, from American Aerospace Controls) are shown here together with other Hall devices such as a wattmeter transducer (rear center) and two types of current probes (at right, from Ohio Semitronics).

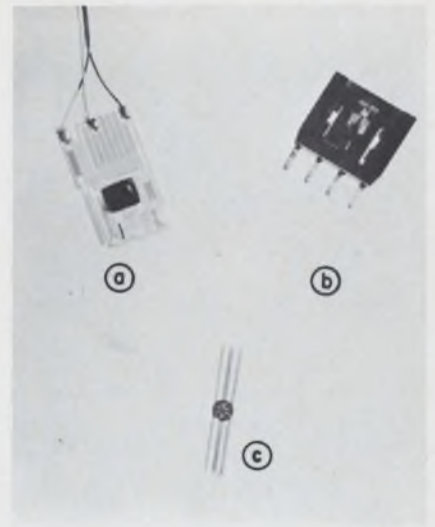

Latest magneto-sensitive devices include: (a) F. W. Bell hybrid switch assembly; (b) Honeywell Hall switching unit; (c) Hudson Magnistor.

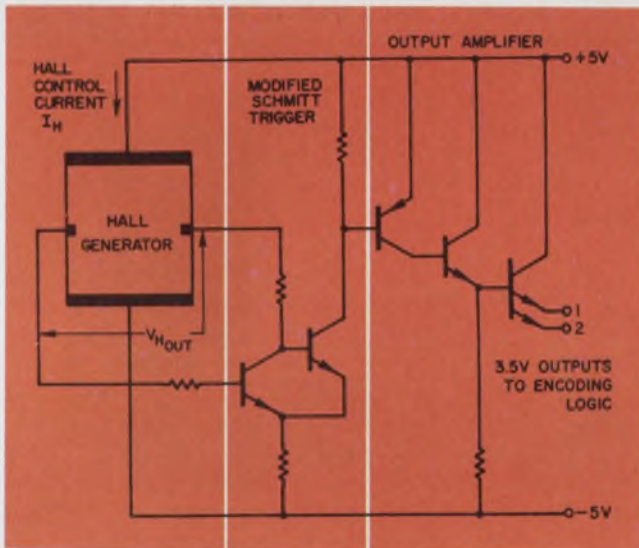

5. The modified Schmitt trigger converts the analog output of the Honeywell keyboard Hall device to a digital signal. The output amplifiers provide two 10 mA outputs.

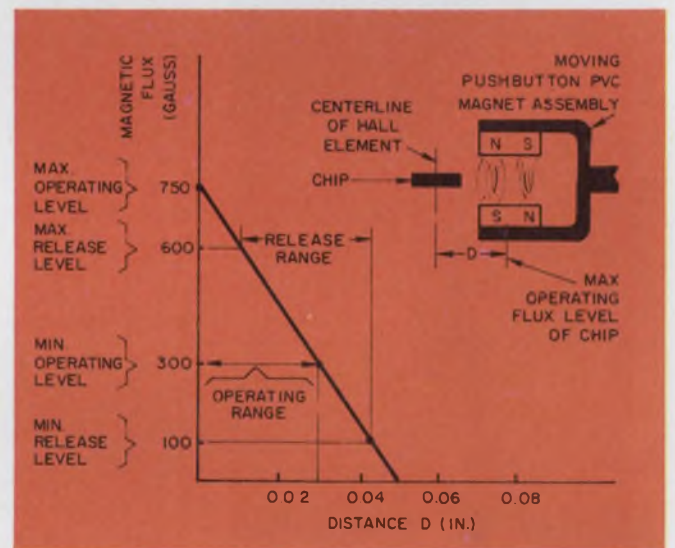

6. A U-shaped piece of iron with two polyvinyl magnets is the magnetic structure of the Honeywell solid-state switch. The chip is stationary, and the magnets move.

that can be mounted alongside the Hall generators.

"Because the device is thin, it reaches thermal stability rapidly.

"Also, we don't have to worry about the signal-to-noise ratio, since it is fundamentally a low-noise device."

A. C. Electronics' experience has been that the Hall systems are extremely reliable—more so than optical or other pickoffs.

Further, there is no bias torque or residual torque that ordinarily is caused by the excitation of magnetic pickoffs, Campbell says. The frequency range is more than

broad enough, and the Hall devices can interface easily with other instrumentation systems.

Campbell reports that his company is now using Hall generators in its top precision instruments.

For the Carousel gyro, Hall generators are used in pairs, one on each side of a 1-inch float. More than 1000 of these gyros have been built.

"And we expect to sell thousands more," Campbell says.

#### Low-field sensing achieved

A two-axis compass element for an autopilot is a good example of

increasing the sensitivity of Hall generators to weak magnetic fields—such as the 0.5-gauss field of the earth—by the use of flux concentrators. These are ferrite rods extending several inches from each side of the Hall generators. According to Wilbur B. Canfield, vice president of Airborne Navigation Corp., Prescott, Ariz., the two-axis unit samples the longitudinal and cross-axis components of the earth's field with respect to the aircraft.

The outputs of the Hall generators are applied to a resolver in an autopilot made by Brittain Indus-

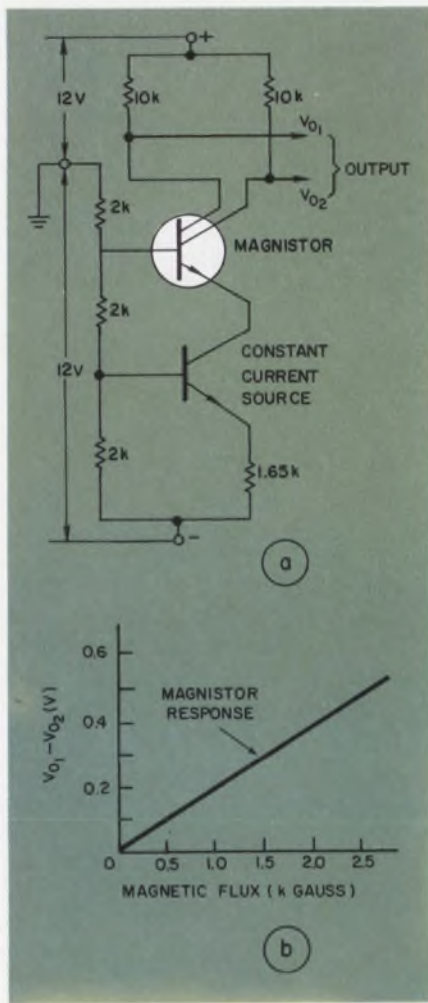

7. The Magnistor is connected in the circuit shown above. The outputs from the two collectors are then applied to a differential amplifier.

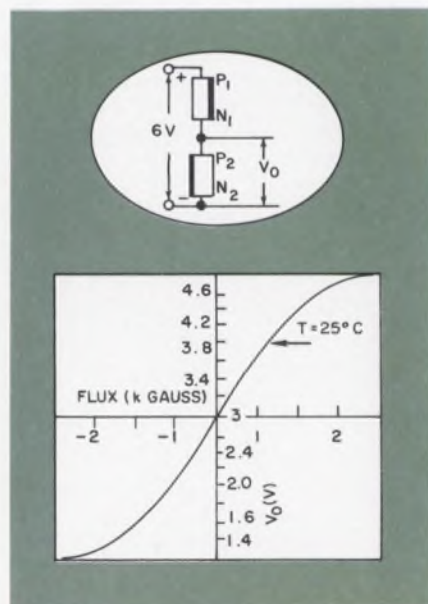

8. Magneto-diodes are sensitive devices. The output for a matched pair is linear up to about 1 kilogauss.

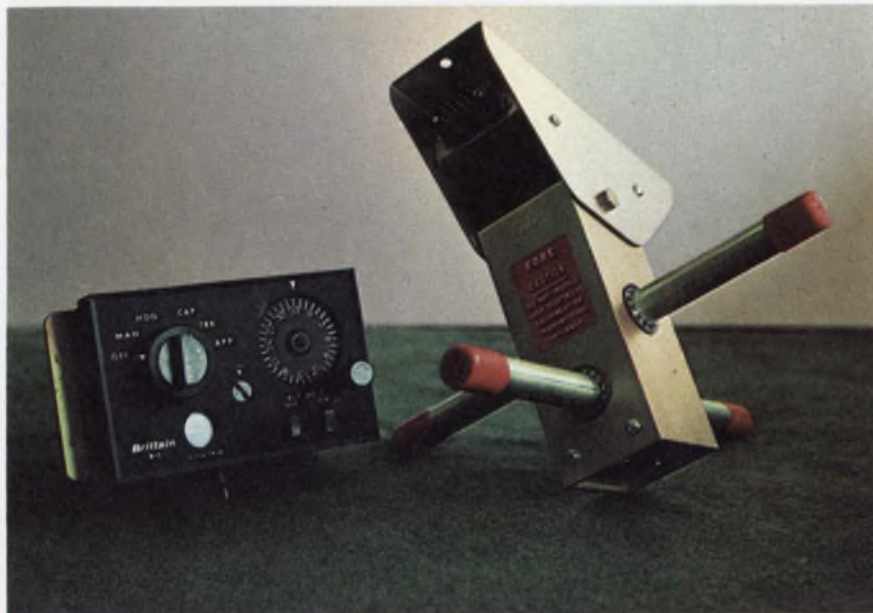

Pickoffs used on the gyros in the Carousel inertial navigation system are Hall generators. They have proved superior to previous approaches. The Hall device is mounted on the rim of the assembly.

tries, Hawthorne, Calif., and this allows the pilot to select a heading at any point of the compass. The assembly is mounted in the plane on a pivot which permits swinging along the fore and aft axis and keeps the compass element level when the plane is climbing or descending.

### Brushless motors redesigned

The day of brushless motors that employ Hall generators for commutation has arrived. Ampex Corp., Redwood City, Calif., is using in-house designs by Albert Stahler, a corporate consultant and member of the research staff, for precision video-recorder capstan servo drives. Ampex is also developing high speed motors for laser beam scanners (rotating mirrors) that operate at up to 150,000 rpm. These are for the Naval Ordnance Laboratory, Silver Spring, Md.

The Avionics Controls Dept. of General Electric, Binghamton, N.Y., is using Hall Effect brushless dc motors and tachometers for lunar roving vehicle motors and also for a classified Air Force program. In addition, Gary Auclair, a project engineer at GE, has designed Hall Effect motors for a reaction wheel controller, part of a spacecraft attitude-control system.

The approach used by Ampex, and General Electric, and others is to provide orthogonal Hall sensors to sense the position of the perma-

nent magnet rotor. The motor field is designed as a two-phase winding.

The Hall generator outputs are amplified and applied to the two-phase windings—thus, in effect, providing a two-phase motor operating with a dc input.

Auclair reports that efficiency is high—over 90 per cent for the motor and 75 per cent for the over-all motor and electronics to drive it. Motor torque is easily controlled and is independent of the speed. Standby losses are close to zero. And reliability, both Stahler and Auclair stress, is high.

For RFI-sensitive applications, motor noise is extremely low.

### Magneto-resistors can be used

Magneto-resistors, which depend upon the Hall effect for their operation, can be substituted for Hall generators in practically all applications. They are made of thin-film grids of bismuth or of thin "field plates" of indium-antimonide compounds.

In weak magnetic fields, the resistance change of these two-terminal elements is proportional to the square of the flux, and consequently they are very nonlinear, particularly at the lower flux ranges. But their use in bridge circuits compensates for much of this nonlinearity.

Unlike the Hall generator, the change in resistance is related to



This two-axis Hall compass element, by Airborne Navigation Corp., provides compass headings in an autopilot by Brittain Industries. The long arms are ferrite flux concentrators, which increase sensitivity.

flux intensity only and is not affected by flux direction. But as in the Hall generator, sensitivity decreases with temperature rise. Upper frequency response is generally limited to about 1 MHz, due to magnetic circuit limitations.

In fabrication, the zero-field resistance of magneto-resistors can be made to vary widely—from 1 ohm to over 10,000 ohms—and consequently a strong point is that they can be rather easily matched to the input impedances of the variety of electronic amplifiers and signal processing circuits with which they are used.

A principal advantage of magneto-resistors, according to Robert Gitlin, president of American Aerospace Controls, Inc., Farmingdale, N.Y., is that for bridge-type configurations, more voltage change per unit flux is generally available than with Hall generators. Also, while the generators require a current source, the magneto-resistor does not.

An important new application is in the Honeywell computer printer mentioned above. But they also appear in multipliers, watt transducers, current measuring devices, choppers, and low-frequency modulators.

#### Magneto-diodes for digital uses

Magneto-diodes, which change resistance under the influence of a magnetic field, have a high in-

trinsic sensitivity. Introduced last year by Sony, they are currently available only in limited sample lots, at \$5 for a single diode and \$10 for a balanced pair.

Some of the suggested applications are in brushless motors, proximity switches, magnetic detectors, and solid-state volume controls. However, response is highly temperature-sensitive, so it seems likely that digital applications will be their strong point.

When asked why availability of the devices was so limited, Dr. O. Mabuchi, vice president of the U. S. engineering division of Sony, in New York, told ELECTRONIC DESIGN that essentially all of their current production is being taken up in Japan by their new (and first) automatic phonograph record-changing turntable. In this, the magneto-diodes are used as position-sensing elements for the phonograph arm, providing the automatic return feature.

Unless someone comes up with a real large-scale application, present production facilities are not likely to be expanded.

#### Magnistor is versatile device

The Magnistor, or magneto-sensitive transistor, is currently being produced in limited quantities by the Hudson Corp., Manchester, N. H. The device comes in a six-leaded, glass package (see photo), 0.125 inch in diameter and

### Here's what's needed

All Hall applications use a magnetic field, the Hall control current, or both as a measured or controlled quantity. Best known Hall equipments are: magnetic-field measuring instruments, wattmeter transducers, current sensing probes, and multipliers.

For devices like multipliers, the Hall probe is fixed in the gap of a solid magnetic structure having a field winding. Field strength is varied by changing winding current. The Hall output is proportional to the product of the field winding and control currents.

For proximity-operated devices, the field is supplied by a permanent magnet which moves to, or away from, a stationary Hall generator.

0.030 inch thick. The sensitivity is 0.2 mV per gauss, with a transistor beta from 2 to 4.

Edward Hudson, the inventor, claims that the gain-bandwidth product of the device itself is 100 MHz. But like the Hall devices, which have an inherent high-frequency response in the microwave region, the realizable frequency response is dictated by the magnetic elements of the magnetic circuit in which it is used. For practical purposes, the maximum frequency response of all magneto-sensitive devices is a few MHz.

Wideband Magnistor noise (0 to 6 MHz), with a load of 5 k $\Omega$  and a collector current of 2 mA, is 100 microvolts.

The uncompensated temperature coefficient is 0.33 per cent per degree C, which should pose no problems for many of the digital applications that Hudson initially sees for the device. These include solid-state switches for push buttons, keyboards and toggles, and digital memory readouts. With flux concentrators the device is sensitive enough for measurement or operation by weak fields, such as that of the earth, which is approximately 0.5 gauss.

The Magnistor, like the Honeywell and Bell microcircuit assemblies, are capable of being mass-produced using conventional integrated circuit techniques. Once in production, cost of these Magnistors should be reasonable. ■■



# NEW

...from CLARESEARCH  
...Ultraminiature  
reed relays

■ Two new lines of Picoreed relays give you a wider choice in sensitivity, contact configurations and space-saving size. For example, note the new low profile of Types PRA and PRB—allows .375" pcb mounting centers. And note the new high sensitivity of Types PRAH and PRBH.

Both lines available in one to five Form A contacts with traditional Clare reliability. 100,000,000 operations at signal levels. 5 volt (must-operate 3.75v), compatible with standard 5 v DTL and TTL logic families. 6, 12 and 24 volt standard relays also available.

For information, circle Reader Service number, or write for Data Sheet 971A. C. P. Clare & Co., Chicago, Illinois 60645...and worldwide.

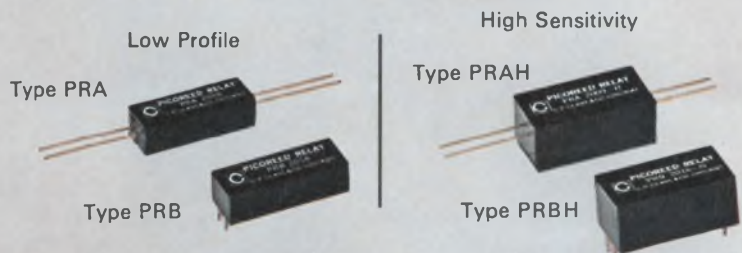

Electrical and Dimensional Characteristics	Types PRA/PRB—Low Profile		Types PRAH/PRBH—High Sensitivity	
	Form 1A	Form 5A	Form 1A	Form 5A
Operate time, including bounce	500 $\mu$ s	600 $\mu$ s	600 $\mu$ s	900 $\mu$ s
Average nominal power for 5 volt units	65 mw	250 mw	46 mw	140 mw
Pcb mounting centers	.375"	.375"	.500"	.500"
Length	.781	.800	.800	.800
Width*	.250	.675	.400	.800
Height	.187	.225	.350	.350

\*Widths vary according to number of switches. One through 5 available.



### Send mail by electronics?

In an attempt to make a giant leap over the mountains of mail now sitting in post offices around the country, the Post Office has contracted General Dynamics to study some really far-out ways of effecting person-to-person communication.

A \$147,046 contract for a "state of the art" study of electronic communication techniques has been awarded, Postmaster Gen. Winton M. Blount has announced, for a 44-week study of all methods of applying electronic technology to the mails, including transmission by microwave and laser. Preservation of letter sanctity in any electronic transmission process has been emphasized as a must.

Highlights of the study will include:

1. Long-range predictions 10 to 15 years in the future, as well as an analysis of present-day applications.
2. Delivery of "hard copy" to addresses would have to be considered as a first possibility for any electronic communications by mail. However, an eventual alternative could be visual delivery on a home facsimile printing device.
3. The study might indicate that receipts, notices, bills and short routine announcements could be worked out by computers, which would "mail" them to customers.

The study will be conducted by scientists, engineers and other experts in the electronics fields from five General Dynamics plants. The company's Electronics division at its San Diego, Calif., plant is the project manager.

### Educational TV for India

India will be the first underdeveloped country to put up a satellite system to provide direct broadcasting of educational television

# Washington Report

CHARLES D. LAFOND  
WASHINGTON BUREAU

programs to thousands of virtually isolated villages. Scheduled to become operational in 1972, the system will be built under a joint agreement between the U.S. National Aeronautics and Space Administration and the Indian Space Research Organization.

The system will enable India to provide its people in 5000 Hindi-speaking villages with programs on planting and cultivating crops, the use of pesticides and birth-control practices. It will enable NASA to test the potential value of satellite technology in the rapid development of effective mass communications in developing countries.

The satellite will be the Applications Technology Satellite, the sixth in NASA's applications technology series. Once in synchronous orbit, the relay station will open a 30-foot-wide antenna and transmit a focused beam with a power of 80 watts. Use of high power will cut the cost of ground terminals considerably. Initially, ground stations will cost about \$500 each. Increased production could cut this to \$200.

### Western Union expanding for the 70s

While Western Union has spent more than half a billion dollars since 1965 in keeping pace with customer demands for computer-based technological innovations, it is now embarking on an all-out push—that may cost another half billion by the mid-Seventies—to build a "new-type national computer-based communications company."

At a recent Telecommunications Seminar in New York City, Western Union's chairman and president, Russell W. McFall, said, "In a scant two decades communications has moved from an industry that has relied for more than a century almost solely on the telephone and telegraph into one that is based on the relatively revolutionary concept of total integrated communications."

"Present plans," he said, "call for even larger, more sophisticated computers, still greater integration of services, and increased diversification within the fast-growing record/data handling communications industry." The company's proposed restructuring should also improve the company's ability "to more aggressively expand into nonregulated communications activities that are not subject to the stringent financing and operational restraints associated with the telegraph operations."

The restructuring plan calls for the formation of an entirely new company—Western Union Corporation, with the Western Union Telegraph Company as a wholly-owned subsidiary. The plan is subject to approval by shareholders at a special meeting next month and by regulatory agencies.

## Satellites prevent air collisions

A new air traffic control system that uses satellites to prevent airliners from colliding in flight is proposed by TRW Inc. of Redondo Beach, Calif.

The satellites, the aerospace producer said, would relay special signals from each plane to ground stations below, where computers would be able to plot the aircraft's location within 50 feet in latitude and longitude and 80 feet in altitude. Such a fix would be 60 times more accurate than any approach using current radar techniques, according to David Otten, a TRW systems manager.

As explained by Otten, the computers would alert ground controllers whenever aircraft were approaching a collision path. The ground controllers would then warn the planes, using conventional radar techniques.

The TRW system would require six satellites—four for active use, two as spares—in orbit over the U.S. A. K. Theil, a vice president and general

manager of TRW's space vehicles division, said the idea has been presented to the Federal Aviation Administration and other government agencies. The government, he said, appears receptive to using satellites in air traffic control.

## E-2C continues with DOD's help

The Defense Dept. gave a small transfusion (\$8.6 million) to the Navy's E-2C early warning carrier aircraft to keep the project alive until the Senate and House Armed Services Committees get together next month to decide its fate. The Senate committee voted against the project in July because, it said, the E-2C, equipped with an advanced radar that looks down for low-flying enemy planes, was too similar to the proposed AWACS, Airborne Warning and Control System, which the Air Force hopes to get. The House committee, on the other hand, is for the Navy's plane.

A plus for the aircraft is the good record its predecessor, the E-2A, has made in Vietnam controlling air strikes and finding pilots downed in the sea. (ED 16, Aug. 2, 1969, p. 21, "New Navy plane facing the ax in Congress.") Anxious developer of the aircraft is Grumman Aerospace Corp., Bethpage, N.Y.

## Rescue sub to take plunge soon

The Navy's first deep-submergence rescue vehicle will slip into the sea off the coast of San Diego sometime in December, according to project manager, Capt. William M. Nicholson, of the Deep Submergence Systems Project Office in Washington, D.C. Sea trials will begin early in 1970. The second rescue vehicle will be launched early next year.

Funds for the remaining four will be released after the Navy sees how the first two vehicles work out. The first one cost \$41 million; the second and succeeding ones, \$20 million. The vehicles can be rushed to a submerged submarine by jet cargo plane or can ride piggyback on a mother submarine. Any submarine can be modified quickly to accommodate one of the rescue vehicles. The Navy plans to keep two of the vehicles ready to go at three strategic points.

Prime contractor is Lockheed Missiles and Space Co., Sunnyvale, Calif.



# Our 5-band carbon comps are cats of a different stripe



Okay, so the other leading brand is also great on military specs. But our Speer resistors have still more to offer.  They provide superior soldering characteristics. They're backed by the first and most sophisticated on-line computerized resistor quality control system. They're delivered in an exclusive foil pack.  And they're accompanied by written documentation.  Another helpful note—both our 1/2-watt and 1/4-watt types qualify under the new Established Reliability Specification at the S level.  Our 4-band carbon comps are something special, too—particularly now. They offer all of our traditional quality features—plus competitive prices.  To learn more about our resistors—and the reliable customer service that backs them up—write AIRCO SPEER ELECTRONIC COMPONENTS, St. Marys, Pennsylvania 15857.  Five "stripes" or four—you may even decide we're a whole new breed.

The passive innovators at **AIRCO** Speer

Speer resistors  Resistor and conductor paste  Jeffers JC precision resistors  Jeffers JXP precision resistors and networks  Jeffers inductors  Jeffers capacitors  PEC variable resistors and trimmer potentiometers.



**Reliability is 756 little dents  
and one big one.**



### The big squeeze.

The heelpiece and frame are the backbone of our Class H relay. The slightest squiggle or shimmy out of either and the whole relay is out of whack.

756 tiny dents on the heelpiece, plus one big one on the frame, make sure this'll never happen.

They're the result of planishing, a big squeeze. Planishing is an extra step we go through in forming the pieces to add strength and stability by relieving surface strain. It also makes the parts extra flat.

This takes the biggest press in the industry and the biggest squeeze. Both exclusively ours.

### A different kind of coil.

The heart of a relay is the coil. If ours looks different, it's because we build it around a glass-filled nylon bobbin. It costs us more, but you know how most plastic tends to chip and crack.

Also, moisture and humidity have no effect on glass-filled nylon. No effect means no malfunctions for you to worry about. No current leakage, either.

The coil is wound on the bobbin automatically. No chance of human error here.

### We didn't forget the solder.

We use a solderless splice. That's because solderless splice connections are sure-fire protection against the coil going open under temperature changes, stress, or electrolysis.

A solderless splice is more expensive to produce, so it's usually found only on the most reliable relays. AE is the only manufacturer to use this method on all of its relays.

Finally, we wrap the whole assembly with extra-tough, mylar-laminated material. A cover is not really necessary here; but why take chances?



### Springs and other things.

We don't take any chances with our contact assembly, either. Even things like the pileup insulators (those little black rectangles) get special attention. We precision mold them. Other manufacturers just punch them out.

It makes a lot of difference. They're stronger, for one thing; and because they're molded, there's no chance of the insulators absorbing even a droplet of harmful moisture. Finally, they'll withstand the high temperatures that knock out punched insulators.



Then there are the contact springs. Ours are phosphor-bronze. Others use nickel-silver. Our lab gave this stuff a thorough check, but found nickel-silver too prone to stress-corrosion. Atmospheric conditions which cause tarnish and ultimately stress corrosion have almost no effect on phosphor-bronze.



### Two are better than one.

Our next step was to make sure our contacts give a completed circuit every time. So we bifurcate both the make and break springs.

Each contact works independently to give you a completed circuit every time.

Edge-tinned contact springs save you the job of solder tinning them later. Also, edge-tinning enables you to safely use the same relay with sockets or mounted directly to a printed circuit board. A simple thing, but it takes a big chunk out of the inventory you have to stock.

### Etc. Etc. Etc.

There's a lot more to tell about what makes our Class H relay reliable. Now we're waiting to hear from you. Automatic Electric Company,

Northlake, Ill. 60164.

# AUTOMATIC ELECTRIC

SUBSIDIARY OF GENERAL TELEPHONE & ELECTRONICS

INFORMATION RETRIEVAL NUMBER 26

## LSI computer to cut time-sharing costs

In a time-sharing system, the billing begins when you contact the computer, and charges mount until you hang up. This forces you to organize your material off-line and type it into the computer as fast as you can. You have neither the time nor the mental conditions necessary to interact freely with the system.

What if you could purchase a small, inexpensive computer that you could convert at will into a scientific machine, an accounting system or a calculator simply by plugging in a magnetic-tape cassette and typing a key word?

Such a computer is being built by Four-Phase Systems, Inc., a new company in Cupertino, Calif., formed by a group of semiconductor, systems and software experts. According to Cloyd Marvin, vice president of marketing, the system will solve problems with up to about 50 variables.

"This means," he says, "that you can solve a good 75 per cent of your circuit problems—including sophisticated transient, ac and dc analysis—in your own office without accessing a central computer."

This will be one of the first general-purpose computing systems built entirely with MOS LSI. Its computing power will be contained in less than a dozen chips. The main, or "core" memory will consist of semiconductor random-access chips with a capacity of 10k to 100k bytes (1 byte = 8 bits). In addition to the computing chips and the semiconductor memory, the system will include a keyboard input,

CRT output and two magnetic-tape cassettes for storing the programs and the finished computations. According to Marvin, the entire system will be about the size of an oscilloscope.

The company expects to announce its completed system by the end of the year at a price of \$10,000 to \$20,000, Marvin says, depending on the amount of semiconductor memory the customer wants.

"This means that if you now use a time-sharing system more than an hour a day," he points out, "this computer will save you money, even if you keep the time-share subscription and use our computer as an adjunct."

### Costs cut by one-third

The typical daily cost of a time-share subscription, he notes, is about \$40.

"For every hour you use the system, you pay \$16 or so—about \$12 for the computer connect time and another \$4, average, for the use of the phone lines" Marvin says, "So for one hour's use, you pay \$20.

"By contrast the daily cost of our computer might be \$12.50—assuming a monthly leasing charge of \$250. For this basic cost, you will be able to do most of your computing problems at the local level without accessing the central computer at all. So the total daily cost of using our computer with the time-share system might be less than the \$20 you now pay for one hour's use of the time-share com-

puter alone."

The user will plug in a pre-recorded cassette that contains the desired programs and formats and will select the one he wants by typing a key word. The computer will search the tape and display a format on the CRT screen. The user then will enter data via the keyboard, while the computer makes the required computations and displays the results on the screen. When the problem is completed, the results will be stored in a second blank cassette. If the user prefers, he will be able to enter the program from the prerecorded tape into computer memory, replace this cassette with a blank tape and let the computer control both cassettes while he spools the data back and forth.

In a large company, he suggests, local systems in each engineer's office could be tied in with the central company computer. Not only would this expand the storage capability of the local system, but also it would allow the interchange of information between departments within the company.

"For example," Marvin says, "suppose the engineering manager uses his local terminal in scheduling the procurement of parts for a particular project. When he has finished, he stores the data in the central data base. Then when the procurement man is ready to make up purchase orders, he requests the transfer of this and similar data to his own terminal, where he sorts it by supplier." ■■

## Powerful laser generates tiny nuclear blasts

By aiming a powerful laser beam at deuterium, French scientists report that they have generated a succession of tiny thermonuclear explosions.

In tests conducted by the French Atomic Energy Commission, a neodymium-doped glass laser was aim-

ed at a tiny deuterium target frozen to near absolute zero. A series of 4 gigawatt pulses, each with a duration of 5 nanoseconds, heated the material to about 15 million degrees F, releasing a small but explosive burst of energy.

Experimenters hope eventually

to produce a "puff-puff" series of explosions—like those in an internal-combustion engine—that could be harnessed for power generation. Such a system, they say, would not require the magnetic "bottles" that have figured in most efforts to control fusion reactions. ■■

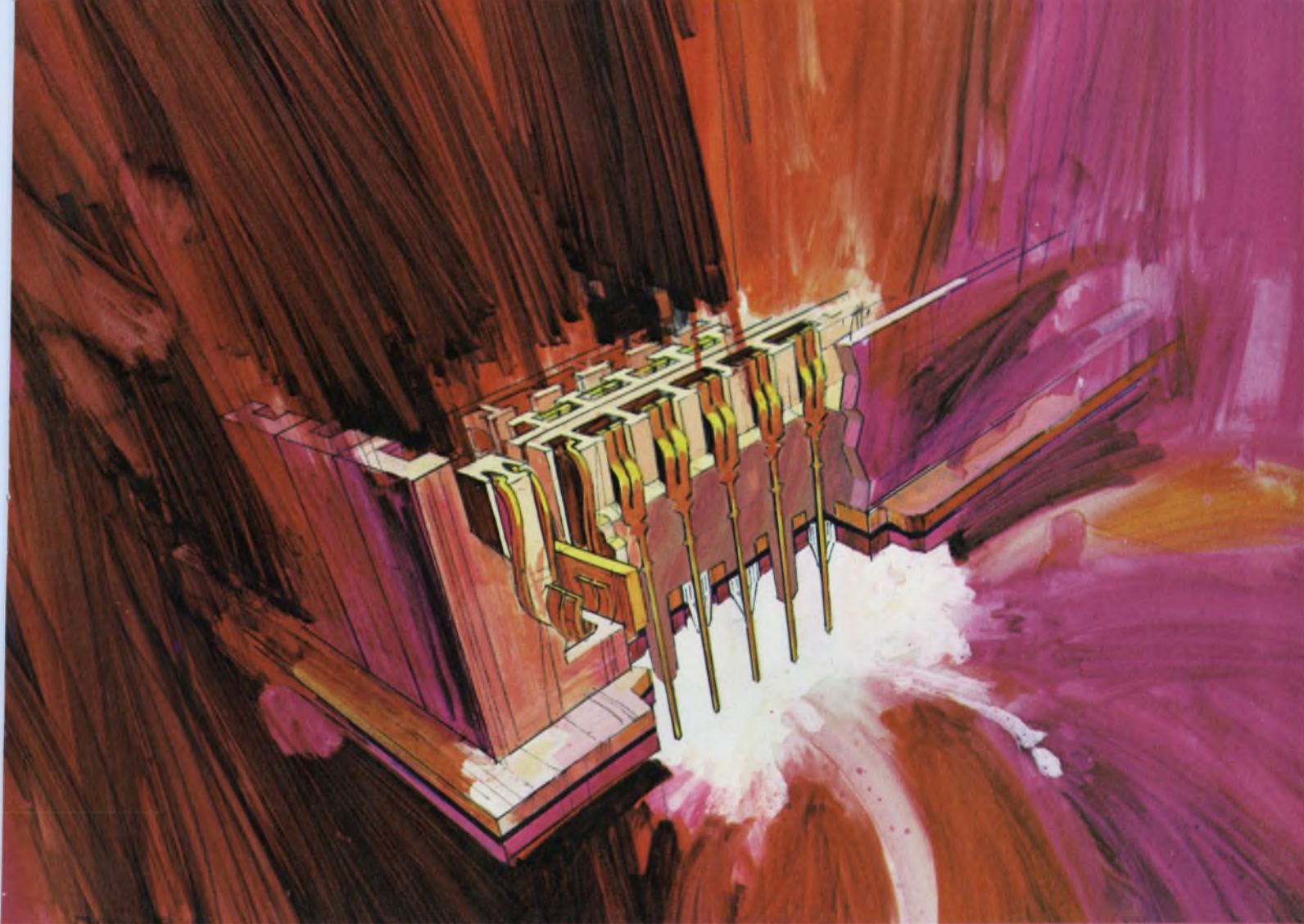

## IMITATED—BUT NOT EQUALLED.

# CINCH BACK PLANE CONNECTOR SYSTEM

Today, most back plane connector systems are being modified to include features first developed by Cinch. But only the Cinch back plane was designed to incorporate these innovations as basic design considerations, not modifications of already existing devices.

Cinch design leadership produced the *first* back plane connector system with these important features:

1. Replaceable buss bars that permit removal and replacement of bussing contacts.
2. Easily replaceable voltage plane and ground contacts, including bussing.
3. Precision monoblock insulators that eliminate modular construction.
4. Cantilevered, preloaded contacts.

Cinch didn't stop with the product. Special design molded styrofoam carriers completely eliminated damage during transit.

Combined with cost reducing techniques of selective gold plating, simultaneous insertion of contact rows and a unique method of terminal positioning, these features result in the most efficient and most economical back plane connectors system you can buy.

For information on this or other Cinch interconnection devices, contact your local Cinch Electronics Group office or write to Cinch Manufacturing Company, 1501 Morse Avenue, Elk Grove Village, Illinois 60007.

C-6914

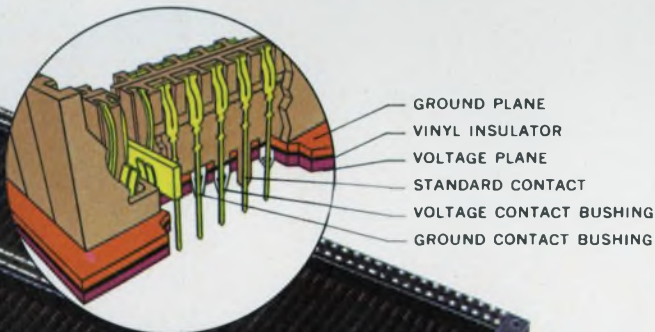

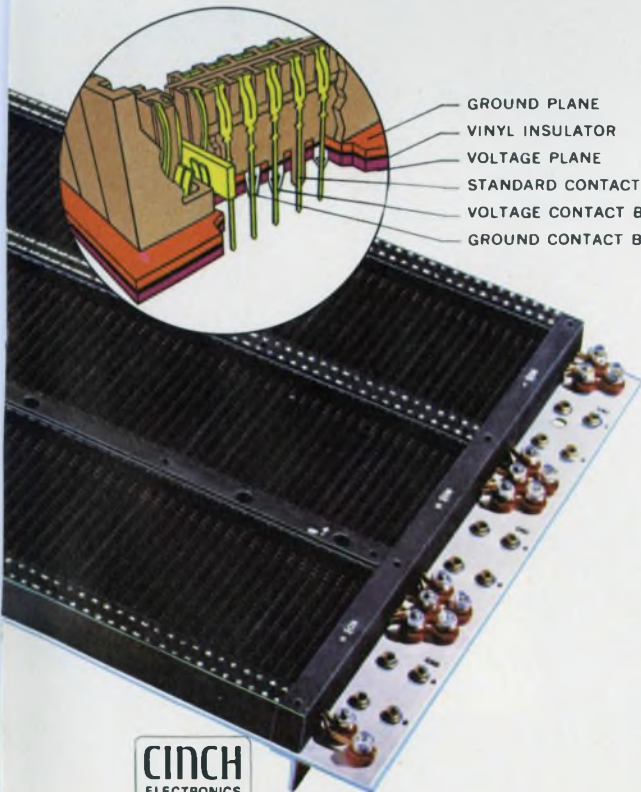

GROUND PLANE  
VINYL INSULATOR  
VOLTAGE PLANE  
STANDARD CONTACT  
VOLTAGE CONTACT BUSHING  
GROUND CONTACT BUSHING

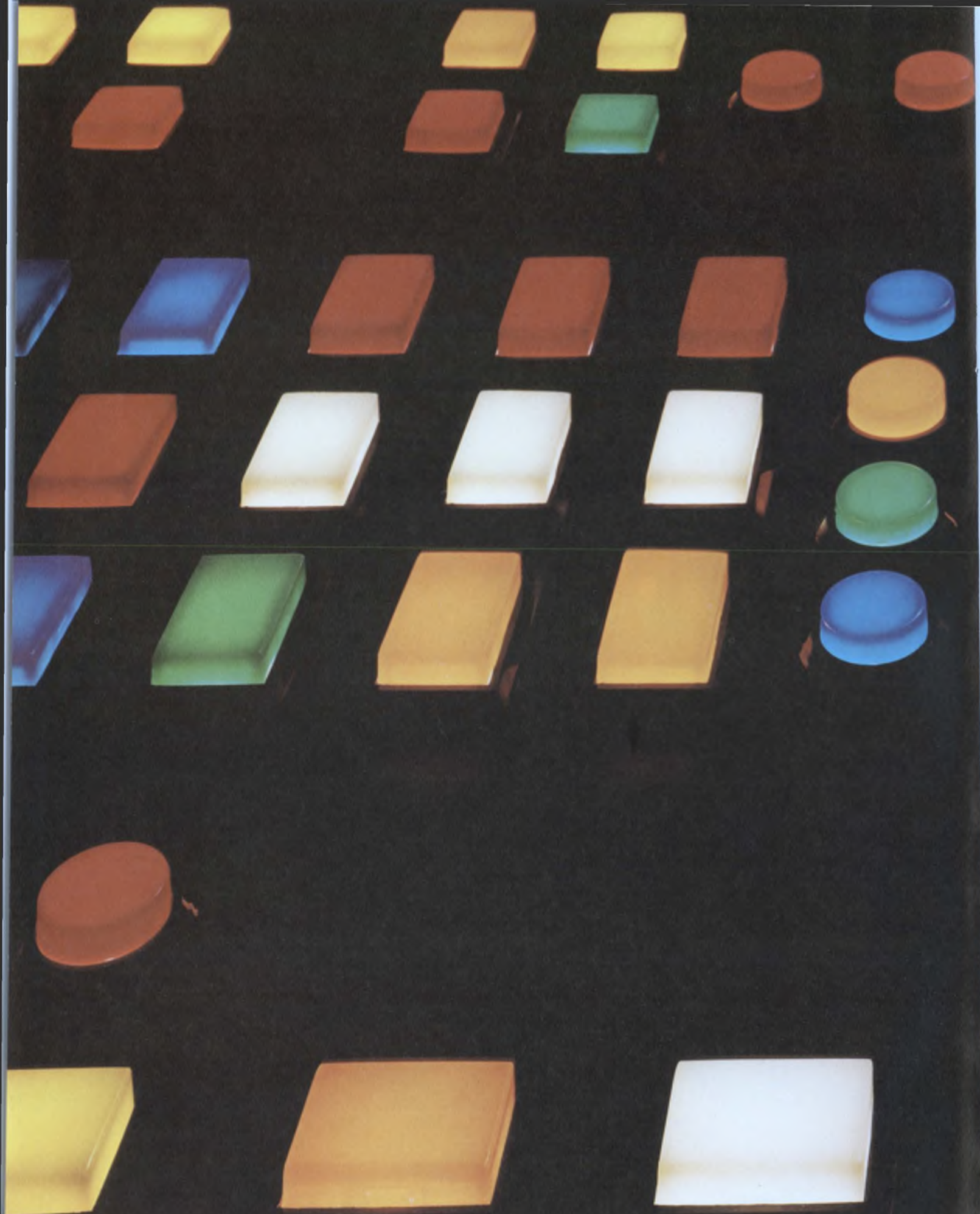

**CINCH**  
ELECTRONICS  
GROUP.

**CINCH**  
DIVISION OF UNITED-CARR





Meanwhile, back on earth.  
Arrow-Hart scores a breakthrough in lighted push-button switches. Snap-on contact blocks make up to 4-pole double throw form Z switches. 31 stock components = 25,344 different variations. Six colored lenses in three shapes. Is your imagination beginning to run away with you? Write or wire for folder. We call all this Adapt-a-Switch. You'll call it ingenious.

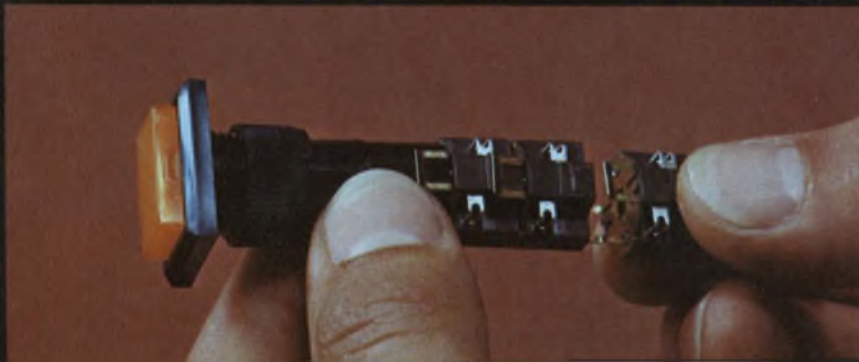

**Arrow  
Hart**

ARROW-HART, INC.  
HARTFORD, CONN.

# Intech takes on the Op Amp Boys.

We're a David among Goliaths. And we know it. So does Philbrick/Nexus, Analog, Burr-Brown, et cetera, et cetera. They're our competition, and maybe your present Op Amp supplier. We're out to change that... and to give you better FET input op amps. Here's our story. We've put together the best component and design engineering talent the industry had available. We let them have the run of the house. What they do constantly amazes us.

Like the A-130: a high speed, FET input Op Amp that has a slewing rate of  $600V/\mu s$  (typ) and a settling time to 0.01% of final value in less than  $0.5 \mu s$  in an amplifier with a 6 dB roll-off. The price is almost half of the competition's.

Don't believe us, or our engineers, though. In this business specifications, performance, and price are the considerations. A test is worth a thousand words.

For more information on our operational amplifier line, contact your nearest Intech representative, or call or write us direct.

**Intech Incorporated, 1220 Coleman Avenue, Santa Clara, California 95050. (408) 244-0500.**



**intech**



### Intech takes on the Op Amp Boys.



## Here are some of our boys

### REPRESENTATIVES

#### Washington, Oregon, Idaho, British Columbia

Arneson Associates, Inc.  
Seattle, Washington 98108  
(206) 762-7664

Arneson Associates, Inc.  
Beaverton, Oregon 97005  
(503) 646-3416

#### California, Nevada

Measurement Associates  
Sunnyvale, California 94086  
(408) 739-7785

Measurement Associates  
Inglewood, California 90309  
(213) 671-7651

#### Texas, Arkansas, Louisiana, Oklahoma

Carter Associates  
Carland, Texas 75040  
(214) 276-7151 TWX 910-860-5097

#### Colorado, Utah, New Mexico, Wyoming

Waugaman Associates, Inc.  
Denver, Colorado 80033  
(303) 423-1020

#### Alabama, Georgia, Tennessee, Mississippi

20th Century Marketing, Inc.  
Huntsville, Alabama 35805  
(205) 536-1596

#### Massachusetts, Maine, New Hampshire, Vermont, Rhode Island, Connecticut

KCA Components Inc.  
Lexington, Massachusetts 02173  
(617) 861-9024

#### N. Illinois, N. Indiana, S. Wisconsin, E. Iowa

Gassner & Clark Company  
Chicago, Illinois 60645  
(312) 764-6121

#### Ohio, Michigan, Western Pennsylvania, Kentucky

J. C. Hofstetter Company  
Medina, Ohio 44256  
(216) 241-4880

#### Northern New Jersey, New York City, Fairfield County (Connecticut)

Salsbury Associates, Inc.  
Hicksville, New York 11801  
(516) 938-1080

#### Up-State New York

Graydon-Sherman  
Fayetteville, New York 13206  
(315) 637-9861 TWX 710-545-0241

#### Southern New Jersey, Eastern Pennsylvania

Biechler Associates, Inc.  
Narberth, Pennsylvania 19072  
(215) 667-1827

#### Florida

Conley and Associates, Inc.  
Oviedo, Florida 32765  
(305) 365-3283

#### Minnesota, N. Wisconsin, W. Iowa, Missouri and Kansas

Carlson Electronic Sales  
7448 Harlem Ave.  
Chicago, Illinois 60648  
(312) 774-0277

**intech**

# Letters

## "Editorial is a public service"

Sir:

Having had 25 years engineering experience, I wish to applaud (the editorial of July 5, 1969). I think that it is absolutely right, and that it is a public service.

Unfortunately, the NSPE (to which I used to belong) represents C.E. employers, just as the IEEE represents E. E. employers, as a glance at its list of officers shows.

Magazines such as ED have been the only sources of information on the realities of economic life to employed engineers. I think that the correctness of this policy is attested by the fact that several of the engineering technical societies have reportedly been in financial difficulties, while the best commercial technical magazines, such as ED, have not been.

What appear to be engineering failures, such as the F-111, are obviously not due to the engineers, but due to the overlay of complex economic and political considerations. Engineers must let this be known, or they may be blamed for everything.

Again, I wish to say that your editorial is a service, not only to employed engineers, but to the American public.

J. L. Borges

625 S. Oak Knoll Ave.  
Pasadena, Calif. 91106

## "My freedom is more important than security"

Sir:

I refer to your editorial of July 5, 1969. My freedom as an individual is far more important to me than any "security" that I might achieve through any collective engineering organization. My own observations indicate that these organizations rapidly become an end in themselves and the individual becomes the pawn of two masters, his employer and his "union." A further criticism which I have of these organizations is that they at-

tempt to create artificial shortages of talent by 1) restricting admission to the profession and 2) feather-bedding. The NSPE (I am a former member) is especially guilty of 1) with its incessant demands for compulsory engineering registration.

Security is ultimately a function of the individual's ability and willingness to provide a valuable service to his employer.

Thank you for listening.

Fred D. Campbell, MTS  
Aerospace Corporation  
Los Angeles, Calif.

## "Engineers need a power structure"

Sir:

Your editorial, "Aren't Engineers Entitled to Job Security Too?" (ED July 5, 1969) is timely and courageous. I was pleased to note that you favored pressure or "coercion" by engineers through an effective organization."

I am a project engineer . . . and have been a practicing engineer for 25 years . . . I hold both the BSSEE and MSSEE. My engineering experience has been gained with five different corporations, so I have a down to earth feeling for an engineer's problems and his need for a *power structure* to represent his interests . . .

My employers would probably "red-line" any engineers working with an engineers organization so please don't identify me.

Kansas City Engineer

## Cold power might solve two major problems

Sir:

I was very intrigued by an article entitled "Cold Power: Tomorrow's Electric System?" in the July 5, 1969, issue (ED 14, p. 30). It describes a superconductive power transmission cable development being done by Linde Div. of Union Carbide. The cable described con-

(continued on p. 60)

# Sonotone's Sub-C Cell.

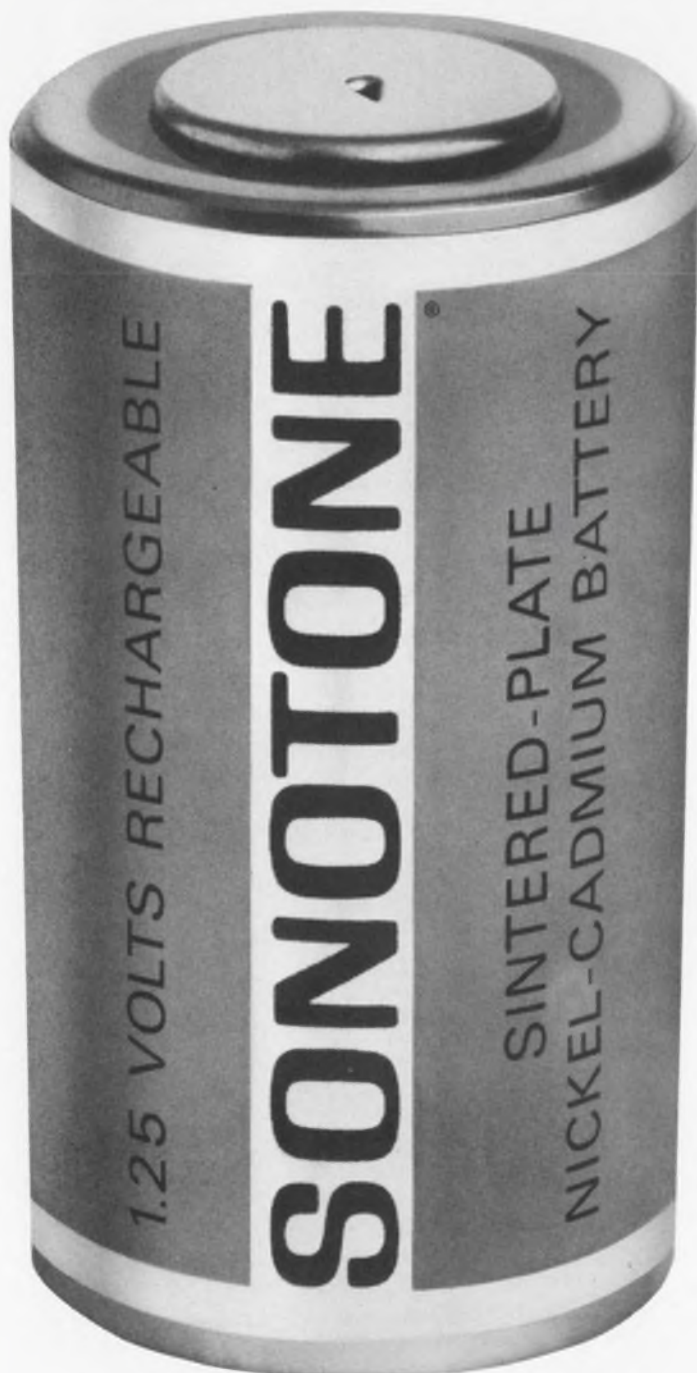

**One size, four power ratings supply the power needed for any cordless product.**

Now you can match power to product with one of Sonotone's Sub-C nickel-cadmium sealed cells. Pick from these four:

**S113**, the industry standard, is a dependable, nickel-cadmium sealed cell rated at 1.2 ampere hours. This is the one that started the cordless revolution. Now in use in cordless toothbrushes, slicing knives, communications and standby power equipment.

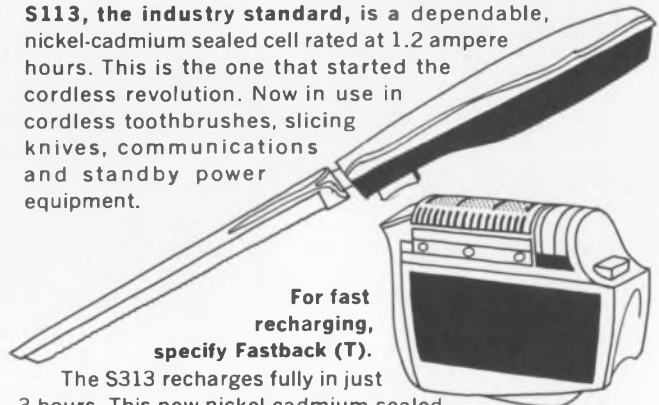

**For fast recharging, specify Fastback (T).**

The S313 recharges fully in just 3 hours. This new nickel-cadmium sealed cell is rated at 0.9 ampere hours. Currently used in cordless shavers and cordless hair clippers.

**S413** is a high rate discharge nickel-cadmium sealed cell with 1.0 ampere hours. Puts out up to 75 amps. of surge power . . . ideal for engine-starting applications.

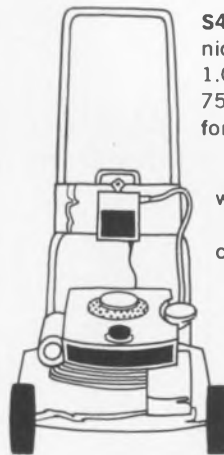

And finally, the economical **S213** with performance the same as the S113, except 0.7 ampere hour capacity. It is used in many of the same applications as the S113 where running time is less critical and economy most essential.

What we've done with the Sub-C cell, we can do with any of our battery products.

Write for full information:  
Sonotone Batteries,  
Elmsford, N. Y. 10523.



## SONOTONE



we goofed.



This Howard Cyclohm Fan was engineered to run 10 years. So far it's been running 12 years, 6 months, 21 days.

Our modest 5-year guarantee on Cyclohm Fans and Blowers is based on an engineered lifespan of 10 years. So, what do we tell our customers when they report the fans are still blowing strong 12 or even 14 years after installation? We tell them we goofed—and they benefit.

There's more to the Howard Cyclohm Fans and

Blowers success story than just long life. There's the high reliability of Howard's unit bearing motor that never needs maintenance or re-lubrication. And all metal construction. Indestructible nylon blades. Standard mounting on 4-1/8" centers. UL yellow card listing. All units are off-the-shelf . . . available for immediate delivery from Standard Motor Product Sales. All the facts are in the newly-published, 14-page Cyclohm Fans and Blowers Catalog ED109. From Howard.



**HOWARD**

HOWARD INDUSTRIES  
A DIVISION OF MSL INDUSTRIES, INC.  
2420 18th STREET, RACINE, WISCONSIN 53403  
414-632-2731 TWX 910-271-2387

# GREAT NEW WAY TO BUY DC POWER



**ERA's Wide-Range, Variable, All-Silicon DC Power Modules at Low, Low Prices**

ERA's new Value-Engineered DC Transpac® power modules provide all-silicon, DC power in a wide-range, variable, low cost module.

Stocking problems are reduced to a minimum and power module obsolescence is practically eliminated. Design changes are easily accommodated since all units can be set to desired voltages by a simple external tap change.

Output Voltage (DC)	Current (71°C)	Model	Price
4-32	0-750 ma	LC32P7	\$ 89.00
4-32	0-2 amps	LC322	\$115.00
4-32	0-5 amps	LC325	\$179.00
4-32	0-10 amps	LC3210	\$215.00
30-60	0-1 amp	LC601	\$145.00

Over-Voltage Protector Option: Add \$35.00 to above prices and Suffix V to Model No. (i.e. LC325V, etc.).

#### SPECIFICATIONS

**Input:** 105-125 VAC, 50-400 cps  
**Ripple:** Less than 800 microvolts RMS or .005%, whichever is greater  
**Line Regulation:** Better than  $\pm 0.01\%$  or 5 mv for full input change  
**Load Regulation:** Better than 0.05% or 8 mv for 0-100% load change  
**Voltage Adjustment:** Taps and screwdriver adjustment  
**Short Circuit Protected:** Automatic recovery  
**Vernier Voltage:** External provision  
**Transient Response:** Less than 50 microseconds  
**Operating Temperature:** -20°C to + 71°C free air, full ratings  
**Maximum Case Temperature:** 130°C  
**Temperature Coefficient:** Less than 0.01% per degrees C or 3 millivolts  
**Long-Term Stability:** Within 8 millivolts (8 hours reference)

Write Today for Catalog #147



**ELECTRONIC RESEARCH ASSOCIATES, INC.**

Dept. E-869, 67 Sand Park Road  
 Cedar Grove, N. J. 07009 • (201) 239-3000  
 Subsidiaries: ERA Electric Co. • ERA Acoustics Corp.  
 ERA Dynamics Corp. • ERA Pacific, Inc.

INFORMATION RETRIEVAL NUMBER 32

## LETTERS

(continued from p. 57)

sists of three copper pipes whose inner surfaces are coated with niobium and cooled to the point of superconductivity. Such a system could solve many future power distribution problems, and the development cost was stated to be approximately \$8 million.

I have thought of an interesting extension to such a system: Why not use those superconducting hollow pipes as waveguides for large-channel-capacity low-loss communications, as well as transmission of power? In this way we might solve two future problems simultaneously—the needs for added power and communications. As a matter of fact, one might even conceive of the power industry and communications industry sharing the costs of development and installation of such a system.

These thoughts represent only my personal opinion of the subject.

Dr. R. J. Chaffin

Sandia Corp.  
 Albuquerque, N. M.

## LSI testing systems need not be costly

Sir:

Since one of the major products of this company is an LSI test system, the article, "LSI Testing is a Large-Scale Headache!" in your August 2, 1969, issue was read here with considerable interest. The article aptly and accurately stated the salient points of the "headache." For the most part we agree. Considerable space was devoted to descriptions of proposed hardware solutions with price tags from \$150,000 to \$300,000 or more. We think a solution with a \$40,000 starting price also should be considered.

We produce two basic models of LSI test systems. Both of these systems are sensibly priced, capable of complete LSI functional testing, and proven in daily use by major array manufacturers.

We surely agree that the LSI test problem was a tough one, but so was the trip to the moon. These

(unequally difficult) problems have both been conquered through aggressive engineering.

Alfred J. Homann

Vice President  
 Educational Computer Corp.  
 Sicklerville, N. J.

## Noise-figure omission could cause trouble

Sir:

Messrs. Grove and Hsu gave a good discussion of semiconductor noise in "Don't Just Fight Semiconductor Noise," ED 17, Aug. 16, 1969, p. 228, but the noise figure explanation in the box on p. 234 failed to mention the crucial condition that the input noise must equal that of a matched ideal resistance at the IEEE standard temperature of 290° Kelvin.

Failure to observe this condition in measurements of antennas and communications equipment, where the effective temperature of the source can range from a few degrees Kelvin to many thousands of degrees, has led others to serious error.

Indeed, it is easily seen in the third unnumbered equation presented by Grove and Hsu to describe noise figure

$$F = 1 + \frac{N_{amb}}{GN_{in}}$$

that if  $N_{in}$  were not restricted to a standard value, no unique noise figure could be defined.

Many authors avoid this technicality by dealing with "equivalent noise temperatures" instead of "noise figures."

Dr. John R. Copeland

Jackson Associates  
 Columbus, Ohio

## Campus problems? Or national symptoms?

Sir:

I read with considerable interest and concern your editorial, "It's the Alumni's Turn to Demonstrate," (ED 12, June 7, 1969, p. 47). I say

(continued on p. 65)

One of the toughest demands ever thrown at coaxial cable designers came along with the new high-flying, high performance manned military aircraft such as the F-111, and EA-6B etc. A lightweight, flexible cable with low VSWR and high temperature capability was needed for easy installation in tight locations, to accommodate aircraft length tolerances, and to connect to shock mounted equipment.

Our response was to develop and qualify Flexispline\*, a flexible coaxial cable with a TFE air-space dielectric which operates to 12 GHz. It handles high cw power levels at elevated temperatures and altitudes while exhibiting low loss and low VSWR. Straight and right angle connectors of N, TNC and SC types are available. Typical VSWR for a 20-foot cable assembly is 1.25:1 from 4 to 8 GHz and 1.35:1 from 8 to 12 GHz.

Times also furnishes semiflexible coaxial cable having corrugated aluminum outer conductor with TFE air-cell

dielectric (no pressurization required) . . . with even lower loss and higher power-handling capability (see graph). We've won our wings on many tough interconnect problems. Let us work with yours. \*Test Data Available

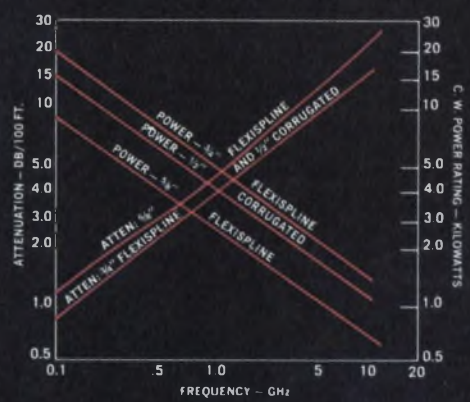

**TIMES WIRE & CABLE**  
 Subsidiary of INSILCO  
 Wallingford, Conn.

# How We Won Our Wings.

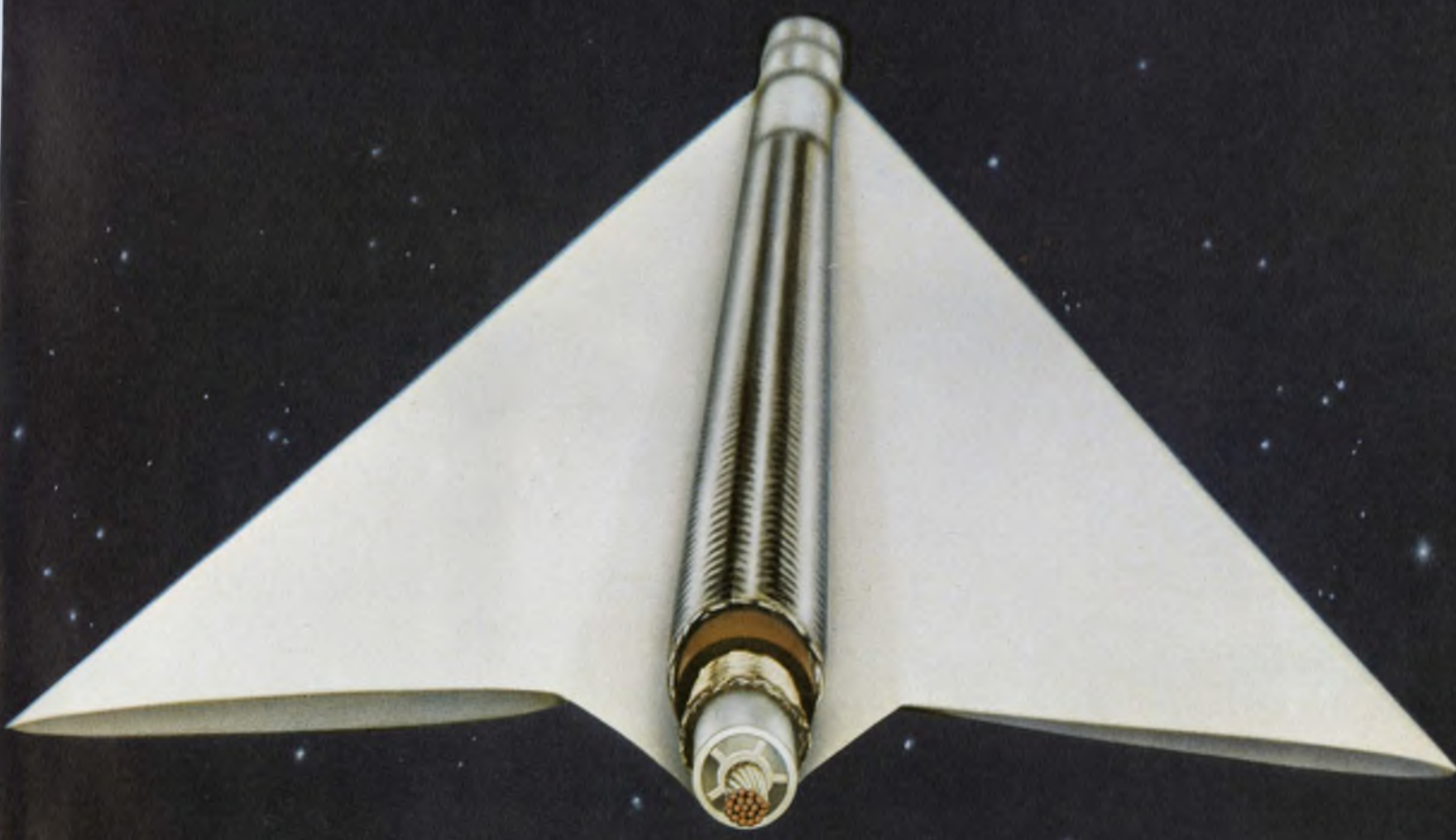

**MYSTIK**  
TAPE  
THE MARK OF QUALITY



**If your problem is too hot to handle  
maybe Mystik can help.**

You can't beat us when it comes to taking the heat off.

Take our Teflon® film tape, for example. It can withstand temperatures of -100 degrees F to 450 degrees F. It's an excellent insulator for all kinds of electrical equipment.

If you're more interested in shielding against heat, we'd recommend our

aluminum foil/glass cloth tape. It's been known to withstand as much as 6,000 degrees F during rocket blast-off.

We have plenty of other tapes, too, for all kinds of jobs. Printed circuits. Motors and generators. Transformers. Just about any tape connected with the electronics and electrical fields.

For a complete description of Mystik's full line of electrical and special purpose tapes write:

Dept. MT-7, Mystik Tape, Division of Borden Chemical, Borden Inc, 1700 Winnetka Ave., Northfield, Ill. 60093.



Teflon® is a DuPont registered trademark.

INFORMATION RETRIEVAL NUMBER 45

# SDS just made a name for itself in the business world:

**Xerox Data Systems.**

When scientific data systems were all we made, Scientific Data Systems was an excellent name.

But for the past few years distinctions between scientific and business computing have been disappearing. And we've been

expanding into applications for general business and industry.

So we're adopting our parent company's name. It's as respected in the business world as the one SDS has in the technical world.

**XDS**  
Xerox Data Systems  
El Segundo, California

# Try to do this with semiconductors

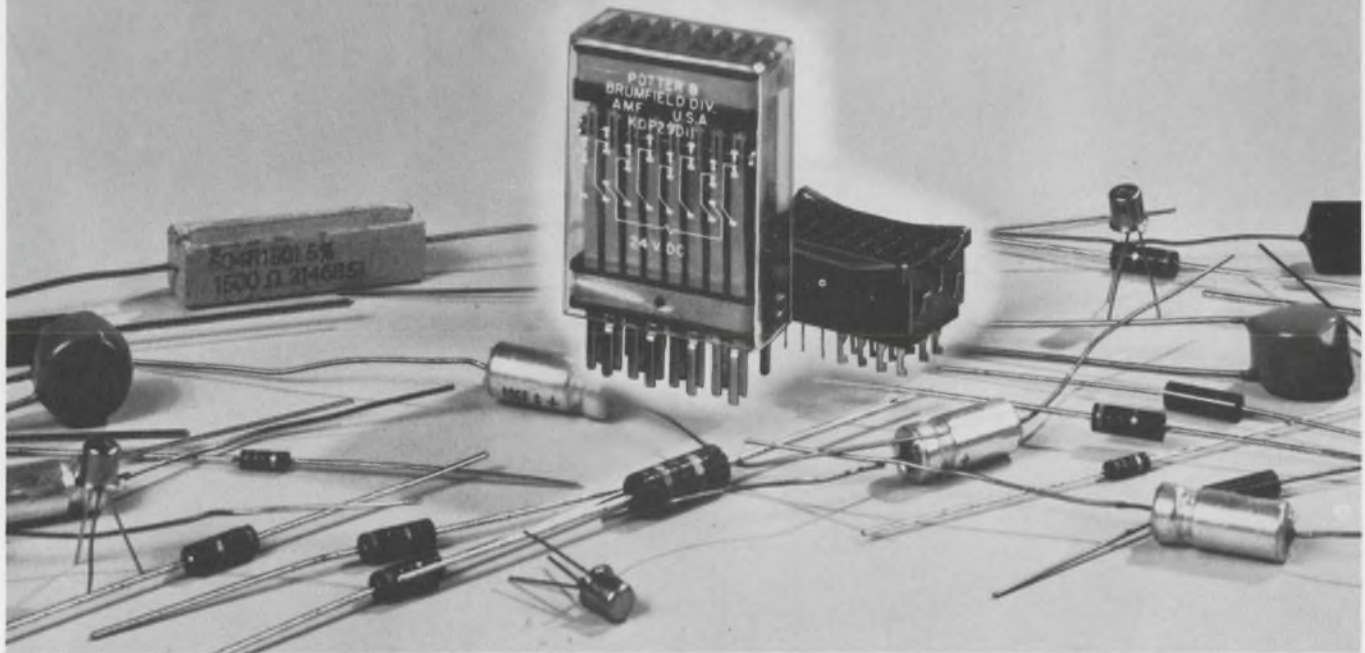

Where else can you get 8 Form C switching in a package that measures just over a cubic inch and costs less than 50¢ per pole?\* You can't with semiconductors. You'd wind up with a much larger, more expensive array.

Speaking of cost, the KDP has a single lot price of \$9.35. The list price, by the way, is less than two of our most popular 4-pole relays.

The compact KDP is ideal for logic circuits where a single input will give you a fan-out of eight. Open-minded engineers will find that a strong case for this relay over solid state switching. Remember, too, you get electrical isolation on both the input and switching sides.

Bifurcated contacts are rated at 1 ampere at 30V DC or 120V AC, resistive. Standard relays have an 8 Form C contact arrangement. Combinations of Form C and Form D (make-before-break) are available on special order. Coil voltages range from 6 to 48V DC.

Order prototype models today from your local P&B representatives or call us direct. Potter & Brumfield Division of American Machine & Foundry Company, Princeton, Indiana 47570. 812-385-5251.

\*Maximum discount

## KDP SPECIFICATIONS

**General**  
Temperature range -45° to +70°C

**Contacts**  
Arrangements: 8 Form C (8PDT)  
Rating: 1 amp at 30V DC or  
120V AC, resistive.

**Coils**  
Voltages: To 48V DC  
Duty: Continuous  
Pick-up @ 25°C: DC, 75% of nominal  
voltage.  
Operate Time: 15 ms maximum at nominal  
voltage @ 25°C.

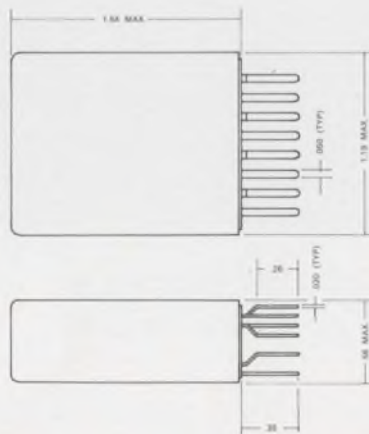

NOTES:  
1. DIMENSIONS APPLY TO TERMINAL CENTERS

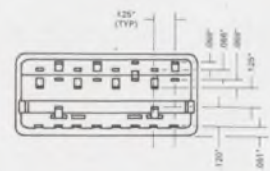

**POTTER & BRUMFIELD**



## LETTERS

(continued from p. 60)

"interest" because few persons in your position of editorial responsibility seem to care enough about this issue to put "extraneous" material of this nature into their professional magazines; and "concern" because I believe you have seriously oversimplified the issue.

Your analysis of the differences between engineering and arts students is in many aspects correct; but the question "Are there solutions for the campus problems?" is based upon the premise that it is a "campus problem." I believe that the campuses have experienced only the first symptoms of our national disease.

It is my view that these symptoms are evidence of a deep-seated pathological condition of our society, which has abdicated its concern for human values. The pathology is recognized by college students for a number of reasons, including these: (a) they have the time to think about things, and they are encouraged to look into the basics; (b) they have less vested interest in the status quo; and (c) they are in personal physical peril on account of at least one of the elements of the pathology. These reasons also bear upon the differences between engineering and arts students.

There are many evidences of the national pathology, and many of them can only be characterized as national scandals. They include (a) the war (and you may be assured that the "campus problems" will not vanish when the war is over); (b) the development of a national defense state managed by a scientific and technological elite (to which Professor Eilenberg referred); (c) the deterioration of the cities; (d) the welfare scandal; (e) the public elementary and secondary school scandal; (f) hunger endemic among ten percent of our own people; (g) the helpless poverty of state and local governments in the midst of enormous industrial and commercial wealth; and many, many more.

(You will have noticed that I omitted any explicit reference to the problem of our blacks. To some extent it is subsumed under the symptoms named above. To the extent that it is not included, it is now quite beyond the control and reach of the white majority. In

the recent mild disturbances at this school, the blacks completely withdrew at the beginning: they have their thing, and they don't want it confused with others'.)

The breathtaking accomplishments of the Apollo adventure have demonstrated our technical ability to achieve man's dreams. Less spectacular accomplishments in recent years have had far greater impact upon human affairs: consider, for example, the breakthrough in rice genetics. I look forward to the day when man's genius and ingenuity are devoted to providing adequate food, clothing, housing, and health; a meaningful education and worthwhile leisure for all men. This dream is no more beyond our grasp today than flying to the moon was 20 years ago, but to achieve these goals we shall need a conscious reassessment of priorities and a broad reallocation of our strength.

Many people believe these things can be done within the present economic and social and political structure: we call them liberals. Some people believe these things cannot be done unless the present structure is changed drastically: some call them revolutionaries and some call them nihilists, but they are the yeast and catalyst of any change, for the liberals have proved quite impotent. The vast majority of the concerned students stand between these positions. To the extent that the liberal position is one of futility, the concerned students turn to more radical positions and more revolutionary action in their search for the changes that need to be effected in our society.

*Berol L. Robinson*

Associate Professor  
Department of Physics  
Case Western Reserve University  
Cleveland, Ohio

### Accuracy is our policy

New product release on miniature rfi/emi filters (ED 18, Sept. 1, 1969, page 118, circle no. 278) should cite U. S. Capacitor Corp. as the manufacturing source, rather than United States Capacitor Corp.

## Looking beyond the 'specs' with P&B

When you need a sensitive relay for:

- Transistorized Computer Networks
- Telephone Systems
- Portable Communications or any battery-powered application

Check the advantages of the ML



ML Series

This small DC telephone type relay has a sensitivity of 20 milliwatts per pole. It requires a mounting area of only 1" x 1½" and weighs less than 2½ oz.

Outstanding switching capabilities at minimum power and small size make this relay satisfactory for a wide range of applications. A heavy-duty "L" shaped frame insures excellent magnetic stability. The armature is supported by a stainless steel bearing pin to provide smooth, efficient action for a minimum of 10 million mechanical operations.

Single or bifurcated contact springs can be furnished with up to 18 springs (9 per stack) for contact combinations of up to 6 Form C. ML relays can be furnished with pierced solder, printed circuit or taper tab terminals. A steel enclosure is also available.



Six plants in the United States and one in Canada, provide the production capacity to handle large orders with on-time deliveries.

**PLUS P&B Capabilities and Facilities that insure**

- Controlled Quality ■ Reliability
- Long Life ■ On Time Deliveries

**AMF**

**POTTER & BRUMFIELD**

Division of American Machine & Foundry Co.  
Princeton, Indiana 47570

INFORMATION RETRIEVAL NUMBER 48

MODEL 605: THE LOW-COST MULTIPLIER  
 1% ACCURACY  
 NO TRIM POTS

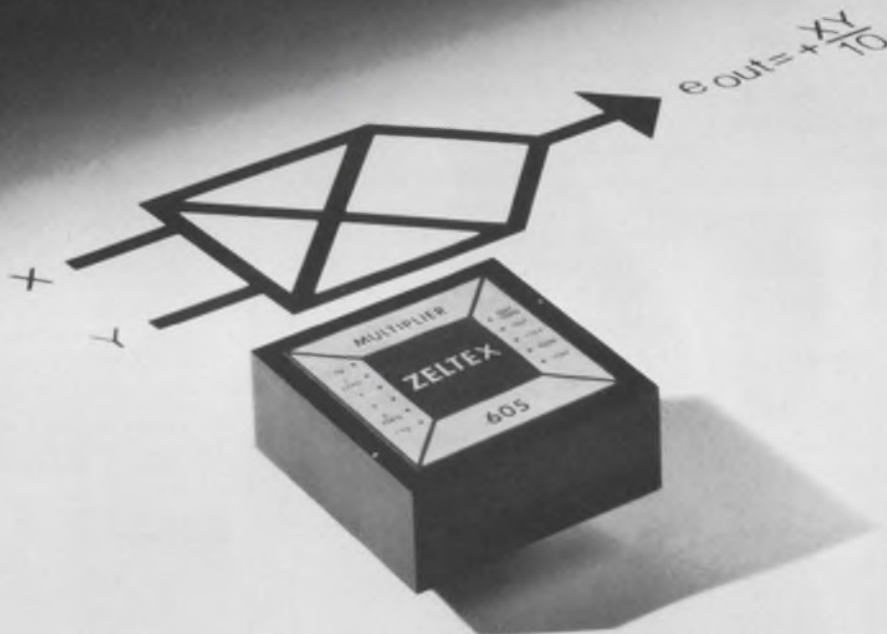

Compare specifications and you'll see that the Zeltex 605 beats every other low-cost multiplier on the market. It provides full-power output to 100 kHz, and small-signal frequency response is 500 kHz.

*Yet the price, in quantity, is only \$39!*

To get your copy of Bulletin 1056C containing complete specifications and Applications Bulletin 1063A, circle the reader service number below, or write or phone

Other key specifications include:

Output ..... 10 V @ 4 mA  
 Noise ..... 2 mV rms  
 Slew Rate ..... 6 V/ $\mu$ s  
 Size ..... 1.5 x 1.5 x 0.62 inches

**ZELTEX, INC.**

A Subsidiary of REDCOR CORPORATION  
 1000 Chalamar Road, Concord, Calif. 94520  
 (415) 686-6660

# SI



**CENTRALAB  
SEMICONDUCTOR**  
Division  
GLOBE-UNION INC.  
4501 NORTH ARDEN DRIVE  
EL MONTE, CALIFORNIA 91734

silicon semiconductor chips made specifically for use in hybrid microcircuits...available from Centralab Semiconductor...designed and fabricated to be compatible with all thick and thin film hybrids...to bond to all types of substrates without problems. We're the chip house. Our hybrid applications engineering group is available to help you with tough problems. Their services are free. And at nominal cost we can supply you with a zener chip sampling kit made for designers' use.

Contact us for information on chips, the zener chip sampler kit or for engineering assistance.

silicon chips in zeners, temperature-compensated zeners, scr's, rectifiers, core drivers, general purpose diodes and tunnel diodes.

## Isolation was the only thing preventing a high-frequency Reed Switch Matrix Until now.



The Cunningham Reed Switch Matrix reduces high-frequency crosstalk and interference to a new low. Unique "sandwich" design seals, shields and separates matrix-mounted reed switches from their controls.

Offers:

- **Excellent signal characteristics:**

50-ohm distributed. Broadband handling with top isolation. Low thermal noise.

- **100% Random access:** Any number or combination of crosspoints can be set, any place, any direction without affecting other crosspoints.

- **Computer compatibility:** Can be directly addressed by all computers using +5 volt logic. No added interfacing needed.

- **Proven reliability:** Up to 100 million operations.

- **Easy inspection and maintenance:** Control and signal sections can be separated for easy access.

- **Applications:** Interconnecting video channels; broadband data switching; test systems for nano-second digital pulses; telemetry equipment for multiple data channels; antenna switching; medical data monitoring.

Write or call for Data Sheet No. 603, Cunningham Corporation, 10 Carriage St., Honeoye Falls, New York 14472. Phone: (716) 624-2000.

## Cunningham Corporation

SUBSIDIARY OF GLEASON WORKS

INFORMATION RETRIEVAL NUMBER 51

## SIDELIGHTS

### Columbus, Ohio—"Hall capital" of U. S.

When East Coast editor Jim McDermott set out to do his story on Hall Effect devices (see p. 38), his research tour nearly turned into a one-stop stand—at Columbus, Ohio. For four big companies make Hall devices there: F. W. Bell, Inc., and Ohio Semitronics, Inc., makers of generators; Halmar Electronics, Inc., specialist in high-current measuring equipment; and Scientific Columbus, Inc., builder of power monitoring equipment for utility power network computer systems.

The "daddy" of the American market is Dr. Warren (Gene) E. Bulman, president of Ohio Semitronics, Inc. As a researcher with Batelle Memorial Institute—also in Columbus—working on the development of the Type III and IV intermetallic compounds in this country, he realized that the materials made by commercial chemical suppliers were not pure enough to produce best results. He then formed Ohio Semiconductor, Inc., in 1956, for the sole purpose of refining these materials and selling them.

In addition, the company fabricated bismuth telluride for use in thermoelectric cooling plates. It began to produce generators, magneto-resistors and thermoelectric cooling systems. These last it sold out to Tecumseh Products (maker of refrigeration compressors), but Tecumseh lost interest and phased out the division.

When Tecumseh cut off the supply of Hall generators, Floyd W. Bell, who depended on them for his gaussmeters, began manufacturing his own. In 1964, Dr. Bulman formed Ohio Semitronics, Inc., which makes custom devices.



By insisting on pure materials—and making them—Dr. Warren E. Bulman was partly responsible for today's boom in Hall devices.

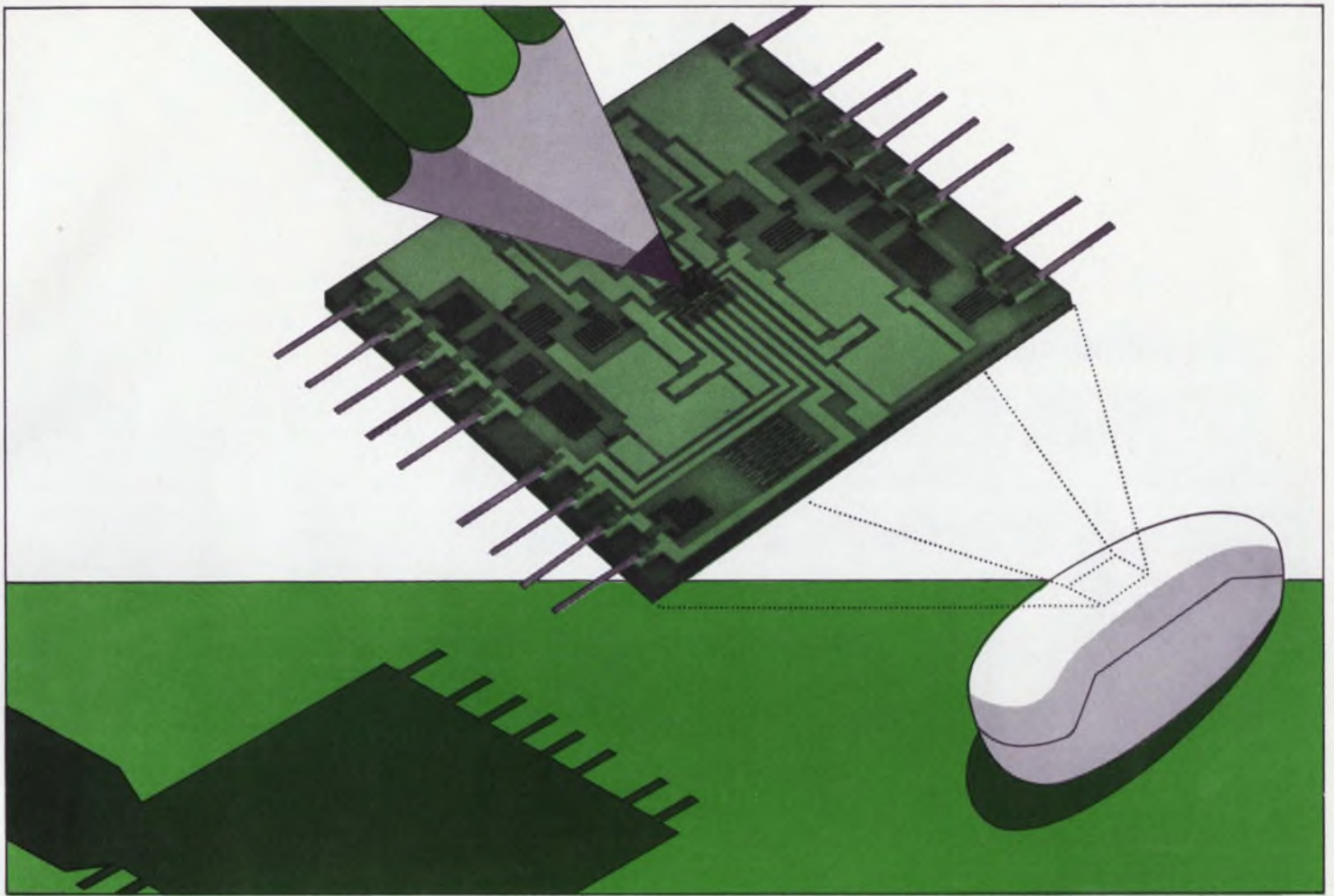

### Big future for little circuits

Bell Laboratories engineers have developed a special TOUCH-TONE Trimline® handset that suggests great possibilities for designers of future telephones. In this one, the musical tones you hear when you push the buttons are generated by two oscillators in a "hybrid" integrated circuit (one combining tantalum and silicon technology).

Such tiny, inexpensive circuits free designers from limits imposed by bulky, costly to assemble, discrete components—which restricted the type and complexity of circuit functions that could be designed into a telephone handset. Now, designers can think of people first—of what is easy to use—knowing that the electronics can be made to fit. The postage-stamp size, rugged integrated circuit above, for instance, contains 14 transistors, a diode, and

16 resistors in the silicon chip (under the pencil point), and 19 resistors and 8 capacitors made with tantalum film on the substrate.

Much of Bell Laboratories' integrated circuit work combines tantalum thin-film circuits (for precision passive components) and silicon integrated circuits (for active devices). To unite the two, we invented beam leads—small gold conductors which are formed as an integral part of the silicon circuit. They allow us to bond the silicon to the tantalum circuit in a simple one-shot operation. We've also developed a chemical-metallurgical system which fully seals off and protects the vulnerable parts of the circuit from environmental damage. So, we don't need costly vacuum-tight enclosures.

The extreme operational and environmental conditions of tele-

phone use gave us some problems: Tailoring the resistance of thin-film resistors so that the resistance-capacitance product remains constant despite changes in temperature. Designing oscillator circuits whose output frequencies are not affected by varied loadings due to differing cable lengths between telephone and central office. Finding an encapsulant to adequately insulate closely spaced conductors in high humidity.

To customers who use them, handsets with this new circuit will seem like other TOUCH-TONE Trimline sets—though a trifle lighter. But this new telephone technology opens the way to greater freedom for designers and even better telephones for Bell System customers.

**From the Research and Development Unit of the Bell System—**



**Bell Labs**

# Facts come in loud and clear on the Brush Mark 280.

## Twice as loud and clear.

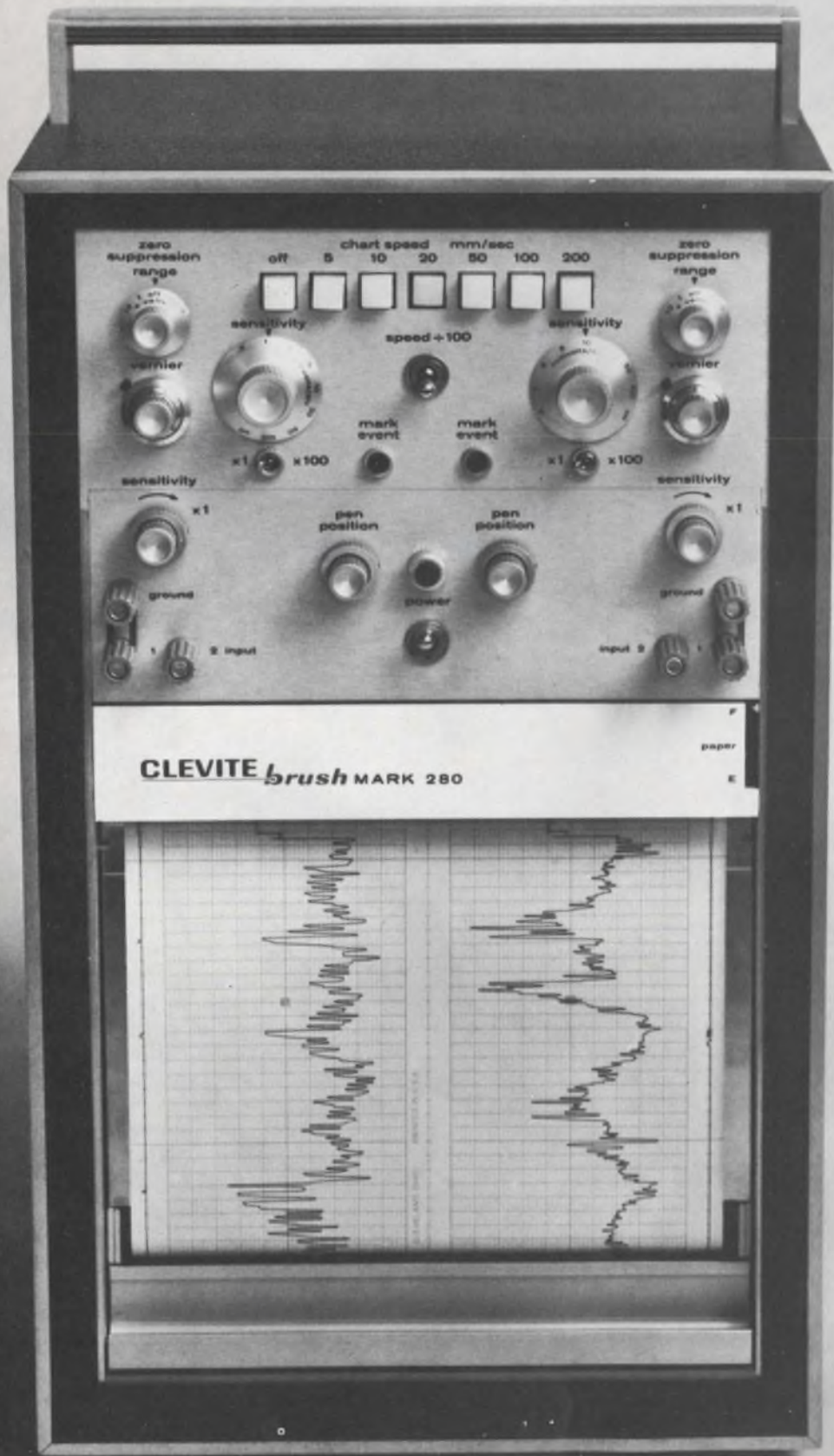

The Mark 280 is the best way yet to get high precision in a portable recorder.

The facts come in on 80mm channels, twice the width of conventional channels. Thus resolution is doubled — because measurements, no matter how complex, are displayed on twice the usual scale — are twice as easy to see and read.

The traces are just plain beautiful — clear, sharp and uniform at any writing speed — so there's no questioning the values you've recorded. They're produced by a pressurized fluid writing method that forces the trace into the paper—not just on it. Never a smudge or smear. The writing's dry on contact.

Accuracy? We guarantee 99½%, and most Mark 280's do even better—thanks to our foolproof pen-position feed-back system that enforces accuracy. Frequency response? To 35 Hz at full 80mm scale — out to 200 Hz at useable amplitudes. Calibrated zero suppression. It's one of many options.



Doubled resolution, near-perfect accuracy, crisp clear traces, high frequency response. That's what you can expect from the Mark 280. Ask your Brush sales engineer for a demonstration. Or write for complete details. Clevite Corporation, Brush Instruments Division, 37th and Perkins, Cleveland, Ohio 44114. We'll include our handy "Chart Running Time" calculator and slide rule.

## CLEVITE BRUSH

**Publisher**

Hugh R. Roome

**Editor**

Howard Bierman

**Managing Editor**

Frank Egan

**Technical Editors**Milton J. Lowenstein  
Michael J. Riezenman  
Raymond D. Speer  
Stella Lawrence**Management and Careers Editor**

Richard L. Turmail

**News Editors**Ralph Dobriner, Chief  
John N. Kessler**Washington News Bureau**

Charles D. LaFond, Chief

**Military-Aerospace Editor**

John F. Mason

**East Coast Editor**

Jim McDermott

**West Coast Editors**Elizabeth deAtley  
David N. Kaye**New Products Editors**Lucinda Matterna  
Roger Allan**Directory Manager**

Greg Guercio

**Copy Editor**

Marion Allen

**Editorial Production**

Dollie S. Viebig

**Art Director**

Clifford M. Gardiner

**Art Assistant**

William Kelly

**Technical Illustrators**Rita Jendrzewski  
Lynn E. Thompson  
JoJo Miskimmon**Production Manager**

Thomas V. Sedita

**Asst. Production Manager**

Helen De Polo

**Production Assistants**Bernard Wolinsky  
Kathleen McConkey**Circulation Manager**

Nancy L. Merritt

**Information Retrieval**

Genate Piccinetti

## EDITORIAL



## Let's broaden those automobile safety standards

A somber anniversary passed last month, unnoticed by all but a very few. The occasion—the 70th anniversary of the first traffic fatality in the United States.

When the victim, Henry H. Bliss, was struck down by what the next morning's newspapers called "an electric taxicab," one of the less attractive statistics of American life began.

Just last year, over 50,000 Americans joined the growing statistics, and the National Safety Council estimates that the 2 millionth victim will die about one year from now. This is a staggering number, considering that the total American deaths in all of the wars fought by the United States is around 1,200,000.

What is being done to bring the highway carnage under control?

The Federal standards imposed largely through the efforts of Ralph Nader are a start—but they are only a start. Next, how about mandatory electronic devices and aids?

Head rests are now mandatory—but how about an automatic alarm system for dozing drivers?

Seat belts are also mandatory—but how about electronic antiskid systems for safe braking under slick road conditions?

Improved-grade tires are now required—but how about systems for giving dashboard indications of tail-light status, brake-fluid status, and other conditions that need checking?

The chances that Detroit auto makers will ever voluntarily incorporate such electronic devices and systems as standard features are slim. The money they cost would most certainly have to be passed on to the purchaser. This can be done if they are offered as options, probably on top-of-the-line models. Safe driving, though, should not be the exclusive province of only those willing to buy more expensive cars.

Unfortunately, it appears that uniform safety and the devices that promote it must be legislated by the Federal Government. But the passage of such legislation requires convincing technical arguments, coupled with persistent effort, combined with an appreciation of mass public relations.

What the electronics industry needs is a little of the Ralph Nader spirit to demonstrate that it could, indeed, contribute to traffic safety on the nation's highways.

FRANK EGAN

**For stronger, smaller, lighter  
PM motors, our alnicos  
pack quite a charge.**



# INDIANA GENERAL *We make it easy for the design engineer.*

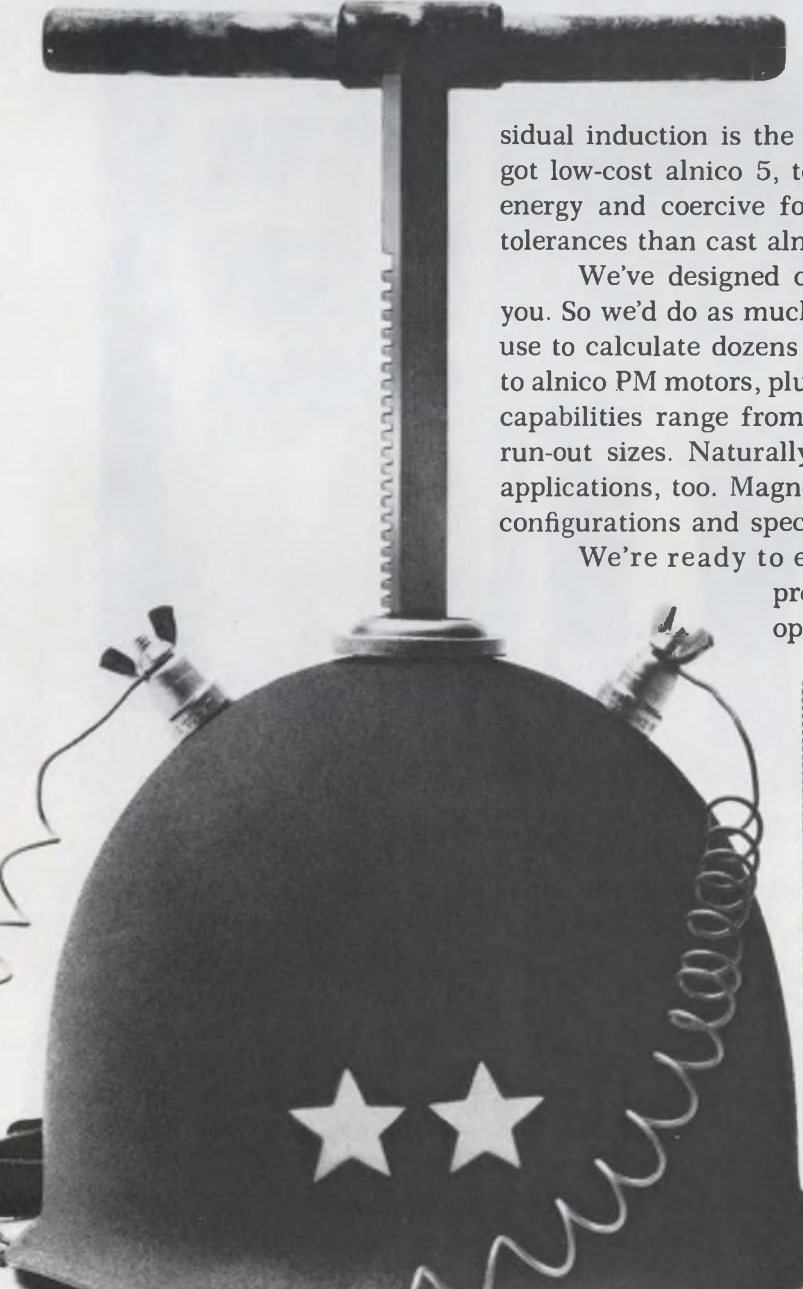

In fact, our HyCo 8H packs 1900 oersted. That's the highest coercive force available anywhere. And HyCo 8B's residual induction is the highest among all alnico 8 types. We've got low-cost alnico 5, too. Our alnicos 5-7 and 6 combine high energy and coercive force. And sintered alnico 8 offers closer tolerances than cast alnicos.

We've designed our magnet materials to work better for you. So we'd do as much for your motor. The same computer we use to calculate dozens of PM motor designs in seconds applies to alnico PM motors, plus a wide variety of generators. Our design capabilities range from small precision motors up to steel mill run-out sizes. Naturally, we can provide magnets for all these applications, too. Magnets with close tolerances, slotting, varied configurations and special magnetization orientation.

We're ready to explode the coercive force and design problems that can logjam your PM motor operations. Write for all the HyCo details.

Mr. C. H. Repenn, Manager of Sales  
Indiana General Corporation  
Magnet Division  
Valparaiso, Indiana

Let's see how your HyCo Alnico 8 and PM motor design capabilities can make it easier for me. Also, please send me the following magnet literature:

- Cast HyCo 8H and 8B     Alnico 5-7  
 Sintered HyCo 8H and 8B     Design and Application Manual

NAME \_\_\_\_\_ TITLE \_\_\_\_\_  
COMPANY \_\_\_\_\_  
ADDRESS \_\_\_\_\_  
CITY \_\_\_\_\_ STATE \_\_\_\_\_ ZIP \_\_\_\_\_

**TELEMETRY'S**  
**MOST**  
**COMPATIBLE**  
**PAIR**



**PC-500 IN THE FIELD**

**TICOR III IN THE LAB**

This matched pair of Mincom Instrumentation Recorder/Reproducers are right out of the same family. Every Mincom PC-500 and every TICOR III grow up together—literally—and this proves out in their faultless cooperation in data acquisition and reduction. They are the industry's most advanced systems for their specified tasks, they share telemetry's ultimate compatibility while providing up to 2 MHz on fourteen channels. The rugged PC-500 was designed from the blackboard up to complement TICOR III's flutter suppression performance. In both systems the basic servo design thinking is identical. At the sub-assembly level, electronics and circuit design are the same. Add to this TICOR III's unmatched servo bandwidth, its low  $\pm 0.4 \mu$  sec time base error, its highly successful two years of field test as Mincom's Model 32—and look no further for **your** complete (and compatible) data team. Write us for details and specifications.

**Mincom Division** **3M**  
COMPANY  
300 SOUTH LEWIS ROAD • CAMARILLO, CALIFORNIA 93010

INFORMATION RETRIEVAL NUMBER 55



## A Mastermox is something more than a metal film.

A Mastermox is a metal oxide glaze resistor. Mastermox resistors combine metal powders with molten glass to bring resistor technology to a new high. Revolutionary design creates high resistance range accuracy — 10K ohms to 10,000 Megohms. Space-savings too. Provides more watts per cubic inch.

Stability? Drift as low as 1% full-load in 2000 hours. On the shelf — less than 0.1% drift per year. Changes in voltage and temperature barely influence Mastermox performance.

Obtain Mastermox critical capability in high

voltage dividers and bleeders, meter multipliers, high voltage probes, oscilloscopes and vacuum tube voltmeters, plate load resistors, pulse forming networks, and similar applications.

Mastermox. Victoreen's master resistor.

Model	Resistance Range	Power Rating @ 70°C	*Max. Oper. Volts	Length Inches	Diameter Inches
MOX-400	1 - 2500 megohms	.25W	1,000V	.420 ± .050	.130 ± .010
MOX-750	1 - 5000 megohms	.50W	2,000V	.790 ± .050	.130 ± .010
MOX-1125	1 - 10000 megohms	1.00W	5,000V	1.175 ± .060	.130 ± .010
MOX-1	10K - 500 megohms	2.50W	7,500V	1.062 ± .060	.284 ± .010
MOX-2	20K - 1000 megohms	5.00W	15,000V	2.062 ± .060	.284 ± .010
MOX-3	30K - 1500 megohms	7.50W	22,500V	3.062 ± .060	.284 ± .010
MOX-4	40K - 2000 megohms	10.00W	30,000V	4.062 ± .060	.284 ± .010
MOX-5	50K - 2500 megohms	12.50W	37,500V	5.062 ± .060	.284 ± .010

\*Applicable above critical resistance. Maximum operating temperature, 220°C. Encapsulation: Si Conformal. Additional technical data in folder form available upon request. Or telephone: (216) 795-8200.

**VICTOREEN INSTRUMENT DIVISION**  
**10101 WOODLAND AVENUE • CLEVELAND, OHIO 44104**  
 EUROPE: ARNDAL HOUSE, THE PRECINCT, EGHAM, SURREY, ENGLAND • TEL: EGHAM 4887



# MORE V LESS ¢

## plastic SCRs from Transitron

### New, silicon planar SCRs in plastic, rated to 300V, at industry's lowest prices\*

Transitron's low-cost RTJ Series plastic SCRs offer new scope to designers of commercial and consumer electronic equipment. Now, for the first time, inexpensive plastic SCRs with documented reliability are available with 200V ratings (for 115V applications) and even 300V ratings for special requirements. Plastic-encapsulated in a TO-92 package, the new units are designed especially for applications requiring long life and high performance.

#### RTJ02 & RTJ05 SERIES

- Ratings to 300V @ .8A RMS
  - Triggering sensitivities to 20 $\mu$ A
- Now also available: 2N5060 Series

\* RTJ0201 (15V rating): \$.44 in 100-quantities, with immediate availability at your local Transitron Distributor. Production quantities, 2-4 weeks ARO.

- Supported by the industry's first reliability and performance report on plastic SCRs . . . 24 pages of valuable information for design engineers — available free.
- Also available . . . up-to-the-minute application data on full plastic SCR line.



**Transitron**  
electronic corporation  
168 Albion Street, Wakefield, Mass. 01880

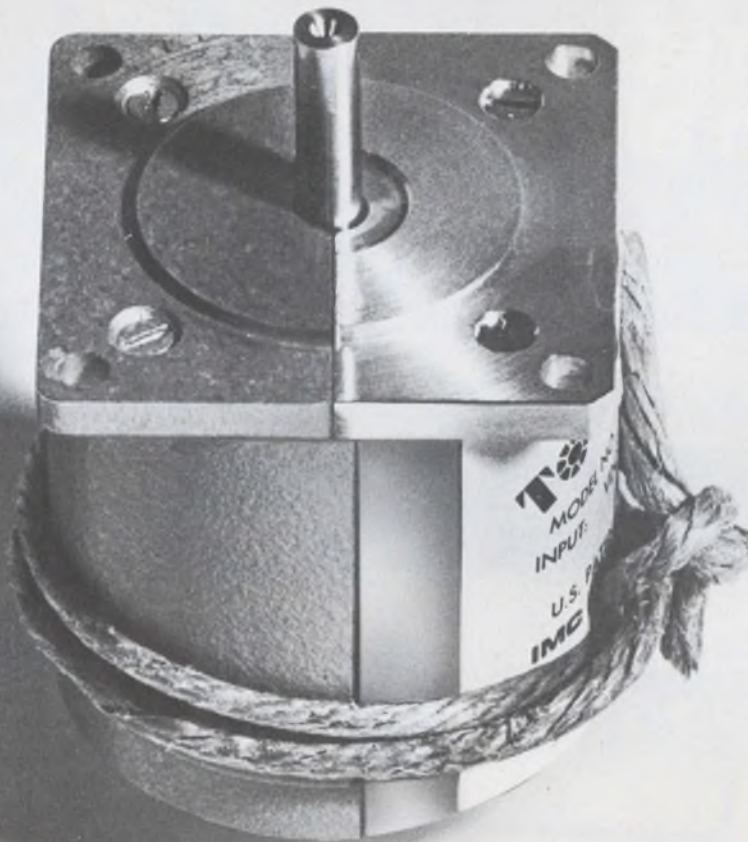

## The Better Halves.

## Or how to get the best of 2 single source suppliers.

Have the best of choices.  
Try IMC's newly patented Tormax 200.

It's directly swappable with the other one.

Steps in 1.8-degree increments at rates up to 550 steps/sec.

Turns at 72 rpm from a 60-Hz input.

Backed by IMC's extensive stepper design and manufacturing capability.

Available immediately in standard models.

A little longer for dual shafts, splines, keyways, different mounts, and so forth.

IMC Magnetix Corp., Western Division, 6058 Walker Avenue, Maywood, California 90270, Tel. (213) 583-4785, TWX 910-321-3089.

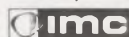

# Signal Generators...

here's the one  
that replaces  
them all.....\*



## The New SG-1000 outperforms all other signal generators from LF to UHF (singly or in combination)

The new Model SG-1000 Signal Generator has obsoleted all others within its frequency range... singly or in combination. The specifications of this 5<sup>1</sup>/<sub>4</sub>" high instrument are unequalled... and are rarely approached.

- LF to UHF coverage... 61 kHz, to 512 MHz, extendable to 1024 MHz with simple passive doubler
- Output frequency is read directly on three digit display with two digit extension
- Unsurpassed frequency accuracy and resolution... typically 0.005%... without the commonplace problems of human error in readout.
- Unparalleled modulation capability, AM, FM, pulse, video (100 MHz bandwidth!)

simultaneous combinations such as AM/FM, FM/pulse, etc. with negligible interaction

- Automatic leveling... within  $\pm 0.25$  dB over *entire* frequency range from +20 dBm to -146 dBm
- Doubles as a frequency counter for measuring external signals between 100 Hz and 2 MHz

And if you are still not convinced that the Model SG-1000 has obsoleted most of your present signal generating equipment, consider the fact that its spectral purity approaches that of a crystal oscillator... that it has negligible warm-up drift... no "settling time" after band switching... and many other performance features not found in ordinary generators.

For additional technical information, or for Singer's new Application/Data Bulletin SG-10, contact your nearest Singer Field Representative or write directly to The Singer Company, Instrumentation Division, 915 Pembroke Street, Bridgeport, Conn. 06608. (203) 366-3201. *In Europe contact:* The Singer Company, Instrumentation Division, P.O. Box 301, 8034 Zurich, Switzerland, Telephone: (051) 47 25 10

**SINGER**  
INSTRUMENTATION

\*Hewlett-Packard Models 608F, 606A and 5245L/5253B / Marconi Model 1066B/6, Pin Diode Modulator, Coaxial Switch



## Programming was pretty slow... Now, the Beckman 6401 is programmable to 136 MHz

In the Model 6401 Programmable Counter and Timer, Beckman offers a general purpose laboratory and production instrument that does what you want it to, at a price you can't resist... \$1375.

The 6401 provides direct frequency measurements to 136 MHz and complete programmability from contact closures. And the 6401 makes new measurements that were "unheard" of in the Good Old Days — like pulsed RF frequency or burst frequency measurements and period measurements from both channels for calibrated phase timing.

Timing measurements are a breeze with the exclusive trigger point monitor lamps in the 6401 for optimum attenuator and trigger adjustments. And maximum utilization of field replaceable IC's assures highest reliability and the lowest cost of ownership.

The 6401 is provided in a compact 3½" rackable package to conserve systems panel space, with 1-2-4-8 BCD outputs and scope markers as standard features. Options for serial input and output data, for nine digit display, and oscillator options with stabilities to 5 parts in 10<sup>10</sup> per 24 hours are available.

Regardless of what "programmable" meant in the good old days, take advantage of what Beckman has

to offer today. For complete information, contact your local Beckman office, sales representative or the factory direct.

### Specifications

*Measurement Modes:* Frequency: Input A, 0-136 MHz; Input B, 0-10 MHz. Burst Frequency: 0-136 MHz. Time Interval: A to B, 0.1 μsec to 10<sup>6</sup> sec. Period: Input A, 0-10 MHz. Period Average: Input A, 1 to 10<sup>6</sup> in decade steps. Ratio: (F<sub>x</sub> ÷ F<sub>y</sub>) × M with F<sub>x</sub> = 0 to 136 MHz, F<sub>y</sub> = 0 to 10 MHz, M = 1 to 10<sup>6</sup>. Totalize and Scale: Input A, 0-10 MHz scale; 136 MHz count, 1 to 10<sup>6</sup> in decade steps. *Sensitivity:* Inputs A & B, 100 mV rms. *Crystal Frequency:* 10 MHz. *Stability Aging Rate:* Temperature: 2.5 × 10<sup>-4</sup> from 0°C to 50°C; Line Voltage: 1 × 10<sup>-2</sup> for ± 10% line voltage change. *Oscillator Output:* 10 MHz. *External Oscillator Input:* 10 MHz. *Time Base Output:* 3 V p-p. *Display:* 8 digits with overflow indication. Storage ON-OFF. Sample Rate: fast recycle and .1 sec to 10 sec display. Gate Lamp. *Remote Programming:* by switch closure to ground; BCD data at rear panel. *Temperature:* 0-55°C. *Power:* 115/230 V ± 10%; 50-400 Hz. *Price:* \$1375. *Options:* ACL: Laboratory Stability Oscillator, 3 parts in 10<sup>9</sup> per 24 hrs; \$400. ACN: Ultra-high Stability Oscillator, fast warm up, 5 parts in 10<sup>10</sup> per 24 hrs; \$800. 9 digits: \$100. Rear Inputs (A and B): \$50.

**Beckman**

INSTRUMENTS, INC.

ELECTRONIC INSTRUMENTS DIVISION

RICHMOND, CALIFORNIA • 94804

INTERNATIONAL SUBSIDIARIES: AMSTERDAM; CAPE TOWN; GENEVA; GLENNHOLTHES, SCOTLAND; LONDON; MEXICO CITY; MUNICH; PARIS; STOCKHOLM; TOKYO; VIENNA

INFORMATION RETRIEVAL NUMBER 60

# 5 GE silicone problem solvers.



**Invisible seal against moisture.** Translucent GE RTV-615 silicone rubber used on this underwater connector assures clear identification of terminals, and improved dielectric strength under high voltage. RTV has excellent electrical properties.



**Mold life doubled.** New RTV-630 silicone molds last twice as long as conventional silicones in molding epoxy parts for electronic modules. Tear strength of 100 lb/in (die B) makes "630" the toughest RTV yet... without sacrificing flexibility.



**Durable marking labels** made of GE silicone rubber withstand temperature extremes, aging, moisture, chemicals, fire. RTV adhesive/sealant keeps flexible labels in place permanently on cable, industrial equipment.



**Beats heat and cold.** Electrical heating strip on pipes keeps temperatures constant, indoors and out. GE silicone rubber "jacket," sealed with RTV, has high dielectric strength, resists aging, corona, from  $-65^{\circ}$  to  $600^{\circ}$ F.



**Cheaper than gaskets.** GE RTV-109 silicone rubber seals plate assemblies of food slicer to keep juices out. Non-toxic, inert RTV-109 is applied easily, forms permanent, moisture-proof bond. Contact GE for FDA data on RTV-109.



## And 500 others waiting in the wings.

Chances are you're wrestling with a design problem that could be solved with a GE silicone.

But *which* GE silicone? We have over 500 varieties to choose from. And thousands of success stories to back them up.

Let's make a deal. You tell us what your problem is, and we'll help you solve it.

Without fail.

Write to Section L10311R1, Silicone Products Department, General Electric Company, Waterford, New York 12188.

GENERAL  ELECTRIC

INFORMATION RETRIEVAL NUMBER 61





ACTUAL SIZE

# RELAYS

## 1/6-Size Relay Model BR10

- Dry Circuit to 1 Amp.  DPDT
- Welded or Soldered  Universal Contacts  To MIL-R-5757

Babcock's Model BR10 1/6-size crystal can relay packs a lot of performance in a small package. Its unique universal contacts give you "non-stop" operation from dry circuit to 1 amp...one subminiature relay to meet all your requirements for high-density circuit-board applications—at no cost premium.

You'll find that this small, versatile, DPDT unit has everything. Designed to specification MIL-R-5757, it features rugged unitized construction for increased shock and vibration resistance. Both soldered or welded versions are offered. Regular and gold-plated plug-in, solder-hook, and long-lead terminal styles are available, in standard circuit-board grid pattern, with a range of mounting types.

The Model BR10 has a record of dependability, attested by its proven conformance to MIL-R-5757 and specified use in programs requiring operation under the most severe environmental extremes. Built-in reliability, outstanding performance, application flexibility...all assurances that your relay is *better because it's Babcock*.

The Babcock Model BR10 relay has proven its reliability in a variety of aerospace and commercial avionics applications. Its subminiature size makes it ideal for single and multi-relay circuit-board installations. In fact, a brace of four BR10's has been found to take less board space than a similar group TO-5 units. You get efficient high-density packaging, *plus* full 1-amp. capability.



**Need 2-amp. performance?** The Model BR10 will operate dependably at 2 amps. (28 VDC), through 100,000 operations, in the temperature range  $-65^{\circ}\text{C}$  to  $+125^{\circ}\text{C}$ . Contact our Applications Engineering Group for further details.

### SPECIFICATIONS

Contact Rating	..... 1 amp. @ 28 VDC
Operate/Release Time	.... 3.5 ms., max.
Pull-In Power	..... 100 mw
Bounce Time	..... 2 ms., max.
Shock	..... 50 g's (11 ms.)
Vibration	..... 30 g's, 38-2000 Hz
Operating Temp.	.... $-65^{\circ}\text{C}$ to $+125^{\circ}\text{C}$
Life	..... 100,000 operations, min.

Get complete information on the versatile, subminiature Model BR10 today...contact Babcock Electronics Corp., Relays Division, Subsidiary of Esterline Corp., 3501 Harbor Blvd., Costa Mesa, Calif. 92626. CALL COLLECT (714) 540-1234 or TWX 910-595-1517.

**Available off-The-Shelf from  
AVNET, POWELL or PDQ.**

Challenging opportunities now exist at Babcock for experienced relay-switch engineers.



Even if your data goes from  to  you can see it all on one display.



Some of your data will barely twitch an indicator.

Some of it goes right off the scale.

No problem. The HP 7563A Voltmeter/Amplifier logarithmically compresses data with a dynamic range of 110 dB—110 dB!—and gives you a single output that includes both high and low amplitude data with constant resolution and accuracy. The 7563A accepts positive or negative signals from vibration tests, geophysical measurements, pulse height analyzers, computers and similar sources, compresses the amplitudes logarithmically and feeds the results directly to a recorder or oscilloscope. The front-panel meter gives an instant visual display in dB. And when it's not performing that job, the 7563A will double as a voltmeter (calibrated from 0.3 mV to 100 V) for

system or bench use. How's that for a voltmeter/amplifier with the modest price of \$695 and one of the widest dynamic ranges you can buy?

To add AC log conversion and voltmeter applications to DC, use the 7562A with its 80 dB dynamic range. It's the only converter on the market that can measure the true rms value of an AC voltage. Turn it loose on vibration studies, biochemical data, seismographi-

studies, audio research or similar data with large asymmetrical wave forms and it will give you the most accurate log conversion you can get in AC. Or use it as an AC/DC voltmeter, calibrated directly in volts. Price is \$995.

For more information, call your local Hewlett-Packard field engineer or write Hewlett-Packard, Palo Alto, California 94304; Europe: 1217 Meyrin-Geneva, Switzerland.

HEWLETT  PACKARD

11907A

# new

# dimensions

WITH

# QMF\*

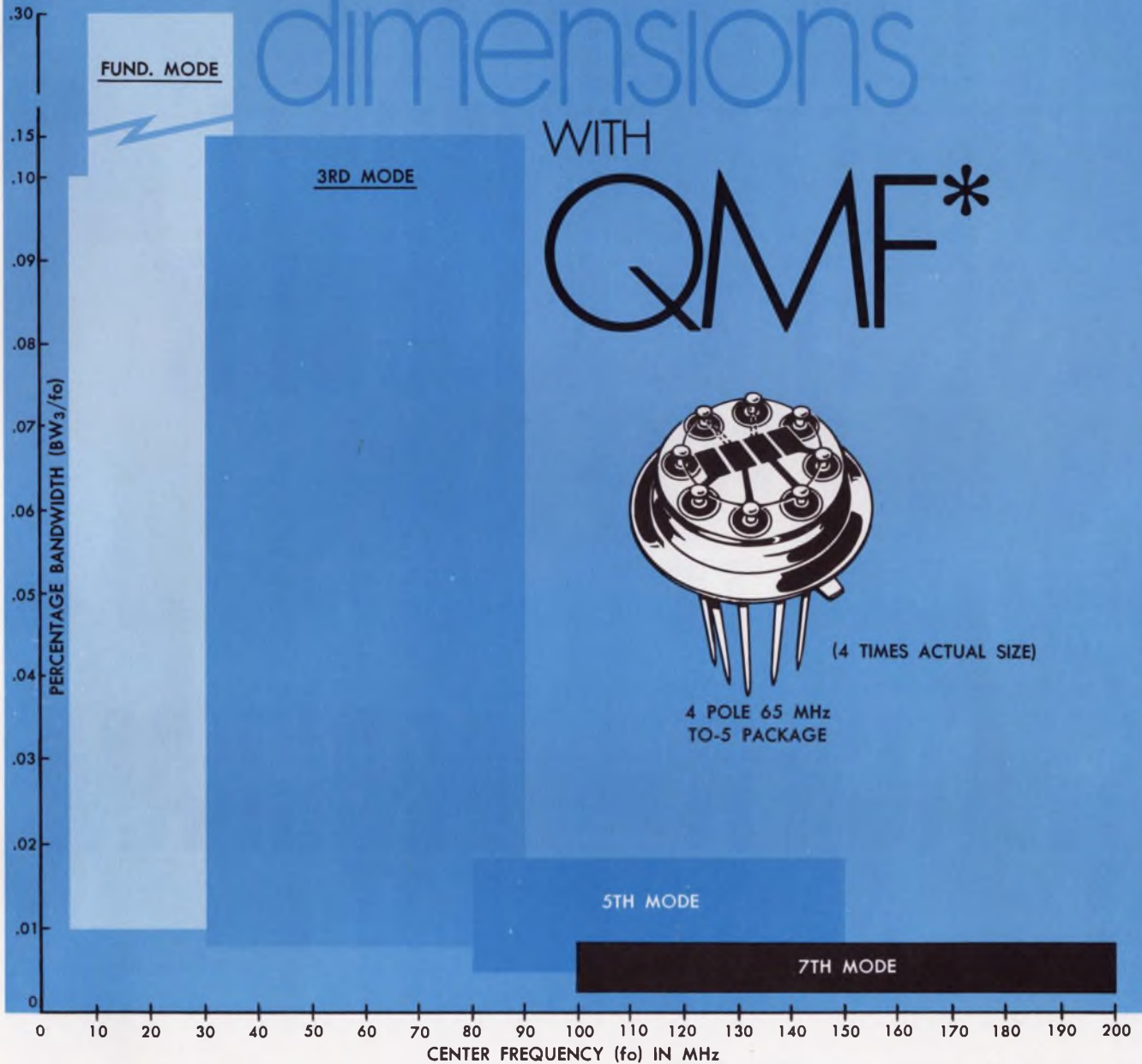

(4 TIMES ACTUAL SIZE)

4 POLE 65 MHz  
TO-5 PACKAGE

(here's valuable bandwidth information you'll want to save)

Regardless of what they are called, M<sup>C</sup>oy Electronics Co. makes available the most complete offering of multi-electroded devices in the industry. From 5 to over 200 MHz, both crystal and filter technologies are combined to provide you assurance of competence, quality and reliability. We engineer and fabricate...

**\*Quartz Mechanical Filters**  
**Uncoupled Filter Devices**  
**Custom Innovations...**



**M<sup>C</sup>COY ELECTRONICS COMPANY**

MT. HOLLY SPRINGS, PENNSYLVANIA 17065

Tel. 717-486-3411 TWX: 510-650-3548



a subsidiary of OAK ELECTRO/NETICS **CORP**

Put our experience to work for you!

INFORMATION RETRIEVAL NUMBER 64

# IF YOU'VE GOT THE TIME...

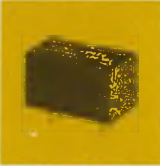
WE CAN DELAY IT 

REPEAT IT  VARY IT 

RESET IT  ADJUST IT

 RE-CYCLE IT 

CALIBRATE IT 

SWITCH IT  PROGRAM

IT  AND STOP IT.

And if that's not enough, we'll custom build almost any combination of the above capabilities to do exactly what you need. We're timing experts. Call us when you have time.

**MIDTEX**   
INCORPORATED  
AEMCO DIVISION  
10 STATE STREET  
MANKATO, MINNESOTA  
56001

PROGRAMMERS/TIME DELAY RELAYS/MINIATURE COAXIAL RELAYS/INDUSTRIAL RELAYS/MERCURY-WETTED CONTACT RELAYS

INFORMATION RETRIEVAL NUMBER 65

# Technology



**"Feedback amplifiers,"** says John DeFalco, an engineer of Honeywell's Computer Control Div., "are a snap for network topology." p. 98.



**Fred Palenschat points** to a dual JFET that provides low common-mode voltage to an IC amplifier's input. p. 86.

## Also in this section:

**Build digital models of analog systems** with a component block program. p. 90.  
**Cut binary-to-BCD conversion costs** with this special circuit. p. 104.  
**Preparing a technical paper?** These steps will help you. p. 112.  
**Ideas for Design.** p. 117.

# Consider dual JFET input stages

when the requirements call for high input-impedance, low common-mode voltage and good temperature tracking.

Are you faced with the problem of creating an amplifier with high dc input impedance, low bias currents, and low temperature drift—perhaps for use as a long-time constant integrator or with a nanoampere transducer? Your solution may be the dual junction FET, which facilitates the design of amplifiers requiring low offset voltages and good temperature tracking.

Serious objections have been raised to the use of discrete field-effect transistors at the input of a high-impedance dc amplifier. These include:

- Junction field-effect transistors (JFETs) are notorious for their wide parameter spread;  $I_{dss}$  currents may vary by a factor of ten.

- A pair of JFETs can show a wide divergence of  $I_{dss}$  and pinchoff voltage as a function of temperature.

- High pinchoff voltage in a JFET used in the source follower mode driving a linear IC appears as an applied high common-mode voltage, and a high gate-source voltage applied to the inputs can result in latchup or breakdown of an input stage.

The dual JFET has matched characteristics that minimize the first two problems, and careful design of the input network reduces the third to acceptable levels.

## Matching characteristics are a big plus

As an example of what dual JFET matched characteristics can accomplish, a 2N5199 has a maximum offset voltage of only 15 mV, and its temperature tracking specifications hold to better than  $40 \mu\text{V}/^\circ\text{C}$ . In a laboratory temperature test of the 2N5199 used to drive a 741 op amp in a unity gain—high input impedance configuration—a  $\pm 30^\circ$  change in temperature, resulted in less than 0.5 mV of drift.

However, the disadvantage of the high pinch-off voltage that is inherent in JFETs, discrete or dual, must be taken into account. It has been common practice to place a potentiometer in the

source (Fig. 1) or gate (Fig. 2) of one or both of the JFETs in order to “balance” the differential output voltage seen by the operational amplifier. These are weak solutions to a perplexing problem. First of all, the pots do not reduce the possible magnitude of common-mode voltage that could be applied to the op amp. Secondly, if discrete JFETs were used, zeroing of the closed-loop circuit would necessarily be very touchy.

But a new circuit design method using dual JFETs minimizes large expected pinchoff voltage levels to tolerable limits without using a potentiometer except for an offset null adjust.

Common sense indicates that, if the pinchoff voltage were split so that JFET units at either extreme of a given type number might yield a plus or minus common-mode voltage, the problem would be divided in half. A pair of diodes or zeners in each source is one way of doing this, except that finding the correct number of diodes or zeners to split the pinchoff voltage exactly might prove to be a bigger and even more complicated problem.

However, if the magnitude of the maximum expected pinchoff voltage could somehow be made to appear to be reduced and then have this value split, the resulting benefits are obvious. Then the common-mode error voltage applied to the IC would be minimized without an extra time-consuming and expensive calibration step. Except for the offset adjustment mentioned previously, no other dc compensating adjustments are necessary—a boon to any production run. In fact, if the maximum offset of the amplifier is insignificant compared to the magnitude of the input signal, or if ac coupling is used, no zeroing adjustment need be made at all.

This leads to a second important benefit of dual JFETs: calibration costs on the final amplifier assembly in a production run are reduced.

## Design the circuit

From the manufacturer's data sheet for a given dual unit, specifications for the minimum and maximum values of  $I_{dss}$  and  $V_p$  can usually be obtained. These are the only values needed

to complete the computations. Often, however,  $V_{pmin}$  is not given. In these instances,  $V_p$  can be approximated by the following formula:

$$V_{pmin} \approx 1.3(I_{dssmin}/y_{fsmin})$$

This could have an error of as much as 30%, but it would have only a minor effect on the final result.

The computations from this point on are in a logical sequence to give an orderly procedure to the design of the final circuit. (Known and accepted empirical formulas describing FET action will be used, since they give fairly accurate results. They are indicated by reference numbers in the text.) Figure 3 shows resistor designations and the final circuit configuration.

1. Select an operating current less than or equal to  $I_{dssmin}$  to ensure that all units in the selected series will be able to supply the required drain current:

$$I_{DL} \leq I_{dssmin}$$

2. Compute the gate-source voltage<sup>1</sup> at  $I_{DL}$ :

$$V_{GSL} = V_{pmin}(1 - \sqrt{I_{DL}/I_{dssmin}})$$

3. Compute the total source resistance  $R_s$ :

$$R_s = (V_{rs} + V_{GSL})/I_{DL}$$

4. Compute the maximum gate-source operating voltage<sup>2</sup>, which is  $V_{GSH}$ .

It can be shown that

$$R_s = (\sqrt{I_D/I_{dss}} - 1)/(I_D/V_p)$$

for a source follower. Combining this equation with results from steps 2 and 3 and observing that maximum values of  $I_{dss}$  and  $V_p$  are used to compute  $V_{GSH}$ :

$$0 = V_{GSH}^2 - V_{GSH}V_p \max(2 + V_p \max/R_s, I_{dss} \max) + V_p^2 \max(1 - V_{rs}/R_s, I_{dss} \max)$$

which is of the form:

$$V_{GSH}^2 - BV_{GSH} + C = 0$$

$$V_{GSH} = (B - \sqrt{B^2 - 4C})/2$$

5. Solve for the drain current,  $I_{DH}$ , which flows with  $V_{GSH}$  applied.

$$I_{DH} = (V_{rs} + V_{GSH})/R_s$$

6. The values of  $R_1$  and  $R_2$  must now be computed. Writing the node equations for Fig. 3 under maximum and minimum conditions:

$$-V_{rs} + I_{DL}R_2 = V_{OL}$$

$$V_{GSL} - I_{DL}R_1 = V_{OL}$$

$$-V_{rs} + I_{DH}R_2 = V_{OH}$$

$$V_{GSH} - I_{DH}R_1 = V_{OH}$$

It is also required that:

$$V_{OL} = -V_{OH} \text{ for symmetry.}$$

Combining these equations yields the result:

$$R_2 = R_1(2V_{rs})/(V_{GSL} + V_{GSH})$$

From step 3:

$$R_s = R_1 + R_2$$

$R_1$  and  $R_2$  can be computed.

7. Compute the quiescent output voltage ranges  $V_{OH}$  and  $V_{OL}$  with the values of  $R_1$  and  $R_2$ .

From step 6:

$$V_{OL} = -R_1 I_{DL} + V_{GSL}$$

$$\text{and } V_{OH} = -R_1 I_{DH} + V_{GSH}$$

This completes the computational analysis of the circuit.

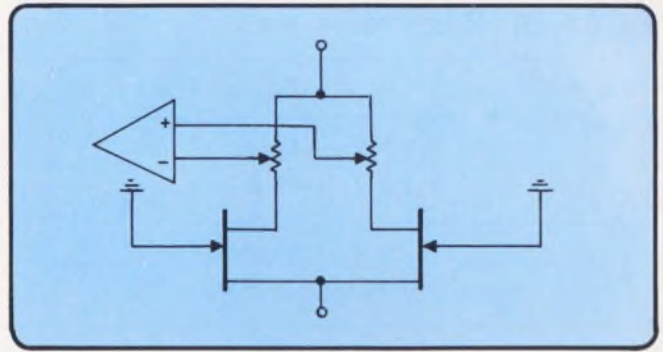

1. With potentiometers in source circuit this dual JFET requires touchy, time-consuming adjustment and the cost of the extra pot. If this circuit is used a pair of discrete JFETs, it would also show poor temperature tracking, and poor  $I_{dss}$ ,  $V_p$  and  $y_{fs}$  tracking.

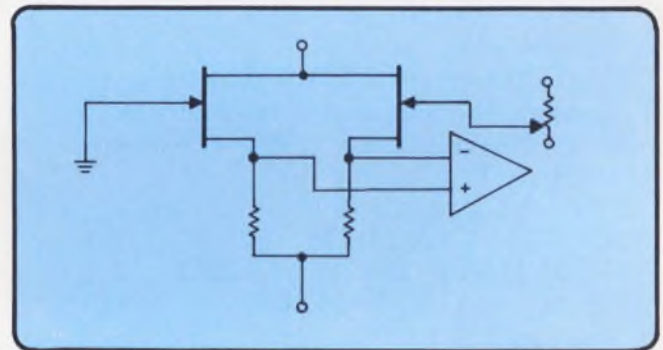

2. With potentiometer in one gate circuit the dual JFET cannot reduce common-mode errors due to high  $V_p$ . A discrete JFET pair would also exhibit this difficulty.

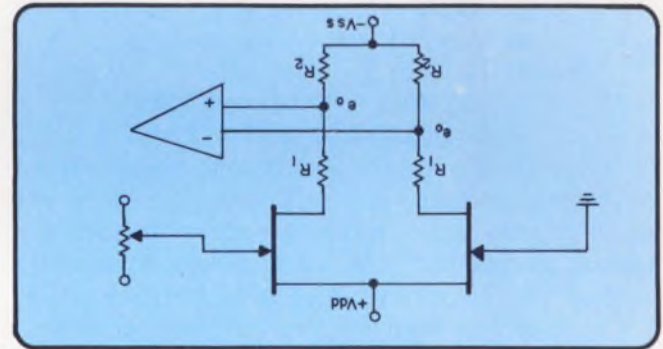

3. This recommended circuit using a dual JFET reduces common-mode errors, exhibits good temperature and parameter tracking, and shows ease of adjustment.

In order to get a feel for the benefits of this design, a simple computation is given, along with the laboratory results.

The manufacturer's specifications for the 2N5199 dual FET, which is used in the example, are as follows:

$$V_{GSmax} = 5 \text{ V}$$

$$I_{dssmax} = 7 \text{ mA}$$

$$V_{GSmin} = 1 \text{ V}$$

$$I_{dssmin} = 0.7 \text{ mA}$$

$$\text{Let } V_{rs} = 10 \text{ V}$$

## Table of Results

Unit No.	$V_D$	$I_{DSS}$	$V_{OL}$ (computed)	$V_{OL}$ (measured)	$V_{OH}$ (computed)	$V_{OH}$ (measured)
1	a	2.3 V 2.1 mA	-0.39 V	-0.44 V	0.37 V	0.36 V
	b	1.3 V 0.89 mA				
2	a	2.3 V 2.1 mA	-0.68 V	-0.70 V	0.68 V	0.77 V
	b	0.85 V 0.25 mA				
3	a	1.3 V 0.89 mA	-0.28 V	-0.28 V	0.28 V	0.33 V
	b	0.85 V 0.25 mA				

1. Select an operating current equal to or less than  $I_{DSS}$  min.

Let  $I_{DL} = 0.5$  mA.

2. Compute  $V_{GSL}$ .

$$V_{GSL} = 1(1 - \sqrt{0.5/0.7}) = 0.16 \text{ V}$$

3. Compute the total source resistance,  $R_s$ .

$$R_s = (10 + 0.16) / 0.5 \times 10^{-3} = 20.32 \text{ k}\Omega$$

4. Compute  $V_{GSH}$ .

From the quadratic equation:

$$B = 5 [2 + 5 / (20.32) (7)] = 10.2$$

$$C = 25 [1 - 10 / (20.32) (7)] = 23.2$$

$$V_{GSH} = 10.2 - \sqrt{104 - 92.8} / 2 = 3.44 \text{ V}$$

5. Compute  $I_{DH}$ .

$$I_{DH} = (10 + 3.44) / 20.32 \times 10^3 = 0.665 \text{ mA}$$

6. Compute  $R_1$  and  $R_2$ .

$$R_2 = (2) (10) R_s / (3.44 + 0.16) = 5.55 R_s$$

$$R_2 + R_1 = 20.32 \text{ k}\Omega$$

$$R_2 = 17.22 \text{ k}\Omega$$

$$\text{and } R_1 = 3.1 \text{ k}\Omega$$

7. Compute  $V_{OH}$  and  $V_{OL}$ .

$$V_{OL} = -(3.1) (0.5) + 0.16 = -1.39 \text{ V}$$

$$V_{OH} = -(3.1) (0.665) + 3.44 = 1.41 \text{ V}$$

It is immediately obvious that the total spread of output voltage,  $e_o = |V_{OH} - V_{OL}|$ , does not equal the maximum pinch-off voltage. In fact, the maximum pinch-off voltage has been apparently reduced in magnitude. Also, this reduced pinch-off voltage has been split in half to give a plus or minus output level, thus further reducing the maximum output common-mode voltage applied to the linear IC by more than 70%.

### Experiments verify theory

In the lab, the preceding circuit was built substituting a 3-k $\Omega$  resistor for  $R_1$  and an 18-k $\Omega$  resistor for  $R_2$ . (Standard values were selected as close as possible to the computed values of  $R_1$  and  $R_2$ .) With the above values for  $R_1$  and  $R_2$  substituted into the circuit, the quiescent output voltage for three typical units was found to be well within the calculated limits of  $e_o$ .

In order to test further the validity of the derived equations, the  $I_{DSS}$  and  $V_p$  parameters of

several units were measured, and the units were then paired off to represent the maximum and minimum extremes of an FET type. The values of  $R_1$  and  $R_2$  and  $V_{OH}$  and  $V_{OL}$  were first computed, and then  $V_{OL}$  and  $V_{OH}$  were actually measured. The results appear in the table.

It is obvious that the computed and measured values of  $V_{OL}$  and  $V_{OH}$  agree very closely. It can also be observed that the total output voltage range in each case is much less than the maximum pinch-off voltage, which is in effect an apparent reduction in the maximum pinch-off voltage.

This design procedure can lead to an extremely stable and repeatable system of a dual FET and linear IC that provides the benefits of good temperature tracking, low offset voltages, low common-mode errors, and with a minimum of calibration time. This is accomplished with standard value components and only one additional pot. ■■

### References:

1. Dickson Electronics Corp., Application Notes, Vol. 1, No. 2.
2. Dickson Electronics Corp., Application Notes, Vol. 1, No. 5.

### Test your retention

Here are questions based on the main points of this article. Their purpose is to help you make sure you have not overlooked any important ideas. You'll find the answers in the article.

1. What are the ill effects of high pinch-off voltage?
2. How can the common-mode voltage be reduced?
3. What advantages do dual JFETs have over discrete JFET pairs?



# ALSiMAG<sup>®</sup>

## Small Precision CERAMICS "As Fired"

Illustrated Approximately Actual Size.

### PROGRESS REPORT



.370 ± .003  
Hole .025 ± .002



O. D. .467 ± .000  
- .005



.532 ± .005



Holes .056 ± .003  
Holes .016 ± .002



Radii .171 ± .002



Slot Width .070 ± .002  
Holes .034 ± .001



O. D. .379 ± .0025  
Holes ± .003



Thickness .0165 ± .0015



Slot Width .064 ± .002  
Floor Thickness .050 ± .001



Hole .042 ± .001



O. D. .484 ± .003  
Hole .016 ± .002



O. D. .304 ± .003  
Holes ± .002



O. D. .369 — .372 ± .0015



O. D. .218 ± .0015  
Hole .094 ± .001



Holes ± .002  
Thickness ± .002

Improvements in electronic devices have been limited by the cost and time requirements of precision ceramics produced by grinding, lapping and polishing. The ability to produce ALSiMag<sup>®</sup> "as fired" ceramics to close tolerances removes the limits on quantity, speeds deliveries, favorably influences cost, and assures greater uniformity from piece to piece and lot to lot. In many cases the "as fired" surface also has more favorable electrical characteristics.

### SPECIAL FACILITIES

The volume of ALSiMag<sup>®</sup> precision "as fired" ceramics has grown steadily each year. Equipment has been refined. Skills have been upgraded. Environment and raw material controls have been strengthened. Engineering know-how has been increased. All these result from years of work on precision "as fired" ceramics.

### ALUMINA, STEATITE OR BERYLLIA

To meet the requirements of our customers, capabilities have gradually been extended to include Forsterite, cordierite, beryllia and steatite as well as the alumina

ceramics. ALSiMag<sup>®</sup> steatite ceramics have long been the leaders in the industry. They have been used for decades with marked success. These highly refined steatites, exclusive with American Lava, have favorable electrical characteristics which are not equaled by any others. They usually offer substantial cost savings, especially in large volume.

### SPECIALIZED EXPERIENCE

Today American Lava has the broadest capabilities available in precision "as fired" ceramics. The illustrations point out significant dimensional tolerances and give an idea of current production capabilities.

### HELP FOR YOU

Inquiries on close tolerance ceramics should be as detailed as possible. Please remember that the broadest tolerances permitted by the design will result in the lowest cost. Designs with tolerances "impossible" a few years ago are now practical. Tell us what you need and our technical people will be glad to make suggestions.

CODE IDENT. NO. 70371

PHONE 615 265-3411 • CHATTANOOGA, TENNESSEE 37405, U.S.A.

American Lava Corporation **3M**  
A SUBSIDIARY OF COMPANY

For service, contact American Lava representatives in Offices of Minnesota Mining and Manufacturing Company in these cities (see your local telephone directory): Boston: Needham Heights, Mass. • Chagrin Falls, Ohio • Chicago: Elmhurst, Ill. • Dallas, Tex. Indianapolis, Ind. • Laurens, S. C. • Los Angeles, Calif. • Metropolitan New York: Ridgefield, N. J. • Up-State New York and Canada: Phoenix, New York • Orange, Conn. • Philadelphia, Penna. • Roanoke, Virginia • St. Louis: Lee's Summit, Mo.

68th  
YEAR  
OF  
CERAMIC  
LEADERSHIP

# Build digital models of analog systems.

A component block program gives analog flexibility to a digital computer.

For the engineer who wants the advantages of analog simulation without the need to learn programming, the Continuous System Modeling Program (CSMP) jumps the language barrier. One version does this by means of computer-typed instructions, punch cards and a console keyboard. Other versions are being offered for use on time sharing terminals. All versions, however, are based on similar concepts although capabilities vary.

The CSMP package, developed by IBM, contains: (1) a complement of functional elements, or blocks; (2) an input language for transforming the systems block diagram into computer statements; and (3) a technique for conducting a simulation run. No prior computer experience is required—in fact, the system is simpler to use than an analog computer for the same type of problem.

When the system uses a relatively small, fast computer, like the 1130, or a time sharing terminal it is economically feasible for the user to interact in an on-line mode with the simulation. Since the typical simulation run takes only a few minutes, it is practical to experiment with a system under study until its design and performance are satisfactory. "Conversation" with the computer takes place by means of a console typewriter and auxiliary switches.

## Digital blocks replace analog

CSMP in conjunction with the IBM 1130 computer makes use of a set of 25 standard simulation elements, or blocks, and five special user-defined elements. The standard elements include such conventional analog devices as summing amplifiers, inverters, integrators, multipliers, relays, potentiometers, absolute value, dead zone, limiters, clippers, zero order hold, time delay and the like.

Figure 1 illustrates a representative group of

Element type	Language symbol	Diagrammatic symbol	Description
Dead space	D		
Function generator	F		
Gain	G		$e_0 = P_1 e_1$
Integrator	I		$e_0 = P_1 + \int (e_1 + e_2 P_2 + e_3 P_3) dt$
Limiter	L		
Offset	O		$e_0 = e_1 + P_1$
Weighted summer	W		$e_0 = P_1 e_1 + P_2 e_2 + P_3 e_3$
Multiplier	X		$e_0 = e_1 e_2$
Divider	/		$e_0 = e_1 / e_2$
Special	1-5		Subroutines supplied by user

1. A few of the 1130 CSMP functions available are shown in this chart of representative elements.

Martin Y. Silberberg, Mgr. Data Acquisition and Control Systems Center, IBM, Palo Alto, Calif., and Charles A. Luke, IBM World Trade Corp., New York.

1130 CSMP functional elements and their symbols. Each functional block has up to three possible inputs and a single output. Special blocks can be created by the user by adding the name of the function to the CSMP language and by specifying the operation of the block in FORTRAN. The special blocks are subroutines that require a knowledge of FORTRAN for their development.

The simulation model of a system is developed by first interconnecting on paper, in block diagram fashion, the various functional elements needed to portray the system. After the system block diagram has been developed, it must be translated into the corresponding set of CSMP language statements.

The input language permits specification of the functional blocks and their interconnection, the parameters and initial conditions for each run, and specific run instructions, such as total time simulated, integration intervals, output format (printed or plotted), and the like. The language provides three types of statements:

- Configuration statements, which specify desired functional blocks and their interconnections.

- Parameter statements, which permit selecting numerical constants for those elements that have parameters associated with them. As shown in Fig. 1, some elements—multipliers, dividers, etc.—have inputs but no associated parameters; these require only configuration statements.

- Function generator statements, to define the input/output relationships for function generator elements. Since function generators also have associated parameters, they require all three types of statements.

#### Keyboard allows user to interact

The user enters the program statements either by means of punched cards or directly from the console keyboard. Punched cards, prepared in a standardized format, are usually preferred for initial problem entry; this reserves the console keyboard and switches for on-line modifications of statements and run conditions. A sequential entry procedure need not be followed; block num-

bers are assigned arbitrarily, and configuration statements are entered in any order. The order of computations to simulate parallel problem functions is determined automatically by a sorting routine. The automatic sorting algorithm eliminates a major headache of previous digital simulations.

During problem entry, the user is guided through the necessary procedures by computer-typed instructions and diagnostics. These instructions tell him to enter the problem data, to select the variables for printer or plotter output, and to specify an appropriate integration interval (one-tenth the period of the highest expected frequency is a good start), total run time, and output intervals. If he has specified an improper configuration, the program generates a "diagnostic message."

During problem solution the user can, by use of the console keyboard and switch options, experiment with the simulation model as spon-

### Table of entry switch options

Interrupt run
Modify configuration
Change initial conditions or parameters
Change function generator intercepts
Change integration specifications
Set print interval
Define print variables
Specify new plot frame
Scale plotter x-axis
Scale plotter y-axis
Suppress instructions
Suppress typing of card input data
Punch updated data deck
Interrogate block outputs
Save status at interrupt point
Restart at previous interrupt point

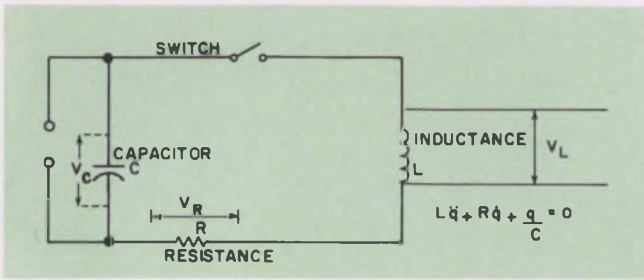

2. This elementary R-L-C circuit illustrates how CSMP can help solve dynamic problems.

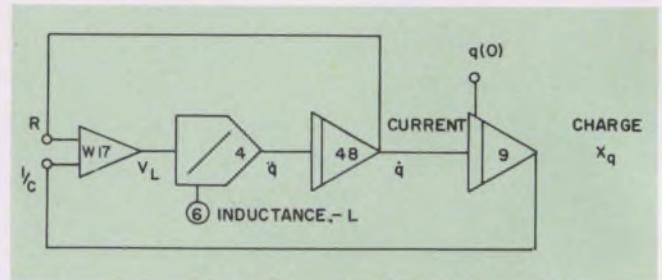

3. Converted into a block diagram for CSMP analysis, the R-L-C circuit of Fig. 2 appears in this form.

**Continuous System Modeling Program**  
**A Digital Analog Simulator Program for the IBM 1130**

Instructional comments may be suppressed at any time by turning on switch 10  
Turn on switch 1 to enter or modify configuration statements via the keyboard  
Turn on switch 2 to enter or modify initial conditions or element parameters via the keyboard  
Turn on switch 3 to enter or modify function generator intercepts via the keyboard

Output name	from block number	Type	Input 1 from block	Input 2 from block	Input 3 from block
$V_L$ v	17	Summer	48	9	-
$\dot{q}$	4	Divider	17	6	-
L Inductance	6	Constant	-	-	-
$\dot{q}$ Current	48	$\int dt$	4	-	-
q Charge	9	$\int dt$	48	-	-

(a)

TIME	OUTPUT(17)	OUTPUT(4)	OUTPUT(48)	OUTPUT(9)	MINIMUM	MAXIMUM
0.000	-10.0000	2.0000	0.0000	-10.0000	-----+-----	
2.000	-2.2647	0.4529	2.4037	-7.0721	-----+-----	
4.000	2.3760	-0.4752	2.2443	-2.1126	-----+-----	
6.000	3.2354	-0.6470	1.0161	1.2032	-----+-----	
8.000	1.9539	-0.3907	-0.0591	2.0722	-----+-----	
10.000	0.3714	-0.0742	-0.5114	1.3944	-----+-----	
12.000	-0.5306	0.1061	-0.4510	0.3714	-----+-----	
14.000	-0.6622	0.1324	-0.1914	-0.2793	-----+-----	
16.000	-0.3800	0.0760	0.0237	-0.4276	-----+-----	
18.000	-0.0574	0.0114	0.1081	-0.2738	-----+-----	
20.000	0.1170	-0.0234	0.0903	-0.0636	-----+-----	
22.000	0.1350	-0.0270	0.0357	0.0635	-----+-----	
24.000	0.0735	-0.0147	-0.0071	0.0879	-----+-----	

TURN ON SWITCH 10 TO SUPPRESS INSTRUCTIONS

SWITCH	OPTION
1	MODIFY CONFIGURATION
2	MODIFY PARAMETERS OR INITIAL CONDITIONS
4	MODIFY INTEGRATION SPECIFICATIONS
5	MODIFY PRINT INTERVAL
6	MODIFY PRINT VARIABLES
11	SUPPRESS TYPING OF CARD INPUT DATA
12	PUNCH CORRECTED DATA DECK
13	INTERROGATE BLOCK OUTPUTS
14	SAVE STATUS AT INTERRUPT TIME
15	RESTART AT PREVIOUS INTERRUPT POINT

PRESS START AFTER SELECTING DESIRED OPTION  
SWITCHES SET ON HERE 2

(b)

4. The computer printout of the sample problem shows the configuration and parameter specifications (a) and

the "print-plot" output (b). The scale in (b) is automatically adjusted to fit the results.

taneously as he would on an analog computer. He need not follow a prescribed pattern of development and testing. Using the console features, he simply types in modifications in configuration, control variables, or parameters. He may interrupt the run at will to make modifications and then proceed either from the point of interruption or initiate a new run. He can even suppress instructions that are no longer needed, by simply throwing a console switch. The various console switch options are listed in the Table.

This type of direct interaction in a digital simulation run is, of course, the equivalent of changing potentiometer settings and patchboard connections on an analog computer. The digital approach has the added advantage of being self-documenting on the process of modifications and final data. The model's response to modifications can be observed at all times through the print-outs at the console printer or, optionally, on the a plotter. All these features add up to easy modeling and a very high degree of operational flexibility.

#### R-L-C circuit illustrates procedure

The simple second-order oscillating system (Fig. 2) illustrates the operation of the 1130 CSMP system. The system consists of an electrical oscillating system, made up of a capacitor,  $C$ ; inductor,  $L$ ; and resistor,  $R$ .

Figure 3 shows the block diagram representation of this simple system, with block numbers assigned in an arbitrary manner. The model consists of only four elements—a summing amplifier, divider, and two integrators. The output of the first integrator is the current,  $i$ , and the output of the second integrator is the charge,  $q$ . These quantities are fed back to the input of the summing amplifier, along with the appropriate parameter constants.

The translation of the block diagram into the corresponding set of 1130 CSMP statements comes next. Simple coding forms assist in preparing the configuration statements for each block, and the associated parameter and function generator statements.

A direct correspondence between the block diagram and the CSMP language statements is evident from Figs. 3 and 4. The statements next are entered either by punched cards or directly, using the console keyboard. The user indicates his choice by means of a sense switch on the console. Fig. 4a shows problem specifications and Fig. 4b the "print-plot" output from the 1130 console printer for the parameters listed. Part of the output is a message indicating the available modification options (sense switches). In

this case switch 2 was turned on to modify the parameters and initial conditions.

#### A larger machine expands capability

System/360 CSMP is based on the most powerful previous continuous-system simulator program the DSL/90<sup>1</sup>. S/360 CSMP combines the block modeling approach of digital-analog simulators, such as the 1130 CSMP, with the algebraic and logical modeling capabilities of conventional digital programming. A knowledge of FORTRAN is not required; however, the program accepts FORTRAN language statements to permit the description of complex nonlinear and time-variant problems.

The input language enables the user to describe the configuration of a physical system, starting either with a system block diagram or directly from the differential equations of the system. Unlike the 1130 CSMP, the program is designed for batch-mode operation on large-scale digital machines (128,000 bytes minimum storage). Interactive operation is economically impractical except on a time-shared system. Various means are therefore provided for automatically sequencing batch runs based on both prescribed data or results of previous runs.

Over all, S/360 CSMP attempts to preserve the simplicity of use and ease of problem description of digital-analog simulators (like the 1130 CSMP), while incorporating greater problem-solving capabilities. It represents a practical compromise between simplicity and flexibility.

The program provides a basic library of 34 functional blocks that includes all the standard functions of analog computers and a complement of special-purpose functions for performing more complex mathematical operations. Figure 5 shows part of the standard complement, including the general form of each language statement and the function it represents. In addition to the functions shown, five switching functions and seven signal sources are available.

Note that the semantic form of the functions differs from the 1130 CSMP blocks, though both are used in the same fashion. For example, to describe a limiting operation on variable  $X$  between the parameters  $-5$  and  $+10$ , we use the function statement:

$$Y = \text{LIMIT} (-5, 10, X)$$

The basic complement of 34 functions is augmented by FORTRAN library routines that include, for example, logarithms, and exponentials. Simple arithmetic operations are performed by conventional FORTRAN operators (arithmetic statements), rather than by functional blocks.

The user can add any desired special function

## Mathematical Functions

General Form	Function
$Y = \text{Intgrl} (IC, X)$ $Y(0) = IC$ Integrator	$Y = \int_0^t X dt + IC$ Equivalent laplace transform: $\frac{1}{S}$
$Y = \text{Deriv} (IC, X)$ $\dot{X}(t=0) = IC$ Derivative	$Y = \frac{dX}{dt}$ Equivalent laplace transform: $S$
$Y = \text{Delay} (N, P, X)$ $P = \text{Delay time}$ $N = \text{Number of points sampled in interval } P \text{ (Integer)}$ Dead time (Delay)	$Y(t) = X(t - P) \quad t \geq P$ $Y = 0 \quad t < P$ Equivalent laplace transform: $e^{-PS}$
$Y = \text{Zhold} (X_1, X_2)$ Zero-order hold	$Y = X_2 \quad X_1 > 0$ $Y = \text{Last output} \quad X_1 \leq 0$ $Y(0) = 0$ Equivalent laplace transform: $\frac{1}{S} (1 - e^{-St})$
$Y = \text{Impl} (IC, P, FOFY)$ $IC = \text{First guess}$ $P = \text{Error bound}$ $FOFY = \text{Output name of last statement in algebraic loop definition}$ Implicit function	$Y = \text{Funcnt} (Y)$ $ Y - \text{Funcnt} (Y)  \leq P  Y $

## System Macros

General Form	Function
$Y = \text{Modint} (IC, X_1, X_2, X_3)$ Mode-controlled integrator	$Y = \int_0^t X_3 dt + IC \quad X_1 > 0, \text{ any } X_2$ $Y = IC \quad X_1 \leq 0, X_2 > 0$ $Y = \text{Last output} \quad X_1 \leq 0, X_2 \leq 0$
$Y = \text{Realpl} (IC, P, X)$ $Y(0) = IC$ 1st Order lag (Real pole)	$P\dot{Y} + Y = X$ Equivalent laplace transform: $\frac{1}{PS + 1}$
$Y = \text{Ledlag} (P_1, P_2, X)$ Lead-lag	$P_2 \dot{Y} + Y = P_1 \dot{X} + X$ Equivalent laplace transform: $\frac{P_1 S + 1}{P_2 S + 1}$
$Y = \text{Cmpxpl} (IC_1, IC_2, P_1, P_2, X)$ $Y(0) = IC_1$ $\dot{Y}(0) = IC_2$ 2nd Order lag (Complex pole)	$\ddot{Y} + 2P_1 P_2 \dot{Y} + P_2^2 Y = X$ Equivalent laplace transform: $\frac{1}{S^2 + 2P_1 P_2 S + P_2^2}$

## Function Generators

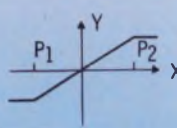
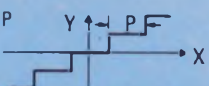
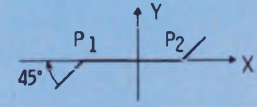
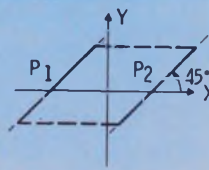
General Form	Function
$Y = \text{Afgn} (\text{Funcnt}, X)$ Arbitrary function generator (Linear interpolation)	$Y = \text{Funcnt} (X)$
$Y = \text{Nifgn} (\text{Funcnt}, X)$ Arbitrary function generator (Quadratic interpolation)	$Y = \text{Funcnt} (X) \quad X_0 \leq X \leq X_n$
$Y = \text{Limit} (P_1, P_2, X)$ Limiter	$Y = P_1 \quad X < P_1$ $Y = P_2 \quad X > P_2$ $Y = X \quad P_1 \leq X \leq P_2$ 
$Y = \text{Qntzr} (P, X)$ Quantizer	$Y = kP \quad (k - 1/2)P < X \leq (k + 1/2)P$ $k = 0, \pm 1, \pm 2, \pm 3 \dots$ 
$Y = \text{Deadsp} (P_1, P_2, X)$ Dead space	$Y = 0 \quad P_1 \leq X \leq P_2$ $Y = X - P_2 \quad X > P_2$ $Y = X - P_1 \quad X < P_1$ 
$Y = \text{Hstrss} (IC, P_1, P_2, X)$ $Y(0) = IC$ Hysteresis loop	$Y = X - P_2 \quad (X - X_{n-1}) > 0 \text{ AND } Y_{n-1} \leq (X - P_2)$ $Y = X - P_1 \quad (X - X_{n-1}) < 0 \text{ AND } Y_{n-1} > (X - P_1)$ Otherwise $Y = \text{Last output}$ 

## Logic Functions

General Form	Function
$Y = \text{AND} (X_1, X_2)$ AND	$Y = 1 \quad X_1 > 0, X_2 > 0$ $Y = 0 \quad \text{Otherwise}$
$Y = \text{NAND} (X_1, X_2)$ Not AND	$Y = 0 \quad X_1 > 0, X_2 > 0$ $Y = 1 \quad \text{Otherwise}$
$Y = \text{IOR} (X_1, X_2)$ Inclusive OR	$Y = 0 \quad X_1 \leq 0, X_2 \leq 0$ $Y = 1 \quad \text{Otherwise}$
$Y = \text{NOR} (X_1, X_2)$ Not OR	$Y = 1 \quad X_1 \leq 0, X_2 \leq 0$ $Y = 0 \quad \text{Otherwise}$
$Y = \text{EOR} (X_1, X_2)$ Exclusive OR	$Y = 1 \quad X_1 \leq 0, X_2 > 0$ $Y = 1 \quad X_1 > 0, X_2 \leq 0$ $Y = 0 \quad \text{Otherwise}$
$Y = \text{NOT} (X)$ NOT	$Y = 1 \quad X \leq 0$ $Y = 0 \quad X > 0$
$Y = \text{Equip} (X_1, X_2)$ Equivalent	$Y = 1 \quad X_1 \leq 0, X_2 \leq 0$ $Y = 1 \quad X_1 > 0, X_2 > 0$ $Y = 0 \quad \text{Otherwise}$

5. This chart is a part of the library of S/360 functional blocks.

to the basic library, either through standard FORTRAN programming, or through a MACRO capability that permits individual functions to be combined into larger functional blocks.

The MACRO capability allows the user to build larger functional blocks from the basic functions available in the library.

For example, an engineer may want to identify a subsection of the system block diagram as a parallel functional entity. Once defined, the MACRO subset can be used any number of times within the simulation program, just like any other library function.

As an example of a user-defined MACRO function, consider a filter simulation study involving several transfer functions with differing parameter values, but all of the form:

$$\frac{Z(s)}{X(s)} = \frac{s^2 + as + b}{s^2 + cs + d}$$

This general functional relationship can be represented by a MACRO function. Assigning some unique name, such a FILTER, to the function, the S/360 CSMP statements defining the MACRO could be as follows:

```
MACRO OUT = FILTER(A, B, C, D, IN)
      S2Y = IN-C*SY*-D*Y
      SY  = INTGRL(0.0, S2Y)
      Y   = INTGRL(0.0, SY)
      OUT = S2Y + A*SY + B*Y
```

ENDMAC

Here the MACRO and ENDMAC cards are translation control statements that provide the boundaries for the set of statements defining the new MACRO function.

### Input language defines operations

The connections between the functional blocks are described by a series of application-oriented input statements. These are of three types: *structure* (configuration) statements, *data* statements, and *control* statements.

Structure statements define the relationships among the functional variables, with the entire set describing the system to be simulated. A translator converts the structure statements into a FORTRAN subroutine, which is then automatically compiled into a program of machine instructions.

Data statements are used to assign the problem's numerical values to all parameters, constants, initial conditions, and table entries.

Control statements specify the choice of available options concerning the translation, execution, and output phases of the program: for example, run time, integration interval, and type of output.

Output options include the printing of variables in standard tabular format, "print-plotting" in graphic form, and the preparation of data for user-written plotting programs.

With a few exceptions, structure statements can be entered in any order and may be intermixed with data and control statements. The correct order of operations is established by automatic sorting of the statements. However, at the user's option, he can specify a sequence in place of automatic sorting.

### The user can modify the program.

In addition to the standard functions and sorting features of CSMP, the user may make his own modifications. Subprograms may be written in FORTRAN, or the PROCEDURE function may be used to alter the automatic sorting algorithm. Integration methods may be specified from among such choices as the trapezoidal rule, Simpson's method or the Runge-Kutta method. Integration intervals can be chosen to give the required degree of resolution. The objective is to give the user as much control over the technique as possible.

An important trend in the future will be the use of graphic input/output consoles and digital simulation languages which with wider use of time-shared terminals will make it economically feasible for users to operate in an on-line interactive mode. ■■

### References:

1. W. M. Syn and R. N. Linebarger, "DSL/90-a digital simulation program for continuous system modeling," AFIPS Conference Proceedings, Spring Joint Computer Conference 28, 165-187 April, 1966.

### Test your retention

*Here are questions based on the main points of this article. Their purpose is to help you make sure you have not overlooked any important ideas. You'll find the answers in the article.*

1. *What programming language is basic to CSMP?*

2. *What principal underlies the use of CSMP?*

3. *Under what conditions can user interaction with the program occur conveniently?*

4. *In what significant way does S/360 CSMP differ from 1130 CSMP?*

# Equal

## Gates

DM8000N (SN7400N)	Quad 2-Input NAND gate
DM8001N (SN7401N)	Quad 2-Input NAND gate (Open Collector)
DM8002N (SN7402N)	Quad 2-Input NOR gate
DM8003N (SN7403N)	Quad 2-Input NAND gate (Open Collector)
DM8004N (SN7404N)	Hex inverter
DM8010N (SN7410N)	Triple 3-Input NAND gate
DM8020N (SN7420N)	Dual 4-Input NAND gate
DM8030N (SN7430N)	Eight-Input NAND gate
DM8040N (SN7440N)	Dual 4-Input buffer
DM8050N (SN7450N)	Expandable Dual 2-Wide, 2-Input AND-OR-INVERT gate
DM8051N (SN7451N)	Dual 2-Wide, 2-Input AND-OR-INVERT gate
DM8053N (SN7453N)	Expandable 4-Wide, 2-Input AND-OR-INVERT gate
DM8054N (SN7454N)	Four-Wide, 2-Input AND-OR-INVERT gate
DM8060N (SN7460N)	Dual 4-Input expander
DM8086N (SN7486N)	Quad Exclusive-OR-gate

## Flip Flops

DM8540N (SN7472N)	MASTER-SLAVE J-K flip flop
DM8501N (SN7473N)	Dual J-K MASTER-SLAVE flip flop
DM8500N (SN7476N)	Dual J-K MASTER-SLAVE flip flop
DM8510N (SN7474N)	Dual D flip flop

## Counters

DM8530N (SN7490N)	Decade counter
DM8532N (SN7492N)	Divide-by-twelve counter
DM8533N (SN7493N)	Four-bit binary counter
DM8560N (SN74192N)	Up-down decade counter
DM8563N (SN74193N)	Up-down binary counter

## Decoders

DM8840N (SN7441AN)	BCD to decimal nixie driver
DM8842N (SN7442N)	BCD to decimal decoder

## Miscellaneous

DM8550N (SN7475N)	Quad latch
-------------------	------------

Spec-for-spec. Pin-for-pin. Second source on all popular 74N.



# Opportunity

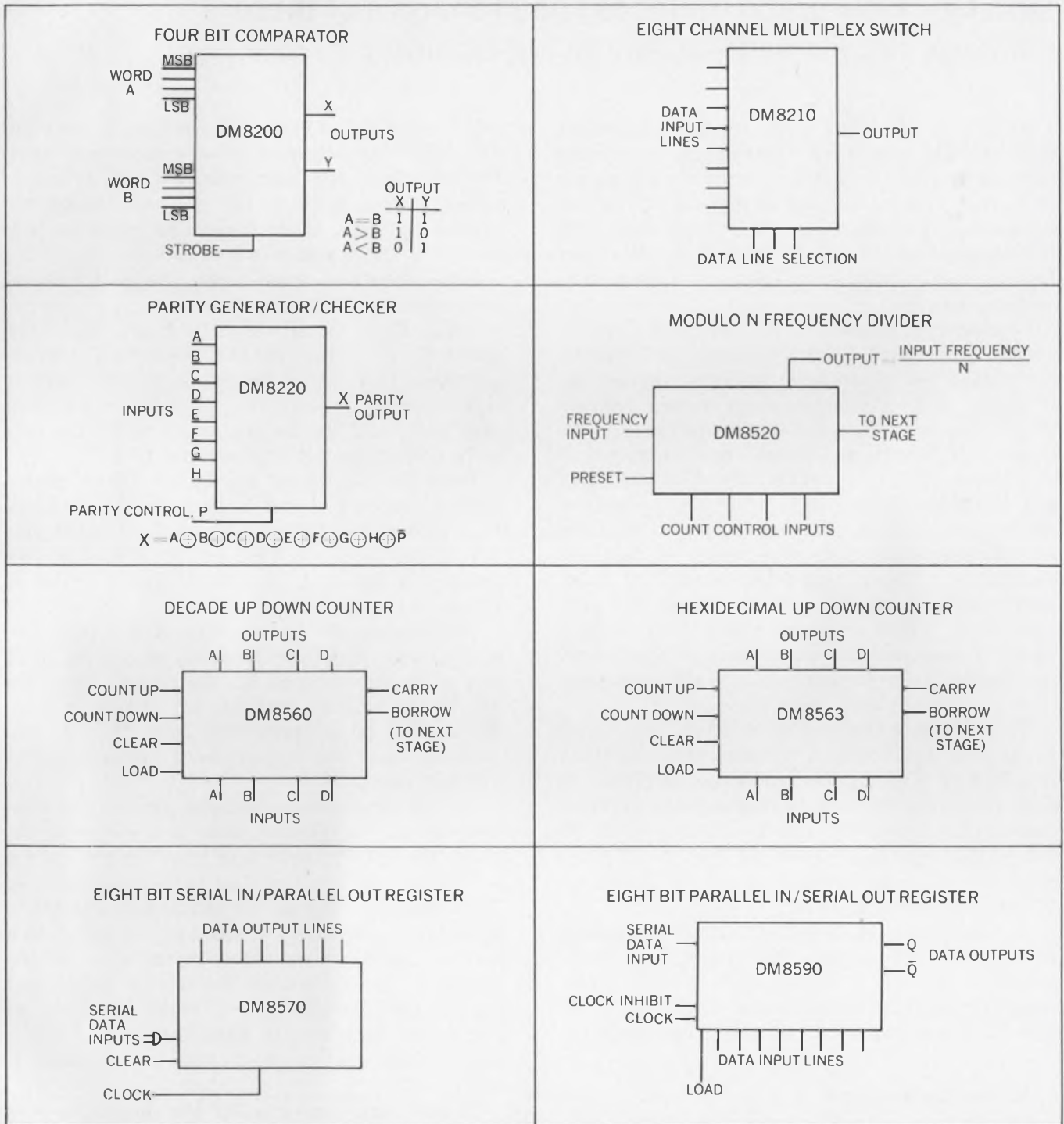

These exclusive National TTL MSI circuits offer designers increased opportunities for circuit savings in design time, board space and costs. Write or call for your free TTL Spec Guide, TTL Cross Reference Guide, and TTL Performance Tables. National Semiconductor, 2975 San Ysidro Way, Santa Clara, California 95051 (408) 245-4320 TWX: 910-339-9240 Cables: NATSEMICON

## National/TTL

# Feedback amplifiers are a snap for network topology. Flow-graph methods speed analysis of these complex circuits without sacrificing accuracy.

Feedback amplifiers offer many advantages over ordinary amplifiers. Their gains can be made independent of transistor parameters such as beta, their bandwidths can be increased, they can be made highly linear and their input and output impedances can be closely controlled.<sup>1</sup> But they have a major drawback: They are usually difficult to analyze.

Conventional methods of analysis require breaking feedback loops, replacing the loops by current or voltage sources, inserting correct impedances, writing equations and solving complex determinants. This makes it very difficult to gain a real insight into the circuit's performance.

A topological flow graph<sup>2</sup> offers an easy way out of this dilemma. It is a simple, convenient method of analysis that can help you find the incremental gains and impedances of feedback amplifiers in their closed-loop condition. Engineers who are familiar with circuits of this type can make whatever assumptions they usually make in conventional analyses and then carry out the details of the analysis with the topological flow graph in a very short time.

To study this application in detail, let's use it to analyze the common voltage-series feedback amplifier of Fig. 1. This particular amplifier, as well as others with similar feedback but different biasing arrangements, can be studied with the aid of the equivalent circuit of Fig. 2. To maximize the generality of the analysis, the first stage is not considered in detail.

In the equivalent circuit, the input impedance of the first stage of the real amplifier is represented by  $R_1 = 1/Y_1$ . Similarly  $R_3 = 1/Y_3$  represents the parallel combination of  $R_{C1}$ ,  $R_{B3}$ ,  $R_{B4}$  and the input impedance of the second stage.

## First generate the graph

The first step in the analysis is the formulation of the network graph of Fig. 3a. The voltage gain expression consists of a set of numerator terms

and a set of denominator terms. Let's look at the numerator terms first. They are dependent upon the paths from the input voltage (node 4) to the output voltage (node 3) not passing through the ground node. There are three such paths: 4 to 2 to 3, 4 to 1 to 3 and 4 to 1 to 2 to 3.

Since there are three paths, the gain expression takes the following form:

$$E_{out}/E_{in} = (P_1\Delta P_1 + P_2\Delta P_2 + P_3\Delta P_3)/\Delta, \quad (1)$$

where  $P_1$ ,  $P_2$  and  $P_3$  are the products of the admittances (arrowhead values) in the direction of signal flow of the network branches comprising each path, and the  $\Delta$ s are as given by the network determinant expansion rule (Eq. 3).

From Fig. 3a, we can see that  $P_1$ , which passes through nodes 4, 2 and 3, has a value of  $+g_m^2$ .  $P_2$ , which passes through nodes 4, 1 and 3, has a value of  $(Y_1 + g_m)Y_4$ , and  $P_3$ , which passes through nodes 4, 1, 2, and 3, has a value of  $(Y_1 + g_m)g_m(-g_m)$ .

To calculate the  $\Delta$ s, we form a separate subgraph for each path by shorting to ground all of the nodes encountered by that path. The subgraphs for  $\Delta P_1$ ,  $\Delta P_2$  and  $\Delta P_3$  are shown in Figs. 3b, 3c and 3d, respectively. Note that  $P_2$  encounters all of the nodes; hence its subgraph is a single node.

For all numerator subgraphs, the arrows converging on the ground node are removed because the ground node has been chosen as the reference node for applying the expansion rule. The subgraphs of Figs. 3b and 3c consist entirely of parallel branches. These are equivalent to a single branch whose value is the sum of the values of its constituent branches (recall that the branch coefficients are really admittances and hence they add in parallel). Fig. 3d is a single node; the value of such a subgraph is unity.

In summary, the values of the subgraphs are:

$$\Delta P_1 = Y_1 + g_m + Y_2 + Y_4.$$

$$\Delta P_2 = Y_3.$$

$$\Delta P_3 = 1.$$

The numerator of Eq. 1 is thus:

$$NUM = g_m^2(Y_2 + Y_4) + (g_m + Y_1)Y_3Y_4 \quad (2)$$

In general, as explained in Ref. 2, the numerator subgraphs will be more complex than simple

John A. DeFalco, Senior Engineer, Honeywell Computer Control Div., Framingham, Mass.

parallel branches or single nodes. The subgraphs have to be evaluated by means of the determinant expansion rule. To apply the rule, a reference node is first selected. For the example of Fig. 3, the ground node was chosen. The arrowheads arriving at the reference node are ignored (removed), and the branches leaving the reference node become reference branches. If the coefficients of the reference branches converging on nodes 1, 2, . . .  $i$  are called  $a_1, a_2 \dots a_i$ , the expansion rule states that the determinant value is given by:

$$\Delta = \sum a_i \Delta_i + \sum a_i a_j \Delta_{ij} + \sum a_i a_j a_k \Delta_{ijk} + \dots + a_1 a_2 a_3 \dots \quad (3)$$

where the  $\Delta_{ijk} \dots$  are the determinants of the subgraphs formed by removing all reference branches as well as arrowheads pointing towards the subscripted nodes. The node obtained by this process becomes a new reference node for reapplication of the rule, if necessary, to any remaining subgraphs. The process can thus be iterated until it is complete.

### Evaluate the denominator

The rule of Eq. 3 is also used to evaluate the denominator determinant in the same manner. To apply the rule, all independent current sources must be open circuited and all independent voltage sources must be short-circuited. When this is done to the graph of Fig. 3a, the graph of Fig. 4a results.

Selecting node 3 as the reference node, we see that there are only two reference branches with non-zero values. From Eq. 3, the denominator determinant for Eq. 1 is found to be:

$$\Delta = Y_4 \Delta_1 + Y_L \Delta_5 + Y_4 Y_L \Delta_{1,5} \quad (4)$$

The subgraphs  $\Delta_5, \Delta_1$  and  $\Delta_{1,5}$  are shown in Figs. 4b, 4c and 4d, respectively. Evaluating them with Eq. 3, we get:

$$\begin{aligned} \Delta_5 &= Y_3(Y_1 + Y_2 + g_m) \\ \Delta_1 &= Y_3(Y_1 + Y_2) + g_m(Y_3 + g_m) \\ \Delta_{1,5} &= Y_3 \end{aligned}$$

These values can be used to find the denominator of Eq. 1. When combined with the numerator (Eq. 2), the result is:

$$\begin{aligned} E_{out}/E_{in} &= [(g_m^2(Y_2 + Y_4) + (Y_1 + g_m)Y_4 Y_3) / \\ & [Y_1 Y_3(Y_1 + Y_2) + g_m Y_4(Y_3 + g_m) \\ & + Y_L Y_3(Y_1 + Y_2 + g_m) + Y_L Y_1 Y_3]] \end{aligned} \quad (5)$$

Eq. 5 is the exact voltage-gain expression for the circuit of Fig. 2. To develop some insight into the operation of the circuit, some simplifying approximations can be made. For transistors at room temperature,<sup>3</sup> the gain is approximately:

$$g_m = |I_c|/26 \text{ mV.}$$

When  $I_c$  is on the order of a milliampere, the  $g_m$  terms will be much greater than any of the others. Thus we can get an excellent approximation of Eq. 5 by retaining only the terms in  $g_m^2$ . This yields:

$$E_{out}/E_{in} = (Y_2 + Y_4)/Y_1 = (R_2 + R_1)/R_2.$$

Note that by using sufficiently high transconductances and resistances, the gain can be made independent of everything except  $R_2$  and  $R_1$ , which can be specified very accurately.

### Calculate the output impedance

Next, let's calculate the output impedance of the feedback amplifier. This is defined (Fig. 2) as the voltage response at the output (node 3) to a unit current excitation applied at that point. Thus  $Z_{out} = E_3/I$ . The graph for this calculation is shown in Fig. 5a. This is the same graph as Fig. 3a, with node 4 shorted to ground (node 5). This is done because the output impedance has been defined with zero volts at the input.

Since we are looking for  $E_3$ , we note that

$$Z_{out} = \Delta_{38}/\Delta, \quad (6)$$

where  $\Delta_{38}$  (Fig. 5b) is the network determinant of Fig. 3a with node 3 shorted to ground. (This comes about because Eq. 6 is a special case of Eq. 1, with only one path,  $P_1$ , of unit value.  $\Delta_{38}$  is formed by shorting to ground all of the nodes that  $P_1$  passes through.)

Using node 5 as the reference node, we get:  $\Delta_{38} = Y_3(Y_1 + g_m + Y_2 + Y_1)$ . The denominator of

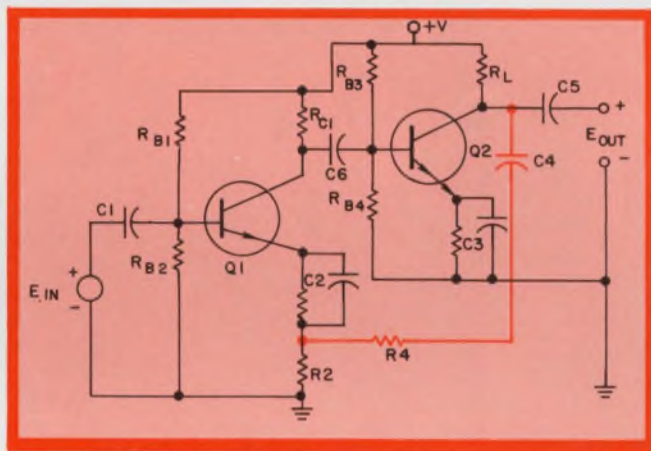

1. **Extremely stable gain**, high input impedance and low output impedance characterize this voltage-series feedback amplifier. It's called a voltage-series type because a portion of the output is fed back (via  $R_1$  and  $R_2$ ) in series with the input. When properly designed, the amplifier's gain is  $(R_2 + R_1)/R_2$ .

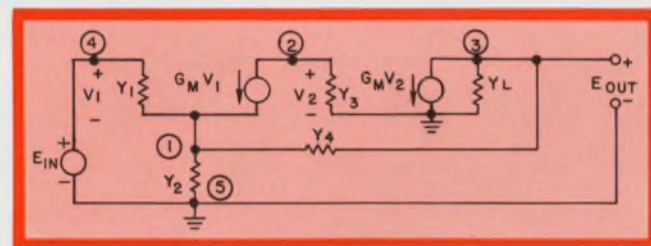

2. **This equivalent circuit** of the amplifier of Fig. 1 can be applied to other amplifiers with similar feedback and different biasing arrangements.

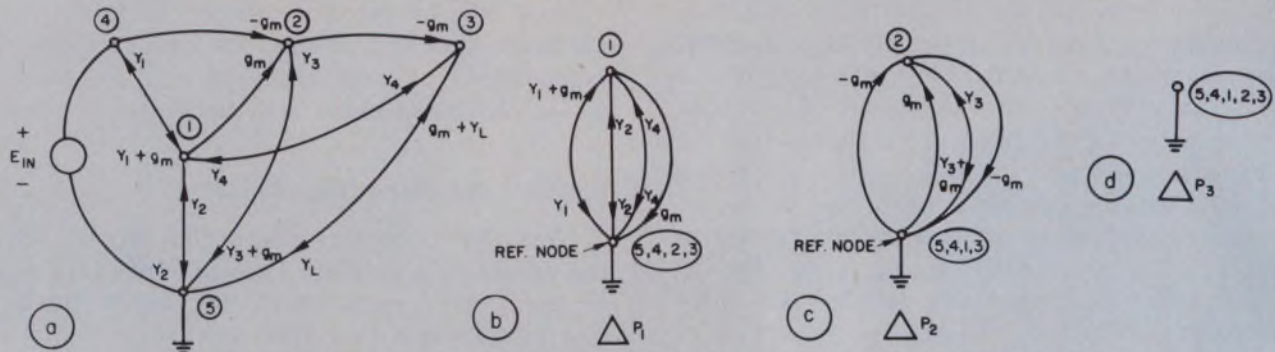

3. Generating the network graph is the first step in the analysis (a). The subgraphs for  $\Delta P_1$  (b),  $\Delta P_2$  (c) and  $\Delta P_3$  (d) are also shown. Note that subgraph  $\Delta P_3$  is only a single node. This has a value of unity.

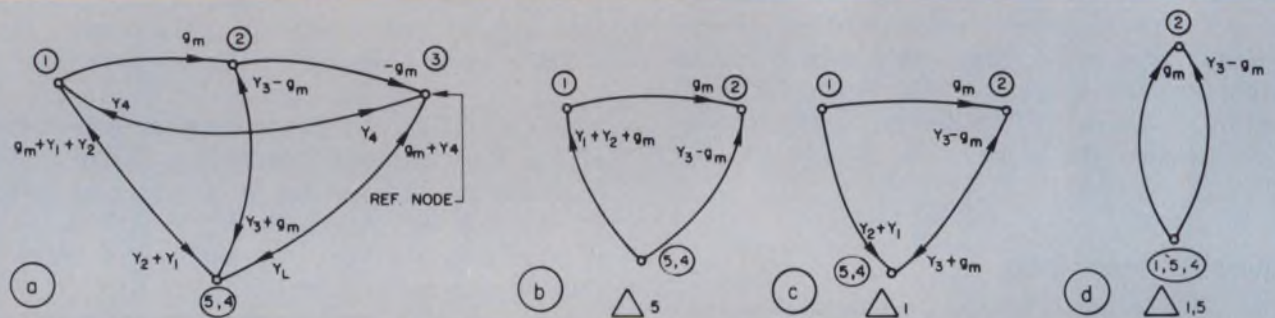

4. To evaluate the denominator, open-circuit all of the independent current sources and short-circuit all of the independent voltage sources. When this is done to the graph of Fig. 3a, the result is that shown in "a." The subgraphs  $\Delta_5$  (b),  $\Delta_1$  (c), and  $\Delta_{1,5}$  (d) are also shown.

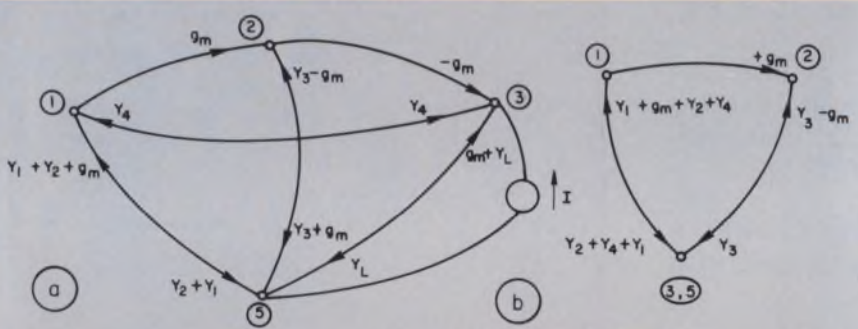

5. The output impedance is found from the graph of Fig. 3a by shorting node 4 to ground (a). Subgraph  $\Delta_{3,5}$  (b) is also derived from Fig. 3a, but by grounding node 3.

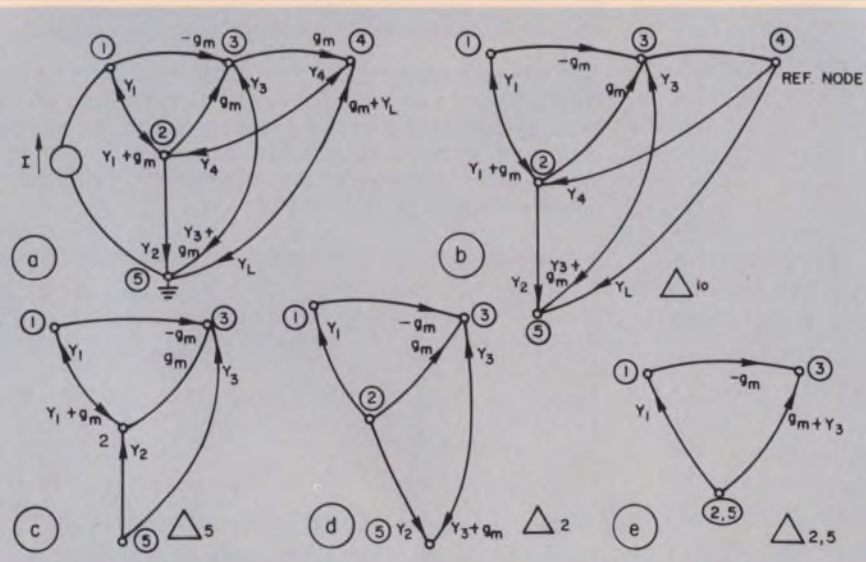

6. The input impedance is found by using the graph (a) to calculate the voltage at node 1. To evaluate  $\Delta_{1,0}$ , the current source is open-circuited (b). The subgraphs  $\Delta_5$  (c),  $\Delta_2$  (d) and  $\Delta_{2,5}$  (e) are also shown.

Eq. 6 is the same as that of Eq. 5 because they both came from identical graphs. The output impedance is therefore given by:

$$Z_{out} = Y_3(Y_1 + g_m + Y_2 + Y_4) / [Y_4 Y_3(Y_1 + Y_2) + Y_4 g_m(Y_3 + g_m) + Y_L Y_4 Y_3 + Y_L Y_3(Y_1 + Y_2 + g_m)].$$

Again, to make some practical sense out of this expression, the same simplifying assumptions can be made as were made in the gain case, yielding  $Z_{out} = R_4/g_m R_3$ . If the load and bias resistors are large compared with the input impedance of the next stage, then  $R_3 \cong (\beta+1)r_e$  where  $r_e = 26 \text{ mV}/I_E$ ,  $\beta$  is the common-emitter current gain and  $I_E$  is the emitter bias current.

Since  $g_m = \beta/(\beta+1)r_e$ , the expression  $Z_{out}$  reduces to  $Z_{out} = R_4/\beta$ , which can be made quite low since  $\beta$  is often 50 or higher.

### What about input impedance?

We can conclude this analysis by finding the input impedance of the feedback amplifier with the same topological methods. The impedance is defined as the voltage response at node 4 to a unit current input. The pertinent graph is shown in Fig. 6a, and the impedance can be seen to be given by  $Z_{in} = \Delta_{is}/\Delta_{io}$ , where  $\Delta_{is}$  is the determinant of Fig. 6a when node 1 is shorted to ground

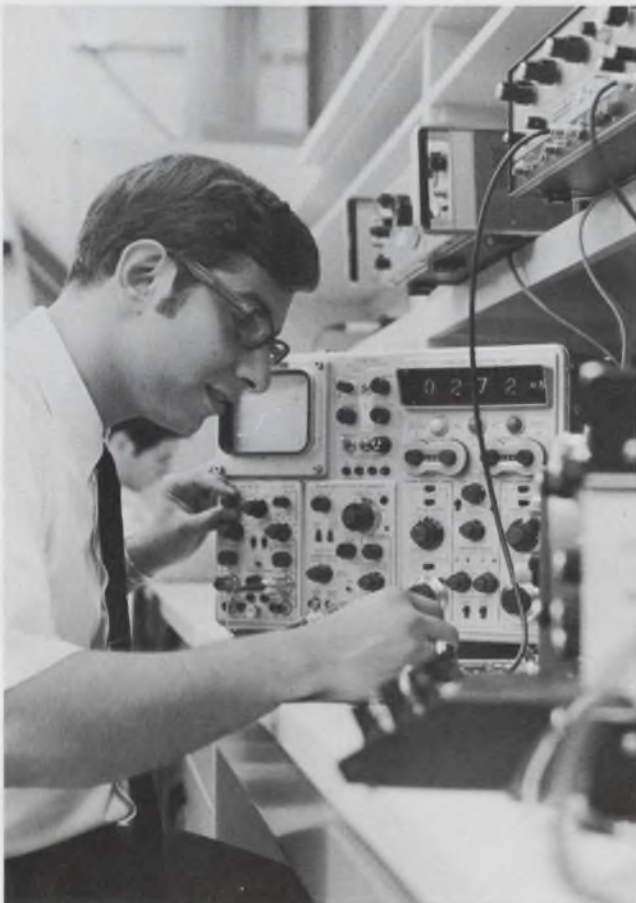

Author DeFalco checks the performance of an amplifier for comparison with topological analysis results.

and  $\Delta_{io}$  is the determinant of Fig. 6a when the current source is open-circuited.  $\Delta_{is}$  is the same determinant evaluated in the denominator of Eq. 5.

To evaluate  $\Delta_{io}$ , we open-circuit the current source and choose node 4 as the reference node. The resulting flow graph is shown in Fig. 6b. There are only two non-zero reference branches; therefore  $\Delta_{io} = Y_L \Delta_5 + Y_4 \Delta_2 + Y_L Y_4 \Delta_{2,5}$ . The  $\Delta_5$ ,  $\Delta_2$  and  $\Delta_{2,5}$  subgraphs are shown in Figs. 6c, 6d and 6e, respectively. From these we find that  $\Delta_5 = Y_1 Y_2 Y_3$ ,  $\Delta_2 = Y_1 Y_2 Y_3$  and  $\Delta_{2,5} = Y_1 Y_3$ . Thus  $Y_{io} = Y_L Y_1 Y_2 Y_3 + Y_4 Y_1 Y_2 Y_3 + Y_4 Y_L Y_1 Y_3$ .

Finally we get:

$$Z_{in} = [Y_3(Y_4 + Y_L)(Y_1 + Y_3 + g_m) + g_m^2 Y_4 + Y_L Y_4 Y_3] / [Y_1 Y_2 Y_3 Y_4 + Y_1 Y_3 Y_4 Y_L + Y_1 Y_2 Y_3 Y_L].$$

If we make the same assumptions as before about the relative magnitudes of the various terms and multiply both numerator and denominator by  $R_1 R_2 R_3 R_4 R_L$ , we get:

$$Z_{in} \cong g_m^2 R_1 R_2 R_3 R_4 / [R_L + R_1 + R_2].$$

If  $R_L \gg R_1 + R_2$ ,  $Z_{in} \cong g_m^2 R_1 R_2 R_3$ .

Now, since  $R_1$  and  $R_3$  are transistor input impedances,  $R_1 \cong R_3 \cong (\beta+1)r_e$ . And since  $g_m = \beta/(\beta+1)r_e$ , then  $Z_{in} \cong \beta^2 R_2$ .

It should be noted that in some designs the approximations used above may not be satisfied and the exact expressions will have to be employed. In any event, the topological method allows the job to be done in the shortest possible time. ■■

### References:

1. Thornton, Searle, et al, *Multistage Transistor Circuits* SEEC, Vol. 5, Chap. 3, John Wiley.
2. John DeFalco, "Speed Network Analysis with Topology," *Electronic Design* 17, April 1, 1969, p. 56.
3. Searle, Boothroyd, et al, *Elementary Circuit Properties of Transistors* SEEC, Vol. 3, p. 99, John Wiley, 1964.

### Test your retention

Here are questions based on the main points of this article. Their purpose is to help you make sure you have not overlooked any important ideas. You'll find the answers in the article.

1. If a subgraph turns out to be a single node, what is its value?

2. What is a voltage-series feedback amplifier.

3. How are parallel branches in a graph combined?

4. What is the general rule for expanding a determinant graph?



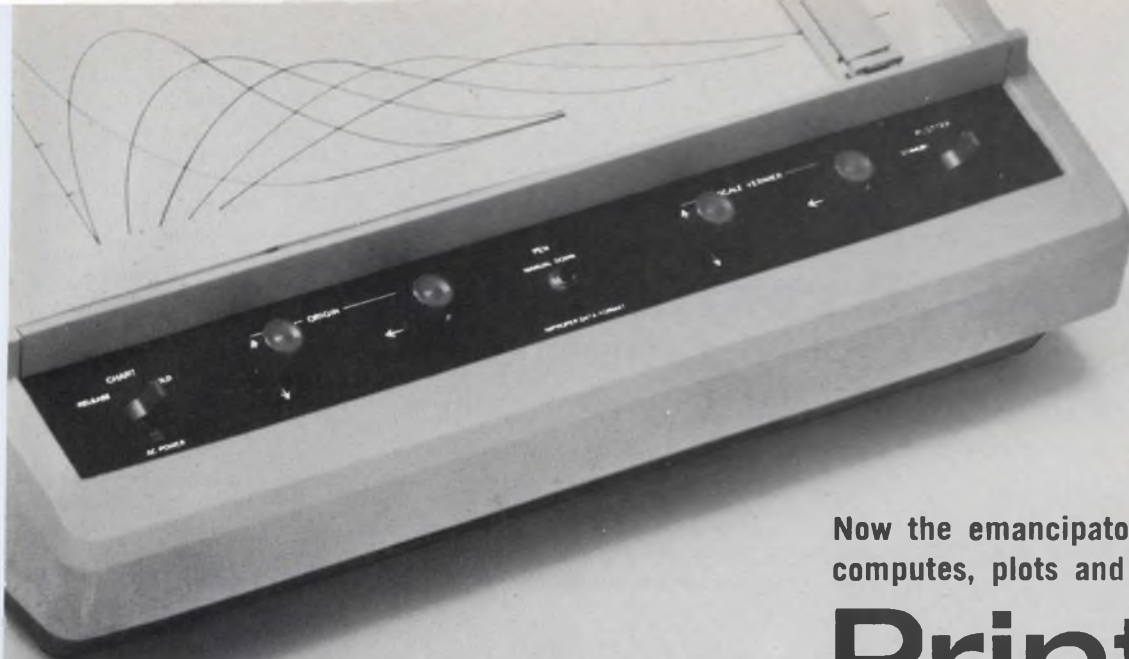

Now the emancipator...  
computes, plots and

# Prints Quietly

The HP 9100A Calculator frees you from the drudgery of complex problem solving.

The HP 9125A Plotter frees you from the tedium of hand-plotting graphs.

And now, the quiet HP 9120A Printer frees you from the manual transfer of data.

Add up these three capabilities, and what do you have?

**THE ONLY TOTAL GRAPHIC COMPUTING SYSTEM AVAILABLE TODAY FOR \$204 PER MONTH!**

With this new electro-sensitive printer you speed up your computations by eliminating the need to record results. You get a permanent record of all inputs—a record that makes error tracing quicker and easier. And, you have printed proof of all your computations.

The 9120A printer gives you maximum flexibility in what you print. You can print all of the displayed information; a complete listing of the program instructions stored in memory; or only the information you specify. The 9120A does this printing at the rate of 3 lines per second—without the distracting noise of a mechanical printer.

You get completely documented calculator programs that are specifically designed for use with the plotter and printer. And, you can put this system to work for you today, not sometime in the distant future.

If you want a printer that operates quietly in an office environment—if you want a low-cost system that gives you total graphic solutions—call for a quiet demonstration of the complete emancipator today.

To put this total system to work for you even faster, send your purchase order to any Hewlett-Packard Sales and Service office (located in principal cities throughout the world). For a 22-page brochure, write Hewlett-Packard, P. O. Box 301, Loveland, Colorado 80537. Europe: 1217 Meyrin-Geneva, Switzerland.

Price: HP 9100A Calculator, \$4,400; HP 9120A Printer, \$975; HP 9125A Plotter, \$2,475. Lease/rental plans start as low as \$1.50/computing hour based on average usage.



**Program from the keyboard.** Record and store 196-step programs on credit-card-size magnetic cards for repeated use.



**Edit programs easily.** Single-step through programs to check and de-bug. Address an individual step and make corrections without re-entering the entire program.

099/32

HEWLETT  PACKARD

INFORMATION RETRIEVAL NUMBER 68

# Cut binary-to-BCD conversion costs.

Reduce your IC package count with a nonsequential circuit using full adders and TTL gates.

A static  $n$ -bit binary-to-BCD converter design can easily require  $10n$  IC packages, for  $n$  less than 16. Sequential  $n$ -bit "add and shift converters" reduce this requirement to about  $1.2n$ , but at a sacrifice of speed. A better way to cut the IC package count and the cost, without loss of conversion speed, is with a nonsequential technique that uses full adders.

With this technique, equations for each decade of the BCD number are developed from the general expressions for binary numbers, and are implemented in a straight-forward step-by-step manner. The circuits used are exclusively MSI full adders and 1-, 2-, 3-, and 4-input TTL gates. Each binary input bit is represented by its equivalent BCD bits, and these are summed in weighted full adders. The nonsequential operation results in very low decode delays—as low as 800 ns for a 16-bit binary input (Table 1).

## Examine the binary-to-BCD conversion

The binary-to-BCD conversion circuit decodes the equivalent BCD number in the same way a designer would perform it in longhand. The general equation for a binary number is

$$a_m(2^{m-1}) + a_{m-1}(2^{m-2}) + \dots + a_4(2^3) + a_3(2^2) + a_2(2^1) + a_1(2^0), \quad (1)$$

where  $a$  is either a 1 or a 0. The equation also can be written in more expanded form as

$$a_m(2^{m-1}) + a_{m-1}(2^{m-2}) + \dots + a_8(128) + a_7(64) + a_6(32) + a_5(16) + a_4(8) + a_3(4) + a_2(2) + a_1(1). \quad (2)$$

Suppose the decimal equivalent of this binary number can be at most a five-digit number  $vwxyz$ ; then,

$$vwxyz = a_m(2^{m-1}) + a_{m-1}(2^{m-2}) + \dots + a_8(128) + a_7(64) + a_6(32) + a_5(16) + a_4(8) + a_3(4) + a_2(2) + a_1(1), \quad (3)$$

where  $z$  is the units digit,  $y$  is the tens digit, and so on. Equation 3 can be expanded to

$$\begin{aligned} vwxyz = & a_m(10,000 v_m + 1,000 w_m + 100 x_m \\ & + 10 y_m + z_m) \\ & + a_{m-1}(10,000 v_{m-1} + 1,000 w_{m-1} + 100 x_{m-1} \\ & + 10 y_{m-1} + z_{m-1}) \\ & + \dots + a_8(100(1) + 10(2) + 8) + a_7(10(6) + 4) \\ & + a_6(10(3) + 2) \\ & + a_5(10(1) + 6) + a_4(8) + a_3(4) + a_2(2) + a_1(1) \end{aligned} \quad (4)$$

A special rule in the nonsequential technique pertains to the unit-digit terms  $z_5, z_9, z_{13}, z_{17}$ , in Eq. 4: these quantities should be equal to 16 for  $m$  greater than 6. (The reason for this will be made evident later.)

For  $m$  equal to 5 or 6,  $z_5$  should be 6. In both cases, the corresponding  $y$ -terms,  $y_5, y_9, y_{13}, y_{17}, \dots$  should be adjusted to make the corresponding  $a$ -terms equal in Eqs. 3 and 4. For example, if  $m = 8$ , the  $a_5$  term in Eq. 4 would be  $a_5(16)$ , where  $y_5 = 0$  and  $z_5 = 16$ . However, if  $m = 6$ , then the  $a_5$  term of Eq. 4 would be written in the form  $a_5(10(1) + 6)$ , where  $y_5 = 1$  and  $z_5 = 6$ .

By grouping the  $z$ -terms,  $y$ -terms,  $x$ -terms, etc., Eq. 4 can be rewritten, then, as

$$\begin{aligned} vwxyz = & 10,000(a_m v_m + a_{m-1} v_{m-1} + \dots + a_{15}(1)) \\ & + 1,000(a_m w_m + a_{m-1} w_{m-1} + \dots + a_{11}(1)) \\ & + 100(a_m x_m + a_{m-1} x_{m-1} + \dots + a_8(1)) \\ & + 10(a_m y_m + a_{m-1} y_{m-1} + \dots + a_6(3)) \\ & + (a_m z_m + a_{m-1} z_{m-1} + \dots + a_5(16) + a_4(8) \\ & + a_3(4) + a_2(2) + a_1(1)) \end{aligned} \quad (5)$$

Equation 5 can be divided into five separate equations, the first of which is

$$z = a_m z_m + a_{m-1} z_{m-1} + \dots + a_5(16) + a_4(8) + a_3(4) + a_2(2) + a_1(1) - p \quad (6)$$

where  $p$  equals the highest multiple of 10 contained



in the sum

$$a_m z_m + a_{m-1} z_{m-1} + \dots + a_5(16) + a_4(8) + a_3(4) + a_2(2) + a_1(1) \quad (7)$$

If the sum of the terms in Eq. 7 were, for example, equal to 23, the value of  $p$  in Eq. 6 would be 20 and that of  $z$  would be 3.

The second equation obtained from Eq. 5 is

$$y = a_m y_m + a_{m-1} y_{m-1} + \dots + a_7(6) + a_6(3) + \frac{p}{10} - q \quad (8)$$

In this equation,  $q$  is equal to the highest multiple of 10 in

$$a_m y_m + a_{m-1} y_{m-1} + \dots + a_7(6) + a_6(3) + \frac{p}{10} \quad (9)$$

Similarly, the remaining three equations are

$$x = a_m x_m + a_{m-1} x_{m-1} + \dots + a_8(1) + \frac{q}{10} - r, \quad (10)$$

$$w = a_m w_m + a_{m-1} w_{m-1} + \dots + a_{11}(1) + \frac{r}{10} - s, \quad (11)$$

and

$$v = a_m v_m + a_{m-1} v_{m-1} + \dots + a_{15}(1) + \frac{s}{10}, \quad (12)$$

where  $r$  is the highest multiple of 10 in

$$a_m x_m + a_{m-1} x_{m-1} + \dots + a_8(1) + \frac{q}{10} \quad (13)$$

and  $s$  is the highest multiple of 10 in

$$a_m w_m + a_{m-1} w_{m-1} + \dots + a_{11}(1) + \frac{r}{10}. \quad (14)$$

Equations 6, 8, 10, 11, and 12 correspond to addition of columns of decimal numbers. Eq. 6 represents the addition of all units digits in the column, where  $p/10$  is the number carried to the tens column and  $z$  is the units digit of the sum being formed. Equation 8 adds the number from the units column and all the digits in the tens column; here  $q/10$  is the digit carried to the hundreds column and  $y$  is the tens digit of the sum. The remaining equations define the equivalent digits by addition for any  $m$ -bit binary number,

$$a_m a_{m-1} a_{m-2} \dots a_4 a_3 a_2 a_1.$$

Note that, if  $m = 6$ ,  $v$  and  $w$  will both be 0, and the number of equations used to describe the decimal equivalent digits of a binary number is dependent on the maximum number of bits in the binary number.

A block diagram of the binary-to-BCD converter defined by Eqs. 6, 8, 10, 11, and 12 is shown in Fig. 1. A logic circuit for each equation can be developed using inverters, 2- and 3-input gates, and full adders. The conversion is performed in three steps:

- The input binary bits are received in the proper weighted full adders, and their binary sum is obtained.
- The sum is reduced to a binary number of maximum value 29; carried numbers are produced to compensate for the difference between this number and the sum from Step 1.

**Table 1. Number of modules versus decode time**

No. of Bits (n)	Dual full adders	Gates	Total modules	Decode time (ns)	Quad full-adders	Gates	Total	modules Decode time (ns)
4	2	1	3	60	1	1	2	40
6	4	3	7	100	3	3	6	65
8	11	4	15	190	8	4	12	130
10	14	5	19	250	10	5	15	180
12	22	6	28	420	15	6	21	350
14	27	7	34	500	19	7	26	420
16	44	10	54	800	28	10	38	600
18	53	11	64	1,000	35	11	46	830
20	65	11	76	1,200	43	11	54	1,000
22	75	11	86	1,380	51	11	62	1,080
24	88	13	101	1,500	59	13	72	1,200

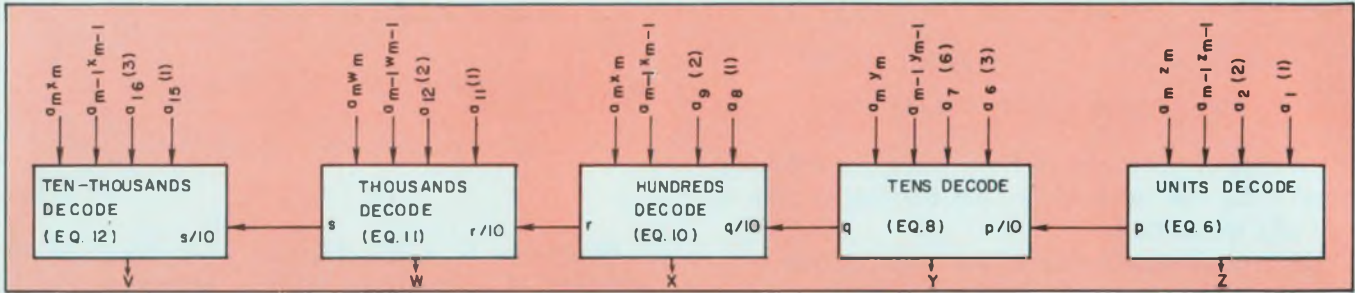

1. The binary-to-BCD decode circuit is defined in block form by the basic conversion equations. A logic circuit can be developed for each block using only inverters, TTL gates and full adders.

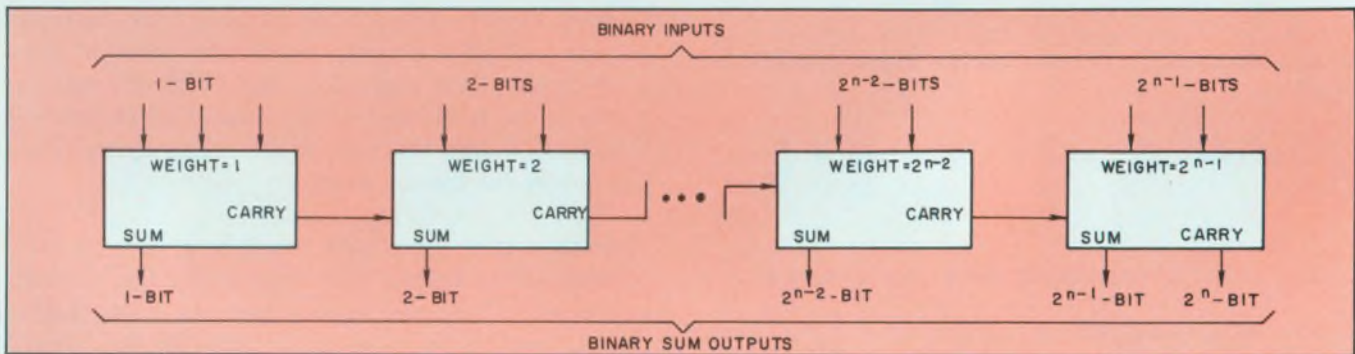

2. The standard binary  $n$ -bit adder is built from full-adder circuits. Although it offers a limited number of input lines, it can be modified to handle more inputs, if desired, simply by ganging adders.

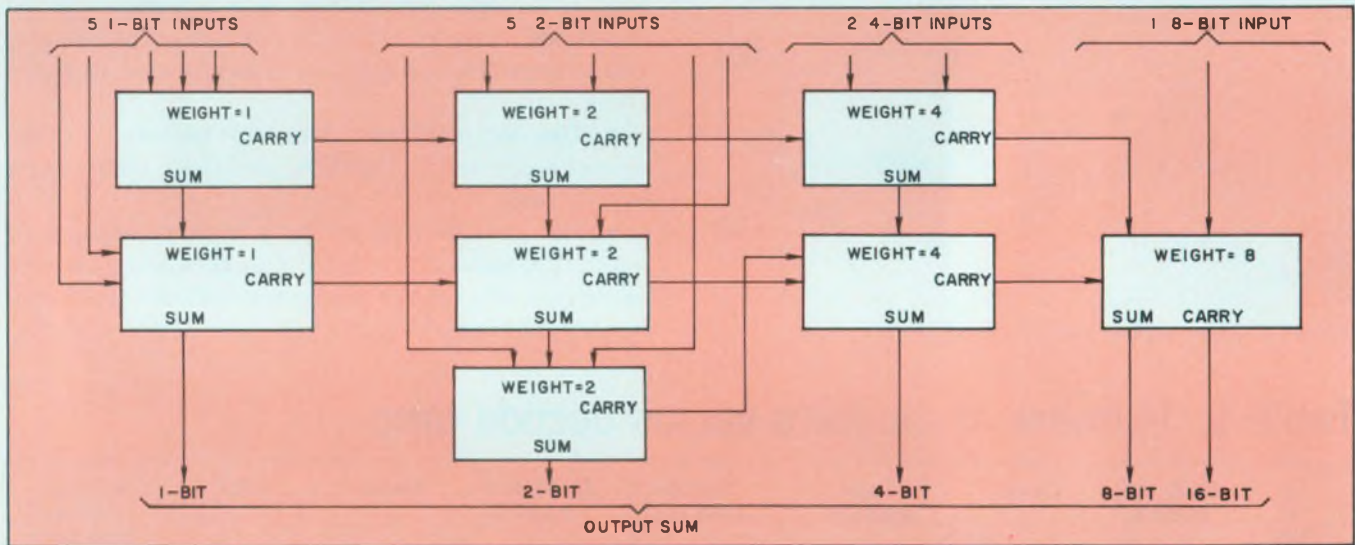

3. Adders are ganged by using the sum and carry outputs of all full adders as inputs to other adders or as outputs of the circuit. This technique ensures that no information has been lost in the circuitry.

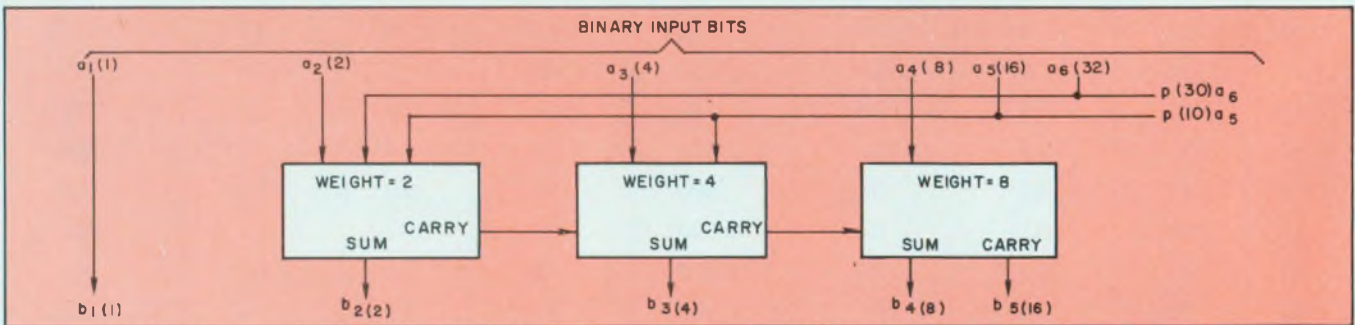

4. The reducing circuit cuts the binary output down to a maximum value of 29, and generates carry outputs to compensate for the difference. The binary output is a multiple of 10 less than the binary inputs.

Some multiple of 10 is subtracted from the reduced number from Step 2 to obtain more carried digits and the final BCD bits.

**Weight and sum the input bits**

A standard *n*-bit binary adder using full-adder circuits is shown in Fig. 2. For the receiving circuit in the binary-to-BCD converter, *n* will be typically 5 or less. Notice that this standard design, with the limited number of input lines it offers, requires modification if it is to handle more inputs of similar weight.

The added capability can be obtained by ganging adders, as shown in Fig. 3. Both the sum and the carry outputs of all the full adders must be used as inputs to other adders, or as outputs of the circuit, to ensure that all information entered into the circuit is contained on the five output lines (and that no information or bits have been lost in the circuit).

The matrix of Table 2 aids in calculation of the number of full adders of each weight required in a receiving circuit, given the number of inputs of each weight. For example, the binary adder circuit in Fig. 3 requires five input lines of weight 1, and there are no carries from other full adders, so the number of full adders of weight 1 required (determined from the intersection of row 5 and column 0 in Table 2) is 2.

The two full adders handling the five weight 1 inputs produce carries of weight 2, which must be used as inputs to full adders of weight 2. Since there are also five inputs of weight 2 to the circuit, the number of full adders of weight 2 required (from the intersection of row 5 and column 2 in Table 2) is 3. Similarly, the need for two full adders of weight 4 and one of weight 8 can be determined from the matrix.

Using Table 2 and the procedure described, a receiving circuit can be designed with any combi-

**Table 2. Number of Y-weight adders required**

Number of y-weight inputs to circuit (row no.)	Number of carry inputs to y-weight adders (col. no.)										
	0	1	2	3	4	5	6	7	8	9	10
0	0	0	1	1	2	2	3	3	4	4	5
1	1	1	1	2	2	3	3	4	4	5	5
2	1	1	2	2	3	3	4	4	5	5	6
3	1	2	2	3	3	4	4	5	5	6	6
4	2	2	3	3	4	4	5	5	6	6	7
5	2	3	3	4	4	5	5	6	6	7	7
6	3	3	4	4	5	5	6	6	7	7	8
7	3	4	4	5	5	6	6	7	7	8	8
8	4	4	5	5	6	6	7	7	8	8	9
9	4	5	5	6	6	7	7	8	8	9	9
10	5	5	6	6	7	7	8	8	9	9	10

**Table 3. Tens decode receiving circuit inputs**

Inputs	Placed into full-adders of weight:			
	1	2	4	8
a <sub>1</sub> (2)		x		
a <sub>1</sub> (6)		x	x	
a <sub>1</sub> (3)	x	x		
p(3)f	x	x		
p(2)m		x		
p(1)l	x			
p(1)e	x			

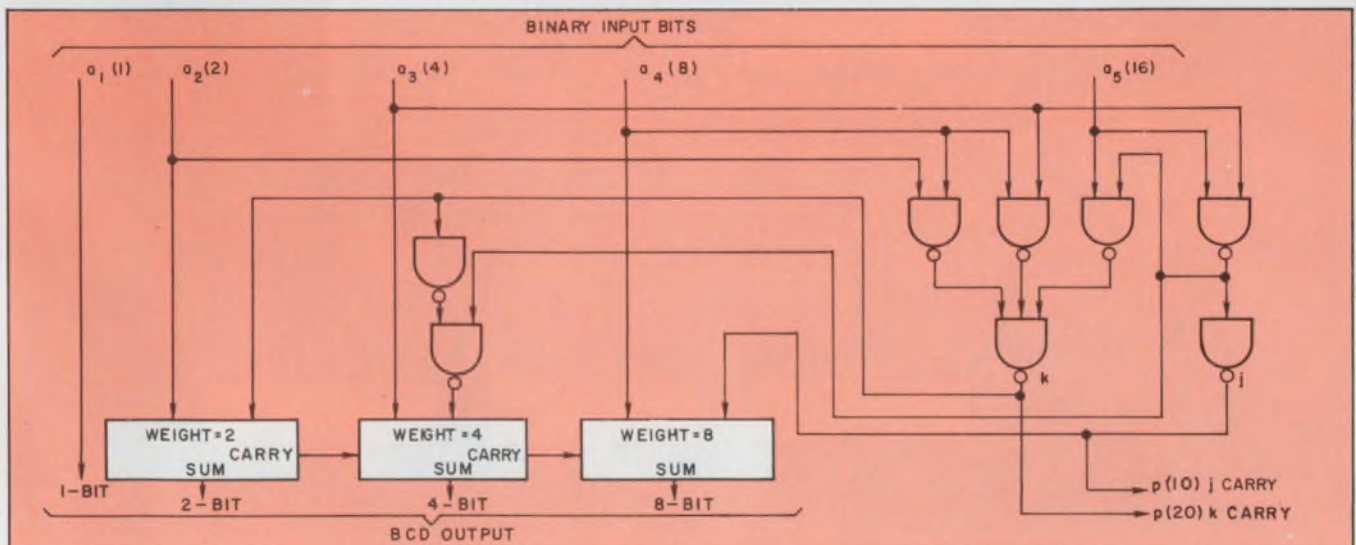

5. The subtracting circuit receives 5-bit binary numbers, with decimal value from 0 to 29, and generates four-bit

binary numbers from 0 to 9 and a carry of weight 0, 10, or 20.

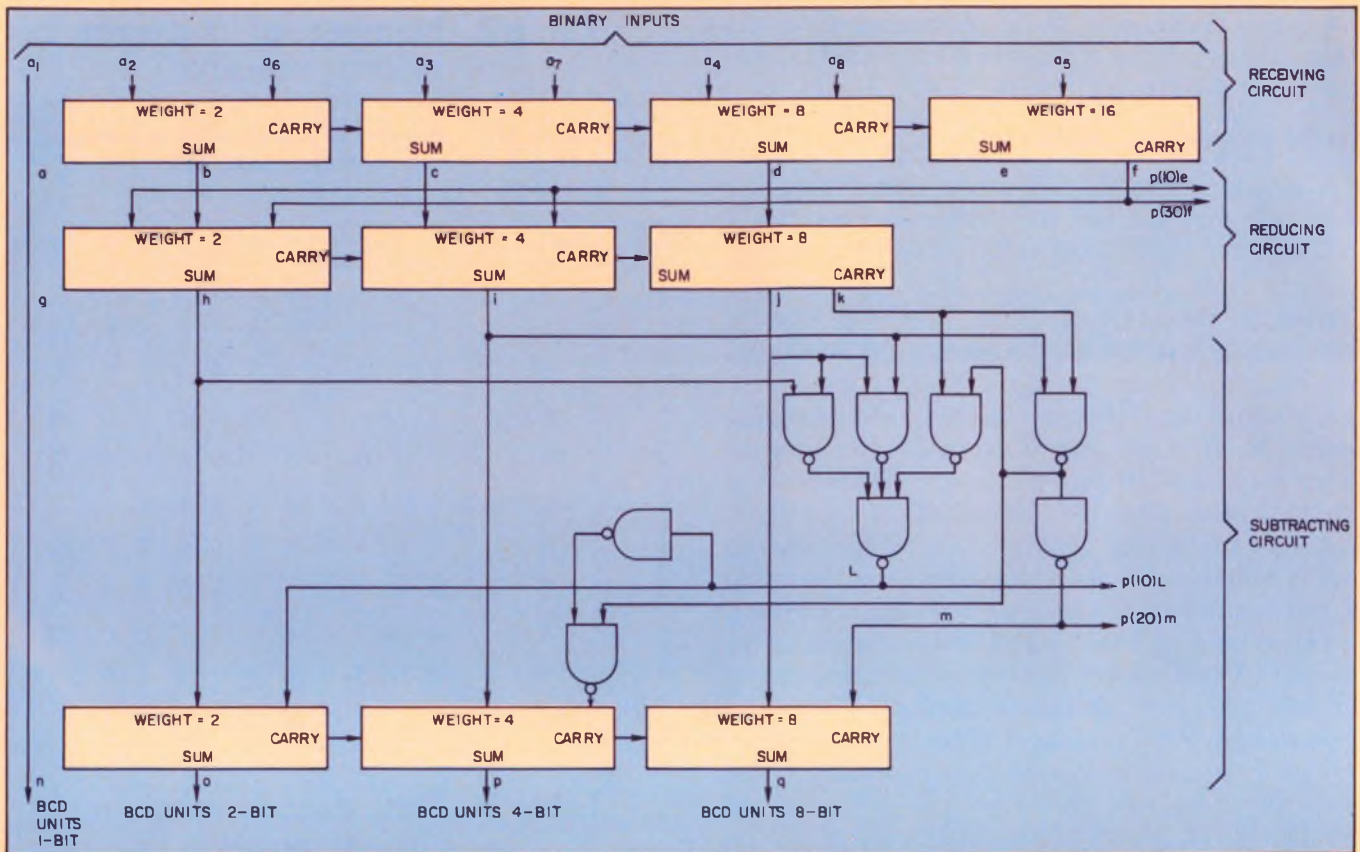

6. In the units decade decode circuit, the "a" inputs to the first row of full adders (the receiving circuit) represent the input binary bits. They are weighted according to their coefficients in Eq. 23 and are fed to

the reducing circuit, a second row of full adders. The subtracting circuit receives the 5-bit output of the reducer, and produces the BCD output. It subtracts from the input number the highest multiple of 10 in it.

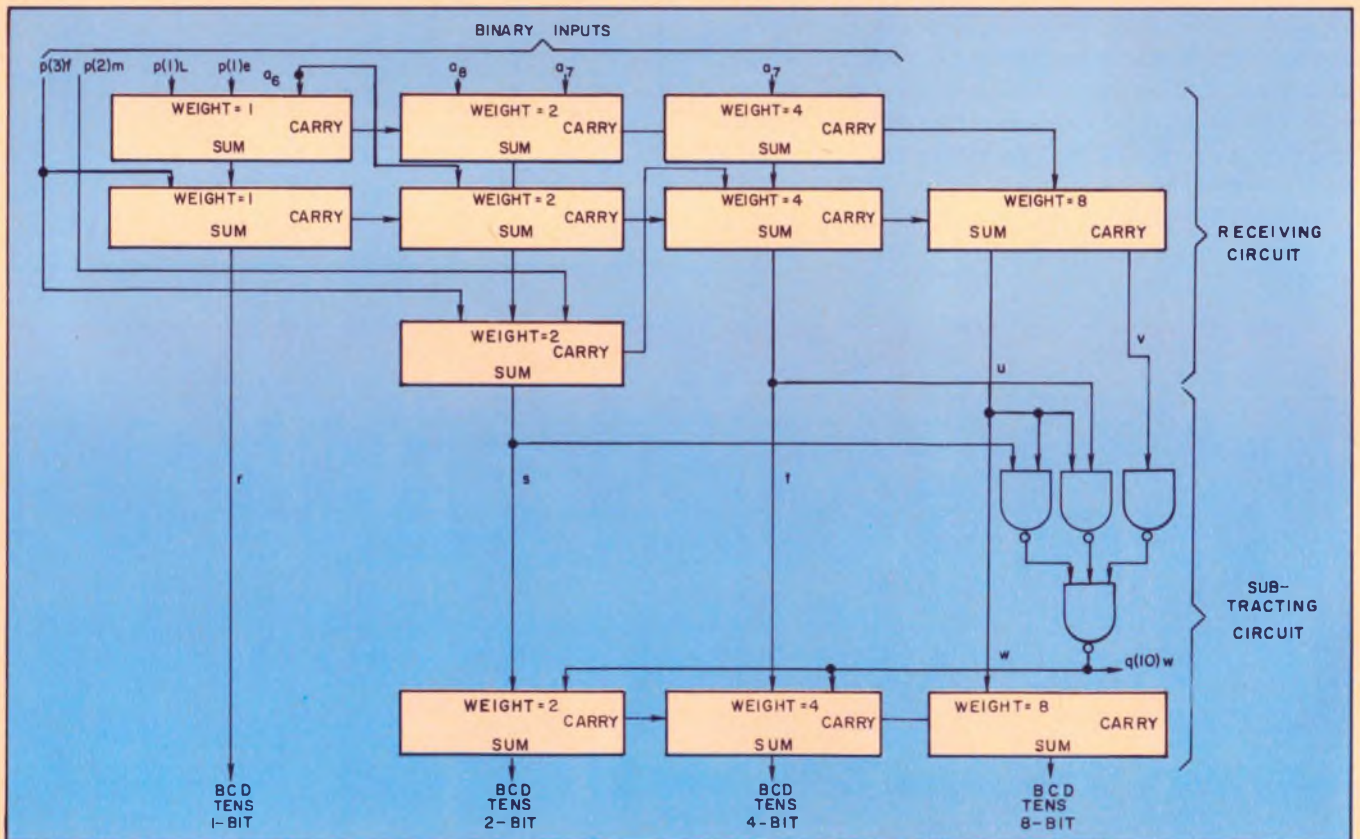

7. The tens decode circuit does not require a reducing circuit, since the maximum value of the 5-bit binary

number from the receiving circuit is less than 23. The subtracting logic is similar to that of the units decade.

nation of inputs. The output lines of such a circuit will contain a binary number equal to the sum of the weights of the binary input bits.

### Reduce sum to 29, generate carry

The reducing circuit for an  $n$ -bit binary number, where  $n$  is equal to or less than 6, is shown in Fig. 4. The  $a_5$  (16) input is routed into the weighted adders of values 2 and 4, and is also used as a carry of value 10. If this input is a 1, 6 will be added to the other full adder inputs, and 10 will be carried to the next higher decade decode circuit, thus accounting for the full value of input weight 16. Similarly, the  $a_6$  (32) input is routed into the full adder of weight 2 and is also used as a carry of weight 30.

The outputs of this circuit in terms of inputs are

$$a_1(1) + a_2(2) + a_3(4) + a_4(8) + a_5(6) + a_6(2) + p(30)a_6 + p(10)a_5 \quad (16)$$

where  $p(30)a_6$  and  $p(10)a_5$  are carries of 30 and 10, and the sum of the remaining terms is on lines  $b_1$  through  $b_5$ . The sum is either equal to, or a multiple of, 10 less than the input on lines  $a_1$  through  $a_6$ . For  $n$  greater than 6, full adders again must be ganged to receive all the inputs.

In essence, then, the receiving and reducing circuits receive the set of inputs defined by Eqs. 6, 8, 10, 11, or 12, and produce a binary number from 0 to 29 and a set of carry bits. The binary output is a multiple of 10 less than the binary input.

### Subtract multiple of 10 for final bits

The output of the reducing circuit must be reduced again to a binary number between 0 and 9, the final BCD bits for a given decade. The subtracting circuit receives a 5-bit binary number with a decimal value from 0 to 29, and produces a 4-bit binary number from 0 to 9 (either 20 less than the input number, 10 less, or equal to it). It also produces a carry of weight 10, 20, or no carry, equal to the difference between the input and output binary numbers. In other words, the circuit subtracts the highest multiple of 10 in the input number from the input number, using the two's complement method.

To subtract binary numbers, say A from B, the binary complement of A, plus 1, is added to B and the highest-valued 1-bit of the result is dropped. Thus, if the circuit is to subtract 10 (binary 1010), the complement of 10 (binary 0101), plus 1 (binary 0110), is added to the input number. The number in the last set of parentheses is a binary 6. To subtract 20 (binary 10100), the complement of 20 (binary 01011), plus 1 (binary 1100) is added to the input number, the last binary number being 12. If the input binary number is between 20 and 29, a

binary 12 is added by the subtraction circuit, and the 32-weighted bit of the result is dropped. This, in effect, subtracts 20 from the input number. If the input number is between 10 and 19, 6 is added and the 16-bit of the result is dropped; this subtracts 10 from the input. If the input is less than 10, nothing is added to or subtracted from it.

### Subtract by two's complement method

A subtracting circuit, capable of receiving binary numbers from 0 to 29, is shown in Fig. 5. Here, the NAND circuitry decides whether the input binary number is between 0 and 9, 10 and 19, or 20 and 29. Depending on the bracket into which the input number falls, a binary 0, 6, or 12 is added to the input number, and the 16- or 32-bit of the result is dropped. The manipulation, according to the two's complement subtraction method, produces a binary number from 0 to 9, which is a multiple of 10 less than the input number. The two carry lines are used as inputs to the next higher decade decode circuit. The outputs of the circuit of Fig. 5 are described by

$$a_1(1) + a_2(2) + a_3(4) + a_4(8) + a_5(16) - j(10) - k(20) + p(10)j + p(20)k, \quad (17)$$

where

$$j = (a_5.k) + (a_3.a_4) + (a_2.a_4) \quad (18)$$

and

$$k = a_3.a_5. \quad (19)$$

The two  $p$  terms in Eq. 17 are the carry terms, and the sum of the remaining terms is present in binary form on the four outputs of the illustrated circuit. Equation 17 clearly states that the sum of the outputs always will equal the input binary number. Subtraction circuits can be designed to receive inputs as high as 11 or 29.

### Let's build an 8-bit converter

For an 8-bit binary to - BCD decoder, Eq. 2 becomes

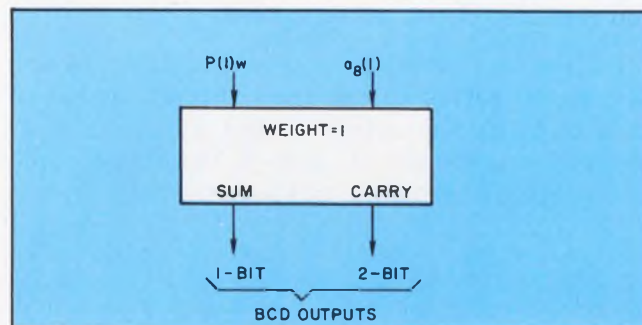

8. The hundreds decode circuit is simply one full adder, which accepts one binary input and the carry term from the tens decode circuit.

$$a_8(128) + a_7(64) + a_6(32) + a_5(16) + a_4(8) + a_3(4) + a_2(2) + a_1(1). \quad (20)$$

Since an 8-bit binary number can have a maximum decimal value of 225, Eq. 20 can be set equal to 3-digit decimal number  $xyz$ , and

$$xyz = a_8(100) + a_6(20) + a_7(60) + a_6(30) + a_8(8) + a_7(4) + a_6(2) + a_5(16) + a_4(8) + a_3(4) + a_2(2) + a_1(1) \quad (21)$$

$$= 100(a_8(1)) + 10(a_8(2) + a_7(6) + a_6(3)) + a_8(8) + a_7(4) + a_6(2) + a_5(16) + a_4(8) + a_3(4) + a_2(2) + a_1(1) \quad (22)$$

Then

$$z = a_8(8) + a_7(4) + a_6(2) + a_5(16) + a_4(8) + a_3(4) + a_2(2) + a_1(1) - P, \quad (23)$$

$$y = a_8(2) + a_7(6) + a_6(3) + \frac{p}{10} - q, \quad (24)$$

and

$$x = a_8(1) + \frac{q}{10}. \quad (25)$$

The three decade decode circuits are based on Eqs. 23, 24, and 25. To obtain the units decade decode circuit, Eq. 23 can be implemented in logic as shown in Fig. 6. In the first row of full adders, the  $a$  inputs represent the binary bits defined in Eq. 21 and are placed into weighted adders according to their coefficients in Eq. 23. The outputs of these adders (lines  $a$  through  $f$ ) contain a 6-bit binary number equal to the sum

$$a_8(8) + a_7(4) + a_6(2) + a_5(16) + a_4(8) + a_3(4) + a_2(2) + a_1(1). \quad (26)$$

In this case, the receiving circuit is only one row of full adders. The  $a_1$  binary input bit is always equal to the 1-bit output of the units BCD decode (this is recognized easily because  $a_1$  is the only odd bit in both number codes).

#### Add reducing circuit where needed

For the case in which  $a_1$  through  $a_8$  in Eq. 26 are all 1's, the output of the receiving circuit has a value of 45. To reduce this number, a second row of adders (reducing circuit) is used. The binary numbers on lines  $g$  through  $k$  will have the value

$$a(1) + b(2) + c(4) + d(8) + e(6) + f(2) \quad (27)$$

where  $a$  through  $f$  can have values of 0 or 1, and the two carries ( $p(1)e$ ) and ( $p(30)f$ ) make up the difference between the numbers represented by Eqs. 26 and 27. The maximum value of Eq. 27 is

23, the reducing circuit having already performed its function.

The remainder of the circuit in Fig. 6 receives the 5-bit output of the reducing circuit. It produces a binary number from 0 to 9 on lines  $n$  through  $q$ , which is a multiple of 10 less than the number on lines  $g$  through  $k$ . The entire circuit in Fig. 6 subtracts from the input number the highest multiple of 10 in that number.

The tens decade decode circuit is derived from Eq. 24. From this equation, and the  $p$ -carry of the circuit in Fig. 6, the inputs to the tens decade circuit are  $a_8(2)$ ,  $a_7(6)$ ,  $a_6(3)$ ,  $p(3)f$ ,  $p(1)e$ ,  $p(1)1$ , and  $p(2)m$ . Table 3 lists these inputs with the weights of the full adders in their respective receiving circuits. Four inputs of weight 1 are required. From Table 2, two full adders of weight 1 are required to handle these inputs. Since two carries of weight 2 are produced by these adders and five inputs of weight 2 are shown in Table 3, the intersection of row 5 and column 2 in Table 2 shows the number of full adders of weight 2 needed in this circuit is three. Similarly, the number of full adders of weight 4 (determined from row 1 and column 5) is 3, and of weight 8 (row 0 and column 2) is 1.

The tens decade circuit is shown in Fig. 7. Lines  $r$ ,  $s$ ,  $t$ ,  $u$ , and  $v$  form a 5-bit binary number that equals the sum of the inputs in Eq. 28. The maximum value of this number is 18. Since this is less than 23, a reducing circuit (the second step) is not required. The remainder of the circuit is subtracting logic similar to that used in the units decade.

From Eq. 25, it can be seen that the hundreds decade decode circuit is simply one full adder (Fig. 8). The only inputs to this circuit are the  $a_8(1)$  term (Eq. 25) and the carry term from the tens decade circuit. ■■

#### Test your retention

Here are questions based on the main points of this article. Their purpose is to help you make sure you have not overlooked any important ideas. You'll find the answers in the article.

1. What are the three steps in the conversion process in the circuit described by the author?

2. How can the converter be easily modified to accommodate more input bits?

3. What convenient method is used to perform subtraction?

4. Why does the author expect it to be obvious that the  $a_1$  binary bit will always be equal to the 1-bit output of the units BCD output in an 8-binary-bit converter?

# When the chips are down, they ought to be on our IC packages.

It's not just because we want to sell our products (which we do).

Or because we're proud of them (which we are).

We think you should buy our IC packages for a number of reasons.

First of all, we make all our own parts. (Many of our competitors must buy frames and ceramics for assembly.)

We assemble the packages ourselves.

We test our packages for insulation, thermal shock resistance, hermeticity, lack of internal shorts, excess glass-ceramic flow.

And if one of our growing line of packages

doesn't fit your requirements, we'll design one that will.

One more thing. Just because you're getting the best IC package money can buy, don't think it takes a lot of money. In fact, ours probably costs less than any others.

Isn't that where you should put your chips?

Sylvania Metals & Chemicals, Parts Division,  
Warren, Pennsylvania 16365.

**SYLVANIA**  
GENERAL TELEPHONE & ELECTRONICS

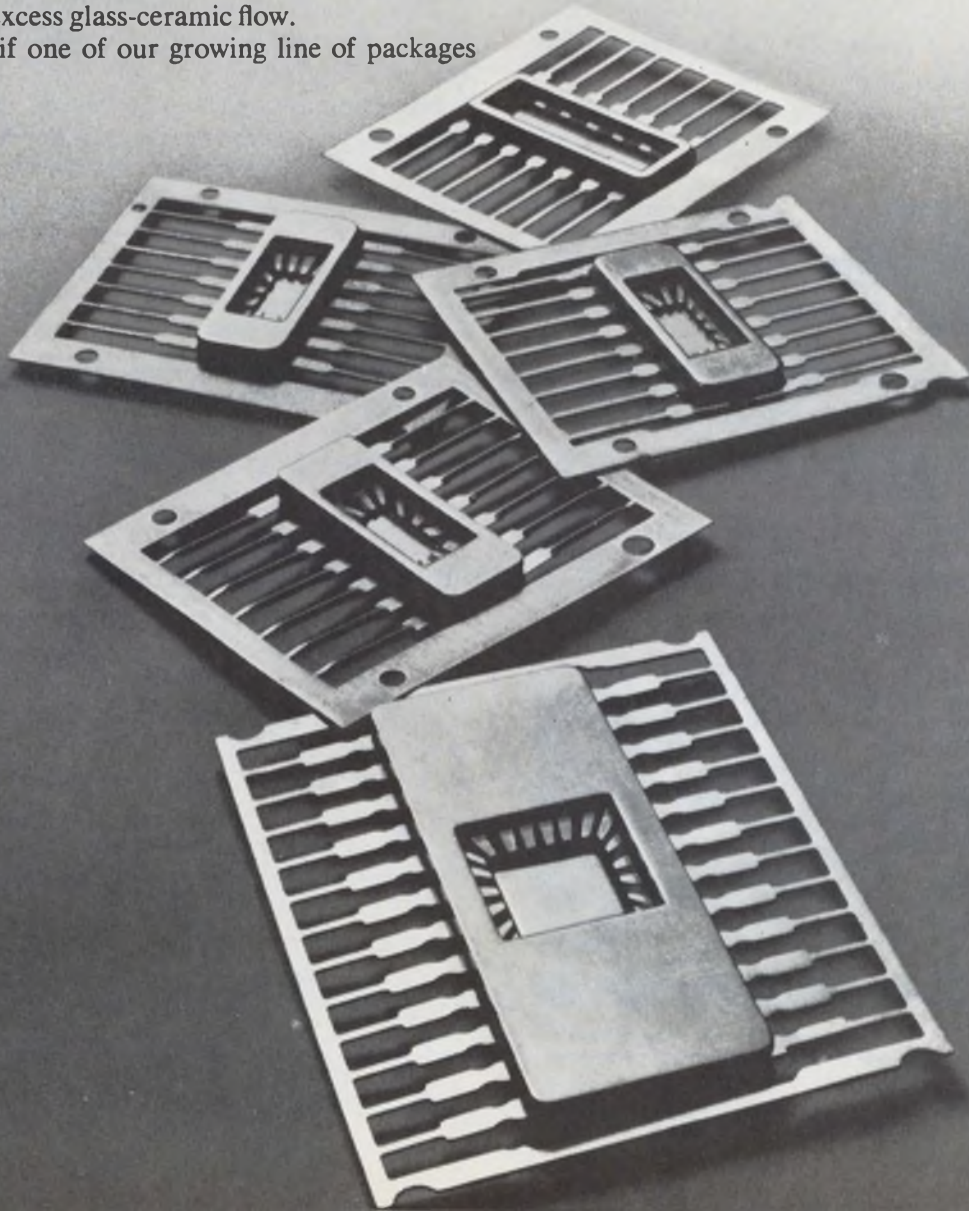

## Preparing a technical paper? Check these steps designed to guide you in the written and oral presentation of your material.

It isn't always the engineer who designs the product who gets credit for it; sometimes it's the first one who talks about it. And one of the best ways to "talk" about an engineering concept is through the presentation of a paper at a technical meeting.

*The check list on the opposite page is not intended to be earthshaking in content. As you can see, most of the points provided are dictated by common sense. But the difference between making a good presentation and making a poor one usually depends on whether or not the writer follows to the letter the simple guidelines that almost guarantee a successful presentation. The check list is there for you to cut out and refer to the next time you present a technical paper*



**Roger D'Aprix**, Manager, Employee Communications, Xerox Corp., Rochester, N.Y. The author has written two other articles for ELECTRONIC DESIGN: "How to get word to the top," and "Join the experts—Publish!"

*and want to refresh your memory on the points of proper oral and written presentation.*

### The do-it-yourself paper

If you have at your disposal a company group charged to assist with technical papers and articles, rely heavily on its services. If your employer does not offer such a service, preparing the paper yourself may test your ingenuity, but you'll be able to do the job if you follow these helpful suggestions.

First—locate a copy of the "call" for papers. These calls are generally distributed to the professional engineering society membership and to a few company officials. If you do not fall under either category, you can obtain the data from the society that's sponsoring the forum.

The call will inform you about the meeting and instruct you on how to submit your paper. Normally, you will be requested to send in a title and a brief summary of your proposal, which will be screened by the papers committee.

If the summary is accepted, you will then be asked to prepare two versions of the paper—one for oral presentation at the actual meeting and the other for publication in the symposium transactions.

### Model paper is 'camera-ready'

In some cases no transactions are printed, but you would do well to prepare a typed copy for reproduction since you will generally receive numerous requests for copies. Further, your company may want to distribute the finished manuscript to certain customers or other interested parties.

When you submit your paper to the symposium for publication, it is essential that the typed pages and illustrations should be "camera ready"; that is, your paper must be clean and free from error. It will be photographed and incorporated into a complete record of all the papers presented.

For your convenience, here are two check lists to help guide you in the oral and written presentation of your material:



## Checklist

### Written presentation

#### *The copy*

- Keep the message simple, concise and readable. Test your paper's readability on your co-workers.
- Get your company's approval before presenting your paper.
- Supply a bibliography for anyone who wants to dig deeper into your background and experience, or check your research.

#### *The art work*

- Submit glossy photos of original art work. No art work will be returned by the symposium.

- Blue-pencil your name and figure number on the back of all illustrations in case they become separated from your paper.
- Mark "top" on each picture in case there's some question about its position.

#### *The mailing*

- Pack your paper with cardboard to prevent mutilation in the mail.
- Send it via registered mail and make a few copies to protect yourself against possible loss.
- Make a list of the names of people who should see your paper.

### Oral Presentation

#### *The preparation*

- Determine what points you can develop in 20 to 30 minutes.
- Give conclusions with just enough information to validate your logic. Your audience cannot absorb more information than that.
- When you cannot express a concept clearly in words, plan to use slides.

#### *The visual aids*

- Use the 3-1/2 × 4-inch slide. It is large enough to be seen in a large meeting hall.
- Use film negative slides (white lines on a black background) for a line drawing.
- Color slides will enhance your presentation, if they are used judiciously. For best results get advice from someone who knows

how to present color slides.

#### *The delivery*

- Above all, relax. Remember that you are the expert. You are among friends who will squirm in embarrassment only if you give a bad performance.
- Use notes rather than reading your paper. A well-done speech requires a certain amount of acting ability to infuse naturalness and enthusiasm into the words.
- Give your talk at least two "dry runs." Use slides, lectern, and a small audience. This rehearsal will provide you with the opportunity to smooth the rough spots in content and delivery; it's also a chance to anticipate questions from the audience.

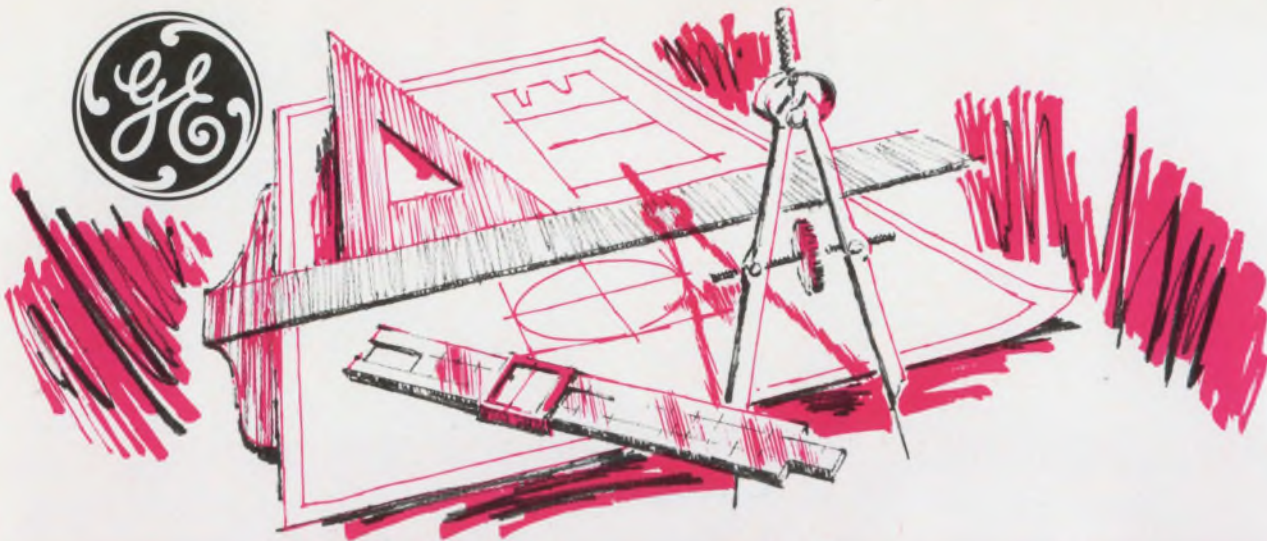

### New 25 amp triac offers several exceptional performance features

GE has extended its broad thyristor line with the addition of a new 25 ampere triac. SC60 (stud-mounted) and SC61 (press-fit) offer several exceptional features:

Current rating	25A RMS
Voltage	200V, 400V,
rating	500V
Surge current	250A Peak
Commutating	5V/ $\mu$ sec.
dv/dt	MIN.
Static	200V/ $\mu$ sec.
dv/dt	TYP.

The SC60/61 triac can handle up to 6KW at 240 volts and is compatible with PA424 and PA436 IC's for control of heaters, lamps and motors.

SC60/61 is well suited to high volume use in residential and industrial space heating, large lamp-dimming controls, temperature control in copying machines and many other applications. For details, circle 211.



Pin-sized Lodex® magnet

### Now get proved Lodex® permanent magnets in sizes smaller than a pin

When designs call for tiny (even less than 1 millimeter) permanent magnets, GE has the answer. GE can produce powerful micro-miniature magnets at low cost—and in complex configurations, too.

The magnets are made of proved Lodex material. This exclusive GE product makes it possible to produce magnets in tiny, intricate shapes meeting extremely tight physical and magnetic tolerances.

Close piece-to-piece physical and magnetic uniformity often eliminates the need for final testing of the end product. These magnets are the perfect answer for such precise applications as reed switches.

For details, circle 212.



### General Electric meter relays give you reliability at lower cost

Reliable performance at lower cost makes GE your best meter relay choice.

Functions include energizing alarms; close differential relaying; and controlling temperature, power, speed and frequency.

Proved GE design is better three ways:

- **New contactless control action.** Solid-state, light sensitive switch means simple, reliable control.
- **"Piggyback" control module.** Plug-in design saves installation time.
- **Choice of styles.** Easy-reading BIG LOOK® or low-profile HORIZON LINE® meter relays.

Applications range from critical monitoring in hospital intensive-care units to deep-well drilling control.

For details, circle 213.



100-CFM unit

### Get reliable cooling for computer cabinets with proved GE fan assemblies

GE cooling fan assemblies offer years of continuous duty without maintenance. Available in two sizes, these blower fans feature all-angle operation and efficient air flow.

Small 90 and 100 CFM fans have KSB33-frame Unitized® motors and fit an opening 4 $\frac{3}{4}$ " square. Near perfect bearing bores, accurate shaft-bearing alignment and metered oil bearings virtually eliminate bearing wear for long motor life.

GE's 500 CFM fan mounts on a 9.7" diameter bolt circle through holes in its aluminum venturi. Its KSP11-frame unit-bearing shaded-pole motor provides quiet, long-life operation.

For more information, circle 214.



### New GE transistor is the ideal epoxy replacement for "hermetic" devices

General Electric's GET transistor series is a new answer to design problems. GET is the newest addition to GE's proved family of epoxy-encapsulated transistors dating back to 1962 . . . over 7 years of epoxy experience.

GET is the ideal epoxy replacement for "hermetic" devices . . . no expensive redesign needed. The new D32 package conforms to TO-18 mounting patterns and is available in these silicon planar, passivated models:

GE Model	Type	JEDEC No.
GET705, 708, 914	NPN	2N705, 708, 914
GET2221, 2222	NPN	2N2221, 2222
GET3638, 3638A	PNP	2N3638, 3638A
GET2369, 3013, 3014, 3646	NPN	2N2369, 3013, 3014, 3646
GET929, 930	NPN	2N929, 930

GE's quality epoxy forms a true chemical bond with metal to provide increased resistance to moisture and vibration damage. Low profile package means smaller circuits and lower cost.

For more information on GET and GE's "specials" capability, circle 215.



### Check this new GE transmitter design

GE's C2003C transmitter is a Microwave Circuit Module containing a master oscillator and power amplifier using planar ceramic triodes.

It is one of many GE MCM's that help reduce design cycles, provide retrofit and lead to improved system performance.

C2003C benefits: meets performance and military requirements of the transmitter portion of IFF transponder

- permits two transmitters to function in space formerly used by one
  - light weight
  - significantly smaller
  - simplified heat sinking
  - excellent frequency stability with wide variations in antenna VSWR.
- For details, circle 221.

# 11 more

## electronic components tailored for designers

General Electric components are engineered for reliability and cost effectiveness. No other single manufacturer offers such a wide selection of quality electronic components as General Electric. Specify GE in your designs.



### GE fused quartz and fused silica add design flexibility to many applications

Highest purity GE Fused Quartz is being applied in crystal pulling, zone refining, semiconductor diffusion and research labware. And many new electronic applications are constantly being developed.

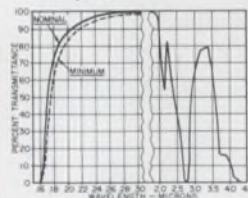

Transmittance Curve—151 Fused Silica for 1cm thickness\*

GE type 151 Fused Silica, for critical optical jobs, is a schlieren grade material offering highest ultra-violet transmission.

Type 151 is one of five optical grades available. It is ideal for use in laser optics, absorption cells, spectrophotometer optical elements and schlieren photography.

For technical data and application assistance, circle 216.

\*Excluding surface reflection losses



### Tough, dependable indicating lights come in four sizes for varied application

GE has a broad assortment of low cost, high quality indicating lights (CR103, type H) that come with four mounting hole diameters for varied applications — 5/16", 15/32", 11/16" and 1". They all feature Lexan® (polycarbonate resin) lenses which diffuse light, eliminate "hot spots" and are virtually unbreakable.

Lens shapes include crown, spherical, torpedo and cylindrical. Lamps and lenses for most models install from the front without removing the assembly or opening the panel.

And a low-cost miniature indicating light (the CR103 HE) has been added to the line for applications where space is at a premium and minimum cost is essential.

The CR103 H line is perfect for applications such as panel indicators, lab equipment, appliances, meters, gauges, timers, and illuminated pointers and indicators for dials.

Get full-line details, circle 217 on the reader service card.



### Innovative design gives GE Klystrons greater bandwidth, gain and efficiency

An experienced team of GE specialists uses innovative techniques to produce high-power Klystrons with greater bandwidth, gain and efficiency.

The Klystron above is just one example of GE's high-power pulsed microwave amplifier used in applications such as radar and particle accelerators.

GE Klystron designs can be developed in tunable and broadband types for all frequencies from UHF to X-band. They feature metal-ceramic construction, integral ion pumps and modular design for long life, low operating costs, and economical repair.

Put GE's team to work on your special Klystron application. For details, circle 218.



### New GE integrated voltage regulator smoothes ripple and protects IC's

GE's new integrated voltage regulator (IVR) is a monolithic IC that helps your power supply deliver constant, ripple-free voltage for solid-state circuit components. The device operates as a shunt regulator over a range of 10 to 40 volts at up to 400mW avg. power.

Total Avg. Power 400mW  
Voltage 10-40V  
Peak Current 1A  
(10 sec pulse width, 1% duty cycle)  
Operating Temp. Range -15C to +125C  
Temp. Coefficient of rated voltage .03%/°C typ.

Housed in the standard epoxy TO-98 package, GE's IVR is a low-cost means to stabilizing voltage for solid-state circuits. Applications are found in auto radios, TV ripple filters and as a reference amplifier for high-power regulation. The IVR can also be used where other voltage regulation methods have been too costly for high-volume use.

For details, circle 219.



### Get over 1/2 farad at 5 volts with GE computer-grade capacitors

GE 86F500 high-capacitance computer-grade capacitors provide up to 540,000  $\mu$ f at five volts (34,000  $\mu$ f at 100 volts) in a single case.

These units are excellent when large blocks of capacitance are required, as in power supply filters.

86F500 units are rated for continuous duty at 65C or at 85C with proper voltage derating. GE's computer-grade capacitors provide highest capacitance per case size, high ripple current capability, low ESR and long life.

Units are available in nine case sizes — diameters 1 3/8" to 3" with lengths up to 8 5/8" — for operation up to 100 VDC.

For details, circle 220.

LOOK TO GENERAL ELECTRIC—your best source for more in electronic components.

ELECTRONIC COMPONENTS SALES OPERATION

GENERAL  ELECTRIC

# $\pm 50 \text{ ppm}/^\circ\text{C}$

## in all Helipot Cermet Trimmers

This significant advance in Helipot's cermet technology is now available at only a dime/unit more . . . 100 ohms thru 2 megohms. In addition, you get essentially infinite resolution, environmental stability, reliability, no catastrophic failures — all superior to wirewound trimmers. We'll also deliver off-the-shelf, locally stocked trimmers with a standard tempco of  $\pm 100 \text{ ppm}/^\circ\text{C}$  in the 100 ohm thru 2 megohm range.

**Beckman**

**INSTRUMENTS, INC.**

**HELIPOT DIVISION**

FULLERTON, CALIFORNIA • 92634

INTERNATIONAL SUBSIDIARIES: AMSTERDAM; CAPE TOWN; GENEVA; GLENROTHES, SCOTLAND; LONDON; MEXICO CITY; MUNICH; PARIS; STOCKHOLM; TOKYO; VIENNA

## Dual level detector uses one active device

Most techniques for monitoring the excursions of a voltage signal employ two Schmitt trigger circuits. One detects excursions above an upper limit level; the other detects excursions below a lower level. The circuit shown in the figure can do the same, using only one active device instead of the four needed to build two Schmitt triggers. The only proviso is that the upper and lower limits must be symmetrically spaced about the center reference level.

The active device is the MIL-approved type 2N2060 dual transistor. The input voltage,  $V_1$ , is connected to the base of a differential amplifier for comparison with a reference voltage. The reference is set by  $R1$ .

When  $V_1$  is at the desired level, the amplifier is balanced. If  $V_1$  deviates from the reference level, one of the collectors will go positive and the steering diodes,  $CR1$  and  $CR2$ , will apply a positive voltage to the zener diode,  $CR3$ . When the deviation is large enough,  $CR3$  will break down, providing an output signal,  $V_2$ . Thus the zener breakdown voltage determines the allowable deviation from the reference level.

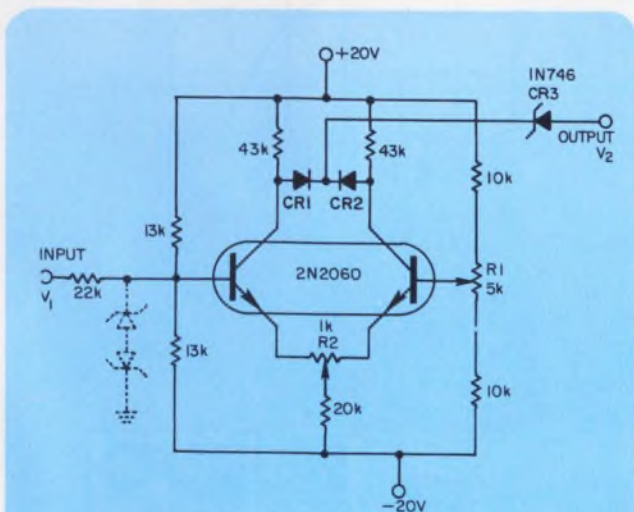

By using a zener diode to set the (symmetrical) upper and lower excursion limits, this single circuit can do the work of two Schmitt triggers.

$R2$  is used to balance the two transistor currents when the base voltages are equal.

The circuit showed less than a 3 per cent change in threshold level over the temperature range of 30°F to 140°F. For low-quantity production or in situations with relaxed temperature requirements, the 2N2060 can be replaced with a matched set of less expensive transistors.

The circuit can also be used to compare the absolute values of two variable voltages by using the reference base as an input and adding zener diodes as shown in dotted lines to restrict operation to the linear region of the differential amplifier.

*B. A. Rogers, Senior Engineer, Bendix Corp., North Hollywood, Calif.*

VOTE FOR 311

## Ultralinear ramp generator uses UJT to drive Darlington

An inexpensive variable-frequency ramp generator can be built with three transistors and one UJT.

The generator consists of a constant current source,  $Q1$ , a charging capacitor;  $C_1$ ; and a uni-junction transistor switch. The output circuit uses  $Q2$  and  $Q3$  in a Darlington configuration.

$Q1$ , used in the common-base configuration, acts as a constant-current source. The zener,  $Z$ , and diode,  $D$ , are used to hold the emitter current fixed. If diode  $D$  is of the same material as  $Q1$ , it will provide temperature compensation, because the voltages across the diode and across the emitter-base junction of  $Q1$  will vary similarly. This means that the zener voltage of  $Z$  will always appear across the 6-k $\Omega$  resistor, and hence the emitter current will be very nearly constant. The zener will also compensate for any drift in the power-supply voltage.

The constant current delivered by  $Q1$  linearly charges capacitor  $C_1$  to the triggering level of



What does our **muffin<sup>®</sup> fan** have that other 4<sup>11</sup>/<sub>16</sub>" square fans do not?

**NOW...OFF-THE-SHELF DELIVERY!**

# RELIABILITY

Performance in excess of 90,000 hours can be expected from 90% of all "muffin fans" manufactured. That's reliability unmatched by any other 4<sup>11</sup>/<sub>16</sub>" square fan. So . . . where life really counts, and where 100 cfm of cooling air is required you can rely on "muffin fans" to perform longer than others, in computer equipment, copying machines, receivers and transmitters, power supplies, and countless other applications.

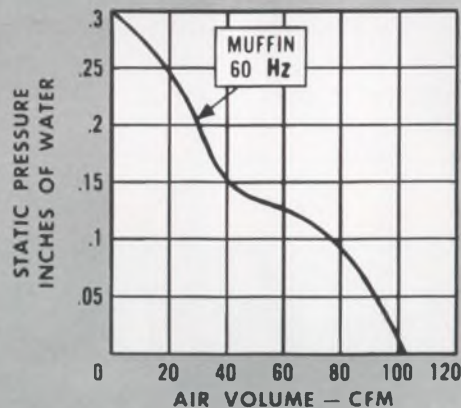

For full details on performance, application, life and other pertinent data be sure to send for our latest catalog sheet. Write to Rotron, Incorporated, Woodstock, New York 12498.

CALL YOUR ROTRON

**4-WARD**  
DISTRIBUTOR

WEST  
R. V. WEATHERFORD CO.  
GLENDALE, CALIF.  
213-849-3451

MIDWEST  
ALLIED ELECTRONICS  
CHICAGO, ILL.  
312-829-9121

SOUTH  
HALL-MARK ELECTRONICS CORP.  
DALLAS, TEXAS  
214-231-6111

EAST  
SCHLEY ELECTRONICS CORP.  
WATERTOWN, MASS.  
617-926-0235



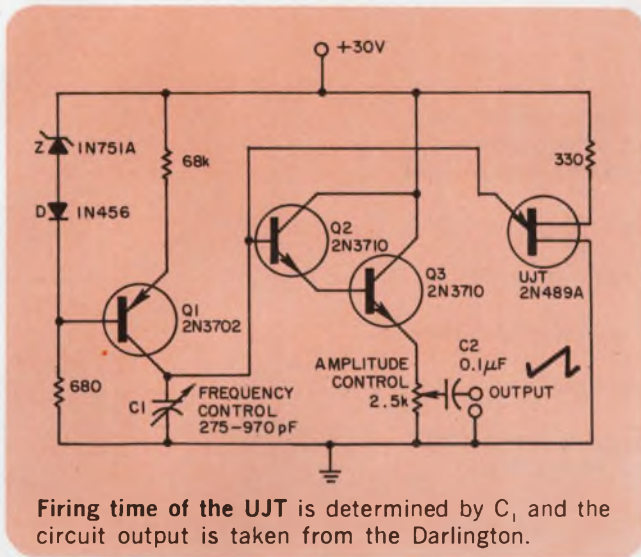

the UJT. At this point,  $C_1$  discharges through the UJT in one microsecond. Varying  $C_1$  adjusts the frequency of the sawtooth wave from 5 to 200 kHz. The charging capacitor is applied to the output terminals through a Darlington amplifier. The very high input impedance of the Darlington circuit does not load  $Q_1$ , and hence will not affect the linearity.

Amplitude of the output signal is determined by potentiometer  $R$ , and can be varied from zero to 10 volts. The linearity for frequencies between 5 and 10 kHz is within 0.1%; between 10 and 50 kHz it is within 1.0%. Power dissipation of the circuit is 1.2 watts.

Godfried T. Toussaint, University of Tulsa, Tulsa, Okla.

VOTE FOR 312

## Drive high-C loads, like MOS registers, by resonating them

System designers are finding more and more uses for MOS shift registers in data handling applications. Frequently large numbers of registers are connected in series and used as serial delay lines. One of the problems involved is the generation of the register clock pulses.

A typical MOS register may require clock pulses of 0.5  $\mu$ s duration with peak amplitudes of up to 26 V. The clock-line impedance is primarily capacitive. With clock-lines of, say, 30 registers connected in parallel, total load capacitances in the neighborhood of 2700 pF can be

expected. Peak currents of up to 350 mA will be encountered when generating pulses with rise times of, say, 200 ns. If the output buffer of the clock driver is a complementary emitter-follower, as is usually the case, excessive power dissipation will result because the transistors will always operate within their linear regions.

The clock driver circuit shown (Fig. 1), actually takes advantage of the load capacitance by combining it with an inductor and a switch to form a series-resonant tank circuit. The switch is closed long enough to allow one half-sinusoid

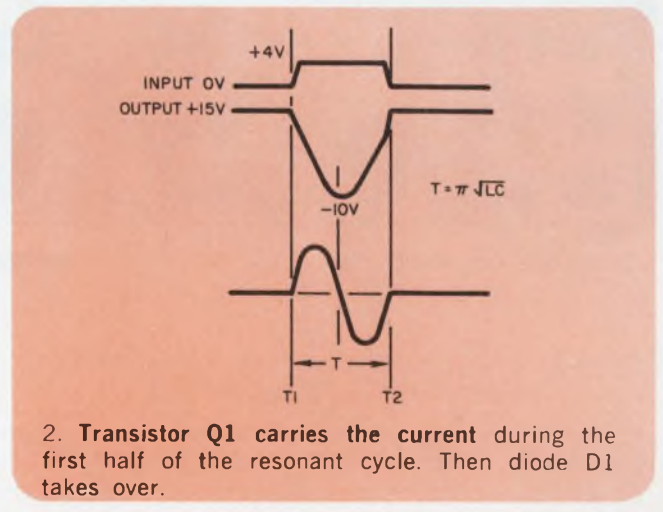
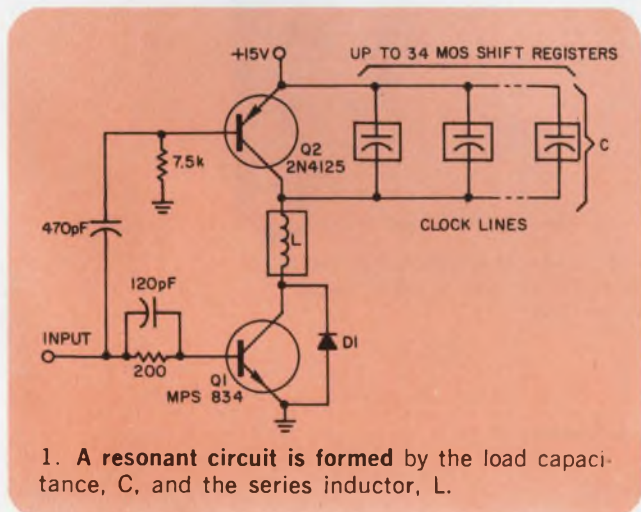

# smooth

**RCA WP-700A, 702A, 703A and 704A** constant voltage dc power supplies are all solid-state. A negative feedback circuit maintains constant output voltage with low ripple—regardless of varying line. In fact, at rated load, these supplies are so smooth that "they hardly cause a ripple."

They are versatile bench-type units—ideally suited for use in circuit design, servicing, industrial, and educational applications.

Output voltage of the WP-700A and WP-702A is continuously adjustable from 0 to 20 volts at current levels up to 200 mA.

Output voltage of the WP-703A is continuously adjustable from 0 to 20 volts at current levels up to 500 mA.

Output voltage of the WP-704A is continuously adjustable from 0 to 40 volts at current levels up to 250 mA.

All four power supplies have built-in electronic short-circuit protection—and a front panel overload-indicator that signals approach to maximum rated current level.



**WP-700A:** \$40.00\* (five or more) \$48.00\* (less than five)

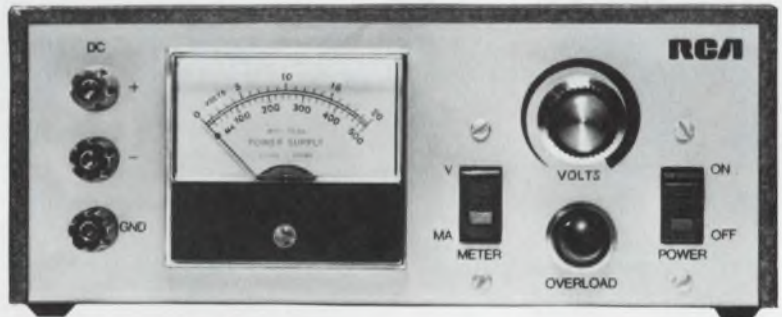

**WP-703A:** \$49.00\* (five or more) \$58.00\* (less than five)

**WP-704A:** \$49.00\* (five or more) \$58.00\* (less than five)



\*Optional Distributor Resale Price.

**WP-702A:** Siamese Twins of WP-700A, but electrically isolated \$73.00\* (five or more) \$87.00\* (less than five)

For further information write: RCA Electronic Components, Commercial Engineering, Department J-18W, Harrison, N. J. 07029.

Look to RCA for instruments to test/measure/view/monitor/generate

INFORMATION RETRIEVAL NUMBER 72



to be induced across the load; then it is opened and another switch across the load is closed to terminate the half-sinusoid and prevent further oscillation.

A positive input pulse at time  $T1$  (Fig. 2), turns on  $Q1$  and turns off  $Q2$ . Current flows first down through the load, the inductor and  $Q1$ , then reverses through the diode  $D1$ . At time,  $T2$  the trailing edge of the input pulse turns off  $Q1$  and turns  $Q2$  back on, thereby terminating the output pulse and clamping the output to +15 V. The input pulse width must be adjusted to  $T = \pi(LC)^{1/2}$ , the resonant half-period of the tank circuit.

The circuit losses prevent the peak voltage amplitude across the load from reaching twice

$B+$  (30V), the theoretical value for an ideal circuit.

The transistors used may be inexpensive epoxy devices since they operate simply as switches and do not conduct large currents during their transition periods.

With the components shown and  $L = 6.8 \mu\text{H}$ , thirty-four 256-bit registers have been operated at 620 kHz. The maximum rep rate may be increased at the expense of a lighter load: Eight 128-bit registers were operated reliably at 4 MHz with  $L = 1.0 \mu\text{H}$ .

*R. O. Brink, Design Engineer, Philco-Ford Corp., Palo Alto, Calif. Now with Novar Corp., Mountain View, Calif.*

VOTE FOR 313

## Transient inrush current is limited by series transistor

It is often necessary when operating equipment from a dc source to limit the inrush current when power is applied. Transient limitation may be required to protect the source, turn-on relay contacts, or the equipment load itself. If the equipment contains large input capacitor filtering on the power line, the starting transient can reach many amperes when power is initially applied. The circuit shown here can be used to limit the maximum current to any arbitrary value greater than the steady-state current drain, yet the steady-state power loss is relatively small.

This circuit has been used with loads requiring

up to 0.5 amp steady-state current. With component values as shown, the maximum current is approximately 1 amp.

When  $S1$  is closed,  $Q1$  and  $Q2$  conduct due to base current supplied through  $R1$ , thus completing the return path for current in the load. However, if the current is sufficient to produce a voltage of about 0.75 volt across  $R4$ , then  $Q3$  will conduct and rob base current from  $Q1$ . This causes the effective resistance of  $Q1$  and  $Q2$  to rise to that value, which will maintain the total current at 1 amp. After the initial charging period is over, the steady-state current drops to a value where  $Q3$  no longer conducts and  $Q1$  and  $Q2$  approach saturation. The full supply voltage now appears across the load except for a small drop across  $Q2$  and  $Q4$ .

*Al Fisher, Senior Electronics Engineer, Leach Corp., Azusa, Calif.*

VOTE FOR 314

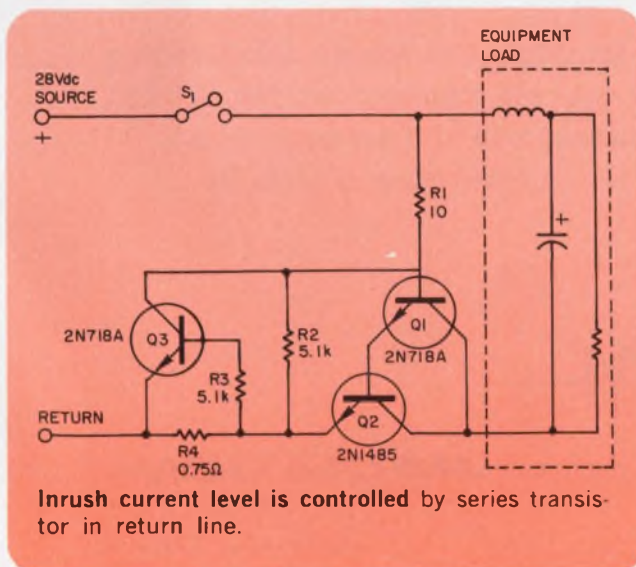

### Send us those programing short cuts

In line with the impact that time-sharing terminals are having on the work of the electronic designer, ELECTRONIC DESIGN will now accept computer programs and subroutines as Ideas for Design. The only requirements are that the program perform some useful design calculation or function, that it be in a recognized computer language, and that it not exceed 60 lines.

So come on—send us those programing short cuts and clever subroutines.

# ON ONE CHIP:

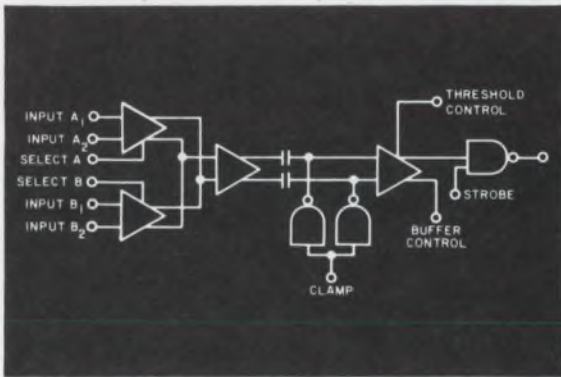

## A PLATED-WIRE, HARDENED SENSE AMP

- The first application of linear and digital technology in one monolithic sub-system.
- The RA-2540R system in a single chip performs the functions of two hardened differential amplifiers and a hardened voltage comparator
- 1 mV signal sensitivity in high noise environment
- 10 ns access time
- Internal D.C. restoration
- Selectable dual channel
- Hardened
  - Photo current compensation
  - Dielectric isolation
  - Thin film resistors
  - Advanced device design

You always get: Off-the-shelf delivery, full plated-wire temperature range and compliance with MIL-STD-883 . . . when you pick the BEST IC for the job from Radiation's fast expanding linear-hardened line.



Lexington, Massachusetts (617) 862-1055  
Norwalk, Connecticut (203) 853-3641  
Washington, D.C. (202) 337-4914  
Dallas, Texas (214) 231-9031  
Long Beach, California (213) 426-7687  
Palo Alto, California (415) 321-2280  
Albuquerque, New Mexico (505) 268-3549

P.O. Box 37, Melbourne, Florida 32901 (305) 727-5430

**RADIATION**  
INCORPORATED  
SUBSIDIARY OF HARRIS INTERTYPE CORPORATION  
MICROELECTRONICS DIVISION

## Diode bridge makes adjustable low-level limiter

A four-diode bridge can be used to make a low-level limiter. Two opposite polarity bias current sources are connected in series with the bridge to supply equal currents. With small signals applied, the bias currents keep the diodes forward biased, and the output waveshape is the same as the input since the diodes do not introduce significant distortion. When large signals are applied, either  $D1$  and  $D3$  or  $D2$  and  $D4$  become reverse biased depending on polarity of the signal. The bias current is then forced to flow through either  $D2$  or  $D3$ , respectively, and  $R$ . The output voltage in these cases is limited to an amplitude of  $IR$  or  $2IR$  peak to peak.

If  $R=50 \Omega$  and the bias resistors are set to  $6 \text{ k}\Omega$ , the bias current is virtually constant. With the bias voltages set to  $+12$  and  $-12$  volts, the bias currents,  $I$ , are  $2 \text{ mA}$  in each branch. Under these conditions, the limiting level is  $2 \times 50 \times 2 \times 10^{-3} = 0.2 \text{ V}$  peak to peak. Note that with no signal the bridge is balanced, and the output is zero.

If fast diodes are used, recovery time is no problem. The effect of diode capacitance is minimized by the high quiescent current,  $1.0 \text{ mA}$  per diode. Under these conditions no significant dis-

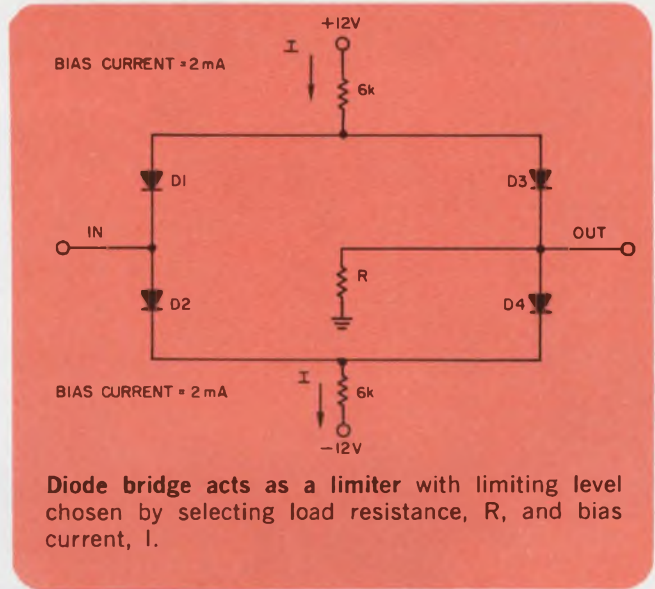

tortion below the limiting level will occur from dc to about  $1 \text{ MHz}$ . The limiting level is independent of temperature. The circuit has relatively low output and high input impedances.

*Goubeau Bernard, Design Engineer, Tours, France*

VOTE FOR 315

## Integrated-circuit hi-peaker shapes frequency response

In the field of video amplifiers for television cameras the designer often has need for a hi-peaker circuit. Over a specified frequency range, the circuit must provide a flat response below the inflection point, and a 6-dB octave rise in

gain for frequencies above the inflection point.

Three commonly used methods to achieve this type of operation are:

- Frequency-selective attenuator (equalizers).
- Frequency-selective emitter degeneration.
- Frequency-selective over-all negative feedback.

The use of an integrated-circuit differential amplifier as a hi-peaker is illustrated. While in some respects it has the "feel" of a frequency-selective negative feedback circuit, it can never become unstable since there is no actual output to input feedback. Instead, the high common-mode rejection characteristic of a good differential-input integrated-circuit video amplifier is utilized.

Assume that the differential gain of the IC is 10, and that resistors  $R_1$  and  $R_2$  are chosen so that 0.9 of the input signal appears across  $R_2$  and 0.1 of it appears across  $R_1$ . The amplifier

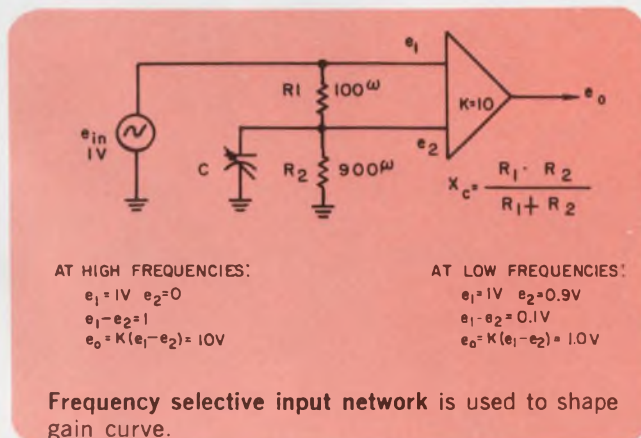

AT HIGH FREQUENCIES:  
 $e_1 = 1\text{V}$   $e_2 = 0$   
 $e_1 - e_2 = 1$   
 $e_o = K(e_1 - e_2) = 10\text{V}$

AT LOW FREQUENCIES:  
 $e_1 = 1\text{V}$   $e_2 = 0.9\text{V}$   
 $e_1 - e_2 = 0.1\text{V}$   
 $e_o = K(e_1 - e_2) = 1.0\text{V}$

# Wirewound

## Because...

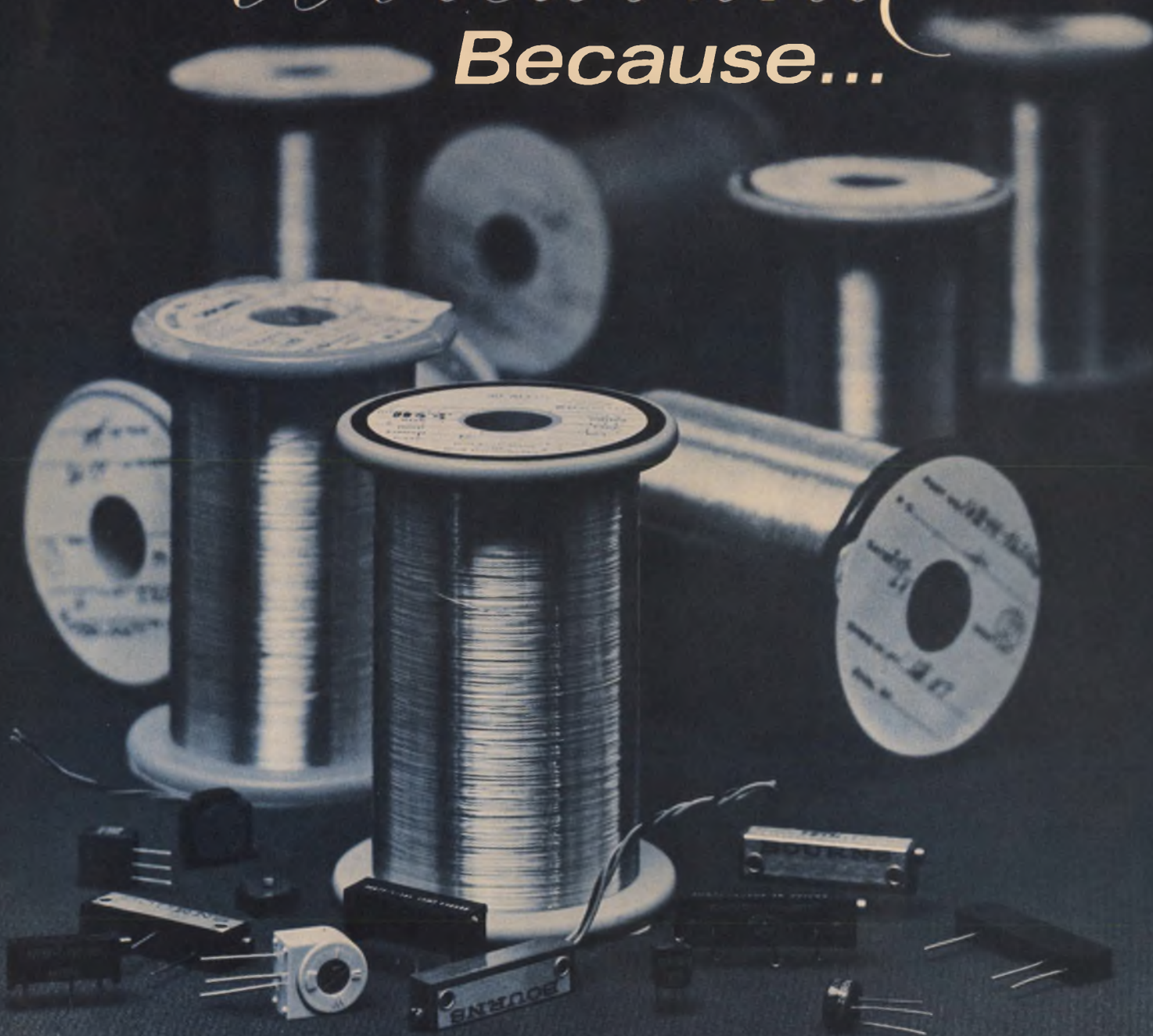

... **Because** the noise in wirewound potentiometers is low—typically 10 ohms ENR in *all* resistance ranges!

... **Because** with temperature coefficient of 50 ppm/°C or less you get exceptional stability!

... **Because** if it's power you need, wirewounds score again and surpass other elements!

... **Because** there's over 20 years of field experience with wirewounds so their reliability can be statistically verified!

... **Because** there's off-the-shelf delivery. We at Bourns stock 500,000 units at the factory while our 63 distributors stock 1,500,000 pieces. Remember . . . whether from factory or distributor stocks you *get* the potentiometers you *need* . . . when you need them by specifying Bourns wirewound potentiometers—the best in the industry!



output will be  $0.1 \times 10$  or unity at low frequencies. At high frequencies the total input signal will appear across  $R_1$  and the output will be  $1 \times 10$  or 10 times. Assuming a zero-source impedance, the inflection point will occur at the frequency where  $X_c = R_1 R_2 / (R_1 + R_2)$ .

By selecting an IC with the proper gain and choosing  $R_1$ ,  $R_2$ , and  $C$  correctly, the designer

has control over the low-frequency gain, the inflection frequency, and the maximum gain at high frequencies. Typical ICs that lend themselves to this application are RCA's CA-3001, CA-3040 and Motorola's MC1510G, with a gain of about 10, 30 and 100, respectively.

*John O. Schroeder, Member Technical Staff, RCA Laboratories, Princeton, N. J.*

VOTE FOR 316

## Fixtures mask selected areas during PC board encapsulating

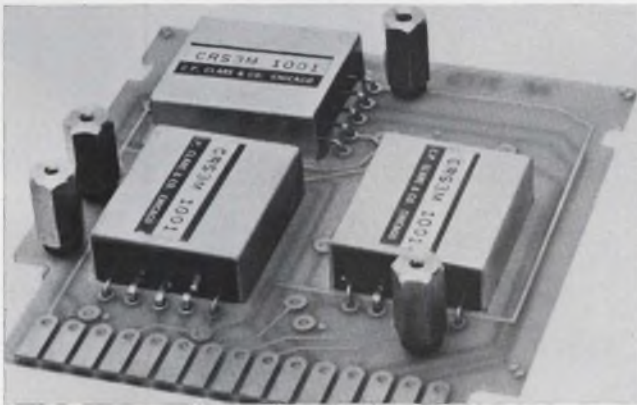

It is often necessary to coat PC board assemblies with encapsulant before final wiring is done. In such cases, there are a number of areas on the board that must be protected, or masked, from the encapsulating material to permit subsequent soldering of lead wires. Masked areas are also often necessary to permit electrical tests subsequent to encapsulation and prior to soldering of lead wires.

Inexpensive fixtures, constructed as shown in A, are handy for this purpose. They use O-rings to mask against the encapsulant, and have shoulders on each handle section to provide electrical contact with the PC board. Although the fixtures work best with brush coating, they may also be used with dip and spray coatings. A 00-90 screw is used to feed through the circuit-board hole.

*Fred W. Kear, Design Engineer, Sparton Southwest, Inc., Albuquerque, N. Mex.*

VOTE FOR 317

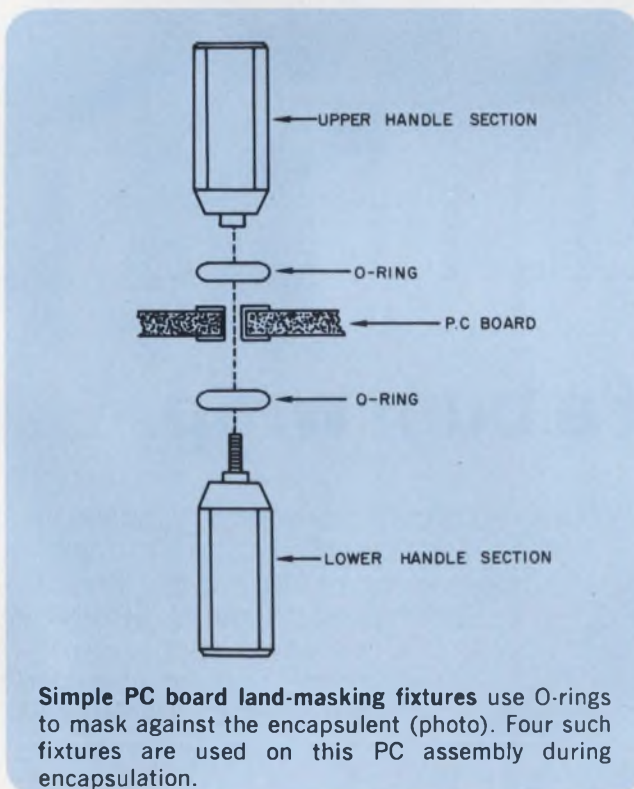

# VOTE

**VOTE!** Go through all Idea-for-Design entries, select the best, and circle the appropriate number on the Reader-Service-Card.

**SEND US YOUR IDEAS FOR DESIGN.** You may win a grand total of \$1050 (cash)! Here's how. Submit your IFD describing a new or important circuit or design technique, the clever use of a new component or test equipment, packaging tips, cost-saving ideas to our Ideas-for-Design editor. You will receive \$20 for each accepted idea, \$30 more if it is voted best-of-issue by our readers. The best-of-issue winners become eligible for the Idea Of the Year award of \$1000.



## You'll never get a bum wrap.

Not with a CDE wrapped tubular. For Cornell Dubilier has set the industry standard in wrap-and-fill capacitors. And we offer the most comprehensive stock in depth. Over 500 items, round and oval, covering capacities from .001 to 5 mfd, voltages from 50 to 600V DCW, and tolerances from 1% through 20%.

In polyester, polycarbonate, or polystyrene, in foil/film or metalized dielectrics—to meet every industrial or military need. And all are Sprint stock standards. SPRINT is the CDE program that assures you quick delivery of standardized components covering 98% of industry requirements.

**CDE** **CORNELL-DUBILIER**  
50 Paris Street, Newark, New Jersey 07101

## Narrow-band rejection filter uses twin-T

In the course of low-frequency amplifier design, it is often necessary to have a narrow-band rejection filter. At vlf, inductors are excessively large, and this suggests the use of an RC filter. The twin-T has theoretically infinite rejection at its null frequency; however, it is unsuitable for narrow-band work since its bandwidth is four times its center frequency. Since the RC passive filter doesn't meet the specifications, the use of an active filter is indicated.

By placing the twin-T in the forward loop there is no transmission at the null frequency.

If the twin-T has a transfer function of  $H(s) = (s^2 + \omega_o^2) / (s^2 + B_w s + \omega_o^2)$  the over-all system has a transfer function of

$$\frac{E_o(s)}{E_i(s)} = \frac{k}{k + 1} \frac{s^2 + \omega_o^2}{s^2 + \frac{B_w s}{k + 1} + \omega_o^2}$$

where  $k =$  amplifier gain,  $\omega_o =$  filter center frequency in radians and  $B_w =$  filter bandwidth of  $H(s)$ . It can be seen that the passive network bandwidth has been narrowed by the factor  $k + 1$ .

The circuit uses two IC amplifiers. Amplifier 1 is simply a subtractor, and amplifier 2 supplies gain with no inversion. This circuit at its null frequency has rejection greater than 40 dB and bandwidth of  $0.04 \omega_o$  with a gain of 100 in A2.

The circuit has the advantage of driving the twin-T from a low impedance and terminating it in a high impedance.

*Jerome Lyman, Electronics Engineer, Servo Corp. of America, Hicksville, N. Y.*

VOTE FOR 318

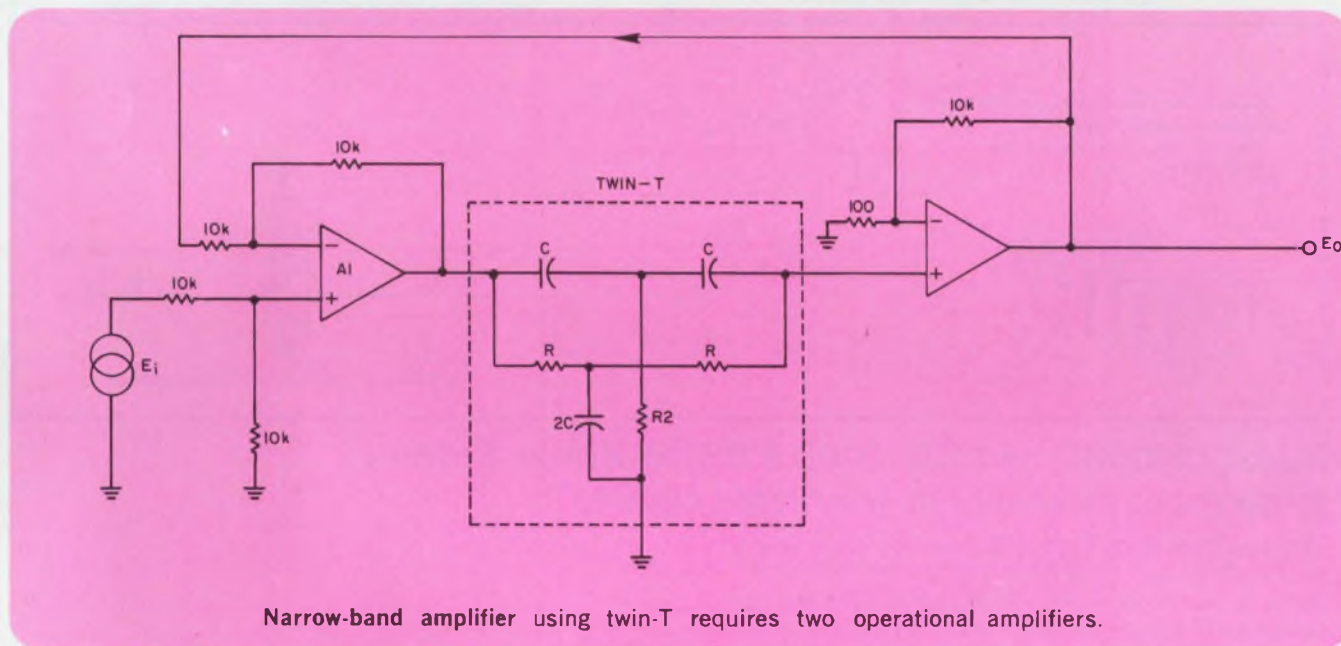

Narrow-band amplifier using twin-T requires two operational amplifiers.

**IFD Winner for May 24, 1969**

**Ronald C. Chauvin**, Associate Electronics System Engineer, LTV Electrosystems, Inc., Greenville, Texas. His Idea "Get emitter-follower action without input/output level shift" has been voted the Most Valuable of Issue award.

**Vote for the Best Idea in this Issue.**

**IFD Winner for June 7, 1969**

**Frederick W. Brown**, Design Engineer, Communications Research, Idyllwild, Calif. His Idea "Rf current probe is immune to interfering magnetic fields" has been voted the Most Valuable of Issue Award.

**Vote for the Best Idea in this Issue.**

# Use COS/MOS more ways in more places

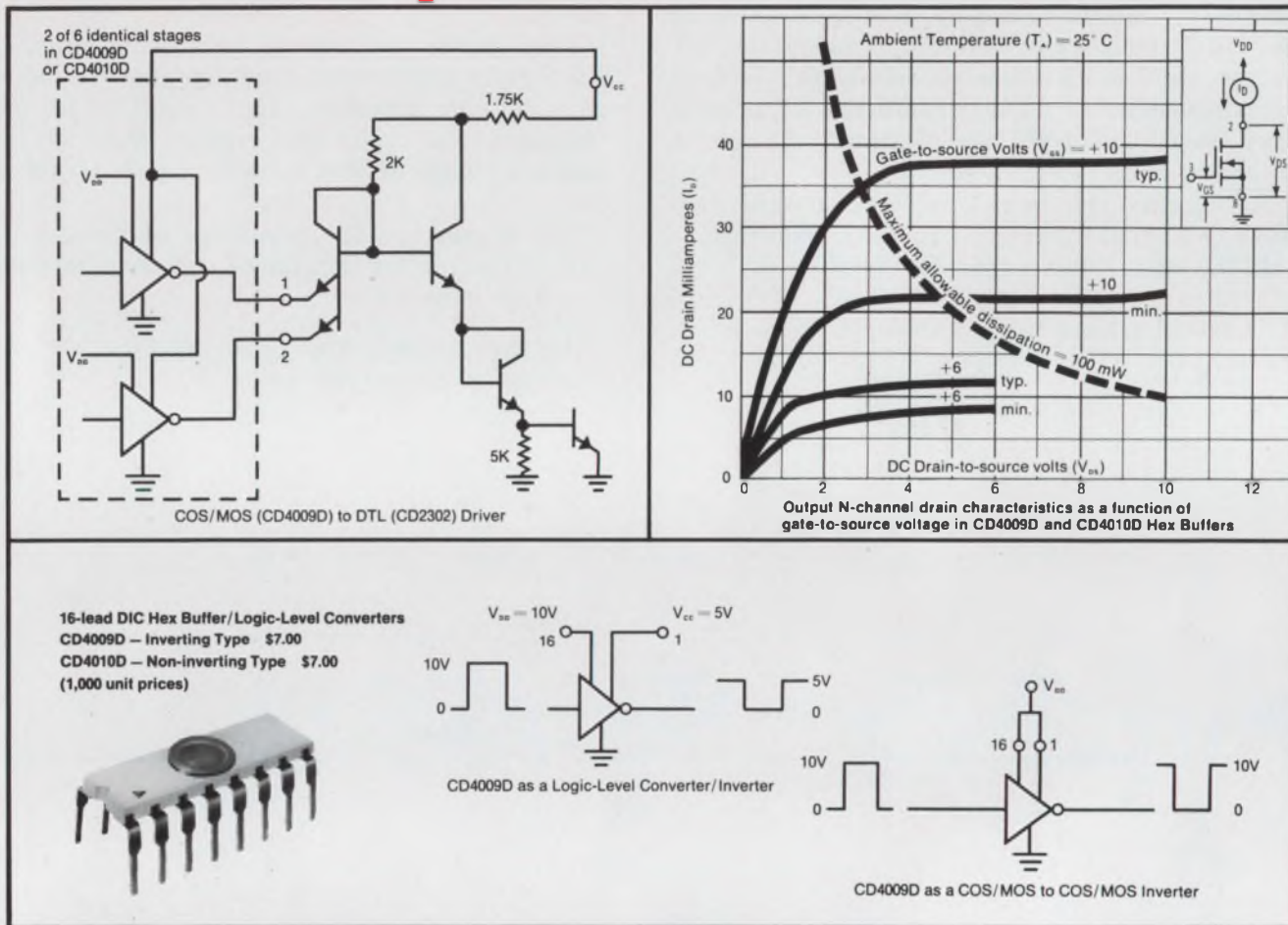

## RCA-CD4009D and CD4010D COS/MOS Hex Buffers bring more flexibility to your logic circuits

Now you have many more opportunities to take advantage of the known capabilities of COS/MOS—RCA's Complementary Symmetry MOS digital integrated circuits. Use the new CD4009D (inverting) and CD4010D (non-inverting) hex buffers for:

- greater driving capability, and wider current flexibility in COS/MOS systems
- greater latitude for interfacing COS/MOS with DTL and/or TTL devices.

A most important feature of these new hex buffers in such applications is their low "1" and "0" output impedances which result in excellent dynamic noise margins.

For more information on the COS/MOS Hex Buffers and the rest of RCA's growing line of COS/MOS Integrated Circuits, get in touch with your local RCA Representative or your RCA Distributor. For specific technical information, write RCA Electronic Components, Commercial Engineering, Sec. ICG-10-1, Harrison N.J. 07029.

**RCA** Integrated Circuits



# Products



**Six-digit clock** improves display versatility with interchangeable light-emitting-film panels, p. 158.



**On-chip Hall generator** digitizes its dual 10-mA output, p. 138.



**Split-screen storage CRT** provides two readout display modes, p. 152.



**Multi-function desktop calculator**, which offers sub-routine capability, stores 392 program steps, p. 130.

## Also in this section:

**Digital TV system** converts gray shades into spectrum of colors, p. 130.

**Low-cost plastic npn/pnp pairs** can handle up to 25 W at 4 A, p. 140.

**Helium-neon laser** delivers two nearly collinear 1-mW outputs, p. 166.

**Evaluation Samples**, p. 192 . . . **Design Aids**, p. 194 . . . **Annual Reports**, p. 196.

**Application Notes**, p. 198 . . . **New Literature**, p. 200.

## Digital TV system colors gray shades



*Spatial Data Systems, 132 Aero Camino, Goleta, Calif. Phone: (805) 968-3594.*

Offering a new approach to image enhancement and quantitative analysis of scientific pictures and photographs, Datacolor digital color television systems convert the shades of gray in an image or scene into a wide spectrum of colors. Typically, twenty or more shades of gray may be resolved. Simple controls provide continuous adjustment of the color display so that any part of the gray scale may be analyzed in detail.

CIRCLE NO. 297

## Image display terminal shows 10<sup>6</sup>-point array

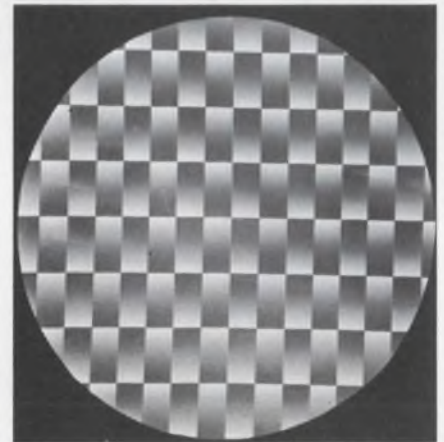

*Dicomed Corp., 4600 W. 77th St., Minneapolis, Minn. Phone: (612) 920-8980.*

Designed to reconstruct digitally derived images from digital computers, digitizers, and other image processing equipment, a new image display terminal provides immediate viewing and long-term storage in one tabletop-size device. The new display utilizes an 8-in.-dia storage CRT that is capable of presenting an array of over one million points, each having an intensity range of 64 levels.

CIRCLE NO. 251

## Versatile desktop calculator accepts 392 program steps



*Hewlett-Packard, 1501 Page Mill Rd., Palo Alto, Calif. Phone: (415) 326-7000. P&A: \$4400; 10 days.*

Part of a fully expandable computing system, a new desktop calculator, which features subroutine capability, can accept up to 392 program steps with its 32 data registers. The model 9100B calculator also provides a dual display for simplified program editing.

Like its predecessor, the 9100A, the new 9100B can perform calculations ranging from simple addition and subtraction to highly sophisticated scientific computations. Prime features for engineering users include finding logarithmic, trigonometric and mathematical functions with a single key stroke.

The subroutine capability permits instant access to subroutines and return from any point in a program. Up to five subroutines may be nested. The calculator remembers up to five return addresses at one time.

An additional feature of the new calculator is a dual display that simplifies program editing. When looking at a program one step at a time, the operator can see the present address and instruction code as well as the next address and instruction code to be executed. This allows the operator to make changes without stepping through the entire program.

The 9100B calculator can be considered as the star member of a fully expandable computing system with peripherals and a large program library that offers a wide variety of practical problem solutions.

The system can accept data via the calculator keyboard, from punched tape, cards, teletypewriters, or from instruments in real time. Results can be displayed on the calculator, on graphs, printed lists, pages, tapes, or on a large-screen CRT.

Peripherals are available to tailor the calculator's input and output to suit the user's specific needs. Since the system can expand as required, it practically eliminates the danger of becoming obsolete.

All elements of the system are fully compatible. They simply plug in. Available accessories include a printer for \$975 and an X-Y plotter for \$2475.

CIRCLE NO. 250



**Sophisticated calculator with 32 data registers is part of a fully expandable computing system that includes a complete line of peripherals.**

From near the banks of Loch Walden we bring you a GRrrrand new product, the 1192 - a wee bonnie counter that'll make your pocketbook smile. But don't let its size or price fool you; it's a real performer. For instance, it measures frequency (from dc to 32 MHz), period (single and multiple), time interval, frequency ratio, and, of course, it counts. Units of measurement and decimal point are automatically displayed. As little as 10 mV will trigger its input (up to 25 MHz), and you can control trigger threshold and attenuation. You get better than average stability with its internal crystal oscillator.

The 1192 can be ordered with 5, 6, or 7 digits, with or without BCD output, and for bench or rack use. A new companion scaler, the 1157-B, extends the upper frequency limit to 500 MHz. This unit mounts side by side with the 1192 in a common cabinet to form the 1192-Z.

Prices\* for the 1192 range from \$575 for the 5-digit bench model without data output

to \$845 for a 7-digit rack model with data output. Add the scaler for another \$850. That gives you a 500-MHz counter for as low as \$1425. How's that for a bonnie bargain? If you order two or more, the unit cost is even less with GR's quantity-discount plan. Discounts range from 3% for 2-4 units to 20% for 100 units.

For free literature (postpaid) or an all-expense-paid demonstration, write or call General Radio Company, West Concord, Massachusetts 01781; telephone 617 369-4400. In Europe (except Scotland), write Postfach 124, CH 8034 Zurich 34, Switzerland. In Scotland, write General Radio Company (U.K.) Limited, Bourne End, Buckinghamshire, England, for special attention.

\*Prices apply only in the USA.

GENERAL RADIO



**Wee Bonnie Counter**

# Superior performance! Improved reliability!

(you get them both in our new  
pre-assembled miniature microwave  
straight plugs and jacks)

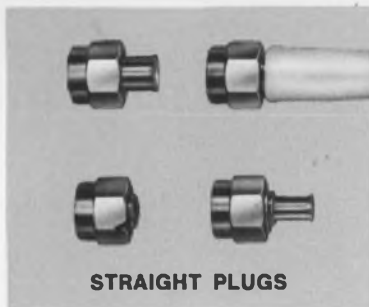

**STRAIGHT PLUGS**

*Reusable. Shipped assembled.  
No snap-ring.*

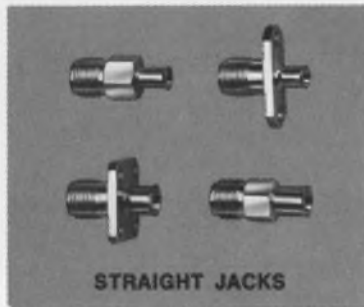

**STRAIGHT JACKS**

*No solder-on center contact.  
Shipped assembled.*

The key is pre-assembly. Until the introduction of our new series of PDM miniature microwave straight plug and straight jack-type cable mounted connectors, no connector manufacturer had control over assembly and was hardly in a position to assure performance or reliability on a truly repeatable basis.

That's all changed now. With our new PDM straight plugs and jacks we have significantly reduced assembly time and the possibility of errors in your assembly operations.

The new PDM straight plug has no snap-ring which makes it reusable. You can unsolder and resolder. The unique design allows ex-

posure of the interface for facing and dressing. And, the straight plug is shipped completely assembled.

Our new straight jack also comes to you as a single unit. There is no center contact to be soldered with the possibility of misalignment.

These PDM straight plugs and straight jacks fully meet MIL C-39012 Type SMA and are available, from stock, for .085 inch and .141 inch semi-rigid cables plus RG 55, 58, 141, 223, 180, 188 and 195 cables.

Asking for samples would be a good way to start. Write today to: *Phelps Dodge Communications Company, 60 Dodge Avenue, North Haven, Connecticut 06473.*

**PHELPS DODGE** COMMUNICATIONS COMPANY 

## DATA PROCESSING

### Pushbutton terminals fit all telephones



*Metroprocessing Corp. of America,  
64 Prospect St., White Plains, N.Y.  
Phone: (914) 949-0890. P&A:  
\$200; first quarter, 1970.*

Two new Fone-Tone Spartan portable Touch-Tone computer terminals are said to work with any telephone handset manufactured in the United States since 1940. The FT-1248 provides a built-in inductively coupled amplifier and speaker, allowing several people at a time to hear the voice responses from a computer.

CIRCLE NO. 252

### Acoustic coupler kit converts Teletypes



*Omnitech Corp., sub. of Nytronics  
Corp., 903 N. 2nd St., Phoenix,  
Ariz. Phone: (602) 258-8246.  
Availability: stock.*

Able to change Teletype machines into acoustic data terminals, a new fully asynchronous coupler kit converts audio tones from standard voice-quality telephone lines to error-free digital signals. The model 701C kit allows any model 33 Teletype to operate with a standard office-type telephone. Either full-duplex or half-duplex operation is possible.

CIRCLE NO. 253

# SCRs



## 20 from the tide

From the tide of 5,364 SCRs now available,\* TI has selected 20 that meet 80% of low-level circuit requirements.

They're part of TI's preferred semiconductor line, selected after months of computer demand analysis to save you time and money in specifying discrete components.

TI's preferred 20 SCRs are popular, proven and readily available from TI distributor and factory stocks. Volume production assures you the most competitive prices.

Applications are many and varied in consumer and industrial equipment such as light flashers, ignition systems, appliance and stereo/TV controls. In military systems they can perform relay-

TI Preferred SCRs							
Type	Avg. Fwd. Current $I_D$ (A)	Fwd. & Rev. Voltage $BV_F/BV_R$ (V)	Gate Current to Fire $I_{GT}$ ( $\mu$ A)	Type	Avg. Fwd. Current $I_D$ (A)	Fwd. & Rev. Voltage $BV_F/BV_R$ (V)	Gate Current to Fire $I_{GT}$ ( $\mu$ A)
TIC44	600	30	200	2N3007	.350	100	200
TIC45	600	60	200	2N3008	.350	200	200
TIC46	600	100	200	2N3555	1.6	30	20
TIC47	600	200	200	2N3556	1.6	60	20
2N3001	.350	30	20	2N3557	1.6	100	20
2N3002	.350	60	20	2N3558	1.6	200	20
2N3003	.350	100	20	2N3559	1.6	30	200
2N3004	.350	200	20	2N3560	1.6	60	200
2N3005	.350	30	200	2N3561	1.6	100	200
2N3006	.350	60	200	2N3562	1.6	200	200

ing, squib firing, fuzing and read-out-tube driving functions.

If one of TI's preferred 20 SCRs doesn't fit your specific requirements, remember TI makes 111 standard and over a thousand special SCR types from which to choose.

Write for TI's brand new 1970 Preferred Semiconductors and Components catalog: Texas Instruments Incorporated, PO Box 5012, MS 308, Dallas, Texas 75222. Or just circle reader service card number 117.



\*1969 Worldwide figure from D.A.T.A., Inc., publishers of *Electronic Data*.

**TEXAS INSTRUMENTS**  
INCORPORATED



## CAS series... industrially oriented cassette decks



The Auricord CAS series of two channel, record/playback CASSETTE decks has been designed for a wide range of applications: computer, AV, space and medical, communications... to name a few. Outstanding features include three-motor design and completely electrical actuation, making the system ideal for remote controlability. Also, simplified slot loading and dynamic braking. Add our EP-1 electronics package for a complete system.

MODEL CAS-3 is similar to CAS-1, but adds the advantage of read-out in fast forward and fast reverse modes and has random access capability.

For complete details on the CAS series and other Auricord products for tape mechanism requirements, contact:

SPECIALISTS IN QUALITY TAPE DECKS

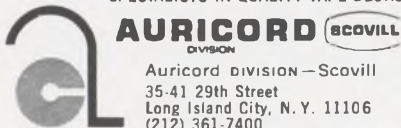

Auricord Division—Scovill  
35-41 29th Street  
Long Island City, N.Y. 11106  
(212) 361-7400

INFORMATION RETRIEVAL NUMBER 79

## DATA PROCESSING

### Xerographic duplicator reduces and copies



Xerox Corp., Xerox Square, Rochester, N.Y. Phone: (716) 546-4500. Price: from \$600/month.

Providing four functions in a single package, a new xerographic duplicator can automatically reduce, duplicate, copy and collate. Called a reduction duplicator, model 7000 can often cut report size and file space by 75%, knock engineering drawings down to handling size and produce same-size copies at the rate of one a second. It reproduces from documents as large as 14 by 18 in.

CIRCLE NO. 254

### Plated-wire memory drops cost per bit



Flexible Circuits Memory Products Div., Val Industrial Park, Warrington, Pa. Phone: (215) 343-2300. Price: 1/4¢ per bit.

Offering switching times of less than 20 ns, a new plated-wire memory plane contains over 165,000 bits at a cost of less than 1/4¢ per bit. The assembly consists of two tunnel structures (one on each side of a printed circuit board) on a 0.25-in. pitch and two single-turn word straps on 0.05-in. centers. It provides low power consumption as well as nondestructive readout.

CIRCLE NO. 255

### Fast mini-computer adds in 300 ns



Data General Corp., Southboro, Mass. Phone: (617) 485-9100. Price: \$12,000.

Claimed to be the fastest of all the mini-computers, a new small-scale general-purpose computer has an add time of only 800 ns using conventional core memory, and an add time of 300 ns using read-only memory, which is interchangeable with core. Called the Supernova, the new unit offers a basic organization of 4096 words with 16-bit core memory, expandable to 32,768 words.

CIRCLE NO. 256

### Memory systems cycle in 125 ns

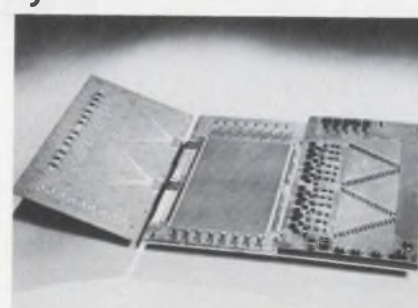

Precision Magnetics, Inc., 525 Park Ave., Minneapolis, Minn. Phone: (612) 339-1489. Availability: 60 to 90 days.

Two new compatible high-speed computer memory systems, the Celeritas 125 (read/write) and the Celeritas 125R (read-only) offer read cycle times of only 125 ns. Word lengths can be as large as 150 bits for the read/write system and up to 96 bits for the read-only system. Both memories are random-access units that use magnetic wire elements.

CIRCLE NO. 257

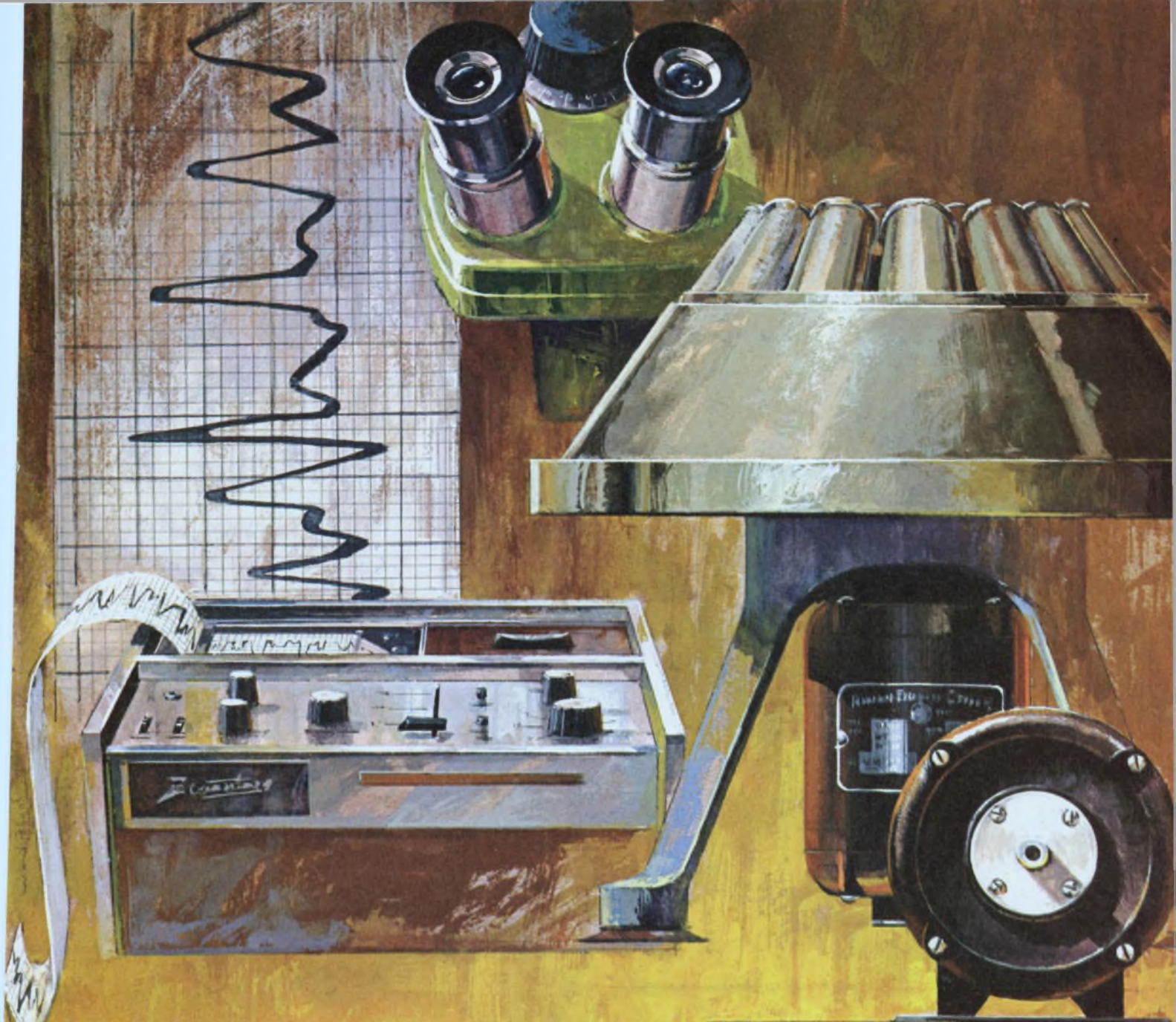

## Bodine helps keep medical equipment strong hearted...

Bodine fractional horsepower drives. Small. Quiet. A complete line designed to keep medical equipment and apparatus powered precisely, reliably, for a long, long time. Motors built with all the integrity you've designed into your product—that deliver as specified with fewer callbacks and service problems. If this is the kind of power you're looking for, you'll find no better source.

Over 3,500 standard specifications to choose from. Bodine also builds custom and special fhp motors to design requirements. Our engineers will be happy to help you pinpoint the right one for your specific application need. Mechanical organ, heart recorder, test unit, pumps—whatever your product, specify Bodine fhp drives. The power behind the leading products for some 63 years. Write for bulletin. Bodine Electric Company, 2500 W. Bradley Place, Chicago, Illinois 60618.

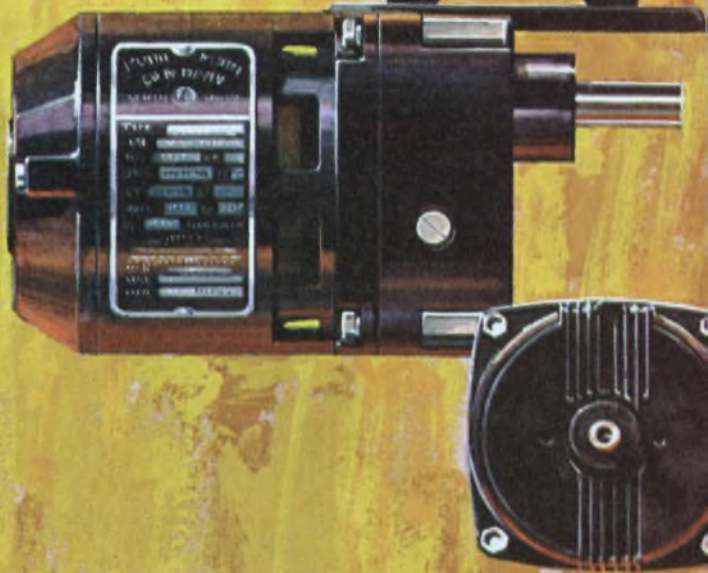

*Bodine Motors Wear Out—It Just Takes Longer*

**BODINE MOTORS/CONTROLS**

Ask about Bodine SCR motor speed controls



# BUY YOUR EMI FILTERS DIRECT FROM THIS FILTER GUIDE!

✓ SPECTRUM OFFERS 30 dB WHERE  
FORMERLY YOU COULD BUY ONLY 5 dB

✓ ALL QUALITY FILTERS... REALISTICALLY PRICED

✓ SPECTRUM FILTERS ARE AVAILABLE  
FOR IMMEDIATE DELIVERY

CURRENT RATING (AMPS)	VOLTAGE RATING @ 125°C	INSERTION LOSS				PARTS SHOWN ACTUAL SIZE	SPECTRUM PART NO. (USE WHEN ORDERING)	PRICE* 1-49 (EACH)
		30kHz	1MHz	10MHz	100MHz			
10	100	-	-	5	42		5.60	2.90
10	100	-	10	30	50		1.60	
10	200	-	-	5	45		4.90	
10	100	-	12	30	50		2.40	
10	500	-	-	5	45		7.25	
15	50	15	44	60	70		8.65	
15	50	15	44	60	70		12.80	
10	50	20	60	70	70		1.32	
25	500	-	-	10	55		2.50	
25	750	-	-	10	50			

SEND ORDER DIRECT  
TO OUR FAIRVIEW PLANT...

OR CALL JOHN LANE  
814/474-5593

QUANTITY PRICE BREAKS  
QUOTED ON REQUEST



**SPECTRUM CONTROL INC.**  
152 EAST MAIN ST. • FAIRVIEW, PENNSYLVANIA 16415

\*PRICES INCLUDE ALL HARDWARE

## DATA PROCESSING

### Fast data modem works 2400 bits/s



RFL Industries, Inc., Boonton, N.J.  
Phone: (201) 334-3100.

Model 3952 high-speed modem can transmit and receive serial binary data over voice bandwidth at a synchronous rate of 2400 bits per second. The new unit is designed for use with all present-day transmission equipment, including conventional and dedicated telephone lines, power lines, microwave and radio. It is compatible with all features and options of Western Electric 201B data sets.

CIRCLE NO. 258

### Portable modems minimize errors



Digital Techniques Corp., 4921  
Leafdale Blvd., Royal Oak, Mich.

A new series of portable acoustic data sets allow error-free coupling of remote terminals with computers via conventional telephone handsets. The DTC 2000 series features a linear frequency discriminator, automatic gain control, multiple tuned receiver circuits, a high-stability transmitter oscillator and low second-order harmonic distortion transmitter output. Typical applications include time-sharing systems and data centers.

CIRCLE NO. 259





*The  
Standard of  
Excellence*

## S/D D/S converters by CLIFTON

Excellent means — "first class, of great worth, eminently good." Definite qualities of our ADverter S/D, D/S converters. But we should add one other feature: *not expensive!* (Model SD12A1, \$795 qty. 1-9.)

In fact, their low cost, combined with such other features as: reliable, all solid state circuitry, easily interchangeable

encapsulated sub-modules, no calibration or adjustments, multi-channel capability, wide variety of options, make them superior in many ways to brush encoders.

Although designed especially for the process control and machine tool fields, this system can easily be modified for military applications.

So take advantage of our

application engineering know-how which is yours for the asking. Call our DITRAN division in Burlington, Mass. (617) 272-6210, or your local Clifton sales office. When you consider Litton, Clifton, Ditrans quality, you couldn't do better!

**CLIFTON**   
DIVISION OF LITTON INDUSTRIES

Pearls by J. E. Caldwell Co., Philadelphia—\$5.600

# Wedge-Action\*



## Relays

Hermetically-sealed, electromagnetic relays that provide high performance and reliability under the most difficult operating conditions in dry-circuit to 2 amp applications.



2 PDT  
MARK II, SERIES 500  
MIL-R-5757/9



6PDT 4PDT  
(1" x 1")  
MARK II, SERIES 300  
(6 PDT).  
SERIES 350 (4 PDT).  
MIL-R-5757/1 and  
MIL-R-5757/7



6PDT  
MARK II, SERIES 085  
(-55°C to +85°C)  
SERIES 100  
(-65°C to +125°C),  
SERIES 200  
(-65°C to +200°C).  
MIL-R-5757/1.



4PDT, 10AMP  
MARK X, SERIES 600-02  
MSFC-339/22A

### \*Wedge-Action



The moving contacts are mounted between two stationary contacts. On actuation, they drive into the stationary contacts, creating high pressures and low

contact resistance at all current levels. In addition, wedge-action contact wipe provides self-cleaning of the precious-metal contacts.

\*Patented

For complete data write Relay Sales and Engineering Office, P. O. Box 667, Ormond Beach, Fla. 32074, Phone 904-677-1771, TWX 810-857-0305.

## Electro-Tec Corp.

A DIVISION OF KDI CORPORATION 

INFORMATION RETRIEVAL NUMBER 83

138

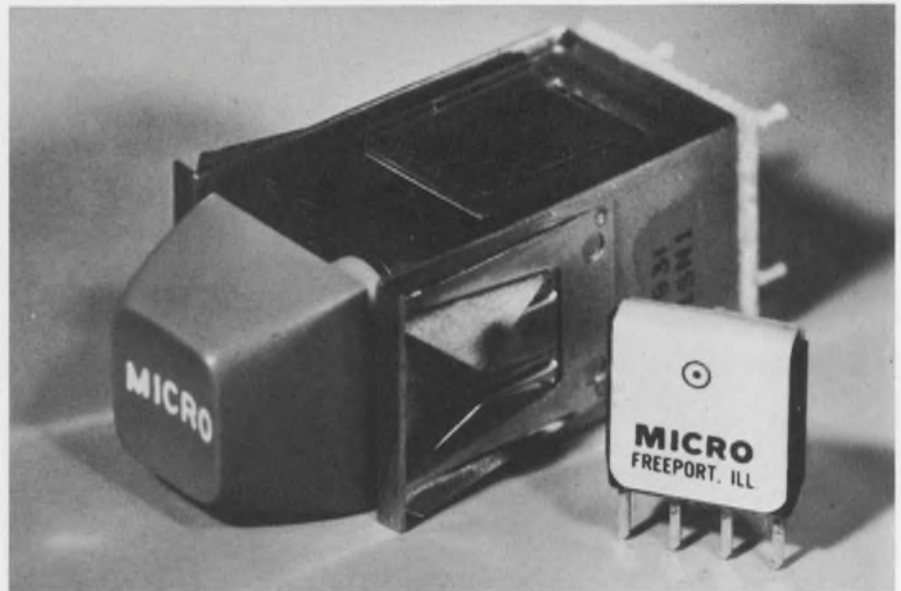

## Hall-effect amplifier chip switches dual load to 10 mA

*MicroSwitch Div., Honeywell Inc., Freeport, Ill. Phone: (815) 232-1122. P&A: \$4; stock.*

Actuated not by physical contact, but by a permanent magnet, a new solid-state switch combines a Hall element with an amplifier and switching circuitry in a single integrated circuit. Labeled the 1SS1, the new chip has two completely digital outputs, either fully on or fully off, for absolute compatibility with digital integrated circuits.

Since the 1SS1 has no moving parts, it can be operated at very fast operating speeds for long periods of time. The absence of physical contact means no mechanical wear and freedom from friction.

In addition, there is no contact bounce on make or break actions. This means that buffering is not required between the switching function and the electronic circuitry.

The 1SS1 internally generates a Hall voltage that is dependent on the proximity of an external magnet. This on-chip Hall generator supplies its neighboring trigger circuit, which, in turn, converts the signal to two digital outputs.

Magnetic flux used to actuate the 1SS1 must pass through the

chip, perpendicular to the substrate face. At 25°C, actuation flux can range from 300 to 750 gauss; minimum deactuation flux is 100 gauss.

With a nominal supply voltage of 5 V dc, load current can range from 1 to 10 mA for each output, and can be as high as 20 mA with the outputs paralleled. Loads are connected between the output terminals and the minus lead of the supply.

When operated, the new Hall-effect IC has a minimum output voltage of 3.15 V dc at the load currents mentioned above. When released, it provides a maximum output voltage of 0.25 V dc with a load of 25 kΩ or less.

Over the full output current range, output switching time remains the same. Risettime is 0.5 μs maximum and fall time is 10 μs maximum.

Also available is a new solid-state pushbutton switch that incorporates the 1SS1 Hall-effect chip. Model 1SN1 offers a choice of momentary (1SN1 for \$4) or alternate (1SN3 for \$5) switching action. It comes complete with snap-in mounting hardware. Its output is bounce free and does not require buffering.

CIRCLE NO. 260

Try shaking it after you've buttoned up your big, heavy, complex equipment. Miles of densely packed wiring and a myriad of interconnected subassemblies. It passes all functional tests at the plant, but often flunks out after handling, transportation or in service use. "Off the air" due to things like bits of wire, unused screws and washers floating around. Loose connections and cut through insulation from poor wire routing also do a pretty good job.

With Ogden's new, inexpensive ROTOCON vibrator, it's easy to find goofs at the subassembly level. This mechanical, complex wave vibrator eliminates lots of expensive disassembly, rework and reassembly. It's also

great for finding simple design errors in R&D or prototypes before you swing into expensive-to-change production.

Some ROTOCON models vibrate assemblies up to 220 lbs. Gently, without degrading reliability. Readings are repeatable too. All frequencies are present from 50 Hz to at least 2000 Hz. For as little as \$2600. Most mechanical vibrators operate at 60 Hz tops and electrodynamic vibrators start at \$10,000.

Wheel it between production areas. Really simple operation. No test parameter decisions, no special operator training. More dollars saved. Lots of time too.

Sound like a great shake? Our new color brochure gives you all of the details. Or call any of our environmental test labs listed.

#### Ogden Technology Laboratories, Inc.

Facility locations:

Deer Park, New York  
(516) 667-7200

Oklahoma City, Oklahoma  
(405) 946-9986

Sunnyvale, California  
(408) 739-5900

Beaumont, California  
(714) 845-1103

Woodside, New York  
(212) 478-2010

Monterey Park, California  
(213) 289-4425

Fullerton, California  
(714) 879-6110



## SHAKE WELL BEFORE USING!



**below \$100 (full 3½ digits) for the OEM to package — we'll supply you with a digital volt-meter to meet your specifications — contact us today (201) 478-2800 Ext. S**



**as you like it-**



**below \$300 in quantities of 100 — you can get the best specified new 4½ digit panel meters -- Model 720 — write today.**

Whatever your requirement, open or shut, look into Datascan . . . we have Uni-polar digital panel meters with or without under-range "Zeroing" capability, 3½ digit and 4½ digit Bi-polar DPM's and an engineering department ready to go to work on your design.



Get your copy of our new DPM catalog-D201.

# Datascan

1111 Paulison Avenue, Clifton, N. J. 07013  
Telephone 201-478-2800

905

**Plastic \$1 complements handle 25 W at 4 A**



*Fairchild Semiconductor, 313 Fairchild Drive, Mountain View, Calif. Phone: (415) 962-5011. P&A: \$1.20 to \$3; stock.*

Offering 25-W power capability in a plastic package, a new line of complementary power transistors cost as little as \$1.20 each in single-unit quantities. Packaged in TO-66 metal cans, these pnp and npn devices can handle peak collector currents as high as 4 A.

Type 2N3054 is a npn transistor that costs only \$1.20 for one to 99 units and 80¢ for 100 to 999 units. Its maximum collector-base voltage is 90 V, while maximum collector-emitter voltage is 55 V. Base current can be as large as 2 A.

Npn types 2N4910, 2N4911 and 2N4912 have price tags of \$1.55, \$1.80 and \$2.10, respectively. They have maximum collector-base and collector-emitter voltages of 40, 60 or 80 V. Peak collector current is 1 A.

Their pnp complements are types 2N4898, 2N4899 and 2N4900. Prices for these are \$1.95, \$2.60 and \$2.90, respectively.

Another npn power transistor is type 2N3441. For a cost of \$2.70, it offers a maximum collector-base of voltage of 160 V and a maximum collector-emitter voltage of 140 V. Collector current can be 3 A.

Types 2N3740 and 2N3741 are 25-W pnp transistors selling for \$2.70 and \$3, respectively. They can carry a peak collector current of 4 A, with a maximum collector-base voltage of -60 V (2N3740) or -80 V (2N3741).

CIRCLE NO. 261

TAKE IT FROM BEETLE BAILEY:



# FOR PANEL METERS, COUNT ON GENERAL ELECTRIC'S SALES AND SERVICE ARMY!

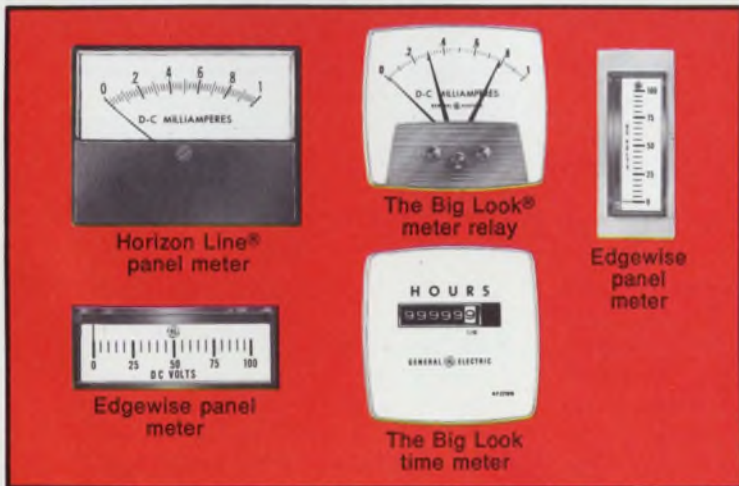
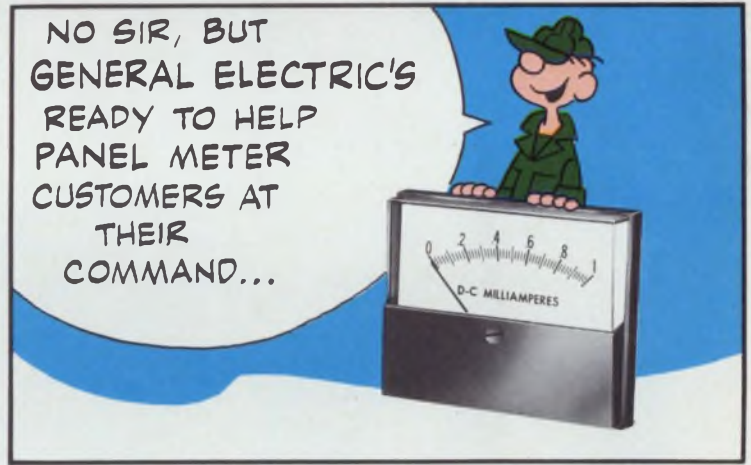
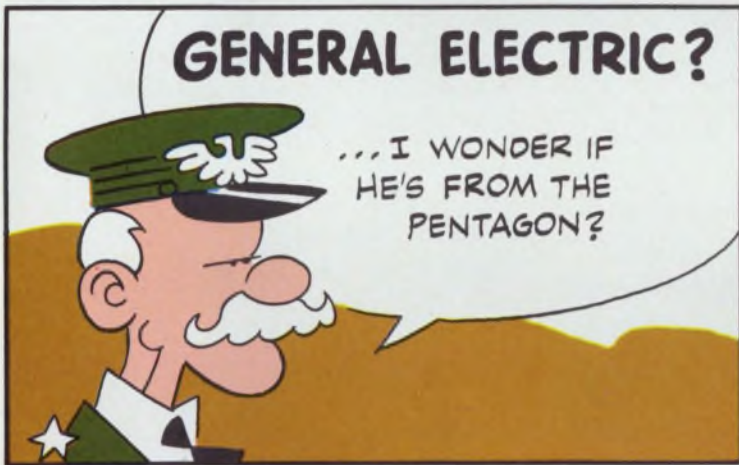
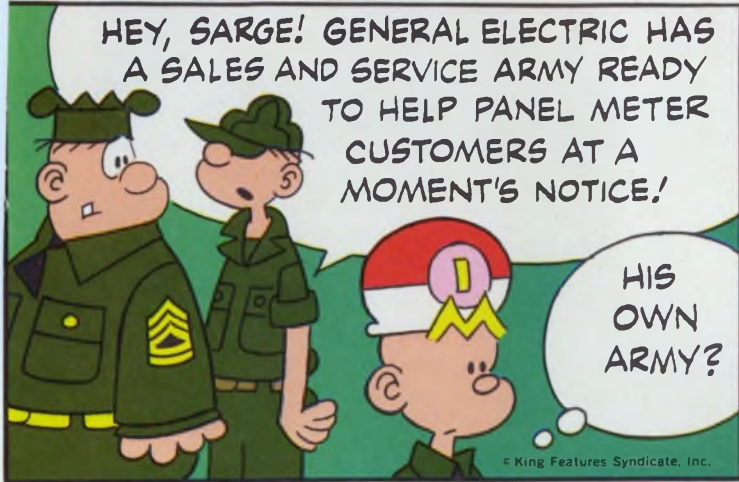

... just give the order. General Electric's Sales and Service Army is prepared to combat any panel meter problem with an arsenal of powerful, up-to-date weapons—a full line of quality panel meters and meter relays, expert application assistance, fast service across the country, and on-time delivery from a nationwide network of sales offices and distributors. Why fight it? Surrender all your panel meter problems to General Electric's Sales and Service Army. Contact your GE Electronic Components Sales Office or your dependable General Electric panel meter distributor. 592-34

GENERAL  ELECTRIC

## HOW ELSE WOULD YOU DO IT . . . ?

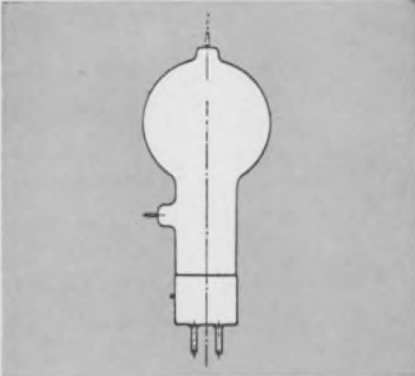

Many of the leading manufacturers of power tubes (and other electronic components) rely on Tempilaq® to determine operating-temperature characteristics of their products . . . recommend it to their customers as a practical and accurate means of monitoring. Here is what some original equipment manufacturers say about Tempilaq® in their technical literature:

"Considering the importance of tube temperatures, every design engineer should familiarize himself with the use of Tempilaq® or some other similar substance. Measurements of this kind yield basic information sometimes obtainable in no other way."

"It is considered that Tempilaq® gives the most suitable method for checking the compliance of valve operating temperatures with their ratings."

"Cooling of power tubes, inductors and other components under operating conditions needed to be carefully evaluated. Tempilaq® temperature indicators proved to be a practical method of checking the operating temperature of these critical items."

"Your products are officially recommended in our Service Bulletin to insure proper operation of our tubes . . . as well as being extensively employed in our production and research facilities."

"Temperature measurements of the x-ray radiator by direct reading instruments was impossible because of the high voltage (125KV to ground) present on the radiator . . . Tempilaq® was the answer."

"The maximum seal temperature of 250°C is a tube rating and is to be observed in the same manner as other ratings. The temperature may be measured with temperature-sensitive paint, such as Tempilaq®."



### Tempilaq®

. . . a simple quick-drying coating, can be applied to glass and other smooth surfaces — frequently provides the only practical means of determining temperatures of electronic tubes and other components.

- 103 certified temperature ratings, available in closely spaced intervals.
- Accuracy within one percent of the stated rating.
- Response delay of a thin coating: a few milliseconds.
- Change of appearance on melting irreversible.

Write to: ELECTRONIC DEPARTMENT

DIVISION OF  
BIG THREE INDUSTRIAL  
GAS & EQUIPMENT CO.

132 WEST 22nd St. NEW YORK, N.Y. 10011  
Phone: 212 • 675-6610 TWX: 212 • 640-5478

INFORMATION RETRIEVAL NUMBER 87

## ICs & SEMICONDUCTORS

### MSI decoder/driver displays numeral 1

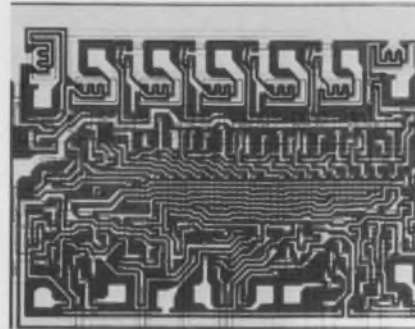

Fairchild Semiconductor, 313 Fairchild Drive, Mountain View, Calif. Phone: (415) 962-3563. Price: \$14 to \$30.80.

Able to directly drive a seven-segment numerical display, a new MSI digital decoder/driver features a display position for the numeral one. Called the MSI 9317, this integrated circuit can convert four inputs in 8-4-2-1 BCD format. To guard against false inputs, incoming code configurations in excess of binary nine cause the outputs to be disabled.

CIRCLE NO. 262

### Optoelectronic arrays are monolithic chips

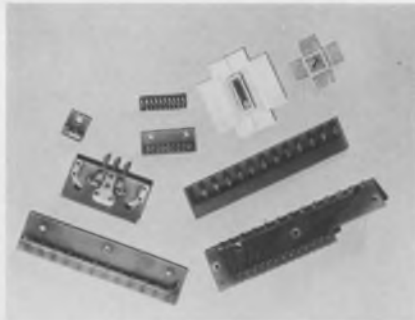

Motorola Semiconductor Products Inc., P. O. Box 20924, Phoenix, Ariz. Phone: (602) 273-6900.

Monolithic arrays of photodetectors are now available for use in light-sensing applications in both digital and analog circuits since their electrical output is proportional to the light level. A typical array contains 31 photodiodes arranged in a line on 0.005-in. centers (200 photodiodes per inch). Each photodiode active area is rectangular with dimensions of 0.005 by 0.0045 in.

CIRCLE NO. 263

### Photodiode detectors sense 0.4 to 1.1 microns

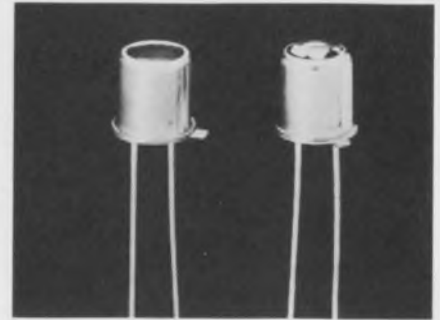

Monsanto Electronic Special Products, 10131 Budd Rd., Cupertino, Calif. Phone: (408) 257-2140. P&A: \$6.25; stock.

Two new general-purpose photodiode detectors, the MD1 and MD2, have a response range from 0.4 to 1.1 microns with a maximum sensitivity at a wavelength of 0.9 microns. At this wavelength, the MD1, which has built-in optics, provides a minimum sensitivity of 1.5  $\mu\text{A}/\text{mW}/\text{cm}^2$ . At the same wavelength, the MD2 with its conventional flat lens has a minimum sensitivity of 3  $\mu\text{A}/\text{mW}/\text{cm}^2$ .

CIRCLE NO. 264

### Power transistor switches at 30 MHz



Westinghouse Electric Corp. Semiconductor Div., P.O. Box 868, Pittsburgh, Pa. Phone: (412) 255-3693. Price: \$45.75 typical.

A new high-voltage epitaxial transistor for high-current industrial applications features a typical operating speed of 30 MHz at voltages as high as 375 V with peak currents to 30 A. Type 1843 is designed for use in power supplies, voltage regulators, dc-to-dc inverters, linear amplifiers, dc-to-ac converters and control circuitry.

CIRCLE NO. 265



# No other multimeter gives you all this

**and no one but Cimron can make a claim like that stick**

Here's the first and only 4-digit instrument that you can take with you and hook up for full multimeter performance anywhere. Cimron, the Customer Concern Company, puts your needs first. That's why this new Cimron 6453 is just one more the competition will have to catch up with.

You get the most advanced MSI and IC construction plus a thin film attenuator... which, by the

way, eliminates 75% of the normal calibration requirements. Single plane Digivac readout tubes result in the lowest power consumption of any digital multimeter, and make full-day battery operation possible. The same amplifier used in the most costly instruments provides an input impedance ten times greater than any meter in its class.

The basic instrument gives you 5 ranges of DC voltage measurement with 5th digit overrange, autoranging in all functions, autopolarity, and pushbutton selection. Add remote control, AC,

resistance, print output and the 8-hour battery pack options, and you have full remote program-

ming capability anywhere. And it's computer compatible. The 6453... just 8 pounds and 3½" x 8" x 12", sells for only \$1,125. A full multimeter is less than \$1,600. *Call us for a demonstration.* Phone (714) 276-3200 or write

Cimron, Dept. D-114, 1152 Morena Blvd., San Diego, Cal. 92110.

**CIMRON**  
first name in measurement

LEAR SIEGLER, INC.  CIMRON DIVISION

## Monolithic regulator supplies 100-mA load

RCA/Electronic Components, 415 S. Fifth St., Harrison, N.J. Phone: (201) 485-3900. Price: \$2.95.

Packaged in an eight-lead TO-5 metal can, the CA3055 monolithic voltage regulator delivers a load current of 100 mA with a line and load regulation of 0.025%. Its input voltage range goes from 7.5 to 40 V, while output voltage varies from 1.8 to 34 V. Typical output resistance is 0.075  $\Omega$  and reference voltage and output voltage temperature coefficient is 0.0025%.

CIRCLE NO. 266

## Plastic 39¢ SCRs can take 300 V

Transitron Electronic Corp., 168 Albion St., Wakefield, Mass. Phone: (617) 245-4500. Price: 39¢ to \$1.08.

Supplied in a TO-92 plastic package, a new line of low-cost SCRs offer blocking voltage ratings from 15 to 300 V at currents as high as 0.8 A rms. Available in quantity, these new devices have 1000-lot prices ranging from 39¢ to 90¢ for the RTJ02 series, and 45¢ to \$1.08 for the RTJ05 series. Triggering sensitivities are as low as 20  $\mu$ A.

CIRCLE NO. 267

## Plastic 800-mA SCR handles up to 200 V

General Electric Co., Semiconductor Products Dept., 1 River Rd., Schenectady, N.Y. Phone: (315) 456-2396. P&A: 33¢ to 48¢; stock.

Rated at 800 mA up to 200 V, a new plastic SCR in a TO-18 package features a maximum sensitivity of 200  $\mu$ A and a surge capability of 8 A. In addition, model C103 has a low forward blocking current of 1  $\mu$ A. Typical applications include computer and military markets, and control circuits in the appliance, industrial and toy markets.

CIRCLE NO. 268



## NO. 1 NAME FOR MOTOR RELIABILITY

McLEAN's computer-designed FHP Motors are built with the understanding that reliability is as important as performance, for these small units, installed, are usually "on their own" — often remote, or not easily accessible, yet key factors in doing a critical job.

Reliability, of course, is the sum of many refinements, and to name a few, McLEAN starts with a computer-analyzed design that assures ample capacity for each rating; air-cooled bearings keep operating temperature low; motor frames are made of dimensionally stable aluminum alloys; rotors exceed requirements of MIL-M-17059 to assure extra-smooth running. Add to these the experience of having thousands of these units in the field under virtually every condition, and you will know where McLEAN gets its name for reliability.

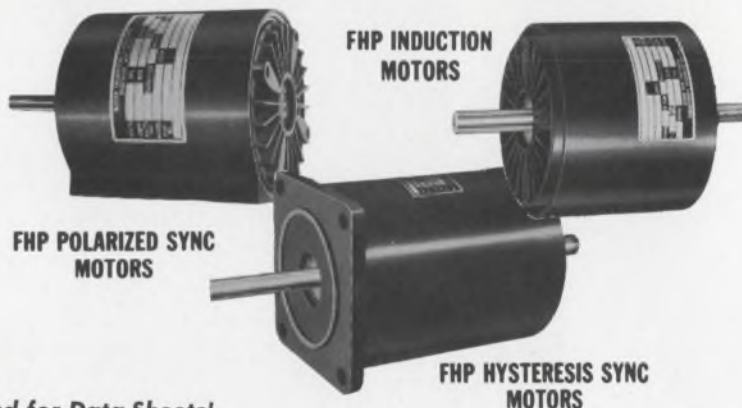

Send for Data Sheets!

**McLEAN** ENGINEERING LABORATORIES 

Princeton Junction, New Jersey 08550 • Phone: 609-799-0100 • TELEX: 84-3422



**They're new, Molex edge connectors. For printed circuit boards. Terminals crimped to wires automatically. We have straight-in and right-angle types. With and without mounting ears. It's another giant step by Molex in helping create high-speed, low-cost devices that simplify circuitry. Reliable? You bet. The connector has bifurcated terminals that provide solid contacts. Yet you can slip the connector on and off many times without damaging printed circuits. And it's not a preloaded unit. Carries only contacts required. From nine to twenty-two.**

**If you want to save assembly time, steps and money, take a close look at this new Molex edge connector. For free samples, write or you can make connections by calling (312) 969-4550.**



# NEW SOLID STATE POWER PACKS

for  
regulated  
low voltage  
applications  
from



Plastic Capacitor's new LV Series Power Packs, ranging from 12 to 100 volts DC, offer an improved solution to today's system requirements. Models available with DC output voltages of 12, 24, 28, 36, 48, and 100 volts with power ratings of approximately 25, 50, 100 & 150 watts.

**FEATURES INCLUDE:**

- 0.01% LINE REGULATION
- 0.05% LOAD REGULATION
- 3MV PEAK TO PEAK RIPPLE AND NOISE
- NEGATIVE 0.015%/°C TEMPERATURE COEFFICIENT
- LESS THAN 0.2 OHMS OUTPUT IMPEDANCE
- TEMPERATURE OPERATING RANGE OF 0°C TO 55°C

For positive proof that good things come in small packages... check your power pack needs with Plastic Capacitors. Write for full engineering data today.

## Plastic Capacitors

INC.  
Phone # 312.348.3735  
2620 N. Clybourn Chicago, Ill. 60614

## ICs & SEMICONDUCTORS

### Hardened amplifier senses 1-mV signals

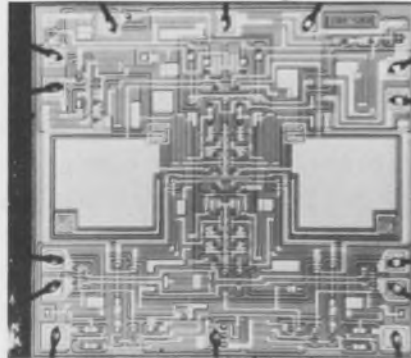

Radiation Inc., Microelectronics Div., sub. of Harris-Intertype Corp., P.O. Box 37, Melbourne, Fla. Phone: (305) 727-4000. P&A: \$85; stock.

A new radiation-hardened dual-channel plated-wire sense amplifier offers a 1-mV signal sensitivity in a high-noise environment and an access time of 10 ns. Model RA-2540R is a monolithic integrated circuit that performs the functions of a hardened differential amplifier and a hardened voltage comparator.

CIRCLE NO. 269

### Hybrid amplifiers drift 0.5μ V/°C

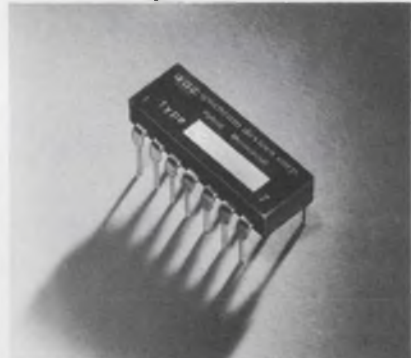

Quantum Devices Corp., 15 W. Main St., Bergenfield, N.J. P&A: \$72; stock.

Operating over the temperature range of -25 to +75°C with only a ±5°C change in their substrate, a new line of hybrid operational amplifiers limit offset voltage drift to less than 0.5 μV/°C. These microcircuits are internally frequency compensated and short-circuit protected on both input and output stages. Voltage offset is trimmable with an external potentiometer.

CIRCLE NO. 270

### MOS counters drive numerics

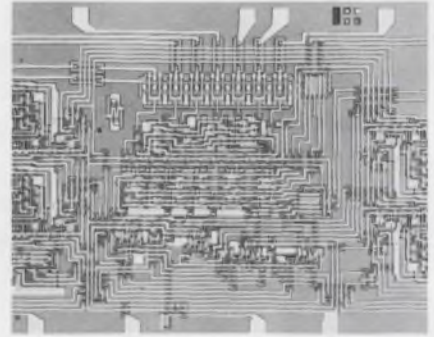

Hughes MOS Devices, 500 Superior Ave., Newport Beach, Calif.

Designed for use with seven-bar electroluminescent numeric indicators, two new universal MOS counters consist of an up-down presettable counter, storage register, a seven-segment decoder, and driver transistors—all on a single chip. Model HCTR0117 uses negative true logic for the set inputs and BCD outputs and has a count frequency of 250 kHz. Model HCTR-0107 uses positive true logic and offers a count frequency of 1 MHz.

CIRCLE NO. 271

### Decoded memories store 256 bits



Intel Corp., 365 Middlefield Rd., Mountain View, Calif. Phone: (415) 969-1670. P&A: \$150 or \$187.50; stock to 30 days.

Using large-scale integration, two new static random-access memories can store 256 bits plus all decoding circuitry on a single silicon chip. Maximum access time is 1.5 μs for model 1101 and 1 μs for model 11011. Power dissipation is only 50 μW per bit on standby and 2 mW per bit during access. Both units come in 16-lead dual-inline packages.

CIRCLE NO. 272

# TRW/Globe Sells Motion



## Application #1: Pumping Fluids and Gases

Most pumps have a problem with leakage around the motor coupling. So they put in a dynamic seal. But seals wear out and have to be replaced. They also put an added load on the motor.

Globe found a solution. Do away with mechanical coupling between motor and impeller. Use magnetic coupling. No dynamic seal is necessary. No leakage; no seal wear; no

unnecessary load on the motor. Result: less power needed; less weight; lower cost; longer maintenance-free performance.

This wasn't a sudden discovery. Globe has been designing and building pumps on this principle since 1963.

The Globe Industries Division of TRW INC. is in the business of solving problems in motion. Any kind of

motion; rotary or linear; rapid or slow; air, liquid or mechanical linkage.

If you have a problem in motion, let Globe's motor system engineers find your optimum answer. Contact Globe Industries Division of TRW INC., 2275 Stanley Ave., Dayton, Ohio 45404. Phone (513) 222-3741.

# TRW®

INFORMATION RETRIEVAL NUMBER 92



- To sweep 5 to 1500 MHz**
- **you don't switch ranges**
  - **or change plug-ins**
  - **or use a second instrument**

## **YOU JUST SWEEP**

The 3305 plug-in oscillator lets you operate over this entire range, using either end point or center frequency calibration, at widths as narrow as 200 kHz, as wide as 1495 MHz.

The 3305, in fact, makes the Telonic 2003 Sweep Generator "every man's" instrument while still permitting total flexibility if your requirements change. All functions of the instrument are on plug-in units — there are 7 oscillators including a new one covering audio frequencies, 6 different attenuators, fixed and variable markers, detectors, and other plug-ins regulating sweep rate and display processing. Complete 2003 Sweep/Signal Generator Systems start as low as \$1396.00. Price will depend on plug-ins selected.



Catalog 80A contains a comprehensive description of the 2003 and specs on all plug-ins. Send for a copy.

**TELONIC INSTRUMENTS**  <sup>TM</sup>  
 A Division of Telonic Industries, Inc.  
 60 N. First Avenue  
 Beech Grove, Indiana 46107  
 Tel: 317 787-3231 · TWX 810 341-3202

**Find it fast!  
in the  
FREE  
NEW  
1970  
Newark  
industrial  
electronic  
catalog**

A \$9,000,000 INDUSTRIAL ELECTRONIC INVENTORY  
720 PAGES • OVER 70,000 ITEMS; 500 MAJOR LINES  
INCLUDING THE COMPLETE LINE OF

**Magnecraft®  
Relays**

For advanced relay technology turn to Magnecraft Relays.



Widest variety of off-the-shelf relays for every design requirement.

- Dry reed and mercury wetted relays
- General purpose • Telephone type
- Power relays • High voltage • Plug-in
- Hermetically sealed relays.

Immediate delivery from stock—factory OEM prices  
—fast efficient service from 11 Newark warehouses.  
One source for the products you need, in the quantities you need.



For your free catalog write to:  
Main Office & Warehouse

**NEWARK ELECTRONICS CORPORATION**

500 North Pulaski Chicago, Illinois 60624  
(312) 638-4411

WAREHOUSES IN

- |  |  |   |
|--|--|---|
| • Minneapolis, Minn.<br>(612) 331-6350 | • Los Angeles Area<br>(213) 678-0441       | • |
| • Cincinnati, Ohio<br>(513) 421-5282   | • Grand Rapids, Michigan<br>(616) 452-1411 | • |
| • Denver, Colorado<br>(303) 757-3351   | • New Orleans, Louisiana<br>(504) 834-9470 | • |
| • Detroit, Michigan<br>(313) 548-0250  | • Dallas, Texas<br>(214) 271-2511          | • |
| • New York City<br>(212) 255-4600      | • Houston, Texas<br>(713) 782-4800         | • |

INFORMATION RETRIEVAL NUMBER 95

COMPONENTS

**Chip capacitors hold  $\pm 30$  ppm**



American Technical Ceramics, 1 Norden Lane, Huntington Station, N.Y. Phone: (516) 271-9600. P&A: 20¢ to \$1.11; stock to 3 wks.

Measuring 50 by 110 mils, a new line of porcelain chip capacitors exhibit a temperature coefficient of  $0 \pm 30$  ppm over the range of  $-55$  to  $+125^\circ\text{C}$ . Series 700 NPO units are available with capacitance values from 0.1 to 1500 pF at 50 Vdew and tolerances of 5, 10 or 20%. They are silver metalized devices that are available with pre-soldered terminations for reflow mounting.

CIRCLE NO. 275

**Shielded inductors fit in  $0.002$  in.<sup>3</sup>**



Lenox-Fugle Electronics, Inc., 100 Sylvania Place, South Plainfield, N.J. Phone: (201) 756-1164. Availability: stock.

Occupying a volume of only 0.002 cubic inches, a new line of shielded rf inductors measures 0.1 in. in diameter by 0.25 in. long. Red Shield units offer inductances from 0.1 to 1000  $\mu\text{H} \pm 10\%$  with power ratings of 0.25 W. They also have a high Q and low distributed capacity. Their envelope is made of non-flammable epoxy.

CIRCLE NO. 276

**Pushbutton switches control and display**



Industrial Electronic Engineers, Inc., 7720 Lemona Ave., Van Nuys, Calif. Phone: (213) 787-0311. P&A: \$55 to \$66; 8 wks.

Using an optical system to project variable legend information onto their pushbutton screen, a new family of switches permits the control of multiple functions from one switch position. Messages are simply changed by switching from one internal incandescent lamp to another. Each Cue-Switch offers up to 24 different messages or instructions.

CIRCLE NO. 277

**Rectangular capacitors measure 70-mils thick**



Sprague Electric Co., 347 Marshall St., North Adams, Mass. Phone: (413) 664-4411.

Designed for use on hybrid substrates and printed wiring boards, a new line of rectangular solid-tantalum capacitors feature profiles as low as 70 mils. These Domino 193D capacitors encompass values from 0.1 to 47  $\mu\text{F}$  over the voltage range of 3 to 35 V. Units are available in lead or leadless styles for mounting by dip-soldering, welding or other conventional techniques.

CIRCLE NO. 278

# The Friden 1150 Digital Printer: fast, reliable— and inexpensive.

The Friden\* 1150 Digital Printer has a printing speed of 50 characters a second.

Because it has fewer moving parts than ordinary medium-speed printers, it is easier to maintain. This means less downtime for your OEM product. The unit contains a single 20-character print wheel and a synchronized print hammer. Both are driven across the tape from right to left at a uniform speed.

The hammer's short impact time ensures quality printing from the continuously rotating wheel. Your output looks good and is easy to read. And we have even eliminated ribbons with a disposable ink roller.

Logic requirements are simple, making it easy for you to integrate the 1150 into your OEM product.

The 1150 is a completely tested and *proven* printer—

a vital component of Friden electronic printing calculators for nearly two years. And Singer's Friden Division provides maintenance backup throughout the world.

With its low initial cost and desirable operating features, the 1150 gives you a price/performance ratio that is unique among OEM printers.

We'd like you to have complete specifications. Just write Friden Division (Component Products), The Singer Company, San Leandro, California 94577. Ask for Specification 1001.

**SINGER**  
FRIDEN DIVISION

**Friden Component Products.**  
One way Singer serves the Original Equipment Market.

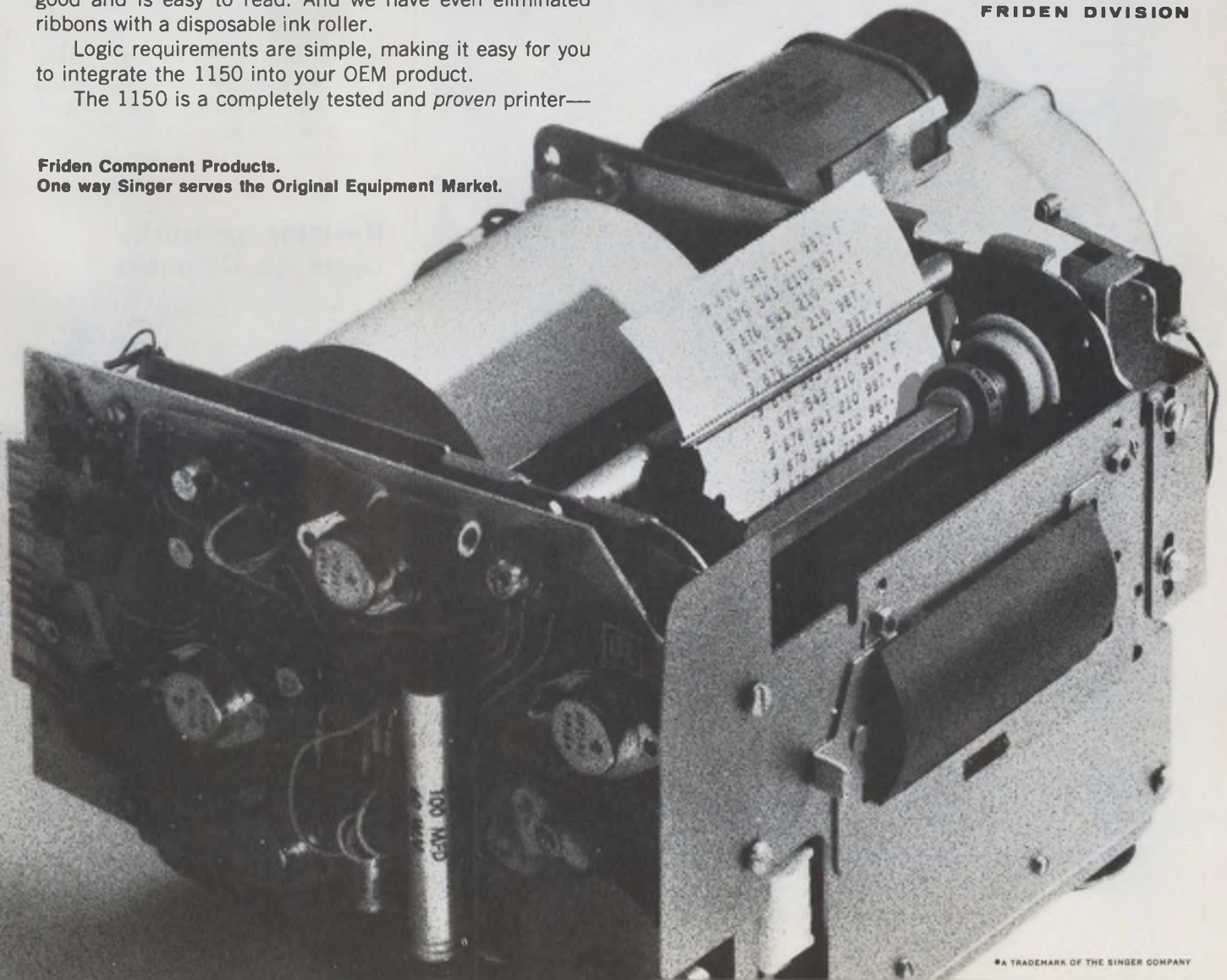

# If BULOVA can't solve your Crystal Oscillator problem... who can?!



PCOXO-101

TCXO-30

Bulova's historic leadership in crystal oscillators means the chances are good that we have the solution to any of your crystal oscillator problems and can save you crucial time! The key to Bulova's expertise — a unique problem-solving capability, plus a production facility that starts with the raw stone.

Problem solving is our specialty! Just give us your electronic/mechanical parameters, and related cost factors, we'll feed the input into our "knowledge bank," correlate it with our Design Engineers, and come up with a type, size and budget to meet your need. If you wonder how we do it . . . just blame it on our unique experience.

Some choice examples of our capability are —

PCOXO-101, a high stability crystal oscillator with a DC proportional oven and an output frequency of 1 or 5 MHz, holds a frequency stability of  $\pm 1\text{PP}10^6$  over an ambient temperature range of  $-55^\circ\text{C}$  to  $+70^\circ\text{C}$ , with an aging rate of  $1\text{PP}10^9$  per day.

And TCXO-30, a temperature compensated crystal oscillator in a frequency range of 3 to 5 MHz, holds a frequency stability of  $\pm 5\text{PP}10^7$  over a temperature range of  $-55^\circ\text{C}$  to  $+85^\circ\text{C}$  and has an aging rate of  $1\text{PP}10^8$  per week.

Solve your crystal oscillator problems fast and easy — call (212) 335-6000, see EEM Section 2300, or write —



**BULOVA** FREQUENCY CONTROL PRODUCTS  
Electronics Division of the Bulova Watch Company, Inc.  
61-20 Woodside Ave., Woodside, N. Y. 11377 (212) 335-6000

Go Bulova, and leave the designing to us!

## COMPONENTS

### Split-screen CRT doubles readout



Westinghouse Electric Corp., P.O. Box 868, Pittsburgh, Pa. Phone: (412) 255-3693.

With its split-screen dual-mode construction, a new display storage tube permits stored information to be displayed on part of its screen while data is continuously readout on the remaining part. The ratio of nonstored-to-stored information can be varied; it is even possible to have the entire viewing area used for nonstored data readout. The new tube has a 4-in.-dia viewing screen.

CIRCLE NO. 279

### Resistor networks come as flatpacks

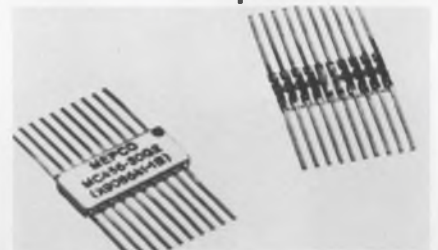

Mepco Inc., Columbia Rd., Morristown, N.J. Phone: (201) 539-2000. Availability: stock.

Ceramic sandwich resistor flatpacks are now available in three sizes— $1/4$  by  $1/4$ ,  $1/4$  by  $3/8$ , and  $1/4$  by  $1/2$  in. The smallest of these thick-film networks weighs 0.25 g and carries up to nine resistors; the next is only 0.3 g and can contain up to 12 resistors, the largest weighs 0.5 g and handles up to 19 resistors. Maximum voltage is 50 V and power dissipation ranges from 0.5 to 1 W.

CIRCLE NO. 280



When you buy a low-cost electronic counter from us, you get a unique bonus. Us.

With 55 service offices in the United States and Canada and 86 offices worldwide, we're always close by if you need help. And we give the same complete, dependable back-up to customers who spend a few hundred dollars for a counter as we do to those who spend a few thousand. That's a good thing to keep in mind when you're looking for an inexpensive way to solve your counting problems. And when you add the price and service to the performance you can expect from these counters, you know you're onto a real bargain.

For instance the Hewlett-Packard

5321A counts frequencies up to 10 MHz, has a 100 mV sensitivity and 1 M $\Omega$ /30 pF input impedance, 4-digit readout with display storage, zero blanking for easier, faster reading. All this is \$425.

The more versatile and more accurate Hewlett-Packard 5321B gives you BCD recorder output, 5-digit readout, frequency ratio and pulse duration measurement, additional gate times and a quartz crystal time base. Yet the price is just \$775.

The Hewlett-Packard 5221A/B Counters are the same in everything but shape. They're higher, narrower and not as long as the 5321A/B.

If you need greater capability, the Hewlett-Packard 5216A will provide it for \$985. This counter will totalize, measure

frequency, period, multiple period averages, ratio, multiple ratios and pulse duration. It has a 7-digit readout, gate times of 0.01 to 10 seconds, 10 millivolt sensitivity, BCD recorder output, and a maximum count rate of 12.5 MHz.

So when you need a low-cost counter, talk to the people who can deliver the goods *and* whatever service you need, whenever you need it. Call your local Hewlett-Packard field engineer for all the details. Or write to Hewlett-Packard, Palo Alto, California 94304; Europe: 1217 Meyrin-Geneva, Switzerland.

**HEWLETT  PACKARD**

**ELECTRONIC COUNTERS**

02912

# Count on us for as little as \$425.



**Exceptionally accurate  
Statham  
Pressure  
Transducer.  
Only \$237.  
Only from  
Honeywell.**

This Statham signal source consists of a Universal Transducing Cell, plus pressure accessory (basic body shell and interchangeable diaphragm) and operates 1 to 5,000 lbs. full scale in 12 ranges. Can now be ordered — by mail — direct from Honeywell for \$237 total, including your choice of diaphragms: 1, 2, 5, 10, 20, 50, 100, 200, 500, 1000, 2000 and 5000 psig. For delivery from stock, send your name, company name, address, purchase order number (or check) and choice of diaphragms to:  
Tom Culhane, M.S. 216C,  
Honeywell Test Instruments  
Division, P. O. Box 5227,  
Denver, Colorado 80217.

**Honeywell**

INFORMATION RETRIEVAL NUMBER 101

COMPONENTS

**Miniature indicators  
work from transistors**

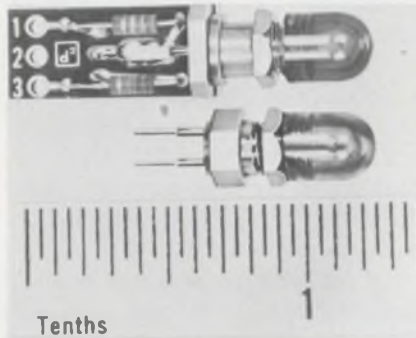

Display Devices Inc., P.O. Box 667, Encinitas, Calif. Phone: (714) 753-0113.

Able to be driven directly by transistors, a new line of miniature indicator lights is ideal for high-density packaging applications. Series TDML units utilize standard unbased T-1 lamps, are relampable from the front, and offer a choice of six lens colors. Bare-board configurations and separate indicator lights for mounting directly to a panel are also available.

CIRCLE NO. 281

**Tiny indicator lamp  
has 0.225-in. dia**



Shelly Associates, Inc., 111 Eucalyptus Dr., El Segundo, Calif. Phone: (213) 322-2374.

Producing a brightness greater than larger-size units, a new micro-miniature neon indicator lamp measures only 0.225 in. in diameter. Designed to be compatible with transistorized or standard incandescent indicators, Glo-Eye neon lights can be capped with ball, lens or square lenses. Lamps used in the new line are the USAI A1K type and meet MIL-L-15098B specifications.

CIRCLE NO. 282

**Subminiature switch  
operates 10<sup>7</sup> times**



Hi-Tek Corp., Switch Div., 2220 S. Anne St., Santa Ana, Calif. Phone: (714) 540-3520. P&A: \$3.50; 3 wks.

Combining a full floating blade with gold alloy contacts, a new sub-miniature snap-action switch can operate over 10 million times with dry circuit 1-A loads. Model 21 measures 0.25 by 0.61 by 0.8 in., and meets UL, CSA and MIL requirements. Optional terminals include solder, wire-wrap and quick-connect types. The unit is housed in a high-temperature diallyl phthalate case.

CIRCLE NO. 283

**Full-wave rectifiers  
cost only 80¢ each**

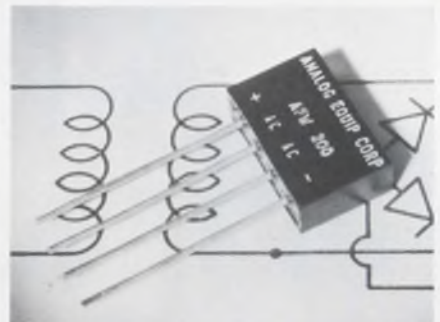

Analog Equipment Corp., 18 Granite St., Haverhill, Mass. Phone: (617) 373-1501. Price: from 80¢.

Ideal for commercial and industrial applications, series AFW full-wave bridge rectifiers sell for as little as 80¢ each in small quantities. These pre-packaged silicon rectifier circuits are available with peak reverse voltage ratings of 50, 100, 200, 300, 400, 500, 600, 800 or 1000 V dc. Output current is 2 A at 50°C ambient temperature.

CIRCLE NO. 284

INFORMATION RETRIEVAL NUMBER 102 ▶

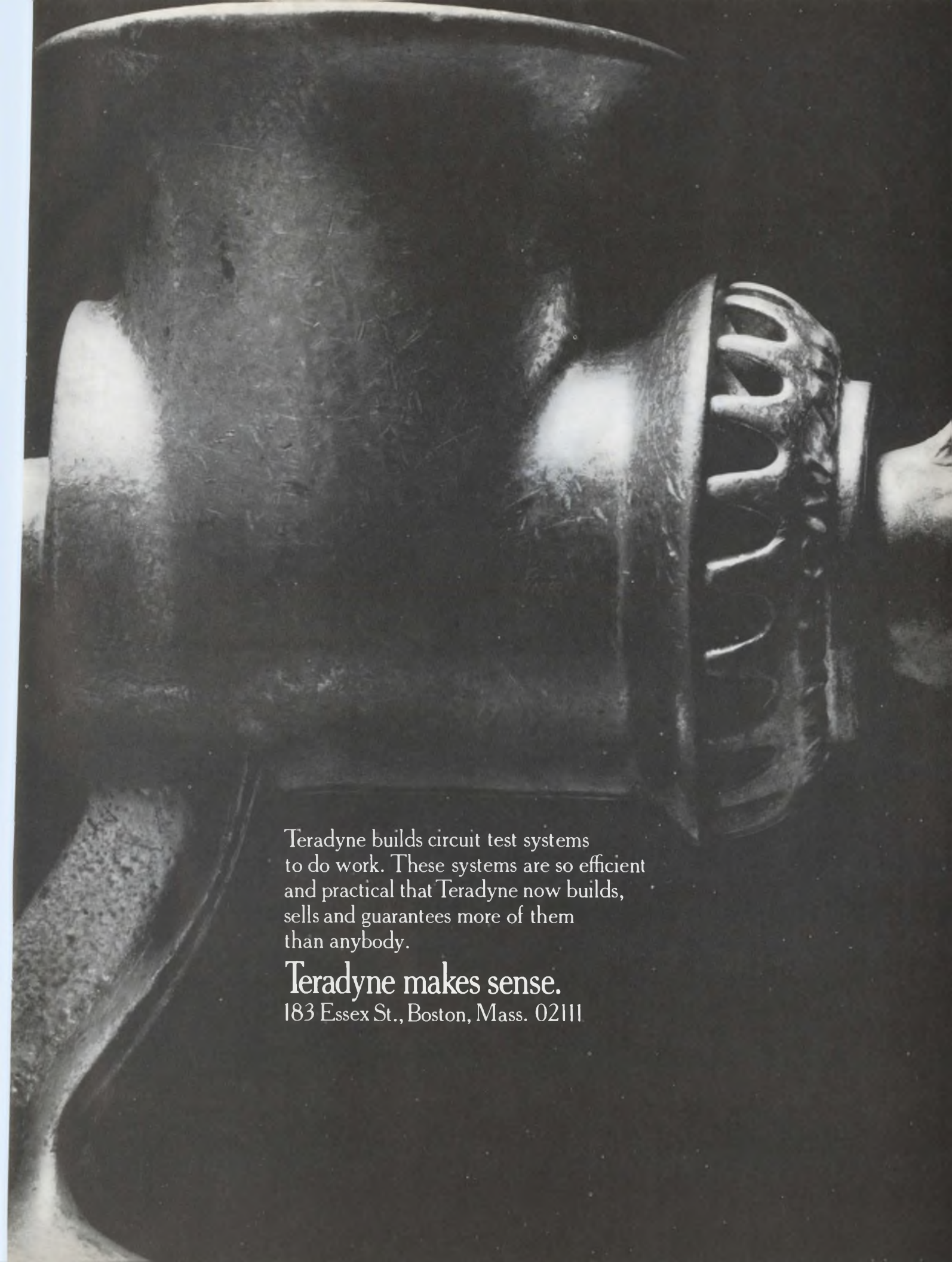

Teradyne builds circuit test systems to do work. These systems are so efficient and practical that Teradyne now builds, sells and guarantees more of them than anybody.

**Teradyne makes sense.**  
183 Essex St., Boston, Mass. 02111

**TO: ANZAC ELECTRONICS**

Please rush complete data sheet on your  
AVL-7560-N attenuator.

NAME \_\_\_\_\_

COMPANY \_\_\_\_\_

STREET \_\_\_\_\_

CITY \_\_\_\_\_

STATE \_\_\_\_\_ ZIP \_\_\_\_\_

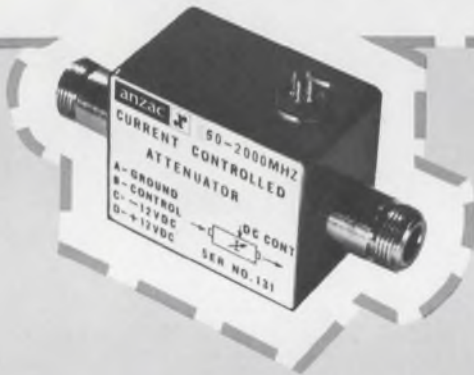

**You get all  
this for  
\$225<sup>00</sup>**

**A current controlled attenuator  
with the control circuitry built in.  
No extra control box.  
No extra expense.**

**If you're working between  
50-2000 MHz and 1-20 dB,  
you can't do any better  
at twice the price.**



39 Green Street, Waltham, Mass. 02154  
(617) 899-1900

PACSETTERS IN ADVANCED  
SIGNAL PROCESSING TECHNOLOGY

INFORMATION RETRIEVAL NUMBER 103

**COMPONENTS**

**Particle detector  
counts and locates**

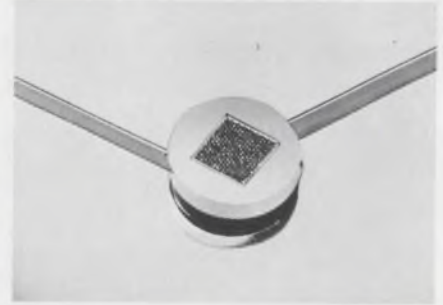

*Bendix Corp., Bendix Center,  
Southfield, Mich. Phone: (313)  
352-7613. P&A: \$950; 90 days.*

Capable of producing a pulse of  $5 \times 10^7$  electrons for each detected input electron, ion, or photon, a new area-sensitive detector can readout the number of particles detected and where each one is located. Model 5205X has a resolution of 0.006 in. in two dimensions. It can detect inputs located anywhere within a 0.18-in.-square area. Output charge pulses are also imaged in exact positional correspondence with the input event.

CIRCLE NO. 285

**Trimmer capacitors  
work in stripline**



*Voltronics Corp., West St., Han-  
over, N.J. Phone: (201) 887-1517.  
P&A: \$4.85 or \$6.30; stock.*

Designed for stripline applica-  
tions, two new high-frequency air  
trimmer capacitors offer a Q rating  
of 2000 at 100 MHz. Models AJ10  
(0.8 to 10 pF) and AJ14 (0.8 to 14  
pF) provide completely linear turn-  
ing and a resolution of 1 pF per  
360° turn. Their temperature co-  
efficient is  $\pm 20$  ppm/°C and oper-  
ating temperature range is  $-55$  to  
 $+125^\circ\text{C}$ . The units have a 0.281-  
in. diameter.

CIRCLE NO. 286

# The supreme sweeper.

Behold the Model 1001: 0.5 MHz to 300 MHz in one sweep; +13 dbm over the entire range at 0.25 db flatness; programmable in frequency, sweep width and 20 db of attenuation; usable as a signal generator with calibrated output attenuator.

Sweeping supremacy for only \$995.



the **semicon**  
0.01g

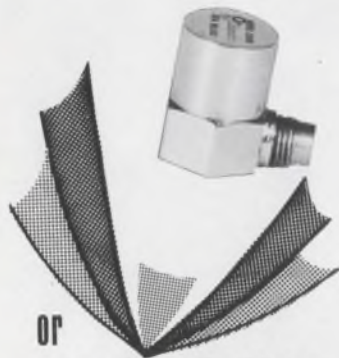

OR  
100,000g

Shock and vibration  
measurements

The revolutionary self-amplifying SEMICON® accelerometer Series provides a voltage output proportional to the shock or vibration level. These units eliminate the need for costly signal conditioning amplifiers. The only transducers rugged enough, tough enough and fast enough to go for a ride in an artillery projectile and accurately measure the shock, vibration, and roll, yet still live to operate another day. They are the simplest sensors to use. Pre-calibrated—just mount, connect to a meter, scope, tape or into your system, and read the shock or vibration level directly in g's. The SEMICON® accelerometers are for operational control and/or early warning of impending failure in all military equipment, industrial and manufacturing processes, automatic machinery and shop equipment, aircraft, reciprocating machinery, gear boxes, rotating shafts, turbines, plant generators, chemical processes, moving structures, power plants, refineries, drilling rigs, distilleries, nuclear reactors, and test labs. Request our specs and technical literature. Discover the unlimited applications. Write to COLUMBIA RESEARCH LABORATORIES, INC., Woodlyn, Penna. 19094; Telephone (215) 532-9464.



**columbia**  
first for transducers

INFORMATION RETRIEVAL NUMBER 105

## INSTRUMENTATION

### All-solid-state clock utilizes novel display



Sigmatron, Inc., 849 Ward Drive, Santa Barbara, Calif. Phone: (805) 967-0131. P&A: \$2400; 4 wks.

Claimed to be the first device of its kind, a new digital clock features a light-emitting-film readout for its six-digit display.

With this unique type of readout, the model 225 clock achieves ultra-high contrasts for better readability, high resolutions, high ambient viewing in any environment, longer life and high brightness.

The new versatile clock uses a seven-segment yellow luminescent readout against a dark light-absorbing background to make reading easier. It can display up to 24 hours of time in hours, minutes and seconds.

Model 225, which is supplied as a complete unit, can accommodate four different interchangeable light-emitting-film display panels. These offer a choice of various character heights, including 0.125, 0.25, 0.4 and 0.6 in.

The new clock also provides an extremely low background reflectivity of less than 1%. In addition, its planar display surface allows wide-angle visibility.

Other features include an initial brightness that is greater than 20 foot-lamberts, plus a service life of greater than 50,000 foot-lambert hours at brightness levels exceeding 5 foot-lamberts.

Time is adjustable from the front panel. There are also controls for remote start, stop, reset and test of display-lamp integrity.

Time outputs, which are simultaneous, are BCD coded. They offer complete compatibility with both DTL and TTL circuits.

The price tag of \$2400 includes the mainframe plus all four variable-character-height plug-ins.

CIRCLE NO. 288

### Dual-beam scope costs only \$345



Tektronix, Inc., P. O. Box 500, Beaverton, Ore. Phone: (503) 644-0161. P&A: \$345; 3 wks.

With a price tag of only \$345, a new dual-beam oscilloscope provides one channel with a bandwidth from dc to 6 MHz and a second channel that covers dc to 3 MHz. Model D51 has deflection factors of 10 mV/cm to 50 V/cm on both channels, sweep rates from 1  $\mu$ s/cm to 100 ms/cm in six steps, and a measurement accuracy of 5%. It also offers selectable sweep triggering.

CIRCLE NO. 289

### Audio generator sells for \$84.50



Leader Instruments Corp., 24-20 Jackson Ave., Long Island City, N. Y. Phone: (212) 729-7411. P&A: \$84.50; stock.

Costing only \$84.50, a new solid-state audio generator, which features FET circuitry, generates sine and square waves over the frequency range of 20 Hz to 200 kHz. Model LAG-54 uses a Wein-bridge oscillator and a Schmitt trigger to shape its output. Sine-wave amplitude is 3 V rms with a 600- $\Omega$  impedance; square-wave output is 5 V pk-pk.

CIRCLE NO. 290

# It's your fault!

Now don't take it personally, but we created the Model 4400 Digital Module Tester just for your mistakes (or those of your supplier).

Mistakes that inevitably bug even the best integrated circuits, arrays, printed circuit cards, and complete sub-systems. Small mistakes that turn into big mistakes later when they're part of a final assembly.

So face up to it. The trick is to catch these errors early. Every last one of them. Isolated down to the exact pin at fault. And, if desired, permanently data logged at the same time.

The 4400 does all that. And much more. An automatic DC functional testing system, the 4400 provides

both Go/No Go inspection and parametric reading capabilities.

Individual electronics associated with each pin under test permit separate programming of the input logic level or output load, plus monitoring of input current, leakage current, and output logic level on a per pin basis. Voltage or current can be accurately read by an integral ADC at any connection (up to 256 pins possible) and also at the system bias supplies.

The computer paces the 4400's remarkable testing rate. Up to 20,000 tests per second. In addition, the computer's inherent flexibility facilitates ease of test result

logging. Finally, since only the software — not the hardware — need ever be changed, the Digital Module Tester is virtually immune to obsolescence.

Programming the tester is easy, too. Test programs are prepared on teletypewriter with computer assistance in an English language format.

Send for a fully detailed brochure today. And don't feel so bad about your faults.

We all make mistakes.

## Datatron Inc.

1562 Reynolds Avenue  
Santa Ana, California 92705  
(714) 540-9330



# You'll love this Red-Head! GE's Newest SSL lamp.

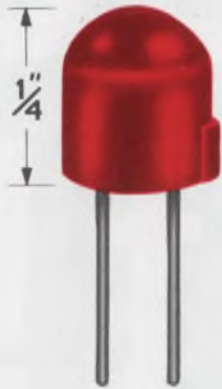

SSL-22's tiny red light has an end-on candle power of 1.5 milli-candela. It is easily visible through a full 180 degrees across the room. No wonder our newest solid state lamp makes such an exceptional indicator or photocell driver.

Efficiency? How's 150 microwatts at 10mA. Current drain? A low 10mA at 2.1 volts. Little SSL-22 (less than a quarter inch tall) shrugs off shock and vibration, keeps lighting brightly for years.

It can be switched at frequencies up to 0.5MHz. With no inrush current. And like the 9 other GE SSL lamps, it's happily compatible with integrated circuits.

SSL-22 and other visible SSL's have hundreds of ap-

plications, as indicators and photocell drivers, in computers, missiles, telephone equipment and aircraft. Infrared SSL's operate in counting devices, machine controls, card and tape readers and many other photoelectric applications.

Free technical bulletins are available for each lamp. Just order by the numbers shown below.

For the whole spectrum of GE SSL applications, together with complete data on all lamps, send for our 64-page Solid State Lamp

Manual. Included are over 80 diagrams, illustrations and graphs. Copies are \$2. Write: General Electric Co., Miniature Lamp Department, M9-4, Nela Park, Cleveland, Ohio 44112.



## Here's the latest picture of the family.

GE Lamp No.	Color	Output	Operating Voltage	Operating Current	Bulletin No.
SSL-1	Yellow	25-65 Ft. L.	2.5-5.1V	50mA	3-8011
SSL-3	Green	100 Ft. L.	1.1-1.7V	100mA	3-8273R
SSL-4	Infrared	0.3mW	1.1-1.5V	100mA	3-8268R
SSL-5A	Infrared	1.4mW	1.1-1.7V	100mA	3-8268R
SSL-5B	Infrared	1.9mW	1.1-1.7V	100mA	3-8268R
SSL-5C	Infrared	2.4mW	1.1-1.7V	100mA	3-8268R
SSL-6	Yellow	25-65 Ft. L.	2.5-5.1V	50mA	3-8011
SSL-15	Infrared	0.5mW	1.1-1.8V	20mA	3-8274
SSL-22	Red	0.15mW	2.1V	10mA	3-9207
SSL-25	Infrared	1.5mW	1.1-1.8V	20mA	3-8274

Miniature Lamp Department

**GENERAL  ELECTRIC**

INFORMATION RETRIEVAL NUMBER 107

## INSTRUMENTATION

### Data generator clocks to 25 MHz



Adar Associates, Inc., 85 Bolton St., Cambridge, Mass. Phone: (617) 492-7110.

Functionally testing digital circuits and systems, a new data generator digitizes at rates up to 25 MHz. Model SQ320 stores and presents, on command, a preprogrammed data block in a 12-bit 32-word parallel sequential format. It also has remote or local format programming, clocked TTL trigger outputs, and counted or measured word-repeat and serializer options.

CIRCLE NO. 291

### Portable voltmeter uses MSI circuits



Lear Seigler, Inc., Cimron Div., 1152 Morena Blvd., San Diego, Calif. Phone: (714) 276-3200. P&A: \$1125 to \$1600; 30 days.

Designated model 6453, a new portable digital voltmeter uses MSI display logic to drive its single-plane readout and keep power consumption down. The unit has a four-digit display with fifth-digit 20% overranging. It measures voltages from 100 mV to 1000 V with an accuracy of 0.01%. Ac and ohms functions are optional.

CIRCLE NO. 292



# Try a better way.

Examine our new military snap-action pushbuttons, and see the difference.

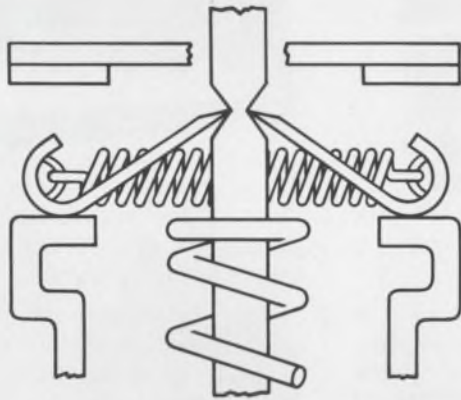

1. Let's start with the advanced switch mechanism design. In this position, the 2-circuit momentary contact switch, built to MIL-S-8805/3B, is not activated. Watch the action.

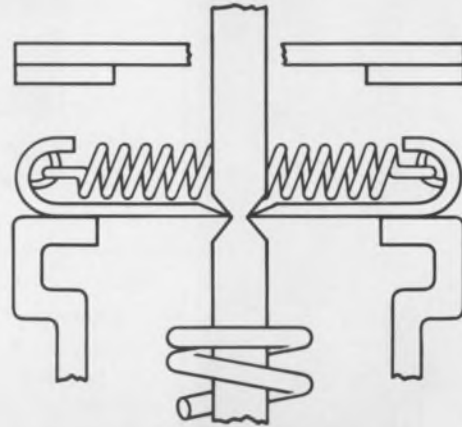

2. As the plunger is pressed down, the contact arms approach the trip position.

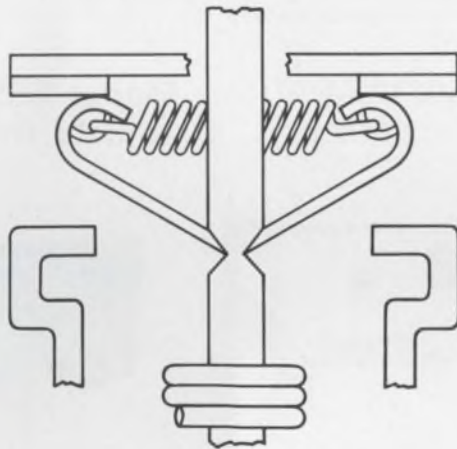

3. The contacts snap up into place and close the NO circuit. This positive snap action provides 120 grams of contact pressure and contact resistance below 10 milliohms—perfect for dry circuits.

This superior mechanical action produces a repeatable trip point accurate to  $\pm .001$  inch, making the pushbutton an excellent and economical pressure or limit switch. And it's ideal for panel-board and control-stick use.

The plunger does not rub other parts during operation, preventing contamination due to wear and prolonging switch life. Contacts are self-wiping. And the unique internal silicone seal acts as a rolling sleeve that moves with the pushbutton for reduced wear and longer life.

And here are some features you can't see. Mechanical life, 250,000 operations, far exceeding the specs. Electrical life of 25,000 cycles at full load. Speedy delivery too. And lots more. Contact your Cutler-Hammer Sales Office or Stocking Distributor today.



Cutler-Hammer's new military pushbuttons include seven distinct configurations, screw and solder-lug terminations, five double-break contact arrangements, and momentary-contact and push-pull types.

**Switch**  
to No. 1

More than just switches:  
prompt availability,  
field help, innovation,  
quality assurance too.

**CUTLER-HAMMER**

SPECIALTY PRODUCTS DIVISION, Milwaukee, Wis. 53201



INFORMATION RETRIEVAL NUMBER 108

**THEY'VE  
GOT  
OUR  
NUMBER!**

**Computer Access  
Systems**

**Hewlett-Packard**

**International  
Computer Products**

**Omnitec**

**Sycor**

**Viatron**

**Wang**

**Laboratories**

**Westinghouse**



**FOR**

**MINI-DIGITAL  
READ/WRITE  
HEADS**



YOU TOO CAN GET THE HEADS  
YOU NEED FOR DESK-TOP,  
INPUT/OUTPUT, TERMINAL, AND  
PERIPHERAL EQUIPMENT,  
BY CALLING THIS NUMBER:

**(612) 545-0401**

**Northronics  
COMPANY, INC.**

*World's Largest Tape Head Manufacturer*

8101 Tenth Avenue North  
Minneapolis, Minnesota 55427  
Phone—(612) 545-0401

INFORMATION RETRIEVAL NUMBER 109

**INSTRUMENTATION**

**Multimeter for \$375  
offers nineteen ranges**



*United Systems Corp., 918 Woodley Rd., Dayton, Ohio. P&A: \$375; 4 wks.*

Nineteen ranges of ac and dc voltage, dc current and resistance are possible with a new digital multimeter that costs \$375. Model 262 has a dc accuracy of 0.1% of reading and incorporates self-checking calibration and an automatic polarity on all dc ranges. The multimeter may also be equipped with an optional battery pack for complete portability.

CIRCLE NO. 293

**Digital \$350 VOM  
has 0.1% accuracy**



*Eldorado Electrodata Corp., 601 Chalomar Rd., Concord, Calif. Phone: (415) 686-4200. P&A: \$350; stock.*

Featuring a three-digit display, a new digital volt-ohm-meter offers an accuracy of 0.1% with a price tag of only \$350. Model 1810 provides a voltage resolution of 1 mV to 1 V in five range selections. It can measure resistance from 0.1  $\Omega$  to 19.99 M $\Omega$  in six measurement ranges. In addition, the unit has 100% overranging and automatic polarity.

CIRCLE NO. 294

**Digital clock  
sells for \$350**



*Tyco Laboratories, Inc., Instrument Div., 16 Hickory Drive, Waltham, Mass. Phone: (617) 899-2440. P&A: \$350; 45 days.*

Able to display 23 hours, 59 minutes and 59 seconds on its 1/2-in.-high six-digit display, a new digital clock sells for only \$350. Model CLK-100 is an ac-powered clock with an 8-4-2-1 BCD output along with programmable positive and negative data strobe timing pulses. It advances once per second, from right to left, and is resettable from the front.

CIRCLE NO. 295

**Digital \$395 clock  
adjusts from front**



*Broadcast Products Co., Inc., 12330 Wilkins Ave., Rockville, Md. Phone: (301) 933-3400. Price: \$395.*

Offering a six-digit display, a new \$395 digital clock can be started, stopped and reset from controls mounted on its front panel. Model BPC-101C can be used as a clock, stopwatch or an elapsed-time indicator. Optional features include a 24/100-hour display to tenths of a second, rear projection display, readout and direct BCD output, and remote function control.

CIRCLE NO. 296

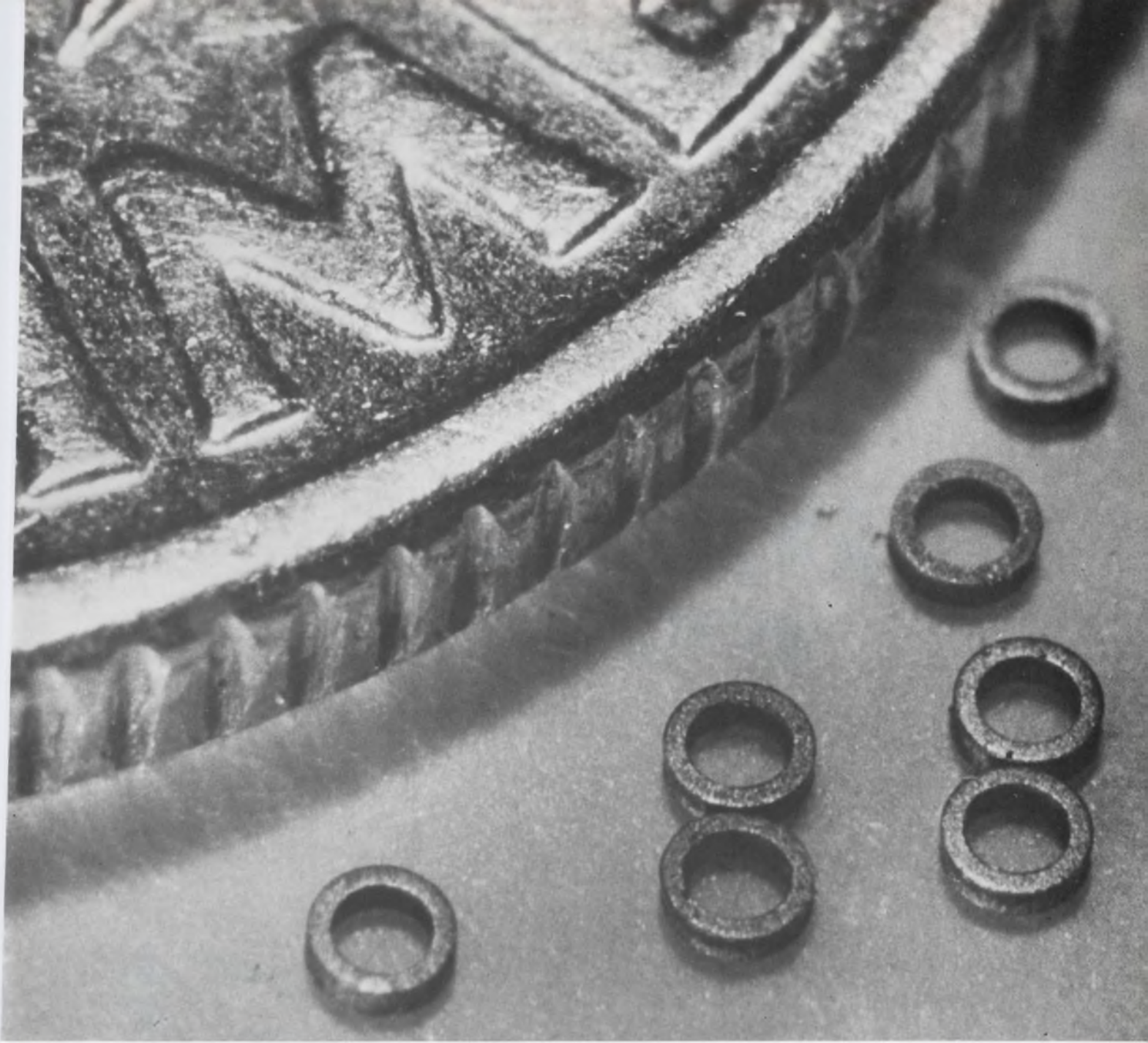

Unretouched photo of U.S. dime and Data Products' 18-mil cores.

Memory cores, greatly magnified. To show that they are precision-cut. And to show their uniformity. Not shown is the price, recently minified to as little as \$2.50/K. Our secret? Technology. In this case a new process developed by our Core Memories Inc. subsidiary. It cookie-cuts cores from continuous ferro-plastic tape. Assures consistent density and size; unvarying electrical and mechanical characteristics. Produces a 90% yield, even on 18-mil cores. Permits off-the-shelf delivery. Let Data Products technology minify your core costs.

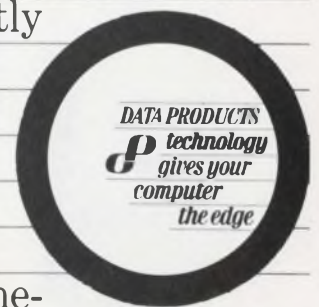

## **DATA PRODUCTS**

6219 De Soto Avenue/Woodland Hills, California 91364

Los Angeles, 213/887-8000 Minneapolis, 612/338-4717 Dallas, 214/239-9641 Acton, Mass., 617/263-3961 Bethesda, Md., 301/652-8120  
Melbourne, Fla., 305/262-4773 Amsterdam, The Netherlands 020/156-297 London, England (1) 579-3116

# Lectrohm knows Resistors...

## We should, they're our only business!

Fixed or Adjustable  
Standard or Custom

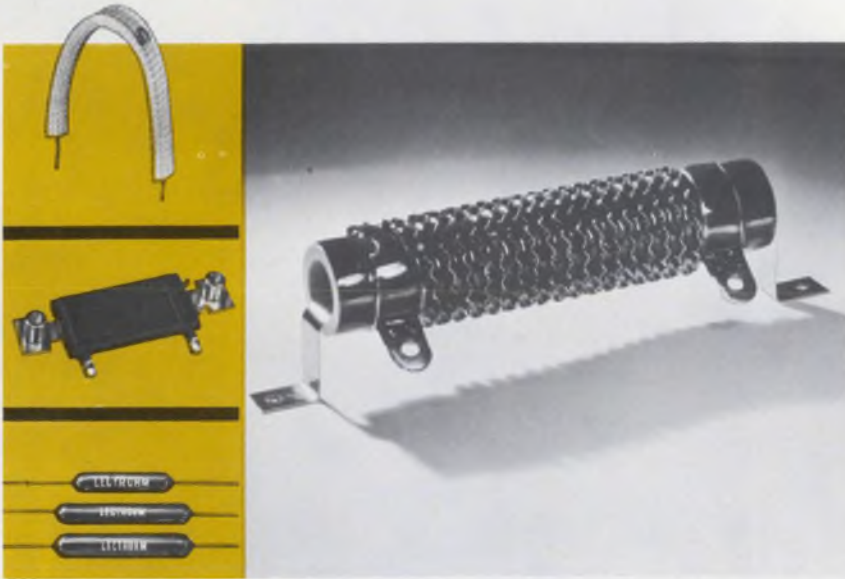

Specialization in the design and production of wire-wound resistors has established LECTROHM'S leadership in the resistor field.

For example, "Rib-on-Edge" resistors are made to order for high wattage service where low resistances from a fraction of an ohm to several ohms are required. They are also used for intermittent duty where relatively small size resistors must dissipate high wattages. Due to its greater heat dissipation and ability to operate at higher temperature, the "Rib-on-Edge" resistor is almost one-half the physical size of the equivalent standard round wire style resistor. It can be furnished in fixed, adjustable or tapped style to afford greater flexibility in equipment design.

Check your resistor needs today . . . send specifications, prints or requirements, no obligation . . . you can trust LECTROHM to match those needs quickly and economically.



**FREE!**

Full line  
LECTROHM  
catalog.

Send for your  
copy today!



**Lectrohm, Inc.**

a subsidiary of



**COOK ELECTRIC**

5562 Northwest Highway, Chicago, Ill. 60630

INFORMATION RETRIEVAL NUMBER 111

## INSTRUMENTATION

### Frequency meter doubles performance



*Eldorado Electrodata Corp., 601 Chalomar Rd., Concord, Calif. Phone: (415) 686-4200. P&A: \$550; 2 to 3 wks.*

Said to be an alternate to expensive reciprocal counters, a new economy expanded digital frequency meter is actually two instruments in one. In its expanded frequency mode, model 365 can make rapid low-frequency measurements from 30 Hz to 3 kHz with a resolution of 0.001 to 1 Hz. In its normal mode, the new meter counts from dc to 10 MHz with a resolution of 1 Hz to 1 kHz.

CIRCLE NO. 340

### Solid-state hf receiver tunes digitally to 10 Hz



*Racal Communications, Inc., 8440 Second Avenue, Silver Spring, Md. Phone: (301) 587-8515. P&A: \$4700; 30 days.*

Utilizing an integral digital-display counter, a hf solid-state communications receiver can be tuned to within 10 Hz. The RA6218 achieves this accuracy by locking its electronic seven-digit counter to a built-in stable crystal-frequency source. High stability and accurate frequency settling are attained by a synthesized drift-cancelling system and electronic band-switching.

CIRCLE NO. 341

## Five-digit ohmmeter reads 1 $\Omega$ to 100 M $\Omega$



Calico Div., California Instruments Corp., 3511 Midway Dr., San Diego, Calif. Phone: (714) 224-3241. P&A: \$1495; 30 days.

With its non-blinking five-digit readout, model 8303 ohmmeter makes full-scale measurements from 1  $\Omega$  to 100 M $\Omega$  at accuracies of  $\pm 0.02\%$  of reading and  $\pm 0.01\%$  of full scale. Its input is a four-wire Kelvin-compensated cable that is protected against inadvertent voltages. The unit has a 0.01% resolution and 20% overranging.

CIRCLE NO. 342

## Analog generator shapes time functions



EMR-Hatboro, a Schlumberger Co., East County Line Rd., Hatboro, Pa. Phone: (215) 672-1240.

Using built-in digital programming, a new analog function generator can produce any desired function of time. Called the Profiler, the instrument features programmable segment end points, segment times, number of segments or cycles, and total number of program repeats. All generated functions are composed of sequentially connected linear or haversine segments. Two versions are available, the 1641 and 1641P.

CIRCLE NO. 343

# Automatic Controls' Industrial Relays provide:

- \* Advance Design
- \* More Switching Capability
- \* Mounting Versatility

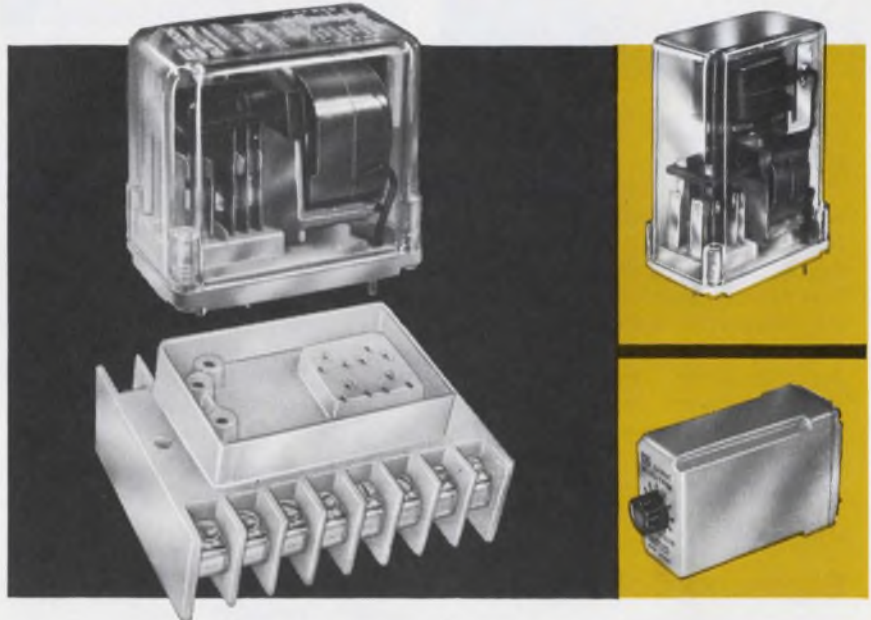

Automatic Controls' "Family" of industrial relays now available with front-connected screw terminal sockets, with nylon construction, wiring without removal of relay, terminals accommodate up to 2-#14 AWG wires — captive pressure plates.

Weigh the advantages of front-connected, behind panel, or quick disconnect termination with 4 PDT 10 Amp capacity; silver cadmium oxide contacts; epoxy encapsulated coil; and sturdy, dust-proof lexan bases and covers. Remember too, the improved design of these relays requires  $\frac{1}{3}$  less volume, 20 percent less mounting space.

Match specific product needs with the industrial mechanical latch and time delay relays . . . Automatic Controls stocks them all to meet immediate needs!

### FREE LITERATURE!

Write for illustrated brochures and technical information:

- #800 Industrial Relays
- #700 Pressure Switches
- #940 Reed Relays
- #720 Military Relays
- #830 Ice Detection Systems
- #874 Contractors
- #859 Program Timers

Specify above by numbers

## Automatic Controls

Division



COOK ELECTRIC

200 East Daniels Rd., Palatine, Ill. 60067

INFORMATION RETRIEVAL NUMBER 112

Sigmund Cohn Corp.  
EXCLUSIVE

## Gold Bonding Wire

- Produced under Total Quality Control
- Wound on Special

**M.E.** Matched Expansion  
**Spools\***

It's a logical conclusion: Gold Bonding Wire should be wound on spools having the same expansion coefficient as the wire itself. . . . That's why we developed Matched Expansion Stainless Steel spools in the first place. . . . When the wire is wound on M.E. spools it is fully controlled, with uniform tension and is evenly spaced so that it pays off properly. . . . You can be absolutely sure the strands stay put — will not shift, slip or slide — in shipment or on the shelf. . . . Provides added economy by scrap reduction.

Write for Data

### Sigmund Cohn Corp.

121 So. Columbus Avenue  
Mount Vernon, N.Y. 10553  
(914) 664-5300



Since 1901

Single or Multi-Layer

INFORMATION RETRIEVAL NUMBER 113

## MICROWAVES & LASERS

### Pulsed gas lasers sock out $10^6$ W

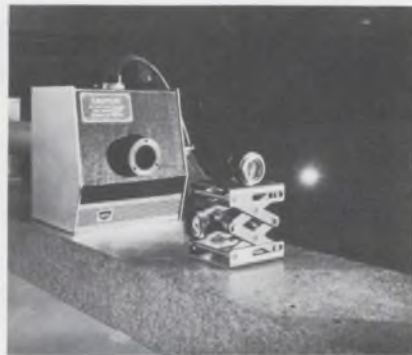

Laser Systems Corp., 313 N. First St., Ann Arbor, Mich. Phone: (313) 761-7150.

Three new pulsed carbon-dioxide gas lasers can produce optical pulses of over a million watts of peak power at pulse rates of 10 to 100 times per second. These characteristics mean that the new lasers could be used for accurate radar work, or adapted to produce spotwelds and holes as desired in a variety of materials. In addition, they are suitable for experimentation in many diversified areas.

CIRCLE NO. 344

### He-Ne \$50 lasers emit bright red



Metrologic Instruments, Inc., 143 Harding Ave., Bellmawr, N. J. Phone: (609) 933-0100. P&A: \$49.50 to \$99.50; stock.

Priced from \$49.50 to \$99.50, three new He-Ne laser tubes and optics, without a power supply or other hardware, operate at the bright-red 633-nm wavelength. Model 205 is a multi-mode 0.3-mW laser with 1.5-milliradian beam divergence; model 210 is a single-mode 0.7-mW output unit with 0.8-milliradian beam divergence; and model 220 is a laser tube with Brewster windows on both ends.

CIRCLE NO. 345

### Helium-neon laser has two outputs

University Laboratories, 733 Allston Way, Berkeley, Calif. Phone: (415) 848-0491. P&A: \$525; stock to 30 days.

Model 280 He-Ne laser produces two nearly collinear outputs, one from each end of its cylindrical head. Each beam provides over 1 mW of unpolarized coherent red light. The second beam can be used as a reference to electronically monitor the relative power output of the main beam, as a visual indicator on a target to verify that the instrument has not moved, or as an alignment aid for use mid-way in long optical trains.

CIRCLE NO. 346

### Pill-type diodes minimize losses

MSI Electronics Inc., 34-32 57th St., Woodside, N.Y. Phone: (212) 672-6500. P&A: \$21; 2 wks.

Housed in a low-loss high-density alumina pill package, a new series of tuning diodes boast a typical package capacitance of 0.15 pF and a series inductance of only 0.05 nH. This means that the new devices are particularly useful in the uhf and microwave frequency regions. Types E1712 to E1726 provide a breakdown voltage of 30 V with leakage currents of only 20 nA.

CIRCLE NO. 347

### Thin-film resistors work in stripline

Struthers Electronics Corp., Railroad Place, Mamaroneck, N. Y. Phone: (914) 698-3000. Price: \$40/kit.

Combining stability with ruggedness, a new line of microstrip stripline film resistors can be used as terminations alongside a circuit board, can be dropped into slots in the board itself, and can act as elements for matching or attenuator pads. The film element cannot pull loose, or become damaged in soldering, and is protected by a hard coating against all external effects.

CIRCLE NO. 348

# Look to Electrotec for all your Sputtering Requirements

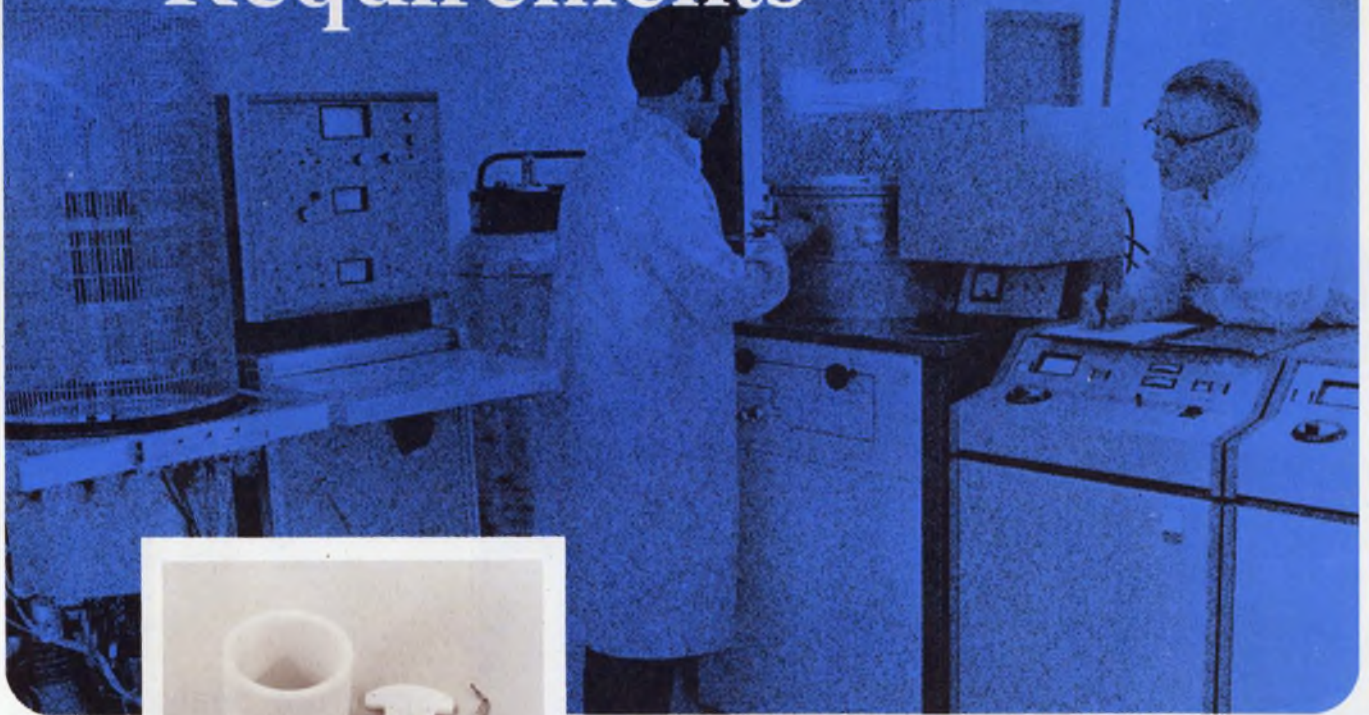

## IF YOUR NEED FALLS IN THESE CATEGORIES

**CALL US IMMEDIATELY:**  Small quantity coating jobs.  
 Large volume parts coating.  R & D projects.  Training your own personnel in rf sputtering technology.  Systems design and fabrication.  Process implementation.  Irregular shaped objects.

**WHY SPUTTER?** Sputtering offers some distinct technological advantages over conventional plating methods. Among these are:  
 Stoichiometric deposition of chemical compounds.  Adherence greater than 1000 times.  Plating with non-conductive materials.  Low unit cost.  Wide variety of material selection. Sputter coatings can be effective over a broad range of industrial uses. Con-

sider that this technique will offer you significant advantages in decorative, functional, protective, and perhaps experimental coatings.

If you can't get the prompt support and reaction your project requires from your own house, why not have a look at ours?

Custom film coatings  
Consultation and technical training  
Custom thick and thin film circuits



**Electrotec** INC.

GENERAL OFFICES AND PLANT / 3726 Cavalier Drive / Garland, Texas 75040 / (214) 276 - 8394  
WESTERN REGIONAL OFFICE / 1439 Johnson Avenue / San Jose, California 95129 / (408) 252 - 6866

INFORMATION RETRIEVAL NUMBER 114

# Dependable Hermetic Seals For Highly Critical Specs...

(E-I produces for aero-space!)

MAXIMUM RESISTANCE  
TO THERMAL CYCLING



EXTREMELY  
HIGH DIELECTRIC  
STRENGTH

MAXIMUM RIGIDITY AND DURABILITY

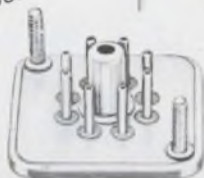

HIGH MECHANICAL  
SHOCK AND  
VIBRATION RESISTANCE



## -Must Have Continuous Quality Control Procedures Like This...

(E-I has the strictest!)

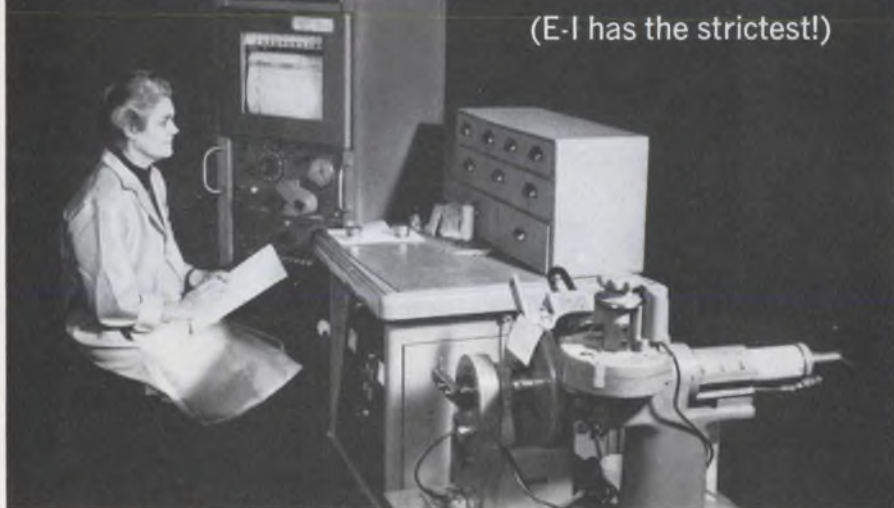

### Specify E-I Glass-to-Metal Seals for Sophisticated Applications:

Quality Control at E-I begins with the raw material and follows through to the finished product. The picture above depicts one phase of this program — X-Ray Spectrographic Analysis. The Spectrograph provides a quantitative chemical analysis of the metals, alloys and glasses which are utilized in the manufacture of Electrical Industries' glass-to-metal seals. Continued surveillance of the chemical constituents of materials is just the beginning of the E-I quality control program that assures our customers of the highest quality hermetic seals each and every time.

If you require standard or custom seals or sealing of your own components, check with E-I. Our engineers will gladly make recommendations. Illustrated technical literature is available — call or write today.

- Sealed Terminals and Multiple Headers • Transistor and Diode Bases • Compression-type Threaded End Seals
- Plug-in Connectors • Vibrator Plug-in Connectors • High Voltage Glass-bonded Ceramic Seals
- Hermetically-sealed Relay Headers • Special Application Custom Seals • Custom Sealing to Specifications



## Electrical Industries

A Division of Philips Electronics and Pharmaceutical Industries Corp.  
Murray Hill, N.J. 07974 — Tel. (201) 464-3200

Patented in U.S.A., No. 3,035,372; in Canada, No. 523,390; in United Kingdom, 734,583; other patents pending.

INFORMATION RETRIEVAL NUMBER 121

## MICROWAVES & LASERS

### Photomultiplier spans UV to IR



Bailey Co., 5919 Massachusetts Ave., Washington, D. C. Phone: (301) 656-2625.

With its unique tri-alkali cathode, Centronic 2-in. photomultiplier covers the ultraviolet through infrared region with a minimum cathode sensitivity of 180  $\mu$ A per lumen, a quantum efficiency to 27%, and a typical dark current of 1 to 2 nA. Offering a wide spectral response from 165 to 850 nm, the Q4283R covers a range previously needing two or more photomultipliers.

CIRCLE NO.. 349

### Spectrum analyzer runs for 8 h on dc



Systron-Donner Corp., Microwave Div., 14844 Oxnard St., Van Nuys, Calif. Phone: (213) 786-1760. P&A: from \$3950; 60 days.

Covering the frequency range of 10 MHz to 6.5 GHz (useable to 10.5 GHz) in six bands, a new portable spectrum analyzer can operate from up to eight hours from its internal rechargeable battery. The weight of model 751, with battery, is only 30 lbs. Scan width is selectable from 100 kHz to 500 MHz, with a calibrated resolution from 1 kHz to 1 MHz.

CIRCLE NO. 350



# NEW! Telemeter Frequency Switch

1 hz - 40,000 hz

Look at this  
**ZAP** response!

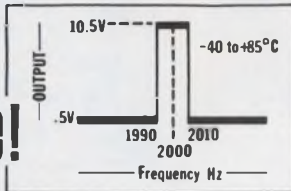

These new Go/NoGo completely solid-state Audio Switches fire whenever input frequency goes above, below or within definite frequency limits... as accurate as 1 cycle per thousand, with maximum response of 2 input cycles.

Input frequency can be a sine

or square wave... even measures length of time between pulses. Easily handles 1hz to 40,000hz... or higher, if dividers and/or mixers are used. Special high-pass, low pass and band pass functions available too. Priced from \$99.50 each.

**GOSH!**  
instruments, inc.

Wethersfield, Connecticut 06109 / phone (203) 527-4794

INFORMATION RETRIEVAL NUMBER 122

WHEN THE  
FUZE GOES OUT,  
THE LIGHT  
GOES  
ON!

Littelfuse Indicating Micro-fuse Holders for military and commercial applications. Ranges 2-1/2 thru 250 Volts. Also available with RFI shielding.



**LITTELFUSE**  
DES PLAINES, ILLINOIS

INFORMATION RETRIEVAL NUMBER 123

ELECTRONIC DESIGN 21, October 11, 1969

New  
Oak  
Versatility



OAK ECONO-LINE  
PUSHBUTTON<sup>T.M.</sup>

JUST 25¢ A BUTTON\*

\*For most applications

We've got the button... throws from 1 PST to 8 PDT per button; sizes: .388" sq., .388" x .585" or .388" x .782"; legends engraved to your specifications; black or white buttons are standard, other colors on special order.

Push Rod Stroke... 3/32" plus 3/4" overtravel; push rod lengths optional at 1/2", 5/8" standard length, 3/4", 7/8" and 1".

Easy to wire... clips are Oak-pioneered double-wiping. For printed circuit boards or wire-soldering, PCB terminals are 3/32", 1/8", 3/16" standard length, 1/32" and 1/4" shoulder to tip. Choose terminals for wiring only or P.C. dual-purpose which have the wire hole in addition to the P.C. lug.

Compact Convenience... more buttons per area—24 on .394" centers, 16 on .591" centers, 12 on .788" centers. Any switching—momentary, push-push, interlock, or blockout or combinations. For full details, write today for Bulletin SP-346.



OAK MANUFACTURING CO.

A Division of OAK ELECTRO/NETICS CORP

Crystal Lake, Illinois 60014

Phone: 815-459-5000 TWX: 910-634-3353

INFORMATION RETRIEVAL NUMBER 124

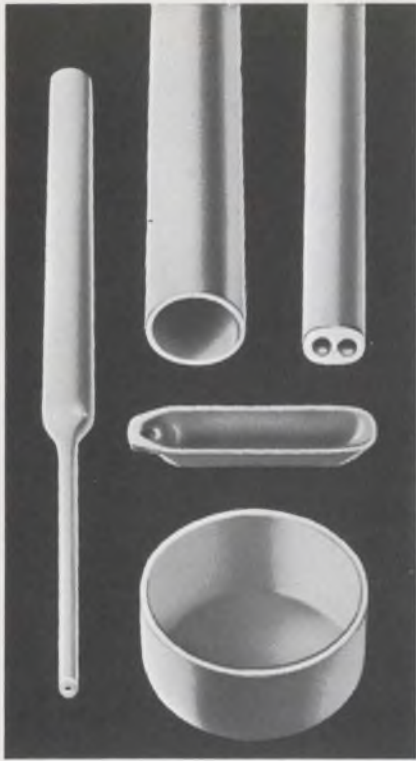

## REFRACTORY PRODUCTS...

In addition to its famous lines of Vitreosil® and Spectrosil® fused quartz products, Thermal American is now supplying a line of crystalline oxide refractory ware and cement for use by industry and laboratories. These products are designed for high resistance to heat, low reaction with metals and chemicals, low porosity, high thermal conductivity, and good mechanical strength.

Included in the complete 16 page catalog with a separate price list is a selector chart providing instant technical, mechanical and application data for refractory products of Aluminous Porcelain, Recrystallized Alumina, Zirconia and Magnesia. Write for your copy.



**FREE  
CATALOG**

73

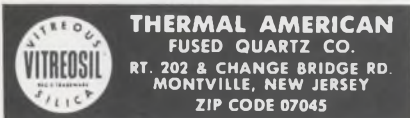

INFORMATION RETRIEVAL NUMBER 125

## MICROWAVES & LASERS

### X-band oscillators punch out 100 mW

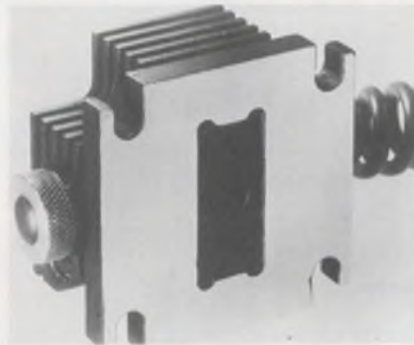

*Monsanto Microwave Products, 11636 Administration Dr., St. Louis, Mo. Phone: (314) 694-4816.*

Series VX2020 X-band Gunn-effect cw oscillators provide a minimum output power of 100 mW with a variation of less than 2 dB over their entire tuning range. The devices are mechanically tunable over a 20% bandwidth within the frequency range of 8.2 to 12.4 GHz. They have a loaded Q of 1000 and hold fm noise to less than 0.7 Hz rms.

CIRCLE NO. 351

### Solid-state amplifiers perform like TWTs

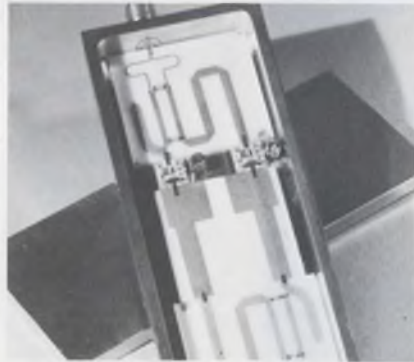

*TRW Semiconductors Inc., 14520 Aviation Blvd., Lawndale, Calif. Phone: (213) 679-4561. P&A: \$1285; stock.*

Capable of providing the performance of traveling-wave tube circuitry, three new broadband solid-state power amplifiers supply a minimum rated output of 10 W. Type PA-3940 covers the band of 1 to 1.5 GHz with 6-dB gain; type PA-3941 performs from 1.5 to 2 GHz with a 5-dB gain; and type PA-3942 covers 2 to 2.3 GHz with 4-dB gain.

CIRCLE NO. 352

### Microwave sweeper measures selectively



*Siemens Aktiengesellschaft, Technischer Pressedienst, 8000 Munchen 1, Postfach 463, Germany.*

Over a frequency range of 5.8 to 8.5 GHz, a microwave sweep measuring setup operates with a heterodyne detector to allow the advantages of selective measurements like high sensitivity and interference elimination. The generator and detector of model K 1046 cover a test level range of +10 to -99 dBm, with calibration in absolute units.

CIRCLE NO. 353

### X-band oscillators work without mixers

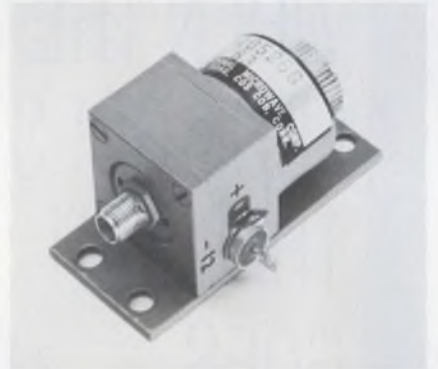

*International Microwave Corp., 33 River Rd., Cos Cob, Conn. Phone: (203) 661-6277. Availability: 30 to 60 days.*

Operating directly from 12 V dc, a new series of X-band Gunn oscillators keep noise so low that balanced mixers are not required for noise cancellation. Fm noise in a 1-kHz slot, 10 kHz from the carrier, is 24 Hz, and is only 6 Hz when 100 kHz from the carrier. Thermal frequency stability is 30 kHz/°C and rf power varies from 5 to 50 mW.

CIRCLE NO. 354

INFORMATION RETRIEVAL NUMBER 126 ►

Lots of people have told us they could use an active filter with low power requirements and a low enough price.

How does 0.3 mW at \$10\* sound?

Ask for carload prices or send \$12 for an evaluation sample.

You'll find there's a lot to evaluate. Like that power spec—ideal for all kinds of battery-powered gear. Plus a price/performance combination that we think will eliminate a lot of in-house filter making, even for commercial applications. Mail the coupon and a check or P.O. for \$12.00 today (please attach your company letterhead). We'll respond by air with a sample FS-60 and our brand new Filter Design Handbook. 'Till then, here are the basic specifications:  Delivers band-pass, high-pass and low-pass outputs simultaneously  Any desired form of the second order transfer function  Complex zeros anywhere in the S-plane  Multi-loop negative feedback for added stability   $F_c$  and Q of basic unit can be tuned by adding external resistors  Frequency range from DC to 10 kHz  Q range from 0.1 to 500  Voltage gain is adjustable to 40dB  Supply voltages from  $\pm 2V$  to  $\pm 15V$  with 0.3 mW power consumption  Dimensions: (14-pin DIP) 0.804" x 0.366" x 0.474"  IC hybrid construction.



Gentlemen at KTI:  
 Please send me an FS-60 evaluation sample. Our  check  P.O. is attached, in the amount \$12.00. Send me more information on:  
 FS-60  All active filters  Hybrid subsystems  
 Please add my name to your permanent mailing list

Name \_\_\_\_\_  
 Company \_\_\_\_\_  
 Address \_\_\_\_\_  
 City \_\_\_\_\_  
 State \_\_\_\_\_ ZIP \_\_\_\_\_  
 My applications are: \_\_\_\_\_  
 \_\_\_\_\_  
 \_\_\_\_\_

PRICES:	1 - 49	\$28	5,000 - 9,999	\$14
	50 - 199	\$23	10,000 - 19,999	\$12
	200 - 999	\$19	*20,000 - 49,999	\$10
	1,000 - 4,999	\$16		



**KINETIC TECHNOLOGY, INCORPORATED**

3393 De La Cruz Boulevard  
 Santa Clara, California 95051  
 (408) 246-8100 TWX: 910-338-0279

The name to remember for Hybrid Integrated Systems and Active Filters . . .

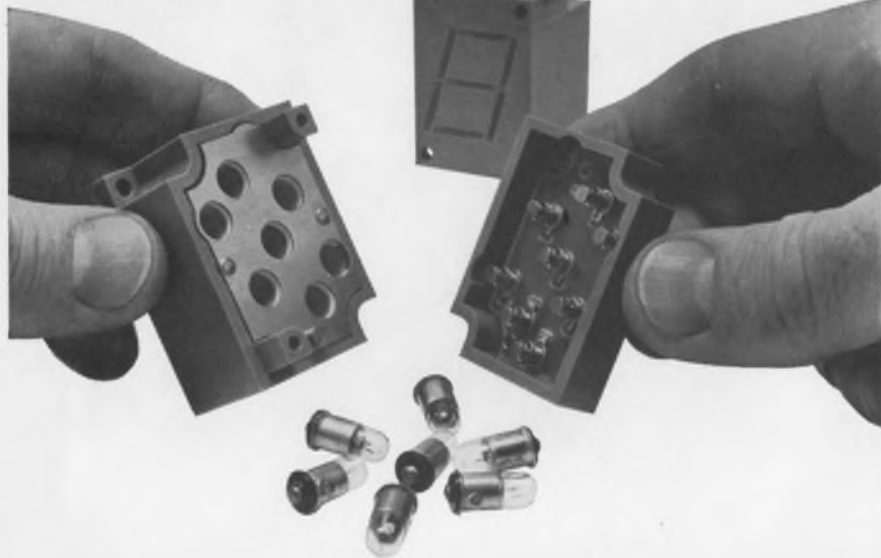

## What makes low-cost Dialight readouts so reliable and easy-to-read?

Reliable because of simple module construction and long life lamps. Designed for use with neon or incandescent lamps to meet circuit voltage requirements. Easy-to-read from any viewing angle. 1" high characters are formed by unique patented light-gathering cells, and may be read from distances of 30 feet. Sharp contrast makes for easy viewing under high ambient lighting conditions.

### Dialight Readout Features

1. Operate at low power.
2. 6V AC-DC, 10V AC-DC, 14-16V AC-DC, 24-28V AC-DC, 150-160V DC or 110-125V AC.
3. Non-glare viewing windows in a choice of colors.
4. Available with RFI-EMI suppression screen.
5. Available with universal BCD to 7 line translator driver.
6. Can be used with integrated circuit decoder devices now universally available.
7. Caption modules available; each can display 6 messages.

## Send for catalog

Catalog-folder contains complete specifying and ordering data on numeric and caption modules, translator drivers, mounting accessories. Dialight Corporation, 60 Stewart Avenue, Brooklyn, New York 11237. Phone: (212) 497-7600.



# DIALIGHT

INFORMATION RETRIEVAL NUMBER 127

DT-126

## MICROWAVES & LASERS

### Fixed attenuators are flat to 0.2 dB



Narda Microwave Corp., Commercial St., Plainview, N. Y. Phone: (516) 433-9000. P&A: \$85; stock.

A new series of fixed coaxial attenuators exhibit a flatness of  $\pm 0.2$  or  $\pm 0.3$  dB throughout the frequency range from dc to 12.4 GHz. Attenuation values for the 777C series include 3, 6, 10 and 20 dB. Maximum VSWR is 1.15 from dc to 6 GHz and 1.2 from 6 to 12.4 GHz. All units are bidirectional with type N stainless-steel connectors that meet the requirements of MIL-C-39012.

CIRCLE NO. 355

### Ku-band source produces 150 mW

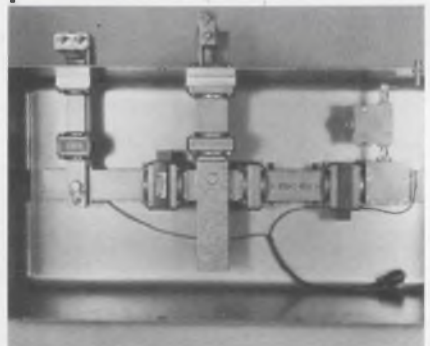

Applied Research Inc., 76 S. Bayles Ave., Port Washington, N.Y. Phone: (516) 883-5700.

Packaged in two aluminum cases, a new solid-state microwave signal source delivers 150 mW in Ku band. Model 503537 has five coherent outputs: a fundamental frequency of 1347.5 MHz, and second, fourth, sixth and twelfth harmonics of 2695, 5390, 8085 and 16,170 MHz, respectively. Output power is 15 and 150 mW for the fundamental, and 10, 75, 5, and 150 mW for the harmonics.

CIRCLE NO. 356

The  
Choice  
is **TTL.**

# TI's new MSI arithmetic element. Add it to your adder...

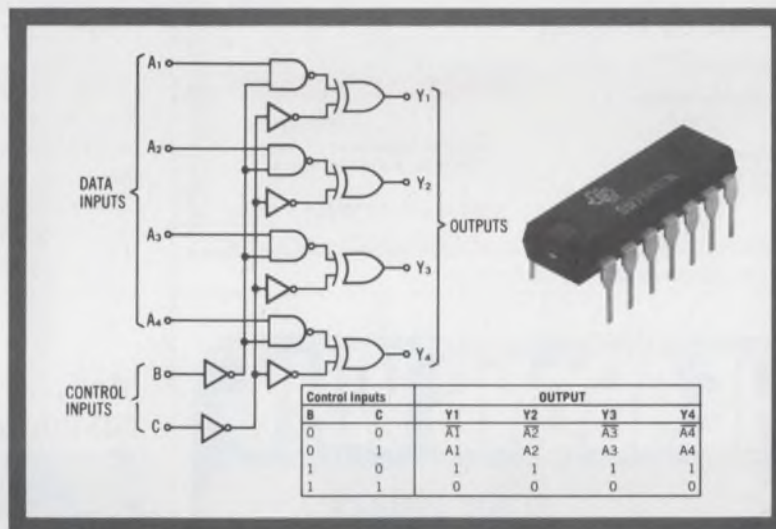

and subtract four.

TI's new 4-bit true/complement element (SN54H87/SN74H87) replaces five IC packages usually necessary for arithmetic operations—a net saving of four packages or 40% of component costs.

This versatile MSI circuit allows you to perform arithmetic operations when used with a binary full adder. You can add, subtract, direct transfer (do nothing), or decrement (subtract) by manipulating the two control lines. And it's fast—typical propagation delay of 13 ns from data input to output.

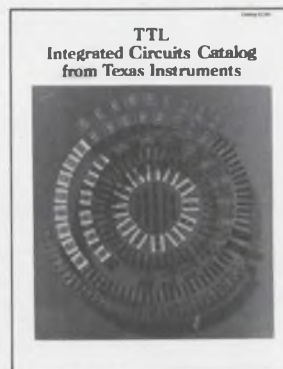

The 74H87 in plastic dual-in-line sells for \$5.12 (100-999 quantities) and is ready for immediate delivery.

We've summed up the SN54H87/SN74H87 in a data sheet. To which we'll add a copy of our new 424-page TTL catalog containing data sheets on all Series 54/74 circuits. Circle 119 on the Reader Service Card, or write Texas Instruments Incorporated, P.O. Box 5012, M.S. 308, Dallas, Texas 75222. Or call your authorized TI Distributor.



**TEXAS INSTRUMENTS**  
INCORPORATED



The things we do to stay in front!



Because we're No. 1 in control knobs . . .



and because we're Rogan

Our reputation means a lot to us. So much in fact that the knobs we make are quality knobs . . . knobs that are "out in front" with "real design appeal" —yet priced right to fit your budget. Write today for free New color catalog or see us in Sweets or Thomas Micro catalogs.

**Rogan**  
BROTHERS, INC.

8031 N. MONTICELLO AVE.  
SKOKIE, ILLINOIS 60076

Visit Booth 1C19 IEEE Show

INFORMATION RETRIEVAL NUMBER 129

PACKAGING & MATERIALS

Transition connector handles 34 positions



3M Co., 3M Center, Dept. E19-37, St. Paul, Minn. Phone: (612) 733-4962.

Interfacing up to 34 printed-circuit board positions to round-connector flat cable can be done simultaneously in less than 30 seconds with a new transition connector. Scotchflex 3402 uses self-stripping U contacts to make gas-tight pressure connections to AWG #28 stranded and AWG #30 solid conductors. Simultaneous transitions are made on 0.05-in. centers when the U contacts are forced down over the insulation.

CIRCLE NO. 357

Modular connector customizes length

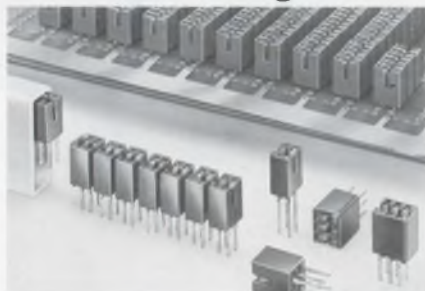

Methode Electronics, Inc., Connector Div., 7447 W. Wilson Ave., Chicago, Ill. Phone: (312) 867-9600.

Easily mounting with their press-fit terminations into the plated-through holes of printed-circuit mother boards, Reli-Amod modular edge-type connectors can be built-up to whatever length desired. End modules have four contact terminations, while center modules have six. Two 0.031-in-square wire-wrap termination lengths are available—0.375 and 0.595 in.

CIRCLE NO. 358

3.999 REASONS WHY



4000 COUNT  
DIGITAL PANEL METER  
\$236<sup>00</sup>\*

Computer Products' new DP400 series digital panel meter measures DC voltage with extreme accuracy: .05% ± ½ count . . . and with 4000 count resolution. It's priced with the DPMs and performs with the DVMs. Using revolutionary encoding techniques, it offers 8 voltage ranges (200mV to 400V) with internally selectable decimal point position.

The DP400 series' styling will enhance the appearance of your system. All this, and behind-panel space required is only 2.5" x 3.0" x 4.2".

As if that weren't enough, DP400s have remote display capabilities.

The temperature coefficient of the DP400 series is .005%/°F and the operating temperature range is 30° to 140°F.

In quantity orders, the DP400 series is available for measuring current and resistance.

SHIPMENT 15 TO 30 DAYS ARO  
Prices 1-3 4-9 \*10-29  
\$262 \$246 \$236

We also make: OP-AMP and logic power supplies, pulse generators, D/A and A/D converters and decimal display modules (with counter).

Call or write for complete information on our entire line.

Computer Products, Inc. • P.O. Box 23849 Ft. Lauderdale, Florida 33307 • 305-565-9565



COMPUTER PRODUCTS™  
FORT LAUDERDALE

INFORMATION RETRIEVAL NUMBER 130

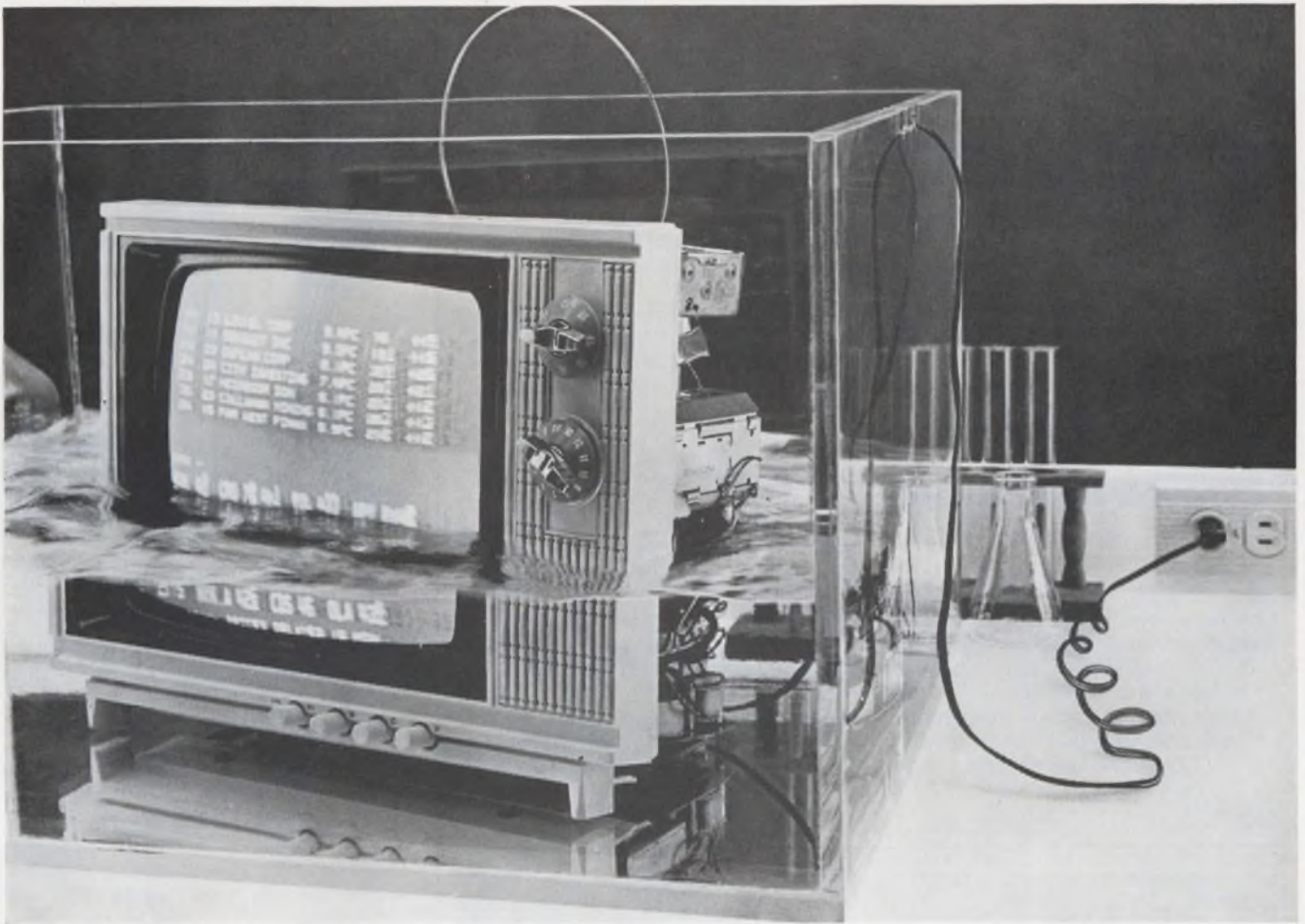

## Our new dry test bath is getting a great reception

This should give you a pretty clear picture of what Fluorinert® Brand Electronic Liquids are all about.

They give you a dry test bath for temperature and gross leak testing of electronic and microelectronic units and integrated circuits. They detect flaws and leaks with great accuracy . . . and are efficient over a wide range of temperatures.

Fluorinert Liquids have high dielectric strength . . . which means you can safely test on-circuit. They do not react with the most sensitive of materials . . . which means you can test about anything.

Fluorinert Liquids drain clean, dry fast and leave no messy residue. You can use and ship units directly out of the test bath, without cleaning.

In fact, Fluorinert Electronic Liquids are now approved for the MIL-Standard 883 and the MIL-Standard 750A gross leak tests for microcircuits.

We have lots more information about this remarkable new test bath. The coupon will bring it all or call your local 3M representative.

### Fluorinert® Electronic Liquids 3M

3M Company, Chemical Division, 3M Center  
St. Paul, Minn. 55101

Dept. KAP 10-69

Send me all the details about Fluorinert Brand Electronic Liquids.

Name \_\_\_\_\_  
 Company \_\_\_\_\_ Title \_\_\_\_\_  
 Address \_\_\_\_\_  
 City \_\_\_\_\_ State \_\_\_\_\_ Zip \_\_\_\_\_

INFORMATION RETRIEVAL NUMBER 131

# COHU'S DESIGN 6000

## hi resolution camera

Cohu's 6100 Series high-resolution camera — one of the new look 6000 design series — is designed for continuous unattended duty. Camera functions are remotely controlled from a Cohu solid-state 6900 Series Camera Control that connects with a single multiconductor cable. Add a TV monitor for a complete CCTV system.

The 6100 is housed in a high-strength cast aluminum-alloy housing with a scuff-resistant epoxy finish, brushed chrome rear panel and lens mount. The control unit is a rack mount in 5¼" vertical space. It is available with horizontal scan rates from 525 to 1225 lines and bandwidths to 32 MHz. Performance of the camera is characterized by superior corner resolution and flatness of field.

The circuit design of the 6100 series high resolution camera features the latest integrated circuits for maximum reliability. Maintainability is simplified by modular construction and plug-in etched circuit boards.

For complete details and specifications, contact your nearest Cohu representative or call Bob Boulio direct at 714-277-6700, Box 623, San Diego, California 92112, TWX 910-335-1244.



## PACKAGING & MATERIALS

### Diamond abrasive sprays on work



Starnetics Co., P.O. Box 9308, North Hollywood, Calif. Phone: (213) 769-8437. Availability: stock.

Packaged in an aerosol container, Diamant Spray MF is a diamond-abrasive material formulated with a novel chemical base that assures permanent stability and diamond particle suspension. Agglomeration is prevented by controlled reaction. The new spray will not clog in the presence of abraded metal and is now water and oil soluble.

CIRCLE NO 359

### Industrial aerosols come in 20-oz cans



Bradford Industries, 100 Fordyce St., Dallas, Tex. Phone: (214) 741-5244. Price: \$1.29 to \$2.89.

Developed to assist in the manufacture, assembly, maintenance and repair of electronic and electro-mechanical equipment, more than twenty industrial aerosol chemical products are now offered in a 20-ounce container. Featured are electronic and mechanical production aids, special-purpose lubricants and cleaners, and safety products.

CIRCLE NO. 360



INFORMATION RETRIEVAL NUMBER 132



## Emi/rfi gasketing doubles protection

Emerson & Cuming, Inc., Microwave Products Div., Canton, Mass. Phone: (617) 828-3300.

Containing a neoprene tubing insert to assure good compression and recovery characteristics as well as additional strength, Eccoshield SV tubing, type NI, is a flexible gasketing for the control of emi and rfi. The conductive tubing, which forms the outer part of the gasket, is a vinyl resin containing pure silver. Nominal outer diameters are 3/16, 1/4 and 5/16 in.

CIRCLE NO. 361

## Heat-sink compound lubes thermal path

Transene Co., Inc., Route 1, Rowley, Mass. Phone: (617) 948-2501. Price: \$3/lb.

Serving as a coupling agent to reduce thermal contact resistance, Xtherm is a thermally conductive heat-sink grease that is applied to the base and mounting stud of transistors, diodes and rectifiers. It contains alumina in a laminar crystallographic orientation dispersed in a special silicone base. The heat removed is often ten times better with Xtherm than with dry plate mountings.

CIRCLE NO. 362

## Non-woven tapes up mica content

General Electric Co., Insulating Materials Div., Schenectady, N. Y. Phone: (518) 374-2211.

Non-woven glass-reinforced Mica Mat tapes offer increased mica content per unit thickness to provide greater voltage life. Designed for temperature loads up to 155°C continuous operation, the tapes may be used in either ac or dc applications. They are not cross-weaved, resulting in improved flexibility.

CIRCLE NO. 363

**NOW AVAILABLE  
FOR IMMEDIATE DELIVERY:**

**FAST  
SWITCHING**

**2 AMP and 5 AMP  
TRANSISTORS**

from **Soliton**

Soliton has expanded its line of ultra-fast switching transistors with the introduction of 2 AMP and 5 AMP devices. These new units are the fastest switching transistors in the industry now available for "off the shelf" immediate delivery. Features include planar construction and rise time less than 10 nanoseconds.



TO-5



TO-60

### 2 AMP SERIES

Type Number TO-5	Type Number TO-60	BV <sub>CBO</sub>	BV <sub>CEO</sub>	t <sub>ON</sub> max.	t <sub>OFF</sub> max.
SDT6101	SDT6104	65	30	50 ns	50 ns
SDT6102	SDT6105	65	40	50 ns	50 ns
SDT6103	SDT6106	65	50	50 ns	50 ns

### 5 AMP SERIES

Type Number TO-5	Type Number TO-60	BV <sub>CBO</sub>	BV <sub>CEO</sub>	t <sub>ON</sub> max.	t <sub>OFF</sub> max.
SDT6110	SDT6113	65	30	65 ns	65 ns
SDT6111	SDT6114	65	40	65 ns	65 ns
SDT6112	SDT6115	65	50	65 ns	65 ns

Dial 1-800-327-3243 for a "No Charge" telephone call and further information

**Soliton  
DEVICES, INC.**

1177 BLUE HERON BLVD. / RIVIERA BEACH, FLA. / (305) 848-4311 / TWX: (510) 952-6676

INFORMATION RETRIEVAL NUMBER 133

# We did it!

## A digital angle indicator for under \$1500

- All Solid State - No Moving Parts
- Digital Output
- 0.1° Resolution and Accuracy
- High Readability

Astrosystems Digital Angle Indicator is a solid state all electronic device for measuring and displaying angle inputs from remote synchro or resolver inputs. For the first time, a low cost, high reliability, solid state angle indicator is available that does not use gears, motors, synchro receivers or any other rotating components. This rugged, versatile, reliable instrument is ideal for system, ground support and laboratory applications. Some of the outstanding features of this new unit are:  **Ultra Reliability**—Accuracy guaranteed for one year without calibration or periodic adjustments.  **High Readability**—Large inch-high characters on Nixie® tube readout.  **High Input Impedance**—200K.  **Versatile**—Accepts synchro or resolver inputs at 11.8, 26 or 90 volts line-to-line.  **Low Audible Noise**—No motors or gears.  **High Slew Speeds**—100°/second.  **Digital Output**—A four decade BCD digital output available.

astrosystems, inc. 6 Nevada Drive, Lake Success, New York 11040 516/328-1600 TWX 510/233-0411. West Coast Office 4341 Commonwealth Avenue, Fullerton, California 92633 714/523-0820.

asi

**astrosystems, inc.**

## PACKAGING & MATERIALS

### Environmental gasket seals out rfi also

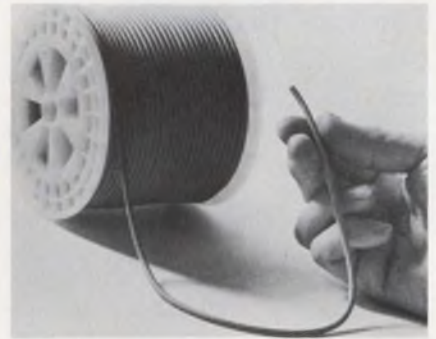

Chomerics, Inc., 77 Dragon Court, Woburn, Mass. Phone: (617) 935-4850.

Supplied on reels in unlimited lengths and standard cross-sections, a new non-corrosive strip gasketing provides both rfi and environmental sealing in a single structure. Available in both Cho-Seal and Cho-Sil materials, this strip gasketing exhibits a compression-deflection rating as high as 50% with 30 pounds per inch and a recovery above 85% after 70 hours at 100°C.

CIRCLE NO. 364

### Carbon textiles resist 5000°F



HITCO, Materials Div., 1600 W. 135th St., Gardena, Calif. Phone: (213) 321-8080.

Developed for numerous industrial applications requiring high-temperature textiles, a new complete line of fibers and fabrics will withstand temperatures up to 5000°F. Made of pure carbon or graphite, the fibers are available in various forms, such as roving, yarn, cordage, cloth in various weaves, sleeving, tapes, bulk fiber and felt. They are also completely inert and immune to attack from most chemicals.

CIRCLE NO. 365

# Introducing the 7½ minute prototype.

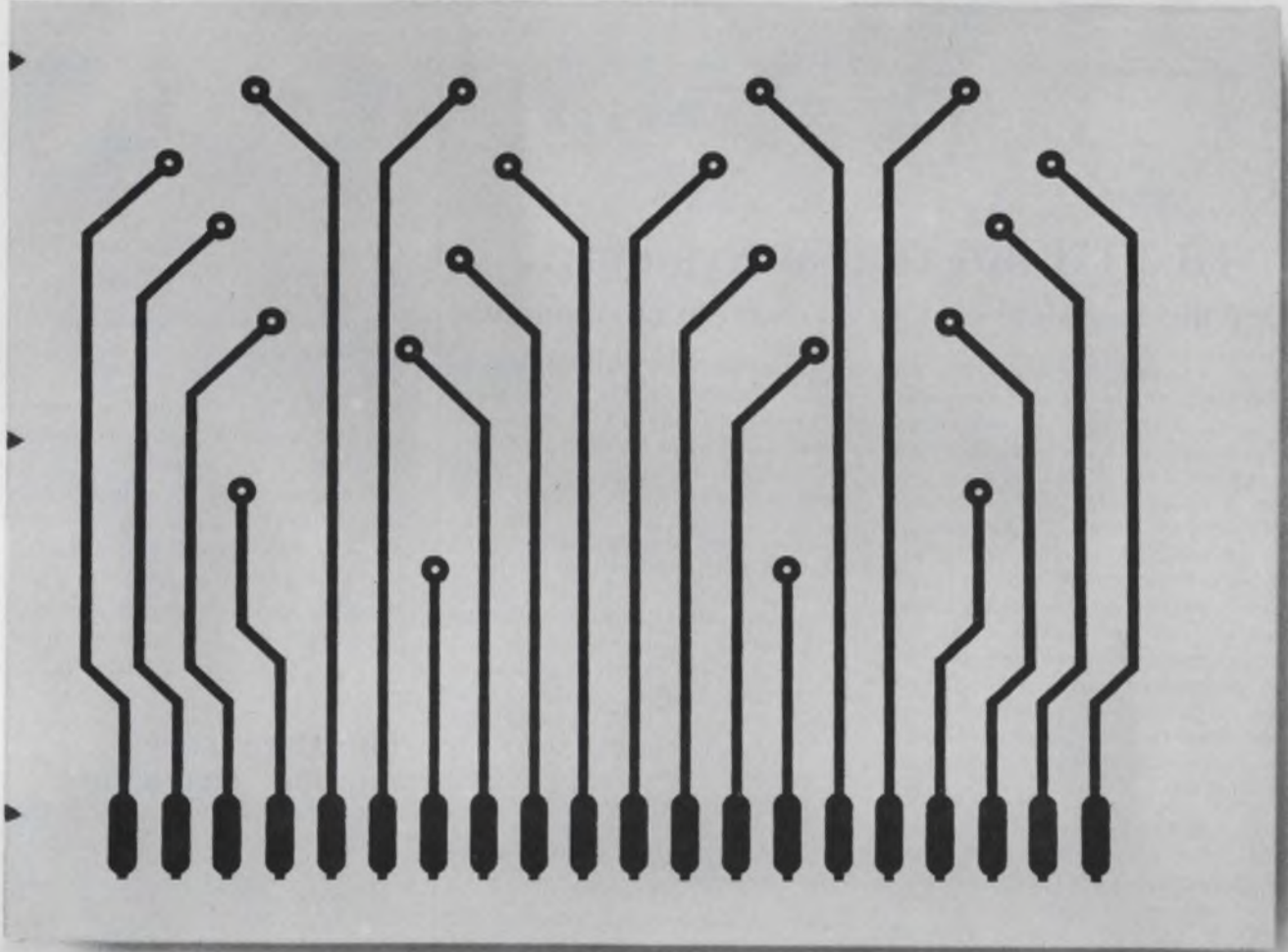

Getting prototype circuit boards used to be the biggest nuisance in design projects.

It took a lot of man-hours, expense, and a lot of space for bulky, awkward equipment.

No more. With Xerox Standard Equipment, chemical resist images can be transferred to copper-clad laminates and prepared for conventional etching—in 7½ minutes flat.

For just pennies per prototype.

And there are no wet, messy chemicals (the xerographic process is

completely dry).

No air-controlled darkroom (the Xerox equipment can be set up in a small corner almost anywhere).

No need for highly-trained technicians (most people can learn to handle it in just 60 minutes).

Of course, the 7½ minute prototype is only one of the ways you can use Xerox Standard Equipment.

If you have another 7½ minutes, we'll explain some of the others. Write Dept. BC14, Xerox Corporation, Rochester, New York 14603.

## XEROX

# a complete digital system



- for:
- circuit breadboarding
  - customized digital instruments
  - learning digital techniques

## HEATH 801 Digital System...

buy the complete system or discrete components

Now . . . A Complete System to Enable You to Get the Most Out of Digital Electronics. Here is a system that is revolutionizing instrumentation in labs and classrooms throughout the world. The basic design concepts of Professors H. V. Malmstadt and C. G. Enke combined with the engineering of Heath's scientific instrument group have resulted in the unique 801 Analog-Digital Designer (ADD) and the EU-51A breadboard and parts group. This versatile system can perform equally well in constructing high performance research-quality instruments, in performing hundreds of experiments in the teaching laboratory, in rapid testing of new digital ideas, or in interfacing to computers.

Start . . . By Learning the New Digital Electronics. Drs. Malmstadt and Enke have written a pioneering new text "Digital Electronics for Scientists" (published by W. A. Benjamin, Inc.) that provides a systematic introduction to the digital circuits, concepts and systems that are basic to the new instrumentation — computation revolution. The book is written for engineering and science students and for practicing engineers, scientists, and technicians so that all may effectively utilize the startling recent advances in digital electronics.

Never before have the latest "state-of-the-art" methods been made so rapidly and conveniently accessible through an integrated combination of new text and versa-

tile equipment. The experimental section of the text is written specifically for utilizing the Heath 801A and 51A to provide experience and working knowledge with hundreds of digital and analog-digital circuits, instruments and systems.

Write . . . for Complete Information on Cards, Modules and Parts in the Heath Digital System. The basic Analog-Digital Designer (EU-801A) contains 3 modules (power supply, binary information, and digital timing) and 13 circuit cards including TTL gates, flip-flops, monostable MVs, relays, op amps, and V-F converter. The EU-51A Experimental Parts Group is a highly flexible breadboard system for circuit design and teaching. The group includes a desk chassis, 493 components, a patch card accepting these components, and a power patch card.

The system is open-ended. New cards and modules are continuously being introduced so you can construct your own special frequency meters, counters, timers, DVM's, rate meters, and many dozens of other instruments.

Take . . . advantage of the digital revolution — order your Heath Digital System now.

**EU-801A**, Analog-Digital Designer . . . \$435.00\*  
**EU-51A**, Experimental Parts Group . . . \$135.00\*  
**EUP-19**, text "Digital Electronics For Scientists" by H. V. Malmstadt and C. G. Enke (published by W. A. Benjamin, Inc.) . . . \$9.50\*

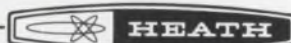

HEATH COMPANY, Dept. 586-21  
 Benton Harbor, Michigan 49022

a Schlumberger company

Please send FREE Heath Scientific Instrumentation Catalog

Name \_\_\_\_\_

Address \_\_\_\_\_

City \_\_\_\_\_

State \_\_\_\_\_

Zip \_\_\_\_\_

Prices and specifications subject to change without notice.

\*Mail Order Prices; F.O.B. Factory

EK-278

### FREE Heath Scientific Instrumentation Catalog



Describes these and other precision instruments for laboratory, engineering, education and R & D applications. Send for your FREE

copy now . . . just write on your school or company letterhead.

INFORMATION RETRIEVAL NUMBER 136

## Plastics solvent strips and deflashes

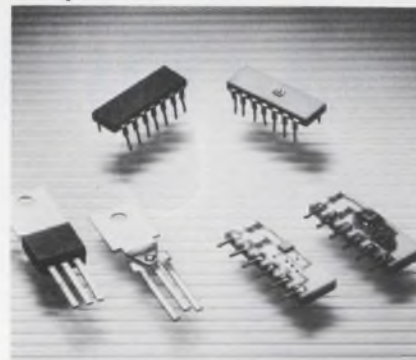

Dynalog, Inc., 7 Great Meadow Lane, Hanover, N.J. Phone: (201) 887-9270. Price: \$10/quart.

A new reactive solvent for dissolving cured silicone compounds and anhydride cured compounds will not affect fragile interconnections or corrode metals. Unresolve Plus SG is a true solvent and does not merely swell the plastic. When used cold, it will remove flash from the leads of silicone and anhydride cured transfer-molded epoxies without affecting the properties of the part.

CIRCLE NO. 366

## Miniature cables multiply conductors



Microtech, Inc., 777 Henderson Blvd., Folcroft, Pa. Phone: (215) 532-3388. P&A: from 10¢/ft; stock.

A new line of miniature coaxial and multi-conductor cable is now available for high-density packaging applications and miniaturization demands in aerospace, medical, transducer, computer and IC applications. The line consists of two coaxial cables with maximum outer diameters of 0.06 and 0.078 in., and two multi-conductor cables of four and seven conductors with outer diameters of 0.11 and 0.12 in.

CIRCLE NO. 367

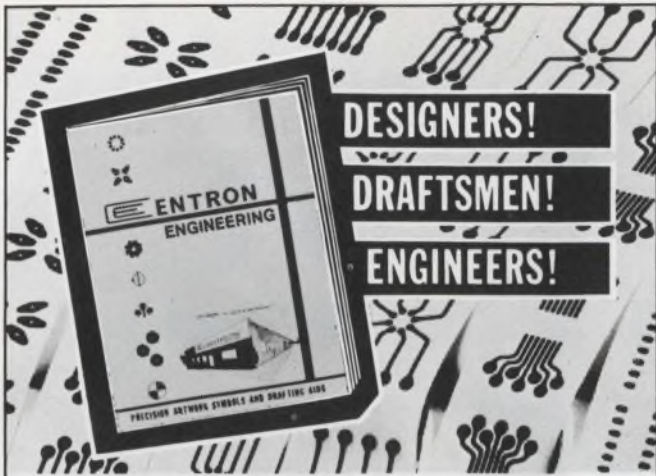

**DESIGNERS!**

**DRAFTSMEN!**

**ENGINEERS!**

# FREE from Centron

## CATALOG AND SAMPLES

Printed circuit artwork materials including symbols, multi-pad patterns and tapes. These precision symbols are pressure sensitive, pre-cut and meet the accuracy requirements of the latest printed circuit and multi-layer techniques. Choose from complete families of I.C. symbols.



**CENTRON ENGINEERING, INC.**  
1518 W. 132nd STREET  
GARDENA, CALIFORNIA 90249  
(213) 321-3220

INFORMATION RETRIEVAL NUMBER 137

# TRUE SOLID-STATE RELAY

Opening New Relay Applications in Multiplexing, Isolated Sensing, High Speed Isolated Control, etc. Offered in A - B - C Contact Configurations for Direct Replacement of Mechanical Types.

- Switching Time . . . . . less than 65 $\mu$  sec
- Contact Open Resistance . . . . . 10<sup>9</sup> ohms
- Contacts Capable of switching D C to 4 M HZ
- Non-Polarized Effective Coil
- Effective Coil Accuate/Release Voltage Hysteresis . . . less than 10 mV . . .
- Non-Polarized Contacts
- No Reference Required Between Effective Coil and Effective Contacts
- Life Expectancy—tested to 10<sup>10</sup> operations with no failure.

## SHAFFSTALL-BALL CORPORATION

5149 E. 65th Street, Indianapolis, Indiana 46220  
Phone: 317-257-6296

INFORMATION RETRIEVAL NUMBER 138

ELECTRONIC DESIGN 21, October 11, 1969

# DISPLAY CIRCUIT MODULES

## DYNAMIC FOCUS FUNCTION GENERATOR

FG100

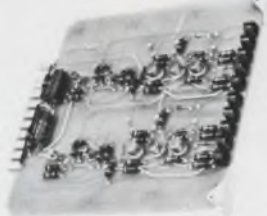

Converts X and Y deflection current samples into parabolic voltage wave forms to maintain beam focus anywhere on the CRT face.

## LINEARITY CORRECTOR

LC101A



Gives on-axis linearity correction for geometric distortion occurring when a flat-faced CRT is used. Ideal for line-scan applications.

## CENTERING COIL CURRENT REGULATOR

CR200



Supplies highly stable constant current to two axes of centering, alignment or static astigmatic correction coils in CRT, storage tube or vidicon systems.

## VIDEO AMPLIFIER

VA105



Linear, featuring high output capability, fast rise and fall time, excellent full power output and bandwidth. Unique damping control.

## STATIC FOCUS CURRENT REGULATOR

SR1000



Provides a fully adjustable constant dc current supply to the static focus coil in magnetically focused systems. Low ripple, adjustable.



*Constantine*  
Engineering Laboratories Company

Mahwah, N. J.  
201-327-1123

Upland, Cal.  
714-982-0215

INFORMATION RETRIEVAL NUMBER 139

**Line-to-logic unit is self-sufficient**

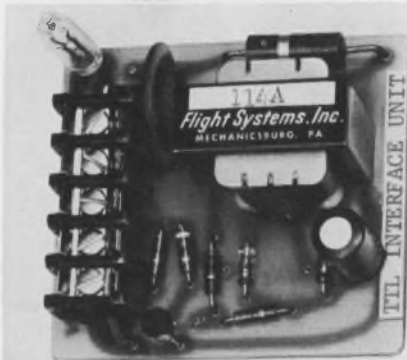

*Flight Systems, Inc., P.O. Box 25, Mechanicsburg, Pa. Phone: (717) 697-0333. Price: \$7 to \$8.*

Converting line-voltage command signals to TTL or DTL levels, a new interface unit does not need a dry circuit to operate. Its isolation of over 100 MΩ means sensitive logic-level circuitry will not be damaged and the input can be shorted without harm. Model 114A is all solid state, with no moving parts or light bulbs to wear out.

CIRCLE NO. 368

**Stable supply costs only \$39**



*Analog Devices, Inc., 221 Fifth St., Cambridge, Mass. Phone: (617) 492-6000. P&A: \$39; stock.*

Providing a dual output of  $\pm 15$  V at 50 mA, a new plug-in modular power supply for operational amplifiers features a  $\pm 0.1\%$  line and load regulation for a cost of only \$39. Model 904 has a ripple of 0.5 V rms (2 mV pk-pk), an output impedance of 0.2 Ω at 10 kHz, and an input isolation of 500 MΩ shunted by 100 pF. The unit measures 3.5 by 2.5 by 0.88 in.

CIRCLE NO. 369

**Miniature regulators supply up to 50 mA**



*Analog Equipment Corp., 18 Granite St., Haverhill, Mass. Phone: (617) 373-1501. Price: \$5.25.*

Supplying positive or negative regulated voltages from 18 to 28 V, a new series of miniature voltage regulators offers an output current capability as high as 50 mA. Series AE units use all-silicon semiconductors to provide a typical regulation of better than 0.5%. They are economical devices designed to operate over the temperature range of 0 to 70°C.

CIRCLE NO. 370

**ECONOMICAL Heat Sinking with Series 200 Featherweights**

Snap-on coolers for entire JEDEC transistor case tolerance range... available in ALUMINUM (except Nos. 222, 224) and in beryllium copper. Horizontal or vertical orientation for natural or forced convection. NATURAL CONVECTION POWER DISSIPATION... for 50°C case rise above ambient.

Model No.	Model No.	Model No.	Model No.
*201 - .7	†205 - .8	*203 - .9	‡209 - 1.8
*202 - .6	†211 - 1.0	‡207 - 1.1	‡215 - 1.9
†204 - .6	‡213 - 1.2		*222 - .9
			‡224 - 1.2

\* For TO-18, etc. with .161/.240 diams.  
 † For TO-5, etc. with .275/.370 diams.  
 ‡ For TO-8, etc. with .440/.554 diams.

WRITE FOR Natural and Forced Convection Characteristics and specifications in new DISTRIBUTOR PRODUCTS CATALOG NO. 102.

**WAKEFIELD ENGINEERING, INC.**  
 WAKEFIELD, MASS. 01880 ■ (617) 245-5900 • TWX 710-348-6713

INFORMATION RETRIEVAL NUMBER 140

**HYBRID CIRCUIT CERAMIC CHIP CAPACITORS...**



**... THAT ARE REALLY THUMBTHING!**

Put your finger on those so-and-so design problems with a selection of type K 1200's. Capacitance range is 10 pF to 2.5 Mfd. Dissipation factor is less than 2% @ 1 kHz. Working voltages available, 25 thru 200 WVDC and more. Tempco is  $\pm 15\%$  max. -55°C to 125°C. Our full line meets the applicable portions of MIL-C-11015 and MIL-C-39014.

Want a complete description, characteristics curves, etc? . . . write us for our latest pattern K-1200.

Monolithic Dielectrics Inc. P.O. Box 647 Burbank, Calif. 91503 Phone 213 848-4465

INFORMATION RETRIEVAL NUMBER 141



# RZ GLASS

...the big news in sputtering targets...from Owens-Illinois

Owens-Illinois RZ Glass Sputtering Target is a NEW copper alumino-silicate glass readily sputtered on a silicon substrate. After sputter deposition, the RZ glass layer is etched to open up contacts to the silicon substrate. A simple oxidation-reduction process then produces *pure* copper conductive layers on the RZ glass, even in etched undercuts.

RZ glasses are ideal for making single or multilayer interconnections in medium or large-scale integrated circuits. The conductive layer is produced uniformly on RZ-coated substrates regardless of surface geometry.

You now have your choice of *three* sputtering targets from Owens-Illinois . . . 1. NEW RZ copper alumino-silicate, silicon-matching, 2. EE-9 alumino-silicate, silicon-matching, 3. EE-10 alumino-silicate, alumina and gallium arsenide matching.

All three are readily deposited at rates of 250 Å/minute with

standard R.F. sputtering equipment, followed by simple etch when needed. A new manufacturing process holds the sodium content of these glasses below 20 ppm.

Owens-Illinois can supply targets promptly in lengths, widths, and thicknesses to fit your R.F. set-up and substrate dimensions. We'll work with you on materials to meet your special needs.

Complete data, specifications, and sputtering procedures developed in the Owens-Illinois microelectronics research labs will be sent to you promptly on request. Ask for information on these other O-I electronic materials: package sealants, substrate glazes and insulating films, preform materials, glazed IC packaged parts and substrates. WRITE TO:

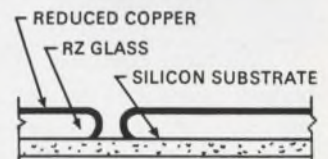

THE O-I FAMILY OF WORK-TOGETHER ELECTRONIC MATERIALS.

**OWENS-ILLINOIS**  
ELECTRONIC MATERIALS  
Toledo, Ohio 43601

INFORMATION RETRIEVAL NUMBER 142

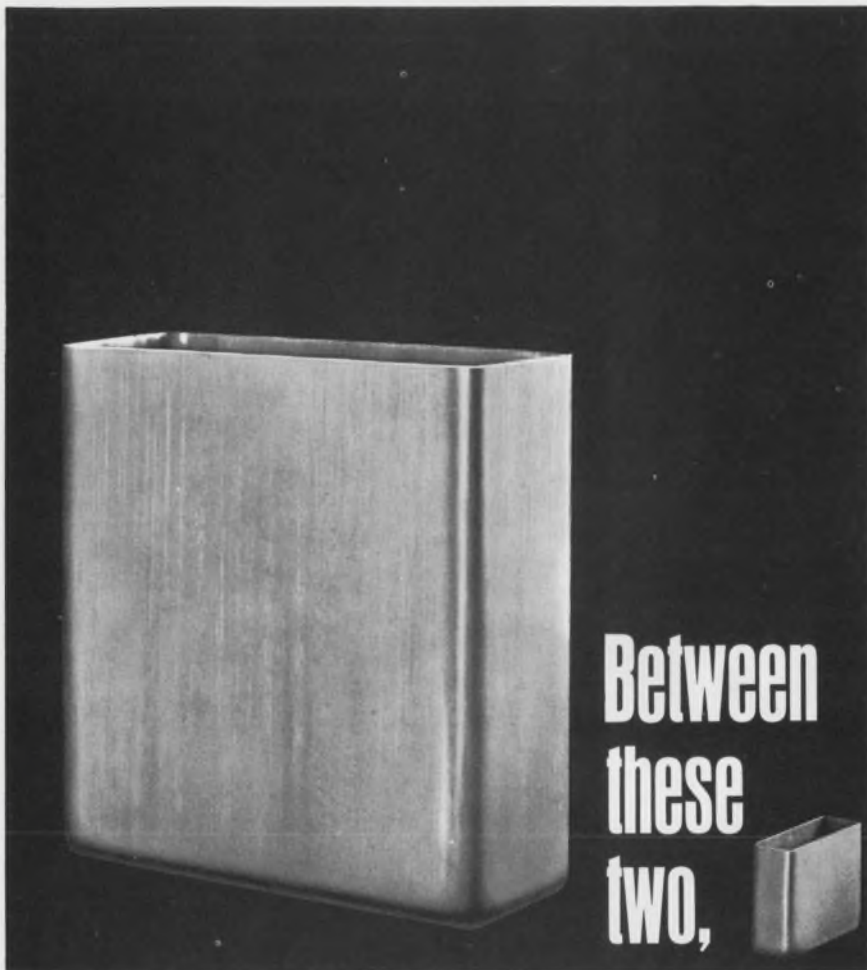

Between  
these  
two,

Square shapes. Rectangular shapes. Round shapes. Five-sided shapes. All shaping up into aluminum cans and covers in the largest selection of sizes available anywhere. Which means you can figure on getting what you want from Moorlee right off the shelf. With no tooling around. At the right price and with the right delivery, too.

In fact, Moorlee has over 200 more sizes in square, rectangular or five-sided cans and covers than the manufacturer with the next largest selection. And over 250 more sizes in round cans and covers.

We have complete facilities, too, for all secondary operations as well as for custom tooling. Plus over 25 years of experience.

See for yourself what's going on at Moorlee. It's all down in our new catalog. Everything on aluminum cans and covers—all arranged so you can find the right size and shape fast. Send now for your free copy. There's more in it than you can imagine.

**Moorlee  
Manufacturing  
Company**

you  
can't  
imagine  
what  
goes  
on!



120 WEST SLAUSON AVE., LOS ANGELES, CALIFORNIA 90003

INFORMATION RETRIEVAL NUMBER 143

MODULES & SUBASSEMBLIES

**Compact servo op amp  
delivers 100 W at 5 A**

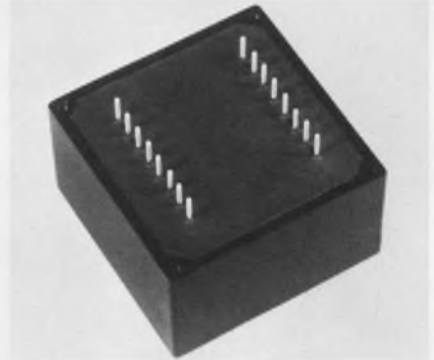

*Control Systems Research, Inc.,  
614 Allegheny River Rd., Verona,  
Pa. P&A: \$180; 1 to 2 wks.*

Measuring 3-1/8 by 3-1/8 by 1-1/2 in., a new ac and dc servo operational amplifier can deliver a full 100-W output. Model PA-2 has a maximum output voltage of  $\pm 24$  V at a maximum current of  $\pm 5$  A. It also features adjustable current limiting, short-circuit protection, a dc-to-10-kHz bandwidth, low drift, over-temperature protection, and operation from non-regulated power supplies.

CIRCLE NO. 371

**Fast data amplifiers  
put out 20 mA at 10 V**



*Data Device Corp., 100 Tec St.,  
Hicksville, N.Y. Phone: (516) 433-  
5330. P&A: \$65 to \$75; stock to  
3 wks.*

Two new high-speed data amplifiers offer outputs of  $\pm 20$  mA at  $\pm 10$  V, 20- $\mu$ V/ $^{\circ}$ C voltage drift and 0.5-nA/ $^{\circ}$ C current drift. Model VA-21 video amplifier provides a slewing rate of 750 V/ $\mu$ s, with a 12-MHz frequency for full output. Model FS-21 amplifier settles to 0.5% within 100 ns maximum. Both units operate over the temperature range of 0 to +70 $^{\circ}$ C.

CIRCLE NO. 372



**For maximum frequency stability,  
get Motorola oscillators.**



**Currently available  
in production or prototype quantities.**

When the maximum in frequency stability is required, choose from Motorola's line of proportional ovenized precision oscillators. All are enclosed in an ovenized housing where the quartz crystal and its oscillator circuit are held to temperature changes of small fractions of a degree.

*High Stabilities.* To parts in  $10^{-10}$  vs. environmental factors.

*Wide Frequency Range.* From 60 KHz to 20 MHz normal. Extended ranges available on special order.

*Wide Temperature Range.* From  $-55^{\circ}\text{C}$  to  $+125^{\circ}\text{C}$ .

*Low Aging.* Less than  $5 \times 10^{-10}$ /day.

And if you need a non-standard oscillator, let us know your requirements. We'll design one specifically to meet your needs.

For complete information send for your free copy of Bulletin TIC-3401 today. Write Component Products Dept., Motorola Communications & Electronics Inc., 4501 W. Augusta Blvd., Chicago, Illinois 60651.



INFORMATION RETRIEVAL NUMBER 144

**Picky!  
Picky!**

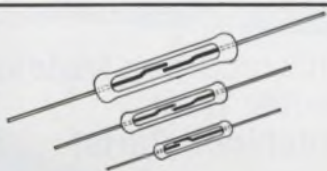

**HATHAWAY MICRO-MINIATURE,  
MINIATURE, AND  
INTERMEDIATE DRIEED SWITCHES**

You bet we are! Some people wonder how we can consistently produce such high quality Dryreed relays. The answer is testing, rigid quality control, and skilled personnel. Our reeds are good because we make them that way, and keep proving it to ourselves and to our users. Hathaway Dryreeds go from pin-sized micro-miniatures up to heavy-duty intermediates. They all turn out giant-sized performance.

Send for our full line mini-catalog.  
Address: 5250 East Evans Avenue,  
Denver, Colorado 80222, (303) 756-8301 —  
TWX—910-931-0569.

**HATHAWAY**  
components

A DIVISION OF HATHAWAY INSTRUMENTS, INC.

*To buy less  
would cost you more*

INFORMATION RETRIEVAL NUMBER 145

ELECTRONIC DESIGN 21, October 11, 1969

**Transients  
stop  
here!**



**New Dale Arrester  
Provides Reliable, Low-Cost  
Surge Protection**

Dangerous transient voltages get nowhere when you put Dale's new Surge Protector in their path. For a few dollars, this new design provides the best insurance you can buy against damage from direct lightning strikes, and from transients induced by lightning and switching. Here are just a few of its advantages over other low-cost protectors:

**SENSITIVITY** Typical breakdown voltage is 1500 volts when subjected to a voltage pulse rising at  $10 \text{ kv}/\mu\text{sec}$ . Power-follow current is extinguished within  $\frac{1}{2}$  cycle or less.

**REPEATABILITY** Will bypass repeated overvoltages without significant change in breakdown level.

It's weatherproof, mounts anywhere, meets all applicable NEMA, USAS and IEEE standards. For a few bucks, it can save you a bundle. Write for complete information.



**DALE ELECTRONICS, INC.**  
**SIoux DIVISION** Dept. ED  
Yankton, South Dakota 57078  
*A subsidiary of The Lionel Corporation*

Producers of: Toroids, Series Resonant Traps, Variable Pitch Inductors, Miniature High Frequency Inductors, Degaussing Coils, Industrial and Military Coils, Subminiature Coils, Surge and Lightning Arresters, Custom Assemblies, Motor Driven Potentiometers.

INFORMATION RETRIEVAL NUMBER 146

### High-impedance op amp presents $10^{11}$ -M $\Omega$ input

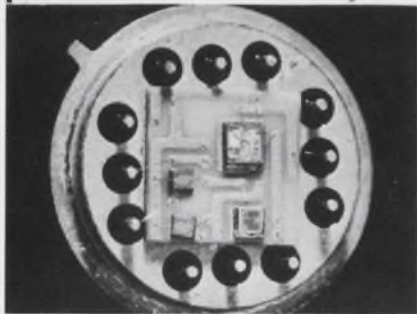

Amelco Semiconductor, 1300 Terra Bella, Mountain View, Calif. Phone: (415) 968-9241. Price: \$22.

With bias and offset currents of 40 and 15 pA respectively, a new hybrid operational amplifier exhibits an input impedance of  $10^{11}$   $\Omega$ . Model 2741 has a power dissipation of 50 mW, internal 6-dB/octave frequency compensation, high gain and low common-mode rejection. The unit can offset external voltages and is short-circuit proof. It is available in either a flatpack or in a TO-8 can.

CIRCLE NO. 373

### FET-input op amp settles in 0.6 $\mu$ s

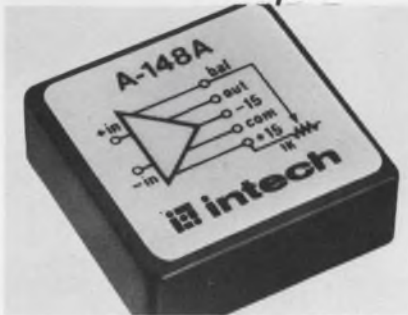

Intech, Inc., 1220 Coleman Ave., Santa Clara, Calif. Phone: (408) 244-0500. P&A: \$40 to \$50; stock.

Designed with an FET input, a new operational amplifier has a typical settling time of 0.6  $\mu$ s to reach 0.01% of final value and a maximum settling time of 1  $\mu$ s to 0.1% of final value. Series A-148 units have a 25-pA bias current and a  $10^{11}$ - $\Omega$  input impedance. Minimum slewing rate is 50 V/ $\mu$ s and minimum gain is 50,000. Temperature coefficients range from 15 to 50  $\mu$ V/ $^{\circ}$ C.

CIRCLE NO. 374

### Bright readout module widens view to 140 $^{\circ}$

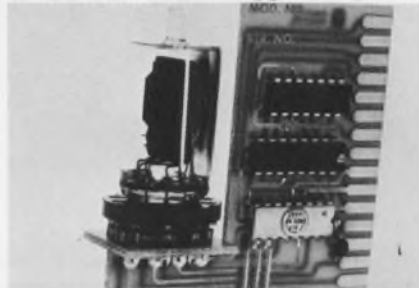

Computer Products, P.O. Box 23849, 2709 N. Dixie Highway, Fort Lauderdale, Fla. Phone: (305) 565-9565. P&A: from \$35.90; 1 to 5 days.

Using a seven-segment side-viewing readout tube, a new decimal mounting and display module series has a 140 $^{\circ}$  viewing angle with enough brightness to be viewed in direct sunlight. Series DM-600 modules are driven by an MSI BCD-to-seven-segment decoder/driver circuit. They offer variable brightness control and TTL/DTL input/output compatibility.

CIRCLE NO. 375

## Motorola VIBRASPONDER Resonant Reeds



Performance proven, they're the industry's smallest and most rugged reeds.

Proven in thousands of remote control and signaling applications, VIBRASPONDER reeds provide unlimited potential in supervisory control, aerospace, military, and telemetry applications, or whenever selective tone signaling or stable audio tones are required.

Special construction gives VIBRASPONDER reeds maximum protection against shock and vibration. Contactless design allows its use as either a tone generator or a decoder. Multiple reeds may be used for sequential coded tone applications.

Over one hundred-fifty standard tone frequencies are available from 67 Hz to 3150 Hz. Other frequencies available on request.

For more information on VIBRASPONDER reeds, write for Bulletin TIC-3521 to Motorola Communications & Electronics Inc., 4501 W. Augusta Blvd., Chicago, Illinois 60651.

MOTOROLA and VIBRASPONDER are trademarks of Motorola Inc.



INFORMATION RETRIEVAL NUMBER 147

## Fluorocarbon Moldings Better Than Machined Parts!



FREE BROCHURE

When tolerances are critical, parts machined from rod stock can be uneconomical. That's the time for a B & W quotation. B & W specializes in precision, intricate injection moldings to your specs. Materials include CTFE, Kel F, FEP, Kynar, Halon and others. We design and build all tooling.

Send part or print for fast, airmail quotation.  
"World's largest custom Fluorocarbon molder"

**BOOKER AND WALLESTAD DIV.**

1202 So. 5th St., Hopkins, Minn. 55343

Area 612/938-7671

Subsidiary of Thermotech Industries, Inc.

DEPT. ED



**BW**

INFORMATION RETRIEVAL NUMBER 148

ELECTRONIC DESIGN 21, October 11, 1969

# circuit problems?

**Signalite Glow Lamps have solved problems in these areas:**

- Voltage Regulation & References • Photo-Cell Drivers • SCR Triggering
- Timing • Photo Choppers • Oscillators • Indicator Lights • Counters
- Voltage Dividers • Surge Protectors • Logic Circuits • Flip-Flops
- Memory • Switching • Digital Readouts

Signalite glow lamps combine long life, close tolerance and economy, and are manufactured with a broad range of characteristics to meet individual application requirements. For a creative approach to your design problem . . . contact Signalite's Application Engineering Department.



**ULTRA HIGH LEAKAGE RESISTANCE.** Devices with leakage resistance in excess of  $10^{12}$  ohms are available for circuits requiring this property. Such applications would include sample and hold for A to D conversion, and capacitor memory systems.

SEE Signalite Application News for TYPICAL APPLICATIONS



## PHOTO-CELL APPLICATIONS

The A074 and A083 have been designed for use with Cadmium Sulfide or Cadmium Selenide photocells. Applications include photo choppers, modulators, demodulators, low noise switching devices, isolated overload protector circuits, etc. Speed of operation is limited only by the photo-cells.

SEE Signalite Application News for TYPICAL APPLICATIONS

## SIGNALITE APPLICATION NEWS



is used to communicate new and proven techniques and applications of Signalite's neon lamps and gas discharge tubes. Signalite Application News provides a forum for an exchange of ideas to keep the design engineer aware of the versatility of neon lamps and their many applications. Copies are available from your Signalite representative or by contacting Signalite.

circle 149



**VOLTAGE REGULATORS BETTER THAN 1% ACCURACY** These subminiature voltage regulators are used in regulated power supplies, as reference sources, photomultiplier regulators, oscilloscopes calibrators, etc. They are available in voltages from 82 to 143 V. They are used in multiples as regulators in KV ranges.

See Signalite Application News for TYPICAL APPLICATIONS.



**NEON TIMERS** The bi-stable characteristics and high leakage resistance of Signalite's special glow lamps make them ideal as a component for timing circuits. The basic circuit resembles a relaxation oscillator network.

SEE Signalite Application News for TYPICAL APPLICATIONS

# Signalite

**INCORPORATED**  
NEPTUNE, NEW JERSEY 07763  
(201) 776-2490



A General Instrument Company

313

# LOW PROFILE IC PACKAGING SOCKET

Directly interchangeable! Exclusive socket configuration, identical to IC package, saves time, simplifies mounting on PC board.

- Permits card stacking on 1/2" centers
- Accepts packages with flat or round leads
- Easy IC insertion with wiping type beryllium copper contacts
- Easy extraction, minimum lead damage—optional extractor tool available
- Available in diallyl phthalate or black phenolic with gold or tin-plated contacts
- Dimensions .79 L x .49 W x .31 H

Request Data Sheet 166.

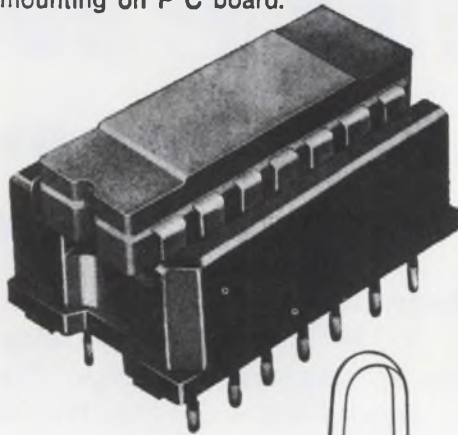

Extractor tool



## AUGAT

INC. 31 PERRY AVE., ATTLEBORO, MASS. 02703  
INFORMATION RETRIEVAL NUMBER 151

## New Microstrip IC Components

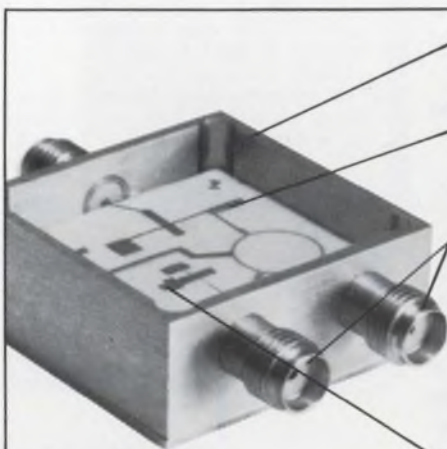

**CIRCUIT FRAME ASSEMBLY**—Consists of mounting enclosure, coax-to-microstrip transitions (launchers) and all mounting hardware. Accommodates Microwave Integrated Circuits (MIC's).

**METALLIZED AND ETCHED SUBSTRATES**—Tek Wave provides metallized copper or gold on alumina oxide ceramics for MIC applications. Sizes to 4" x 4". Typical tolerances .0005" with 2 micro-inch surface finish.

**LAUNCHERS**—3mm and 1.7mm coax-to-microstrip transitions. For use with high dielectric constant substrates. Available for a variety of substrate thicknesses and line widths. Tek-Wave has the most comprehensive line of launchers available. There are over 100 standard models to choose from including launchers with special flange configurations, for other ground plane spacings, for any size substrate, for any frequency range, and for special dielectric materials. Precision 7mm transitions are also available.

**CHIP RESISTORS AND LOAD TERMINATIONS**—Available 50 and 100 ohms, with typical VSWR 1:15 to 1. Standard resistor size is .075" x .025" x .012".



**TEK-WAVE, INC.**

Raymond Rd., Princeton, N. J. 08540, (609) 921-8910  
The Leader in Advanced Microstrip IC Components

INFORMATION RETRIEVAL NUMBER 152

## PRODUCTION

### Automatic cutter trims wire plus



Compton Industries, Inc., 413 Commerce Rd., Vestal, N. Y. Phone: (607) 729-9221. Price: from \$495.

Working to a tolerance of 3% for diameters up to 3/16 in., a new automatic cutter will trim insulating sleeving, bare-wire jumpers, wicks, solder, braided wires, fiberglass and teflon tubing, and wires from AWG #18 to #50. Merely changing Com-Tek's dial setting or flipping its multiplier switch allows the length of the pieces cut to be changed while the unit is in operation.

CIRCLE NO. 338

### DIP extractor ends bent leads



Techni-Tool, Inc., 1216 Arch St., Philadelphia, Pa. Phone: (215) 568-4457. P&A: \$12.95; stock.

Part of second-generation tooling, a new DIP extractor plier removes the package straight up out of the board without bending any leads. Type 4916 handles dual-in-line packages with 14, 16, 24 and 36 leads. It has metal teeth and a self-closing molded body. The new tool simplifies removal, is safe to operate and will not lift up socket pads.

CIRCLE NO. 339

# New Plug-In Timer with Spider Clutch provides 1/4 of 1% repeat accuracy



Spider is the name of our revolutionary clutch which provides our new Series GP Plug-in Timers with 1/4 of 1% repeat accuracy.

The patented Spider Clutch, an exclusively new feature of Series GP, incorporates the high accuracy of infinite engagement clutches with the mechanical integrity of toothed clutches. The Spider insures non-slip

repeat accuracy that's unequalled by any other positive engagement, motor-driven timer.

Series GP is completely interchangeable with most of today's widely used plug-in type delay/interval timers. Priced as low as \$29.10 (500-999 units). For additional information, ask for bulletin 310. Call 201-887-2200.

## SINGER

INDUSTRIAL TIMER CORPORATION  
U.S. HIGHWAY 287, PARSIPPANY, N.J. 07054

INFORMATION RETRIEVAL NUMBER 153



# FREE CATALOG! OPTICS! SCIENCE! MATH! GIANT 148 PAGES

## 1000's OF UNUSUAL BUYS FOR INDUSTRY

Many on-the-job Helps . . . Quality Control Aids! Write for this completely new, 1970 Catalog New items, new categories, new illustrations, 148 easy-to-read pages packed with hundreds of charts, diagrams, illustrations. A treasure-house of optical and scientific information . . . unusual bargains galore. Optics for industry, research labs, design engineers, experimenters, hobbyists! Instruments for checking, measuring — to speed work, improve quality, cut production costs. We give you facts: what it is — how it works — where it's used.

### Comparators, Magnifiers, Microscopes

Hard-to-get war surplus bargains — ingenious scientific tools — imported — domestic. Thousands of components: lenses, prisms, wedges, mirrors, mounts, accessories of all descriptions. Dozens of instruments: magnifiers, stereo, microscopes, telescopes, binoculars, infrared equipment, photo attachments. Shop by mail. No salesman will call. Use the Catalog of America's greatest Optics — Science — Math Mart. Known for reliability. Mail the coupon below to:

Edmund Scientific Co., 300 Edscorp Building,  
Barrington, New Jersey 08007. Ask for Catalog "DA"

MAIL COUPON FOR FREE CATALOG "DA"  
EDMUND SCIENTIFIC CO.  
300 EDSCORP BLDG., BARRINGTON, N.J. 08007

Please send FREE Giant 148-page Catalog "DA"

NAME .....

ADDRESS .....

COMPANY .....

CITY .....

STATE .....

ZIP .....

INFORMATION RETRIEVAL NUMBER 154

ELECTRONIC DESIGN 21, October 11, 1969

# MINIATURE MEGOHM RESISTORS

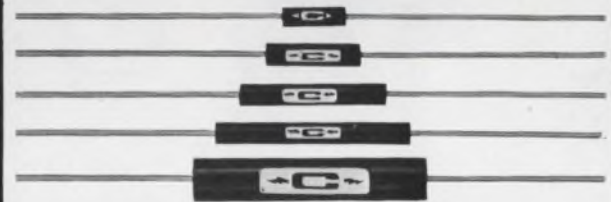

T.C. Absolute: 80 PPM/°C\*

T.C. Tracking: to 5 PPM/°C on special order.

Applications include high voltage dividers, high resistance networks, precision RC timing circuits, etc. We specialize in network sets with matched characteristics. Facilities available to perform Hi Rel screening.

Model No.	Wattage	Max. Voltage	Dielect. Str'gth	Resistance		Dimensions		
				Min.	Max.	Length	Dia.	Lead Dia.
MH 651	.5	600	750	500 K	5 meg.	.313 ±.020	.094 ±.006	.025 ±.002
MH 661	.6	1000	2000	1 meg.	10 meg.	.500 ±.030	.114 ±.010	.025 ±.002
MH 681	.8	1500	2000	1 meg.	15 meg.	.750 ±.030	.114 ±.010	.025 ±.002
MH 713	1.0	2000	2000	1 meg.	20 meg.	1.000 ±.030	.114 ±.010	.025 ±.002
Type MH with special internal shielding, designed to eliminate degradation due to corona								
MH 711	1.0	2000	2000	1 meg.	20 meg.	1.200 ±.040	.220 ±.015	.025 ±.002

\*Temperature Coefficient: 80 ppm/°C referenced to 25°C, Δ R taken at -15°C and +105°C. Maximum operating temperature: 175°C. Resistance Tolerance: ±1% (tolerances to .2% on special order). Insulation Resistance: 100 megohms, minimum. Overvoltage: 1.5 times working voltage for 5 seconds, R shift .8% max. Thermal Shock: MIL-STD-202, method 107, cond. C, R shift .5% max. Moisture Resistance: MIL-STD-202, method 106, R shift .8% max. Loadlife: 1000 hours at rated power, R shift .8% max. Encapsulation: Molded Silicone. Leadwire: Gold Plated Dumet 1 1/2" long ±1/8".

## MICRONOX™ Resistance Films

Micronox resistance films are produced exclusively by Caddock Electronics. They are composed of complex oxides fired in air at temperatures above 1400°F. The resulting films are relatively insensitive to high ambient temperatures and thermal shock. Films show negligible effect from moisture.

This totally new approach to precision resistors and networks opens new design possibilities because of the wide resistance range, precise temperature characteristics, and high temperature and power capability. Temperature coefficient can be accurately reproduced (within ±10 ppm/°C of curve if required). The typical curve shown below will vary slightly with resistivity of the film and configuration of the substrate.

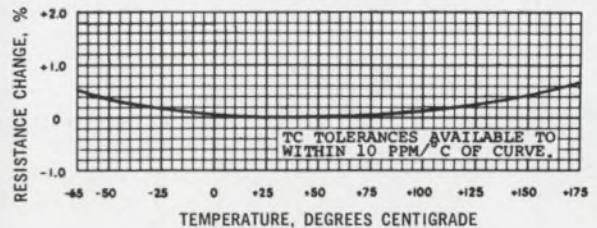

CADDOCK ELECTRONICS

3127 Chicago Avenue, Riverside, California 92507 • (714) 683-5361

INFORMATION RETRIEVAL NUMBER 155

189

### Electric eraser eliminates cord



Pierce Corp., Instrument Div., Mound View Rd., River Falls, Wis. Phone: (715) 425-6761.

Hailed as an industry first, a new cordless electric eraser is now available for engineering draftsmen, architects, designers and general office use. The compact rechargeable unit offers excellent mobility and ease of handling, besides being lightweight and shock-proof. The erasing unit rests on a charging console when not in use, similar to an electric shaver.

CIRCLE NO. 376

### Soldering tip tinner eliminates corrosion



Zeva Electric Corp., 3 Great Meadow Lane, Hanover, N. J.

Developed for high-heat high-volume production soldering, a new non-toxic tip tinner for soldering irons contains no acid-type fluxes, thus eliminating corrosion on the tip, on the soldering connections, and even on neighboring parts. This new product is intended to replace costly dip tinning operations for iron-clad long-life soldering tips. It comes in rolls of 10 cans weighing approximately 3/4 oz each.

CIRCLE NO. 377

### Lead frame solderer bonds in under 1 s



Development Associates Control, 725 Reddick Ave., Santa Barbara, Calif. Phone: (805) 963-3708. P&A: \$5000 to \$7500; 45 to 60 days.

A new reflow soldering system for the attachment of lead frames to ceramic substrates completes bonding of all leads in less than one second. The system consists of a multi-probe soldering head, a multiple-output power supply and a set of optics. The probes are quickly replaceable by a single set screw for ease of maintenance.

CIRCLE NO. 378

#### ENVIRONMENT PROOF ROTARY SWITCHES

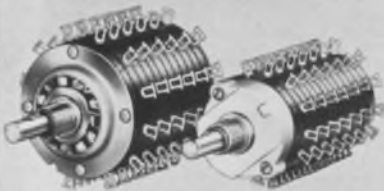

Series 600 1 1/2" Dia.—Series 100 1 1/8" Dia.

- Both index mechanism and electrical sections are completely enclosed.
- Corrosive atmospheres, dust, dirt and moisture are permanently sealed out, lubricants sealed in.
- Solder or quick-connect terminals molded permanently into position minimize production damage.
- Standard index angles include 15°, 30°, 36°, 60° and 90°, special angles available on request.
- Write for engineering bulletin.



INFORMATION RETRIEVAL NUMBER 156

#### UNEXCELLED QUALITY FOR LESS THAN 4¢

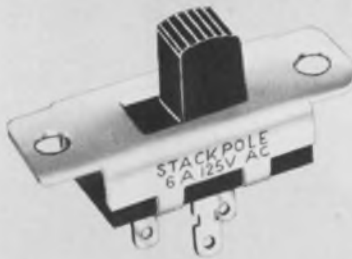

- Listed by UL AND CSA, 1 to 10 amps at 125V AC.
- 7960 slide switch combinations—23 basic types.
- New rugged solder lug terminal, designed for use with quick connectors.
- Uniform quality assured by automated assembly.
- Electro-silver plated terminals and contacts—shorting and non-shorting.
- Phenolic or nylon triggers in a variety of colors.
- Write for engineering literature.



INFORMATION RETRIEVAL NUMBER 157

#### UNIQUE DESIGN ADDS VALUE AND APPEAL

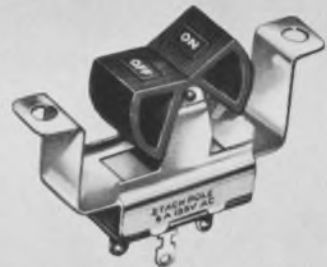

- 23 rocker switch configurations, including 2-3 positions, spring return and center-off.
- Variety of rocker designs available in a spectrum of colors and hot-stamped lettering.
- Listed by UL AND CSA, 1 to 10 amps at 125V AC.
- Solder lug, space saver, quick-connect or printed circuit terminals.
- Field-proven quality same as famous Stackpole slide switches.
- Prices start at less than 15¢.
- Write for engineering literature.



INFORMATION RETRIEVAL NUMBER 158

## Coating machine does small components

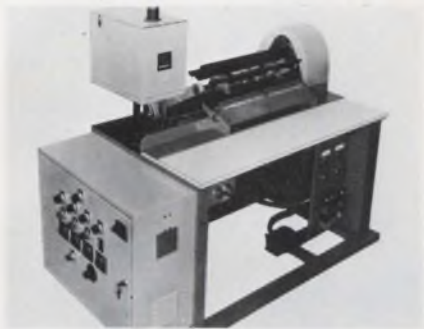

English Electric Corp., Badalex Group, One Park Ave., New York City. Phone: (212) 679-3522. P&A: \$11,000; 4 to 6 months.

A new component-coating machine, which uses the fluidized bed principle, provides a truly conformal coating with recycling possibilities. Model CC3 is primarily intended for the epoxy-resin coating of radial-lead components such as small printed circuits, capacitors and resistors. An unskilled operator can turn out 15,000 units per hour.

CIRCLE NO. 379

## IC transfer system uses magnetic strips

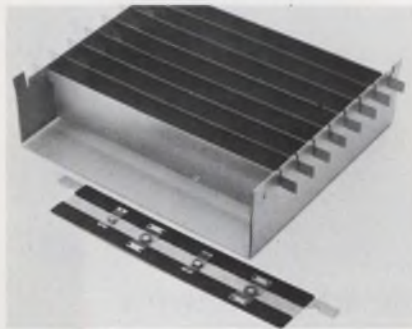

Macronetics, Inc., EXTEL Manufacturing Div., 220 California Ave., Palo Alto, Calif. Phone: (415) 321-1744. Price: \$15.25 to \$26.60.

Model 90 magnetic transfer system for flatpacks and DIPs expedites efficient in-plant handling of these devices during processing and station-to-station transportation. The new system consists of slotted stackable trays that accommodate up to nine anodized aluminum blades with bonded magnetic-rubber strips.

CIRCLE NO. 380

## Ultrasonic degreasers multiply cleaning power

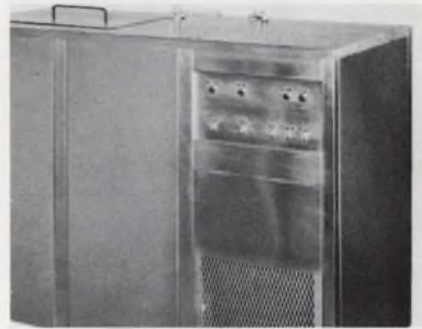

Crest Ultrasonics Corp., Scotch Rd., Mercer County Airport, Trenton, N.J. Phone: (609) 883-4000.

Packing a five-stage cleaning cycle and multi-frequency cleaning power within a single machine, a new line of ultrasonic vapor degreasers increase productivity as well as cleaning efficiency. CDU cleaners use a special titante alloy transducer bonded in metal to simultaneously generate a wide band of ultrasonic frequencies, 20 through 90 kHz, within the cleaning chamber.

CIRCLE NO. 381

### SLIDE-TROL® — NEW CONCEPT IN POTENTIOMETER DESIGN

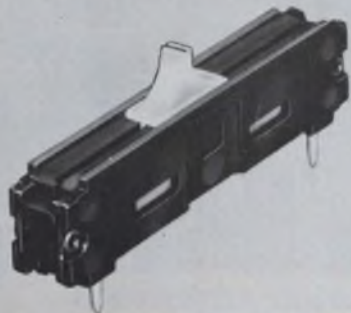

- Mount horizontally, vertically or sideways, either singly or in multiple units.
- Standard solder lug, wire wrap or printed circuit terminals available.
- Low noise and low contact resistance, plus uniform heat distribution.
- Ratings 40-500Ω 1.5 watts, 500-5KΩ 1.25 watts, 5KΩ and over 1. watt.
- Thermal expansion-contraction and shock hazard problems eliminated.
- Know resistance setting at a glance.
- Compact, lightweight, functional, attractive.
- Write for SLIDE-TROL® Brochure.



**STACKPOLE**  
COMPONENTS COMPANY  
P. O. Box 14466  
Raleigh, N. C. 27610

INFORMATION RETRIEVAL NUMBER 159

### GUARANTEED UNIFORMITY IN ELECTRICAL, PHYSICAL CHARACTERISTICS

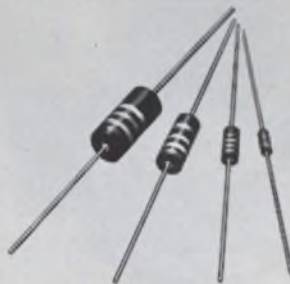

- Available in 2, 1, 1/2 and 1/4 watt sizes.
- Uniform from resistor to resistor, order to order.
- 100% tested for resistance value.
- Solderability, load life and humidity-temperature characteristic checked.
- Impregnated to assure moisture resistance.
- Write for literature.



**STACKPOLE**  
CARBON COMPANY  
Electronic Components Division  
Kane, Pa. 16735

INFORMATION RETRIEVAL NUMBER 160

### NEW 5000 PERM CERAMAG® FERRITE MATERIAL FOR TOROID APPLICATIONS



- 5000 initial permeability ± 20%.
- Ceramag® 24H is a precision engineered material for use in shielding and pulse transformer applications. Highly stable.
- Saturation flux density — 4100 gauss. Residual magnetism — 850 gauss.
- Currently available in a size range of .100" OD to .375" OD.
- Curie point is 175° C.
- Temperature coefficient at — 25° C to 25° C is + 0.700 and at 25° C to 75° C it is — 0.450.
- Write for additional data.



**STACKPOLE**  
CARBON COMPANY  
Electronic Components Division  
St. Marys, Pa. 15857

INFORMATION RETRIEVAL NUMBER 161



Acro-Probe. It's the most useful logic circuit testing instrument there is. Hand-held, it has two lights right on top to give you instantaneous read-out on circuit status.

Perfect for assembly or field use, Acro-Probe has many practical features you can't get on any other probe. Like adjustable 0-state and 1-state threshold levels; open circuit detection capability; full performance with any logic circuit, even custom; response from dc to 5ns pulse; no operating controls; full protection from burn-out; and a lot more.

Acro-Probe: Better than any other computer logic circuit tester, yet it sells for \$99.50.

Write for details to **ACRON CORPORATION**, 1209 River Avenue, Lakewood, N.J. 08701. Or call (201) 364-7200.

IN LOGIC  
CIRCUIT TESTING ...

**ONLY  
ACRO-PROBE  
ACCURATELY  
DETECTS  
MARGINAL  
CONDITIONS**

(It separately adjusts to any 0- and 1-state thresholds.)



INFORMATION RETRIEVAL NUMBER 162

## Evaluation Samples



### DIP artwork patterns

Designed for high-density printed wiring patterns where conductor paths and spacing tolerances are critical, a new line of 14- and 16-lead dual-in-line-package (DIP) artwork patterns provide accuracies to 0.002 in. They conform to MIL-STD-275 and Institute of Printed Circuit guidelines, and are printed on 1.5-mil pressure-sensitive matte acetate. The new patterns are also available in compatible transparent red and blue for making master artwork for two-sided printed wiring boards in which perfect registration is achieved by photographic separation of the different-colored circuit patterns. Bishop Graphics, Inc.

CIRCLE NO. 382



### Instrument knobs

Dual concentric instrument knobs are now available as free evaluation samples to suit specific control needs. Choose from ten standard colors and three different shaft sizes (to accommodate shaft diameters of 1/8, 3/16 or 1/4 in.). In addition, there is a variety of skirts, flanges, and decorative caps. Aluminum inlays can be provided in colors and with index marking. Kentron Corp.

CIRCLE NO. 383

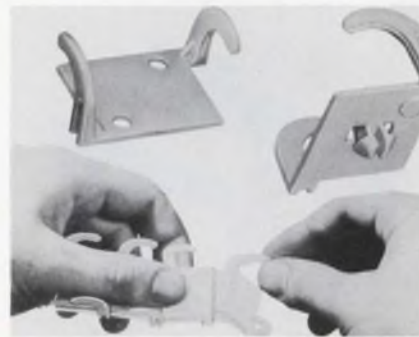

### Non-binding cable clamp

Called the Cable Keeper, a new molded nylon cable clamp eliminates the problem of binding, common with the usual type of clamp. It is particularly suitable in applications where binding causes a change in impedance. The novel double-half-loop design holds cable securely yet does not cut into the insulation. Cable Keeper is supplied in three styles, each with a different mounting method. A free sample is available. Weckesser Co., Inc.

CIRCLE NO. 384



### Durable nameplates

Adding a new dimension to heavy-duty permanent nameplates is Durashield, an embossable nameplate using high-strength adhesive. The nameplate's printing is protected against weather, abrasion and chemicals beneath a clear shield of five-mil polyester film. Durashield is designed for use as decorative nameplates, serial plates, instructional markings or gauge plates for outdoor as well as indoor use, on flat or simple curved surfaces. It comes in roll form or in individual sheets. Free samples are available. Avery Label Co.

CIRCLE NO. 385



**Introducing  
a little revolution  
in fail-safe  
reed switching.**

This new Cunningham Hystareed™ Magnetic Latching Relay operates *without permanent biasing magnets* or holding currents. Latches and

stays latched. Won't change its programmed state because of vibration, shock, power interruptions or transients. Needs no adjustment or calibration. Available up to 6 form A's, 4 form C's in a single assembly. Operates as standard relay for scanning. Ideal for: data acquisition, low-level switching, computer interfacing, logic control, industrial machinery control.

**Samples available.** For complete facts, request Brochure No. 606B. Write or phone Cunningham Corporation, Carriage St., Honeoye Falls, N. Y. 14472. Phone (716) 624-2000.

**Cunningham  
Corporation**

SUBSIDIARY OF GLEASON WORKS

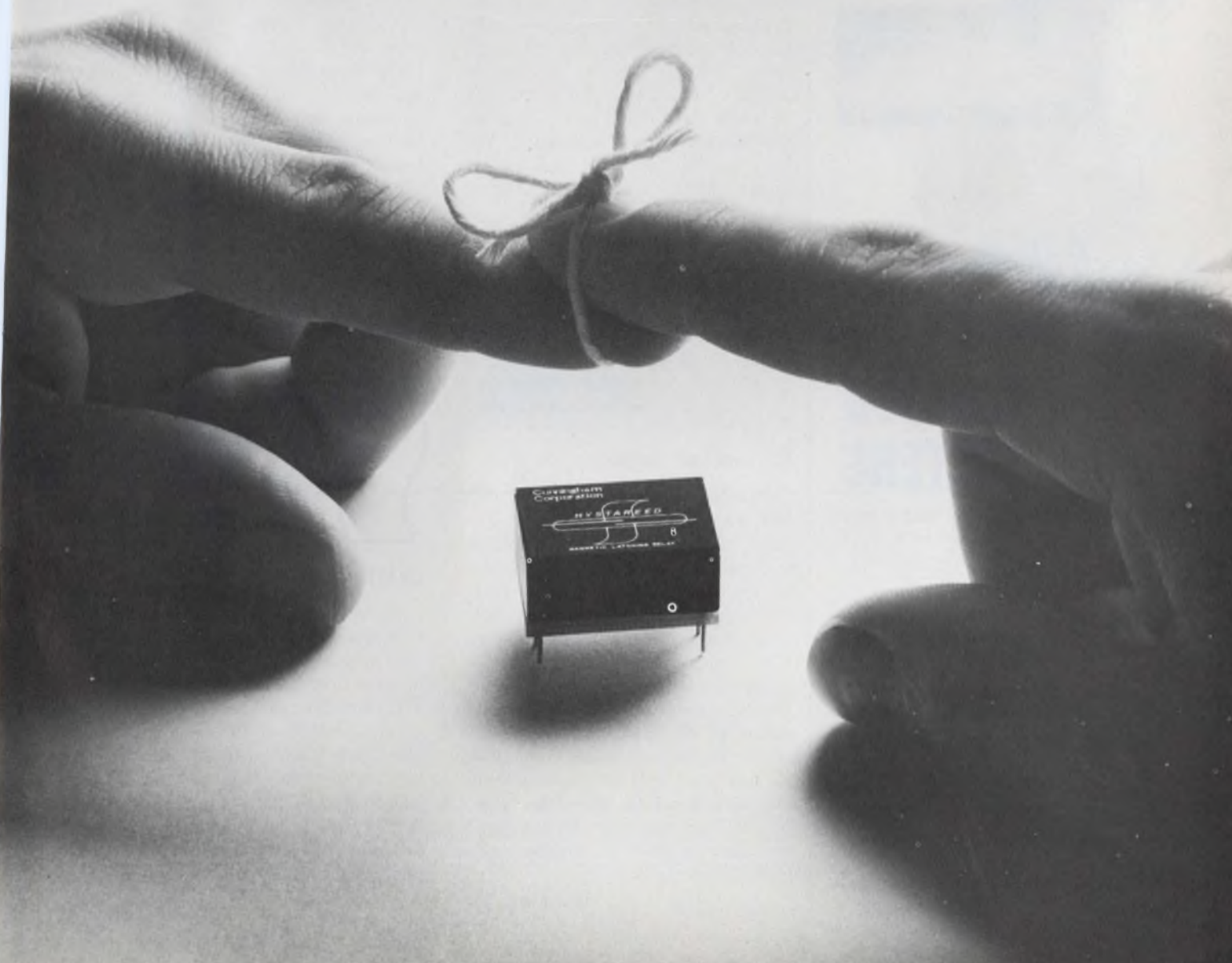



**perfect  
balance**

**technical  
know-how  
and  
modern  
design**

## GORDON METERS

Gordon Panel Meters are the result of more than 50 years' instrument experience, plus a combination of superior design features:

- Sparkling clear Lexan® covers
- Alnico self-shielded core magnets
- Sapphire spring-backed bearings
- Easy-to-read scales

For standard off-the-shelf meters, or custom designs tailored to your needs, order Gordon.

**FREE GORDON METER CATALOG. WRITE TODAY!**

**PDC GORDON**  
A SUBSIDIARY OF  
**PNEUMO DYNAMICS CORPORATION**  
5710 KENOSHA ST., RICHMOND, ILL. 60071  
Export: 2200 Shames Dr., Westbury, N.Y. 11590  
Cable CHURCHIN

INFORMATION RETRIEVAL NUMBER 164

## Design Aids

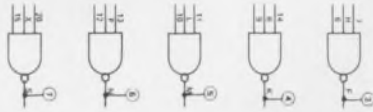

### Logic aids

Standard logic symbols, for use as engineering and drafting design aids when detailing TTL and DTL cards, eliminate the need for the engineer or draftsman to draw symbols by hand on his logic diagram. Since each sheet has enough symbols for three typical logic cards, time-consuming errors in using a circuit twice or forgetting to use a circuit and adding an unnecessary card are eliminated. The logic symbols are printed on clear mylar film. Wyle Laboratories, Computer Products Div.

CIRCLE NO. 386

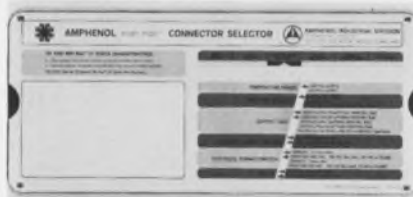

### Connector selector

Besides cataloging Amphenol's Min-Rac series 17 connectors, a handy connector slide rule contains a complete competitive part-number cross-reference in a convenient vertical format. The user simply picks out one of six family types (i.e. fixed contact, high density, encapsulated contact, hard dielectric) and then reads pin-and-socket connector characteristics. Temperature range, insulator material, contact size, and electrical specifications are shown. For added versatility, the new connector selector can also be used in reverse. Amphenol Industrial Div.

CIRCLE NO. 387



### French curve set

Normally retailing for \$1.50, a set of three French curves is now available free to readers of ELECTRONIC DESIGN. Designated No. FC-3, the curves range in size from 5-1/2 to 12-1/2 in. They are made from 0.09-in.-thick green-tint eye-ease molded plastic. Each set is packaged in a durable vinyl snap-button protective case. Alvin & Co., Inc.

CIRCLE NO. 388

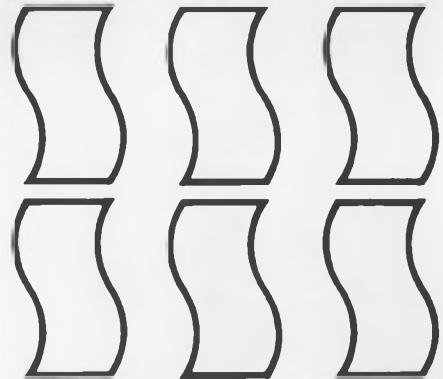

### Drafting aids

Covering data processing symbols to BS 4058, a new line of drafting aids also includes PERT diagram symbols and work flow diagram symbols, as well as consecutive letters and numbers. There are over 180 symbols available printed in black or five other colors. They are printed on 0.0012-in.-thick transparent matt surface, and are suitable for dye-line printing photography. Circuitape Ltd.

CIRCLE NO. 389

One  
for the  
road.



## 417—the lightweight recorder for heavy duty field use

Hit the road with the rugged, portable Lockheed 417. Take it where the data is—around the plant, around the lab, around the campus or around the world.

Weight: only 28 lbs. with battery—50 lbs. under any comparable recorder. Measures 14"x15"x6" (fits under a plane seat).

Runs on 110/220v AC/DC or internal battery. Power consumption as low as 10w.

Accuracy matches large rack machines. Has phaselock servo for precise speed control. Records on 7 channels, IRIG compatible.

Tagged as low as \$7,000.



Exclusive low-mass differential capstan drive gives precision recording even in rough field conditions. Simplified, maintenance-free mechanism works under vibration and in any position.

Frequency response: 100 kc direct, 10 kc FM.

Send for our catalog containing full details on the 417—one of a family of precision data recorders for land, ocean, air and space application. Write: Boyd McKnight, Dept. ED-100, Lockheed Electronics Company, Edison, New Jersey.

Have questions on data recording?  
Call (201) 757-1600.

**LOCKHEED**

Lockheed Electronics Company. A Division of Lockheed Aircraft Corporation

## We make silicon rectifiers:

miniature...



medium current...

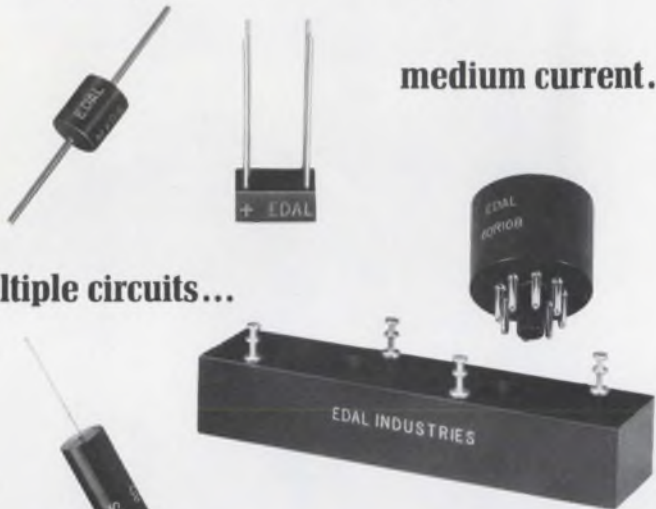

multiple circuits...

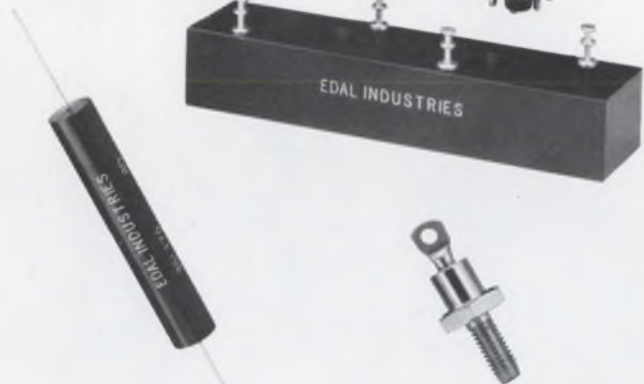

high voltage...

and power rectifiers

## Annual Reports

Learn how to read annual reports in "How to investigate a company." For a copy, circle no. 474.

**CCI Marquardt Corp.**, 4111 S. Darlington Ave., Tulsa, Okla.: aerospace technology, transportation, materials handling; sales, \$103,917,000; earnings, \$3,727,000; assets, \$48,110,000; liabilities, \$11,701,000.

CIRCLE NO. 390

**Franklin Electric Co.**, Bluffton, Ind.: submersible and electric motors, food packaging systems, wrapping machines; net earnings, \$1,482,652; net sales, \$26,697,588; assets, \$12,322,142; liabilities, \$2,501,274.

CIRCLE NO. 391

**KDI Corp.**, 5721 Dragon Way, Cincinnati, Ohio: computer terminals, education, recreation and environmental systems; sales, \$30,542,586; income, \$2,112,410; assets, \$19,445,436; liabilities, \$8,268,233.

CIRCLE NO. 392

**New Hampshire Ball Bearings, Inc.**, U.S. Route 202, Peterborough, N. H.: all types of ball bearings; sales, \$12,498,000; income, \$149,000; assets, \$15,334,000; liabilities, \$5,976,000.

CIRCLE NO. 393

**Potter-Englewood Corp.**, 5801 S. Halsted St., Chicago, Ill.: capacitors, filters, machine tool gages, distribution; sales, \$36,076,439; income, \$464,943; assets, \$10,291,584; liabilities, \$4,962,976.

CIRCLE NO. 394

**Veeco Instruments, Inc.**, Terminal Drive, Plainview, N.Y.: high-vacuum technology, power supplies; sales, \$19,408,885; income, \$1,091,299; assets, \$13,022,352; liabilities, \$5,368,187.

CIRCLE NO. 395

And so do a lot of other companies. But if we can get a bit old fashioned — and talk quality — we can come up with a long list of reasons why Edal silicon rectifiers aren't like competitive units, but a good deal better.

Take any circuit rectification problem you may have. Get on the phone and let's see if we can

suggest a solution. It could be as simple as that.

If there's nothing pressing about your needs, write for literature or ask that our Technical Representative stop by. Using a silicon rectifier but not happy with performance? We'll be happy to send a unit that we're confident will handle the job.

# EDAL

Rectifiers  
Silicon  
Selenium  
Copper Oxide

**Edal Industries, Incorporated**  
4 Short Beach Road, East Haven, Connecticut 06512

WE MAKE MORE DIFFERENT TYPES OF RECTIFIERS THAN ANYONE IN THE WORLD  
INFORMATION RETRIEVAL NUMBER 166

## 80 MHz WIDEBAND RF POWER AMPLIFIER



### MODEL RF-805

- 10 Watts Output into 50Ω
- 0.1 Volts In — 22.5 Volts Out
- .05 MHz to 80 MHz Broadband
- Low Distortion
- Solid State
- Flat 47 db Gain

The RF-805 is a solid state amplifier, broadband from .05 to 80 megahertz, which produces ten watts with -30 db harmonic and intermodulation distortion. Lower distortion is available at lower output levels. Gain is 47 db minimum, constant within 1 db, so that full output is developed with less than 0.1 volt at the 50 ohm input. Accurate output metering and overload protection is provided.

The RF-805 will raise the power of most manual and swept tuned signal generators and thus extend the usefulness and versatility of available signal generators. Receiver testing, wattmeter calibration, antenna testing, RFI testing, attenuator measurements, and filter and component testing will be aided with the use of this equipment.



**R F COMMUNICATIONS, INC.**

1680 University Avenue • Rochester, N. Y. 14610

INFORMATION RETRIEVAL NUMBER 167

## Fast? Fast!

## Nanosecond fast? Faster!

No question about it.

Computer Labs HS Series

A/D converters are fast.

Aperture time as short  
as 0.2 nanosecond!

Word rates vary from  
4 bits at 25 MHz  
to 9 bits at 5 MHz.

Even delivery is fast!

**COMPUTER  
LABS**

*for tomorrow's technology today*

(919) 292-6427 • 1109 S. Chapman St.  
Greensboro, N. C. 27403

INFORMATION RETRIEVAL NUMBER 168

ELECTRONIC DESIGN 21, October 11, 1969

## the latest advanced phase coherent transponder



The Vega Model 333C

Pulse Coherent Transponder is an

extremely compact, lightweight and accurate unit used with C-Band tracking radars designed to extract doppler information from the return pulse. The transponder is compatible with the modified AN/FPS-16 and the FPQ-6 radars and may also be used in a non-coherent mode with unmodified radars. With a volume of less than 97 cubic inches and weight of less than 5¼ pounds, the transponder features a high performance superheterodyne receiver with a solid triggering sensitivity of at least -65 dbm and a minimum power output of 100 watts.

**Vega Precision Laboratories, Inc.,**

239 Maple Avenue W., Vienna, Virginia 22180

Phone: (703) 938-6300



INFORMATION RETRIEVAL NUMBER 169

# NEW!

from



HYBRID MICROCIRCUITS—

R. F. AMPLIFIERS



- WIDEBAND
- HI-GAIN
- LOW NOISE
- MICROMINIATURE

BALANCED MIXERS



- LOW N.F.
- WIDEBAND
- HIGH ISOLATION
- HIGH EFFICIENCY

I.F. AMPLIFIERS



- HI-GAIN
- LOW NOISE
- HYBRID CIRCUITRY
- HIGH RELIABILITY

Send your unique specifications for review by our engineering staff today.

**SIERRA  
SYSTEMS, INC.**

2255 Old Middlefield Way  
Mountain View, California 94040  
(415) 969-3056

## Application Notes



### Op amps plus

A 100-page illustrated catalog features a complete selection of operational amplifiers, nonlinear function modules, instruments, boosters, power supplies, regulators and accessories. Given are selection guidelines, suggested applications, and user parameter definitions. Philbrick/Nexus Research, a Teledyne Co.

CIRCLE NO. 396

### Electron analysis

A 14-page comprehensive set of application notes, "The Use of Copper Beryllium Electron Multipliers to Detect Ions, Neutral Particles, Electrons and Photons," is now available. The booklet not only includes detailed curves and data, but also an extensive compilation of references. Johnston Laboratories, Inc.

CIRCLE NO. 397

### Machining manual

Containing practical suggestions for machining copper, brass, bronze and nickel silver, a new 36-page edition of "Machining Coppermetals" discusses cutting tool materials, cutting speeds and feeds, and tool rakes and clearances. In addition, typical copper alloy rods are tabulated according to composition, machinability, and physical and mechanical properties. Anaconda American Brass Co.

CIRCLE NO. 398



### Semiconductor notes

The first three booklets in a continuing series of to-be-published semiconductor application notes are now available. One is an eight-page note entitled "Thyristor Design Trade-Offs in Turn-off Specifications," which emphasizes motor controls and inverters. A second four-page publication discusses the alternative to conventional dc linear series voltage regulators in systems requiring high efficiency. The last, "Selecting Your Thyristor Gate Drive," provides useful round-up information for circuit designers, with numerous schematics, graphs and charts. Westinghouse Electric Corp.

CIRCLE NO. 399

### CATV amplifier design

Originally presented at the 18th Annual National Cable Television Association Convention, a paper entitled "CATV Repeater Amplifier Design Utilizing Digital Computer" is now available as a six-page reprint. According to the author, there are three distinct advantages in applying computer-aided-design techniques to CATV equipment: determination of limits of performance, design reproducibility, and application to hybrid and integrated circuit design. Anaconda Electronics Co.

CIRCLE NO. 400

# Isolate with light...

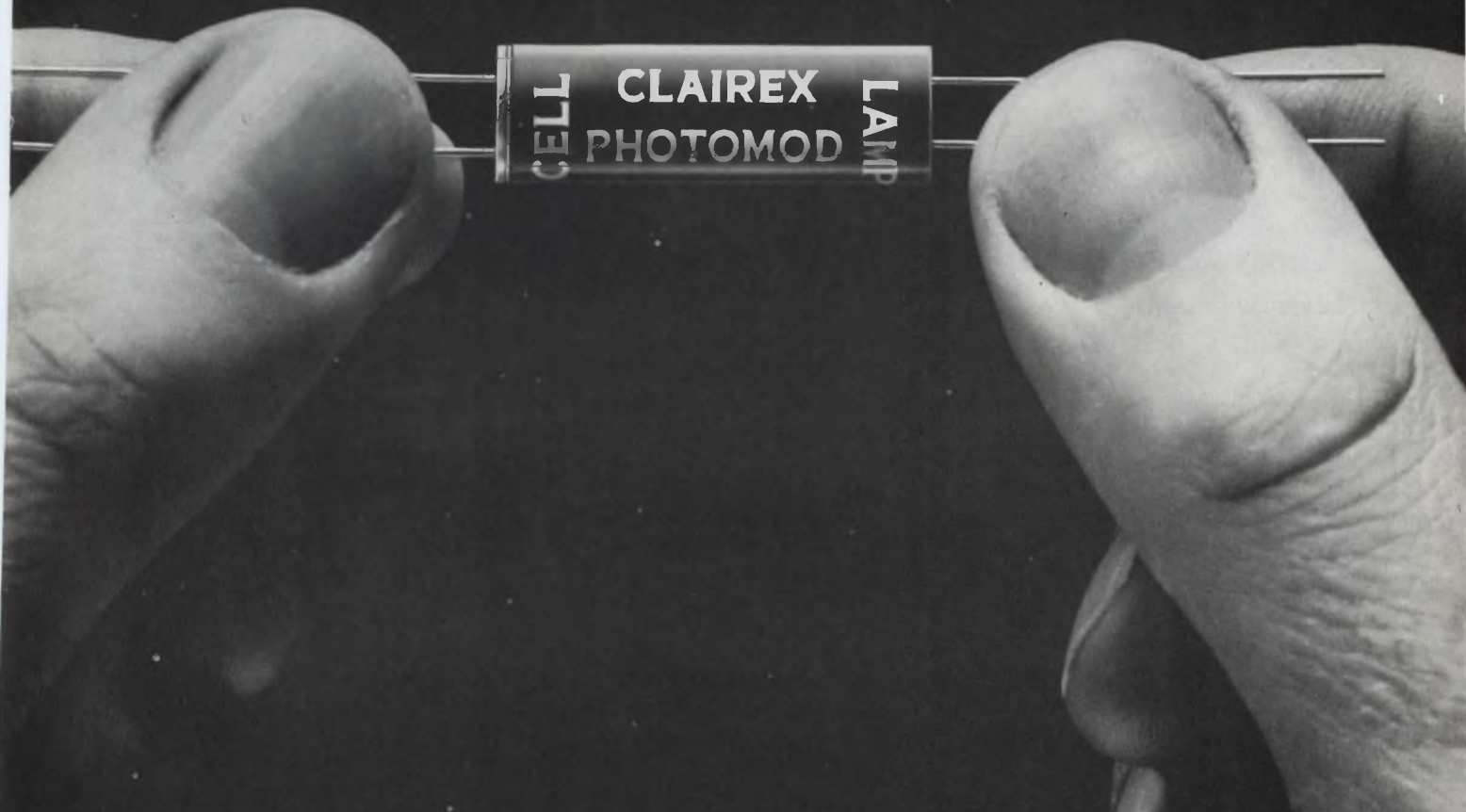

## get clickless switching and 1,000,000,000 $\Omega$ isolation.

Clairex Photomods<sup>®</sup> permit contactless switching. No moving contacts mean *no electrical noise!*

Clairex Photomods combine hermetically sealed photocells with a high-quality, long-life lamp in a single, sturdy, light-tight encapsulated package.

The higher the voltage or current applied to the lamp, the brighter the lamp. The brighter the lamp, the lower the resistance of the cell. Thus, resistance of the cell is varied without physical contact, and no noise is generated in the signal circuit.

Let us show you how the "light touch in automation and control" can provide you with noiseless switching and control. Call (212) 684-5512 or write Clairex, 1239 Broadway, New York, N. Y. 10001.

**CLAIREX ELECTRONICS, INC.<sup>®</sup>**

# New Literature

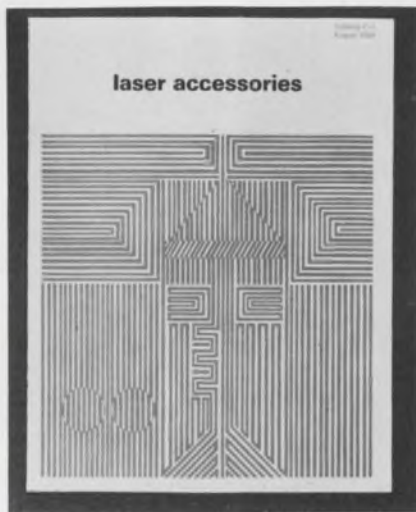

## Laser accessories

Consisting of 20 pages, a comprehensive catalog on laser accessories illustrates reflex beam expanders, focus assemblies, corner-cube retroreflectors, line filters, bolometers and bolometer amplifiers, beam splitters, and tenth-wave front surface mirrors. Seven pages in the catalog are devoted to the theory and application of the company's line of Pockel Cells. Baird-Atomic, Inc., System Components Div.

CIRCLE NO. 401

## DIP panels

High-density dual-in-line packaging panels are the subject of a new 16-page catalog. Included is test data, technical and dimensional information for two series of IC packaging panels. Augat Inc.

CIRCLE NO. 402

## Lafayette catalog

Comprising 496 pages, the new 1970 annual Lafayette catalog is now available. This electronic buyer's guide describes: brand-name stereo amplifiers, tuners, speakers, tape recorders, citizen-band two-way radios and accessories, amateur equipment, cameras, marine equipment, test equipment, tools, books and thousands of other electronic components for the home, industry, and laboratory. Lafayette Radio Electronics.

CIRCLE NO. 403



## Drafting furniture

With a four-color cover and two-color printing throughout, a 52-page catalog covers a complete line of drafting and engineering furniture. This includes coordinate group automatic drafting stations, drafting and reference tables, filing systems, stools and chairs, art department equipment, tracing units, engineering and executive desks, and school library furniture. An unusual feature of the new catalog is its table of contents, which refers readers to pages by means of photographs of the furniture rather than by the usual text listings. Stacor Corp.

CIRCLE NO. 404

## PC connectors

An expanded 32-page guide describes 18 card-edge connector series including MIL-C-21097, modular, and metal-plate designs. Among the 27 sizes, ranging from four to 84 contacts, are connectors compatible with most terminating techniques including automatic and manual wire-wrap, solder, and taper tab. A three-page illustrated index to all PC connectors permits identifying the required connector series instantly. The guide also contains complete drawings, detailed specifications and connector descriptions. Elco Corp.

CIRCLE NO. 405

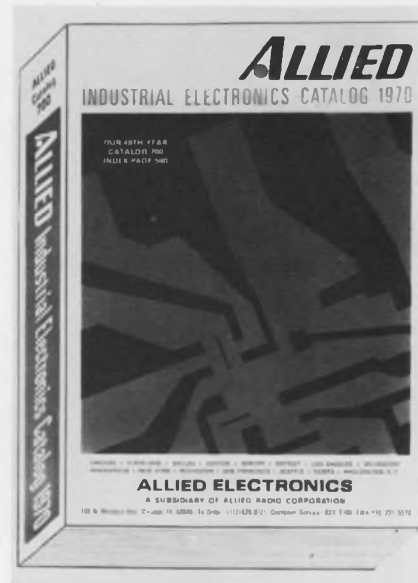

## Allied catalog

Containing 600 pages, Allied's new 1970 catalog of electronics equipment for industry and government lists over 50,000 separate stock items from over 500 manufacturers for research and development, production, communications, education, control and entertainment. Described are integrated circuit devices, semiconductors, vacuum tubes, relays, timers, transformers, resistors, capacitors, and other components and hardware. Also shown are test instruments, two-way radios, recording and sound equipment, power supplies, electronic counters, industrial materials, technical books, and tools. Allied Electronics Corp.

CIRCLE NO. 406

## Modular indicators

An eight-page brochure gives details on modular series V-5A indicators, for use with pneumatic or electronic transmitters to indicate process variables or measure vacuum, pressure, differential pressure, and temperature directly. Included are full specifications, complete descriptions and methods of joining the modules. Diagrams of outline and mounting dimensions are also indicated. Beckman Instruments, Inc., Process Instruments Div.

CIRCLE NO. 407



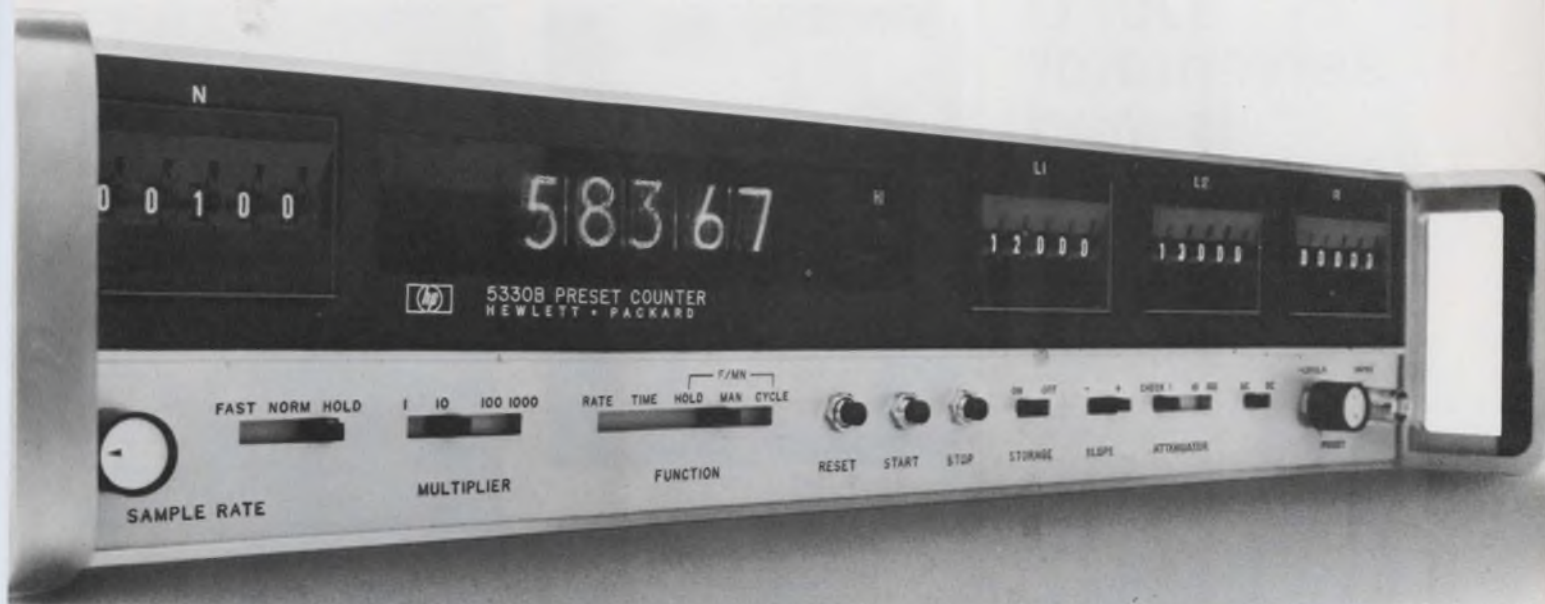

# Quite simply, the most versatile preset counter ever.

It's the new 5330B Preset Counter from Hewlett-Packard. It can do about twice as much work as the second best preset counters. Yet it's priced about the same.

This 10 MHz counter can:

- Normalize counted data to units such as gpm, psi and rpm.

- Issue control signals when preset count or count rates are reached.

- Introduce a selected offset in the reading. Be programmed remotely by automatic systems.

- Totalize, find ratios and time intervals.

The 5330B gate times can be selected by a 5-decade front-panel "N" switch to any number of time units between 1 and 100,000. With a choice of  $1\mu\text{s}$ ,  $10\mu\text{s}$ ,

$0.1\text{ ms}$  and  $1\text{ ms}$  time units ("M"). So you can get normalizing factors from 1 to  $10^8$ .

This flexibility, together with the two limit control switches (L1 and L2), lets you virtually automate many processes such as batching. The limit switches generate output signals when the preset count is reached. These signals become the commands for your computer-run system.

The optional zero offset can be set at any number between 0 and 99,999. This lets your count start from a specific number and return to that number automatically.

All four of these functions can be remotely preset. It's also the first preset counter to offer an anti-noise option. This rejects high frequency noise that might mask low-frequency data.

You can also use this preset counter as a frequency divider. As a delay generator. Or as a precise, digitally selectable pulse generator.

If the 5330B is too versatile for you, the 5330A should be just right. It does slightly less (without limits, but zero offset option available), and costs slightly less.

The 5330A is \$1200. The 5330B is \$1550. To find out just how much they can do for you, call your local HP field engineer. Or write to Hewlett-Packard, Palo Alto, California 94304; Europe: 1217 Meyrin-Geneva, Switzerland.

**HEWLETT  PACKARD**

**ELECTRONIC COUNTERS**

# Our D servomotor is mad with power.

That's our SU-680D-29 permanent-magnet D-C servomotor. We call it our D motor for short. It's small, rugged and powerful. It delivers 12.7 watts of continuous power output at 8600 rpm and is a natural for any servomechanism that requires a prime mover. It has a high repeatability-to-time ratio which makes it immensely stable, a 0-10,000 rpm speed range and a high acceleration Torque/Inertia. Torque peaks at 15 oz-in., 2 oz-in. continuous at 8600 rpm. It measures only 1 1/8 inches in diameter and weighs just 8 1/4 ounces.

SERVO-TEK PRODUCTS COMPANY  
1086 Goffle Road, Hawthorne, New Jersey 07506.

**SERVO-TEK**  
PRODUCTS COMPANY

*For full details write for our interesting technical sheets and get mad with power yourself.*



INFORMATION RETRIEVAL NUMBER 183

## NEW LITERATURE

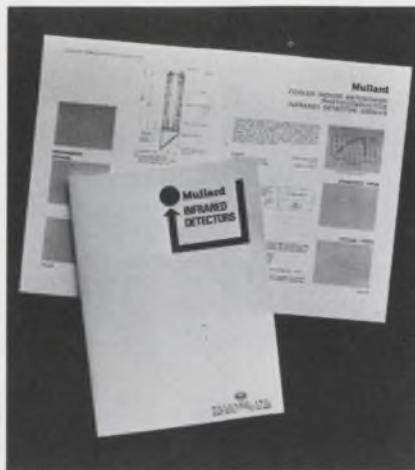

### Infrared detectors

Designed as a ready reference source for designers and electro-optical consultants, a two-color easy-to-use 68-page handbook is a carefully indexed catalog on infrared detectors. There are sections on infrared detection and detectors, mercury-doped germanium photoconductive infrared detectors, yttrium-iron-garnet infrared modulators and cadmium-mercury-telluride infrared detectors. Mullard, Inc.

CIRCLE NO. 408

### Scopes and shields

Modular oscilloscopes and magnetic shields and bezels are listed in a new 21-page catalog. Also included are such plug-in modules as high-voltage power supplies, deflection amplifiers and deflection sweep generators. The magnetic shields are intended for use with cathode-ray tubes, photomultiplier tubes, and charge storage tubes. James Millen Mfg. Co., Inc.

CIRCLE NO. 409

### Angle indicators

A four-page two-color brochure describes a series of solid-state all-electronic digital angle indicators, for measuring and displaying angle inputs from remote synchros or resolvers. The brochure includes outline drawings and ordering information on basic units, multiplexed units, cabinet and half-rack configurations, and adapter hardware for multiple full-rack configurations. AstroSystems, Inc.

CIRCLE NO. 410

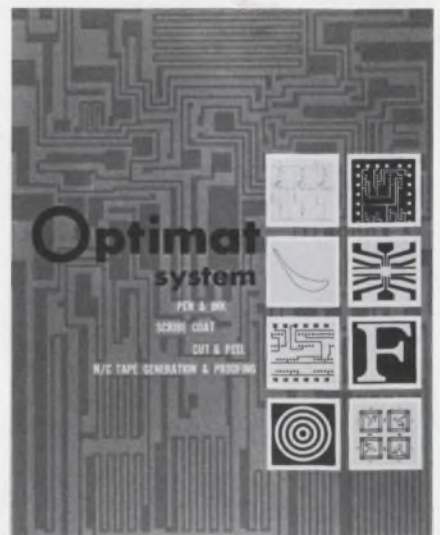

### Artwork generation

Automated artwork generation is the subject of a four-page color brochure. Given is detailed information on the layout and readout coordinator graphs of the Optimat system, as well as the data processor with appropriate electronic interfacing. Optical Gaging Products, a Division of Ex-Cell-O Corporation.

CIRCLE NO. 411



### Instrument rental

A new electronic instrument rental catalog features Hewlett-Packard's 9100A programmable calculator and 8553L/8552A spectrum analyzer, Tektronix's 323 portable oscilloscope, Systron Donner's 7015 uhf frequency counter, Dynamic's 7514 differential dc amplifiers and Lambda's complete line of power supplies. Included are the terms and conditions of rental, as well as seven new optional purchase plans with or without maintenance and calibration. Electro Rents.

CIRCLE NO. 412



# C-COR AMPLIFIERS

## — UNIVERSAL —

**Wide Dynamic Range  
Super Video - Wideband R.F.**

Bandwidth: 5 Hz-425 MHz  
Gain: 20-60 dB  
Output: +10 to +28 dBm  
Price: \$85-\$850

## — FAMILY FEATURES —

- High Output
- Wide Dynamic Range  
—greater than 80 dB
- Spin-offs from Critical Military/  
Aerospace Projects
- Meet Many MILSPEC Applications  
without Modification
- Exceptional Reliability
- 20/40/60 dB Gain Versions  
Available



### EXAMPLES

Model	Freq Hz	Gain	Output
3364*	1K-200MHz	40dB	+20dBm
3388-E*	5Hz-130MHz	60dB	+25dBm
3010-A	.6MHz-425MHz	23dB	+28dBm
3007-L	2K-230MHz	20dB	+28dBm
3528	100Hz-100MHz	20dB	+12dBm

\*20/40/60 dB Gain Versions Available

Select from 29 models off-the-shelf.  
See EEM '69-'70 Edition Section  
1100, Page 517.

"C-COR Amplifiers . . . Rated First  
Where Performance is Rated First."



# C-COR

ELECTRONICS, INC.

60 Decibel Road  
State College, Pennsylvania 16801  
814 238-2461

## NEW LITERATURE



### Visual control

Printed in full color, a new catalog graphically shows the versatility and efficiency of all-magnetic visual control systems. Presented are both wall and floor-stand magnetic control boards, perpetual control systems with movable panels, and accessories like color-coded symbols, numbers, letters, arrows and strips. There are also a number of specific application sheets to aid the user in working out similar control boards for his own particular requirements. Magnagraph.

CIRCLE NO. 413

### Electroplated gold

Complete copies of the latest military specification, MIL-G-45204B (issued March 27, 1969), for electroplated gold are now available. The new specification defines three purity types and four hardness grades. For the first time both purity and hardness will be specified. Technic, Inc.

CIRCLE NO. 414

### Tin and industry

Originally released this spring, a 48-page book entitled "Tin in Your Industry" delineates how and why modern industry uses tin. Individual sections of the book are devoted to the invention and growth of the world tinsplate industry and to such other major uses as solder, bronze, babbitt and miscellaneous alloys. There is also a section on new research developed uses for tin. Malayan Tin Bureau.

CIRCLE NO. 415



### Sockets and carriers

Describing configurations, applications and special features, a new six-page short-form catalog tells of a line of versatile test sockets and carriers for integrated and hybrid circuits, including MSI and LSI devices, rectifiers, and other semiconductors. Also presented is a variety of test and burn-in sockets, power semiconductor test sockets, carriers for flatpack ICs and hybrids, and test sockets for SCRs, TRIACs, power transistors, and other components. Other items include connectors, lollipop carriers and sockets, and end-user sockets for OEMs. Textool Products, Inc.

CIRCLE NO. 416



### Snap switches

Providing technical data on a line of precision snap switches, a new 28-page distributor stock catalog contains a special section on auxiliary actuators, contact separations and terminal designs. A price list and a comprehensive cross-reference guide are also included. Sigma Instruments Inc.

CIRCLE NO. 417

# When your IC bugs out, chances are the heat's on!

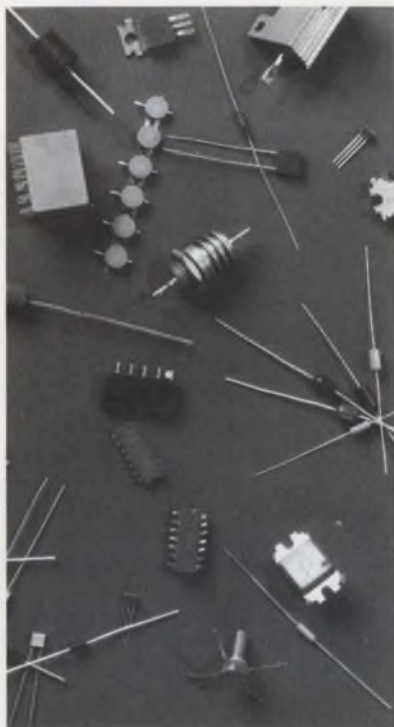

Devices packaged in Dow Corning® silicone molding compound are physically and electrically stable—even after long term exposure to both high heat and humidity. Derating, a practice common with organic packaging, is not necessary. In fact, you can design for high device and component density by using silicone molding compound. One manufacturer of glass package power diodes reduced the part to 1/30th of its former volume. Sizes from 1/5th to 1/3rd smaller can be obtained by using silicone molding compound in place of other plastics.

**Little moisture absorption.** Silicone molding compounds when exposed for 1000 hours to 93% RH at 70 C showed an average weight increase of 0.32% with the greatest increase being 0.5% and the least being 0.17%. Five organic plastics had average weight increases ranging from 1.0 to 2.1%—an average of nearly five times greater than silicone molding compounds under the same test conditions.

**No cracking.** Unlike other thermal setting plastics, Dow Corning silicone molding compounds are virtually unaffected by thermal shock. For example, a power resistor molded in Dow Corning® 307 compound was cycled repeatedly from -65 to 350 C without damaging the packaging material or the component.

**Will not burn.** Silicone molding compounds are

inherently nonburning. Thus, components and devices packaged in silicone molding compound do not constitute a fire hazard. No flame snuffers are used—a source of ionic contamination for devices packaged in organic materials.

**Corrosion free.** These silicone molding compounds are free of ionic contaminants which may contribute to metallic corrosion when operating in high humidity and influenced by voltage bias.

**Competitive price.** Costing only a fraction of a cent per device, Dow Corning silicone molding compounds enjoy a substantial price advantage over metal cans . . . glass packages.

**Manufacturing economies.** Transfer molding enables manufacturers to package devices and components with a minimum of manual labor and supervision. Good mold release and minimum flash assure high production rates . . . reduced deflashing costs. These manufacturing advantages make silicone molding compounds totally competitive with organic plastics.

So why be bugged by device failures because of a cheap plastic package? Specify Dow Corning® brand silicone molding compound, and get the best package protection in your electronic equipment . . . lets you keep your cool. For technical data, write: Dept. D-8472, Dow Corning Corporation, Midland, Michigan 48640.

## DOW CORNING

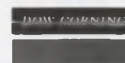

# High Current Silicon Rectifier Stacks...

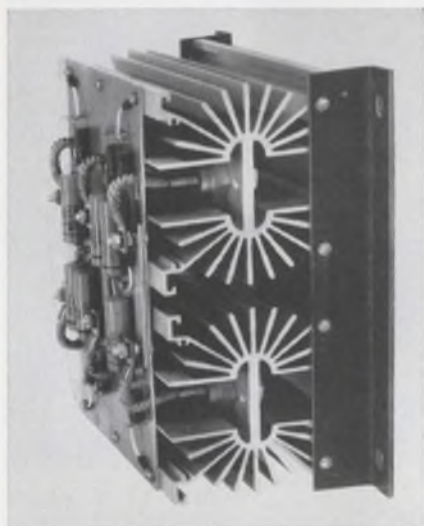

Typical Tung-Sol high current silicon rectifier stack assembly.

## Outstanding efficiencies in size, weight and power

Exclusive finned-aluminum radiator design, combined with low-thermal-impedance silicon rectifiers, provides Tung-Sol rectifier stacks with efficiencies unmatched in the high current range. Bolt grooves and interlock channels, integral to the radiator extrusions, ease assembly and permit mounting in any plane.

These standard, high-efficiency stacks are available in single phase center tap, single phase bridge, three phase bridge, and six phase star assemblies. All are fully described in Catalog T-483. Write for your free copy today. Tung-Sol Division, Wagner Electric Corporation, 630 W. Mt. Pleasant Avenue, Livingston, N. J. 07039. TWX: 710-994-4865. Phone: (201) 992-1100.

# TUNG-SOL®

HELPS YOU DO MORE  
...WITH LESS

©Reg. T.M. Wagner Electric Corporation

INFORMATION RETRIEVAL NUMBER 187

## NEW LITERATURE



### Microwave equipment

Revised and expanded, a new microwave test equipment catalog contains information on over 1200 standard waveguide and coaxial instruments and components, which cover the frequency range from 2 to 40 GHz. Complete technical data is given on noise sources, attenuators, directional couplers, phase shifters, crystal mounts, transitions, terminations, waveguide switches, frequency meters, and accessories. In addition, there are a number of engineering reports on noise measurement, attenuators, directional couplers, and filters, as well as charts of standard waveguide data. Waveline Inc.

CIRCLE NO. 418



### Motors and parts

Bound in a sturdy three-ring cover for easy page additions, a new catalog covers both sub-fractional-horsepower ac motors and metal stampings. The metal stampings include transformer covers, plates, insulators, and other products for the electrical and electronic industries. Jakel Inc.

CIRCLE NO. 419

## Opportunities for CIRCUIT DESIGNERS

Expanding activity on long-range programs and advanced projects has created many stimulating growth-assignments for Circuit Designers at Hughes.

Some of our most urgent requirements exist in the following areas:

- Development of high-power airborne radar transmitters, the design of which involves the use of the most advanced components
- Design of low-noise radar receivers using parametric amplifiers and other advanced microwave components
- Design of digital radar signal processing subsystem circuits, including range and speed trackers, doppler filter banks and a variety of display circuits
- Design of high-efficiency power supplies for airborne and space electronic systems
- Development of telemetering and command circuits for space vehicles and communications satellites

Requirements: an accredited Engineering degree, a minimum of two years of directly relatable experience and U.S. citizenship.

For immediate consideration, please airmail your resume to:

**MR. ROBERT A. MARTIN**  
Head of Employment  
Hughes Aerospace Divisions  
Dept. 48  
11940 W. Jefferson Blvd.  
Culver City, Calif. 90230

# HUGHES

HUGHES AIRCRAFT COMPANY  
AEROSPACE DIVISIONS

An equal opportunity employer—M & F

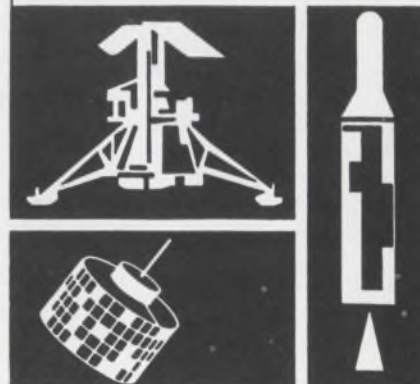



### Sensor catalog

Packed with technical information, a newly revised 14-page catalog describes a wide variety of vertical, level, and tilt angle sensors. The brochure presents text, diagrams, schematics, graphs, tabulations, and application data on electrolytic and electroytic and electromagnetic sensors, including single- and two-axis models. Novel bubble-type sensors are also detailed, as are sensing packages containing one or more sensors together with the circiutry required for particular applications. Singer-General Precision, Inc.

CIRCLE NO. 420



### Tool guide

A new 114-page tool directory details standard production-line tools, plus many new innovations and ideas for electronic assembly and maintenance. Also described is a completely new line of tools specifically designed to handle flat-pack and DIP circuitry. Techni-Tool, Inc.

CIRCLE NO. 421

In servo use, Waters' exclusive new MystR Conductive Plastic delivers "Second Generation" pot performance • Infinite Resolution • Resistance Ranges from 10 ohms to 5 megohms • Excellent Linearities • Output smoothness, less than 0.1% • Rotational Life upwards from 10 million cycles • Dither life in excess of 400 million cycles • Operational temperature to 150°C • Hysteresis <0.25°. From Waters now — a complete line of MIL Spec rated precision potentiometers, standard or custom, wire-wound, linear or non-linear or with MystR Conductive Plastic. Also Trimmers and Torque Measuring Devices.



WRITE FOR NEW CATALOG

# Waters' MystR<sup>®</sup> the new conductive plastic puts muscle where it matters in Servo Pot Performance

MIL-R-39023



**WATERS**

WATERS MANUFACTURING, INC./ WAYLAND, MASSACHUSETTS 01778

INFORMATION RETRIEVAL NUMBER 188



*Extending man's senses:*

## Command joint forces from 20,000 feet.

Bounce a newscast around the world.

Navigate precisely from Cape Horn to the Cape of Good Hope.

Turn night into day with an airborne floodlight.

Set up a TACAN transceiver, anywhere, in minutes.

Airborne command and control stations. Communications satellite networks. The global Omega navigation system. Nighttime military and civilian operations. Portable TACAN.

All demand fail-safe technology — the finest electronics

and systems available.

That's our business.

LTV Electrosystems has the scientific and engineering talent, fast-reaction capacity and the production facilities (15 nationwide) to build the sophisticated, new-generation systems our customers need to extend their senses and capabilities into every environment.

Why don't you join us?

See the opposite page for a listing of current professional opportunities at LTV Electrosystems.

**LTV ELECTROSYSTEMS, INC.**

PO BOX 6030, DALLAS, TEXAS 75222

A quality company of Ling-Temco-Vought, Inc. **LTV**





**Sealing products**

Ceramic-to-metal seal products for electronic applications are shown in a new four-page bulletin. Used where high resistance to thermal conductivity is required, these ceramic-to-metal seals are available as standard or customized units. Vernitron Electrical Components, Norwalk Div.

CIRCLE NO. 422

**Microwave products**

In capsule form, a new four-page catalog describes 2000 microwave products such as fixed, variable, and step attenuators, and rf components like terminations, tuners, connectors and switches. Also included are microwave parameter measuring instruments for fixed- and swept-frequency insertion loss, VSWR gain measurements, and power measuring and calibration instruments. Weinschel Engineering.

CIRCLE NO. 423

**Physical measurements**

Discussions, definitions, conversion factors and slide-rule settings regarding the new International (SI) System of Units are provided in a new 88-page booklet entitled "Physical Measurements and the International System of Units." The brochure is designed for use as a reference during the transition from the old to the new measurement system. Cubic Corp., Systems Div.

CIRCLE NO. 424



**Production tools**

Fully illustrated, a new 128-page tool and supply catalog is now available to engineers in the electronic and instrument industries engaged in miniature or micro-miniature component work. Described are the latest in time-saving tools and supplies, including hand tools (pliers, tweezers, screwdrivers), precision machinery (lathes, engravers, polishers), cutting tools (pivot drills, burs, saws, files), and magnifiers (loupes, readers, stand magnifiers, inspection lights). Hammel, Riglander & Co., Inc.

CIRCLE NO. 425



**DIP socket boards**

High-density DIP socket boards are the subject of a new catalog. These boards employ a unique method of mounting the DIP socket bodies—through, rather than on the PC board. This technique allows the economy and flexibility of a socket assembly over a lead socket without the usual increase in over-all height. Robinson-Nugent, Inc.

CIRCLE NO. 426



**A new bulletin of professional opportunities at LTV Electrosystems.**

**Greenville Division**

(Systems for strategic and tactical surveillance, reconnaissance, detection; tracking; command and control; airborne lighting systems; artificial intelligence; tactical warfare.)

- Digital Systems Analysts
- Digital Circuits Designers
- Electro-Optics Systems Analysts
- RF Systems Analysts
- RF Circuits Designers
- Scientific Programmers
- Business Programmers

Facilities — Greenville, Texas; Greenville, South Carolina; Roswell, New Mexico

**Garland Division**

(Long-range digital communications; fluid mechanical systems for aircraft, missiles, spacecraft; high-precision antennas; guidance and navigation systems; space systems.)

- RF Circuits Designers
- RF Systems Analysts
- Digital Circuits Designers
- Digital Systems Analysts
- Antenna Design Engineers
- Scientific Programmers

Facilities — Garland and Arlington, Texas

**Continental Electronics**

(This subsidiary company builds super-power RF transmitters for radio communications, broadcasting, re-entry physics radars, radio astronomy, nuclear accelerators.)

- Transmitter Design Engineers
- RF Circuit Designers
- RF Systems Engineers

Facilities — Dallas, Texas; Waltham, Massachusetts

**Memcor Division**

( Portable and stationary TACAN systems, tactical radio systems, nuclear controls, resistance products.)

- Project Engineers (TACAN Systems)
- Electronic Design Engineers
- Instrumentation Engineers
- Mechanical Engineers
- Digital Systems Engineers

Facilities — Huntington, Indiana; Salt Lake City, Utah

Please call or write: Bill Hickey, Supervisor of Professional Placement, LTV Electrosystems, Inc., P. O. Box 6118, Dallas, Texas 75222, Telephone (214) 276-7111. An equal opportunity employer.

**LTV Electrosystems: extending man's senses.**

INFORMATION RETRIEVAL NUMBER 901

### Reed switches

A load selection guide for many standard types of reed switches is included in a new condensed eight-page catalog. In addition, easy-to-read charts show contact arrangement, dimensions, switching voltage and other electrical characteristics. Also included is the basic operation of the reed switch with both permanent magnet and electro-magnet actuation. Hamlin Inc.

CIRCLE NO. 427

### Air-operated tools

Designed for the production of printed circuit boards, air-operated hand tools for cut-and-bend and cutter-crimping operations are the subject of a new eight-page catalog. Also included is data on pneumatic tools for cutting metal, cable, wire, plastics, wood and fiber glass parts. The catalog contains both product and applications information. Simonds Machine Co.

CIRCLE NO. 428



### Pneumatic instruments

Designed for users of low-pressure gages, flowmeters, manometers and air-operated electric control switches, a 100-page instrument catalog offers basic technical help and application examples. Included are descriptions of differential pressure, air velocity and combustion testing instruments. Dwyer Instruments, Inc.

CIRCLE NO. 429

# "TECHNOVATORS"



To continue our pursuit of tomorrow's technology, Hallicrafters needs talented electronic engineers who thrive on challenging assignments offered in an atmosphere of intellectual and creative freedom—"technovators" who thrive in an environment of curiosity, controversy, commitment and change.

Specifically, we have openings for EE's in ECM Systems, Solid State, Microwave, Antennas, Communications and Electronics Packaging.

If you're a "technovator"—a thinker ready to make significant contributions to advancing the state-of-the-art, consider working for Hallicrafters, where progress is based on electronic excellence.

Please submit your resume, in complete confidence, to: Professional Placement Director, The Hallicrafters Co., 600 Hicks Road, Rolling Meadows, Illinois 60008.

An Equal Opportunity Employer.

*the hallicrafters co.*  
A Subsidiary of Northrop Corporation



### Ultrasonic transducers

A full line of ultrasonic non-destructive testing transducers is described in an illustrated 35-page catalog that provides background information on piezoelectric materials and transducer design requirements for various test applications. A description of a high-temperature kit for difficult on-stream thickness testing applications is included, along with a complete listing of transducer accessories. Branson Instruments Co.

CIRCLE NO. 430

### Time sharing

The expanding role of data terminals in time-sharing operations is discussed in an eight-page brochure. Described is how Teletype terminals can give quick access to time-sharing terminals for business planning, manufacturing, financial analysis, engineering, medicine, education, and order processing. Teletype Corp.

CIRCLE NO. 431

# Free Career Inquiry Service

## Absolutely Confidential

Respond to the career opportunities advertised in this issue. Fill out and send us this handy resume. **Electronic Design** will do the rest – neatly typed copies of this form will be mailed to the companies of your choice, indicated by the circled Career Inquiry Numbers at the bottom of this page.

# 21

<b>Name</b>		<b>Home Phone</b>	
<b>Home Address (Street)</b>		<b>City</b>	<b>State</b>
			<b>ZIP Code</b>
<b>Age</b>	<b>U.S. Citizen</b>	<b>Security Clearance</b>	
	<input type="checkbox"/> Yes <input type="checkbox"/> No		

Prime Experience	Secondary Experience

<b>Desired Salary</b>	<b>Availability Date</b>
-----------------------	--------------------------

**Employment History – present and previous employers**

Company	City, State	Dates	Title
		to	
		to	
		to	

**Education – indicate major if degree is not self-explanatory**

Degree	College	City, State	Dates
			to
			to
			to

**Additional Training – non-degree, industry, military, etc.**

---



---

**Professional Societies**

---

**Published Articles**

---

**Career Inquiry Numbers:**

- |     |     |     |     |     |     |     |     |     |         |
|-----|-----|-----|-----|-----|-----|-----|-----|-----|---------|
| 900 | 901 | 902 | 903 | 904 | 905 | 906 | 907 | 908 | 909     |
| 910 | 911 | 912 | 913 | 914 | 915 | 916 | 917 | 918 | 919 925 |

**ELECTRONIC DESIGN**  
 850 Third Avenue  
 New York, New York 10022

ELECTRONIC DESIGN'S function is:

- To aid progress in the electronics manufacturing industry by promoting good design.
- To give the electronic design engineer concepts and ideas that make his job easier and more productive.
- To provide a central source of timely electronics information.
- To promote two-way communication between manufacturer and engineer.

**Want a subscription?** ELECTRONIC DESIGN is sent free to qualified engineers and engineering managers doing design work, supervising design or setting standards in the United States and Western Europe. For a free subscription, use the postfree application form inside the back cover. If none is included, write to us direct for an application form.

If you do not qualify, you may take out a paid subscription for \$25 a year in the U.S.A., \$35 a year elsewhere. Single copies are \$1.50 each.

**If you change your address,** send us an old mailing label and your new address; there is generally a prepaid postcard for this inside the back cover. You will have to requalify to continue receiving ELECTRONIC DESIGN free.

**The accuracy policy of ELECTRONIC DESIGN is:**

- To make reasonable efforts to ensure the accuracy of editorial matter.
- To publish prompt corrections whenever inaccuracies are brought to our attention. Corrections appear at the end of the Letters column.
- To refuse any advertisement deemed to be misleading or fraudulent.

Microfilm copies are available of complete volumes of ELECTRONIC DESIGN at \$19.00 per volume, beginning with Volume 9, 1961. Work is now in process to complete the microfilm edition of Volumes 1-8. Reprints of individual articles may be obtained for \$2.00 each, prepaid (\$.50 for each additional copy of the same article) no matter how long the article. For further details and to place orders, contact the Customer Services Department, University Microfilms, 300 North Zeeb Road, Ann Arbor, Michigan 48106; telephone (313) 761-4700.

**Want to contact us?** If you have any comments or wish to submit a manuscript or article outline, address your correspondence to:

Howard Bierman, Editor,  
ELECTRONIC DESIGN,  
850 Third Avenue,  
New York, N.Y. 10022.

## HOW TO SUCCEED WHILE YOU'RE STILL YOUNG



The average engineer — despite a high starting salary — hardly ever reaches \$20,000 a year. Recent surveys indicate that the average engineer earns only \$15,500 at today's salary levels. But middle management engineers expect salaries up to \$30,000 . . . and young middle managers are still promotable! The Alexander Hamilton Institute representative can tell you the exciting story. But first, find out how you, too, can qualify for the highest rewards in industry. Send for our FREE booklet, "Forging Ahead in Business." Act now. No obligation.

**Alexander Hamilton Institute**

Department A-975  
235 East 42nd Street  
New York, N. Y. 10017

174

## Quality Fasteners For All Designs



This 8-page catalog provides design data on the complete group of DZUS 1/4-turn self-locking fasteners for standard, high speed and panel applications, as well as universal high strength multiple thread fasteners for high tensile and shear stresses. Dzus stud assemblies, wire forms and receptacles offer an exceptional, wide variety of combinations from stock to fit specific fastening requirements. Diagrams and tables give full details for rapid, unlimited design selection. Condensed or complete Catalog available on request.

**Dzus Fastener Co., Inc.**

425 Union Boulevard  
West Islip, L. I., N. Y. 11795

175

## Welded stud fasteners — no holes or distortion



This new brochure describes a solid-state-controlled system for welding threaded stud fasteners to steel and aluminum as thin as .016" and .040", respectively. Welds are reliable and consistent because the control may be adjusted quickly and conveniently to all conditions. The one-side fasteners may be located wherever the best design requires. No holes involved — which means no expenses for sealing, drilling, through-bolting, staking. Standard studs, up to 1/4" in diameter, from stock. System operates from 115-volt AC outlet, welds studs at production rate of 8 per minute, 15 per minute for short periods.

**Nelson Stud Welding Division**

A United-Carr Division Of TRW Inc.  
Lorain, Ohio 44055

176

# Manufacturers

Advertisements of booklets, brochures, catalogs and data sheets. To order use Reader-ServiceCard (Advertisement)

## A FREE Cross Reference Guide



### to better Printed Circuit drafting

No engineer or draftsman should be without the NEW By-Buk Printed Circuit Drafting Aids P-45 Catalog with color-coded MIL-SPEC sizes. Also contains over 2000 pads, shapes, tapes, transistor tri-pads, spaced integrated circuit terminal pad sets and many other drafting aids for faster, more accurate, distortion-free printed circuit master drawings. Send for your FREE catalog.

### By-Buk Company

4326 West Pico Blvd., Los Angeles, Calif. 90019  
Telephone: (213) 937-3511

177

## Bus Bars For Noise Reduction



A 16 page Technical Bulletin is now available, describing a new concept in power or signal distribution. Basic mechanical and electrical design principles, along with descriptive pictures and diagrams, are included in this bulletin. These compact buses can replace bulky cable harnesses and repetitive wiring for computer or modular application. This method of construction satisfies the demanding requirements of low inductance and resistance of high speed, solid state systems, while controlling electrical noises.

Send For Free Sample

### Eldre Components, Inc.

1239 University Avenue  
Rochester, New York 14607

178

## Toggle, Push-button, Rotary Switch, Panel Environmental Seals



Hexseals® positively seal standard switches and rotary shafts against air, gas and fluids — without redesign of present components or equipment. Hexseals (and RubRglas® Seals, which are transparent seals designed to fit switches, indicator lights and other "see-through" devices) are moveable, single unit, high-pressure seals that in no way interfere with the free motion of a shaft or lever. In addition to their positive sealing function they serve as a vibration-resistant mounting nut. Custom molded panel sandwich seals and special RFI shielding models also available. Hexseals® meet applicable Military Specifications. Write today for free samples and Bulletin HEX-4.

### APM-Hexseal Corporation

44 Honeck Street, Englewood, New Jersey 07631  
(201) 569-5700

179

# Electronic Design

## Advertising Sales Staff

### New York 10022

Keith Aldrich  
Sales Manager  
Robert W. Gascoigne  
Thomas P. Barth  
Samuel M. Deitch  
Byron Adams  
850 Third Avenue  
(212) Plaza 1-5530  
TWX: 867-7866

### Philadelphia 19066

William C. Repetto  
P. O. Box 206  
Merion Station, Pa.  
(215) MA-3-5888

### Boston 01945

Richard Parker  
P. O. Box 206  
Clifton Station  
Marblehead, Mass.  
(617) 742-0252

### Chicago 60611

Thomas P. Kavooras  
Berry Conner, Jr.  
200 East Ontario  
(312) 337-0588

### Cleveland

Thomas P. Kavooras  
(Chicago)  
(312) 337-0588  
(call collect)

### Los Angeles 90303

Stanley I. Ehrenclou  
W. James Bischof  
2930 Imperial Highway  
Inglewood, Calif.  
(213) 757-0183

### San Francisco 94022

Arthur R. Shields, Jr.  
175 San Antonio Rd., S 243  
Los Altos, Calif.  
(415) 941-3084

### London W. 1

For United Kingdom and Holland  
Brayton C. Nichols  
44 Conduit Street  
Tel: REGent 4714

### Verviers, Belgium

For Continental Europe  
Andre Jamar  
1, Rue Mallar, 1  
(087) 253.83 Telex 41563

### Tokyo

Haruki Hirayama  
Rm. 601, Daini Miyauchi Bldg.  
6-8-14, Roppongi,  
Minato-ku  
Phone: 447-0086







## Which discipline will Ed Whitaker use tomorrow

When Delco says multi-disciplinarian, they mean it. Just ask Ed Whitaker. And the solid professionals who have helped him grow into jobs like developing the microcircuits for a fire and overheat detection computer for jet aircraft. Twenty-five hundred components in a package 4" x 2" x 1/2". From concept to hardware in eight months flat. And then a fast hop to Air Force testing. From beginning to final delivery, Ed was a full member of the team. The question is . . . does your job permit you this kind of growth? Take a good look at how your career shapes up, compared with Ed Whitaker's and his colleagues at Delco. You might even call us collect. Or, write: Mr. C. D. Longshore, Supervisor, Salaried Employment, Dept. 602, Delco Radio Division of General Motors, Kokomo, Indiana.

**DELCO  
RADIO**



AN EQUAL OPPORTUNITY EMPLOYER  
DIVISION OF GENERAL MOTORS  
KOKOMO, INDIANA

INFORMATION RETRIEVAL NUMBER 903





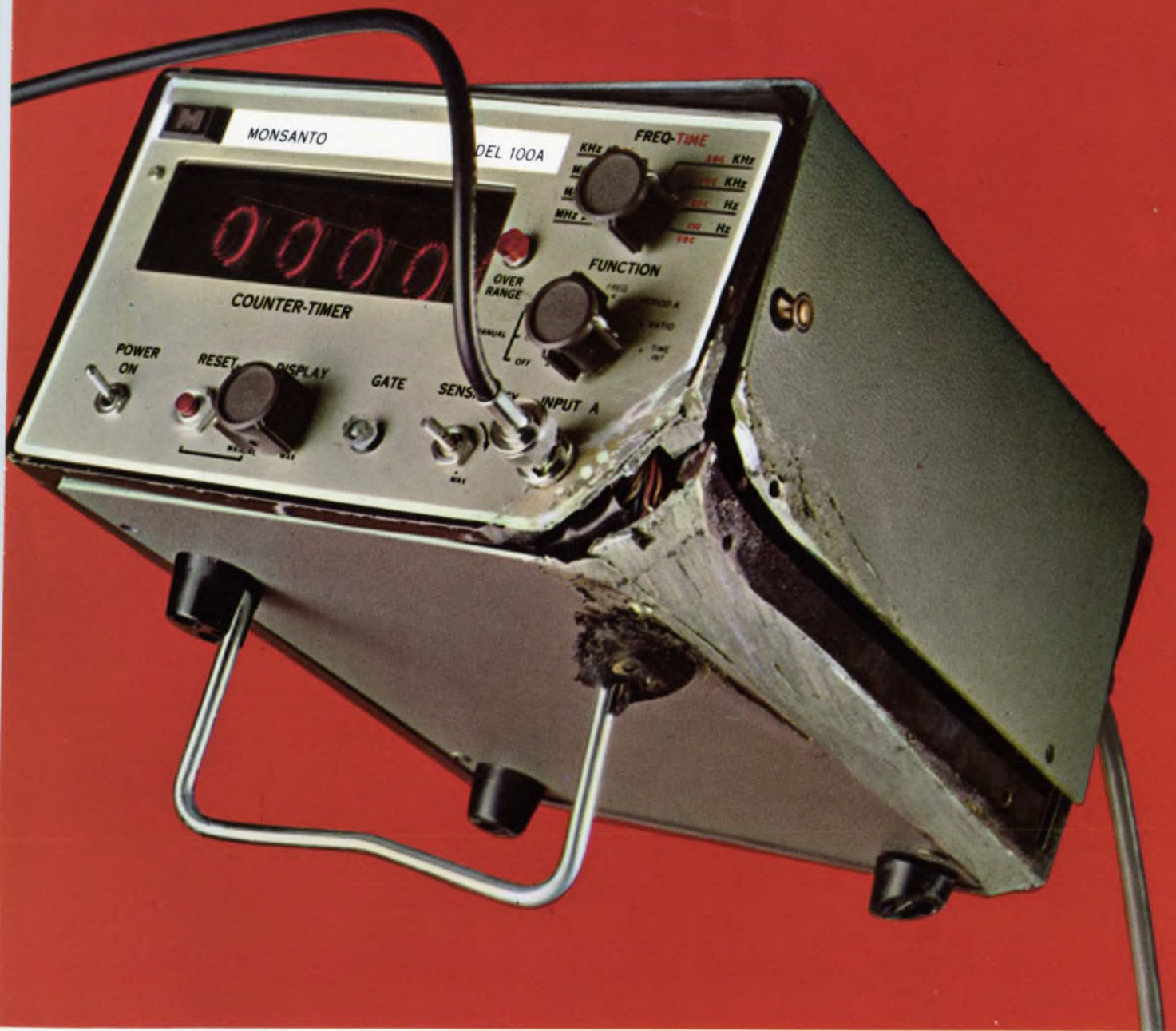

**This counter fell off a plane.  
It didn't need service  
(but when one does, we're ready).**

This Model 100A Counter-Timer was enroute to a customer. A freight handler laid it on the wing of the airplane—and forgot it. The package finally slid off as the wheels left the runway. Instantly freed of its container, the "Small Wonder," as our customers sometimes call it, chased the plane for about a hundred yards, then ground-looped.

Our nearby Service Center, bored with inaction, brightened at the thought of a real challenge when it was brought in. But they were disappointed: electrically, the "Small Wonder" picked up right where it left off in Final Inspection. (Of course, *mechanically* there were a few abra-

sions to take care of, as you can see.)

Please help us keep our 37 Service Centers with their factory-trained technicians alive and well. Call the one nearest you anytime you feel that a Monsanto instrument requires service or calibration...or even verification of its performance. In addition to their expertise and factory specified test equipment, all carry a complete stock of spare parts. If there should be a defect in materials or workmanship during the 2-year warranty period, it won't cost you anything.

Monsanto Company, Electronic Instruments, West Caldwell, New Jersey 07006.



**Measure...**  
 the little pencil tube oscillator  
 that's big in aircraft transponder systems

This pencil tube and cavity oscillator, RCA-4068, is 3" long, weighs 4 oz., and costs less than \$50 in quantity. Ideal, you see, for general aviation use.

What's more, its reliability is so impressive that it's warranted for 1000 hours.

The RCA-4068 is an integral device adjusted at the factory. Hence, it is easily replaceable at the factory where the whole device can be reoptimized—and, in fact, go back to the user adjusted to original

specs. The device features low power drain with a dc supply voltage of 1,400 volts or less and a 500 W useful power output at peak of pulse. Note these other practical data:

- Tuning range . . . . .  $\pm 15$  MHz
- Maximum output VSWR (all phase angles) . . . . . 1.3:1
- Operating temperature . . .  $-46^{\circ}\text{C}$  to  $+71^{\circ}\text{C}$
- Altitude . . . . . up to 35,000'
- Duty factor . . . . . up to 0.01

For further information, see your

local RCA representative. For technical data on the RCA-4068 and other pencil tubes and cavities, write: RCA Electronic Components, Commercial Engineering, Section J-18Q-1, Harrison, N. J. 07029.

