

Electronic Design 15

FOR ENGINEERS AND ENGINEERING MANAGERS

VOL. 17 NO.
JULY 19, 1969

Electronics in general aviation, a \$200 million market, is being pushed along by soaring sales of private planes as well as by stricter demands of air traffic

control. Competition is stiff, with emphasis on high performance and reliability at low cost. The need for design innovation is sky high. For details, see page 38.





**TRW/Globe
sells motion**

Application #4: continuous motion

There's no place for compromise in continuous motion motor systems... and no need for compromise when you specify TRW/Globe.

Computer-aided design, supported by more than 25 years of design and manufacturing supremacy, assures a system which will mirror your exact requirements. Tests, checks, and controls

assure it will go the full distance... and more. This is how TRW/Globe repeatedly earns its place in the most exciting motor systems of our time.

TRW/Globe is in the business of solving problems in motion. Any kind of motion: continuous or intermittent, rotary or linear, gas or liquid, or mechanical linkage.

Perhaps your continuous mo-

tion project could benefit from a fresh insight. Let TRW/Globe motor *systems engineers* look it over. A phone call will do.

Contact Globe Industries Division of TRW Inc., 2275 Stanley Ave., Dayton, Ohio, 45404. Phone (513) 228-3171.

TRW®



Red Alert

A bright red light, visible across the room even at a 45° angle, switches on in less than 10 nanoseconds. No matter how long it's been sitting there, how many vibrations have jarred it, how severe the environment, the signal flashes the status of a circuit or a steady condition. Conceivably, it could shine a million hours before half-brightness.

Yet the HP 5082-4400 Visible Light Emitting Diode is packaged in a small hermetically sealed TO-46 can, uses only 15 mW drive power, combines IC devices, and costs only \$2.90 in quantities of a 1000. You can use it anywhere you need high reliability, long life, small size, low drive power and resistance to shock.

If you'd like more information on an indicator light that never blows out, call your HP field engineer. Or write Hewlett-Packard, Palo Alto, California 94304; Europe: 1217 Meyrin-Geneva, Switzerland.

HEWLETT  PACKARD

SOLID STATE DEVICES

INFORMATION RETRIEVAL NUMBER 2

01905

Systron-Donner's Model 6316A gives you automatic final-answer frequency readings non-stop from dc through X band.

It's the perfect systems counter — a completely programmable unit that mounts in a slim 1¼ inches of panel space and costs only \$4750. Before now you needed a collection of instruments totaling five times the bulk and costing half again as much to do the same job.

Model 6316A covers the full range by combining a dc-to-100 MHz counter with built-in automatic frequency extenders. Readings can be taken in milliseconds, and the extenders lock in phase with the input to preserve counter accuracy to 12.4 GHz. That accuracy depends only on time base stability—which can be an ultra-high 5 parts in 10^{10} per 24 hours.

Reliability is superb—proven by more than a year's operation in the field. For a prompt demonstration, phone or write Measurements Division, Systron-Donner Corporation, One Systron Drive, Concord, California 94520. Phone (415) 682-6161.

First counter to measure automatically from dc to 12.4 gigahertz!



SYSTRON  DONNER



Another first. One of 144 Systron-Donner instruments

Electronic counters	Digital voltmeters
Pulse generators	Digital panel meters
Microwave frequency indicators	Microwave signal generators
Digital clocks	Laboratory magnets
Memory testers	Data acquisition systems
Analog computers	Microwave test sets
Time code generators	
Data generators	

Electronic Design 15

VOL. 17 NO.

FOR ENGINEERS AND ENGINEERING MANAGERS

JULY 19, 1969

NEWS

- 21 News Scope
- 25 **Tests aim to tame nuclear-blast pulse**
Susceptibility of military electronics to electromagnetic pulses is evaluated at new research facility
- 28 **\$1 million for 747 Superjet electronics**
Luxury aircraft carries over-the-horizon vhf radio, inertial systems and satellite communications gear
- 34 **Innovations in stereo, color TV designs**
brighten consumer electronics show
- 38 **Avionics for the private flier ready for take-off**—a Special Report
- 47 Washington Report
- 50 Letters
- 56 Sidelights of the Issue
- 59 **Editorial: Time, tide and technology wait for no one**

TECHNOLOGY

- 78 **Count backward for high resolution** in laser or radar ranging measurements. It eliminates undesired early returns.
- 84 **Get rid of ground-loop noise.** Follow these clever circuit techniques that use simple bypass capacitors and op amps.
- 90 **Determine diode parameters graphically** using your curve tracer. Here is the basic technique.
- 96 **Diary of a leadership trainee:** Our man takes a sensitivity training course and tells the electronics world what he thinks about it.
- 106 Ideas for Design

PRODUCTS

- 118 **Microwaves and Lasers:** Solid-state S-band amplifier gains 25 dB.
- 124 **ICs and Semiconductors:** MOS 2560-bit memory has ASCII address.
- 130 **Data Processing:** Wiresonic memories offer random-access address.
- 138 Components
- 144 Modules and Subassemblies
- 146 Production
- 148 Instrumentation
- 152 Packaging and Materials

Departments

- | | |
|------------------------|-----------------------------------|
| 16 Designers' Datebook | 160 Application Notes |
| 154 Evaluation Samples | 162 New Literature |
| 156 Design Aids | 174 Advertisers' Index |
| 158 Annual Reports | 176 Information Retrieval Service |

Information Retrieval Service Card inside back cover

COVER PHOTO by Dave Porter, staff photographer, Bendix Avionics Div. The Pipe Aztec C, approaching Miami International Airport in the evening, is used by Bendix for flight testing and demonstrations.

ELECTRONIC DESIGN is published biweekly by Hayden Publishing Company, Inc., 850 Third Avenue, New York, N.Y. 10022. James S. Mulholland, Jr., President. Printed at Brown Printing Co., Inc., Waseca, Minn. Controlled circulation postage paid at Waseca, Minn., and New York, N.Y. Copyright © 1969, Hayden Publishing Company, Inc. 77,523 copies this issue.

Visicorder--recording

When we designed our original Honeywell Model 906 Visicorder back in 1956, we didn't start with an idea of how it would work.

We started with the idea of what it should do: give you *immediate* readout of high-frequency analog data.

So instead of using a conventional recording technique (with chemicals, ink or vapor), our Model 906 was designed around a whole, new, unconventional technique . . . of recording on light-sensitive paper, which then developed on exposure



to an ambient light.

Since then, we have seen this "unconventional" technique become the most widely accepted system in

oscillography, an accomplishment that might have been enough to content most manufacturers.

But not Honeywell. We expanded this technique to fit virtually any application, by introducing Visicorders of greater capacity.

Then we introduced Visicorders with added convenience features and increased versatility, including a new fiber-optics recorder.

And then we introduced a complete range of accessories, such as our microfilm recorder accessory (that provides expanded resolution,

1 Model 906: 6" compact, "handyman" Visicorder

2 Model 2206: 6" battery-powered, portable, Visicorder

3 Model 1508A: 8" Visicorder with takeup unit

4 Model 2106: 6" laboratory Visicorder

5 Model 1204: Visiprinter accessory

6 Model 2400: Microfilm recorder accessory

7 Model 1912: 12" high-performance Visicorder

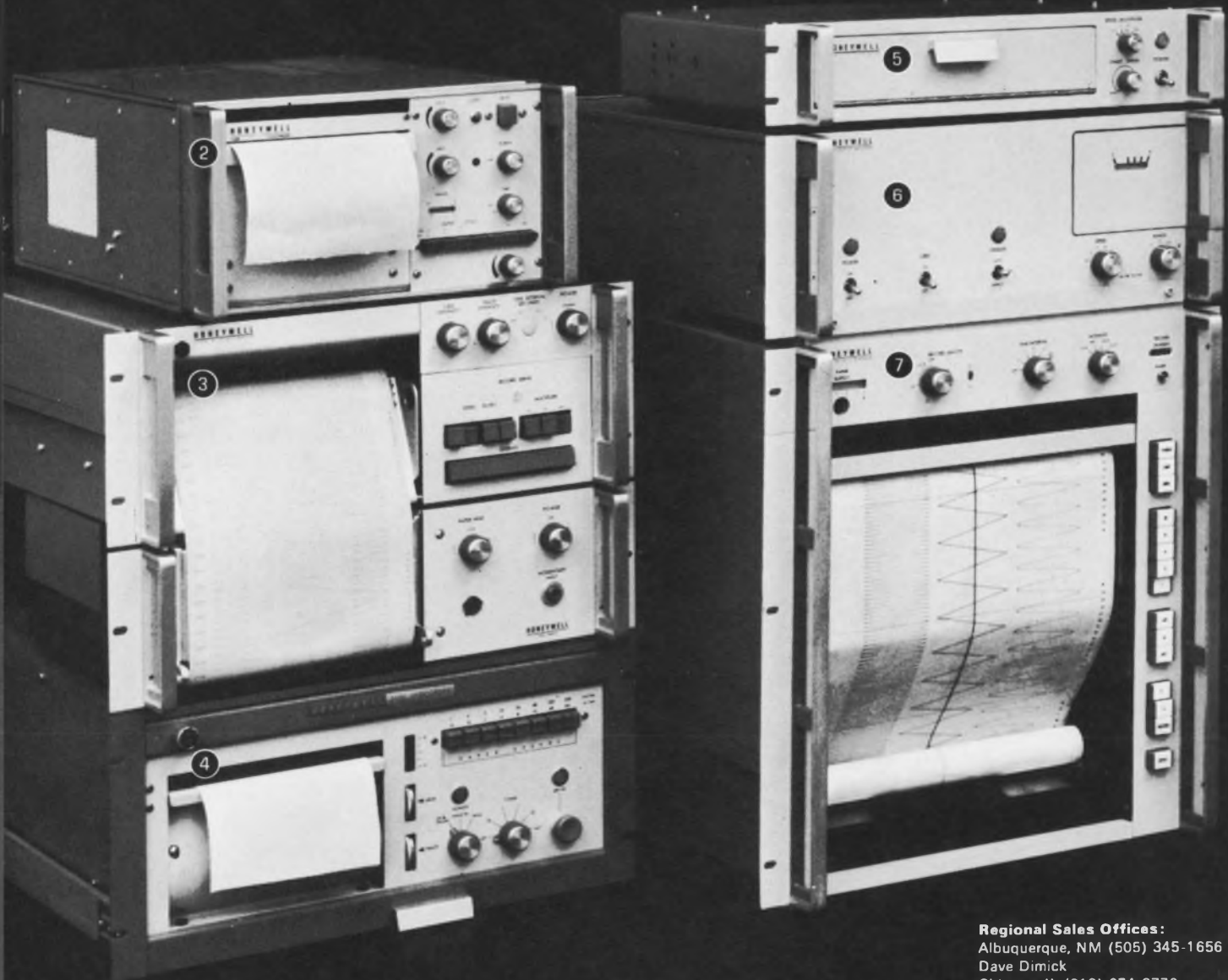

Regional Sales Offices:

Albuquerque, NM (505) 345-1656

Dave Dimick

Chicago, IL (312) 674-9770

Eldred Jones

solutions since 1956

reduced record storage space, increased economy, and a permanent record); and our Visiprinter, a digital printer accessory that allows you to record digital data, along with the analog traces on any Visicorder.

And then, finally, we complemented this line with a variety of signal conditioning instruments, including amplifiers, attenuators, strain gage and thermocouple control units. Plus a wide selection of thermocouples and Satham transducers.

Until now, today, when we can

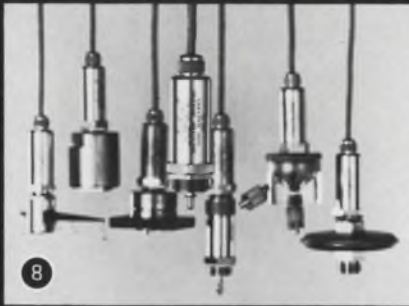

honestly say that we offer the world's finest and most complete line of direct recording light beam oscillo-

graphs, systems and accessories. Which means that a Honeywell engineer can provide the solution to *any* recording problem, no matter the size or complexity.

And that from small portables to 36-channel Visicorders, DC to 1 MHz, Honeywell can deliver, install and maintain any size system.

For more information, call your nearest regional sales manager listed below, or write: Honeywell Test Instruments Division, P.O. Box 5227, Denver, Colorado 80217 (303) 771-4700.

- 8 Satham Transducers
- 9 Model 1108: 8" general purpose Visicorder

- 10 Model 1806: Fiber-optic recording oscillograph
- 11 Signal Conditioning

Honeywell

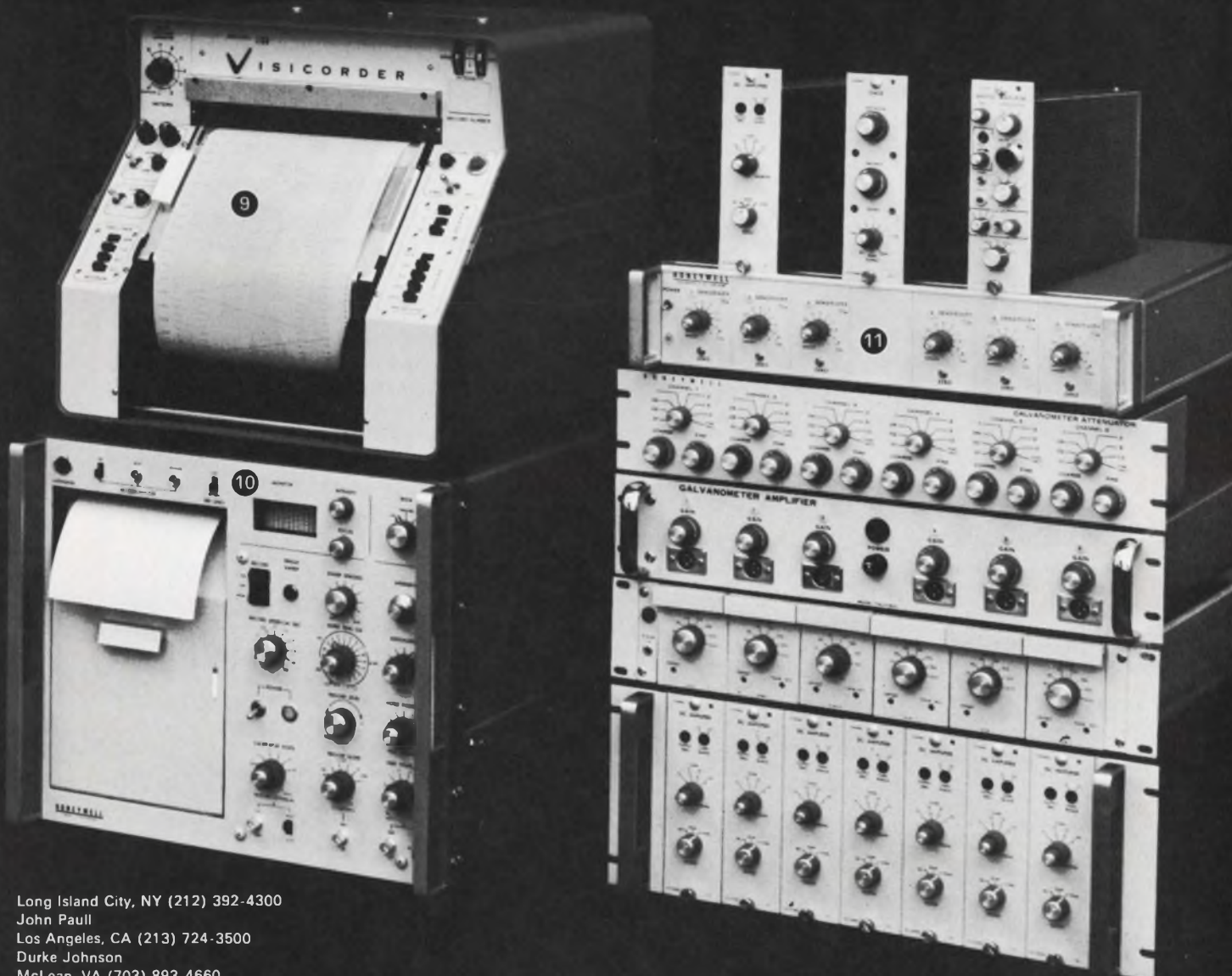

Long Island City, NY (212) 392-4300
John Paull
Los Angeles, CA (213) 724-3500
Durke Johnson
McLean, VA (703) 893-4660
Bill Schmick

See us at WESCON, Booths 1306-1309.

INFORMATION RETRIEVAL NUMBER 4

Let's put an end to op-amp compromise

**Eight new versions
of the 741 let you
match the op amp
to your design,
instead of
vice versa.**

Send for new technical data
on all these units, as well as
Transitron's improved 709
series, the TOA1709, TOA4709,
TOA7709, and TOA7809, all now
offered with *short circuit
protection*.

1

Need the 741 with complete internal compensation?
Ask for TOA1741 — direct mechanical and electrical
replacement for the μ A741.

2

**Need the 741 with variable bandwidth to 5 MHz and
variable slew rate to 5.0 volts/ μ sec?**
Try the TOA1741W — Using one external capacitor for
maximum performance flexibility.

3

**Need the 741 with internal compensation, plus 20X lower
input bias current, 20X lower input offset current,
10X higher input Z?**
There's nothing like the TOA7741 — featuring min. input Z
of 3 megohms, max. input bias current of 30 nA, max. input
offset current of 10 nA.

4

**Need a 741 with variable bandwidth to 5 MHz & variable
slew rate to 10 v/ μ sec PLUS 20X lower input bias — 20X
lower input offset current — 10X higher input Z?**
Use the incomparable TOA7741W — with an external
capacitor for performance flexibility, plus same input
characteristics as TOA7741.

5

Need any of the above in industrial temperature ratings?
Ask for TOA2741, TOA2741W, TOA8741, and TOA8741W
respectively.

Transitron
electronic corporation
168 Albion Street, Wakefield, Massachusetts 01880

"The Pill"

for price control

TELEDYNE



TO-5 Relay

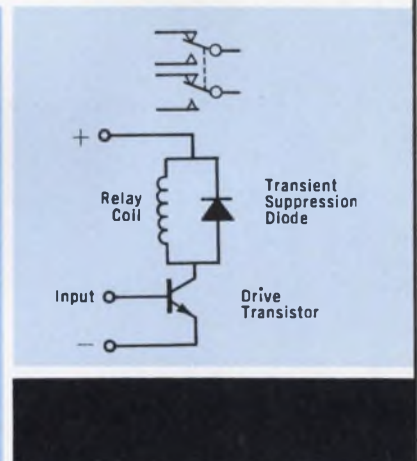
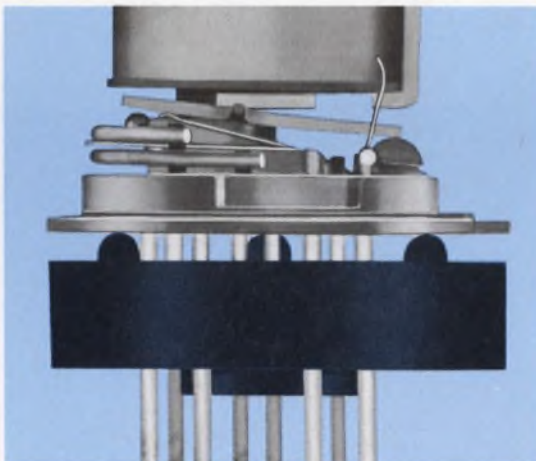

We keep our promises! Last month we promised a low-priced industrial application DPDT TO-5 case relay with an internal transistor driver. We call this new contraption "THE PILL." "THE PILL" contains a transistor driver and suppression diode, attaches externally to our DPDT industrial 712T . . . and does double duty as a transapad.

The 712T combines the advantages of relay operation, i.e., high isolation, low contact resistance, double throw contacts, high current and overload capability with the low signal drive requirement offered by the transistor front-end.

It's hermetically sealed; utilizes all welded construction; requires a turn on (trigger) power of only 200 microwatts or less depending on coil voltage; and may be driven directly from standard T⁴L or similar logic. The relay coil is paralleled with a diode to suppress transients.

The entire package is only 0.405 high by 0.370 in diameter (including "THE PILL"), and is available from stock at your local Teledyne Relay distributor or from the factory at the following price schedule:

Quantity	100	1,000	10,000
Price	\$12.50	\$10.40	\$ 9.25

We call our first price control PILL the 712T . . . Look for an op-amp

PILL in July for DO-IT-YOURSELF time delays and level sensing applications.

No blue sky promises from us . . . just fast delivery for quick price relief.

Phone, wire or write for technical data.



TELEDYNE RELAYS
A TELEDYNE COMPANY

3155 West El Segundo Boulevard Hawthorne, California
90250 Telephone: (213) 679-2205

16½"

This is actual size.

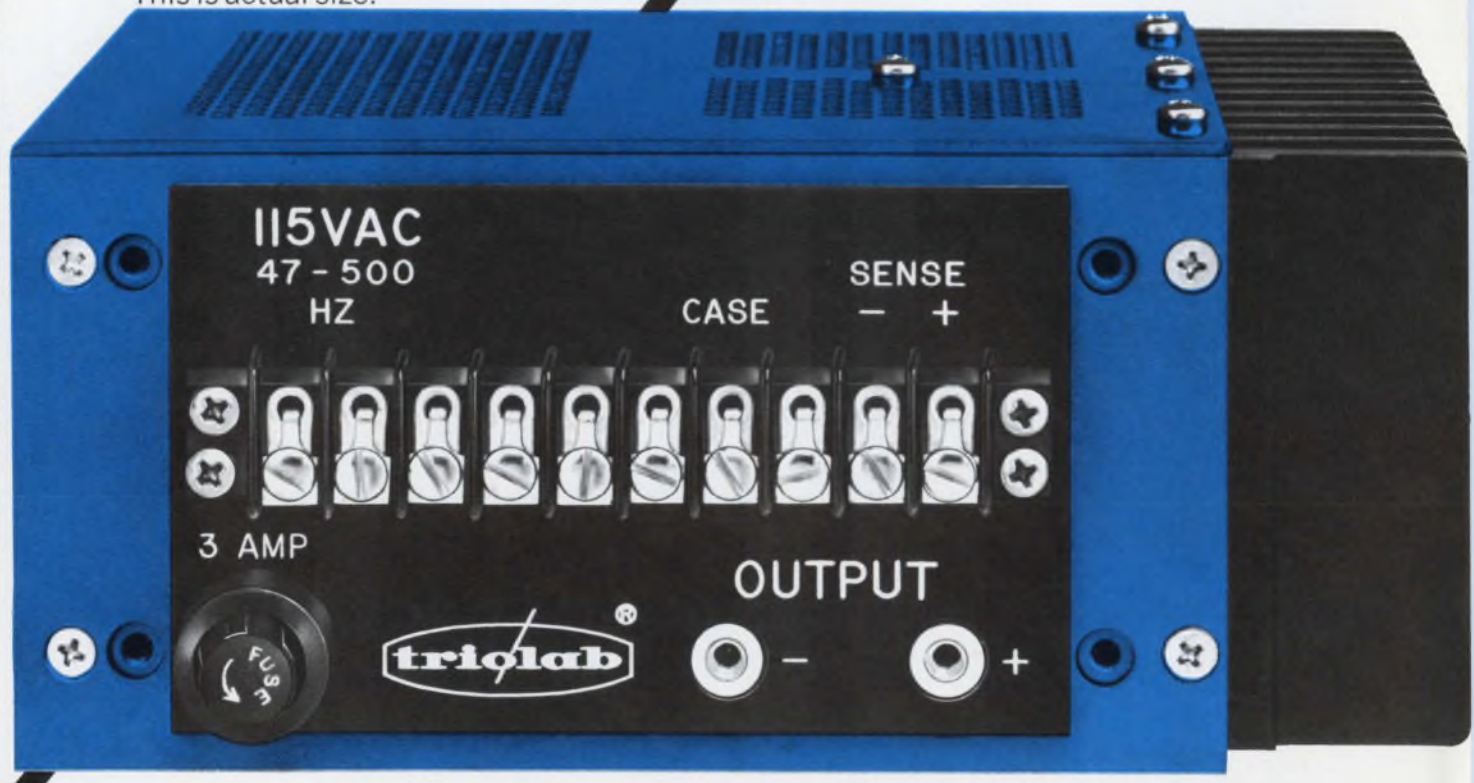

5¼"

115VAC
47 - 500
HZ

CASE SENSE
- +

3 AMP

OUTPUT



- +

- Only $\frac{1}{3}$ the volume, $\frac{1}{4}$ the weight of conventional supplies—3.25" x 6.50" x 7.50"; weight 6 pounds.
- High efficiency — 60-90% depending on model.
- 100 watt output — maintains full regulated power from -20 to $+71^{\circ}\text{C}$ ambient — no derating or heat sink.
- Ripple & noise (including all spikes) 50 MV P-P — input and output meet MIL-I-6181.
- Maintains regulated output power at rated full load for 30 MSEC after AC power dropout.
- Over-voltage crowbar and self-recovering over-current protection.
- Remote sensing.
- Can be mounted on 3 sides.
- Input power 105-125VAC, 47-500 Hz.
- Designed for both military and industrial applications.
- All models \$400 each.

SINGLE OUTPUT HIGH EFFICIENCY SERIES		
*Model No.	DC Output Voltage (Adjustable Range)	Current
SP601	5V $\pm 1\frac{1}{2}$ V	20A
SP602	6V $\pm 1\frac{1}{2}$ V	17A
SP603	10V ± 2 V	10A
SP604	15V ± 3 V	7A
SP605	22V ± 4 V	5A
SP606	30V ± 4 V	4A

DUAL OUTPUT HIGH EFFICIENCY SERIES		
*Model No.	DC Output Voltage (Adjustable Range)	Current
SP611	± 7 V ± 1 V	8A
SP612	± 10 V ± 2 V	5A
SP613	± 15 V ± 3 V	3A
SP614	± 22 V ± 4 V	2 $\frac{1}{2}$ A

*Other values available down to 3V and up to 60V with appropriate currents.

**This 5V/20A power supply saves you
more space than we can show
on these two pages.**

trio/labs' 100 Watt Switching Regulator Power Supplies
setting new standards for high efficiency, low noise, computer/military applications

Trio Laboratories, Inc., 80 Dupont Street, Plainview, L. I., N. Y. 11803. Tel: (516) 681-0400. TWX: (510) 221-1861.

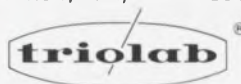

Tantalum Foil



3 ways better
than solid in
non-polar
applications

- smaller than solid tantalum
- more reliable than solid tantalum
- delivers more microfarads than solid tantalum

Design is the big difference between General Electric's Type 29F non-polar tantalum foil capacitor and an equivalent solid tantalum capacitor. A design that's specifically for **non-polar** applications.

GE Type 29F non-polar tantalum foil is about half the case size of an equivalent solid, yet accepts voltage and current variations in either direction. And from one small, single roll that in no way impairs the inherent reliability characteristics of tantalum foil. (Totally unlike its bulky solid counterpart that requires two slugs connected back-to-back and, in most cases, within a single case.)

The difference doesn't end with just size and reliability. Consider microfarads. GE tantalum foil delivers 50 percent more microfarads per case size, in practically all cases, when compared with solid tantalum. So for your next non-polar application, contact your General Electric Sales Representative and ask to see the Type 29F tantalum foil capacitor. It could make a big difference. In size. In reliability. In microfarads. Electronic Capacitor and Battery Dept., Irmo, S.C.

430-36

GENERAL  ELECTRIC

When accuracy is important — and noise, harmonic distortion, or non-sinusoidal wave shapes are a problem—a true rms responding voltmeter is the only answer.

With the HP 3450A digital multi-function meter you get **true rms** readings! The AC Voltage and AC Ratio (Option 001) makes the 3450A the only five-digit DVM available today with this capability. And you not only get **true rms** readings, but you get them from 45 Hz to 1 MHz on any of four ranges (1 V to 1000 V). When you add the midband accuracy of $\pm 0.05\%$ you know that what you are reading or recording is the true value of the ac voltage you are measuring.

The same ac converter (Option 001) also provides true four-terminal ac ratio capability. Gives you the com-

plete isolation you need between X and Y inputs to make accurate ratio measurements between two ac voltages. Four ranges (1:1 to 1000:1) of true four-terminal ac ratio are provided. Option 001 gives the 3450A the capability to make fast, accurate ac readings for **all** the ac information you need.

And, true rms ac voltage measurement is only one face of the incredible dodecameter! The 3450A can also be used for dc and ohms—with ratio, limit tests and ratio limit tests. You get autoranging on all functions and there are options to provide remote control and rear input terminals.

The basic dc unit is integrating and fully guarded for excellent noise immunity. You can make 15 readings

per second with a sensitivity of $1 \mu\text{V}$. You start with this basic meter and add the capability that best fits your requirements. If your requirements change, any of the options (except the rear input terminals) can be easily installed in the field.

To get more information on how rms readings will improve the quality of your ac measurements or on any of the other options for the 3450—just call your local HP Field Engineer. Or, write Hewlett-Packard, Palo Alto, California 94304. Europe: 1217 Meyrin-Geneva, Switzerland.

Price: Basic 3450A, \$3150; AC Option 001, \$1250; Ohms Option 002, \$400; Limit Test Option 003, \$350; Digital Output Option 004, \$175; Remote Control Option 005, \$225; Rear Input Terminal Option 006, \$50.

True rms readings! Just one face of the Incredible Dodecameter —

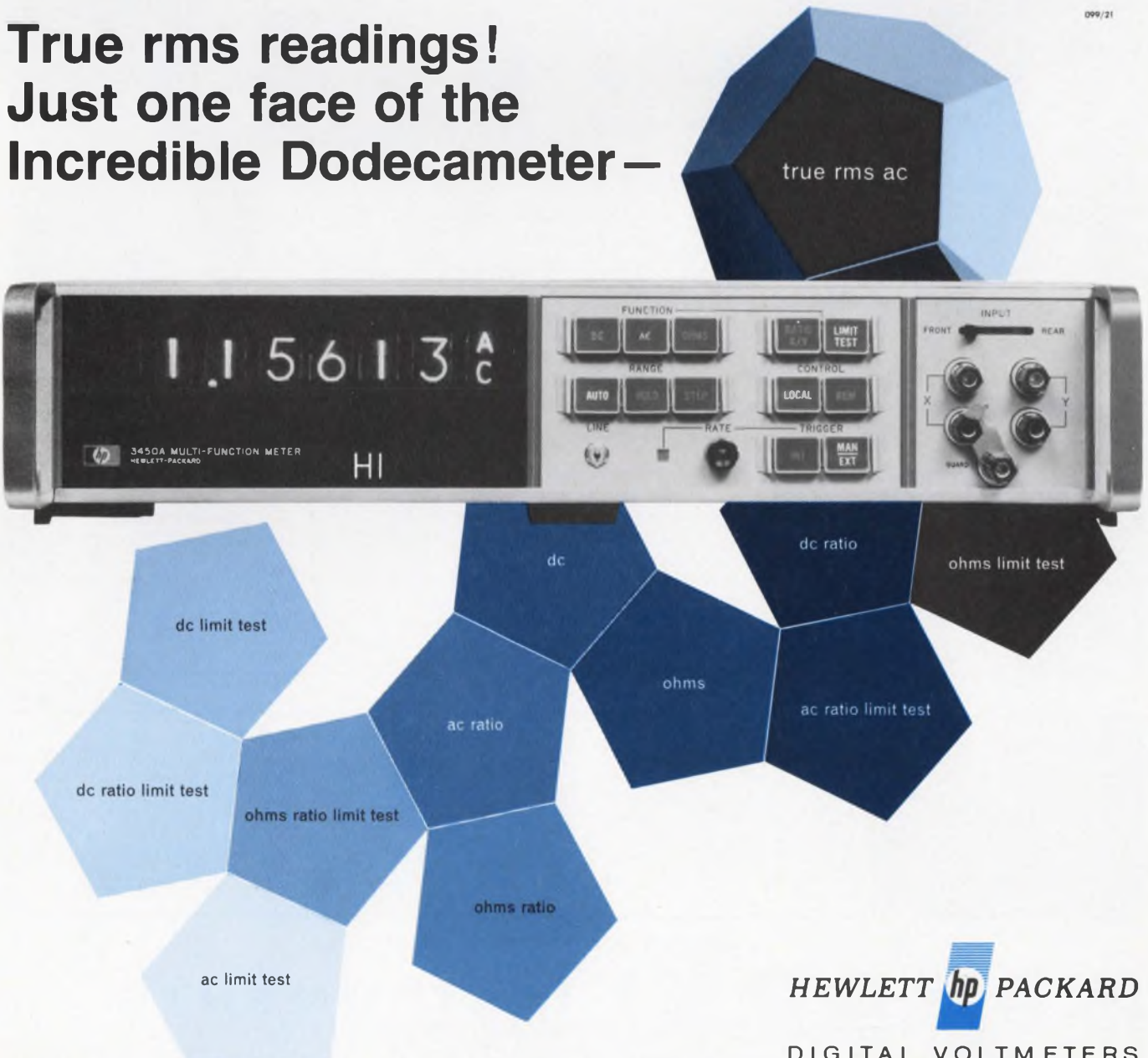

HEWLETT **hp** PACKARD
DIGITAL VOLTMETERS

THE ONLY SOLID-STATE AM/FM MODULATION METER

MODEL 2300



Carrier Frequency: 4 mc to 1000 mc

Sensitivity: 20 mV to 250 mc
50 mV to 500 mc
100 mV to 1000 mc

need we say more?

	<p>FM MEASUREMENT Peak deviation in five ranges of 5, 15, 50, 150 and 500 kc. Modulating frequencies 30 cps to 150 kc. Suitable for AM or FM broadcast (mono or stereo) TV Sound, telemetry and communications.</p>		<p>AM REJECTION. Less than ± 1 kc additional deviation error with 80% amplitude modulation superimposed at 1 kc using a 15 kc audio bandwidth.</p>
	<p>AM MEASUREMENT for carriers to 500 Mc. Two ranges of 30% and 100% (usable to 95%). Peaks or troughs switch selected. Modulating frequencies 30 cps to 15 kc.</p>		<p>L. F. OUTPUT Low distortion, low noise de-modulated signal derived from FM or AM carrier. Switchable de-emphasis 50 μsec and 75 μsec. Level 0dB into 600Ω feeds distortion or wave analyser.</p>

WRITE FOR DETAILED CATALOG SHEET

MARCONI INSTRUMENTS

DIVISION OF ENGLISH ELECTRIC CORPORATION

111 CEDAR LANE

ENGLEWOOD, NEW JERSEY

(201) 567-0607

INFORMATION RETRIEVAL NUMBER 10

What this country
needs is a good
nickel cigar...
and a $\frac{3}{8}$ " square
industrial
cermet
trimmer.



Helipot has the trimmer for \$3.50 list...
now available in local stock.

(But you'll have to find the cigar.)

Beckman®

INSTRUMENTS, INC.
HELIPOT DIVISION

FULLERTON, CALIFORNIA • 92634

INTERNATIONAL SUBSIDIARIES: AMSTERDAM; CAPE TOWN; GENEVA; GLENROTHES
SCOTLAND; LONDON; MEXICO CITY; MUNICH; PARIS; STOCKHOLM; TOKYO; VIENNA

MEET THE MC1596G "PRIVATE EYE"

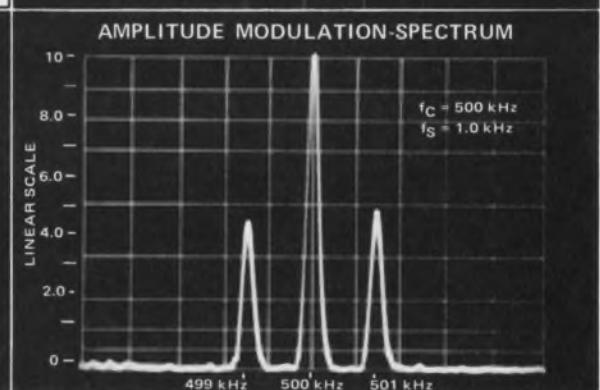
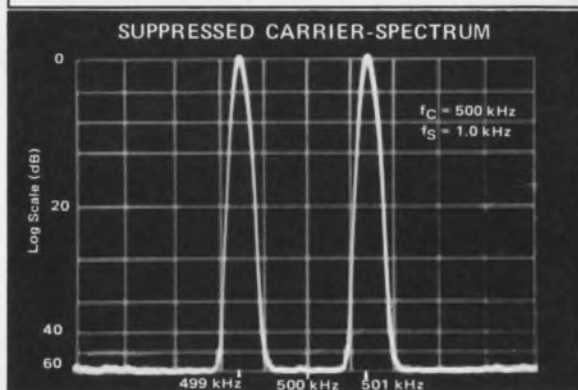
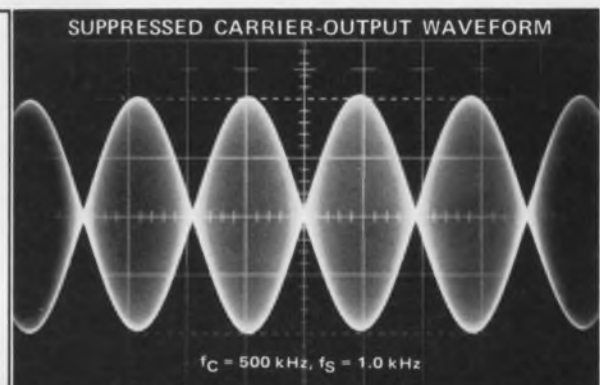
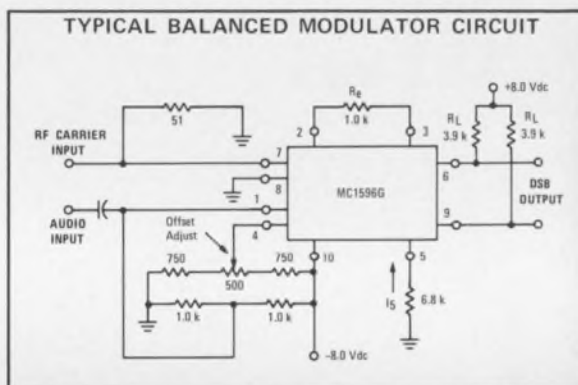

For Hire in Your "Detecting" Jobs!

What's the caper? Synchronous Detection? FM Detection? Phase Detection? MC1596G is the monolithic Balanced Modulator/Demodulator that can handle all of them, and then some. Other capabilities include: Suppressed Carrier and Amplitude Modulation plus chopper applications.

Here are the credentials for the MC1596G that make possible "better than discrete" design performance at the low, 100-up price of \$4.80.

- Closely-matched transistors "on the chip"

provide higher Carrier Suppression in Balanced Modulator applications . . . like 60 dB (typ) at 0.5 MHz — and, the MC1596G drastically reduces spurious signals.

- Adjustable gain and signal handling.
- Balanced inputs and outputs.
- High common-mode rejection—85 dB (typ).

MC1596G comes equipped with a 10-pin metal package — for both industrial and military activities — and operates over the full range of temperatures, from -55 to $+125^\circ\text{C}$. You can put the MC1596G to work on your case by talking to your Motorola Semiconductor distributor. Call him today.

— where the priceless ingredient is *care!*



MOTOROLA
Integrated Circuits

Motorola Semiconductor Products Inc. / P.O. Box 20912 / Phoenix, Arizona 85036

INFORMATION RETRIEVAL NUMBER 12



2 NEW DUAL FETs for electrometers and low noise diff amps

Electrometers The low gate current of the U248A series makes them ideally suited for this application. In the circuit shown, input current is typically less than 0.1 picoamp (10^{-15} amp). By operating at lower gate-drain voltages, lower gate input currents may be achieved; the only restriction is that $V_{DG} > V_P$. On special order, we'll select low V_P devices for you.

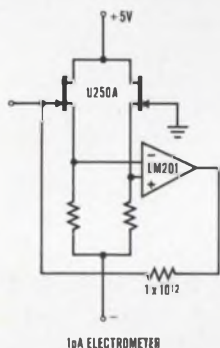

1pA ELECTROMETER

Characteristic	Symbol	Min	Max	Conditions
Gate Current	I_G		1 pA	$I_D = 30 \mu A$ $V_{DG} = 10V$
Transconductance	g_{fs}	50 μmho	150 μmho	
Offset Voltage	$ V_{GS1} - V_{GS2} $		5 mV*	$I_D = 1 \mu A$
Differential Voltage Drift	$\Delta V_{GS1} - V_{GS2} / \Delta T$		5 $\mu V/^\circ C$ *	
Breakdown Voltage	B_{VGS}	-40V		

* The U248A-U251 series presents a range of devices with offset voltages from 5 mV and drift from 5 $\mu V/^\circ C$.

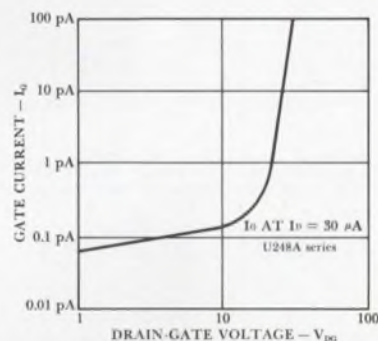

Low Level Differential Amplifiers The 2N5515 series gives you low noise and high common mode rejection. Short circuit input noise voltage is less than 10nv/ \sqrt{Hz} ; common mode rejection ratio (CMRR) is greater than 100 dB. Differential voltage drifts are available from 5 $\mu V/^\circ C$.

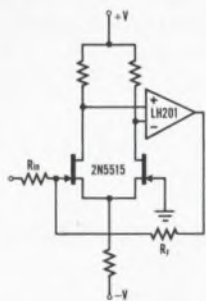

LOW NOISE DIFFERENTIAL AMPLIFIER

Characteristic	Symbol	Min	Max	Conditions
Common Mode Rejection Ratio	CMRR	100 dB		$I_D = 200 \mu A$ $V_{DG} = 10V \text{ to } 20V$
Short Circuit Input Noise Voltage	e_n		15nv/ \sqrt{Hz} @10 Hz (2N5520-24)	
Gate Current	I_G		100 pA	$I_D = 200 \mu A$ $V_{DG} = 20V$
Transconductance	g_{fs}	500	1000 μmho	
Offset Voltage	$ V_{GS1} - V_{GS2} $		5mV*	$I_D = 1 \mu A$
Differential Voltage Drift	$\Delta V_{GS1} - V_{GS2} / \Delta T$		5 $\mu V/^\circ C$ *	
Breakdown Voltage	B_{VGS}	-40V		

* The 2N5515-2N5524 series presents a range of devices with offset voltages from 5 mV and drift from 5 $\mu V/^\circ C$.

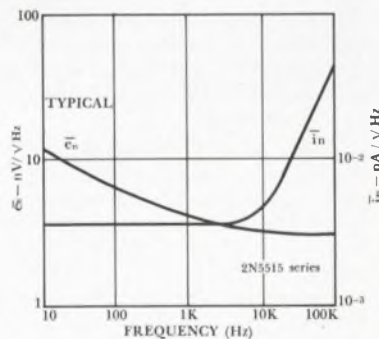

* These are just *two* ways of using *two* series of Siliconix duals. We also have a general purpose series and a high frequency series; If you're involved in any type of design problem requiring duals, just give us a call. We'll deliver the service as well as the goods. That's *applications* power!

... in Europe Siliconix Ltd.
Siliconix House
Sketty Park
Saunders Way
Swansea, U.K.



Our new address ...

Siliconix incorporated

2201 Laurelwood Road • Santa Clara, Calif. 95054
Telephone (408) 246-8905 • TWX: 910-338-0227

What are Engineers Saying About Abbott's Power Supply Modules?

Saves Space — Abbott Power Supply Modules save chassis space in missile systems where space is at a premium. Some DC to DC modules are as small as a package of cigarettes—yet rugged enough to meet MIL specs.

Reliable — Space and missile systems must first be reliable. Abbott Power Modules are reliable. According to an analysis by a leading prime contractor, the Abbott units have an expected M.T.B.F. (mean time between failure) of 71,150 hours.

Saves Weight — Since every ounce of weight in a missile system is worth more than gold, we have designed the Abbott modules for minimum weight. For example, one model has a 120 watt power output in less than three pounds. Other models weigh less than a pound yet still have this high performance.

Most models are listed in EEM (1968-69 ELECTRONICS ENGINEERS MASTER Directory) on Pages 1727 to 1740. For our complete line of power modules covering voltages between 4.7 and 10,000 volts, send for your FREE catalog.

abbott transistor

LABORATORIES, INCORPORATED

5200 W. Jefferson Blvd./ Los Angeles 90016
(213) WEBSTER 6-8185 Cable ABTLABS

High Temp. Operation — The new Abbott Hi-Temp models will operate continuously at 100°C at full load. They use all silicon semiconductors. Good thermal design allows heat to flow into the heat sink by conduction.

Good Regulation — When a missile system's line voltage is varying, the power supply output voltage must usually be constant. Abbott Power Supplies have line regulation as close as 0.2%. (Regulations of 0.005% have been designed when required.)

Protects Circuitry — No short circuit damage to an expensive missile system occurs when an Abbott Power Module is used. Special Short Circuit Protection works automatically to deactivate the power supply when it senses a short circuit in the system.

TO: Abbott Transistor Labs, Inc. Dept. 42
5200 W. Jefferson Blvd.
Los Angeles, California 90016

Sir:
Please send me your latest catalog on power supply modules:

NAME _____ DEPT. _____

COMPANY _____

ADDRESS _____

CITY & STATE _____

Designer's Datebook

AUGUST 1969						
Sun	Mon	Tue	Wed	Thu	Fri	Sat
					1	2
3	4	5	6	7	8	9
10	11	12	13	14	15	16
17	18	19	20	21	22	23
24	25	26	27	28	29	30
31						

SEPTEMBER 1969						
Sun	Mon	Tue	Wed	Thu	Fri	Sat
	1	2	3	4	5	6
7	8	9	10	11	12	13
14	15	16	17	18	19	20
21	22	23	24	25	26	27
28	29	30				
31						

For further information on meetings, use Information Retrieval Card.

Aug. 19-22

Western Electronic Show & Convention (WESCON) (San Francisco) Sponsor: IEEE, WEMA, T. Shields, WESCON, 3600 Wilshire Blvd., Los Angeles, Calif. 90005

CIRCLE NO. 401

Aug. 19-22

Science and Technology of Information Display Seminar (Farmingdale, N.Y.) Sponsor: Polytechnic Institute of Brooklyn, Mrs. H. Warren, Adm. Officer, L.I. Grad. Center, Polytechnic Institute of Brooklyn, Farmingdale, N. Y. 11735

CIRCLE NO. 402

Aug. 24-27

Electronic Materials Technical Conference (Boston, Mass.) Sponsor: AIME, Edward L. Kern, Metallurgical Society of AIME, 345 E. 47th St., New York, N.Y. 10017

CIRCLE NO. 403

Sept. 7-11

Electrical Insulation Conference (Boston) Sponsor: IEEE et al, H. P. Walker, NAVSEC, Code 6156D, Washington, D. C. 20360

CIRCLE NO. 404

Sept. 8-10

Aerospace Computer Conference (Los Angeles) Sponsor: AIAA, R. W. Rector, American Institute of Aeronautics and Astronautics, 1290 Sixth Ave., New York City 10019

CIRCLE NO. 405

Sept. 15-17

International Telemetering Conference (Washington, D.C.) Sponsor: ITC et al, R. J. Blanchard, Defense Electronics Inc., Rockville, Md. 20854

CIRCLE NO. 406



When you want radar as pure and coherent as a laser beam . . .

Symbolic electronic signal undistorted by EMI —
photographed by Howard Sochurek

bring ERIE in early.

31,000 feet . . . heavy traffic . . . ugly weather over the Plains. This isn't the time for "noise" in the radar. But, no sweat! RCA's exciting new AVQ-30X Weather Radar is up front, sweeping the sky . . . protected from EMI by 39 special ERIE filters. No other airborne radar has ever approached the single or dual system reliability of the AVQ-30. From the start, RCA has called on the outstanding research and component capability of ERIE TECHNOLOGICAL to help in the development of this great new unit. Proof, once again, that it pays to bring ERIE in early.

ERIE TECHNOLOGICAL PRODUCTS, INC.

644 West 12th Street, Erie, Pa. 16512
(814) 456-8592

We don't know who'll design it. But we know where he can get the batteries.

At the nearest Burgess Distributor. They're probably somewhere in his stock of batteries.

One's bound to be right for the electric spaghetti windlass. And one's exactly what you need for whatever you're designing. Another thing. Whether it's a standard or special, your Burgess Battery will be power-fresh.

All distributor inventories are checked, rotated, and filled-in according to a systematic schedule.

So the battery you get comes on strong . . . and stays that way.

When you need batteries, check with your Burgess Distributor. He's a great source of power.

And when you need technical information, give us a call. Burgess has a library filled with the latest, most complete engineering data and technical battery material in the business.

Meanwhile, send for our new engineering manual and do a little window shopping. It's got comprehensive listings of all batteries available through Burgess. Clevite Corporation, Burgess Battery Division, Freeport, Illinois 61032.



CLEVITE BURGESS

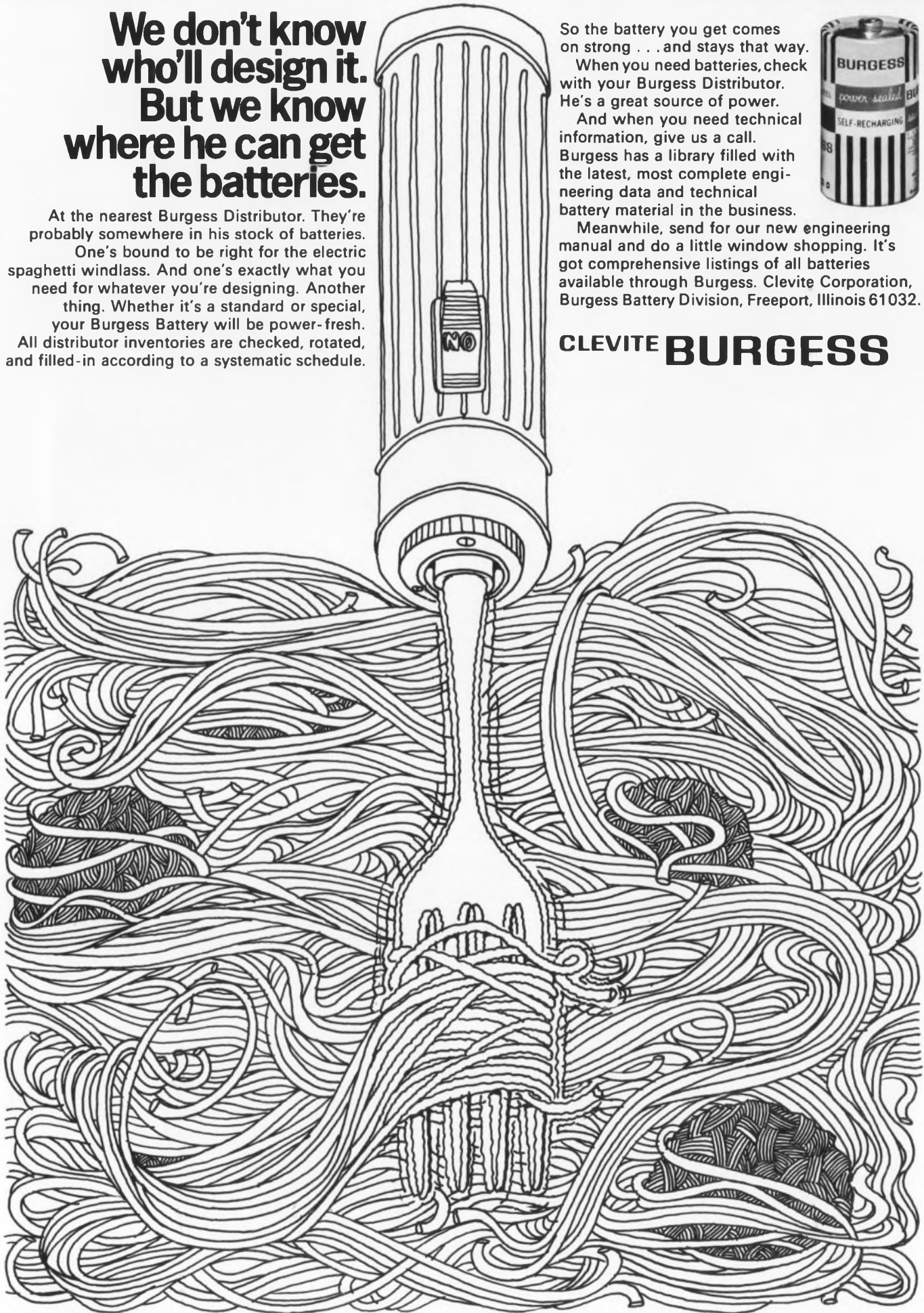

HAPPENINGS IN ELECTRONICS

August, 1969

Motorola features radiation resistant Integrated Circuits

The increasing need for radiation resistant circuits in military equipment is the reason for Motorola's commitment to the production of such devices by forming a separate Radiation Resistant Circuits Production Group with its own processing areas. The first announcement from this new group introduces a radiation resistant MDTL series to be known as the MCE930F Series, which have the same electrical specifications and pin arrangements as Motorola's MC930 series. Six circuits have been released as follows:

Part Number	Circuit Description	1-24	25-99	100 Up	Part Number	Circuit Description	1-24	25-99	100 Up
MCE930F	Expandable Dual 4-Input NAND Gate	15.00	12.50	10.00	MCE945F	Clocked JK Flip-Flop	27.00	22.50	18.00
MCE932F	Expandable Dual 4-Input Buffers	16.40	13.65	10.95	MCE948F	Clocked JK Flip-Flop	27.00	22.50	18.00
MCE933F	Dual 4-Input Expanders	10.95	9.15	7.30	MCE962F	Triple 3-Input NAND Gate	15.00	12.50	10.00

This series is available from Schweber off-the-shelf. A general information bulletin on the radiation hardened MCE930 Series is also available. Circle No. 241.

Big push at Bourns on Cermet Pots

Bourns has lifted the curtain on five new adjustment potentiometers with cermet elements. The physical properties of cermet equal or exceed wirewound and metal film at no extra cost. Some advantages are critically important such as superior performance over the maximum resistance range that is presently available: 1 to 1,000,000. One of the five new models, 3329 @ 1.45", is a single-turn pot which is the first such commercial pot to meet or exceed the requirements of Mil-R-22097. The other four models are multi-turn versions. Models 3009 and 3069 are industrial cermet pots at 1.65" with Mil-Spec immersion seals for trouble free operation after printed circuit board processing. Model 3059 is also an industrial type with a power rating of 1.0 watt at 70°C selling at 2.43". Model 3292 has a thin line (.150" thin), square configuration featuring "insured reliability" and high performance to mil specs characteristic C of MIL-R-22097 (RJ24), and is priced at 5.52". Data sheets available. Stocked at Schweber. Circle No. 242.

*100 pc. quantities

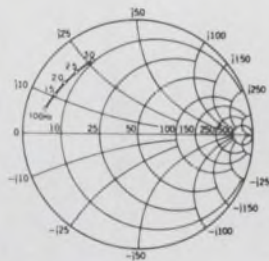

S-Parameters for Fairchild Microwave Transistors

A new Fairchild brochure offers microwave design engineers a more desirable method of transistor circuit analysis than the more familiar Y-parameters which become awkward at the higher frequencies. The new method employs "scattering parameters," hence the term S-parameters,—described as the relationships between incident and reflected waves in any N-port network. The brochure is divided into 1) a review of the S-parameter measurements and important device parameter calculations; 2) a listing of the S-parameters for the four key device families, along with the essential Y-parameters. Additional information and the devices listed in the brochure may be obtained from Schweber. Circle No. 243.

Cross-modulation effects in RCA single & dual-gate MOSFETs

Now that MOSFETs have gain and noise performance equal to or better than bipolars in the VHF and UHF bands, the designer can take advantage of the low cross-modulation distortion of these devices for front-end receiver stages. RCA has prepared an application note discussing cross-modulation effects, and suggesting a test circuit that can provide a measure of the inherent susceptibility of a device to cross-modulation distortion. Application information centers around the front-end performance of RCA's 3N128 and 3N140. An appendix includes an analytic approach to the phenomenon of cross-modulation. Circle No. 244.

Invitation to a Seminar

You are invited to a technical and application seminar concerning itself with three way-out electronic fields: *Solid State Light Emitters (Monsanto)* • *Temperature Sensing Resistors (Sensitron)* • *Ultrafast Recovery Diodes (Isofilm)*. The seminar is sponsored by the above named manufacturers and Schweber, and will be held in the following cities in the month of August: Ft. Lauderdale, Orlando, Washington DC, Philadelphia, New Jersey area, Connecticut area, Long Island area, Boston area, Cleveland area. Write for your personal invitation.

Isodiodes® and Isorectifiers® by Isofilm

Isofilm International, makers of ion-implanted semiconductors, has just issued a bulletin listing five Isodiodes and five Isorectifiers. Implantation of ions into semiconductor surfaces creates characteristics not available to other processes. The most noteworthy of these unusual features would have to include extremely fast turn-on and reverse recovery times without sacrifice of high current-carrying capability, and low forward voltage drop. All devices listed can be ordered for immediate delivery from Schweber stock. Circle No. 245.



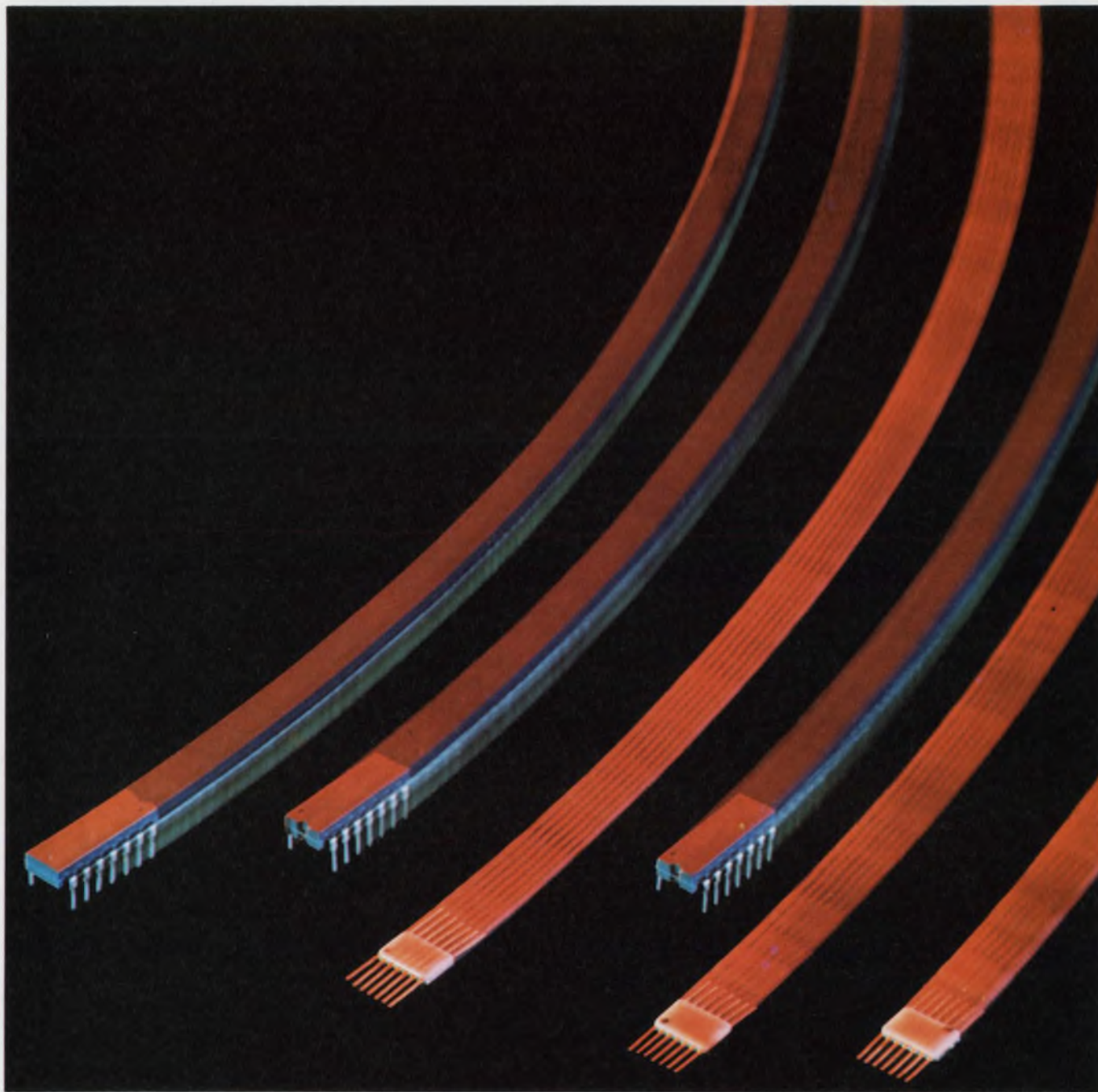

Sprague Digital ICs. Illustration: Series 54H/74H in flatpack and DIP

Just arrived. Series 54H/74H. The fast ones.

Just about the fastest saturated logic circuits around. Series 54H/74H from Sprague. The whole family. Flip-flops and all.

Use them in arithmetic and processing sections, where speed really counts. Mix and match them with Sprague's standard Series 54/74.

Get off to a fast start with Sprague Series 54H/74H.

TYPICAL CHARACTERISTICS	GATES	FLIP-FLOPS
Propagation Delay	6 nsec	17 nsec
Power Dissipation	22 mW	80 mW
Noise Immunity	1 V	1 V
Temperature Range	-55 to +125° C	
Series 54H	0 to +70° C	
Series 74H	DIP or Flatpack	
Packages		

Call Sprague Info-Central (617) 853-5000 extension 5474.

Or call your Sprague industrial distributor. He has them on the shelf.
For complete specifications, circle the reader service number below.



INFORMATION RETRIEVAL NUMBER 16

News

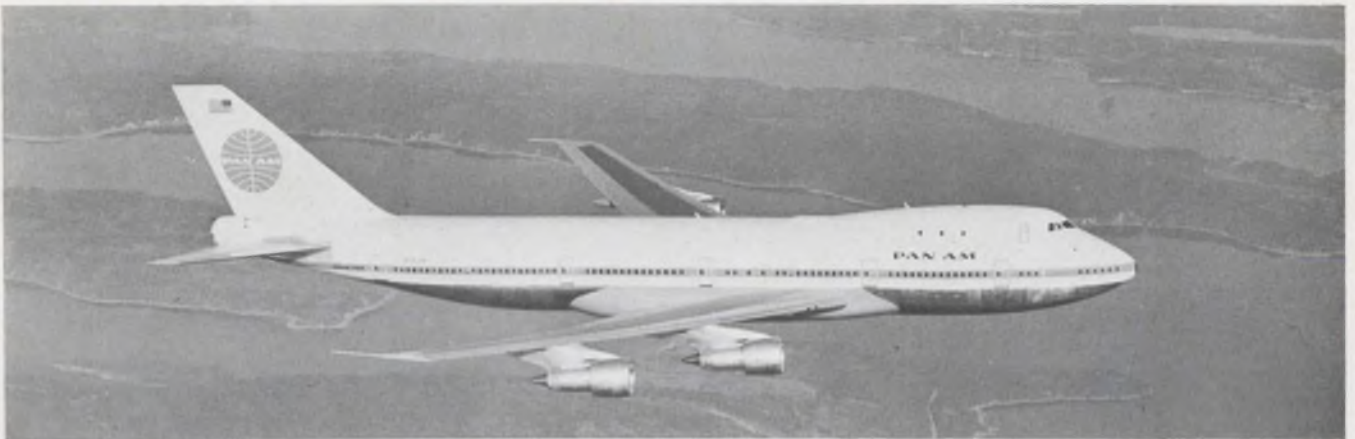

Pan Am's new Boeing 747 Superjets will fly \$1 million worth of electronic equipment in-

cluding over-the-horizon vhf radio, inertial navigators and stereo systems. p. 28



Private plane owners spent about \$150 million last year on electronics equipment alone. This figure is expected to soar. p. 38

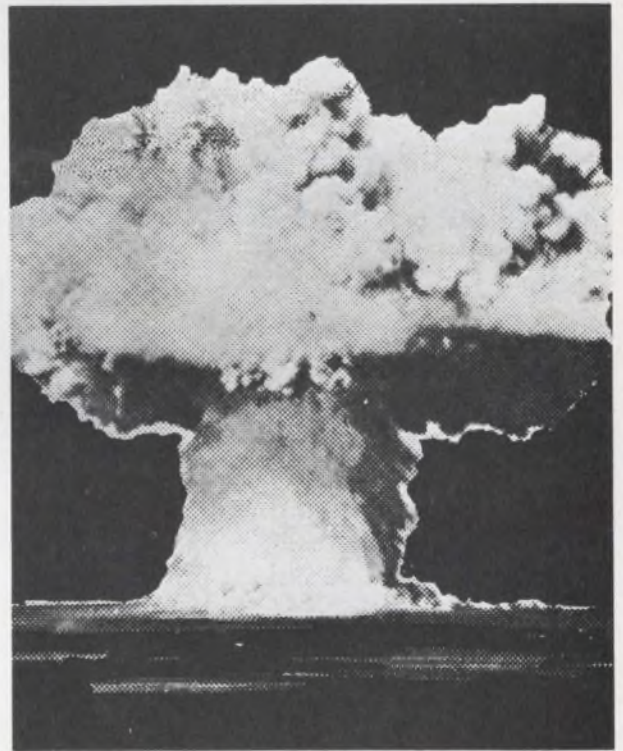

Electromagnetic pulses created by nuclear explosions are being simulated in a new long-wire EMP test facility. p. 25

Also in this section:

Innovations in stereo, color TV brighten electronics show. p. 34

News Scope, p. 21 . . . **Washington Report**, p. 47 . . . **Editorial**, p. 59

...looking for a subminiature EMI filter?

Investigate **SPRAGUE** **SERIES JX2000/JX3000** **FILTERS**



Series JX2000 Subminiature Filters for d-c applications are rated for 50 and 100 VDC operation @ 125 C. This broad line includes L and Pi circuit configurations rated from 0.1 to 2.0 amperes, as well as feed-thru capacitor styles with a rating of 7.0 amperes.

Series JX3000, especially developed for 125 VAC - 400 Hz (or 60 Hz) applications, are available as L and Pi circuits with current ratings of 0.1 to 1.5 amperes, as well as feed-thru capacitors with a current rating of 5 amperes. All units are designed to operate over a temperature range of -55 C to +125 C.

INFORMATION RETRIEVAL NUMBER 821

45F-0109

Tiny in size...Giants in volume efficiency!

Type 160D, 161D **Solid-Electrolyte** **Tantalex[®] Capacitors** **for hearing aids and ultra-miniature circuits**

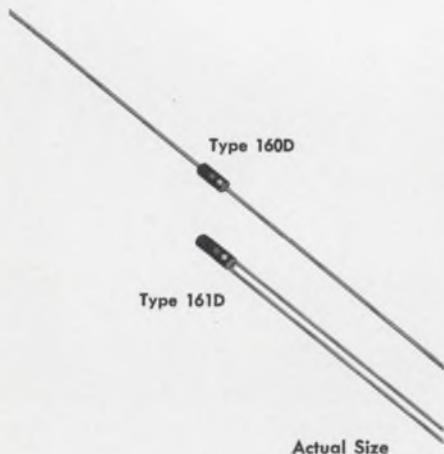

Tiny Type 160D/161D Tantalex Capacitors are sealed within a polyester film tube with tightly-bonded epoxy fill, so the assembly is both electrically insulated and highly resistant to moisture. They are available with axial leads as well as in single-ended construction.

Offering extremely high capacitance per unit volume (for example: 0.25 μ F @ 20 VDC in a case only .065" D. x .125" L.), Tantalex Hearing-aid Capacitors let you select from a broad range of ratings in five different case sizes.

INFORMATION RETRIEVAL NUMBER 822

48C-0128

For complete technical data on any of the above, request engineering bulletins as follows: D-C Filters, Bulletin 8130A; A-C Filters, Bulletin 8131; Type 160D/161D Capacitors, Bulletin 3515D. Write to: Technical Literature Service, Sprague Electric Co. 347 Marshall St., North Adams, Mass. 01247.



Sprague' and '®' are registered trademarks of the Sprague Electric Co.

THE BROAD-LINE PRODUCER OF ELECTRONIC PARTS

Industry still demanding wide procurement probe

Now that the Nixon Administration has set up a blue-ribbon panel to study Defense Dept. operations (including procurement) for a year, some observers on Capitol Hill are asking: "Is HR 474 dead?"

The answer: Not if Rep. Chet Holifield (D-Calif.) who introduced the bill in the House, and the Aerospace Industries Association, which has backed it, have anything to say about it.

HR 474 calls for the establishment of a fact-finding commission that would spend two years studying Government procurement—and nothing else. All Government agencies, including such key ones as NASA, the Federal Aviation Administration and the Atomic Energy Commission, would come under its scrutiny.

The Nixon panel, on the other hand, will examine only the Defense Dept., and procurement will be only one part of its broad review. For starters, it will study the organization and management of the department, including the Joint Chiefs of Staff; decision-making processes; command and control functions and facilities; and how the department coordinates with other Government agencies. It will also look into R&D, from the standpoint of mission fulfillment, time, cost and organization. Somewhere along the line procurement will be investigated, as well as "other matters" that the President might want the panel to study.

Gilbert W. Fitzhugh, chairman and chief executive officer of the Metropolitan Life Insurance Co., is heading the 12-to-15-member Presidential panel.

The commission proposed by Representative Holifield would be made up of 14 or so members—half U.S. Senators and Representa-

tives and half from industry.

Defense Secretary Melvin R. Laird had indicated he sees no conflict between the aims of the Nixon study, and the one proposed in HR 474. And in recent hearings before the House Military Operations Subcommittee, Karl G. Harr Jr., president of the Aerospace Industries Association, gave the bill strong support. He said:

"Today's procurement is light-years beyond the assembly-line tank and plane orders of World War II, or even of the Korean War. The complex systems required for today's space and defense programs, for example, invoke lead times which virtually guarantee that there will be no significant changes, even in the state of the art, in the lifetime of the program—not to mention changes in the prevailing economic, strategic and political conditions."

Government contractors have charged that evils that have crept into procurement are hobbling their efforts to deliver quality products at a fair profit (see "Contractors and Government Clash Over Rules," ED 12, June 6, 1968, p. 36). They have called for an investigation.

HR 474 is being backed in the Senate by Sen. Henry M. Jackson (D-Wash.).

Airlines moving to spot malfunctions in advance

The airlines are looking forward to the day when it will be a rare thing to delay or cancel a flight because of the sudden malfunction of equipment. A new research effort aims to detect impending aircraft system malfunctions before they occur.

The effort which is being direct-

ed by IIT Research Institute of Chicago in cooperation with a group of airlines and major aircraft manufacturers, is seeking checkout systems to counter mechanical, electromechanical and electronic trouble.

Examples of checkout modes that can be used to give information about the relative "health" of a system include electromagnetic signals generated by arcing in faulty electrical components; vibrations created by mechanical malfunctions; odor or vapors given off by overheated components, and changes in the electromagnetic field surrounding a malfunctioning mechanical or electrical device. These signs can be sensed or measured electronically.

Anticollision device protects copter pilots

Student pilot helicopter collisions in high-density training areas are a constant hazard at the Army training facilities for combat pilots. To reduce the accident rate, the Army Aviation Center at Fort Rucker, Ala., has awarded a \$755,000 contract to Honeywell, Inc., of Minneapolis, Minn., for 222 new helicopter anticollision radar devices. These will be installed in the TH-13T helicopters used in basic training at Fort Rucker and at Hunter Army Airfield, near Savannah, Ga.

The new Proximity Warning System (PWS) has an effective horizontal radius of 1,000, 2,000, or 3,000 feet. Vertical protection extends to 300 feet above and 300 feet below the helicopter for the selected range.

The system is cooperative, in that it functions only in conjunc-

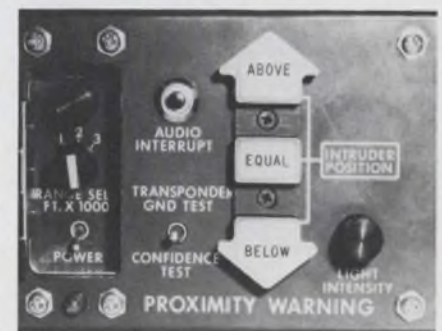

Control and display panel for new helicopter anticollision system

tion with similarly equipped aircraft.

Principal components of the system include a radar transponder, two small omnidirectional dipole antennas, a barometric pressure sensor, and a cockpit control and display panel.

An important feature of the system is its ability to operate effectively when more than 50 other similarly equipped aircraft are present within the maximum warning radius, according to John Maynard, radar section head at Honeywell's Aerospace Division.

Entry of an "intruder" within the selected warning radius lights one of the position indicators, corresponding to the upper, middle, or lower 200 feet of the vertical warning zone. A simultaneous audio warning alerts the pilot that another craft has entered the hazard area.

Design features include an immunity to noise and rf interference, a capability for operating over any type of terrain, self-test capabilities, and a projected MTBF of more than 8000 hours. Provisions are also included for a remote warning display for the copilot.

Delivery for the initial units is slated to begin in five months. The contract includes an option for an additional 1,293 units, with a total contract potential of \$4.5 million.

Army's war on EMC fought along 5 fronts

The Army Electronics Command at Fort Monmouth, N.J., has asked a basic question about electromagnetic compatibility (EMC) and has come up with some answers that may affect the design of electronic equipment for a few years to come.

At the IEEE International Symposium on EMC, held in Asbury Park, N.J., Melvin M. Morris of the R&D Directorate at Fort Monmouth posed this question: How can we design EMC into equipment instead of waiting to suppress

interference after the equipment is built?

Morris then listed these steps that the Army is taking to combat the problem along five major fronts:

- **EMC education**—It has published two volumes under the title "Interference Reduction Guide for Design Engineers." These are available to the public.

- **Nonlinear devices**—It has conducted research on the reduction of spurious frequencies when two or more signals are mixed in a nonlinear device.

- **Shielding and filtering**—It has studied how to reduce shielding requirements through an understanding of the nature of electromagnetic waves and use of the shields as useful circuit elements.

- **Mathematical analysis**—It has come up with a binomial expansion of a function that it has found to be more useful than Fourier analysis of pulse forms.

- **Receivers**—It has investigated local oscillator pumping powers and found how to increase dynamic range and decrease intermodulation without much increase in noise power for some diodes.

Aircraft com system has 8000-foot antenna

If a nuclear blast blacks out conventional air-to-ground communications via the ionosphere, how can the Air Force maintain emergency communications? One way is to use 60 kHz, but that would require an antenna a mile and a half long. Trailing such an antenna from an aircraft looked like an impossible task, until the Air Force Ionospheric Physics Laboratory examined the problem.

The solution? Carry an expendable battery-powered transmitter plus a tape recorder with a message put on it just before the package is dropped from the aircraft. As the package descends, a parachute is deployed, and two reels of wire, each 4000 feet long, are run out simultaneously. One reel is weighted and dropped with an aerodynamic brake to control its descent. The other is extended by parachute above the transmitter package. Descent time, from 45,000 feet to sea level, is nearly an hour.

When the reels are unwound, the transmitter is at the center of a 60-kHz, half-wave dipole with an impedance of 90 to 100 ohms.

EIA approves guide to laser exposure

A plan for safe use of lasers—based on identifying categories of equipment and the degree of radiation hazard connected with each—has been approved by the Electronic Industries Association.

It groups laser equipment and installation into four main categories:

1. Excluded access—Laser system radiation fully contained in an enclosure or area from which people are physically excluded.
2. Emission controlled—Laser system radiation partly contained in an enclosure or area from which people are physically excluded.
3. Controlled area—Laser system radiation contained in an area that is accessible to human but is controlled by a responsible operator.
4. Non-controlled installation—Lasers operated without control over human exposure to the radiation.

Computer parley plans wide-awake touches

The Program Committee of the 1969 Fall Joint Computer Conference has taken steps to combat "conference fatigue." To make the conference more interesting for the audience, it has recommended that:

- Professional speaker training be provided for authors.

- Papers be used only as references, with the oral version "an instructive audio-visual presentation of highlights."

- Visual aids be critically reviewed by the committee before being presented.

- Awards will be given for the best presentation as well as the best paper.

- Physical staging details be arranged to aid in "massaging" the messages.

The conference is scheduled for Nov. 18-20 at Las Vegas Convention Center.

LOW PROFILE

hot-molded trimmer for
close circuit board stacking



Basic Type Y unit
shown actual size



With wheel for
side adjustment



With attachment for
horizontal mounting and
wheel for side adjustment



With attachment for
horizontal mounting

New Type Y single turn trimmer is especially designed for use on printed circuit boards. It has pin-type terminals for use on boards with a 1/10" pattern. And the new low profile easily fits within the commonly used 3/8" space between stacked printed circuit boards.

For greater operating convenience, the Type Y can be supplied with an optional thumb wheel for side adjustment, or an optional base for horizontal mounting, or both. The Type Y enclosure is splash-proof as well as dust-tight, and the metal case is isolated to prevent accidental grounding.

While featuring a new low profile, this new Type Y trimmer retains the popular Allen-Bradley solid resistance element, which is produced by A-B's exclusive hot-molding technique. With virtually infinite resolution, adjustment is smooth at all times. Being essentially noninductive, the Type Y can be used at frequencies where wirewound units are inadequate. The Type Y is rated 1/4 watt at 70°C and is available in resistance values from 100 ohms to 5.0 megohms. Standard and special tapers are available.

Let us send you complete specifications on this newest addition to the Allen-Bradley line of quality electronic components. Please write: Allen-Bradley Co., 1201 South Second Street, Milwaukee, Wis. 53204. Export Office: 1293 Broad St., Bloomfield, New Jersey, U.S.A. 07003. In Canada: Allen-Bradley Canada Ltd.

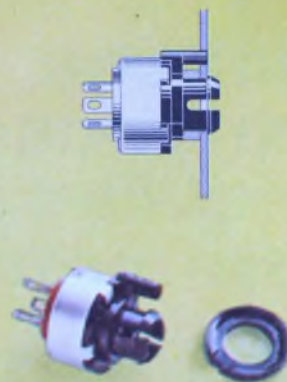

New Type Y with handy
snap-in panel mount,
supplied with spacers for use
on panels up to 1/8" in thickness



winning form

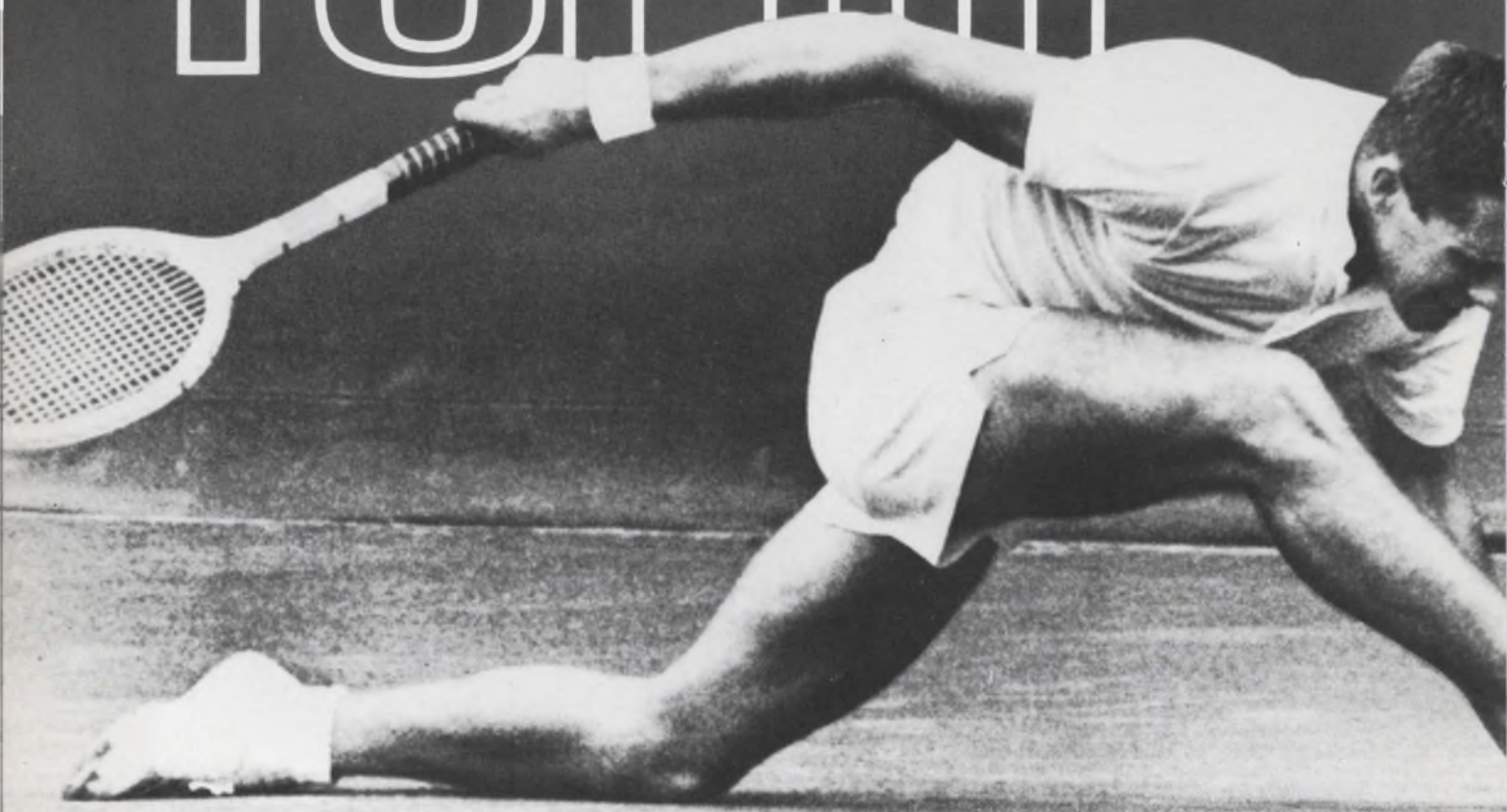

from the form-factor specialists at Damon

Getting a true AFC lock-on can be a problem with a discriminator that produces extraneous zero-crossings. That's a problem you can forget with the new **Damon Model 6283MDA Monolithic Discriminator**. You also get a highly symmetrical characteristic—even beyond peaks—resulting in improved performance with noisy signals. Plus a monolithic multi-resonator for excellent stability over a wide temperature range. All in a compact one cubic inch package.

The high-reliability Model 6283MDA has a center frequency of 10.2 MHz \pm 100 Hz, and peak separation of 10 KHz nominal.

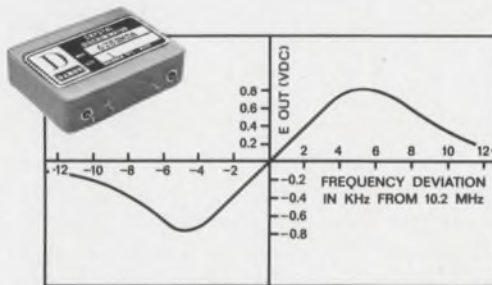

Sensitivity: 0.2 volts/KHz \pm 10%. Linearity: $<$ 5% over $f_r \pm 2$ KHz. Input: 2 volts P-P square wave. Supply: 12.5 volts at 22 ma.

Whatever your signal-shaping needs—from a narrow-band discriminator characteristic to a broad band-pass—rely on the form-factor specialists at Damon. Write: Electronics Division, Damon Engineering, Inc., 115 Fourth Avenue, Needham, Mass. 02194, or call (617) 449-0800.

 DAMON

Tests aim to tame nuclear-blast pulse

Susceptibility of military electronics to electromagnetic pulses is evaluated at new facility

Jim McDermott
East Coast Editor

A tremendous electromagnetic pulse, like that from a bolt of lightning, is produced by a nuclear explosion in addition to blast, shock and thermal radiation. This super high-intensity electromagnetic pulse (EMP) radiates in all directions, and it not only can damage unprotected military electronic equipment close by but can

disrupt systems operations hundreds of miles away.

The EMP, upon striking antennas, power lines, or long communications or control cables, can induce damaging voltages or currents, according to Don B. Clark and Homer Lassiter of the Naval Civil Engineering Laboratory at Port Hueneme, Calif. In addition, EMP can cause damage by coupling into electronic systems through equipment that is sensitive to such

fields, like the magnetic memories of computers.

The problem of EMP-proofing military electronics has long been recognized. And although much effort has been expended toward its solution, progress has been, until recently, disappointingly slow. In fact, Senator Henry M. Jackson, the atomic weapons expert on the Armed Services Committee of the U. S. Senate, stated, in a speech last fall, that EMP effects were still a serious problem. This statement came five years after expert witnesses before the Senate had assured him the problem would be solved by "overdesign"—a drastic and costly solution of designing to meet the worst possible conditions.

Because the test ban treaty prohibits us from setting off nuclear bursts above ground, the study of EMP has been tackled by analytical methods, as well as by experimentation at installations producing high-current discharges and strong EMP fields, such as at Sandia, N.M., and at the General Electric lightning laboratory in Pittsfield, Mass. However, strengths of the pulsed fields have been limited, and extrapolation to simulate a real nuclear EMP has not been generally satisfactory.

Test results stepped up

Now, a new, long-wire EMP test facility at Martin Marietta's Orlando plant has produced EMP radiation some 15 or 20 times more powerful than previous similar systems. The facility, constructed from company funds, has been in operation slightly over a year. According to Dr. Jose E. Godts, who is in charge of special programs and analytical support, results have been very promising. In fact, the installation has enabled the Martin engineers to verify experimentally, for the first time anywhere, the fundamental manner in which the EMP is coupled into long lines.

(Continued on p. 26)



Long-wire, electromagnetic pulse (EMP) test facility of Martin Marietta at Orlando, Florida. The "wire" is a 1000-foot dipole antenna with a spark gap in the center. Used to determine effect of nuclear EMP on military electronics equipment, a 20,000-ampere discharge produces a giant pulse.

(EMP, continued)

The Orlando facility was designed to provide a high-intensity pulse, simulating the nuclear EMP on a reduced scale. Because the phenomenon is by nature similar in some respects to the pulse produced by a lightning discharge, Martin simulated the EMP by discharge of high voltage across a spark-gap system coupled to pulse-shaping networks and a 1000-foot-long dipole antenna.

The antenna, which is comprised of two 500-foot arms, joined together at the center by a gas-filled spark gap, is fabricated of sections of aluminum pipe. It is supported by 44 telephone poles, each with a winch and nylon cable to raise it to an operating level 45 feet above the ground.

Design problem met

The big problem in designing the long-wire antenna, according to Dr. Godts, was due to the fact that the EMP of a nuclear blast is a single, giant, unidirectional pulse that rises and falls within a microsecond, without oscillations. But a spark gap discharging into a conventional dipole produces a damped wave-train, just as spark-gap transmitters did in the early 1900s.

To prevent this, Dr. Godts explained, rectifiers in the spark-gap power supply (see Fig. 1) are connected to permit the discharge in one direction only. But more important, the entire antenna structure is designed to appear to be a pure resistance.

To be purely resistive, each dipole of the long-wire antenna would ideally be tapered both physically and resistively. Practically, this was accomplished first, by constructing the antenna of multiple sections of aluminum pipe ranging from 12 inches in diameter at the spark gap down to 4 inches in diameter at the far ends. This provided both impedance and current matching.

Next, the pipes were connected together at regular intervals by giant-sized resistors of varying value, ranging from 5.5 ohms at the spark gap to 225 ohms at the last section (see Fig. 1). At the resistor locations, corona rings (see

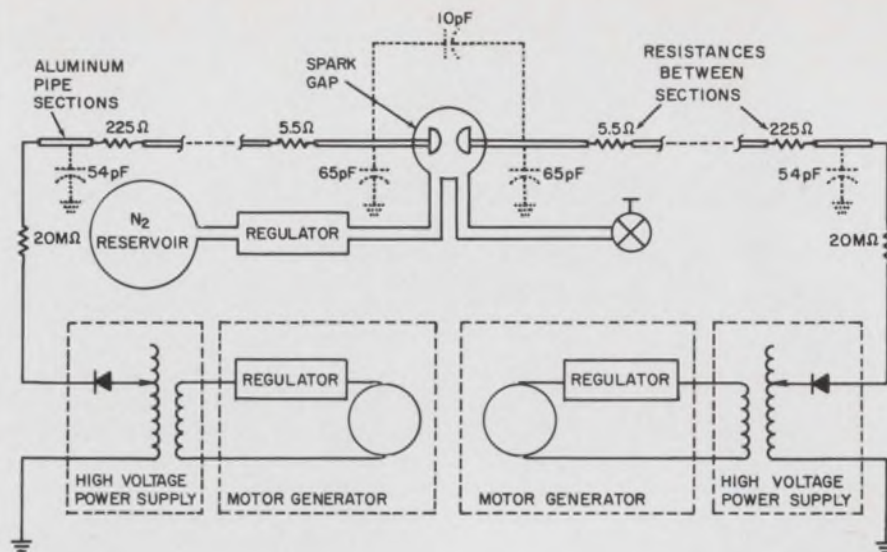

1. Electrical design of long-wire antenna and power supplies. The antenna is comprised of sections of aluminum pipe connected through large resistors. The pipe diameters vary from 12 inches at the center to 4 inches at the ends. The high-voltage supplies charge the gap and antenna capacities.

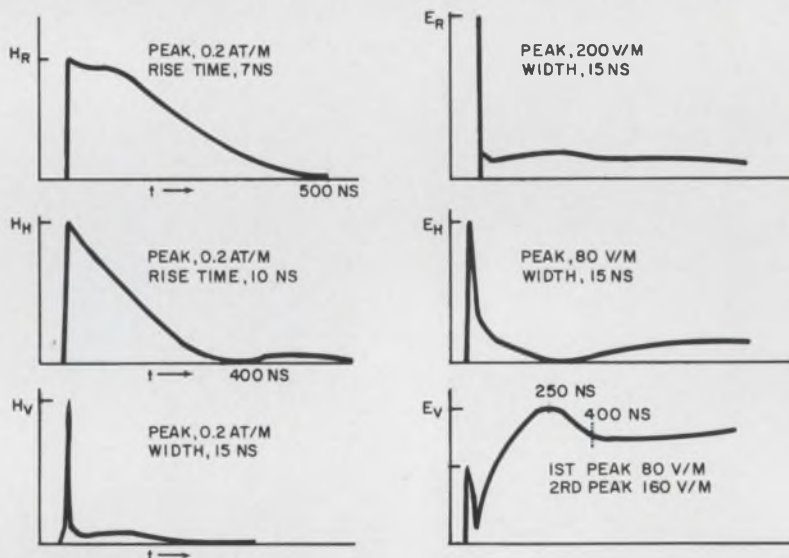

2. Magnetic and electric fields produced 300 feet from the long-wire antenna. The H_R and E_R fields occur at right angles to the antenna and above the ground plane. The H_H and E_H fields were radiated along the wire, while the H_V and E_V fields are at right angles to the antenna and the ground plane.

photo) are added to prevent unnecessary losses, particularly in the humid climate of Florida. These resistors damp the wavefront and avoid undesirable reflections during a discharge across the spark gap.

The two power supplies each deliver 250 kilovolts when charging up the capacity of the antenna and the spark gap. When the spark discharges, some 20,000 amperes of current pass across the gap. Typical strengths of the pulse fields—magnetic and electric—are shown in Fig. 2.

While the Martin installation is currently the most powerful, a new and larger facility is being constructed in Albuquerque, N. M., by the Technical Support Group of EG&G Inc., Bedford, Mass.

Constructed under the direction of the Air Force Weapons Laboratory, this facility will cost from \$5 to \$6 million. According to an Air Force spokesman it will be large enough to contain an intercontinental ballistic missile. It is expected to be completed before the end of the year. ■■

Only magicians need apply.

Dear Signetics:

I want to work all sorts of magic. With MSI. So I'm applying for your applications booklet, "Designing with MSI." The one that helps work wizardry with all these Signetics arrays: decoding/gating and steering functions, counters, shift registers, memories, adders.

So send me your magic-making ideas, time-savers, new designs. Right now. Today. Or I'll turn you into a two-inch toad.

Name _____ Company _____

Address _____

City _____ State _____ Zip _____

More complex magic from **Signetics** 

Signetics Corporation / 811 E. Arques Ave., Sunnyvale, Calif. 94086 / A subsidiary of Corning Glass Works

\$1 million for 747 Superjet electronics

Luxury aircraft carries over-the-horizon vhf radio, inertial systems and satellite communications gear

John F. Mason
Military-Aerospace Editor

When veteran pilot Capt. William W. Moss lifts the first of Pan American Airways' 33 new Boeing 747 Superjets off the runway at New York's J. F. Kennedy airport in September he will be aided by \$1 million worth of electronic equipment. In striking contrast, Jim McDermott points out in his special avionics report, p. 38, the private flier need pay out only \$10,000 for electronics that would qualify his plane for instrument flying.

Working for Capt. Moss are two inertial navigation systems that will have been sensing and recording every move the \$20-million 747 has made since it left the hangar. Besides, a third standby set will be there to switch on if one of the

other two fails. An extended-range vhf radio will be available for reliable over-the-horizon communications, reaching much farther than the old vhf did—at times up to 2400 miles.

The plane is wired and equipped with an antenna for communicating via satellite when such orbiting relay stations for commercial air carriers are put up. Until then, it will make tests with NASA's ATS research satellites.

Besides these improvements over the avionics in the 707 fleet that Pan Am now flies, the 747s have an elaborate entertainment system, new radar, and a new automatic landing system.

Navigating with gyros

Most of the electronic subsystems in the big jets are chosen

and bought by the user. But, because the navigation system is an integral part of the 747, the airframe builder selected it. It is an inertial system, the Carousel IV, developed by the AC Electronics div. of General Motors, in Milwaukee, Wis.

Pan Am bought three sets for each of its 33 planes, plus 40 spares. The bill came to \$14 million or, roughly, \$100,000 a set.

The system is comprised of a precision inertial reference unit, a digital computer, electronic and heat-control elements and a power supply. It weighs about 50 pounds and takes up less than one cubic foot of space.

The system is so accurate, Pan Am says, it does not need updating with new position information even on a long trip. On a 4000-mile flight, it was off by only two miles. AC Electronics says this accuracy was achieved by a "carousel" technique. That is, the inertial platform is slowly rotated at a con-



Pan Am's 747 Superjet (rear) dwarfs a 707 in size and in the electronics it will use. Included in the \$1-million

suite is an inertial navigator Pan Am says is five times more accurate than the 707's doppler.

**The industry's tiniest 5 watt zener...
has double
the
surge capacity
of an
ordinary
10 watt...**

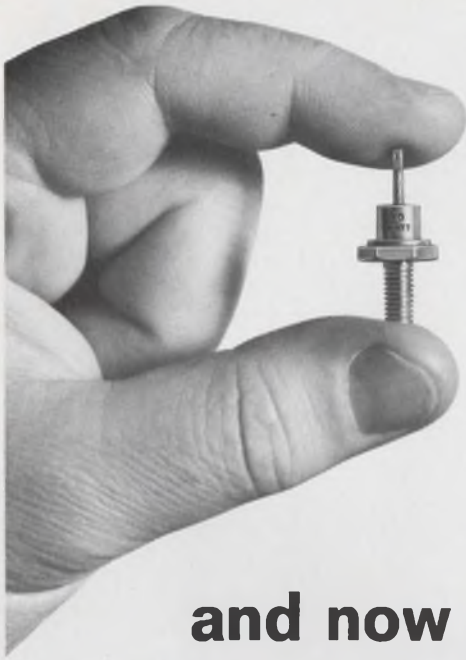

and now meets MIL-S-19500/356

**Unitrode's tough JAN Type 1N4954 Series
has fused-in-glass reliability,
voltage ratings from 6.8 to 400V,
and is available from stock**

- Surge capacities to 10,000 watts — 1 microsecond
- Surge current capability up to 40 Amps
- Sharp knees, voidless glass construction
- Price competitive to conventional 10 watt zeners
- Solves MIL-STD 704 surge problems
- No plastics, epoxies, silicones, oxides, gases or solders are used.
- ... and TX soon to come

580 Pleasant Street, Watertown, Mass. 02172 (617) 926-0404

UNITRODE

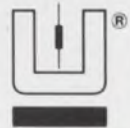

**TOUGH AS ALL GET-OUT
FROM THE INSIDE OUT**

With the silicon die metallurgically bonded between terminal pins of the same thermal coefficient, the hard glass sleeve is fused to the entire outer silicon surface. Result — a voidless, monolithic structure.



For fast action call Fred Swymer COLLECT at (617) 926-0404
Or if you're not in that big a hurry, check off the reply card
and get our new complete diode catalog C-107.

INFORMATION RETRIEVAL NUMBER 20

Try to do this with semiconductors

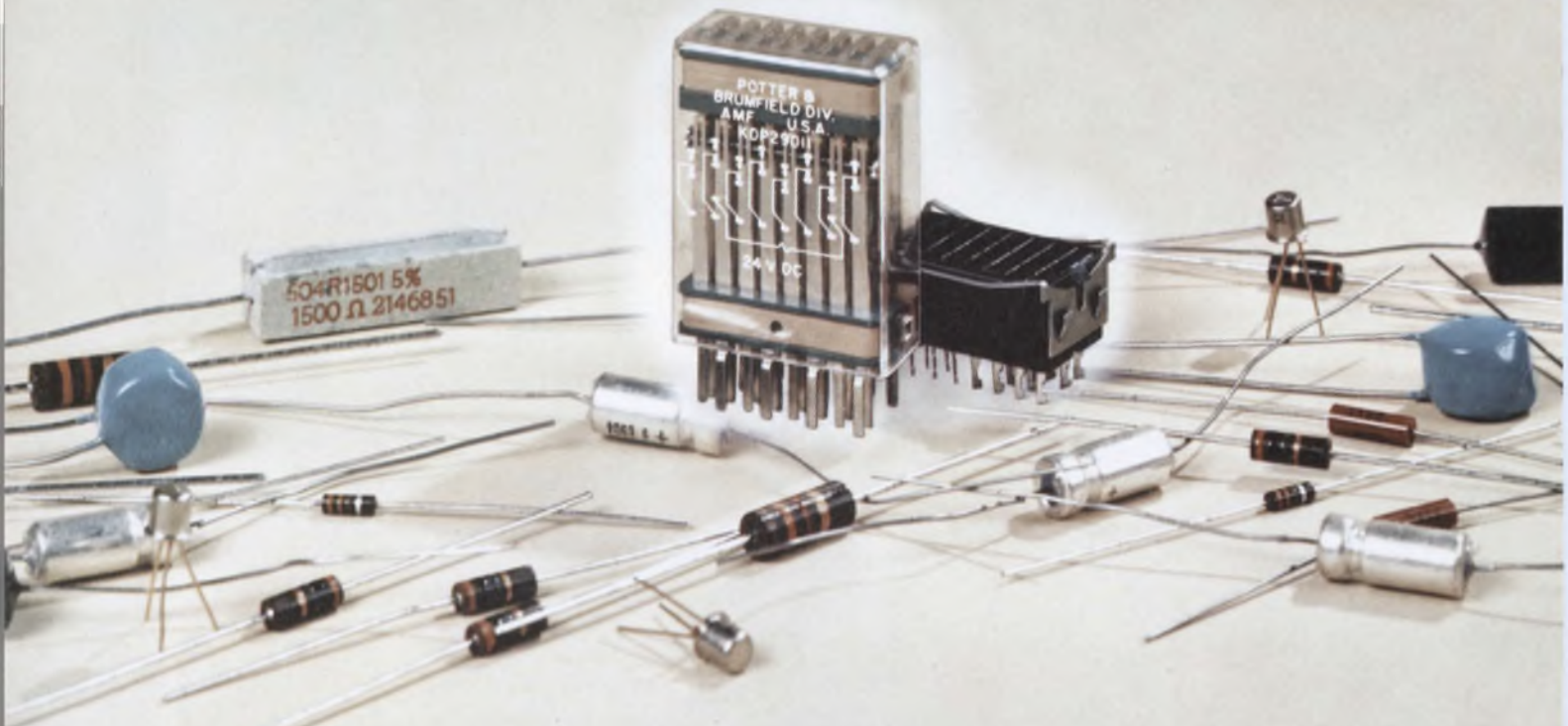

Where else can you get 8 Form C switching in a package that measures just over a cubic inch and costs less than 50¢ per pole?* You can't with semiconductors. You'd wind up with a much larger, more expensive array.

Speaking of cost, the KDP has a single lot price of \$9.35. The list price, by the way, is less than two of our most popular 4-pole relays.

The compact KDP is ideal for logic circuits where a single input will give you a fan-out of eight. Open-minded engineers will find that a strong case for this relay over solid state switching. Remember, too, you get electrical isolation on both the input and switching sides.

Bifurcated contacts are rated at 1 ampere at 30V DC or 120V AC, resistive. Standard relays have an 8 Form C contact arrangement. Combinations of Form C and Form D (make-before-break) are available on special order. Coil voltages range from 6 to 48V DC.

Order prototype models today from your local P&B representatives or call us direct. Potter & Brumfield Division of American Machine & Foundry Company, Princeton, Indiana 47570. 812-385-5251.

*Maximum discount

KDP SPECIFICATIONS

General
Temperature range -45° to +70°C.

Contacts
Arrangements: 8 Form C (8PDT).
Rating: 1 amp at 30V DC or
120V AC, resistive.

Coils
Voltages: To 48V DC
Duty: Continuous
Pick-up @ 25°C: DC, 75% of nominal
voltage.
Operate Time: 15 ms maximum at nomi-
nal voltage @ 25°C.

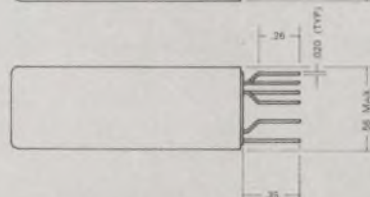
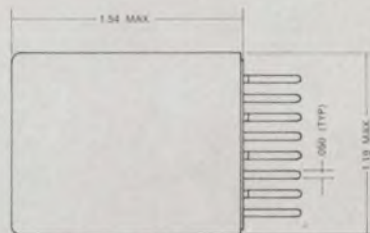

NOTES
1. DIMENSIONS APPLY TO TERMINAL
CENTERS

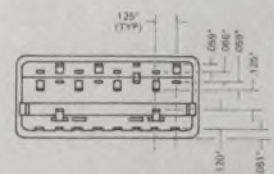

POTTER & BRUMFIELD

**LOOKING
BEYOND
THE
"SPECS"
WITH P&B**

**Save up to \$2.40
per installed relay
with this KUP Relay**



KUP relay with high impact polycarbonate dust cover

Flanged covers for direct chassis mounting are available

The KUP can save you up to \$2.40 (including socket costs) over similar relays with factory wired octal plugs. A true 10 ampere nylon socket can be supplied to receive the quick-connect terminals.

Quick-connect terminals mean faster installation on your production line . . . easier replacement in the field. Standard models have .187" terminals, but .205" may be ordered. All terminals are punched for those who prefer solder connections.

KUP relays are accepted under the U/L Component Recognition Program File No. E22575.

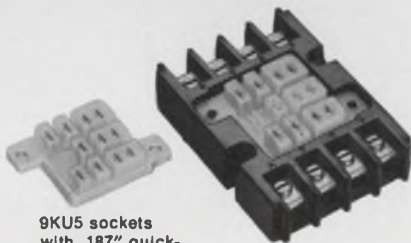

9KU5 sockets with .187" quick-connect terminals.

9KU4 screw terminal socket for KUP plain case relays. The nylon socket (accepts .187" terminals) is riveted to the bakelite frame that provides screw terminals.

**PLUS P&B Capabilities and
Facilities that insure**

- **Controlled Quality** ■ **Reliability**
- **Long Life** ■ **On Time Deliveries**

AMF

POTTER & BRUMFIELD
Division of American Machine & Foundry Co.
Princeton, Indiana 47570

INFORMATION RETRIEVAL NUMBER 21

◀ INFORMATION RETRIEVAL NUMBER 128

NEWS

(Superjet, continued)

stant rate that tends to nullify drift rates in the horizontal gyros. During preflight alignment, the rotational technique permits completely automatic inertial instrument calibration and helps improve alignment accuracy.

The information the Carousel automatically provides the pilot on his request includes distance to destination, wind velocity and direction, drift angle, ground speed and position.

When tied in with the autopilot, the system will fly the plane. On a London to Seattle nonstop flight in March, the 747 was put on autopilot five minutes after takeoff and was automatically guided to within five minutes of its destination.

Pan Am says the inertial system is five times more accurate than the doppler it now uses.

Supplements standard equipment

The inertial is accompanied by the standard carrier equipment—DME (Distance Measuring Equipment), ADF (Automatic Direction Finder), VOR/ILS (vhf omnidirectional range finder/instrument

landing system), beacon transponders and radio altimeters.

The inertial is used over water and on long flights, while the conventional aids will be used in the U.S. and Europe.

Keeping in touch

The 747 is equipped with three conventional vhf radio transceivers for air-ground communications, each using a blade antenna that sticks up from the top of the fuselage or down from the belly. The maximum range these sets can reach is limited. At a 30,000-foot altitude, the range is only 220 nautical miles; at lower altitudes it is, of course, less.

Besides having one more of these sets than the 707 has, the 747 carries a brute-force vhf radio using a power amplifier that can push the signal over the horizon. "About 90 per cent of the time," Robert R. Bohannon, Assistant to the Director of Electronic Engineering for Pam Am, told ELECTRONIC DESIGN, "we get 500 nautical miles range with the extended range vhf, and once or twice a year we have made it from the West Coast to Honolulu, about 2400 miles."

(Continued on p. 32)



Upper deck lounge of the Boeing 747 provides space for 16 passengers. The seat-operated entertainment system will also go in the 707s.

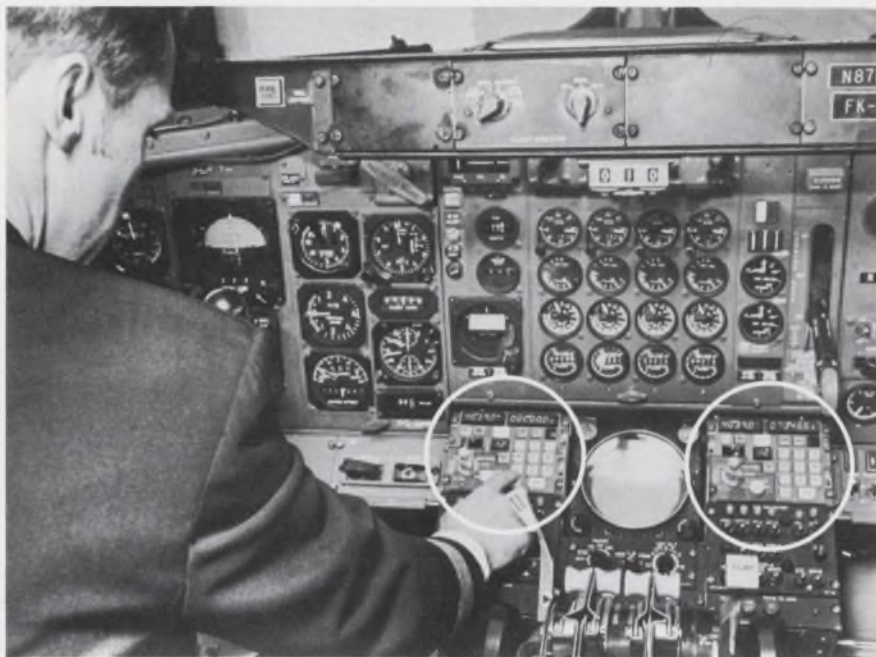

Carousel IV inertial navigation system, built by AC Electronics, is off only two miles on a 4000-mile flight, Pan Am says. The two units (a third is on hand as a spare) tell the pilot his position, distance to destination, wind velocity and direction, drift angle and ground speed.

The extended-range vhf uses the plane's facilities for satellite communications. The antenna is a slot-dipole mounted flush in the top of the fuselage where the bubble that forms the cockpit joins the straight line of the fuselage top. Power output for the extended-range vhf is from 175 to 200 watts for a-m transmission. For use with a satellite, the f-m transmission would require a 500 to 700-watt output.

Bendix Avionics div. at Fort Lauderdale, Fla., provided the vhf transceivers, amplifiers, preamplifiers and radio altimeters.

Two high-frequency radios in the 747 will use trailing probes pointed backward off the wing tip. These probes are approximately five feet long and seven inches wide at the base, tapering down to about one inch.

Both hf radios share one of the probe antennas for transmitting. One radio receives on the other probe and the second radio receives on a flush antenna built into the belly of the fuselage.

The 707 has two hf radios but only one antenna, and it is mounted at the top of the tail fin. "If the antenna malfunctions at some airport that doesn't have equipment for hoisting a man up to the top of that fin, you're out of luck," Bohannon says. Not only will the extra probe antenna improve reliability, but their location on the

wings makes them more accessible for maintenance.

Collins Radio, Cedar Rapids, Iowa, provided the h-f transceivers, the VOR/ILS receivers, the ADF receivers, the h-f and ADF panel controls, the DME unit, and the air traffic control transponders.

Additional features

Weather radar for the 747, built by the Radio Corp. of America, will have an added feature over that used in the 707. Besides looking for rough weather, the radar



Blade antennas for the conventional vhf transceiver emerge from the top of the fuselage or from the belly.

scope can serve as a closed-circuit television screen. A camera might, for example, be trained on the landing gear after take-off and before landing to see if the 16 wheels are where they ought to be.

The landing system for the 747 will permit Category II landings—50-foot ceiling and 1200-foot runway visibility. Sperry-Phoenix provides the system. Unfortunately there are only six airports in the United States that have the equipment for a plane to make a Category II landing. There are only 16 in the world that are qualified for automatic landings—100-foot ceiling and 1600-foot runway visibility.

The entertainment unit, which includes color movies and stereo recordings controlled by individual seat panels, was provided by Bell and Howell.

There is still no collision avoidance system. A Pan Am spokesman says there just isn't one promising enough to test.

Pan Am is testing two clean-air turbulence detectors but neither is scheduled for operational use in the near future. Both systems employ infrared sensors to detect turbulence. Maximum range is 60 miles. So far, the systems simply warn that turbulence is ahead; they don't pinpoint its location sufficiently to tell the pilot how to avoid it. ■■



TRIMPOT®

Single Turn
POTENTIOMETERS

... ARE SUPERB!!!

We think "superb" is just the right word when we talk about Trimpot single-turn potentiometers. They have outstanding specifications. For instance, our 8 single-turn models range in diameter from ¼" to ½"; have wirewound, cermet or carbon elements; cover the temperature range from -55 to +175°C; are available in resistance ranges from 10 ohms to 1 megohm; and have a power rating from 0.25 watt to 1.0 watt.

Technically, that says a lot for our single-turns. But there's more. There's a Bourns unit to answer every single-turn application . . . competitively priced . . . ready for immediate delivery from factory or distributor stocks.

Find out the entire single-turn story from the factory, your local stocking Bourns distributor, or field representative.



Innovations in stereo, color TV designs brighten consumer electronics show

Howard Bierman, Editor

Clever and enticing product designs highlighted the Consumer Electronics Show held in New York City a few weeks ago. Attractively styled stereos, tape decks, car tape players and color TVs by the hundreds were enthusiastically received by more than 30,000 dealers, dis-

tributors and major retail merchants who anticipate a banner year in home entertainment sales. Experts predict sales of \$5.5 billion in 1969.

Although booth staffing by technical personnel was just about non-existent, and the few engineers present were tight-

lipped about design details, the products highlighted here illustrate what's in store in the consumer market. Some of the products shown are available now (Toshiba, Kenwood) while the others are being market-tested with plans for end-of-the-year delivery. ■■

"Pop-up" TV is the surprise extra in the attaché-case FM/AM TR-425 portable by Panasonic. A self-contained rechargeable battery provides up to 500 hours of listening or viewing.



"Instant color TV service" is promised by Clairtone in its modular receiver design concept. Eight function module boards, containing a total of 80 discrete solid-state devices and 4 ICs, are easily accessible for removal and service.

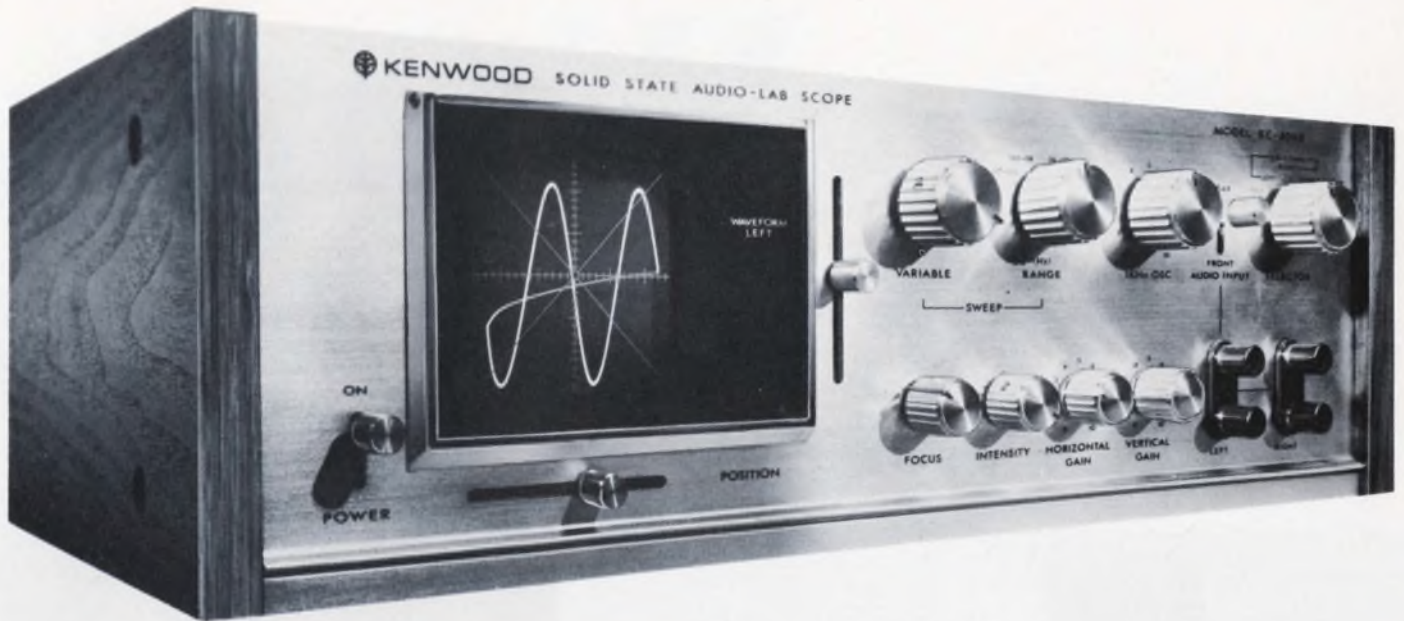

Want built-in test facilities for your stereo? Add a Kenwood KC-6060 audio/lab scope (top) or a TEAC AZ-20 to monitor antenna orientation, precise tuning and stereo separation.



Compact stereos are slimmer as illustrated by Toshiba's 550C 24-transistor AM/FM stereo package.

We make guys who can't



components for stand failures.

Picture yourself in your living room in front of the TV on a quiet Sunday afternoon. It's the bottom of the ninth and the bases are loaded. Your team trails by two runs, but your star hitter is up.

That's when your set decides to burn out. And that's when you first mutter the words that officially put you in the group of enraged guys that our components are designed to stamp out.

At Corning we make components to please guys who can't stand failures. We build an extra measure of performance into all our resistors and capacitors to help you build extra reliability into all of your systems. Like you and the guys who use your equipment, we have to admit that we can't stand failures either.

Consider our tin oxide resistors, they're the best of the metal film class. Because the resistive tin film is completely oxidized and molecularly bonded to the glass core, our tin oxide resistors are impervious to moisture and environmental degradation. No other resistor can deliver the same stability and reliability over load life. They offer guaranteed moisture resistance across all ohmic values to set a standard of

reliability that can't be matched by metal film, wire wounds, carbon comps or metal glaze resistors.

No other resistor can give the same value. Our tin oxide resistors offer long term economy over metal film, precision wire wound and metal glaze resistors. And our new C3 resistors, in addition to the benefits of small case size, compete costwise with carbon comps.

Another important Corning development for men who can't stand failures is our flame proof tin oxide resistor. Ideal for circuitry where functions, environments and duty cycles demand low power resistors with excellent frequency characteristics, our flame proof resistors can withstand overloads of up to 100 times rated power without any trace of flame. And because they open under overload, they provide protection for your other, more expensive components. For this reason, plus safety, CORNING® Flame Proof Resistors are now being widely used in Color and Monochrome TV receivers.

And consider our Glass-K™ capacitors. We developed them to give you the volumetric efficiency and economy of monolithic ceramic capacitors, but with the much

improved stability and reliability that only a glass dielectric can add. Our Glass-K™ capacitors are extremely reliable for bypass and filtering applications—the traditional capacitor failure spot.

Then consider our glass capacitors. There's only one reason why they've been designed into so many major aerospace and missile programs. Only glass capacitors could give their designers the proven stability and reliability that these important systems demand.

At Corning we make components for guys who can't stand failures. Guys like your customers. Guys like you. Next time you're designing a system, reach for your Corning capacitor and resistor catalogs and call your local Corning authorized distributor for off-the-shelf delivery. They'll help you design-in an extra measure of performance.

If you don't have our catalogs, ask your Corning distributor for copies or drop us a line at: Corning Glass Works, Electronic Products Division, Corning, New York 14830.

CORNING
E L E C T R O N I C S

Avionics for the private flier ready for takeoff

Small size and small price are the keys to success in this fast-climbing, design-challenging market

Jim McDermott
East Coast Editor

Electronics for the private plane owner appears headed for a mini-boom.

Last year alone about \$150 million was spent for avionics in the 13,211 new general-aviation aircraft produced in this country. The outlays ranged from about \$2000 a plane to over \$150,000 for large corporate jets.

Retrofitting—an increasingly growing market—accounted for at least \$50 million more in sales.

The spending is expected to climb. For general aviation (defined by the Federal Aviation Administration as all flying except that done by the airlines and military) is itself in the midst of a spectacular growth. There are 400,000 licensed general-aviation pilots and 125,000 active general-aviation planes in the country today, compared with 15,280 pilots and 9818 aircraft in 1930. And the future is all upward.

Opportunities in 2 major areas

The bulk of general-aviation avionics money is being spent for communications and navigation equipment for instrument flying. But a healthy outlay is also going for such executive goodies as on-board telephones and such supplementary pilot aids as radio altimeters, time-distance computers, cockpit recorders and other devices to lighten the pilot's workload and give him extra security.

Compactness and lightness are the keys to success in avionics design for general aviation—small, light packages that won't crowd the relatively small planes, and small, light prices that the average plane owner can afford.

Competition is keen among the principal manufacturers of general-aviation electronics: Aircraft Radio, Boonton, N. J., Bendix Avi-

onics, Fort Lauderdale, Fla.; King Radio Corp., Olathe, Kan., and Narco Avionics, Fort Washington, Pa. And the growth of private aviation in the last 10 years has supported a commensurate expansion in the avionics industry.

A good example is the King Radio Corp., founded by Edward J. King Jr. in a two-story Kansas farmhouse in the summer of 1959. King's first shipment—five 90-channel, crystal-controlled, communications/navigation (com/nav) radios, each costing \$845 and designed specifically for the private pilot—was made on Jan. 5, 1960. From that point on, gross sales have climbed steadily to over \$11 million last year.

Enter the newcomer

Avionic equipment, unlike mass-produced electronics, such as automobile radios, is still a low-volume product. Like the aircraft, it is hand-assembled and individually tested. As a result, prices are not especially low (see Fig. 1).

But this situation is tailor-made for the enterprising newcomer, who can shave costs by design and production innovations and still produce reliable equipment.

A case in point is General Aviation Electronics (Genave) in Indianapolis, founded in 1967 by William Rice, former chief engineer of Regency Electronics. In 1968, Rice entered the market with the \$695 Alpha-200, an all-solid-state unit with 100 nav 200 com channels, competing directly with the \$795 Mark III 90/100 channel nav/com set of Narco Avionics. These sets are used primarily for daytime VFR (visual flight rule) flying in noncongested areas, or as a backup for more expensive equipment. Genave claims that an independent survey shows that the Alpha-200 has reached second place in national sales less than a year

after its introduction.

Last April, Genave announced its intention to pierce the "low cost" transponder market, served by the \$1000 to \$1300 transponders of King, Bendix and Narco. Genave now produces a \$795 unit.

Asked to explain his success, Rice told ELECTRONIC DESIGN:

"We're dedicated to the philosophy that reliable avionics with good performance can be designed and produced at economical prices. We attempt this through two principal approaches: vigorous value engineering and analysis, and strict attention to design details.

"For example, in the last 10 years the state of the art in mass-produced components for consumer devices such as TV and for digital computers has progressed to the point where many of these low-cost components have unusually high reliability.

"Considerable time and effort is spent in tracking down those components with the reliability we seek. Once reliability of a particular component is established, we try to use it in as many places as we can. In some instances, it might be better than we actually need.

"Design-wise, we concentrate on performance to specification at the lowest cost. For example, in one instance, instead of buying a plated resonant cavity, we created one by stamping and forming a portion of the chassis, itself."

Innovations in demand

While some of the newcomers, like Genave, are challenging the avionics industry's navigation-and-communication-equipment giants, others in laboratories are busy innovating and turning out their own proprietary products to help the pilot who doesn't "have everything" fly from one place to another easier, safer and with greater peace of mind.

Their items include:

- Cockpit recorders to read back checklists and to copy en route

1. VHF nav/com antenna
2. Weather radar antenna
3. Transponder antenna
4. Autopilot computer
5. Stabilized compass flux sensor
6. Radar antenna tilt control
7. Transponder
8. Audio control panel
9. Weather radar indicator
10. Automatic direction finder (ADF)
11. Communications transceiver
12. Navigation receiver
13. Flight computer/controller
14. ADF loop antenna
15. VOR/localizer/glide-slope indicator
16. VOR/localizer indicator
17. Flight director/horizon indicator
18. Navigation situation display
19. ADF indicator
20. Marker beacon receiver antenna
21. Radar receive/transmit unit
22. Marker beacon receiver
23. Glide-slope antenna

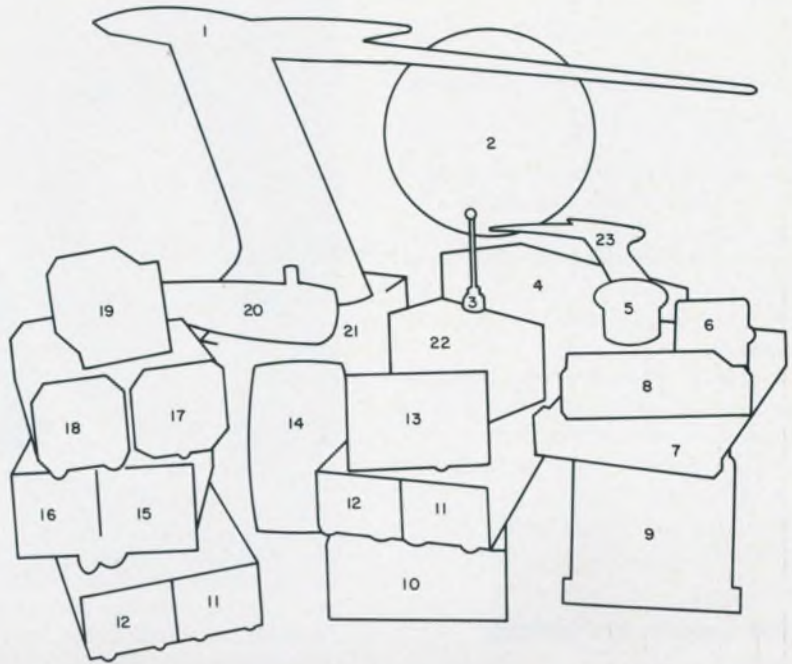

1. Avionics is low-volume, hand-crafted equipment that is not usually low-cost. For example, the collection shown here is, except for the absence of distance-measuring equipment (DME), a full complement of Bendix avionics

for a twin-engine general-aviation plane. It costs about \$30,000 and includes communications, navigation and radar. There are 23 items to help to pilot fly in instrument weather. To identify the items, see key above.

clearances or messages from surveillance radar operators or flight service stations.

- Time-and-distance computers to enable the pilot to keep reasonable track of how fast he's going, how far he's gone and how long it will be before he'll get there.

- Flashing strobe lights to warn other pilots of the aircraft's presence.

- Systems to monitor aircraft operation.

- Radio altimeters to keep pilots from running into the ground at night or in bad weather.

- Vhf homers to locate airports.

- Air-rescue beacons to get help rapidly in case of crashes in remote areas.

Improvements are needed

The potential for new avionics products is great. General-aviation pilots, once strictly fair-weather fliers, are turning increasingly to instruments for flying through clouds, rain and snow. And the basic instruments available today, are, in many cases, in need of improvements.

For example, the standard altimeter in all planes is some refined form of the old wall aneroid barometer, which one tapped before reading. But it is the only standard for maintaining terrain clearance and separation from other aircraft under instrument-flight conditions.

FAA records show that pilots sometimes accidentally set the altimeter wrong. Some have crashed into the ground during night or IFR (instrument flight rule) approaches, thinking they were hundreds of feet higher. Altimeter instrument and system malfunctions have also produced disastrous results.

Radar altimeter offered

To help prevent such accidents, Wallace Wiley, president and chief designer of Bonzer, Inc., Shawnee Mission, Kan., is producing the TRN-70, a \$1000, 1630-MHz, pulse-type, super-regenerative radar altimeter with a nominal range of 80 to 2500 feet. Except for the transmitting tube, the unit is solid-state.

Designed to sell for one-tenth the



New central avionics control panel proposed by Wilcox Electric. Mounted in the pilot's control wheel, it permits selection of navigation and communications frequencies by touch rather than by twisting some 15 knobs.

cost of competitive cw radars operating in the 4200-4400-MHz band, Wiley chose pulsed super-regeneration because of its superior signal-to-noise ratio, as contrasted with non-gated receivers. Choice of operating frequency was dictated by the substantially lower costs of the transmitter tube and cavity at 1630 MHz, as compared with 4200 MHz.

Altitude readout is on a non-linear scaled panel meter, like that of expensive competitive equipment. Wiley says that this analog readout is best for the pilot because the altitude trend is readily established by the direction and rate of the needle movement. The readout response time becomes faster with decreasing altitudes.

For an extra \$100, the system comes with an adjustable height-warning control. With this, a warning light appears when a set-in altitude is reached during descent.

The basic altimeter concept has been redesigned into two smaller items. One is a \$320 ground-proximity and landing-gear-up warning device that beeps and flashes a light as the plane descends through 300 to 400 feet above the terrain.

The second item is a small, \$200 hand-sized, fixed-distance radar package that provides a triggering signal at preset altitudes up to several hundred feet.

Wiley says he delivered close to

1000 TRN-70 units last year and expects to do one and a half times as good this year. Although the system was designed for night and IFR flight, Wiley notes that an unexpectedly high percentage of sales are to obviously fair-weather fliers. But the most novel use for the TRN-70 so far, he says, has been in the depths of a Colorado mine. In this case, the altimeter has been mounted on the bottom of an elevator in a deep shaft, to warn the operator when he is approaching the bottom.

A similar system, the \$975 GAR (ground-avoidance radar) by In-Flight Devices Corp., Columbus, Ohio, is a new entry into the field. But, for a readout, it has a digital display, in contrast with the analog-meter displays on all the other radio altimeters, including \$10,000 models.

James Ferguson, vice president of engineering at In-Flight, says his company's servo-driven counter system provides an easily readable presentation during climbs or descents. Further, since the counters actually rotate, they give the pilot a "feel" for the rate of climb or descent, he argues.

Interesting to note, Bonzer and In-Flight may be the sole producers of radio altimeters operating in the 1535-to-1660-MHz band, because the FCC proposed in May that a portion of this band be allocated exclusively to aircraft col-

lision-avoidance systems. Altimeters now using the band would be able to continue such use, under the FCC proposal, but no new assignments would be authorized. All new requests would be assigned to the present radio-altimeter band (4200 to 4400 MHz), in which the higher-priced systems now operate.

A need to cut costs

With more and more private pilots turning to instrument flying, lower costs for equipment are eagerly sought, along with small size. The minimum desirable full complement of avionics costs at least \$8000 to \$10,000 today. It includes the following equipment:

- Dual communication sets.
- Dual navigation receivers.
- LF automatic direction finder.
- Distance-measuring equipment.
- Radar transponder.
- ILS (instrument landing system) marker-beacon receiver.
- Dual ILS localizer receivers.
- ILS glide-slope receiver.

(The functions of these units are described in the table.)

A group of avionics like this occupies considerable space and weighs 60 or 70 pounds. For the smaller single-engine aircraft, with a limited load capacity, these added avionics mean that less luggage, fuel or passengers can be carried. Further, squeezing several avionics packages into limited space creates installation problems and high installation costs.

Savings in weight noted

A moderate degree of progress has been made in combining more avionics into fewer and smaller packages. But RCA's Aviation Equipment Dept. in Los Angeles recently came up with an industry eye-opener in its AVN-210 all-solid-state avionics unit. It combines a VOR/localizer receiver, VOR and localizer converters, marker beacon receiver and glide-slope receiver, all in one 3-by-3-by-10-inch case.

The AVN-210 weighs less than

four pounds, and Joseph R. Shirley, manager of the RCA Aviation Equipment Dept., says this represents a 10-to-12-pound saving over a comparable collection of separate units. A reduction of \$500 or \$600 in installation costs is also reported. And the \$4000 cost of the AVN-210 is somewhat less than the total for individual comparable units.

The packaging breakthrough was accomplished, according to John Shirley, by using the latest technologies, chief among them monolithic integrated circuits and the application of high-density packaging techniques.

Designing for reliability

Another example of good design, blending maximum avionics performance and reliability with minimum cost, is King Radio's new KX-170, an all-solid-state, 360-channel NAV/COM version due to replace the company's KX-160, the last of King's tube models.

Gary Burrell, project engineer

Air traffic control and related aircraft avionics

Air traffic control equipment	Function	Aircraft avionics	Remarks
Vhf communications	Permits pilot to talk to: FAA ground control; tower; departure, enroute, and approach control; flight service stations; and private airports	Communications transceiver	118.00 - 135.95 MHz 360 100-kHz channels
Vhf OmniRanges (VOR)	Provide highways in sky and point-to-point navigation	Navigation receiver - includes both VOR and LOC	108.0 - 117.9 MHz VOR - 80 100-kHz channels LOC - 20 100-kHz channels
Vhf ILS localizers (LOC)	Line aircraft up with runway		
Uhf ILS glide slopes	Provide glide path to touchdown	Glide slope receiver	329.3 - 335 MHz 20 300-kHz channels paired with localizer
Low frequency (LF) homing beacons (compass locators) (200 - 400 kHz)	Provide transition from enroute navigational aids to ILS system; identify holding and ILS marker beacon sites; provide final ADF approach fix to ILS	Automatic direction finder (ADF)	190 to 1750 kHz in 3 bands Receives LF beacons and AM broadcast stations
Marker beacons	Identify exact locations of LF homing beacons and ILS outer and middle markers	Marker beacon receiver	75 MHz 3 tone-energized lights 400, 1300 and 3000 Hz
VORTAC distance measuring equipment (DME)	Gives distance from interrogating aircraft to VORTAC station	DME receiver	Interrogator - 1041 to 1150 MHz Receiver - 978 to 1213 MHz 100 channels, paired with VOR and LOC channels Range - 0 to 150 nautical miles Speed - 250 knots or higher
Radar beacon system	Identifies aircraft on controller's radar scope	Transponder	Receiver - 1030 MHz Transmitter - 1090 MHz

for the KX-170, is enthusiastic about achieving an MTBF of 3000 hours, contrasted with 700 to 800 hours for the KX-160.

"The key here," he explained to ELECTRONIC DESIGN, "was a marked reduction in the number of crystals used for frequency synthesis: 65 for the KX-160 and six for the KX-170. What we've done is to redesign the synthesizer circuits, substituting phase-lock loops and digital ICs for the crystals—that is, we've traded the lower reliability of crystals for the superior reliability of integrated circuits. Reliability was enhanced, but synthesizer cost was reduced.

"We're currently using T²L ICs in the stabilized master oscillator section, along with RTL logic for other, noncritical functions. But

MECL [Motorola emitter-coupled logic] is being considered for the next-generation equipment."

Flight-control costs shrinking

A sizable portion of the avionics industry is turning out flight-control instrumentation. An excellent example of clever cost-cutting redesign to bring a \$25,000 flight-control system to the general-aviation market is the director/

horizon indicator of the Bendix FDS-840 Flight Director System.

The system, comprised of the director/horizon indicator and a flight-director computer, is essentially an autopilot in which the pilot closes the loop—that is, the various flight commands, such as climb, descend or track a VOR, localizer or glide slope, are inserted by the pilot into the computer. The computer then produces signals that move the director/horizon dis-

A unique flight director by Kaiser Electronics shows a "highway in the sky" on a Sony TV tube. Flight commands inserted in the director control produce a computer-generated highway that moves in the direction—up, down, left or right—that the pilot should fly.



Navigation situation display (above) by Wilcox Electric is typical of trend toward combining data from several instruments into one to ease the pilot's workload. This display tells where the plane is headed and where the navigation stations are, and how the craft is lined up with the ILS localizer and glide path for an instrument landing.

New flight director (at left) for general aviation, by Bendix, is a front-runner in both cost and performance. A redesign of a \$25,000 system, this model has all of the operating features of the expensive equipment at one-fifth the cost.

play elements, which in turn tell him how to maneuver the aircraft to satisfy that command.

The junior-size approach

A prime objective of the Bendix general-aviation flight-control design group, headed by Carl C. Bath, chief engineer, was to duplicate the performance and display effectiveness of costly Bendix airline flight directors, which have complicated servos operating within servos to display the plane's attitude, the controller commands and the pilot's response.

"We knew we had to eliminate the servos, to effectively reduce the price," Bath told *ELECTRONIC DESIGN*. "And at first, this was apparently impossible."

But the servos were finally eliminated, and command and response bars were mounted on the ends of pointers driven by high-quality, vibration-proof meter movements. Other system improvements were made as well. The price of the system was finally reduced to about \$5000—one-fifth that of the air-transport model. And performance is highly satisfactory.

Flight directors for general aviation are a recent development, and one of the most remarkable is the video Flite-Path—a simplified version of a "highway in the sky" video display that Kaiser Aerospace and Electronics, Palo Alto, Calif., has been producing for Navy aircraft since 1963. The principal system elements are two: a display and a computer module, which together weigh about 15 pounds. The display, which appears on a 3-by-5-inch Sony TV tube, is a computer-generated picture of a sky highway that moves up, down, right or left, directing the pilot which way to maneuver the plane, to track the desired course and altitude.

The "ground" moves realistically beneath the sky highway. VOR stations appear on the screen as small white squares that travel toward the pilot, then pass underneath as the plane flies over them.

The net effect, described by those who have flown the system, is that even "in the soup," the pilot feels as if he were flying VFR on a clear day, with unlimited visibility, following a main highway.

The price is still somewhat high for the smaller planes—\$9700. But the presently available systems are comprised of discrete, solid-state components. The use of ICs can obviously reduce the cost, size and weight substantially.

A trend toward concentrating more navigation information in one panel display is demonstrated by the new Wilcox Electric "horizontal situation indicator," a multi-element navigation display

to be marketed later this year. It provides simultaneous presentation of four situations: the plane's magnetic heading and its physical relationship to a selected VOR radial, to the ILS localizer path and to the ILS glide slope.

Competitive instruments, according to Gul Asnani, project engineer at Wilcox's plant in Kansas City, Mo., have a remote-mounted, slaved directional gyro, fully as large as the panel-mounted unit.



A popular general-aviation plane, the Mooney, in flight over Midland, Tex.

But in the Wilcox unit, gyro and slaving electronics are inside the panel-mounted display.

Antennas, antennas everywhere

Whether a plane's avionics is packaged in a few small boxes or several large ones, the number of antennas needed to transmit and receive the communications and navigation signals presents a formidable installation program (see Fig. 2). Structural reinforcements are needed and considerable drag is added to higher-speed planes.

To reduce the number of antennas on the aircraft, combination navigation-communications antennas, fabricated within a single "ram's horn" structure, are available. At a cost of about \$250, these antennas usually supply one communications and two navigation receivers from the one antenna.

Ordinarily, the 3-dB reduction in signal strength caused by sharing the antenna output, is not noticeable. But under marginal conditions, the useful VOR range can be substantially decreased.

Another drawback of the one-antenna-for-all concept is that the added reliability of separate antennas is lost. Despite this, the demand for the combination antenna continues, primarily because of substantially lower costs.

The combined-antenna principle has been extended by Lapa 300, Inc., Miami, Fla., to provide five outputs from its new Deerhorn antenna, which has a vertical streamlined communications mast supporting one large VOR/localizer and one small glide-slope antenna. Connectors are provided for one communications transceiver, two navigation receivers and two glide-slope receivers.

In early Lapa designs, decoupling the communications, navigation and glide-slope antennas was a real headache. But Henry B. Graves, Lapa antenna engineer, told ELECTRONIC DESIGN that present models have better than 50 to 60 dB isolation. This performance has been obtained by careful configuration and interconnection of the coupling networks, as well as by use of a proprietary dielectric for mounting and encapsulating the network assemblies.

The obvious solution to antenna drag is to use flush-mounted units. But, according to William J. Heritage, sales manager of the commercial division at Dorne & Margolin, Inc., Bohemia, N. Y., these antennas have been primarily developed for military and aerospace applications, and their cost can run to one-third that of the associated avionics. Consequently the general-aviation market prefers the limitations of the substantially lower-

cost versions.

A new trend has appeared in the industry, Heritage says. Historically, he notes, avionics equipment and antennas have been designed and manufactured independently, and the two have worked reasonably well together; communications antenna mismatching and undesirable navigational antenna effects have been within the operating tolerance of the present air-traffic system.

But with the increased navigational accuracy that will be demanded in future high-density traffic systems, avionics manufacturers are beginning to look at the design and choice of antennas as a system problem, requiring close coordination between avionics and antenna designers.

The strongest push in this direction is being exerted by a 20-year-old development—area navigation—now enjoying a resurgence of interest, this time on the part of the FAA. This system involves the use of an on-board, course-line computer, which takes the standard VOR/DME (or VORTAC) bearing and distance information, and gives the pilot the capability of electronically moving the station to just about any location he wants within the strong-signal-area coverage of the VOR/DME station.

Thus, instead of being confined to the airways, the pilot can provide himself with a "phantom" VOR station over some remote airport, and fly to it in the conventional manner by keeping a needle centered. Or he can simply displace a station to the right or left of an airway and fly parallel to it.

The implications of this system—the first major vhf navigational innovation since VOR/DME—are almost boundless. It offers a way to relieve growing congestion on some airways in instrument-flying weather, and the remedy can be implemented rapidly, because the equipment cost is borne by the users rather than by the FAA or other governmental agency.

One company, the Butler National Corp. of Mission, Kans., has spent over a decade, according to Robert Zimmerman, its director of marketing, developing a course-line computer aimed at the general-aviation market. Butler's \$15,000

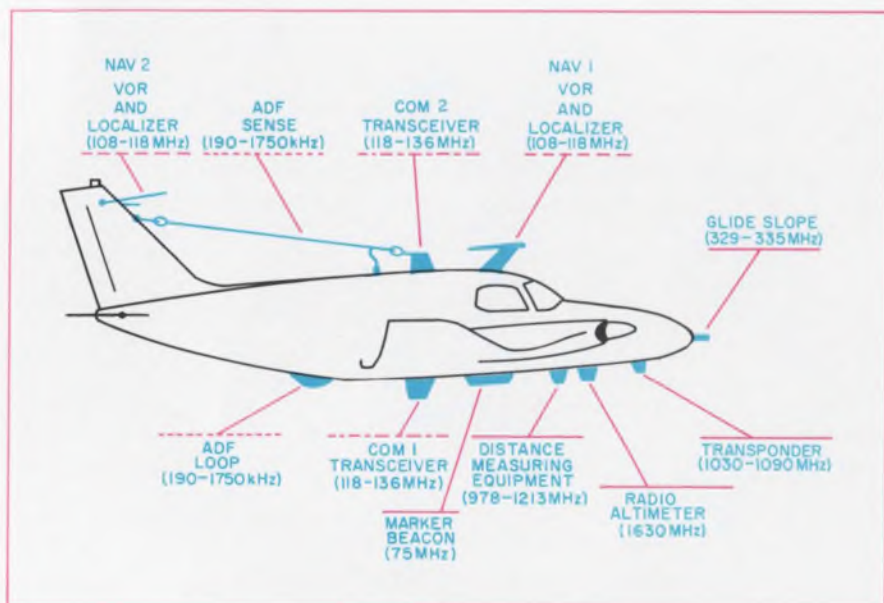

2. No master antenna installation has yet been devised for general aviation to reduce the host of antennas required for a full complement of on-board avionics. Installation costs, as well as air drag, are increased.

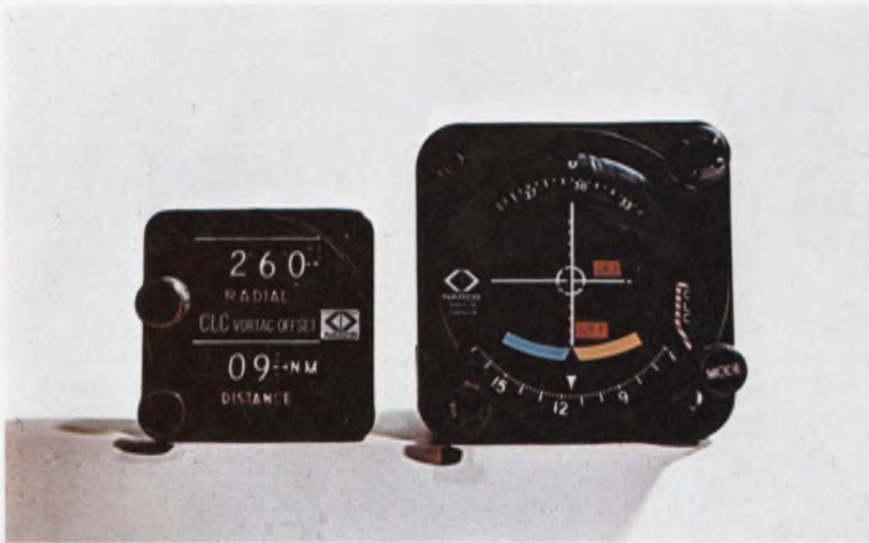

Control head and course indicator for Narco's new course-line computer for area navigation. This is the first low-cost general aviation unit.



A more complex control panel and rectilinear indicator is featured in Butler National's Vector Analog Computer for the company's area-navigation system.

VAC (vector analog computer) system has been flown for some time now and has been operationally tested by American Airlines on the New York-to-Chicago run.

Narco Avionics, also recognizing the potential of such a system, began work a few years ago on its \$2855 Free Flight course-line computer. Production began last May.

Wilcox Electric is also developing a course-line system. Monte R. Mitchell, manager of commercial marketing, says it will be integrated with Wilcox's navigation receiver rather than take inputs from other onboard VOR equipment. The price, Monte says, will be competitive.

During test runs of developmental course-line computers by Butler, Narco, Wilcox and others, a universal experience has been that, under some circumstances,

the geometry involved in course-line computer calculations amplifies normally tolerable instabilities of the VOR signal to the point where they become excessive for area navigation—that is, the VOR indicator needle, which the pilot keeps centered to remain on course, fluctuates rather wildly at times. If the VOR output is connected to an autopilot, the plane attempts to follow the fluctuations, resulting in dangerous maneuvers.

The basic VOR course perturbations are due to course bending, or "scaloping," because of propagation characteristics that are produced by reflections of the signal from surrounding terrain or buildings, or sometimes from clouds.

Inherent nonlinearities in the receiver and detector also contribute to the effect, as does poor antenna discrimination against

vertically polarized reflections.

The solution in the Butler National system, Hobbs reports, is use of a continuously adjustable filter in the computer. This prevents a change of VOR bearing more rapid than the plane can fly.

Wilcox Electric minimizes the problem by integrating its course line computer with the VOR receiver and using a new type of VOR multiplier detector.

Narco uses pilot-selectable, variable VOR output damping.

One source of VOR signal fluctuation has been found in the standard, horizontal-V antenna. Although intended to receive only the horizontally polarized radiation of the VOR station, it has proved to be undesirably susceptible to vertically polarized components of the reflected signals.

The solution has been the balanced loop, or "towel bar," type of antenna. It has proved to have the best discrimination against vertical polarization, and both Butler National and Narco specify it as part of their system.

Maintenance: A coming crisis

Of the many factors influencing design in the avionics industry, one of the most powerful in the future market will be maintenance. Equipment must be designed so it can be maintained with a minimum of skills. Statistics from the Aircraft Electronics Association, the national avionics maintenance society, show that while the use of equipment is increasing rapidly, the supply of skilled technicians is decreasing.

Gil Quinby, vice president of Narco Avionics puts the challenge to avionics manufacturers this way:

"Technician availability and technician skills for the installation and repair of general avionics are in very short supply. It is one of the leading problems of the industry—and certainly a problem in which many designers will be actively designing the technician's skill out of their product, to the point that you'll plug a set or a module into a test jig. If a light flashes green, put it back in the plane. If the light flashes red, throw the module away and get another." ■■

TAKE IT FROM BEETLE BAILEY:



FOR PANEL METERS, COUNT ON GENERAL ELECTRIC'S SALES AND SERVICE ARMY!

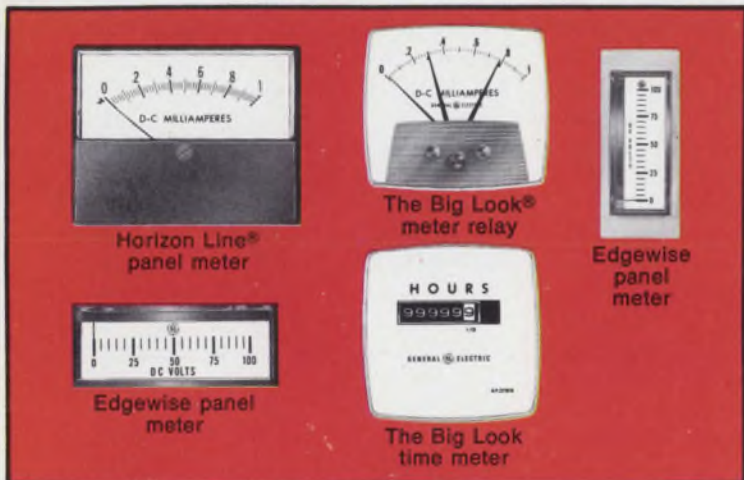
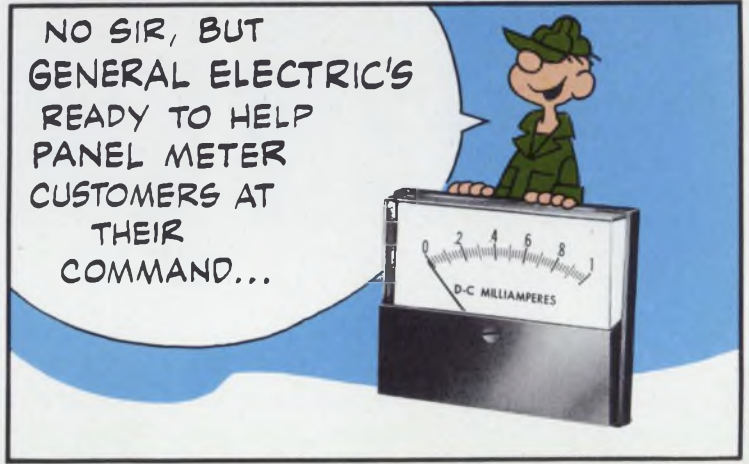
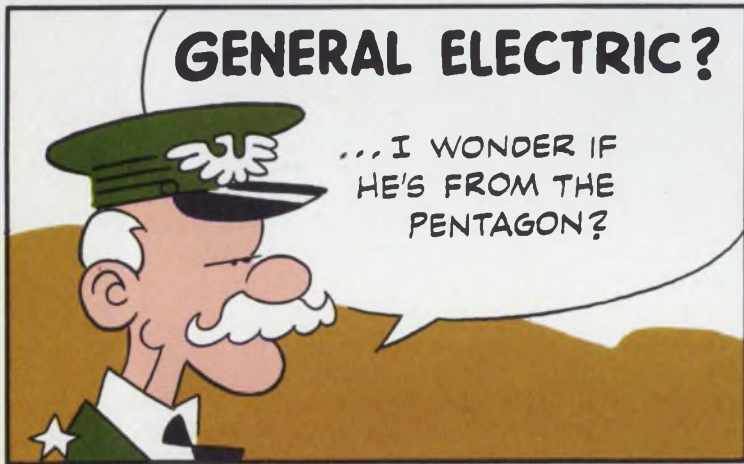
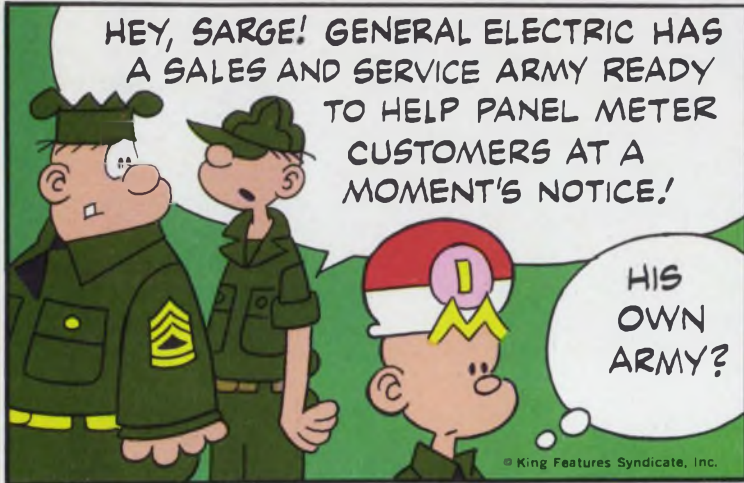

... just give the order. General Electric's Sales and Service Army is prepared to combat any panel meter problem with an arsenal of powerful, up-to-date weapons—a full line of quality panel meters and meter relays, expert application assistance, fast service across the country, and on-time delivery from a nationwide network of sales offices and distributors.

Why fight it? Surrender all your panel meter problems to General Electric's Sales and Service Army. Contact your GE Electronic Components Sales Office or your dependable General Electric panel meter distributor. 592-34

GENERAL  ELECTRIC



FAA seeks safety recommendations

The Federal Aviation Administration has requested each of its U.S. regional centers to prepare recommendations for new high- and low-altitude corridors between major air terminals for future use by aircraft equipped with area navigational systems now being tested by various airlines. The FAA had already requested comments to be submitted by July 11, from potential users of these lanes—mainly commercial air lines.

The intention is to relieve the present high congestion along VOR (vhf omnidirectional radio) routes through the gradual introduction of what the FAA terms any "technique or device that will insure compatibility with the operational procedures and route widths prescribed." Such equipment, now referred to as R-Nav, includes any of a group of navigational systems, Narco Avionics' course-line computer and Litton or AC Electronics' inertial guidance and navigation systems.

To meet R-Nav safety requirements, FAA has specified that positional error for any user must be no more than 4 nautical miles when the aircraft is 51 n. miles from a VOR-Tacan transmitting station; 2 n. miles at 25 n. miles range; or 0.85 mile when at 10 n. miles distance. FAA air traffic control centers will protect R-Nav routes with four nautical mile-wide zones laterally at either side of the corridor center lines out to 51 nautical miles from each station. Beyond this distance, pilots must hold their courses to ± 4.5 degrees of the route center line.

New Vietnam defense plan proposed

A new defense strategy proposed to promote early withdrawal of U. S. forces from Vietnam would include the construction of two deep canals, with banks up to 150 feet high, topped with chain link fencing and protected with fields of barbed wire, mines and electronic sensing devices.

Washington Report

CHARLES D. LAFOND
WASHINGTON BUREAU

The plan, proposed by the Hudson Institute, a non-profit organization of professionals specializing primarily in strategic military analyses for the Pentagon—involves early withdrawal, during the next two years, of over a quarter of a million men. Half of the remaining combat troops would be redispersed along the coast as a strategic reserve force—the proposed canals, heavily fortified and broadly salted with electronic sensors, would be formidable physical barriers to attack.

One of the two defense canals would extend along the Cambodian border from the Gulf of Siam westward to a point near Saigon. It would then move eastward to connect with the second canal built around the outer perimeter of Saigon.

Top military planners at the Pentagon and selected Nixon Administration officials reportedly have had a series of briefings on the proposed strategy, designed to lessen U. S. participation in the Vietnamese conflict. The Hudson Institute is located at Croton-on-Hudson in Westchester County, N. Y.

RCA is top bidder for Alaskan network

For a high bid of \$28.4 million, RCA Global Communications, Inc., will purchase the commercial portion of the Alaska Communications System. In a race that some insiders report was not even close, RCA was selected by the Air Force as leader in all three critical requirements for the bids: purchase price, planned capital investment in the system and rate reductions to subscribers.

In late 1967 Congress authorized the Dept. of Defense to dispose of the non-military portion of the Alaskan system. Authorization to seek bids was given late in the summer of 1968, and requests for quotations were sent out last October. In addition to RCA, responses were obtained from General Telephone & Electronics Corp., New York City; Continental Telephone

Washington Report

CONTINUED

Corp., St. Louis; and Universal Telephone, Inc., Milwaukee.

RCA President, Robert W. Sarnoff, says the system will be operated under a new subsidiary to be called RCA Alaska Communications, Inc. The firm has guaranteed to invest nearly \$27.7 million in network improvements. Service will begin in the Anchorage area by 1970 and will be extended throughout the state by mid-1971, RCA officials assert.

Sarnoff says intrastate and interstate phone rates will be reduced by an average of over 29 per cent. He also is reported to have estimated that RCA will gross between \$40 and \$60 million during the first year of full operation.

Major changes to be made by RCA include new telephone service to 124 outlying towns (these now employ only radio for outside contact); a wideband microwave system to connect major cities with a planned Communications Satellite Corp. earth station to be built near Talkeetna, Alaska; and the introduction of direct long-distance dialing.

Satellite questions—sea buoy answers

The recent interrogation and tracking of an instrumental buoy in the Atlantic Ocean by a satellite is believed to be the first successful attempt of its kind. The satellite was one of NASA's Applications Technology Satellites (ATS-3), and the free-drifting buoy carried Omega Position Location Equipment (OPLE). The test was performed by the Environmental Science Services Administration of the Dept. of Commerce and the Space Agency.

The buoy was placed in the Gulf Stream about 15 miles off the east coast of Miami. It was allowed to drift freely for 24 hours and was recovered about 18 miles off West Palm Beach, having traveled a total distance of 66 nautical miles. To insure that primary buoy movement was caused by ocean current and not surface action, the device was fitted with a drogue chute suspended at a depth of 90 feet.

In response to each satellite query, the OPLE system automatically transmitted position

data, which was then telemetered from the satellite to Goddard Space Flight Center at Greenbelt, Md., for processing. ESSA officials optimistically predict that by means of such space observations ocean currents can now be accurately traced. They also predict that, through the use of other sensors, a variety of oceanographic and atmospheric data can be acquired from remote regions of the world.

Radiation-hazard studies stepped up

Last month alone three groups moved to study the effects of radiation and to take steps to remedy the hazards involved. First the Dept. of Health, Education and Welfare announced it was planning to establish a performance standard for the control of color television X-ray emissions. The next day the Laser Subdivision of the Electronic Industries Association developed a plan, during its 45th Annual Convention in Chicago, to promote the safer use of lasers in industry. And three days later the Bureau of Radiological Health, a part of HEW, announced plans for a scientific symposium on the biological effects of microwave radiation to be held in Richmond, Va., September 17-19.

The Technical Electronic Product Radiation Safety Standards Committee met last month in a two-day conference to discuss HEW's proposed new TV X-ray standard. A chief point of concern is whether or not the present safety limit for X-ray exposure of 0.5 milliroentgen per hour should be further reduced. The real question seems to be whether or not radiation of this type is additive and whether there is, in fact, any tolerable level that exceeds that of normal background radiation.

The EIA plan to promote laser safety seeks to define the magnitudes of laser radiation considered acceptable for exposure to both human eyes and skin.

Management guide offered to industry

Electronic companies seeking new non-defense markets will be able this month to consult a management guide being prepared by the Electronics Industries Association. The book will be divided into chapters covering space, marine sciences, law enforcement, civil rights, housing, poverty, pollution, education, balance of payments, health and internal security.

Count On New 5 to 60 A, Annular Silicon Power For Hi-Rel Designs — Right From The Start!

If you demand above-and-beyond silicon power transistor specs, performance and consistent capability to shrug off temperature excursions from the new-design word go . . . your answer is Annular* silicon power. Here are 3 new series featuring ultra-low leakage and hard solder construction techniques — an unbeatable combination which means inherent state-of-the-art, device and design high reliability, right from the start!

ONE . . . new, 60,000 current-gain, Darlington series! The MJ3801-3802 units . . . a truly unique, state-of-the-art "family first" . . . furnish ultra-high gain with 50MHz frequency capability — ideal for space-limited applications as switching regulators where only one package is desirable.

These prime-quality devices have excellent SOA carrying 4 A at 10 V . . . and feature an added commutating diode to protect against reverse, inductive voltage transients. Switching times of this 3-leaded, TO-66 come in nanoseconds!

TWO . . . new 30 and 60 A, NPN, stud families! Big, brawny versions of the broadest TO-3 line available, the MJ7000 and MJ7200/7201 types provide high-gain efficiency in rugged power amplifier and switching designs. High usable gain range of 20 to 100 at 10 A, 4 V, plus low 1.0 V "sat" voltage make these 7/8" and 1-1/16" stud types right for the most rugged industrial/military applications.

THREE . . . new 60 and 80 V, medium power families for high-reliability switching and wide-band amplifying! You have a choice of two, 7 A types in common collector, 7/16" stud designs . . . two 7/16" stud Isolector* packages for non-grounded, "floating" systems . . . or a high-wattage, 5A, TO-39 unit providing 800 mA at 80 V V_{CE0} SOA for space-critical designs. All have DC current gain spec'd at 3 points to 5 A and only 100 uA leakage. Switching performance? A sparkling 200 ns (max) delay/rise time and 150 ns fall time!

Write for just-published data sheets on these high-reliability types now!

Type	Hi-Rel Application	$I_{C(cont.)}$ Amps	V_{CE0} (sat) Volts	h_{FE} @ I_C	$V_{CE(sat)}$ @ $I_{C(max)}$ Volts	Leakage Current (max)
MJ3801 MJ3802	Darlington Amplifiers	10	80	60,000 @ 6 A	1.5 @ 6 A	10 μ A @ 80 V
MJ7000	Power Amplifiers & Switches	30	100	20-100 @ 10 A	1.0 @ 10 A	5 μ A
MJ7200 MJ7201		60 60	80 100	20-100 @ 20 A	1.0 @ 20 A	1 mA
MJ500 MJ501	Stud & TO-39 Switches & Wide-Band Amplifiers	7	60 80	25-180 @ 2 A	0.7 @ 2 A	100 μ A
MJ6700 MJ6701		7	60 80			
MJ8100 MJ8101		5	60 80			

*Trademark Motorola, Inc.

MOTOROLA

Silicon Power Transistors

Motorola Semiconductor Products Inc. / P.O. Box 20912 / Phoenix, Arizona 85036



INFORMATION RETRIEVAL NUMBER 25



Great little performers: 1.5 mW min. @ 100 mA. And all the power they need is .15 W.

Fast, too. Switching time is light-quick—typically 1 nanosecond.

Long life and reliability are assured by our with-it planar solid-state technology.

Put those features together with their instant availability and you've got a good reason to call Schweber, Kierulff, K-Tronics or Semiconductor Specialists.

Get all the details about our four varieties of IR LED's by writing to us at 10131 Bubb Road, Cupertino, California 95014.

Monsanto

INFORMATION RETRIEVAL NUMBER 26

Letters

[Ordinarily, *ELECTRONIC DESIGN* does not publish anonymous letters. In the interest of learning just how representative the opinions expressed above are, we break our rule. We invite comment—but signed, please. We will, of course, withhold names upon request.—Ed.]

'I flatly refuse to work for my dog'

Sir:

Your editorial "Who does a man really work for . . .?" in the Dec. 19, 1968, issue of *ELECTRONIC DESIGN* made me sick!

The subject matter was brought up at a recent social gathering, attended by myself and eleven other local engineers. Four other guests had read your editorial and experienced the same reaction. This precipitated a lively discussion.

During this time, these thought-provoking items came out into the open:

1. The perpetual Big Lie that engineers don't care about money but are primarily looking for lots of "challenges" must desist at once! Articles like your editorial are partially responsible for our present catastrophic economic situation.

2. Engineers are not a bunch of eggheads existing only for their work, while neglecting their family life and recreation. This, again, is an outgrowth of the Big Lie; in most European and Latin countries, engineers work shorter hours, receive up to three months' vacation, and retire at a much earlier time. Their social standing is also considerably higher.

3. Engineers' problems are real and many; in this country, effective representation is essential and long overdue. Salaries, retirement, and sane working hours are of prime importance.

Life is quite complicated and demanding already; we are not looking for more "challenges" or

more work. What we are looking for is interesting work, but at a reasonable pace. We envy our foreign colleagues and their long vacations.

A "good man" who spends endless hours at the plant is no longer a man; he is a machine, a robot—an industrial tool. His only reward is an early grave.

Oh, sure, by putting in a 50-hour week, year after year, he "gets ahead." He has a nice house, a nice wife, nice kids, a dog, wall-to-wall carpet, two cars and a boat. But he does not live there; he only goes there to sleep. His wife is neglected, his kids are neglected, and he seldom has time to enjoy his boat. So what does he really accomplish? Why, he makes a hell of a nice home for his dog!

You ask: "Who does a man really work for?" Well, sir, I flatly refuse to work for my dog.

Baltimore Engineer

Two readers come up with an easier way

Sir:

With reference to the article, "Simplify Your Loss Calculations," that appeared in the April 12, 1969 issue (ED 8, p. 94), I wish to offer an alternative method that I believe is simpler.

Since most slide rules have an inverted C or D scale (CI or DI) simply set the cursor hair line to the numerical power ratio on the CI (or DI) scale, and read the mantissa directly on the log scale. The inverted scales provide the reciprocal of the number directly, so no conversion of the log scale is required.

On some slide rules the log scale may not be on the same side of the slide rule as the CI or DI scale. In this case, the hair lines on both sides of the cursor should be precisely aligned to each other, so that the cursor setting is accurately carried from one side to the other. On other slide rules, the log scale

The Fine Art of ONEUPMANSHIP



ONEUP

4PDT Miniature 3 Ampere Industrial Relay—Type 156

All features of competitive models, *plus* U/L recognition through 240 VAC instead of a mere 125 VAC.



ONEUP

General Purpose 1,2&3PDT Industrial Relay—Type 157

All features of competitive models, with U/L recognition through 240 VAC, potential recognition through 600 VAC. Superior electrical performance.



ONEUP

Magnetic Latching, General Purpose, 1,2&3PDT Industrial Relay—Type 157

Same electrical parameters as standard Type 157. Modern approach to magnetic latching does not employ hard permanent magnets.



ONEUP

1&2PDT Coaxial Crystal Can Relay—Type 153

Only Coaxial Crystal Can Relay that will switch above 500 MHz with VSWRs below 1.2. Now improved to switch 2000 MHz with low VSWRs.

Who's ONEUP? MIDTEX/AEMCO . . . and *YOU*, when you get in touch with the MIDTEX/AEMCO distributor in your area. CALL ONE UP!

MIDTEX  **AEMCO DIVISION**
INCORPORATED

10 STATE STREET
MANKATO, MINNESOTA
56001

PROGRAMMERS/TIME DELAY RELAYS/MINIATURE COAXIAL RELAYS/INDUSTRIAL RELAYS/MERCURY-WETTED CONTACT RELAYS

INFORMATION RETRIEVAL NUMBER 27



Slot supplies have you in a rut? GET OUT OF IT!

Replace obsolete, narrow-range slot supplies with POWER/MATE CORP.'s UniPower Series. These nine all-purpose, wide voltage range power supplies can replace thousands of narrow-range slot supplies and give you these big advantages: current output up to 34 amps • adjustable to any range from 0-34 volts • regulation to 0.005% • ripple a low 250 microvolts. The wide voltage range of the UniPower Series simplifies your power supply requirements because you can stock fewer units. In addition, these modules can be mounted in standard size racks or on any of three surfaces and in any position!



Uni-30F

The UniPower Series of Nine

- Uni-76 — 0-34 volts, 0.5 amps — \$76.00
- Uni-88 — 0-34 volts, 1.5 amps — \$99.00
- Uni-30C — 0-30 volts, up to 5 amps — \$134.00
- Uni-30D — 0-30 volts, up to 8 amps — \$151.00
- Uni-30E — 0-30 volts, up to 12 amps — \$174.00
- Uni-30F — 0-30 volts, up to 18 amps — \$205.00
- Uni-30G — 0-30 volts, up to 24 amps — \$265.00
- Uni-30H — 0-30 volts, up to 34 amps — \$315.00
- UniTwin-164 — dual output 0-25 volts, 0.75 amps — \$164.00

MODEL	CURRENT vs. VOLTAGE OUTPUT													
	0-6V	8	10	12	14	15	16	18	20	22	24	26	28	30
Uni-76	0.05 amp throughout range													
Uni-88	1.5 amps throughout range													
Uni-30C	5.0	4.6	4.4	4.2	4.1	4.0	3.8	3.6	3.4	3.2	3.0	2.8	2.6	2.5
Uni-30D	8.0	7.6	7.3	6.9	6.6	6.4	6.2	6.0	5.7	5.3	5.0	4.7	4.4	4.0
Uni-30E	12.0	11.2	10.8	10.3	9.8	9.5	9.2	8.8	8.3	7.9	7.4	6.9	6.4	6.0
Uni-30F	18.0	16.9	16.2	15.5	14.8	14.4	14.0	13.3	12.6	11.9	11.2	10.5	9.8	9.0
Uni-30G	24.0	22.5	21.6	20.6	19.6	19.1	18.6	17.7	16.7	15.8	14.8	13.8	12.9	12.0
Uni-30H	34.0	31.9	30.5	29.2	27.8	27.1	26.4	25.0	23.7	22.4	21.0	19.7	18.3	17.0

SPECIFICATIONS: Regulation — up to $\pm 0.005\%$ or 1 MV for line and load; Ripple — Less than 250 microvolts; Response Time — Less than 20 microseconds; Overload and Short Circuit Protection — Solid state. Instantaneous recovery, and automatic reset. Cannot be damaged by prolonged short circuit or overload. Internal or External Adjustable OVP Available.

FREE: Send for complete catalog. Write to:



POWER/MATE CORPORATION

514 S. RIVER ST., HACKENSACK, NEW JERSEY 07601
PHONE: (201) 343-6294 TWX: (710) 990-5023

INFORMATION RETRIEVAL NUMBER 28

LETTERS

may be on the slide, and the CI or DI scale on the fixed part of the slide rule on the reverse side. In this case, remove the slide, turn it over, and reinsert it. Then run off the series of power ratio conversions.

Robert R. Reyers

Federal Aviation Administration
NAFEC
Atlantic City, N. J.

Sir:

I have read Mr. Wright's article, "Simplify Your Loss Calculations." Although it is a clever approach, I would like to propose the following modification:

The inverted log scale can be read directly by setting the cursor on either the DI (inverse D) or CI scale. In this way there is no need to perform any subtraction. The inverse log is read directly.

Saul A. Ritterman

Electrical Technology Dept.
Bronx Community College
New York, N. Y.

Accuracy is our policy

Sir:

May I call your attention to a few discrepancies in my article, "Specify your trap filter the easy way" (ED 9, April 26, 1969, p. 58). First, my name is incorrectly spelled. It should be as it appears at the end of this letter.

In Fig. 2, the first line under the right-hand diagram should read:

$$\dots R_1 = R_o \frac{R_o R_L}{R_o R_i}$$

In Eq. 1, p. 58, delete: (=A).

In Fig. 3, the last two letters of the third line of the caption should read: "Up-"

In Eqs. 19 and 20, both the small and large terms on the right-hand side of the equals sign should be multiplied.

Jerome H. Horwitz

Bunker-Ramo Corp.,
Silver Spring, Md.

In the book review of *How to Use Grid-Dip Oscillators*, ED 10, May 10, 1969, p. 146, the name of the author, Rufus P. Turner, was omitted.

THICK SKINNED

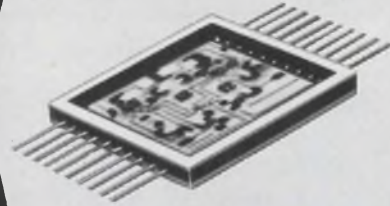

**That's why Columbia
custom hi-rel, thick film hybrids
pass all their survival tests.**

When we finish hybridizing one of your circuits, you can use it with confidence. Confident that it'll perform to your requirements. And confident that it won't fail. It's the result of the industry's most demanding quality control procedures.

At Columbia, from prototype to delivery, our hybrids are handled by skilled people, using the latest scientific methods, materials and equipment. And our Quality Control department continuously monitors all activities so that nothing is left to chance.

That's why our production and test procedures are, literally, a survival program. When we ship your circuit, we know it can't be better. We wouldn't have it any other way. Neither would you.

And whatever the circuit or quantity you require, we can produce it fast. If necessary, we'll even work with you to develop it. In short, we'll do everything we can to give you exactly what you want, when you want it.

So, write or call Hal Salzman at (516) 483-8200. He's thick skinned enough to listen to your most complex circuit problem. And help you survive it.



COLUMBIA COMPONENTS CORP.

A SUBSIDIARY OF COMPUTER INSTRUMENTS CORP.

60 MADISON AVENUE, HEMPSTEAD, NEW YORK 11550

(516) 483-8200 TWX 510-222-4189

fastest, most accurate resistor tester yet



Model 501 Resistance Deviation Bridge System: \$5750.

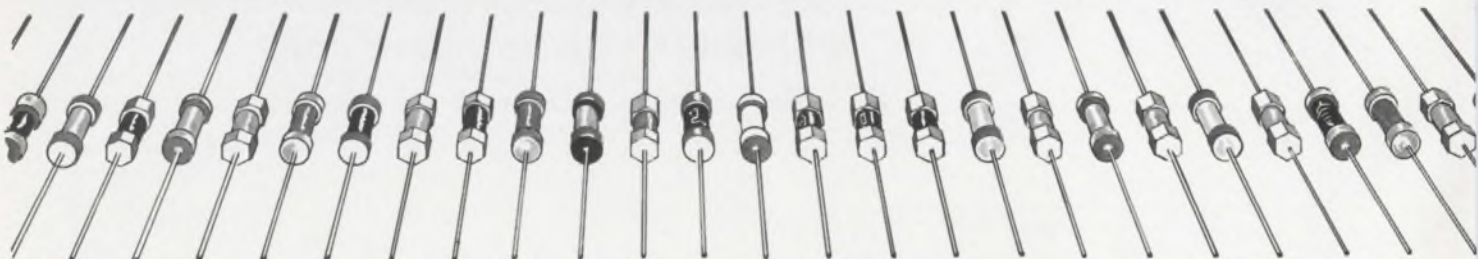

Everybody's talking "automatic-automatic", but we're doing it for resistor testing — and with the speed (100 milliseconds), accuracy (.01% or better) and reliability you're looking for (like our standards, for instance). We've even eliminated thermal emf problems.

Here's a new bridge system that provides all the automation, speed and accuracy you need for your resistor production line, or for any big volume testing, sorting, matching of resistors.

Called the Model 501, the system employs a fully automatic, Kelvin resistance deviation bridge which measures a component and displays its deviation digitally in percent from the setting of the system's standard. Standard measuring accuracy of the total system is 100 ppm, with 10 ppm available as an option.

The 501 completes a measurement cycle in 100 milliseconds, while at the same time cancelling out thermal emf's — through a unique auto zero circuit — and achieving excellent normal mode AC rejection (greater than 80db). The system verifies its connections to the component under test and stops if contact closure is not made.

Complete automation of the entire test

operation is available from ESI, including parts handlers, scanners, data couplers, data logging equipment and computerization.

Several different basic applications can be fulfilled by a 501 system and appropriate peripheral gear, including:

- a) rapid sorting of resistors of all accuracy classes (.005% down to 30% accuracy).
- b) automatic testing for environmental and temperature coefficient characteristics.
- c) computerized matching of resistors by value and temperature coefficients.
- d) automatic control of thin-film resistor manufacturing processes.

Only at ESI will you find the complete system capability you need, coupled with the warranted accuracy and reliability ensured by a leading designer of standards and calibration instruments.

Call us now, collect, or write for our brochure on "Automated Resistance Measuring."

TESTING FOR TEMPERATURE COEFFICIENTS

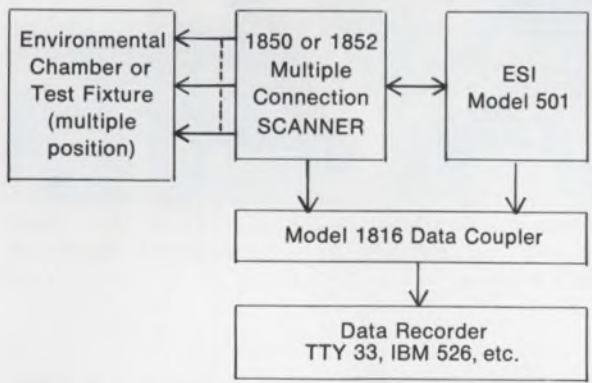

HIGH SPEED SORTING WITH DATA LOGGING

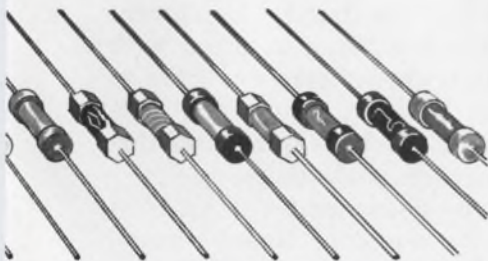
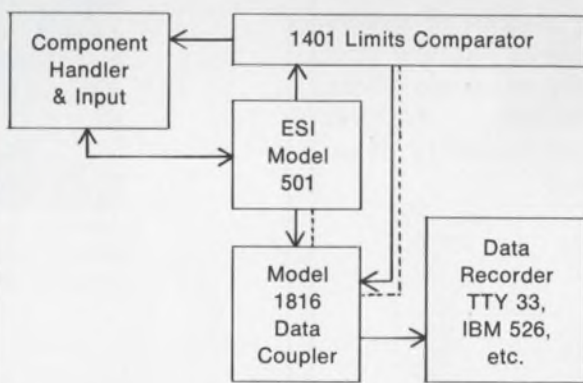

Electro Scientific Industries

13900 N.W. Science Park Drive

Portland, Oregon 97229 • Phone 503/646-4141

INFORMATION RETRIEVAL NUMBER 30

LOWEST COST . . . FULL WAVE BRIDGE RECTIFIERS & ASSEMBLIES

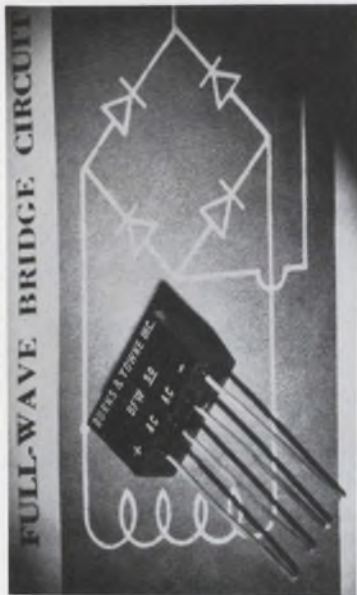

Burns & Towne pre-packaged rectifier circuits represent a significant cost savings over individual components used in multi-rectifier units. Yet, you are always assured of quality and reliability. The low cost BFW family of single phase full wave bridges . . . features high current capability of up to 2.0 amps.

Part No.	Max. PRV (volts)
BFW-50	50
BFW-100	100
BFW-200	200
BFW-300	300
BFW-400	400
BFW-500	500
BFW-600	600
BFW-800	800
BFW-1000	1000

Call or write for full specifications and price data.

BURNS & TOWNE INC.
18-36 Granite St.
Haverhill, Mass. 01830, Tel (617) 373-1333

SIDELIGHTS OF THE ISSUE

Covering the story firsthand

When you read Jim McDermott's story on the general aviation electronics industry, (see page 38) you can be sure it was written by a pro. Jim, a licensed pilot with 500 hours of flying time, has a special interest in avionics, and for his article, he tested much of the equipment he describes.

His trip took him from New England to Florida and as far west as Kansas, and he interviewed a good cross section of old-timers in the avionics business, as well as a number of newcomers. He found the industry to be lively and growing, although it had been jogging along leisurely for the last 12 or 15 years. This unhurried development has been due to some extent, Jim says, to the fact that smaller plane owners have historically outfitted their aircraft on a "mix and match" basis, by starting with the simplest communications gear and then adding navigation and more sophisticated communications as time and their pocketbooks could afford.

But because of the pressure of increasing require-



Antenna problems are discussed by Jim McDermott, East Coast Editor, (right) and George Racey, principal engineer, flight controls, of Bendix Avionics.

ments of the FAA, and because an increasing number of general-aviation owners are turning to instrument flying, more and more planes are being outfitted with more and more avionics. And where there are gaps in equipment, due to expense, avionics innovators have provided lower-cost substitutes such as time and distance computers, radar altimeters, and others.

With Jim as a flying editor—he commutes to his New York City office from his Easthampton, Mass., home—ED has every expectation of keeping abreast of news in the avionics field.

RELAYS

NEW MIL-R-6106

- One-Inch Cube
- 4PDT-10 Amps
- 28VDC-115VAC
- All Welded

IT'S BABCOCK'S BR30

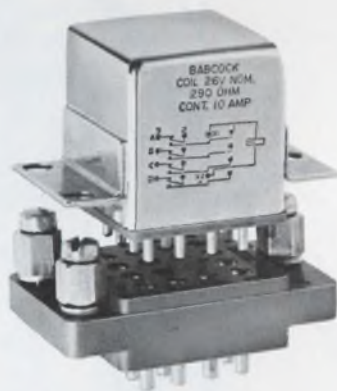

Babcock's new Model BR30 is a miniature, all-welded, 4PDT relay . . . designed specifically to meet the requirements of MIL-R-6106 (MS-27400)—and to be completely interchangeable with other models of this type. Characterized by reliable op-

eration in environmental extremes, this new relay is the first developed by Babcock to meet the needs of airframe applications. Performance is outstanding . . . to 200g's shock, 30g's vibration, over a temperature range of -70°C to $+125^{\circ}\text{C}$, for a minimum of 100,000 operations. All welded construction, inside and out, assures a contaminant-free unit. Plug-in and solder-hook versions are offered; qualified relay sockets also available.

The Model BR30 is a new relay for new applications . . . and it carries the same mark of proven Babcock dependability. Your assurance that it's better because it's Babcock.

The Babcock Model BR30 is a brand new MIL-R-6106 relay . . . featuring a new symmetrical magnetic circuit. Utilizing two permanent magnets, this system provides a positive holding force, undisturbed by shock and vibration extremes . . . and

dependable switching action throughout the life of the relay.

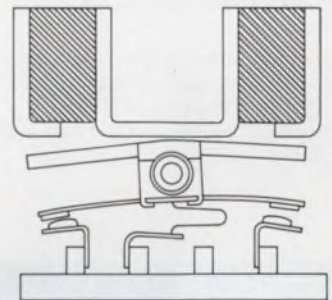

Coil design has also undergone some innovation. AC versions have been fabricated such that coil frequency is operational from 60 Hz to 400Hz, without degradation of ratings.

SPECIFICATIONS

Contact Rating (@ 28VDC, 115/208VAC 400Hz)	Resistive: 10amps. Inductive: 8amps.
Overload	D. C. 40amps. A. C. 60amps.
Rupture	D. C. 50amps. A. C. 80amps.
Coil Voltages	6, 12 and 28VDC, 115VAC
Shock	200g's (8ms.)
Vibration	30g's, 70-3000Hz
Operation Temp.	-70°C to $+125^{\circ}\text{C}$
Pull-In Power	600mw
Operate/Release Time	15ms, max.
Bounce Time	1ms, max.
Life	100,000 operation, min.

Get complete information on the new Model BR30 . . . contact Babcock Electronics Corp., Relays Division, Subsidiary of Esterline Corp., 3501 Harbor Blvd., Costa Mesa, Calif. 92626. CALL COLLECT (714) 540-1234 or TWX 910-595-1517.

Challenging opportunities for relay-switch engineers.



Trip the light fantastic...

stimulate lasers...make photocopies...stop motion...phototypeset millions of times with **EG&G Xenon and Krypton Flashtubes**

EG&G can satisfy your total light output requirements in a wide variety of applications through its capability to design, develop and mass produce Xenon and Krypton flashtubes and complete systems. With a maximum number of flashes at the lowest cost per flash, you get consistent levels of spectral response . . . flash after flash after flash.

EG&G Xenon pulsed or Krypton CW tubes are available in linear, air and liquid cooled, helical, U-shaped and coaxial designs. Envelope materials are quartz, germisil, soft glass or hard glass. Energy inputs range

from 0.1 to 25,000 watt-seconds with operating voltages from 400 volts to 3.5KV. Light output includes the entire visible spectrum and extends into the UV and IR ranges. EG&G Flashtubes are known for their extreme longevity. EG&G will supply the application assistance needed to select the right tube for your job.

Along with our standard flashtubes, EG&G also supplies chokes, trigger transformers, and trigger modules off the shelf. On request we'll design flashtube circuitry to meet your application needs.

If you'd like more information on EG&G pulsed Xenon and Krypton Flashtube Systems, thyratrons, krytrons, spark gaps, photodiodes, thermal testers or light instrumentation, contact your local EG&G representative or EG&G, Inc., 173 Brookline Avenue, Boston, Massachusetts 02215. Telephone: (617) 267-9700. TWX: (617) 262-9317.

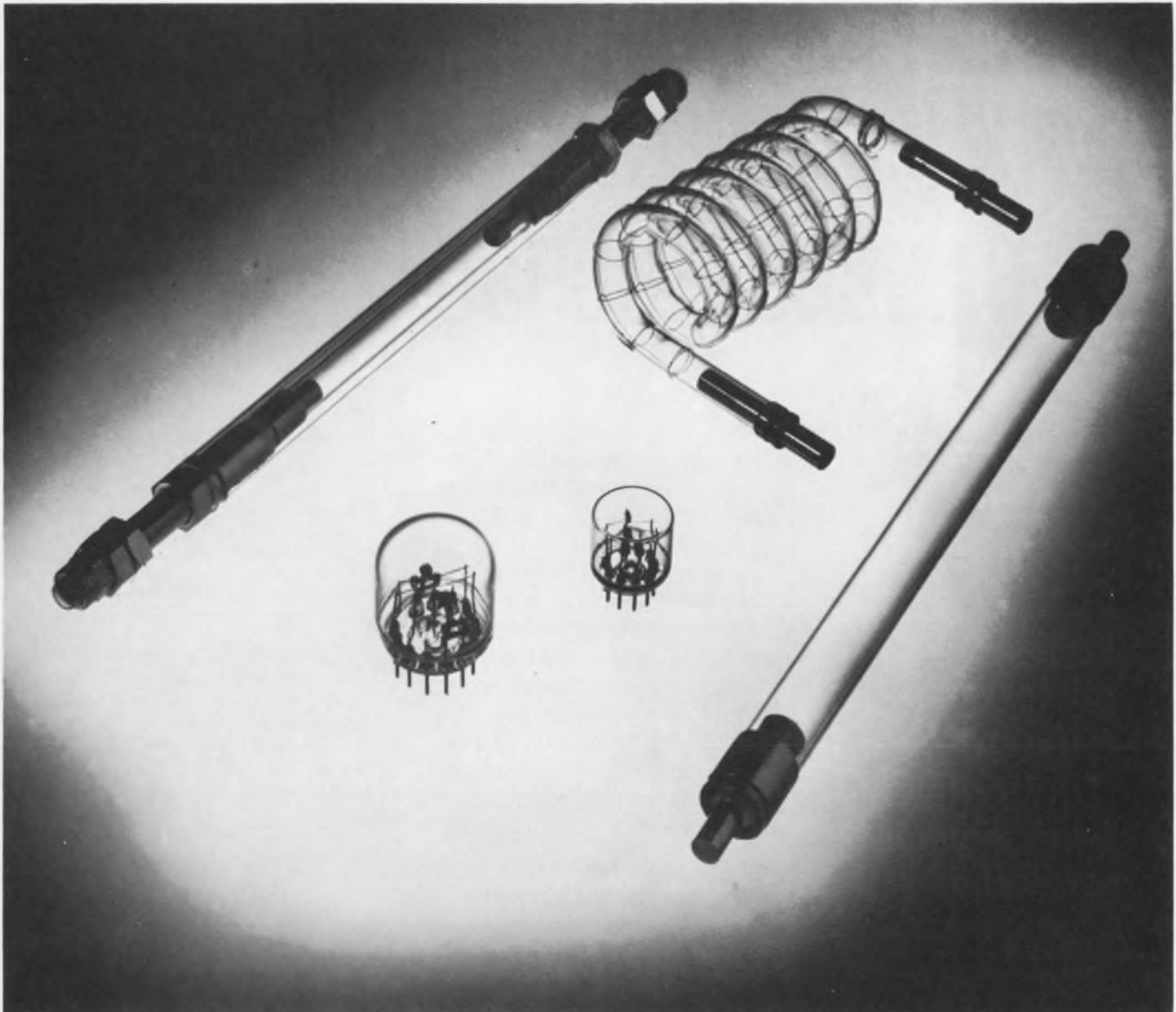

Publisher

Hugh R. Roome

Editor

Howard Bierman

Managing Editor

Frank Egan

Technical Editors

Milton J. Lowenstein
 Michael J. Riezenman
 Raymond D. Speer
 Stella Lawrence

Management and Careers Editor

Richard L. Turmail

News Editors

Ralph Dobriner, Chief
 John N. Kessler

Washington News Bureau

Charles D. LaFond, Chief

Military-Aerospace Editor

John F. Mason

East Coast Editor

Jim McDermott

West Coast Editors

Elizabeth deAtley
 David N. Kaye

New Products Editor

Lucinda Mattera

Copy Editor

Marion Allen

Editorial Production

Dollie S. Viebig
 Anita F. Needleman

Art Director

Clifford M. Gardiner

Art Assistant

William Kelly

Technical Illustrators

William Alvarez
 Rita Jendrzewski
 Lynn E. Thompson

Production Manager

Thomas V. Sedita

Asst. Production Manager

Helen De Polo

Production Assistants

Bernard Wolinsky
 Carl A. Merkin

Circulation Manager

Nancy L. Merritt

Information Retrieval

Genate Piccinetti

EDITORIAL



Time, tide and technology wait for no one

Recently, we were asked which of the following we considered the most significant achievement of the past 20 years:

- Mass media communications
- The computer
- Space advances
- DNA
- Organ transplants
- The Pill

As is usually the case with lists of this sort, some items at first glance appeared to be of far less significance than others. But a few moments of objective evaluation corrected this impression.

Mass media communications have indeed made this an age of public awareness.

The computer has revolutionized business and the sciences.

Our space advances have not only been breathtaking, but they represent man's first grappling with the grand scheme of the universe.

But DNA, as the essence of life, cannot be neglected, nor can organ transplants or The Pill, both of which profoundly affect man's attitude toward and control over life and death.

In essence, then, we found it difficult to separate the "most significant" from six extremely significant developments.

One thing about the list, though, did pop into mind. And that was the dependence of many of the items on the computer. Most of the listed achievements have either been made possible or hastened by modern computing techniques.

And all this has occurred in a relatively brief span of time. It makes one wonder what the computer will make possible in the next 20 years.

A related thought also occurred—is your company prepared to take full advantage of this versatile and powerful tool? Or is it content to sit back, with maybe computerized payroll and personnel records, but with traditional and conventional engineering and production methods? Such conservatism is easy to foster, avoiding as it often does the expenditure of large sums and the upsetting of the status quo.

Unfortunately, companies that follow such a comfortable wait-and-see course may one day find that technology has passed them by—and that the future belongs to those who were prepared.

FRANK EGAN

We'll go to any length to get into your memory

National's capable of going a long way (or short) to get the right MOS shift registers into your memory. The applications are unlimited.

For starters, you get a variety of bit lengths from our standard line, available immediately. Your National distributor's got them on the shelf and waiting.

If you can't find the register length your application requires, give us a call. We'll program your register length into our standard process. We've been making MOS so long, our memory's capable of anything.

Write or call National Semiconductor,
2975 San Ysidro Way, Santa Clara, California
95051. (408) 245-4320. TWX: 910-339-9240
Cables: NATSEMICON

National/MOS

How's that register?

DYNAMIC

Dual-25	MM400	-55°C to +125°C
	MM401	-55°C to +125°C (Internal 20K pull-up resistor)
	MM500	-25°C to +70°C
	MM501	-25°C to +70°C (Internal 20K pull-up resistor)
Dual-50	MM402	-55°C to +125°C
	MM403	-55°C to +125°C (Internal 20K pull-up resistor)
	MM502	-25°C to +70°C
	MM503	-25°C to +70°C (Internal 20K pull-up resistor)
Dual-100	MM406	-55°C to +125°C
	MM407	-55°C to +125°C (Internal 20K pull-up resistor)
	MM506	-25°C to +70°C
	MM507	-25°C to +70°C (Internal 20K pull-up resistor)
Dual-64	MM410	-55°C to +125°C
Accumulator	MM510	-25°C to +70°C
Triple-60+4	MM415	-55°C to +125°C
	Accumulator	MM515

STATIC

Dual-16	MM404	-55°C to +125°C
	MM504	-25°C to +70°C
Dual-32	MM405	-55°C to +125°C
	MM505	-25°C to +70°C
8-bit	MM408	-55°C to +125°C
Serial to Parallel	MM508	-25°C to +70°C
8-bit	MM409	-55°C to +125°C
Parallel to Serial	MM509	-25°C to +70°C
Dual-32	MM419	-55°C to +125°C
Split clock	MM519	-25°C to +70°C

Plotting the dielectric constant of a TEFLON resin against frequency, or temperature, or what-not makes a pretty dull-looking graph.

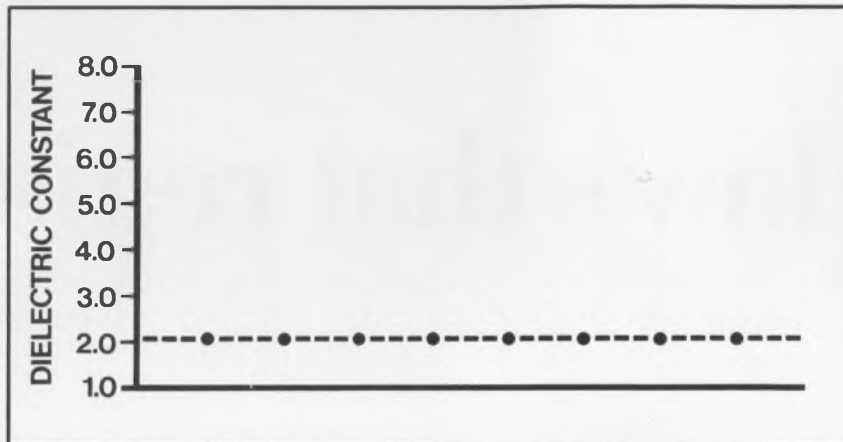

But useful to an electronic designer.

A straight line parallel to the X axis is about all you get when you plot the dielectric constant of a Du Pont TEFLON fluorocarbon resin — over a wide frequency range — and over a wide temperature range. The same stubborn constancy applies also to the other excellent electrical characteristics of TEFLON: a dissipation factor of only 0.0002 and a high dielectric strength (500 volts/mil).

The dielectric constant is in the lowest range of any solid material: between 2.0 and 2.1, depending on the exact TEFLON resin used and its processing.

But once established, it remains a fixed design constant. This is particularly important to designers of RF cable who require the highest propagation velocity and a constant impedance — and to designers of microwave transmission lines.

Some of the typical hazards that may affect the use of conventional insulations but leave TEFLON virtually unaffected include: moisture, fungus, deicing fluids, UV radiation, salt spray, chemical fumes, cleaning agents, fuels and lubricants.

These are some of the reasons why insulations of

TEFLON have established their reliability in use for more than 20 years. When you specify TEFLON, you specify electrical characteristics that can be depended on consistently.

We'd like to send you more detailed information on the electrical properties of TEFLON. Write: Du Pont Company, Room 7314C, Wilmington, Del. 19898.



TEFLON[®]
fluorocarbon resins

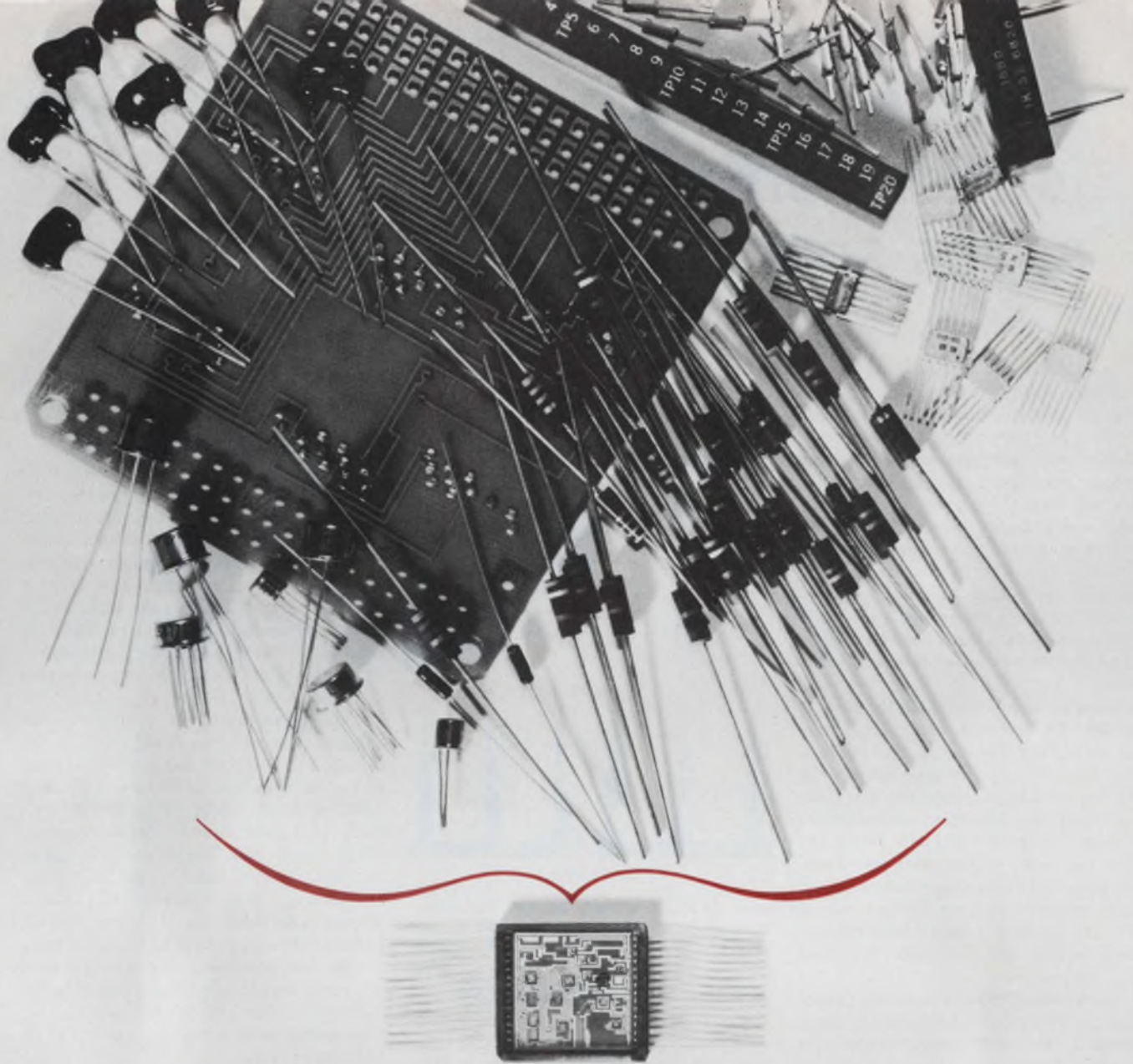

be concise

This is Collins' data detector hybrid thin-film circuit #351-7301-010. All the components above are required to accomplish its identical function. It eliminated hundreds of interconnections. Besides its advantages of reducing equipment volume, weight and cost, it offers impressive improvements in overall reliability, versatility, performance and maintainability. Collins has designed 1000 such hybrid thin-film circuits and manufactured more than a million units. If we have not yet made the circuit for your requirements, put our experience to work for you. Call or write your Collins Engineering Sales Representative or Distributor, or contact Component Marketing, Collins Radio Company, Newport Beach, California 92663. Phone: (714) 833-0600.



Staggered-finger heat sink design is more efficient, saves space and weight

Unique design is causing circuit designers to re-think their thermal theory.

Design engineers are learning daily that power ratings of power transistors are often not at all what they appear to be at first glance. For example, the data sheet on a transistor may state, "maximum power dissipation — 50 watts." But the fine print — if there is any — says, "at 25°C case temperature." Actually, the transistor alone will dissipate only 3 to 4 watts before the maximum allowable junction temperature is reached!

Obviously, something must be done to maintain the specified case temperature when more than 3-4 watts are to be dissipated. This is normally accomplished by mounting the transistor case to a dissipator or heat sink, but dissipator state-of-the-art has been such that these devices are too bulky, too heavy — just plain inefficient. Now you needn't tolerate these size and weight penalties in your design because IERC has achieved a major breakthrough in heat sink design: The IERC Staggered Finger Dissipator.

International Electronic Research Corporation has developed a broad line of these smaller, lighter, much more efficient heat dissipators based on the unique, multiple staggered finger design which has proven to be 30% more efficient overall, and in some

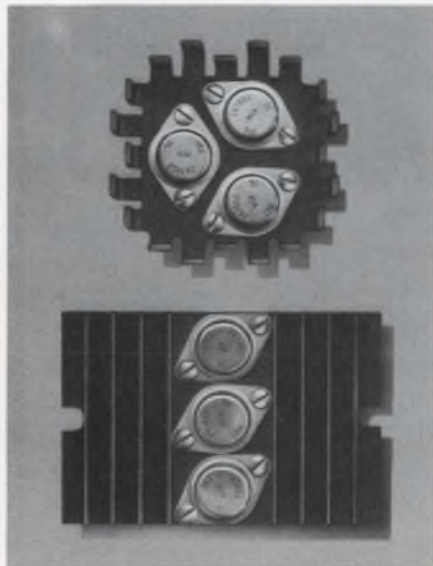

FIGURE 1

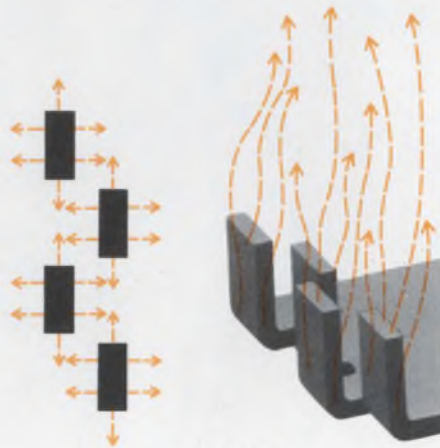

FIGURE 2



FIGURE 3

cases up to 500% more effective than many conventional designs now in wide use. An example of the staggered finger design is shown in Figure 1. This is an IERC HP3 Heat Dissipator. To show how efficient this device is, it is shown compared to a common finned extrusion. The HP3 and the extrusion are virtually equivalent in their heat dissipating ability; however, the HP3 is only 1/3rd the weight and 2/3rd the volume of the extrusion.

The secret to the efficiency of the new dissipators is the staggered fingers. (Figure 2) Note how the fingers are positioned so they do not radiate to each other and the configuration is so arranged that natural convection takes place very readily.

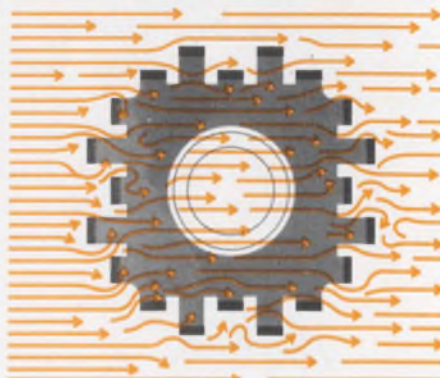

FIGURE 4

In a finned extrusion the fins radiate to each other and it is difficult for natural convection to take place in the confined area between the fins. (Figure 3)

In a forced air environment the staggered finger configuration is even more effective. The air can be from any direction. (Figure 4) As it hits the fingers, turbulence causes it to move around each of the fingers, striking many surfaces in its flow past the part. The turbulent air against these surfaces disturbs their surface barrier and is the principal reason for the significant improvement in the forced air heat dissipating properties of these parts.

Compare this turbulent air flow over the staggered fingers of the IERC part with the air flow conditions when directed at a finned extrusion. Here laminar air flow, rather than turbulent air flow, takes place. The air must be directed in one direction only, (Figure 5) parallel to the fins; but because of this restricted space, it immediately tries to leave. Shortly after entering, it is not flowing against the bottom of the fin surfaces. Since the air flow is laminar, not turbulent, and it is not disturbing the surface barrier at the bottom of the fins shortly after entering, the surface areas of the fins are only partially effective.

The old rule-of-thumb which considers only the surface

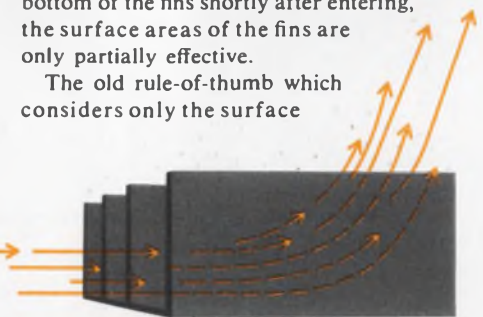

FIGURE 5

area relative to heat dissipation is not valid. The effectiveness of the area must also be considered. The staggered finger concept is a significant breakthrough in heat dissipating devices and is the first improvement in heat dissipator design since the flat fin or extrusion design.

Broad line accommodates all lead and case mounted semiconductors.

During the past several years, IERC has developed numerous heat dissipating devices

using the staggered finger configuration.

The UP style (Figure 6) is just 1.78 inches square and is available in various heights up to one inch. It was designed particularly to accommodate a single power transistor such as a TO36, TO3, TO15, etc. However, it will also accommodate more than one smaller semiconductor, including the newer plastic case power transistors.

To really appreciate the efficiency of the UP, refer to the temperature vs. power

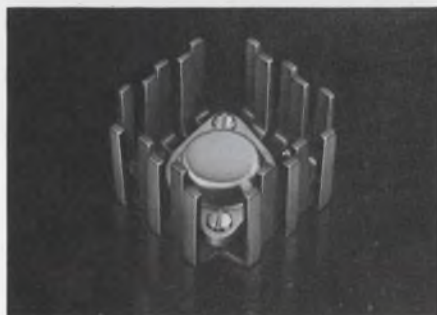

FIGURE 6

curve (Figure 7) showing a 2N1208 power transistor mounted in a UP-TO15-B dissipator. Remember, now, that this UP part weighs *less than one ounce*. Considering a maximum case rise of 100°C, the 2N1208 by itself will dissipate only 3 watts. When mounted in the UP dissipator in natural convection, it will dissipate 14 watts, or

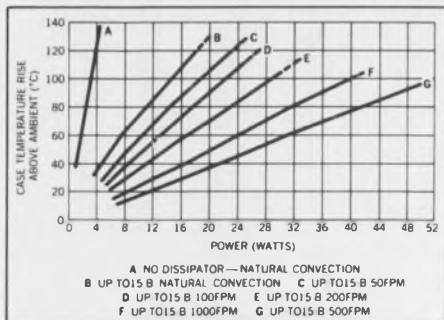

FIGURE 7

more than four times more power at the same case temperature. In a forced air environment of only 200 FPM, 28 watts can be dissipated — more than nine times the power at the same case temperature. With 1000 FPM, the remarkable light weight UP will allow 50 watts of dissipation from the transistor — *seventeen times more power at the same case temperature.*

Think now. You must limit the case temperature rise of a power transistor to 100°C. You need to dissipate 14, 28 or 50 watts. You have three cubic inches of space and are limited to adding one ounce of weight. And you can't spend more than 40 cents for a dissipator or sink in medium quantities. What would your present thinking lead you to do?



FIGURE 8

Another IERC dissipator, the HP1, is a companion to the HP3 shown in Figure 1. The HP1 is 2½ inches square, slightly larger than the UP. At the same case temperature rise of 100°C, it will dissipate 23 watts in natural convection; in a forced air flow of 200 FPM, it will dissipate 33 watts; and 65 watts with 1000 FPM. The HP3, which is 3⅞ inches square, will dissipate 28 watts in natural convection, 42 watts with 200 FPM, and 74 watts with 1000 FPM. When the HP1 and HP3 are nested, Figure 8, more than 100 watts can be dissipated at the same 100°C case temperature rise with 1000 FPM.

Stop and contemplate the sizes of heat dissipating devices which would have been required to dissipate these powers before the advent of the staggered finger design, and you will appreciate the savings of space and weight which the UP and HP make possible.

The staggered finger design has also been used in heat dissipators for TO5 and TO18 metal case transistors. Models in the LP Series, Figure 9, are available in three lengths and two heights and to accommodate one or two transistors. These parts are so efficient that when a TO5 transistor is mounted in the largest model



FIGURE 9

LP dissipator (only 2.31 x 1.12 x ½), the dissipator is virtually an infinite heat sink. The case temperature rises only 65°C when 5 watts are being dissipated. When 1000 FPM of air is used at 5 watts dissipation, the case temperature rise is phenomenally low — less than 15°C.

In addition to their thermal efficiency, LP parts are extremely versatile. Almost any application problem where a conduction plane is not available can be solved with these simple, low cost devices.

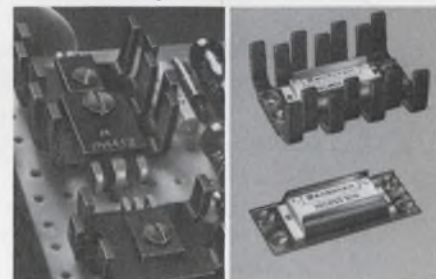

FIGURE 10

The staggered finger concept is also available in dissipators for plastic case power transistors and integrated circuits and microcircuit packages as shown in Figure 10.

The staggered finger concept of heat dissipation is the most significant breakthrough in heat sink technology since the advent of the power transistor. Get specific technical and pricing information on those IERC heat dissipators most applicable to your needs. Write on your company letterhead for Technical Bulletin 149 for more detailed information on the PA and PB series and Technical Bulletin 151 for the LB series. Technical Bulletin 134 and Test Report 172A detail the UP series; Technical Bulletin 139 and Test Report 198 cover the HP series; and for the LP series, ask for Technical Bulletin 135 and Test Report 182. You'll be surprised how substantially these advanced new heat sinks will contribute to the efficiency of your design and your equipment.

International Electronic Research Corporation, a corporate division of Dynamics Corporation of America, 135 West Magnolia Boulevard, Burbank, California 91502.



attention readers:

What does **DMT** mean to you? **DMT** is **Electronic Design's Data Marketing Technique**. It is a technique we have evolved for a special kind of advertisement, one that gives you complete information about a product — sufficient information to allow you to make a specifying decision.

Here is what you will find in a **DMT** advertisement:

- Types of applications** and uses for product.
- Product features** and advantages.
- Specifications** of weight, dimensions, composition, speed, capacity, power requirements, MIL approval, etc.
- Performance data**, operating ranges, key performance parameters, accuracy ratings, reliability, sensitivity, interconnections, etc.
- Test results**.
- Maintenance information**.
- Cost and delivery time**.

The **Data Marketing Technique** is ideal for many manufacturers who advertise in **Electronic Design**. You will probably recall a number of **DMT** advertisements that have appeared during the past year. Very likely, you have already made use of **DMT** advertisements by specifying directly from them.

Our advertisers who utilize **DMT** go to considerable lengths to provide you with complete data that will help solve your design problems. In addition to problem solving, they also save your valuable time.

Look for **DMT** advertisements in **Electronic Design**. You will see more of them in this magazine because, like yourself, all of our readers are either engineers or engineering managers in the EOEM who can make immediate use of such information.

Electronic Design

DMT
DMT
DMT
DMT
DMT

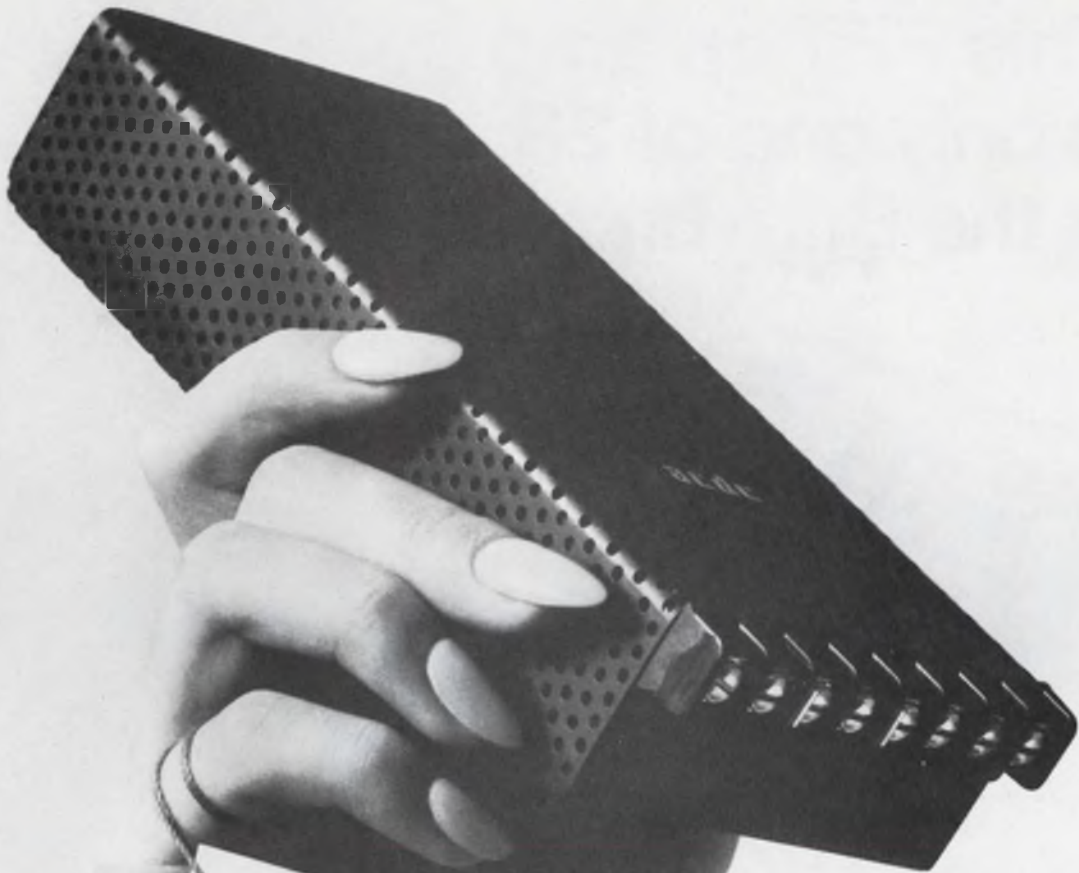

DC Power Supply Modules
**GUARANTEED
FOREVER**
acdc electronics inc.

**New tiny
product.**

**Old giant
guarantee.**

Meet JR.
The world's first
Guaranteed Forever
miniaturized power supply.
Five times smaller. 50%
better efficiency.
Competitively priced.
Write for complete catalog.
acdc electronics, inc.
2979 North Ontario St.,
Burbank, Calif. 91504.

This FET op amp is only one of 28 in the Burr-Brown line



And, it sells for just \$13.90*

It's no wonder Burr-Brown is one of the major suppliers of FET input operational amplifiers. With twenty-eight standard FET units in our catalog, design engineers are able to find the exact devices for specific applications. And, since they don't have to buy performance they don't need, they get them at prices that make purchasing departments happy.

We have always had a respectable line of FETs, but there's been some new ones added (and some major price reductions) which certainly deserve your full consideration.

***LOW COST - Model 3112/12C** is a tremendous value. It's only \$13.90 in 100 quantity. Don't let the price fool you. It's an excellent general purpose FET with a maximum input bias current of ± 0.10 nA, a maximum voltage drift of ± 50 $\mu\text{V}/^\circ\text{C}$, and an input impedance of 10^{11} ohms.

BATTERY OPERATION - Model 3230/12C is specifically designed for battery powered operation. It has a low quiescent drain of ± 60 μA and

operates from a supply range of ± 4 to $\pm 18\text{V}$ with ± 1 to $\pm 15\text{V}$ output. The price is just \$21.20 in 100 unit quantity.

HIGH VOLTAGE - Model 3038/25 has a rated output of ± 20 to $\pm 115\text{V}$ from a ± 40 to $\pm 135\text{V}$ source. It offers excellent common mode rejection, 90 db minimum, with a common mode voltage of 115 volts.

LOW DRIFT - Model 3129/15 is an extremely low drift unit, rated at ± 3 $\mu\text{V}/^\circ\text{C}$, maximum.

That's just four of our FETs. Remember, we have twenty-eight and every one of them is favored by a number of customers for specific performance-price features. Hadn't you better get the facts on our FETs?

For Complete Technical Information on Burr-Brown FET input operational amplifiers, contact your Burr-Brown Engineering Representative or use this publication's reader service card.

BURR-BROWN
RESEARCH CORPORATION

International Airport Industrial Park • Tucson, Arizona 85706
TELEPHONE: 602-294-1431 • TWX: 910-952-1111 • CABLE: BBRCORP



Operational Amplifiers
Instrumentation Amplifiers
Function Modules
Active Filters
Power Supplies

They're new, Molex edge connectors. For printed circuit boards. Terminals crimped to wires automatically. We have straight-in and right-angle types. With and without mounting ears. It's another giant step by Molex in helping create high-speed, low-cost devices that simplify circuitry.

Reliable? You bet. The connector has bifurcated terminals that provide solid contacts. Yet you can slip the connector on and off many times without damaging printed circuits. And it's not a preloaded unit. Carries only contacts required. From nine to twenty-two.

If you want to save assembly time, steps and money, take a close look at this new Molex edge connector. For free samples, write or you can make connections by calling (312) 969-4550.



M155A

**MOLEX PRODUCTS
COMPANY**
Downers Grove, Ill. 60615

The wreckless rechargeable.



Sonotone's Fastback[®] battery won't wreck itself. Even under fast charging. Over and over and over again.

Sonotone's new nickel-cadmium sealed cell is called the Fastback because it gets back into action *fast*. In just five minutes, it gets enough charge to start a lawn mower or to operate a camera. So your product goes to work today... not tomorrow.

The Fastback's safe, too. In laboratory tests, it's been deliberately overcharged for months at the 3-hour rate. Without overheating or blowing its top. Even after that, it delivers full rated output under load.

And there's no need for expensive, bulky external charging apparatus. All

the charging capability is built right into the Fastback. Already, the Fastback's found its place in many consumer products. Should it be in yours? Find out by writing for full specifications and performance charts. Sonotone Corporation, Battery Division, Elmsford, New York 10523.

CLEVITE SONOTONE

New random-noise generator with flat output from 20 Hz to 20 MHz

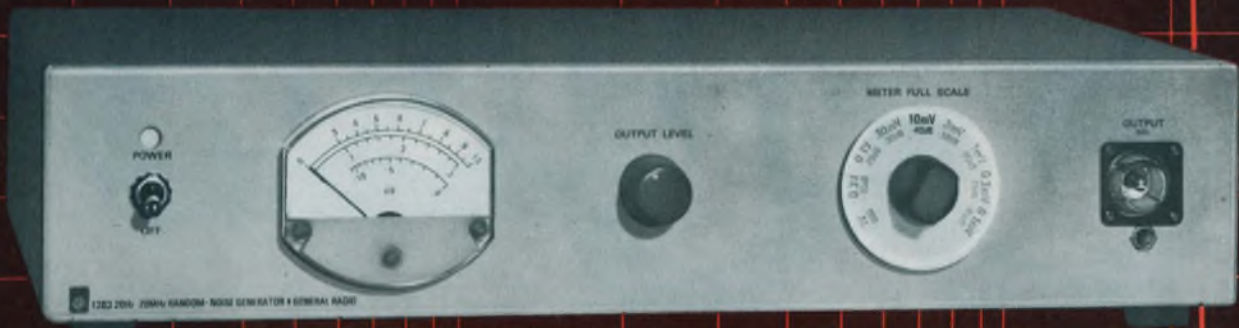

Wide frequency range, calibrated output, and carefully specified Gaussian amplitude distribution are the key features that distinguish this new random-noise generator from others available. The 1383 generates white noise of uniform spectrum level out to 20 MHz, particularly useful for tests in video- and radio-frequency systems. It is also an ideal broad-band, high-level noise source for use in amplifier testing, noise measurements, tests of signal-detection schemes, distortion measurements, and signal modulation to produce noise sidebands at higher frequencies. The 1383 contains a temperature-limited thermionic diode as a noise source, semiconductor amplifiers, an output meter, an 80-dB attenuator, and power supply, all enclosed in a convenient cabinet for bench use or rack mounting.

Frequency Range. The spectrum is flat (constant energy per hertz of bandwidth) ± 1 dB from 20 Hz to 10 MHz, ± 1.5 dB from 10 to 20 MHz.

Calibrated Output. The maximum output is one volt, open circuit, from a 50-ohm source impedance.

Carefully Specified Gaussian Distribution. The noise source provides symmetrical Gaussian amplitude distribution, specified to $\pm 3 \sigma$ as measured with a "window" of 0.2σ .

Price: Bench model, \$775; rack model, \$795.

Prices apply only in the USA. All GR products are subject to a quantity discount ranging from 3% for 2-4 units to 20% for 100 units. For complete information, write General Radio Company, W. Concord, Massachusetts 01781; telephone (617) 369-4400. In Europe: Postfach 124, Ch 8034 Zurich 34, Switzerland.

Other true random-noise generators:



- 1381**
- 2 Hz to 2.5, or 50 kHz
 - Gaussian distribution
 - adjustable clipping
 - 3-V rms output
- Price: \$375, bench model
\$398, rack model



- 1382**
- 20 Hz to 50 kHz
 - white, pink, or USASI spectra
 - Gaussian distribution
 - 3-V rms output, balanced, unbalanced, or floating
- Price: \$375, bench model
\$398, rack model



- 1390-B**
- 5 Hz to 5 MHz
 - 30 μ V to 3-V output
 - ± 1 dB audio-spectrum-level uniformity
 - white spectra, and pink (with filter)
- Price: \$375; \$50 for pink-noise filter

GENERAL RADIO

Now from Philco!

MOS1024-bit read-only memory — 4-week delivery!

We'll write your bit pattern into our pM1024 memory, fast and accurately, through the aid of our computerized programs. Send us your pattern of 128 eight-bit words or 256 four-bit words and we'll deliver product in four to six weeks. The built-in chip select feature allows you to stack chips for any desired bit capacity.

The pM1024 chip contains address decoding, memory storage, and output buffers. High-speed output drive bipolar or MOS logic directly.

This high-speed MOS memory has a world of applications:

- lookup tables
- character generators
- microprogrammed computer instructions

- synced 8-signal waveform generators
- code converters
- and many others. Just turn your imagination loose.

The pM1024 is the highest speed, lowest power dissipation MOS memory available in production quantities today —at unit price competitive with any memory product on the market.

Want samples to check out circuitry? We can ship the pM1024 sine lookup table off the shelf.

Get complete facts now, from MOS Marketing, Microelectronics Div., Philco-Ford Corporation, Blue Bell, Pa. 19422.

the NOW people in MOS

PHILCO





SPEED WINS THE BALLGAME!

In computers, too, time is money; and the lowest computer time often wins the ballgame. So if speed is important to you, why settle for typical TTL times of 13 nanoseconds when you can have typical ECL II times of 4 nanoseconds?

At Stewart-Warner, the high-speed logic of the future is available today. We are now announcing another 14 new ECL II's in both the industrial series (1000) and military series

(1200). We have previously announced 14 circuits in these two ultra-high-speed series, as well as 11 ECL's in the high-speed 300 and 350 series.*

Since ECL's offer the designer the same functional capability and design freedom as he has with the slower TTL logics, there's no longer any need to compromise when speed is important...especially when Stewart-Warner ECL prices may be lower than what you have been paying for TTL's.

For more information, send for our ECL data sheets. And, for off-the-shelf delivery, call your local Stewart-Warner Microcircuits Distributor.

*All Stewart-Warner ECL's interchangeable with Motorola MECL and MECL II units.

STEWART-WARNER SYMBOL OF
COMPANIES **SW**
EXCELLENCE

STEWART-WARNER MICROCIRCUITS, INC.
730 EAST EVELYN AVENUE, SUNNYVALE, CALIFORNIA 94086
PHONE 408/245-9200 TWX 910-339-9210

Take a look... this counte



speaks for itself

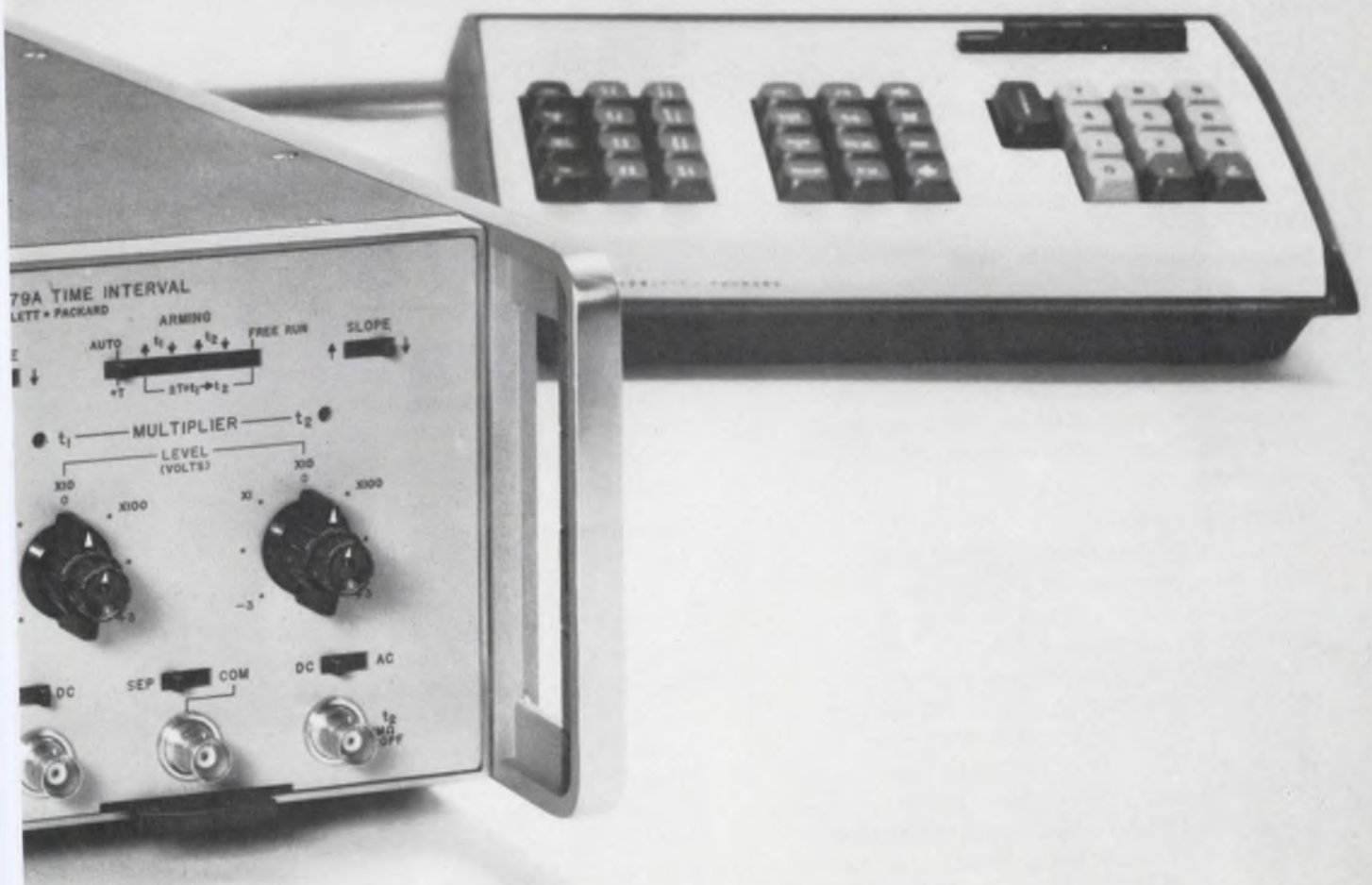

A word from the new HP 5360A Computing Counter:

Measurement and computation

The revolutionary new Hewlett-Packard 5360A Computing Counter, the most significant advance in counter technology since 1952, uses built-in interpolation with computation to eliminate the traditional ± 1 count ambiguity. It combines an IC period-measuring counter and an internal computer in a compact, easy-to-use package. Lets you measure frequency 1000 times faster, much more accurately and over a wider range than ever possible before. Basic measurements, 0.01 Hz to 320 MHz are automatic, with period and time interval resolution to 0.1 ns — a resolution never before offered in a counter. The 5360A's computing capability lets you automatically and in real time solve equations whose variables are the counter's measurements!

Fast and true

Take speed — the 5360A's up to 100 times more accurate than previous counters for the same speed. Take accuracy — it's 3 to 1000 times faster for the same accuracy. The previous ± 1 count accuracy limitation is decreased by a factor of 1000 by interpolators and digital computation within the 5360A.

Widest range

Besides the basic 0.01 Hz to 320 MHz measurement range, the 5360A accepts all the heterodyne converters of the popular HP 5245L, 5246L and 5248L Counters and lets you make spurious-free measurements to 18 GHz. Basic measurements without prescalers, too.

Finest resolution

No previous direct-reading digital instrument has given you the 0.1 ns resolution available in the 5360A for time interval and period measurements. In addition, with the 5379A Time-Interval Plug-in (not required for period measurements) you get more versatile input controls than ever before, automatic error detection and measurement of positive or negative intervals down to zero seconds, at rates over 1000 measurements per second.

Pulsed RF measurement

With none of the tedious transfer oscillator manipulation and calculation, the 5360A will measure pulsed signals up to 320 MHz with pulse length as short as 1 microsecond — and do it automatically and directly. Using the frequency converter plug-ins, you can measure pulsed carriers all the way to 18 GHz. And you can even measure a single burst of signal, which you can't do with transfer oscillators.

Computation

The 5360A and its accessory plug-in program module (available now) or its keyboard (available later this year) let you get direct answers in final form, real-time solutions to equations... without additional costly processing equipment and interface design. Two simple examples are direct readout measurements of phase or the rms value of a series of measurements.

Easy to use

Front-panel controls provide new dimensions of versatility, yet the 5360A is easy to use. There's a new minimum in the need to manipulate controls. Range selection, for example, is automatic over the entire frequency range, no matter what the setting of the Measurement Time switch. The 5360A gives you a fixed-decimal display, with automatic blanking — your reading is always in the same position, with up to three digits to the left of the decimal, up to 11 digits in resolution... all via internal calculation. It's virtually impossible to read the 5360A incorrectly.

Questions?

The 5360A Computing Counter with the 5365A Input Module costs \$6500. The 5367A Time-Interval Plug-in costs \$750. Accessory keyboard, approximately \$1000. Accessory plug-in program module, \$190.

For all the information on this break-through instrument in counter technology, call your local HP field engineer. Or write for our fully illustrated brochure and data sheet: Hewlett-Packard, Palo Alto, California 94304; Europe: 1217 Meyrin-Geneva, Switzerland.



ELECTRONIC COUNTERS

INFORMATION RETRIEVAL NUMBER 45

02907

Technology



Diode parameters can be determined graphically with a curve tracer. Author J. A. Williamson, right, discusses the technique with R. E. Jones. p. 90



Counting backward eliminates undesired early returns in laser ranging measurements. Here an engineer sights a Colidar Mark II range-finder. p. 78

Also in this section:

Get rid of ground-loop noise using novel circuit techniques. p. 84

Diary of a leadership trainee (Part I). Getting through to people? p. 96

Ideas for Design. p. 106

Count backward for high resolution

in laser or radar ranging measurements. The technique eliminates undesired early returns.

If you aim a range-measuring laser or radar at a target partially obscured by foliage, you will often detect a return pulse from the foliage before the return from the target. On a hazy day, you may receive several such early returns.

In such cases, to measure the target range accurately, you must measure the time interval from the transmission of the initial pulse to the reception of the last return. Since you have no prior information as to which return is the last one, you must store the range of all of them until the end of the measuring interval.

Most systems use a counter to measure the time interval. But to store the range of each return, data must be transferred out of the counter while it is running. This limits the counter's speed and hence the resolution of the system.

A better way to measure the target range accurately is to reset the counter to zero every time a return pulse is received. Then, at the end of the measuring interval, the counter will contain a measure of the time from the last return to the end of the counting interval. The difference between this count and the maximum range is the distance to the target. This technique might well be called backward counting.

Why is it better? Because it eliminates the need for synchronous counting, which can create layout and drive-power problems. In backward counting a ripple counter is used, and it offers, without layout or power problems, the highest counting speed that the flip-flops can handle.

Synchronous vs ripple counters

A counter is a series of flip-flops. If the flip-flops are all triggered simultaneously by a master clock, the counter is a synchronous one. On the other hand, if each stage in the counter is triggered by the previous one, the counter is called a ripple counter.

Synchronous counters do have some advantages

over ripple counters. As can be seen from Fig. 1, the propagation delays of each of the flip-flops in a ripple counter accumulate from stage to stage, causing a considerable amount of skewing in the final stages. This makes the ripple counter error-prone for last-return measurements in systems that require the transfer of data while the counter is running. For example, if data were transferred at the instant shown by the dashed line in Fig. 1, the number transferred would be 000 instead of 100.

The synchronous counter is much better suited for this application, but other problems make it less useful for measuring target range. For one thing, the delays of the gates between the stages of a synchronous counter limit the operating frequency to substantially less than the maximum toggling frequency of the individual flip-flops. For example, a counter built with flip-flops that can toggle at a maximum rate of 100 MHz would be hard pressed to work well at, say, 70 MHz.

Also, as the frequency of the counter goes up, the delays of the individual gates become appreciable, and delay matching between individual components becomes necessary. For example, in the clock distribution throughout the counter, if the clock pulse appears too early at any one flip-flop, an error in the count will result. Matching component delays is difficult and very costly.

Another undesirable feature of synchronous counters is that the clock drivers must operate at the oscillator frequency. This causes a very difficult and sometimes impossible design problem with existing transistors and components. As the frequency goes up, most integrated-circuit flip-flops require higher transient current drive for the clock input. If the system is synchronous, the number of high-frequency flip-flops becomes quite large, and thus the required drive is large. This begins to limit the fanout and rise and fall time capabilities of the clock drivers.

Overcoming the difficulties

Backward counting overcomes these difficulties. With this technique (Fig. 2) two counters are started at the receipt of the start pulse. When

Howard J. Gannes, Development Engineer, General Electric Co., Binghamton, N.Y.

a return is received, the master counter is reset and started over from zero; the reference counter keeps going. When the reference counter reaches a predetermined maximum range, it produces a pulse that is used to stop the master counter. The number in the master counter is thus the time (or range) between the return and the predetermined maximum range. If this number, X , is subtracted from the maximum range, Z , the range, Y , from the start pulse to the return will be established (Fig. 3).

Since it is not necessary to obtain information during the counting period, the scheme can be implemented with ripple counters for both the master and reference functions. Ripple counters have an advantage over their synchronous counterparts: Only the first few stages operate at high frequency. Each stage operates at one-half the frequency of the preceding one, so that after only three stages, a 100-MHz counter is operating at 12.5 MHz and the lead length and layout of components becomes less critical. Also, the drive current requirement is way below that of a synchronous counter, because the input clock signal has only to drive one flip-flop.

Counter delays are critical

The backward-counting scheme requires the master counter to be stopped precisely when the reference counter reaches a predetermined count. The total variation in the delays encountered in determining when the reference counter reaches its predetermined count and in generating the stop signal must be less than one clock period.

If the predetermined count is the full count (when counting up) or zero (when counting down), then the only critical delays occur in the first two stages, as can be seen in Table 1. The table shows the sequence of states in a four-stage counter.

Assume the stop signal is to occur when the state 1 1 1 1 is detected. Stage one changes just prior to this maximum count. The second stage changes to a ONE, two clock periods before it has to be detected. Stage three has changed four clock periods before detection, and stage four has

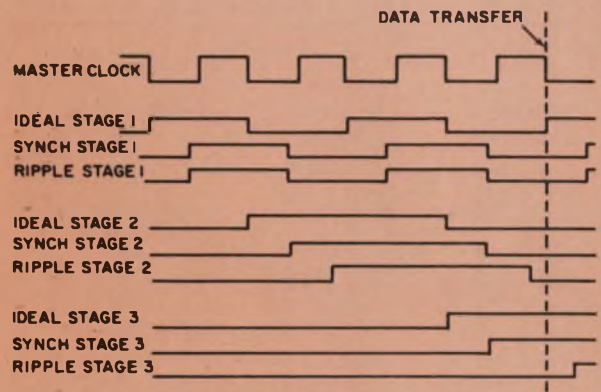

1. Stage delays are cumulative in the case of ripple counters, but synchronous counters have only an initial delay. If data is transferred at the instant shown by the dashed line, the ripple counter will introduce errors in all stages after the second one.

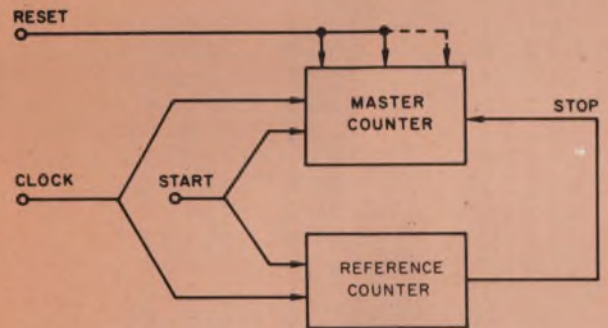

2. By resetting the master counter every time a return is detected, this backward counter can operate at high speed using ripple counters. The reference counter sets the length of the total measuring interval.

Table 1. Four-stage counter

8	4	2	1
1	1	1	1
1	1	1	0
1	1	0	1
1	1	0	0
1	0	1	1
1	0	1	0
1	0	0	1
1	0	0	0
0	1	1	1
0	1	1	0
0	1	0	1
0	1	0	0
0	0	1	1
0	0	1	0
0	0	0	1
0	0	0	0

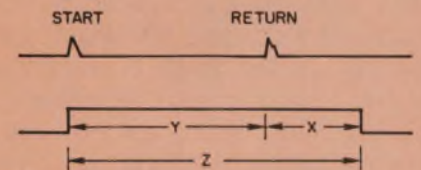

3. A two-step procedure is used to measure range with the new technique. First the range, X , between the last return and the end of the measuring interval is determined. Then X is subtracted from the length of the interval, Z , to determine the target range, Y .

Table 2. Counter operating sequences

Master counter	Reference Counter	
	Non-synchronized	Synchronized
00000	00000	00000
00001	00000	00001
00010	00001	00010
00011	00010	00011
00100	00011	00100
00101	00100	00101
00110	00101	00110
00111	00110	00111
01000	00111	01000
01001	01000	01001
01010 Return	01001	01010
00000 Reset	01010	01011
00001	01011	01100
00010	01100	01101
00011	01101	01110
00100	01110	01111
00101	01111	10000
00110	10000	10001
00111	10001	10010
01000	10010	10011
01001	10011	10100
01010	10100	10101
01011	10101	10110
01100	10110	10111
01101	10111	11000
01110	11000	11001
01111	11001	11010
10000	11010	11011
10001	11011	11100
10010	11100	11101
10011	11101	11110
10100	11110	11111 Detection
10101	11111 Stop	00000 Stop

changed eight clock periods before detection. The output of stage three could therefore be delayed as much as three clock periods; or stage four, seven clock periods, without introducing any error.

For a binary counter, the most significant bit will change at the half-way point in the count. The next bit will change three-quarters of the way through, and the least significant bit will change as the count is completed.

An n -stage counter will have a maximum count of $C=2^n$ and stage x will change $C/2^{n+1-x} = 2^{x-1}$ counts before the count is completed. The time, T , between the end of the counting period and the last change of state x is found by multiplying 2^{x-1} by $1/f$ (where f is the clock frequency) and adding the quantity of xt_d , where t_d is the propagation delay per stage. The expression for T then becomes

$$T = \frac{2^{x-1}}{f} - xt_d \quad (1)$$

For precision in determining the time at which to stop the master counter, the stop signal should be synchronized with the master clock. This is

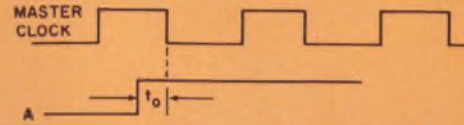
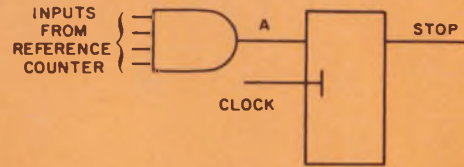

4. Input A must precede the master clock's negative-going transition by at least t_0 if it is to be reliably detected. This sets a constraint on the maximum permissible delay per stage (Eq. 2).

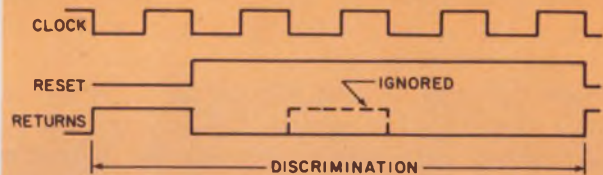

5. All returns will be ignored as long as the reset pulse is present (logical ONE). The discrimination, or minimum distance between two targets that can be separately detected, is therefore proportional to the reset time.

done by ANDing all of the stop outputs of the reference counter into a clocked flip-flop (Fig. 4).

For a signal to be detected at the input of a flip-flop, it must be present for a certain minimum time, t_0 , before the clock signal arrives. The time t_0 is normally specified by the logic circuit manufacturer. Since the time $2^{x-1}/f$ is fixed for a given counter stage and frequency, Eq. 1 can be solved for t_d subject to the condition that T equal or exceed t_0 . The result is

$$t_d \leq \frac{2^{x-1}}{f} - t_0 \quad (2)$$

Since all the factors are specified for any particular application, the permissible delay for any particular stage is known. For example, if t_0 is given as 6 ns and the frequency (f) as 100 MHz, the maximum permissible delay for stage 1 is 4 ns. For stages past the first, this delay is less critical. For example, in stage 5 the permitted delay is 30.8 ns.

It must be remembered that if the master counter ripples, the data will not be available for



The author, Howard J. Gannes, checks out an early version of the backward counter.

100 ns or so after it is stopped. This normally will not cause any problems as long as the dead time is considered in the design.

Reset time is important

A primary consideration in the design of a ranging system is target discrimination—distinguishing between closely spaced targets. How well this is done is determined by the time it takes to reset and restart the master counter. To insure proper operation, the reset pulse should be synchronized to the master clock. If it takes more than one clock period to reset the master counter, all returns that occur while the counter is being reset will be ignored. For example, if it takes four clock periods to reset the counter, the closest that two returns can be, and still be discriminated, will be five counts.

Figure 5 shows the timing associated with a four-clock period reset pulse. If shorter reset periods are considered, the target discrimination becomes better. For example, if the master clock is 100 MHz (1.5-meter resolution) and the reset

time is one clock period, the target discrimination will be two clock periods, or 3 meters. The target discrimination is therefore given by

$$D = R (N_R + 1), \quad (3)$$

where D is the target discrimination in meters, R is the resolution of the counter in meters, and N_R is the number of clock periods needed to reset the counter.

One problem associated with a long reset time is that the range value will appear as too long a range. This factor therefore must be considered and compensated for in the design.

The generation of a narrow reset pulse is not very difficult, but even if it became necessary to widen the pulse, the resolution would not be affected, only the discrimination. Present experience dictates that the discrimination for most applications is not as critical as the resolution.

Complementing provides automatic subtraction

We saw earlier that the number in the master counter has to be subtracted from the maximum range to obtain the target range. An easier and simpler way to do it is simply to complement the number in the master counter. For this technique to work, the reference counter must be delayed by one count with respect to the master counter as can be seen by examining the first two columns of Table 2. However, in actual operation, the delay is automatically built into the system by the STOP signal synchronizing circuit (Fig. 4). This circuit causes a delay in the generation of the STOP signal because a clock pulse must arrive after all of the AND gate inputs are present before the STOP signal can be generated.

Therefore, the actual operation of the circuit is depicted by columns one and three of Table 2. A return occurs at 01010. If the counter is stopped as shown, the complement of the number in the counter, 10101, is the correct result. ■■

Test your retention

Here are questions based on the main points of this article. Their purpose is to help you make sure you have not overlooked any important ideas. You'll find the answers in the article.

1. Under what conditions is it desirable to measure the range of the last return?
2. What is the problem with the standard method of measuring range? How does backward counting solve this problem?
3. How does the STOP pulse delay help in implementing automatic subtraction?
4. What factors affect the system resolution? The discrimination?

What are TI semiconductors doing in department stores?

(Solving problems like yours)



In industry after industry, our customers are doing old jobs better and new jobs in new ways.

In department stores

Digital Data Systems' "Creditmaster" validating system (left) enables retailers to check credit cards in one second from counter-top remote terminals. A central processor identifies card as (a) good, (b) good for a limited amount, (c) lost or stolen, or (d) possible counterfeit.

Extensive use of TI medium-scale integration (MSI) and plastic-encapsulated TTL integrated circuits greatly reduced equipment size and design time and cost, while increasing reliability and ease of maintenance.

In currency changers

Transmarine Corporation uses TI's SN72709N operational amplifier in a currency validating system so fraud-proof no counterfeit bill can beat it.

TI linear integrated circuits enabled Transmarine to reduce d-c amplifier drift from ± 50 to ± 8 percent. Production time was cut by 25 percent, size by 60 percent, and cost by 50 percent.



In your broker's office

The VidiQuote display from Trans-Lux Corporation converts stock-market quotations into a continuously updated display.

LSI/MOS 32-bit shift registers maintain the display on the monitor screen for a continuous image. Synchronization signals are provided by Series 74 TTL integrated circuits and TI DTL circuits. The new Trans-Lux system features significant cost savings, plus reduction in size.



In highway construction

MicroMetric Corporation's 3-axis reversible scaler simplifies translation of data from drawings or photos into computer language for computation of construction problems such as the amount of roadbed fill required. MSI/TTL from TI enabled MicroMetric to cut costs while increasing speed from 30 kHz to 5 MHz and reducing size by two-thirds.



In power plants

Scam Instrument Corporation developed a new recording annunciator to monitor up to a thousand points in power plants and other industrial systems.

Series 74N MSI/TTL integrated circuits were used, and as a result, logic hardware costs were cut by two-thirds. Monitoring capacity was nearly doubled, resolution was improved from 1250 to 800 microseconds, and overall size was reduced by 80 percent.

In hospitals...chemical plants... machine shops...printing plants... paper mills...water metering... offices...automotive skid controls...TI is helping customers like you do old jobs better and new things in new ways.

What's *your* problem? Chances are, TI can help with industry's broadest line of semiconductors, advanced custom technologies, and applications assistance. Call your local TI distributor or TI sales engineer.



TEXAS INSTRUMENTS

INCORPORATED

Get rid of ground-loop noise.

Follow these clever circuit techniques that use simple bypass capacitors and op amps.

Ground loops are a problem for the circuit designer, especially in complex systems. Ground paths and currents often cannot be predicted accurately before the system is assembled, and after assembly large dc and ac currents must frequently be carried between separated chassis by ground leads or buses. If low-level signals have to be transmitted between these chassis, the designer may find himself with a severe noise problem.

Transformers and baluns can be used to reduce ground-loop problems. They are generally effective, but their useful frequency range is limited, and they are very bulky circuit components. On the other hand, clever circuit techniques can yield greater noise reduction, improved frequency response and smaller circuit size—and do it with only bypass capacitors or op amps.

The ground-loop problem

In a typical circuit, a low-level signal is transmitted from a chassis tied to ground at point A to another chassis tied to ground point B (Fig. 1). A ground impedance, R_g , exists between them. An equivalent noise source, v_n , which exists elsewhere in the system, has an equivalent load resistance R_n and makes its ground return through the common ground-impedance R_g . The voltage that exists across the amplifier input is the desired signal, v_s , plus the undesired noise, $I_n R_g$.

Suppose, for example, that the common ground connection is one foot of AWG 20 copper wire ($R_g = 0.026$ ohms) and that the unwanted noise current, I_n , is 10 mA. The unwanted noise voltage is thus $v_n = I_n R_g = 260 \mu\text{V}$. In low-level circuits, where voltages of 10 microvolts or less are encountered, the results of this noise would be disastrous. Even if the noise frequencies were largely out of the over-all amplifier bandwidth, they could drive amplifiers ahead of the bandpass elements into nonlinear operation, thus intermodulating with the signal.

Using the chassis as a ground return may not improve this situation, because ground currents

H. C. Brown, Member, Technical Staff, Aerospace Div., Westinghouse Defense & Space Center, Baltimore, Md.

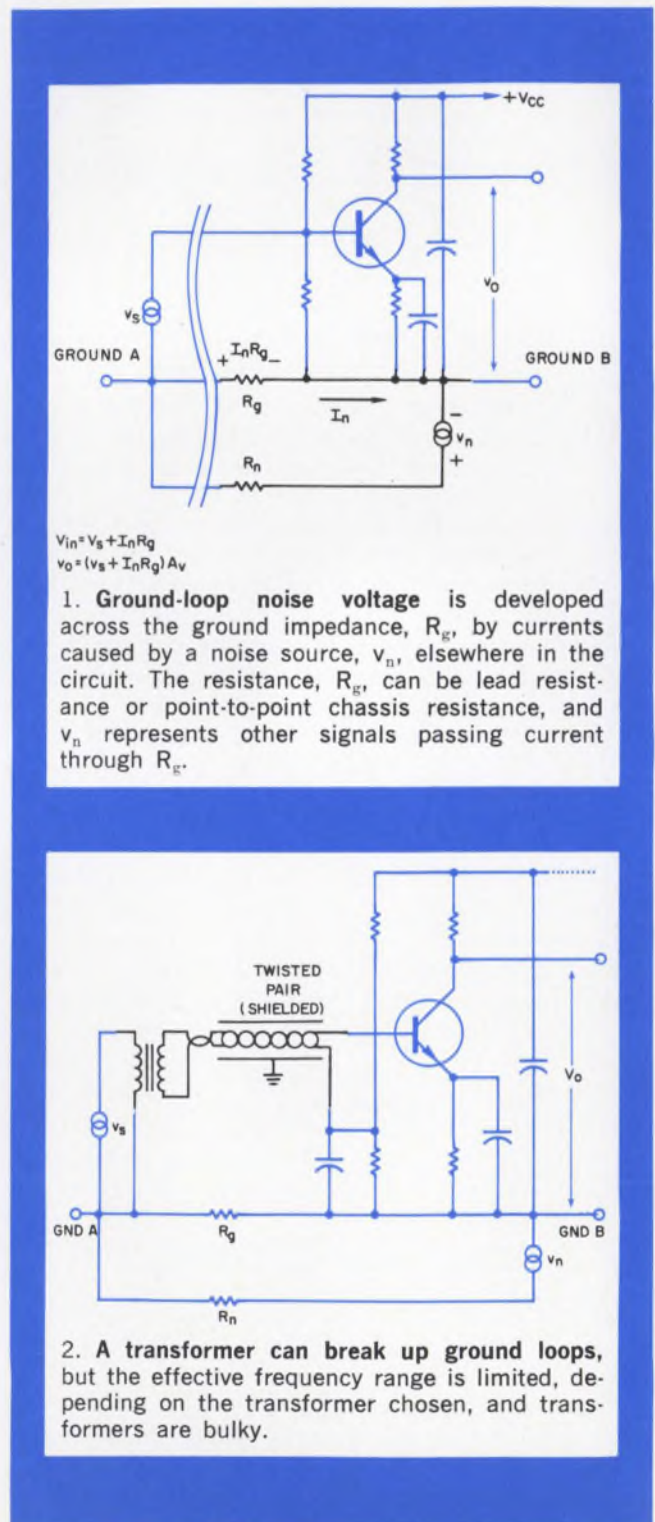

being drawn all over the chassis will contribute to the noise between ground points A and B. Typical noise levels of 10 mV or more, for example, have been measured across chassis ground points in radar systems. In large aircraft, where such heavy current sources as main generators draw their current through the airframe, noise levels of a volt or more are not unusual.

Unfortunately, the sources of common-ground currents are not always obvious in the early design phases, when the design of other units in the system or the packaging concepts have not been sufficiently defined. Packaging considerations or system complexity may make it impossible to use a single-path ground system to avoid common-ground currents. But the designer must take pains to understand fully, as early in the design phase as possible, the ground-noise environment that his circuits will encounter in order to prevent noise problems when the system is assembled.

Transformers are an obvious solution

There are several conventional techniques for preventing common-ground noise. One method is to use heavy wire or ground-braid between the two affected subassemblies. This is sometimes sufficient, when the ratio of unwanted noise to signal is low, but it usually amounts to placing some finite low impedance across an already low impedance, and the noise improvement is not great.

This classical solution—using a transformer to isolate the grounds and running a separate return for the transformer (Fig. 2)—offers drastically improved isolation, provided that the interwinding capacitance, or capacitance from the secondary to the core, is not excessive. But for this method to be successful the primary return has to be connected only at the source and the secondary return only at the load.

Where dc coupling is needed, baluns can be used to provide ground-noise isolation similar to that provided by a transformer. A balun is essentially a broadband, tightly coupled 1:1 transformer (Fig. 3). Connected as shown, the noise across winding 1 is induced across winding 2, and the sum of the voltage across v_i is simply v_s . Assuming an ideal transformer, any signal drop across winding 2 induces an equal drop across winding 1 in such a direction as to cancel its effect at the input to the amplifier. Signal losses are usually negligible.

Special circuit techniques are better

While transformers and baluns have been used with much success, their size, weight, and frequency-response limitations make them undesirable for modern circuit design, particularly where microelectronic devices are employed.

Semiconductor devices or operational amplifiers

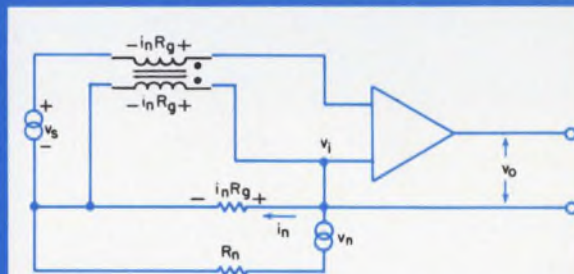

3. A balun reduces ground-loop noise by canceling noise voltages in opposing windings. It is essentially a transformer, and has the same limitations.

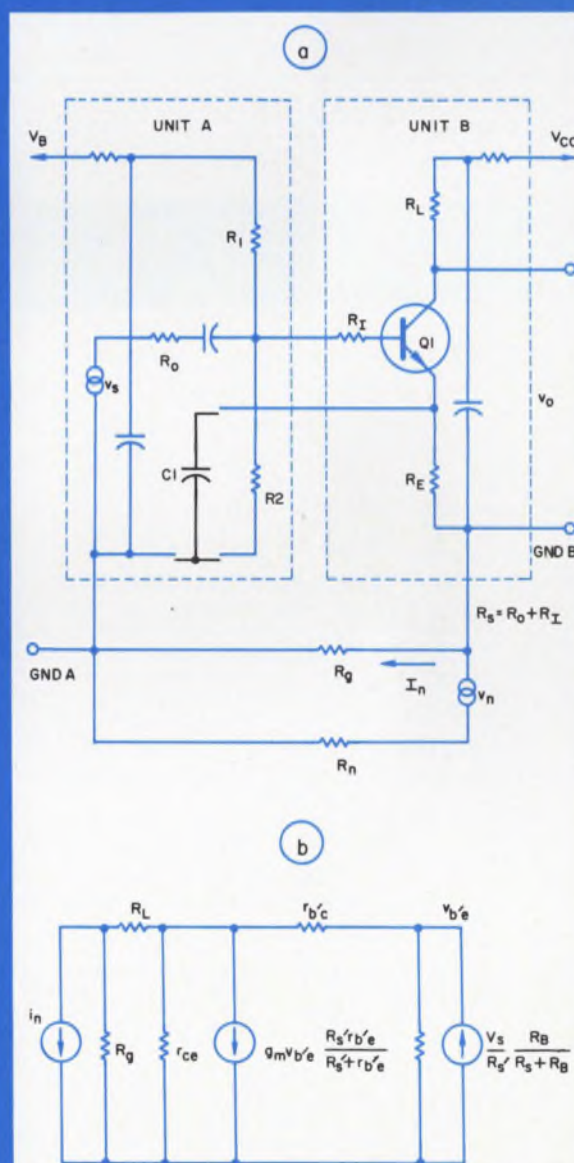

4. A common-emitter stage isolates ground-loop noise if the emitter bypass capacitor is placed at the signal source (a). An equivalent circuit is used for circuit analysis (b).

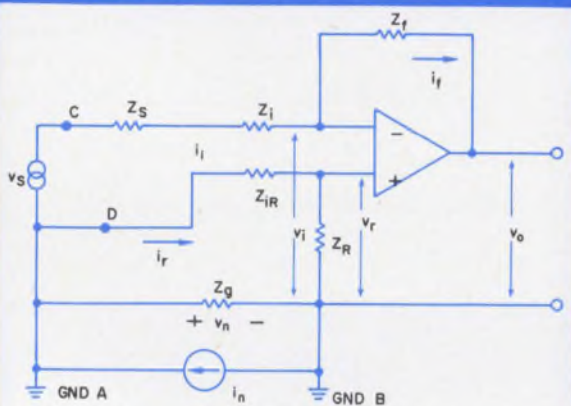

5. A differential amplifier cancels common-mode noise caused by the ground loop in this circuit. Impedances Z_{iR} and Z_R are selected to provide a balanced noise signal to the amplifier input leads, and thus cancel the noise at the amplifier output.

can frequently be used to achieve ground-noise isolation as effective as that provided by transformers or baluns.

A common-emitter amplifier located in one unit can be connected to a signal source located in another, as shown in Fig. 4, to provide excellent suppression of ground noise. This arrangement prevents the insertion of ground noise between the signal source and the base-emitter junction of the transistor.

Unlike the circuit shown in Fig. 1, the emitter bypass capacitor C_1 is connected to ground at the signal source by a signal return wire, and bias resistors R_1 and R_2 are referenced to the source ground. Emitter degeneration is provided by inserting a resistor between the emitter of the transistor and the bypass capacitor, if desired.

Since transistors connected in the common-emitter configuration are good constant-current sources, very little ground noise will appear between the collector of Q_1 and ground B. C_1 must be large enough to shunt the ground-noise current flowing through R_1 to ground. Resistor R_1 is used to prevent high-frequency instability due to the distributed series inductance and shunt capacitance of the wires from the source.

The equivalent circuit shown in Fig. 4b is used to analyze the noise suppression achieved by this configuration. The ratio of output noise, v_{on} , to the output signal, v_{os} , can be expressed as:

$$\frac{V_{on}}{V_{os}} = - \left(\frac{v_n}{v_s} \right) \left(\frac{R'_s (R_s + R_B)}{R_B (g_m - 1/r_{b'e})} \right) \left[\left(\frac{1}{r_{b'e}} + \frac{r_{b'e} + R'_s}{R'_s r_{b'e}} \right) \left(\frac{1}{r_{b'e}} + \frac{1}{r_{ce}} \right) + \frac{1}{r_{b'e}} \left(g_m - \frac{1}{r_{b'e}} \right) \right] \quad (1)$$

where:

$$R_s \approx R_o + R_l$$

$$R'_s \approx \frac{R_s R_1 R_2}{R_s (R_1 + R_2) + R_1 R_2}$$

Typically, $R_s = 600$ ohms, and the remaining circuit parameters have the following values: $R'_s = 550$ ohms, $R_B = 6k$, $R_l = 10k$, $R_o = 0.026$ ohms, $g_m = 40 \times 10^{-3}$, $r_{b'e} = 7 \times 10^6$, $r_{b'c} = 2.5 \times 10^3$, and $r_{ce} = 200 \times 10^3$.

By eliminating insignificant terms, Eq. 1 may be simplified to:

$$\frac{v_{on}}{v_{os}} \approx \left(\frac{-v_n}{v_s} \right) \left(\frac{R'_s (R_s + R_B)}{R_B g_m} \right) \left[\frac{r_{b'e} + R'_s}{R'_s r_{b'e} r_{ce}} + \frac{g_m}{r_{b'e}} \right] \quad (2)$$

Then, using the parameters for the circuit of Fig. 4b,

$$\frac{v_{on}}{v_{os}} \cong - \left(\frac{v_n}{v_s} \right) \left(\frac{(0.55) \times 10^3}{6 \times 10^3} \right) \left(\frac{(6.6) \times 10^3}{40 \times 10^{-3}} \right)$$

$$\left[\frac{(2.5 + 0.55) \times 10^3}{2.5 \times 10^3 \times 0.55 \times 10^3 \times 200 \times 10^3} + \frac{40 \times 10^{-3}}{7 \times 10^6} \right]$$

$$= \left(- \frac{v_n}{v_s} \right) (15.1 \times 10^{-6}) \quad [16]$$

or $v_{os}/v_{on} = 4160$, if $v_n = v_s$.

This is a noise-suppression ratio of 72.5 dB, and it is accomplished with a simple common-emitter stage.

Another useful method of suppressing ground noise involves using a differential amplifier. The emergence of low-cost wideband IC differential amplifiers, such as the WM 1709, makes this method very attractive, since bulky bypass capacitors are not required and the noise rejection can theoretically approach infinity. In a typical arrangement (Fig. 5), common-ground noise is injected into both the inverting and noninverting inputs. By proper choice of Z_{ir} and Z_r , the noninverting gain can be made equal to the inverting gain, resulting in equal in-phase and 180° out-of-phase noise components that cancel each other at the output.

Circuit analysis to determine the values of Z_r and Z_{ir} , and to establish the amount of rejection that may be expected with realizable component tolerance, is quite simple. From Fig. 5, the voltage across the noninverting input of the amplifier is:

$$v_R = \frac{v_n Z_R R_2}{Z_{iR} (Z_R + R_2) + Z_R R_2} \quad (3)$$

where R_1 is the impedance of the inverting input of the amplifier and R_2 is the impedance of the noninverting input.

The voltage across the inverting input is

$$v_i = \frac{(v_n + v_s) Z_f R_1}{(Z_f + R_1) (Z_i + Z_s) + Z_f R_1}$$

$$+ \frac{v_o (Z_i + Z_s) R_1}{(Z_i + Z_s + R_1) Z_f + (Z_i + Z_s) R_1} \quad (4)$$

After some algebraic manipulation, we obtain

$$\frac{v_{on}/v_{os}}{v_n/v_s} = 1 - \frac{Z_R R_2 [(Z_f + R_1) (Z_i + Z_s) + (Z_f R_1)]}{Z_f R_1 [(Z_R + R_2) Z_{iR} + Z_R R_2]}$$

Perfect ground noise cancellation occurs when:

$$\frac{Z_f R_1}{(Z_f + R_1) (Z_i + Z_s) + Z_f R_1}$$

$$= \frac{Z_R R_2}{(Z_R + R_2) Z_{iR} + Z_R R_2}$$

If it is assumed that $R_1 = R_2$, then this relationship is satisfied when $Z_R = Z_f$ and $Z_{iR} = Z_i + Z_s$.

Consider the situation where $R_1 + R_2 = 10 \text{ k}\Omega$, and $R_f = 100 \text{ k}\Omega$, all resistors are 1%, the amplifier is a WM 1709, and worst-case analysis is assumed:

For a typical WM 1709, $R_1 = 400 \text{ k}\Omega$, $R_2 = R_1 \pm 25\%$, and $A_v = 45 \times 10^3$.

As a worst case, assume that $Z_i = 10.1 \text{ k}\Omega$, $Z_f = 99 \text{ k}\Omega$, $Z_{iR} = 9.9 \text{ k}\Omega$, $Z_r = 101 \text{ k}\Omega$, $R_1 = 400 \text{ k}\Omega$, and $R_2 = 300 \text{ k}\Omega$. Then

$$\frac{v_{on}/v_{os}}{v_n/v_s} = 1$$

$$= \frac{101 \times 300 [(99 + 400) (10.1) + 99 \times 400]}{99 \times 400 [(101 + 300) 9.9 + 101 \times 300]}$$

$$= 1 - 0.997 = 3 \times 10^{-3}$$

The fact that this results in only 50 dB of noise rejection in the worst case is due, in part, to the large mismatch between the comparatively low values of R_1 and R_2 , and the use of 1% network resistors. The rejection can be improved by using 0.1% resistors and either an amplifier having a higher input impedance or lower values of resistance in the network. For example, if $Z_i = 1.001 \text{ k}\Omega$, $Z_f = 9.99 \text{ k}\Omega$, $Z_{iR} = 0.999 \text{ k}\Omega$, $Z_r = 10.01 \text{ k}\Omega$, $R_1 = 400 \text{ k}\Omega$, and $R_2 = 300 \text{ k}\Omega$, then

$$\frac{v_{on}/v_{os}}{v_n/v_s} = 1$$

$$= \frac{10.01 \times 300 [(9.99 + 400) 1.001 + 9.99 \times 400]}{9.99 \times 400 [(10.01 + 300) .999 + 10.01 \times 300]}$$

$$= 6 \times 10^{-1}$$

This is a five-fold improvement over the previous case. If $R_1 = R_2 = 400 \text{ k}\Omega$ and 0.1% resistors are used, the noise rejection is 1.73×10^{-1} , or 75 dB. ■ ■

Test your retention

Here are questions based on the main points of this article. Their purpose is to help you make sure you have not overlooked any important ideas.

1. How do ground loops introduce noise?
2. What three standard techniques are often used to reduce ground loop noise?
3. What two circuit techniques for noise reduction are suggested by the author?
4. Name two advantages of these circuit techniques.



MOTOR 4

START

Pushbuttons?

Why not go where you have the whole spectrum to choose from!

With panel design continually increasing in sophistication, pushbutton specifications are becoming more and more exacting. Whatever the case—whether your needs call for the simple or the complex—your best bet is to call MICRO SWITCH. The reason is plain. No one can match our pushbutton line in breadth of selection.

What's more, your MICRO SWITCH Distributor can offer you literally thousands of pushbutton varieties *right off the shelf*. For example, he stocks hundreds of interchangeable operator and switch modules that combine into thousands of different assemblies—allowing

you to economically customize your panel with unlimited design freedom.

Special problems? MICRO SWITCH also puts the broadest field engineering service at your beck and call. These pushbutton specialists, backed up by the largest manufacturing and design facilities in the industry, can come up with the right solutions fast.

Just a sampling from our spectrum of pushbuttons is shown at left and described below. For more details, call a Branch Office or an Authorized Distributor (Yellow Pages, "Switches, Electric"). Ask for Catalog 51.

1. Unlighted Pushbutton Switches. Bushing or bracket mounted. Available in 1-, 2-, 3- or 4-pole double-throw circuitry, momentary or alternate action. Black, red and green buttons in various diameters. Sealed designs available. Wide range of electrical power-handling capabilities.

2. Series 2C200 Modular Lighted Pushbutton Switches. Rectangular display lighted by projected or transmitted 4-lamp color. Can be relamped without tools. 1, 2, 3 and 4 section split-display screens. Maintained, momentary or magnetic hold-in operation. Switch modules with silver or gold contacts, multiple circuits and broad choice of contact arrangements and electrical capacities. Also reed switch module.

3. PT Heavy-duty and CMC Pilot-duty Industrial Manual Controls. Oiltight pushbuttons, selectors and indicators with the modern square look. Lighted or unlighted. Large easy-reading legends. Multi-circuit control with up to 32 circuits per unit.

4. KB Switch/Display Matrix. New keyboard building block concept consisting of pushbuttons and pushbars (lighted and unlighted), switches, indicators, mechanical interlock units, and modular hardware for mounting and wiring. En-

tire KB matrix can be bench assembled. Switches can be pre-wired and plugged in like a radio tube. Milliamp-rated "encoding" switch produces a coded output for data entry, exclusive of separate circuit packages. "Power" switch with 5 amp. 115 vac rating has lighted display option.

5. 50PB Bushing Mounted Pushbutton Switches. One-lamp indication. Choice of button sizes, shape and colors. Long- and short-stroke and turn-to-hold momentary action; one- and two-level alternate-action. 1-4 pole double-throw and two-circuit double-break contact arrangement.

6. DM Pushbutton Switches: Attractive, rugged snap-in panel mount. SPDT or

DPDT circuitry. Three snap-on button styles, 1/2" to 1" diameter, red or black. Also 1 1/16" diameter integral momentary-action and push-pull alternate action buttons. Rating: 10 amps, 125 or 250 vac; 1/3 hp, 125 or 250 vac.

7. 302PB Miniature Pushbutton Switches. One- or two-section two-lamp display. Momentary and alternate-action operation of two SPDT switches. Spacing barriers and panel seals available.

8. Series 2N Modular Lighted Pushbutton Switches. Relampable without tools, these switches feature spring-lock mounting. Molded color housings, in gray, white or black, can be supplied with terminals for two or four lamps. Modularity provides a number of circuit, operation and display possibilities paralleling the 2C200 options. Spacing barriers and hold-in coil modules are available.

9. Series 2M Round Display Modular Lighted Pushbutton Switches. Colored guard rings encircle display screen, prevent accidental operation, code control function. Broad choice of circuitry through switch modules used with Series 2N. Many choices of transmitted and projected display colors. Panel mount in 1/16" to 5/16" thick panels.

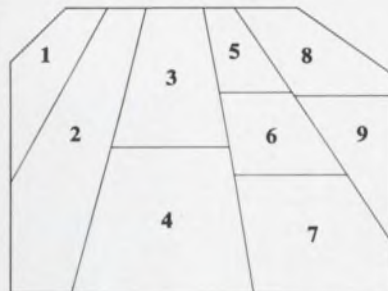

MICRO SWITCH

FREEPORT, ILLINOIS 61032

A DIVISION OF HONEYWELL

HONEYWELL INTERNATIONAL • Sales and service offices in all principal cities of the world. Manufacturing in United States, United Kingdom, Canada, Netherlands, Germany, Japan.

INFORMATION RETRIEVAL NUMBER 49

Upgrade your diode applications

by using curve tracer measurements to obtain precise knowledge of diode behavior.

Although semiconductor diodes are being used more and more in analog computation circuits,¹ knowledge about their characteristics has not kept pace. Yet proper application of the diodes usually requires accurate data.² Little information about diode parameters is available in manufacturers' specifications, and the characteristic equation is not very helpful, since it is in transcendental form.

But there is a way out. Curve tracer measurements can be used, not only to help determine the diode parameters and their effect on diode behavior but also as the basis of a simpler form for the diode equation.

The designer would probably start with the equivalent circuit, Fig. 1, which is generally used to represent the diode during forward conduction. This circuit consists of a semiconductor junction and a series resistance (the resistance of the semiconductor chip and the associated contact and lead resistance). The current-voltage relation at the junction is given by the equation:

$$i = i_o (e^{V/V_o} - 1) \quad (1)$$

where

i_o = leakage current

V_o = voltage constant (for the diode).

Equation 1 is accurate enough for low current operation. For higher currents the voltage drop across the series resistance relative to the drop across the junction becomes appreciable, and Eq. 1 must be modified to include the effect of the series resistance. The total diode equation then becomes:

$$V = V_o \ln[(i + i_o)/i_o] + ir_s, \quad (2)$$

where

r_s = dynamic resistance of the diode.

Unfortunately, neither of the above equations is adequate to describe the diode behavior for reverse voltage conditions. The measured leakage current, particularly in a silicon device, is larger than i_o . More important, the equations contain nothing to predict avalanche or zener breakdown.

Let's consider the curve tracer as an alternative.

Measurements can easily yield the following diode parameters:

dynamic resistance = r_s

voltage constant = V_o

leakage current = i_o .

These parameters are significant in any circuit, regardless of whether steady-state, slowly varying or transient operation is involved.

Note dynamic resistance first

The derivative of the total diode equation, Eq. 2, is

$$dv/di = [V_o/(i + i_o)] + r_s.$$

As the diode current becomes progressively larger, dv/di approaches r_s . The value of the dynamic resistance (r_s) may therefore be determined from the reciprocal of the slope of the diode curve, as displayed on the curve tracer (Fig. 2). When the drive voltage is increased, the displayed trace will ultimately approach linearity at the upper end. Greater measurement accuracy can be achieved by increasing the voltage and current sensitivity as much as possible while still allowing a display of the upper segment of the curve.

Find voltage constant next

To evaluate the voltage constant, V_o (Fig. 3),

1. Pick an arbitrary current i_1
2. Let $i_2 = 10i_1$
3. Measure $\Delta V = V_2 - V_1$

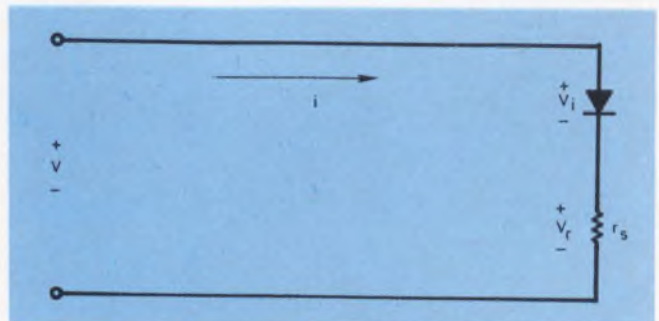

1. Equivalent diode circuit consists of a semiconductor junction in series with a resistance.

J. A. Williamson, Member of Technical Staff, and R. E. Jones, Technical Editor, Autonetics Div. of North American Rockwell Corp., Anaheim, Calif.

(i_1 , i_2 , and ΔV will remain fixed for the rest of the calculations.)

4. Apply Eq. 1 to the ratio i_2/i_1 :

$$\frac{i_2}{i_1} = 10 = \frac{i_o (e^{V_2/V_0} - 1)}{i_o (e^{V_1/V_0} - 1)} \approx e^{(V_2 - V_1)/V_0} = e^{\Delta V/V_0}. \quad (3)$$

5. The voltage constant is then:

$$V_o = \Delta V / \ln 10 \approx \Delta V / 2.3. \quad (4)$$

The value of i_1 must be chosen so that i_1 is much larger than i_o (theoretical leakage current) and still not so large that the voltage developed across r_s becomes appreciable with respect to V_o . This procedure insures that ΔV will remain constant. All diodes have a wide range of current within these limits.

Now determine leakage current

Using the previously determined value of ΔV , select an integer, n , and at the voltage corresponding to $n\Delta V$ measure the current, i_n , (flowing through the diode), as shown in Fig. 4.

Applying Eq. 1:

$$i_o (e^{n\Delta V/V_0} - 1) \approx i_o (e^{\Delta V/V_0})^n.$$

Since $e^{\Delta V/V_0} = 10$ (Eq. 3),

$$i_n = i_o \times 10^n.$$

The theoretical leakage current, i_o , is given by $i_o = 10^{-n} i_n$.

Note that the theoretical leakage current is defined in Eq. 1; it is not the current that is measured when a reverse voltage is applied to the diode.

Use simpler diode equation

Equation 1 can be put into a more practical and intuitive form by using Eqs. 3 and 4.

$$i = i_o (e^{(\ln 10) (V/\Delta V)} - 1)$$

which reduces to

$$i = i_o (10^{V/\Delta V} - 1).$$

It is apparent that the current increases by an order of magnitude for every ΔV increase in the applied voltage.

See effects of parameter variation

The scope curves, together with the parameters r_s , i_o and V_o , provide a method for determining whether a replacement diode is satisfactory or not

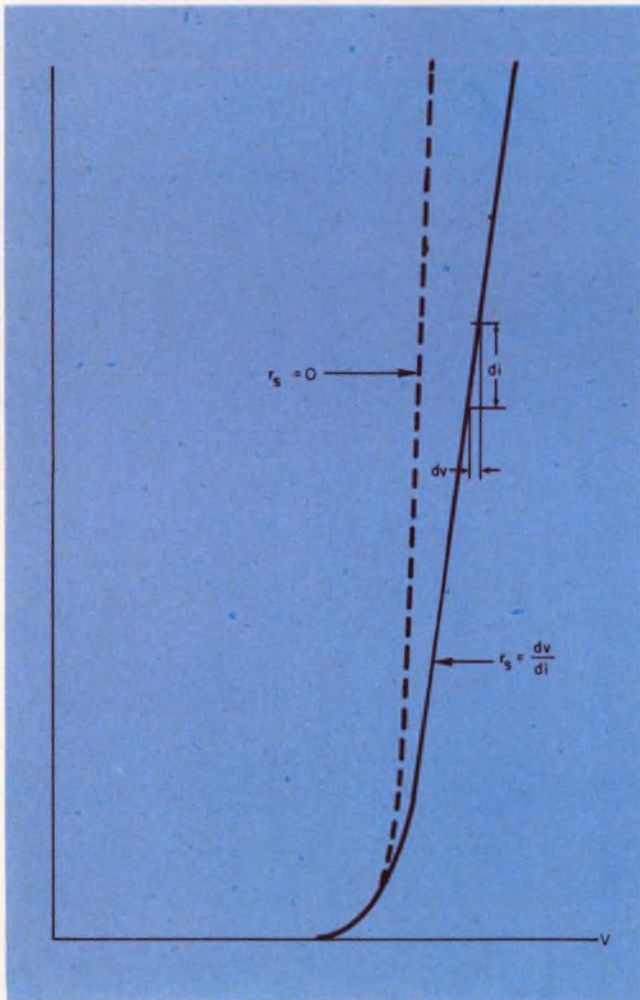

2. Obtain r_s by measuring the reciprocal of the slope of i vs V , as displayed on a curve tracer.

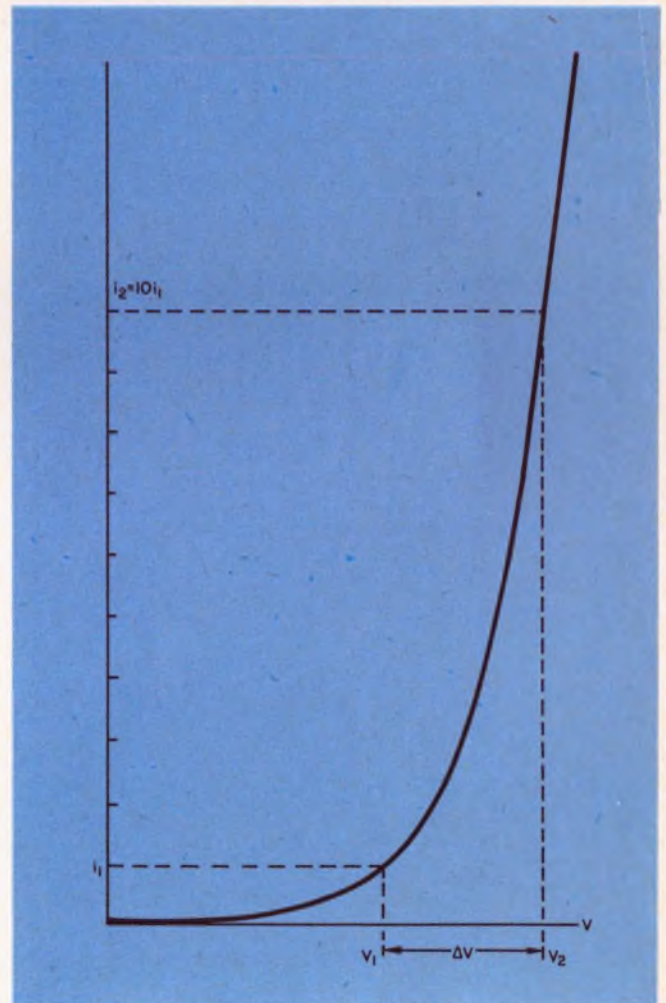

3. Evaluate V_o from the curve tracer display of i_2 vs V . Here, i_1 must be much larger than i_o .

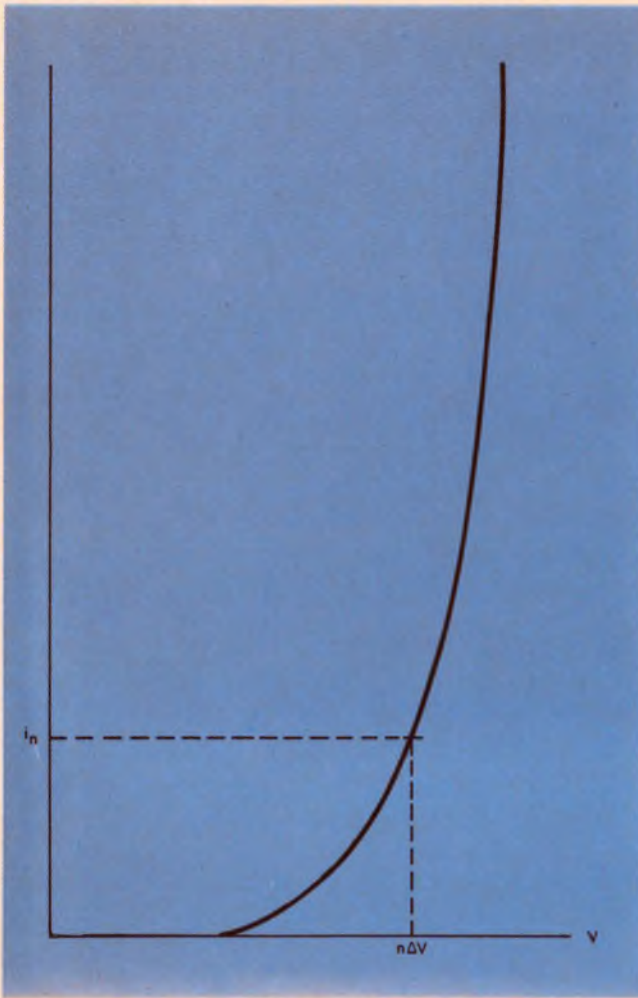

4. Leakage current can be obtained from a plot of i_n vs ΔV , where n is an integer.

for a particular application.

Figure 5a shows how the performance of a typical diode varies with a change in theoretical leakage current, i_o . In this case the voltage drop decreases as i_o increases, but the variational resistance versus current remains the same. The sharp curvature at the knee of the diode is also unchanged.

Fig. 5b illustrates changes in the diode's performance resulting from changes in the voltage constant, V_o . An increase in the voltage constant increases voltage drop, increases the variational resistance, and softens the knee of the curve.

Changes in diode temperature can cause both of the above illustrated effects.

As an example of the techniques described, curve tracer measurements (Fig. 6a, b, c and d) were used to evaluate the parameters of General Electric diode 1N3065. The curve displayed in Fig. 6a can be described by the equation:

$$V = \Delta V \log_{10} [(i + i_o)/i_o] + ir_s.$$

This equation expressed in terms of common logarithms, for convenience, is based upon Eqs. 2 and 4.

$$V = 140 \log_{10} \left(\frac{i + 5 \times 10^{-6}}{5 \times 10^{-6}} \right) + 2i,$$

where the voltages are measured in millivolts and the current in milliamperes. Substituting $i = 100$ mA gives a $V = 1220$ mV, which is where the trace in photo 6a crosses the center horizontal line ($i = 100$ mA). Other points may be checked to verify

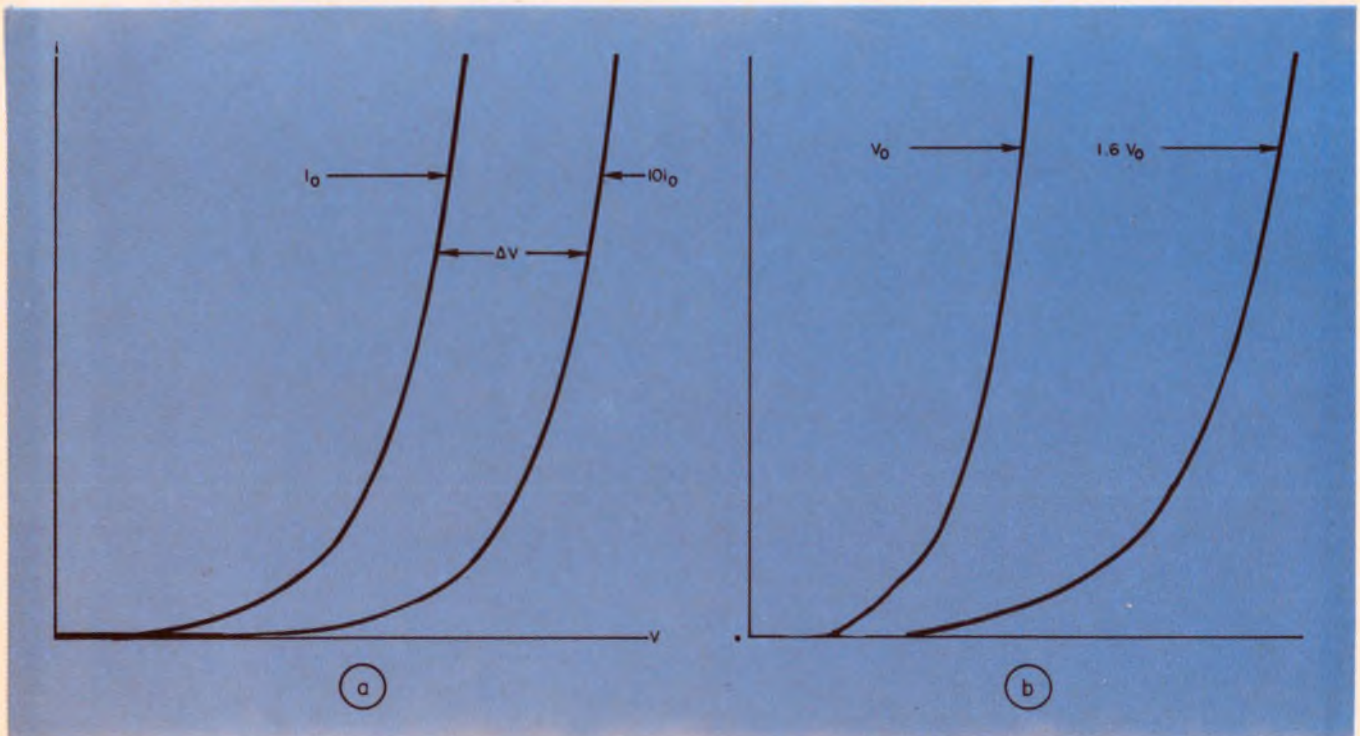

5. Variation in diode performance is readily seen from scope traces that show change due to leakage current

(a) or voltage constant (b). Changes in diode temperature can cause both of these effects.

VERTICAL 20mA/cm
HORIZONTAL 200mV/cm

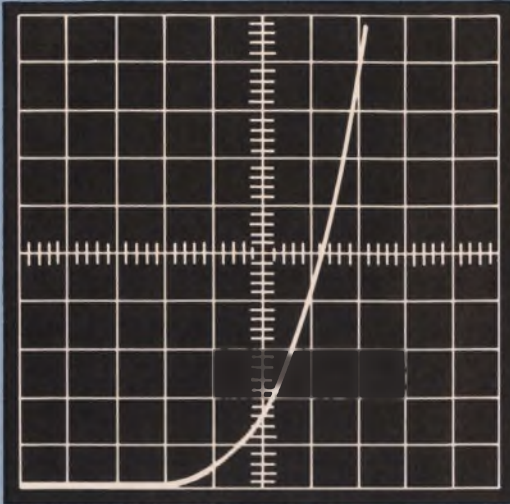

(a)

VERTICAL 10μA/cm
HORIZONTAL 100mV/cm

$n = 4$
 $n\Delta V = 4 \times 140 = 560\text{mV}$
 $i_n = i_4 = 50\mu\text{A}$
 $i_0 = 50 \times 10^{-4} \times 10^{-6}\text{A}$
 $= 5\text{ nanoA}$

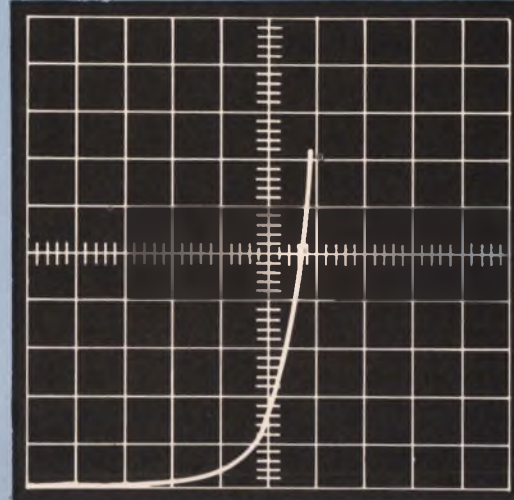

560 mV

(c)

VERTICAL 20mA/cm
HORIZONTAL 100mV/cm

$r_s = \frac{100\text{mV}}{50\text{mA}} = 2\text{OHMS}$

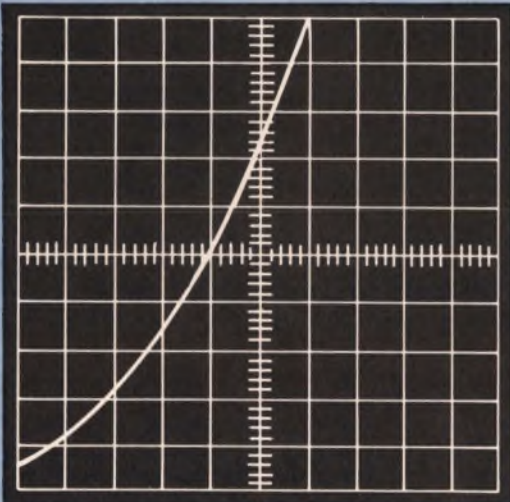

$d_i = 50\text{mA}$

$d_v = 100\text{mV}$

(b)

VERTICAL 100μA/cm
HORIZONTAL 100mV/cm

$n = 5$
 $n\Delta V = 5 \times 140 = 700\text{mV}$
 $i_5 = 500\mu\text{A}$
 $i_0 = 500 \times 10^{-5} \times 10^{-6}$
 $= 5\text{ nanoA}$

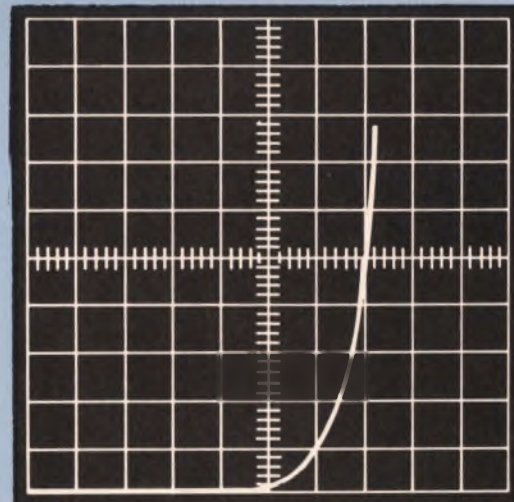

700 mV

(d)

6. Actual curve tracer measurements are shown for the 1N3065 diode. The characteristic curve of the diode up to 200 mA is shown in (a). In (b) the upper end of the curve is expanded to give a measured r_s of approximately two ohms. Photo (c) shows measurement taken to evaluate i_n for $n = 4$. The current measured at $v = 4 \times 140 = 560$ mV, is $50 \mu\text{A}$, giving an $i_0 = 5$ nA. Photo (d) is a verification of i_0 at $n = 5$; it yields the same value.

Log and log⁻¹ amplifiers

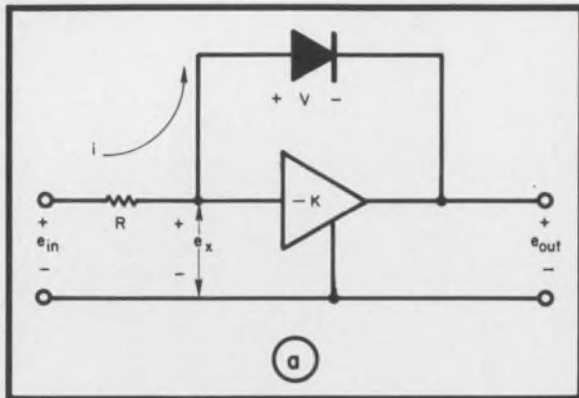

Diodes used in the logarithmic amplifier (a) or the log⁻¹ amplifier (b) must be carefully selected. The

$$i = \frac{e_{in} - e_x}{R} \quad V = e_x - e_{out}$$

$$e_{out} = -Ke_x$$

$$V = V_o \ln \left(1 + \frac{i}{i_o} \right)$$

For operating conditions

$$(a) \quad i \gg i_o$$

$$(b) \quad K \gg 1$$

$$(c) \quad e_{in} \gg e_x$$

the transfer characteristic of the circuit is:

$$e_{out} = V_o \left[\ln(i_o R) - \ln(e_{in}) \right]$$

$$\text{or} \quad e_{out} = \Delta V \left[\log_{10}(i_o R) - \log_{10}(e_{in}) \right]$$

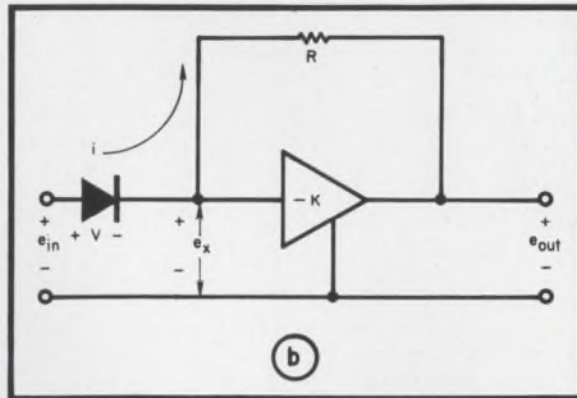

diode parameters control the output signal. These amplifiers are utilized in analog multipliers.

$$i = \frac{e_x - e_{out}}{R} \quad V = e_{in} - e_x$$

$$e_{out} = -Ke_x$$

$$V = V_o \ln \left[1 + \frac{i}{i_o} \right]$$

For the operating conditions:

$$(a) \quad i \gg i_o$$

$$(b) \quad K \gg 1$$

$$(c) \quad e_{in} \gg e_x$$

the transfer characteristic of the circuit is:

$$e_{out} = -i_o R e^{-e_{in}/V_o}$$

$$\text{or} \quad e_{out} = -i_o R 10^{e_{in}/\Delta V}$$

that the final equation does, indeed, provide an accurate model for the particular diode.

Diode parameters control output signal.

With the proper diode circuit configuration, log and log⁻¹ amplifiers can readily be constructed² (see Box). Note that care must be taken in selecting the proper diodes. The equation for the transfer characteristic shows the output signal to be determined completely by the external resistor, R , and the diode parameters (i_o and V_o , or i_o and ΔV). Consequently, if the characteristic of the circuit is to be known, the parameters of the diode must be known. The curve tracer measurements outlined provide the necessary information simply, rapidly and accurately. ■ ■

References:

1. James Raby and Ronald Embley, "Log Diodes Can Simplify Design of Analog Computation Circuits," *ELECTRONIC DESIGN* (ED 2), Jan. 18, 1969, pp. 58-59.
2. *Integrated Circuits Data Book*, Phoenix, Ariz: Motorola Semiconductor Products, Inc., 1968, pp. 10-65 and 10-66.

Test your retention

Here are questions based on the main points of this article. They are to help you see if you have overlooked any important ideas.

You'll find the answers in the article.

1. How can the dynamic resistance of the diode be found from the scope trace?

2. How can the leakage current be found from the scope trace?

3. What important information does the simplified diode equation provide about current increases?

4. How can variation of diode parameters with temperature be estimated?



MIL-C-81511 SUBMINIATURE CONNECTORS CINCH-NULINE DELIVERS THEM **NOW!**

The MIL-C-81511 Astro/348 represent the highest state-of-the-art in round connectors. They have .085" contact centers with dielectric separation of .021" (equal to other connectors with .130" centers). The dielectric has a one-piece retention system that eliminates metal construction. Other important features include scoop-proof mating, grounding prior to electrical contact, removable crimp contacts and extreme environmental stability.

The complete line includes shell sizes for contact configurations of 4, 12, 37, 55, and 85 contacts, five receptacle styles and standardized accessories.

For additional information contact any Cinch Electronics Group Sales Office or write to Cinch-NuLine, 1015 S. Sixth Street, Minneapolis, Minnesota, 55415.

MIL-C-26500 Omega Connectors are also available from Cinch-NuLine on short delivery cycles (generally 6-8 weeks) for any shell style, contact size and insert configuration.



CINCH
ELECTRONICS
GROUP.

CINCH MANUFACTURING, CINCH-GRAFIK, CINCH-MONADNOCK, CINCH-NULINE AND PLAXIAL DIVISIONS OF UNITED-CARR INC., A SUBSIDIARY OF TRW INC.

CINCH-NULINE
DIVISION OF UNITED-CARR

Diary of a leadership trainee: 'I fluctuated between gratitude and fear in this constructive self-development, job-centered critique for managers.'

Richard Turmail, Management & Careers Editor
First of two articles

How do you impress others? Are you making the impression you want to make? If you're not sure, ask yourself: Would your friends and co-workers describe you as confident or self-conscious? Open-minded or narrow-minded? Honest or deceitful? Intelligent or stupid?

There's a possibility that you aren't aware of how you affect others. You may even be communicating an impression that is the opposite of the one you intend to convey. We don't always know when our motives are misinterpreted, our voice inflections misread and our words misunderstood. Yet such personal behavior strongly influences our effectiveness on the job.

If you're an engineering manager or an engineer on the brink of an advance in your career, you are, or will be, responsible for managing others. Before you can manage others effectively, you must learn to manage yourself. An important part of managing yourself is knowing how you impress your superiors, your peers and your subordinates. How can you find out if you're coming across?

Making an impression—the LDA way

There are workshops designed for the development of the business personality. One session, in

particular, that I attended recently is called Leadership Workshop. It's a two-phase program for supervisors, managers and executives designed by Leadership Development Associates (LDA) of Westwood, N. J. The two phases of the program are Self Development and Management Interaction. I participated in the Self Development phase, which LDA describes as "a unit that focuses on the individual—his present job effectiveness and his career potential."

"During this phase," LDA continues, "the individual will be able to secure a constructive appraisal of his leadership skills and the impact his behavior and attitudes have on others. He will be able to take stock of his own strengths and improvement needs, plan his career goals and develop a specific action plan for self-improvement on-the-job and career development."

In some secluded spot

Because more and more electronics companies are sending their managing and prospective managing engineers to programs like this, ELECTRONIC DESIGN assigned me to investigate the effectiveness of the approach. I enrolled in the LDA course and was assigned to a workshop at the Mount Hope Farm, Williamstown, Mass. Secluded in the Berkshire Mountains as we were, we found there were no distractions through which we could have avoided each other, no plans or tasks to which we could have subordinated each other, and no credentials or titles behind which we could have hidden. We were forced to abandon the accustomed poses we use in dealing with people, and thus we were stripped of our various barriers to communications. As a result, we were receptive to new ideas, new relationships and new experiences.

Thus the stage was set for interaction. I knew that to offer an objective and meaningful report, I had to participate fully in the activities of the next five days. I could pull no behavioral punches. On the eve of the program, I was the personification of anticipation. My reactions and comments follow in diary form.

(continued on page 98)

Putting psychology to work

Kurt Lewin, a German-born psychologist, is generally credited with being the father of sensitivity, or leadership, training. He is said to have been the first to use unstructured, leaderless discussion groups to develop leadership. After his death, in 1947, his colleagues moved to expand his concept as a training device. Led by Leland P. Bradford, a social psychologist, the National Training Laboratory in Group Development, now affiliated with the University of Michigan, organized a series of human relations laboratories. These sessions were held in Bethel, Me., and were subsidized by the Carnegie Corp.

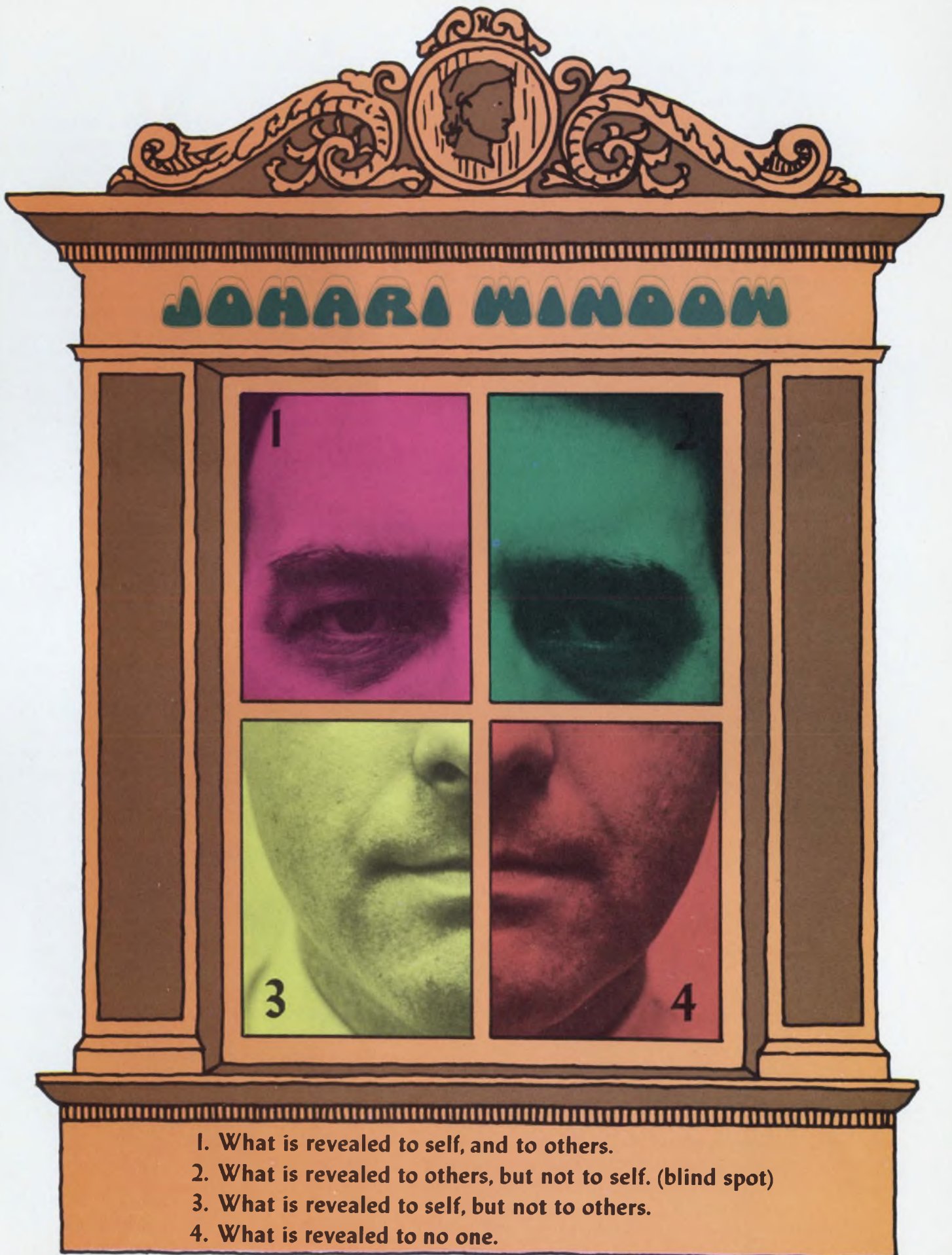

Arise : 7:30 am

Breakfast: 8 am

Orientation: 9 am

There are 18 of us registered for the program. The two LDA management trainers, who are industrial psychologists, divide us into two groups of nine each. They tell us that we will study ourselves and our own group at work rather than abstract concepts or theories. This appeals to me. It would seem to be a most honest and practical approach, because everyone starts on a par. We are advised that the data used for analysis and improvement planning will be obtained from three sources:

1. The Self-Assessment Form each of us filled out prior to our arrival.
2. Our boss's assessment of us.
3. The appraisal we receive from the members of our group.

One trainer leads our group to an overstuffed, but comfortable, Victorian parlor.

Getting to know me: 10 am

We are asked to introduce ourselves.

Ray, personnel recruiter.

Charles, machine shop foreman.

Frank, research engineer.

Jim, chief engineer.

Lon, packaging engineer.

Sid, accountant.

Arthur, staff systems analyst.

Paul, research physicist.

I tell the group that I have a B.A. degree, that I was an actor and playwright for several years before entering the publishing field as an editor and a writer, that I am married and have no children, and that I am currently renovating a carriage house in Brooklyn, N. Y. I tell them also that my hobbies include playing bridge and participating in competitive sports.

Each man responds with his own data.

Buddy bidding: 11:15 am

Our trainer, whom I nickname "Guru," tells us to bid for a partner. Our partners, he says, will be responsible for revealing their impressions of our behavior to the rest of the group; they will be especially helpful in watching for our blind spots. My "buddy" will study my Self-Assessment Form to get

an idea of who I am and where I'm heading.

To bid for a partner, we have to list our first two choices and our last choice. Guru tells us that our bids should depend on how much help we think our choice can give us.

I jump in quickly and bid for Ray. Ray turns me down and chooses Lon. Frank bids for me. I think that if I can't pair up with my like pole, I'll go with my opposite. I accept. There are no challenges. The other members of the group also choose their opposite poles. The bidding is closed, and we break for lunch.

After lunch we are given a couple of hours to get acquainted with our partners. Frank and I read each other's Self-Assessment Form and interview each other. Frank asks me why I didn't fill out all the questions on the form. I explain to him that those particular questions are not applicable to my job. He insists that they should have been filled out; he also wonders why the answers to the other questions are so brief. I explain to him that I am an editor, that "brevity is the soul of wit," and that my boss's assessment of me will be even more brief. He smiles, but he shakes his head. His own report is filled out in painful detail. A behavior pattern is already beginning to take shape. He impresses me as being abrupt and narrow-minded. As a result, he tends to make snap judgements about people. Heaven knows how I impress him!

The critique: 3:30 pm

The group convenes in the overstuffed parlor to report its findings. We notice that Guru leads the group activities with a minimum of direction. Ray suggests that Guru is obviously trying to get us to take charge of our own group. I suggest we elect a spokesman to keep things going. Since the idea is mine, the group elects me.

Guru gives us an outline to follow for reporting orally on the results of our interviews:

- I. How does your partner see himself?
 - (a) Major strengths.
 - (b) Job effectiveness.
 - (c) Career goals.
- II. How does he feel about being here? What would he like to get out of the week?

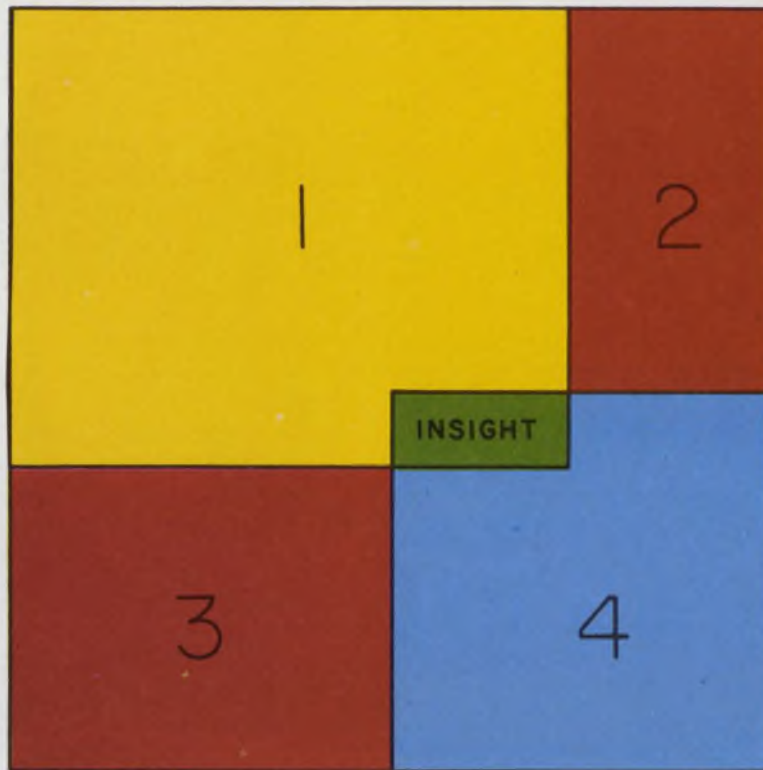

It's called the "Johari Window", but it acts as a mirror because it reflects one's interaction on many levels. Leadership Development Associates says the ultimate goal of each participant in its workshops should be to enlarge the first pane of the Johari Window. When the first pane intersects any other pane, insight results.

- III. How do you see him?
- IV. How do you feel you can help him this week?
- V. On a 1-to-9 scale, how well do you feel you know him?
- VI. Other impressions.

For the next two hours, we give our reports in polite fashion. No one is offended. We break for supper at 6:30 pm.

After dining, we are given an outline to follow for evaluating our partner's critique of us:

- I. How would you describe and rate your partner's skill and effectiveness in:
 - (a) Establishing a climate that encouraged you to open up?
 - (b) Digging below the surface to secure deeper understanding?
 - (c) Organizing and directing the interview so objectives are met?
 - (d) Listening actively?
- II. What did he do that helped during the interview?
- III. What did he do that blocked or slowed down or diverted progress of the interview?
- IV. How do you feel about the report he

- gave you?
- V. What changes would you like to make?
- VI. Other observations?

A stream of analyses follow—again, without animosity—and the hours slip by.

The 'longest day' ends: midnight

The evaluations are finished. It is midnight. I know now that Frank's negative impression of me is that I am evasive. I feel we all know each other perhaps a little better than even some of our friends at home know us. Getting to know each other is, I believe, the LDA objective this first day. In the process, I have spent one of the longest days of my life; I am drained, physically and mentally.

Except for one member of the group who seems to be losing interest, and another who complains that he is not interested in having his head shrunk by a bunch of amateurs, everyone appears to be interested in the program. But the group seems to lack direction; still we do have a feeling of wanting to get on with it. To what, no one knows.

Arise : 7:15 am

Breakfast: 8 am

Observation posts: 10 am

Guru tells us that for 20 minutes we are going to watch the other group in action. We are to focus on the process of the interactions, not the content of the conversations. We are to determine what conversation patterns emerge, which members of the group attempt to monopolize the conversation and who does not participate at all. Then, we are told, the group will watch us.

In our critique of the other group, we say that two or three of the members are vying for leadership; that there is a "chimer-in"; that there are a couple of guys who don't participate very much; that the group as a whole is loud and overly animate, and that although there is give and take around the table, there is also a good deal of "bull" thrown.

In their critique of our group, they say that we are boring and nauseatingly polite, that if they had been assigned to our group, they would have walked out, and that there seems to be a battle for leadership developing between Ray and me.

We are generally stunned by their assessment (especially the part about being boring), and Ray feels it is necessary to defend us. We counterattack as a group by contending that the other group did not abide by the ground rule—that of commenting on process rather than content.

The groups break, and we are led by our trainer to our parlor. We are, as a group, a bit shaken and quite a bit angry.

First impressions: 11:30 am

Abruptly, Guru tells us to list each group member's name on a piece of paper. Next to each name, he says, write three adjectives that describe our impressions of him. My impressions of the members are:

- Ray:** quick - direct - friendly.
- Charles:** quiet - calm - inexpressive.
- Lon:** honest - friendly - searching.
- Jim:** direct - courteous - friendly.
- Paul:** direct - factual - logical.
- Frank:** questioning - logical - open.
- Arthur:** friendly - confused - unhappy.
- Sid:** frustrated - frank - unhappy.

The group tells me I impress them as being friendly, dramatic, positive, helpful, re-

freshing, interesting, articulate and perceptive. I am overwhelmed with gratitude.

Each of us gives his reasons for his choice of adjectives. Each person is given a chance to dispute the adjectives assigned to him. Everyone is kind, not wanting to criticize.

The group also tells me I am evasive of personal revelation. There it is again, "evasive." Hmmm.

We have supper at 6:30 pm.

After supper Guru asks us to complete a written questionnaire.

On the basis of present behavior in the group, he asks, who do you predict will:

- Assume prominent leadership functions in the group?
- Be inclined to sit back and not participate in discussions?
- Be a source of annoyance to you?
- Be interested and helpful to you and others in the group?
- Be a lot of fun in the group and in social activities?
- Be the kind of person you would like to work for?
- Be the kind of person you would like to work with?

I score high in "leadership" and in being "helpful." But the barriers to constructive criticism have indeed been lowered. I shall concentrate on the most provocative item on the list, the source of annoyance.

I list Frank as a source of annoyance to me. His reaction: shock! He does not understand. I explain to him in front of the group that he annoys me because, after telling him that I left some of the questions blank on the form because they do not apply, he promptly tells the group that I did not finish the form and what I did finish was too brief for him to bother with.

Frank thinks about my accusation. He says that he was not aware of the impression he was creating. He says he understands now why he annoys me. It is a breakthrough!

Suddenly we call for reactions to the workshop. The scale for scoring ranges from "want to leave the group" (1) to "very enthusiastic" (9). The group averages 7.5.

It is 10 pm. We call it quits for the night. Tomorrow, we might even get enthusiastic about the program.

Arise : 7:45 am

Breakfast: 8:30 am

Boss's assessment: 9:30 am

Guru gives our boss's assessment to our partners for evaluation. It is based on a rating scale of 1 to 9. It contains:

A. What you think your boss's assessment of you will be.

B. Your own assessment of yourself.

C. The boss's assessment

Although there are 12 performance areas on the regular profile, there are only seven areas that apply to my job. The other performance areas are: Conducting Performance Reviews; Training Subordinates; Making Subordinates Promotable; Organizing and Delegating Work; Controlling Costs.

In two areas, my own assessment and my boss's are the same. In one his assessment of me is lower than my own. In the remaining four areas, his assessment of me is higher than my own. All in all, my boss's assessment of me gives my ego a boost. Unfortunately the same kind of boost is not forthcoming for some of the other group members. Sometimes a difference of three or four points on the scale separate a self rating and a boss's rating.

During the ensuing discussion, we attempt

to ascertain if there are any similarities between some of our behavioral shortcomings that have been spotted at the LDA workshop and the shortcomings that could have caused the boss's negative assessment. We arrive at three basic conclusions:

1. There's a lack of communication between some group members and their bosses.
2. Some bosses would benefit if their subordinates could assess them.
3. It is impossible to standardize the rating scale. Personal values vary. Some bosses obviously believe that no one rates an 8 on the scale much less a 9. We cannot agree, however, on a better rating system.

The discussion has not helped everyone. Two members of our group are still shaken by their boss's assessment of them.

It has been another long day but these first three days have really sped by. We have been looking for tomorrow ever since we started. It is the day we assess each other.

Now, at 4 pm, we take the rest of the day off.

GENERAL DUTIES	PERFORMANCE AREAS	KEY	RATING SCALE								
			1	2	3	4	5	6	7	8	9
COMMUNICATIONS	STAFF MEETING PARTICIPATION	A GUESS								X	
		B SELF								X	
		C BOSS								X	
	KEEPING BOSS INFORMED	A GUESS								X	
		B SELF								X	
		C BOSS								X	
	KEEPING SUBORDINATES INFORMED	A GUESS									X
		B SELF									X
		C BOSS								X	
TASK LEADERSHIP	DECISION MAKING	A GUESS								X	
		B SELF						X			
		C BOSS							X		
	MAINTAINING PRODUCTIVITY	A GUESS							X		
		B SELF						X			
		C BOSS								X	
	MAINTAINING MORALE	A GUESS									X
		B SELF								X	
		C BOSS								X	
	CARRYING OUT INSTRUCTIONS	A GUESS								X	
		B SELF							X		
		C BOSS								X	

Arise : 8 am

Breakfast: 8:30 am

A dip in the "fishbowl": 9:30 am

Guru picks five members of the group and instructs them to sit facing each other in a circle in the middle of the room. They are given a simulated problem to solve: Should we or should we not change partners for the rest of the week? While the discussion takes place, four of us watch and listen.

Frank, my partner, jumps in and leads the discussion. Charles and Sid sit quietly watching Lon, who tries to organize the "fishbowl" group for decision-making. Arthur makes occasional comment. Lon comes on strong; he is extremely well organized, which is important because only 10 minutes have been allotted to solve the problem. The fishbowl group decides that each member in the total group should change partners. Lon and Jerry take the honors for seeing that the decision is made within the time allotted.

The rest of us critique the fishbowl group. Our main criticism is that the decision to change partners was made even though one of the partnerships (Jim and Paul) was not represented in the group that made the decision.

Jim, Paul, Ray and I are told to take a "dip" in the fishbowl. Since the four of us have been vying for leadership (Jim and Paul have made late, but strong, bids for the crown), the machinations of our decision-making method should be interesting.

Guru announces the problem to be solved: Two members of the entire group must leave. We must pick the two who have either contributed the least to the group conversations or who have the least to gain from the group. There is only one ground rule. No man is allowed to pick himself.

I quickly suggest that each of us gives his own two choices and the reasons for them. The suggestion is accepted. Paul jumps up and lists our choices on the black board. Except for Jim, all of us have arrived at the same two choices. Although Jim disagrees with one of our choices, he submits to the majority, and changes his choice. We are now unanimous in our choice of choices, and we have made our decision well within the time limit.

Paul asks Guru to give us another problem. Guru tells us to choose a spokesman to

tell the two men we have chosen that they must leave.

Jim asks if there is one among us who wants to be the spokesman. I volunteer. Jim and Paul back me up, but Ray is adamant: Either he feels we should allow for more discussion or *he* believes he is the best man to break the news. Jim tells Ray that we don't need his vote, since he's outvoted by 3 to 1, anyway. I threaten to deadlock the vote, however, if we fail to reach a unanimous decision. Ray submits to the majority. Our second decision has been made within the time limit that was allotted for the first.

Paul asks for another problem. Guru tells me to carry out the spokesman's job. I do, and the two men we have chosen tell me that they agree with our choices.

During the critique that follows we are given high marks for organizing for the decision, for productivity and for the decisions we made. We are also told, however, that our group has had a "steamroller" effect; that we pushed so hard for a decision, we rolled over anyone who disagreed with the majority. Jim is cited for being "ruthless" for trying to force Ray into a decision by telling him that his opinion wasn't needed. Ray is accused of not wanting to make any decisions at all, because he was revolted by the premise of the problem. Paul is said to have been interested only in the productivity of the exercise. I agree with the critique.

Conclusion: Although our "fishbowl" group was effective and decisive, we were ruthless in our approach to the problems. We failed to even consider our option to refuse to deal with the problem.

How I impress the group: 10:30 am

Guru tells us that we will assess each other. He lists the following points of focus:

- Assess behavior, not personality (what the man did, not what he is).
- Be descriptive, not evaluative.
- Be specific, not vague.
- Use your own data.
- Adopt a problem-solving attitude; try not to advise, sermonize or philosophize.
- Tell the truth kindly.

We are now told to write the three most

negative adjectives and the three most positive adjectives we can think of next to each group member's name. My impressions of each group member follow:

Ray: image-minded; self-centered; sensitive perceptive; helpful; astute.

Paul: stubborn; self-conscious; image-minded humorous; self-critical; earnest.

Jim: disorganized; self-centered; immature involved; industrious; competitive.

Arthur: image-minded; self-conscious; confused earnest; questioning; reasonable.

Lon: impressionable; self-conscious; habitual forthright; well-intentioned; emphatic.

Sid: narrow-minded; smug; a loner concerned; respectful; courteous

Charles: blunt; stubborn; narrow-minded sincere; frank; positive.

Frank: self-conscious; impatient; immature direct; natural; positive.

The group's impression of me (I list the six most often quoted adjectives) are as follows:

egotistical; guarded in self-disclosure; evasive

flexible; emphatic; helpful.

Before and during my assessment, I fluctuate between a feeling of gratitude and a feeling of fear. The gratitude stems partly from the positive things the group has to say about me and partly from my feeling of brotherhood for the group. My fear stems only from the thought of the negative things the group might say. But my fears are never justified. Most of the negative attributes I have impressed them with, I am all too aware of myself. I have, however, taken stock of one negative impression. They say that I am somewhat evasive, guarded in self-disclosure; I am guilty of shallow relationships. I will have to find a cure for that. They have struck a nerve.

Arise : 7:30 am

Breakfast: 8:15 am

Self development program: 9:30 am

We are relaxed now. The assessments are over, and we are looking forward to going home. We have one more task to perform. Guru tells us to fill out our Performance and Career Development Plan. He says that this guide will assist us in crystallizing goals and actions on the job, and he recommends that we use it as a progress review reference and as a basis for career planning.

The program is finished. From Monday through Friday we have introduced ourselves to the group; been introduced to the group by our partners; critiqued each other on our introductions; been assessed by our supervisors; assessed each other, and sup-

posedly planned a better future based on the feedback we have received here.

The LDA program is effective because it is spontaneous and directed to a positive goal. I wonder, though, if most of what I have been impressed with this week will continue to impress me when I get back on the job. It takes considerable impression, it seems to me, to change behavior. ■■

The second article in this series will present on-the-job feedback from members of the LDA workshop, whether or not the experience has helped them to be more effective and whether or not they would recommend it to others.

the
GIANTTM

GENERAL INSTRUMENT ADVANCED NITRIDE TECHNOLOGY

among RAMs

GIANT 32-bit static RAM – the first Random Access Memory directly compatible with TTL, DTL and MOS, expandable in all directions, is also the lowest priced.*

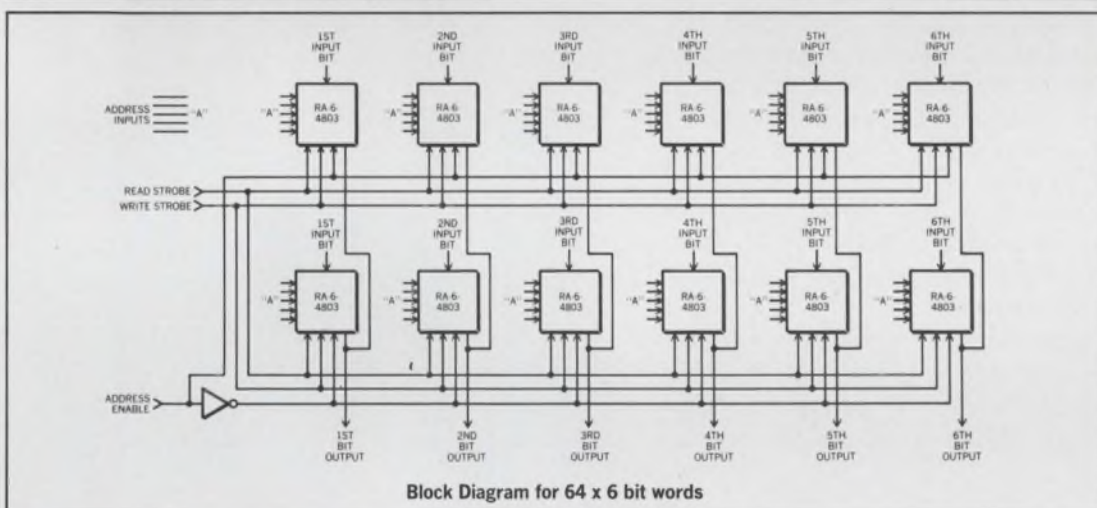
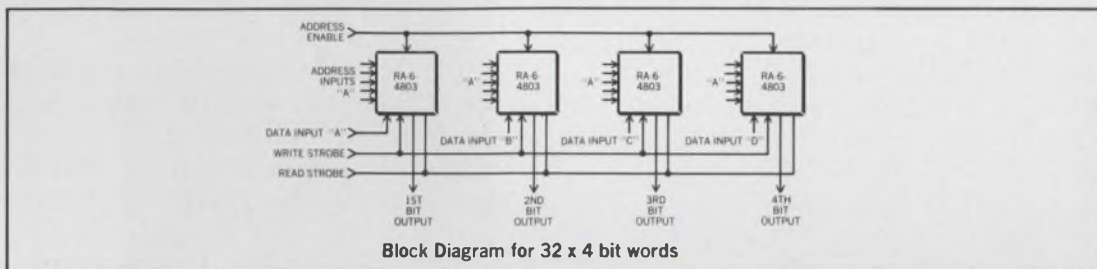
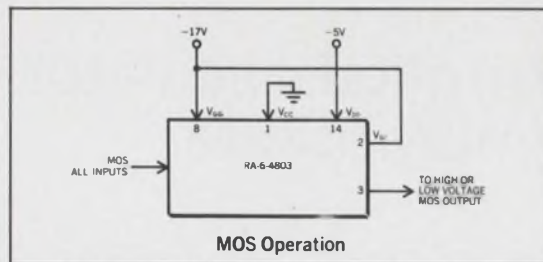
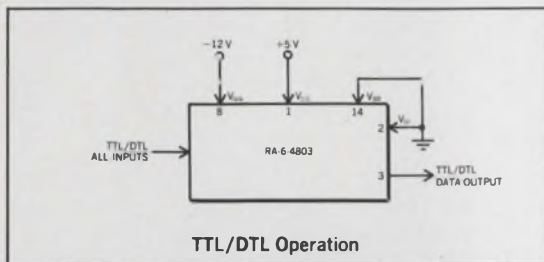

The GIANT 32-bit RAM stands far above the others. Designed for both large and small memory system applications, it is the latest addition to General Instrument's exclusive GIANT family of LSI devices. Present in the 32-bit RAM are all the advantages inherent to products of the General Instrument Advanced Nitride Technology (GIANT). These include: the elimination of interface circuitry, a reduction in the number of system power supplies, a reduced parts count and fewer interconnections, lower power dissipation, increased operating frequency and an increased operating temperature range.

A most significant feature of this GIANT RAM—and of every standard GIANT product—is the V_{oi} terminal, which gives the user a choice of interfacing directly with TTL/DTL or MOS.

The GIANT 32-bit RAM is a monolithic circuit containing 32 DC storage flip-flops with 5-bit address decoding for both read and write. It is intended for use in medium and large

arrays as a scratch-pad memory and as a replacement for core memory systems. Upon application of the correct binary address and strobe pulse, any one bit word may be updated or read out on the corresponding data-in or data-out terminal.

Included in the features of the GIANT 32-bit RAM are: low power dissipation of 90 mW, high speed, non destructive read-out (NDRO), and a full military temperature range of -55°C to $+125^{\circ}\text{C}$.

The GIANT 32-bit RAM is immediately available from your authorized General Instrument Distributor.

For full information write, General Instrument Corporation, Dept. R, 600 West John Street, Hicksville, L.I., N.Y. 11802.

(In Europe, write to General Instrument Europe S.P.A., Piazza Amendola 9, 20149 Milano, Italy; in the U.K., to General Instrument U.K., Ltd., Stonefield Way, Victoria Road, South Ruislip, Middlesex, England.)

*\$11.80 each in quantities of 100 pcs. for the RA-6-4803 in a 14-lead dual in-line or 14-lead flat pack.



GENERAL INSTRUMENT CORPORATION • 600 WEST JOHN STREET, HICKSVILLE, L. I., NEW YORK

Agc controlled oscillator is extremely stable

A modified Pierce-type oscillator can be built that is extremely insensitive to both ambient temperature and power supply variations.

The circuit (Fig. 1) employs a dual-gate MOSFET, with the oscillator crystal connected between the drain and gate 2, instead of between the drain and gate 1, as it is in conventional circuits. This frees gate 1, making it available for very efficient AGC control.

Rf voltage is taken from the drain and fed back, via C_3 to gate 1. Diode $D1$ clamps the waveform to zero. A dc feedback is thus provided, proportional to the output rf amplitude, in addition to the ac feedback. While the former keeps the output rf level constant for dc supply variations from 5 to 15 V, the latter keeps the output waveform sinusoidal, with negligible harmonic content, in spite of the square-law transfer characteristic of the MOSFET.

The results of frequency vs temperature measurements on the circuit are plotted in Fig. 2a. A drift of 2×10^{-7} parts per °C is typical. This is consistent with the figure given by the crystal

manufacturer, and shows that the circuit contribution to drift is negligible.

A plot of frequency vs supply voltage is shown in Fig. 2b. Variations of 2×10^{-7} parts per volt are typical from 9 to 15 volts.

The component values shown in Fig. 1 are optimized for a 10-MHz crystal. Nevertheless, the circuit works well, without any modifications, at much lower frequencies (for example, 455 kHz). At lower frequencies, though, owing to

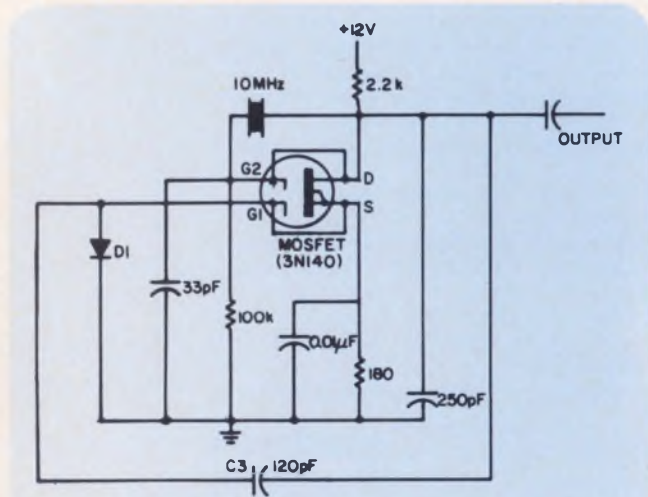

D1 - ANY GOOD SILICON RF DIODE

1. Pierce-type oscillator has the crystal connected between the drain and gate 2 of a MOSFET circuit; this leaves gate 1 free for efficient agc control.

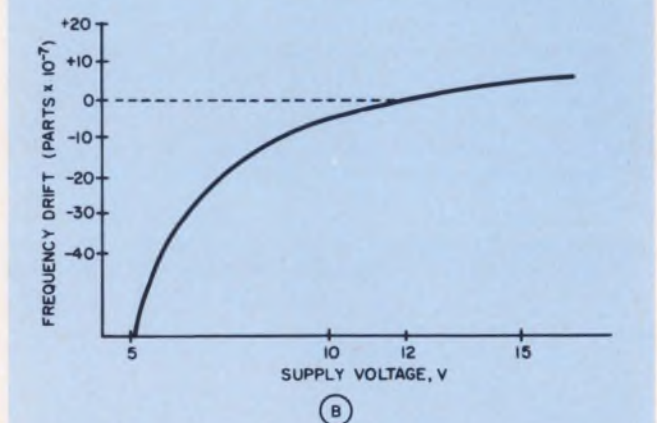
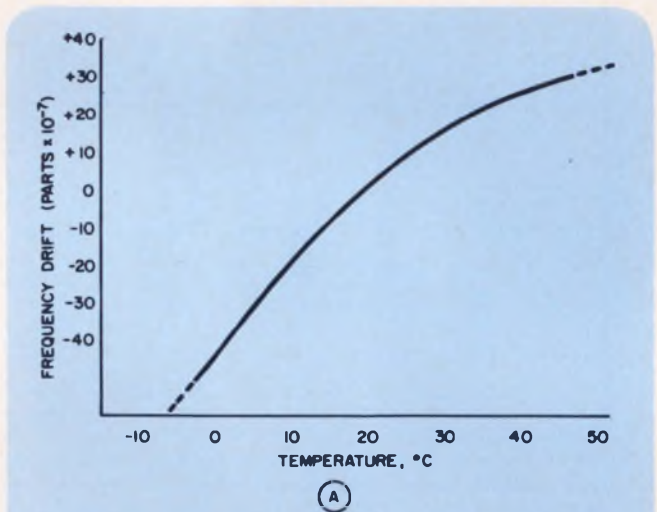

2. Frequency vs temperature curve (a) and frequency vs supply voltage curve (b) show the circuit's high degree of stability.

Not everyone needs our 5700

Sure it's the most accurate DVM there is — 0.0025%. And the most stable — 0.0065% for a year. But if you don't really need a DVM that's good enough to calibrate other DVMs, don't buy it. Buy one of our 32 others instead.

We make them for labs and production lines, for use on the bench and in systems, militarized models, four digit DVMs and five, from \$1150 to over \$8000. (Actually, with our unique plug-in modules, you can create some 300 different configurations. For every imaginable application. To fit every budget.)

And no matter which of our other 32 you buy, you'll have a DVM made with the same meticulous care as our 5700. With many of the same circuits. By the same people. To give you the confidence you've come to expect from Dana.

Which one suits you best? Ask for the decision maker, our free brochure.

Dana Laboratories, Inc., 2401 Campus Drive, Irvine, California 92664.

DANA



increased crystal activity, the circuit output might not be perfectly sinusoidal. This can be remedied by increasing the value of C_s .

G. Colla, G. Tomassetti, *Design Engineers, University Degli Studi Di Bologna, Bologna, Italy.*
 VOTE FOR 311

Simple pulse stretcher uses three integrated circuits

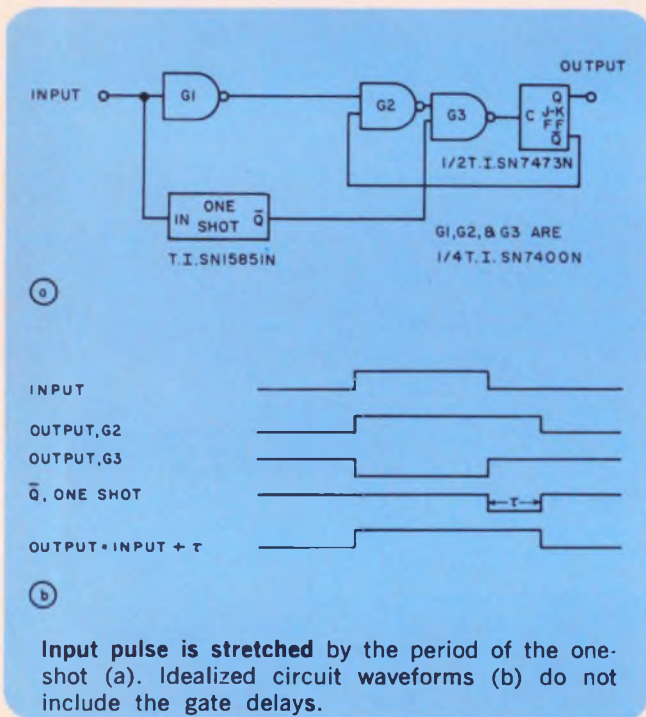

Pulse stretchers are often required in the design of digital control circuitry. Such a circuit can be built with only three integrated circuits (a). Using the components shown, the circuit has a two input NAND gate and a J-K flip-flop to spare.

The circuit timing is illustrated in b, assuming that the flip-flop is initially reset. If this condition does not exist when power is initially applied to the circuit, the first input pulse resets the flip-flop, and the circuit then functions normally with each succeeding pulse.

Philip J. Stein, *Design Engineer, Hughes Aircraft, Culver City, Calif.*

VOTE FOR 312

SCRs provide bidirectional dynamic braking for dc motors

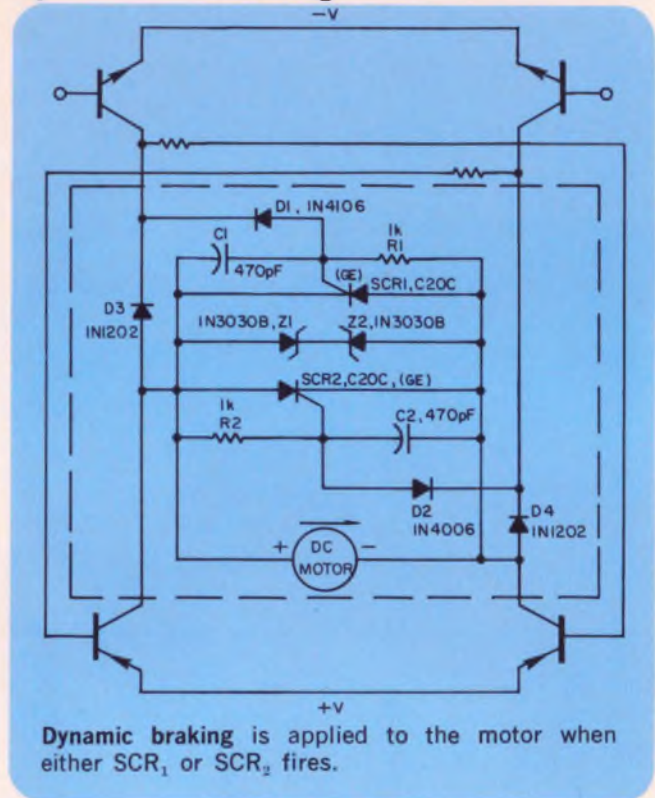

Bi-directional dynamic braking of a dc motor can be obtained by using the back emf of the motor to provide the firing signal for a pair of SCRs. When either SCR_1 or SCR_2 is fired (see illustration), dynamic braking is applied to the motor.

Operation of the circuit is as follows: if current is flowing through the motor as indicated in the figure, SCR_1 is reverse-biased and SCR_2 is forward-biased. But SCR_2 is prevented from firing by diodes $D2$ and $D4$. Capacitor C_2 helps prevent transient firing during turn-on.

When the motor is turned off, the back emf forward-biases SCR_1 . Gate current through R_1 then fires SCR_1 , virtually short-circuiting the motor. When the motor direction is reversed, SCR_2 provides the braking in a similar manner. Zener diodes $Z1$ and $Z2$ clip the voltage spikes and help prevent damage to components.

B. W. Speller, *Development Engineer, Union Carbide Corp., Oak Ridge, Tenn.*

VOTE FOR 313

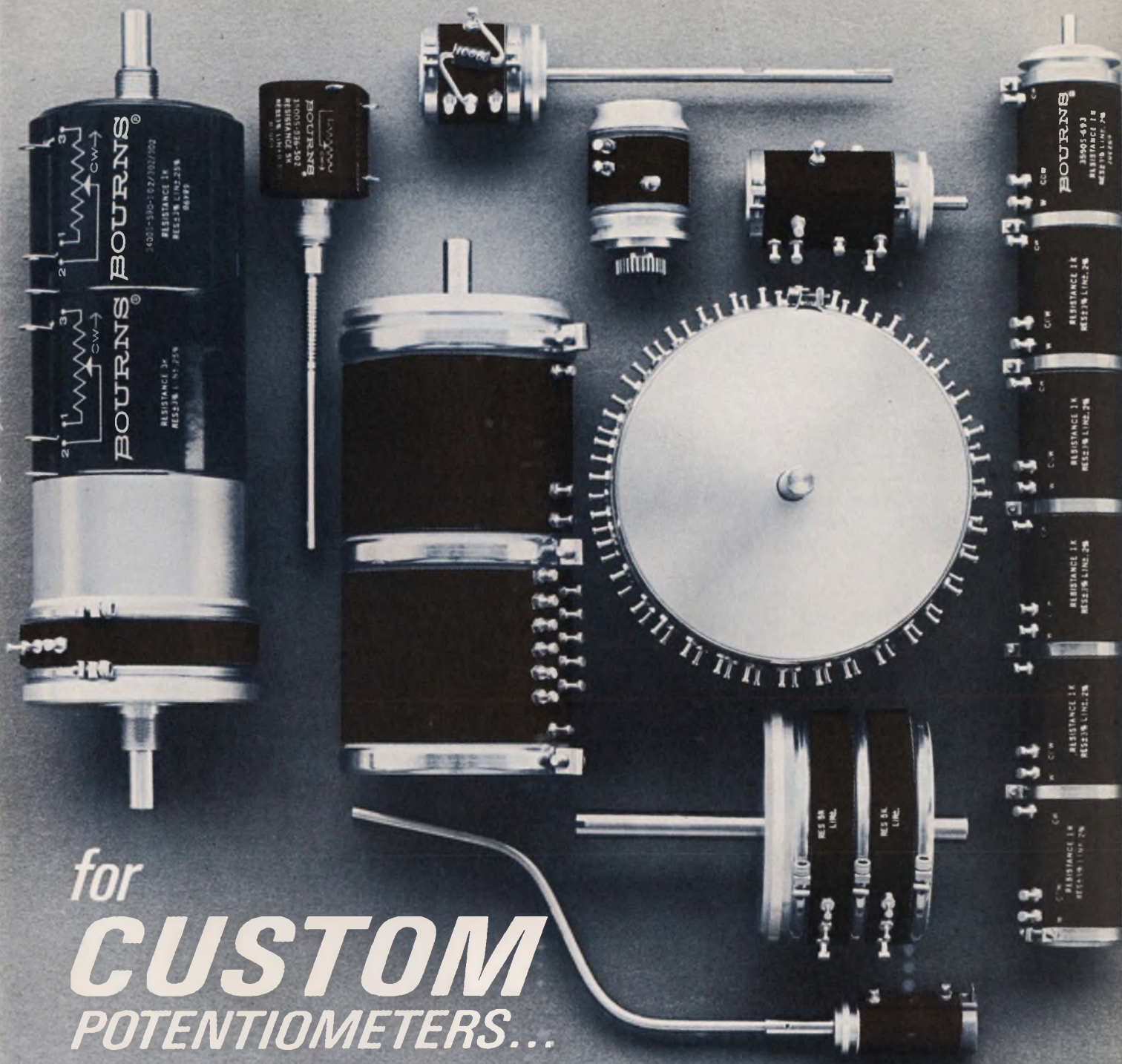

for
CUSTOM
 POTENTIOMETERS...
 ...come to BOURNS!

Bourns can show you how their engineering capability and manufacturing experience can deliver the special design or modifications to standard units in as little as 1-5 weeks!

Let us prove it. At Bourns, we make progress while others are making excuses. Why? Because Bourns builds them all: solenoid controlled wiper lift-off; multi-turn conductive plastic in 1/2", 3/8" and 2" diameters, single-turn wire and conductive plastic single and multi-cup linear and nonlinear functions.

One conference on an engineer-to-engineer basis will illustrate why Bourns can deliver the custom unit you require, when you require it. Your schedule is our deadline.

We're building tomorrow's custom precisions right now . . . can you really afford to wait any longer? Contact the factory or your nearest Bourns office or representative today!



Circuit and simple recorder make inexpensive digital test system

Recording and playback of pulse trains or non-periodic wave forms by an entertainment type of tape recorder can be very useful while testing digital circuitry. A simple additional circuit (see illustration) will change the recorded signals into clean square waves; it will also provide an interface from a simple tape recorder to DTL or similar logic.

For recording, the digital signal is connected to the radio or phono input of the tape recorder. Then, the rising and falling edges of the signal will produce positive and negative pulses at the speaker output during playback.

The pulses from the speaker output are differentiated by C_1 , with a time constant $C_1 \cdot R_7$, and turn $Q1$ on or off when they exceed the threshold set by $D1$ or $D2$. $Q1$, $Q2$, R_1 , and R_5 form a bistable circuit, so that the output at the collector of $Q2$ stays at a high potential after a positive pulse has occurred at C_1 . A negative pulse at C_1 , on the other hand, will make the output voltage low. The output will stay low until the next positive pulse arrives. R_3 and $D3$ provide a bias voltage for symmetrical thresholds, while R_6 replaces the loudspeaker of the tape recorder.

The output of the circuit can be connected directly to one DTL gate input. With the circuit as shown and a typical entertainment tape recorder, pulse rates from 0.1 Hz to 8 kHz can be reproduced. A stereo tape recorder can be used

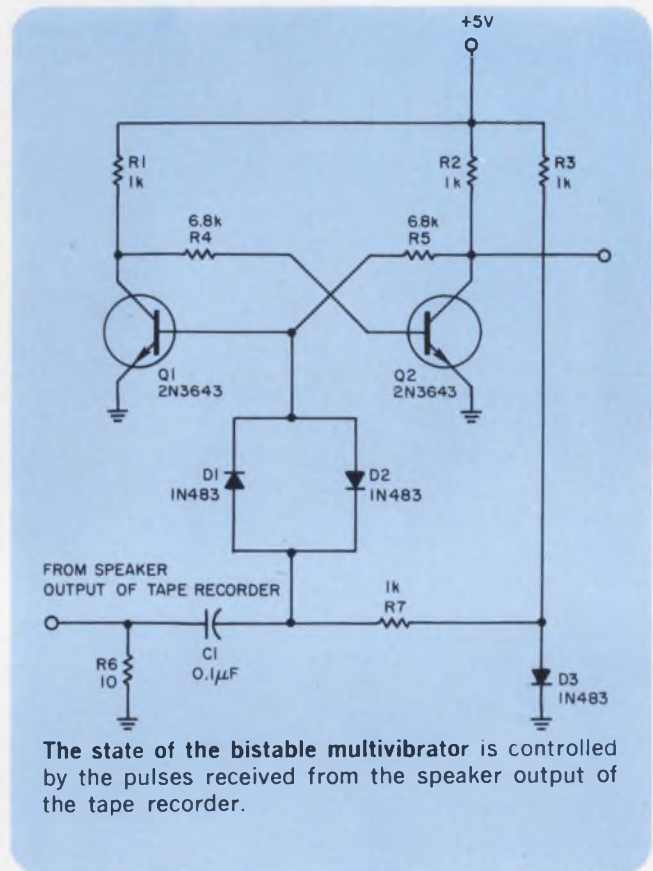

The state of the bistable multivibrator is controlled by the pulses received from the speaker output of the tape recorder.

to record a reference or clock signal on the second track.

Peter Zander, Development Engineer, Barrett Electronics Corp., Palo Alto, Calif.

VOTE FOR 314

VOTE

VOTE! Go through all Idea-for-Design entries, select the best, and circle the appropriate number on the Reader-Service-Card.

SEND US YOUR IDEAS FOR DESIGN. You may win a grand total of \$1050 (cash)! Here's how. Submit your IFD describing a new or important circuit or design technique, the clever use of a new component or test equipment, packaging tips, cost-saving ideas to our Ideas-for-Design editor. You will receive \$20 for each accepted idea, \$30 more if it is voted best-of-issue by our readers. The best-of-issue winners become eligible for the Idea Of the Year award of \$1000.

Variable length counter is switched easily

A variable-length digital counter can be constructed by adding only a few inexpensive components to the basic counter flip-flops. The counter operates straight binary, and requires no extra delay for clearing.

As shown, the positions of switches $S1$, $S2$, . . . , SN determine the maximum count. When this value is reached, NOR gate 1 is activated, and the inverted clock-pulse sets the auxiliary flip-flop by means of NOR gate 2. The next clock pulse clears the counter by means of NOR gate 3. NOR gate 1 is then deactivated and the next inverted clock pulse resets the auxiliary flip-flop.



Cimron's DVM outguns the rest!

We don't believe you can match this second generation digital multimeter for speed, accuracy and stability in this price range. It provides you with the greatest number of options, including sample and hold, AC, millivolts and ohms. With the autorange and combined ohms/millivolt converter plugged in, it can autorange through all 6 DC ranges. For systems applications it has a digitizing rate of 1,000 readings per second, but that's only part of the story. It offers 5 printout options, buffered or non-buffered remote control of all front panel functions and unparalleled

flexibility for interface design. The handles retract so it can be flushmounted in a rack. Pushbutton controls are mounted directly to the master pc board, minimizing hand wiring for even greater reliability. All IC logic and the newest design features insure that it won't be obsoleted before you turn around. The basic Model 6653A, including DC and DC ratio functions with an accuracy of ± 1 digit, is just \$1740. And it all adds up to Cimron *customern concern!* Write to Cimron, Department D-103, 1152 Morena Boulevard, San Diego, California 92110.

LEAR SIEGLER, INC.



CIMRON DIVISION



INFORMATION RETRIEVAL NUMBER 54

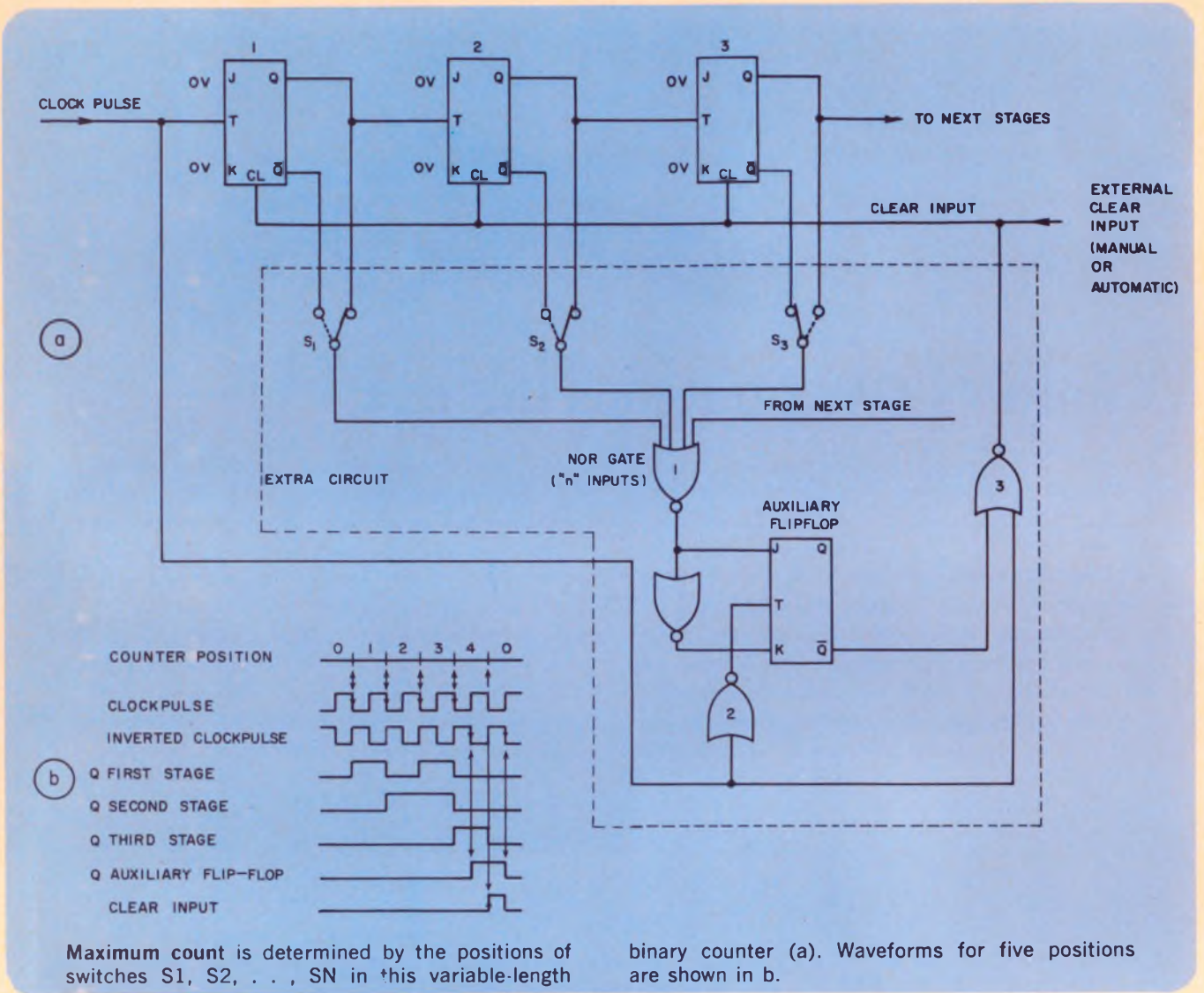

The counter is now ready to start counting from zero on the next clock-pulse.

If desired, an external clear input can be used to provide the start condition for the first cycle.

Waveforms for five switch positions are shown in b. Actually, any number of positions, between 0 and 2^n , is possible. It should be noted from the waveforms that the circuit is designed for use with ICs that trigger on the trailing edge

of the waveform. The basic idea, however, can be applied to other types of ICs; the use of NAND gates instead of NOR gates is possible too.

This technique can also be used with synchronous counters. The portion of the circuit labeled "extra circuit" is the same in these cases.

C. Van Holten, Electronics Engineer, Technological University, Delft, Holland. VOTE FOR 315

Inexpensive staircase generator spans 1 to 16 V in 1/2-V steps

Although the staircase generator shown was originally designed to coarse-tune the voltage-controlled oscillator in a phase locked loop (PLL), it can be used for a variety of other applications. The circuit steps from approximately

1 to 16 V in 1/2-V steps. In addition, it can be held at a particular level by a logic signal applied to the INHIBIT input.

The circuit (Fig. 1) is essentially a simple divide-by-32 ripple counter that uses weighted

IF 10 BRAND-NEW LINEAR ICs WON'T GET YOU TO OUR SEMINAR, MAYBE THE FREEBIES WILL.

FREE ADMISSION

Fairchild is giving a series of 60 free, Linear IC Applications Seminars. And at the seminars we'll be introducing 10 new, never-before-seen linear ICs. We'll go over all the ways that you can plug them into your circuits. And show you how they can make your systems better and simpler.

FREE ADVICE

Then you can start asking questions. And you're not limited to the new devices. If it's a linear problem, we'll try to solve it. This could be your chance to get a few trouble-

some projects off the drawing boards.

FREE HANDBOOK

You'll also get a free copy of our latest Linear Applications Handbook. Complete with information on all our new devices. And a lot of design information that we've picked up while becoming the world's largest supplier of linear integrated circuits.

FREE LINEAR ICs

And we're giving away more than 20,000 linear ICs—both new and standard designs—as door prizes. With the informa-

tion from the seminar, you'll be ready to use them by the time you step out the door.

MAKE YOUR RESERVATIONS NOW

The seminars will be held during the first two weeks in August in major cities across the country. Please call your local Fairchild distributor or sales office for the exact place and time in your area.

Fairchild Semiconductor / A Division of Fairchild Camera and Instrument Corporation / Mountain View, California 94040 (415) 962-5011/TWX: 910-379-6435.



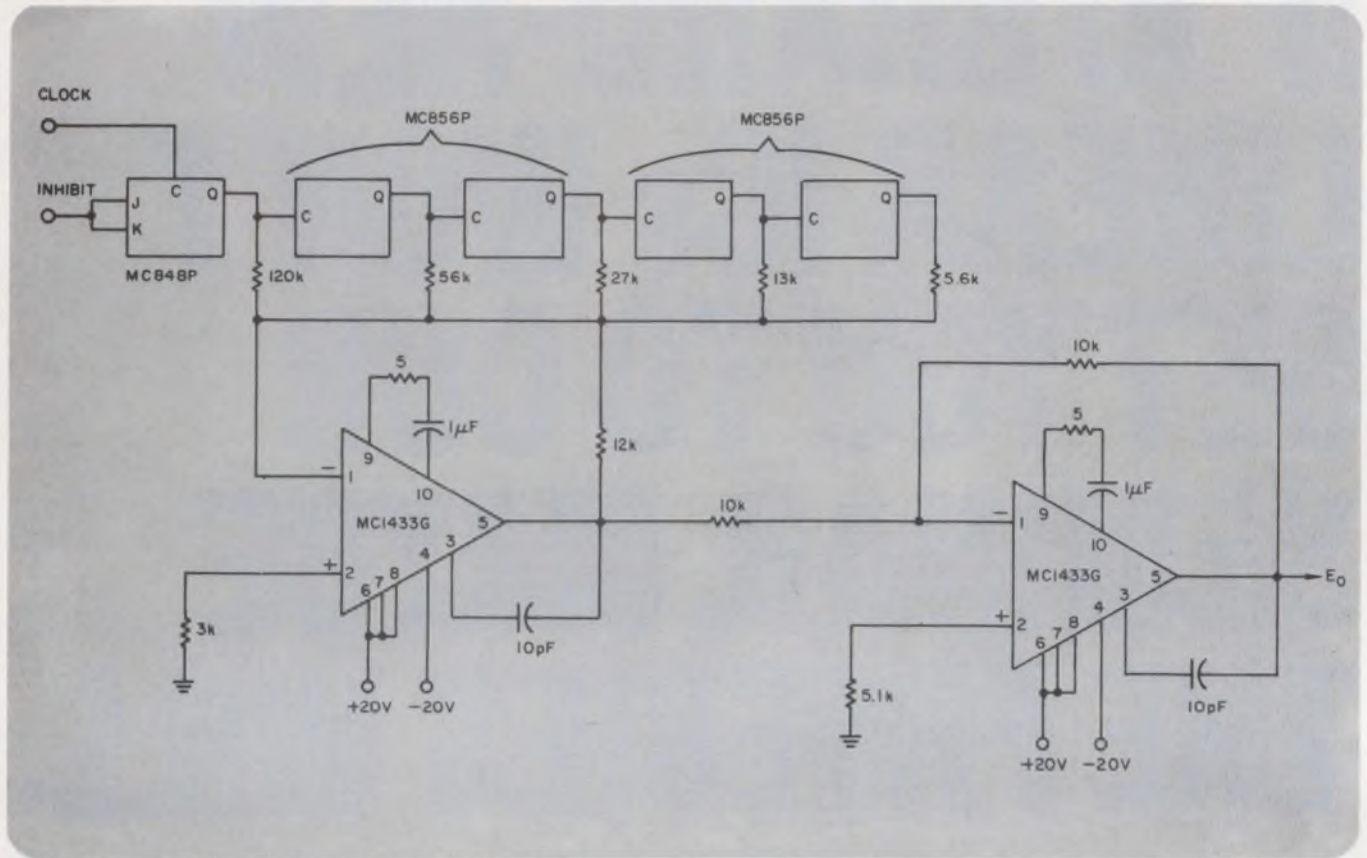

1. Staircase generator is essentially a divide-by-32 counter with weighted resistors for each stage.

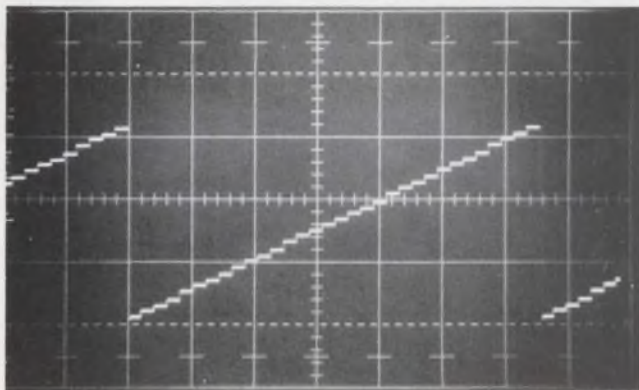

2. Output waveform has the vertical scale of 5 V/cm and horizontal scale of 1 ms/cm. The clock rate is 5 kHz.

resistors at the output of each divide-by-2 stage. The resistors are connected together at the summing point of an operational amplifier to give an output voltage that is the sum of the weighted input levels. Since the output of the first operational amplifier is inverted (ramping negative), a second inverting amplifier having unity gain is used to invert the signal. The MC1433G op amp was chosen because of its slew rate at unity gain ($\approx 1 \text{ V}/\mu\text{s}$) and its ability to operate at $\pm 20\text{-V}$ supplies to achieve a 16-V output swing.

A photograph of the output staircase is shown in Fig. 2.

Brent Welling, Motorola Semiconductor, Tempe, Ariz.
VOTE FOR 316

IFD Winners for March 15, 1969

Ralph Anderson, Systems Engineer, Perkin-Elmer Corp., Pomona, Calif. for his Idea "Low-noise, gainstable amplifier uses only five components"; And **Richard C. Gerdes**, President, Optical Electronics Inc., Tucson, Arizona for his Idea "Constant-current source is stable and inexpensive." Both have been voted the Most Valuable of Issue Award.

Vote for the Best Idea in this Issue.

IFD Winner for April 1, 1969

H. D. Carlstrom, Design Engineer, Sanders Associates, Inc., Nashua, N.H. His Idea "Resonant charging technique simplifies ignition systems" has been voted the most Valuable of Issue Award.

Vote for the Best Idea in this Issue.

Facts come in loud and clear on the Brush Mark 280.

Twice as loud and clear.

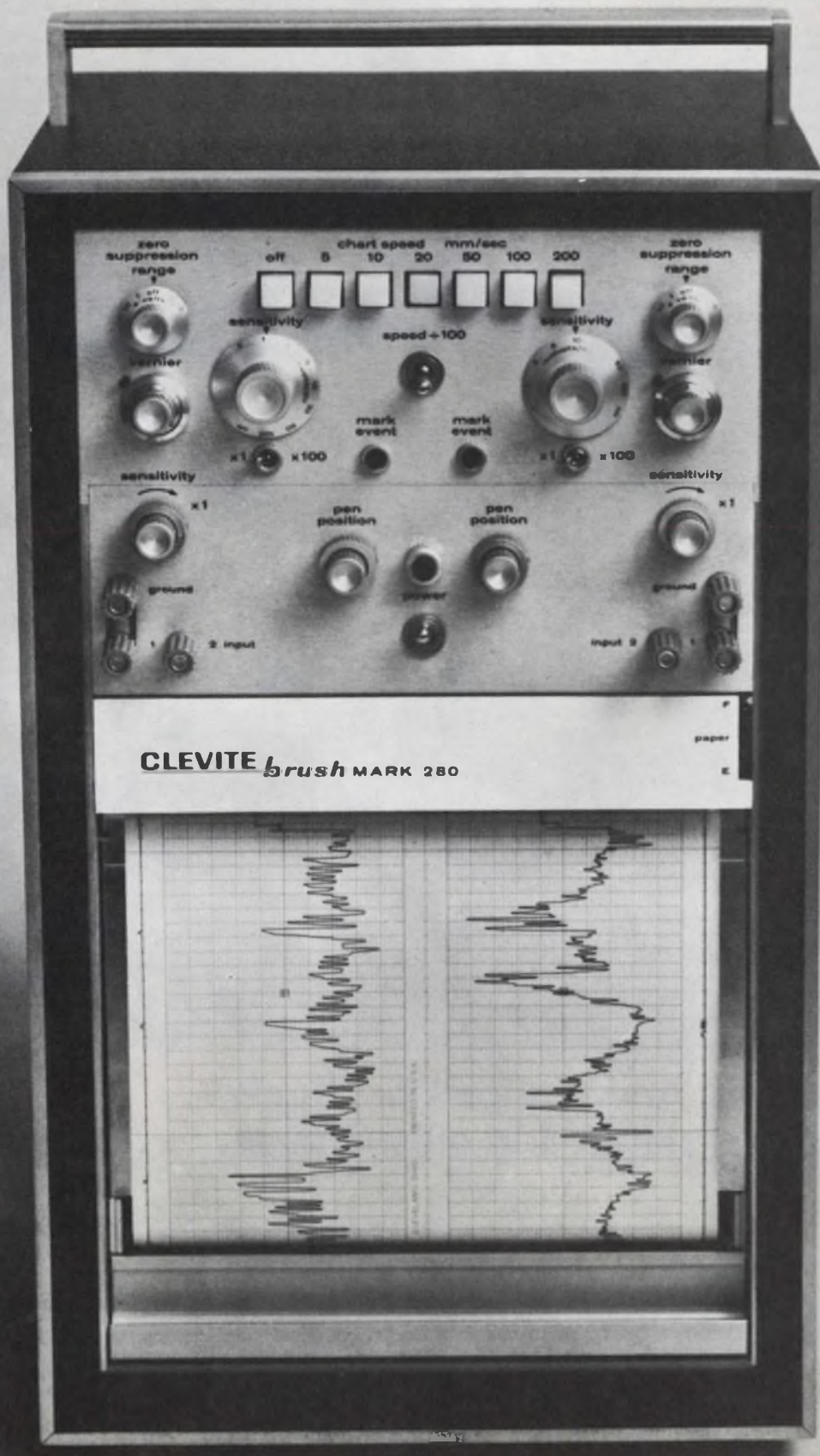

The Mark 280 is the best way yet to get high precision in a portable recorder.

The facts come in on 80mm channels, twice the width of conventional channels. Thus resolution is doubled — because measurements, no matter how complex, are displayed on twice the usual scale — are twice as easy to see and read.

The traces are just plain beautiful — clear, sharp and uniform at any writing speed — so there's no questioning the values you've recorded. They're produced by a pressurized fluid writing method that forces the trace into the paper—not just on it. Never a smudge or smear. The writing's dry on contact.

Accuracy? We guarantee 99½%, and most Mark 280's do even better—thanks to our foolproof pen-position feed-back system that enforces accuracy. Frequency response? To 35 Hz at full 80mm scale — out to 200 Hz at useable amplitudes. Calibrated zero suppression. It's one of many options.



Doubled resolution, near-perfect accuracy, crisp clear traces, high frequency response. That's what you can expect from the Mark 280. Ask your Brush sales engineer for a demonstration. Or write for complete details. Clevite Corporation, Brush Instruments Division, 37th and Perkins, Cleveland, Ohio 44114. We'll include our handy "Chart Running Time" calculator and slide rule.

CLEVITE BRUSH



Happiness is an Acopian power supply . . . because it's shipped in only 3 days.

Whether your application is op amps, ICs, logic circuits, relays, lamps or electronic measuring equipment, look to Acopian to meet your needs for AC to DC plug-in power supplies. Acopian's new catalog lists over 62,000 different supplies . . . all available for shipment within 3 days. Get your 16 pages of happiness by writing or calling Acopian Corp., Easton, Pennsylvania (215) 258-5441. 



Products

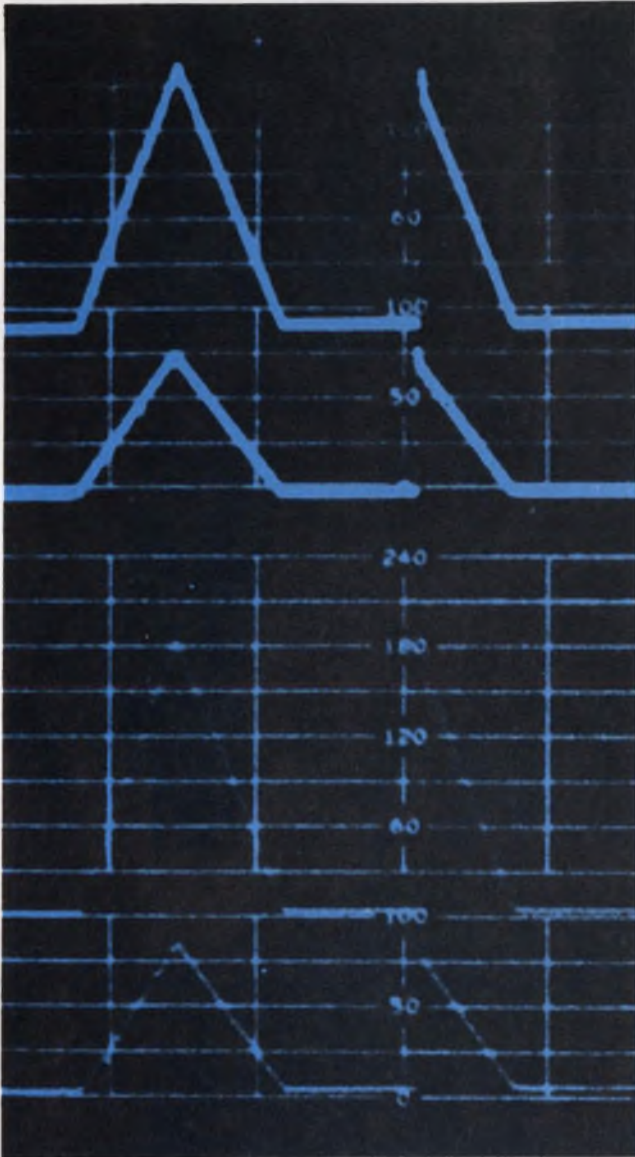

Wiresonic serial memories offer random-access address and 50% cost savings, p. 130.



Trim IC supplies can power entire computer board with their 5-V 10-A output, p. 144.

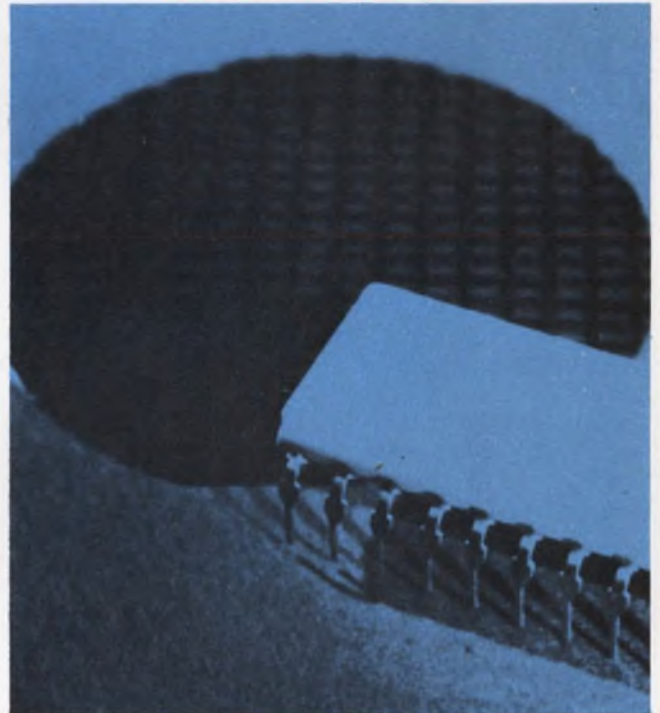

MOS 2560-bit read-only memory addresses in ASCII format, p. 124.

Also in this section:

Solid-state microwave amplifier gains 25 dB minimum from 2 to 4 GHz, p. 118.

Microminiature fiber-optic matrices generate ultra-tiny characters, p. 138.

Economy multimeter selling for \$15 can measure voltages below 250 mV, p. 148.

Evaluation Samples, p. 154 . . . **Design Aids**, p. 156 . . . **Annual Reports**, p. 158.

Application Notes, p. 160 . . . **New Literature**, p. 162.

Solid-state S-band amplifier delivers gain and downs noise



Avantek, Inc., 2981 Copper Rd., Santa Clara, Calif. Phone: (408) 739-6170. P&A: \$2500 to \$3000; stock to 30 days.

Occupying only one-tenth the volume of a traveling-wave tube (TWT) while doing an equivalent job, a new transistorized microwave amplifier maintains a minimum gain of 25 dB over the complete octave band of 2 to 4 GHz. Incorporating a cascade of high-performance microwave microstrip design, this S-band amplifier, model AMP-4000, holds noise figure down to 10 dB max at 4 GHz.

Besides offering a size advantage,

the new amplifier weighs only 8 oz, compared to 10 lb for a TWT. In addition, the solid-state unit dissipates approximately 0.5 W, while a TWT requires several watts.

Smooth bandpass response, low ripple and absence of fine-grain structure are other features. There are also no vacuum or magnetic shielding problems.

The AMP-4000 has typical dimensions of 3 in. long by 2 in. wide by 3/4 in. high. Its minimum power output is +8 dBm for 1-dB gain compression.

CIRCLE NO. 250

Ga-As laser diodes lower thresholds

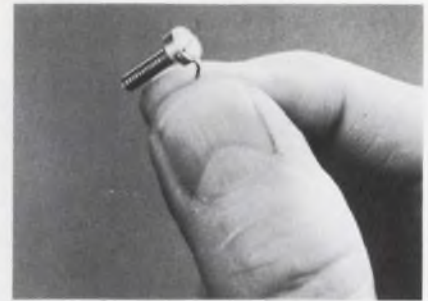

Laser Diode Laboratories, 205 Forrest St., Metuchen, N.J. Phone: (201) 549-7700.

Requiring a drive current of only 100 A, model LD-22 gallium-arsenide laser diode can operate with thresholds as low as 10 A while holding power levels to 6 W at 30 A. Another unit, model LD-23, functions with thresholds of 20 A and power levels of 10 W at 60 A. To achieve this low threshold and high power efficiency, both lasers have a heterojunction structure, rather than a homojunction one.

CIRCLE NO. 251

Thin-film MIC hybrids swing over 17% bands

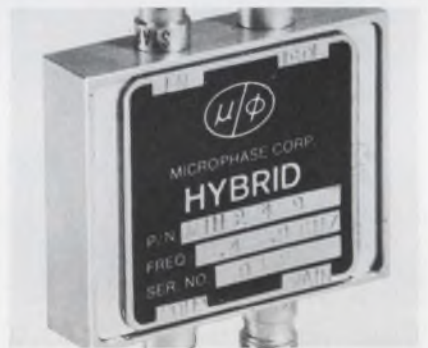

Microphase Corp., 35 River Rd., Cos Cob, Conn. Phone: (203) 661-6277. P&A: \$125 to \$175; 30 to 60 days.

Manufactured by thin-film techniques on high-density ceramic substrates, series 1000 single-section MIC branch hybrids feature bandwidths of 17% for any center frequency from 1 to 12.4 GHz. Their coupling is typically 3.2 ± 0.5 dB and isolation is greater than 20 dB. The units measure 1.5 by 1.25 by 0.375 in. and weigh less than 1 oz.

CIRCLE NO. 252

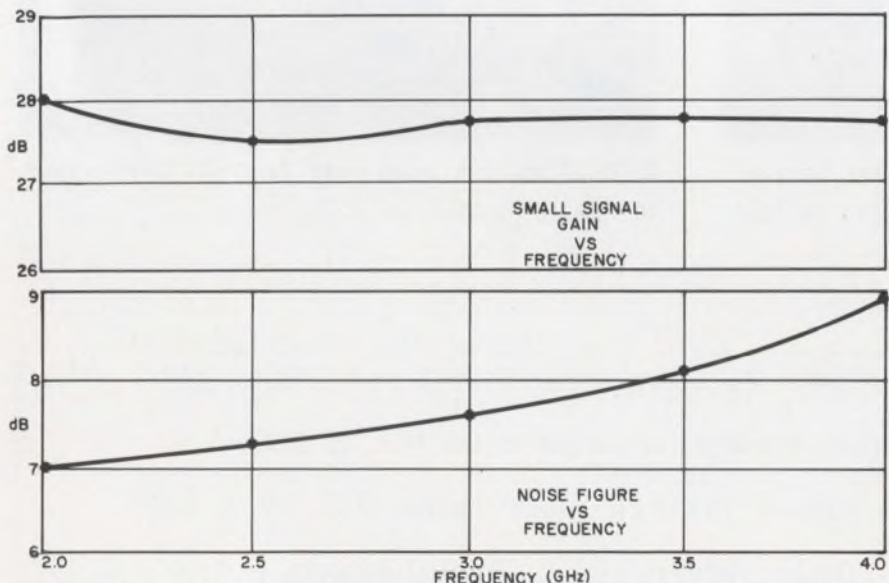

Typical gain and noise-figure plots for new solid-state amplifier show its high-performance capabilities over complete octave band from 2 to 4 GHz. Minimum gain is 25 dB; maximum noise figure is 10 dB at 4 GHz.

The new Fluke 893A will retire lots of good old Fluke voltmeters.

They won't be the only ones to go!

All kinds of differential voltmeters are likely to find quick retirement when you check out the new solid state Fluke Model 893A AC/DC Differential Voltmeter. Here's a low cost differential voltmeter with infinite resistance at null to 1100 volts, dc accuracy of 0.01%, ac accuracy of 0.05%, and integral battery pack operation.

Available in both half and full rack models, price is \$995 for either. Battery operation can be added at any time for only \$100. Grounded recorder output is available for \$50 more.

Ranges are 1, 10, 100, and 1000 volts ac and dc with 10% overranging. Resolution is 1 ppm of range. Reference regulation is the best available. Reference stability is 15 ppm/hr.

Using the instrument in the battery mode assures portability and complete isolation from the effects of power line interference. In the ac mode, the useful frequency range is 5 Hz to 100 KHz with a 1 mv accuracy. In the TVM mode, input resistance is 100 megohms, so you get the same advantages of low source loading as with older vacuum tube differentials.

Other user features include large, in-line readout with 360° rotation of voltage dials, virtual immunity to damage by accidental overload, and automatic decimal switching with range.

Ready to make the change?

We'd like to help. Your friendly Fluke sales engineer (listed in EEM and EBG) has all the facts as well as demo equipment. Call him or contact us directly if it's more convenient.



Fluke, Box 7428, Seattle, Washington 98133. Phone: (206) 774-2211.
TWX: 910-449-2850.

In Europe, address Fluke Nederland (N.V.), P. O. Box 5053, Tilburg, Holland.
Telex: 884-50237. In the U. K., address Fluke International Corp., Garnett Close,
Watford, WD2 4TT, England. Phone: Watford 27769. Telex: 934583.



Thin image intensifier senses from UV to IR



Bendix Corp., Electro-Optics Div., 1975 Green Rd., Ann Arbor, Mich. Phone: (313) 663-3311.

Less than 0.5 in. from photocathode window to output screen, a new ultra-thin image intensifier provides a spectral sensitivity from near ultraviolet to near infrared with a very effective response to Ga-As lasers and light-emitting diodes. This extended-red photocathode tube, model Bx-749, has a nominal luminous gain of 25 foot-lamberts per foot-candle with a radiant conversion gain of 20 W/W.

CIRCLE NO. 253

Telemetry receiver uses pushbuttons



Defense Electronics Div., DEI Industries, Rockville, Md. Phone: (301) 762-5700.

Claimed to be an industry first, a new pushbutton telemetry receiver allows front-panel selection of up to nine independent i-f bandwidths and three fm discriminators. Model TMR-74 is qualified and certified to MIL-STD-461 and offers plug-in spectrum display units with sweep widths to 8 MHz. It is supplied as a single-channel double superheterodyne design.

CIRCLE NO. 254

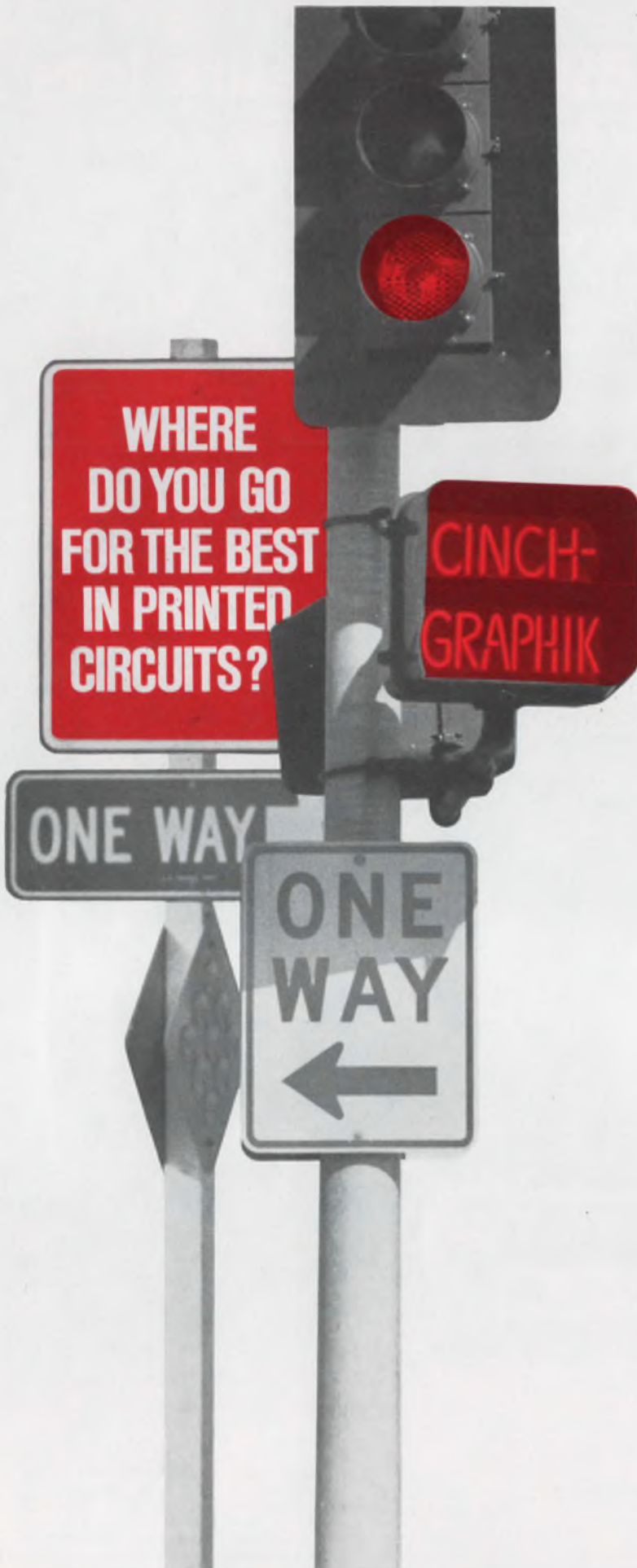



**new direct
card mounting
EECOSWITCH kits offer...**

startling savings in assembly time



8000 Series Kit Contents



EECO's new 8000 Series rotary thumbwheel switches mount directly on circuit cards. Switch-to-card interconnecting wiring, switch mounting hardware, and related assembly time have been eliminated . . . resulting in a compact, wire-free, economical package.

Offered in kit form for fast snap together assembly, EECO 8000 Series switches are priced at \$3.25 each in 1000 quantities. They're sealed against dust, come in six optional colors for coding of switch functions and each switch has a guaranteed service life of over 1,000,000 detent operations.

For full details on these economical new switch kits . . . contact the EECO sales office nearest you or circle reader reply number today.

ELECTRONIC PRODUCTS DIVISION

ELECTRONIC ENGINEERING COMPANY OF CALIFORNIA

1441 EAST CHESTNUT AVENUE • SANTA ANA, CALIFORNIA 92701 • (714) 547-5651

Look what just blew in.

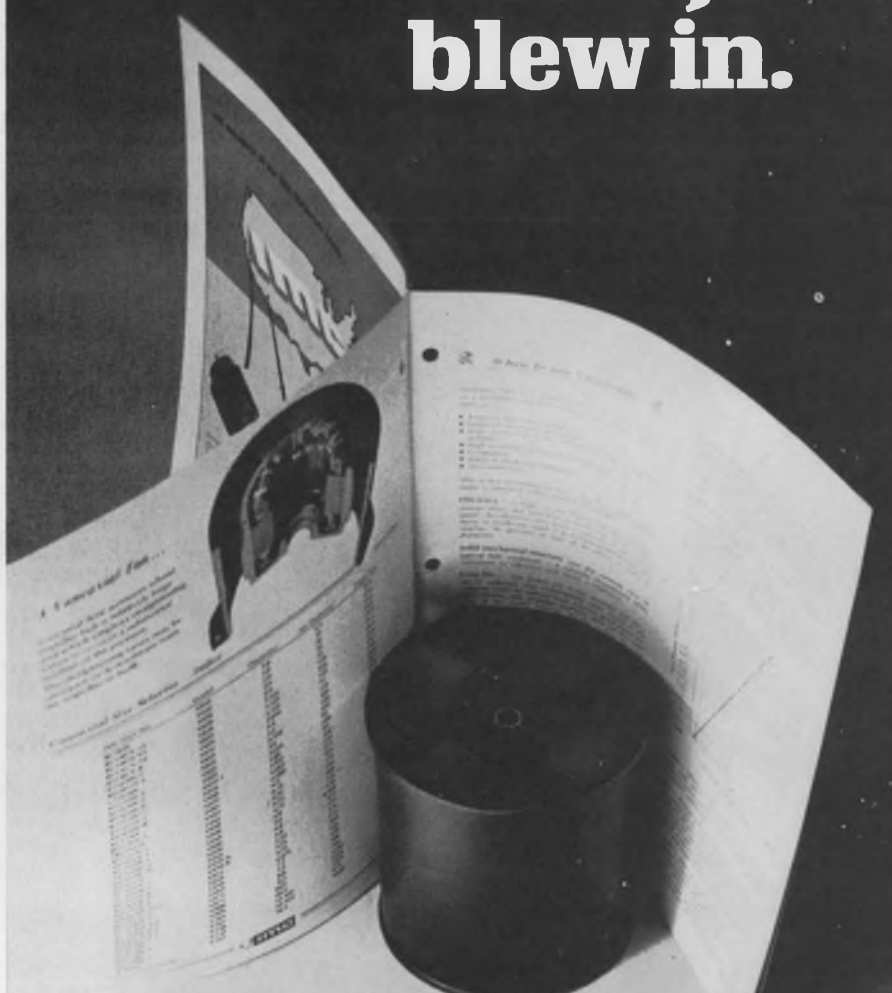

IMC's newest vaneaxial catalog

Prepared especially for designers who need information on vaneaxials, the most efficient and sophisticated of all airmovers. Versatile in application—for cooling electronic enclosures, ECM, klystrons, high-power tubes, and also for inflating shelters, dispensing chaff, refrigeration equipment, dust precipitators, and many others.

The 32-page catalog presents 40 different vaneaxial airmovers ranging in size from one to 15 inches in diameter, from 6.5 to 3450 cfm in output. Ample technical notes precede the detailed presentation of performance parameters, dimensions, and other specifications.

imc IMC Magnetics Corp., Eastern Division, 570 Main St., Westbury, N.Y. 11591, (516) 334-7070, TWX 510-222-4469.

INFORMATION RETRIEVAL NUMBER 60

Wave/dip meter quintuples uses



Melsey Corp., 202 Carle Rd., Carle Place, N.Y. Phone: (516) 333-0655. Price: \$185.

Operating over the frequency range of 400 to 1150 MHz, a new multi-function wave/dip meter can also be used as a signal generator, a Q meter, an inductance meter, a capacitance meter or a field strength meter. Model SN-2 provides continuous direct tuning calibrated to better than 1%. The unit also features a solid-state battery-operated oscillator.

CIRCLE NO. 255

Wideband insert limiter holds 25 dB at 1 kW

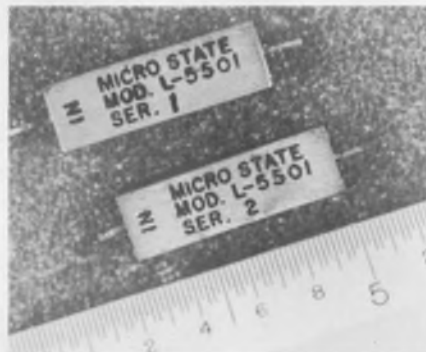

Micro State Electronics, Raytheon Co., 152 Floral Ave., Murray Hill, N.J.

Capable of handling 1 kW of rf power, a new insert limiter provides 25-dB limiting over the frequency range of 2 to 9 GHz. Model L-5501 can handle average powers up to 8 W with a maximum insertion loss of 1.25 dB. Its VSWR is no greater than 1.75. The unit measures 0.75 by 0.125 by 0.125 in.

CIRCLE NO. 256

INFORMATION RETRIEVAL NUMBER 61 ►

GET

a new source
of reliable
epoxy case
replacements
for TO-18
transistors

The General Electric GET transistor series is your new answer to circuit design problems. GET is the most recent member of GE's proved epoxy encapsulated transistor family dating back to 1962 . . . over 6 years of epoxy experience.

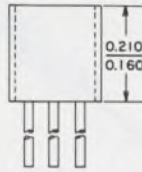

GET's package design conforms to TO-18 mounting patterns in existing PC boards. It's the ideal epoxy replacement for "hermetic devices" . . . no expensive redesign necessary.



These new units use the same industry proved production methods and quality epoxy that made our TO-98 (D16) series so successful. GE epoxy plastic forms a true chemical bond with metal to curb moisture permeation, eliminate internal wire lead fatigue failures, and vibration destruction. Low profile package design means smaller circuits and lower cost.

General Electric epoxy has the ability to contend successfully with a wide range of environmental conditions as shown in the extensive Reliability Evaluation Program described in Pub. 95.36A. Failures experienced with hermetic devices under these levels of shock, acceleration and stress have been eliminated with GE's solid epoxy encapsulant. Standard NPN and PNP devices are available now through GE distributors. Five family groups representing GE's new epoxy transistor lines are shown below. Additional family types are being added. For more information on GET's for all applications, plus GE's "specials" capability, call or write your GE sales representative or distributor, or write General Electric Company, Section 220-69, 1 River Road, Schenectady, N.Y. 12305. In Canada: Canadian General Electric, 189 Dufferin Street, Toronto, Ont. Export: Electronic Component Sales, IGE Export Division, 159 Madison Avenue, New York, N.Y. 10016.

GENERAL  ELECTRIC

NPN
GET706
GET708
GET914
Pub. No. 45.16 (1/69)

NPN
GET2221
GET2222
Pub. No. 45.17 (1/69)

PNP
GET3638
GET3638A
Pub. No. 41.22 (1/69)

NPN
GET2369
Pub. No. 45.19 (1/69)
GET3013
GET3014
Pub. No. 45.18 (1/69)
GET3646
Pub. No. 45.20 (1/69)

NPN
GET929
GET930
Pub. No. 40.33 (5/69)

**Do you think you have to
sacrifice performance because
no single capacitor possesses
all your critical requirements?**

**Don't think negative...
think DEARBORN**

**METALIZED POLYCARBONATE
FILM CAPACITORS**



- Extremely low leakage current
- Low dissipation factor
- Non-polar construction
- 125 C operation without derating
- Light weight
- Mini-size
- Suitable for ac/rf applications
- Low temperature coefficient
- Long term stability
- Close capacitance tolerance
- Low dielectric absorption
- Consistent retrace
- Capacitance values to 100 μ F
- Voltage ratings, 50 V to 400 V

There's a style for every circuit need...

Style No.	Description
LP8	Hermetically-sealed metal-case tubular
LP9	Hermetically-sealed metal-case tubular, insulating sleeve
LP7A	Epoxy-case rectangular, axial leads
LP7S	Epoxy-case rectangular, radial leads
LP66	Wrap-and-fill round tubular
LP77	Wrap-and-fill oval tubular
LP88	Fuz-ion® sealed tubular

*For engineering bulletins on the capacitor styles
in which you are interested, write to Dearborn
Electronics, Inc., Box 530, Orlando, Fla. 32802.*

Dearborn Electronics, Inc.
(a subsidiary of the Sprague Electric Company)
FOREMOST IN FILM CAPACITORS

INFORMATION RETRIEVAL NUMBER 62

**MOS 2560-bit memory
codes in ASCII format**

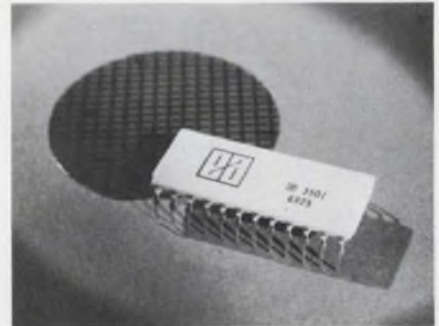

*Electronic Arrays, Inc., 501 Ellis
St., Mountain View, Calif. Phone:
(415) 964-4321. P&A: \$115; 2 to
3 wks.*

Containing the basic 64 characters of the standard ASCII address format, a new 2560-bit MOS read-only memory is said to be the largest-capacity device of its kind. The EA 3501 is a low-power high-performance chip that typically dissipates less than 90 mW total and has an access time of 750 ns at a clock rate of 1 MHz.

This new integrated circuit contains 512 words, each presented on five parallel output buffers for horizontal-scan CRT displays using the 5 by 7 ASCII code matrix. Since only 448 (64 by 35) words are required for the ASCII pattern, the EA 3501 offers 64 extra five-bit words for other custom-bit-pattern read-only memory applications.

It uses a nine-bit input address. Six address inputs select the desired characters for the ASCII format. Three additional address inputs determine one of the seven five-bit rows needed to completely write each character.

Although this new monolithic device requires a two-phase clock, its outputs appear as steady-state signals as long as the address remain unchanged.

Only the output buffers require a dc supply. When properly biased, these voltage-variable outputs can drive bipolar circuits directly. There is also an output inhibit control for chip select.

The entire circuit is contained on a single 65 by 94 mil chip and utilizes 2994 MOS enhancement-mode p-channel transistors.

CIRCLE NO. 257

New from Cutler-Hammer— environmentally sealed switches built to MIL-S-3950C.

Our newest line of military switches gives you still another choice in Cutler-Hammer military toggle switches.

Built to the environmentally sealed standard of the new MIL-S-3950C specs, this new line employs a patented silicone-rubber sealing process that lasts for the life of the switch.

Double insulation is achieved because the seal covers the entire inside of the cover. Terminals are molded into the base without elastomers.

Other features include a self-extinguishing melamine base material and back-wired terminals with

molded-in identification—to simplify wiring and bussing.

The line is available with standard bat levers or lever-lock toggles in one, two and four poles.

For the ultimate in reliability, you can still choose our positive-action switches, full-size or miniature, built to MIL-S-8834. And for less demanding applications, our standard military toggle switches built to MIL-S-3950.

Contact your Cutler-Hammer Sales Office or the Cutler-Hammer Stocking Distributor near you for complete information.



Military relays, too—from a full line which includes these hermetically sealed 25-, 50-, and 100-amp relays and a 175-amp generator contactor, and a full line of dust-sealed power relays up to 400 amps.

Newest member of an old military family.



Switch
to No. 1

More than just switches.
prompt availability,
field help, innovation,
quality assurance too.

INFORMATION RETRIEVAL NUMBER 63



CUTLER-HAMMER
SPECIALTY PRODUCTS DIVISION, Milwaukee, Wis. 53201

N-channel JFETs add another source



Dickson Electronics Corp., P.O. Box 1390, Scottsdale, Ariz. Phone: (602) 947-2231. P&A: \$1.70 to \$14; stock.

A wide range of the most popular n-channel junction field-effect transistors is now available. Included are: types 2N3821, 2N3822, 2N3823 and 2N4416 for small-signal, vhf and mixer applications; types 2N3069, 2N3458, 2N3684 and 2N3436 for general-purpose and low-level amplifier applications; types 2N4091 and 2N4391 for chopper and switching applications; and type 2N3954 matched pairs for use in high-input-impedance differential amplifiers.

CIRCLE NO. 258

Plastic micro-FET boasts 8-mil dia



Continental Device Components, Mail Station 701, 12515 Chadron Ave., Hawthorne, Calif. Phone: (213) 772-4551.

Measuring just 8 mils in diameter, a new plastic microminiature field-effect transistor offers performance capabilities equal to its metal-can counterpart. This micro-FET can operate at a junction temperature of 125°C and is highly shock resistant. Its thermal resistance is as low as 350°C/W and power dissipation is as high as 175 mW.

CIRCLE NO. 259

Solid-state diode ousts damper tubes



Scientific Components, Inc., 350 Hurst St., Linden, N.J. Phone: (201) 925-4022.

Only one-fifteenth the size of conventional damper tubes used in CRT horizontal sweep circuits, a new plastic silicon diode can rectify 5000 V ac at frequencies up to 15 kHz and deliver an average forward rectified current of 300 mA. Called Vidiodi, this high-voltage device can increase picture size, improve picture brightness and reduce picture distortion.

CIRCLE NO. 260

Multi-chip memory operates in 35 ns

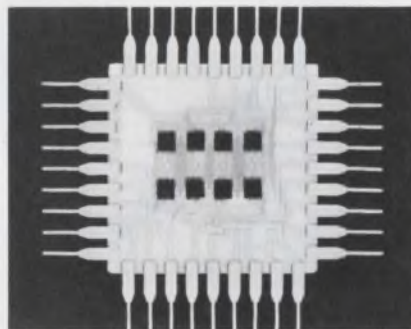

Fairchild Semiconductor, 313 Fairchild Drive, Mountain View, Calif. Phone: (415) 962-3563. Price: \$100.

Supplied in a 1 by 1 in. multi-chip package, a new 128-bit read/write random-access memory features an access speed of 35 ns. Using face-down bonding techniques, the M μ L4027 is a bipolar product with a ceramic substrate that incorporates two layers of metalized interconnects. This design eliminates die attach and wire bonding operations, and contributes to improved performance and reliability. The device consists of eight 16-bit chips.

CIRCLE NO. 261

FET's on-resistance is only 2.5 Ω max

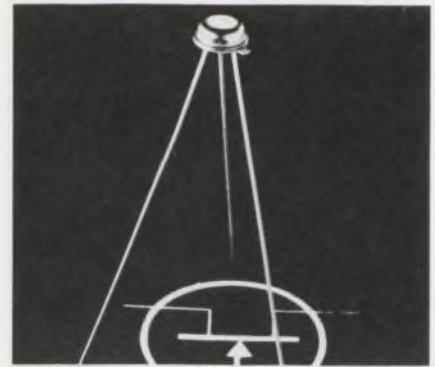

Crystalonics, A Teledyne Co., 147 Sherman St., Cambridge, Mass. Phone: (617) 491-1670. Price: \$85.

Providing extremely accurate switching in d/a and a/d converters, a new field-effect transistor offers an ultra-low on-resistance of only 2.5 Ω maximum. In addition, the CMX740 is a very fast core driving transistor, able to handle short-duration high-current pulses up to 0.5 A minimum. The unit has typical on and off times of 50 and 75 ns, respectively.

CIRCLE NO. 262

Hardened circuits withstand 10⁹ rad/s

Motorola Semiconductor Products Inc., P.O. Box 20924, Phoenix, Ariz. Phone: (602) 273-6900. P&A: \$7.30 to \$18; stock.

Radiation-resistant versions of six MDTL series 930 integrated circuits, including gates and flip-flops, are now available as standard off-the-shelf products. Electrically equivalent to the parent devices, the new MCE930 series ICs will survive all radiation levels presently required by the military. They are fully functional during and after gamma radiation of 10¹⁰ rad per second, provided that a cumulative dose of 5 \times 10⁸ rad is not exceeded. The circuits can also resist exposure to a fluence (neutron dose) of 7 \times 10¹³ neutrons/cm². They feature dielectric isolation of active areas, shallow p-n junctions, high concentration of dopants, thin-film resistors and aluminum wire bonds.

CIRCLE NO. 263

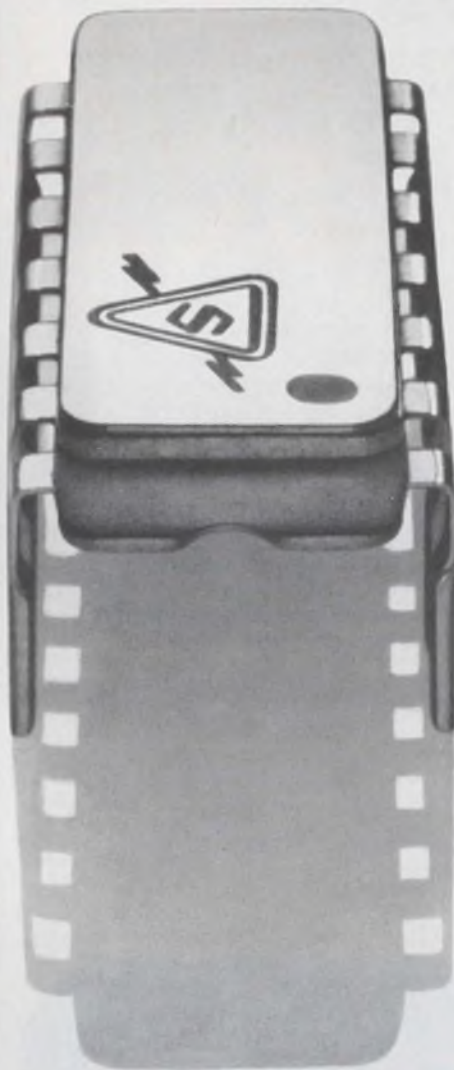

Here are two kinds of SUHL circuits. A fast one and a slow one.

Everybody knows that SUHL TTL is a great high-speed logic circuit.

Sometimes they forget that it's great in slow-speed systems, too.

SUHL TTL has better speed/power ratios than most other logic forms at any speed.

At low speeds, SUHL TTL gives you superior current-sinking capability. And you don't have the loading problems associated with other logic forms.

Input/output leads are isolated, and you get a wider choice of configurations in SUHL TTL.

And then there's price. You don't pay a premium for SUHL speed. SUHL prices are competitive with slower speed circuits.

Which makes SUHL TTL the logical choice for any system, fast or slow.

SYLVANIA
GENERAL TELEPHONE & ELECTRONICS

Sylvania Electronic Components, Semiconductor Division, Woburn, Massachusetts 01801.

DL 620A

**A COMPLETE
18-CHANNEL
DIGITAL DATA
ACQUISITION
SYSTEM**

for only
\$3,900

The compact and lightweight design, plus low power requirements, makes the DL 620A an extremely versatile unit. Ideal for general purpose recording of analog or digital data on magnetic tape both in the laboratory and remote installations... or portable airborne applications.

This complete 18-channel data acquisition system weighs only 18 lbs. and needs minimal power of 35 watts. Features include a presettable crystal controlled clock; ability to accept either analog or direct digital data; high Z differential analog input stage; selectable recording rates; cartridge magnetic tape system with associated drive; plus all necessary logic and power supplies. Data recovery options include; tape-to-tape, tape-to-computer, and real-time.

For the complete story on the Model DL 620A and associated equipment write MetroData Systems, Inc., P. O. Box 1307, Norman, Oklahoma 73069.



INFORMATION RETRIEVAL NUMBER 65

ICs & SEMICONDUCTORS

Vhf hybrid IC amp delivers +12 dBm



Ampar Div., Adams-Russell Co., Inc., 39 Green St., Waltham, Mass. Phone: (617) 899-1900. P&A: \$225; stock to 6 wks.

Providing stabilized operation from 500 kHz to 200 MHz, a new vhf hybrid IC amplifier features a gain of 21 dB, a power output of ± 12 dBm and a noise figure of 4.6 dB (measured at 30 MHz). Model MWDH-20G-12 is supplied in a ruggedized package with feed-through leads for convenient use with printed circuits and strip transmission line assemblies.

CIRCLE NO. 264

Power transistors turn-on in 10 ns



Solitron Devices, Inc., Transistor Div., 1177 Blue Heron Blvd., Rivera Beach, Fla. Phone: (305) 848-4311.

Series SDT6100 fast-switching power transistors are 5-A devices with turn-on times of less than 10 ns. Packaged in TO-5 cases, the new transistors feature total switching times of under 60 ns and risetimes of less than 10 ns. Their unity-gain cut-off frequency is typically 500 MHz. They are designed to replace many parallel low-current devices now used to obtain fast switching at high currents.

CIRCLE NO. 265

TDM SERIES POWER SUPPLY MODULES

BUILT-IN FEATURES...NOT EXTRA-COST OPTIONS



- Overvoltage Crowbar Protection
- Front Panel Test Points
- Front Panel Indicator Lamp
- Front Panel Mounting Provisions
- Multiple Units may be mounted on common 5¼" Front Panel
- Chassis Mounting Provisions
- Front Panel Voltage Adjust
- Front Panel Current Limit Adjust
- Military or Computer Grade Components and Workmanship
- Remote Sensing
- Polarity Floating

SPECIFICATIONS

- Input: 103.5 - 127.5 V, 47-63 Hz
- Output Current as selected
- Output Adjustment Range as selected
- Wide Range Adjustment optional (zero to rated voltage)
- Regulation, Line: .01% +5 MV
- Regulation, Load: .01% +5 MV
- Ripple: .001% +200 μ V RMS
- Transient Response 50 usec max. for ½ load or 3A whichever is less.
- Temperature Coefficient .01% ° C
- Ambient Temperature Range: -20 to +55° C at full rated current. Derate by .5 for 71° C operation.

ALL TDM SERIES UNITS ARE 4⅞" IN HEIGHT AND 7½" IN DEPTH

DC OUTPUT VOLTAGE	OVERVOLTAGE MAXIMUM	CASE "A" MAX. AMPS.	CASE "B" MAX. AMPS.	CASE "C" MAX. AMPS.	CASE "D" MAX. AMPS.	CASE "E" MAX. AMPS.	CASE "F" MAX. AMPS.
TDM-3.5-4.5	6	2.8	5	9	12	17	30
TDM-4.5-5.5	7	2.8	5	9	12	17	30
TDM-5.5-8.5	10	1.7	5		10		17
TDM-8.5-11.5	13	1.7	5		10		17
TDM-11.5-13.5	15	1.2	3.5		7		12
TDM-13.5-15.5	18	1.2	3.5		7		12
TDM-15.5-18.5	21	.9	3		6		10
TDM-18.5-22.5	25	.9	3		6		10
TDM-22.5-26.5	30	.7	2		4		7
TDM-26.5-30.5	35	.7	2		4		7
WIDTH		2½"	3½"	5¼"	7"	8¼"	13"
PRICE		\$109.00	\$135.00	\$150.00	\$185.00	\$235.00	\$315.00
WEIGHT IN POUNDS		4½	7	9	11	13	25

WHEN DOES 1 + 1 + 1 = 1?

When 3 Standard Power Supplies are combined as 1 Special.

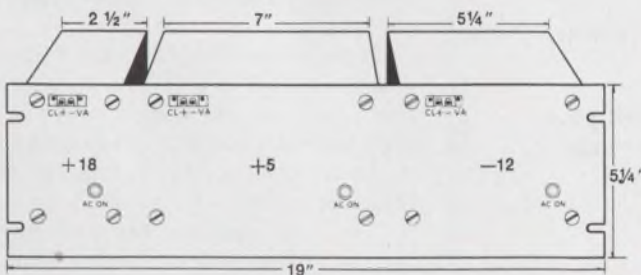

HOW TO PLAN YOUR SPECIAL MULTIPLE OUTPUT POWER SUPPLIES:

The TDM Series of Modules may be directly mounted onto a 5¼" front panel by means of four #10 screws. Clearance holes should be cut in the front panel for test points, voltage adjust, current limit adjust, and indicator lamp. Related Power Supply Modules may be mounted side by side (a minimum of ½" spacing should be left between modules for ventilation). The utilization equipment may also be mounted on a common front panel with the power supply. This permits the rapid and professional fabrication of special test and measuring equipment, displays, etc., to custom specifications at minimum cost with minimum design and engineering time.

Transistor Devices Inc.

85 HORSEHILL ROAD, CEDAR KNOLLS, N. J. 07927 • (201) 267-1900

INFORMATION RETRIEVAL NUMBER 66

**Atec's new
12.5 MHz
universal
counter/timer
measures
Frequency,
Time Interval,
Ratio, Period,
Multiple Period,
and
Totalizes. **That's
quite
a bit
for
\$850!****



Atec's new Model 2000 offers more performance for less money than any competitive instrument. Standard features include a 1 MHz crystal-controlled time base stable to one part in 10^8 /day, remote programming, and 1-2-4-8 BCD output. Options include display storage, oven-stabilized crystal, and additional digits (to seven). Modular plug-in design makes it simple to add options at any time.

Input sensitivity is 10 mV (DC to 5 MHz) and 30 mV to 12.5 MHz. Front panel height is only $1\frac{3}{4}$ inches.

For complete specifications or a free demonstration, call your local Atec engineering-sales representative, or write Atec today.

Atec, Inc.

1125 LUMPKIN STREET, HOUSTON, TEXAS • PHONE (713) 468-7971
MAILING ADDRESS: P.O. BOX 19426 • HOUSTON, TEXAS 77024

INFORMATION RETRIEVAL NUMBER 67

DATA PROCESSING

**Wiresonic memories
access at random**

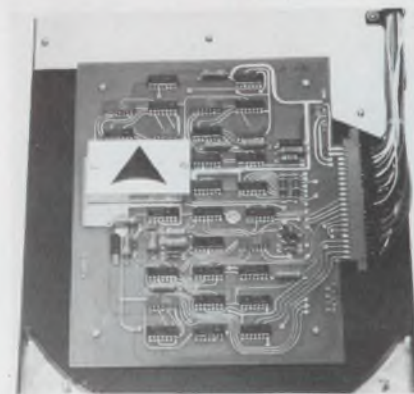

Andersen Laboratories, 1280 Blue Hills Ave., Bloomfield, Conn. Phone: (203) 242-0761. P&A: \$800; stock.

A new series of random-access wiresonic memories can often replace expensive access-by-address core memories, with a better than 50% savings in cost, in applications where extremely fast access times are not required. As opposed to conventional serial wiresonic memories, series RAM-8 units permit readout of specifically addressed information without requiring the entire memory to be unloaded.

The new memories combine serial-memory technology with integrated-circuit interface logic. This means that they can offer the cost advantage of serial memories with the versatility of random access.

Using wiresonics to accomplish digital storage, the RAM-8 systems convert electrical signals to acoustic energy with piezoelectric or ceramic-type transducers. The acoustic signals are then introduced to pathways of acoustic-grade metal, and reconverted to electrical signals by output transducers.

Each series RAM-8 model has a non-destruct read mode. In addition, the new memories can present requested output data indefinitely, or until a new command is initiated.

Power dissipation remains low for the entire series, ranging from 5 V at 2.2 A to 12 V at 0.1 A. Access times vary from 1.1 to 8.4 μ s. Maximum storage capacity is 2048 words with 8-bit lengths.

CIRCLE NO. 266



5 more

electronic components tailored for designers

General Electric components are engineered for reliability and cost effectiveness. No other manufacturer offers such a wide selection of quality electronic components as General Electric. Specify GE in your designs.



General Electric's programmable UJT lets you control the key parameters

GE's D13T is a programmable unijunction transistor (PUT) with characteristics (η , R_{B1} , I_P , I_V) that can be selected to fit your circuit. Just two circuit resistors give the D13T1 and T2 programmability which permits the designer to:

- reduce a risk of thermal runaway
- use PUT in battery and other low-voltage circuits
- use base 2 as low impedance pulse output terminal
- use PUT in high volume applications.

Especially suited for long-interval timers, D13T2 features very low leakage and peak point currents. D13T1 is for more general use in high gain phase controls and relaxation oscillators.

Both are 3-terminal planar passivated PNP devices in the low-cost plastic TO-98 case. Circle number 221.



Pin-sized Lodex magnet

New—Lodex® permanent magnets in microminiature sizes

When designs call for tiny (even less than 1 millimeter) permanent magnets, GE has the answer. GE can produce powerful microminiature magnets at low cost—and in complex configurations, too.

The magnets are made of proved Lodex material that consists of elongated single domain iron cobalt particles bonded in a lead matrix and pressed to final dimensions at room temperature without the use of high temperature fabrication or heat treatment. This exclusive process makes it possible to produce Lodex magnets in very small or intricate shapes meeting extremely tight physical and magnetic tolerances.

Close piece-to-piece physical and magnetic uniformity often eliminates the need for final testing of the end product. These GE magnets are often the perfect answer for such precise applications as reed switches or magnetic pick-ups.

For more information, circle number 222.



New transmitter design gives high performance to IFF and ATC transponders

GE's new C2003C transmitter is a Micro-wave Circuit Module (MCM) containing a master oscillator and power amplifier using planar ceramic triodes.

It is just one of many MCM's now available from GE to help reduce design cycles, provide retrofit and lead to improved system performance.

Other benefits include: meets performance and military requirements of the transmitter portion of IFF transponder significantly smaller than earlier designs permits two transmitters to function in space formerly used by one light-weight simplified heat sinking excellent frequency stability with wide variations in antenna VSWR.

For more technical information on this and other MCM's from General Electric, circle magazine inquiry number 223.



actual size

GE makes the only 150-grid relay that performs the AND-logic function

GE's 3SBR 4-pole relay is the only one available that performs the AND-logic function without any additional circuitry or components. Nine different input conditions control the relay's operation.

The 3SBR is another addition to GE's proved family of 150-grid relays for mil spec applications. It features all-welded construction, small size and a low profile—only 0.32" high. The 3SBR is available with a choice of coil ratings, mounting forms and headers.

For more technical data, circle number 224.



Rechargeable nickel-cadmium batteries give design flexibility—long life

Get lasting battery power and versatility suitable for many industrial and consumer applications. Types include sealed, pressure-relieved and vented cells. Custom designs to your specifications are also available.

Nominal ratings range from 0.1 amp-hours to 4.0 amp-hours in sealed cells and up to 160 amp-hours in vented types at the one-hour rate.

GE nickel-cadmium cells feature unique construction providing a very high discharge rate capability.

See how GE's proved line of nickel-cadmium batteries can increase your circuit performance. For more information, circle magazine reader card number 225.

LOOK TO GENERAL ELECTRIC—your best source for more in electronic components.

ELECTRONIC COMPONENTS SALES OPERATION

GENERAL ELECTRIC

285-52

For
fast,
fast,
fast relief
from congested data...

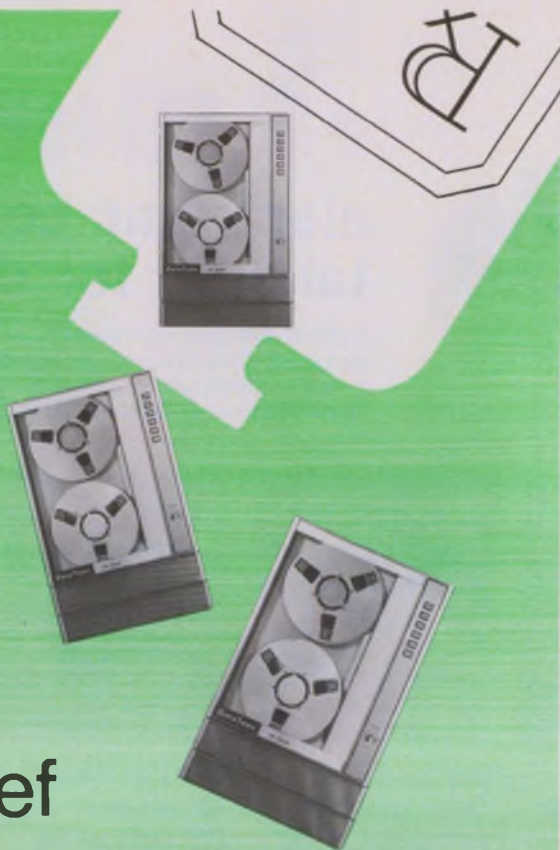

take one VR-3360.

Anytime, anywhere. Submarine, shipboard, copter, van, proving ground, laboratory. Oceanographic, geophysical, medical, industrial.

The VR-3360 is no longer just the most capable portable recorder. And the most reliable. It's *fast*.

Reason: an electrically-switchable speed change. This feature provides six speeds— $1\frac{1}{8}$ through 60 ips.

The rest of the VR-3360's advantages are well known to those involved with laboratory-caliber recorders. Such as its baseplate of aluminum tool alloy which won't flex under severe environmental stress, thereby assuring precision tape guidance. Dual differential capstans which deliver superior reel-to-head isolation while maintaining uniform tape-to-head contact. Precision-torque motors which provide uniform, repeatable tape tension with dynamic braking to stop the tape safely from any mode. Interlocking controls to indicate operation mode and prevent accidental erasure or damage to tape. Front-accessible electronic test points and adjustment controls. And recording heads that are guaranteed for 1000 hours and require no alignment.

For the complete story, call our nearest office. Or write Bell & Howell, Pasadena, California 91109. Ask for Bulletin Kit 3307-X2.



CEC/DATA INSTRUMENTS DIVISION



BELL & HOWELL

INFORMATION RETRIEVAL NUMBER 68

DATA PROCESSING

Equalized data modem transmits 7200 bits/s

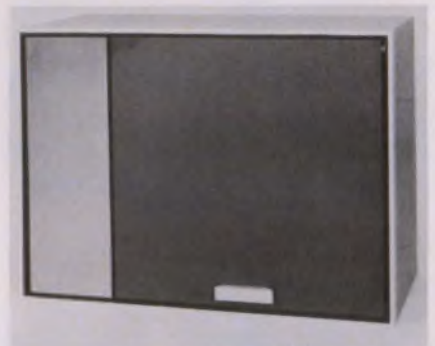

Rixon Electronics, Inc., 2120 Industrial Parkway, Silver Spring, Md. Phone: (301) 622-2121. Price: \$9950.

Featuring integral continuous adaptive automatic equalization, a new data set operates at switch-selectable speeds of 7200, 4800 or 3600 bits per second over C2 conditioned lines. The Sebit-72 is intended for use with computers or other high-speed terminals in a point-to-point private line network. It is not pattern sensitive to input data.

CIRCLE NO. 267

Low-cost calculator incorporates LSI



Toshiba America, Inc., Business Equipment Div., 477 Madison Ave., New York, N.Y. Price: \$595.

Retailing for only \$595, a new all-purpose electronic desktop calculator uses large-scale integrated circuitry (LSI) to provide an unusual degree of reliability and performance flexibility. Model BC-1202 is a 12-digit instrument that handles basic operations like addition, subtraction, multiplication and division, as well as constant or mixed calculation and successive multiplication and division.

CIRCLE NO. 268

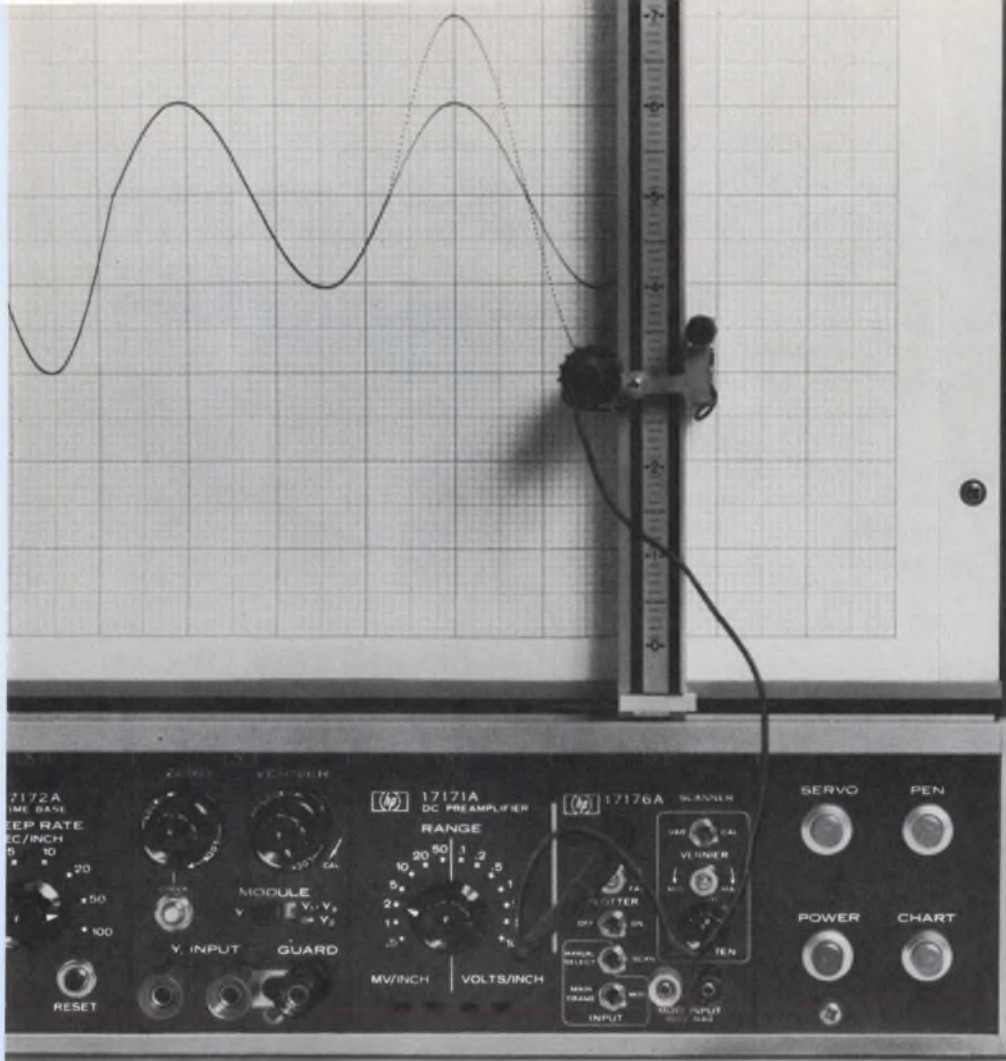

Two in one

Hewlett-Packard now offers you a new extra advantage in X-Y recording – the 17176A Dual-Trace unit – a new accessory for the world's first truly "plug-in" recorder, the 7004A. It lets you plot, with a standard recorder, two variables against a third – without the expense of a two-pen system.

Teamed up with the 7004A and the 17012B Point Plotter, the new 17176A gives you two y-traces by alternately scanning between two y-input channels. Plotting rate is continuously variable between 10 points per second and 6 points per minute, depending on the resolution you need. Points are divided equally between the two traces. A built-in attenuator modifies the additional channel.

Price, too, is part of the new plug-in's uniqueness: \$300. The 7004 X-Y Recorder costs \$1395. The 17012B Point Plotter, \$95. Additional plug-ins for either x or y channels start at \$25.

To find out how you can get double your money's worth in an X-Y recorder, call your local HP field engineer. Or write Hewlett-Packard, Palo Alto, California 94304; Europe: 1217 Meyrin-Geneva, Switzerland.

HEWLETT  PACKARD

GRAPHIC RECORDERS

Compact light pen responds in 200 ns



Peripheral Products Co., 892 Worcester St., Wellesley, Mass. Phone: (617) 235-1623.

Housing all its IC electronics in its pen barrel, a new light pen is a compact and rugged device with a response time of under 200 ns, from light input to logic output, over a wide temperature range. Known as the Hawk, the device measures 6-1/2 in. long by 3/8 in. in diameter. **CIRCLE NO. 269**

Wideband data systems go to 230 kilobits/s



General Electric Co., Communication Products Dept., P.O. Box 4197, Lynchburg, Va. Phone: (703) 846-7311.

DigiNet 500 wideband data systems perform at 230 kilobits per second—nearly ten times faster than voice-channel digital communications—for transmission of digital signals between extremely rapid terminal equipment. The high speed of the units makes possible facsimile systems that can transmit a page in several seconds. They include baseband data sets, baseband repeaters and carrier modems. **CIRCLE NO. 270**



Heavy Duty Filter Chokes In Stock Custom Filter Chokes In 10 Days

Series 7830 heavy duty line filter chokes provide up to 250 uh, carry up to 75 amps; widely used for RFI filters and reducing transient surge peaks; available from L.A. shelf stock; see Catalog 69.



Special RF chokes and coils designed to meet your requirements are shipped within 10 days to 2 weeks; production quantities start within 3 to 4 weeks after sample approval.



Intensive specialization in coil design and manufacture assures excellent operating results with a high degree of reliability. Engineering assistance helps achieve optimum performance.



Write for your copy of Catalog 70 containing specifications and prices for the complete line of J. W. Miller Co. RF chokes, RF and IF coils, transformers, filters, coil forms and components.

Call a Miller coil design specialist for your special coil requirements — (213) 537-5200.



J.W. MILLER COMPANY

19070 REYES AVE. • P.O. BOX 5825 • COMPTON, CALIF. 90224

See your local distributor for the full line of standard coils and chokes

Multiplexing converter operates at 100 kHz



Hewlett-Packard, 1501 Page Mill Rd., Palo Alto, Calif. Phone: (415) 326-7000. P&A: \$2000 to \$2500; August, 1969.

Multiplexing up to 16 channels, a new analog-to-digital converter translates analog voltages into binary numbers at the rate of 100,000 conversions per second. In less than 10 μ s, model 5610A samples an analog input voltage and generates a 10-bit (including sign) digital output for direct entry into a computer. Sample-and-hold circuits permit a 50-ns aperture time for accurate acquisition of fast changing data. **CIRCLE NO. 271**

The Friden 1150 Digital Printer.

It didn't fail us.

So it won't fail you.

For nearly two years now, the Friden* 1150 Digital Printer has been an integral part of our electronic printing calculator.

So we know all about its reliability from first-hand experience, out in the field.

This 50-character-a-second printer is *durable* because it has fewer moving parts than ordinary medium-speed printers. It is easier to maintain. This means less downtime for your OEM product. The 1150 Digital Printer contains a single 20-character print wheel and a synchronized print hammer. Both are driven across the tape from right to left at a uniform speed. The hammer's short impact time insures quality printing from the continuously rotat-

ing wheel. And we have eliminated messy ribbons with our disposable ink roller.

Logic requirements are simple, making it easy to integrate the 1150 Digital Printer into your OEM product.

One more important thing: the 1150 Digital Printer is *not* expensive. It just sounds expensive. With its low initial cost and desirable operating features, the 1150 Digital Printer gives you a price/performance ratio unique among OEM printers.

The complete specs are all in our Specification 1001.

For your copy, write: Friden Division, Component Products, The Singer Company, San Leandro, California 94577.

• A TRADEMARK OF THE SINGER COMPANY

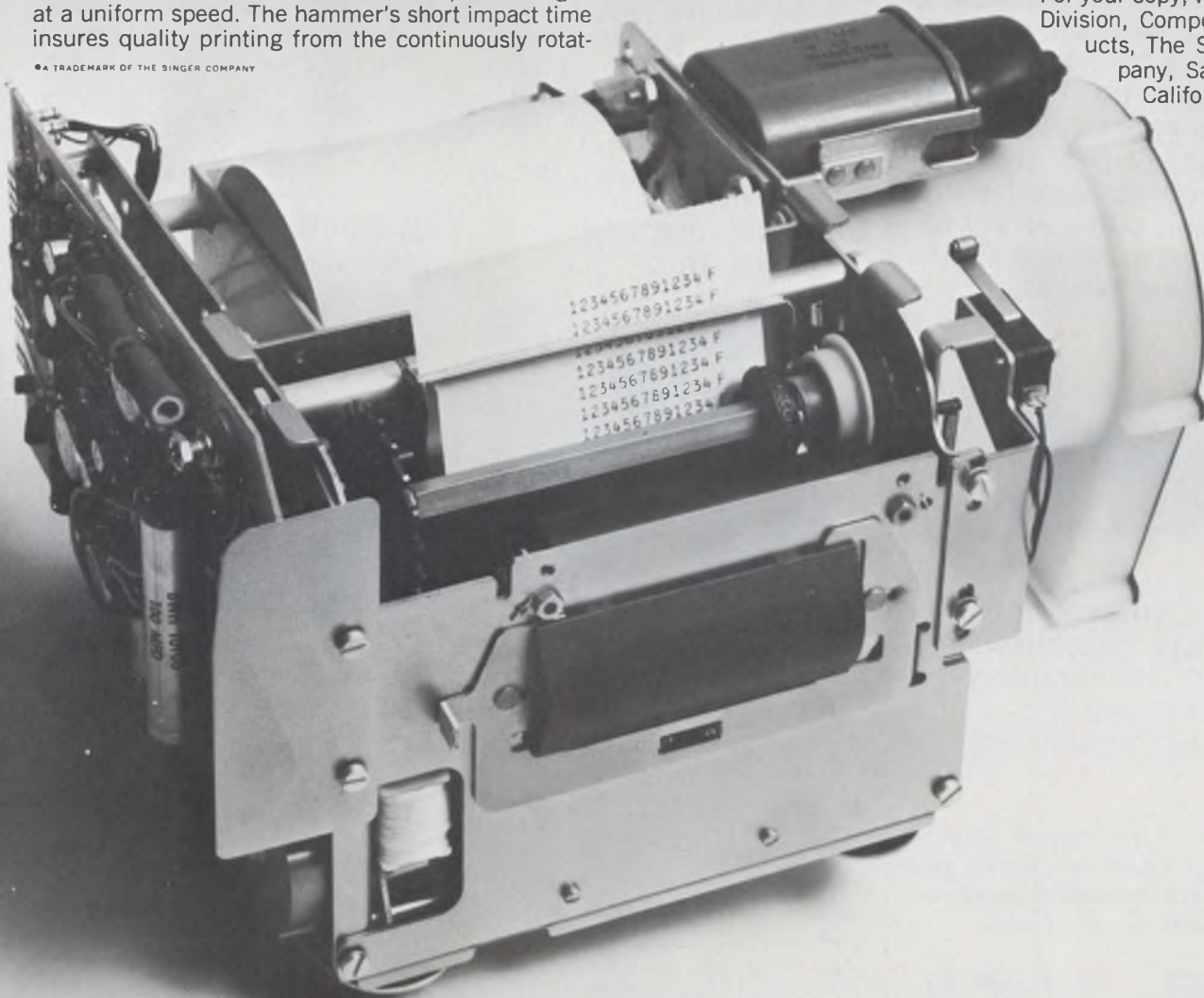

2 SPEED 10", 10 MV 1/2% \$305.00



MODEL 28 SERVO GRAPHIC

A RUGGED, DEPENDABLE, RACK MOUNTED, SERVO RECORDER WITH ACCURACY TO MEET YOUR REQUIREMENTS, BUT AT A PRICE TO SATISFY YOUR BUDGET. AVAILABLE IN SINGLE OR DUAL PEN MODELS FROM YEISER LABORATORIES, THE LEADERS IN SERVO RECORDER DESIGN FOR OVER FIFTEEN YEARS. DUAL OVERLAPPING CHANNELS FROM \$600.00.



- ALL SILICON SOLID STATE ELECTRONICS
- PLUG-IN CIRCUITRY
- FET CHOPPER
- ZENER REFERENCE

Remember! If you have an OEM requirement, Y-LAB can furnish strip chart or X-Y recorders to meet your specific needs, so call or write:



881 W. 18th ST.
COSTA MESA,
CALIF. 92627
714-548-2458

INFORMATION RETRIEVAL NUMBER 72

DATA PROCESSING

Data coupler tests itself



Novation, Inc., 18664 Topham St., Tarzana, Calif. Phone: (213) 344-7191. Price: \$650.

Small enough to fit into a desk drawer or to carry in an attache case, a new self-testing acoustic data coupler uses a closed-loop circuit to check total operation of the terminal and the coupler. A carrier-on light insures that the incoming tone is present and that the volume is adequate. The DC/100 incorporates answer, originate and two test modes.

CIRCLE NO. 272

Card set memory accesses in 2 μ s

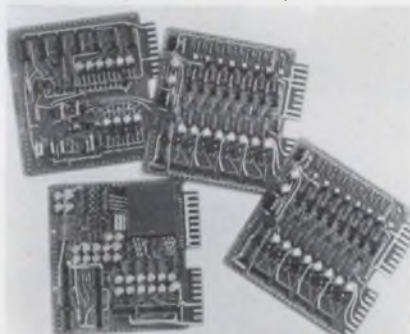

Ferroxcube Systems Div., a North American Philips Co., Englewood, Colo. Phone: (303) 771-2000. Availability: stock.

Consisting of plug-in cards, a new small core memory system features an access time of 2 μ s and low-temperature-coefficient cores. With a capacity of 160 words having 8- or 16-bit lengths, the CM-1 card set memory requires a maximum space of only 2 by 6 by 6 in. with 1/2-in. spacing between cards. Address decoding, drive circuits, timing, data logic and temperature compensating circuitry are all included.

CIRCLE NO. 273

Flexible mini-computer has read-only memory



General Electric Co., Process Computer Dept., 2255 W. Desert Cv., Phoenix, Ariz. Phone: (602) 943-2341. Price: \$10,000.

Joining the mini-computer revolution, series GE-PAC 30 read-only-memory-based computers allow special-purpose instructions to be built right into the hardware. Other features include dual-in-line integrated circuits, functional plug-in modular design, easy programming with 16- to 32-bit instructions, and direct addressing to 64k bytes.

CIRCLE NO. 274

Computer-like system puts data on tape



Data Instruments Co., 16611 Roscoe Place, Sepulveda, Calif. P&A: \$2850/terminal, \$24,950/processor; 120 days.

A new business system automatically gathers data as it is generated and converts it directly into computer-usable form. Dataplex can function in virtually any business entity without a change in routine or forms. It consists of a terminal that acquires and stores data, and a processor that reads the data, converts it into a computer format, and prepares a magnetic tape.

CIRCLE NO. 275

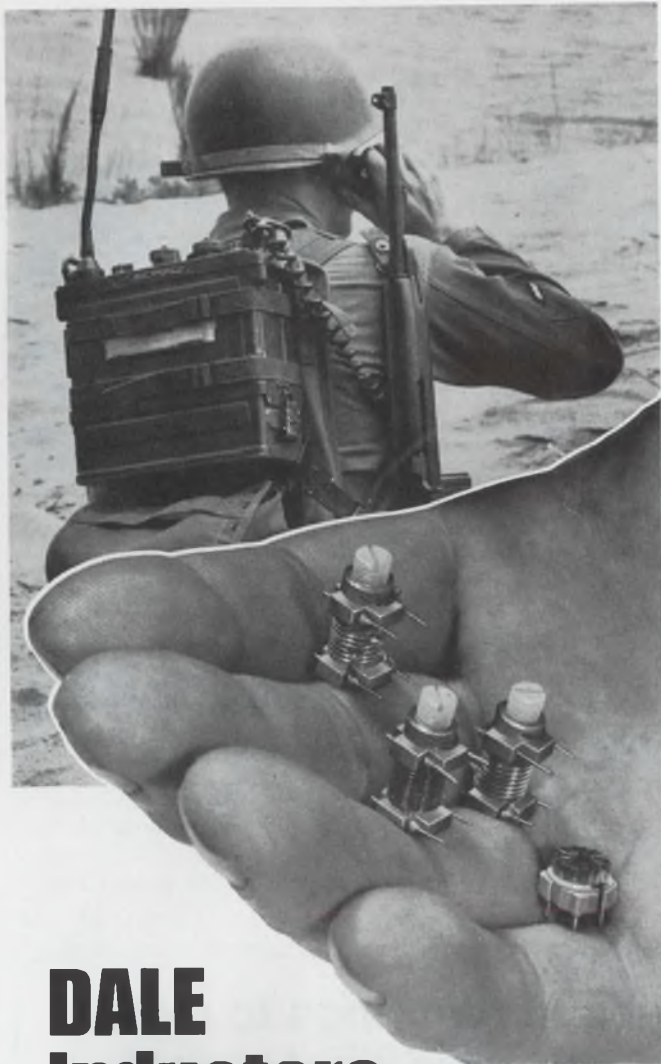

DALE Inductors... high Q in a back-pack

Few radios can take as much abuse as the Army's AN/PRC-25 Back-Pack. Designed for rugged field conditions, this transceiver, built by Memcor, Inc., Division of LTV ElectroSystems, Inc., uses specially-developed Dale miniature high frequency inductors. These tiny core-tuned inductors provide high Q (approx. 170 @ 75 MHz) over a wide inductance range. Once tuned, they stay tuned—because of the positive action of a special core tension spring. Ability to meet the rigid requirements of MIL-C-15305C with mass-produced parts is only one of many broad inductive capabilities of Dale's Sioux Division.

Get the complete story—phone 605-665-9301 or write for new Facilities Report.



DALE ELECTRONICS, INC.
SIOUX DIVISION Dept. ED
Yankton, South Dakota 57078

Producers of: Toroids, Series Resonant Traps, Variable Pitch Inductors, Miniature High Frequency Inductors, Degaussing Coils, Industrial and Military Coils, Sub-Miniature Coils, Surge and Lightning Arresters, Custom Assemblies, Motor Driven Potentiometers.

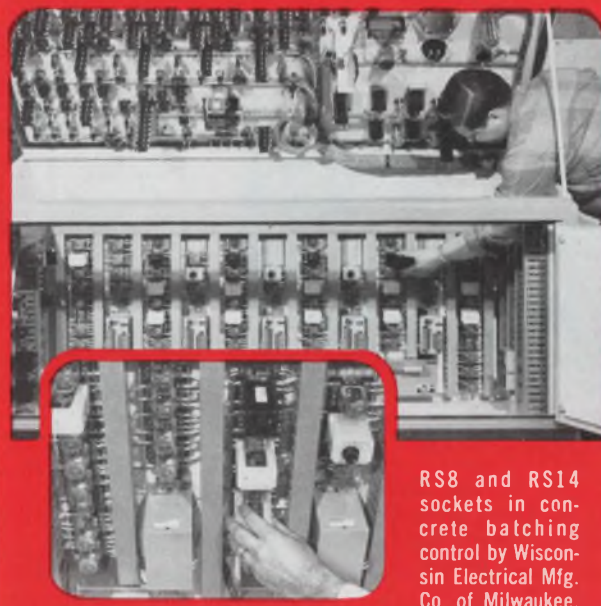

RS8 and RS14 sockets in concrete batching control by Wisconsin Electrical Mfg. Co. of Milwaukee.

CURTIS TRACK-MOUNT RELAY SOCKET ASSEMBLIES SLASH INSTALLATION COSTS

Compact, factory-assembled printed circuit relay socket assemblies snap in (or out) vertically into pre-punched vinyl track. Lengths to 48" securely hold up to 24 relay sockets with only 2 or 3 mounting screws.

Curtis quality barrier-type terminal blocks feature screw terminals. Sockets have recessed center post chambers for easy fracture-free relay replacement. All 3 relay types mount in the same 2 7/8" wide track.

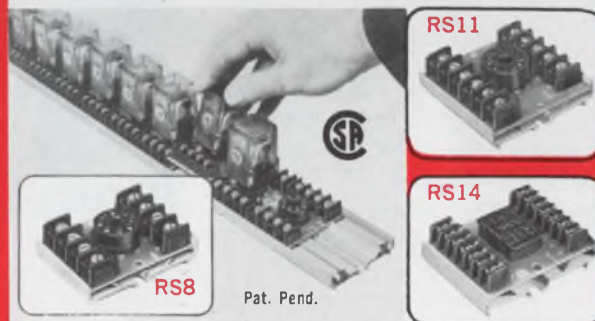

RS8 Octal socket assembly for 8 pin 2 P.D.T. relays. Assembly 2" long. Rated: 10 amps, 250 volts.

RS11 Socket assembly for 11 pin 3 P.D.T. relays. Assembly 2 7/8" long. Rated: 10 amps, 250 volts.

RS14 Socket assembly for 14 pin 4 P.D.T. relays. Assembly 2" long. Rated: 5 amps, 125 volts.

Send today for FREE information and name of your local Curtis representative or distributor.



CURTIS
DEVELOPMENT & MFG. CO.
3236 N. 33rd St., Milwaukee, Wi. 53216

See us at WESCON — BOOTH 4911

Fiber-optic matrices display tiny characters

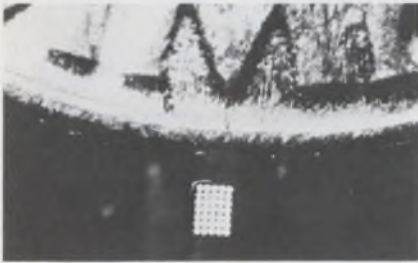

Fibert Photics, 2557 Soquel Drive, Santa Cruz, Calif. Phone: (408) 475-5242. Price: \$15.

Generating characters as small as 10 by 14 thousandths that are dwarfed by the dime above, a new line of microminiature fiber-optic alphanumeric generators, character readers and image scramblers offer resolution capabilities from 0.002 to 0.03 in. The units use separate detectors for best signal-to-noise ratios. Element or fiber size ranges from 2 to 30 mils in diameter. Standard row and column arrangement is 5 by 7 elements.

CIRCLE NO. 276

Tiny disc capacitors go as high as 60 pF

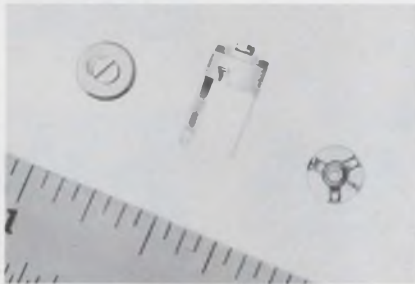

JFD Electronics Co., Components Div., 15th Ave. at 62nd St., Brooklyn, N.Y. Phone: (212) 331-1000. Availability: stock.

Measuring only 0.145 inch in length and 0.220 inch in diameter, a new line of subminiature variable ceramic disc capacitors cover a minimum capacitance of 1 to 3 pF and a maximum capacitance of 12 to 60 pF. Most series Mini-DV-5 units have a Q of at least 500. Their monolithic rotor uses a proprietary ceramic material for good stability.

CIRCLE NO. 277

Thick-film chips are dual resistors

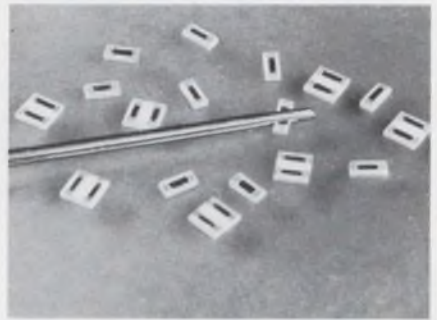

Mini-Systems, Inc., P.O. Box 429, North Attleboro, Mass. Phone: (617) 695-0206. P&A: \$1.25 typical; stock.

Covering the resistance range of 10 Ω to 5 M Ω , a new line of thick-film chip resistors includes dual resistors on 50 by 50 mil chips and single-chip resistors measuring only 20 by 50 mils. Standard metalization on the chips is gold for optimum wire bonding acceptance. Temperature coefficients range from below 50 to 200 ppm.

CIRCLE NO. 278

EASTMAN 910[®] Adhesive bonds rubber rings to metal, joins together sections of supersonic wind tunnel

Wind tunnels capable of simulating velocities up to three times the speed of sound need materials of construction that withstand not only shock and vibration, but also extreme differences in pressure. That's why Philco-Ford Corporation's Aeronutronic Division uses EASTMAN 910 Adhesive to bond Buna-N rubber rings between the sections of its advanced aerodynamics Mach 3 wind tunnel.

This unique adhesive not only meets Philco-Ford's specifications for shear strength, but also provides a vacuum tight seal between the sections of the tunnel. And because of the fast setting time and rapid cure of the adhesive, the sections can be assembled quickly and easily.

Philco-Ford has used EASTMAN 910 Adhesive in this application for over three years at its Newport Beach, Cali-



fornia plant, and also uses it to bond aluminum accelerometers to the brass or Plexiglas sections of the tunnel. In addition, the company uses this adhesive to bond piezoelectric accelerometers to test specimens made of aluminum, magnesium, glass or steel—and to bond aluminum strain gages and other instruments to test missiles.

EASTMAN 910 Adhesive is versatile, forms a bond with almost any material. It requires no heat, solvent evaporation, or catalyst. Offers fast setting, high

strength and low shrinkage. Comes ready to use, cures at room temperature with only contact pressure. And gives about 20 one-drop applications for only a nickel.

For technical data and further information, write to Chemicals Division, EASTMAN CHEMICAL PRODUCTS, INC., Kingsport, Tennessee. EASTMAN 910 Adhesive is distributed by Armstrong Cork Company, Industry Products Division, Lancaster, Pennsylvania.

Here are some of the bonds that can be made with versatile EASTMAN 910 Adhesive. Among the stronger: steel, aluminum, brass, copper, vinyls, phenolics, cellulose, polyesters, polyurethanes, nylon, butyl, nitrile, SBR, natural rubber, most types of neoprene; some woods. Among the weaker: polystyrene, polyethylene (shear strengths up to 150 lb./sq. in.).

See Sweet's Product Design Catalog File

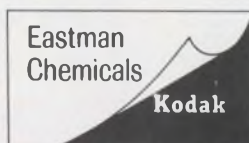

INFORMATION RETRIEVAL NUMBER 75

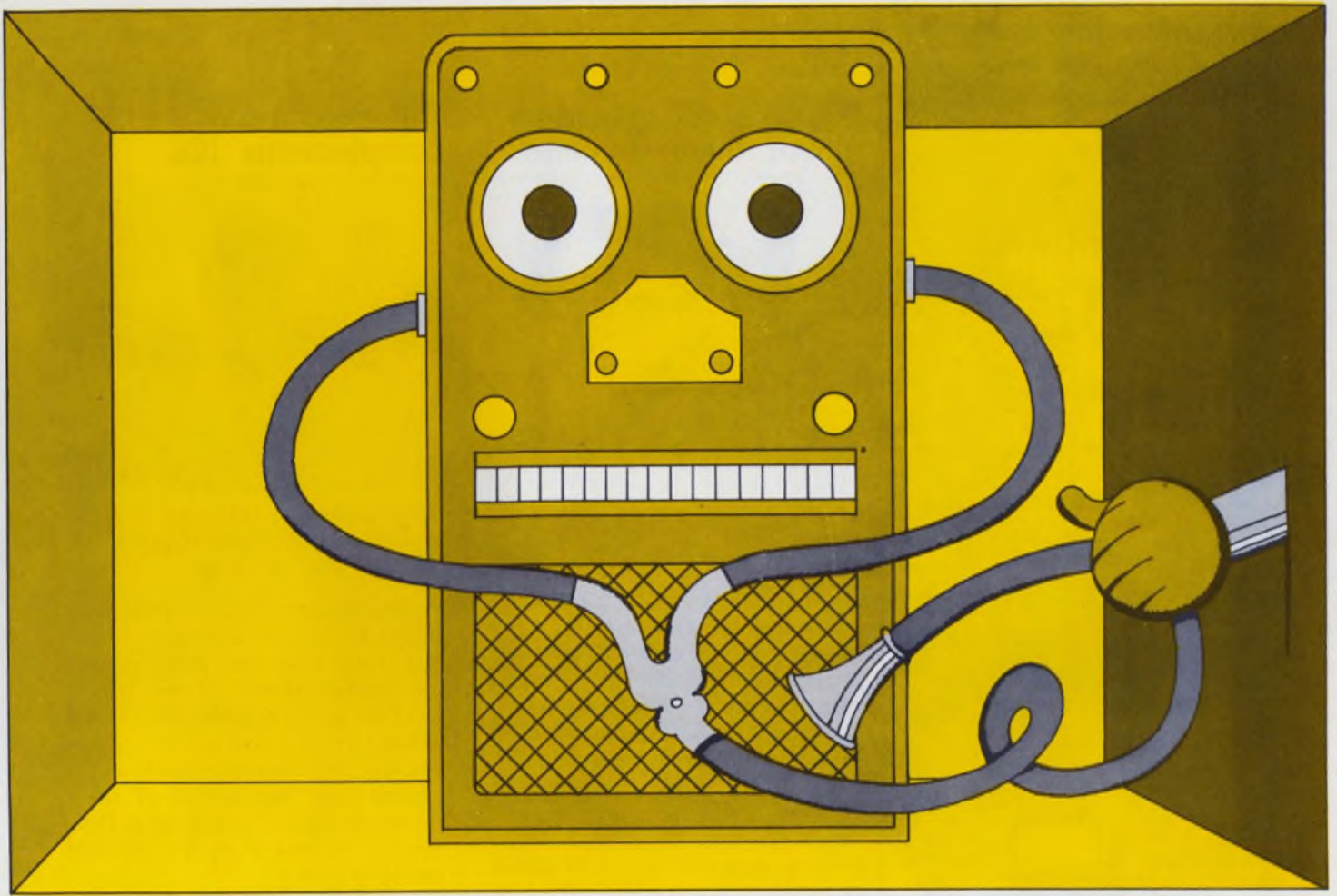

No time for downtime

A machine as complex as the Bell System's new Electronic Switching System (ESS) must help with its own maintenance. Consider, for example, that an ESS installation in a single Bell System central office can perform nearly a billion and a half switching, logic, and memory operations per second. And that we expect it to provide service for 99.999 percent of the next 40 years. Also, that the system employs a totally new concept: "stored program control." That is, each of the many actions in connecting one telephone with another is governed by a central digital data processor which draws upon program instructions and other stored data; new and revised features are incorporated by changing memory content rather than by rewiring.

All of this makes traditional servicing obsolete, and calls for advanced

ideas in reliability and maintenance of electronic equipment.

Vital units such as the central data processor and the memories operate in pairs; if one unit ever falters, its twin maintains service. But, because there is no standby until the defect is repaired, ESS itself helps with the work. For instance, there are three principal fault-detection schemes:

"Match and Check Circuits" constantly compare critical information in duplicated units.

"Audit Programs" check that the system's temporary memory reflects what is actually going on.

"Exercise Programs" use the brief intervals between telephone calls to check all circuits, including those for maintenance.

If a fault is found, alarms operate and "fault recognition" programs take

over. These automatically find the defective unit and reroute the information flow through its duplicate. Or, if the problem is simply a memory error, it is corrected. Such actions take less than a millisecond; office operation is unaffected.

Finally, "diagnostic programs" test any faulty unit, store the results, and print them out with a reference number. A craftsman looks the number up in his "ESS Troubleshooting Manual" and finds a list of possibly defective circuit packs. He replaces one or more of them to clear the problem.

Over half of ESS—circuits and stored program—is devoted to maintenance. But only with modern techniques can so complex a system meet today's communications needs.

From the Research and Development Unit of the Bell System—



Bell Labs

**RX Bridge
spans the
500 kHz
to 250 MHz
range
...precisely**



oscillator, bridge and null detector all-in-one

The 250B RX Meter is a self-contained RF bridge that reads impedance in terms of R_p and X_p from 500 kHz to 250 MHz. It consists of an accurate, continuously tuned oscillator, Schering bridge, amplifier-detector and null indicating meter.

Ruggedly constructed, the 250B bridge assures the user of the stability necessary for precise measurements. A front panel control adjusts the RF excitation signal to as low as 20 mV, permitting measurement of input and output "Y" parameters of transistors with the accessory 13510A Transistor Test Jig, and use of the bridge for other low-level measurements. Another accessory, the 00515A Coax Adapter Kit, provides a convenient means for adapting the bridge terminals to type "N" connectors for measuring devices with coaxial connections.

The 250B RX Meter is especially useful in determining electrical characteristics of devices and circuits such as inductors, capacitors, transformers; and filters. Price: \$2050.

For complete information and a copy of the 250B Technical Data Sheet, contact your Hewlett-Packard field engineer or write: Hewlett-Packard, Green Pond Road, Rockaway, New Jersey 07866. In Europe: 1217 Meyrin-Geneva, Switzerland.

HEWLETT *hp* PACKARD
IMPEDANCE INSTRUMENTS
10908

INFORMATION RETRIEVAL NUMBER 76

COMPONENTS

Digital strip indicators mount flush to panel

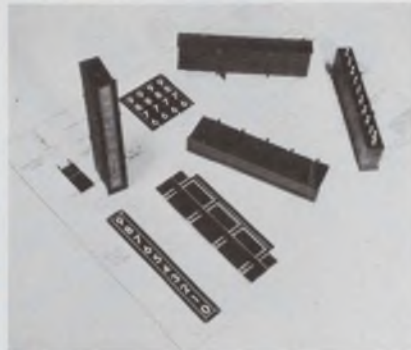

Cartelli Technology, Info-Lite Div., 41-10 102nd St., Corona, N.Y. Phone: (212) 334-6070. P&A: \$7.70/decade; stock to 2 wks.

Displaying numerals 0 through 9 in single or multiple decades, series 68020 digital strip indicators snap into panel cutouts to provide an attractive built-in appearance. The light sources are T-1-3/4 flange-based lamps, incandescent or neon (10 lamps per decade), which are front-panel replaceable. Both vertical and horizontal legend orientations are available.

CIRCLE NO. 279

Fluidic OR-NOR isolates inputs



General Electric Co., Specialty Fluidics Operation, Section 37-209, 1 River Rd., Schenectady, N.Y. Phone: (518) 374-2211.

Known as a micro-fluidic module, a new miniature OR-NOR element is a three-input device that features noninteraction between inputs. Model 24DN43 measures only 1/2 by 1/2 by 7/16 inches. It is a stainless-steel laminates module requiring a fluid supply flow of 10 psig.

CIRCLE NO. 280

DIP reed relay complements ICs

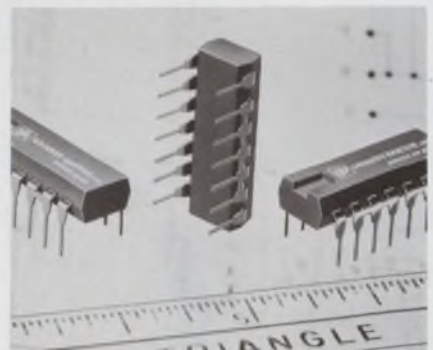

Grigsby-Barton, Inc., 107 N. Hickory Ave., Arlington Heights, Ill. Phone: (312) 392-5900.

Completely compatible with dual-in-line IC devices, a compact 14-pin DIP reed relay can have various pin configurations. Model GB811 has four pins available for the reed switch, five for the coil and diode, and five for the electrostatic shield ground lead. Any or all of these can be specified for maximum freedom in PC-board design. Contact rating is 3 W.

CIRCLE NO. 281

Tiny transformers uphold performance

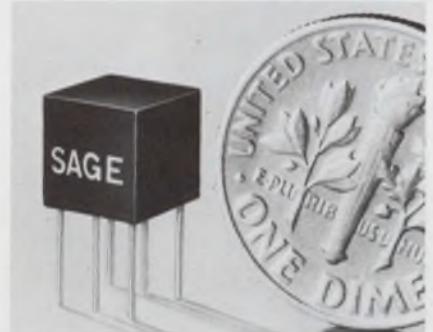

Sage Electronics, P.O. Box 3926, Rochester, N. Y. Phone: (716) 586-8010.

Designated Microcube, two new miniature transformers are now available. One is a broadband audio transformer with standard grid spacing and power ratings up to 50 mW at 1 kHz. Its frequency response is ± 2 dB from 400 Hz to 250 kHz. The other is a plug-in pulse transformer with risetimes to 50 ns.

CIRCLE NO. 282

it's as smart inside as it is outside!



new Exact 505B waveform generator

Inside the smart, new black-and-white packaging, Exact's Model 505B Waveform Generator is designed for the engineer who wants no-compromise versatility, performance and reliability.

Its basic function is to generate sine, square, pulse, triangle, and ramp waveforms, at frequencies from .0001 Hz to 1 MHz (to 2 MHz on square and triangle.)

To add to its flexibility, the 505B has variable trigger start level, so you can adjust the start-stop point of the waveforms, effectively adding haversine and havertriangle waveforms.

The instrument has three amplifier-attenuators; a square-wave and two multi-waveform amplifiers. Fixed positive/negative or variable $\pm 4V$ D.C. offset gives capabilities including threshold testing of linear or digital families of integrated or modular circuits. Other features include VCF with a 50:1 sweep ratio, expansion control, and input signal conditioning. Also gating, triggering and push-pull capability.

For your convenience, the 3½-inch-high cabinet has removable top and bottom panels for quick calibration and easy access to all PC boards. The frequency control is digital, with a vernier that has setability equal to a 5-inch dial. Newly-styled carrying handles, full floating outputs and a tilt stand are standard.

Model 505B Waveform Generator **\$645.00**
(Exact's 500-series of waveform generators also includes instruments as low as \$385.)



Box 160
Hillsboro, Oregon 97123
Telephone (503) 648-6661

EXACT electronics, inc.

INFORMATION RETRIEVAL NUMBER 77

TRANSTECTOR

CIRCUIT PROTECTOR



prevents transients from causing "unexplainable" circuit failures.

Don't blame circuit failures on bad luck.

Voltage transients can cause circuits to fail or suffer undetected and progressive damage.

Transtector* circuit protector, a new solid state device, senses transients within nanoseconds, absorbs the surge and resets itself. Gives continuous protection for tubes, transistors, diodes and integrated circuits.

Find out about Transtector Systems from M&T Chemicals Inc., 3025 W. Mission Rd., Alhambra, California 91803.

*Trademark of M&T Chemicals Inc.

Phone (213) 283-9278

M&T Chemicals Inc. 
SUBSIDIARY OF AMERICAN CAN COMPANY

INFORMATION RETRIEVAL NUMBER 78

ELECTRONIC DESIGN 15, July 19, 1969



**take
the headaches
out of designing**

by putting this

tiny-tiger*

to your task—

**power slide switch—Type 23-021-012 illustrated.*

Outperforms and outlives any switch sold in competition.

Here are the happy facts

A. Measures 0.25" x 0.5" x 0.300", 6, 4, 3, or 2 terminals
B. Resistive load up to 3 amps at 125 VAC, contact resistance .020 ohms
C. More than 250,000 operations Mechanical Life
D. High and low energy capabilities



CHICAGO SWITCH, INC.
2035 Wabansia Avenue • Chicago, Illinois 60647
(312) 489-5500

INFORMATION RETRIEVAL NUMBER 79

It's simple when your IC's do the driving!

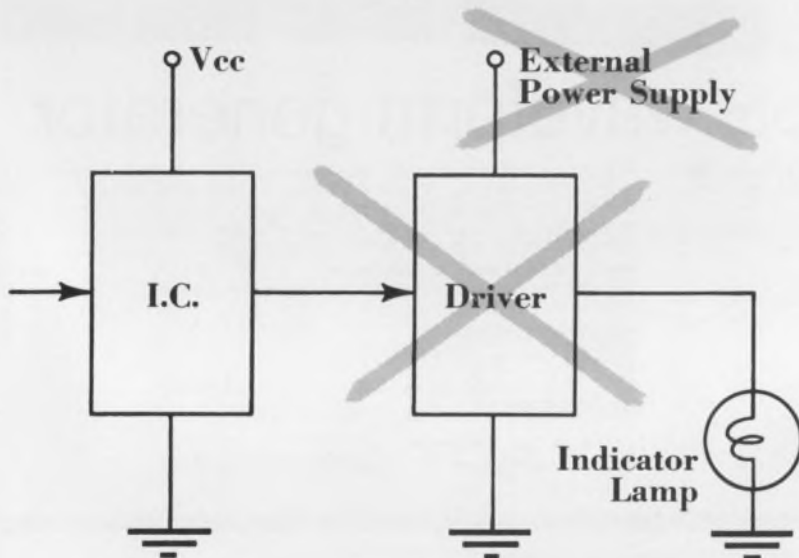

And your indicator lights fit your IC design.

You can save time, trouble and space when you choose from 13 General Electric IC-compatible indicator lamps . . . each of which can be driven directly from common integrated circuits. Their low current requirements make relays or supplemental switching unnecessary.

Your result: a simplified system, in less space. And a lower overall cost, too!

General Electric's IC-compatible Sub-Miniatures range in voltages from 3 to 10. Currents range from .012-.060 ma; in C.P. up to .050; in diameter from 1/8" to 7/32"; in life from 1,000 to 25,000 hours; and in OEM prices from 25¢ to 95¢.

You can get them with either wire terminal or midget flanged bases. Fact is, there's a lamp available for nearly every IC requirement.

See your General Electric Miniature Lamp Representative before you finalize your design. That's his favorite time to save you money.

For detailed technical data, and application information, write: General Electric Company, Miniature Lamp Dept., M9-3, Nela Park, Cleveland, Ohio 44112. Ask for Bulletin 3-9135.

Miniature Lamp Department

GENERAL  ELECTRIC

INFORMATION RETRIEVAL NUMBER 81

COMPONENTS

Transistorized lights respond to 0.25 mA



Shelly Associates, Inc., 111 Eucalyptus Drive, El Segundo, Calif. (213) 322-2374.

Able to combat emi and rfi by operating at dry-circuit levels, a new series of transistorized miniature indicator lights include a built-in pnp or npn transistor to control indicator turn-on from signal levels as low as 0.25 mA. In addition, optional resistors can be encapsulated in an indicator's base for operation to 2 mA maximum. Trans-eye indicators are available in a selection of 15 standard wire terminal lamps, ranging from 1.5 to 28 V.

CIRCLE NO. 283

Pneumatic amplifier senses 0.001 psi

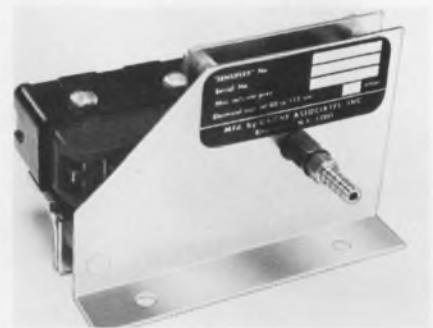

Gagne Associates, Inc., Binghamton, N.Y. Price: \$29.95.

Extremely sensitive, a new all-air amplifier, the Sensiflex SFA-1, responds to 0.03 inch of water, which corresponds to 0.001 psi. The unit can also react more rapidly at higher pressures, such as inputs of 0.01 to 0.1 psi, to the sensing bellows. Its sensing jets are not affected by vibration, temperature or radiation.

CIRCLE NO. 284

Ten-turn potentiometer has nonmetallic shaft



Bourns, Inc., Trimpot Products Div., 1200 Columbia Ave., Riverside, Calif. Phone: (714) 684-1700. P&A: \$4.30; stock.

Featuring a nonmetallic shaft and bushing, a new 7/8-in.-diameter, 10-turn, bushing-mount, wire-wound potentiometer has a standard resistance range of 100 Ω to 100 k Ω . Model 3509 operates over an extended temperature range of -55 to $+105^{\circ}\text{C}$. Its power rating is 2 W at 25°C , and load life is 1000 hours per MIL-R-12934.

CIRCLE NO. 285

Delay lines come as DIPs

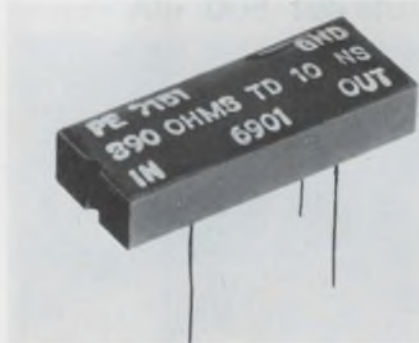

Pulse Engineering Inc., 560 Robert Ave., Santa Clara, Calif. Phone: (408) 248-6040. P&A: \$6.50 to \$7.50; stock.

Compatible with dual-in-line integrated-circuit packaging, a new series of distributed delay lines offers time delays from 10 to 100 ns. Standard units are available with 390- Ω impedances, a maximum distortion of 15% and a maximum attenuation of 5%. Risetime varies from 6 to 24 ns, and peak pulse voltage is 100 V.

CIRCLE NO. 286

This is our service manager.



He hasn't seen his best relay customer in weeks.

One of our best customers is also the toughest we know when it comes to quality control. The mercury-displacement relays he buys must perform correctly every time. That's why he used to personally check every relay he ordered before a single one left our plant.

But no more. Adlake's quality control checks proved so reliable, his last visit was weeks ago.

What are your relay requirements?

Time Delay Relays, normally open or normally closed, with up to a 30 minute delay; *Load Relays*, to 100 amp capacity; *Dry Reed Relays*, standard and miniature types, with 1 to 4 poles; *Mercury Wetted Contact Relays*, Form C and Form D, 2 amp and 5 amp capacity, both plug-in and printed circuit types.

Find out how Adlake can help you. Write for our *new* catalog. For service, delivery, and *quality*, you can depend on Adlake. Just like our best customers do.



THE ADAMS & WESTLAKE COMPANY

Elkhart, Indiana 46514 • (219) 264-1141 • TWX (219) 522-3102 • TELEX 25-8458 • Cable ADLAKE



SUBSIDIARY OF
ALLIED PRODUCTS CORPORATION

See our complete catalogue in EEM

Compact IC supplies put out 5 V at 10 A



ACDC Electronics, 2979 N. Ontario St., Burbank, Calif. Phone: (213) 849-2414. P&A: \$225; 60 days.

Weighing less than 1.5 pounds, a new series of compact low-voltage high-current power supplies deliver 50 W of regulated dc power. Directly compatible with integrated circuits, series JR units can power an entire computer board with their output of 5 V at 10 A. (Other output voltages are also available, from 3 to 30 V.)

Housed in a trim package, the new supplies measure only 6-1/2 by 3-1/8 by 1-3/4 in. They dissipate heat through the mounting surface of their aluminum package.

Line or load regulation is 0.1%, and maximum ripple is held to 3 mV rms. Transient response is typically under 1 ms, and efficiency varies between 70 and 80%.

For remote sensing applications, terminals are provided to maintain regulation at the load. This compensates for any dc voltage drop in the load cable.

Voltage may also be adjusted remotely. A resistance inserted in the negative sensing lead can change the output voltage at a rate of approximately 1000 Ω/V .

The new supplies are protected against overloads and short circuits by a foldback-type voltage/current characteristic. An optional overvoltage protection module crowbars the output when its adjustable trip voltage level is reached. Nominal output voltages are 5, 15 and 25 V; respective maximum currents are 10, 4 and 2.5 A.

CIRCLE NO. 287

FET amplifier varies its gain

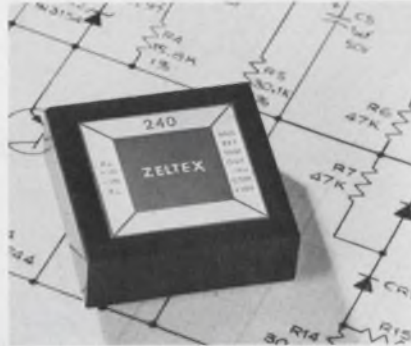

Zeltex Inc., 1000 Chalomar Rd., Concord, Calif. Phone: (415) 686-6660. P&A: \$70; stock.

Using an external resistor, model 240 FET-input differential amplifier with a built-in feedback network can adjust its closed-loop gain between 1 and 1000. The unit has a high input impedance of $10^{11} \Omega$ and 80-dB common-mode rejection ratio at any gain setting. Its non-linearity is 0.5% maximum, output is ± 10 V at 4 mA minimum, and slew rate is 5 V/ μ s minimum.

CIRCLE NO. 288

Stabilized op amps keep noise to 1.5 μ V



Analog Devices, Inc., 221 Fifth St., Cambridge, Mass. Phone: (617) 492-6000. P&A: \$80 or \$115; stock.

With a MOSFET chopper circuit for stability and reduced voltage noise down to 1.5 μ V, two new operational amplifiers offer voltage stabilities of 0.1 μ V/ $^{\circ}$ C (model 231K) and 0.25 μ V/ $^{\circ}$ C (model 231J) as well as maximum current drifts of 0.5 pA/ $^{\circ}$ C (231K) and 1 pA/ $^{\circ}$ C (231J). In addition, current noise is only 10 pA from 0.1 to 1 Hz. Both models supply outputs of ± 10 V at 25 mA.

CIRCLE NO. 289

Relay in TO-5 can contain op amp

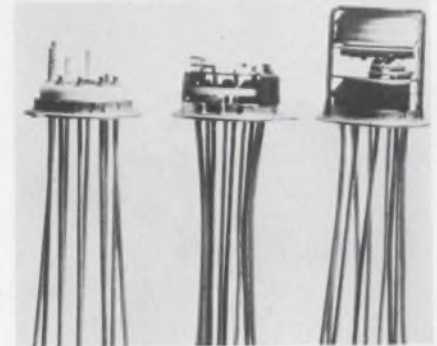

Teledyne Relays, a Teledyne Co., 3155 W. El Segundo Blvd., Hawthorne, Calif. Phone: (213) 679-2205. P&A: \$52; stock to 8 wks.

A new TO-5 relay incorporates an operational amplifier, a relay driver and a surge suppression network inside the same case. By proper choice of external circuit components, a wide range of operating parameters can be obtained with the type 501 spdt relay. For example, in a time-delay application, delay on actuate or delay on release can be varied from milliseconds to minutes.

CIRCLE NO. 290

Relay/lamp driver puts out 500 mA

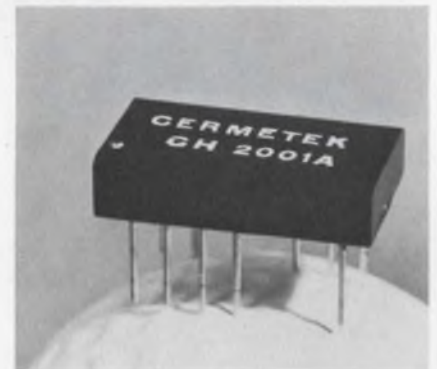

Cermetek, Inc., 660 National Ave., Mountain View, Calif. Phone: (415) 969-9433. P&A: \$6.10; stock.

Model CH2001A hybrid relay and lamp driver handles an output current of 500 mA at an output voltage of 40 V. Its input uses a four-input TTL NAND gate in series with a single NOR gate. The new driver, which can be used as a latching device, comes in a dual-in-line package.

CIRCLE NO. 291

Save \$500- plus pick your purchase plan

That's right, the outstanding acceptance of the HP 9100A computing calculator now allows us to reduce the price \$500—from \$4900 to the new price of \$4400.

Plus you now have a choice of purchase plans. Buy, rent, or lease—you pick the purchase plan that best meets your needs.

How is HP able to do all this? Volume production. In fact, we're adding a new plant to produce more calculators.

Which brings up another important point. Volume production means you don't have to wait in line 6 weeks or 6 months to put this calculator to work for you. Call any of the 135 world-wide HP Sales and Service Offices today. You'll have a 9100A computing calculator on your desk faster than you thought possible.

So, if you have been sitting on the fence—now is the time to jump.

Lease/rental plans start as low as \$1.50/computing hour based on average usage. Pick your purchase plan and save money by ordering the HP 9100A computing calculator today.

For additional information, contact Hewlett-Packard, Box 301, Loveland, Colorado 80537. (303) 667-5000.

Europe: 1217 Meyrin-Geneva, Switzerland.



754 8367 z temporary
5.228 045 815 05 y accumulate
33 50 x keyboard

Dynamic range
10⁰⁰ to 10⁹⁹,
nearly 200 dec-

ades. Observation of math operations on 3 displayed registers. Up to 16 more registers for data storage.



Complex and vector arithmetic simplified with coordinate transformation keys, rectangular-to-polar and vice-versa, in milliseconds.



Trig functions covering all quadrants and any size angle in degrees or radians.



Branching and looping flexibility provided by "IF" keys expands programming capability.



Program from the keyboard. Record and store 196-step programs on credit-card-size magnetic cards for repeated use.



Designed for expansion. Printer and plotter are available.

HEWLETT  PACKARD



Edit programs easily. Single-step through programs to check and de-bug. Address an individual step and make corrections without re-entering the entire program.

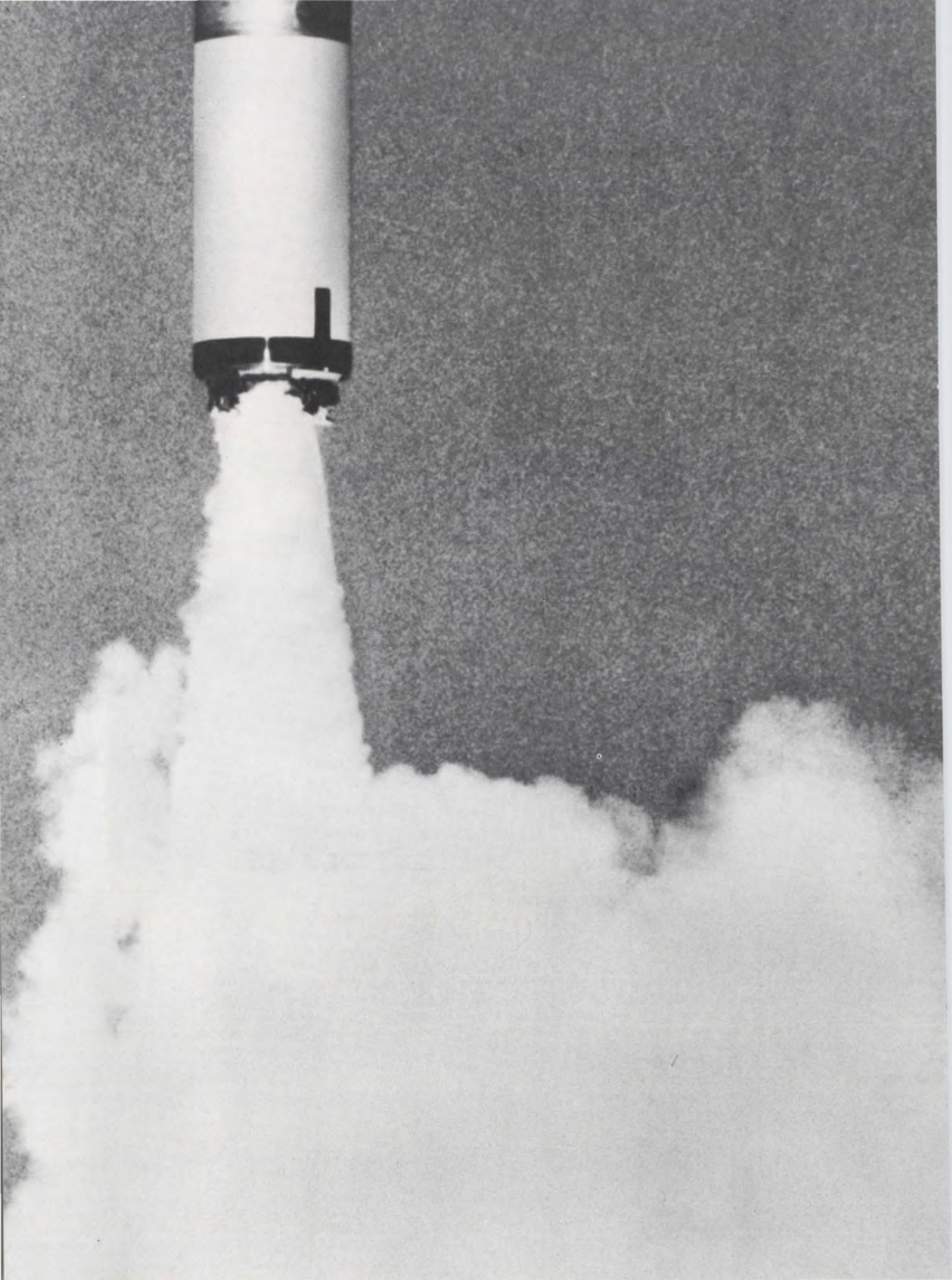

A lot of our connectors will be going up the tube.

They're the new low profile, light-weight connectors made by ITT Cannon going up with the Poseidon missiles through the tubes of our nuclear powered submarines.

This miniature-circular KJ connector series meets the rigorous requirements of the Fleet Ballistic Missile System with an operating temperature range from -85°F up to $+392^{\circ}\text{F}$. And high contact density and environmental resistance make our KJ connectors perfect mates for both commercial and space age applications.

One of the exclusive features in this MIL-C-38999 designed series is the LITTLE CAESAR[®] rear-release contact retention assembly. It permits contacts to be crimped, inserted and extracted from the rear — making installa-

tion a snap. And within this lightweight, low profile KJ series, you have a choice of 3 to 128 contacts in 33 different layouts. You can pick from 8 shell sizes (10 through 24) and 9 styles. Three of them are hermetic versions with contact sizes from 16 through 22. KJ connectors will intermate with comparable types, already in use. So whether your connector application is sea or airborne, our new KJ series is the perfect mate.

The Cannon[®] KJ connector line is completely tooled and available *now* on a short lead-time basis.

Write to: ITT Cannon Electric, a division of International Telephone and Telegraph Corporation, 3208 Humboldt Street, Los Angeles, California 90031.



CANNON ITT

THE GIANT KILLERS

**SMALLER
TOUGHER**

\$1995*



FOR LESS!

**Regulated DC Power
Supplies designed
— and priced —
to solve big problems.**

The Computer Products family of DC power supplies — 3.6V 250 MA to 180V 10 MA, P.C. and Octal Plug-in, are consistently smaller, tougher and better-performing than competitors' near-equivalents.

Prices are smaller, too. By about 50%.

Here's a sample:

Output Voltage	15VDC
Input Voltage	115 ± 10VAC
Output Current	100 MA
Line-load Reg. Ea.	± 0.02%
Temp. Co./°C	0.02%
Ripple/Noise	0.5 mV RMS
Output Z @ 10KHz	0.2 ohms
Case size	1.75" x 2.25" x 1"
Model No.	PM576
PRICE 1-9	\$24.95
*10-29	\$19.95

Call or write for complete information . . . or

CALL TODAY FOR 3-DAY SHIPMENT
305/565-9565

Computer Products, Inc.,
P. O. Box 23849
Ft. Lauderdale, Fla. 33307



**COMPUTER
PRODUCTS**

FORT LAUDERDALE

INFORMATION RETRIEVAL NUMBER 133

MODULES & SUBASSEMBLIES

Amplifier/booster spans 100 MHz



Optical Electronics Inc., P.O. Box 11140, Tucson, Ariz. Phone: (602) 624-8358. P&A: \$56; stock.

Said to be the first current booster that provides a true minimum 100-MHz bandwidth, a new linear positive-follower amplifier can be used with virtually any operational amplifier to increase output driving capability without upsetting stability. Model 9510 has a minimum slewing rate of ± 2000 V/ μ s and an output capability of ± 10 V to a 100- Ω load. The unit operates with no cross-over distortion.

CIRCLE NO. 292

Voltage multiplier goes solid state



General Instrument Corp., 65 Gouverneur St., Newark, N.J. Phone: (201) 485-2100.

Primarily developed for color television applications, a new solid-state voltage multiplier replaces three components—the high-voltage rectifier tube in the horizontal deflection circuit, the voltage regulator tube, and the selenium focus rectifier. This new multiplier can deliver 25 kV to the CRT without emitting X-rays.

CIRCLE NO. 293

I-f amplifiers build-in agc



Hybrid Microelectronics Operation, Sylvania Electric Products Inc., 100 First Ave., Waltham, Mass. P&A: \$75 or \$80; 4 wks.

Two new 30-MHz i-f amplifiers, which are hermetically sealed ceramic/metal-film hybrid units for hf, vhf and uhf communication systems, feature built-in agc that can be used for gating. The relatively narrow bandwidths of models MS500 and MS501 permit the design of systems with minimum spurious responses and intermodulation effects caused by out-of-band signals.

CIRCLE NO. 294

Power amplifiers sock out ± 18.5 V



Data Device Corp., 100 Tec St., Hicksville, N.Y. Phone: (516) 433-5330. P&A: \$110; stock to 3 wks.

A new series of operational amplifiers with a common-mode voltage rating of ± 18.5 V have a minimum output of ± 250 mA and a surge capability of 1.5 A. Ideally suited to servo and synchro applications, series D-35 units are self-balanced devices offering internal output short-circuit protection and input overload protection. Voltage drift is 15 μ V/ $^{\circ}$ C; input bias current is 0.7 nA/ $^{\circ}$ C.

CIRCLE NO. 295

TRUE SOLID-STATE RELAY



Opening New Relay Applications in Multiplexing, Isolated Sensing, High Speed Isolated Control, etc. Offered in A - B - C Contact Configurations for Direct Replacement of Mechanical Types.

- Switching Time less than 65μ sec
- Contact Open Resistance . . . 10^9 ohms
- Contacts Capable of switching DC to 4 M HZ
- Non-Polarized Effective Coil
- Effective Coil Accuate/Release Voltage Hysteresis . . . less than 10 mV . . .
- Non-Polarized Contacts
- No Reference Required Between Effective Coil and Effective Contacts
- Life Expectancy—tested to 10^{10} operations with no failure.

SHAFFSTALL-BALL CORPORATION

5149 E. 65th Street, Indianapolis, Indiana 46220
Phone: 317-257-6296

INFORMATION RETRIEVAL NUMBER 83

Get the Latest Facts On Electronic Packaging & Encapsulation Techniques

Electrical
Insulation
Conference

Attend the *Electrical Insulation Conference* for how-to-do-it workshop on molding, vacuum, spraying, thermoforming, conformal coating, melting, fluidized bed, foaming, pyrolytic coating, and other encapsulation techniques. Also, sessions on microwave and printed circuit materials, potting compounds, insulating films for SC devices and ICs, etc. Plenty of exhibits to see and other activities, too. Plan to come—Sept. 8-11, 1969, Sheraton-Boston Hotel, Boston. Write or circle inquiry number for free booklet

FREE

ELECTRICAL INSULATION CONFERENCE
BOX 270 • LIBERTYVILLE, ILL. 60048 USA

INFORMATION RETRIEVAL NUMBER 84

Oak Versatility



Now! One new exclusive switch replaces seven You can easily eliminate tedious design engineering problems—just use versatile Multidex® switches. They're available in thousands of variations...are smaller than the switches they replace...yet provide more contacts (up to 36) at no additional cost. **Crisp Detenting**... the patented Unidex™ detent offers uniform "feel" for long life in choices from 10° to 36° throw. Meets MIL-S-3786, SR32 requirements.

Superb Insulation...molded diallyl phthalate meets MIL-M-14 requirements and guarantees electrical continuity between mounting and housing. Glass-alkyd insulation available on request. **Special contacts and clips**... Oak-pioneered, double-wiping, self-cleaning contacts assure trouble-free operation. Special AF clips with large windows speed wiring.

What's more, Multidex switches meet commercial and military environmental requirements. Special options available on request. For full details, write today for Bulletin SP-324.



OAK MANUFACTURING CO.

A Division of OAK ELECTRO/NETICS CORP.
Crystal Lake, Illinois 60014
PHONE: 815-459-5000 TWX: 910-634-3353

INFORMATION RETRIEVAL NUMBER 85

telonic's new log amp detector has a dynamic range of **105 dB** *(without a pit stop)*



And that's a long stretch of signal by any standard. This new log amp detector will accept voltage swings as wide as 178,000 to 1, and still provide an output that gives you an on-scale display. Operable over 400 kHz to 130 MHz, the amplifier converts any RF input to a logarithmic value and supplies a linear output for 'scope, meter, or recorder.

Ideal for gain measurement, log plotting, response testing or other applications where the input signal takes wide excursions, this new instrument has built-in Expansion and Reference adjustments to maximize its versatility.



The Model 3353 is a plug-in unit for the 2003 Sweep/Signal Genera-

tor System permitting the user to recover swept or CW signals as low as -85 dBm. This allows the user to display wide ranges of input frequencies and power levels without attenuating or changing the oscilloscope sweep settings.

Other Specifications

Useful Input

Power Range	-80 dBm to +20 dBm
Linear Log Range	-70 dBm to +20 dBm
Departure from Ideal Log Response	± 2 dB
Tangential Sensitivity	-85 dBm

Also available is the Model 6001 Log Amp Detector which is a completely self-contained unit, offering the same specifications as called out above as well as an offset control and front panel meter calibrated from -70 to +20 dBm.

Write For Details—Complete specifications on both versions plus the 2003 Sweep Generator are available on request. Write the Marketing Department for File 3353.



TELONIC INSTRUMENTS
A Division of Telonic Industries, Inc.
60 N. First Avenue
Beech Grove, Indiana 46107
Tel: 317 787-3231 • TWX: 810 341-3202



PRODUCTION

Lightweight grinder polishes and deburrs



Dremel Manufacturing Co., 4915 21st St., Racine, Wis. Phone: (414) 637-8831.

Handling as easily as a pencil, a new hand grinder is a light, compact and powerful tool for grinding, routing, sanding, deburring and polishing. Called Moto-Tool, the unit weighs only 9 oz in the home craftsman's model and 11 oz in the industrial model. Its motor, which is mounted in an unbreakable plastic housing, delivers a speed of 30,000 rpm and has a very gradual torque dropoff to combat stalling.

CIRCLE NO. 296

PC-board rack holds 4 at a time

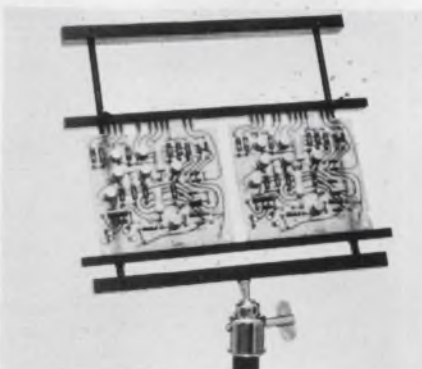

Electronic Tool Co., 3980 White Plains Rd., Bronx, N. Y. Phone: (212) 231-7760.

Orienting boards lengthwise for greater support, a new parallel-jaw PC-board holder can hold two, three, or four boards at the same time. Model 1001 has a 360° ball joint for excellent positioning and a spring-loaded bottom bar for easy-on/easy-off handling. Rack size is 7-1/2 in. wide by 10 in. long by 12 in. high.

CIRCLE NO. 297

Micro-wiring system ousts layered boards



Wells Electronics, Inc., Equipment Div., 1701 S. Main St., South Bend, Ind. Phone: (219) 288-4651. P&A: \$29,150 to \$36,000; 12 wks.

Using a process called TIERS (Through Insulation Electronic Reflow Soldering), a new numerically controlled micro-wiring system eliminates the need for multi-layer boards. TIERS is a means of handling, locating and reflow soldering insulated wire to select areas on a printed circuit board. Model NCW can handle boards as large as 12 by 12 in.

CIRCLE NO. 298

Compact loader sequences parts



Macdonald & Co., 213 S. Brand Blvd., Glendale, Calif. Phone: (213) 241-4131. Price: \$48.50.

Occupying only 9 square inches of bench space, a new sequential revolving component loader reduces operator fatigue and the possibility of wrong component selection. Its compact size leaves ample room to work multiple circuit boards. The loader consists of five removable metal tubes; each tube contains ten clear plastic cups.

CIRCLE NO. 299

FAST SWITCHING

POWER TRANSISTORS

from **Soliton**

...with Turn-on Time
Less than 10 Nanoseconds!

SDT6100 SERIES

- $V_{CEO} = 40 \text{ V}$
- $h_{FE} @ 2.0 \text{ A} = 20 \text{ to } 60$
- $V_{CE(SAT)} = 1.5 \text{ V Max}$
- $t_R @ 2.0 \text{ A} = 10 \text{ n sec Max}$
- $I_C \text{ Max} = 5.0 \text{ A}$

TO-5

Soliton's new SDT6100 Series of 5.0 Amp fast switching power transistors have total switching time typically less than 60 nanoseconds and rise time less than 10 nanoseconds. They are designed to function in place of many parallel high speed, low current units.

Features of these fast switching transistors include:

- 5.0 AMP CAPABILITIES
- PLANAR CONSTRUCTION
- LESS THAN 10 NANoseconds RISE TIME
- TYPICALLY 500 MHz, f_T

Contact us today for complete information and prices.

Soliton
DEVICES, INC.

Parelco R10 Relay

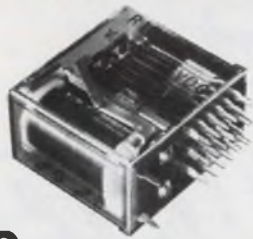

2 times more pull force

Here's Why: The optimum distribution between magnetic core and pole piece cross sections and coil volume, and a low reluctance armature bearing, produces a force-displacement product of 140 gm/mm at .050" actuator displacement. The end result is higher contact pressure and greater overtravel. Sensitivities to 20 mw/pole.

Contacts—From 2 to 8 Form C. 6 types: From heavy duty 10A silver cadmium oxide to bifurcated cross bar gold-platinum-silver for dry circuits.

Coils—From 3 to 115 vdc. UL listed.

New Parelco R40 Slimline®

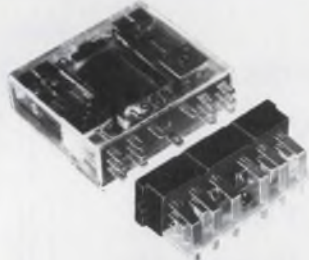

.43" max. thickness

Lowest profile industrial relay available. Higher switching density: .18 cubic inches/Form C. Easy pc board layout. Lower cost, wider switching range (dry circuit to 10A) than dry reed packages. 5 mounting options.

Contacts—2 and 4 Form C. 5 types: From heavy duty 10A silver cadmium oxide to bifurcated cross bar gold-platinum-silver alloy for dry circuits

Coils—From 3 to 115 vdc.

Other Standard Models

R11, a guarded, low capacitance type for instrumentation use; R30, magnetic latching relays; R10-T octal base relays.

Specials—Custom coils and contacts. Various mounting configurations. Special engineering.

Fast delivery—110 standard models stocked. Prototypes in 3 days; production quantities in 3 weeks! FREE: Parelco's know-how and sample relay to your specs. Phone, TWX or write now. Complete data in EEM, Section 4500.

PI
PARELCO, INC.

26181 Avenida Aeroportu
San Juan Capistrano, California 92675
Phone (714) 493-4507
TWX (910) 596-1412

INFORMATION RETRIEVAL NUMBER 88

INSTRUMENTATION

Inexpensive multimeter measures below 0.25 V



Mura Corp., 355 Great Neck Rd., Great Neck, N.Y. Phone: (516) 487-0430. Price: \$14.95.

Costing only \$14.95, a new multimeter is a 21-range 20,000- Ω /V dc meter that can achieve full-scale needle deflection at signals as low as 50 μ A, 0.25 V. Double-wedge shaped to fit the hand, model NH-65 has safety diodes for overload protection and an ultrasensitive 0.44- μ A D'Arsonval movement. It uses 1% matched precision resistors throughout.

CIRCLE NO. 340

Low-cost multimeter autoranges fully

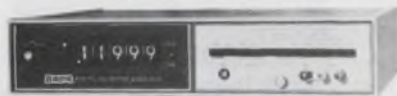

Dana Laboratories, Inc. 2401 Campus Drive, Irvine, Calif. Phone: (714) 833-1234. Price: \$1800.

A new economy digital multimeter features $\pm 0.01\%$ accuracy, 10- μ V dc resolution, and full autoranging in all functions. Model 4430/230 is a four-digit (with fifth-digit, 20% overrange) instrument with an input impedance of 10,000 M Ω and active three-pole broadband filtering. Normal-mode rejection is 60 dB at 60 Hz and common-mode rejection is 100 dB at 60 Hz.

CIRCLE NO. 341

Go/no-go limit tester checks SCRs and triacs



Alfred-Thomas Controls, Inc., P.O. Box 157, Auburn, N.Y.

Model ST-100 semiconductor limit tester provides go/no-go readout for SCRs, triacs, and diode/rectifiers. Devices can be tested that have a leakage current of 10 mA or less at rated blocking voltage, a blocking voltage rating of 20 to 500 V, a conduction current rating of 20 mA or more, and a gate trigger current requirement of less than 100 mA (for SCRs and triacs).

CIRCLE NO. 342

Transmission test set flattens out response

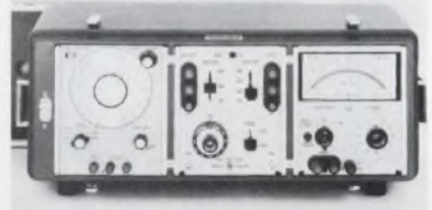

Hewlett-Packard, 1501 Page Mill Rd., Palo Alto, Calif. Phone: (415) 326-7000. P&A: \$1150 to \$1270; 4 wks.

Designed to make measurements of transmission levels, gain, and loss on voice-frequency, program, or carrier systems, a new portable telecommunications test set keeps its frequency response flat within 0.05 dB between 30 Hz and 300 kHz and within 0.1 dB to 1.2 MHz. Model 3550B also holds distortion to less than 0.1% from 30 Hz to 200 kHz. The new instrument covers the frequency range between 5 Hz and 1.2 MHz.

CIRCLE NO. 343

EMI/RFI SHIELDING GASKET CONDUCTIVE SILVER/SILICONE

CONSIL® ■ Highly conductive pure silver/silicone. ■ Produced as sheets, cut gaskets, strips, custom molded parts. ■ Very compressible . . . Firmness 30 to 60 + durometer. ■ Volume resistivity .001 ohm-cm. ■ Operating temperature — 65°F. to + 450°F. ■ Patent pending. ■ Write for data #850 and FREE sample.

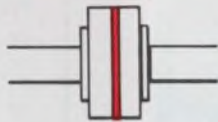

CONSIL® — Waveguide flange gaskets or "O" rings.

TECKNIT TECHNICAL WIRE PRODUCTS, INC.

East Division • 129 Dermody St., Cranford, N. J. 07016 (201) 272-5500
West Division • 427 Olive St., Santa Barbara, Calif. 93101 (805) 963-1867

INFORMATION RETRIEVAL NUMBER 89

NEW GRC GEAR KIT demonstrates

BIG STOCK AND
CUSTOM SERVICES
IN . . .

TINY GEARS

(Die-cast Zinc Alloy or Molded Plastic)

- Gear Clusters
- Gears with Hubs, Spacers
- Gears with Shafts
- Gears with Cams
- Spur Gears
- Bevel Gears
- Crown Gears
- Miter Gears
- Rack Gears
- Worm Gears
- Helical Gears
- Spiral Gears
- Ring Gears



Write today for GRC Gear Kit, Stock List and Designers' Aids on Your Letterhead

GRIES REPRODUCER CO.

Division of Coats & Clark Inc.

GRIES
world's foremost producer of small die castings & plastic moldings

40 Second St., New Rochelle, N.Y. 10802 • (914) 633-8600

Plants in: New Rochelle, N. Y.; Warren, R. I.; Toccoa, Ga.

In Canada: Gries Div., Dynacast Ltd. Lachine, Que.

INFORMATION RETRIEVAL NUMBER 90

ELECTRONIC DESIGN 15, July 19, 1969

We can't say enough about our Series 23000 Three-Phase Frequency Changers



Series 23000 — for converting three phase 60 Hz to 50, 60 or 400 Hz three phase with output power ranging from 2.5 KVA to 25 KVA. Four models available, priced from \$5,000 to \$25,000. Formerly sold as Micro-dot converters.

FEATURES

- Completely solid state — All silicon semiconductors
- Highest reliability available
- Maximum efficiency
- Latest state of the art circuit techniques
- Complete modular construction for ease of maintenance
- Internal adjust current limiting
- Short circuit proof
- Wide range of standard options
- Meets RFI requirements

OUTSTANDING SPECIFICATIONS

Voltage Adjustment Range: $\pm 10\%$.

Frequency Adjustment Range: $\pm 5\%$.

Steady-state Voltage Regulation: $\pm 0.5\%$.

Frequency Stability: $\pm 0.25\%$.

Phase Balance (Voltage): $\pm 1\%$ with balanced loads.

$\pm 5\%$ of average with load unbalance of 1/3 rated phase current.

Overload: 110% at 1.0 P.F. for 1 minute.

180% at 0.8 P.F. lag for 10 seconds (for motor starting).

Efficiency (Typical): 75% at 1.0 P.F. 60% at 0.7 P.F.

Harmonic Distortion: Maximum 5% total, maximum 3% any single harmonic.

APPLICATIONS

Series 23000 has been specifically designed for higher power frequency and voltage control applications requiring three phase power for major test installations, ground support systems, shipboard frequency changers, industrial process control systems, and plant facilities.

(Continued in bulletin FC-23
Write for it.)

WANLASS INSTRUMENTS

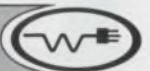

a division of WANLASS ELECTRIC COMPANY

A SUBSIDIARY OF AMBAC INDUSTRIES INC.

1540 EAST EDINGER ■ SANTA ANA, CALIFORNIA 92707

TELEPHONE: (714) 547-5613/TOLL FREE (800) 854-3258 ■ TWX 910-595-1526

INFORMATION RETRIEVAL NUMBER 91

149

We make rectifiers:

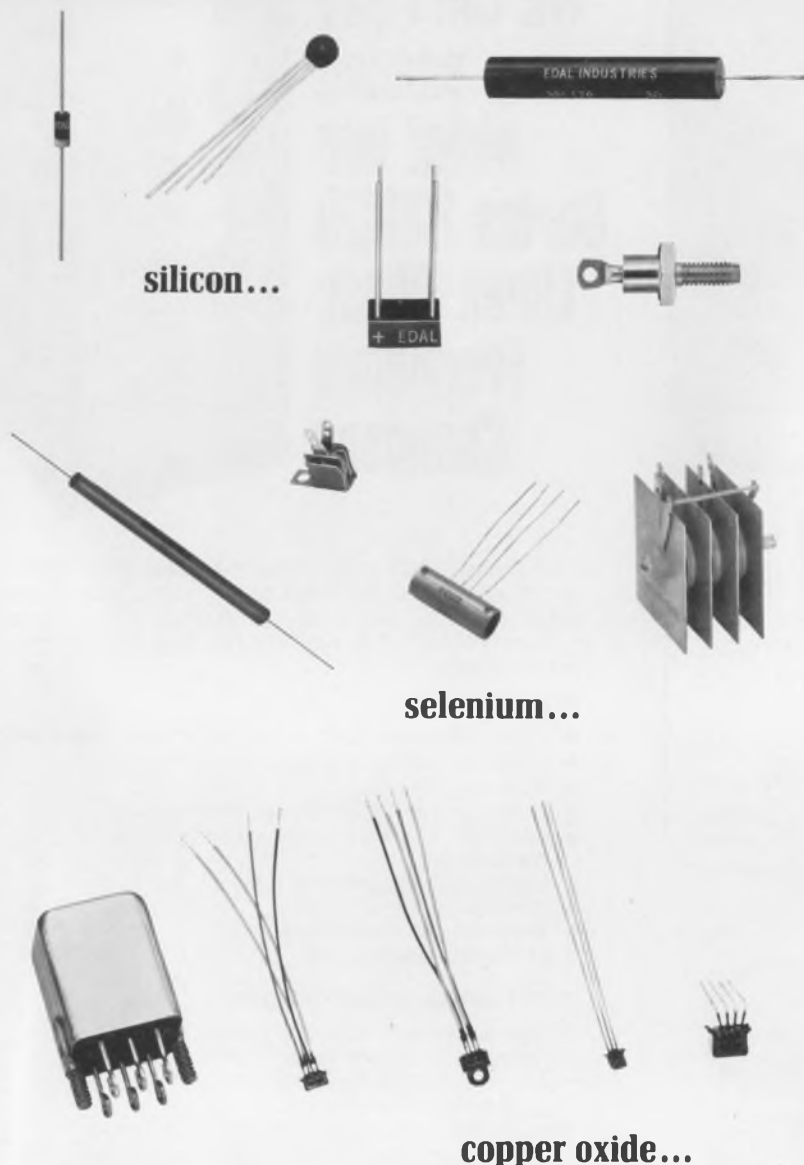

silicon...

selenium...

copper oxide...

We have no axe to grind when it comes to suggesting the best type for your application. With an infinite number of variations within the three basic types, you get the ideal solution without "over-specifying" building up cost.

Design and construction of

Edal rectifiers make them demonstrably better. Prove it yourself. Just ask and we'll send you samples. Put them to the test.

If you prefer, let us send you complete descriptive literature or have our Technical Representative in your area come in and give you our story.

EDAL

Edal Industries, Incorporated
4 Short Beach Road, East Haven, Connecticut 06512

WE MAKE MORE DIFFERENT TYPES OF RECTIFIERS THAN ANYONE IN THE WORLD
INFORMATION RETRIEVAL NUMBER 92

Rectifiers
Silicon
Selenium
Copper Oxide

INSTRUMENTATION

Compact CRT display has 3 by 5 in. face



Infodex, Inc., 7 Cherry Ave., Waterbury, Conn. Phone: (203) 754-4159.

Offering much of the flexibility of the general-purpose lab scope, a new compact CRT display occupies a panel size of only 3-1/2 by 5-3/4 in. with a useful screen area of 4 by 5 cm. Model 8602 offers three sets of sweep ranges: 1 μ s/division to 2 ms/division, 10 μ s division to 20 ms/division, and 100 μ s division to 200 ms/division. It is a basic X-Y unit that may be fitted with front-panel-controlled attenuators for both channels.

CIRCLE NO. 344

Signal generator checks fluidics



General Electric Co., Specialty Fluidics Operation, Section 37-209, 1 River Road, Schenectady, N.Y. Phone: (518) 374-2211.

Providing both differential and single-sided pneumatic signals, a new fluidic signal generator is an electrical-to-pneumatic signal transducer for testing fluidic devices and circuits. Model 24AT22 can also be used as an interface component in a system where electrical-to-pneumatic signal conversion is required. It operates at supply pressures of 3 to 15 psig.

CIRCLE NO. 345

Flashing logic probe works independently

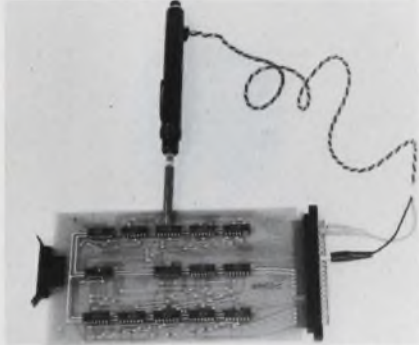

Digital Logic Control, P.O. Box 567, Barre, Mass. Phone: (617) 355-4361. Price: \$28.95.

Operating from any positive 5-V source, a new probe is able to detect steady-state logic levels and repetitive pulses without requiring a supplementary oscilloscope or voltmeter. Logic Monitor I flashes a bright circle of light to indicate the presence or absence of logical highs or lows for most DTL, TTL and RTL logic levels. It is not sensitive to logic polarity, risetimes, falltimes and waveform configurations.

CIRCLE NO. 346

Up/down counter adds and subtracts



Instrument Displays, Inc., 18 Granite St., Haverhill, Mass. Phone: (617) 373-1501.

In a self-contained package that requires no additional mounting hardware, a new small bidirectional counter can log incoming positive pulses at a rate exceeding 15 MHz and, with proper signal applied, can add or subtract these pulses to arrive at a net accumulation. Mini-Diget MDDB also enables the user to preset to an arbitrary count of zero before initiating a new count.

CIRCLE NO. 347



World Famous Simpson 260® Millions now in use!

Better than ever

with New
Taut Band
Movement
cannot develop
error-causing
friction.



- SELF-SHIELDING, SHOCK PROOF . . . for outstanding accuracy and repeatability.
- VARISTOR PROTECTED against even 200,000% overloads.
- RUGGED DEPENDABILITY that has no equal.

New Taut Band 260®-5 complete with test leads, batteries, and 40-page operator's manual . . . \$62.00

New Taut Band 260®-5M with anti-parallax mirror scale and knife-edge pointer . . . \$64.00

New Taut Band 260®-5P with circuit breaker overload protection of VOM circuitry . . . \$94.00

GET "OFF-THE-SHELF" DELIVERY FROM
YOUR LOCAL ELECTRONIC DISTRIBUTOR

Simpson

ELECTRIC COMPANY



5200 W. Kinzie Street, Chicago, Illinois 60644 • Phone (312) 379-1121
Export Dept: 400 W. Madison Street, Chicago, Illinois 60606. Cable Simelco
IN CANADA: Bach-Simpson Ltd., London, Ontario • IN INDIA: Ruttonsha-Simpson
Private Ltd., International House, Bombay-Agra Road, Vikhroli, Bombay

INSTRUMENTS THAT STAY ACCURATE

INFORMATION RETRIEVAL NUMBER 93

T-1-3/4 lamp socket snaps on and off

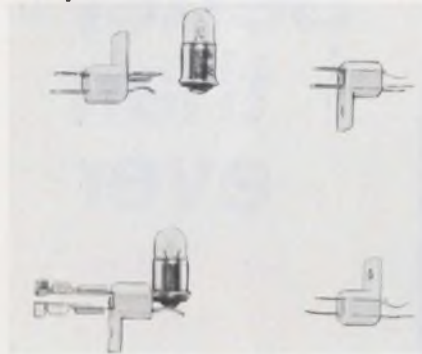

Chicago Switch, Inc., 2035 Wabansia Ave., Chicago, Ill. Phone: (312) 489-5500. P&A: 9¢; 4 to 6 wks.

Klipsocket is a new universal snap-on bracket that fits all T-1-3/4 midget flanged-based lamps with voltage ratings from 1 to 28 V ac or dc. It clips on quickly, fits snugly, and engages and disengages easily; it can be ordered to fit in any one of four ways. The new plastic socket has non-corrosive terminals.

CIRCLE NO. 348

Ribbon cables replace coax

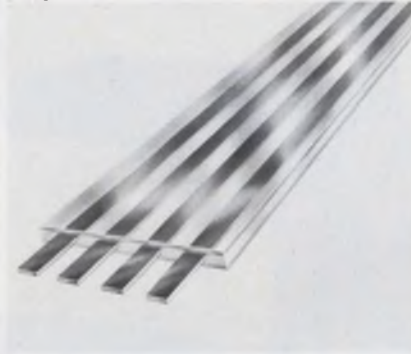

Burndy Corp., Tape Cable Div., Rochester, N. Y.

Able to replace coaxial cables and twisted pairs in some applications, new flat cable tapes for connectors with 0.05-in. centers can be used as a multiple transmission line for several pulse circuits with a characteristic impedance of 150 Ω. Type 50M 2 × 25 series can also be used for dc and audio applications in signal, pulse or relay circuits where currents are normally less than 100 mA.

CIRCLE NO. 349

Hf-transistor package dissipates 145 watts

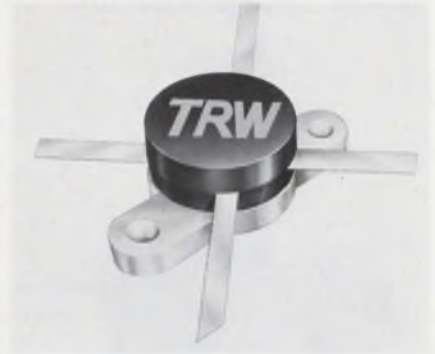

TRW Semiconductors Inc., 14520 Aviation Blvd., Lawndale, Calif. Phone: (213) 477-6061.

Extending the technology of high power at high frequencies, a new transistor package, which isolates all leads from the mounting base, is capable of dissipating over 145 W. The new Diamond package now houses a 40-W 20-to-88-MHz transistor (2N5691) and a 40-W 144-to-175-MHz transistor (2N5706). Prototype devices for an 80-W output are currently being tested.

CIRCLE NO. 350

ENVIRONMENT PROOF ROTARY SWITCHES

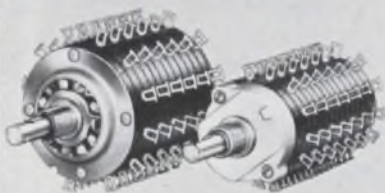

Series 600 1 1/2" Dia. — Series 100 1 1/8" Dia.

- Both index mechanism and electrical sections are completely enclosed.
- Corrosive atmospheres, dust, dirt and moisture are permanently sealed out, lubricants sealed in.
- Solder or quick-connect terminals molded permanently into position minimize production damage.
- Standard index angles include 15°, 30°, 36°, 60° and 90°, special angles available on request.
- Write for engineering bulletin.



STACKPOLE
COMPONENTS COMPANY
P. O. Box 14466
Raleigh, N. C. 27610

INFORMATION RETRIEVAL NUMBER 94

UNEXCELLED QUALITY FOR LESS THAN 4¢

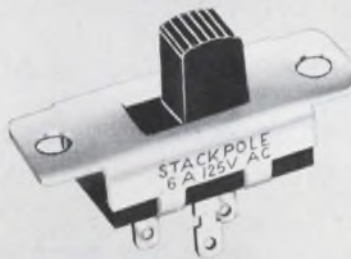

- Listed by UL AND CSA, 1 to 10 amps at 125V AC.
- 7960 slide switch combinations—23 basic types.
- New rugged solder lug terminal, designed for use with quick connectors.
- Uniform quality assured by automated assembly.
- Electro-silver plated terminals and contacts—shorting and non-shorting.
- Phenolic or nylon triggers in a variety of colors.
- Write for engineering literature.



STACKPOLE
COMPONENTS COMPANY
P. O. Box 14466
Raleigh, N. C. 27610

INFORMATION RETRIEVAL NUMBER 95

UNIQUE DESIGN ADDS VALUE AND APPEAL



- 23 rocker switch configurations, including 2-3 positions, spring return and center-off.
- Variety of rocker designs available in a spectrum of colors and hot-stamped lettering.
- Listed by UL AND CSA, 1 to 10 amps at 125V AC.
- Solder lug, space saver, quick-connect or printed circuit terminals.
- Field-proven quality same as famous Stackpole slide switches.
- Prices start at less than 15¢.
- Write for engineering literature.



STACKPOLE
COMPONENTS COMPANY
P. O. Box 14466
Raleigh, N. C. 27610

INFORMATION RETRIEVAL NUMBER 96
ELECTRONIC DESIGN 15, July 19, 1969

PC-board kit sells for \$7



F. Huddleston Associates, Inc., 408 S. Rosemead Blvd., Pasadena, Calif. Phone: (213) 681-3751. Price: \$6.95.

Offered at an introductory price of \$6.95, Cir-Kit B-1 is a new printed-circuit kit that includes two photosensitized board blanks—one measures 6 by 8 by 1/16 in., the other is 3 by 3 by 1/32 in. There is also an 8 by 10 in. sheet of Mylar-backed ruby masking, 7 oz of each developing and etching solution, and rubber finger covers.

CIRCLE NO. 351

Microminiature tubing downs ID to 6 mils

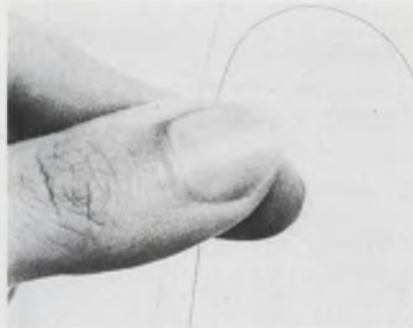

Niemand Brothers, Inc., Dept ML, 45-10 94th St., Elmhurst, N. Y. Phone: (212) 672-1346. Price: 35¢ to 55¢/ft.

Only twice the diameter of a human hair, a new line of microminiature tubing has an inside diameter as low as 0.006 in. with a wall thickness of only 0.00075 in. Micro ML tubing is produced from a polyimide polymer and is said to possess excellent electrical, thermal and physical properties. Its dielectric strength is 4000 V.

CIRCLE NO. 352

Dual-in-line cable plug looks like standard IC

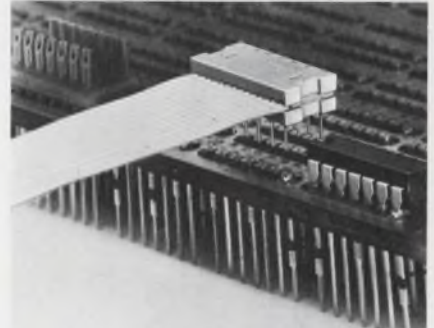

Augat Inc., 33 Perry Ave., Attleboro, Mass. Phone: (617) 222-2202. Price: 75¢ to \$1.25.

Useful for interfacing, input/output connections and testing, a new standard IC pattern plug fits 28-gauge stranded 14-conductor flat cable. Model 2P14-1 comes unassembled, but its unique assembly design permits it to be installed on the ends of a cable or at any desired bussing location. It is glass-filled nylon with beryllium-copper contacts, gold-over-nickel plated.

CIRCLE NO. 353

SLIDE-TROL® — NEW CONCEPT IN POTENTIOMETER DESIGN

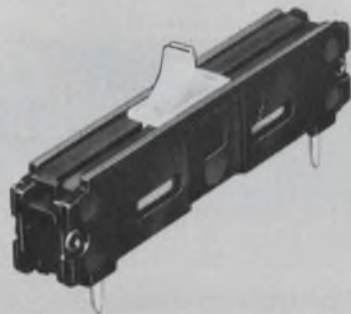

- Mount horizontally, vertically or sideways, either singly or in multiple units.
- Standard solder lug, wire wrap or printed circuit terminals available.
- Low noise and low contact resistance, plus uniform heat distribution.
- Ratings 40-500Ω 1.5 watts, 500-5KΩ 1.25 watts, 5KΩ and over 1. watt.
- Thermal expansion-contraction and shock hazard problems eliminated.
- Know resistance setting at a glance.
- Compact, lightweight, functional, attractive.
- Write for SLIDE-TROL® Brochure.



STACKPOLE
COMPONENTS COMPANY
P. O. Box 14466
Raleigh, N. C. 27610

INFORMATION RETRIEVAL NUMBER 97

ELECTRONIC DESIGN 15, July 19, 1969

GUARANTEED UNIFORMITY IN ELECTRICAL, PHYSICAL CHARACTERISTICS

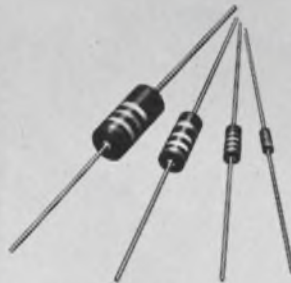

- Available in 2, 1, 1/2 and 1/4 watt sizes.
- Uniform from resistor to resistor, order to order.
- 100% tested for resistance value.
- Solderability, load life and humidity-temperature characteristic checked.
- Impregnated to assure moisture resistance.
- Write for literature.



STACKPOLE
CARBON COMPANY
Electronic Components Division
Kane, Pa. 16735

INFORMATION RETRIEVAL NUMBER 98

NEW 5000 PERM CERAMAG® FERRITE MATERIAL FOR TOROID APPLICATIONS



- 5000 initial permeability ± 20%.
- Ceramag® 24H is a precision engineered material for use in shielding and pulse transformer applications. Highly stable.
- Saturation flux density — 4100 gauss. Residual magnetism — 850 gauss.
- Currently available in a size range of .100" OD to .375" OD.
- Curie point is 175° C.
- Temperature coefficient at — 25° C to 25° C is ± 0.700 and at 25° C to 75° C it is — 0.450.
- Write for additional data.



STACKPOLE
CARBON COMPANY
Electronic Components Division
St. Marys, Pa. 15857

INFORMATION RETRIEVAL NUMBER 99

153

Wedge-Action*

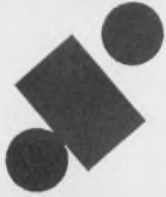

Relays

Hermetically-sealed, electromagnetic relays that provide high performance and reliability under the most difficult operating conditions in dry-circuit to 2 amp applications.



2 PDT
MARK II, SERIES 500
MIL-R-5757/9



6 PDT 4 PDT
(1" x 1")
MARK II, SERIES 300
(6 PDT).
SERIES 350 (4 PDT).
MIL-R-5757/1 and
MIL-R-5757/7



6 PDT
MARK II, SERIES 085
(-55°C to +85°C)
SERIES 100
(-65°C to +125°C),
SERIES 200
(-65°C to +200°C).
MIL-R-5757/1.



4 PDT, 10 AMP
MARK X, SERIES 600-02
MSFC-339/22A

*Wedge-Action



The moving contacts are mounted between two stationary contacts. On actuation, they drive into the stationary contacts, creating high pressures and low contact resistance at all current levels. In addition, wedge-action contact wipe provides self-cleaning of the precious-metal contacts.

*Patented

For complete data write Relay Sales and Engineering Office, P. O. Box 667, Ormond Beach, Fla. 32074, Phone 904-677-1771, TWX 810-857-0305.

Electro-Tec Corp.

A DIVISION OF KDI CORPORATION

Evaluation Samples



Electrical tapes

Sample strips of 37 types of standard Scotch brand electrical tapes are available free. The tape samples include cotton cloth and polyimide film types, and tapes with treated paper backing, glass cloth backing, acetate backing, and polyester and fluorocarbon backing. They are mounted on a chart that contains curing data for thermo-setting adhesives and information on slitting tolerances. 3M Co.

CIRCLE NO. 354

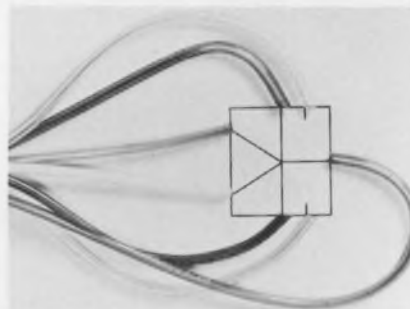

Fluidic cable

Composed of adhered multiples of polyvinylchloride tubing, a new fluidic cable easily strips for connection to various ports in a system. The smooth bore of multichannel Flotube tubing assures uniform impedance and low pressure drop in fluidic circuits. The tubing holds tight leakproof connections and will not kink even on small radii. It is available in most common sizes and in ten colors. A free sample of multichannel Flotube is available. Natvar Corp.

CIRCLE NO. 355

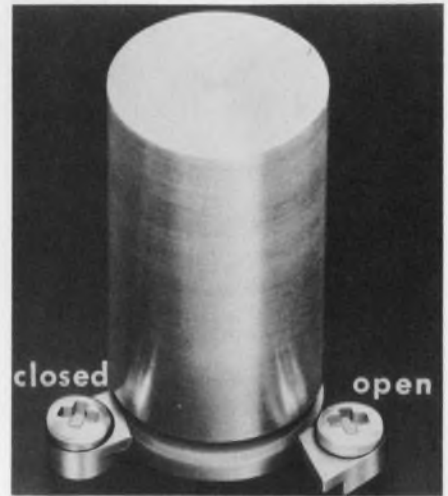

Synchro clamps

Quick-releasing, self-locking, instant-nulling synchro clamps lock and unlock simply with a quarter-turn of the screw. QT-Synchclamps hold a component radially, as well as axially. This prevents any lateral movement under shock or vibration, within the tolerance of the mounting hole. Conversely, Synclamps can be used to move a component within its mounting-hole tolerance, for example, to adjust gear mesh. Component flange thicknesses of 0.031 to 0.25 in. can be accommodated. A free sample is available. Timber Top, Inc.

CIRCLE NO. 356

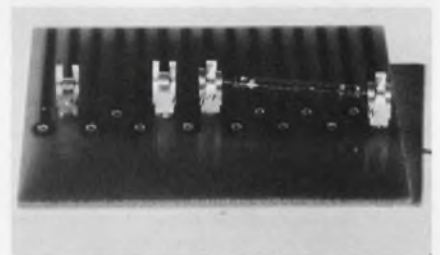

PC-board terminals

Providing plug-in capability for axial-lead components on printed circuit boards, a new inexpensive terminal allows fast and easy replacement of reed switches, diodes, resistors, capacitors and similar components. Because only the 1988 terminal itself is wave soldered, after being pressed into the PC board, the danger of overheating components is eliminated. The terminal comes in bulk form, with gold or tin plating optional. It accepts 0.025-in. diameter wires. Free samples are available. Molex Products Co.

CIRCLE NO. 357

High Ripple Current in Electrolytic Capacitors

Did you know that electrolytic capacitors can be specifically designed to handle high ripple current applications? Standard lines are not normally designed to optimize this characteristic—if you have had the problem of overheated capacitors in a filter circuit, we think the following information will interest you.

Many electrolytic capacitors used in power supply filter circuits have to handle high ripple currents in high ambient temperatures. In order to provide reliability and long life assurance, electrolytic capacitors could be specifically constructed for these conditions.

Ripple current is the AC component of the current flowing through the capacitor. It causes heating, or heat rise, in the capacitor due to the inherent losses in electrolytic capacitors. The losses are a function of the ripple frequency, construction of the capacitor and the ambient temperature.

The ambient temperature will govern the capacitor's heat dissipation capability. The lower the ambient

**Ripple Current Capability of Specially
Constructed Type FP 450 VDC Mallory Electrolytic**

Size Dia. Ht.	Max. Mfd.	65° C Ambient		85° C Ambient	
		60 Hz	120 Hz	60 Hz	120 Hz
1 3/8" x 2"	80	1.44 amps	1.92 amps	.90 amps	1.20 amps
1 3/8" x 2 1/2"	110	1.84	2.32	1.15	1.45
1 3/8" x 3"	150	2.16	2.64	1.35	1.65
1 3/8" x 3 1/2"	175	2.32	3.04	1.45	1.90
1 3/8" x 4"	200	2.56	3.28	1.60	2.05
1 3/8" x 4 1/2"	225	2.80	3.44	1.75	2.15
1 3/8" x 5"	250	3.20	3.60	2.00	2.25

**Ripple Current Capability of Standard
Construction Type FP 450 VDC Capacitor**

Size Dia. Ht.	Max. Mfd.	65° C Ambient		85° C Ambient	
		60 Hz	120 Hz	60 Hz	120 Hz
1 3/8" x 2"	80	.600 amps	.750amps	.400amps	.500amps
1 3/8" x 2 1/2"	110	.640	.800	.425	.530
1 3/8" x 3"	150	.660	.825	.490	.550
1 3/8" x 3 1/2"	175	.780	.975	.520	.650
1 3/8" x 4"	200	.960	1.200	.640	.800
1 3/8" x 4 1/2"	225	1.080	1.350	.720	.900
1 3/8" x 5"	250	1.200	1.500	.800	1.000

temperature, the greater the dissipation. The greater the heat dissipation, the greater the current carrying capability. In a high ambient temperature, the internal temperature should not reach a run-away heat condition. Ideally, a state of temperature equilibrium should be established that will not cause degradation of the capacitor such as a sharp decrease in capacitance and rapid increase in dissipation factor.

The electrical losses in the capacitor consist of the resistivity of the electrolyte system, the losses in the oxide film on the anode plate, and the tabs and electrical connections. These losses are lumped and expressed in ohms as the ESR. (Equivalent Series Resistance.) The ESR is greater at low frequencies than at high frequencies. Thus, the current carrying capability is greater at 120 Hz than at 60 Hz.

Ripple current capabilities are published for standard construction

electrolytic capacitors. When operated within the published ripple current and maximum ambient temperature conditions, capacitors will provide reliable long-life service. However, when these conditions are exceeded, a much shorter life or even catastrophic failure can be expected.

The tables show the ripple current capabilities of standard construction type FP capacitors compared to the ripple capability of specially constructed FP capacitors for reliable high ripple current performance.

If you have a high ripple current application, specify the R.M.S. current, frequency, ambient temperature, nominal capacitance and capacitance tolerance, working voltage, and surge voltage conditions.

For data, call or write Mallory Capacitor Company, a division of P. R. Mallory & Co. Inc., Indianapolis, Indiana 46206.



PERFORM WITH CHAMPIONS



ONLY \$44.95 ppd.

BUY THE BEST

MARK TEN[®] CAPACITIVE DISCHARGE IGNITION SYSTEM

DELTA KIT only \$29.95 ASSEMBLE IT YOURSELF!

Now discover for yourself the dramatic improvement in performance of your car, camper, jeep, truck, boat—any vehicle! Delta's remarkable electronic achievement saves on gas, promotes better acceleration, gives your car that zip you've always wanted. Find out why even Detroit has finally come around. In four years of proven reliability, Delta's Mark Ten has set new records of ignition benefits. No re-wiring! Works on literally any type of gasoline engine.

COMPARE THESE PROVEN BENEFITS...

- ▲ Dramatic Increase in Performance and in Fast Acceleration
- ▲ Promotes more Complete Combustion
- ▲ Points and Plugs last 3 to 10 Times Longer
- ▲ Up to 20% Mileage Increase (saves gas)

Order Your MARK TEN Today Shipped Postpaid at once . . .



DELTA PRODUCTS, INC. DP 9-6

P.O. Box 1147 ED • Grand Junction, Colo. 81501

Enclosed is \$ _____ Ship ppd. Ship C.O.D.

Please send:

- Mark Tens (Deltakit[®]) @ \$29.95
 (12 VOLT POSITIVE OR NEGATIVE GROUND ONLY)
 Mark Tens (Assembled) @ \$44.95
 6 Volt: Negative Ground only
 12 Volt: Specify Positive Ground Negative Ground

Car Year _____ Make _____

Name _____

Address _____

City/State _____ Zip _____

Design Aids



Torque sliderule

The proper hole size and torque recommendations for threadforming screws and specific metal thicknesses are easily found with an easy-to-use slide rule. One side of the rule covers punched or drilled sheet metal and structural steel thicknesses to 1/4 in.; the other side deals with cored or drilled holes in zinc and aluminum die castings from 1/4 to 1/2 in. thick. The drive, strip, tightening, and break-away torque is easily read out. Elco Tool & Screw Corp.

CIRCLE NO. 358

Precious metals

High-purity precious metals and alloys are the subject of a chart on gold and gold alloys, silver and silver alloys, and platinum. The typical purities and impurities of these materials is shown along with the numerous available forms of each. Semi-Alloys, Inc.

CIRCLE NO. 359

Wire insulation

Comparing the performance of various wire insulations, a two-page chart tabulates the results of such tests as abrasion, soldering, markability, flammability, and cold and reverse bending. The general geometry of both conventional and thin-wall wire insulation is shown, along with physical and electrical properties. The wire insulations include Kapton, Teflon, Mylar, Kynar, polysulfone, vinyl and vinyl-nylon. American Enka Corp., Brand-Rex Div.

CIRCLE NO. 360

Conversion charts

Two useful conversion charts are contained in a 16-page catalog on oscillators. One chart, shown above, relates dBm, power and impedance; the other chart equates frequency tolerance expressed in Hertz to frequency tolerance expressed in per cent. The oscillators described cover the frequency range from 1 Hz to 250 MHz. Included are crystal, tuning-fork, voltage-controlled, high-stability and power oscillators. Accutronics, Inc.

CIRCLE NO. 361

Load nomograph

A nomograph eases the calculation of voltage drop across load supply leads as a function of wire size and load current. Voltage drop is gauged in millivolts per foot, while load current is shown as maximum operating amperes. Included with the nomograph is a glossary of power supply terms and useful applications information like error terms in current regulators and remote error sensing. There is also a listing, within the 67-page catalog, of a wide variety of power supplies and accessories. Kepco, Inc.

CIRCLE NO. 362

Environmental charts

A trio of environmental charts covers temperature conversion, altitude conversion and relative humidity. Direct conversion from degrees centigrade to degrees fahrenheit is shown for temperatures between -273 and +538°C. Conversion factors for translation to degrees Kelvin or degrees Rankine are also presented. The altitude conversion chart relates altitude in feet to temperature in degrees fahrenheit and pressure expressed in four different terms. A 48-page catalog describing various environmental chambers is also included. Webber Manufacturing Co., Inc.

CIRCLE NO. 363



DESIGNERS: AVOID SHOTGUN MARRIAGES

For design freedom, 12 sizes, all 550 Mu



Use Magnetics Inc. 550 Mu Powder Cores

Magnetics Inc. first filled the void between 300 Mu powder cores and nickel laminations with the 550 Mu moly-permalloy powder core. We introduced it in three sizes.

And this perm is still exclusive with us. However, now you can get it in 9 new sizes—an O.D. range of .250" to 1.602". These fixed-gap toroids keep you from being forced into undesirable component marriages, let you tighten design to meet packaging requirements, cut total assembly costs in filters, chokes, transformers, inductors. They also provide: 1. A high inductance-to-size ratio. 2. Reduced d.c. copper resistance. 3. Less distributed capacity. 4.

Greater temperature stability than laminations. Avoid shotgun designing and get more freedom in using magnetic cores for circuit components. Try 550 Mu—we can ship from stock all 12 sizes. For additional information on 550 Mu powder core advantages, write Dept. ED-105 for Bul. FLC-02. Magnetics Inc., Butler, Pa. 16001.



Tape, bobbin, ferrite, powder cores • Laminations • Photo-etched parts • Specialty metals • Engineered control systems

INFORMATION RETRIEVAL NUMBER 104

exposé

Localized backplane wiring.

Adjustable mounting bracket for hard-mount.

4-Lamp housing for easy changing.

Display screen divider holds 1 to 4 lenses for 384 std. display options.

One-piece integrated design switch mechanism... 4PDT config. at 2 PDT prices... reliable at both logic or power levels.

Quick disconnect latch allows front panel removal of push button and lamp housing.

Legend plate and diffusers for quick change artists.

Space-saver push button housing (0.70" square)... flush-panel or extended mount.

The Series 40 STACOSWITCH—easy to install, maintain, and pay for— plus MIL SPEC COMPLIANCE. Send for Series 40 Catalog now.



STACO, INC. CALIFORNIA • AN LTV/LING ALTEC COMPANY
1139 Baker Street / Costa Mesa, California 92626 • Tel. (714) 549-3041

INFORMATION RETRIEVAL NUMBER 105

Annual Reports

Learn how to read annual reports in "How to investigate a company." For a copy, circle no. 474.

Corning Glass Works, Houghton Park, Corning, N. Y.: components, fluidic modules, information processing, memories, materials; net sales, \$479,089,067; net income, \$46,766,679; assets, \$207,354,903; liabilities, \$81,235,910.

CIRCLE NO. 410

Datascan, Inc., 1111 Paulison Ave., Clifton, N. J.: logic cards, digital panel meters, analyzing systems, typesetters; net sales, \$3,053,691; net income, \$241,766; assets, \$1,659,573.

CIRCLE NO. 411

Fimaco, Inc., 230 W. Washington Square, Philadelphia, Pa.: subscription services; net earnings, \$51,942; net income per share, 9¢; current assets, \$1,005,344; current liabilities, \$374,504.

CIRCLE NO. 412

Greater Washington Investors, Inc., 1725 K St. N.W., Washington, D. C.: data processing, computers, communications, instruments, materials; net income, \$441,648; assets, \$23,965,663; liabilities, \$2,595,599.

CIRCLE NO. 413

Singer Co., 30 Rockefeller Plaza, New York City: defense and space systems, office equipment, consumer, educational and consumer products; net earnings \$1,766,315,000; net income, \$69,392,000; assets, \$970,094.

CIRCLE NO. 414

Technical Materiel Corp., Fenimore Rd., Mamaroneck, N. Y.: communications systems, crystal filters, education, diesel engines; net sales, \$17,408,523; net income (loss), \$603,107; assets, \$12,068,690.

CIRCLE NO. 415

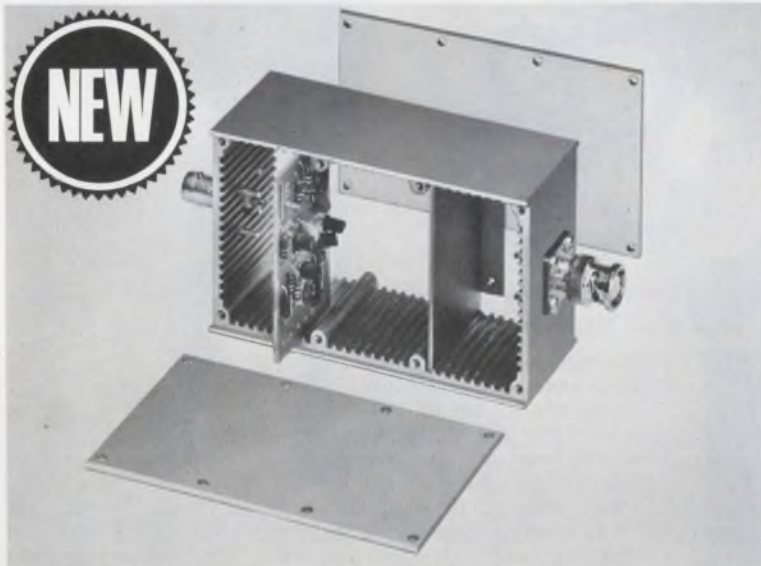

SHIELDED BOXES with CARD GUIDES

Rugged die-cast aluminum boxes, slotted to accept 1/8" circuit boards and shielding dividers. Excellent for packaging electronic circuitry. Boxes have removable top and bottom covers. Useable inside space: 4"x2"x1 1/2". Several models with various connectors.

Write for 1969 Catalog



POMONA ELECTRONICS CO., INC.
1500 E. Ninth Street, Pomona, California 91766

INFORMATION RETRIEVAL NUMBER 106

For micro-accuracy... Starrett measures up

When it comes down to the ultimate in measurement control, or even for fine increments of movement with or without linear measurement, it's time for Starrett. Starrett micrometer heads are precision built to give you the preciseness that your design requires. Starrett is world-known as the leader in precision tools. When you just can't afford to be wrong, be precision-perfect with Starrett.

Starrett micrometer heads are stocked in a wide range of standard designs, and custom-built heads can be manufactured for special applications.

Write today for additional information about what Starrett can do for you to make your design better.

The L. S. Starrett Company,
Athol, Massachusetts.

Starrett®
WORLD'S GREATEST TOOLMAKERS

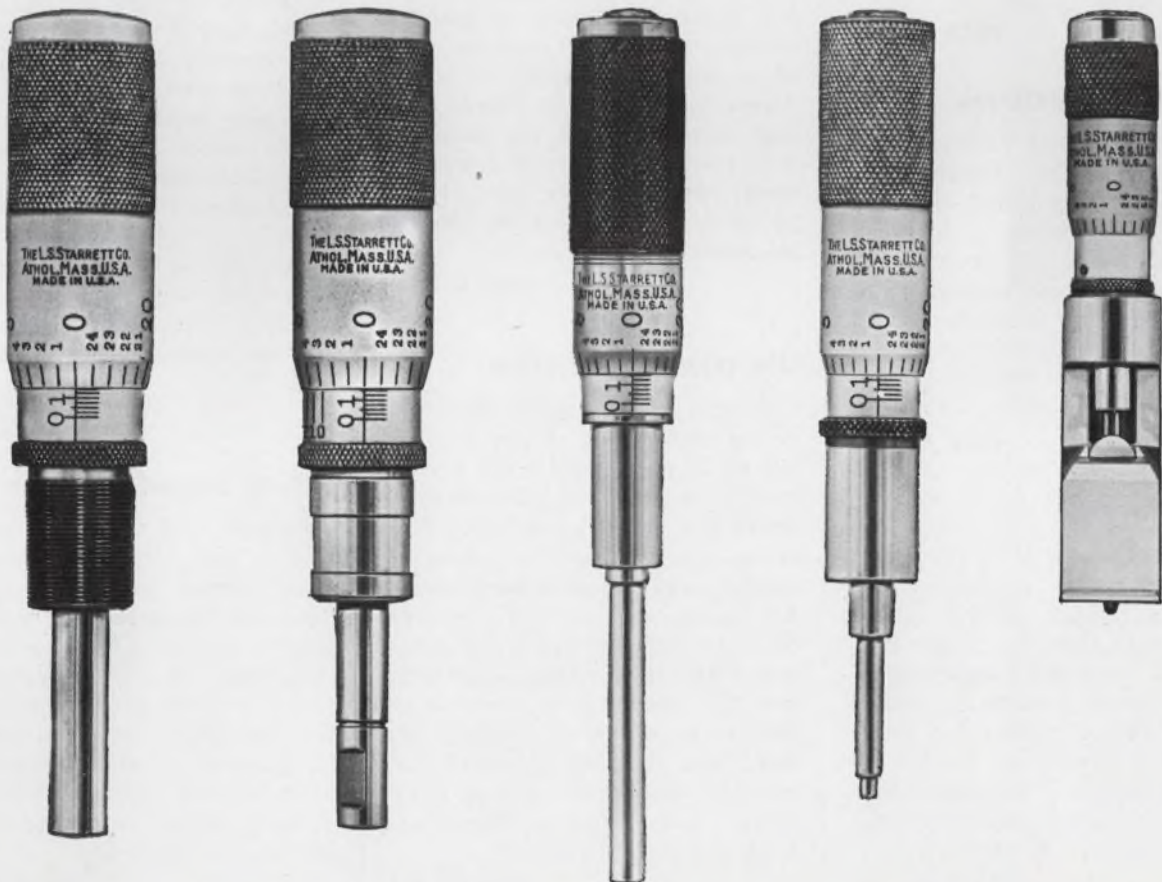

INFORMATION RETRIEVAL NUMBER 107

Application Notes



FET designs

Entitled "FET Design Ideas," a 12-page booklet is intended as a thought-starter for designers employing field-effect transistors in their circuits. The bulletin describes how to properly bias FETs, and provides 20 examples of FET usage in a wide range of applications. A complete listing of currently available FET application reports is included. Texas Instruments Inc.

CIRCLE NO. 364

Instrument handbook

Comprising 100 information-packed pages, the "Instrumentation Users' Handbook" contains technical and application data in the fields of magnetic tape recording/reproducing, oscillography, signal conditioning, magnetic heads, and other related subjects. Glossaries and technical articles are included. Bell & Howell.

CIRCLE NO. 365

Rf sputtering

A 12-page article reprint deals with the type of equipment, design considerations and the prime circuit particulars for proper coupling and impedance matching of rf sputtering systems. Entitled "Design Considerations for Radio Frequency Sputtering Equipment and Impedance Matching Networks," the article is amply illustrated. McDowell Electronics, Inc.

CIRCLE NO. 366

Fluid ultracleaning

With photomicrographs, a 20-page manual documents the case against particulate contamination and prescribes cures for such critical fluids as high-purity water, photoresists, circuit mask processing solutions, process gases, ultrasonic cleaning fluids and CRT phosphor dispersions. A chapter is devoted to the preparation and handling of high-purity water. The manual also furnishes a design guide on microfiltration systems and a primer on absolute microfiltration which explains, among other things, the critical differences between depth and screen filters. Millipore Corp.

CIRCLE NO. 367

Rf power transducers

Serving as direct monitors or controllers of power levels, thermocouple coaxial power transducers can act as rf and dc converters in conjunction with a meter readout or can be used in a feedback system without metering or readout devices. A 12-page brochure tells of several applications for transducers that convert rf energy to a high dc output level. For example, it is possible to convert a conventional sweep oscillator into a leveled sweep signal generator. Narda Microwave Corp.

CIRCLE NO. 368

Uhf power generation

A 12-page application note discusses the use of rf power transistors in narrow-band and broadband uhf power-amplifier circuits under cw pulse conditions. Presented are the basic principles of narrow-band and broadband amplifier design, the intrinsic structure of rf power transistors, the parasitic elements limiting bandwidth, and the electrical characteristics relative to uhf power-amplifier design. Also included are brief discussions on package design, reliability, and safe-area operation. RCA Electronic Components.

CIRCLE NO. 369



IC applications

Detailing a line of linear integrated circuits, a 24-page brochure contains more than 45 specific applications for both the circuit and system designer. The linear devices range from core memory sense amplifiers to video amplifiers. Illustrated applications include an active bandpass filter with adjustable Q, Weinbridge oscillator, audio preamplifier with RIAA/NAB compensation, logarithmic amplifier/video compressor and a 10-MHz crystal oscillator. Signetics Corp.

CIRCLE NO. 370

Miniature lamps

Providing a technical review of the current state-of-the-art of miniature and subminiature lamps, a 16-page catalog covers: filament design; shock and vibration characteristics; mean spherical candle power measurements; correlations between voltage, current, candle power and useful life; color characteristics, including Kelvin temperature and spectral response; and rise time and light intensity. LAMPS, Inc.

CIRCLE NO. 371

Tubing considerations

Factors the design engineer should consider when choosing metal tubing for flexing applications are discussed in a four-page article reprint. Key properties to investigate when a tubing part is to flex, vibrate, expand or contract are formability and resistance to fatigue and corrosion. Dimensional tolerances and the possibilities of multiple-walled tubing are discussed. Superior Tube Co.

CIRCLE NO. 372

The ultimate oscillator.

Now there's a true function generator that's priced like an oscillator.

The new Model 130 delivers sine, square, triangle and sync outputs from 0.2 Hz to 2 MHz with flat frequency response and low sine distortion.

The ultimate is only \$295.*



WAVETEK®
9045 Balboa Ave., San Diego, Calif. 92123; Tel. 279-2200
P.O. Box 651, San Diego, Calif. 92112; TWX 910-335-2007

*You can also get our Model 131 VCG for just \$345
or our Model 134 Sweeper for just \$495.

TUBULAR,
BULKHEAD
MOUNTING TYPE

RFI/EMI FILTERS

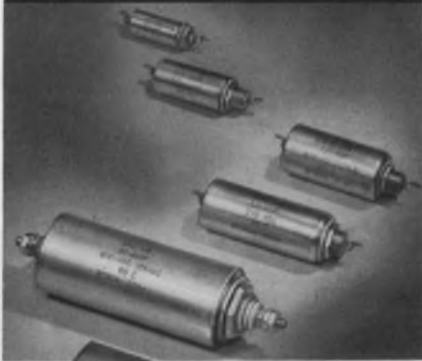

Rtron

Cylindrical Style Interference Filters

that reduce or eliminate unwanted noise or signals. Small size, light weight, maximum attenuation. Voltage current or insertion loss characteristics required, determine physical size. Maximum isolation of terminals and high frequency performance are assured by threaded neck design for bulkhead mounting. Feed-thru capacitor circuitry conservatively rated for both military and commercial applications.

Rtron corporation

P.O. Box 743 Skokie, Illinois 60076

- Send catalog and prices.
- Have Representative call for appointment.
- Specifications enclosed on Multi-circuit or custom design filters. Send estimate.

Name _____

Firm _____

Address _____

City _____

State _____ Zip _____

INFORMATION RETRIEVAL NUMBER 109

NEW LITERATURE

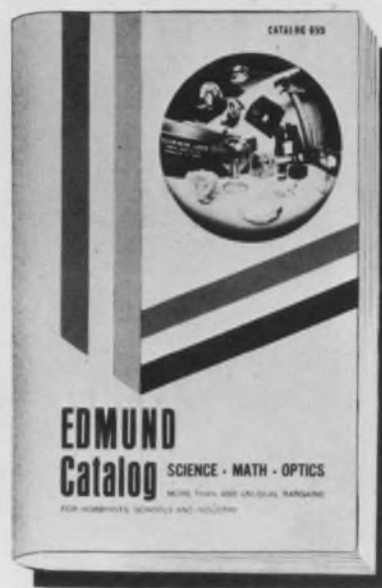

Product potpourri

Keeping abreast with the latest industrial developments, the new Edmund Scientific catalog includes several fiber-optic devices, two low-cost lasers as well as liquid crystal kits. Chock-full of product information, this 148-page catalog also describes an economical magnetic sweeper that can physically pick up metal objects. Edmund Scientific Co.

CIRCLE NO. 373

IC literature index

An index to application literature with informative abstracts is now available for integrated circuits and discrete semiconductors. The booklets listed, which can be obtained free of charge, discuss such topics as the basics of uni-junction transistors, diode transient response and microcircuit packaging. Texas Instruments.

CIRCLE NO. 374

Products plus

Lafayette's summer catalog packs 100 pages with listings of audio equipment, power tools, radio control devices, communications components, and telephone and mobile equipment. Lafayette Radio Electronics.

CIRCLE NO. 375

ADVANCE

your avionic cooling system
with AiResearch.



Your entire system will move ahead with maximum savings in time, weight, size, and power consumption if you let AiResearch work with you from the beginning to optimize avionic cooling.

How about starting by letting us help you conduct your thermal optimization studies?

An example of our work is shown above: a 3,000 watt cooling capacity enclosure for a pod-mounted ECM system. It is integral with the pod structure and part of the pod skin.

AiResearch capability includes over 30 years of experience and complete in-house component and system control.

For detailed specifications contact: AiResearch Manufacturing Company, 9851 Sepulveda Blvd., Los Angeles, Calif. 90009. Ph. (213) 776-1010 or (213) 670-0131.



AiResearch
Heat Transfer Systems

one of The Signal Companies

INFORMATION RETRIEVAL NUMBER 110

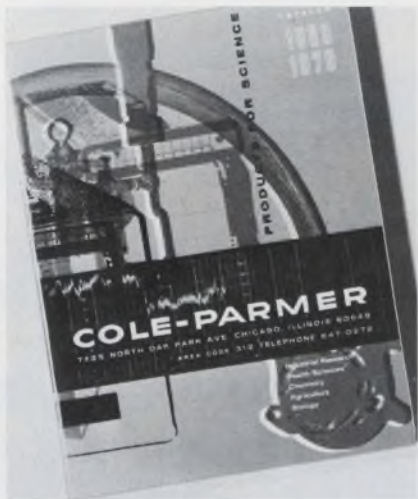

Lab instruments

Using color coding for fast and easy selection of specific product groups, a new catalog describes over 3000 laboratory instruments and scientific products designed for industrial research, the health sciences, chemistry, agriculture and biology. Included are instruments and sensors for reading and controlling temperature, pumps and related hardware, mixers and stirrers, plastic ware, vacuum and pressure instrumentation, and low-temperature equipment and apparatus. Cole-Parmer Instrument Co.

CIRCLE NO. 376

Silicon diodes

Enumerating electrical and mechanical characteristics as well as operating parameters, a 20-page brochure fully describes a broad line of silicon diodes. The devices can meet a variety of needs like high forward conduction, low capacitance, high speed or low reverse leakage. Sylvania Electronic Components.

CIRCLE NO. 377

Microwave components

Showing thousands of microwave components, a new 140-page catalog shows all of the standard coaxial, waveguide and millimeter microwave products. In addition, there are expanded sections on attenuators, high-sensitivity detectors, directional couplers, high-power loads, filters, preselectors, diplexers, and a complete line of miniature components with 3-mm MFM connectors. Microlab/FXR.

CIRCLE NO. 378

The
Trend
is TTL.

SN7441AN MSI Nixie* driver
**3 WEEKS
AWO**
(Same day shipment on 250 pieces or less)



Faster deliveries on all TTL circuits—made possible by greatly expanded manufacturing capability. Get full information on the IC types *you* need. Call your TI representative—*now!*

*Burroughs trademark

TEXAS INSTRUMENTS
INCORPORATED

**BOURNS INTRODUCES
NEW CONCEPT
CERMET RESISTIVE
AND CONDUCTIVE INKS**

New Concept permits Calibration/Targeting of Inks to your equipment and facilities, assuring desired resistance values, temperature coefficient of resistance and repeatability. Evaluation kits are available containing four resistive inks, one conductive ink and an instruction manual at \$200 per kit.

WRITE FOR COMPLETE TECHNICAL DATA TODAY!

BOURNS TECHNICAL MATERIALS

3231 KANSAS AVENUE • RIVERSIDE, CALIFORNIA 92507

INFORMATION RETRIEVAL NUMBER 111

CONDUCTIVE SILVER COATING IN AEROSOL SPRAY



Eccocoat CC-2 and Eccoshield ES coatings produce surface resistivities below 0.1 ohm per square. Silver particles are plastic bonded to form a tough film which adheres to most materials.

INFORMATION RETRIEVAL NUMBER 231

CLEAR EPOXY GEL FOR REPAIRABLE EMBEDMENTS



Eccogel 1265 makes the electronic troubleshooter's life a little easier. It provides good environmental protection, and the unit is visible for inspection. If repair is necessary, the gel can be cut with a knife to expose parts. After repair, Eccogel 1265 can be poured into the cavity to restore encapsulation.

INFORMATION RETRIEVAL NUMBER 232

DIELECTRIC MATERIALS CHARTS



Charts in full color contain data on all important materials used by electrical and electronic engineers.

INFORMATION RETRIEVAL NUMBER 233

Emerson & Cuming, Inc.



CANTON, MASS.
GARDENA, CALIF.
NORTHBROOK, ILL.
Sales Offices
in Principal Cities

EMERSON & CUMING EUROPE N.V., Oevel, Belgium

NEW LITERATURE



Solid-state choppers

Describing a complete line of solid-state choppers, a 62-page catalog presents electrical and mechanical specifications, test data and typical applications for 30 types of these modulators. Designed to alternately connect and disconnect a load from a signal source, these solid-state devices may also be used as demodulators to convert an ac signal to dc. Solid State Electronics Corp.

CIRCLE NO. 379

MOSFET data

A new literature package on MOS field-effect transistors for switching and chopping applications is now available. It consists of a bundle of data sheets and a listing of 29 FETs with illustrated capsule-form applications. Siliconix, Inc.

CIRCLE NO. 380

Engineers are humane

Besides supplying the heartbeat for today's throbbing technology, electronic design engineers are also responsive and responsible members of society. They are often acutely aware of the problems that besiege their social world and feel that they could somehow apply their technical know-how to help solve them. A new 29-page booklet called "Solving the Crisis in Our Cities" assists the engineer in applying his "tools." It is a workbook of ideas to help him plan corporate programs designed to alleviate urban social problems. American Business Press, Inc.

CIRCLE NO. 381

EMI

**four
stage
magnetically
focused
image
intensifier
9694**

...offers an overall light gain of 10^6 with a typical background of 10^{-10} lumens/cm². (light equivalent input.)

Typical operating voltage for these conditions is 40kV. The background indicated is for a tube having alkali photocathodes.—tubes are also available with a range of S-20 cathodes for use out to 8,000 Angstroms. Input and output windows are flat Zinc crown glass, 50 mm diameter. Type 9693 is available with sapphire input window for use in the UV. Developmental types are now being made with fibre optic windows. All present types are furnished with P-11 phosphors throughout although other types of phosphors are under investigation. □ Tubes are normally supplied potted in silicon rubber and a number of variations are available. A complete package, including electromagnet, divider chain, high voltage power supply and magnet supply is offered. A permanent magnet is also available. □ An extensive technical manual, as well as useful application notes, are available on request. Write on your company letterhead to:

GENCOM DIVISION varian/EMI

80 EXPRESS STREET, PLAINVIEW, N. Y. 11803
TELEPHONE: (516) 433-5900

INFORMATION RETRIEVAL NUMBER 112
ELECTRONIC DESIGN 15, July 19, 1969



Active filter note

Capable of providing simultaneous low-pass, high-pass, and band-pass outputs, a hybrid IC universal active filter is the subject of a new application note. The publication describes several potential applications in depth and also includes design curves and formulae to allow the design engineer to best utilize the performance advantages of the active filter. Kinetic Technology, Inc.

CIRCLE NO. 382

Semiconductor products

A 20-page semiconductor catalog describes a wide variety of power semiconductor devices, ranging from the largest commercially available single-chip transistor to low-cost rectifier assemblies. The catalog includes specifications, charts and dimensional diagrams for power transistors, thyristors, and rectifiers. It also describes rectifier and thyristor assemblies for a wide range of circuit applications. Westinghouse Electric Corp.

CIRCLE NO. 383

Lamp literature

Four revised and updated lamp catalogs and a separate index listing more than a thousand miniature, subminiature, sealed-beam and glow lamps are now available. More application information and simplified format highlight the revised catalogs. The index pin-points exactly where to find a given lamp in its proper catalog. General Electric Miniature Lamp Dept.

CIRCLE NO. 384

The
Trend
is TTL.

SN7496N MSI 5-bit shift register
**3 WEEKS
AHEAD**
(Same day shipment on 250 pieces or less)



Faster deliveries on all TTL circuits—made possible by greatly expanded manufacturing capability. Get full information on the IC types *you* need. Call your TI representative—*now!*

TEXAS INSTRUMENTS
INCORPORATED

LOW PROFILE IC PACKAGING SOCKET

Directly interchangeable! Exclusive socket configuration, identical to IC package, saves time, simplifies mounting on P C board.

- Permits card stacking on 1/2" centers
- Accepts packages with flat or round leads
- Easy IC insertion with wiping type beryllium copper contacts
- Easy extraction, minimum lead damage—optional extractor tool available
- Available in diallyl phthalate or black phenolic with gold or tin-plated contacts
- Dimensions .79 L x .49 W x .31 H

Request Data Sheet 166.

AUGAT

INC. 31 PERRY AVE., ATTLEBORO, MASS. 02703

INFORMATION RETRIEVAL NUMBER 113

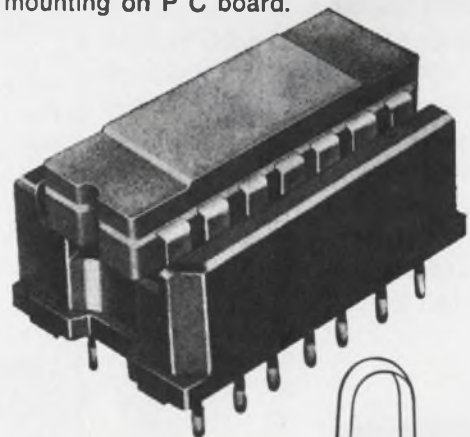

Extractor tool

family of computers

COMPUTER AUTOMATION ANNOUNCES FAMILY OF COMPATIBLE COMPUTERS

Computer Automation has announced a family of four compatible computers including its two current models. All four machines are termed Programmed Digital Controllers but are in fact full-fledged binary, parallel, control computers. The company has placed heavy emphasis on reliability, ease of programming and memory efficiency. Reliability is stressed since the computers are designed for on-line systems where down time can be extremely costly.

Since programming cost is sometimes greater than the hardware purchase price, the company has designed the machines for the programmer. Powerful, meaningful and flexible instruction sets reduce the programmer's task to a minimum.

Core memory efficiency is meaningful since about half the mainframe cost is memory. All four machines are organized to make maximum use of core. Comparisons against other mini-computers have shown the Controllers require as little as half the memory for the identical task. Of the four machines, two are sixteen-bit units and two are eight-bit units. All units use identical peripheral adapters interchangeably. Software compatibility exists between the two eight-bit units and between the two sixteen-bit units. Mainframe prices (4K core) start at \$4,990 and go to \$13,000. Deliveries range from off-the-shelf to 120 days.



COMPUTER AUTOMATION, INC.
895 W. 16th St., Newport Beach, Calif. 92660
Telephone (714) 642-9630

INFORMATION RETRIEVAL NUMBER 114

NEW LITERATURE



MOS LSI arrays

"Micromosaic Arrays . . . an MOS Approach to Custom LSI" is a 28-page design handbook that contains a complete explanation of the 3400 Micromosaic array capability. The text is devoted to descriptions of custom array organization, computer-aided design procedures, customer interface, array logic elements, logic symbols, and Fairsim (digital simulation program) formats. Other subjects include array compatibility, high- and low-threshold circuits, applications, packaging, and testing arrays. Fairchild Semiconductor.

CIRCLE NO. 385

Servicing HV sources

The latest issue of "Tekscope" tells how to troubleshoot high-voltage power supplies. Illustrated with block diagrams and schematics, the section first describes the problem and then the remedy. Also included are specifications and suggested applications for several graphic computer terminals. Tektronix.

CIRCLE NO. 386

Labels and nameplates

Color coded for easy use, a 32-page catalog of stock labels and nameplates simplifies selection by grouping them according to application. Carbonless and self-adhesive labels are also shown. Ever Ready Label Corp.

CIRCLE NO. 387

VALUE-PACKED



GORDON METERS

Only Gordon Panel Meters offer you all these outstanding features:

- Sparkling clear high-impact Lexan® covers for optimum visibility, protection
- Classic D'Arsonval DC mechanisms, AC rectifier type models, flush or edgewise
- Self-shielded Alnico core magnets
- Sapphire spring-backed bearings
- One-piece bridge for accurate alignment
- Easy-to-read scales, lance pointers
- Clean-room-built by GORDON to ASA standards in popular sizes and ranges
- Custom design capability, backed by over 50 years' instrument know-how
- Get the Gordon Meter value package...meters attractively priced and packed in cartons with a touch of gold!

FREE GORDON METERS CATALOG. WRITE TODAY!

PDC GORDON
A SUBSIDIARY OF

PNEUMO DYNAMICS CORPORATION
5710 KENOSHA ST., RICHMOND, ILL 60071

Export: 2200 Shames Dr., Westbury, N.Y. 11590
Cable CHURCHIN

INFORMATION RETRIEVAL NUMBER 115

ELECTRONIC DESIGN 15, July 19, 1969

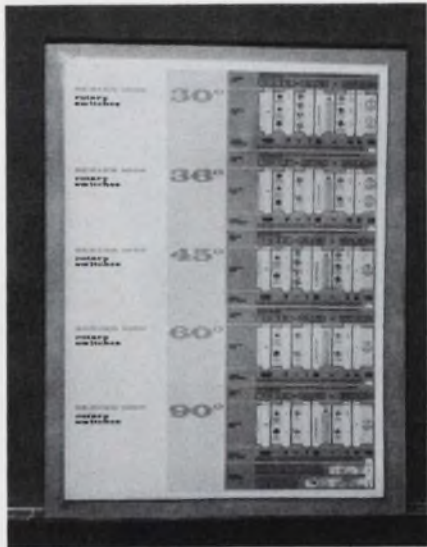

Rotary-switch guide

Five rotary-switch selection guides are provided in a new 20-page engineering catalog. Convenient pictorial-schematic diagrams aid the design engineer in visualizing and selecting proper switching circuits for his particular applications. Design guides cover 30-, 36-, 45-, 60- and 90-degree angles of throw together with variations in stops, poles, positions, decks and type contacts. Complete electrical and mechanical design data are provided for each. The ASM Corp.

CIRCLE NO. 388

Silicones news

The spring/1969 issue of "Silicones Digest" features a new silicone lubricant for ferrous, non-ferrous and bimetallic applications and silicone fluids for detergent-resistant auto polishes. Also included in this issue is an article on the growing demand for silicone-based finishes for coil coated construction panels and paints used in equipment maintenance. General Electric Co., Silicone Products Dept.

CIRCLE NO. 389

ICs and MSI arrays

A 48-page short-form catalog gives salient information on both TTL and high-speed TTL integrated circuits. It also lists compatible medium-scale integrated circuit arrays, thin-film hybrid circuits, and transistors. Sprague Electric Co.

CIRCLE NO. 390

The
Trend
is TTL.

Series 74F MSI flatpacks
**I WEEK
ARRO**
(Same day shipment on 250 pieces or less)



Faster deliveries on all TTL circuits—made possible by greatly expanded manufacturing capability. Get full information on the IC types you need. Call your TI representative—now!

TEXAS INSTRUMENTS
INCORPORATED

IT'S LOGICAL!

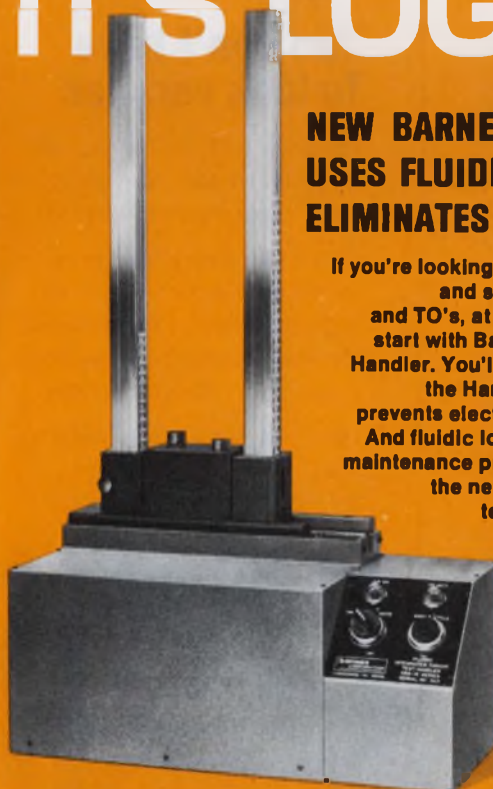

**NEW BARNES IC TEST HANDLER
USES FLUIDIC LOGIC CONTROL...
ELIMINATES ELECTRICAL NOISE!**

If you're looking for fast, interchangeable testing and sorting of flat-packs, dual-in-lines and TO's, at up to 4800 cycles an hour, better start with Barnes new Fluidic Automatic Test Handler. You'll get error-free test results, since the Handler's fully pneumatic operation prevents electrical noise and spurious signals. And fluidic logic virtually eliminates wear and maintenance problems. Used with any IC tester, the new Handler is ideal for production testing or QC inspection. Two and four-sort categories are available, with manual, magazine or vibratory bowl loading. Write for data.

barnes
CORPORATION

Lansdowne, Pa. 19050 • 215/MA2-1525

barnes / THE WORLD'S MOST COMPLETE LINE OF SOCKETS, CARRIERS AND CONTACTORS FOR I.C.'S

INFORMATION RETRIEVAL NUMBER 116

**BUILD MDS
"DATA-RECORDER
QUALITY"
INTO YOUR SYSTEMS**



MDS BUFFERED
TAPE UNIT

Transcription . . . verification . . . all the advantages of magnetic tape . . . In the MDS 701 and 901 Buffered Tape Units. These units are buffered magnetic tape transports; each providing three modes of operation . . . Write, Read and Search.
MDS 701 . . . Handles data on 7-channel tape at 200 bpi.
MDS 901 . . . Handles data on 9-channel tape at 800 bpi.
Input and output communication between a parent machine and the magnetic tape is via a program controlled buffer. The controller is your own, designed to fit your application.

Easy integration with a system is made possible through the asynchronous bit parallel, character serial interface provided with the 701 and 901. And you get the high speed, solid state electronics, quiet operation and versatility that are engineered into all MDS Data-Recorders.

Ask for: Folder file on MDS 701/901 Buffered Tape Units
FOR MORE — MEET YOUR MAN FROM MDS

MOHAWK MB
DATA SCIENCES CORPORATION
OEM MARKETING

P. O. Box 630, Palisade St., Herkimer, N.Y. 13350
Telephone 315/866-6800
Every MDS Office is an OEM Marketing Office
Digital Strip Printers • Buffered Tape Units
High-Speed and Low-Speed Line Printers
Card Punches and Readers

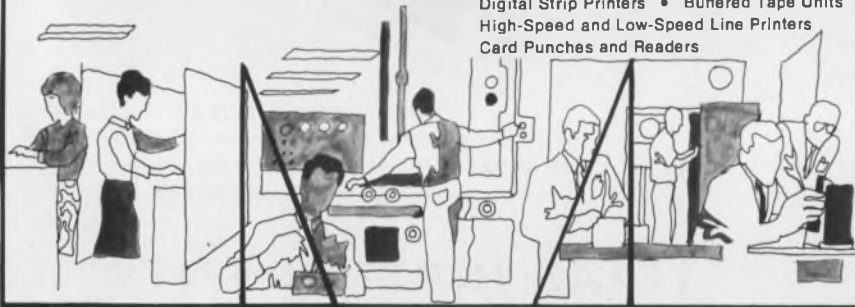

INFORMATION RETRIEVAL NUMBER 117

NEW LITERATURE



Hand tool catalog

A complete line of hand tools, comprising 144 models, is the subject of a 28-page catalog. Specifications and illustrations cover pliers, nippers, cutters, standard and aviation snips, adjustable wrenches, compound-action pliers, scissors, shears, holding forceps, chisels, punches and awls. The hand tools are forged from high-alloy steel with precision ground cutting edges. Boker Manufacturing Co., a sub. of The New Britain Machine Co.

CIRCLE NO. 391

EXCELLENT FREQUENCY RESPONSE FERRITE
AT 1 MEG PLUS — DENSE ENOUGH TO
AFFORD GEM-LIKE MICROFINISHES

Contact Us



ceramic magnetics, inc.

87 FAIRFIELD ROAD • FAIRFIELD, N. J. 07006 • (201) 227-4222

**Looking for
a great vacation?
You don't have
to look very far.**

America with all its natural and man-made marvels is right in your own backyard.

You'll find everything from historical monuments, mile-high mountains, sand-duned deserts, bustling cities—and more. The natives, friendly.

America. It's a great place to visit, and aren't you glad you live here.



Space Contributed By
Hayden Publishing Company, Inc.

CIRCLE NO. 392

Plastic IC reliability

A reliability report on transfer-mold encapsulation of integrated circuits tells of the environmental and life test results of various combinations of possible materials. In addition, a complete description and step-by-step flow chart of the molded encapsulation process is given. Quality control and production screening is explained, as well as what the future holds for the molded package in the way of continuing reliability programs, new product qualifications, step stress testing, and ultimate military qualification. National Semiconductor Corp.

CIRCLE NO. 393

Radio equipment

Radio communication accessories as well as base and mobile equipment are the subject of a 26-page brochure. Data on various types of antennas, speakers, microphones and control consoles is presented. Motorola Communications & Electronics, Inc.

INFORMATION RETRIEVAL NUMBER 118



LOCK WASHERS
SHAKEPROOF

FABRICATING, RESEARCH, DEVELOPMENT AND PRODUCTION HEADQUARTERS

Lock washers

Revised and comprehensive, a 32-page lock-washer catalog covers such areas as choosing the right lock washer, standard types and sizes, as well as information on specials. Standard lock-washer types include: external, internal, heavy-duty internal, countersunk, external-internal, dome, dished and pyramidal. Special types are cup washers, folded rim pipe, tab, locking plate, irregular hole, and sealing lock washers. Shakeproof, Div. Illinois Tool Works Inc.

CIRCLE NO. 394



Precision gears

A 256-page catalog lists over 15,000 precision gears with pitches ranging from 16 to 120 and bores from 1/8 to 1/2 inch in diameter. Materials can be stainless steel, aluminum, nylon, urethane, phenolic or bronze. Winfred M. Berg, Inc.

CIRCLE NO. 395

The
Trend
is **TTL.**

Series 54H 6 ns TTL (flatpacks or ceramic DIP)
**4 WEEKS
AHEAD**
(Same day shipment on 250 pieces or less)



Faster deliveries on all TTL circuits—made possible by greatly expanded manufacturing capability. Get full information on the IC types *you* need. Call your TI representative—*now!*

TEXAS INSTRUMENTS
INCORPORATED

**Communications
Engineers**

Immediate openings for solid state electronics engineers to design circuitry of over-all systems for transmitting and receiving.

Position involves new business proposals for advanced missile programs and offers the opportunity to work beyond the state of the art. Must have the ability to translate knowledge into practical hardware. A B.S. required plus minimum of four years' experience, M.S. preferred.

Receiver Design

Establish solid state receiver component specifications for RF Filters, pre-amps, mixers, local oscillators and detector elements. Knowledge of AGC Loop and Signal Compression Techniques and small volume packaging required.

Transmitter Design

Circuit design, RF amplifiers, modulator and frequency synthesis. Design of transmitter systems for phased array and frequency diversity.

For further information please write Mr. H. W. Bissell, Professional Placement Manager, P.O. Box 504, Sunnyvale, California 94088. An equal opportunity employer.

LOCKHEED
MISSILES & SPACE COMPANY
A GROUP DIVISION OF LOCKHEED AIRCRAFT CORPORATION

INFORMATION RETRIEVAL NUMBER 901

Free Career Inquiry Service

Absolutely Confidential

Respond to the career opportunities advertised in this issue. Fill out and send us this handy resume. **Electronic Design** will do the rest – neatly typed copies of this form will be mailed to the companies of your choice, indicated by the circled Career Inquiry Numbers at the bottom of this page.

15

Name		Home Phone	
Home Address (Street)		City	State
			ZIP Code
Age	U.S. Citizen	Security Clearance	
	<input type="checkbox"/> Yes <input type="checkbox"/> No		

Prime Experience	Secondary Experience

Desired Salary	Availability Date
-----------------------	--------------------------

Employment History – present and previous employers

Company	City, State	Dates	Title
		to	
		to	
		to	

Education – indicate major if degree is not self-explanatory

Degree	College	City, State	Dates
			to
			to
			to

Additional Training – non-degree, industry, military, etc.

Professional Societies

Published Articles

Career Inquiry Numbers:

900	901	902	903	904	905	906	907	908	909	
910	911	912	913	914	915	916	917	918	919	925

ELECTRONIC DESIGN
 850 Third Avenue
 New York, New York 10022

VIDEO CIRCUIT DESIGNERS *Colorado Opportunity!*

Career opportunities are available for qualified engineers to assume responsibility for the design of circuits for cameras and displays. A familiarity with camera tubes, image intensifiers and CRTs is desired. BS-MSEE or equivalent required.

Other opportunities exist in the area of
VIDEO SYSTEMS DESIGN

Our engineers and scientists enjoy a working environment in which creativity, innovation and imagination are encouraged. The technical challenge they find at work is complemented by the unsurpassed recreational environment of Colorado. Excellent climate: fishing, skiing, hunting, hiking, cultural activities, proximity to a metropolitan area, and an excellent University within a ten minute drive are among the many advantages of living in Boulder. And, we offer four weeks annual vacation to our professional employees — time to enjoy Colorado!

Please send your resume, in confidence, to our Employee Relations Dept.:

BALL BROTHERS RESEARCH CORP.

**BOULDER INDUSTRIAL PARK
BOULDER, COLORADO 80302**

An Equal Opportunity Employer

BBRC



INFORMATION RETRIEVAL NUMBER 902

the MINI-MAXI



MP32

Miniature size... Maximum dependability



ACTUAL SIZE

The Minelco MP32 miniature trimmer potentiometer is a tiny $\frac{3}{16}$ " x $\frac{5}{16}$ "! Fits easily into the latest design concepts of modular printed circuit board stacking. With new "Posi-Weld" termination that eliminates the unreliable single-wire termination. Available in standard resistance ranges from 10 ohms through 20K ohms...special intermediate resistances on request.

Write for specifications and additional information on MP32 and other Minelco miniature electronic components.

MINELCO

600 SOUTH STREET, HOLBROOK, MASS. 02343 • (617) 963-7717

INFORMATION RETRIEVAL NUMBER 119

ELECTRONIC DESIGN 15, July 19, 1969

VIDEO RECORDER ENGINEERS

Arvin Industries

has established a new development laboratory at Lake of the Pines, near Grass Valley in the Sierra foothills in California. We have an immediate need for engineers to fill important ground-level positions working on development of a very sophisticated consumer color video tape recorder.

TAPE TRANSPORT DYNAMICS ENGINEER

This is a particularly challenging and rewarding job for a man who has had several years' experience in design and analysis of transport mechanisms. We need a man who understands the physical mechanics of tape transport systems and who can establish design criteria through experimental techniques. Knowledge of electronic measurement of dynamic phenomena is essential.

CONTROL LOGIC ENGINEER

A second position requires experience in design of control systems including operational linkages, fail-safe logic systems and associated control mechanisms. We need a man who can assume full system responsibility.

CIRCUIT DESIGN ENGINEERS

We will need several engineers this summer, men who have experience in or capability for design of solid state color video signal processing circuits, or who are experienced in color video cameras.

We have a completely new laboratory, located in the famous Mother Lode Country of California's Sierra foothills, a convenient 2 hour drive from San Francisco. We are an hour away from great skiing, even nearer hunting and fishing.

If you qualify for one of these positions, we would like to hear from you. We will treat your inquiry in strict confidence. Address your letter to: Jim Roder, at

ARVIN INDUSTRIES

Color Video Recording Development Laboratory
P.O. Box 1031, Grass Valley, California 95945
an equal opportunity employer

INFORMATION RETRIEVAL NUMBER 903

ELECTRONIC DESIGN'S function is:

- To aid progress in the electronics manufacturing industry by promoting good design.
- To give the electronic design engineer concepts and ideas that make his job easier and more productive.
- To provide a central source of timely electronics information.
- To promote two-way communication between manufacturer and engineer.

Want a subscription? ELECTRONIC DESIGN is sent free to qualified engineers and engineering managers doing design work, supervising design or setting standards in the United States and Western Europe. For a free subscription, use the postfree application form inside the back cover. If none is included, write to us direct for an application form.

If you do not qualify, you may take out a paid subscription for \$25 a year in the U.S.A., \$35 a year elsewhere. Single copies are \$1.50 each.

If you change your address, send us an old mailing label and your new address; there is generally a prepaid postcard for this inside the back cover. You will have to requalify to continue receiving ELECTRONIC DESIGN free.

The accuracy policy of ELECTRONIC DESIGN is:

- To make reasonable efforts to ensure the accuracy of editorial matter.
- To publish prompt corrections whenever inaccuracies are brought to our attention. Corrections appear at the end of the Letters column.
- To refuse any advertisement deemed to be misleading or fraudulent.

Microfilm copies are available of complete volumes of ELECTRONIC DESIGN at \$19.00 per volume, beginning with Volume 9, 1961. Work is now in process to complete the microfilm edition of Volumes 1-8. Reprints of individual articles may be obtained for \$2.00 each, prepaid (\$.50 for each additional copy of the same article) no matter how long the article. For further details and to place orders, contact the Customer Services Department, University Microfilms, 300 North Zeeb Road, Ann Arbor, Michigan 48106; telephone (313) 761-4700.

Want to contact us? If you have any comments or wish to submit a manuscript or article outline, address your correspondence to:

Howard Bierman, Editor,
ELECTRONIC DESIGN,
850 Third Avenue,
New York, N.Y. 10022.

Design Data from

Clamp or Tie Wire Bundles In Seconds!



Six-page catalog contains complete ordering information for CAB-L-TITE® clamps and BUND-L-TITE® straps, devices which provide a fast and reliable means of securing wires and wire bundles. Units withstand loadings greater than 50 G's, are removable in seconds for re-routing wires, and are self-locking—no tying, no knots, no hitches to come loose. Lightweight Du Pont Zytel meets MIL-P-17091 and MIL-P-20693. Proved in aircraft and missiles. Photos, dimensional drawings, tables, physical properties, specifications, price list. Request catalog A.

Dakota Engineering, Inc.
4315 Sepulveda Blvd.
Culver City, California 90230

174

A FREE Cross Reference Guide



to better Printed Circuit drafting

No engineer or draftsman should be without the NEW By-Buk Printed Circuit Drafting Aids P-45 Catalog with color-coded MIL-SPEC sizes. Also contains over 2000 pads, shapes, tapes, transistor tri-pads, spaced integrated circuit terminal pad sets and many other drafting aids for faster, more accurate, distortion-free printed circuit master drawings. Send for your FREE catalog.

By-Buk Company

4326 West Pico Blvd., Los Angeles, Calif. 90019
Telephone: (213) 937-3511

175

FUNDAMENTALS OF INTEGRATED CIRCUITS

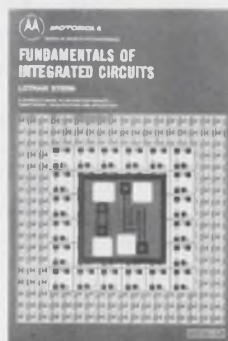

A practical guide to integrated circuits, their theory, manufacture, and applications. This new guide by Lothar Stern offers complete, highly readable coverage of the various techniques of circuit fabrication, and their effect on circuit design and performance. As to marketing considerations, it compares the characteristics of the numerous IC structures devised to date in terms of economics and logistics. A volume in the **Motorola Series in Solid-State Electronics**. 198 pages, 7 x 10, illustrated. \$8.95, clothbound. Send for 15-day examination copies.

Hayden Book Company, Inc.
116 West 14th Street
New York, N.Y. 10011

176

Manufacturers

Advertisements of booklets, brochures, catalogs and data sheets. To order use Reader-ServiceCard (Advertisement)

FREE — Bulova Servo Products '69 Short-Form Catalog



Here's the latest in Servo Product Capability . . . from a full line of AC Servo Amplifiers (ranging from 3.5 to 50 watts of output power) to a newly-designed series of DC Torquer Amplifiers (up to 300 watts in standard types). Includes complete electrical and physical spec information on a line of off-the-shelf standard items, Resolver Amplifiers, Modulators and Demodulators (400 Hz - 800 Hz), DC Torquer Amplifiers and AC to DC Power Supplies. For the circuit designer who has servo loop requirements, this Bulova Servo Products Catalog will provide him with a quick product guide.

BULOVA Servo Products
Electronics Division of the Bulova Watch Company
61-20 Woodside Avenue
Woodside, N. Y. 11377

177

Bus Bars For Noise Reduction

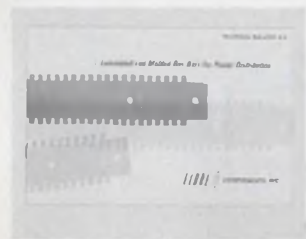

A 16 page Technical Bulletin is now available, describing a new concept in power or signal distribution. Basic mechanical and electrical design principles, along with descriptive pictures and diagrams, are included in this bulletin. These compact buses can replace bulky cable harnesses and repetitive wiring for computer or modular application. This method of construction satisfies the demanding requirements of low inductance and resistance of high speed, solid state systems, while controlling electrical noises.

Send For Free Sample

Eldre Components, Inc.
1239 University Avenue
Rochester, New York 14607

178

How To Write Technical Articles



A guide for the engineer-author, "How to Write Articles for Electronic Design" shows how easy it is to write for publication—once the engineer knows what to write and how to write it. The Author's Guide includes a complete run-down of the types of articles published by Electronic Design—plus detailed instructions on how to prepare technical articles and short special features. A **MUST** for every "would-be-writer" in the electronics industry. Send for your complimentary copy by circling the number to the right.

Electronic Design
850 Third Avenue
New York, N.Y. 10022

179

Electronic Design

Advertising Sales Staff

New York 10022

Edward F. Clancy
Sales Service Manager
Robert W. Gascoigne
Thomas P. Barth
Samuel M. Deitch
Byron K. Adams
850 Third Avenue
(212) Plaza 1-5530
TWX: 710-581-2874

Philadelphia 19066

William C. Repetto
P. O. Box 206
Merion Station, Pa.
(215) MA-3-5888

Boston 01945

Richard Parker
P.O. Box 645
Clifton Station
Marblehead, Mass.
(617) 742-0252

Chicago 60611

Thomas P. Kavooras
Berry Conner, Jr.
200 East Ontario
(312) 337-0588

Cleveland

Thomas P. Kavooras
(Chicago)
(312) 337-0588
(call collect)

Los Angeles 90303

Stanley I. Ehrenclou
John V. Quillman
W. James Bischof
2930 Imperial Highway
Inglewood, Calif.
(213) 757-0183

San Francisco 94022

Arthur R. Shields, Jr.
175 San Antonio Rd., S 243
Los Altos, Calif.
(415) 941-3084

London W. 1

For United Kingdom & Holland
Brayton C. Nichols
44 Conduit Street
Tel: REGent 4714

Verviers, Belgium

For Continental Europe
Andre Jamar
1, Rue Mallar, 1
(087) 253.83 Telex 41563

Tokyo

Yoshiro Takemura
IPS Group Ltd.
Box 36, Ohsaki Post Office
Phone (504) 1485
Cable Joshplans, Tokyo



AMERICAN BUSINESS PRESS, INC.



WANT LOW-COST d-c POWER?



Model PR 15-30M

KEPCO'S GOT IT!

Check out Kepeco's line of partially regulated (PR) power supplies. They feature the Kepeco ferroresonant power transformer "Flux-O-Tran"® for low cost, 1% line regulation.

MODEL	VOLTS	AMPS	PRICE
PR 15-10M	0-7.5-15	0-10	\$378.00
PR 15-30M	0-15	0-30	552.00
PR 38-5M	0-19-38	0-5	357.00
PR 38-15M	0-38	0-15	520.00
PR 80-2.5M	0-40-80	0-2.5	357.00
PR 80-8M	0-80	0-8	499.00
PR 155-1M	0-78-155	0-1	357.00
PR 155-4M	0-155	0-4	473.00
PR 220-3M	0-220	0-3	473.00
PR 310-0.6M	0-165-310	0-0.6	378.00
PR 310-2M	0-310	0-2	473.00

If you have 3Φ power you can get up to 2 kW at about 50 cents per watt.

MODEL	VOLTS	AMPS	PRICE
PR 20-100AM	0-20	0-100	\$1,103.00
PR 40-50AM	0-40	0-50	940.00
PR 50-40AM	0-50	0-40	940.00

For complete specifications
write Dept. CG-05



131-38 SANFORD AVE. • FLUSHING, N.Y. 11352
(212) 461-7000 • TWX # 710-582-2631
INFORMATION RETRIEVAL NUMBER 123

Advertisers' Index

Advertiser	Page	Advertiser	Page
ACDC Electronics, Inc.	67	IMC Magnetics Corporation	122
Abbott Transistor Laboratories Incorporated	16	ITT Cannon Electric, A Division of International Telephone and Telegraph Corp.	144B, 144C
Acopian Corporation	116	International Electronic Research Corporation	64, 65
Adams & Westlake Company, The	143	Kepeco, Inc.	174
Allen-Bradley Co.	23	Lear Siegler Inc., Cimron Division	111
Atec, Inc.	130	M & T Chemicals, Inc.	141
Augat, Inc.	165	Magnetics, Inc.	157
Babcock Relays, Division of Babcock Electronics Corporation	57	Mallory Capacitor Company	155
Ball Brothers Research Corp.	171	Marconi Instruments Division of English Electric Corporation	12
Barnes Corporation	167	Metrodata Systems, Inc.	128
Beckman Instruments, Inc., Helipot Division	13	MicroSwitch, A Division of Honeywell	88, 89
Bell & Howell	132	Midtex, Incorporated Aemco Division	51
Bell Telephone Laboratories	139	Miller Company, J. W.	134
Bourns, Inc.	33, 109	Minelco	171
Bourns Technical Materials	163	Mohawk Data Sciences Corporation	168
Buckbee Mears Co.	175	Molex Products Company	69
Bulova Servo Products Electronics, Division of Bulova Watch Company	173	Monsanto Company	50, Cover III
Burns & Towne, Inc.	56	Motorola Semiconductor Products, Inc.	14, 49
Burr-Brown Research Corporation	68	National Semiconductor Corporation	60, 61
By-Buk Company	172	Oak Manufacturing Co.	145
Ceramic Magnetics, Inc.	168	Parelco, Inc.	148
Chicago Switch, Inc.	141	Philco-Ford Corporation	72
Cinch-Graphik	120	Pomona Electronics Co., Inc.	158
Cinch Nu-line, A Division of United-Carr	95	Potter & Brumfield Division of American Machine & Foundry Company	30, 31
Clevite Corporation, Brush Instruments Division	115	Power/Mate Corp.	52
Clevite Corporation, Burgess Battery Division	16B	RCA Electronic Components and Devices	Cover IV
Clevite Corporation, Piezoelectric Division	175	Rtron Corporation	162
Collins Radio Company	63	Schweber Electronics	17
Columbia Components Corp.	53	Shaffstall Ball Corporation	145
Computer Automation, Inc.	166	Signetics Corporation	27
Computer Products	144D	Siliconix Incorporated	15
Corning Glass Works, Electronic Products Division	36, 37	Simpson Electric Company	151
Curtis Development & Mfg. Co.	137	Singer Company, The Friden Division	135
Cutler-Hammer	125	Solitron Devices, Inc.	147
Dana Laboratories, Inc.	107	Sonotone Corporation, Battery Division	70
Dakota Engineering, Inc.	172	Sprague Electric Company	18, 20
Dale Electronics, Inc.	137	Stackpole Carbon Company	153
Damon Engineering, Inc.	24	Stackpole Components Company	152, 133
Dana Laboratories, Inc.	107	Slaco, Incorporated	158
Dearborn Electronics, Inc.	124	Starrett Company, The L. S.	159
Delta Products, Inc.	156	Stewart Warner Microcircuits Inc.	73
Du Pont Company	62	Sylvania Electric Products, Inc., Electronic Components Group	127
EG&G, Inc.	58	Synco Capacitor Corporation	175
ESI Electro Scientific Industries, Inc.	54, 55	Systron-Donner Corporation	2
Eastman Chemical Products, Inc.	138	TRW, Inc., Globe Industries Division	Cover II
Edal Industries, Incorporated	150	Technical Wire Products, Inc.	149
Eldre Components, Inc.	173	Teledyne Relays, A Teledyne Company	7
Electrical Insulation Conference	145	Telonic Instruments, A Division of Telonics Industries, Inc.	146
Electro Tec Corp.	154	Texas Instruments Incorporated, Components Group	82, 83, 163, 165, 167, 169
Electronic Design	121	Transistor Devices, Inc.	129
Electronic Engineering Co. of California	126	Transitron Electronic Corporation	6
Emerson & Cuming, Inc.	164	Trio Laboratories, Inc.	8, 9
Erie Technological Products, Inc.	16A	Unitrode Corporation	29
Exact Electronics, Inc.	141	Wanlass Electric Co.	149
Fairchild Semiconductor, A Division Fairchild Camera and Instrument Corporation	113	Wavetek	161
Fluke Mfg. Co., Inc., John	119	Y-Lab	136
Garrett Corporation, Airesearch Division	162	Career Advertising	
Gencom Division, Varian EMI	164	Arvin Industries	171
General Electric Company, Electronic Components	46, 123, 131	Ball Bros. Research Corp.	171
General Electric Company, Electronic Capacitor and Battery Dept.	10	Lockheed Missiles & Space Company	169
General Electric Company, Miniature Lamp Dept.	142		
General Instrument Corporation	104, 105		
General Radio Company	71		
Gordon, a Subsidiary of Pneumo Dynamics Company	166		
Gries Reproducer Corp.	149		
Hayden Book Company, Inc.	172		
Hewlett-Packard	1, 11, 74, 75, 76, 133, 140, 144A		
Honeywell Test Instrument Division	4, 5		

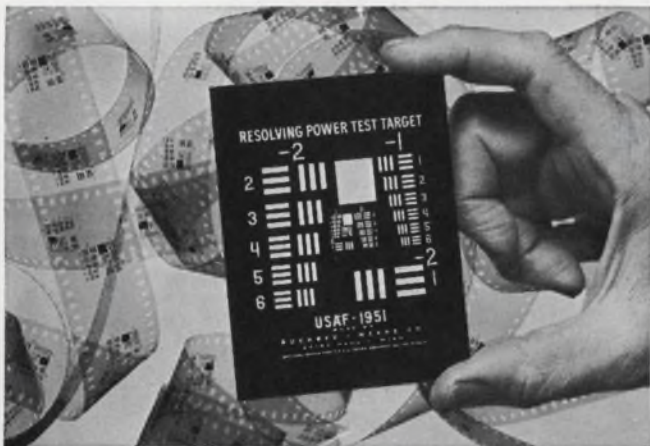

RESOLVING POWER TEST TARGETS

Resolving Power Test Targets have been designed and produced for U.S.A.F. under contract, for American Standards Association Resolution Chart and National Bureau of Standards Microcopy Resolution Test Chart . . . High and low resolution targets are available — low targets in high, medium and low contrast. Special Resolution Chart Targets are made on 35 mm film in 20 foot rolls. Specialized targets to custom specification. Send us your requirements in sketch or blue print — we will rush quote.



**BUCKBEE - MEARS
COMPANY**

245 E. 6th St., St. Paul, Minn. 55101 / (612) 227-6371

INFORMATION RETRIEVAL NUMBER 124

**Need an extra
source for
Dry Electrolytic
Capacitors?**

SYNCRO
may be your answer
(Electrolytics are all we make)

Which means we do a specialized custom job of supplying customer needs. Engineering assistance. Please furnish complete specifications when requesting quotations and/or samples.



WRITE FOR CATALOG!

1081

SYNCRO Capacitor Corporation

HICKSVILLE, OHIO 43526 • (419) 542-2711 • TWX 810-490-2550

INFORMATION RETRIEVAL NUMBER 125

ELECTRONIC DESIGN 15, July 19, 1969

Going to IC's? Or Higher IF's?

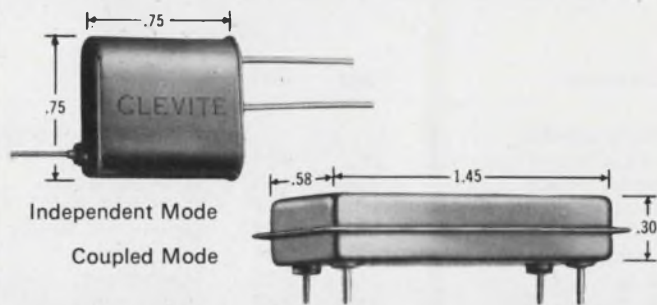

Go two ways with Monolithic Quartz Uni-Wafer® Filters

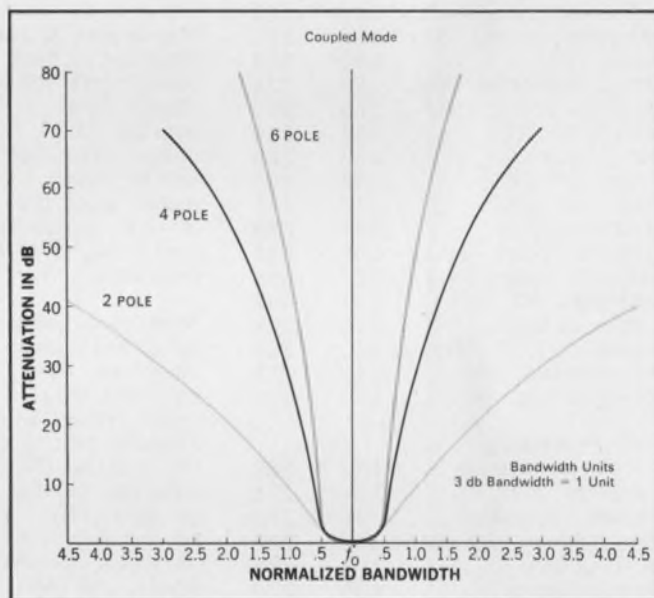

Go independent mode. Go coupled mode. You can go either mode with monolithic Clevite Uni-Wafer® filters. They're smaller and more reliable (fewer interconnections) than conventional filters.

Clevite Uni-Wafer filters are ideal for matching IC circuitry in communications receivers operating in the VHF and UHF frequency ranges as well as in telemetry, radar and aerospace systems.

They are 2, 4 and 6 pole crystal filters with a choice of center frequencies ranging from 8 MHz to 75 MHz. They've been developed using Clevite's advanced engineering techniques and Clevite's original thin film approach to quartz filters. In this concept, arrays of resonators are achieved on a single quartz wafer with resonator isolation and spurious suppression controlled by the trapped energy principle.

So if you're going to IC's or higher IF's, go Clevite Uni-Wafer filters. They're available in both independent and coupled mode.

For more information and complete specification data, write: Clevite Corporation, Piezoelectric Division, 232 Forbes Road, Bedford, Ohio 44146.

CLEVITE

INFORMATION RETRIEVAL NUMBER 126



**This counter fell off a plane.
It didn't need service
(but when one does, we're ready).**

This Model 100A Counter-Timer was enroute to a customer. A freight handler laid it on the wing of the airplane—and forgot it. The package finally slid off as the wheels left the runway. Instantly freed of its container, the “Small Wonder,” as our customers sometimes call it, chased the plane for about a hundred yards, then ground-looped.

Our nearby Service Center, bored with inaction, brightened at the thought of a real challenge when it was brought in. But they were disappointed: electrically, the “Small Wonder” picked up right where it left off in Final Inspection. (Of course, *mechanically* there were a few abra-

sions to take care of, as you can see.)

Please help us keep our 37 Service Centers with their factory-trained technicians alive and well. Call the one nearest you anytime you feel that a Monsanto instrument requires service or calibration... or even verification of its performance. In addition to their expertise and factory specified test equipment, all carry a complete stock of spare parts. If there should be a defect in materials or workmanship during the 2-year warranty period, it won't cost you anything.

Monsanto Company, Electronic Instruments, West Caldwell, New Jersey 07006.

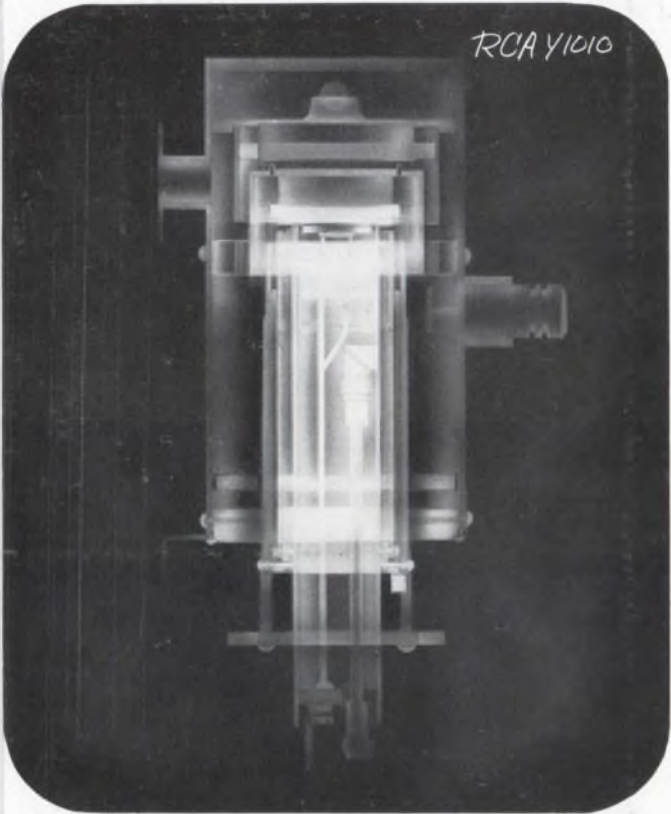
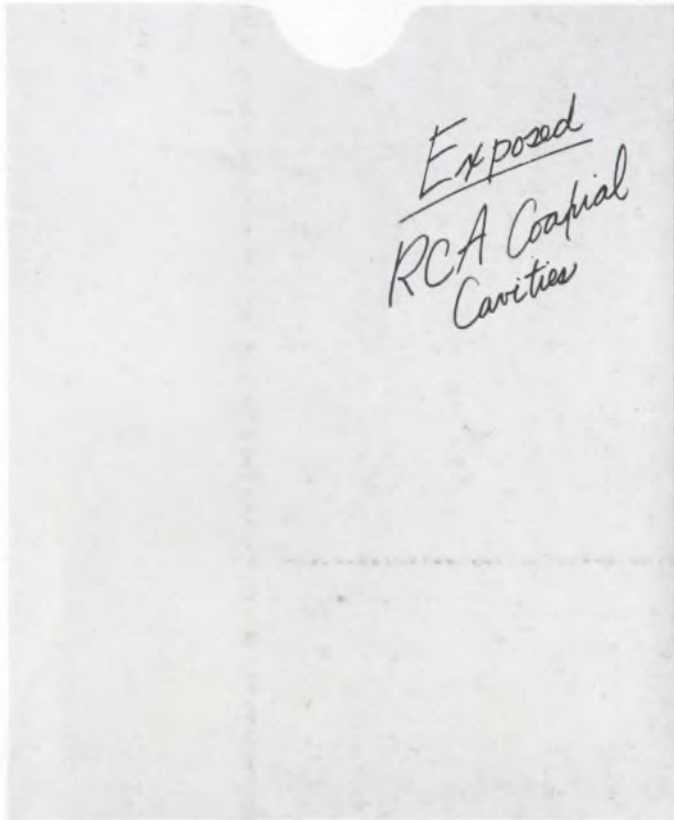

Now—continuing its leadership in the development of electronic products—RCA announces a complete range of coaxial cavities to assure optimum performance from its line of CERMOLOX® Power Tubes.

Suitable for use either as complete amplifiers or as oscillators, these cavities assure specified performance with fully engineered circuitry, minimum RF losses, simplified connections, and high overall efficiency.

To fulfill your requirements, cavities are available for frequencies up to L-band and powers up to 10 kW.

The performance, reliability, and efficiency of CERMOLOX tubes have been proved. This line of cavities will augment and assure these benefits. In addition, if your requirements call for special parameters, our Application Engineers will gladly modify existing cavities or develop new ones to assure you of optimum equipment performance.

For more information on RCA coaxial cavities and RCA CERMOLOX Tubes, see your local RCA Representative. For technical data on specific types, write: RCA Electronic Components, Commercial Engineering, Section G-18T-3, Harrison, N. J. 07029.

RCA Coaxial Cavities—Available Off-the-Shelf

RCA TYPE	TUBE	POWER OUTPUT (Watts)	MODE	FREQUENCY (MHz)
Y1010	8226	100	CW	1170
Y1044	8501	10,000	pulse	400
Y1050	7651	5,000	pulse	500
Y1051	8227	450	pulse	500
Y1052	8227	400	pulse	350
Y1054A	7651	5,500	pulse	150
Y1059	7214	12,500	pulse	150
Y1070	7651	6,500	pulse	200
Y1086	7651	375	pulse	200

