

Electronic Design

VOL. 17 NO.

9

FOR ENGINEERS AND ENGINEERING MANAGERS

APRIL 26, 1969

Have a load of data to send? For quantities like this, over a short distance, your best bet is probably a truck. But under less extreme circumstances, electronic

communication provides a better way. For a look at the rapidly growing fields of data communication and digital transmission, see the report starting on p. C1



They're on our shelf



The "special" audio transformers you need are "standard" at UTC.

When you're ready to specify transformers and inductors, before you turn to costly specials, check UTC. Chances are there's a *standard* unit that fits your special electrical and mechanical requirements exactly.

UTC has over 500 audio types in stock, ready for immediate delivery. And UTC engineers are constantly adding to the line. Microwatts to kilowatts. Less than $\frac{1}{4}$ Hz to greater than 1 MHz. MIL-T-27 or industrial. Metal-encased or open frame. Input, output, mixing, matching, modulating, phase shifting, hybrid.

baluns, ring modulator. All in continuous production for sample or high-volume requirements.

If the specific unit you need isn't on our shelf, we'll tailor a standard unit to your special requirements—saving the time and costs of starting from scratch. Check your local distributor for immediate off-the-shelf delivery. For catalog, write: United Transformer Company, Division of TRW INC., 150 Varick Street, New York, N.Y. 10013.

TRW
UNITED TRANSFORMER COMPANY

The Fog Cutter...

Sees through noise! When you need to cut through the fog of random noise, use the HP 3410A AC Microvoltmeter. This instrument measures 300 nanovolt repetitive signals buried in noise. You can measure $3 \mu\text{V}$ to 3 V full scale—with an accuracy of $\pm 3\%$ —over a frequency range of 5 Hz to 600 kHz. RMS noise voltages up to 20 dB above full scale have no effect on readings.

Simply adjust the front panel tuning control within 1% of signal frequency and phase-lock circuits

lock-on the input to separate the signal from the random noise. The 3410A remains locked on an input signal which has as much as $\pm 5\%$ frequency variation. The phase-lock circuits accommodate a 0.5%/sec change in signal frequency, without a change in voltmeter accuracy.

The meter has two outputs on the rear panel—one is a dc recorder output for monitoring long-term drifting ac voltage amplitudes. The other

output drives an electronic counter for precise frequency measurements.

Clear the fog out of your low level repetitive signals. Get full specifications on the HP 3410 AC Microvoltmeter from your nearest HP field engineer. Or, write to Hewlett-Packard, Palo Alto, California 94304. Europe: 1217 Meyrin-Geneva, Switzerland. Price HP 3410A, \$875.

099/5

HEWLETT  PACKARD
ANALOG VOLTMETERS

Measure 10 mV, 5 Hz amplitude modulating 1 V, 400 Hz.



Measure $1 \mu\text{V}$, 500 kHz signal out of 40 dB noise.

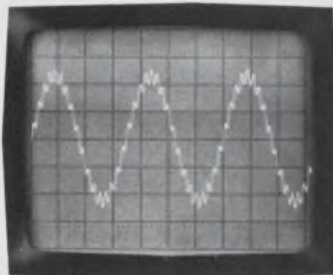
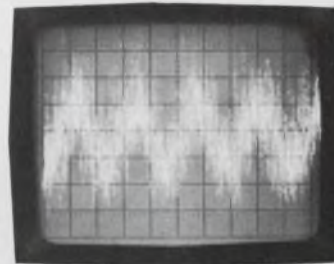

Measure 300 nanovolts, 10 kHz signal superimposed on $10 \mu\text{V}$, 1 kHz.

Measure frequency of signal in noise up to 560 kHz by using square wave output, i.e. as a counter preamplifier.

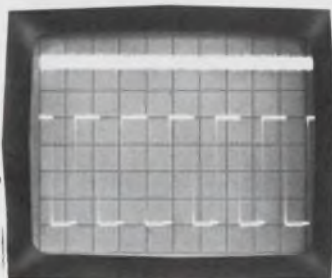

INFORMATION RETRIEVAL NUMBER 2



Put time on your tape for \$1495 ...and read it too!

New Model 8350 generates and reads serial time code with unprecedented economy. Enables you to find recorded data at search speeds up to 250 times the recording speed. Displays real time when recording and recorded time when searching. Takes only half the rack space usually occupied by generator/readers.

Tapes containing high noise or flutter can be searched reliably, because Model 8350 will disregard as many as three consecutive garbled time frames and will compensate for brief signal drop-outs.

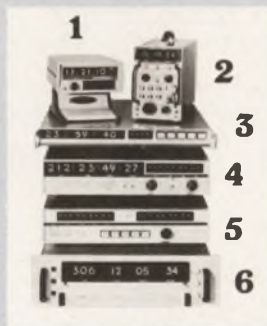

Systron-Donner produces a complete line of time code equipment built with modern integrated circuits. Shown in the photo at left are: 1. Digital clock with BCD output and time stability of 2 parts in 10^6 per month. 2. Battery-powered time code generator for field use. 3. Model 8350 described above. 4. Generator/reader with switch selection of six different codes. 5. Bi-directional tape search control for automatic data location. 6. Precision generator with time stability of 5 parts in 10^6 per day.

Send for catalog.

SYSTRON  DONNER

888 Galindo Street, Concord, California 94520. Telephone (415) 682-6161

NEWS

- 21 News Scope
- 25 **European technology is closing the IC 'gap'**
Overseas semiconductor firms display digital and linear expertise at Paris components show
- 32 **Instant DF aid for combat pilots in trouble**
- 34 **Mothball and fast-haul electronics needed**
Equipment, to be stored in allied lands or carried by airlifted GIs, must be small, rugged and reliable
- 41 Washington Report
- 44 Sidelights of the Issue
- 57 **Editorial: How broad is your concept of the engineer's job?**

TECHNOLOGY

- 24 **Stabilize your op amp experimentally:** Use step-function response under operating conditions to determine component values.
- 58 **Specify your trap filter the easy way.** Computer-generated tables can be used to establish Q, notch depth, attenuation and group delay.
- 66 **Design bias circuits with nomographs.** They take the 'guess' out of your work and give stable and speedy results.
- 74 Ideas for Design
- C1 Data communication: a Special Report
- C4 Data systems emerging fast from infancy
- C6 Why digital transmission?
- C14 Many problems confront data engineers
- C28 The 99.9% effective communications system
- C40 Small general-purpose digital computer
- C42 Microfilm system processes computer output tapes

PRODUCTS

- 86 **Microwaves and Lasers:** X-band sweepers are going solid state
- 92 **ICs and Semiconductors:** Military hybrid op amp has metal-can DIP.
- 96 **Materials and Packaging:** Excited nematic liquid crystals turn frosty.
- 98 Instrumentation
- 102 Data Processing
- 104 Modules and Subassemblies
- 108 Components

Departments

- 14 Designer's Datebook
- 110 Evaluation Samples
- 112 Design Aids
- 114 Application Notes
- 116 New Literature
- 126 Advertisers' Index
- 128 Information Retrieval Service

Information Retrieval Service Card inside back cover

COVER CREDIT: 3M Company and Firestone Tire and Rubber Company

Look What You Can Do Now With High Voltage, TO-3 Silicon Power!

That's right! . . . you can now put standard, inherently-economical, TO-3 packaged silicon power transistors — the 2N5629-31 series — right to work in high voltage operation in your rugged, audio/servo amplifiers, inverters, converters, choppers and switching and series pass regulators.

You can now reduce the size, cost and complexity of input, output and filtering components without the use of large, cumbersome — and costly — silicon power stud packages. Plus, reduce required current and keep your circuitry more compact, lighter and easier to cool through elimination of step-down componentry.

Performance? How about: 200-watt power dissipation . . . 16-ampere collector current . . . 1-volt saturation voltage . . . 20 to 100 beta at 8-amperes . . . 140-volt rating!

The 2N5629 series is a nimble switch, too, with f_r a minimum of 1 at 1 ampere and 20 volts. And, there's no "punch-through" (second breakdown) in your designs because Motorola's diffusion process allows acceptance of high voltages even in the most demanding designs.

The new unit's operating temperature range extends from -65° to 200°C , making them ideal replacements for germanium types in today's "brute power" systems.

Scan these specs on the 2N5629-31 series and its 10-ampere companion — then contact your franchised Motorola distributor or the factory about evaluation or production quantities of either economical, high power silicon transistor!

Write today for new data sheets!

INFORMATION RETRIEVAL NUMBER 248

Highlight Parameters	2N5629, 30, 31	2N5632, 33, 34
Polarity	NPN	
High $V_{CE(sat)}$	100, 120, 140 V	
High $I_{C(cont.)}$	16 A	10 A
Fast Switching - f_r @ 1 A/20 V (min)	1 MHz	
Low $V_{CE(sat)}$ @ $I_C = 10$ A (max)	1 V	2 V
High P_D @ 25°C	200 W	150 W

...ON THE MOVE
IN SOLID-STATE
POWER!

- where the priceless ingredient is care!



You've Just Discovered State-of-the-Art, 50 A Silicon Power Complements!

And you can now discover how easy it is to put extra performance in — and take the cost and circuit complexity out of — those rugged, new-design audio/servo amplifiers . . . with the highest-rated, TO-3 PNP/NPN complements in the business: the 60 and 80-volt, 2N5683-86 series!

A pair of these in your designs gives you *unprecedented* power in compact, low-silhouette packaging — 300 watts of DC to 50 amperes! Plus, you realize a higher degree of frequency stability through elimination of expensive, impedance-matching driver transformers. And you're ensured lighter, simpler, less-costly heat sinking in all designs through low thermal resistance — θ_{jc} of only 1.43 W/°C maximum.

When you're looking for heavy muscle in switching applications, there's no power/speed trade-off with either polarity . . . at 50 watts, the units furnish a high minimum f_T of 2 MHz minimizing switching losses.

Both series ensure efficient, low-power-loss performance — 1.0 volt maximum saturation voltage at 25 amperes and provide the capability to swing down in voltage without the loss of current gain to 2 volts at 25 amperes, important in low distortion, audio amplifiers.

Motorola's exclusive EpiBase* die fabrication process affords minimum user cost while maintaining long-term reliability and stability.

More than 30 PNP/NPN silicon power complements are available for today's cost and performance-conscious designer from 1 to 50 amperes and 5 to 250 watts . . . they're immediately available for evaluation from your franchised Motorola distributor or in production quantities from the factory!

Write for data now!

INFORMATION RETRIEVAL NUMBER 249

Highlight Parameters	2N5683, 84	2N5685, 68
Polarity	PNP	NPN
High I_C (cont.)		50 A
Low $V_{CE(sat)}$ @ $I_C = 25 A$ (max)		1 V
High P_D @ 25°C		300 W
Fast Switching — f_T @ 5 A/10 V (min)		2 MHz
High h_{FE} @ $I_C = 25 A$		15-60

*Trademark of Motorola, Inc.

MOTOROLA Silicon Power Transistors

Motorola Semiconductor Products Inc. / P.O. Box 20912 / Phoenix, Arizona 85036



The wreckless rechargeable.



Sonotone's Fastback[®] battery won't wreck itself. Even under fast charging. Over and over and over again.

Sonotone's new nickel-cadmium sealed cell is called the Fastback because it gets back into action *fast*. In just five minutes, it gets enough charge to start a lawn mower or to operate a camera. So your product goes to work today... not tomorrow.

The Fastback's safe, too. In laboratory tests, it's been deliberately overcharged for months at the 3-hour rate. Without overheating or blowing its top. Even after that, it delivers full rated output under load.

And there's no need for expensive, bulky external charging apparatus. All

the charging capability is built right into the Fastback. Already, the Fastback's found its place in many consumer products. Should it be in yours? Find out by writing for full specifications and performance charts. Sonotone Corporation, Battery Division, Elmsford, New York 10523.

CLEVITE SONOTONE

And you can take your time turning off as well as on.

We weren't satisfied with giving you just a 120-second time delay. Or merely providing delay-on relays. So we've added both delay-off relays and 300-second relays to a line that was already the most complete in the industry.

Our solid-state line includes four full-size models with time delays adjustable from 0 to 300 seconds; there are delay-on and delay-off forms in both $\pm 2\%$ and $\pm 10\%$ accuracy ratings.

Delay-on units can be supplied for remote time-interval adjustment, making

them ideal for use on control panels, or where space or environment prevent direct access.

Where size is a factor, select our delay-on miniature model, adjustable 0 to 120 seconds with $\pm 2\%$ accuracy.

Check our low-cost thermal line, too. Available in plug-in and panel-mount models. Rated 2 amps resistive.

Don't delay in ordering our time-delay units. Call your Cutler-Hammer Sales Engineer or Stocking Distributor soon.



Circle the Reader Service Number below for our free catalog.

Now we offer the 300-second break.



CUTLER-HAMMER
SPECIALTY PRODUCTS DIVISION, Milwaukee, Wis. 53201

INFORMATION RETRIEVAL NUMBER 5

step up!



to perfect performance

—with Bodine fhp motors and D.C. Motor Controls Now...precise control of speed, torque and power for every fractional horsepower need. Motor controls perfectly matched to characteristics of Bodine's NSH line of D.C. shunt-wound motors. Or, for just reliable fractional horsepower, Bodine motors available in over 3,500 standard catalogued specifications. Plus numerous specials. Virtually any type, size or rating: 1.45 milli-hp. to ¼ hp., torques from 0.18 oz.-in. to 350 lb.-in., speeds from 0.6 to 10,000 rpm. Also more than 330 stock types and sizes. Write for Bulletin. Bodine Electric Company, 2500 W. Bradley Place, Chicago, Illinois 60618.

Power/controls for office machines
■ machine tools ■ electronic equipment
■ electrical control devices
■ medical apparatus ■ communications equipment
■ data processing equipment ■ laboratory equipment
■ recording instruments
■ inspection and testing equipment
■ musical instruments ■ scientific apparatus ■ many other applications.

Bodine Motors Wear Out—It Just Takes Longer



BODINE MOTORS/CONTROLS

INFORMATION RETRIEVAL NUMBER 6





Match your systems design installation with a CRT Display custom-ordered to the most narrow specifications The Benrus concept is simple. You determine the bandwidth and sensitivity required—as far as 1 mv div and up to 25 MHz. Then select a unit to your rack dimensions and choose from a virtually endless range of channel amplifier combinations. Add any number of available options, such as sweeps, heat dissipators, screwdriver controls The result? A system designer's dream... the disappearance of Installation Frustration through unequalled versatility. Catalog 802 lists 3110 variations.

... and a few others for that matter.

RAPROMATIC® oscilloscope camera systems are also available in building block variations. The Rapromatic film process, applied to any oscilloscope, permits rapid photography, developing, fixing and immediate viewing of processed film. Provides permanent records of waveforms, 24-hour time information, four digit counter readout, or written data.

The LA-40A Spectrum Analyzer offers systems designers a wide range of unique advantages... such as dynamic range exceeding 70 db; simplified, single tuning control; 10 cps resolution; sweep rates and resolution automatically optimized for calibrated spectrum widths of 0.5 Kc. to 100 Kc.

spedcor electronics, inc.

Lavoie Analab Benrus Instrument Division
70-31 84TH ST., GLENDALE, NEW YORK 11227 212-894-8100

ACTUAL SIZE

we have quite a thing for systems design, our benrus CRT DISPLAY, for one



INFORMATION RETRIEVAL NUMBER 8

New ways in digital automation with:

- Shaft Encoders, 34 types
- Synchro-to-Digital Converters, 6 types
- Analog-to-Digital Converters, 10 types
- Solid-State Digital Modules, 136 types

FREE ... 58 Pages

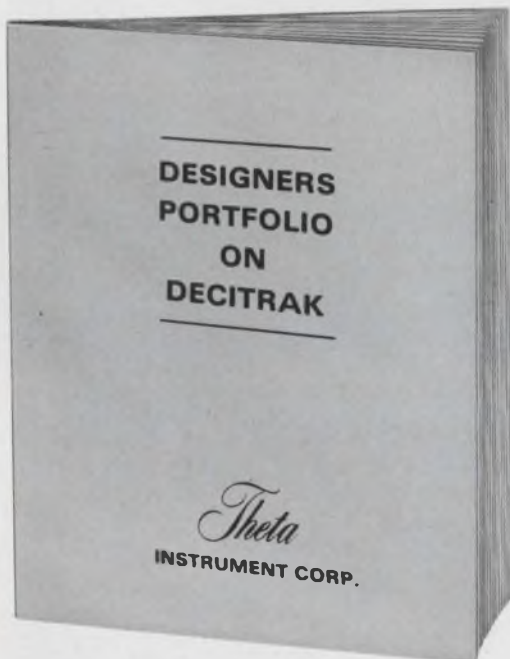

Includes copy of
"A Primer on Shaft Encoders"

We call it the DECITRAK® SYSTEM

Selecting from hundreds of off-the-shelf digital transducers and circuits, we assemble a remarkably low-cost, customized digital system for control/display/logging. DECITRAK can perform as simple a job as providing remote digital display of antenna pedestal position. Or, as impressive a task as the precise control of massive prime movers in response to punched-card commands.

Need a computer interface? A code converter? A typewriter driver? Set-point controls? Let a Theta Application Specialist tailor a system to your specific needs from the field-proven line of DECITRAK digital components.

More than 1,000 of these systems are now in use in nuclear installations, satellite tracking stations, wind tunnels, and aboard ships.

Theta

INSTRUMENT CORPORATION

FAIRFIELD, NEW JERSEY 07006 • PHONE: 201 - 227-1700 • TELEX: 138353

INFORMATION RETRIEVAL NUMBER 9



In 1711 John Shore struck a fork!

In 1937 BULOVA put it to work!



The year 1711 was way before Bulova's time, but what we're doing with the fork today is still revolutionary! Since 1937 we have been advancing Fork developments and broadening their application. From time/frequency control to light modulation and scanning, Bulova continues to engineer for applications yet to come. An example of this is our unique line of light light choppers that provide long life, low power requirements, and more efficient handling of light, in a small, lightweight device.

FORKS

In frequencies up to 20KHz, with accuracies typically $\pm .02\%$ (up to $\pm .001\%$ for specialized uses), Bulova ATP forks provide low cost, small size, light weight, and remarkable long-term stability. Bi-metallic or

NISPAN-C forks are available, in a variety of mechanical constructions to meet many requirements for resistance to shock and vibration.

FORK OSCILLATORS



Well-known for quality of performance, Bulova fork oscillators are especially noted for their low power drain. For example, the FS-200, a subminiature fork oscillator uses less than 8 microwatts! This same oscillator takes up about $\frac{1}{2}$ cu. in. of space and weighs in at 1 ounce! Accuracies are typically $\pm .02\%$.

FORK LIGHT CHOPPERS/SCANNERS



In this unique new concept, a pair of vanes are attached to a fork's tines, and the vibrating fork chops light or similar energy beams. Two advantages over motor-drive types—no wearing parts and no lubrication needed. Another variation — a torsional fork scanner with a uniform repeat rate.

Bulova is the source for tuning forks, fork oscillators and fork light choppers. Call American Time Products at 212-335-6000, check EEM Section 2300 and 3800 or write today!



BULOVA AMERICAN TIME PRODUCTS

Electronics Division of Bulova Watch Company, Inc.

61-20 Woodside Ave., Woodside, N. Y. 11377 (212) 335-6000

Go Bulova, and leave the designing to us!



For the engineer whose responsibility is checking out incoming precision components, the new Fluke 3330 Programmable Constant Current/Voltage Calibrator will shorten your day and heighten your nights. For the first time, computer programmed checkout over a wide range of voltages and currents is available with an off-the-shelf low priced quality instrument.

The Fluke 3330 is unique. It can be operated in either a constant current or constant voltage mode. Modes can be changed without turning the unit off. Voltage range is 0 to 1000 volts in three ranges with 10% overranging. Voltage accuracy is $\pm 0.005\%$. Resolution is 0.1 ppm. Stability is 25 ppm per month. Line and load regulation are 2 ppm of range. Ripple and noise are less than 50 μv . Voltage trip is adjustable from 1 v to 1000 v. Output current is 100 ma in the 10 and 100 v ranges and 50 ma in the 1000 v range.

In the constant current mode, ranges are 0 to 100 ma in three ranges with 10% overranging. Accuracy is $\pm 0.01\%$. Resolution is 1 ppm. Stability is 50 ppm/month. Line and load are 2 ppm of range. Compliance voltage is 1000 volts on the 1 and 10 ma ranges and 500 volts on the 100 ma range.

Crowbar effect through a programmable relay shorts output to limit voltage while changing loads.

Programmable functions are output range, mode, level and polarity, voltage and current limit, crowbar, and standby/operate. Programming time is tens of milliseconds. Price is \$2,995.

For full details write or call us today.

Fluke, Box 7428, Seattle, Washington 98133.
Phone: (206) 774-2211. TWX: 910-449-2850.

In Europe, address Fluke Nederland (N.V.), P. O. Box 5053, Tilburg, Holland. Phone: (04250) 70130. Telex: 884-50237.
In the U. K., address Fluke International Corp., Garnett Close, Watford, WD2 4TT. Phone: Watford 27769. Telex: 934583.

PRECISION TESTING AND CALIBRATION MADE EASY...

or how the new Fluke programmable constant voltage calibrator goes to work calibrating and testing precision instruments, semi-conductors, resistors and sub-assemblies.

When You Buy a Power Supply, Why Not Get the Best?

Designer's Datebook

MAY 1968						
Sun	Mon	Tue	Wed	Thu	Fri	Sat
				1	2	3
4	5	6	7	8	9	10
11	12	13	14	15	16	17
18	19	20	21	22	23	24
25	26	27	28	29	30	31

JUNE 1968						
Sun	Mon	Tue	Wed	Thu	Fri	Sat
1	2	3	4	5	6	7
8	9	10	11	12	13	14
15	16	17	18	19	20	21
22	23	24	25	26	27	28
29	30					

For further information on meetings, use Information Retrieval Card.

May 14-16
Spring Joint Computer Conference (Boston, Mass.) Sponsor: G-C AFIPS, T. D. Bonn, Honeywell EDP, 200 Smith St., Waltham, Mass. 02154.

CIRCLE NO. 391

May 19-21
Aerospace Electronics Conference (NAECON) (Dayton, Ohio) Sponsor: G-AES, Dayton Section, J. E. Singer, 5705 Coach & Four Drive E., Kettering, Ohio 45440

CIRCLE NO. 392

May 19-22
Imagery in Medicine Symposium (Ann Arbor, Mich.) Sponsor: ISA & University of Mich., Ernest E. Sellers, BSIS Host Chairman, Box 618, Ann Arbor, Mich. 48107

CIRCLE NO. 393

May 26-28
Laser Engineering & Applications Conference (Washington, D. C.) Sponsor: G-Ed, G-MTT, W. B. Bridges, Hughes Res. Lab., 3011 Malibu Canyon Rd., Malibu, Calif.

CIRCLE NO. 394

June 9-10
Chicago Spring Conf. on Broadcast & Television Receivers (Des Plaines, Ill.) Sponsor: G-BTR, N. T. Watters, Zenith Radio Corp., 6001 W. Dickens Ave., Chicago, Ill. 60606

CIRCLE NO. 395

June 9-11
Int'l. Communications Conference (Boulder, Colo.) Sponsor: G-Com-Tech, Martin Nesenbergs, Inst. for Telecommunications Sci., R-614, Boulder, Colo. 80302

CIRCLE NO. 396

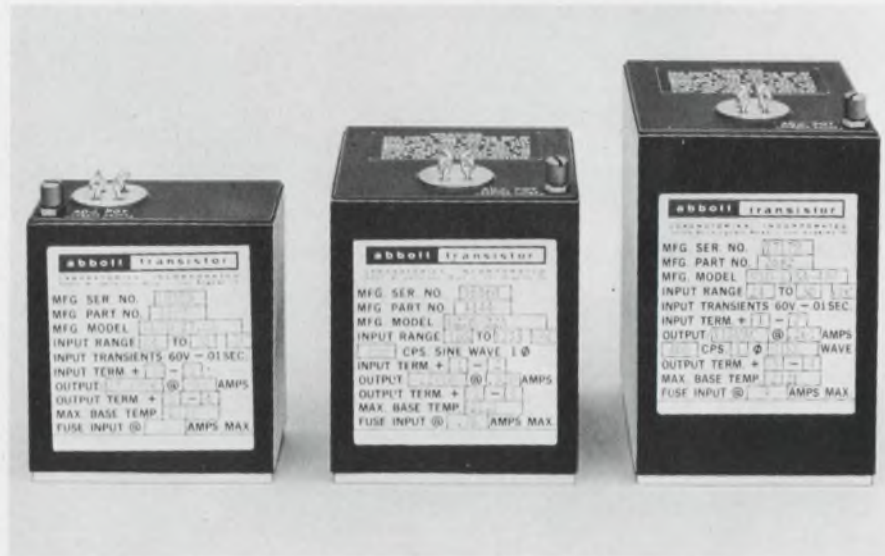

BL1D-27.6A
(109,890 Hrs.)

U2DS-22A
(73,585 Hrs.)

53D-115A-400
(61,387 Hrs.)

Abbott's New Family of 100°C Units—

are designed to operate in the stringent environment required by military and aerospace systems — (per MIL-E-5400 or MIL-E-5272C) from -54°C to $+100^{\circ}\text{C}$.

RELIABILITY — MTBF (mean time between failures) as calculated in the MIL-HDBK-217 handbook can be expected in excess of 50,000 hours at 100°C for many of our power modules. The hours listed under the photos above are the MTBF figures for each of the models shown. Additional information on typical MTBF's for our other models can be obtained by phoning or writing to us at the address below.

QUALITY CONTROL — High reliability can only be obtained through high quality control. Only the highest quality components are used in the construction of the Abbott power module. Each unit is tested no less than 41 times as it passes through our factory during fabrication — tests which include the scrutinizing of the power module and all of its

component parts by our experienced inspectors.

NEW CATALOG — Useful data is contained in the new Abbott Catalog. It includes a discussion of thermal considerations using heat sinks and air convection, a description of optional features such as short circuit protection and remote output adjustment as well as operating hints for power supplies and a listing of environmental testing costs.

WIDE RANGE OF OUTPUTS — The Abbott line of power modules includes output voltages from 5.0 volts DC to 10,000 volts DC with output currents from 2 milliamperes to 20 amperes. Over 3000 models are listed with prices in the new Abbott Catalog with various inputs:

- 60 ϕ to DC, Regulated
- 400 ϕ to DC, Regulated
- 28 VDC to DC, Regulated
- 28 VDC to 400 ϕ , 1 ϕ or 3 ϕ
- 60 ϕ to 400 ϕ , 1 ϕ or 3 ϕ

Please write for your FREE copy of this new catalog or see EEM (1968-69 ELECTRONIC ENGINEERS MASTER Directory), Pages 1727 to 1740.

abbott transistor
LABORATORIES, INCORPORATED
5200 W. Jefferson Blvd./ Los Angeles 90016
(213) Webster 6-8185 Cable ABTLABS

TO: Abbott Transistor Labs., Inc., Dept. 67
5200 West Jefferson Blvd.
Los Angeles, California 90016

Sir:
Please send me your latest catalog on power supply modules:

NAME _____ DEPT. _____
COMPANY _____
ADDRESS _____
CITY & STATE _____

For the first time, Varian has combined three Pulse-TWT improvements, illustrated in this cutaway photo, which greatly improve duty cycles and provide better pulse radar performance: (1) Latest focusing techniques decrease size and weight. (2) State-of-the-art fabrication provides better heat dissipation, more reliable environmental service. (3) Advanced slow wave structures allow higher gain and efficiency in shorter tubes, with outstanding stability.

Here are some examples of our line, each with at least 50 dB gain. One standard L-band TWT puts out 5 kW at 5% duty. An 8 lb S-band model delivers 3 kW at 10%, a 5 lb C-band tube at 6% duty gives 1½ kW. This capability extends through X-band and Ku-band, where we have an off-the-shelf 1 kW model with a 1% duty cycle. And each tube in our line is broadband enough to cover an entire radar band. So get what your pulse radar really needs from any of our more than 30 Electron Tube and Device Group Sales Offices throughout the world, or from our TWT Division, 611 Hansen Way, Palo Alto, California 94303.



varian
twt division

1. Lightweight focusing
2. Improved heat conduction
3. Ultra-stable high gain circuits

Three reasons we can guarantee better radar performance.

For micro-accuracy... Starrett measures up

When it comes down to the ultimate in measurement control, or even for fine increments of movement with or without linear measurement, it's time for Starrett. Starrett micrometer heads are precision built to give you the preciseness that your design requires. Starrett is world-known as the leader in precision tools. When you just can't afford to be wrong, be precision-perfect with Starrett.

Starrett micrometer heads are stocked in a wide range of standard designs, and custom-built heads can be manufactured for special applications.

Write today for additional information about what Starrett can do for you to make your design better.

The L. S. Starrett Company,
Athol, Massachusetts.

Starrett[®]

WORLD'S GREATEST TOOLMAKERS

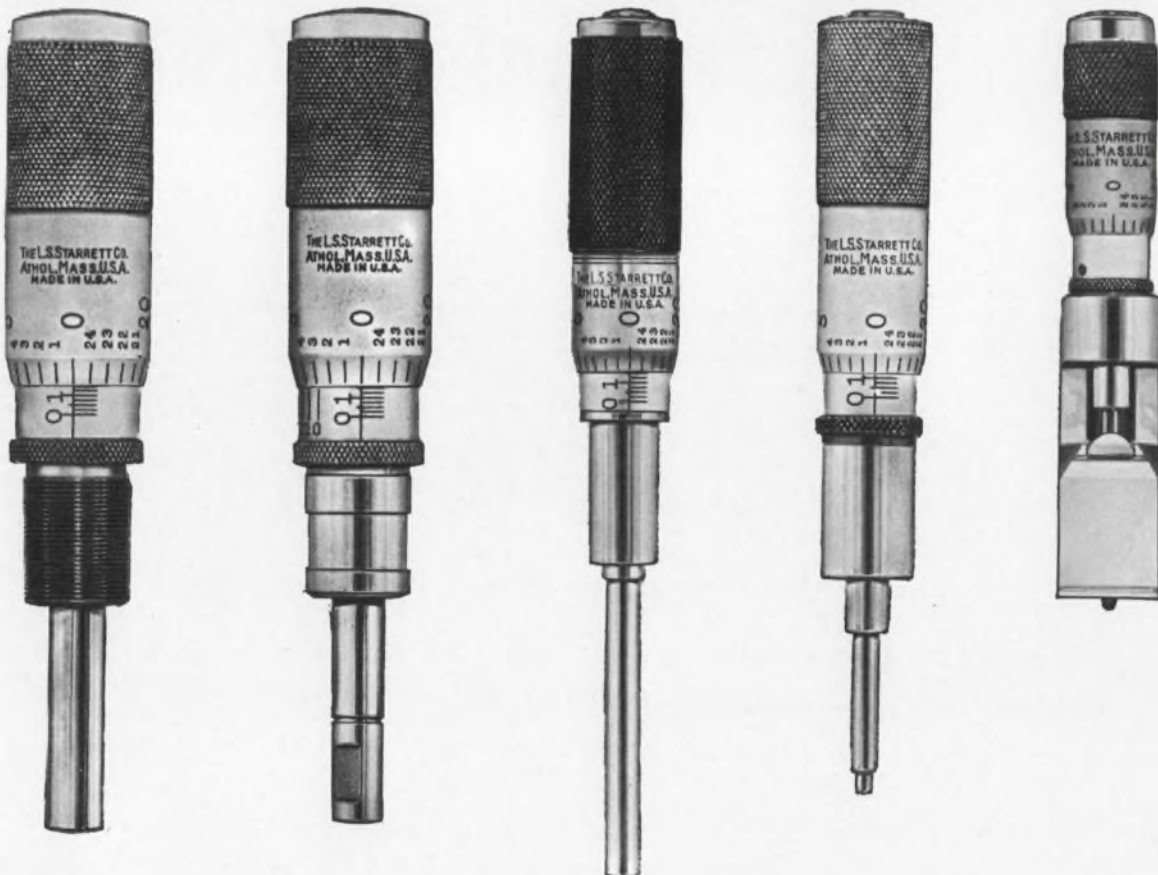



PLUG-IN OSCILLOSCOPES

New Tektronix 560B Series

New Solid-State Versions



of Valued Performers

Solid-state, large screen (8 x 10 cm), internal graticule, dual plug-in oscilloscope defines the new Type 561B. Use of solid-state components throughout offers low-heat dissipation for reliable operation to further expand the performance capabilities of this oscilloscope. Short-proof circuitry has been designed into all low-level power supplies, providing lower output impedance and minimum signal crosstalk. The addition of a quick-change line voltage selector permits operation from any of the following voltage ranges: 90 to 110 V, 104 to 126 V, 112 to 136 V, 180 to 220 V, 208 to 252 V, or 224 to 272 V over a line frequency range from 48 Hz to 440 Hz. The Type 561B calibrator accuracy has been significantly improved in both frequency and amplitude. The 1-kHz frequency is held to $\pm 1\%$, while the amplitude is maintained at $\pm 1\frac{1}{2}\%$.

Total measurement capabilities, through the use of more than 25 different plug-in units, offer the user complete versatility in measurement applications. The dual plug-in unit feature allows conventional displays or X-Y displays with either single-trace, dual-trace or four-trace units. Sampling displays, as well as spectrum analysis and raster generation, are also possible with the Type 561B.

The Type 564B offers all the advantages of the Type 561B, plus an added split-screen storage feature. Greater versatility is thus provided in that either half of the 8 x 10 cm display can be independently controlled, allowing stored or conventional displays on either the upper or lower half. The contrast ratio and brightness of the stored displays are constant and independent of viewing time, writing and sweep rates, or signal repetition rates.

Automatic erasure, after a preselected viewing time of 1 to 12 seconds, is added to the Type 564B MOD 121N. Also incorporated is a SAVE mode which interrupts the automatic erase cycle and preserves the stored information. Remote operation of the erase function is also possible with the Type 564B MOD 121N.

Both the Type 561B and Type 564B have rack-mounted counterparts that occupy only seven inches of rack height.

Type 561B	\$ 560
Type 564B	\$ 995
Type 564B Mod 121N	\$1150

U.S. Sales Prices FOB Beaverton, Oregon

← please open for additional information →

ement Capability Series Oscilloscopes

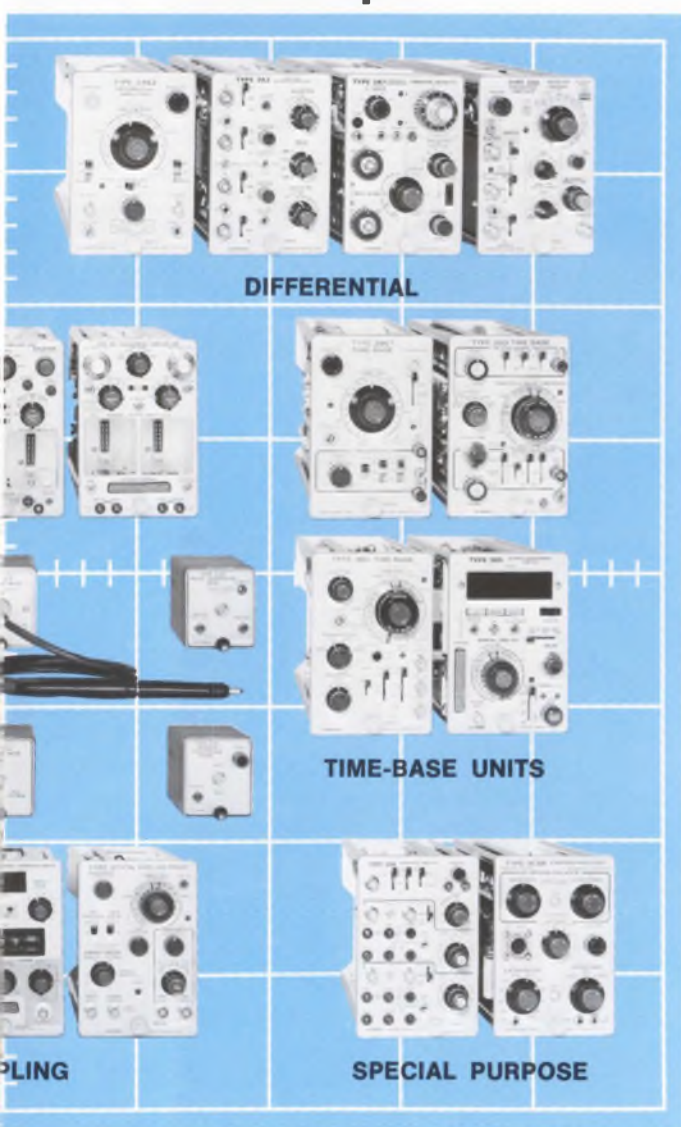

DIFFERENTIAL

TIME-BASE UNITS

PLUG-IN

SPECIAL PURPOSE

lines normally preclude the need for a pretrigger.

The Type 3S2 and its programmable counterpart, the Type 3S5, use the new sampling head principle. Both units are dual trace and will accept any of 6 available heads: the Type S-1 head is 50- Ω input, 350-ps t_r ; the Type S-2 head is 50- Ω input, 50-ps t_r ; the Type S-3 head includes a captive probe with 100 k Ω , 2.3-pF input impedance, 350-ps t_r ; the Type S-4 head is 50- Ω input, 25-ps t_r ; the Type S-50 head is a 25-ps pulse generator with a 400-mV, 100-ns wide pulse; and the Type S-51 head provides trigger countdown for stable synchronization from 1 GHz to 18 GHz. When using the S-1, S-2, S-3 or S-4 heads both the Type 3S2 and 3S5 provide deflection factors of 2 mV/div to 200 mV/div.

Companion sampling time bases are the Types 3T2, 3T5 and 3T77A. The Type 3T2 provides for either random or sequential sampling with sweep ranges from 20 ps/div to 100 μ s/div. The Type 3T5 is a programmable counterpart of the Type 3S5 and provides 10 ps/div to 100 μ s/div sweep ranges, as well as a calibrated sweep delay. The Type 3T77A provides calibrated sweep ranges of 20 ps/div to 10 μ s/div. Each of these time bases includes a time expander that provides 10X expansion of the time scale while maintaining a constant number of dots/div.

DIFFERENTIAL

PLUG-IN	DF	BANDWIDTH	T_r	PRICE
2A63	1 mV/div	DC to 300 kHz	1.2 μ s	\$ 175
3A3	100 μ V/div	DC to 500 kHz	0.7 μ s	850
3A7	1 mV/div	DC to 10 MHz	35 ns	695
3A9	10 μ V/div	DC to 1 MHz	350 ns	490

Differential operation is useful for measurements between two above ground points and for cancellation of in-phase signals such as hum pick-up at the signal source.

The Type 2A63 is a low-cost DC coupled differential unit. It provides 1 mV/div deflection factor at a bandwidth of DC — 300 kHz. The common-mode rejection ratio of this unit is up to 250:1.

The Type 3A3 is a dual-trace differential unit with deflection factors of 100 μ V/div to 10 V/div at a constant bandwidth of DC—500 kHz, and up to 50,000:1 CMRR.

The Type 3A7 adds to its capabilities of up to 20,000:1 CMRR and deflection factors of 1 mV/div to 50 V/div, an internal comparison voltage for use as a differential comparator.

The Type 3A9, a state-of-the-art differential plug-in, provides selectable upper and lower frequency limits from DC to 1 MHz, 10 μ V/div to 10 V/div deflection factors, and a CMRR of up to 100,000:1. A separate current probe input provides AC current readings from 1 mA/div to 1 A/div using available Tektronix current probes.

TIME-BASE UNITS

PLUG-IN	FASTEST RATE	MAGNIFIER	PRICE
2B67	1 μ s/div	X5	\$ 225
3B3	0.5 μ s/div	X5	650
3B4	0.2 μ s/div	X1 to X50	450
3B5	0.1 μ s/div	X10, X100	950

Time-base plug-ins are linear sweep generators that provide a wide range of calibrated time ranges for accurate time measurements.

The Type 2B67 is a low-cost time base providing calibrated sweep speeds from 1 μ s/div to 5 s/div. A 5X magnifier operates over the full time base and increases the fastest rate to 0.2 μ s/div.

The Type 3B3 is used to generate normal and delayed sweeps from 0.5 μ s/div to 1 s/div. A 5X magnifier increases the fastest rate to 0.1 μ s/div, while an incorporated single sweep function facilitates photographic recording of waveforms.

The Type 3B4 features a direct reading magnifier of up to 50X operating over the full range of 0.2 μ s/div to 5 s/div and extending the fastest range to 0.05 μ s/div. A single sweep function and a calibrated external horizontal input are also incorporated.

A companion to the Type 3A5 vertical unit, the Type 3B5 operates automatically from 0.1 μ s/div to 5 s/div.

SPECIAL PURPOSE

PLUG-IN	DF	BANDWIDTH	T_r	PRICE
3A8	20 mV/div	DC to 3.5 MHz	100 ns	\$ 650
3C66	10 μ strain/div	DC to 5 kHz	70 μ s	450

The Type 3A8 provides two operational amplifiers, each with an open loop gain of 15,000 at DC and an open loop gain bandwidth product of 10 MHz or greater.

The Type 3C66 carrier amplifier unit with suitable transducers allows for measurements as broad as the mechanical field itself. The Type 3C66 provides calibrated deflection factors from 10 μ strain/div to 10,000 μ strain/div at a bandwidth from DC to 5 kHz.

MULTI-TRACE

PLUG-IN	DF	BANDWIDTH	T_r	PRICE
3A3 Dual-Trace	100 μ V/div	DC to 500 kHz	0.7 μ s	\$ 850
3A6 Dual-Trace	10 mV/div	DC to 10 MHz	35 ns	525
3A72 Dual-Trace	10 mV/div	DC to 650 kHz	0.54 μ s	295
3A74 Four-Trace	20 mV/div	DC to 2 MHz	0.18 μ s	650

Multi-trace plug-ins provide a time-sharing method of displaying output signals of two or more channels with a single gun CRT. It may be done in one of two ways: alternate mode of operation—switching is done in sequence after each sweep; chopped mode—switching is done in sequence at a rate not referenced to the sweep.

The Type 3A3 contains two independent high-gain differential amplifier channels with FET inputs. Deflection factors of 100 μ V/div to 10 V/div at a constant bandwidth of DC—500 kHz as well as 50,000:1 common-mode rejection ratio are features of this plug-in.

The Type 3A6 can be operated in any one of five modes for variety of single- and dual-trace displays. The Type 3A6 has 10mV/div deflection factor, 35-ns risetime and internal vertical signal delay lines.

The Type 3A72 is a general-purpose dual-trace plug-in featuring 10 mV/div—20 V/div deflection factor with DC—650 kHz bandwidth.

The Type 3A74 provides four separate but identical channels. Each channel has a deflection factor of 20 mV/div from DC to 2 MHz. An internal trigger signal can be selected from one of two sources.

SINGLE TRACE

PLUG-IN	DF	BANDWIDTH	T_r	PRICE
2A60	50 mV/div	DC to 1 MHz	0.35 μ s	\$ 125
3A5	10 mV/div	DC to 15 MHz	23 ns	825
3A75	50 mV/div	DC to 4 MHz	90 ns	195

The Type 2A60 is a low-cost general-purpose plug-in with a DC—1 MHz bandwidth and decade deflection factor steps from 0.05 V/div to 50 V/div.

The Type 3A5, an automatic plug-in unit, features a bandwidth of DC—15 MHz and deflection factors from 10 mV/div to 50 V/div in its seeking mode. A manual control provides additional deflection factors of 1, 2 and 5 mV/div. Programmable functions include V/div, input coupling and AC trace stabilization by contact closure to ground.

The Type 3A75 is a wideband general-purpose plug-in unit with deflection factors of 50 mV/div to 20 V/div and a bandwidth from DC—4 MHz.

SPECTRUM ANALYZERS

PLUG-IN	DF	CENTER FREQ	PRICE
3L5	10 μ V/div	50 Hz to 1 MHz	\$1,125
3L10	-100 dBm	1 MHz to 36 MHz	1,275

Spectrum analyzer plug-ins provide a method of studying the energy distribution of a given electrical signal by plotting relative amplitudes against a frequency base.

The Type 3L5 operates over a center frequency range of 50 Hz to 1 MHz and provides accurate spectral and time-base displays from 10 Hz to 1 MHz. A deflection factor of 10 μ V/div to 2 V/div and a dynamic range of 60 dB makes the Type 3L5 applicable for vibration studies, waveform analysis and noise measurements.

The Type 3L10 operates over a center frequency range of 1 MHz to 36 MHz, with a CW sensitivity of -100 dBm. Calibrated dispersion and coupled resolution on both the Type 3L5 and 3L10 make frequency measurements as easy and accurate as time measurements.

Complete Measure with Tektronix 560

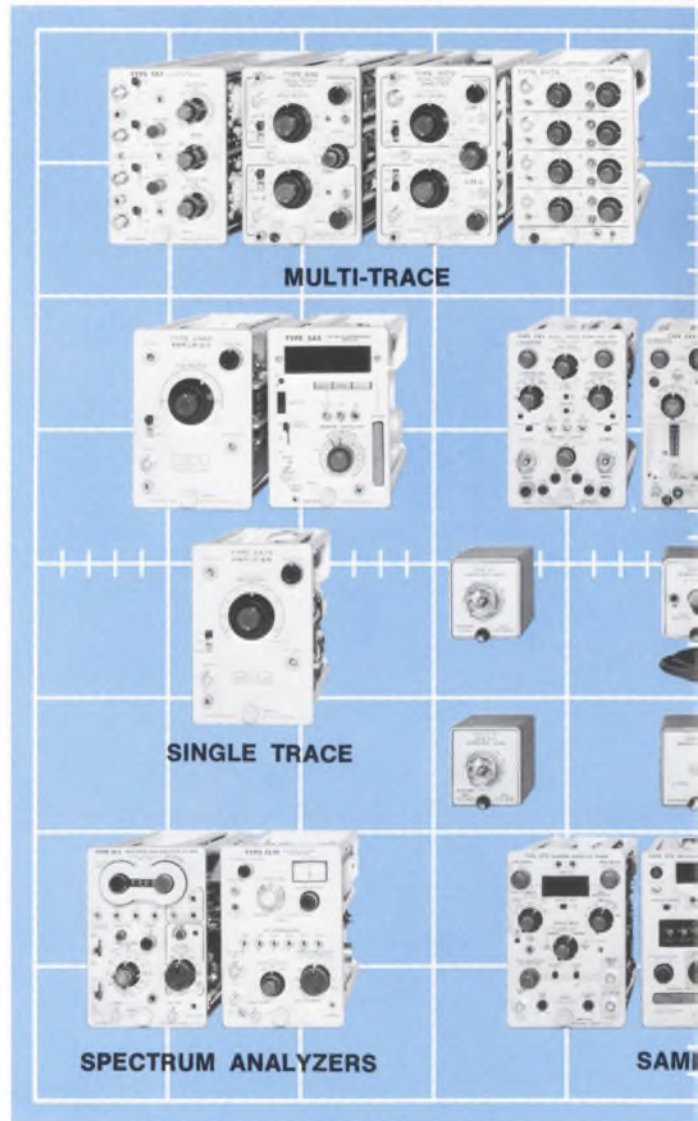

MULTI-TRACE

SINGLE TRACE

SPECTRUM ANALYZERS

SAMPLING

SAMPLING

PLUG-IN	DF	BANDWIDTH	T_r	PRICE
3S1 Dual-Trace	2 mV/div	DC to 1 GHz	350 ps	\$1,195
3S2 Dual-Trace	2 mV/div	S-Series Heads		850
3S5 Program	2 mV/div	S-Series Heads		1,550
PLUG-IN	FASTEST RATE	MAGNIFIER	PRICE	
3T2	0.2 ns/div	X10		\$1,000
3T5 Program	0.1 ns/div			1,650
3T77A	0.2 ns/div	X10		700

Sampling plug-in units convert the Types 561B and 564B into sampling oscilloscopes. As opposed to conventional or real-time oscilloscopes, sampling oscilloscopes do not display a waveform directly but rather rely on a stroboscopic approach of looking at many discrete portions of the input waveform to reconstruct it. Compared with conventional oscilloscopes, sampling provides better sensitivity with risetimes of 25 ps and equivalent bandwidths of 14 GHz and beyond. Time scaling, random-noise cancellation and better overload-recovery capabilities are other advantages offered by sampling techniques. However, as its name implies, multiple samples must be taken with the requirement that the input waveform must be repetitive.

The dual trace Type 3S1 is a nominal 50- Ω input unit with a risetime of 350 ps. Deflection factors of 2 mV/div to 200 mV/div are available. Internal delay

Extra Values

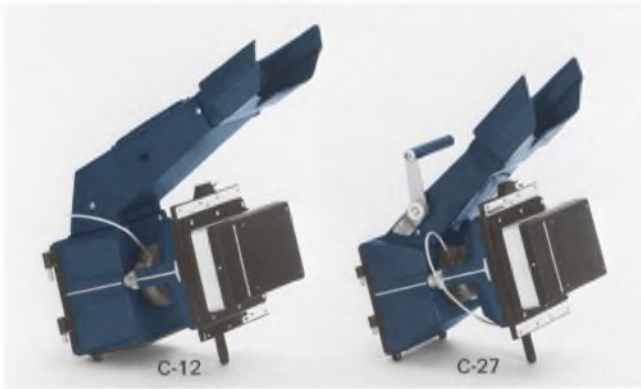

CAMERAS

The C-12 and C-27 general purpose trace recording cameras are suitable for use with the Tektronix 560 series oscilloscopes. Both cameras feature lift-on mounting, swing-away hinging, comfortable binocular viewing, easily-accessible controls, and lens and back options. A special beam-splitting mirror in the C-12 reflects a portion of the image up through the viewing tunnel, giving the viewer the impression of a straight-on view of the CRT. This no-parallax binocular viewing is especially desirable when the oscilloscope has an external graticule.

C-12	\$460
C-27	\$430

ELECTRIC SHUTTER/SPEED COMPUTER

An Electric Shutter/Speed Computer is available for both the C-12 and C-27 cameras, permitting remote actuation of the camera. It is intended for use in areas where a large number of cameras need to be remotely controlled or when there is limited access to the oscilloscope and camera at the time of use.



C-12-E Electric Shutter Camera	\$665
C-27-E Electric Shutter Camera	\$635

SCOPE-MOBILE® CARTS

Type 201 Scope-Mobile® carts feature tilt locking in any one of nine tray positions. The adjustable tray locks in six 4.5° steps in the upward direction and two 4.5° steps in the downward direction from the horizontal axis. A storage drawer is provided in the Type 201-1 while the Type 201-2 provides both a storage drawer and a plug-in carrier.



Type 201-1

Type 201-1	\$130
Type 201-2	\$140

U.S. Sales Prices
FOB Beaverton, Oregon

PROBES

Tektronix offers a choice of voltage and current probes designed to be compatible with circuit measurement requirements. The probes are designed to monitor the signal source with minimum circuit loading while maintaining waveform fidelity.

A prime consideration in selecting the proper probe is the circuit loading effect of the oscilloscope/probe combination. The probe with the highest input impedance will provide the least circuit loading. Probe attenuation ratio is also an important consideration. The oscilloscope must have enough gain to compensate for the attenuation of the probe.



The P6021 AC Current Probe and Type 134 Amplifier provide the facility for accurate current measurements over the wide range of 12 Hz to 40 MHz without breaking the circuit under test. Used with any plug-in unit having a deflection factor of 50 mV/div, the P6021/134 provides deflection factors from 1 mA/div to 1 A/div.

P6021/134	\$295
-----------------	-------



The P6042 DC-50 MHz current probe utilizes a variation of the Hall effect, offering capabilities for making both high-frequency and DC current measurements. The P6042 consists of an amplifier with built-in power supply, six-foot probe cable, and probe head. Deflection factors from 1 mA/div to 1 A/div are provided when the P6042 is used with a plug-in unit having a deflection factor of 50 mV/div.

P6042 DC Current Probe	\$625
------------------------------	-------

To help you select the right probe for your application, please consult Tektronix Catalog #28 or call your Tektronix Field Engineer.

**For a demonstration, call your local Tektronix field engineer or write:
Tektronix, Inc., P. O. Box 500, Beaverton, Oregon 97005.**



Tektronix, Inc.

committed to progress in waveform measurement

HAPPENINGS IN ELECTRONICS

May, 1969

RCA's novel approach to Linear Integrated Circuits

Designers can now use ICs and still retain control over the technical aspects of their circuits. It is done by providing a chip containing all the active elements and omitting the bias and load resistors to provide the

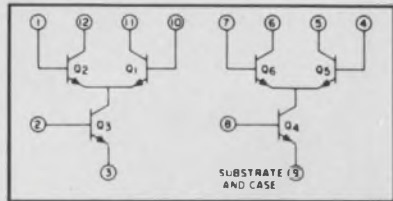

designer maximum application flexibility. An example of this approach is RCA's transistor array CA3049, a dual independent differential amplifier.

(See schematic) The engineer who is reluctant to convert his discrete designs over to integrated circuits because of their technical complexity can now combine the advantages of discrete design with the valuable features of monolithic construction which provides close electrical and thermal matching of amplifiers. RCA is now making a complete line of linear arrays, call

them "building blocks" if you like, but remember, they are building blocks with new flexibilities and freedoms for creative circuit designs. To help you make the transition to this unique concept, RCA is offering a sampler kit of linear arrays, QK2202. The kit consists of the following products and literature:

Quan.	Type	PRODUCT DESCRIPTION	LITERATURE
2	CA3035	Ultra-High-Gain Wide-Band Amplifier Arrays.	Linear Integrated Circuit Manual, IC-41.
2	CA3018A	2 Isolated Transistors & a Darlington-Connected Transistor Pair.	Integrated Circuit Product Guide, CDL-820B.
2	CA3019	2 Isolated Diodes & a Diode "Quad".	Integrated Circuit Mounting & Connecting
3	CA3026	Dual Independent Differential Amplifiers (to 120 MHz).	Techniques, ICE-338.
3	CA3046	3 Isolated Transistors & a Differentially-Connected Pair.	Technical Bulletins
2	CA3048	4 Independent AC Amplifiers.	Application Notes
2	CA3036	Dual Darlington Array.	Design Ideas for RCA Linear Arrays, ST-395.
3	CA3039	6 Ultra-Fast, Low Capacitance Matched Diodes.	
2	CA3049	Dual Independent Differential Amplifiers (to 500 MHz).	
2	CA3051	2 Darlington-Connected Diff. Amps with Diode Bias String.	

The 23 products listed above sell for 51.70 at these quantities; the literature is worth 6.25. When you buy the beautifully packaged sampler kit at 37.95, you save 20.00. Any of the Linear Arrays listed above may be purchased separately. Call any Schweber office for immediate delivery.

Half-priced, half-size General Electric Relay

A plastic-encased, half crystal can size, microminiature relay with grid spaced terminals is now available from Schweber at less than half the price of the stringent environmental type required for military applications. Model 3SBV will provide top performance in electronic applications where the environmental conditions are such that the expense of a hermetic seal cannot be justified. 100-pc. price 4.69. Data sheet available. Circle #242.

Sensitron's PTC Thermistor is here

Semiconductor designers have been looking for a good, reasonably priced, positive temperature coefficient (PTC) thermistor for a long time. Not the type rated at a couple of hundred ohms, but all the way up to 10K. Sensitron is now making such a device, and Schweber is selling them. The temperature coefficient of resistance is 0.7%/°C; the wattage ratings are 1/8 and 1/4 watt. They can be used wherever temperature compensating and sensing is required, such as amplifiers, power supplies, telemetry, computers, thermometry, and the like. Data sheet available, and of course, immediate shipment from Schweber stock. Circle #243.

Review of new catalogs: Fairchild's Second Generation LICs

A 28-page brochure listing Second Generation linear integrated circuits. Also included are eight pages devoted to applications of LICs, and another three pages to "Tomorrow's" second generation circuits to be released in the future. Watch out for page markings — they are not on the bottom of the pages as you would expect, but half way up the page margins; also no holes punched for insertion in loose leaf books. Otherwise, this is an interesting brochure well deserving of the descriptive cliché: chockful of information. Circle #244.

Theory and characteristics of Phototransistors

This application note from Motorola's famed Information Center will be welcomed by the growing number of engineers interested in Opto-Electronics. Prices are down, efficiency of devices up, and products available from Schweber stock. A short history of the photo effect in semiconductors is followed by sections on "Static Electrical Characteristics of Phototransistors" and ditto for the "Dynamic Characteristics." Circle #245.

Monsanto achieves isolation factor of 100 billion ohms

A new photodiode coupled pair — MCD1, offers the designer 5 nanosecond rise and fall times together with over 3,000 volts isolation between input and output. The IR emitter and companion detector are optically coupled through clear epoxy. The unit is then encased in opaque epoxy for maximum dark resistance. It's ideal for high speed isolated switching and high voltage isolation. Circle #246.



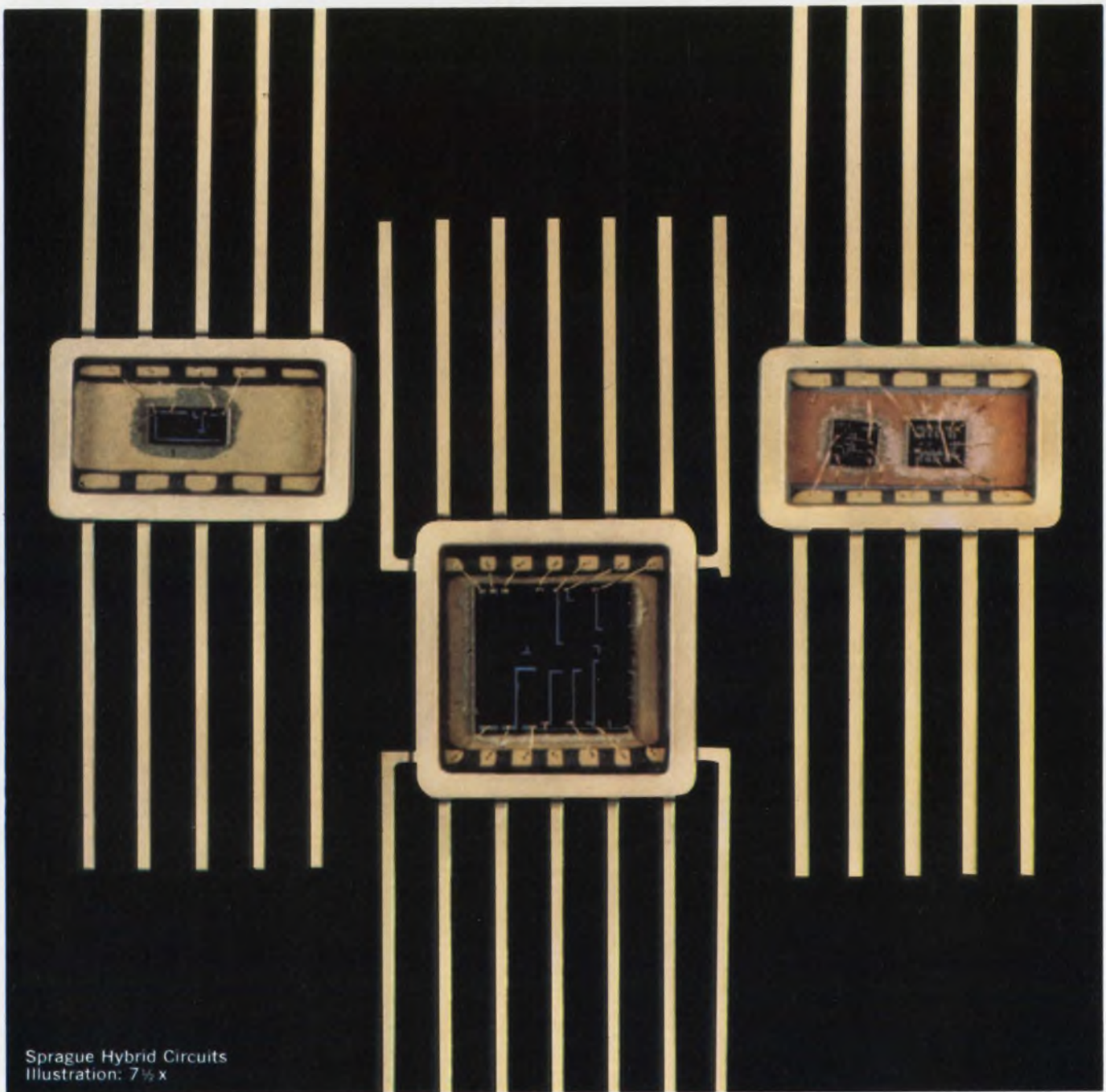

Sprague Hybrid Circuits
Illustration: 7 1/2 x

Look. Look into a 10-bit D-to-A with 2.8 MHz count rate.

Get 10-bit accuracy with only eight packages. You get ladder networks, ladder switches, and buffers. Just add a PC board and the fastest Op Amp you can find.

Only 240 mW total power dissipation. There's no

speed/power trade-offs with these new Sprague Hybrids. And you save space, too. The circuits are in 1/4" x 1/4" and 1/8" x 1/4" ceramic flatpacks, for operation -55 to +100° C.

Other D-to-A hybrids from 4 bits...

can be made from our standard line of packaged ladders, switches and buffers. Get the high accuracy tanta-

lum resistor ladder alone, or a complete kit for up to 12 bits. Start your conversion to Sprague hybrids now.

Call Sprague Info-Central (617) 853-5000 extension 1969.

Or call your Sprague industrial distributor. He has the 10-bit 2.8 MHz circuits on the shelf. For complete specification data, circle the reader service number below.



INFORMATION RETRIEVAL NUMBER 15

ELECTRONIC DESIGN 9, April 26, 1969

News



U.S. military policy is to store gear abroad and, in case of trouble, to rush troops in by

air. It's creating a need for electronics that can be readily mothballed. Page 34.



Overseas semiconductor firms display digital and linear expertise at Paris show. Page 25.



Vhf/uhf direction finder has 1-degree accuracy and 4200 channels. Page 32.

Also in this section:

News Scope. Page 21 . . . **Washington Report.** Page 41 . . . **Editorial.** Page 47.

Wet-sintered-anode Tantalex[®] Capacitors

Buy the best. And save money doing it.

Here's how: Select from the broadest line of tantalum capacitors anywhere. From Sprague. The lower your temperature requirement, the lower your cost.

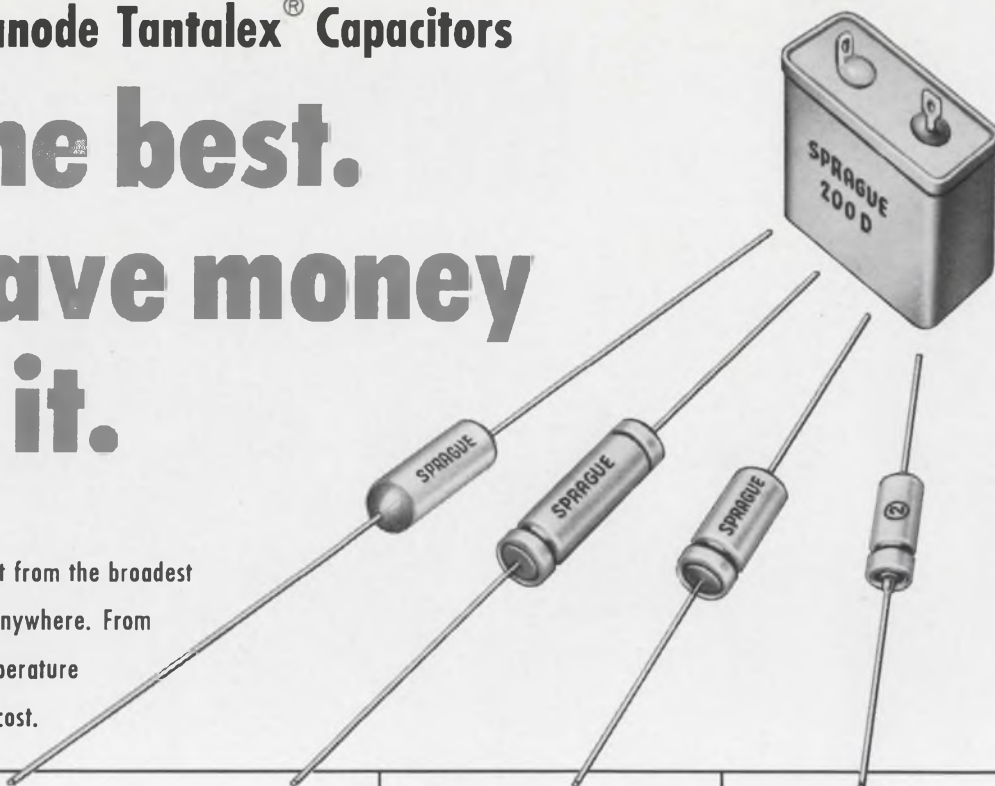

For operation to + 85 C		For operation to + 125 C		For operation to + 175 C			
<p>Type 145D</p> <p>Volumetric efficiency up to 210,000 μF-volts per cubic inch. For use in miniature commercial/industrial printed wiring boards, packaged circuit modules, and wherever else cost and space are prime considerations. Elastomer end seal capped with plastic resin insures against electrolyte leakage and lead breakage. Available in voltage ratings from 6 to 75 VDC.</p>		<p>Type 109D</p> <p>A superior design that meets all the basic military requirements for capacitors within this temperature limit. There is no compromise in quality. Voltage ratings from 6 to 150 VDC.</p> <p>For extra large values of capacitance, use Type 200D or 202D package assemblies, which consist of several 109D - type capacitor elements in a hermetically-sealed case.</p>		<p>Type 130D</p> <p>Exceptional electrical stability due to chemical inertness of tantalum oxide film to specific electrolytes used, low diffusion of TFE-fluorocarbon elastomer seal, and special aging for 125C operation. Voltage ratings from 4 to 100 VDC.</p> <p>Dual temperature ratings of Type 200D and 202D package assemblies give you extra high capacitance values for +125 C operation.</p>		<p>Type 137D</p> <p>Proven glass-to-metal hermetic seal qualifies these outstanding capacitors for use in satellites, missiles, and other critical aerospace applications. They have greater volume efficiency than has been previously available for wet-sintered-anode capacitors in this temperature range. Type 137D capacitors exhibit extremely low leakage currents. Available in voltage ratings from 2 to 150 VDC.</p>	

INFORMATION RETRIEVAL NO. 821

INFORMATION RETRIEVAL NO. 822

INFORMATION RETRIEVAL NO. 823

INFORMATION RETRIEVAL NO. 824

Select the capacitor type that meets your temperature requirements. That's how to save money. Specify Sprague Tantalex[®] Capacitors. That's how to get the best.

For complete information on Type 145D Capacitors, write for Engineering Bulletin 3750 (Type 109D, Bulletins 3700F and 3700.2; Type 130D, Bulletins 3701B and 3701.2; Type 137D, Bulletin 3703A; Type 200D and 202D, Bulletin 3705B) to the Technical Literature Service, Sprague Electric Company, 347 Marshall St., North Adams, Mass. 01247.



Sprague and *®* are registered trademarks of the Sprague Electric Co.

THE BROAD-LINE PRODUCER OF ELECTRONIC PARTS

INFORMATION RETRIEVAL NUMBER 16

Transistor-like device has fused-in power

Imagine a transistor radio with batteries built into the transistors themselves and lasting for the life of the equipment. And that's only a part of the possibilities painted for a new radioactive device called the Electristor.

Invented by Daniel E. Speers, 28-year-old director of research for Danecho R & D Laboratories, Miami, the device is at present a laboratory model of a self-powered, tiny, transistor-like unit that needs no external power supply. Speers sees practical devices resulting from his concept within two or three years.

Present models have been operated as amplifiers, oscillators and detectors, but the power output is still only on the order of a few milliwatts, and response is in the low-frequency ranges.

As described by Speers, the developmental Electristor is a radioactive-powered device built in three layers, on a wafer about the size of a dime (see figure). The energy

particles released by the strontium-90 radioisotope break loose cascades of electrons within the semiconductor wafer, thus creating holes and free electrons.

A chip of antimony is fused to the semiconductor layer because it is an exceptionally good carrier of electrons. Some of the electrons disassociated by the atomic energy particles reach the junction and readily pass from the semiconductor layer, across the junction, and into the antimony.

When the antimony and the semiconductor wafer are electrically connected, electrons flow from the former to the latter, completing the circuit and providing the "battery" which powers the Electristor.

For amplification, the signal is applied to the junction, but Speers declines to disclose, on proprietary grounds, just how the junction is modulated.

One of the problems with the device stems from the fact that it requires shielding for the radioactive source, thus limiting its miniaturization—at least in its present state. But Speers says he has developed a thin-film radiation screen to solve this problem in practical devices.

Invention of the device is traced by Speers to research that he was doing on a photochromic battery. It was intended to provide power for areas of the world that have plenty of sunshine but little economic development. The photochromic cell didn't prove out, but it led to the Electristor.

Satellite communications for AF command planes

The Air Force's Worldwide Airborne Command Post—the couple dozen aircraft that are supposed to house the nation's commanding

generals in case ground headquarters are destroyed in an atomic attack—plans to swing over to satellite communications.

The new terminals will permit communication over thousands of miles without atmospheric fading that high-frequency sets are subject to. The terminals, designated AN/ARA-64, will operate at 70 MHz with the uhf Les-6 satellite and the uhf-shf TacSat I tactical communications satellite. Les-6 is in synchronous orbit over the equator west of Chile, and TacSat I is over the equator a little farther west.

Prime contractor for the satellite terminals is Electronic Communications, Inc., of St. Petersburg, Fla., a subsidiary of National Cash Register. It is building 23 experimental terminals for the Defense Dept.

The same company helped the Air Force Strike Command at MacDill AFB, Fla., build five air-transportable satellite terminals that can be flown to any trouble spot in the world.

Talking digital voltmeter developed in France

Not only are instruments becoming automated and more compact. Now they're even talking.

Schneider Electronique, a major radio and TV equipment manufacturer in France, introduced a talking digital voltmeter at the recent electronic components show in Paris.

It's only a prototype to prove the concept, according to a Schneider spokesman, but a number of companies have expressed interest in the idea.

The unit, called Digivox, consists of a standard four-digit Nixie readout with a 15-channel tape recorder.

Recording is done on a continuous drum wheel that is run by a synchronous motor. The bcd-coded output of the DVM moves a recording head in proper sequence across each of the pre-recorded tapes. The channels contain a spoken numeral from 1 through 9 plus spare channels for periods and other vocal items. The recording head rests on each channel for about a half second, so it takes about 2.5 seconds

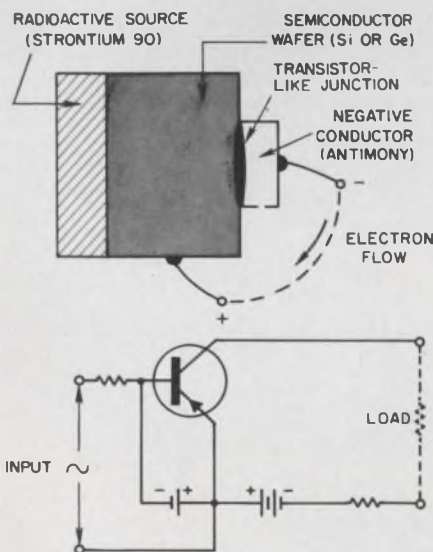

Basic construction of the Electristor (above) and its equivalent circuit.



Digital voltmeter talks back

to read out a four-digit number including the "period."

One obvious use for such an instrument is in laboratory situations where the engineer is too far from DVM to read the display but close enough to listen to it. It would also be theoretically possible to interrogate the instrument over a telephone line.

The recording technique could be used with any instrument with a bcd output, it was noted. The instrument could sell for less than \$1500, according to a spokesman, who also noted that the tapes could be prerecorded in any language.

Collins-Honeywell merger is under negotiation

Merger discussions between Collins Radio and Honeywell, Inc. have been brought to light by a joint statement handed out by Arthur A. Collins, chairman and president of Collins, and James H. Binger, chairman of Honeywell. In it, they said, "... the terms of the transaction haven't yet been arrived at, and further announcements will be made as negotiations continue."

But in line with recent keen Justice Department interest in such activity, the merger may be opposed as a violation of the Clayton Act, according to observers of the recent maneuvering of Collins to resist a take-over by the Electronic Data Systems Corp., a much smaller Dallas outfit.

In this case, application of the Clayton Act—which bars mergers that tend to reduce competition, or which may result in a monopoly—might stem from the fact that while large divisions of Honeywell are devoted to the manufacture and

sale of computer equipment and automatic controls, Collins recently announced plans to provide computing services and computer-control-process technology to industry and government.

The offer of Electronic Data Systems, a computer-services company was recently rejected by the Collins board with a statement to its shareholders that it was "evaluating a number of other transactions that might have an important effect on the current situation and the future of Collins."

Riderless jeep makes mine detection safer

Being in the driver's seat may be a great feeling—unless you happen to be riding across a mine-infested field. To cut down on casualties, the Army is evaluating a new electronic-controlled mine-detecting system that would take its men out of the driver's seat.

The system consists of a jeep with a mine detector that sweeps back and forth in front of it. Instead of riding, the driver walks behind the jeep—as far away as 300 feet. Or he can ride in another vehicle. From his safe position, he can start the jeep, engage the clutch, shift gears, steer, speed up or slow down, apply the brakes and move a searchlight—all with a 12-pound remote-control transmitter unit mounted on his chest.

When the magnetic direction unit in front of the jeep passes over a mine, the jeep stops automatically, and the operator hears a beep tone and sees a light on his control box.

The system, which was developed by Ryan Aeronautical Co., San Diego, Calif., can be used with any convenient vehicle; it isn't limited to jeeps.

Computer unit will offer self-service parcel post

Within a year, the Post Office expects to have small computerized machines that will make possible self-service parcel post.

Essentially a vending machine designed for use in small, self-service post offices, the module is being developed by Design and Development, Inc. of Washington,

D.C., under a two-year, \$250,000 contract.

"The unit is intended to compute parcel post charges under a variety of assumed customer options," says the Post Office's R&D director, Dr. Edward M. Reilley. "The vending machines will be capable of computing all the different rates from point to point and at varying package rates."

Patrons will insert addresses into the computer by push buttons, and an electronic scale will telemeter the weight to the computer. Because of the limited calculating required, the computer under development is a very small, special-purpose device with a core memory of several hundred words, Reilley says.

The Post Office is looking to the day when summary outputs from self-service facilities and additional computer-directed automatic devices at manned postal stations would be fed into centralized control computers.

\$2 billion spending seen for night-vision aids

The \$240 million to \$300 million presently being spent annually by the U.S. military for night-vision aids may rise to \$2 billion over the next four to five years, according to a report published by Frost & Sullivan, a New York market research firm.

The five-year forecast estimates what will be required to continue to extend the military's capability to fight at night and how much it will cost.

The bulk of the expenditures will be for direct-viewing, hand-held scopes and weapon devices and for remote low-light-level television systems.

The purpose of the study is to provide information to companies planning to enter the expanding night-vision aid equipment field.

Data to 3-D pictures

Scientists at Bell Telephone Laboratories have developed a method for converting equations, statistical and other data stored in a computer's memory into holograms for 3-D viewing.

This label of "quality"



*covers everything
made by
Allen-Bradley*

EXCLUSIVE HOT MOLDED RESISTORS

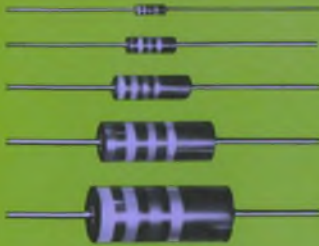

World renowned for their conservative ratings and stable characteristics. Due to uniformity of production, long term performance can be accurately predicted. With billions of these resistors in service, there is no known instance of catastrophic failure. Rated $\frac{1}{8}$, $\frac{1}{4}$, $\frac{1}{2}$, 1, and 2 watts at 70°C. Available in all standard EIA and MIL-R-11 resistance values and tolerances, plus values above and below standard limits.

**CERMET TRIMMERS
Type S and Type Z**



Both units are one-turn trimmers. The Type S is $\frac{3}{8}$ " in diameter, and the Type Z is a $\frac{1}{4}$ " cube. Enclosures are watertight. Smooth adjustment—approaches infinite resolution. Temperature coefficient less than 250 ppm/°C for all resistances and over complete temperature range. Type S rated $\frac{1}{2}$ watt at 85°C and Type Z $\frac{1}{2}$ watt at 70°C. Resistances from 50 ohms to 1.0 megohms.

**ADJUSTABLE FIXED RESISTORS
Type R**

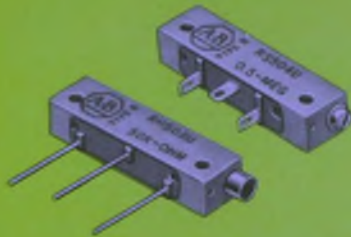

Type R built to withstand environmental extremes. Resistance element and terminals hot molded into integral unit with insulated mounting base. Has stepless adjustment and is noninductive. Watertight, can be encapsulated. Rated $\frac{1}{4}$ watt at 70°C. Values from 100 ohms to 2.5 megohms. Tol. ± 10 and 20%. Type N similar in construction but for less critical environments. Rated $\frac{1}{3}$ watt at 50°C.

**HOT MOLDED POTENTIOMETERS
Type J and Type K**

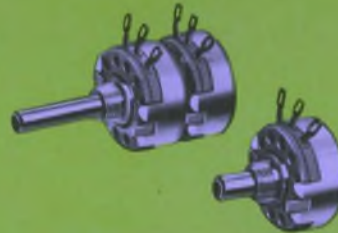

Type J potentiometers have solid, hot molded resistance element. Smooth, quiet control. Available in single, dual, and triple units, also with vernier adjustment. Rated 2.25 watts at 70°C. Values to 5 megohms. Type K have similar construction rated 1 watt at 125°C, 2 watts at 100°C, and 3 watts at 70°C.

**HOT-MOLDED POTENTIOMETERS
Type G, Type W and Type L**

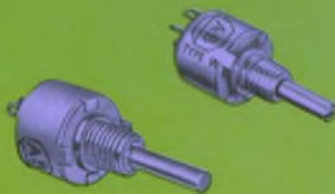

Type G and W are miniature controls with solid molded resistance elements. Only $\frac{1}{2}$ " in diameter. Quiet, stepless operation. Rated $\frac{1}{2}$ watt at 70°C. Values to 5.0 megohms. Type G qualifies under MIL-R-94 for Style RV6. Type W is a commercial version with the same characteristics. The Type L is rated $\frac{1}{2}$ watt at 100°C. Can be used at 150°C with "no load."

**HOT MOLDED TRIMMERS
Type Y**



The Type Y single turn trimmer has a low profile which easily fits within the commonly used $\frac{3}{8}$ " stacking space. Can be supplied with an optional thumb wheel for side adjustment, or an optional base for horizontal mounting, or both. Also made with a handy snap-in panel mount. Rated $\frac{1}{4}$ watt at 70°C. Resistances from 100 ohms to 5.0 megohms.

**HOT MOLDED TRIMMERS
Type F**

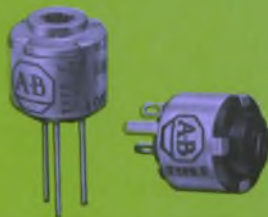

Type F trimmers are single turn controls built to withstand severe environmental condition. Adjustment approaches infinite resolution. Can be used at higher frequencies where wire-wound controls are impractical. Only $\frac{1}{2}$ " in diameter. Rated $\frac{1}{4}$ watt at 70°C. Usable from -55°C to +120°C. Available in resistances from 100 ohms to 50 megohms. Various tapers can be furnished.

METAL-GRID THIN FILM NETWORKS

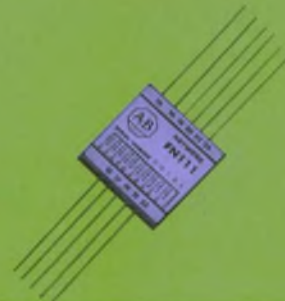

A-B metal-grid networks can provide complex precision resistive networks on a single substrate. Simultaneous disposition results in high uniformity. Tracking to 2 ppm/°C is normal. Resistances to 2.0 megohms.

Please send for Publication 6024:
Allen-Bradley Co., 1201 S. Second St.
Milwaukee, Wis. 53204. Export Office:
1293 Broad Street, Bloomfield, N.J., U.S.A. 07003.
In Canada: Allen-Bradley Canada Limited.



ALLEN-BRADLEY

QUALITY ELECTRONIC COMPONENTS

The case of Lockheed vs. Lockheed

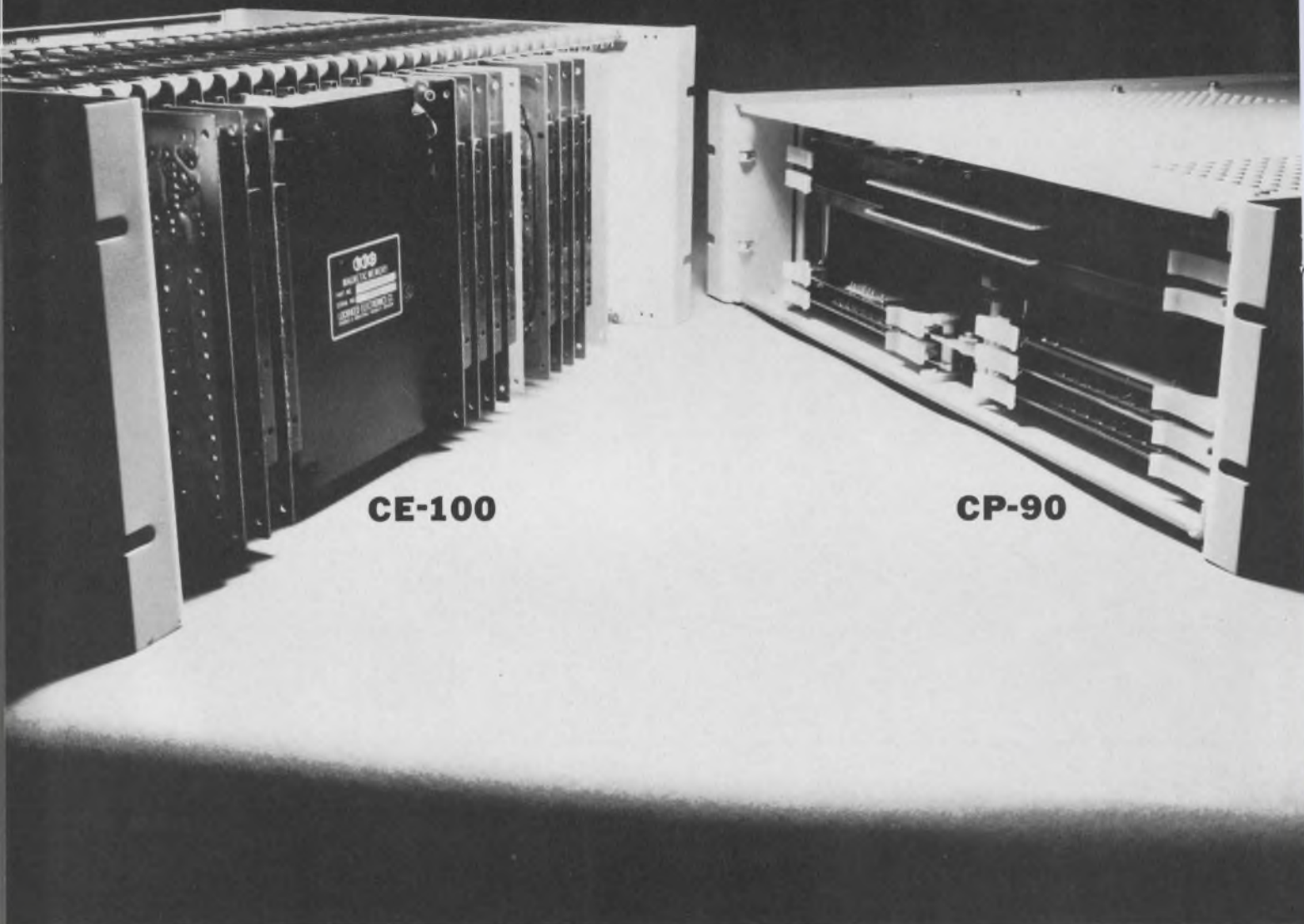

CE-100

CP-90

- | | |
|---|---|
| <ol style="list-style-type: none">1. Capacity: 4,096 words x 16 bits.2. Available in capabilities of 4, 8, 16K with 8 to 32 bits.3. Size: 19" x 7" x 13".4. Speed: 1 microsecond.5. Random access time: 450 nanoseconds.6. Market Response: Excellent. | <ol style="list-style-type: none">1. Capacity: 4,096 words x 16 bits.2. Available in 4K by 16 or 18 bits.3. Size: 19" x 5¼" x 13".4. Speed: 900 nanoseconds.5. Random access time: 400 nanoseconds.6. Market Response: Too early to form any sort of judgment. |
|---|---|

VERDICT

The CE-100 has been the most successful low-cost memory unit on the market (and with good reason). But since the CP-90 is faster, smaller, and since the 16-bit version costs less — it is our considered opinion that the CP-90 will become one of Lockheed's all-time best-selling memory units.

For further information write: Memory Products, Lockheed Electronics Company, Data Products Division, 6201 East Randolph Street, Los Angeles, California 90022. Telephone (213) 722-6810.

LOCKHEED ELECTRONICS COMPANY

 A Division of Lockheed Aircraft Corporation

European technology is closing IC 'gap'

Overseas semiconductor firms display digital and linear expertise at Paris components show

Ralph Dobriner
Chief News Editor

Though European semiconductor manufacturers are still considered a year or two behind the U. S. in complex MSI and LSI technology, the "gap" in integrated circuits is being narrowed. This was the belief at the electronic components show (Salons Internationaux des Composants Electroniques et de l'Electroacoustique), held earlier this month in Paris.

Despite the assault of such American giants as Fairchild, Motorola, Texas Instruments and Signetics on the European market, such major semiconductor firms as Marconi-Elliott, Plessey, Radiotechnique-Compelec, CSF-Thompson, Siemens and Philips are producing a line of digital and linear ICs that are often considered technologically competitive with U. S. circuits.

Marconi-Elliott of England, for example, is developing complex MSI custom circuits by means of computer-aided design techniques.

Stephen Forte, manager of Marconi's custom IC division, said the company is experimenting with beam-leaded ECL devices mounted on ceramic substrates with a 1.5-ns speed.

"We will manufacture three million ICs this year and six million next year and are selling everything we manufacture. The technology gap is definitely eliminated. The biggest problem we have of course is to compete with American production efficiency."

He pointed to a 7-layer screen-printed thick-film interconnect pattern on a ceramic substrate that will accommodate 20 chips. "It pays us to take on specialized custom circuits in limited quantities," he said. "The Americans can't afford to do this. They have delivery problems and often can't fill orders on time. But we can." He added, "We're perfectly satisfied to be a

number two source in the market."

Another major British semiconductor supplier, Ferranti, displayed a line of DTL circuits with 9-ns and 15-ns speed, and a TTL family that is being mass-produced for Type-1900 computer systems made by International Computers Ltd. The company also exhibited a va-

riety of MSI structures, including a 64-bit memory, an 8-bit shift register, a digital multiplexer and a TTL monostable control device for a memory matrix.

Finally, Plessey, another British firm, displayed a family of bipolar and MOS integrated circuits, including an MOS driver, MOS shift registers with up to 64-bit capacity and a family of standard RTL circuits.

One of the real attention-getters

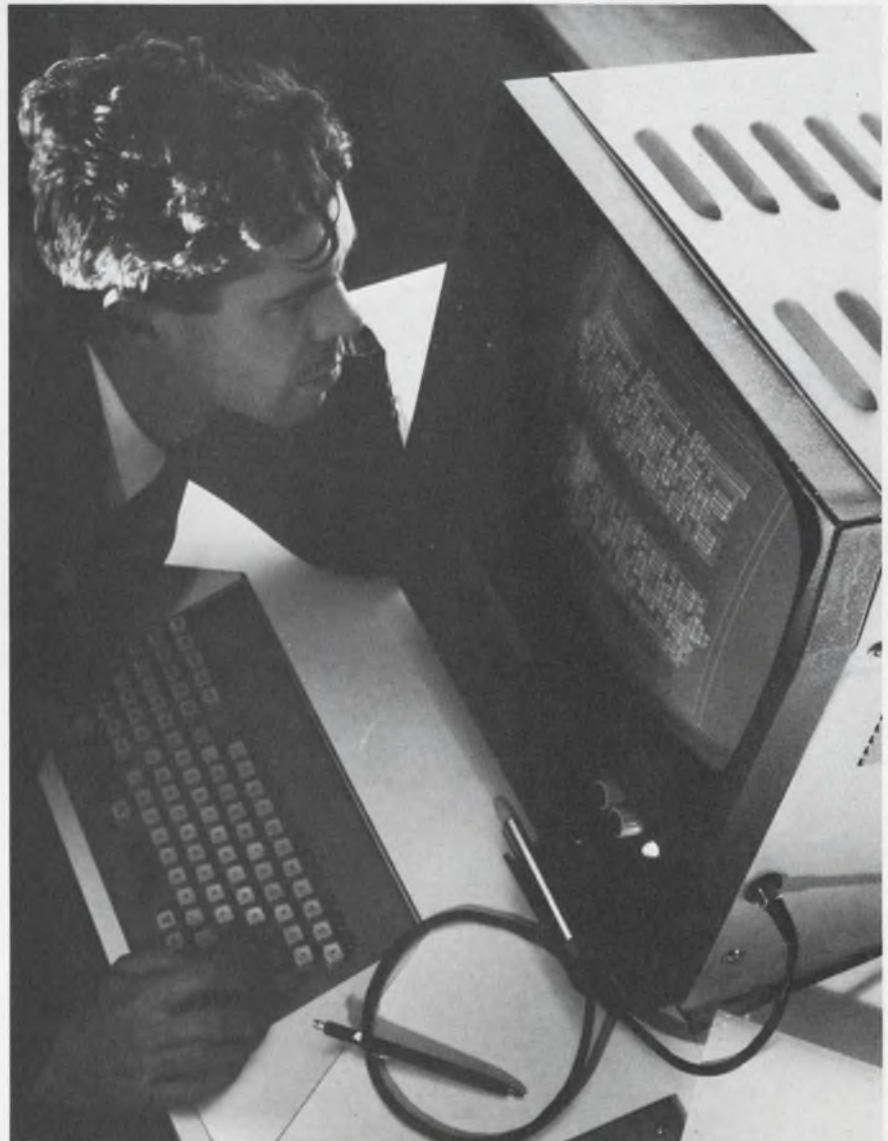

Complex microcircuits are designed at Marconi with the company's Myriad computer and graphical display system. Simon Bird, senior Marconi engineer, is viewing a portion of an MOS device that contains some 1500 separate devices on a silicon chip.

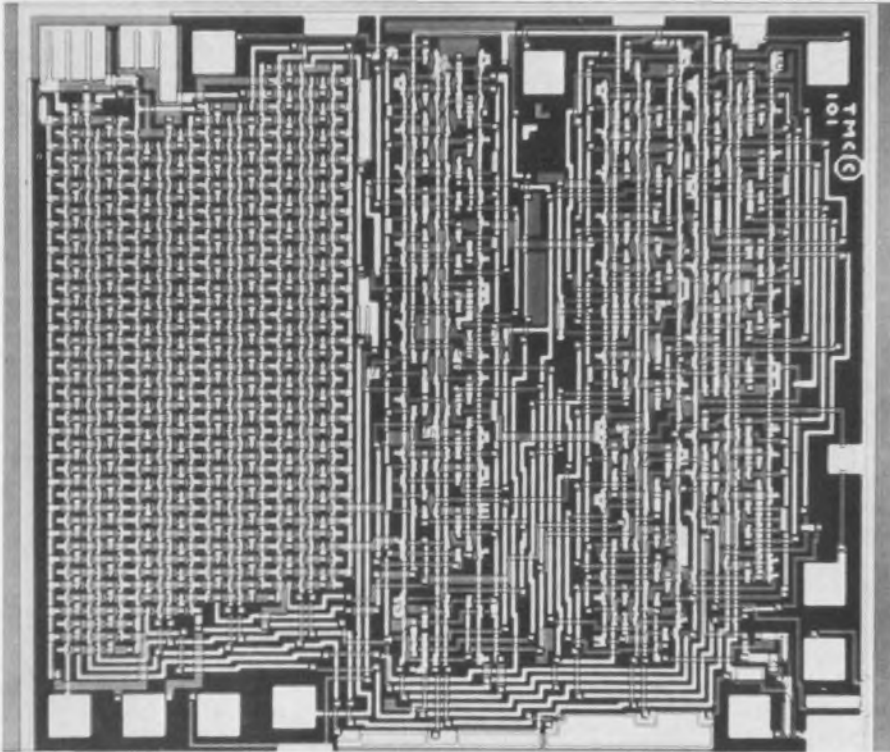
(Paris components show, *continued*)

This 64-bit MOS digital integrated shift register was developed by Radiotechnique-Compelec of France.



Handset portion of an experimental all-electronic "telephone of the future," designed by Northern Electric Ltd. of Canada, houses integrated circuits and thin-film components.

at the show was the display by Radiotechnique-Compelec (RTC), an independent subsidiary of Philips and one of the largest semiconductor manufacturers in France.

The company exhibited a line of DTL logic circuits, including a 5-bit comparator, 10-bit parity checker, binary decimal decoder and 4-bit binary memory. In fast TTL, the company showed 4-gate, 6-ns circuits which, it says, is equivalent to Sylvania's SG and SM lines.

By the end of the year, RTC says, it will introduce EECL logic circuits operating off a single 4-volt power supply and containing integrated voltage references in each circuit. Propagation delays will be on the order of 2.5 ns.

M. Fontan, an RTC sales engineer, predicted that by 1970 the company will have developed a line of MOS circuits including a 64-bit shift register and 512-bit NDRO memory.

In the linear circuit area, Fontan said, RTC will within a few months start production of: an operational amplifier equivalent to the LM709; a medium-frequency amplifier with demodulator and preamp quadrature detector; a double-differential amplifier for memory applications and the Compteur 27 series—an MOS binary frequency divider that will be used in electronic musical organs. The company also plans to manufacture linear circuits for the TV market such as its TAA 470, a processor that prepares RGB signals from the luminance and chrominance signals in color TV receivers.

Government help scarce

Compared with the massive government-supported R&D funding of companies in the United States, most European firms get virtually no government help. This year, for example, the British government doled out the equivalent of only \$15 million to be distributed among three semiconductor manufacturers—Marconi, Ferranti and Plessey.

In France, only CSF-Thompson's microelectronics facility, Sescossem,

**MOST
RESISTORS ARE
PRETTY MUCH
ALIKE
IT'S THE NAME
BEHIND THEM
THAT COUNTS**

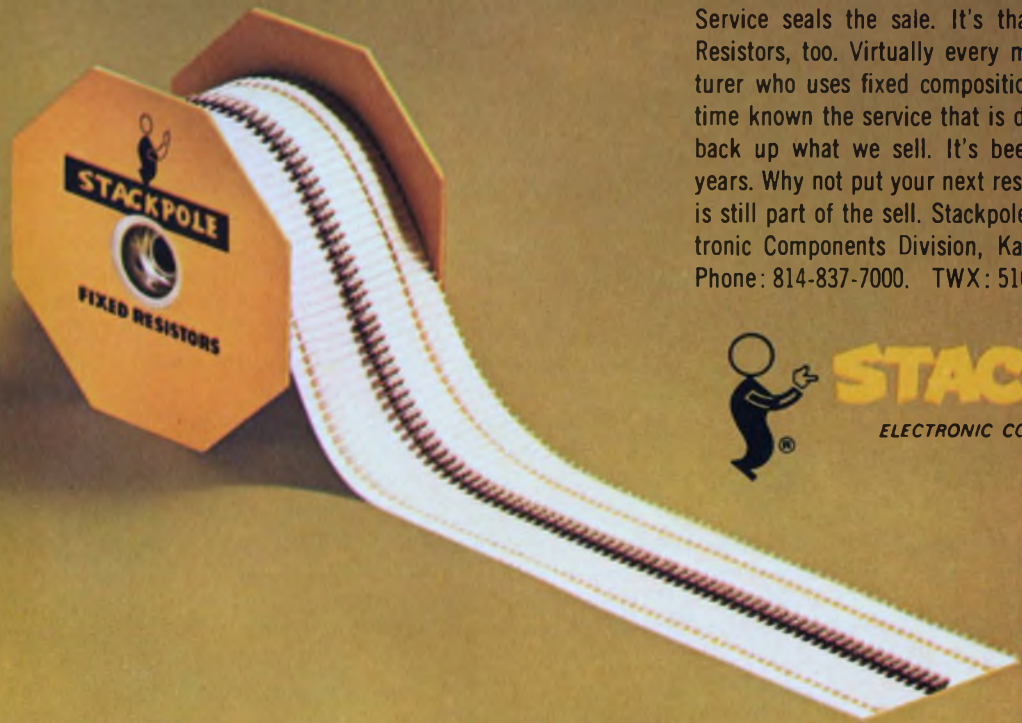

Service seals the sale. It's that way with everything. Resistors, too. Virtually every major domestic manufacturer who uses fixed composition resistors has at some time known the service that is distinctly Stackpole's. We back up what we sell. It's been that way for over 35 years. Why not put your next resistor order where service is still part of the sell. Stackpole Carbon Company, Electronic Components Division, Kane, Pennsylvania 16735. Phone: 814-837-7000. TWX: 510-695-8404.



(Paris components show, *continued*)

The digital multimeter containing an LSI MTOS chip was a hit at the Paris show. The 2-1/2-pound unit was developed by Schneider Electronique of France.

is receiving any substantial government aid under a special program to develop integrated circuits for Plan Calcul—a government scheme to develop a native computer industry.

The military is also providing some funds to French semiconductor firms. Among these is RTC, which is developing 4-bit and 16-bit IC memories and various other IC devices for the Service Technique Telecommunications Air, a military government agency.

Sescosem (Compagnie Generale des Semiconductors) now produces an estimated 150,000 ICs per month. The company presently makes some 80 different versions of DTL and TTL logic. By the end of this year, it says, it will have available TTL logic with a 6-ns speed, 400-mV noise immunity and using 22 mW per gate.

Siemens AG of Munich, Germany,

displayed a TTL family that it says is equivalent to TI's SN74 series. The company plans to start production soon on a new type of low-speed (300-ns), 15-volt logic with high dynamic noise immunity. Switching speed can be changed by adding an external capacitor. Siemens also exhibited a broadband operational amplifier that it claims is similar to the 709. The amplifier has an 82-dB gain when operating across a 2000-ohm load and can deliver up to 100 mA to drive a relay directly.

Though it may take European semiconductor manufacturers another two years to catch up in MSI and LSI technology, one French company, Schneider Electronique, couldn't wait. One of the hits of the show was the firm's portable digital multimeter that contains an LSI MTOS chip. Containing 475 transistors, the chip is enclosed in

a 16-pin, dual-in-line package, which was custom-designed for Schneider by General Instruments Corp. of Europe. The Digitest 500 multimeter performs counting, logic A/D conversion and some switching functions.

The unit weighs 2-1/2 pounds and will sell for about \$190. It will be distributed in the U.S. by Honeywell Corp. sometime in July. The multimeter has 17 measuring ranges, a resolution of 100 microvolts, 100 nanoamperes and 1/10 ohm. It can be operated off-line or by eight 1.5-volt batteries.

Francis Barroux, assistant director of Schneider's electronics division, says the company—which produces some 300,000 TV sets a year—is studying the possibility of incorporating ICs in the RF or audio sections of TV receivers.

Concerning the so-called technological gap, Barroux noted: "A few years ago it was a ten-year gap, now it's just a year and closing rapidly."

'Telephone of the future'

A miniaturized "all electronic telephone of the future" containing integrated circuits and thin-film components was unveiled by Northern Electric Co. Ltd. of Canada. The complete telephone network circuitry is housed in the handset, which weighs about half as much as today's version. A push-button telephone dial is contained in the underside of the handset close to the ear piece.

The telephone circuitry developed by Microsystems International Ltd. of Canada consists of three silicon integrated circuits and five thin-films joined together by a double-sided flexible printed circuit board. The ICs are used for amplifying and transmitting, while the tantalum thin-film circuits are used for passive components and conducting paths.

The experimental telephone also incorporates an "electret" microphone and associated circuitry in the mouthpiece, which weighs one-tenth as much as the conventional carbon type of microphone in use today. Electronic tone ringing is also used. ■■

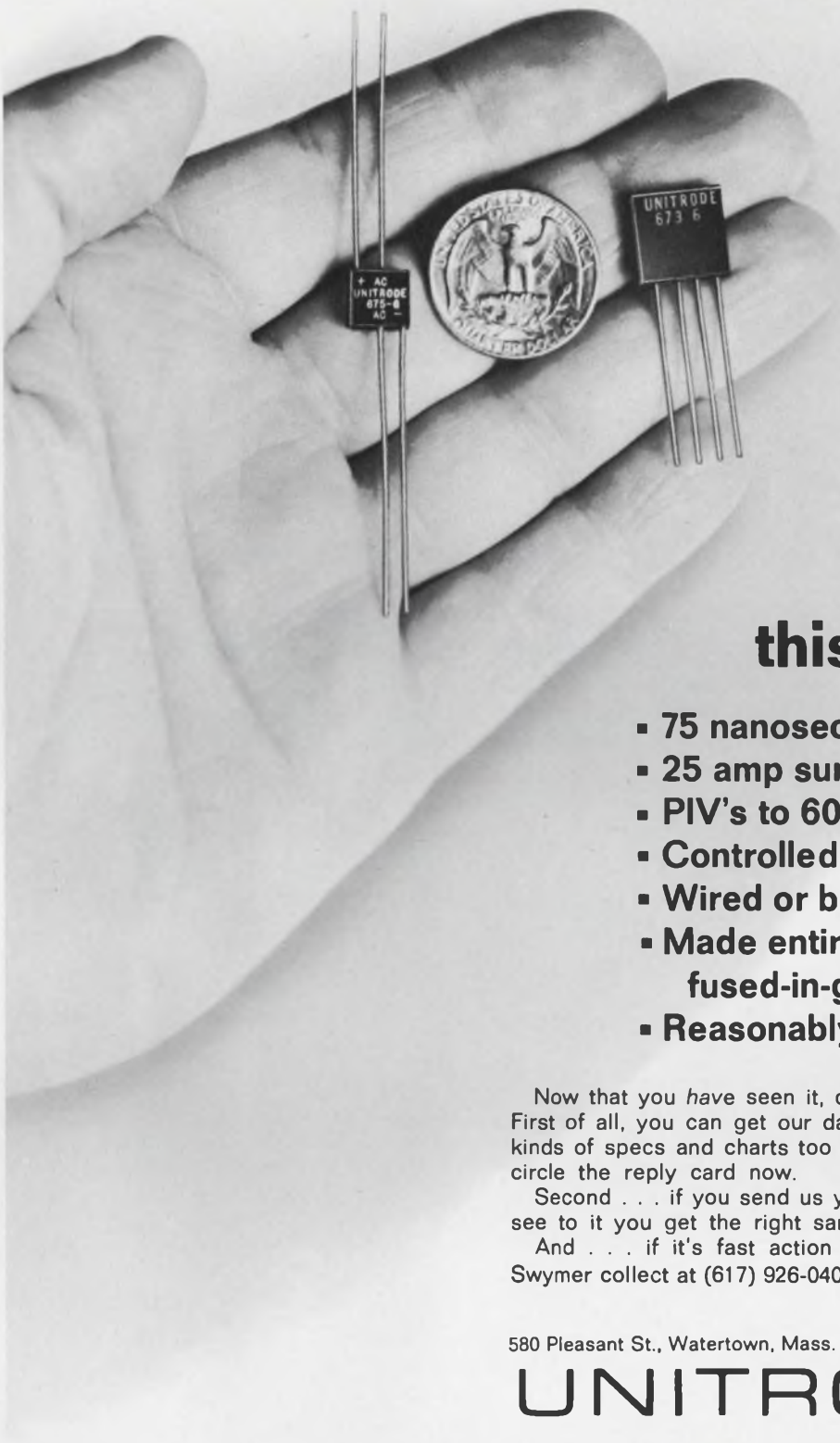

Two bits says you've never seen a 1.5 amp bridge this small with

- 75 nanosecond recovery
- 25 amp surge rating
- PIV's to 600V
- Controlled avalanche
- Wired or board mounted
- Made entirely with individually fused-in-glass diodes
- Reasonably priced

Now that you *have* seen it, don't you want to know more? First of all, you can get our data sheet, just packed with all kinds of specs and charts too detailed to put in this ad. Just circle the reply card now.

Second . . . if you send us your circuit requirements, we'll see to it you get the right sample for the job.

And . . . if it's fast action you want, why not call Fred Swymer collect at (617) 926-0404.

580 Pleasant St., Watertown, Mass. 02172, (617) 926-0404

UNITRODE

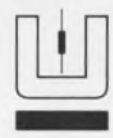

STANDARD RECOVERY

PIV to 600V
 Rating 1.5A
 Surge 25A

FAST RECOVERY (500 nsec)

PIV to 600V
 Rating 1.0A
 Surge 20A

ULTRA-FAST RECOVERY (75 nsec)

PIV to 200V
 Rating 1.0A
 Surge 20A

HERE'S WHAT IT LOOKS LIKE INSIDE

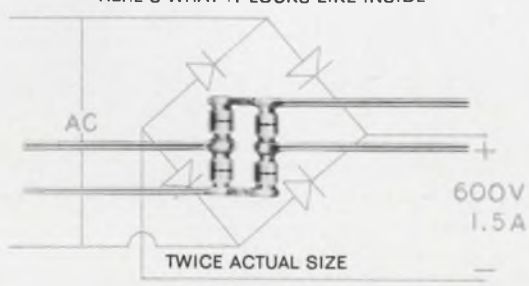

AND HERE'S WHAT IT LOOKS LIKE INSIDE THE INSIDE

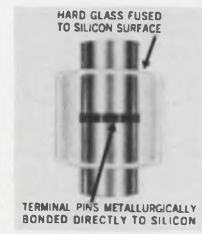

With the silicon die metallurgically bonded between terminal pins of the same thermal coefficient, the hard glass sleeve is fused to the entire outer silicon surface. Result — a voidless, monolithic structure.

INFORMATION RETRIEVAL NUMBER 20



We make components for guys who can't stand failures.

Everybody hates failures in their electronic gear. It's just that some guys hate failures a little bit more than others.

These are the guys that we try to please.

At Corning, we make our resistors and capacitors to perform like your whole system depended on them, because many times it does. We build an extra measure of performance into all our components to let you build extra reliability into the equipment you design.

Take our precision tin oxide resistors, for example. They're the best of the metal film class. Because the resistive tin film is completely oxidized and molecularly bonded to the glass substrate, our tin oxide resistors are impervious to moisture and environmental degradation. No other resistor can deliver the same stability and reliability over load life. They offer guaranteed moisture resistance across all ohmic values to set a standard of reliability that can't be matched by metal film, wire wounds, carbon comps or metal glaze resistors.

After a recent 56-day-long heat

test in an environment of extremely high humidity, our tin oxide resistors showed a resistance change of just 0.2 per cent. And in an ambient temperature test—now in its ninth year—not one of the 600 tin oxide resistors being tested has exceeded a resistance change of 1.5 per cent.

Take our glass capacitors. The U.S. Air Force has found that our glass capacitors have much better stability and much higher insulation resistance than the ceramic, mica and the other capacitor types they tested. That's why glass capacitors are designed into so many major aerospace and missile projects.

And we've got something to offer when economy and value are the prime considerations. We've developed the Glass-K™ capacitor to give you the volumetric efficiency and economy of monolithic ceramic capacitors, but with the much improved stability and reliability that only a glass dielectric can add. In resistors, our tin oxide resistors already offer long term economy over metal film, precision wire wound and metal glaze resistors.

Our new C3 resistors, in addition to giving you a small case size, compete costwise with carbon comps.

Another important Corning development is the flame proof resistor. These resistors can withstand overloads of up to 100 times rated power without any trace of flame. And because they open under overload, they provide protection for the rest of the system.

At Corning we make components for guys who can't stand failures. Guys like your most important customers. Guys like you. So, next time you're designing a system, reach for your CORNING® capacitor and resistor catalogs and call your local Corning authorized distributor for off-the-shelf delivery. They'll help you design-in an extra measure of performance.

If you don't have our catalogs, ask your Corning distributor for copies or drop us a line at: Corning Glass Works, Electronic Products Division, Corning, New York 14830.

CORNING
ELECTRONICS

Instant DF aid for combat pilots in trouble

Say an Air Force combat pilot is in trouble. He's lost and needs directional guidance, or his jet has just flamed out and he wants to tell the nearest base where it can find him after he bails out. Ground stations, using the best direction-finding equipment available today, have 10 vhf and 10 uhf channels available at any one time to receive such calls of distress. With new

equipment undergoing tests at Otis Air Force Base, Cape Cod, Mass., they will have 4800 channels.

When zeroing in on aircraft with present DF networks, the best accuracy ground stations can hope for today is 6 degrees. With the new equipment, accuracy improves to 1 or 2 degrees.

With present gear, the aircraft trace appears briefly as a line of

bearing on an oscilloscope tube and then fades—sometimes forever. The new DF gives the bearing as a digital readout and then stores it automatically in a memory; it can be recalled indefinitely, even after but one distress call.

The vastly improved equipment, called AN/TRD-24 DF, is a pseudo-doppler set that can be taken any place in the world and be put into instant operation. Instead of the plug-in, crystal-controlled channels that the old sets use, it employs a digital frequency synthesizer with finger-tip control.

Developed by Cook Electric of Morton Grove, Ill., for RCA, Burlington, Mass., the new DF set is part of the Air Force's instant air traffic control central—designated AN/TSW-7, with RCA the prime contractor (see "Light Air-Traffic Tower Turns Strip into Airport," ED 4, Feb. 15, 1969, p. 22).

The AN/TRD-24 is called a pseudo-doppler set because its 16 vhf and 16 uhf dipole antennas are scanned electronically, in contrast with the original Adcock DF set with a mechanically spun dipole. The electronic scanning is at the rate of 560 times a second.

The inherent bearing accuracy of the equipment is ± 1 degree, and 90 per cent of the readings fell within 1 degree during recent operational tests in cooperation with the Federal Aviation Administration. FAA requirements call for accuracy of ± 6 degrees in zeroing in true north and ± 10 degrees throughout the rest of the azimuth bearings.

Alexander Kelley, project engineer in the Air Force Command Electronic Systems Div., says the digital readout memory, which allows a controller to recall the position of an aircraft on the numerical display, is the single most valuable combat feature of the new equipment. With it, it will be possible to locate downed pilots without continual use of beacons and radars, which can also be pinpointed by the enemy. ■■

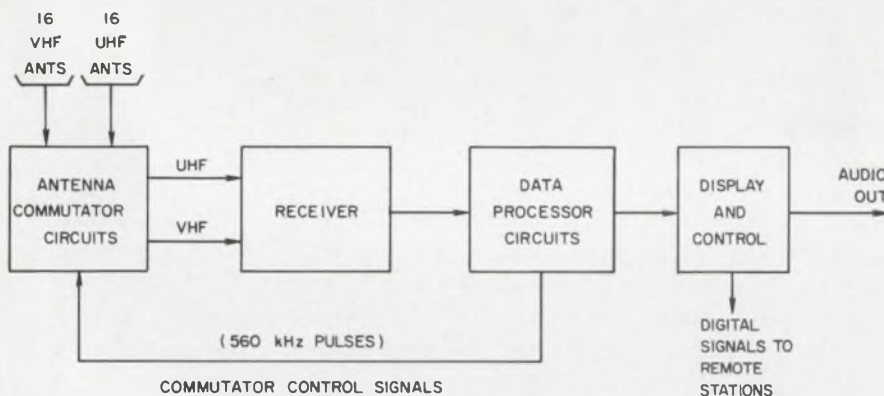

1. New Air Force pseudo-doppler DF equipment scans 16 vhf and 16 uhf dipoles electronically. Outputs are applied, through coaxial lines, to receiver, processor and indicator circuits.

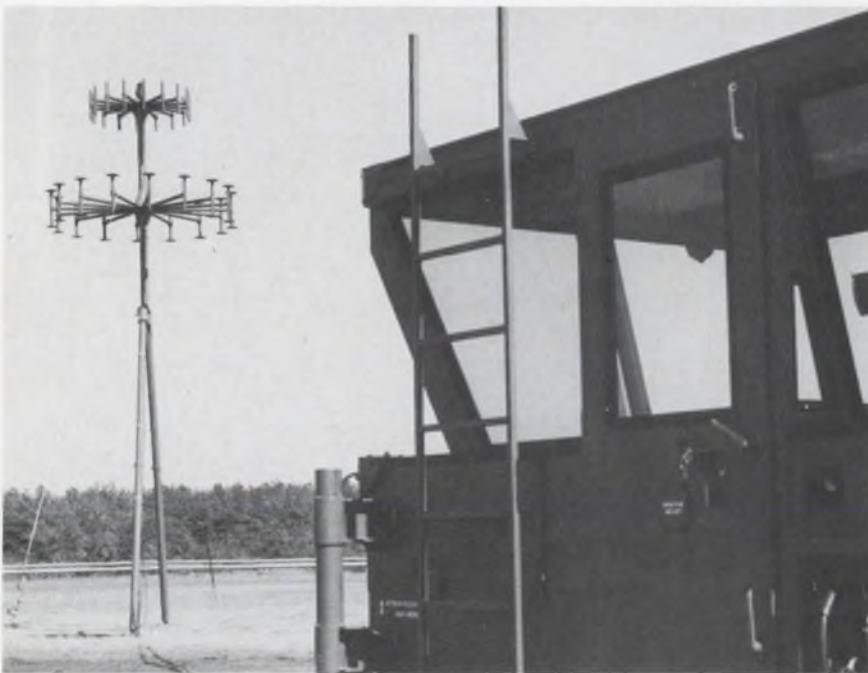

2. Antenna system for AN/TRD-24 DF equipment. At top, 16 uhf and, at bottom, 16 vhf dipole elements. Antennas are scanned in the mast and outputs fed through single coax to receiver.

CROWBAR...?



The One Inside is FREE

Not so many years ago, the prudent transmitter engineer discharged a high voltage capacitor bank by dropping a shorting "crowbar" across its terminals. Today's "crowbar" is a protective overvoltage circuit found on DC power supplies — usually at extra cost. Now HP includes a crowbar as standard on its recently updated series of low-voltage rack supplies . . . at no change in price.

Long established as preferred system supplies for component aging, production testing, and special applications, these supplies have now been redesigned and expanded to meet the stringent demands of today's power supply user. Advantages include low ripple (peak-to-peak as well as rms), well-regulated constant voltage/constant current DC with outputs to 60 volts and 100 amps.

Where loads are critical and expensive, the extra pro-

tection — say, against inadvertent knob-twiddling — from a crowbar is invaluable. On all internal crowbars in this series, the trip voltage margin is set by screwdriver at the front-panel.

Pertinent specifications are: triggering margins are settable at 1V plus 7% of operating level; voltage ripple and noise is 200 μ V rms/10mV peak-to-peak (DC to 20 MHz); current ripple is 5 mA rms or less depending on output rating; voltage regulation is 0.01%; resolution, 0.25% or better; remote programming, RFI conformance to MIL-I-6181D.

Prices start from \$350. For complete specifications and prices, contact your local HP Sales Office or write: Hewlett-Packard, New Jersey Division, 100 Locust Avenue, Berkeley Heights, New Jersey 07922 or call (201) 464-1234 . . . In Europe, 1217 Meyrin, Geneva.

HEWLETT  **PACKARD**
POWER SUPPLIES

Additional data sheets available upon request

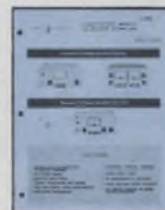

LAB SERIES
smaller package,
lower power,
optional crowbar



CROWBARS
A Technical
Discussion



**1969 Power
Supply Catalog**
— includes total
HP power supply line.

FOR 'DUAL-BASED' DEFENSE:

Mothball and fast-haul electronics needed



Equipment, to be stored in allied lands or carried by airlifted GIs, must be small, rugged and reliable

John F. Mason
Military/Aerospace Editor
With photos and on-the-scene reporting by Thecla

There was trouble in Bavaria's Black Forest. Six-thousand "aggressor" troops had bivouacked near the Czechoslovakian border. Hostilities threatened. After a quick but careful study, the commander of the U. S. forces in Germany asked the Pentagon for help.

That was the hypothetical problem posed by the military leadership late in January. And the troop maneuvers that followed were a unique test of electronic gear.

For a "dual-based" defense—heavy equipment stored in allied countries with U.S.-based troops ready to be rushed to the trouble spot by plane—is shaping up as the new policy. This will forestall a dollar drain while the nation continues to honor its treaties with allies throughout the world.

Electronic equipment from now on must be more transportable than ever—small, rugged and reliable, and it must be built to lie moth-balled for months, or even years, and still operate when needed.

When even bigger transport planes are in operation, such as the C-5, perhaps less equipment will have to be stored abroad and more of it carried over by air.

The January maneuvers involved 16,000 men from bases across the U. S. plus thousands of other GIs in West Germany. The alarm that sent them into action was part of a procedure worked out in advance, to the smallest detail.

American forces in Germany pulled tens of thousands of tons of equipment out of mothballs—radios, radars, missile site gear, tanks, trucks. The equipment had been stored by U. S. troops last year before they returned to the States. Now, packed on trains and trucks, the supplies were sent off to the "battle" area, near the village of Grafenwoehr.

Airlift to 'battle'

Meanwhile in the United States, Army troops and Air Force support personnel, along with 180 tons of equipment, were loaded on 63 Air Force C-141 jets at scattered bases. They were flown to McGuire Air Force Base, N. J., where the planes refueled. From there, they hopped to Nuremberg. Trucks took them to Grafenwoehr.

The movement consisted of 12,000 Army men and four tactical fighter squadrons. To support F-4 fighter planes, 3500 Air Force personnel went over in the C-141 transport planes.

The exercise, called Reforger I (for Redeployment of Forces in Germany), lasted six days in the field. It was a logistic nightmare, but it worked.

"The big equipment—such as radars, our fm AN/VRC-12 vehicular radios and our big a-m radios—were stored in Germany," Lt. Col. Harold B. Phillips, signal commander for the 24th Infantry Div., told ELECTRONIC DESIGN. "We brought our multi-channel radio telephone and teletypewriters over with us."

Asked whether there was any difference in the condition of the

Against a backdrop of burning napalm, U. S. and German pilots staged Europe's biggest chopper exercise.





Tens of thousands of tons of radars, communication units, tanks and trucks traveled 150 miles by convoy

and train to the "battle" zone near the Czechoslovakian border. An unexpected thaw turned roads to mud.



AN/TPS-44 search radar, built for the Air Force 407L air control network, is operating satisfactorily.



Radar operations van, AN/TSQ-61, for the Air Force AN/TPS-44 search radar, includes five videos, remote controls.

equipment that was stored and the equipment that was flown over, Colonel Phillips said: "Very little. A few of the AN/GRC-26 and -46 a-m radios were slightly damaged by moisture and mildew, but this was caused by a faulty shelter. We also found a few wires and tubes broken in these radios, but the reason for this is that they're big radios, not solid-state, and they perform a lot of functions.

"They require high power. They have several receivers and teletypewriter equipment. Cryptographic devices have to be installed on-line. And it just isn't easy to get everything going at once.

"We are looking forward to a new series of a-m radios, the GRC-106. These will be solid-state and also provide us with single sideband capability.

"We took 20 MRC-69 vhf radio telephone terminals with us and pulled seven out of mothballs in Germany. All 27 worked well.

"The VRC-12 series operated with no problem whatsoever."

One sergeant, interviewed while using the VRC-12 vhf, fm vehicular radio in a chilly tent near Grafenwoehr, wasn't all praise: "The audio connectors are too small; they're not rugged enough," he said. "The old radios we had had more rugged speakers and connectors. The ceramic materials break in cold weather. Maybe they should be made with rubber."

The sergeant had another complaint. The antenna connector and the relay are built together. If a small insulator inside the connector breaks, the entire relay has to be replaced. "It would be better," he said, "if the connector were tied to the relay by a coaxial cable."

It wasn't all bad

The sergeant liked the fm radios, though, because they had a tone-operated squelch. "This is

an improvement," he said, "over noise-operated sets. This way you don't have to listen to the tube noise all the time."

A Pulse Acquisition Radar, used with the Hawk ground-to-air anti-aircraft missile to detect enemy planes at medium altitude, was stationed high on a hilltop to scan the skies—as well as to watch the Czech border, which was lined with equally watchful Soviet troops. The operator said the Raytheon radar worked well, except that "fog condensation on the antenna dripped down into the radar, causing circuits to short."

"What we need," he said, "is a waterproof radome."

One thing this operator liked was Bite (for built-in test equipment). "I live by it," he said. "It shows me when something is going wrong before it happens."

Another radar used was the Air Force's AN/TPS-44 search model. A year ago, this part of the 407L air-transportable, tactical air control system was under test at Eglin Air Force Base, Fla. (See "Air Force Getting War Network That Can Travel," ED 6, March 14, 1968, p. 25).

At Grafenwoehr the radar, with its collapsible 10-by-16-foot dish antenna, was mounted on a 2-1/2 ton truck on a hill near the Hawk radars. Alongside it was its TSQ-61 radar operations van.

An operator in the van noted: "We have remote control capability for the radar so we can watch it either here or in the communications van. We have communications for dialing any channel we wish. We have two scopes.

"And while the theoretical range is 275 miles, we usually put it on the 40-to-80 mile range for close air support work with the forward air controller. We turn the aircraft over to him when he can see it.

"The radar maintenance shelter is on another 2-1/2 ton truck, but one generator and a power distribution unit handles both vans."

Did he like the TPS-44?

"It's a good piece of equipment," the operator said. "At first it took too long to erect, but now we can do it in five minutes. We can have the whole unit operational 35 minutes after we get to a site."

At Eglin a year ago the goal was one hour. ■■



High-powered illuminator radar, (Hipar) illuminates enemy aircraft with electromagnetic radiation on which the ground-to-air Hawk missile can home.

Introducing pulling.



As opposed to pushing and swearing a lot.

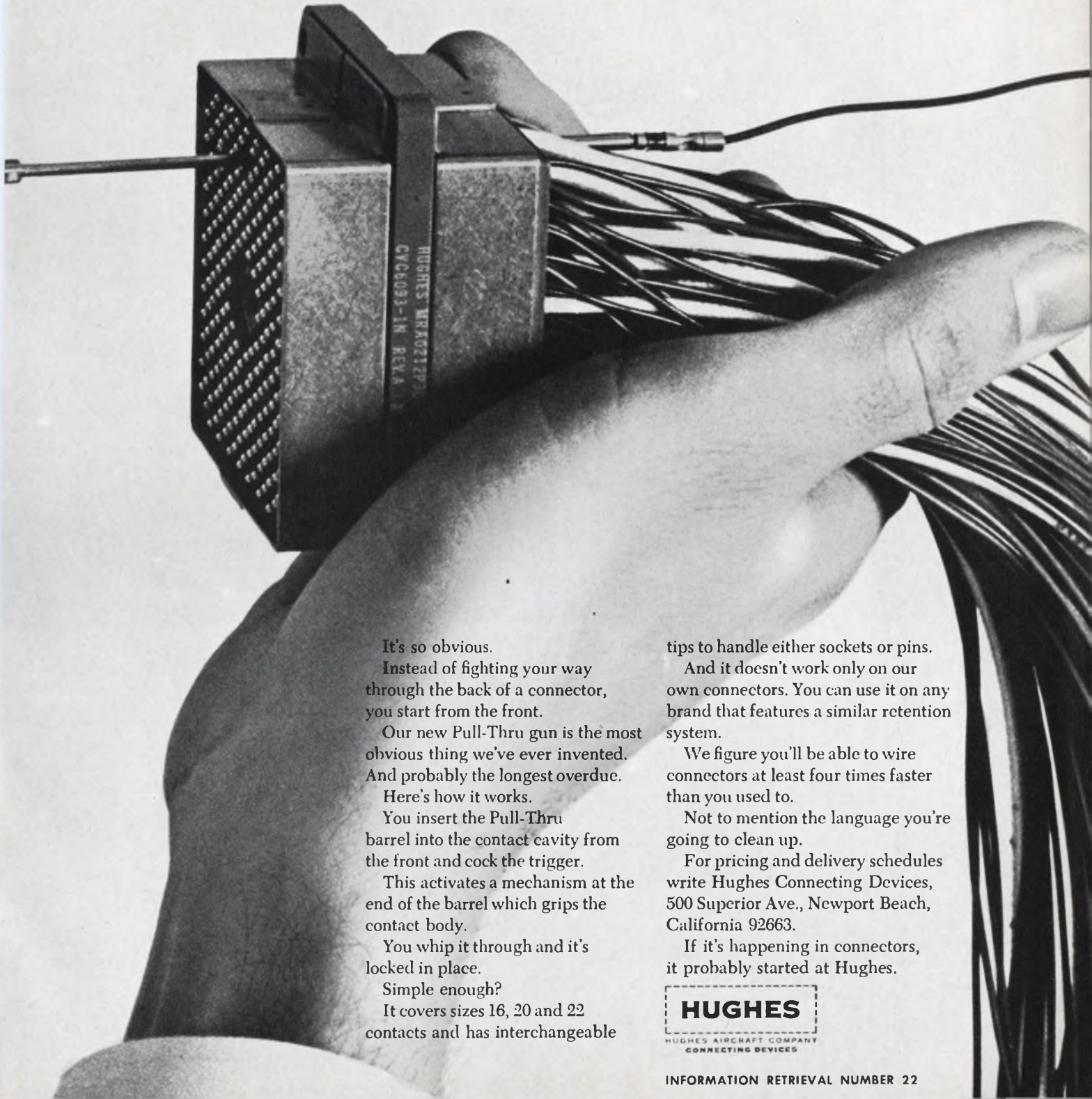

It's so obvious.

Instead of fighting your way through the back of a connector, you start from the front.

Our new Pull-Thru gun is the most obvious thing we've ever invented. And probably the longest overdue.

Here's how it works.

You insert the Pull-Thru barrel into the contact cavity from the front and cock the trigger.

This activates a mechanism at the end of the barrel which grips the contact body.

You whip it through and it's locked in place.

Simple enough?

It covers sizes 16, 20 and 22 contacts and has interchangeable

tips to handle either sockets or pins.

And it doesn't work only on our own connectors. You can use it on any brand that features a similar retention system.

We figure you'll be able to wire connectors at least four times faster than you used to.

Not to mention the language you're going to clean up.

For pricing and delivery schedules write Hughes Connecting Devices, 500 Superior Ave., Newport Beach, California 92663.

If it's happening in connectors, it probably started at Hughes.



General Electric introduces a faster, more convenient and less costly technique for production line encapsulating and potting. And the RTV's used in the process are as tough as any previously available.

Called the RTV-800 series, the new liquid silicone rubbers do not need a catalyst to activate them, so no premixing is needed.

They cure at temperatures ranging from 200°F to 450°F, so pot life is far longer than is customary with RTV's. A typical deep section cure would be one hour at 300°F. For really rapid cure, components can be preheated and dipped into the RTV.

These three new products are supplied in both opaque and clear grades, with viscosities ranging from very pourable to pourable. They can be blended with one another to suit your particular encapsulating job.

For more information about these new encapsulating RTV silicones (they also make good short-run molding-

materials), write Section 300, Silicone Products Dept., General Electric Company, Waterford, N.Y. 12188.

TYPICAL PROPERTIES

Uncured	RTV-815	RTV-830	RTV-835
Color	Clear	Beige	Beige
Consistency	Easily pourable	Pourable	Easily pourable
Viscosity, cps	3500	200,000	8000
Specific Gravity	1.02	1.28	1.18
Solids, %	100	100	100
Shelf Life, months	4	4	4
Cured, ±1 hr. @ 150°C	RTV-815	RTV-830	RTV-835
Hardness, Shore A durometer	35	50	35
Tensile Strength, psi	700	800	500
Elongation, %	150	250	200
Tear Strength, lb/in.	15	100	20

GENERAL  **ELECTRIC**

Now. Heat-curing,
no-mixing, high-strength
RTV silicones.

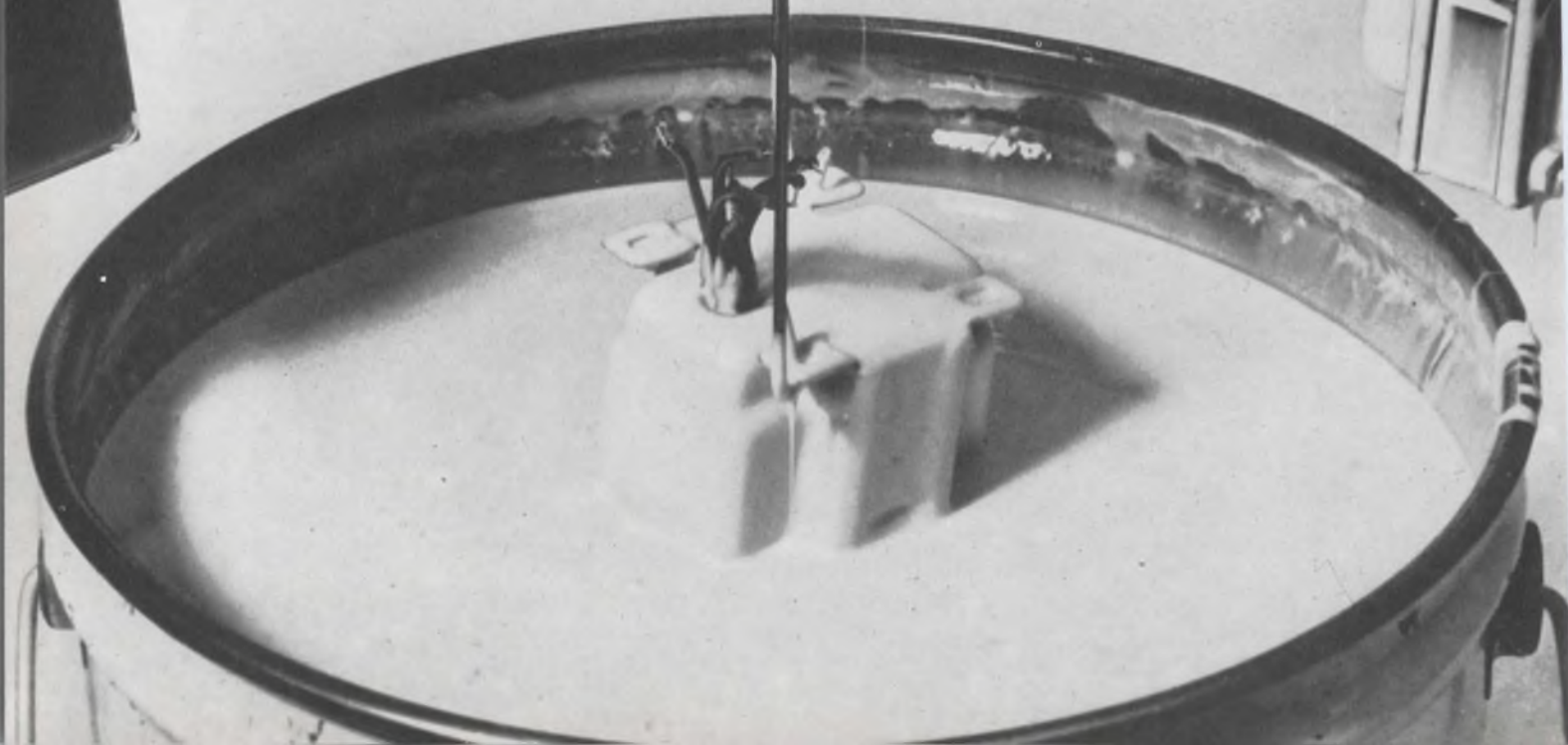

Saturn, workhorse in space



Military space funds hold, despite cuts

After all the pluses and minuses in Defense Department budget requests for military space programs are totaled, the final figure appears to remain something well over \$2 billion. In recent testimony before the Senate Armed Services Committee, Defense Secretary Melvin R. Laird made the following changes: the Air Force Manned Orbiting Laboratory program was cut \$20 million, and planned launches were reduced from seven to six (the revised total is now \$525 million); and the Air Force Satellite Early Warning Detection System was first increased \$93 million and then cut back \$50 million. Other military space programs remain largely untouched.

Military interest in unmanned satellites seems to be increasing, according to the evidence.

In addition to the existing Navy Navigational Satellite System, the Air Force strategic and tactical satellite communications systems—and its highly classified SAMOS (Space and Missile Observation Satellite) and MIDAS (Missile Infrared Detection and Surveillance) programs, a number of other efforts are under way. One, dubbed Project 417, is believed to be an RCA-built surveillance satellite based on the design of the weather satellites, but its mission is unclear. Another is Air Force Project 949, a new Integrated Early Warning Surveillance Satellite under development by TRW, Inc. Aerojet General is providing the first principal sensor package, probably infrared. A third undertaking, Air Force Project 920A, may or may not be directly associated with SAMOS, but it is a GE-produced photo reconnaissance satellite. (The original SAMOS was labeled Project

Washington Report

CHARLES D. LAFOND
WASHINGTON BUREAU

720A and was built by Lockheed Aircraft.)

Several other programs are under study and may see active development within the year. One, which may be related to Project 417, is an Air Force plan for a synchronous weather satellite system that could provide data required by other Air Force surveillance satellites.

Another, alluded to by Secretary Laird, may be related to Project 949. Emphasis in this effort would be ocean surveillance using high-resolution radar to detect enemy surface craft and sea-launched missiles. A third is a satellite-to-satellite data relay system to speed up observational data from other surveillance satellites to main Air Force data-reduction centers.

New Department of Oceanography?

Last month Rep. Claude Pepper (D.-Fla.) introduced a bill (H.R. 9482) to establish a Dept. of Oceanographic Services with Cabinet-level status. His intention, Pepper said, is to centralize maritime and marine interests now being carried out by 11 separate agencies within the government. "Not one of these agencies functions in any substantial part for the total interest of a national marine science policy," he declared.

Under the Pepper bill, the department would be headed by a Secretary, with four Assistant Secretaries—one each for Merchant Marine, Exploration and Resource Development, Marine Fisheries, and Port and Harbor Development. The new department would be made up of most of the existing agencies now related to maritime and marine sciences and operations.

The Pepper bill spells out its message clearly. For example, in his Declaration

of Purposes and Policies in Section 2 of the bill, he states ". . . the development and improvement of the capabilities, performance, and efficiency of vehicles, equipment and instruments for use in exploration, research, surveys, the recovery of resources, and transmission of energy in the marine environments is an integral and prerequisite part of the national effort and is worthy of maximum encouragement."

Group studies mining-rescue techniques

The National Academy of Engineering, under a \$75,000 contract from the U. S. Bureau of Mines, will perform a study to determine how different technologies might contribute to reduce fatalities in mining disasters. The chairman of the newly formed Academy Committee on Mining Rescue and Survival Techniques is Walter R. Hibbard, Jr., vice president for R&D at Owens-Corning Fiberglas Corp. and a former director of the Bureau of Mines.

The Committee, says NAE president Eric A. Walker, will concentrate on improving rescue techniques and increasing the workers' prospects for survival. The group, declares Walker, will consider the use of technological resources from a variety of fields, such as space exploration, deep-ocean submergence, telecommunications, seismology and civil defense.

TV radiation still a problem

Although much of the noise accompanying last year's hearings on the Radiation Safety Act has subsided, and the act was passed, considerable concern still exists about the hazard of X-ray emissions by color TV sets.

The confused situation today is reflected in three public statements made last month. The U. S.

Radiological Health Center near Washington announced its studies indicate that TV manufacturers have reduced X-ray emissions on all sets presently produced to a level well within safety tolerance. The Suffolk County, N. Y., Health Department released a report revealing that 20% of home color TVs in that area were found to radiate X-rays at hazardous levels. Through a press release, Rep. Benjamin Rosenthal and Rep. Edward Coch (both D-N.Y.) castigated the Federal Trade Commission and the Public Health Services for their failure to act on existing unsafe home TVs. In letters to each agency, the congressmen asked whether or not gauges might be built into new TVs and made available to owners of older sets to detect hazardous X-ray levels.

Several months ago this columnist talked with officials of the newly formed Advanced Research Corp., headquartered in Washington. That firm has developed and is now marketing a simple radiation detector called Ray-Alert, which is available for \$3.95 at drugstores and supermarkets throughout much of the country. The manufacturers claim that the Ray-Alert is the next thing to being "idiot proof." The small, flat, triangular plastic unit is provided with three legs having adhesive footpads that permit installing the device on the center of the TV faceplate, five centimeters from the surface. Contained in the center of the unit is a square, flat crystal of calcium fluoride, doped with a manganese phosphor. The crystal is sealed in with a 1/16-inch film of polypropylene, which serves as a spectral filter to X-rays.

To test the set, the instrument must remain on an operating TV for exactly ten hours. It may then be removed, the legs dismantled, and the instrument mailed to Advanced Research Corp. for analysis of the crystal. The laboratory service is a part of the Ray-Alert purchase price, and results are returned to the user within two weeks. Using the National Radiation Council safety limit of 0.5 mR per hour, the analysis shows only whether the set is or is not operating safely. The firm claims an absolute error factor of $\pm 10\%$.

Convert your present scope into a curve tracer: \$595.00*

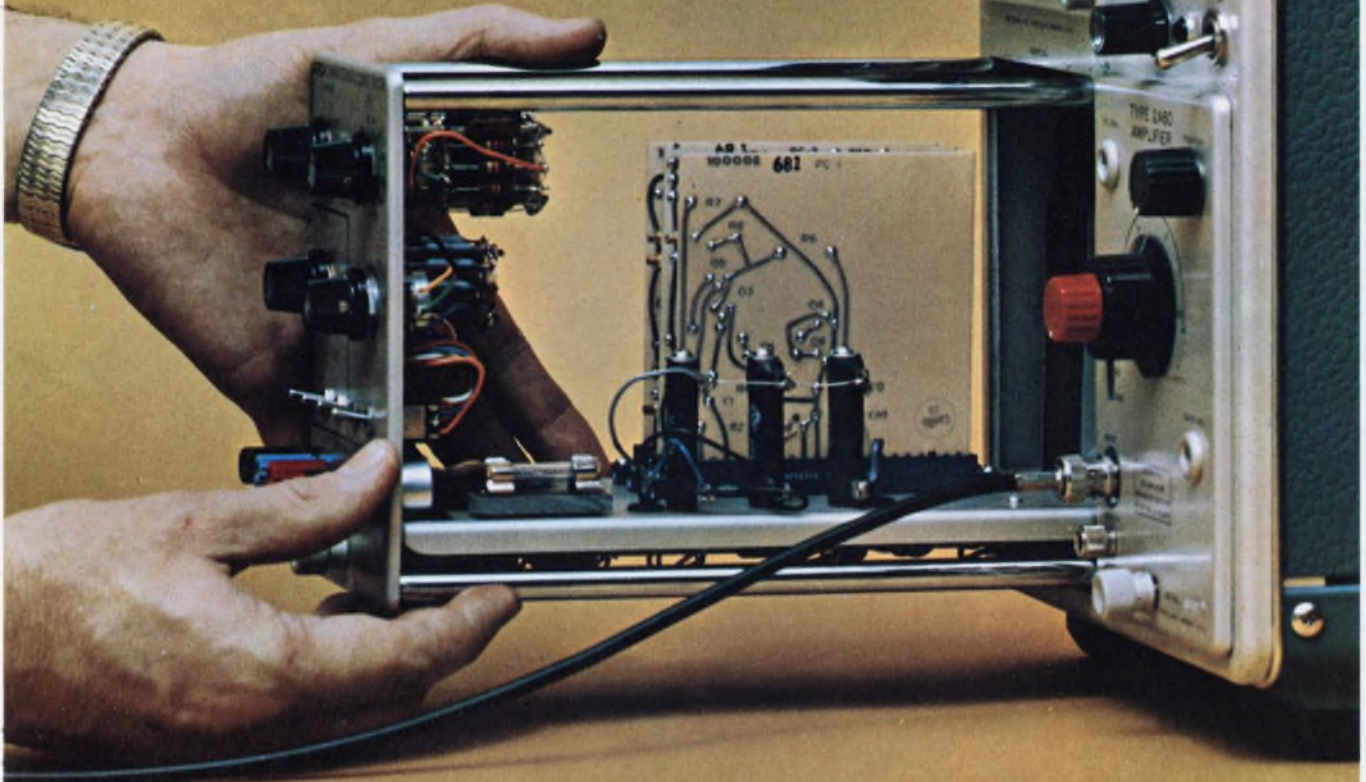

The first plug-in unit that transforms an existing scope into a curve tracer—at 1/2 to 1/3 the cost!

Now you can expand your present Oscilloscope to include curve tracer capabilities. U-Tech plug-in and console units enable any X-Y Oscilloscope to display the dynamic characteristics of both NPN and PNP transistors, N Channel and P Channel junctions, FETs, MOS-FETs, bipolars, unijunctions, diodes, tunnel diodes and SCRs.

So, if it wasn't in the budget before, now it can be, and even if you were planning for a curve tracer, you can now buy two, possibly three, of these units for the price of any other characteristic curve tracer.

Ask your distributor about these U-Tech curve tracer units or order direct.



U-Tech plug-in
Model 681: \$595.00*
For use with Tektronix 560 series Oscilloscopes.



U-Tech plug-in
Model 682: \$615.00*
For use with Tektronix 530, 540, 550, 580 series Oscilloscopes.



U-Tech Console
Model 683: \$625.00*
For use with any X-Y Oscilloscope.

*Prices apply to purchases and shipments within U.S.A. fob Salt Lake City, Utah

U-TECH

A Division of Industrial Physics and Electronics Company

4190 South State Street, Salt Lake City, Utah 84107

Yes, send me curve tracer model _____
Enclosed is: Check P.O. Bill me Send literature

Name _____ Title _____

Company Name _____

Company Address _____

City _____ State _____ Zip _____

18.6 MHz SELECTIVE LEVEL METER... EXCEPTIONAL ACCURACY...

THE SPM-6

A field instrument with laboratory accuracy was our objective — a selective level meter with -100 dBm sensitivity and a phase locked, digitally indicated frequency setting to 18.6 MHz that could operate from rechargeable batteries or from the power line in a field environment.



To accomplish it we developed a new automatic calibration system which continually readjusts the amplifier circuits to

compensate for warm up drift, attenuator errors, frequency response errors and the majority of other causes of measuring uncertainty. The result is level measurements 5 to 10 times more accurate than can be made by most precision "laboratory" type instruments. The SPM-6 is, consequently, used in the lab and on the production line as much (and maybe more) than in the field.

Our philosophy is to produce only the finest measuring instrument current technology allows and to back them up with comparable service.

Wandel & Goltermann West Germany

represented in U.S.A. by W & G INSTRUMENTS, INC. 6 Great Meadow Lane, Hanover, N. J. 07936 • Tel: (201) 887-8700



SIDELIGHTS OF THE ISSUE

Our woman in Germany

Thecla, whose dramatic photographs of Exercise Reforger I begin on page 34, was ELECTRONIC DESIGN's freelance representative in Germany when the U. S. military staged its giant preparedness games in late January.

Thecla Haldane of New York City—she uses only her first name professionally—has had pictures in several national magazines including *Life*, *Fortune*, *National Geographic*—and *Glamour*. She also had a picture story about Buic III in ED's March 1, 1969, issue.

On this trip with the Air Force and Army to Nuremberg and Grafenwoehr, Germany Thecla not only took pictures of electronic equipment but also checked on how it was operating and how it could be redesigned.

We think you'll enjoy this report of a new trend in U. S. defense—the quick airlifting of troops to allied countries where equipment has been stored for instant use. Thecla worked closely on this story with ED's military-aerospace editor, John F. Mason.



How much data is a load?

The photo on the cover shows part of the Firestone Tire and Rubber Co.'s 18,000-reel library of computer tapes. According to the 3M Co., manufacturer of the tapes, an average reel contains 2000 feet of tape, which packs an average of 1000 bits to the inch. We calculate that the library contains about 5×10^{11} bits. If this data is transmitted over a high-speed (250 kb/s) line, it would take over three weeks to send it all—assuming, of course, that there are no transmission errors and that reel-handling time can be ignored. Now turn to the Special Section on p. C1. (Photograph by IBM Corp.)



we goofed.



This Howard Cyclohm Fan was engineered to run 10 years. So far it's been running 12 years, 6 months, 21 days.

Our modest 5-year guarantee on Cyclohm Fans and Blowers is based on an engineered lifespan of 10 years. So, what do we tell our customers when they report the fans are still blowing strong 12 or even 14 years after installation? We tell them we goofed—and they benefit.

There's more to the Howard Cyclohm Fans and

Blowers success story than just long life. There's the high reliability of Howard's unit bearing motor that never needs maintenance or re-lubrication. And all metal construction. Indestructible nylon blades. Standard mounting on 4-1/8" centers. UL yellow card listing. And still more. All the facts are in five newly-published bulletins that are yours for the asking. Just write for the Cyclohm Fans and Blowers Information Packet No. ED-49. From Howard.



HOWARD

HOWARD INDUSTRIES
A DIVISION OF MSL INDUSTRIES, INC.
2420 18th STREET, RACINE, WISCONSIN 53403
414-632-2731 TWX 910-271-2387

INFORMATION RETRIEVAL NUMBER 26

ANOTHER BOURNS FIRST...

10 MIL-SPEC TRIMPOT® POTENTIOMETERS

MIL-R-27208



RT10



RT11



RT12



RT22



RT24



RT26*

MIL-R-22097



RJ11



RJ12



RJ22

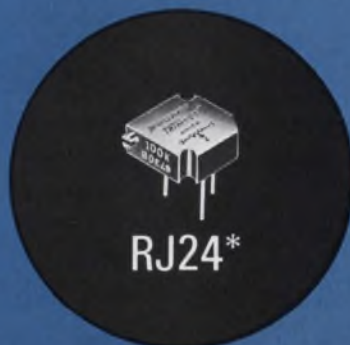

RJ24*

AVAILABLE FROM YOUR LOCAL BOURNS DISTRIBUTOR!

Bourns is the world's largest manufacturer of Adjustment potentiometers with 22 years of leadership. Bourns is also the largest manufacturer of MIL-Spec potentiometers backed by a total of 10 RT and RJ models in our line.

The 6 RT and 4 RJ models not only meet the specifications of MIL-R-27208 and MIL-R-22097, but each is designed and manufactured to consistently exceed each facet of these requirements.

As in the past, you can depend on Bourns to deliver the potentiometer you need. In this tradition of service, we now offer the MIL-Spec unit you may need for your next critical application with 10 RT and RJ models.

Full data is available from the factory, local field office, representative or your stocking distributor.

* Not yet stocked in depth by distributors.



BOURNS, INC., TRIMPOT PRODUCTS DIVISION
1200 COLUMBIA AVENUE, RIVERSIDE, CALIFORNIA 92507
714 684-1700 • TWX: 910 332-1252 • CABLE: BOURNSINC

Publisher

Hugh R. Roome

Editor

Howard Bierman

Managing Editor

Robert C. Haavind

Technical EditorsFrank Egan
Michael J. Riezenman
Raymond D. Speer**Management and Careers Editor**

Richard L. Turmail

Chief News Editor

Ralph Dobriner

Washington News Bureau

Charles D. LaFond, Chief

Military/Aerospace Editor

John F. Mason

East Coast Editor

Jim McDermott

West Coast Editor

Elizabeth deAtley

New Products EditorsRobert Patton
Lucinda Mattera**Copy Editor**

Marion Allen

Editorial ProductionDollie S. Viebig
Phyllis Gura**Art Director**

Clifford M. Gardiner

Art Assistant

William Kelly

Technical IllustratorsWilliam Alvarez
Rita Jendrzewski
Lynn E. Thompson**Production Manager**

Thomas V. Sedita

Asst. Production Manager

Helen De Polo

Production Assistants

Bernard Wolinsky

Circulation Manager

Nancy L. Merritt

Information Retrieval

Genate Piccinetti

EDITORIAL



How broad is your concept of the engineer's job?

An engineer's job is to design the best product that he can, in the time available and at the lowest feasible cost. Right?

Many engineers, perhaps with a few frills or flourishes, would be willing to accept this as a reasonable job description in brief. Many of these same engineers might be seen at various gripe sessions, either about the plant or at a local bar, complaining about the quality of management's thinking, or the ineptness of other departments in their company.

Could it be that some of these problems stem from the views these engineers have of their own roles? We contend that they probably do. For today's engineer or engineering manager must take a broad view of his function in the company structure.

To see what we mean, look at some of the elements that are usually necessary for a company to enjoy sustained success and growth. Creative innovation is one for which engineers have a primary responsibility. But in addition, factors such as empathy with customers and users, marketing direction, financial skill and loyal, responsive employees are crucial. Here's where the engineer with the broader perspective sees opportunities for expanding his contributions to the firm.

Getting to know customers or users—learning how they think, how they use his creations—gives an engineer a solid basis for future design thinking. Studying market research reports can turn up unusual responses. Tracking them down can lead to important product changes, or even to new products.

A common lament of engineers is that the marketing people are not selling the right features in the right way. This calls for communication rather than griping. Do the marketing people know something the engineers don't? Or are they really off in left field and in need of helpful suggestions?

In the financial area, engineers may never participate in making up a balance sheet. Yet they play a major role in the over-all financial scheme of the organization. Can some purchasing be pooled among projects to get better prices? Is expensive test equipment being bought that will be used very little? Or conversely, is equipment not being bought that could save engineering time and thus far more than pay for itself?

Loyal, responsive employees are a central element in building for sustained success. Management should have clear objectives, and the company must pull as a team to reach them. If you find yourself griping frequently, stop and think for a few minutes about what's bothering you. Is your company really operating in an unreasonable fashion? If so, you'd make better use of your time and energy by finding another job. Or are you simply aware of a lot of improvements that you could help to implement if you had a broader concept of what you, as an engineer, might contribute? If so, then expand your horizons.

ROBERT HAAVIND



Our new mini-computers have built-in programmers.

Most small computers are designed for programmers. Ours are designed for people.

Just tell our 16-bit machines what you want done. The CE16 and CF16 will do it, because their "built-in programmers" (a comprehensive set of sophisticated instructions) let any engineer use them with ease. For example, the single instruction "scan memory" makes our machines compare a given number with the contents of the entire memory.

The CE16 and CF16 have 125 other heroic instructions that specify comprehensive maneuvers. So you give fewer instructions and use far less core memory than with any other small computer. Problem run times are shortened and Input/Output operations are simplified.

The CE16 and CF16 are designed to control and exchange information with a large number of external devices while doing related computation. Their "automatic I/O" enables them to talk back and forth between memory and a group of interrupting peripherals, in order of priority,

without needing attention from the on-going program.

Automatic I/O isn't a high priced option. Neither is a teletype, nor three priority interrupts, one of which is indefinitely expandable. They're all standard. The only thing you might pay extra for is speed. The CF16 can do a fully signed software multiply in 42 micro-seconds. But it costs a little more than the CE16 which takes 126 micro-seconds (which isn't bad) for the same job.

Don't take our word for all this. Drop us a line asking for:

- A brochure with straight from the shoulder specs so you can compare.
- A representative with more information than could fit in a brochure.
- Or a meeting between our sales engineer and one from any competitor you want, at your office. The competition can even bring a programmer along. We won't have to.

SDS
Scientific Data Systems,
El Segundo, California

Technology

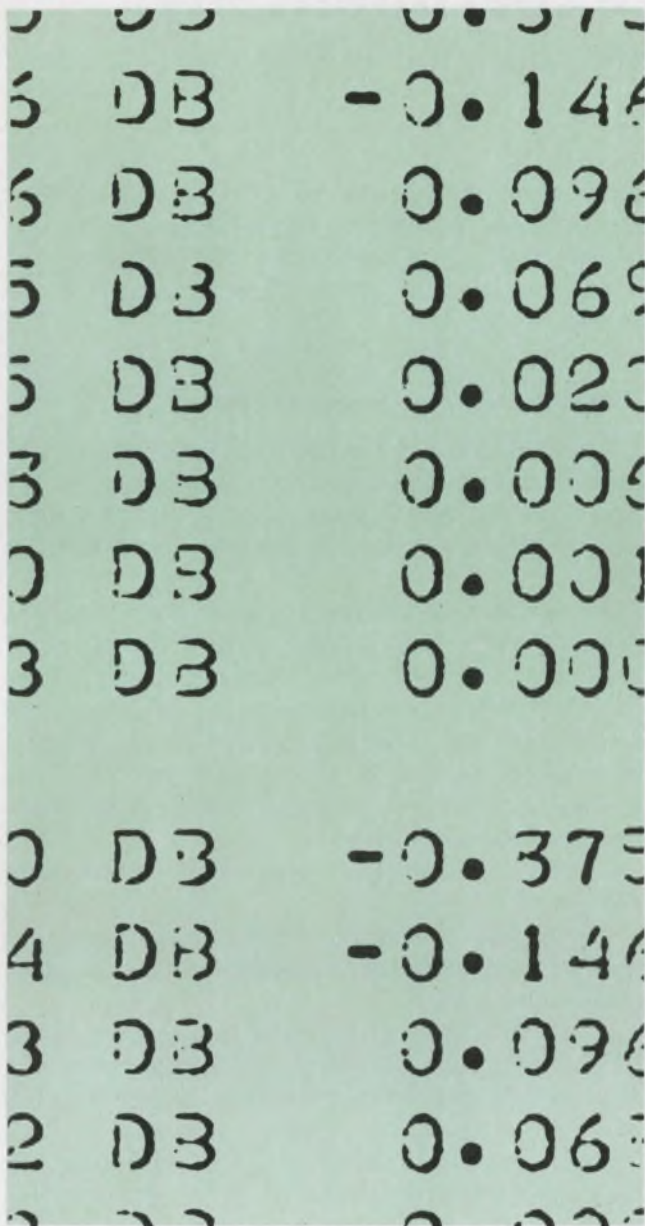

5	DB	-0.144
6	DB	0.096
5	DB	0.069
5	DB	0.023
3	DB	0.009
0	DB	0.000
3	DB	0.000
0	DB	-0.375
4	DB	-0.144
3	DB	0.096
2	DB	0.069
0	DB	0.000

Specify your trap filter the easy way. Use computer tables to establish Q, notch depth, attenuation and group delay. See page 58.



Spring Joint Computer Conference special section, including a detailed report on data communication. See page C1.

Also in this section:

Stabilize your op amp experimentally by using step-function response. Page 50.

Design bias circuits with nomographs for greater accuracy. Page 66.

Ideas for Design. Page 74.

Stabilize your op amp experimentally.

Use step-function response under operating conditions to determine component values.

In high-gain multistage operational amplifiers each stage contributes phase shifts. The loop cannot be closed down very far (increasing percentage of feedback) before excessive phase shift (180° at a gain of 1) and instability occur. To stabilize the amplifier a compensating capacitor is usually applied; however, the size of the capacitor affects the amplifier's high-frequency response.

How then can the designer choose a compensating capacitor which though small enough to provide a high slew rate¹ will still assure the desired amplifier stability (Fig. 1)?

He could devote a lot of time and effort to a painstaking analysis, probably based on inaccurate information, and follow this up with extensive bench testing; or, to save time, he could try one of the worst-case configurations specified by the amplifier manufacturer. Often, though, he winds up with too large a value of capacitance.

A faster, more effective method uses simple oscilloscope measurements *made under actual amplifier operating conditions*. With this technique the designer can quickly determine the optimum parameter values required for a stable amplifier—values that also serve to satisfy additional auxiliary conditions; namely, in this particular example, a high slew rate.

Transient response peaks indicate damping rate

The step-function response of a damped oscillatory system is shown in Fig. 2a. The more stable the amplifier, the greater is the damping as indicated on the scope by a more rapid decrease in amplitude of successive oscillatory peaks. In the method described in this article the designer utilizes the damping ratio and natural frequency of the amplifier—determined by correlating the (specific component values or component configurations, for example). Strictly speaking, the mathematical derivation outlined applies only to second

order systems, characterized by means of linear, second-order differential equations. Application of this method to third-order systems, however, yields results that are sufficiently accurate for practical use.

Take only five basic measurements

Fundamentally the method consists of five basic measurements. These are the amplitudes of the first three successive peaks, V_{p1} , V_{p2} , V_{p3} (Fig. 2b), and the times, t_1 and t_3 , so that we can determine $t_3 - t_1$.

From these measurements, the values of ζ , the damping ratio, and ω_n , the natural frequency of oscillation, can be obtained. Knowing ζ and ω_n , the dB of peaking (relative increase in gain), the small-signal unity bandwidth, and the phase shift may be obtained from Table 1 or from Fig. 4a and Fig. 5. The procedures for making the measurements are as follows:

1. *Wire up amplifier and auxiliary circuits* (Fig. 3).

The amplifier should be tested under conditions that conform as closely as possible to actual operating conditions.

2. *Apply step-function pulse to amplifier input.*

The input pulse may be simulated by means of a square-wave generator for which the rise and fall times are of the order of 10 nanoseconds. A pulse generator may be used as an alternate source, but the pulse widths must be on the order of 100 microseconds. Both the square-wave generator and the pulse generator should be capable of frequencies below 5 kHz. The purpose of the last two restrictions is to ensure that the response has sufficient time to reach a steady state before the next pulse appears.

The input amplitude should be small enough to preclude effects of slew rate limiting or amplifier saturation. Further, the pulse generator should be terminated in its matching impedance, R_T , to obtain quality pulses. The pulse width and frequency controls are adjusted to allow sufficient time for the amplifier to reach quiescent values.

3. *Obtain transient response on oscilloscope* (Fig. 2b).

Karl Huehne, Senior Applications Engineer, Motorola Semiconductor Products Inc., Phoenix, Ariz.

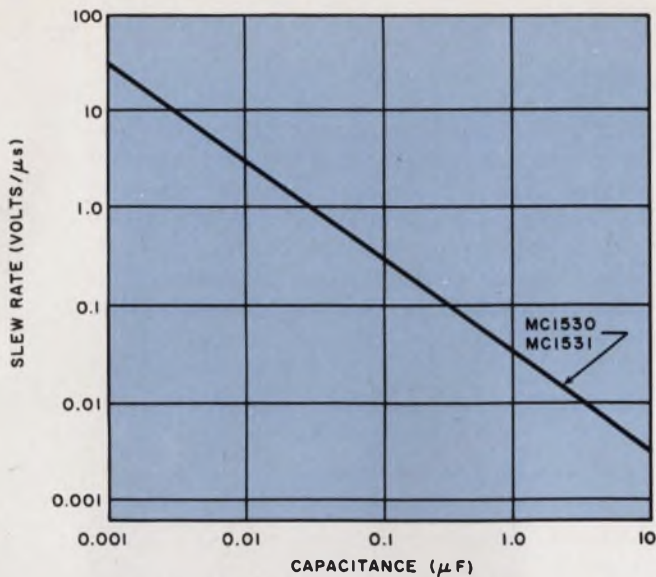

1. Slew rate of a typical operational amplifier (maximum rate of change of output voltage) is a direct function of the compensation capacity. At higher frequencies, current required to charge and discharge the capacitors is limited to the current available from the internal current source.

The key to accurate measurement lies in the oscilloscope display of the output response. To achieve maximum accuracy the response waveform should occupy as much of the oscilloscope graticule as possible. To do this the graticule is scaled with the initial value of the waveform at zero and the final value at one, then the horizontal scale is adjusted so that all of the three peaks required for the determination of ζ are visible.

4. Measure V_{p1} , V_{p2} , V_{p3} , t_1 and t_3 .

Calculate stability from damping ratio

To utilize the measurements, two fundamental relationships have been derived (Box 1):

$$\zeta = \frac{\left| \log_{10} \left(\frac{V_{p1} - V_{p3}}{V_{p2}} \right) \right|}{\left[\log_{10}^2 \left(\frac{V_{p1} - V_{p3}}{V_{p2}} \right) + 1.86 \right]^{1/2}} \quad (1)$$

$$\omega_n = 2\pi / (t_3 - t_1) \sqrt{1 - \zeta^2} \quad (2)$$

The values of ζ and ω_n may be calculated readily by substituting into Eqs. 1 and 2. The value of peaking in dB can be obtained from

$$p \text{ (dB peaking)} = 20 \log_{10} (1/2\zeta\sqrt{1 - \zeta^2}),$$

where $\zeta \leq 1/\sqrt{2}$. (3)

It can also be determined from Table 1, which lists "dB of peaking" versus ζ for selected values of ζ , or from Fig. 5, which is a plot of Table 1 (Box 2).

After determining ζ, ω_n and the dB of peaking,

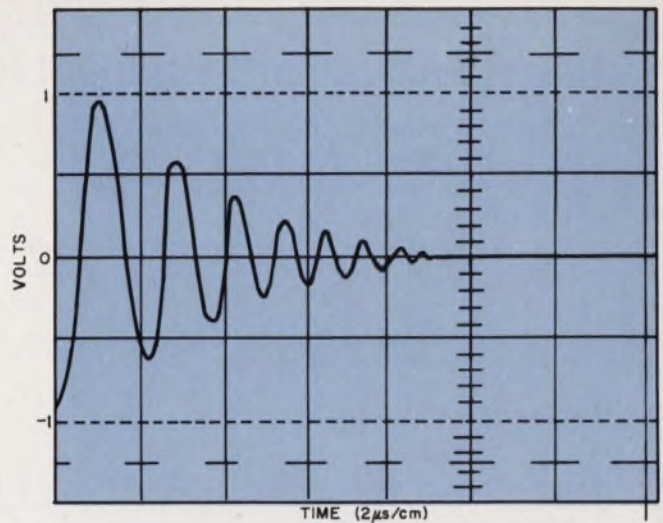

(A)

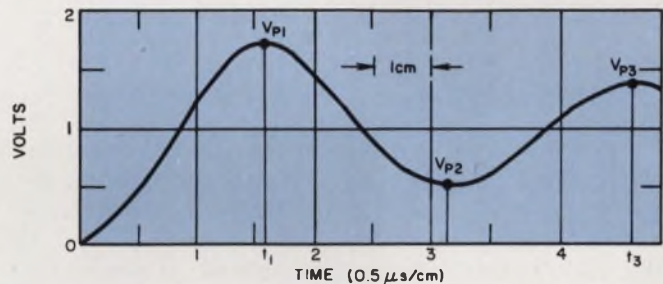

(B)

2. Step-function response (A) helps to determine amplifier stability; the more stable the amplifier, the greater the damping, and the more rapid the decrease in amplitude of successive oscillatory peaks. The pulse-response waveform (B) should occupy as much of the oscilloscope graticule as possible, to achieve maximum accuracy.

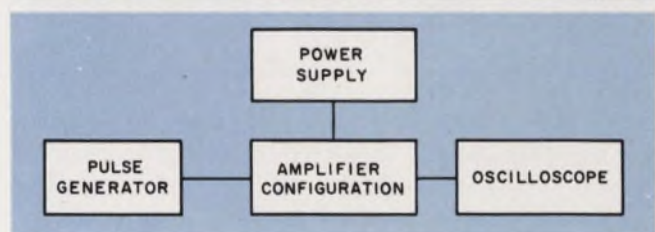
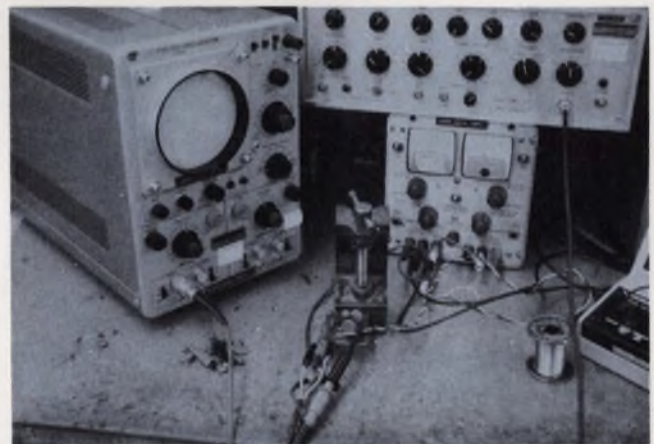

3. Transient response of amplifier under test is determined through use of this setup.

Box 1. Analysis of Step Input Response

Equations 1 and 2, the cornerstones of this method, are based upon analysis of the *time response* of a second-order, linear system to a step input.

The system response can be described by means of a linear, second-order differential equation:

$$\frac{d^2x}{dt^2} + a \frac{dx}{dt} + bx = c, \quad (4)$$

where c is a step input.

Transient response is damped sinusoid

If the system is stable the transient response may be expressed as a damped sinusoid,

$$x(t) = ke^{-\zeta\omega_n t} \sin [(\omega_n \sqrt{1 - \zeta^2}) t + \phi], \quad (5)$$

of frequency $\omega_d = \omega_n \sqrt{1 - \zeta^2}$ and amplitude $A = ke^{-\zeta\omega_n t}$,

where ω_d is the damped frequency of oscillation, ζ is the damping ratio, and ω_n is the natural (undamped) frequency of oscillation; note that $\omega_d = \omega_n$, when $\zeta = 0$.

In a stable system the amplitude of the oscillations must decay to zero (damped oscillations); to insure this the exponent of the exponential, $-\zeta\omega_n$, must be negative. If the exponent is zero or positive the indication is that the oscillation will either continue at some constant amplitude or will grow, unless limited by other system constants.

Complete solution readily obtained

Equation 5 represents the transient response. To obtain the complete solution the steady-state response must be added to the transient response.

The steady-state output will be the product of the input step-function and the closed-loop dc gain of the amplifier, $V_{in} u(t) \cdot A_{VCL}$, where $V_{in} u(t)$ = input step-function, and A_{VCL} = amplifier closed-loop dc gain.

The complete solution is given by

$$V_o(t) = V_{in} A_{VCL} u(t) + ke^{-\zeta\omega_n t} \sin [(\omega_n \sqrt{1 - \zeta^2}) t + \phi]. \quad (6)$$

The two constants, k and ϕ , must be determined from the initial conditions:

$$V_o(t) = 0, \text{ at } t = 0+ \text{ (just after } V_{in} \text{ is applied),}$$

$$dV_o(t)/dt = 0, \text{ at } t = 0.$$

The first condition assumes that the system output is zero immediately after the application of the step function. Since the output was zero immediately prior to the application of the step function the output will not change instantaneously because of the system capacitance. This constraint gives us the second initial condition. The values of the two constants are found to be

$$\phi = \cos^{-1}\zeta,$$

$$k = -V_{in} A_{VCL} / \sqrt{1 - \zeta^2}.$$

Equation 6 therefore becomes

$$V_o(t) = V_{in} A_{VCL} - \frac{V_{in} A_{VCL}}{\sqrt{1 - \zeta^2}} \sin (\omega_n \sqrt{1 - \zeta^2} t + \cos^{-1}\zeta),$$

or

$$V_o(t) = V_{in} A_{VCL} \left[1 - \frac{e^{-\zeta\omega_n t}}{\sqrt{1 - \zeta^2}} \sin (\omega_n \sqrt{1 - \zeta^2} t + \cos^{-1}\zeta) \right]. \quad (7)$$

Peak values decrease with time

The peak values of the oscillation can now be determined by differentiating Eq. 7, and equating the derivative to zero. With the assistance of a little bit of trigonometry, the formula for $\sin(A - B)_t$ the derivative reduces to

$$\sin (\omega_n \sqrt{1 - \zeta^2}) t.$$

This is equal to zero when

$$\omega_n \sqrt{1 - \zeta^2} t = m\pi, \text{ and } m = 0, 1, 2, 3 \dots$$

or

$$t = m\pi / \omega_n \sqrt{1 - \zeta^2}, \text{ and } m = 0, 1, 2, 3 \dots$$

Substituting this value of t into Eq. 7,

$$V_o(t) = V_{in} A_{VCL} [1 - e^{-m\pi\zeta / \sqrt{1 - \zeta^2}} \sin (m\pi + \theta)], \quad (8)$$

where $\cos \theta = \zeta$ and $\sin \theta = \sqrt{1 - \zeta^2}$. Equation 8 simplifies to

$$V_o(t) = V_{in} A_{VCL} [1 - (\cos m\pi) e^{-m\pi\zeta / \sqrt{1 - \zeta^2}}]. \quad (9)$$

Normalizing $V_o(t)$ with respect to $V_{in} A_{VCL}$,

$$V_o(t_m) \approx 1 - (\cos m\pi) e^{-m\pi\zeta / \sqrt{1 - \zeta^2}}. \quad (10)$$

refer to Fig. 4a and trace the log magnitude curve for the calculated ζ to where the curve crosses the actual (non-normalized) 0-dB line of the amplifier. The 0-dB line in Fig. 4A is the normalized low-frequency gain. Therefore, the intended closed-loop gain in dB must be added to each value on the log

magnitude scale to obtain the non-normalized dB lines.

The horizontal scale is normalized to ω/ω_n , so the value of 1 on the normalized curve corresponds to a frequency of ω_n on the non-normalized curve. The abscissa at the point where the log magnitude curve

The first three peaks of the transient response (oscillation) are now seen to be, in normalized form:

$$V_{p1} = V_o(t_1) = 1 + e^{-\pi\zeta/(1-\zeta^2)^{1/2}}, \quad m = 1,$$

$$t_1 = \pi/\omega_n (1 - \zeta^2)^{1/2};$$

$$V_{p2} = V_o(t_2) = 1 - e^{-2\pi\zeta/(1-\zeta^2)^{1/2}}, \quad m = 2,$$

$$t_2 = 2\pi/\omega_n (1 - \zeta^2)^{1/2};$$

$$V_{p3} = V_o(t_3) = 1 + e^{-3\pi\zeta/(1-\zeta^2)^{1/2}}, \quad m = 3,$$

$$t_3 = 3\pi/\omega_n (1 - \zeta^2)^{1/2}.$$

The value of ζ , as a function of the three measurements, V_{p1} , V_{p2} , and V_{p3} , note that:

$$\frac{V_{p1} - V_{p3}}{V_{p2}} = \frac{(1 + e^{-\zeta\pi/\sqrt{1-\zeta^2}}) - (1 + e^{-3\zeta\pi/\sqrt{1-\zeta^2}})}{(1 - e^{-2\zeta\pi/\sqrt{1-\zeta^2}})}$$

$$= e^{-\zeta\pi/\sqrt{1-\zeta^2}}$$

Taking the natural logarithm of both sides:

$$\ln\left(\frac{V_{p1} - V_{p3}}{V_{p2}}\right) = -\frac{\zeta\pi}{\sqrt{1-\zeta^2}}.$$

Since $\ln N = 2.3 \log_{10} N$,

$$\log_{10}\left(\frac{V_{p1} - V_{p3}}{V_{p2}}\right) = -\frac{1}{2.3}\left(\frac{\zeta\pi}{\sqrt{1-\zeta^2}}\right) \text{ and}$$

$$\zeta = \frac{|\log_{10} [(V_{p1} - V_{p3})/(V_{p2})]|}{\{\log_{10} [(V_{p1} - V_{p3})/(V_{p2})] + 1.86\}^{1/2}} \quad (11)$$

Remember that the peak values are normalized, so that

$$\frac{V_{pm}}{V_{in}A_{VCL}} \approx V_{pm}.$$

Since the value of ζ has now been found, ω_n may be determined from the value of t at $m = 1$, the first peak, and at $m = 3$, the third peak, as follows:

$$t_m = m\pi/\omega_n \sqrt{1 - \zeta^2},$$

$$t_1 = \pi/\omega_n \sqrt{1 - \zeta^2},$$

$$t_3 = 3\pi/\omega_n \sqrt{1 - \zeta^2},$$

$$\omega_n = 2\pi/(t_3 - t_1) \sqrt{1 - \zeta^2}.$$

The two parameters, ζ , the damping ratio, and ω_n , the natural frequency of oscillation, completely specify the response of the second order system.

for the calculated ζ crosses the non-normalized 0-dB line represents ω . Since ω_n has already been calculated, ω represents the *small-signal unity bandwidth in radians/second*.

In addition, the closed-loop phase shift for any frequency of interest can be evaluated merely by

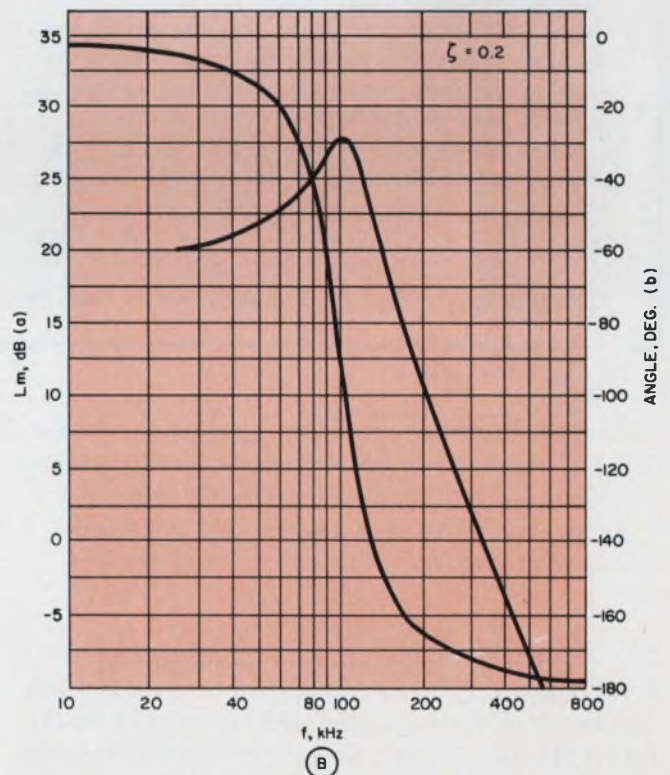
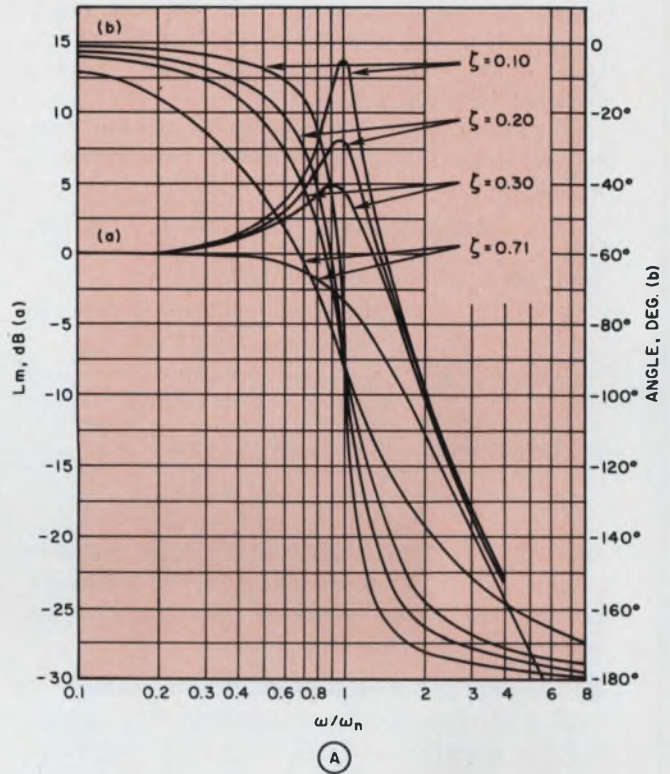

4. Gain and phase shift of closed loop amplifier response (A) are determined using design curves that show normalized log magnitude and phase. Specific curves for $\zeta = 0.2$ are shown in (B).

Box 2. System Stability

System stability is usually determined by means of frequency response analysis.² The designer utilizes the ζ -curves, Fig. 4a, to derive the small signal unity-gain bandwidth, ω , and the phase margin. It is also possible to calculate the magnitude of the peaking (increase in gain), as a function of ζ , Table 1, or Fig. 5.

In general terms, the response of a single pole, (single-stage) open-loop amplifier can be represented as

$$A_{VOL}(\omega) = A_{VOL} \left(1 + j \frac{\omega}{\omega_0} \right), \quad (12)$$

where $A_{VOL}(\omega)$ = open-loop voltage gain,
 = ratio of change in output voltage to a change in input voltage,
 ω_0 = open-loop bandwidth (frequency where gain is down 3 dB).

The expression for closed loop gain is

$$A_{VCL}(\omega) = \frac{-A_{VOL}(\omega)}{1 + \beta A_{VOL}(\omega)}$$

where β = portion of the output voltage fed back to the input. The term $\beta A_{VOL}(\omega)$ is commonly termed loop gain. Instability occurs when the value of the denominator is zero.

Use asymptotic sketch to determine stability

In order to analyze the stability of the amplifier, an asymptotic sketch of the log amplitude of the amplifier response as a function of the log frequency, (Bode plot), Fig. P, is usually undertaken. Since the maximum possible phase shift for Eq. 13 is 90°, a closed-loop amplifier utilizing this single pole, open-loop amplifier would be unconditionally stable.

The response of a double pole (dual stage) open-loop amplifier can be represented as

$$A_{VOL}(\omega) = A_{VOL} / \left[\left(1 + j \frac{\omega}{\omega_0} \right) \left(1 + j \frac{\omega}{\omega_1} \right) \right]. \quad (13)$$

The total phase shift of this amplifier approaches

180° as ω increases. A closed-loop amplifier with a gain as low as unity, at a frequency for which the phase shift is 180°, would be an unstable amplifier, Fig. QA. To assure closed-loop amplifier stability, the slope of its open-loop asymptotic response—as it passes through A_{VOL} —must be less than 12 dB/octave (Fig. QB) or the closed-loop system will be only conditionally stable.

Find closed-loop gain as a function of frequency

Standard feedback theory^{1,2} states that the closed-loop gain of a feedback amplifier is

$$A_{VCL} = A_{VOL} / (1 + \beta A_{VOL}). \quad (14)$$

Substituting Eq. 13 into Eq. 14 yields

$$A_{VCL} = \frac{1/\beta}{1 + j\omega \left(\frac{\omega_0 + \omega_1}{A'\beta\omega_0\omega_1} \right) + \frac{1}{A'\beta\omega_0\omega_1} (j\omega)^2}. \quad (15)$$

Compare with standard theoretical formula

The response of a second-order linear system in the frequency domain in terms of ζ and ω_n , as derived from the general theory², turns out to be

$$A_{VCL}(\omega) = A_{VCL}(0) / \left[1 + j\omega \frac{2\zeta}{\omega_n} + \frac{1}{\omega_n^2} (j\omega)^2 \right]. \quad (16)$$

A term-by-term comparison of Eqs. 15 and 16 yields the following relationships:

$$\begin{aligned} A_{VCL}(0) &= 1/\beta \\ \omega_n &= \sqrt{A\beta\omega_0\omega_1} \\ \zeta &= (\omega_0 + \omega_1) / 2\sqrt{A\beta\omega_0\omega_1} \end{aligned}$$

where $A = A_{VOL}(0)$.

Neglecting the scale factor $A_{VCL}(0)$, the

finding the intersection of the “frequency of interest line” (vertical on the log magnitude curve) and the phase shift curve for the zeta of the amplifier.

As an example of this, assume that the following values were obtained from the pulse response:

$$\begin{aligned} \zeta &= 0.2, \\ f_n &= 100 \text{ kHz.} \end{aligned}$$

Fig. 4B shows the two curves (obtained from Fig. 4A) for $\zeta = 0.2$. Since the horizontal axis is a frequency ratio, it can just as well be taken to be f/f_n rather than ω/ω_n . Therefore the horizontal axis has been scaled in hertz for convenience.

If the amplifier in question has a nominal closed-loop gain of 10 (20 dB), the vertical log magnitude scale must be modified to reflect this, as in Fig. 4B.

Table 1. Peaking (dB) versus ζ

Zeta (ζ)	Peaking (p) dB
0.01	34.0
0.02	28.0
0.03	24.4
0.04	21.9
0.05	20.0
0.06	18.4
0.07	17.1
0.08	15.9
0.09	14.9
0.15	10.6
0.2	8.1
0.3	4.8
0.4	2.7

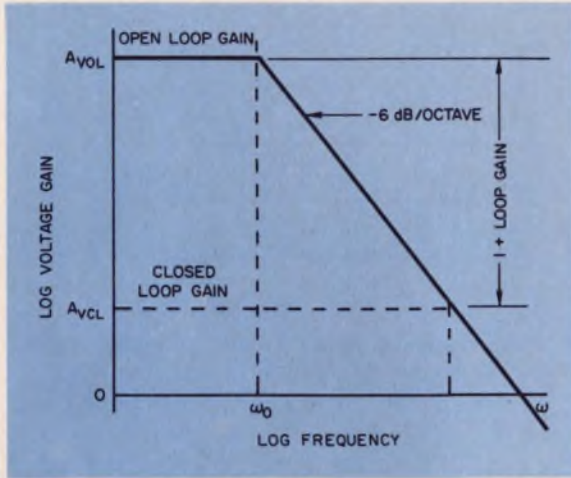

P. Single-pole amplifier is shown, by asymptotic sketch (Bode plot), to be unconditionally stable, since a slope of -6 dB per octave is associated with a maximum phase shift of 90° .

normalized form of the response is obtained. The characteristics of this function,

$$\left[1 + j\omega \frac{2\zeta}{\omega_n} + \frac{1}{\omega_n^2} (j\omega)^2 \right]^{-1}, \quad (17)$$

are treated extensively in the literature. Figure 4a shows both a magnitude and a phase plot versus ω/ω_n for selected values of ζ , the “ ζ -curves” mentioned previously.

It is also possible to calculate the peaking, p , in dB. This can be done accurately by setting the derivative of Eq. 17 equal to zero and then solving. The following result is obtained:

$$p \text{ (peaking in dB)} = 20 \log_{10} [1/2\zeta \sqrt{1 - \zeta^2}] \quad (18)$$

Table 1 lists “dB of peaking” versus ζ for selected values of ζ , while Fig. 5, a plot of Eq. 3, demonstrates graphically the effect of ζ on peaking.

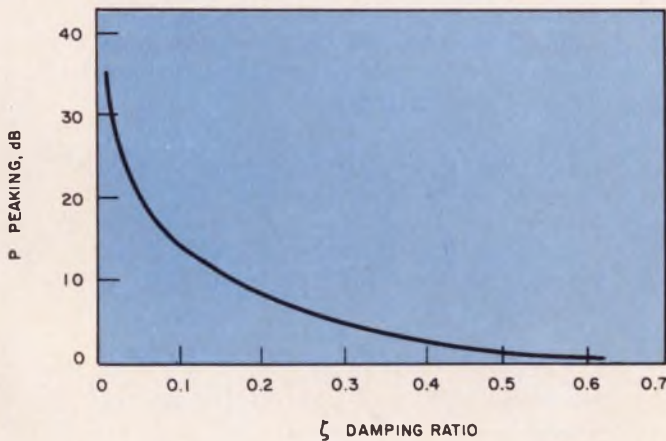

5. Value of peaking is given by design curve as a function of ζ .

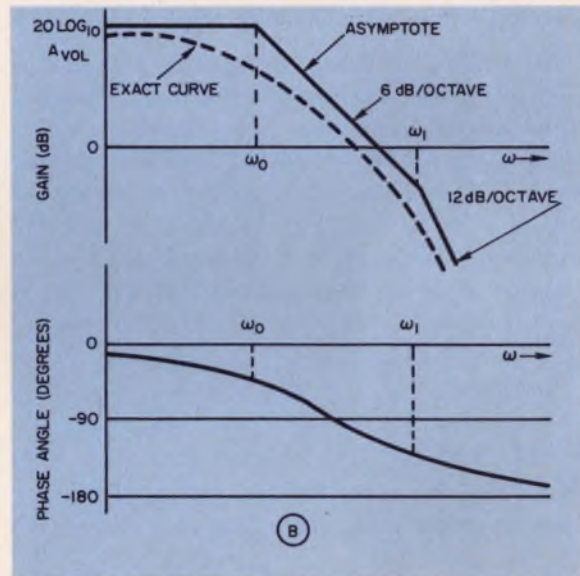
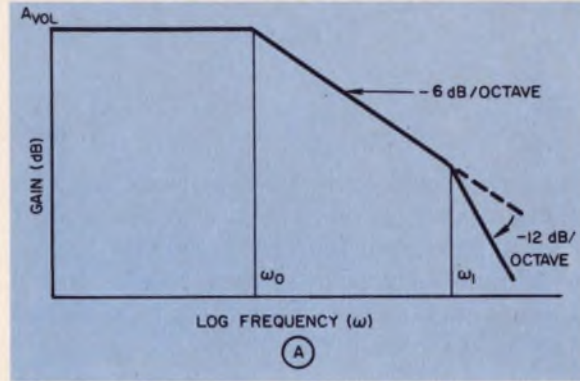

Q. Open-loop response (A) for operational amplifier indicates marginal stability because of the 12-dB per octave rolloff at a gain of A_{VOL} , or the possibility of 180° phase shift at that point. Bode plot of open-loop operational amplifier response (B) shows a 6 dB per octave rolloff at a gain of 0 dB, or a phase shift of less than 180° , indicating a stable closed-loop amplifier for any value of closed loop gain.

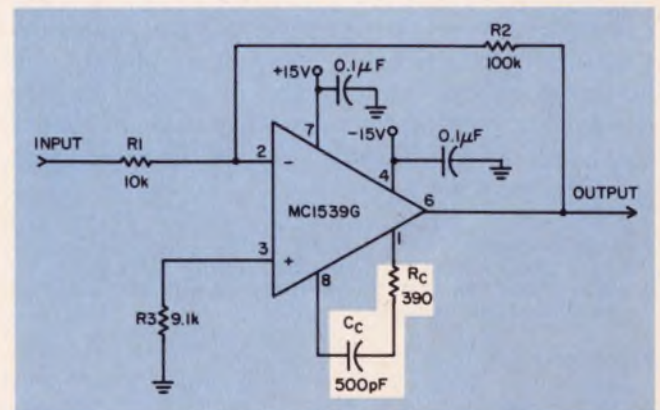

6. MC 1539G amplifier is used to determine the design technique.

The following information may now be read from Fig. 4b:

Frequency (kHz)	Phase Shift (degrees)	Gain (dB)
10	2	20
50	18	22
100	90	28
200	165	10

Note the rapid increase in phase shift from 50 kHz to 100 kHz, as well as the increase in phase shift and rolloff in gain from 100 kHz to 200 kHz.

This example demonstrates how detailed information regarding an amplifier may be obtained once ζ and ω_n have been determined.

Design example illustrates technique

The MC 1539G, a monolithic operational amplifier has been chosen to demonstrate the technique. Although the recommended compensation for a closed-loop gain of 10, as stated in the amplifier data sheet, is $R_c = 1k$ and $C_c = 2200$ pF, the actual values used were $R_c = 390$ ohms and $C_c = 500$ pF. The amplifier configuration is shown in Fig. 6.

The observed pulse response is shown in Fig. 7, with the following values read from the figure:

$$\begin{aligned} V_{p1} &= 1.867, \\ V_{p2} &= 0.366, \\ V_{p3} &= 1.534, \\ t_1 &= 1.16 \mu\text{s}, \\ t_3 &= 3.48 \mu\text{s}. \end{aligned}$$

Substituting these values into Eqs. 1 and 2 yields

$$\begin{aligned} \zeta &= 0.029, \\ \omega_n &= 2.71 \times 10^6 \text{ radians}, \\ f_n &= 431 \text{ kHz}. \end{aligned}$$

For the above calculated value of ζ , Table 1 indicates that approximately 24 dB of peaking should be expected. The actual frequency response, as run in the laboratory (Fig. 8), shows 20 dB of peaking at 425 kHz. The theoretical analysis and experimental results therefore agree quite closely.

The particular value of C_c chosen, about 0.25 of the recommended value, resulted in a low value of damping ratio.

Lower values of the damping ratio are associated with oscillatory peaks of greater amplitude and higher peaking; thus, greater accuracy may be achieved in reading the laboratory data. For more stable amplifiers the experimental accuracy tends to decrease. ■ ■

Acknowledgment

The author wishes to thank Mr. Brent Welling for his encouragement and advice in carrying out the work on which this article is based.

References:

1. Application Note AN-273, "Getting More Value Out of an Integrated Operational Amplifier Data Sheet," Motorola Semiconductor Products Inc., Phoenix, Arizona.
2. J. D'Azzo and C. Houpis, *Feedback Control Systems Analysis and Synthesis*. (2nd ed; New York: McGraw-Hill Book Co., 1966).

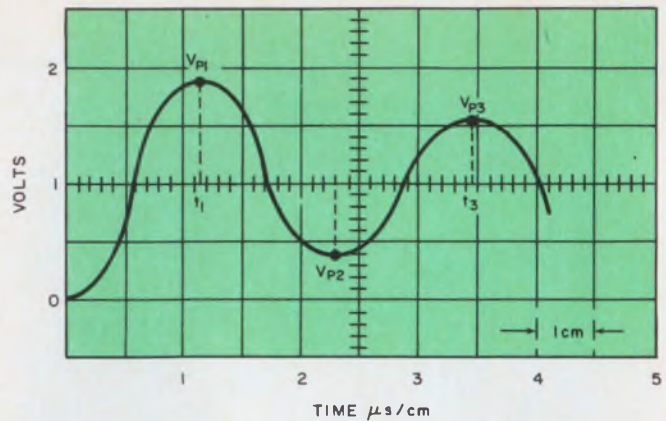

7. Pulse response of the 1539G amplifier configuration shows the amplitude peaks at V_{p1} , V_{p2} , and V_{p3} .

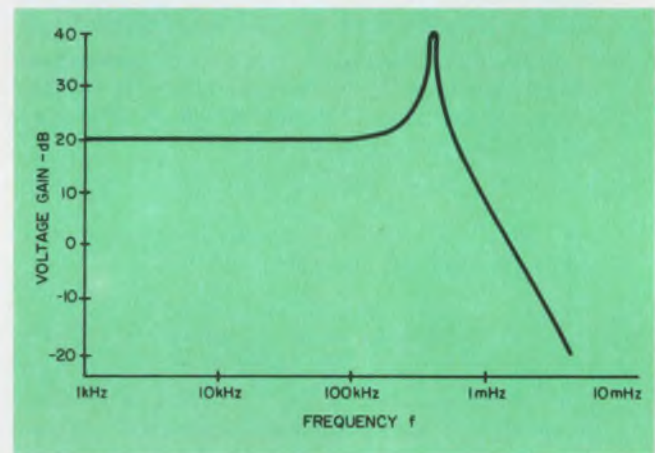

8. Frequency response shows voltage gain in dB versus frequency (peaking) for design example.

Test your retention

Here are questions based on the main points of this article. Their purpose is to help you make sure you have not overlooked any important ideas. You'll find the answers in the article.

1. What are the advantages of utilizing an experimental test method of design?
2. What is true of the successive peaks of the transient response of a stable closed-loop amplifier to a step input?
3. What is the Bode plot criterion for amplifier stability?
4. Given the values of ζ and ω_n , how can the peaking (in dB) of the operation amplifier be determined?
5. For given values of ζ and ω_n , how can the phase shift and gain of the operational amplifier be determined at any specific frequency?

Last year, we sent some of our hybrids into outer space. This year, we've come down to earth.



We started producing hybrids because we had to be 101% sure about the ones we put into aerospace projects. (There are no retakes in outer space.)

Guess what happened then.

We solved the tough circuitry problems Hughes engineers gave us. Lived up to their rigid reliability standards. And met their often-impossible deadlines.

The word got around. Demand for Hughes hybrids kept growing. Most of all, in inner space.

We're reasonable people. So here we are—a down-to-earth company, ready to do business with you.

We're well established in MOSFETs and flip chips. We make all the other components that go into custom circuits. We'll assemble, package and test whatever you need.

Bring us your problem, and we'll deliver a guaranteed solution. Or, if you like, we'll work with you on an à la carte basis...

We'll provide thin or thick film substrates. Or substrates masked and etched with capacitor, conductor and resistor patterns. Multilayer circuits. Or whatever.

Big order or small order, we offer some pluses.

Experience in handling the knottiest aerospace problems. Plenty of practice living up to the highest reliability levels. The research resources of a leader in electronics and the manufacturing facilities for big jobs.

We'd like to share all this, and the hybrids themselves. But first, let us send our brochure. Just address: Hughes Hybrid Integrated Circuits, 500 Superior Ave., Newport Beach, California 92663.

HUGHES
HUGHES AIRCRAFT COMPANY
HYBRID CIRCUITS

Specify your trap filter the easy way

by using computer-generated tables to establish Q, notch depth, attenuation and group delay

Designing simple, resonant trap circuits to suppress undesired signals is normally a tedious, cut-and-try job that involves juggling filter-Q and insertion loss at the rejection frequency, and then computing the performance at off-resonant frequencies to see if the over-all performance is satisfactory. To obtain group (or envelope) time delays involves added computation.

But the computer-derived tables and design method, described here, substantially simplify the problem by presenting the already computed factors that are required for design of the series-resonant shunt trap (see Fig. 1) and the parallel-resonant series trap (see Fig. 2). With these tables, trap designs can be readily conceived and evaluated—almost by inspection. The tabular quantities, normalized for application to general solutions, provide notch and skirt attenuations ranging from -5 dB to -60 dB for trap Q's of from 5 to 400, as well as factors for determining time delays for the same ranges.

Trap circuit performances are identical

Two principal trap circuits—shunt and series—are widely applied. For the shunt trap (Fig. 1) the general response is defined by

$$\frac{e_o}{e_i} = \frac{R + j\left(\omega L - \frac{1}{\omega C}\right)}{R_1 + R + j\left(\omega L - \frac{1}{\omega C}\right)} (= A). \quad (1)$$

At trap resonant frequency ω_o , the loss is

$$A_o = \frac{R}{R + R_1}. \quad (2)$$

But maximum attenuation occurs at ω_o , at which

$$Q \text{ is defined by } Q = \frac{\omega_o L}{R}; \quad (3)$$

$$\text{and } \omega_o = \frac{1}{\sqrt{LC}}. \quad (4)$$

But Eq. 1 can be rewritten as

$$\frac{e_o}{e_i} = \frac{1 + jQ\left(\frac{\omega}{\omega_o} - \frac{\omega_o}{\omega}\right)}{\frac{1}{A_o} + jQ\left(\frac{\omega}{\omega_o} - \frac{\omega_o}{\omega}\right)}; \quad (5)$$

For the series trap (Fig. 2) the general response is defined by

$$\frac{e_o}{e_i} = R_1 / \left(R_1 + \frac{1}{1/R + j\omega C + 1/j\omega L} \right). \quad (6)$$

at resonant frequency ω_o , the loss is

$$A_o = \frac{R_1}{R + R_1}; \quad (7)$$

And the Q at maximum attenuation is

$$Q = R\omega_o C, \quad (8)$$

and

$$\omega_o = \frac{1}{\sqrt{LC}}. \quad (9)$$

But Eq. 6 can be rewritten to produce Eq. 5; thus, the performances of the two traps are seen to be identical. Consequently, the data in the tables can be applied equally well to both trap designs. There are six columns in the tabulation, of which columns 1, 5 and 2 are directly related to the characteristics of the basic attenuation curve shown in Fig. 3.

Computer tables are key to design method

Column 1 lists the upper normalized frequencies, or those incremental frequencies on the higher side of the normalized resonant frequency W_u , as shown in Fig. 3. These are used in evaluating attenuation and time delay at increments removed from normalized resonant frequency. Actual frequency is given by: $\omega = W \cdot \omega_o$.

Column 5 lists the lower normalized frequencies ($= 1/W$) for evaluating response at increments removed from the lower side of normalized resonant frequency. The actual frequency is given by: $\omega = (1/W) \omega_o$.

Column 2 lists trap attenuation A, in dB, at the upper and lower normalized, incremental frequencies. The computation of A in dB begins with the amplitude response, which is given by

$$A = \left| \frac{e_o}{e_i} \right|. \quad (10)$$

Jerome H. Howitz, Member, Technical Staff, Eastern Technical Center, Bunker-Ramo Corp., Silver Spring, Md.

Combining Eq. 5 and Eq. 10, we have

$$A = \left[\frac{1 + Q^2 \left(\frac{\omega}{\omega_o} - \frac{\omega_o}{\omega} \right)^2}{\frac{1}{A_o^2} + Q^2 \left(\frac{\omega}{\omega_o} - \frac{\omega_o}{\omega} \right)^2} \right]^{1/2} \quad (11)$$

At $\omega = \omega_o$, note that $A = A_o$, so that A_o is the response at resonance, or maximum attenuation. And where the actual frequency is much greater or less than the resonant frequency, A approaches unity, or zero attenuation.

$$\text{Since } A_{dB} = 20 \log_{10} A \quad (12)$$

$$\text{and } A_o = 10^{(A_o, dB/20)}, \quad (13)$$

Eq. 11 can be rewritten as:

$$A_{dB} = 10 \log_{10} \left[\frac{1 + Q^2 \left(\frac{\omega}{\omega_o} - \frac{\omega_o}{\omega} \right)^2}{10^{-(A_o, dB/10)} + Q^2 \left(\frac{\omega}{\omega_o} - \frac{\omega_o}{\omega} \right)^2} \right], \quad (14)$$

which is the form used for computing A .

Columns 3 and 6 contain a time-delay product $(\omega_o/Q)T$, by which group-delay T , normalized to the resonant 3-dB bandwidth ω_o/Q , can be obtained at desired incremental frequencies by multiplying by a factor of Q/ω_o . Use columns 3 and 6 in computing the performance of a trap at frequencies other than resonant. Column 6 applies to the upper normalized frequencies, while column 3 is for the lower.

Column 4 gives a time-delay product $(\omega/Q)T$ normalized for both upper and lower normalized frequencies. To obtain group-delay T here, simply multiply the column values by Q/ω . Use column 4 to evaluate a trap at varying center frequencies.

These envelope delays are derived from Eq. 5. The phase shift ϕ is given by

$$\phi = \arctan \left[Q \left(\frac{\omega}{\omega_o} - \frac{\omega_o}{\omega} \right) \right] - \arctan \left[A_o Q \left(\frac{\omega}{\omega_o} - \frac{\omega_o}{\omega} \right) \right]. \quad (15)$$

Delay T or more properly τ , is given by:

$$\begin{aligned} \tau &= - \frac{d\phi}{d\omega} \\ &= - \frac{d}{d\omega} \left\{ \arctan \left[Q \left(\frac{\omega}{\omega_o} - \frac{\omega_o}{\omega} \right) \right] \right\} \\ &\quad + \frac{d}{d\omega} \left\{ \arctan \left[A_o Q \left(\frac{\omega}{\omega_o} - \frac{\omega_o}{\omega} \right) \right] \right\} \end{aligned} \quad (16)$$

The derivative of the arc tan function is of the general form:

$$\frac{d}{dx} (\arctan u) = \frac{1}{1 + u^2} \cdot \frac{du}{dx}, \quad (17)$$

where the letter u represents the argument of the arc tan function and x represents ω .

So Eqs. (16) and (17) give

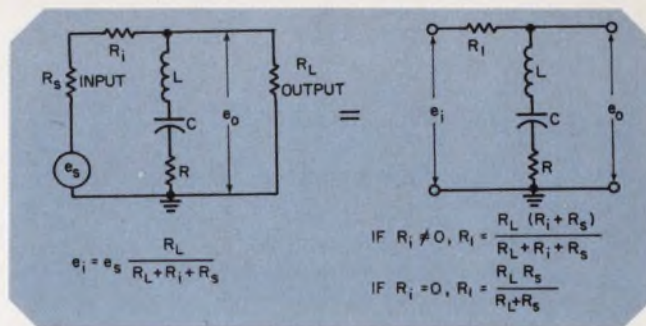

1. **Series-resonant shunt-trap circuit**, at left, with equivalent circuit at right. R_s is source resistance; R_i is input resistance between source and network, which may or may not be present; and R_L is load resistance. Attenuation of circuit at resonance is equal to $R/(R + R_i)$

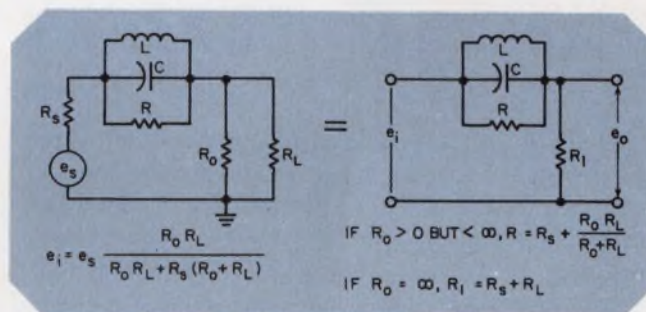

2. **Parallel-resonant series-trap circuit**, at left, with equivalent circuit at right. R_s is source resistance; R_o is circuit resistance in output, which may or may not be present; and R_L is load resistance. Attenuation of circuit at resonance is equal to the relationship $R_i/(R + R_i)$.

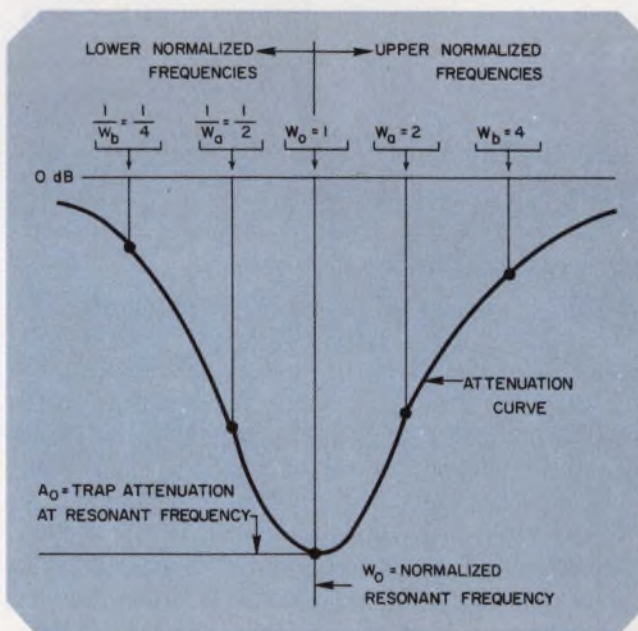

3. **Generalized attenuation curve** for shunt and series trap circuits. Normalized frequency W_o is equal to actual frequency divided by resonant frequency, or ω/ω_o . Upper and lower normalized frequencies are shown in equal increments on each side of center frequency. Note that the lower frequencies are reciprocals of the higher.

$$\tau = \frac{-Q \left(\frac{1}{\omega_o} + \frac{\omega_o}{\omega^2} \right)}{1 + Q^2 \left(\frac{\omega}{\omega_o} - \frac{\omega_o}{\omega} \right)^2} + \frac{A_o Q \left(\frac{1}{\omega_o} + \frac{\omega_o}{\omega^2} \right)}{1 + A_o^2 Q^2 \left(\frac{\omega}{\omega_o} - \frac{\omega_o}{\omega} \right)^2} \quad (18)$$

Equation 18 can be normalized in the following two ways:

$$\frac{\omega_o \tau}{Q} = \left(1 + \frac{\omega_o^2}{\omega^2} \right) \left(\frac{-1}{1 + Q^2 \left(\frac{\omega}{\omega_o} - \frac{\omega_o}{\omega} \right)^2} + \frac{A_o}{1 + A_o^2 Q^2 \left(\frac{\omega}{\omega_o} - \frac{\omega_o}{\omega} \right)^2} \right) \quad (19)$$

$$\frac{\omega \tau}{Q} = \left(\frac{\omega}{\omega_o} + \frac{\omega_o}{\omega} \right) \left(\frac{-1}{1 + Q^2 \left(\frac{\omega}{\omega_o} - \frac{\omega_o}{\omega} \right)^2} + \frac{A_o}{1 + A_o^2 Q^2 \left(\frac{\omega}{\omega_o} - \frac{\omega_o}{\omega} \right)^2} \right) \quad (20)$$

Since Eq. 20 is geometrically symmetric about ω_o , the values in column 4 are valid for both upper (W) and lower ($1/W$) normalized frequencies. But because Eq. 19 is not symmetric, separate calculations are given in column 6 for the upper normalized frequencies, and in column 3 for the lower.

In general, the data in the table are sufficient to meet normal design needs for attenuation, Q , and accuracy. Thus the data are presented for resonant (notch) attenuations of from 5 dB to 60 dB, in 5-dB increments, and for $Q = 25, 50, 100, 200$ and 400. The frequencies computed begin with resonance, and follow progressive deviations off resonance by octaves of 3-dB bandwidth; so that

$$W = \frac{\omega}{\omega_o} = 1, 1 + \frac{1}{2Q}, 1 + \frac{1}{Q}, 1 + \frac{2}{Q}, 1 + \frac{4}{Q} \dots \quad (21)$$

thus producing finer increments for higher network Q .

Design example demonstrates method

To illustrate use of the table, let's assume that a resonant trap is to be designed with 40-dB attenuation at a center frequency of 455 kHz, or $A_o = 40$ dB. Also, there is to be less than 1-dB attenuation at 910 kHz. In this case, the normalized resonant frequency W_o of 455 kHz = 1, and the upper normalized frequency W of 910 kHz = 2.

In the table, look up the $A_o = -40.0$ dB listing. Under this heading, starting with the $Q = 25$ tabulation, look in the A (attenuation) column for an attenuation of 1 dB alongside a normalized frequency $W = 2$. Inspection shows us that the solution is not in the Q -listings of 25, 50, or even 100. But under the $Q = 200$ tabulation, our desired value of $A = 1$ for $W = 2$ is in the neighborhood of $A = -0.918$ dB for $W = 1.64$.

From this, we may estimate that the specific Q would be about 150, but we'll be safe in designing for $Q = 200$. However, to obtain such a high Q , care in eliminating all internal circuit resistance and in choosing high quality inductive and capacitive components is necessary.

Having established the Q -value, we can proceed in the following manner:

1. First, compute R_1 from Fig. 1 or Fig. 2.
2. Set attenuation $A_o = -40$ dB.
3. Convert A_o from dB to a ratio by using Eq. 13:
 $A_o = 10^{(-40/20)} = 10^{-2} = 0.01$
4. From Eqs. 2 or 7, compute the value of R , by substituting $A_o = 0.01$.
5. Having obtained R , now compute the values of L or C , using $Q = 200$:

$$L = \frac{200 R}{(2\pi)455 \times 10^3} \quad (\text{Eq. 3})$$

$$C = \frac{200}{R(2\pi)455 \times 10^3} \quad (\text{Eq. 8})$$

6. Having obtained the value of L or C , determine the value of the other element necessary to resonate at the desired frequency, from Eq. 4 or 9:

$$\omega_o = \frac{1}{\sqrt{LC}}$$

7. To obtain the group delay at 910 kHz, as normalized with respect to the 3-dB resonant bandwidth, inspection of column 6 tells us that it will lie between the values of 0.002583 (Q/ω_o) and 0.000810 (Q/ω_o). Or, using the column 4, the value will lie between 0.004236 (Q/ω) and 0.001847 (Q/ω).

The tables follow on the next four pages.

Test your retention

Here are questions based on the main points of this article. Their purpose is to help you make sure you have not overlooked any important ideas. You'll find the answers in the article.

1. What are the two principal types of resonant trap filters?
2. What are their maximum attenuations based on, at resonant frequencies?
3. What factors are specified as the starting point for design, and then obtained from the table?
4. How are the time delays obtained?
5. For a given Q , how are the values of L or C derived?

Upper normalized freqs. (W)	Atten., dB	Time-delay product for 1/W freqs. $(\frac{\omega_0 T}{Q})$	Time delay product $(\frac{\omega T}{Q})$	Lower normalized freqs. (1/W)	Time delay product for W freqs. $(\frac{\omega_0 T}{Q})$	Upper normalized freqs. (W)	Atten., dB	Time delay product for 1/W freqs. $(\frac{\omega_0 T}{Q})$	Time delay product $(\frac{\omega T}{Q})$	Lower normalized freqs. (1/W)	Time delay product for W freqs. $(\frac{\omega_0 T}{Q})$
1.1600	-0.030 DB	0.001475	0.001271	8.620690	0.001096	1.0050	-23.045 DB	-0.340299	-0.333606	.9950249	-0.336921
1.3200	-0.008 DB	0.000487	0.000369	7.575758	0.000279	1.0100	-17.804 DB	-0.057059	-0.056494	.9900990	-0.055935
AO = -25.0 DB											
Q = 25											
1.0000	-25.000 DB	-1.887532	-1.887532	1.0000000	-1.887532	1.0200	-12.219 DB	0.028703	0.028145	.9803922	-0.027593
1.0200	-22.046 DB	-0.915866	-0.897907	.9803922	-0.880301	1.0400	-7.025 DB	0.044400	0.042693	.9615385	-0.041051
1.0400	-18.197 DB	-0.313756	-0.301688	.9615385	-0.290085	1.0800	-3.120 DB	0.032861	0.030427	.9259259	-0.028173
1.0800	-13.202 DB	-0.020430	-0.018916	.9259259	-0.017515	1.1600	-1.076 DB	0.015640	0.013483	.8620690	-0.011623
1.1600	-8.183 DB	0.070684	0.060935	.8620690	-0.052530	1.3200	-0.330 DB	0.006135	0.004648	.7575758	-0.003521
1.3200	-4.127 DB	0.081090	0.061432	.7575758	-0.046539	1.6400	-0.101 DB	0.002593	0.001564	.6037561	-0.000966
1.6400	-1.686 DB	0.061424	0.037454	.6037561	-0.022838	2.2800	-0.032 DB	0.001339	0.000809	.4385965	-0.000267
2.2800	-0.602 DB	0.042335	0.018568	.4385965	-0.008144	3.5600	-0.010 DB	0.000971	0.000273	.2803989	-0.000077
3.5600	-0.199 DB	0.032522	0.009135	.2808989	-0.002566	Q = 400					
6.1200	-0.061 DB	0.028669	0.004685	.1633987	-0.000765	1.0000	-30.000 DB	-1.936754	-1.936754	1.0000000	-1.936754
11.2400	-0.018 DB	0.027381	0.002436	.0889680	-0.000217	1.0012	-26.997 DB	-0.938615	-0.937443	.9937516	-0.936272
21.4800	-0.005 DB	0.026996	0.001257	.0465549	-0.000059	1.0025	-23.036 DB	-0.338650	-0.337806	.9975062	-0.336964
Q = 50											
1.0000	-25.000 DB	-1.887532	-1.887532	1.0000000	-1.887532	1.0050	-17.784 DB	-0.056226	-0.055946	.9950249	-0.055668
1.0100	-22.025 DB	-0.901819	-0.892890	.9900990	-0.884049	1.0100	-12.180 DB	0.028691	0.023407	.9900990	-0.028125
1.0200	-18.132 DB	-0.301216	-0.295310	.9803922	-0.289520	1.0200	-7.992 DB	0.042623	0.040623	.9803922	-0.041752
1.0400	-13.060 DB	-0.015376	-0.014784	.9615385	-0.014216	1.0400	-3.039 DB	0.031051	0.029856	.9615385	-0.028708
1.0800	-7.940 DB	0.066676	0.061737	.9259259	-0.057164	1.0800	-1.014 DB	0.013708	0.012692	.9259259	-0.011752
1.1600	-3.828 DB	0.066988	0.057748	.8620690	-0.049783	1.1600	-0.295 DB	0.004714	0.004064	.8620690	-0.003503
1.3200	-1.455 DB	0.040589	0.030749	.7575758	-0.023295	1.3200	-0.085 DB	0.001626	0.001232	.7575758	-0.000933
1.6400	-0.487 DB	0.020703	0.012624	.6097561	-0.007698	1.6400	-0.025 DB	0.000661	0.000403	.6097561	-0.000246
2.2800	-0.159 DB	0.011804	0.005177	.4385965	-0.002271	2.2800	-0.008 DB	0.000349	0.000153	.4385965	-0.000067
3.5600	-0.051 DB	0.008432	0.002368	.2808989	-0.000665	AO = -35.0 DB					
6.1200	-0.015 DB	0.007248	0.001184	.1633987	-0.000194	Q = 25					
11.2400	-0.004 DB	0.006867	0.000611	.0889680	-0.000054	1.0000	-35.000 DB	-1.964434	-1.964434	1.0000000	-1.964434
Q = 100											
1.0000	-25.000 DB	-1.887532	-1.887532	1.0000000	-1.887532	1.0200	-32.034 DB	-0.993978	-0.994488	.9803922	-0.995381
1.0050	-22.014 DB	-0.894838	-0.890386	.9950249	-0.885956	1.0400	-28.150 DB	-0.392434	-0.377340	.9615385	-0.362827
1.0100	-18.099 DB	-0.295044	-0.292123	.9900990	-0.289231	1.0800	-23.004 DB	-0.098451	-0.091158	.9259259	-0.084406
1.0200	-12.986 DB	-0.012952	-0.012698	.9803922	-0.012449	1.1600	-17.557 DB	-0.000540	-0.000465	.8620690	-0.000401
1.0400	-7.809 DB	0.064710	0.062221	.9615385	-0.059828	1.3200	-12.281 DB	0.032096	0.024315	.7575758	-0.012421
1.0800	-3.659 DB	0.060500	0.056018	.9259259	-0.051869	1.6400	-7.603 DB	0.048681	0.029683	.6097561	-0.018100
1.1600	-1.319 DB	0.032009	0.027594	.8620690	-0.023788	2.2800	-3.964 DB	0.063073	0.027664	.4385965	-0.012133
1.3200	-0.412 DB	0.013149	0.009962	.7575758	-0.007547	3.5600	-1.674 DB	0.075771	0.021284	.2808989	-0.005979
1.6400	-0.127 DB	0.005565	0.003448	.6097561	-0.002103	6.1200	-0.579 DB	0.083610	0.013662	.1633987	-0.002232
2.2800	-0.040 DB	0.003038	0.001332	.4385965	-0.000584	11.2400	-0.173 DB	0.086899	0.007731	.0889680	-0.000688
3.5600	-0.013 DB	0.002128	0.000598	.2808989	-0.000168	21.4800	-0.043 DB	0.087965	0.004095	.0465549	-0.000191
Q = 200											
1.0000	-25.000 DB	-1.887532	-1.887532	1.0000000	-1.887532	41.9600	-0.012 DB	0.088267	0.002104	.0238322	-0.000050
1.0025	-22.009 DB	-0.891359	-0.889136	.9975062	-0.886919	82.9200	-0.003 DB	0.088347	0.001065	.0120594	-0.000013
1.0050	-18.082 DB	-0.291982	-0.290530	.9950249	-0.289084	Q = 50					
1.0100	-12.948 DB	-0.011765	-0.011649	.9900990	-0.011533	1.0000	-35.000 DB	-1.964434	-1.964434	1.0000000	-1.964434
1.0200	-7.741 DB	0.063736	0.062486	.9803922	-0.061261	1.0100	-32.013 DB	-0.979151	-0.969456	.9900990	-0.969853
1.0400	-3.570 DB	0.057391	0.055184	.9615385	-0.053061	1.0200	-28.084 DB	-0.378312	-0.370894	.9803922	-0.363289
1.0800	-1.244 DB	0.028156	0.026071	.9259259	-0.024140	1.0400	-22.875 DB	-0.090163	-0.086695	.9615385	-0.083361
1.1600	-0.369 DB	0.010127	0.008730	.8620690	-0.007526	1.0800	-17.274 DB	0.001916	0.001774	.9259259	-0.011624
1.3200	-0.107 DB	0.003544	0.002685	.7575758	-0.002034	1.1600	-11.813 DB	0.028453	0.024529	.8620690	-0.021146
1.6400	-0.032 DB	0.001447	0.000882	.6097561	-0.000538	1.3200	-6.983 DB	0.035548	0.026930	.7575758	-0.020042
2.2800	-0.010 DB	0.000765	0.000336	.4385965	-0.000147	1.6400	-3.406 DB	0.034286	0.020906	.6097561	-0.012747
Q = 400											
1.0000	-25.000 DB	-1.887532	-1.887532	1.0000000	-1.887532	2.2800	-1.376 DB	0.029216	0.012814	.4385965	-0.005620
1.0012	-22.006 DB	-0.889622	-0.888511	.9987516	-0.887402	3.5600	-0.483 DB	0.025085	0.007046	.2808989	-0.001979
1.0025	-18.073 DB	-0.290457	-0.289733	.9975062	-0.289014	6.1200	-0.152 DB	0.023106	0.003775	.1633987	-0.000617
1.0050	-12.929 DB	-0.011178	-0.011123	.9950249	-0.011067	11.2400	-0.044 DB	0.022393	0.001992	.0889680	-0.000177
1.0100	-7.707 DB	0.063251	0.062625	.9900990	-0.062005	21.4800	-0.012 DB	0.022176	0.001032	.0465549	-0.000043
1.0200	-3.524 DB	0.055870	0.054775	.9803922	-0.053701	41.9600	-0.003 DB	0.022115	0.000527	.0238322	-0.000013
1.0400	-1.205 DB	0.026336	0.025324	.9615385	-0.024350	Q = 100					
1.0800	-0.346 DB	0.008793	0.008142	.9259259	-0.007539	1.0000	-35.000 DB	-1.964434	-1.964434	1.0000000	-1.964434
1.1600	-0.095 DB	0.002708	0.002334	.8620690	-0.002012	1.0050	-32.002 DB	-0.971783	-0.966948	.9950249	-0.962138
1.3200	-0.027 DB	0.000903	0.000684	.7575758	-0.000518	1.0100	-28.050 DB	-0.371360	-0.367683	.9900990	-0.364042
1.6400	-0.008 DB	0.000364	0.000222	.6097561	-0.000135	1.0200	-22.797 DB	-0.086164	-0.084474	.9803922	-0.082818
AO = -30.0 DB											
Q = 25											
1.0000	-30.000 DB	-1.936754	-1.936754	1.0000000	-1.936754	1.0400	-17.121 DB	0.030307	0.002920	.9615385	-0.002808
1.0012	-27.037 DB	-0.965791	-0.946854	.9803922	-0.928288	1.0800	-11.542 DB	0.026747	0.024766	.9259259	-0.022931
1.0025	-23.161 DB	-0.349838	-0.349838	.9615385	-0.346383	1.1600	-6.587 DB	0.029930	0.025802	.8620690	-0.022243
1.0050	-18.067 DB	-0.069290	-0.064157	.9259259	-0.059405	1.3200	-3.008 DB	0.023513	0.017813	.7575758	-0.013495
1.1600	-12.716 DB	0.028744	0.024779	.8620690	-0.021361	1.6400	-1.132 DB	0.014713	0.008971	.6097561	-0.005470
1.3200	-7.801 DB	0.058606	0.044398	.7575758	-0.033635	2.2800	-0.387 DB	0.009220	0.004044	.4385965	-0.001774
1.6400	-3.986 DB	0.064500	0.039384	.6097561	-0.024015	3.5600	-0.126 DB	0.006820	0.001916	.2808989	-0.000533
2.2800	-1.677 DB	0.059916	0.026279	.4385965	-0.011526	6.1200	-0.039 DB	0.005932	0.000969	.1633987	-0.000153
3.5600	-0.602 DB	0.053973	0.015161	.2808989	-0.004259	11.2400	-0.011 DB	0.005642	0.000502	.0889680	-0.000045
6.1200	-0.191 DB	0.050736	0.008290	.1633987	-0.001355	Q = 200					
11.2400	-0.055 DB	0.049517	0.004405	.0889680	-0.000392	1.0000	-35.000 DB	-1.964434	-1.964434	1.0000000	-1.964434
21.4800	-0.015 DB	0.049139	0.002288	.0465549	-0.000107	1.0025	-31.996 DB	-0.968111	-0.965696	.9975062	-0.963289
41.9600	-0.004 DB	0.049034	0.001169	.0238322	-0.000028	1.0050	-28.033 DB	-0.367910	-0.366080	.9950249	-0.364259
Q = 50											
1.0000	-30.000 DB	-1.936754	-1.936754	1.0000000	-1.936754	1.0100	-22.758 DB	-0.084200	-0.083367	.9900990	-0.082541
1.0100	-27.015 DB	-0.951245	-0.941826	.9900990	-0.932501	1.0200	-17.040 DB	0.003572	0.003502	.9803922	-0.003447
1.0200	-23.096 DB	-0.350280	-0.343412	.9803922	-0.336678	1.0400	-11.394 DB	0.025923	0.024926	.9615385	-0.023963
1.0400	-17.920 DB	-0.062172	-0.059781	.9615385	-0.057481	1.0800	-6.361 DB	0.027349	0.025323	.9259259	-0.023447
1.0800	-12.444 DB	0.028771	0.026639	.9259259	-0.024666	1.1600	-2.765 DB	0.018989	0.016370	.8620690	-0.014112
1.1600	-7.389 DB	0.050181	0.043259	.8620690	-0.037293	1.3200	-0.969 DB	0.009534	0.007223	.7575758	-0.005472
1.3200	-3.544 DB	0.044963	0.034063	.7575758	-0.025805	1.6400	-0.312 DB	0.004461	0.002720	.6	

Upper normalized freqs. (W)		Atten., dB	Time-delay product for 1/W freqs. ($\frac{\omega_0 T}{Q}$)	Time delay product ($\frac{\omega_0 T}{Q}$)	Lower normalized freqs. (1/W)	Time-delay product for W freqs. ($\frac{\omega_0 T}{Q}$)	Upper normalized freqs. (W)	Atten., dB	Time-delay product for 1/W freqs. ($\frac{\omega_0 T}{Q}$)	Time delay product ($\frac{\omega_0 T}{Q}$)	Lower normalized freqs. (1/W)	Time-delay product for W freqs. ($\frac{\omega_0 T}{Q}$)														
41.9600	-0.039	DB	0.157225	0.003747	0.0238322	0.000089	1.0000	-45.000	DB	-1.988753	-1.988753	1.0000000	-1.988753													
82.9200	-0.010	DB	0.158097	0.001907	0.0120598	0.000023	1.0000	-41.995	DB	-0.992479	-0.990004	0.9975062	-0.987535													
Q = 50																										
1.0000	-40.000	DB	-1.980000	-1.980000	1.0000000	-1.980000	1.0005	-38.028	DB	-0.392308	-0.390356	0.9950249	-0.388414													
1.0100	-37.012	DB	-0.994864	-0.985013	0.9900990	-0.975261	1.0100	-32.738	DB	-0.108590	-0.107515	0.9900990	-0.106451													
1.0200	-33.080	DB	-0.394155	-0.386426	0.9803922	-0.378849	1.0200	-26.964	DB	-0.020554	-0.020151	0.9803922	-0.019756													
1.0400	-27.861	DB	-0.106216	-0.102131	0.9615385	-0.098203	1.0400	-21.102	DB	0.003196	0.003073	0.9615385	0.002955													
1.0800	-22.219	DB	-0.014363	-0.013299	0.9259259	-0.012314	1.0800	-15.349	DB	0.009548	0.008841	0.9259259	0.008186													
1.1600	-16.614	DB	0.012424	0.010710	0.8620690	0.009233	1.1600	-9.958	DB	0.011198	0.009654	0.8620690	0.008322													
1.3200	-11.344	DB	0.021951	0.016629	0.7575758	0.012598	1.3200	-5.439	DB	0.010798	0.008180	0.7575758	0.006197													
1.6400	-6.782	DB	0.027769	0.016932	0.6097561	0.010325	1.6400	-2.417	DB	0.008770	0.005348	0.6097561	0.003261													
2.2800	-3.383	DB	0.032816	0.014393	0.4385965	0.006313	2.2800	-0.910	DB	0.006545	0.002870	0.4385965	0.001259													
3.5600	-1.373	DB	0.036566	0.010271	0.2808989	0.002885	3.5600	-0.308	DB	0.005234	0.001470	0.2808989	0.000413													
6.1200	-0.464	DB	0.038526	0.006295	0.1633987	0.001029	6.1200	-0.096	DB	0.004686	0.000766	0.1633987	0.000125													
11.2400	-0.137	DB	0.039276	0.003494	0.089680	0.000311	11.2400	-0.028	DB	0.004498	0.000400	0.089680	0.000036													
21.4800	-0.038	DB	0.039511	0.001839	0.0465549	0.000086	21.4800	-0.007	DB	0.004442	0.000207	0.0465549	0.000010													
41.9600	-0.010	DB	0.339577	0.000943	0.0238322	0.000022	Q = 400						1.0000	-45.000	DB	-1.988753	-1.988753	1.0000000	-1.988753							
Q = 100													1.0012	-41.993	DB	-0.990615	-0.989379	0.9975062	-0.988144	1.0025	-38.020	DB	-0.390529	-0.389555	0.9950249	-0.388583
1.0005	-40.000	DB	-1.980000	-1.980000	1.0000000	-1.980000	1.0050	-32.718	DB	-0.107495	-0.106960	0.9900990	-0.106428													
1.0050	-37.031	DB	-0.992479	-0.982505	0.9950249	-0.977617	1.0100	-26.922	DB	-0.020047	-0.019848	0.9900990	-0.019652													
1.0100	-33.046	DB	-0.3937045	-0.383213	0.9900990	-0.379418	1.0200	-21.020	DB	0.003287	0.003223	0.9803922	0.003159													
1.0200	-27.733	DB	-0.101897	-0.099899	0.9803922	-0.097940	1.0400	-15.194	DB	0.009241	0.008886	0.9615385	0.008544													
1.0400	-22.064	DB	-0.012584	-0.012100	0.9615385	-0.011635	1.0800	-9.969	DB	0.010306	0.009543	0.9259259	0.008836													
1.0800	-16.329	DB	0.012074	0.011180	0.9259259	0.010353	1.1600	-5.087	DB	0.008937	0.007704	0.8620690	0.006642													
1.1600	-10.882	DB	0.018904	0.016297	0.8620690	0.014049	1.3200	-2.108	DB	0.005876	0.004452	0.7575758	0.003372													
1.3200	-6.191	DB	0.019396	0.015127	0.7575758	0.011460	1.6400	-0.742	DB	0.003235	0.001973	0.6097561	0.001203													
1.6400	-2.882	DB	0.017551	0.010702	0.6097561	0.006525	2.2800	-0.246	DB	0.001908	0.000837	0.4385965	0.000367													
2.2300	-1.122	DB	0.013934	0.006111	0.4385965	0.002680	3.5600	-0.079	DB	0.001380	0.000388	0.2808989	0.000109													
3.5600	-0.386	DB	0.011507	0.003232	0.2808989	0.000978	6.1200	-0.024	DB	0.001191	0.000195	0.1633987	0.000032													
6.1200	-0.121	DB	0.010433	0.001705	0.1633987	0.000279	11.2400	-0.007	DB	0.001130	0.000101	0.089680	0.000009													
11.2400	-0.035	DB	0.010057	0.000895	0.089680	0.000080	Q = 200						1.0000	-45.000	DB	-1.988753	-1.988753	1.0000000	-1.988753							
21.4800	-0.009	DB	0.009943	0.000463	0.0465549	0.000022	1.0012	-41.993	DB	-0.990615	-0.989379	0.9975062	-0.988144													
Q = 200													1.0025	-38.020	DB	-0.390529	-0.389555	0.9950249	-0.388583	1.0050	-32.718	DB	-0.107495	-0.106960	0.9900990	-0.106428
1.0003	-40.000	DB	-1.980000	-1.930000	1.0000000	-1.980000	1.0100	-26.922	DB	-0.020047	-0.019848	0.9900990	-0.019652													
1.0025	-36.996	DB	-0.983706	-0.981253	0.9975062	-0.978806	1.0200	-21.020	DB	0.003287	0.003223	0.9803922	0.003159													
1.0050	-33.029	DB	-0.383517	-0.381609	0.9950249	-0.379711	1.0400	-15.194	DB	0.009241	0.008886	0.9615385	0.008544													
1.0100	-27.743	DB	-0.099775	-0.097377	0.9900990	-0.097800	1.0800	-9.969	DB	0.010306	0.009543	0.9259259	0.008836													
1.0200	-21.932	DB	-0.011729	-0.011499	0.9803922	-0.011273	1.1600	-5.087	DB	0.008937	0.007704	0.8620690	0.006642													
1.0400	-16.174	DB	0.011897	0.011439	0.9615385	0.010399	1.3200	-2.108	DB	0.005876	0.004452	0.7575758	0.003372													
1.0800	-10.614	DB	0.017506	0.016209	0.9259259	0.015009	1.6400	-0.742	DB	0.003235	0.001973	0.6097561	0.001203													
1.1600	-5.815	DB	0.016650	0.014353	0.8620690	0.012373	2.2800	-0.246	DB	0.001908	0.000837	0.4385965	0.000367													
1.3200	-2.529	DB	0.011889	0.009007	0.7575758	0.006324	3.5600	-0.079	DB	0.001380	0.000388	0.2808989	0.000109													
1.6400	-0.913	DB	0.006497	0.004236	0.6097561	0.002583	6.1200	-0.024	DB	0.001191	0.000195	0.1633987	0.000032													
2.2800	-0.309	DB	0.004211	0.001847	0.4385965	0.000310	11.2400	-0.007	DB	0.001130	0.000101	0.089680	0.000009													
3.5600	-0.100	DB	0.003075	0.000864	0.2808989	0.000243	Q = 25						1.0000	-50.000	DB	-1.993675	-1.993675	1.0000000	-1.993675							
6.1200	-0.030	DB	0.002663	0.000435	0.1633987	0.000071	1.0020	-47.032	DB	-1.023799	-1.003724	0.9803922	-0.984043													
11.2400	-0.007	DB	0.002529	0.000225	0.089680	0.000020	1.0400	-33.145	DB	-0.422823	-0.406561	0.9615385	-0.390924													
Q = 400													1.0800	-28.004	DB	-0.129946	-0.120320	0.9259259	-0.111408	1.1600	-22.484	DB	-0.034119	-0.029413	0.8620690	-0.025356
1.0000	-40.000	DB	-1.980000	-1.980000	1.0000000	-1.980000	1.3200	-16.827	DB	-0.005147	-0.003899	0.7575758	-0.029254													
1.0012	-36.993	DB	-0.981853	-0.980627	0.9975062	-0.979403	1.6400	-9.805	DB	0.006037	0.003681	0.6097561	0.002245													
1.0025	-33.021	DB	-0.381760	-0.380808	0.9950249	-0.379859	2.2800	-3.627	DB	0.016271	0.007136	0.4385965	0.001310													
1.0050	-27.723	DB	-0.093724	-0.092833	0.9900990	-0.093744	3.5600	-1.200	DB	0.003882	0.010810	0.2808989	0.000306													
1.0100	-21.941	DB	-0.011310	-0.011198	0.9803922	-0.011087	6.1200	-0.411	DB	0.009778	0.015980	0.1633987	0.000261													
1.0200	-16.094	DB	0.011808	0.011576	0.9615385	0.011349	11.2400	-0.137	DB	0.002494	0.002013	0.089680	0.000181													
1.0400	-10.469	DB	0.016838	0.016191	0.9259259	0.012972	21.4800	-0.048	DB	0.001610	0.000101	0.0465549	0.000085													
1.0800	-5.601	DB	0.015130	0.014010	0.8620690	0.007080	41.9600	-0.018	DB	0.000930	0.000103	0.0238322	0.000026													
1.1600	-2.315	DB	0.009527	0.008213	0.7575758	0.002566	82.9200	-0.008	DB	0.000548	0.000103	0.0120598	0.000018													
1.3200	-0.753	DB	0.004470	0.003387	0.6097561	0.000755	164.8400	-0.005	DB	0.000458	0.000103	0.0060665	0.000018													
1.6400	-0.248	DB	0.002030	0.001238	0.4385965	0.000214	Q = 50						1.0000	-50.000	DB	-1.993675	-1.993675	1.0000000	-1.993675							
2.2800	-0.079	DB	0.001110	0.000487	0.2808989	0.000062	1.0005	-47.001	DB	-1.001159	-0.996179	0.9950249	-0.991222													
3.5600	-0.025	DB	0.000782	0.000220	0.1633987	0.000018	1.0100	-43.045	DB	-0.400850	-0.396881	0.9900990	-0.392951													
6.1200	-0.008	DB	0.000669	0.000109	0.089680	0.000010	1.0200	-37.777	DB	-0.115818	-0.113547	0.9803922	-0.111320													
A0 = -45.0 dB													1.0400	-32.040	DB	-0.026694	-0.025667	0.9615385	-0.024680	1.0800	-26.237	DB	-0.002253	-0.002086	0.9259259	-0.019192
1.0000	-45.000	DB	-1.988753	-1.988753	1.0000000	-1.988753	1.1600	-20.551	DB	0.004713	0.004063	0.8620690	0.003502													
1.0020	-42.032	DB	-1.018777	-0.998801	0.9803922	-0.979217	1.3200	-15.133	DB	0.007540	0.005712	0.7575758	0.004327													
1.0040	-38.145	DB	-0.417701	-0.401636	0.9615385	-0.386183	1.6400	-10.179	DB	0.010200	0.006220	0.6097561	0.003793													
1.0080	-33.005	DB	-0.126419	-0.115388	0.9259259	-0.106841	2.2800	-5.965	DB	0.014455	0.006340	0.4385965	0.002871													
1.1600	-27.489	DB	-0.028365	-0.024453	0.8620690	-0.021080	3.5600	-2.856	DB	0.020709	0.005817	0.2808989	0.001634													
1.3200	-22.045	DB	0.001524	0.001155	0.7575758	0.000875	6.1200	-1.078	DB	0.026629	0.004351	0.1633987	0.000711													
1.6400	-16.866	DB	0.014763	0.010905	0.6097561	0.005491	11.2400	-0.336	DB	0.029871	0.002658	0.089680	0.000236													
2.2800	-12.018	DB	0.029744	0.013045	0.4385965	0.005722	21.4800	-0.094	DB	0.031050	0.001446	0.0465549	0.000067													
3.5600	-7.562	DB	0.0261381	0.017242	0.2808989	0.004843	41.9600	-0.025	DB																	

Upper normalized freqs. (W)	Atten. dB	Time-delay product for 1/W freqs. ($\frac{\omega_0 T}{Q}$)	Time delay product ($\frac{\omega T}{Q}$)	Lower normalized freqs. (1/W)	Time-delay product for W freqs. ($\frac{\omega_0 T}{Q}$)	Upper normalized freqs. (W)	Atten. dB	Time-delay product for 1/W freqs. ($\frac{\omega_0 T}{Q}$)	Time delay product ($\frac{\omega T}{Q}$)	Lower normalized freqs. (1/W)	Time-delay product for W freqs. ($\frac{\omega_0 T}{Q}$)
1.6400	-2.011	0.004302	0.002623	.6097561	0.001600	1.0000	-60.000	-1.998000	-1.998000	1.0000000	-1.998000
2.2300	-0.735	0.003039	0.001333	.4385965	0.000585	1.0200	-57.032	-1.023211	-1.000303	.9803922	-0.938284
3.5600	-0.245	0.002367	0.000665	.2808989	0.000187	1.0400	-53.145	-0.427324	-0.410888	.9615385	-0.395085
6.1200	-0.076	0.002098	0.000343	.1633937	0.000056	1.0800	-48.033	-0.134627	-0.124657	.9259259	-0.115423
11.2400	-0.022	0.002007	0.000179	.0839680	0.000016	1.1600	-42.482	-0.039187	-0.033742	.8620690	-0.029122
21.4800	-0.006	0.001980	0.000092	.0465549	0.000004	1.3200	-37.019	-0.011060	-0.008379	.7575758	-0.006347
40 = -55.0 DB						40 = -60.0 DB					
Q = 25						Q = 25					
1.0000	-55.000	-1.996443	-1.996443	1.0000000	-1.996443	1.0000	-60.000	-1.998000	-1.998000	1.0000000	-1.998000
1.0200	-52.032	-1.026623	-1.006493	.9803922	-0.986758	1.0200	-57.032	-1.023211	-1.000303	.9803922	-0.938284
1.0400	-48.145	-0.425704	-0.409331	.9615385	-0.393587	1.0400	-53.145	-0.427324	-0.410888	.9615385	-0.395085
1.0800	-43.004	-0.132943	-0.123036	.9259259	-0.113977	1.0800	-48.033	-0.134627	-0.124657	.9259259	-0.115423
1.1600	-37.432	-0.037362	-0.032208	.8620690	-0.027766	1.1600	-42.482	-0.039187	-0.033742	.8620690	-0.029122
1.3200	-32.021	-0.008928	-0.006764	.7575758	-0.005124	1.3200	-37.019	-0.011060	-0.008379	.7575758	-0.006347
1.6400	-26.785	0.003994	0.003060	.6097561	0.000370	1.6400	-31.779	-0.001866	-0.001138	.6097561	-0.000694
2.2300	-21.765	0.003026	0.003520	.4385965	0.000370	2.2800	-26.745	0.003262	0.001431	.4385965	0.000627
3.5600	-16.817	0.021775	0.011617	.2808989	0.001718	3.5600	-21.755	0.011543	0.003244	.2808989	0.000911
6.1200	-11.335	0.163393	0.111158	.1633937	0.001660	6.1200	-16.636	0.035886	0.005864	.1633937	0.000953
11.2400	-7.349	0.130132	0.016026	.0889680	0.001426	11.2400	-11.420	0.116517	0.010366	.0889680	0.000922
21.4800	-3.225	0.429353	0.019989	.0465549	0.000931	21.4800	-6.516	0.357634	0.016650	.0465549	0.000775
41.9600	-1.093	0.698311	0.016642	.0233322	0.000397	41.9600	-2.810	0.837613	0.019962	.0233322	0.000476
82.9200	-0.308	0.836823	0.010092	.0120523	0.000122	82.9200	-0.909	1.296355	0.015640	.0120523	0.000189
164.8400	-0.080	0.881795	0.005347	.0060665	0.000032	164.8400	-0.248	1.509586	0.009158	.0060665	0.000066
323.6800	-0.020	0.393977	0.002720	.0030425	0.000008	323.6800	-0.064	1.575092	0.004792	.0030425	0.000015
656.3600	-0.005	0.397397	0.001367	.0015236	0.000002	656.3600	-0.016	1.592491	0.002426	.0015236	0.000004
Q = 50						Q = 50					
1.0000	-55.000	-1.996443	-1.996443	1.0000000	-1.996443	1.0000	-60.000	-1.998000	-1.998000	1.0000000	-1.998000
1.0100	-52.031	-1.011470	-1.001456	.9903990	-0.991540	1.0100	-57.011	-1.013043	-1.003012	.9900990	-0.993082
1.0200	-48.079	-0.410923	-0.402865	.9303922	-0.394966	1.0200	-53.079	-0.412510	-0.404422	.9803922	-0.396492
1.0400	-42.834	-0.123299	-0.118536	.9615385	-0.113977	1.0400	-47.854	-0.124919	-0.120114	.9615385	-0.115494
1.0800	-37.194	-0.032047	-0.029673	.8620690	-0.027475	1.0800	-42.194	-0.033733	-0.031234	.8620690	-0.028920
1.1600	-31.522	-0.006355	-0.005473	.7575758	-0.004722	1.1600	-36.520	-0.008178	-0.007050	.7575758	-0.006077
1.3200	-26.025	0.001431	0.001061	.6097561	0.000370	1.3200	-31.017	-0.009723	-0.008548	.6097561	-0.004451
1.6400	-20.796	0.005117	0.003120	.4385965	0.001902	1.6400	-25.772	0.002920	0.001396	.4385965	0.000885
2.2300	-15.332	0.010004	0.004388	.2808989	0.001924	2.2800	-20.754	0.005415	0.002375	.2808989	0.001042
3.5600	-11.060	0.021902	0.006152	.1633937	0.001924	3.5600	-15.821	0.012807	0.003597	.1633937	0.001011
6.1200	-6.594	0.052969	0.008655	.0889680	0.001414	6.1200	-10.890	0.034888	0.005701	.0889680	0.000931
11.2400	-3.043	0.113780	0.010123	.0465549	0.000901	11.2400	-6.250	0.096731	0.008606	.0465549	0.000766
21.4800	-1.056	0.177122	0.008246	.0233322	0.000384	21.4800	-2.720	0.214815	0.010001	.0233322	0.000466
41.9600	-0.302	0.203931	0.005000	.0120523	0.000119	41.9600	-0.890	0.326034	0.007770	.0120523	0.000185
82.9200	-0.079	0.220563	0.002660	.0060665	0.000032	82.9200	-0.246	0.377768	0.004556	.0060665	0.000055
164.8400	-0.020	0.223519	0.001356	.0030425	0.000008	164.8400	-0.063	0.393840	0.002339	.0030425	0.000014
323.6800	-0.005	0.224280	0.000682	.0015236	0.000002	323.6800	-0.016	0.398135	0.001211	.0015236	0.000004
Q = 100						Q = 100					
1.0000	-55.000	-1.996443	-1.996443	1.0000000	-1.996443	1.0000	-60.000	-1.998000	-1.998000	1.0000000	-1.998000
1.0050	-52.001	-1.003941	-1.000947	.9950249	-0.993977	1.0050	-57.001	-1.005506	-1.000503	.9950249	-0.995525
1.0100	-48.043	-0.403645	-0.399649	.9900990	-0.395632	1.0100	-53.045	-0.405213	-0.401206	.9900990	-0.397233
1.0200	-42.776	-0.113641	-0.116314	.9803922	-0.114334	1.0200	-47.776	-0.120229	-0.117471	.9803922	-0.115560
1.0400	-37.033	-0.029572	-0.029434	.9615385	-0.027341	1.0400	-42.037	-0.031191	-0.029991	.9615385	-0.028338
1.0800	-31.230	-0.005233	-0.004850	.8620690	-0.004491	1.0800	-36.228	-0.006922	-0.006409	.8620690	-0.005934
1.1600	-25.525	0.001520	0.001310	.7575758	0.001130	1.1600	-30.517	-0.002026	-0.002255	.7575758	-0.002020
1.3200	-20.041	0.003962	0.003001	.6097561	0.002274	1.3200	-25.011	0.001367	0.001414	.6097561	0.001072
1.6400	-14.384	0.006000	0.003659	.4385965	0.002231	1.6400	-19.787	0.003303	0.002014	.4385965	0.001228
2.2800	-10.139	0.009772	0.004236	.2808989	0.001422	2.2300	-14.842	0.005312	0.002549	.2808989	0.001118
3.5600	-5.956	0.013019	0.005061	.1633937	0.000857	3.5600	-10.123	0.012219	0.003432	.1633937	0.000964
6.1200	-2.767	0.032117	0.005248	.0889680	0.000363	6.1200	-5.819	0.029275	0.004620	.0889680	0.000755
11.2400	-0.934	0.054039	0.004076	.0465549	0.000115	11.2400	-2.563	0.056657	0.005041	.0465549	0.000443
21.4800	-0.239	0.052855	0.002461	.0233322	0.000031	21.4800	-0.855	0.082559	0.003844	.0233322	0.000179
41.9600	-0.077	0.055235	0.001316	.0120523	0.000008	41.9600	-0.240	0.094631	0.002256	.0120523	0.000054
82.9200	-0.020	0.055901	0.000674	.0060665	0.000002	82.9200	-0.063	0.093509	0.001138	.0060665	0.000014
164.8400	-0.005	0.056075	0.000340	.0030425	0.000000	164.8400	-0.016	0.099544	0.000604	.0030425	0.000004
Q = 200						Q = 200					
1.0000	-55.000	-1.996443	-1.996443	1.0000000	-1.996443	1.0000	-60.000	-1.998000	-1.998000	1.0000000	-1.998000
1.0025	-51.995	-1.000133	-0.997694	.9975062	-0.995206	1.0025	-56.995	-1.001749	-0.999251	.9975062	-0.996759
1.0050	-48.023	-0.400035	-0.399045	.9950249	-0.396065	1.0050	-53.028	-0.401599	-0.399601	.9950249	-0.397630
1.0100	-42.736	-0.116352	-0.115200	.9900990	-0.114360	1.0100	-47.736	-0.117924	-0.116752	.9900990	-0.115601
1.0200	-36.956	-0.023373	-0.027322	.9803922	-0.027276	1.0200	-41.955	-0.029965	-0.029378	.9803922	-0.028302
1.0400	-31.072	-0.004720	-0.004539	.9615385	-0.004364	1.0400	-36.070	-0.006338	-0.006094	.9615385	-0.005860
1.0800	-25.233	0.001562	0.001446	.8620690	0.001339	1.0800	-30.224	-0.001115	-0.001106	.8620690	-0.000988
1.1600	-19.544	0.003464	0.002987	.7575758	0.002575	1.1600	-24.511	0.001677	0.001446	.7575758	0.001246
1.3200	-14.143	0.004472	0.003388	.6097561	0.002567	1.3200	-19.332	0.002491	0.001887	.6097561	0.001304
1.6400	-9.263	0.005693	0.003363	.4385965	0.002115	1.6400	-13.901	0.003452	0.002105	.4385965	0.001234
2.2800	-5.226	0.007663	0.003347	.2808989	0.001475	2.2800	-9.229	0.005412	0.002374	.2808989	0.001041
3.5600	-2.394	0.010271	0.002335	.1633937	0.000810	3.5600	-5.218	0.009529	0.002677	.1633937	0.000752
6.1200	-0.874	0.012433	0.002032	.0889680	0.000332	6.1200	-2.316	0.015363	0.002593	.0889680	0.000424
11.2400	-0.268	0.013511	0.001202	.0465549	0.000137	11.2400	-0.796	0.021290	0.001394	.0465549	0.000169
21.4800	-0.074	0.013886	0.000646	.0233322	0.000030	21.4800	-0.230	0.023839	0.001110	.0233322	0.000054
41.9600	-0.019	0.013994	0.000334	.0120523	0.000008	41.9600	-0.061	0.024667	0.000583	.0120523	0.000014
82.9200	-0.005	0.014024	0.000169	.0060665	0.000002	82.9200	-0.016	0.024895	0.000300	.0060665	0.000004
Q = 400						Q = 400					
1.0000	-55.000	-1.996443	-1.996443	1.0000000	-1.996443	1.0000	-60.000	-1.998000	-1.998000	1.0000000	-1.998000
1.0012	-51.992	-1.000315	-0.997067	.9975162	-0.995324	1.0012	-56.992	-1.001987	-0.999813	.9975162	-0.997378
1.0025	-48.019	-0.399237	-0.397244	.9950249	-0.396253						

LAB POWER

New PVC Power Supply

Voltage	Current	
0-10V DC	2A	4A
0-20V DC	1A	2A
0-50V DC	0.5A	1.0A



The
Maxi
Line

with these features

- Voltage / Current Crossover
- Three (3) Range Voltmeter
- Three (3) Range Ammeter
- Plug-in Amplifiers with I. C.
- Precision Current Regulation
- Mil-T-27A Transformer
- Remote Voltage or Resistance Programming
- Master Slave Series / Parallel
- Available in Singles & Duals

NJE CORPORATION
Electronic Development & Manufacturing

Kenilworth, New Jersey 07033 / (201) 272-6000

TELEFAX: FFP • TWX: (710) 996-5967

A subsidiary of **CONDEC** Corporation

Design bias circuits with nomographs.

They take the guess-work out of design, and give stable and speedy results as well.

Designing the bias circuit for a transistor amplifier is a complex procedure. Not only do transistor parameters vary, but so do the biasing resistors. This results in complex equations that include all the variables but do not make clear which factors are dominant. Many engineers, in desperation, resort to rule-of-thumb techniques, or arbitrarily select stability factors without knowing if the correct value has actually been chosen.

A far better solution is the use of nomographs. Those given here are based on design equations which consider the critical biasing parameters.

By combining the nomographs with a simple step-by-step procedure, bias circuits can be designed that are accurate within specifications selected by the designer.

Operating point comes first

In using the nomographs, the object is to design a bias circuit for a given operating point, usually defined in terms of V_{CE} and I_E . The precise operating point is determined by noise figure, gain requirement, available power supply voltage, etc. Once the operating point is selected, the bias circuit must hold it within a prescribed tolerance. The chief factors that determine operating point stability are Δh_{FE} , ΔI_{CO} , ΔV_{BE} and ΔR (the variation in the biasing resistor values). These changes are caused by temperature variations, as well as normal component production tolerances.

The following factors are considered in the nomograph bias design:

- Maximum and minimum expected h_{FE} , and its variation with temperature.
- Maximum expected I_{CO} , and its variation with temperature.
- Maximum expected V_{BE} , and its variation with temperature.
- Tolerance of the bias resistors.

The basic bias circuit used for design purposes,

suitable for all class-A situations, is shown in Fig. 1. Practical versions of the basic circuit are shown in Fig. 2. Other circuits may also be analyzed in terms of the basic circuit, if reduced to a Thevenin equivalent.

Nomographs based on general equations

In the specific circuit being used, nominal values of I_E , R_E , V_{CE} and V_C are chosen to satisfy the design requirements. The values of V_B and R_B required for a given circuit stability are then expressed by the following equations:

$$R_B = \frac{\overbrace{(I_{E(max)} - I_{E(min)}) R_E}^{Y_1} + \overbrace{(V_{BE(max)} - V_{BE(min)})}^{\Delta V_{BE}}}{I_{CO(max)} + \frac{I_{E(min)}}{h_{FE(min)} + 1} - \frac{I_{E(max)}}{h_{FE(max)} + 1}} \Delta X \quad (1)$$

$$V_B = \left[\frac{R_B}{h_{FE(min)} + 1} + R_E \right] I_{E(min)} + \overbrace{V_{BE(max)}}^Y \quad (2)$$

These equations have been reduced to nomograph form to eliminate tedious calculations. (The brackets over the equations define the parameters used in the nomographs). Since this analysis is based on small signal operation, variations of h_{FE} with increased current or thermal runaway problems are not considered.

The three nomographs given on pages 69-71 form the basis for this bias circuit design technique. Step-by-step procedures for using the nomographs, together with a specific design example, are presented on page 68. ■■

Bibliography:

- Brown, W. L. and D. E. Penine, "Don't Guess at Bias Design," *ELECTRONIC DESIGN*, May 9, 1968.
 Corning, John J., *Transistor Circuit Analysis and Design*, Englewood Cliffs, N.J.: Prentice-Hall pp 75-115.
General Electric Transistor Manual, 7th Edition, General Electric Co.
 Linvill and Gibbons, *Transistors and Active Circuits*, New York: McGraw-Hill.
 "Semiconductor Directory," *ELECTRONIC DESIGN*, April 26, 1967.

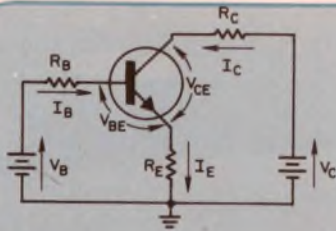

$$I_C = \alpha I_E + I_{CBO}$$

$$I_C = h_{FE} I_B + (h_{FE} + 1) I_{CBO}$$

$$h_{FE} = \frac{\alpha}{1 - \alpha}$$

1. Basic bias circuit can be used to analyze any class-A common emitter bias configuration.

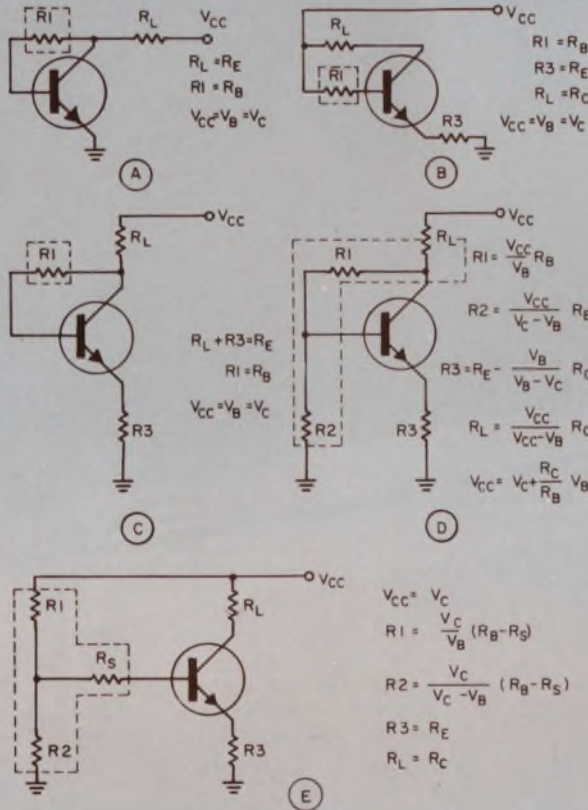

2. A variety of practical bias circuits can be designed with the nomograph technique. The equations show the relationship between the actual circuit values and the values of the basic circuit. All resistors which are represented by R_B in the basic circuit are shown by dashed lines.

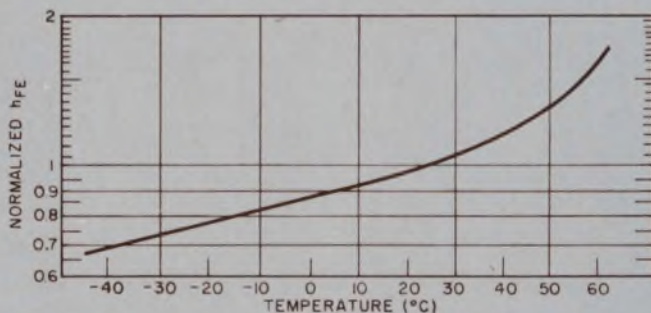

3. Temperature dependence of h_{FE} for germanium devices must be considered in the bias circuit design. For silicon transistors this may be neglected.

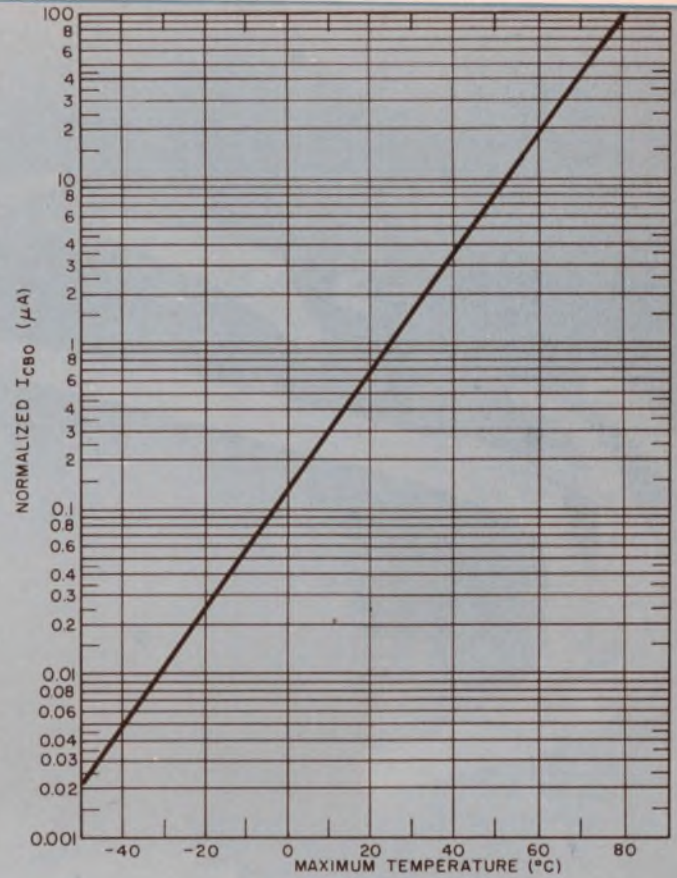

4. Temperature dependence of I_{CBO} for germanium devices must be considered in the bias circuit design. For silicon transistors it can be neglected.

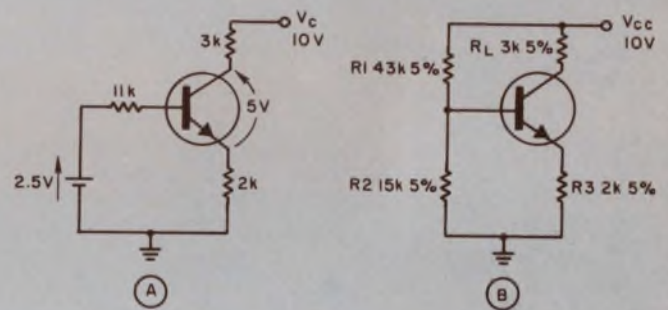

5. Completed bias circuit is shown for general case (a) and final design (b).

Standard resistor values

5%				10%	
1.00	1.80	3.30	5.60	1.00	3.30
1.10	2.00	3.60	6.20	1.20	3.90
1.20	2.20	3.90	6.80	1.50	4.70
1.30	2.40	4.30	7.50	1.80	5.60
1.50	2.70	4.70	8.20	2.20	6.80
1.60	3.00	5.10	9.10	2.70	8.20

(Continued on next page)

Step-by-step procedure includes example

Step	Procedure	Design example
1.	Select the transistor type.	2Nxxxx is a suitable germanium device.
2.	Specify the temperature range.	Requirements are $T_{\min} = -30^{\circ}\text{C}$, $T_{\max} = +60^{\circ}\text{C}$; so $\Delta T = 90^{\circ}\text{C}$
3.	Decide on acceptable minimum and maximum acceptable emitter currents, considering resistor tolerances. (a) For 5% resistors, multiply $I_{E(\max)}$ by 0.85 and $I_{E(\min)}$ by 1.15. (b) For 10% resistors, multiply $I_{E(\max)}$ by 0.70 and $I_{E(\min)}$ by 1.30.	$I_{E(\min)} = 0.9 \text{ mA}$, $I_{E(\max)} = 1.0 \text{ mA}$; so, $\Delta I_E = 0.1 \text{ mA}$
4.	Determine $h_{FE(\min)}$ and $h_{FE(\max)}$ (a) For germanium, extend h_{FE} limits to account for h_{FE} temperature dependence (Fig. 3). (b) For silicon, disregard h_{FE} temperature dependence.	From the manufacturer's data sheet: $h_{FE(\min)} = 50$, $h_{FE(\max)} = 150$ Use Fig. 3 for temperature correction: at -30°C $h_{FE(\min)} = 0.73 \times 50 = 36.5$ at $+60^{\circ}\text{C}$ $h_{FE(\max)} = 1.16 \times 150 = 240$
5.	Use Nomograph 1 to determine ΔX . X_{\max} is based on $h_{FE(\min)}$ and $I_{E(\min)}$. X_{\min} is based on $h_{FE(\max)}$ and $I_{E(\max)}$. $\Delta X = X_{\max} - X_{\min}$	$\Delta X = 22 \mu\text{A}$
6.	Select R_E R_E is chosen to satisfy the V_{CE} requirement: $V_{CE} = V_C - I_E (R_E + R_C)$	$R_E = 2 \text{ k}\Omega$
7.	Calculate Y on Nomograph 2, using R_E and ΔI_E .	$Y = 200 \text{ mV}$
8.	Calculate ΔV_{BE} . $\Delta V_{BE} = 2.5 \text{ mV} \times \Delta T$ (ΔT from step 2)	$\Delta V_{BE} = 2.5 \times 90 = 225 \text{ mV}$
9.	Add Y (from step 7) to ΔV_{BE} to obtain Y_I . $Y_I = Y + \Delta V_{BE}$	$Y_I = 200 + 225 = 425 \text{ mV}$
10.	Determine $I_{CO(\max)}$ (a) For silicon, use manufacturer's I_{CO} . (b) For germanium, compensate for temperature dependence, using Fig. 4.	From manufacturer's data sheet, $I_{CO(\max)} = 2 \mu\text{A}$ at 25°C Using Fig. 4 for temperature correction, at 60°C , $I_{CO} = 8 \times 2 \mu\text{A} = 16 \mu\text{A}$
11.	Using Nomograph 2, calculate ΔX_I . $\Delta X_I = I_{CO(\max)} + \Delta X$	From step 10: $I_{CO(\max)} = 16 \mu\text{A}$ From step 5: $\Delta X = 22 \mu\text{A}$ so, $\Delta X_I = 36 \mu\text{A}$
12.	Using Y_I and ΔX_I , find R_B on Nomograph 2.	From step 9: $Y_I = 425 \text{ mV}$; From step 11: $\Delta X_I = 38 \mu\text{A}$ so, $R_B = 11 \text{ k}\Omega$ (this is the shunt input impedance due to the bias resistors)
13.	Using Nomograph 3, find Z. First use $h_{FE(\min)}$ and R_B . Then add R_E to Z.	$Z = 2.3 \text{ K}\Omega$
14.	Using Nomograph 3, find V_B . This is determined from $I_{E(\min)}$ and Z.	$V_B = 2.5 \text{ V}$
15.	Select the bias circuit according to Fig. 2. If circuit desired is not included in Fig. 2, derive the Thevenin equivalent.	For example, if Fig. 2e is the desired circuit, and $R_S = 0$, $V_{CC} = V_C = 10\text{V}$ $R_1 = (V_C/V_B)R_B = (10/2.5)11\text{K} = 44 \text{ k}\Omega$ $R_2 = (V_C/V_C - V_B)R_B = (10/10 - 2.5)11\text{K} = 14.7 \text{ k}\Omega$ $R_3 = R_E = 2 \text{ k}\Omega$; and $R_L = R_C = 3 \text{ k}\Omega$
16.	Select the closest standard value resistors. The completed bias circuit is shown in Fig. 9.	If 5% resistors are used, $R_1 = 43 \text{ k}\Omega$, $R_2 = 15 \text{ k}\Omega$, $R_3 = 2 \text{ k}\Omega$, $R_L = 3 \text{ k}\Omega$.

Nomograph 1

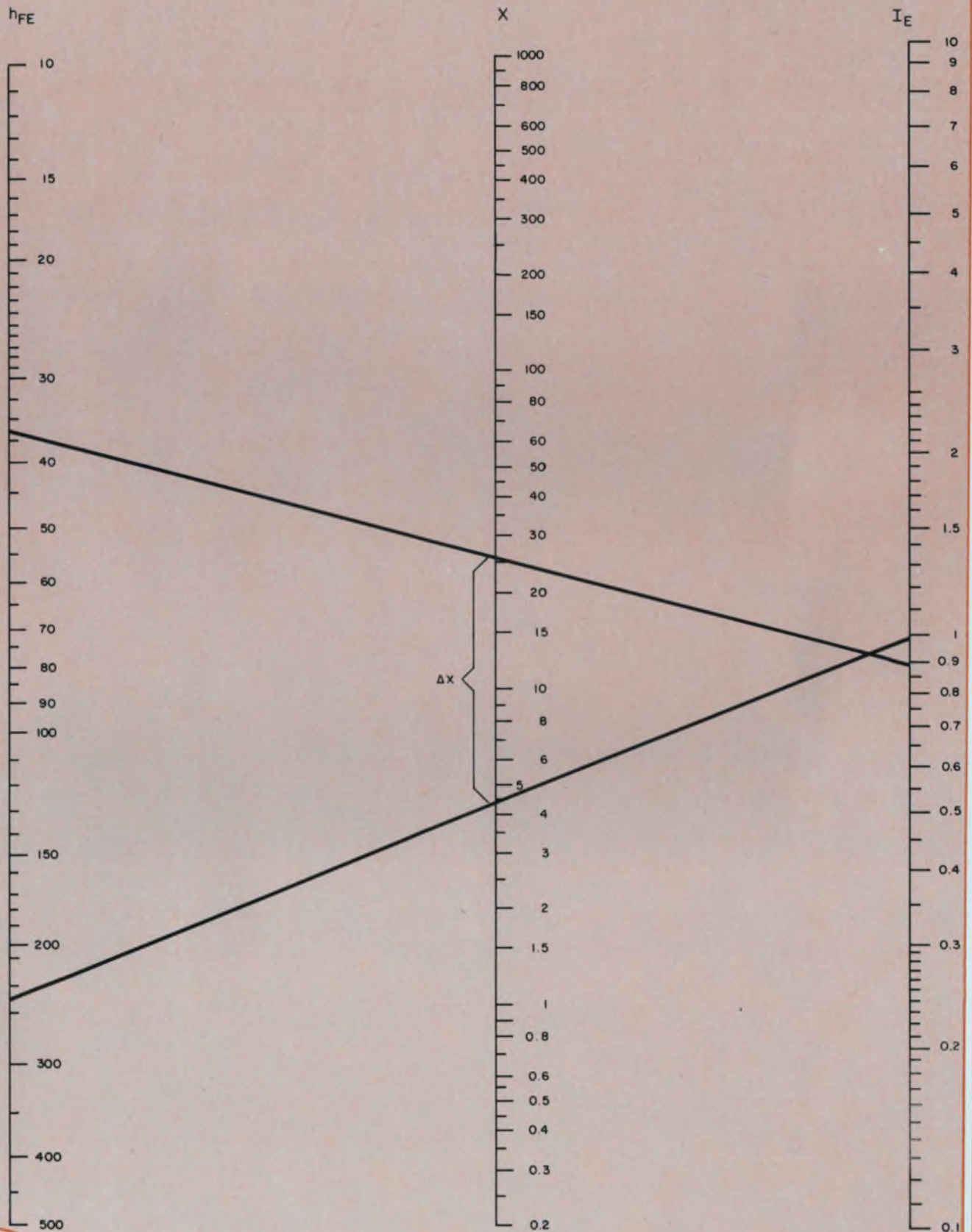

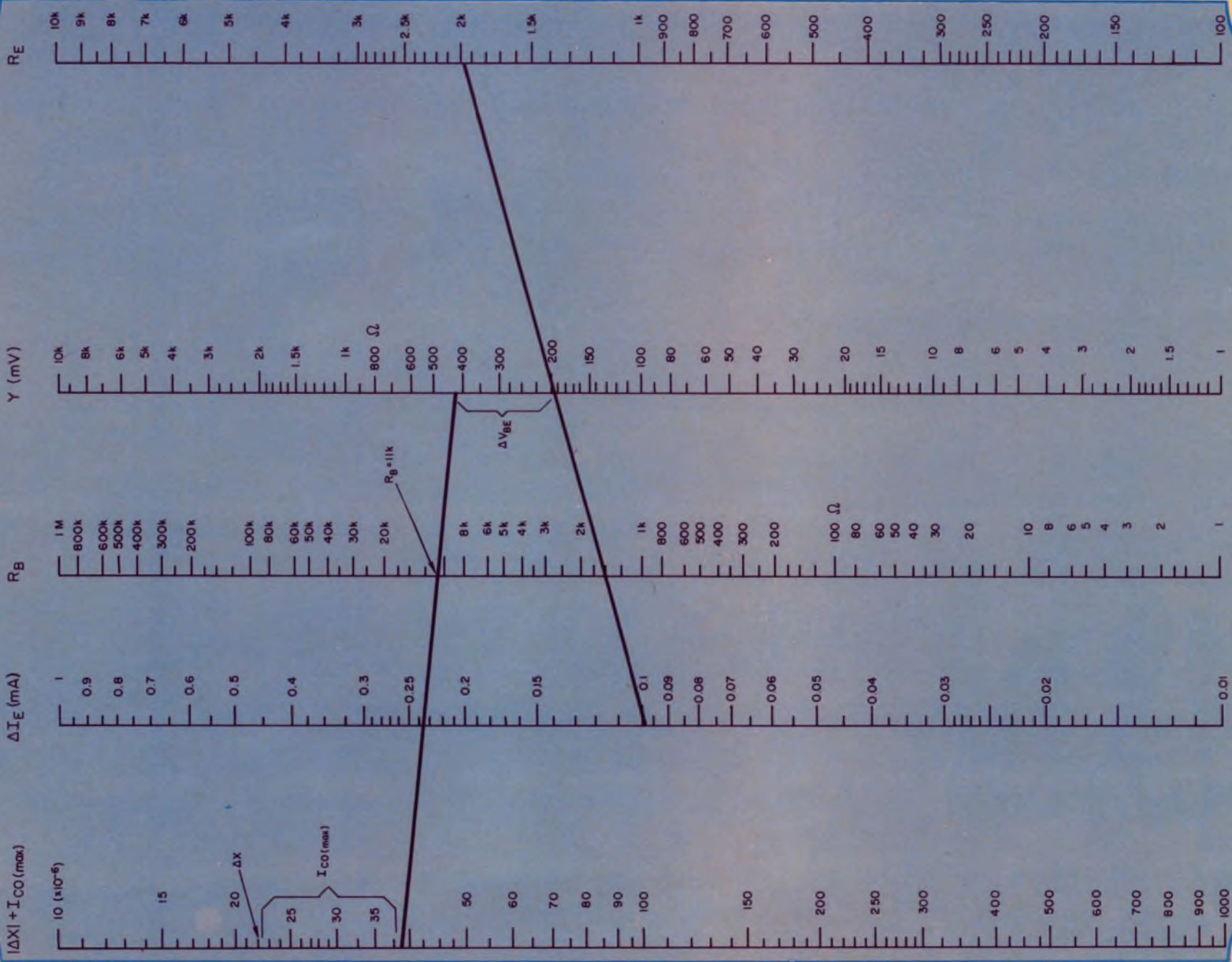

(Continued on next page)

Nomograph 2

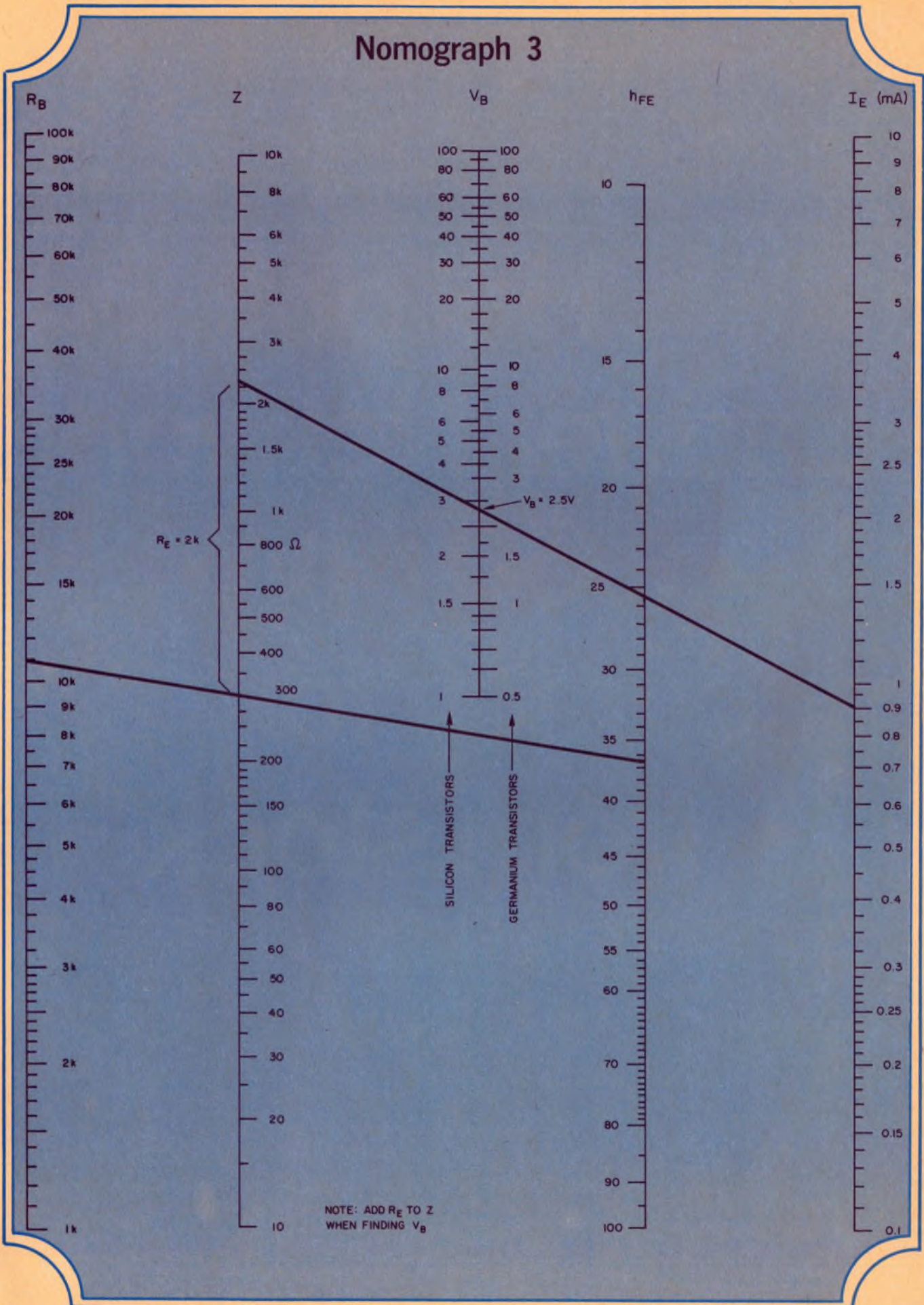

Nomograph 3





**Helipot
Ladder Networks
...60 ppm
accuracy for \$27.00
from stock***

* Model 811-A12, 100 piece price.

Helipot offers the widest variety of off-the-shelf miniature ladder networks. From low cost networks with 9-bit accuracies to precision 14-bit units. Either binary or BCD designs. And with a variety of stock resistance values and a selection of standard temperature ranges.

They typically feature:

- 60 ppm accuracy (initial worst case accuracy at 25°C)
 - 0.6 ppm/°C tempco
- 50 nanosecond settling
- 20 ppm per year stability
 - low profile

They are constructed of Helipot's exclusive cermet thick film passive elements and fused to alumina substrates at extremely high temperatures. By screen printing all resistors on each network simultaneously, uniform electrical characteristics and excellent stability are achieved. In addition, every unit is 100% tested at 5 temperature points and serialized accuracy tapes are available for only \$1.00 more.

For more information, contact your local Helipot Sales Representative or Distributor or circle the Reader Service No.

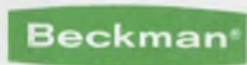

INSTRUMENTS, INC.
HELIPOT DIVISION
 FULLERTON, CALIFORNIA • 92634

INTERNATIONAL SUBSIDIARIES: AMSTERDAM; CAPE TOWN; GENEVA; GLENROTHES, SCOTLAND; LONDON; MEXICO CITY; MUNICH; PARIS; STOCKHOLM; TOKYO; VIENNA

Model 811:
 A 12-bit Binary Ladder Network for use in DAC/ADC applications requiring fast switching and high accuracy over a wide temperature range.



Model 812:
 A 12-bit R-2R Binary Ladder Network designed specifically for MOSFET switch applications.

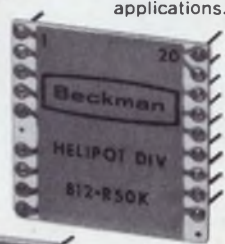

Model 813:
 A Conductance Ladder designed to be used with Fairchild's μ A722 10-bit current source.



Model 814:
 An Ultraprecision 14-bit R-2R Binary Ladder Network with accuracies to ± 30 ppm from -20° to $+80^\circ\text{C}$.



BCD Ladder Networks are also available in many standard configurations.

Fast a/d converter provides parallel-digital output

The output of an analog-to-digital converter is often required to be in parallel-digital form. Such a conversion can be accomplished in various ways. Many a/d converters perform a serial-to-parallel conversion as an intermediate step in producing the parallel-digital output. This intermediate conversion, though, is time consuming. The successive-approximation method is much faster, but the settling time of the analog circuitry limits the clock rate, and one clock pulse is needed for each bit. Using the approach shown in the illustration, an analog input can be converted directly into a parallel-digital output with good accuracy and at high speed.

In the circuit, all resistances, R , are equal, and I_{2A} , I_{4A} , I_{8A} , I_{8B} and I_{8C} are gated current sources that are normally OFF. Under quiescent conditions (analog input is zero), $V_1 = iR$,

$V_2 = 2iR$, $V_4 = 4iR$ and $V_8 = 8iR$. Also, comparators X_1 , X_2 , X_4 and X_8 are OFF.

When the analog input exceeds the threshold of any comparator, that comparator is turned on. Each comparator that is ON turns on its associated gate current sources, which feed back currents proportional to that comparator's binary significance to all less significant comparators. The feedback, in turn, automatically switches each comparator to the state that provides the proper digital output.

For example, assume that an analog signal slightly greater than $10 iR$ but less than $11 iR$ is applied at the input to the converter. When the input is initially applied, X_1 , X_2 , X_4 , and X_8 all turn ON. X_8 then turns on I_{8A} , I_{8B} and I_{8C} ; X_4 turns on I_{4A} and I_{4B} ; and X_2 turns on I_{2A} . Current I_{8C} adds to I_1 to produce a new reference, $V_4 =$

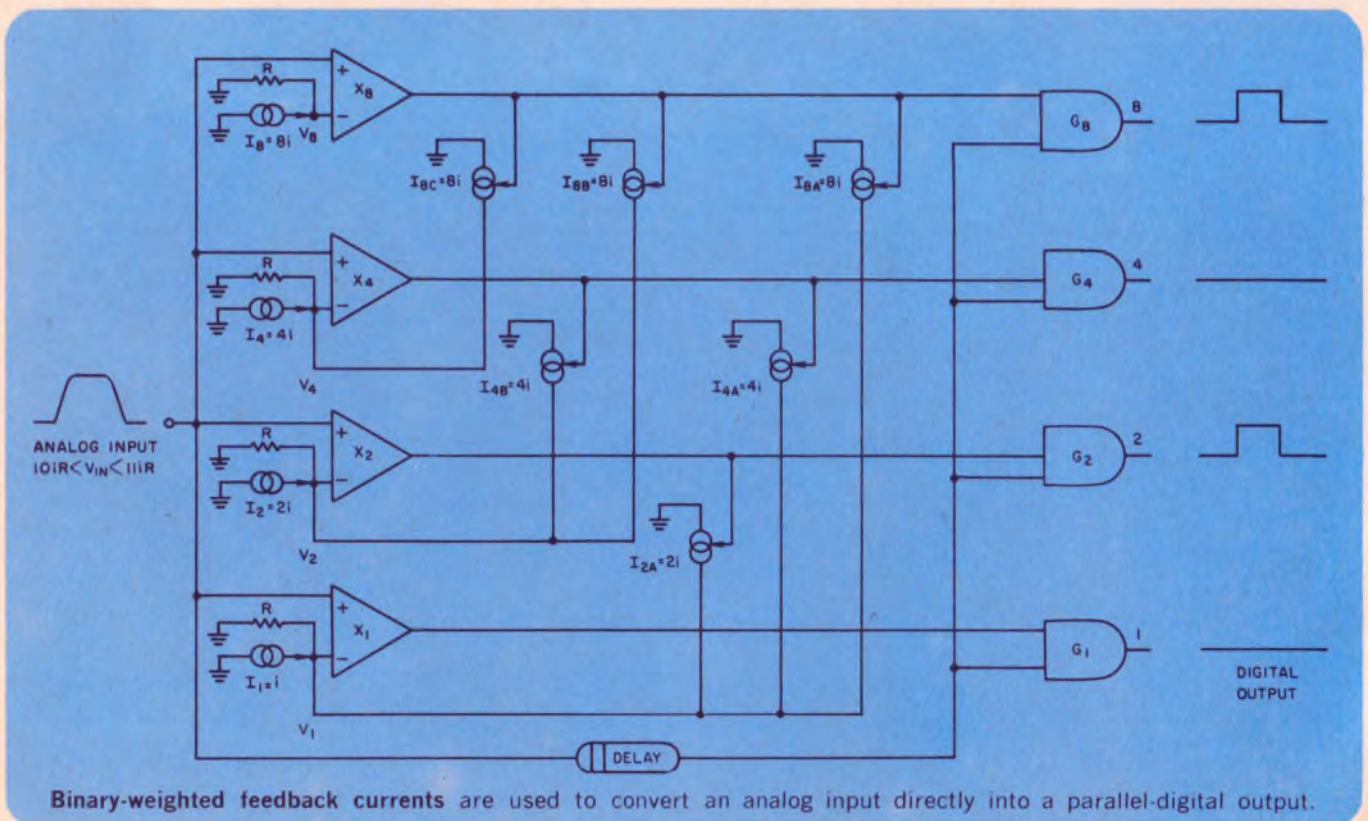

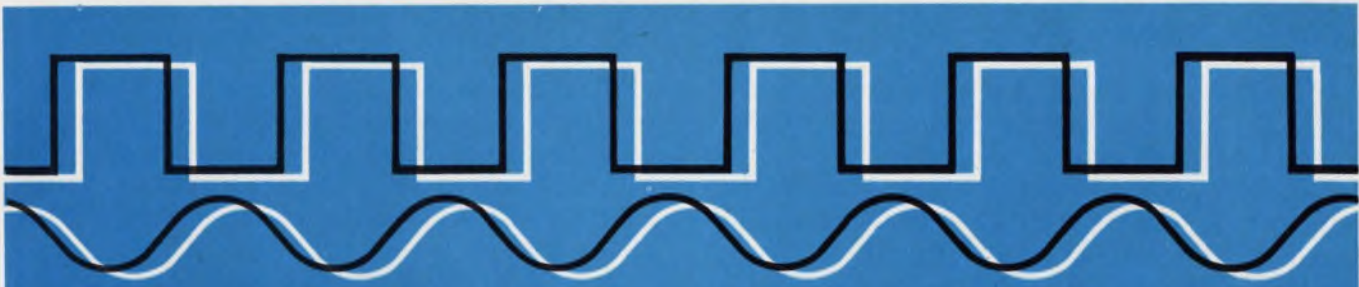

a function generator
with the
accent on

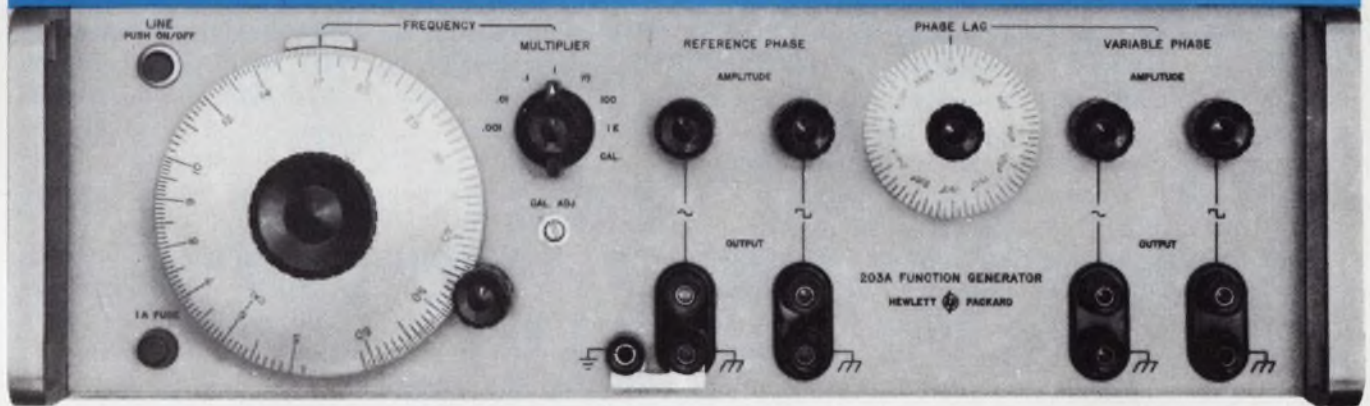

FUNCTION

The array of features on the Hewlett-Packard 203A Variable Phase Function Generator make it one of the most useful and versatile function generators available. It's a fast, practical way to get high-quality test signals for a variety of field and lab applications.

First, the 203A gives you simultaneous sine and square waves from 0.005 Hz to 60 kHz. Or from 0.00005 Hz with optional bands for tests at extremely low frequencies. Two additional outputs give you a continuously variable phase shift of each signal from 0° to 360°. Yet total harmonic distortion is less than 0.06%.

Second, you get 1% frequency accuracy from a dial

calibrated in 180 divisions and precision vernier drive. All four outputs float with respect to the power line, and each has a 40 dB continuously adjustable attenuator. With all its features, the solid-state 203A fits neatly and economically into medical, geophysical and servo applications as well as audio and vibrations testing. Price: \$1250 (options 01 and 02 for lower frequency decades, \$50 and \$150, respectively.)

For complete details on each and every function, call your local HP field engineer, or write Hewlett-Packard, Palo Alto, California 94304; Europe: 1217 Meyrin-Geneva, Switzerland.

HEWLETT  PACKARD

SIGNAL SOURCES

INFORMATION RETRIEVAL NUMBER 32

$(8i + 4i) = R = 12 iR$, at the input to X_4 . Since the analog input is slightly greater than $10 iR$, X_4 is turned OFF again.

Simultaneously, I_{8B} adds to I_2 to produce a new reference, $V_2 = (8i + 2i) R = 10 iR$. Since the analog input is slightly greater than $10 iR$, X_2 is kept ON. Similarly, X_2 turns on I_{2A} , and I_{2A} , I_{8A} and I_1 all add to produce a new reference, $V_1 = (8i + 2i + i) R = 11 iR$, at the input to X_1 . Since the analog input is less than $11 iR$, X_1 is forced OFF. The delay circuit allows time for all transients to disappear before gates G_1 , G_2 , G_3 and G_4 deliver the parallel-digital output.

With this technique and using precision current sources, precision resistors and fast operational amplifiers, it should be possible to build an 8-10 bit a/d converter that has 1-bit accuracy, good temperature stability and a conversion time of less than $2 \mu s$.

This work was performed under the auspices of the U.S. Atomic Energy Commission.

Donald E. Trinko, Argonne National Laboratory, Argonne, Ill.

VOTE FOR 311

180-Hz synchronous switch drives two loads alternately

In control systems, the need frequently arises for a circuit that will alternately switch two loads on and off: that is, while one is ON, the other is OFF, and vice versa. A relatively inexpensive circuit that will do this at the rate of 180 cycles per second—one that is synchronized with the ac supply line—is described here.

The circuit (Fig. 1) is basically a symmetrical collector-coupled astable multivibrator running at 180 Hz, which supplies base drive to two npn power switches. The output of these switches is synchronized with the line by an intentional ripple voltage from a low-level, zener-clipped power supply.

The circuit is supplied with a full-wave rectified signal from a diode bridge, formed by diodes $D1$ through $D4$. This signal is lowered by the IR drop resistor R_1 , and filtered and clipped by the parallel combination of zener diode $D7$ and capacitor C_1 . The output voltage developed by capacitor C_1 supplies power for the multivibrator section.

The value of the C_1 filter capacitor is chosen so that a ripple voltage appears between nodes 3 and 1 of the circuit. This ripple voltage then synchronizes the switching of the multivibrator with the line voltage.

The active elements in the multivibrator por-

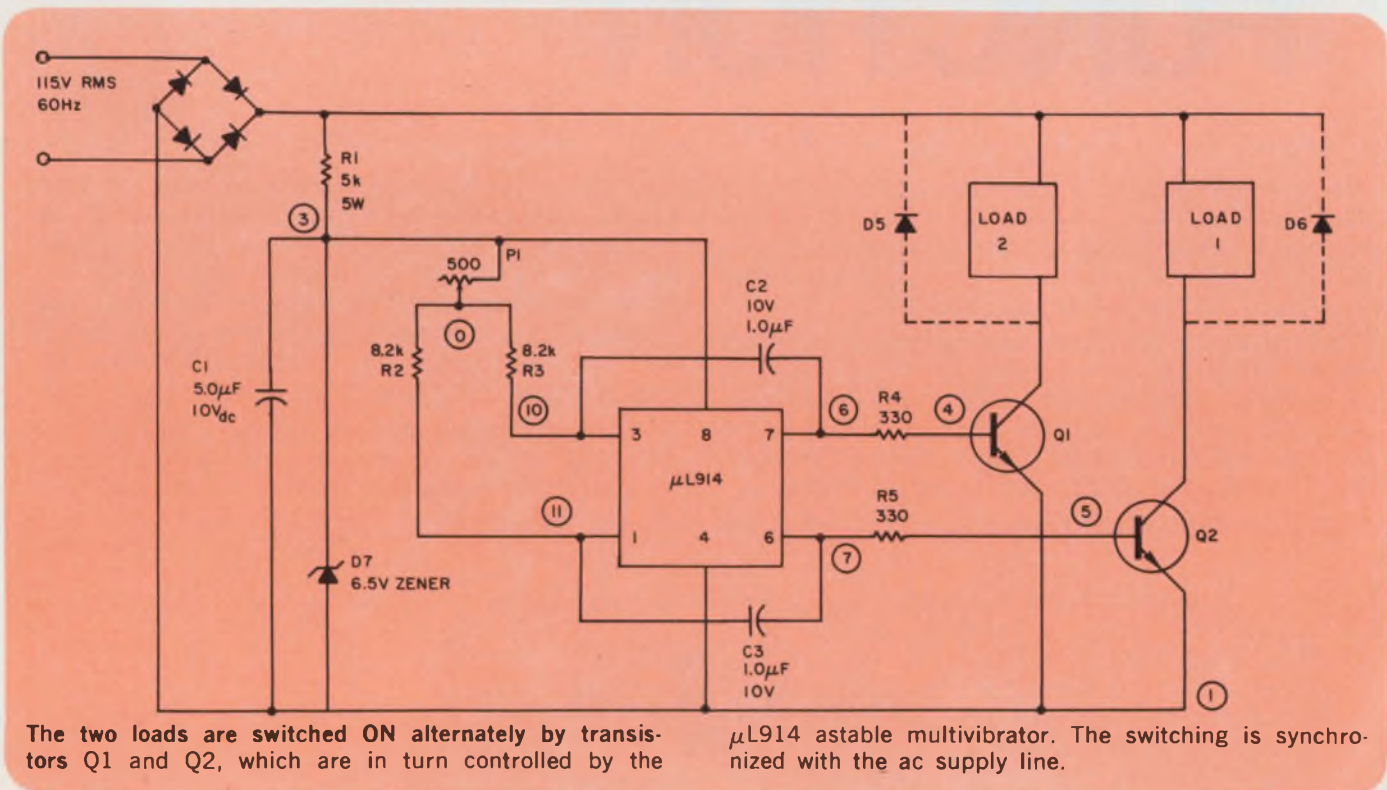

The two loads are switched ON alternately by transistors Q1 and Q2, which are in turn controlled by the

$\mu L914$ astable multivibrator. The switching is synchronized with the ac supply line.

New random-noise generator with flat output from 20 Hz to 20 MHz



Wide frequency range, calibrated output, and carefully specified Gaussian amplitude distribution are the key features that distinguish this new random-noise generator from others available. The 1383 generates white noise of uniform spectrum level out to 20 MHz, particularly useful for tests in video- and radio-frequency systems. It is also an ideal broad-band, high-level noise source for use in amplifier testing, noise measurements, tests of signal-detection schemes, distortion measurements, and signal modulation to produce noise sidebands at higher frequencies. The 1383 contains a temperature-limited thermionic diode as a noise source, semiconductor amplifiers, an output meter, an 80-dB attenuator, and power supply, all enclosed in a convenient cabinet for bench use or rack mounting.

Frequency Range. The spectrum is flat (constant energy per hertz of bandwidth) ± 1 dB from 20 Hz to 10 MHz, ± 1.5 dB from 10 to 20 MHz.

Calibrated Output. The maximum output is one volt, open circuit, from a 50-ohm source impedance.

Carefully Specified Gaussian Distribution. The noise source provides symmetrical Gaussian amplitude distribution, specified to $\pm 3 \sigma$ as measured with a "window" of 0.2σ .

Price: Bench model, \$775; rack model, \$795.

Prices apply only in the USA. All GR products are subject to a quantity discount ranging from 3% for 2-4 units to 20% for 100 units. For complete information, write General Radio Company, W. Concord, Massachusetts 01781; telephone (617) 369-4400. In Europe: Postfach 124, Ch 8034 Zurich 34, Switzerland.

Other true random-noise generators:



1381

- 2 Hz to 2, 5, or 50 kHz
 - Gaussian distribution
 - adjustable clipping
 - 3-V rms output
- Price \$375, bench model
\$398, rack model



1382

- 20 Hz to 50 kHz
 - white, pink, or USASI spectra
 - Gaussian distribution
 - 3-V rms output, balanced, unbalanced, or floating
- Price \$375, bench model
\$398, rack model



1390-B

- 5 Hz to 5 MHz
 - 30 μ V to 3-V output
 - 21-dB audio spectrum-level uniformity
 - white spectra, and pink (with filter)
- Price \$375; \$50 for pink noise filter

GENERAL RADIO

tion of the circuit are contained in a μL914 dual-input gate. The μL914 operates as an astable multivibrator, as shown in Fig. 2 (Only the IC parts that are used in this circuit are shown in the diagram. Note that $R_2 = R_3$ and $C_2 = C_3$.)

The rate at which switching occurs in the multivibrator is determined mainly by the product of R_2 and C_3 (or R_3 and C_2), and by the value of the voltage V_{o1} (Fig. 1), according to the relationship:

$$T = R_2 C_3 \ln \left[\frac{V_{o1} + \frac{R_5}{RC + R_5} V_{31} + V_{51(\text{on})} - V_{71(\text{sat})}}{V_{o1} - V_{11-1}(\text{turn-on})} \right]$$

which can be simplified to:

$$T = R_2 C_3 \ln \left[\frac{V_{o1} + \frac{R_5}{640 + R_5} V_{31} + 0.3}{V_{o1} - 0.6} \right]$$

A complete cycle requires double this interval. Fine adjustments in the switching rate may be made by varying potentiometer P_1 , which is in series with the supply to timing resistors R_2 and R_3 .

Transfer of power into the two loads being switched is controlled by two high-voltage npn switches, $Q1$ and $Q2$. Base drive for these stages is supplied from the two collectors of the multivibrator stage, via resistors R_3 and R_1 . The

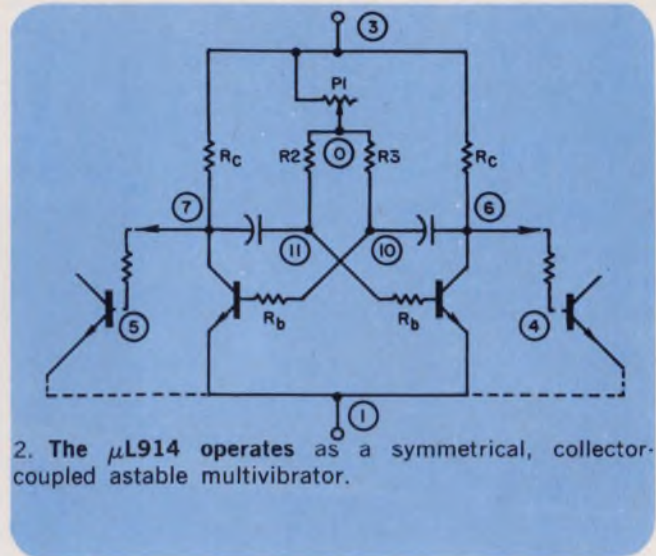

2. The μL914 operates as a symmetrical, collector-coupled astable multivibrator.

power transistors are either OFF or ON, depending on the state of the associated portion of the multivibrator. Diodes $D5$ and $D6$ are used to suppress voltage transients, if the loads are inductive. For resistive loads, they are not necessary.

Robert B. Hood, Supervising Engineer, Applications, Fairchild Semiconductor, Mountain View, Calif.

VOTE FOR 312

Simple circuit 'tags' beginning and end of square-wave signals

Frequently, it is necessary to determine the beginning and end of a square wave of varying width. The circuit shown (a) will produce a negative output spike at both the leading and trailing edges of an input pulse of either polarity.

The action of the circuit is straightforward. The positive-going edge of the input pulse is differentiated, to provide a positive spike to the bases of both transistors. This turns on the npn unit ($Q1$), and keeps $Q2$, which is pnp, off. The

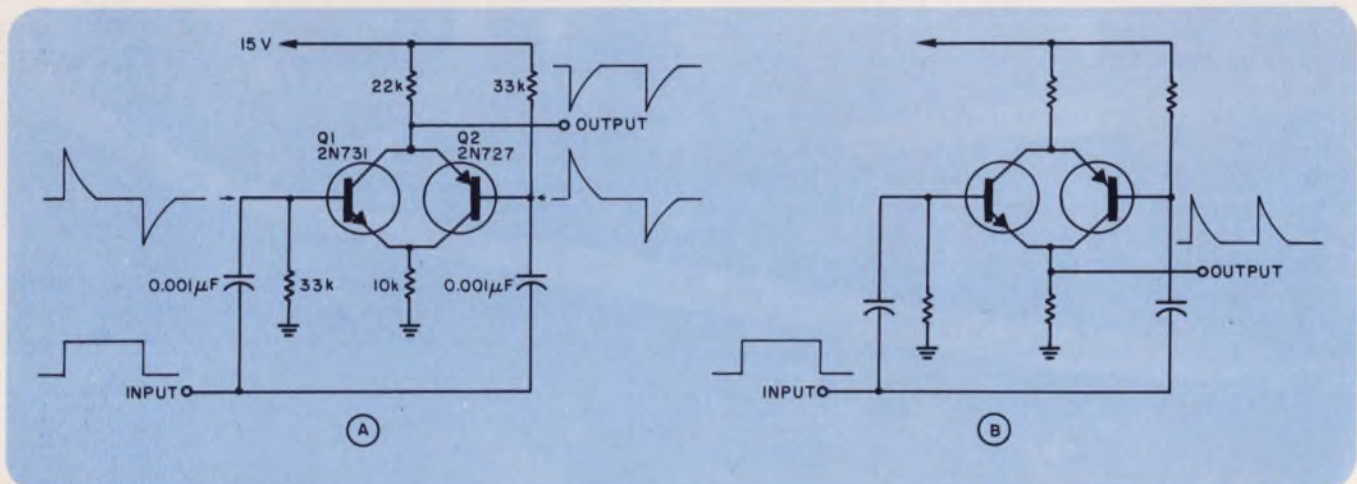

Negative output spikes are produced at both the beginning and end of each input square wave (a). Positive

output spikes are produced by the circuit of (b). The circuits work with input pulses of either polarity.



the new smoothies

Centralab's substrates in 95% and 99.6% alumina, provide unexcelled surface finish and reliability for hybrid microcircuits

Available in sizes and shapes to meet any design requirement, these materials are available as fired, glazed or metallized. (Glazed units are available only in 99.6% alumina.) They have high mechanical strength and good dimensional tolerance control.

Bodies	Surface Finish (μ in.)		Glazed
	As Fired	Ground	
95% Alumina	40	10*	(not available in 95% Al.)
99.6% Alumina	10-20	2-5*	1 max.

*Lapped, diamond polished.

Exclusive processing

These precision substrate materials are produced by an exclusive thin sheet process in specialized alumina kilns. They meet demanding design criteria of thick-film and thin-film hybrid circuit manufacturers and have been used in all types of circuit deposition: brushing, screening, dipping, spraying, vapor deposition, evaporation, tapes, decalcomania, solution metallizing and printing.

Glazed substrates have a 1½ mil maximum glaze thickness. Edge meniscus is negligible. Metallized units are available with up to 200 or more terminals, and can be brazed with kovar, nickel, copper or brass hardware.

All in all, for performance, variety and application, your design is in for smooth sailing when you specify substrates and ScoreStrates™ from Centralab.

TM-Scored substrates for multiple processing



CENTRALAB

Electronics Division
GLOBE-UNION INC.

5757 NORTH GREEN BAY AVENUE
MILWAUKEE, WISCONSIN 53201

M-6902

For more information and/or design assistance on substrates and ScoreStrates, contact Centralab Application Engineering.

INFORMATION RETRIEVAL NUMBER 34

trailing edge of the input pulse causes a similar action, except that now $Q2$ is turned on and $Q1$ off. Both the leading and trailing edges of the input pulse thus cause a negative spike at the circuit output.

To produce a positive pair of output spikes for

an input square wave, the circuit of (b) can be used.

E. E. Barnes, Research Assistant, Penn State University, University Park, Pa.

VOTE FOR 313

IC differential amplifiers yield matched zener pairs

The unique properties of monolithic transistors that provide matched V_{be} 's and matched gain characteristics can also yield matched zener voltages. This is accomplished by using the emitter-base diodes of a typical differential pair of transistors as back-to-back zeners. The result is an extremely well-matched diode pair—a combination that would be hard to duplicate with discrete zeners, both electrically and economically.

Tests have been run on two representative IC differential amplifiers; namely, the National

Semiconductor LM171 and Signetics NE510A. No difference could be detected between the two emitter-base diodes on a Tektronix 575 curve tracer. In addition, the zener knee was remarkably sharp and the slope very flat. This suggests possible use as a hard back-to-back clamp, or as a matched bidirectional clipper.

A curve from each test sample is shown.

Walter G. Jung, Engineer, MTI, Div. of KMS Industries, Inc., Cockeysville, Md.

VOTE FOR 314

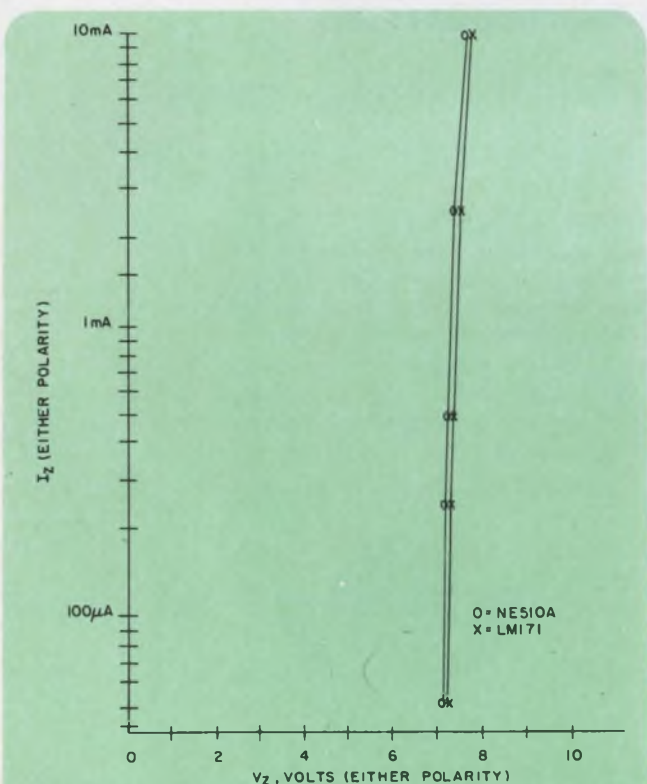

The characteristics in the zener region tell the story of matched zener pairs that are derived from IC differential amplifiers.

IFD Winner for January 4, 1969

Earl F. Carlow, Design Engineer, Motorola Government Electronics Div., Scottsdale, Arizona. His Idea "IC op amp simplifies design of crystal-controlled oscillator" has been voted the Most Valuable of Issue Award.

Vote for the Best Idea in this Issue.

VOTE

VOTE! Go through all Idea-for-Design entries, select the best, and circle the appropriate number on the Reader-Service-Card.

SEND US YOUR IDEAS FOR DESIGN. You may win a grand total of \$1050 (cash)! Here's how. Submit your IFD describing a new or important circuit or design technique, the clever use of a new component or test equipment, packaging tips, cost-saving ideas to our Ideas-for-Design editor. You will receive \$20 for each accepted idea, \$30 more if it is voted best-of-issue by our readers. The best-of-issue winners become eligible for the Idea Of the Year award of \$1000.



**Spring Joint
Computer Conference
Special Section**



The Sh-h-h-h is already built in

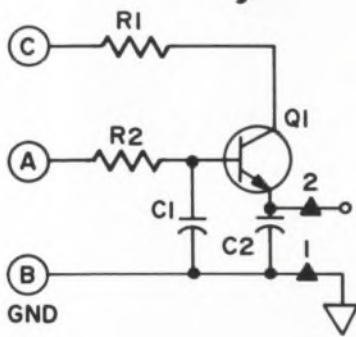
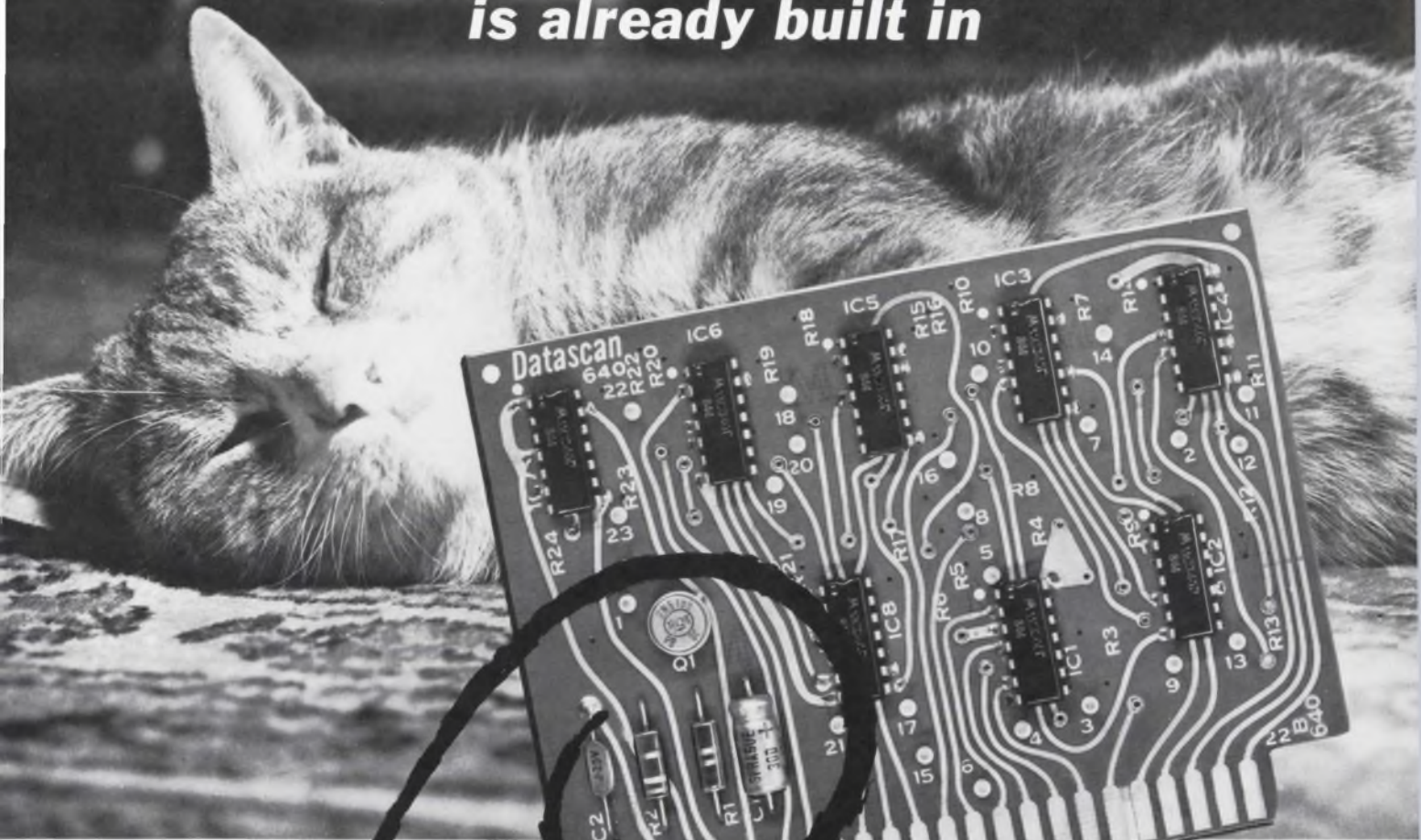

The Dynamic Decoupling™ circuit eliminates high and low frequency noise for extremely reliable system operation. You get a clean 5 V DC power buss on each card.

High Noise Immunity of New TTL Cards is just one of the benefits you get with Datascan

The only line of cards to give you an active power supply decoupling circuit right on the card, is available now. You can get wide bandwidth without the worry and cost of debugging system noise, typically found in TTL systems. You get much more with our new TTL 600 Series Logic Cards.

We probably have the most complete line of cards available — all with the *Dynamic Decoupling™* benefit. And we're heavy on function cards rather than general purpose — this reduces the cost and trouble of back plane wiring. The DTL — 200 Series, HTL — 400 Series as well as the TTL — 600 Series have additional benefits you can use — Pull-Up Resistor mounting provision on the card; maximum number of test points; 44 pin edge connector; 3-slot interpin keying and color-coded 1/16" thick glass epoxy cards (G10).

See us at Spring Joint Conference Booth No. E13

Get your own copy of
Datascan's new 210-page
Logic Card Handbook.



Datascan

DATASCAN, INC.
1111 Paulson Avenue, Clifton, N. J. 07013
Telephone 201-478-2800

Other Datascan Products Include: DIGITAL VOLTMETERS AND PANEL METERS • EQUIPMENT AND SYSTEMS

1969 Spring Joint Computer Conference

special report

Data Communication: The medium and the message

by Michael J. Riezenman
Technical Editor

Data systems emerging fast from infancy. Digital transmission looms as best choice for transfer of both analog and digital information..... C 4

Why digital transmission? Greater security and automatic error correction become possible and regenerative repeaters can be used..... C 6

Many problems confront data engineers. Dispersion, propagation delay, errors and channel loading must be dealt with to send signals efficiently..... C 14

news

The 99.9% effective communications system. Diversification and backup capabilities help keep NASA global network going despite malfunctions..... C 28

products

Small general-purpose digital computer with 72 instructions adds in 3.2 microseconds..... C 40

Microfilm system processes computer output tapes into readable film images..... C 42

Data systems emerging fast from infancy

Digital transmission looms as best
choice for transfer of both
analog and digital information

Data communication—the transfer of information in digital form—has barely started to realize its potential. But already it is winning wide acceptance.

Banks have started to use it to keep up-to-the-minute track of customers' accounts and to eliminate mounds of paperwork. Airlines, theaters, professional ball clubs and others are finding it useful to make instantaneous reservations for buyers across the country. The Dept. of Defense reports that the volume of military data traffic is rising 25 per cent a year, compared with an increase of only 10 per cent for voice and it is already about 10 per cent of the total. And spurring ever-higher growth is the fact that the digital data can be sent over either a digital or an analog transmission system. With a data set that ties into the regular telephone line, any phone user is a potential user of data communication. The Bell Telephone System reports a 30 to 40 per cent annual growth in the use of its Dataphone sets. But there are problems in sending digital data over analog systems. They include modem difficulties that restrict the signals that can be handled and limitations on the speed of data transfer.

The future appears to favor the digital transmission system. For analog data can be sent over the digital system, as well as digital data, and—with the use of such techniques as pulse code modulation—often with an improvement in the quality of the received signal.

In a digital transmission system regenerative repeaters are used, error-correcting codes may be employed, signals can be multiplexed easily in the time domain—in fact, a whole new bag of tricks is available to the designer to improve the quality and efficiency of both digital and analog communications.

What does this mean to the design engineer? For one thing, it means that if he is in communications, he is going to be devoting more of his time to the design of systems that can handle digital data. For another, it means that a computer designer will have to devote more thought to the problem of interfacing his machine with a communications facility.

The paperless society

Data communication is already making it possible to use the computer more effectively; it has started a trend toward what some people call the "paperless society." By putting computer users in direct contact with the machines, data communication is making it unnecessary to turn out the reams of printed information that computers now do every day.

Without data communication, an organization such as a bank, which has considerable data processing to do every day, usually processes its data in a tape sequence. Each day's work is gathered together and batch-fed into a computer, and the results are stored on magnetic tape. Since tape-stored data is not very accessible, the usual procedure is to print out all of the information about all of the accounts every day.

This is not only cumbersome, but the information is not up-to-the-minute; the record of a day's activities is not available to the bank personnel until the following day. A digital communication system has obvious advantages. One installed recently at the Beverly Bank in Chicago—called BASIS (for Bank Automated Service Information System)—works like this:

Touch-tone telephones, with card dialers, are used to interrogate a central computer. The cards are of plastic with punched holes and are inserted into the phones to establish a connection with the computer. Each card contains a code that identifies the user and prevents unauthorized access to the bank's records. The buttons on

the phones are used to read in data—such as the customer's account number and standard questions as to his account balance, mortgage status, loan payments, etc.

A special IBM audio-response unit, formulating a reply from a library of prerecorded words, tells the user orally what he wants to know.

Data communication for every man

And this is only the beginning of mass data communication. Frank J. Militello Jr., assistant vice president in charge of data-processing research at the Beverly Bank, says that in the not-too-distant future the bank will be selling computing services to any customer with a Touch-tone phone.

Of course, once people start using telephones to get routine computing services, they may want to start ordering and paying for food from a supermarket this way. And if supermarkets, why not department stores and other businesses?

And after that, the future is anybody's guess. ■■

What is data communication?



Analog data communication: Electrocardiograms can be transmitted over standard telephone lines with a special Bell Dataphone set.

To the Bell Telephone System, *data* is any traffic that is neither voice nor video. Thus, according to Leonard R. Pamm, director of the Data Communication Engineering Center, Bell Telephone Laboratories, Holmdel, N.J., data does not have to be digital and digital signals are not necessarily data.

Electrocardiograms are an example of analog data. These signals can be transmitted over telephone lines with a special acoustically coupled data set. Such a device (see photo) can be coupled to any telephone by simply placing the telephone handset into a cradle in the data set. It can be used in the home of any patient who has a telephone.

The electrocardiogram can be transmitted to a hospital where a cardiologist is available to interpret it, and the cardiologist can advise the general practitioner of the results over the same telephone used to transmit the data. Because of the need for very low distortion in electrocardiogram transmission, a frequency modulation scheme is employed.

Outside of the Bell System, most people in the business of transmitting information consider the terms *digital* and *data* synonymous. The Army, for example, considers data traffic any information transferred in digital form. Thus, to the Army, voice signals are data if they are transmitted digitally, as they would be with a pulse code modulation (PCM) system.

Why digital transmission?

Greater security and automatic error correction become possible and regenerative repeaters can be used

Item: Although a transmission system called T1 is the only operational digital system in Bell Telephone's catalog of carrier facilities, it accounts for approximately 150,000 new channels each year—about half of all new carrier channels.

Item: In its long-range plans for a world-wide military communication system, the Army is looking to all-digital networks. For example, the Mallard Project, which will provide tactical communications in 1975-77, is going to be an all-digital system.

Item: The Comsat Corp. is about to field-test its MAT-1 system—a digital time-division, multiple-access approach to satellite communication.

Why all this interest and enthusiasm for digital transmission? Perhaps the most obvious reason is simply that the amount of digital data that people want to send to each other is increasing at a very high rate. And under the present communications setup, which mainly employs analog transmission systems to handle the digital data, the problem of crowding looms. For example, in the Bell Telephone System's Dataphone 50 service, each time someone decides to use a wideband data channel to transmit computer data at 50 kb/s, he uses up the bandwidth that would normally be occupied by 12 voice channels.¹

Digital transmission is ideally suited for sending these digital signals. Moreover, with techniques such as pulse code modulation, a digital system can send analog signals more efficiently than an analog network can. And there are these other advantages:

- The repeaters in digital transmission systems are superior to their analog counterparts because they regenerate signals rather than merely amplify them.
- Digital systems are more compatible with the emerging satellite, waveguide and laser communication techniques.
- For military networks, digital transmission offers increased security in the handling of messages, because it is easy to mask the type of information and the rate at which it is being sent.
- There are techniques for correcting errors in a digital system. No comparable techniques exist for an analog system.

Regenerative repeaters reduce ruckus

In most transmission systems, the losses experienced by the signals as they propagate along the transmission path must be compensated for by repeaters. In analog systems these repeaters are high-quality amplifiers with equalizing filters to compensate for both the losses and the

distortions introduced by the channel.

Unfortunately repeater amplifiers, like all other amplifiers, introduce some noise into the system, and this noise accumulates as the signal is processed through a chain of repeaters. Also, although the equalizers used in today's transmission systems are quite good, they aren't perfect, and so distortion, as well as noise, increases with the number of repeaters in the channel. For a specified quality of over-all transmission, it is clear that the longer the total path, the more stringent will be the specifications for each repeater. If N repeaters are to be cascaded, the maximum noise power that each can be allowed to add is only $1/N$ times what would be allowed in a one-repeater path.

In a digital transmission system, a completely different set of rules applies. A digital repeater does not amplify the signals it receives; it regenerates them. Each time a pulse passes through a digital repeater, it is born anew—the repeater simply detects the presence of an input pulse and generates a new output pulse. In this way

there is no accumulation of noise and distortion between repeaters.

Of course, this assumes that the system has been designed so that the signals reaching each repeater exceed a certain detection threshold. As long as this is true, the system will work practically without error; if it is not true, the system won't work at all.

It is difficult to overstate the significance of digital repeaters. James Polyzou, an engineering manager at ITT Defense Communications, Nutley, N.J., points out that the specifications for some very-long-haul military communication links simply could not be met without digital repeatering.

Digits in orbit

Now let's see why digital techniques are better for exploiting satellite, waveguide and laser technologies.

In satellite communication the most precious ingredient is power. Power affects weight (via the required array of solar cells), and weight



A digital first: These are terminals for Bell's T1 carrier system, which uses PCM to transmit 24 two-way tele-

phone conversations over two voice pairs. It's the first widespread use of PCM in telephony.

translates into dollars on the launching pad. To squeeze as much power as they can from their hardware, satellite designers operate output power amplifiers in a semisaturated mode. This causes three problems when the traditional frequency-division, multiple-access (FDMA) scheme for sharing the satellite is used.

First, since the output stage is nonlinear, intermodulation results between the various carriers.

Second, about 1.5 dB of output power is wasted by these intermodulation products. And third, to hold the intermodulation to a tolerable level, the output stage is operated only in a semisaturated mode, and this is not as efficient as hard-limiting. Furthermore, without a hard-limiting amplifier, the output power is dependent on the input power, so that very tight control ($\pm 1/2$ dB) of the up-link power is required.

Much more serious than all of these factors, however, is the inflexibility of a frequency-division, multiple-access system. As John J. Puente, manager of communications processing laboratories for the Comsat Corp. explains it, the problems associated with the system make it impossible to adapt a satellite communication network to changes in the flow of traffic.

For one thing, he says, fm receivers are built to operate with a specified modulation index, bandwidth and carrier-to-noise ratio. Therefore satellite services come in a variety of fixed channel capacities:

- A 5-MHz channel, capable of carrying 24 telephone conversations.
- A 10-MHz channel, capable of carrying 60 telephone conversations.
- A 20-MHz channel, capable of carrying 132 telephone conversations.

From this, it is clear that if a satellite earth terminal has to handle 25 telephone channels, it must pay for 48 of them and waste 23. This isn't too efficient.

Also, the problem of minimizing intermodulation is so difficult that a computer must be used to draw up the plan that assigns frequencies to the links passing through the satellite. Since the wideband links use more carrier power than the narrowband, great care must be taken to make sure that the big carriers don't bury the little ones in cross-talk.

Time division to the rescue

What all of this implies is that once a satellite is set up, changes can't be made in the assignment of channels. For if one station decided that it wanted a wider frequency slot, the change would require a completely new frequency plan, which would require all other stations to buy new equipment to operate on their new frequencies.

The way out of all these problems is to use time-division multiple-access (TDMA), a scheme in which the various users share the satellite by occupying different time slots rather than different frequency bands. With this approach, the necessity for frequency planning disappears, because everyone uses the same frequency. The intermodulation problem is also eliminated, because only one user uses the satellite at any given time. And the system becomes completely adaptable to the demands of traffic, because the time slots can be assigned to any pair of earth stations as they are needed.

But time-division multiplexing is difficult in the extreme, unless a digital mode of transmission is used. In Comsat's prototype MAT-1 system, a four-phase synchronous phase-shift-keying (PSK) modulation scheme is used. In this, the phase of the carrier can assume any of four different phases—spaced 90° apart—with respect to a fixed reference. Since the phase represents a one-out-of-four choice, each phase change carries two bits of information.

Not only does the digital approach solve the flexibility problem, it also uses less bandwidth than the standard analog approach. And pulse code modulation makes a more efficient trade-off of bandwidth for noise immunity than fm does. Comsat's Puente points out that with fm, a single voice channel takes up about 200 kHz of rf bandwidth; with PCM, this is reduced to about 45 kHz.

Digital repeaters needed for waveguide

In their planning for future transmission facilities, scientists at Bell Telephone Laboratories are seriously considering the use of buried millimeter waveguide. This waveguide, although expensive to install, would have a usable bandwidth of perhaps 80 GHz and thus could prove economical because of its tremendous channel capacity. According to Daniel F. Hoth, director of the Special Transmission Systems Studies Center of Bell Laboratories, Holmdel, N.J., losses of only 2 to 3 dB per mile can be obtained with circular waveguide 2 inches in diameter if the TE_{01} transmission mode is used. In TE_{01} mode there are no longitudinal currents in the waveguide.

The big problem with waveguide, says Hoth, is that it is a highly dispersive medium. Despite the use of equalized repeaters, he explains, waveguide introduces too much distortion to be used in a long-haul analog system. However, because digital repeaters reshape and retune the pulses, the distortion cannot accumulate, and thus digital transmission seems to be the best way to exploit the full potential of this medium.

Current plans of the Bell Telephone System call for placing the repeaters about 20 miles

apart and for carrying about 250,000 telephone channels simultaneously. An experimental all-solid-state millimeter-wave repeater has been built and tested by Bell. It operates at 51.7 GHz and transmits binary PCM at 306 Mb/s.² Of course, this 306 Mb/s repeater would regenerate only one of the many channels in a complete waveguide system.

As system planners look toward the day when Picturephone service and data communication are so widespread that "conventional" methods no longer provide enough channels, their thoughts

turn to that ultimate of high-frequency carriers, the laser beam.³ As is well known, the amount of information that can be transmitted on a carrier increases as the frequency of the carrier wave increases. If optical components had the same percentage bandwidth that microwave components have, there would be no problem in realizing the potential of a laser. Unfortunately, they don't—at least not when they are used the way conventional microwave components are used.

One method being explored at Bell Labora-

Pulse code modulation: How it works

Pulse code modulation (PCM) is a scheme for converting analog signals into digital to improve the quality of information transmission. The process is basically a three-step operation: (1) sampling, (2) quantization and (3) coding.

The sampling theorem tells us that a band-limited signal is restricted in the number of independent values that it can assume in a given time period. A signal that contains no frequencies above W_0 Hz can assume no more than $2W_0$ independent values per second. Thus if the signal is periodically sampled at a rate of $2W_0$ samples per second (or faster), the samples will specify the signal completely.

Assume that the analog signal is a voice waveform and that it contains no frequencies above 4 kHz. It can be sampled 8000 times a second (every 125 μ s) without loss of information.

In the quantization step, the samples are rounded off to the nearest "standard" signal level. Naturally this introduces some error, which is called quantization noise. This error can be made arbitrarily small by increasing the number of standard levels, thus packing them more closely together.

In the accompanying figure, eight levels are used. These levels are represented by a three-bit binary code. Other number bases can be used, but binary is the easiest to implement. It is also the most rugged in terms of noise immunity.

The effect of the PCM process is to convert the original analog signal into a stream of binary pulses. The latter are much more immune to noise than the original signal, because one has only to decide whether a binary pulse is present or absent to receive it accurately. To receive an analog signal accurately, its precise value must be measured.

But there is a drawback to PCM, and that is the quantization noise. This noise can be made arbitrarily small by using an arbitrarily large number of quantization levels. However, as the number of levels increases, the number of bits required to encode each level increases.

To send a signal of bandwidth W_0 by PCM,

$2W_0$ samples per second must be transmitted. If each sample is encoded into an n -bit code word (corresponding to 2^n quantizing levels), then $2nW_0$ pulses per second must be sent. Even if the system is operated at the Nyquist limit, this requires nW_0 Hz of bandwidth. With PCM, therefore, noise immunity is being purchased at the expense of bandwidth. The question is: Is it a good deal?

In general, the answer depends upon the relative costs of signal power and bandwidth in any given application. If, for example, legal restrictions have made spectrum space too expensive, it might be better to buy noise immunity simply by increasing the power of the transmitter.

However, if PCM is compared with wideband fm—another scheme for trading off bandwidth for noise immunity—PCM comes out on top. If both systems are operated above threshold, with the transmitter power proportional to the rf bandwidth, the received S/N ratio varies as the log of the bandwidth for fm but directly as the bandwidth for PCM.⁵

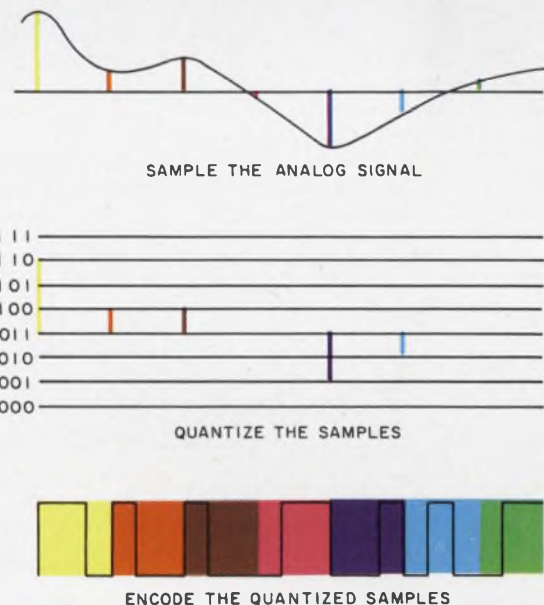

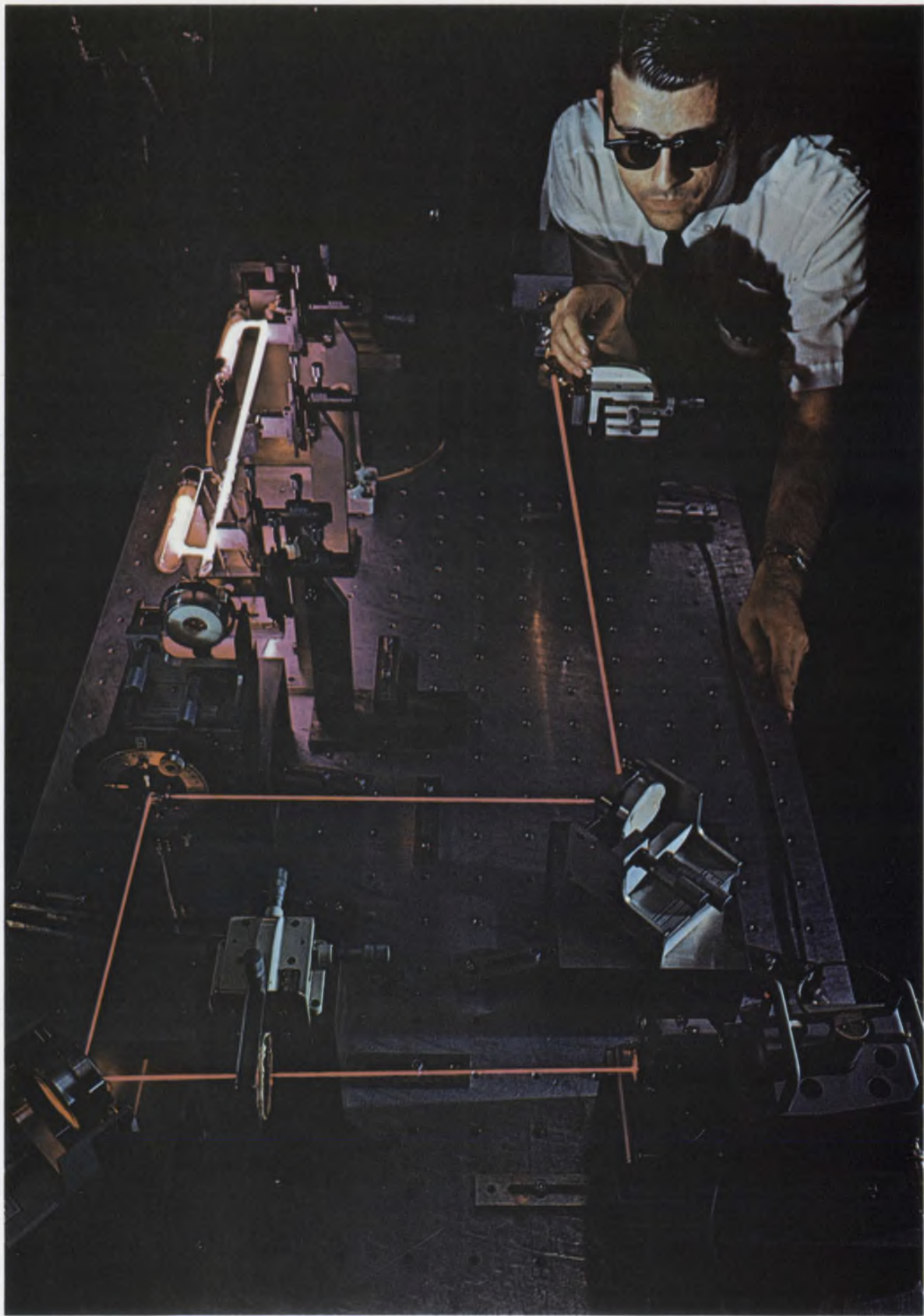

tories to exploit more fully the information-carrying capability of a laser beam is PCM.

"Unlike a-m or fm system," says R. T. Denton of Bell, writing in *The Bell Laboratories Record*, "a PCM system can take advantage of the laser's tendency to oscillate at several different frequencies simultaneously. Contrary to popular opinion, the laser is not naturally monochromatic. It has to be made so."⁴ What this means is that the many frequencies emitted by a laser can be locked in the proper phase relationship to produce a chain of pulses. These pulses have durations that are a small fraction of the time between them. Since they are widely spaced, the pulses can be modulated by an optical gate at relatively low frequencies, and then the wide spaces between the pulses can be filled with pulses from other trains.

These other pulse trains can all be derived from the same laser as the original train through use of a series of beam splitters. The latter merely split up the laser output into several lower-powered pulse trains. Each train can then be delayed by a different length of time. Each can also be modulated by a separate optical gate, and finally all can be recombined to form a high-repetition-rate time-division multiplexed system (see box).

This technique is only one of several under study for the exploitation of lasers as a communication tool. But a high-capacity laser system, in which many optical carriers are processed together, would be very vulnerable to delay distortion, and this could lead to serious cross-talk problems. Regenerative repeaters are very good at eliminating this type of cross talk, and therefore PCM is a very strong contender for use in any future laser system.

The military also favors digital transmission over analog. The most important reason, according to a researcher for the Army Electronics Command, Fort Monmouth, N.J., is security. With digital transmission, he explains, all traffic looks the same. The information flow rate and the type of traffic can easily be masked. One way to do this is to add a pseudo-random bit stream to the data stream (via modulo 2 addition) and then to unscramble the data at the receiving end. This method has the additional advantage of putting out a continuous signal, whether the user is transmitting or not. With this approach, the enemy can't tell if anything at all—let alone what—is being sent.

. . . goes round and round, and it comes out here. Only those pulses whose polarity was changed by the modulator (lower right) are reflected by the polarizing prism into the photodetector (which is being adjusted here).

However, there are other advantages to digital transmission. One very important one is that it permits effective forward error correction through the use of redundant codes. At present, there is no equivalent technique available for analog systems.

What about digital switching?

It is desirable, when employing digital transmission, to also use digital switching. In the case of satellite communications, digital switching offers increased flexibility over analog in certain situations. Also, it is obviously wasteful of equipment to convert a signal from digital to analog form just for switching.

To multiplex many digital signals together, their bit rates must be related by the ratios of whole numbers. This can create problems at a switching center if the bit streams have originated at different places. There are three basic methods, now being evaluated by the military and the commercial communications companies, to attack this problem:

- Lock all of the clocks in the system to a single master clock.
- Use extremely accurate clocks and buffer stores.
- Operate the high-speed line at a slightly higher speed than the ideal and stuff in extra pulses when necessary.

The master clock approach is a good one when the various data sources are fairly close together. But for large distances, the delay-time variations will necessitate the use of rather large buffer stores that might make the scheme uneconomical at high bit rates. More important, a nationwide system all tied to one master clock sounds like an invitation to disaster. A failure in one part of the system might prove difficult to contain.

Atomic clocks can provide acceptable system performance when used in conjunction with buffer stores. The buffers would absorb the differences in bit rates until they either overflowed or were depleted. At that time transmission would have to be interrupted so the lost data could be repeated.

If a clock with an accuracy of, say, 1 part in 10^{11} is used, a 1-megabit signal would fill or deplete its buffer store at the rate of about one bit a day. Obviously a memory with a capacity of a few thousand bits can provide trouble-free operation for many years. But such trouble-free operation is costly. Atomic clocks aren't cheap, and many of them would be needed in a nationwide network.

Of course, the two preceding ideas could be combined in a system where a nationwide network would be broken up into a set of inde-

Multiplexing a laser: It's done with mirrors

Because the interval between pulses in a phase-locked laser is long compared with the pulse width, some type of time-division multiplexing can be used to increase the effective bit rate. One way to do this is to use a series of beam splitters (optical power dividers) to split the output of the laser into a series of identical, but lower-power bit streams.

In the diagram below, three beam splitters are used. They are not all identical; this is necessary so the resulting beams all have equal power. The uppermost beam splitter reflects two-thirds of the light incident upon it and transmits one-third. The next splitter reflects one-half and

transmits one-half. The last one is simply a totally reflecting mirror.

Each pulse stream is modulated by its own optical gate at the relatively slow repetition rate of the laser. After this, the beams are differentially delayed—by adjustment of their individual optical path lengths—and combined to form a high-speed bit stream.

To further increase the capacity of an optical PCM system, several time-division-multiplexed streams can be generated at different wavelengths and then multiplexed in frequency for transmission. At the receiver, optical filters would separate the beams for time-demultiplexing.

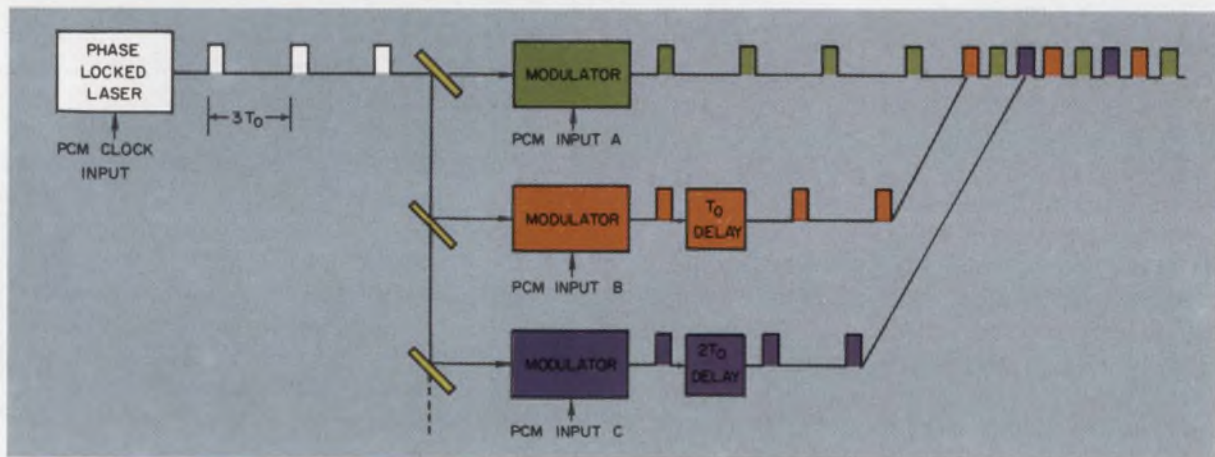

pendent regional networks. Each regional network could have its own atomic standard, and all of the local clocks in the region would be controlled by it. This would confine the damage caused by any clock failure to a single region, while keeping the costs down to a lower level than the all-atomic clock method.

Pulse stuffing uses a synchronizing slot

Pulse stuffing is a completely different idea. It involves operating the multiplex clock at a high enough rate so that there are more than enough time slots on the multiplexed line for each of the channels that are being combined. For example, if five 10-kb/s bit streams are to be combined into one 50-kb/s multiplex stream, a 51-kb/s clock might be used. This clock will want to put a pulse onto the line every 19.6 μ s instead of every 20 μ s. For this system to work, a buffer store would have to be provided for each of the 10-kb/s streams. Data could be put into those stores at a 10-kb/s rate (one bit every 10 μ s) and could be read out at a 10.2 kb/s rate (every $5 \times 19.6 = 98 \mu$ s). Eventually the store would

get depleted; at that time the multiplexer would let a time slot go by without putting anything into it. At this point it would be essential for the multiplexer to tell the demultiplexer which of the time slots on the high-speed line have been left empty and must be ignored.

This information would be sent in a special synchronizing slot, or slots, reserved for this purpose on the high-speed line. For the case under consideration, a sixth slot might be added to the multiplexed bit stream; five information streams and one control stream would thus be transmitted together. Of course, the control stream would be timed by the same clock that provides the timing for the high-speed stream so that no possibility of losing control pulses would arise.

This method does not require large buffer stores, it is economical and it's not subject to catastrophic failure. It will work so long as the various input bit streams don't exceed a certain bit rate (10.2 kb/s in the example just cited). If they get too slow, it simply means that a lot of pulses will be wasted, but synchronism will still be maintained. ■■

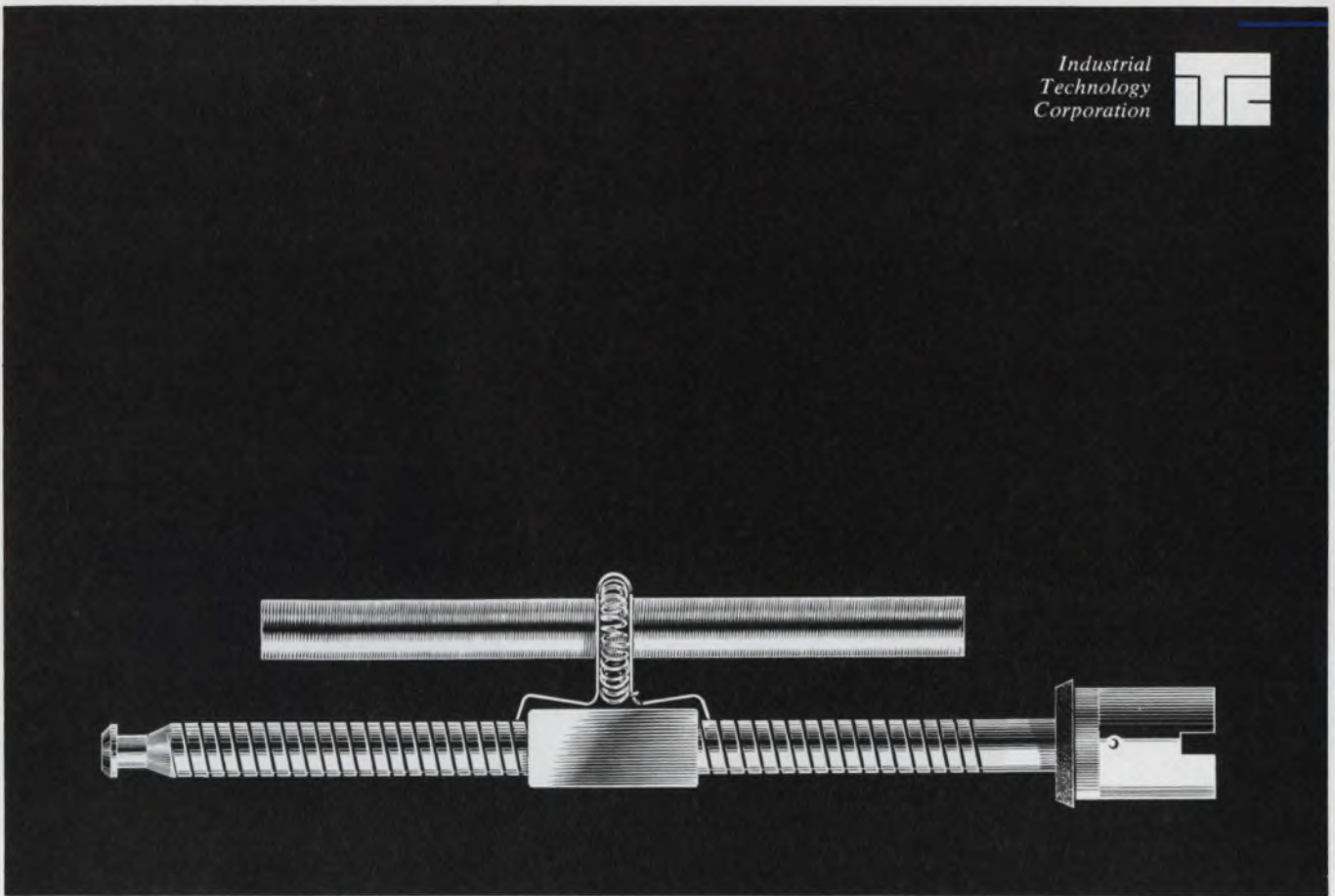

**ITC Riedon's unique new
spring ring wiper
gives two times better resolution,
less than 20 ohms noise.**

Quiet-trim is a remarkable new trimming potentiometer that uses a ring of multiple contacts around the resistance element as the wiper. During adjustment, this ring makes many sequential contacts on each turn of resistance wire. As a result of this light but constant contact, resolution is increased and the unit is essentially noiseless even under extreme shock and vibration.

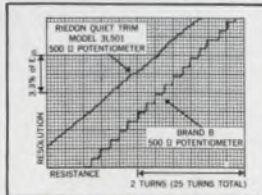

Designed for both military (per MIL-R-27208) and industrial applications, these rugged trimming potentiometers are available in lead, pin or panel mounts; interchangeable with most standard designs. They feature a dual metal end clutch, 50 ppm/°C temperature coefficient and virtually zero end resistance.

Other ITC Riedon products: Precision wirewound resistors, resistor networks, temperature sensors, magnetic components, filters and transformers.

For complete specifications and prices, contact: ITC Riedon, a division of Industrial Technology Corporation, a subsidiary of Republic Corporation, 7932 Haskell Avenue, Van Nuys, California 91406, (213) 873-3464.



ITC RIEDON

Many problems confront data engineers

Dispersion, propagation delay, errors
and channel loading must be
dealt with to send signals efficiently

The bulk of communication systems in use today were not originally designed to handle digital signals. Anyone who wants to use them for that purpose can, but he must compensate for the restrictions they impose if he wants to achieve anything approaching efficient communication. Among the more formidable problems are these:

- Dispersive distortion, which limits the maximum data rate to far less than the channel's theoretical capacity.
- Propagation delay, which is most severe in satellite communication, where it limits the data rate when an error-checking and retransmission procedure is used.
- Error generation.
- Channel loading, a major problem in wide-band communications over common-carrier facilities.

Dispersive distortion gets its name from the fact that it tends to disperse—or spread out in time—signals that were originally narrow pulses. This phenomenon clearly limits the rate at which data can be sent without intersymbol interference. Sufficient time must be provided between pulses to allow for the spreading that the channel is expected to cause.

Dispersion is usually caused by one of two phenomena: multipath distortion or linear distortion. In the case of multipath (Fig. 1), more than one transmission path exists between the transmitter and receiver. Generally there will be a different delay associated with each path, and therefore signal spreading will result. This is what causes ghosts in television reception. If the delay difference of the two paths is sufficiently large compared with a pulse width, two pulses may be received for each one that is transmitted.

Linear distortion is associated with transmission lines in which the phase response is not a linear function of frequency. The delay introduced by such lines is different for different signal frequencies. Since pulse signals contain many different frequencies, they are very easily "smeared" out in time by dispersive lines.

What can be done to reduce or eliminate the effects of delay distortion? One thing that communication companies have been doing for years is to equalize the lines by placing filters in them to cancel out the lines' distortion. Ideally the cascaded phase response of the filter-line combination is linear and distortion is eliminated.

Of course, since no equalizer is perfect, some dispersion always exists in any communication channel. It is up to the communications system designer to decide how much distortion the chan-

nel will be allowed to introduce.

The designers of present telephone networks allowed quite a bit of phase distortion in their specifications because the ear is insensitive to phase differences. Unfortunately, as we have seen, pulse data signals are not insensitive to phase distortion and it's a little too late to change the specifications on the equalizers in the existing networks.

Automatic equalizers reduce distortion

The solution is to add an extra equalizer at the receiving end of the channel. This equalizer can be used to reduce the channel distortion, thereby permitting higher bit rates. The idea works nicely on private lines, but if the user wants to send data through the switched telephone network, he must readjust the equalizer every time he establishes a new connection.

Adjusting an equalizer can be time-consuming; so an automatic equalizer is really the desired solution.^{6,7,8} Such an equalizer measures the distortion of a line as soon as a connection is established and then automatically adjusts itself to minimize the distortion in accordance with some criterion—such as minimum mean-squared difference between the equalized line response and some ideal line response. A higher level of sophistication is embodied in the concept of an *adaptive* equalizer, which *continuously* monitors the line response and is constantly adjusting for any changes that might occur.^{9,10} Adaptive equalization is of particular interest to the military

because many of its communication links involve one or more moving parties. A radio link with moving terminals is very likely to be subject to a time-varying multipath situation.

The key to both automatic and adaptive equalizers is the transversal filter (Fig. 2). This is made up of a tapped delay line, an "attenuator" associated with each tap and a summing network. The attenuators are actually amplitude adjustment devices, not merely lossy elements. They can provide loss, gain and polarity adjustment. The delay line is tapped at regular intervals, τ seconds apart. If an impulse, $\delta(t)$, is applied to the input of the transversal filter, the output is given by

$$h(t) = \sum_{n=0}^N C_n \delta(t-n\tau)$$

This output is a train of impulses spaced τ seconds apart and possessing completely independent amplitudes. Therefore the transversal filter can be set for any desired impulse response whose duration doesn't exceed the total delay of the line and whose spectrum is limited to frequencies below $1/2\tau$ Hz.

For instance, it can be set up to generate a response that is the negative of the impulse response of a given transmission line everywhere except at $t=0$. The response at $t=0$ would be set so that the sum of the transmission line and transversal filter responses is unity at that point. Of course, a low-pass filter, with cutoff frequency $f=1/2\tau$, would be required to convert the impulse chain into the desired response. The filter

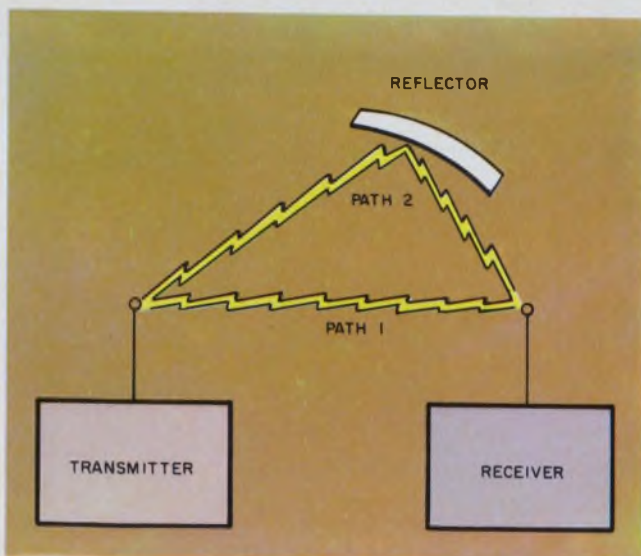

1. Multipath distortion results when more than one path exists between transmitter and receiver. The reflector can be almost anything: a building, a mountain or the ionosphere.

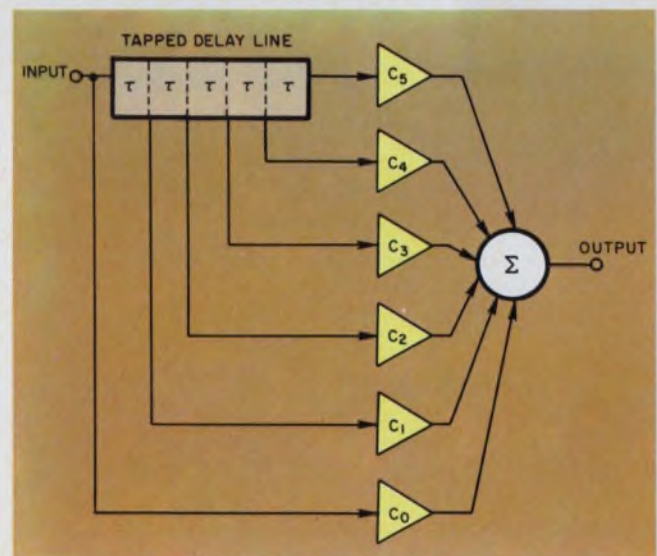

2. Great flexibility in equalizing transmission lines is provided by transversal filters. The filter's impulse response is adjusted by changing the weighting on each tap of the delay line.

does not have to be a separate item if the lines and equipment with which the filter is working are themselves band-limited.

When a transversal filter is used as an adaptive or automatic equalizer, a setup of the type shown in Fig. 3 is needed. In the automatic mode of equalizer operation, a "training" period is employed to adjust the equalizer. During this period a known standard waveform is transmitted and received in distorted form by the equalizer. It is compared with a copy of the (undistorted) original signal, and the resulting error signal is used to adjust the filter. When the training period is over, the control circuitry is disabled and the equalized channel can be used for communication. Of course, should anything happen to the channel's transmission characteristic after the training period, the equalizer will not respond to the change.

In the adaptive mode, the information signal itself is used to adjust the equalizer. This idea can be implemented in synchronous digital systems, where the pulse shapes and spacings are predetermined, even though the actual occurrence of the pulses is not known beforehand. Another equalization scheme, used to accomplish adaptive equalization with nondigital signals, consists of periodically interrupting the information signal and substituting for it a short training signal. While this scheme does not provide truly continuous adjustment, it is good enough for most purposes and does not restrict the type of message traffic that can be handled.

To see how an actual controlled equalizer works let's consider the case of an automatic equalizer. In this case a reference signal is generated, and the received signal must be compared with it.

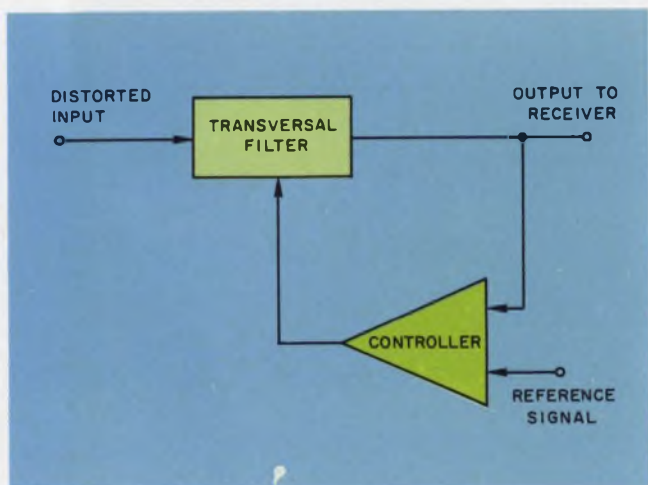

3. Automatic or adaptive equalization means putting a servo loop around a transversal filter to adjust it to changing line conditions. The reference signal is derived from the input data in an adaptive equalizer; it is locally generated in an automatic one.

Obviously some form of synchronization or timing recovery must be employed to provide a time origin for the reference signal.

The error signal is formed by simply taking the difference between the reference signal and the equalizer output (Fig. 4). Then the cross correlation coefficient of the error signal and each of the delay line's tap signals is formed. The weighting of each tap signal is adjusted to minimize the cross-correlation of that tap signal with the error signal.

To understand why this procedure works, it is necessary to consider that the signals at the various taps combine linearly to form the error function. Under a mean-squared error criterion, the cross-correlation provides a measure of the systematic contribution of each tap signal to the error signal. Thus when all of the cross-correlation coefficients have been reduced to zero, no further adjustment of the attenuators can reduce the error.¹¹

Propagation delay causes problems

When a transmission link is perfectly equalized, the delay encountered by all of the signals passing through it is the same. It is not, however, zero. There is a propagation delay in transmission that is caused by the finite propagation velocity of radio waves, and there is nothing that can be done to reduce this. However, for certain modes of communication, this delay does cause problems, and they can be reduced with clever design ideas.

The total round-trip delay encountered by a radio signal going through a communications satellite at synchronous altitude is about 300 ms. This doesn't seem like much—it's not a problem

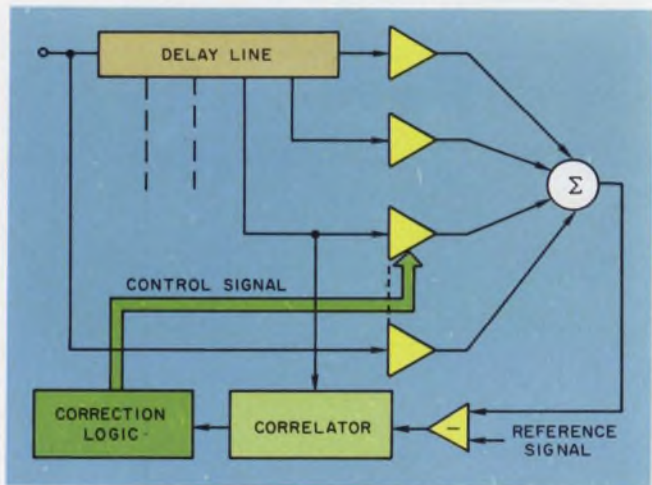

4. The cross-correlation coefficient of the error signal and each of the delay-line tap signals provides a measure of the contribution of each tap signal to the error. Minimizing this coefficient will minimize the distortion of the line.

for voice communication—yet it has caused great concern to people who want to send data. Why?

Because in sending data, it is always desirable to include a certain amount of error detection in the transmitted signal. The data is sent in blocks, the blocks are checked at the receiver site for errors, and a message is sent back to the transmitter either confirming error-free reception or asking for retransmission. This is equivalent to one person asking another to repeat himself during an ordinary telephone conversation.

It is now clear why propagation delay can be a serious problem. Each block of data takes 300 ms to reach the receiver, 300 ms more is spent waiting for the acknowledgements, and additional time might be needed if there is any error in receipt of the acknowledgement.

One way to improve the efficiency of transmission under these circumstances is to increase the length of each transmission block. This will increase the amount of data that is sent between the time-wasting turn-around periods. Unfortunately, however, for a given error rate, the likelihood of error increases as the block length increases. Therefore, for very long block lengths, there is almost certain to be an error in every block and the efficiency will fall to zero as the receiver keeps asking for retransmission of the first data block.

It should be clear from this that for a given error rate and propagation delay, there is an optimum block length (Fig. 5). However, even at this optimum, the efficiency is generally far from 100 per cent, and something further must be done to improve it.

One approach that can be used to solve this problem is to combine the techniques of super

blocking and selective retransmission.

As explained by Harold G. Markey, a systems development division manager with IBM Corp., Research Triangle Park, N. C., this approach involves sending many blocks of data at once, without stopping between blocks, and then asking for the retransmission of only those blocks found to contain errors. Of course, a few identification bits must be added to each block, so they can be referred to by number when retransmission is requested. A drawback of this approach is that it requires very large amounts of buffer storage at the transmission site. The sender must retain all of the data in a superblock until it has all been correctly received. If the sender is planning to keep all of the information anyhow—in a disk or drum file, for example—then the need for much buffering poses no great problem. But if this isn't the case, then the savings of efficient transmission must be weighed against the cost of the necessary buffer memory.

A more attractive alternative in some situations is to use a full duplex communication channel and to employ overlapping responses. A full duplex channel is one in which both communications terminals can send and receive data simultaneously. If the channel and terminal equipment can operate in the full duplex mode, then it is not necessary for the transmitter to stop after each block of data and wait for a reply.

For example, block No. 2 can be sent right after block No. 1. Then, as long as the response to block No. 1 gets back to the transmitter before the transmission of block No. 2 ends, the transmitter can be instructed either to retransmit block No. 1 or to continue with block No. 3.

The drawback of this technique is that rather sophisticated terminal equipment is needed for full duplex operation. An ordinary telephone circuit is a full duplex channel, but the terminal equipment is a human who has to tell the difference between what he's sending and what he's receiving. Machines find this rather difficult to do, and full duplex is usually provided by using two completely independent transmission channels. The overlapping response scheme, therefore, requires a more expensive communications link than the ordinary retransmission techniques do.

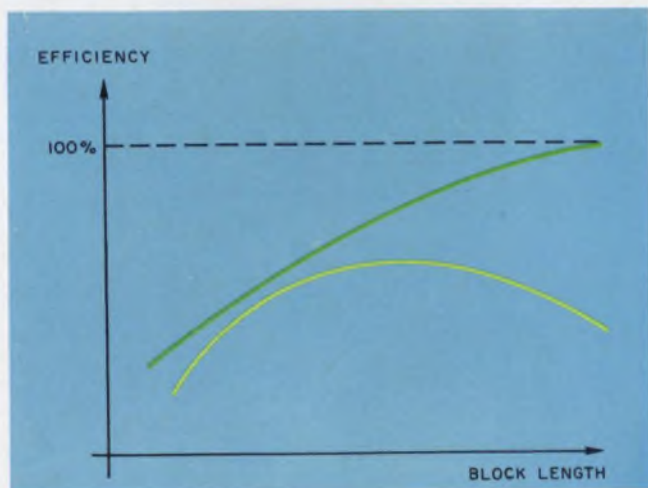

5. Errors limit communication efficiency. If there were none, 100% efficiency could be reached (upper line). The lower line shows the effects of errors. As the likelihood of error decreases, the peak gets larger and moves to the right.

Detecting the errors

All of the various schemes for retransmission involve checking the receiver data for errors. There are many ways to do this, and each is applicable under different channel conditions. For example, if the predominant source of error in the channel is white noise, then it is reason-

able to assume that the errors will occur at random and will usually be single-bit errors. Under these conditions the ordinary parity checking procedure is a good one to use.

This involves the addition of an extra "parity check" bit to each character in a message. For example, if the standard American Standard Code for Information Interchange (ASCII) is used, each character contains seven information bits and a parity bit. The parity bit is generated for each character by operating on the first seven bits with some specified algorithm. The usual procedure is to add up the seven information bits and then let the parity bit be whatever is necessary to make the sum of all eight bits either even or odd.

Let's say that even parity is used. Then, for the character shown in Fig. 6a, a ONE must be inserted into the parity bit slot. The receiver knows that each received character must have even parity, and so if one of the received bits is in error, it can easily detect this and request a retransmission.

There are two very important ideas in this simple error-detecting procedure:

- Redundancy is being employed to detect an error—that is, a piece of information is being transmitted that can be calculated from previously transmitted information. The effective rate of information transfer has been reduced to increase the reliability of transmission.

- The scheme is limited in the number of errors it can tolerate. It is obvious that two errors in the same character will be interpreted as no errors. That is why this scheme is recommended for use only when the bit errors are expected to occur singly and with a reasonably

long time between them.

It is logical to ask at this point if increasing the redundancy—adding more redundant bits—can improve the scheme's tolerance of errors. The answer is yes. In fact, if enough redundancy is used, it is possible not only to detect errors but to correct them as well. Let's first see how improved error checking can be done.

The longitudinal redundancy check

It often happens that errors occur in bursts, rather than singly. The reason for this is that transients (impulses) commonly occur on communication lines, particularly in the switched telephone network. These transients, when introduced into a band-limited channel, are spread out in time in the form of the impulse response of the channel. Thus, unless data is being sent very slowly, each burst of impulsive noise can be expected to affect several bits in a row.

The trick to overcoming this problem is to form the parity check bits from a series of information bits that are not close together in time. One way to do this is to employ longitudinal redundancy checking, as shown in Fig. 6b. In this example, four 7-bit characters have been sent, along with their associated parity bits, in time sequence. The first character is the top row of the matrix, the second is the second row, etc. A fifth character has also been sent. It is entirely derived from the other characters and has been generated so that all of the columns, as well as the rows, have even parity. The significance of this idea is that the column parity checks are done on bits spaced 8 bits apart from each other and are thus not likely to be affected

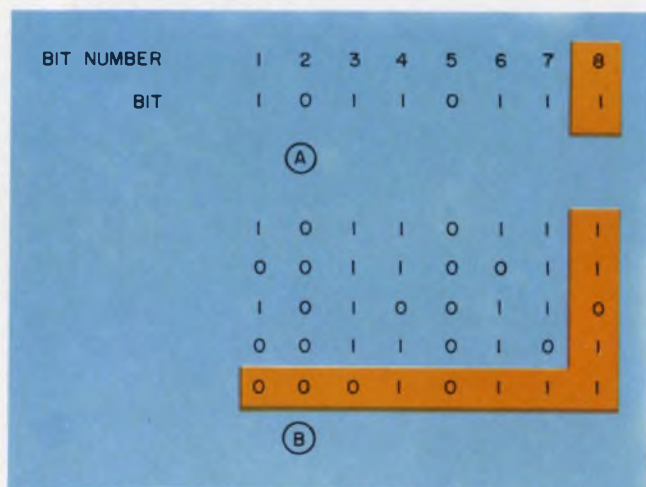

6. Redundancy can detect errors. In (a) a simple parity check is shown. In (b) longitudinal redundancy is added to increase the resistance to impulsive noise. Even parity is used in both cases.

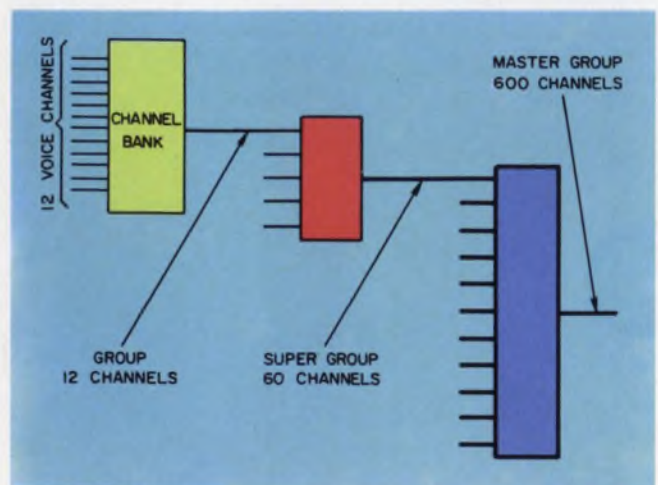

7. High-speed data can be sent through the voice telephone network by using a wideband carrier as a single data channel. Care must be taken not to overload the carriers and cause intermodulation.

by the same burst of noise.

By pushing these concepts of increased redundancy and operation on nonadjacent bits even further, one can devise codes that can detect many errors and correct a certain number as well.¹²

As is clear from our comparison of random and burst errors, it is necessary to match the error detecting or correcting procedure to the error statistics of the communications channel. Toward this end, the Army has been conducting studies of the error properties of various channels. Bernard Goldberg, chief of the adaptive techniques team of the Communications Automatic Data Processing Laboratory, Army Electronics Command, Fort Monmouth, N.J., looks forward to the day when an adaptive coding scheme is devised to change the type of coding as the channel error statistics vary. At present his team is investigating the suitability of various code schemes for different types of channels.

The Army is particularly interested in error-correcting codes, Goldberg explains, because much of its transmission is of the broadcast type, which offers no opportunity for a request for retransmission. Under these circumstances, forward error correction is essentially the only way to improve the reliability of transmission. Another way is simply to decrease the transmitted bit rate, but a well-designed code makes more efficient use of the total transmission time.

Data isn't voice

In addition to the various random, burst and other transmission errors that are not related to the traffic on the communications system, there is the problem of errors caused by intermodulation noise resulting from overloading of voice network. This is not much of a problem when data is sent over a voice-band line, but if wide-band data is to be handled, certain precautions must be taken. Let's see why.

It is generally known that carrier systems are extensively employed in telephony to send more than one message over a single wire pair, cable or radio link. In the Bell System, according to Daniel F. Hoth, director of the Special Transmission Systems Study Center, Bell Telephone Laboratories, Holmdel, N.J., a hierarchy of carrier systems is employed, as shown in Fig. 7. Actually the master groups are then further combined for transmission over cable or microwave radio. But the point is clear that large numbers of voice channels are being transmitted together over wideband facilities.

To make efficient use of carrier facilities, the designers of the Bell System and other voice communication networks take advantage of some of the known statistical properties of human

Extra bits can correct errors

Suppose that a message of m bits is to be transmitted and the sender wants to add enough redundancy to it to correct one error. How many bits should be added? If r redundant bits are added, they will be able to detect and correct 2^r possible contingencies. The total number of contingencies that must be checked is $m+r+1$ (no errors, error in first bit, error in second bit, etc.). Thus r must be chosen to satisfy the relation

$$2^r > m+r+1.$$

It is clear that error correction is not very efficient for short messages but gets increasingly attractive as the message size increases.

For a 4-bit message ($m=4$), three check bits are required. Let's say the message is 1101. How are the check bits to be chosen? One way is to set up a table defining a 3-bit error code. This error code can assume $2^3=8$ different values corresponding to the eight possible error conditions (including the condition of no errors).

One possible form that the table might take is the following:

Error digits			Error location
e_1	e_2	e_3	
0	0	0	No errors
0	1	1	m_1
1	1	1	m_2
1	1	0	m_3
1	0	1	m_4
1	0	0	r_1
0	1	0	r_2
0	0	1	r_3

where the m -bits are the message bits and the r -bits are the redundant bits. From this table, the following equations can be written:

$$e_1 = m_2 + m_3 + m_4 + r_1$$

$$e_2 = m_1 + m_2 + m_3 + r_2$$

$$e_3 = m_1 + m_2 + m_4 + r_3$$

(all of these sums are understood to be modulo 2). Since the no-error condition is to be represented by $e_1 = e_2 = e_3 = 0$, the various r values can be found by setting each of the three above equations equal to zero. This yields:

$$r_1 = m_2 + m_3 + m_4$$

$$r_2 = m_1 + m_2 + m_3$$

$$r_3 = m_1 + m_2 + m_4$$

which, for the message 1101, yields $r_1 = 0$, $r_2 = 0$, and $r_3 = 1$.

The transmitted message, complete with redundancy, is therefore 1101001.

Now let's see what happens if an error sneaks in. As an example, assume that the incorrectly received message is 1001001. Plugging these numbers into the three error-bit equations yields $e_1 = 1$, $e_2 = 1$, $e_3 = 1$. Consulting the table, we can see that this means that m_2 is in error. Therefore, we change it from a ZERO to a ONE, and the error is corrected.

Many services available

A variety of commercial services are already available for data communication—and at relatively low cost. Most of the transmission facilities are supplied by the Bell System, but quite a few manufacturers, in addition to Bell, make the data modems needed to convert the data signals into a form suitable for transmission over a telephone line.

Until Jan. 1 of this year, modems made by non-Bell System companies could be used only over private lines. Since then, however, Federal Communications Commission Tariff No. 263 has allowed customers to supply their own modems for use on the switched telephone network as well.

For this setup, Bell supplies a service called a Data Access Arrangement, which includes a small interfacing box that contains some diode clipping circuitry to prevent overloading of the phone lines. The Data Access Arrangement costs only \$2 a month to rent.

A basic teletypewriter costs about \$700 and a low-speed (300 b/s) modem, about \$350. Thus, for a little over \$1000, plus \$2 a month, anyone can have a teletypewriter data terminal attached to his telephone. By making suitable arrangements with a computer utility, this teletypewriter terminal can give the user access to a large time-shared computer right from his office or his home.

Using the switched voice network, the fastest data rates available today are on the order of 2000 b/s. Several manufacturers have indicated that they expect to extend that figure by using adaptive equalization. Speeds of up to 9600 b/s have been reported over specially conditioned private voice lines.

For really high bit rates, special wideband channels can be leased from the telephone company. These channels, which must be used with Bell System modems, can provide bit rates as high as 250 kb/s. With the exception of Dataphone 50, all of these high-speed services are provided strictly on a private-line basis. The Dataphone 50 is an experimental dial-up service working at speeds up to 50 kb/s.

For further information on the lines of modems made by various manufacturers, circle the following Information Retrieval numbers:

American Tel. and Tel. Co.	290
Collins Radio Co.	291
General Electric Co.	292
International Communication Corp.	293
Lenkurt Electric Co.	294
RFL Industries Inc.	295
Rixon Electronics	296
Ultronix Inc.	297

speech. They know, for example, that the average phone user talks only about 25 per cent of the time. Fifty per cent of the time he is listening. And in the remaining 25 per cent of the time he is pausing or remaining silent. Also, the average volume of a talker varies over a range of 40 dB, depending on who's doing the talking and what he has on his mind.

In selecting the operating levels for the carrier systems, the designers use the average values for a large number of talkers. The gains and saturation levels of the broadband amplifiers are adjusted to provide good performance under average conditions, with sufficient margin so that poor performance occurs only a small fraction of the time.

In selecting the carrier levels for the various carrier stages, the designers assume, of course, that a fairly uniform distribution of power over the bandwidth of the channel will be maintained.

As you might guess by now, the statistics of data transmission are not the same as those for voice. When a data set is on the air, it usually puts out a signal until it's finished, and then it stops. Furthermore its average power output level is the same as its minimum and maximum levels. And worst of all, during periods when a synchronous data set is not sending information, it may want to remain in synchronism with its receiver; so it sends a periodic "framing" or sync signal. This is hardly a random waveform; it has most of its energy concentrated at one frequency.

The trouble with sending a single frequency over a wideband channel is that the amount of noise in the channel will overpower the signal



Data communication today: This IBM 2265 display station can be connected to most System/360 computers through ordinary voice telephone lines.

unless the signal is quite strong. But if enough energy is concentrated at one frequency to overcome the broadband noise, the amplifiers in the carrier system which are limited in power density as well as in total power, will be overloaded and intermodulation noise and crosstalk will result. Thus if a 48-kHz group channel is carrying wideband data and the transmitter sends a periodic framing signal without lowering its total power output from its normal random-data level, cross modulation may occur between two voice channels that happen to be sharing the same supergroup or master group. Under sufficiently bad conditions, the crosstalk may even be intelligible.

Signal scramblers save the day

What can be done to overcome these problems? As Jerry Randell, group manager of communications in the Univac Div. of Sperry Rand Corp., Philadelphia, explains, he doesn't want to redesign his computers to accommodate the peculiarities of the transmission system. If he's leasing an expensive communications channel and wants to send a periodic signal over it, he believes he should be able to.

The solution is actually quite simple. Scramblers are employed to add a pseudo-random bit stream to the desired bit stream on a bit-by-bit basis. A device at the receiving end of the channel contains a stored replica of the pseudo-random signal and uses this to recover the desired message. Since a random signal remains random even when a periodic signal is added to it, the actual transmitted signal has an appropriately wide frequency distribution and doesn't disturb the channel.

Overloading is not a big problem on voice channels because the noise bandwidth is not too great. This means that, even at the reduced levels that must be employed when pure tones are transmitted, no problems in reception are usually encountered. The main factors to consider in this case are the total power limitation (about 12 dB lower for data than for voice) and the avoidance of certain frequencies which are used for signaling.

As Hoth of Bell Laboratories explains, avoidance of the signal frequencies doesn't mean that no energy can be sent at those frequencies. It just means that the energy at any one of them should not exceed the total energy in the rest of the band. The switching system only considers a signaling tone to have been received when the tone power is more than half of the total received power, Hoth explains.

In addition to solving the framing signal problem, the scrambler, by ensuring that transitions are always occurring in the data stream, also

solves the problem of providing clock recovery when no data is being sent. As Univac's Randell points out, some early data modems could not tolerate the transmission of more than 50 consecutive ZEROS in an even parity system, because this means that there would be no data transitions for the clock in the receiver modem to synchronize itself with. However, since the scrambler puts out a signal even when there is no input, this problem is eliminated. ■■

References:

1. D. F. Hoth, "Digital Communication," *Bell Laboratories Record*, February, 1967, pp. 38-43.
2. W. M. Hubbard et al, "A Solid-State Regenerative Repeater for Guided Millimeter-Wave Communication Systems," *Bell System Technical Journal*, Vol. 46, No. 9, Nov. 1967, pp. 1977-2018.
3. R. N. Einhorn, "Advances in Lasers," *ELECTRONIC DESIGN*, ED 19, Sept. 12, 1968, pp. 49-70.
4. R. T. Denton, "The Laser and PCM," *Bell Laboratories Record*, June, 1968, pp. 175-179.
5. B. M. Oliver, J. R. Pierce, and C. E. Shannon, "The Philosophy of PCM," *Proc. IRE*, Vol. 36, No. 11, Nov. 1948, pp. 1324-1331.
6. R. W. Lucky, "Automatic Equalization for Digital Communication," *Bell System Technical Journal*, Vol. 44, No. 4, April, 1965, pp. 547-588.
7. H. Rudin, Jr., "Automatic Equalization Using Transversal Filters," *IEEE Spectrum*, Vol. 4, No. 1, Jan. 1967, pp. 53-59.
8. R. W. Lucky, and H. R. Hardin, "An Automatic Equalizer for General-Purpose Communication Channels," *Bell System Technical Journal*, Vol. 46, No. 9, Nov. 1967, pp. 2179-2208.
9. R. W. Lucky, "Techniques for Adaptive Equalization of Digital Communication Systems," *Bell System Technical Journal*, Vol. 45, No. 2, Feb. 1966, pp. 255-286.
10. M. J. DiToro, "Communication in Time-Frequency Spread Media Using Adaptive Equalization," *Proc. IEEE*, Vol. 56, No. 10, Oct. 1968, pp. 1653-1679.
11. R. W. Lucky and H. R. Rudin, "An Automatic Equalizer for General-Purpose Communication Channels," *Bell System Technical Journal*, Vol. 46, No. 9, Nov. 1967, p. 2185.
12. W. W. Peterson, *Error-Correcting Codes*, M.I.T. Press and Wiley, New York, 1961.

Bibliography:

- Bairstow, J. N., "Time-Sharing: A Computer for Everyone," *ELECTRONIC DESIGN*, ED 9, April 25, 1968, pp. C1-C-23.
- Davis, R. L., "New Wideband Data Communications Services," *Datamation*, Sept. 1968, pp. 62-66.
- Bennett, W. R., and Davey, J. R., *Data Transmission*, McGraw-Hill, New York, 1965.
- Harman, W. W., *Principles of the Statistical Theory of Communication*, McGraw-Hill, New York, 1963.
- Mayo, J. S., "Pulse-Code Modulation," *Scientific American*, March 1968, pp. 103-108.
- Nyquist, H., "Certain Topics in Telegraph Transmission Theory," *Trans. AIEE*, Vol. 47, April, 1928, pp. 617-644.
- Pierce, J. R., "Some Practical Aspects of Digital Transmission," *IEEE Spectrum*, Nov. 1968, pp. 63-70.
- Reeves, A. H., "Pulse Code Modulation: Past, Present and Future," *Journal of the Franklin Institute*, Vol. 285, No. 4, April, 1968, pp. 243-250.
- Shannon, C. E., "A Mathematical Theory of Communication," *Bell System Technical Journal*, Vol. 27, July 1948, pp. 379-423; Oct. 1948, pp. 623-656.

At IEEE, Hewlett-Packard unveiled the revolutionary 5360A

Here's why it stole the show—

BETTER MEASUREMENTS PLUS INTERNAL DATA PROCESSING

Using a revolutionary counting technique made practical by an internal computer, the 5360A measures more rapidly, accurately, and over a wider range than counters ever did before. And it can solve equations whose variables are the counter's measurements. Thus, it is a measuring and computing device both in one compact, ready-to-use package. Everything a general purpose electric counter might be asked to do, the 5360A does better—a hundred, even a thousand times better.

GREATER SPEED AND ACCURACY THAN COUNTERS EVER HAD BEFORE

For equal accuracy, the 5360A is 3 to 1000 times faster than counters could be before, and for equal speed it's up to 100 times more accurate. For example, in 1 millisecond you can make a 1 MHz measurement to 7 digits! Previously, four digits was the limit. This is because the 5360A's accuracy is no longer limited to plus or minus one count of the counted signal.

AUTOMATICALLY MEASURES PULSED CARRIERS WITHOUT TRANSFER OSCILLATOR

Direct, automatic, digital measurement of pulsed signals (even a microsecond pulse length) is now possible with the 5360A—up to 320 MHz. And with the same HP frequency converter plug-ins used in model 5245, 5246 or 5248 counters, pulsed signal or CW range is extended to 18 GHz. No tedious transfer oscillator manipulation or calculation! And the 5360A will even measure a single burst of signal—something transfer oscillators cannot do.

COMPUTING COUNTER

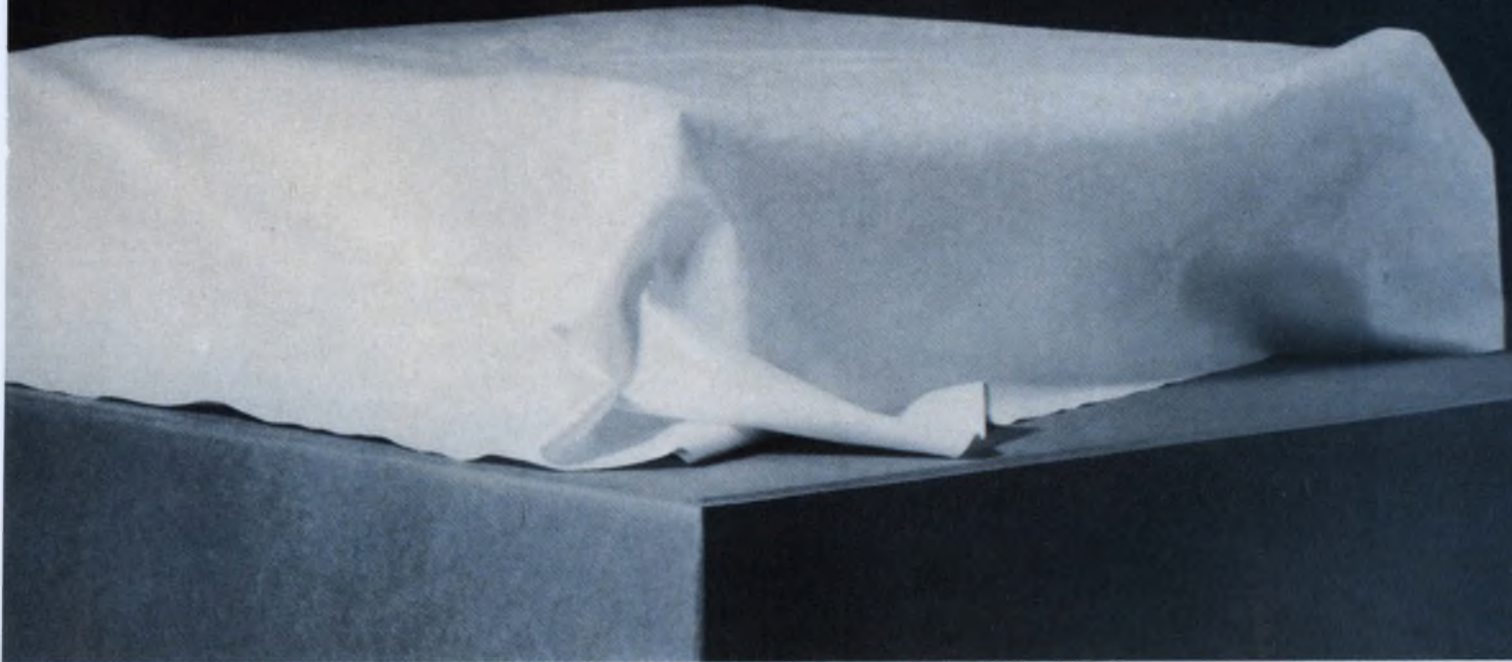

0.1 NANOSECOND TIME INTERVAL RESOLUTION

The 5360A gives the finest resolution in time-interval and waveform period measurements ever available in a direct reading digital instrument. Furthermore, with the model 5379A Time-Interval plug-in (not needed for period measurements) you get automatic error detection and measurement of positive or negative intervals down to zero seconds, at rates over 1000 measurements per second.

WIDEST FREQUENCY RANGE OF ANY COUNTER

Up till now, you had to use an accuracy-destroying prescaler or other accessory to measure up to 320 MHz. Not only is the 5360A's automatic measurement range 0.01 Hz to 320 MHz, but the 5360A also gives greater accuracy and speed than any previous counting technique. Frequency measurement range is extended to 18 GHz using the same spurious-free HP frequency-converter plug-ins originally designed for HP models 5245, 5246 and 5248.

A COMPLETE MEASURING AND PROCESSING SYSTEM IN ONE PACKAGE

Now you can get answers direct in final form without adding \$10,000 worth of processing equipment. The 5360A and its accessory plug-in program module (available now) or its keyboard (available later this year) provide real-time solutions to equations whose variables are the 5360A's measurements. For example, you can get direct digital phase measurements or the rms value of a series of measurements.

Prices: 5360A Computing Counter with 5365A Input Module, \$6500; 5367A Time-Interval plug-in, \$750; accessory keyboard, approximately \$1000; accessory plug-in program module, approximately \$190.

The leader in counter technology has taken another revolutionary step. If you missed the show, call your local HP field engineer. Or write for our fully illustrated brochure and data sheet: Hewlett-Packard, Palo Alto, California 94304; Europe: 1217 Meyrin-Geneva, Switzerland.

HEWLETT  **PACKARD**
ELECTRONIC COUNTERS

Time was when refractory metals were used only as filaments and tube frame grids.

Times change.

Consider some more current design applications. Evaporating boats for vapor deposition. Spectrographic analysis equipment. Springs and washers in high temperature environments. And more.

Refractory metals could be the answer to some of your tough design problems. Examine the family characteristics. All readily lend themselves to forming, machining and welding. Melting point to 3410° C. Electrical resistivity to 20 microhms/cm. No other metals even approach in corrosion resistance capability. Or can hold a candle in high temperature environments. And the way we work them—with precision tolerances down to .00005"—there's no problem in getting predictable, repeatable performance out of your circuit designs.

You have a lot of flexibility, too. Because within the family each metal possesses a set of unique qualities which could make it a natural for your particular application—if it can be formed to just the dimensions you need.

That's where we come in. We roll to the tightest specs in the business. Ribbons, strips, whatever you need. Any width to .006". Any thickness to .0005". Any metal suitable for fabrication. With such superior results even the competition comes to us for the tough jobs.

If you'd like to know more about what refractory metals can do for you in circuit design call (201) 863-1134 or write H. Cross Co., 363 Park Ave., Weehawken, New Jersey. We'll take it from there.



**H. Cross
Company**

Tungsten – for filaments, heaters, grids, etc. **Rhenium Tungsten** – Tungsten containing 3% Rhenium. Used in application where resistance to recrystallization, room temperature, elongation, and pliability, after heating, are needed. **Thoriated Tungsten** – Tungsten containing 1% or 2% thorium. Used where relatively high electron emission is required. **Molybdenum** – Used as support for lamps and electron tube mandrels, for tungsten coil winding, traveling wave tube helices, furnace windings, tube grids, etc. **Molybdenum Rhenium** – 50% Molybdenum and 50% Rhenium used for grids, heaters, supports etc. where high electrical resistivity and low thermal conductivity, ductility, weldability are of importance. **Rhenium** – Used for filaments in mass spectrographs and ion gauges and other electronic components where electrical resistivity, electron emission weldability and ductility are important. **Tantalum** – Used for heat exchangers. Electron tube capacitors, filaments, grid wires and getters. **Columbium** – Used for getters in electron tubes and electrical rectifiers.



The AMP point-to-point most versatile

One Technique Covers Widest Range Of Interconnection Requirements

Whatever your interconnection requirements, TERMI-POINT★ products can move in to fulfill them over the widest variety of applications. The components shown below are only a few of the applications now being used in industry. In addition, AMP Engineering is available to

be applied against any particular or unusual interconnection problems you may have in point-to-point wiring.

AMP Pre-Wired Panels And Component Service

If you prefer AMP to pre-wire panels or connectors, a special division in our Harrisburg plant offers complete

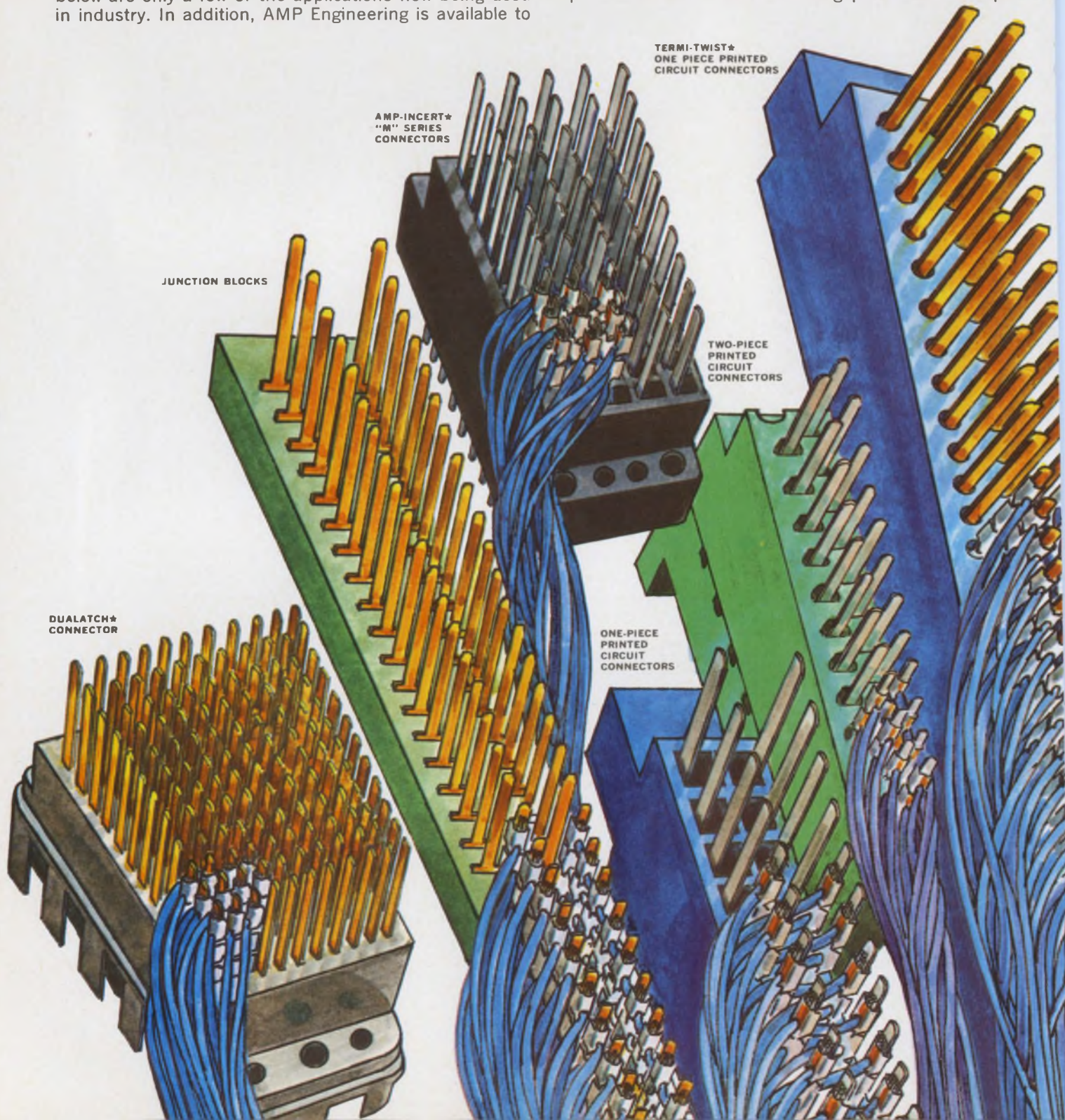

wiring technique is the in the world

facilities from taping specifications to finished product. Fully tested panels will be shipped ready for installation to give you the benefits of automated wiring at lowest applied cost. Quotes on your point-to-point wiring requirements will be supplied on request.

Write For Special Point-To-Point Wiring Report And Complete Product Information

Send for our 6-page special report, "A Stored Energy Connection for Point-to-Point Wiring" plus complete information including specifications and test data on TERMI-POINT Clips, Tools and companion products. Write **INDUSTRIAL DIVISION, AMP INCORPORATED, HARRISBURG, PA. 17105.**

★Trademark of AMP Incorporated

GRID PANEL

BUSS BARS

TERMI-PLATE★
PRINTED CIRCUIT
CONNECTORS

FEED THRU BLOCKS

AMPMODU★
INTERCONNECTION
SYSTEM

TERMI-GRID★
INTERCONNECTION SYSTEM
TWO PIECE PRINTED
CIRCUIT CONNECTORS

AMP
INCORPORATED

INFORMATION RETRIEVAL NUMBER 105

The 99.9% effective communications system

Diversification and backup capabilities help keep NASA global network going despite malfunctions

Charles D. LaFond, Chief
Washington News Bureau

Every time an Apollo spacecraft boils up from a launching pad at Cape Kennedy and arches into space, more than 600,000 miles of circuitry around the world clicks and hums with activity. Voice, analog and digital data race over this network, along with teleprinter messages. It is NASA's communications, tracking and data-acquisition complex, and its performance, according to L. R. Stelter, Chief of the Communication Div. at the Goddard Space Flight Center, Greenbelt, Md., is 99.92 per cent reliable.

To meet such demands, the system is fully controlled by digital computers, and critical electronic subsystems and communications circuits are redundant. But its success depends in large measure, too, on advance planning in the space

agency. Designers had to anticipate a requirement for handling a vast data flow in real time.

NASA's Associate Administrator for Manned Space Flight, Dr. George E. Mueller, notes: "The computer complex that handled the Mercury flights performed 1 million calculations a minute. Today's Apollo system handles 50 times that many—50 million a minute, 80 billion a day."

No longer can space agency commands be sent by voice alone, and no longer can spacecraft performance and biomedical data be processed after a flight. Mueller says: "We have to know on a real-time basis . . . how fast the hearts of the astronauts are beating . . . how much oxygen they are using and how their muscles are responding to their strange environment."

So NASA invented a new kind of "system," one connecting sensors to computers, to a communica-

tions network, and ultimately to Mission Control at the Manned Spacecraft Center near Houston, Tex. The fallout from this advance is already evident.

"A half dozen newly formed companies are manufacturing adapted space-created instruments for the use of doctors and hospitals here on earth," Mueller notes.

An evolutionary system

In the early days of the manned space program, the communications-computer support for Project Mercury was relatively simple. By the time Astronaut John Glenn had become the first American to orbit the earth, the total network consisted of 16 land stations.

"At that time we placed our first computer on the network," recalls H. William Wood, Chief of the Manned Flight Operations Div. at Goddard. "We really didn't use it as a computer. No computations were performed on site, but we used it to format data to send back to the control center and to display



RTCC, the Real Time Computer Complex, at NASA's Apollo Mission Control Center in Houston is one of the world's largest digital processing facilities. A portion of the five IBM System/360-75s employed is shown in this

wide-angle view. These machines provide flight controllers with solutions to spacecraft trajectory and all other vehicle and biomedical problems requiring solution during Apollo missions.

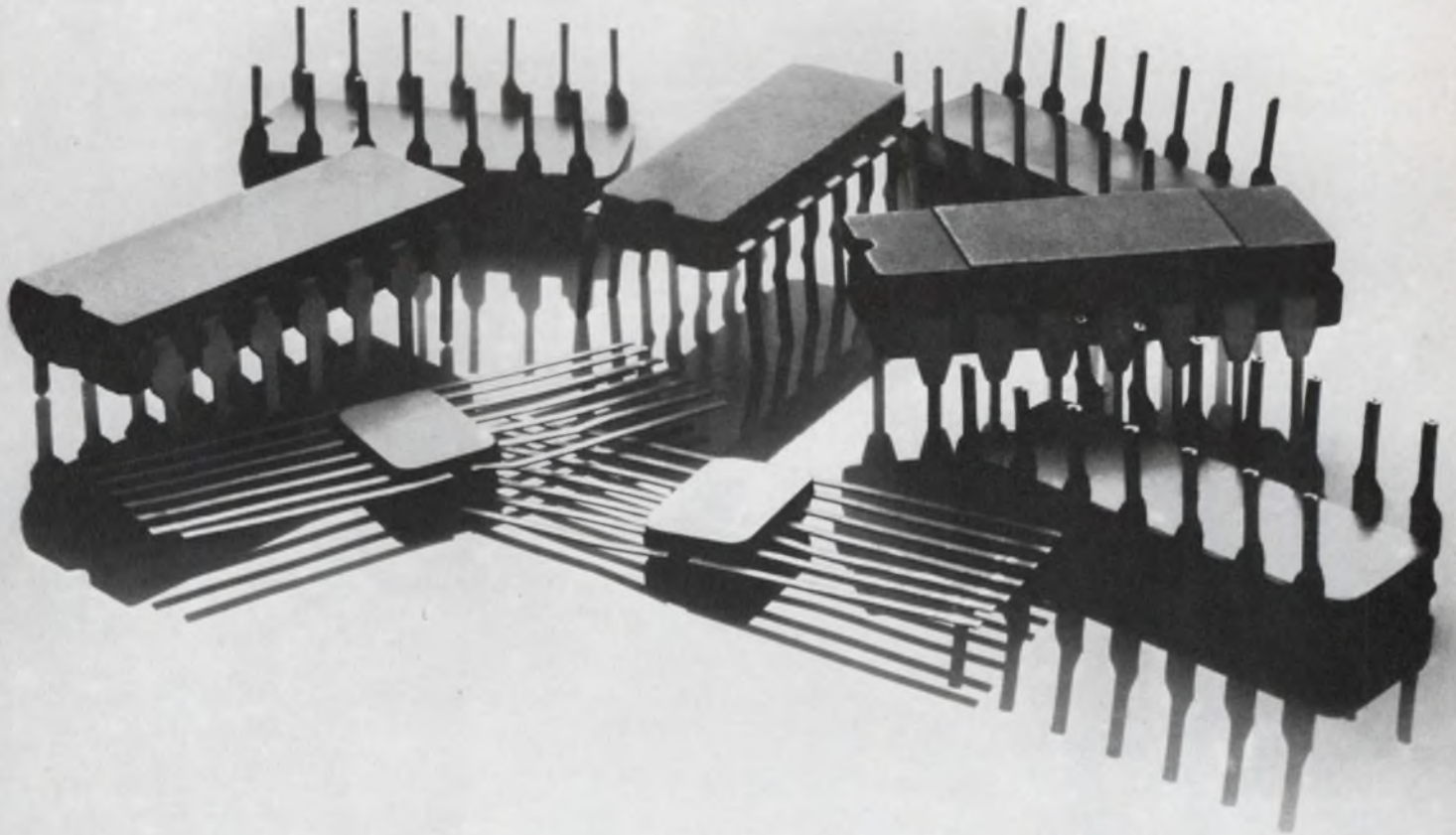

Sylvania presents eight good imitations.

The only way our competitors could match Sylvania SUHL integrated circuits was to copy them.

They're good imitations but we think our circuits are still better.

For instance, we use aluminum bonding wires where others use gold. This eliminates the chance of "purple plague" and gives better reliability, too.

The lower mass of aluminum wire also improves shock and vibration characteristics.

We are the only maker that performs 100% DC tests at temperature extremes. Of course, we make 100% AC tests, too.

We use a metal-to-metal seal for better hermeticity. We've been told that we have the best package on the market, based on tests by large-

scale users.

Our entire SUHL circuit line is available in both flat packs and dual-in-line packages.

And we have the broadest SUHL circuit line in the marketplace. And that includes MSI.

All Sylvania MSI are completely compatible with SUHL circuits. Which means, if you are thinking of going the MSI route, Sylvania MSI is the only way to go.

So why settle for good imitations when you can get the real thing?

Sylvania Electronic Components,
Semiconductor Division, Woburn, Mass. 01801.

SYLVANIA
GENERAL TELEPHONE & ELECTRONICS

(Apollo, continued)

that to flight controllers who were located on site."

The beginning of today's system really had its start in the Gemini program in 1964. Gerald M. Truszynski, NASA's Associate Administrator for Tracking and Data Acquisition, recalls: "The addition of digital data processing and digital command equipment increased the flight control capabilities of individual network stations and permitted a reduction in the number of stations used for Gemini support."

The network at that time consisted of 12 stations. Despite an improved capability during Gemini flights, Truszynski notes: "It was not possible to transmit in real time the volume of data required for flight-control decisions."

When the Gemini network intro-

duced the first computers, Sperry Rand's Univac Div. provided 14 Model 1218 systems for telemetry receiving—one for each remote tracking station. Univac also provided Model 418 computers for the four regional switching centers and a 494 computer for the primary message switching center at Goddard.

Yet data flow then was really very low. Wood says: "For Gemini, we received what might be thought of as a small paperback novel in one minute. For Apollo, we receive, normally, 51.2 thousand bits of information per second. This might be thought of as a small encyclopedia every minute."

A multiplicity of computers

Following Gemini, the manned space flight network added well over 100 digital computers (see table). Over 70 of these, installed in 15 stations around the world, are classed as medium to large

general-purpose systems.

Fourteen remote stations, four instrumented ships and eight instrumented aircraft are required in the network. Goddard is responsible for the entire operation and handles all communications between the spacecraft and the Mission Control Center in Houston. Wood estimates the cost of the entire network at approximately \$550 million.

NASA communications support for Apollo missions is based on use of the unified S-band system as the primary link, with vhf as backup. For near-earth operations, antennas 30 feet in diameter are used; for translunar and lunar operations, three dual 85-foot dish stations, spaced 120 degrees apart around the earth, are employed.

All tracking, telemetry, communications and command functions are provided through a single carrier frequency in each direction for both the command and service modules and the lunar module: up-link, 2090-2120 MHz; down-link, 2270-2300 MHz. Two sets of frequencies, separated by 5 MHz, are required on each directional link. The down-link is referred to as "telemetry," the up-link as "command."

To get data to and from the remote tracking ships and range ships, each station has four full-duplex, 2.4-kilobit-per-second circuits. All data is transferred via a variety of communication links between Univac computers at the remote sites to computers at Goddard and finally to the Houston computer facility. In general, pre-processing and communications computers are Univac equipment; the real-time processing computers at Goddard and at Houston are by IBM.

These facilities combined handle all processing required by the Apollo spacecraft for launching, telemetry, orbital computation trajectory determination, mission planning, digital command and re-entry. They also are used for simulations and training. The Houston systems serve in all functions of mission control; the Goddard systems are used to calibrate and check the global network and to evaluate data received during each mission.

Together, all these systems con-



Redundancy is the name of the game. Here, at NASA's Goddard Space Flight Center one Univac 494 is actually in use, one is on hot standby and a third is off-line backing up the other two.

Table. Apollo computer distribution

	UNIVAC					IBM
	1230	1218	494	1108	418	360-75
Manned Spaceraft Center (Houston, Tex.)	1	4	3	5	2	5
Goddard Space Flight Center (Greenbelt, Md.)	5	3	3	2	1	2
Remote Network Stations (14 land, 4 ships)	42	26	—	—	4	—
TOTAL	48	33	6	7	7	7

Test your logic.

a) Suppose you designed the DCL MSI 8260, world's fastest adder, and its logic diagram looked like this:

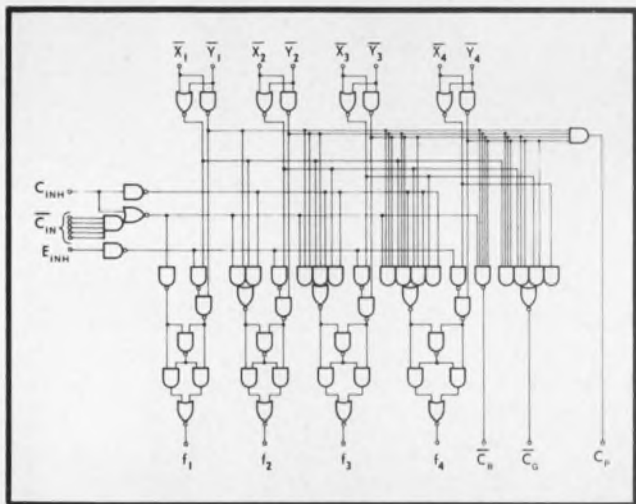

b) And it gave a speed and package count, which beat any other IC family, like this:

No. of Bits	Package Count			Addition Time per Bit (ns)	Total Addition Time Input to Output (ns)
	8260	8261	Quad 2-Input NAND Gates		
16	4	1	—	3.3	52
24	6	3	—	3.3	52
32	8	3	—	2.0	64
48	12	6	1	1.3	64
64	16	7	1	1.2	76

c) Next, suppose you came up with eleven new MSI elements—all perfect fits with the 8260, our other MSI elements, and the entire DCL family—like this:

8230	8-Input Digital Multiplexer
8232	8-Input Digital Multiplexer
8241	Quad Exclusive-OR
8242	4-Bit Comparator
8266	2-Input, 4-Bit Multiplexer
8267	2-Input, 4-Bit Multiplexer with Bare Collector
8268	Full Adder
8275	Quadruple Latch
8276	8-Bit Shift Register with Clock Inhibit
8284	4-Bit Binary Up/Down Counter
8285	BCD Up/Down Counter

d) Now then: wouldn't you logically buy a full-page ad to tell the world in Electronic Design? And wouldn't you sign it like this:

Signetics DCL

Signetics Corporation/811 E. Arques Ave., Sunnyvale, Calif. 94086/A subsidiary of Corning Glass Works

Logical afterthought: For written proof that Signetics is right in the middle of MSI, send for our DCL handbook. It's 120 pages—and free!

INFORMATION RETRIEVAL NUMBER 107

(Apollo, continued)

tribute to what is believed to be the most advanced real-time computer communications network in existence today.

The reliability of the Apollo network results from a great diversity of links and backup equipment. NASA's communications chief admits: "We do have trouble continually somewhere in the world on these circuits. Equipment has malfunctioned, but the hardware and circuit redundancy is such that a working alternate always is available. We've never lost total communications with a remote station. If a single link fails, we still have three alternate voice-data circuits that can be used to carry the load."

Stelter discloses that during the Apollo 8 flight last December, 1148 digital commands were sent from Houston to the orbiting spacecraft. Of these, he reports, only one command was rejected during validation by a remote station because of a detected error.

Stelter asserts: "This was phenomenal. More normal was the situation in the Apollo 9 flight in February—4651 digital commands with 26 rejects." In general, he says, these errors were probably caused by minor transmission or temporary computer anomalies.

The quantity of data handled during an Apollo mission is large but not considered staggering. In Apollo 8, Stelter says, 10 billion bits of data passed between the Univac 494 computers at Goddard and Mission Control in Houston. The data normally is sent in blocks of 600 bits at high speed. Of the more than 16 million blocks transmitted, Stelter estimates, errors requiring retransmission were detected in roughly 13,000 blocks. Thus the error rate, Stelter figures, "based on valid through-put data, was 99.92 per cent."

In designing, installing and combining this worldwide system, NASA apparently encountered few interface problems. Stelter notes: "We've never had any major hardware interfacing problems associated with the individual systems themselves. Rather, it's been one of format. Software has proved to be the key to handling and avoiding

interface problems. Formats employed must be identified and agreed on by all users."

He acknowledges one difficulty with peripheral equipment. A need developed for the introduction of polynomial buffer terminals for

use between the Goddard and Houston interfacing computers, Univac Model 494s. The problem, solved by Univac, centered on the interface with the high-speed, 50-kilo-bit links at each center required for error checking. ■■



This 30-foot diameter antenna is part of NASA's Unified S-band communications system. It is used for near-earth operation—tracking and communicating with the Apollo spacecraft during launch.



IBM computer complex data output is monitored in the RTCC. The same data are observed by NASA flight controllers in Mission Control to follow every critical phase during each Apollo mission.

Oh, you'll put it together, all right, and after a while, it'll work, more or less. Then you'll take the prototype to engineering for board design, get it back, attach the components, test it, make a few compromises, try it again. What you have then is an engineering model.

Then the manufacturing design. Back to engineering for debugging. More testing. Parts procurement. Incoming inspection. Telephone calls. Late deliveries. More testing. Heartache.

Final release and the module is ready for manufacture. Maybe.

All this time, an already designed, fully debugged, guaranteed, computer-tested, solid state module sits on Digital's shelf. Fifty engineers in offices around the country wait for your call to help. Application notes, installation drawings, catalogs sit in our mail room.

Power supplies, hardware, racks are piled high in the stock room.

M Series modules are the most complete, fully compatible, fast, all IC, TTL, inexpensive solid state logic available anywhere. With a few million modules in our recent history, and a few million dollars worth of test equipment, we really know how to put them out.

Read all about them in the new Logic Handbook. Free.

digital
COMPUTERS · MODULES



Hold it, right there.

DIGITAL EQUIPMENT CORPORATION
Maynard, Massachusetts 01754. Telephone:
(617) 897-5111 / Cambridge, Mass. / New
Haven / Washington, D.C. / Parsippany, Palisades
Park, N.J. / Princeton, N.J. / Rochester, N.Y. / Long
Island, N.Y. / Philadelphia / Pittsburgh / Cleveland /
Dayton / Huntsville / Cocoa, Fla. / Chicago / Denver /
Ann Arbor / Salt Lake City / Houston / Albuquerque /
Los Angeles / Palo Alto / Seattle. INTERNATIONAL,
Carleton Place and Toronto, Ont. / Montreal,
Quebec / Edmonton, Alberta, Canada / Reading and
Manchester, England / Paris, France / Munich and
Cologne, Germany / Oslo, Norway / Stockholm,
Sweden / Sydney and West Perth, Australia.

DIT-MCO IMMODESTLY PRESENTS THE FASTEST WIRING SYSTEM ANALYZER ON THE FACE OF THE EARTH

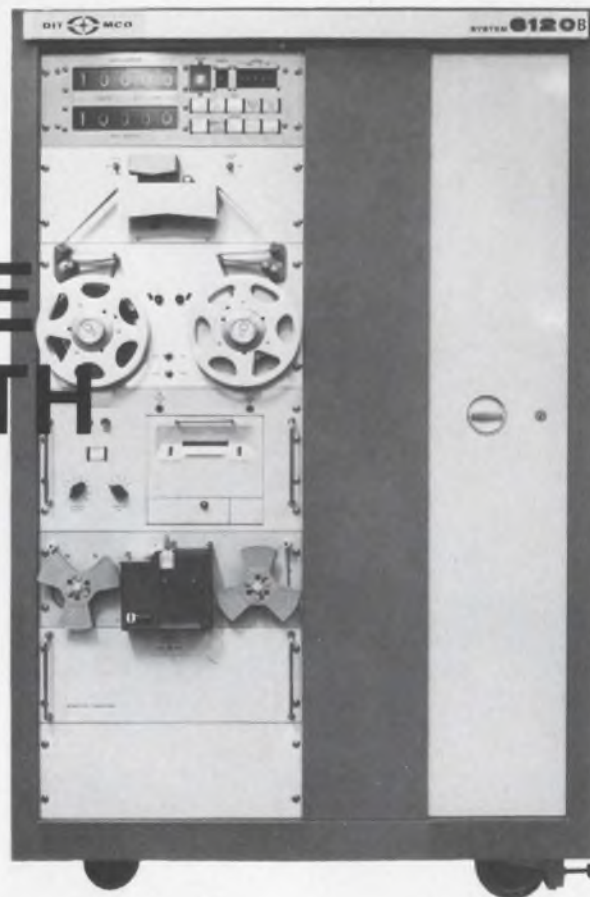

Humility be hanged. Either you've got it or you don't. We do. It's called the DIT-MCO System 6120B.

The DIT-MCO System 6120B, a random access wiring analyzer working on the fully automatic taped program and printout concept, will perform continuity tests at the rate of 4,000 per minute. Insulation tests at the rate of 3,000 per minute.

That makes it more than fast. That makes it the fastest wiring system analyzer on the face of the earth.

Switching console contains high-speed 500-termination Reed relay switching modules for a total capacity of up to 50,000 terminations.

Versatility, enhanced through use of economical DIT-MCO access fixtures, is virtually unlimited.

Improve both the testing function and the tested product. Specify unfailing accuracy, extreme flexibility, and unprecedented speed. Specify the DIT-MCO System 6120B.

For Full Details, WRITE, WIRE, Or PHONE:



DIT-MCO INTERNATIONAL
A DIVISION OF
XEBEC CORPORATION

5612 BRIGHTON TERRACE
KANSAS CITY, MISSOURI 64130
TELEPHONE: (816) 363-6288
TELEX NUMBER: 42-6149



ARITHMETIC FUNCTIONS USING MOS REGISTERS

An increasing number of desk calculators (and related equipment) are using MOS shift registers for data storage or memory. In most cases the earlier equipment used delay lines for this function. In the transition, it was a natural tendency to use a configuration similar to that used with delay lines. This was reinforced by the penalty of MOS-bipolar interfacing with the earliest MOS registers.

The use of "100" material by National has produced directly compatible MOS/TTL registers. Now the MM415/515 has a structure that utilizes the freedom of the MOS register with the direct bipolar compatibility to simplify the hardware necessary for arithmetic operations.

MM415/MM515 CONFIGURATION

The MM515 is a triple 64 bit MOS shift register. Each of the three registers has independent control over recirculating data or loading from an external source. In addition to the normal 64 bit output, an early 60 bit output is available for each register. While other functional uses are the primary objective, a number of delay line lengths may be made with the device by connecting the 60 or 64 bit sections in series. The pin diagram of Figure 1 illustrates the ease of interconnection, particularly for a 192 bit delay line. (Input to Pin 1, Pin 3 to Pin 4, Pin 6 to Pin 7, Pins 2, 4, and 9 to GND, Output on Pin 10.)

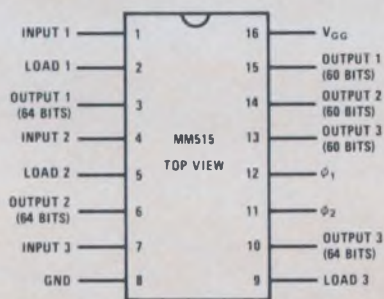

FIGURE 1. 16 Pin DIP

The primary usage of the device is as working registers in a digit and bit serial format of 16, 4 bit, coded numbers. The three registers are sufficient for the basic arithmetic operations. As an example, one contains the multiplier, one the

multiplacand, and the other receives the product. Normally these registers will recirculate with no data change. However during the execution of certain steps of an arithmetic algorithm the data will be loaded under a control command. The input may be a digit from the keyboard, the contents of another register, cleared (or zeroed) data, or the output of an adder. Figure 2 is an example

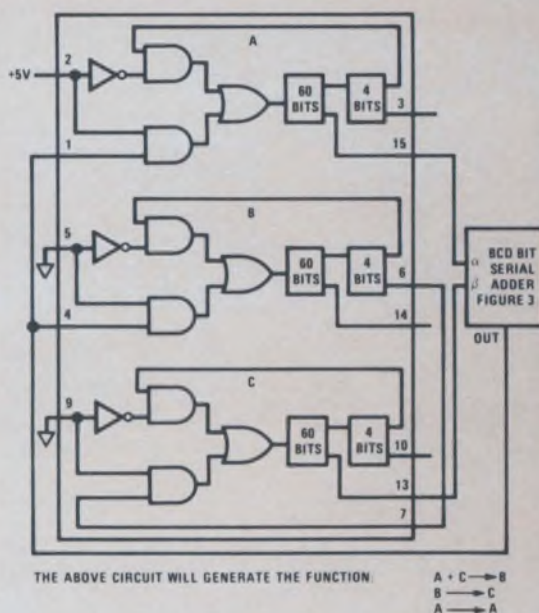

Figure 2. Typical Arithmetic Configuration

showing some of these modes of operation. The three registers are labeled A, B, and C. The data input to A and B is connected to the output of the adder. The load control input to register 1 (Pin 2) is at a logic "0" while the load control for register B (Pin 5) is at a logic "1". This forces the A register to recirculate while the B register is loaded with the output of the adder. With a logic "1" on the load control for C (Pin 9) and the output of B (Pin 6) to the input of C (Pin 7) data would be transferred from the B register to the C register. With these connections and control levels the following data movement occurs during the time the controls are active. A register is recirculated through its internal feedback path. The B register is transferred to the C. The sum of the A and the C registers will be placed in the B.

Special emphasis should be placed on the outputs used for the adder from the A and C registers. To best understand the need for the data out of the 60 bit top, examine Figure 3. In performing coded decimal arithmetic operations, a correction is necessary in addition if the result is greater than 9, or in subtraction, if a borrow is not generated. When a bit serial configuration is used it is necessary to wait until the last bit (T_4) is available before it is known whether correction is needed. One of the simpler methods of handling this is to store the result in a four bit shift register, as shown in Figure 3. During the final bit time of the digit

of the data and it must be right shifted to get it back in "sync" with the remainder of the data. This complicates the timing and control circuitry in addition to taking some time in a synchronous common clock system.

By taking the output from the 60 bit taps, the data is available 4 bits earlier. If the selection of this data is accomplished at the proper time, the output of the adder/subtractor is correct in time to be inserted back into the result register. Referring to Figure 2, the 60 bit output of the A and C registers (Pins 15 and 13) are used for the inputs to the adder.

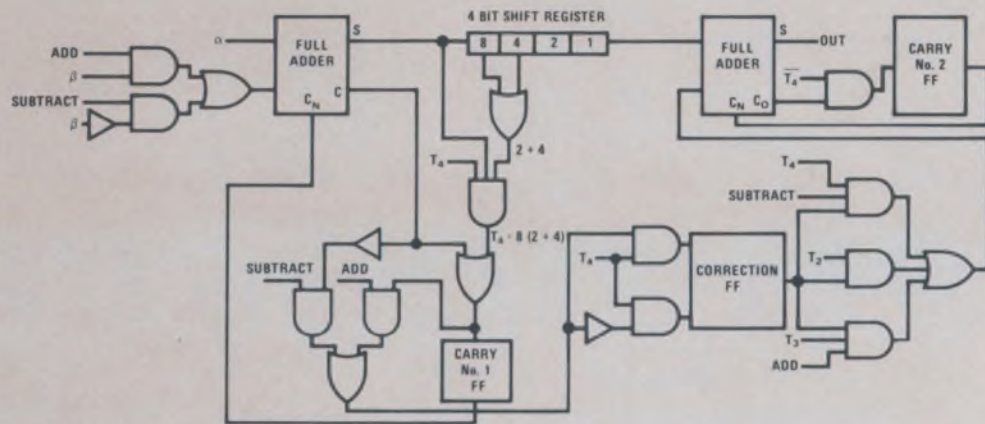

FIGURE 3. Bit Serial Adder/Subtractor

(T_4), the digit is examined for potential correction. If this is required, the correction FF is set and during the next four bit times the proper value is added to the result of this operation so that the output is available four bit times after it went into the adder/subtractor.

If a normal register/adder configuration is used, the result of the addition (or subtraction) is delayed by four bits. This amounts to a left shift

Figure 4 provides a more general configuration for the arithmetic operation. Signals g and h select the second source of data for the adder/subtractor. Addition/subtraction is selected by signal i. These signals must be activated four bit times before the other control signals (a - f) that control data flow.

Write for more information on National's MOS line of shift registers, ROM's, gates, drivers, interface circuits and analog switches.

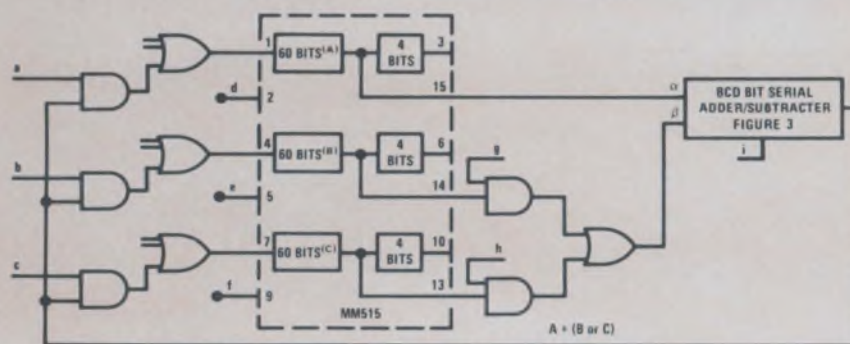

FIGURE 4. BCD Arithmetic Functions Using the MM515 for Register Storage.

National Semiconductor Corporation

2975 San Ysidro Way, Santa Clara, California 95051
(408) 245-4320/TWX (910) 339-9240



The D/A for stingy engineers



You want to convert from 4 bits at 25 MHz; or 9 bits at 10 MHz (or anywhere in between); and be ± 2 millivolts accurate in less than 90 nanoseconds.

But you also want to vary external bias and reference from dc to 25 MHz.

That way, your converter can be used as a function generator, a modulator, or a programmable attenuator.

But you want to pay only \$1480 to \$1760 for any of six models.

You're not stingy. You're thrifty.

You want our HS-2000 Series D/A Converters.



Not only that . . .

As a thrifty engineer, you would also like our A/D converters that require no external test equipment.

Word conversion rates can vary from 1 MHz to 25 MHz; and aperture time is as low as 0.2 nanosecond!

COMPUTER LABS

for tomorrow's technology today

(919) 292-6427 • 1109 SOUTH CHAPMAN ST.
GREENSBORO, N. C. 27403

INFORMATION RETRIEVAL NUMBER 111



automate



Unique Gardner-Denver Wire-Wrap[®] machines wire back panels at the rate of 1,600 connections an hour... without error

What happens when you try to wire panels where the pin matrices have 0.100-inch centers? You create a rat's nest, that's what, unless—

Unless you use a Gardner-Denver Wire-Wrap machine. Wire-Wrap machines, assisted by computers and instructed by punched cards, automatically position the back panels, cut the wire, strip the insulation from it, and wrap the wire around the desired terminals—at a speed 25 times faster than hand-soldering. Complete computer back panels may be wired in 2 hours.

Cost-savings, needless to say, are spectacular, can range as high as 50 to 1 over hand-soldering.

And the connections are reliable, remain airtight even when exposed to extreme changes of temperature and humidity. Not a single reported electrical failure in billions of connections. There's minimum crosstalk between wires. The wirepath consistency is nearly equal to that of printed circuits.

So sensitive to error is the Wire-Wrap machine that it will stop if it detects an error in card sequence or card punching. Wiring defects stop the machine immediately so the operator can correct them.

Wire-Wrap machines today are widely used in fabricating telephone exchanges, computers, communications equipment, guidance systems.

Call today for complete information—or write for Bulletin 14-121.



GARDNER-DENVER

Gardner-Denver Company, Quincy, Illinois 62301

first it was MOS...
then it was MTOS...

now it's...

The Nitride "Sandwich"

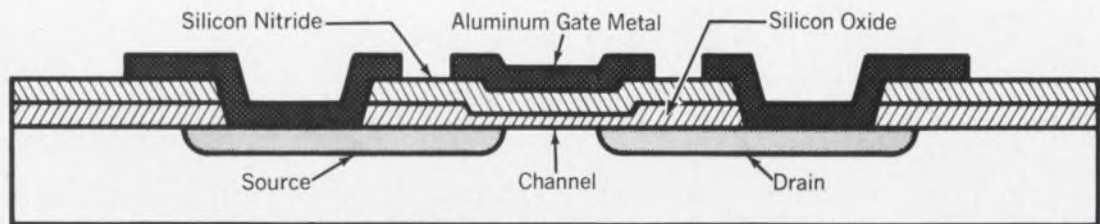

Cross-section of MTNS device

General Instrument's MTNS (Metal-Thick Oxide-Nitride-Silicon) represents the latest stage in the development of Large Scale Integration that began with MOS and continued with MTOS. The exclusive Silicon Nitride process signifies the achievement of goals General Instrument has intensively pursued since pioneering in this technology... constant improvement in reliability, performance and cost reduction in LSI.

At the basis of this latest advance in the technology is the Nitride "sandwich." The low threshold voltages achieved (typically 2 volts) allow General Instrument LSI circuits to be directly compatible with existing TTL, DTL circuits — ie, they can be driven from and are capable of driving bipolar ICs. The importance of eliminating the interface circuitry usually required in any given system can hardly be stressed enough in terms of the resulting systems' cost saving, performance and reliability. Several good things happen right off.

- First, there is a reduction in the number of system power supplies required. The -27 volt supply is eliminated completely. The existing 5 or 6 volt supply used for the bipolar devices can be used as one of the nitride device supplies. The only other supply needed is -12 volts which is often available in the system.

- Second, elimination of the interface circuits, which often cost more than the LSI circuit they interface, eliminates additional propagation delays which degrade system performance.

- Third, the reduced parts count and reduced number of interconnections enhance system reliability.

The silicon nitride used in the gate structure of the device has some very desirable qualities. One of these is a high dielectric constant. It is, in fact, this feature which makes possible the low threshold voltage. The high dielectric constant also manifests itself in an electrical parameter called k' , increasing it by

MTNS

An exclusive Nitride process that makes General Instrument LSI circuits directly compatible with bipolar ICs (without input-output interfacing)

50%. (k' is the gain factor of the device.) The increased k' makes possible both faster circuits and lower "on resistance" devices.

Another property of the silicon nitride is its extremely good passivation characteristics. Silicon nitride is virtually impervious to sodium ion migration at temperatures in excess of 200°C. This has impact on cost in that devices may be encapsulated in inexpensive plastic packages . . . and impact on reliability in that in a hermetically sealed package this characteristic gives added protection against contamination.

The gate structure of these devices is actually a sandwich of silicon oxide and silicon nitride. These two materials are incorporated in the structure by two different kinetic processes which tend to compensate each other in that pinholes introduced by the one process are eliminated by the second. This reduces that normal occurrence of short circuits caused by pinholes in gate areas, raises yield and results in lower cost.

Increased Operating Temperature

An important property of the nitride process relates to high temperature operation. With proper engineering design, circuits can be made to operate at 125°C. The nitride passivation qualities eliminate concern for contamination migration at elevated temperature and therefore, MTNS devices are typically rated at 125°C. Another consideration in this rating is that the low voltage circuits typically dissipate less power than the standard voltage circuits and therefore have less internal heating which keeps junction temperatures nearer to the ambient temperature.

Reduction In Power Dissipation

One of the more dramatic results of the nitride process is the reduction of power dissipation of dc and two phase circuits. Reducing the V_{dd} supply from the usual 12 volts to 6 volts reduces power by a factor of 4 for the same operating speed.

Increased Operating Frequency

When driving into a TTL circuit, the operating frequency of the device is usually increased. This comes about because MTNS devices are typically frequency-limited by the output stage, being much faster internally. Limiting the output voltage swing to less than 4 volts by driving into TTL then raises the frequency limit.

General Instrument has been delivering thousands of MTNS circuits for selected military applications over the past six months, where particular advantage has been taken of their unique properties. A standard product line for general use will be available from distributors beginning in 60 days.

MTNS not only sets significantly higher standards of performance and reliability, but it also affords a degree of flexibility of design and application previously unattainable. General Instrument engineers are ready and anxious to assist you in exploring the vast and intriguing possibilities both in standard and custom circuits.

Write to General Instrument Corporation, Microelectronics Division, 600 West John St., Hicksville, L. I., New York. (In Europe, to General Instrument Europe S.P.A., Piazza Amendola 9, 20149 Milano, Italy.)



GENERAL INSTRUMENT CORPORATION • 600 WEST JOHN STREET, HICKSVILLE, L. I., NEW YORK



Small fast digital computer commands 72 instructions

Honeywell Computer Control Div., Old Connecticut Path, Framingham, Mass. Phone: (617) 879-2600. P&A: from \$9700; June, 1969.

The newest and smallest member of Honeywell's series 16 computer family, the H316, is a small general-purpose full-scale digital computer of the stored-program, single-address, binary, parallel type. It features 72 commands and an add time of 3.2 μ s.

The memory is a four-wire coincident-current unit with magnetic core. It has a 1.6- μ s cycle time and a size of 4096 words, expandable in increments to 16,384 words.

Available in three versions, table-top, rack mountable and self-standing, the H316 computer offers more than 500 field-proven software packages. These include more than 300 application programs, as well as Fortran, a computer language.

Major applications for the H316 are expected to be in remote terminal and display control, communications concentration, scien-

tific data acquisition, and process control. Additional application areas encompass industrial and military/aerospace control systems, research, and hybrid, as well as data storage and retrieval.

There are many peripherals and interfaces compatible with the new computer, including: analog and discrete input/outputs (I/Os), disc files, drums, displays, magnetic tapes, card I/Os, paper tape I/Os, line printers, communications interfaces, Teletype printers and logging typewriters.

Many options are also available for equipping the H316 to satisfy special needs. A real-time clock can permit the new computer to track real time through a memory location. A high-speed arithmetic package can add ten commands to the H316's instruction set. In addition, a direct multiplex control can allow data transfer between peripherals and the memory, concurrent with computation, at a maximum transfer rate of 156 kHz. *Booth No. 2800 Circle No. 263*

Four-phase data modem transmits 2400 bits/s



International Communications Corp., 7620 N. W. 36th Ave., Miami, Fla. Phone: (305) 691-1220. P&A: \$2350; summer, 1969.

Compatible with most existing four-phase modems such as the Western Electric 201B, a new data set transmits data at rates of 2400 bits per second over either dial-up or dedicated leased telephone lines. Model 2200/24 permits full communication on a dial-up basis, or use of dial-up as back-up to dedicated leased lines through the telephone company's new Data Access Arrangement.

Booth No. E8 Circle No. 280

Computer data terminal uses telephone lines



Computer Transceiver Systems Inc., 123 Pleasant Ave., Upper Saddle River, N.J. Phone: (201) 825-0820.

A small data communications terminal transmits data to a remote computer, receives data from the computer, and provides both input and output printout. Designed to operate over ordinary telephone lines, the Execuport 300 includes a special keyboard, a 10, 15 or 30 character-per-second (operator selectable) thermal page printer, built-in telephone coupler and interface, and a universal interface for peripheral accessories.

Booth No. 610 Circle No. 259

Anyone can think small.



Frankly, we had something bigger in mind.



We built our second generation DPM* to fit into seven square inches of panel. *That's less than any other digital panel meter requires.* But we didn't stop there. The Model 1290 mounts completely from the front of the panel. *The entire chassis pulls out from the front for servicing or replacement.* Even the Nixie** tubes are pluggable! Think of the convenience in continuous systems opera-

tion. Despite the smaller package, Model 1290 has all the features our original DPM is so widely acclaimed for—3-digit plus 100% overrange display, 0.1% ± 1 digit accuracy, circularly polarized window filter, dual slope integration, full-buffered storage display and BCD output. Many of these standard Weston features are still "optional at extra cost" on competitive units. Our new compact

is styled for tomorrow, available today, and priced below \$200 in quantity. Anything else in the industry is just small talk. WESTON INSTRUMENTS DIVISION, Weston Instruments, Inc., Newark, New Jersey 07114.

a Schlumberger company

WESTON®

*U.S. Pat. #3,051,939 and patents pending.
**Registered trademark, Burroughs Corp.

Our D servomotor is mad with power.

That's our SU-680D-29 permanent-magnet D-C servomotor. We call it our D motor for short. It's small, rugged and powerful. It delivers 12.7 watts of continuous power output at 8600 rpm and is a natural for any servomechanism that requires a prime mover. It has a high repeatability-to-time ratio which makes it immensely stable, a 0-10,000 rpm speed range and a high acceleration Torque/Inertia. Torque peaks at 15 oz-in., 2 oz-in. continuous at 8600 rpm. It measures only 1 1/8 inches in diameter and weighs just 8 1/4 ounces.

SERVO-TEK PRODUCTS COMPANY
1086 Goffle Road, Hawthorne, New Jersey 07506.

SERVO-TEK
PRODUCTS COMPANY

For full details write for our interesting technical sheets and get mad with power yourself.

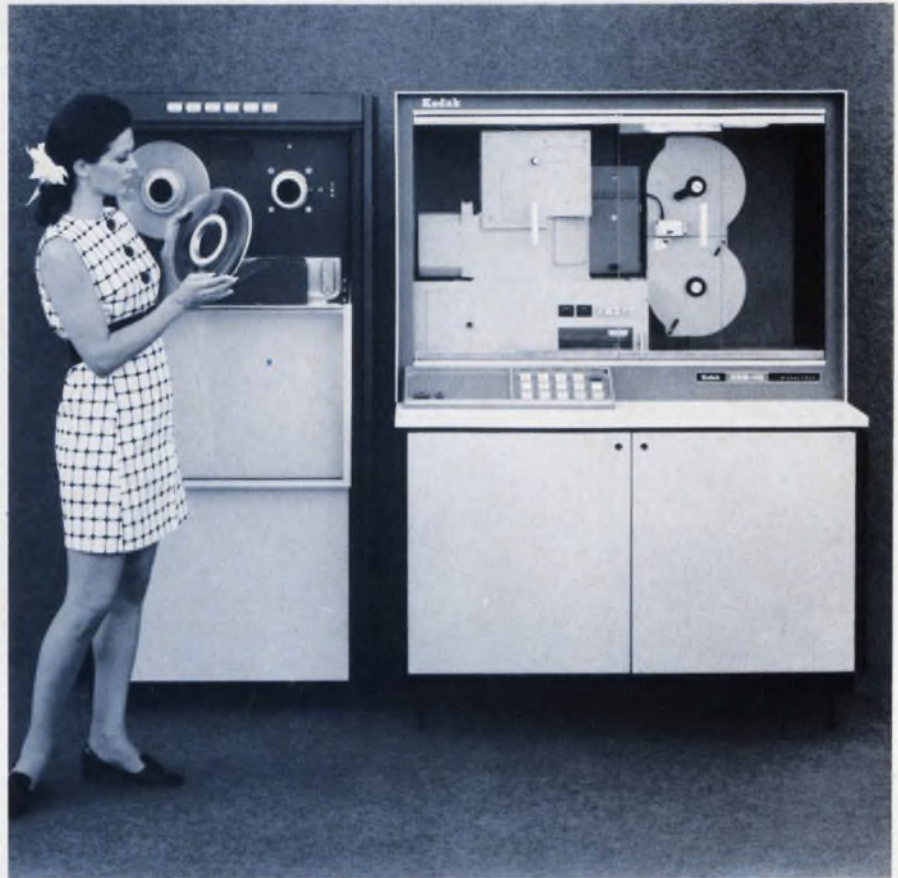

Computer microfilm system records computer data

Eastman Kodak Co., Business Systems Markets Division, 343 State St., Rochester, N.Y. Phone: (716) 325-2000. P&A: \$117,000; April.

Computer output tapes can be processed into readable film images by a new microfilm system that eliminates or cuts down the need for paper printout.

Processing up to 90,000 computer characters per second, the model KOM-90 microfilm system decodes magnetic tape data and records as many as 300 pages of man-readable data per minute. The decoded computer data is displayed on the face of a cathode ray tube and photographed on 16-mm microfilm.

After exposure, the rolls of 16-mm film from the microfilmer can be packaged in magazines, prepared as strips, or reproduced as microfiche. All of these formats can be used for filing, reading, information retrieval, duplication or hard-copy printout by microfilm

reader-printers.

System flexibility is achieved by the use of job control cards. These cards, quickly and easily changed, control such functions as reduction ratios, image rotation, vertical line skip, and horizontal tabbing. Interchangeable overlays can be used to superimpose charts, grids, or other standard forms on displayed information.

Modular organization of the internal logic package makes it easy to add special characters, to change formats or even to revise character fonts. Three document-indexing sections are available to speed and simplify information retrieval. An indexing film code is recorded on the microfilm at the same time as the data from the computer tape.

Several software packages are available to simplify programing and reliability is enhanced by the use of integrated circuits and solid-state components.

Booth No. H3 Circle No. 268

The great digital systems kit!

step 2:

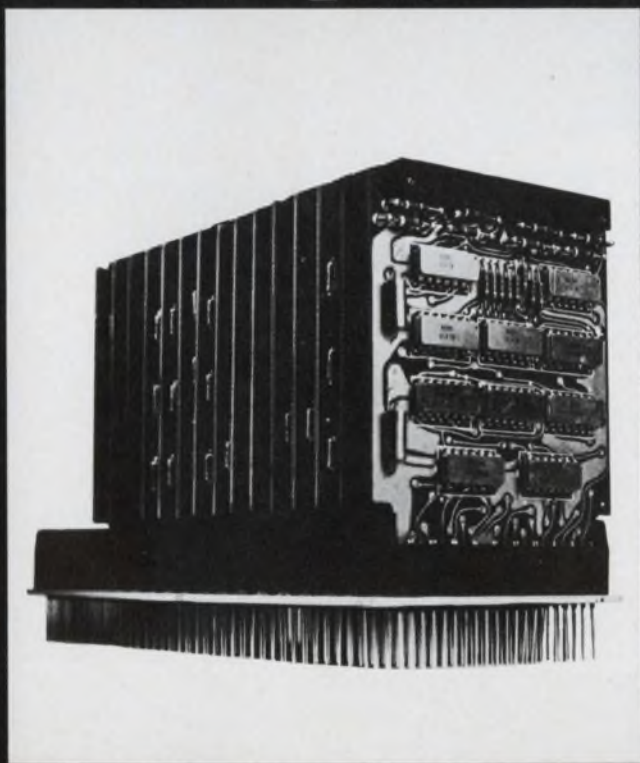

PLUG-IN RAYTHEON COMPUTER'S 15 NEW TTL MODULES.

These fifteen new modules combine TTL speed and applications so you can design and build your system with packaged functions, not just circuits. Several are specifically designed to simplify interfacing with 8 and 16-bit computers. Here's the list:

1. MDB10—BCD to Binary Converter
2. MBD10—Binary to BCD Converter
3. MMM10—128-Bit Scratch Pad Memory
4. MTG40—16 Term, Power Transfer Gate
5. MDT10—Driver Transmitter
6. MDR10—Driver Receiver
7. MDG20—12 Term, 2 Input NAND Gate
8. MDG40—6 Term, 4 Input NAND Gate
9. MFF30—4 J-K Flip-Flops
10. MFF40—16-Bit Buffer Register
11. MSR10—Dual 4-Bit Shift Register
12. MBC20—Dual 4-Bit Binary or BCD Counter
13. MSC20—4-Bit Up/Down Counter
14. MSR30—16-Bit Shift Register
15. MCG20—Crystal Controlled Oscillator

Like the 80 other compatible M-Series modules, these new TTL units have features like test points in the handle, compact 3 by 3.65 inch size, high noise rejection. They're in stock now, along with power supplies, chassis and related hardware, applications help and automatic wirewrap service that converts ideas into hardware in as little as 30 days. Write or call for Data File DK167. Raytheon Computer, 2700 S. Fairview St., Santa Ana, Calif., 92704. Phone (714) 546-7160.

RAYTHEON

DDC'S NEW
VIDEO AMPLIFIER

1000 V/ μ SECOND
SLEWING RATE
DC - 150 MHz
UNITY GAIN
6 dB/OCTAVE ROLLOFF

WOW!

This highly stable, wide-band op amp offers a unique capability for high frequency inverting applications, such as video summing, deflection control amplifiers, high speed integrators and high speed data processing.

DDC's Model VA-23 DC video amplifier is available in an encapsulated module designed for PC card mounting. It meets the environmental requirements of Mil-Std-202C.

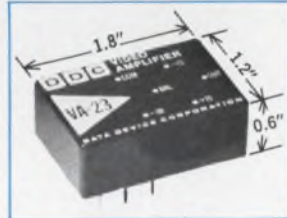

SPECIFICATIONS

Slewing Rate, Inverting Only	1000V/ μ sec typ.
Frequency for Full Output, Inverting Only	10 MHz min.
Frequency for Unity Gain, Inverting Only	150 MHz typ.
Rated Output	
Voltage-Peak at rated load	± 10 V min.
Current-Peak*	± 50 mA min.
Input Impedance, Differential	350 K Ω typ.
Input Capacitance	6 pF typ.
Price (1-9)	\$125.

*Model CD-23 with 100 mA output available for driving 50 ohm, 75 ohm and 91 ohm coax lines.

All specifications are at 25°C and ± 15 V supplies, and are subject to change without notice.

TYPICAL APPLICATION
High Frequency Summing

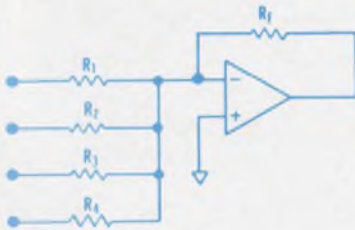

**Compact data system
is multifunctional**



Astrodata Inc., P. O. Box 3003, Anaheim, Calif. Phone: (714) 772-1000. Price: from \$1825.

A new data acquisition instrument is housed in a compact 7-in. high rack. Depending on the selection of inserted circuit cards, it performs as a multiplexer, an analog-to-digital converter, a digital-to-analog converter, a sample-and-hold amplifier, or a buffer amplifier. Called the Astroverter, model 3900 consists of a built-in power supply, 16 card slots, and a family of 5 by 5 in. plug-in cards. Any combination of cards can be inserted into the 15 card slots. Two cards provide all circuitry for the 12-bit a/d converter, while only one additional card is required for sample-and-hold or differential buffering.

Booth No. KK6 Circle No. 285

**Frequency multiplexer
blends terminal inputs**

Ultron Systems Corp., Data Communication Products Div., Mt. Laurel Industrial Park, P.O. Box 315, Moorestown, N.J.

Combining the input of various terminals for economical transmission over a single voice-grade telephone line, a new frequency multiplexing system eliminates the need for multiple leased transmission lines. Called the Ultracom FMU, this unit handles inputs from as many as 25 75-bit/s terminals, or 18 110-bit/s terminals, or seven 200-bit/s terminals, or any combination of these.

Booth No. 3G01 Circle No. 254



DDC has a better design

DATA DEVICE CORPORATION

100 Tec Street / Hicksville, N.Y. 11801 / (516) 433-5330

INFORMATION RETRIEVAL NUMBER 117

Ultramation is here.

The Honeywell 316 computer: new dimension on the path to ultimate efficiency . . . That's Ultramation





H316 is the first under-\$10,000 16-bit computer with the backup you deserve

When Honeywell hangs an under-\$10K price tag on a computer, you get something you've never had before at this price: big-computer-company backup. This means on-time delivery for one H316 or hundreds . . . world-wide support . . . a full line of proven peripherals.

The H316 comes in three versions — each a full-scale digital computer — with the rack-mountable model priced under \$10,000. Newest and smallest member of the Honeywell Series family (116, 316, 416, 516) of computer systems, the H316 is logically identical to the DDP-516 — same organization, instructions, interface characteristics.

Result: over 500 programs you know will work; peripherals and options you can count on; experience that means better results for you; growth to larger Series 16 computers without costly reprogramming.

The H316 could be just the small computer you're looking for. Typical applications are: industrial and mil/aero control systems, research, scientific data acquisition, hybrid, data storage and retrieval, and communications. Actually, Series 16 computers do real-time tasks so efficiently, they've been teamed as high-performance front ends with computers made by other manufacturers.

Find out how much more Ultramation offers you in an under-\$10K computer backed by thousands of Honeywell people around the world . . . first to deliver 16-bit computers.

The specs on the following page might help you make your decision to head for Ultramation . . .

Honeywell
A U T O M A T I O N

Move up to Ultramation. Reserve your H316s.

SPECIFICATIONS

TYPE — Stored program, single address, 16-bit, binary, parallel, general-purpose, two's complement.

MEMORY — Type: Four wire, coincident current, magnetic core
Size: 4,096 words, expandable in same increments to 16,384
Cycle time: 1.6 μ secs
Add time: 3.2 μ secs

INSTRUCTION COMPLEMENT — 72

REGISTER COMPLEMENT (all 16-bit) — A-Accumulator, B-Accumulator Extension, P-Program Counter, M-Memory Information, Y-Memory Address, X-Index Register

POWER FAILURE INTERRUPT — Power failure causes an interrupt through a unique location in memory to store contents of registers in memory.

INDEXING — By hardware index register, adds no time to instruction execution. Index register addressable directly and/or as memory location Zero.

SENSE SWITCHES — Four switches on control panel are capable of being tested by programmed instruction.

INPUT/OUTPUT — Word parallel. Programmed via A Register, or, optionally,

automatic to/from memory under control of Direct Multiplex Control Unit.

I/O CHANNELS — Up to 20 individually addressable channels or interfaces on the I/O bus. Multiple devices per interface or channel.

PRIORITY INTERRUPT — Basic machine has capability for up to 16 individually maskable priority interrupts. 48 additional interrupt lines optionally available.

TEMPERATURE — Room ambient.

HUMIDITY — 0-90% relative humidity with no condensation.

POWER — 475 watts at 115 volts AC $\pm 10\%$, 60 cycle, ± 2 cycles, single phase. Input current, 5.5 Amps.

CONFIGURATION — The basic 316 is supplied as a rack-mountable unit complete with power supply and control panel. This unit requires 14 inches of panel height in a 19" rack. Table-top and pedestal configurations also available.

DIMENSIONS — 17.88" wide x 24.5" deep x 14" high. This unit can contain the central processor, 16K of memory, real-time clock, high speed arithmetic, Teletype interface and logic for several other internal options and/or device interface.

WEIGHT — Approximately 150 pounds.

PLEASE RESERVE _____ H316(s) AND
number
CONFIRM APPROXIMATE DELIVERY DATE.

- Send more information by return mail. Hold this delivery date for me for 15 days so I can make a final decision and get my P.O. to you.
- Don't reserve an H316 for me yet. I need more facts. Send me your H316 brochure.
- I think I need a more powerful computer. Send me your DDP-516 brochure.

NAME _____

TITLE _____

COMPANY _____

STREET _____

CITY _____ STATE _____ ZIP _____

The application I have in mind is:

Attach this coupon to your letterhead and mail to: Honeywell, Computer Control Division, Dept. 20, Old Connecticut Path, Framingham, Mass. 01701.

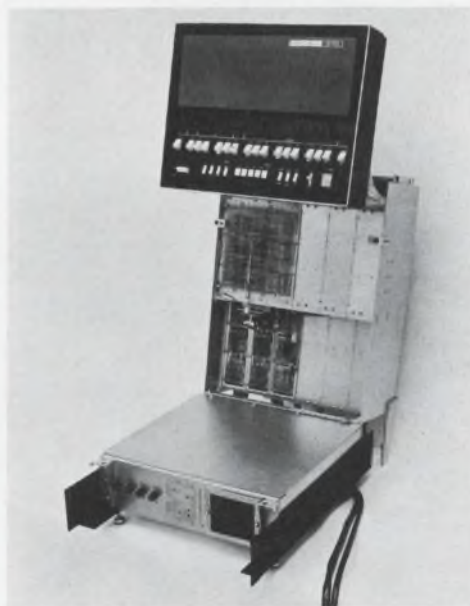

For easy maintenance purposes, access to the unit is implemented by a front pull-out and tilt mechanism.

Honeywell
AUTOMATION

Microfilm terminal makes hard copies



Xerox Corp., Xerox Square, Rochester, N.Y. Phone: (716) 546-4500. Price: from \$125/month.

Called the Microprinter, a new xerographic device previews microfilm images on a screen and enlarges them onto ordinary paper. Users can scan rolls of microfilm or study individual images on the machine's 9 by 11-1/2-in. viewing screen. Single or multiple enlargements of the document or chart shown on the screen can be copied on 8-1/2 by 11-in. bond paper at the rate of seven copies a minute. Booth No. 6 Circle No. 338

Desktop terminal time-shares computers



Applied Dynamics, P.O. Box 1488, Ann Arbor, Mich. Phone: (313) 971-4444. P&A: \$6200 to \$7500; 60 to 90 days.

Called the Dynamics terminal, a new compact desktop computer device makes possible the time-shared use of analog/hybrid computers. Although individual terminals share the central computer on a sequential basis, their response time, up to 1000 time-shared solutions per second, is considerably faster than that of existing time-shared general-purpose digital computers. Booth No. GG Circle No. 278

McLEAN BLOWERS PACK A RACK OF COOLING POWER!

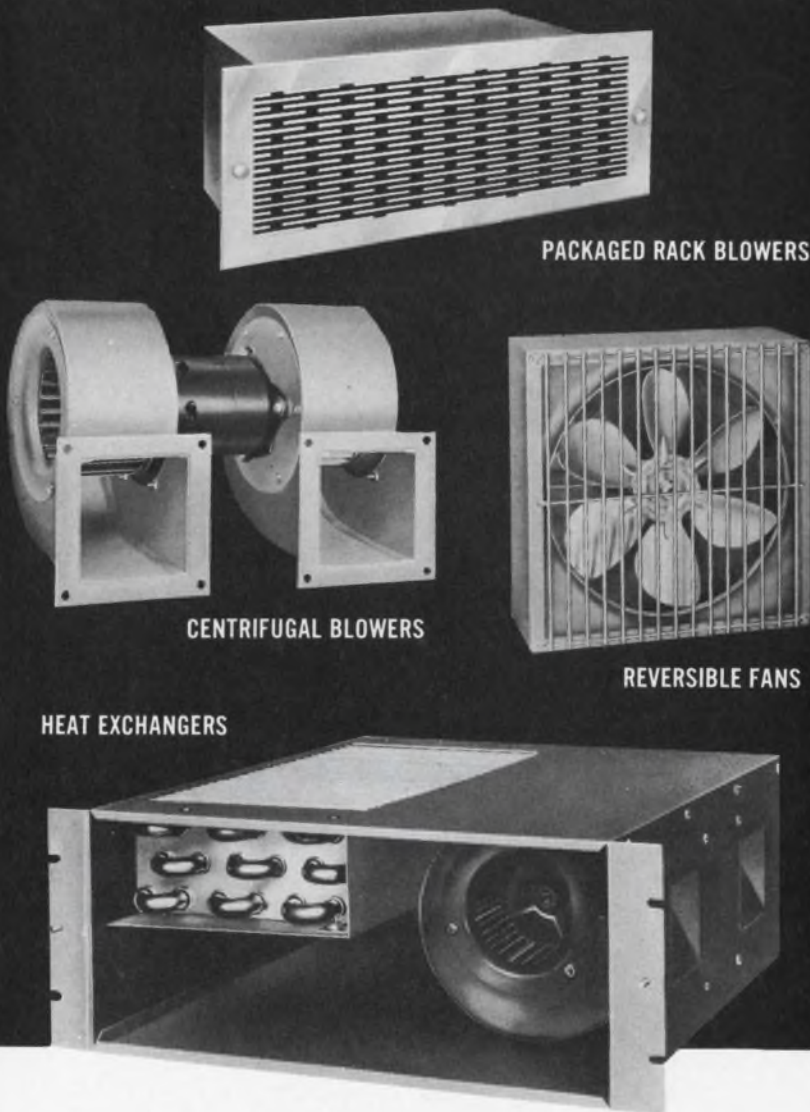

PACKAGED RACK BLOWERS

CENTRIFUGAL BLOWERS

REVERSIBLE FANS

HEAT EXCHANGERS

Send for our 1969 Catalog

McLEAN ENGINEERING LABORATORIES



Princeton Junction, New Jersey 08550 • Phone 609-799-0100 • TELEX: 84-3422

The New Mini Boxer



dressed or undressed, fits places too small for the full-size Boxer fan.

Small and vigorous. Measures only 3.625 square by 1.5 inches deep, yet the Mini Boxer delivers a lusty 46 cubic feet of air per minute.

Durable. Ball bearing models survive difficult environments for five years and more, due to patented extra-large lube reservoir. Sleeve type Grand Prix (pat. pending) bearings run cool and reliably, offering exceptional life at low cost. Rugged metal frame won't crack under stress like plastic.

Versatile too, in skeleton or venturi version it flips to reverse airflow, mounts easily anywhere. Special skeleton version fits within 3.5-inch square for standard racks.

Available. It's at your nearest distributor.



IMC Magnetics Corp., New Hampshire Division
Route 16B, Rochester, N.H.03867. Tel: (603) 332-5300

INFORMATION RETRIEVAL NUMBER 122

This was the result of an IMC reducing plan.

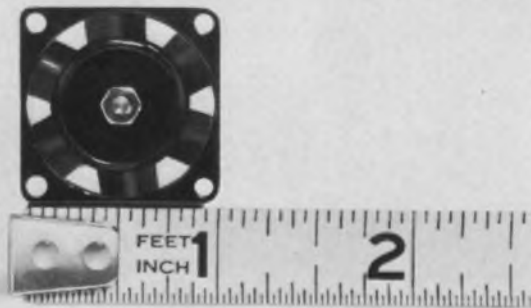

Moves more than 11,000 times its own volume of air each minute.

For spot cooling of miniaturized equipment.

Cools micro-circuits, transistor heat sinks, airborne computers and instrumentation . . . de-fogs radomes and optical equipment.

Delivers 6.5 cubic feet of cooling air per minute, yet this precision engineered vaneaxial fan weighs only 1 ounce and measures just 1 inch on a side.

Meets demanding environmental,

performance, and reliability specifications, operating efficiently for 1000 hours at 125° C, much longer at lower temperature ranges.

Standardized, for low cost and easy mounting, IMCube fans are readily placed throughout a system, whether it's already completed, or still in design stage.

IMCube fans with cylindrical housing optionally available.



IMC Magnetics Corp., Eastern Division, 570 Main St., Westbury, N.Y. 11591
Phone (516) 334-7070 or TWX 510 222-4469

INFORMATION RETRIEVAL NUMBER 123

Equalized data modem transmits 9600 bits/s

Rixon Electronics, Inc., 2120 Industrial Parkway, Silver Spring, Md. Phone: (301) 622-2121. Price: \$10,000.

Operating at data rates of 9600 bits per second, a new data modem with an automatic equalizer compensates for the differential delay distortions inherent in telephone transmission facilities and for the amplitude deviations sometimes encountered. This full-duplex data set is not sensitive to input data patterns because it has an internal code translator for near-flat spectral component distribution. The basic line signal is a four-level a-m, suppressed carrier, vestigial sideband signal, with lower sideband being transmitted.

Booth No. 612 Circle No. 252

Data processor expands vertically

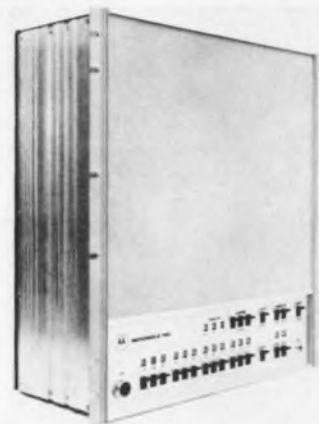

Motorola Instrumentation and Control Inc., P.O. Box 5409, Phoenix, Ariz. Phone: (602) 959-1000.

A new slimline configuration of the MDP-1000 digital data processor is a rack-mountable package that permits expansion of memory while maintaining minimum package depth. The Phase II has a vertical configuration with a maximum depth of 13 in. (with 16k of core memory). Its random-access single-address memory cycles in 2.16 μ s.

Booth No. 2201 Circle No. 277



Collins Radio uses
Dale 1600 Wirewound
Trimmers in this
RF Oscillator
Circuit

Accurate frequency adjustment ...a job for Dale trimmers



Single sideband radio demands precise frequency control. This is assured with Dale 1600 Series Trimmers. One application of these RT-12 wirewounds is in the RF oscillator circuit of the versatile Collins 618T/HF SSB Transceiver. Here, Dale wirewound trimmers provide: (1) The smooth resolution necessary for fast, accurate crystal adjustment during assembly; (2) Long-term stability which is a factor in the universal acceptance of Collins-built military and commercial radio equipment.

Let Dale trimmers handle your circuit adjustment needs. From any angle — reliability...price...delivery...they deserve a place on your prints.

Circle 201 for Potentiometer Catalog B

Call today for fast delivery of
these Dale Mil-Style Trimmers

600 SERIES Mil. Equiv. RT-10



1200 SERIES Mil. Equiv. RT-11



1600 SERIES Mil. Equiv. RT-12



5000 SERIES Mil. Equiv. RT-22



Available in all standard terminal configurations in
regular or panel mount styles.



for optimum value in potentiometers

DALE ELECTRONICS, INC., 1300 28th Ave., Columbus, Nebr. 68601 Phone 402-564-3131
In Canada: Dale Electronics Canada, Ltd.



Printed in U.S.A.



DALE

stacks up
better in
industrial
wirewounds!



*Dale CW Resistors chosen for North Electric's
advanced NX Crossbar Switching System*

For more than seven years, Dale CW Wirewounds have been an integral part of the high efficiency NX Crossbar Switching Systems produced by North Electric Company, Galion, Ohio. Found in Independent telephone exchanges nationwide, North's NX Crossbar uses proven components, such as the CW, to provide decades of continuous, trouble-free service.

Chances are your industrial applications are similar – requiring long-term assurance of stable performance and uninterrupted delivery. Here are three solid reasons why Dale CW Resistors provide the best all-around value:

FOR COMPLETE INFORMATION OR A QUICK QUOTE PHONE 402-564-3131

Circle No. 181 for Dale's complete Resistor Catalog A

1. HIGHER STABILITY is provided by silicone coating and wirewinding methods patterned after Dale's precision RS Series. Meets MIL-R-26C, RW-57, 58, 59.

2. HIGH POWER TO SIZE RATIO. Eight standard models provide up to 13 watts (Char. V) in 1.781" x .375" size.

3. VERSATILE. Pre-engineered to meet hundreds of special applications.

DALE ELECTRONICS, INC.
1300 28th Avenue Columbus, Nebraska
In Canada: Dale Electronics Canada, Ltd.



Terminal printer system uses telephone lines



Datamark, Inc., Cantiague Rd., Westbury, N.Y. Phone: (516) 333-8910.

A terminal printer system can be used to print data received over a telephone line at its maximum capacity, using a model 201, 202, or similar Dataphone. The interface is easily tailored to operate with any computer. Worst case print speed is 300 lines per minute with a full 64-character type font. Ninety-six character fonts are available, including optical scanning characters, upper and lower case letters, and special symbols. Booth No. 2704 Circle No. 273

Microfilm plotter expands modularly

Singer Co., Link Div-Advanced Technology, 1077 E. Arques Ave., Sunnyvale, Calif. Phone: (408) 732-3800.

Designed for converting computer-generated data into filmed alphanumeric printout or graphical plots at computer speeds, a new modular microfilm plotter can adapt to many on-line or off-line uses. Because of its modular design concept, the APD-5000 is able to satisfy individual requirements without cost for unnecessary features.

Booth No. 611 Circle No. 257

SPACE SAVERS!

BARNES 041 SERIES PRODUCTION-MOUNTING SOCKETS FOR MAXIMUM "TO" TRANSISTOR PACKING DENSITY



Want to socket-mount your transistors on P. C. boards? Pack them tightest with the new Space Savers from Barnes. These miniature production-mounting sockets feature extremely low profiles and small diameters for maximum packing density. Double wiping contacts assure reliable electrical contact, positive device retention. Temperature ranges from -55°C to 150°C . The low-cost Space Savers from Barnes: Write or call for free samples and more data.



Lansdowne, Pa. 19050 • 215/MA2-1525

barnes / THE FIRST WORD IN CARRIERS, CONTACTORS AND SOCKETS FOR I.C.'S

INFORMATION RETRIEVAL NUMBER 124

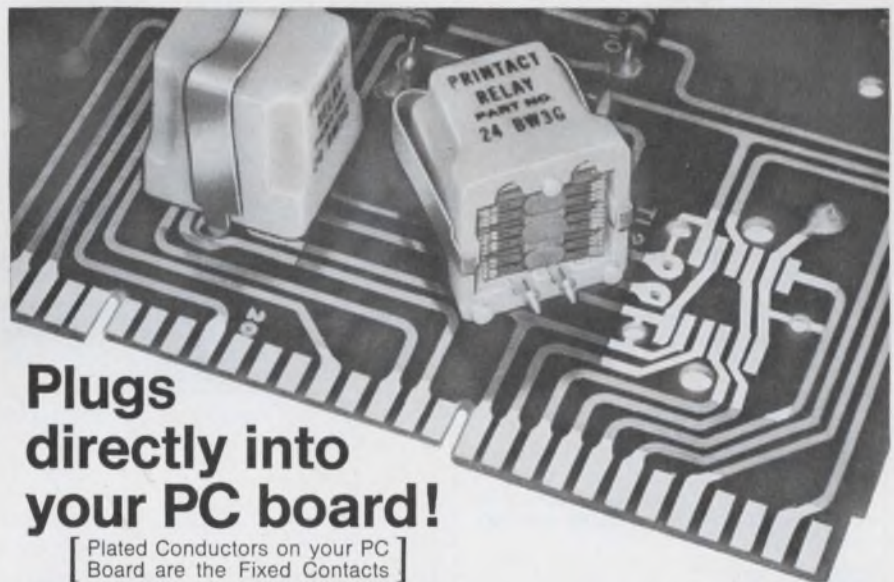

Plugs directly into your PC board!

[Plated Conductors on your PC Board are the Fixed Contacts]

Printact® Latching and Non-Latching MAGNETIC RELAYS

Designed for reliability and switching versatility, the Printact is a unique relay. The coil and ceramic magnet are encapsulated in a $\frac{3}{8}$ " cube for environmental protection. The magnet returns the balanced armature and applies contact pressure. In-line, series-break swingers afford constant impedance, low thermal EMF, and 100,000,000 cycle mechanical life.

Bifurcated contacts, gold alloy or palladium, provide low contact resistance and bounce for switching low level or up to 2 amp. PC board layouts provide up to 4 Form C or 8 pole single throw (4 Form A and 4 Form B) switching. Coils for 6, 12, 24 and 48 VDC are rated 0.5 watt.

For data write or call 212-EX 2-4800.

Printact Relay Division, Executone, Inc., Box 1430, Long Island City, N.Y. 11101

INFORMATION RETRIEVAL NUMBER 125

condenser products
has capability,
reliability, versatility ...



Special OEM designs to suit customer applications and space limitations. A wide range of voltages, capacities and constructional styles available to meet your specifications.

for all your high voltage
component needs.

DC FILTER CAPACITORS

Miniature glass — 1 to 50 KV standard; Rugged bakelite — 40 to 150 KV standard; CP70 type — 600 V to 50 KV standard.

TRANSMITTING CAPACITORS

Pulse or RF Series — 1 to 30 KV standard. Temperature ranges up to 210°C without derating.

LABORATORY AND INSTRUMENTATION CAPACITORS

Glass or CP70 containers to 60 KV at 0.1 mfd.

HIGH VOLTAGE POWER SUPPLIES

Modular compact and capacitor charging — output from 1 to 75 KV standard. OEM specials promptly quoted.

PULSE FORMING NETWORKS

Designed to your specifications and applications.

ULTRA LOW INDUCTANCE CAPACITORS

For laser, simulation and spark discharge technology.

Call or write for complete technical information. Special requirements tailored to your applications and specifications are promptly quoted.



**CONDENSER
PRODUCTS
CORPORATION**

Box 997, Brooksville, Florida
Phone: 904-796-3562
California: 213-391-1641
New York: 212-245-3866

SJCC PRODUCTS

Small computer adds in 7.2 μ s

*Elbit Computers Ltd., 86-88 Hagi-
borim St., Haifa, Israel. P&A:
from \$4900; 75 to 90 days.*

Capable of interfacing with up to 256 channels of input/output equipment, a new small digital computer is a 12-bit single address fixed-word-length machine with an add time of 7.2 μ s. Model U of the series 100 family has a central processor with 1024 words of core memory and a 2- μ s cycle time. It also features self-contained power supplies, power fail protection, automatic restart, and interface to a Teletype ASR 33.

Booth No. 804 Circle No. 250

CRT display system shows dynamic images



*Adage Inc., 1079 Commonwealth
Ave., Boston, Mass. Phone: (617)
783-1100.*

Designed for use in interactive graphics applications, a new general-purpose CRT display system incorporates its own internal computer and a matrix multiplier subsystem to produce dynamic three-dimensional displays that can be translated, rotated and scaled continuously. Model AGT/50 can be connected to a central computer system without presenting an excessive burden on the response time and arithmetic capabilities of the central system.

Booth No. FF Circle No. 282

CRT display terminal shows 1030 characters



*Stromberg Datagraphics, Inc. P.O.
Box 2449, San Diego, Calif. Phone:
(714) 298-8331. Price: from \$8500.*

Presenting flicker-free characters in a single action, a new on-line CRT display terminal accommodates 1030 characters on its 10-in.-square viewing screen. There are up to 80 characters per line with a size of 0.126-in. high by 0.07-in. wide. Operating at 50 frames per second, the DatagraphiX has a format control for fixed and variable information, including split-screen operations.

Booth No. E5 Circle No. 253

Data entry system stores 10⁷ bits



*Jonker Corp., 26 N. Summit Ave.,
Gaithersburg, Md. Phone: (301)
948-9440. P&A: \$17,850; 30 days.*

Able to serve as a completely independent information retrieval center, a new automatic data entry system can store up to 10 million bits of information in only a cubic foot of space. Model J410 can retrieve or store any of this information within two minutes. The system consists of an input, a control console, and a punched card reader.

Booth No. H2 Circle No. 275

Pick the
BEST IC
for the job

Problem: Four DC to 30 kHz signals from high impedance sources must be summed into a $2k\Omega$, 100 pF load. The output is to be a guaranteed minimum ± 12 volts over the full frequency and military temperature range. The logical choice would be a Radiation RA-909. But amplifier offset current drift must not exceed $2 \text{ nA}/^\circ\text{C}$. Pick the Best IC for the job.

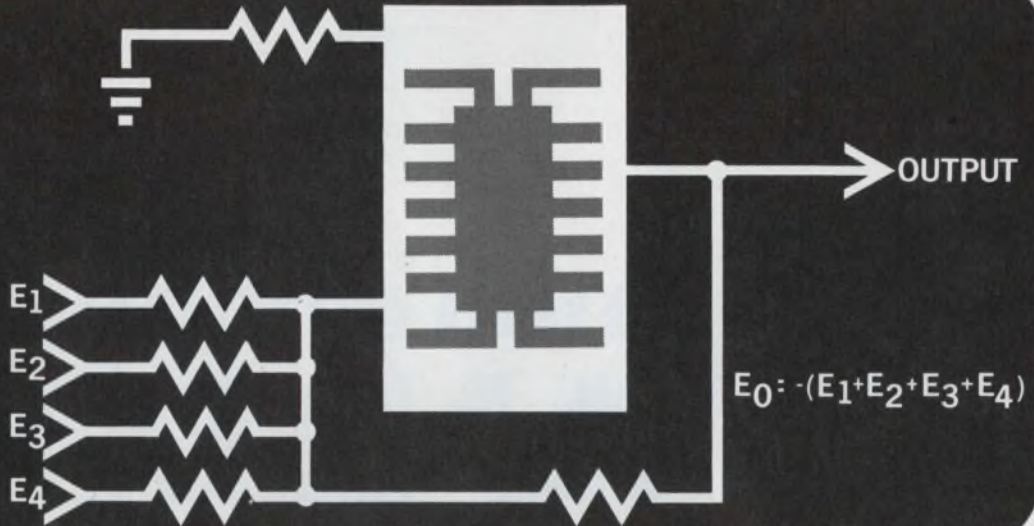

the **BEST** Solution:

THE NEW RA-909A COMPENSATIONLESS OPERATIONAL AMPLIFIER



Drift error is very low in the new dielectrically isolated compensationless RA-909A. Between -55°C and $+25^\circ\text{C}$ offset current drift is a low $2 \text{ nA}/^\circ\text{C}$. From $+25^\circ\text{C}$ to $+125^\circ\text{C}$... an even lower $0.5 \text{ nA}/^\circ\text{C}$! And Radiation guarantees less than $15 \mu\text{V}/^\circ\text{C}$ offset voltage drift over the military temperature range. Compare this performance with any 709 type op amp over this extremely wide operating frequency range. You'll pick the Best op amp for the job. The RA-909A.

Like the RA-909, no external compensation is needed. Dielectric isolation and good circuit design eliminates the need for compensation. The RA-909A is in both a TO-99 package and a TO-86 flatpack configuration. A direct replacement for 709 type op amps.

Contact your nearest Radiation sales office. Let us help you pick the Best IC for the job.

WE MAKE THE **BEST** IC FOR THE JOB



RADIATION
INCORPORATED

SUBSIDIARY OF HARRIS-INTERTYPE CORPORATION

MICROELECTRONICS DIVISION

RADIATION SALES OFFICES: P. O. Box 476, Lexington, Mass. 02173, (617) 862-1055 • 600 Old Country Road, Garden City, N.Y. 11530, (516) 747-3730 • 2600 Virginia Ave. N.W., Washington, D.C. 20037, (202) 337-4914 • 6151 W. Century Blvd., Los Angeles, Calif. 90045, (213) 670-5432 • Saratoga, Calif., (408) 253-5058 • P. O. Box 37, Melbourne, Fla. 32901, (305) 727-5430 • International Sales: Marketing Department, P. O. Box 37, Melbourne, Fla. 32901, (305) 727-5412

INFORMATION RETRIEVAL NUMBER 127



multichannel
**ANALOG
SWITCHES
& OP AMPS**
for data
transmission
systems

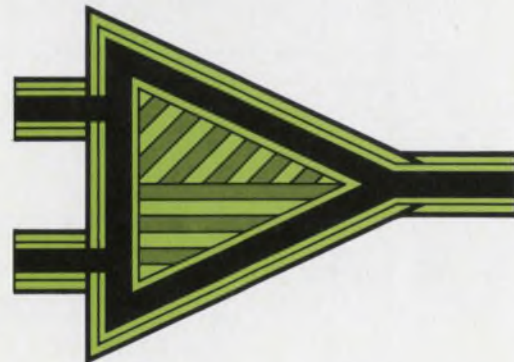

* Applications Power: A wide variety of driver/FET switch combinations and an in-depth applications team waiting to serve you!

Siliconix offers over 32 integrated driver/switch combinations particularly suited to data transmission systems. Choose from a wide variety of junction or MOS FET switches, depending on your system requirements. These, combined with a Siliconix OP AMP, can be applied to a great variety of data transmission requirements.

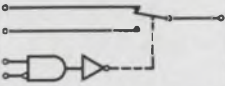
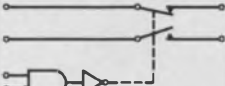
Functional Description	Type	Max. $r_{DS(ON)}$ (ohms)	Switch Type
SPDT 1-CHANNEL 	DG136	600	PMOS
	SI3002	600	PMOS
SPDT 1-CHANNEL 	DG113	600	PMOS
	143	80	N
	144	30	N
	146	10	N

A number of switches with the ON resistance ranges best suited to your application are available from Siliconix. These driver-switches accept standard DTL, RTL, and TTL logic control inputs.

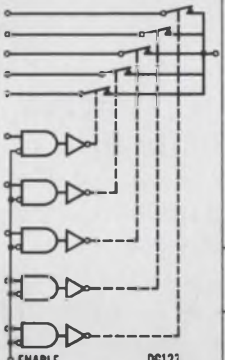
Functional Description	Channels	Type	Max. $r_{DS(ON)}$ (ohms)	Switch Type
	2	DG102	100	N
		103	100	N
		104	100	N
		110	600	PMOS
		111	600	PMOS
		112	600	PMOS
		133	30	N
		134	80	N
		141	10	N
		147	600	PMOS
		148	40	PMOS
		4	DG116	600
118	600		PMOS	
5	DG123	600	PMOS	
	125	600	PMOS	

System requirements will dictate which of the above combinations are best for your multiplexer combination.

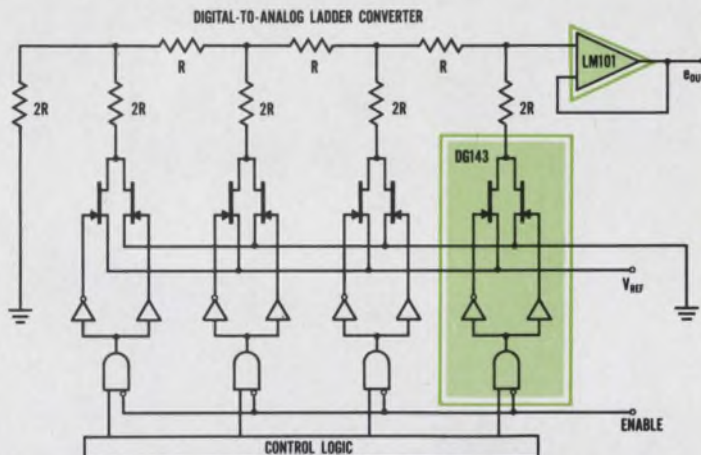

We recommend Junction FETs for this popular digital to analog converter, but if you prefer MOS FETs, we have them, too.

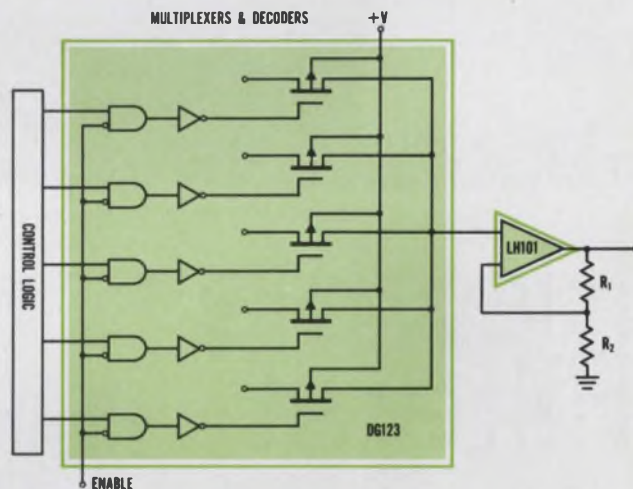

Only one TO-86 package is required to accomplish the above switching functions. Packages include switch drivers that accept standard DTL, RTL, or TTL logic signals.

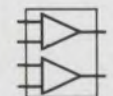
SILICONIX OP AMPS	Max. input offset voltage -55 to +125°C	Max. input current	Min. open loop gain	Output voltage swing	Slew rate	
 LM 101 LH 101 (Internally compensated)	6 mV	200 nA	50K	±12V	.25V/μsec.	<ul style="list-style-type: none"> • Operation from ±5 to ±20V power supplies • Low current drain • Continuous short circuit protection • Same pin configuration as 709 amplifier
 L 120	200 mV	50 pA	100	±12V	20V/μsec.	<ul style="list-style-type: none"> • Low input leakage • High slew rate • Unity gain stable • Ideal for sample and hold, integrating and fast voltage comparisons

Working on data transmission? Write today for complete information on all Siliconix FET switch combinations and OP AMPS.

For instant applications assistance, call the number below. Ask for Extension 19.

 **Siliconix incorporated**
 1140 West Evelyn Ave. • Sunnyvale, Calif. 94086
 Telephone (408) 245-1000 • TWX 910-339-9216

INFORMATION RETRIEVAL NUMBER 128

double take!



MICRODYNE'S NEW IC TESTER TAKES SIMULTANEOUS D.C. and FUNCTIONAL MEASUREMENTS

Want to production test digital IC's faster and more accurately? Automatic Model 721 makes 1024 sequential D.C. and functional measurements in less than 100 μ s. Tests 5000 IC's a shift, with accuracy of 1.5%! Readout with go/no-go lamps and 3-digit volt/current meter for out of tolerance value. Program matrix card. Use coupon for more data.

MICRODYNE

Please send me Model 721 Bulletin.

NAME _____

TITLE _____

COMPANY _____

ADDRESS _____

CITY _____ STATE/ZIP _____

Dept. ED-26

SUBSIDIARY OF COMPUTEST CORP.

MICRODYNE

MICRODYNE INSTRUMENTS, INC.

203 Middlesex Tpk. • Burlington, Mass. 01803

Phone: 617/272-5691

INFORMATION RETRIEVAL NUMBER 129

Flexible Filters!



Or should we say flexible filter design. If you have an application for passive, active, digital or hybrid networks, contact us for an objective evaluation. Let our computer program library offer you a choice of optimum designs to your specifications.

P.S. We also design and manufacture a line of solid state function modules, multipliers and dividers that are pretty flexible too. Browsers welcome.



NU-DEVICES, INC.

18 MARSHALL STREET,
NORWALK, CONN. 06854
(203) 853-3410

INFORMATION RETRIEVAL NUMBER 130

C56

YOUR HEART FUND FIGHTS

HEART ATTACK
STROKE
HIGH BLOOD PRESSURE
INBORN HEART DEFECTS



SJCC PRODUCTS

Alphanumeric display superimposes graphics

Monitor Systems, an Aydin Co.,
401 Commerce Dr., Fort Washington,
Pa. Phone: (215) 646-8100.
P&A: from \$6300; 90 days.

Converting coded inputs into standard TV signals for transmission, a new display terminal allows alphanumeric and graphic information to be superimposed on its viewing screen. Model 8200 accommodates 32 24-character rows and has a 256 by 240 dot array for graphics. Compatible with standard data modems, it can be used for computer-aided design, information retrieval, or as a time-sharing terminal.

Booth No. E3 Circle No. 251

Two memory systems interface computers

Bryant Computer Products, 850
Ladd Rd., Walled Lake, Mich.
Phone: (313) 868-3900.

A compact, low-cost memory system (CLC-1) is a 1.2 million bit capacity, 10-inch, magnetic memory drum system with serial write/read/select electronics. The CLC-1 fits easily into a standard 19-inch relay rack and its small size, large capacity, low cost, and high transfer rate of 2.2 million bits-per-second makes the CLC-1 ideal for a variety of systems applications. Also being shown is a compact positioning head drum system, model CPhD, that features a storage capacity of 900,000 8-bit characters accessible in an average time of 60 ms. An important feature is the head pad arrangement, where eight write/read heads are mounted on one head pad. The result is compactness and economy for the end user. Like the CLC-1 the CPhD is ideally suited for small and medium size data processing applications. Both the CLC-1 and the CPhD can be interfaced to almost any computer system.

Booth No. 4 Circle No. 261

ELECTRONIC DESIGN 9, April 26, 1969

So what if Grant Slides save hours of down time?

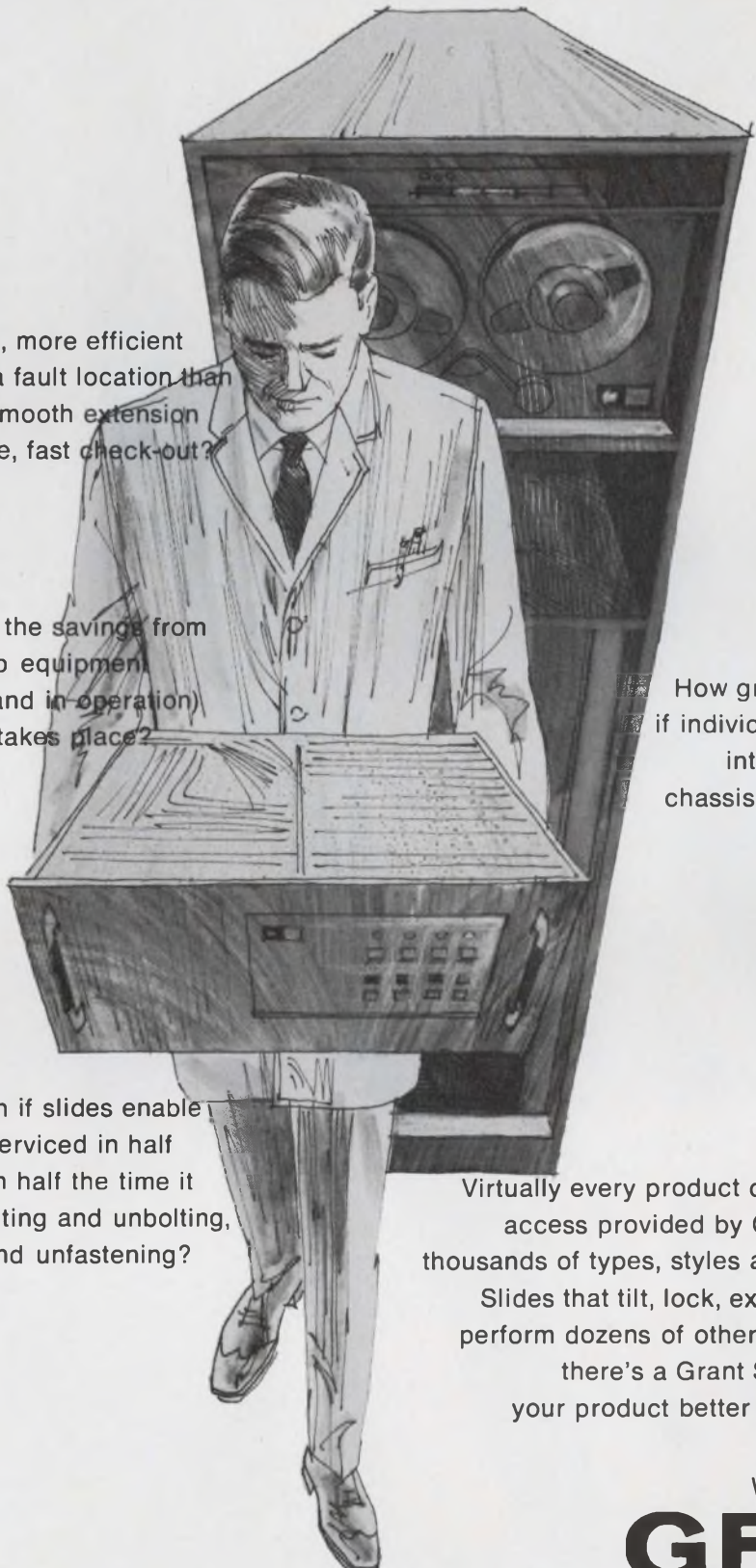

Is there a quicker, more efficient way to get to a fault location than by immediate and smooth extension of the unit for simple, fast check-out?

Would you guess the savings from being able to keep equipment connected (and in operation) while maintenance takes place?

How great is the value of slides if individual chassis' can be interchanged with similar chassis' in moments?

What's it worth if slides enable equipment to be serviced in half—or less than half the time it ordinarily takes bolting and unbolting, fastening and unfastening?

Virtually every product can use the ready access provided by Grant Slides. There are thousands of types, styles and sizes available. Slides that tilt, lock, extend and lock and perform dozens of other functions. Undoubtedly, there's a Grant Slide that can help make your product better too.

Write for complete data.

GRANT
PULLEY & HARDWARE CORPORATION

EASTERN DIVISION: 21 HIGH STREET, WEST NYACK, NEW YORK 10994
WESTERN DIVISION: 944 LONG BEACH AVE., LOS ANGELES, CALIF. 90021

INFORMATION RETRIEVAL NUMBER 131



For environmental protection . . . silicone encapsulating resins

Whatever the operating conditions — heat, cold, moisture, or other harsh environments . . . there's a Dow Corning silicone encapsulating resin to provide protection for your electronic equipment.

Sylgard® brand encapsulating resins from Dow Corning are ideally suited for filling, potting, coating, impregnating and embedding. Processing flexibilities include room

temperature cure, heat accelerated cure, one-part and two-part systems. All provide these unique properties:

- cure in thick section without reversion
- no damaging exotherm during cure
- are self-extinguishing
- provide excellent dielectric strength
- have excellent resistance to moisture, ozone and oxygen

- maintain constant physical and electrical properties from — 65 to 200 C or better
- excellent thermal shock resistance

Regardless of your encapsulating protection problems . . . Dow Corning offers a silicone resin to meet your needs. Find out by writing Dept. F-8474, Dow Corning Corporation, Midland, Michigan 48640, or call 517-636-8940.

DOW CORNING

DOW CORNING

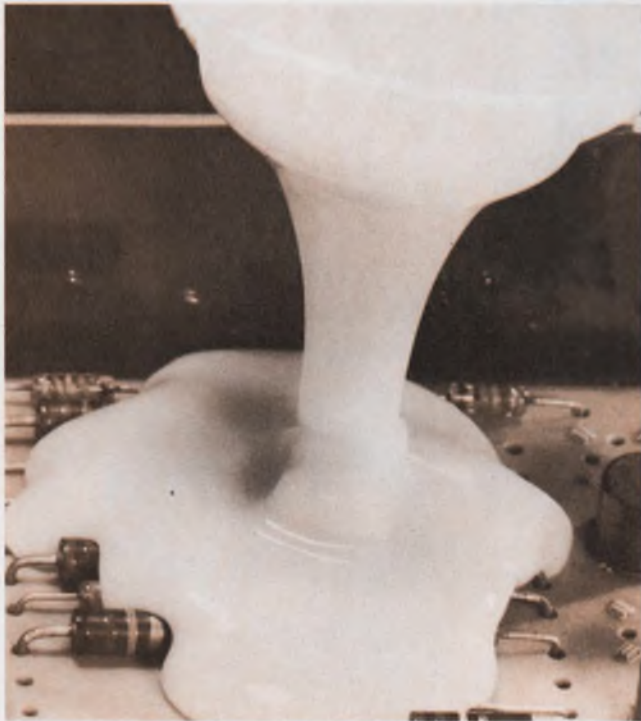

New premixed, ready-to-use white Sylgard silicone encapsulating resin flows freely around components and provides virtually unlimited working time at room temperature . . . cures in one hour at 135 C and in two hours at 100 C . . . no post cure required . . . no reversion . . . low water absorption . . . self-extinguishing.

New shock absorbing Sylgard silicone resins are ideal encapsulants for delicate electronic equipment subject to high G shock loads and continuous vibration. These low bayshore materials dampen out external forces with little internal reaction . . . available in either clear or black . . . deep section cure without reversion.



Why Make A Big Thing Of It?

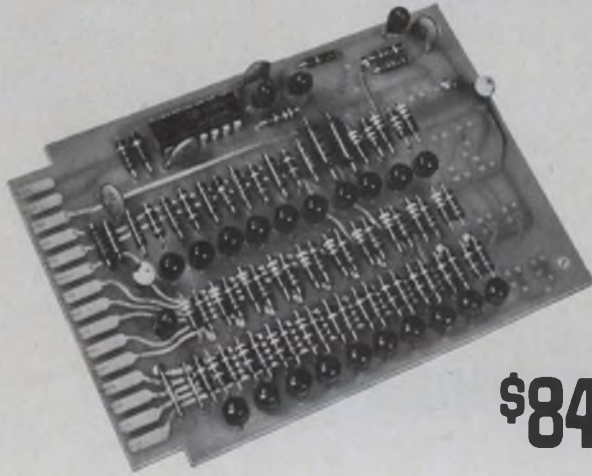

\$84.40*

This 10-Bit D/A Converter is Small. And Small-Priced.

It also features very small power consumption. And small output impedance. You probably could build it yourself. But why bother, when Computer Products can make it better, smaller, faster, and at less cost to you?

This is one of Computer Products' new DA025 series — 18 variations of D/A converter units with 8, 10 or 12-bit resolution, packaged on printed circuit cards measuring only 2.75 x 4 inches. Six analog output ranges to ± 10.24 V into 1K ohm load (10.24 MA); output can drive up to 300 feet of twisted pair cable.

Up to 16 converters and all necessary DC power supplies can be packaged in a standard 19-inch chassis, requiring only 3.5 inches vertical rack space.

LOW PRICES

QUANTITY	1-3	4-9	10-29	30-99	100-up
DA225A thru F (8 bits binary)	\$89.40	\$79.60	\$70.40	\$66.30	\$63.20
DA025 Series DA425A thru F (10 bits binary)	\$103.90	\$93.60	*\$84.40	\$79.30	\$75.20
DA625A thru F (12 bits binary)	\$117.90	\$107.60	\$98.40	\$93.30	\$89.20

Write or call for complete information and specifications. We'll also be glad to send you full details on our DA231 Series of 8-bit D/A converters with internal storage. Ask for bulletins PL005-025 and PL005-231A. Shipment 3 weeks ARO.

Computer Products, Inc., 2801 E. Oakland Park Blvd.
Fort Lauderdale, Fla. 33306 • Phone: 305/565-9565



**COMPUTER
PRODUCTS™**

FORT LAUDERDALE

INFORMATION RETRIEVAL NUMBER 133

SJCC PRODUCTS

Magnetic tape transport accepts 300-ft cassettes



Sykes Datatronics, 375 Orchard St., Rochester, N.Y. Phone: (716) 458-8000. P&A: \$2500; June.

A cassette-loaded, magnetic tape transport has comprehensive software packages and complete electrical interfaces for the small DEC, Data General and Varian computers. Compu/Corder uses a 3/8-by 2-1/2-by 4-in. reel-to-reel cassette, containing up to 300 feet of 1/7-in.-wide, 3/4-mil computer-certified magnetic tape. Read/write transfer rates are 5000 bits per second, and rewind speed is 110 inches per second.

Booth No. E12 Circle No. 270

Off-line tape reader boosts I/O capability

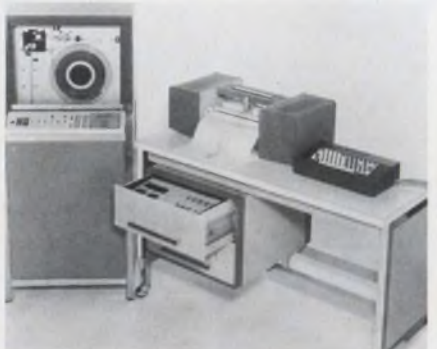

Houston Instrument, div. of Bausch & Lomb, 4950 Terminal Ave., Bellaire, Tex. Phone: (713) 667-7403. P&A: \$11,000, 30 days.

The MTR-9 Complot magnetic tape reader uses a buffered tape unit to increase its input/output capability. High-speed search with block selection is standard; a control panel readout indicates the block being plotted.

Booth No. 601 Circle No. 256

How a lab wallflower, measuring ohms at 10 ppm, has blossomed in the field:

news and innovations in metrology **e|s|i**

Upgrading of accuracy by resistor manufacturers has made a triple-threat star out of our newest general purpose Resistance Measuring System—the Model 242C. It's "flown the coop" (standards lab) for bigger things in the production and engineering departments or wherever resistors need to be checked to 10-ppm-or-better in batches.

By delivering 10 ppm direct-reading accuracy over a wide range and 1-ppm comparison accuracy—all in an exceptionally easy-to-operate console—we apparently have discovered a flexible answer for which both makers and buyers of precision resistors have found a need.

The 242C is simple enough for batch testing on a GO-NO-GO basis (meter deflection without bridge adjustment). Or if you prefer to read percent deviation from nominal value, you do so with a one-dial adjustment. Then when the perfectionist has a need, he can resolve actual value of a resistor to 10 places (with 8 decades plus a vernier). And when calibrated against ESI standards, comparisons can be made to 0.1 ppm with accuracy directly traceable to the National Bureau of Standards.

The 242C is the latest in a 10-year model series of general purpose Kelvin bridge systems, which owe their accuracy, dependability and wide range (10

milliohms to 120 megohms) to a unique guarding and lead compensation technique. Trimmable ratios and decades in our new "C" model simplify calibration for any production environment—even yours. Price \$5500.

ESI's portable lab—the 300A PVB® that measures "everything"—now 0.01%

We call it our little portable lab—and indeed it's all of that with measurement capability for seven different electronic functions. It's a potentiometric voltmeter, a precision voltage source, ammeter, guarded Kelvin bridge, resistance comparison bridge, ratiometer, electronic null detector, pH indicator, temperature bridge, meter calibrator, components tester and more—with the addition of several plug-in accessories.

Our news is that accuracy on the Model 300A PVB has been improved to .01% on all functions and ranges. And yet the basic 300A PVB package sells for only \$1045.

As with the proven 300 PVB, the Model 300A affords the user 5 dc-voltmeter ranges to 511.10 volts with 1 microvolt minimum steps, 8 ammeter ranges to 5.1110 amperes with 10 pA minimum steps and 10 resistance ranges to 511.10 MΩ with 10 microhm minimum steps and it's completely portable with typical one-year battery life.

Applications include potentiometric temperature measurement, calibration of recorder controllers, dc voltmeters and ammeters, X-Y recorders, analog computing elements, checking of dc power supplies, measurement of chemically generated potentials and calibration of resistance thermometers and thermocouples.

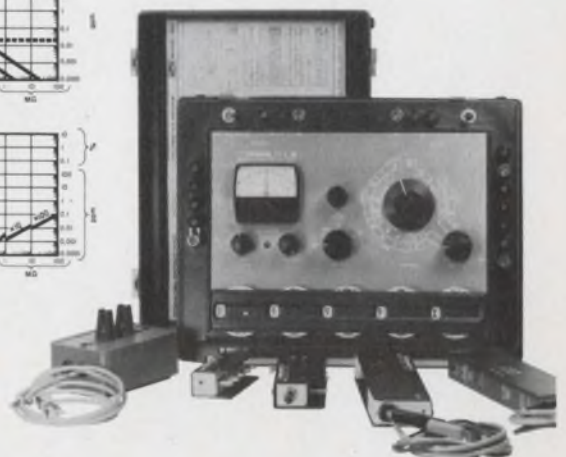
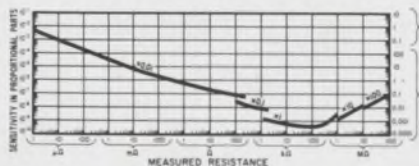
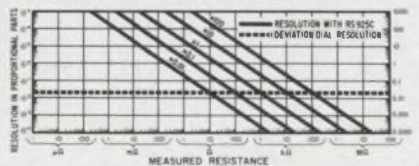
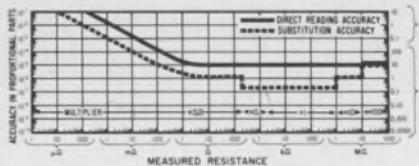

e|s|i®

ELECTRO SCIENTIFIC INDUSTRIES, INC.

13900 N.W. SCIENCE PARK DRIVE • PORTLAND, OREGON 97229

**If you like
the IBM 1800 or 1130
and want a totally
software compatible computer
at compact prices... see**



GENERAL AUTOMATION, INC.
Automation Products Division,
706 West Katella, Orange, Calif. (714) 633-1091

See the 18/30 at the SJCC — Booth 801

the new GA 18/30 from General Automation

Here's a new industrial computer system completely software compatible with IBM's 1800 and 1130. This program compatibility allows you, the IBM 1800 and 1130 user, to apply your experience to automation projects throughout your company.

With this compatibility you can take advantage of your software investment and add compatible computer power at less than 40% of the cost of IBM equipment.

For sheer computer power, the new GA 18/30 processor executes over 400,000 instructions per second, has an 18-bit (including parity and protection) word length, and a 960-nanosecond directly addressable memory available from 4K to

32K. The GA 18/30 has 16 GP hardware registers with an extra-powerful class of register-to-register commands.

The GA 18/30 system includes data processing, communication, and process I/O. The data processing I/O includes magnetic paper tape, discs, cards, printers and plotters. The process I/O includes — analog, digital, communications and contacts.

With its low cost and early delivery the new GA 18/30 will allow you to immediately undertake new automation projects.

We have all the facts and figures on the GA 18/30 in a new brochure. Write for it today.

Sales Offices: Waltham, Mass. (617) 899-6170 • Willow Grove, Pa. (215) 657-2657 • New Rochelle, N.Y. (914) 235-9300 • Eau Gallie, Fla. (305) 727-3205 • Wheeling, Ill. (312) 537-3500 • Cleveland, O. (216) 333-8366 • Dallas, Tex. (214) 358-0271 • Los Altos, Calif. (415) 941-5966 • Orange, Calif. (714) 633-1091

Recording heads prolong tape life



Applied Magnetics Corp., 75 Robin Hill Rd., Goleta, Calif. Phone: (805) 964-4881.

Compatible with 1/2-in. computer tape formats, digital magnetic recording heads insure maximum protection for tape surfaces as well as extended operating life. Both seven and nine-track versions are available. Features include a tilt held to within 0.00015 in. Booth No. 702 Circle No. 279

Special computer minimizes software



Sanders Associates, Inc., 95 Canal St., Nashua, N.H. Phone: (603) 885-2814.

Designated as Sandac 200, a new high-speed programmable communications processor with 256 input/output terminals can operate simultaneously with a variety of peripheral devices such as display terminals, hard copy and paper-tape machines. Developed for real-time data applications, this special computer features hardware that automatically performs functions previously requiring complex programming.

Booth No. BB Circle No. 276

Compact core memory stores over 655 kbits



Fabri-Tek Inc., 5901 S. County Rd. 18, Minneapolis, Minn. Phone: (612) 935-8811. Price: 6¢/bit.

Including its integral power supply and self-test module, model 380 high-speed compact memory system offers a storage capacity of 655,360 bits in only 10.5 inches of panel height. The on-line plug-in self-test module, which is removable as a separate subassembly, automatically sequences through its four test patterns with a 40-bit data display and a 14-bit address display.

Booth No. 2601 Circle No. 255

The Perfect Match

... Like this

50 ohm

SIGNAFLO[®]

Transmission Line System

And we mean 50 ohms end to end! Ground planes in multilayer connector boards*, and flat, flexible cable (that's flame-retardant too) produce a complete, perfectly matched 50 ohm Signaflo transmission line system . . . no coax, no twisted pairs. We'll match you impedance for impedance. Try us.

*produced by the Ansley Division of aci Incorporated

aci

SIGNAFLO[®]

SYSTEMS

INCORPORATED

206 Industrial Center, Princeton, N.J. 08540

AVAILABLE NOW!

ITT DTL INTERCHANGEABILITY GUIDE



To make it easier for you to specify ITT Semiconductors, we've prepared this comprehensive DTL cross-reference. You'll find that it lists the ITT part numbers as well as the part numbers of other leading manufacturers.

14-LEAD CERAMIC DUAL IN-LINE PACKAGE

CIRCUIT FUNCTION	ITT	FSC	Motorola*	TI*	Philco	Stewart Warner
Dual 4-Input NAND/NOR Gate w/Expander	MIC930-1D	U6A993051X	N/A	SN15930N	PD993051	SW930-1P
Dual 4-Input NAND/NOR Buffer w/Expander	MIC932-1D	U6A993251X	N/A	SN15932N	PD993251	SW932-1P
Dual 4-Input AND Expander	MIC933-1D	U6A993351X	N/A	SN15933N	PD993351	SW933-1P
Hex Inverter	MIC936-1D	U6A993651X	N/A	SN15936N	PD993651	SW936-1P
Hex Inverter	MIC937-1D	U6A993751X	N/A	SN15937N	PD993751	SW937-1P
Dual 4-Input NAND/NOR Power Gate w/Expander	MIC944-1D	U6A994451X	N/A	SN15944N	PD994451	SW944-1P
RS/JK Clocked Flip-Flop	MIC945-1D	U6A994551X	N/A	SN15945N	PD994551	SW945-1P
Quad 2-Input NAND/NOR Gate (6K)	MIC946-1D	U6A994651X	N/A	SN15946N	PD994651	SW946-1P
RS/JK Clocked Flip-Flop	MIC948-1D	U6A994851X	N/A	SN15948N	PD994851	SW948-1P
Quad 2-Input NAND/NOR Gate (2K)	MIC949-1D	U6A994951X	N/A	SN15949N	PD994951	SW949-1P
Pulse Triggered Binary Monostable Multivibrator	MIC950-1D	U6A995051X	N/A	SN15950N	PD995051	SW950-1P
Monostable Multivibrator	MIC951-1D	U6A995151X	N/A	SN15951N	PD995151	SW951-1P
Dual 4-Input NAND/NOR Gate w/Expander (2K)	MIC961-1D	U6A996151X	N/A	SN15961N	PD996151	SW961-1P
Triple 3-Input NAND/NOR Gate (2K)	MIC962-1D	U6A996251X	N/A	SN15962N	PD996251	SW962-1P
Triple 3-Input NAND/NOR Gate (2K)	MIC963-1D	U6A996351X	N/A	SN15963N	PD996351	SW963-1P
Dual J-K Flip-Flop	MIC9093-1D	U6A909351X	N/A	SN159093N	PD909351	SW705-1P
Dual J-K Flip-Flop	MIC9094-1D	U6A909451X	N/A	SN159094N	PD909451	SW708-1P
Dual J-K Flip-Flop	MIC9097-1D	U6A909751X	N/A	SN159097N	PD909751	SW709-1P
Dual J-K Flip-Flop	MIC9099-1D	U6A909951X	N/A	SN159099N	PD909951	SW706-1P

CIRCUIT FUNCTION	ITT	FSC	Motorola*	TI*	Philco	Stewart Warner
Dual 4-Input NAND/NOR Gate w/Expander	MIC930-5D	U6A993059X	MC830P	SN15830N	PD993059	SW930-2P
Dual 4-Input NAND/NOR Buffer w/Expander	MIC932-5D	U6A993259X	MC832P	SN15832N	PD993259	SW932-2P
Dual 4-Input AND Expander	MIC933-5D	U6A993359X	MC833P	SN15833N	PD993359	SW933-2P
Hex Inverter	MIC936-5D	U6A993659X	MC836P	SN15836N	PD993659	SW936-2P
Hex Inverter	MIC937-5D	U6A993759X	MC837P	SN15837N	PD993759	SW937-2P
Dual 4-Input NAND/NOR Power Gate w/Expander	MIC944-5D	U6A994459X	MC844P	SN15844N	PD994459	SW944-2P
RS/JK Clocked Flip-Flop	MIC945-5D	U6A994559X	MC845P	SN15845N	PD994559	SW945-2P
Quad 2-Input NAND/NOR Gate (6K)	MIC946-5D	U6A994659X	MC846P	SN15846N	PD994659	SW946-2P
RS/JK Clocked Flip-Flop	MIC948-5D	U6A994859X	MC848P	SN15848N	PD994859	SW948-2P
Quad 2-Input NAND/NOR Gate (2K)	MIC949-5D	U6A994959X	MC849P	SN15849N	PD994959	SW949-2P
Pulse Triggered Binary Monostable Multivibrator	MIC950-5D	U6A995059X	MC850P	SN15850N	PD995059	SW950-2P
Monostable Multivibrator	MIC951-5D	U6A995159X	MC851P	SN15851N	PD995159	SW951-2P
Dual 4-Input NAND/NOR Gate w/Expander (2K)	MIC961-5D	U6A996159X	MC861P	SN15861N	PD996159	SW961-2P
Triple 3-Input NAND/NOR Gate (2K)	MIC962-5D	U6A996259X	MC862P	SN15862N	PD996259	SW962-2P
Triple 3-Input NAND/NOR Gate (2K)	MIC963-5D	U6A996359X	MC863P	SN15863N	PD996359	SW963-2P
Dual J-K Flip-Flop	MIC9093-5D	U6A909359X	MC853P	SN158093N	PD909359	SW705-2P
Dual J-K Flip-Flop	MIC9094-5D	U6A909459X	MC856P	SN158094N	PD909459	SW708-2P
Dual J-K Flip-Flop	MIC9097-5D	U6A909759X	MC855P	SN158097N	PD909759	SW709-2P
Dual J-K Flip-Flop	MIC9099-5D	U6A909959X	MC852P	SN158099N	PD909959	SW706-2P

*Plastic

Get the interchangeable DTL circuits with the built-in differences, try ITT's top quality circuits.

- ITT DTL's are sealed in ceramic for long-term reliability. See for yourself how much better our quality is — put our truly hermetically ceramic packages on test.
 - ITT's DTL's are available — See for yourself how much better our response is — put us on test, give us the order.
- Call your local ITT Sales Office or Stocking Distributor today for the latest price and delivery information.
- Always call ITT when you need diodes, epoxy and glass rectifiers, 4-layer diodes, small signal silicon planar transistors, RF power transistors, and linear and digital integrated circuits.

ITT

semiconductors

ITT SEMICONDUCTORS IS A DIVISION OF INTERNATIONAL TELEPHONE AND TELEGRAPH CORPORATION, 3801 ELECTRONICS WAY, WEST PALM BEACH, FLORIDA 33411
 FACTORIES IN FLORIDA • MASSACHUSETTS • ENGLAND • FRANCE • GERMANY • PORTUGAL • AUSTRALIA

(TO-5 AND FLAT PACK LISTING ON REVERSE SIDE)

and we mean the parts
 as well as the literature

TO: ITT Semiconductors, Dept., I.S. — D
 3301 Electronics Way
 West Palm Beach, Fla. 33407
 305/842-2411

YES! Have Sales Representative call to discuss price and delivery
 Send me ITT DTL Interchangeability Guide.

NAME _____ TITLE _____
 COMPANY _____
 ADDRESS _____
 TELEPHONE _____ ZIP _____

We've re-invented the name is the same.

The unmechanical marvel.

We've uncomplicated the keyboard by getting rid of the mechanical linkages, the electromechanical parts, the moving contacts. And came up with a virtually trouble-free, all solid state design.

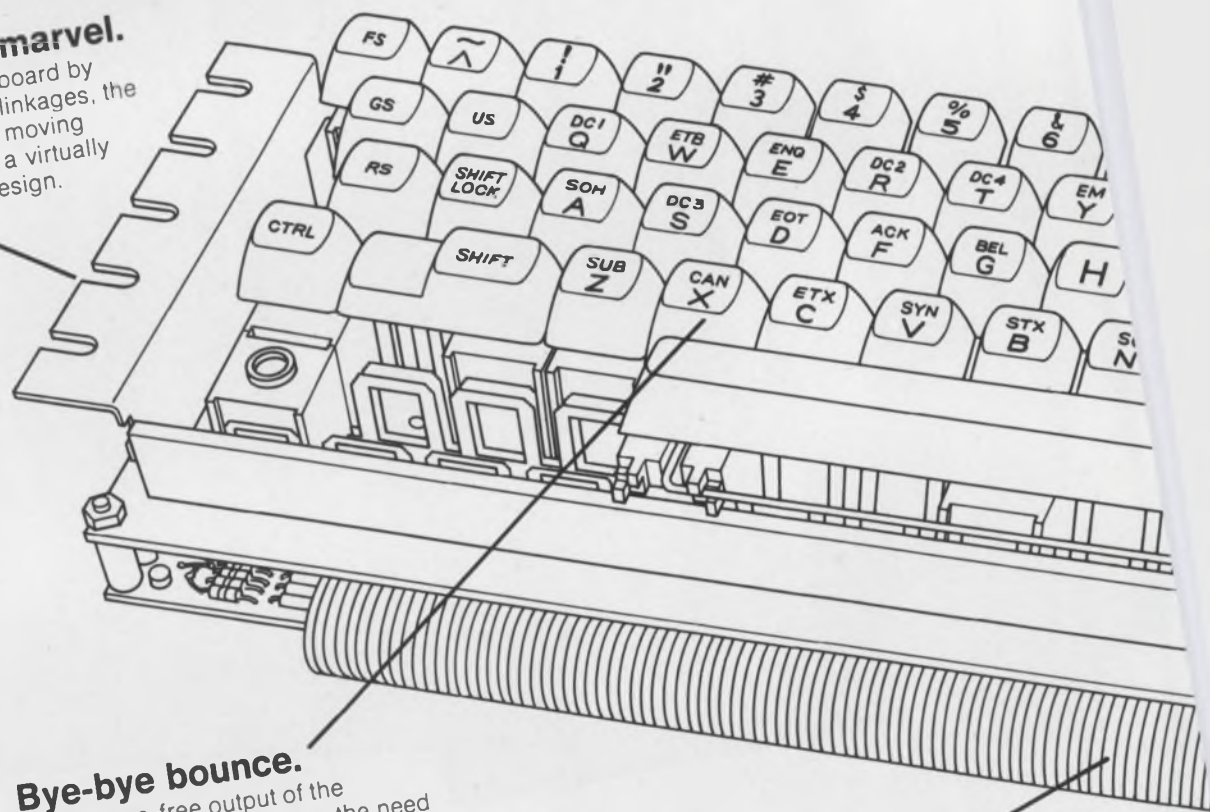

Bye-bye bounce.

The bounce-free output of the integrated circuit eliminates the need for any special interface circuitry to adapt it to your equipment. Just plug it in.

Pick a code.

We supply any 8-bit code (or less); hexadecimal; Baudot, BCD; USASCII mono-mode, dual-mode and tri-function; plus EBCDIC and custom codes.

keyboard. Only the

Solid state all the way.

The re-inventing started with the world's first application of an integrated circuit as a keyboard switching element. Actuated by a magnet on the key plunger, the integrated circuit delivers a digital output which is fed into the encoding matrix of the keyboard.

The \$100 understanding.

We agreed with you that a one hundred dollar volume price for an all solid state, assembled and encoded keyboard was ideal. And realistic. If we could get rid of the hundreds of moving parts and the big black box of buffer circuitry.

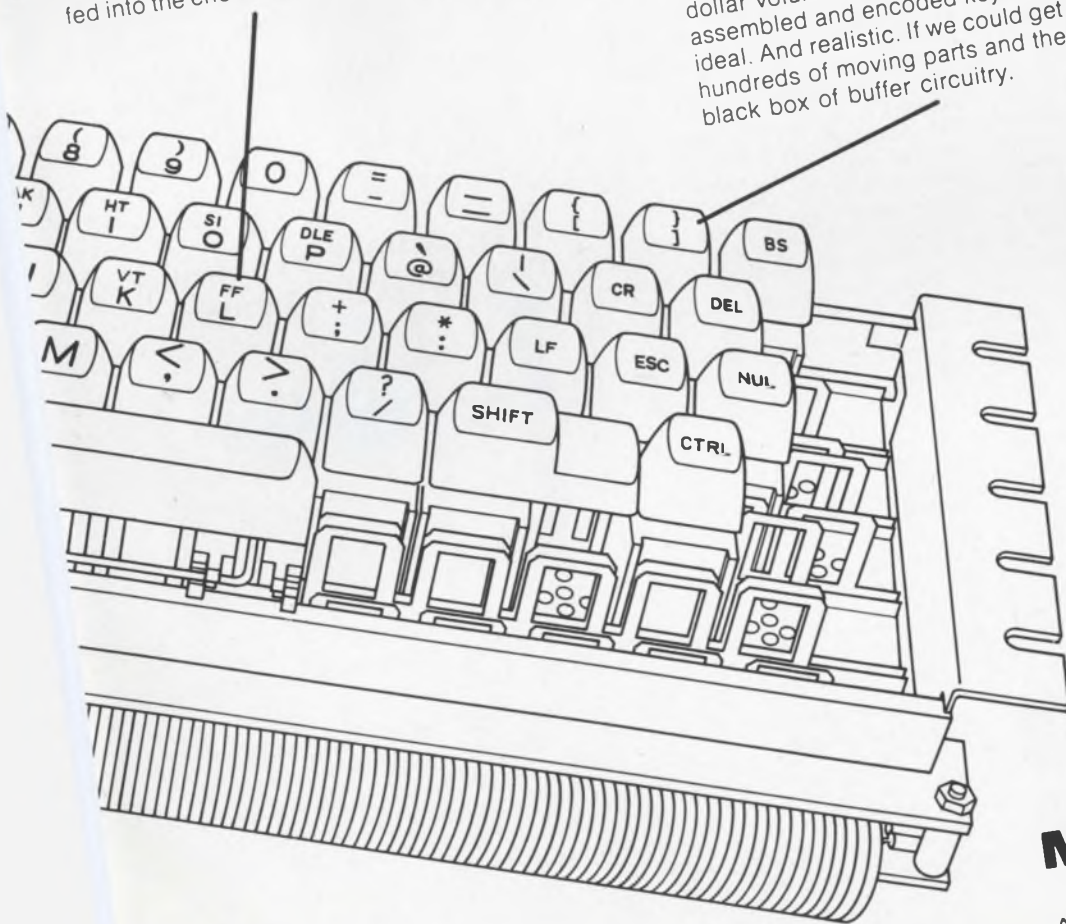

A good start.

Our handy "Condensed Keyboard Guide" briefly discusses keyboards and options to give you an idea of the broad offering that we already have available. MICRO SWITCH application engineers are ready to work with you in developing the most economical keyboard designs to meet your precise format and encoding needs.

MICRO SWITCH

FREEPORT, ILLINOIS 61032
A DIVISION OF HONEYWELL

INFORMATION RETRIEVAL NUMBER 138

CARDEC 125

SJCC PRODUCTS

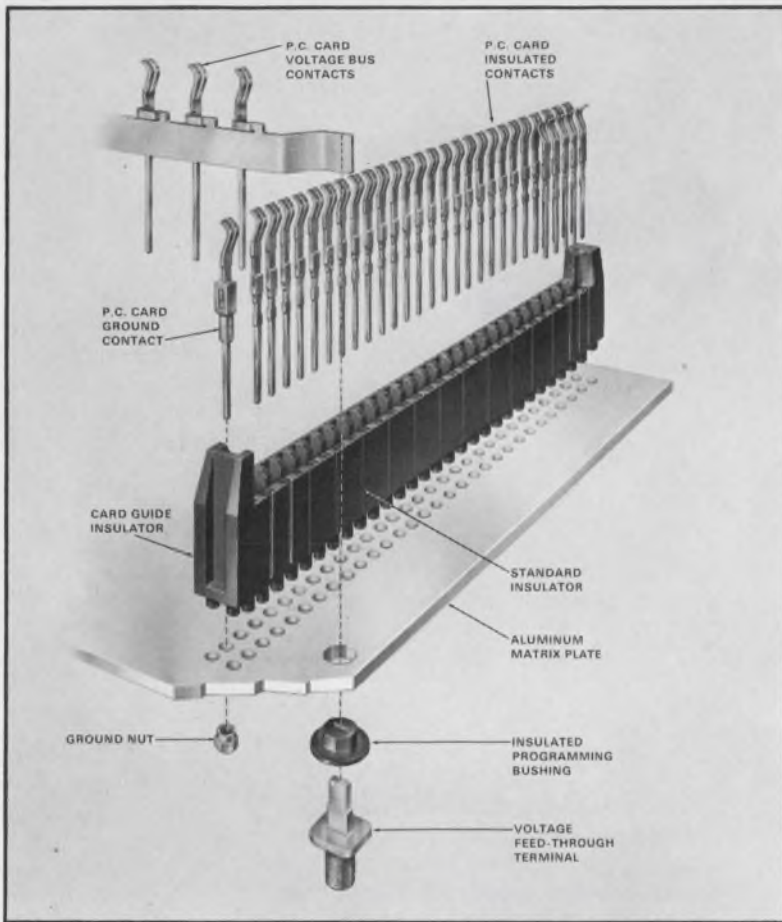

CARDEC 125, the exciting new card edge plate connector system, is tailored to fulfill your individual requirements. It provides maximum packaging density with instantaneous reaction to ground and power distribution, without wiring, for low noise high speed circuits. In one complete package, compatible with IC's, LSI's or any other type circuit, CARDEC 125 offers all the built-in extras you need, plus the advantages of modular component design for inexpensive and flexible replacement capability. Standard features include a base plate coupled with Malco's unique screw-in ground which provides nearly perfect "ground" or zero voltage, the availability of card-to-card voltage bussing with Malco in-line buss contact strips, power distribution, stiffener bars and card guides to insure ease of module changing and exact card alignment. Of course, the system is designed for automatic wire wrapping without any extra "in house" costs.

CARDEC 125 is completely adaptable to your needs with its modular connector system which fits your card regardless of the number of card contacts, whether single or dual readout. With flexible ground and bussing pin positions, card slots on .250", .500" or any multiple of .125" centers, the aluminum base plate/ground plane is available in any size or shape up to 24" by 24"

Don't miss the opportunity to reduce your total packaging cost with this amazingly economical system—let us fill you in with the details, specifications and costs. Write or call for further information.



PRECISION ELECTRONIC TERMINALS AND CONNECTORS

MALCO MANUFACTURING COMPANY INC
5150 W ROOSEVELT RD. · CHICAGO, ILLINOIS 60650 · PHONE (312) 287-6700

See Us At The NEP/CON
EAST SHOW June 10-12,
Booth B44

Data entry scanner reads unit documents



Addressograph, Multigraph Corp.
1200 Babbitt Rd., Cleveland.
Phone: (216) 731-8000.

The 9650 C.O.D.E. Scanner reads unit documents imprinted with either fields of A-M Bar Code, Hollerith punched data, or combinations of both on one document. In one operation, data is converted to magnetic tape ready for computer entry. This computer-oriented data entry scanner is an optical code reader and data converter, interfaced to a buffered magnetic tape unit that permits manual entry.

Booth No. 401 Circle No. 272

Programmable controller has 16 I/O channels



Transistor Electronics Corp., P.O.
Box 6191, Minneapolis, Minn.
Phone: (612) 941-1100.

The TEC 520 programmable controller is a buffered processor with 16 programmed I/O channels and up to 10 direct access channels. A one microsecond cycle time ferrite core memory system is expandable to 16k words of 16 bits, plus parity. The new controller can interface to the central processor in parallel or serial mode.

Booth No. 2701 Circle No. 271

INFORMATION RETRIEVAL NUMBER 139

Clevite quartz & ceramic filters

for the man with designs on something better.

Clevite's full line of solid-state filters covers *all* your selectivity requirements. Whether it's adjacent channel interference . . . weak signals . . . 180 dB stopband rejection . . . single or double conversion . . . a smaller package . . . higher shock . . . or cost reduction . . . Clevite can supply the amount of selectivity your design requires at the frequency that serves you best.

■ And we can do it entirely in quartz, or combine the economy and shape factors of a ceramic ladder with a minimal number of quartz sections for the optimum performance/cost package.

Either way, you're sure of getting the smallest, lightest, most rugged filters around.

■ Take our monolithic quartz filters, which are ideal for going to IC's and higher IF's. They're developed through advanced engineering techniques that use Clevite's original thin film

approach. Resonator isolation and spurious suppression are controlled by the trapped energy principle. Clevite quartz filters come in 2, 4, and 6 pole models, with a range

of center frequencies from 8 mHz to 75 mHz, in independent or coupled mode.

■ Clevite ceramic filters provide steep-sided selectivity . . . a large bandwidth range . . . high stopband rejection . . . and clean response.

They're permanently tuned . . . immune to magnetic fields. And they remain highly stable with both temperature and time. It's your choice of TCF, split ring, 11 or 17 disc ladder and fixed-tuned transfilter models in a range of bandwidths and characteristics to cover almost any communications application.

■ Clevite solid-state filters run the gamut from economy to mil spec grades, in 9 kHz through 75 mHz. With bandwidth capabilities to 80 kHz. And your choice of lumped or distributed selectivity. In a broad range of performance characteristics and prices.

■ Clevite . . . the single, reliable source for all your selectivity requirements. Call us for application assistance. Or write for descriptive literature on our complete filter line. Clevite

Corporation, Piezo-electric Division,
232 Forbes Road,
Bedford, Ohio 44146.

CLEVITE

INFORMATION RETRIEVAL NUMBER 140

FOR DIGITAL READ/WRITE ON 1/4" TAPE



Since we pay a lot of attention to everybody's magnetic recording needs, we can readily understand both how and why yours are different. That's why we offer not only a tremendous range of tape heads, but also the expert counsel that guides you to the most effective specifications.

Study our technical literature on these 8-track heads (available free on request):

MODEL B2L



The basic head of the 8-track stereo industry, for record and/or playback. Response through 15Khz at 3.75 ips.

MODEL ZJ2L



First Combo head for 8-track stereo. Record, playback, and erase in a single unit. Eliminates assembly tolerance, track alignment and pressure pad problems. Simplify circuitry: internal automatic biasing.

MODEL P-BQL



For duplicating or instrumentation applications. Maximum information storage at minimum cost. Four in-line tracks. A staggered pair provides 8 tracks on 1/4" tape.

Which one fits your needs? Nortronics, the world's largest tape head manufacturer, has what it takes to analyze your requirements and to recommend the right head... for any audio or instrumentation application.

When you have a tape head need, head for Nortronics. We'll head you right.

Nortronics
COMPANY, INC.

8101 Tenth Avenue North
Minneapolis, Minnesota 55427
Phone—(612) 545-0401

Sales Offices throughout the world

SJCC PRODUCTS

Batch station operates remotely

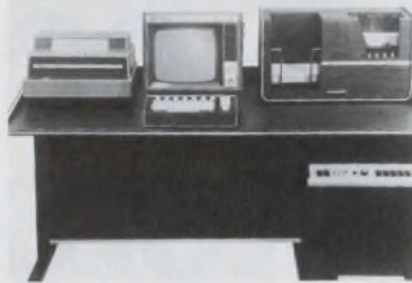

Computer Communications, Inc., 701 N. Manchester Blvd., Inglewood, Calif. Phone: (213) 674-5300. P&A: from \$23,900; 5 months.

A new conversational/batch station is an integrated console system designed for use as a remote batch terminal or a remote on-line conversational station, or for off-line operations. The CC-36 console includes a keyboard for operator control and data entry, a television screen, a card reader, a line printer, a sequencer for automatic control of specified batch operations, and an interface to a data set for remote communications.

Booth No. J7 Circle No. 258

Multiplexing system boosts printer speed



Hendrix Electronics, div. of Hendrix Wire & Cable Corp., Milford, N. H. Phone: (603) 673-4560. Price: from \$1800.

Able to interface with any readily available Bell data sets, a new time division multiplexer converts full-duplex, time-division multiplex, Teletype-speed input lines into high-speed outputs. With a sufficient amount of internal storage to allow good throughput, the unit allows 16 input lines.

Booth No. 303 Circle No. 281

Remote processor programs easily



Scientific Control Corp., 1215 W. Crosby Rd., Carrollton, Tex. Phone: (214) 242-6555. Price: from \$21,000.

Able to directly replace a remote terminal without requiring modifications to the central computer's operating system, a new programmable remote processing terminal can change its functions in as much time as it takes to load a new program. When interfaced with a dial-up switched network or a dedicated line, model DCT-132 transmits and receives data at rates from 2000 to 4800 bits per second.

Booth No. 2208 Circle No. 283

High-speed printer offers 20 lines/s

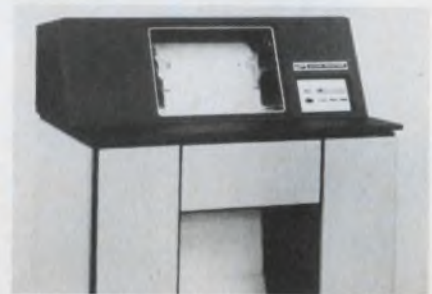

Potter Instrument Co., Inc., E. Bethpage Rd., Plainview, L.I., N.Y. Phone: (516) 694-9000.

A 1200-line-per-minute, fourth generation printer for data processing systems offers up to 192 different characters—numeric, alphanumeric and symbolic—in sets of 48, 64, 96 or 192. Four-character slugs are individually replaceable. The HSP 3550 features dual speed and servo-controlled paper feed for maximum throughput, and provides IBM compatible vertical format (12 channel).

Booth No. Q5 Circle No. 260



Electrical Engineers:

Join a small, hard-hitting logic design team at IBM.

Here's your chance to really get involved with designing the logic for sophisticated new systems for both military and commercial projects.

New Engineering Center

Here at IBM's new Communications and Engineering Sciences Center, near Washington, D.C., we work in small groups. This allows each member to dig into the project from the very beginning—from sitting down with the customers before we begin to conducting the maintenance training after we finish.

The entire group is involved with everything from hardware design to systems acceptance and program management.

You should have a degree in electrical engineering. Experience in logic design, digital systems or some other data processing area would be helpful.

Projects now underway

Several high-priority projects are already underway. They range from an advanced reservations system for commercial airlines to highly classified ground-based military systems.

We are also helping to develop greater mission capability for the post-Apollo period.

Why choose IBM?

Today's major growth industry is information handling and control. And IBM is a leader in that field. This growth environment can bring out the best of your talents and abilities, because in a growth company like IBM you can work constantly toward greater achievement. This means more opportunities to achieve distinction and personal recognition.

So if you're a problem-solver who wants a personal sense of achievement and recognition for your hard work in an exciting growth company, consider IBM.

Call or write

If you are an Electrical Engineer and want to join a small, hard-hitting team, call Jim Dunn at (301) 921-7724 collect any weekday between 9 and 4:30. Or, send a brief letter or resume to him at IBM Corporation, Federal Systems Division, Dept. CD1073, 18100 Frederick Pike, Gaithersburg, Maryland 20760.

An Equal Opportunity Employer

IBM®

DL 620A

A COMPLETE 18-CHANNEL DIGITAL DATA ACQUISITION SYSTEM

for only
\$3,900

The compact and lightweight design, plus low power requirements, makes the DL 620A an extremely versatile unit. Ideal for general purpose recording of analog or digital data on magnetic tape both in the laboratory and remote installations... or portable airborne applications.

This complete 18-channel data acquisition system weighs only 18 lbs. and needs minimal power of 35 watts. Features include a presettable crystal controlled clock; ability to accept either analog or direct digital data; high Z differential analog input stage; selectable recording rates; cartridge magnetic tape system with associated drive; plus all necessary logic and power supplies. Data recovery options include; tape-to-tape, tape-to-computer, and real-time.

For the complete story on the Model DL 620A and associated equipment write MetroData Systems, Inc., P. O. Box 1307, Norman, Oklahoma 73069.



INFORMATION RETRIEVAL NUMBER 143

SJCC PRODUCTS

Read-only memory is 2048-word system

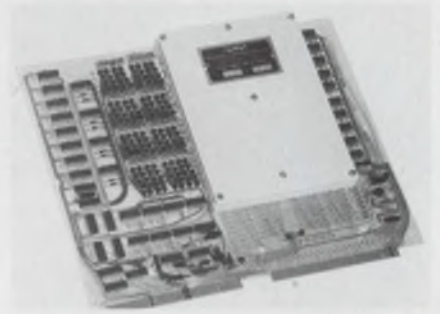

Memory Technology Inc., 223 Crescent St., Waltham, Mass. Phone: (617) 891-8465. P&A: \$300 to \$1300; 30 days.

Read-only memory systems range in capacity from 64 words to 2048 words with word lengths that range from 10 to 80 bits per word. The new S series is compatible with the F series and the standard SBS memories. Other specifications of the S series are 700 ns access time, 1- μ s cycle time, 5-W power requirement, TTL and DTL compatible interface.

Booth No. 607 Circle No. 262

CRT display terminal accepts dial-up data



Hendrix Electronics, div. of Hendrix Wire and Cable Corp., Milford, N.H. Phone: (603) 673-4560.

Featuring random-access text storage, a new CRT display terminal can receive text input directly by local memory over dial-up telephone circuits. Able to display 264,000 characters, the unit has incremental graph capability as well as alphanumeric data capability. It also features four-level format hierarchy and correction techniques.

Booth No. 303 Circle No. 337

RF Noise and Space Problems?

— and are you using RG178/U, RG196/U — RG-161/U, RG179/U, RG187/U — RG174/U, RG188/U, RG316/U, miniature co-ax cables?

Combine CO-AX and POWER Contacts in **U.S.C. ANYCON** Connectors

MIL-C-22857 connectors

MIL-C-23216 power and miniature co-ax contacts

Our URC ANYCON connectors permit combining crimp-removable standard #16, #20 and co-ax contacts in any contact position.

Write for our URC-SF catalog and see what U.S.C. Established Reliability can do!

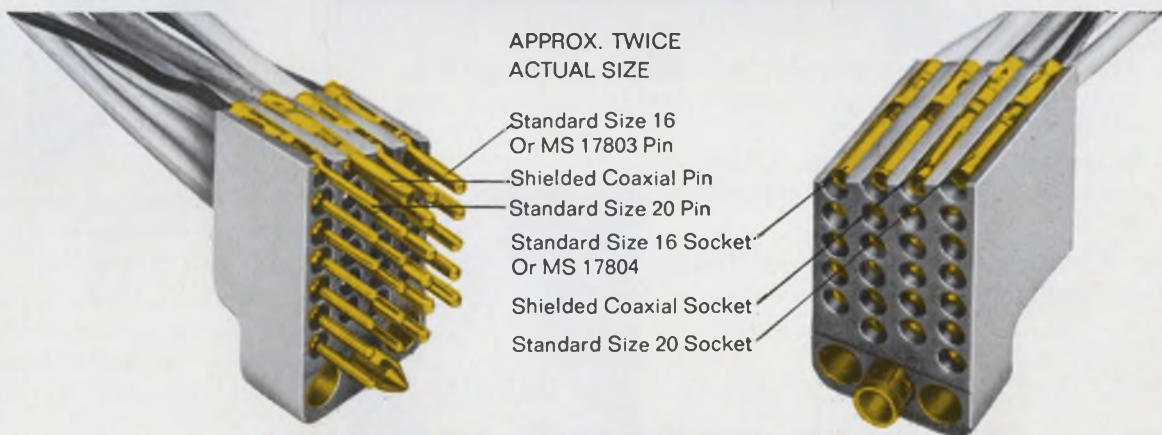

APPROX. TWICE
ACTUAL SIZE

- Standard Size 16 Or MS 17803 Pin
- Shielded Coaxial Pin
- Standard Size 20 Pin
- Standard Size 16 Socket Or MS 17804
- Shielded Coaxial Socket
- Standard Size 20 Socket



©1969, USC

1320 ZEREGA AVENUE • BRONX, N.Y. 10462 or use TWX: 710-593-2141 • Tel. 212-824-1600 TELEX: 1-2411 • or Cable: COMPONENTS N.Y.K.
See what is new at NEPCON U. S. Components, Inc. Booth 635 Philadelphia, June 10th-12th

INFORMATION RETRIEVAL NUMBER 144

YOKE SPECIALISTS

FOR INFORMATION DISPLAYS



Syntronic's devotion to precision and attention to detail assure skillfully engineered deflection yokes in prototype or full production quantities. A complete line of value engineered yokes offer cost saving solutions to your CRT projects. Consult scientifically oriented Syntronic Yoke Specialists for the right yoke for your display.

Syntronic INSTRUMENTS, INC.
 100 Industrial Road, Addison, Ill.
 Phone: Area 312, 543-6444

INFORMATION RETRIEVAL NUMBER 145

SJCC PRODUCTS

Analog computer expands to hybrid

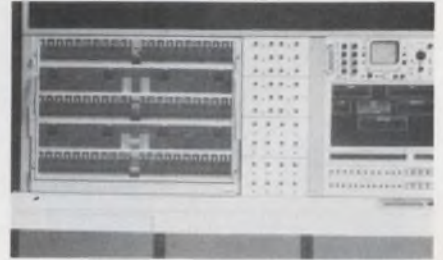

Astrodata, Inc., 240 E. Palais Rd., Anaheim, Calif. Phone: (714) 772-1000. P&A: \$40,000; 3 to 6 mos.

A 100-volt, solid-state analog computer offers, in a compact and economical systems package, the capabilities of large-scale computers. The C-550 is specifically designed for expansion to hybrid operation and is comparable with digital equipment. An integrated patchboard, with both analog and digital patching facilities on the same panel, provides easy storage, reduced costs, and quick programming.

Booth No. KK6 Circle No. 269

Read-only memories store 2k by 10 words



Varian Data Machines, 2722 Michelson Drive, Irvine, Calif. Phone: (714) 833-2400.

Operating with an access time of 200 ns, non-destructive variable-word read-only memory systems store up to 2048 words having 10-bit lengths. Each system includes address buffer and decoding, output data register, braid transformer memory, and sensing, timing, and control. Typical applications include character generation for CRT displays, code conversion and micro-program control.

Booth No. 2104 Circle No. 284

New and Better Communications with . . .

TELEMATE 300 ACOUSTICAL COUPLER



TELEMATE 300 was designed and developed to specifications of DACC, a time-sharing computer company that knows the needs of users.

That's why Telemate 300 is more compact, more reliable and elegantly styled.

Top Quality • Competitively Priced

- Easily portable
- Data Rate: 300 Baud
- Carrier and on/off lights
- Highly selective tuned oscillator circuit
- Half/full Duplex
- Triple tuned circuitry
- AGC circuit
- Acoustic isolation min. 20 db
- Teletype or EIA interface
- Optional: Carrying case, originate/answer, cable interface, loud speaker and RS 232B

FULL WARRANTY • WRITE FOR BROCHURE



Use TELEMATE 300 with your telephone and/or your teletype system. Comes in walnut and attractive office decorator colors.

DACC

DIRECT ACCESS COMPUTING CORP.
 Communications Equipment Group

24175 Northwestern Highway Southfield, Michigan 48075 313/358-5000

INFORMATION RETRIEVAL NUMBER 146

Why does the best-selling digital printer sell for \$335?

Because Victor sells so many of them.

The Victor Imperial digital printer does superbly what any top-quality serial entry printer does. For less money. Because we sell so many.

It prints 8 column figures from remote sources on either 24 or 48 volt solenoids. Addition and subtraction for just \$50 more. Ten column capacity? Add \$20. Victor's exclusive printing press action reduces wear (and extra parts), and assures legibility and long, long life, under the roughest use.

OEM and quantity discounts available, with factory-trained service representatives covering every county in the U.S.

Does craftsmanship combined with volume manufacturing economies sell digital printers?

The most.  **VICTOR**

Victor Comptometer Corporation
Business Machines Group
3900 North Rockwell Street
Chicago, Illinois 60618

Tell me more about your best-seller,
the Victor Imperial digital printer:

Name _____

Title _____

Address _____

City _____

State _____ Zip _____

...

Call on Victor and you're in business.

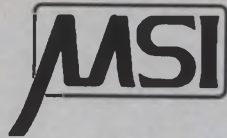

MICRO SYSTEMS INC.

Low Cost • 900 Nanosecond

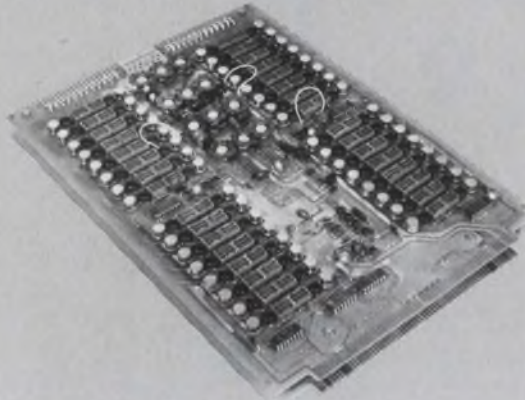

CORE MEMORY

MODEL 140

- 900 nanosecond full cycle time.
- 300 nanosecond access time.
- Wide operating margins.
- Plug-in modularity.

The MSI-140 is a field tested memory module forming a basic low cost building block for implementation of custom memory systems. Modularity allows for a wide range of word capacity/word size configurations.

Address input, data input/output, mode control, and power are supplied externally via a pc connector (specified by the user), providing maximum system flexibility with minimum interface cost. Experienced engineering assistance is available from MSI to support special integration requirements.

Standard memory systems using the MSI-140 are also available. These systems are plug-in expandable and provide such optional features as internal data and address registers, timing, power, and self-test.

Specifications

Size	4096 x 8, 9, 10
Construction	3 wire, 3D, continuous stack wiring
Cycle Time	900 nanoseconds
Address Mode	Random access
Interface	TTL Integrated

WRITE FOR COMPLETE DETAILS IN BULLETIN 140.



MICRO SYSTEMS INC.

644 East Young St., Santa Ana, California 92705 • (714) 540-6730

INFORMATION RETRIEVAL NUMBER 148

SJCC PRODUCTS

Solid-state modem works at 300 baud



Sangamo Electric Co., P.O. Box 359, Springfield, Ill. Phone: (217) 544-6411.

Completely solid state with its basic modem circuitry contained on two plug-in cards, a new data set transmits and receives asynchronous serial digital data at up to 300 bits per second, full duplex, on two-wire facilities. Called Transidata T103A, the unit features end-to-end compatibility with Western Electric 103A series data sets, 804B data auxiliary sets, and 801A and 801C automatic call units.

Booth No. 1001 Circle No. 289

IC 3-D core memory cycles in 900 ns

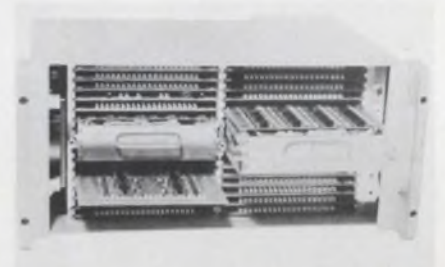

Information Control Corp., 1320 E. Franklin Ave., El Segundo, Calif. Phone: (213) 322-6930.

Employing 3-D selection, fast-switching 20-mil cores, and integrated circuits, a new core memory system achieves high speed, high reliability and high density. The ComRac 1000 has a full-cycle time of 900 ns, an access time of 350 ns and memory capacities up to 32k words by 72 bits. It is packaged as 19-in. rack-mounted 16k by 36 modules.

Booth No. 307 Circle No. 298

Would you Believe?
**A REALLY NEW
 DATA
 ACQUISITION
 SYSTEM**

(Very Interesting!)

Yes, DACAP™-1000 is new and **very** interesting. For here is a versatile system for data acquisition, controlling and processing that **finally** offers the ultimate in flexibility.

DACAP™-1000 will handle from one to **one thousand** inputs using any type or combination of transducers.

What is more, DACAP™-1000 drives your choice (or choices) of output equipment . . . tape print out, punch paper tape, magnetic tape, selectric or larger computer. And of course, **visual engineering units display** and process and data display are standard.

But best of all, DACAP™-1000 is **expandable**. You buy only what you need **now** — and you buy with the confidence that DACAP™-1000 can readily expand to meet **all** your future needs. Lease and other purchase options available.

Let's exchange some very interesting data. Tell us about your applications and problems and we'll show you the truly new acquisition system to solve them: The DACAP™-1000.

Yes . . . I'm **very** interested in your **very** interesting DACAP™-1000.

The equipment I'm using is _____

I would like to process _____

Name _____

Company _____ Title _____

Street _____

City _____ State _____ Zip _____

Send this coupon with your name and address to:

International **Contronics Inc.**

1038 W. Evelyn Ave. Sunnyvale, Calif. 94086 (408) 736-7620

INFORMATION RETRIEVAL NUMBER 149

MAC
 goes
Mod(ular)

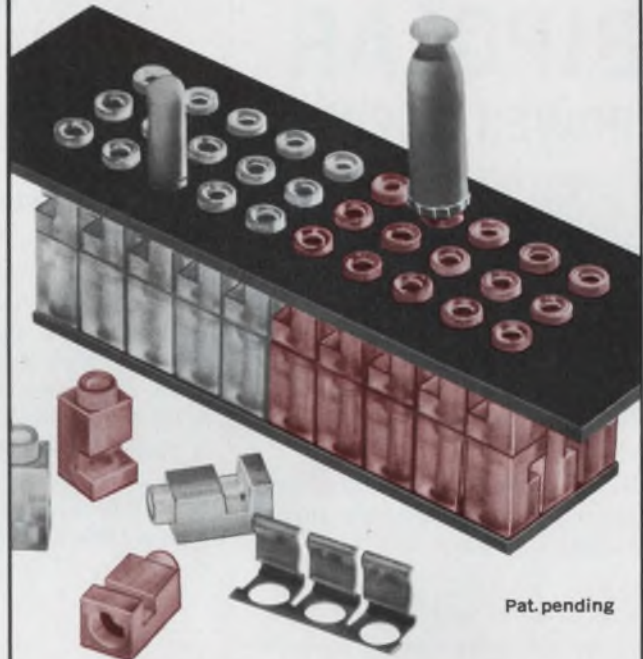

**color coded
 CROSSPOINT
 PROGRAMMING**

Exclusive Features:

- Any size to 99 x 99 positions
- Modules color coded to your requirements
- 8 colors available
- Rigid, cordwood construction
- Two-layer crosspoint standard
- Three, four, five or more layers to your order

Additional Features:

- Fully guided, closed-entry contacts
- Shorting plug ● Component plug
- Skip plug
- Tin-plated contacts standard
 Gold-plated contacts optional

For further information write

MAC Panel Co.

Box 5027(A) High Point, N. C. 27262 • (919) 882-8138



KEPCO'S NEW BIPOLAR POWER SUPPLY

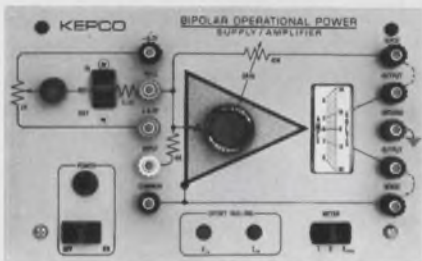

Model BOP 36-5M — \$585.00

can be used with voltage feedback as a bipolar voltage controller —36V to +36V

or

it can be used with current feedback as a bipolar current controller —5A to +5A

to drive

servo mechanisms, deflection coils, shake tables, loud speakers . . .

It will accept your d-c to 20 kHz input signal and will amplify it mightily (180 watts)

or

take your input (whatever waveform) and sum it plus or minus with the built-in bipolar reference

or

let you manipulate input and feedback elements for scaling and integrating and things like that

For complete specifications, write Dept. BZ-5

**with KEPCO
IT'S CONTROL!**



131-38 SANFORD AVE. • FLUSHING, N.Y. 11352
(212) 461-7000 • TWX # 710-582-2631

INFORMATION RETRIEVAL NUMBER 151

C78

SJCC PRODUCTS

Compact core memory retains 4k 16-bit words

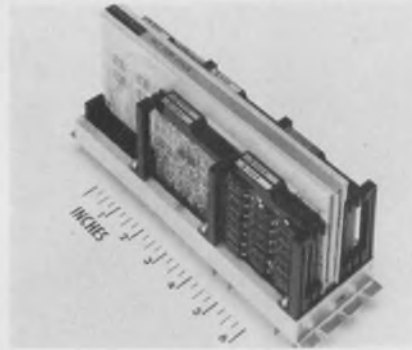

Honeywell Computer Control Div., Old Connecticut Path, Farmingham, Mass. Phone: (617) 879-2600. P&A: 5¢/bit; 30 days.

Costing as little as five cents per bit, a new core memory system, the ICM-160, is a 4096-word memory, available with 8, 12, or 16 bits per word, that measures only 2-3/4 by 5 by 9 in. This four-wire system is field expandable to other word and bit sizes on a modular basis. Its full-cycle time is 1.6 μ s with an access time of 550 ns.

Booth No. 2800 Circle No. 334

A/d converters vary clock rate

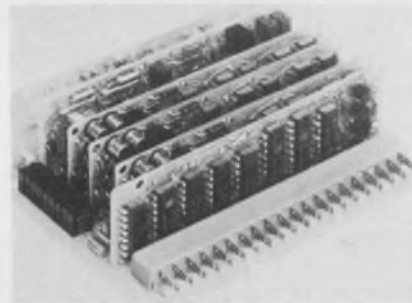

Monitor Systems, Inc., an Aydin Co., 401 Commerce Dr., Fort Washington, Pa. Phone: (215) 648-8100. Price: from \$440.

Monologic A68 high-speed analog-to-digital converter cards, which operate at conversion rates of 1 μ s per bit, feature an adjustable-frequency clock. Pads are provided on all cards to allow mounting an external timing capacitor for adjusting the frequency of the internal clock. Each card also contains a reference supply, successive-approximation logic circuitry, and a high-speed comparator.

Booth No. E3 Circle No. 286

Computer system runs in real time



Hewlett Packard Palo Alto Div., 395 Page Mill Rd., Palo Alto, Calif. Phone: (415) 326-1755. P&A: \$74,100; 20 wks.

Completely compatible with a wide variety of instrumentation, a new user-oriented computer system permits several programs to run in real time, concurrent with background programs. Called the 2005A Executive, the basic unit includes a computer, a head-per-track storage disc, a tele-printer and a punched-tape reader.

Booth No. F Circle No. 288

Ferrite core memory has 3- μ s full cycle

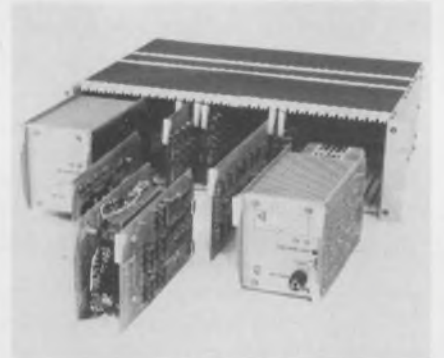











Ferroxcube Corp., P.O. Box 359, Saugerties, N.Y. Phone: (914) 246-2811. P&A: \$4300; 60 days.

With a capacity of 4096 20-bit words, a coincident-current ferrite core memory offers a 3- μ s full-cycle time (2- μ s half-cycle time) and an access time of 1 μ s maximum. The FI-3 utilizes DTL integrated circuits and silicon semiconductors mounted on printed circuit cards. It is available with address register, sequential counter and memory retention.

Booth No. G12 Circle No. 287

What can you do with memory? [except forget it]

Well, if you get it from UTE you can do almost anything. Start small  pick any   size, use a , a , or . Enlarge  , protect , address  , or think up something new...

But remember the place to start with memory is UTE. We can help. After all, we're flexible...See how we stack up at Booth 608 at the SJCC.

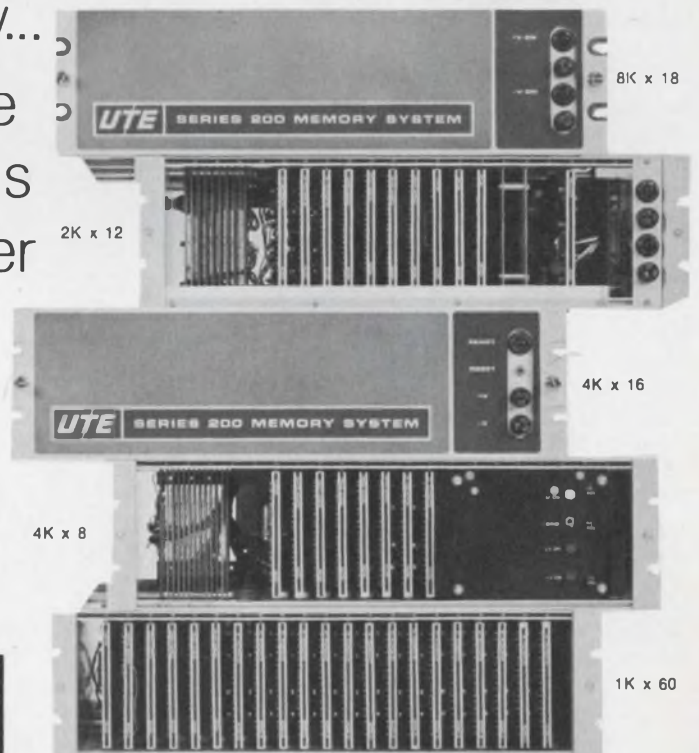

UNITED TELECONTROL ELECTRONICS INC.
3500 Sunset Ave., Asbury Park, N. J. 07712 • 201-988-0400

INFORMATION RETRIEVAL NUMBER 152

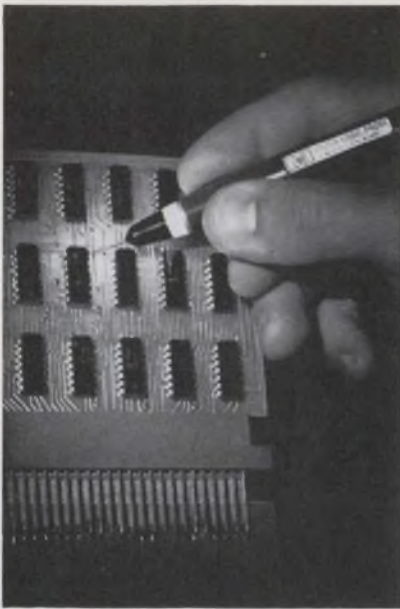

This probe lights up when a pulse goes by.

Even a pulse as short as 30 ns—positive or negative—will cause this logic indicator to flash a signal. You can trace pulses, or test the logic state of TTL or DTL integrated circuits, without taking your eyes off your work. In effect, the probes act like a second oscilloscope at your fingertips.

No adjustments of trigger level, slope or polarity are needed. A lamp in the tip will flash on 0.1 second for a positive pulse, momentarily extinguish for a negative pulse, come on low for a pulse train, burn brightly for a high logic state, and turn off for a low logic state.

The logic probe—with all circuits built into the handpiece—is rugged. Overload protection: -50 to +200 V continuous; 120 V ac for 10 s. Input impedance: 10 kΩ. Price of HP 10525A Logic Probe: \$95, quantity discounts available.

Ask your HP field engineer how you could put this new tool to work in logic circuit design or troubleshooting. Or write Hewlett-Packard, Palo Alto, Calif. 94304; Europe: 54 Route des Acacias, Geneva.

02825A

HEWLETT  PACKARD

INFORMATION RETRIEVAL NUMBER 153

C80

Advertisers' Index

Advertiser	Page
ACI Incorporated	C64
AMP, Incorporated	C26, C27
Barnes Corporation	C51
Clevite Corporation, Piezoelectric Division	C59
Computer Labs	C35
Computer Products	C60
Condenser Products Corporation	C52
Cross Company, H.	C24, C25
Dale Electronics, Inc.	C50 A—B
Data Device Corporation	C44
Datascan, Inc.	C-2
Digital Equipment Corporation	C33
Direct Access Computing Corporation	C74
DIT MCO	C34
Dow Corning Corporation	C58, C59
ESI/Electro Scientific Industries, Inc.	C61
Executone, Inc.	C51
Gardner-Denver Company	C36, C37
General Automation, Inc.	C62, C63
General Instrument Corporation	C38, C39
Grant Pulley & Hardware Corporation	C57
Hewlett-Packard	C22, C23, C80
Honeywell, Computer Control Division	C45, C46, C47, C48
IMC Magnetics Corporation	C50
ITT Semiconductors, A Division of International Telephone and Telegraph Corporation	C65
Industrial Technology Corporation	C13
International Contronics, Inc.	C77
Kepco, Inc.	C78
Lambda Electronics Corp.	C81, C82, C83
McLean Engineering Laboratories	C49
Mac Panel Company	C77
Malco Manufacturing Company, Inc.	C68
Metrodata Systems, Inc.	C72
Microdyne Instruments, Inc.	C56
Micro Systems Incorporated	C76
MicroSwitch, A Division of Honeywell	C66, C67
National Semiconductor Corporation	C34 A—B
Nortronics Company, Inc.	C70
Nu Devices, Inc.	C56
RCA Electronic Components and Devices	C84
Radiata, Incorporated	C53
Raytheon Computer	C43
Servo-Tek Products Company	C-42
Signetics Integrated Circuits, A Subsidiary of Corning Glass Works	C31
Siliconix Incorporated	C54, C55
Sylvania Electric Products, Inc.	C29
Syntronic Instruments, Inc.	C74
United Telecontrol Electronics, Inc.	C79
U.S. Components, Inc.	C73
Victor Comptometer Corporation	C75
Weston Instruments, Inc., Newark Division	C41
<i>Career Advertising:</i>	
IBM Corporation	C71

Advertising Sales Staff

New York 10022

Edward F. Clancy
Sales Service Manager

Robert W. Gascoigne
Thomas P. Barth
Samuel M. Deitch
Byron Adams
850 Third Avenue
(212) Plaza 1-5530
TWX: 867-7866

Philadelphia 19066

William C. Repetto
P. O. Box 206
Merion Station, Pa.
(215) MA-3-5888

Boston 01945

Richard Parker
P.O. Box 645
Clifton Station
Marblehead, Mass.
(617) 742-0252

Chicago 60611

Thomas P. Kavooras
Berry Conner, Jr.
200 East Ontario
(312) 337-0588

Cleveland

Thomas P. Kavooras
(Chicago)
(312) 337-0588
(call collect)

Los Angeles 90303

Stanley I. Ehrenclou
John V. Quillman
W. James Bischof
2930 Imperial Highway
Inglewood, Calif.
(213) 757-0183

San Francisco 94022

Arthur R. Shields, Jr.
175 San Antonio Rd., S 243
Los Altos, Calif.
(415) 941-3084

London W. 1

For United Kingdom & Holland
Brayton C. Nichols
44 Conduit Street
Tel: REGent 4714

Verviers, Belgium

For Continental Europe
Andre Jamar
1, Rue Mallar, 1
(087) 253.83 Telex 41563

Tokyo

Yoshihiro Takemura
IPS Group Ltd.
Box 36, Ohsaki Post Office
Phone (431) 5804



AMERICAN BUSINESS PRESS, INC.

LR series high-performance power supplies

regulation—0.0005%, ripple—35 μ v

For test equipment and lab use—rack or bench 0-20, 0-40, 0-120, 0-250 VDC, from 60 ma. to 1.8 amps.

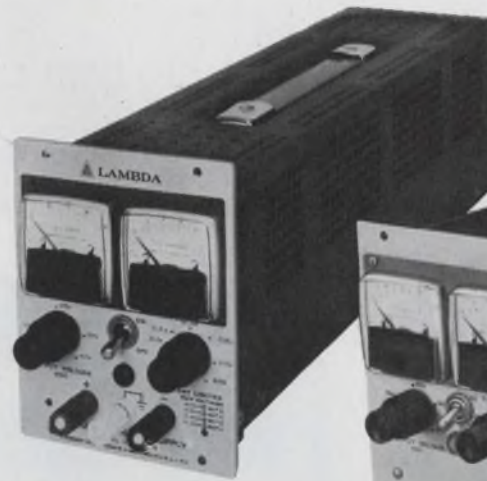

1/4 rack models



1/2 rack models

ONE DAY DELIVERY ALL MODELS



Features and Data

- 0.0005% plus 100 μ regulation.
- 35 μ V rms, 100 μ p-to-p ripple.
- AC Input: 105-132 VAC, 47-440 Hz (Ratings based on 55-65 Hz; derate current 10% at 50 Hz.) 205-265 VAC on request at no extra charge ("V" option).
- 2 meters monitor both voltage and current simultaneously and continuously.
- Accuracy—0.01% plus 1mV
- Stability—0.001% plus 100 μ V for 8 hours
- Temperature coefficient—0.001% plus 10 μ V/ $^{\circ}$ C
- Multi-Current-Rated.

- Guaranteed for 5 years. The only 5-year guarantee that includes labor as well as parts. Guarantee applies to operation at full published specifications at end of 5 years.
- Only 5 $\frac{1}{4}$ " high. Convenient 1/4 and 1/2 rack sizes for rack or bench use.
- All silicon-designed for maximum reliability.
- Convection Cooled—no blowers, no external heat sinks.
- Auto Series/Auto Parallel with Master-Slave tracking.
- Constant Voltage/Constant Current
- Completely protected—short-circuit proof—continuously adjustable, automatic current limiting.
- Overvoltage protection available for all models up to 70 VDC.
- Remotely Programmable

LR Series 1/4-rack models		Size: 5 $\frac{3}{16}$ " x 4 $\frac{3}{16}$ " x 15 $\frac{1}{2}$ "				
Model	Voltage Range	MAX. AMPS AT AMBIENT OF: ¹				Price
		30 $^{\circ}$ C	40 $^{\circ}$ C	50 $^{\circ}$ C	60 $^{\circ}$ C	
LR-602-FM	0-20 VDC	1.1	.95	.80	.64	\$265
LR-603-FM	0-40 VDC	.60	.50	.42	.33	265
LR-605-FM	0-120 VDC	.23	.20	.17	.14	295
LR-606-FM	0-250 VDC	80ma	72ma	65ma	60ma	310

LR Series 1/2-rack models		Size: 5 $\frac{3}{16}$ " x 8 $\frac{3}{8}$ " x 10 $\frac{5}{8}$ "				
Model	Voltage Range	MAX. AMPS AT AMBIENT OF: ¹				Price ²
		30 $^{\circ}$ C	40 $^{\circ}$ C	50 $^{\circ}$ C	60 $^{\circ}$ C	
LR-612-FM	0-20 VDC	1.8A	1.6A	1.3A	1.1A	\$305
LR-613-FM	0-40 VDC	1.0A	0.9A	0.75A	0.6A	305
LR-615-FM	0-120 VDC	0.33A	0.29A	0.25A	0.21A	320
LR-616-FM	0-250 VDC	100ma	90ma	80ma	70ma	340

NOTES:

- 1 Current rating applies over entire voltage range. Ratings based on 55-65 Hz operation. Derate current 10% for 50 Hz input.
- 2 Prices are for metered models. LR Series models are not available without meters.

Accessories

Rack Adapter LRA-1 Price \$60.00 • 5 $\frac{1}{4}$ " H x 16 $\frac{1}{2}$ " D

Rack Adapter LRA-2 Price \$35.00 • 5 $\frac{1}{4}$ " H

OVERVOLTAGE PROTECTION ACCESSORIES			
For Use With	Model	Adj. Volt Range	Price
LR-602-FM, LR-612-FM	LH-OV-4	3-24 V	\$35
LR-603-FM, LR-613-FM	LH-OV-5	3-47 V	35

Prices F.O.B. factory, Melville, N. Y. All specifications and prices subject to change without notice.

 **LAMBDA**
ELECTRONICS CORP.
515 BROAD HOLLOW ROAD, MELVILLE, L.I., NEW YORK 11746
TEL. 516-694-4200. TWX: 510-224-6484 CABLE: VEECOVAC PLAINVIEW NY

LK series high-current power supplies all silicon, convection cooled—bench or rack

For test equipment
and lab use—
0-20, 0-36, 0-60 VDC
from 0-4.0 amps.
to 0-66 amps.

7"

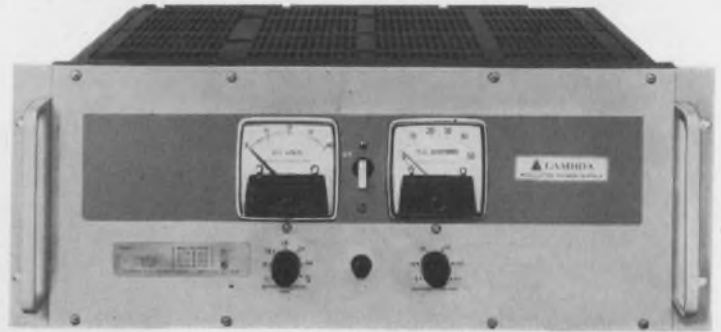

5 1/4"

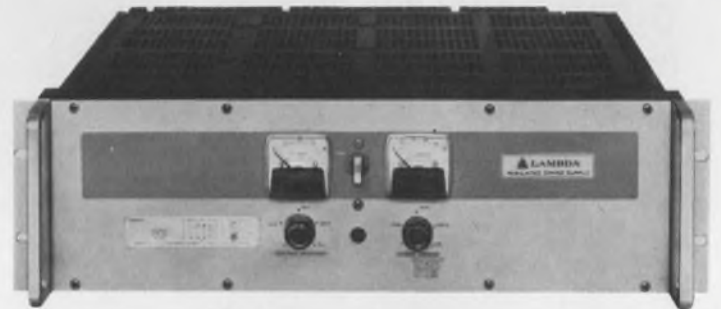

LK Series metered 1/2-rack

LK Series metered full-rack

**ONE
DAY
DELIVERY
ALL
MODELS**



Features and Data

- All silicon-designed for maximum reliability
- Convection Cooled—no blowers, no external heat sinks.
- Regulation—.015% or 1 mV (line or load)
- Ripple—500mV RMS
- AC Input—105-132 VAC, 57-63 Hz. LK7 "series" 188-238 VAC, 57-63 Hz (derate current 10% at 50 Hz.)
- No Voltage Spikes or Overshoot on "turn on", "turn off" or power failure
- Temperature coefficient—0.015% + 0.5mV/°C.
- Series/Parallel Operation

- Completely Protected—short circuit proof—Continuously adjustable automatic current limiting
- Constant Voltage/Constant Current
- Remotely Programable
- Meet Mil. Environment Specs.
Vibration: MIL-T-4807A
Shock: MIL-E-4970A Proc. 1 & 2
Humidity: MIL-STD-819 Meth. 507
Temp. Shock: MIL-E-5272C (ASG) Proc. 1
Altitude: MIL-E-4970A (ASG) Proc. 1
Marking: MIL-STD-130
Quality: MIL-Q-9858

LK Series full-rack models		Size 7" x 19" x 18 1/2"				Price ²
Model ²	ADJ. VOLT. RANGE VDC	CURRENT RANGE AT AMBIENT OF: ¹				
		40°C	50°C	60°C	71°C	
LK-360 FM	0-20	0-66A	0-59A	0-50A	0-40A	\$995
LK-361 FM	0-36	0-48A	0-43A	0-36A	0-30A	950
LK-362 FM	0-60	0-25A	0-24A	0-22A	0-19A	995

LK Series full-rack models		Size 5 3/16" x 19" x 16 1/2"				Price ²
Model ²	ADJ. VOLT. RANGE VDC	CURRENT RANGE AT AMBIENT OF: ¹				
		40°C	50°C	60°C	71°C	
LK-350	0-20	0-35A	0-31A	0-26A	0-20A	\$675
LK-351	0-36	0-25A	0-23A	0-20A	0-15A	640
LK-352	0-60	0-15A	0-14A	0-12.5A	0-10A	650

LK Series 1/2-rack models		Size 5 3/16" x 8 3/8" x 16 1/2"				Price ²
Model ²	ADJ. VOLT. RANGE VDC	CURRENT RANGE AT AMBIENT OF: ¹				
		40°C	50°C	60°C	71°C	
LK-340 A	0-20	0- 8.0A	0- 7.0A	0- 6.1A	0-4.9A	\$330
LK-341 A	0-20	0-13.5A	0-11.0A	0-10.0A	0-7.7A	385
LK-342 A	0-36	0- 5.2A	0- 5.0A	0- 4.5A	0-3.7A	335
LK-343 A	0-36	0- 9.0A	0- 8.5A	0- 7.6A	0-6.1A	395
LK-344 A	0-60	0- 4.0A	0- 3.5A	0- 3.0A	0-2.5A	340
LK-345 A	0-60	0- 6.0A	0- 5.2A	0- 4.5A	0-4.0A	395

Prices F.O.B. factory, Melville, N. Y. All specifications and prices subject to change without notice.

OVERVOLTAGE PROTECTION ACCESSORIES			
For Use With	Model	Adj. Volt Range	Price
LK-340A, 341A	LH-OV-4	3-24 VDC	\$35
LK-342A, 343A	LH-OV-5	3-47 VDC	35
LK-344A, 345A	LH-OV-6	3-70 VDC	35
LK-350-352	LH-OV-7	3-70 VDC	35
LK-360 FM-362 FM			

Overvoltage Protection up to 70 VDC as a built-in option for full-rack models. To order, add suffix (-OV) and add \$90.00 to price of models LK-350-352, add \$120.00 for models LK-360-FM-362-FM.

NOTES:

- 1 Current rating applies over entire voltage range.
- 2 Prices are for non-metered models. For metered models, add suffix (-FM) and add \$30.00 to price. Models LK-360-FM, LK-361-FM, and LK-362-FM which are metered models not available without meters.
- 3 Chassis Slides for full rack models: Add suffix (-CS) to model number and add \$60.00 to the price, except for models LK-360-FM-LK-362-FM, for which add \$100.00.

 **LAMBDA**
ELECTRONICS CORP.
515 BROAD HOLLOW ROAD, MELVILLE, L.I., NEW YORK 11746
TEL. 516-694-4200, TWX: 510-224-6484 CABLE: VEECOVAC PLAINVIEW NY

LP/LPD series general purpose power supplies for test equipment and lab use—bench or rack



LP Series — single output

ONE DAY DELIVERY ALL MODELS

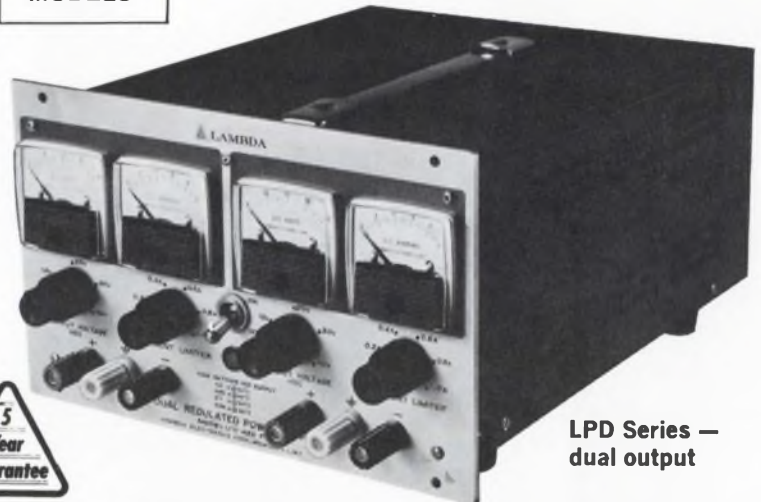

LPD Series — dual output

- Twice the voltage (up to 500 VDC) with outputs in series.
- Twice the current (up to 3.4 amps) with outputs in parallel.

Features and Data

- 5 LPD Models with two independent DC outputs offer widest choice—Up to ± 250 VDC, up to 1.7 amps. Either output may be + or -, or both outputs may be + or -.
- Series/Parallel operation with LPD Series, both outputs yield *two times* the voltage or *two times* the current—up to 500 volts or up to 3.4 amps.
- Regulation (line or load)—0.01% + 1mV.
- Ripple—500 μ V RMS, 1.5 mV p-p. Models LP-415 and LP-425-FM only—1mV RMS, 3mV p-p.

- AC Input—105-132 VAC 47-440 Hz (ratings based on 57-63 Hz operation). For operation at 205-265 VAC, add suffix "-V" to model numbers. No change in price.
- Temperature coefficient—0.015% + 0.5mV/°C.
- Auto Series/Auto Parallel with Master-Slave tracking
- All silicon-designed for maximum reliability
- Convection cooled—no blowers, no external heat sinks.
- Constant voltage/constant current.
- Designed to meet RFI per MIL STD 826A.
- Remotely programmable.
- Remote sensing.
- Fungus Proofing Option—Add suffix "R" to model number and add \$15.00 to price.

LP Series 1/4-rack models		Size: 5 3/16" x 4 3/16" x 10"				
Model	Voltage Range VDC	MAX. AMPS AT AMBIENT OF: ¹				Price ²
		30°C	40°C	50°C	60°C	
LP-410*	0-10	0-2A	0-1.8A	0-1.6A	0-1.4A	\$129
LP-411*	0-20	0-1.2A	0-1.1A	0-1.0A	0-0.8A	119
LP-412*	0-40	0-0.70A	0-0.65A	0-0.60A	0-0.50A	114
LP-413*	0-60	0-0.45A	0-0.41A	0-0.37A	0-0.33A	129
LP-414	0-120	0-0.20A	0-0.18A	0-0.16A	0-0.12A	149
LP-415	0-250	0-80mA	0-72mA	0-65mA	0-60mA	164

LPD Series 1/2-rack models		Size: 5 3/16" x 8 3/8" x 10 5/8"				
Model	Voltage Range Per output/Outputs in series VDC	I MAX AMPS AT AMBIENT OF: (1) Per output/Outputs in parallel				Price (2)
		30°C	40°C	50°C	60°C	
LPD-421-FM*	0-±20/0-40	1.7A/3.4A	1.5A/3.0A	1.3A/2.6A	0.9A/1.8A	\$325
LPD-422-FM*	0-±40/0-80	1.0A/2.0A	0.85A/1.7A	0.7A/1.4A	0.55A/1.1A	260
LPD-423-FM*	0-±60/0-120	0.7A/1.4A	0.6A/1.2A	0.5A/1.0A	0.4A/0.8A	325
LPD-424-FM	0-±120/0-240	0.38A/0.76A	0.32A/0.64A	0.26A/0.52A	0.20A/0.40A	325
LPD-425-FM	0-±250/0-500	0.13A/0.26A	0.12A/0.24A	0.11A/0.22A	0.10A/0.20A	350

NOTES:

- * Overvoltage Protection available as an accessory. Each output requires separate OV accessory—add \$35.00 for each output.
- 1 Current rating applies over entire voltage range. Ratings based on 57-63 Hz operation.
- 2 Prices of LP series are for non-metered models. For metered models, add suffix (-FM) and add \$10.00 to price.
- 3 Prices of LPD series are for metered models. LPD Series models are not available without meters.

Accessories

Rack Adapter LRA-1 Price \$60.00 • 5 1/4" H x 16 1/2" D
 Rack Adapter LRA-2 Price \$35.00 • 5 1/4" H

OVERVOLTAGE PROTECTION ACCESSORIES			
For Use With	Model	Adj. Volt Range	Price per Output
LP-410; (0-10VDC)	LH-OV-4	3-24V	\$35
LP-411; LPD-421-FM (0-20VDC)	LH-OV-4	3-24V	35
LP-412; LPD-422-FM (0-40VDC)	LH-OV-5	3-47V	35
LP-413; LPD-423-FM (0-60VDC)	LH-OV-6	3-70V	35

Prices F.O.B. factory, Melville, N. Y. All specifications and prices subject to change without notice.

LAMBDA
ELECTRONICS CORP.
 515 BROAD HOLLOW ROAD, MELVILLE, L.I., NEW YORK 11746
 TEL. 516-694-4200. TWX: 510-224-6484 CABLE: VEECOVAC PLAINVIEW NY

Now get IC Op Amp power...

with high gain and high voltage

RCA has these two monolithic OP AMP units for you—ready to meet your design requirements for high input impedance, high gain and high power output. Only the price isn't high! Ask your RCA Distributor for his price and delivery. Write RCA Electronic Components, Commercial Engineering, Section ICG4-CS Harrison, New Jersey 07029 for Data Sheet.

All characteristics below are typical

Power output (8% THD)
Output swing voltage (P-P)
Input impedance
Open-loop Gain
Input Offset Voltage
Input Offset Current
Input Bias Current
Slew Rate

RCA-CA3033
for $\pm 12V$ Supply

122 mW
21V
1.5 M Ω
90 dB
2.6 mV
5 nA
83 nA
1.2V/us

RCA-CA3033A
for $\pm 18V$ Supply

255 mW
32V
1 M Ω
96 dB
2.9 mV
9 nA
103 nA
2.5V/us

\$3.95 (1000 units)

\$4.95 (1000 units)

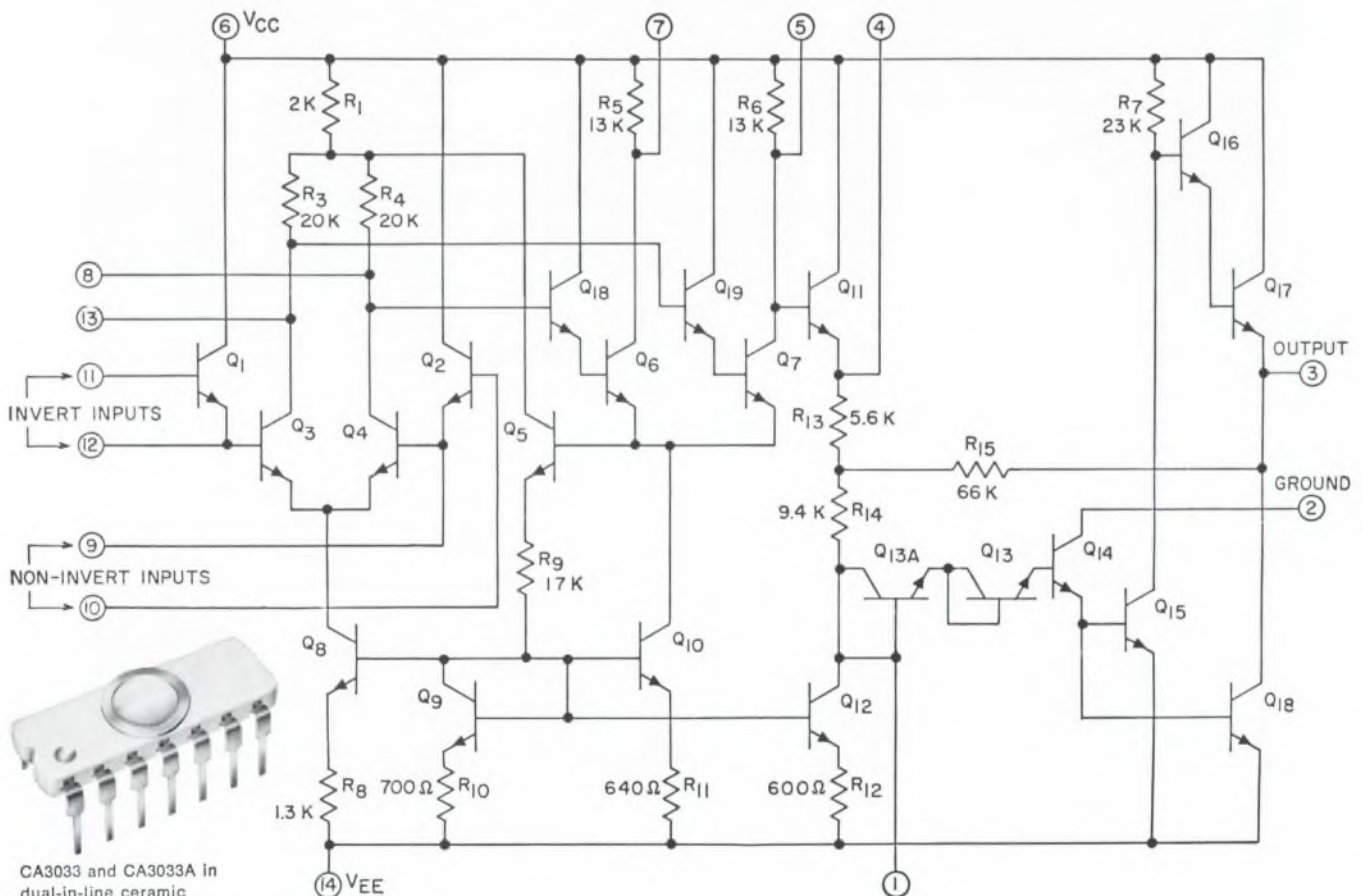

CA3033 and CA3033A in dual-in-line ceramic package (-55° to $+125^{\circ}\text{C}$ operating temperatures)

RCA
Integrated
Circuits

Now in plastic packages at economy prices.

CA3033 now available in dual-in-line plastic as CA3047 at \$1.95 (1000 units)
CA3033A now available in dual-in-line plastic as CA3047A at \$2.95 (1000 units)

THE PRACTICAL REFERENCE SHELF

FUNDAMENTALS OF INTEGRATED CIRCUITS Lothar Stern

A practical guide to integrated circuits — their theory, manufacture and applications. This book offers complete discussion of the various techniques of integrated circuit fabrication and their strong influence on circuit design and performance. From a marketing viewpoint, it compares the relative qualities of the numerous IC's devised to date in terms of economics and logistics.

The book covers basic semiconductor principles, monolithic integrated circuits, thin-film circuits and their characteristics, hybrid and other integrated structures. There is also discussion of packaging, design and layout principles, and LSI. A volume in the *Motorola Series in Solid-State Electronics*. 208 pages, 7 x 10, illustrated, cloth cover.
#5695 \$8.95

LEVEL-HEADED LETTERS Dr. Dugan Laird and Joseph R. Hayes.

Will help the executive to write better letters, faster. In practical, down-to-earth style, this book shows how to find the real reasons for writing; provides a simple plan for organizing ideas logically and psychologically, and points out ways to get affirmative responses from readers. Shows how to avoid cliches, verbiage and how to inject an air of informality into letters. Key feature is the programmed learning section on painless grammar. 134 pages, 6 x 9.

Paper cover, #5032 \$3.50
Cloth cover, #5033 \$4.95

PROJECT ESTIMATING BY ENGINEERING METHODS Paul F. Gallagher.

A practical approach to attaining consistently accurate estimates by summarizing many general practices and introducing specific methods proven valuable in various kinds of work. Five methods of estimating are discussed, the fifth of which combines the two most important developments in the field: standard hours and the learning curve. To insure complete understanding, full coverage is given to construction and use of learning curves. Nearly 100 pages of learning curve tables appear in the appendix. 344 pages, 8½ x 11, illustrated, cloth cover.

#5018 \$15.00

PRACTICAL PA GUIDEBOOK: HOW TO INSTALL, OPERATE AND SERVICE PUBLIC ADDRESS SYSTEMS Norman H. Crowhurst

A practical guide covering all aspects of the subject. The book shows how to select and install the appropriate equipment, covers routine operation and maintenance of the finished system. Special attention is given to solving the problems encountered in providing successful service. 136 pp., 6 x 9, illus., paper.

#0778 \$3.95

THEORY AND APPLICATIONS OF TOPOLOGICAL AND MATRIX METHODS Keats A. Pullen.

The dependence of electrical circuit theory on topology (theory of line graphs) is of growing importance because line graphs for networks represent their flow patterns. Application of topological methods has lagged behind the use of matrix methods only because of minor application problems. This volume resolves these problems in a logical and understandable way. 100 pages, 5½ x 8½, paper cover.

#0300 \$2.50

INDUSTRIAL STROBOSCOPY Gilbert Kivenson.

A comprehensive description of the history, development and use of stroboscopy in industry, commerce and research. Stroboscopy for analysis and measurement has spread to many specialized areas of science and engineering, such as high-speed cinematography, photometry, radiometry, torsional vibration and other areas. This book discusses the state of the art today and areas of further usage. 284 pages, 6 x 9, illustrated, cloth cover.

#5045 \$9.95

DESIGN OF LOW-NOISE TRANSISTOR INPUT CIRCUITS William A. Rheinfelder.

Design engineers and others interested in low-noise circuit design will find this book a real time saver. Gives a multitude of labor saving graphs and design curves for the practical circuit designer. Simple derivations of all important formulas help the reader obtain a deeper insight into the fundamentals of practical low-noise design. 128 pages, 6 x 9, illustrated, cloth cover.

#5014 \$5.50

WAVEFORM MEASUREMENTS Rufus P. Turner.

Complete how-to information on the various techniques of electrical waveform measurement—from troubleshooting to signal synthesis. Book details procedures for the isolation and measurement of a single harmonic from a multisignal mixture, measurement of total distortion, calculation of harmonic values from heights of the wave patterns, etc. 96 pages, 5¾ x 8¼, illustrated, paper cover.

#0775 \$2.95

UNDERSTANDING SILICON CONTROLLED RECTIFIERS Saul Heller

A compact, illustrated guide to the capabilities and operation of the versatile SCR and the triggering circuits associated with these devices. Throughout the book, schematic diagrams illustrate the application of the various SCR's as static switches, phase-control switches, inverters, choppers, etc. Emphasis is placed on choosing the right SCR to do a given job. 134 pages, 5¾ x 8¼, illustrated, paper cover.

#0782 \$3.50

TRANSISTOR AND DIODE NETWORK PROBLEMS AND SOLUTIONS Harry E. Stockman.

This two-way reference demonstrates the practical application of theory and serves as sourcebook of step-by-step mathematical solutions to practical problems. With schematic situations covering the entire field of transistor and diode networks, the reader develops effective techniques by comparing his own solution methods with the author's. 352 pages, 6 x 9, illustrated.

#5694 \$9.95

TRANSISTOR AND DIODE LABORATORY COURSE Harry E. Stockman

Structured on engineering concepts and facts, this new course first provides a groundwork in transistor technology. Two-part theory viewpoints are applied continuously to give the work an engineering slant. The balance of the experiments deal with more intricate transistor networks, such as the theory and operation of multivibrators, and the concept of parametric action. 128 pages, 7¼ x 10, illus.

#5671 \$3.95

REVIEW ANY OF THESE BOOKS FOR 10 FULL DAYS — FREE!

HAYDEN BOOK COMPANY, INC. 116 W. 14 St., N. Y., N. Y. 10011

Please send me the books circled below, on a 10-day free examination. At the end of that time I will remit payment, plus postage, or return the books without obligation.

5695	0778	5014
5694	5032	0775
5671	5033	0782
5018	0300	5045

Payment enclosed (Hayden pays postage). Same return privilege.

Name _____

Firm _____

Address _____

City _____ State _____ Zip _____

On all overseas orders, payment in U.S. dollars must be enclosed. Publisher pays postage with same return privilege.

ED-469



Where will Matt Tate be tomorrow?

Wherever the project leads, Matt Tate is on his way. Board . . . bench . . . conference table. This young engineer sees them all at Delco. He was there when the project came from the car division. He'll be there when the model shop builds his prototype. He'll be looking over the shoulders of draftsmen, mechanics and stylists. The project's his. From start to finish. Step by step, skill by skill, Matt Tate's growing with the job. The question is . . . can you say the same? Take a good hard look at how your career shapes up, compared with Matt's and his colleagues' at Delco. We need men who want every week to be a little different. For details, call collect, Area Code 317/459-2808. Or write: Mr. C. D. Longshore, Supervisor, Salaried Employment, Dept. 502, Delco Radio Division of General Motors, Kokomo, Indiana.

**DELCO
RADIO**



AN EQUAL OPPORTUNITY EMPLOYER
DIVISION OF GENERAL MOTORS
KOKOMO, INDIANA

INFORMATION RETRIEVAL NUMBER 901

Free Career Inquiry Service

Absolutely Confidential

Respond to the career opportunities advertised in this issue. Fill out and send us this handy resume. **Electronic Design** will do the rest – neatly typed copies of this form will be mailed to the companies of your choice, indicated by the circled Career Inquiry Numbers at the bottom of this page.

9

Name		Home Phone	
Home Address (Street)		City	State
			ZIP Code
Age	U.S. Citizen	Security Clearance	
	<input type="checkbox"/> Yes <input type="checkbox"/> No		
Prime Experience		Secondary Experience	
Desired Salary		Availability Date	

Employment History – present and previous employers

Company			
City, State			
Dates	to	to	to
Title			
Specialty			

Education – indicate major if degree is not self-explanatory

Degree			
College			
City, State			
Dates	to	to	to

Additional Training – non-degree, industry, military, etc.

Professional Societies

Published Articles

- Career Inquiry Numbers:**
- | | | | | | | | | | | |
|-----|-----|-----|-----|-----|-----|-----|-----|-----|-----|-----|
| 900 | 901 | 902 | 903 | 904 | 905 | 906 | 907 | 908 | 909 | |
| 910 | 911 | 912 | 913 | 914 | 915 | 916 | 917 | 918 | 919 | 925 |

ELECTRONIC DESIGN
 850 Third Avenue
 New York, New York 10022

ZM1000 READOUT TUBE NOW

\$ 2.95

IN THOUSAND LOTS



The AmpereX ZM1000 is the first digital numerical indicator tube, designed from the ground up for high-volume applications. It provides big economies, not only in initial cost but also in application. Its low price of \$2.95 in thousand lots is only part of the story... in volume, the ZM1000 sells for less than \$2.00.

We scrapped every notion about how to make numerical indicator tubes and developed a completely new design that offers unsurpassed performance and reliability at mass-production prices.

Every ZM1000 has a built-in decimal-point indicator. Use it if you wish — or ignore it... in either case, there's no additional cost for the decimal-point. The ZM1000's large numerals are clearly legible at 35 feet, yet an 8-digit readout can be installed in only 6 inches of panel.

Superior design makes the ZM1000 more economical to use, too; its high-temperature base is designed to plug directly into a printed circuit board or an inexpensive, readily available socket.

IMPORTANT FEATURES

- Dynamic life expectancy..... 200,000 hrs.
- Height of numeral..... 0.6"
- Tube diameter..... 0.75"
- Height of tube..... 1.67"

For complete data and comprehensive application bulletin on indicator-driver circuits for the ZM1000, write: AmpereX Electronic Corporation, Semiconductor and Microcircuits Division, Slatersville, Rhode Island 02876.

AmpereX®

TOMORROW'S THINKING IN TODAY'S PRODUCTS

A NORTH AMERICAN PHILIPS COMPANY

Products

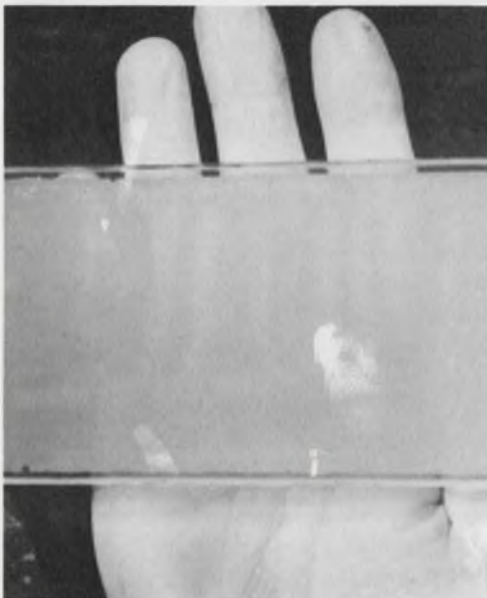
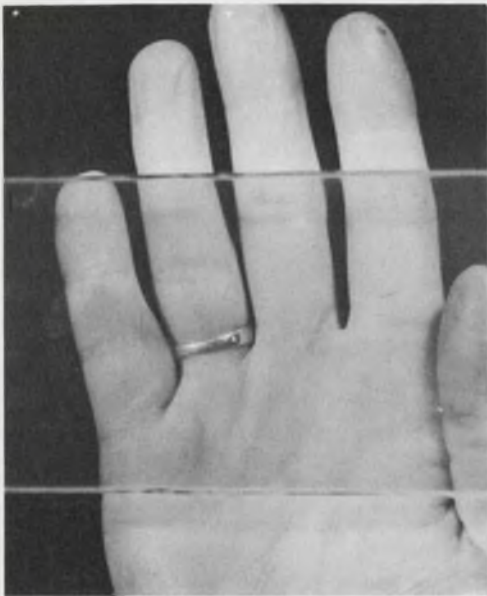

Nematic liquid crystals frost over when voltage is applied, p. 96

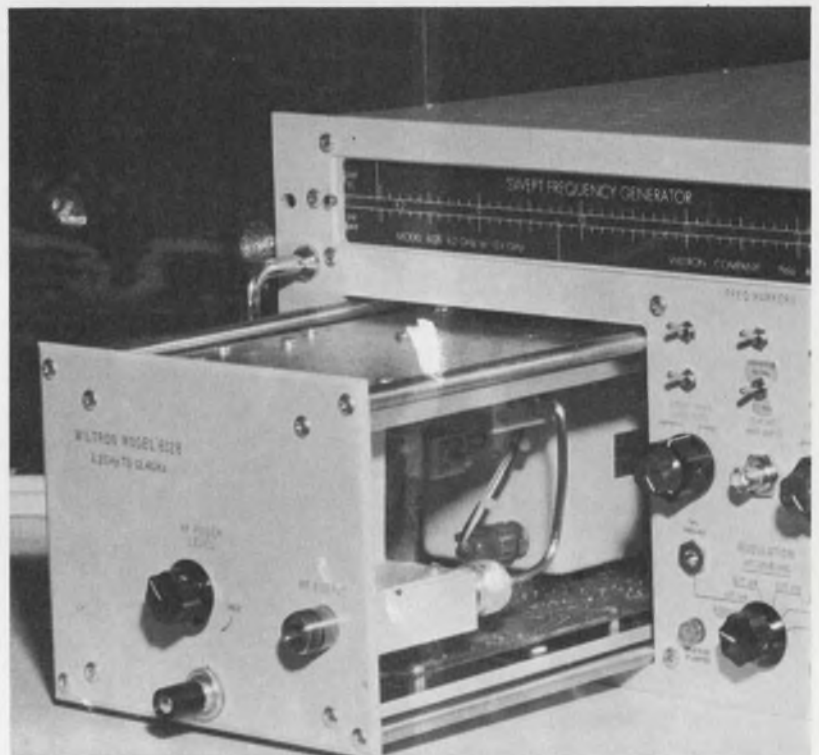
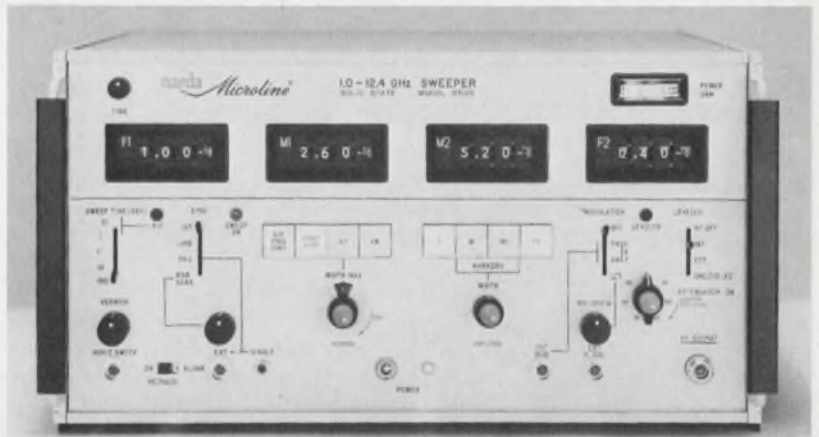

Solid-state sweepers invade X band. One sweeps 1 to 12.4 GHz; another adds a new X-band plug-in, p. 86

Also in this section:

Tiny alphanumeric display panel rivals size of penlight battery, p. 104

Wideband oscillator smooths output amplitude variations to ± 0.5 dB, p. 98

Military hybrid IC op amp features metal-can dual-in-line package, p. 92

Design Aids, p. 112 . . . **Application Notes**, p. 114 . . . **New Literature**, p. 116

X-band sweepers are going solid state; two are here and more are on the way

Robert Patton
New Products Editor

Solid state has invaded the microwave sweeper market. Shown at last month's IEEE show in New York were two solid-state units with X-band capabilities.

Narda Microwave Corporation introduced an all solid-state instrument that sweeps continuously from 1 to 12.4 GHz. Previous broadband sweepers have relied on BWO oscillators for at least part of their range, but Narda's model 9500 provides full L-, S-, C- and X-band coverage in a single, solid-state instrument.

Another unique feature of the Narda unit is digital tuning provided by four front-panel, frequency-programming wheels with a resolution of better than 200 kHz. In the start-stop, sweep mode any pair of the four front-panel pushbuttons may be used to set the sweep limits; the sweep may be either up or down in frequency. Operating in the Δf sweep mode, any pushbutton can be used to select center frequency, while a decade switch and vernier is used to adjust sweep width between 100 kHz and 100 MHz. In the cw mode each push-

button selects a frequency while one pushbutton features a fine tuning adjustment for precise trimming.

The basic unit sells for \$9800, with an additional \$650 for an internal leveling option. Leveled output power is 1 mW minimum over the entire band with additional power available over narrower sweep widths. Harmonically related spurious signals are better than 20 dB below the fundamental while non-harmonically related spurious signals are more than 30 db down.

The instrument is voltage programmable with voltage directly corresponding to frequency at the rate of 1 V/GHz. Thus, frequency may be read directly by a DVM, with BCD output available for printout or parity check. A digital power supply can be used for computer programming of frequency without additional interfaces. In this instrument Narda is using a proprietary technique involving frequency multiplication, while other firms are using separate fundamental oscillators for each octave.

A second entry in the solid-state sweeper market is Wiltron's model

6128 X-band plug-in for its model 610B main frame. Priced at \$3900 (main frame: \$1100), the Wiltron unit uses a YIG-tuned Gunn-effect diode to cover the 8- to 12.4-GHz range. One advantage offered by this unit is 5-mW leveled power output compared to the 1 mW offered by the Narda unit. Spurious signals are more than 50 dB below the output signal, and harmonics are better than 30 dB down. At present Wiltron cannot match the range of the Narda unit, but a 4- to 8-GHz plug-in is in the works. Spokesmen for the firm indicated that this unit will be announced in the near future at a price of approximately \$2900. This would allow Wiltron to offer full coverage of the 1- to 12.4-GHz range, with the model 610B main frame and four plug-ins, at a total cost of about \$12,350.

All Wiltron sweeper plug-ins include a coupler and detector for internal leveling, a filter to minimize harmonics, a p-i-n diode modulator to permit external amplitude modulation, and isolators for minimizing frequency pulling due to external load VSWR and for providing low VSWR output.

Narda and Wiltron are far from the only contenders in the solid-state, multiband sweeper market. Servo Corporation of America introduced at WESCON last year a hybrid unit that incorporated two solid-state oscillators and two BWOs to cover the 1- to 12.4-GHz range. The unit is now offered for \$11,260 with 30-day delivery.

Although Servo is sold on solid state, they are not yet ready to bury the BWO. Later this year they expect to incorporate a solid-state X-band oscillator, but they insist that they will not settle for lower power for the sake of going solid state. As solid-state oscillators become available for the higher bands they intend to take advantage of the space saved by

(continued on page 88)

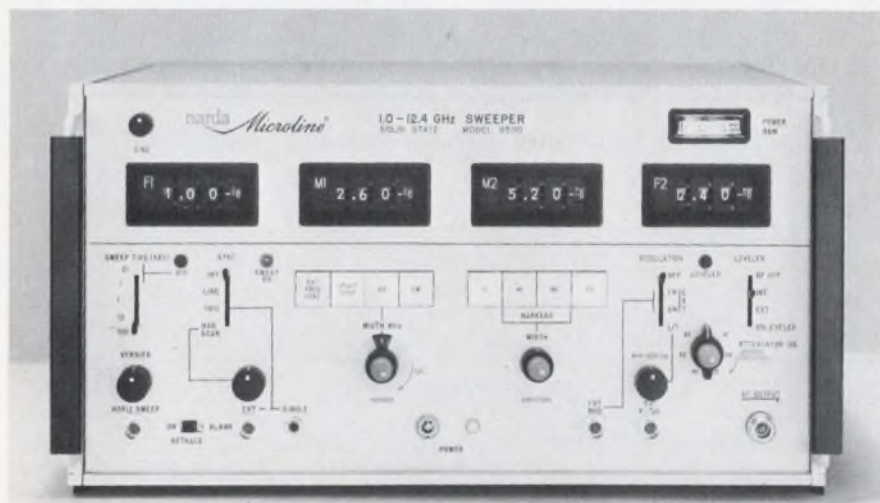

Solid-state sweeper from Narda Microwave offers full L-, S-, C and X-band coverage in a single package with external voltage programming.

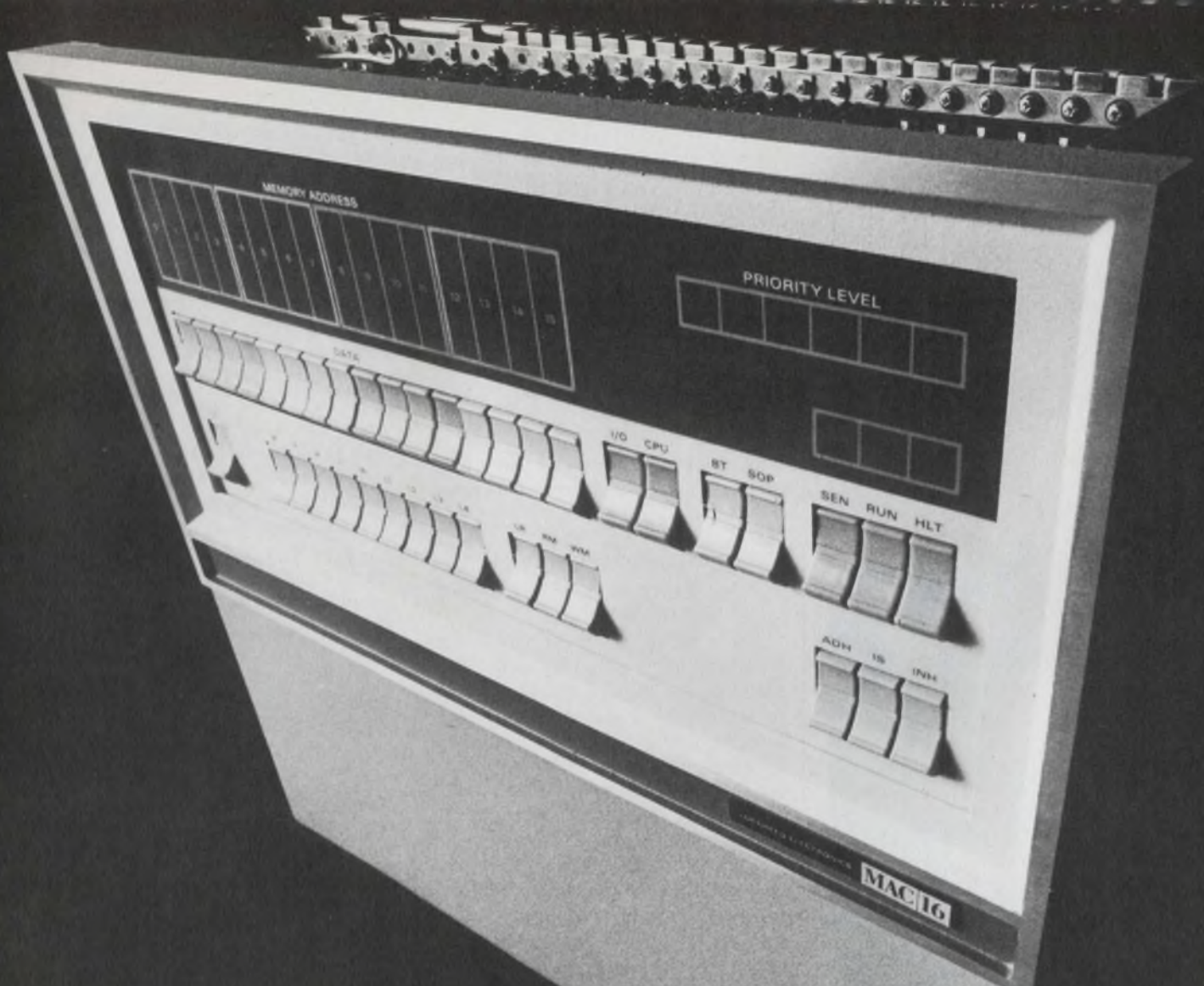

MAC makes your money talk louder.

Putting out \$11,950 for MAC won't make you a big spender. Just a smart one. With MAC in the middle of your real-time system, you've scored.

First, the price is a steal. And it includes teletype. Which makes you a hero with the comptroller — he knows you're watching the shop instead of budget-busting.

Then, you spike the chance of later hang-ups. If the system needs stretching or changing, MAC is capable, flexible and expandable.

Where else, for instance, can \$11,950 buy a basic 4K memory of 16-bit words expandable to 64K with 8K in the mainframe? At 1 μ sec cycle time? With 72 basic hardware instructions?

And who else gives you options you want but can't always get, like hard-

ware multiply/divide, automatic bootstrap, and direct memory access channel? Plus an I/O bus with 255 device addresses, and 4 hardware priority interrupt levels, expandable to 64?

That's bare-bones hardware. But MAC also has the gamut of third-generation software — ready now — including some eye-opening Lockheed exclusives.

Put it this way: If there's a bigger pack of computer value than MAC anywhere near the price, we haven't been watching the shop.

Write to MAC, Lockheed Electronics Company, Data Products Division, 6201 East Randolph Street, Los Angeles, California 90022.

MEET MAC AT THE SJCC, BOOTH 2005-8.

LOCKHEED ELECTRONICS COMPANY



A Division of Lockheed Aircraft Corporation

HANSEN'S NEW 900 SERIES



gives you
standard Synchron®
reliability with up
to 98 oz.-in. torque

Now, without sacrificing compact size, you can get high torque even at higher speeds—from 1 to 900 RPM. Synchron® 900 Series has thick, wide gears, specially designed to give the added gear strength that makes full use of its power increase. Highest quality instrument gear train for all speeds below 900 RPM.

The new self-starting hysteresis motor has positive direction of rotation—right or left hand. Plus extra heavy phenolic first gear for low noise level. It can be stalled continuously without electrical or mechanical damage.

Added strength in both the rotor and gear train enables 900 Series to handle your toughest timing and control jobs. Because of its compact dimensions, it is often interchangeable with motors of lower torque. To find out what 900 SERIES can do for you, write or phone today to have a representative contact you.

VISIT BOOTH No. 3133,
DESIGN ENGINEERING SHOW



HANSEN MFG. CO., INC.
Princeton, Indiana 47570

HANSEN REPRESENTATIVES: CAREY & ASSOCIATES, Houston and Dallas, Texas; R. S. HOPKINS CO., Sherman Oaks, Calif.; MELCHIOR ASSOCIATES, INC., San Carlos, Calif.; THE FROMM CO., Elmwood Park, Ill.; JOHN ORR ASSOCIATES, Grand Rapids, Mich.; H. C. JOHNSON AGENCY, INC., Rochester, N.Y.; WINSLOW ELECTRIC CO., Essex, Conn.; Villanova, Pa., and New York, N.Y.

EXPORT DEPARTMENT: 2200 Shames Drive, Westbury, N.Y. 11590

INFORMATION RETRIEVAL NUMBER 48

MICROWAVES FEATURE



X-band plug-in adds 8.2- to 12.4-GHz capabilities to Wiltron sweepers.

incorporating another BWO to extend the range of their instrument by an additional octave.

The Servo sweeper features separate pairs of adjustments for each octave. This makes it possible to set up the instrument to sweep discrete portions of each octave. In this instrument, leveled power outputs of 30 to 35 mW are available at X-band and about 60 to 70 at L-band; leveling on all bands is better than ± 1 dB. Servo's unit has been criticized because the coaxial switches between octaves are somewhat noisy; however, the company expects to go over to a four-pole diode switch in the near future to eliminate this objection.

Among the manufacturers using a plug-in approach to multiband capability are Kruse-Storke, Alfred Electronics, and Hewlett-Packard. All three firms are working on the development of solid-state plug-ins for their existing sweepers. Kruse-Storke hopes to be able to introduce C- and X-band units some time this year. When these become available the company will be able to offer a package that, comprising its model 5000 sweeper, two model 5090 power units, and six plug-ins, will offer full coverage up to 12.4 GHz. Total cost will be in the \$10,000 to \$12,000 range; the C- and X-band plug-ins alone will cost in the vicinity of \$2000 each. The new units will offer leveled power outputs of about 10 mW—comparable to the presently available model 5013 S-band plug-in. The model 5090 multiband power unit is available now, accommodates three plug-ins and is digitally programmable.

A similar approach is being followed by Hewlett-Packard and Alfred Electronics. Both firms offer a basic unit with plug-ins in a separate box for about \$10,000. Alfred expects to have C-band plug-ins using YIG-tuned transistors within a year. Surprisingly, most manufacturers agree that the development of C-band oscillators poses a bigger problem than X-band. The 4- to 8-GHz range is too high for a varactor-tuned transistor approach and too low to use Gunn or avalanche diodes. On this point the industry is split; some favor an approach that uses low-power transistor oscillators with subsequent amplification and others feel that Gunn diodes can be used down to 4 GHz.

At least one firm, Micro-Power, feels that the solid-state units that are presently available leave much to be desired compared to BWO oscillators. BWO units do offer considerably higher power at lower cost, but are not likely to retain this advantage much longer. Although Micro Power is taking the conservative view, it is looking into solid state as the way of the future. Other manufacturers feel that the future is upon us. ■■

Use the Information Retrieval Card to request additional data from the firms mentioned in this article.

Alfred Electronics, 3176 Porter St., Palo Alto, Calif. Phone: (415) 326-6496.

CIRCLE NO. 340

Hewlett-Packard, 1501 Page Mill Rd., Palo Alto, Calif. Phone: (415) 326-7000.

CIRCLE NO. 341

Kruse-Storke Electronics, 790 Hemmeter Lane, Mountain View, Calif. Phone: (415) 967-2299.

CIRCLE NO. 342

Micro-Power, Inc., 25-14 Broadway, Long Island City, N.Y., Phone: (212) 726-4060.

CIRCLE NO. 343

The Narda Microwave Corp., Commercial St., Plainview, L.I., N.Y. Phone: (516) 433-9000.

CIRCLE NO. 344

Wiltron Co., 930 E. Meadow Dr., Palo Alto, Calif. Phone: (415) 321-7428.

CIRCLE NO. 345

Infrared detector senses uniformly

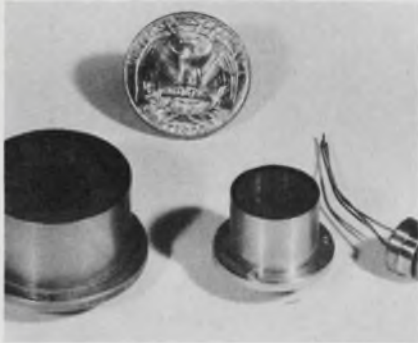

Barnes Engineering Co., 44 Commerce Rd., Stamford, Conn. Phone: (203) 348-5381.

Suitable for use in long-wavelength infrared scanning systems, a new pyroelectric detector provides uniform sensitivity and a useful noise equivalent power from near dc to beyond 2 MHz. The basic detector consists of a thin flake of triglycine sulfate sandwiched between two electrodes. When heated by IR radiation, it generates a voltage across the electroded surfaces that is proportional to the impinging radiant energy.

CIRCLE NO. 321

Miniature hybrid coupler covers 12.4 to 18 GHz

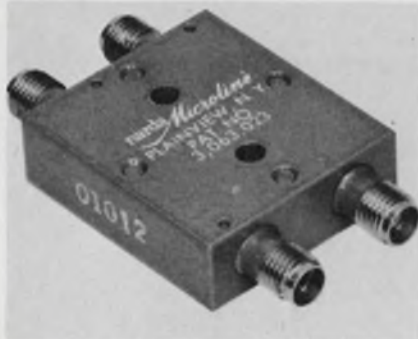

Narda Microwave Corp., Commercial St., Plainview, N.Y. Phone: (516) 433-9000. P&A: \$175; stock.

A new miniature 3-dB hybrid coaxial coupler, model 4036, covers the frequency range from 12.4 to 18 GHz in a package that weighs only one ounce. Dimensions are 1-1/8-in. long, 1-1/2-in. wide (excluding connectors), and only 3/8-in. thick. Minimum isolation is 15 dB and VSWR is 1.5 max. Power is 50 W average and 5 kW peak.

CIRCLE NO. 322



Generation Gap

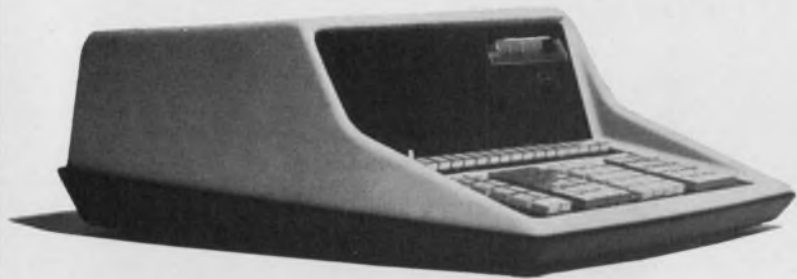

The Wang 700 Calculator is a whole lot smarter than its predecessors.

It's the first of a new breed, a third generation programmable calculator. The difference is more revolutionary than evolutionary. It's ten times faster and more powerful than the best of the 2nd generation machines. It handles far longer programs (learns on a built-in 8192-bit core and stores permanently up to 10 blocks of 960 steps each on snap-in magnetic tape cassettes), has many more data storage registers (up to 120), and provides more hardware operations (like logs to base e and base 10, π , e^x , 10^x , etc.), than any existing calculator or so-called desk-top computer.

Execution speeds for various functions range from 300 μ sec for + and - to 250 msec for trig functions. A dual Nixie-type display produces 12 digit answers plus 2-digit (-98 to +99) exponents each register.

The Wang 700 has commands for loops, branches and subroutines, unmatched power for matrix and array operations. Exclusive integrated circuit design concentrates all these capabilities into a self-contained, convenient desk-top package. It's the logical heir to Wang leadership in high performance problem-solving.



Dept. 4CB.836 North St., Tewksbury, Massachusetts 01876 • Tel. 617 851-7311

Call today

for immediate trial:

(201) 241-0250	(216) 333-6611	(313) 278-4744	(502) 426-1116	(608) 244-9261	(714) 234-5651
(203) 223-7588	(301) 588-3711	(314) 727-0256	(504) 729-6858	(612) 881-5324	(716) 381-5440
(203) 288-8481	(301) 821-8212	(315) 463-9770	(505) 255-9042	(615) 588-5731	(717) 397-3212
(205) 881-5360	(303) 364-7361	(402) 341-6042	(512) 454-4324	(616) 454-4212	(801) 487-2551
(206) 622-2466	(304) 344-9431	(404) 633-6327	(513) 531-2729	(617) 542-7160	(805) 962-6112
(212) 682-5921	(305) 563-8458	(405) 842-7882	(517) 835-7300	(617) 851-7311	(816) 444-8388
(213) 278-3232	(305) 841-3691	(412) 366-1906	(518) 463-8877	(702) 322-4692	(817) 834-1433
(214) 361-7156	(309) 674-8931	(414) 442-0160	(601) 234-7631	(703) 595-6777	(901) 272-7488
(215) 642-4321	(312) 297-4323	(415) 692-0584	(601) 982-1721	(713) 668-0275	(916) 489-7326
			(602) 265-8747	(713) 668-3753	(919) 288-1695

Wide-range sweeper scans 50-GHz band



Micro-Now Instrument Co., Inc., 6124 North Pulaski Road, Chicago, Ill. Phone: (312) 282-0846. P&A: \$10,500; 60 days.

Using only two plug-in heads, a new millimeter-wave sweep system covers the frequency range of 40 to 90 GHz. Model 740 consists of a multiple-output power supply, the plug-in heads, and a special, wide-range backward-wave oscillator tube. The 723 plug-in delivers 20 mW from 40 to 62 GHz; model 724 plug in is rated at 5 mW from 60 to 90 GHz.

CIRCLE NO. 323

Pulse switching diodes operate in picoseconds

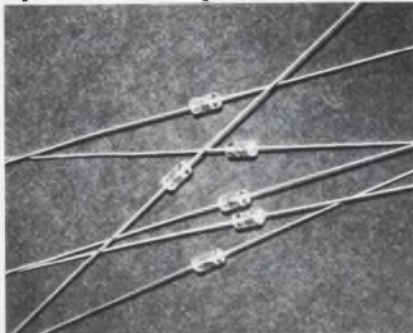

Microwave Associates (West) Inc., 999 E. Arques Ave., Sunnyvale, Calif. Phone: (408) 736-9330. Price: \$5.90.

A picosecond-pulse switching diode is the first of a new series of charge-control devices specifically characterized for speed. The MA4-B200 diodes are fully pulse tested, providing outstanding performance over a wide temperature range. The devices have a minimum breakdown voltage of 70 V, and capacitance range of 3 to 5 pF.

CIRCLE NO. 324

YIG-tuned receiver plugs into scope



Electro/Data, Inc., 3121 Benton St., Garland, Tex. Phone: (214) 276-6167. P&A: \$2795; 30 to 45 days.

A high-frequency YIG-tuned panoramic receiver plug-in module covers the 1.8 to 25 GHz frequency range in a single sweep. The receiver is designated as model PN1013 and is available for plug-in use with Tektronix 560 series and letter series oscilloscopes. This module will convert an ordinary oscilloscope into a wideband, microwave receiver with a panoramic display of signals on the scope face.

CIRCLE NO. 325

Interboard feed-thru stacks MIC boards

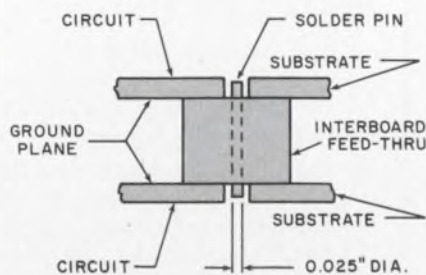

Tek-Wave, Inc., Raymond Rd., Princeton, N.J. Phone: (609) 921-8910.

A new microwave integrated circuit (MIC) interboard feed-through enables the engineer to feed-through 50- Ω rf signals with a minimum of discontinuity and with considerable savings of space. Bringing the circuit from microstrip to coax and back to microstrip, the interboard feed-through serves as a mounting fixture.

CIRCLE NO. 347

Coaxial patch panels go as high as 1 GHz

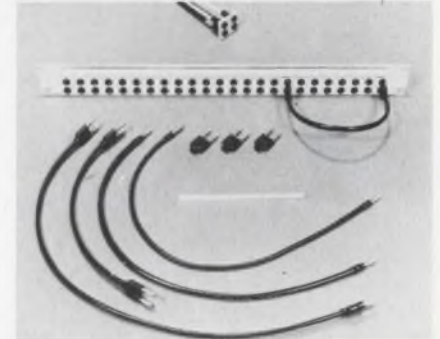

AMP Inc., Harrisburg, Pa. Phone: (717) 564-0101.

A complete coaxial patching system, including patch panels, standard and keyed patchcords and shunts, is designed for use in telemetry, instrumentation, communication and data-processing equipment operating at frequencies up to 1 GHz. Various standard panel configurations are available, using 1/2-in. spacing and having up to 132 contact positions. The patch panels are available in anodized or enameled aluminum to fit standard 19-in. racks.

CIRCLE NO. 346

Ka-band oscillator uses Gunn effect



Varian, 611 Hansen Way, Palo Alto, Calif. Phone: (415) 326-4000. P&A: \$1500; 75 days.

A Gunn-effect oscillator line has been expanded into Ka-band with the VSA-9010. This unit offers 10 mW minimum power output over any customer-selected 1000-MHz tuning range in the 26.5 to 40 GHz region. Maximum operating bias requirements are 6 V and 500 mA. It is capable of operating in ambients up to 100°C.

CIRCLE NO. 339

**This portable will record
more facts in less time, at less cost
than any other 2-channel recorder
on the market.**

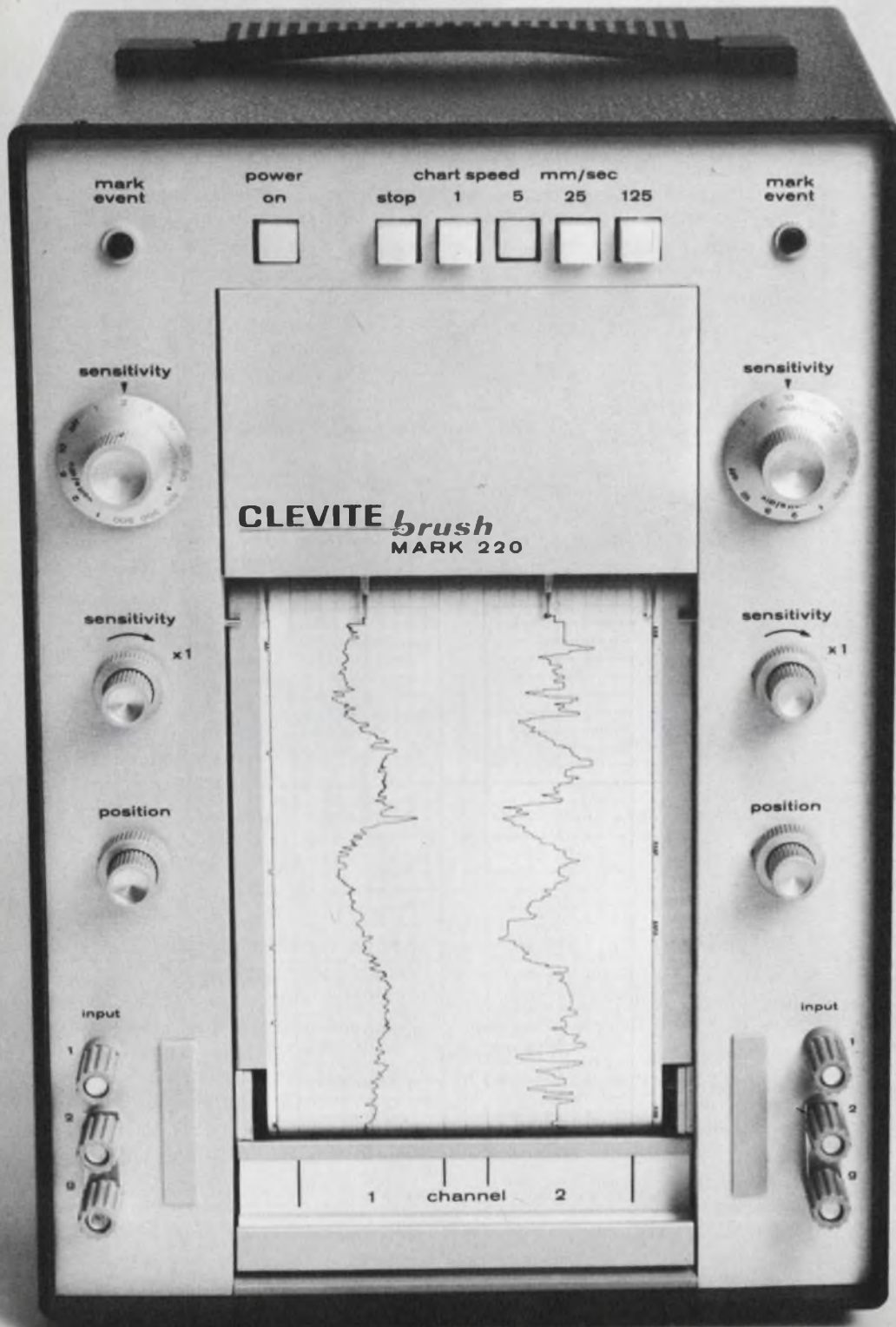

We call it the Mark 220.

And once we put it through its paces for you, you'll call it the most amazing piece of recording gear around.

To begin with, we guarantee the Mark 220 to be 99½% accurate. Which is a good deal better than almost anything else on the market . . . regardless of size or price. The pressurized ink-writing system is the same one you'll find in our six and eight channel systems. Instead of laying the trace on the



paper, it forces it *in*. Run your finger over it. There's no smear, no smudge. And trace crispness and uniformity is in a class by itself.

Built-in preamplifiers give you measurement range from 1 mV per division to 500 V full scale — and you never have to re-calibrate. Pushbutton controlled chart speeds. Two handy event markers. Ink supply is a disposable cartridge, good for a year.

Yes, for a 25 pound portable that's no bigger than a breadbox, the Mark 220 is quite a recorder. Ask your Brush representative for a demonstration. Or, write for complete details. Clevite Corporation, Brush Instruments Division, 37th and Perkins, Cleveland, Ohio 44114. We'll include our informative booklet "Elimination of Noise in Low-Level Circuits".

CLEVITE BRUSH

a Custom Meter Design by **BEEDE** for

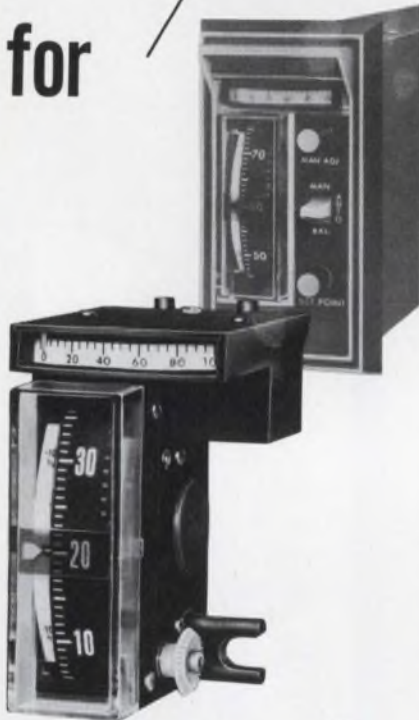

Beede designed the special meter movements installed in this new, solid-state Robertshaw Model 323 Process Controller. Robertshaw's demanding meter requirements were met by close engineering cooperation and Beede's experience in the panel meter instrument field. Beede worked with Robertshaw in the design of the special meter case. Robertshaw ships these cases to Beede for installation of the large taut band and smaller pivot-and-jewel meter movements.

Beede has the capability to solve your meter problems, as we did for the Robertshaw Controls Company. Call or write us about your custom meter requirements . . . or send for our Catalog of standard panel meter cases and meter movements.

BEEDE
ELECTRICAL INSTRUMENT CO., INC.
PENACOOK, NEW HAMPSHIRE
Area Code: 603-753-6362

BUY VALUE / BUY BEEDE

INFORMATION RETRIEVAL NUMBER 51

ICs & SEMICONDUCTORS

Hybrid IC amplifier has metal-can DIP

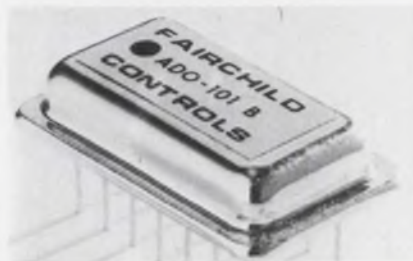

Fairchild Controls, a div. of Fairchild Camera and Instrument Corp., 423 National Ave., Mountain View, Calif. Phone: (415) 962-3833. P&A: \$95; stock.

Designed for military applications, a new FET-input thin-film hybrid operational amplifier is hermetically sealed in a metal can version of the 14-pin dual-in-line package. Model ADO-101B has a maximum voltage drift of 25 $\mu\text{V}/^\circ\text{C}$ over the full military temperature range of -55 to $+125^\circ\text{C}$.

CIRCLE NO. 348

Tunnel diodes minimize leakage

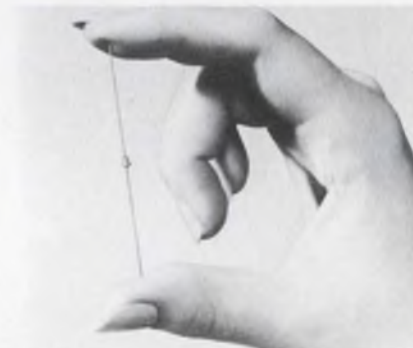

Centralab Semiconductor Div., Globe-Union Inc., 4501 N. Arden Drive, El Monte, Calif. Phone: (414) 228-2769. P&A: \$4.75; 4 wks.

Identified as types U1001 through U1010, new silicon tunnel diodes exhibit high reverse conductance at milliwatt levels and operate with leakage tunneling currents in the order of microamperes when forward biased. Furnished in DO-17 packages, the hermetically sealed units have gold-plated weldable Kovar leads. They meet the environmental requirements of MIL-S-19500 and MIL-STD-750.

CIRCLE NO. 349

Power thyristors switch in 10 ns



Solid State Products, Div. of Unitorde Corp., 1 Pingree St., Salem, Mass. Phone: (617) 745-2900.

Combining the turn-on speed of small-signal transistors with the current handling capability of SCR devices, series GA200 thyristor switches provide risetimes of 10 ns to 1 A or 20 ns to 30 A. These silicon planar passivated devices have recovery times down to 0.5 μs and surge current capabilities as high as 50 A. They can handle voltages of 2 kV with no significant decrease in speed when series stringing circuits are used.

CIRCLE NO. 350

Dual-in-line IC drives and counts

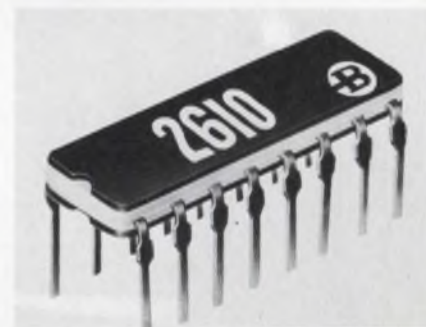

Burroughs Corp., Electronic Components Div. Plainfield, N.J. Phone: (201) 757-5000

Housed in a dual-in-line package, a new monolithic decade counter has decimal outputs that can drive Nixie tubes directly. Since model BIP-2610 is designed for 300-KHz 12-V logic, it also features high noise immunity. The unit uses a ten-stage silicon-controlled switch ring-counter logic that can be preset and reset to any number.

CIRCLE NO. 351

Pressfit rectifiers
carry 35 A at 300 V

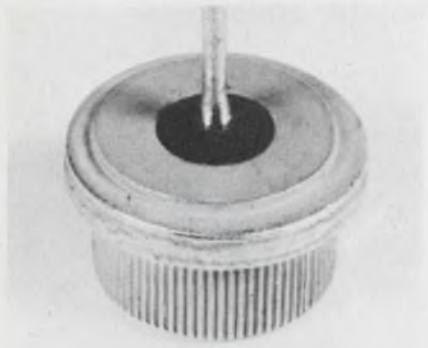

Wagner Electric Corp., Tung-Sol
Div., One Summer Ave., Newark,
N. J. Phone: (201) 484-8500.

Handling maximum average rectified currents of 35 A at 150°C for three-phase circuits, a new line of pressfit rectifiers provide maximum dc blockvoltages and maximum recurrent peak reverse voltages of 50, 100, 200 or 300 V. The new devices can withstand a one-cycle surge of overload current up to 400 A for 8 ms.

CIRCLE NO. 352

Uhf tuning diodes
stabilize capacitance

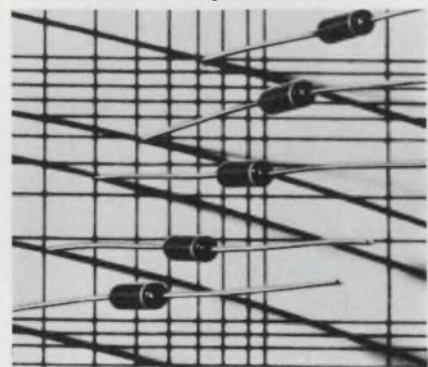

Motorola Semiconductor Products,
Inc., P.O. Box 20924, Phoenix,
Ariz. Phone: (602) 273-8466.
P&A: \$2.50 to \$8; stock.

Providing sophisticated frequency control of uhf circuits, either remote or programed, a new series of high-Q tuning diodes operate over 30-V range with a nominal capacitance tolerance of 2, 5 or 10%. Types 1N5461A,B,C through 1N5476A,B,C, have a nominal capacitance range of 6.8 to 100 pF and minimum Q of 200 or 600 at 50 MHz.

CIRCLE NO. 353

Two great bench-top temperature chambers

to match your testing needs at great low prices from Tenney!

PLAIN

The new TENNEY SST

Sturdy new "Hermeticool" mechanically refrigerated chamber now available at a great low price. Check these features:

Range: -95° F to +350° F, $\pm 1/2$ ° F control

Chamber Dimensions: 16" wide x

11" deep x 12" high

Heatup: To +350° F
in 35 minutes

Pulldown: From ambient
to -95° in 55 minutes

Power: 110 volts

FULL PRICE:

\$890

including
temperature indicator.
Available from stock.

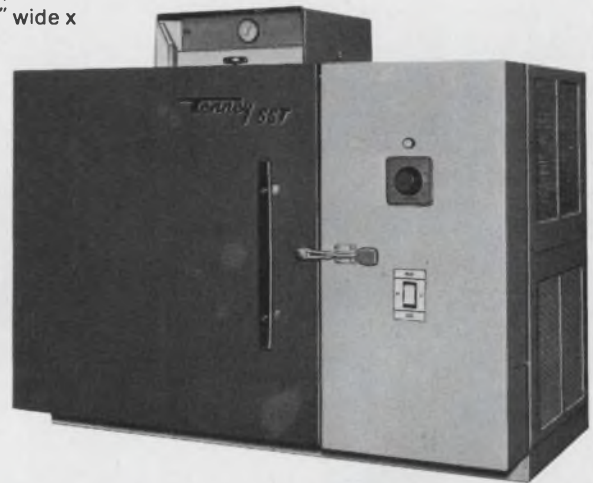

& FANCY

TENNEY JR.

The ultimate in a bench-top high-low temperature chamber.

"Hermeticool" mechanically refrigerated, solid-state SCR instrumentation, and many other exceptional features!

Range: -120° F to +350° F,
 $\pm 1/4$ ° F control

Chamber Dimensions: 16" wide x
11" deep x 12" high

Heatup: To +350° F in 35 minutes

Pulldown: From +75° F ambient to
-100° F in 35 minutes

Power: 115 volts

FULL PRICE:

\$1080

Available
from stock

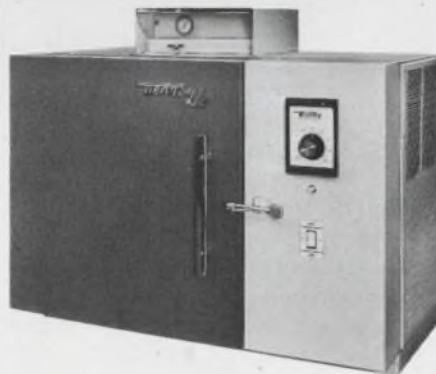

Tenney
ENGINEERING, INC.

1090 Springfield Rd., Unlon, New Jersey 07083 • (201) 686-7870
Western Division: 15721 Texaco St., Paramount, Calif. 90723

514A

INFORMATION RETRIEVAL NUMBER 52

Dual-gate MOSFET protects itself

RCA Electronic Components, 415 South 5th St., Harrison, N.J. Phone: (201) 485-3900. P&A: \$1.25; stock.

Offering integral gate protection, a new monolithic dual-gate MOSFET has on-chip back-to-back pro-

teective diodes for each gate. Intended for use in rf mixer and i-f applications from 10 to 400 MHz, the 40673 features inherently high input impedance and square-law transfer characteristics. At 200 MHz, its noise level is typically 3.5 dB and power gain is typically 18 dB.

CIRCLE NO. 354

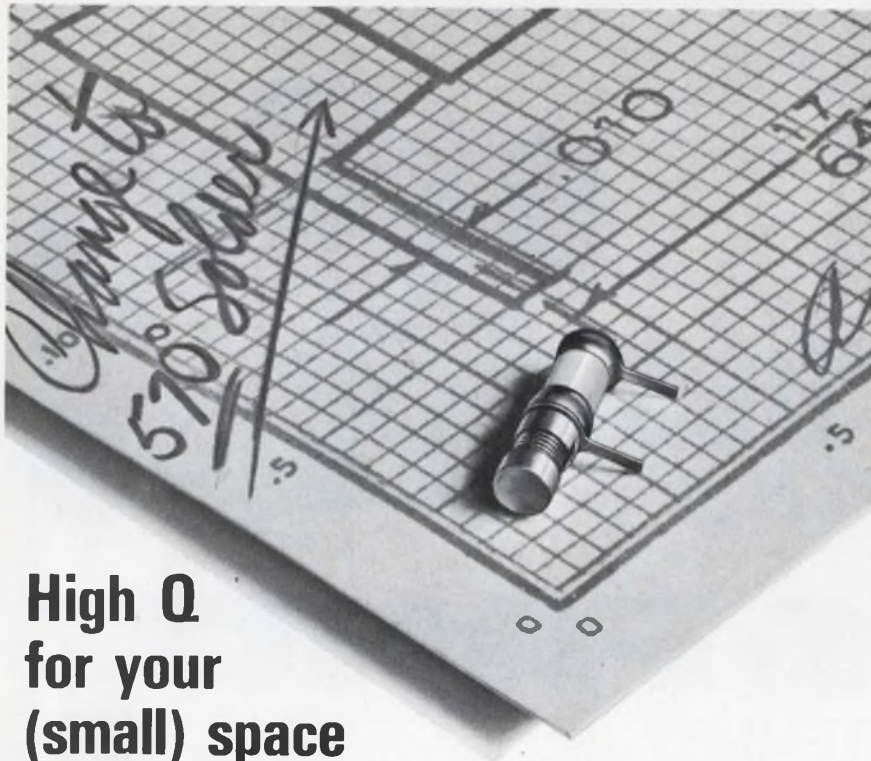

High Q for your (small) space requirements!

The Johanson 4700 Series Variable Air Capacitors provide, in micro-miniature size, the extremely high Q important in demanding aerospace applications. In addition, the ultra-rugged construction of the 4700 Series capacitors assures highest reliability in the most critical environments.

- Available in printed circuit, turret and threaded terminal types.
- Meets Mil Specs for salt spray requirements.
- Features 570° solder, which prevents distortion and is not affected by conventional soldering temperatures.

SPECIFICATIONS

Size: 1/8" diameter, 1/2" length
Q @ 100 MC: > 5000
Q @ 250 MC: > 2000
Capacity Range: 0.35 pF to 3.5 pF
Working Voltage: 250 VDC
 (Test voltage, 500 VDC)
Insulation Resistance: > 10⁶ Megohms
Temp. Ranges: -55°C to 125°C
Temp. Coefficient: 50 ± 50 ppm/°C

WRITE TODAY FOR FULL DATA.

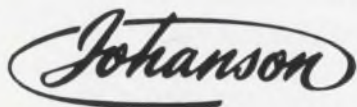

MANUFACTURING CORPORATION

400 Rockaway Valley Road, Boonton, N. J. 07005 (201) 334-2676

INFORMATION RETRIEVAL NUMBER 54

Power transistors isolate collectors



Motorola Semiconductor Products Inc., P.O. Box 20924, Phoenix, Ariz. Phone: (602) 273-8465. Price: \$24 to \$34.95.

Ideal for circuits that use common heat sinks, new isolated-collector stud-mounted silicon power transistors mount in a single hole without requiring insulating washers. The absence of an insulator improves heat dissipation. Types 2N5346 through 2N5349 are medium-power 7-A npn devices with collector-to-emitter voltages of 80 or 100 V.

CIRCLE NO. 355

Low-power inverters delay only 6 ns

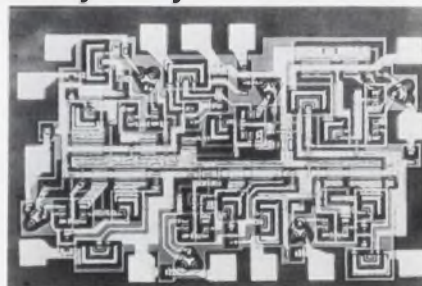

Sylvania Electric Products, Semiconductor Div., 100 Sylvan Rd., Woburn, Mass. Phone: (617) 933-3500.

Designated as series SG370 in the SUHL I family and as SG380 in the SUHL II line, two new single-input hex inverter series are characterized by high speed at low power, high noise immunity, and high capacitance drive. Typical propagation delays are 12 ns and 6 ns, respectively; power dissipation per gate function is typically 22 mW.

CIRCLE NO. 356

MystR®

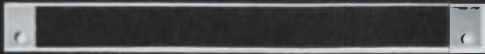

(Waters Own Conductive Plastic)

Potentiometers



"PERFORMANCE *PLUS*"

MystR® Potentiometers offer widest versatility with such performance-plus factors as: Resistance Ranges from 10 ohms to 5 megohms; Linearity as low as 0.25%; Output Smoothness less than 0.1%; Rotational Life well beyond 5,000,000 cycles; Dither Life in excess of 400,000,000 cycles; Operational Temperatures to 150°C; Infinite Resolution. And what's more they're even quiet!



WATERS
MANUFACTURING INC.
WAYLAND, MASS. 01778

IT'S WHAT'S INSIDE THAT COUNTS!

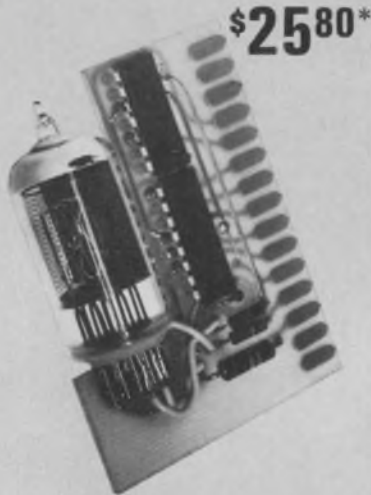

\$2580*

DM519 DECIMAL COUNTING UNIT

A compact (2.5" x 1.75" x .75") decimal display with IC decoder/driver and decade counter, the DM519 has TTL and DTL compatible inputs and outputs and is compatible with standard connectors — 15 position, 0.156" spacing. BCD counter output is available externally, and there also is an external reset input.

Indicator tube is an Amperex type ZM 1000, which provides numerical read-out 0 through 9, with decimal point. Dynamic life expectancy of the tube is 200,000 hours.

Economy you can count on!

Price: 1-3 \$31.80, *10-29 \$25.80.

CALL OR WRITE FOR COMPLETE INFORMATION ON THE ENTIRE DM500 SERIES—A CALL WILL BRING SHIPMENT WITHIN 3 DAYS.

Computer Products, Inc.
2801 E. Oakland Park Blvd.
Fort Lauderdale, Fla. 33306
Phone: 305/565-9565



**COMPUTER
PRODUCTS™**

FORT LAUDERDALE

INFORMATION RETRIEVAL NUMBER 56

PACKAGING & MATERIALS

Glass-ceramic paste insulates thick films

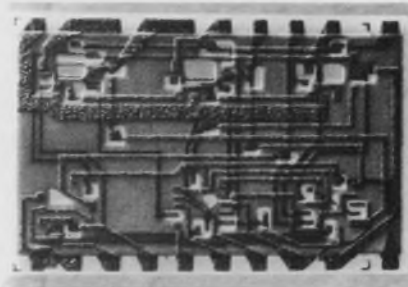

Electro-Science Labs., Inc., 1133 Arch St., Philadelphia, Pa. Phone: (215) 699-4482.

A new glass-ceramic, type 4610 has been developed for crossover and multilayer applications requiring a low dielectric constant ($K=10$). The new paste is a suspension of a glass-ceramic in organic vehicles. When brought to firing temperature, the glass fuses to form a cohesive adherent coating, and then crystallizes to form a glass-ceramic.

CIRCLE NO. 357

Push-pull plug converts bayonets



The Deutsch Co., Electronic Components Div., Municipal Airport, Banning, Calif. Phone: (714) 849-6701.

Requiring no change in existing receptacles, a new adaptor plug converts bayonet-type connectors to fast-action push-pull units. Type 469 mates by simply pushing its coupling ring forward and unmates by pulling the ring back. The new, lightweight plug is available in a variety of shell sizes and insert arrangements to fit all MIL-C-26482 and NAS-1599 bayonet-type receptacles.

CIRCLE NO. 358

Liquid crystals get frosty look

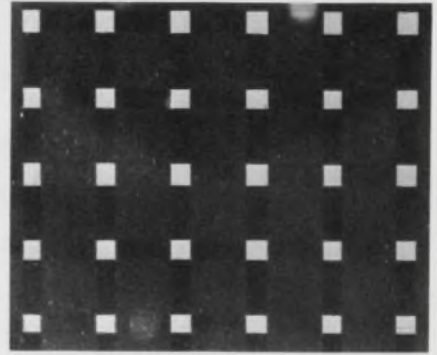

Liquid Crystal Industries, Inc., 460 Brown Ave., Turtle Creek, Pa. Phone: (412) 823-4300. Price: \$15/gram.

Nematic liquid crystals are now available for such electro-optical applications as optical shutters, flat-screen displays, alphanumeric displays, and windows and mirrors that automatically dim or brighten in response to outside light. When nematic liquid crystals are sandwiched between two conductive surfaces, one of which is transparent, an applied ac or dc voltage, from 3 to 30 V, causes what was transparent to become translucent or frosted.

CIRCLE NO. 359

Tri-line ribbon cables stop insulation damage

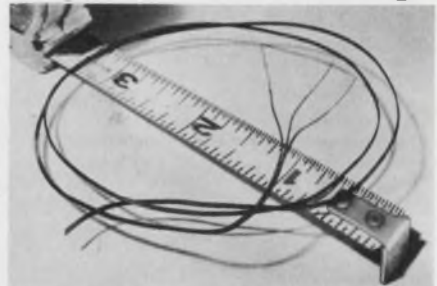

Berkshire Technical Products, Inc., P.O. Box 60, Reading, Pa. Phone: (215) 376-8071.

Consisting of 28, 30, and 28 gage wires separately insulated with a 1-mil extrusion of FEP Teflon, new tri-line transmission ribbon cables permit strand separation without damage to the insulation. Using extruded rather than dispersion-coated Teflon means uniform pin-hole-free insulation and ease of strippability from the conductor.

CIRCLE NO. 360

INFORMATION RETRIEVAL NUMBER 236 ►



Photographed in Vietnam by Howard Sochurek

When you need a new way to see in the dark...

bring ERIE in early.

The jungle night falls fast for a pilot downed behind "Charlie's" lines. But, rescue choppers no longer wait for morning light to find him. The answer? New portable night vision devices that actually intensify available light...even starlight...thousands of times. From the start, those working on this project have relied on the Research Engineers and component capability of ERIE TECHNOLOGICAL. Our new sub-miniature high voltage supply is at the heart of the system. Proof, once again, that whatever your area of electronics, it pays to bring ERIE in early.

ERIE TECHNOLOGICAL PRODUCTS, INC.

644 West 12th Street, Erie, Pennsylvania 16512
Area Code 814-456-8592

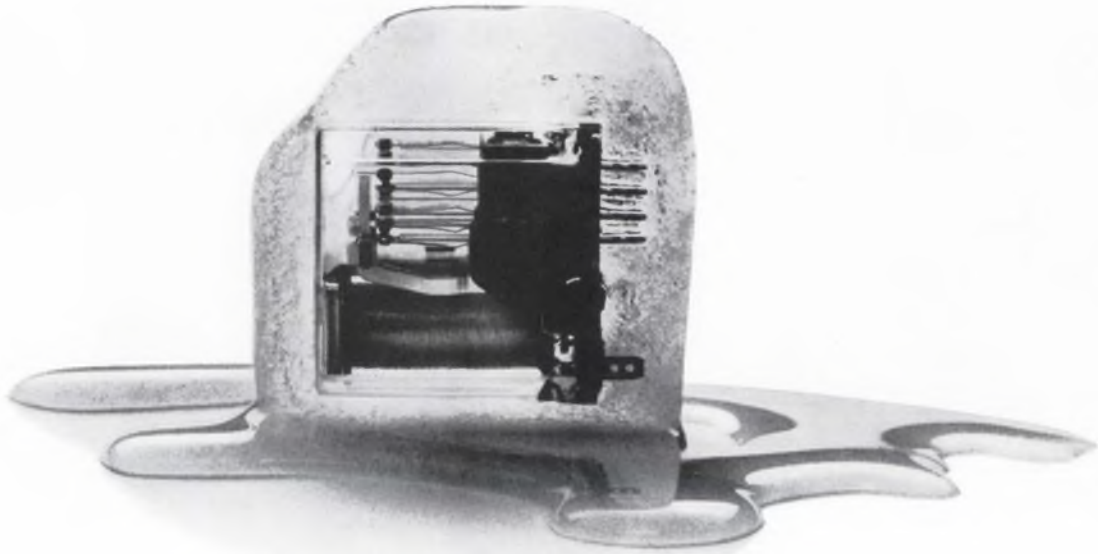

The stable, well-adjusted relay.

A real cool customer. That's our cradle type relay. Freeze it down to -55°C . and it stays adjusted. Or, heat it to $+71^{\circ}\text{C}$. and it stays adjusted. And all that performance in less than a cubic inch.

Our cradle type relay has a right to be well adjusted. Because it has so much going for it. Like magnetic structure of hydrogen annealed iron, which allows it to operate as low as 35 milliwatts. And nickel plated bearing parts. And gold plated terminals and contacts. Add to that its unique plug-in design, integral dust cover, and one million operation life expectancy at rated load, and you'd feel stable too.

What do you do with a cradle type relay that has this much going for it? Some people use them in computer systems, control systems, business machines, flight simulators, data processing equipment and vending machines.

You can do the same thing. Or you can use your imagination and find some applications we haven't even thought of yet. Whatever you decide, you can find out all you want to know about our well-adjusted relay. Just fill in and mail the coupon.

Deutsch Filtrors Industrial Products, Dept. A
Industrial Road, East Hampton, New York 11937

Please send me more information on your
cradle type relay.

Name _____

Address _____

City _____ State _____ Zip Code _____

Company _____

Title _____



INFORMATION RETRIEVAL NUMBER 237

Conductive coatings vary reflectivity



Emerson & Cuming, Inc., Dielectric Materials Div., Canton, Mass. Phone: (617) 828-3300. Price: \$12 or \$35/lb.

Two new elastomeric electrically conductive coatings allow the user to control the electrical reflectivity of a surface. Eccocoat 258 is an elastomeric carbon-based semiconductive coating that produces a surface resistivity of 100 to 120 ohms per square. Eccocoat CC-4 is a silver-filled coating that will produce surface resistances of 0.05 ohms per square in a 1-mil coating thickness.

CIRCLE NO. 361

Conductive epoxy withstands 300°C

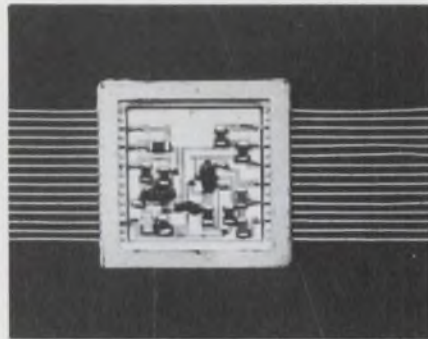

Epoxy Technology, Inc., 65 Grove St., Watertown, Mass. Phone: (617) 926-1949. Price: \$15/2 oz.

With a volume resistivity of 0.0001 to 0.0005 ohm-cm, a new electrically conductive epoxy compound will withstand 300°C for 12 hours without any loss of electrical conductivity or physical properties. Designed for the assembly of integrated circuits and other applications requiring high temperature resistance, Epo-Tek 418-H exhibits a high order of chemical and solvent resistance.

CIRCLE NO. 362

Interconnection system provides high density

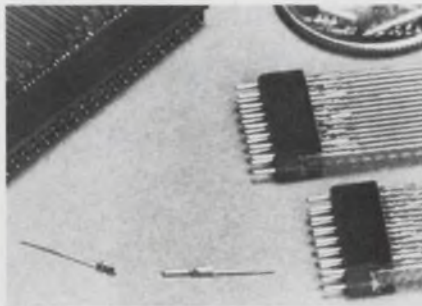

AMP Inc., Harrisburg, Pa. Phone: (717) 564-0101.

A new high-density interconnection system for parallel, perpendicular or in-line mating is available in a variety of configurations with contacts on 0.05 (true) and 0.025-in. (staggered) grids, including a full 16-position connector only 0.437-in. long. The system is built around a unique receptacle contact having two integral V-shaped spiral springs which deflect at right angles to the mating pin contact.

CIRCLE NO. 363

Ceramic gold paste bonds and prints

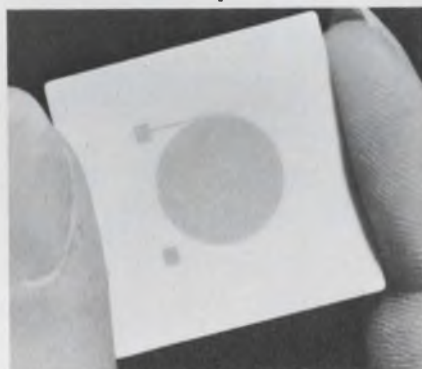

Electro-Science Laboratories, Inc., 1133 Arch St., Philadelphia, Pa. P&A: \$75/oz.; stock.

Specifically created for fine line printing and chip bonding, a new ceramic conductive gold paste readily accepts most methods of bonding (except tin-lead solder), including various binary gold alloy solders, thermal compression bonding, parallel-gap welding and ultrasonic bonding. Type 8831 allows silicon chip attachment to be accomplished in room atmosphere at temperatures as low as 390°C.

CIRCLE NO. 364

Applications Power*



PUTTING CURRENT-LIMITER DIODES TO WORK

Problem: How to improve the performance of this bipolar series voltage regulator and reduce circuit complexity?

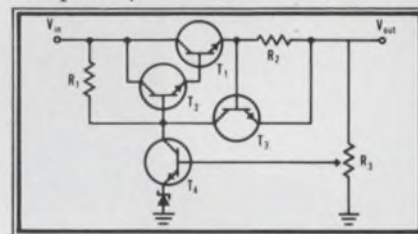

Solution: Replace the darlington pair with a FET and a CL diode.

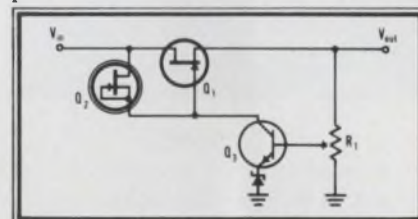

Increases in V_{OUT} are inverted and amplified by Q3. The increased V_{GS} on Q1 reduces the supply current, decreasing output voltage. Current-limiter Q2 (1) acts as a load for Q3 and (2) when the output is short circuited it limits the forward bias current of Q1, limiting short circuit output current to the I_{DSS} of Q1. The use of the FET increases circuit power gain, reducing ripple, and increasing regulation.

For immediate applications assistance call the number below; ask for extension 19.

Siliconix Incorporated

1140 W. Evelyn Ave. • Sunnyvale, CA 94086
Phone (408) 245-1000 • TWX: 910-339-9216

***Applications Power:** A broad product line and an in-depth applications team waiting to serve you.

Buying Power?



Here's the new, single source for all your power needs.

- Mil Spec DC Modules
- Wide Range DC Modules
- Slot Voltage DC Modules
- Full-Range Lab Supplies
- Inverters, Frequency Changers
- High-Voltage Supplies
- AC Regulators
- Full Technical Data
- Full Specifications
- Mechanical Data
- Model Types
- Prices & Availability

Ask for Your Free Catalog #154 Today!



ELECTRONIC RESEARCH ASSOCIATES, INC.

67 Sand Park Road, Cedar Grove, N. J. 07009
(201) 239-3000
SUBSIDIARIES:
ERA Acoustics Corp. • ERA Dynamics Corp.
ERA Pacific, Inc. • Astrocom, Inc.

INSTRUMENTATION

Wideband oscillator keeps output flat



Hewlett-Packard, 1501 Page Mill Rd., Palo Alto, Calif. Phone: (415) 326-7000. Price: \$875.

With a balanced output over its full operating frequency range, model 654A wideband test oscillator holds output amplitude variations to less than ± 0.05 dB (0.5%) from 10 Hz to 10 MHz. This flatness greatly speeds up multipoint frequency response tests by eliminating the need for frequent re-adjustment of oscillator amplitude, a characteristic that is particularly useful during production and other repetitive tests.

CIRCLE NO. 365

Dual-slope multimeter has selectable filter



Systron-Donner Corp., 888 Galindo St., Concord, Calif. Phone: (415) 682-6161. P&A: \$1175; 45 days.

Featuring $\pm 0.01\%$ accuracy, 9200-series voltmeters and multimeters combine integration features with provision for selectable input filtering to achieve high speed with narrowband noise rejection or wideband noise rejection at lower speed. A choice of five different models provides dc either alone or combined with millivolts, ac volts, and/or ohms. This 4-digit series also features automatic ranging and polarity, sampling speed to six per second and 20% overranging.

CIRCLE NO. 366

Plug-in sampling head has 1-ns risetime



Textronix, Inc., P.O. Box 500, Beaverton, Ore. Phone: (503) 644-0161. P&A: \$315; June.

The type S-5 plug-in sampling head expands the sampling-head concept originated with the type 3S2, 3S5 and 3S6 sampling plug-in units. The new unit is a low noise, 1-ns risetime sampling head, with a 1-M Ω , 15-pF input impedance. When used with the included P6010 passive probe, the input impedance increases to 10 M Ω paralleled by 10 pF while maintaining the 1-ns risetime at the probe tip.

CIRCLE NO. 367

Programmable generator divides and pulses



Antekna, Inc., 4015 Fabian Way, Palo Alto, Calif. Phone: (415) 328-3700. P&A: \$1790; 30 days.

A programmable frequency divider and pulse generator, model 1205 has two modes that provide either exact frequency division ratios from 1 to 99,999, or pulse bursts, with each burst containing exactly 1 to 99,999 pulses. Solid-state integrated-circuit design provides front-panel thumbwheel programming with no ambiguity. In the pulse burst mode, the unit can be used as a digital clock, or as a repetitive burst generator to simulate radar signals.

CIRCLE NO. 368

Digital voltmeter overranges 130%



Tyco Labs., Inc., Bear Hill, Waltham, Mass. Phone: (617) 899-2400. Price: \$595.

Model 404 digital voltmeter has a four digit in-line display, with a fifth digit that permits overrange measurements of up to 130% on each of four ranges. The instrument has four dc voltage ranges (1, 10, 100 and 1000 volts), with sensitivity of 100 μ V in the 1-V range. Resolution is 0.1% of full scale. This unit has two operating modes, automatic and external. Accuracy is 0.02% reading \pm 1 digit.

CIRCLE NO. 369

Pen-sized probe shows logic state



Automated Control Technology Inc., 3452 Kenneth Dr., Palo Alto, Calif. Phone: (415) 328-6080. P&A: \$18.50; stock to 30 days.

Presenting a visual distinction between logic 1 and logic 0 conditions, a pen-sized probe can be used to observe quiescent states or low-repetition-rate pulses. The solid-state device, called LogicProbe 31A, has a high input impedance to prevent the upset of flip-flops or one-shots.

CIRCLE NO. 370

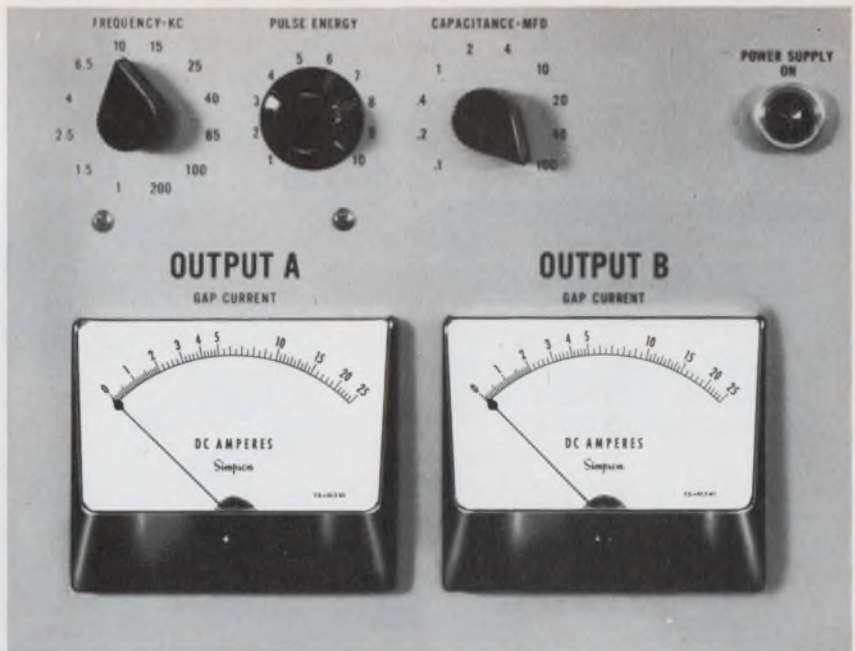

the sure way to let customers know you care about quality...

Simpson panel instruments on your equipment

Simpson's advanced self-shielding annular and core magnet construction provides optimum torque-to-mass ratio. Rugged Taut Band and Pivot & Jewel movements can withstand punishing shock and vibration. Your assurance of an instrument that will *stay* accurate. No wonder so many manufacturers with reputations to protect (or build!) specify Simpson.

Over 1,400 stock ranges, sizes, and types. Get "off the shelf" delivery from your local electronic distributor.

For special needs contact your local Simpson Representative. He's ready to help.

Simpson

ELECTRIC COMPANY



5200 W. Kinzie Street, Chicago, Illinois 60644 • Phone (312) 379-1121

EXPORT DEPT.: 400 W. Madison Street, Chicago, Illinois 60606. Cable Simelco
IN CANADA: Bach-Simpson Ltd., London, Ontario • IN INDIA: Ruttonsha-Simpson Private Ltd., International House, Bombay-Agra Road, Vikhroli, Bombay

INSTRUMENTS THAT STAY ACCURATE

INFORMATION RETRIEVAL NUMBER 59

Digital multimeter has 0.01% accuracy



Data Technology Corp., 1050 E. Meadow Circle, Palo Alto, Calif. Phone: (415) 321-0551. P&A: \$695; 30 days.

The 350 integrating digital multimeter provides an accuracy of 0.01% and has four basic dc ranges of 100 μ V to 1000 V. Guarded input, BCD and remote programming are standard features. Available options include: a preamplifier that extends the measurement range to 1 μ V; an ac converter with a resolution of 100 μ V and frequency range from 50 Hz to 100 kHz; a resistance capability from 100 M Ω ; and a dc ratio of 0.9999:1.

CIRCLE NO. 403

Digital panel meters start at \$150



Newport Labs., Inc., 630 E. Young St., Santa Ana, Calif. Phone: (714) 540-4914. Price: \$150.

A new line of digital panel meters includes 31 different models and 13 options. Package size is 47 in.³ and power requirements are 4.5 W. Models are available that measure currents from 1 nA to 200 mA and voltages from 10 μ V to 200 V. The cost of these instruments is low, starting at only \$150 for three-digit units that have a full-scale display of 199 counts.

CIRCLE NO. 404

Digital panel meter occupies only 7 in.²

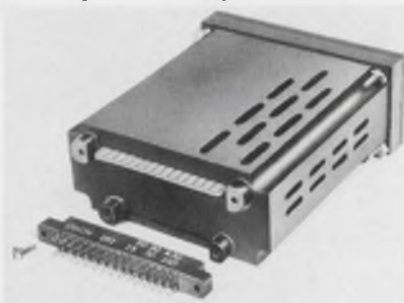

Weston Instruments, Inc., 614 Frelinghuysen Ave., Newark, N.J. Phone: (201) 243-4700. P&A: \$200; stock.

A digital panel meter requires only seven square inches of panel area. The 1290 provides three digits plus 100% overrange display, and 0.1% \pm 1 digit accuracy. Other features include full buffered storage display, 1-2-4-8 BCD positive output logic as well as true circularly polarized viewing windows. Plug-in sockets are provided for readout tubes; replacement, when necessary, requires no soldering.

CIRCLE NO. 405

Scope calibrator cuts testing costs



Edwin Industries Corp., 11933 Tech Rd., Silver Spring, Md. Phone: (301) 622-0700.

Model 156 oscilloscope calibrator permits time, voltage and risetime calibration, with automatic readout of percentage error. Operation is simple and straightforward. The instrument provides a deviation control that allows the percentage error of either voltage or time functions to be read directly on a meter without the need of further calculation. The calibrator can also be used as a laboratory instrument, because its time calibration section is a wide range time-mark generator of high accuracy.

CIRCLE NO. 406

Pushbuttons control IC test functions



Amptek Corp., 3737 Birch St., Newport Beach, Calif. Phone: (714) 546-6645.

Designed for precision static and dynamic testing of linear integrated circuit operational amplifiers, model 391-linear IC tester is completely self-contained and needs no auxiliary equipment or external power supplies. Pushbutton function-selector switches control parameter measurements and checks. Parallel entry eliminates prearranged sequencing of tests. Noise-free measurements are afforded by use of active filtering and by extensive shielding throughout.

CIRCLE NO. 407

Active filters cover 99.9 kHz

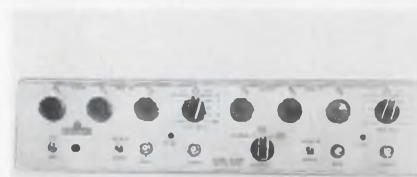

Multimetrics, Inc., 401 Concord Ave., Bronx, N.Y. Phone: (212) 665-6484.

AF-400 series active filters are available in the single-channel model AF-410 and the dual-channel AF-420. Cutoff frequency range is 0.01 Hz to 99.9 kHz \pm 2%; attenuation characteristics are Butterworth or T/D, 24 or 48 dB/octave; maximum attenuation is 80 dB. Operating from 115/230 V ac or battery, the digital units are suitable for fixed or portable use.

CIRCLE NO. 408

When Only Excellent is Adequate **TURN** to Grayhill

for MINIATURE PUSH BUTTON SWITCHES

- WIPING, SNAP ACTION and BUTT CONTACTS.
- SPST, SPDT, DPST, DPDT.
- PUSH-PULL — LIGHTED.
- 25,000 to 1,000,000 OPERATIONS.



... the Difference Between Excellent and Adequate

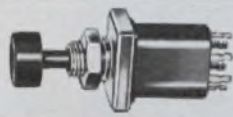

Select Materials

- Contacts — Fine Silver
- Springs — Tinned Music Wire
- Housing — Molded Phenolic per MIL-M-14
- Shorting Bar & Terminals — Fine Silver or Silver Plated Copper Alloy

Typical Specifications:

- ¼ Amp. to 10 Amps., 115 VAC Resistive
- Contact Resistance 10 Milliohms
- Insulation Resistance — 25,000 to 900,000 Megohms

All fully described in Engineering Catalog G-304-A Write



565 Hillgrove Avenue
LaGrange, Illinois 60525
Area Code 312, Phone 354-1040

"PIONEERS IN MINIATURIZATION"

INFORMATION RETRIEVAL NUMBER 60

New from IGC: sintered form of the industry's best alnico 8.

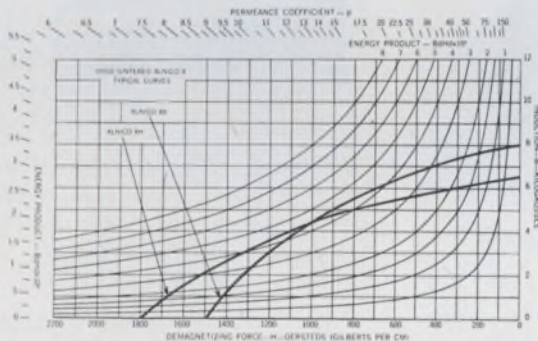

You might be able to get sintered alnico 8 somewhere else —but not like this. Our HyCo 8 has the greatest coercive force of all sintered alnicos. Typically, 1500 oersted for HyCo 8B, and 1800 oersted for 8H.

Sintered alnico 8 is well suited for miniaturized applications requiring a high coercive force. Typical uses include motors, TWTs, polarized relays, reed switches, pick-up cartridges, core meters, and holding and torque transmitting devices. And sintered has it all over cast alnicos when it comes to smoother surfaces, closer tolerances, physical strength, and flexibility of shapes.

For the complete characteristics and further details on sintered HyCo Alnico 8B and 8H, write Mr. C. H. Repenn, Manager of Sales, Indiana General Corporation, Magnet Division, Valparaiso, Indiana.

INDIANA GENERAL



We make it easy for the design engineer.

INFORMATION RETRIEVAL NUMBER 61



Now! One new exclusive switch replaces seven You can easily eliminate tedious design engineering problems—just use versatile Multidex® switches. They're available in thousands of variations...yet provide more contacts (up to 36) at no additional cost. **Crisp Detenting**... the patented Unidex™ detent offers uniform "feel" for long life in choices from 10° to 36° throw. Meets MIL-S-3786, SR32 requirements.

Superb Insulation... molded diallyl phthalate meets MIL-M-14 requirements and guarantees electrical continuity between mounting and housing. Glass-alkyd insulation available on request.

Special contacts and clips... Oak-pioneered, double-wiping, self-cleaning contacts assure trouble-free operation. Special AF clips with large windows speed wiring.

What's more, Multidex switches meet commercial and military environmental requirements. Special options available on request. For full details, write today for Bulletin SP-324.



OAK MANUFACTURING CO.

A Division of OAK ELECTRO/NETICS CORP.
Crystal Lake, Illinois 60014
PHONE: 815-459-5000 TWX: 910-634-3353

INFORMATION RETRIEVAL NUMBER 62

GIANNINI on MS27400 type relays

"We've been designing and manufacturing relays to the requirements of MIL-R-6106 for years. It's only natural that we now make available an all welded 4 pole double throw 10 amp relay in a 1" cube enclosure, shown below.



The unit is hermetically sealed and utilizes a polarized magnetic circuit for high contact forces. Rugged construction resists high vibration levels of 30 G's 10 to 3000 Hz and 200 G shock. Arc barriers provide 3 phase load switching capability.

This series, designated the GRY14-410, is available with plug-in or solder hook terminals, AC or DC coil operation.

If you will write us your needs, or simply your name and address, we will mail you our data sheet. If you are in a real rush, call us at (213) 723-3371. Ask for Dan Glynn."

Gabriel M. Giannini

Giannini

12140 E. Rivera Rd., Whittier, Calif. 90606 • (213) 698-1245
Plants in Whittier and Costa Mesa
An Independent Company/An Equal Opportunity Employer
INFORMATION RETRIEVAL NUMBER 95

DATA PROCESSING

Data-entry console has movable keyboard



Logic Corp., 15 E. Euclid Ave., Haddonfield, N.J. Phone: (215) 735-0814.

Functioning as a general-purpose terminal that provides two-way communications with a computer, a new data-entry console features a standard IBM 029 key-punch configuration on a movable keyboard. The principal advantage of the LC-728 is greater flexibility and operator convenience in accommodating routine or specialized keypunching assignments. The LC-728 is especially designed as part of the company's LC-720 data-entry system.

CIRCLE NO. 402

Digital comparators perform in 1 μ s



Automation Dynamics, Inhl. Pky., Northvale, N. J. Phone: (201) 768-9200. P&A: \$540 to \$925; 60 days.

Compatible with a wide range of digital instruments and systems, series 66 programmable digital comparators operate with comparison times as fast as 1 μ s. Using the manual thumbwheel switches or remote programing, positive high, low or go decisions are made and identified by indicator lights on the front panel. An enabling circuit can be used to command the comparison time.

CIRCLE NO. 401

High-speed photo reader fan-folds stored tape

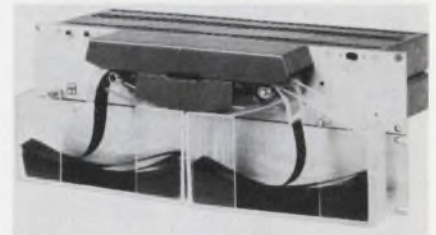

Chalco Engineering Corp., 15126 S. Broadway, Gardena, Calif. Phone: (213) 323-5525. P&A: from \$850; 1 wk.

A photoelectric punched-tape reader with fan-fold tape storage handles 650 characters per second synchronously, and 300 characters per second asynchronously. Available in a unidirectional or a bi-directional version, model TH155 has a tape capacity of 200 feet for 4-mil paper. It incorporates a lamp-brightness control that automatically compensates for changes in tape opacity.

CIRCLE NO. 410

High-speed converter resolves 15 bits



Electronic Engineering Company of California, 1601 East Chestnut Ave., Santa Ana, Calif. Phone: (714) 547-5501. P&A: from \$8,000; June, 1969.

A new high-speed combination multiplexer and analog-to-digital converter completes 200,000 conversions per second with a resolution of 15 binary bits, and will accept up to 128 single-ended input channels. Model 1202 minimizes noise pickup by using transformer coupling of input and output control signals; the a/d conversion itself is insulated from the main chassis. The unit will operate in automatic mode, external command mode, random or sequential channel select, or manual mode.

CIRCLE NO. 411

Modular converter transforms any code

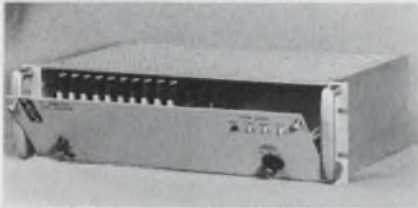

Nation Wide Electronic Systems, Inc., 570 Bloomingdale Rd., Itasca, Ill. Phone: (312) 833-1040. P&A: \$750 to \$1200; 6 to 8 wks.

Allowing direct communication between computers, data links and communication systems, the CC 1000 code converter transforms any data transmission code to any other type, without regard to form, level, or any other compatibility requirement. Using integrated circuits, 10-MHz logic and silicon solid-state power stages, the modular interfacing device fits into any system, whether existing or planned.

CIRCLE NO. 412

Decimal converter transforms 1 bit/ μ s



Beckman Instruments, Inc., Electronic Instruments Div., 2400 Harbor Blvd., Fullerton, Calif. Phone: (213) 691-0841.

Able to be used as part of a complete data system or as a separate data-processing device, a new binary-to-decimal converter transforms binary numbers of up to 13 bits plus sign to equivalent BCD numbers at a rate of 1 μ s per bit, and then displays them in digital form. Model 4060 requires an additional 4 μ s for control functions. Positive numbers are directly converted; negative numbers are represented in one's complement or two's complement form.

CIRCLE NO. 413

THE Gulton **BUTTON** FILTER



EMI SUBMINIATURE DEVICES

ACTUAL SIZE



SUB-MINIATURE BUTTON FILTER SOLVES MAJOR E.M.I. PROBLEMS!

Developments in ceramic capacitor technology have made possible this further miniaturization of EMI high current, low pass devices. The **BUTTON** filter occupies less than 20% of the volume of a miniature broad band filter.

The **BUTTON** series guarantees a minimum attenuation (60 db at 10 MHz) with full load applied and no voltage derating up to 125°C. It consists of an L type network and has a 50 VDC and 15 amp rating. The **BUTTON** filter is supplied in a hermetically sealed or epoxy potted version.

For further information on the **BUTTON** series and other EMI filter devices, write for our catalog to:

GULTON INDUSTRIES, INC.
Gulton Street
Metuchen, New Jersey 08840

Gulton Industries, Inc.

Metuchen, New Jersey 08840 / Tel. (201) 548-2800 / TWX 710-998-0592

Alphanumeric display shrinks panel size

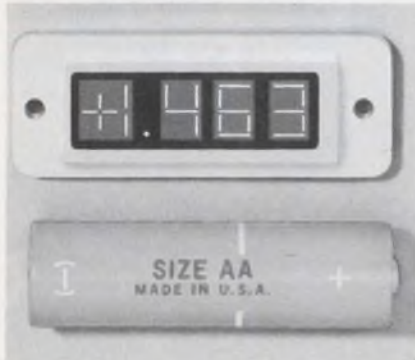

Pinlites Inc., 1275 Bloomfield Ave., Fairfield, N.J. Phone: (201) 226-7724. Price: \$200/3-digit unit.

Rivaling the AA penlight battery in size, a new alphanumeric panel display can accommodate from two to ten digital positions. Called the Midgi-Panel-Mate, the integrated package provides an 8-4-2-1 BCD to seven-segment display or a decade counter to seven-segment display. The new display is replaceable from the front panel, includes polarity and decimal-point display, and can accept 5-V logic levels.

CIRCLE NO. 414

Two decade counters are TTL compatible



Burroughs Corp., Electronic Components Div., P. O. Box 1226, Plainfield, N.J. Phone: (201) 757-5000.

BIP-8820 and BIP-8821 modules are TTL-compatible 20-MHz unidirectional decade counters. Both units include an integral rectangular Nixie tube and are packaged in socket-pack modules that are fully compatible with a wide assortment of inexpensive bezels and assembly hardware.

CIRCLE NO. 415

FET input op amp has low voltage drift

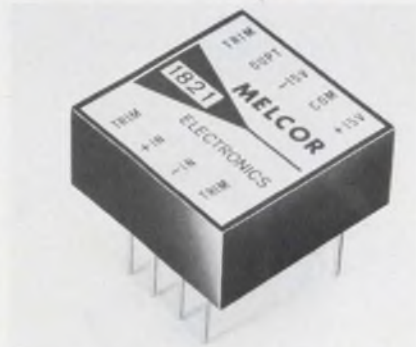

Melcor Electronics Corp., 1750 New Highway, Farmingdale, N.Y. Phone: (516) 694-5570. P&A: \$14.50; stock.

A new economy FET-input differential operational amplifier features low voltage drift and bias current. Model 1821 is contained in a standard 1/2-in. high by 1-1/8-in. square package. Main features include high small-signal and full-power bandwidth, and high slew rate. This solid-state differential operational amplifier can be used in control instrumentation, computation, test equipment and data logging.

CIRCLE NO. 416

Efficient dc regulator holds ripple to 3 mV



Fairchild Controls, 423 National Ave., Mountain View, Calif. P&A: \$49; stock.

With an output ripple of only 3 mV peak and an efficiency of 85%, a new 20-V dc regulator delivers 3 W of power at +65°C without requiring a heat sink. Model FRD-203 fills the need for a low-priced 2% regulator that has negligible noise, yet good power output. It measures 1.125 by 1.125 by 0.5-in., and is suitable for socket mounting.

CIRCLE NO. 417

Fast packet relays integrate assemblies

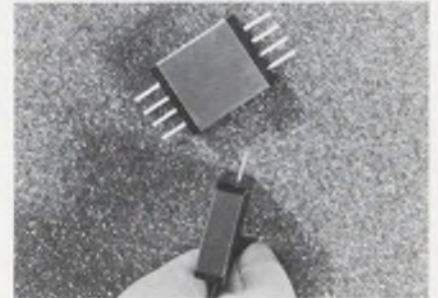

Compac Engineering Inc., 845 Commercial St., San Jose, Calif. Phone: (408) 286-4944. Price: \$2.25 to \$7.00.

A totally new concept for high-speed switching devices, series 14 packet relays incorporate the contact assembly, bobbin, housing, and magnetic-shield/protective-cover into a single integrated sealed assembly. The new relays, which operate in 1 ms, have 3.6-, 6-, or 12-V coils with 300-mW sensitivity and dpdt contacts.

CIRCLE NO. 418

Servo amplifier occupies 1/2 in.³



Industrial Control Co., Central Ave. at Pinelawn, Farmingdale, L.I., N.Y. Phone: (516) 694-3000. P&A: \$110; 30 days.

Without external components, the 972A servo amplifier drives a 9-W, 400-Hz servo motor. Size is only 1 by 3/4 by 5/8 in. Transfer gain is X500, input impedance is 20 kΩ and required supply voltage is 28 V dc unregulated. The 972A drives any servo motor, size 8 to 18, wound for 36-V center-tapped. Heat sinking is through the base. The package is hermetically sealed for long life in environmental extremes.

CIRCLE NO. 419



Our timing relays can reset as fast as 2/100 of a second.

Cutler-Hammer pneumatic timing relays (below left) reset quick as a wink. Perfect for high speed continuous timing operations. They offer superb repeat accuracy, a range of one to three minutes in an enclosed system, and on-the-job convertibility from delay-on to delay-off.

Or, take our synchronous timing relays (below right) with time elapse read-out, seven timing ranges from 15 seconds to 5 hours, and automatic reset. They feature easy-to-adjust on-delay, off-delay, and interval timing.

Don't overlook our electronic timing relay with repeat accuracy of $\pm 2\%$. Offers time delay to 60 seconds and reset time of 1.5 seconds.

Call your C-H Distributor or circle number.



CUTLER-HAMMER

POWER DISTRIBUTION & CONTROL DIVISION, Milwaukee, Wis. 53201



INFORMATION RETRIEVAL NUMBER 63

CHICAGO SWITCH
announces
**a true snap switch in
a slide snap case**
NEW mini/mike
MINIATURE SNAP SWITCH FOR SMALL
POWER AND SIGNAL APPLICATIONS

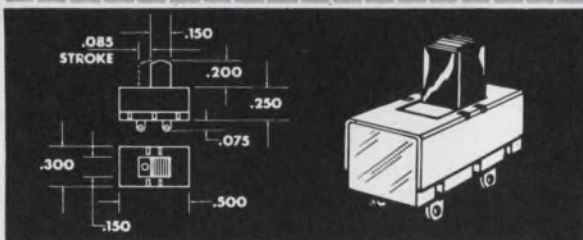

Here is the missing link between micro miniature electronics and "people sized fingers." Smallest in the field, yet packed with exceptional quality engineering and performance. Features anti-tease design, ultra low bounce, ultra long life.

Excellent for dry signal circuit applications on computers, portable electronics, test equipment for military, commercial or OEM projects. Fast, simple installation—can be wave soldered, hand wired, or supplied with wire leads. CS switches are covered by many patents, licenses available.

With MINI/MIKE it's a snap to start something.
Write for free sample and specification sheets.

pat. pend.

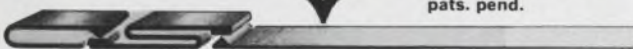

CHICAGO SWITCH
Div. of F & F Enterprises, Inc.
2035 Wabansia Ave., Chicago, Ill. 60647/Phone: (312) 489-5500 • Telex 25-3842

INFORMATION RETRIEVAL NUMBER 64

ELECTRONIC DESIGN 9, April 26, 1969

SYNCRO
Makes Dry
Electrolytics
exclusively

(And we're
proud of it)

We serve OEM's in the Industrial, Entertainment and Instrument industries only!

Please furnish complete specifications when requesting quotations and/or samples.



WRITE FOR CATALOG!

SYNCRO Capacitor Corporation

HICKSVILLE, OHIO 43526 • (419) 542-2711 • TWX 810-490-2550

INFORMATION RETRIEVAL NUMBER 65

105

Dual op amp supply feeds 100-mA loads



Melcor Electronics Corp., 1750 New Highway, Farmingdale, N.Y. Phone: (516) 694-5570. P&A: \$78; stock.

Able to power more than one operational amplifier, a new compact dual supply delivers ± 15 V dc at ± 100 mA, regulated against line and load variations. Model 1784 is a self-contained plug-in module designed for printed-circuit board mounting. It operates from a standard 60-Hz or 400-Hz 115-V ac input.

CIRCLE NO. 420

Operational supplies include fast op amp

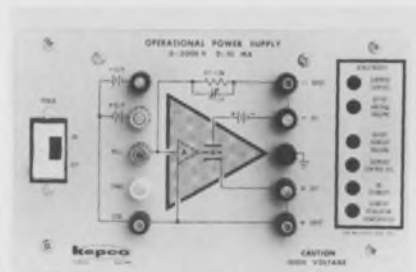

Kepco, Inc., 131-38 Sanford Ave., Flushing, N.Y. Phone: (212) 461-7000. P&A: \$368; 30 days.

Controllable power regulators include a unique 0 to 2000 V, 0 to 10 mA high gain, fast-slewing op amp. Model OPS 2000 features an operational patch panel embodying a human engineered layout of schematic elements as a guide in setting up input and feedback conditions. For added user convenience, current, offsets, calibration and stability adjustments are accessible through the panel.

CIRCLE NO. 421

FET-input op amps drift only 1 μ V/ $^{\circ}$ C



Data Device Corp., 100 Tec St., Hicksville, N.Y. Phone: (516) 433-5330. P&A: \$98; stock to 2 wks.

Holding voltage drift to 1 μ V/ $^{\circ}$ C, a new series of FET-input operational amplifiers feature an open-loop dc gain of 108 dB with an output of 12 mA at ± 12 V. Series D-27 units have an initial current offset of 3 pA, at either input terminal. Their broadband noise is 2 μ V rms; common-mode rejection ratio is 100 dB, and unity-gain frequency is 2.5 MHz.

CIRCLE NO. 422



**RF INTERFERENCE
KEEPING YOU AWAKE?**



Rest easy with reliable Littelfuse RFI shielded fuse posts. Wide range available for military and commercial applications.

LITTELFUSE
DES PLAINES, ILLINOIS

INFORMATION RETRIEVAL NUMBER 66

**TRUE
SOLID-STATE
RELAY**



Opening New Relay Applications in Multiplexing, Isolated Sensing, High Speed Isolated Control, etc. Offered in A - B - C Contact Configurations for Direct Replacement of Mechanical Types.

- Switching Time less than 65 μ sec
- Contact Open Resistance 10⁹ ohms
- Contacts Capable of switching D C to 4 M HZ
- Non-Polarized Effective Coil
- Effective Coil Accuate/Release Voltage Hysteresis . . . less than 10 mV . . .
- Non-Polarized Contacts
- No Reference Required Between Effective Coil and Effective Contacts
- Life Expectancy—tested to 10¹⁰ operations with no failure.

SHAFFSTALL-BALL CORPORATION
5149 E. 65th Street, Indianapolis, Indiana 46220
Phone: 317-257-6296

INFORMATION RETRIEVAL NUMBER 67

Electrometer op amp runs on ± 15 V, 30 mV



Keithley Instruments, Inc., 28775 Aurora Rd., Cleveland. Phone: (316) 248-0400. Price: \$250.

Model 50200 solid-state electrometer operational amplifier features light weight and low power consumption. The unit can be used as a linear or logarithmic amplifier, charge amplifier, current integrator, voltage follower, or high input resistance voltage amplifier. Common mode input resistance is either 10^{12} or $10^5 \Omega$. Power requirements are 30 mW at a nominal power supply voltage of ± 15 volts. Protected MOSFETs are used at the amplifier's inputs.

CIRCLE NO. 423

IC power supplies are MIL-certified



Lambda Electronics, Rte. 110, Melville, N.Y. Phone: (516) 694-4200. Price: \$115.

Integrated circuit power supplies, certified to meet military performance specifications, have a five-year guarantee that includes labor and material. An integrated circuit is used in the regulation system to increase reliability, replacing 32 discrete components. Integrated circuitry also reduces the size of the power package. Over 18 models are offered at voltage ranges to 120 V dc and current ratings to 300 A.

CIRCLE NO. 424



the hottest thing in coldweld crystals



The hottest thing in crystals today is coldwelding . . . the hottest **supplier** of coldweld crystals is Reeves-Hoffman.

To assure the most stringent control of quality, we make our own glass-to-metal seals, apply corrosion-resistant material, and coldweld all units in a controlled atmosphere.

You choose from the greatest variety of coldweld holder configurations obtainable, in a frequency range from 2.5 kHz to 200 MHz, as shown below.

Impartial 1968 government tests have shown coldweld crystal aging rates to be 100% better than aging in glass or soldered holders. Referring to hermeticity of coldweld seals, the report states: "The number of crystal manufacturers having this capability at present is limited."

Reeves-Hoffman, a coldweld pioneer, has that exacting capability! Your inquiry is invited.

Holder	Frequency Range	Dimensions (Maximum, untrimmed)
A	18 kHz-200 MHz	.400" diam., .260" to 1.55" high
B	2.5 kHz-100 MHz	.600" diam., .260" to 1.55" high
C	900 kHz-10 MHz	.830" diam., .350" high
E	1 kHz-100 MHz	.360" high x .730" wide, .770" to 2.100" long
36	100 kHz-100 MHz	.810" high x .820" wide x .420" thick

craft-masters in crystal controls

REEVES-HOFFMAN

DIVISION, DYNAMICS CORPORATION OF AMERICA

400 WEST NORTH ST., CARLISLE, PENNSYLVANIA 17013 • 717/243-5929 • TWX: 510-650-3510

INFORMATION RETRIEVAL NUMBER 68

Magnetic latching relay reduces standby power

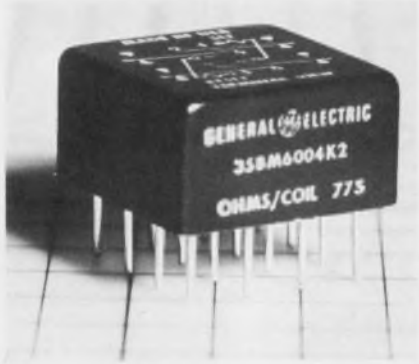

General Electric Co., Specialty Control Dept., 1 River Rd., Schenectady, N.Y. Phone: (518) 374-2211. Price: \$32.

Suited for applications requiring low power drain such as operating from batteries, a new four-pole double-throw magnetic latching relay contains a permanent magnet to latch its armature in position, thus eliminating the need for constant power. Type 3SBM is an all-welded hermetically sealed unit that is rated at 2A, 28 V dc resistive.

CIRCLE NO. 425

DIP-like reed relay ends bounce in 200 μ s

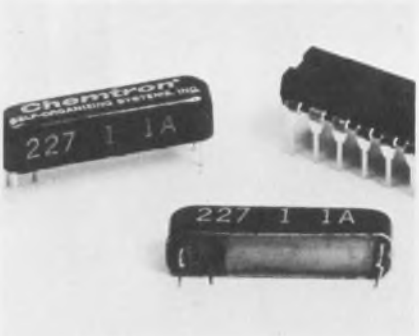

Self-Organizing Systems, Inc., P.O. Box 9918, Dallas. Phone: (214) 276-9487. Availability: stock.

Smaller than a standard dual-in-line package, a new reed relay stops bouncing after initial contact in less than 200 μ s. Ideal for high-speed computer-controlled equipment where speed and size are critical, model 227-1-1A works from a 5-V logic supply and is magnetically and electrostatically shielded. It measures only 0.8 by 0.2 by 0.2 in.

CIRCLE NO. 426

Gravity-sensing switch proportions output

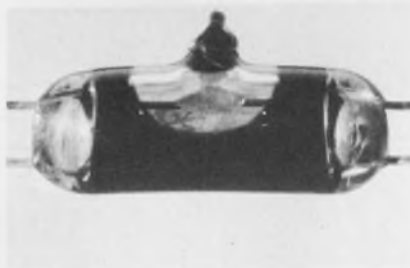

Hamlin Inc., Lake & Grove St., Lake Mills, Wis. Phone: (414) 648-2361.

Model EP-304 miniature tilt-indicating switch provides a typical 20-mV change per arcminute tilt with phase proportional to the direction of tilt. The switch electrodes are positioned for proportional voltage output between the two electrodes and common, as the switch nears the level position. This permits highly accurate bridge-circuit readout (typical 50 mV/arcminute) and minimizes hunting when used with correction servo systems.

CIRCLE NO. 427

Tiny transformers insulate with 10 G Ω

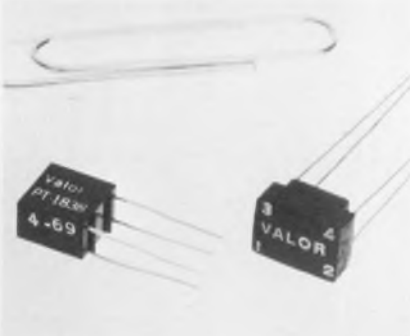

Valor Electronics, Inc., Sub. of Aerological Research, Inc. 3100 Pullman Ave., Costa Mesa, Calif. Phone: (714) 540-9261.

Miniature transformers for core memory and transistor applications feature miniature ferrite toroids, low leakage, and a winding-to-winding insulation resistance of 10,000 M Ω . Model PT 1851 is 0.5 by 0.35 by 0.24 in. high with channeled base; model PT 1838 is 0.365 by 0.235 by 0.28 by 0.325 in. high.

CIRCLE NO. 428

Ceramic capacitors shrink over-all length

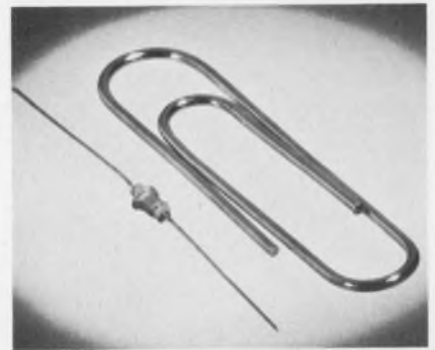

Denes Co., Inc., 3311 Winona Ave., Burbank, Calif. Availability: stock.

Measuring only 0.14-in. long, two new 50-V ceramic capacitors have a minimum capacitance of 1000 pF over a temperature range of -55 to +125°C. When used as a low-pass filter, model 05-FE-2004 exhibits a minimum insertion loss of 25 dB from 100 to 200 MHz, and 30 dB from 200 to 10,000 MHz. Model 05-FE-2003 is designed to be used as a standoff-type capacitor.

CIRCLE NO. 429

Contactless switch uses semiconductors

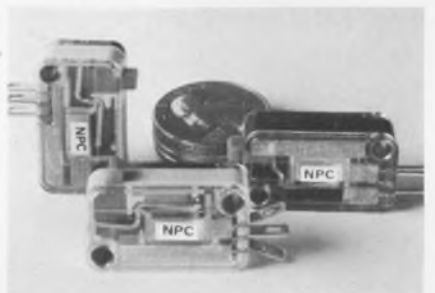

Nucleonic Products Co., Inc., Electro-Mechanical Div., 3133 E. 12th St., Los Angeles, Calif. Phone: (213) 268-3464.

Operating on a principle of variable resistance, a new miniature contactless switch contains magnetically controllable solid-state resistors made of indium antimonide. An internal permanent magnet is used to alter the resistance of these fieldplate resistors. The resistance change, in turn, triggers an internal transistor circuit, providing switching voltage at the output terminals.

CIRCLE NO. 430

Fastest Speed - Lowest Noise
Unsurpassed Performance

with **JAMES**
"Micro-Scan"
RELAYS



- Up to 3-pole switch contacts
- 10^{-4} pf isolation between contacts & coil
- 750 μ sec operating speed
- No bounce closures
- Less than 1 μ volt thermal offset or drift
- 1 billion operation life

James Micro-Scan relays provide high common mode isolation with guard shield switching. Thermal and noise problems are non-existent with signals less than 1 micro-volt. Micro-Scan relays provide an economical and high-performance method of switching low-level signals for data acquisition systems, sampling, and digital memory registers. Send today for complete information.

JAMES ELECTRONICS INC.

4050 N. Rockwell St., Chicago, Ill. 60618
Telephone 312 463-6500
INFORMATION RETRIEVAL NUMBER 69

Reticles

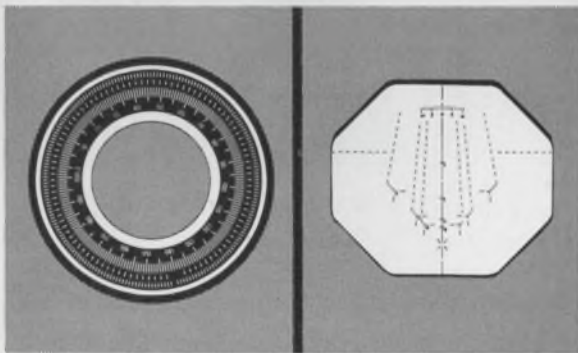

Precision etching of glass reticles, scales and other critical tolerance items is a specialty at Buckbee-Mears. We etch polished or water white plate, crown or flint glass to $\pm .0001$ " with lines filled permanently with a choice of compounds if required. We etch flat, concave or convex surfaces.

May we tell you more? See your Buckbee-Mears technical representative, or call or write Bill Amundson, our industrial sales manager.

lmc

**BUCKBEE - MEARS
COMPANY**

245 E. 6th St., St. Paul, Minn. 55101 / (612) 227-6371

INFORMATION RETRIEVAL NUMBER 70

ELECTRONIC DESIGN 9, April 26, 1969

Cut remote control costs with Dale Motorized Potentiometers

Thoroughly proven in entertainment instruments, Dale's AC Reversible Motor Driven Pot is a cost cutter for business machines and industrial equipment as well.

■ Used as a bias regulator for solid state devices, it now handles the remote control function for many types of heavy power equipment — eliminating heavy cables between control panels and resistive devices.

■ Versatility increases when equipped with Dale's patented motor load decoupler. Coasting is eliminated and manual control is free of gear motor inertial load.

■ Hysteresis synchronous motor and gear train can be coupled with a wide range of single and multi-turn carbon and wirewound pots as well as with variable capacitors. Motor and gear train are also used as television tuner drive.

SPECIFICATIONS

Operating Voltage — 6, 12, 24, 117 VAC or any specified; **Power Input** — 7.5 volt amperes; **Output** — 5.6 RPM; **Torque at Pot Shaft** — 10 in./oz. min. (with decoupler), 21 in./oz. min. (without decoupler). Up to 4 auxiliary switches can be added for actuation at any degree of cam rotation.

For complete specifications and application information, call 605-665-9301 or write



DALE ELECTRONICS, INC.
SIOUX DIVISION, Dept. ED
Yankton, South Dakota 57078

INFORMATION RETRIEVAL NUMBER 71



ACOPIAN DUALS...

2

POWER SUPPLIES IN THE SPACE OF

1

Where your equipment or system requires more than one regulated DC output, consider Acopian duals. They consist of two independent regulated power supplies housed in a single module. You can select two like outputs (such as for op amps) or any of 80,000 combinations of different outputs.

Acopian duals cut mounting space requirements roughly in half, cost less than two individual modules and, like all Acopian power supplies save you time because they're shipped three days after receipt of your order.

For information on the complete line of 82,000 different Acopian power supplies, including singles and duals, regulated and unregulated, and rack mounted assemblies, ask for our new catalog. Write Acopian Corp., Easton, Pa. 18042 call (215) 258-5441.



INFORMATION RETRIEVAL NUMBER 72

Evaluation Samples

Circuit-board holders

Printed circuit-board guides are offered in plastic, steel, and beryllium copper versions. Easily installed, the plastic units offer maximum economy; the low-cost steel units are available in a variety of lengths; and the lightweight beryllium copper versions provide a firm grip. Samples of all and an eight-page catalog that includes full specifications and engineering drawings are available. Taurus Corp.

CIRCLE NO. 431

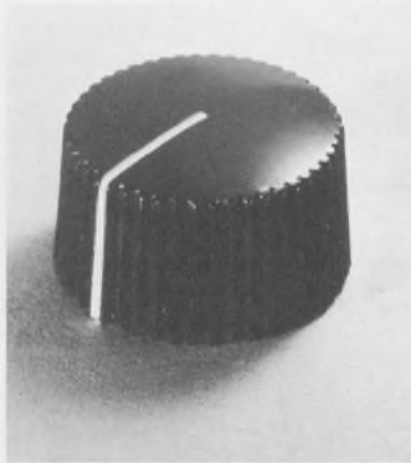

Control knobs

A serrated knob design with a calibration line on top blends with almost any console and complements the other controls. It measures 13/16 in. in dia. by 7/16 in. high and is supplied with a 1/4-in. molded hole and a single set screw. In standard form the knob is made from general-purpose phenolics molded in black. At a slightly higher cost, the knob may be purchased in white or in a variety of colors made from ureas and melamine plastics. The knob is intended for volume production so that it can be priced at about 7¢ each in quantity. Further information and samples are available. Kurz-Kasch, Inc.

CIRCLE NO. 432



Rfi shielding gaskets

Composed of a laminate of self-adhesive foam and foil, an rfi shielding gasket combines the compression characteristics of foam with the shielding properties of foil. To meet military metal protection specifications, these gaskets are available with either cadmium or gold-plated foil. Supplied with a pressure-sensitive adhesive backing, the gaskets can be applied quickly and easily to cabinet coverplates or doors. Further information and samples are available on request. Tapecon, Inc.

CIRCLE NO. 433



Clear shrinkable tubing

Shrinkdown HT-105 is a flexible, Class A (105°C), clear extruded tubing that shrinks 35% in diameter with the application of heat. It can be used over irregular shapes to provide a snug, transparent insulating covering that offers both electrical and mechanical protection. Since shrinkage occurs at temperatures below 200°C, this material is particularly suitable for applications where higher temperatures could damage heat-sensitive components. Additional technical data and an evaluation sample packet is available on request. L. Frank Markel & Sons.

CIRCLE NO. 434

The drip-dry test bath.

As soon as you pull your electronic circuit or component out of a 3M Brand Inert Fluorochemical Liquid test bath, it drains clean, and dries almost as fast as it drains.

No more messy residue. No more time-consuming and expensive cleaning to remove the testing fluid. You can package your component or use it right out of the bath.

This makes our fluids ideal for gross leak testing and integrated circuit performance testing.

Other properties of our Inert Liquids are equally important for test bath applications. You can use them over a wide temperature range. They're completely compatible with the most sensitive materials. A high dielectric strength provides electrical protection during testing. Non-flammability adds safety.

Those are also some of the reasons why 3M Brand Inert Liquids started out to be—and still are—the most reliable electronic coolants on the market. Tests have proved that.

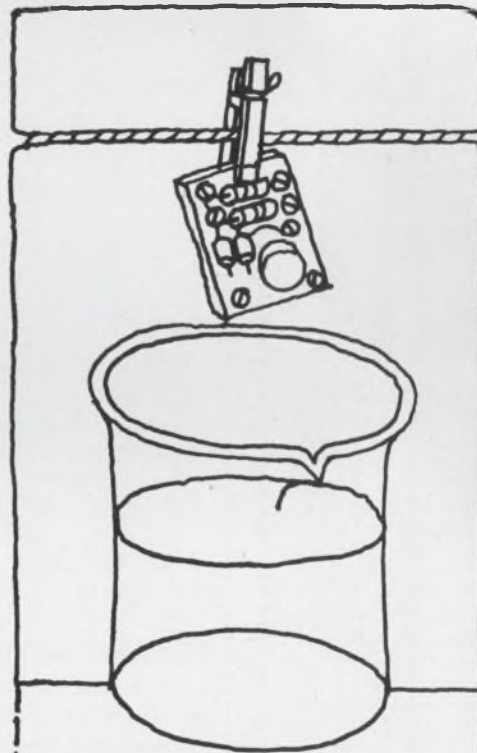

3M Company, 3M Center Dept. KAP-4-69
St. Paul, Minn. 55101
Send me all the details about 3M Brand
Inert Liquids

Name _____

Company _____ Title _____

Address _____

City _____ State _____ Zip _____

Chemical Division 3M

In a word **DSE** means
CAPABILITY

Performance-proved capability in **SYSTEMS** for the Low/High-Level data acquisition and data conversion field . . . performance-proved capability in **STANDARD PRODUCTS** for a wide range of airborne, ground support, oceanographic, and commercial-industrial applications. The accomplishments of Dynamic System Electronics (DSE) in

- Data Acquisition
- Data Conversion
- Signal Conditioning
- Data Recording Systems
- Computer-Interfaced Systems
- System Integration and Interface

are a matter of record. Call our local representative or DSE and update yourself on DSE's products and capabilities in the Computer Peripheral, Systems Interface, and Data Conversion fields.

NEW MODEL 910 SERIES DYNAFACER



This versatile Data Acquisition and Conversion System Series has the capability of interfacing with general purpose digital computers as well as all of the modern computer peripherals such as tape transports (7-track or 9-track IBM compatible), memories, printers, punches, signal conditioners, analog displays, and X-Y Recorders. The 910 Series is generated from DSE's **STANDARD** modular building blocks with performance-proved reliability that offer flexibility and expandability at minimum cost, in minimum time.

See us at **SJCC**
Booth **JJ1**

**DYNAMIC
SYSTEM
ELECTRONICS**

1040 West Alameda Drive Tempe, Arizona 85281
Phone (602) 967-8644 TWX 910-950-1941

INFORMATION RETRIEVAL NUMBER 74

Design Aids

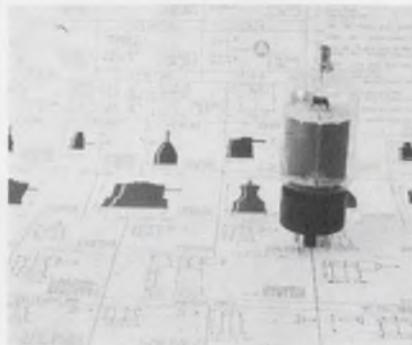

Tube-cap wall chart

Offered as an aid to designers specifying tube caps, a large wall chart displays a wide variety of types and styles. Phenolic, integrally molded and silicone-rubber insulated types are shown, as are uninsulated contact versions. Outline drawings of every type are fully dimensioned and both electrical and mechanical specifications of insulating materials are given. Alden Products Co.

CIRCLE NO. 435

NOMOGRAPH RELATING
WIRE SIZE/CURRENT/TEMPERATURE



EXPLANATION OF NOMOGRAPH

1. Tungsten filament wire size (AWG) vs. current (A) vs. temperature (°C).
2. Tungsten filament wire size (AWG) vs. current (A) vs. temperature (°F).
3. Tungsten filament wire size (AWG) vs. current (A) vs. temperature (°C) for different filament types.
4. Tungsten filament wire size (AWG) vs. current (A) vs. temperature (°C) for different filament types.

Filament nomogram

A nomogram that relates the wire size of tungsten filaments to current and temperature is offered as part of a technical report on tungsten metalizing filaments. The eight-page report contains useful information on how to obtain increased filament life in vacuum metalizing operations. The nomogram can be used to determine the temperature of single or stranded wire at a given current. General Electric Co., Lamp Metals and Components Dept.

CIRCLE NO. 436



Reliability calculator

A new calculator has been designed for preparing estimates of reliability, maintainability, and availability of assemblies and systems. If the user has access to failure rates and can estimate assembly-maintenance and mission-operating time, the device can be used to calculate reliability, maintainability, and availability parameters within minutes. The calculator is priced at \$5, and descriptive literature is available. Sylvania Electric Products, Inc.

CIRCLE NO. 437

Waveguides wall chart

A 17- by 22-in. wall chart contains complete technical descriptions of over 54 types of rigid rectangular waveguides and flanges under the category of MIL-W-85C. The wall chart contains E.I.A. equivalents, MIL-W-85/1 dash numbers, and frequency ranges (GHz) on each of the 54 types of rigid rectangular waveguides and flanges shown. In addition, the chart contains complete specifications and technical data on materials and dimensions. Washburn Div. of A. T. Wall Co.

CIRCLE NO. 438

Lamp nomogram

An incandescent lamp nomogram is included with a 12-page bulletin on photocell-lamp modules. The four-bar nomogram relates such variables as voltage ratio, current factor, candlepower, and life. The bulletin also includes general application and design information, as well as complete specifications for eight different types of modules. Clairex Electronics, Inc.

CIRCLE NO. 439



IF YOU LIKE
NEW YORK
IN JUNE
YOU'LL
LOVE IT BY
JULY!

1969 MICROWAVE
EXPOSITION east

By then you will have had time to process the orders you will obtain by exhibiting at MICROWAVE EXPOSITION/EAST. That's right—orders! At MICROWAVE EXPOSITION/WEST, last January in Los Angeles, the visitors were bringing blueprints into the exhibitor's booths, to get the quickest possible quote!

If your cup of tea is quantity, quantity, quantity, stay away because we are offering quality. The kind of quality that specifies. The kind of quality that brings blueprints. The kind of quality that means business! There are lots of Shows with 50,000 attendance. Show us one with more buyers!

Call today for an immediate booth assignment. (Collect, of course.) June 3, 4 and 5—Statler Hilton Hotel.

CO-SPONSORED BY:

Technical Industry Expositions, Inc.
100 Avenue of the Americas
New York, N.Y. 10013
Tel: 212-925-1200

Hayden Publishing Co.
MICROWAVES MAGAZINE
850 3rd Avenue
New York, N.Y. 10022

**ENGINEERS! PRE-REGISTER BY CIRCLING
READER SERVICE NUMBER 225**

Application Notes

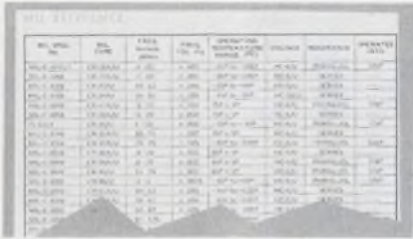

MIL crystal reference

A MIL reference table for quartz crystals is offered with a 16-page technical bulletin. For a given MIL-type crystal, the table supplies the appropriate MIL spec, frequency range and tolerance, crystal holder, operating temperature, etc. The brochure gives crystal specifications, dimensions, and design considerations. Erie Technological Products, Inc.

CIRCLE NO. 440

Shunt regulators

A four-page brochure for design engineers describes shunt regulators and how to use them for precision power supplies, voltage regulation at the load, voltage limiting, and deripling of regulated power supplies. Although analogous to a zener diode in simplicity of circuit application, shunt regulators include the essential electronics of precision power supplies. Trio Laboratories, Inc.

CIRCLE NO. 441

Applications literature

A new index of applications literature available from Texas Instruments contains abstracts of over 50 application reports and notes related to solid-state devices and integrated circuits. All literature listed in the index is available without charge. All application reports are cross referenced both by circuit type and by product type. Texas Instruments Inc.

CIRCLE NO. 442

Emi measurement

A 26-page application note discusses the principles of electromagnetic interference measurements, and it describes how modern calibrated spectrum analyzers can be used as tuned rf microvoltmeters with visual display, in order to make these measurements with substantial savings in time. The note begins with a general summary of emi principles. It describes techniques for making standardized emi measurements. Hewlett-Packard Co.

CIRCLE NO. 444

Noise in TTL systems

A 12-page application report describes various types of noise that can appear in systems using transistor-transistor-logic (TTL) integrated circuits and prescribes specific ways to cope with such noise. Rather than dealing with complicated theoretical aspects of electronic noise, the report gives practical rules for preventing noise problems with these digital ICs. Nine circuit diagrams, eight scope traces, and five plots of device properties provide ample illustration of the principles involved. Texas Instruments Inc.

CIRCLE NO. 443

Dual photocell notes

Circuit design with dual photocells is covered in some depth by an eight-page application note on analog multipliers and low-noise choppers. The dual photocell has several advantages. Among these are close resistance balance and tracking characteristics. The 12-page publication gives circuits, design equations, and trade-off possibilities in detail for choppers and analog multipliers. Hewlett-Packard Co.

CIRCLE NO. 445



Wideband amplifiers

An application note on the use of wideband amplifiers covers the sometimes controversial definitions of frequency for full output, gain-bandwidth product and slew rate. The importance of 6 dB/octave roll-off, large gain-bandwidth product, and low input capacitance are covered in detail, as are precautions to be taken in the use of wideband amplifiers. Data Device Corp.

CIRCLE NO. 447

Plastics selection guide

A two-part brochure describes how to specify and order high-pressure laminated plastics and gives complete property values for 34 standard stock grades that meet the requirements of virtually all laminated plastic applications. The first section gives useful handbook information on laminate specification, including a discussion of the various types of high-pressure laminated plastics. Part Two tabulates the property values of the 34 standard stock grades of laminates plastics in an easy-to-read three-page spread. The various grades in the table are given comparative ratings for dimensional stability, fabricability and chemical resistance. Taylor Corp.

CIRCLE NO. 448

TRW/Globe Sells Motion

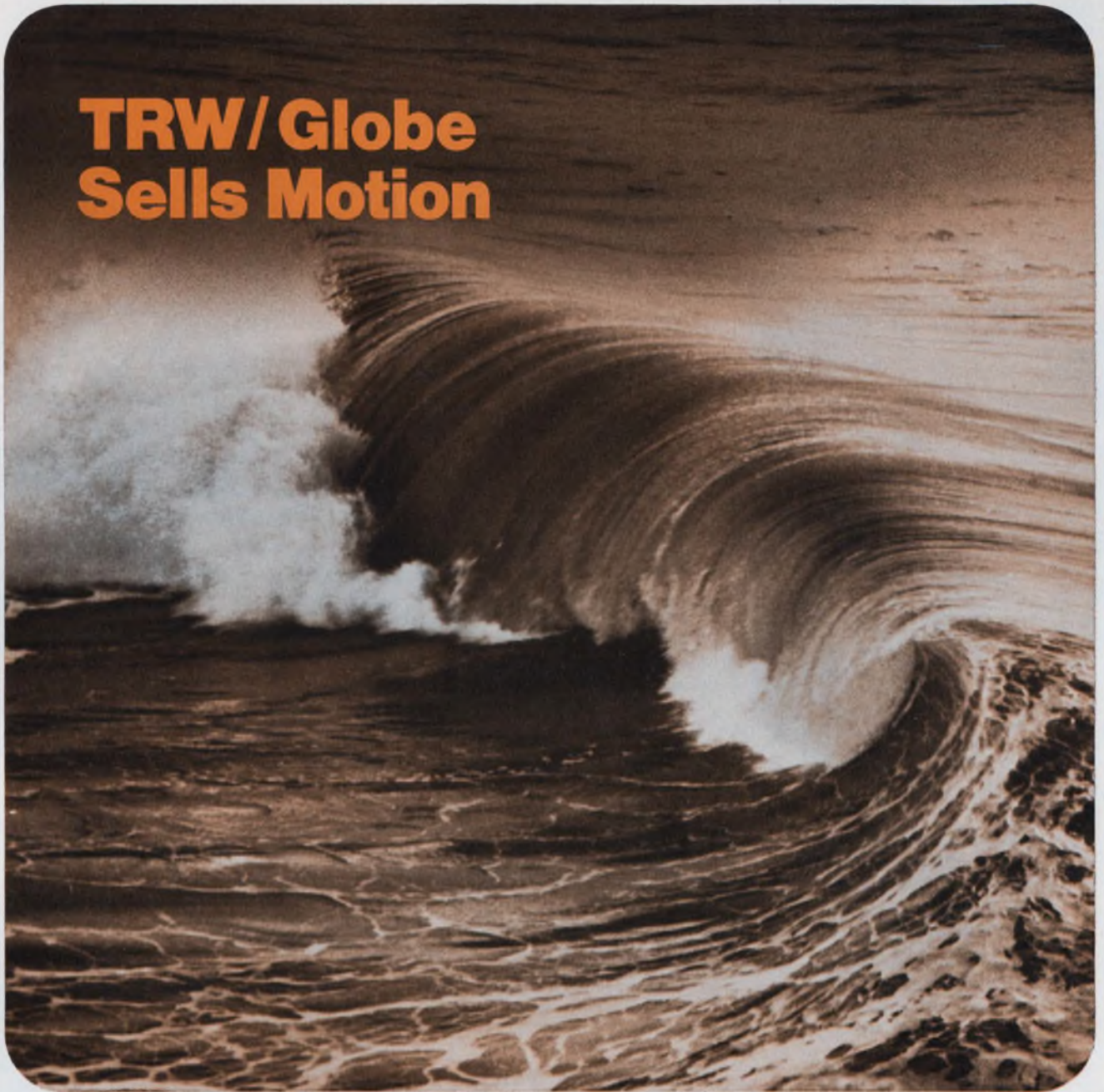

Application #1: Pumping Fluids and Gases

Most pumps have a problem with leakage around the motor coupling. So they put in a dynamic seal. But seals wear out and have to be replaced. They also put an added load on the motor.

Globe found a solution. Do away with mechanical coupling between motor and impeller. Use magnetic coupling. No dynamic seal is necessary. No leakage; no seal wear; no

unnecessary load on the motor. Result: less power needed; less weight; lower cost; longer maintenance-free performance.

This wasn't a sudden discovery. Globe has been designing and building pumps on this principle since 1963.

The Globe Industries Division of TRW INC. is in the business of solving problems in motion. Any kind of

motion; rotary or linear; rapid or slow; air, liquid or mechanical linkage.

If you have a problem in motion, let Globe's motor system engineers find your optimum answer. Contact Globe Industries Division of TRW INC., 2275 Stanley Ave., Dayton, Ohio 45404. Phone (513) 222-3741.

TRW®

INFORMATION RETRIEVAL NUMBER 76

**Do You
Receive More
Than You
Give?
Half a Data
Terminal
May Be All
That You
Really Need.**



The Shepard "500A" Communication Terminal Page Printer is a new concept in data communications.

This low cost, 80 column, Receive Only Printing System, receives data (up to 2400 BAUD) directly from your communication line via a Data-Phone or Modem.

The system provides printout on sprocket fed fan-fold, multiple copy forms.

The 500A's integral electronic system permits continuous data transmission thus minimizing line costs.

If you'd like to know more about it, send for free literature.



**Shepard
Division**

480 MORRIS AVE., SUMMIT, N.J. 07901
(201) 273-5255 • TWX 710-984-7989

INFORMATION RETRIEVAL NUMBER 77

New Literature



Hard-to-find tools

A new 24-page, fully illustrated catalog of hard-to-find tools gives detailed descriptions of each tool and its application. It contains a unique collection of extremely useful tools rarely sold by industrial distributors or stores. Among these are electronic pliers, jewelers' tools, sensitive drillers, precision tools, flexible shaft machines, unusual solders, soldering jigs, hard-wire cutters, screw and nut starters, glass drills, miniature files, rifflers, and reamers. Brookstone Co.

CIRCLE NO. 449

Diode test equipment

A 12-page brochure covers a line of automatic test instruments for diodes. The booklet discusses the use of automatic testers in high-speed production-line and incoming-inspection applications. The use of automatic handling equipment and of multiplexers is also covered. Teradyne, Inc.

CIRCLE NO. 450

Computer products

Description and specifications of a full line of magnetic-tape drives, core memories, memory stacks and bulk cores are contained in a 19-page quick-reference, pocket catalog. Ampex Corp.

CIRCLE NO. 451



Digital data handling

A multisection literature package on digital modules features two items of particular interest: an application note that presents useful generic block diagrams and explanations of various experiments of a general nature; and a selection guide of data-handling instruments, showing the manner in which they can be interconnected. Ortec Inc.

CIRCLE NO. 452

Trimmer catalog

An expanded trimmer potentiometer line is shown in detail in a new 32-page catalog that contains 50 per cent more models than previous editions. The catalog also contains information on precision potentiometers. Listing film element trimmers for the first time, the catalog includes complete descriptions of six new rectilinear and square series. Dale Electronics, Inc.

CIRCLE NO. 453

Delay-lines catalog

A new 16-page catalog describes miniature nanosecond lumped-constant delay lines. Designed for PC mounting and IC compatibility, these units are encapsulated with epoxy in a diallyl phthalate housing that incorporates four stand-off feet to permit flush cleaning of flux residues after the soldering operation. Pins are gold plated. Engineered Components Co.

CIRCLE NO. 454

NOW AVAILABLE!
FLOW Series SP-400
Time Code Generator/Reader



The most economical and completely versatile analog data indexing and retrieval subsystem available. Designed for compatible use with tape recorder, oscillograph, stripchart recorder, and photographic film systems.

FLOW Series SP-400 uniquely offers flexibility, function and control by simply adding or subtracting front-panel plug-ins to the basic unit.

FLOW Series SP-400 offers real cost savings by permitting selection of only desired functions:

Automatic Tape Search Unit / Slow Code Generator for Oscillographs / Automatic Time Synchronization to external time reference / Computer Clock Interface / Sequential Clock Programmer / Other standard and special purpose plug-ins available / All integrated circuits, offering space age reliability.

Order now — from stock — write or call for Bulletin SP-400.



FLOW CORPORATION —Department D
 127 Coolidge Hill Road, Watertown, Mass. 02172
 Telephone Number: 924-8505

INFORMATION RETRIEVAL NUMBER 78

PROTOTYPES

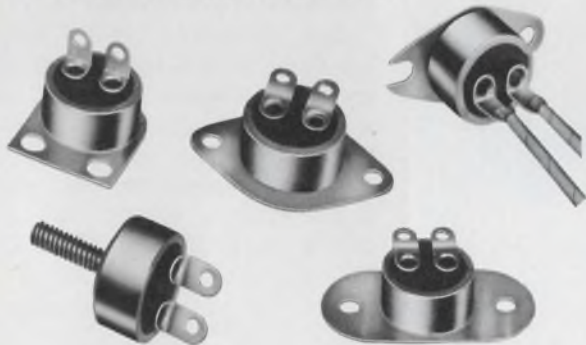

Model 3100
 Hermetically Sealed

PRECISION SNAP ACTION THERMOSTATS

Fast, intelligent service on prototype requests for fully qualified, tested and proven thermal switches. Usually available from stock. Write, TWX or phone for latest complete catalog.

ELMWOOD SENSORS, INC.
 1645 Elmwood Avenue, Cranston, R.I. 02910
 (401) 781-6500 • TWX 710-381-6413
 See our ad in EEM, Section 5300

ELMWOOD SENSORS

INFORMATION RETRIEVAL NUMBER 79

Very
Unrevolutionary

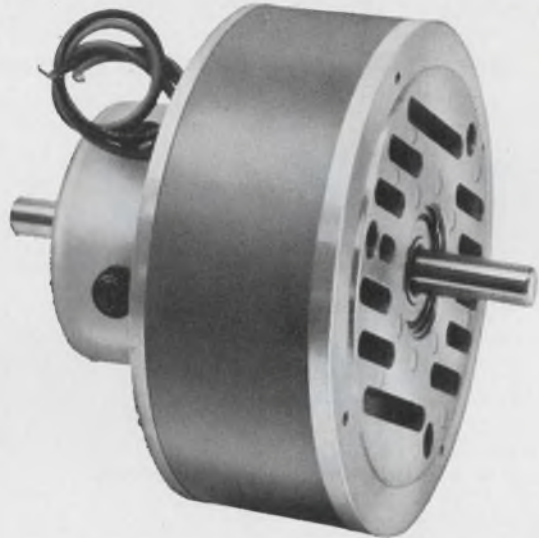

CEDAR'S low inertia motor
adds a new improved design
to a proven motor concept
to give you
unsurpassed performance
at a very low cost

CEDAR's design improvements on the cup-type motor have resulted in a new low inertia DC servo motor that matches or exceeds the performance of "printed circuit" type motors, but costs less. It has, in addition, the capacity for even greater performance outputs in the very same standard sizes.

Whether you use it for computer peripheral equipment or instrumentation and control systems, CEDAR's new improved low inertia motor will deliver the performance you need. Get complete information from your local CEDAR Sales Representative or contact CEDAR's DC Product Manager.

CEDAR CONTROL DATA
DIVISION CORPORATION

5806 West 36th Street • Minneapolis, Minnesota 55416
 Phone: 612/929-1681

INFORMATION RETRIEVAL NUMBER 80

The things we do to stay in front!

Because we're No. 1 in control knobs . . .

and because we're Rogan

Our reputation means a lot to us. So much in fact that the knobs we make are quality knobs . . . knobs that are "out in front" with "real design appeal" —yet priced right to fit your budget. Write today for free New color catalog or see us in Sweets or Thomas Micro catalogs.

Rogan
BROTHERS, INC.
8031 N. MONTICELLO AVE.
SKOKIE, ILLINOIS 60076

INFORMATION RETRIEVAL NUMBER 81

CUT CONSTRUCTION DELAY

with pre-punched
**VECTORBORD,*
PLUGBORDS and
Push-in TERMINALS**

Make circuits the fast, easy way . . . simply insert Vector push-in terminals (wide variety available) and component wires into pre-punched Vectorbord, or use punched copper clad for do-it-yourself etching; and, for production, we're geared to omit the holes not required and assemble terminals, eyelets, etc. to your specifications. Eleven patterns available with .025", .040", .062", .093" holes in XXXP phenolic, glass silicone, glass or paper epoxy and copper clad. Plugbords supplied in many sizes with etched pads, .040" dia. Edge-Pins or Elco Varicon® contacts.

Save time — Save work — Save money!

TRADE MARK

Send for complete literature

Vector ELECTRONIC COMPANY, INC.
12460 Gladstone Ave., Sylmar, Calif. 91342

INFORMATION RETRIEVAL NUMBER 82

NEW LITERATURE

Superconducting magnets

The theory, design and construction of large stabilized superconducting magnet coils is reviewed in detail in a 24-page publication. Topics discussed in the book include the superconductivity phenomena, superconducting coil operation, and operational difficulties with early coils. Also covered are the problems of instability and degradation, how they frustrated designers and how the final solution was achieved in 1965. AMAX Copper, Inc., American Metal Climax, Inc.

CIRCLE NO. 455

Fan motors

A 16-page selection and cross-reference guide describes and lists 48 versatile service motors that can replace over 30 million fan motors presently in use. The guide also contains motor ratings and sizes, dimensional diagrams and information on motor accessories. General Electric Co., General Purpose Motor Dept.

CIRCLE NO. 456

Infrared accessories

Just published is a 36-page handbook on a complete line of IR spectrophotometer cells and accessories. The hundreds of items illustrated include prices and part numbers, along with performance characteristics, spectra and application data. Barnes Engineering Co.

CIRCLE NO. 457

Miniature lamps

A new four-page, four-color brochure on miniature sealed-beam lamps describes the new 2-in. lamps and includes specifications and dimensional drawings. The new lamps, developed for 48-volt service in a trouble lamp for rugged environments, are also available for use in 12 and 24-volt applications. Tung-Sol Division, Wagner Electric Corp.

CIRCLE NO. 458

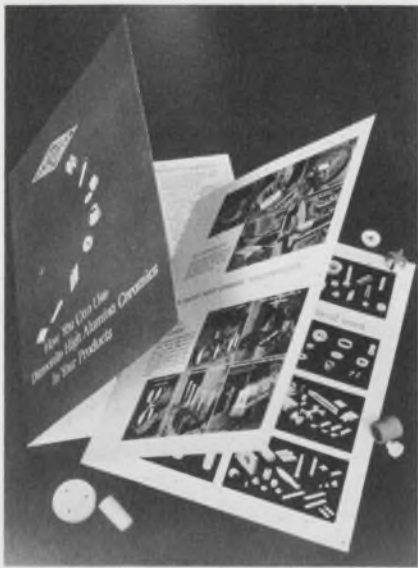

High alumina ceramics

Information and illustrations helpful in designing high alumina ceramic parts for critical electronic uses are provided in an 8-page catalog. A chart compares the properties of these compounds. Recommendations concerning tolerances, parallelism, wall thickness, warpage, threads, holes and counterbores, fillets and corner breaks, ground corners, glaze, chipping, simplicity, and appearance are included. Diamonite Products Manufacturing Co.

CIRCLE NO. 459



Fasteners

A pocket-sized portfolio is jammed with two yards of fastening ideas. On one side of the accordion-folded packet, which opens to six feet in length, is a montage of hundreds of spring steel and plastic fasteners. On the other side, 21 different types of fasteners, including most popular standards and new production developments, are featured. Tinnerman Products, Inc.

CIRCLE NO. 460

RMC DISCAPS the complete Ceramic Disc line

Over the years Radio Materials Company has maintained its leadership in the production of ceramic disc capacitors. A complete line offering outstanding quality has been the key to continuing growth.

STANDARD

Type C, B, BA, JF, JL and JE

RMC
.0039

SUBMINIATURE

Type SM, BT, TA and Magnacaps

GREENCAPS

Type CG, JG, and BG

SPECIAL

U.L. Listed Discaps, T.C. High Voltage, High K High Voltage and Dual Section By-Pass

SOLDER-IN T.C. DISCAPS

For application in equipment where lead inductance effects must be reduced to an absolute minimum.

U.L. LISTED T.C. DISCAPS

Should be specified when the use is an integral part of an antenna coupling network where compliance with Underwriters' Laboratories specifications are required.

If your application requires special physical or electrical characteristics, contact RMC's Engineering Department.

DISCAP
CERAMIC
CAPACITORS



RADIO MATERIALS COMPANY

A DIVISION OF P. B. MALLORY & CO., INC.
GENERAL OFFICE: 4242 W. Bryn Mawr Ave., Chicago 46, Ill.
Two RMC Plants Devoted Exclusively to Ceramic Capacitors
FACTORIES AT CHICAGO, ILL. AND ATTICA, IND.

A "MINI-BABY" STRIP PRINTER — BUT WHAT A WALLOP!

At seven pounds and one-half the size of an attache case, the MDS Series 120A Digital Strip Printer outperforms many bigger, heavier and more expensive units.

When the high cost of a multiple column printer is prohibitive, upgrade your system with the 120A. "Ticker-tape" printing . . . at 20 characters per second . . . a full 64-character font . . . with or without operating and control electronics.

The 120-day warranty . . . and MDS engineering . . . assure you that the MDS 120A will give top performance with minimum maintenance at an economical price.



With cover panels removed, miniaturization of the 120A is easily seen.

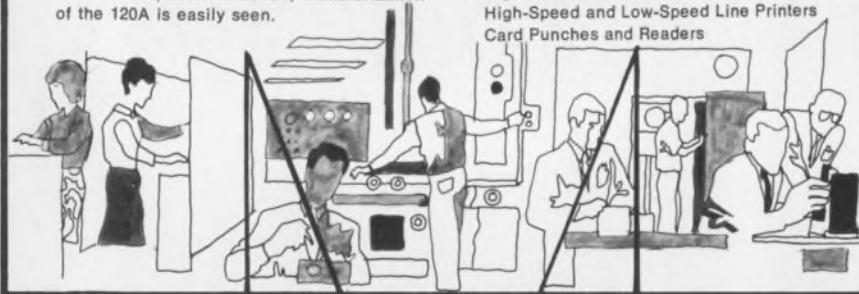

Ask for: The MDS folder-file on the 120A

**FOR MORE — MEET YOUR MAN
FROM MDS**

MOHAWK MDS
DATA SCIENCES CORPORATION
OEM MARKETING
122 E. Ridgewood Ave. • Paramus, N.J. 07652

Telephone 201/265-7333

Every MDS Office is an OEM Marketing Office

Digital Strip Printers • Buffered Tape Units
High-Speed and Low-Speed Line Printers
Card Punches and Readers

INFORMATION RETRIEVAL NUMBER 84

ELECTRONIC MOTOR SPEED CONTROLS

The most complete source of every type: SCR, Variac, Transistorized, Ferrite, 172 models. 1/1000 to 150 H.P. From .01 RPM to 15,000 RPM. Low-cost and feature packed models: 1000:1 range, reversing, braking, speed readout, remote control, positioning, feedback, 0.25% reg. Custom controls and systems. Thousands of motors, controls; hundreds of accessories, clutches, brakes, timers, etc.



FREE CATALOG

28 pages of variable speed motor controls

IBB MOTOR & CONTROL
CORP. • 96 Spring Street, New York, N.Y. 10012
Phone (212) 966-5777

INFORMATION RETRIEVAL NUMBER 85

NEW LITERATURE

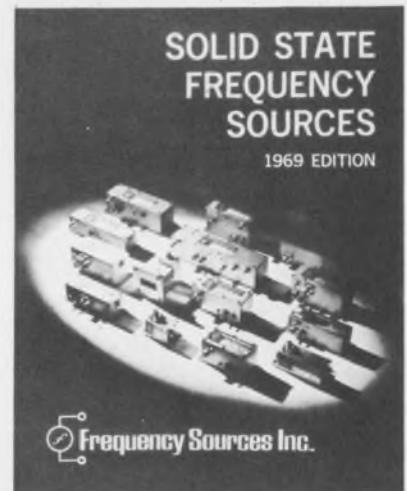

Frequency sources

A 1969 catalog describes a broad line of microwave solid-state sources that includes voltage-tuned, cavity, stabilized, crystal-controlled, mechanically tuned, crystal-stabilized (phase lock) and avalanche diode sources. The 20-page, two-color catalog gives complete specifications for more than 80 models, including application information and curves useful to the design engineer. Frequency coverage extends to 18 GHz (Ku-band), and power output capabilities range up to 2 W in some models. Frequency Sources, Inc.

CIRCLE NO. 461

SCR catalog

An eight-page short-form catalog lists the characteristics of approximately 350 high-current SCRs covering the range from 55 to 275 A rms. This line of high-current SCRs includes JEDEC as well as non-JEDEC industrial types. KSC Semiconductor Corp.

CIRCLE NO. 462

Knob catalog

A 16-page, full-color catalog outlines a new series of instrumentation control knobs. Mechanical drawings and charts showing dimensions, shaft diameters and sizes, together with other pertinent information on knobs, are contained in the new catalog. Rogan Brothers, Inc.

CIRCLE NO. 463

Microphone catalog

A 20-page catalog describes a line of microphones, including several recently developed models. Included in the catalog are professional cardioid dynamic, mobile and transistorized mobile, base-station, paging, public-address and tape-recording microphones, plus microphone cartridges, stands and accessories. The publication includes technical sections and product descriptions, specifications, photographs and list prices on each microphone. The Turner Co.

CIRCLE NO. 464

Gear catalog

A 32-page catalog covers a complete line of molded and stamped gears. This illustrated catalog provides detailed tables giving all critical specifications for hundreds of sizes of stamped spur gears, crowns, segments, internals, ring gears, ratchets and sprockets that are made to order from stock tooling. Also included is information on rules and formulas for spur gears, electrical discharge machining, special stampings, stamping dies, and custom-molded parts. Winzeler Manufacturing & Tool Co.

CIRCLE NO. 465

Magnetic-tape recorders



A 36-page catalog offers thorough description, specifications and prices on a complete line of magnetic-tape recorders, accessories, and special machines. Complete information on application and interface of recorders is also included, with diagrams and a glossary of terms. Kennedy Co.

CIRCLE NO. 466

A single capable source for both lamps and fiber optic light guide systems

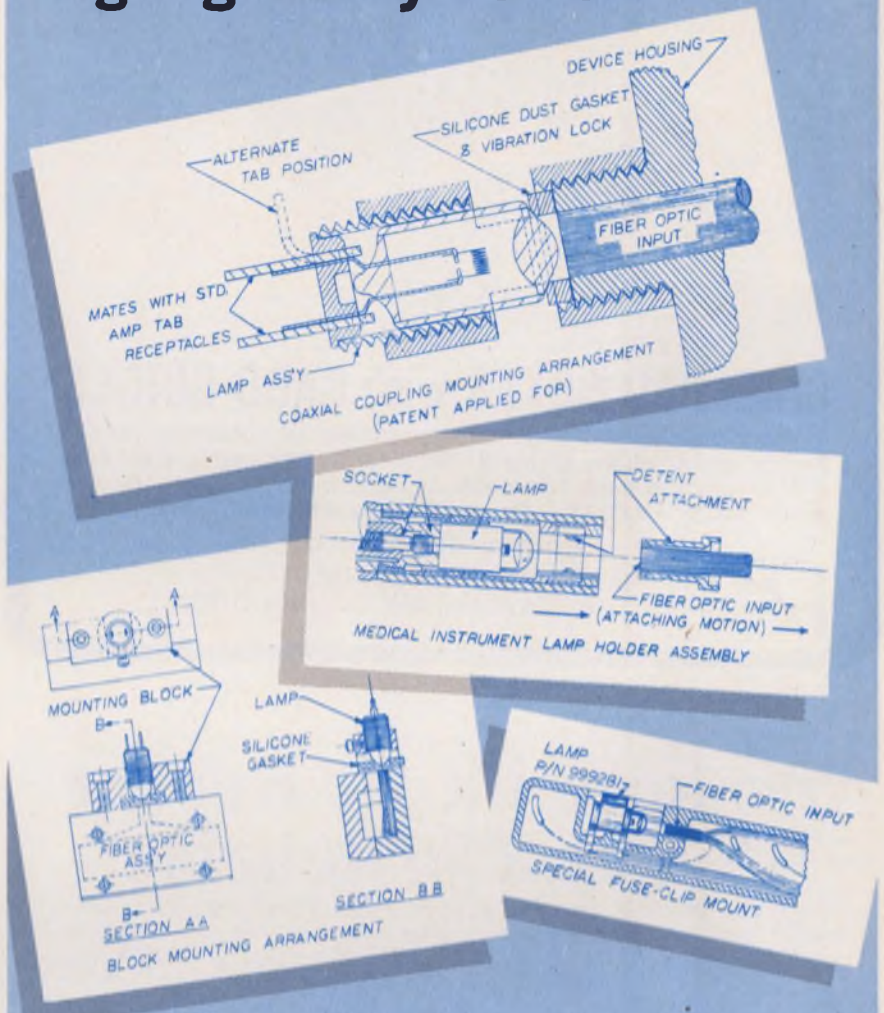

There are obvious advantages in speed, cost and often in efficiency of the ultimate system in having one source produce both miniature lamps and fiber optic assemblies. Welch Allyn has that capability.

We are major suppliers of fiber optics and incandescent illumination sources to principal computer manufacturers and other light guide users.

In addition to our standard lamp designs, we have recently developed a new family of customized miniature vacuum lamps for fiber optic and photo-sensitive device applications with selectable lens-filament combinations and basing for optimum utilization of energy.

Our lamp-fiber optic systems are designed for maximum efficiency and are often less costly than standard multiple-lamp systems.

Phone or write for more information

WELCH ALLYN, INC.
Skaneateles Falls, N.Y. 13153
(315) 685-5788



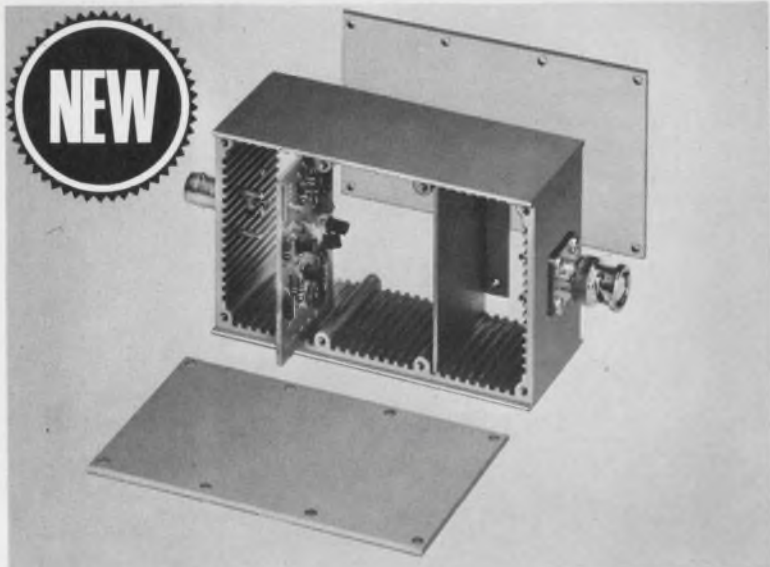

SHIELDED BOXES with CARD GUIDES

Rugged die-cast aluminum boxes, slotted to accept $\frac{1}{8}$ " circuit boards and shielding dividers. Excellent for packaging electronic circuitry. Boxes have removable top and bottom covers. Useable inside space: 4"x2"x1 $\frac{1}{2}$ ". Several models with various connectors.

Write for 1969 Catalog



POMONA ELECTRONICS CO., INC.
1500 E. Ninth Street, Pomona, California 91766

INFORMATION RETRIEVAL NUMBER 87

Watlow Silicone Rubber Heater... Old Reliable.

It may not look like much. But when you need a flexible electric surface heater capable of providing continuous heat up to 450°F, you can depend on Watlow's "Old Reliable" Silicone Rubber Heater. Used in thousands of applications without special engineering, it can be cemented or fastened to almost any surface. Plus it resists weathering, chemicals, vibration and is available in a multitude of sizes from stock.

If "Old Reliable" can't do it, we'll make you a "Custom Job" that will. Write for free stock heater spec sheet and application guide.



WATLOW

WATLOW ELECTRIC COMPANY OF CALIFORNIA
Subsidiary of Watlow Electric Manufacturing Company
141 W. Hazel Street, Inglewood, California, Tel. (213) 673-4711

INFORMATION RETRIEVAL NUMBER 88

Motor replacement guide

Newly revised, a 40-page publication provides a motor cross-reference guide, listing current models available to replace superseded motors and many current special designs. This new motor guide provides complete ordering information for over 5500 three-phase, capacitor-start, split-phase and other types of motors, 1/20-through 5-hp, in NEMA 48 and 56 frame sizes. General Electric.

CIRCLE NO. 467

Audio connectors

A new catalog describes a complete line of audio connectors, standard microphone connectors, adapters, rf connectors, Y connectors, ac receptacles, and phone jacks. The catalog includes specifications, detailed drawings, application hints and prices for single and multiple conductor models. It provides engineers and designers with an up-to-the-minute guide to audio connectors and related components. Switchcraft, Inc.

CIRCLE NO. 468

Crystal oscillators

Miniature precision crystal-controlled oscillators are described in a new 12-page catalog. The brochure features photographs, line drawings, electrical characteristics and mechanical specifications on dozens of different oscillators. A cross-referenced selection chart provides information necessary for finding the right oscillator for any given circuit application. Oak Electro/Netics Corp.

CIRCLE NO. 469

Resistance-welding guide

A comprehensive guide discusses the selection of resistance-welding equipment, particularly for precise electronics applications. The guide illustrates and describes functional details of over two dozen typical resistance-welding machines, ranging from small, treadle-actuated bench models to sophisticated units designed for automated production lines. Tweezer-Weld Div. of Federal Tool Engineering Co.

CIRCLE NO. 470

DC power supplies

An eight-page illustrated catalog on a series of modular, wide range, convection cooled, dc power supplies for system applications is now available. The complete line of 29 models with optional rack adapters is described in a table detailing values for voltage and current output, voltage regulation, resolution, optional over-voltage protection, temperature coefficient, transient response time, and output impedance. Raytheon Co.

CIRCLE NO. 471

Rf instruments

A 64-page instrument catalog contains selection and technical information on sweep generators. Discussed are frequency range and power, sweep width, flatness, frequency stability, sweep rate, and frequency linearity. Other instruments are also described. These include frequency markers, oscilloscopes, and Smith-chart impedance plotters. An additional section gives information on such rf components as attenuators, dc blocks, detectors and bridges, impedance matching pads, and coaxial switches. Texscan Corp.

CIRCLE NO. 472

Switch catalog

A comprehensive catalog covers limit, enclosed, explosionproof, basic, miniature, subminiature and mercury switches and presents a comprehensive discussion of proximity switches. The 92-page guide offers descriptions, electrical ratings, characteristics, actuator and terminal variations. Micro Switch, Div. of Honeywell Inc.

CIRCLE NO. 473

PC boards

A 24-page catalog covers off-the-shelf IC breadboards, custom-designed PC boards, and related accessories. The illustrated catalog includes all of the company's printed circuit boards, ejectors, connectors, bus bars, card racks, and card rack cases. Also included is a detailed checklist for use as a guide in preparing specifications for custom-designed boards. Douglas Electronics.

CIRCLE NO. 474

More Power than you ever pressed into a heat sink before!



35 and 44 amps! Two new Tung-Sol diffused junction silicon power rectifiers in the JEDEC DO-21 package.

Both feature high surge capability and they cost less than equivalent-rated, stud-mounted units. Plus the economy of pressfit installation.

Use this coupon to get complete information in only a couple of days.

Quick-Action Coupon

Tung-Sol Division/Wagner Electric Corporation
630 W. Mt. Pleasant Avenue
Livingston, N.J. 07039

Please send data on new high power pressfit rectifiers:

() 35 amp () 44 amp () both

Name _____

Company _____

Address _____

City _____ State _____ Zip _____

ELECTRONIC DESIGN's function is:

- To aid progress in the electronics manufacturing industry by promoting good design.
- To give the electronic design engineer concepts and ideas that make his job easier and more productive.
- To provide a central source of timely electronics information.
- To promote two-way communication between manufacturer and engineer.

Want a subscription? ELECTRONIC DESIGN is sent free to qualified engineers and engineering managers doing design work, supervising design or setting standards in the United States and Western Europe. For a free subscription, use the postfree application form inside the back cover. If none is included, write to us direct for an application form.

If you do not qualify, you may take out a paid subscription for \$25 a year in the U.S.A., \$35 a year elsewhere. Single copies are \$1.50 each.

If you change your address, send us an old mailing label and your new address; there is generally a prepaid postcard for this inside the back cover. You will have to requalify to continue receiving ELECTRONIC DESIGN free.

The accuracy policy of ELECTRONIC DESIGN is:

- To make reasonable efforts to ensure the accuracy of editorial matter.
- To publish prompt corrections whenever inaccuracies are brought to our attention. Corrections appear at the end of the Letters column.
- To refuse any advertisement deemed to be misleading or fraudulent.

Microfilm copies are available of complete volumes of ELECTRONIC DESIGN at \$19.00 per volume, beginning with Volume 9, 1961. Work is now in process to complete the microfilm edition of Volumes 1-8. Reprints of individual articles may be obtained for \$2.00 each, prepaid (\$.50 for each additional copy of the same article) no matter how long the article. For further details and to place orders, contact the Customer Services Department, University Microfilms, 300 North Zeeb Road, Ann Arbor, Michigan 48106; telephone (313) 761-4700.

Want to contact us? If you have any comments or wish to submit a manuscript or article outline, address your correspondence to:

Howard Bierman, Editor,
ELECTRONIC DESIGN,
850 Third Avenue,
New York, N.Y. 10022.

Bus Bars For Noise Reduction

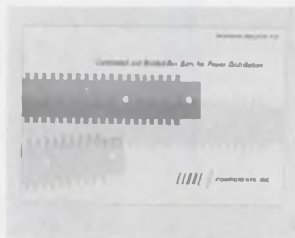

A 16 page Technical Bulletin is now available, describing a new concept in power or signal distribution. Basic mechanical and electrical design principles, along with descriptive pictures and diagrams, are included in this bulletin. These compact buses can replace bulky cable harnesses and repetitive wiring for computer or modular application. This method of construction satisfies the demanding requirements of low inductance and resistance of high speed, solid state systems, while controlling electrical noises.

Send For Free Sample

Eldre Components, Inc.
1239 University Avenue
Rochester, New York 14607

174

A FREE Cross Reference Guide



to better Printed Circuit drafting

No engineer or draftsman should be without the NEW By-Buk Printed Circuit Drafting Aids P-45 Catalog with color-coded MIL-SPEC sizes. Also contains over 2000 pads, shapes, tapes, transistor tri-pads, spaced integrated circuit terminal pad sets and many other drafting aids for faster, more accurate, distortion-free printed circuit master drawings. Send for your FREE catalog.

By-Buk Company

4326 West Pico Blvd., Los Angeles, Calif. 90019
Telephone: (213) 937-3511

175

FUNDAMENTALS OF INTEGRATED CIRCUITS

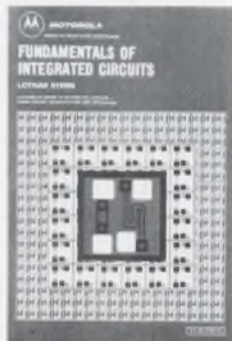

A practical guide to integrated circuits, their theory, manufacture, and applications. This new guide by Lothar Stern offers complete, highly readable coverage of the various techniques of circuit fabrication, and their effect on circuit design and performance. As to marketing considerations, it compares the characteristics of the numerous IC structures devised to date in terms of economics and logistics. A volume in the Motorola Series in Solid-State Electronics. 198 pages, 7 x 10, illustrated. \$8.95, clothbound. Send for 15-day examination copies.

Hayden Book Company, Inc.
116 West 14th Street
New York, N.Y. 10011

176

Manufacturers

Advertisements of booklets, brochures, catalogs and data sheets. To order use Reader-ServiceCard (Advertisement)

Free: 2,500 Plastic Parts Catalog



New from Nylomatic, molders and fabricators of mechanical plastic components, a highly informative 48-page catalog of more than 2,500 standard parts. It can help you save time and money in design, test and production. Advantages of Nylomatic standard parts: no tooling charges, low unit costs, quick delivery, complete range of sizes. Nylomatic standard parts are made of Nylon, Delrin® and other thermoplastic materials. You'll find our new free catalog a real problem solver for designers, send for it today.

Nylomatic Corporation

Dept. P

Nolan Ave., Morrisville, Pa. 19067

177

Clamp or Tie Wire Bundles In Seconds!



Six-page catalog contains complete ordering information for CAB-L-TITE® clamps and BUND-L-TITE® straps, devices which provide a fast and reliable means of securing wires and wire bundles. Units withstand loadings greater than 50 G's, are removable in seconds for re-routing wires, and are self-locking—no tying, no knots, no hitches to come loose. Lightweight Du Pont Zytel meets MIL-P-17091 and MIL-P-20693. Proved in aircraft and missiles. Photos, dimensional drawings, tables, physical properties, specifications, price list. Request catalog A.

Dakota Engineering, Inc.

4315 Sepulveda Blvd.
Culver City, California 90230

178

NEW SOLID STATE MODULE CATALOG



A new 186 page indexed catalog is available which describes Solid State Choppers (30 types), Signal Isolators, DC amplifiers, Frequency-to-DC Converters, Frequency Sensitive Relays, Phase-meters, LC, Crystal & Tuning Fork Oscillators, Voltage Controlled Oscillators, Voltage-to-Frequency Converters, A-D Converter, Transducers, FM Telemeters, Light Controlled Resistors, Discriminators, Transformers, Solid State and Reed Relays.

Each data sheet gives a complete description of the product which includes electronic data, mechanical data and typical applications. These solid state modules are designed for aerospace, military, industrial, and ground support applications.

Solid State Electronics Corp.

15321 Rayen St., Sepulveda, Ca. 91343
Telephone: (213) 894-2271

179

Electronic Design

Advertising Sales Staff

New York 10022

Edward F. Clancy
Sales Service Manager
Robert W. Gascoigne
Thomas P. Barth
Samuel M. Deitch
Byron Adams
850 Third Avenue
(212) Plaza 1-5530
TWX: 867-7866

Philadelphia 19066

William C. Repetto
P. O. Box 206
Merion Station, Pa.
(215) MA-3-5888

Boston 01945

Richard Parker
P.O. Box 645
Clifton Station
Marblehead, Mass.
(617) 742-0252

Chicago 60611

Thomas P. Kavooras
Berry Conner, Jr.
200 East Ontario
(312) 337-0588

Cleveland

Thomas P. Kavooras
(Chicago)
(312) 337-0588
(call collect)

Los Angeles 90303

Stanley I. Ehrenclou
John V. Quillman
W. James Bischof
2930 Imperial Highway
Inglewood, Calif.
(213) 757-0183

San Francisco 94022

Arthur R. Shields, Jr.
175 San Antonio Rd., S 243
Los Altos, Calif.
(415) 941-3084

London W. 1

For United Kingdom & Holland
Brayton C. Nichols
44 Conduit Street
Tel: REGent 4714

Verviers, Belgium

For Continental Europe
Andre Jamar
1, Rue Mallar, 1
(087) 253.83 Telex 41563

Tokyo

Yoshihiro Takemura
IPS Group Ltd.
Box 36, Ohsaki Post Office
Phone (431) 5804



DO YOU HAVE AN APPLICATION FOR
A FERRITE
OPERATING AT UP TO 300 MHZ?

Contact Us

ceramic magnetics, inc.



87 FAIRFIELD ROAD • FAIRFIELD, N. J. 07006 • (201) 227-4222

INFORMATION RETRIEVAL NUMBER 90

NEW! PLUG-IN PRINTED CIRCUIT POWER TRANSFORMERS

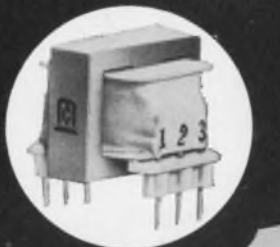

60 & 400 Hz
3 TO 115V C. T. — 25 RATINGS
1/3 TO 7 1/2 WATTS
COMPACT DESIGN
MIL CONSTRUCTION
AT
COMMERCIAL
PRICING

FROM
STOCK

SEND FOR BULLETIN F162

MICROTRAN
VALLEY STREAM, N. Y. 11582

INFORMATION RETRIEVAL NUMBER 91

Advertisers' Index

Advertiser	Page	Advertiser	Page
ACI Incorporated	C64	Lambda Electronics Corp.	C81, C82, C83
AMP, Incorporated	C26, C27	Littlefuse	106
Abbott Transistor Laboratories Incorporated	14	Lockheed Electronics Company	24, 87
Acopian Corporation	110		
Allen-Bradley Co.	23	3M Company, Chemical Division	111
Amperex Electronic Corporation	84	McLean Engineering Laboratories	C49
		Mac Panel Company	C77
B & B Motor & Control Corp.	120	Malco Manufacturing Company, Inc.	C68
Barnes Corporation	C51	Metrodata Systems, Inc.	C72
Beckman Instruments, Inc.		Microdyne Instruments, Inc.	C56
Helipot Division	72, 73	Micro Systems Incorporated	C76
Beede Electrical Instrument Co., Inc.	92	MicroSwitch, A Division of Honeywell	C66, C67
Bodine Electric Company	8, 9	Microran Company, Inc.	126
Bourns, Inc.	46	Microwave Expositions, Inc.	113
Buckbee Mears Co.	109	Mohawk Data Sciences Corporation	120
Bulova Electronics Division of Bulova Watch Company	12	Monsanto Company	Cover 111
By-Buk Company	124	Motorola Semiconductor Products, Inc.	4, 5
Cedar Division, Data Control Corporation	117	NJE Corporation	65
Centralab, the Electronics Division of Globe-Union, Inc.	79	National Semiconductor Corporation	C34A-B
Ceramic Magnetics, Inc.	126	Nortronics Company, Inc.	C70
Chicago Switch Division, F & F Enterprises, Inc.	105	Nu Devices, Inc.	C56
Clevite Corporation Brush Instruments Division	91	Nylomatic Corporation	125
Clevite Corporation, Piezoelectric Division	C69		
Computer Labs	C35	Oak Manufacturing Co.	101
Computer Products	C60, 96		
Condenser Products Corporation	C52	Pomona Electronics Co., Inc.	122
Corning Glass Works, Electronic Products Division	30, 31		
Cross Company, H.	C24, C25	RCA Electronic Components and Devices	C84, Cover IV
Cutler-Hammer	7, 105	Radiation, Incorporated	C53
		Radio Materials Company	119
Dakota Engineering, Inc.	125	Raytheon Computer	C43
Dale Electronics, Inc.	C50 A-B, 109	Reeves Hoffman Division of Dynamics Corporation of America	107
Data Device Corporation	C44	Rogan Brothers, Inc.	118
Datascan, Inc.	C2		
Deutsch Filtrors Industrial Products	96B	Schweber Electronics	17
Digital Equipment Corporation	C33	Scientific Data Systems, Inc.	48
Direct Access Computing Corporation	C74	Servo-Tek Products Company, Inc.	C42
DIT, MCO	C34	Shaffstall Ball Corporation	106
Dow Corning Corporation	C58, C59	Shepard Division of Vogue	116
Dynamic Systems Electronics	112	Signetics Integrated Circuits, A Subsidiary of Corning Glass Works	C31
		Siliconix Incorporated	C54, C55, 97
ESI/Electro Scientific Industries, Inc.	C61	Simpson Electric Company	99
Eldre Components, Inc.	124	Solid State Electronics Corporation	124
Electronic Research Associates, Inc.	98	Sonotone Corporation, Battery Division	6
Elmwood Sensors, Inc.	117	Spedcor Electronics, Inc.	10
Erie Technological Products, Inc.	96A	Sprague Electric Company	18, 20
Executone, Inc.	C51	Stackpole Carbon Company	27
		Starrett Company, The L. S.	16
Flow Corporation	117	Sylvania Electric Products, Inc., Electronic Components	C29
Fluke Mfg. Co., Inc., John	13	Synco Capacitor Corporation	105
		Syntronic Instruments, Inc.	C74
Gardner-Denver Company	C36, C37	Systron-Donner Corporation	2
General Automation, Inc.	C62, C63		
General Electric Company, Silicone Products Department	40	TRW, Inc., Globe Industries Division	115
General Instrument Corporation	C38, C39	Tektronix, Inc., Oscilloscopes	16A-D
General Radio Company	77	Tenney Engineering, Inc.	93
Giannini Whittier	102	Theta Instrument Corporation	11
Grant Pulley & Hardware Corporation	C57	Tung Sol Division, Wagner Electric Corporation	123
Grayhill, Inc.	101		
Gulton Industries, Inc.	103	U-Tech, A Division of Industrial Physics and Electronics Company	43
		United Telecontrol Electronics, Inc.	C79
Hansen Mfg. Co., Inc.	88	United Transformer Co., Division of TRW Inc.	Cover II
Hayden Book Company, Inc.	81, 124, 127	U S Components Inc.	C73
Hewlett-Packard	1, C22, C23, 75, C80	Unitrode Corporation	29
Hewlett-Packard, New Jersey	33		
Honeywell, Computer Control Division	C45, C46, C47, C48	Varian Associates TWT Division	15
Howard Industries, A Division MSL Industries, Inc.	45	Vector Electronic Co., Inc.	118
Hughes Aircraft Company, Connecting Devices	38, 39	Victor Comptometer Corporation	C75
Hughes Aircraft Company, Hybrid Circuits	57		
		W & G Instruments Inc.	44
IMC Magnetics Corporation	C50	Wang Laboratories, Inc.	89
ITT Semiconductors, A Division of International Telephone and Telegraph Corporation	C65	Waters Manufacturing, Inc.	95
Indiana General Corporation	101	Watlow Electric Co. of California	122
Industrial Technology Corporation	C13	Welch Allyn Inc.	121
International Contronics, Inc.	C77	Weston Instruments, Inc., Newark Division	C41
James Electronics, Inc.	109	Career Advertising	
Johanson Manufacturing Corp.	94	Delco Radio Division, General Motors	82
		IBM Corporation	C71
Kepeco, Inc.	C78		

Need a book on computer tapes, circuits, math...?

Digital Magnetic Tape Recording Principles and Computer Applications

Bernard B. Bycer

This valuable reference describes functions and operations in terms of basic mechanic, magnetic, electronic and computer techniques. By developing a representative computer module integrated by a tape control unit, the book presents a unique design tool. Practical information is also provided for the specification, purchase, and use of digital magnetic tape equipment. 328 pp., 6 x 9, illus. cloth.

#5031 \$11.00

Design of Transistorized Circuits For Digital Computers

Abraham I. Pressman

Authoritative coverage of the design of building blocks required in transistorized circuits, with emphasis on worst-case techniques. Book treats the major schemes currently employed in designing digital computer logic, including Pyramiding factors, Turn On, Turn Off, and Storage Time Calculations. Circuit analysis and all aspects of output waveforms are calculated treating the transistor as a current switch. 328 pp., 6 x 9, illus., cloth.

#2115 \$9.95

Computer Arithmetic

Henry Jacobowitz

Useful as a refresher course or working guide, this compact book reviews the basic arithmetical operations of all positional number systems — the decimal, binary, and other number systems that are likely to find application in computers. It fully explains binary, octal hexadecimal, and ternary arithmetic, along with practical methods for converting one number system into another. 128 pp., 5½ x 8½, illus., paperback.

#0297 \$3.49

Computer Numbering Systems And Binary Arithmetic

Training Systems, Inc., and Stanley L. Levine

A programmed introduction to the mathematical heart of computer functioning. The book requires no prior acquaintance with binary or octal systems, or with computers. After describing the function of binary systems in digital computers, it covers the methods of converting between decimal, octal, and binary systems and the operations of addition, subtraction, multiplication and division. Book includes material on fractional conversions and mixed numbers. 232 pp., 6 x 9, illus., paper.

#0380 \$4.95

Data Transmission and Data Processing Dictionary

James F. Holmes

Ready-at-hand definitions for more than 3,000 terms used in data-processing, telephony, teletype, facsimile and data transmission work. Book eliminates much of the confusion caused by words and terms which have several different meanings. It defines all the multiple-meaning terms — some showing as many as seven differ-

ent meanings. 103 pp., 6 x 9, illus., paper.

#0396 \$2.50

Comprehensive Fortran Programming

James N. Haag

Full coverage of programming in the BEST-SAM areas: Business, Engineering, Science, Technology, Social Science, Agriculture, and Mathematics. After introducing a small portion of FORTRAN II, the book immediately requires the reader to write a complete program. It teaches FORTRAN II as specifically used by a 20,000 digit memory IBM 1620 compiler with an attached 1311 Disk Drive, with adaptations to suit other systems. Modifications for FORTRAN IV are detailed. 264 pp., 7¾ x 10¾, illus., paper.

#5646 \$5.45

IBM 1620 Programming — For Science and Mathematics

Irving Allen Dodes

Clearly shows how to analyze, program, debug, and completely solve problems in science and mathematics using the IBM 1620 and related machines. Book details every phase of programming including the use of flow charts and block diagrams, machine limitations, etc. It covers four main areas of programming: Numerical Analysis, Machine Language, a Symbolic Programming System, and the FORTRAN System. Appendixes contain useful reference data. 276 pp., 6 x 9, illus., cloth.

#5511 \$6.75

Basics of Digital Computer Programming

John S. Murphy

Ideal for beginning programmers or interested businessmen, this book explains the fundamentals of business-data computer programming. General programming examples illustrate practical computer operations. To clarify discussion, the book continually refers to the general internal organization of a typical computer. 118 pp., 6 x 9, illus., paper.

#0405 \$3.75

Understanding Digital Computers

Ronald Benrey

Without involving the reader in unnecessary technical detail, this book provides depth cov-

erage of digital computers and their operation. Computers are discussed in terms of similar, and simple, building blocks that make up the system. Book stresses the function of these building blocks, rather than their actual electronic construction. 166 pp., 6 x 9, illus., paper

#0473 \$4.25

Basics of Digital Computers (3 Vols.)

John S. Murphy

Three-volume course in computer fundamentals requires only a basic knowledge of electronics. At least one illustration on each page makes the discussion unusually clear. Ideal as an introduction or a "brush-up" reading, it provides the broad, general background that is the key to any specific computer system. 3 vols., 416 pp., 6 x 9, illus.

#0070 — Vol. 1, Early Thoughts on Computers

#0071 — Vol. 2, Logic Block Diagrams and Symbols

#0072 — Vol. 3, Computer Memory

#0069, paper, 3 vols. \$9.75

Individual volumes, paper \$3.25

Basics of Analog Computers

T. D. Truitt and A. E. Rogers

Three volumes in one — a concise review of the principles, hardware, and applications of the modern analog computer. Book reveals the principles of analysis through the methods of analogy and simulation. More than 400 illustrations spotlight essentials of analog computer principles and techniques, general purpose computers, and use of the D.C. analog computer. 400 pp., 6 x 9, illus., cloth.

#0256 \$12.50

How To Build A Working Digital Computer

Edward Alcosser, James P. Phillips, and Allen Wolk

A unique way to learn how and why computers work. Book provides detailed instructions on how to build an inexpensive, working computer, lists component specifications, gives step-by-step assembly instructions. Explanations of component functions precede the construction details. Book shows how to program the computer to solve actual problems. 176 pp., 6 x 9, illus.

#0748 paper \$3.95

All books available for free 10-day examination

Hayden Book Co., Inc., 116 W. 14 St., N.Y., N.Y. 10011

Send me the books circled below for a free ten-day examination. At the end of that time I will remit payment (plus postage), or return the books without further obligation:

5031	0396	0473	0071	0215	5646	0069	0072
0297	5511	0073	0256	0380	0405	0070	0748

Name _____

Firm _____

Address _____

City _____ State _____ ZIP _____

Check here if payment enclosed. Publisher pays postage with same return guarantee. (On all overseas orders, payment in \$US must be enclosed.)

ED-C9

Information Retrieval Service

All products, design aids (DA), application notes (AN), new literature (NL), and reprints (R) in this issue are listed here with Page and Information Retrieval numbers. Reader requests will be promptly processed by computer and mailed to the manufacturer within three days.

Category	Page	IRN	Category	Page	IRN	Category	Page	IRN
Components			op amp, military	92	348	PC-board holders (ES)	110	431
capacitors, ceramic	108	429	rectifiers, 35-A	93	352	plug, adaptor	96	358
lamp nomogram (DA)	112	439	thyristor switches	92	350	tube-cap chart (DA)	112	435
photocells (AN)	114	445	transistors, power	94	355	tubing, shrinkable (ES)	110	434
relay, latching	108	425						
relay, reed	108	426	Instrumentation			New Literature		
switch, contactless	108	430	calibrator, scope	100	406	ceramics	119	459
switch, gravity	108	427	emi measurement (AN)	114	444	computer products	116	451
transformers, miniature	108	428	filters, active	100	408	connectors, audio	122	468
			meter, digital panel	100	405	data handling	116	452
Data Processing			meters, digital panel	100	404	delay lines	116	454
batch station	C70	258	multimeter, digital	100	403	diode testers	116	450
code converter	103	412	multimeter, dual slope	98	366	fasteners	119	460
comparators, digital	102	401	oscillator, test	98	365	frequency sources	120	461
computer, analog	C74	269	probe, logic	99	370	gears	121	465
computer, small	C40	263	pulse generator, divider	98	368	instruments, rf	123	472
computer, small	C52	250	sampling head	98	367	IR accessories	118	457
computer, special	C64	276	tester, linear IC	100	407	knobs	120	463
computer system	C78	288	voltmeter, digital	99	369	lamps, miniature	118	458
controller	C68	271				magnets	118	455
converter, a/d	102	411	Microwaves & Lasers			microphones	121	464
converter, decimal	103	413	detector, pyroelectric	89	321	motor replacements	122	467
converter cards, a/d	C78	286	diodes, switching	90	324	motors, fan	118	456
copier, microfilm	C49	338	feed-through, MIC	90	339	oscillators	122	469
data acquisition system	C44	285	hybrid coupler, 18-GHz	89	322	PC boards	123	474
data entry console	102	402	microwave sweepers	86	340	power supplies	123	471
data entry system	C52	275	microwave sweepers	86	341	recorders, tape	121	466
data processor	C50	277	microwave sweepers	86	342	SCRs	120	462
data set	C40	280	microwave sweepers	86	343	switches	123	473
data set	C50	252	microwave sweepers	86	344	tools	116	449
data set	C76	289	microwave sweepers	86	345	trimmers	116	453
data terminal	C40	259	microwave sweepers	86	345	welding, resistance	122	470
display system	C52	282	oscillator, Ka-band	90	339			
display terminal	C52	253	patch panels, coax	90	346			
display terminal	C56	251	receiver, panoramic	90	325			
display terminal	C72	337	sweep system	90	323			
memories, read-only	C74	284	waveguides chart (DA)	112	438			
memory, 3- μ s	C78	287				Application Notes		
memory, 2048-word	C72	262				amplifiers	114	447
memory, core	C64	255				application notes	114	442
memory, core	C78	334				emi measurement	114	444
memory system	C76	298				military crystals	114	440
memory systems, drum	C56	261				noise, TTL circuit	114	443
microfilmer, computer	C42	268				photocells	114	445
multiplexer	C44	254				plastics guide	114	448
multiplexer system	C70	281				regulators, shunt	114	441
plotter, microfilm	C51	257						
printer, high-speed	C70	260				Design Aids		
processor, remote	C70	283				filament nomogram	112	436
recording heads	C64	279				lamp nomogram	112	439
scanner, data entry	C68	272				reliability calculator	112	437
tape reader	C60	256				tube-cap chart	112	435
tape reader	102	410				waveguides chart	112	438
tape transport	C60	270						
terminal printer	C51	273				Evaluation Samples		
time-share terminal	C49	278				gaskets, shielding	110	433
						knobs, control	110	432
ICs & Semiconductors						PC-board holders	110	431
counter/driver	92	351				tubing, shrinkable	110	434
diodes, tuning	93	353						
diodes, tunnel	92	349						
inverters, hex	94	356						
MOSFET, dual	94	354						



Programmable.

Full-function programmability
DC to 50 MHz Counting Range
Universal counter / timer functions
BCD output
... all for only \$1285

The new Monsanto Model 110A offers you a broader range of operational advantages than any counter/timer in its price range. Front-panel functions are tailor-made for programming with the Monsanto Model 501A Digital Programmer, or with virtually any other contact-closure or logic-level source.

Now consider these other features of the Model 110A: the full complement of counter/timer functions; dc to 50 MHz counting range; marker and gate outputs; provision for external time base; and BCD output. Plus the inherent reliability of Monsanto "4th generation" integrated circuit construction. Plus the 2-year Monsanto warranty.

Price of the Model 110A is \$1285; of the Model 501A, \$375. For a demonstration or technical data call your local Monsanto Field Engineering Representative or contact us direct. Monsanto Company, Electronic Instruments, West Caldwell, New Jersey 07006; (201) 228-3800.

4 Amplifier High Gain "Building Block" Array

Here you are—four identical linear amplifiers built on a single IC chip and mounted in the new 16-lead dual-in-line plastic package ready to plug into your design plans. Use them as AF feedback amplifiers; equalizers; in 2- or 4-channel audio applications. Figure them into linear signal mixer designs; as oscillators; as low frequency high gain amplifiers and as multivibrators.

The "matched set" of four is the RCA-CA3048. It provides 57 dB (typ.) voltage gain per amplifier or 114 dB (typ.) when two amplifiers are cascaded. Each amplifier features a Noise Figure of 2 dB (typ.)

at 1 kHz, -3 dB bandwidth of 300 kHz, and an input resistance of 90 k Ω (typ.).

Ask your local RCA Representative or your RCA Distributor for full details. Or write for technical data to RCA Electronic Components, Commercial Engineering, Section ICG4-4, Harrison, N. J. 07029.

If you need an array with greater bandwidth—check: **RCA-CA3035**—Three individual general-purpose amplifiers with gain-bandwidth externally adjustable. \$1.50 (1,000 units)

RCA-CA3048 in 16-lead dual-in-line plastic package, \$2.45 (1,000 units)

