

Electronic Design 2

VOL. 17 NO.

FOR ENGINEERS AND ENGINEERING MANAGERS

JAN. 18, 1969

Computing counter makes debut. Unlike other counters, it has built-in computation circuits for direct readout of average or differential frequency, or quantities such as

$\Delta f/f_0$. And the calculations can be programmed by the user. The specs are impressive too. Dc to 320 MHz for frequency, and 1 ns for period (turn to page 92).



NEW Calibrated TDR with 35 ps risetime and 12.4 GHz sampling in one easy-to-use plug-in

See More...Do More with the HP 180 Scope System! Now, in one measurement, you can find out what, where, and how much—when you design connectors, circuits, antennas, strip lines and similar components. No interpolation or extrapolation needed. Now HP has combined high resolution time domain reflectometry and 12.4 GHz sampling in the HP 1815A double-size plug-in that fits the standard 180A Oscilloscope mainframe or the 181A Variable Persistence and Storage mainframe.

The 1815A in conjunction with the 1817A remote feed-through sampler and the 1106A pulse generator provides calibrated 35 ps risetime TDR—with capability of resolving discontinuities down to a *quarter of an inch apart*. New signal averaging

circuitry reduces noise and jitter at a ratio of 2 to 1 or more.

And the 1815A not only provides more accurate answers, it provides them faster and easier. Why waste your valuable time? Get direct readouts in reflection coefficient (ρ) and feet (meters optional) for instant answers that previously required time-consuming calculations. Get direct, front panel calibration of dielectric constants for air and polyethylene, or use a variable control to

set the dielectric constant between $\epsilon = 1$ to $\epsilon \cong 4$.

In addition, the 1815A/1817A combination can be externally triggered to provide 12.4 GHz (28 ps) sampling capability. The signal averaging technique allows you to use the entire bandwidth capabilities of the plug-in/sampler — undistorted by noise and jitter.

If you don't need the full capability of the 1815A, a lower cost and lower frequency sampling head (1816A) and tunnel diode pulse generator (1108A) are available for 4 GHz 90 ps risetime sampling and 110 ps TDR (60 ps pulses).

Prices: 1815A, \$1100; 1817 Remote Sampler, \$1500; 1106A Tunnel Diode Pulse Generator, \$550; 1816A Remote Sampler, \$850; 1108A Tunnel Diode Pulse Generator, \$175.

Isn't it time you took a step forward in your oscilloscope measurements? Call your HP field engineer and he'll tell you about the all-solid-state, proven HP 180 scope system, which now includes TDR and sampling. Or, write for data sheet to Hewlett-Packard, Palo Alto, California 94304. Europe: 1217 Meyrin-Geneva, Switzerland.

STEP FORWARD

HEWLETT *hp* PACKARD

OSCILLOSCOPE SYSTEMS
INFORMATION RETRIEVAL NUMBER 242



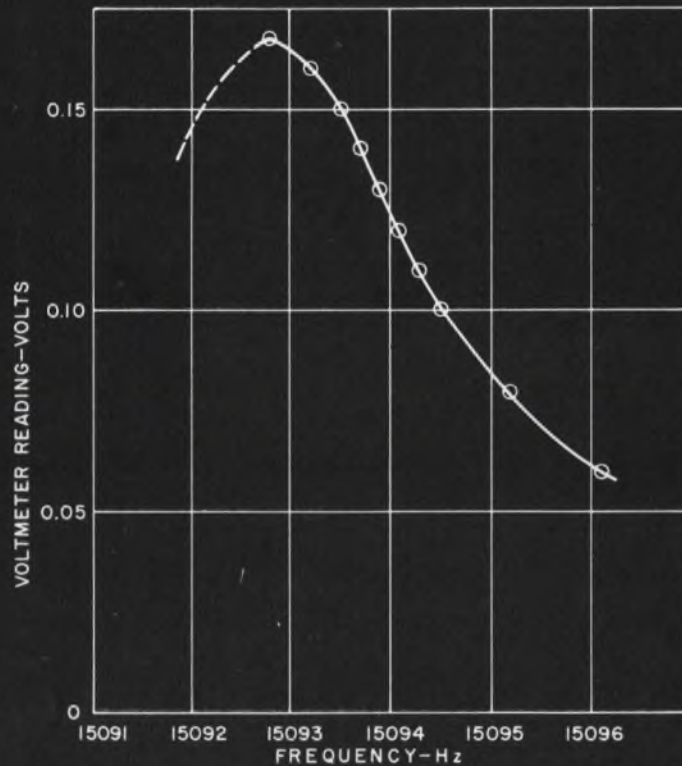

Synthesizer Stability From A Low-Cost Oscillator

This resonance curve is only a few hertz wide at about 15 kHz. You'd expect to achieve this kind of resolution and stability with a frequency synthesizer as a source. But would you expect it from a \$325 oscillator?

The curve shows the high-Q mechanical resonance of a sample of metal alloy. It was plotted from actual data obtained with a GR 1310 oscillator in the closed-loop system shown in the block diagram below.

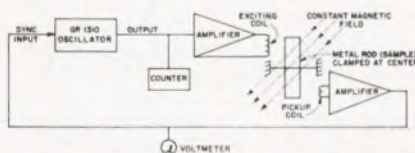

The scheme was submitted by a customer, and it is described more completely in the October, 1968 issue of the *GR Experimenter*. The synchronization capability and the excellent leveling ($\pm 2\%$) of the 1310 combine to make this technique possible.

General Radio makes a whole line of quality oscillators with well-leveled outputs. Each has a distinctive feature to best match your needs. The 1309's (\$325) distortion is less than 0.05%; the 1310 (\$325) has a 2 Hz-to-2 MHz frequency range and a 20-volt output; the 1311 (\$260) offers 1-watt, transformer-coupled output; the 1312 (\$415) has in-line frequency readout and 10 Hz-to-1.1 MHz range; and the

1313 (\$325) gives you single-dial frequency control (no range-switching transients). All have constant output ($\pm 2\%$), and all are covered by a two-year warranty.

For more information, call your nearest GR office, or write General Radio, West Concord, Massachusetts 01781; telephone (617) 369-4400. In Europe: Postfach 124, CH 8034, Zurich 34, Switzerland.

GENERAL RADIO

Prices apply only in the USA.

New Datapulse 112 gives you higher rep rates (to 125 MHz), faster rise times (1.3ns) and narrower pulses (to 3ns)—yet it costs you hundreds of dollars less.

What's more it has all the pulse parameter control you need to test high-speed circuits: simultaneous $\pm 5V$ outputs, single or double pulses, independent dc offset to $\pm 2V$, widths from 3ns to 5 ms, and delays to 5 ms.

You can control the pulse train with external gating pulses, produce complementary outputs for duty cycles approaching 100%, set the baseline at exact ground with a switch, and reduce rep rate to 10 Hz for low-speed testing.

No other high-speed pulser offers so much for just \$1595.00 . . . and the 112 is being delivered now. For a demo contact Datapulse Division, Systron-Donner Corporation, 10150 W. Jefferson Blvd., Culver City, Calif. 90230 213-836-6100.

Why buy a high-priced 100 MHz pulser? Here's 125 MHz for \$1595!



Oscilloscope photo. 2ns/div, 2v/div.

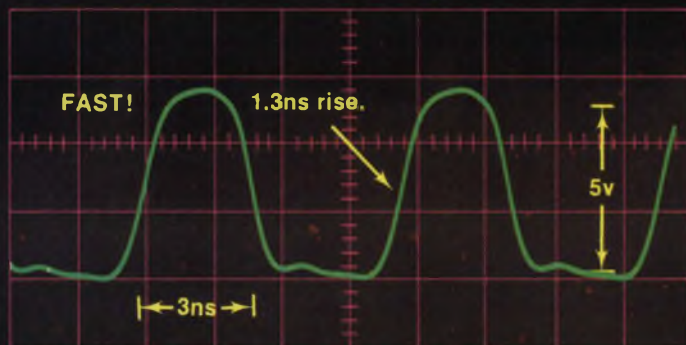

DATAPULSE
DIVISION

SYSTRON  **DONNER**

Another first. One of 135 Systron-Donner instruments

Electronic counters	Analog computers
Pulse generators	Digital panel meters
Microwave frequency indicators	Microwave signal generators
Digital clocks	Laboratory magnets
Memory testers	Data acquisition systems
Digital voltmeters	Microwave test sets
Time code generators	
Data generators	

NEWS

- 21 News Scope
- 25 **Designing for the explosive undersea depths**
Sealab III electronics, built to operate in helium at 20 atmospheres and in air at sea level, is protected against equipment 'bends'
- 30 **Apollo 8 electronics systems are go, go, go**
Unified S-band communications, guidance unit, miniature television camera operated perfectly on historic flight to the moon and back
- 36 Laser chirping peaks up picosecond pulses
- 41 Washington Report
- 44 Sidelights of the Issue
- 47 **Editorial:** Take a tip from the old slogan: "The customer is always right."

TECHNOLOGY

- 50 **Design broadband rf power amplifiers** by using filters, ferrite transformers and hybrids to provide broadband matching for your transistors.
- 58 **Log diodes are a natural** in analog computation circuits, when you are multiplying, dividing, raising to powers or taking roots.
- 62 **Build a programmable word generator with MOS ICs.** Multiple output channels supply easily programed 100-bit words at a 1-MHz bit-rate.
- 70 **Here are the facts on one-shot design** that eliminate the usual debugging by trial-and-error and let you meet the specs on your first try.
- 76 Ideas for Design

PRODUCTS

- 92 **Instrumentation:** Computing counter works like calculator.
- 104 **ICs and Semiconductors:** Dual amplifier is MOS/bipolar IC.
- 116 **Microwaves and Lasers:** Chip capacitors fill microstrip needs.
- 122 **Data Processing:** Desktop terminal displays complex graphics.
- 130 Components
- 136 Modules and Subassemblies
- 142 Packaging and Materials
- 146 Production

Departments

- 14 Designer's Datebook
- 88 Books
- 150 Design Aids
- 152 Application Notes
- 156 New Literature
- 166 Advertisers' Index
- 168 Information Retrieval Service

Information Retrieval Service Card inside back cover

COVER CREDIT: Wally Crane of Bill Arbogast Photo Studio.

If you took all the low input current monolithic op amps in the world, you'd have our LM101A, 102 and 107

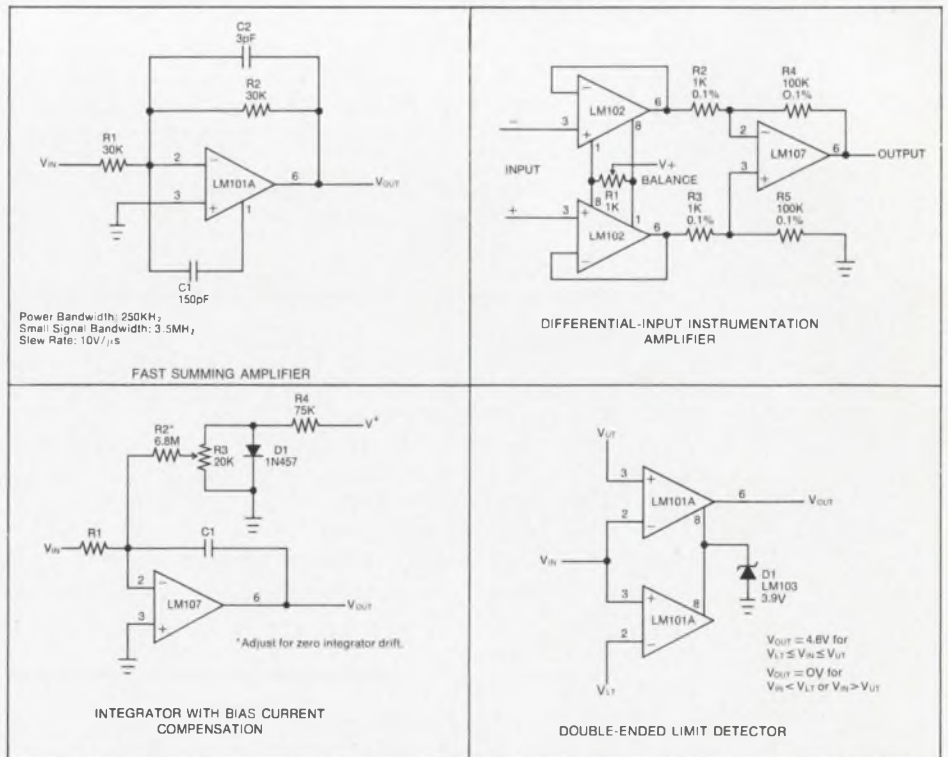

Three of our Op Amps have input bias currents untouched by anything else on the market. In fact, you can even use them to replace FET amplifiers.

With the LM102 Voltage Follower, 10 V/ μ sec slow rate couples with a maximum input bias current of 20nA, guaranteed over full mil temp range. The LM101A is extremely versatile; tailor its compensation to the application or even use it as a voltage comparator. Its partner, the LM107, is fully compensated and easiest to use. Both have input bias currents less than 100nA, offset currents less than 20nA, and offset voltages less than 3mV guaranteed over full mil temp range. All are immediately available off-the-shelf. Prices 100 piece quantities: full mil types: LM101A @ \$30.00, LM102 @ \$15.00, and LM107 @ \$33.00; instrumentation types: LM201A @ \$12.00, LM202 @ \$6.00, LM207 @ \$13.00; commercial types: LM301A @ \$3.45, LM302 @ \$3.00

Get the low down. National Semiconductor Corporation, 2975 San Ysidro Way, Santa Clara, California 95051 (408) 245-4320
 TWX: 910-339-9240
 Cables: NATSEMICON

National Linear

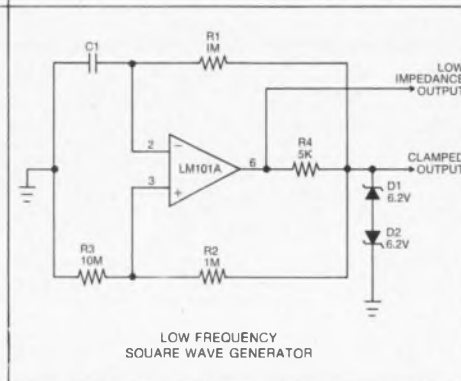
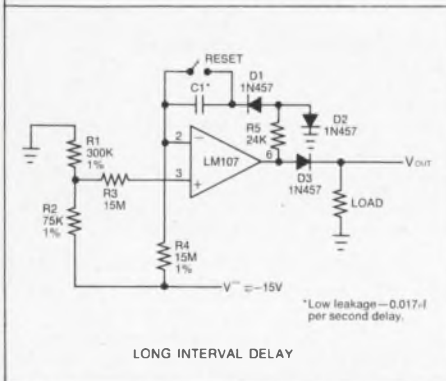
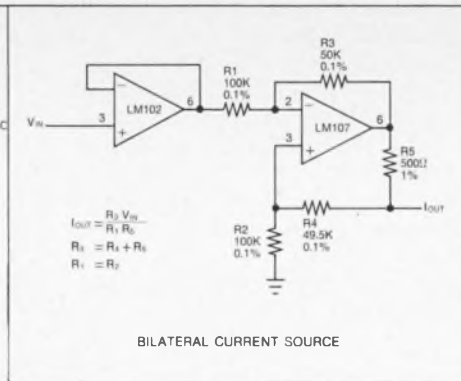
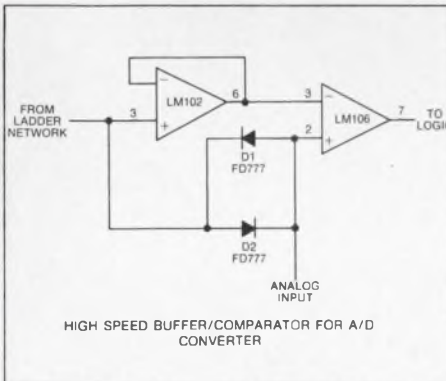

Thou shalt not invert.

Not when you have AND, OR, NAND and NOR functions available in one logic family.

With the recent addition of seven new

gates to the line, Utilogic II now allows you to implement functions simply, any way you choose — with AND, OR, NAND or NOR elements. No other logic family permits this flexibility.

It's possible to eliminate inverters, commonly required in DTL designs. The Utilogic II implementation of the Up-Down Counter shown below requires 11% fewer packages than the typical DTL version. In terms of comparative system costs based on 1000-up pricing, the Utilogic II implementation saves you 30% in parts cost alone.

The new circuits include dual 4-input expandable, triple 3-input and quad gates in both OR and NAND logic functions, plus a triple 2-input expandable OR gate and a diode expander.

All the new circuits are immediately available in volume in a 14-pin dual-in-line silicone package in the SP (0°C to 75°C) and LU (10°C to 55°C) operating temperature

ranges. Utilogic II, as you recall, has three times greater noise margins and double the fan-out of any other available logic family. And its performance has been proven by over 15 million elements in the field. For our Utilogic II Handbook write Signetics, 811 East Arques Avenue, Sunnyvale, California 94086. Bless you.

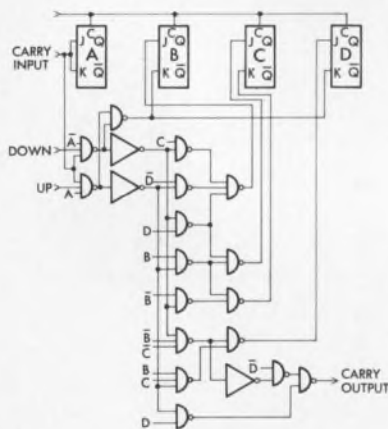

DTL implemented up-down counter

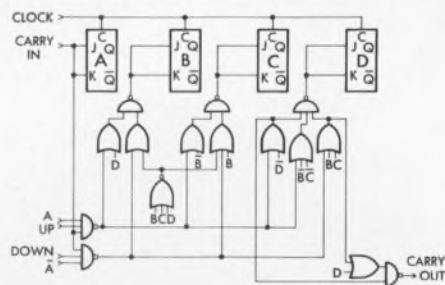

UTILOGIC II implemented up-down counter

Signetics Integrated Circuits 
A SUBSIDIARY OF CORNING GLASS WORKS

SIGNETICS SALES OFFICES: Wakefield, Massachusetts (617) 245-8200; Trumbull, Connecticut (203) 268-8010; Poughkeepsie, New York (914) 471-3292; Syracuse, New York (315) 469-1072; Fort Lee, New Jersey (201) 947-9870; Radnor, Pennsylvania (215) 687-2660; Silver Spring, Maryland (301) 946-6030; Clearwater, Florida (813) 726-3734; Winter Park, Florida (305) 671-5350; Dayton, Ohio (513) 433-4133; Minneapolis, Minnesota (612) 920-3256; Rolling Meadows, Illinois (312) 259-8300; Richardson, Texas (214) 231-6344; Garden Grove, California (714) 636-4260; Burbank, California (213) 846-1020; Redwood City, California (415) 369-0333.

DISTRIBUTORS: Avnet Electronics Corp., Burlington, Mass (617) 272-3060; Cesco Electronics, Ltd., Montreal, Quebec, Canada (514) 735-5511; Compar Corporation at the following locations: Huntsville, Alabama (205) 539-8476; Los Angeles, California (213) 245-1172; Burlingame, California (415) 347-8244; Hamden, Connecticut (203) 288-9276; Clearwater, Florida (813) 446-2991; Orlando, Florida (305) 855-3964; Park Ridge, Illinois (312) 692-4125; Baltimore, Maryland (301) 484-5400; Newton Highlands, Mass (617) 969-7140; Minneapolis, Minnesota (612) 922-7011; St. Louis, Missouri (314) 542-3399; Albany, New York (518) 489-7408; Endwell, New York (607) 723-8743; Woodbury, New York (516) 921-9393; Fairport, New York (716) 271-2230; Syracuse, New York (315) 471-3356; Winston Salem, North Carolina (919) 723-1002; Seattle, Washington (206) 763-1711; Hamilton Electro Sales, Culver City, Calif (213) 870-7171; Cherry Hill, N.J. (609) 662-9337; Hammond Electronics, Orlando, Florida (305) 241-6601; Mierull Electronics, Seattle, Wash (206) 763-1550; G. S. Marshall, San Marino, Calif (213) 684-1530; Milgray-Delaware Valley, Inc., Philadelphia, Pa. (215) 228-2000; Pioneer Standard Electronics, Rockville, Maryland (301) 427-3300; Schley Electronics, Watertown, Mass. (617) 926-0235; Semiconductor Specialists, Inc., Elmhurst, Illinois (312) 279-1000; Terminal-Hudson Electronics, New York, New York (212) 243-5200; Universal Electronics, Inc., Houston, Texas (713) 781-0421; Wesco Electronics, Inc., Los Angeles, Calif. (213) 685-9525; Palo Alto, Calif. (405) 968-3475.

DOMESTIC REPRESENTATIVES: Compar Corporation at the following locations: Scottsdale, Arizona (602) 947-4336; Denver, Colorado (303) 781-0912; Southfield, Michigan (313) 357-5369; Haddonfield, New Jersey (609) 429-1526; Albuquerque, New Mexico (505) 265-1020; Albany, New York (518) 489-7408; Endwell, New York (607) 723-8743; Fairport, New York (716) 271-2230; Syracuse, New York (315) 471-3356; Rocky River, Ohio (216) 333-4120; Fairborn, Ohio (513) 878-2631; Dallas, Texas (214) 363-1526; Houston, Texas (713) 667-3420; Ozark Electronic Marketing, Inc., St. Louis, Missouri (314) 423-7200.

INTERNATIONAL SALES: France, Germany, Italy, Belgium, Holland, Luxembourg, Spain—Sovcor Electronique, 11, Chemin de Ronde, Le Vesinet, (S. & O.) France, United Kingdom, Ireland, Sweden, Denmark, Norway, Switzerland, Austria, Portugal—Electrosil Ltd., Lakeside Estate, Colnbrook By Pass Slough, Buckinghamshire, Great Britain. Australia—Corning, 1202 Plaza Building, Australia Square, Sydney, N.S.W. 27-4318. Canada—Corning Glass Works of Canada, Ltd., Leaside Plant, Ontario, Canada (416) 421-1500. Israel—Talvion, P.O. Box 3282, Tel-Aviv, Israel 236-666. Japan—ASAHI Glass Co., Ltd., Corning Products Sales Dept. No. 14, 2-Chome Marunouchi, Chiyoda-ku, Tokyo, Japan 211-0411.

The biggest up-down counter news in a decade

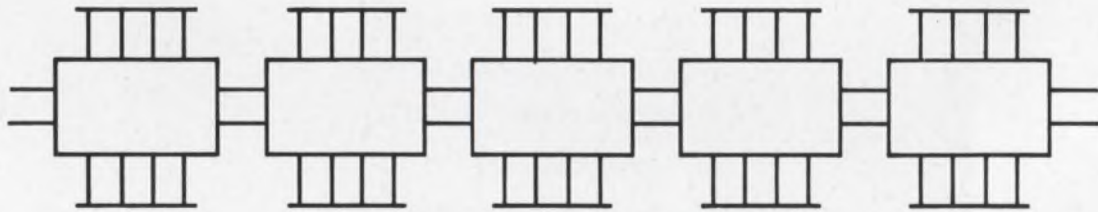

(also in a binary)

You can add decades forever without ever adding additional logic circuitry. Simpler circuitry and faster too. Our new monolithic up-down counter series are pre-settable, synchronous and packaged in 16 pin Dual In Lines, the same pin configuration for both decade and binary. Completely compatible with the popular TTL series 54/74.

Full temperature range -55° to $+125^{\circ}\text{C}$., the decade DM7560 and the binary DM7563 are priced at \$36.50 in hundred quantities. Both are available in the commercial/industrial $0-70^{\circ}\text{C}$. temperature range, decade DM8560 and the binary DM8563 at \$21.00 in hundred lots.

In total TTL, National leads again with MSI circuits of advanced complexity. Write for the total TTL story. National Semiconductor, 2975 San Ysidro Way, Santa Clara, California 95051 (408) 245-4320 TWX: 910-339-9240.

Cable: NATSEMICON

National

TTL

scr series

Power Supplies

for high power applications

Smallest volume per watt

Low ripple, both voltage & current

Constant voltage/constant current

0.1% constant current regulation

High efficiency

Remote programming/mhogramming

Plug-in circuit boards

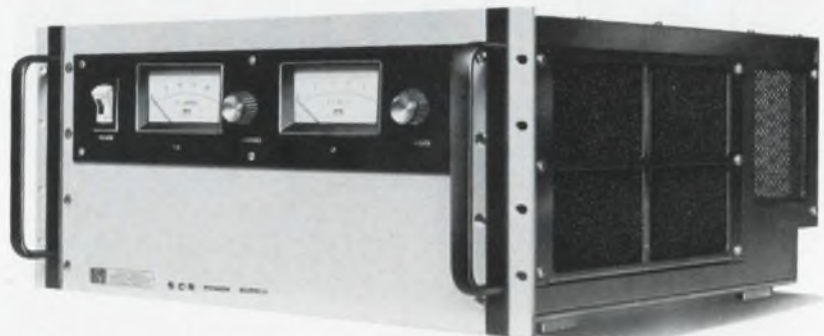

Low output ripple plus constant voltage and current makes the SCR Series ideal for a wide range of industrial uses — including CW and pulse lasers, capacitor forming, electro plating, battery charging, focusing coils for accelerators, aging racks for semi-conductors, electronic memory systems and cryogenic magnet applications. The SCR Series includes standard models with DC outputs of 0-500V, 5-500 amps, regulating at 0.1% for both constant voltage and constant current, with a price range from \$900 to \$1700. Two new models for 28V DC applications, covering 0 to 30V. One of the new models rated at 100 amps current and priced at \$1250; the other rated at 200 amps, price \$1600.

Our Applications Engineers are always available to help you solve your power supply problems.



ELECTRONIC MEASUREMENTS

division of ROWAN INDUSTRIES

2 Crescent Place ■ Oceanport, N.J. 07757 ■ 201-229-5000

INFORMATION RETRIEVAL NUMBER 7

Looking for Fast, High Volume AC and DC Calibration Capability?

Whenever and wherever you need precision, high volume calibration capability for your calibration laboratory, production line, maintenance testing shop — Hewlett-Packard has an instrument that specifically meets your requirements.

Two of these instruments—designed specifically to meet high accuracy and high volume calibration needs—are the hp 740B for DC and the hp 745A for AC. With either instrument, you press a button, turn a dial and you have an instant voltage reference!

High Resolution DC Calibration. The hp 740B DC Standard/Differential Voltmeter delivers output voltage to 1000 V with six digit resolution in discrete steps of 1 ppm of range. Accuracy of $\pm(0.002\%$ of setting $+0.0004\%$ of range) extends over 30 days.

As a differential voltmeter, the 740B measures voltage to 1000 Vdc with an input resistance of $>10^{10}\Omega$, independent of null condition. Accuracy is $\pm(0.005\%$ of reading $+0.0004\%$ of range $+1\mu\text{V}$).

The 740B is also a precision dc amplifier and high impedance voltmeter, and can be used to drive a recorder.

Fast, Accurate AC Calibration—Cut your ac calibration time in half with the state-of-the-art hp 745A AC Calibrator—an excellent choice for pro-

duction line calibration and maintenance testing.

The 745A has a calibrated output voltage with $\pm 0.02\%$ accuracy. It also has a six-digit readout, pushbutton ranging and a continuously adjustable frequency from 10 Hz to 110 kHz.

Eliminate tedious error calculations with the exclusive 745A direct reading percent error scale.

Get full specifications on these and other calibration instruments from your hp field engineer. Or, write to Hewlett-Packard, Palo Alto, California 94304. Europe: 1217 Meyrin-Geneva, Switzerland. Price, 740B, \$2350; 745A, \$4500.

008/18 B

HEWLETT  PACKARD

WORKING STANDARDS



INFORMATION RETRIEVAL NUMBER 8

TRIMMERS

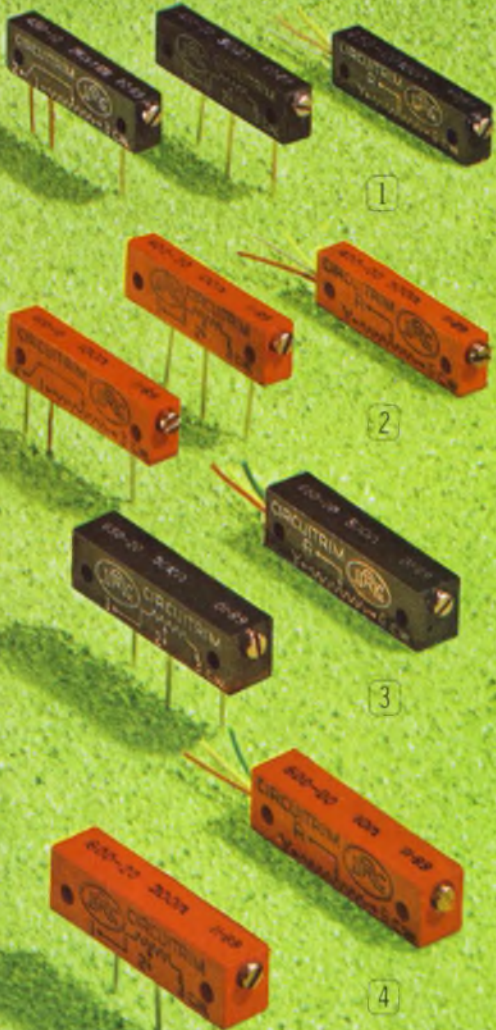

1. **SERIES 450.** Infinite resolution. RJ-12 size. 50 Ω thru 1 meg. 1/2 watt @ 70°C. $\pm 10\%$ tolerance. $\pm 20\%$ available for low-cost needs. Choice of two PC pin arrangements.
2. **SERIES 400.** Wirewound RT-12 C2L or RT-12 C2P size. Also with staggered RT-11 pins for direct replacement while saving space. 1 watt @ 70°C. $\pm 5\%$ tolerance. 10 Ω to 100K.
3. **SERIES 650.** Infinite resolution in RJ-11 size. $\pm 5\%$ tolerance. ± 250 -ppm/ $^{\circ}\text{C}$ over range of 100 Ω to 20K. 1 watt @ 70°C.
4. **SERIES 600.** Wirewound RT-11 has MIL quality at industrial prices. Moisture-sealed construction. 1 watt @ 70°C. $\pm 5\%$ tolerance. 10 Ω to 100K.

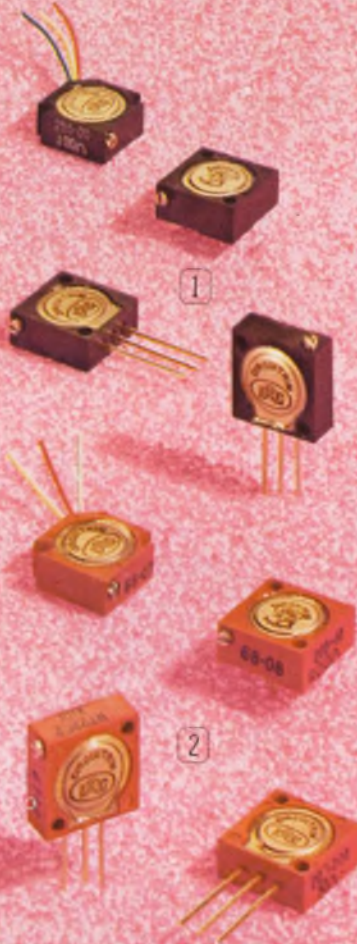

1. **SERIES 255.** RJ-22 styles with infinite resolution. ± 5 , 10, 20% tolerances to meet all your needs. 3/4 watt @ 70°C. 100 Ω to 1 meg.
2. **SERIES 205.** Four RT-22 styles for MIL or high-grade industrial needs. 1 watt @ 70°C. $\pm 5\%$ tolerance. 10 Ω to 50K.

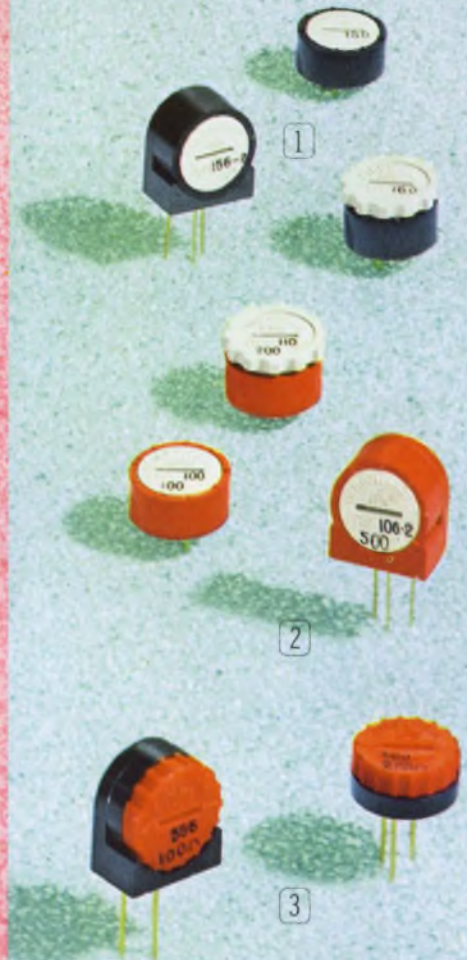

1. **SERIES 150.** Infinite resolution companions to wirewound types. Many configurations. 3/4 watt @ 70°C. ± 5 , 10, 20% tolerances. 100 Ω to 1 meg.
2. **SERIES 100.** Largest 1/2" round selection. Well sealed for MIL or industrial use. Positive stops. Longer winding for better resolution and closer settings. 1 watt @ 50°C. $\pm 5\%$ tol. 10 Ω to 50K.
3. **NEW LOW-COST SERIES 550 and 500.** Most economical 1/2 watt trimmers for commercial and industrial use. Infinite resolution Series 550 has excellent high-frequency characteristics. $\pm 30\%$ tolerance. 100 Ω to 1 meg. Wirewound Series 500 has best resolution at lowest cost. $\pm 10\%$ tolerance. 10 Ω to 50K. Vertical mounts available.

All styles available from IRC Qualified Industrial Distributors.

Panel mounting versions available for all styles. IRC also offers hundreds of terminations, mounting variations and adjustments.

Only IRC offers all popular styles

NOW...



NEW 3/8" MIL TRIMMERS

Infinite resolution or wirewound types

The simplified design of these new IRC 3/8" MIL units provides precision, stability, and economy in a small, board-hugging package.

A proven clutch assembly assures positive drive of the wiper at all times. These trimmers have molded-in pins, and are sealed to resist moisture. Dielectric strength is a full 1,000V A.C.

METAL GLAZE TYPE 750 offers essentially infinite resolution over the full resistance range from 100Ω to 1 megohm. The glass-hard, thick-film resistance element defies catastrophic failure. MIL-R-22097 performance. Rugged epoxy case.

WIREWOUND SERIES 700 in RT-24 size exceeds all MIL-R-27208 requirements. Silver brazed terminations guarantee 0.25% minimum resistance setting and freedom from catastrophic termination failures. Precious metal wiper. Heat-resistant dialyl phthalate case.

CAPSULE SPECIFICATIONS

	METAL GLAZE TYPE 750	WIREWOUND TYPE 700
POWER:	1/2 watt @ 70°C	1 watt @ 70°C
TOLERANCES:	±10, 20%	±5%
RESISTANCE:	100Ω to 1 meg.	10Ω to 50K
TEMP. COEF.:	±250ppm/°C max. (+25°C to +125°C)	±50ppm/°C max.
TEMP. RANGE:	-65°C to +125°C	-65°C to +175°C

Both types are immediately available and at prices that are lower than you would expect. Write for data on these new 3/8" trimmers. Or ask for our new potentiometer catalog.



1. 5/16" CUBETRIM® Miniature units provide significant space savings for all PC board applications. Infinite resolution Series 350: 0.3 watt @ 70°C. ±10 and 20% tolerances. 50Ω thru 500K. Wirewound Series 300: 0.6 watt @ 60°C. ±5% tolerance. 50Ω to 20K. Both series available with top or side adjust.



DIVISION OF TRW INC.

401 N. Broad St., Philadelphia, Pa. 19108

INFORMATION RETRIEVAL NUMBER 9

Here's How To Design Complex Custom Circuits Without Custom Costs

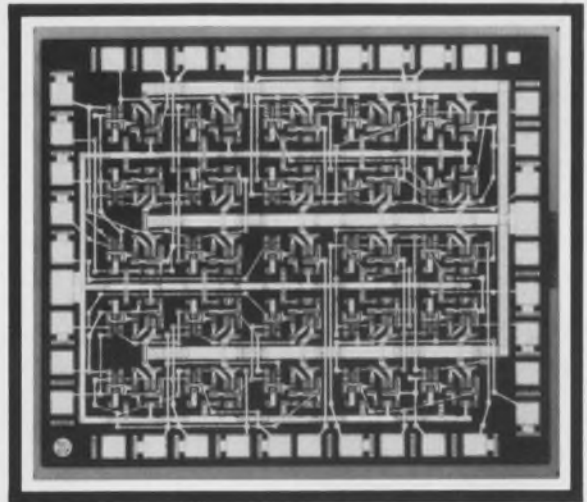

Interconnect The XC177

A monolithic circuit array of 25 TTL-DTL compatible gates, XC177, makes it possible to design complex circuit functions such as the Universal Quad Type "D" Flip-Flop with two layers of metalization, as shown. Yes, the XC177 now puts design flexibility right in the designer's hands. It provides more logic power, too. XC177 has a full 25 NAND gates. Plus, of course, Wired "OR" capability, both on and off the chip — thanks to passive pull-ups that also help to minimize noise generation.

Then, too, it's easy to interface with XC177. Each of the gates may be "metalized" into *any one of four* different configurations: Internal Gate (INT) for fan-out on the chip . . . External gate (EXT) for high fan-out on chip or driving circuitry off chip . . . Expander (EXP) for expansion of input and for deriving AOI function . . . or Buss Gate (Buss) for wired "OR"ing, to reduce power consumption.

By employing two layers of metalization, XC177 extends logic capability into the MSI/LSI area. And, all that's required is for you to supply an interconnected logic diagram to describe the metal routing. Our data sheet provides an example. It also shows three custom design examples that are available without development cost. Otherwise, development costs are approximately \$2,500 per layer of metal; and, unit costs would be in the \$20 range (100-up).

Here are descriptions and 100-up prices for the three Custom Design examples that are available as standard types.

Description:	Price:
Universal Quad D Flip-Flop	\$18.00
4 to 10 Gated Decoder	15.00
6 Bit Latch	15.00

An 8-page data sheet, complete with custom design examples, is yours for the asking. Send for it.

- where the priceless ingredient is care!



MOTOROLA
Integrated Circuits

Motorola Semiconductor Products Inc. / P. O. Box 20912 / Phoenix, Arizona 85036

INDUSTRIAL TO-5 RELAYS!

FROM TELEDYNE RELAYS

.... THE ORIGINATORS OF THE TO-5 RELAYS
FOR MILITARY APPLICATIONS.

TELEDYNE RELAYS ANNOUNCES A NEW LINE OF
HERMETICALLY SEALED INDUSTRIAL RELAYS PACKAGED
IN TO-5 TRANSISTOR CASES.

TELEDYNE HAS PRODUCED OVER 1/2 MILLION MILITARY
GRADE TO-5 RELAYS DURING THE PAST 6 YEARS!

BECAUSE OF RECENT TECHNOLOGICAL BREAKTHROUGHS
IN AUTOMATED PRODUCTION TELEDYNE CAN NOW
OFFER A DPDT (MODEL 712) INDUSTRIAL GRADE
RELAY FOR AS LITTLE AS \$6.35 EACH. THE
INDUSTRIAL MODEL 712 IS SIMILAR IN CONSTRUCTION
TO THE MILITARY MODEL 412 RELAY.

THE INDUSTRIAL 712 RELAY IS IDEALLY SUITED
FOR THE REPLACEMENT OF CRYSTAL CAN, HALF-SIZE
CRYSTAL CAN, ALL FRACTIONAL CRYSTAL CAN
SIZES AND REED PACKAGES.

TYPICAL APPLICATION AREAS INCLUDE:

- TEST EQUIPMENT
- PERIPHERAL COMPUTER HARDWARE
- COMMUNICATION EQUIPMENT
- INSTRUMENTATION
- INDUSTRIAL CONTROLS
- COMMERCIAL AVIONICS

*Real quality... look
who it's from!*

*They must really
know how to
build 'em!*

*Double check
this price. I can't
believe it!*

*Steve: This is
great news, check w/our
local distributor on this list!*

DISTRIBUTOR LISTING

- Andsco - Chicago, Ill.
- Bodette Co. - Chicago, Ill.
- DRW Electronics - Farmingdale, N.Y.
- Electronics Mkt'g. Corp. - Columbus, O.
- Electronics Wholesalers - Orlando, Fla.
- Elmar Electronics - Mt. View, Calif.

- Kierulff Electronics - Los Angeles, San Diego, Palo Alto, Phoenix, Albuquerque, Denver, Seattle, Portland and Vancouver, B.C.
- Liberty Electronics - Inglewood, Calif., Seattle and Phoenix
- Milgray Electronics - New York, N.Y. Burlington, Mass.
- Milo of Calif. - San Diego
- Pyttronic Ind. - Baltimore and Raleigh, N.C.
- Solid State Electronics - Dallas



TELEDYNE RELAYS
A TELEDYNE COMPANY

3155 West El Segundo Boulevard Hawthorne, California 90250
Telephone (213) 679-2205 772-4357

The 100,000,000,000 ohm Nanosecond Switch



This new photodiode coupled pair offers the designer 5 ns rise and fall times together with over 3,000 volts isolation between input and output. The IR emitter and companion detector are optically coupled through clear epoxy—as seen here. The unit is then encased in opaque epoxy for

maximum dark resistance. It's ideal for high speed isolated switching and high voltage isolation

For additional information and applications write or call Monsanto Electronic Special Products, 10131 Bubb Road, Cupertino, Ca. 95014 (408) 257-2140.

Monsanto

INFORMATION RETRIEVAL NUMBER 12

Designer's Datebook

MARCH 1969						
Sun	Mon	Tue	Wed	Thu	Fri	Sat
2	3	4	5	6	7	8
9	10	11	12	13	14	15
16	17	18	19	20	21	22
23	24	25	26	27	28	29
30	31					

APRIL 1969						
Sun	Mon	Tue	Wed	Thu	Fri	Sat
		1	2	3	4	5
6	7	8	9	10	11	12
13	14	15	16	17	18	19
20	21	22	23	24	25	26
27	28	29	30			

For further information on meetings, use Information Retrieval Card.

Feb. 19-21

Solid-State Circuits Conference (Philadelphia) Sponsor: IEEE, Univ. of Pennsylvania; L. Winner, 152 W. 42 St., New York, N. Y. 10036

CIRCLE NO. 433

Mar. 12-14

Microwave Technique Conference (Cologne, Germany) Sponsor: IEEE; H. H. Burghoff, Stresemann Allee 21, VDE-Haus, 6 Frankfurt/Main 70, Federal Republic.

CIRCLE NO. 434

Mar. 24-27

IEEE International Convention (New York City) Sponsor: IEEE; J. M. Kinn, 345 E. 47 St., New York, N. Y. 10017

CIRCLE NO. 435

Mar. 25-27

Conference on Lasers and Optoelectronics (Southampton, England) Sponsor: IEE; IEE, Savoy Place, London W. C. 2, England.

CIRCLE NO. 436

Apr. 15-18

International Magnetics Conference (Amsterdam, the Netherlands) Sponsor: G-MAG; U.F. Gianola, Bell Telephone Labs., Murray Hill, N.J. 07971

CIRCLE NO. 437

Apr. 16-18

Geoscience Electronics Symposium (Washington, D. C.) Sponsor: G-GE; Maurice Ringenback, Weather Bureau, ESSA, Gramax Bldg., Silver Spring, Md. 20910

CIRCLE NO. 438

Hewlett-Packard's respected track record of top performance, flexibility and reliability in the strip-chart recorder field is now available to OEM buyers. And while we're pretty sure you won't require rally stripes, we can offer you almost any option.

Here's a comprehensive source of *user-specified* precision strip-chart recorders offering a multiplicity of options, a variety of 5" and 10" rugged recorders, and a wide choice of recording speeds. Fast delivery of standard recorders or "specials." Maintenance, repair, parts available to you and your customer, nation-wide on a fast, local basis. And Hewlett-Packard has had years of experience in matching recorders to systems needs. We'll paint them any color you want, too.

You could say we're offering the OEM market classic models at fleet prices.

Talk to your HP field engineer. He sells lab and research recorders . . . and he sells recorders as systems components. He'll look at your problem and come up with the right answer . . . a recorder that's made . . . and priced . . . to order in quantity. Or write Hewlett-Packard, Palo Alto, California 94304; Europe; 54 Route des Acacias, Geneva.

11807

HEWLETT  **PACKARD**

GRAPHIC RECORDERS

Front Runner

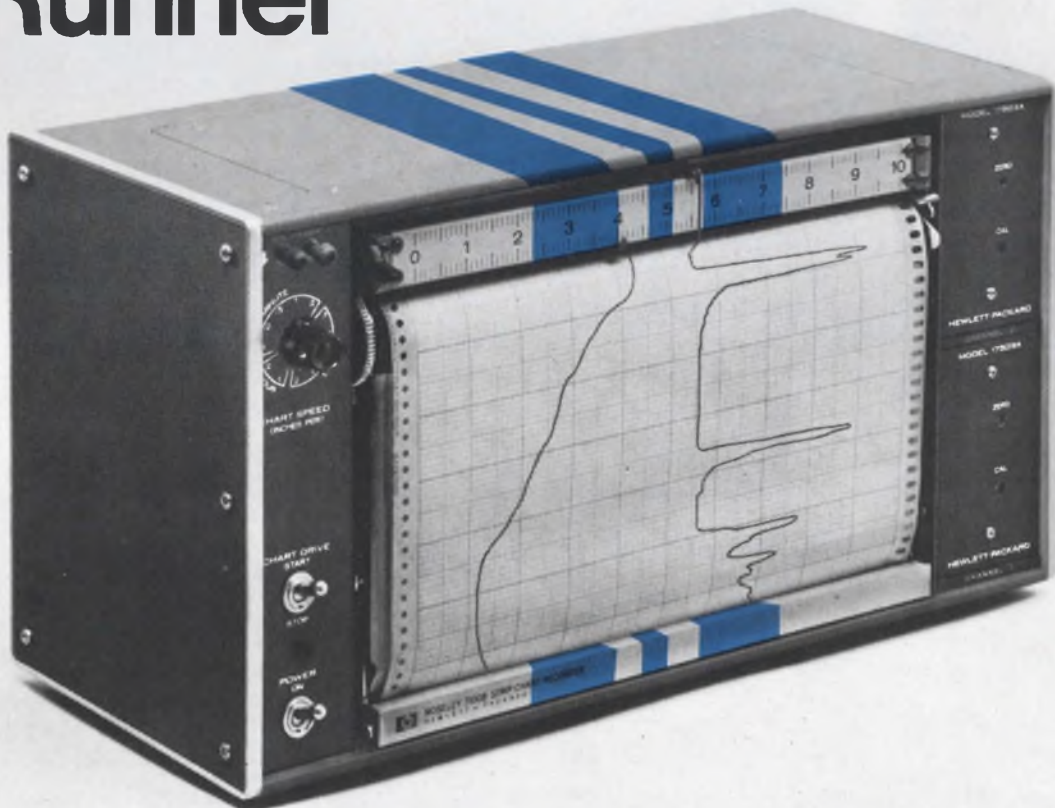

INFORMATION RETRIEVAL NUMBER 69

Fairchild told everyone what MSI could do.

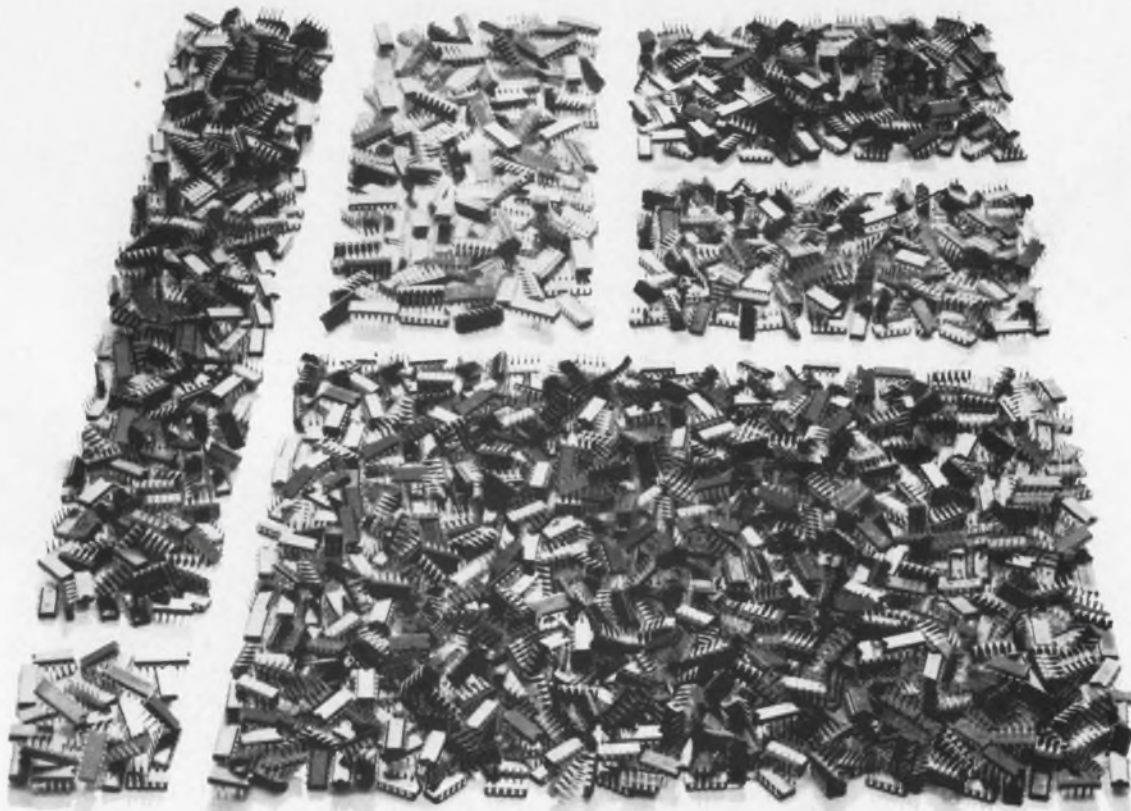

Ever since we introduced medium scale integration in 1967, we've been talking about the systems approach to computer design. Basic, compatible fundamental building blocks that do more jobs than a hundred Integrated Circuits.

Versatile circuits that function like shift

registers, counters, decoders, latching circuits, storage elements, comparators, function generators, etc. We said we had enough MSI device types to build more than half of any digital system you could design. An imaginative company in Boston took us up on it.

We're glad someone was listening.

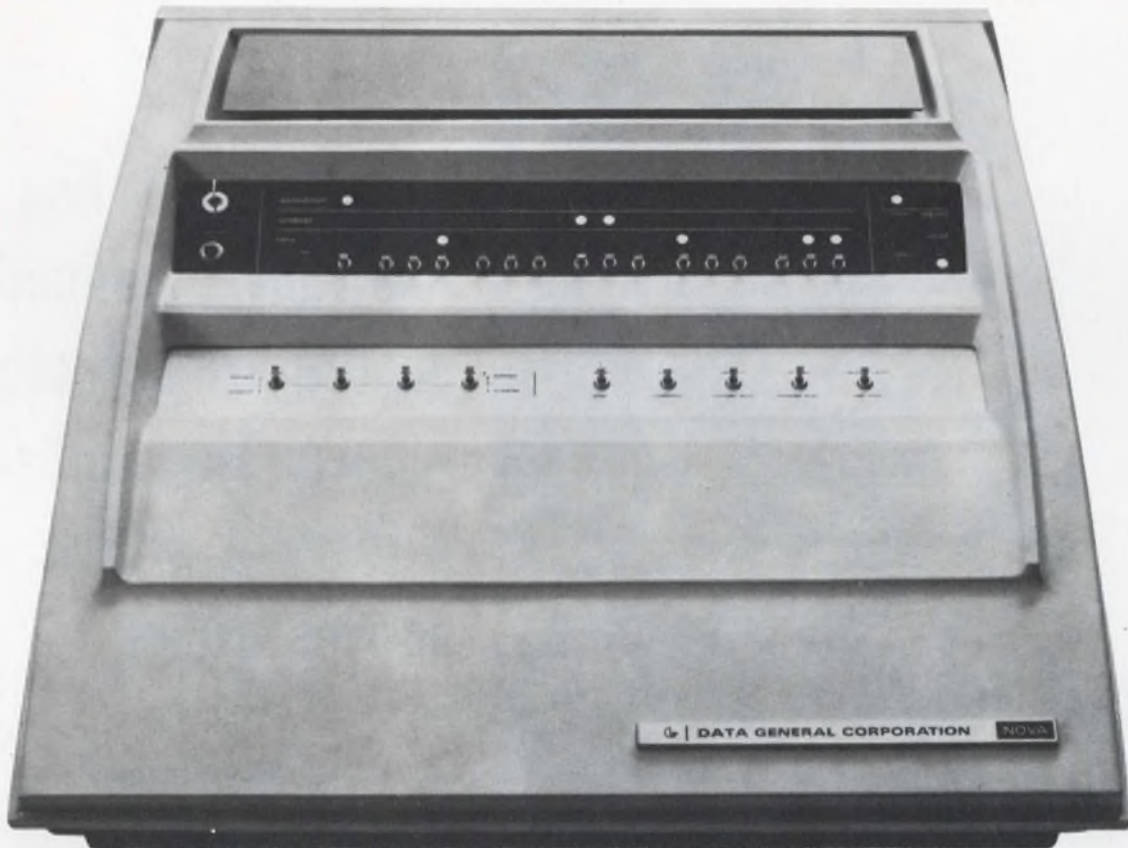

Data General Corporation built a revolutionary computer with Fairchild MSI circuits. The building block approach allowed them to design and build the whole system in six months. And put it in either a desk top console (shown above) or a 5¼-inch high standard 19-inch rack mount package. The central processor fits on two 15-inch by 15-inch plug-in circuit boards.

Another board houses a 4,096-word core memory. A fourth board provides enough space for eight I/O devices. And there's still enough room left for boards that expand the memory capability up to 16K. Any circuit board can be changed in seconds, so the computer has zero down

time. The NOVA is the world's first computer built around medium scale integration. The first general-purpose computer with multi-accumulator/index register organization. The first with a read-only memory you can program like core. The first low-cost computer that allows you to expand memory or build interfaces within the basic configuration. And the first to prove the price/performance economy of MSI circuitry: The NOVA 16-bit, 4K word memory computer with Teletype interface costs less than \$8,000.

If you'd like more information on MSI, use the reader service number on the opposite page. For specs on the NOVA, use the reader service number below.



FAIRCHILD SEMICONDUCTOR / A Division of Fairchild Camera and Instrument Corporation ■ 313 Fairchild Drive, Mountain View, California 94040, (415) 962-5011 ■ TWX: 910-379-6435

INFORMATION RETRIEVAL NUMBER 152

STOP TV COLOR DRIFT

with the SPRAGUE ULN-2114K IC COLOR DEMODULATOR

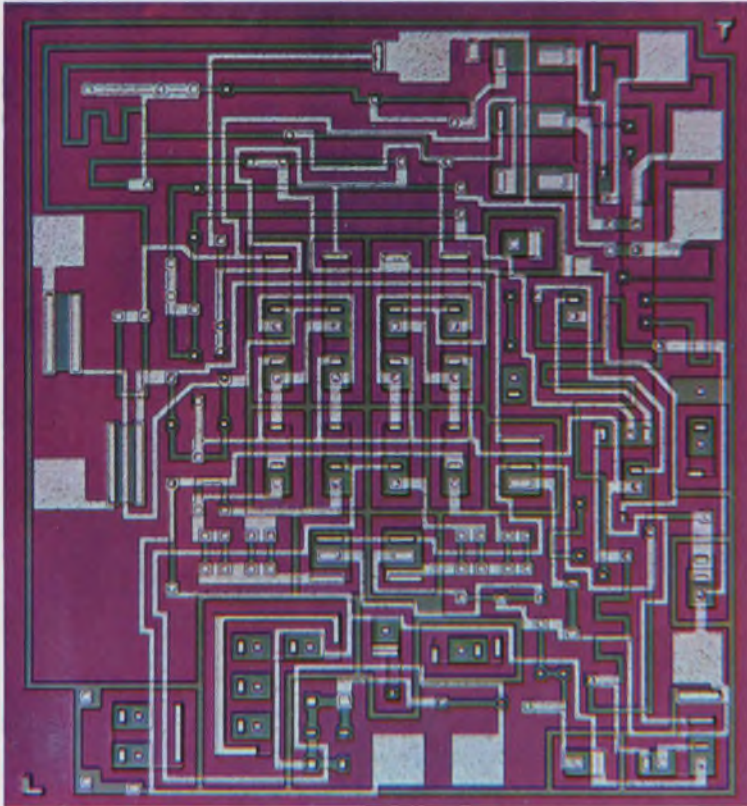

This linear IC has two fully-balanced quadrature detectors to recover **blue** and **red**. A resistor matrix derives **green**.

Matching, tuning, and stabilization problems are solved by having all components on a single chip.

SPECIFICATIONS

ULN-2114K TV COLOR DEMODULATOR

Input Voltage, V_{CC}	24 V
Power Dissipation	300 mW
Reference Injection	1.5 V (pp)
Chroma Injection	200 mV (pp)
Output Quiescent Voltage	14.7 V
Output Temperature Coefficient	-5.0 mV/°C max.
Blue Output Swing	10 V (pp) max.

To request samples, call your Sprague representative or Semiconductor Div., Sprague Electric Co., Worcester, Mass. Tel. 617- 853-5000, Ext. 322. For descriptive Engineering Bulletin 27103, write: Technical Literature Service, Sprague Electric Co., 347 Marshall St., North Adams, Mass. 01247.

THE BROAD-LINE PRODUCER OF ELECTRONIC PARTS



'Sprague' and '®' are registered trademarks of the Sprague Electric Co.

This advertisement will appear in forthcoming issues of leading trade publications.

INFORMATION RETRIEVAL NUMBER 14

PRINTED IN U. S. AMER.

News



Life support for Navy's city, 100 fathoms deep, called for new electronic designs. Page 25.

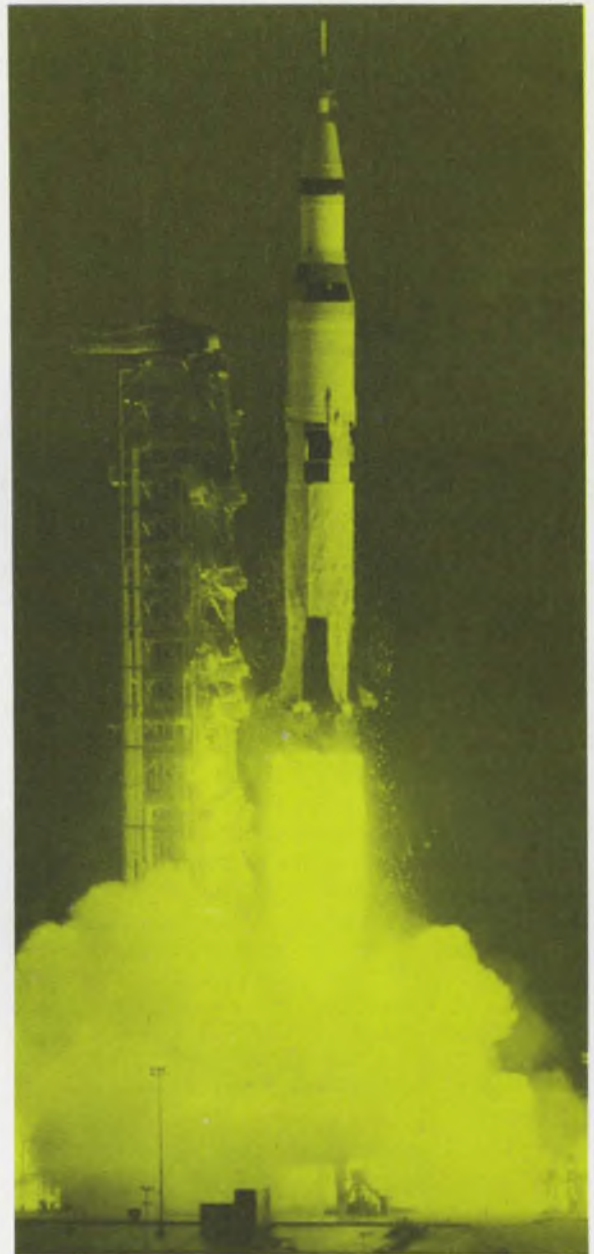

Stellar performance of Apollo 8's electronics may speed lunar landing. P. 30

Also in this section:

Laser chirping produces man's shortest impulses. Page 36.

A growing role for seismic monitoring devices. Page 37.

News Scope, Page 21 . . . Washington Report, Page 39 . . . Editorial, Page 47

hybrid microcircuits from the “total capability” source

There's a reason why Burroughs is a preferred source for hybrid microcircuits. It's TOTAL CAPABILITY. TOTAL CAPABILITY is the unique ingredient that keeps Burroughs ahead in hybrid circuit leadership and enables you to reduce system size with increased reliability.

Burroughs now offers the entire circuit package* and its components — all designed and fabricated under the eyes of experts in one complete in-house operation, providing economy, high reliability, quality control and prompt delivery.

■ Hermetic Packaging ■ MSI Capability ■ Computer Test Facility ■ Fully Documented to MIL-Q-9858A and MIL-I-45208

Buy your hybrid microcircuits NOW from Burroughs, and discover what Burroughs Total Capability can do for you.

Call or write Burroughs Corporation, Electronic Components Division,
P.O. Box 1226, Dept. H1, Plainfield, New Jersey 07061.
Tel. (201) 757-5000, or contact your nearest Burroughs
representative or sales engineer.

*Circuits are available in various configurations with resistors, capacitors, and discrete IC and MSI chips, mounted.

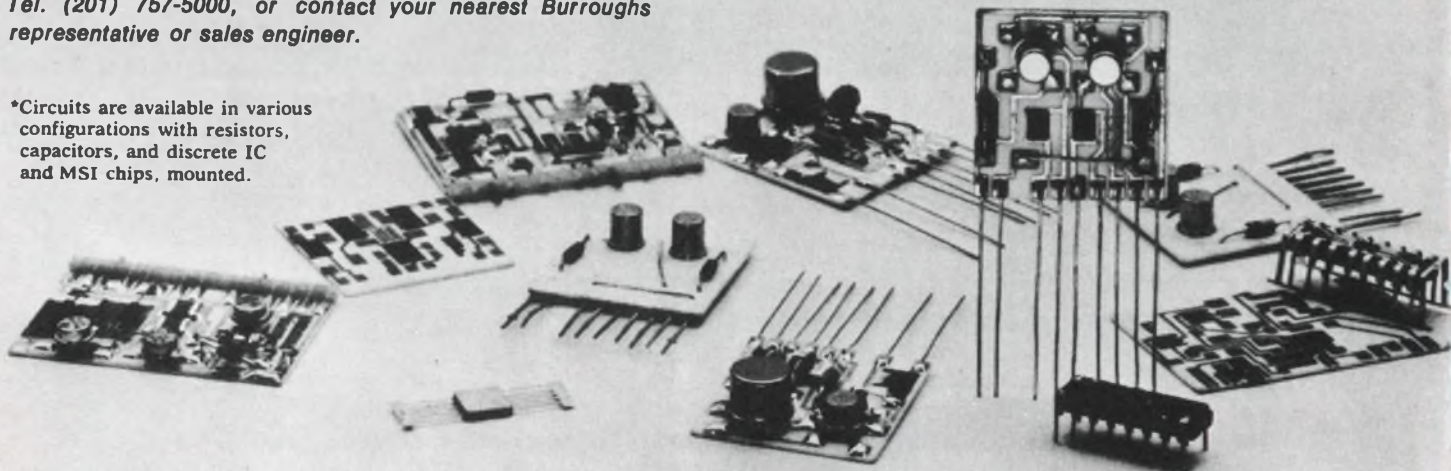

Burroughs 

IBM is sued again on trust-law charges

International Business Machines Corp., the leader of the computer industry, may well be asking itself these days: Doesn't anybody out there like us?

Already involved in a court skirmish with a competitor that has charged violations of the anti-trust laws in the marketing of hardware, the nation's computer giant now finds itself on the defensive on two fronts. The latest attack is by Data Processing Financial and General Corp., a New York City computer leasing company. In a suit in Federal Court, the computer user has charged IBM with numerous violations of the trust laws in its manufacture and distribution of computer software and related products and services.

This legal thrust, made two weeks ago, followed by less than a month a suit filed by Control Data Corp. in Federal Court in St. Paul, Minn. (see "Computer Industry Girds for IBM-CDC Battle," ED 1, Jan. 4, 1969, p. 21). Control Data has accused IBM of unfair practices in an attempt to discourage competition in the computer industry.

In both cases IBM has entered vigorous denials.

Besides matching Control Data's plea to the court to divest IBM of some of its operations, Data Processing is asking the court for punitive damages from IBM to the tune of \$1,054,500,000.

Hinting that the number of industry attackers may grow, Data Processing's president, Harvey Goodman, says that other members of the Computer Lessors Association "welcome the present action."

Among the charges by Data Processing: "Discriminatory maintenance policies" by IBM, making it impractical for Data Processing to service its own equipment; "intimidating" users planning to acquire

competitive peripheral equipment "by threatening to withdraw general technical support," and "giving its software away 'free' to its users [which] merely forces users to pay for the software as part of a single, bundled price."

IBM says it considers Data Processing's allegations "to be completely without merit."

"No later than July 1, 1969," IBM states, it expects to make changes in the way it charges for and supports its data-processing equipment, "which is apparently Data Processing's current principal complaint."

Meanwhile it's rumored that the Justice Dept., which will neither confirm nor deny the report, may attempt to prosecute IBM for alleged violations of the antitrust law. This action is said to be under consideration on a recommendation by Antitrust Div. But any action here would undoubtedly be tempered by the need to retain undamaged the tremendous contribution IBM makes to the U.S. defense and space efforts.

A voice for electronics in the Defense Dept.?

If David Packard, chairman of the company that he and William Hewlett founded, is confirmed for the No. 2 post in the Defense Dept., he would be the first high defense official with such an electronics background. Although no one responsible in the electronics industry would expect Packard to favor the industry he made his fortune in, his appointment could, according to one industry official, at least give the Defense Dept. a better understanding of industry problems and perhaps result in more efficient relations.

But Packard's fortune and how



David Packard. Will "conflict of interest" keep him from defense post?

he handles it while in Government service has raised a flurry of controversy. Despite his promise to resign as chairman of Hewlett-Packard and from the boards of other companies and institutions, his pledge to put his 3.6 million shares of Hewlett-Packard in trust and to give all the profits to charity, some critics say the potential conflict of interest is unwise; they believe he should divest himself of all interest in electronics through resignations and outright sale of his stock.

The Senate Armed Services Committee cannot formally vote on approving Packard as Deputy Secretary of Defense until after the Nixon Administration takes over on Jan. 20, but informal hearings are expected to be under way before the changeover.

The Soviet hops off to a fast SST lead

The recent test flight of the Russian TU-144 supersonic airliner hands the Soviet Union a long lead over the United States supersonic transport. The SST being designed by Boeing Aircraft Co. is not expected to be test-flown until 1972.

The Soviet lead could have adverse economic and political effects for the U.S., according to Wash-

News Scope

CONTINUED

ington observers.

Questioned about the Soviet accomplishment, a Boeing spokesman commented: "We expected it would be this fast, but we have to congratulate them; it's a significant feat, but it also demonstrates the real need to keep the U.S. program going on a timely basis. Because if we don't, the Russians can offer real competition.

"For example, today the U.S. supplies four out of five of the free-world jetliners. But the day is coming when the jet transport will be principally supersonic. And if American SSTs aren't flying, someone else's will be. This would mean a great loss of revenue for this country."

Maj. Gen. Jewel C. Maxwell, director of supersonic transport of the Federal Aviation Administration, takes a more cautious view: "They have a substantial lead. Just how they intend to exploit this or just what it means, we don't know. Nor has there been a real thorough analysis of this in the U.S."

Others believe that the Soviet SST could be employed in a diplomatic coup, in which the Russians might offer the plane at a cut price to smaller, pivotal countries. They might, for example, offer the TU-144 cheaply to Japan and some of the Mideast nations in return for landing privileges. In return the Soviet could offer reciprocal landing rights and privileges to fly across the Soviet Union.

F-15A contenders cut from 4 to 3 companies

In a surprise move, the Air Force has announced the selection of three aircraft contractors for the contract-definition phase of its F-15A fighter plane, despite earlier indications that only two would be chosen.

Awards of \$9.6-million each have been made to Fairchild Hiller Corp., McDonnell Douglas, and North American Rockwell for six-month competitive efforts. Only

General Dynamics was scratched from the race—with no comment.

Each contractor will produce an advanced aircraft design and complete production data for the single-place, air-superiority fighter. The selection of three manufacturers is believed to reflect a Defense Dept. desire to get the best in performance at the lowest cost for what is sure to be a multi-billion-dollar program.

A final contractor is to be selected by January, 1970, and hopefully an aircraft will be available for tactical use by 1975.

Because of the high degree of automation required in a single-place fighter, heavy reliance will be made on electronics subsystems. During this definition phase, it is expected that electronic subcontractors will be selected for each competitive team. The attack radar system, however, is being developed under a separate Air Force competition between Westinghouse and Hughes Aircraft.

New machine for blind reads English out loud

Scientists at the Massachusetts Institute of Technology have developed an experimental reading machine for the blind that scans English text, recognizes 40,000 different words and pronounces them in real time with appropriate pauses and intonations.

The total equipment is about the size of two upright pianos and two TV sets. It includes a flying spot scanner, a small, general-purpose computer and some specially constructed electronics for speech synthesis.

Dr. Samuel Mason, who guided the work at the MIT Research Laboratory of Electronics, says the machine's built-in dictionary does not contain full words. Instead, it contains root words, prefixes and suffixes. For example, he says, the word "lovingly" consists of the root word "love" and two suffixes.

The machine scans letters on the printed page, consults its dictionary and combines the appropriate root words, prefixes and suffixes with parts of speech information, based on the position of each word in the sentence. Then it speaks the words.

The system can also put out Grade 2 Braille—a highly abbreviated version of Braille, comparable to shorthand.

"The purpose of this system is not to provide a prototype of a practical engineering design," says Dr. Mason, "but rather to provide experimental equipment that will give us answers to questions that we need—such as: What controls are necessary? How fast can a blind user listen to artificial speech? How easy is it to learn? How big an error rate can he tolerate in the character recognition?"

"Our eventual aims are to provide a central library facility where blind persons can go, and in addition to develop specialized, small machines for personal use."

Bargain prices for used computer programs

More than 350 used computer programs that, in their aggregate, cost NASA and the Defense Dept. hundreds of thousands of dollars are being made available to industry, educational institutions, scientific and technical organizations and almost anyone else for as little as \$275 each. The top price asked is \$1240. The programs are in the form of magnetic tapes or decks of punched cards.

Typical of the programs offered is a set that can produce all the design information needed to construct electronic printed-circuit boards. Others perform such jobs as inventory control, accounting, data processing and information retrieval.

Basic information for converting these programs is available to potential users at no cost or at a nominal charge.

The distributing agency is Computer Software Management and Information Center (Cosmic), which was established in 1966 at the Univ. of Georgia by NASA's Office of Technology Utilization to encourage secondary use of the results of aerospace research and development work.

Catalogs of available programs and announcements of those forthcoming are available on an annual subscription basis for \$10 from Cosmic, Barrow Hall (B), Univ. of Georgia, Athens, Ga. 30601.



THE SPACE SAVER

This is one of our growing family of AMP's High Density Rectangular Connectors. Its contacts are on a .100" grid with 54 circuits in 1.800" x .700". It has center jackscrew, non conductive backshell and cable clamp. Size 20 pins (.040 diameter) and contacts are used throughout. Major features:

- Wire range is 20-24 and 24-30 AWG.

- Mix pins and sockets in either half of housing.

- Contact furnished in selective gold, full gold or tin plating.

- Five amp rating. Eight ounce maximum engagement. Half ounce separation force. Ten pound retention in housings.

- Cable clamp handles up to half-inch cable.

- One side-feed stripper-crimper automatic tool applies both pins and sockets and provides assembly Economization with speeds up to 4000 terminations per hour.

- Designed for communications, avionics, ground support, office and test equipment.

Write for complete details to AMP Incorporated, Harrisburg, Pa. 17105

AMP
INCORPORATED

New from Damon...



MONOLITHIC CRYSTAL FILTERS

Significantly smaller.
Far more reliable.
Lower in price.

You'll find no maze of capacitors, coils, or multiple soldered joints in the new Damon Monolithic Crystal Filter. Instead, a single crystal substrate with coupled resonators provides far more reliable performance in far less space than conventional multicomponent filters — and at a significantly lower price. Failure rate is nearly zero.

Since all resonators are on a single AT-cut quartz plate, you get superior temperature characteristics. And the coldweld enclosure assures improved aging. Damon monolithic filters are available in a variety of computer-assisted designs from Chebyshev to Gaussian characteristics — with minimum delivery time.

Specifications: Center frequency (f_0): 3 MHz to 30 MHz. Bandwidth at -3 dB (B_3): 300 Hz to 30 KHz. Coupled resonators (N): 2 to 8. Insertion loss: 1 to 6 dB (determined by f_0 , B_3 , and N). Termination impedance: 50 ohms to 5 kilohms (determined by f_0 and B_3). Ripple: 0.5 dB max.

For a detailed technical brochure on new Damon Monolithic Crystal Filters, write:
Electronics Division,
Damon Engineering, Inc.,
115 Fourth Ave.,
Needham, Mass. 02194.
Or call (617) 449-0800.



DAMON

Designing for the explosive undersea depths

Sealab III electronic equipment built to withstand operation in helium atmosphere, with safe retrieval

John F. Mason
Military/Aerospace Editor

At 620 feet below the surface of the Pacific Ocean, not only humans are subject to the bends.

"You don't think of components getting the bends, but when they've been diffused with helium at 300 pounds per square inch and then brought to the surface, they explode," says Omer Lamborn, program manager for two sonic communicators developed by the Bendix Electrodynamics Div., North Hollywood, Calif.

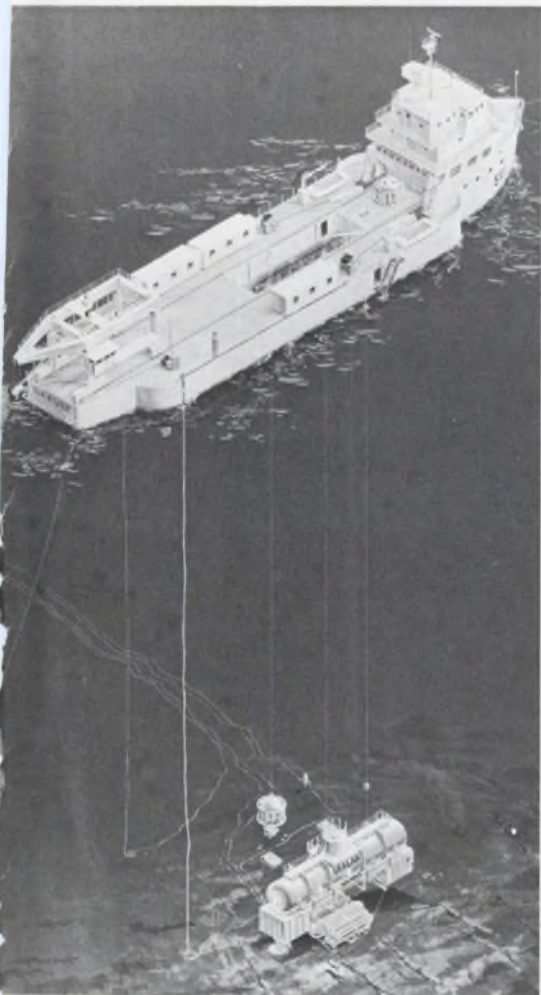

Support ship supplies communications, electricity, breathing gas and heat to Sealab III via umbilical cord.

Lamborn was describing in an interview with *ELECTRONIC DESIGN* some of the problems encountered in designing electronic equipment for Sealab III, the experimental structure that the Navy will place on the ocean floor off San Clemente Island, Calif. Nine aquanauts at a time will live in the tank structure, testing the reactions of man and equipment to the 620-foot depth.

The equipment bends problem sent design engineers to a test chamber for painstaking observations before it was overcome.

"This happened with crystals, tuning coils, transformers, transducers and capacitors," Lamborn reported. "All these components had to be carefully tested to find replacements that could take the punishment of helium under pressure. We tested them for a month in a small pressure chamber in a saturated helium atmosphere, then cut off the pressure and stood back.

"Some components had to be sealed in containers, others had vents cut into them so the helium could get in and out when the component was brought to the surface, without damaging the material. The technique used depended on the particular component involved. You could write a book on all the tricks used to protect components from helium."

Much of the equipment used in the 60-day Sealab III experiment has changed from that used three years ago in Sealab II. The old equipment didn't work well, even though Sealab II's environment—a relatively comfortable 205 feet—wasn't as severe as Sealab III's.

Sealab II's pressure was rated at seven atmospheres. For Sealab III, the figure is 20. The aquanauts in Sealab II breathed a mixture of gas that contained 77 to 79 per cent helium; in Sealab III the men will breathe 95 per cent helium while

swimming and 97 per cent while living in their tank habitat. Helium is used because oxygen causes a lethal narcotic effect on humans under pressure.

Besides causing human speech to sound like Donald Duck, helium has potentially disastrous effects on a wide range of equipment. Instead of brass or aluminum power transistors, for example, the Navy found that steel cases were the only ones that didn't deflect or short out under a 700-foot pressure test. The only capacitors that would stand up were those in glass-Kovar seals.

All components that operate on the basis of a thermal effect, such as relays and circuit breakers, had to be readjusted to work in the helium environment, a Navy spokesman told *ELECTRONIC DESIGN*. Helium, being a super conductor of heat, disables equipment that must reach a high degree of heat before it can function. To get components to operate, they were adjusted to function at lower, attainable temperatures.

In Sealab II, helium destroyed the TV cameras that had been put in the habitat to monitor the aquanauts. The gas seeped into the cameras, changed the heat conductivity and caused high-voltage circuits to arc. Finally, the cameras were put outside in the salt water, where they monitored the men through the portholes.

In Sealab III a different solution has been found for its seven TV cameras and for a six-inch Sony TV receiver that the aquanauts will use to watch commercial TV. Each camera is enclosed in a container to protect it from the 20-atmosphere pressure and then sealed in another container, of plastic, to keep the helium out.

Pressure caused a big problem in an early version of Bendix's sonic communicator. It either collapsed the diaphragm in the microphone or degraded its compliancy to sound waves, so that it became ineffective. Bendix worked with

(Sealab III, continued)

Industrial Research Products, Inc., of Franklin Park, Ill., which used a special material and design—both proprietary—and built a diaphragm that would withstand 300 psi and still respond sensitively to sound.

Laboratory testing is not always conclusive in designing for the harsh undersea environment. The communicator, for example, was thoroughly tested in water ranging in temperatures from just above freezing to 90 degrees.

"Nevertheless we developed a temperature problem when we tested the device in the sea with two swimmers," Lamborn said. "First of all, the men were swimming within a few feet of each other—so close that the automatic gain control circuits in the transmitter and receiver could not compensate for the high gain. An acoustic feedback occurred.

"We took out the age on the transmitter, since the voice doesn't fluctuate that much anyway, and left it in the receiver. But this solution left a new problem in its

wake. The temperature-compensating circuit had been in the old age circuit, to provide constant frequency response at various temperatures. With this gone, the transmitter was now vulnerable to temperature. When we tested it in cold water, its transmitter gain was off.

"We solved this, though, by obtaining the voltage from a different place in the electronic circuit. We established a voltage divider network right off the voltage power supply. This gave us a bias voltage insensitive to temperature."

Designated the AN/PQC-3, the communicator is a-m, operates in the single-sideband, suppressed-carrier mode, using the upper sideband. It is a low-frequency device (8.0875 kHz) with a range of more than 1500 feet.

The microphone is in the face-mask cavity, and the earphones work on the bone-conduction principle. Bendix is also building a variation of this communicator for the Marine Corps. Designated the PQC-2, the Marine Corps unit uses bone conduction for the microphone as well as for the earphones. The only other difference is that the Marine unit is built to operate to

depths of 100 feet while the PQC-3 is designed for 620 feet.

The sonic communicator also sends a continuous tone for homing and for transmitting in Morse code. Ordinarily code is more intelligible than voice for diver-to-diver communications, unless some way can be found to unscramble the helium speech either in the transmitter or the receiver.

Talking is a problem

Because the Sealab III aquanauts will be tethered by an umbilical cord to their habitat when they are swimming, they will not rely on direct diver-to-diver communication through the water with such sonic devices as the PQC-3, or with bone-conduction systems that connect the swimmers by wire. Both of these techniques were tried in Sealab II.

The PQC-3 will be tested now for use in future missions in which the aquanauts will not be tethered to the habitat.

For regular communication between divers in the Sealab III experiment, the divers will merely talk into a microphone in their helmets. The sound is transmitted by wire through the cord to the habitat, up to a support ship on the surface, where the Donald Duck speech caused by the helium that the men are breathing is unscrambled, then down to the habitat again and out to the divers.

The helmet, which completely covers the aquanaut's head, is an improvement over the gear used in Sealab II. It has a face lens that houses a speaking cavity with a microphone. The old mask had a mouthpiece for breathing that made enunciation poor.

One carryover from Sealab II is the "boomer"—an underwater loudspeaker, the AN/BQC-1, that blasts out messages in the water from the side of the habitat.

Getting rid of Donald Duck

Two kinds of helium speech unscramblers are being used on the support ship: a modified version of one designed by the Naval Applied Science Laboratory in Brooklyn for use in Sealab II, and a new one built by the Westinghouse Electric Underseas Div., Annapolis,



Sealab III's helium gas breathing-mixture is vital for the aquanauts but gives electronic components the bends.



CINCH UNIQUE BACK PLANE DESIGN

PERMITS UNEQUALLED SYSTEMS FLEXIBILITY

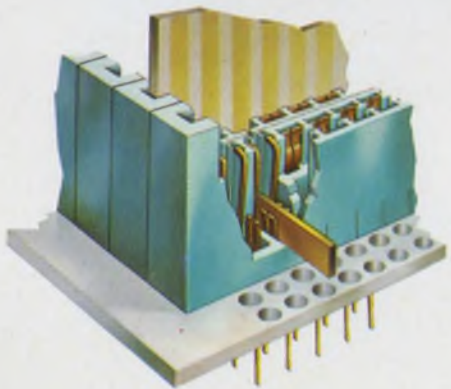

Using the basic connector-plane concept, Cinch engineers have developed an unusual device for data processing equipment and other high density automatic wiring applications. This new system substantially reduces the high labor content of conventional back plane interconnection systems and, at the same time, provides increased design flexibility and precise location of the terminal tips.

- The plane can be bussed from the PC board side or the terminal side.
- Individual contacts, including bussing contacts, can be easily replaced.
- Common voltage input can be provided to any position on the plane.
- Cinch designed automatic assembly equipment inserts an entire row of contacts in a single operation. ■ Contact tail positions on a .125" grid are held to a $\pm .010$ " radius tolerance when checked on an X-Y coordinate machine, as shown in the illustration.

HOW IS IT DONE? A new brochure describing this Cinch interconnection system and the Cinch capabilities available to you is available by writing to Cinch Manufacturing Company, 1501 Morse Avenue, Elk Grove Village, Illinois 60007. C-6812

CINCH
DIVISION OF UNITED-CARR

MEMBER



CONSISTING OF CINCH MANUFACTURING COMPANY, CINCH-GRAPHIK, CINCH-MONADNOCK, CINCH-NULINE, UCINITE (ELECTRONICS) AND PLAXIAL CABLE DEPT.

Now get IC Op Amp power...

with high gain and high voltage

RCA has these two monolithic OP AMP units for you—ready to meet your design requirements for high input impedance, high gain and high power output. Only the price isn't high! Ask your RCA Distributor for his price and delivery. Write RCA Electronic Components, Commercial Engineering, Section IC-G-1-2 Harrison, New Jersey 07029 for Data Sheet.

All characteristics below are typical

Power output (8% THD)
Output swing voltage (P-P)
Input impedance
Open-loop Gain
Input Offset Voltage
Input Offset Current
Input Bias Current
Slew Rate

RCA-CA3033
for $\pm 12V$ Supply

122 mW
21V
1.5 M Ω
90 dB
2.6 mV
5 nA
83 nA
1.2V/us

RCA-CA3033A
for $\pm 18V$ Supply

255 mW
32V
1 M Ω
96 dB
2.9 mV
9 nA
103 nA
2.5V/us

\$3.95 (1000 units)

\$4.95 (1000 units)

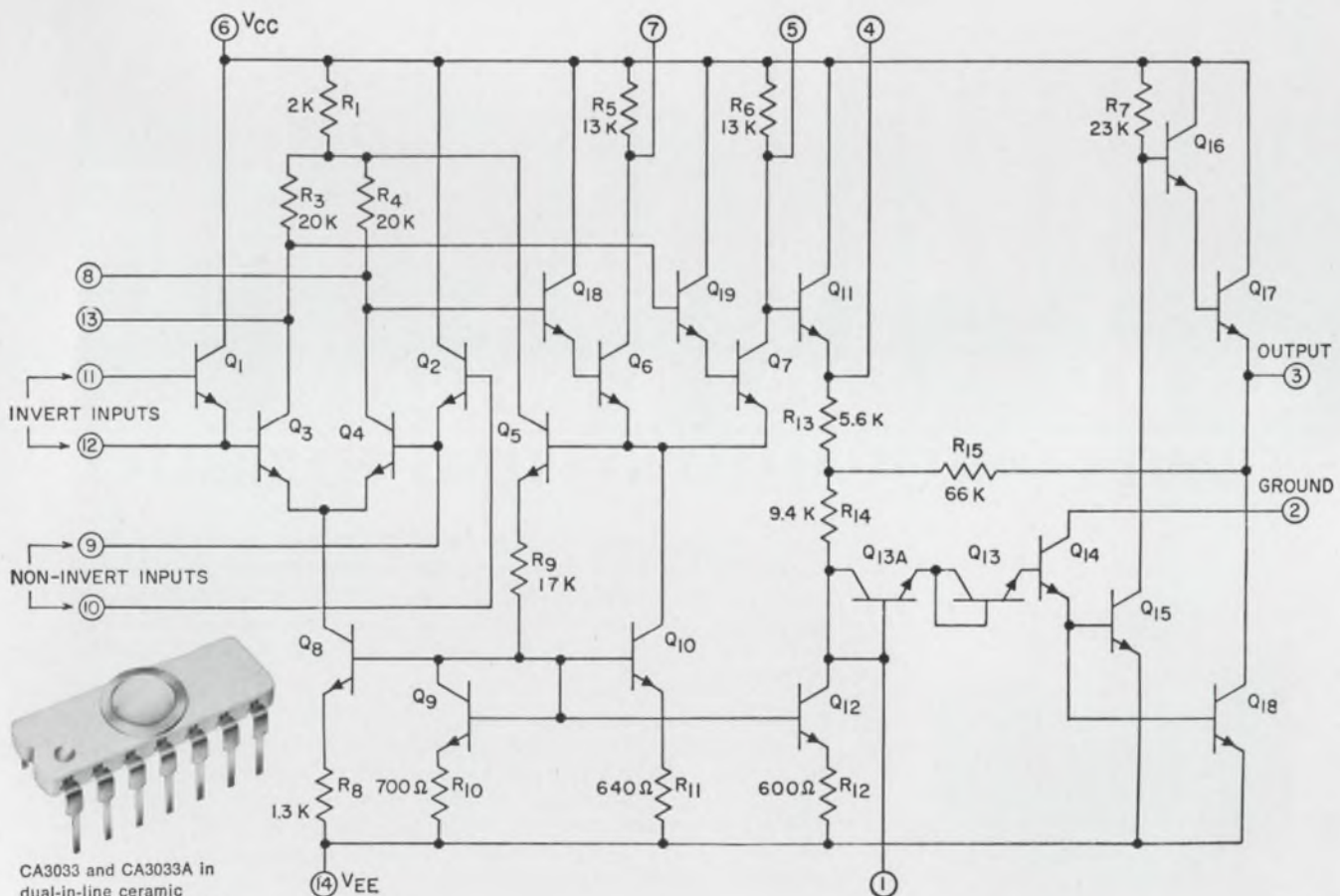

CA3033 and CA3033A in dual-in-line ceramic package (-55° to $+125^{\circ}C$ operating temperatures)

RCA
Integrated
Circuits

Now in plastic packages at economy prices.

CA3033 now available in dual-in-line plastic as CA3047 at \$1.95 (1000 units)

CA3033A now available in dual-in-line plastic as CA3047A at \$2.95 (1000 units)

(Sealab III, continued)

Md. The Sealab II device suffered from poor interface; the earphones and speaker were made by different manufacturers, and they didn't match well. The new unit is made by a single company, Integrated Electronics, Inc., Huntington, N.Y., and promises to be better.

The Navy speech unscrambler separates the speech into harmonic frequencies. The amplitudes are measured and then shifted back toward a more normal sound.

The Westinghouse approach slows down the speed by one-half to reduce voice frequency. It uses an analog chopping and digital integration process (see "Aquanauts' Goal: Cordless Living Under Sea," ED 4, Feb. 15, 1968, page 25).

Finding the way

The divers in Sealab III won't have any navigation problems, since they can follow their tether back to the habitat. But for future missions, without umbilical cords, they may test a prototype free-swimming system called PALS (for Position and Location System). The network consists of three pingers planted on the sea bottom at known locations and a hand-held directional receiver for each man. Each pinger is identified by its frequency, and its direction is indicated by a luminescent needle on the diver's receiver. The prototype was built by the Navy Undersea Warfare Center in Pasadena, Calif.

Several problems with equipment were discovered so late before the Sealab III structure was scheduled to go down that there was not time to clear them up. None is considered dangerous.

The umbilical cord to the diver, for example, carries electricity for his heated suit and a light, it also carries communication channels plus telemetry data on the amount of oxygen in the breathing mixture. Part of the communications equipment in each aquanaut's backpack is not shielded properly, and the SCR controller for his electric suit interferes with communications.

"To repair this would have been a major job, and there just wasn't time when it was discovered." Ber-



Helium speech unscrambler to eliminate Donald Duck talk operates in real time, is completely solid state, provides frequency shifting in two channels, 0 to 1000 Hz. Device is made by Integrated Electronics.

ry Cannon, an electronics engineer and one of the aquanauts, said in an interview before the Sealab III experiment began. "All the pre-amplifiers potted in the microphone cables would have to be changed. The noise is a little irritating, but it's something we are going to have to live with."

There is also interference between the TV cameras and the sonar, or pingers, that are fastened to the habitat. There was no way to test this precisely enough to know how to repair it before lowering the habitat. The aquanauts hope to block out the noise with filters.

One piece of equipment that has been discarded as a result of the operation at lower depths is a hand-held sonar that was used in Sealab II. It was able to detect a water bucket at 120 yards and a beer can at 20. The AN/PQS-1B hand-held sonar, built by Textron's Dalmo Victor Co., was designed to operate at 200 feet. Taking it to 600 feet would have caused it to implode.

The aquanauts will be relieved of a number of chores they had to perform in Sealab II. Instead of recording measurements by hand, approximately 60 telemetry channels will send engineering data from transducers by wire to the support ship for automatic recording. These measurements include the temperature of the habitat, water and the freezing units. All this will be recorded digitally on tape. ■■

The more you need from crystal filters, the more you need Bulova!

Today's sophisticated systems call for filters with "difficult" characteristics. Difficult, that is, for everyone but Bulova! Bulova has had so much experience with crystal filters, there's hardly anything we don't know about them.

Take single side-band filters, for example: Attenuation figures alone are not enough to adequately describe today's military communication filters. More and more filters require limitations on envelope time delay, while others must follow a precise time-delay envelope curve.

Bulova has been testing for these parameters — providing measurements both in terms of phase linearity and, in many cases, directly in envelope time-delay readings. As a result,

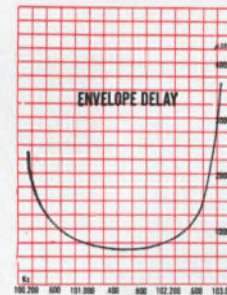

Bulova can engineer and produce to the exact measurements you specify. And at a realistic price!

Proof: Here are the actual curves and specs for just one Bulova filter, Model 562.

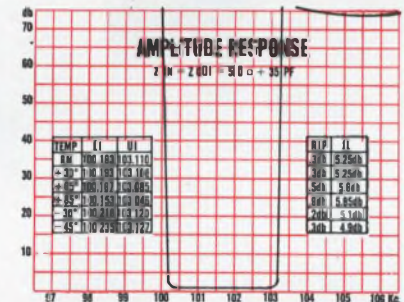

- Bandwidth (1db) 100.255 to 103.035 Kc
- Bandwidth (60 db) 99.990 to 103.260 Kc
- Carrier frequency — is 100 Kc
- Loss at carrier — 55 db min.
- Ultimate attenuation — 70 db
- Max. insertion loss — 6 db
- Max. ripple — 1 db max.
- Operating temperature — -40° to +65°C
- Impedance — 500Ω (in and out)
- Differential envelope time delay — 500 μsec max. over 80% of pass band

With specs like these you can see why we say — the more you need from a filter, the more you need Bulova! Call or write Dept. ED-21.

Try Bulova first!

FREQUENCY CONTROL PRODUCTS

ELECTRONICS DIVISION
OF BULOVA WATCH COMPANY, INC.
61-20 WOODSIDE AVENUE
WOODSIDE, N.Y. 11377, (212) DE 5-6000

INFORMATION RETRIEVAL NUMBER 20

Apollo 8 electronics systems are go, go, go

Communication, TV and guidance units operated perfectly on historic flight to the moon and back

Charles D. LaFond
Chief, Washington News Bureau

NASA officials have confirmed what most observers have assumed: The first manned flight around the moon was, from the standpoint of engineering, a flawless performance. All systems on the Apollo 8 spacecraft and Saturn V launching vehicle operated as planned.

Praise for the industry team that made this possible has come from Lt. Gen. Samuel Phillips, director of the NASA Apollo Program Office. The three-man astronaut crew, he noted, was able to accomplish "more than 100 per cent of the planned mission objectives."

Essentially these were to test and prove the operation of communications, guidance and control

systems, as well as the key propulsion units. So perfect were the results that NASA officials claimed a U. S. technological lead in space and said that similar success with Apollo 9, scheduled to be launched late in February, would in all likelihood lead to manned exploration of the surface of the moon by the middle of the year.

Communications are superb

The combination of communication equipment—a unified S-band system as the prime radio link, a new four-dish, high-gain directional spacecraft antenna and 85-foot antennas at the prime ground stations—was highly effective. In the Apollo 7 earth-orbit flight, vhf was the primary radio link, and voice communications were generally noisy, often broke up and frequently faded suddenly.

This did not occur on Appollo 8. Communications were excellent at nearly all times. There were brief breaks in the radio circuits when ground stations switched antennas and when the spacecraft switched from its omnidirectional to directional antenna. Also, there was an expected 45-minute communications blackout during each lunar revolution as the vehicle passed on the far side of the moon.

The Manned Space Flight Network for Apollo 8 consisted of 14 ground stations, four instrumented ocean ships and six instrumented aircraft. These were supported by many additional military, ships, aircraft and tracking stations around the world.

During the early phase of the mission, including the earth-parking orbit, communications were maintained with the ground through the 30-foot-diameter antenna facilities of the network. Following injection of the spacecraft into its translunar trajectory, NASA's dual 85-foot-dish stations at Goldstone, Calif.; Madrid and Canberra, Australia, became



Triumphant crew of the Apollo 8 command module that circled the moon flawlessly 10 times. From left: Capt. James A. Lovell, Jr., Maj. William A. Anders and Commander Frank Borman.

primes. The handover occurred when the spacecraft was at an altitude of 10,000 nautical miles on its way to the moon. The reverse occurred when Apollo 8 returned to earth.

Data between earth stations were relayed via radio and hard-wire links and through two Intel-sat communications satellites, one over the Atlantic and the other over the Pacific. All communications were fed through the Goddard Space Flight Center, Greenbelt, Md., to the Mission Control Center in Houston, Tex.

Data to the spacecraft were fed at 1200 bits a second. Data to ground stations from the spacecraft were transmitted at 51.2 kilobits a second. Generally data between stations on the ground were sent at 1200 bits from remote stations, at 2400 bits between Cape Kennedy, Fla., and Goddard, and at 40.8 kilobits from Goddard to Houston.

Nearly all communications equipment for the Apollo mission was developed and built by Collins Radio Co. It developed the vhf and unified S-band equipment for the spacecraft under a subcontract from North American-Rockwell. Under a prime contract to Goddard, it built all of the equipment used in the 14 Manned Space Flight Network ground stations, the tracking ships and the instrumented aircraft.

While S-band serves as the primary communications link for ranging and tracking, voice and data and television transmissions through a single, multiplexed frequency in each direction, the vhf system serves as a backup. Vhf can be used only in near-earth orbit and up to about 10,000 nautical miles in space, and it is always used for communications during recovery. It is also expected in the future to be used as a secondary link between the crews of the lunar and command modules when they are separated. The unified S-band was developed specifically for the Apollo program; the vhf system is very similar to that used in the previous Mercury and Gemini spacecraft programs.

Remarkable TV quality

Apollo 8 television transmissions

1970

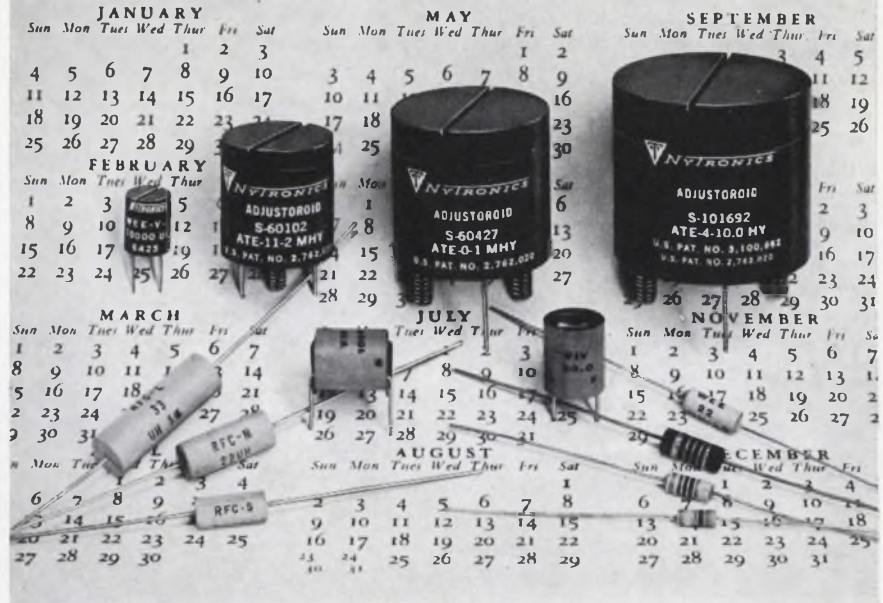

Nytronics Inductors are ahead of their time!

Nytronics continuous research and development have produced standardized quality inductors with the superb precision and stability to meet the demanding requirements of tomorrow's circuitry. Yours today — delivered off the shelf from a large inventory. Pioneering is a Nytronics speciality!

WEE-DUCTOR — Magnetically shielded with inductance range 0.1 to 180,000uH, designed to MIL-C-15305, Grade 1, Class B. Encapsulated Envelope: 0.157" diameter x .450" length.

SUPER WEE-DUCTOR/90537 TYPE — Manufactured in accordance with MS90537, Molded Magnetically shielded with inductance range 0.1 to 100,000uH ±10% tolerance. Molded Envelope: 0.163" diameter x 0.410" length.

WEE WEE-DUCTOR — Magnetically shielded with inductance range 0.1 to 10,000uH. Designed to MIL-C-15305. Encapsulated Envelope: 0.125" diameter x 0.335" length.

DECI-DUCTOR — Subminiature with inductance range 0.1 to 1000uH. Designed to MIL-C-15305, Grade 1, Class B. Molded Envelope: 0.100" diameter x 0.250" length.

S-M-L INDUCTORS — Non-shielded with inductance range 0.1 to 10,000uH. Designed to MIL-C-15305, Grade 1, Class B. Molded Envelope: "S" Type — 0.188" diameter x 0.44" length, "M" Type — 0.25" diameter x 0.60" length, "L" Type — 0.31" diameter x 0.90" length.

VARIABLE INDUCTOR — Unshielded with adjustable range 0.1 to 4700uH. Designed to meet MIL-C-15305, Grade 1, Class B. Encapsulated Envelope: 0.400" diameter x 0.500" length. Vertical or Horizontal mounting.

WEE V-L — Magnetically shielded adjustable range 0.1 to 100,000uH. Designed to MIL-C-15305, Grade 1, Class B. Epoxy Molded 0.300" diameter x 0.400" length.

ADJUSTOROID — Adjustable toroid available in nominal values from 0.01Hy to 12Hy. This unit provides stepless adjustment in a completely hermetically sealed package.

Nytronics off-the-shelf inventory also includes a wide range of capacitors, delay lines, and resistors. Write today for complete engineering data.



NYTRONICS
Essex Electronics Division

(Apollo 8, continued)

to earth were of remarkable quality. RCA developed both the small onboard TV camera and the scan converters needed to produce an output that was compatible with commercial telecasting. The system was first used during the Apollo 7 mission last October. The 4.5-pound onboard camera uses a 1-inch vidicon tube and requires a maximum of 6.7 watts. It has a 500-kHz bandwidth and provides 10 frames per second with a 320-line raster, according to RCA (NASA claims 227 lines per frame). It has two lenses, which may be interchanged, to provide either 160° wide-angle coverage within the spacecraft or a 100-millimeter telephoto view of the outside of the spacecraft.

With such an output, the TV transmissions from space had to be converted to meet the commercial TV need of 30 frames a second and a 525-line raster. For Apollo 8, RCA provided scan converters for the Goldstone and Madrid stations and one for use at Cape Kennedy. A fourth converter, custom-built by NASA, is in use at Corpus Christi, Tex. The Madrid converter was used to provide a television outlet for the Eurovision network, which serves many European countries.

The RCA camera provides 320 active lines and produces a TV picture with 220 lines of resolution, horizontally and vertically. The camera can be used in two modes, one for telecasts to the public and the other to transmit still photographs at a rate of one frame every 1.6 seconds at 1280 lines a frame. The scan converter handles both transmission modes.

Sophisticated guidance system

Years ago a decision was made to give primary guidance responsibility in space missions to ground control—that is, from the Mission Control Center in Houston through the unified S-band to the spacecraft. However, a main onboard feature is an inertial guidance and navigation system that offers multi-redundancy and gives the crew at all times the capability to

continue or terminate a mission and to fly home accurately, even if there is an interruption in the communications link.

The Apollo guidance and navigation system was designed originally by the Instrumentation Laboratory at MIT. During the early days of development, the university served as a system director, and major subsystem contracts were given to AC Electronics for the instrument measurement unit (which includes the stable platform and associated electronics), to Raytheon Co. for the digital computer, and to Kollsman Instrument Corp. for the associated optics, which include a scanning telescope and a celestial sextant. Combined, the result is probably the most sophisticated guidance and navigation instrumentation yet produced in the world.

Later in the program, AC Electronics was named prime contractor over the others, and MIT has had continuing responsibility for mission programming. The complete system is carried in the Apollo command module, and a nearly identical system will be carried in the lunar module. The latter will employ a different telescope, with no space sextant, and its computer programming will be different.

It always knows where it is

The system provides the basic functions of internal guidance (it always knows where it is because it knew where it began and keeps track of how fast and where it went) attitude reference, optical navigation and spacecraft control. The whole is linked to a Honeywell spacecraft stabilization and control system, the service propulsion system, the reaction control system, the environmental control system and the communications and instrumentation system.

Failure of any one of the three subsystems does not disable the others. Each may be operated independently. The accuracy of the system, according to Hugh Brady, Apollo program director at AC Electronics, is within 0.25 degree per day. As long as communications hold, this error can be regularly removed with updating information from ground control,



TV camera that sent back views of the moon and earth never seen before weighs 4.5 pounds, uses a 1-inch vidicon tube and pulls 6.7 watts. Built by RCA, it uses a 500-kHz bandwidth and provides 10 frames per second with a 320-line raster.

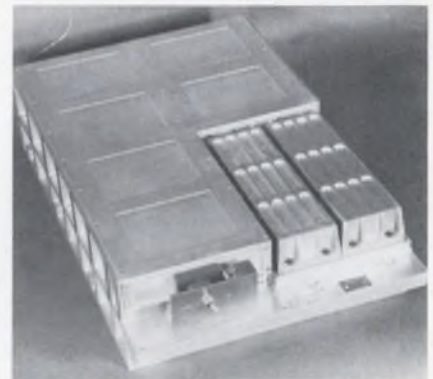

Digital computer built by Raytheon is a key element in the Apollo guidance and navigation system built by AC Electronics. The computer is less than 1-1/4 cubic feet in volume and weighs less than 85 pounds.

and the optical navigation subsystem can be used for position updating.

While the computer stores all the necessary programming and provides a limited scratch-pad memory, it also serves as a control for the issuance of commands, following computation, for attitude steering or velocity change. The inertial system measures changes in three axes of spacecraft attitude, assists in generating steering commands and measures any change in the spacecraft velocity in all axes.

Dr. Thomas Paine, NASA's acting administrator, has described the first lunar venture as a "culmination of a great human dream." But he emphasized:

"This is not the end, but the beginning." ■■

TTL Trends

from Texas Instruments

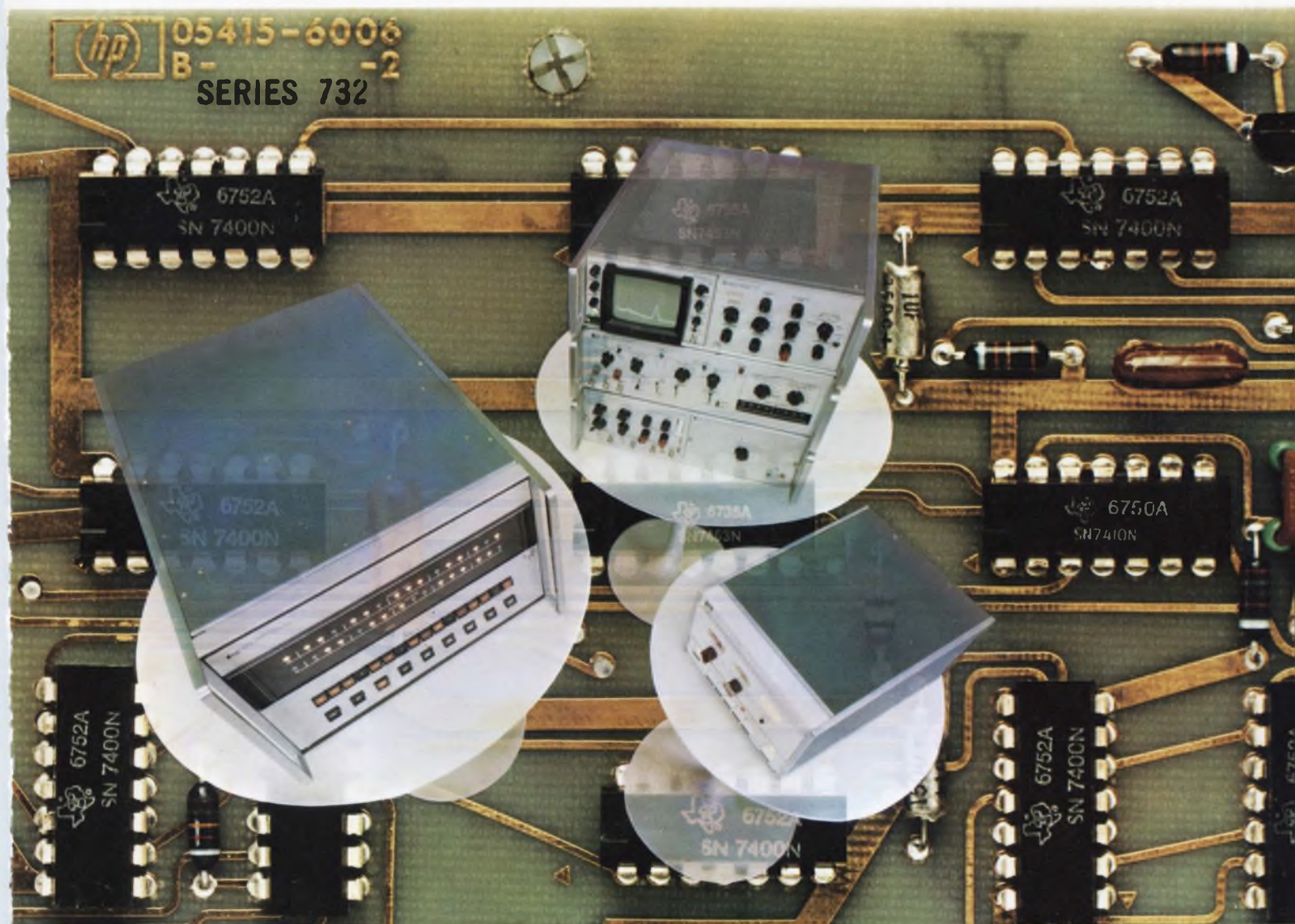

At Hewlett-Packard, TTL from TI is taking over the tough jobs...in measurement...in computation...in analysis. The following pages tell why, and show how TTL is helping HP better serve tomorrow's customer needs — today!

TI helps Hewlett-Packard...

head off heart attacks before they happen

Recent events have focused attention on the "Cardiac Intensive Care Unit"—one of modern medicine's newest weapons in the battle against heart disease. It is here that diagnosis and prompt treatment enables doctors to effectively head off fatal coronaries before they happen. To serve this need, Hewlett-Packard developed the Model 7822A Arrhythmia Monitor—first of a new generation of ultra-high-reliability, compact and low-cost medical instruments made possible with Series 74N TTL integrated circuits from TI.

This instrument "remembers" the normal heartbeat characteristics of a coronary patient, then compares each succeeding beat against the stored norm. If disturbances occur, it provides an immediate warning, enabling hospital personnel to effectively head off catastrophic heart attacks before they happen.

Selling for under \$2,000, the HP 7822A uses fewer than 75 TTL plastic plug-in packages, neatly arranged on just four PC boards.

This simplicity underlies the inherent reliability of the instrument. Circuits such as SN7473N and SN7474N multifunction flip-flops plus MSI Counters, Shift Registers and Quad Latches greatly reduce the probability of failure.

And the rugged plastic package was proven—by months of actual hospital field trials and lab tests—to have outstanding durability. For example, one HP engineering testing program subjected the 7822A to 6 months of continuous operation under the most severe hospital environment conceivable: 45°C temperatures and 95-98% relative humidity. *Not a single IC failed during the entire 6-month period!*

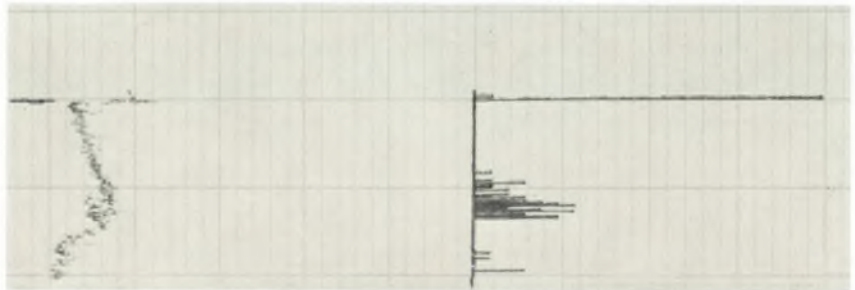

Typical use of HP 7822A is shown here. As a focal instrument in today's "Cardiac Intensive Care Unit," it is an important new aid in the prompt detection and treatment of potentially fatal coronaries.

at Hewlett-Packard

TTL takes over the tough jobs

Recently, three divisions of Hewlett-Packard faced three difficult—but totally different—design challenges. Independently, all three solved their problems with Series 74N TTL integrated circuits from Texas Instruments. Here's what happened:

In measurement—many exclusive MSI functions helped drastically reduce package count and interconnections, giving life-saving reliability to HP's new 7822A Arrhythmia Monitor.

This instrument "remembers" the normal heartbeat characteristics of a coronary patient, then compares each succeeding beat against the stored norm. If disturbances occur, it provides an immediate warning, enabling hospital personnel to effectively head off catastrophic heart attacks before they happen.



In computation—Over 290 TTL circuits—including high speed Series 74H units—helped HP to halve the size and trim the cost of its lowest-cost computer by another 31%. The Model 2114A accomplishes all this while retaining 2.0 μ sec memory performance and a wide range of input/output options.



In analysis—HP cracked a two-year design deadlock when they zeroed in on TTL. After two state-of-the-art logic approaches were explored without success, HP engineers tried TTL and that turned the trick. The Model 5400A Multi-Channel Analyzer features 100 MHz clock rate, 1024 channels, and a 2.2 μ sec memory . . . all this for \$9950. Nearly 400 Series 74N ICs make it possible.

In yet another instance, the same division significantly reduced development time on the Model 5480A Signal Averager by building on experience gained with the 5400A.



TTL added values

These successes brought bonus benefits. Other HP divisions are now designing new instruments around TTL and achieving lower development expense, better performance, reduced overall costs, and improved reliability.

This mushrooming usage of TTL also brings to HP the advantages of volume purchasing . . . quantity discounts and assured availability. Furthermore, inventory costs are held down because one family of ICs now takes the place of several.

What are your problems? Take a tip from Hewlett-Packard and design with TTL from TI. You'll likely end up with a better product at a more attractive price—and probably increase your profits to boot!



TEXAS INSTRUMENTS
INCORPORATED

crack a two-year design deadlock

HP 5480A Signal Averager helps researchers pull weak signals out of overwhelming noise.

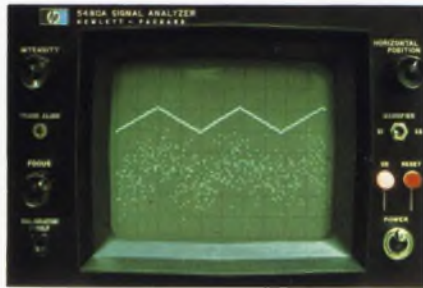

HP 5400A Multi-Channel Analyzer typifies sophisticated new generation of analytical instruments — made possible by TTL integrated circuits.



HP engineers liked what they saw when they investigated Series 74N TTL. They had already spent two years trying to develop the 5400A Multi-Channel Analyzer...an advanced instrument which would feature the fastest known A/D converter (100 MHz clock rate), 1024 channels with 10^6 counts per channel, and a 2.2 μ sec memory cycle. Two state-of-the-art custom logic approaches had been explored without success.

With Series 74N TTL, HP found a broad selection of standard multifunction circuits, a reliable plastic package, volume availability, and low cost per function — important considerations in a design using almost 400 IC packages and yet carrying a price tag of only \$9950.

Performance-wise, the 74N TTL line proved to have almost ideal characteristics — speed, fan-out and noise immunity.

One success leads to another. Experience with TTL in the Model 5400A paved the way for its use in the Model 5480A Signal Averager. This new instrument enables scientists to see low-level repetitive signals literally buried in extraneous noise. It also features a 1000-word, 24 bit-per-word memory, and 100,000-sample-per-second sweep rate.

Again, use of Series 74N TTL logic substantially shortened the overall design cycle. Although development of the 5480A Signal Averager started two years later than the Model 5400A, both reached production at virtually the same time.

Let TI plastic ICs tackle your tough jobs, too.

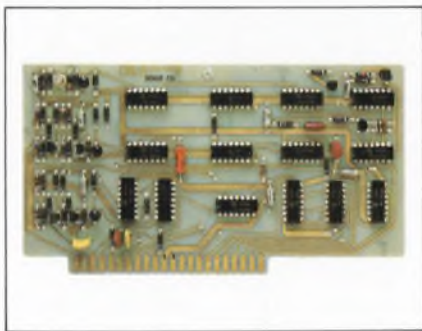

This circuit board contains 14 of the nearly 1000 plastic integrated circuits used in the Hewlett-Packard products described on these pages.

Hewlett-Packard engineers took a long, hard look at packages as well as circuits when they selected TTL from TI. They considered ruggedness and reliability along with price and availability before deciding on Series 74N TTL.

They weren't alone. More than 1500 other users and OEM's—including such companies as Bunker-Ramo, Systron-Donner and Friden—have put to work more than 20 million TI plastic IC packages during the past three years.

Experience has been so satisfactory that TI plastic is the industry's fastest growing IC package design.

The economy of plastic is only half the story. MSI makes possible even lower costs as well as greatly improved reliability.

MSI means fewer packages, fewer interconnections, fewer circuit boards...in short, fewer things to go wrong in your systems, and fewer things to add to costs.

That's why TI's proven plastic package—along with MSI—assures you the lowest cost-per-function of any logic available today.

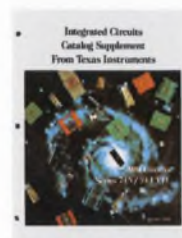

Why not decide for yourself? This new IC Catalog Supplement details all TTL/MSI circuits from TI—including flat-packs and C-DIPs as well as the popular proven plastic. Functions run the gamut from decoders to shift registers to active element memories—all told, full specs for 22 MSI devices including 14 completely new types.

For your copy, plus data sheets on other TTL circuits, just drop a note on the back of your business card and mail to Texas Instruments Incorporated, P.O. Box 5012, MS 980, Dallas, Texas 75222. Better yet, simply phone your TI sales engineer or authorized distributor.



TEXAS INSTRUMENTS
INCORPORATED

trim the cost of low-cost computers by another 31%



General lab use typifies new low-cost applications for HP 2114A Computer — made possible by TTL technology. Desk-top compactness and easy accessibility are IC bonus features.



Cut cost by another 31 percent... reduce size by 50 percent...yet retain virtually all the speed and performance capabilities of the existing HP lowest-cost model. This tall order faced HP engineers when they set out to design a desk-top, third generation computer to serve scientific and industrial markets. Specifically, they wanted the new Model 2114A to sell for less than \$10,000.

An analysis of various logic types soon cut the problem down to size. Comparison revealed that TI's Series 74N TTL cost less than half as much and consumed only one-third the power of the logic family then considered standard. Equally important, there were no serious interface problems between TTL and the earlier logic. This assured compatibility with a wide variety of existing HP input/output peripherals and companion accessory equipment.

In the area of performance, HP engineers were pleased to find that standard and high-speed TTL logic could more than fill the bill. And all circuits were available in the same plug-in plastic package.

Furthermore, the single voltage requirement of both standard and high-speed TTL further reduced power supply requirements. And noise margin and other characteristics were also compatible.

Finally, a large selection of MSI functions was readily available. Among more than 250 IC's in the Model 2114A are such key circuits as 7483N Four-bit Full Adders and 7475N Quad Latches. These paved the way to important package count reductions, resulting in lower cost, smaller size and improved reliability.

OUR MAGNETIC PERSONALITY GIVES US SOME OF THE BEST CONTACTS IN THE RELAY BUSINESS

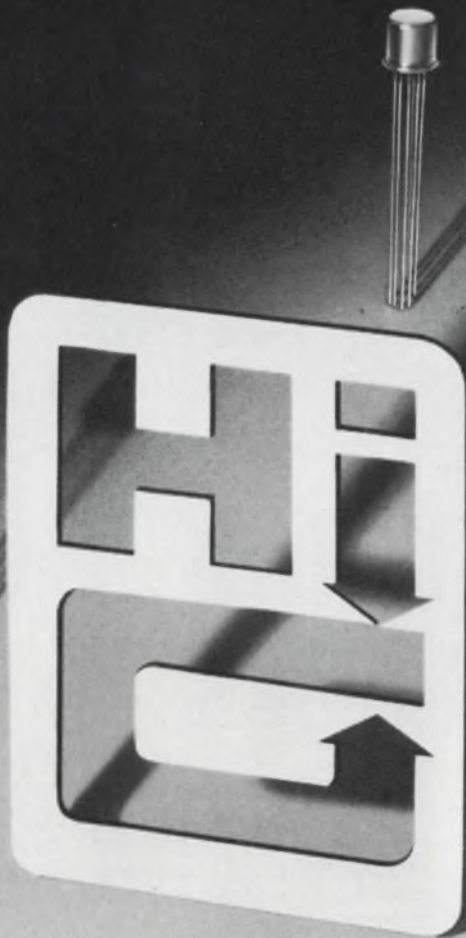

RELAY TYPE	SERIES MA & MS
Size	TO-5
Contact Arrangement	DPDT
Max. Rated Contact Current	1 amp at 32 Vdc
Construction	All Welded
Weight	
Series MA	2.9 Gms Max
Series MS	4.5 Gms Max

A uniquely designed and unusually efficient magnetic assembly gives our new TO-5 size relays exceptionally good contact resistance. But this isn't the only reason for great reliability in our MA-MS series.

For example, every MA-MS relay we make is miss-tested. Relays that pass our test are accepted only on the basis of *uniformity* within the acceptable maximum limits.

Relays are assembled and then subjected to a multi step cleaning process all in laminar flow chambers. All units are then out-gassed in an open state at .001 microns of mercury and over 200°C temperature. From start to finish all assembly including welding is done under a strictly controlled atmosphere.

Hi-G's concern for design and manufacturing processes gives you an ultra reliable relay that will withstand tough environmental stresses and meet all applicable portions of MIL-R-5757.

For more details write or call Hi-G for Bulletin #90. It could be one of the best contacts you've ever made.

"Image-wise, how would it be if the competition found out there was some infighting going on here?" That from George Korecht, Public Relations, who was looking very sincere in a sincere dark, vested suit. He toyed slowly with horn rimmed glasses, waiting.

"Infighting is a little strong, George," puffed Eldredge Oldadt, Senior Engineer and Group Elder Statesman. "I realize you public relations types are looking for words with sizzle, but we're seeking more than a word. What we want is a proper statement that will exactly describe our insuperable technical capability without resorting to polemics and without getting boxed in by too many parameters."

"Gad. Look, El. I got an eight megabuck potential going and I need an ad. And you give me a klutzed up R&D nostrum." With that, Bart Selitall, Product Manager, slammed his notepad on the table. An aggressive, thirtyish cum laude ME from the Nevada Institute of Technology, Bart always wanted action. And quite frequently got it.

"Gentlemen, please. Let's get back to the problem congruency-wise." Korecht again. "We have several magnificently great products to cover here. And our first hang up seems to be in describing our terminal, feed-thru and programming blocks. In our headline we need, what we in the trade call a grabber. How would you describe them?"

"Adequate."

"Fantastically preeminent over anything else."

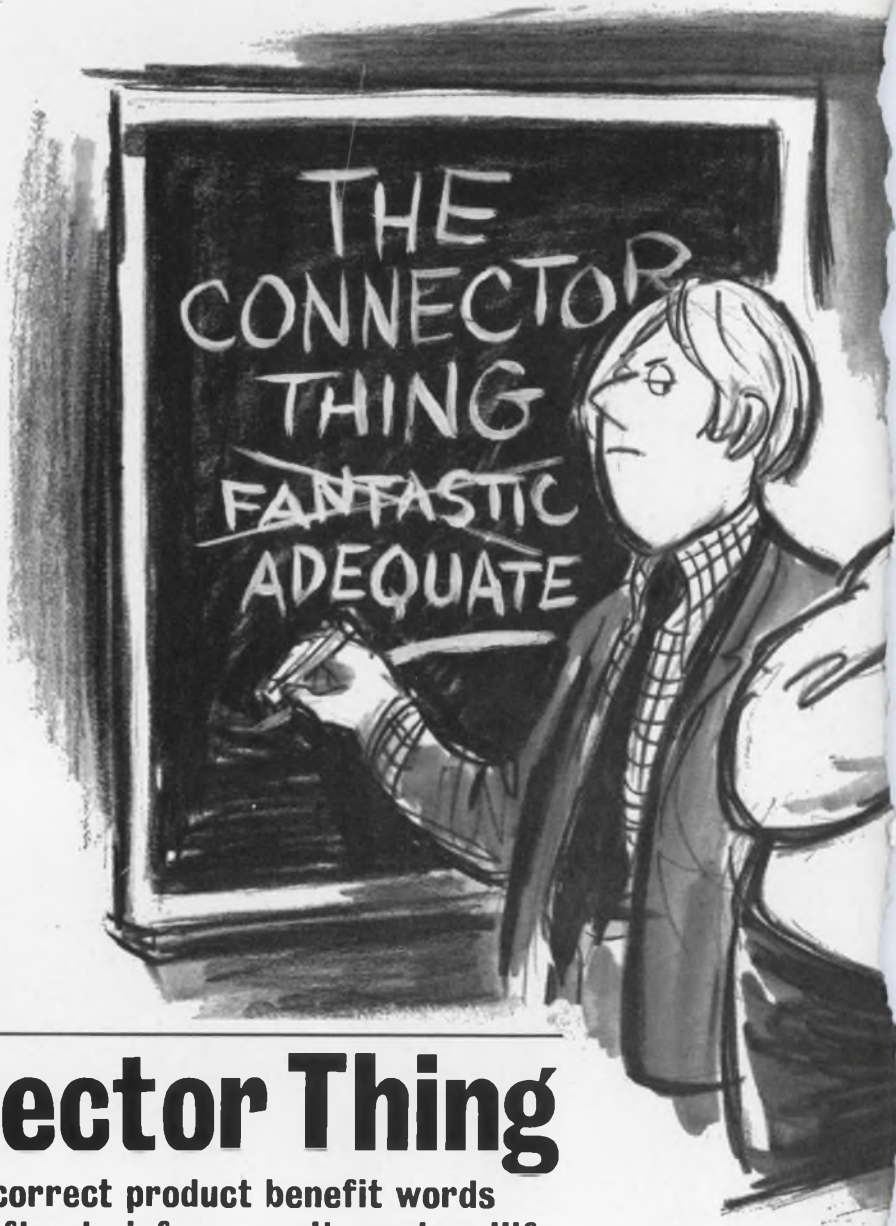

The Connector Thing

in which the correct product benefit words are sought after to inform, excite and mollify.

"Ennnnnnnnn."

"Who's the ennnnnnnnn?"

"Us. We in R&D feel that anything that has finally been committed to production is but a megapossibility of what..."

"Okay. Okay. Forget that jazz. You El. What's with the adequate bit. Have we or haven't we?"

"George, of course it's an excellent product. With highly imaginative parameters. But we feel with a few improvements..."

"Hey, El. Cut it out!"

"Bart?"

"Look guys. We got the greatest way to interconnect wires in the business. Now why don't we say so? Do you bums read your reports? Or ever look at what the competition does or doesn't have?"

"While people are taking the time to screw down or solder connections, all they really have to do is plug them in if they use our modules. And ours lock. There's a little re-tainer doohicky in the block that really latches onto that contact. It can't wiggle out.

And the contact is really snug. You guys sit around and dream perfection all you want, but what more do you want? This terminal junction system design has been selected by the military as the best design for them. Period. And why? The rated voltage is 1 kVAC at sea level and 375 kVAC at 100,000 feet in the environmental models. With the shock and vibration guarantee of 20 G's, 2,000 Hz. The rated current is 20 amps/buss in the size 16 contacts, and 10 amps/buss in the size 20. And you can get as many as seven bussing arrangements as standard. And we'll even make special arrangements. With these things we can give people a lot greater design flexibility. And tremendous weight and space savings. So anywhere anybody needs to have wires tied together, we got the greatest thing going and you pussy-foot over a word."

"Come on guys, let's agree on an adjective. Bart? El?"

"Fantastic."

"R&D?"

"Well, a modified, qualified fantastic in your terms, that is."

"Fine, I think we can put that one to bed."

"Now, gentlemen. The coffee break is almost on us. And we know what that all does morale-wise. So let's get on briefly with the next shot. Twist/Con."

"Well, hasn't everything that can be said about our micromin pin and socket connection been said?" That's Bernard Weyout, R&D. "I mean economical. High density packaging of contacts on 0.050" centers. That's up to 420 contacts per square inch. And it's got a helical breathing spring that gives it 100% wiping action. The contacts are protected. And it's highly reliable. So what's to be talked about again? Frankly, I'm sick of it. Seems every time I pick up an..."

"Look, Bernard. We're tremendously sympathetic to your problem. We realize that in R&D you're theorizing on one-kay and up contacts on the head of a pin, but until NASA has a requirement, let us get our licks in first. All right?"



PROGRAMMING, FEED-THRU
AND TERMINAL BLOCKS.

Interlandi

"You production cats really bug me, you know. What do you know about creativity? All you're interested in is money and..."

"Cool it, Bernard. Now what can we say about Twist/Con. EI?"

"Well, without going out on a limb, George, we could really talk about our quality and delivery. Oh, I know those are a couple of hacked up words, but look, we've shipped thousands of connectors in the last three weeks and not one of 'em has come back.

"I hear people have complained about some pretty sad wares. Including cracked insulation. And poor workmanship. Even the wrong orders. But not from us.

"You know that sub min connector is really something. A lot of people don't realize that our Twist/Con pin contact is formed with a breathing helical spring and it really works better under vibration than any other design.

"So Twist/Con is really more than acceptable as connections for IC's, interconnecting of PC boards, and on modules with connectors welded to hybrid circuits. Twist/Con is adaptable to 22 AWG to 30 AWG standard wires."

"Well, could you call our Twist/Con supe-

rior? Highly economical?"

"Well, George, both those descriptive words are relative. We in the scientific world look on superiority as..."

"Jam it EI, baby. I need a sales piece. I've seen our specs and I've seen competitors. Our Twist/Con is great. I vote for using superior and economical."

"Agreed."

"All right, it's almost lunch time anyhow."

"Well, with qualifications..."

"Look, team, thanks. It's really been great, you know, the participation. The bedrock. The nitty gritty. Now, next month we'll be talking with Ben Efitts from personnel and some new sales engineers about multi-pin connectors and terminal modules. Uh, Bernard, that's a meeting I don't think we need R&D represented at. Thanks, fellows.

"Hello, Brenda. Will you get me advertising? Thanks, Hon. Hello, Harry. Look, the ad's are okay. Both. Look, use terrific on the terminal, programming and feed-thru modules. What? Right, terrific. Sure. I got an unquali-

fied adequate out of Product Management and if that isn't terrific I don't know what is. And, uh, superior and economical on the Twist/Con. Look, do you know any other sub min you can get contact density like 420 per inch and at such a price? Okay. And neither does anybody else. Print it.

"And put in the line to write for catalogs for the modules and Twist/Con.

"Man, like \$400 bucks an hour to wrestle over three words. Why don't they just leave it up to PR in the first place? Then we could come up with something like Microdot... because."



MICRODOT INC.
220 Pasadena Ave., South Pasadena, Calif. 91030

Laser pulses compressed to 0.4 ps

Chirp radar techniques yield paper-thin spikes of coherent infrared for optical radar and ranging

Richard N. Einhorn
Contributing Editor

Pulses of coherent light less than a trillionth of a second in duration have been produced for the first time in the laboratory. This is the claim of scientists at the United Aircraft Research Laboratories, East Hartford, Conn., who report that they used a technique similar to chirp radar to compress optical pulses in time to 0.4 picosecond—five times shorter than any previously reported—without appreciable loss of energy.

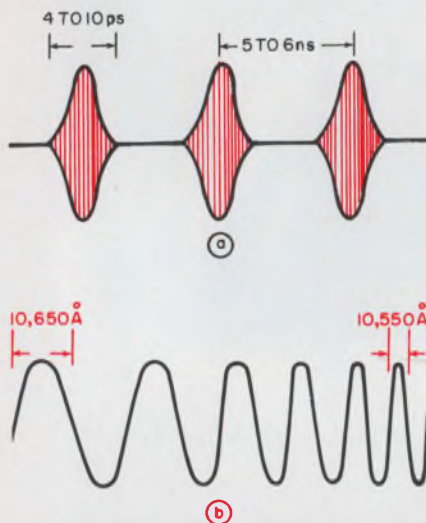

1. Nd:glass laser produces a train of picosecond pulses (a), each of which contains a number of wavelength components (b). The early-arriving pulses are of longer wavelength than the later.

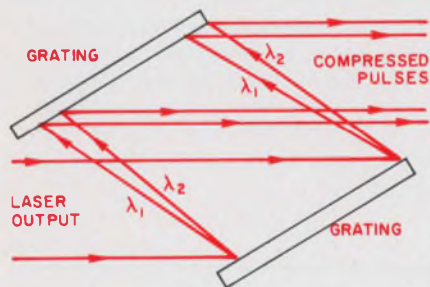

2. Facing diffraction gratings sort out wavelength components and delay the longer ones, relative to the shorter ones, as in chirp radar. This compresses the optical pulses to 0.4 picosecond.

Dr. Anthony J. DeMaria, head of United Aircraft's quantum physics group, points out that an optical radar or ranging system capable of generating such narrow spikes of light could have a resolution equal to the thickness of two or three pages from this magazine—even across a distance of many miles. This, he says, is thousands of times finer than the resolution of the best microwave radar.

"Years ago," DeMaria says, "the radar people couldn't propagate enough peak power without breakdown. They therefore hit upon the idea of using less power but peaking it up in narrower pulses. Well, all of the advantages of chirp radar carry over to the optical case."

Used in materials studies

A more significant, potential application for these ultrashort pulses, in DeMaria's opinion, is that they should permit precise observations of physical events to be made in an extremely small time scale. He suggests, for example, studies of certain nonreciprocal properties of materials: the optical spikes may be so brief that certain materials cannot respond to them at all. Scientists have already used this phenomenon to pass coherent light from a ruby laser through another ruby rod, even though the rod is ordinarily opaque to light of that wavelength.

The honor of breaking the picosecond barrier fell to Dr. E. Brian Treacy, a physicist in DeMaria's group. Scientists in several laboratories in this country and abroad had previously noted that, although neodymium-doped glass lasers have unusually broad bandwidths, the pulses actually obtained from mode-locked Nd:glass lasers failed to use the entire bandwidth—a typical pulse was anywhere from

4 to 10 picoseconds in duration; 10 or 20 times as broad as one would expect. On the other hand, according to Treacy, the pulse width for a ruby laser is exactly what it ought to be for the calculated bandwidth.

This discrepancy between theoretical and measured pulse width in the case of the glass laser suggested that the pulses were either amplitude- or frequency-modulated. According to Treacy, the laser produces a train of pulses that look like (a) in Fig. 1. Each pulse is of the form (b). The wavelength component at the start of each pulse λ_1 , is 100-to-200 angstroms longer than that at the end, λ_2 ; the change in frequency is linear with time and it is about one per cent of the center wavelength.

Treacy devised a scheme for compressing the pulses to a length that approached the reciprocal of the bandwidth. He passed them through a dispersive system that has a linear relation between time delay and wavelength.

How to get the pulses

The apparatus he used to produce the subpicosecond pulses consisted simply of a pair of blazed diffraction gratings—1200 lines per millimeter (Fig. 2) The gratings were set up so that their faces were parallel and the rulings aligned.

The laser beam strikes the first grating at an angle and is successively diffracted by the two gratings, in turn. Wavelength component λ_1 has to traverse a longer optical path than λ_2 . Therefore, it takes longer for λ_1 to emerge than it does λ_2 .

Compression takes place because path length increases with wavelength. The longer wavelength component, λ_1 , is retarded with respect to the shorter, λ_2 , so that the latter tends to catch up with the former. If the frequency sweep in the pulse is exactly linear, the resultant pulse is compressed to the

theoretical minimum; it is shorter, but of greater height (amplitude) than the original.

As the separation of the two gratings varies, the relative delay varies along with it. Treacy says that, typically, the relative time delay between two wavelength components, λ_1 and λ_2 , that differ by 100 angstroms, is about half-a-picosecond per centimeter of separation between the gratings. A 5-picosecond pulse input is changed from 10,650 to 10,550 angstroms within 5 picoseconds.

The gratings were set 10 centimeters apart, Treacy says. The correction due to the gratings was 5 picoseconds (equal to the original pulse length), and all of the

components emerged at the same time.

Soviets also involved

Work on ultrashort optical pulses has also been going on at Bell Telephone Laboratories in Murray Hill, N.J., and in France and the Soviet Union, DeMaria says. Russian scientists have reported attaining instantaneous peak powers of 100 billion watts or more from Nd:glass lasers.

A team of scientists from Bell Labs predicted that 0.4-picosecond pulses should be attainable. Their proposed technique, however, differs from the one that was successfully employed by Treacy in

that an optical Doppler shifter (an electro-optic crystal whose refractive index is modulated at an rf frequency that is equal to a multiple of the light-pulse repetition frequency and is phase-locked to it) is used for the linear sweep. In the Bell approach, the wavelength components of each pulse would be swept in such a way that those present at the beginning of the pulse will be at a higher frequency than those at the end. Passage of the beam through a dispersive medium, such as bromobenzene, will then cause the later components to catch up with the earlier ones, thus resulting in pulse compression. The bromobenzene acts like a radar delay line. ■■

A growing role for 'earth-shaking' electronics

Keeping tabs on the earth's vibrations is assuming major importance in our complex industrial society and is placing increased demands on a wide variety of seismic monitoring and alarm systems.

The vibrations range from the microseismic, between 0.1 and 200 Hz, to those large enough to cause structural failure of equipment and buildings. The periods extend from several cycles per second to oscillations lasting several hours.

In general, there are three elements in the measuring system: a transducer to pick up the vibrations, an amplifying unit to increase the signal level and a recording unit.

In buildings, accelerographs with all three elements in one package are used. For listening to ground or rock noises, a geophone, or earth microphone, is the transducer.

One leading equipment maker, Earth Sciences, a Teledyne company of Pasadena, Calif., notes that safety is an important factor in ground-shake monitoring in buildings. This is especially true in regions of the country where earth faults are present. For example, in Los Angeles and Beverly Hills, Calif.—where the San Andreas Fault poses a threat—the building codes require the installation of three strong-motion-accelerographs in all new buildings if they are more than six stories high and contain more than 60,000 feet of

office or living space.

These seismic sensors normally are installed in the basement, halfway up the building and at the top floor. If an earthquake occurs, strong enough to move an internal pendulum and make an electrical contact, the quake's vibrations are recorded. Evaluation of the records indicates whether or not the building has been damaged.

Seismic monitoring for tunnel construction has proved to be a "a tremendous step forward in underground rock work safety," according to Prof. Karl N. Hendrickson of the Dept. of Civil Engineering, University of Massachusetts. The rock noise is monitored by geophones, which are set up where trouble is expected and connected to a central guard station. When the noise level gets too high, the danger is signaled, anywhere from three to four hours to two days ahead of time.

Tilt phenomena—long-period vibrations of lower than 0.1 Hz—are of prime interest in the testing of large optical systems and other precise instrumentation. Vibrations from traffic or heavy machinery may also have adverse effects here. In most cases, these vibrations can be attenuated by an isolation system, but a seismic survey is needed to determine local vibration levels. If the disturbances cannot be quieted, the testing installation may be forced to move.

A prime example here is the

special optical test facility designed by Kollmorgen Corp., Northampton, Mass., for the Navy to test the Mark 11A star-tracker periscope used aboard Polaris missile submarines. In tests of the Mark 11A at the Northampton factory, it was found that the periscope, about 44 feet long, had a natural frequency in the test stand of about 2 Hz. This period matched the natural ground frequency of the industrial environment and prohibited conclusive testing.

A survey by the Alpine Physical Co. of Norwood, N. J., indicated that ambient seismic levels were prohibitively high. Subsequently an area survey located a remote site, a few miles away in Hadley, Mass., that was more than 1000 times quieter than the original plant. Here the Navy optical test facility, one of the most accurate in the world, was built.

Where microseismic vibrations are involved, the growing of large single crystals can be hampered by misalignment of atoms in the crystal-lattice structure.

Monitoring devices are also effective in countering lawsuits or damage claims that may result from blasting near populous areas. The ground-vibration levels measured are used to limit the size of the blasting charge, and the recorded ground-shock levels can indicate whether any damage claims are realistic. Such records are accepted as evidence in court. ■■

MAGNETICS

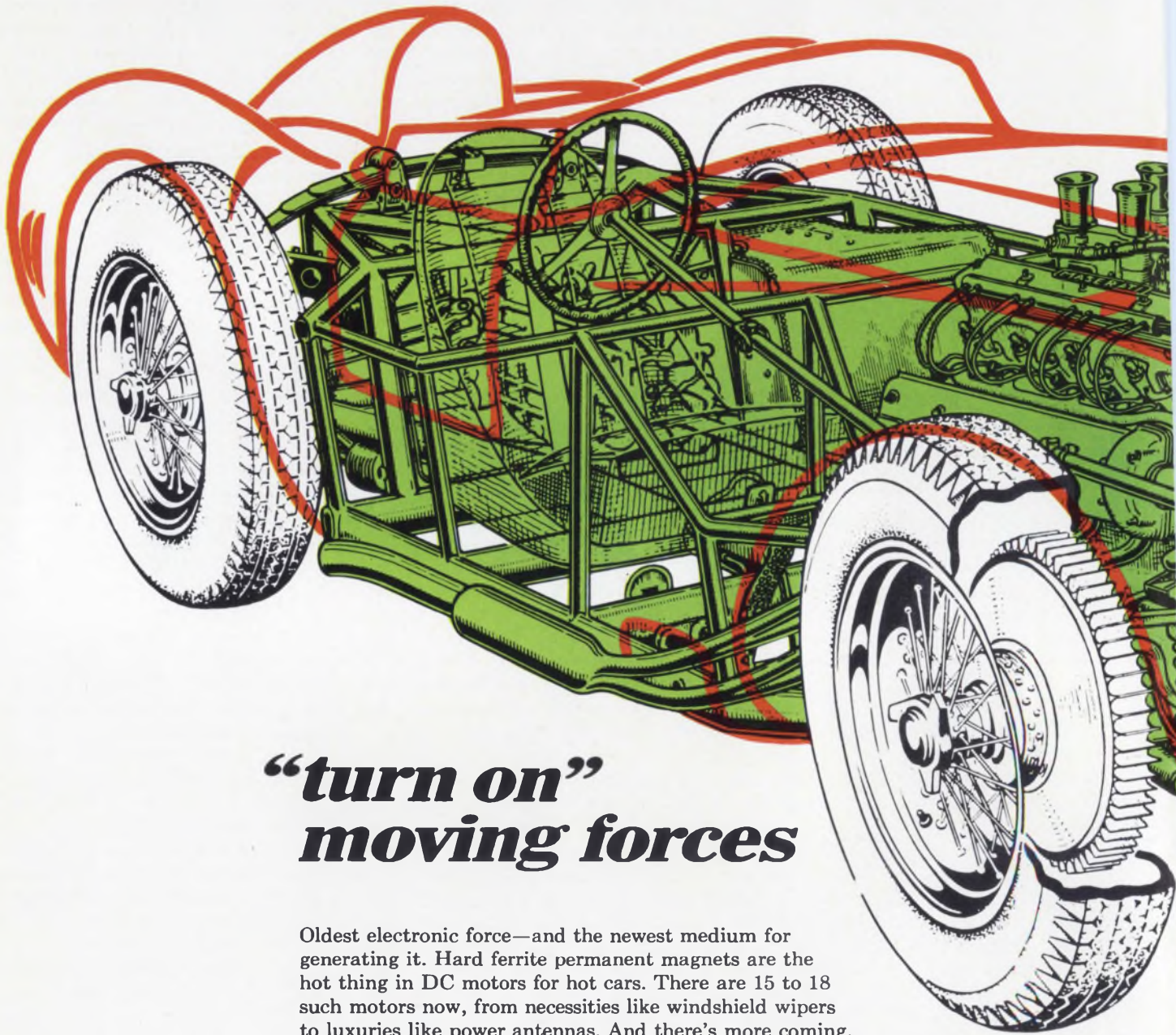

“turn on” moving forces

Oldest electronic force—and the newest medium for generating it. Hard ferrite permanent magnets are the hot thing in DC motors for hot cars. There are 15 to 18 such motors now, from necessities like windshield wipers to luxuries like power antennas. And there's more coming. Forward-looking manufacturers are now experimenting with hard ferrite starters and alternators. And, of course, forward-looking manufacturers look at Arnold for high-quality magnetic materials, design, technology, components. Magnetic cores. Powder cores. Laminations. Permanent magnets. You ask. We'll supply. The best in magnetic materials.

BY ARNOLD

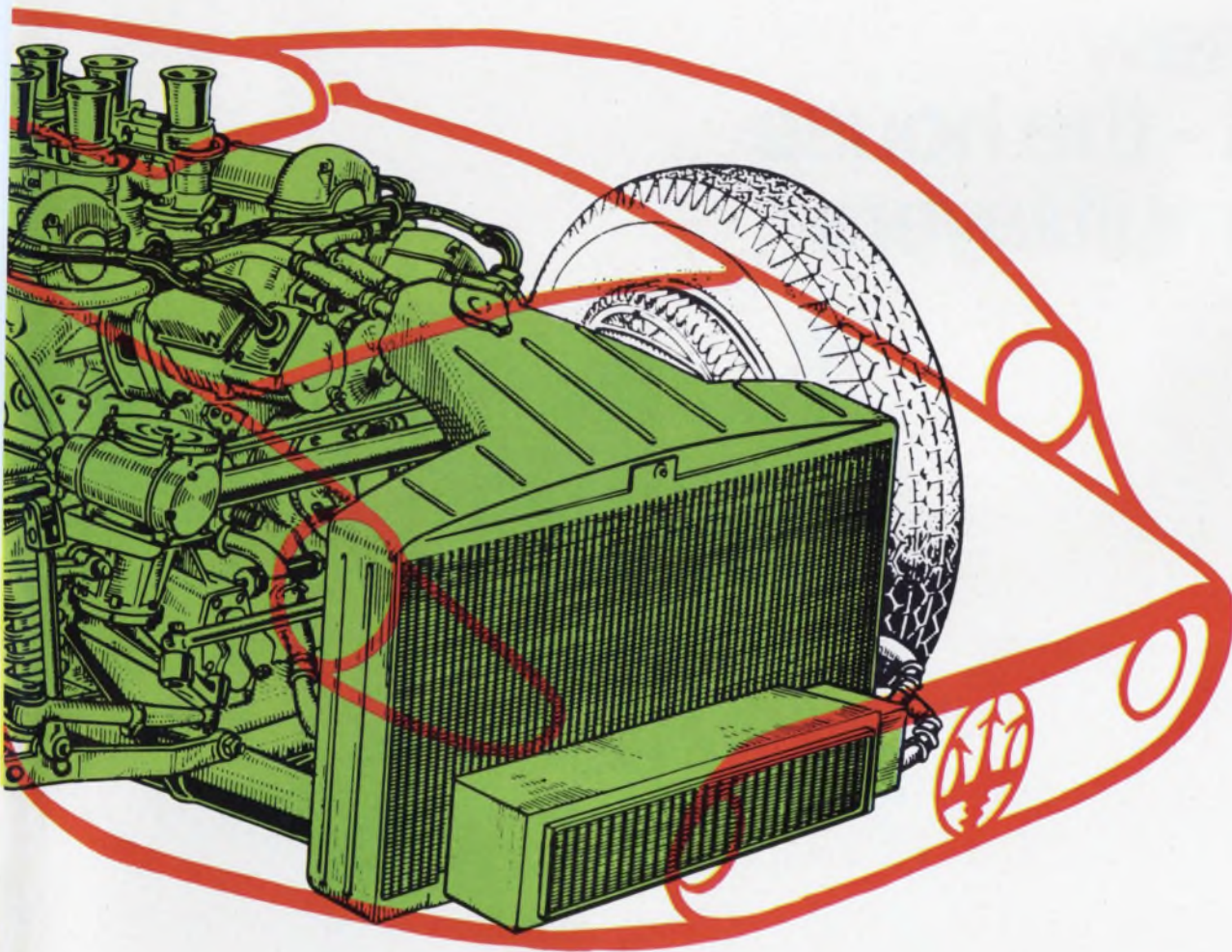

ARNOLD
SPECIALISTS IN MAGNETIC MATERIALS

The Arnold Engineering Company, Main Office: Marengo, Ill.
Branch Offices and Representatives in Principal Cities

In the average family car you'll find hard ferrite permanent magnets in windshield wiper motors • power windows • heater • defroster • rear window defogger • power seats • power antenna • air conditioner. Arnox I magnets collect metal chips in the transmission and differential. An Arnold Alnico magnet for loudspeakers helps the radio sound off.



Write for your free guide to the only complete line of magnetic materials.

INFORMATION RETRIEVAL NUMBER 25

We've expanded our plant for the fourth time and doubled our multilayer production.

We will now be able to produce more boards of all types, including higher density multilayer boards. Our present experience is 36 layers. Our new 24 x 40 fully automatic press will increase versatility and capacity. Our new equipment includes a 28-foot camera—largest and most precise in the industry. Together with our 18 foot camera this gives us unique capability. We're steadily expanding our engineering staff to meet our customer's needs.

If you know us by our record, that's all we need say.

If not, we'll add that we are known as the leader in the PC board industry.

Our story is quality. We hire the best people, train them our own way. NASA, the "mil spec" people, the big computer and consumer producers— they all come to us. They demand skill, reliability. They get it. We're busy, but we're always interested in additional challenges. There's room for another wing out back.

CINCH-GRAFIK

DIVISION OF UNITED-CARR

200 South Turnbull Canyon Road, City of Industry (Los Angeles), Calif. 91744 • Phone (213) ED 3-1201. Sales offices in 33 principal cities throughout the United States, Great Britain, Canada, Australia and West Germany.

Our new plant - the house that multilayers built.



MEMBER

CONSISTING OF CINCH MANUFACTURING COMPANY, CINCH-GRAFIK, CINCH-MONADNOCK, CINCH-NULINE, UCINITE (ELECTRONICS) AND PLAXIAL CABLE DEPT.



Moon mission at the crossroads

The next Apollo mission—Apollo 9, an earth-orbital flight scheduled to begin Feb. 28—will tell NASA whether or not to try for a lunar landing by summer. At stake will be critical tests for the lunar module (LM)—the odd-shaped vehicle that will be attached to the front of the moon spacecraft and be used to shuttle two astronauts to the surface of the planet and back to their spaceship again. Critical tests are planned of the electronics and the descent and ascent engines in the LM.

The LM has been a delaying factor in the program, but Grumman, developer of the module, reportedly has corrected all of its flaws, principally electronic or electrical. The LM-4 has completed its ground tests and is being mated with the other Apollo 9 segments for next month's flight.

When the lunar-landing mission is undertaken, a crew of three astronauts will first orbit the distant planet. Then two astronauts will crawl into the LM, separate it from the main craft and descend to the lunar surface, while the third crew member remains in orbit above. After explorations, the LM team will blast off into lunar orbit again and dock with the main spacecraft.

One LM has already been flight-tested successfully in an unmanned mission. But there was no separation or maneuvering of the module. Apollo 9 will be an open-ended test mission of up to 10 days and will involve vehicle separation from the Apollo command and service modules. This will provide docking experience.

F-14 winner due this month

The Navy has picked up speed in its contractor selection process for the planned F-14A fleet air-superiority fighter. It narrowed

Washington Report

CHARLES D. LAFOND
WASHINGTON BUREAU

the field from five to two last month by selecting Grumman Aircraft and McDonnell Douglas to continue in the contract-definition phase. This followed an evaluation of five engineering-development proposals submitted to the Naval Air Systems Command last Oct. 1. A single contractor to continue development will be selected this month, the Navy says.

Plans recently revealed by the Navy indicate a total purchase of nearly 470 aircraft, including six test vehicles. The unit price tag now envisioned is over \$7 million apiece. The competition for such large procurement has been very tight, but the two bidders will be forced to employ care at the negotiating table. The Navy is seeking a very binding combination fixed-price and fixed-price-plus-incentive-fee contract.

The aircraft will be 50,000-pound, swing-wing fighters carrying the fire-control system and much of the avionics already developed for the now defunct F-111B. The Navy reportedly would like to get the A version of the craft operational by 1972-3 and an improved B version by 1975-6. The improved model must await completion of a high-thrust engine under development for the Air Force F-15 fighter. It is also expected that the follow-on Navy aircraft will be provided with a highly advanced, multifunction array radar.

RADA system delivery near

The Army's Random Access Discrete Address (RADA) Communications System is nearing the end of its third-phase development program, and an operable system is due for delivery to Ft. Monmouth, N.J., in April. Under development for the Army Electronics Command by Martin Marietta's Orlando Div., RADA has been demonstrated in mobile operation at distances of up to 35 km between terminals, according to Charles Finnegan, program manager at the Orlando center.

RADA, a highly mobile communications system for use within an Army division, has automatic dialing for up to 2000 subscriber units. The equipment operates in the uhf band and has a basic channel width of 50 kHz. The present demonstration system consists of three subscriber units and one rather massive retransmission unit. The latter serves as the switching central for automatic message routing, and in a large system it would interconnect calls for relay where range extension is required.

The present retransmission unit employs 24 transmitters and 31 receivers (which include seven supervisory units). Computation and logic is provided by a Univac Model 1530. The subscriber unit, designed only for demonstration, weighs about 65 pounds and makes broad use of integrated circuits. However, Finnegan emphasizes that a production unit would weigh only 30 to 35 pounds and make extensive use of more advanced MOS devices.

Martin Marietta has proposed a "military potential test" for the equipment. This would call for field development of at least 30 subscriber units and two retransmission units. Multiscatter-condition testing and some helicopter-operation tests were performed at the Electronic Proving Ground at Ft. Huachuca, Ariz., in 1967. The present units are to complete their tests in Orlando next month.

Comsat gains a little, loses a little

December was an up and down month for the Comsat Corp. It successfully launched and placed into a proper orbit its large Intelsat III communications satellite. Meanwhile the 18-member Interim Communications Satellite Committee recommended to the 63 nation Intelsat Consortium that Comsat be replaced as manager of the global network.

Intelsat III-A is the first of four 1200-channel, active-relay vehicles that will be used by Intelsat to increase global circuit capacity. The first craft is in synchronous orbit off the east coast of South America. In February, April and July additional craft

are to be orbited over the Pacific, the Atlantic (near Africa) and the Indian Ocean. The Intelsat III series was developed and built by TRW, Inc.

Comsat's managerial efforts for Intelsat generally have been praised by consortium members, and Comsat vigorously sought to continue as the international system manager. However, an increasing number of member nations have expressed discontent with the mixed position of Comsat, since the organization, by its charter, must represent both the interests of the U.S. Government and its shareholders. To counter this conflict of interest, Comsat established early last year a separate Intelsat managerial group.

A formal meeting of the Intelsat members will be convened here Feb. 24 to establish future plans for the world organization. Should Comsat, in fact, be removed from its present role as manager, a question will automatically arise as to the responsibility for development of next-generation spacecraft. Intelsat IV is already being built for Comsat under a contract with Hughes Aircraft.

Two Navy research subs launched

The first two deep-diving research submarines to be built to military specifications were launched simultaneously last month at Groton, Conn. The Turtle and the Seacliff, built by the Electric Boat Div. of General Dynamics are 26-foot undersea craft capable of carrying three-men crews.

Designed purely for deep-water oceanographic studies (the Navy has not revealed their maximum operating depth), the subs can remain under water for up to eight hours. Each has television monitors, special cameras, sonar systems, a gyro compass and both surface and underwater communications systems.

Primary power is provided by battery-driven side propellers and a hydraulically driven steam propeller. Each craft has two hydraulically powered manipulator arms that can lift objects of up to 50 pounds. After testing, the Turtle will be assigned to the Atlantic Underwater Test and Evaluation Center in the Bahamas, and the Seacliff will be used at the Woods Hole Oceanographic Institute in Massachusetts for functional and reliability certification tests and for communications and navigation equipment tests.

whatever direction
your design takes...

Allen-Bradley thick film networks will put you out front in...

Packaging—Advanced manufacturing capability covers virtually every type and every configuration of resistive and/or capacitive networks—single or dual in-line, as well as flat-packs, with or without hermetic sealing.

Characteristics—Exclusive and patented formulations enable A-B to provide resistance values from 1 ohm to 5.0 megohm. Ratings to 20 watts/in² at 85°C. Capacitance values from 10 pfd to 0.5 mfd with voltage ratings to 50 volts. Applications include precision tuned circuits.

Performance—Standard resistance tolerance $\pm 10\%$. For critical circuitry, tolerances to $\pm 0.1\%$ can be furnished—with resistances and TC's matched. Temperature coefficient less than 250 ppm in all cases. Special units to 100 ppm or less. Load life stability of 1% in 10,000 hours can be achieved.

Reliability—Allen-Bradley has precise control over all raw materials and manufactures all basic components—glasses, organic materials, and substrates. Special machines—designed and built by A-B—assure uniform product quality—at a competitive price.

Timing—Allen-Bradley has unique in-plant ceramic facilities. Prototype networks—with or without holes—can be prepared to meet your specific needs. Quickly. Economically.

For more details, write Henry G. Rosenkranz, Allen-Bradley Co., 1315 S. First St., Milwaukee, Wis. 53204. In Canada: Allen-Bradley Canada Ltd. Export Office: 630 Third Ave., New York, N. Y., U.S.A. 10017.

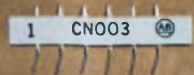
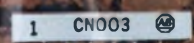

ALLEN-BRADLEY
QUALITY ELECTRONIC COMPONENTS

NEW O.E.M.

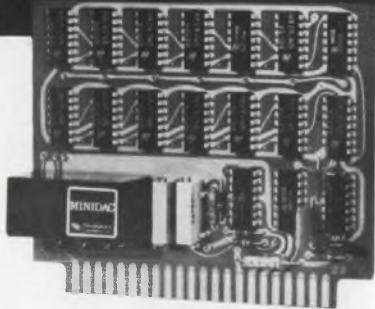

3 3/4" x 4 1/2" x 1/2"

A-to-D Converter

Pastoriza offers the
first utility converter for
systems applications . . .
priced for quantity sales.

Having first introduced the modular A-to-D and D-to-A converter, Pastoriza Electronics now offers an unprecedented innovation: A printed circuit card A-to-D converter featuring . . .

High Performance

- 12 bits conversion in 8 microseconds.
- 10 bits conversion in 4 microseconds.
- 8 bits conversion in 2 microseconds.

Low Cost

Priced competitively with any ADC available today, and designed for volume production.

Open Book Concept

No black magic in the design — circuitry is accessible and repairable.

User Confidence

Design and component information is supplied to insure ease and confidence in customer application.

This complete single-card A-to-D converter includes reference supply and comparison amplifier, using dual in-line integrated circuit logic with a MINIDAC D-to-A module. It accepts 0 to +10 volts input range, and provides up to 12 bits resolution.

Write for eye-opening facts on this newest modular A-to-D utility converter.

PASTORIZA
ELECTRONICS, INC.

385 Elliot St., Newton, Mass. 02164 • 617-332-2131

INFORMATION RETRIEVAL NUMBER 27

Going down to the sea again

For the last four and a half years, Military/Aerospace editor John F. Mason has been following the Navy's Sealab experiments—exciting advances in converting the bottom of the sea into a habitable place for work and relaxation. Soon, five nine-man teams of Navy divers will begin the longest, deepest and most sophisticated underwater living experiment attempted to date. Each team will live and work 12 days at a depth of 610 feet—a pressure equivalent to 20 atmospheres.

Mason, who has spent time at the Navy Mine Defense Laboratory in Panama City, Fla., where the divers for Sealab II were trained and much of the electronic equipment is built, brought himself up to date on Sealab III with visits to the Man-in-the-Sea Program headquarters in Chevy Chase, Md. and talks with Berry L. Cannon, the only electronics engineer/aquanaut in Sealab. Cannon gave Mason a firsthand account of some of the trials he encountered with the electronic equipment. Start reading on page 44.



Getting it firsthand: ED's John Mason, who met Engineer/Aquanaut Berry L. Cannon while covering Sealab II three years ago in Panama City, Fla., renewed acquaintances for the story on Sealab III.

Do it with diodes

Although the analog computer and the silicon diode have both been around for some time, the use of the diode in the analog circuit has long been considered impractical. James Raby and Ronald Embley, engineers at Electronics Associates, Inc., West Long Branch, N.J., are skeptics at heart. In their article "Log Diodes in Analog Circuits," page 58, they describe how the logarithmic characteristics of the silicon diode can be exploited to perform mathematical functions in analog circuitry.

ALLEN-BRADLEY

Metal-Grid resistor networks
combine a new measure of

precision, stability and performance in a sealed, compact package



Precision Metal-Grid resistor network shown
approximately 1½ times actual size

The advanced capabilities—developed from years of manufacturing Allen-Bradley Metal-Grid resistors—are now applied to a new line of resistor networks. This technology enables the production of complex resistive networks on a single substrate.

Allen-Bradley's exclusive simultaneous deposition method is used to obtain the best resistance tolerance and temperature coefficient matching. The reliability of interconnections on the common resistance plane is incomparable. Uniformity and quality are inherent in A-B networks. To illustrate, 2 PPM temperature tracking is normal.

A-B Metal-Grid networks offer a wide range of values—with individual resistances as low as 25 ohms and as high as 2.0 megohms. Both the inductance and capacitance are low, permitting efficient operation at high frequencies.

A-B engineers will be pleased to cooperate in developing networks for your specific need. For additional details, please write to Henry G. Rosenkranz, Allen-Bradley Co., 1315 S. First Street, Milwaukee, Wisconsin 53204. In Canada: Allen-Bradley Canada Ltd. Export Office: 630 Third Avenue, New York, N. Y., U.S.A. 10017.

BRIEF SPECIFICATIONS

Resistor Networks

Tolerances: $\pm 1.0\%$ to $\pm 0.01\%$
Resistance Matching: to 0.005%
Temperature Range: -65°C to $+175^{\circ}\text{C}$
Temp. Coef.: to ± 5 ppm/ $^{\circ}\text{C}$
Load Life (Full load for 1000 hr @ 125°C): 0.2% maximum change

Ladder Networks

Full Scale Accuracy: 10 bits or less, better than $\pm \frac{1}{4}$ least significant bit. More than 10 bits, better than $\pm \frac{1}{2}$ least significant bit.
Frequency Response: Less than 100 nanosecond rise time or settling time
Temp. Coef.: Less than 10 ppm/ $^{\circ}\text{C}$
Temperature Range: -65°C to $+175^{\circ}\text{C}$

ALLEN-BRADLEY
QUALITY ELECTRONIC COMPONENTS

new 4 WAY INDUSTRIAL CERMET

MODEL 3059



...with *BOURNS* Reliability Sealed in!

"4-way" means our new industrial Model 3059 is available in two printed circuit pin configurations of MIL-R-22097 (RJ-11 and RJ-12), as well as solder lugs and stranded insulated leads.

It was designed that way because as the newest member of the growing line of Bourns cermet potentiometers, it must — like every Bourns product — offer more by design and deliver more by performance.

The Model 3059 has a maximum temperature coefficient of 150 ppm/°C for all resistances; a power rating of 1.0 watt at 70°C, and an operating temperature range of -55 to +150°C. In addition, each unit is individually inspected for performance to guaranteed electrical and physical characteristics.

Complete technical data on the new industrial cermet Model 3059 potentiometer is available from the factory or your local Bourns field representative.



SPECIFICATION TABLE

Standard Resistance Range	10 ohms to 1 megohm
Resistance Tolerance	±10%
Power Rating	1.0 watt
Operating Temperature Range	-55 to +150°C
Temperature Coefficient	±150 ppm/°C maximum*
Seal	Mil-Spec immersion
Terminals	RJ-11 and RJ-12 Printed Circuit Pins, also Solder Lugs and Stranded Insulated Wires.

*100 ppm/°C available



BOURNS, INC. TRIMPOT PRODUCTS DIVISION
1200 COLUMBIA AVENUE RIVERSIDE, CALIFORNIA 92507
714 684 1700 • TWX 910 332 1252 • CABLE: BOURNSINC

Publisher

Hugh R. Roome

Editor

Howard Bierman

Managing Editor

Robert C. Haavind

Technical EditorsFrank Egan
Michael J. Riesenman
Raymond D. Speer**Management and Careers Editor**

Lawrence Locke

News Editor

Ralph Dobriner, Chief

Washington News Bureau

Charles D. LaFond, Chief

Military/Aerospace Editor

John F. Mason

East Coast Editor

Jim McDermott

West Coast Editor

Elizabeth deAtley

New Products EditorsRobert Patton
Lucinda Mattera**Copy Editor**

Peter Irving

Editorial ProductionDollie S. Viebig
Phyllis Gura**Art Director**

Clifford M. Gardiner

Art Assistant

William Kelly

Technical IllustratorsWilliam Alvarez
Rita Jendrzewski
Lynn E. Thompson**Production Manager**

Thomas V. Sedita

Asst. Production Manager

Helen De Polo

Production AssistantsBernard Wolinsky
Carl A. Merkin**Circulation Manager**

Nancy L. Merritt

Information Retrieval

Genate Pazmino

EDITORIAL



Take a tip from an old slogan: "The customer is always right."

Countless businesses are prospering today because their people adhere to a simple credo: "The customer is always right."

In the electronics industry it's surprising to find how many men have risen to top positions despite their "obvious" personality flaws or weaknesses in education.

Listen to one such fellow—a top manager—sum up *his* formula for success:

"I went out and found what the customers needed. And then, when they got in a bind, I got on it right away, all night long or on weekends. If they needed the stuff, I got it to 'em."

This man today heads a significant group in a large electronics firm. He enjoys an enviable reputation as a straight shooter—a guy who delivers the goods, among an elite group of influential purchasers.

Unfortunately, his attitude is not prevalent among design engineers.

Ability to manipulate a matrix or to pick signal from noise is certainly valuable—but it doesn't necessarily lead to a satisfied customer: *Does the product indeed do what he, the customer—not just you, its designer—wants it to do?* And does he get service when he needs it?

Humbleness is required here. The designer who gets a true feel of user need into his creations will immediately have the competitive edge. But in order to do this the engineer must respect the users. He has to get out and observe some of the users of his designs, listen to them, learn how they feel about things. Hopefully, a prototype of the product will be used in the field under "real-world" conditions, before the design is frozen.

A few years back, the discipline called "human factors" was developed. The emphasis here, though, was directed to the height of the eyes and the reach of the left hand. Not that these factors aren't important. They are. But they are the "engineering" kinds of things that get you only half-way home, the sorts of things you can put a tape measure to.

It wasn't so very long ago that electronics was used almost exclusively by electronics people. Today, the fruits of electronic technology are spreading throughout our society. There are new things that designers must learn about.

How do little kids learn? What would an accountant like to be able to do with computers that he can't do today? How does a housewife view the controls on her washing machine? Why do air controllers get tired and make mistakes?

These sorts of questions require an open mind and the willingness to get out and meet the end-users of the products being designed.

ROBERT HAAVIND

variable viewing time 5 cm/ μ s stored writing speed

split-screen displays

all in the Tektronix Type 549 Storage Oscilloscope

Waveform display showing train of pulses. Upper screen in the stored mode shows three pulses with falltime of the pulse trailing edge showing system deficiency. Lower screen in conventional display mode shows the same pulse train with corrections applied to provide a well formed pulse shape. Pulse width shown is 8 μ s with risetime of 0.1 μ s. Vertical deflection factor is 0.5 volts/cm. Horizontal deflection factor is 10 μ s/cm. Repetitive sweep used for both displays.

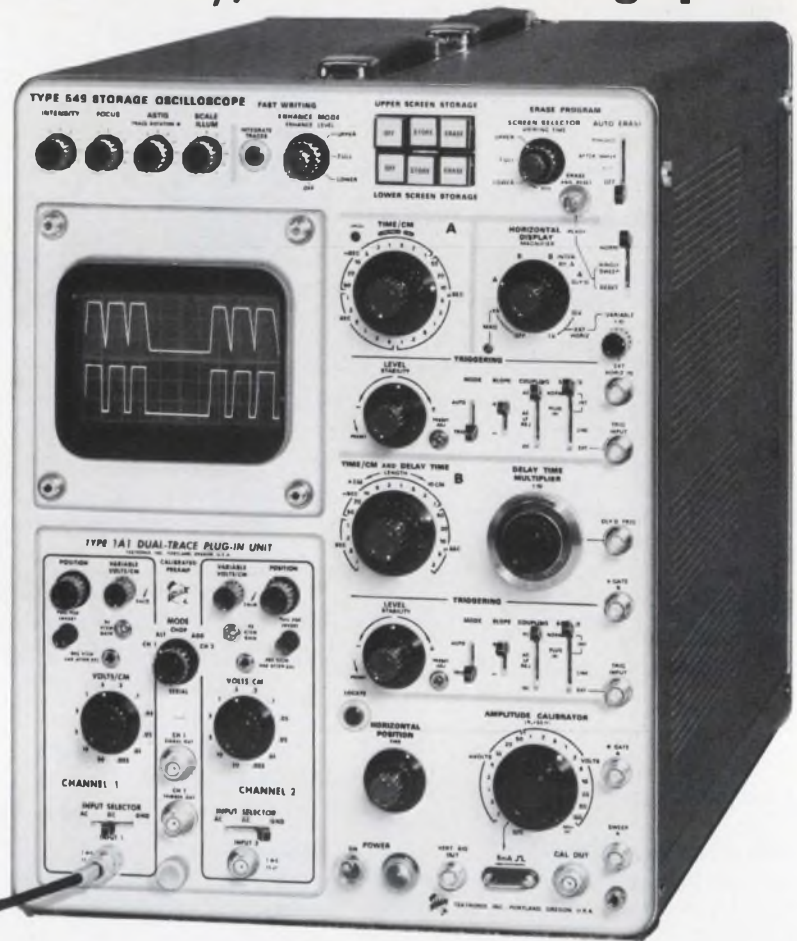

The Type 549 allows up to one hour of continuous visual storage, giving you ample time in most applications to measure and analyze stored waveforms. Stored displays can be erased in less than one-quarter of a second.

Split-screen displays

Unique with Tektronix storage oscilloscopes, split-screen displays bring you many advantages in waveform-comparison applications. You can use either half of the 6 cm by 10 cm display area for stored displays, the other half for nonstored displays, with independent control of each half. You can also use the entire screen for either type of display.

Variable viewing time

Variable viewing time — an outstanding feature of the Type 549 — allows you to automatically store displays, view them for a selected time, then automatically erase them on either or both halves of the screen. Two modes of operation are possible. In the After-Sweep Automatic Erase Mode, the selectable viewing time of 0.5 s to 5 s begins at the end of each complete sweep. After the viewing time, the display is automatically erased and the cycle begins again when the next sweep is triggered by a signal.

In the Periodic Automatic Erase Mode, the sequence of storing, viewing time and erasure is continuous and independent of the sweep or signal. In this mode, the viewing time can also be varied from 0.5 s to 5 s.

There is no degradation of stored traces during the selected viewing time, in either mode, and you can retain or erase displays manually whenever desired.

For a demonstration, contact your nearby Tektronix field engineer or write: Tektronix, Inc., P.O. Box 500, Beaverton, Oregon 97005.

Bistable storage advantages

With bistable storage oscilloscopes, such as the Type 564 and Type 549, the contrast ratio and brightness of stored displays are constant and independent of the viewing time, writing and sweep speeds, or signal repetition rates. This also simplifies waveform photography. Once initial camera settings are made for photographs of one stored display, no further adjustments are needed for photographs of subsequent stored displays.

Tektronix bistable storage cathode ray tubes are not inherently susceptible to burn-damage and require only the ordinary precautions taken in operating conventional oscilloscopes.

Plug-in unit adaptability

Vertical deflection characteristics of the Type 549 are extremely flexible through use of any of the Tektronix letter- or 1-series plug-in units. These include multi-trace, differential, sampling, and spectrum analyzer units. Depending upon the plug-in being used, bandwidth of nonstored displays extends from DC to 30 MHz.

Among other features of the Type 549 are 5 cm/ μ s stored writing speed, calibrated sweep delay from 1 μ s to 10 s, sweep speeds to 20 ns/cm, amplitude calibrator from 0.2 mV to 100 V and a locate zone for easy positioning of stored traces.

Type 549, without plug-in units \$2575

Type 1A1 Dual-Trace Plug-In Unit \$ 625

DC to 30 MHz at 50 mV/cm; DC to 23 MHz at 5 mV/cm.
2 Hz to 14 MHz at 500 μ V/cm, single-channel.

U.S. Sales Prices, FOB Beaverton, Oregon



Technology

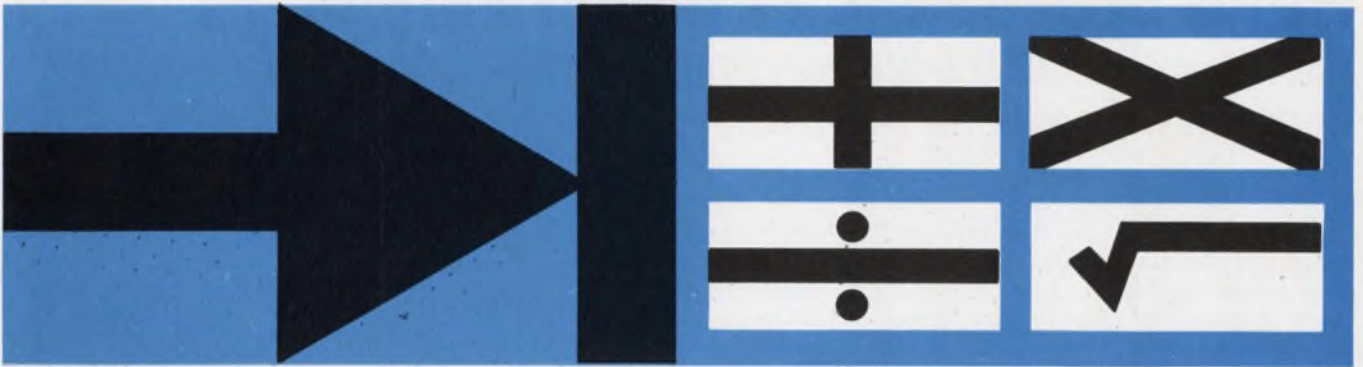

Log diodes are versatile components in analog computation circuits. They can be used

for raising to powers, or for multiplication and division. Page 58

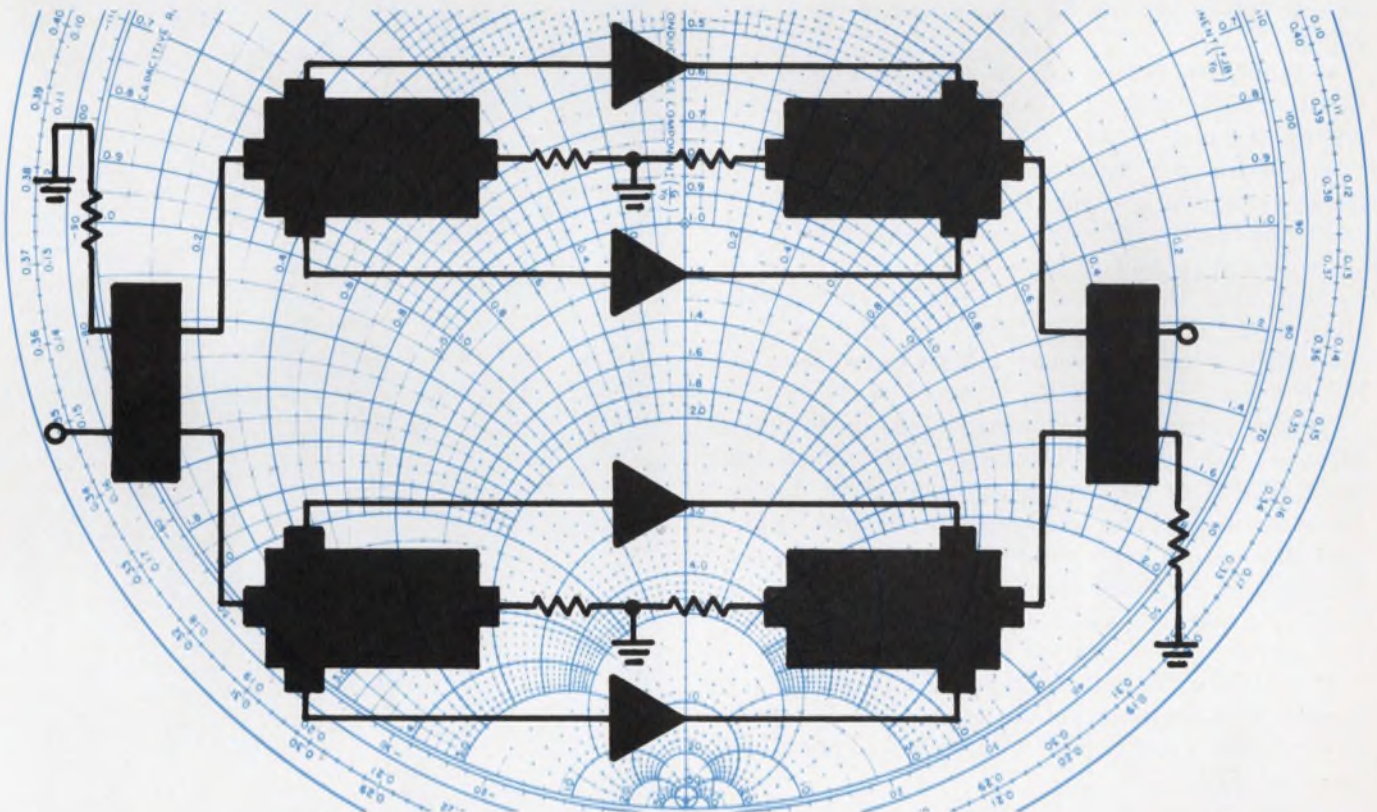

Broadband matching is the big problem in designing wideband transistor power ampli-

fiers. Solve it with filters, ferrite transformers and hybrids. Page 50

Also in this section:

Build a programmable word generator with MOS ICs. Page 62

Ideas for Design. Page 76

Build broadband rf power amplifiers.

Use filters, ferrite transformers and hybrids to provide broadband matching for your transistors.

The big problem in designing broadband transistor power amplifiers is not in obtaining suitable active devices, but, rather, it is in matching these devices to their drive sources and loads over a desired wide range of frequencies. Such broadband matching is difficult because large-signal input and output equivalent circuits of a typical rf power transistor are reactive networks—not pure resistances (see Fig. 1).

At the input, where the problem is most severe, a solution can be approached in these two ways:

- Bandpass filters can be used to match the input impedance to a 50-ohm line or to the output of a driver stage.

- Quadrature hybrids may be employed to isolate the driver from the returned mismatch power of the transistors, provided that the power transistors are used in pairs. This is not the same as matching the power amplifier to the driver, since some of the input power is dissipated in the hybrid's load. However, it does have the same result—low input VSWR.

At the output, the problem is easier to solve because the output elastance can often be neglected, at hf and vhf. A simple ferrite transformer can then be employed to set the output load line over a very wide bandwidth. At higher frequencies, in those cases when it can't be neglected, a parallel inductor or a filter similar to that on the input can be used.

But before we get involved with the output circuit, let's go back to the input and see what kind of filters are needed to match an impedance like that of Fig. 1a.

Match the input

In studying the input equivalent circuit, we should note that the value of R is dependent on the frequency, the collector loading, the drive level, the circuit inductance and on temperature.

James A. Benjamin, Engineering Specialist, ITT Semiconductors, West Palm Beach, Fla.

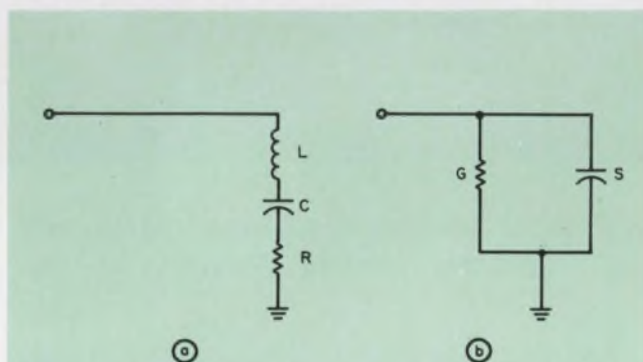

1. The large-signal equivalent circuits for the input (a) and output (b) of a typical rf power transistor contain both resistive and reactive elements. The circuit is a common emitter configuration with a series R-L-C equivalent for the base (input) and a parallel conductance-elastance equivalent for the collector (output).



2. The large-signal input impedance of an ITT 3TE445 transistor is shown by curve (a) from 225 to 400 MHz. In (b), the effect of putting a capacitor in series with the base is shown. Curve (c) results when a shunt pole (Fig. 3) is added. All curves are normalized to a 1-ohm line.

The frequency and output circuit dependence can largely be removed by unilateralizing the device through some form of broadband neutralizing.

C, the large-signal base-emitter junction capacity, is quite drive-sensitive. If the amplifier is to operate at various drive levels—as would the final amplifier in an a-m transmitter—this capacity must be known over the full range of drive levels that will be encountered.

L is the series parasitic inductance of the package. It is the major bandwidth-reducing element in the transistor, about which something can be done. Typical values for *L* are: 10 nH for a TO-5; 4.5 nH for a TO-60, and 1 to 3 nH for the various stripline packages. Since these values are all dependent upon the circuit and layout, they should be measured in a condition that is as close as possible to the actual operating environment.

The resonant frequency of the input circuit may, or may not be, in the band of interest; however, this is not relevant to the matching problem. The important point here is to realize that it is not a resistive load that must be matched but rather a reactive network with a *Q* of between 1 and 5. Consequently, our matching network, itself, should have reactive components. Fortunately, this same problem was faced and solved some years ago by persons working on antenna problems, and we may draw on their experience here.

If the circuit to be matched is a reactive network, it cannot be perfectly matched over a band of frequencies. In fact, if it is perfectly matched at any frequency within the band, the performance over the rest of the band will be degraded. The best that can be done is to design a circuit that will not exceed a certain VSWR across the band. The value of this VSWR will depend on the bandwidth and on the device *Q*.¹⁻⁴

Realizing this; knowing that any deviation from a perfect match will mean a reduction in gain, and keeping in mind that mismatches on the input can cause problems in the driver circuit, how then does one proceed?

One might begin by studying a Smith Chart plot of the impedance in question. In Fig. 2, curve *a* is such a plot, normalized to a one-ohm line; it shows the large-signal input impedance of an ITT 3TE445 transistor from 225 to 400 MHz. This plot is essentially what one would expect from the circuit of Fig. 1a.

If a capacitor is placed in series with the base of the transistor, so that it shifts the resonant point to midband (also raising the *Q*), the plot then becomes symmetrical (Fig. 2, curve *b*).

Now, if a shunt pole of the right value is added (Fig. 3), the impedance plot appears as in curve *c* of Fig. 2. Transformation of this result along a quarter-wave transmission line re-

sults in the plot of curve *a* of Fig. 4. Finally, adding a series zero (Fig. 5) yields curve *b* of Fig. 4.

Note that the VSWR does not exceed 2.4 across the band. This corresponds to a reflection loss of only 0.75 dB.

The fly in the ointment, at this point, is that some of the component values needed for the input filter (for this circuit is really a bandpass filter⁵) may not be physically realizable. The shunt pole in question, for example, should con-

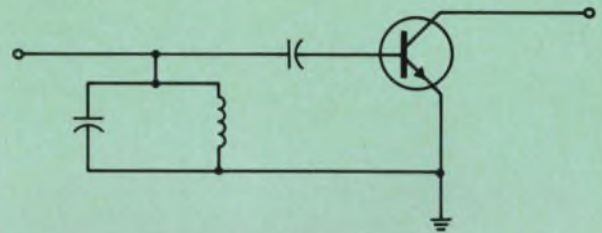

3. The shunt pole and series capacitor on the input of this transistor combine to modify its large-signal input impedance as shown in Fig. 2.

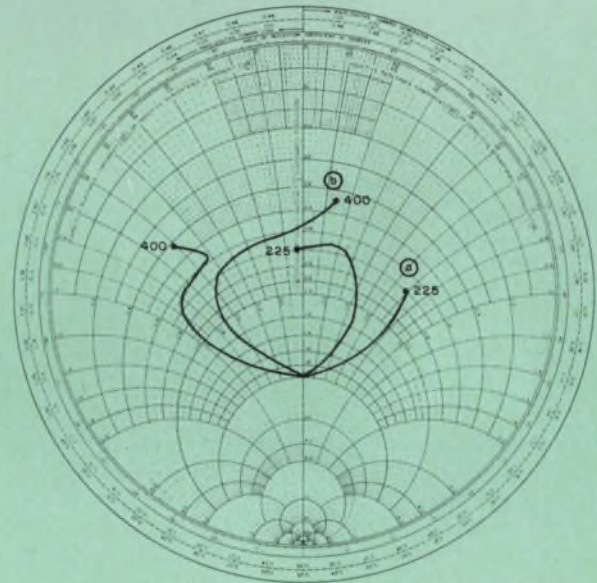

4. A quarter-wave line transforms curve (c) of Fig. 2 to curve (a) above. Then adding a series zero (Fig. 5) tightens up the curve as shown in (b). Curve (b) is normalized to a 12.5-ohm line and exhibits a maximum VSWR of about 2.4.

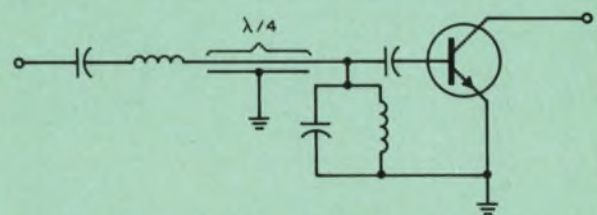

5. The series zero and quarter-wave line added to the circuit of Fig. 3, have transformed the input impedance to that of Fig. 4b.

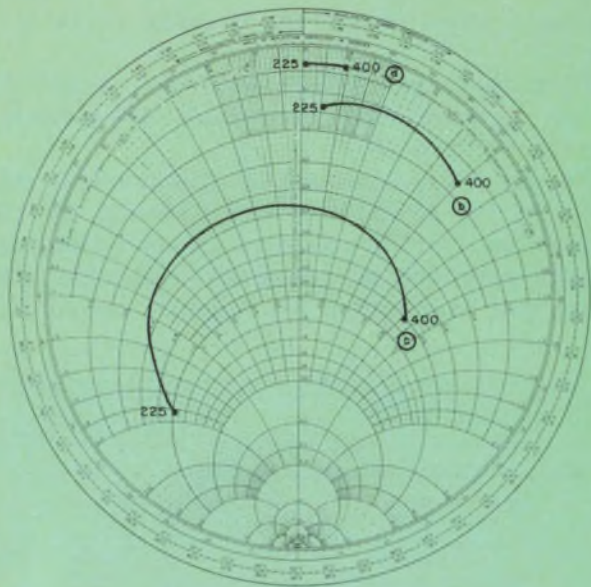

6. The large-signal input impedance of an experimental 3TE467 transistor is shown in curve (a) from 225 to 400 MHz. Curve (b) shows the result of placing a 4:1 impedance transformer in the base circuit. Curve (c) shows the effects of two cascaded transformers with a coupling capacitor. The capacitor value has been chosen to allow a degradation in VSWR at the low end of the band to compensate for the increased device gain there. The curves are normalized to a 50-ohm line.

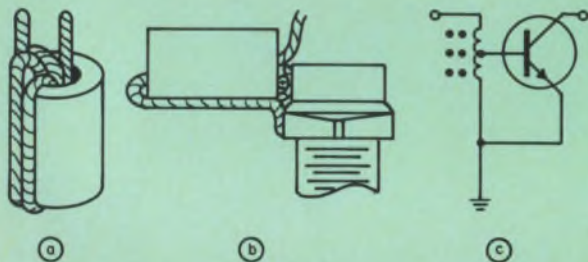

7. What could be simpler than this ferrite auto-transformer (a)? To eliminate undesired parasitics, a special mount was designed to get the transformer right up close to the transistor (b). The schematic representation of this circuit is shown in (c).

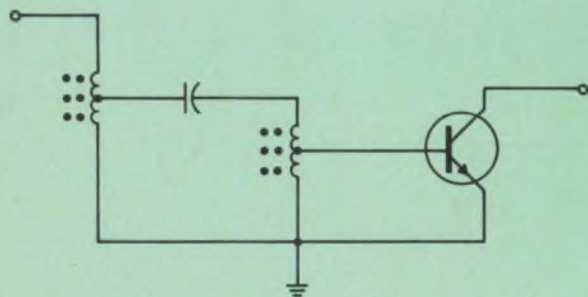

8. Two transformers coupled with a capacitor not only provide a large transformer ratio, they allow gain compensation as well (Fig. 6c).

tain a 1000-pF capacitor and a 0.3-nH inductor. The way out is to utilize a mathematical entity that has only recently been developed by engineers: the ideal transformer.^{6,7}

Ferrite transformers make a good match

To see how the transformer can be used, let's consider the problem of matching an experimental transistor, the 3TE467. The series $L-C-R$ values (Fig. 1a) for this transistor are 2.8 nH, 210 pF, and 2.0 ohms. The Smith Chart plot of this impedance, normalized to a 50-ohm line, is shown in curve *a* of Fig. 6. Curve *b* shows the effect of adding a 4:1 impedance transformer, wound of low-impedance (7-ohm) twisted wire on a ferrite bead. The construction and mounting techniques for this transformer are shown in Fig. 7.

Now, if we add a series capacitor and a second 4:1 autotransformer, we can play some games with the capacitor value to compensate for the increase in transistor gain at the low end of the band. Figure 8 shows the circuit, and curve *c* of Fig. 6 shows the new impedance plot. The VSWR at 225 MHz was purposely allowed to roll off to compensate for the device-gain variation, as we have just discussed. It is important that this gain compensation be accomplished at the input to the transistor—attempts to mismatch the output may destroy the device.

The insertion gain of the two-transformer amplifier stage of Fig. 8 is shown in Fig. 9.

Although we have now transformed the impedance of the transistor to a workable level, and although we have compensated for the gain variations, the input is not very well matched: the VSWR varies from about 2.0 to 5.0 over the band.

This problem can be solved by using the transistors in pairs and combining them in quadrature hybrids.^{7,8} The quadrature hybrid has this property: if both stages are reasonably similar, the input port is isolated from the returned mismatch power of the networks. The mismatch power is dissipated in the load on the fourth port and is manifested as a reduction in gain.

To see how well-isolated the input port really is, four stages like that of Fig. 8 were constructed and combined, two-at-a-time, with Magic-T hybrids, to form a pair of 5-watt amplifiers. These, in turn, were next combined by using a pair of quadrature hybrids to yield the 10-watt amplifier of Fig. 10 with the input characteristic of Fig. 11.

While this is an excellent match for the driver, a problem still exists for the pre-driver. This was overcome by matching the driver to the pre-driver with the bandpass filter technique that we discussed earlier. A pair of the same transistors was used as the driver and compensated with the filter scheme. An autotransformer was added to

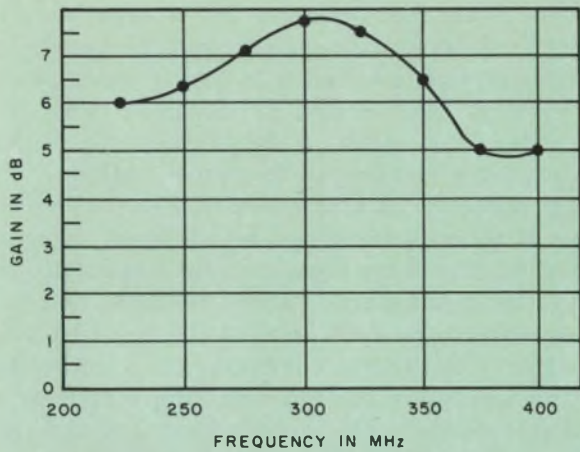

9. The insertion gain of the amplifier stage of Fig. 8 is plotted at an output power of 2.5 W. The 3TE467 was operated at a V_{ce} of 12.5 V.

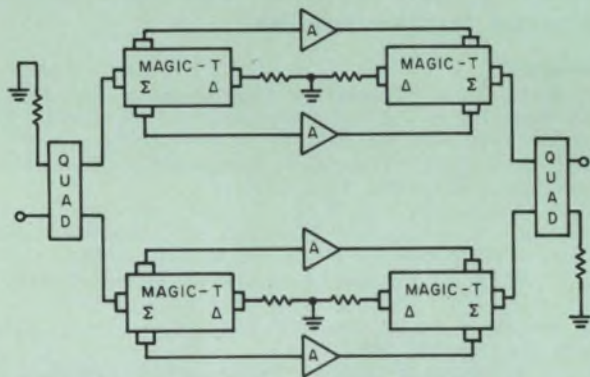

10. Four transistors are combined using four Magic-T hybrids and two quadrature hybrids. Each amplifier module, labeled A, contains a circuit like that of Fig. 8.

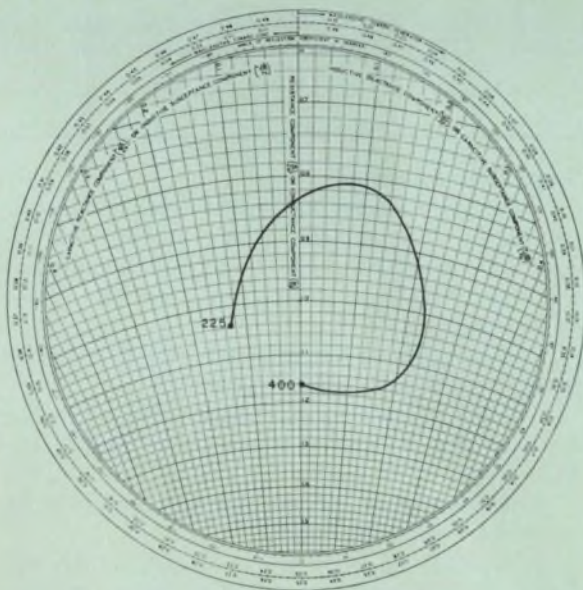

11. This expanded Smith Chart shows the excellent isolation provided by the hybrids in the circuit of Fig. 10.

the front end for matching to a 50-ohm line. With this setup, an over-all VSWR of less than 2.0 was obtained, and 1.5 should be possible with more careful compensation.

A further lowering of the input Q can be obtained, at least into the vhf region, through broadband neutralization. The scheme shown in Fig. 12a has produced excellent results. Curve a of Fig. 13 is the large-signal input impedance to an ITT 2N5423, before neutralization, while curve b is the input after neutralization. As can be seen, the real part of the input impedance has been increased two to three times; that is the circuit Q has been lowered 50 to 60 per cent.

The phase-reversing transformer and capacitor provide an out-of-phase voltage equal to that fed back through C_{ob} . Since the instantaneous value of C_{ob} is a function of the collector voltage, perfect neutralization over the entire rf cycle is not possible. However, adjustment at the highest power level at the highest frequency holds up well. Figure 12b shows a possible scheme for including the neutralization winding in the output transformer.

Get the power out

Referring to Fig. 1b, we see that the large-signal output admittance may be represented as a parallel conductance-elasticance combination. The conductance, G , is approximately given by:

$$G = 2P_o / (V_{ce} - V_{sat})^2$$

and is essentially independent of the transistor.

The elastic susceptance, B , is given by:

$$B = 2\pi f(2C_{oe}),$$

where C_{oe} must be measured at the operating voltage. This equation holds true for frequencies that are less-than-half of the cutoff frequency, f_T . As cutoff is approached, the value of B tends to remain constant with frequency. In other words, the large-signal value of C_{oe} tends to decrease with frequency. It has been suggested¹¹ that this is caused by the fact that, as f_T is approached, the emitter-base junction never shuts off. Consequently, the angle of collector flow changes. Since the average value of the large-signal output capacitance is dependent upon the average charge in the junction, the C_{oe} will become frequency-dependent just as does the conduction angle.

Since the output load line is dependent only on the power output and operating voltage, a simple ferrite autotransformer can set the load line over an extremely wide range of frequencies, providing that C_{oe} can be neglected. This is possible in the hf and vhf regions.

If C_{oe} were to pose a problem, a filter similar to that on the input could be used or, perhaps, a parallel inductor resonant with C_{oe} at the high end of the band would be sufficient; whatever is used should open-circuit the harmonics or effi-

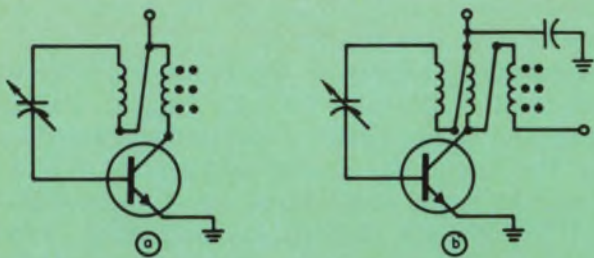

12. Broadband neutralization can be achieved by combining a ferrite transformer and a capacitor in a feedback circuit (a) to cancel the voltage fed back through C_{ob} . It is also possible to include the neutralization winding in the output transformer (b).

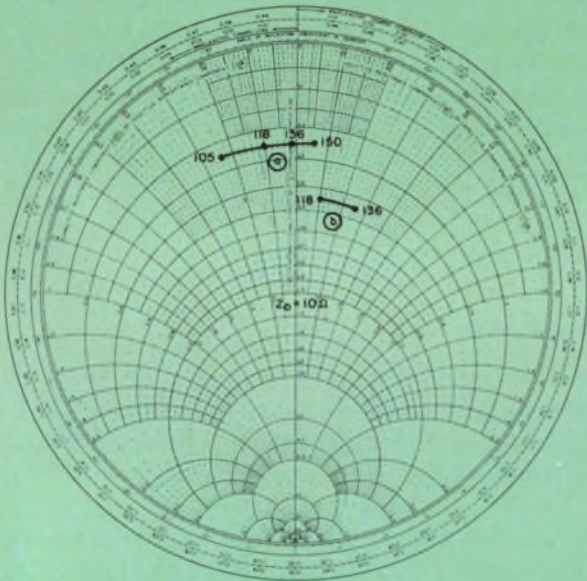

13. The effect of neutralization on the input impedance of a 2N5423 transistor is evident in this before, (a), and after, (b), chart. The real part of the input impedance has been increased 2 to 3 times.

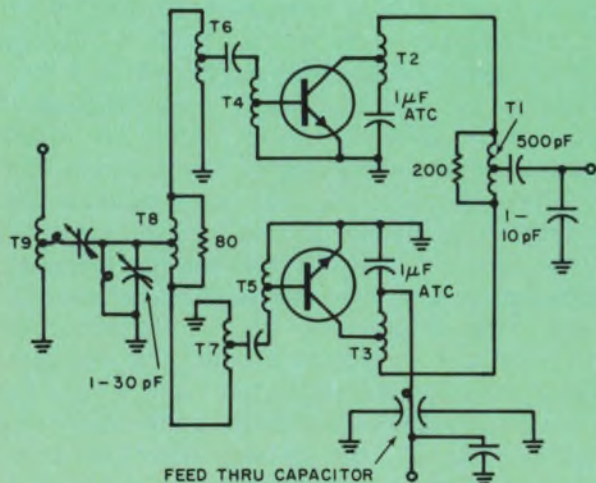

14. This 5-watt amplifier spans 225 to 400 MHz. Its gain is shown in Fig. 9 and its efficiency varies between 45% and 50% across the band. Transformers T1 and T8 are Magic-T hybrids which can combine the power from the two transistors while keeping them isolated from each other.

ciency will suffer.

There is no real necessity for a tank circuit, as such, since enough energy can be stored in the transformer inductance to supply the missing half-cycle in Class B and C operation. The efficiency need not suffer if the harmonic energies are reactively terminated in proper fashion.

This approach is illustrated in Fig. 14, which is one of those 5-watt amplifiers that we discussed earlier. The large-signal output impedance of each of the transistors is about 25 ohms, and the 4:1 transformers (T2 and T3) bring these to 100 ohms. The hybrid combiner (T1) combines the two amplifiers and presents the output at a 50-ohm level. T8 is the input hybrid, and the two pairs T4-T6 and T5-T7 are the cascaded impedance transformers that we discussed earlier.

The two 1- μ F capacitors labelled ATC are special low-inductance units made by the American Technical Ceramic Co. They are used as dc blocks to permit biasing the transistors through the output transformers. ■■

References:

1. R. M. Fano, "Theoretical Limitations on the Broadband Matching of Arbitrary Impedances," *Journal of the Franklin Institute*, Vol. 249, No. 1, Jan. 1950.
2. R. L. Tanner, "Theoretical Limitations to Broadband Matching," *Electronics*, Feb. 1951.
3. H. Vassiliadis and R. L. Tanner, "Evaluating the Impedance Broadbanding Potential of Antennas," *IRE Trans. on Antennas and Propagation*, July, 1958.
4. H. W. Bode, *Network Analysis and Feedback Amplifier Design*, New York: D. Van Nostrand, 1945.
5. *Handbook of Electrical Filters*, White Electromagnetics, Inc., pp. 155-160.
6. C. L. Ruthroff, "Some Broadband Transformers," *Proc. IRE*, Aug. 1959, pp. 1337-1342.
7. James Benjamin, "Use Hybrid Junctions for More VHF Power," *ELECTRONIC DESIGN* (ED 16), Aug. 1, 1968, pp. 54-59.
8. C. G. Montgomery, R. H. Dicke and E. M. Purcell, *Principles of Microwave Circuits*, New York: McGraw-Hill, 1947.
9. J. G. Tatum, *VHF/UHF Power Transistor Amplifier Design*, ITT Semiconductor Application Note, 1967.

Test your retention

Here are questions based on the main points of this article. Their purpose is to help you make sure you have not overlooked any important ideas. You'll find the answers in the article.

1. Over how wide a band can a reactive network be perfectly matched?
2. How would you compensate for the transistor's fall-off in gain at high frequencies?
3. Under what conditions can hybrids be used for input isolation?
4. Discuss at least one method for broadband neutralization of a power transistor.
5. What two factors are the principal determinants of the output load line of an rf power transistor?

What is the life of a good aluminum capacitor?

Sample #7, shown below, survived 100,000 hours. It is one of a group of computer grade aluminum electrolytic capacitors that we put under test back in 1957.

All capacitors were operated at rated DC working voltage, surge voltage, ripple current and temperature range found in typical computer type power supply circuits.

Sample #7 works almost as well today as it did eleven years ago.

Mallory capacitors enjoy long, reliable life because they are built to exacting standards and tested for surge voltage, vibration resistance, container seal tightness, shelf life, and capacitance, ESR, DC leakage current

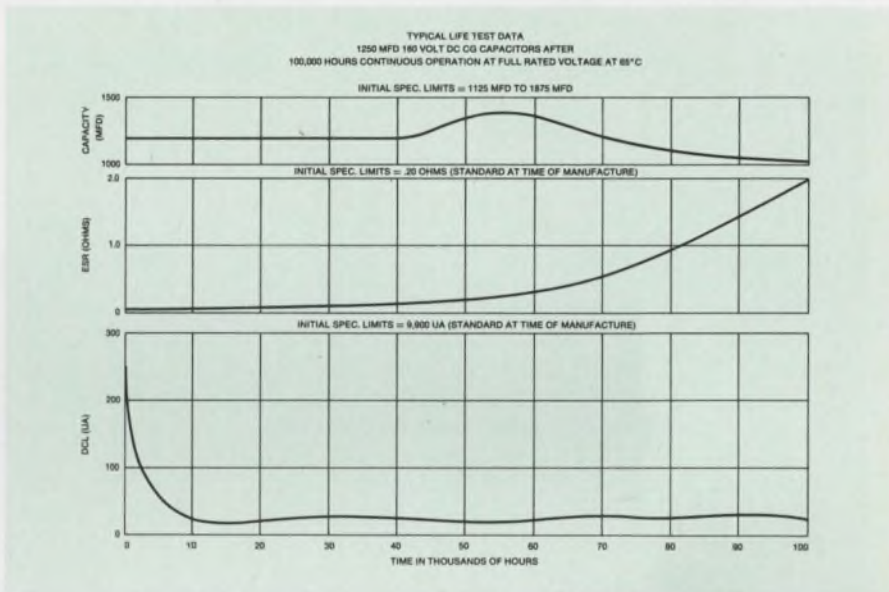

and electrolyte leakage.

All Mallory CG capacitors should have a useful life of about ten years, when operated at specified conditions. They will last even longer if derated in one or more operating conditions.

Temperature Range

CG capacitors are designed to operate within a range of -40°C to $+85^{\circ}\text{C}$. They have been tested at 105°C at less than rated voltage without immediate catastrophic failure. Extended operation under these conditions, however, will shorten their life.

Capacitance

Capacity is measured at 120 cps and at 25°C . Tolerance of capacitors rated at 3 to 150 volts is $-10, +75\%$. For capacitors rated at 151 to 450 volts, the tolerance is $-10, +50\%$.

Low Temperature Capacitance

Capacitance of Mallory CG capacitors at reduced temperatures and 120 cps does not fall below

the following percentage of nominal rated room temperature ($+25^{\circ}\text{C}$) capacity.

Rated DC Voltage	Percent of Nominal Rated Capacitance		
	-20°C	-30°C	-40°C
0-15	65	50	30
16-100	80	65	40
101 and up	85	75	50

Equivalent Series Resistance

ESR measurements are made at 120 cps and 25°C . ESR for Mallory computer grade capacitors is very low.

Mallory wants the highest possible rating for its CG capacitors—but not at the expense of long life and reliable operation. The object of all our research and care in manufacturing and testing is to provide our customers with the “best” capacitor. For data, write or call Mallory Capacitor Company, a division of P. R. Mallory & Co. Inc., Indianapolis, Indiana 46206.



BELDEN...new ideas for moving electrical energy

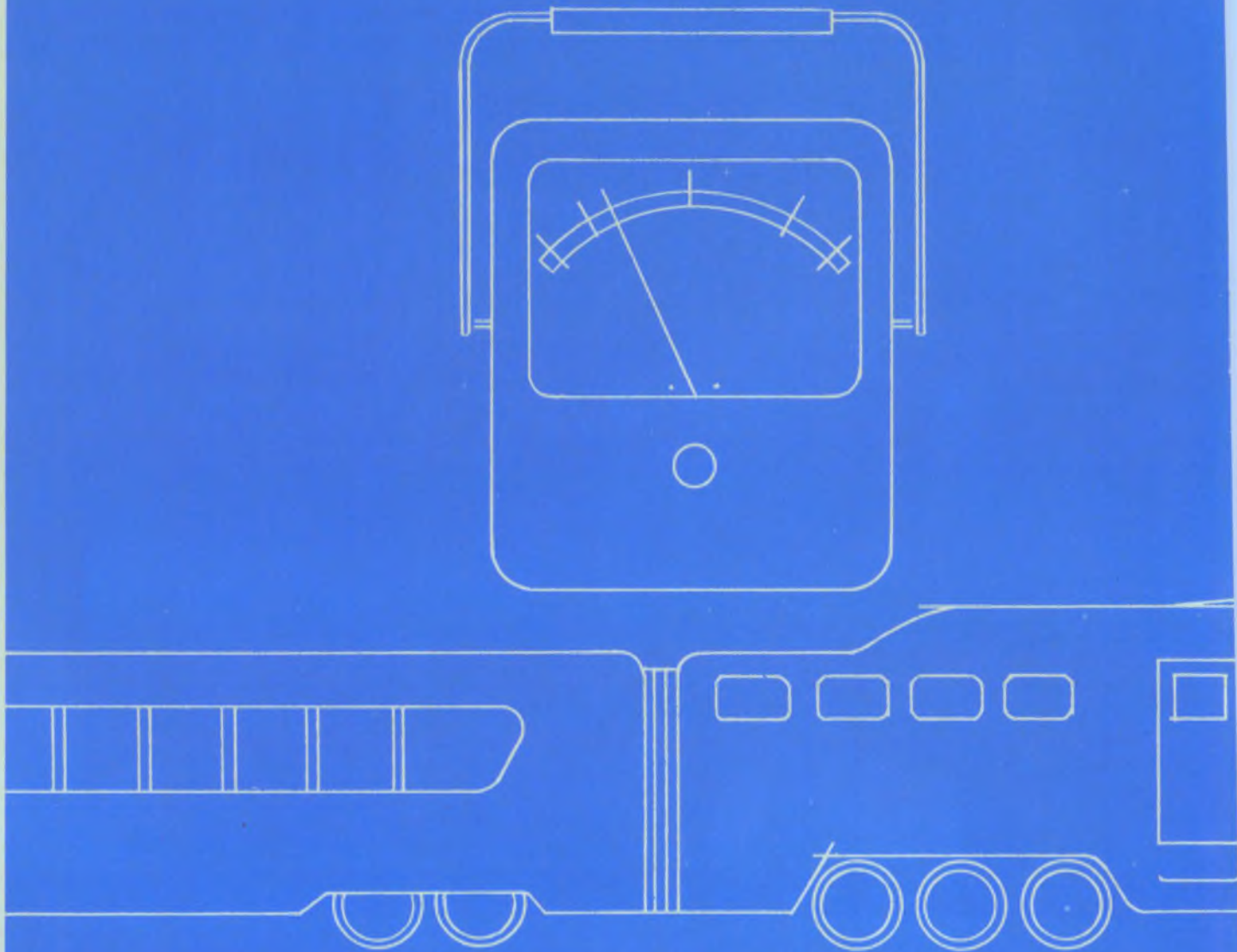

Belden's systems savvy is

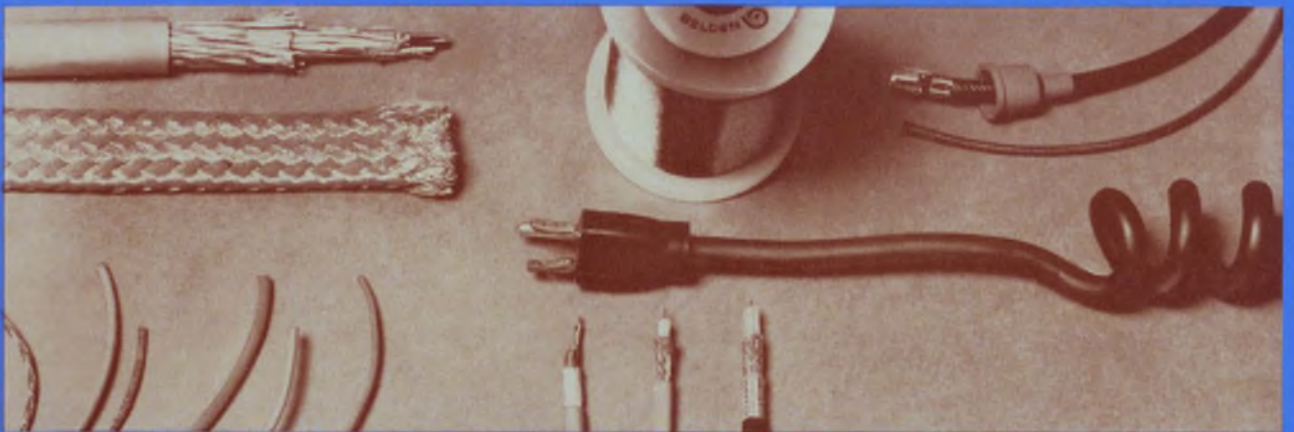

BELDEN

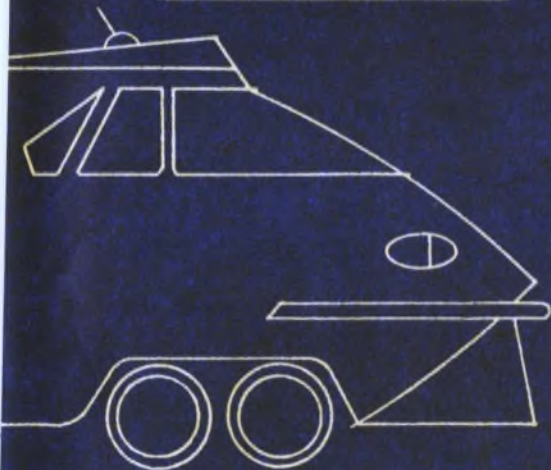
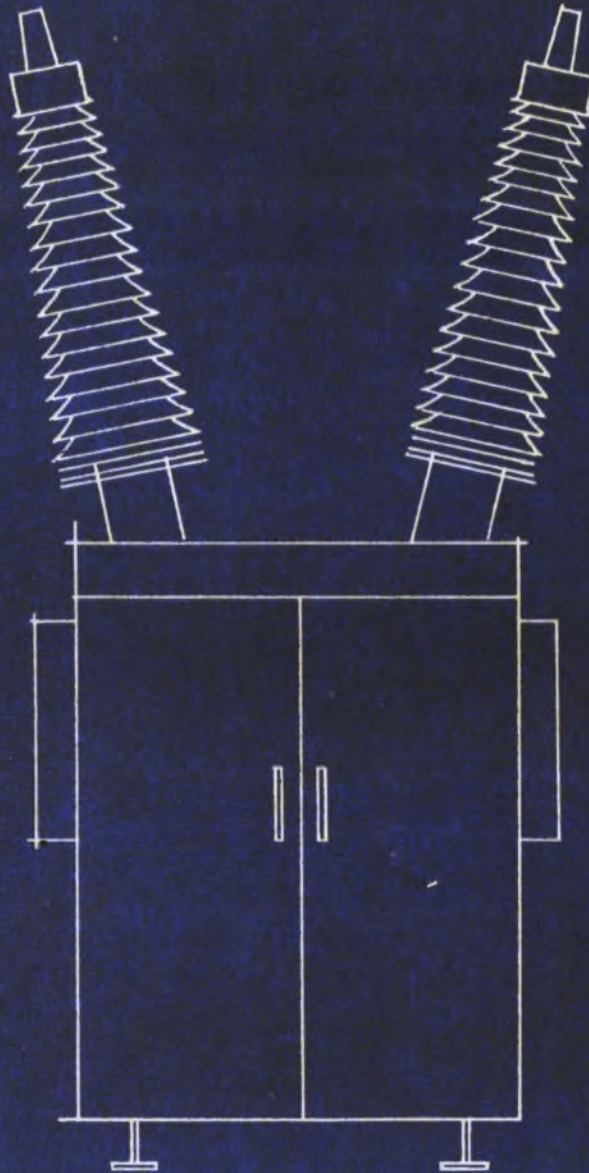
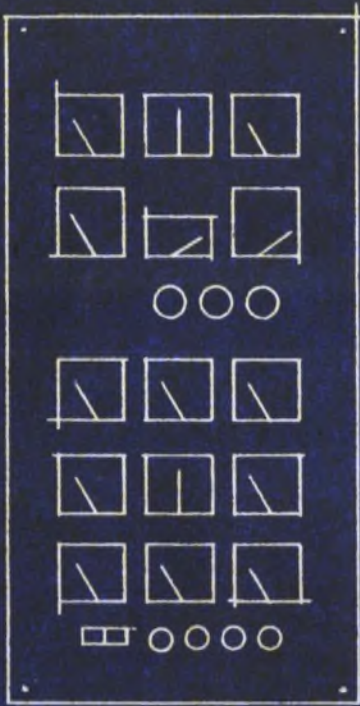

no big deal

It's a lot of little deals, that add up to something big. Like lower costs. Fewer production headaches. Enhanced product reliability. By poking and probing into your product's electrical system and the way it's manufactured and used, Belden Wire Systems Specialists may be able to suggest a wire or cable that costs less. Or that lasts longer, or that takes up less space*. Or maybe they'll suggest a different put-up that saves you assembly time. Or a solution to a stripping problem. They'll also offer you one responsible source for all your wire needs. Because we're the

people who make all kinds of wire for all kinds of systems. So if you're making plans or having problems, get yourself a good deal. Call or write: Belden Corporation, P.O. Box 5070-A, Chicago, Illinois 60680. And ask for our catalog, and the reprint article, "Key Questions and Answers on Specifying Electronic Cable."

*For example: Beldfoil® shielding in Belden cable. It isolates conductors better than anything yet. And it's thinner. You can pack more conductors into a conduit . . . hold down size and weight.

0-2-8

Log diodes can simplify design

of analog computation circuits, whether for multiplying, dividing, raising to powers or taking roots.

The modern analog computer uses numerous circuits which perform the mathematical operations of multiplication, division, raising to powers and taking of roots. Although various analog circuits can be used for this purpose, one of the simplest techniques employs silicon diodes.

The conventional silicon diode exhibits an exponential relationship between forward current and forward voltage. If the exact nature of this relationship is known over the entire operating range, such diodes can be used successfully in analog circuits (see box). Diodes of this type will be called log diodes here.

The fundamental equation for the output of a diode is

$$V_f = A \log I_f + BI_f + C, \quad (1)$$

where V_f is the forward voltage, and I_f is the forward current.

The constant A determines the slope of the voltage-vs-log current output of the diode, while

James Raby and Ronald Embley, Electronic Associates, Inc., West Long Branch, N.J.

B describes the ohmic component of the diode. Constant C is the forward voltage drop at some predetermined reference current.

If all diodes in an analog circuit are the same, the constants A and C become unimportant, because they can be easily eliminated from the answer by suitable biasing. In a properly designed and constructed diode, the B term normally represents a small error, which can be ignored for all practical purposes. This is especially true for operation at lower current levels, (< 1 mA).

To perform multiplication, consider the simple log diode circuit of Fig. 1. In this circuit, $E_o = E_1 + E_2$. From Eq. 1 then,

$$E_1 = A \log I_1 + C \text{ and}$$

$$E_2 = A \log I_2 + C$$

summing for E_o yields:

$$E_o = A (\log I_1 + \log I_2) + 2C,$$

or (2)

$$E_o = A (\log I_1 I_2) + 2C.$$

At this point, the output of the simple example is not usable. However, although the voltage

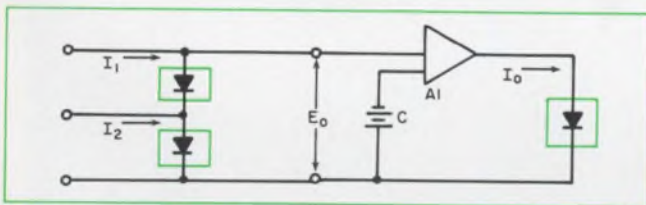

1. Two log diodes develop a total output voltage that is essentially the product of the logarithms of the current through the diodes.

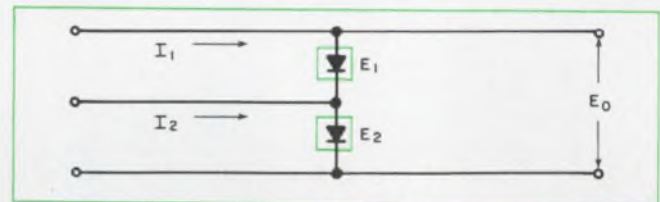

2. The antilog of voltage E_o , namely current I_o , is developed by amplifier A1 and the output log diode, where $I_o \propto I_1 \times I_2$.

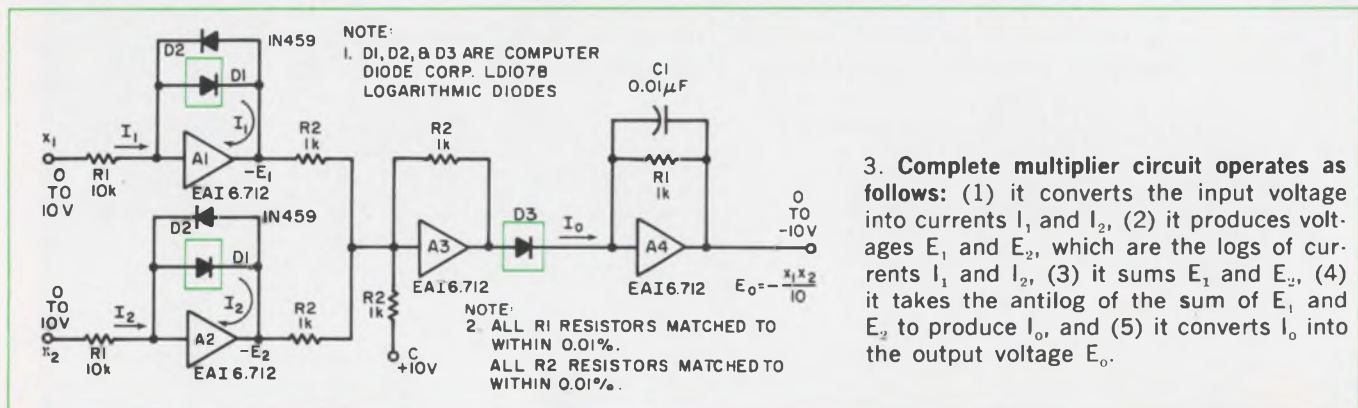

3. Complete multiplier circuit operates as follows: (1) it converts the input voltage into currents I_1 and I_2 , (2) it produces voltages E_1 and E_2 , which are the logs of currents I_1 and I_2 , (3) it sums E_1 and E_2 , (4) it takes the antilog of the sum of E_1 and E_2 to produce I_o , and (5) it converts I_o into the output voltage E_o .

across each log diode is proportional to the log of the current, the current through the diode is also proportional to the antilog of the voltage. Thus, to obtain a usable output, we need merely add an antilog circuit, as shown in Fig. 2. The output current, I_o , through the output log diode is then proportional to the product of I_1 and I_2 , or

$$I_o \propto (I_1 I_2). \quad (3)$$

Although the circuit of Fig. 2 shows the multiplier operation in principle, it is not a practical circuit. To obtain a working analog circuit, high-gain operational amplifiers are needed to precisely convert the input voltages to currents I_1 and I_2 and to convert output current I_o to a voltage. Such a circuit is shown in Fig. 3.

Operational amplifier A3 of Fig. 3, is used to add voltages E_1 , E_2 and C so that their sum is equal to $A \log (X_1 X_2) + C$. Since diodes whose characteristics are matched and verified are being used, it can be assumed for a first-order approximation that the constants A and C are equal in all cases. If desired, to eliminate errors introduced by the finite differences in constants A and C , the gains of the three inputs to amplifier A3 may be adjusted individually.

Diodes $D1$ are the log diodes. Diodes $D2$ are clamping diodes that prevent a hangup of the circuit, in the event polarity is reversed. R_1 and C_1 form a low-pass filter around amplifier A4 to screen out noise. The filter then determines the bandwidth of the multiplier. The magnitude of the R_1 input resistors is chosen to scale current I_1 and I_2 for the best logarithmic operation of the diodes. Static accuracy of $\pm 0.1\%$ of full scale and a bandwidth of 100 Hz have both been achieved with this circuit. If A3 is a low-noise amplifier, the bandwidth can be extended several orders of magnitude while maintaining a large signal-to-noise ratio.

Other operations are similar

Division is performed in a manner similar to multiplication, except that the polarity of one of

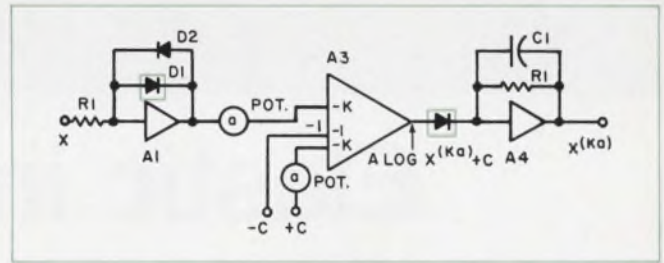

4. Raising to a power or taking roots requires only one of the log-taking channels of Fig. 3. The particular root or power is determined by the setting of the potentiometers at the dual inputs to amplifier A3 and the gains of the amplifier.

the input variables is reversed and logs are subtracted instead of added. This requires that the $D1$ and $D2$ diodes of the negative input variable be reversed and also that the polarity of the bias, C , be reversed.

To use this approach for raising a variable to a power requires only one of the logging channels together with the addition of two potentiometers at the input of amplifier A3. The pots are used to select the desired exponent. The resulting circuit is shown in Fig. 4 for exponents less than one. In operation, the linear input is compressed to logarithmic form in the logger section, and is multiplied by the desired component in amplifier A3. The antilog of this result is then taken by amplifier A4, whose output is the variable raised to a power, Ka .

For example, in order to extract the square root, the pots in Fig. 4 would be set to $a = 0.5$, and the gains of amplifier A3 would be 1. Similarly, to generate a squaring function, the pots could be set to 0.2 and the gains of amplifier A3 to 10.

The analog principles discussed in this article have been successfully used in such commercial applications as on-line process control and graphic reproduction of engravings, as well as for inputs to digital computers in hybrid installations. ■■

Predictable log diodes

Logarithmic diodes having fully predictable and matched characteristics are available from several manufacturers. One of these, Computer Diode Corp., checks the diodes against their theoretical mathematical equations at as many as 800 testing points over the V_f vs I_f characteristic.

Test your retention

Here are questions based on the main points of this article. Their purpose is to help you make sure you have not overlooked any important ideas. You'll find the answers in the article.

1. What are the essential requirements for diodes that are to be used in analog computation circuits?
2. What mathematical operations can be performed with circuits that employ log diodes?

Elastic interconnection.

Ten years ago Hughes started inventing conductor systems that you could twist and curve and tie in knots if you wanted to.

Not many people wanted to. They had to see it work first.

Well, a series of Surveyors and a few Phoenix Missiles proved that electrical interconnection would never be the same again. Flexibility eliminated too many wiring errors. It saved too much space and weight and money.

The art of elasticity was underway at Hughes.

Today flat conductor cable is known as Contour™ Cable. And we have a whole division

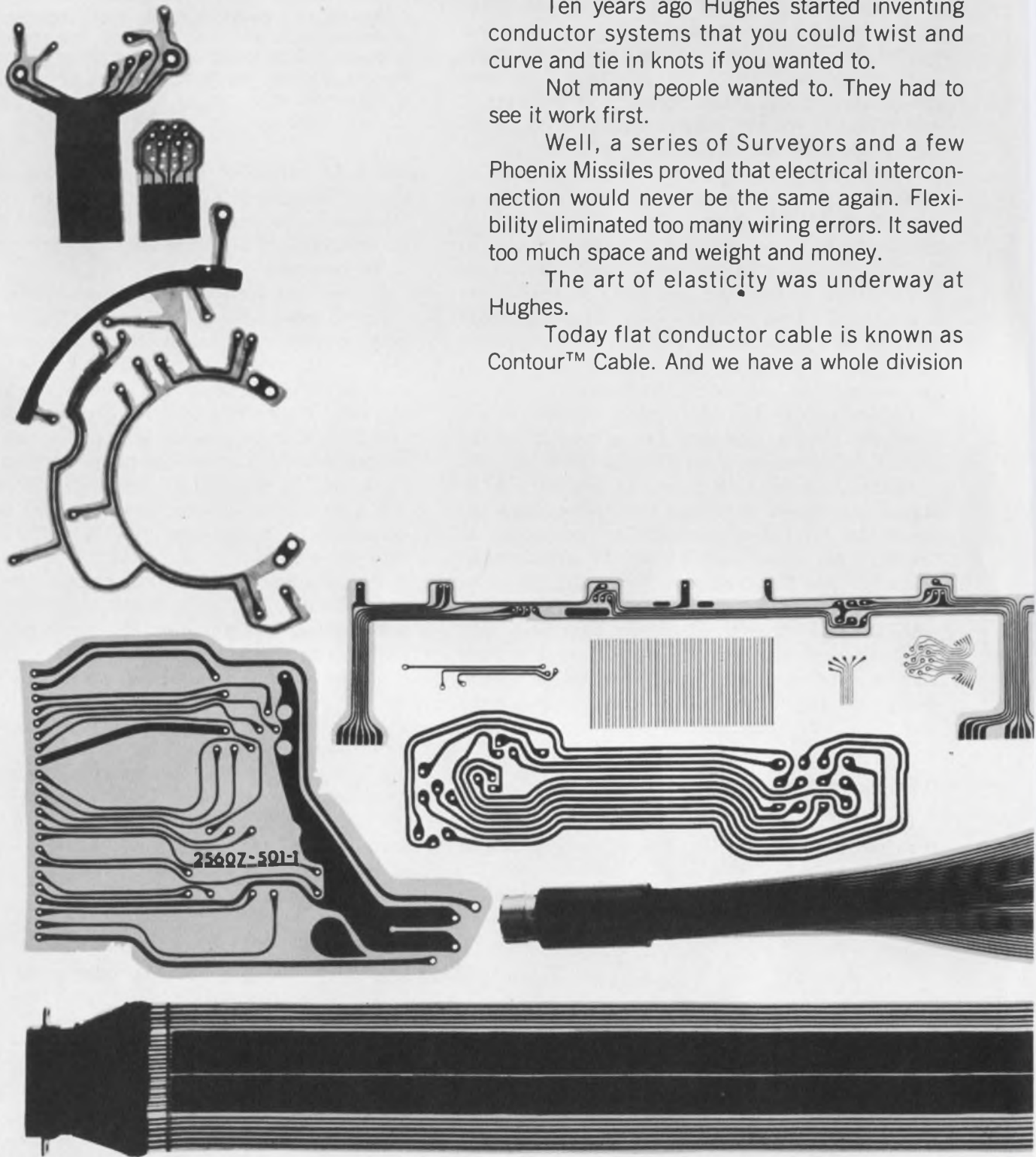

The start of the art.

devoted to it. Over 60 proprietary processes have already been developed for various commercial, military and space applications.

Today Hughes is the only place where you can buy all three versions of flexible cable—etched, collated and bulk assemblies.

We don't place limits on imagination.

Regardless of the circuit problems, our engineers seem to make a thing work.

The art has just started at Hughes.

Write Hughes Aircraft Company, 
Connecting Devices, 500 Superior Avenue,
Newport Beach, California 92663. Phone (714)
548-0671. TWX (714) 642-1353.

HUGHES

HUGHES AIRCRAFT COMPANY

INFORMATION RETRIEVAL NUMBER 33

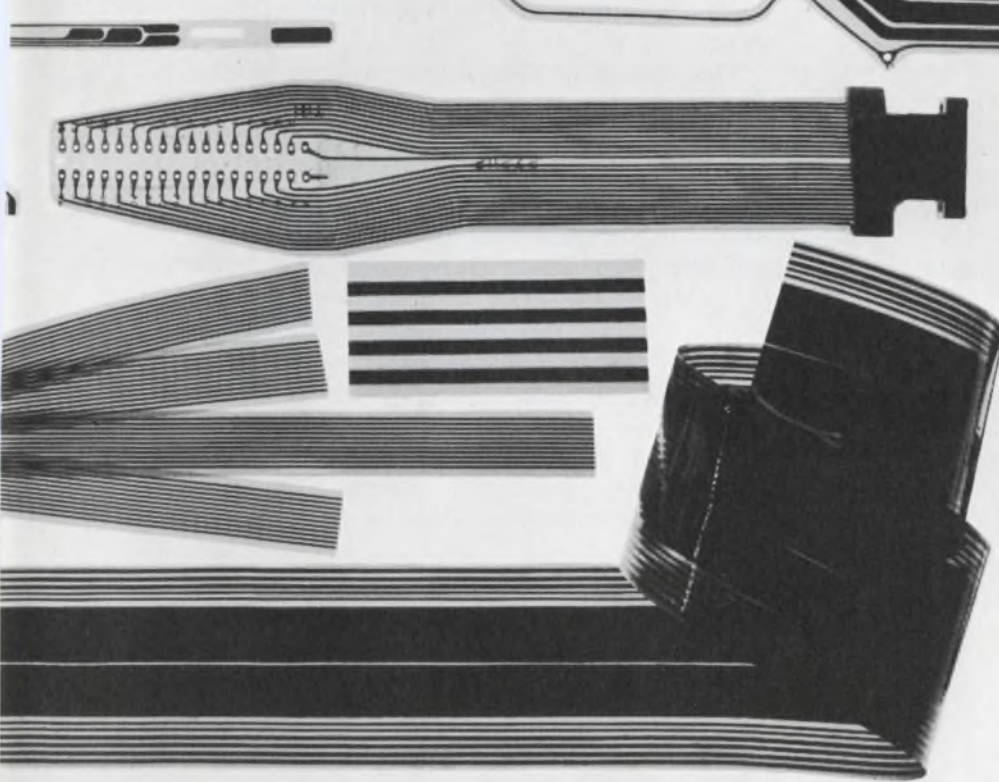
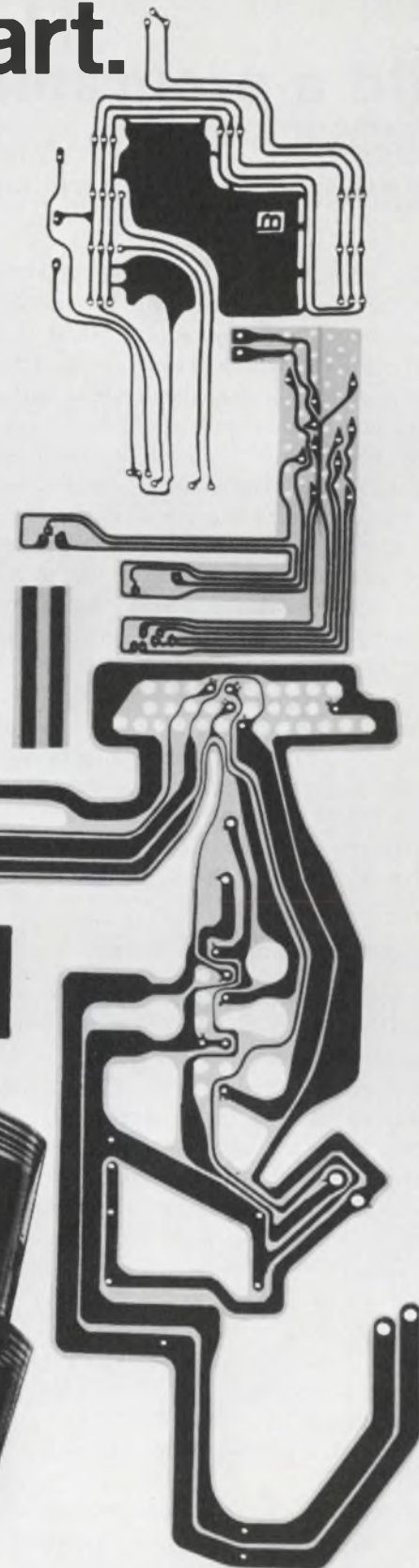

If it's happening in connectors,
it probably started at Hughes.

Build a programmable word generator

with MOS ICs. Multiple output channels supply easily programed 100-bit words at a 1-MHz bit rate.

As the complexity of a digital system grows, so does the problem of testing it. Checkout hardware can become very complex. One of the basic needs for all digital test systems is a means for providing stimulus for the system under test—artificial commands and simulated data must be supplied in digital form. The required words may be so long that simple pulse generators cannot begin to fill the requirement.

The answer to this need? A programmable word-generator. It can be used in both test and checkout equipment for a wide range of applications. One such generator is used to supply input address words to test a 4096-bit IC memory array. The addresses are programed into the generator by means of toggle switches, then read into the memory at a 1-MHz bit rate.

The block diagram (Fig. 1) shows seven subsystems. Three of them (*A*, *B*, and *G*) are built using discrete components. The remaining four are entirely MOS ICs, plus necessary hardware.

Simple sequence programs words

A typical sequence for generating several synchronous channels of digital data is as follows: The repetition-rate control switch is set to the load position, and an output channel is selected by means of the channel selector switch. The desired word is programed by means of toggle switches (one for each bit) in the program switch-matrix. Depressing the load-command pushbutton stores the word in the selected channel-accumulator; it immediately appears on the channel output. Additional channels are programed by simply selecting a new channel on the channel-selector switch, changing the program switch-matrix to the new word, and pushing the load button. All outputs are synchronous (bit number 1 appears in all channels simultaneously).

When all desired information has been loaded into the channel accumulators, the repetition-rate control switch may be set to the "run" position.

This increases the system clock-rate and produces the stored words at a bit-rate of 1 MHz. Since the stored words are being circulated in the accumulators, they are repeated continuously at the outputs, with bit 1 immediately following bit 100.

With this centralized programing and loading scheme, the system is easily expandable in terms of the number of programed channels, at the expense of one accumulator and one channel-selector switch position per output channel.

The length of the programed word is easily made longer (or shorter) than 100 bits by changing the length of the accumulator and by modifying the counter.

The clock (block *A*) provides the internal stimulus, which is common to all synchronous digital machines. The clock used in this system is a two-speed circuit, with frequency determined by the position of the repetition-rate control switch.

The operating frequency possible in the accumulator (block *E*) and the output buffer (block *G*) is more than 1 MHz, while the multiplexer (block *D*) used for loading the word has a maximum operating frequency of about 250 kHz. The clock is run at 100 kHz while words are loaded into the accumulators; it is then switched to 1 MHz. The clock phase-buffers (block *B*) are used to generate the two-phase signals needed to drive the accumulators.

The counter and decoder section (block *C*) divides time into 100 bit-positions. This is accomplished by counting clock cycles up to 100 and decoding each of the possible 100 states of the counter. Each bit in the word is assigned a time location that corresponds to a decoded state.

A sync pulse can be obtained from the counter by NORing the outputs of the two decoders. If the "9" output of the first decoder and the "90" output of the second decoder are NORed, an output is obtained that is coincident with bit 99.

The 100-channel multiplexer (block *D*) is the electronic equivalent of a 100-position mechanical commutator. Each position on the commutator

James J. Kubinec, Senior Application Engineer, National Semiconductor Corporation, Santa Clara, Calif.

(each channel of the multiplexer) interrogates one of the toggle switches in the program matrix. The multiplexer is driven by the decoded outputs of blocks C. It serializes the information set in the toggle switches onto one wire, with each bit of information having one specific time position.

The bit pattern originally contained in the switch positions in the matrix is converted to a serial 100-bit word. The word can be loaded into a 100-bit accumulator (block E), which is a 100-bit serial shift-register. The shift-register has input steering-gates that provide for closing the register upon itself so that the stored data continually recirculates, or for entering new data into the register.

The load-command generator (block F) produces the stimulus to the steering gates in the accumulators to enter new data. It must assure proper and complete loading, regardless of the duration of time the load-command pushbutton is depressed and regardless of switch noise or bounce. The circuit is therefore designed to be insensitive to switch bounce.

The output buffer (block G) provides a low

driving-point impedance for each channel output. Most test equipment environments are plagued with capacitances associated with cables and hook-up wire. A low-impedance driver will allow use of the words at 1-MHz bit-rate.

Two-speed clock switches electronically

Shown in Fig. 2 is a schematic diagram of the dual-frequency clock used in the generator. The circuit is a collector-coupled astable multivibrator with some modification. Timing is produced by use of a current-source capacitor combination rather than the standard resistor-capacitor combination. This offers distinct advantages. The frequency is stable and always close to the predicted frequency, and frequency modulation from 100 kHz to 1 MHz is easily accomplished. Since the charging current for the capacitor C is constant, the equation for the clock period is

$$T \approx 2 [C \Delta Vc / I']$$

or, in the case of Fig. 2,

$$T \approx (8.7 \times 10^{-6}) / I'$$

The diode, D_1 , protects transistor, T_2 , from avalanche breakdown in the BV_{EBO} mode, since the

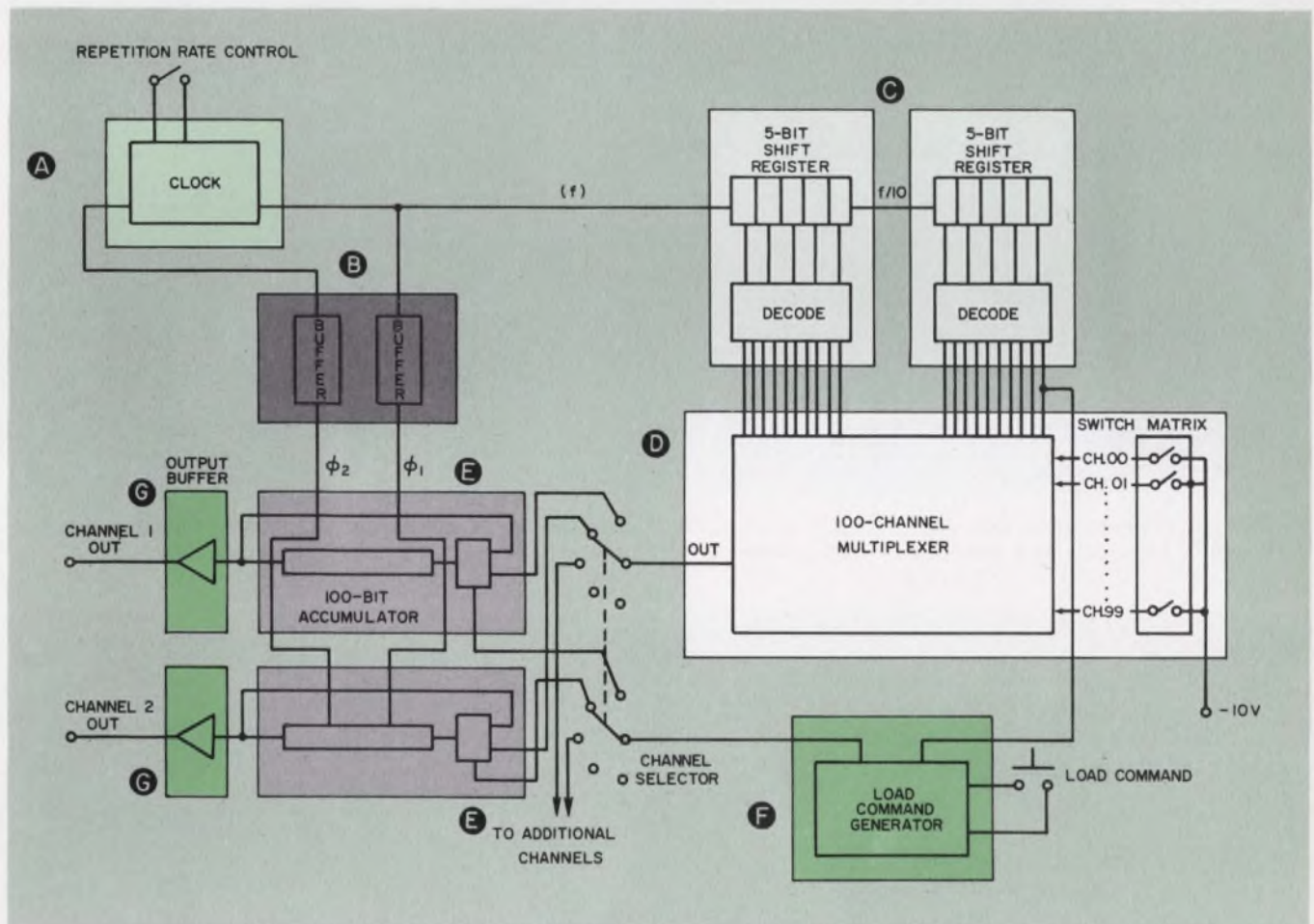

1. The programmable 100-bit word generator supplies digital words at a 1-MHz bit rate. The words are continuously repeated at the channel outputs and can be

used as command or test signals for digital systems. In a typical application, a generator provides character definition words to test an alphanumeric display unit.

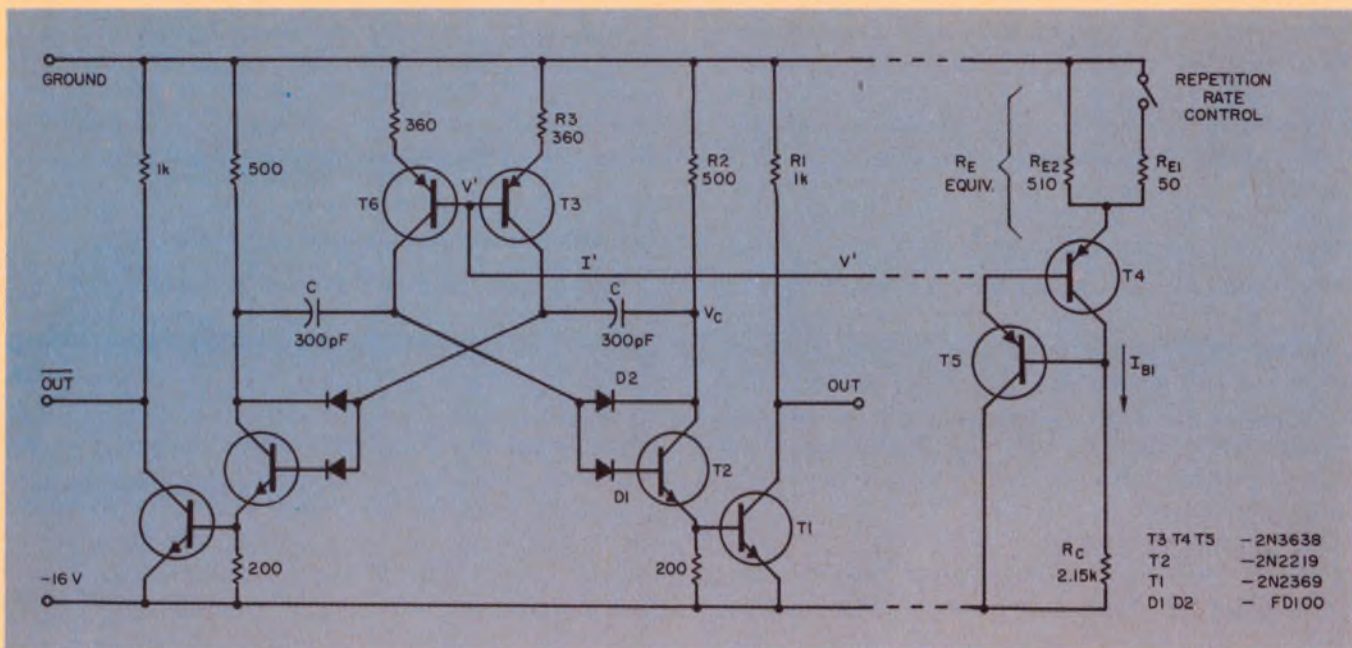

2. A collector-coupled astable multivibrator serves as a variable-speed clock. Timing is accomplished by the

constant-current source, T3 and T6, which charges the capacitor C.

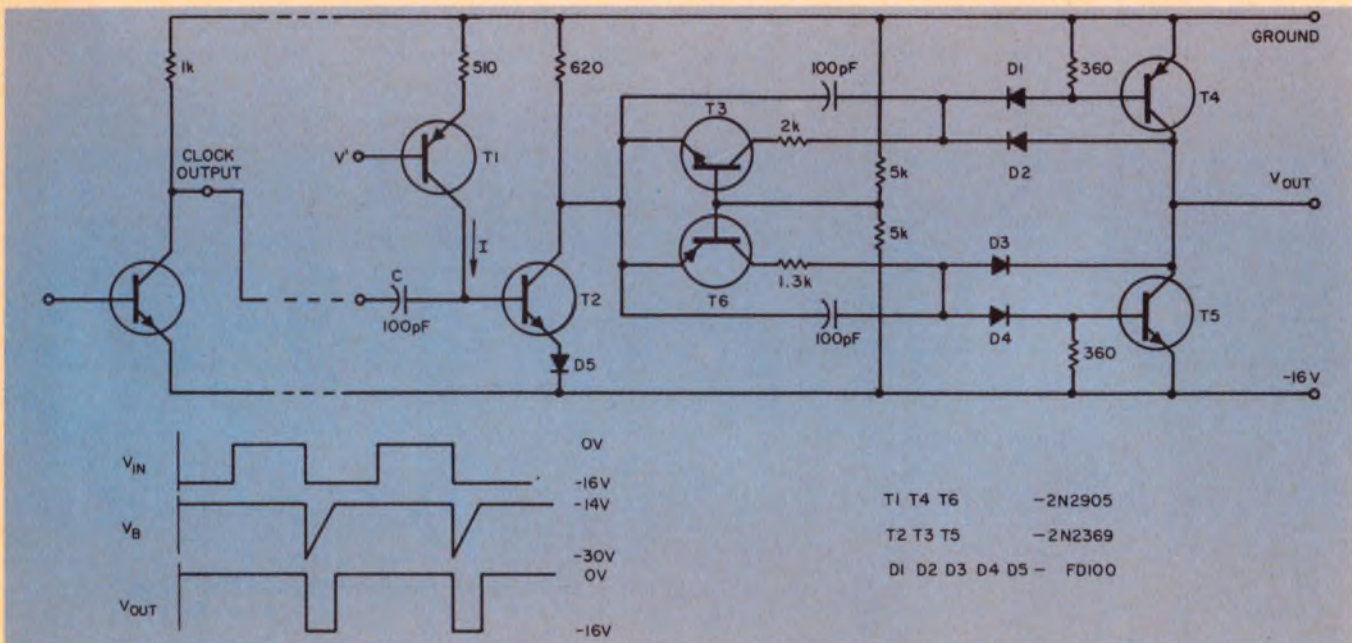

3. The clock phase-generator and buffer accepts the pulses from the clock, and provides an output with con-

trollable pulse width. The push-pull complementary output provides high current drive capability.

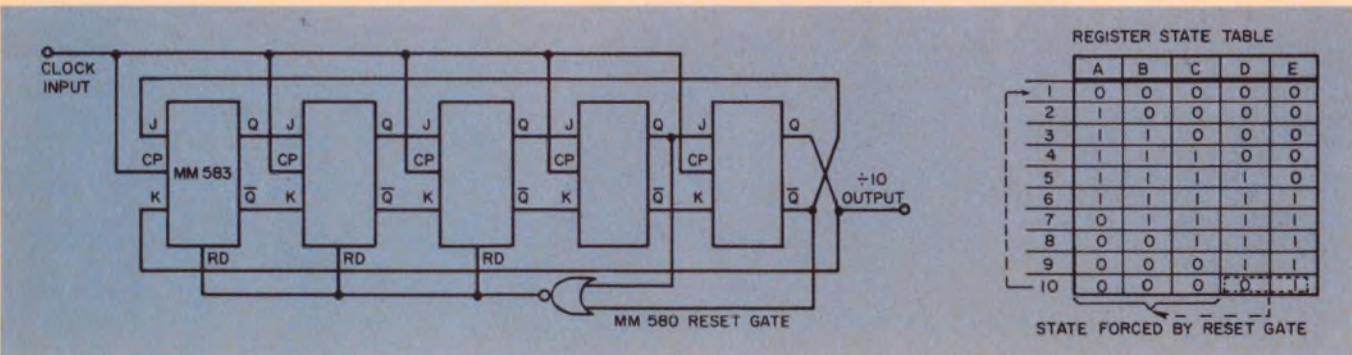

4. A 5-bit Johnson counter is used as a synchronous decade counter. A reset gate ensures that the registers

are in the proper state after counter turn-on. Note that the 5-bit counter can handle 10 states.

base voltage makes a negative swing to near the power-supply value. The addition of diode, D_2 , forms a Baker anti-saturation clamp for device, T_2 . This eliminates all storage-time effects.

The collector of device T_2 has a voltage on it, (V_c), that is a square wave at the clock frequency. This point is not used as the output of the clock. Although the negative-going transition at this point is very fast, the positive-going transition is an RC time constant to $R_2 \times C$; also, any loading at this point affects the operating frequency of the clock. Transistor, T_1 , and resistor, R_1 , form an output buffer-stage, eliminating both problems.

Transistors T_1 and T_5 , R_E , R_{E2} and R_C form a bias-supply that regulates the current in current source, T_3 . Transistor T_5 delivers base-current for devices T_1 and T_3 . Base current does not flow in R_C , and the current, I' becomes independent of beta. Devices T_1 and T_3 are the same type of transistor, and should be well-matched. A bias current, I_{B1} is set up in T_1 , and since $R_C \gg R_{E \text{ equiv}}$, I_{B1} is almost entirely a function of R_C and is constant. This implies:

$$I' = I_{B1} (R_{E \text{ equiv}}) / R_C$$

The repetition-rate control switch changes $R_{E \text{ equiv}}$ by about one order of magnitude, and hence I' and the clock frequency by the same amount. Note that the voltage on capacitor C is the integral of current I' , and is integrated. This assures a smooth transition from one frequency to another when the repetition-rate control switch is operated.

A two-phase clock is needed to drive the output accumulators. The duration of each phase should be less than one-half clock-period to conserve power. Clock inputs to the accumulator are almost purely capacitive, and the phase buffer must be able to drive these capacitive loads at 1 MHz. The schematic of a clock phase buffer is shown in Fig. 3.

When the clock output makes a negative transition, device T_2 is turned off through C . The length of time that T_2 is held off depends on the charging rate of the capacitor C by the current source T_1 . This period of time determines the pulse width of the clock phase output. The current source is biased from the same bias supply as the clock. This means the pulse width of the clock phases will always be a fixed percentage of the clock period. The pulse width in this system was set at 20% of the clock period, or 200 ns at 1 MHz, and 2 μ s at 100 kHz.

A push-pull complementary output is used to buffer the phase pulse. This allows driving capacitive loads in either direction while dissipating a minimum amount of standby power. Baker clamps (diodes D_3 and D_1) are used to eliminate storage time and to eliminate the possibility of a

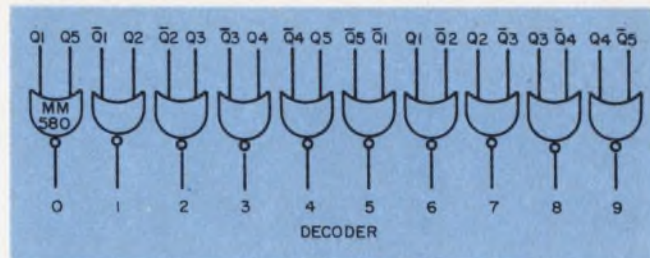

5. Each decoder converts the outputs of its Johnson counter to ten address lines, which are used to drive the multiplexer gates.

momentary short through T_1 and T_5 .

For improved speed and accuracy in the multiplexer, two levels of multiplex switches are used. This requires two identical counter-decoder sections to drive the multiplexer. Each section contains a decode counter with the divided-by-ten output of the first counter being the input clock for the second counter.

The decade counter is shown with its state table in Fig. 4. A five-bit shift counter is used with complement feedback. An N-stage counter of this type will count $2N$ decodable states (an N-stage counter using JK binaries in a ripple counter code will count 2^N states). This results in a little inefficiency in terms of parts-count, but the advantages are worth the extra elements. A shift counter will count to any even modulus without special feedback, whereas a ripple counter is limited to the binary moduli 2^N without feedback. For the shift counter, any state can be decoded with a single two-input gate. This type of decoding is hazard-free, in that only one input to a decoder gate will change in each clock period. Also, the shift counter is synchronous, and all outputs change after one propagation delay from the clock transmission.

It is possible, at power turn-on, that the shift counter will assume a mode of operation different from that in the state table. The reset gate assures that when a "0" "1" combination appear in the last two stages, (a possibility for all modes of operation), the counter is set into the proper mode.

The decoder used to obtain the 10 decodable states of each counter is shown in Fig. 5. Since one counter is running at one-tenth the rate of the other, we may think of one decoder decoding the tens digits and the other decoding the units digits. The interaction (or AND function) of any "unit" output with any "tens" output will give one unique state out of the 100 possible states in the counters.

Two-level multiplexing improves speed

The 100-channel multiplexer is used to serialize the information set in the 100 toggle-switches

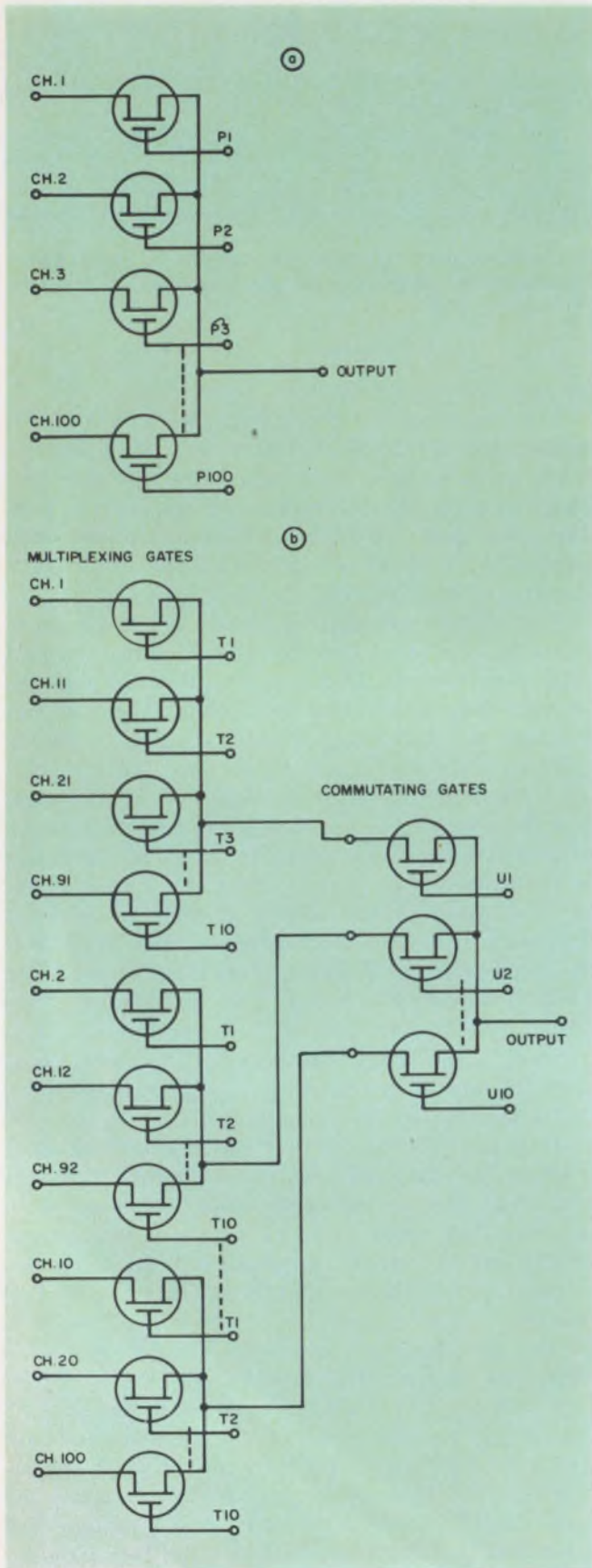

6. The 100-channel multiplexer, if built with a single level of gates, has all drains common to the output lead (a). The parasitic capacitance adds delay. By adding a second level of commutating gates (b), the number of outputs commoned is reduced by a factor of 10, and speed is increased by a factor of roughly five.

in the pattern-program switch array. The multiplexer is the electronic equivalent of a mechanical commutator with 100 commutating points. The direct approach to a 100-channel multiplexer using MOS multiplexing gates is shown in Fig. 6. This configuration has two somewhat unattractive requirements. First, the decoder logic that addresses each multiplexer gate individually in sequence must have 100 outputs and, therefore, must have at least 100 gates. Second, the individual multiplex gate that is on at any time-instant has 99 complex switches connected to its output in the off state. The output capacities of these "off" switches puts a serious limitation on the operating speed of the multiplexer. Leakage currents that may flow in each of the "off" switches is summed on the output line and may detract from the accuracy of the multiplexer.

A 100-channel multiplexer using two levels of switching is shown in Fig. 6b. This configuration is shown using the "units" pulses and "tens" pulses produced by the counter and decoder, as discussed in the previous section. Since only one of the "units" and "tens" signals can be true at any interval of time, there can be only one unique path for data from the input to the output of the multiplexer. We are essentially using multiplex switches in series to perform a logical AND function. A total of twenty decoder outputs (and thus twenty gates) are needed from the decoder, as compared to the 100 shown in Fig. 6a. In terms of the output capacity and the leakage current of multiplex switches in the off state, each channel when turned on will see only 18 off-switches.

The multiplexer shown in Fig. 6b would work if the "units" and "tens" address lines were interchanged. This is physical proof that the logical AND function is commutative. Notice that the group of decoder outputs which drives the commutating gate need only drive one gate per line, but each signal driving the multiplexer gates must fan out to ten gates. It makes sense then, for optimum speed, to use the slower address lines (in this case the "tens" lines) to drive the multiplex gates.

The 100-bit accumulator used for each output channel serves as the storage medium for each 100-bit word (Fig. 7). The operation is quite simple. With the load command in the logic "0" state the input to the first bit of the register is the output of the hundredth bit. This means the 100 bits in the register recirculate with each bit appearing in succession at the output. If the load command is made a logical "1", the input to the register equals whatever is present on the new data-line. To update or load an accumulator with a new pattern we must maintain the load command in the logic "1" state and present the new data input line.

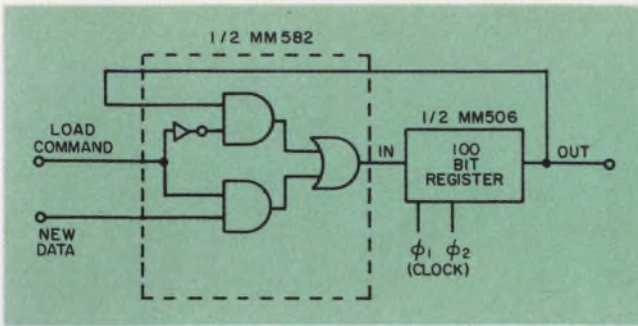

7. The 100-bit accumulator consists of a 100-bit shift register and gating elements. Information is routed into the register from the multiplexer and is then allowed to recirculate.

The load-command generator must produce a pulse that is sufficiently long and noise-free, to allow it to be used to enter new data at any one of the 100-bit accumulators. The problem with mechanical switches and push buttons is that all have contact bounce and switch noise, which can cause incorrect loading of new data. A scheme for error-free loading, regardless of switch noise, is shown in Fig. 8. The true load-command signal is generated after the push-button contacts open for the last time; this includes all noise and contact bounce. Any one of the "tens" decoder outputs may be used to drive the two JK flip-flops.

When the push button is depressed, both flip-flops set to zero. If the contacts bounce, the flip-flops are set to zero again after each bounce. Switch bounce does not interfere with circuit operation. When the button is released, the contacts break. Flip-flop 1 sets on the first drive pulse and resets on the second drive pulse to toggle flip-flop 2. Flip-flop 2 generates the load command between the second and third drive pulse; the circuit then returns to its stable state. The load-command pulse is 100 bits long.

The output buffer is used to isolate external loads—those associated with cables and test fixtures—from the output of the accumulator. The output of the MM506 100-bit shift register is 1000 ohms; it therefore cannot be expected to drive high-capacitance loads. The output buffer has to perform a power-level translation. If desired, a voltage-level translation may be accomplished at the same time. The output buffer shown in Fig. 9 performs only power gain, and the voltage-level input is approximately the voltage-level output. The input stage is an MM580 and a 3-input NOR gate. This assures voltage level and impedance level compatibility with the output of the 100-bit accumulator. The output stage is virtually identical to the clock buffers described earlier. This buffer can supply or sink currents in the 200-mA region from a source resistance of only a few ohms. ■■

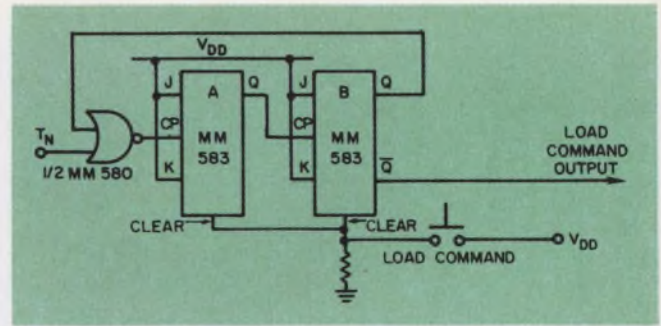

8. The load command generator controls the gates in the 100-bit accumulator. It provides a command pulse to the accumulator gates that is exactly 100 clock periods long, to ensure complete loading of each 100-bit word.

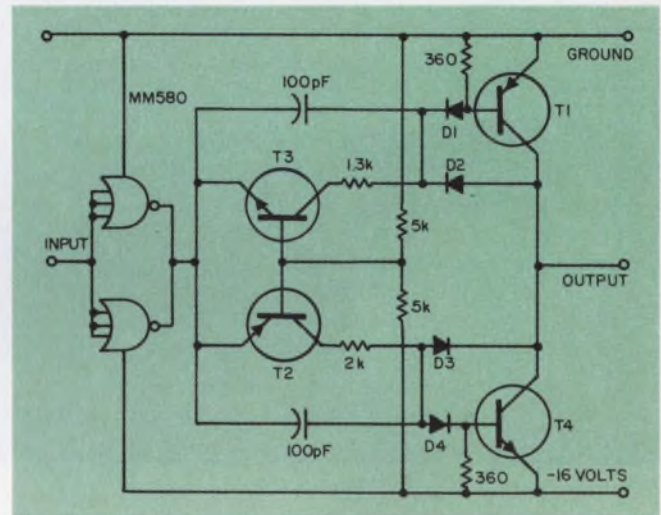

9. The output buffer is a push-pull complementary output stage which provides a high current drive capability and ensures 1-MHz operation of capacitive loads. An MOS input stage assures voltage compatibility with the output of the 100-bit shift register.

Test your retention

Here are questions based on the main points of this article. Their purpose is to help you make sure you have not overlooked any important ideas. You'll find the answers in the article.

1. Why is the circuit described equipped with a dual-rate clock?
2. What are the advantages of using a current-source capacitor combination for timing in the clock circuit?
3. How are data transferred from the input toggle switches to the 100-bit accumulator?
4. What are the advantages of the shift counter with complement feedback?
5. Why are two levels of switching used in the 100-channel multiplexer?

**Our new
high energy
silicon power
transistors.
15 Amperes.
80 to 120 Volts.**

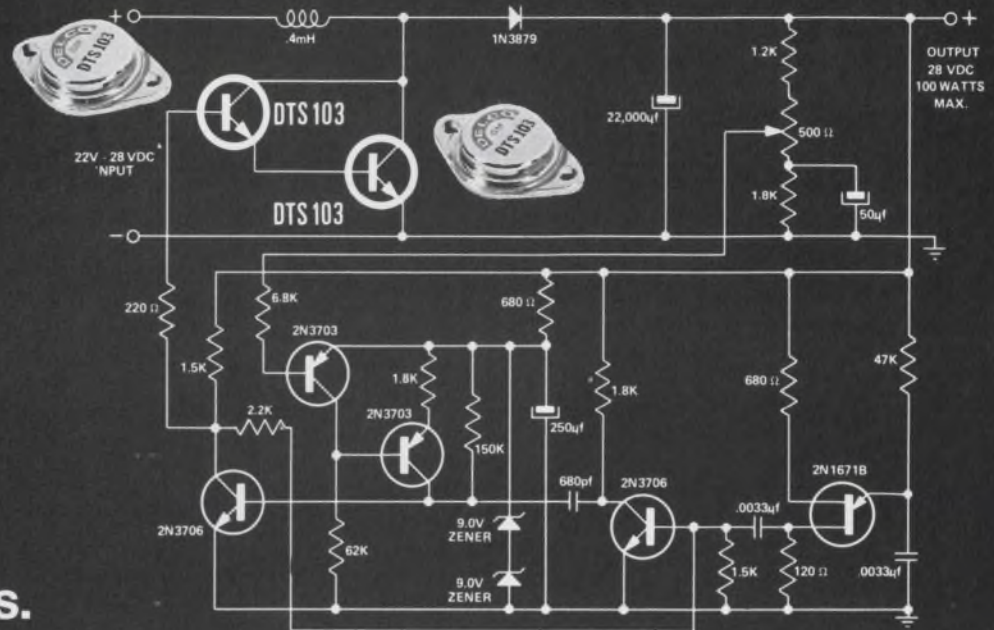

For Switching.

The Delco Radio DTS-100 series. NPN. Triple diffused. Rugged.

All the experience gained from our very high voltage silicon power line has gone into the development of these new transistors.

They were especially designed for the extreme under-the-hood environment of our I.C. voltage regulator. We found these devices ideal for applications requiring high efficiency switching or high power amplification.

The Delco triple sequential diffusion gives the DTS-100 series the high

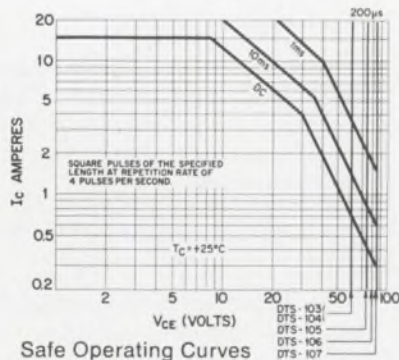

energy reliability that's needed for very tough switching jobs—resistive or inductive. The 28-volt shunt regulator above, for example, is amply handled by the DTS-103 (V_{CEX} of 80 volts). For complete data on this circuit, ask for our application note No. 42.

In the direct coupled audio amplifier above right, the DTS-107 displays the excellent frequency response, gain linearity and transconductance of this family. This circuit is covered in our application note No. 43.

Our solid copper TO-3 package provides maximum thermal capacitance to absorb peak power pulses. Its low thermal resistance (0.75°C/W Max.) assures the extra reliability you expect from Delco.

Like more information? Just call us or your nearest Delco Radio distributor. All our distributors are stocked to handle your sample orders.

SEMICONDUCTOR DISTRIBUTORS: EAST—BALTIMORE, MD. 21201, Radio Electric Service Co., 5 North Howard Street, (301)-539-3835 BINGHAMTON, N.Y. 13902, Federal Electronics, Inc., P. O. Box 1208, (607)-748-8211 CLIFTON, N.J. 07015, Eastern Radio Corporation, 312 Clifton Avenue, (201)-471-6600 NEWTON, MASS. 02195, The Greene Shaw Co., Inc., 341-347 Watertown St., (617)-969-8900 NEW YORK, NEW YORK 10036, Harvey Radio Co., Inc., 2 West 45th St., (212)-582-2590 PHILADELPHIA, PENN. 19123, Almo Industrial Electronics, Inc., 412 North 6th Street, (215)-922-5918 PITTSBURGH, PENN. 15328 RPC Electronics, 620 Alpha Drive, RIDC Park, (412)-782-3770 WOODBURY, L.I., N.Y. 11797, Harvey Radio Company, Inc., 60 Crossways Park West, (516)-921-8700 **SOUTH**—BIRMINGHAM, ALA. 35233, Forbes Distributing Company, Inc., 1416 Fourth Ave., South, (205)-251-4104 MIAMI, FLORIDA 33142, Mountain Electronics, Division of Mountain National Co., 3730 Northwest 36th St., (305)-634-4556 RICHMOND, VA. 23220, Meridian Electronics, Inc., 1001 West Broad Street, (703)-353-6648 WEST PALM BEACH, FLA. 33402, Mountain Electronics, Division of Mountain National Co., 1000 N. Dixie Highway, (305)-833-5701 **MIDWEST**—CINCINNATI, OHIO 45237, United Radio, Inc., 7713 Reinhold Drive, (513)-761-4030 CLEVELAND, OHIO 44125, The W. M. Pattison Supply Co., Industrial Electronics Division, 4550 Willow Parkway, (216)-411-3000 INDIANAPOLIS, IND. 46225, Graham Electronics Supply, Inc., 122 South Senate Avenue, (317)-634-8486 KALAMAZOO, MICH. 49005, Electronic Supply Corp., P.O. Box 831, (616)-4626 KANSAS CITY, MO. 64111, Walters Radio Supply, Inc., 3635 Main

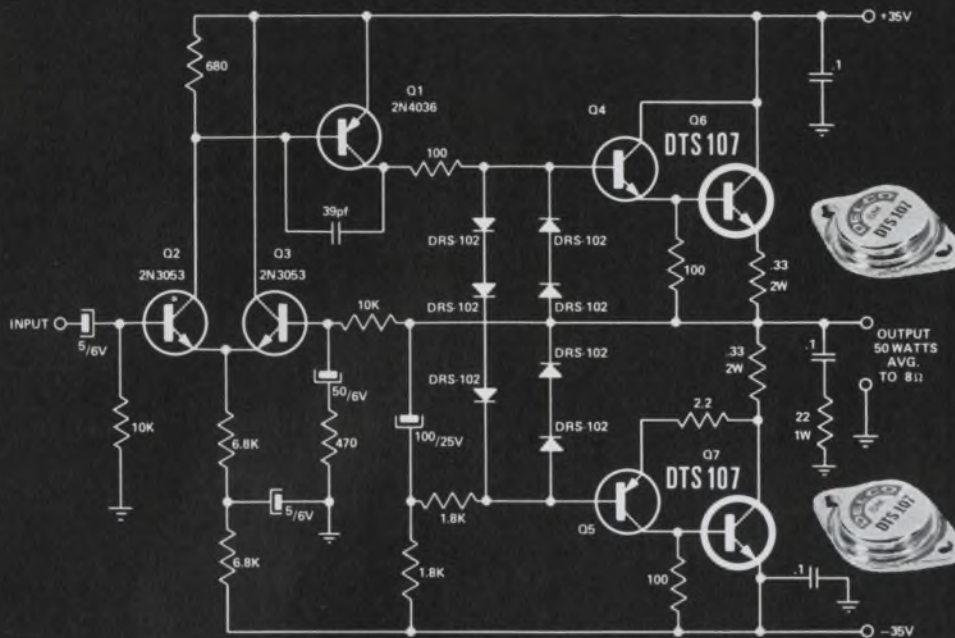

For Audio Amplification.

	I _c Cont. Amps.	I _c Pulsed Amps.	V _{CEX} @ .5mA Volts	V _{CEO} @ .25mA Volts	V _{CEO(SUS)} @ 250mA Volts	h _{FE} @ 5A	h _{FE} @ 20A (Min.)	V _{CE(sat)} @ 10A (Max.)	f _t MHz (Min.)	P _t Watts (Max.)
DTS-103	15	20	80	60	60	20-55	5	1.8	4	125
DTS-104	15	20	80	60	60	50-120	10	1.5	4	125
DTS-105	15	20	100	80	75	20-55	5	1.8	4	125
DTS-106	15	20	110	90	80	20-55	5	1.8	4	125
DTS-107	15	20	120	100	85	20-55	5	1.8	4	125

FIELD SALES OFFICES

Union, New Jersey* 07083 Detroit, Michigan 48202
 Box 1018 Chestnut Station 57 Harper Avenue
 (201) 687-3770 (313) 873-6560
 Syracuse, New York 13203 Chicago, Illinois* 60656
 1054 James Street 5151 N. Harlem Avenue
 (315) 472-2668 (312) 775-5411
 Santa Monica, Calif.* 90401 Kokomo, Ind. 46901
 726 Santa Monica Blvd. 700 E. Firmin
 (213) 870-8807 (317) 459-2175 Home Office

*Office includes field lab and resident engineer for application assistance.



DELCO RADIO
 DIVISION OF GENERAL MOTORS
 KOKOMO, INDIANA
 THE KOKOMOANS ARE IN POWER

Street, (816)-531-7015 MINNEAPOLIS, MINNESOTA 55401, Stark Electronics Supply Co., 112 3rd Ave., North, (612)-332-1325 SKOKIE, ILL. 60076, Merquip Electronics, Inc., 7701 N. Austin Ave., (312)-282-5400 ST. LOUIS, MO. 63144, Electronic Components for Industry Co., 2605 South Hanley Road, (314)-647-5505 WEST—ALBUQUERQUE, N. M. 87103, Sterling Electronics, Inc., 1712 Lomas Blvd., N. E., (505)-247-2486 DALLAS, TEXAS 75201, Adleta Electronics Company, 1907 McKinney Ave., (214)-742-8257 DENVER, COLO. 80219, L. B. Walker Radio Company, 300 Bryant Street, (303)-935-2406 HOUSTON, TEXAS 77001, Harrison Equipment Co., Inc., 1422 San Jacinto Street, (713) 224-9131 LOS ANGELES, CAL. 90015, Radio Products Sales, Inc., 1501 South Hill Street, (213)-748-1271 LOS ANGELES, CAL. 90022, Kierulff Electronics, Inc., 2585 Commerce Way, (213)-685-5511 OKLAHOMA CITY, OKLAHOMA 73102, Radio, Inc., 903 North Hudson, (405)-235-1551 PALO ALTO, CAL. 94303, Kierulff Electronics, Inc., 3969 East Bayshore Road, (415)-968-6292 PHOENIX, ARIZ. 85005, Sterling Electronics, Inc., 1930 North 22nd Ave., (602)-258-4531 SAN DIEGO, CAL. 92101, Milo of California, Inc., 2060 India Street, Box 2710, (714)-232-8951 SEATTLE, WASH. 98108, Kierulff Electronics, Inc., 5940 6th Ave., South, (206)-763-1550 TACOMA, WASH. 98402, C & G Electronics Company, 2502 Jefferson Ave., (206)-272-3181 TULSA, OKLAHOMA 74119, Radio, Inc., 1000 South Main Street, (918)-587-9124 CANADA—SCARBOROUGH ONTARIO, Lake Engineering Co., Ltd., 123 Manville Rd., (416)-751-5980

INFORMATION RETRIEVAL NUMBER 34

Get the facts on one-shot design

and eliminate the usual trial-and-error debugging.
You can meet the specs on the first try.

Building a one-shot with discrete components can still be the cheapest way! Transistor and diode prices have plummeted to mere pennies, and the few resistors and capacitors needed cost only a couple of dollars per circuit. ICs, of course, offer lower parts count and a great reduction of design and assembly work. But if you already have an inventory of discrete components, and the facilities for building with them, then it may not be economical to switch to ICs.

If you build with discretely, the design job is yours! Certainly you can build a one-shot that works. But can you meet those period and output specs?

Here's a thorough discussion of a design procedure that should ensure that you come out right on target every time. It will also help you to determine such things as the minimum time between trigger pulses, so you can ensure reliable operation.

Review one-shot operation

The transistor one-shot (Fig. 1) is an emitter-coupled regenerative circuit with one stable state. Transistor Q_2 is normally saturated, and Q_1 is off. When a positive pulse of the proper level triggers the base of Q_1 , Q_1 turns on (saturates) and pulls capacitor C to ground. The base voltage of Q_2 thus decreases to $-V_{CC}$ (the initial charge on C) and turns Q_2 off, regeneratively ensuring that Q_1 remains saturated. The capacitor discharges from $-V_{CC}$ toward $+V_{CC}$; however, on reaching the turn-on voltage of Q_2 , the latter saturates, regeneratively turning Q_1 off. The time during which Q_1 is turned on is termed the period of the one-shot, T , and is a direct function of R , C , and V_C (the voltage that capacitor C is initially charged to).

Stable, or quiescent, analysis

During the quiescent state, Q_1 is off and Q_2 is saturated. To ensure that Q_2 is saturated,

$$I_{B2} > I_{C2} / \beta_{2(\min)}. \quad (1)$$

The collector voltage of Q_2 is

$$V_{C2(\text{sat})} \approx V_{CE2(\text{sat})} + I_{C2} R_E, \quad (2)$$

where

$$I_{C2} \approx [V_{CC} - V_{C2(\text{sat})}] / R_{C2}. \quad (3)$$

Equation 3 assumes that the collector current of Q_2 is much larger than the current through R_1 and R_2 , or $V_{C2(\text{sat})} / (R_1 + R_2) \ll I_{C2}$, which is usually a valid condition. Thus, from Eqs. 2 and 3, we have

$$V_{C2(\text{sat})} = [V_{CE2(\text{sat})} R_{C2} + R_E V_{CC}] / \{R_{C2} [1 + (R_E / R_{C2})]\}. \quad (4)$$

Under normal conditions

$$R_{C2} \gg R_E \quad (5)$$

so that Eq. 4 simplifies to

$$V_{C2(\text{sat})} = [V_{CE2(\text{sat})} R_{C2} + R_E V_{CC}] / R_{C2}. \quad (6)$$

The collector current, I_{C2} , given by Eq. 3, can be also defined by combining Eqs. 3, 5 and 6 as

$$I_{C2} \approx [V_{CC} - V_{CE2(\text{sat})}] / R_{C2}. \quad (7)$$

The base current of Q_2 is given by

$$I_{B2} = [V_{CC} - V_{B2(\text{sat})}] / R, \quad (8)$$

where

$$V_{B2(\text{sat})} = V_{BE2(\text{sat})} + I_{C2} R_E. \quad (9)$$

Combining Eqs. 7, 8 and 9, we get

$$I_{B2} = [V_{CC} (R_{C2} - R_E) - R_{C2} V_{BE2(\text{sat})} + V_{CE2(\text{sat})} R_E] / R_{C2} R. \quad (10)$$

If we make the simplifying assumptions

$$R_{C2} \gg R_E \quad (11)$$

and

$$R_{C2} V_{CC} \gg R_{C2} V_{BE2(\text{sat})} - R_E V_{CE2(\text{sat})}, \quad (12)$$

the base-two current becomes

$$I_{B2} \approx V_{CC} / R. \quad (13)$$

We can now relate the values of R_{C2} , R and β_2 . Thus, from Eqs. 7 (and assuming $V_{CC} \gg V_{CE2(\text{sat})}$) and 13, Eq. 1 becomes

$$R / R_{C2} < \beta_{2(\min)}, \quad (14)$$

or

$$R < R_{C2} \beta_{2(\min)}. \quad (15)$$

The stable-state condition, Q_1 off, means that the emitter voltage that results from the saturation of Q_2 must be greater than $V_{B1(\text{off})}$, or

$$V_E > V_{B1(\text{off})}. \quad (16)$$

The emitter voltage, V_E , is simply

$$V_E \approx I_{C2} R_E, \quad (17)$$

or, using Eq. 3 and assuming $V_{CC} \gg V_{CE2(\text{sat})}$,

$$V_E = R_E V_{CC} / R_{C2}. \quad (18)$$

The base voltage of Q_1 can be written as

$$V_{B1(\text{off})} = R_2 V_{C2(\text{sat})} / (R_1 + R_2), \quad (19)$$

Richard S. Hughes, Senior Electronic Engineer, U. S. Naval Weapons Center, China Lake, Calif.

where

$$V_{C2(sat)} = V_{CE2(sat)} + I_{C2} R_E \quad (20)$$

Using Eqs. 3 and 20, we get

$$V_{C2(sat)} \approx V_{CE2(sat)} + (R_E V_{CC}/R_{C2}), \quad (21)$$

and the final expression for the base-one voltage becomes

$$V_{B1(off)} = R_2 [R_{C2} V_{CE2(sat)} + R_E V_{CC}] / R_{C2} (R_1 + R_2). \quad (22)$$

Combining Eqs. 16, 18 and 22, we can now write the stable-state condition for the one-shot, in terms of the circuit parameters, as

$$R_E V_{CC} > R_2 [R_{C2} V_{CE2(sat)} + R_E V_{CC}] / (R_1 + R_2),$$

or, rearranging,

$$[R_2 / (R_1 + R_2)] < R_E V_{CC} / [R_{C2} V_{CE2(sat)} + R_E V_{CC}]. \quad (23)$$

Since R_1 and R_2 also have a controlling effect on the saturation of Q_1 (during the active state), we will postpone defining their values until completion of the active-state analysis.

On state (active) analysis

Normally C is charged to $V_{CC} - V_{B2}$ (Fig. 1). When the one-shot is triggered on (by a positive pulse of proper amplitude at V_{B1}), Q_1 is turned on (saturated). If C is large enough so that it does not discharge during the turn-on of Q_1 , the base-two voltage, (V_{B2}), is driven to $-|V_{CC} - V_{B2(sat)}|$, turning off Q_2 . The capacitor, C , now starts discharging through R towards V_{CC} . V_{B2} then starts at $-|V_{CC} - V_{B2(sat)}|$ and climbs toward V_{CC} . But, when it reaches $I_E' R_E + V_{BE2}$ (I_E' being the emitter saturating current of Q_1), Q_2 is turned on, turning off Q_1 .

To ensure that Q_1 will be saturated, let us see what is happening. To this end we will use the equivalent circuit of Fig. 2. This equivalent circuit assumes that $V_{B1(sat)} \approx$ constant and is given by

$$V_{B1(sat)} \approx I_{C1} R_E + V_{BE1(sat)}. \quad (24)$$

If Q_1 is saturated, Eq. 24 is a valid assumption. Increasing the base current under these conditions has a small effect (millivolts) on V_{B1} . To ensure that Q_1 is saturated, the following relations must be satisfied:

$$I_{R'} - I_{R2} > I_{B1(sat)}, \quad (25)$$

where

$$I_{R'} = [V_{CC} - V_{B1(sat)}] / R_1' \quad (26)$$

and

$$I_{B1} = I_{C1(sat)} / \beta_{1(min)}. \quad (27)$$

The collector current of Q_1 is given by

$$I_{C1(sat)} = V_{CC} - (V_{CE1(sat)} + I_{C1} R_E) / R_{C1}, \quad (28)$$

or, making the valid assumption that

$$V_{CC} \gg V_{CE1(sat)} + I_{C1} R_E, \quad (29)$$

it can be written as

$$I_{C1(sat)} \approx V_{CC} / R_{C1}. \quad (30)$$

Substituting this value into Eq. 27, we obtain the final expression for the base-one current:

$$I_{B1} = V_{CC} / \beta_{1(min)} R_{C1}. \quad (31)$$

To ensure that $I_{R'(min)}$ (see Fig. 2) will be large enough to supply enough current for $I_{B1(max)}$, the following relationship must be satisfied:

$$I_{R'} - I_{R2} > I_{B1(max)}. \quad (32)$$

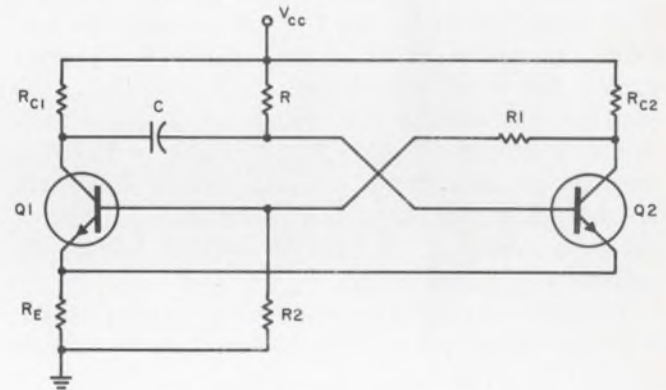

1. The detailed analysis of a one-shot begins by considering the simplest version of the circuit. The desired design equations are for R_1 , R_2 , R and C .

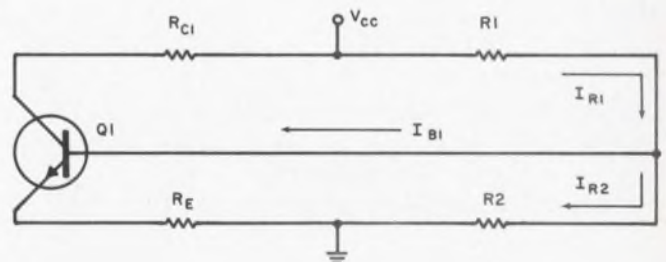

2. The analysis of the active state (Q_1 saturated) is carried out with the help of this equivalent circuit. Here $R_1' = R_1 + R_{C2}$. The circuit is valid for $V_{B1(sat)} = I_{C1} R_E + V_{BE1(sat)} =$ constant.

This condition can be expressed in terms of the circuit parameters, with the use of Eqs. 26, 31 and 32, as

$$[V_{CC} - V_{B1(sat)}] / R_1' > (V_{B1(sat)} / R_2) I_{B1(max)}. \quad (33)$$

The circuit component of interest is R_2 . It can be obtained by solving Eqs. 32 and 33:

$$R_2 > R_1' V_{B1(sat)} / [(V_{CC} - V_{B1(sat)}) R_1' I_{B1(max)}]. \quad (34)$$

To ensure that R_1' (Fig. 2) will supply enough current to saturate Q_1 , let

$$I_{R1} > 2I_{B1(max)}, \quad (35)$$

or

$$[V_{CC} - V_{B1(sat)}] / (R_1 + R_{C2}) > 2I_{B1(max)}. \quad (36)$$

Solving Eq. 36 for R_1 , we get

$$R_1 < [(V_{CC} - V_{B1(sat)}) - 2I_{B1(max)} R_{C2}] / 2I_{B1(max)}. \quad (37)$$

Finally, we can rewrite Eq. 34 for R_2 in terms of the actual circuit parameters as

$$R_2 > [(R_{C1} + R_1) V_{B1(sat)}] / [(V_{CC} - V_{B1(sat)}) - (R_{C1} + R_1) I_{B(max)}]. \quad (38)$$

While we can now solve for R_1 and R_2 with Eqs. 23, 37 and 38, we will do so later, when we consider the general design procedure, for the sake of brevity.

The time during which Q_1 is saturated is the period of the one-shot, and this may be determined by observing the base-two waveform (Fig. 3).

During the off state, Q_1 is off and Q_2 is saturated. A positive pulse of proper amplitude at base one will saturate Q_1 and turn off Q_2 . Initially the timing capacitor C is charged to $V_{CC} - V_{B2(sat)}$. If C is large enough not to discharge during the turning on of Q_1 , the voltage on base two will become negative, as illustrated in Fig. 3. V_{B2} may drop to either of two voltages: If $V_{CC} > V_{EB02}$ (the emitter-base breakdown voltage of Q_2), the voltage will drop to $V_{EB02} - V_E$. If $V_{EB02} > V_{CC}$, the voltage will drop to $V_{CC} - V_{B2(sat)}$. The voltage will start discharging through R_1 towards $+V_{CC}$; however, on reaching the turn-on voltage for Q_2 , Q_2 saturates, turning off Q_1 .

To derive an expression for the period of the one-shot, let us write the equation for the voltage at the base of Q_2 as

$$V_{B2}(t) = -(V_{EB02} - V_E + V_{B2(sat)}) + (V_{CC} + V_{EB02} - V_E + V_{B2(sat)}) [1 - \exp(-t/RC)]. \quad (39)$$

Setting $V_{B2}(t) = 0$ and solving for t , we get the desired expression for the period of one-shot, T :

$$T = -RC \ln [V_{CC} / (V_{CC} + V_{EB02} - V_E + V_{B2(sat)})]. \quad (40)$$

Equation 40 is plotted for various values of V_{CC} in Fig. 4. If $V_{EB02} > V_{CC}$, this equation reduces to

$$T = 0.694 RC. \quad (41)$$

Note that Eq. 40 limits at 0.694 when $V_{CC} = V_{EB02}$.

Let's design a one-shot

The various pulse shapes occurring in a one-shot are illustrated in Fig. 5.

Now that the one-shot equations have been derived, let's consider a general design approach. Suppose you want to design a circuit to meet the following specifications:

$$T = 80 \mu s, \\ V_{CC} = +12 \text{ V dc}, \\ Q_1 = Q_2 = 2N744.$$

Other required values can be jotted down from the 2N744 data sheet:

$$V_{CE(sat)} = 0.35 \text{ V (max)}, \\ \beta_{(min)} = 20, \\ V_{EBO} = 6.3 \text{ V}, \\ V_{BE(sat)} = 1.1 \text{ V (max)}.$$

Step 1: Determine R_{C1} and R_{C2} . The values chosen for R_{C1} and R_{C2} are dependent on the desired rise time, collector current, etc. The data given for the 2N744 are for a collector current of 10 mA. Thus the values for R_{C1} and R_{C2} are (assuming $V_{CC} > V_{CE(sat)} + I_C R_E$):

$$R_{C1} = R_{C2} = 12 \text{ V} / 10 \text{ mA} = 1.2 \text{ k}.$$

Step 2. Determine R . Using Eq. 4, we get

$$R < R_{C2} \beta_{2(min)}, \\ R < 24 \text{ k}.$$

Let

$$R = 15 \text{ k}.$$

Step 3. Determine R_E . This resistor should be large enough to ensure that Q_1 will be cut off (this is also a function of many other variables). In general, it is valid to pick $R_E I_E = 0.5 \text{ V}$ (remembering that $R_C \gg R_E$). Then

$$R_E = 0.5 \text{ V} / 10 \text{ mA} = 50 \text{ ohms}.$$

Step 4. Determine R_1 and R_2 . The equations necessary to calculate R_1 and R_2 have been previously derived as Eqs. 23, 37 and 38.

Substituting known values into Eq. 23, we get

$$R_2 / (R_1 + R_2) < 50 (12) / [1.2 \text{ k} (0.35) + 50 (12)] < 0.588,$$

which is the condition for the stable state (Q_1 off).

Using Eq. 37, we calculate the value of R_1 as

$$R_1 < [(12 - 1.1) - (1 \text{ mA}) (1.2 \text{ k})] / 1 \text{ mA}$$

and

$$R_1 < 9.7 \text{ k}\Omega,$$

where the value of base-one current was calculated from

$$I_{B1} = I_{C1} / \beta_{1(min)}.$$

Let's use an R_1 value that is appreciably lower than the limiting value of 9.7 k, and let

$$R_1 = 5 \text{ k}.$$

Using Eq. 38, we can calculate the value of R_2 as

$$R_2 > [(5 \text{ k} + 1.2 \text{ k}) 1.6] / [12 - 1.6) - (5 \text{ k} + 1.2 \text{ k}) 0.5 \text{ mA}] > 1.31 \text{ k},$$

where the $V_{B1(sat)}$ was obtained from

$$V_{B1(sat)} = V_{BE1(sat)} + V_E.$$

As in the case of the R_1 , we will choose an R_2 that is sufficiently higher than the limiting value of 1.31 k, or

$$R_2 = 2 \text{ k}\Omega.$$

We can now check the condition of Eq. 23 by substituting the values of R_1 and R_2 into it. Thus

$2k / (5k + 2k) = 0.285$,
 which is lower than 0.588 meaning that the one-shot will have a reliable stable state.

Step 5. Determine C for the desired period. Since $V_{CC} > V_{EBO2}$, Eq. 40 and Fig. 4 will be used. Before, however, we should calculate the effective emitter-base breakdown voltage as follows:

$$V'_{EBO2} = V_{EBO2} - V_E + V_{B2(sat)} \\ = 6.3 - 0.5 + 1.6 = 7.4 \text{ V.}$$

Using $V'_{EBO2} = 7.4 \text{ V}$ and a $V_{CC} = 12 \text{ V}$ in Eq. 40, we get

$$T \approx RC (0.48).$$

Remembering that the desired $T = 80 \mu\text{s}$ and R has been calculated to be 15 k , we get

$$C = (80 \times 10^{-6}) / (15 \times 10^3) (0.48) = 0.011 \mu\text{F},$$

or, rounding it off,

$$C = 0.01 \mu\text{F}.$$

Actually, as will be seen later, this reduction in the calculated value of C is beneficial, since it helps to account for various stray capacitances. For the time being let us recalculate T with the reduced C_1 :
 $T = 0.48 (15 \times 10^3) (0.01 \times 10^{-6}) = 73 \mu\text{s}$.

Step 6. Determine the retrigger time. While we omitted mentioning the retrigger time during the development of the design equations, there are many situations where it must be considered. The retrigger time, T_R , is defined as the time between the instant when Q_2 turns back on and the time at which another trigger may be accepted without affecting the one-shot's pulse width. As was pointed out, the period is a function of the initial charge on C . Figure 5 shows that the voltage at V_{C1} has a time constant of $R_{C1} C$ (fall time). Thus, if we assume that after three time constant V_{C1} has reached its quiescent value,

$$T_R \approx 3R_{C1}C,$$

or, for our design,

$$T_R = 3 (1.2 \times 10^3) (0.01 \times 10^{-6}) = 36 \mu\text{s}.$$

Step 7. Determine output voltage levels (Fig. 5).

The output of Q_1 , V_{C1} , will have a maximum value of $+12 \text{ V}$ in the off state. In the active state we will have:

$$V_{C1(on)} = 0.35 (\text{max}) + (10 \text{ mA}) (50) \\ = 0.85 \text{ V.}$$

The output of Q_2 will be

$$V_{C2(on)} = 0.85 \text{ V,}$$

during the off state and

$$V_{C2(off)} = (V_{B1} R_{C2} + V_{CC} R_1) / (R_1 + R_{C2}),$$

during the on state.

Since

$$V_{B1} = V_{BE1(sat)} + I_{E1} R_E \approx 1.6 \text{ V,} \\ V_{C2(off)} = [1.6 (1.2 \text{ k}) + 12 (5 \text{ k})] / 6.2 \text{ k} \\ = 10 \text{ V.}$$

The complete circuit and its output wave-shapes are illustrated in Fig. 6. The measured period is $80 \mu\text{s}$, which is in good agreement with the predicted period of $73 \mu\text{s}$ (recall the validity of rounding off the value of C). The measured recovery time is $33 \mu\text{s}$, which is also in agreement with the

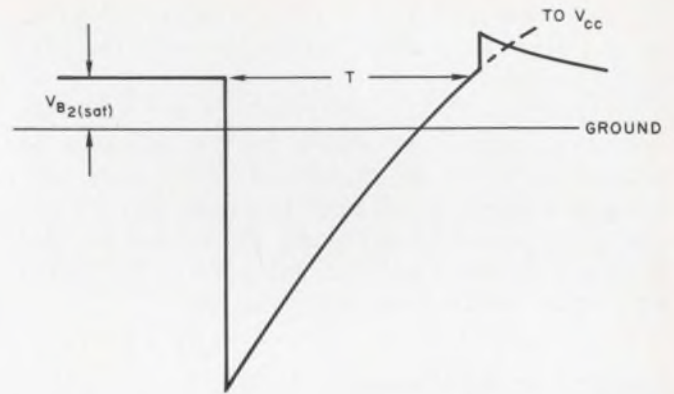

3. The period, T , of the one-shot can be observed from this waveshape, which occurs at the base of Q_2 . Note that the end of the period is right after the $V_{B2(sat)}$ is reached.

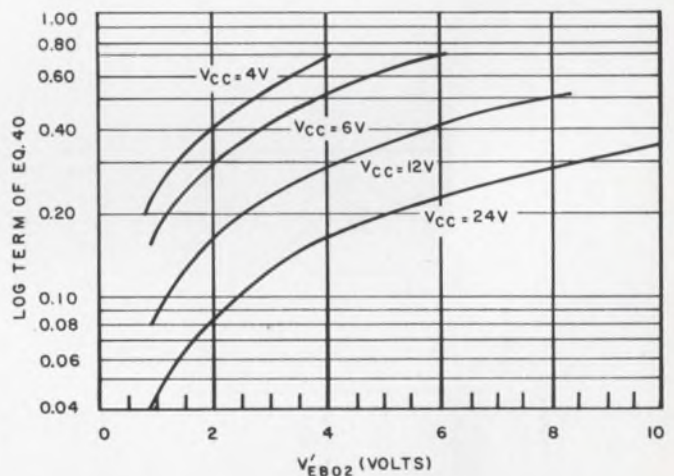

4. Effect of V_{CC} , V_{EBO2} , V_E , and $V_{B2(sat)}$ on the one-shot period, T . The V'_{EBO2} on the abscissa is the effective emitter-base breakdown voltage given by $V'_{EBO2} = V_{EBO2} - V_E + V_{B2(sat)}$. To find T , multiply RC of the one-shot by the corresponding ordinate value. For more details see Eq. 40.

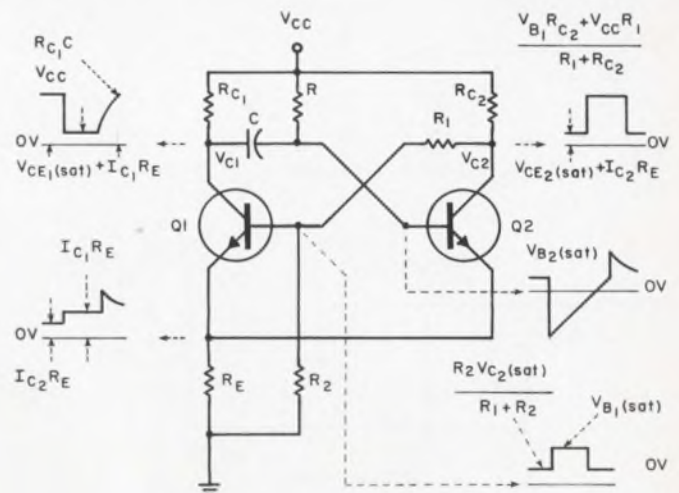

5. Pulse shapes and their values are illustrated in this figure. This circuit, as that of Fig. 1, does not include the triggering circuit.

predicted value of $36 \mu\text{s}$. The output levels (Fig. 6) are also in excellent agreement with the predicted values.

Note that a diode, a $5\text{-k}\Omega$ resistor and a 200-pF capacitor have been added to the one-shot to accommodate the trigger input. Thus the input pulse is differentiated, and then only the positive portion is passed by the diode. The reason for this is that a negative pulse on the base of Q_1 (when saturated) will turn it off.

Speeding up the one-shot

It has been shown that the period of a one-shot is a function of V_{EB02} for $V_{CC} > V_{EB02}$. In this case the emitter acts as a zener diode. Be careful not to exceed the power breakdown for this junction. This specification is not normally given in transistor data sheets. The problem, however, may be

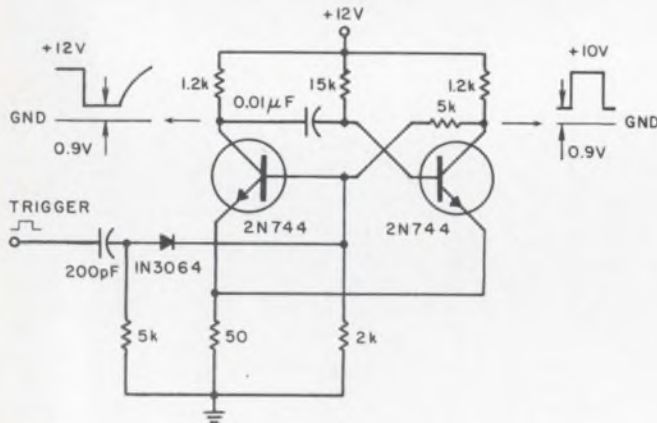

6. Here is a complete one-shot designed to meet the $80\text{-}\mu\text{s}$ period spec. Its retrigger time is $33 \mu\text{s}$. Note the addition of a three-element trigger network.

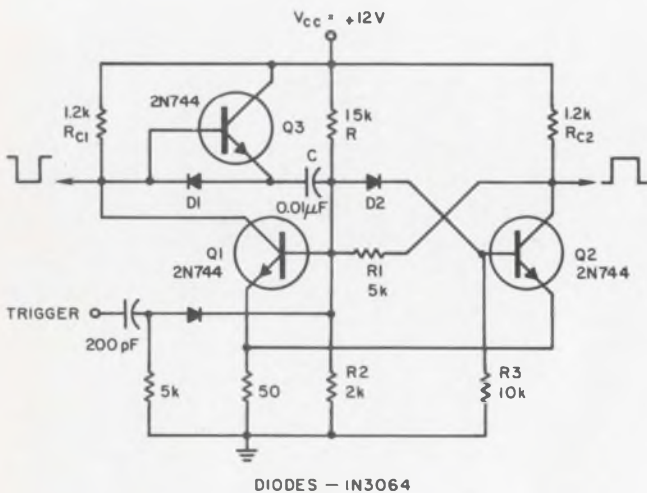

7. Faster retrigger time is obtained by adding a transistor and a diode, Q_3 and D_1 . The retrigger time of the one-shot of Fig. 6 ($33 \mu\text{s}$) was reduced to only $5 \mu\text{s}$. D_2 is added to protect the base-emitter junction of Q_2 .

solved by placing a diode, with a high reverse breakdown voltage, in series with base two.

The period is also a function of the trigger rate. The voltage at V_{C1} has a time constant $R_{C1}C$ after Q_1 turns off. Thus the charge on C (and the period) depends on the trigger rate and the $R_{C1}C$.

As shown, the retrigger time (the time after the one-shot's period during which it can be triggered again) is quite long. A diode and a transistor, D_1 and Q_3 , illustrated in Fig. 7, help to reduce the trigger time by ensuring that C charges through the low impedance of Q_3 . Circuit operation with this modification is as follows: During the stable state (Q_1 off, Q_2 saturated), C is charged to $V_{C1} - V_{BE3}$. When Q_1 is turned on, C drops to $V_{CE1(sat)} + V_{D1}$. Thus the base of Q_2 drops to $-|V_{C1} - V_{BE3}|$ (diode D_2 prevents any exceeding of the V_{EB02}). When the voltage on base two reaches the Q_2 turn-on voltage, Q_2 saturates, turning Q_1 off. The collector of Q_1 is dc-isolated from C by D_1 ; thus V_{C1} quickly rises to V_{CC} . The capacitor charges through the low impedance of Q_3 . Thus the time constant is small, and the one-shot may be quickly retriggered. Resistor R_3 is to discharge the stored base charge from Q_2 .

The period for the one-shot of Fig. 7 is $T \approx 0.69 RC = 104 \mu\text{s}$.

The measured rise time is $108 \mu\text{s}$, which is in agreement with the theory. The retrigger time is a function of the dynamic emitter resistance of Q_3 , R_{E3} , and is difficult to calculate directly. The measured retrigger time is $5 \mu\text{s}$, which is well below the $33 \mu\text{s}$ for the circuit of Fig. 6. ■ ■

Test your retention

Here are questions based on the main points of this article. Their purpose is to help you make sure you have not overlooked any important ideas. You'll find the answers in the article.

1. Can you describe (qualitatively) the operation of the basic one-shot of Fig. 1?
2. What are the conditions for the one-shot off state? For the on state?
3. Why is the value of C rounded off downwards?
4. How can the base-emitter junction of Q_2 be protected when V_{CC} exceeds its breakdown voltage?
5. How can the retrigger time be reduced?

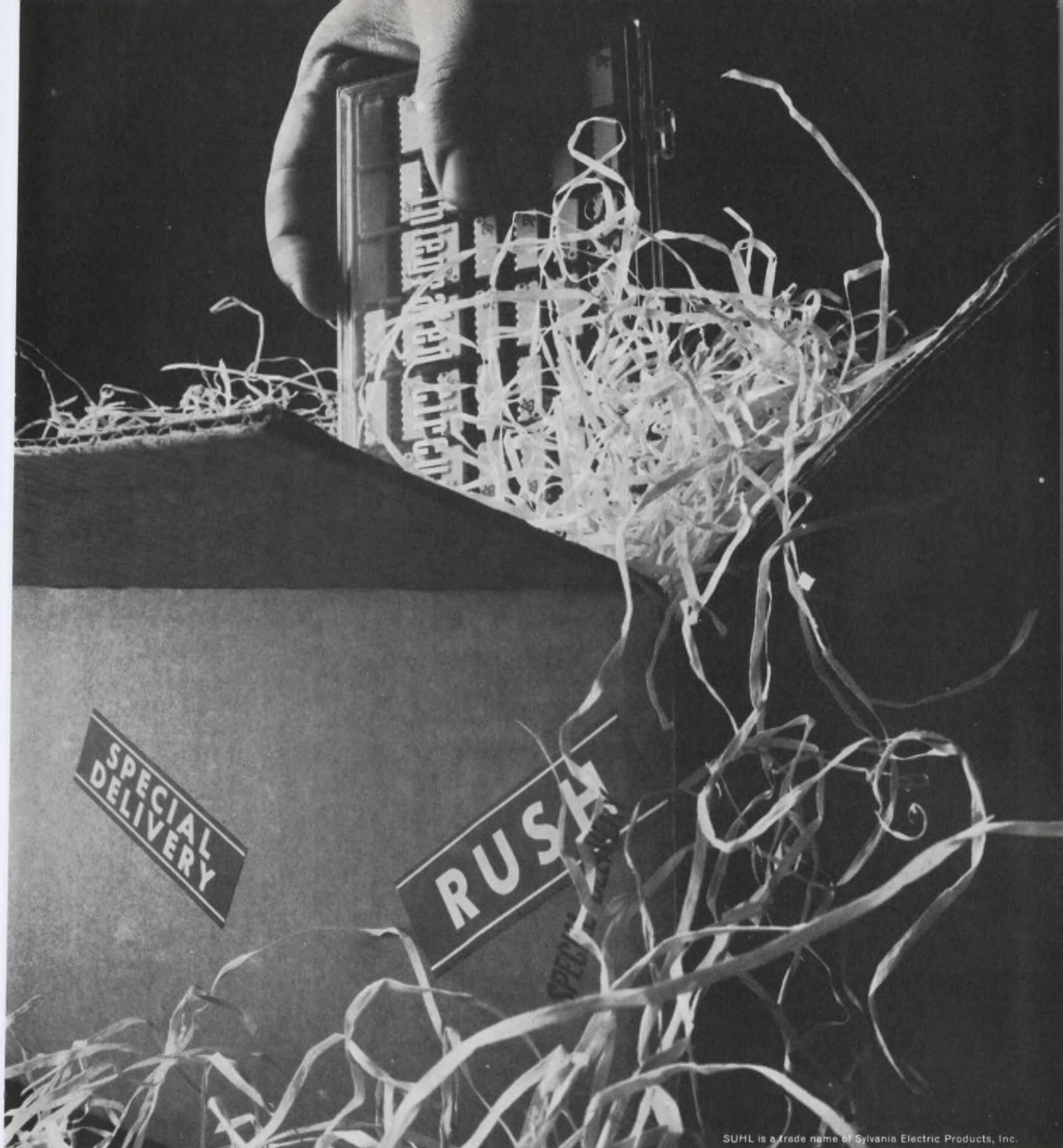

SUHL is a trade name of Sylvania Electric Products, Inc.

SUHL's latest edge is speed.

SUHL integrated circuits have always had the edge in operating speed. Now, we've added an extra edge. Delivery speed.

We can deliver the most complete line in the industry just as fast as we can pluck them off the shelf.

They're there, ready and waiting. Both SUHL I and super-fast SUHL II.

You can get flip-flops that flip at a 50 MHz rate, gates with propagation delays as low as 6 ns. And they have the high noise immunity inherent in SUHL circuits.

Why wait for delivery from second

sources, when you can get fast delivery from the originators of SUHL.

Sylvania Electronic Components, Semiconductor Division, Woburn, Mass. 01801.

SYLVANIA
A SUBSIDIARY OF
GENERAL TELEPHONE & ELECTRONICS

Reliable bistable circuit uses only 4 inexpensive components

A simple bistable circuit can be built using a D13T1 programmable unijunction transistor, two resistors, and a capacitor (see diagram). The circuit is very reliable as long as the output load is 200 k Ω or larger, or 0.01 μ F or smaller. A negative pulse of 2 V or more is required to turn the D13T1 ON or OFF.

The circuit (a) functions as follows. The D13T1 is initially OFF, since the gate and anode are both returned to the supply voltage. In order for the D13T1 to turn ON, the gate must be about 0.5-V more positive than the anode. A negative pulse applied to the anode will provide this condition, and turn the D13T1 ON. The 0.001- μ F capacitor from anode to cathode adds enough energy to accelerate the negative-resistance characteristic of the D13T1, and the anode resistor is small enough to allow holding current. The D13T1 then stays on with about 0.8 V from the cathode (ground) to either the gate or anode. The next negative pulse drives the anode to a potential more negative than the cathode, and the D13T1 is turned off. The output from the circuit can be taken from either the gate or anode.

The coupling network (b) is needed if two or more of these stages are to be connected together. The speed of the circuit is determined by the

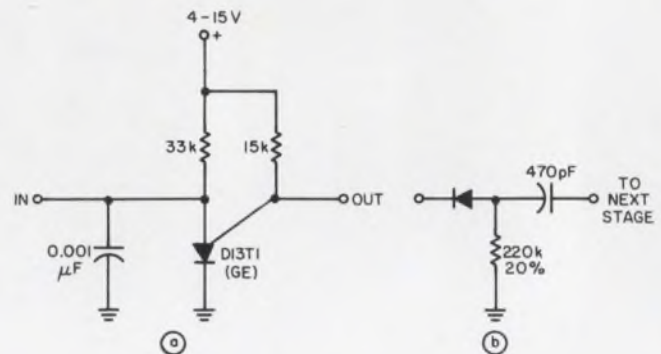

Bistable circuit (a) uses only four components. Coupling network (b) is needed if two or more of these circuits are connected together.

0.001- μ F capacitor and the anode resistor. However, the capacitor must not be much smaller than 0.001 μ F, or not enough energy will be produced to reliably support the negative resistance action of the D13T1.

With the values shown, the circuit will operate reliably with a supply voltage of 3 to 15 V.

A. G. Richardson, Supervisor, Automated Specialties, Charlottesville, Va.

VOTE FOR 311

Feedback technique dynamically resonates tuned circuit

Manual adjustment of tuned circuits can often be a troublesome requirement. The problem can be eliminated by using a feedback-control technique that provides dynamic tuning without regard to the input signal's frequency, waveshape or absolute amplitude. This can be accomplished with the circuit shown.

In operation, the bias voltage applied to the voltage-variable capacitors, C_1 and C_2 , is automatically increased or decreased when the tuned circuit is out of resonance. This tunes the circuit either higher or lower in frequency until the signal voltage reaches a maximum, at which point equilibrium is established. By using this configuration as the tuned circuit of an amplifier or filter, the advantages of a manually tuned, high-Q

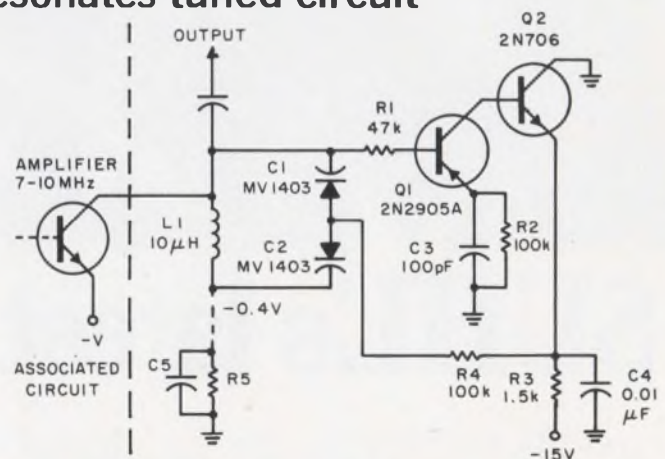

Feedback signal controls the capacitance of voltage variable capacitors C_1 and C_2 to provide automatic circuit tuning.



Helipot's new, economy dc voltage regulators are only \$10⁸⁰ (100 piece quantity)

Helipot's new *positive* (Model 809) and *negative* (Model 859) *self-contained* hybrid *cermet* units are designed to give you high performance at budget prices.

- 5 to 28 volts fixed outputs
- 0.003%/ma maximum load regulation
- 2 volt minimum ΔV across regulator
- 750 ma load capability
- 34 db ripple attenuation to 100 kHz
- -55° to $+125^{\circ}\text{C}$ operating temperature range
- Add-on capabilities include: short circuit protection with an external transistor, loads over 5 amps with an external pass transistor, and adjustable outputs with an external resistor.

These regulators are small (1" x 0.5" x 0.170" high), fully sealed (1×10^{-7}) and compatible with flat pack and dual in-line packaging. And, they're available from local stock. For more information, call your local Helipot sales representative or circle the reader service number.

Beckman

INSTRUMENTS, INC.
HELIPOT DIVISION
FULLERTON, CALIFORNIA • 92634

INTERNATIONAL SUBSIDIARIES: GENEVA, MUNICH, GLENROTHES, SCOTLAND;
TOKYO, PARIS, CAPE TOWN, LONDON, MEXICO CITY, STOCKHOLM, VIENNA

circuit are obtained; no manual adjustment, though, is required to attain optimum performance. Instantaneous change in frequency is possible—at no sacrifice in performance.

The negative-going portions of the input signal tend to charge C_3 , through $Q1$, to a level equal to the peak input voltage. Each time that C_3 is incrementally charged, $Q1$ turns on $Q2$, and C_4 is incrementally discharged. This increases the capacitance of C_1 and C_2 , lowering the resonant frequency of the tuned circuit and increasing the signal voltage across the tuned circuit as resonance is approached.

The process reiterates until the point of reso-

nance is reached, and $Q1$ is back-biased through the entire input-voltage cycle. C_1 then tends to recharge through R_3 , but C_3 simultaneously discharges through R_2 at a slightly faster rate; thus, $Q1$ can again turn ON and maintain equilibrium at the resonant frequency.

R_5 and C_5 serve to keep $Q1$ biased to the point of turn-ON, so that the relatively small signal voltage present across the tuned circuit, when the circuits out of resonance, is amplified and initiates the peaking process.

Thomas E. Skopal, Piscataway, New Jersey.

VOTE FOR 312

Self-switching of active devices improves performance

Auxiliary components can be used to switch transistor stages ON and OFF, but usually at an increase in current drain and over-all cost. A better way is to use the active stage itself to provide the ON-OFF operation.

An example of this method is its use for enabling and disabling detector stages in a multi-mode receiver. Not only does the technique result in minimum distortion, but it also makes possible remote switching between receiver modes.

The basic switching action is illustrated in Fig. 1. With switch $S1$ in the ACTIVE position, the emitter-base diode is forward-biased and E_{in} is amplified at E_{out} . When $S1$ is in the CUTOFF position, the emitter-base diode is back-biased,

making the signal voltage at E_{out} very low. In practice, the ON/OFF ratio at E_{out} can be 60 dB and greater.

The voltage that back-biases the “unused” active device may, by proper selection, be obtained from currents that would have been required to operate another active device. In addition the same decoupling networks can function for the “diode switch” as well as for the active stage.

An example of this technique is the selection between a-m and ssb detectors in a radio receiver (see Fig. 2). In the illustration:

- Q_1 is a conventional product detector for ssb or cw modulation.
- Q_2 is an infinite-impedance type of envelope detector for a-m.
- T_1 is an i-f transformer, with the secondary centertapped (turn ratio 1:1).

VOTE

VOTE! Go through all Idea-for-Design entries, select the best, and circle the appropriate number on the Reader-Service-Card.

SEND US YOUR IDEAS FOR DESIGN. You may win a grand total of \$1050 (cash)! Here's how. Submit your IFD describing a new or important circuit or design technique, the clever use of a new component or test equipment, packaging tips, cost-saving ideas to our Ideas-for-Design editor. You will receive \$20 for each accepted idea, \$30 more if it is voted best-of-issue by our readers. The best-of-issue winners become eligible for the Idea Of the Year award of \$1000.

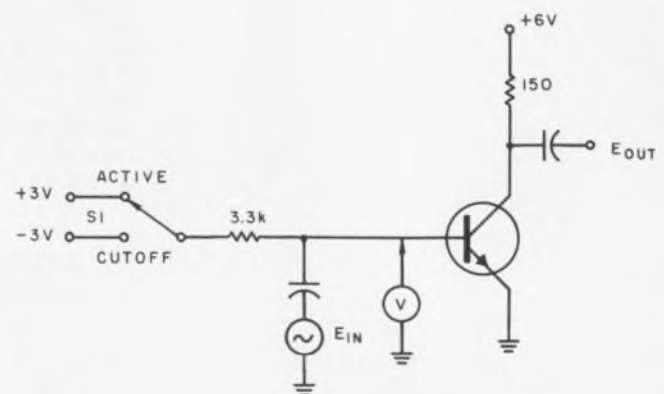

1. Basic switching action is performed by the transistor emitter-base diode.



This is our Molex 1175. A lighted push button switch. Snap mounts. Spade or wire terminals make assembly easy. In quantity, costs about sixty cents.

You could pay more, but that's the point. Men who use switches have told us, "enough is enough". We take that seriously. By creating switches that do the job right, yet aren't over-engineered to the point that costs wind up in left field.

So this switch is available in nine colors, 500 variations, and is built to go on and off—and on and on. For about sixty cents.

If that makes sense to you, and you would like a free sample of our 1175 switch, write or phone (312) 969-4550.



- R_2 provides a low impedance for the emitter-base of the product detector.
- R_3 and C_1 are for B+ decoupling.
- R_1 is a load resistor for the carrier injection oscillator.
- R_8 and C_2 are for emitter bypassing.
- R_6, R_7 and R_8 are for conventional base-biasing.
- C_3 works with R_6 and R_7 for decoupling the remote ssb/a-m switch.
- R_9 is an ssb and a-m "load" resistor. In ssb, the dc voltage developed across R_9 cuts off the a-m detector.
- C_4 is a 455-kHz bypass.
- R_{10} functions in a-m to produce a slight forward-bias on the a-m detector.
- R_{11} and C_5 are the a-m detector's rf bypass capacitor and most of its diode-load resistor.

Especially note on the diagram that R_1 serves four purposes:

1. In ssb, R_1 reduces the input signal from the larger level, required to run an agc and the a-m detectors, to a value more suitable for the product detector.

2. Also in ssb, R_1 keeps the injection of the bfo from feeding into the agc detector and generating a false agc signal.

3. In a-m, R_1 passes a dc current through R_9 to cause the emitter of the product detector to be negative with respect to its base, thus ensuring that the product detector is cut off.

4. This same current is passed through R_{10} to bias the a-m detector for least crossover distortion. (Bypassing R_{10} increases the output very slightly but does not further reduce the distortion.)

W. Herzog, RF Communications, Inc., Rochester, N.Y.

VOTE FOR 313

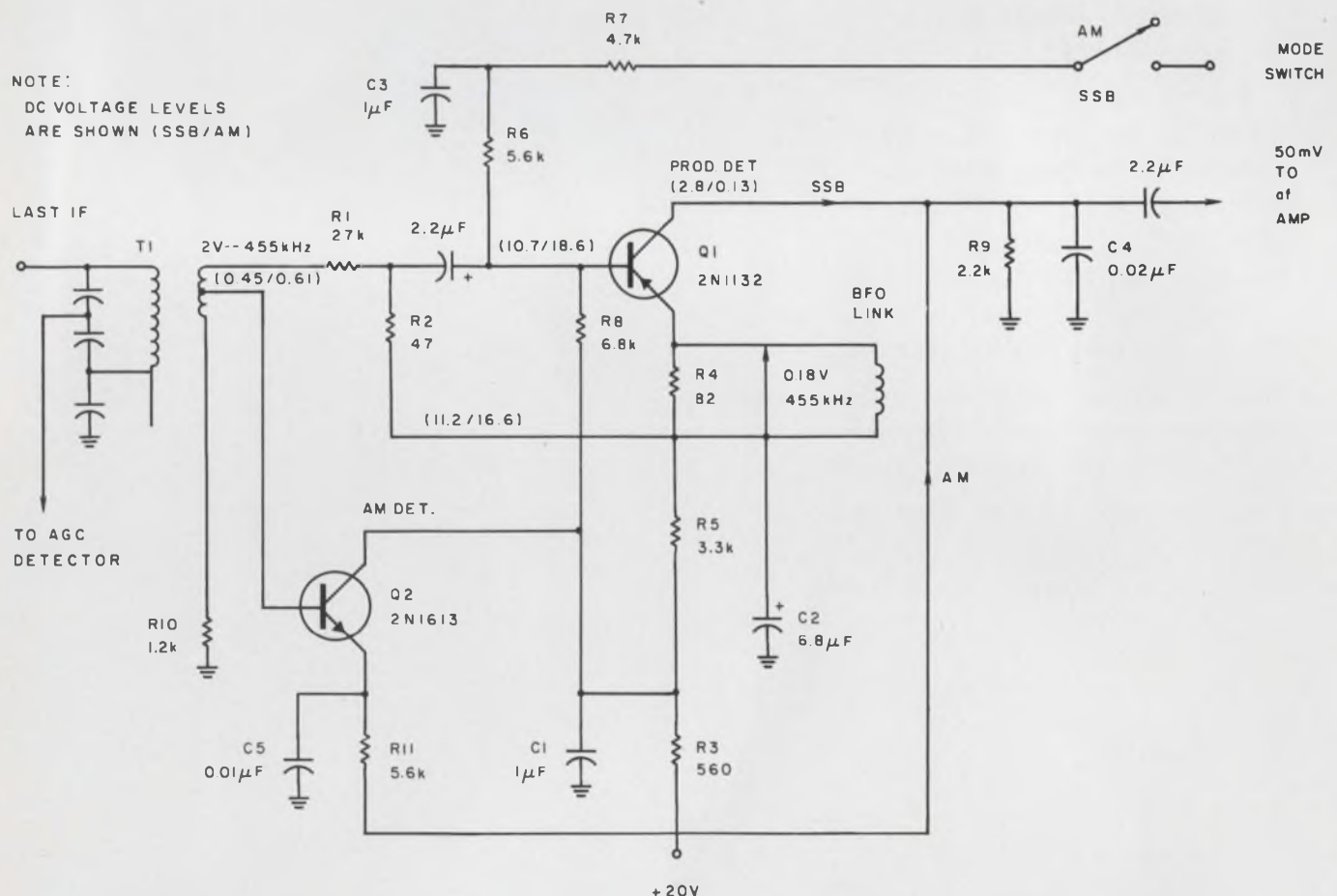

2. The position of the MODE switch determines whether product detector Q1 or a-m detector Q2 is cut off.

We're not afraid to say it out loud:

Delivery OF ELCO CARD-EDGE CONNECTORS FROM OUR STOCKING DISTRIBUTORS IN 24 HOURS. PERIOD.

Why wait? And wait?? And wait??? When you can not only get delivery in a day, but the Card-Edge Connectors that meet your exact requirements. At competitive prices. MIL-Spec designs. 6 to 100 bifurcated or non-bifurcated contacts at .100" to .200" spacing. Single or dual readout. For wire wrap and other terminations. Insulators with or without extended p. c. card guides. Even a new Series with single-cantilever contacts, with noses pre-loaded for maximum performance. Down with down-time. And up to your nearest Distributor listed here. Or write, call, wire or TWX us for Card-Edge Connector Guide and complete data. Elco Corporation, Willow Grove, Pa. 19090; 215-659-7000; TWX 510-665-5573.

P.S.—FREE SAMPLE? Let us know after you read our literature. We'll be delighted to send you one.

**EAST COAST**

CAROLINA RADIO SUPPLY COMPANY
838 Huffman St., Greensboro, N.C. 27405; Phone: 919-273-8669

CONNECTOR CORPORATION
137 Hamilton St., New Haven, Conn. 06510; Phone: 203-624-0127

D.R.W. ELECTRONICS
100 Milbar Blvd., Farmingdale, L. I., N. Y. 11735; Phone: 516-249-2660

HAMMOND ELECTRONICS
911 W. Central Blvd., Orlando, Fla. 32805; Phone: 305-241-6601

POWELL/FLORIDA
2049 W. Central Blvd., Orlando, Fla. 32805; Phone: 305-423-8586

POWELL/HUNTSVILLE
Huntsville Highway, Fayetteville, Tenn. 37334; Phone: 615-433-5737

POWELL/PHILADELPHIA
Island and Enterprise Rds., Phila., Pa. 19101; Phone: 215-724-1900

POWELL/WASHINGTON
10728 Hanna St., Beltsville, Md. 20705; Phone: 301-474-1030

PYTRONICS/BALTIMORE
2035 Worcester St., Baltimore, Md. 21230; Phone: 301-539-6525

PYTRONICS/MONTGOMERYVILLE
Bldg. 2-Stump Rd., Montgomeryville, Pa. 18936; Phone: 215-643-2850

RADIO SHACK
920 Main Street, Waltham, Mass. 02154; Phone: 617-891-8700

SAGER ELECTRICAL SUPPLY COMPANY
172 High St., Boston, Mass. 02107
Phone: 617-542-2281

STERLING/ATLAS ELECTRONICS
774 Pfeiffer Blvd., Perth Amboy, N.J. 08861; Phone: 201-442-8000

SUMMIT DISTRIBUTORS
916 Main St., Buffalo, N.Y. 14202
Phone: 716-884-3450

TERMINAL-HUDSON ELECTRONICS
236 W. 17th St., New York, N.Y. 10011; Phone: 212-243-5200

MID-WEST

ALLIED RADIO CORPORATION
111 N. Campbell Ave., Chicago, Ill. 60680; Phone: 312-421-6800

HAMILTON ELECTRO SALES OF TEXAS
1216 W. Clay St., Houston, Tex. 77019; Phone: 713-526-4661

CONTACT ELECTRONICS
2403 Farrington St., Dallas, Tex. 75207; Phone: 214-638-2850

D. F. COUNTRYMAN & COMPANY
1955 University Ave., St. Paul, Minn. 55104; Phone: 612-645-9151

ELECTRONIC EXPEDITORS, INC.
6045 N. Green Bay Ave., Milwaukee, Wis. 53209; Phone: 414-374-6666

LECTRONIX, INC.
214 N. Second St., St. Charles, Mo. 63301; Phone: 314-723-1122

PIONEER-STANDARD ELECT. SUPPLY CO.
5403 Prospect Ave., Cleveland, Ohio 44103; Phone: 216-432-0010

SREPCO, INC.
314 Leo St., Dayton, Ohio 45404
Phone: 513-224-0871

WEST COAST

ALMAC/STROUM ELECTRONICS
5811-Sixth Ave., S., Seattle, Wash. 98108; Phone: 206-763-2300

ELECTRO-SONIC COMPONENTS
14126 Lemoll Ave., Hawthorne, Cal. 90250; Phone: 213-679-9781

HOLLYWOOD RADIO
5250 Hollywood Blvd., Hollywood, Cal. 90027; Phone: 213-466-3181

KIERULFF/DENVER
10890 E. 47th St., Denver, Colo. 80239; Phone: 303-343-7090

KIERULFF/LOS ANGELES
2585 Commerce Way, Los Angeles, Cal. 90022; Phone: 213-685-5511

KIERULFF/PALO ALTO
3969 E. Bayshore Rd., Palo Alto, Cal. 94303; Phone: 415-968-6292

KIERULFF/SAN DIEGO
8797 Balboa Ave., San Diego, Cal. 92123; Phone: 714-278-2112

RICHEY ELECTRONICS
5505 Riverton Ave., N. Hollywood, Cal. 91601; Phone: 213-761-6133

WEATHERBIE INDUSTRIAL ELECTRONICS
1280 N. Fourth St., San Jose, Cal. 95112; Phone: 408-297-9550

Milliwatt ac regulator uses low-cost components

Close regulation of low-power ac rms outputs derived from line supplies is frequently required. A circuit that accomplishes this, and uses low-cost components and a simple-to-wind output transformer, is shown. Although intended for 400-Hz operation, the circuit is also suitable for 60-Hz, if appropriate inductive components are used.

In the circuit, a zener diode is connected across the dc-side of a bridge rectifier. The clipping action of the zener causes a square-wave voltage to appear across the ac-side of the bridge. The series reactor limits current when the zener is conducting, and the difference between the

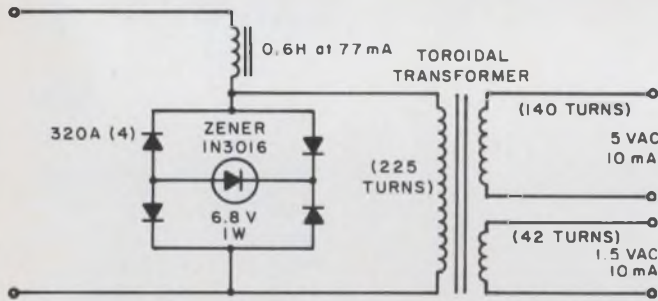

Good regulation of milliwatt outputs is provided by this ac rms regulator arrangement.

bridge voltage and the applied voltage appears across the reactor.

The zener diode is selected for small positive temperature coefficient so that, when it is combined with two series bridge diodes having negative temperature coefficients, a suitable over-all temperature characteristic is produced.

If a series limiting resistor were used, instead of a reactor, it would dissipate about 9 W, causing lowered efficiency as well as potential packaging problems. A series reactor is therefore more appropriate for most applications.

The toroidal transformer furnishes isolation between outputs and low excitation-current drain, while aiding the over-all regulation. If desirable, taps on the windings of this transformer can allow for individual selection of output levels to compensate for zener tolerances. Tests have indicated that no appreciable benefit will result from using a bleeder resistor on the transformer secondary.

For the circuit shown, worst-case regulation of about 9% can be expected for a 0 to 200% load range. The regulation is approximately twice as good for a 0 to 100% load.

R. Klein, Acme Electric, Cuba, N.Y.

VOTE FOR 314

Simple circuit eliminates switch contact bounce

It is often difficult to interface slow peripheral equipment with high-speed digital systems. This is especially true when interfacing a push-button control with an integrated circuit, because the IC can respond to the speed of the switch bounce. The usual solution is to use either an RC network across the switch or a one-shot multivibrator whose period is long, compared to the bounce period. Both methods, however, suffer

from the fact that they are slow and dependent on the switch characteristics. The circuit shown overcomes both problems and produces complementary outputs.

The two gates are connected as an R-S flip-flop. With the switch open, output 1 is in the HIGH state. Since both inputs of gate 2 are HIGH, its output is LOW. While the switch is being activated, output 2 keeps output 1 in the HIGH state. As soon as the switch reaches position 2, output 2 goes HIGH, and since both inputs to gate 1 are now HIGH, its output changes state. Because output 1 is also coupled back into gate 2, output 2 remains HIGH even if the switch bounces. The flip-flop resets when the switch returns to position 1. Rise and fall times of the two complementary outputs is approximately 10 ns. The two resistors shown furnish logical ONE current into both gates.

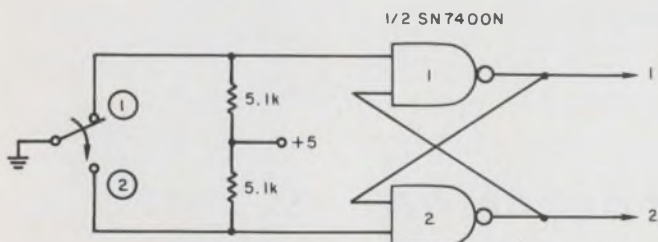

Contact bounce is eliminated and complementary outputs are produced by this arrangement of two gates and two resistors.

Ted Tuchsens, Texas Instruments, Dallas, Texas

VOTE FOR 317

Ask Amperex for the most reliable^{*} 74N TTL's in the business.



SERIES 74N	DESCRIPTION	AMPEREX ULTRA RELIABLE IDENTICAL TYPE
GATES		
SN 7400N	Quadruple 2-input Nand Gate	FJH131
SN 7401N	Quad. 2-input Nand Gate (no collector load)	FJH231
SN 7402N	Quadruple 2-input Nor Gate	FJH221
SN 7410N	Triple 3-input Nand Gate	FJH121
SN 7420N	Dual 4-input Nand Gate	FJH111
SN 7430N	Single 8-input Nand Gate	FJH101
SN 7440N	Dual 4-input Nand Buffer	FJH141
SN 7450N	Dual And-Or-Not Gate Expandable	FJH151
SN 7451N	Dual And-Or-Not Gate	FJH161
SN 7453N	Single And-Or-Not Gate Expandable	FJH171
SN 7454N	Single And-Or-Not Gate	FJH181
SN 7460N	Dual 4-input Expander	FJY101
FLIP-FLOPS		
SN 7470N	Single J-K Flip-Flop	FJJ101
SN 7472N	Single J-K M/S Flip-Flop	FJJ111
SN 7473N	Dual J-K M/S Flip-Flop	FJJ121
SN 7474N	Dual D Latch Flip-Flop	FJJ131
SN 7476N	Dual J-K M/S Flip-Flop with P and C	FJJ191
HIGHER ORDER FUNCTIONS		
SN 7441N	BCD-Decimal Decoder/Driver	FJL101
SN 7475N	Quadruple Bistable Latch	FJJ181
SN 7490N	Decade Counter	FJJ141
SN 7492N	Divide-by-Twelve Counter	FJJ251
SN 7493N	4-Bit Binary Counter	FJJ211

*We've eliminated a major cause of failure in these devices, previously caused by bonding over steps in the oxide.

For data, write:
Amperex Electronic Corporation
Semiconductor and Microcircuits Division
Slatersville, Rhode Island 02876.

Amperex
TOMORROW'S THINKING IN TODAY'S PRODUCTS

SCRs provide mutually exclusive lamp-sequencing

Circuits for sequential lighting of lamps often pose tricky design problems, particularly when the sequencing is to be controlled by momentary (and noisy) switch contact closures. A circuit of this type, shown here, also provides for mutually exclusive operation with no overlaps or gaps, and switch operation in either direction. The circuit was designed for small (14-V) lamps, but can easily be adapted for larger loads by using appropriately rated SCRs and commutating capacitors.

Operation of the circuit is as follows: assume that the switch, *S1* is in the "start" position, that all SCRs are off and all commutating capacitors (*C_c*), and trigger capacitors (*C_t*), are uncharged. The start lamp (*I-S*) is ON. When *S1* is advanced to position "1", *SCR-1* is fired, turning on lamp *I-1*. The capacitor, *C_c*, between *SCR-1* and *SCR-2* charges to about 10 V, since there are one-volt drops across both the isolation resistor, *R₁*, and *SCR-1*.

When the switch is advanced to position "2," *SCR-2* is turned on, lighting *I-2*, and dropping its anode voltage to about 1 V. This 10-V drop is coupled to the anode of *SCR-1*, turning it off, and putting out lamp *I-1*. The action repeats as *S-1* is advanced (or retarded), and any number of stages can be employed. When the switch is returned to the "start" position, lamp *I-S* and Capacitor *C₁* are switched across the lamp sup-

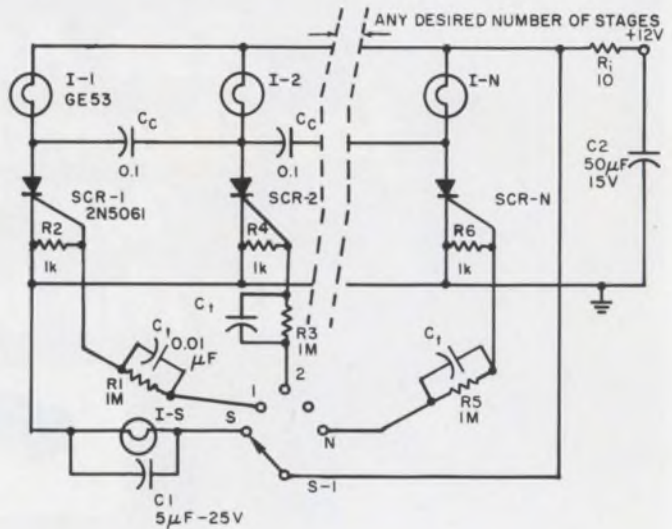

Sequencing of any number of lamps, with mutually exclusive operation of each, can be performed with this SCR-controlled circuit.

ply-voltage, dropping it momentarily to near zero, and shutting off *SCR-1*.

The specified parts for the circuit are inexpensive and noncritical. They can be bought at a small quantity price of about \$1.70 per stage.

Emerson M. Hoyt, Senior Systems Engineer, Industrial Systems Operation, Philco Ford Corp., Dearborn, Mich.

VOTE FOR 315

Pulse differentiator has very narrow output

If the output of a standard RC pulse differentiator network is too wide for your application, the circuit shown can be used to generate 3-to-10-ns pulses.

A positive pulse of greater than 0.7 V is applied to the base of the transistor through *R₁*. The transistor is operated in the avalanche mode and discharges *C₁* through the emitter network. A positive 2-ns rise-time pulse at the emitter is then coupled into a series hi-Q resonant circuit. The circuit is tuned to the major harmonic contained by the pulse (125 MHz). The resonant circuit rings for one positive cycle and is damped by a diode. The resulting output across the inductor is a half-sinusoid pulse, which may be adjusted in amplitude and width by trimming capacitor *C₂*.

David A. Sands, Engineer, EG&G, Inc., Boston.
VOTE FOR 316

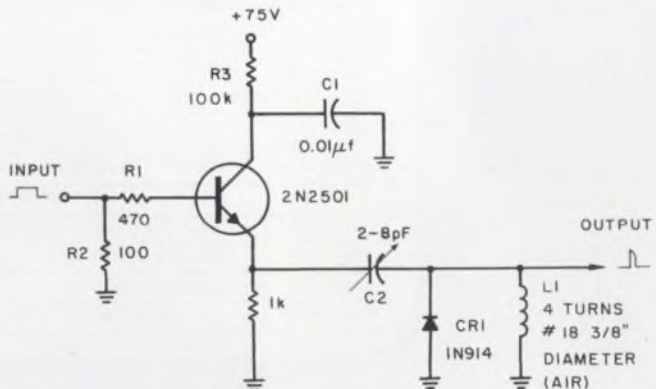

Very narrow output pulse is produced by this pulse differentiator each time a pulse is applied to the input.

IFD Winner for October 10, 1968
Hy Drexler and Fred Rubin, Design Engineers, Grumman Aircraft, Bethpage, N. Y. Their Idea "Circuit protects line driver against inadvertent shorts" has been voted the Most Valuable of Issue Award.
Vote for the Best Idea in this Issue.

Pick the
BEST IC
for the job

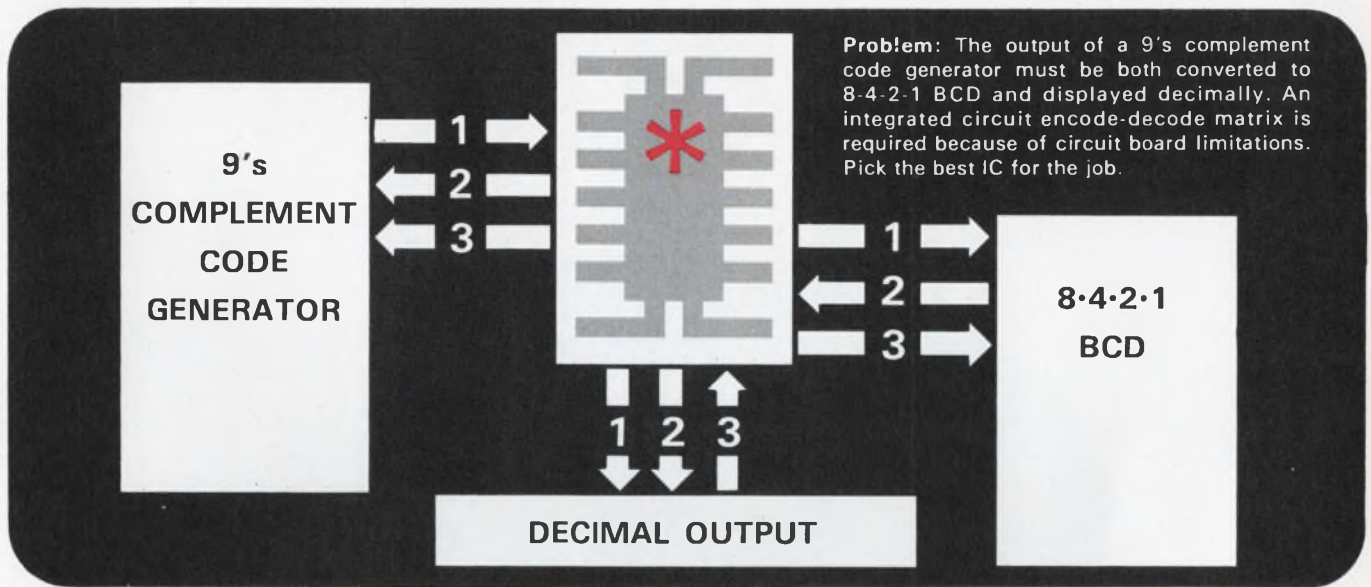

the **BEST** Solution:

THE RADIATION RM-84 DIODE MATRIX



Solve the problem easily. Combine only *four* * RM-84 diode matrices from Radiation and form a 16 x 10 matrix array. Six code conversions can be performed by this single bi-directional array to replace approximately 80 logic elements. The code pattern will be customized quickly from our complete stock of standard matrices.

Radiation diode matrices are dielectrically isolated, eliminating cross-coupling and allowing easy customization. These circuits can be combined with Radiation interface circuits to provide the most economical, convenient and reliable diode logic available.

Contact your nearest Radiation sales office. Ask about our diode matrix line. Let us help you pick The Best IC for The Job.

WE MAKE THE **BEST IC** FOR THE JOB



RADIATION
INCORPORATED

SUBSIDIARY OF HARRIS-INTERTYPE CORPORATION
MICROELECTRONICS DIVISION

RADIATION SALES OFFICES: P. O. Box 476, Lexington, Mass. 02173, (617) 682-1055 • 600 Old Country Road, Garden City, N.Y. 11530, (516) 747-3730 • 2600 Virginia Ave. N.W., Washington, D.C. 20037, (202) 337-4914 • 6151 W. Century Blvd., Los Angeles, Calif. 90045, (213) 670-5432 • Saratoga, Calif., (408) 253-5058 • P. O. Box 37, Melbourne, Fla. 32901, (305) 727-5430 • International Sales: Marketing Department, P. O. Box 37, Melbourne, Fla. 32901, (305) 727-5412

INFORMATION RETRIEVAL NUMBER 40

Engineers: Stay put while you move up.



Men who want to move up, securely and without frequent changes of company and residence, should take a long look at Lockheed . . . starting with the Lockheed 1011.

The L-1011 is just the first in our new series of long-range commercial programs. And the task ahead is immense. The many aspects of preliminary analysis and design are still to be completed. Numbers of qualified engineers are needed at all levels of nearly all disciplines . . . and such men can look forward to a long, rewarding future. First L-1011 deliveries are scheduled for late 1971. Various L-1011 versions and follow-on derivatives are already in the concept stages. It's a big beginning—the largest total order in commercial aviation history—with no end in sight.

But airliners aren't all. Other expanding Lockheed projects include the VS(X), YF-12A, SR-71, ASW aircraft, advanced fighter/bombers, AH-56A Cheyenne helicopter, and the future L-1026 intercity helicopter.

Positions are now open in the following areas: structural design and design of avionics, flight controls, real-time computers, digital displays, EMI, and tooling. Analysis assignments in acoustics, aerodynamics, structural dynamics, thermodynamics, propulsion, weights, and reliability.

For more information, or to submit résumé, please write to Mr. C.R. Alexander, Professional Placement Supervisor, Dept. 1701, 3415 Empire Ave., Burbank, California 91503. An equal opportunity employer.



LOCKHEED-CALIFORNIA COMPANY
A Division of Lockheed Aircraft Corporation

Free Career Inquiry Service

Absolutely Confidential

Respond to the career opportunities advertised in this issue. Fill out and send us this handy resume. **Electronic Design** will do the rest – neatly typed copies of this form will be mailed to the companies of your choice, indicated by the circled Career Inquiry Numbers at the bottom of this page.

Name		Home Phone	
Home Address (Street)		City	State
			ZIP Code
Age	U.S. Citizen	Security Clearance	
	<input type="checkbox"/> Yes <input type="checkbox"/> No		

Prime Experience	Secondary Experience

Desired Salary	Availability Date
-----------------------	--------------------------

Employment History – present and previous employers

Company	City, State	Dates	Title
		to	
		to	
		to	

Education – indicate major if degree is not self-explanatory

Degree	College	City, State	Dates
			to
			to
			to

Additional Training – non-degree, industry, military, etc.

Professional Societies

Published Articles

- Career Inquiry Numbers:**
- | | | | | | | | | | |
|-----|-----|-----|-----|-----|-----|-----|-----|-----|-----|
| 900 | 901 | 902 | 903 | 904 | 905 | 906 | 907 | 908 | 909 |
| 910 | 911 | 912 | 913 | 914 | 915 | 916 | 917 | 918 | 919 |

ELECTRONIC DESIGN
 850 Third Avenue
 New York, New York 10022

GROUND-FLOOR OPPORTUNITIES in COMMERCIAL EDP

In the last year Honeywell has started or opened five complete new facilities. Requirements now exist for Technical Specialists at all levels with special emphasis on the following areas:

MAGNETIC COMPONENTS ENGINEERS

BSEE or BS in Physics with 1 to 5 years' experience in magnetic memory storage devices.

CIRCUIT DESIGNERS

To design control circuitry for computer peripheral devices. Minimum of 2 years' circuit design experience.

POWER SUPPLY SPECIALIST

To design and develop power supplies and distributions for computers and peripheral devices. BSEE, advanced degree preferred, with 3 to 5 years' related experience.

MEMORY PACKAGING ENGINEERS

BSME with experience in electronic packaging with emphasis on inter-connection techniques, printed circuit technology and cooling analysis.

ELECTROMECHANICAL PROJECT ENGINEERS

For design and development on computer peripheral devices. BSME or BSEE; prefer MSME or MSEE; 5 or more years' related experience.

DEVELOPMENT ENGINEERS — Electrical

BSEE and 5 to 10 years' experience; preferably in any or all of the following areas: servo systems, position transducers, actuators, logic, solid state and integrated circuits.

ADVANCED DEVELOPMENT — Mass Memory

2 to 5 years' experience in magnetic recording devices or related areas with BS in EE or Physics.

MASS MEMORY — Mechanical

2 to 5 years' experience in magnetic recording devices or equivalent with BS in ME, Physics or EE.

TAPE DRIVE — Electronic

For development of high performance tape drives. EE or ME with 3 or more years' experience in peripheral equipment design.

STANDARDS ENGINEER

BSEE with a minimum of 3 years' experience in commercial electronics.

Please forward your resume to Mr. Jack Wermuth, Honeywell, 200 Smith Street, Dept. ED-1, Waltham, Massachusetts 02154.

The Other Computer Company:
Honeywell

Opportunities exist in other Honeywell Divisions. Send resumes to F. E. Laing, Honeywell, Minneapolis, Minnesota 55408. An Equal Opportunity Employer.

INFORMATION RETRIEVAL NUMBER 902

BOOK Reviews

IC Data Book

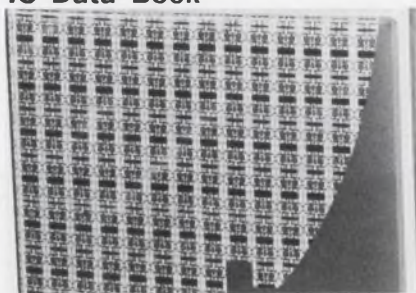

Integrated Circuits Data Book, (Motorola Semiconductor Products, Phoenix, 960 pp., \$3.95.

Many engineers will find the *Integrated Circuits Data Book* extremely useful. It contains complete data sheet specifications and other applications and test data for all standard digital and linear Motorola integrated circuits. Also, a valuable interchangeability guide to all major IC manufacturers is conveniently included.

Calculus revisited

Calculus and Analytical Geometry, George B. Thomas, Jr. (Addison-Wesley Publishing Co., Reading, Mass.), 818 pp.

Calculus and Analytical Geometry by George B. Thomas Jr. is, to many, still the best basic text available. It is therefore satisfying to report that the fourth edition is worthy of the reputation of its predecessors. Discussions of the divergence theorem, Green's theorem, and Stokes theorem are for the first time included in this text, as is the deduction of Kepler's laws of planetary motion from Newton's inverse square law of gravitational attraction. Three new chapters have been added on limits, linear algebra and vector analysis.

The most significant improvement, however, is in the format and graphics. Two-color treatment contributes to the clarity of many illustrations and diagrams and an attractive two-column page layout assists faster reading and scanning.

Robert Patton

Needed: Electronics Engineers to think small

Join our rapidly expanding microelectronics department. Research specialists and engineers are needed immediately to develop compatible thin film resistors for monolithic integrated circuits; to develop NICK sputtering procedures; to generate all necessary process specifications for electron beam, filament and sputtering processes; to develop resistor contact techniques; to optimize resistor annealing cycle for optimum stability; and to plan and direct all activities associated with the development of advanced thin film integrated circuits. A degree in physics or electronics with three to five years' experience in integrated circuits is required.

For more information please write J. N. Love, Professional Placement Manager, P.O. Box 504, Sunnyvale, California 94088. An equal opportunity employer.

LOCKHEED
MISSILES & SPACE COMPANY
A GROUP DIVISION OF LOCKHEED AIRCRAFT CORPORATION

INFORMATION RETRIEVAL NUMBER 903

ELECTRONIC DESIGN 2, January 18, 1969

HEARD THE LATEST?

As an engineering editor for Electronic Design you will be sure to learn about the latest developments in technology as they happen. An editor:

- *Attends the major conferences in his specialty.
- *Talks to top design engineers and scientists about their work.
- *Solicits and edits articles describing new design techniques.
- *Writes by-lined articles about new developments in electronics.

Interested?

If your background is in computers, circuit design or systems work we are especially interested in you. Even if your expertise is in other areas, but you enjoy writing, we may have a good spot for you.

Call or send resume to Robert Haavind,
Managing Editor, Electronic Design,
850 Third Avenue, New York,
New York 10022. (212) PL 1-5530.

We developed the 4031/25 for your low-frequency applications



It's quite a multiplier for only \$145⁰⁰

Stop a moment to consider the possible applications for this new low-frequency multiplier. With a bandwidth of 100Hz, it is certainly ideal for use in many process control systems as well as in a wide range of avionic systems — including navigation computers, autopilots, and display generators.

The 4031/25 may be used for four-quadrant multiplication and two-quadrant division, squaring, and square-rooting. It offers low output impedance and excellent accuracy. The combination of high performance and low cost was made possible through the use

of Burr-Brown's own proprietary IC op amps. Module size is 2.4" X 1.8" X .60".

HIGHLIGHT SPECIFICATIONS	
Accuracy, %f.s. (max. worst case) (1)	±0.5%
Frequency Response	100 Hz
Input Impedance	X-25 kΩ
Input Impedance	Y-100 kΩ
Output Impedance	1Ω
Rated Supply	±15 V
Price	\$145.00

(1) Includes all offset error, scale factor error, and nonlinearity error for any combination of inputs.



16-PAGE MULTIPLIER CATALOG
From Burr-Brown you now have a multiple choice of choice multipliers... covering the 3 Hz to 40 kHz frequency response range. For complete specification and application information, contact your local Burr-Brown Engineering Representative or use this publication's reader service card.

BURR-BROWN

RESEARCH CORPORATION

International Airport Industrial Park • Tucson, Arizona 85706
TELEPHONE: 602-294-1431 • TWX: 910-952-1111 • CABLE: BBRCORP



Operational Amplifiers
Instrumentation Amplifiers
Function Modules
Active Filters
Power Supplies

ENGINEERING REPRESENTATIVES: ALABAMA, HUNTSVILLE (205) 534-1648 / ARIZONA, PHOENIX (602) 254-6085 / CALIF., LOS ANGELES (213) 665-5181, SAN DIEGO (714) 232-2017, SAN FRANCISCO (408) 244-1505 / COLO., DENVER (303) 399-4391 / CONN., EAST HARTFORD (203) 874-9222 / D.C., WASHINGTON (SEE MARYLAND) / FLORIDA, ORLANDO (305) 425-2764 / ILLINOIS, CHICAGO (312) 286-6824 / LA., NEW ORLEANS (504) 888-2266 / MD., SILVER SPRING (301) 588-8134 / MASS., BOSTON (617) 245-4870 / MICH., DETROIT (313) 358-3333 / MINN., MINNEAPOLIS (612) 781-1611 / MO., ST. LOUIS (314) 524-4800 / N.C., GREENSBORO (919) 273-1918 / N.J., CAMDEN (215) 925-8711 / N.M., ALBUQUERQUE (505) 255-1638 / N.Y., ALBANY

(518) 489-4777, BINGHAMTON (607) 723-9661, MT. VERNON (914) 968-2200, NEWBURGH (914) 561-4510, NEW HARTFORD (315) 732-3775, ROCHESTER (716) 473-2115 / OHIO, CINCINNATI (513) 761-5432, CLEVELAND (216) 237-9145, DAYTON (513) 277-8911 / PENN., PHILADELPHIA (SEE CAMDEN, N.J.), PITTSBURGH (412) 243-6655 / TEXAS, DALLAS (214) 357-6451, HOUSTON (713) 774-2568 / UTAH, SALT LAKE CITY (801) 466-8709 / VIRGINIA, (SEE MARYLAND) / WASH., SEATTLE (206) 767-4260 / CANADA, DOWNSVIEW, ONT. (416) 636-4910, MONTREAL, QUE. (514) 739-6776, OTTAWA, ONT. (613) 725-1288, VANCOUVER B.C. (604) 291-7161

Products



Multi-function 320-MHz computing counter processes measurements like desk calcula-

tor. Its main frame accepts input amplifier and 18-GHz frequency converter. Page 92

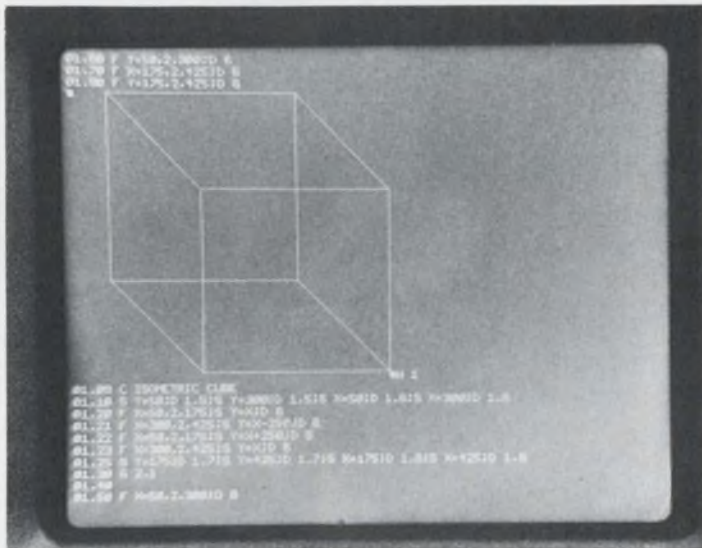

Desk-top display system with solid-state keyboard features complex graphics capability. Page 122

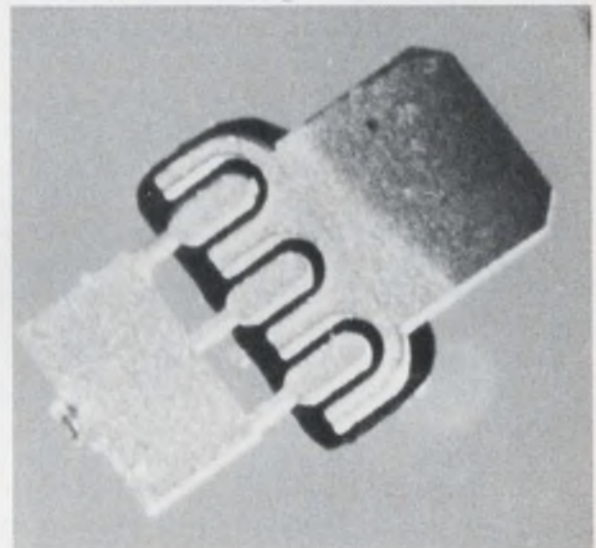

Microwave chip capacitors for microstrip circuits exhibit low losses. Page 116

Also in this section:

Dual-amplifier IC combines MOS and bipolar devices on same chip. Page 105

Monolithic voltage regulator maintains 0.002%/V regulation. Page 104

Miniature fuses protect ICs by blowing in 50 μ s for 30-A overloads. Page 130

Design Aids, Page 150 . . . **Application Notes**, Page 152 . . . **New Literature**, Page 156

Versatile computing counter performs real-time calculations on measurements



Hewlett-Packard, 1501 Page Mill Rd., Palo Alto, Calif. Phone: (415) 326-7000. P&A: \$6500 with amplifier plug-in; March, 1969.

Employing computation as an integral part of its measurement technique, a computing counter uses ICs to pack more functions and improved performance into a single cabinet. Model 5360A makes measurements that are one or more orders of magnitude more accurate and more rapid than any previously available direct-readout counter.

In addition to featuring wider measuring ranges for both frequency and time interval, the new counter processes measurements as capably as a multi-program desk calculator. It displays, in real time, the solution to equations whose input variables are the counter's measurements and externally entered constants. Programming devices can be internal or external plug-in modules, or a keyboard that will be available later in the year. Final answers are displayed on the counter's readout.

This computing capability simplifies the man-machine interface, reduces the need for manipulating front-panel controls, and minimizes errors in reading units and decimal point. It also offers solutions to many measurement and computation problems that previously entailed substantial cost in design time.

Basic instrument is sophisticated counter

Essentially, the 5360A is an 11-digit counter with a frequency range of 0.01 Hz to 320 MHz. It is capable of making sampled frequency and pulsed rf measurements, and also makes time interval and period measurements down to 1 ns (0.1-ns resolution) with an effective clock rate of 10 GHz. These high performance levels are due to the use of time-interval interpolators that re-

duce count ambiguity by several orders of magnitude. The frequency range can be extended to 18 GHz with a standard front-panel plug-in.

There are two front-panel plug-in compartments: one for frequency expansion, time interval and auxiliary computing functions; the other for the input amplifier, trigger controls and additional input signal-conditioning circuits—if desired.

The 5360A has a 12-digit display that permits shifting the 11-digit measurement around a fixed decimal point. Insignificant digits can be automatically blanked, and the number of desired digits can be selected manually.

Computer adds flexibility

The counter's computing circuits are accessible from three places: through front-panel input modules, through accessory plug-in compartments, and through a rear-panel connector.

Computations performed via the front-panel accessory compartments will allow computation-free readout, and automatic entry of harmonic numbers, prescaling factors, preset counting factors, frequency offsets and heterodyne converter mixing frequencies. Applications can include direct-readout phase measurements, as well as automatic computation of the average or differential values of frequency, or of fractional frequency deviation.

Fixed programs could also be handled by a small diode matrix inside a connector shell plugged into the rear panel. More rapid program changes, as well as data storage, can be handled by the general-purpose keyboard.

Basic operation codes will include: input (count, recall constant and manual digit entry); transfer (interchange register contents); arithmetic (add, subtract, multiply, divide and in-

This 40 Amp TRIAC really controls power

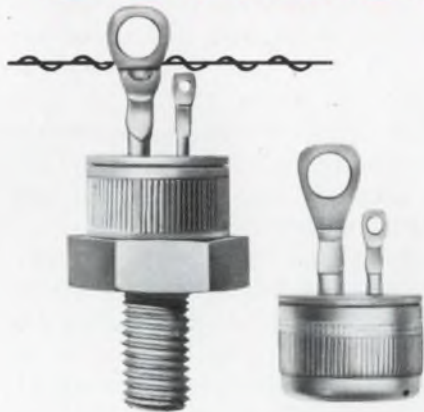

2N5441 and 2N5442 press-fit types give you:

- 300 amp full cycle surge capability
- power handling capability of 5,000 watts for 120-volt operation
- power handling capability of 10,000 watts for 240-volt operation

Because a Triac can do the job of two SCR's back-to-back, the 2N5441 or the 2N5442 can virtually replace any two types in the 2N690-series or the 2N3873-series in circuits having comparable voltage and current ratings—and with fewer components.

2N5444 and 2N5445 stud types also available.

Please give your RCA Field Representative a call if you need application assistance in applying Thyristors to your control problems. Ask him, too, for pricing information—or contact your RCA Distributor. For technical data, write RCA Electronic Components, Commercial Engineering, Section RG-1-2 Harrison, N. J. 07029.

RCA



heating control.



arc welding control

furnace control

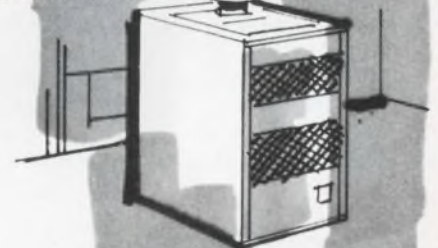

motor control

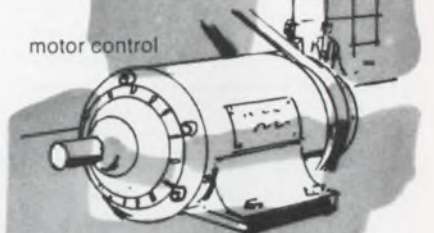

photocopying



light control

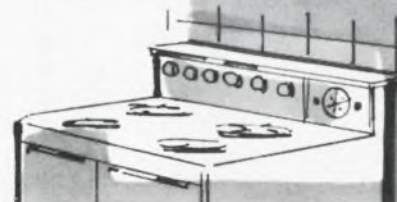

oven control

RCA ANNOUNCES 5-DAY SEMINARS FOR ENGINEERS AND SCIENTISTS

Here's an opportunity to engage in a 5-day program that will review the latest advances and engineering techniques in your field. Five full days that can advance your career—presented by RCA Institutes.

DIGITAL COMMUNICATIONS	San Francisco	2/24-28
	San Diego	3/3-7
	New York	4/14-18
	Washington, D.C.	4/21-25
	Rochester, N.Y.	5/5-9
	Huntsville, Ala.	5/19-23
DIGITAL SYSTEMS ENGINEERING	New York	2/24-28
	Washington, D.C.	3/10-14
	Palm Beach	4/14-18
	Detroit	5/5-9
LOGIC DESIGN	Huntsville, Ala.	2/24-28
	Boston	3/10-14
	Chicago	3/17-21
	Los Angeles	4/14-18
	San Francisco	4/21-25
	Houston	5/5-9
MODERN OPTICS	Washington, D.C.	3/3-7
	San Francisco	3/17-21
	Los Angeles	3/24-28
	Detroit	4/14-18
	New York	4/21-25
	Boston	5/5-9
INTEGRATED CIRCUITS	Dallas	2/24-28
	Rochester	3/17-21
	Boston	4/21-25
	New York	5/19-23
	San Francisco	6/2-6

The above schedules are subject to change.

RCA

RCA Institutes, Inc. Dept. ZELD-19A
Institute for Professional Development
132 West 31st Street, New York, N.Y. 10001

For free descriptive brochure, please check the seminar in which you are interested.

Logic Design Modern Optics Digital Systems Engineering
 Digital Communications Integrated Circuits

Name _____ Title _____

Company _____

Address _____

City _____ State _____ Zip _____

INFORMATION RETRIEVAL NUMBER 43

COVER FEATURE

vert); sub-programs like deriving the basic time interval from the interpolator outputs; and output (display, print or store).

The internal computer, which has a 1-MHz clock rate, can perform 32 commands of any length and in any sequence. The arithmetic unit handles an 11-digit mantissa with an exponent from -31 to +31.

Counter features performance and accuracy

Able to sample and measure the input frequency or period at rates greater than 300 times per second (100 times/s for time interval), the 5360A automatically measures pulsed rf with direct readout in frequency. It can also accurately and rapidly measure a single burst of carrier; for example, a single burst of 320-MHz carrier can be known to 3 digits within 0.3 μ s.

The new counter achieves these high performance levels because it is not confined to a synchronous measurement cycle or to decade values for gate times. The 5360A can automatically start its cycle at any time upon arrival of the input signal, as in an oscilloscope with a signal-triggered sweep. Since the 5360A measures its own gate time concurrently with counting input cycles, the measurement time can be of any duration up to 100 s.

Furthermore, the 5360A can automatically measure a single cycle of any frequency from dc to 10 MHz, or 32 cycles from 100 kHz to 320 MHz. This allows the shortest measuring time possible to be obtained, when desired. A quartz-crystal time-base oscillator is used as the frequency standard. ■■

CIRCLE NO. 250



Computing counter's main frame houses counting, computing and power circuits with ample room for input amplifier plug-in and compartment for accessories.

INFORMATION RETRIEVAL NUMBER 45 ►

Our private stock isn't private any more.



Motorola's Frequency Control Products are now on the market.

They say that if you want a thing done right, you do it yourself. And so we did. For thirty years, we've been designing and manufacturing our own

frequency control components. Because they had to be good enough to use in our own products.

We've been selfish long enough. Now our precision crystals, oscillators, filters, and tone modules are available to designers and manufacturers throughout the electronics industry. And if the mile-long list of components

isn't long enough, our designers and engineers are ready to go to work on custom projects.

For additional information on existing products and design potentials, write to Motorola Communications & Electronics Inc., 4501 W. Augusta Boulevard, Chicago, Illinois 60651. Ask for Bulletin TIC-3401.



NEED MORE POWER?

TELONIC'S PD-B SWEEP GENERATORS PUT OUT A WILD .054 H.P. (40 WATTS).



- 20-1000 MHz
- Oscillator Overload Protection
- Swept or CW
- Birdy By-Pass Markers

Telonic High-Performance PD-B Sweep Generators are available in 4 Models.

MODEL	PD-2B	PD-3B	PD-7B	PD-8B
Center Freq., MHz	20-100	100-250	200-375	375-1000
Sweep Width	0.2-15%	0.2-15%	0.2-10%	0.2-15%
Max. Output	40 watts			
Min. Leveled Swept RF Output	8 watts			
Flatness	± 0.5 dB with internal leveling			
Attenuation	0-59 dB in 1 dB steps			
Linearity	1.2:1			

If you want complete specifications and descriptions, send for New Product Data Sheet #81.



TELONIC INSTRUMENTS
 A Division of Telonic Industries, Inc.
 60 N. First Avenue • Beech Grove, Indiana 46107
 TEL (317) 787-3231 • TWX-810-341-3202

INFORMATION RETRIEVAL NUMBER 46

INSTRUMENTATION

High Z electrometer has 81 ranges



Keithley Instruments, Inc., 28775 Aurora Rd., Cleveland, Ohio. Phone: (216) 248-0400. P&A: \$585; 15 days.

The first all solid state, line-operated electrometer with overload protection can measure 81 ranges of dc voltage, current, resistance, and charge. Input impedance of the model 610C is $10^{14} \Omega$ shunted by 20 pF. Zero drift of the electrometer is less than 1 mV each 24 hours. A unique protection circuit is used to shield the input from up to 500-V overloads, without degrading high impedance characteristics.

CIRCLE NO. 251

Universal counter-timer covers 150-MHz range



Eldorado Electronics, 601 Chalamar Rd., Concord, Calif. Phone: (415) 686-4200. P&A: \$1450; 45 days.

A low-cost universal counter-timer measures frequencies from dc to 150 MHz, time interval with 100-ns resolution, period, multiple period and ratio. Eight-digit indicators display legend and decimal point. Oscillator stabilities are available from a part in 10^6 per month to a part in 10^9 per day.

CIRCLE NO. 252

Let us throw you a curve

If you've problems with LC circuits, Magnetics' new Iso-Q contour curves speed ferrite pot core selection.

No more squinting at tangles of curves on log paper to find the ferrite pot core size you need. Magnetics' new Iso-Q contour curves let you zero in on your target size in seconds. We've plotted over 100 of these time-savers to handle more than 90% of normal design

requirements. They're all contained in our new Ferrite Cores Catalog, first of its kind in the industry.

Magnetics' high purity ferrites cover frequencies up to 2 megahertz. Linear temperature coefficients on 750, 1400 and 2000 permeability materials are guaranteed from -30° to $+70^{\circ}\text{C}$. Flat temperature coefficient on 2300 perm material is guaranteed from $+20^{\circ}$ to $+70^{\circ}\text{C}$.

Magnetics' wide selection of ferrites comprises eight international standard sizes and five additional sizes—175 part numbers for design freedom. We can give you quick

delivery from our large inventory that includes both gapped and un-gapped cores in your most asked-for sizes. Of course, we provide one-piece clamping hardware for most sizes. Finally, we offer you a complete choice of tuning assemblies, bobbins and shapes—toroid, E, U and I.



Get your set of our new Iso-Q Curves. You'll like their curvilinearity. Magnetics Inc., Butler, Pa. 16001

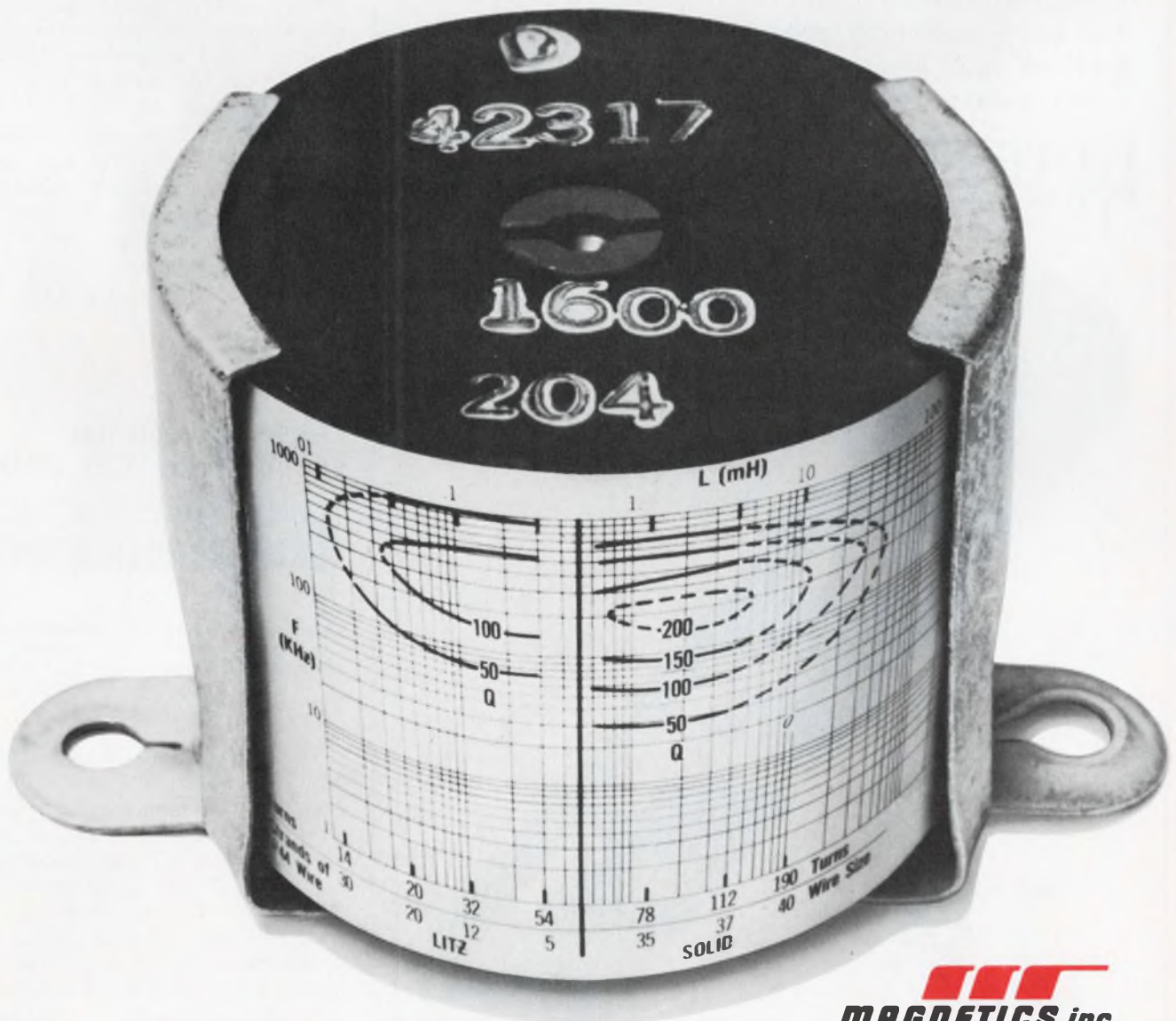

MAGNETICS inc.
®

Tape, Powder, Bobbin, Ferrite Cores • Laminations • Photo-etched Parts • Specialty Metals • Engineered Control Systems

INFORMATION RETRIEVAL NUMBER 47

you don't
have to
hack
out...
what we
cast in



We specialize in giving you air space . . . holes that don't have to be drilled, slots that don't have to be milled, cam tracks that don't have to be profiled. You save machining time and machining money. We think you'll like the idea of hacking out dollars — not metal.



HITCHINER
MANUFACTURING CO., INC.
MILFORD, NEW HAMPSHIRE 03055
Tel. (603) 673-1100, TWX (710) 366-1863

AEROSPACE DIVISION
Wallingford, Connecticut 06492
DELTA MICROWAVE CORP.
Hackensack, New Jersey 07601
NONFERROUS DIVISION
O'Fallon, Missouri 63366

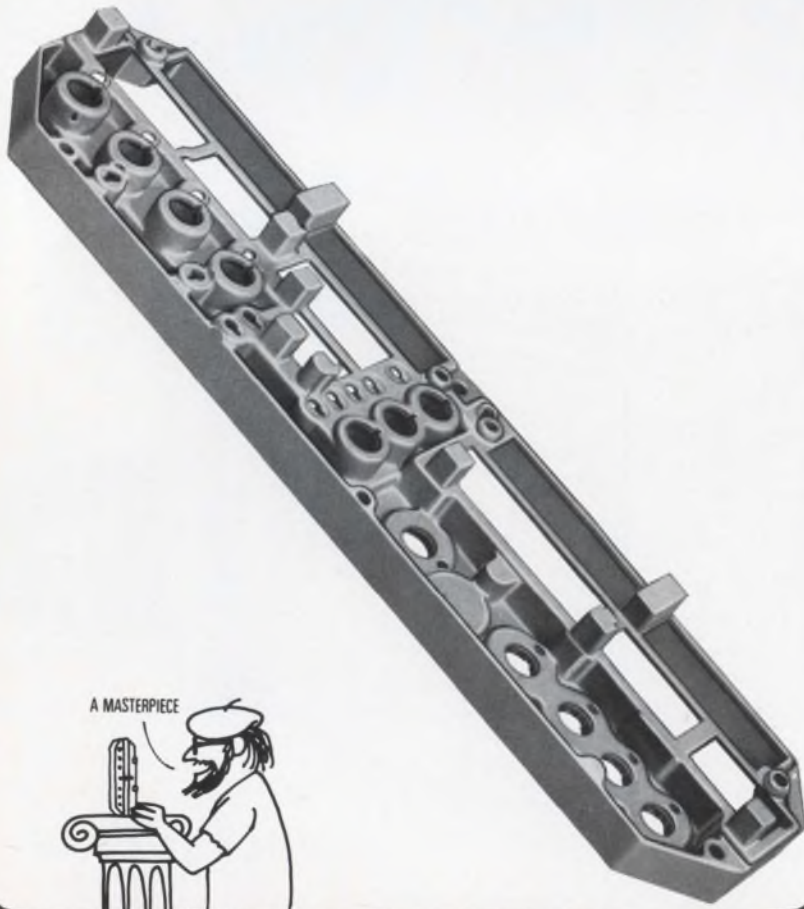

INFORMATION RETRIEVAL NUMBER 48

INSTRUMENTATION

**X-Y oscilloscope
has 7-in. CRT**



Data Instruments Div., 7300 Crescent Blvd., Pennsauken, N.J. Price: \$566.

A low-cost X-Y oscilloscope with matched amplifiers and a 7-in. display tube is capable of highly accurate phase comparison and measurement that involve Lissajou functions and differential signals. The 572 can be converted to a conventional single-beam scope by means of a front-panel control. All amplifiers are solid state and are fully compensated for optimum response; a four-step attenuator is provided with a variable trimmer for frequency compensation.

CIRCLE NO. 253

**Electronic counter
spans dc to 125 MHz**



Monsanto Electronics, 620 Passaic Ave., W. Caldwell, N.J. Phone: (201) 228-3800. Price: \$2495.

The model 1510A electronic counter features a dc-to-125-MHz range that can be extended to 3 GHz with a single frequency converter plug-in. The unit totalizes from 0 to 10^8 . Its frequency ratio is 10^{-16} to 10^{16} , and sensitivity is 100 mV. The internal output is scaled from 0.1 Hz to 10 MHz in decade steps. There is provision for an externally supplied time base from 100 Hz to 10 MHz.

CIRCLE NO. 254

THE SUPER SWEEPER



Alfred introduces the pushbutton, programmable sweeper with up to ten different heads for complete coverage from 250 MHz to 40 GHz. (And if you already have a sweeper, we'll show you how to make your own "super sweeper").

If you are working in a wide range of microwave frequencies, you know how much time it takes to change heads and how cumbersome it is to set up automatic programmed testing. Now you can relax.

Alfred's new multi-band sweep oscillator solves both problems and at the same time offers you all the performance proven features of the Alfred 650 Sweep Oscillator.

Front Panel Plug-in. For convenient head changes, the "super sweeper" offers Alfred's exclusive front plug-in design. Alfred multi-band sweep oscillators provide sweep coverage of the complete range from 250 MHz to 40 GHz or any portion thereof. Systems consist of the Alfred 650 Sweep Oscillator, any combination of up to ten 650 series plug-in oscillator units, Model 9510 Pushbutton Control Unit, and the Model 9511 Plug-in Container Unit. A rear panel connector can be used for remote programming.

Calibrated Frequency Dial for All Ranges. Read frequency directly as soon as you switch to a new range. A preset sweep range can be set independent of the 650 sweep control for each plug-in oscillator.

So I already own an Alfred 650 and a set of oscillator plug-ins, what about me?

You're in luck. You simply buy the Model 9510 Push Button Control unit and the Model 9511 Plug-in Container Unit and make your own "Super Sweeper" just like the one shown above. Add more container units to bring the system up to its 10 head capacity.

For more information. To arrange a demonstration and secure complete technical information, please call your Alfred sales engineer (listed in EEM and EBG) or write us directly. Please address Alfred Electronics, 3176 Porter Drive, Palo Alto, California 94304. Phone: 415-326-6496. TWX: 910-373-1765.

ALFRED ELECTRONICS

See Us at IEEE

INFORMATION RETRIEVAL NUMBER 49



NO. 1 NAME FOR MOTOR RELIABILITY

McLEAN's computer-designed FHP Motors are built with the understanding that reliability is as important as performance, for these small units, installed, are usually "on their own" — often remote, or not easily accessible, yet key factors in doing a critical job.

Reliability, of course, is the sum of many refinements, and to name a few, McLEAN starts with a computer-analyzed design that assures ample capacity for each rating; air-cooled bearings keep operating temperature low; motor frames are made of dimensionally stable aluminum alloys; rotors exceed requirements of MIL-M-17059 to assure extra-smooth running. Add to these the experience of having thousands of these units in the field under virtually every condition, and you will know where McLEAN gets its name for reliability.

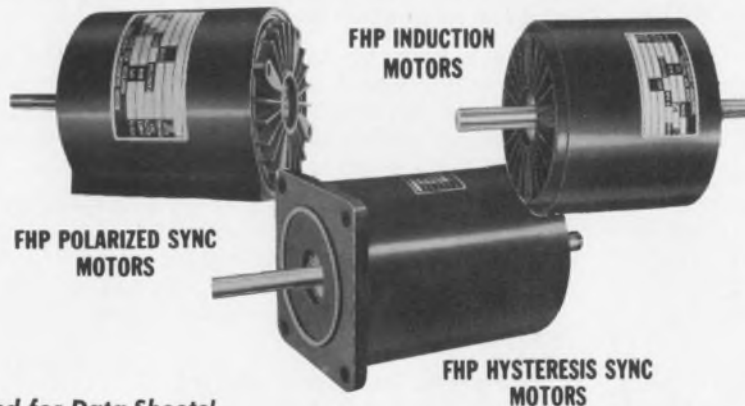

Send for Data Sheets!

McLEAN ENGINEERING LABORATORIES 

Princeton Junction, New Jersey 08550 • Phone: 609-799-0100 • TELEX: 84-3422

INSTRUMENTATION

Spectrum analyzer calibrates amplitude



Hewlett-Packard, 1501 Page Mill Rd., Palo Alto, Calif. Phone: (415) 326-7000. P&A: from \$5925; March, 1969.

With absolute calibration of amplitude, as well as frequency, a 1250-MHz spectrum analyzer allows accurate reading of the voltage or dBm of individual signals directly from its cathode-ray screen. Also called a frequency-domain oscilloscope, model 8554L presents easily interpreted displays that are free of spurious responses. In addition, its high stability and sensitivity permit effective analysis of a wide array of rf signals.

CIRCLE NO. 255

Stepping oscillator programs frequency

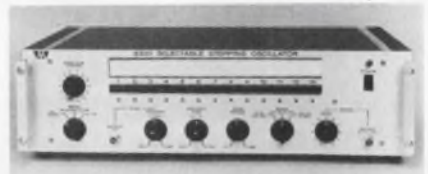

Micom, Inc., 855 Commercial St., Palo Alto, Calif. P&A: \$1800; 30 days.

A selectable stepping oscillator will allow selection of up to 13 preset frequencies, or will automatically program a complete or selected set of fixed frequencies in a serial time or sequential format. Combining the advantages of discrete and sweep oscillators, model 6300 provides a virtually simultaneous frequency display over a four-decade range. Frequency stepping, as opposed to sweeping, is accomplished by time indexing the oscillator to successive frequency steps selected for a given time period.

CIRCLE NO. 256

at 3,000 tests/minute this new wiring and circuit analyzer is a

money saver.

OmniTester

Here is a major breakthrough in high speed automatic test equipment that will dramatically slash your production test costs. The OmniTester Model 1000 accurately checks equipment wiring on a point-to-point basis at speeds up to 3,000 tests per minute. Simple modular expansion of the tester gives it the flexibility to whiz through as many as 100,000 points in a single test sequence.

Self-programming, a plus feature. Adding to savings in time and cost is a unique self-programming feature of the OmniTester which enables it to prepare its own punched tape programs by automatically analyzing a known working sample of the wiring.

Dynamic test capability adds to versatility. In addition to continuity, hi-pot, and leakage testing, dynamic test capability is another outstanding advantage of this sophisticated, yet economical system. The OmniTester dynamically tests circuits by applying stimuli and verifying response in terms of required voltages, currents or impedances. Test results are printed out in permanent record form.

Performance at the right price. No other automatic wiring and circuit analyzer can match the speed, accuracy, flexibility and performance of the OmniTester Model 1000. Especially at the price. Basic system starts at \$9950.



Teleproducts

TELEPRODUCTS, INC. 351 New Albany Road, Moorestown, N.J. 08057 (609) 235-6227

INFORMATION RETRIEVAL NUMBER 51

Never has one company
 offered so many standard
 high performance
Lumped Constant Filters
 covering so broad a band.
AT SO LOW A PRICE!

2 MHz to 1 GHz
Band Pass • Low Pass • High Pass

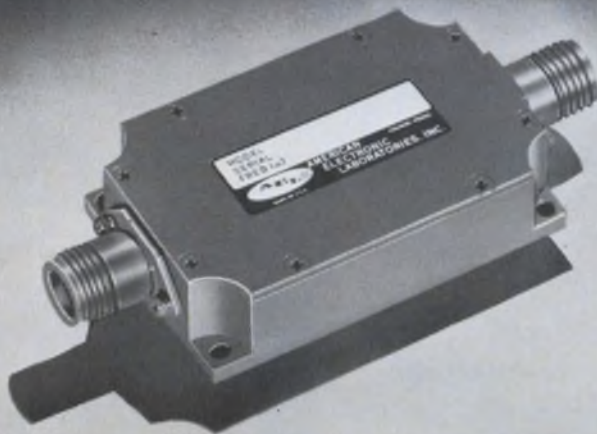

Specifications, price and delivery
 Contact AEL, Washington, D.C.
 Division for . . .

**Filter
 Capability
 Now**

American **E**lectronic **L**aboratories, Inc.

Main Office: P.O. Box 552 • BV Lansdale, Pa. 19446
 (215) 882-2929 • TWX: 510-661-4976 • Cable: AMERLAB

Washington, D.C. Division: 6629 Iron Place, Springfield, Va. 22151 • (703) 354-5700
 California Office: 8939 S. Sepulveda Blvd., Los Angeles, Calif. 90045 • (213) 670-8755



INFORMATION RETRIEVAL NUMBER 52

INSTRUMENTATION

**Digital VOM
 has new look**



Syston Donner Corp., 888 Galindo St., Concord, Calif. Phone: (415) 682-6161. P&A: \$395; 30 days.

Providing three instruments in one, a portable digital VOM has a removable pedestal, so that it can be panel mounted, used on a bench, or mounted high and pointed down for improved readability. Model 9000 uses dual-slope integration to provide 80-dB noise rejection, 0.1% accuracy, and speeds as high as 6 samples per second.

CIRCLE NO. 257

**Function generator
 locks phase angle**



Data Royal Corp., 8014 Armour St., San Diego, Calif. Phone: (714) 279-4020. P&A: \$805; 30 to 45 days.

Model F240A function generator provides trigger, gate and phase-lock capability. When locked to an external frequency standard, it will generate sine, square, triangle and ramp outputs with the frequency, accuracy and stability of that standard. A front-panel meter indicates the phase-angle relationship of the output signal to the external standard. Phase angle may be adjusted from 0 to 180°, lead or lag, without loss of phase lock.

CIRCLE NO. 258

Slowdown!

(and read about the world's fastest IC adder.)

Signetics announces a no-kidding leadership device: the 8260 Arithmetic Logic Element, latest addition to our DCL family.

The 8260, now available in volume, is a monolithic gate array incorporating four full adders structured in a look-ahead mode. The device may be used as four mutually independent Exclusive-NOR or AND gates by proper addressing of the inhibit lines. Here is a device which in typical application increases speed three to four times, greatly reduces package count and appreciably lowers over-all system costs.

As a four-bit adder, the 8260 permits parallel addition of four sets of data and features simultaneous (look ahead) carry on each bit within the package. Extension of the look-ahead feature for 16 bits or more is facilitated by the 8261 Fast Carry

Extender.

Access to the 8260 from previous stage(s) is provided through five OR-ed channels, and inhibition of carry-in-data and bit-to-bit carries is accomplished by a true (active high) logic level of C_{INH} .

The "carry-outs" available are: Internally Generated (\bar{C}_G); Propagated (C_P); and Ripple (\bar{C}_R). This gives the 8260 complete flexibility when used in Ripple Carry or Anticipated Carry Adder systems.

The 8260 is available now in 24-lead flat pak, -55°C to $+125^\circ\text{C}$ and 0°C to $+75^\circ\text{C}$, and will soon be available in both full MIL and commercial DIPs.

For complete information on the world's fastest adder write Signetics, 811 East Arques Avenue, Sunnyvale, California 94086. Fast!

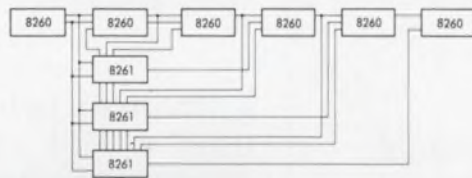

24-bit Fast Adder System; 9 packages; minimum external connections.

No. of Bits	Package Count			Addition Time per Bit (ns)	Total Addition Time Input to Output (ns)
	8260	8261	Quad 2-Input NAND Gates		
16	4	1	—	3.3	52
24	6	3	—	3.3	52
32	8	3	—	2.0	64
48	12	6	1	1.3	64
64	16	7	1	1.2	76

Increased speed and reduced package count far exceed what is attainable with any other IC family.

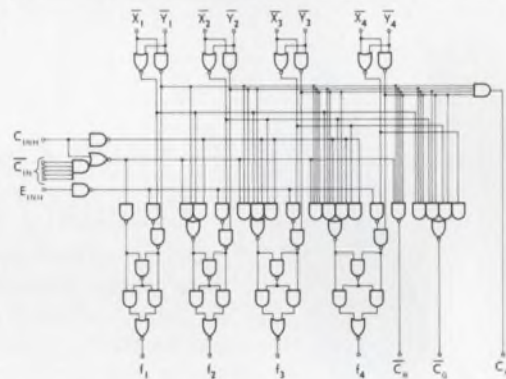

The 8260 Arithmetic Logic Element.

Signetics Integrated Circuits 
A SUBSIDIARY OF CORNING GLASS WORKS

SIGNETICS SALES OFFICES: Wakefield, Massachusetts (617) 245-8200; Trumbull, Connecticut (203) 268-8010; Poughkeepsie, New York (914) 471-3292; Syracuse, New York (315) 469-1072; Fort Lee, New Jersey (201) 947-9870; Radnor, Pennsylvania (215) 687-2660; Silver Spring, Maryland (301) 946-6030; Clearwater, Florida (813) 726-3734; Winter Park, Florida (305) 671-5350; Dayton, Ohio (513) 433-4133; Minneapolis, Minnesota (612) 920-3256; Rolling Meadows, Illinois (312) 259-8300; Richardson, Texas (214) 231-6344; Garden Grove, California (714) 636-4260; Burbank, California (213) 846-1020; Redwood City, California (415) 369-0333.

DISTRIBUTORS: Avnet Electronics Corp., Burlington, Mass (617) 272-3060; Cesco Electronics, Ltd., Montreal, Quebec, Canada (514) 735-5511; Compar Corporation at the following locations: Huntsville, Alabama (205) 539-8476; Los Angeles, California (213) 245-1172; Burlingame, California (415) 347-8244; Hamden, Connecticut (203) 288-9276; Clearwater, Florida (813) 446-2991; Orlando, Florida (305) 855-3964; Park Ridge, Illinois (312) 692-4125; Baltimore, Maryland (301) 484-5400; Newton Highlands, Mass (617) 969-7140; Minneapolis, Minnesota (612) 922-7011; St. Louis, Missouri (314) 542-3399; Albany, New York (518) 489-7408; Endwell, New York (607) 723-8743; Woodbury, New York (516) 921-9393; Fairport, New York (716) 271-2230; Syracuse, New York (315) 471-3356; Winston-Salem, North Carolina (919) 723-1002; Seattle, Washington (206) 763-1711; Hamilton Electro Sales, Culver City, Calif. (213) 870-7171; Hamilton Electro Sales, Cherry Hill, N.J. (609) 662-9337; Hammond Electronics, Orlando, Florida (305) 241-6601; Kierulff Electronics, Seattle, Wash. (206) 763-1550; G. S. Marshall, San Marino, Calif. (213) 684-1530; Milgray Delaware Valley, Inc., Philadelphia, Pa. (215) 228-2000; Pioneer Standard Electronics, Rockville, Maryland (301) 427-3300; Schley Electronics, Watertown, Mass. (617) 926-0235; Semiconductor Specialists, Inc., Elmhurst, Illinois (312) 279-1000; Terminal-Hudson Electronics, New York, New York (212) 243-5200; Universal Electronics, Inc., Houston, Texas (713) 781-0421; Wesco Electronics, Inc., Los Angeles, Calif. (213) 685-9525; Palo Alto, Calif. (405) 968-3475.

DOMESTIC REPRESENTATIVES: Compar Corporation at the following locations: Scottsdale, Arizona (602) 947-4336; Denver, Colorado (303) 781-0912; Southfield, Michigan (313) 357-5369; Haddonfield, New Jersey (609) 429-1526; Albuquerque, New Mexico (505) 265-1020; Albany, New York (518) 489-7408; Endwell, New York (607) 723-8743; Fairport, New York (716) 271-2230; Syracuse, New York (315) 471-3356; Rocky River, Ohio (216) 333-4120; Fairborn, Ohio (513) 878-2631; Dallas, Texas (214) 363-1526; Houston, Texas (713) 667-3420; Ozark Electronic Marketing, Inc., St. Louis, Missouri (314) 423-7200.

INTERNATIONAL SALES: France, Germany, Italy, Belgium, Holland, Luxemburg, Spain—Sovcar Electronique, 11, Chemin de Ronde, Le Vesinet, (S. & O.) France; United Kingdom, Ireland, Sweden, Denmark, Norway, Switzerland, Austria, Portugal—Electrosil Ltd., Lakeside Estate, Colnbrook By Pass Slough, Buckinghamshire, Great Britain; Australia—Corning, 1202 Plaza Building, Australia Square, Sydney, N.S.W. 27-4318; Canada—Corning Glass Works of Canada, Ltd., Leaside Plant, Ontario, Canada (416) 421-1500; Israel—Talvint, P.O. Box 3282, Tel Aviv, Israel 236-666; Japan—ASAHI Glass Co., Ltd., Corning Products Sales Dept. No. 14, 2 Chome Marunouchi, Chiyoda-ku, Tokyo, Japan 211-0411.

From any Angle...

Atec's New

SLIM LINE

1 3/4" (H) x 17" (W) x 12" (D)

2802 Electronic Counter/Timer

gives you more capability for less money than **any** other model available . . . and in a compact configuration. ■ Compare these features with other counter-timers ■ measures frequency from DC to 12.5 MHz and time intervals to 1 μ sec ■ measures ratio ■ totalizes ■ BCD 1-2-4-8 output available on rear chassis for driving printers and punches ■ input sensitivity of 10 mV DC to 5 MHz, 30 mV DC to 12.5 MHz ■ remote programming ■ pushbutton switching ■ dual input channels ■ IC circuitry ■ illuminating overflow indicator. Now compare the price . . . \$455! ■ The 2802's plug-in, modular design allows the following options to be added at any time ■ additional digits (seven maximum) ■ display storage ■ 1 MHz, crystal-controlled time base. For complete specifications or a free demonstration, call your local Atec engineering-sales representative or contact Atec directly.

Atec, Inc.

P. O. Box 19426 / 1125 Lumpkin Street, Houston, Texas 77024
Telephone: (713) 468-7971

INFORMATION RETRIEVAL NUMBER 54

ICs & SEMICONDUCTORS

Monolithic regulator holds 0.002%/V



Motorola Semiconductor Products Inc., P.O. Box 20924, Phoenix, Ariz. Phone: (602) 273-8467. Price: \$15.

When output current is as high as 500 mA, a new monolithic voltage regulator maintains a typical regulation of 0.002% with changes in input voltage and temperature. In addition, the MC1560 has an output impedance of 20 m Ω that varies only a few m Ω over the output voltage range of 2.5 to 17 V, and is only 60 m Ω with frequency as high as 1 MHz.

CIRCLE NO. 259

Arithmetic hybrid uses 4 MSI chips

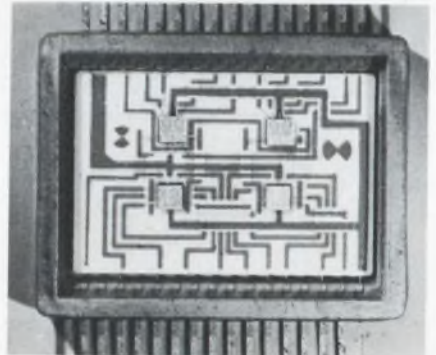

Fairchild Semiconductor, 313 Fairchild Dr., Mountain View, Calif. Phone: (415) 962-2530. P&A: \$120; stock.

Introducing the concept of multiple MSI, a 4-bit arithmetic unit is the first hybrid circuit to incorporate four MSI chips. Within a single compact package, the SH8080 combines a ripple carry adder and a holding register. It is compatible with current-sinking logic and performs with a typical carry propagation time of 32 ns. Noise margin is 1 V.

CIRCLE NO. 260



Don't risk it!

This hookup wire was wrapped around a mandrel and heat-aged for 88 hours at its rated temperature. When it was unwrapped, cracks developed and exposed the conductor.

This won't happen with insulation of Du Pont TEFLON* (TFE). At its own high rated temperature (up to 500°F, depending on the specification), TEFLON shows excellent resistance to cracking after much longer periods of heat aging.

That's only one of the reasons we call TEFLON the sure one. Among others: TEFLON is nonflammable. It's inert to virtually all chemicals and corrosives. It resists solder-iron damage. And it provides weight and space savings without sacrificing performance.

In short, when you specify insulation of TEFLON, you minimize risk.

For detailed data on the resistance of TEFLON to thermal stress cracking and other hazards, write Du Pont Company, Room 6670C, Wilmington, Delaware 19898.

*Reg. U.S. Pat. Off. for Du Pont fluorocarbon resins and film.

TEFLON®...the sure one



Better things for better living
...through chemistry

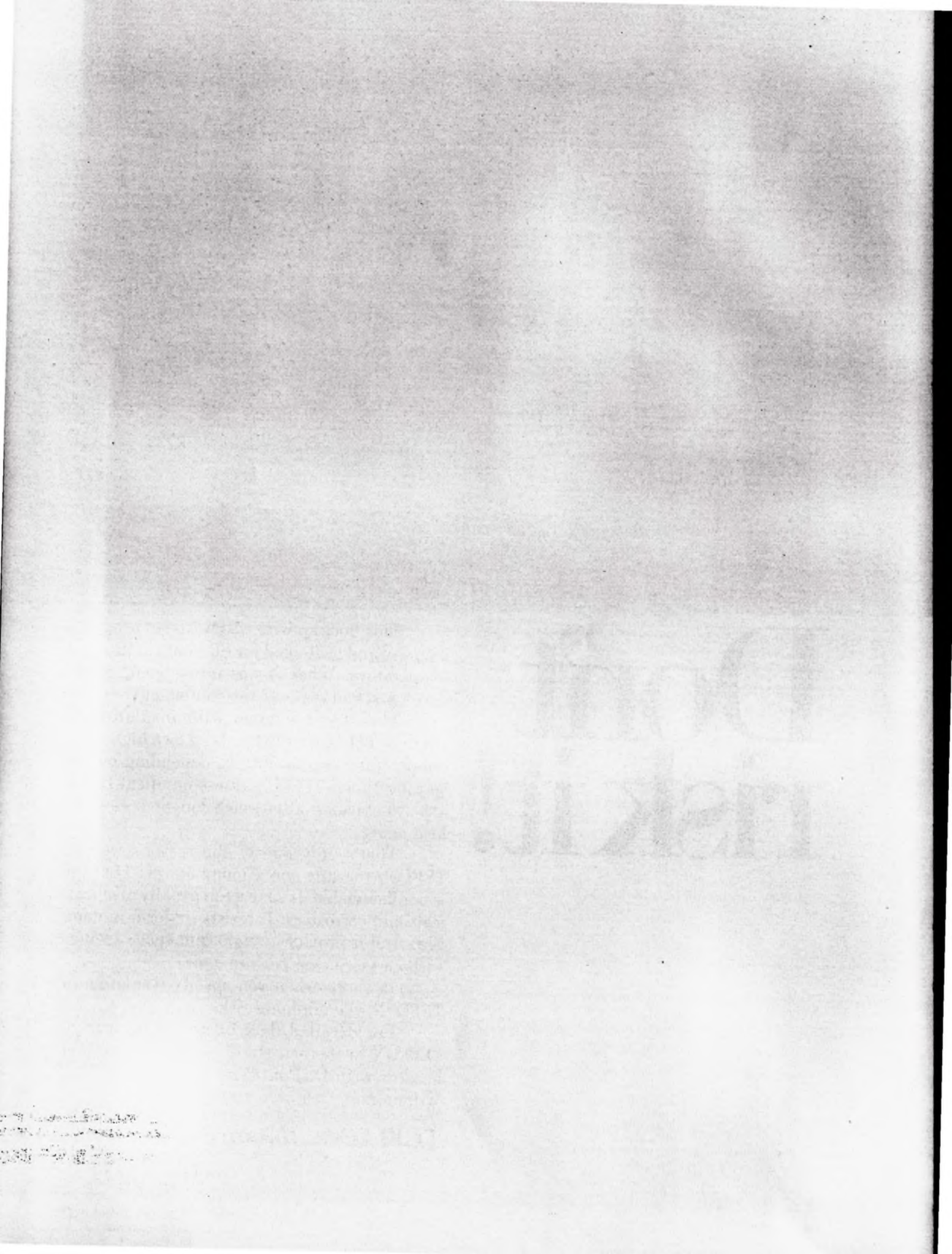

BOOK
MARKER

Faint text at the bottom left corner, possibly a page number or footer.

Dual-amplifier chip is MOS-bipolar IC

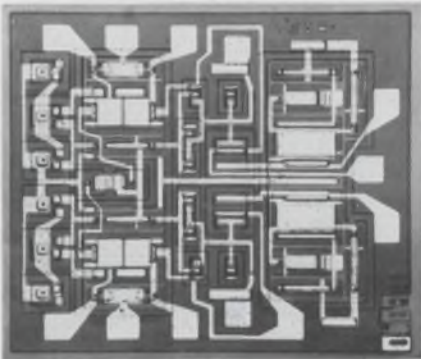

Siliconix Inc., 1140 W. Evelyn Ave., Sunnyvale, Calif. Phone: (408) 245-1000. Price: \$40.60.

Combining MOS and bipolar devices on the same chip, a dual differential-input amplifier has 14 MOSFETS and 12 bipolar transistors on a substrate measuring 55 by 65 mils. Model L120 is a stable unity-gain device that can be used for sample-and-hold, integrating and fast voltage-comparison applications.

CIRCLE NO. 261

IC audio amplifiers boost power to 1 W



Trans-Tek Mfg. Co., 4405 S. Clinton Ave., South Plainfield, N.J. Phone: (201) 561-2400.

Housed in a TO-78 package, two integrated-circuit audio amplifiers deliver powers of 0.5 and 1 W, respectively. Able to boost power from milliwatts to low-distortion audio levels, the new devices operate from a supply of 6 to 20 V dc. They are temperature compensated from 0 to 85°C and have an input impedance of 400 kΩ.

CIRCLE NO. 262

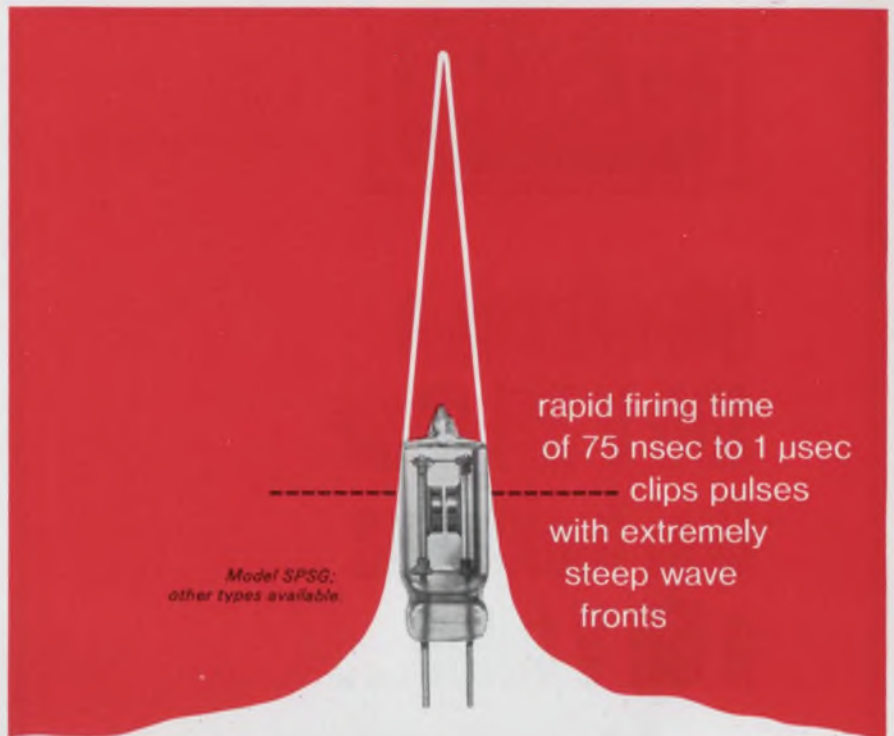

protect solid state circuits from catastrophic transient spikes with VICTOREEN SPARK GAPS

Extremely rapid firing time (as fast as 75 nsec, depending on circuit parameters) combined with excellent energy handling capabilities (100 joules for currents as high as 2000 amperes) anywhere in a broad range (85-5000 volts), including our new miniature version. And that's why they're providing sophisticated circuit designers with positive, economical protection for their solid state circuits.

Low interelectrode capacitance also makes them ideal for high frequency application where wave form must be preserved. In ignition applications, Victoreen Spark Gaps are used as hold-off devices to prevent current flow until circuit voltage reaches predetermined gap breakdown voltage. High repeatability and long service life enhance reliability of continuous duty systems in ambients from -65° to 125°F. Shock resistance to 100g for 11 milliseconds, vibration resistance a full 10g from 55 to 2000 cps. For positive protection of exotic solid state circuits, call Applications Engineering Dept., (216) 795-8200, Ext. 306.

A-2732

VICTOREEN INSTRUMENT DIVISION
10101 WOODLAND AVENUE • CLEVELAND, OHIO 44104
IN EUROPE: GROVE HOUSE, LONDON RD., ISLEWORTH, MIDDLESEX, ENGLAND



INFORMATION RETRIEVAL NUMBER 55

USCC

RFI/EMI
Filter Breakthrough

introduces a 100 V RFI filter that looks like a 50 V filter...



and there the comparison ends.

Here are look alikes that are miles apart in performance. In a packaging breakthrough, USCC has designed a 100 Vdc L Section RFI/EMI filter into a miniature package the size previously available only for filters up to 50 Vdc. This makes it the smallest 100 V filter around.

Look at these outstanding advantages never available before in a filter this size:

100 V at 85°C
50 V at 125°C
withstands transients to 200 V

Try this. Replace a 50 V filter with a new 2100 Series 100 V filter. You can expect an effective operating life eight times as great.

Using feedthrough construction, the bulkhead mounted units demonstrate superior RFI/EMI shielding for performance in the 10 kHz to 10 GHz range. The applicable requirements of MIL-F-15733 are also met.

The unique internal construction of these low pass filters incorporates mechanical assembly techniques as well as soldered connections that greatly improve reliability. The low inductive capacitance element is responsible for improved high frequency response. And power dissipation is so low you will want to forget it as a design factor. They're even double plated for increased corrosion resistance.

For complete information contact: U.S. Capacitor Corporation, 2151 N. Lincoln Street, Burbank, California 91504. Telephone: (213) 843-4222. TWX: 910-498-2222.

USCC

INFORMATION RETRIEVAL NUMBER 56

ICs & SEMICONDUCTORS

ECL circuits delay 2 ns/gate

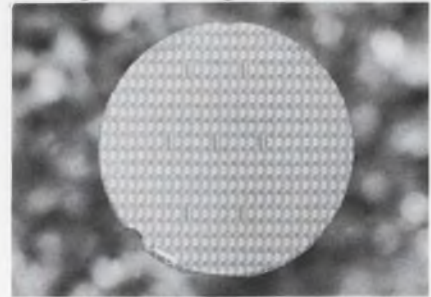

Texas Instruments Inc., Components Group, P.O. Box 5012, Dallas, Tex. Phone (214) 238-2011. Availability: first quarter, 1969.

Designated the ECL2500 series, a compatible line of 29 ECL (emitter-coupled logic) functions provides typical propagation delays of 2 to 3 ns per gate. The new series consists of 18 basic logic configurations, three complex logic functions, four interface circuits and three storage functions. Also included is a 4-word by 2-bit MSI active-element memory. All circuits are available in plastic-encapsulated dual-in-line packages.

CIRCLE NO. 263

Miniature zeners handle 400 mW

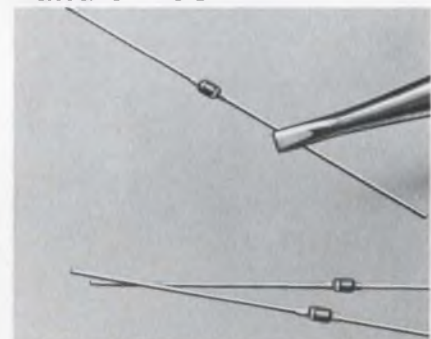

Centralab Semiconductor Div., 4501 North Arden Dr., El Monte, Calif. Phone: (213) 686-0567. P&A: from 15¢; 4 wks.

Series C4011 miniature zener diodes dissipate 400 mW in a package that is one-seventh the size of a DO-7 configuration. Designed to meet the requirements of MIL-S-19500, they offer features of micro-glass devices that are usually higher priced. The new series is available in 19 zener voltages, ranging from 6.2 to 36 V.

CIRCLE NO. 264

Sealectro RF connectors, adaptors and cable assemblies are designed and manufactured to meet the most stringent requirements of military, space and commercial applications including MIL-C-22557 and MIL-C-39012, Series SMA. Microminiature Microhex connectors offer outstanding VSWR to 5 GHz . . . Sub-miniature ConhoX connectors to 12.4 GHz . . . and the best performers of all . . . stainless steel SRM® connectors with low, low VSWR all the way to 18 GHz.

Over 350 standard connector and adaptor configurations with a wide selection of mating engagements and cable terminations are included in the Sealectro line to provide you with the widest selection and with the fastest possible delivery in the industry. And . . . Sealectro maintains complete custom cable assembly

facilities staffed by trained personnel to save you time and money.

Why not find out about Sealectro's complete RF connector line. Drop us a line or phone. We'll send you our complete set of RF connector catalogs and technical specifications.



RF COMPONENTS DIVISION

SEALECTRO CORPORATION

MAMARONECK • NEW YORK 10543

PHONE: 914 698-5600 TWX: 710-566-1110

Sealectro Ltd. Portsmouth, Hants, England

Sealectro S.A. Villiers-le-Bel, Paris, France

The proof of the quality of our connectors is in their performance

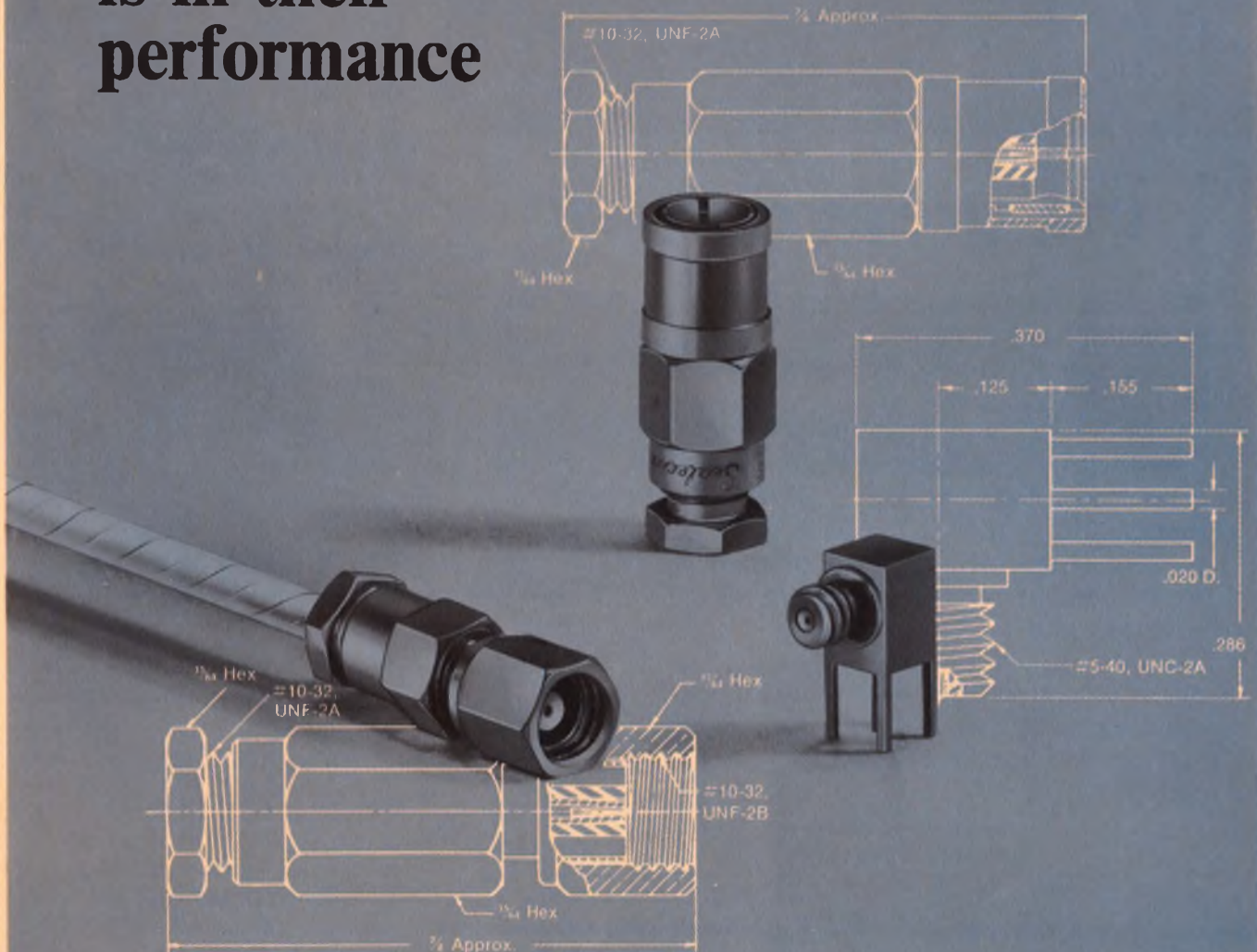

IC voltage translator doubles output swing

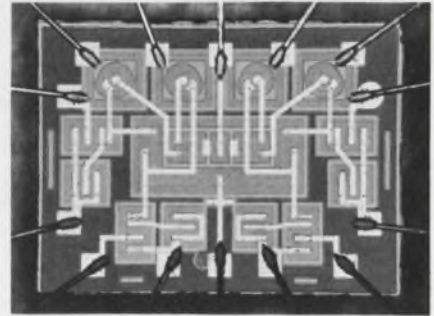

United Aircraft, Electronic Components Div., Treviso, Pa. Phone: (215) 355-5000. P&A: \$21; stock.

A new monolithic quad voltage translator IC offers more than double the output-voltage swing of previously available circuits. Model 1026 achieves a 60-V output swing with no increase in propagation delay, which is less than 1 μ s at 50% of input to 90% of output. Designed as an interface between standard current-sinking logic and MOS multiplexers, the circuit has negligible power dissipation in the high-output condition.

CIRCLE NO. 265

Monolithic amplifier holds offset to 20 nA



National Semiconductor Corp., 2950 San Ysidro Way, Santa Clara, Calif. Phone: (408) 245-4320. P&A: \$45; stock.

A monolithic operational amplifier, model LM101A, guarantees input bias currents of 100 nA and input offset currents of 20 nA over a temperature range of -55 to $+125^{\circ}\text{C}$. In addition, offset voltages of 3 mV, offset voltage drifts of $15 \mu\text{V}/^{\circ}\text{C}$, and offset current drifts of $0.2 \text{ nA}/^{\circ}\text{C}$ are guaranteed over this full temperature range.

CIRCLE NO. 266

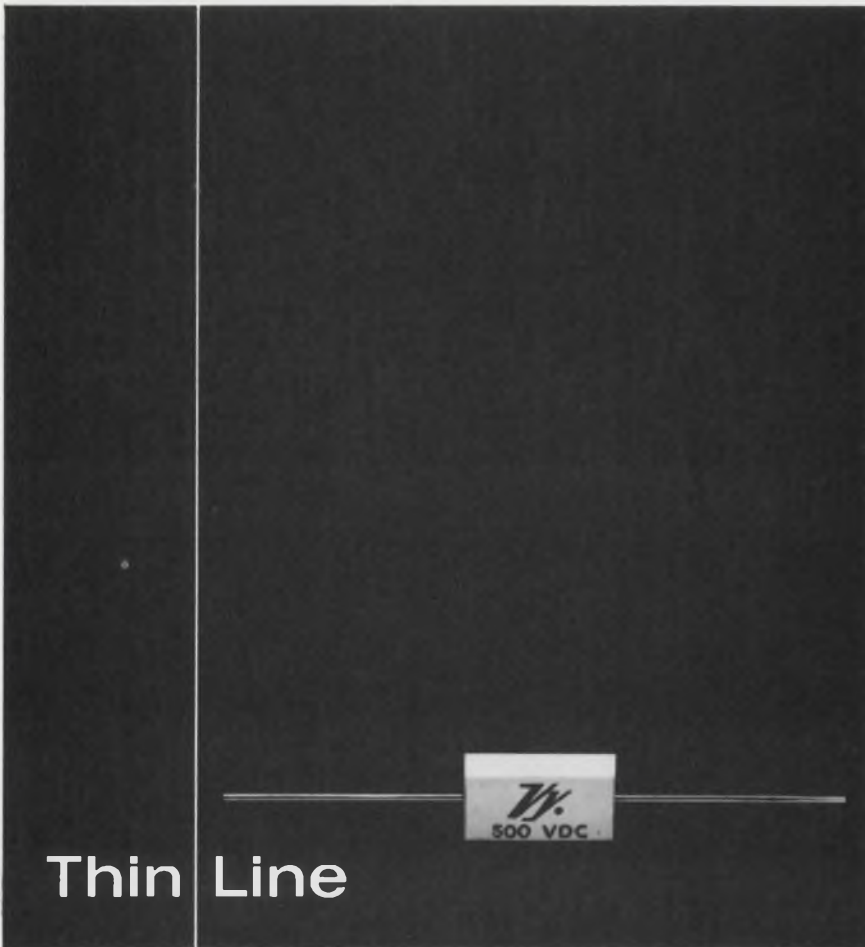

the great divider

It separates special, quality capacitors from run-of-the-mill components.

You see, Vitramon, Inc. produces them carefully (but rapidly).

As a result, only "Thin Line" Porcelain Capacitors come with a zero temperature coefficient . . . tight 0.1 pf and 1% tolerances . . . a low failure rate of less than 0.03% . . . ratings to 500 vdc.

Want consistent performance at all operating frequencies, voltages and environments?

Then you want "Thin Line"—because a thin line is often the difference between circuit perfection and run-of-the-mill performance.

For complete information, request Data Sheet P10.



Vitramon

VITRAMON, INCORPORATED
BOX 544
BRIDGEPORT, CONN. 06601

In Greater Europe Contact:
VITRAMON EUROPE
Wooburn Green, Bucks, England

lowest profile – smallest over-all mercury-wetted contact relay

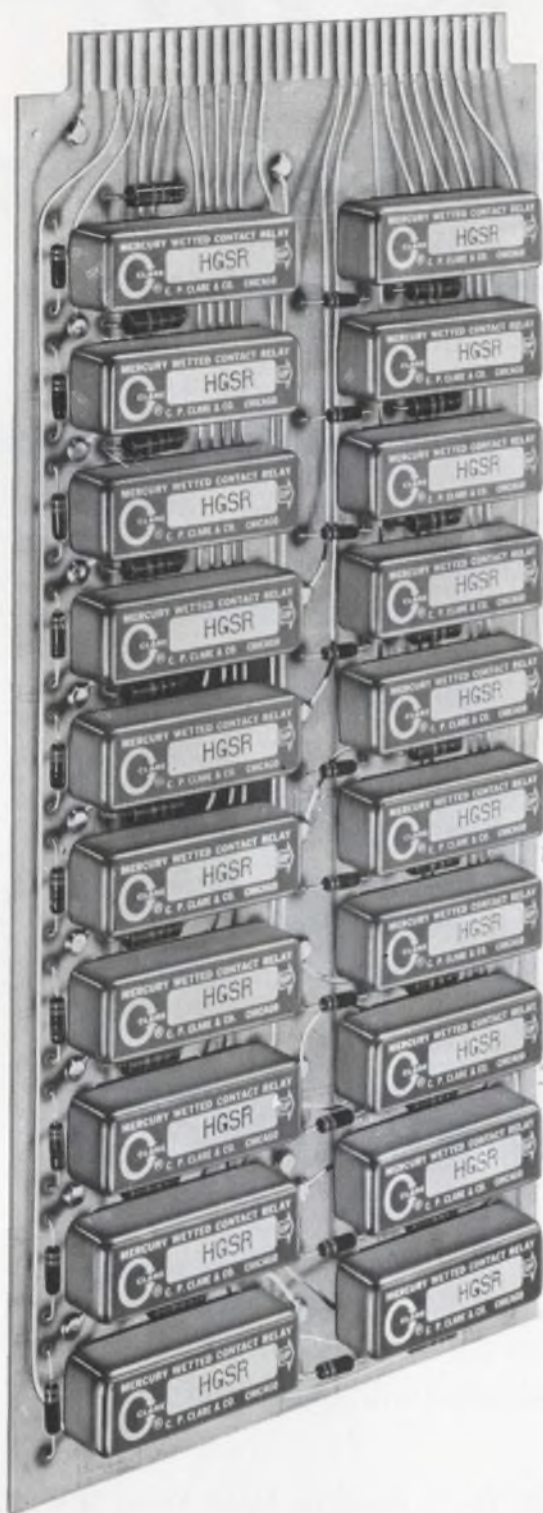

The Clare HGSR (only .33 cu. in.) puts more switching capacity on a board than ever before possible with long life mercury-wetted contacts.

It's fast and tough—serves most process control operations . . . provides over 22 billion operations without fail or falsing. And like the widely recognized Clare HGM and half-size HGSM, it provides a combination of high speed and low contact noise generation . . . the elimination of contact bounce and chatter and resulting false signalling. Advanced circuits can be designed with power gain up to 5000 . . . sensitivities as low as 20 mw. For solid state buffering, you get built-in input/output isolation . . . for measurement circuitry, minimal contact resistance, constant over billions of operations.

For complete information, circle reader service number—ask Clare for Data Sheet 855C . . . Write Group 1A8.

C. P. Clare & Co., Chicago, Illinois 60645 . . . and worldwide.



a GENERAL INSTRUMENT company

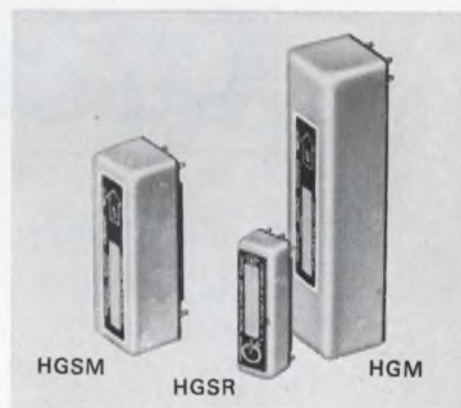

- Life: 22×10^9 operations—with no maintenance
- Low, constant contact resistance—no mechanical wear or electrical erosion
- No contact bounce
- Switching speeds to 1 ms
- Versatile contact load capabilities—low level to 250 va
- High power gain—to 5000 with no noise sensitivity
- Sensitivities as low as 20 mw

CLARE MERCURY-WETTED CONTACT RELAYS

for input analog switching, output power conversion switching,
solid state input and output buffering

INFORMATION RETRIEVAL NUMBER 59

Order Now!

“A Practical Design Guide For A/D and D/A Conversion”

By Hermann Schmid, senior engineer, General Electric Company

100 pages, 8½ x 11.



This Electronic Design reprint contains complete, up-to-date design information covering all aspects of A/D and D/A converters. Here are just *some* of the subjects covered: A/D Converter Types — Successive Approximation; Charge Equalization; Indirect; Serial Feedback; Ultra-High Speed; D/A Converter Types — Parallel; Serial; Indirect; Digital-to-A/C. Also covers automatic offset correction and time sharing.

As digital computation techniques are used in increasingly broad areas such as industrial control systems, instrumentation systems, computers and telemetry systems, this information-packed “how-to-do-it reprint” is one you can't afford to be without. To get your copy, order now at \$2.75 each. To keep the price of this valuable reprint as low as possible, we must ask your check or money order be included with the request.

Reader Service Department, Electronic Design, 850 Third Avenue, New York, N.Y. 10022

Gentlemen:

Please send me ___ copy (ies) of “A Practical Design Guide For A/D and D/A Conversion.” (\$2.75 each. This includes all mailing and handling charges.)

Enclosed is _____ check money order.

Name _____

Address _____

City _____ State _____ Zip _____

NPN-PNP pairs to 60amps

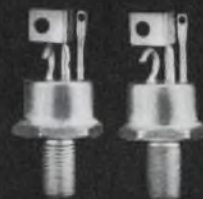

TRUE NPN-PNP PLANAR POWER TRANSISTOR COMPLEMENTS IN RATINGS FROM 1 TO 60 AMPERES..... NOW, FROM TRANSITRON

More Complementary Pairs — More NPN-PNP complements than any other manufacturer. Pairs available in all ratings up to 60 Amps.

Wider Selection — Well over a thousand silicon planar types — both high power and high voltage . . . all available for fast delivery. NPN and PNP types with power dissipation 5 to 300 watts; collector current 1 to 100 amps; BV_{CE0} (NPN) to 200 V; BV_{CE0} (PNP) to 140 V; high-voltage NPN types with BV_{CE0} to 400 V.

Single-chip reliability — Exclusive single-chip

construction provides greater reliability than standard multiple-chip designs.

More Packaging Flexibility — Standard packages available include TO-114, TO-3, TO-63, TO-61, TO-59 and TO-5. (TO-5, TO-59 and TO-61 in isolated cases, also.) High power types available in smaller-than-usual packages, providing important space and weight savings.

Proved Performance — Transitron power transistors are in use in many military and aerospace programs where reliability and performance are critical.

TYPICAL POWER TRANSISTORS						HIGH VOLTAGE TRANSISTORS				
Typical NPN type	Typical Complementary PNP type	Package	Maximum Power Dissipation (Watts)	BV_{CE0} (Volts)	I_C (max) (Amps)	Typical NPN type	Package	(Watts) Maximum Power Dissipation	BV_{CE0} (Volts)	I_C (max) (Amps)
ST14030	ST40003	TO-63	300	100	60	ST18007	TO-63	100	375	30
2N5250	—	TO-114	300	100	90	ST18010	TO-63	100	200	30
ST15044	ST54005	TO-63	187	100	40	ST18011	TO-61	50	375	20
ST17061	ST10008	TO-61	150	100	30	ST18014	TO-61	50	200	20
ST86021	—	TO-61	75	100	5	ST18015	TO-59	30	375	10
ST91058	ST76019	TO-59	60	100	10	ST18018	TO-59	30	200	10
ST92007	ST72037	TO-59	45	100	2					
ST91055	ST72039	TO-5	15	100	5					
ST74050	ST75004	TO-5	11	100	2					
ST84028	—	TO-5	7.5	140	1					

Want more information on Transitron power transistors? Call today for complete data and specifications. Specify types of particular interest.

Transitron
electronic corporation
168 Albion Street Wakefield, Massachusetts 01880

INFORMATION RETRIEVAL NUMBER 61

SMALL — REGULATED DC POWER SUPPLIES

IMPROVE YOUR PRODUCT'S
PRICE — PERFORMANCE — DELIVERY

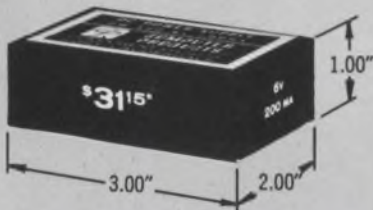
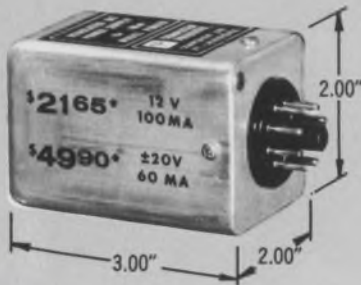

- Single and Dual Output Models
- Short Circuit Proof Output
- Integral Transformer for Operation from AC Line (115 ± 10 VAC, 60 to 400 Hz)
- PC Mount or Octal Plug-in
- All Silicon Semiconductors

* Prices for 10-29 Units. Single Unit Prices are shown in chart below.

Voltage	3.6V	5V	6V	10V	12V	15V	±15V
Current	250 MA	250 MA	200 MA	120MA	100 MA	100 MA	100 MA
Line-Load Reg. Ea.	± 0.05%	± 0.05%	± 0.05%	± 0.02%	± 0.02%	± 0.02%	± 0.02%
Temp. Coeff./°C	± 0.05%	± 0.05%	± 0.05%	± 0.02%	± 0.02%	± 0.02%	± 0.02%
Ripple & Noise	0.5 mV RMS	0.5 mV RMS	0.5 mV RMS	0.5 mV RMS	0.5 mV RMS	0.5 mV RMS	0.5 mV RMS
Output Z @ 10 KHz	0.2 ohms	0.2 ohms	0.2 ohms	0.2 ohms	0.2 ohms	0.2 ohms	0.2 ohms
Model No.—Octal	PM644	PM629	PM622	PM687	PM663	PM676	PM652
Price—Case Size	\$37.75-E	\$37.75-E	\$37.75-E	\$26.95-E	\$26.95-E	\$26.95-E	\$44.95-E
Model No.—P.C.	PM544	PM529	PM522	PM587	PM563	PM576	PM552
Price—Case Size	\$36.15-B	\$36.15-B	\$36.15-B	\$24.95-A	\$24.95-A	\$24.95-A	\$42.95-C

Case Sizes: A-1.75"x2.25"x1.00"; B-2.00"x3.00"x1.00"; C-2.30"x3.50"x1.00"; E-2.00"x2.00"x3.00"

Voltage	20V	±20V	22V	24V	28V	170V	180V
Current	60 MA	60 MA	55 MA	50 MA	40 MA	10 MA	10 MA
Line-Load Reg. Ea.	± 0.02%	± 0.02%	± 0.02%	± 0.02%	± 0.02%	± 0.05%	± 0.05%
Temp. Coeff./°C	± 0.02%	± 0.02%	± 0.02%	± 0.02%	± 0.02%	± 0.05%	± 0.05%
Ripple & Noise	1.0 mV RMS	1.0 mV RMS	1.0 mV RMS	1.0 mV RMS	1.0 mV RMS	15 mV RMS	15 mV RMS
Output Z @ 10 KHz	0.2 ohms	0.2 ohms	0.2 ohms	0.2 ohms	0.2 ohms	5 ohms	5 ohms
Model No.—Octal	PM674	PM648	PM656	PM685	PM662	PM638	PM639
Price—Case Size	\$29.95-E	\$59.90-E	\$29.95-E	\$29.95-E	\$29.95-E	\$37.75-E	\$37.75-E
Model No.—P.C.	PM574	PM548	PM556	PM585	PM562	PM538	PM539
Price—Case Size	\$27.95-A	\$55.90-C	\$27.95-A	\$27.95-A	\$27.95-A	\$36.15-B	\$36.15-B

Case Sizes: A-1.75"x2.25"x1.00"; B-2.00"x3.00"x1.00"; C-2.30"x3.50"x1.00"; E-2.00"x2.00"x3.00"

PLACE AN ORDER TODAY / TELEPHONE (305) 565-9565

Computer Products, Inc., 2801 E. Oakland Park Blvd., Fort Lauderdale, Fla. 33306



COMPUTER
PRODUCTS™

FORT LAUDERDALE

INFORMATION RETRIEVAL NUMBER 62

ICs & SEMICONDUCTORS

MOS switch/driver decodes to four lines

Siliconix Inc., 1140 W. Evelyn Ave., Sunnyvale, Calif. Phone: (408) 245-1000. P&A: \$27.60; stock.

A monolithic MOS quad switch/driver couples three inputs per gate to decode a binary counter into four lines. Used as an interface between DTL/TTL binary counters and multichannel FET switches, model D129 cuts component count in multiplexers, time-sharing systems, and d/a converters. Its npn output transistor has a 50-V minimum breakdown with a maximum saturation condition of 0.5 V and 10 mA. Typical turn-on propagation time is 100 ns; turn-off is 400 ns.

CIRCLE NO. 267

Quad core drivers switch in 25 ns

Fairchild Semiconductor, 313 Fairchild Dr., Mountain View, Calif. Phone: (415) 962-2530. P&A: \$14 or \$24; stock.

Two quad core drivers, which are supplied in hybrid packages, have typical turn-on switching times of 25 ns. Each hybrid circuit consists of four transistors that operate at currents up to 1 A, sustaining voltages up to 50 V. The drivers are designated as the SH-6400, a pnp unit, and the SH-6500, the npn counterpart. Turn-off times are 65 and 45 ns.

CIRCLE NO. 268

Matched dual FETs hold Y_o below 1 μ mho

Union Carbide Electronics, Semiconductor Dept., 8888 Balboa Ave., San Diego, Calif. Phone: (714) 279-4500. Availability: stock.

Matched dual junction FETs exhibit an output admittance that is guaranteed to be below 1 μ mho—four times lower than comparable units. The 2N5452 offers a tight match in output admittance of 0.05 μ mhos at a frequency of 1 kHz. The 2N5453 and 2N5454 offer a typical match of 0.1 μ mho.

CIRCLE NO. 269

The Inside Story of Handling Current at High Speeds

Now, RCA introduces the multiple-emitter chip, a concept using RCA "overlay" techniques, in 2N5038 and 2N5039—multi-epitaxial silicon transistors for high-speed switching circuits. On the inside is the pellet with 12 discrete emitter sites, interconnected by a 12-pronged heat-conducting copper slug. The use of individual emitter sites provides the excellent 20-ampere current handling capabilities of these devices by increasing the emitter periphery. The copper slug assures good temperature and voltage distribution among the emitter sites across the pellet, and further contributes to the current handling, *while adding significantly to the forward second break-down capability of the device.* These concepts (discrete emitters and copper slug) eliminate the non-uniform current injection normally associated with high current interdigitated transistor structures.

For the design engineer, 2N5038 and 2N5039 represent the right combination of mechanical structure and performance characteristics. They have low saturation voltage (1.0 volt max. at 12 A for 2N5038 and at 10 A for 2N5039) and fast saturated switching times (turn-on less than $0.5 \mu\text{s}$ and turn-off less than $2 \mu\text{s}$).

Available in production quantities, 2N5038 and 2N5039 are useful in a wide variety of applications including: dc-to-dc converters (at 25 KHz, 250 watts and 85% eff. may be achieved) and high frequency switching regulators (up to 50 KHz, 700 watts output, with 95% eff.). Both units make good linear amplifiers at frequencies up to 5 MHz.

Call your RCA representative today for more information or see your RCA Distributor. For technical data, write: RCA Electronic Components, Commercial Engineering, Section No. IG-1-2, Harrison, N. J. 07029.

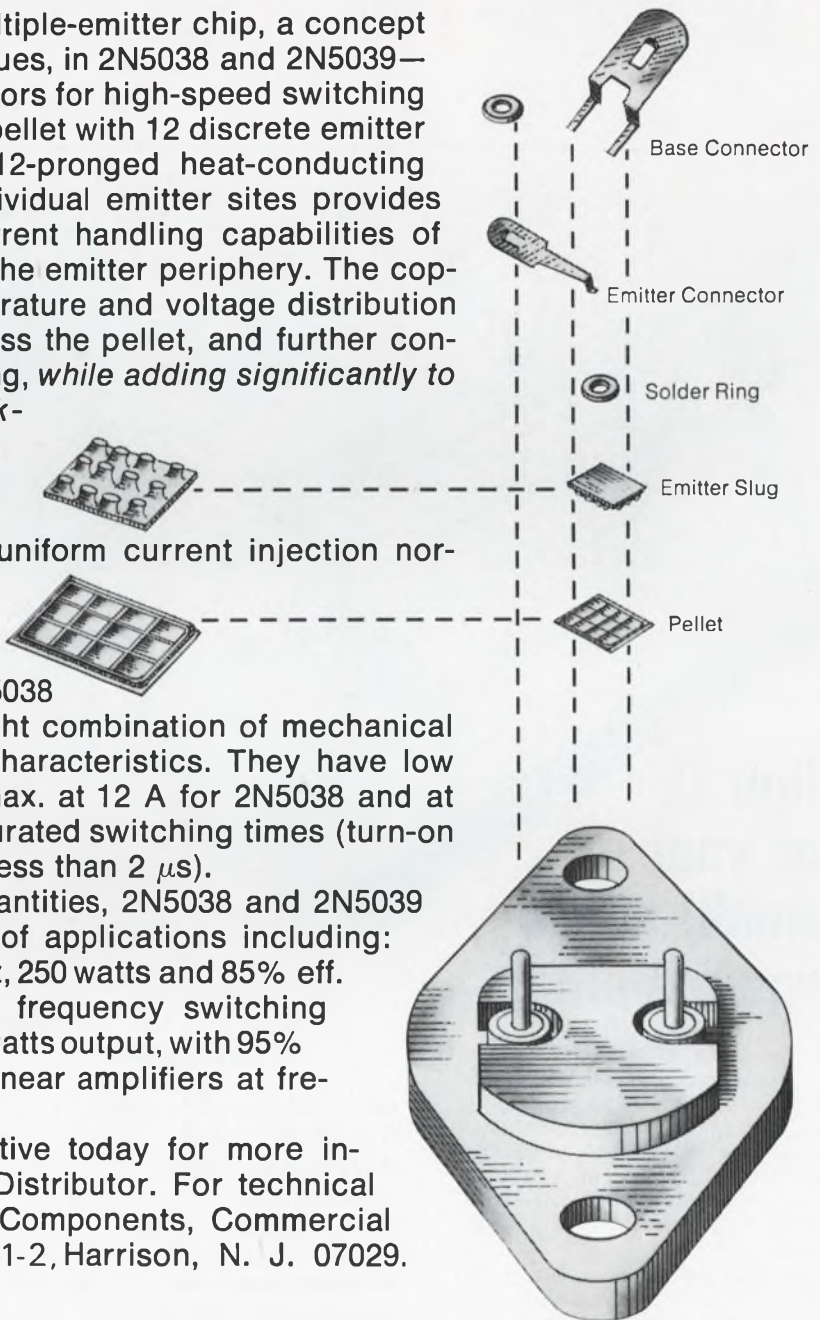

Hybrid regulator sustains 250 mW

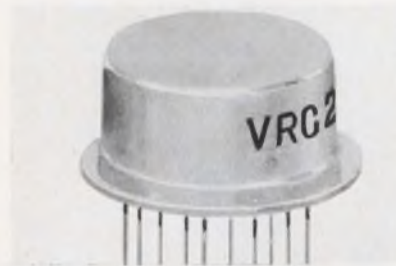

Electronics for Measurement, 848 Marcheta St., Altadena, Calif. Phone: (213) 798-9131.

Housed in a low-profile, 12-lead, TO-5 package, a hybrid voltage regulator is a dc-to-dc converter for handling low-to-medium power levels up to 250 mW. Model VRC 2820 has a regulation of 0.05% for voltages from 7 to 30-V dc.

CIRCLE NO. 270

Voltage comparator has ± 1 -mV accuracy



Optical Electronics Inc., P.O. Box 11140, Tucson, Ariz. Phone: (602) 624-3605. P&A: \$27; stock.

Model 5501 monolithic voltage comparator allows a maximum comparison error of only ± 1 mV, including gain and offset errors. It features 80-dB minimum voltage gain, ± 1 -mV maximum input offset, ± 25 -mA minimum output current, and ± 10 - μ V/ $^{\circ}$ C maximum input voltage drift. The unit is compatible with MOS digital, bipolar digital (RTL, DTL and TTL), and ± 10 -V analog signal levels.

CIRCLE NO. 271

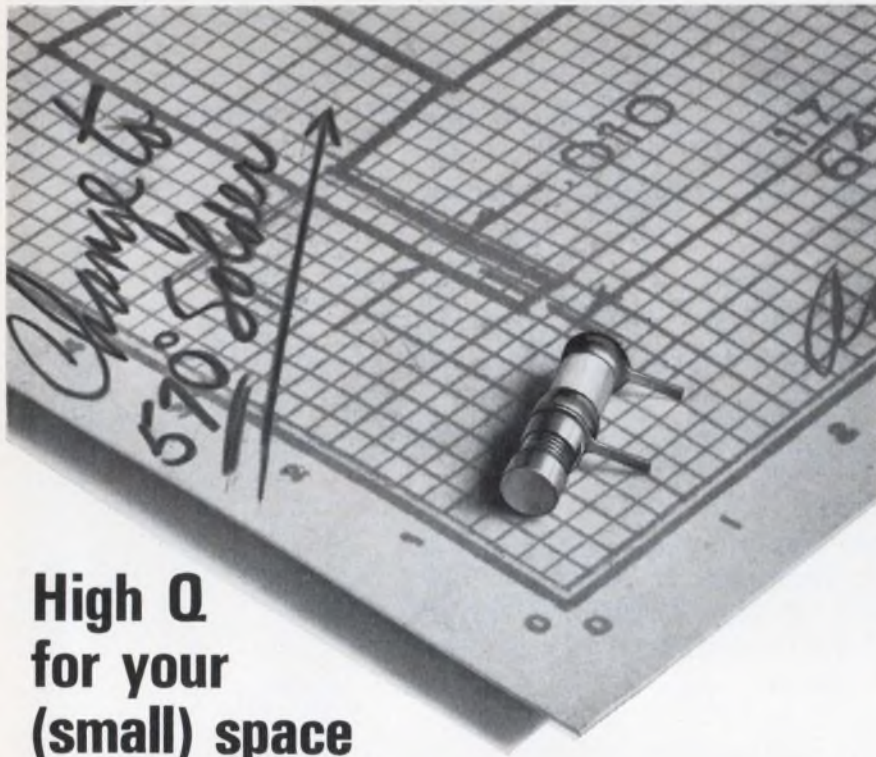

High Q for your (small) space requirements!

The Johanson 4700 Series Variable Air Capacitors provide, in micro-miniature size, the extremely high Q important in demanding aerospace applications. In addition, the ultrarugged construction of the 4700 Series capacitors assures highest reliability in the most critical environments.

- Available in printed circuit, turret and threaded terminal types.
- Meets Mil Specs for salt spray requirements.
- Features 570° solder, which prevents distortion and is not affected by conventional soldering temperatures.

SPECIFICATIONS

Size: .140 diameter, 1/2" length
Q @ 100 MC: > 5000
Q @ 250 MC: > 2000
Capacity Range: 0.35 pF to 3.5 pF
Working Voltage: 250 VDC
 (Test voltage, 500 VDC)
Insulation Resistance: > 10⁸ Megohms
Temp. Ranges: -55°C to 125°C
Temp. Coefficient: 50 \pm 50 ppm/ $^{\circ}$ C

WRITE TODAY FOR FULL DATA.

Johanson

MANUFACTURING CORPORATION

400 Rockaway Valley Road, Boonton, N. J. 07005 (201) 334-2676

INFORMATION RETRIEVAL NUMBER 64

Ge 60-A transistors boost current by 15



Motorola Semiconductor Products, Inc., P.O. Box 20924, Phoenix, Ariz. Phone: (602) 273-8465. Price: \$7.25 to \$15.

Operating at 60 A continuous, six germanium power transistors, types 2N5435 through 2N5440, feature a minimum current gain of 10 or 15. In addition, the new units minimize saturated power loss and maximize efficiency with typical saturation voltages of 0.25 V at 60 A.

CIRCLE NO. 272

Let's talk about high noise immunity . . . number of



available logic functions . . . number of test points



per card . . . and economical logic system design

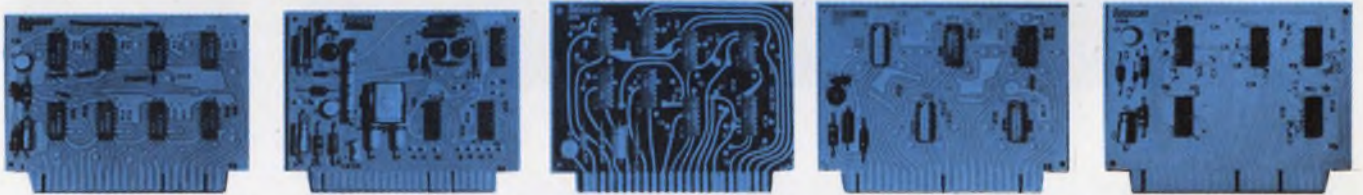

Datascan Integrated Circuit Logic Cards

Two complete lines — the Standard Series 200 (DTL) and the high noise immunity Series 400 (HTL) offer system designers maximum flexibility and economy in developing high performance systems. And, on every Datascan IC card you get these exclusive features:

- **DYNAMIC DECOUPLING (Optional)** — this is the only integrated circuit card that offers an active power supply decoupling element, to eliminate noise, particularly in larger systems.
- **PULL-UP RESISTORS** — provision has been made for adding resistors directly on individual cards.
- **MORE TEST POINTS** — located at all convenient circuit nodes, not limited in number — valuable in simplified system troubleshooting.
- **CODED CARDS** — color coded for quick identification of same-function cards; slot interpin keyed to prevent interchange of card types or card reversing.

Contact your local Datascan representative or call us direct, for complete technical catalog information or to arrange for engineering consultation.



Datascan, Inc.

1111 Paulison Ave., P.O. Box 785, Clifton, New Jersey 07013

Tel. 201-478-2800



System Designers: Write, on your company letterhead only, for a copy of the complete Datascan technical catalog and Application Notes — the most complete publication of its type in the electronics industry.

Solve all Resistor problems fast...

TALK TO THE SPECIALIST... LECTROHM

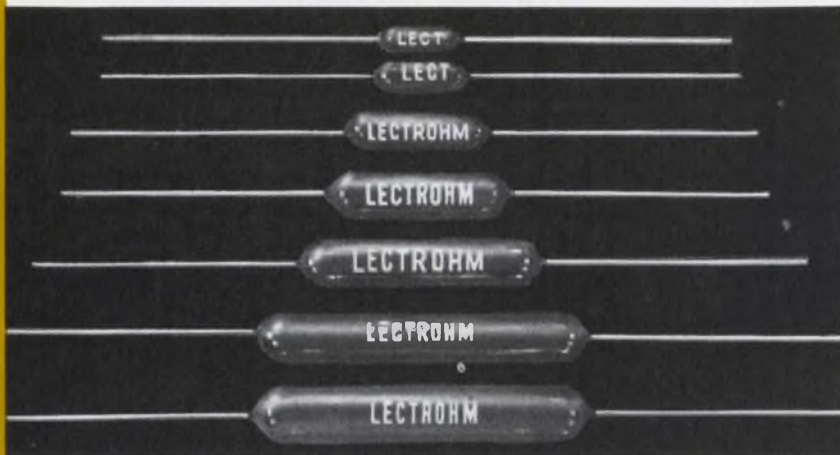

With LECTROHM's entire production facilities devoted to the manufacture of quality power, wire-wound resistors, we are in the unique position to provide quick, economical solutions to all resistor problems. As specialists in the field, LECTROHM knows resistors.

Whether your products require "standard" or "custom" styles — fixed or adjustable types, vitreous enamel or silicone coated — there is a LECTROHM resistor to match those needs precisely. To meet your production schedules, large stocks of standard styles in popular values are always available for immediate shipment, with special facilities geared to fast delivery on small orders of special values.

Whatever your resistor problems entail, you will do better talking to the specialist — talk to LECTROHM. You'll be time and money ahead, everytime.



FREE!

Full line LECTROHM catalog.

Send for your copy today!



Vitreous Enameled Fixed Resistors



Vitreous Enameled Adjustable Resistors



Type FP Resistors

Lectrohm, Inc.

A subsidiary of



COOK ELECTRIC

5562 Northwest Highway, Chicago, Ill. 60630

MICROWAVES & LASERS

Hybrid microstrip chips are low-loss capacitors

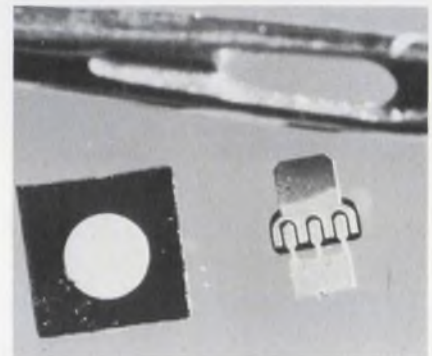

Sylvania Electric Products Inc., Microwave Operations, 100 Sylvan Rd., Woburn, Mass. Phone: (617) 933-3500.

High-temperature, thermally grown, quartz microwave capacitors are now available for use in hybrid microstrip circuits. They use silicon dioxide, about one micron thick, as the dielectric. Gold, which is evaporated and plated on both sides of the silicon-dioxide chip, acts as the plate. Measurements up to 12 GHz show that insertion losses are equal to, or better than, the microstrip itself.

CIRCLE NO. 273

Laser diode pulser measures 1 in.³



Washington Technological Associates, Inc., 939 Rollins Ave., Rockville, Md. Phone: (301) 427-7550. Price: \$185.

A laser pulser, model LP-1, can pulse modulate a solid-state laser diode. Size is less than 1 in.³. The device draws less than 200 μ A from a 36-V supply, when producing a 14-A peak pulse 100-ns-wide at a repetition rate of 100 Hz. Maximum repetition rate is 10 kHz. Higher peak currents are available on special order.

CIRCLE NO. 274

X-band coax switch has 60 dB isolation



Amphenol RF Division, 33 E. Franklin St., Danbury, Conn.

Superior isolation characteristics, over a dc to 12.4 GHz operating range, and high power-handling capability are offered by a new coaxial switch. Standard-size spdt units provide 60 dB of isolation at 12.4 GHz; VSWR at this frequency is under 1.5 and insertion loss is only 0.5 dB maximum. Rated at 100 V of rf power with an operating time of 15 ms and 60-m Ω contact resistance, the switches are available with standard type N or TNC connectors.

CIRCLE NO. 275

Ku-band generator forms 50-kW pulses



Crescent Technology Corp., 2222 Michelson Dr., Newport Beach, Calif. Phone: (714) 833-2000.

A high-power, tunable rf pulse generator for Ku band is designed for a variety of radar system applications, where size and weight are critical parameters. Output parameters include pulsed rf output of 50 kW over a frequency range of 16.145 to 16.805 GHz (mechanically tunable), at pulse repetition rates of from 0.1 to 4 kHz (tunable).

CIRCLE NO. 276

Reed Relays that deliver more of what you need most...

VERSATILITY ■ RELIABILITY ■ ECONOMY



Standard and Miniature Reed Relays



Special Design Reed Relays



Front-Connected Screw Terminal Socket

Automatic Controls' Reed Relays — standard, miniature, or your special designs — offer individually supported reed switches, magnetic foil wrapped coils, non-magnetic terminals, and rhodium plated contacts, providing peak performance and reliability. Standardized contact configurations assure off-the-shelf delivery and maximum economy. For more of what you need most — specify Automatic Controls' Reed Relays everytime!

NEW from Automatic Controls... Front-Connected Screw Terminal Socket.

Accommodates the Automatic Controls' "family" of general purpose plug-in relays and time delay relays.

Automatic Controls

Division



COOK ELECTRIC

200 East Daniels Rd., Palatine, Ill. 60067



FREE!

Automatic Controls Industrial Relay Booklet.

Send for your copy today!

Miniature coax switch handles 12.4 GHz



Amphenol RF Division, Bunker Ramo Corp., 33 E. Franklin St., Danbury, Conn. Phone: (203) 743-9272.

Miniature coaxial switches with superior isolation characteristics over a 0-to-12.4-GHz operating range provide 60-dB minimum isolation at 12.4 GHz. VSWR at this frequency is under 1.5 and insertion loss is only 0.5 dB maximum.

CIRCLE NO. 277

Uhf tuning diodes feature high Q

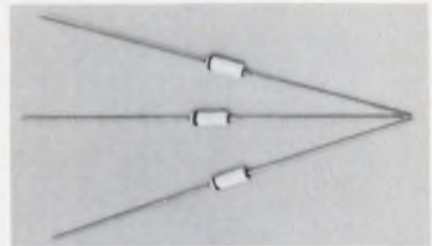

MSI Electronics Inc., 34-32 57th St., Woodside, N.Y. Phone: (212) 672-6500. P&A: \$12.80; 2 wks.

New tuning diodes feature high Q to achieve tuning performance at uhf comparable to that obtained with mechanical capacitors. Typical 3-pF devices with a minimum Q of 1200 at 50 MHz give an unloaded Q of approximately 150 at 400 MHz. The self-resonant frequency for a 10-pF device is above 1000 MHz, making it suitable for operation in the 225-to-400-MHz range.

CIRCLE NO. 278



**Heavy Duty Filter Chokes
In Stock
Custom Filter Chokes
In 10 Days**

Series 7830 heavy duty line filter chokes provide up to 250 uH, carry up to 75 amps; widely used for RFI filters and reducing transient surge peaks; available from L.A. shelf stock; see Catalog 69.



Special RF chokes and coils designed to meet your requirements are shipped within 10 days to 2 weeks; production quantities start within 3 to 4 weeks after sample approval.



Intensive specialization in coil design and manufacture assures excellent operating results with a high degree of reliability. Engineering assistance helps achieve optimum performance.



Write for your copy of Catalog 69 containing specifications and prices for the complete line of J. W. Miller Co. RF chokes, RF and IF coils, transformers, filters, coil forms and components.

Call a Miller coil design specialist for your special coil requirements — (213) 233-4294.



J.W. MILLER COMPANY

5917 SOUTH MAIN STREET ■ LOS ANGELES, CALIFORNIA 90003

See your local distributor for the full line of standard coils and chokes

Ferrite circulators handle 300 W at 6 GHz



General Electric Co., 1 River Rd., Schenectady, N.Y. Phone: (518) 374-2211.

Designed for systems demanding a high degree of system-component compatibility, stripline ferrite circulators and isolators operate from 0.3 to 6 GHz over bandwidth ranges from 10 to 20% at cw levels up to 300 W. They can be customized for operation in stringent environments and are available as miniaturized and magnetically shielded units. Most of the new devices are designed to operate over the temperature range of -55 to +125°C.

CIRCLE NO. 279

How to use the SINGER Model MF-5 Family of Spectrum Analyzers for Audio, Telemetry and Broadcasting Band Analysis

Singer Instrumentation's Model MF-5 Spectrum Analyzer main frame accepts three interchangeable plug-in spectrum analyzer modules, ranging in frequency from 20 Hz to 27.5 MHz. Since interchangeability of the modules is effected in seconds, many users buy only the module they need, adding other modules as their requirements change.



The spectrum analyzer with an **AL-2** module is often used in audio distortion measurements. Amplitudes of all frequency components in the scanned spectrum are simultaneously displayed for rapid analysis. Typical of its applications are measurement of IM distortion in transducers such as phonograph cartridges. IM products are displayed as side bands on a recorded carrier.

The display shows the side bands down 23 dB and 26 dB from the carrier level. This simple spectrum analyzer method is much faster than using IM analyzers, which require several adjustments for each measurement and which can not supply continuous, graphic displays of distortion.

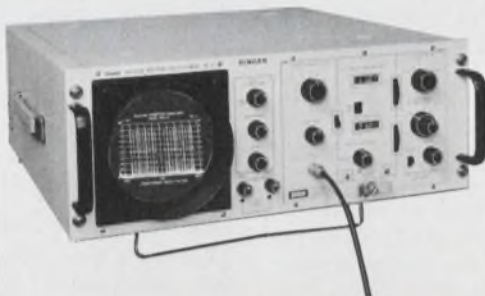
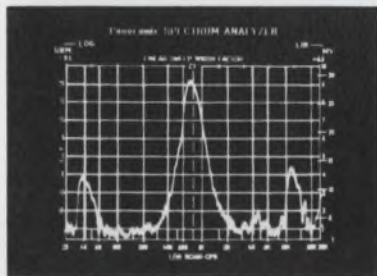

A **UR-3** module (100 Hz to 700 KHz) is ideal for applications in telemetry systems. This module is shown here scanning all 21 constant bandwidth IRIG telemetry channels.

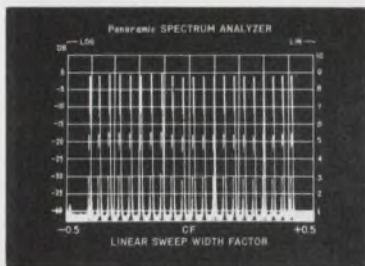

When two channels drop away, their absence shows up instantly on the spectrum analyzer's CRT display. The analyzer is also used for checking signal to noise ratio, the amplitude taper of a telemetry system, or distortion. Besides scanning all the channels, it can provide an expanded display of any one of them.

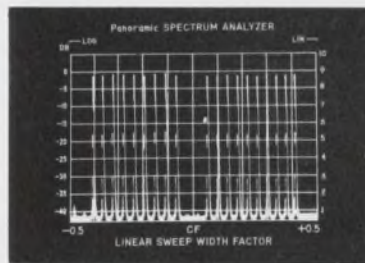

The **VR-4** module (1 KHz to 27.5 MHz) can be used to survey the entire communication frequency spectrum. For this and other applications, Singer provides a full range of accessories, including both antennas shown in this picture.

Shown below is a typical display of the broadcast band. When we want to examine one station's channel occupancy, or a station's average program modulation, the analyzer sweep width is reduced and this display is presented on the CRT. The spectrum analyzer is set for a 20 KHz sweep width (2 KHz/division) in this application. The modulation sideband occupancy at 12 KHz bandwidth is clearly visible as is the carrier of a weaker station (far left of the CRT).

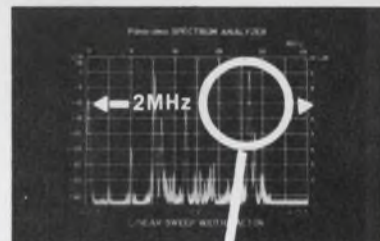

Expanded View of One Channel

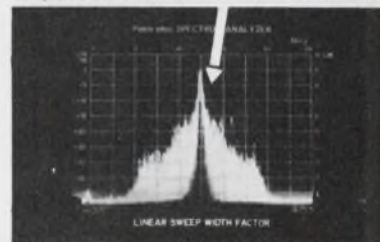

Panoramic **SINGER**
INSTRUMENTATION

The Singer Company Metrics Division, 915 Pembroke St. Bridgeport, Conn. 06608 (203) 366-3201

INFORMATION RETRIEVAL NUMBER 10

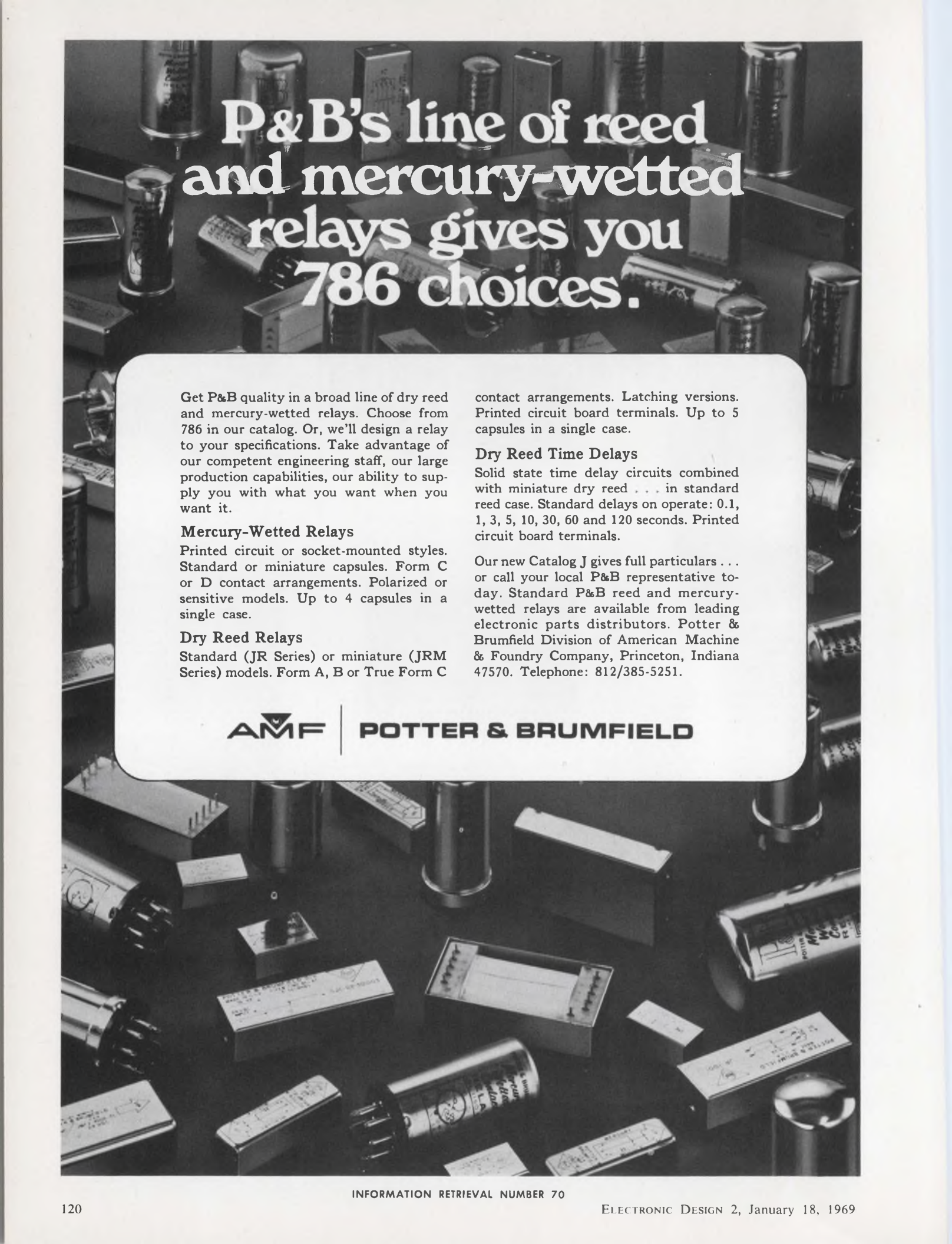

P&B's line of reed and mercury-wetted relays gives you 786 choices.

Get P&B quality in a broad line of dry reed and mercury-wetted relays. Choose from 786 in our catalog. Or, we'll design a relay to your specifications. Take advantage of our competent engineering staff, our large production capabilities, our ability to supply you with what you want when you want it.

Mercury-Wetted Relays

Printed circuit or socket-mounted styles. Standard or miniature capsules. Form C or D contact arrangements. Polarized or sensitive models. Up to 4 capsules in a single case.

Dry Reed Relays

Standard (JR Series) or miniature (JRM Series) models. Form A, B or True Form C

contact arrangements. Latching versions. Printed circuit board terminals. Up to 5 capsules in a single case.

Dry Reed Time Delays

Solid state time delay circuits combined with miniature dry reed . . . in standard reed case. Standard delays on operate: 0.1, 1, 3, 5, 10, 30, 60 and 120 seconds. Printed circuit board terminals.

Our new Catalog J gives full particulars . . . or call your local P&B representative today. Standard P&B reed and mercury-wetted relays are available from leading electronic parts distributors. Potter & Brumfield Division of American Machine & Foundry Company, Princeton, Indiana 47570. Telephone: 812/385-5251.

AMF

POTTER & BRUMFIELD

Spectrum analyzer covers 0.7 to 15.7 GHz



Electromagnetic Information Processing Labs., 2353 DeLaCruz Blvd., Santa Clara, Calif. Phone: (408) 244-7975.

A YIG-tuned crystal video spectrum analyzer provides 0.7-to-15.7-GHz frequency coverage and a large, spurious-free dynamic range. The unit can be set on zero dispersion and used as a receiver to view fast pulses. It may be used with Tektronix scopes that accept letter-series plug-ins, or ordered with the optional, self-contained power supply and carrying case for use with all scopes, large tube displays and recorders.

CIRCLE NO. 280

Shutter switch isolates 60 dB

Amphenol RF Div., Bunker-Ramo Corp., 33 E. Franklin St., Danbury, Conn. Phone: (312) 329-9292.

Shielding critical circuitry from extraneous signals and outside fields, a spst coaxial shutter switch provides 60 dB of isolation at 12.4 GHz. At this frequency, its VSWR is under 1.5, and insertion loss is only 0.5 dB maximum. Rated at 50 W, the switch has an operating time of 15 ms and a contact resistance of 60 mΩ. It is available with type N or type TNC connectors.

CIRCLE NO. 281

Lightweight laser puts out 10-W pulse



Electro-Nuclear Labs., 115 Independence Dr., Menlo Park, Calif. Phone: (415) 322-8451.

Requiring only a low-voltage dc input, a 2-lb portable injection laser system delivers fast-rise (0.5 ns) high-energy (10 W) pulses of radiant energy at 9000 Å. The complete model 492 package consists of a gallium-arsenide laser diode, pulse forming network, dc-to-dc voltage-up converter, and a repetition rate control.

CIRCLE NO. 282

Laser diode arrays develop 10,000 W



Laser Diode Laboratories, Inc., 205 Forrest Rd., Metuchen, N.J. Phone: (201) 549-7700.

Two series of large-scale laser diode arrays have high power outputs at room and at cryogenic temperatures. At 27°C, minimum peak power output for arrays in the LD300 series is as high as 600 W, and for the LD400 series is as high as 10,000 W. The arrays emit coherent infrared radiation at 9040Å at 27°C.

CIRCLE NO. 283

LOOKING BEYOND THE "SPECS" WITH P&B

NEW SOLID STATE TIME DELAY RELAYS AS LOW AS \$12.50



This new solid state time delay relay (CU Series) could be the biggest \$12.50 relay value you've ever seen. Timing tolerance is ±5%. Internal dpdt relay is rated at 10 amperes. Fixed timing ranges: 1, 5, 10, 30, 60 and 120 seconds. Designed for delay on operate applications. Both AC and DC models are available.

DC relays are internally protected against reversal of input polarity and will not be damaged by a transient input up to twice rated voltage for a duration of eight milliseconds.

Mounting versatility: Standard .187" quick-connect terminals are pierced for solder connections. A slotted case for direct-to-chassis mounting is available. A nylon socket is also available for plug-in convenience.

Resistor-adjustable models are available for any timing period up to 120 seconds at a slightly higher price.

PLUS P&B Capabilities and Facilities that insure

- **Controlled Quality**
- **Reliability**
- **Long Life**
- **On Time Deliveries**



P&B's facilities include the most sophisticated quality control tests. Here the hermetic seals of aerospace relays are being leak-tested by radioactive krypton 85, at a sensitivity of 1 X 10⁻⁸ cc/sec. at a differential of one atmosphere.

AMF

POTTER & BRUMFIELD
Division of American Machine & Foundry Co.
Princeton, Indiana 47570

INFORMATION RETRIEVAL NUMBER 71

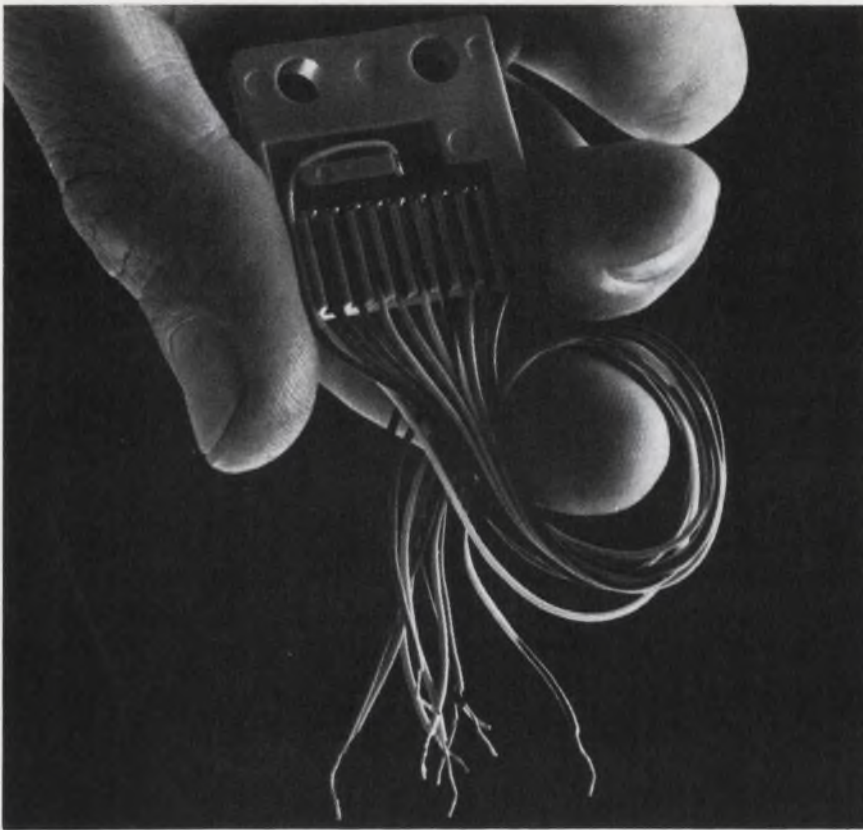

We'll even send your light sensors in a sealed package.

For top security.

That's our specialty. We were the first company to mount fragile light sensor devices in custom-designed, secure, durable packages. And we're the most experienced at producing them for commercial applications. Our skilled personnel use our specially-designed precision equipment to place and wire the sensors in your package. We save you the handling risk . . . and the time. You can buy anything from a single cell in a TO-15 can up to a special 960-position, plug-in, full-card reader. Or an array for a tape reader, or a badge or key recognition system. We'll even design for your special application we may never have heard of before. We'll package it securely, color-code it, design it so it can be easily incorporated into your system. But first we have to know what that is. Send your requirements to the engineering design department of Solar Systems Division, Tyco Laboratories, Inc., 3241 Kimball Avenue, Skokie, Illinois 60078. Or phone (312) 676-2040.

tyco

INFORMATION RETRIEVAL NUMBER 72

DATA PROCESSING

Computer terminal displays graphics



Tektronix, Inc., P.O. Box 500, Beaverton, Ore. Phone: (503) 644-0161. Price: \$8000.

Completely self-contained, a desk-top information display system provides complex graphics capability. The type T4002 graphic computer terminal features a solid-state data entry keyboard and visual displays. The 6-1/2 by 8-3/4-in. screen will accommodate up to 35 lines of alphanumeric characters with 80 symbols per line. More than 2800 characters may be displayed.

CIRCLE NO. 284

D/A 10-bit converter has 16 analog outputs

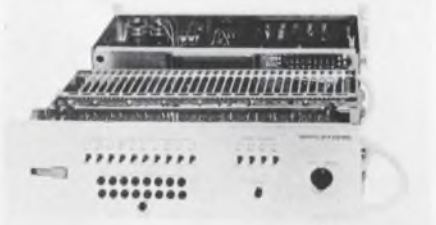

Scientific Data Systems, 701 S. Aviation Blvd., El Segundo, Calif. Phone: (213) 772-4511.

Completely self-contained, model DA40 digital-to-analog converter provides 16 channels of analog output from a 10-bit digital input. The unit accommodates all the digital functions associated with conversion, including unit-address and channel-address decoding. Each channel contains an internal register to store the digital data during conversion, allowing new data to be inserted at 2- μ s intervals.

CIRCLE NO. 285

The Honeywell 500

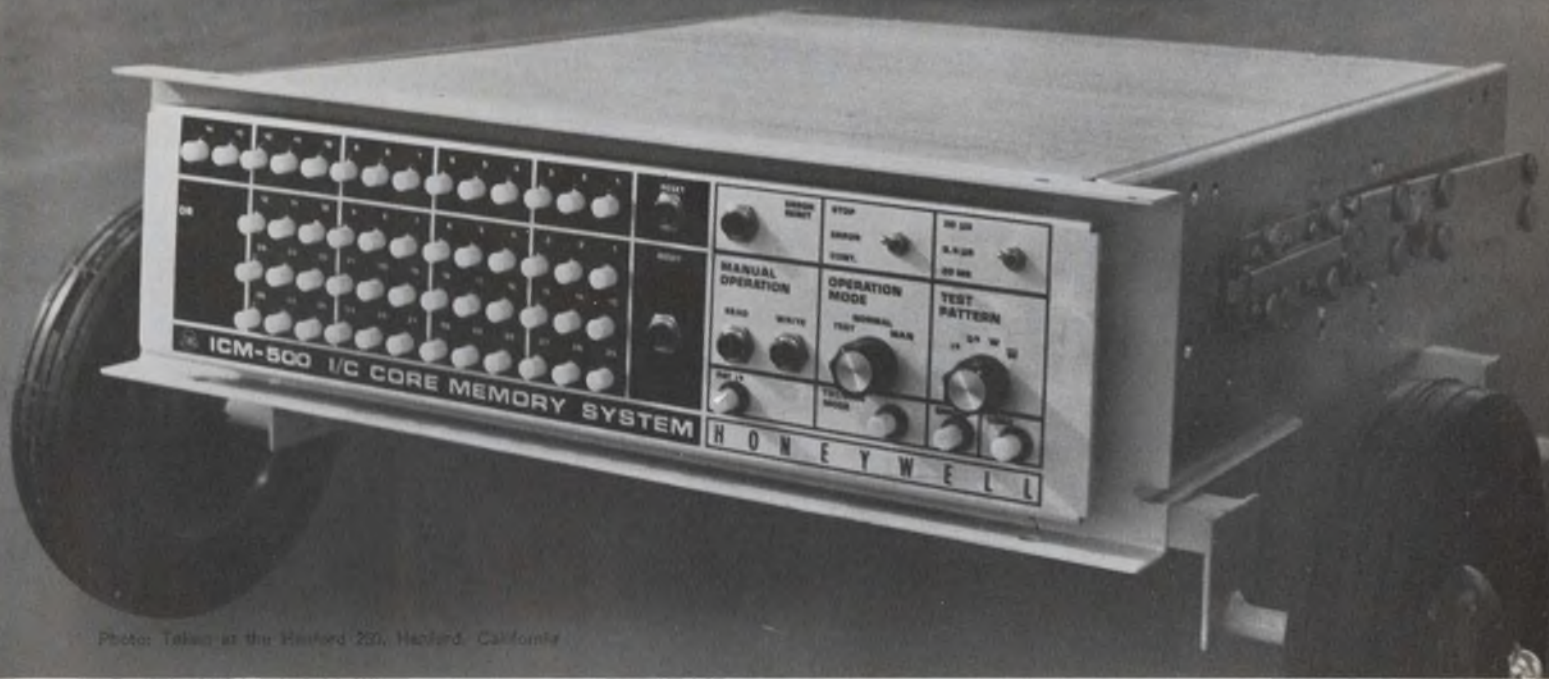

Photo: Taken at the Harvard 220, Harvard, California

Honeywell's fastest, high-performance memory system: the ICM-500. Standard model, 600 nsecs full cycle with capacity up to 32K words in a 5 $\frac{1}{4}$ " high chassis.

Overhauls are rare. The all I/C (even sensing and direct-drive selection lines) ICM-500 clocks out at 22,000 hours MTBF.

If you're looking for a winner in high-speed storage and buffering, go ICM-500. In the Honeywell Age, it's the systems man's edge. Want the track record? Write Honeywell, Computer Control Division, Dept. 500, Old Connecticut Path, Framingham, Massachusetts 01701.

Honeywell
A U T O M A T I O N

(206) 746-9250 Ext. 2100
(212) 275-6200 Ext. 770
(213) 278-1901 Ext. 32
(214) 363-5441 Ext. 0219
(215) 835-2500 Ext. 2214
(305) 841-1570 Ext. 2400
(312) 671-1800 Ext. 73
(313) 836-7170 Ext. 7171
(314) 862-1000 Ext. 135
(315) 463-4534 Ext. 1177
(404) 875-9561 Ext. 12
(408) 732-0120 Ext. 1041
(412) 922-4422 Ext. 107
(505) 345-1656 Ext. 2954
(617) 893-2610 Ext. 2710
(703) 524-8200 Ext. 227
(713) 785-3200 Ext. 322
(714) 276-4162 Ext. 2017

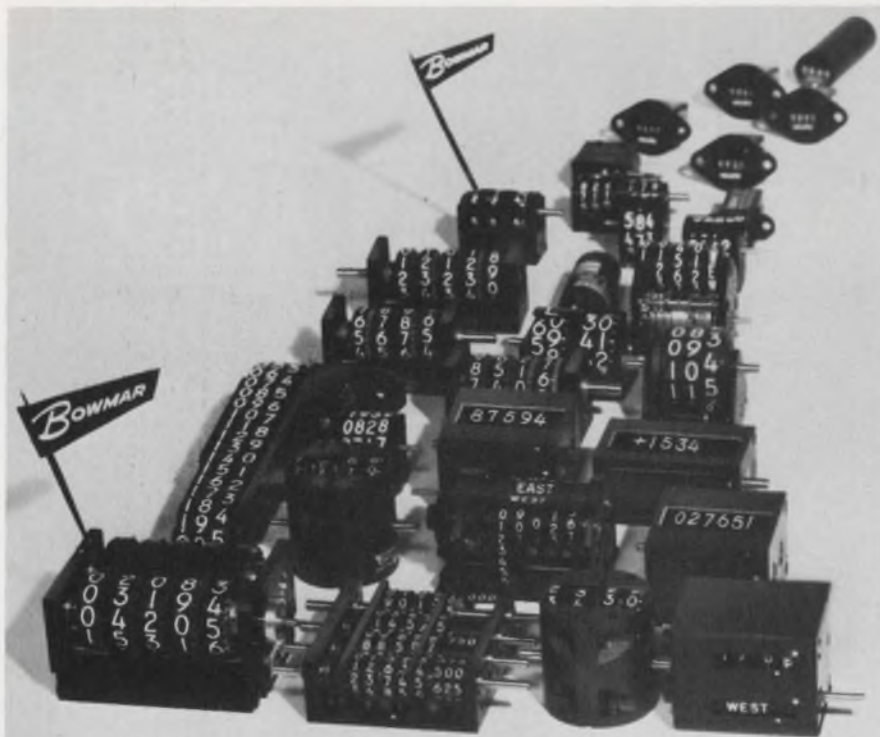

**In the name of design freedom
...join Bowmar's
counter revolution!**

While others have been trumpeting the merits of standards, we've spent the past 18 years quietly meeting the mechanical counter needs of the world's 100 toughest customers. Now, with thousands of field-proven configurations in our *B-line*[™] design library, we can't stay quiet any longer.

**WE'RE STARTING A
COUNTER REVOLUTION!**

Bowmar's *B-line*[™] design library, which includes all popular counter configurations, enables us to compare favorably in price and delivery with many "off the shelf" counters. *B-line* also offers you unique design freedom. You don't have to design

around our counters; we'll design around your *requirements* . . . quickly and economically. If you want complete design *liberation*, simply give us the inputs and outputs, and we'll supply your entire counter/display package.

Our *B-line*[™] counters and display assemblies have met the toughest reliability and life demands of military, NASA, commercial aviation, and heavy industry.

Be a counter-revolutionary! Strike a blow for design freedom by adding Bowmar to your qualified bidder list.



**The shortest distance between
output and display
is the Bowmar *B-line****

* Call (219) 747-3121 for engineering assistance



INSTRUMENT CORPORATION
8000 BLUFFTON ROAD □ FORT WAYNE, INDIANA 46809

DATA PROCESSING

**A/D 8-bit converter
handles 10⁷ numbers**



Computer Labs., 1109 Valley Park Dr., Greensboro, N.C. Phone: (914) 292-6427. P&A: \$8750; 5 wks.

The HS-810 analog-to-digital converter assigns up to ten million 8-bit binary numbers per second to a wideband analog signal. It has a maximum error of 0.2% and a maximum aperture time of 0.4 ns. Available codes include straight or offset binary, one's or two's complement, or Gray. The unit comes equipped with internal sample and hold, automatic test features and power supplies.

CIRCLE NO. 286

**Five pound attache case
packs computer terminal**



Metroprocessing Corp. of America, 64 Prospect St., White Plains, N.Y., Phone: (914) 949-0890. Price: \$235.

Packaged in an attache-type carrying case, an acoustic-coupled telephone computer terminal can be attached to any telephone in seconds. The portable battery-operated unit uses the 12-button Touch-Tone dialing system to send letters and numbers. The five-pound unit includes an amplifier for the voice or tone responses of a computer.

CIRCLE NO. 287

Small digital computer remembers 4096 words

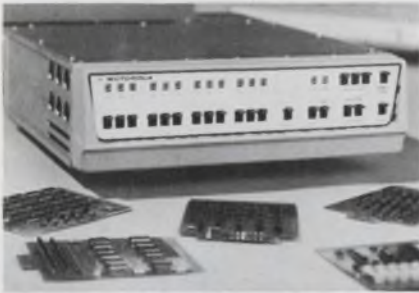

Motorola Instrumentation and Controls, Inc., P.O. Box 5409, Phoenix, Ariz. Phone: (602) 959-1000. Price: \$8000.

Designed to provide versatility of application in real-time situations, the MDP-1000 digital computer features a wide variety of input/output options: a 4096-word random-access memory (expandable to 16k with a cycle time of 2.16 μ s); six programmable 12-bit registers; a parallel adder; two accumulators; and a priority interrupt system. A line of interface modules and software is also available with the new machine.

CIRCLE NO. 288

A/D converter/scanner digitizes 400 signals/s



Analog Digital Data Systems, Inc., 830 Linden Ave., Rochester, N.Y. Phone: (716) 381-2370. Price: \$2750.

Designed for use in data acquisition systems and automatic checkout equipment, a combination scanner and a/d converter with a conversion speed of 400 per second accepts 10 channels of input data. Model 013-022 has a pin board that allows programing of up to four functions per channel. Visual front-panel readouts indicate the selected channel, while other indicators display the input signal values in decimal form.

CIRCLE NO. 289

Now, three standard LOGICATOR models give you new flexibility in designing your logic indicators. The basic DA-3305 electromagnetically positions the readout drum directly from **computer-level voltages**. The companion DA-3306 contains **built-in drive**. The DA-3307 contains both **drive and memory** to store computer data at microsecond speed, freeing the computer for other work between reading changes. Only LOGICATOR displays provide this versatility.

The LOGICATOR display is also the only indicator with **excellent readability** under all light conditions . . . combining printed-drum legibility with exclusive back-lighting . . . ideal for airborne instrumentation requiring Mil-E-5400 Class 2 performance. Features such as 1 million cycle life, fast response, 1 watt power consumption, and inherent magnetic memory make LOGICATOR displays your logical choice in computer indicators. Make a **B-line*** for Bowmar.

Only LOGICATOR[®] computer displays solve your readability, drive, and memory problems.

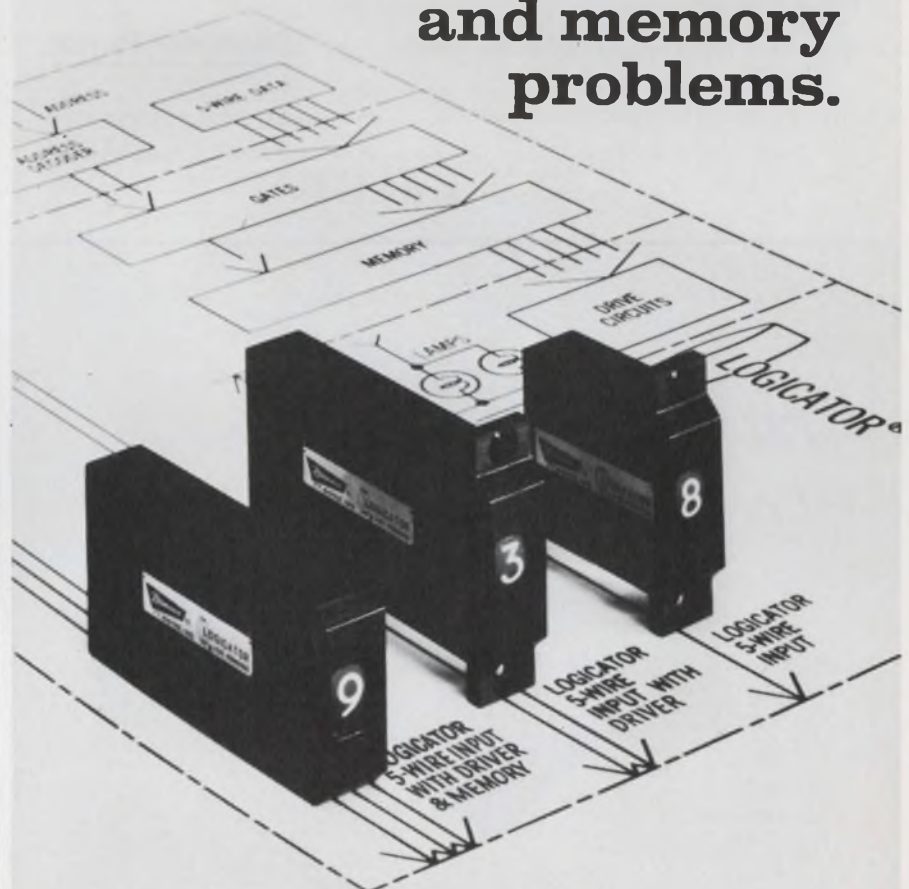

The shortest distance between computer and display is the Bowmar B-line*

*Call (219) 747-3121 for engineering assistance



INSTRUMENT CORPORATION
8000 BLUFFTON ROAD □ FORT WAYNE, INDIANA 46809

INFORMATION RETRIEVAL NUMBER 75

Chart-Pak® short cuts get printed circuit masters off the board fast!



- Trans-Pak die-cut symbols and Chart-Pak pressure sensitive tapes cut time, cut cost.
 - Trans-Pak's unique patented "position, press and peel" method permits fast application of distortion-free symbols.
 - Chart-Pak crepe paper tapes precision-slit guaranteed to $\pm .002$ " accuracy.
 - Finished masters reproduce with maximum sharpness . . . require minimum opaquing.
 - Chart-Pak's Precision Grids guarantee master accuracy.
- Using is believing . . . write for free catalog showing complete line of printed circuit materials.

CHARTPAK ROTEX

A Division of Avery Products Corp
Santa Ana, Calif. & Leeds, Mass.
Look in The Yellow Pages under Drafting Supplies
Art Tapes, Charts/Business for your dealer's name

Look In The Yellow Pages under Charts/Business, Drafting Supplies, Tapes or Art Supplies for your dealer's name.

INFORMATION RETRIEVAL NUMBER 76

DATA PROCESSING

Single circuit board is high-speed memory

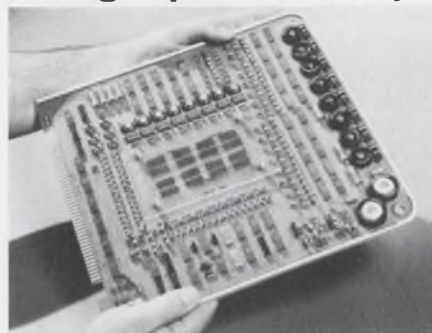

Sanders Associates, Inc., 95 Canal St., Nashua, N.H. Phone: (603) 885-2816.

A low-cost, high-speed memory system, contained entirely on a 12 x 12 x 1/2 in. circuit board, reduces volume requirements by 30 to 50 per cent. The 1024-word 8-bit core memory features plug-in convenience, for easy maintenance or replacement, and cycle times of 1.5 μ s. Complete in itself, the system includes address registers, power on/off, core memory and associated electronics.

CIRCLE NO. 290

*Unlocking
the Future*

**Electrical
Electronics
Engineering**

**4 FLOORS OF EXHIBITS
NEW YORK COLISEUM**

**48 TECHNICAL SESSIONS
NEW YORK HILTON**

Monday through Thursday

- 48 TECHNICAL SESSIONS at the New York Hilton. Hours: 10:00-12:30; 2:00-4:30.
- FOUR FLOORS OF EXHIBITS at the N. Y. Coliseum including over 600 firms. Hours: 10 a.m.-8 p.m. 4 Days.
- GALA ANNUAL BANQUET—Wednesday 7:15 p.m. N. Y. Hilton Grand Ballroom — \$18.00.
- FREE SHUTTLE BUSES between the Hilton and the Coliseum — every few minutes.

- REGISTRATION — Good all days — Technical Sessions and exhibits. In and out privileges. — IEEE Members \$3.00. Non-members \$6.00. Ladies \$1.00. High School Students \$3.00 if accompanied by an adult — One student per adult; Thursday only — limit of 3 students per adult.
- REG-IDENT CARD speeds request for exhibitors' literature. Ask for one when registering.
- ESCALATORS/EXPRESS ELEVATORS to the Fourth Floor.

IEEE '69  **INTERNATIONAL
CONVENTION & EXHIBITION
MARCH 24-27, 1969**

INFORMATION RETRIEVAL NUMBER 77

Transmitters/receivers double data channels



Da-Tel Research Co., P.O. Box 1206, Montrose, Colo. Phone: (303) 249-6129. P&A: \$384/channel; 90 to 90 days.

Series 6800 general-purpose transmitters and receivers double the number of tone or data channels that can be transmitted through standard 300- to 3200-Hz voice channels. In addition to standard frequency-shift modulation, the new units can use a hybrid form of amplitude- and frequency-shift modulation.

CIRCLE NO. 291

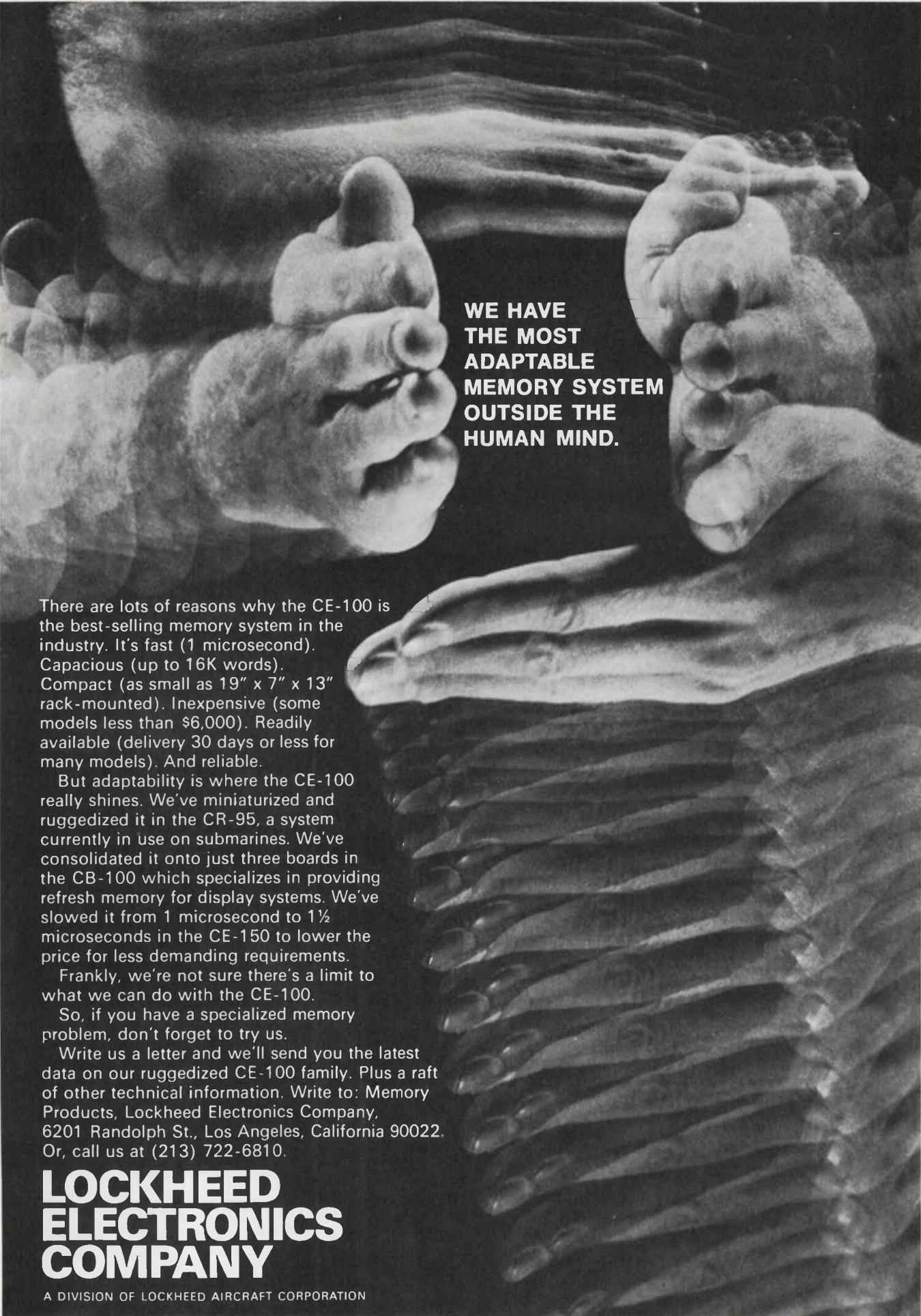

**WE HAVE
THE MOST
ADAPTABLE
MEMORY SYSTEM
OUTSIDE THE
HUMAN MIND.**

There are lots of reasons why the CE-100 is the best-selling memory system in the industry. It's fast (1 microsecond). Capacious (up to 16K words). Compact (as small as 19" x 7" x 13" rack-mounted). Inexpensive (some models less than \$6,000). Readily available (delivery 30 days or less for many models). And reliable.

But adaptability is where the CE-100 really shines. We've miniaturized and ruggedized it in the CR-95, a system currently in use on submarines. We've consolidated it onto just three boards in the CB-100 which specializes in providing refresh memory for display systems. We've slowed it from 1 microsecond to 1½ microseconds in the CE-150 to lower the price for less demanding requirements.

Frankly, we're not sure there's a limit to what we can do with the CE-100.

So, if you have a specialized memory problem, don't forget to try us.

Write us a letter and we'll send you the latest data on our ruggedized CE-100 family. Plus a raft of other technical information. Write to: Memory Products, Lockheed Electronics Company, 6201 Randolph St., Los Angeles, California 90022. Or, call us at (213) 722-6810.

**LOCKHEED
ELECTRONICS
COMPANY**

A DIVISION OF LOCKHEED AIRCRAFT CORPORATION

New Low Power AC Sources.



**Prices even
lower.**

175 VA-\$565

350 VA-\$1120

CML has been making the best low power AC sources around. For years. Now low power hits a new low in price. All with interchangeable oscillator modules for fixed or adjustable output frequencies from 45 to 6000 Hz. All feature excellent frequency stability and load regulation, low distortion, and lightning-fast response. Write or call today.

Model NS175 (175 VA) Model NS350 (350 VA)

With fixed 400 Hz oscillator	\$565	\$1120
Adjustable 350-450 Hz	685	1225
Adjustable 45-6000 Hz	785	1385

CML, Inc.

A Subsidiary of
Tenney Engineering, Inc.
350 Leland Avenue
Plainfield, N.J. 07062
(201) 754-5502 • TWX 710-997-9529



DATA PROCESSING

Acoustic data coupler interfaces card reader



Anderson Jacobson, Inc., 2235 Mora Dr., Mountain View, Calif. Phone: (415) 968-2400. Price: \$598.

Model ADC 262 acoustic data coupler allows the simultaneous use of a Teletype and an EIA device, such as a mark-sense card reader. In operation, the coupler, when linked with Teletype and card reader, provides both keyboard and cards as input sources to a time-sharing computer or other data collection point over an ordinary phone line.

CIRCLE NO. 292

Scan converter unit delivers video signals

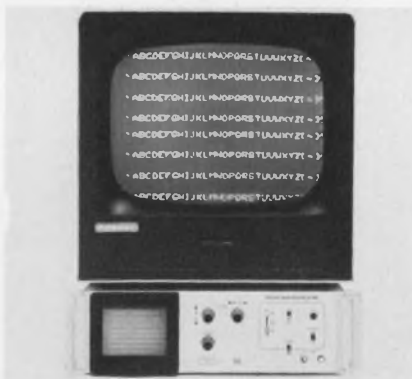

Tektronix, Inc., P.O. Box 500, Beaverton, Ore. Phone: (503) 644-0161. P&A: \$2200; fall, 1969.

A new scan converter unit converts information written on its display tube to composite video or modulated-rf signals for viewing on large-screen television monitors or receivers. Model 4501 uses a 5-in. rectangular bistable storage tube as the display device. This tube can legibly display up to 1250 alphanumeric characters.

CIRCLE NO. 293

Small d/a converters are $\pm 0.025\%$ accurate

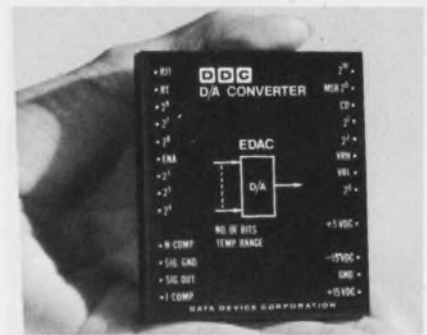

Data Device Corp., 240 Old Country Rd., Hicksville, N.Y. Phone: (516) 433-5330. P&A: from \$150; stock to 3 wks.

Compact d/a converters that measure only 0.4-in. high, handle 8 to 11 bits of data with accuracies to $\pm 0.025\%$ full-scale and temperature coefficients as low as $\pm 0.0025\%/^{\circ}\text{C}$. Series EDAC units have an update rate of 10 MHz and a settling time of 5 μs .

CIRCLE NO. 294

Computer buffer puts data on tape

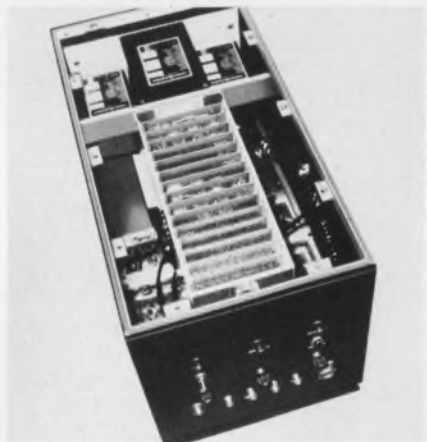

Digital Devices, Div. of Tyco Laboratories, Inc., 200 Michael Dr., Syosset, N.Y. Phone: (516) 921-2400. Availability: 10 to 12 wks.

Taking the outputs of the IBM 4 π computer, at the 1-MHz internal clock rate of the computer, a new buffer system puts the data on magnetic tape at a 12.4-kHz word rate. Designated as type 611E, the system has inputs that include data, load command, shift in pulses, system clock and unload command.

CIRCLE NO. 295

Propensity for density

or: C.I. capacitors cut another space problem down to size

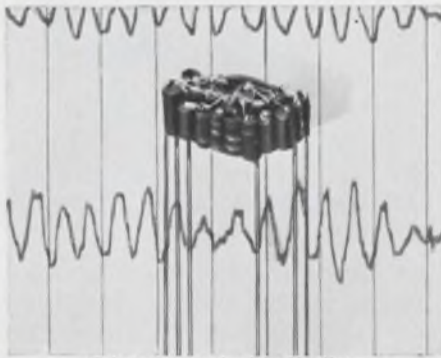

Enlarged approximately 1 1/2 times

When you convince more than 30 discrete components, including 10 electrolytic capacitors ranging from 0.01 to 2.2 mfd., to huddle together in a space somewhat smaller than 1/20 of a cubic inch, you've got yourself some pretty high-density packaging.

That's what engineers did at Signatron, Inc., Gardena, California, when they designed their miniature Model 2300-EEG differential amplifier—a potted, high-reliability unit designed primarily for use in their telemetry devices for physiological monitoring such as electro-encephalographs.

Of course they turned to Components, Inc. for the capacitors because, as

everybody knows, C.I. makes the smallest, most dependable solid tantalum capacitors available . . . anywhere. Results: No capacitor failures, no leakage problems, excellent performance.

The Minitan® Cordwood Series used in this application were specifically designed for miniature equipment. They are available in five different case sizes from 1/8" to 1/4" in length, with radial or axial leads, and capacitance values up to 47 mfd.

Performance is maximum, leakage is minimum, prices are optimum. Full reliability up to 125°C. Non-polar versions available in standard capacitance ratings.

C.I. . . . space race ace We offer more subminiature case styles and ratings than anyone else in the business. Samples, performance and reliability data, and application assistance are yours for the asking.

First in reliability . . . service . . . delivery. We prove it every day.

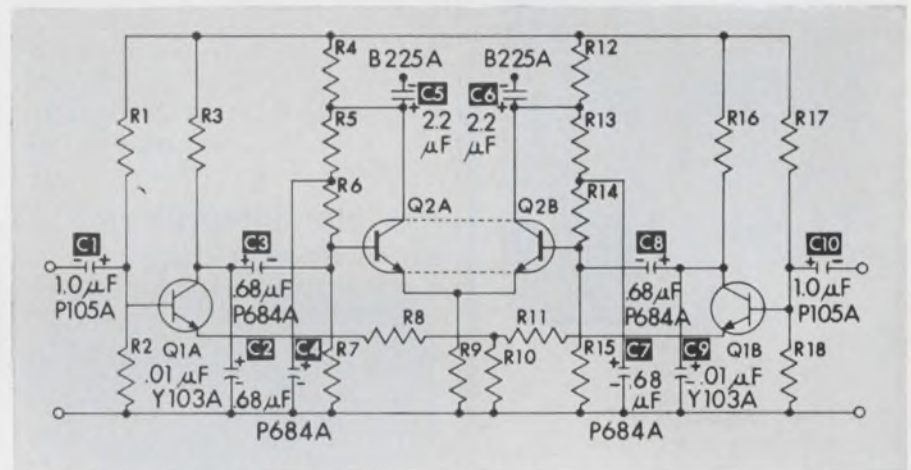

MINITAN MODULAR

(Also available with axial leads)

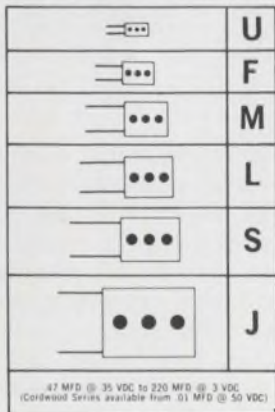

(ACTUAL SIZE)

MINITAN CORDWOOD

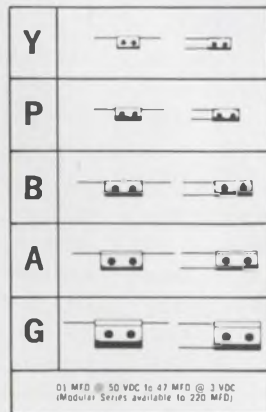

(ACTUAL SIZE)



NEW

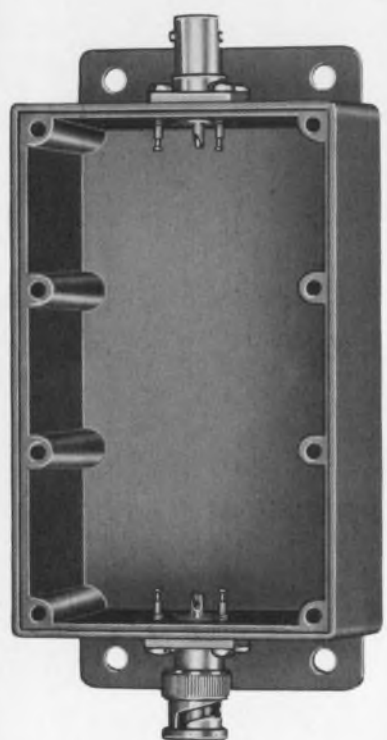

MODEL 2903
Shown 2/3 Actual Size

**LARGER SHIELDED
"BLACK BOXES"**

Useable inside space: 4" long x 2" wide x 1 1/2" deep. Large enough to permanently protect and shield custom test circuits. Six models, with four connector combinations. Rugged die-cast aluminum boxes supplied with aluminum cover.

Featured in our 1968 general catalog.
Write for your free copy.

POMONA
ELECTRONICS CO., INC.
1500 E. Ninth Street, Pomona, Calif. 91766

INFORMATION RETRIEVAL NUMBER 83

COMPONENTS

**Indicator lights
self-test lamps**



Chicago Miniature Lamp Works, 4433 N. Ravenswood, Chicago, Ill. Phone: (312) 784-1020.

Series CM31 industrial indicators permit an immediate check of lamp condition by simply applying a slight pressure to the indicator lens. This pressure breaks the signal circuit and connects the lamp to a test circuit. If the lamp fails to light, it is burned out; if it does light, there is a failure somewhere in the signal circuit.

CIRCLE NO. 298

**Modular integrators
store analog data**

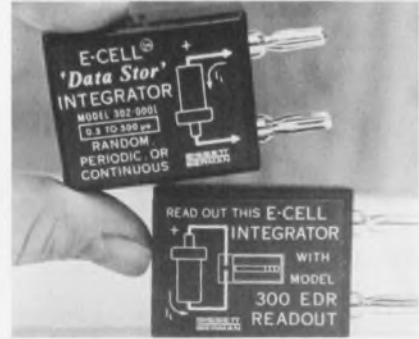

Bissett-Berman Corp., Components Div., 3860 Centinela Ave., Los Angeles. Phone: (213) 390-3585. Price: \$15.

Acquiring analog data from sensors to yield digital readouts, two new integrators accumulate periodic or random events over time periods from milliseconds to years. Model 302-0001 has a current-time integrating range of 0 to 2000 microampere-hours, while model 302-0002 ranges from 0 to 1000 microampere-hours.

CIRCLE NO. 299

**Diaphragm relay
switches 30 W**

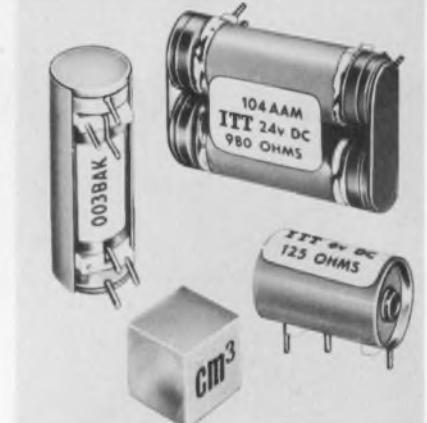

ITT Components Group Europe, 970 McLaughlin Ave., P.O. Box 1278, San Jose, Calif.

Using a flexible metallic diaphragm as its moving contact, a new relay is able to switch as much as 30 W in a volume of only 1.5 cm³. The PC-board unit handles currents as high as 0.5 A, and voltages as high as 150 V dc or 250 V ac. It is capable of performing 650 operations per second. It is rated at one billion operations for dry-circuit conditions.

CIRCLE NO. 321

**Pushbutton switches
cut cost by one third**



Dialight Corp., 60 Stewart Ave., Brooklyn, N.Y. Phone: (212) 497-7600.

Costing only two-thirds as much as comparable momentary four-lamp units, series 513 switches with matching indicator units are available in 3/4-by-1-in. rectangular, 5/8-in. round, or square pushbutton caps. Both switches and indicators snap into panels up to 3/16-in. thick. The pushbutton caps are fingertip removable, for easy lamp replacement.

CIRCLE NO. 322

SCRs and Triacs from the Power House.

Need to control electrical power? Check with us. We have the industry's finest selection of power-control components and assemblies to help you keep design problems in line.

Our SCRs range from 4.7 to 550 amperes rms, 25 to 1300 volts. And we make the firing circuits, heat sinks and surge arrestors you need to go with them. Get individual components or complete assemblies, pre-engineered and guaranteed. Or go all the way and buy our complete power-control systems. And if it's AC power you're wrestling with, remember we're still the only ones on the market with the 100- and 200-ampere logic-triacs.

Write for complete 32-page Product Selection Guide, or tell us your particular problem. We specialize in complete engineering assistance. The Power House, 233 Kansas Street, El Segundo, California 90245.

INTERNATIONAL RECTIFIER

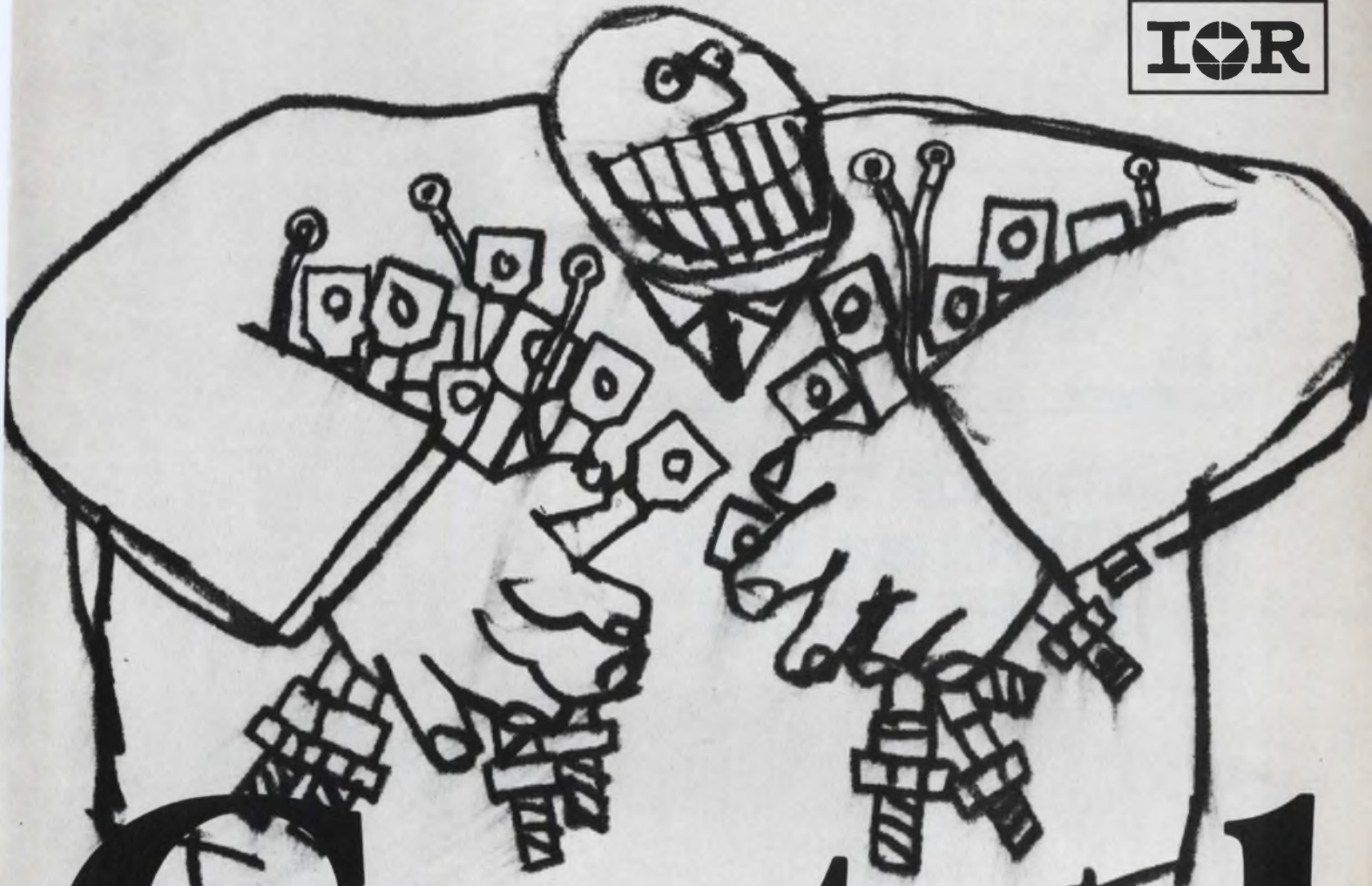

Control power.



Simpson's NEW solid-state VOM with FET-Input

- **HIGH INPUT IMPEDANCE...**
11 Meg Ω DC 10 Meg Ω AC
- **PORTABLE..... battery operated**
- **7-INCH METER..... overload protected**

Simpson's new 313 gives you high input impedance for accurate testing of latest circuit designs . . . free of line cord connections. Over 300 hours operation on inexpensive batteries. And the new 313 is *stable*, which means positive, simplified zero and ohms adjustments. Protected FET-input handles large overloads. DC current ranges to 1000 mA. Sensitive Taut Band movement and 7-inch meter scale provide superior resolution down to 5 millivolts. Write today for complete specifications.

Complete with batteries, 3-way AC-DC-Ohms probe, and operator's manual..... **\$100⁰⁰**

GET "OFF-THE-SHELF" DELIVERY FROM YOUR LOCAL ELECTRONIC DISTRIBUTOR

Simpson

ELECTRIC COMPANY



5200 W. Kinzie Street, Chicago, Illinois 60644 • Phone (312) 379-1121
 EXPORT DEPT.: 400 W. Madison Street, Chicago, Illinois 60606. Cable Simelco
 IN CANADA: Bach-Simpson Ltd., London, Ontario • IN INDIA: Ruttonsha-Simpson Private Ltd., International House, Bombay-Agra Road, Vikhroli, Bombay

INFORMATION RETRIEVAL NUMBER 81

COMPONENTS

Miniature fuses blow in 50 μ s

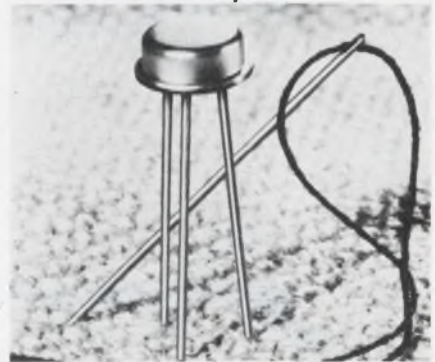

Beckman Instruments, Helipot Div., 2500 Harbor Blvd., Fullerton, Calif. Phone: (714) 871-4848. P&A: \$1; stock.

Designed to protect ICs and power transistors in digital microcircuits, series 817 high-speed fuses operate in 1 ms with small overloads, and as fast as 50 μ s with 30-A overloads. They are available with ratings of 0.5, 0.75 and 1.5 A. Packaged in a TO-46 can, these miniature fuses feature 40-V, 50-A circuit interruption and an insulation resistance of 10 M Ω at 150 V. Operating temperature range is -55 to +125°C.

CIRCLE NO. 296

TO-5 relays extend life

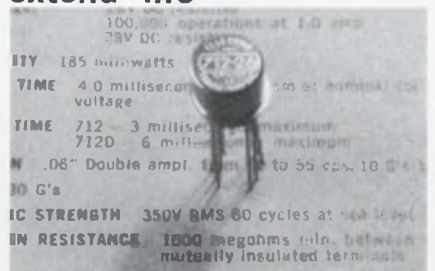

Teledyne Relays, 3155 W. El Segundo Blvd., Hawthorne, Calif. Phone: (213) 756-8301. P&A: \$6 to \$10; stock.

Industrial dpdt TO-5 relays—hermetically sealed to prevent contamination—are rated for 10⁷ operations at low level, 10⁶ operations at 0.5 A, and 10⁵ operations at 1 A. Standard coil voltages include 5, 6, 9, 12, 18 and 26 V dc, and operating power is 185 mW. An internal diode chip for arc suppression is also available.

CIRCLE NO. 297



PG-11. \$375. Hallelujah.

The high performance, sensibly priced PULSE GENERATOR you've been looking for is here! Meet the Model PG-11: 10 Hz to 20 MHz.

±15 volts at maximum or any other rep rate. Rise time typically 4 ns at full amplitude. Single or double pulses, manual one-shot, pulse bursts. Synchronous or asynchronous gating. Triggering, DC to 20 MHz. Continuously variable rep. rate, width, delay, amplitude.

Clean pulses: total distortion at full amplitude from all sources is less than 5%. All

solid state. Optional rack adapter for mounting one PG-11, or mounting two PG-11's side by side in 3-1/2" of rack height. Bench model dimensions are 4" h x 8-1/2" wd x 9-1/2" d; weight 7 pounds, net. Full year guarantee. Available from stock.

Write or phone your nearest Representative (eem) for literature, a prompt demonstration or both.

PG-11. \$375. Hallelujah.

Chronetics, Inc. 500 Nuber Avenue, Mt. Vernon, N. Y. (914) 699-4400. In Europe: 39 Rue Rothschild, Geneva, Switzerland (022) 31 81 80.



INFORMATION RETRIEVAL NUMBER 84

EASTMAN 910® Adhesive.... reduces assembly time of airborne data system.

Encoder assemblies for digital recording systems manufactured by Lockheed Aircraft Company, Ontario, California are assembled with EASTMAN 910 Adhesive at a significant time saving. The completed system supplies data on in-flight engine performance and other important functions.



One half of a ferrite "E" core transformer is bonded to a glass epoxy board with one drop of EASTMAN 910 Adhesive. Coding wires are installed around the core. The second half of an "E" core is bonded to the first with two droplets of the adhesive. Bonding procedures take from 10-15 seconds.

EASTMAN 910 Adhesive will form bonds with almost any kind of material without heat, solvent evaporation, catalysts, or more than contact pressure. Try it on your toughest bonding jobs.

For technical data and additional information, write to Chemicals Division, Eastman Chemical Products, Inc., Kingsport, Tennessee. EASTMAN 910 Adhesive is distributed by Armstrong Cork Company, Industry Products Division, Lancaster, Pa.

Here are some of the bonds that can be made with EASTMAN 910 Adhesive

Among the stronger: steel, aluminum, brass, copper, vinyls, phenolics, cellulose, polyesters, polyurethanes, nylon; butyl, nitrile, SBR, natural rubber, most types of neoprene; most woods. Among the weaker: polystyrene, polyethylene (shear strengths up to 150 lb./sq. in.).

INFORMATION RETRIEVAL NUMBER 85



There is no adhesive like EASTMAN 910® Adhesive

- SETS FAST**—Makes firm bonds in seconds to minutes.
- VERSATILE**—Joins virtually any combination of materials.
- HIGH STRENGTH**—Up to 5000 lb./in.² depending on the materials being bonded.
- READY TO USE**—No catalyst or mixing necessary.
- CURES AT ROOM TEMPERATURE**—No heat required to initiate or accelerate setting.
- CONTACT PRESSURE SUFFICIENT.**
- LOW SHRINKAGE**—Virtually no shrinkage on setting as neither solvent nor heat is used.
- GOES FAR**—One-pound package contains about 30,000 one-drop applications. (Or in more specific terms, approximately 20 fast setting one-drop applications for a nickel.)
- The use of EASTMAN 910 Adhesive is not suggested at temperatures continuously above 175°F., or in the presence of extreme moisture for prolonged periods.

See Sweet's 1968 Product Design File FAS-5/En.

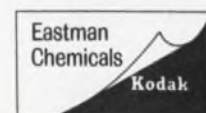

Interference or Information?

With active filters, the choice is yours.



Here are examples of what we think effective signal conditioning should be:

Series AF-100-20Hz to 2MHz.

Series AF-200-0.2Hz to 20kHz.

High pass, low pass, band pass and band reject. Continuously adjustable cutoff frequency. Selectable frequency response flatness (Time Domain/Butterworth). Unity pass band gain. Attenuation slope of 24



db/octave and 48 db/octave. **Series AF-400**-0.01Hz to 99.9kHz. Digitally tuned.

Series AF-500-0.2Hz to 20kHz. Empirically tuned.

Series AF-300-0.001Hz to 200kHz. Fixed frequency modules. Especially if small size is a big consideration. So look into active filtering. And separate the waves from the noise.



multimetrix, inc.

401 Concord Avenue, Bronx, N. Y. 10454 (212) 665-6484

INFORMATION RETRIEVAL NUMBER 86

Cadmium mercury telluride detector for 10.6 micron laser radiation

Another state of the art infrared detector from Mullard. Microsecond response times. Operates at 77°K in the 8-13 micron window. $D^*(11,800,1) > 10^{10} \text{ cm Hz}^{\frac{1}{2}} \text{ W}^{-1}$. Samples now available from stock. Sensible prices.

Other products available now: Tri-glycine sulphate bolometer; Yttrium iron garnet modulator; Indium antimonide labyrinths and arrays; Filtered lead sulphide and doped germanium photoconductive detectors. Also custom building. Send us your spec. for quotation.

Write today:
U.S. enquiries to Mullard Inc.,
100 Finn Court, Farmingdale,
Long Island, New York.
11735 U.S.A. Telephone:
(516) 694-8989. Telex: 961455.
Other enquiries to Mullard Ltd.,
Mullard House,
Torrington Place, London,
W.C.1, England.



INFORMATION RETRIEVAL NUMBER 87

COMPONENTS

Gas-filled trigger tube switches 51-kA circuits



Amperex Electronics Corp., 280 Northern Blvd., Great Neck, N.Y. Phone: (516) 466-4880.

A subminiature gas-filled trigger tube, type ZC1060, can handle peak currents as high as 5000 A at 60 J per discharge. The required trigger waveform is a 30 μs 3.5-kV pulse at 400 to 500 kHz; trigger energy can be as low as 1 mJ. With normal anode voltage (350 to 800 V), ignition delay of the ZC1060 is a maximum of 2 μs . Open circuit impedance is 300 $\text{M}\Omega$; in the conducting condition, impedance falls to 30 $\text{m}\Omega$.

CIRCLE NO. 323

Plastic indicator shows fluid flow

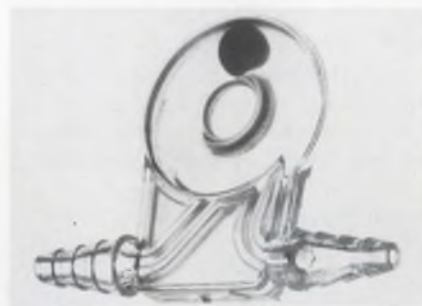

Vanton Pump & Equipment Corp., 201 Sweetland Ave., Hillside, N.J. Phone: (201) 926-2435.

A simple plastic indicator provides a positive means of determining whether a fluid is flowing through a tube or a small chamber, as well as its rate of flow. It will fit any flexible plastic tube that is up to 1/4 in. in diameter, and may be used to indicate flows of 0.1 to 1 gallons per minute with an accuracy of $\pm 5\%$.

CIRCLE NO. 324

The phenomenal ferrite bead:

Stackpole's simple solution to noise and filter problems.



Ceramag[®] ferrite beads offer a simple, inexpensive, yet effective means of obtaining RF decoupling, shielding, and parasitic suppression without sacrificing low frequency power or signal level.

Unlike conventional RF chokes, beads are compact, have no DC losses, and will not couple to stray capacity and introduce detuning or spurious oscillations. Ceramag[®] beads offer an impedance which varies from quite low at low frequencies to quite high at noise frequencies. Beads need not be grounded; however, chassis contact is permissible when desired, as beads possess sufficiently high resistivity to preclude grounding.

Installation of Stackpole

beads is easy. Simply slip one (or several) over appropriate conductor(s) for the desired noise suppression or high frequency isolation. Beads are available in sleeve form in a range of sizes starting at .025 ID, .060 OD, and .400 long. For special compact filtering applications such as cable connectors, beads can be supplied to tight mechanical tolerances.

Several ferrite grades provide a variety of attenuation characteristics. Inductance tolerance is normally $\pm 30\%$ as measured on an LC meter. The performance of a Ceramag[®] 7D bead as a parasitic suppressor is shown in Figure 1.

Other applications might include: decoupling in "B" circuitry; noise suppression; RF isolation in filament circuits;

use in combination with capacitors to form "L" networks.

FIGURE 1

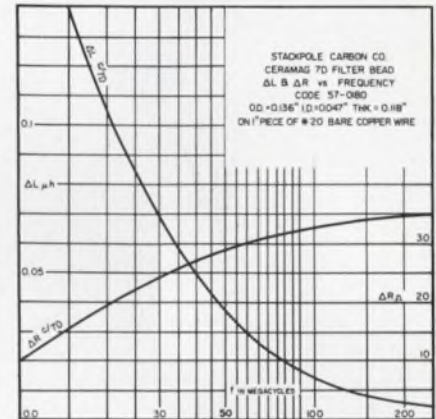

Sample quantities of Ceramag[®] beads and beads with leads are available without charge upon request. Send your requirements to Stackpole Carbon Company, Electronic Components Division, St. Marys, Pennsylvania 15857. Phone: 814-781-8521. TWX: 510-693-4511.



Now available...Ceramag[®] beads with leads

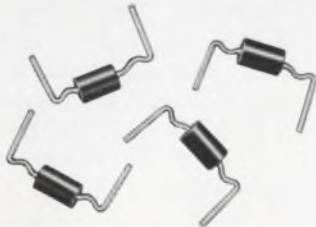

Additional savings in production time and labor costs are now possible by utilizing automatic insertion equipment to install Ceramag[®] ferrite beads in printed circuit boards.

High Voltage Rectifiers



New! From Varo.

Silicon Rectifiers At Selenium Prices!

At last, economical high voltage silicon rectifiers. Ideal for use in all high voltage, low current applications.

- 5,000-40,000 Volts
- 5, 10, 25 milliamp ratings
- Standard and Fast Recovery
- In 1/4" square package.

These are the high voltage rectifiers that make completely solid state television circuits possible. Equally well suited for use in other cathode ray tube applications, electrostatic power supplies and voltage multipliers.

Only \$1.32

10,000V, 5mA rating. Quantity of 1,000. Complete details, applications, and price list available.



SEMICONDUCTOR DIVISION
2203 WALNUT STREET, GARLAND, TEXAS 75040
(214) 272-3561

INFORMATION RETRIEVAL NUMBER 89

SUBASSEMBLIES & MODULES

Analog multiplier has 1-MHz bandwidth

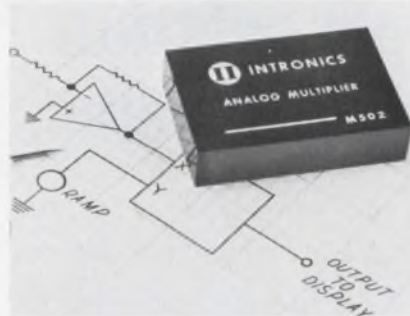

Intronics, Inc., 57 Chapel St., Newton, Mass. Phone: (617) 332-7350. P&A: \$325; stock.

The M502 solid-state analog multiplier, featuring a 1-MHz bandwidth, employs the transconductance principle to give smooth continuous multiplication from ± 10 V through zero. It features 0.25% linearity over any range of operation. Specifications include 0.5% four-quadrant accuracy, 0.25% single-quadrant accuracy, 5-mA output current, 10-k Ω input impedance and 30 V/ μ s slew rate.

CIRCLE NO. 325

Miniature supplies power op amps



Phipps Precision Products, 7749 Densmore Ave., Van Nuys, Calif. Phone: (213) 785-3109. P&A: \$39; stock.

Designed to power operational amplifiers that require ± 15 V dc or 30 V dc, a line of miniature power supplies mounts directly to PC boards. Model 301 power supplies are self-contained. Short-circuit protection permits either or both outputs to be shorted together, or to ground without damage to the supply. These 8-oz units provide up to 50 mA with ripple less than 1-mV rms.

CIRCLE NO. 326

Hybrid amplifier spans 1.3 GHz



Optical Electronics Inc., P.O. Box 11140, Tucson, Ariz. Phone: (602) 624-3605. P&A: \$34; stock.

Model 9406 hybrid operational amplifier features a maximum gain-bandwidth product of 1.3 GHz and a maximum slewing rate of ± 360 V/ μ s. The unit does not require external phase correction for stable unity-gain operation. It also provides a single-ended output and a true differential input that has equal frequency-response characteristics for inverting and non-inverting applications.

CIRCLE NO. 327

Memory drivers use thick films

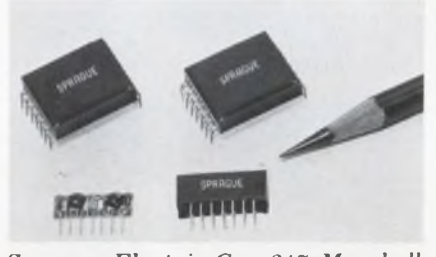

Sprague Electric Co., 347 Marshall St., North Adams, Mass. Phone: (413) 664-4411.

Designed for use in digital computers that utilize a combination of magnetic elements and thick-film circuits, memory driver modules combine miniaturized inductive elements with metal-film resistors on ceramic substrates. Models 905Z and 906Z allow the circuit designer to obtain, in one package, the necessary pulse characteristics without the elaborate system of guard-band tolerances that are required for discrete component assemblies.

CIRCLE NO. 328

ISN'T IT ABOUT TIME SOMEONE DESIGNED A TRULY MODERN, PROFESSIONAL MULTIMETER?

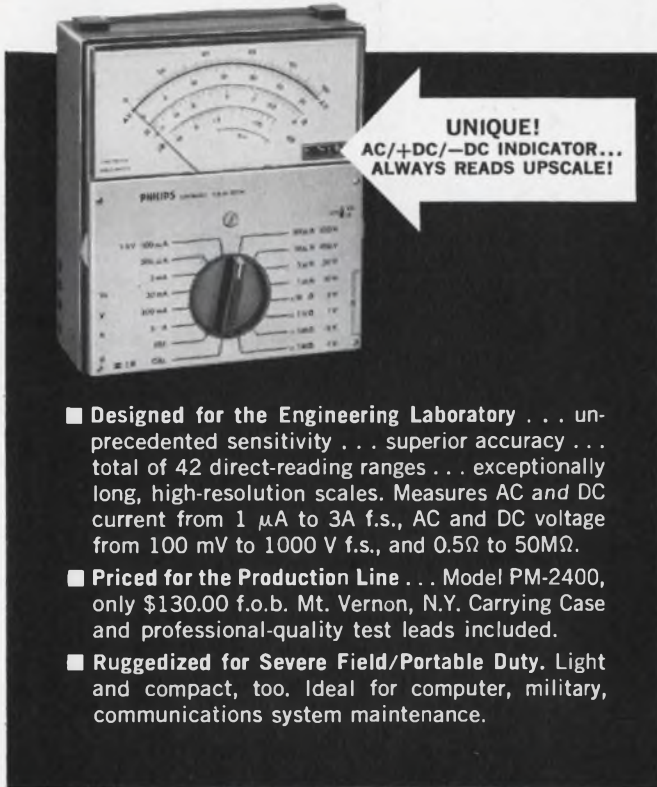

- Designed for the Engineering Laboratory . . . unprecedented sensitivity . . . superior accuracy . . . total of 42 direct-reading ranges . . . exceptionally long, high-resolution scales. Measures AC and DC current from 1 μ A to 3A f.s., AC and DC voltage from 100 mV to 1000 V f.s., and 0.5Ω to $50M\Omega$.
- Priced for the Production Line . . . Model PM-2400, only \$130.00 f.o.b. Mt. Vernon, N.Y. Carrying Case and professional-quality test leads included.
- Ruggedized for Severe Field/Portable Duty. Light and compact, too. Ideal for computer, military, communications system maintenance.

Tired of swearing at multimeters that were designed 20 years ago and are still essentially crude radio-service instrumentation? You use \$1500 'scopes . . . \$750 signal generators . . . why be satisfied with a \$70 "approximeter," when, for only \$130 you can go first class with this modern, time-saving, error-preventing highly professional instrument! It's all-solid-state, electronic, battery operated, and far more versatile than any passive VOM.

FREE 14-DAY TRIAL: Send us a "memo" purchase order, and we'll ship you a PM-2400 from stock, on consignment . . . returnable in 2 weeks. For full specs and an opportunity to see this fine instrument, call 914-664-4500 or write Dept. MM-1 Philips Electronic Instruments, 750 South Fulton Avenue, Mount Vernon, N.Y. 10550. Your local Philips man will contact you.

World's Highest Standards in Quality Instrumentation



EMA-58

INFORMATION RETRIEVAL NUMBER 90
ELECTRONIC DESIGN 2, January 18, 1969

MINIATURE MEGOHM RESISTORS

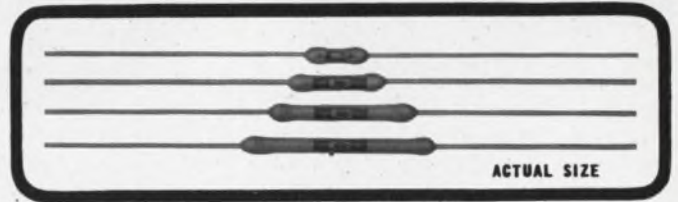

T.C. Absolute: 80 PPM/ $^{\circ}$ C*
T.C. Tracking: to 5 PPM/ $^{\circ}$ C on special order.

Applications include high voltage dividers, high resistance networks, precision RC timing circuits, etc. We specialize in network sets with matched characteristics. Facilities available to perform Hi Rel screening.

Model No.	Watt-age	Max. Voltage	Dielect Str'gth	Resistance		Dimensions		
				Min.	Max.	Length	Dia.	Lead Dia.
MG 650	.5	600	750	500 K	5 meg	.313 ±.020	.094 ±.015	.025 ±.002
MG 660	.6	1000	750	1 meg	10 meg	.500 ±.030	.094 ±.015	.025 ±.002
MG 680	.8	1500	750	1 meg	15 meg	.750 ±.030	.094 ±.015	.025 ±.002
MG 710	1.0	2000	750	1 meg	20 meg	1.000 ±.040	.094 ±.015	.025 ±.002
MG 721	2.0	2500	1000	1 meg	30 meg	1.000 ±.050	.240 ±.030	.040 ±.002
MG 750	3.0	3000	1000	3 meg	150 meg	2.125 ±.060	.315 ±.030	.040 ±.002
MG 780	5.0	4000	1000	4 meg	220 meg	3.125 ±.060	.315 ±.030	.040 ±.002

*Temperature Coefficient: 80 ppm/ $^{\circ}$ C referenced to 25 $^{\circ}$ C, ΔR taken at -15 $^{\circ}$ C and +105 $^{\circ}$ C. Maximum operating temperature: 225 $^{\circ}$ C. Resistance Tolerance: $\pm 1\%$ (tolerances to .2% on special order). Insulation Resistance: 100 megohms, minimum. Overvoltage: 1.5 times working voltage for 5 seconds, R shift .8% max. Thermal Shock: MIL-STD-202, method 107, cond. C, R shift .5% max. Moisture Resistance: MIL-STD-202, method 106, R shift .8% max. Leadlife: 1000 hours at rated power, R shift .8% max. Encapsulation: Silicone Conformal. Leadwire: Gold Plated Dumet 1/2" long $\pm 1/8$ ".

MICRONOX™ Resistance Films

Micronox resistance films are produced exclusively by Caddock Electronics. They are composed of complex oxides fired in air at temperatures above 1400 $^{\circ}$ F. The resulting films are relatively insensitive to high ambient temperatures and thermal shock. Films show negligible effect from moisture.

This totally new approach to precision resistors and networks opens new design possibilities because of the wide resistance range, precise temperature characteristics, and high temperature and power capability. Temperature coefficient can be accurately reproduced (within ± 10 ppm/ $^{\circ}$ C of curve if required). The typical curve shown below will vary slightly with resistivity of the film and configuration of the substrate.

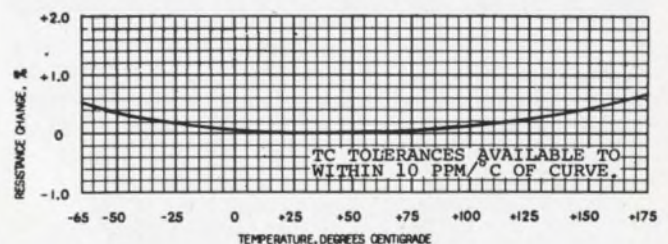

CADDOCK ELECTRONICS

3127 Chicago Avenue, Riverside, California 92507 • Telephone: (714) 683-5361

INFORMATION RETRIEVAL NUMBER 91

Analog multiplier is self-contained

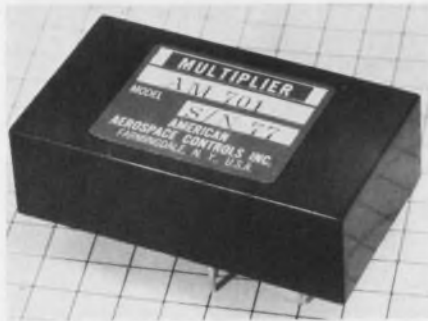

American Aerospace Controls, Inc., 129 Verdi St., Farmingdale, N.Y. P&A: \$98.50; 2 to 4 wks.

Combining ICs with a magneto-resistor bridge, an analog multiplier performs multiplication and squaring operations without external amplifiers or circuitry. Division can be achieved by connecting the unit in the feedback network of an operational amplifier. Model AM701 accepts ± 10 -V signals and delivers a ± 10 -V output at 5 mA.

CIRCLE NO. 329

Wideband amplifier operates at 15 MHz

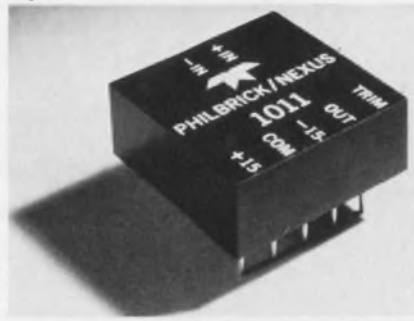

Philbrick/Nexus Research, A Tele-dyne Co., Allied Drive at Route 128, Dedham, Mass. Phone: (617) 329-1600. Price: \$50.

Type 1011 operational amplifier performs high-speed operations as fast as 1 MHz at full output, or up to 15 MHz for small signals. The fully encapsulated module slews at 70 V/ μ s under full load, and settles in 3 μ s. In addition to these features, the unit offers minimum open-loop gain of 150,000.

CIRCLE NO. 330

Solid-state relay operates in 50 μ s



Flight Systems, Inc., P.O. Box 25, Mechanicsburg, Pa. Phone: (717) 697-0333. P&A: \$27.50; stock to 2 wks.

A solid-state relay, which is said to have an unlimited operating life, features an actuating and release time of only 50 μ s. Called Static relay, the unit isolates the controlling circuit from the load by 10 M Ω . It performs at repetition rates as high as 2 kHz.

CIRCLE NO. 331

Reliability at moderate cost is the key to the Lundey Clinch-Loc[®] Line of feed-thru terminals

The new #609-TH is the smallest, for mounting on centers as close as 7/32"

Utilizing the superior properties of Teflon,* the 609TH is designed for components which must meet MIL-T-27 and other military specifications. It is rated at 2KV-RMS test voltage. (If you have any terminal problem—let us help you solve it.)

*Dupont Trademark

SEND FOR FREE SAMPLE KIT AND LITERATURE
another quality product in **THE LUNDEY LINE**

LUNDEY ASSOCIATES, INC.
694 Main Street Waltham, Massachusetts 02154

INFORMATION RETRIEVAL NUMBER 92

FREE!

TA'S Instrument Case Engineering Manual

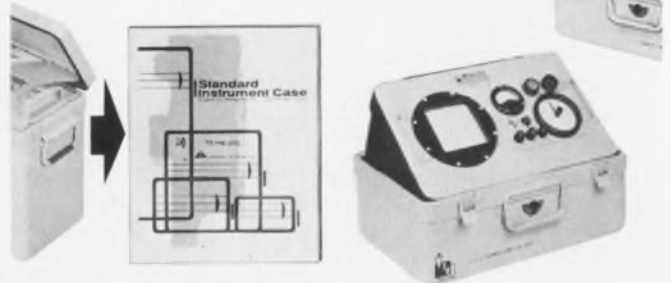

Makes you a packaging expert!

This one-of-a-kind booklet contains everything you need know to select the proper case for your particular packaging requirements. ■ Save money for your firm by selecting one of TA's standard cases rather than going to the expense of designing a custom case to package your product. ■ Huge warehouse stock for fast delivery at low prices... no tooling charges. All TA cases are designed to surpass Mil-Spec requirements... completely dust and waterproof. Free vellum service and panel templates. ■ Write or phone for a quotation and let us put our staff of case engineers to work for you today. Send for your free case manual now.

TA MFG CORP  A DAYCO COMPANY

4607 Alger Street, Los Angeles, California 90039 ■ Phone 213-245-3748/
TWX 910-497-2065 L. A./WUX CAT L. A., Calif.

INFORMATION RETRIEVAL NUMBER 93

Objective:

Design an ultra-lightweight, multi-speed, compensated resolver for a satellite application • Must have an angular position accuracy of 5 seconds, or better • Input to output phase shift of 0° • Maintain transformation ratio & phase shift constant with temperature

AEI's answer is a 72-speed 8.375 in. Dia. x 1.00 in. thick pancake resolver packaged in a lightweight beryllium housing. Weighing a total of 3 lbs. and operating at 2KC, the resolver has a repeatability of 1 second of arc. Transformation ratio and phase shift remain constant with temperature.

Whatever the requirement or application, AEI's background and experience assure you of the finest performance specifications, and fastest delivery schedules.

In addition to designing a broad variety of special units to mil-spec and customer requirements, AEI manufactures and stocks many standard resolvers, synchro's and amplisolvers for immediate delivery.

For more information on these units, as well as small AC and DC motors, that meet your specifications, why not call Jerry Bolt at (714) 871-3020.

ELECTRO-MECHANICAL/INSTRUMENTS GROUP • CONTROL COMPONENTS DIVISION • AMERICAN ELECTRONICS INC.
1600 East Valencia Drive, Fullerton, California 92634, (714) 871-3020, TWX 910-592-1256.



TRIMMER CAPACITOR

Breakthrough

PUFTRIMtm

- **HIGHEST Q**
... 5,000 at 20 MHz
- **HIGHEST VOLTAGE**
... 500 vdc
- **IN SMALLEST SIZE**
... 5/32" dia.



ACTUAL SIZE
0.3 to 6.0 pF

This new coaxial precision Trimmer Capacitor offers 0.3 to 6.0 pufs in the tiniest, reliable package using thin film dielectric techniques and non-rotating electrodes. Excellent thermal stability. Ideal for PC Board and Panel-Mounted Applications. Designed to exceed military specifications. Pat. #3,239,730.

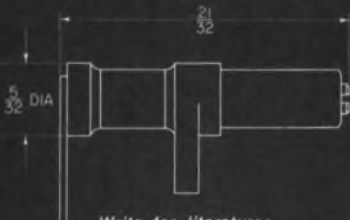

Write for literature:



Premier Microwave Corporation

33 New Broad Street / Port Chester, N.Y. 10573
(914) 939-8900 TWX: (914) 937-5080

INFORMATION RETRIEVAL NUMBER 95

SUBASSEMBLIES & MODULES

Voltage monitor responds in 50 ns

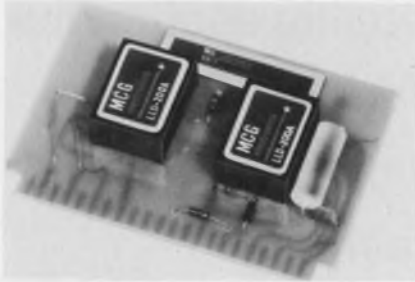

MCG Electronics, 279 Skidmore Rd., Deer Park, N.Y. Phone: (516) 586-5125. P&A: \$113; 2 wks.

Model HLD-1 monitor detects and indicates any voltage excursions, even those as short as 50 ns, above or below a preselected voltage threshold. The unit, which handles signals as high as 40 V peak, can operate lamps or relays to indicate whether the input excursion was high, low, or both. Provisions for resetting are incorporated in its circuitry.

CIRCLE NO. 332

MOSFET op amps minimize drift



Analog Devices, Inc., 221 Fifth St., Cambridge, Mass. Phone: (617) 492-6000. P&A: \$64 or \$89; stock to 3 wks.

Chopper-stabilized operational amplifiers use MOSFET modulators to set new performance levels for initial offsets and temperature stability. Model 232K has initial offsets of 10 μ V and 50 pA, while holding voltage drift to 0.1 μ V/ $^{\circ}$ C and bias current drift to 0.5 pA/ $^{\circ}$ C. Model 232J provides initial offsets of 25 μ V and 100 pA, and drifts of only 0.5 μ V/ $^{\circ}$ C and 1 pA/ $^{\circ}$ C.

CIRCLE NO. 333

Low-power op amp draws only 200 μ A



Philbrick/Nexus Research, A Teledyne Co., Allied Drive at Route 128, Dedham, Mass. Phone: (617) 329-1600.

An operational amplifier operates from power-supply voltages of ± 2 to ± 16 V with a maximum quiescent current of 200 μ A. This low-power requirement of type 1006 makes battery operation of remote equipment economically practical; it also prolongs battery life in portable instrumentation, with no compromise made in specifications.

CIRCLE NO. 334

Line driver receivers work at 500 kHz

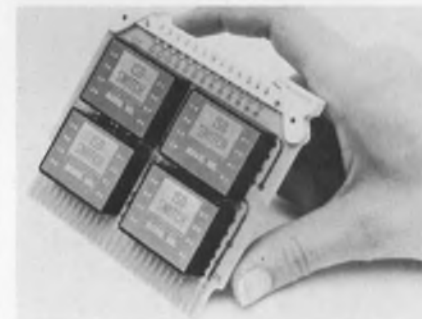

Electronic Engineering Co. of Calif., 1441 E. Chestnut Ave., Santa Ana, Calif. Phone: (714) 547-5501. Price: \$170 to \$240.

Five new isolating long-line driver/receivers can drive digital data over 10,000 feet of line at 100 kHz or over 1000 feet at 500 kHz. Typical applications for the EECo-LogIC 2 digital logic cards include: two-way communication between central processor and remote stations; hard-wired data links that provide isolation and level shift; coupling black boxes and peripherals into computer main frames; and elimination of ground loops and noise in d/a systems.

CIRCLE NO. 335



high performance, solid-state plug-in POWER SUPPLIES

If you're looking for a reliable but low cost power supply that gives good regulation and that can be chassis or rack mounted with an octal plug—you can stop. POWER/MATE CORP. has just what you're looking for. The RC/RD series of power supplies feature all silicon solid state circuitry, a MIL-T-27 Transformer, 85°C Capacitors, overload and short circuit protection and 100,000 hours MTBF. In addition to that, only POWER/MATE CORP. can offer you

SAME DAY SHIPMENT!*

All RC Series Models only **\$65.00** All RD Series Models only **\$55.00**

MODEL NO.	OUTPUT VOLTS	OUTPUT AMPS	REGULATION ±%	
			LINE	LOAD
RC-5	3-7	1.0	0.3	0.7
RC-9	7-11	1.0	0.1	0.3
RC-12	11-13	1.0	0.075	0.1
RC-15	13-16	0.5	0.075	0.1
RC-19	16-21	0.5	0.075	0.1
RC-24	21-26	0.5	0.075	0.1
RC-28	26-31	0.5	0.06	0.1
RC-34	31-37	0.5	0.05	0.1
RC-40	37-43	0.5	0.05	0.1
RC-48	43-50	0.5	0.05	0.1

MODEL NO.	OUTPUT VOLTS	OUTPUT AMPS	REGULATION ±%	
			LINE	LOAD
RD-5	3-7	1.0	0.6	1.4
RD-9	7-11	1.0	0.2	0.6
RD-12	11-13	1.0	0.15	0.2
RD-15	13-16	0.5	0.15	0.2
RD-19	16-21	0.5	0.15	0.2
RD-24	21-26	0.5	0.15	0.2
RD-28	26-31	0.5	0.12	0.2
RD-34	31-37	0.5	0.1	0.2
RD-40	37-43	0.5	0.1	0.2
RD-48	43-50	0.5	0.1	0.2

* on RC Models

Write today for complete information on thousands of POWER/MATE CORP. power supplies in voltages to 400 and currents to 50 amps.



POWER/MATE CORP.

163 Clay St., Hackensack, N. J. 07601 / (201) 343-6294, / TWX: (710) 990-5023

INFORMATION RETRIEVAL NUMBER 96

WIRE WRAP[®], LOW-PROFILE IC SOCKET

Provides Increased versatility and speed in testing and packaging 14 and 16 lead integrated circuits.

- Fast, easy mounting on boards. For .036 diameter holes. Retention and alignment assured by positive lock-in design...no cement or special fasteners required.
- Contacts are Individually replaceable without removal of entire socket. Unique insulator removal tool available.
- Inner rail design for fast, easy insertion of IC's.
- Accepts all packages with round or flat leads.
- Wire wrap terminals... .025" square tails. Sufficient length for 3 levels of 30 gauge wire. Automatic machine wrappable.
- Also available with saddle for chassis mounting.
- In Diallyl Phthalate or Phenolic with gold or tin plated contacts.
- Spacer provided to assure proper alignment of pins.

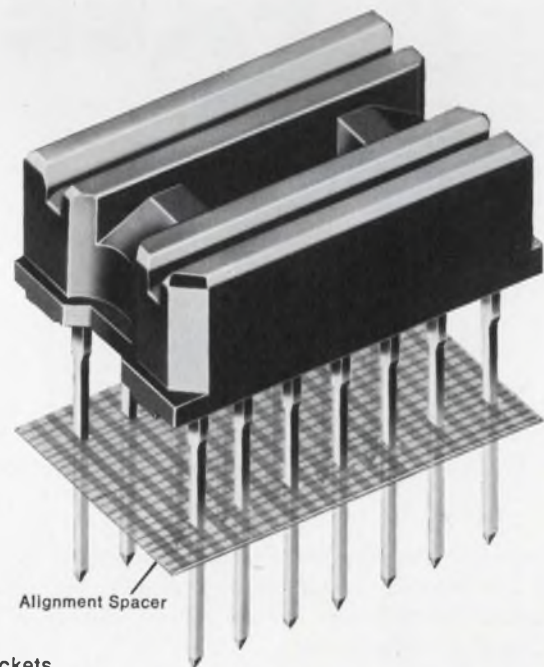

Request Catalog 166 for complete line of Dual-In-Line I.C. sockets

AUGAT INC.

TEL: 617-222-2202
31 PERRY AVE., ATTLEBORO, MASS. 02703

INFORMATION RETRIEVAL NUMBER 97

Embedded wires attenuate rfi

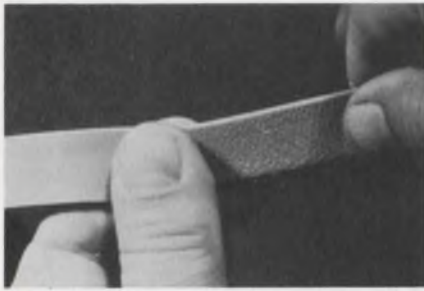

Raysteel Corp., 4621 Sheila St., Los Angeles.

A complete line of oriented wires in rubber strips, sheets and gaskets provides a high degree of rfi attenuation, as well as excellent moisture and environmental sealing characteristics. Only the tips of the individually oriented metal conductors extend through the sealant. Elastomers, neoprene or silicone are used as sealants, depending upon the application, to protect up to 1000 oriented conductors per square inch.

CIRCLE NO. 336

Sexless fork contacts handle 3 PC assemblies

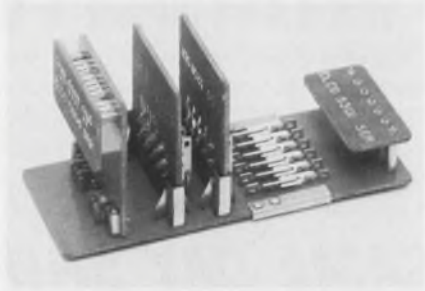

Elco Corp., Willow Grove, Pa. Phone: (215) 659-7000. P&A: 4¢/contact position; 4 to 6 wks.

Providing both electrical connections and mechanical support, Vari-con hermaphroditic fork-contacts for modular printed-circuit interconnections accommodate parallel, perpendicular, and even end-to-end assemblies. The contacts are pre-assembled on disposable plastic carrier strip to simplify direct mounting on PC cards. Each contact is precisely positioned on centers as close as 0.1 in.

CIRCLE NO. 337

Silver-epoxy compound silk-screens boards

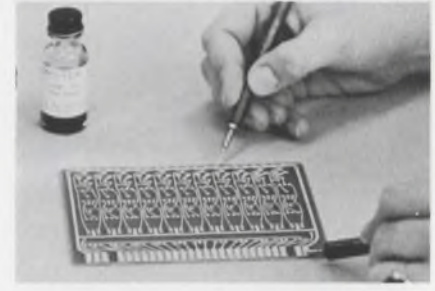

Epoxy Technology, Inc., 65 Grove St., Watertown, Mass. Phone: (617) 926-1949.

An improved pure silver-epoxy compound has a high order of electrical conductivity and a wide range of physical properties. The two-part system remains stable for two years, when stored at room temperature. The 410-E epoxy system meets the requirements of silk-screen applications for PC boards, and can also be used to assemble microminiature components in hybrid circuits.

CIRCLE NO 338

FREE

MOTOROLA S1302A PORTABLE DUAL-BEAM OSCILLOSCOPE

Solid-State - Internal Battery Option - Choice of Plug-In Amplifiers

Ideal for Aircraft, Computer, Microwave, Radar, And Other Sophisticated Electronic Systems.

Get technical literature on new solid state, portable dual-beam oscilloscope. Choice of two plug-in Y-amplifiers. Features differential input, internal voltage calibration, and both signal and time delay.

Write to Motorola Communications & Electronics Inc., 4501 W. Augusta Blvd., Chicago, Ill. 60651.



MOTOROLA
Precision Instrument Products

INFORMATION RETRIEVAL NUMBER 98

TYPE SHN 3

ZIPPERTUBING® R.F.I. SHIELDING JACKETING

for quick application and protection of multi conductor cables!

SHN 3 for R.F.I. shielding and protection. Tinned copper braid, attached to inside overlap provides gasket type seal and solderable termination point.

SHX 4 — of special knitted compounded wire for highly flexible R.F.I. shielding.

CPE conductive polyethylene for electrostatic protection.

MS provides low frequency magnetic shielding.

For full information on specialized, high-performance jacketing, contact

THE ZIPPERTUBING® CO.

CORPORATE HEADQUARTERS
13000 S. BROADWAY
LOS ANGELES, CALIF. 90061
Los Angeles Phone: (213) 321-3901
New Jersey Phone: (201) 256-4980

BALTIMORE • BOSTON • CHICAGO • DALLAS • NEW YORK
ORLANDO • PHOENIX • SAN FRANCISCO • WEST GERMANY

INFORMATION RETRIEVAL NUMBER 99

ELECTRONIC DESIGN 2, January 18, 1969

3 weeks ago this was just someone's wild idea

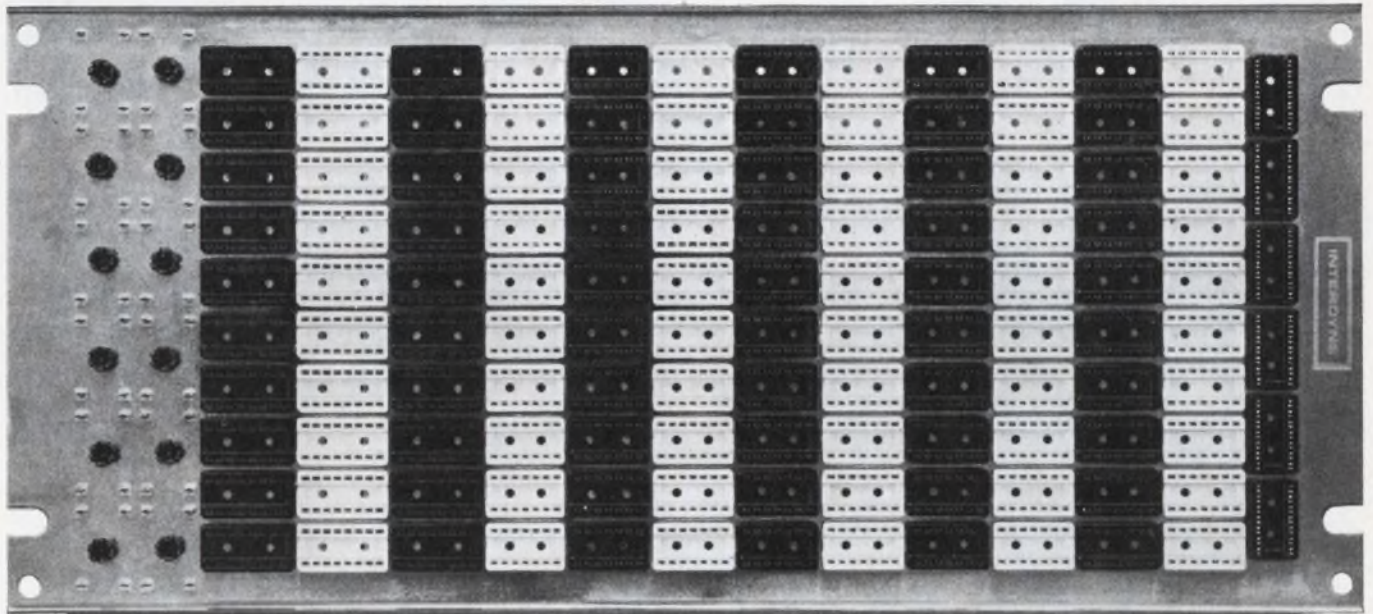

Now here it is. Finished hardware, ready to go to work.

What makes this fast turn around possible is our complete systems capability. It starts with design automation—everything from forming logic equations to final documentation is done on a computer. Next we use mod-

ular hardware to construct the exact configuration required. (It's the only quick way to get a custom design out of standard, off-the-shelf hardware.) Then we assemble the required components—digital, analog or a mixture. Finally we use completely automatic wire-wrap machines to finish the work.

The net result is a better system, cheaper and faster than you could build it yourself. So next time you have a wild idea, call us.

We'll put it to work.

INTERDYNE

2217 Purdue Avenue
Los Angeles, California 90064
(213) 477-6051

ECCOAMP

ELECTRICALLY CONDUCTIVE ADHESIVES & COATINGS



New four page folder describes materials from 0.0001 to 100 ohm-cm. Adhesive pastes to replace hot solder, thin liquids, silver lacquer in aerosol spray, glossy coatings, etc.

INFORMATION RETRIEVAL NUMBER 191

THERMAL CONDUCTIVE DIELECTRICS



Electrically insulating, thermally conductive . . . for bonding, encapsulating, coating or sealing heat sinks, components or cryogenic devices where rapid heat transfer is desired. New four-page folder describes materials and applications.

INFORMATION RETRIEVAL NUMBER 192

ECCOMAX HI-Q LOW-LOSS DIELECTRICS



18 low loss systems are described in new folder and chart. Casting resins, impregnants, coatings, adhesives, rod & sheet — some foams — some Hi K — all with dissipation factors below 0.001. For RF, UHF, VHF and microwaves — capacitors, coils, etc.

INFORMATION RETRIEVAL NUMBER 193

Emerson & Cuming, Inc.



CANTON, MASS.
GARDENA, CALIF.
NORTHBROOK, ILL.
Sales Offices
in Principal Cities

EMERSON & CUMING EUROPE N.V., Oevel, Belgium

PACKAGING & MATERIALS

Teflon multilayer tape heat-seals to itself

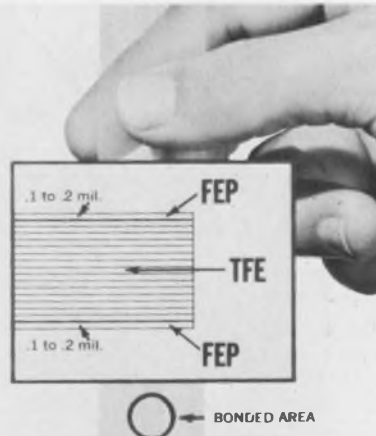

Dilectrix Corp., a sub. of Natvar Corp., 69 Allen Blvd., Farmingdale, N.Y. Phone: (516) 249-7800.

Heat-bondable teflon multilayer tape can be heat-sealed to itself, to teflon TFE or to teflon FEP. A thin layer of FEP on one or both sides of a base of cast TFE gives the tape a heat-sealable coating. Since the thin layer of FEP actually diffuses into the base TFE during the heat-sealing process, the composite tape may be used at normal TFE operating temperatures.

CIRCLE NO. 339

Flat woven cable has 10 to 80 wires

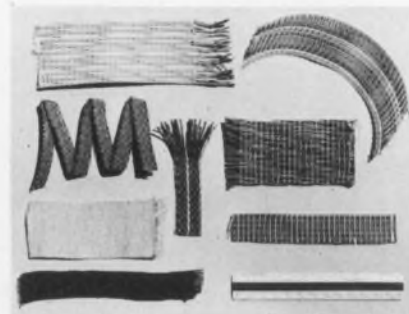

Alliance Webbing, Inc., 180 Madison Ave., New York City. Phone: (212) 685-2678.

Flat woven multiconductor cable has high tensile strength, minimum space requirements and good heat dissipation. This cable can be used with standard terminals and connectors. It is available in various sizes, electrical characteristics and weave patterns to customer, MIL, NASA or UL specifications.

CIRCLE NO. 340

Shrinkable tubing protects flat cable

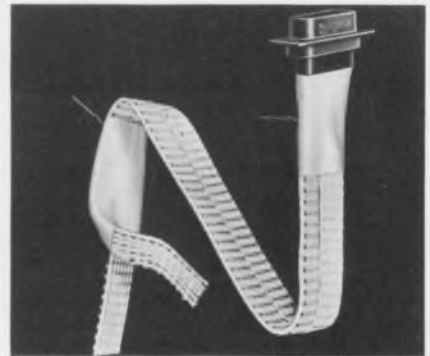

Zippertubing Co., 13000 S. Broadway, Los Angeles. Phone: (213) 321-3901.

A thin-wall low-cost shrinkable tubing prevents separation of flat ribbon cable conductors, while providing protection at break-outs or from moving drawers. Type TLT tubing is also particularly useful in insulating conductors at the point of attachment to connectors.

CIRCLE NO. 341

Miniature coax cable has 0.01-in. diameter



United-Carr, Inc., Plaxial Cable Dept., 70 Jaconnet St., Newton Highlands, Mass. Phone: (617) 527-6438.

Fully-shielded, flexible coaxial cable, only 0.01-inch in diameter, has been developed for use in high-density computer circuits and in other integrated and hybrid circuits. The cable consists of a continuous outer sheath of 0.001-in.-thick copper, electrodeposited on teflon FEP dielectric with a 0.0084 in. OD, over a gold-plated inner conductor of AWG #42 high-strength copper wire.

CIRCLE NO. 342

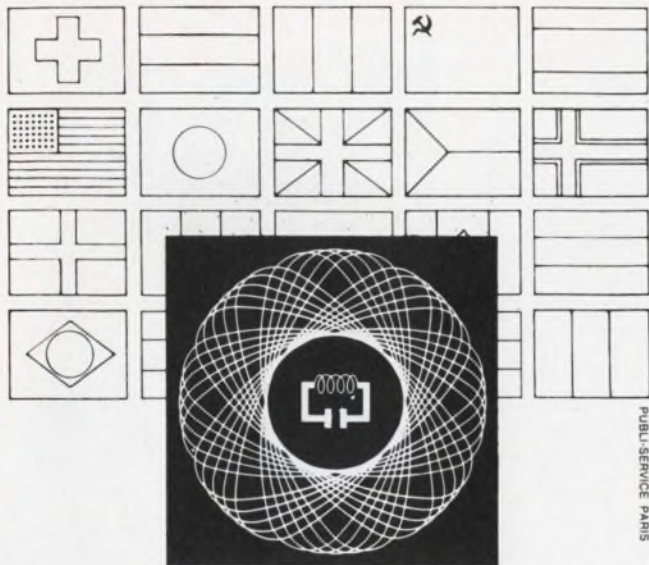

PUBLI-SERVICE PARIS

**150.000
electronic engineers
in Paris**

**This concerns
YOU DIRECTLY !**

SALONS INTERNATIONAUX DES
**COMPOSANTS
ELECTRONIQUES**

ET DE L'ÉLECTROACOUSTIQUE

FROM MARCH 28th TO APRIL 2nd 1969
PORTE DE VERSAILLES - PARIS



**INTERNATIONAL CONFERENCE ON
REMOTE DATA PROCESSING**

Scientific, technical and economic aspects
Program and registration conditions on request
FROM MARCH 24th TO 28th 1969 - PARIS

S. D. S. A. - RELATIONS EXTERIEURES 16, RUE DE PRESLES - 75 PARIS 15^e - FRANCE
CALL FOR INFORMATION : FRENCH TRADE SHOWS - NEW YORK - PHONE : (212) 582-4960-1

INFORMATION RETRIEVAL NUMBER 101

ELECTRONIC DESIGN 2, January 18, 1969

**Going to IC's?
Or Higher IF's?**

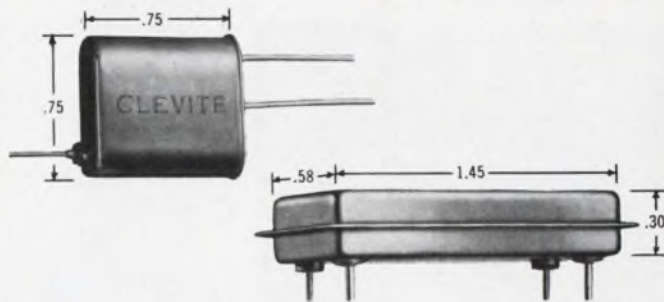

**Go two ways
with Monolithic Clevite
Uni-Wafer Filters**

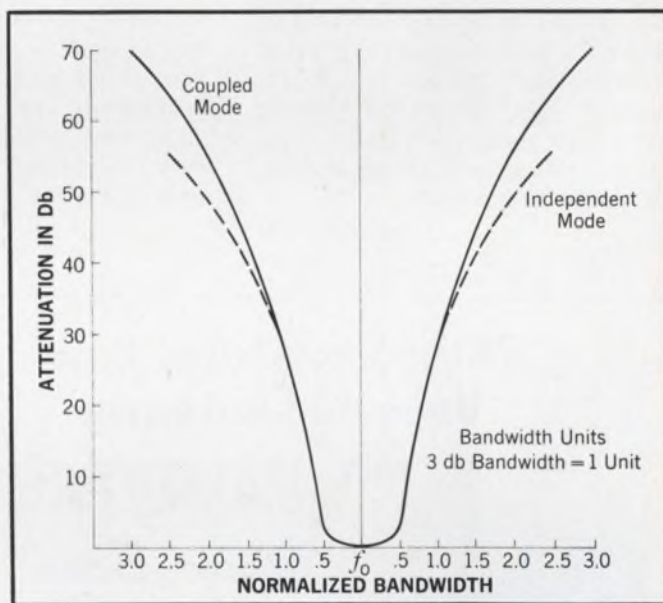

Go independent mode. Go coupled mode. You can go either mode with monolithic Clevite Uni-Wafer filters. They're smaller and more reliable (fewer interconnections) than conventional filters.

Clevite Uni-Wafer filters are ideal for matching IC circuitry in communications receivers operating in the VHF and UHF frequency ranges as well as in telemetry, radar and aerospace systems.

They are four-pole crystal filters with a choice of center frequencies ranging from 8 MHz to 75 MHz. They've been developed using Clevite's advanced engineering techniques and Clevite's original thin film approach to quartz filters. In this concept, arrays of resonators are achieved on a single quartz wafer with resonator isolation and spurious suppression controlled by the trapped energy principle.

So if you're going to IC's or higher IF's, go Clevite Uni-Wafer filters. They're available in both independent and coupled mode.

For more information and complete specification data, write: Clevite Corporation, Piezoelectric Division, 232 Forbes Road, Bedford, Ohio 44146.

CLEVITE

INFORMATON RETRIEVAL NUMBER 102

Low-cost tool cuts gaskets



Edmund Scientific Co., 380 Edscorp Bldg., Barrington, N.J. Phone: (609) 547-3488. P&A: \$5; stock.

Gaskets, washers, and similar items can be cut on the spot with an inexpensive circle-and-gasket cutter. This plastic-and-steel cutter, 2-1/2-in.-long, makes gaskets, washers and curved or circular parts from materials such as cardboard, rubber, balsa, vinyl, acetate, cork, felt, and leather.

CIRCLE NO. 343

Rolling laboratory processes PCs

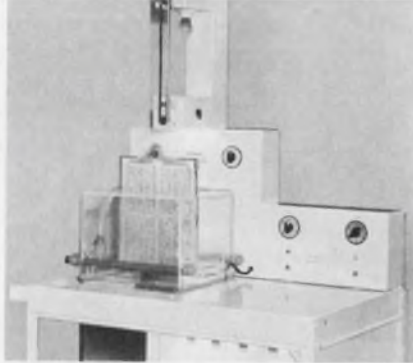

Cyclo-Tronics, Inc., 3858 N. Cicero Ave., Chicago. Phone: (312) 282-6141. Price: \$1495.

Mounted on wheels for mobility, a compact, PC processing and etching laboratory unit has been developed for work areas where space is limited. The unit contains all equipment needed for printed-circuit processing. It will process boards up to 11 by 14-in.

CIRCLE NO. 344

Resin mixing system formulates epoxies



Resin Systems Div. of Fenwal Inc., 400 Main St., Ashland, Mass. Phone: (617) 881-2000.

A system designed to simplify the mixing and application of multi-component resin systems, stores epoxy and related materials until mixed and ready for use. Precise formulations are supplied in separate packages, and proper mixing is assured by the use of an electric or a hand mixing-machine.

CIRCLE NO. 345

Fastest Speed - Lowest Noise Unsurpassed Performance

with **JAMES**
"Micro-Scan"
RELAYS



- Up to 3-pole switch contacts
- 10⁻⁴ pf isolation between contacts & coil
- 750 μ sec operating speed
- No bounce closures
- Less than 1 μ volt thermal offset or drift
- 1 billion operation life

James Micro-Scan relays provide high common mode isolation with guard shield switching. Thermal and noise problems are non-existent with signals less than 1 micro-volt. Micro-Scan relays provide an economical and high-performance method of switching low-level signals for data acquisition systems, sampling, and digital memory registers. Send today for complete information.

JAMES ELECTRONICS INC.

4050 N. Rockwell St., Chicago, Ill. 60618
Telephone 312 463-6500

INFORMATION RETRIEVAL NUMBER 103

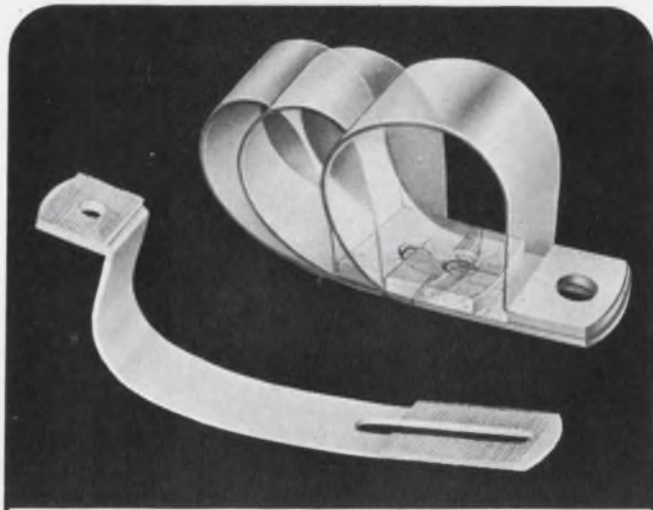

ADJUSTABLE P-CLIPS

Only nine sizes provide controlled tension for all bundle and cable diameters from 1/8" thru 2". Add or remove wires and the same clip can be adjusted to the new bundle diameter. Molded nylon ratchet teeth provide positive locking action — no slip, no slide — even under vibration or shock. Adjustable P-Clips simplify work, ordering, and inventories.

Send for Free Samples

ELECTROVERT INC.

Components Division
86 Hartford Ave., Mt. Vernon, N. Y. 10553
Milwaukee, Wis. • Burbank, Calif.



SOLD COAST-TO-COAST THROUGH AUTHORIZED DISTRIBUTORS

INFORMATION RETRIEVAL NUMBER 104

At last, an IC tester that even a company president can use.



It's the new Signetics Model 1100 Integrated Circuit tester series. Never before have such simple-to-use machines performed such complex functions in the hands of a totally unskilled operator (company presidents *do* forget). In fact, the 1100's were designed to be the most compact, comprehensive, inexpensive, easy to use, production-oriented IC testers on the market. And that's just what they are.

You simply select and insert a single program board, plug in the IC and punch the test button. Instantly, you get complete "go-no-go" assurance, including AC performance capability. With just

a few minutes training, incoming inspection or production personnel can test 5 to 10,000 IC's per day (that's over 2 million per year). On the other hand, engineers can completely test single IC's in seconds. Prices start at \$3,795. See below for information or a demonstration. And if you're a company president, we'll throw in a box of cigars.



SIGNETICS CORPORATION
MEASUREMENT/DATA
 A subsidiary of Corning Glass Works

For detailed information or a demonstration write Signetics, Measurement/Data, 811 E. Arques Ave., Sunnyvale, Calif. 94086, or contact one of the following:

AUTHORIZED SIGNETICS REPRESENTATIVES (Measurement/Data) □ Alabama and Tennessee Col-Ins.-Co., Inc., Huntsville (205) 539-1771 □ California L and M Engineering, Inc., Inglewood (213) 678-5409; Santa Clara (408) 243-6681 □ Connecticut Ditech Associates, Inc., New Haven (203) 624-7291 □ District of Columbia (see Silver Spring, Maryland) □ Florida Col-Ins.-Co., Inc., Orlando (305) 423-7615 □ Georgia Col-Ins.-Co., Inc., Marietta (404) 422-8327 □ Illinois Carter Electronics, Inc., Chicago (312) 776-1601 □ Indiana Carter Electronics, Inc., Indianapolis (317) 293-0698 □ Maryland OED Electronics, Inc., Silver Spring (301) 588-8134 □ Massachusetts Ditech Associates, Inc., Newtonville (617) 527-5394 □ Minnesota Carter Electronics, Inc., Minneapolis (612) 869-3261 □ Mississippi/Louisiana Col-Ins.-Co., Inc., St. Louis (504) 833-1116 □ New Jersey OED Electronics, Inc., Camden (215) 925-8711 □ New York OED Electronics, Inc., Mt. Vernon (914) 968-2200 □ J. A. Reagan Co., Inc., Albany (518) 489-4777; Binghamton (607) 723-9661; Newburgh (914) 561-4510; Syracuse (315) 471-7274; Utica (315) 732-3775; Rochester (716) 473-2115 □ North Carolina Col-Ins.-Co., Inc., Winston-Salem (919) 765-3650 □ Ohio WKM Associates, Inc., Cleveland (216) 885-5616; Dayton (513) 434-7500 □ Pennsylvania WKM Associates, Inc., Pittsburgh (412) 892-2953 □ Michigan WKM Associates, Inc., Detroit (313) 892-2500

INFORMATION RETRIEVAL NUMBER 105

New from the **SPEC-TROLL!**

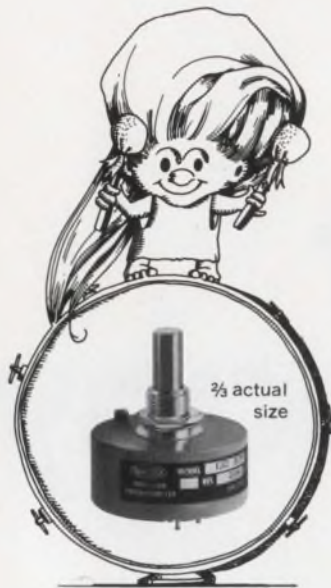

A LOW-COST INDUSTRIAL WIREWOUND POT WITH PREMIUM FEATURES

Welded termination—With heavy-duty ribbon taps welded to several turns of wire, the new single-turn Model 132 can better withstand high-level vibrations and short-term overloads.

Unitized design—With only 4 major subassemblies — a stainless-steel shaft and rotor, a coil, a molded housing, and a rear lid — the 132 offers a new simpler design for greater reliability, with rear terminals for better packaging.

Rugged construction — The materials used in the 132 have been selected for their ability to withstand impacts and abrasions during assembly or maintenance to assure the customer a trouble-free, serviceable pot.

Low cost—For less than \$6 (in quantity)—you can buy this precision industrial pot! Also, heavy-duty stops (8 in. lb. static) are optional at no extra cost.

For full specs, circle the reader service card. Qualified respondents requesting a sample will receive a Model 132 free of charge from their local Spectrol representative.



Spectrol Electronics Corporation
A subsidiary of Carrier Corporation
17070 East Gale Avenue
City of Industry, Calif. 91745
Phone: (213) 964-6565
TWX: (910) 584-1314

PRODUCTION

Automatic lead trimmer operates in seconds



Kenbil Engineering Co., 2419 C. Grand Ave., Los Angeles.

Providing fast, uniform lead trimming the AIDE P.C.B. lead trimmer processes PC boards in seconds rather than the minutes required by hand trimming. The machine handles a variety of board sizes up to 6 by 10 in. Its multi-toothed circular cutter rotates at 35,000 rpm, producing so light a pressure that no damage occurs to components or solder connections.

CIRCLE NO. 346

All-fluidic controller ousts d/a converters



Applied Fluidics, Inc., 44 Homestead Ave., Stamford, Conn. Phone: (203) 323-3108.

Using digital techniques to achieve analog outputs, a fluidic digital controller accepts standard pneumatic inputs and delivers equivalent outputs to the final control element. When used with a computer, model FC-100 completely eliminates the need for a/d and d/a converters.

CIRCLE NO. 347

TRYGON HAS THE POWER

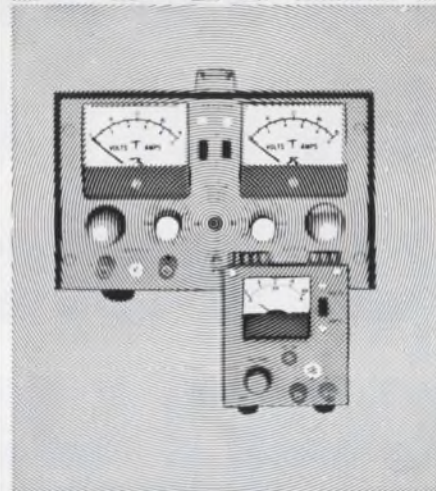

to deliver these two great laboratory supplies immediately.

Trygon's economy EAL and precision DL-series laboratory power supplies are available—right now—from 36 sales offices, nationwide. So when we say you'll have them, you can depend on it. You can also depend on them.

The versatile DL Series gives you two independent dual-range supplies (0-20V @ 1 amp or 0-40V @ 0.5 amps) in one half-rack package. And you can run them independently, in series or in parallel (from 20V @ 2 amps up to 80V @ 0.5 amps. All for \$249, only a few dollars more than comparable single-output units.

The compact EAL fits in a corner of your bench and your budget (only \$99) and comes in the four most commonly used laboratory voltage ranges: 0-10VDC @ 1.0 amp, 0-20VDC @ 500 mA, 0-32 @ 300 mA, and 0-50 @ 250 mA.

Both the EAL and the DL come complete with combination volt/ammeters and both give you .01% regulation, .05% stability.

Put Trygon power to work for you. Today. For the name of the sales office nearest you, call us collect.



TRYGON POWER SUPPLIES

111 Pleasant Avenue, Roosevelt, L.I., N.Y. 11575
Trygon GmbH 8 Munchen 60, Haidelweg 20, Germany
Write for Trygon 1968 Power Supply Handbook.
Prices slightly higher in Europe.

INFORMATION RETRIEVAL NUMBER 107
ELECTRONIC DESIGN 2, January 18, 1969

flying spot
scanner,
photometer,
densitometer,
or
scintillation
counter



The new range of EMI photomultipliers with "SUPER" S-11 photocathodes will enhance your project performance. High quantum efficiency, (23/24%) high gain at relatively low overall voltage, and low dark current at the rated overall sensitivity are typical of these types. They maintain the EMI standard of excellent gain stability and linearity. The narrow spread in characteristics makes these types ideal for systems or for multiple installations. The table below gives the typical values for the significant parameters.

Dia.	Type No.	Amps/ Lumen	Volts/ Overall	Anode Dark Current Nanoamps
2"	9656R	50	1150	2
3"	9708R	50	1250	5
3.5"	9531R	200	1300	25
4"	9732R	50	1250	10
5"	9709R	50	1350	15

Note that the anode dark current is given for the overall voltage at the specified overall sensitivity. The maximum overall sensitivity is 10 times the values given above. Each Tube is individually calibrated and data is supplied with the tube.

Send for our new 64 page catalog giving data and technical information on the complete range of EMI photomultipliers.

Whittaker
CORPORATION

GENCOM DIVISION

80 Express St., Plainview, L. I., N. Y.
516-433-5900

INFORMATION RETRIEVAL NUMBER 108
ELECTRONIC DESIGN 2, January 18, 1969

Thermal stripper shaves all insulations

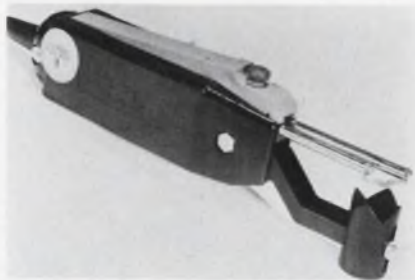

Henry Mann Inc., P.O. Box 237,
Cornwells Heights, Pa. P&A:
\$69.95 or \$99.95; stock.

Model TW-6 handheld thermal stripper removes all types of insulations and outer coverings from single- or multiple-conductor cable and from coaxial cable up to 5/8 in. in diameter. A standard version operates at a fixed blade temperature of 1700°F and is especially useful for removal of Teflon, Kel-F and Kapton.

CIRCLE NO. 348

Multi-point prober checks and tests

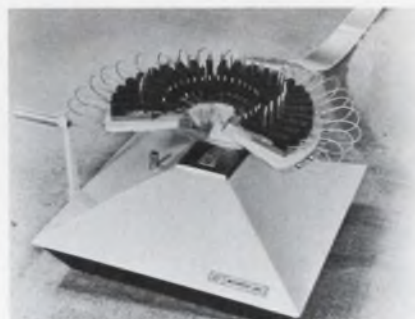

Wentworth Laboratories, Route 7,
Brookfield, Conn. Phone (203) 775-
1750.

Model MP-0200 manually operated microcircuit prober is a 24-point, precision test-and-handling mechanism that rapidly checks resistors and other devices utilized in thick- and thin-film hybrid circuits. It can also be used for such similar applications as finished package testing, dynamic testing, and wafer and chip probing. As standard equipment, the machine includes an interchangeable chuck for any substrate that is up to 2-1/4-in. square.

CIRCLE NO. 349



If You Still Pay

"PREVAILING PRICES"
for STEPPING MOTORS
... YOU SHOULD BE
CRYING BY NOW!!!

YOU CAN GET OUR
INSTANT RESPONSE

RAPID/SYN

STEPPING MOTORS
FOR A LOT LESS!!!



Look at these quality features:

- Class H insulation
- Precision 5 shielded bearings
- Corrosion resistant construction
- Sizes 5-20
- Step angles 15°-90°

Isn't this a good reason to contact
us—immediately?



11925 Burke Street, Santa Fe Springs,
Calif. 90670 • (213) 698-2595 • 723-6593

"The only real home stepping motors ever had"

INFORMATION RETRIEVAL NUMBER 109

Design Aids



Cutting speed tables

Included with a 28-page cutting tool catalog are a cutting-speed conversion chart and a bar graph that gives cutting speed recommendations for a variety of materials. The chart converts between surface feet per minute and rpm for any given tool diameter up to one inch. The bar graph gives recommended surface feet per minute when machining four classes of material with boring or grinding tools, end mills, drills, burs, reamers, and countersinks. M.A. Ford Manufacturing Co., Inc.

CIRCLE NO. 350

Plastic properties chart

Offered as an aid to designers is a plastic properties chart that contains a large volume of data on a broad range of materials. Bound as a 14-page booklet, the chart lists 34 specific properties for each of 80 different materials. The physical properties specified include specific gravity, refractive index, tensile strength, Rockwell hardness, thermal conductivity, and specific heat. Electrical properties include volume resistivity, dielectric strength as well as dielectric constant and dissipation factor for a wide range of frequencies. Commercial Plastics and Supply Corp.

CIRCLE NO. 351



Rfi shielding sampler

A compact product sample kit, containing a selection of radio frequency and magnetic shielding sample materials is available without cost to industrial engineers, packaging engineers, and others who specify electronic and related equipment. The kit contents are representative of a complete line of knitted wire mesh strips, gaskets, sheets, shielding foil, tapes, rolls and contact finger strips. Problems of product evaluation are solved within minutes by the engineer through the use of the kit. Rayseel Corp.

CIRCLE NO. 352



Drafting samples

A sample pack of sequential reference designations (letters and numbers) is included with a master catalog. Catalog SRD-1 includes twelve different reference designations, the complete alphabet and numerals in five character heights. All symbols and heights are available in opaque black matte, transparent red and transparent blue. Also included are suggestions on application technique, and complete ordering information. Bishop Industries Corp.

CIRCLE NO. 353



Floating fasteners

A free designer's kit includes captive floating fasteners that speed assembly by correcting chassis hole misalignment. Type FN floating nuts make hole misalignment adjustments possible by means of a free floating threaded insert, movable 0.015 in. through 360°, encased in a stainless steel housing. Easy to apply, the floating nuts are simply pressed into drilled or punched holes. The hexagonal head displaces metal by cold flow into a special recess ring the insert. Precision Metal Products Co.

CIRCLE NO. 354



Sample washer kit

A sample assortment of stamped thrust washers is available in sizes suitable for a wide range of applications. The washers are available in a variety of thicknesses and materials—low and high carbon steels, stainless steel, brass, bronze and aluminum. Washers are stamped, hardened and polished. These inexpensive unground washers approach the qualities of ground washers. National Bearings Co.

CIRCLE NO. 355

Tips on cooling off hot "plastic" transistors

See how circuit and packaging designers use new IERC heat dissipators to increase the efficiency of epoxy and ceramic semiconductors. Models are available for all TO-5, TO-18 and D-case sizes, with and without flanges.

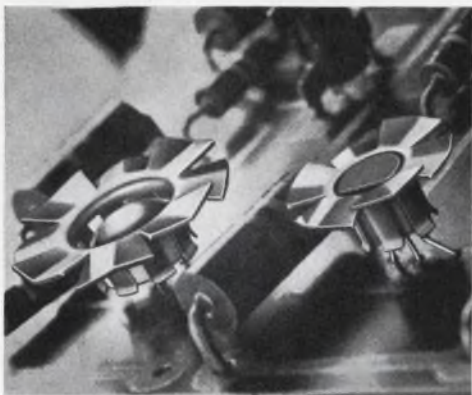

New, press-on "Fan Tops" fit all TO-5, TO-18 and D-case size devices. Need no board area; add virtually nothing to board height. An RO-97 with Fan Top dissipates 400 milliwatts at 65°C. compared to 200 milliwatts with no dissipator.

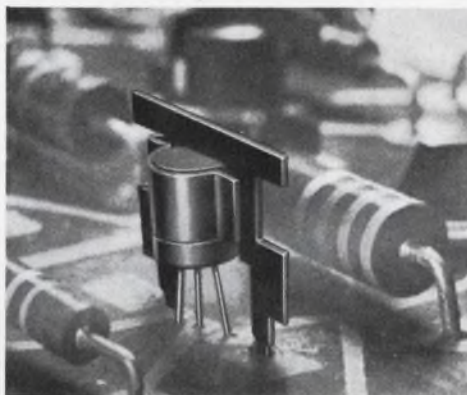

New "Universal" Spade types fit all D-case sizes, including the flanged type. Permit operating power of transistors to be increased 33%. Unique spring-clip retainer accommodates variations in case diameters. Single and dual models.

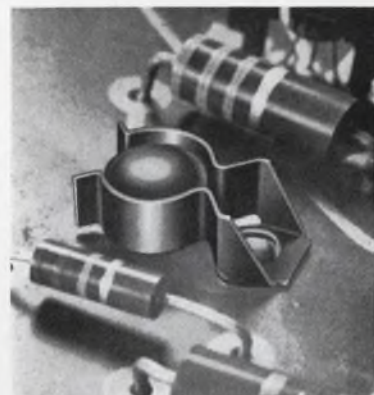

New Clip types are especially effective in high g environments. Hold TO-5 and TO-18 size devices securely; reduce load on leads. Allow 30% more operating power.

Unique new Spade types fit all TO-5, TO-18 and no-flange D-case sizes. Provide excellent retention and dissipation and are also valuable production aids. "Stand-off" legs give a positive 0.1" grid location for automatic insertion in p-c boards and hold transistors above the solder, preventing possible thermal damage. Single and dual models.

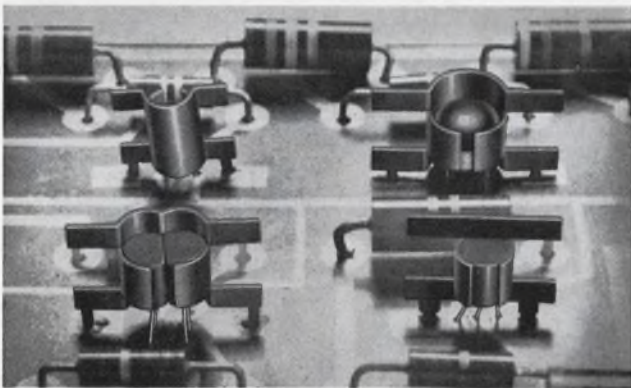

New PA and PB dissipators for medium power plastic devices accommodate the flat, rectangular shaped thyristors, transistors and SCR's. Patented, staggered-finger design and aluminum construction maximize dissipation. In natural convection a PA will permit a single X-58 or M332 case device to be operated with 80% more power. A PB type will allow matched pairs or larger devices to be operated with 200% more power.

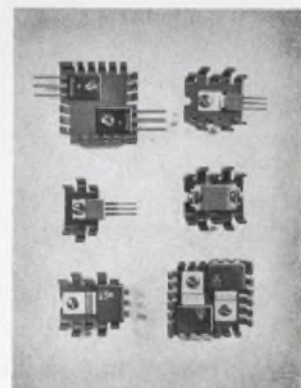
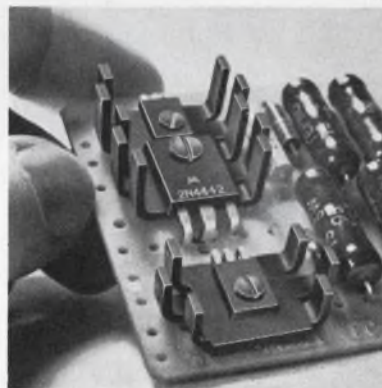

IMPROVED SEMICONDUCTOR PERFORMANCE FOR ONLY PENNIES

Epoxy and ceramic case semiconductors, like those in metal cases, have maximum allowable operating temperatures. Exceeding these limits can damage or destroy the component. Low cost IERC dissipators/retainers reduce operating temperatures, permitting semiconductors to be operated at power ratings up to 33% higher without increasing case temperatures. Their use also sharply reduces failures caused by excessive solder heat during assembly. **New SHORT FORM CATALOG** gives complete specifications and other helpful information for selecting transistors/dissipators. May we send you a copy?

Transistor dissipators/retainers • Forced air cooling packages • Fluid cooled heat sinks • Tube shields

ierc
SEMICONDUCTOR
HEAT DISSIPATORS

INTERNATIONAL ELECTRONIC RESEARCH CORPORATION • A corporate division of Dynamics Corporation of America • 135 West Magnolia Ave. • Burbank, Calif. 91502

INFORMATION RETRIEVAL NUMBER 110

Application Notes

Detectors and emitters

A new product-file-folder on infrared detectors and semiconductor lasers is now available. Device information includes both coherent and incoherent gallium-arsenide emitters, indium-arsenide lasers, photoconductive infrared detectors, detector-preamplifiers, and gas shielded dewars. Primarily for long-wavelength applications that require extremely fast response time, the photoconductive detectors are well-suited for detection of carbon dioxide laser radiation. The semiconductor lasers operate in the near infrared, providing up to five watts of continuous wave output for some models. Applications for these devices include surveillance, reconnaissance, and general infrared illumination applications. Raytheon Co.

CIRCLE NO. 356

Multiplier applications

An 8-page applications booklet is designed to aid the engineer in using a new series of six high-performance, 4-quadrant multipliers. The package includes 12 basic application notes covering the simple multiplication of two variables, sampling techniques, squaring, second harmonic generation and modulation and sophisticated correlation computation. GPS Instrument Co., Inc.

CIRCLE NO. 357

Transistor testing

A new 12-page illustrated brochure describes a line of automatic transistor test instruments. The use of such instruments for production work and for receiving and inspection applications is discussed, along with reliability and safety considerations. The booklet further discusses the use of transistor test systems to test diodes and FETs. Teradyne, Inc.

CIRCLE NO. 358

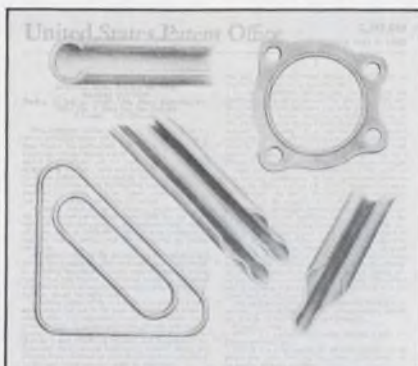

Metallic static seals

Just issued, a new 20-page engineer's data book shows complete specifications on over 2000 C-seals, E-seals, and Y-seals for use in high temperature, radioactive, hard-vacuum, cryogenic, and corrosive environments. Seals of these types have been used from -400 to $+3500^{\circ}\text{F}$, 10^{-10} torr to 20,000 psi, with severe pressure pulsations and flange distortions. Data includes selection criteria, force-deflection curves, and methods of specifying quality level. Pressure Science Inc.

CIRCLE NO. 359

Parametric power

Several technical papers have been published that discuss both the theory of operation as well as applications for parametric power conversion devices. This technical information has recently been published and bound in an eight-page booklet entitled "Recent Technical Papers on Parametric Power." A copy of this booklet is obtainable without charge. Wanlass Instruments.

CIRCLE NO. 360

Absorption spectroscopy

A comprehensive, new 64-page bibliography on atomic absorption spectroscopy is now available. The bibliography references pertinent articles by element, matrix and author. Cary Instruments.

CIRCLE NO. 361

ICs vs relays

Control equipment designers will find valuable technical assistance in a new 16-page white paper. The 16-page treatise emphasizes the practical advantages of IC logic assemblies for performing relay functions in industrial control situations. Written for the industrial control designer, the new literature includes descriptions of Boolean Algebra (switching algebra), truth tables and implementation of various logic functions (AND, OR and NOT). The booklet aims to help the industrial control designer set up a consistent plan of attack, by using truth tables, Karnaugh maps and the NAND transform for logic design. Cambridge Thermionic Corp.

CIRCLE NO. 362

Switch applications

Planned for design engineers and offered three times a year, a two-color publication describes a variety of innovations in switch applications. The current issue features eight design applications that exemplify various aspects of industrial controls. An additional item in the booklet illustrates the use of a dual function taut-band meter, which registers either output voltage or milliamperes. Micro Switch, a Div. of Honeywell.

CIRCLE NO. 363

Logarithmic notes

Notes on the theory and applications of log elements illustrate the use of log elements with operational amplifiers to obtain log and anti-log functions. Multipliers and dividers are covered, as are logs of a single variable, logs of a ratio, and antilogs. These applications notes are part of a series, and will be followed by other investigations into areas of interest to design engineers. Data Device Corp.

CIRCLE NO. 364

Theta Decitrak[®] puts information to work

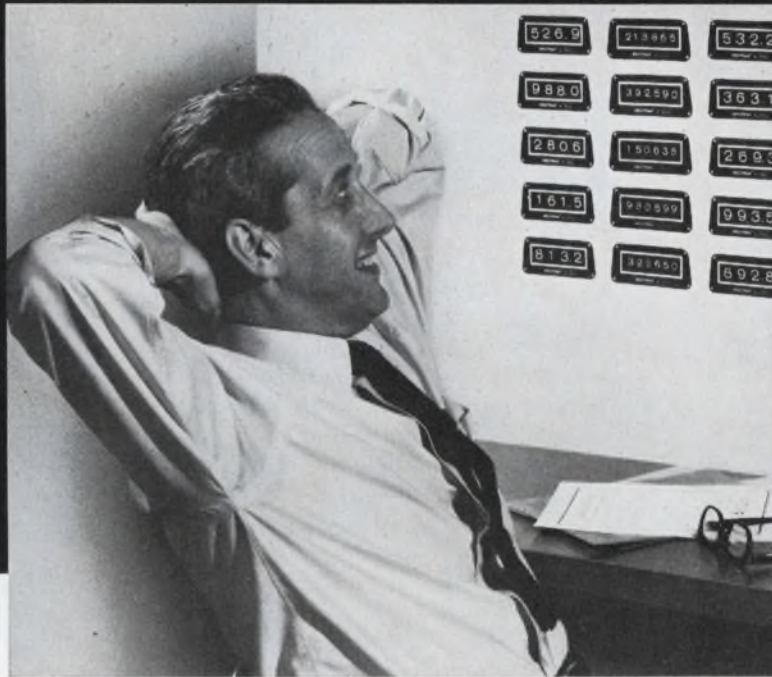

Now, information from *your* analog sensor can command machinery, automate processes, interface computers, and provide remote digital display.

How? With a Theta Decitrak system, analog information is uniquely converted to digital format. Of course, data transmission and data acquisition applications abound. Over and above these, Decitrak delivers automatic digital-control of *your* prime mover.

The Decitrak control system will accept commands from punched cards, tape, or manual set-points. In addition, it will introduce high/low limits and arithmetical operations into the control loop. The end result is the precision control you would expect from a custom-engineered, closed-loop servomechanism.

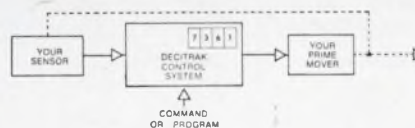

More than 1,000 of these systems are now in use in nuclear installations, satellite tracking stations, wind tunnels, and aboard ships. Theta can assemble a low-cost, customized system for *your* application from 32 basic off-the-shelf electronic modules and 27 types of shaft encoders.

Send for "Designer's Portfolio on Decitrak" — and see how Decitrak can put *your* information to work!

Theta

THETA
Decitrak

INSTRUMENT CORP • 22 Spielman Road, Fairfield, New Jersey 07006 • Phone: 201-227-1700 • TWX: 710-734-4431

INFORMATION RETRIEVAL NUMBER 111

GREAT NEW WAY TO BUY DC POWER



**ERA's Wide-Range, Variable,
All-Silicon DC Power Modules at
Low, Low Prices**

ERA's new Value-Engineered DC Transpac® power modules provide all-silicon, DC power in a wide-range, variable, low cost module.

Stocking problems are reduced to a minimum and power module obsolescence is practically eliminated. Design changes are easily accommodated since all units can be set to desired voltages by a simple external tap change.

Output Voltage (DC)	Current (71°C)	Model	Price
4-32	0-750 ma	LC32P7	\$ 89.00
4-32	0-2 amps	LC322	\$115.00
4-32	0-5 amps	LC325	\$179.00
4-32	0-10 amps	LC3210	\$215.00
30-60	0-1 amp	LC601	\$145.00

Over-Voltage Protector Option: Add \$35.00 to above prices and Suffix V to Model No. (i.e. LC325V, etc.).

SPECIFICATIONS

Input: 105-125 VAC, 50-400 cps

Ripple: Less than 800 microvolts RMS or .005%, whichever is greater

Line Regulation: Better than $\pm 0.01\%$ or 5 mv for full input change

Load Regulation: Better than 0.05% or 8 mv for 0-100% load change

Voltage Adjustment: Taps and screwdriver adjustment

Short Circuit Protected: Automatic recovery

Vernier Voltage: External provision

Transient Response: Less than 50 microseconds

Operating Temperature: -20°C to + 71°C free air, full ratings

Maximum Case Temperature: 130°C

Temperature Coefficient: Less than 0.01% per degrees C or 3 millivolts

Long-Term Stability: Within 8 millivolts (8 hours reference)

Write Today for Catalog #147



**ELECTRONIC RESEARCH
ASSOCIATES, INC.**

Dept. ED-1, 67 Sand Park Road
Cedar Grove, N. J. 07009 • (201) 239-3000
Subsidiaries: ERA Electric Co. • ERA Acoustics Corp.
ERA Dynamics Corp. • ERA Pacific, Inc.

INFORMATION RETRIEVAL NUMBER 112

APPLICATION NOTES

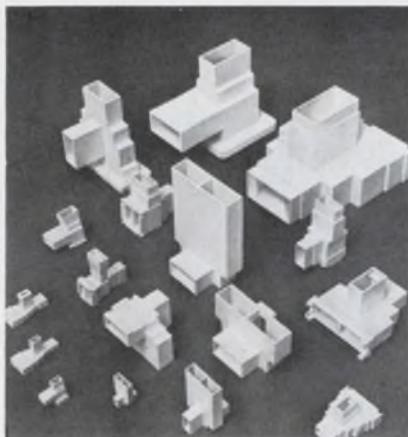

Magic tees

Catalog TH68 describes in detail H- and E-plane tees, magic tees, and mitre H-plane tees covering WR10 to WR2100 and many non-standard waveguide sizes. Illustrations of various styles and terminations as well as tabulated mechanical and electrical data are provided. Microwave Development Labs, Inc.

CIRCLE NO. 365



PC design handbook

This designer's handbook, a compendium of the printed circuit industry's progress to date, is a must for every designer interested in utilizing the newer, more sophisticated types of printed circuitry and wiring. The text, augmented with photographs, schematic drawings, illustrations and charts, treats every type of flexible and multi-layer wiring as well as multi-layer, weldable and prefabricated printed circuits. Methode Electronics, Inc.

CIRCLE NO. 366

DIALCO DATALITES®

mount as close
as 1/2 inch center
to center



SHOWN ACTUAL SIZE

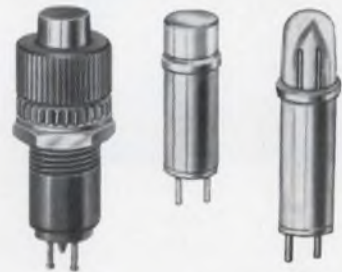

Designed to meet
or exceed requirements of
MIL-L-3661B.

Replaceable plug-in
cartridges: Incandescent for
1.35-120V; neon—high-brightness
operation 110-125V AC, and
standard brightness operation
105-125V AC-DC.

Wide range of lens
shapes, colors and finishes.

Broad selection of
positive or negative legends.

Available off-the-shelf
for prompt delivery.

Send for free catalog



SAMPLES ON REQUEST—AT ONCE
NO CHARGE

Dialight Corporation, 60 Stewart Ave.,
Brooklyn, N. Y. 11237. (212) 497-7600



INFORMATION RETRIEVAL NUMBER 113
ELECTRONIC DESIGN 2, January 18, 1969

Instrumentation recorders

Rotary head instrumentation recorders are the answer to the bandwidth limitations of conventional fixed head units. A discussion of rotary head fundamentals and applications is offered in an article reprint available at no charge. The article explores such applications as multiple instrumentation and airborne search radar recording, predetection data, television signals, and digital data of 20 megabits/s and higher. Ampex Corp.

CIRCLE NO. 367

Hybrid design data

Hybrid microcircuit design is the subject of a 12-page book that is well-illustrated with schematics and dimensional drawings. The booklet leads off with a discussion of circuit design philosophy and goes on to cover such topics as component compatibility, packaging, reliability, circuit characterization, and test methods. Typical circuits are illustrated and described. The design guide also illustrates such packaging configurations as TO-5, TO-8, and flat-pack. Circuit Technology Inc.

CIRCLE NO. 368

Accelerometer data

How to minimize accelerometer measurement errors that are caused by base bending phenomena is described in a new technical data sheet. A basic discussion of the effects of base bending, or strain sensitivity, is included, along with guidelines to be used in evaluating their role in the accuracy of acceleration measurements. The advantages and disadvantages of various accelerometer types, in relation to base bending errors, are described; a table illustrates both nonlinearities and the spread of data for a specific accelerometer model. Endevco, sub. of Becton, Dickinson and Co.

CIRCLE NO. 369

SOLITRODE[®]

—The ultra reliable rectifier.

NOW AVAILABLE IN 3 RECOVERY SPEEDS

RECOVERY SPEED	SERIES	PIV	t_{rr}	FORWARD CURRENT
Normal (BF)	1N5180 & 1N5207	1200	5 u sec.	to 4 Amps
Fast (BFR)	1N5185 to 1N5190	800	150 n sec.	to 4 Amps
Ultra Fast (BFX)		400	75 n sec.	to 4 Amps

NOW AVAILABLE IN 3 FORMS

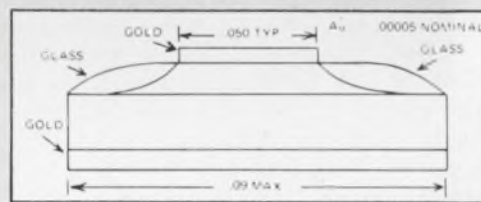

Chip



Stud



Axial Lead twice actual size

SOLITRODE[®] is a void free, double glass passivated rectifier. The outer glass casing withstands temperatures up to 800° C. The inner glass (the one that passivates the junction itself) withstands up to 1000° C.

SOLITRODE[®] exceeds the requirements of MIL-S-19500, and does not exhibit ionic migration.

SOLITRODE[®] is a highly reliable miniature rectifier that performs equally to other devices over 100 times its size.

For specifications and prices, write the address below. Or call 800-431-1850. (It's a local call from anywhere in the U.S.)



256 OAKTREE ROAD,
TAPPAN, N.Y. 10983
TWX: 710-576-2654
TELEX: 13-7346

FREE CALL: 800-431-1850

New Literature

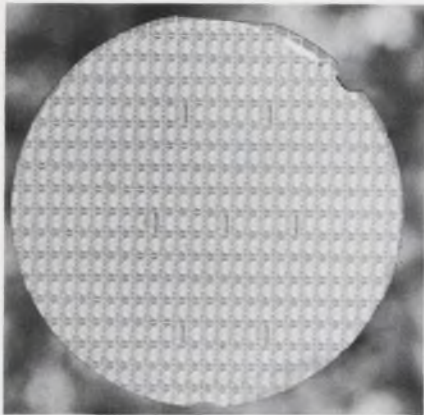

Integrated circuits

A 30-page catalog describes a compatible line of 29 ECL functions that will be available in the first quarter of 1969. Shown for the first time at the Fall Joint Computer Conference in San Francisco, the family will fulfill the high-speed performance requirements of future digital systems. The circuit family, designated the ECL2500 series, features typical propagation delays of 2 to 3 ns per gate. The line consists of 18 basic logic configurations, 3 complex logic functions, 4 interface circuits and 3 storage functions. Also included is a 4-word by 2-bit MSI active-element memory. All circuits will be available in the economical, plastic-encapsulated, dual-in-line packages. Texas Instruments, Inc.

CIRCLE NO. 370

Tone-signal systems

A 16-page booklet describes audio tone signaling and control transmitters and receivers. Equipment is miniature and solid state; no reeds, tuning forks or other mechanical vibrating elements are used. Up to 28 discrete tones may be individually or simultaneously transmitted, resulting in an extremely large monitoring capability of over 100 million discrete codes or combinations. The booklet is replete with application notes and circuits, and gives many examples of signaling, control and monitor functions. Trepac Corp. of America.

CIRCLE NO. 371

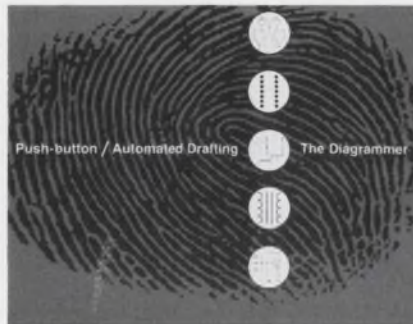

Automated drafting

A new brochure gives details on an automated drafting system. The pushbutton operated system produces printed quality drawings three to four times faster than conventional drafting methods. Drawing speed is up to 30 times faster with tape operation (produced from digitized drawings). Mergenthaler Linotype Co., Automated Drafting Systems.

CIRCLE NO. 372

Pneumatic instruments

A 12-page publication describes the design concepts of a line of small-case pneumatic instruments. The booklet summarizes and illustrates advanced design techniques built into the complete line of controllers, recorders, indicators and auxiliary units. Actual size pictures of the instruments are included. Foxboro Company.

CIRCLE NO. 373

Plastic rivets

Described in a new catalog are one-piece, self-expanding rivets molded from nylon, polystyrene or polyethylene that can be used to fasten any material from paper-board to metal. Installed from the front, the rivets lock themselves in. They are available in many sizes and types of heads including round, bender, truss and counter-sunk. They may also be obtained in decorator colors to match your product. Illinois Tool Works Inc., Fastex Div.

CIRCLE NO. 374

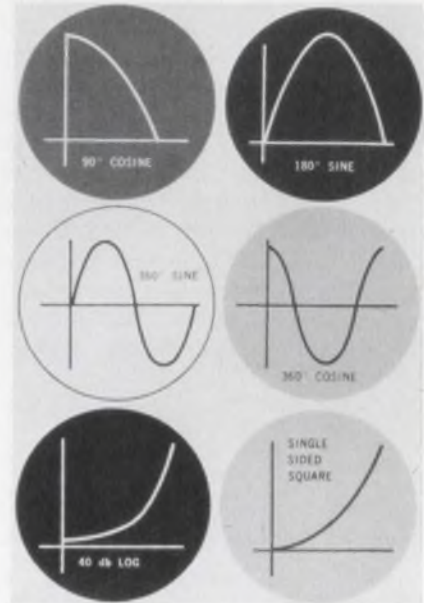

Nonlinear pots

The nonlinear properties of a line of precision potentiometers are depicted graphically in a four-page brochure. Standard nonlinear functions are pictured and complete specifications including circuit diagrams and output equations are given. Bourns, Inc.

CIRCLE NO. 375



Capacitor sample

A capacitor catalog and a free component sample are available to design engineers. Capacitance up to 1500 pF and dimensions as small as 0.31 by 0.23 in. are available in these miniature dipped mica capacitors. This highly stable new unit makes it possible to place up to 40,000 pF in one square inch of board space. Sangamo Electric Co.

CIRCLE NO. 376

Now you can put Powereed* switches to work on your projects.

The Powereed switch is the first reed switch to carry enough current for industrial control circuitry. (Capacity: 360 volt-amps.)

This revolutionary new reed switch is the heart of our ultra-dependable Powereed* relay. And now Powereed switches are available for your use as components.

What's so great about them?

First, hermetically sealed, glass-enclosed contacts. They are immune to gases, liquids and dust. The entire switch is unusually resistant to shock and vibration. So you get an operating life of many millions of operations, even on industrial circuits.

Powereed switches are ideal for high-speed applications. Contacts

open and close in milliseconds. Gold-plated stationary contacts make Powereed switches perfect for dry circuits, too.

Evaluate our Powereed switches fully. See how they can add performance, reliability, and operating life to your projects.

We will help you. Your Cutler-Hammer Sales Engineer will demonstrate Powereed switches, supply you with samples, and provide expert application help.

Just call him, or write us on your company letterhead. If you want more information first, circle the Reader Service number below. Either way, you'll be a lot closer to a breakthrough.

*Trademark of Cutler-Hammer, Inc.

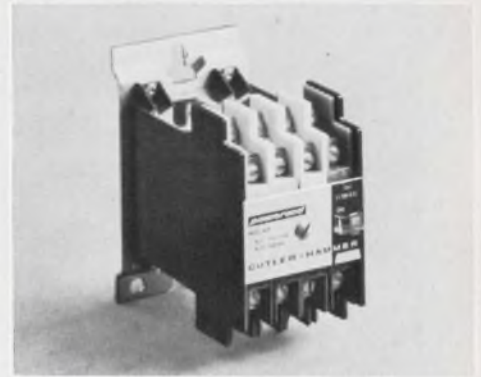

The compact Powereed relay allows you to add or change poles (up to a total of 7 in many combinations). Terminal accessibility and arrangement simplifies wiring.



CUTLER-HAMMER

POWER DISTRIBUTION & CONTROL DIVISION, Milwaukee Wis 53201

INFORMATION RETRIEVAL NUMBER 115

Hire a breakthrough

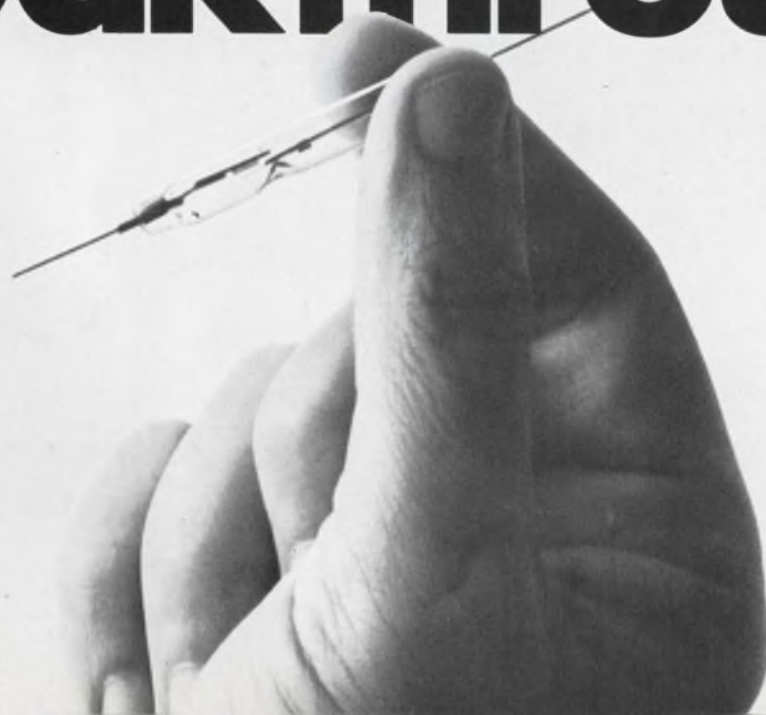

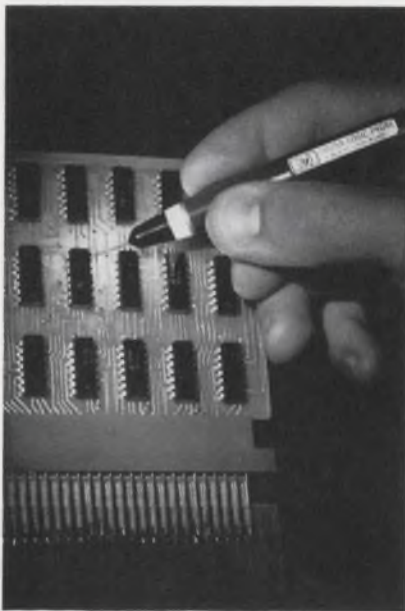

This probe lights up when a pulse goes by.

Even a pulse as short as 30 ns—positive or negative—will cause this logic indicator to flash a signal. You can trace pulses, or test the logic state of TTL or DTL integrated circuits, without taking your eyes off your work. In effect, the probes act like a second oscilloscope at your fingertips.

No adjustments of trigger level, slope or polarity are needed. A lamp in the tip will flash on 0.1 second for a positive pulse, momentarily extinguish for a negative pulse, come on low for a pulse train, burn brightly for a high logic state, and turn off for a low logic state.

The logic probe—with all circuits built into the handpiece—is rugged. Overload protection: -50 to +200 V continuous; 120 V ac for 10 s. Input impedance: 10 k Ω . Price of HP 10525A Logic Probe: \$95, quantity discounts available.

Ask your HP field engineer how you could put this new tool to work in logic circuit design or troubleshooting. Or write Hewlett-Packard, Palo Alto, Calif. 94304; Europe: 54 Route des Acacias, Geneva.

02825A

HEWLETT  **PACKARD**

INFORMATION RETRIEVAL NUMBER 116
158

NEW LITERATURE

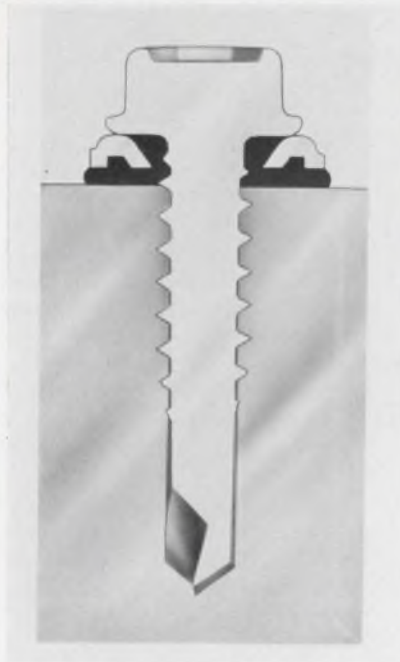

Sealing washers

A four-page bulletin describes a double-seal washer that offers improved sealing and appearance. The washer uses a metal stamping and a molded neoprene sealing element to provide a double seal under the screw head and at the edge of the washer. The sealing material contained under the washer periphery prevents metal-to-metal contact, and thus protects painted materials. Shakeproof, Div. of Illinois Tool Works, Inc.

CIRCLE NO. 396



Lettering catalog

A 48-page dry transfer lettering catalog contains over 100 type styles in hundreds of point sizes from 8 to 180 point—many in several colors. This catalog highlights 18 new fonts available in the dry transfer process. These transfers adhere to any clean surface; just position and rub. Chartpak Rotex.

CIRCLE NO. 377

STABILITY & QUALITY
MATSUO

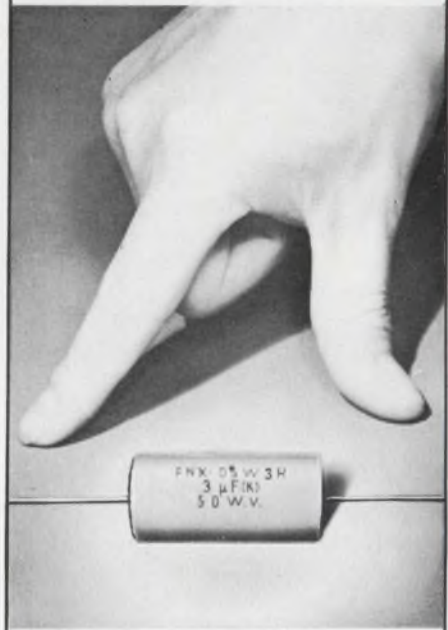

METALLIZED POLYESTER FILM CAPACITOR - "TYPE FNX-H"

Sub-miniature size and oval section ideal for space economy. Lightweight, self-healing and with high insulation resistance. Capacitance values up to 10 MFD. Outer wrap of tough polyester protects against moisture. Perfect in both transistorized and low voltage tube circuits and others where size and cost are paramount.

Specifications:

Operating Temperature Range: -40°C to +85°C

Standard Voltage Rating: 100V, 200V, 400V, 600V

Standard Capacitance Value: .1 MFD to 10 MFD.

Standard Capacitance Tolerance: $\pm 20\%$ (available $\pm 10\%$)

MATSUO'S Other Capacitors Include.
Solid Tantalum Capacitors: MICROCAP

for hybrid ICs, Type TAX hermetically sealed in metallic case, Type TSX encased in metallic case and sealed with epoxy resin, Type TSL encased in metallic case and sealed with epoxy resin
Polyester Film Capacitors: Type MFL epoxy dipped, Type MFK epoxy dipped non inductive, Type MXT encased in plastic tube non inductive.

For further information, Please write to:

MATSUO ELECTRIC CO., LTD.

Head Office: 3-5, 3-chome, Sennari-cho, Toyonaka-shi, Osaka, Japan

Cable: "NCCMATSUO" OSAKA Telex: 523-4164 OSA

Tokyo Office: 7, 3-chome, Nishi-Gotanda, Shinagawa-ku, Tokyo

INFORMATION RETRIEVAL NUMBER 117
ELECTRONIC DESIGN 2, January 18, 1969

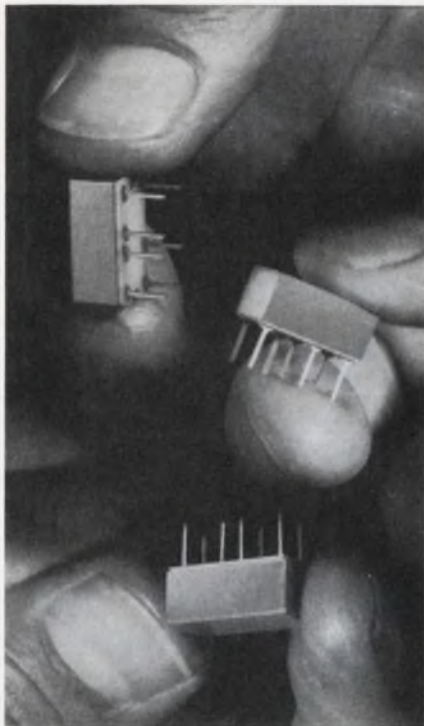

This miniature mercury relay operates in ANY POSITION

It's the new Logcell® Mercury Film Relay and it combines all the advantages of conventional mercury wetted relays with miniature size (0.06 cu. in.), operation in any mounting position, and shock and vibration resistance. Use Logcell Relays in computer logic circuits, precision instrumentation, high speed control systems or wherever you need a relay that offers:

- Long life — tested to billions of cycles
- No contact bounce
- Form "C" SPDT contacts
- Operation in any mounting plane
- Fast operating time — 2.5 ms
- No measurable AC contact noise
- Thermal noise less than 0.2 microvolt
- Switches dry circuits to 2 amps
- Inherent memory — requires no latching current (mono-stable models also available)

For complete information on Logcell Relays — and Switches — write Fifth Dimension Inc., Box 483, Princeton, N. J. 08540 or call (609) 924-5990.



FIFTH DIMENSION INC.
INFORMATION RETRIEVAL NUMBER 118
ELECTRONIC DESIGN 2, January 18, 1969



Quartz accelerometer

Bulletin 327468 details the performance characteristics of the model 801 quartz accelerometer. In addition to complete specifications, the bulletin also contains typical frequency-response and thermal-sensitivity shift curves. An oscilloscope photo shows response to a long duration shock. A block diagram illustrates a typical measurement system. Kistler Instrument Corp.

CIRCLE NO. 378

Wire and cable

Complete technical data both military and commercial types of wire and cable are given in a 46-page catalog. Tables of wire characteristics and a military specification index are also included. Standard Wire and Cable Company.

CIRCLE NO. 379

Conference publications

A listing of 1968 conference publications is now available from the Instrument Society of America. The brochure describes abstracts, preprints, and proceedings of the 23rd Annual ISA Conference and Exhibit held last year in New York. The brochure lists prices and includes an order form. Instrument Society of America.

CIRCLE NO. 380

INFORMATION RETRIEVAL NUMBER 119 ▶

small wonders



Ever wonder who leads the way in miniature toggle switches? Since 1961 ALCO SWITCH has pioneered and introduced hundreds of ideas and the newest switch types that have set the standard for miniatures. Over half-dozen switch families are now available to choose from. Here are a few examples:

MST SERIES — Is the original and most-copied miniature toggle switch in the world. Rated 5 amps @ 115 VAC.

A SERIES — ALCO's newest series incorporates the most-wanted features that make this your "best buy" in miniature toggle switches. Rated 6 amps @ 125 VAC.

E SERIES — The "top of the line" miniature with the waterproof feature that makes it excel over all others. 6 amps @ 125 VAC.

MUSTANG — The miniature switch with the standard switch appearance having 15/32" bushing. Rated 6 amps @ 125 VAC.

ALCO continues to provide you quality features without paying a premium such as solid silver contacts, use of better grade materials, combined mass-production techniques and latest switch technology.

ALCO

ELECTRONIC PRODUCTS, INC.
Lawrence, Massachusetts 01843

SCHAUER

1%

tolerance

1 WATT ZENERS ARE A REAL BUY!

ANY voltage from 2.0 to 16.0
at the industry's **LOWEST
PRICES!**

Quantity	Price each
1-99	\$1.07
100-499	.97
500-999	.91
1000-4999	.86
5000 up	.82



THE HI-RELIABLE!

No fragile nail heads.
Silicon junction aligned between two, parallel, offset tantalum heat sinks . . . great lead tension strength.
All welded and brazed assembly.
High pressure molded package.
Gold plated nickel-clad copper leads.
Write or phone for Form 68-4 for complete rating data and other tolerance prices.

Semiconductor Division

**SCHAUER
MANUFACTURING
CORP.** 4511 Alpine Avenue
Cincinnati, O. 45242
Ph. (513) 791-3030

NEW LITERATURE

Control systems

A fully illustrated eight-page technical bulletin covers a complete line of instruments and systems used in precision level measurement and control. Presented in this new brochure is information on design features, materials of construction, connections, ratings, applications, ranges and pressures. Photographs, charts and schematic diagrams are included. Brooks Instrument Div., Emerson Electric Co.

CIRCLE NO. 381

IC transducers

Depicted in a new catalog is a line of piezoelectric transducers for measuring dynamic pressures. These transducers are built around IC amplifiers, which are also offered for upgrading conventional piezoelectric systems. A short introduction to pertinent technical principles is included. PCB Piezotronics, Inc.

CIRCLE NO. 382

IC data

The new Linear Integrated Circuit D.A.T.A. Book is fully described in a new brochure. In addition to descriptive information regarding the book's content, format, utility, and application, the literature illustrates the various tabular headings which identify the parameters used. D.A.T.A., Inc.

CIRCLE NO. 383

Digital/analog instruments

A six-page brochure on digital/analog system applications is offered free of charge. This two-color brochure gives examples of three system applications utilizing digital/analog instruments. Each application shows a photograph of the unit and a block diagram, plus a complete explanation of what the system is comprised of and what it does. Anadex Instruments Inc.

CIRCLE NO. 384

What do you expect from a high-per- formance matrix switch?

Probably perfection. And here's one that comes pretty close. The Cunningham general purpose, high-performance crossbar switch: **1. Versatile.** Covers the full range of data acquisition requirements. Handles voltages from 1 microvolt to 1000 volts—usable up to 30 MHz. **2. Reliable.** 20-million operations per crosspoint assured. Up to 100-million are common. **3. Readily Programmable.** By every control device from tape to direct computer input.



The Cunningham Crossbar Switch

Switching systems problems? Let our know-how in systems engineering work for you with: **Crossbar switches; McKee random access matrices** for high voltage and current; **reed matrix switches** for high frequencies; **Telefunken OHS (ordinate holding) switches** for low cost applications.

Free Design Data. Request new Data Sheet No. 601. Write or call Cunningham, Carriage St., Honeoye Falls, N. Y. 14472. Phone: (716) 624-2000.

Cunningham
Subsidiary of Gleason Works
Proven capability in engineered
switch products and systems.

Get
**"PLUS
 FEATURES"**

That
 Count...

**PLASTIC
 DIELECTRIC
 CAPACITORS
 TYPE "OF" GLASS CAP**

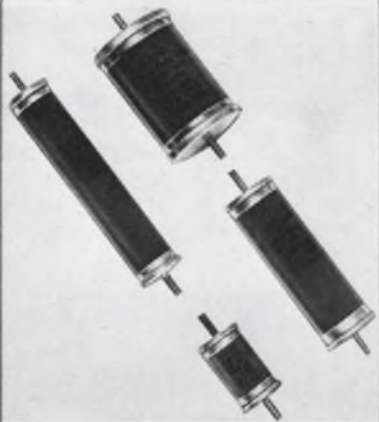

- ★ Continuous operation for 10,000 hours at ambient temperature of 85°C.
- ★ Adaptable to all DC filter applications
- ★ Complete mounting versatility
- ★ Hermetically sealed construction
- ★ Available 2KV to 60KV—capacitance range .0001 mfd. to .5 mfd

Built to precise specifications, Type "OF" capacitors give you more "plus features" that count when quality can and does make the difference. Best of all, most sizes are available in stock to meet your immediate needs.

Write for complete list of Standard High Voltage Capacitors in stock—or, send specifications for custom quotations.



Plastic Capacitors, Inc.

2620 N. Clybourn • Chicago 14, Ill.
 DI 8-3735

Nuclear instruments

Covering a complete line of nuclear instrumentation, a 136-page publication contains detailed descriptions and specifications for semiconductor radiation detectors, ion sources and other plasma-physics products, and electronic nuclear-instrument modules. Considerable space is devoted to discussions, both theoretical and practical, surrounding the use of charged particle and photon spectrometry with semiconductor detectors. The largest segment of the catalog concerns the selection and use of electronic instrumentation. Ortec Inc.

CIRCLE NO. 385

Reliability program

An illustrated booklet describes a high reliability program for transformers and inductors. The booklet defines reliability, as applied to the design, manufacture, and testing of magnetic components, for applications having quantitative reliability requirements. Raytheon Co., Microwave and Power Tube Div.

CIRCLE NO. 386

Thick-film light arrays

Bulletin HEI-100 describes the LA-800-series light arrays. Advantages of thick film arrays over discrete arrays are discussed. Light detector specifications, dimensions, and packaging ideas for custom light arrays are also included and a number of typical applications are suggested. Hybrid Electronics, Inc.

CIRCLE NO. 387

Relay catalog

Technical data and prices on miniature industrial relays are now available in a four-page catalog. These dc-operated electromagnetic relays are dust protected (one model is also available open) and listed in a variety of contact and terminal designs. Hi-G Industrial Products.

CIRCLE NO. 388

**your
 best
 move**

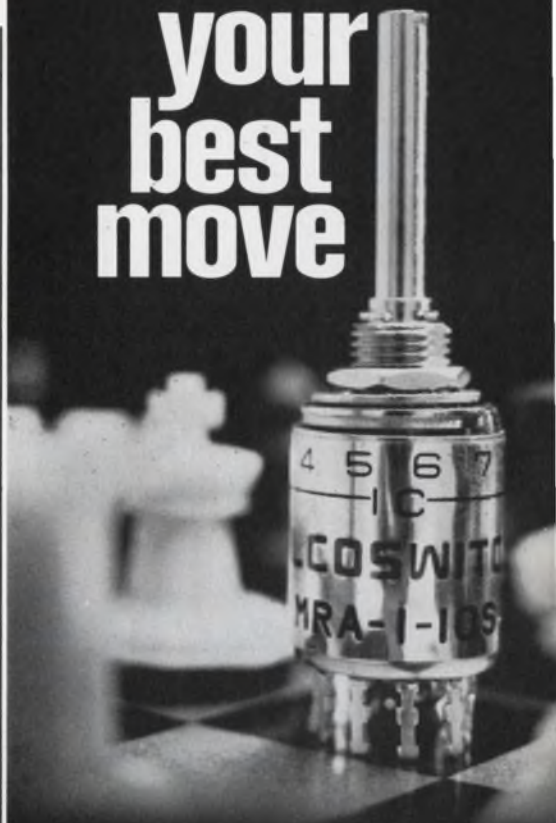

The world's first ultra-miniature 1/2" rotary switch with the invaluable feature of an adjustable stop. The MRA Series is available as 1, 2, 3, or 4 poles on a single deck with a maximum of 10 or 12 positions. You can choose the universal 1/8" diameter shaft, or a switch with its own specially mated knob. Ideal for installations where size and space limitations are a factor. Conservatively rated at 500 mA @ 125 VAC.

The MSRE waterproof rotary switch series is similar to the MRA Series, but built to meet the highest reliability standards required under any environmental condition.



LOCKING TOGGLE

World's first totally miniature toggle switches capable of being locked to safeguard against accidents. Full line available in 1-2-3-4 poles. 6 amps @ 125 VAC.

SLIDE SWITCH

The world's best mini-slide switch with a compact 1/2" case and new anti-tease design. Available in one and two pole, double throw models; 2 amps @ 120 VAC.



ALCO

ELECTRONIC PRODUCTS, INC.
 Lawrence, Massachusetts 01843



ACTUAL SIZE

DO YOU MAKE OR BUY ?

\$60,000 will buy you 1000 M401 multipliers. You could spend 2/3 of that amount making just one modular unit if you designed, tested and produced your own in house. So why not order a single Intronics unit at \$95 — check it out in your system circuit — and let Intronics supply you with your quantity requirements. We can provide low cost solutions to the multiplying function for many applications including the following:

DYNAMIC HORSEPOWER MEASUREMENT
 PHASE DETECTION
 RMS VOLTAGE MEASUREMENT
 CRT DISPLAYS
 AUTOCORRELATION
 SIGNAL MODULATION
 TRIGONOMETRIC COMPUTATION
 SOLID STATE RESOLVER

SPECIFICATIONS

Accuracy 1%
 Linearity Y25%
 Linearity X75%
 Full output (20vp-p) 20kHz
 Small signal response (—3db) 125kHz
 Noise p-p wideband 3mvp-p
 Gain temp. stability03%/°C
 Offset temp. stability 2mv/°C
 XY/10 input/output range ±10V AC or DC
 Power supply requirement ±15V, 12ma
 Price (1-9) \$95.00
 Delivery Stock



TWX 710-335-6835
 (617) 332-7350

57 CHAPEL STREET, NEWTON, MASS. 02158

INFORMATION RETRIEVAL NUMBER 134

NEW LITERATURE

Temperature sensors

Instruments for temperature measurement and control that provide precise temperature sensing from —40 to +150°C are described in a 4-page brochure. Offering single- or multiple-channel operation, these instruments are designed for use with precision interchangeable thermistor probes. A single probe can be used over the entire range, and replacement probes require no special calibration. Details on the thermistor probes are contained in an accompanying 6-page folder. Yellow Springs Instruments Co., Inc.

CIRCLE NO. 389

Optical machine control

A four-page, color brochure describes features and functions of an optically controlled ram turret milling machine. The brochure describes the profiling and positioning control used to ream, mill or drill. Each of the three modes of operation is outlined, and a partial list of specifications is included. Detailed data is also given on the steering head, the offset, speed and depth control. A schematic of the optical-tracing configuration is included. Ex-Cell-O Corporation of Canada Ltd.

CIRCLE NO. 390

Current probes

Current probes for commercial, military, laboratory and related applications are described in an 8-page brochure. The illustrated booklet gives major specifications including frequency range, transfer impedance, and relevant dimensions. The brochure also features an introductory discussion of current probes and their applications —including their use as rfi accessories, general monitoring devices, and as pickup devices or sensors for signal conditioning equipment in telemetry systems. Genisco Technology Corp.

CIRCLE NO. 391

ULTRA-LINEAR V/F OR F/V CONVERSION

NUS



Preserve your data integrity by converting quasi-static DC signals to frequency analogs prior to transmission and back to DC signals for a recording at receiving site with the new rack mounted version of the Ultra-Linear NUS V/F model 7400 or F/V model 7450 . . . with practically NO DEGRADATION OF DATA.

- Linearity .003% Stability .002%/°C.
- Available in single unit bench mount or seven channel rack mount.

For further information and specifications, please contact:

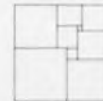

NUS Corporation
 Electronic Systems Division

9 Keystone Place, P.O. Box 248
 Paramus, N. J., 07652 • (201) 265-2400
 INFORMATION RETRIEVAL NUMBER 124

Fingerprints Look Alike . . .



... So Do Resistors! But One Is 6 Ways Better!

Like fingerprints, precision wire-wound and metal film resistors only look alike.

Kelvin precision wire-wound resistors offer:

1. **Faster Deliveries** (down to 4 days on Kelvin "Blue-Line").
2. **Special Temperature Coefficients** (from —50 ppm to +6000 ppm readily available).
3. **Closer Tolerance at Lower Cost** (to .0025% absolute).

Metal films have their place, but Kelvin precision wire-wounds are 6 ways better. Want the other 3 ways? Please call us!



KELVIN
 5919 Noble Ave., Van Nuys, Calif.
 Phone: (213) 782-6662

INFORMATION RETRIEVAL NUMBER 125
 ELECTRONIC DESIGN 2, January 18, 1969



when you think
**HIGH
 VOLTAGE**
 think
**KEPCO
 Hybrid**

The Kepco hybrid technique for taming high voltage uses high voltage tubes in high voltage control circuits and low voltage transistors in small signal gain circuits. A natural division of labor that places no undue strain on any component — the secret of high reliability.



Model HB 4AM — \$365.00

We also get reliability by using hermetically sealed metal can TO-5 transistors plugged into nylon sockets, on coated glass epoxy plug-in circuit boards. Filter capacitors are all high temperature aluminum types; rectifiers are of silicon and all wiring is harnessed. HB models are available from 0–250 volts at 1 ampere to 0–525 volts at a half amp. All have built-in coarse/fine voltage controls and are, additionally, programmable.

For complete specifications, write Dept. AS-5

with **KEPCO**
IT'S CONTROL!



131-38 SANFORD AVE. • FLUSHING, N.Y. 11352

(212) 461-7000 • TWX # 710-582-2631

INFORMATION RETRIEVAL NUMBER 126

ELECTRONIC DESIGN 2, January 18, 1969



High-voltage wire

Literature describing the high-voltage and high-temperature capabilities of a line of silicone wire is available at no charge. This 4-page brochure describes the high resistance of silicone-rubber insulated wire to corona attack and its wide operating temperature range of -65 to 175°C . A wire sample is included. ITT Wire and Cable Div.

CIRCLE NO. 392

Aerospace materials

A colorful 20-page brochure illustrates the capabilities of a variety of specialized non-metallic aerospace materials. These include protective coatings, ablatives and thermal insulating materials, adhesive/sealants, dielectric materials, silicone and fluorosilicone fluids, fluid-film and solid-film lubricants, laminating resins, coupling agents and semiconductor materials. Dow Corning Corp.

CIRCLE NO. 393

Loudspeaker catalog

Catalog 1090-C presents a line of loudspeakers for custom installation and replacement applications. Featured in the catalog is a new special automotive speaker with special waterproofing treatment of the diaphragm and voice coil assembly. Another new product is a special "flame retardant" aircraft speaker, which will be required equipment in many aircraft applications. Jensen Mfg. Div., The Muter Co.

CIRCLE NO. 394

the twisters

The twist of the fingertips tells the user that he is handling quality.

A lot of effort has gone into making these aluminum knobs the best money can buy. ALCOKNOBS have been painstakingly machined and anodized to a high satin finish. A wide choice of stock knobs are now available to compliment your equipment design. All are available at a reasonable cost and competitive to plastics.

Send for the new ALCOKNOB catalog describing a wide variety of stock knobs and with particulars whereby ALCO can customize knobs to create your own individual image.



ALCO

ELECTRONIC PRODUCTS, INC.

Lawrence, Massachusetts 01843

INFORMATION RETRIEVAL NUMBER 127 ▶

Electronic Design

ELECTRONIC DESIGN'S function is:

- To aid progress in the electronics manufacturing industry by promoting good design.
- To give the electronic design engineer concepts and ideas that make his job easier and more productive.
- To provide a central source of timely electronics information.
- To promote two-way communication between manufacturer and engineer.

Want a subscription? ELECTRONIC DESIGN is sent free to qualified engineers and engineering managers doing design work, supervising design or setting standards in the United States and Western Europe. For a free subscription, use the postfree application form inside the back cover. If none is included, write to us direct for an application form.

If you do not qualify, you may take out a paid subscription for \$25 a year in the U.S.A., \$35 a year elsewhere. Single copies are \$1.50 each.

If you change your address, send us an old mailing label and your new address; there is generally a prepaid postcard for this inside the back cover. You will have to requalify to continue receiving ELECTRONIC DESIGN free.

The accuracy policy of ELECTRONIC DESIGN is:

- To make reasonable efforts to ensure the accuracy of editorial matter.
- To publish prompt corrections whenever inaccuracies are brought to our attention. Corrections appear at the end of the Letters column.
- To refuse any advertisement deemed to be misleading or fraudulent.

Microfilm copies are available of complete volumes of ELECTRONIC DESIGN at \$19.00 per volume, beginning with Volume 9, 1961. Work is now in process to complete the microfilm edition of Volumes 1-8. Reprints of individual articles may be obtained for \$2.00 each, prepaid (\$.50 for each additional copy of the same article) no matter how long the article. For further details and to place orders, contact the Customer Services Department, University Microfilms, 300 North Zeeb Road, Ann Arbor, Michigan 48106; telephone (313) 761-4700.

Want to contact us? If you have any comments or wish to submit a manuscript or article outline, address your correspondence to:

Howard Bierman, Editor,
ELECTRONIC DESIGN,
850 Third Avenue,
New York, N.Y. 10022.

Design Data from

NEW RELAY SOCKET ASSEMBLIES CATALOG

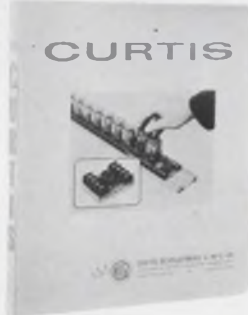

The new Curtis line of printed circuit snap-in track-mounted relay socket assemblies is completely illustrated in this new 2-color, 6 page catalog. Variations include RS8 octal relay sockets, as well as RS11 and RS15 with eleven and fifteen pin relay sockets. Complete dimensional drawings and list prices are included. All units snap in or pop out vertically from prepunched vinyl track and feature Curtis barrier terminal blocks. CSA approved. Send today for your free copy.

Curtis Development & Mfg. Co.
3236 North 33rd Street
Milwaukee, Wisconsin 53216

174

HOW TO SUCCEED WHILE YOU ARE YOUNG

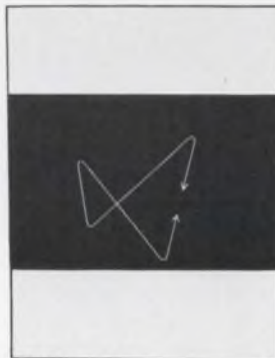

The average engineer — despite a high starting salary — climbs fast but not far. Recent surveys indicate that engineers in the top 10% earn only about 18,500 a year. Middle management men can expect a maximum salary of \$30,000 and young middle managers are still promotable. Engineers, if they have business knowledge, are ideally qualified for the highest rewards in industry. Send for our FREE booklet, "Forging Ahead in Business." It tells you what you must know and what you must do to be a success early in your career.

Alexander Hamilton Institute
235 East 42nd Street
N.Y., N.Y. 10017, Dept. A-918

175

ELECTRONIC DRAFTING AIDS CATALOG



Just published! Bishop Industries' NEW Catalog No. 103. This NEW catalog shows Bishop's complete line of PreKut StikOn drafting patterns and symbols for the electronic/aerospace industries. These patterns save countless hours of repetitive drafting time. Use Bishop's Drafting Aids Systems and save labor, time, money, and achieve perfect exactness every time! Bishop's NEW catalog features pre-printed patterns for integrated circuits, printed circuits, micrologics, flat packs, tape, plus hundreds of symbols for varieties of pads, elbows, corners and dozens of other shapes. Send today for your NEW catalog and sample pack.

Bishop Industries Corp.
7300 Radford Ave.
North Hollywood, California 91605

176

Manufacturers

Advertisements of booklets, brochures, catalogs and data sheets. To order use Reader-ServiceCard.
(Advertisement)

MANUAL ON TRIGONOMETRIC MODULES



A new design manual, illustrating more than 45 applications for trigonometric modules, is available free for engineers.

The "building block" modules, around which the manual is based, allow designers to develop all solid state computing systems. The devices replace synchro or resolver servos or provide interfacing with them.

The manual contains nearly two dozen applications, complete with drawings and diagrams, for analog systems and subsystems and digital applications.

Transmagnetics, Inc.

134-25 Northern Blvd.

Flushing, New York 11354

177

Clamp or Tie Wire Bundles In Seconds!



Six-page catalog contains complete ordering information for CAB-L-TITE® clamps and BUND-L-TITE® straps, devices which provide a fast and reliable means of securing wires and wire bundles. Units withstand loadings greater than 50 G's, are removable in seconds for re-routing wires, and are self-locking—no tying, no knots, no hitches to come loose. Lightweight Du Pont Zytel meets MIL-P-17091 and MIL-P-20693. Proved in aircraft and missiles. Photos, dimensional drawings, tables, physical properties, specifications, price list. Request catalog A.

Dakota Engineering, Inc.

4315 Sepulveda Blvd.

Culver City, California 90230

178

Designing Around Tubing



This six-page article details design considerations in determining whether a particular part should be machined from bar stock, formed from sheet or fabricated from tubing. Drawings and photos show how tubular parts have been designed so that they can be fabricated from tubing at considerable savings.

The data provides design criteria for tubular parts with flanges, bends, beads, flares, expanded ends, ultra-thin walls, turned-in ends and ID-radiused ends. Typical parts cited as fabricated best from tubing include spring contacts, cathode support sleeves, tone arms, and fuel cell nozzles to name a few.

Uniform Tubes, Inc.

Collegeville, Pa. 19426

179

Electronic Design

Advertising Sales Staff

New York 10022

Robert G. Drake
Sales Manager
Edward F. Clancy
Sales Service Manager
Robert W. Gascoigne
Thomas P. Barth
Samuel M. Deitch
Byron Adams
850 Third Avenue
(212) Plaza 1-5530
TWX: 867-7866

Philadelphia 19066

William C. Repetto
P. O. Box 206
Merion Station, Pa.
(215) MA-3-5888

Boston 01945

Richard Parker
P.O. Box 645
Clifton Station
Marblehead, Mass.
(617) 742-0252

Chicago 60611

Thomas P. Kavooras
Berry Conner, Jr.
200 East Ontario
(312) 337-0588

Cleveland

(216) 247-7670

Los Angeles 90303

Stanley I. Ehrenclou
John V. Quillman
W. James Bischof
2930 Imperial Highway
Inglewood, Calif.
(213) 757-0183

San Francisco 94022

Arthur R. Shields, Jr.
175 San Antonio Rd., S 243
Los Altos, Calif.
(415) 941-3084

London W. 1

For United Kingdom & Holland
Brayton C. Nichols
44 Conduit Street
Tel: REGent 4714

Verviers, Belgium

For Continental Europe
Andre Jamar
1, Rue Mallar, 1
(087) 253.83 Telex 41563

Tokyo

Yoshihiro Takemura
IPS Group Ltd.
Box 36, Ohsaki Post Office
Phone (431) 5804



**SUPERIOR
COAXIAL
ATTENUATORS**

**reasonable
price,
medium
power,**



**high
performance!**

With a 5 watt average, 2 kW peak power rating, these DC-12.4 GHz $\frac{1}{2}$ Model 20 Attenuators weigh only 2 ounces. They exhibit long-term, maximum stability. Because of their size and weight, they are ideal for systems use. What's more, they're typically $\frac{1}{2}$ high quality at a competitive price.

$\frac{1}{2}$ Model 20's are available in nine standard nominal values from 3 to 80 dB. VSWR is held to 1.2 maximum to 4 GHz and 1.35 maximum to 12.4 GHz. They are calibrated at DC, 4, 8, and 12 GHz using very-sophisticated $\frac{1}{2}$ insertion loss measuring systems. Calibrations are permanently marked on the attached nameplate; in addition, each attenuator is supplied with a Certificate of Calibration of stated accuracy.

The $\frac{1}{2}$ Model 20 bodies are compactly constructed of lightweight aluminum, while the connectors are semi-precision stainless steel Type N.

Designers and
Manufacturers of Precision
Microwave Equipment

**WEINSCH
ENGINEERING**
Gaithersburg, Maryland

Advertisers' Index

Advertiser	Page	Advertiser	Page
AMP, Incorporated	23	James Electronics, Inc.	146
Alco Electronic Products, Inc.	159, 161, 163	Johanson Manufacturing Corp.	114
Alexander Hamilton Institute	164		
Alfred Electronics	99	Kelvin Co.	162
Allen-Bradley Co.	43, 45	Kepeco, Inc.	163
American Electronic Laboratories, Inc.	102		
American Electronics, Inc.	139	Leach Corporation	167
Amperex Electronic Corporation	83	Lectrohm, Inc., A Subsidiary of	
Arnold Engineering Company, The	38, 39	Cook Electric	116
Automatic Control Division of		Lockheed Electronics Company	127
Cook Electric	117	Lundey Associates, Inc.	138
Augat, Inc.	141		
Atec, Inc.	104		
		McLean Engineering Laboratories	100
Beckman Instruments, Inc.,		Magnetics, Inc.	97
Helipot Division	77	Mallory & Co., Inc., P. R.	55
Beckman Instruments, Inc.,		Matsuo Electric Co., Ltd.	158
Belden Corporation	56, 57	Microdot, Inc.	34, 35
Bishop Industries Corp.	164	Miller Company, J. W.	118
Bourns, Inc.	46	Molex Products Company	79
Bowmar Instrument Corporation	124, 125	Monsanto Company	14
Bulova Electronics Division of		Motorola Communications &	
Bulova Watch Company	29	Electronics, Inc.	95, 142
Burr-Brown Research Corporation	90	Motorola Semiconductor Products, Inc.	12
Burroughs Corporation	20	Mullard, Inc.	134
		Multimeters, Inc.	134
CML, Inc.	128		
Caddock Electronics	137	National Semiconductor Corporation	4, 5, 7
Chartpak Rotex, A Division of		Nytronics, Inc.	31
Avery Products Corp.	126	Nus Corporation	162
Chronetics, Inc.	133		
Cinch-Graphik, Division of United-Carr	40	Pastorizia Electronics, Inc.	44
Cinch Manufacturing Company	27	Philips Electronic Measuring Instruments	137
Clare & Co., C. P.	109	Plastic Capacitors, Inc.	161
Clevite Corporation,		Pomona Electronics Co., Inc.	132
Piezoelectric Division	145	Potter & Brumfield Division of American	
Components, Inc., Capacitor Products	131	Machine & Foundry Company	120, 121
Computer Devices	149	Power/Mate Corp.	141
Computer Products	112	Premier Microwave Corporation	140
Cunningham, Subsidiary of Gleason Works	160		
Curtis Development & Mfg. Co.	164	RCA Electronic Components and	
Cutler-Hammer	157	Devices	28, 93, 113, Cover IV
		RCA Institutes, Inc.	94
Dakota Engineering, Inc.	165	Radiation, Incorporated	85
Dale Electronics, Inc.	Cover III		
Damon Engineering, Inc.	24	S. D. S. A.	145
Datascan, Inc.	115	Sealectro Corporation	107
Delco Radio, Division of		Shauer Manufacturing Corp.	160
General Motors	68, 69	Signetics Integrated Circuits, A	
Dialight Corporation	154	Subsidiary of Corning Glass Works 6, 103, 147	
Du Pont Co.	104 A	Simpson Electric Company	130
		Singer Company, The—Metrics Division	119
Eastman Chemical Products, Inc.	133	Solitron Devices, Inc.	155
Elco Corporation	81	Spectrol Electronics Corporation	148
Electronic Design	89, 110	Sprague Electric Company	18
Electronic Measurements, A Division of		Stackpole Carbon Company	135
Rowan Industries	8	Sylvania Electric Products, Inc.,	
Electronic Research Associates, Inc.	154	Semiconductor Division	75
Electrovert, Inc.	146	Syston-Donner Corporation	2
Emerson & Cuming, Inc.	144		
		T & A Mfg. Corp.	138
Fairchild Semiconductor, A Division		Tektronix, Inc., Oscilloscopes	48
Fairchild Camera and Instrument	16, 17	Teledyne Relays, A Teledyne Company	13
Corporation		Teleproducts, Inc.	101
Fifth Dimension, Inc.	159	Telonic Instruments, A Division of	
		Telonic Industries, Inc.	96
Gencom Division, Whittaker Corp.	149	Texas Instruments Incorporated,	
General Radio Company	1	Components Group	32A-F
		Theta Instrument Corporation	153
Hewlett-Packard	Cover II, 9, 158	Transitron Electronic Corporation	111
Hi-G, Inc.	33	Transmagnetics, Inc.	165
Hitchner Mfg. Co., Inc.	98	Trygon Electronics, Inc.	148
Honeywell, Computer Control Division	123	Tyco Laboratories, Inc.	122
Hughes Aircraft Company,			
Connecting Devices	60, 61	U. S. Capacitor Corporation	106
		Uniform Tube Inc.	165
IEEE	126		
IRC, Division of TRW, Inc.	10, 11	Varo Inc.	136
Interdyne, Inc.	143	Victoreen Instrument Division	105
International Electronic Research		Vitramon, Incorporated	108
Corporation	151	Weinschel Engineering	166
International Rectifier Corp.	129		
Intronics, Incorporated	162	Zippertubing Corp., The	142

Career Advertising

Honeywell	88
Lockheed-California Company	86
Lockheed Missiles & Space Company	88

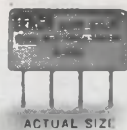

ACTUAL SIZE

. Our new 150 Grid, Series G relays are only 0.32" high. You can stack more PC boards in a given height and increase the packing density of components. The Series G is a sealed, mil-spec, 2 amp, 2 pdt unit—54% smaller and 52% lighter than 1/2 size crystal can relays. Complete details are in our new Bulletin 3200. Write for it. Leach Corporation Relay Division, Dept. A, 5915 Avalon Blvd.,

LEACH

Los Angeles, Calif. 90003.
(213) 232-8221

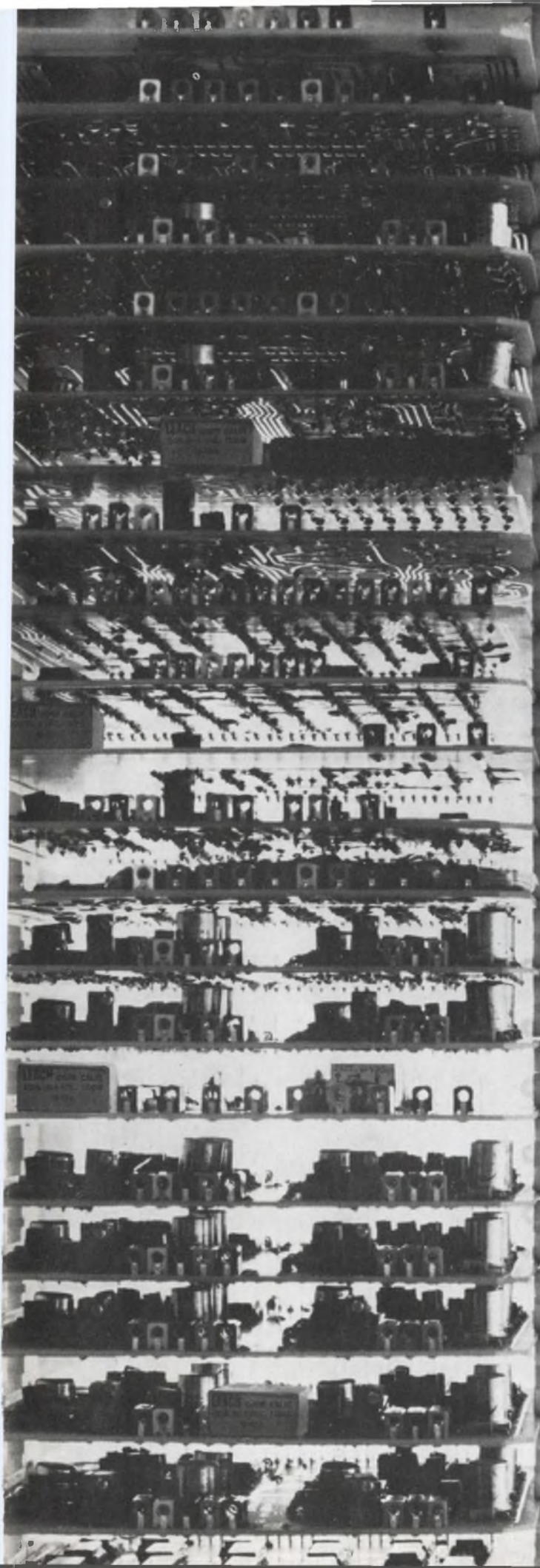

J61
J60
J59
J58
J57
J56
J55
J54
J53
J52
J51
J50
J49
J47
J48
J46
J45
J44
J43
J42
J41
J40

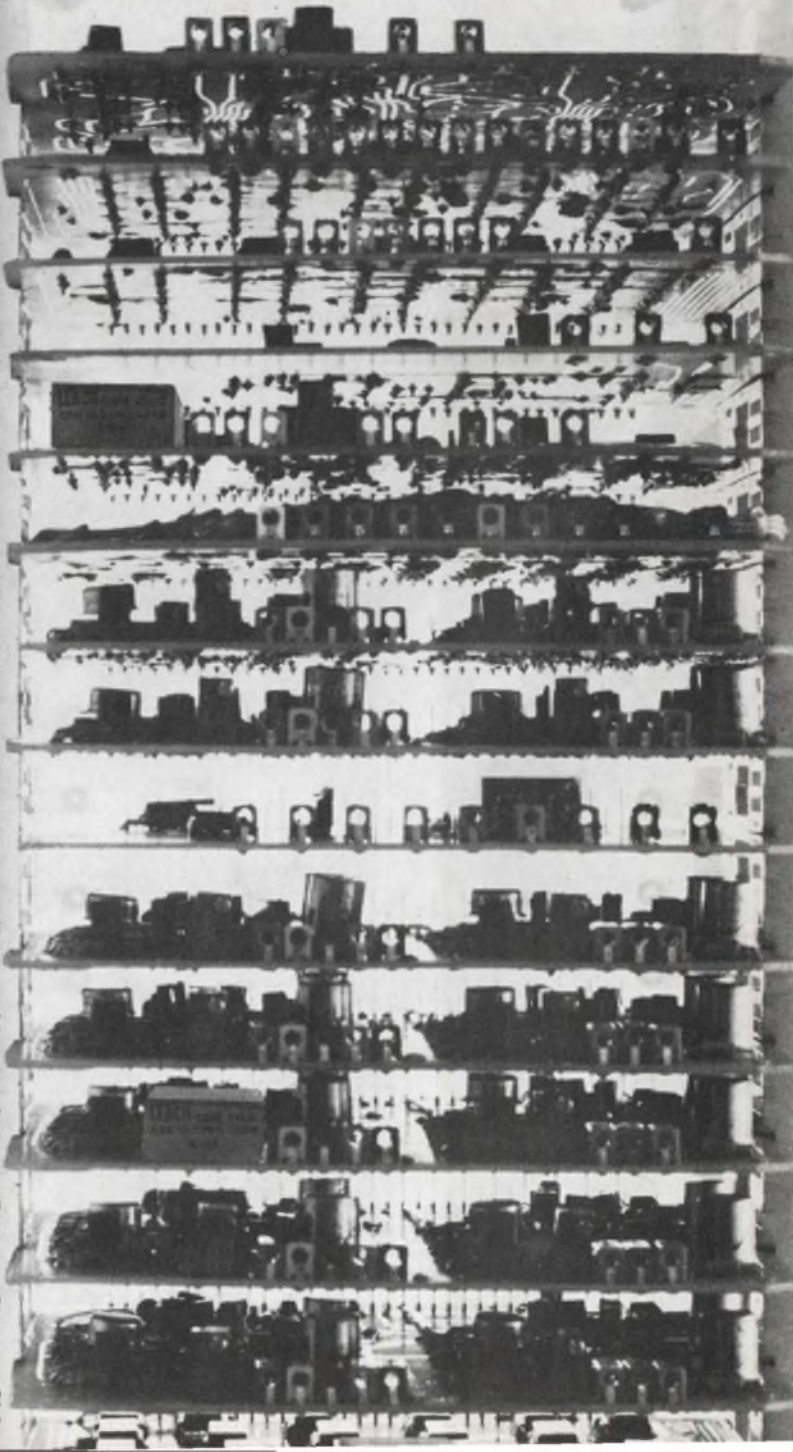

Information Retrieval Service

All products, design aids (DA), application notes (AN), new literature (NL), and reprints (R) in this issue are listed here with Page and Information Retrieval numbers. Reader requests will be promptly processed by computer and mailed to the manufacturer within three days.

Category	Page	IRN	Category	Page	IRN	Category	Page	IRN
Components			sensors, temp (NL)	162	389	processor, PC	146	344
capacitors (NL)	156	376	signal systems (NL)	156	371	stripper, thermal	149	348
components (NL)	161	386	spectrum analyzer	100	255			
fuses, 50- μ s	130	296	testers (AN)	152	358			
ICs and relays (AN)	152	362	transducers, IC (NL)	160	382			
indicator, fluid flow	134	324	VOM, digital	102	257			
indicators	132	298						
integrators, modular	132	299	Microwave & Lasers			New Literature		
loudspeakers (NL)	163	394	capacitors, chip	116	273	aerospace materials	163	393
pots, nonlinear (NL)	156	375	circulators, ferrite	118	279	accelerometer	159	378
relay, diaphragm	132	321	detectors, IR (AN)	152	356	arrays, thick-film	161	387
relays, TO-5	130	297	generator, Ku-band	117	276	capacitors	156	376
switches (AN)	152	363	laser, portable	121	282	component reliability	161	386
switches, pushbutton	132	322	laser, diode arrays	121	283	control systems	160	381
trigger tube, 5-kA	134	323	laser pulser	116	274	d/a systems	160	384
			power (AN)	152	360	drafting, automated	156	372
Data Processing			spectrum analyzer	121	280	instrument papers	159	380
buffer, computer-tape	128	295	switch, coax	118	277	integrated circuits	156	370
computer, small	125	288	switch, shutter	121	281	lettering, transfer	158	377
computer, terminal	124	287	switch, X-band	117	275	loud speakers	163	394
converter, a/d	124	286	tees, microwave (AN)	154	365	milling machine	162	390
converter, d/a	122	285	varactors, high-Q	118	278	nuclear instruments	161	385
converter, scan	128	292				pneumatic instruments	156	373
converter/scanner	125	289	Modules & Subassemblies			pots, nonlinear	156	375
converters, d/a	128	294	drive modules	136	328	probes, current	162	391
d/a systems (NL)	160	384	driver/receivers	140	335	relays	161	388
data coupler	128	292	logarithmic notes (AN)	152	364	rivets, plastic	156	374
graphics terminal	122	284	monitor, voltage	140	332	temperature sensors	162	389
memory, high-speed	126	290	multiplier, analog	136	325	tone-signal systems	156	371
transmitters, data	126	291	multiplier, analog	138	329	transducers, IC	160	382
			multipliers (AN)	152	357	washers, sealing	158	396
ICs & Semiconductors			op amp	138	330	wire, HV	163	392
amplifiers, audio	105	262	op amp, hybrid	136	327	wire and cable	159	379
amplifier, MOS/bipolar	105	261	op amp, low-power	140	334			
arithmetic hybrid	104	260	op amps	140	333			
arrays (NL)	161	387	power supply	136	326			
comparator, voltage	114	271	relay, solid-state	138	331			
diodes, zener	106	264	relays (NL)	161	388			
drivers, quad	112	268						
FETs, dual	112	269	Packaging & Materials			Application Notes		
hybrid IC design (AN)	155	368	cable, flat woven	144	340	absorption spectroscopy	152	361
ICs (NL)	156	370	cable, coax	144	342	accelerometers	155	369
ICs, logic	106	263	contacts, fork	142	337	detectors, IR	152	356
op amp	108	266	epoxy, conductive	142	338	hybrid IC design	155	368
regulator, voltage	104	259	fasteners (DA)	150	354	ICs and relays	152	362
regulator, voltage	114	270	PC design (AN)	154	366	logarithmic notes	152	364
switch/driver, quad	112	267	plastics chart (DA)	150	351	multipliers	152	357
translator, voltage	108	265	rfi shielding (DA)	150	352	PC design	154	366
transistors, 60-A	114	272	rivets, plastic (NL)	156	374	power, parametric	152	360
			seals, static (AN)	152	359	recorders	155	367
			tape, heat-sealable	144	339	seals, static	152	359
			tubing, flat cable	144	341	switches	152	363
			washers (DA)	150	355	tees, microwave	154	365
			washers, sealing (NL)	158	396	testers, transistor	152	358
			wire, HV (NL)	163	392			
			wire and cable (NL)	159	379			
			wires, embedded	142	336			
Instrumentation								
accelerometer (NL)	159	378	Production			Design Aids		
accelerometers (AN)	155	369	control systems (NL)	160	381	cutting speed tables	150	350
counter, 125-MHz	98	254	controller, fluidic	148	347	drafting samples	150	353
counter, computing	92	250	cutter, gasket	146	343	fasteners	150	354
counter-timer	96	252	lead trimmer	148	346	plastics chart	150	351
electrometer	96	251	mixing system, epoxy	146	345	rfi shielding	150	352
generator, function	102	258	prober, 24-point	149	349	washers	150	355
instrument papers (NL)	159	380						
nuclear instruments (NL)	161	385						
oscillator, stepping	100	256						
oscilloscope, 7-in.	98	253						
probes, current (NL)	162	391						
recorders (AN)	155	367						

Competitively priced

Dale Econo-Trims

let you choose wirewound or film T-Pots in both 3/4" and 1" styles – sealed or unsealed!



3/4" ECONO-TRIM

2400 SERIES/WIREWOUND 8400 SERIES/FILM

SPECIFICATIONS

Dimensions: .31" H x .16" W x .75 L

Standard Resistance: 2400 = 10 ohms to 50K ohms; 8400 = 10 ohms to 2 Megohms

Resistance Tolerance: 2400 = $\pm 10\%$;
8400 = $\pm 10\%$ 100 ohms thru 500K ohms,
 $\pm 20\%$ all other values

Power Rating: 2400 = 1 watt at 40° C;
8400 = .75 watt at 25° C

Operating Temperature Range: –55° C to 125° C

Mechanical Adjustment: 20 turns nominal

Mechanical Stops: None. Clutch permits overtravel without damage

Models: Sealed or unsealed with gold-plated PC terminals

DALE ELECTRONICS, INC.

1336 28th Avenue, Columbus, Nebr. 68601
In Canada: Dale Electronics Canada, Ltd.



1" ECONO-TRIM

2300 SERIES/WIREWOUND 8300 SERIES/FILM

SPECIFICATIONS

Dimensions: .36" H x .28" W x 1.00" L

Standard Resistance: 2300 = 10 ohms to 50K ohms; 8300 = 10 ohms to 2 Megohms

Resistance Tolerance: 2300 = $\pm 10\%$;
8300 = $\pm 10\%$ 100 ohms thru 500K ohms,
 $\pm 20\%$ all other values

Power Rating: 2300 = 0.5 watt at 25° C;
8300 = .75 watt at 25° C

Operating Temperature Range: –55° C to 105° C

Mechanical Adjustment: 15 turns nominal

Mechanical Stops: None. Clutch permits overtravel without damage

Models: Sealed or unsealed. Gold-plated PC terminals or gold-plated hook type solder lugs

DALE ELECTRONICS, INC.

1336 28th Avenue, Columbus, Nebr. 68601
In Canada: Dale Electronics Canada, Ltd.

You can do more with
Dale T-Pots... call 402-564-3131 today



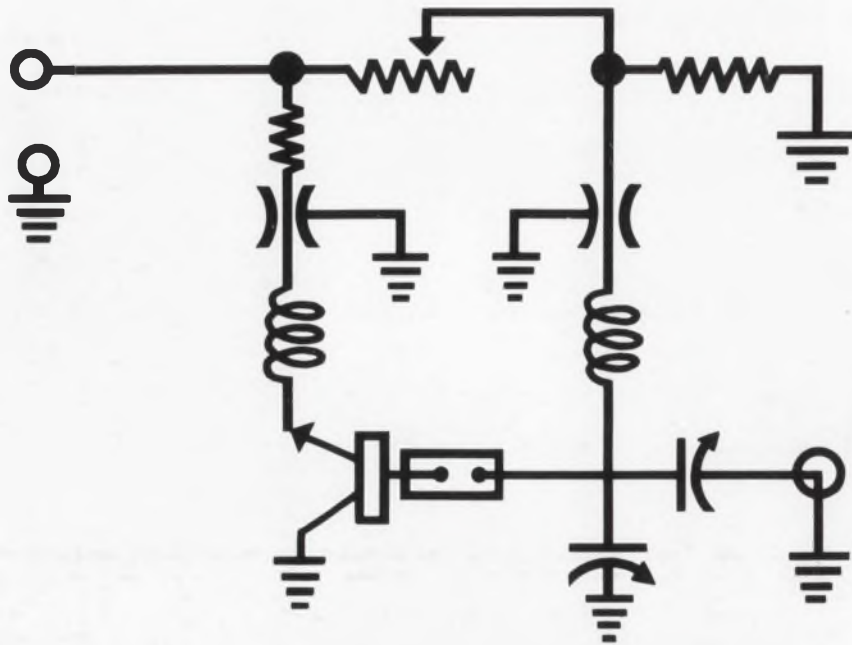

TA7403 is a new configuration... designed especially to simplify oscillator circuitry. Featuring 0.5 watt output at 2 GHz (at 21 V operation), this all-new RCA epitaxial silicon n-p-n transistor will be especially attractive to designers looking for a device that acts as a superior self-excited oscillator at L-band and higher microwave frequencies.

Incorporating all the advantages of the RCA-developed "overlay" structure, RCA developmental type TA7403 is a compact unit in a hermetically-sealed ceramic-to-metal coaxial package... a package that features very low inductances and low parasitic capacitances. This is the industry's first unit that lends itself to cavity, stripline, and "lumped" constant circuits.

Here, then, is definitely a transistor intended primarily for simple oscillator circuits. TA7403 will find applications in such areas as: local oscillator for receivers, microwave power source—low power klystron replacement, sonde oscillator.

For more information on RCA-TA7403, see your RCA Representative. Ask him, too, about RCA-2N5470 for your UHF and microwave amplifier applications. For technical data, write: RCA Electronic Components, Commercial Engineering, Section PG-1-2, Harrison, N.J. 07029.

A Microwave
Fundamental
Frequency
Oscillator
Circuit is as
simple as
RCA-TA7403
"overlay" can
make it



RCA