

# Electronic Design 25

VOL. 16 NO.

FOR ENGINEERS AND ENGINEERING MANAGERS

DEC. 5, 1968

**Upgrade your a/d converter IQ** and reap the rewards of improved system performance. It's all a matter of selecting an appropriate conversion technique and then

implementing it with the right components. For a comprehensive analysis of a/d converter design, whether for use in a steel mill, below, or elsewhere, see p. 49.





# Pulsepower

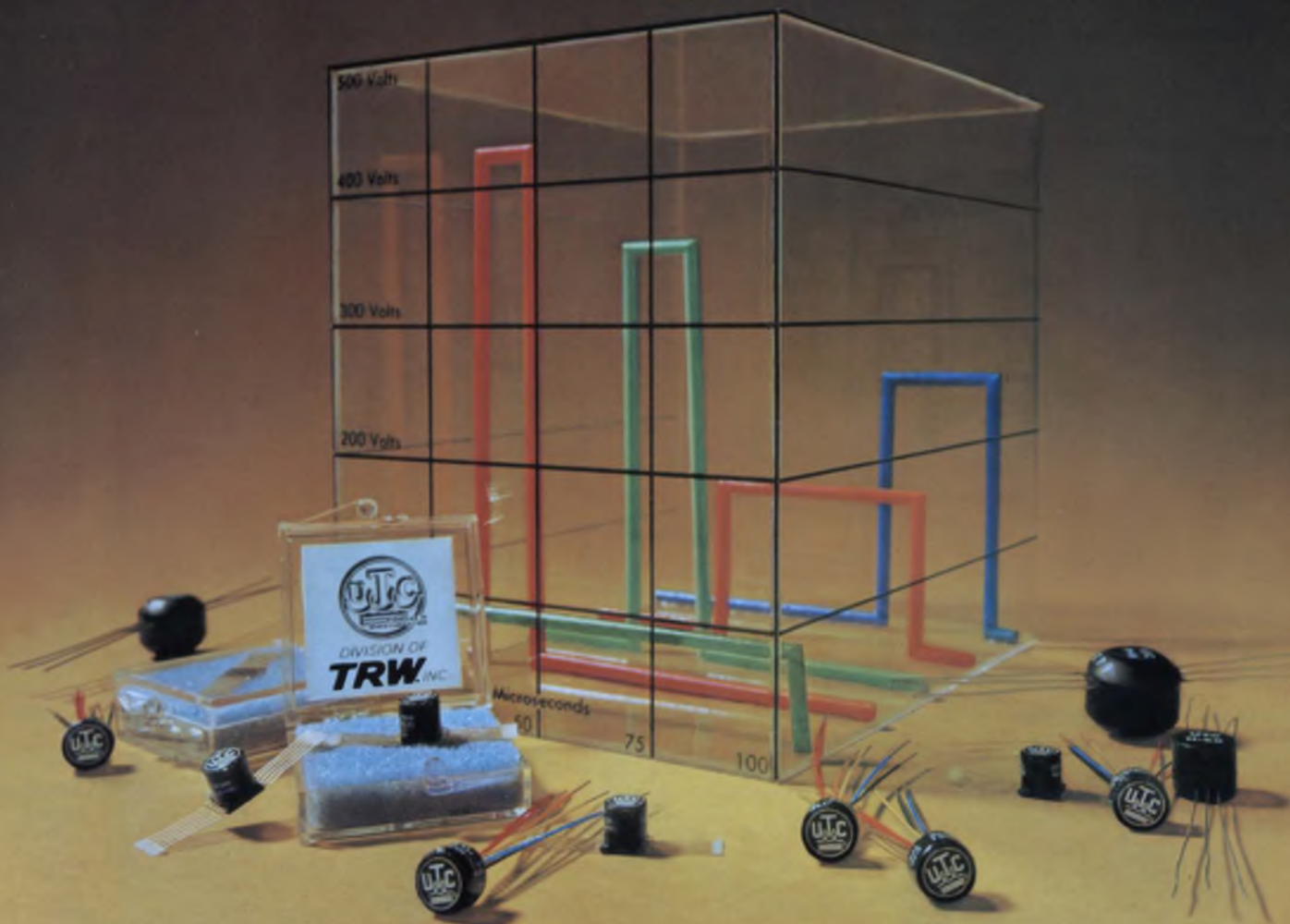

## UTC miniature transformers assure high pulse integrity at ET constants exceeding 7500 volt-microseconds

The high ET constants of UTC miniature pulse transformers give you fast rise time plus low droop at highest peak-power for size in the industry. That's pulsepower.

UTC's BIT-P and PIP standard lines are the smallest metal-encased pulse transformers made. Unique structures, plus manufacturing controls, enable UTC pulse transformers to achieve high flux densities and unrivalled temperature stability. All units are individually adjusted in a standard blocking oscillator circuit, assuring parameter uniformity unavailable elsewhere.

UTC's broad lines cover most pulse applications. Note particularly: use in high-gain, low-level, high-density packaged circuits made possible by high shielding of units; SCR di/dt failure reduction due to fast rise time and high pulse-

energy capability. The units are also suitable for wide-band applications of 1 kHz to 100 MHz.

UTC's metal-encased standard lines exceed MIL Grade 6 (MIL-T-21038B). They're ruggedized, hermetically sealed, and electromagnetically shielded. Molded units to MIL Grade 7, Class S temperature (+130°C), are available with a dielectric strength of 1250 volts. Where special parameters are needed we'll tailor them to your circuits.

When your design calls for pulsepower—high pulse integrity—UTC has the answer. Check your local distributor for immediate off-the-shelf delivery, or contact United Transformer Company, Division of TRW INC., 150 Varick St., New York, New York 10013.

**TRW**  
UNITED TRANSFORMER COMPANY

In quartz oscillators,  
 what more **?** could you ask  
 for than high **?** stability,  
 great spectral **?** purity and  
 fast **●** warm-up?

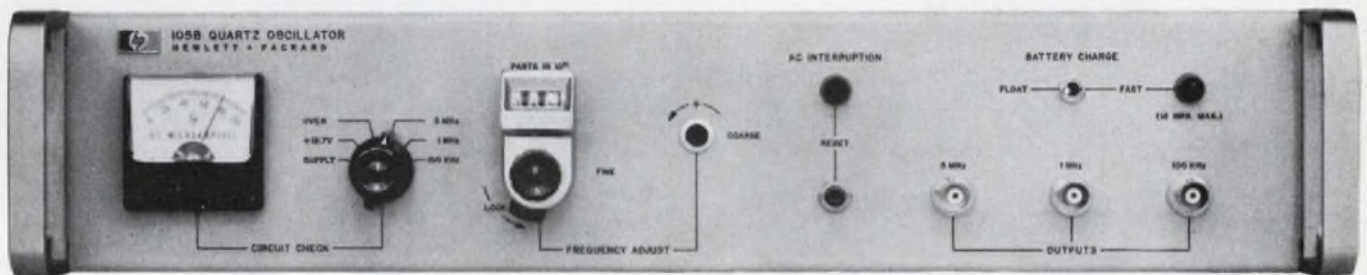

How about phase-locking,  
 small size  
 and lowest price?

That's right. The new Hewlett-Packard 105A/B Quartz Oscillators combine all these features to create the best buy for your precision quartz oscillator requirement. Short-term stability is better than one part in  $10^{11}$  rms for 1-sec averaging time. Output typically reaches  $1 \times 10^{-7}$  of final frequency in 30 minutes; aging rate of  $5 \times 10^{-10}/24$  hours after full warm-up.

S/N exceeds 90 dB. Rated output is 1 V rms

into  $50\Omega$ . Outputs are 5 MHz, 1 MHz, 100 kHz sine wave and 1 MHz or 100 kHz clock drive. Height is only  $3\frac{1}{2}$ "; 105A weighs only 16 lbs.

Price: 105A, \$1500; 105B (8-hour standby battery supply), \$1800.

Call your local HP field engineer or write Hewlett-Packard, Palo Alto, California 94304; Europe: 54 Route des Acacias, Geneva.

HEWLETT  PACKARD

FREQUENCY STANDARDS

INFORMATION RETRIEVAL NUMBER 2



# 100A Pulse Generator

for an EXTRA MEASURE of rep rate, width, and delay.

Slower Rep Rates / Wider Widths / Longer Delays

More  
champagne  
pulses for beer  
budgets

\$470.00 F.O.B. Factory

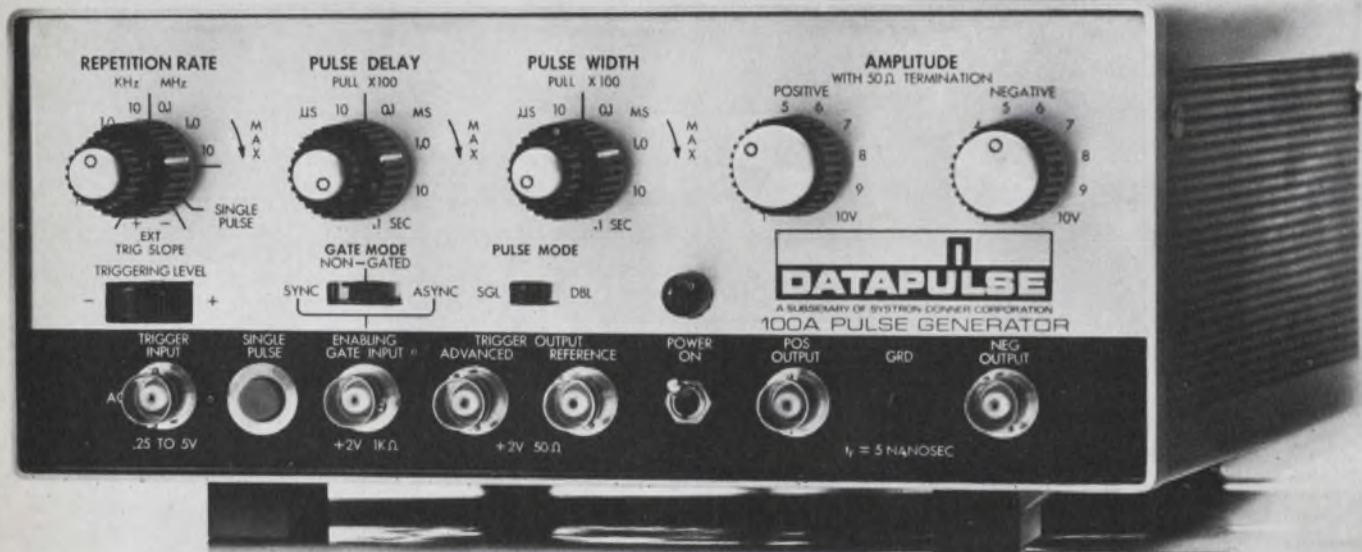

Extra wide range width, delay, and repetition rate plus all the features found on the compact, low cost, widely used Datapulse 101, are yours in the NEW Datapulse 100A Pulse Generator.

**SPECIFICATIONS:** Width and delays from 35 ns to 10 seconds. Rep. rates from one cycle every 10 seconds to 10 MHz. Single or double pulses. 5 ns rise time.  $\pm 10V$  simultaneous outputs. Duty cycles to 70%.  $\pm 400mV$  trigger sensitivity. Synchronous and asynchronous gating.

Anything the Datapulse 101 can do, the 100A can do as well or better. The 100A can be used to generate stable pulse bursts, to gate digital signals, and to count down rep rate. Power control circuit design, storage and recovery time studies, and beacon interrogation are typical applications.

Extended range capabilities of the 100A are useful in medical, biological, and geophysical research. The unit is also ideal for instructional purposes in university and school laboratories.

The 100A is as portable as a book. One unit weighs but eight pounds. Two units can be rack mounted in only 3½ inches of panel height. Single unit rack mount leaves adjacent space for data source or system controls.

Low cost of the 100A is as refreshing as paying for beer and getting champagne. Complete specifications (available on request) should exhilarate you. But the most powerful demonstration is a demonstration. Ask your Datapulse representative to set one up today! Datapulse Inc., 10150 W. Jefferson Boulevard, Culver City, California 90230. Telephone: 213-836-6100. TWX: 910-340-6766

**DATAPULSE**  
A SUBSIDIARY OF SYSTRON-DONNER



---

## NEWS

- 21 News Scope
- 25 **Problem: How to power the artificial heart?**  
Rechargeable storage approach is being considered for today; implanted fuel cell and isotopes for the future.
- 28 **Light-sensitive flip-flops read holograms**  
New storage array accepts optical data, provides fast random access and nondestructive readout.
- 32 Old satellite to test Einstein theory
- 33 TWT device interest grows
- 39 Washington Report
- 42 Sidelights of the Issue
- 45 **Editorial: Trend toward obfuscation breeds "irreproducible results."**

---

## TECHNOLOGY

- 49 A practical guide to a/d conversion: Part One
- 50 Parallel-feedback a/d converters
- 58 Serial-feedback a/d converters
- 74 **Speed immittance calculations.** A computer takes the sweat out of figuring the impedance or admittance matrix of interconnected networks.
- 80 **Cut synthesizer current consumption.**  
Use this marker-synchronized phase-lock loop technique and avoid high-speed divide-by-N counters.
- 92 Ideas for Design

---

## PRODUCTS

- 102 **ICs & Semiconductors:** Surface-passivated all-diffused UJTs are MIL-qualified.
- 104 **Components:** IC-compatible rotary switch packs 10 positions in 5/16-in.
- 112 Instrumentation
- 116 Microwaves & Lasers
- 124 Modules & Subassemblies
- 128 Data Processing
- 132 Packaging & Materials
- 136 Production

---

## Departments

- 14 Designer's Datebook
  - 88 Books
  - 138 Design Aids
  - 140 Application Notes
  - 142 New Literature
  - 150 Advertisers' Index
  - 152 Information Retrieval Service
- Information Retrieval Service Card inside back cover



# There's a new computer

Multi-Application Computer. That's MAC. And for \$11,950, MAC's 16-bit words say a lot.

Take versatility. MAC handles nearly any application. Highly I/O compatible, it integrates easily into your system. Its basic 4K memory is expandable to 65K words, all usable. It has 4 priority interrupt levels—the only true-nesting interrupts in its class—expandable to 64 levels.

MAC also has 72 basic hardware instructions and offers a raft of hardware options. Multiplex data channel. Direct memory access channel. Multiply/divide. And more.

Then there's speed. MAC is the fastest computer in its class. Memory cycle time, 1 microsecond. Add, 2  $\mu$ s. Full-word shift, 5  $\mu$ s. Interrupt response, 6  $\mu$ s.

## Meet

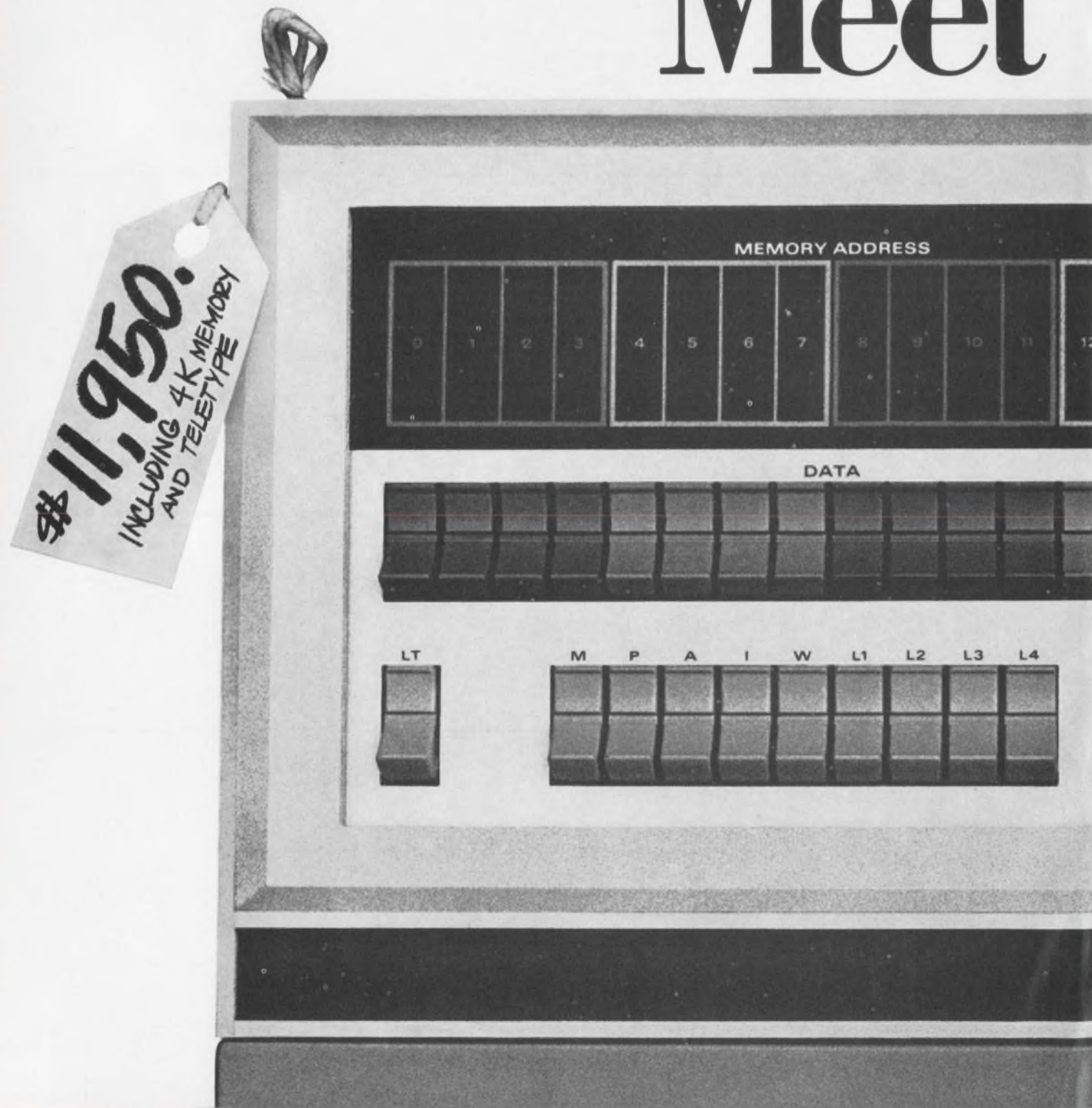



# on the block.

As for software, MAC doesn't play hard to get. Documentation and software are ready *now*. All checked out and debugged. LEAP, MAC's assembler, has nested macros and pseudo-ops, plus a relocating, linking loader. MAC also offers 2 unique advantages: LEAPFORT, the assembler in FORTRAN IV, lets you create new programs on large machines. And MACSIM lets you simu-

late operation without disturbing MAC's work.

Of course this is only an introduction to MAC. For full details write MAC, Lockheed Electronics Company, Data Products Division, 6201 East Randolph Street, Los Angeles, California 90022.

**LOCKHEED ELECTRONICS COMPANY**

A Division of Lockheed Aircraft Corporation

INFORMATION RETRIEVAL NUMBER 4

# MAC

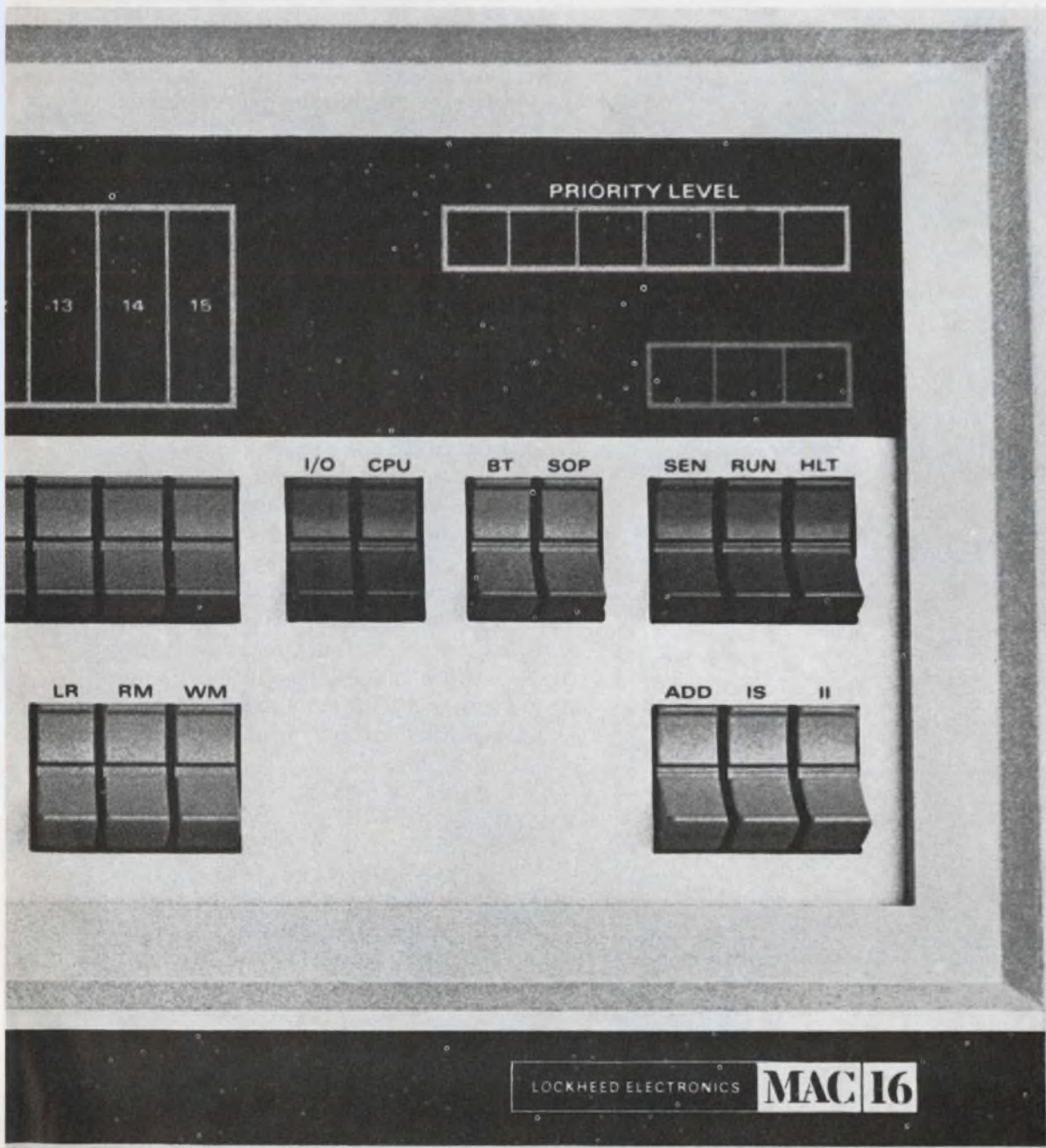

Let  
MAC  
do it.



# 16 FET SOLUTIONS TO CHOPPER PROBLEMS

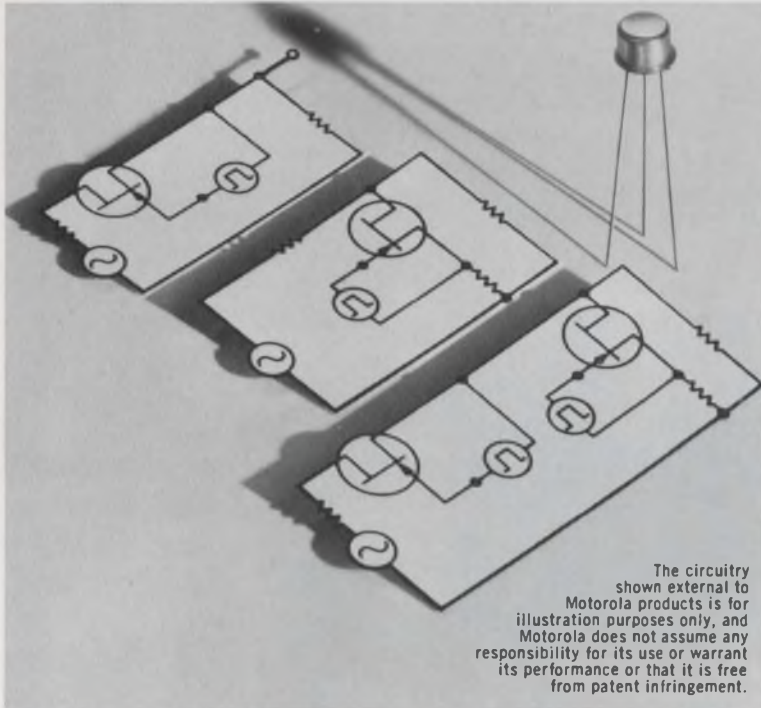

Remember when the best way to convert a dc signal to ac was by using a relay as the chopper element? Although suitable for low dc levels the mechanical choppers required high-drive power, were subject to wearout, and performed poorly under extreme environmental conditions. Along came the transistor which required lower drive power, had no moving parts, operated at higher frequencies, and sustained environmental extremes in stride. But even the transistor had disadvantages. Compensation was needed for the inherent offset voltage and floating drive circuits were required for isolation. Introduction of FET choppers combined the best features of mechanical and transistor choppers. FETs offered the advantage of no inherent offset voltage and did not require isolated drives.

Motorola now introduces 16 new N-Channel JFETs in the TO-18 package. These devices are tailor-made for chopper applications as mentioned above and also in demodulator, gating and sampling circuits. Circuit designers concerned with switching speed and output levels will appreciate the low drain-source "on" resistance (as low as 10 ohms, max.). Leakage currents as low as 0.2 nA produce minimum error voltages in output circuits.  $C_{iss}$  and  $C_{rss}$  characteristics are minimal insuring optimum chopper action. Check the specs for the type that best fits your particular application.

TYPE	$r_{ds(on)}$ OHMS (max)	$C_{iss}$ (pF) $f = 1 \text{ MHz}$	$C_{rss}$ (pF) $f = 1 \text{ MHz}$	$V_{(BR)GSS}$ Vdc	$I_{DSS}$ mA	$V_{DS(on)}$ Vdc	Price (100-up)
MFE2004	80	16	5	30	8	0.4	\$2.00
MFE2005	50	16	5	30	15	0.4	2.70
MFE2006	30	16	5	30	30	0.4	3.70
MFE2007	40	30	15	25	8	0.75	2.80
MFE2008	30	30	15	25	20	0.75	3.50
MFE2009	20	30	15	25	50	0.75	4.50
MFE2010	25	50	20	25	15	0.75	3.50
MFE2011	15	50	20	25	40	0.75	5.00
MFE2012	10	50	20	25	100	0.75	6.50
2N4091	30	16	5	40	30	0.2	4.10
2N4092	50	16	5	40	15	0.2	3.10
2N4093	80	16	5	40	8	0.2	2.30
2N4391	30	14	3.5	40	50-150	0.4	4.30
2N4392	60	14	3.5	40	25-75	0.4	3.30
2N4393	100	14	3.5	40	5-30	0.4	3.80
2N5555	150	5	1.2	25	15	1.5	0.80

Send for a complete data sheet of one or all of the above types. We'll also include our Application Note on Field-Effect Transistors in Chopper and Analog Switching Circuits.

*PS.* Your nearby franchised Motorola Semiconductor distributor has these "chopper problem solvers" available and waiting. Call him.

- where the priceless ingredient is care!



**MOTOROLA**  
Field-Effect Transistors

MOTOROLA SEMICONDUCTOR PRODUCTS INC., P.O. BOX 20912 / PHOENIX, ARIZONA / 85036

INFORMATION RETRIEVAL NUMBER 5

INFORMATION RETRIEVAL NUMBER 6 ►

# Get Fast, Low-Cost Total Harmonic Distortion Measurements

There are several ways you can make total harmonic distortion measurements:

1. Eyeball approach using oscilloscope which is accurate enough for some applications.
2. Point-by-point measuring using wave analysis which is often too slow, involves needless expense for unused capability and requires you to calculate THD.
3. Plot information using spectrum analysis which is again needlessly expensive for the job... and you still must calculate THD.

OR, you can use HP 333A or 334A distortion analyzers and cut your measurement time from minutes to seconds. Simply set your level, tune, and flip the auto-nulling switch to

AUTOMATIC. The instrument does the rest! It automatically and accurately completes the nulling—typically > 80 dB rejection. It will also track drifting and unstable signals!

Use the all-solid-state HP 333A or 334A where you need fast measurement of harmonic distortion of fundamentals between 5 Hz and 600 kHz—harmonics up to 3 MHz. Measure voltage up to 3 MHz.

Not only do these analyzers save you money by cutting measurement time, their initial cost is less than other measurement methods. HP 333A costs \$865 and HP 334A is \$895.

Both instruments have a high pass filter that can be switched-in to provide pure distortion measurements of signals greater than 1 kHz without 60 cycle and harmonics. With

the 334A RF detector, you can measure audio envelope distortion from 550 kHz to 65 MHz.

HP 331A and 332A Distortion Analyzers have all these features except automatic nulling and high-pass filters. (Price HP 331A, \$650; HP 332A, \$680.) HO5-332A and HO5-334A meet FCC requirements on broadcast distortion measurements. (Prices on request)

Cut your distortion measurement time with fast, low cost HP 333A or 334A. Consult your HP Instrumentation Catalog for full specifications on distortion analyzers. Order the instrument of your choice by calling your nearest HP order desk. For data sheets, write Hewlett-Packard, Palo Alto, California 94304. Europe: 1217 Meyrin-Geneva, Switzerland.

099/3  
**HEWLETT  PACKARD**  
SIGNAL ANALYZERS





**How do you  
improve on  
an Op Amp  
like the  
LM 101?**

COMPARISON OF THE TYPICAL INPUT OFFSET CURRENT OF THE LM101A WITH THE 709 AND LM101.

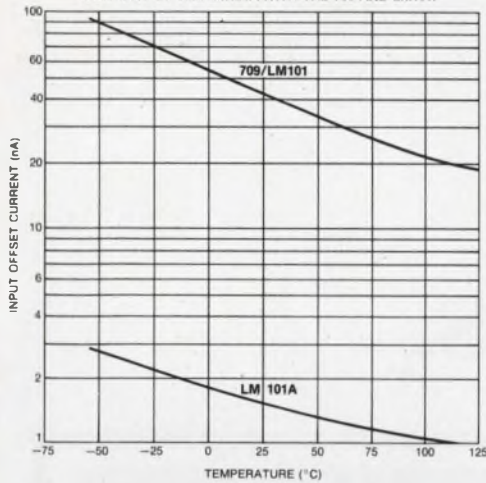

COMPARISON OF THE TYPICAL INPUT BIAS CURRENT OF THE LM101A WITH THE 709 AND LM101.

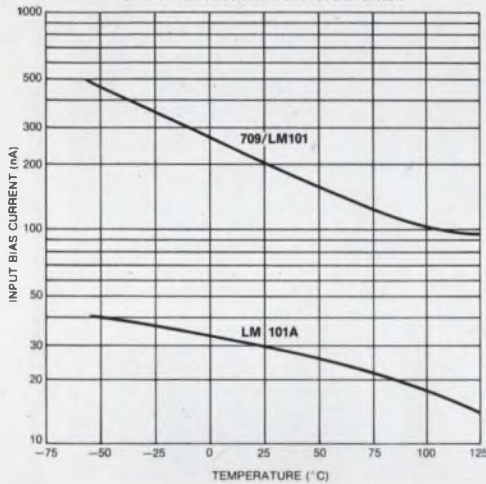

An order of magnitude improvement. The LM 101A has every advantage of the LM 101, but with 20 nA offset current and 100 nA bias current guaranteed over a  $-55^{\circ}$  to  $125^{\circ}\text{C}$  temperature range.

With this device, we also guarantee offset voltages of 3 mV, offset voltage drifts of  $15\mu\text{V}/^{\circ}\text{C}$  and offset current drifts of  $0.2\text{ nA}/^{\circ}\text{C}$ . Again over the  $-55^{\circ}$  to  $125^{\circ}\text{C}$  mil range. The offsets are specified over the common mode range and both the common mode and supply rejection have been improved. A new processing technique gives the LM 101A lower noise and input currents, and the input stage biasing has been changed to reduce temperature drift.

None of the other 101 basics have changed. You still get frequency compensation with just one 30 pF capacitor. Insensitivity to oscillations with capacitive loads or loose supply by-passing. Overload protection on the input and output. No latch up modes. All the good things. Completely interchangeable with old LM 101.

The price is right, too. \$30.00 from 100 pieces. And \$12.00 in the commercial/industrial version, LM 201A.

Write for the details. National Semiconductor Corporation, 2975 San Ysidro Way, Santa Clara, California 95051 (408) 245-4320.

**National Semiconductor**

# the LM 101A



# The product improvers.

Improved N-channel FET choppers from TI feature lower capacitances for reduced feedthrough plus faster chopping and switching.



Here's the new look in FET chopper transistors from TI. A new design gives significantly lower  $C_{iss}$  and  $C_{rss}$ .

These lower capacitances reduce feedthrough of the input signal into the output line. Faster chopping and switching are other results.

In addition to the improved 2N4856A-61A series, this family now includes 2N3970-72, 2N4091-93, and 2N4391-93 FETs, as well.

Use of any or all of these FET "product improvers" will mean big dividends for you...in upgraded performance and reduced costs.

You won't have to wait, either, because production quantities are immediately available.

So don't put off evaluation any longer. Call your TI sales engineer or distributor now. Or, for data sheets, write on your company letterhead to Texas Instruments Incorporated, P.O. Box 5012, MS 980-A Dallas, Texas 75222.

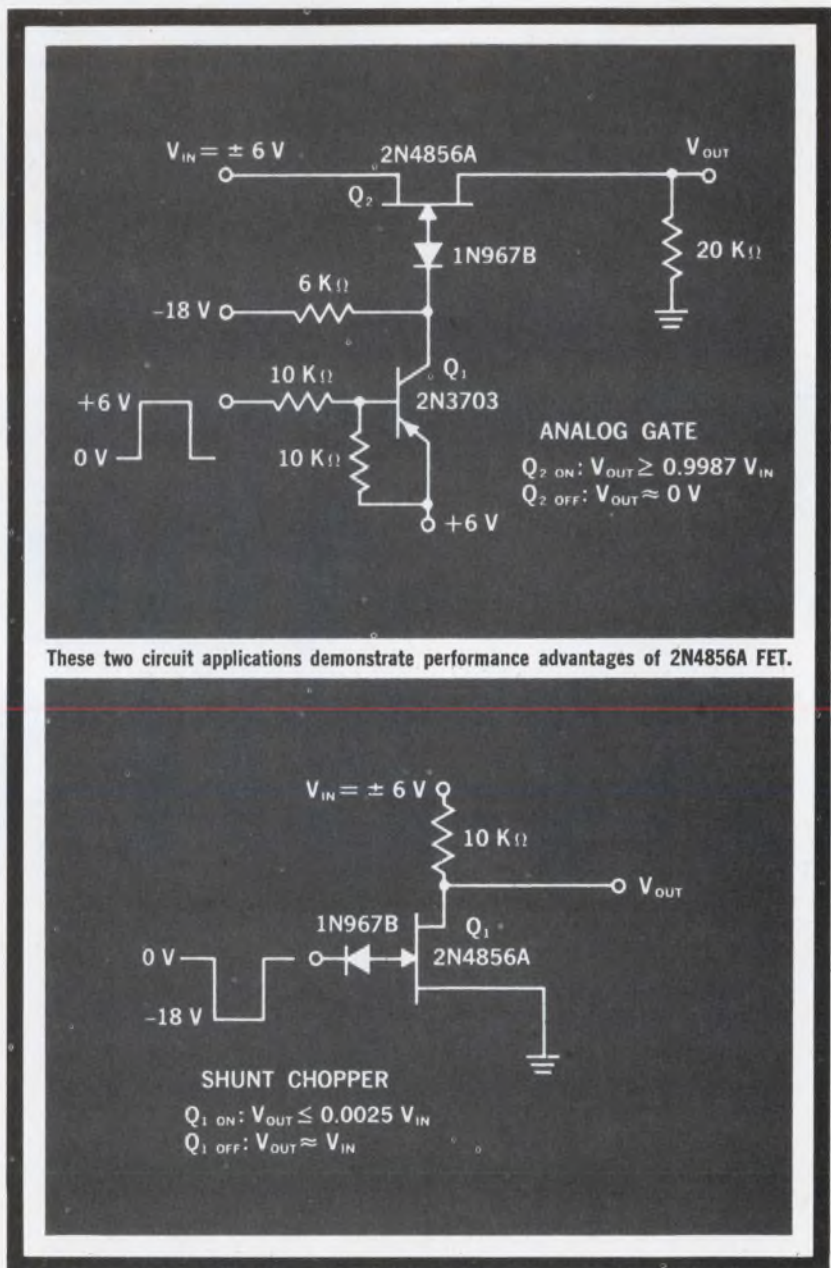

**TEXAS INSTRUMENTS**  
 INCORPORATED

# our subminiature relay line:

## If you make electronic things (to MIL-R-5757), this is your group

**SERIES D** (10 amp, 2 pdt)—Most compact welded relay for use where size and performance are critical. 50g shock, 20g vibration.

**SERIES CL** (10 amp, 2 pdt)—Magnetic latch, all-welded relay. 50g shock, 20g vibration.

**SERIES E** (2 amp, 2 pdt)—All-welded half size relay for dry circuit/low level and 2 amp switching. 100g shock, 30g vibration.

**SERIES G** (2 amp, 2 pole)—All-welded, 150 grid relay only 0.32" x 0.310" x 0.610". 100g shock, 30g vibration.

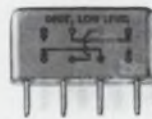

SERIES G quantities available October 1st.

## If you make electrical things (to MIL-R-6106), this is your group

**SERIES J** (10 amp, 2 pdt)—Balanced-Force\* relay for DC current. 100g shock, 30g vibration.

**SERIES JA** (10 amp, 2 pdt)—Balanced-Force\* relay for AC current. 100g shock, 30g vibration.

**SERIES K** (10 amp, 4 pdt)—Balanced-Force\* relay for DC current. 100g shock, 30g vibration.

**SERIES C** (10 amp, 2 pdt)—50g shock, 20g vibration.

**SERIES KA** (10 amp, 4 pdt)—Balanced-Force\* relay for AC current. 100g shock, 30g vibration.

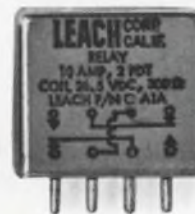
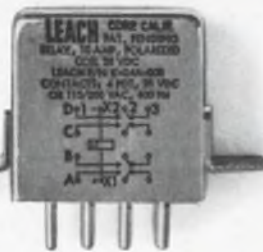

\*Patent Pending.

Complete specs are yours for the asking. Write Leach Corporation, Relay Division, 5915 Avalon Boulevard, Los Angeles, California 90003. Telephone: (213) 232-8221.

# LEACH

INFORMATION RETRIEVAL NUMBER 8



# microtopics

product news from Philco-Ford Microelectronics

## MIL Cerdip IC Packaging Makes Sense, Saves Dollars

On new MIL logic circuits you're designing, forget flat packs. You can cut costs without cutting corners by going to modern CERDIP packaging, in full temperature rating from  $-55^{\circ}\text{C}$  to  $+125^{\circ}\text{C}$ .

Philco-Ford CERDIP packages cost no more than flat packs. They save substantially on production costs, because they're far more convenient to handle, insert and connect. Their hermeticity has been proved by qual-

ification testing, and their quality is assured by the most extensive inspection procedures in the industry.

We're the people with long CERDIP experience. Immediately available in this preferred style are our Series 930 DTL gates, buffers, expanders, flip-flops and multivibrators . . . and Series 9620 TTL gates, expanders and flip-flops.

INFORMATION RETRIEVAL NUMBER 211

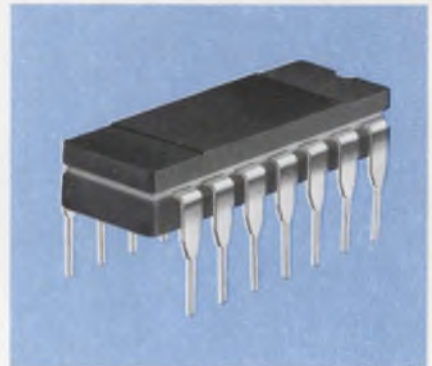

## Photo-Detectors? — We cover the spectrum

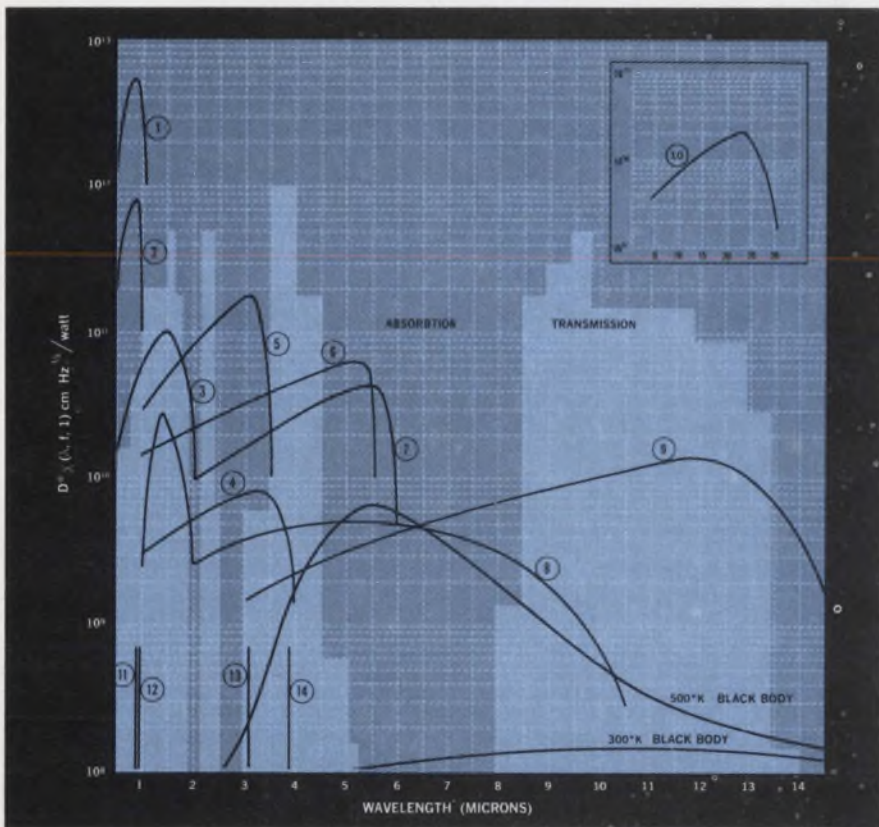

1 Si (PV), 300°K	4 InAs (PV), 300°K	8 Ge (Au) (PC), 77°K	12 GaAs EMITTER 300°K
2 GaAs (PV), 300°K	5 InAs (PV), 196°K	9 Ge (Hg) (PC), 30°K	13 InAs EMITTER 77°K
3 Ge (PV), 300°K	6 InSb (PV), 77°K	10 Ge (Cu) (PC), 4°K	14 InAs EMITTER 300°K
	7 InSb (PC), 77°K	11 GaAs LASER 77°K	

(PV) indicates photovoltaic. (PC) indicates photoconductive.

\*Line indicates region of spectral emission and is independent of the vertical axis.

Pick the portion of the spectrum where you want your guidance, surveillance, communications or instrumentation system to operate. Visible or IR. Anywhere from 0.4 to 30.0 microns. Then pick your detector from the field-proved Philco-Ford line, the most comprehensive in the industry.

INFORMATION RETRIEVAL NUMBER 212

### MOS products now consolidated at Lansdale plant

Consolidation of engineering, manufacturing and testing of Philco-Ford MOS integrated circuits at our Lansdale plant is going ahead at full speed. A broad line of standard 128, 250 and 256 Bit shift registers, 1024 read-only and various read-write memories, multiplexers, A/D and D/A circuits will soon be in full production. Watch for MOS news from Philco-Ford!



# Take the fast, economical Hybrid route to miniaturizing discrete circuits



TO-8

### One month later

Prototype delivered. Two weeks more and full-scale production. Performance: electrically equal to or better than discrete version. Superior under shock, vibration and constant acceleration.

If you are looking for a fast, low cost way to miniaturize circuits . . . can't afford the time, tooling costs and operational limitations of monolithics . . . will pay about the same cost as discretives . . . are ready to sit down in *your* office and talk about your circuit and delivery requirements, we'll send a specialist to you.

INFORMATION RETRIEVAL NUMBER 213

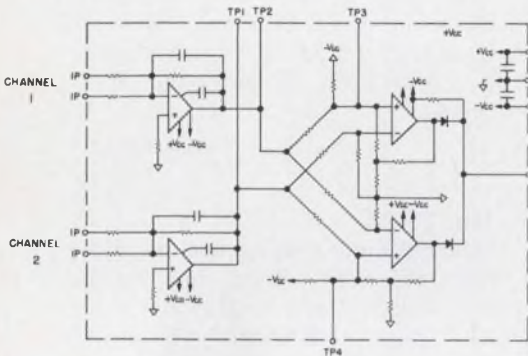

### The circuit

#### Dual Channel Comparator

Design engineer supplied this circuit and detailed delivery information. Philco hybrid specialist and design engineer agreed on . . .

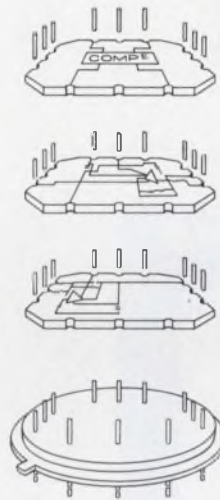

### Partitioning

They came up with a three layer hybrid to optimize cost/performance. The go ahead was given, and . . .

# Axial-lead switching diodes offer lowest dynamic resistance

Through the use of advanced processing techniques, we are now making a line of glass-package, axial-lead high-speed switching diodes with the lowest dynamic resistance available anywhere. They use an improved substrate with lower resistivity, and at the same time maintain breakdown in excess of 80 volts. They make possible microwave switching assemblies with lower insertion loss and higher isolation than previously possible.

Available in production quantities, the new diodes have been widely used in switching applications through  $K_u$  band, at speeds of less than 1 nanosecond. They have been qualified for use in a number of military airborne systems.

Take a look at the performance of our new "A" series diodes. They're even better than our standard models, which equal or exceed any on the market. Dynamic resistance values are shown at 40 ma. drive current; lower resistances are obtained at higher currents.

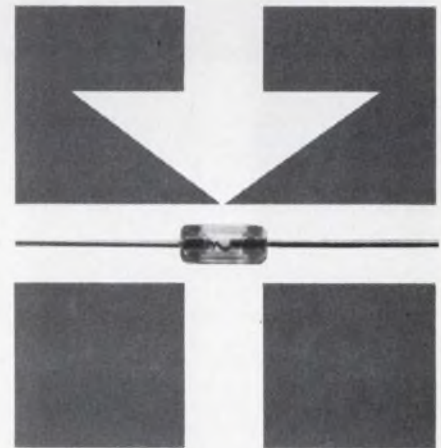

INFORMATION RETRIEVAL NUMBER 214

Type	Capacitance (max.)		Dynamic Z <sub>f</sub> @ 40 ma	
	pF @ 20V		New "A" Series	Standard Models
L8700	0.2		1.5	2.5
L8701	0.1		2.0	3.0
L8702	0.09		2.5	4.0
L8703	0.08		3.0	5.0
L8704	0.07		5.0	6.0



# A Smart Way to Beat Your Power Supply Size Problem



# abbott

1½" thin, 2¾" short, yet this converter produces 1000 volts DC, regulated, from a battery input of 28 VDC! It weighs less than 15 ounces. This is only one of our wide variety of many small light weight converters, inverters and power supplies — there are over 3000 models listed in our newest catalog, including size, weight, and prices. If you have a size problem, why not send for an Abbott catalog?

**MIL SPEC ENVIRONMENT** — All of the power modules listed in our new catalog have been designed to meet the severe environmental conditions required by modern aerospace systems, including MIL-E-5272C and MIL-E-5400. They are hermetically sealed and encapsulated in heavy steel containers. New all silicon units will operate at 100°C.

Please write for your FREE copy of this new catalog or see EEM (1968-69 ELECTRONIC ENGINEERS MASTER Directory), Pages 1727 to 1740.

**abbott transistor**

LABORATORIES, INCORPORATED

5200 W. Jefferson Blvd./ Los Angeles 90016  
(213) WEBster 6-8185 Cable ABTLABS

**RELIABLE** — Highest quality components are used in Abbott power modules to yield the high MTBF (mean time between failure) as calculated in the MIL-HDBK-217 handbook. Typical power modules have over 100,000 hours MTBF — proving that the quality was built in from the beginning.

**WIDE RANGE OF OUTPUTS** — Any voltage from 5 volts DC to 10,000 VDC is available by selecting the correct model you need from our catalog with any of a variety of inputs including:

- 60Ω to DC, Regulated
- 400Ω to DC, Regulated
- 28 VDC to DC, Regulated
- 28 VDC to 400Ω, 1φ or 3φ
- 60Ω to 400Ω, 1φ or 3φ

TO: Abbott Transistor Labs., Inc., Dept. 57  
5200 West Jefferson Blvd.  
Los Angeles, California 90016

Sir:  
Please send me your latest catalog on power supply modules:

NAME \_\_\_\_\_ DEPT. \_\_\_\_\_  
COMPANY \_\_\_\_\_  
ADDRESS \_\_\_\_\_  
CITY & STATE \_\_\_\_\_

# Designer's Datebook

JANUARY						
S	M	T	W	T	F	S
			1	2	3	4
5	6	7	8	9	10	11
12	13	14	15	16	17	18
19	20	21	22	23	24	25
26	27	28	29	30	31	

FEBRUARY						
S	M	T	W	T	F	S
						1
2	3	4	5	6	7	8
9	10	11	12	13	14	15
16	17	18	19	20	21	22
23	24	25	26	27	28	

For further information on meetings, use Information Retrieval Card.

## Jan. 21-23

**Reliability Symposium** (Chicago). Sponsor: J. E. Condon, Office of Reliability & Quality Assurance, NASA Hdqrs., Washington, D.C. 20006

CIRCLE NO. 401

## Jan. 23-24

**International Conference on Systems Sciences** (Honolulu). Sponsor: IEEE; Univ. of Hawaii; F.F. Kuo, Dept. of EE, 2565 The Mall, Univ. of Hawaii, Honolulu, Hawaii 96822

CIRCLE NO. 403

## Jan. 26-31

**Winter Power Meeting** (New York City). Sponsor: IEEE; J. W. Bean, American Electric Power Service Corp., 2 Broadway, New York, N.Y. 10004

CIRCLE NO. 404

## Jan. 28-31

**International Symposium on Information Theory** (Ellenville, N.Y.). Sponsor: David Slepian, Dept. of Transportation, Washington, D.C. 20006

CIRCLE NO. 402

## Feb. 10-11

**Transducer Conference** (Washington, D.C.). Sponsor: IEEE; H. P. Kalmus, Harry Diamond Labs., Dept. of the Army, Washington, D.C. 20438

CIRCLE NO. 405

## Feb. 19-21

**Solid-State Circuits Conference** (Philadelphia). Sponsor: IEEE; Univ. of Pennsylvania; L. Winner, 152 W. 42 St., New York, N.Y. 10036

CIRCLE NO. 406

# Here's something you should look into

## INSTRUMENTATION DESIGN AND APPLICATIONS (Continued)

**SOURCES OF ERROR**

When choosing among these bridge circuit configurations, it is not the fact that one configuration is an absolute advantage over the other that is the deciding factor. When making differential bridge configurations, the fact that one configuration is an absolute advantage over the other is not the deciding factor. When making differential bridge configurations, the fact that one configuration is an absolute advantage over the other is not the deciding factor.

Figure 20. Bridge Circuit with Amplifier

**RESISTOR MATCHING CIRCUIT**

**WINDUP COMPENSATOR**

A Burr-Brown windup compensator, Model 491-75, is a convenient way to get a bridge of "zero," "nonzero," or "high" gain. The "nonzero" output of the 491-75 is shown in Figure 21.

Figure 21. Typical Transfer Curve (Nonzero Gain)

**LINEARIZING A NON-LINEAR BRIDGE OUTPUT**

The nonlinearity of a bridge output signal may be compensated using a linearizing circuit. The Burr-Brown Catalog for a description of the 491-75. The nonlinearity of the output signal is compensated using a linearizing circuit.

Figure 22. Maximum Output of Transfer Bridge

Figure 23. Burr-Brown Model 491-75 Windup Compensator

**APPLICATIONS INFORMATION**

**RESISTOR MATCHING CIRCUIT**

**WINDUP COMPENSATOR**

**LINEARIZING A NON-LINEAR BRIDGE OUTPUT**

## New Burr-Brown handbook and catalog of Instrumentation Amplifiers

This new 32-page publication is one you'll refer to again and again. It contains IN-DEPTH INSTRUMENTATION DESIGN AND APPLICATIONS INFORMATION including: transducers and bridge circuits; sources of error; a resistor matching circuit; linearizing a nonlinear bridge output; a power measurement circuit; a buffer-amplifier tester; and a review of instrumentation system power supply requirements. There's also a fundamental discussion of the various considerations involved in the selection of amplifiers for instrumentation applications.

In addition, the catalog section contains DETAILED SPECIFICATION AND TEST DATA on Burr-Brown's broad line of standard instrumentation amplifiers. All units are covered including new high-performance, encapsulated devices with prices as low as \$95 in single unit quantity.

### IT'S YOURS FOR THE ASKING

Simply check this publication's reader service card, or phone the nearest Burr-Brown Engineering Representative listed below.

# BURR-BROWN

## RESEARCH CORPORATION

International Airport Industrial Park • Tucson, Arizona 85706  
TELEPHONE: 602-294-1431 • TWX: 910-952-1111 • CABLE: BBRCORP



Operational Amplifiers  
Instrumentation Amplifiers  
Function Modules  
Active Filters  
Power Supplies

ENGINEERING REPRESENTATIVES: ALABAMA, HUNTSVILLE (205) 534-1648 / ARIZONA, PHOENIX (602) 254-6085 / CALIF., LOS ANGELES (213) 665-5181, SAN DIEGO (714) 232-2017, SAN FRANCISCO (408) 244-1505 / COLO., DENVER (303) 399-4391 / CONN., EAST HARTFORD (203) 874-9222 / D.C., WASHINGTON (SEE MARYLAND) / FLORIDA, ORLANDO (305) 425-2764 / ILLINOIS, CHICAGO (312) 286-6824 / LA., NEW ORLEANS (504) 888-2266 / MD., SILVER SPRING (301) 588-8134 / MASS., BOSTON (617) 245-4870 / MICH., DETROIT (313) 358-3333 / MINN., MINNEAPOLIS (612) 781-1611 / MO., ST. LOUIS (314) 524-4800 / N.C., GREENSBORO (919) 273-1918 / N.J., CAMDEN (215) 925-8711 / N.M., ALBUQUERQUE (505) 255-1638 / N.Y., ALBANY

(518) 489-4777, BINGHAMTON (607) 723-9661, MT. VERNON (914) 664-0080, NEWBURGH (914) 561-4510, NEW HARTFORD (315) 732-3775, ROCHESTER (716) 473-2115 / OHIO, CINCINNATI (513) 761-5432, CLEVELAND (216) 237-9145, DAYTON (513) 277-8911 / PENN., PHILADELPHIA (SEE CAMDEN, N.J.), PITTSBURGH (412) 243-6655 / TEXAS, DALLAS (214) 357-6451, HOUSTON (713) 774-2568 / UTAH, SALT LAKE CITY (801) 466-8709 / VIRGINIA, (SEE MARYLAND) / WASH., SEATTLE (206) 767-4260 / CANADA, DOWNSVIEW, ONT. (416) 636-4910, MONTREAL, QUE. (514) 739-6776, OTTAWA, ONT. (613) 725-1288, VANCOUVER B.C. (604) 291-7161



# Our apologies to anyone who just

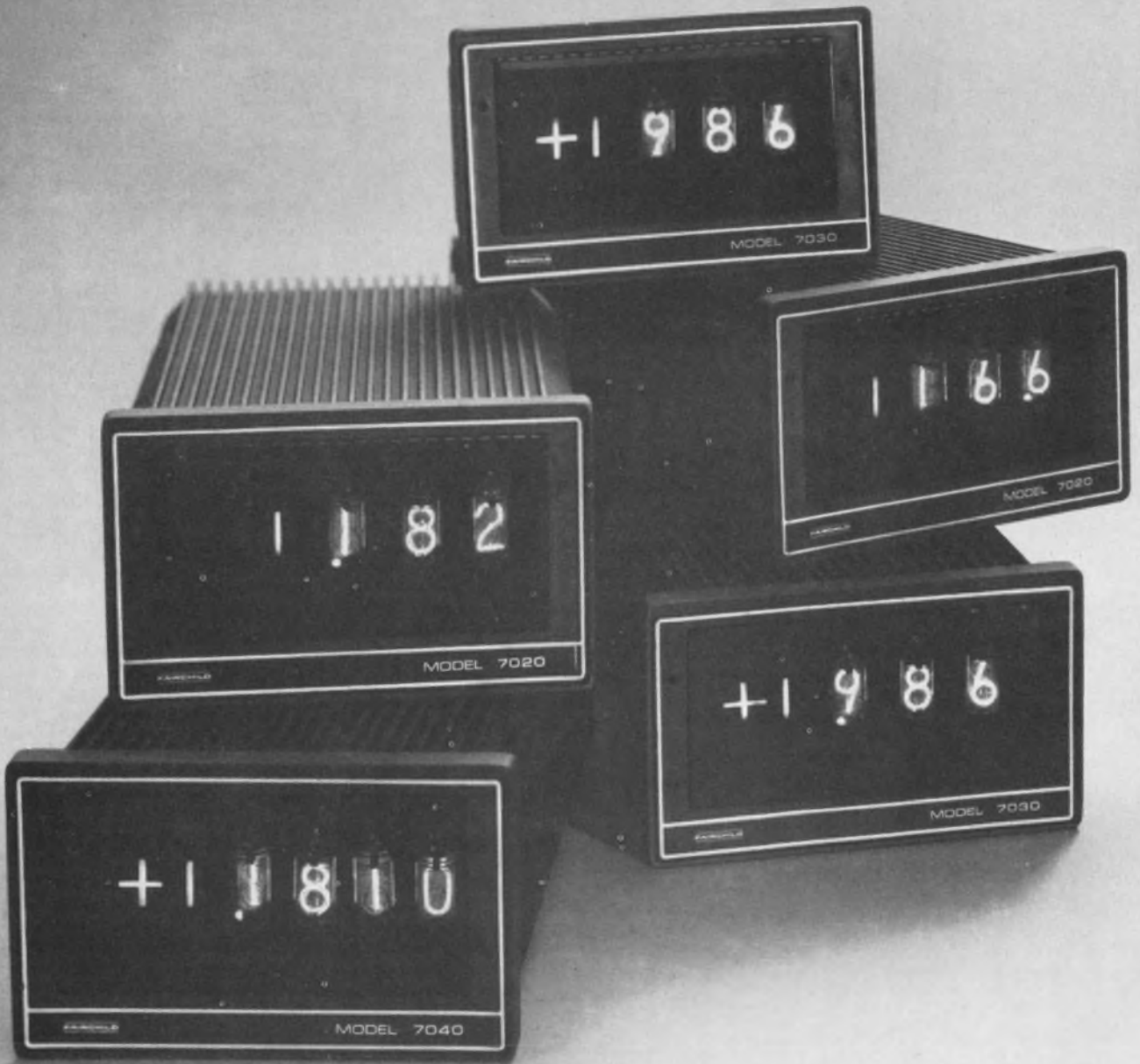

# bought an analog panel meter.

You can now get a much greater value: a digital panel meter from Fairchild Instrumentation. Each Fairchild meter gives your system higher resolution, higher accuracy and computer compatibility. And they're all priced to let you upgrade your military, medical or process control systems economically.

The Fairchild meters are essentially digital voltmeters using dual slope integration. Performance is an order of magnitude better than the best analog meters on the market.

Our Model 7020 is a three-digit, single range, single polarity meter. It covers any one of five input ranges from 150mV to 1000V full scale. It only costs \$230 when you buy quantities of 25 or more.

Model 7030 has three digits and an overrange bit. It handles input ranges from 199.9mV to 1000V full scale. The price is \$251 each for 100 or more.

The top of our line is model 7040. It reads out to four digits plus an overrange bit. Input ranges go from 1.2000V to 1000.0V full scale. It costs \$435 in quantities of 100.

Remote read-outs are available for Models 7030 and 7040. They cost \$100 and \$125, respectively.

Delivery is 30 days for any model. Call us now for complete details or experienced applications assistance.

Fairchild Instrumentation / A Division of Fairchild Camera and  
**FAIRCHILD** Instrument Corporation / 974 E. Arques Ave., Sunny-  
INSTRUMENTATION vale, Calif. 94086 / (408) 735-5011 / TWX: 910-339-9217.



# Something *New* Has Been Added!

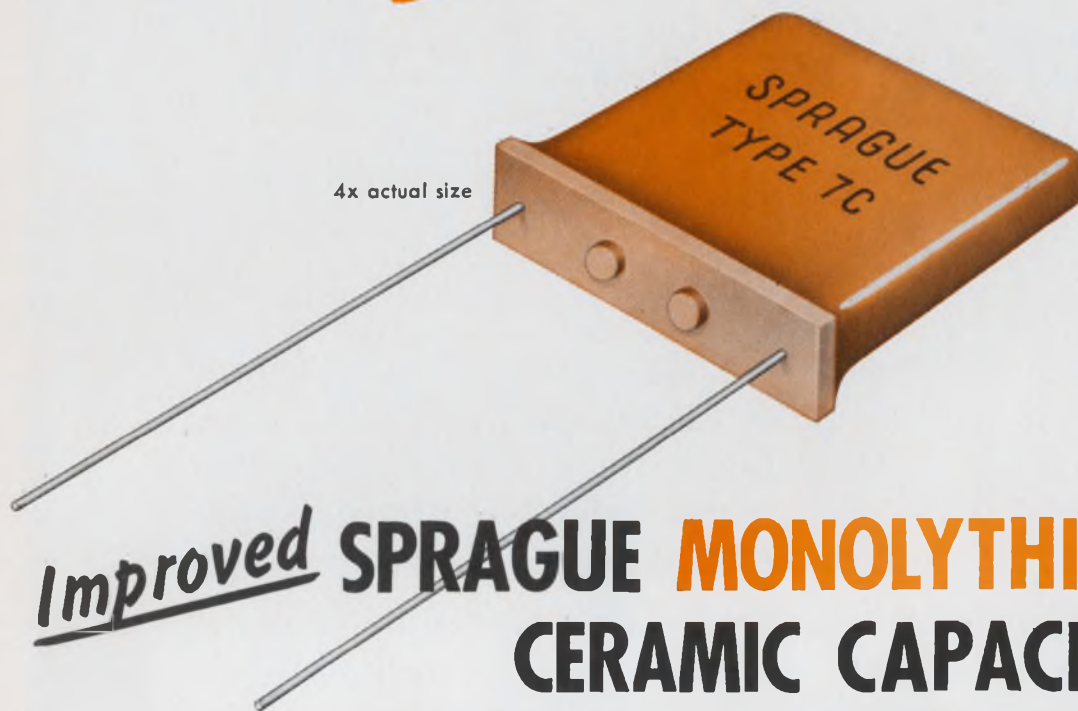

## *Improved* SPRAGUE MONOLYTHIC<sup>®</sup> CERAMIC CAPACITORS

now have a phenolic terminal base

Type 7C Radial-lead Capacitors are made with alternate layers of sprayed ceramic dielectric material and screened metallic electrodes, fired into a solid homogeneous block and coated with a tough phenolic resin. Their new bossed terminal base construction provides these advantages: (1) No resin run-down on leads. (2) Uniform lead spacing is automatically maintained. (3) No dirt and moisture entrapment; degreasing fluid flows freely between capacitor and board.

Body Code	EIA Characteristic	Operating Temperature Range	Maximum Cap. Change over Temp. Range	WVDC	Capacitance Range	Capacitance Tolerance
082	N030	-55 C to +125 C	-30ppm/°C, ±30ppm/°C	50 100 200	51 pF to .024 μF	±20% ±10% ±5% ±2%
075	N750	+25 C to +85 C	Meets MIL-C-20 Char. UJ	50 100 200	.001 μF to .082 μF	±20% ±10% ±5% ±2%
		-55 C to +125 C	-750ppm/°C, ±120ppm/°C			
067	W5R	-55 C to +125 C	±15%	50 100	.0018 μF to 1.5 μF	±20% ±10%
023	Z5U	+10 C to +85 C	+22%, -56%	50	.01 μF to 3.3 μF	+80, -20% ±20%

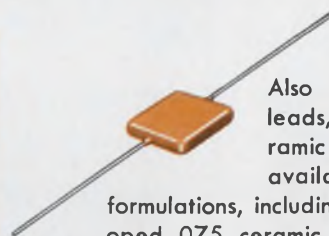

Also made with axial leads, Monolythic<sup>®</sup> Ceramic Capacitors are available in four body formulations, including a newly-developed 075 ceramic material, as described in the adjacent chart.



For complete technical data write for engineering bulletins on Monolythic Ceramic Capacitors to: Technical Literature Service, Sprague Electric Co., 347 Marshall St., North Adams, Mass. 01247.

### SPRAGUE COMPONENTS

CAPACITORS  
TRANSISTORS  
RESISTORS  
INTEGRATED CIRCUITS  
THIN-FILM MICROCIRCUITS

PULSE TRANSFORMERS  
INTERFERENCE FILTERS  
PULSE-FORMING NETWORKS  
TOROIDAL INDUCTORS  
ELECTRIC WAVE FILTERS

CERAMIC-BASE PRINTED NETWORKS  
PACKAGED COMPONENT ASSEMBLIES  
BOBBIN and TAPE WOUND MAGNETIC CORES  
SILICON RECTIFIER GATE CONTROLS  
FUNCTIONAL DIGITAL CIRCUITS



Sprague and ® are registered trademarks of the Sprague Electric Co.

# News



**Calves with implanted heart-assist pumps** undergo study at Boston Children's Hospital. P. 25

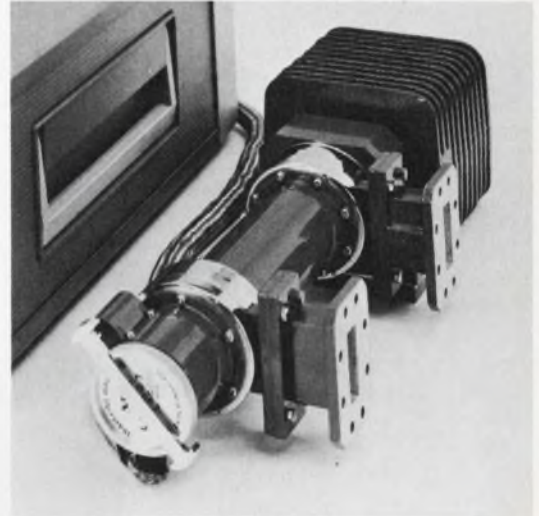

**Traveling-wave device** technology advances on all fronts. P. 33

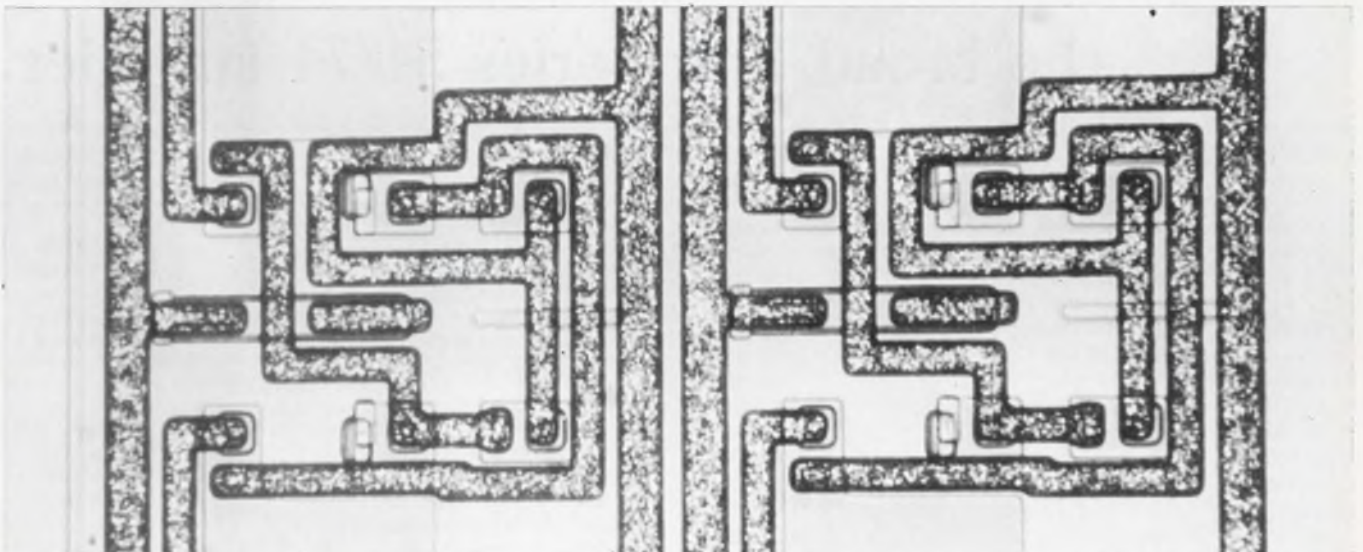

**New buffer-storage array** accepts optical data direct from hologram storage. The sys-

tem allows fast random access and nondestructive readout of the stored data. P. 28

## Also in this section:

**Old satellite to test Einstein theory.** Page 32

**IR array camera developed for satellites.** Page 32

**News Scope,** Page 21 . . . **Washington Report,** Page 39 . . . **Editorial,** Page 45



# Two new Series 54/74 AND gates.

The 54/7408—a Quad 2-input AND.

The 54/7411—a Triple 3-input AND.

Choice of flat pack  or DIP. 

Full of  
features.....

- High Speed— $t_{pd} = 13$  nsec.
- Low Power—25 mW/gate
- Full Fan-out of 10
- Input Diode Clamping
- Reduce Package Count

Available now from Sprague—  
the broad line Series 54/74 supplier.

SERIES 74N	FUNCTION	SPRAGUE PART NO.*	SERIES 74N	FUNCTION	SPRAGUE PART NO.*
SN7400N	Quad 2-Input NAND	USN-7400A	SN7473N	Dual J-K Master Slave Flip Flop: Single chip, pin 11 GND	USN-7473A
SN7401N	Quad 2-Input NAND (No Collector Load)	USN-7401A	—	Single chip, pin 7 GND	USN-74107A
SN7402N	Quad 2-Input NOR	USN-7402A	SN7474N	Dual D-Type Edge-Triggered Flip Flop	USN-7474A
—	Quad 2-Input AND	USN-7408A	—	Dual J-K MS Flip Flop with Preset and Clear	USN-7476B
SN7410N	Triple 3-Input NAND	USN-7410A	—	Dual AC Clocked J-K Flip Flop	USN-7479A
—	Triple 3-Input AND	USN-7411A	<b>COMPLEX ARRAYS</b>		
SN7420N	Dual 4-Input NAND	USN-7420A	SN7441N	BCD-To-Decimal Decoder/Driver	USN-7441B
SN7430N	Single 8-Input NAND	USN-7430A	SN7475N	Quadruple Bistable Latch	USN-7475B
SN7440N	Dual 4-Input NAND Buffer	USN-7440A	SN7480N	Gated Full Adder	USN-7480A
SN7450N	2-Wide 2-Input Expandable AND-OR-INVERT	USN-7450A	SN7482N	2-Bit Binary Adder	USN-7482A
SN7451N	2-Wide 2-Input AND-OR-INVERT	USN-7451A	SN7483N	4-Bit Binary Adder	USN-7483B
SN7453N	4-Wide 2-Input Expandable AND-OR-INVERT	USN-7453A	SN7490N	Decade Counter	USN-7490A
SN7454N	4-Wide 2-Input AND-OR-INVERT	USN-7454A	SN7491AN	8-Bit Shift Register	USN-7491A
SN7460N	Dual 4-Input Expander	USN-7460A	SN7492N	Divide-By-Twelve Counter	USN-7492A
SN7470N	D-C Clocked J-K Flip Flop	USN-7470A	SN7493N	4-Bit Binary Counter	USN-7493A
SN7472N	J-K Master Slave Flip Flop	USN-7472A			

\*0 to 70 C dual in-line circuits. Standard devices also available in flat pack, as well as Series 5400 full-temperature-range equivalents in flat pack or DIP.

For complete technical data on Series 54/74 circuits, write to Technical Literature Service, Sprague Electric Company, 347 Marshall Street, North Adams, Mass. 01247



**THE BROAD-LINE PRODUCER OF ELECTRONIC PARTS**

'Sprague' and '®' are registered trademarks of the Sprague Electric Co.

## Soviet fleet buildup to spur ASW effort

Concern over the ever-growing Soviet fleet in the Mediterranean—a top issue at the recent NATO conference in Brussels—will undoubtedly mean an increase in antisubmarine warfare work.

Some sources have reported as many as 55 Russian ships sailing alongside NATO-member ships—up to 12 submarines; a carrier, the Moskva, that supports submarine-hunting helicopters, and missile-firing destroyers. There has also been some talk that the Russians would lay a hydrophone line across the floor of the Straits of Gibraltar to check on U.S. Polaris-missile submarines.

Sen. John Stennis (D-Miss.), chairman of the Preparedness Investigation Subcommittee of the Armed Services Committee who many think will be the next chairman of the full committee, called the Mediterranean a “developing trouble spot.” He added that “something must be done before it’s too late.” After attending the conference in Brussels, Stennis visited the Sixth Fleet and talked with ship commanders and aircraft carrier pilots.

To maintain military strength in the Mediterranean, which Stennis

says is needed “to avoid military conflict,” additional ASW equipment would undoubtedly be needed. According to one congressional source, the Navy would like to have a hunter-killer group assigned to the area.

The Soviet submarine fleet the world over, according to a Preparedness Subcommittee report, consists of about 40 ballistic-missile submarines and 50 cruise-missile subs.

The Pentagon has already started to combat the threat. A \$35 million contract with General Dynamic’s Electric Boat Div., Groton, Conn., has been awarded to begin construction of the “quiet” submarine. By August 1969, a team will be selected to build a destroyer fleet that is expected to cost \$2 billion over a ten-year period—40 per cent of which will be for electronics. A contractor to develop the VSX, the antisubmarine warfare carrier-based plane, is expected to be announced later this month.

Work will continue on improving detection capabilities at longer ranges. Results from the high-power, hull-mounted AN/SQS-26 sonar now being installed on surface ships will be studied carefully before the Navy continues this technique. Results from the active planar array sonar program will be fed into these considerations. Variable depth sonars and towed arrays will be pushed, as will be the use of deep submersibles to identify the cause of deep scattering layers—the phenomena that limit the performance of echo ranging sonar.

### GE offers companies rights to processes

General Electric, which says it holds “the world’s largest portfolio of unexpired patents,” has decided

to share its bonanza with other companies. For \$150 a year, it will give subscribers information about new business opportunities through license agreements.

The GE “Business Opportunities Service” will offer rights to certain GE products, processes, machines, tools and instruments that have been carefully evaluated for business potential.

Beginning next month, the service will issue a bi-monthly publication listing at least 10 new business opportunities in a number of fields. The publication will describe, for example, a product or process, state its advantage or benefits, suggest possible uses or applications, provide an overview of the potential market and state the general terms regarding availability for licensing.

A major obstacle to obtaining patent rights—particularly for small business—is that vast amount of effort and expense required to screen and evaluate thousands of patents for technical feasibility and market potential, according to a GE spokesman. In the new GE service, such screening will be performed in advance by professionals.

The subscription service will be administered by GE’s Patent and Technology Marketing Operation in Schenectady, N.Y.

### Court upholds patents for computer software

Last month the U. S. Patent Office issued new guidelines limiting patent protection of computer programs (See News Scope, ED 23, Nov. 7, 1968, p. 21). Now, in what is considered a landmark case, the United States Court of Customs and Patent Appeals has ruled that computer programs are indeed patentable.

Edward J. Brenner, Commissioner of Patents, says that if the decision stands, it will require considerable revision of the recently published guidelines, “which take a substantially opposite approach in holding that, generally speaking, computer programs are not patentable subject matter.”

The Patent Office is planning to file a petition for reconsideration by the court. Brenner has indicated that any decision on an appeal to



Russian warships in the Mediterranean will alter NATO and U.S. defense plans.



the U. S. Supreme Court would await the results of the petition. If the case ends up in court, a final decision could be a year or longer away.

The Customs and Patent Court's decision does not mean that all computer programs can be patented, according to patent lawyers. It means that an applicant must meet normal tests of patentability by showing that his program is new and was not apparent to others skilled in computer programming.

The decision, if it stands, would have considerable economic impact, because the users of patented computer programs would have to pay royalties to the patent holders. Estimates are that the computer software business will pass the \$1.5-billion sales mark by 1970.

The court ruling was made on an appeal by the Mobil Oil Corp. computer center in Princeton, N. J., after the Patent Office had rejected its application for a program patent. The program permits the accurate measurement of gases in mixtures with an analog computer.

## Byrd warns against lag in electronic warfare

When the raids first began, U.S. aircraft flying over North Vietnam were sitting ducks for enemy radar and other counter-measure devices, Sen. Robert C. Byrd (D-W. Va.) revealed at a recent meeting of the Association of Old Crows in San Antonio. The Old Crows are made up of individuals from the military, industry and universities, whose work furthers the art of fighting by electronic means.

Only after a crash program to develop new electronic warfare equipment was it possible for "strike aircraft to fly in the previously lethal surface-to-air missile envelope with relative impunity," the Senator said. And only "for the past year or so" have our planes been equipped with threat warning and radar jamming devices" (ED 22, Oct. 24, 1968, p. 22).

So that we will not be caught

short again, Byrd, who is a top-ranking member of both the Senate's Armed Service Committee and its Preparedness Subcommittee, warns against any let-up in developing electronic warfare capability in our aircraft and ships.

Electronic Warfare (EW) work must be continued, he said, despite the suspension of bombing in North Vietnam.

To do this, Byrd called for an operational test range that would enable designers to test and evaluate new ways to penetrate highly defended target areas.

An important trend, he pointed out, is integration of EW equipment. The Navy has in some cases integrated its EW systems with its command and control network. The Navy is alleviating its crowded deck problem by multiple use of shipboard antennas.

## First fluidics exhibit held and the stress is on use

Too much theory and not enough practical data on how to apply fluidics—that has been a long-standing complaint of device users. In response, leading fluidics manufacturers have held their First Fluidics Conference and Exhibit. It offered in Chicago (Nov. 21-22) papers, exhibits, workshops and movies emphasizing new devices and applications, as well as candid discussions of device limitations and application problems.

As an example of applications, the problem of operating fluidic devices in contaminated industrial air, particularly where oil mists are present, was analyzed at a standing-room-only, three-hour Contamination Clinic. General specifications for oil-mist filters have indicated that a 5-micron unit is adequate. But Robert O'Keefe, manager of fluid technology for Pitney-Bowes, Stamford, Conn., and Roland Jones manager of industrial applications for Bowles Engineering Corp., Silver Spring, Md., agreed that a 1-micron filter would be more realistic.

Many of the devices exhibited at the conference demonstrated a new level of sophistication. For example, Bowles Engineering and Parker Hannifin Corp., Des Plaines,

Ill., both displayed fluidic logic packages that plug into a master manifold like a printed-circuit card. And Johnson Service Co., Milwaukee, displayed a six-element manifold and small, cylindrical plug-in logic elements.

Two new fluidic logic items utilizing flexible diaphragms for control, rather than pure fluidics, were introduced—one by Robertshaw Controls, Goshen, Ind., the other by Double A Company, Manchester, Michigan. Robertshaw, according to Robert Konter, manager of marketing, is developing a pneumatic system for control of home laundry equipment; it would be competitive with more modern electronic controls.

Fluidics hardware, the displays indicated, is taking on an electrical and electronics look. For example, Bendix Electrical Components Div., Sidney, N.Y., is using its standard AN-connectors in fluidic systems by replacing electrical contacts in the insert with fluidic connectors. Push-buttons by Double A Products Co. and Honeywell, Freeport, Ill., have front-panel configurations that are identical to their electrical counterparts.

Digital indicators by Pitney-Bowes look like an electronic version of a 5-by-7 matrix. Floating pistons are driven into or out of the field of view by fluidic signals.

## Contracts are awarded for new AF fighter

The proposed Air Force air-superiority tactical fighter has been designated the ZF-15A. The Air Force also revealed the selection of Westinghouse Electric and Hughes Aircraft Co. as contract winners for the competitive development of the attack radar system for the fighter. This is the first in a long series of contracts that will be awarded in this program over the next six months. Hopefully, the air-frame contractor will be selected in January.

The two 20-month radar contracts will total \$22 million. The initial obligation to each contractor is \$3,941,508. Each contractor will produce radar flight models. Following this, a single contractor will be selected, subsequent to flight-test evaluation.



# How to use the SINGER Model MF-5 Family of Spectrum Analyzers for Audio, Telemetry and Broadcasting Band Analysis

Singer Instrumentation's Model MF-5 Spectrum Analyzer main frame accepts three interchangeable plug-in spectrum analyzer modules, ranging in frequency from 20 Hz to 27.5 MHz. Since interchangeability of the modules is effected in seconds, many users buy only the module they need, adding other modules as their requirements change.



The spectrum analyzer with an **AL-2** module is often used in audio distortion measurements. Amplitudes of all frequency components in the scanned spectrum are simultaneously displayed for rapid analysis. Typical of its applications are measurement of IM distortion in transducers such as phonograph cartridges. IM products are displayed as side bands on a recorded carrier.

The display shows the side bands down 23 dB and 26 dB from the carrier level. This simple spectrum analyzer method is much faster than using IM analyzers, which require several adjustments for each measurement and which can not supply continuous, graphic displays of distortion.

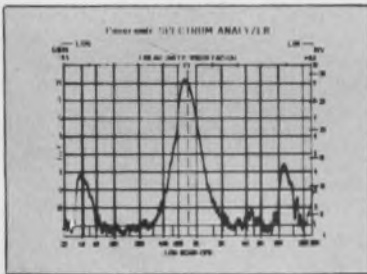

A **UR-3** module (100 Hz to 700 KHz) is ideal for applications in telemetry systems. This module is shown here scanning all 21 constant bandwidth IRIG telemetry channels.

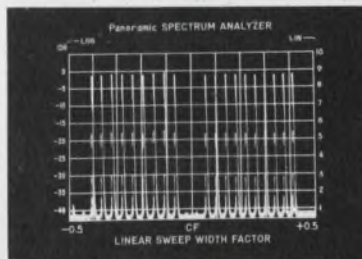

When two channels drop away, their absence shows up instantly on the spectrum analyzer's CRT display. The analyzer is also used for checking signal to noise ratio, the amplitude taper of a telemetry system, or distortion. Besides scanning all the channels, it can provide an expanded display of any one of them.

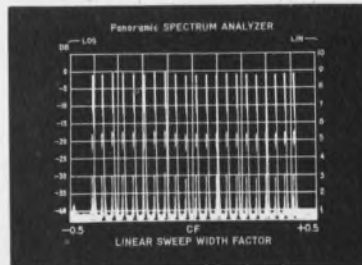

The **VR-4** module (1 KHz to 27.5 MHz) can be used to survey the entire communication frequency spectrum. For this and other applications, Singer provides a full range of accessories, including both antennas shown in this picture.

Shown below is a typical display of the broadcast band. When we want to examine one station's channel occupancy, or a station's average program modulation, the analyzer sweep width is reduced and this display is presented on the CRT. The spectrum analyzer is set for a 20 KHz sweep width (2 KHz/division) in this application. The modulation sideband occupancy at 12 KHz bandwidth is clearly visible as is the carrier of a weaker station (far left of the CRT).

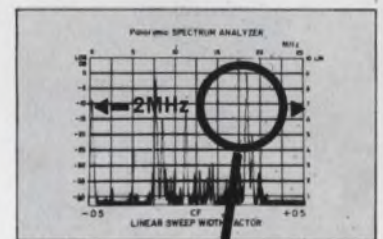

Expanded View of One Channel

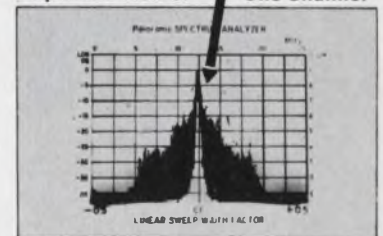

**Panoramic SINGER INSTRUMENTATION**

The Singer Company Metrics Division, 915 Pembroke St. Bridgeport, Conn. 06608 (203) 366-3201

INFORMATION RETRIEVAL NUMBER 15



# winning form

from the  
form-factor  
specialists  
at Damon

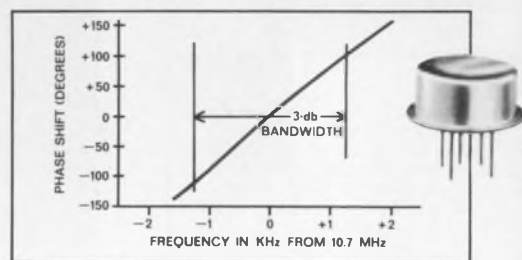

Take all the virtues of conventional Gaussian or Bessel filters . . . add monolithic construction . . . and you have the new **Damon line of Monolithic Gaussian Crystal Filters**. They're smaller, more reliable, and less costly than previous designs. And they're the ideal filters for minimum delay distortion in FM, non-overshooting pulse response in radar systems, and reduced ringing in swept-frequency applications.

The Damon Model 6354MA, for example, is a four-pole design housed in a cold-welded TO-8 enclosure. Specifications: Center frequency ( $f_c$ ): 10.7 MHz. 3-dB bandwidth: 2.5 KHz. 40-dB bandwidth: 17.5 KHz max. Source impedance: 500 ohms resistive. Load resistance: 2 kilohms resistive. Insertion loss: 9-dB max. Impulse response: Gaussian shape, ringing >35-dB down. Package: TO-8 (.580" dia. x .260" high).

Whatever your signal shaping needs . . . from a Gaussian curve to a sharp rejection notch . . . rely on the form-factor specialists at Damon. Write: Electronics Div., Damon Engineering, Inc., 115 Fourth Ave., Needham, Mass. 02194, or call (617) 449-0800.

## DAMON



# Problem: How to power the artificial heart?

## Rechargeable storage approach being considered with implanted fuel cell and isotopes in the future

**Jim McDermott**  
East Coast Editor

The big question that electronics designers face is no longer whether an artificial heart can be developed. It's how to power the pump.

The sources under consideration vary from implanted biological fuel cells and miniature atomic reactors to inductively coupled rf energy.

Based on a sampling of expert opinions—including that of Dr. F. W. Hastings, chief of the artificial heart program at the National Heart Institute in Bethesda, Md.—the artificial heart of the future will be comprised of a pump, connected by plumbing or wires to an

energy source that drives it, plus a control system to regulate the pumping.

The ultimate man-made blood circulator will be self-sufficient. Its power source will be implanted in the stomach cavity. Power ideally will come from a biological glucose-oxygen fuel cell that will directly produce the needed electricity from elements in the blood coursing through it.

An entirely different approach to the self-sufficient energy source will generate its power from an implanted miniature atomic reactor that employs plutonium-238. In the atomic version, either heat or electricity—depending on design—will do the driving.

"But since," as Dr. Hastings points out, "neither the glucose-oxygen fuel cell or the radioisotope system is likely in the next few years," through-the-skin methods of electrical energy transfer will have to be used to recharge internally implanted power sources directly. These will be of two types: rechargeable batteries, or replenishable thermal storage systems that store energy in thermal form by chemical means.

### The problem is power

The heat generated by radioactive sources can be applied to a miniature steam engine, as in the design currently under development by Thermo Electron, Inc., Waltham, Mass. In this design, engine output is applied to a hydraulic subsystem that operates the heart pump.

Another alternative is to operate an engine based on the Stirling cycle, as in the system devised by Aerojet General, San Ramon, Calif. According to K. E. Buck, program manager, the original Stirling engine has been reworked into a compressor in which the mechanical stroke has been converted into a helium gas pressure system. Fluctuating gas pressure compresses and decompresses a flexible sac-type of heart pump.

Buck does not foresee any real stumbling blocks. "There's nothing new we have to invent. But the biggest problem with total replacement is that the body is sensitive to pressure levels in the veins, to within a few millimeters of mercury. This is very difficult to control."

Harry Diamond Laboratories, Washington, D. C., has come up with a form of fluidic control in the internal artificial heart pump system it developed in conjunction with the National Heart Institute. Originally designed and patented by Kenneth E. Woodward, the heart has been successfully operated for up to 50 hours in calves; it uses a 10-to-20-psi pneumatic



An early version of a piezoelectric heart pump made by Hamilton Standard's Biomedical Division. Pump is at top, ventricle at bottom.



## NEWS

(artificial hearts, *continued*)

source. The limitation here is that pneumatic lines must be passed through the skin.

Because it is recognized that totally-implemented energy systems will be slow in coming, other programs seek new methods for transmitting energy through intact skin. Up to now, no satisfactory permanent method for bringing electrical connections out through the skin's surface has yet been devised for humans.

Work on rf systems is being carried on at the Biomedical Div. of Hamilton Standard, Windsor Locks, Conn., and at New York University. In both approaches, two coils are used: The receiver is implanted under the skin, while the transmitter is placed outside and aligned with the receiver.

The Hamilton Standard system works at 530 kHz and the N.Y.U. system at 13 kHz.

An obvious problem is the change in received power with movement of the external coil. Hamilton Standard uses a somewhat complicated system in which an implanted subcarrier oscillator retransmits the received signal level back to external power control electronics.

The N.Y.U. design is an over-coupled transformer that permits a reasonable amount of patient movement, with minimum change in received power. Energy levels at the internal coils meet or exceed the established requirement of 30 watts or more. Both systems are now undergoing evaluation in animals.

In a system for energy transfer at lower power frequencies, from 60 to 1200 Hz. Stanford Research Institute at Menlo Park, Calif., has devised a system in which the secondary coil of a transformer is sewn into a two-pedicle flap of skin that looks like a suitcase handle. A two-part C-core is passed through the hole in the handle and is clamped together with a primary. Ultimately the secondary voltage will be rectified to charge internal nickel-cadmium batteries.

The battery output will be converted to ac to operate a piezoelectric-hydraulic heart pump, designed by Dr. Glen Benson, technical director of ERG, Inc., Oakland, Calif. It is essentially a stack of thin piezoelectric discs, elec-

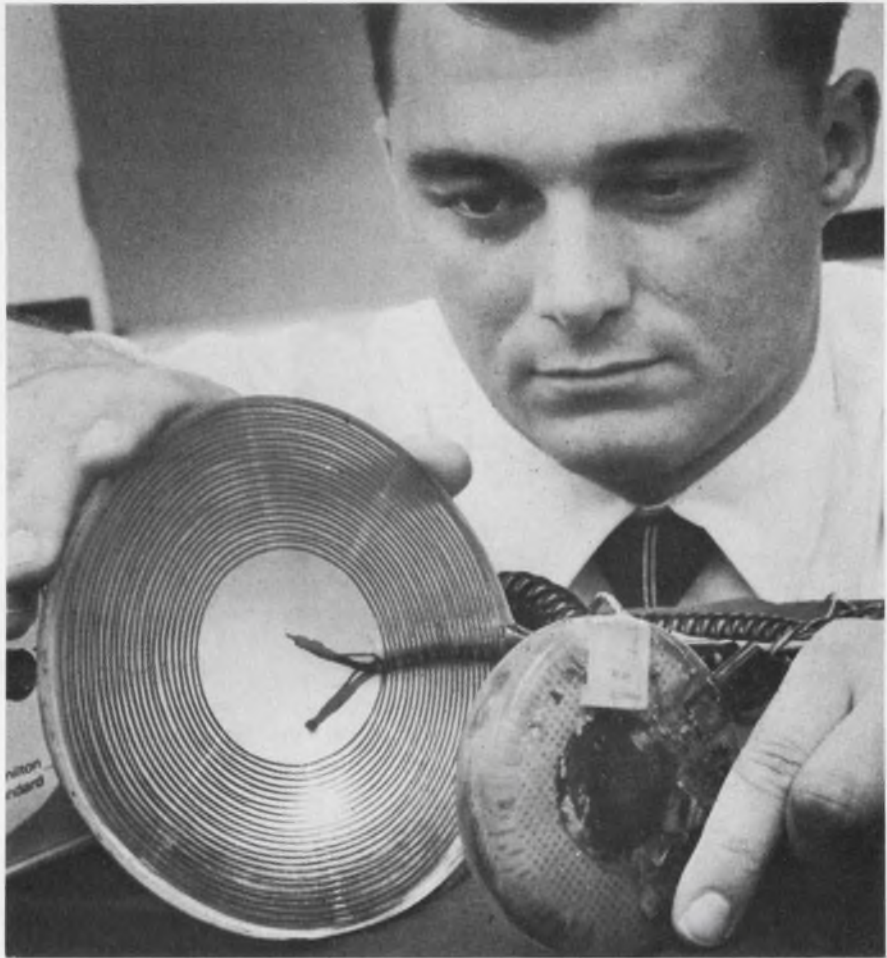

In rf system by Hamilton Standard, external transmitter (left) is aligned with the energy receiver (right), and the latter is implanted inside the heart patient.

trically in parallel and mechanically in series, as with sonar transducers. By mechanical impedance transformation, with the use of bellows in a sealed system, the resonant and operating frequency is reduced to 120 Hz.

Hamilton Standard has also devised a somewhat different piezoelectric-hydraulic heart pump that uses a single bimorph crystal driven at between 500 and 1000 Hz. A special feature is the use of electroviscous, rather than mechanical valves. The system flow is on the order of 60 to 70 pulses a minute.

### A twofold goal pressed

Who is supporting these developments? A major backer is the National Heart Institute. Its goal is twofold: to assist people who need such hearts and to reduce the vast sums doled out each year to the disabled. As Dr. Hastings told the recent Northeast Electronics Research and Engineering Meeting in Boston, Social Security payments to totally and permanently disabled

heart patients are costing the Government over \$150 million a year.

Originally the institute gave its main support to the development of heart-assist devices. However, when it realized that these would not provide full patient rehabilitation, the search expanded to include artificial hearts. The institute is now supporting more than 100 programs throughout the country.

"The current heart-transplant programs have shown," Dr. Hastings told *ELECTRONIC DESIGN*, "that there are problems of supply and demand. Whereas formerly we assumed that they would be implanted only in patients who were dying, recent experience makes it evident that heart transplants have been and will be used on Class 4 cardiacs—those completely disabled but who can walk around for only limited periods of time. And even Class 3 cardiacs are now asking for transplants.

"Eventually the number of people running around with permanently implanted devices may run to over 100,000 per year. ■■



Now S through X-band airborne systems can be more sensitive without getting any bigger. Varian's new DRPM TWTA combines the best points of the finest low-noise tubes our competition has to offer. Take for instance any of the very small ( $2\frac{3}{8}$ " square) competitive PPM TWTA's. Ours is as small, but 56% less noisy. Or consider another company's very low noise (8 dB average) "Compact" model. Ours is as quiet, and about 30% smaller.

This metal-ceramic TWT is the first to use Double Reversal Permanent Magnet focusing in a 5 pound miniature case. And that includes the solid state power supply, too. You get octave bandwidths in S, C, X and straddle bands, gain over 30 dB, and at least 10 dBm output. Don't settle for more noise or bulk. Get what your system needs from the more than 30 Varian Electron Tube and Device Group Sales Offices throughout the world, or from our TWT Division, 611 Hansen Way, Palo Alto, California 94303.



**varian**  
twt division



# Stop trading off sensitivity for size.



# Light-sensitive flip-flops read holograms

## New storage array accepts optical data, provides fast random access and nondestructive readout

**Raymond D. Speer**  
Microelectronics Editor

A new way of reading holograms—an optical read-in buffer-storage scheme—is proposed by Samuel Brojdo of Bell Telephone Laboratories, Murray Hill, N.J.

Brojdo's system transfers optical information directly from a hologram to a semiconductor memory structure. It offers fast random access to the data and nondestructive readout.

The scheme (Fig. 1) uses an array of light-sensitive charge-storage flip-flops, placed in the readout plane of a hologram display, to read digital data that are stored optically in the hologram. Photo-generated charge determines the states of the flip-flops.

"Arrays of these flip-flop cells," Brojdo says, "can be used to read digital information out of hologram storage a page at a time." The data can be stored in the arrays indefinitely.

Holograms offer very dense information storage and fast access time. "A photographic plate only 4 inches square," Brojdo says, "stores  $10^8$  bits of data." In his system, access time is limited by the deflection time of the laser

beam he uses to interrogate the hologram—as short as one microsecond. Because readout is by page, one microsecond is the access time per page of data.

"Digital information can be stored in the hologram in such a way," states the Bell researcher, "that it can be reconstructed in a readout plane as an array of light spots. Each spot can be made to have two possible locations, corresponding to binary states."

Brojdo's optical read-in flip-flops are set or reset according to the position of the light spots. An array of photodetectors could also serve to read out the data, but the buffer-storage can read it and retain it.

### Basic cells store charge

The basic charge-storage flip-flop is a conventional flip-flop with two diodes added (Fig. 2). If the flip-flop is set and the word-line voltage removed, the diodes are cut off. The base of the transistor that was in saturation cannot discharge immediately—the only discharge paths are leakage paths.

If, during the discharge period,

the word-line voltage is reapplied, the flip-flop assumes its previous state because that transistor still has the highest base potential. Thus the flip-flop has a "memory" and will retain information. Brojdo claims that non-optimized experimental circuits have retained input data for as long as 1.5 seconds with word-line voltage removed.

To electrically write into the flip-flop, word-line voltage and a "write" signal on one of the digit-lines are applied simultaneously. The desired state is thus forced on the flip-flop. Both word-line voltage and write signal are then removed, and no further current is drawn by the flip-flop. It is necessary only to pulse the write line periodically—every 100 milliseconds or so—to ensure that the flip-flop retains the desired state. The pulses need be only 100 nanoseconds in length. This pulsed operation, which is sufficient to maintain the stored data, results in an average standby power dissipation of perhaps 1 nanowatt per flip-flop cell.

To read data out, word-line voltage is applied and sense circuits read the presence or absence of current in the digit lines.

The transistors in the integrated array are well matched, of course, but not perfectly so. Each flip-flop has a "preferred" state, caused by

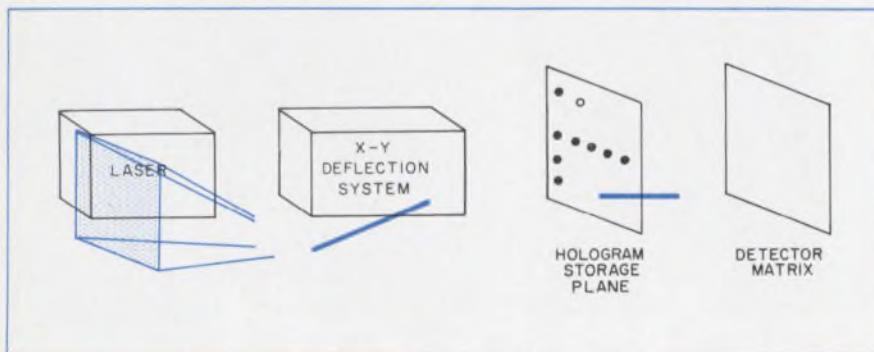

1. A proposed hologram-reading array uses modified charge-storage flip-flops for optical data read-in. Information stored in the hologram in binary form is reconstructed in an array of light spots in a readout plane. Each spot occupies one of two positions and thus corresponds to a binary bit. The array of light sensitive flip-flops at the readout plane is set or reset according to the positions of the light spots.

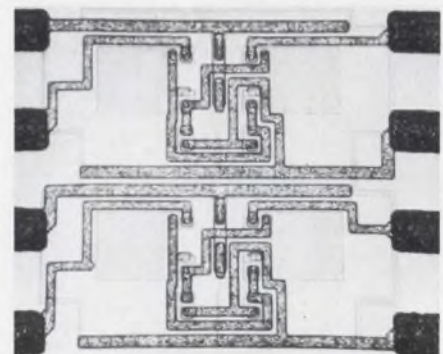

Light-sensitive flip-flops are the basic cells of the hologram-reading array. The base regions are made quite large (4 by 4 mils) to increase the amount of photocharge accumulated and thus the sensitivity.

# Component Engineers and Physicists

**For:**  
Application • Design  
Reliability • Evaluation  
Failure Analysis  
Phenomena Studies

The Components and Materials Laboratory of Hughes Aircraft Company in Southern California has immediate needs for Engineers and Physicists to fill challenging, permanent positions in the following fields:

**Microelectronics Engineers.** To evaluate integrated and hybrid devices, analyze failure modes, investigate effects of environments and materials on device characteristics and determine application criteria.

**Component Engineers.** Will coordinate component-equipment requirements, provide technical consultation, select vendors, determine evaluation programs and initiate procurement documentation.

**Component Application Engineers.** Will provide technical consultation and liaison to design activities, assist in selection and application

of component parts and participate in design reviews.

**Magnetic Designers.** To design static magnetic components, develop new magnetic devices, initiate evaluation tests, investigate and apply new design concepts.

**Reliability Engineers.** To coordinate reliability programs, conduct component failure analyses, define and direct experiments, establish mathematical models and investigate component performance.

**Physicists.** Will investigate component performance, analyze failure mechanisms, conduct phenomena studies and experiments.

**Component Development Engineers.** To develop components using advanced techniques, investigate new design concepts, study component phenomena, direct experiments and design evaluations.

**Supervisors.** In addition to requirements for both junior and senior engineers for these positions, several supervisory openings are available.

**Requirements.** BS, MS or PhD degree in Physics or in Electrical/Mechanical Engineering. (Openings are also available for non-degreed engineering personnel.) Assignments are available in the following and associated technical fields:

Microelectronics • Electron Tubes • Potentiometers • Connectors • Microwave • Capacitors • Crystals • Relays • Instruments • Mechanical • Filters • Motors • Semiconductors • Resistors • Switches • Reactors • Resolvers • Transformers.

U. S. Citizenship Is Required

For immediate consideration, please airmail your resume to:

Mr. Robert A. Martin  
Head of Employment  
Dept. 8  
11940 W. Jefferson Blvd.  
Culver City, Calif. 90230

**HUGHES**

HUGHES AIRCRAFT COMPANY  
AEROSPACE DIVISIONS

An equal opportunity  
employer — M & F



(holograms, continued)

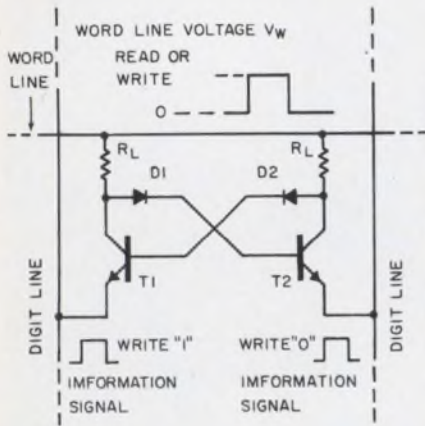

2. A charge-storage flip-flop results from the addition of two diodes to a conventional flip-flop. The diodes retard the discharge of the base region of the ON transistor, giving the flip-flop a short-term memory.

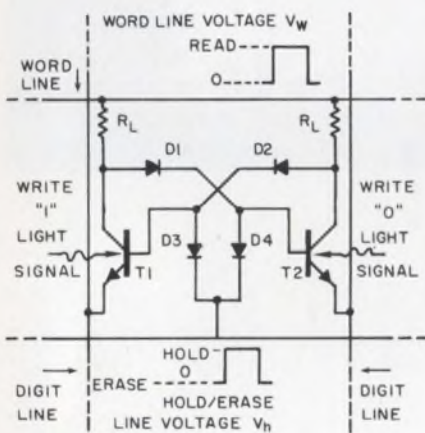

3. A photosensitive flip-flop must be more sensitive than one that is written into electrically, because the amount of light available is limited. Two extra diodes are added and are connected to a hold/erase line. This arrangement allows complete discharge of both transistor bases.

inherent structural unbalance; it will naturally assume that state if freed from outside influence. The degree to which the flip-flops seek their preferred states directly limits their sensitivity. The input stimulus must, therefore, be capable of forcing the flip-flop into its non-preferred state.

**Modification increases sensitivity**

If the charge-storage flip-flop is to be set and reset by light spots, the basic circuit is modified—by the addition of two diodes—to in-

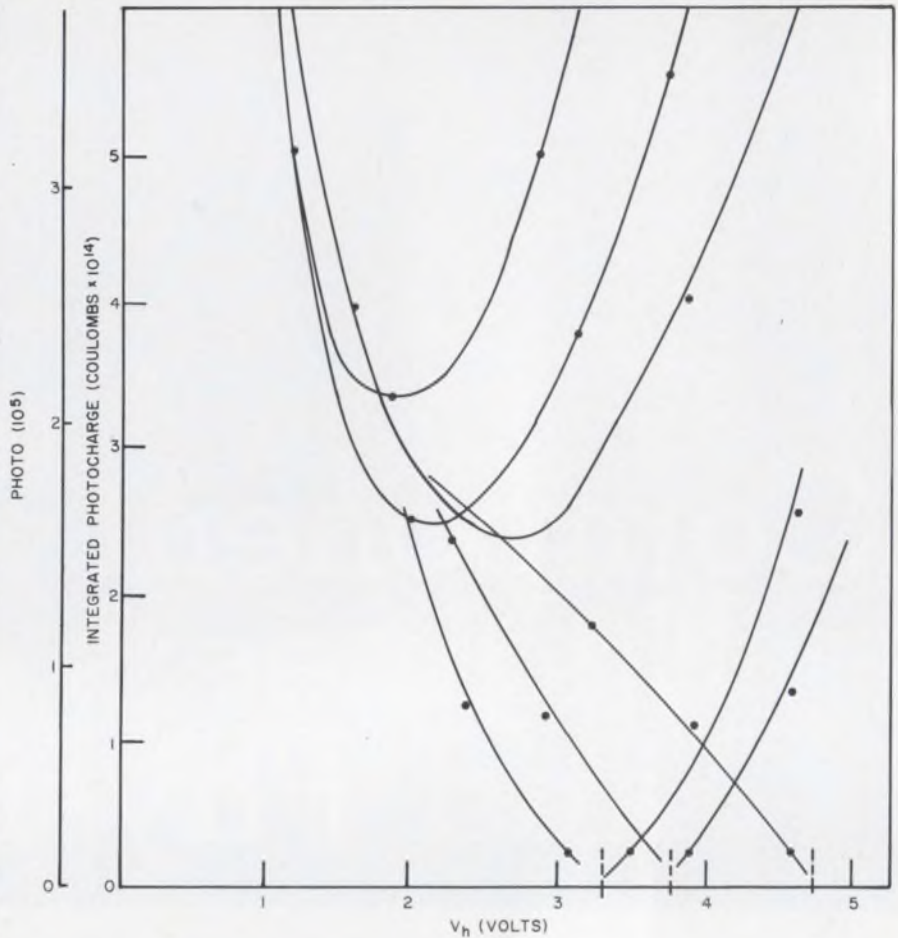

4. The sensitivity of the flip-flops is dependent on the applied hold-line voltage, because of the internal effects associated with the diodes and their capacitances. A very definite maximum occurs for a hold-line voltage level of about two volts.

crease its sensitivity (Fig. 3). This addition makes possible the complete discharge of the bases of both transistors prior to read-in.

The erasure is accomplished by applying a negative potential to the hold/erase line with word-line voltage at zero volts. All four diodes conduct, and the bases are fully discharged. A positive hold voltage is then applied to the hold/erase line, the diodes are back-biased, and both bases are left with approximately equal potentials.

The transistors operate in the light-flux integration mode. Photo-generated current is integrated in the illuminated transistor to charge the base capacitance and to raise the base potential. The illumination period can be 300 nanoseconds or less, depending on the light source. After the illumination pulse, the word-line voltage is applied, and the illuminated transistor conducts. Regeneration begins, and the flip-flop is set to the desired state. The word-line voltage can then be re-

moved and need only be pulsed every 0.1 second or so to retain the data.

Brojdo found that sensitivity depends on the hold voltage applied. Initially, the word line is at zero volts, and the hold/erase line is negative, so the diodes D3 and D4 conduct. As the hold/erase line goes positive, to the hold level, the diodes D3 and D4 are back biased, forming capacitive dividers with the bases. The bases of the transistors T1 and T2 therefore have some initial potential which is determined by the hold voltage.

The initial base potential can be adjusted by changing the hold level. Figure 4 shows the minimum stored photocharge required to force the non-preferred state on the flip-flop as a function of V<sub>h</sub>, the hold-line voltage. The extreme sensitivity illustrated in the lower set of curves is not predictable in fabrication; the rounded curves represent the sensitivity that could be achieved in production. ■■

# RELAYS

## NEW MIL-R-6106

- One-Inch Cube
- 4PDT-10 Amps
- 28VDC-115VAC
- All Welded

## IT'S BABCOCK'S BR30

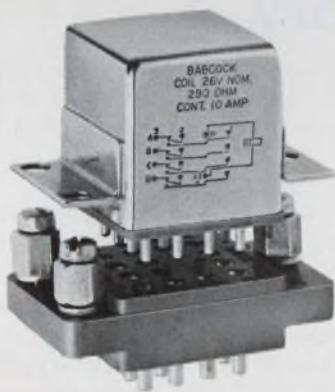

Babcock's new Model BR30 is a miniature, all-welded, 4PDT relay . . . designed specifically to meet the requirements of MIL-R-6106 (MS-27400)—and to be completely interchangeable with other models of this type. Characterized by reliable op-

eration in environmental extremes, this new relay is the first developed by Babcock to meet the needs of airframe applications. Performance is outstanding . . . to 200g's shock, 30g's vibration, over a temperature range of  $-70^{\circ}\text{C}$  to  $+125^{\circ}\text{C}$ , for a minimum of 100,000 operations. All welded construction, inside and out, assures a contaminant-free unit. Plug-in and solder-hook versions are offered; qualified relay sockets also available.

The Model BR30 is a new relay for new applications . . . and it carries the same mark of proven Babcock dependability. Your assurance that it's better because it's Babcock.

The Babcock Model BR30 is a brand new MIL-R-6106 relay . . . featuring a new symmetrical magnetic circuit. Utilizing two permanent magnets, this system provides a positive holding force, undisturbed by shock and vibration extremes . . . and

dependable switching action throughout the life of the relay.

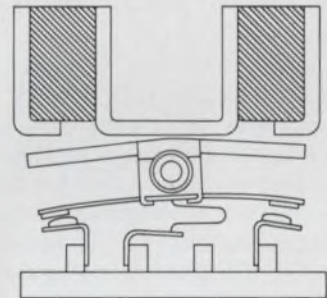

Coil design has also undergone some innovation. AC versions have been fabricated such that coil frequency is operational from 60 Hz to 400Hz, without degradation of ratings.

### SPECIFICATIONS

Contact Rating (@ 28VDC, 115/208VAC 400Hz)	Resistive: 10 amps. Inductive: 8 amps.
Overload	D. C. 40 amps A. C. 60 amps
Rupture	D. C. 50 amps. A. C. 80 amps.
Coil Voltages	6, 12 and 28VDC. 115VAC
Shock	200g's (6ms.)
Vibration	30g's, 70-3000Hz
Operation Temp.	$-70^{\circ}\text{C}$ to $+125^{\circ}\text{C}$
Pull-In Power	600mw
Operate/Release Time	15ms, max.
Bounce Time	1ms, max.
Life	100,000 operation, min.

Get complete information on the new Model BR30 . . . contact Babcock Electronics Corp., Relays Division, Subsidiary of Esterline Corp., 3501 Harbor Blvd., Costa Mesa, Calif. 92626. CALL COLLECT (714) 540-1234 or TWX 910-595-1517.

Challenging opportunities for relay-switch engineers.





## Infrared array camera developed for satellites

A high-resolution, solid-state infrared camera, using a detector array that consists of 50 photodiodes, has been developed for long-life meteorological and earth resources satellites.

The array of detectors has several obvious advantages over a single-point detector. It is mechanically less complex, since it does not have to scan physically, and it is more sensitive, because the more detectors there are on a target, the more time each has to measure radiation. The time each detector in an array has to integrate optical signals is, in fact, greater than a point-detector camera by the ratio of the number of detectors in each.

The camera was built by General Electric's Electronics Laboratory, Syracuse, N.Y., for the National Aeronautics and Space Administration's Electronic Research Center in Boston.

The array consists of 50 photodiode detectors fabricated in a single chip of indium arsenide with a density of 200 elements per inch. Each diode is connected to external preamplifiers and commutator ter-

minals. The array is packaged in a molded plastic block. This package, along with the associated lens count, provides a vacuum enclosure around the array, vacuum feed-throughs for all 50 signal leads and a heat sink for frost-free operation of the detectors at  $-80^{\circ}\text{C}$ .

The complete camera consists of an optical portion in front of the detectors, including the lens and chopper, the detector array, and preamplifiers and scanning circuits

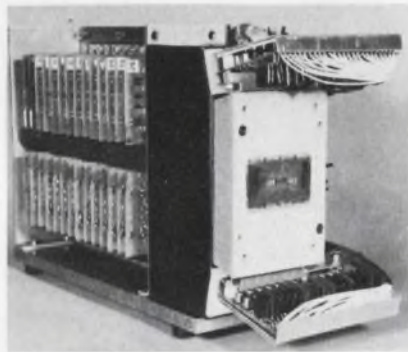

Cover and optics are removed here to show the 50-photodiode detector array, Dewar and other components in GE's indium arsenide infrared camera for weather satellites.

with supporting scan control circuits and output amplifier circuit.

The preamplifiers and the charge storage capacitors provide the readout of the individual photovoltaic detectors. Each preamplifier circuit provides an impedance match between the detector and its associated capacitor. The integrated signal on the capacitor is then sampled by the commutator circuitry and made available for processing.

The array is cooled by a Dewar, which is part of the camera package. The detectors are thermally coupled through an insulated "cold finger," that draws heat from the array through a copper wafer mount into the Dewar. Since the indium arsenide detector elements operate efficiently at  $-80^{\circ}\text{C}$ , liquid nitrogen is not required. Dry ice in alcohol provides the required detector temperature with less heat loss from the Dewar.

An auxiliary chassis provides a stable reference frequency used to synchronize the optical chopper and the electronic readout circuitry. Detector temperature monitoring and control are also included. ■■

## Old satellite to test Einstein theory

An aging satellite—Pioneer VI—is being used by a team of Jet Propulsion Laboratory scientists to test a key aspect of Einstein's general theory of relativity.

Launched on Dec. 16, 1965, Pioneer VI is the first spacecraft ever to pass directly behind the sun. Twice since mid-November, as the satellite's signals passed close by the sun on their way back to Earth, the Pasadena-based JPL team conducted observations to determine if the signals sent back exhibited the frequency shift postulated by Einstein—and if they did, by how much.

Relativity theory predicts that an electromagnetic wave passing through a gravitational field will be shifted down in frequency. This change is the result of the slowing of time in the vicinity of the field.

If, for example, two perfectly synchronized clocks are separated and one is placed in a gravitational field, they will no longer keep the same time—the clock subjected to gravitational field forces will be retarded. Light or radio waves, in their turn, experience a shift toward the red end of the spectrum.

Led by Dr. John Anderson, the JPL experimenters are using a frequency synthesizer with a rubidium oscillator as a reference source, to generate S-band signals for driving the 20-kW transmitter operated by the Deep Space Network. The signals examined were those sent back by a transponder in the spacecraft.

A problem occurred during the tests when a sudden increase in solar activity masked the signals that were being studied. Observations were, however, continued up

to the time the satellite slipped behind the sun's corona on November 15; they were resumed on Nov. 27 when the satellite emerged on the other side of the sun.

Relativistic shifts are ordinarily difficult to observe. Electromagnetic waves emitted from the surface of a star predictably should display a red shift, because of the influence of a star's gravitational field. This shift, however, is obscured by the classic doppler shift that results from the star's radial velocity. To attempt experimental observation, star mass and radial velocity must be known. While the mass and radial velocity of our sun are known, expanding gases in the solar atmosphere cause a violet shift that masks the relativistic effects—hence the need for a man-made signal source. ■■

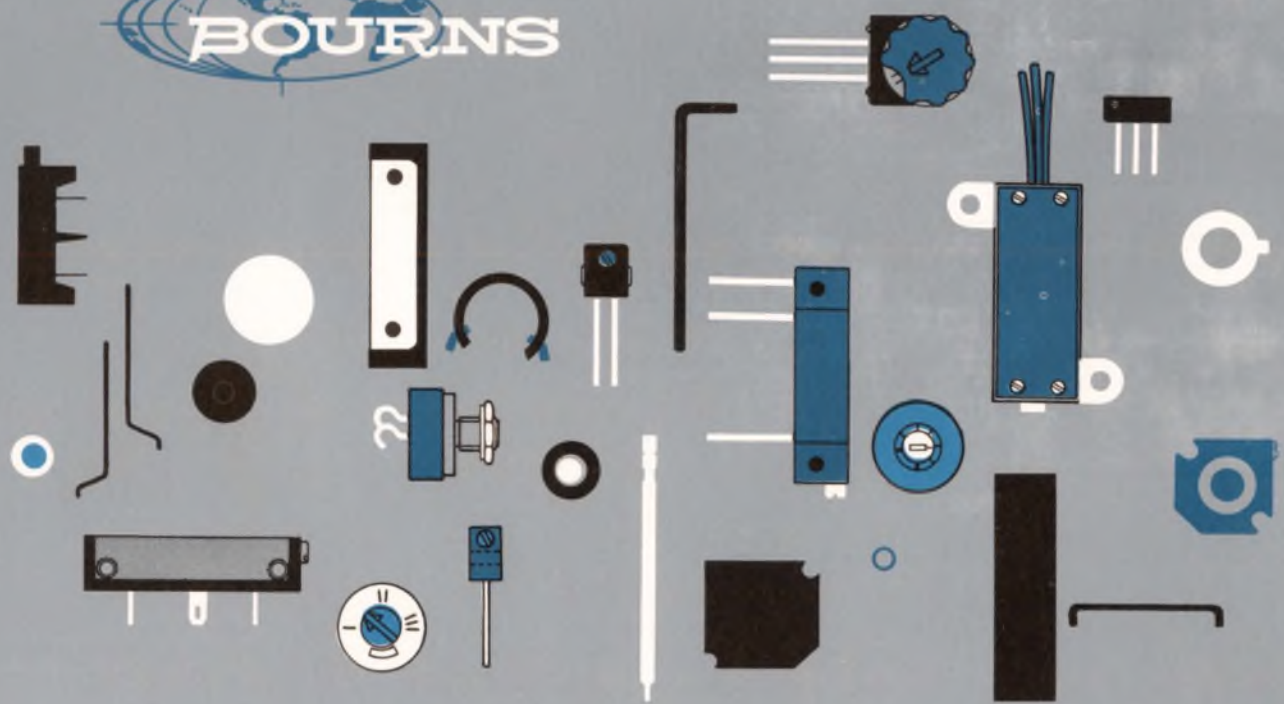

# ADJUSTMENT POTENTIOMETERS



# CERMET ELEMENT TRIMPOT POTENTIOMETER

	DIMENSIONS H W L	TERMINALS ①	RES. TOL. (%)	POWER (WATT) at 70°C	MAX. TEMP. °C	ADJ. TURNS	HUMIDITY ③ MIL SPEC	STANDARD RESIST- ANCES Ω ④	PRICES		
									1-9	10-24	25-49
<p><b>3012</b> HIGH TEMPERATURE PALIRIUM ③ CERMET ELEMENT (RJ 11)④</p>	.31 x .28 x 1.25	L.P	±10	1.0	175	22	Yes	10-1 Meg	5.94	5.50	4.95
<p><b>3052</b> HIGH TEMPERATURE PALIRIUM ③ CERMET ELEMENT (RJ 12)④</p>	.31 x .19 x 1.25	L.S.P	±10	1.0	175	22	Yes	10-1 Meg	5.94	5.50	4.95
<p><b>3009</b> COMMERCIAL E-Z-TRIM ③ POTENTIOMETER</p>	.35 x .19 x .75	P.Y	±10	0.75 at 25°C	125	20	Yes	10-1 Meg	1.94	1.84	1.75
<p><b>3059</b> HIGH TEMPERATURE HUMIDITY PROOF</p>	.32 x .19 x 1.25	L.P.Y.J	±10	1.0	150	22	Yes	10-1 Meg	Contact Factory For Prices		
<p><b>3069</b> COMMERCIAL E-Z-TRIM ③ POTENTIOMETER</p>	.35 x .25 x .75	P	±10	0.75 at 25°C	125	20	Yes	10-1 Meg	1.94	1.84	1.75
<p><b>3082</b> MICRO-MINIATURE PALIRIUM ③ CERMET ELEMENT</p>	.10 x .15 x .50	P	±10	0.5	175	10	Yes	10-1 Meg	Contact Factory For Prices		
<p><b>3252</b> HIGH PERFORMANCE HUMIDITY PROOF</p>	.50 x .50 x .22	L.P.W.X	±10	1.0	150	23	Yes	10-2 Meg	Contact Factory For Prices		
<p><b>3262</b> MICRO-MINIATURE HIGH TEMPERATURE</p>	.25 x .17 x .25	W.X	±10	0.25	175	12	Yes	10-1 Meg	7.70	7.40	7.10
<p><b>3282</b> MICRO-MINIATURE PALIRIUM ③ CERMET ELEMENT</p>	.20 x .375 x .375	L.P.W.H	±10	1.0	175	25	Yes	10-1 Meg	6.50	6.18	5.85
<p><b>3292</b> THIN LINE PALIRIUM ③ CERMET ELEMENT (RT 24)④</p>	.15 x .375 x .375	L.P.W.X	±10	1.0	175	22	Yes	10-1 Meg	6.50	6.18	5.85
<p><b>3329</b> HIGH PERFORMANCE PALIRIUM ③ CERMET ELEMENT</p>	.250 Dia. x .180	H	±20	0.50	150	285 <sup>ⓐ</sup>	Yes	10-1 Meg	Contact Factory For Prices		









① ② ③ ④ ⑤ ⑥ ⑦ SEE FIFTH PAGE OF THIS INSERT FOR NOTES.

# WIREWOUND ELEMENT GENERAL PURPOSE

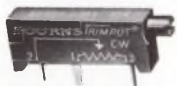
	DIMENSIONS H W L	TERMI- NALS ①	RES. TOL. (%)	POWER (WATT) at 70°C	MAX. TEMP. °C	ADJ. TURNS	HUMIDITY ② MIL SPEC	STANDARD RESIST- ANCES Ω ③	PRICES		
									1-9	10-24	25-49
								10-10K 20K & 25K 50K 100K	4.86 6.48 7.56 9.18	4.50 6.00 7.00 8.50	4.05 5.40 6.30 7.65
 HUMIDITY PROOF	.36 x .30 x 1.34	L,S,P L	±10	0.8	135	25	Yes	10-10K 20K & 25K 50K 100K	7.02 8.64 9.18 11.34	6.50 8.00 8.50 10.50	5.85 7.20 7.65 9.45
 HIGH TEMPERATURE	.31 x .25 x 1.25	L,S,P L	±10	1.0	175	25	Steady State	10-10K 20K & 25K 50K 100K	5.94 7.56 8.10 9.72	5.50 7.00 7.50 9.00	4.95 6.30 6.75 8.10
 COMMERCIAL TRIMIT POTENTIOMETER	.31 x .25 x 1.25	L,S,P	±10	0.50 at 25°C	105	25	Steady State	10-10K 20K 50K	3.19 4.32 5.40	2.95 4.00 5.00	2.66 3.60 4.50
 SEALED COMMERCIAL E-Z-TRIM POTENTIOMETER	.31 x .17 x .75	P	±10	1.0 at 40°C	125	20	Steady State	10-20K	2.00	1.85	1.75
 COMMERCIAL E-Z-TRIM POTENTIOMETER	.31 x .16 x .75	P	±10	1.0 at 40°C	125	20	Steady State	10-20K	1.75	1.62	1.46
 HUMIDITY PROOF COMMERCIAL E-Z-TRIM POTENTIOMETER	.36 x .28 x 1.0	P	±10	0.5 at 25°C	85	15	Steady State	50-20K	1.95	1.85	1.75
 COMMERCIAL E-Z-TRIM POTENTIOMETER	.36 x .28 x 1.0	S,P	±10	0.5 at 25°C	85	15	Steady State	50-20K	1.85	1.71	1.54
 COMMERCIAL TRIMIT POTENTIOMETER	.19 x .50 x .50 .22 x .50 x .50	L P,W,X	±5	1.0 at 50°C	150	25	No	10-10K 20K-25K 50K	4.76 5.25 5.71	4.52 4.99 5.42	4.28 4.73 5.14
 COMMERCIAL TRIMIT POTENTIOMETER	.31 x .25 x .38 .31 dia. x .19	W P	±5	0.5 at 25°C	125	280°	Steady State	50-5K 10K 20K 50-5K 10K 20K	2.25 2.50 3.00 1.75 2.00 2.50	2.16 2.40 2.88 1.68 1.92 2.40	2.07 2.30 2.76 1.61 1.84 2.30
 INDUSTRIAL TRIMIT POTENTIOMETER	.59 x .315 x .50 .50 dia. x .23	W P	±5	1.0 at 25°C	125	280°	Steady State	10-10K 20K & 25K 50K 10-10K 20K & 25K 50K	3.55 4.38 4.71 3.30 4.13 4.46	3.23 3.98 4.28 3.00 3.75 4.05	2.90 3.58 3.85 2.70 3.38 3.65
 SUB-MINIATURE SINGLE-TURN	.50 dia. x .23 .50 dia. x .55	P S	±5	0.5	105	285°	Steady State	10-20K 50K 10-20K 50K	4.86 6.84 5.67 7.65	4.50 6.33 5.25 7.08	4.05 5.70 4.73 6.38

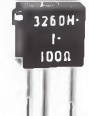

# WIREWOUND ELEMENT SPECIAL PURPOSE

	DIMENSIONS H W L	TERMI- NALS ①	(% RES. TOL.	POWER (WATT) at 70°C	MAX. TEMP. °C	ADJ. TURNS	HUMIDITY ② MIL SPEC	STANDARD RESIST- ANCES Ω ③	PRICES		
									1-9	10-24	25-49
	.31 x .19 x 1.0	L,W	±5	1.0	175	15	Yes	10-10K 20K & 30K	8.64 10.26	8.00 9.50	7.20 8.55
	.31 x .19 x 1.25	L,S,P	±5	1.0	175	22	Yes	10-10K 20K & 25K 50K 100K	7.02 8.64 9.18 11.34	6.50 8.00 8.50 10.50	5.85 7.20 7.65 9.45
	.31 x .16 x .75	P	±10	0.5	175	15	Yes	50-10K 20K	9.72 10.80	9.00 10.00	8.10 9.00
	.31 x .28 x 1.25	L,P	±5	1.0	175	25	Yes	10-10K 20K & 25K 50K 100K	7.02 8.64 9.18 11.34	6.50 8.00 8.50 10.50	5.85 7.20 7.65 9.45
	.31 x .31 x 1.06 .375 x .31 x 1.06 .31 x .31 x 1.06	H P S L	±5	1.5	175	10	Yes	100-20K 50K 100-20K 50K	10.50 12.50 11.50 13.50	10.25 12.25 11.20 13.20	10.00 12.00 10.90 12.90
	.19 x .50 x .50 .22 x .50 x .50	L P,W,X	±5	1.0	175	25	Yes	10-10K 20K & 25K 50K 10-10K 20K & 25K 50K	6.71 7.56 10.00 7.23 7.97 10.53	6.22 7.00 9.27 6.69 7.38 9.75	5.59 6.30 8.34 6.02 6.64 8.78
	.25 x .25 x .17	H,W	±5	0.2	175	11	Yes	10-1K 2K & 5K 10K & 20K 25K	7.50 8.25 10.50 11.00	6.95 7.64 9.72 10.19	6.25 6.88 8.75 9.17
	.150 x .375 x .375 .145 x .375 x .375 .145 x .375 x .390	P L,W,H	±5	1.0	175	25	Yes	10-10K 20K & 25K 50K	7.33 8.75 10.10	6.79 8.10 9.35	6.11 7.30 8.42
	.375 x .25 x .31 .31 dia. x .187 .31 dia. x .47	W P S	±5	0.5	175	300°	Yes	10-10K 20K 10-10K 20K	5.94 7.56 8.91 10.53	5.50 7.00 8.25 9.75	4.95 6.30 7.43 8.78

## NEW PRODUCT DEVELOPMENT





The vast improvements following the original design and prototype of the first adjustment potentiometer has now, as in the past, meant that Bourns sets the standard for the industry. The new products and processes constantly being developed — RESISTON® carbon and PALIRIUM® cermet elements, and the virtually indestructible SILVERWELD® termination, to name a few — serve to show that Bourns produces today what others predict for tomorrow.

Bourns potentiometers — not merely first, but the largest producer in the industry.

## PRODUCT ENGINEERING

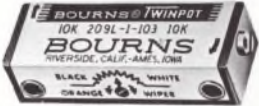
This group of highly trained, professional personnel utilize their specialized training to provide rapid, accurate technical assistance. Their individual experience and technical knowledge about adjustment potentiometers enables them to provide this service in a concise manner which saves you time and cuts costs. Such vital and time-saving assistance — available, incidentally, only from Bourns — is another part of the Bourns Total Value picture.

# WIREWOUND ELEMENT HIGH - PERFORMANCE

		DIMENSIONS			TERMINALS ①	RES. TOL. (%)	POWER (WATT) at 70°C	TEMP. °C	ADJ. TURNS	HUMIDITY ② MIL SPEC	STANDARD RESIST- ANCES ③	PRICES		
		H	W	L								1-9	10-24	25-49
	<b>207</b> HIGH POWER (2-WATT)	.81	.28	x 1.25	L	±10	2.0 at 50°C	175	25	No ④	100-50K 100K	10.26 11.88	9.50 11.00	8.55 9.90
	<b>209</b> DUAL ELEMENT TWINPOT ⑤ POTENTIOMETER	.31	.50	x 1.25	L	±10	0.5 (each element)	135	25	No ④	10-10K 20K & 25K 50K	12.96 14.58 16.20	12.00 13.50 15.00	10.80 12.15 13.50
	<b>224 - 500</b> ULTRA-RELIABLE (RTR 12) ⑥	.32	.19	x 1.25	L,P	±5	0.5	150	22	Yes	100-10K 20K	14.58 16.20	13.50 15.00	12.15 13.50
	<b>3020</b> HIGH POWER HUMIDITY PROOF	.33	.25	x 1.25	L	±5	3.75	200	25	Yes	100-10K 20K & 25K 50K	14.04 15.66 16.20	13.00 14.50 15.00	11.70 13.05 13.50
	<b>3250 - 501</b> HIGH RELIABILITY	.19 .22	.50 .50	x .50 x .50	L P,W,X	±5	0.5	150	25	Yes	100-10K 20K	13.50 14.58	12.50 13.50	11.25 12.15

## NOTES:

- ① Key to terminal types: L=Insulated stranded leads. S=Solder Lugs (includes panel mount bushings on models 3300S, 3301S, 3367S, 3368S only). P=Printed circuit pins (flat mounting). W=Printed circuit pins (edge mounting). Additional worm gear terminal classification: W=Printed circuit pins edge mounting - top adjustment). H=Printed Circuit pins (edge mounting - side adjustment).
- ② Mil-Spec pricing on request.
- ③ The following resistances are standard if they fall within the limits listed: Wirewound — 10, 20, 50, 100, 200, 500, 1K, 2K, 5K, 10K, 25K, 50K, 100K. RESISTON, RESISTALOY — 5K, 10K, 20K, 50K, 100K, 200K, 500K, 750K, 1 Meg., 2 Meg., 5 Meg. PALIRIUM — 2, 5, 10, 20, 50, 100, 200, 500, 1K, 2K, 5K, 10K, 20K, 50K, 100K, 200K, 500K, 750K, 1 Meg. Other resistances available on special order.
- ④ Closer tolerances available on request except commercial models.
- ⑤ All models are sealed against sand and dust.
- ⑥ Humidity-proof versions available on special order. Contact factory for part number, price and delivery.
- ⑦ BOURNS, TRIMPOT, TWINPOT, TRIMIT, E-2-TRIM, RESISTALOY, RESISTON, PALIRIUM, SILVERWELD, KNOBPOT and QUADRATRON are registered trademarks of Bourns, Inc. Other products made by Bourns, Inc., are identified by trademarks which include: TRIMISTOR, TRIMM, MIL-F-TRIM, CARBOLON, PANLTRIM, MILISEAL, CLOCKPOT, TRIMR, MICRO-TRIM, RESISTRIM, TRIMPOT JR., B, LABPOT, INFINITRON, DIALPOT, and TRIMPONENT. Bourns, Inc. is the owner of rights under the following listed United States Letters Patents relating to certain of its adjustment potentiometers: 2,706,230/2,777,926/2,805,307/2,831,949/2,873,337/2,882,375/2,922,976/2,935,716/2,945,198/2,946,975/3,010,092/3,018,459/2,898,569/3,089,110/RE 25,412/RE 25,725/3,107,336/RE 25,510/3,124,779/3,124,955/3,139,601. Other patents pending. Certain Bourns products are under issued and pending foreign patents.

## RELIABILITY ASSURANCE TEST PROGRAM

The high standards of Bourns Reliability Test Program is unique in the potentiometer industry. One of its important functions is the frequent requalification of all standard models to determine their conformance to published technical specifications.





Test data is available to you with our compliments. This service eliminates the time and expense to you in obtaining quality verification. The utilization of this program, in conjunction with NPC-200-3 and MIL-R-9858A quality control, assures our customers that Bourns potentiometers are subjected to the most stringent inspection and testing in the industry.

## SUPERIOR QUALITY CONTROL

Our quality control and reliability monitoring departments comprise over one-fifth of our production employees. This high ratio — in fact, the highest ratio of quality control personnel and inspectors in the electronics industry — is indicative of the attention to detail that is prevalent in each operation during the manufacture of a Bourns potentiometer. This is further evinced by the extensive in-process and 100% final inspection to published electrical characteristics that each standard Bourns product undergoes.

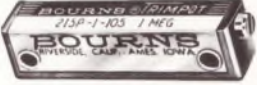
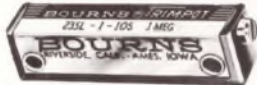





# CARBON ELEMENT GENERAL PURPOSE

	DIMENSIONS			TERMINALS ①	RES. TOL. (%)	POWER (WATT) at 70°C	MAX. TEMP. °C	ADJ. TURNS	HUMIDITY ② MIL SPEC	STANDARD RESIST- ANCES Ω ③	PRICES		
	H	W	L								1-9	10-24	25-49
 <b>215</b> RESISTOR ④ ELEMENT	.31	.25	x 1.25	L,S,P	±20	0.25 at 50°C	135	22	Steady State	5K-5 Meg	4.86	4.50	4.05
 <b>235</b> RESISTOR ④ ELEMENT	.36	.30	x 1.34	L,S,P	±20	0.25 at 50°C	135	22	Yes	5K-5 Meg	7.02	6.50	5.85
 <b>272, 4, 6</b> COMMERCIAL TRIMIT RESISTALOY ④ ELEMENT POTENTIOMETER	.31	.25	x 1.25	L,S,P	±20	0.20 at 25°C	105	25	No	5K-5 Meg	3.78	3.50	3.15
 <b>3066</b> HUMIDITY PROOF COMMERCIAL E-Z-TRIM ④ POTENTIOMETER	.36	.28	x 1.0	S,P	±20	0.20 at 25°C	85	15	No	20K-1 Meg	1.95	1.85	1.75
 <b>3068</b> COMMERCIAL E-Z-TRIM ④ POTENTIOMETER	.36	.28	x 1.0	S,P	±20	0.20 at 25°C	85	15	No	20K-1 Meg	1.85	1.71	1.54
 <b>3368</b> SINGLE-TURN RESISTOR ④ ELEMENT	.50 dia. x .24 .50 dia. x .55			P S	±20	0.25 at 50°C	105	285°	Steady State	20K-1 Meg 20K-1 Meg	5.94 6.75	5.50 6.25	4.95 5.63

## NOTES:

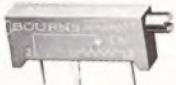
- ① Key to terminal types: L=Insulated stranded leads. S=Solder Lugs (includes panel mount bushings on models 3300S, 3301S, 3367S, 3368S only). P=Printed circuit pins (flat mounting). W=Printed circuit pins (edge mounting). Additional worm gear terminal classification: W=Printed circuit pins edge mounting - top adjustment. H=Printed Circuit pins (edge mounting - side adjustment).
- ② Mil-Spec pricing on request.
- ③ The following resistances are standard if they fall within the limits listed: Wirewound — 10, 20, 50, 100, 200, 500, 1K, 2K, 5K, 10K, 25K, 50K, 100K. RESISTOR, RESISTALOY — 5K, 10K, 20K, 50K, 100K, 200K, 500K, 1 Meg., 2 Meg., 5 Meg. PALIRIUM — 2, 5, 10, 20, 50, 100, 200, 500, 1K, 2K, 5K, 10K, 20K, 50K, 100K, 200K, 500K, 750K, 1 Meg. Other resistances available on special order.
- ④ Closer tolerances available on request except commercial models.
- ⑤ All models are sealed against sand and dust.
- ⑥ Humidity-proof versions available on special order. Contact factory for part number, price and delivery.
- ⑦ BOURNS, TRIMPOT, TWINPOT, TRIMIT, E-Z-TRIM, RESISTALOY, RESISTOR, PALIRIUM, SILVERWELD, KNOBPOT and QUADRATRON are registered trademarks of Bourns, Inc. Other products made by Bourns, Inc., are identified by trademarks which include: TRIMISTOR, TRIMM, MIL-F-TRIM, CARBOLON, PANLTRIM, MILISEAL, CLOCKPOT, TRIMR, MICRO-TRIM, RESISTRIM, TRIMPOT JR., LABPOT, INFINITRON, DIALPOT, and TRIMPONENT. Bourns, Inc. is the owner of rights under the following listed United States Letters Patents relating to certain of its adjustment potentiometers: 2,706,230/2,777,926/2,805,307/2,831,949/2,873,337/2,882,375/2,922,976/2,935,716/2,945,198/2,946,975/3,010,092/3,018,459/2,898,569/3,089,110/RE 25,412/RE 25,725/3,107,336/RE 25,510/3,124,779/3,124,955/3,139,601. Other patents pending. Certain Bourns products are under issued and pending foreign patents.

# CARBON ELEMENT HIGH - PERFORMANCE

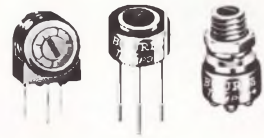
	DIMENSIONS H W L	TERMINALS ①	RES. TOL. (%)	POWER (WATT) at 70°C	MAX. TEMP. °C	ADJ. TURNS	HUMIDITY ② MIL SPEC	STANDARD RESIST- ANCES Ω ③	PRICES		
									1-9	10-24	25-49
	.31 x .16 x .75	P	±20	0.20	150	15	Yes	20K-1 Meg	9.18	8.50	7.65
	.31 x .28 x 1.25	L,P	±20	0.25 at 50°C	150	22	Yes	5K-5 Meg	7.02	6.50	5.85
	.31 x .19 x 1.25	L,S,P	±20	0.25 at 50°C	150	22	Yes	5K-5 Meg	7.02	6.50	5.85
	.19 x .50 x .50 .22 x .50 x .50	L P,W	±20	0.5 at 50°C	150	25	Yes	20K-1 Meg	7.83	7.25	6.53
	.20 x .375 x .375	L,P,W	±20	0.5 at 50°C	150	25	Yes	20K-1 Meg	7.56	7.00	6.30
	.375 x .25 x .31 .31 dia. x .19 .31 dia. x .47	W P S	±20	0.25	150	300°	Yes	10K-1 Meg 10K-1 Meg	5.94 8.91	5.50 8.25	4.95 7.43

## OTHER PRODUCTS BY BOURNS

### PRECISION POTENTIOMETERS

Bourns precision potentiometers are available in both bushing and servo mount styles and are supplied in diameters from 7/8" to 3", in single and multi-turn configurations, and with INFINITRON® conductive plastic and wirewound elements.

### RELAYS AND RELAY SYSTEMS

A number of special and diversified products are available in this product line. Among them are the Bourns TRIMPOT® subminiature relays rated at 1.0 ampere which form the basic precision unit for the intricate and customer-designed systems. Also available are Bourns solid state time delay relays and voltage sensing modules.

### MAGNETIC PRODUCTS

This specialized series encompasses many unique items of the Bourns line. Transformers, inductors, and miniature power supplies are some of the key products in this growing family.



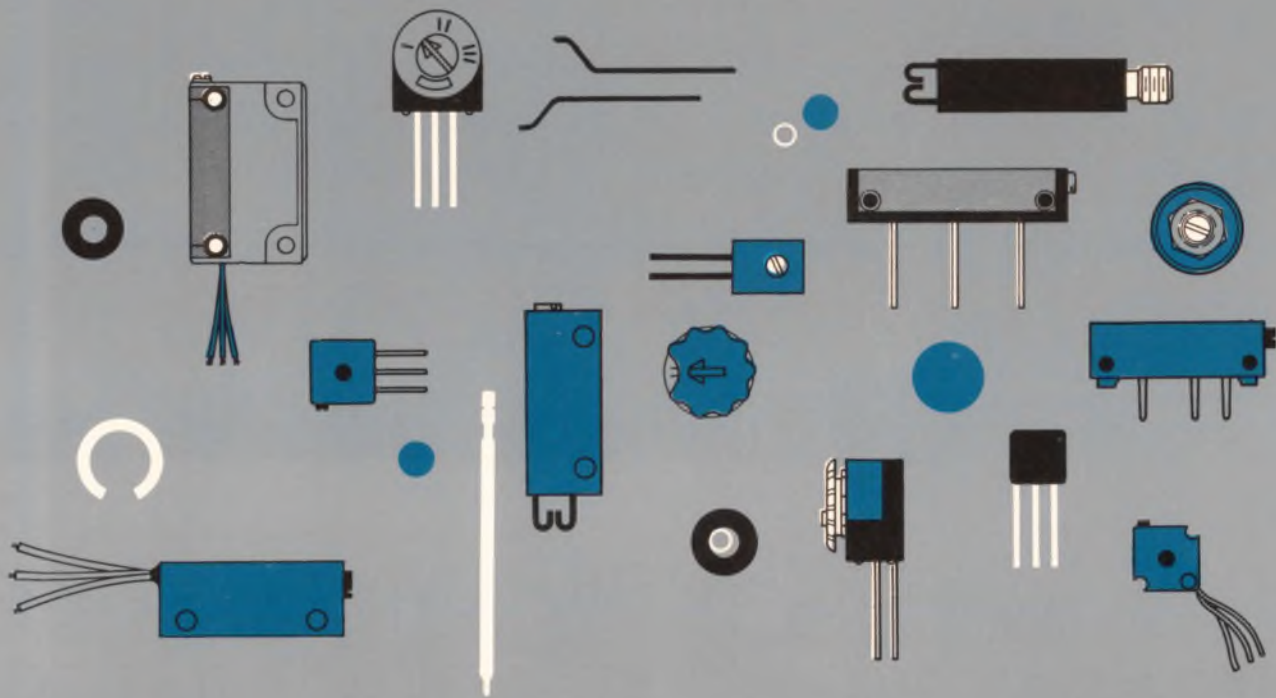

BOURNS, INC., ELECTRONIC COMPONENTS OPERATIONS, TRIMPOT PRODUCTS DIVISION  
 1200 COLUMBIA AVENUE, RIVERSIDE, CALIFORNIA 92507  
 TELEPHONE: 714 684-1700 • TWX: 910 332-1252 • CABLE: BOURNSINC

CANADIAN HQ: BOURNS (CANADA), LTD. 36 CRANFIELD ROAD, TORONTO 16, ONTARIO  
 PHONE: 751-3880 TELEX: 02-29276

MONTREAL OFFICE: SUITE 305 PLACE ST. LAURENT, 790 BLVD. LAURENTIAN, ST. LAURENT, P.Q.

EUROPEAN HQ: BOURNS, A G., ALPENSTRASSE 1, ZUG, SWITZERLAND

BENELUX: BOURNS (NEDERLAND) N. V., KONNINGINNEGRACHT 26, THE HAGUE

UNITED KINGDOM: BOURNS (TRIMPOT) LTD., 17-27 HIGH ST., HOUNSLOW, MIDDLESEX

GERMANY: BOURNS, A G., EBERHARDSTRASSE 63, 7 STUTTGART S, WEST GERMANY

# TWT device interest grows

Michael J. Riezenman  
Technical Editor

The growing importance of traveling-wave technology is highlighted by the great deal of interest shown in the construction of very broadband devices that are needed for such applications as frequency-agile radars and surveillance receivers. Among such devices are a traveling-wave IMPATT diode amplifier with potential phased-array applications; a traveling-wave electroacoustic amplifier; and high-efficiency, high-power traveling-wave tubes.

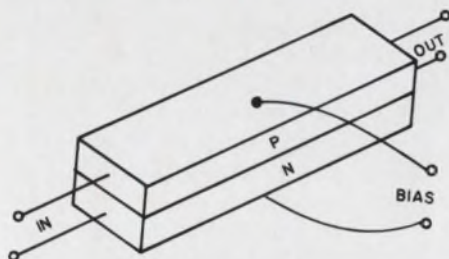

1. Traveling waves propagating along the junction of this IMPATT diode will be amplified if proper bias and frequency conditions are satisfied.

The IMPATT diode amplifier (Fig. 1) is unique because its avalanche junction is in the form of a strip transmission line. The input signal is amplified as it propagates along the junction. In contrast, amplification in more conventional IMPATT amplifiers occurs when the signal is reflected from a small-area junction.

The device was designed by Harold C. Bowers and Thomas A. Midford, General Electric Co., Syracuse, N.Y., who announced its development at the International Electron Devices meeting in Washington, D. C. They explained that the wavelength of a signal in the device and the gain each increase with increasing bias current.

## Phased-array applications

However, as Midford points out, the bias level and frequency can be chosen to minimize gain variations and to obtain a linear phase-shift characteristic. This makes the device attractive as a combined power amplifier and phase shifter for phased-array applications.

Thus far in their research, Bow-

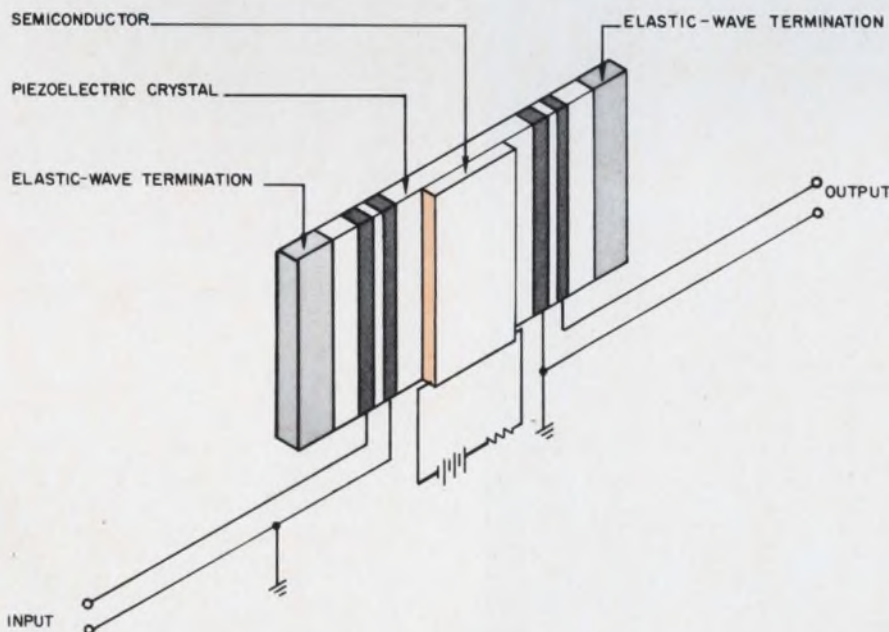

2. A gain of 12 dB/cm was obtained with this phonon amplifier using a lead-zirconate-titanate piezoelectric crystal and n-type silicon as the semiconductor. The elastic-wave terminations prevent reflections by absorbing the acoustic waves that hit them.

# NEW! VACTEC Light Emitting Diode/Photoresistor Control

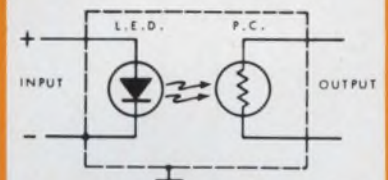
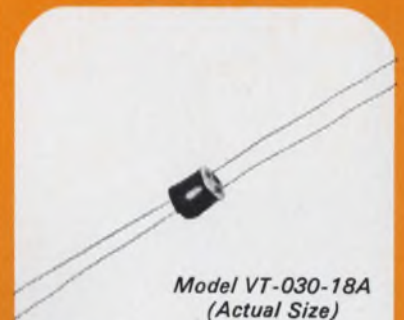

Case common to negative terminal on LED

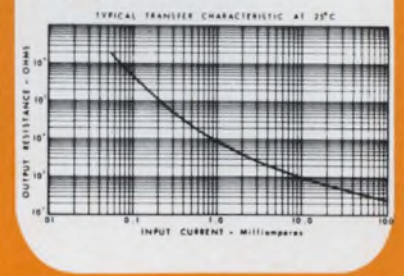

- All solid state LED Vactrol Input-Output Device with true electrical isolation.
- Light emitting diode coupled with an ohmic photo-conductive cell.
- Extremely low input power requirement with operation as low as 1-milliwatt input.
- Ideal for battery operation.
- Wide range control, 1000 to 1 or greater light to dark ratio.
- Less than \$8.00 in quantity of 1000.

Two sizes, TO-8 hermetic and TO-18 axial. Write for Bulletins LEDV-1 and LEDV-2.

**VACTEC, INC.**  
2423 Northline Ind. Blvd.  
Maryland Hts., Mo. 63042 • (314) 432-4200



# SPECIFY **NEW** PANEL BOARD INSTRUMENTS by **Hickok**

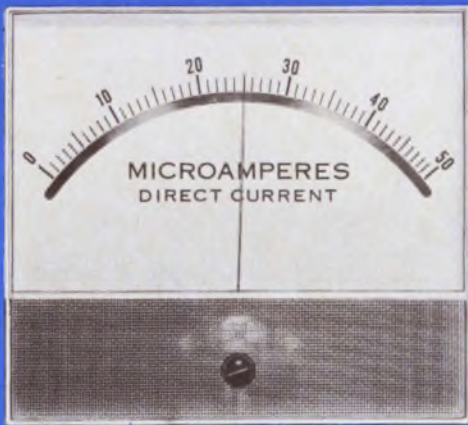

Three  
Standard  
Sizes

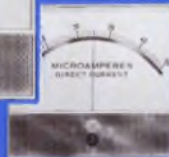
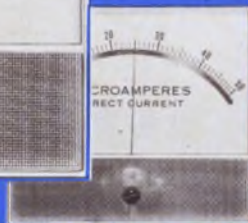

Rear Panel  
Flush Mounted

## A NEW LINE OF INSTRUMENTS PRECISION QUALITY AT COMPETITIVE PRICES

Colorado Hickok Corp., Division of Hickok Electrical Instrument Co., Cleveland, announces a NEW LINE of Panel Board Instruments at highly competitive prices. Hickok Instruments can read anything in electronics — ruggedized instrumentation with pioneer-proven reliability. Fast deliveries can also be made from Hickok's factory mod department. Hickok's NEW LINE features clear acrylic plastic front cases for front or rear-of-panel mounting, available in 3½ — 4½ — 5½ inch width cases, in D-C D'Arsonval and A-C Repulsion Vane and Dynamometer Movements, CALL OR WRITE FOR ADDITIONAL INFORMATION.

- Accuracies 1.5% full-scale
- A-C Iron Vane Repulsion
- Current Range 10 milliamps — 30 amps\*
- Voltage Range 5-300 volts\*
- D-C Self-Shielded Core Magnet
- Pivot-Jewel or Tautband Suspension
- Current Range 10 microamps — 30 amps\*
- Voltage Range 15 millivolts — 300 volts\*

\*Higher A-C current and voltage ranges may be supplied for use with transformers or multipliers; and with D-C shunts and multipliers.

# Colorado **Hickok**

CORPORATION

A Division of The Hickok Electrical Instrument Co. — Cleveland.  
2897 North Avenue Grand Junction, Colorado 81501  
Telephone — Area Code 303 / 243-2124

## NEWS

(TWT, continued)

ers and Midford report gains of 10 dB at 7.4 GHz with a bias current of 3 A and gains of 20 dB at 400 MHz with a bias current of 1.5 A.

A two-material phonon amplifier (Fig. 2), using a traveling-wave approach, was announced by Stephen Yando and Dr. Chava Fischler of General Telephone and Electronics Laboratories, Bayside, N.Y.

In this amplifier, the input signal is applied to a pair of electrodes on a piezoelectric crystal.

The resultant strain created in the crystal causes acoustic waves to propagate through its bulk. The wave traveling to the left is absorbed by the termination; the wave traveling to the right creates a piezoelectric field that penetrates the semiconductor wafer in which a carrier drift current has been established.

When the carrier drift velocity is made to exceed the elastic-wave velocity, energy is transferred to the wave and amplification results.

So far, the device has been operated in the 0.5 to 4.0 MHz region with octave instantaneous bandwidths. The GT&E scientists report output signals of 400 V peak-to-peak. Although they have not measured the efficiency of the device, the researchers believe it will prove to be quite high.

## TWTs stay in sync

The efficiency of high-power TWTs can now be increased, says Dr. O. Sauseng, of Hughes Aircraft Co., Torrance, Calif. The problem has been to keep the speed of the electron beam and the traveling wave equal, as energy is transferred from beam to wave.

The techniques he uses include tapering the slow-wave structure to slow down the wave, so that the wave remains synchronous with the beam; and elevating the voltage of the last section of the structure to speed up the beam, so that the beam can keep up with the wave.

Using the latter approach in a grounded-collector tube, Sauseng has obtained 52% efficiency. He predicts 60% efficiency with depressed-collector operation. ■■



**MOST  
RESISTORS ARE  
PRETTY MUCH  
ALIKE  
IT'S THE NAME  
BEHIND THEM  
THAT COUNTS**

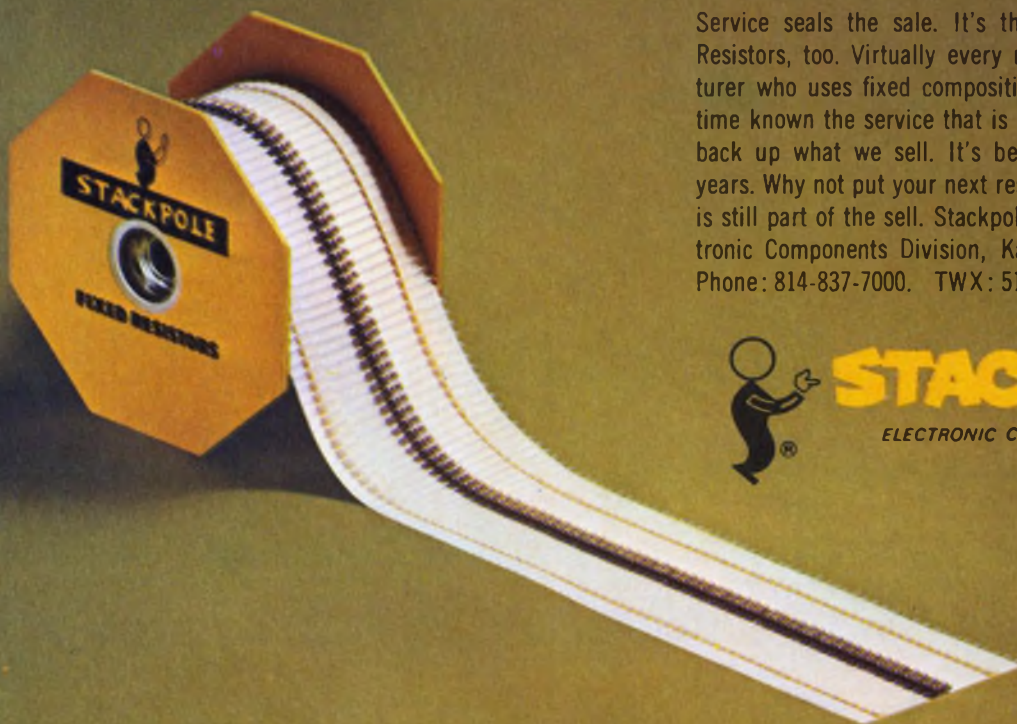

Service seals the sale. It's that way with everything. Resistors, too. Virtually every major domestic manufacturer who uses fixed composition resistors has at some time known the service that is distinctly Stackpole's. We back up what we sell. It's been that way for over 35 years. Why not put your next resistor order where service is still part of the sell. Stackpole Carbon Company, Electronic Components Division, Kane, Pennsylvania 16735. Phone: 814-837-7000. TWX: 510-695-8404.



**STACKPOLE**

ELECTRONIC COMPONENTS DIVISION







# For environmental protection... silicone encapsulating resins

Whatever the operating conditions — heat, cold, moisture, or other harsh environments...there's a Dow Corning silicone encapsulating resin to provide protection for your electronic equipment.

Sylgard® brand encapsulating resins from Dow Corning are ideally suited for filling, potting, coating, impregnating and embedding. Processing flexibilities include room

temperature cure, heat accelerated cure, one-part and two-part systems. All provide these unique properties:

- cure in thick section without reversion
- no damaging exotherm during cure
- are self-extinguishing
- provide excellent dielectric strength
- have excellent resistance to moisture, ozone and oxygen

- maintain constant physical and electrical properties from — 65 to 200 C or better
- excellent thermal shock resistance

Regardless of your encapsulating protection problems...Dow Corning offers a silicone resin to meet your needs. Find out by writing Dept. F-8474, Dow Corning Corporation, Midland, Michigan 48640, or call 517-636-8940.

## DOW CORNING

DOW CORNING



*New premixed, ready-to-use white Sylgard silicone encapsulating resin flows freely around components and provides virtually unlimited working time at room temperature... cures in one hour at 135 C and in two hours at 100 C... no post cure required... no reversion... low water absorption... self-extinguishing.*

*New shock absorbing Sylgard silicone resins are ideal encapsulants for delicate electronic equipment subject to high G shock loads and continuous vibration. These low bayshore materials dampen out external forces with little internal reaction... available in either clear or black... deep section cure without reversion.*



INFORMATION RETRIEVAL NUMBER 23



# Penny-Pincher's Pac



If you're looking for low-cost, high-performance logic that can help you pinch pennies, see how some typical HONEYWELL  $\mu$ -PAC logic module prices have been reduced:

Model	Description	Unit Price*		New Price per Function
		Old	New	
DI-320	10, two input NAND gates	\$25.00	\$20.00	\$2.00/gate
DN-320	6, multi-input NAND gates	21.00	16.00	2.66/gate
DF-320	8, three input NAND gates	New	20.00	2.50/gate
FF-320	8 basic flip-flops	New	31.00	3.87/flip-flop
FA-320	4 clocked flip-flops	31.75	25.00	6.25/flip-flop
BC-320	6 stage binary counter	46.50	38.00	6.33/stage
SR-321	8 stage shift register	New	54.00	6.75/stage
AP-335	8 half adders	168.00	129.00	16.12/half adder

We'll give you 102 more price comparisons on request.  
\*Inquire about our discounts.

Whether you're an OEM buyer watching dollars, or a one shot watching pennies — see how  $\mu$ -PAC modules bring your costs down. Call your Honeywell 3C salesman now, or write for our summary brochure. Honeywell, Computer Control Division, Dept. 08, Old Connecticut Path, Framingham, Massachusetts 01701.

Need  $\mu$ -PAC logic modules in a pinch? Ask about our 72-hour Certified Fast Shipment (CFS) plan.

## Honeywell

**COMPUTER CONTROL  
DIVISION**



It's "go" for Apollo 8



# Washington Report

CHARLES D. LAFOND  
WASHINGTON BUREAU

## Vote unanimous for December moon flight

It's nearly impossible to find a dissenting vote among NASA space officials concerning the planned circumlunar manned mission on Dec. 21. In his announcement last month of the pioneering Apollo 8 flight, Dr. Thomas Paine, NASA Deputy Administrator, reported unanimity among top NASA officials at headquarters here, at the Manned Spacecraft Center in Houston, and at the Kennedy Space Center in Florida. The launch facility is ready, the Saturn-V/Apollo 8 is equipped and programmed for a low lunar orbit, and the global support network is undergoing checkout.

In brief, this is the flight plan: The mission is broken down into steps, each of which must be accomplished successfully before officials commit the mission to the next level. As such, the mission is open-ended, with four major sequential alternatives: a low earth orbit, a high elliptical orbit (out to 60,000 miles), a swing around the moon without orbit and return to the earth, and a low lunar orbit and return to earth.

On launching day the giant Saturn-V will carry the three astronauts upward into a 115-mile parking orbit, with the final rocket stage still attached to the Apollo command and service module. After several revolutions around the earth, the final propulsion unit will be available to fire the craft into a translunar trajectory. With mid-course corrections, the spacecraft could reach the moon 66 hours later. The vehicle would leave its earth orbit at 24,200 mph, then coast freely until the speed dropped to 2120 mph at a point about 30,000 miles from the moon.

Lunar gravity would then take over, accelerating the speed to 5700 mph as the craft orbited the moon in an

elliptical path 70 to 196 miles high. To enter the elliptical orbit, the astronauts would slow the spacecraft's velocity to 3720 mph. But two revolutions later, with the firing of the propulsion unit, the craft would pick up speed.

After 10 revolutions, following photographic coverage of the moon's surface and extensive gravitational measurements, the spacecraft crew would again use propulsion to return to the earth. The entire mission will take about six days.

## Congress told of large defense profits

Economics Professor Murray L. Weidenbaum of Washington University has told Congress at hearings on military procurement costs that large defense contractors are getting a 70 per cent higher profit than the average company engaged in private business. Weidenbaum was the lead-off witness last month, along with Controller General Elmer B. Staats, before Chairman William Proxmire's Senate Subcommittee on Economy in Government. The Washington University professor is a long-time critic of the so-called military-industrial complex (See "Contractors and Government clash over rules" ED 12, June 6, 1968, p. 36) and first revealed his studies on defense profits last March during the EIA Conference on Economics and the Defense Industry here.

A solution, says Weidenbaum, is to increase competition for Government business and to establish larger incentives for companies to foster use of their own working capital, rather than depending excessively on the Government. Staats, in agreeing, proposed giving larger profits



to those defense contractors who purchased their own facilities and equipment, as opposed to those who leased facilities.

Most studies of defense-contract practices—including that of the Logistics Management Institute, which reported its findings at the EIA conference—have concluded that profit margins are considerably lower for Government business, compared with private. The difference in opinion seems to stem from the method of determining real profits. Weidenbaum says that profit as a percentage of sales is lower for large defense contractors, but he asserts that a truer picture is obtained when profit is measured as a percentage of net worth. Using the latter method, he says, a sample of leaders in the defense industry averaged 17.5 per cent return in 1962-65, compared with a 10.6 per cent profit for similar nondefense industrial companies.

## Huge market predicted for Omega electron

Market experts here are forecasting a market of several billion dollars in the next decade for surface-ship and aircraft navigation sets to be used in the operational Omega system—a worldwide navigation system. As reported previously in this column (see ED 24, Nov. 21, 1968), the Dept. of Defense has now approved the eight-station global Omega Navigation System for completion by late 1972. Four stations are in operation now; four more are to be instrumented. With the proper receiving equipment, civil or military craft in any nation can use the system.

Development for the system has been under the direction of the Naval Research Laboratory here. The hyperbolic-grid, vlf system provides a range coverage from each station that significantly

overlaps that of several other stations. The stations are being set up with separations of about 5000 nautical miles. Grid lines will cover roughly one-quarter of the earth's circumference from each, and users will ordinarily receive signals from five or six stations at any point. Operation is in the range of 10 to 14 kHz, and position accuracies are reported to be from one to two miles.

## FAA reveals five-year program

In its annual National Airport Plan, submitted last month to President Johnson, the Federal Aviation Administration proposed a five-year improvement effort. It calls for the construction of 800 new airports and the improvement of 3000 existing airports, to reduce flight congestion and to accommodate projected growth. The estimated cost: \$2.2 billion, most of which would have to be raised by state and local governments. Of greatest interest to the electronics industry is the FAA estimate that 6 per cent of the total spending or about \$1.4 billion would be for development projects in the first two years.

The program proposes 22 new airports to supplement highly congested fields in major cities. The report also includes plans for 31 new heliports, four seaplane bases and the introduction of special facilities for short take-off and landing aircraft (STOLs) at 25 airports. The FAA stresses that none of its cost estimates cover terminal buildings or passenger-facility improvements.

## Aerospace sales continue climb

Latest market estimates from the Aerospace Industries Association show aerospace sales for the first six months of this year running at an annual rate of \$30.2 billion, compared with sales last year of \$27.2 billion. The industry backlog, according to the monthly AIA Economic Indicators, totaled \$34.3 billion at the end of June, or more than \$5 billion more than the backlog at the end of June, 1967. Employment is up slightly to over 1.4 million. While the profits for all manufacturing in the United States have remained constant at 5.2 per cent, aerospace profits have risen from 2.5 to 3.2 per cent, AIA says.



GOOF-  
PROOF

VOM



Here's the most foolproof volt-ohm-milliammeter ever made. Protection approaches 100%. It's the VOM you will want to have on hand where inexperienced people are running tests . . . or will reach for yourself on those days when you're all thumbs. The 260-5P will save you all kinds of headaches from burned out meters and resistors, bent pointers, and inaccuracies caused by overheating.

**Combined Protection You Won't Find In Any Other VOM**

1. Reset button pops out to indicate overload.
2. You cannot reset circuits while overload is present.
3. Protective circuit does *not require* massive overloads which can cause hidden damage to the instrument.
4. All ranges are protected except those not feasible in a portable instrument—1000 and 5000 volts DC and AC; 10 amp DC.

SIMPSON  
260-5P

**ONLY \$94.00**

*Write for Bulletin 2078*

**Ranges**—The 260-5P has the same ranges and takes the same accessories as Simpson's famous 260-5 volt-ohm-milliammeter.



DIVISION

**Simpson**  
INSTRUMENTS THAT STAY ACCURATE

**SIMPSON ELECTRIC COMPANY**

5200 W. Kinzie Street, Chicago, Ill. 60644 • Phone: (312) 379-1121

Representatives in Principal Cities . . . . . See Telephone Yellow Pages

Export Dept.: 400 W. Madison St., Chicago, Ill. 60606 Cable: Simelco

In Canada: Bach-Simpson Ltd., London, Ontario

In India: Ruttonsha-Simpson Private Ltd., Vikhroli, Bombay

WORLD'S LARGEST MANUFACTURER OF ELECTRONIC TEST EQUIPMENT

INFORMATION RETRIEVAL NUMBER 25



## The human interest in the human heart

To hunt down his news story (see page 25), Jim McDermott followed a path that was almost as circuitous as the design flow lines in the subject he was assigned to cover: artificial human hearts, and the growing biotechnological effort to develop reliable power sources for energizing them.

At Boston's Northeast Regional Electronics Meeting, at widespread health service centers, at the National Heart Institute in Bethesda, Md., Jim's search for the new and the significant brought him into contact with many of those who are leading the effort to merge the healing and the engineering arts. In one area alone—care for the aged—the opportunity for relieving heart disabilities is profound. The prognosis is hopeful. But the artificial hearts are still years away.

## Wonder where we got the photos?



The cover photo and the divider-pages for our LSI report (ED 24, Nov. 21, 1968) were designed and photographed by Jim Kellett, Art Director, and Lennie Zbiegien, Chief Photographer, of Motorola Semiconductor Products, Inc., Phoenix, Ariz. Jim and Lenny worked in close cooperation with ELECTRONIC DESIGN's Art Director Cliff Gardiner. Our sincere thanks.

## Encore: An a-to-d conversion guide

Many readers have expressed appreciation for ELECTRONIC DESIGN's 40-page design guide for d/a conversion, written by Hermann Schmid, senior engineer for General Electric, Binghamton, N.Y., and published in the Oct. 24 issue. For an encore, we offer a natural: a guide to a-to-d converters. A three-part series by Schmid, it starts on page 49.

Both guides are adaptations from a chapter in a forthcoming book by Schmid, to be published by the McGraw-Hill Book Co.

Before starting the new series, take a good look at how the theories work in practice. The photo on the cover of this issue is a view of the computer control room at the Portsmouth, Ohio, plant of the Detroit Steel Corp. A General Electric PAC-4040 is maintaining control of the complete roughing and finishing mill. Installed in 1966, the system was one of the first industrial adaptive control systems in the United States.

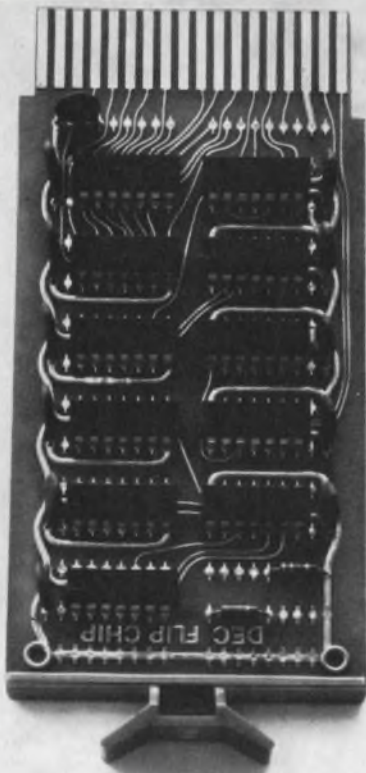

## Complete 10 MHz IC shift register at \$10.50 per stage

M-208 is an 8-stage digital logic shift register, complete. It, like all 25 modules in the M Series, works at 10 MHz. And it, like all other modules in the series, is designed for a cost/performance ratio that is the best in the industry. The M-208 sells for \$84, unless you buy large quantities. Then it's less.

M-208 control lines are buffered, eliminating complex loading rules. Provision is made for parallel loading of bits. TTL integrated circuits, the latest and best available, are used exclusively. Typical dc noise margin is 1 volt at either logic 1 or logic 0 levels.

M Series modules, including the M-208, and several other series of compatible modules, are fully described in the new Logic Handbook. Write for a free copy.

**digital**  
MODULES · COMPUTERS  
Maynard, Mass.,



# ALSiMAG<sup>®</sup>

## Progress Report

### NOW A SUBSTRATE WITH SIX TIMES THE THERMAL CONDUCTIVITY

Since the thermal conductivity of ALSiMag 794 Beryllia Ceramic is about six times that of an alumina ceramic, a Beryllia Substrate can solve many thermal dissipation problems. An engineer may oversimplify when he says: "We can pack the same amount of performance in one-sixth the area" but this new Beryllia ceramic composition does solve a number of circuit problems associated with high circuit density or with the use of higher power resistors. And it has the same favorable electrical characteristics as an ALSiMag alumina ceramic . . . the most widely used of all ceramic substrates.

American Lava Corporation pioneered in the production of thin, flat, precision alumina ceramic substrates with an as-fired surface of 8 micro-inches (CLA) or better as measured on the Talsurf. American Lava also pioneered precision slots, holes and notches for substrates and has shared in the progress on precision metallized patterns.

For many years, Beryllia Ceramic Substrates were limited by production problems. At American Lava, great progress has been made in technical knowledge and skill in processing Beryllia. The new dense ALSiMag 794 Beryllia Ceramic, as shown on the chart at right, has been developed and refined. As a result, American Lava Corporation now produces ALSiMag Beryllia Ceramics in virtually the same wide variety and precision tolerances as alumina ceramics.

ALSiMag 754 was the original ALSiMag Beryllia Ceramic composition. It is in wide use in a large number of applications where it offers advantages in ease of production plus proven performance. But for other requirements, there has been a need for a still finer grained Beryllia ceramic with higher strength and superior electrical, mechanical and thermal characteristics. That composition, ALSiMag 794, with a flexural strength of 33,000 psi, was developed and is now announced after more than a year of volume production which proves its reliability and usefulness.

ALSiMag 794 has grown rapidly in substrate use because of its remarkable ability to dissipate heat. Hand made prototypes are promptly available. Send your operating requirements and sketches or prints and you can quickly evaluate ALSiMag 794 Beryllia Ceramic Substrates for your application.

PROPERTY	ALSiMAG 794
Water Absorption	0 Impervious
Specific Gravity	2.92
Hardness { Mohs' Scale Rockwell 45 N	9 62
Thermal Expansion Linear Coefficient Per °C	25-100 6.1 x 10 <sup>-6</sup> 25-300 7.5 x 10 <sup>-6</sup> 25-700 8.4 x 10 <sup>-6</sup> 25-1000 8.8 x 10 <sup>-6</sup>
Ultimate Tensile Strength, psi	23,000
Compressive Strength	260,000
Flexural Strength (test specimen .070" x .070" 1" span)	33,000
Precision Elastic Limit, psi	14,400
Dielectric Strength 60 Cycle AC Test Discs 1/4" thick	230
Dielectric Constant 1 MC at 25°C	6.1
Loss Factor 1 MC at 25°C	.0008

**WARNING**—In working with beryllia ceramics personnel should avoid exposure to dust or fume producing operations, such as sawing, grinding, drilling, or processing in moist atmospheres at high temperatures. Specialized equipment is necessary to prevent the dispersal of the dust and fumes into the air.

CODE IDENT. NO. 70371

PHONE 615 265-3411, CHATTANOOGA, TENN. 37405

American Lava Corporation **3M**

A SUBSIDIARY OF COMPANY

For service, contact American Lava representatives in Offices of Minnesota Mining and Manufacturing Company in these cities (see your local telephone directory): Boston: Needham Heights, Mass. • Chicago: Elmhurst, Ill. • Dallas, Texas • Chagrin Falls, Ohio • Harvard, Mass. • Laurens, S. C. • Los Angeles, Calif. • Metropolitan New York: Ridgefield, N. J. • Up-State New York and Canada: Phoenix, N. Y. • Orange, Conn. • Philadelphia, Penn. • Roanoke, Va. • St. Louis: Lee's Summit, Mo. So. San Francisco, Calif. • 3M International: c/o American Lava Corporation, Chattanooga, Tenn. 37405 U.S.A. 615/265-3411

67th  
YEAR  
OF  
CERAMIC  
LEADERSHIP



## TRW METALLIZED POLYCARBONATES



...good things come in small packages

A 10 mfd 50 volt type X483 capacitor measures a scant .670" x 1 $\frac{1}{8}$ ". It's hermetically sealed and provides outstanding temperature stability and electrical properties. Meets all MIL-C-18312 and MIL-C-19978 requirements.

Type X483 are advanced technology capacitors tailor-made for advanced technology applications. Values from .001 to 10 mfd, 50, 100, 200 and 400 volts.

Contact TRW Capacitor Division, Box 1000, Ogallala, Neb.

INFORMATION RETRIEVAL NUMBER 28

Phone: (308) 284-3611. TWX:  
910-620-0321.

# TRW<sup>®</sup>

**Publisher**

Hugh R. Roome

**Editor**

Howard Bierman

**Managing Editor**

Robert C. Haavind

**Technical Editors**Frank Egan  
A. Craig Reynolds, Jr.  
Michael J. Riezenman  
Raymond D. Speer**Management and Careers Editor**

Bruce Trabue

**News Editor**

Ralph Dobriner, Chief

**Washington News Bureau**

Charles D. LaFond, Chief

**Military/Aerospace Editor**

John F. Mason

**East Coast Editor**

Jim McDermott

**West Coast Editor**

Elizabeth deAtley

**New Products Editors**Robert Patton  
Lucinda Mattera**Copy Editor**

Peter Irving

**Editorial Production**Dollie S. Viebig  
Phyllis Gura**Art Director**

Clifford M. Gardiner

**Art Assistant**

William Kelly

**Technical Illustrators**William Alvarez  
Rita Jendrzejewski  
Barney Krochek  
Lynn E. Thompson**Production Manager**

Thomas V. Sedita

**Asst. Production Manager**

Helen De Polo

**Production Assistants**Bernard Wolinsky  
Carl A. Merkin**Circulation Manager**

Nancy L. Merritt

**Information Retrieval**

Genate Pazmino

## EDITORIAL



## Trend toward obfuscation breeds 'irreproducible results'

A recent conversation between one of our editors and an author is symptomatic of a malaise that we feel is affecting technological progress.

The editor was asking for clarifications of a number of points raised in the article, so that readers who were not deeply immersed in the particular subject would not have to chase to references in order to understand it. The author confessed that he'd edited out some of these explanations before sending the article on to us.

The reason, he said, was that normally his superiors (at a large, top-level engineering company) automatically eliminated any simplifying explanations in a paper. Their goal, he confessed, was to make this company look like one where tossing around difficult concepts is as simple as falling off a log. Questioned further, the author admitted that he personally felt that most readers, except for top specialists, would not be able to follow his article very well without the extra explanation—yet the clarifying material added very few lines of print.

This trend to technical obscurity is becoming so fashionable that it is becoming automatic. It holds true not only for companies, but also characterizes individual educators caught in the "publish or perish" squeeze. Communication is purposefully restricted to others in the particular "in" group.

For example, months may go by before researchers can get important new work published in journals. It often takes that long for the editorial reviewers to figure out what in blazes the author is trying to say! In a moment of candor, one such top reviewer admitted that, although one of his peers had had numerous papers published, not even the top authorities in the field were quite sure of what the author was doing. But the reviewers didn't want to take a chance on rejecting important work! Is it possible that, in some cases, research funds would not be so free-flowing if the researchers' real findings were clearer?

Obfuscation has, in fact, become so widespread that a rather poor effort at satirizing the situation has gained a surprising amount of comment in certain technological and scientific circles. We refer to the "Journal of Irreproducible Results."\* A recent issue of this "Journal" features such articles as the "Fundamentals of Abstruse Algebra" and "The Swinger Function." (The latter piece is categorized under "Researchmanship".)

Such a journal would never have seen print, if this present-day trend did not exist.

Clear communication is as much a requirement of technological progress as is clear thinking.

ROBERT HAAVIND

\*Published three times a year, subscription \$1, as the "Official Organ of the Society for Basic Irreproducible Research," P.O. Box 234, Chicago Heights, Ill.



# *Cermet*

AND THE

## *Model 3082*

POTENTIOMETER

Microminiature Size - Only .5" x .1" x .15"

TC 150PPM/°C\* over entire resistance range 10Ω to 1 Meg.



Designed and manufactured to meet your exacting requirements in the highest tradition of quality — by Bourns . . . the leader in adjustment potentiometers. Write or call the factory, your local field office or representative today for complete details!

\* 100PPM/°C AVAILABLE



BOURNS, INC., TRIMPOT PRODUCTS DIVISION • 1200 COLUMBIA AVE., RIVERSIDE, CALIF. 92507



# Technology



**A/d converter design** can be simple if you know the various techniques. Page 49

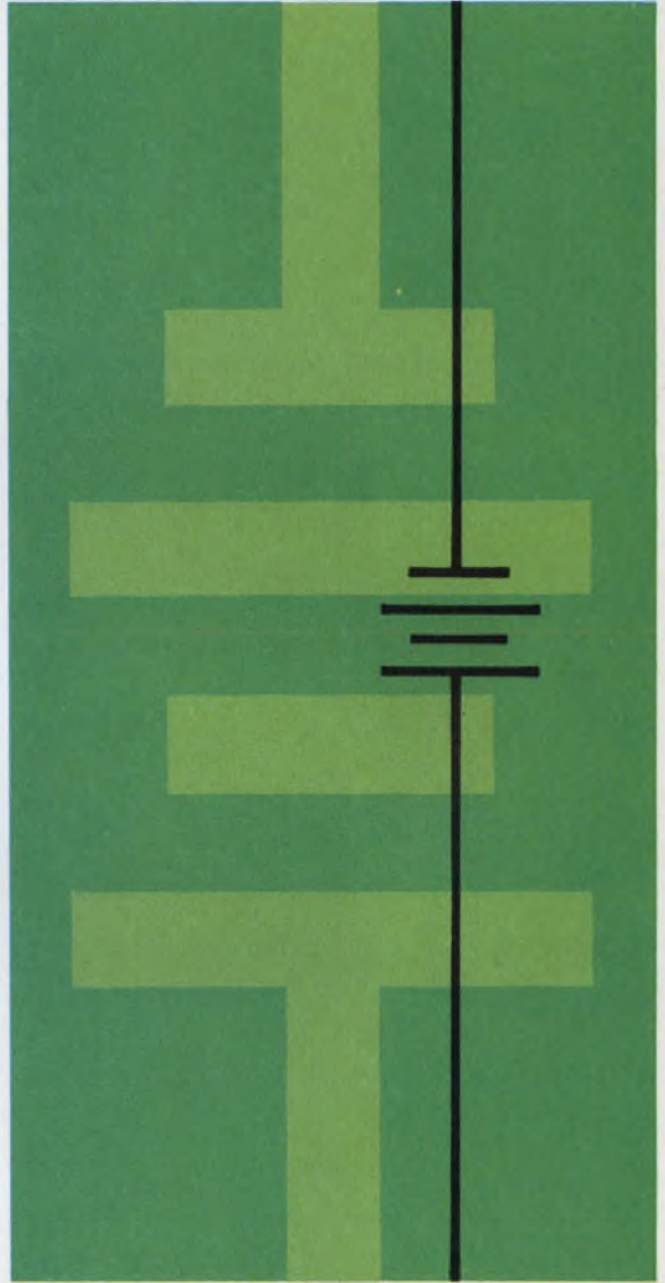

**Redesign your synthesizer**, cut dc power drain to as little as 60 mW. Page 80

## Also in this section:

**Speed immittance calculations** with a computer. Page 74

**Ideas for Design**. Page 104



**Dual Differential Amplifiers—  
DC to 120 MHz:  
RCA - CA3026 @ \$1.25 (1,000 units)**

Here—from RCA—is another Integrated Circuit “building block” —two differential amplifiers on a single substrate with uncommitted bases and collectors. Use them as differential and/or cascode amplifiers, IF amplifiers, limiters, video amplifiers, doubly-balanced modulators and demodulators. CA3026 brings the advantages of monolithic IC devices to a more comprehensive range of solid-state circuit applications.

Ask your RCA Representative for details or see your RCA Distributor for his price and delivery. For technical details, write RCA Electronic Components, Commercial Engineering, Section No. ICG-12-1, Harrison, N.J. 07029.

Matched differential amplifiers with:  
Independent inputs and outputs  
Max. input offset voltage  $\pm 5$  mV  
Max. collector to emitter voltage ( $V_{CEO}$ ) 15 V  
Max. collector current ( $I_C$ ) 50 mA  
Dynamic forward current transfer ratio ( $h_{fe}$ ) (typ) 110  
Operating temperature range  $-55^\circ\text{C}$  to  $+125^\circ\text{C}$

**RCA** Integrated Circuits

# New Linear IC “Building Block”

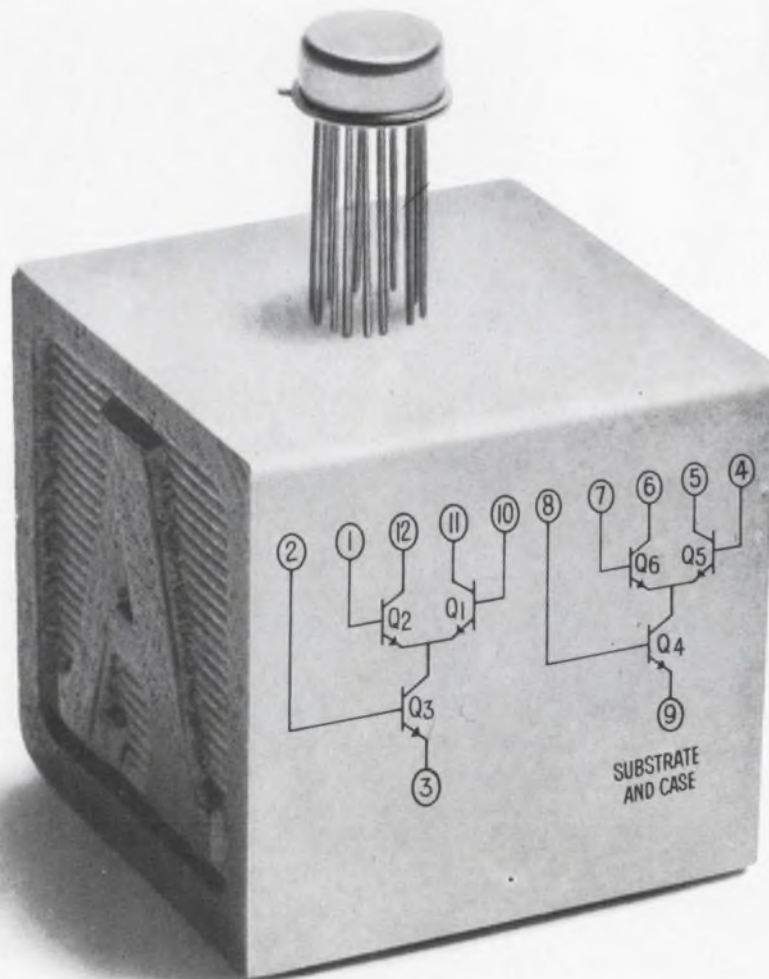

# An Electronic Design practical guide to a/d conversion

## Part 1

Written by: Hermann Schmid, Senior Engineer,  
General Electric Co., Binghamton, New York

Edited by: Frank Egan, Technical Editor

Analog-to-digital converters are integral parts in all digital control, telemetering, simulation or measuring systems. And as such, they must be designed to be compatible in every respect with the other parts of the systems that they interconnect. This is no small task, though, in light of the diversity of both a/d conversion techniques and specific application requirements.

In this three-part design guide, the various a/d conversion techniques are examined from a practical standpoint. Performance and cost considerations are given for each, together with design details. This first part of the guide covers the following:

- Parallel-feedback a/d converters ..... 50
  - Servo type
  - Successive-approximation type
  
- Serial-feedback a/d converters ..... 58
  - Circulation type
  - Charge-equalizing type



# parallel

## Parallel-feedback a/d converters have many advantages, as shown by their widespread popularity.

Circuits for converting analog currents or voltages into digital signals have become increasingly important, as more and more digital control and computation techniques are applied to industrial, commercial and military control systems.

The reasons for this growing trend, of course, lie in the advantages of digital control and computation circuits—advantages which include high accuracy and wide dynamic range. These digital techniques also have disadvantages, the major one being that they are not compatible with the analog outputs of sensors and the analog inputs to controls.

A logical alternative, therefore, might be the development of sensors having digital outputs and controllers having digital inputs. But although considerable research has been conducted in this area, the problems are such that it is economically unfeasible today to consider using an a/d converter in every sensor. As a result, an a/d converter is essentially a system component that accepts the outputs from analog sensors and provides ON/OFF signals for operating digital control or computation circuits.

Mathematically, an analog-to-digital converter is an encoder that accepts as inputs an analog voltage  $V_x$  and an analog reference voltage  $V_R$  and provides as output a digital signal  $X$ . In an ideal a/d converter the output signal  $X$  is related to  $V_x$  and  $V_R$  by:

$$X \equiv [V_x/V_R] \quad (1)$$

where the identity sign and the brackets define that  $X$  is the closest approximation to the ratio  $V_x/V_R$  within the resolution of  $X$ . This approximation is illustrated better if Eq. 1 is rewritten in implicit form, and it is assumed that  $X$  represents a fractional binary number. Equation 1 then becomes:

$$V_x \approx V_R [a_1 2^{-1} + a_2 2^{-2} \dots + a_n 2^{-n}]. \quad (2)$$

All a/d converters are subject to a quantization error, which is determined by the smallest increment of analog voltage to which the digital output signal can be approximated. Mathematically, the quantization error,  $\Delta V_x$  is usually defined as

$$\Delta V_x = V_x/r^n$$

where  $r$  is the radix and  $n$  is the number of digits in  $X$ .

The quantization error occurs no matter whether the input signal  $V_x$  is static (dc) or

changing with time (ac). Another type of error, called the sampling error, occurs only when the input signal changes as a function of time. The sampling error arises from the fact that a typical converter uses a specific input signal only for a very short time and then ignores it for a relatively long period. When the frequency of the input signal is high and the rate at which it is sampled is small, considerable sampling error occurs.

The process of converting from analog to digital is very similar to the mechanical process of weighing, as shown in Fig. 1. The unknown weight,  $W_x$ , in the illustration, is analogous to the analog input  $V_x$ ; the reference weights,  $W_R$ , are analogous to the reference voltage values of the various digital bit positions; and the specific number of reference weights required to balance the scale correspond to the output binary word.

To provide a basis for comparison of the many types of a/d converters described in this report, certain common features and operating criteria are assumed. These are:

**Signals.** All analog signals are dc voltages, with 0 V representing zero signal, +10 V positive full scale and -10 V negative full scale. For simplicity, the diagrams show the circuit arrangements for unipolar analog signals. However, the modifications required for handling bipolar signals are described.

Digital signals are limited, in general, to serial and parallel binary numbers in offset-binary or two's-complement form. Positive logic convention is used, so that in bipolar circuits a logical ZERO is represented by 0 V, and a logical ONE by a positive voltage.

**Power supplies.** Where possible, the number of power supplies required for one a/d converter is limited to three. Two of these,  $+V_R$  (+12 V to +18 V) and  $-V_R$  (-12 V to -18 V), are used primarily for amplifiers and comparators, and the other,  $V_{DD}$ , primarily for the logic circuits.  $V_{DD}$  is +5 V for bipolar logic circuits and -24 V for MOS logic circuits.

**Reference supplies.** All bipolar a/d converters require both a positive and a negative reference voltage, which must be stable and accurate to at least  $\pm 0.01\%$  of its actual value if the converter is to be accurate to  $\pm 0.05\%$  of full scale.

**Environmental conditions.** The performance of the converters described is for the temperature range from  $-55^\circ\text{C}$  to  $+85^\circ\text{C}$ .

**Amplifiers.** Each a/d converter has at least one operational amplifier, which sums the various current components and converts them into a low impedance voltage output.

It is assumed throughout this report that amplifiers are available with these features:

- A total voltage and equivalent current offset

of less than  $\pm 1$  mV over the temperature range  $-55^\circ$  to  $+85^\circ\text{C}$ .

- An open-loop voltage gain of more than 10,000.
- An input impedance larger than 1 M $\Omega$ .
- An output voltage swing of  $\pm 10$  V and an output current capability of  $\pm 2$  mA.
- A small-signal, unity-gain bandwidth of 1 MHz and a slewing rate of 1 V/ $\mu\text{s}$ .

If any of these characteristics is not sufficient for a particular converter, or if additional parameters must be specified, the new requirements are indicated.

**Sample-hold circuits.** To minimize dynamic errors, it is customary to employ a sample-hold circuit at the input to the amplifier. Although the effects of using such circuits are discussed for each group of a/d converters, the circuits themselves are not shown on the converter diagrams. This is merely to keep the diagrams simple.

### Parallel-feedback a/d converters are most common

Most a/d converters built today are characterized by the fact that they incorporate a feedback path containing a parallel d/a converter (Fig. 2).

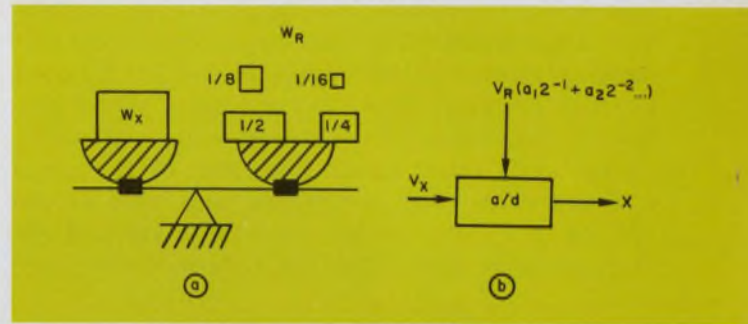

1. The mechanical process of weighing (a) is analogous to analog-to-digital conversion (b).

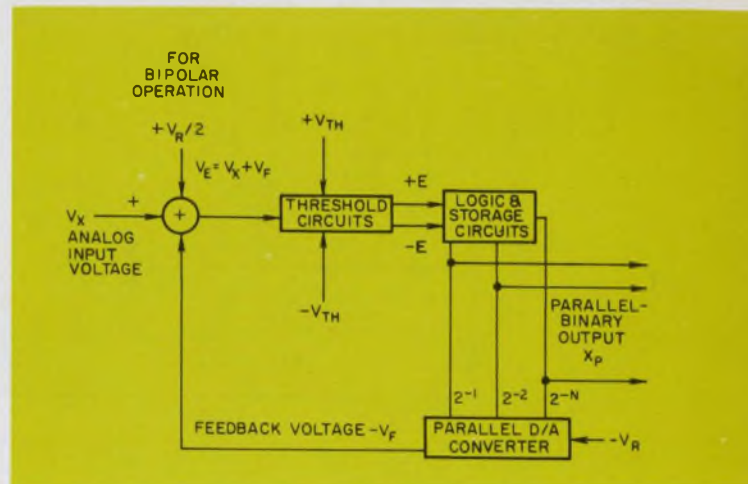

2. Parallel-feedback a/d converters use feedback between output and input to control the conversion process. The feedback is provided by a parallel d/a converter.



Within this major category there are two basic types: The servo a/d converter and the successive-approximation a/d converter.

The **servo a/d converter** is conceptually the simpler of the two. It employs an up-down counter to generate the parallel-binary output,  $X_p$ , from the digital error signals,  $+E$  and  $-E$ . The error signals are generated when the feedback voltage indicates that the digital output does not yet fully approximate the analog input. The small-signal frequency response of the servo converter is excellent, because it can follow small bidirectional input changes within one clock period. However, its slew capability is very poor. If, for example, the clock frequency,  $f_c$ , is 500 kHz and the counter has 12 binary stages, the converter can follow small changes in input ( $\Delta V_x = 1/4096 V_{xmax}$ ) within 2  $\mu s$ , but it requires as much as 8.192 ms to slew from zero to full scale.

The **successive-approximation a/d converter**, by contrast, appears complex, although its parts count is not any higher. Its operation is based on making  $n$ -successive comparisons between the input signal  $V_x$  and the feedback signal  $-V_F$ , which is the output of the d/a feedback converter. Here  $n$  is the number of bits in the digital output word  $X_p$ . With a clock frequency of 200 kHz and a 12-bit word, the successive-approximation a/d converter requires 60  $\mu s$  for any conversion, no matter if the change in the input signal is small or large. Therefore the small-signal frequency response of the successive-approximation converter is much lower than that of the servo a/d converter. Only when the amplitude of the change in  $V_x$  is larger than a certain amount will the successive-approximation a/d converter prove

to be faster.

The clock frequencies of the two converters were intentionally made different in the previous examples, because a servo a/d converter with the same quality components can indeed operate with much higher clock frequencies than a successive-approximation converter.

The diagram of Fig. 2 illustrates that any parallel-feedback a/d converter is comprised of a summing circuit, a threshold circuit, logic and storage circuits and a parallel d/a converter.

In the generalized parallel-feedback a/d converter, the negative feedback voltage  $-V_F$  is added to the input voltage  $V_x$ . Neglecting for the moment the bias voltage which is required for bipolar operation, the sum of the two is the analog error voltage  $V_E$ , or

$$V_E = V_x + (-V_F).$$

Since the feedback voltage  $-V_F$  is directly proportional to the output parallel-binary number  $X_p$ , the polarity of error voltage  $V_E$  will indicate whether the value of  $X_p$  is larger or smaller than the value of  $V_x$ . When  $V_E$  is positive,  $X_p$  is smaller than  $V_x$ ; when  $V_E$  is negative,  $X_p$  is larger. The amplitude of error voltage indicates how much  $X_p$  is larger or smaller than  $V_x$ .

The threshold circuits compare  $V_E$  with the constant voltages  $+V_{th}$  and  $-V_{th}$ . Whenever  $V_E$  is larger than  $+V_{th}$  or more negative than  $-V_{th}$ , the threshold circuits generate digital control signals, which indicate these conditions.

The circuitry discussed so far must be able to detect differences between the magnitude of  $X_p$  and the magnitude of  $V_x$  that correspond to the least significant position. For example, in a 12-bit a/d converter with a 10-V reference signal, the least-significant bit is represented by

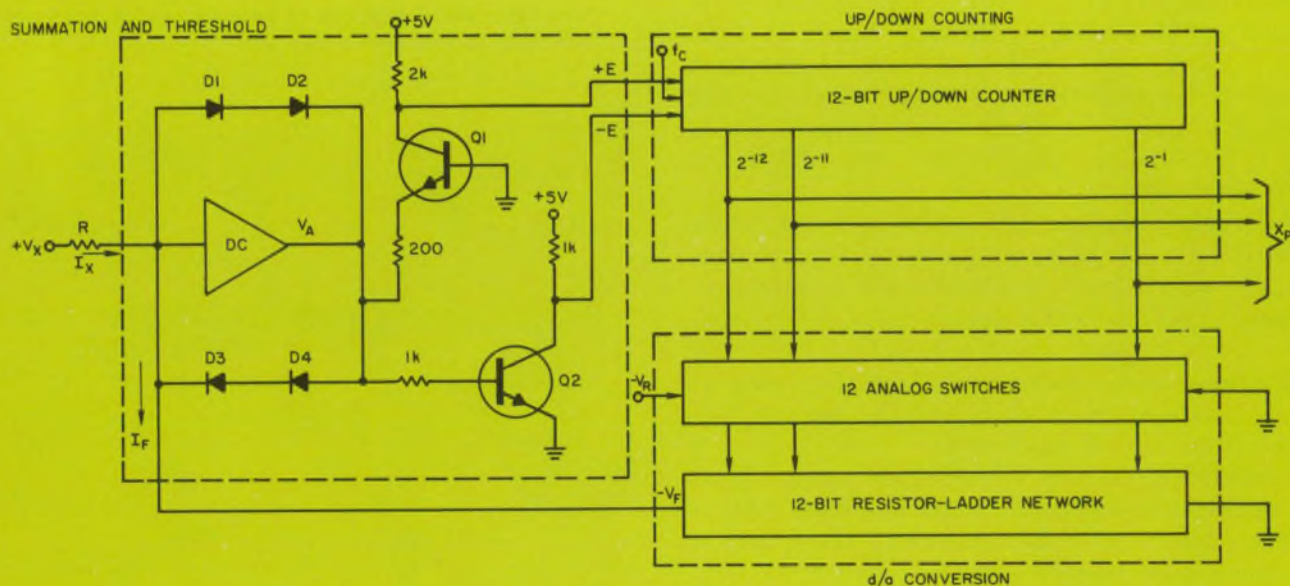

3. The servo a/d converter uses an up-down counter to generate the digital output signal. The counter is driven

by error signals  $+E$  and  $-E$ , which are produced when  $V_x$  and  $V_f$  differ.



$V_R/2^{12} = 10 \text{ V}/4096$ , or approximately 2.5 mV. A difference of one least-significant bit between  $V_x$  and  $X_p$  therefore produces an error voltage  $V_E$  of only  $\pm 2.5 \text{ mV}$ . To detect this error voltage, the threshold voltages would have to be set to  $+V_{th} = +1.25 \text{ mV}$  and  $-V_{th} = -1.25 \text{ mV}$ .

While it is quite feasible with presently available circuits to compare at such low voltages, the usual way is to amplify the error voltage before it enters the threshold circuits.

For now, it will suffice to assume that the threshold circuits generate two digital ON/OFF signals,  $+E$  and  $-E$ , which indicate whether  $|X_p|$  is larger, the same or smaller than  $|V_x|$ .

The purpose of the digital logic and storage circuits is to generate the parallel-binary number  $X_p$  from the digital error signals  $+E$  and  $-E$ , and to hold it until it is updated again. The digital logic and storage circuits for servo and successive-approximation a/d converters differ greatly and are described separately for each converter.

Any of the parallel, digital-to-dc converters covered in reference 1 can be used to provide the feedback in either the servo or the successive-approximation a/d converter. There is no general answer as to which d/a converter is most suitable, although most a/d converters built today use a resistor-ladder d/a converter.

The relationship between the input and output of any feedback system having high gain in the forward loop is, within limits, always a function of the behavior of the circuitry in the feedback path. The performance of the parallel-feedback a/d converter is therefore mainly a function of the performance of the parallel d/a converter.

The following descriptions of the servo and successive-approximation a/d converters are based on unipolar models. There are several ways, however, to convert them to a form suitable for bipolar signals. The choice of which method to use depends largely on the form in which the digital signal  $X_p$  is presented, and this in turn depends on the type of logic and storage circuits used.

In the servo converter an up-down counter is used to generate  $X_p$ , so  $X_p$  is in the one's-complement form. In the successive-approximation converter,  $X_p$  is generated most-significant bit first and is in the two's-complement form. However, with the exception of the inverted-ladder d/a converter, it is easier to implement parallel d/a converters for digital input signals in the offset-binary presentation.<sup>1</sup> The reason for this is that the analog voltage switches need to switch only one reference voltage, either  $+V_R$  or  $-V_R$ , and hence can be less complex.

To take advantage of the simpler switches, it is therefore preferable to operate the a/d con-

verter in the offset-binary form. This necessitates inversion of the sign of  $X_p$  and the addition of a bias voltage of  $+V_R/2$  to the input signal. The error voltage in the bipolar mode is, then,

$$V_E = X_x + (-V_F) + V_R/2.$$

This is just like biasing  $V_x$  by half its full-scale value, so that it can never go negative.

### 1. Servo a/d converter

As the name implies, the servo a/d converter behaves like a follow-up servo. As soon as the analog input voltage  $V_x$  changes, and as long as there is any difference between  $V_x$  and the feedback voltage  $V_F$ , the digital output will change in such a direction as to reduce the error voltage. In other words, the error voltage  $V_E$  is driven to zero.

The three basic circuit functions of a simple servo a/d converter are shown in Fig. 3. These functions are summation and threshold function, up-down counting and d/a conversion.

A high-speed dc amplifier is employed to sum  $+V_x$  and  $-V_F$  and to amplify the result. The gain of this amplifier must be at least 500 at the frequency of interest to produce an error voltage,  $V_E$ , larger than 1 V with an error in the least-significant bit of 2.5 mV ( $2^{-12}$  or  $10 \text{ V}/4096 \approx 2.5 \text{ mV}$ ).

The amplifier is operated in the open-loop configuration, and the output voltage swing is limited to values more positive than  $-1.2 \text{ V}$  by diodes  $D1$  and  $D2$ , and to values smaller than  $+1.2 \text{ V}$  by diodes  $D3$  and  $D4$ . The output voltage,  $V_A$ , of the amplifier is the error voltage  $V_E = V_x - V_F$  multiplied by the gain of the amplifier  $K$ , or

$$V_A = KV_E = K(V_x - V_F).$$

The threshold circuits consist of transistors  $Q1$  and  $Q2$ , which are both turned OFF when  $V_A$  is in a deadband between  $-0.6$  and  $+0.6 \text{ V}$ . When  $V_A$  is more negative than  $-0.6 \text{ V}$ ,  $Q1$  turns ON and its output indicates a negative error,  $-E$ . When  $V_A$  is more positive than  $0.6 \text{ V}$ ,  $Q2$  turns ON, indicating a positive error,  $+E$ . The outputs of  $Q1$  and  $Q2$ , which serve as control signals for the up-down counter, are mutually exclusive—that is, they never occur at the same time. Control signals for MOS logic circuits can be generated by using pnp transistors for  $Q1$  and  $Q2$ , with their load resistors returned to a negative supply potential between  $-9$  and  $-15 \text{ V}$ .

Any 12-bit up-down counter is rather complex, whether it is a ripple or a synchronous type. A serial-carry synchronous counter of the type shown in Fig. 4 is a reasonable compromise between maximum counting speed and complexity. It can be built with two IC packages per stage and a three-input AND/OR circuit. The additional flip-flop, FF-13, assures that the up-down lines will not change simultaneously with, or just



prior to, the instant the counting flip-flops, FF-1 to FF-12, change.

The up-down control signals are generated by setting or resetting flip-flop FF-13 with the positive error signal  $+E$  and the negative error signal  $-E$ , respectively. The output of FF-13 changes only with the negative-going transition of the clock pulse. With the delays in FF-13 and the AND gates, the up-down lines always change after the counting flip-flops, FF-1 to FF-12, have switched. This allows maximum time to set up the input gates for the next switching operation.

The error signals  $+E$  and  $-E$  also control the duration of counting. This is normally done by ORing the two error signals and then gating the clock pulses with the output of the OR gate. However, this causes negative transitions when  $+E$  or  $-E$  change back to ZERO and the clock pulse is HIGH. And as a result, additional and undesirable counts would normally occur.

To avoid this,  $+E$  and  $-E$  are ORed with the inverted clock pulse,  $\overline{f_c}$ , and the output signal of the OR gate is connected directly into the  $J$  and  $K$  input gates of all counting flip-flops. In this connection it is important only that the signals to the  $J$  and  $K$  gates are set up some 25 ns before the clock pulse goes negative. ORing  $+E$ ,  $-E$  and  $\overline{f_c}$  will guarantee this, because the output of the OR gate can change only when  $\overline{f_c}$  is positive or when  $f_c$  is zero; that is, the half period after the clock is switched back to ZERO.

The counter of Fig. 4 is therefore truly reversible and synchronous. However, the maxi-

mum clock frequency, or the minimum clock period, is limited to a value which is larger than the maximum propagation delay of the 12-cascaded AND gates.

A resistor-ladder d/a converter is shown as part of the servo a/d converter in Fig. 3. However, an inverted-ladder d/a converter could have been used just as well. The 12 analog switches of the d/a converter, which are driven from the output signals of the up-down counter, connect either  $-V_R$  or ground to the inputs of the ladder.

Strictly speaking, it is incorrect to refer to a voltage,  $-V_F$ , as the output of the ladder network, since in reality there is only a current,  $-I_F$ , flowing into the summing point of the amplifier. This current is summed with the current  $I_X$ , produced by the analog input voltage  $V_X$ . But the use of currents complicates the description of the summing and threshold circuits.

Connecting the output of the d/a converter into the summing point of the operational amplifier closes the loop on the servo a/d converter.

#### Feedback determines accuracy

As mentioned previously, the accuracy of the servo a/d converter is primarily a function of how precisely the parallel-binary output signal,  $X_p$ , can be converted to the feedback current,  $-I_F$ , and on how well  $-I_F$  can be summed with input current  $I_X$ . But this is true only when the gain,  $K$ , of the operational amplifier is high enough to produce an output voltage,  $V_A = K V_E$ , that is larger than the threshold voltage of 0.6 V. Here,  $V_E$  is the error voltage for a difference

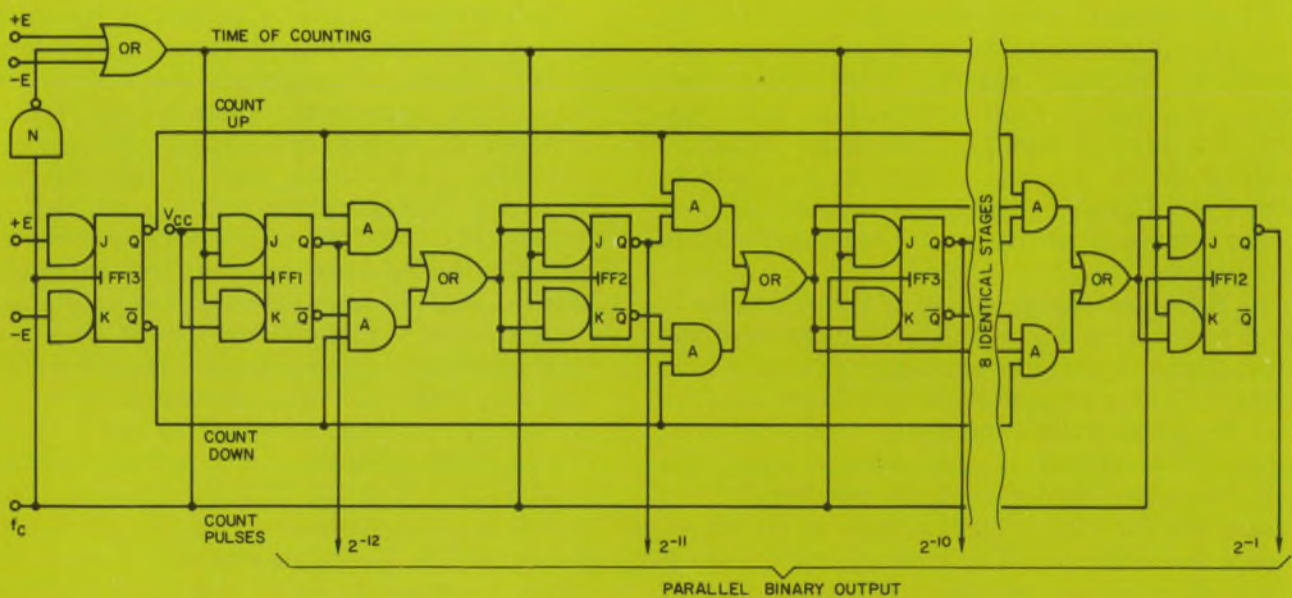

4. Serial-carry counter is enabled when either error signal,  $+E$  or  $-E$ , is LOW. When both error signals are

HIGH, the counter is disabled and counting ceases. This counter is both reversible and synchronous.



between  $|V_x|$  and  $|X_p|$  equal to one least-significant bit. If—and only if—this condition is satisfied, then the accuracy of the a/d converter is essentially the same as that of the d/a converter in its feedback path. In fact, the accuracy of the a/d converter may be even better than that of the d/a converter, if an automatic offset-correction circuit is used.

The speed of operation of the servo a/d converter is mainly a function of the clock frequency,  $f_c$ , that is used. How high the value of  $f_c$  can be made, though, depends mainly on how fast the operational amplifier can change from zero to +0.6 V or from zero to -0.6 V, and vice versa. In one of the most common monolithic amplifiers, the  $\mu A709$ , the slew rate is less than 200 mV/ $\mu s$ . This means that it would require at least 6  $\mu s$  to slew from -0.6 to 0.6 V, or that the maximum clock frequency must be less than 160 kHz.

Only a few monolithic amplifiers, like the Fairchild  $\mu A715$ , have slew rates in excess of 6 V/ $\mu s$ . Thus, if high-speed operation is important, a hybrid or discrete-component amplifier is probably required. For example, the Burr-Brown 3010/25 discrete component amplifier has a slew rate of 60 V/ $\mu s$ , making possible clock frequencies as high as several megahertz. However, when  $f_c$  becomes that high, the analog switches and parasitic reactances of the ladder resistor in the d/a converter become the limiting factor on speed. A reasonable compromise is a clock frequency of approximately 500 kHz and a monolithic amplifier with a slew rate of about 1 V/ $\mu s$ .

## 2. Successive-approximation a/d converter

The successive-approximation a/d converter has become so popular that to many no other type of a/d converter seems to exist. Approximately 90% of all the a/d converters marketed today use the successive-approximation technique, which is sometimes also referred to as the successive-comparison, or the "put-and-take," technique.

In a successive-approximation a/d converter, a feedback voltage,  $-V_F$ , is made to approximate the input voltage  $V_x$  in a sequence of successive steps. And in each step,  $-V_F$  is changed in accordance with the result of the previous comparison between  $V_x$  and  $-V_F$ . The amount by which  $-V_F$  is increased or decreased is equal to  $V_R/2^i$ , where  $i$  defines the  $i$ -th step in the operation, and  $V_R$  is the reference voltage.

The basic operation of the successive-approximation a/d converter can best be described by a specific example. Consider the case where

$$V_R = 10 \text{ V}; V_x = 8.3 \text{ V},$$

and where the feedback voltage  $V_F$  must approximate  $V_x$  to within  $\pm 1\%$  of  $V_R$ , or  $\pm 0.1$  V. The following steps will be required:

(1)  $V_F$  is made  $V_R/2 = -5$  V and compared with  $V_x = 8.3$  V. The error voltage  $V_E$  is positive, and hence the most-significant bit,  $2^{-1}$ , of digital output signal  $X_p$  is a logical ONE.

(2)  $V_F$  is increased to  $(3/4)V_R = 7.5$  V.  $V_E$  is still positive, so the  $2^{-2}$  bit of  $X_p$  is also a ONE.

(3)  $V_F$  is increased to  $(7/8)V_R = 8.75$  V.  $V_E$  is negative in this case, so the  $2^{-3}$  bit of  $X_p$  is a logical ZERO.

(4)  $V_F$  is decreased to  $(13/16)V_R = 8.125$  V.  $V_E$  is positive, and the  $2^{-4}$  bit is a ONE.

(5)  $V_F$  is increased to  $(27/32)V_R = 8.4375$  V.  $V_E$  is negative, so  $2^{-5}$  is ZERO.

(6)  $V_F$  is decreased to  $(53/64)V_R = 8.27125$  V.  $V_E$  is positive, so  $2^{-6}$  is ONE.

$V_F$  is now within the required  $\pm 0.1$  V of  $V_x$ . Six comparison steps were needed to achieve this. The digital output so generated is 110101, which represents  $53/64$  of full scale, which in turn approximates  $8.3/10 = 0.83$  to within the required  $\pm 1\%$ .

A complete 12-bit successive-approximation a/d converter is shown in Fig. 5a. It consists of the summing and threshold circuits, a 14-stage timing generator, sequence control and storage circuits, a 12-bit parallel d/a converter, and output gating logic. The complete operation of this converter is controlled by, and synchronized with, the clock frequency  $f_c$ .

The summing and threshold function is performed by a single operational amplifier that has an input resistor  $R$ , and a 3-V zener diode as its feedback. The amplifier sums the input voltage  $V_x$  with the feedback voltage  $-V_F$  and generates an error voltage  $V_A$ , which is  $K(V_x - V_F)$ , where  $K$  is the gain of the operational amplifier. For the 12-bit converter shown,  $K$  must be at least 1000 at the frequency of interest, in order to produce a  $V_A = 2.5$  V from a  $V_E = 2.5$  mV, which is the error voltage due to a difference between input and output of one least-significant bit.

The amplifier output voltage  $V_A$  is limited in excursion by the feedback zener diode to values between -0.6 V and +3.0 V, whereby a level of -0.6 V indicates that  $|V_x|$  is larger than  $|V_E|$ , and a level of +3.0 V indicates that  $|V_x|$  is smaller than  $|V_E|$ . There is no information indicating when  $V_x$  and  $V_F$  are equal in magnitude. This is not because such information is difficult to generate but because it is very difficult to use. And actually it is not necessary for converter operation. With the levels indicated, the amplifier output can drive bipolar logic circuits directly. To drive MOS logic circuits, a 0 to -12 V excursion is required. This can be obtained by connecting a 12-V zener diode into the feedback of the operational amplifier, but in the reverse direction from that shown in Fig. 5a.

The 14-stage timing generator must produce



14 mutually-exclusive timing intervals,  $t_1$  to  $t_{14}$ . The duration of these intervals is most conveniently kept constant, although high-speed operation sometimes demands that the duration of the first, or the first few, intervals be made longer, to allow more time for the amplifier to settle. Although there are several methods of generating these time intervals, a ring counter of the type shown in Fig. 6 is the most practical at present. A 14-bit ring counter can be implemented, as shown in Fig. 6, simply with 14 flip-flops interconnected as a shift register and with additional logic to set the first stage to ONE when all other stages are ZERO. With the availability of monolithic serial-IN, parallel-OUT shift registers, ring counters can now be built very economically, especially with MOS logic circuits.

The sequence control circuits of Fig. 5a must set or reset the storage circuits at the appropriate times and under the appropriate conditions. If we assume that each of the 14 timing intervals is one clock period wide, then each storage circuit must be set at the beginning of its associated clock period. That is,  $L_1$  with  $t_1$ ,  $L_2$  with  $t_2$ , etc. The SET signals for the storage circuits are generated by digitally differentiating clock pulse  $f_c$  and gating the resulting narrow pulse  $f'_c$  with the timing intervals  $t_1$  to  $t_{12}$ . The RESET signals are generated by digitally differentiating the inverted clock pulse  $\bar{f}_c$  and gating the resulting narrow pulse,  $\bar{f}'_c$ , with the output  $V_A$  of the summing amplifier. Digital differentiation can be performed with three standard NAND gates, as shown in Fig. 5b.

In addition to these principal SET and RESET signals, the storage circuits can be set and reset by other signals as well. For example, it is necessary for proper operation to reset all storage circuits prior to the start of each conversion. To accomplish this, timing pulse  $t_{14}$  is connected into all of the 12 auxiliary RESET inputs.

Generally, any type of flip-flop can be used for the 12 storage circuits shown. However, the simplest is a bistable latch (Fig. 5c), which contains only two cross-coupled NAND gates. Whenever any of the SET inputs are LOW, the Q output is HIGH; and whenever any of the RESET inputs are LOW,  $\bar{Q}$  is HIGH. Precautions must be taken, though, to ensure that the SET and the RESET inputs are never simultaneously LOW, because the operation of the flip-flop is then undefined.

For medium accuracy, any of the parallel d/a converters described in reference 1 could be used in the circuit of Fig. 5a. For ultimate accuracy, however, it is essential that either the resistor-ladder or the inverted-ladder d/a converter be used.

The switches in the d/a converter are driven directly from the outputs of the 12 latches, and the output from the d/a converter is connected directly into the summing point of the operational amplifier. For a positive analog input voltage,  $+V_x$ , a negative reference voltage,  $-V_R$ , must be connected to the d/a converter, and vice versa.

Twelve NAND gates, one for each output line, make up the output gating of the a/d converter. These gates connect the signals from the 12 stor-

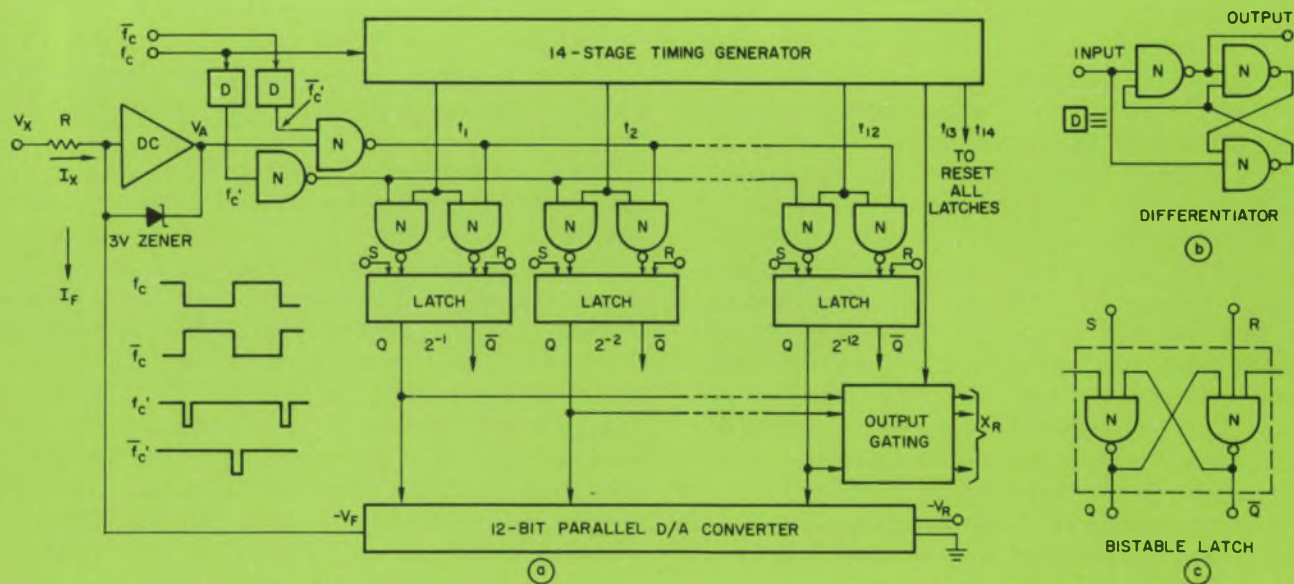

5. The successive-approximation a/d converter sets each output storage circuit to either a logical ONE or ZERO in accordance with input  $V_x$  and feedback voltage  $V_f$ . The

total analog weight of the binary number finally contained in the storage circuits equals the analog input voltage. This binary number is the converter output.



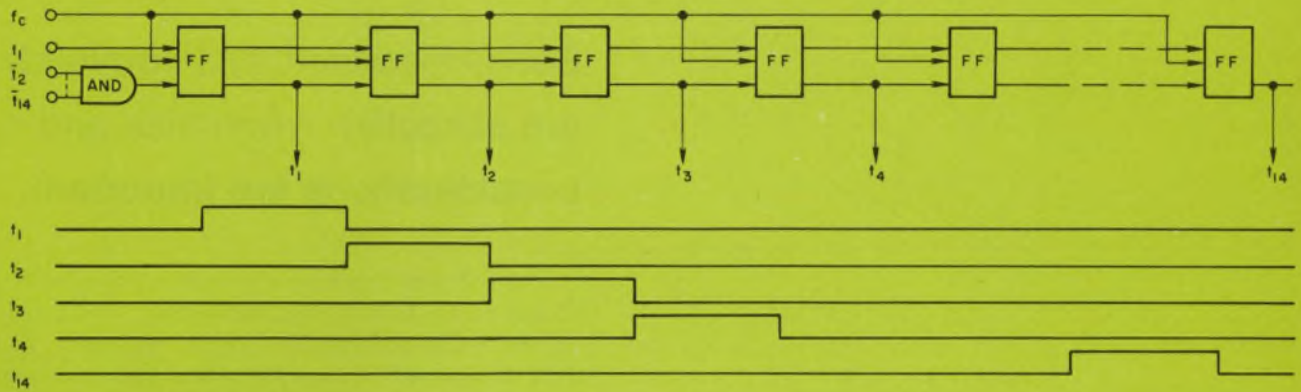

6. Ring counter is a simple way to implement the 14-stage timing generator needed in the successive-approxi-

age circuits to the converter output terminals. This transfer is performed during timing interval  $t_{13}$ , just after the last operation step has been completed. Since the outputs of the storage circuits are incomplete, or even in error, no output is provided at all other times during  $t_1$  to  $t_{12}$  and during  $t_{14}$ .

Basically the performance of a successive-approximation a/d converter is a compromise between static accuracy and conversion speed. The higher the conversion speed is set, the lower will be the accuracy that can be obtained from the converter. This limitation is basically a function of the comparison amplifier, which senses the difference between the magnitude of  $V_x$  and  $V_F$  and generates a digital control signal from it. The shorter the time for one conversion, the shorter the time allowed for one comparison step, and the faster the amplifier must switch from zero to the threshold voltage. For faster operation, the amplifier frequency compensation should be selected so that the amplifier is critically damped, or slightly underdamped.

Some of the faster converters built today provide less than  $1 \mu\text{s}$  for one comparison step. During this short time interval, the following operations must be performed:

- (1) The appropriate storage circuit must be set.
- (2) The appropriate switch in the d/a converter must be energized.
- (3) The feedback voltage must change and settle out.
- (4) The amplifier must slew from its previous level to its new level.
- (5) The storage circuit must be reset.
- (6) The switch in the d/a converter must be turned OFF.
- (7) The feedback voltage must return to its original level.

To perform all of these seven operations within

mation a/d converter. It can be built with flip-flops connected as a shift register.

one clock period, it is necessary that each be executed in a fraction of that clock period. Generally, it is quite simple to set and reset the storage circuits, to turn ON and turn OFF the electronic analog switches and to keep the delays introduced in the resistor ladder network to much less than  $1 \mu\text{s}$ . However, to change the output of the amplifier in less than  $0.3 \mu\text{s}$  requires slew rates that are larger than  $10 \text{ V}/\mu\text{s}$ , and few presently available monolithic amplifiers have this capability. It is thus mainly the comparison amplifier that determines how fast the converter can operate.

How accurate is the successive-approximation converter at a given conversion rate? As mentioned before, the accuracy of any feedback a/d converter is almost exclusively determined by the accuracy of the d/a converter in the feedback path and by the precision of the summing circuit.

At low conversion rates, errors in accuracy are caused only by the static parameters of the analog switches, the ratio tolerances of the ladder and the mismatch between the input resistor  $R$  and the output impedance of the ladder. At high conversion rates, however, the turn-ON and turn-OFF transients in the switches, the delays in the resistor-ladder-network and the frequency response of the comparison amplifier, create errors, in addition to the low-frequency errors. The higher the conversion rate, the more important these high-frequency errors become, since the time provided for the transient response to die out is not enough. At this point it also becomes very difficult to separate the noise from the signal.

Many 12-bit successive-approximation a/d converters have been built that provide an accuracy of  $\pm 0.05\%$  of full scale at a rate of 10,000 or more conversions per second. Most employ very sophisticated, low-offset and high-speed operational amplifiers. ■■



# Serial

## Serial-feedback a/d converters are attractive when size and cost considerations are important.

The parallel d/a converter in the feedback path of any successive-approximation or servo a/d converter is the bulkiest and most expensive part of that converter. To make matters worse, there are no substantial indications that parallel d/a converters can be built much cheaper or much smaller in the near future. Faced with this impasse, designers have searched for different and less complex ways of implementing a/d converters, particularly of the successive-approximation type.

One approach considered has been the use of serial d/a converters in the feedback path, since they use considerably fewer parts than parallel d/a converters. This is impractical, however, because the output from a successive-approximation a/d converter appears most-significant bit first, whereas the input to any serial d/a converter must be least-significant bit first.

Although the idea of using a serial d/a converter in the feedback of a successive-approximation a/d converter does not work, it triggered new ideas which led to the development of what can be classified as serial-feedback a/d converters. The circulation, or cyclic, a/d converter, is one category of serial feedback a/d converter, while the charge-equalizing a/d converter is another. One peculiarity of all serial-feedback a/d converters is that there is no specific part in the circuit than can be classified as a d/a converter.

Circulation a/d converters can be divided into two groups: single-amplifier converters and dual-amplifier converters. In both, the conversion from an analog voltage  $V_x$  to a serial-digital signal  $X_{s-M}$ , is performed by  $n$  successive steps, where  $n$  is the number of bits in  $X_{s-M}$ . (The subscript  $M$  refers to the fact that the most-significant bit,  $2^{-1}$ , appears first in the serial-binary word.)

All circulation a/d converters can be further subdivided into either restoring or nonrestoring converters. Only nonrestoring types will be covered here, because they can operate on either unipolar or bipolar signals without any change in circuitry.

Mathematically, the operation of most nonrestoring converters can be expressed by:

$$V_{i+1} = 2(V_i - a_i V_R/2 + \bar{a}_i V_R/2)$$

This states that in each operating step a reference voltage,  $V_R/2$ , is either added to or subtracted from voltage  $V_i$ , which is the result of the addition or subtraction during the previous operating step. The initial value of  $V_i$  during the

first operating step is the analog input voltage,  $V_x$ .

Whether an addition or subtraction takes place during a particular operating step is determined by the logical value (ONE or ZERO) of  $a_i$ , which is the digital output bit produced during the  $i^{\text{th}}$  step.

Circulation a/d converters have both advantages and disadvantages when compared with other conversion circuits. Among their more desirable features are:

- Considerably fewer parts are required, making them less complex, smaller, lighter and less expensive.
- The capacitors need to be neither precise nor stable.
- Usually only two precision resistors are needed, of which only the ratio must be precise.
- The number of bits of the digital output signal can be varied, without requiring any changes in circuitry. Only the word synchronization pulse must be different.
- There is no need for a separate sample-hold circuit to hold the input signal,  $V_x$ , because the first operating step always samples  $V_x$ .
- Bipolar operation can be implemented easily.

### 1. Single-amplifier circulation a/d converter

A basic single-amplifier circulation a/d converter is shown in Fig. 7. It consists of one dc amplifier, one dc comparator, one flip-flop, five 2-input NAND gates, two precision resistors, and seven analog voltage switches. If timing is not provided externally, the converter also requires another flip-flop and a 12-bit ring counter. However, these timing circuits can be time-shared between many converters.

The dc amplifier is connected as a voltage follower, whose gain can be changed between 1.0 and 2.0, depending on the positions of switches  $S_1$  and  $S_2$ . Normally,  $S_1$  and  $S_2$  are used to connect either  $+V_R$ , or ground, to one side of a 30 k $\Omega$  resistor. Switches  $S_3$ ,  $S_4$  and  $S_5$  connect either the analog input voltage  $V_x$ , or capacitor voltage  $V_{C_A}$  or  $V_{C_B}$  to the non-inverting input of the amplifier. Switches  $S_6$  and  $S_7$  connect the output voltage,  $V_o$ , either to capacitor  $C_A$  or to  $C_B$ .

The dc comparator compares the output voltage  $V_o$  with the reference voltage  $V_R/2$ . Flip-flop FF-1 is connected like a single-stage shift register and stores the output of the comparator for one clock period,  $T_i$ . Flip-flop FF-2 divides the clock frequency,  $f_c$ , by a factor of two, while the 12-bit ring counter generates the word-synchronized pulse,  $T_1$ .

Operation of the converter begins with clock period,  $T_1$ , during which switches  $S_3$  and  $S_6$  are closed and all other switches are open. Since  $S_1$  and

$S_2$  are open, the amplifier operates as a unity-gain voltage follower. The output voltage of the amplifier,  $V_o$ , is thus equal to  $V_x$ . With  $S_6$  closed, capacitor  $C_A$  charges to  $V_x$ . In addition,  $V_o$  is compared with  $+V_R/2$ , where  $V_R$  is equal to  $V_{X_{\text{max}}}$ .

If  $V_x$  is larger than  $V_R/2$ , the output of the comparator,  $V_C$ , is a logical ONE; if  $V_x$  is smaller than  $V_R/2$ ,  $V_C$  is a ZERO. When the clock frequency  $2f_c$  changes from HIGH to LOW, which always occurs at the center of each clock period,  $T_i$ , the output of the comparator is shifted into the 1-bit shift register. The output of the shift register during the second-half of  $T_1$ , and the first-half of  $T_2$ , therefore represents the most-significant bit of  $X_{S-M}$ , namely  $a_1$ .

During  $T_2$ , either switch  $S_1$  (if  $a_1 = 1$ ) or  $S_2$  (if  $a_1 = 0$ ), together with switches  $S_4$  and  $S_7$ , is closed. All other switches are open. With  $S_1$  or  $S_2$  closed, the amplifier operates as a non-inverting amplifier with a gain of 2.0. The amplifier also performs the operation of subtraction: with  $V_o$  and  $V_R$  connected across the voltage divider, and with  $V_{C_A}$  connected to the non-inverting input, the following equation can be written at the amplifier input

$$(V_o + V_R)/2 = V_{C_A}$$

or

$$V_o = 2[V_{C_A} - (V_R/2)],$$

which is one version of the basic nonrestoring circulation converter equation for  $a_i = 1$ .

In addition, during clock period  $T_2$ ,  $V_o$  is both stored on capacitor  $C_B$  and compared against  $V_R/2$ . The output of the comparator is then shifted into, and stored in, the single-stage shift register. The output of the flip-flop during the second-half of  $T_2$  and the first-half of  $T_3$  represents the second-most-significant bit of  $X_{S-M}$ .

The operation of the circulation converter during clock periods  $T_3$  to  $T_{11}$  is similar to that during  $T_2$ . Depending on whether the particular bit,  $a_i$ , of  $X_{S-M}$  is a ONE or a ZERO, one-half of the reference voltage will be either subtracted from  $V_i$  or not. During all even clock periods, the voltage across capacitor  $C_A$  is connected back to the input of the amplifier; during all odd periods, the voltage across  $C_B$  is connected back. Similarly, capacitor  $C_B$  is charged to the amplifier output voltage,  $V_o$ , during all even clock periods, and  $C_A$  during all odd periods. The only exception is during  $T_1$ , when both  $S_4$  and  $S_5$  must stay open.

The operation of the single-amplifier circulation a/d converter can best be understood by means of a specific example. Figure 8 shows the voltage,  $V_o$ , at the output of the amplifier and the voltages across the two capacitors  $C_A$  and  $C_B$  as functions of time, in synchronism with clock frequency  $f_c$ . The input voltage is  $V_x = +8.4$  V, and  $V_R$  is 10 V.



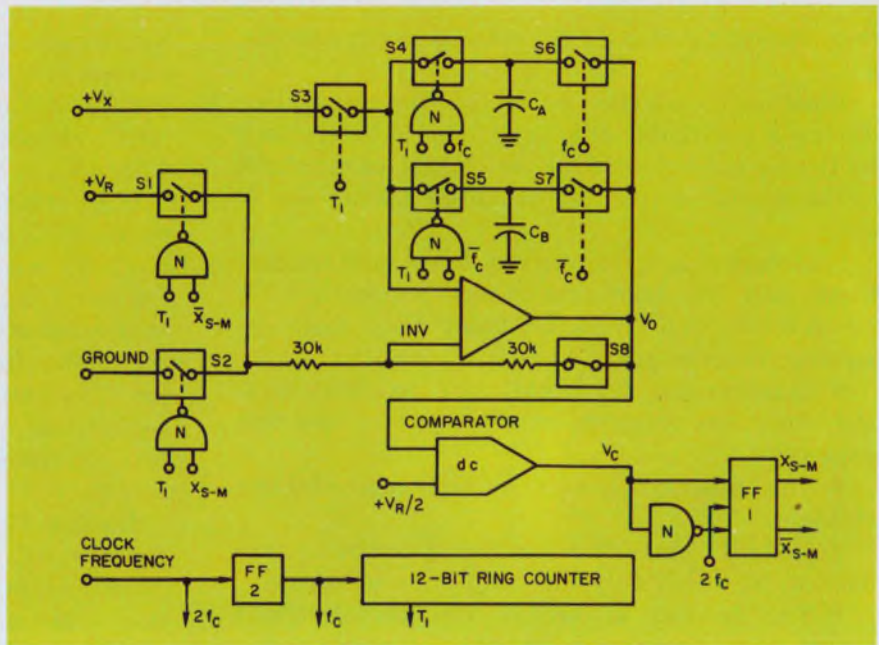

7. The single-amplifier circulation a/d converter employs two capacitors,  $C_A$  and  $C_B$ , alternately as storage devices. When  $C_A$  is charged,  $C_B$  holds, and vice versa.

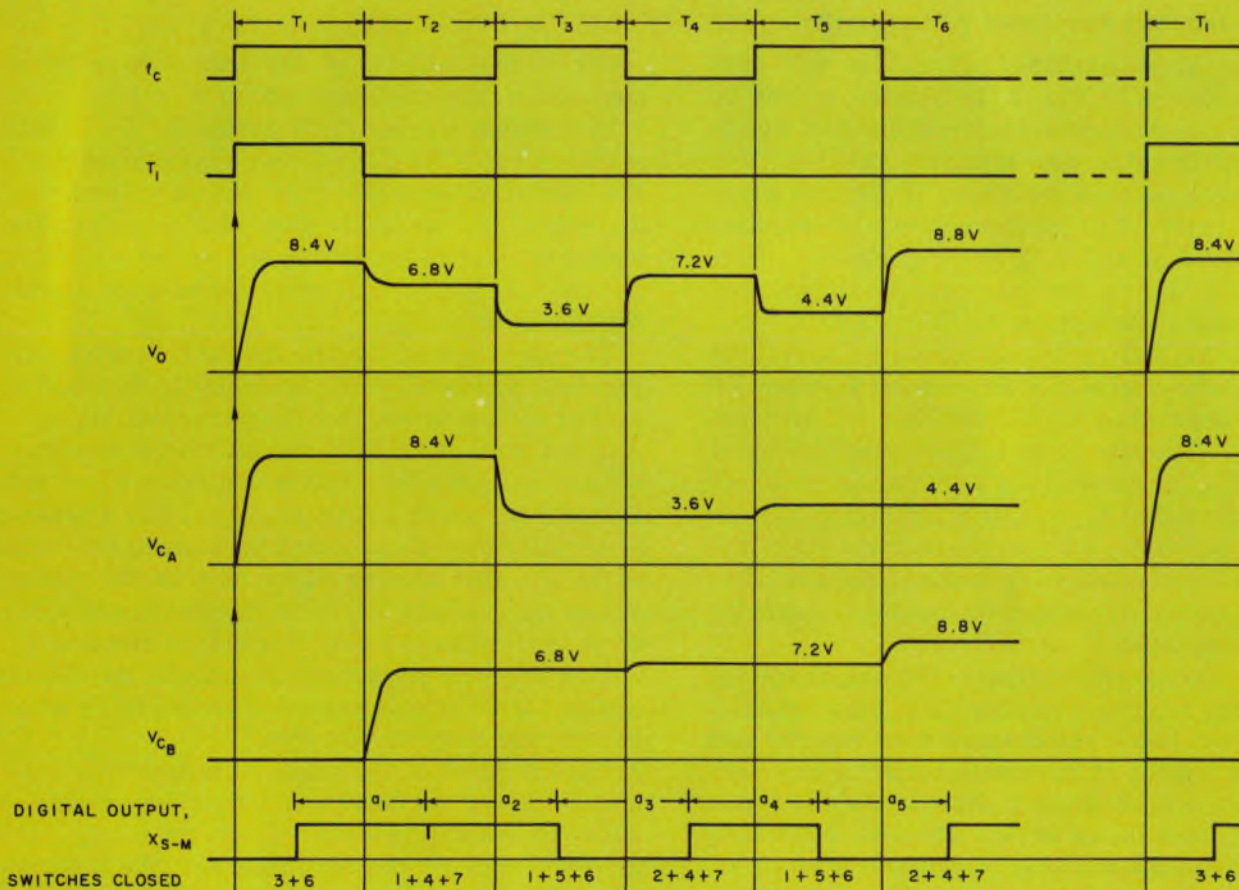

8. The waveforms at the output of the amplifier and across the two capacitors illustrate the operation of the

single-amplifier circulation a/d converter. Waveforms shown are for  $V_x = +8.4$  V and  $V_R = 10$  V.



■ During  $T_1$  only switches  $S_3$  and  $S_6$  are closed, so  $V_{o_1}$  and  $V_{c_A}$  increase to  $+8.4$  V. Since  $V_{o_1}$  is larger than  $V_R/2$ ,  $a_1$  becomes a ONE.  $V_{o_1}$  here refers to the amplifier output-voltage during clock period  $T_1$ .

■ During  $T_2$ , switches  $S_1$ ,  $S_4$  and  $S_7$  are closed, and  $V_{o_2} = 2[V_{o_1} - (a_1 V_R/2)] = 2(8.4 \text{ V} - 5 \text{ V}) = 6.8 \text{ V}$ . Since  $V_{o_2}$  is larger than  $V_R/2$ ,  $a_2$  becomes a ONE also.

■ During  $T_3$ ,  $S_1$ ,  $S_5$  and  $S_6$  are closed, and  $V_{o_3} = 2[V_{o_2} - (a_2 V_R/2)] = 2(6.8 \text{ V} - 5 \text{ V}) = 3.6 \text{ V}$ .  $V_{o_3}$  is less than  $V_R/2$ , so  $a_3$  becomes ZERO.

■ During  $T_4$ ,  $S_1$ ,  $S_5$  and  $S_6$  are closed, and  $V_{o_4} = 2[V_{o_3} - (a_3 V_R/2)] = 2(3.6 \text{ V} - 0 \text{ V}) = 7.2 \text{ V}$ .  $V_{o_4}$  is larger than  $V_R/2$ , and  $a_4$  becomes a ONE.

■ During  $T_5$ ,  $S_1$ ,  $S_5$  and  $S_6$  are closed, and  $V_{o_5} = 2[V_{o_4} - (a_4 V_R/2)] = 2(7.2 \text{ V} - 5 \text{ V}) = 4.4 \text{ V}$ .  $V_{o_5}$  is less than  $V_R/2$ , and  $a_5$  becomes a ZERO.

■ During  $T_6$ ,  $S_2$ ,  $S_4$  and  $S_7$  are closed, and  $V_{o_6} = 2[V_{o_5} - (a_5 V_R/2)] = 2(4.4 - 0 \text{ V}) = 8.8 \text{ V}$ .  $V_{o_6}$  is larger than  $V_R/2$ , and  $a_6$  becomes a ONE.

The operation of all succeeding time periods continues in a similar fashion. The operation can be stopped, or started over again, by application of the word-synchronization pulse  $T_1$ . When  $T_1$  is present, a new value of  $V_x$  is fed into the converter and will override any information that has been in the converter before. There is, therefore, no need to discharge capacitors  $C_A$  and  $C_B$ .

In the example of Fig. 8, the first six bits of digital output  $X_{S-M}$  are shown to be 11001. This fractional binary number represents  $53/64$ , which is the closest approximation to  $8.4 \text{ V}/10 \text{ V} = 0.84$  that is possible with a six-bit word. The more bits there are in  $X_{S-M}$ , the closer can be the final approximation.

### Circuit requirements dictate components

Compared with a parallel feedback a/d converter, the circuitry of a single-amplifier circulation converter is relatively simple. However, it must be kept in mind that the output appears most-significant bit first, which is not compatible with most digital circuits. Additional circuits are therefore required to convert the output into a more conventional form.

In addition to the usual amplifier requirements, the dc amplifier for this converter must be able to charge capacitors fast; in other words, it must have high output current and fast slewing capabilities. This is because the capacitors must be charged from zero to full scale in about one-tenth of one clock period,  $T_c$ . For a 100-kHz clock frequency, the charging time constant must be about  $1 \mu\text{s}$ . If the capacitor is assumed to be  $2000 \text{ pF}$ ,

the series resistance  $500 \text{ ohms}$ , and the voltage differential  $10 \text{ V}$ , then the amplifier must deliver a maximum current of  $20 \text{ mA}$  and must rise with a rate of approximately  $6 \text{ V}/\mu\text{s}$ . This is beyond the capabilities of most monolithic amplifiers, but is well within the range of available hybrid or discrete component units.

More severe than the output requirements are the input requirements for the amplifier. It must not only have a very low bias current and a high differential input resistance, but also a very small input capacitance. The bias current and input-resistance requirements are relatively easy to satisfy. Unfortunately there is no simple way of eliminating the input capacity, which consists mainly of the interelectrode capacitances of the transistor in the input stage and the wiring capacitance. A low value is necessary because the input capacitance causes an error in charge, when capacitor  $C_A$  or  $C_B$  is connected to the amplifier input.

The input capacitance can be reduced by using small-geometry transistors and by careful layout of the input stage, but this is usually not enough. One way to eliminate the problem is by using buffer amplifiers having FET input stages between storage capacitors  $C_A$  and  $C_B$  and switches  $S_4$  and  $S_5$ , respectively. The input capacitance of the amplifier then becomes part of the storage capacitor. However, the addition of two more amplifiers will again introduce offset and drift problems and will increase the complexity of the converter considerably.

One other way to reduce the effects of the amplifier input capacitance significantly is to compensate for the error in charge,  $\Delta Q$ , which is introduced when storage capacitor  $C_A$  or  $C_B$  is connected to the amplifier input. Unfortunately, no easy way is known to perform such compensation.

The dc-comparator portion of the converter poses no particular problems; various monolithic devices are adequate for the application. The required offset voltage is typically less than  $2 \text{ mV}$ , which is reasonably small for most applications. If the impedance in the two inputs is kept small, temperature drift will then be negligible.

For good accuracy it is essential that the ratio tolerance of the two resistors in Fig. 7 be maintained a factor of five lower than the expected over-all accuracy. For example, if an accuracy of  $\pm 0.05\%$  of full scale is desired, the ratio between the two resistors should be at least within  $\pm 0.01\%$ , under all operating conditions and over the desired range of temperatures.

The analog voltage switches create, by far, the greatest problems in the single-amplifier circulation a/d converter. Switches  $S_1$  and  $S_2$  require an ON-resistance,  $R_{ON}$ , of less than  $3 \text{ ohms}$ , if the error in the voltage divider is to be less than



$\pm 0.01\%$  of full scale. If this is not possible, the value of the resistor in series with the switches can be reduced by the magnitude of  $R_{ON}$ . In that case the ON-resistance can be much larger, but both the change in  $R_{ON}$  over temperature, and the difference in  $R_{ON}$  between the two switches must be less than 3 ohms.

One other way to reduce the effects of  $R_{ON}$  is to connect a permanently turned-ON switch,  $S_8$ , in the feedback path, as indicated in Fig. 7. In this configuration, it is only necessary to match  $R_{ON}$  values of  $S_1$ ,  $S_2$  and  $S_8$  to within 3 ohms initially, since they track well over temperature.

Switches  $S_3$  to  $S_7$  must have very low feedthrough capacitances so that the transients through them do not change the charges on and voltages across the capacitors significantly. Nevertheless, these switches do not need small ON-resistances.

The switching speed of all switches is not critical, because the converter operating speed is limited primarily by the amplifier characteristics. For a 100-kHz clock frequency, turn-ON and turn-OFF times of less than 500 ns are sufficient.

Some of the control signals to the analog switches must be generated from the basic timing, clock and output signals. In all these cases, a simple two-input NAND gate is sufficient to perform the required logic operations. A quad 2-input NAND gate, such as the Sylvania SUHL SG 140, can execute all the necessary gating.

The single-stage shift-register stage is straightforward and can be performed with almost any type of flip-flop. A single-stage inverter is necessary to generate the required complementary input signals.

The output signal,  $X_{S-M}$ , from the converter is generated in serial-binary form, but most-significant bit first. To convert  $X_{S-M}$  into a 12-bit parallel signal,  $X_p$ , a shift register with serial input and parallel output is needed. To convert  $X_{S-M}$  to serial-binary with least-significant bit first, either a shift-left/shift-right register is needed, or a serial-in, parallel-out register combined with a parallel-in, serial-out register must be used. It is expected that register circuits like these will soon be available in a single package, in MOS form.

From the foregoing, it should be apparent that design of a single-amplifier circulation a/d converter is no project for an amateur. To obtain only moderate performance from such a converter, careful consideration must be given to all of the usual speed-accuracy trade-offs. In a converter of this type, it is meaningless to talk about static accuracy, since nothing is static or at rest. Accuracy for this converter is meaningful only when it is referenced to a specific conversion rate or to a clock frequency.

At a given clock frequency, the accuracy of the single-amplifier circulation a/d converter is determined by many factors. The most important are:

- The voltage offset and drift in the amplifier.
- The accuracy of the resistor voltage divider, including the differences in  $R_{ON}$  of  $S_1$ ,  $S_2$  and  $S_8$ .
- The voltage offset and drift in the comparator.
- The net effect of the capacitive feedthrough transients of  $S_4$ ,  $S_5$ ,  $S_6$  and  $S_7$ .
- The error due to the input capacity of the amplifier.
- The deviation of the reference voltage from the nominal value.

The effect of these errors on over-all accuracy differs greatly. This is explained by the fact that some of these errors have the largest effect on the most-significant bit and by the fact that, for each lesser-significant bit, the effects are reduced by a proportional factor of two. Other errors, like the offset in the amplifier, have the same effect on all digits, because this offset becomes multiplied by two during each clock period. To make an error analysis for this converter is, therefore, no easy task.

Gordon Engineering Co., Waltham, Mass., recently has built a breadboard of a 12-bit bipolar single-amplifier circulation a/d converter for General Electric's Avionic Controls Department. The unit operates at a clock frequency of 100 kHz and has an accuracy of  $\pm 0.25\%$  of full scale at room temperature and  $\pm 0.1\%$  over a temperature range from  $-55^\circ\text{C}$  to  $+125^\circ\text{C}$ . With the 12-bit word and 100 kHz clock frequency, the conversion rate of this converter is approximately 8000 per second.

## 2. Dual-amplifier circulation a/d converter

The dual-amplifier circulation a/d converter uses two dc amplifiers. Nevertheless, it is not any more complex than the single-amplifier converter, because it requires only half-as-many switches. The real significance of the dual-amplifier converter, however, is the fact that it overcomes many of the limitations and problems of the single-amplifier converter. The advantages of the dual-amplifier converter are:

- The amplifier input-capacity problem is not present.
- Only four switches, with relatively high ON-resistance, are needed.
- When the amplifiers must slew, their load currents are zero.
- The resistor voltage divider is more accurate, because there are no switches in series with it.
- Only one reference voltage,  $V_R/2$ , is required for bipolar operation.

The principal disadvantage of the dual-ampli-



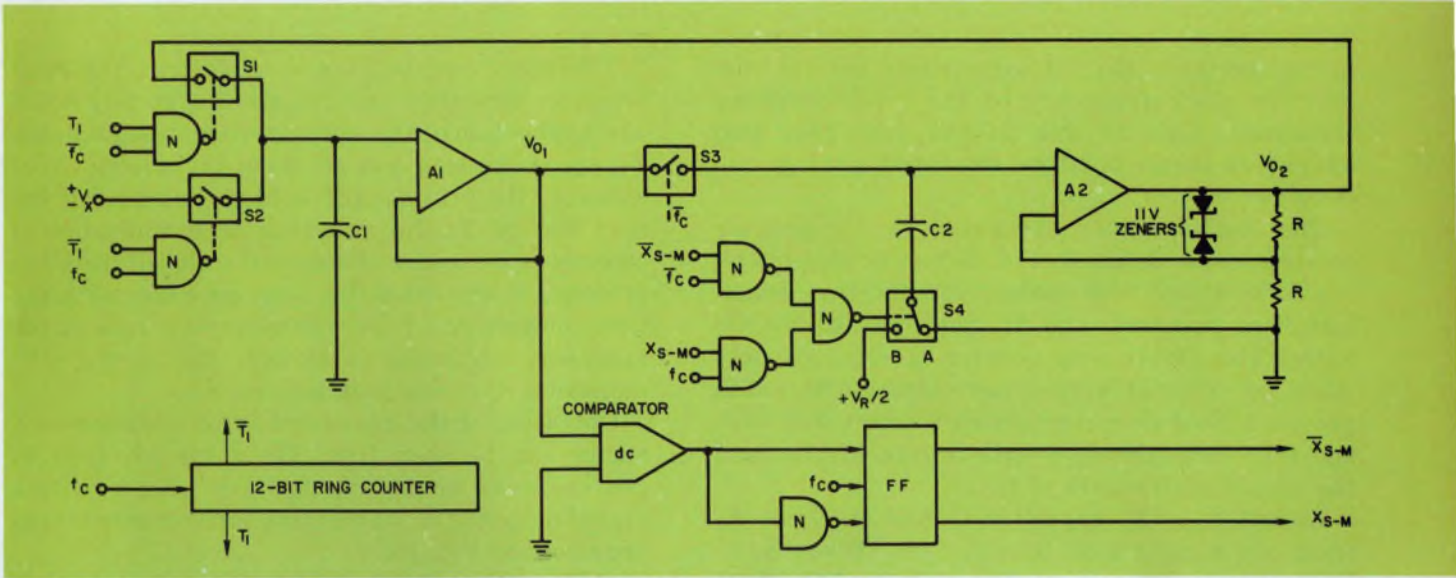

9. Two sample-hold circuits are used in the dual-amplifier circulation a/d converter. SH1 has unity gain. SH2

has a gain of 2 and a capability to add and subtract  $V_R/2$  from  $V_{x1}$ .

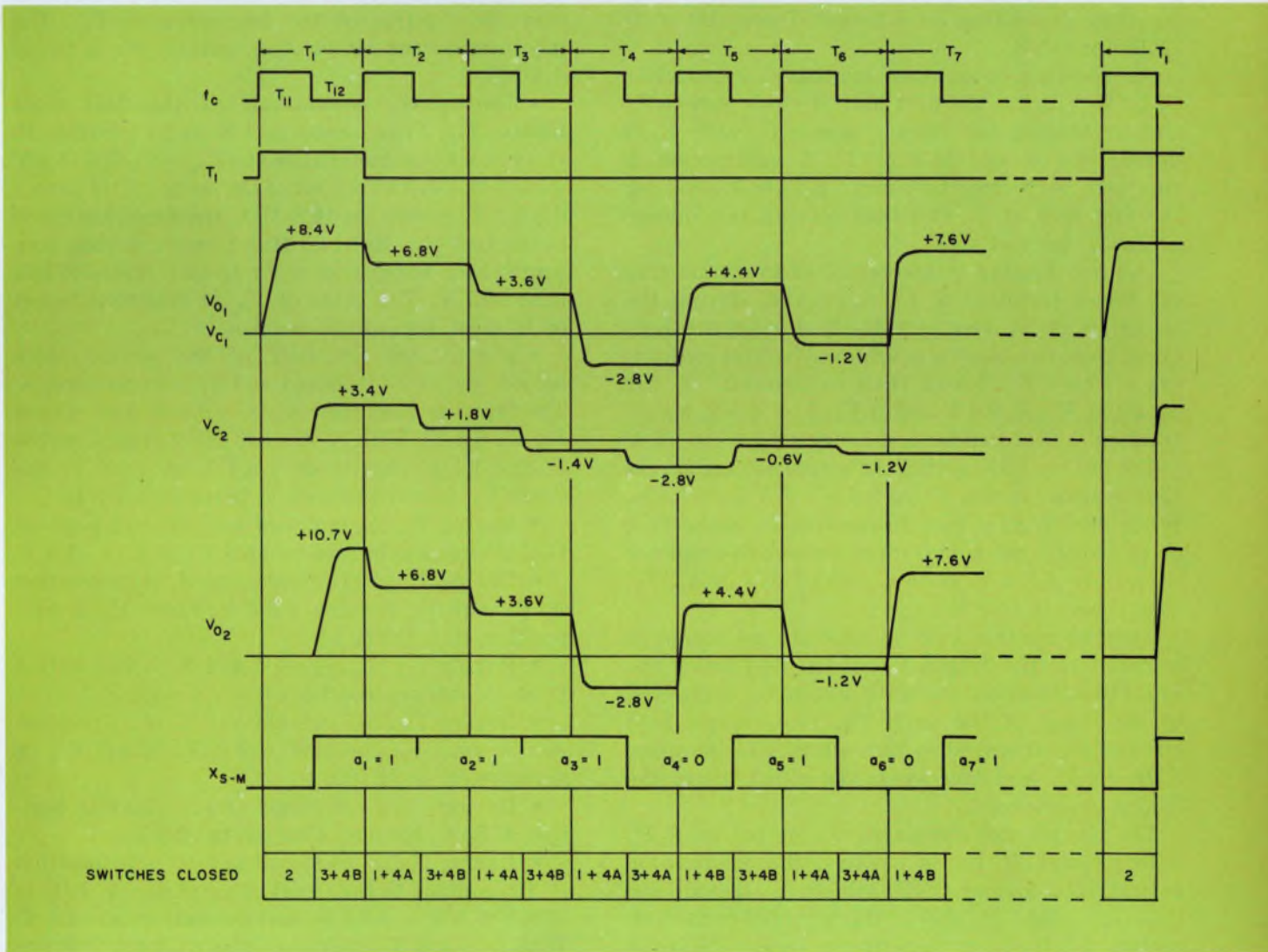

10. Sample waveforms of the dual-amplifier circulation a/d converter are shown here for  $V_x = +8.4$  V.



fier converter is that, it can operate only at one-half the clock frequency of the single-amplifier converter. This is due to the fact that two operation steps must be executed during one clock period.

The dual-amplifier circulation a/d converter comprises, as shown in Fig. 9, two dc amplifiers, one comparator, four analog switches, two capacitors, two resistors, one flip-flop and six NAND gates. The 12-bit ring counter is required only when no external word-synchronization signal is provided. Both dc amplifiers are connected as voltage followers; the first with a gain of one, and the second with a gain of two.

Switch  $S_1$  or  $S_2$ , capacitor  $C_1$  and amplifier  $A_1$  form one sample/hold circuit,  $S/H_1$ . When  $S_1$  or  $S_2$  is closed, the output voltage,  $V_{o_1}$ , of the first amplifier will follow the amplifier input. And when the switch is open,  $V_{o_1}$  will stay constant.

The second sample/hold circuit,  $S/H_2$ , consists of  $S_3$ ,  $C_2$ ,  $S_4$  and  $A_2$ . Amplifier  $A_2$  has a voltage gain of two. It also performs an addition or subtraction, depending on whether digital bit  $a_i$  is ZERO or ONE.

An addition is executed by charging capacitor  $C_2$  to  $V_{o_1}$  during the first half of clock period  $T_i$ , and by biasing the voltage across  $C_2$  with  $V_R/2$  during the second half of  $T_i$ . A subtraction is similarly performed by charging  $C_2$  to  $V_{o_1}$  during the first half of  $T_i$ , and then biasing the voltage across  $C_2$  with  $-V_R/2$ .

Positive biasing is accomplished by connecting the lower terminal of  $C_2$  to ground, during the charging cycle, and to  $+V_R/2$ , during the hold cycle. Negative biasing is achieved by first connecting  $C_2$  to  $+V_R/2$  and then to ground. If, for example,  $V_{o_1} = 8.4$  V and  $+V_R/2 = +5$  V, a subtraction is executed by first connecting  $C_2$  to  $+5$  V ( $S_4$  in position B), so that the actual voltage across the capacitor is only  $V_{c_2} = 8.4$  V  $- 5$  V =  $+3.4$  V. When switch  $S_4$  is then in position A, connecting  $C_2$  to ground, the actual input voltage to amplifier  $A_2$  is only  $+3.4$  V. With a gain of two in  $A_2$ ,  $V_{o_2}$  then becomes  $+6.8$  V.

The two sample/hold circuits are connected in a loop, with the output  $V_{o_1}$  of the first being the input to the second, and with output  $V_{o_2}$  connected to the input of the first. The two sample/hold circuits are arranged so that when  $S/H_1$  samples,  $S/H_2$  holds, and vice versa. In effect, then, the loop is never closed.

The comparator compares the output of  $S/H_1$  with ground. If  $V_{o_1}$  is positive, the comparator output is a logical ONE, which is shifted into the single-stage register at the center of each clock period,  $T_i$ . If  $V_{o_1}$  is negative, a logical ZERO is shifted into the register.

Like other circulation a/d converters, the dual-amplifier converter can be started at any time. The application of the word-synchronization pulse,  $T_1$ , opens the loop and connects the analog input signal to the first sample/hold circuit during the first half of  $T_1$ . No resetting or discharging of capacitors is required because the old information is simply disregarded.  $V_{o_1}$  thus increases with the time constant  $R_{ON} C_1$ , or with the slew rate of the amplifier, whichever is slower.  $R_{ON}$  is the ON-resistance of either switch  $S_1$  or  $S_2$ .

Operation of the dual-amplifier circulation converter can be seen from the steps involved in converting an analog input,  $V_x = +8.4$  V, into a digital output. The waveforms for this conversion are shown in Fig. 10.

- During the first-half of the first clock period,  $T_{11}$ , only switch  $S_2$  is closed. The input voltage,  $V_x$  is connected across capacitor  $C_1$ . The output,  $V_{o_1}$  of the first  $S/H$  circuit will thus rise exponentially to  $+8.4$  V. Since  $V_{o_1}$  is positive, the output of the comparator is a ONE, which is shifted into the flip-flop at the beginning of  $T_{12}$ . The most-significant bit of  $X_{S-M}$ , namely  $a_1$ , is hence a ONE.

- During the second-half of the first clock period,  $T_{12}$ ,  $S_3$  is closed and  $S_4$  is in position B. Capacitor  $C_2$  is thus charged to  $V_{o_1} - V_R/2 = 8.4$  V  $- 5$  V =  $3.4$  V. The output of the second  $S/H$  circuit during  $T_{12}$  would be  $16.8$  V, if the amplifier could swing that far. But two 10.7-V zener diodes, connected back-to-back, keep  $V_{o_2}$  to amplitudes of less than 10.7 V. The value of  $V_{o_2}$  at this time is not of interest, because  $S_1$  is open.

- During the first-half of the second clock period, switch  $S_1$  is closed and  $S_4$  is in position A. The input to amplifier  $A_2$  is  $+3.4$  V and output  $V_{o_2} = 6.8$  V. With  $S_1$  closed, the voltages across  $C_1$  and  $V_{o_1}$  change from  $+8.4$  V to  $+6.8$  V. Because  $V_{o_1}$  is still positive,  $a_2$  becomes a ONE.

- During  $T_{22}$ ,  $S_3$  is closed and  $S_4$  is in position B.  $C_2$  therefore charges to  $+6.8$  V  $- 5$  V =  $+1.8$  V.

- During  $T_{31}$ ,  $S_1$  is closed and  $S_4$  is in position A.  $V_{o_1}$  and  $V_{o_2}$  become  $+3.6$  V. Since  $V_{o_1}$  is still positive,  $a_3$  is ONE.

- During  $T_{32}$ ,  $S_3$  is closed and  $S_4$  is in position B. So  $C_2$  charges to  $+3.6$  V  $- 5$  V =  $-1.4$  V.

- During  $T_{41}$ ,  $S_1$  is closed and  $S_4$  is in position A.  $V_{o_1}$  and  $V_{o_2}$  become  $-2.8$  V. Since  $V_{o_1}$  is negative,  $a_4$  is ZERO.

- During  $T_{42}$ ,  $S_3$  is closed and  $S_4$  stays in position A. So  $C_2$  becomes charged to  $-2.8$  V.

- During  $T_{51}$ ,  $S_1$  is closed and  $S_4$  is in position B. The voltage to the input of amplifier  $A_2$  is thus  $-2.8$  V  $+ 5$  V =  $+2.2$  V, and the output is  $+4.4$  V. With  $S_1$  closed  $V_{o_1}$  increases also to  $+4.4$  V. Since  $V_{o_1}$  is positive,  $a_5$  is ONE.



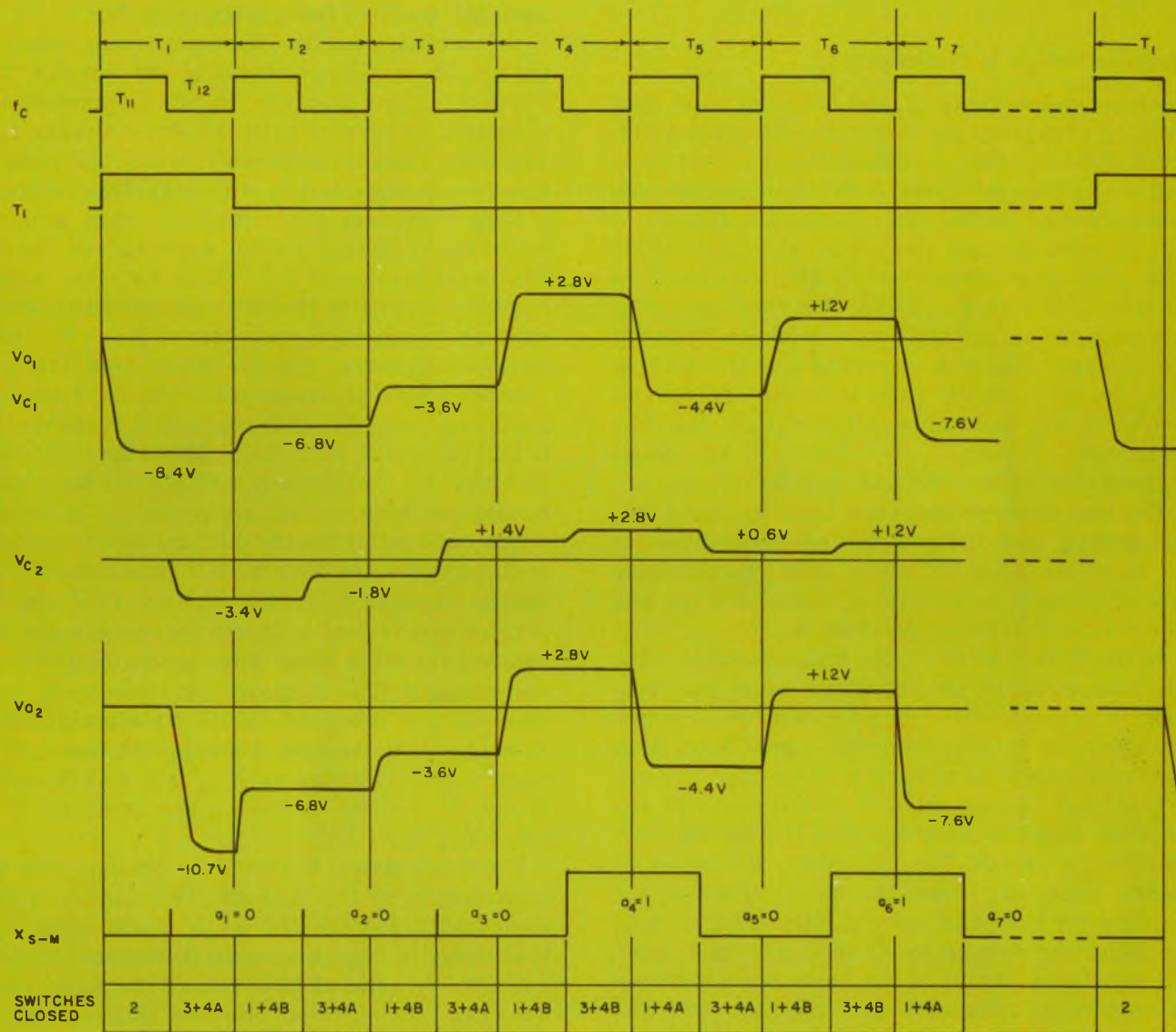

11. With a negative analog voltage, the waveforms of a dual-amplifier circulation converter are identical, al-

though of opposite polarity, to those for the case of a positive analog voltage (Fig. 10).

- During  $T_{52}$ ,  $S_3$  is closed and  $S_4$  stays in position B.  $C_2$  is thus charged to  $+4.4V - 5V = -0.6V$ .
- During  $T_{61}$ ,  $S_1$  is closed and  $S_4$  is in position A.  $V_{o2}$  and  $V_{o1}$  become  $-1.2V$ . Since  $V_{o1}$  is negative,  $a_6$  is ZERO.
- During  $T_{62}$ ,  $S_3$  is closed and  $S_4$  stays in position A. So  $C_2$  becomes charged to  $-1.2V$ .
- During  $T_{71}$ ,  $S_1$  is closed and  $S_4$  is in position B.  $V_{o2}$  is  $2(-1.2V + 5V) = +7.6V$ , and  $V_{o1}$  increases to the same value. Since  $V_{o1}$  is positive,  $a_7$  is ONE.

The serial-binary output signal so generated is thus 1110101, which represents  $+53/64$  in the offset-binary code. This is the closest approximation to  $+8.4V/10V = 0.84$  in a bipolar seven-bit num-

ber, and hence is the desired result.

Conversion of a negative analog input voltage is carried out in a similar manner, as shown in Fig. 11 for the case of  $V_X = -8.4V$ . For a negative input, only the polarity of the  $V_{o1}$  and  $V_{o2}$  voltages is reversed; what was positive before is now negative, and vice versa. Also reversed is the operation of switch  $S_4$ , since it must always be in position A during the first-half of a clock period for an addition, and in position B during the first half of a clock period for a subtraction.

The serial-binary output signal  $X_{S-M}$  for an analog input  $V_X = -8.4V$  is 0001010, which represents  $-54/64$  in the offset-binary form. This is again the closest approximation to  $-8.4V/10V =$



-0.84 that can be represented with a seven-bit bipolar number.

### Precision design is challenging

Although less complex, and easier to build than the single-amplifier converter, the design of a precision dual-amplifier circulation a/d converter is still a challenging task, even at moderate conversion rates. In the description that follows, it will be assumed that the converter is to operate with a clock frequency of 50 kHz and that the number of bits in  $X_{S-M}$  is 12. One clock period is, therefore, 20  $\mu$ s, and the time available to transfer a signal from one  $S/H$  circuit to another is 10  $\mu$ s. This requires an RC time constant of approximately 1  $\mu$ s. Assuming further that the two capacitors,  $C_1$  and  $C_2$ , are 2000 pF, the series impedance must then be less than 500 ohms.

The two dc amplifiers must have the same output-slewing and current-driving capabilities as the single-amplifier converter that was discussed earlier; namely, a slew rate of at least 6 V/ $\mu$ s, and a maximum drive current of 20 mA.

In the HOLD mode of the sample-and-hold circuits, the voltage across the capacitors must stay constant to within  $\pm 0.01\%$  for a period of 10  $\mu$ s, which is  $\pm 1$  mV for a 10-V maximum signal level. This requires a total leakage current of less than 200 nA.

The total leakage current is composed of the amplifier input bias current and the leakage current of the switch. This is within the realm of reality, especially when the initial offset of the amplifier is compensated for. However, to hold the capacitor voltage to  $\pm 1$  mV at a 10-V level, the resistance shunting the capacitor must also be very high, otherwise the capacitor will discharge itself. In practice, the total shunt resistance must be at least 50 M $\Omega$  if a capacitor with 10 V across it is to discharge less than 1 mV. In the

circuit of Fig. 9, the shunt resistance is made up of the amplifier input resistance and the OFF-resistance of the switch feeding the capacitor.

As mentioned earlier, the input capacitances of the amplifiers will not introduce any errors in this converter since they are, in effect, permanently connected in parallel with the storage capacitors. The input capacitors merely increase the value of the storage capacitors by an insignificant amount.

Only three series voltage-switches and one series-shunt voltage switch are required for the dual-amplifier converter. These switches should have low capacitive feedthrough, low leakage current and high OFF-resistance. None of these switches, however, requires either very low ON-resistance or high speed. Since the RC time constant requires a 500-ohm resistor, it is convenient to build  $S_1$  and  $S_2$  with  $R_{ON} = 500$  ohms and  $S_3$  and  $S_4$  with  $R_{ON} = 250$  ohms.  $S_3$  and  $S_4$  must have lower resistances, because they are connected in series.

The logic gating for the dual-amplifier converter is straightforward. Two NAND gates generate the control signals,  $\bar{T}_1 \cdot f_c$  for  $S_1$ , and  $T_1 \cdot \bar{f}_c$  for  $S_2$ . A third gate is used to invert the comparator output, and the other three gates are connected as an exclusive-OR. The exclusive-OR connects  $\bar{f}_c$  to  $S_4$  when  $X_{S-M}$  is a logical ZERO. This assures that  $S_4$  is always in position A during the first-half of clock period  $T_i$  whenever  $X_{S-M}$  is a ZERO, and is always in position B during the first-half of  $T_i$  when  $X_{S-M}$  is a ONE.

From the above, it should be obvious that the performance of the dual-amplifier converter is a complicated function of many parameters, and that these, in turn, are again dependent on other variables. In general, however, all the major problems can be condensed into one single problem: that of sampling and holding voltages, since the converter mainly consists of two cascaded sample-and-hold circuits.

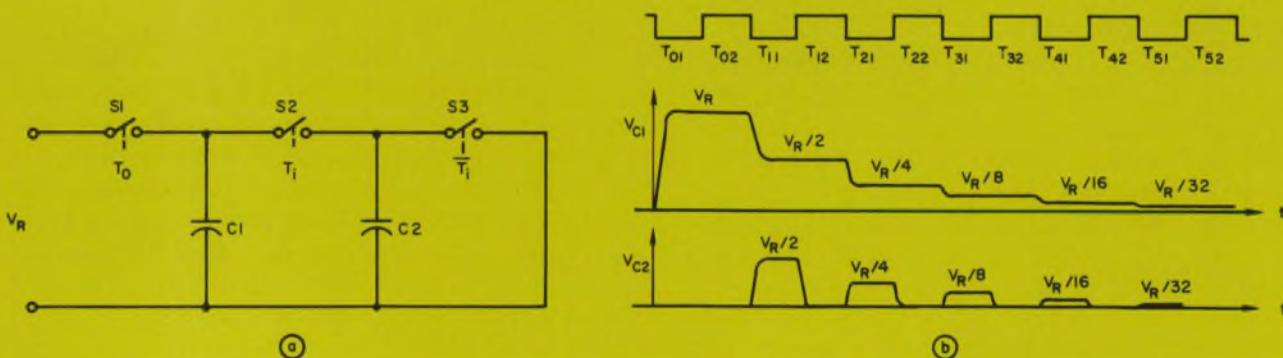

12. Equalizing charge between two capacitors provides a method of generating the binary fractions  $V_R/2$ ,  $V_R/4$ ,

etc. The initial charge,  $V_R$ , is developed across  $C_1$  during  $T_{01}$ , and is thereafter manipulated by the switches.



How well a signal can be sampled depends only on the duration of the sampling, with respect to the RC time constant. After approximately eight time constants, the voltage across a capacitor is always a very precise replica of the signal. Except for making up the time constant, the size of the resistor and capacitor have no effect upon the precision of the sampling process. Usually, it is the driving capability of the source that determines the time required for charging. Therefore, if sufficient time is provided, the sampling operation is always precise.

In the HOLD operation, almost exactly the opposite is true. The longer a signal must be held, the larger will be the errors. Fortunately, the hold time in this converter is relatively short. The precision with which a voltage or a charge is held on a capacitor can be defined by specifying the amount by which the voltage or the charge is allowed to change during the hold interval. As pointed out previously, this change, or error, is a function of the total leakage current flowing into the capacitor, the total resistance across it, and the sum of all other (transient) charges entering or leaving the capacitor. The offset, drift and gain errors of the amplifier must also be included in the over-all error of the sample-hold circuits. In  $S/H_2$  the gain is primarily a function of the ratio of the two resistors.

Another, although not significant source of error in the dual-amplifier converter is the offset and drift of the dc comparator. But even with conventional monolithic comparators, this error can be maintained below  $\pm 2$  mV over the temperature range without any compensation.

Limited performance data is available on the dual-amplifier circulation a/d converter. However, and judging by the performance of the single-amplifier converter, the dual-amplifier converter should exhibit the same accuracy of  $\pm 0.1\%$  of full scale over the temperature range, at a clock frequency of 50 kHz. Judged in terms of the performance data of commercially-available sample-hold circuits, much finer accuracy should be possible at much higher clock frequencies.

### 3. Charge-equalizing a/d converter

While the charge-equalizing a/d converter is also a serial-feedback a/d converter, its operation differs drastically from that of the circulation converters. In the charge-equalizing converter, a feedback voltage  $V_F$  is generated and summed with the input voltage  $V_X$ , just as in a successive-approximation a/d converter. During each operation step,  $V_F$  is made to approximate  $V_X$  more closely, in the familiar binary fashion, by generating feedback voltages which have the following values in

successive time intervals:

$$V_F = \pm 1/2 V_R \text{ in } T_1$$

$$V_F = \pm 1/2 V_R \pm 1/4 V_R \text{ in } T_2$$

$$V_F = \pm 1/2 V_R \pm 1/4 V_R \pm 1/8 V_R \text{ in } T_3, \text{ etc.}$$

A (+) is used in these equations when the appropriate digit,  $a_i$ , in  $X_{S-M}$  is a ONE, and a (-) is used when  $a_i$  is a ZERO. The general form of this relationship is therefore:

$$\begin{aligned} V_F &= a_1 2^{-1} V_R + a_2 2^{-2} V_R + a_3 2^{-3} V_R + \\ &\dots + a_n 2^{-n} V_R \\ &= V_R (a_1 2^{-1} + a_2 2^{-2} + a_3 2^{-3} + \dots a_n 2^{-n}) \quad (3) \end{aligned}$$

or

$$V_F = V_R \sum_{i=1}^n a_i 2^{-i},$$

where  $a_i$  is either +1 or -1.

In the successive-approximation a/d converter,  $V_F$  is generated with a parallel d/a converter. In a charge-equalizing a/d converter, the feedback voltage is produced sequentially by a circuit that is similar to that described as the charge-equalizing d/a converter in reference 1.

In addition to circuit simplicity, the charge-equalizing a/d converter combines many of the advantages of circulation a/d converters and successive-approximation converters. For example, while it has a built-in sample/hold feature for the input signal, just as does a circulation converter, it also offers the capability of converting ac signals directly into digital form, just as is possible with successive-approximation converters.

The charge-equalizing a/d converter generates the feedback voltage,  $V_F$ , by sampling a reference voltage during the first clock period,  $T_1$ , and manipulating the resultant charge,  $Q_R = V_R C_1$ , in the succeeding periods,  $T_i$ , to produce the multiple-binary fractions defined in Eq. 3. There are four basic manipulations of electric charges employed in this conversion process.

1. Connecting a discharged capacitor  $C_2$  across a capacitor  $C_1$  that is charged to a voltage  $V_R$  will cause charge to flow from  $C_1$  to  $C_2$  until the voltages across the two capacitors are equal. When the values of the two capacitors are equal, each holds half the charge initially on  $C_1$ , and the voltage across each capacitor is exactly  $V_R/2$ . This equalization of the charges does not occur immediately; it takes a finite amount of time, which is a function of the value of  $C_2$  and the resistance of the closed switch,  $R_s$ , used to connect the two capacitors. In nine time constants,  $R_s C_2$ , the voltage across  $C_2$  has reached its final value to within 0.01%.

2. The second manipulation is an extension of the first. Capacitor  $C_2$  is repeatedly charged from capacitor  $C_1$  and discharged to generate the binary fractions of the reference voltage,  $V_R/2$ ,  $V_R/4$ ,  $V_R/8$ , etc. As shown in Fig. 12, capacitor  $C_1$  is



charged to the reference voltage  $+V_R$ , during  $T_{01}$ , by closing switch  $S_1$ . During  $T_{11}$ , switch  $S_2$  is closed and the charges equalize to make the voltage across the two capacitors equal to  $V_R/2$ . In the period  $T_{12}$ , capacitor  $C_2$  is discharged to zero by closing  $S_3$ . During  $T_{21}$ ,  $S_2$  is again closed. The charges and the voltages equalize again and make  $V_{C_1} = V_{C_2} = V_R/4$ .

This operation can be repeated as many times as is desired. Each time the charges are equalized, the voltage is reduced by a factor of two; thus producing  $V_R/2$  during  $T_1$ ,  $V_R/4$  during  $T_2$ ,  $V_R/8$  during  $T_3$ , and so on.

3. The third manipulation involves the addition of charges. A circuit to perform this task comprises a dc operational amplifier and two capacitors (Fig. 13). One of the capacitors,  $C_2$ , is connected to the input of the amplifier by a switch,  $S_3$ . The other capacitor,  $C_3$ , is connected in the feedback of the amplifier.  $C_2$  and  $C_3$  are equal in value.

When switch  $S_3$  closes, capacitor  $C_2$  discharges, and a current  $I_i$  flows into the summing point of the amplifier. The basic rule of operational amplifiers demands that the sum of the currents flowing into the summing point be zero. This can be maintained only if a feedback current  $I_f = -I_i$  also flows into the summing point. Based on this, it can be shown that the closure of  $S_3$  causes the negative of the voltage on  $C_2$  namely  $V_{C_2}$ , to be added to the initial voltage on  $C_3$ .

4. The fourth manipulation is an extension of the third and involves the adding of charges sequentially in time. This can be seen from the circuit of Fig. 13 and the waveforms of Fig. 14. Assume that the voltage across capacitor  $C_2$  is  $-V_R/2$  in clock period  $T_1$ , is  $-V_R/4$  in  $T_2$ , is  $-V_R/8$  in  $T_3$ , and so on (Fig. 14a). Closure of switch  $S_3$ , during the first-half of each clock period, will therefore cause the voltage across capacitor  $C_3$  to increase from zero to  $V_R/2$  in  $T_1$ , to  $3V_R/4$  in  $T_2$ , to  $7V_R/8$  in  $T_3$ , to  $15V_R/16$  in  $T_4$ , etc.

Next, assume that  $V_{C_2}$  is  $+V_R/2$  in  $T_1$ ,  $+V_R/4$  in  $T_2$ ,  $+V_R/8$  in  $T_3$ , etc., and that the voltage across  $V_{C_3}$  is  $V_i$  in  $T_0$ . Closure of  $S_3$ , during all  $T_{11}$  periods, will thus change  $V_{C_3}$  from  $V_i$  in  $T_0$ , to  $V_i - V_R/2$  in  $T_1$ , to  $V_i - 3V_R/4$  in  $T_2$ , and so on (Fig. 14c).

Finally, assume (1) that either the positive or the negative values of  $V_{C_2}$ , namely  $+V_R/2$  or  $-V_R/2$  in  $T_1$ ,  $+V_R/4$  or  $-V_R/4$  in  $T_2$ , etc., can, at will, be connected to the amplifier input; (2) that the initial value of  $V_{C_3}$  is  $V_i = +9V_R/16$ ; and (3) that the objective is to reduce  $V_i$  to zero in as few steps as possible. This can be accomplished, as shown in Fig. 14d, by connecting  $+V_R/2$  in  $T_1$ ,  $+V_R/4$  in  $T_2$ ,  $-V_R/8$  in  $T_3$  and  $+V_R/16$  in  $T_4$  to the input of the amplifier. The choice of whether  $+V_R/2'$  or  $-V_R/2'$  is to be

used depends on whether  $V_{C_3}$  is positive or negative, during a specific clock period  $T_i$ .

The diagram of Fig. 15 shows how the above principles are implemented in the charge-equalizing a/d converter. There are three equal capacitors,  $C_1$  through  $C_3$ .  $C_1$  and  $C_2$  are used to generate the binary fractions  $V_R/2$ ,  $V_R/4$ ,  $V_R/8$ , etc., which are then added to, or subtracted from, the analog input voltage  $V_X$  in capacitor  $C_3$ . In addition, there are seven transistor switches.

The input voltage  $V_X$  is connected to capacitor  $C_2$  by switch  $S_1$ . Closure of switch  $S_2$  charges  $C_1$  to the reference voltage  $V_R$ . Closing switch  $S_3$  equalizes the charges on  $C_1$  and  $C_2$ . Switch  $S_4$  connects either the upper or the lower terminal of  $C_2$  to ground; and switches  $S_5$  and  $S_6$  connect either the upper or lower terminal of  $C_2$  to the summing point of the amplifier.

The status of the digital output signal  $X_{S-M}$  determines whether  $S_5$  or  $S_6$  is closed during a specific time period. When the voltage across  $C_3$  is negative, during a period  $T_i$ , the digital output  $a_i$  becomes a logical ONE. Switch  $S_6$  is therefore closed, so that  $V_R/2'$  is added to  $V_{C_3}$ . In contrast, if  $V_{C_3}$  is positive, making  $a_i$  a ZERO,  $S_5$  is closed and  $V_R/2'$  is subtracted from  $V_{C_3}$ . Switches  $S_5$  and  $S_6$  are operated only during the second half of each clock period. All other switches are operated during the first half. Closure of switch  $S_7$ , which occurs during the second half of the first clock period,  $T_{01}$ , discharges  $C_3$ .

### Example illustrates operation

The operation of the charge-equalizing a/d converter can be seen from a specific example, in which the input voltage  $V_X = 8.4$  V, and the reference voltage  $V_R = +10$  V (Fig. 16). The operation starts with clock period  $T_0$ . During the first half of this period,  $T_{01}$ , switches  $S_1$ ,  $S_2$ ,  $S_{4A}$  and  $S_7$  are closed. Capacitor  $C_1$  is charged to  $+10$  V,  $C_2$  to  $+8.4$  V and  $C_3$  is discharged. During  $T_{02}$ , switch  $S_5$  is closed and  $S_4$  remains in position A. The charge on capacitor  $C_2$  is transferred, with opposite polarity, to  $C_3$ . At the end of  $T_0$ , the voltages across the three capacitors are  $V_{C_1} = +10$  V,  $V_{C_2} = 0$ , and  $V_{C_3} = 8.4$  V. Also, the output voltage of the amplifier is  $V_0 = V_{C_3} = -8.4$  V, and the output of the comparator is a logical ONE. This ONE is shifted into the flip-flop at the beginning of  $T_1$ , so that the value of  $X_{S-M}$  during  $T_1$ , namely  $a_1$ , is a logical ONE.

During  $T_{11}$ , switch  $S_3$  is closed and, with  $a_1$  a ONE,  $S_4$  stays in position A. The charges on  $C_1$  and  $C_2$  equalize, making  $V_{C_1} = V_{C_2} = +5$  V. During  $T_{12}$ , switches  $S_{4B}$  and  $S_6$  are closed, so that  $V_{C_2}$  is added to  $V_{C_3}$ , which then becomes  $-8.4$  V  $+5$  V  $= -3.4$  V. Since  $V_0$  is still negative, a ONE

13. Adding of charges can be accomplished with an operational amplifier and two capacitors.

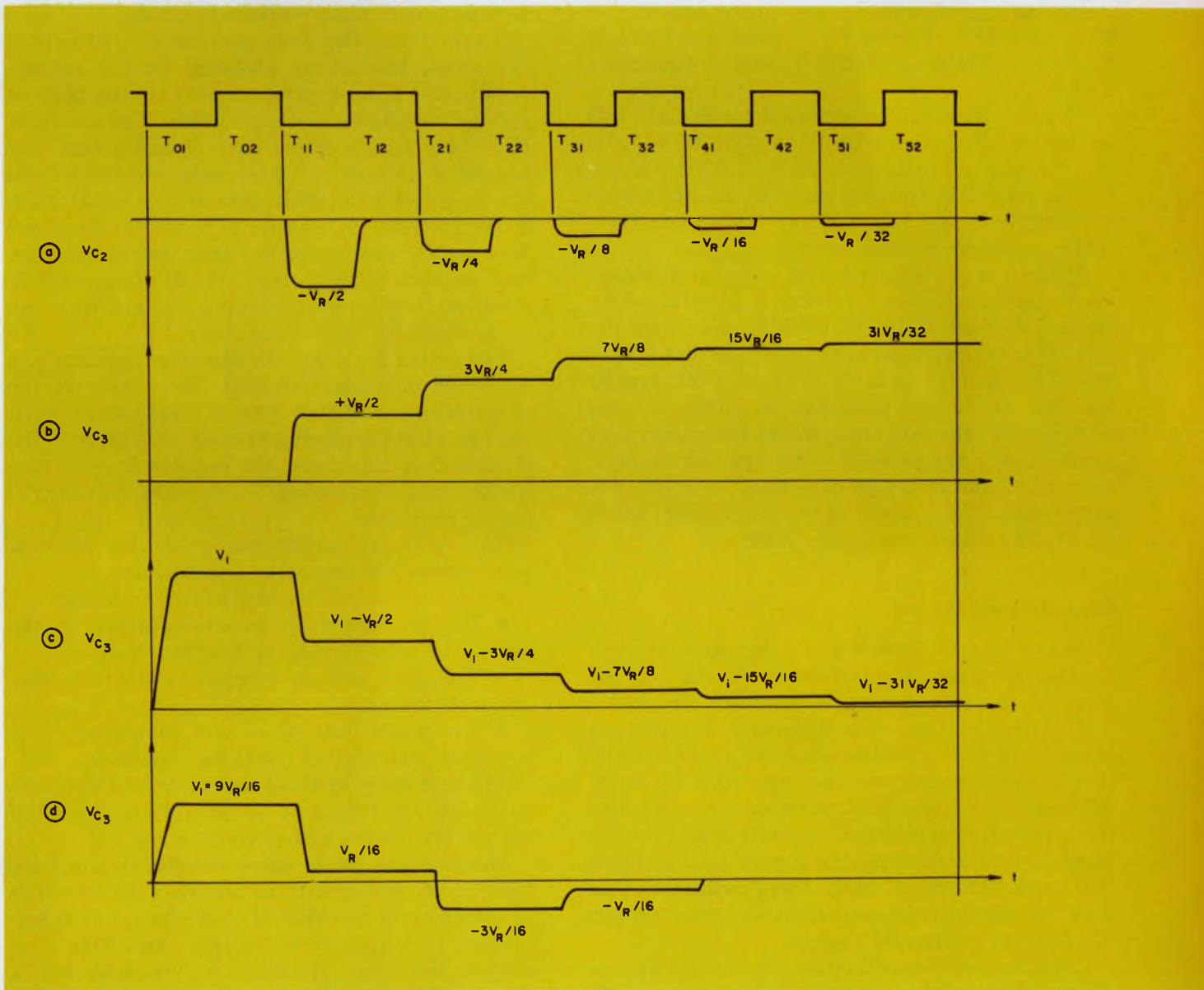
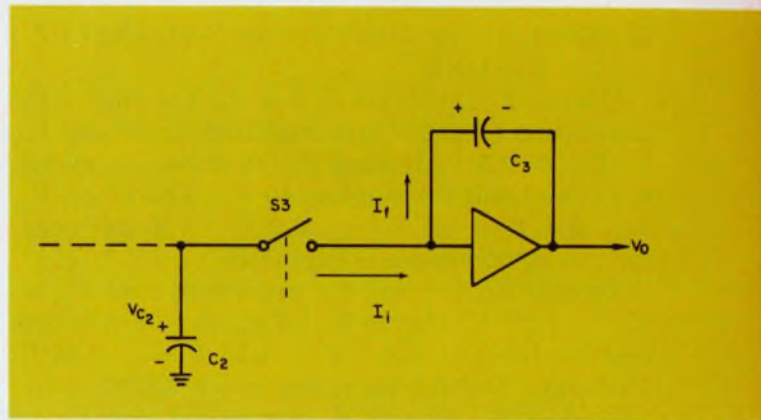

14. Waveforms show how the addition of charges by the dc operational amplifier and two capacitors of Fig. 13

can reduce the voltage  $V_{C_3}$  across capacitor  $C_3$  to zero. Timing pulses show the relative timing of the steps.



is shifted into the flip-flop at the beginning of  $T_2$ ; so  $a_2$  is also ONE.

During  $T_{21}$ , switches  $S_3$  and  $S_{4A}$  are closed, the charges on  $C_1$  and  $C_2$  are equalized again, and  $V_{C_1} = V_{C_2} = 2.5$  V. During  $T_{22}$ , switches  $S_{1B}$  and  $S_6$  are closed and  $V_{C_2}$  is added to  $V_{C_3}$ . Therefore,  $V_{C_3} = -3.4$  V +  $2.5$  V =  $-0.9$  V.  $V_o$  is still negative, so  $a_3$  becomes a logical ONE.

During  $T_{31}$ ,  $S_3$  and  $S_{4A}$  are closed and  $V_{C_1} = V_{C_2} = 1.25$  V. During  $T_{32}$ ,  $S_{1B}$  and  $S_6$  are closed, and  $V_{C_3}$  becomes  $-0.9$  V +  $1.25$  V =  $+0.35$  V.  $V_o$  is now positive, so  $a_4$  becomes a ZERO.

During  $T_{41}$ ,  $S_3$  and  $S_{4A}$  are closed and  $V_{C_1} = V_{C_2} = 0.625$  V. During  $T_{42}$ ,  $S_6$  is closed and, because  $a_3$  is ZERO,  $S_4$  stays in position A.  $V_{C_2}$  is hence subtracted from  $V_{C_3}$ , which becomes  $+0.35$  V  $-0.625$  V =  $-0.275$  V. With  $V_o$  being negative,  $a_5$  becomes a ONE.

During  $T_{51}$ ,  $S_3$  and  $S_{4A}$  are closed and  $V_{C_1} = V_{C_2} = 0.3125$  V. During  $T_{52}$ ,  $S_{1B}$  and  $S_6$  are closed,  $V_{C_3} = -0.275$  V +  $0.0375$  V, and  $a_6$  becomes a ZERO.

This operation can be continued for as many bits as desired. However, after about 12 bits,  $V_{C_1}$  and  $V_{C_2}$  are only approximately 2.5 mV. At this point, the signal levels are very close to the noise level (offsets, drifts, etc.), so that any further operation will not produce reliable results.

The output of the comparator is the serial-binary word (most-significant bit first) 111010, which represents  $+26/32$  in the offset-binary presentation. This is the closest approximation to  $8.4$  V/10 V = 0.84 that is possible with a 6-bit bipolar number. If, in the preceding example,  $V_x$  had been  $-8.4$  V, the operation would have been very similar; only the polarity signs and the designations of  $S_5$  and  $S_6$  would have been reversed. The serial output  $X_{S-M}$  would have been 000101, which is  $-26/32$  in the offset binary form.

### Capacitors are the key

As can be seen from Fig. 15, the parts count of the charge-equalization a/d converter is almost the same as that for the single-amplifier circulation a/d converter. The major difference in hardware between them is that the single-amplifier circulation converter requires two precision resistors, whereas the charge-equalization converter requires three precision capacitors. While it is no problem to find two resistors having a very precise ratio, it is quite difficult to obtain three capacitors that have the same values and maintain them through life and environmental changes.

Corning now offers glass capacitors to accuracies of  $\pm 0.025\%$ , with matching temperature coefficients of  $140 \pm 25$  PPM. However, buying a 1000-pF capacitor with a tolerance of  $\pm 0.025\%$  is one thing,

but realizing a capacitance of  $1000 \pm 0.25$  pF in a circuit is something else. This is because the components and wires connected to the capacitor have parasitic capacitances, which must be added to the value of the capacitor.

One way out of this dilemma is to make the values of the capacitors larger; but this has several disadvantages: Larger currents must be switched and supplied by the amplifier, or else more time must be provided to charge the capacitors. In the first case, lower-impedance switches and amplifiers with higher output currents are needed, both of which result in larger parasitic capacitances. In the second case, providing more time for capacitor-charging results in longer conversion times or lower conversion rates. Another disadvantage of larger capacitors is in their larger size; values that exceed 10,000 pF can become quite objectionable to designers in today's microcircuit age.

Apart from the requirement for precision capacitors, the circuit problems in the charge-equalization a/d converter are very similar to those for the circulation a/d converters. The amplifier must have a high output current and a fast slew capability, as well as a high gain and low offsets (if no offset correction network is used). The analog switches do not have to be very fast or have very low ON-resistance, but they should have low feed-through capacitances. In addition, the dc comparator offset should also be low, and its sensitivity should be better than 2 mV.

The output logic for the charge-equalizing a/d converter is straightforward. The output of the comparator is shifted into a single-stage shift register at the beginning of each clock period. The flip-flop that constitutes the register is reset during the initiation period,  $T_o$ , to make  $X_{S-M}$  ZERO during that time.

The over-all performance of the charge-equalization a/d converter is a function of:

- The time available to transfer a charge.
- The magnitude of errors occurring in the process of transferring or holding charges.
- The offset and gain errors of the amplifier and comparator.
- The magnitude of errors resulting from improper matching of the three capacitors.

The first three of these and their effect on performance are the same as previously described for the circulation a/d converters.

Summarizing these three briefly, it has been pointed out that specifying accuracy for this type of converter is meaningful only when it is referenced to a specific conversion rate. This then defines the time available for transferring a charge. If this time is large, the charge-transfer errors can be maintained small much easier.

The errors occurring in the process of holding



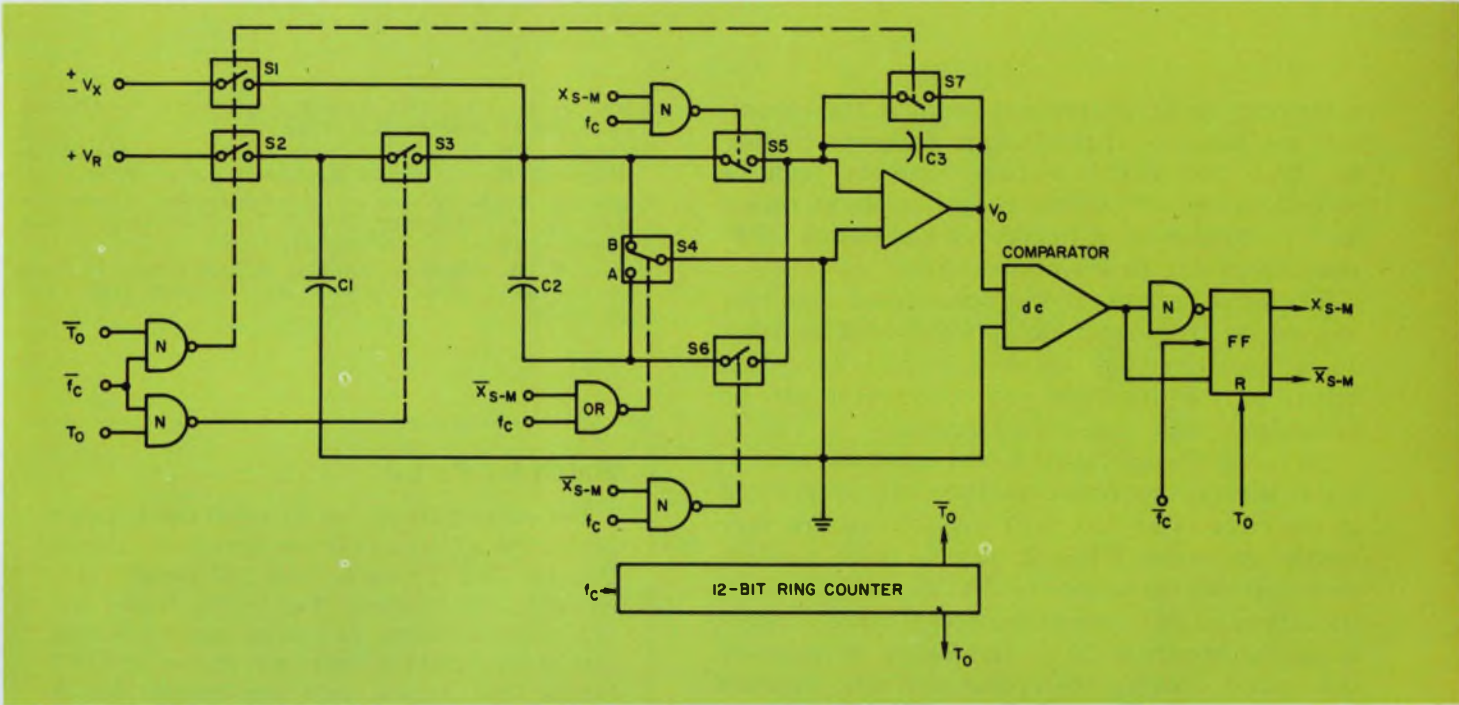

5. The charge-equalizing a/d converter uses two capacitors,  $C_1$  and  $C_2$  to generate the binary fractions.

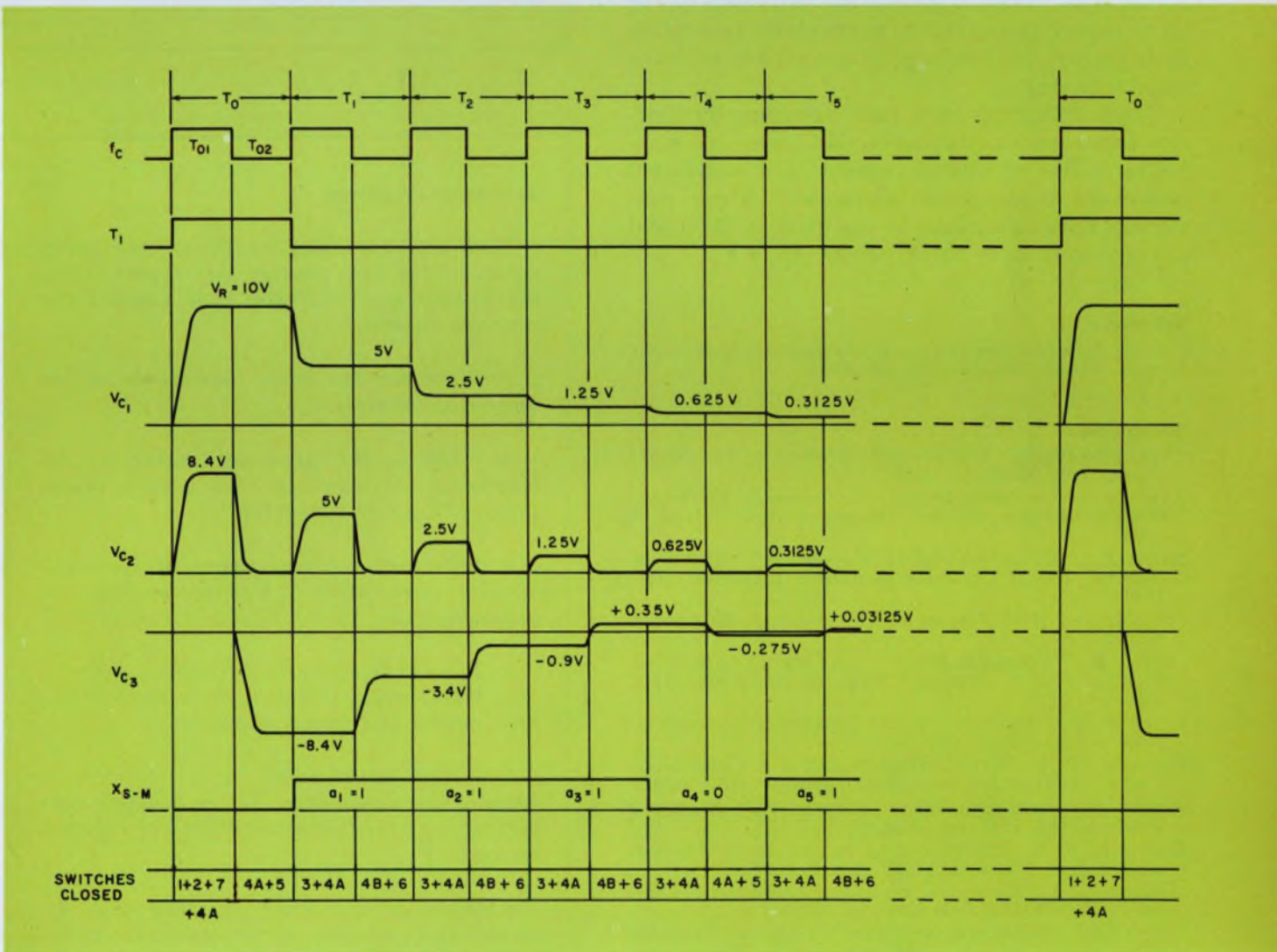

16. Waveforms of the charge-equalizing converter show that digital output  $X_{S-M}$  is a ONE when voltage

$V_{C3}$  is negative. Alternately,  $X_{S-M}$  is a ZERO when voltage  $V_{C3}$  is positive.



a charge can be maintained small if the capacitors are large, or if the leakage currents (amplifier bias and switch leakage currents) can be maintained small and the capacitor shunt resistance (amplifier input-impedance and switch OFF-resistance) can be maintained high.

The offset errors of the operational amplifier and the dc comparator can be eliminated by using an offset-correction network, while the gain errors of the amplifier and comparator can be minimized with high-gain circuits.

As far as the last factor is concerned and according to theory, the three capacitors can be trimmed in the circuits so that their magnitudes are very nearly the same. While it may be quite possible to match two capacitors to  $\pm 0.1\%$  within a short time, in practice it may require considerably longer to match three to  $0.025\%$ . And finally, to maintain this match, during the operational life, depends not only on the temperature coefficients of the actual capacitors but also on the variations of the stray capacitances; this is particularly true when their magnitudes are large in comparison with the desired tolerance.

These difficulties have been overcome by Towson Laboratories, Baltimore, Md., who are marketing a line of charge-transfer a/d converters under the trade name "Capcoder." These converters have accuracies to one part in 2000 and conversion rates to 20,000 per second. ■ ■

#### References:

1. H. Schmid, "Practical d/a Conversion," *ELECTRONIC DESIGN*, ED 22, Oct. 24, 1968, pp. 49-88.

#### Bibliography:

"Analog-to-Digital Converters," *Electronic Instrument Digest*, July 1966, pp. 41-57.

Barr, P., "Voltage-to-Digital Converters," *Electromechanical Design*, Systems Designers Handbook, Jan. 1964.

Barr, P., "Voltage-to-Digital Converters," *Electromechanical Design*, Systems Designers Handbook, Jan. 1966.

"Bipolar and MOS Teamed up in Op-Amp," *Electronics*, Oct. 2, 1967, p. 25.

Dakin, R., "Voltage-to-Digital Converters," *Electromechanical Design*, Systems Designers Handbook, April 1967.

Daley, F. D., "Analog-to-Digital Conversion Techniques," *Electro-Technology*, May 1967.

Farrand, W. A., "A/D Converters and D/A Converters," *Computer Handbook*, New York: McGraw-Hill, 1962.

Flynn, G., "Analog-to-Digital Converters," *Electronic Products*, Oct. 1967, pp. 18-48.

Gloss, P. F. M., *Binary Coding by Successive Approximation*, U.S. Patent 2,569,927, Oct. 2, 1957.

Herring, G. J., "Electronic Digitizing Techniques," *Journal of British IRE*, July 1960, pp. 513-517.

"Integrated Operational Amplifier," Tentative Technical Specifications," Amelco Semiconductor, Mt. View, Calif., July 1967.

Jackson, A. S., *Analog Computation*, Chapt. 14. New York: McGraw-Hill, 1960.

Korn, G. A., *Electronic Analog and Hybrid Computers*. New York: McGraw-Hill, 1965.

Stephenson, B. W., *Analog Digital Conversion Handbook*. Maynard, Mass.: Digital Equipment Corp., 1964.

Susskind, A. K., *Notes on Analog/Digital Conversion Techniques*. Cambridge, Mass.: The Technology Press, Mass. Institute of Technology, 1957.

Young, F. M., "Factors Limiting A/D Conversion, State of the Art," *Data Systems Engineering*, May 1964, pp. 35-39.

## Watch for Part 2

The second part of this Practical Guide to a/d Conversion will appear in our next issue, ED 26, Dec. 19, 1968. Topics covered will include Indirect a/d Converters and High-Speed, High-Accuracy a/d Converters. The third, and concluding, part of the Practical Guide will appear in ED 1, Jan. 4, 1969. Among the topics covered will be Offset Correction in a/d Converters, and Time-Sharing of a/d Converters.

## Test your retention

Here are questions based on the main points of the first part of this report. They are to help you see if you have grasped the concepts involved.

1. What are the basic limitations of the servo a/d converter?

2. What is the principal factor in determining the accuracy of a successive-approximation a/d converter?

3. What are the advantages of the dual-amplifier circulation a/d converter over the single-amplifier circulation a/d converter?

4. In what type of serial-feedback converter is the accuracy critically dependent on the precision of the circuit capacitors?

5. Which can provide higher conversion speeds: the single-amplifier circulation converter, or the dual-amplifier circulation converter?

6. What is the basic equation that describes the operation of nonrestoring, circulation-type a/d converters?

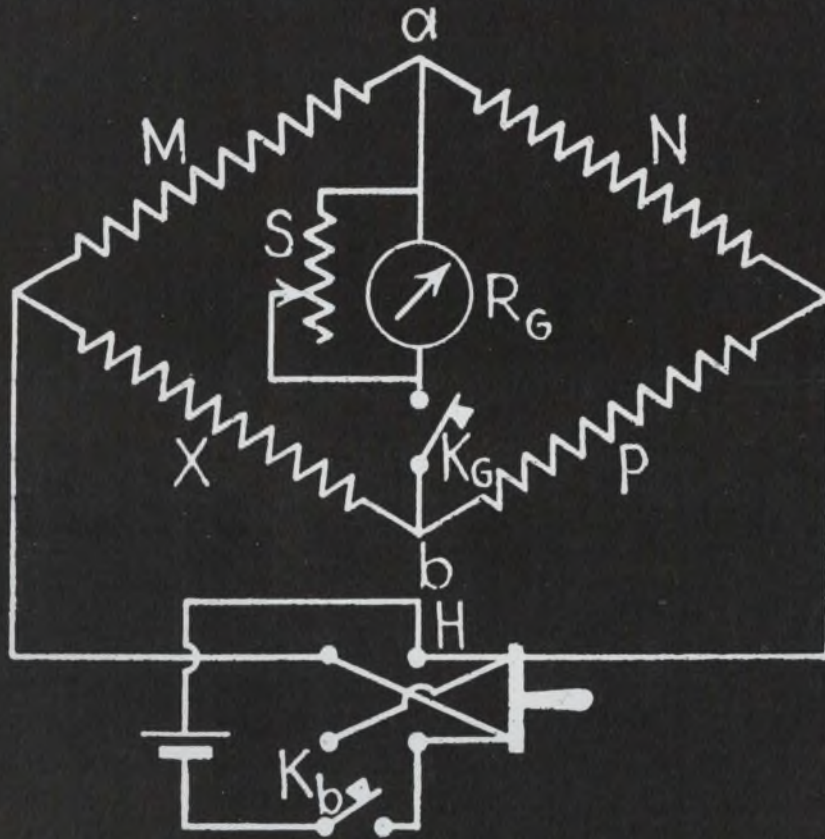

## A new bridge?

Redesigning something as basic as an R-L-C Bridge is like reinventing the wheel. What more can be done beyond just a face-lifting? A lot. You can always improve on basic old concepts by adapting them to meet today's needs. This is what happened to the new GR1650-B Impedance Bridge. After all, what did Wheatstone, Maxwell, and Hay know about transistors?

Oh sure, we're guilty of face-lifting too — we gave the 1650-B a new, light look; but we also added features that adapt the bridge to today's and tomorrow's needs. For example:

Access has been provided to the bridge arm opposite the unknown. An external capacitance decade may be connected here to make a reactive balance of inductive resistors. This is often useful when measuring an amplifier's input impedance.

A conductance bridge has been added. It permits direct readout in micromhos of parameters such as  $h_{oe}$ . A simple test jig allows you to measure all the transistor h parameters including input and output capacitance.\*

A convenient external DQ jack simplifies inserting a dc blocking capacitor for incremental inductance measurements of inductors carrying direct current.

A slow-motion dial drive has been added to ensure fine accurate balances. The drive comes into use during the final stages of balance.

DC sensitivity for low resistance has been improved and the bridge transformer has been redesigned to permit low-frequency measurement with less drive power.

With all these additions, you probably wonder about subtractions. There is one and it's in the price. The 1650-B sells for \$450 in the USA. That's \$25 less than the price of its predecessor, the 1650-A.

\*See General Radio Experimenter.

## What's old about this new bridge?

The features that made the 1650-A Bridge so versatile have been maintained and strengthened:

- Wide measuring ranges: C from 1pF to 1100 $\mu$ F, series or parallel; L from 1 $\mu$ H to 1100H, series or parallel; R from 1 m $\Omega$  to 1.1 M $\Omega$ , ac or dc; G from 1 nanomho to 1.1 mhos, ac or dc; D (at 1 kHz) for  $C_s$  from 0.001 to 1, for  $C_p$  from 0.1 to 50; Q (at 1 kHz) for  $L_s$  from 0.02 to 10, for  $L_p$  from 1 to 1000.
- $\pm 1\%$  accuracy for G, C, R, and L measurements holds on all ranges, is not reduced at range extremes, and holds from 20 Hz to 20 kHz. Accuracy is only slightly reduced at 100 kHz.
- Exclusive Orthonull<sup>®</sup> balance finder avoids false nulls when measuring lossy components. The bridge's DQ dial has now been color coded to indicate when Orthonull should be switched in.
- High DQ resolution and accuracy make for accurate determinations of equivalent circuits and network modeling for computer analysis. You could almost call the 1650-B "computer software".
- Battery operation for portability and isolation from the power line . . . Solid state 1-kHz oscillator and selective null detector . . . External biasing provision . . . Useful for both two- and three-terminal measurements . . . Flip-tilt case provides protection and doubles as an adjustable stand.

For complete information, write General Radio Company, W. Concord, Massachusetts 01781; telephone (617) 369-4400. In Europe: Postfach 124, CH 8034 Zurich 34, Switzerland.



**GENERAL RADIO**

INFORMATION RETRIEVAL NUMBER 30



# Speed immittance calculations.

A computer takes the sweat out of figuring the impedance or admittance matrix of interconnected networks.

Just the idea of doing an involved series of matrix manipulations makes engineers shudder. Yet, time-sharing computers are capable of doing matrix operations with one simple program statement. They make short work of the problem of finding the immittance (admittance or impedance) matrix for a network formed by interconnecting two or more multiport networks.

A systematic matrix technique,<sup>1</sup> organized for the computer, makes maximum use of the computer's matrix-manipulative ability: The engineer programs the computer and gives it the immittance matrices of the original networks. He then describes the interconnection to the computer by means of a third matrix. This last matrix contains only plus and minus ones and zeros and is written by inspection. The computer program forms a combined immittance matrix, post-multiplies it by the interconnection matrix, and premultiplies the result by the transpose of the interconnection matrix.

This is really simpler than it sounds. If, for example, we call the combined immittance matrix  $[I]$ , and we call the interconnection matrix  $[M]$ , the expression is then given by:

$$[M]^t [I] [M],$$

where the factors must be written in the order shown because matrix multiplication is not commutative. (For a quick review of matrix algebra, see the matrix manipulation box.)

Suppose we want to interconnect network  $A$ , an  $m$ -port network, and network  $B$ , an  $n$ -port network. To be specific, let's assume we're dealing with admittances. Let  $[Y_A]$  be the  $m \times m$  admittance matrix for network  $A$ , and let  $[Y_B]$  be the  $n \times n$  admittance matrix for network  $B$ . The relationship between the currents and voltages in the two networks is given in the system of equations represented by:

$$\begin{bmatrix} [I_A] \\ [I_B] \end{bmatrix} = \begin{bmatrix} [Y_A] & [0] \\ [0] & [Y_B] \end{bmatrix} \begin{bmatrix} [V_A] \\ [V_B] \end{bmatrix} \quad (1)$$

where  $[I_A]$  and  $[V_A]$  are the current and voltage

vectors for network  $A$ , and  $[I_B]$  and  $[V_B]$  are the current and voltage vectors for network  $B$ . The  $[0]$ s are matrices of zeros.

The square matrix generated by combining  $[Y_A]$  and  $[Y_B]$  in this fashion is called the *direct sum* of  $[Y_A]$  and  $[Y_B]$ . It is written

$$[Y_A] \dot{+} [Y_B] = \begin{bmatrix} [Y_A] & [0] \\ [0] & [Y_B] \end{bmatrix}. \quad (2)$$

The matrix  $[Y_A] \dot{+} [Y_B]$  can be considered the admittance matrix of the two networks, side by side and without any interconnection.

## Write the interconnection matrix

Every connection of a port of network  $A$  to a port of network  $B$  can be either a series or a parallel connection. Right now, let's consider the case of parallel connections only. Later on, we'll see that the series-only case is the dual of the parallel-only case, and we'll also see how to handle the general series-parallel case.

When a port of network  $A$  is connected in parallel to a port of network  $B$ , the new port thus formed has a voltage that is equal to plus or minus the voltages of the original ports, and a current equal to the algebraic sum of the currents of the original ports. Thus in Fig. 1,

$$v = v_A = -v_B \text{ and } i = i_A - i_B.$$

Now consider the two networks interconnected, and let  $[V]$  be the voltage vector for the new network. If we write equations for the old voltages in terms of the new voltages, the system of equations will be of the form

$$\begin{bmatrix} [V_A] \\ [V_B] \end{bmatrix} = [U] [V], \quad (3)$$

where the interconnection matrix,  $[U]$ , contains only  $\pm 1$ s and 0s and can be written by inspection. For the one-port networks of Fig. 1,

$$\begin{bmatrix} v_A \\ v_B \end{bmatrix} = \begin{bmatrix} 1 \\ -1 \end{bmatrix} [v] = [U] [v]$$

If the same current convention is used for all ports, it follows that when the voltages of two ports are made equal by parallel interconnection,

Luiz Peregrino, Project Engineer, Hewlett-Packard Co., Palo Alto, Calif.

## Matrix manipulation

For the reader whose matrix algebra is a little rusty, these brief definitions of the basic operations should prove of help.

Let's define a generalized  $m \times n$  matrix with  $m$  rows and  $n$  columns:

$$A = \begin{bmatrix} a_{11} & a_{12} & \dots & a_{1n} \\ a_{21} & a_{22} & \dots & a_{2n} \\ \dots & \dots & \dots & \dots \\ a_{m1} & a_{m2} & \dots & a_{mn} \end{bmatrix},$$

in which the general element is called  $a_{ij}$ . Two matrices are added by adding their corresponding elements. Similarly, the general element of the matrix  $A - B$  is given by  $a_{ij} - b_{ij}$ .

An  $m \times n$  matrix can be multiplied by an  $n \times p$  matrix to form an  $m \times p$  matrix whose general

term is given by:

$$c_{ij} = \sum_{r=1}^n a_{ir} b_{rj}.$$

Notice that matrix multiplication is not commutative, that is  $AB \neq BA$ .

The transpose of an  $m \times n$  matrix is the  $n \times m$  matrix formed by interchanging the rows and columns of the original.

Finally, the general term of the inverse of a square matrix (one where  $m = n$ ) is given by

$$c_{ij} = A_{ji}/a$$

where  $A_{ji}$  is the matrix that remains when row  $j$  and column  $i$  are removed from the matrix  $A$  and  $a$  is the determinant of  $A$ . (For a fuller discussion of matrix algebra, see an engineering math text.<sup>2</sup>)

the corresponding currents add. Therefore, the new current vector  $[I]$  is just

$$[I] = [U]^t \begin{bmatrix} [I_A] \\ [I_B] \end{bmatrix}, \quad (4)$$

where  $[U]^t$  is the transpose of  $[U]$ . In Fig. 1,

$$[i] = [1 \quad -1] \begin{bmatrix} i_A \\ i_B \end{bmatrix} = i_A - i_B.$$

### Find the new admittance matrix

Combining Eqs. 1, 2, 3 and 4 gives

$$[I] = [U]^t \left[ [Y_A] \dot{+} [Y_B] \right] [U] [V]. \quad (5)$$

Therefore, since  $[I] = [Y] [V]$ , the new admittance matrix is

$$[Y] = [U]^t \left[ [Y_A] \dot{+} [Y_B] \right] [U]. \quad (6)$$

Here are the steps in the computer program for calculating  $[Y]$ .

1. Read in  $[Y_A]$  and  $[Y_B]$ . (If these are complex matrices and the language you are using doesn't provide for complex-variable operation as, for example, BASIC, see the box on how to handle complex variables.)
2. Form the direct sum  $[X] = \left[ [Y_A] \dot{+} [Y_B] \right]$ .
3. Read in, or set in, the interconnection matrix  $[U]$ .
4. If you are using BASIC, do the following: (If you are not, do the equivalent steps in the language you are using.)

```
MAT T = TRN(U)
MAT W = X*U
MAT Y = T*W
```

where MAT means *matrix*, TRN denotes the transpose, and the asterisk indicates multiplication.

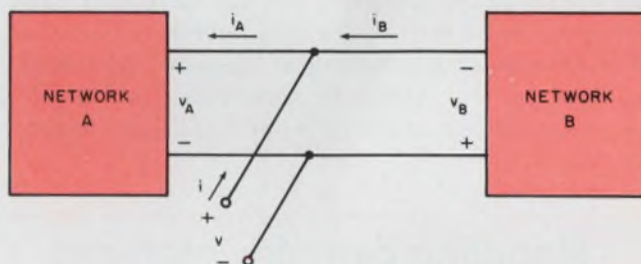

1. **Forced equality is imposed** on all voltages in a parallel interconnection. The current,  $i$ , of the new port is the algebraic sum of the currents of the original ports.

This method of finding the new admittance matrix can be generalized to more than two networks without modification.

Transformers used for interconnecting networks can be handled by simply including them as part of one of the networks.

The effects of short-circuiting any port can be easily examined by inserting zeros in the row of the interconnection matrix that corresponds to the port in question.

### How about series connections?

Series connections are the dual of parallel connections and are handled in a dual manner. The impedance matrix is used instead of the admittance matrix, and the roles of voltage and current are interchanged. If we call the series interconnection matrix  $[W]$ , we can write the dual of Eq. 6:

$$[Z] = [W]^t \left[ [Z_A] \dot{+} [Z_B] \right] [W]. \quad (7)$$

Clearly, this equation can be solved by the same computer program used for Eq. 6. Just as inserting a row of zeros in the  $[U]$  matrix short-circuited one of the ports (constrained one of the voltages to



be zero) so inserting a row of zeros in the [W] matrix open-circuits one of the ports (forces the current to be zero).

To solve the general series-parallel case, the series and parallel connections are simply handled separately. One possible procedure is to begin with all of the networks described by admittance matrices and to form the direct sum of all of them. Then, write the interconnection matrix, [U], for all of the parallel connections and solve for the new admittance matrix, [Y]. Next, take the inverse of [Y] which is an impedance matrix, [Z]. Now you can write the interconnection matrix, [W], for the series connections. And finally, using the [Z] we just calculated, in place of the direct sum factor in Eq. 7, you can solve for the new impedance matrix of the completely interconnected set of networks.

### Cascaded networks are no problem

When two networks are cascaded, their ports are connected in parallel, but the new port thus formed is not a port of the new network. To calculate the admittance matrix of cascaded networks, we can use our standard technique for parallel interconnections and set the currents equal to zero

at the ports that are to be eliminated. For example, consider the cascading of the two four-port networks of Fig. 2.

The new network will have four ports: ports 1 and 4 of network A, and ports 2 and 3 of network B. If this were a standard parallel interconnection the new network would have six ports. Its fifth port would be the one formed by connecting ports 2A and 1B in parallel, and its sixth port would be the one formed by connecting ports 3A and 4B in parallel. Because the fifth and sixth ports are not to be ports of the new network, we will eliminate them by setting  $i_5 = i_6 = 0$  after interconnection. By inspection, we have for the parallel interconnection:

$$\begin{bmatrix} V_{1A} \\ V_{2A} \\ V_{3A} \\ V_{4A} \\ V_{1B} \\ V_{2B} \\ V_{3B} \\ V_{4B} \end{bmatrix} = \begin{bmatrix} 1 & 0 & 0 & 0 & 0 & 0 \\ 0 & 0 & 0 & 0 & 1 & 0 \\ 0 & 0 & 0 & 0 & 0 & 1 \\ 0 & 0 & 0 & 1 & 0 & 0 \\ 0 & 0 & 0 & 0 & 1 & 0 \\ 0 & 1 & 0 & 0 & 0 & 0 \\ 0 & 0 & 1 & 0 & 0 & 0 \\ 0 & 0 & 0 & 0 & 0 & 1 \end{bmatrix} \begin{bmatrix} V_1 \\ V_2 \\ V_3 \\ V_4 \\ V_5 \\ V_6 \end{bmatrix} = [U] \begin{bmatrix} V_1 \\ V_2 \\ V_3 \\ V_4 \\ V_5 \\ V_6 \end{bmatrix} \quad (8)$$

## Handling complex matrices

You can operate with complex matrices in a time-sharing computer capable of operating only with real matrices by "representing" each complex number by a  $2 \times 2$  matrix. The complex number  $Z = X + jY$  is represented, for example, by the matrix<sup>3</sup>

$$\begin{bmatrix} X & Y \\ -Y & X \end{bmatrix}$$

'Represented' means that all operations (multiplication, addition, inversion, etc.) with this matrix will give the same results as the same operations with the complex number. Therefore, when operating with an admittance or impedance matrix that has complex elements, simply replace each element by the appropriate  $2 \times 2$  matrix. For example

$$\begin{bmatrix} Z_{11} & Z_{12} \\ Z_{21} & Z_{22} \end{bmatrix} \rightarrow \begin{bmatrix} \text{Re } Z_{11} & \text{Im } Z_{11} & \text{Re } Z_{12} & \text{Im } Z_{12} \\ -\text{Im } Z_{11} & \text{Re } Z_{11} & -\text{Im } Z_{12} & \text{Re } Z_{12} \\ \text{Re } Z_{21} & \text{Im } Z_{21} & \text{Re } Z_{22} & \text{Im } Z_{22} \\ -\text{Im } Z_{21} & \text{Re } Z_{21} & -\text{Im } Z_{22} & \text{Re } Z_{22} \end{bmatrix}$$

Observe that all of the information in this matrix is in the first and third rows. Therefore, when entering a complex matrix into the computer, simply enter the information in the first row, third row, fifth row, and so on, and then transfer this information to the second row, fourth row, sixth row, and so on. Do this with the interconnection matrices as well as with the admittance matrices.

Here is an example, using the BASIC language

of the GE time-sharing system. After entering the information in the even rows (GE numbers the first row 0, the second row 1, and so on) of an  $M \times N$  complex matrix, do the following.

```
FOR I = 0 TO M - 1
FOR J = 0 TO 2*N - 1
LET Z(2*I+1, J+(-1)^J) = (-1)^J * Z(2*I, J)
NEXT J
NEXT I
```

To read an  $M \times N$  complex matrix, do the following.

```
FOR I = 0 TO M - 1
FOR J = 0 TO 2*N - 1
READ Z(2*I, J)
LET Z(2*I+1, J+(-1)^J) = (-1)^J * Z(2*I, J)
NEXT J
NEXT I
```

Having done this, operate on this enlarged real matrix just as you would on the original complex matrix. The useful output information is, again, in the even rows (0, 2, etc.) of the new admittance or impedance matrix calculated by the computer. (Transposing the enlarged real matrix is equivalent to transposing the complex matrix and taking its complex conjugate. However, this is of no concern in the technique described in this article, since we only have to transpose the interconnection matrices, which are always real.)

The admittance matrix of the parallel-interconnected network can be calculated using Eq. 6. Let's call it  $[Y]$ .

Now, to set  $i_5 = i_6 = 0$ , we can take the inverse of  $[Y]$  and write a series interconnection matrix,  $[W]$ , with two rows of zeros in it that correspond to the two ports we wish to have open circuited.

By inspection, we can write:

$$\begin{bmatrix} i_1 \\ i_2 \\ i_3 \\ i_4 \\ i_5 \\ i_6 \end{bmatrix} = \begin{bmatrix} 1 & 0 & 0 & 0 \\ 0 & 1 & 0 & 0 \\ 0 & 0 & 1 & 0 \\ 0 & 0 & 0 & 1 \\ 0 & 0 & 0 & 0 \\ 0 & 0 & 0 & 0 \end{bmatrix} \begin{bmatrix} i_1 \\ i_2 \\ i_3 \\ i_4 \end{bmatrix} = [W] \begin{bmatrix} i_1 \\ i_2 \\ i_3 \\ i_4 \end{bmatrix} \quad (9)$$

Following the procedure we outlined earlier, we can write the impedance matrix of the new four-port network formed by cascading  $A$  and  $B$  as:

$$[Z] = [W]^t [Y]^{-1} [W]. \quad (10)$$

### Now let's try the general case

As a final example, and to see just how the  $[W]$  matrix can be used for more general series connections, suppose we again cascade the two networks of Fig. 2, but this time let's also connect ports 1A and 2B in series as shown in Fig. 3.

Since the parallel interconnections are the same as in the previous example, the matrix  $[U]$  is again given by Eq. 8. This time, however, in writing the  $[W]$  matrix, we must have the conditions:

$$i_1 = i_1', \quad i_2 = -i_1', \quad i_3 = i_2', \quad i_4 = i_3',$$

in addition to the previous condition,  $i_5 = i_6 = 0$ .

The unprimed numbers are as defined in Fig. 2.

As before,  $[W]$  can be written by inspection; this time it comes out this way:

$$\begin{bmatrix} i_1 \\ i_2 \\ i_3 \\ i_4 \\ i_5 \\ i_6 \end{bmatrix} = \begin{bmatrix} 1 & 0 & 0 \\ -1 & 0 & 0 \\ 0 & 1 & 0 \\ 0 & 0 & 1 \\ 0 & 0 & 0 \\ 0 & 0 & 0 \end{bmatrix} \begin{bmatrix} i_1' \\ i_2' \\ i_3' \end{bmatrix} = [W] \begin{bmatrix} i_1' \\ i_2' \\ i_3' \end{bmatrix} \quad (11)$$

And the impedance matrix of the new three-port network is again given by Eq. 10 with the substitution of the new  $[W]$  matrix. ■■

### References:

1. G. Kron, *Tensor Analysis of Networks*, John Wiley & Sons, New York, 1939, Chapters 5 and 14.
2. E. A. Guillemin, *The Mathematics of Circuit Analysis*, John Wiley & Sons, New York, 1949, Chapter 2.
3. G. Kron, *Tensor Analysis of Networks*, John Wiley & Sons, New York, 1939, pp 541-542. (Note: this reference uses a slightly different notation for the isomorphic  $2 \times 2$  matrix than the one given here; either will work, if applied consistently.)

### Acknowledgment:

The author is grateful to Pedro Szente for many helpful discussions and suggestions.

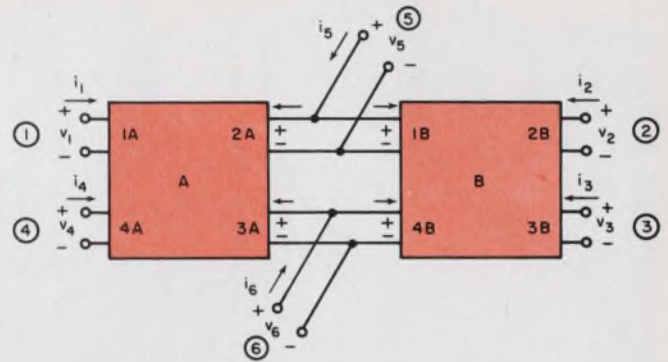

2. **Cascaded networks** have ports connected in parallel; the new ports thus formed are not considered ports of the network. Thus, currents at these ports must be constrained to be zero.

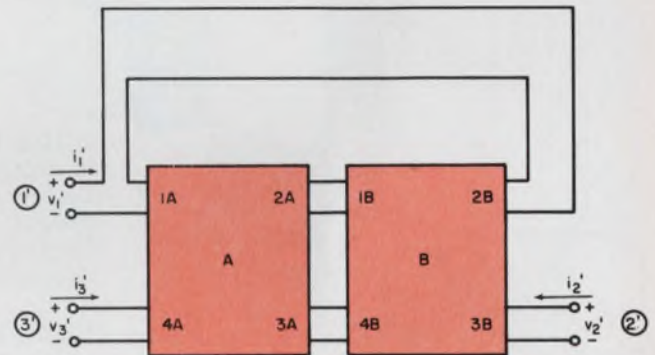

3. **The most general interconnection** of two networks has both series and parallel connections. The two 4-port networks shown here are the same ones shown in Fig. 2, and the same notation applies.

For a manual on the BASIC language and a booklet describing the GE time-sharing system, circle No. 250.

### Test your retention

Here are questions based on the main points of this article. Their purpose is to help you make sure you have not overlooked any important ideas. You'll find the answers in the article.

1. What is the "direct sum" of two matrices?

2. If you connected a one-port network (say, a termination) to a port of another network, how would you eliminate the port thus formed from the matrix description of the new network?

3. Can this technique be used in cases where the  $Y$ -matrix does not exist (goes to infinity)? Answer is on page 146.



# Using spot ties for wire harnessing?



## HERE IS THE **GUDEBROD SYSTEM "S"**

**—SPEEDS THE WORK—SAVES MONEY, TOO!**

**GUDE-TIES CUT LENGTHS**—Specifically produced for spot knotting these handy cut lengths of Gudebrod Flat Braided Lacing Tape are dispenser packaged for one hand, speedy withdrawal. Available in 6", 8", 10", 12", 15", 18", 20" and 22" lengths (other lengths on order). Meet or exceed MIL-T Specs, no-slip knots hold firmly without cutting insulation.

**GUDE-SNIPS**—These palm-of-the-hand snips cut cleanly, easily. For right or left hand use, spring action, DuPont Teflon bearing. Allow operator to have free use of fingers without constant reaching for knife or shears. Save motion, save time.

**GUDEBROD SWIVEL-TILT HARNESS BOARD MOUNT**—Balanced, two dimensional action brings every section of the harness within easy reach. No stretching, no straining. Knots are tied in an easy, natural position. Cuts fatigue—speeds work.

Here you have the Gudebrod System "S" for spot tie lacing, based on the high quality, high speed Gudebrod Lacing Tape—if you're interested in saving money while speeding the harness work, get in touch with us. (For continuous tying, ask about System "C".)

Available also in other types  
of Gudebrod Lacing Tapes

**G**UDEBROD  
*Electronics Division*

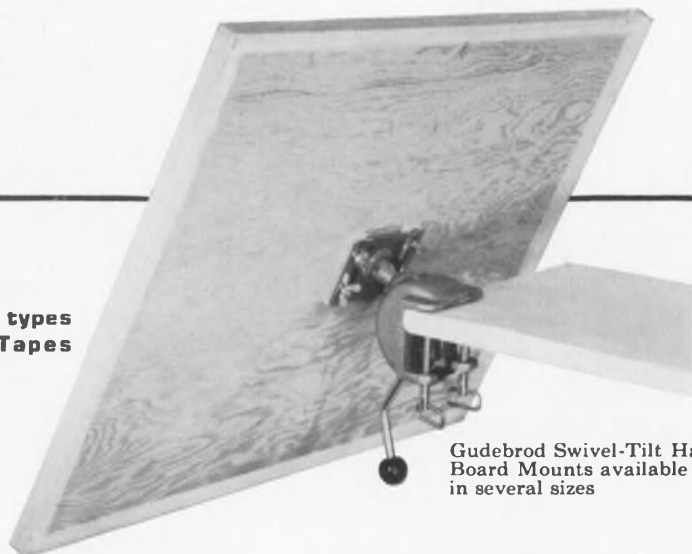

Gudebrod Swivel-Tilt Harness Board Mounts available in several sizes

GUDEBROD BROS. SILK CO., INC. Founded 1870, 12 South 12th Street, Philadelphia, Pa. 19107

INFORMATION RETRIEVAL NUMBER 31



TO-3



TO-66

# rugged! low cost!

## SINGLE DIFFUSED INTERMEDIATE FREQUENCY SILICON POWER TRANSISTORS

TYPE NO.	PACKAGE	CURRENT	$V_{CEO(sus)}$
2N3441	TO-66	3.0A	140V
2N3054	TO-66	4.0A	55V
2N4347	TO-3	7.0A	120V
2N3442	TO-3	10.A	140V
2N4348	TO-3	10.A	120V
2N3055	TO-3	15.A	60V
2N3773	TO-3	15.A	140V
2N3772	TO-3	20.A	60V
2N3771	TO-3	30.A	40V

Rugged reliability. Superior performance. That's what you'll get with Solitron's single-diffused NPN silicon power family. They're ideal for power supplies, audio power stages, series and shunt regulators, inverters . . . for every intermediate frequency application. All of these transistors are low priced and are available for immediate shipment.

*Dial 1-800-327-3243 for a "No Charge" telephone call and further information.*

from **Solitron**, of course!

**Solitron** SEMICONDUCTOR DIVISION

**DEVICES, INC.** / 1177 BLUE HERON BLVD. / RIVIERA BEACH, FLORIDA 33404 / TWX: 510-95266

INFORMATION RETRIEVAL NUMBER 32



# Cut synthesizer current consumption

Use this marker-synchronized phase-lock loop and avoid high-speed divide-by-N counters.

Ordinary digital synthesizers use a lot of power. They incorporate divide-by-N counters, and these counters draw high current at high count speeds. But what if your synthesizer must be battery operated? How do you beat the high current drain?

Start by avoiding high-speed counters. Get rid of them, and you decrease dc power drain to as little as 60 mW. And you can get rid of them—by using a low-frequency oscillator to generate a spectrum of accurate frequencies, and then phase-locking a voltage-controlled oscillator (VCO) to one of these frequencies. No high-frequency divider is necessary.

First, you have to create a spectrum of marker frequencies. These are best derived from a blocking oscillator, or some other source of short

pulses, which is triggered by a highly accurate crystal-controlled oscillator. The resulting train of very short pulses is rich in harmonics; these are the required markers.

The pulse repetition rate determines the spacing between the markers, and hence the spacing between the channels available from the synthesizer. Accuracy is provided by the crystal oscillator which triggers the pulse source.

It now remains to lock the VCO onto the desired marker. But, with this technique, your major problem is to identify and lock onto the desired spectral component. Your tuning apparatus must be able to select the one desired channel out of the nearly one thousand available.

## Count beat-notes to find the marker

A circuit that will do this selection is shown in block form in Fig. 1. This prototype provides 920 vhf receiving channels between 30 and 76 MHz, and draws only 53 milliwatts of power

Dieter R. Lohrmann, Electronic Engineer, and Arthur R. Sills, Electronic Technician, Modulation Techniques Team, U. S. Army Electronics Command, Fort Monmouth, N.J.

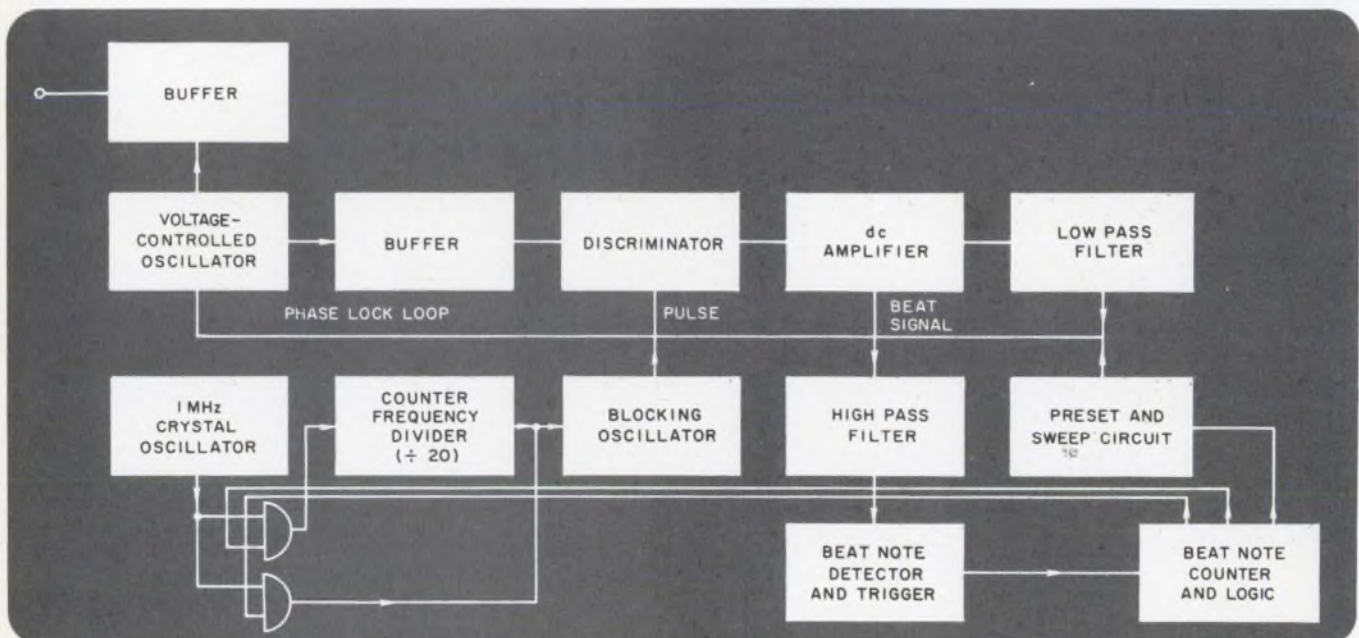

1. This frequency synthesizer eliminates high-frequency counters and avoids the associated high current drain. Only one divide-by-N counter is used, at a comparatively

low frequency of 1 MHz. The circuit uses only 53 milliwatts (excluding VCO power drain), and is particularly suited for battery-powered instruments.



(excluding the power consumption of the VCO). Channels are spaced at 50 kHz.

In this circuit, a special beat-note detector provides an output whenever the VCO falls into lock. The tuning operation is begun at a known-integer MHz-marker. The number of 50-kHz increments by which the VCO is removed from that frequency is indicated by the number of pulses from the beat-note detector (the number of times the VCO is pulled out of lock). A count of pulses provides the frequency control.

A crystal oscillator provides a 1-MHz reference, which is divided down to 50 kHz by a binary frequency-divider. The divider design is chosen to minimize current consumption, by using complementary transistors, thereby eliminating collector load resistors.<sup>1</sup> Power consumption of the divider can typically be as low as 3.5 mW.

Two steering gates, operated by the logic, pass either the 1 MHz or the 50 kHz to a blocking-oscillator that creates the spectrum. The blocking oscillator output is a train of 7-ns pulses (Fig. 2), with a repetition rate of either 50 kHz or 1 MHz.

The transistor *Q1* (Fig. 3) is normally biased off. Triggering is achieved by applying a negative-going signal pulse to the emitter. Regenerative feedback is applied to the base through transformer *T1*, with diodes *D6* and *D7* used to short out ringing after the pulse. A 100-pF capacitor, *C10*, partially bypasses the emitter to maintain gain. A fourth dc-isolated winding on *T1* is used to couple out the pulse signal. At the 50-kHz repetition rate, the blocking oscillator draws only 0.25 mW of dc power.

The output pulses from the blocking oscillator are fed to the phase discriminator in the phase-lock loop. The discriminator output signal is passed through a dc amplifier and low-pass filter network to voltage-variable capacitors in the VCO. The VCO is thus locked to a particular spectral line.

The discriminator is a sampling bridge which is biased off by the voltage across a capacitor *C3* (Fig. 3). The pulse from the blocking oscillator is coupled to the bridge through transmission-line transformer *L2* and capacitors *C4* and *C5*. These capacitors charge up during diode conduction and discharge through *R3* and *D1* after the pulse. *D1* determines the voltage remaining on *C3*. The time constant of capacitors *C4* and *C5* and resistor *R3* is less than one microsecond. Dc bias for the amplifier is supplied through *L1*.

During the tuning procedure, the VFO is first locked to the MHz-marker nearest the desired channel. This is done by bypassing the divide by 20 counter and applying the 1-MHz crystal-oscillator output signal directly to the trigger of the blocking oscillator.

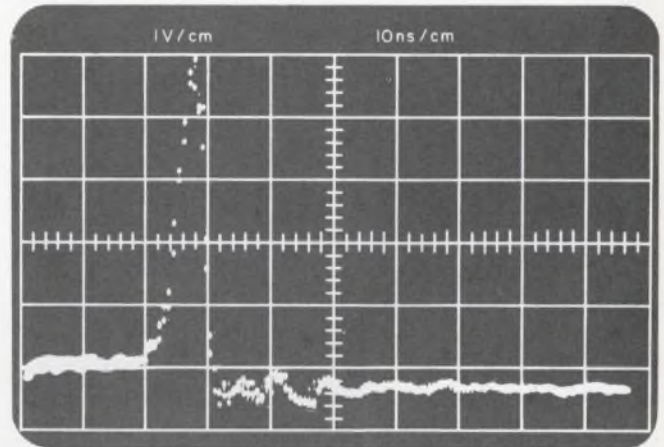

2. A train of very short pulses, rich in harmonics, provides frequency markers which are spaced at intervals equal to the repetition frequency of the pulse train.

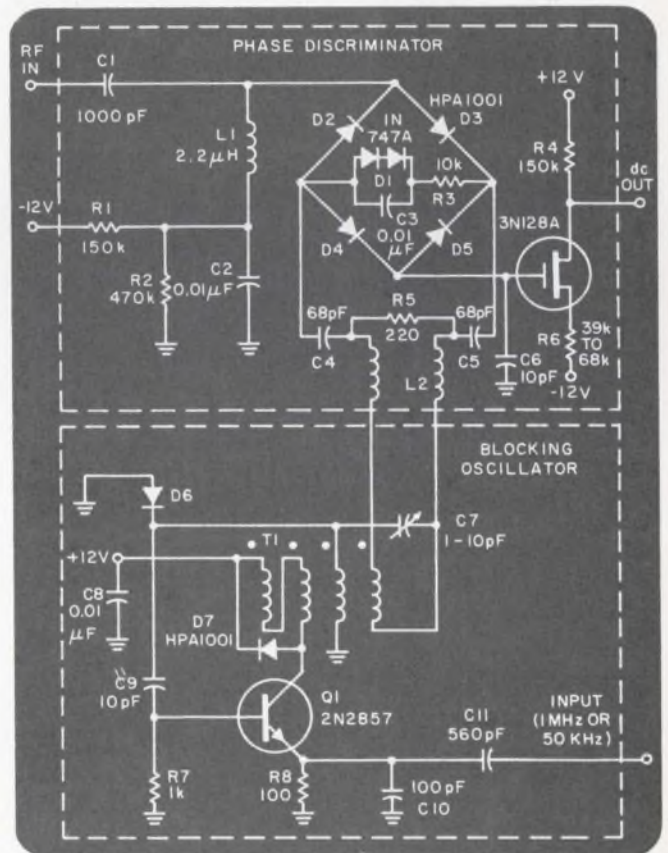

3. A blocking oscillator that draws only 0.25 mW is used to generate the train of short pulses. The pulses are fed to a phase discriminator which generates the control voltage for the loop.



The VCO frequency is preset to 500 kHz below this MHz-marker, then is swept upwards by a special sweep circuit. When the VCO frequency nears the marker frequency it locks onto it, producing a short beat-note while snapping in. It is important to note that the free-running VCO must be tunable to an accuracy of  $\pm 450$  kHz or better. If tuning inaccuracies exceed 500 kHz, it is possible that the VCO will lock onto the wrong MHz-marker.

#### Logic circuitry does the counting

The logic circuitry counts beat-notes and turns off the sweep after a preset number of counts. If the full MHz-marker chosen is the desired frequency, the sweep is turned off by preset logic circuitry after one count.

The logic is also arranged to provide the proper signals to the steering gates on the 1-MHz oscillator, so that the blocking oscillator receives 50-kHz triggers after the first beat-note indicates lock on the MHz-marker.

The logic circuitry (not shown here) merely accepts and counts the pulses from the beat-note trigger circuit, and turns the sweep off at a preset count by applying ground to input A of the sweep circuits. Any of the popular transistor or IC count-circuits will work.

If tuning to one of the 50-kHz channels is desired, logic associated with the sweep circuitry is preset to stop the sweep at that channel. The number of counts preset equals the number of channels away from the 1-MHz-marker, plus one count, which is registered as the circuit locks to the MHz-marker. After locking to the full-MHz-line, the sweep remains active. The loop is pulled out of lock by the sweep circuit after a delay of about 4 ms, creating a beat-note at the output of the discriminator. During this beat-note, which continues for as long as the loop is unlocked, the marker spectrum is switched from 1-MHz to 50-kHz intervals. This avoids switch-over from the 1-MHz to the 50-kHz spectrum while the loop is locked, since any transient thus created would cause an additional, unwanted, beat-note.

The loop then locks to the first 50-kHz-line above the 1-MHz-reference (Fig. 4). If this is the desired frequency, about 4 ms after the beat-note has disappeared (signaling that the loop is locked), the logic turns off the sweep. Otherwise, the sweep stays on, and the circuit seeks the next higher 50-kHz-marker.

To count beat-notes, a signal is taken from the first stage of the dc amplifier behind the discriminator and is passed through a high-pass filter. Then it is detected in the beat-note detector (Fig. 5). The output of this detector is fed to the beat-note counter. When the preset count is

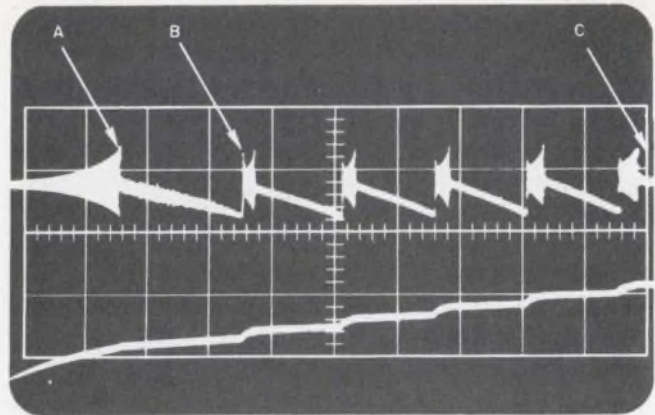

4. The beat note signal from the first dc amplifier (upper trace, horiz. 40 ms/cm, vert. 0.5 V/cm) indicates when lock is achieved. First, the VCO locks to a MHz marker, generating a beat note (a), then is "pulled" upward by the sweep circuit until it locks to the next 50 kHz marker, generating a second beat note (b). This process continues to the fifth 50 kHz marker (c), where the sweep is turned off. The final frequency is 250 kHz above the original MHz marker. The lower trace (horiz. 40 ms/cm, vert. 0.5 V/cm) shows the corresponding voltage at the control input of the VCO.

reached, the counter sends an output pulse to the logic, which turns off the sweep.

#### Diode circuit pulls frequency

Opening and closing the loop by electronic means, without creating a transient, complicates the circuit and renders it less reliable. Therefore, a technique was devised to "pull" the VCO in a predictable manner, even though the locking loop is active during the pulling. This was achieved in a very simple manner by using a diode in the sweeping circuitry (Fig. 6).

When the rising voltage across the capacitor reaches the loop voltage, the diode starts to conduct. The loop tries to counteract and is pulled out of lock. The voltage on the loop then jumps upward and falls into the next locking position, disengaging the diode. The loop is momentarily free of the effects of the sweep circuit. The voltage on the capacitor rises further, until it reaches the new loop voltage; the diode then starts conducting again, and so on. In the actual circuit, a base-to-emitter transistor junction was used instead of a diode. The current gain of this transistor allows use of a high-impedance sawtooth-voltage source. The sweep used is 1 kHz/ms.

The complete preset and loop-pulling circuit is shown in Fig. 7. The loop can be swept upward or downward, depending on the positions of switches *S5*, *S6*, and *S7*. If switches *S5* and *S6* are closed and *S7* opened, the VCO frequency is preset to 500-kHz below the integer-MHz reference frequency, and the sweep goes upwards, reaching the channels 0, +50, +100 . . . +500 kHz above reference. If switches *S5* and *S6* are



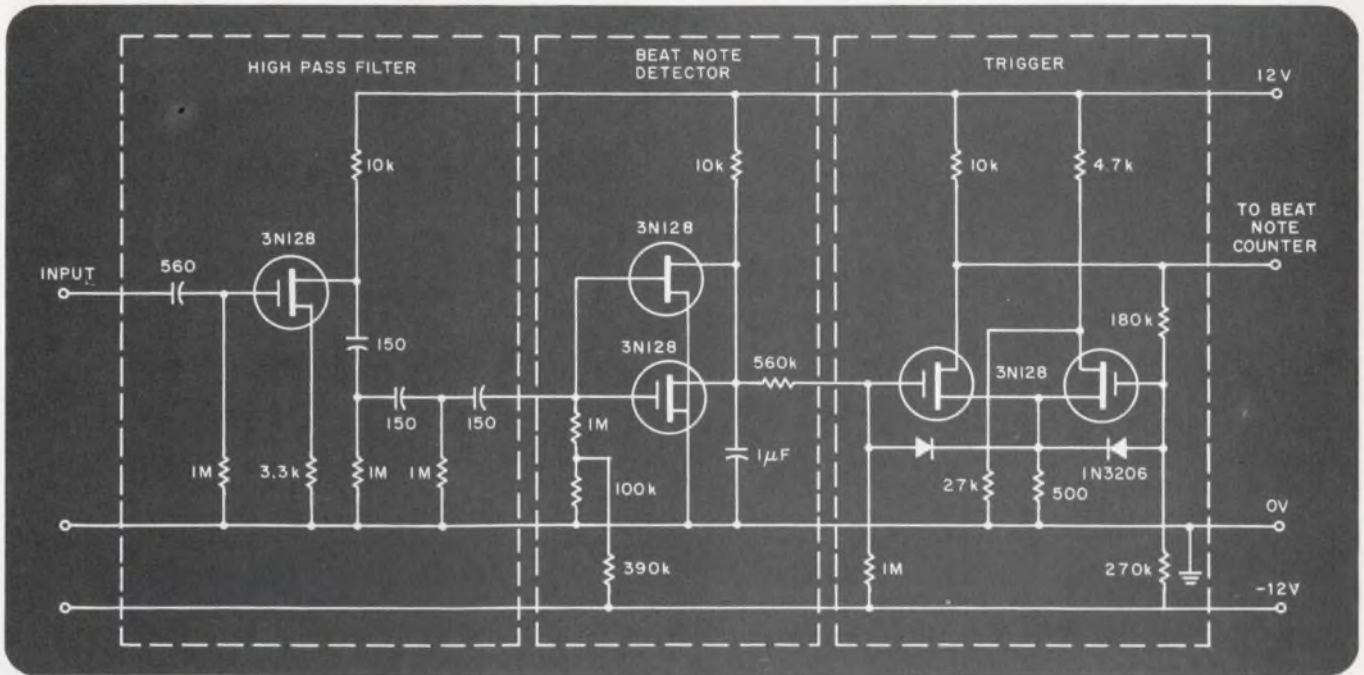

5. The high pass filter, beat note detector, and trigger detect "lock-in" and generate beat-note pulses.

opened and  $S_7$  is closed, the VCO frequency is preset to 500-kHz above the integer-MHz reference-line and the sweep goes downward, reaching the channels 0, -950, -900 . . . -450 kHz. This method saves tuning time. The switches  $S_5$ ,  $S_6$ ,  $S_7$  are operated from the channel-preset control knob on the beat-note counter. ■■

**References:**

1. Jack Schroeder, "Micropower Fast Switching Circuits," *ELECTRONIC DESIGN* 15, July, 1967, pp 94-97.

**Acknowledgment:**

We thank Mr. A. C. Colaguori and Mr. J. H. Anderl for their encouragement and discussion.

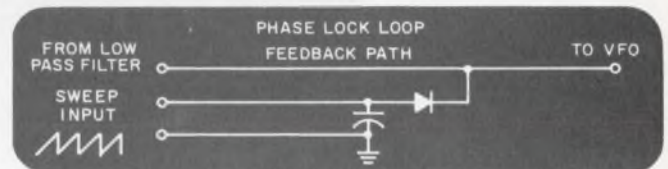

6. The sweep circuit applies an increasing voltage to the diode until it begins to conduct. As the loop counteracts, it is pulled out of lock. The loop control-voltage jumps upward to lock on the next higher marker, thus back-biasing the diode. This process is repeated as the VCO is swept upward.

**Test your retention**

Here are questions based on the main points of this article. They are to help you see if you have overlooked any important ideas. You'll find the answers in the article.

1. Why does this design achieve a reduction in total power drain?
2. Why is the marker spectrum switched from 1 MHz to 50 kHz intervals only during a beat note output from the dc amplifier?
3. What is the function of the diode junction in the sweep circuit?
4. Why was a transistor used in the sweep circuit instead of a diode?

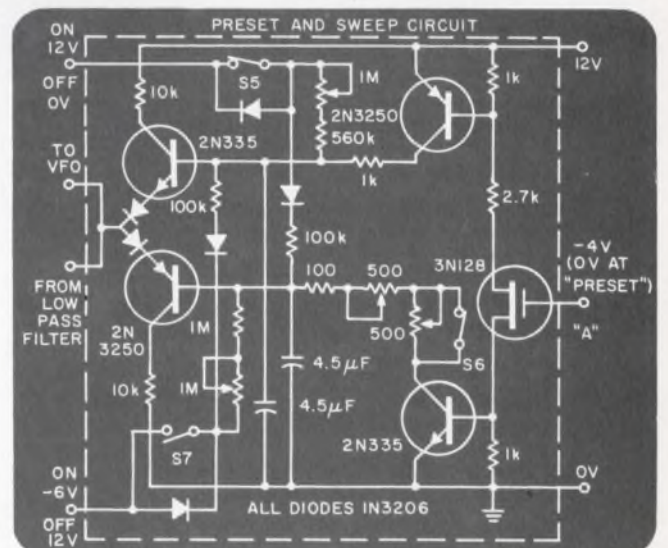

7. The sweep circuit "pulls" the VCO frequency upward or downward, depending on the position of the switches, until the beat note counter and logic apply ground to input A.



# NCR Los Angeles offers you the challenge of the Century

NCR, creator of the sophisticated and fast-selling Century Series computer systems, offers you immediate opportunity to work in new-generation technology. Join the men responsible for the industry's most advanced developments in high-speed thin-film memories, monolithic integrated circuitry, disc memory innovation, and automated production techniques. NCR Electronics Division is the largest commercial computer manufacturing facility in Southern California and one of the most advanced in the world. Benefits include a thoroughly professional environment, an excellent salary, non-defense stability, and fully paid life, hospital and medical plans for you and your dependents. Look into NCR now and accelerate your career.

## ENGINEERS

### ADVANCED DEVELOPMENT ENGINEERS

Positions available for senior MECHANICAL and ELECTRONIC engineers with strong experience in high-speed mechanisms, and mechanical, hydraulic, and electro-mechanical mechanisms. Will work in area of high-speed precision positioning devices and be responsible for concept, design and fabrication. BSME/BSEE and five years' related experience required.



Plated disc memory with multiple read/write heads

### MAGNETIC HEAD DESIGN ENGINEERS

Will design and develop flying magnetic recording heads and the required prototype tooling. Requires BS or MS in EE, ME or physics plus three years' applicable experience. Knowledge of ferrite machining technology and ferrite heads desirable.



Standardized short rod memory plane

### ELECTRONIC DEVELOPMENT ENGINEERS

Specification, design, checkout and documentation of digital and digital/analog equipment for use with on-line data processing and data communications systems. Requires BSEE and five years' related experience.

### CIRCUIT DESIGN ENGINEERS

Will design and develop digital and analog semiconductor circuits, including discrete, integrated and hybrid types. Requires a BS/MSEE and two years' related experience.

### LOGIC DESIGN ENGINEERS

Will participate in logical design of fourth-generation digital computers. Position requires BSEE and minimum of two years' experience in digital logic or circuit design.

## INDUSTRIAL ENGINEERS

Will develop manufacturing machining processes for various projects. Will be responsible for capital equipment analysis, fabrication tooling and initial production. Positions require BSIE and heavy mechanical/industrial engineering experience.

## CHEMICAL ENGINEERS

Positions are available for college trained engineers to assume responsibility for film plating, organic finish analysis, and production plating process functions. Successful candidates will possess a BS degree in chemical engineering, a knowledge of organic coatings, the ability to develop and direct a process laboratory, and 3 to 5 years' experience in electro-plating of magnetic thin-film materials for chemical process analysis.

Automatically produced thin-film magnetic rods

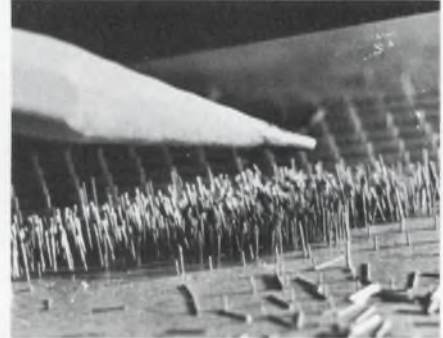

## OTHER OPENINGS

### DIAGNOSTIC PROGRAMMERS

Positions involve the writing of diagnostic programs for checkout, acceptance test, file maintenance of EDP systems. Requires previous programming experience.

### ARRANGE NOW FOR INTERVIEW AT FJCC

Confidential interviews will be held at the St. Francis Hotel during the Fall Joint Computer Conference in San Francisco, Dec. 9-11. To schedule an appointment, submit detailed resume including salary history to Steve Williams at the Division. If you do not plan to attend FJCC, an interview will be arranged soon in your area.



The National Cash Register Company<sup>®</sup>  
ELECTRONICS DIVISION  
2817 W. El Segundo Blvd.  
Hawthorne, California 90250  
An equal-opportunity employer

# Free Career Inquiry Service

## Absolutely Confidential

# 25

Respond to the career opportunities advertised in this issue. Fill out and send us this handy resume. **Electronic Design** will do the rest – neatly typed copies of this form will be mailed to the companies of your choice, indicated by the circled Career Inquiry Numbers at the bottom of this page.

<b>Name</b>		<b>Home Phone</b>	
<b>Home Address (Street)</b>		<b>City</b>	<b>State</b>
		<b>ZIP Code</b>	
<b>Age</b>	<b>U.S. Citizen</b>		<b>Security Clearance</b>
	<input type="checkbox"/> Yes	<input type="checkbox"/> No	

Prime Experience	Secondary Experience

<b>Desired Salary</b>	<b>Availability Date</b>
-----------------------	--------------------------

**Employment History – present and previous employers**

Company	City, State	Dates	Title
		to	
		to	
		to	
		to	
		to	

**Education – indicate major if degree is not self-explanatory**

Degree	College	City, State	Dates
			to
			to
			to

**Additional Training – non-degree, industry, military, etc.**

---



---



---

**Professional Societies**

---

**Published Articles**

---

- Career Inquiry Numbers:**
- |     |     |     |     |     |     |     |     |     |     |
|-----|-----|-----|-----|-----|-----|-----|-----|-----|-----|
| 900 | 901 | 902 | 903 | 904 | 905 | 906 | 907 | 908 | 909 |
| 910 | 911 | 912 | 913 | 914 | 915 | 916 | 917 | 918 | 919 |

**ELECTRONIC DESIGN**  
 850 Third Avenue  
 New York, New York 10022



ENGINEERS, SCIENTISTS, MATHEMATICIANS:

# Rate your job against the career opportunities at AC Electronics.

**Confidential.** The material contained in AC Electronics Career Evaluation Form will be held in strictest confidence.



Name: \_\_\_\_\_ Area of job interest: \_\_\_\_\_

Company: \_\_\_\_\_ Home address & phone number: \_\_\_\_\_

How long on present job: \_\_\_\_\_ Current experience: \_\_\_\_\_

Degrees: \_\_\_\_\_ Year: \_\_\_\_\_ Present salary: \_\_\_\_\_

- |   |                          |                          |
|---|--------------------------|--------------------------|
|   | <b>No</b>                | <b>Yes</b>               |
| 1 Is your company making full use of your talents and abilities?  | <input type="checkbox"/> | <input type="checkbox"/> |
| 2 Are you happy doing the type of work currently assigned to you? | <input type="checkbox"/> | <input type="checkbox"/> |
| 3 Do your supervisors listen when you offer constructive ideas?   | <input type="checkbox"/> | <input type="checkbox"/> |
| 4 Are you given opportunities for learning on and off the job?    | <input type="checkbox"/> | <input type="checkbox"/> |
| 5 Is your salary commensurate with your abilities?                | <input type="checkbox"/> | <input type="checkbox"/> |

- |  |                          |                          |
|--|--------------------------|--------------------------|
|  | <b>No</b>                | <b>Yes</b>               |
| 6 Does your company enjoy a high reputation in the industry?                     | <input type="checkbox"/> | <input type="checkbox"/> |
| 7 Are you able to contribute meaningfully to the state of the art where you are? | <input type="checkbox"/> | <input type="checkbox"/> |
| 8 Are the people you work with of high caliber?                                  | <input type="checkbox"/> | <input type="checkbox"/> |
| 9 Would you rate your company high in terms of stability and job security?       | <input type="checkbox"/> | <input type="checkbox"/> |

If you answered "no" to two or more of the questions above, maybe you should be looking into the career opportunities at AC Electronics.

Who are we? We're the AC Electronics Division of General Motors Corporation. We make the guidance, navigation, control and computer systems for many of today's most advanced

projects in space, air, land and sea.

Just fill out the Career Evaluation Form, above, and mail to: Mr. R. E. Schroeder, Dir. of Professional and Scientific Employment, AC Electronics Division, Milwaukee, Wisconsin 53201. We'll get right back to you with some answers that may shed new light on your career.

- Systems Mechanization Engineers
- Systems Test Engineers
- System Analysis Engineers
- Managers—Systems Requirements for Computers, Sea and Missile Systems
- Digital Test Equipment Designer
- Environmental Test Engineer (Components)
- Scientific Programmers
- Optics Engineers

**AC ELECTRONICS**



MASTER NAVIGATORS THROUGH TIME AND SPACE MARK OF EXCELLENCE  
MILWAUKEE • BOSTON • SANTA BARBARA  
An Equal Opportunity Employer

At ECI in St. Petersburg, Florida...  
Digital Communications Opportunities

## For a special breed of engineer

If you're one of that special breed of communication engineers who finds a challenge in projects beginning with applied research and advanced development and continuing through prototype and product design, you may well be the kind of person we're looking for.

Check this partial list of digital engineering activities at ECI. If you'd like to help push the state-of-the-art in any of these or other areas in communications, send us your resume. You'll design systems and equipment for satellite communications, multiplexing, electronic switching, command and control and advanced radio communications for some of the nation's major defense and space programs.

### Digital Communication Engineering Activities:

- Frequency Synthesis
- MODEM Technology
- Microelectronic Applications
- Error Control Coding
- Electronic Switching
- Time Division Multiplexing
- Reliability Techniques

### CHALLENGE, GROWTH . . . and LOCATION TOO!

At ECI your job will be challenging. At ECI you'll find real opportunity for growth instead of just another confining groove — two-thirds of all advanced development is done in regular engineering development areas. And, at ECI you'll like where you're living just as much as you'll like your job. We'll match subtropical, sunny St. Petersburg against any location in the U. S. for stimulating, comfortable living.

SEND YOUR RESUME TODAY — in confidence — to K. N. Nipper, Supervisor of Professional Placement, Electronic Communications, Inc., P. O. Box 12248, St. Petersburg, Florida 33733.  
(An equal opportunity employer, M & F.)



**ELECTRONIC COMMUNICATIONS, INC.  
ST. PETERSBURG DIVISION**

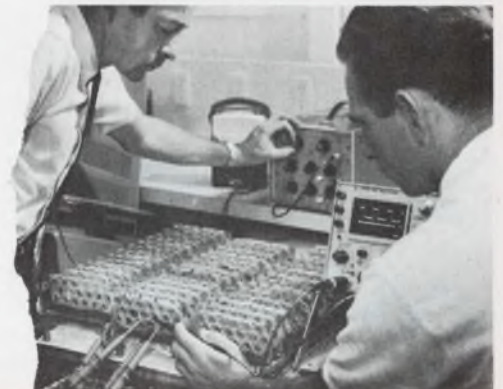



## FOR HIGHEST INSULATION RESISTANCE

# Stabelex "D" CAPACITORS

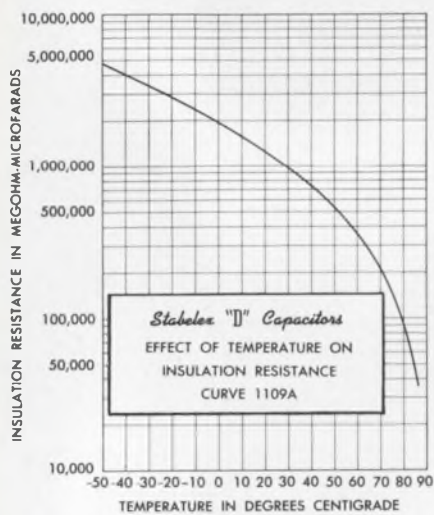

Insulation resistance of STABELEX Capacitors can reach 10,000,000 megohm-microfarads or more at room temperature or above under certain operating conditions. This feature, plus their low temperature coefficient of capacity, low power factor and extreme stability, makes STABELEX Capacitors the logical choice for instrumentation and other advanced circuitry.

When you need more than either laboratory type or commercial capacitors can offer, specify STABELEX!

### OUTSTANDING CHARACTERISTICS OF *Stabelex* CAPACITORS.

- Extremely high insulation resistance
- Low temperature coefficient of capacity
- Extreme low losses and power factor
- Extremely low dielectric absorption
- High "Q"
- Hermetically sealed

For complete specifications, write for STABELEX Catalog No. 1117C



3243 No. California Ave.  
Chicago, Illinois 60618

INFORMATION RETRIEVAL NUMBER 33

## Book Reviews

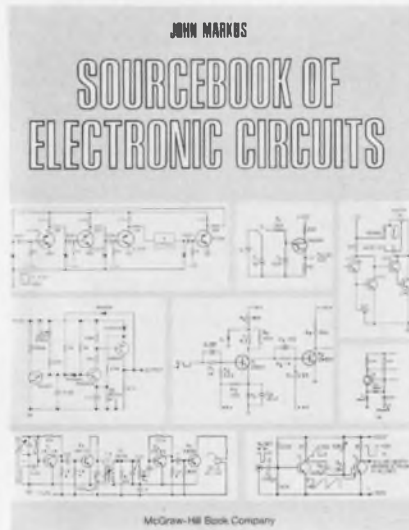

### Circuit data file

*Sourcebook of Electronic Circuits*, John Markus, (McGraw-Hill, Inc., New York City) 864 pp. \$18.50.

*Sourcebook of Electronic Circuits*, offers essential construction and adjustment details, design precautions, and other application data on over 3000 different circuits. Arranged in 100 chapters for easy reference, the book lists circuits with a concise description of significant features, performance data, operating characteristics, and schematics. The original source in which the circuit appeared is provided with each description.

CIRCLE NO. 251

### Bilingual dictionary

*German-English and English-German Electronics Dictionary*, Charles J. Hyman, (Consultants Bureau, New York City), 182 pp. \$14.00.

Designed as a key to technical information in the German language, this bilingual dictionary has over 6000 entries. Not limited to strictly electronics terminology, the slim volume also includes terms from optics, mathematics and nuclear physics. As the small size and relatively low price would indicate, this dictionary cannot be considered a definitive reference for the technical translator. For the engineer who occasionally must refer to foreign journals, it should prove satisfactory.

CIRCLE NO. 252



PHOTO COURTESY OF CHARLES DALY, INC.

**ELECTRICAL ENGINEERS**—Will deal with a wide variety of solid state devices, laboratory test equipment, using basic logic theory to design control logic. Responsibilities include all phases of electrical layout, packaging and documentation such as: system power, interconnector, circuit layout, component specification, and liaison with vendors, drafting and manufacturing. BSEE required with a minimum of 4 years' related experience.

### MECHANICAL & ELECTRICAL DESIGNERS

—Generate original and creative machine design concepts. Prepare complete and accurate design layouts to resolve design or redesign problems identified by Engineers, Scientists, Sr. Designers and Managers. Mechanical design in areas of complex mechanisms, castings, cams, gears, drive systems, optics, sheet metal and plastics. Electrical design in areas of schematics, printed circuit boards, integrated circuits, cable harnesses and wire lists: familiarity with controls logic, etc. At least 8-10 years' experience in mechanical and electrical development practices. Good working knowledge in applying geometric dimensioning including true positioning desirable, for both development and production programs.

### MECHANICAL DEVELOPMENT ENGINEERS

—Will generate novel approaches in the development of new products; develop and prove product concepts through design, test and evaluation of appropriate models of products for quantity production. Previous design and development experience of consumer products such as business machines, appliances, photographic equipment, printing machines, instruments, light machinery, or automotive equipment. BS or MS in ME, EE, or Engineering Sciences.





## Can there be this kind of excitement in engineering?

### Try Xerox and see



An engineer checks out a data collection machine using punched tape to record number and type of operations performed.

You've forgotten the rising long before dawn and the drive along deserted roads. Now the morning is still and crisp; the waist-high weeds are perfect cover. You work through them carefully, quietly, expectantly. Then—the multi-colored explosion of a flushed bird\*, beating up in a blur of speed and sound. The over-and-under is at your shoulder by pure reflex... you lead and squeeze...

This is the age-old excitement of the hunt, the instant coordination of mind and muscle against the finely-honed instincts of your game. Engineering offers a kindred excitement, or should. The stalking of ideas, the shooting down of tough and wily technical obstacles, the well-trained engineering mind against the complexities of nature.

But too often today, this excitement is lost in routine and fragmented assignments or a company climate in which engineering is taken for granted. Which is why, if you're hunting for professional excitement, it's worth looking into the opportunities at Xerox.

See for yourself. Specific positions available at our suburban Rochester, New York facilities are outlined at the left.

Please forward your resume to Mr. Richard L. Melnotte, Dept. MZ-32-N1, Xerox Corporation, P.O. Box 1995, Rochester, New York 14603.

\*Rochester is in the upper New York State region noted for its fine hunting of all kinds.

# XEROX

An Equal Opportunity Employer (m/f)





## why should the only cargo that loads itself be toughest to ship?

Getting you to and fro has been a series of outright blunders, slow-dying half-measures, and scattered bits of good ideas.

The trend in surface commuting, for example, is for more and wider roads with more and fatter cars carrying fewer persons. The logical extension is an infinite number of empty cars, hub to hub and dent to dent, on a 15-mile circle of asphalt centered on each community.

We think system engineering can bring order to this chaos, and we intend to be there when it happens. What system engineers have done so far has

been merely practice for what lies ahead.

That's why we stress continuing education, offering graduate degree programs in our facilities and fellowships at nearby universities. We have found no substitute for formal training in the engineering of advanced systems.

Bringing system engineering disciplines to urban renewal, biomedical research and practice, safer streets, better nutrition, education, employment, international security, arms control — these are some of the real opportunities.

Tell us how you would take ad-

vantage of these opportunities in an atmosphere like this: engineering innovation as a way of life, systems the business of everyone, and the individual as contributor.

**WRITE TO** Mr. James L. Hackbush, Sanders Associates, Inc., Dept. 467ED, 95 Canal St., Nashua, N. H. 03060.

SYSTEM ENGINEERS • ECM ENGINEERS • ASW ENGINEERS • DIGITAL ENGINEERS • ANTENNA ENGINEERS • MICROWAVE ENGINEERS

CREATING NEW DIRECTIONS IN ELECTRONICS

**SA**  **SANDERS ASSOCIATES, INC.**  
© T. H. SANDERS ASSOCIATES, INC.  
 An Equal Opportunity and Affirmative Action Employer M/F

NASHUA, N.H. □ MANCHESTER, N.H. □ BEDFORD, MASS. □ CAMBRIDGE, MASS. □ PORTLAND, ME. □ PLAINVIEW, L.I., N.Y. □ RESTON, VA.

INFORMATION RETRIEVAL NUMBER 904

ELECTRONIC DESIGN 25, December 5, 1968

# Here is a collection of the world's best precision components.

All taken from Penny & Giles' North American catalogue.

Penny & Giles have just arrived in Canada. To supply top quality precision components to the North American market and to back up their products with unrivalled technical knowledge.

For full details of these and other products please write to Penny & Giles International.

We'll send you our catalogue.



Penny & Giles International (Canada), Box 519  
Harrow, Ontario, Canada.

Ask Penny & Giles about  
coarse/fine rotary  
transducers, signal conditioning  
units, servo modules and  
data recorders.



Make a note that Penny & Giles  
make the world's best rotary and  
rectilinear potentiometers  
(both conductive plastic and  
wire wound).

And ask about  
linear displacement  
transducers, absolute  
and differential pressure  
transducers, acceleration  
and force/load transducers.

INFORMATION RETRIEVAL NUMBER 34



# Choose a number, any number, with a variable modulo counter

When testing digital systems, a need frequently arises for a counter that will count to any desired number. The basis of this variable-modulo counter is a storage register,  $K$ , that counts up to the desired number. The ONE's complement of this number is entered directly into a ripple counter,  $L$ , which can then count only up to the chosen modulo.

For example, if the chosen modulo is three, then three pulses are applied to register  $K$  from

the pulse generator. Register  $K$  will then contain 1100. The ONE's complement of this (0011) is gated in parallel into counter  $L$  which can then count up to three before being reset.

The transfer of the preset number is accomplished by monostable  $M_3$  which impresses a logical ZERO on the  $\bar{Q}$  outputs of counter  $L$  and opens the transfer gates by means of monostables  $M_1$  and  $M_2$ .  $M_1$  also inhibits counter  $L$  while the preset number is being entered. Note that the monostable pulse duration of  $M_1$  is greater than that of  $M_2$ , which is greater than that of  $M_3$ , for correct transfer without spurious counting.

*Paris Cosmatos, Electronic Engineer, Athens, Greece.*  
VOTE FOR 311

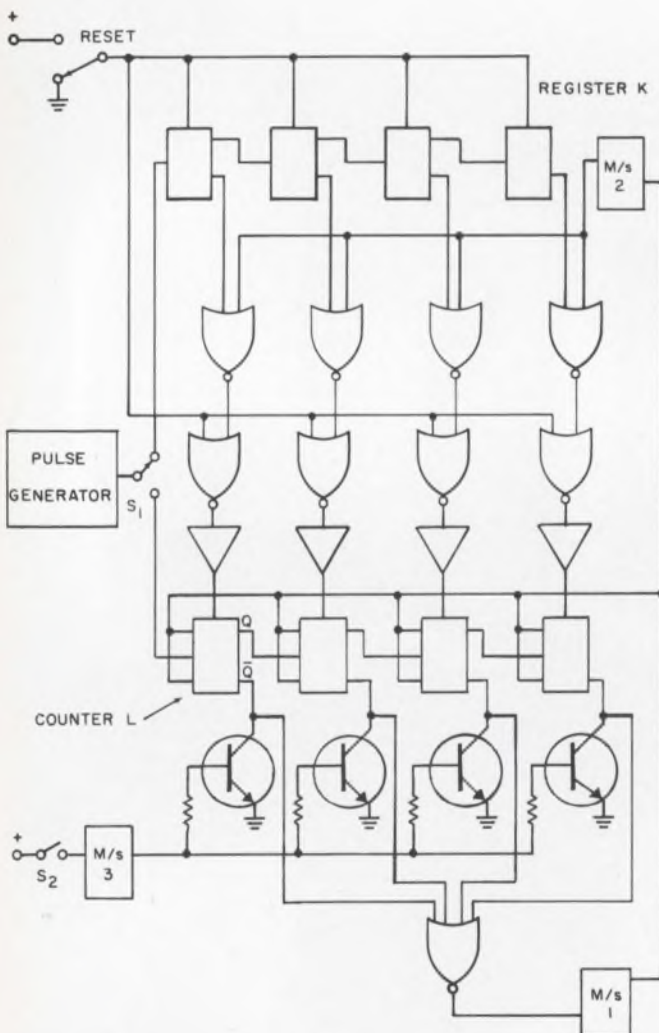

The storage register will store the desired modulo in this variable modulo counter. The stored modulo is used to preset a conventional ripple counter.

## Flip-flop latch adds versatility to unijunction circuit

A versatile circuit for use in timing, frequency division or control applications can be built by combining a latch flip-flop with a unijunction transistor. The circuit can function as a delay line, a one-shot multivibrator, a ramp generator or a sync generator, and will provide temperature stability of one per cent over the military temperature range, if stable RC components are used in the timing section.

A single trigger at the input of the circuit (see figure) provides three possible outputs: a single, delayed trigger, a single ramp output, or a plain one-shot pulse. The circuit can also be converted into a free-running sync and ramp generator by grounding the trigger input.

The heart of the unit is a unijunction transistor and a latch flip-flop, formed by cross-coupled NAND gates  $B$  and  $C$ . An input trigger sets the flip-flop, thereby opening switch  $Q_2$  and allowing capacitor  $C_1$  to be charged by the constant current source,  $Q_1$ . As the emitter voltage of unijunction transistor  $Q_3$  reaches the peak-point voltage, the emitter will draw current. This causes the dynamic resistance between the emitter and base 1 to be negative, thus discharging  $C_1$  to a value below the emitter saturation voltage. At this point the cycle

# The endless line

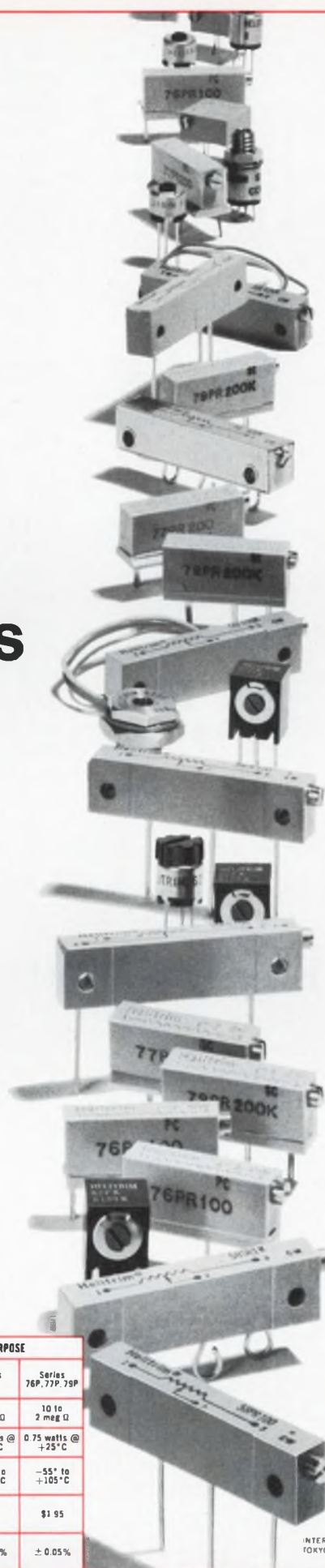

It's a complete line – an endless line of Helipot® cermet trimming potentiometers with a current field failure rate of only 0.08%.

And all have essentially infinite resolution. Plus a wide range of standard resistance values. And excellent setting and total resistance stability under a wide range of environmental extremes. Helipot stocks almost 2 million trimmers in a wide range of models and values at 13 stocking locations. All to fit your every need—whatever it is. To fit your budget—list prices from \$1.75. And to assure you immediate delivery—anywhere in the U.S. and in Canada.

For more details on “the endless line” of cermet trimmers, contact your local Helipot sales representative. He'll tell you all about cermet reliability, fill you in with all available test data and personally handle your Helipot orders.

	MILITARY		HIGH TEMP.		GENERAL PURPOSE		
	Series 55, 56, 58 (R111 & R112)	Series 61 (R150)	Series 63 (R124)	Series 50	Series 62	Series 78	Series 76P, 77P, 79P
Resistance Range	10 to 2 meg Ω	10 to 1 meg Ω	10 to 2 meg Ω	10 to 2 meg Ω	10 to 1 meg Ω	10 to 2 meg Ω	10 to 2 meg Ω
Power Rating	1 watt @ +85°C	0.5 watts @ +85°C	0.5 watts @ +85°C	1.5 watts @ +125°C	0.5 watts @ +70°C	0.75 watts @ +70°C	0.75 watts @ +25°C
Operating Temperature Range	-65° to +175°C	-65° to +150°C	-65° to +150°C	-65° to +200°C	-25° to +125°C	-25° to +125°C	-55° to +105°C
Price (List 1 to 8)	\$5.50	\$5.50 (61P) \$6.50 (all others)	\$6.50	\$8.00 (50) \$7.50 (53, 54)	\$1.75 (62P) \$2.00 (62PF) \$2.50 (all others)	\$3.00	\$1.95
Typical Setting Ability	±0.01%	±0.05%	±0.01%	±0.01%	±0.05%	±0.05%	±0.05%

**Beckman**

**INSTRUMENTS, INC.**  
**HELIPOT DIVISION**

FULLERTON, CALIFORNIA • 92634

INTERNATIONAL SUBSIDIARIES: GENEVA; MUNICH; GLENROTHES, SCOTLAND; TOKYO; PARIS; CARPETOWN; LONDON; MEXICO CITY; STOCKHOLM; VIENNA

INFORMATION RETRIEVAL NUMBER 35



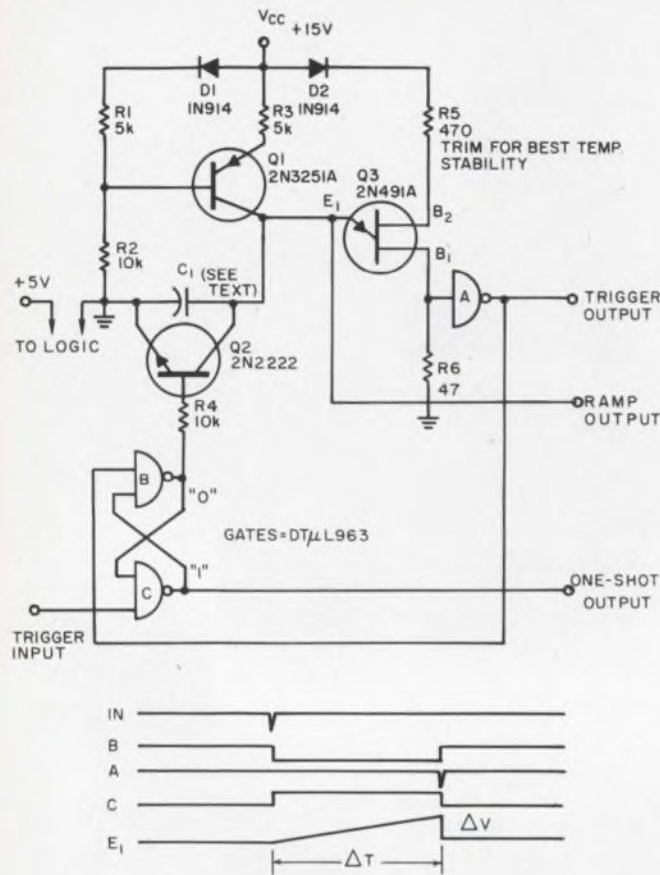

A latch enables the generation of a single-shot pulse, ramp and delayed trigger.

would normally be repeated. However, the discharge current is sensed by  $R_6$ , which resets the flip-flop by means of NAND gate A. Capacitor  $C_1$  is thus prevented from charging until another input trigger is supplied. An added feature is the inhibiting of the input trigger gate, C, as long as  $C_1$  is in its charge cycle.

The delay time or the one-shot period of the circuit is also  $C_1$ 's integration time, and is derived as follows:

$$i = C (dv/dt) ; \text{ and}$$

$$\text{since } i = \text{constant:}$$

$$\Delta t = C (\Delta v/i)$$

$$i = (V_{cc}/R_3) [R_1/(R_1 + R_2)]$$

$$\Delta v = n (V_{bb} + V_{diode})$$

$$V_{bb} = \text{interbase voltage of } Q_3$$

$$n = \text{intrinsic standoff ratio} = 0.56 \text{ to } 0.68$$

For the values shown,  $\Delta t \approx 8.4 C_1$ , where  $C_1$  is in microfarads and  $\Delta t$  is in milliseconds.  $R_1$  can be made variable, but care must be taken that the current source,  $Q_1$ , can still supply about  $10 \mu A$  of emitter current. (For a low current,  $C_1$  must be a low-leakage capacitor.) By making  $R_1$  variable and choosing capacitor values from 0.001 to  $100 \mu F$ , a delay ratio of ten million to one is easily achieved.

Don Atlas, Research Engineer, Singer-General Precision, Inc., Kearfott Group, Little Falls, N.J.  
VOTE FOR 312

## IC ramp generator is simple and fast

One of the more familiar uses for an operational amplifier is as an integrator. Since the output voltage ramp for most available op-amps connected as an integrator is fairly linear, it would seem logical to develop these linear ramp functions into sawtooth generators. This mode of operation requires a circuit that has an output with a definable and adjustable rate of rise and an instantaneous, or at least an extremely fast, fall-time characteristic.

Such a circuit is shown in the figure, and its operation is as follows.

With a small amount of offset voltage connected to the (-) input of the operational amplifier, the output will rise in the positive direction at a rate governed by the time constant of  $C$ ,  $R_1$ , and  $R_2$ .

The polarity of the current flow to charge  $C$  is such that the diode  $CR_1$  will conduct. The capacitor, effectively connected to the input, then completes the feedback loop.

A positive pulse applied to the input through

$R_3$  overcomes the negative offset voltage and the output tends to fall in the negative direction. This reverses the current flow to disconnect the feedback capacitor from the circuit by back-biasing  $CR_1$ .  $CR_2$  discharges the capacitor, thereby preventing the circuit from remembering its

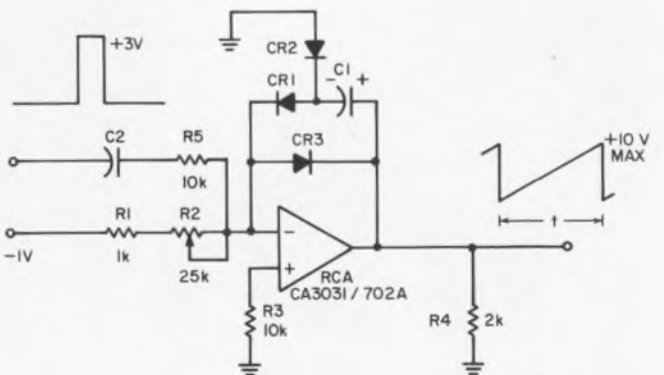

Ramp generator has a fast fall time and is fairly linear. All diodes can be any germanium types. The value of C is selected to provide the desired period.



## Happiness is an Acopian power supply . . . because it's shipped in only 3 days.

Whether your application is op amps, ICs, logic circuits, relays, lamps or electronic measuring equipment, look to Acopian to meet your needs for AC to DC plug-in power supplies. Acopian's new catalog lists over 62,000 different supplies . . . all available for shipment within 3 days. Get your 16 pages of happiness by writing or calling Acopian Corp., Easton, Pennsylvania (215) 258-5441.





last output level.  $CR_3$  clamps the output to zero by reducing the feedback path to a short and preventing negative saturation.

When the positive pulse is removed, the negative offset voltage is again integrated, and the output begins to rise towards the positive satu-

ration point until the next positive pulse resets it again.

*D. C. Pidgeon, Systems Service Engineer, Technical Support Group, RCA Service Co., Inc., Rosman, N.C.*

VOTE FOR 313

## Leading-edge synchronization provided by pulse generator

Digital systems that utilize two independent pulse repetition frequencies (PRF) often require the generation of narrow pulses that are in sync with the leading edge of the lower PRF signal. These pulses can be used as test signals for simulating actual system input conditions.

One common method of generating these narrow sync pulses is by a one-shot. Although the one-shot may offer advantages in some cases, it does have the disadvantage of being susceptible to false triggering caused by noise. Another method for accomplishing the same task uses only logic gates and J-K flip-flops (see diagram). The circuit is particularly useful in a system that has a high internal PRF (clock) and a lower PRF input signal. This design allows the two PRF's to remain independent while generating the desired pulse. The output pulse width is a function of the high PRF, but is in sync with the leading edge of the low PRF.

Operation of the circuit can be described with the aid of the circuit timing diagram shown, with  $S_1$  being the high PRF and  $S_2$  the low PRF. The 3 flip-flops are labeled A, B and C respectively.

At time  $T_0$ ,  $S_2$  triggers C, setting the Q side of C high. Some  $\Delta$  time later, at  $T_1$ ,  $S_1$  appears at the trigger of A, setting the Q side of A high. Flip-flop A will remain in the set state until the next trailing edge of  $S_1$  occurs, at  $T_2$ , and resets A. The negative transition of A sets the Q side of B high, so the  $\bar{Q}$  of B will go low, resetting C and holding A in the reset state. This produces an output pulse from C that is exactly in sync with the leading edge of  $S_2$ , but whose width is a function of  $S_1$ .

The time  $\Delta$  can be described as the time between the leading edge of  $S_2$  and the first negative transition of  $S_1$ ; therefore:

$$0 < \Delta < T_1.$$

Under the assumption of a 50% duty cycle for both  $S_1$  and  $S_2$ , the periods of  $S_1$  and  $S_2$  are seen to be as follows:

$$\text{Period of } S_1 = T_{(S_1)} = 1/\text{PRF}_{(S_1)}$$

$$\text{Period of } S_2 = T_{(S_2)} = 1/\text{PRF}_{(S_2)}$$

The relationship between the two periods is:

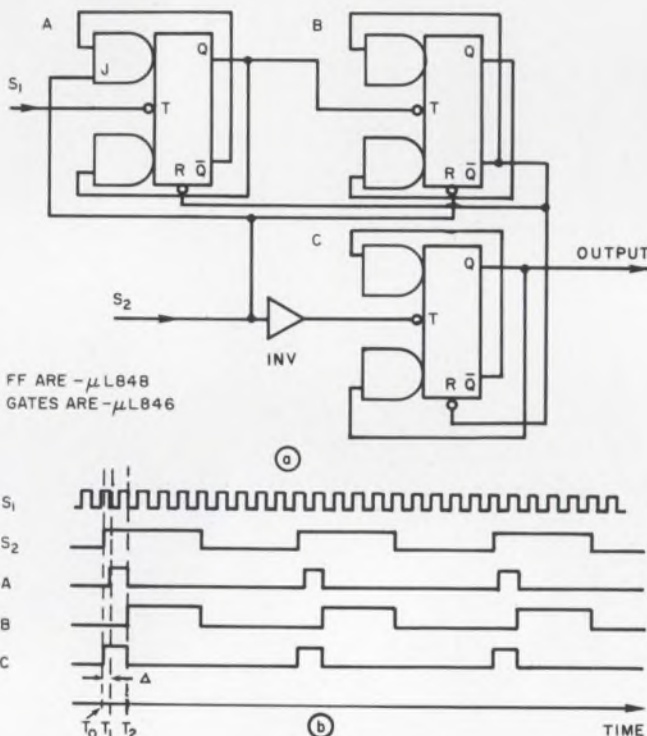

Output pulses from flip-flop C are exactly in sync with the leading edge of input pulses  $S_2$ .

$$T_{(S_1)} \leq T_{(S_2)}/4.$$

Under the above conditions, the output pulse width (PW) can be described as:

$$PW = T_2 - T_0 \tag{1}$$

where:  $T_2 = T_0 + \Delta + T_{(S_1)}$ . (2)

The PW in equation (1) now becomes,

$$PW = T_0 + \Delta + T_{(S_1)} - T_0 \tag{3}$$

or:  $PW = \Delta + T_{(S_1)}$  (4)

From Eq. 4 the output pulse width can be seen to vary as a function of  $\Delta$ . In considering input signals that have less than a 50% duty cycle, correct circuit operation requires that the period of  $S_1$  be equal to, or less than, one half the positive width of  $S_2$ .

*Joseph L. Spatafore and Wayne Bicehouse, Design Engineers, HRB Singer, Inc., State College, Pa.*

VOTE FOR 314

Mount in free air as is, or with a heat radiator. In any case, all you do is drop an RCA all-diffused, three-lead TO-5 SCR package into the circuit board. Current rating for circuit board mounting in free air at 25°C is 1.5 amperes. It's 3.5 A rms at 180° conduction angle with the radiator.

SCR's 40654 and 40655 (free air types) complemented by types 40658 and 40659 (with radiator) are designed for use in 120 and 240 volt lines at 50 or 60 cycles, and in pulse operation from dc supplies. Applications run the

gamut from lamp controls, motor speed controls and power switching, to ignition systems for automobiles, boats or lawn mowers.

Added advantages: high surge current (80 A single cycle) and pulse current (100 A peak repetitive at 0.1% duty factor) ratings; high di/dt and dv/dt capability; and high forward and reverse gate capability. Plus the inherent reliability you can expect from all RCA Thyristors...the broadest line of SCR's, Triacs, and Diacs the industry has to offer.

See your RCA Field Representative or your RCA Distributor for further information. For technical data, write RCA Electronic Components, Commercial Engineering, Section RG12-1, Harrison, New Jersey 07029.

**This RCA SCR drops right into  
a circuit board  
like this...or this...**



**for a wide variety of applications**

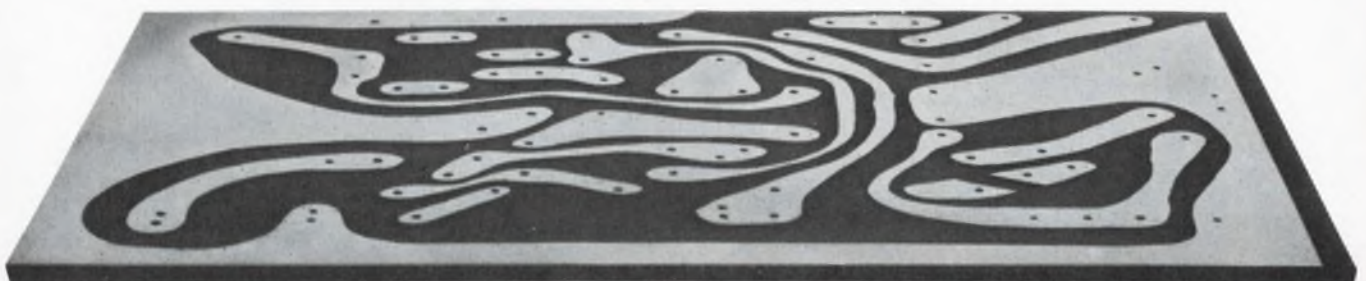

INFORMATION RETRIEVAL NUMBER 37



## Cascode blocking oscillator yields improved performance

A cascode blocking oscillator (Fig. 1a) eliminates the driver stage and improves frequency stability in the line deflection circuit of an industrial TV camera.

The oscillator is a modification of the circuit of Fig. 1b. In both cases the blocking period (10  $\mu$ s) is only a fraction of the total period (64  $\mu$ s). The amplitude of the blocking pulse at the collector of the cascode unit is 50-60 V peak-to-peak (Fig. 2). This is sufficient to drive the output stage for 200-to-250-mA (peak-to-peak) deflection current with good initial linearity.

The cascode blocking oscillator offers these advantages:

- Better frequency stability (14 Hz in 15,625 Hz, as against 100 to 150 Hz in the case of the circuit of Fig. 1b).

- Wider frequency coverage (200 Hz to 20 kHz, against 6.25 kHz to 22.2 kHz in the case of Fig. 1b, with  $R_e$  changing from zero to 500 ohms in both cases).

- Downward control of the amplitude of the blocking pulse from its maximum value, without causing a considerable change in frequency. This is accomplished by changing the value of resistor  $R_2$ .

- Better synchronization capability and flexibility, since more points are available for applying the synchronization.

- Further improvement in frequency stability, since it is possible to apply negative feedback between  $T_1$  and  $T_2$ .

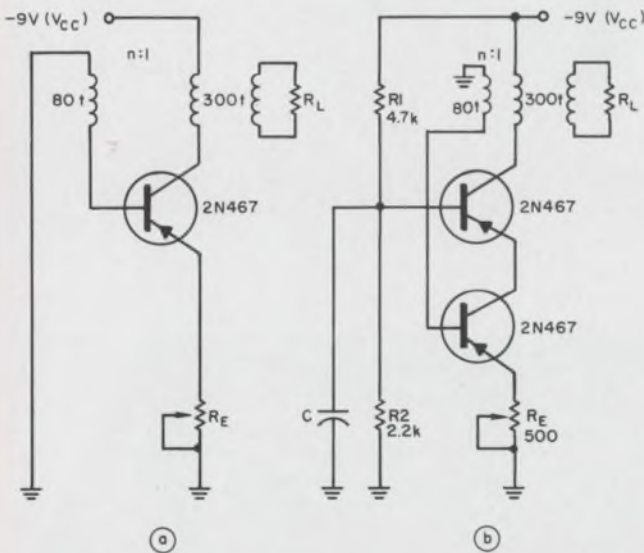

1. Cascode blocking oscillator (a) is a modification of the conventional blocking oscillator (b).

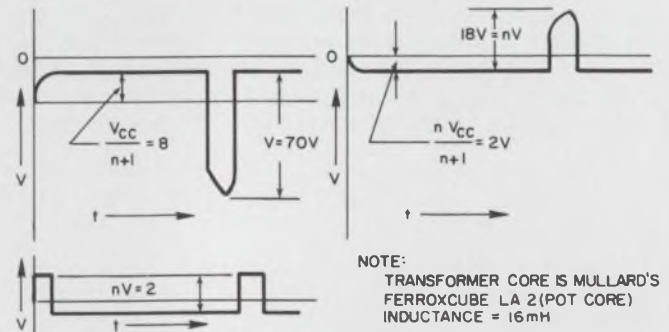

2. Waveforms show performance of cascode blocking oscillator for one cycle of operation.

- Elimination of the need for any external forward bias at the base.
- High dc stability, since the base winding is grounded and the only dc resistance at the base is that of the base winding itself.

A. Razzaque, Senior Scientific Assistant, Central Electronics Engineering Research Institute, Pilani, (Rajasthan), India.

VOTE FOR 315

### IFD Winner for September 1, 1968

Hy Dreksler, Group Leader, Grumman Aircraft, Bethpage, N.Y. His Idea "Eliminate contact bounce in your IC system" has been voted the most Valuable of Issue Award.

Vote for the Best Idea in this Issue.

# VOTE

**VOTE!** Go through all Idea-for-Design entries, select the best, and circle the appropriate number on the Reader-Service-Card.

**SEND US YOUR IDEAS FOR DESIGN.** You may win a grand total of \$1050 (cash)! Here's how. Submit your IFD describing a new or important circuit or design technique, the clever use of a new component or test equipment, packaging tips, cost-saving ideas to our Ideas-for-Design editor. You will receive \$20 for each accepted idea, \$30 more if it is voted best-of-issue by our readers. The best-of-issue winners become eligible for the Idea Of the Year award of \$1000.





## After 17 years Sylvania breaks with custom.

You probably never knew it, but Sylvania is one of the biggest makers of precision-built circuit-board connectors. For years we have been supplying the biggest names in the computer and communications fields. But strictly on a custom basis.

Some of our custom designs have become industry standards. And now we are making them available as off-the-shelf items. This means you can now get the benefits of cus-

tom design without tooling or set-up charges.

And it means you can buy in small quantities at low prices.

You get Sylvania's special welded gold-dot contact design that puts the gold only where it's needed for low contact resistance (less than 50mV drop at 5A). And less gold means less expense.

You also get Sylvania's precision construction that puts wire-wrap terminals exactly in the right posi-

tion for programmed wiring systems.

Formats available include: 44-pin single position, 20-pin single position, 212-pin eight position, and 220-pin five position. Contact ratings up to 5 Amperes.

If these types won't fill your needs, remember we're still one of the biggest names in custom designs. Call us. Sylvania Metals & Chemicals, Parts Division, Warren, Pa. 16365.

CONNECTORS BY  
**SYLVANIA**  
A DIVISION OF  
GENERAL TELEPHONE & ELECTRONICS





What KTTV, Los Angeles, says about Cohu's new chroma detector . . . "The Cohu chroma detector enables us to run the highest quality monochrome film on a color chain, eliminating the need for duplicate equipment. This means color and monochrome film can be interspliced without concern."

## COLOR-FREE B/W TRANSMISSION AUTOMATICALLY

The 2610/2620 Series chroma detector detects the transition between color and monochrome information and automatically removes all discernible chrominance from the encoder output. Modular, solid-

state, plug-in, this new accessory operates with the 9800 Series color video encoder. Available only from Cohu.



For more information, contact your nearest Cohu engineering representative, or call Bob Boulio direct at 714-277-6700 in San Diego.



# Products

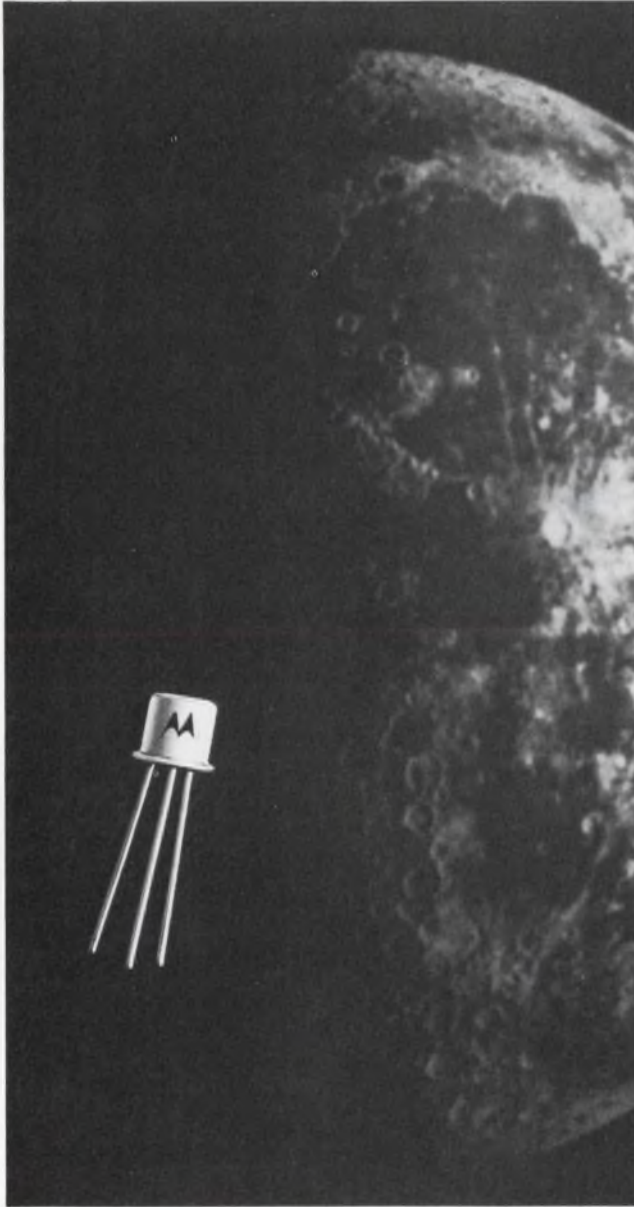

**Surface-passivated all-diffused UJTs** are first such devices to be MIL-qualified. Page 102

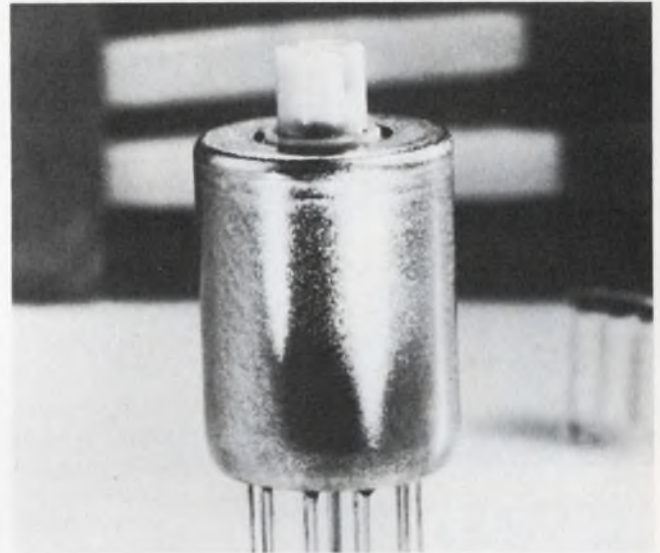

**IC-compatible rotary switch** packs ten positions in 5/16-in. diameter. Page 104

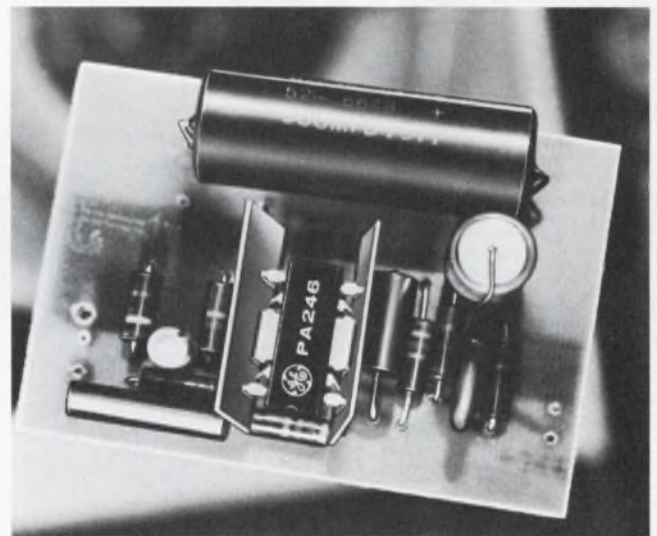

**Monolithic audio amplifier** in modified DIP delivers 5 W to 16- $\Omega$  load. Page 102

## Also in this section:

**Modular multi-function systems** generate variable pulses. Page 112

**New micropill varactor package** drops case capacitance by 30%. Page 116

**Design Aids**, Page 138 . . . **Application Notes**, Page 140 . . . **New Literature**, Page 142



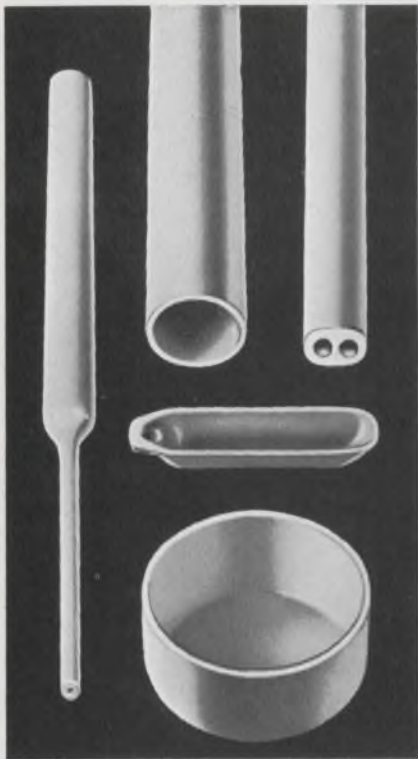

# REFRACTORY PRODUCTS...

In addition to its famous lines of Vitresil® and Spectrosil® fused quartz products, Thermal American is now supplying a line of crystalline oxide refractory ware and cement for use by industry and laboratories. These products are designed for high resistance to heat, low reaction with metals and chemicals, low porosity, high thermal conductivity, and good mechanical strength.

Included in the complete 16 page catalog with a separate price list is a selector chart providing instant technical, mechanical and application data for refractory products of Aluminous Porcelain, Recrystallized Alumina, Zirconia and Magnesia. Write for your copy.



**FREE CATALOG**

73

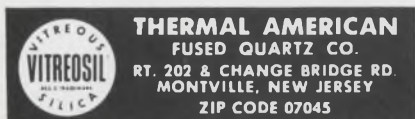

INFORMATION RETRIEVAL NUMBER 40

## ICs & SEMICONDUCTORS

### Monolithic amplifier gives 5-W audio out

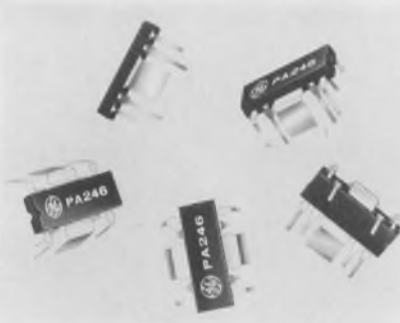

General Electric Co., Northern Concourse Office Building, North Syracuse, N.Y. Phone: (315) 456-2396. P&A: \$3.84; 30 days.

A monolithic IC delivers a power output of 5 W into a 16-Ω load. Two heat-sink tabs and eight leads extend from each side of the dual-in-line package. Supply voltages up to 37 V will drive the PA246. Frequency response is 30 Hz to 100 kHz and noise output is 70 dB down. At full power, input sensitivity is 180 mV and output harmonic distortion is below 1% at 1 kHz.

CIRCLE NO. 253

### Character generator drives CRT display

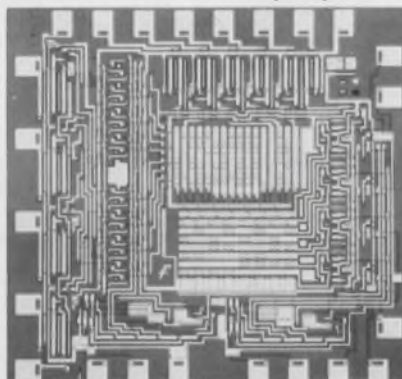

Fairchild Semiconductor, 313 Fairchild Dr., Mountain View, Calif. Phone: (415) 962-2530. Price: \$60.

A 7-segment character generator designed for use with a CRT in the display of numeric information is an MOS/LSI circuit with a single-chip complexity of 150 gates. Offered in a 24-pin dual in-line package, the 3250 accepts a 4-bit binary-coded word and generates four deflection pulses.

CIRCLE NO. 254

### Passivated UJTs are MIL-qualified

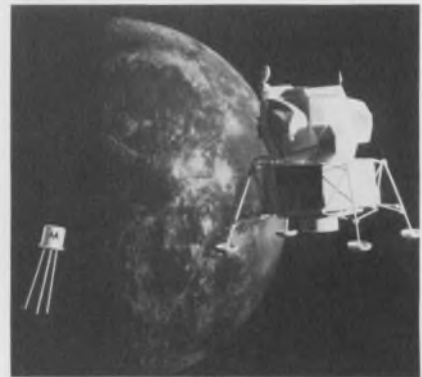

Motorola Semiconductor Products Inc., P.O. Box 20924, Phoenix, Ariz. Phone: (602) 273-6900. P&A: \$1.80 or \$2.60.

Made by a surface-passivated process, two silicon unijunction transistors, Types JAN2N4948 and JAN2N4949, are the first all-diffused devices to qualify under MIL-S-19500/388. Their modern construction permits the new UJTs to improve on three vital parameters. They have low emitter-saturation voltages of 9 or 3 V maximum, a low leakage current of only 10 nA maximum, and a low peak-point current of only 2 μA maximum.

CIRCLE NO. 255

### Monolithic amplifier spans dc to 500 kHz



Optical Electronics, Inc., P.O. Box 11140, Tucson, Ariz. Phone: (602) 624-3605. P&A: \$32; stock.

Packaged in a 7-lead TO-5 metal can, a monolithic operational amplifier provides a full output swing of ±10 V from dc to 500 kHz. Model 9308 has a minimum open-loop gain of 80 dB, a minimum gain-bandwidth product of 80 MHz, and a minimum slewing rate of ±30 V/μs. It settles in 150 ns to 0.01% of final output amplitude. Output current is ±3 mA.

CIRCLE NO. 256

**MOLY-PERMALLOY  
POWDER CORES**

16 standard sizes with ID's from .110" to 1.40", and OD's from .250" to 2.25". Guaranteed  $\pm 8\%$  inductance limits on toroids with permeabilities of 14, 26, 60, 125, 160, 200, 300 and 550. Available either stabilized or unstabilized with temperature.

**TAPE WOUND CORES**

Made from nickel, silicon, or cobalt irons. We supply all AIEE standards plus special sizes in thicknesses from  $\frac{1}{2}$  through 14 mils. All sizes boxed in phenolic or plastic, aluminum or GVB-coated aluminum boxes.

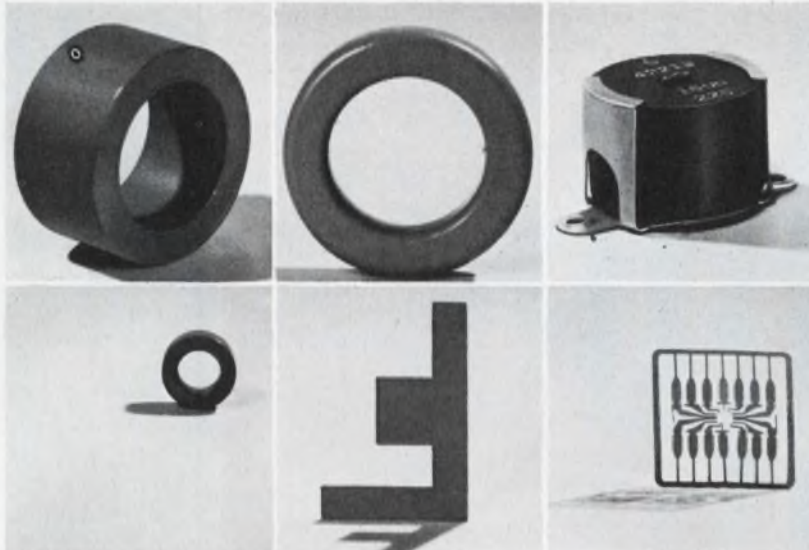

**BOBBIN CORES**

Made from Permalloy 80 and Orthonol<sup>®</sup> strip .000125" to .001" thick and .023" to .250" wide. Diameters range to less than .050", with flux capacities as low as several maxwells.

**FERRITES**

Guaranteed linear temperature coefficients on 750, 1400 and 2000 perm materials. Flat temperature coefficient on 2300 perm material also guaranteed. A total of 175 part numbers to choose from.

**PHOTOFAB<sup>®</sup> PARTS**

Precision flat components chemically milled from almost any magnetic or specialty alloy. Thickness tolerances range from  $\pm 5\%$  to  $\pm 10\%$ , depending on thickness and type of material.

**MAGNETIC  
LAMINATIONS**

Nickel-iron materials in thicknesses of .004", .006" and .014". 38 standard shapes in sizes from DU-87 and EI-12 down to EI-093, EE-30-31 and F-094.

# Magnetics Inc. gives you total quality control and single-source responsibility on every component

At Magnetics Inc., we're particular about what the finished component does for you. So particular that we maintain up-tight control right from the start. On ferrites and powder cores, we begin with the exact blending of powders. Our metal strip products also evolve from closely controlled custom blending and composition. This emphasis on precision, from start to finish, results in product uniformity—you get optimum characteristics and full-measure performance every time. That's what we mean by single-source responsibility. For additional information on any of our products, mail coupon today.

Magnetics Inc.  
Dept. ED-103, Butler, Pa. 16001

Please send me additional information on:

- Tape Wound Cores
- Bobbin Cores
- Moly-Permalloy Powder Cores
- Ferrite Cores
- Magnetic Laminations
- Photofab Parts
- Specialty Metals

Name \_\_\_\_\_

Title \_\_\_\_\_

Company \_\_\_\_\_

Street \_\_\_\_\_

City \_\_\_\_\_ State \_\_\_\_\_ Zip \_\_\_\_\_



Tape, Powder, Bobbin, Ferrite Cores • Laminations • Photo-etched Parts • Specialty Metals • Engineered Control Systems



7.5kv  
2.5W - 500MΩ

per inch

## New Victoreen MOX Resistors Now values to 2500 megohms in a compact package only 1/4" OD x 5" long

Now — by specifying new Victoreen metal oxide glaze resistors — you can buy resistance by the inch.

Based on our standard 1/4" OD size, Victoreen Series MOX resistors, per inch of lineal length, give up to 7.5 kv ratings . . . 500 megohms resistance . . . 2.5 watts power dissipation. Tolerances are  $\pm 2\%$  or  $\pm 5\%$  right across the board up to the 5" size . . .  $\pm 1\%$  and  $\pm 0.5\%$  in some sizes. Stability is exceptional, too — less than 1% full-load drift in 2000 hours . . . shelf life drift less than 0.1% per year.

Victoreen MOX Resistors are available right now in sizes and ratings that make them near-perfect — for HV probes with DVMs, meter multipliers, HV plate load resistors and similar circuits. And still more new sizes and ratings are on the way, too.

A-1962

**VICTOREEN INSTRUMENT DIVISION**  
10101 WOODLAND AVENUE • CLEVELAND, OHIO 44104  
IN EUROPE: GROVE HOUSE, LONDON RD., ISLEWORTH, MIDDLESEX, ENGLAND



INFORMATION RETRIEVAL NUMBER 41

## COMPONENTS

### Small rotary switch has 5/16-in. dia

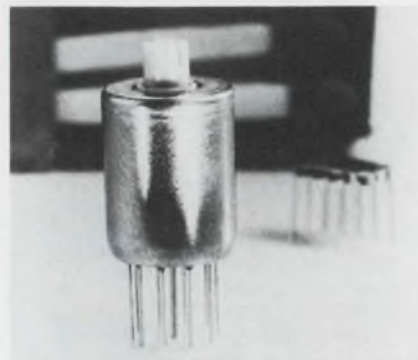

*Oak Electro/Nectics Corp., Crystal Lake, Ill. Phone: (815) 459-5000.*

Designed for use with ICs, a 10-position continuous-turn rotary switch measures only 5/16 inch in diameter. Basically a single-pole unit, type 3 is also available with stops to limit rotation from two to ten positions. Contact ratings are 0.5 A at 28 V dc, 0.1 A at 120 V ac (non-inductive). Breakdown voltage is 500 V ac between contacts, and between contacts and ground. Insulation resistance is 25,000 MΩ between terminals, and terminals to ground.

CIRCLE NO. 257

### In-line amplifier installs in coax



*Piezotronics, Inc., 3311 Walden Ave., Depew, N.Y. Phone: (716) 684-0001.*

Containing a tiny integrated circuit, an in-line source-follower amplifier lowers the output impedance of crystal transducers to less than 100 Ω. Measuring less than 1 inch in length and 0.25 inch in diameter, model 402A operates into single-conductor shielded cable. Both signal and power are carried over the center conductor, with the shield completing the circuit.

CIRCLE NO. 258

INFORMATION RETRIEVAL NUMBER 248 ►



product report  
digital instruments

# Automate Your Measurements . . .

. . . with these NEW Tektronix products.



## Digital Oscilloscope

The Type 568/230 Digital Oscilloscope System provides digital readout of measurements that are displayed in analog form on the CRT. They enable the engineer, technician or production worker to make dynamic switching-time measurements with greater speed, convenience and repeatability than is possible by making measurements directly from the cathode-ray oscilloscope display. Typical measurements include pulse voltages, risetime, falltime, delay time, storage time, pulse width and many other specific measurements.

With the NEW programmable plug-in units and Sampling Heads, all of the measurement functions of the Type 568/230 can be externally programmed for use in high-speed automated measurement systems. The Type 568/230 can make more than 100 dynamic measurements per second, and data output connectors provide measurement results in convenient BCD code. Programming is easily accomplished with the use of new Tektronix Program Units.

Type 568/230/3T6/3S6/S-1/S-1 . . . . . \$7340

TEKTRONIX PRODUCT REPORT—DIGITAL INSTRUMENTS

## Automatic Measurements



### NEW Type 241

Add the NEW Type 241 Programmer to the Type 568/230 Digital Oscilloscope and obtain up to 15 automatic measurements. The Type 241 will automatically sequence through 15 programs, stopping on out-of-limit measurements. Programs are easy to setup and change, enabling a person having minimum training to program the Type 241.

Type 241 . . . . . \$1950



### NEW Type 240

The NEW Type 240 Program Control Unit and NEW Disc Memory program the Type 568/230 at speeds up to 100 measurements per second and provide local storage of 1600 independent measurements. Sorting, classifying and diagnostic test routines are also obtained using the Disc Memory. A Punched Tape Reader is used with the Type 240 in low-speed systems, providing a maximum of 6 measurements per second.

Type R240 . . . . . \$3800  
Disc Memory . . . . . \$6600  
Punched Tape Reader . . . . . \$1250



### NEW Type R250

The NEW Type R250 Auxiliary Program Unit adds additional programming capabilities to the Type 240 and provides programming and buffering for pulse generators, power supplies and other equipment. System engineering and design is required with the Type R250. The NEW Type R116 MOD 703L and Type R293 MOD 703M Programmable Pulse Generators are designed specifically for use with the Type R250 in automated systems.

Type R250 . . . . . \$1400  
6 Shift-Register Cards . . . . . \$ 420  
Type R116 MOD 703L . . . . . \$2775  
Type R293 MOD 703M . . . . . \$1300

U.S. Sales Prices FOB Beaverton, Oregon



# Making the Measurement . . . . Tektronix Measurement Systems

*Tektronix Measurement Systems use Tektronix Catalog products and additional equipment such as programmable power supplies, test stations, equipment racks and other equipment. Tektronix does the systems engineering and supplies a digital measurement system ready to do your measurement job. Your requirements to test integrated circuits, transistors, circuit boards and subassemblies can be met with a Tektronix dynamic measurement system.*



**NEW**

**Type S-3120**  
**Switching-Time Measurements**

The Type S-3120 is designed to verify the switching-time performance of transistors, diodes and IC's. The Type S-3120 is intended for use where power supply voltages and pulse parameters do not require programming. Program branching with the Type S-3120 permits sorting and classifying of semi-conductors. For example, when making a rise-time measurement, a within-limits measurement will continue the normal measurement sequence; an above-limit measurement (slow risetime) can stop the sequence to reject the component; and a below-limit measurement (fast risetime) can branch to a new measurement sequence for reclassifying the transistor.

Type S-3120 . . . . . \$28,000

**Type S-3110 Pulse Testing**

The Type S-3110 provides up to 15 measurement programs and eliminates operator interpretation and error when testing pulse generators and other pulse sources. Programmable measurements provide consistent GO, NO-GO readings with the speed and repeatability required for production testing and QC. Measure pulse period, pulse width, risetime, falltime, pulse amplitude, overshoot, DC offset and many other specific pulse parameters. Sampling Heads provide a choice of system measurement capabilities. Select the measurement performance you need today and update your performance with future Sampling Heads.

Type S-3110 . . . . . \$11,500



**Type S-3130 Integrated Circuit Testing**

Tektronix Type S-3130 Digital Measurement System makes 100% dynamic testing feasible for incoming inspection of IC's. Dynamic testing now can check the performance of your IC's under simulated operating conditions at a low cost per unit tested. Measurement speeds of 100 measurements per second with local storage of 1600 independent measurements provides the flexibility and versatility required of a dynamic IC tester. Measurement programs change power supply and pulse generator parameters over a wide range; extra program lines from the Type R250 can be used to switch test point and operating and load conditions.

Type S-3130 . . . . . \$41,000

U.S. Sales Prices FOB Beaverton, Oregon

**For a demonstration, call your local Tektronix field engineer or write: Tektronix, Inc., P. O. Box 500, Beaverton, Oregon 97005.**



**Tektronix, Inc.**

*committed to progress in waveform measurement*

# new

# Low Cost...

## LINE OF VOLTAGE REGULATORS



PRICED AS LOW AS **38¢**

these new Signalite voltage regulators feature:

- orders of magnitude better than Zener Diodes under transient conditions
- temp. coef. less than 15 mv/°C
- life greater than 20,000 hours
- stacking capability for higher voltage regulation

### VOLTAGE REGULATOR AND REFERENCE TUBES

SIGNALITE TYPE	BREAKDOWN VOLTAGE vdc max.	REFERENCE VOLTAGE MEAS. AT		CURRENT RANGE* FOR REGULATOR ma	OPERATING CURRENT ma		
		vdc	ma		MAX.**	MIN. AS SHUNT REG.	MIN. IN PARALLEL WITH A CAPACITOR
V83R4	115	83±2	1.5	0.25 — 4.0	6.0	0.25	0.4
V84R2	115	84±2	1.0	0.15 — 2.0	3.0	0.15	0.35
V91R2	125	91±2	1.0	0.1 — 2.0	3.0	0.1	0.3
V103R2	135	103±2	0.8	0.2 — 2.0	3.0	0.2	0.25
V110R4	170	110±2	1.5	0.5 — 4.0	6.0	0.5	0.95
V115R4	155	115±2	0.8	0.15 — 4.0	6.0	0.15	0.3
V116R2	150	116±2	0.6	0.12 — 2.0	3.0	0.15	0.3
V139R1.9	190	139±4	0.5	0.3 — 1.9	3.0	0.3	0.6
V143R1.9	225	143±4	0.5	0.3 — 1.9	3.0	0.3	0.6

**NOTES:**  
 \*Limits for less than two volt variation.  
 \*\*Maximum continuous current without permanent damage to tube.  
 Equilibrium condition reached within 2 minutes after ignition.

302

### APPLICATION NEWS LETTER



The Signalite News Letter fully illustrates how voltage regulating tubes are used as reference voltage sources, and in: regulated power supplies, oscilloscope calibrators, photo multipliers, zener diode type voltage sources, digital voltmeters, timing circuits, over voltage protection, suppressed 0 voltmeters, frequency dividers, indicating voltmeters . . . and many other applications. Copies are available from your Signalite representative or contact Signalite.

**Signalite**  
 INCORPORATED

A General Instrument Company



1933 HECK AVENUE, NEPTUNE  
 NEW JERSEY 07753 • (201) 775-2490

INFORMATION RETRIEVAL NUMBER 42



# step up!





# to perfect performance

—with Bodine fhp motors and D.C. Motor Controls Now...precise control of speed, torque and power for every fractional horsepower need. Motor controls perfectly matched to characteristics of Bodine's NSH line of D.C. shunt-wound motors. Or, for just reliable fractional horsepower, Bodine motors available in over 3,500 standard catalogued specifications. Plus numerous specials. Virtually any type, size or rating: 1.45 milli-hp. to ¼ hp., torques from 0.18 oz.-in. to 350 lb.-in., speeds from 0.6 to 10,000 rpm. Also more than 330 stock types and sizes. Write for Bulletin. Bodine Electric Company, 2500 W. Bradley Place, Chicago, Illinois 60618.

Power/controls for office machines  
■ machine tools ■ electronic equipment  
■ electrical control devices  
■ medical apparatus ■ communications equipment  
■ data processing equipment ■ laboratory equipment  
■ recording instruments  
■ inspection and testing equipment  
■ musical instruments ■ scientific apparatus  
■ many other applications.

*Bodine Motors Wear Out—It Just Takes Longer*



## BODINE MOTORS/CONTROLS

INFORMATION RETRIEVAL NUMBER 43

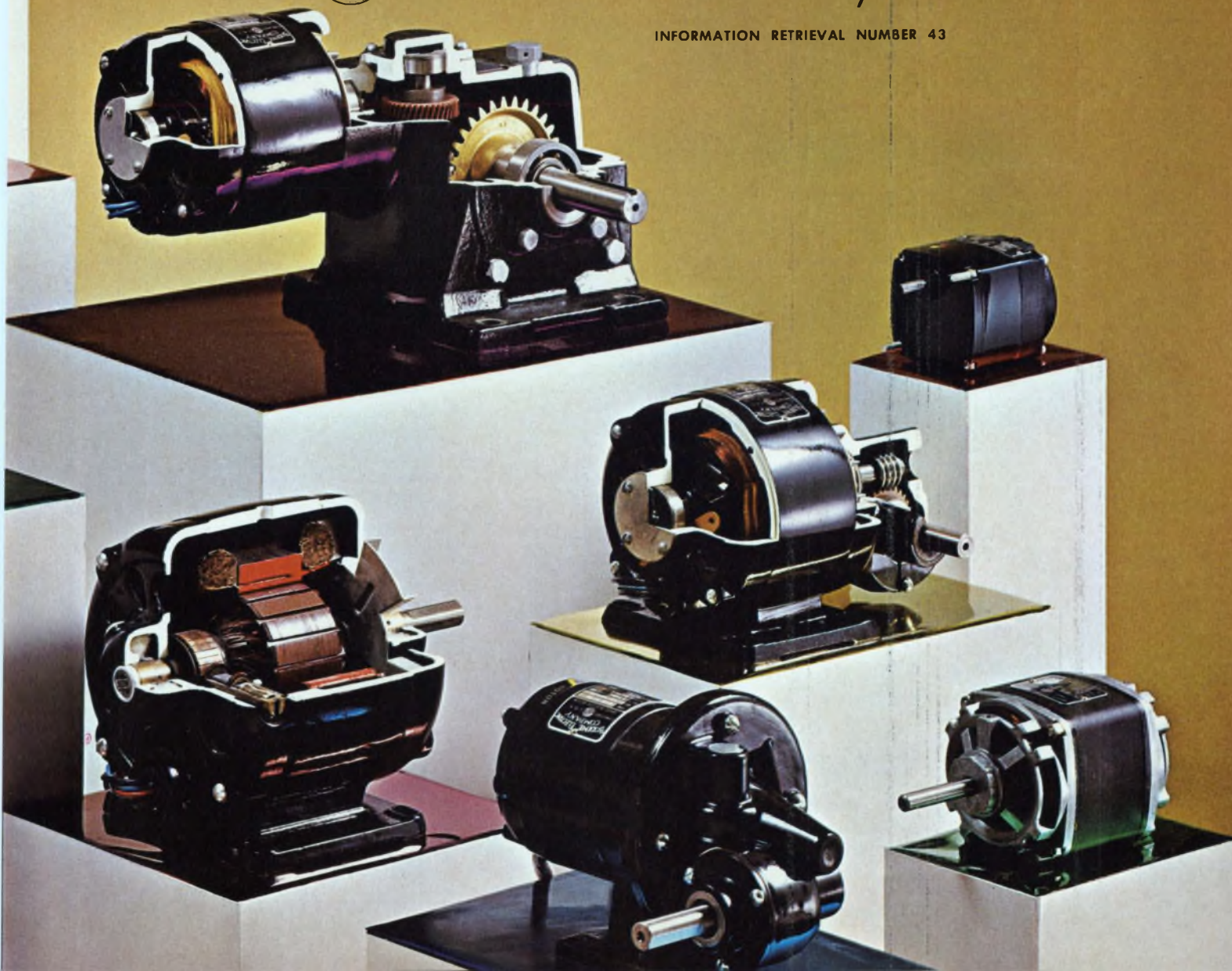



KROHN-HITE MODEL 4200 VS MAJOR COMPET

MFR	H-P	H-P	G-R	K-H
Model Number				4200
Price				\$350
Frequency Range				10 Hz to 10 MHz
Power Out				500 mw
Waveform Distortion				<0.1%



**Stack this  
\$350 oscillator  
against the  
competition**

**regardless of price!**

You'll be surprised! In spite of its low price, the Model 4200 exhibits extraordinary performance. It excels in those specifications most eagerly sought by men who really know oscillators. Krohn-Hite's twenty years of frequency-generator know-how has produced a unique circuit\* that makes low-priced high performance a reality at last.

Here's how the Model 4200 stacks up against several competitors:

**BROADER FREQUENCY RANGE:** The Model 4200 outranges most of the others, including more expensive units.

**MORE OUTPUT POWER:** The Model 4200 has from 2.5 to 50 times the power of the other units.

**BEST WAVEFORM PURITY:** The Model 4200 is unexcelled.

**BEST BUY:** The \$350 price speaks for itself.

See for yourself. Write for data. Then contact your Krohn-Hite Representative for a no-holds-barred demonstration. The Model 4200 is a lot of oscillator for \$350.

\*Patent applied for.



580 Massachusetts Ave., Cambridge, Mass. 02139, U.S.A.  
Phone: (617) 491-3211 TWX: 710-320-6583

COMPONENTS

**Fluidic actuator reads and multiplies**



*Trish Energetics, Inc., W. Bare Hill Rd., Harvard, Mass. Phone: (617) 456-3909. P&A: \$35; stock to 30 days.*

Operating at fluidic pressure levels, a pressure-controlled actuator performs mechanical readout or activation tasks, as well as force multiplying. Model F-201 is available with strokes from 0.08 to 0.75 in., forces from 2 to 16 oz., and applied signal activation pressures from 0.25 to 2.50 psi.

CIRCLE NO. 259

**Miniature transducers change resistance 30%**

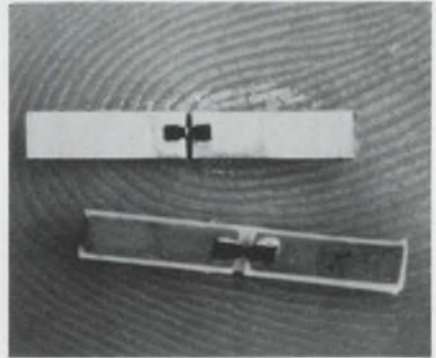

*Endevco Laboratories, div. of Endevco Corp., 1675 Stierlin Rd., Mountain View, Calif. Phone: (415) 968-7744.*

At room temperature, miniature solid-state transducing elements can change resistance up to 30% for force inputs as small as 10 grams. Fully compatible with integrated circuits, series 8100 covers the resistance range of 400 to 1500 Ω. They can be operated from dc to 50 kHz and, for many applications, provide sufficient signal power without amplification.

CIRCLE NO. 260

**MICROWAVE IC  
PROGRESS  
REPORT #5**

# PACT proves microstrip is compatible for MIC mixers, filters, hybrids

Before microwave integrated circuits can become a reality this important question must be answered — can present stripline technology be converted to microstrip without a prohibitive performance penalty? Engineers and scientists engaged in Sperry's PACT (Progress in Advanced Component Technology) Program have found the answer, and the answer is yes!

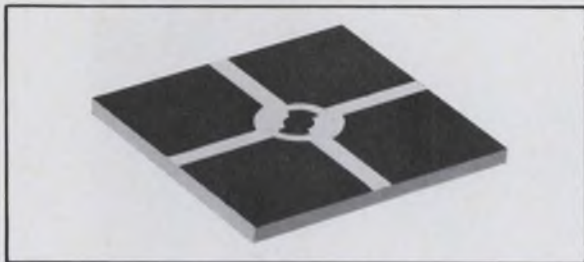

**TWO-BRANCH MICROSTRIP 3 DB COUPLER**

PACT investigations have already produced couplers, balanced mixers and a number of hybrid circuits, all utilizing the basic microstrip technology. Performance penalties have been negligible, and all indicators point to production availability of entire subsystems deposited on a single substrate.

Like other PACT activities, this effort has depended heavily on the proper selection of materials. For multi-function substrates, such as those capable of carrying entire subsystems, Sperry's choice is a composite of ferrimagnetic and alumina substrates. In some cases all-ferrimagnetic substrates are recommended.

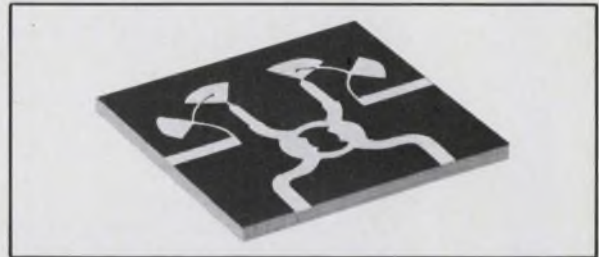

**MICROSTRIP BALANCED MIXER CIRCUIT**

This approach provides maximum size, weight and cost savings, along with significant increases in thermal and mechanical stability.

PACT has also benefited from the use of the computer as a design aid. For example, the computer was programmed to calculate the electrostatic potentials around a microstrip circuit and determine its impedance. Options were then added to the program to obtain a print-out of actual potentials around the microstrip and to plot equal potential lines.

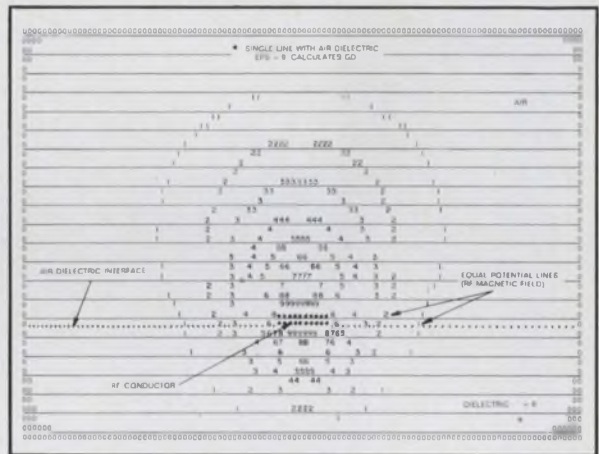

**COMPUTER PLOT OF EQUAL-POTENTIAL SURFACES  
(RF MAGNETIC FIELD) AROUND MICROSTRIP LINE  
WITH  $\epsilon = 9$**

The result is optimum configuration for microstrip circuits prior to their fabrication.

To learn more about Sperry progress in design and fabrication of multi-function MICs for your applications, ask your Cain & Co. representative or write Sperry Microwave Electronics Division, Sperry Rand Corporation, Clearwater, Florida.

*For faster microwave progress,  
make a PACT with people  
who know microwaves.*

**SPEYRY**  
MICROWAVE ELECTRONICS DIVISION  
CLEARWATER, FLORIDA



# Capacitor problems?

## General Electric has 1844 application-designed solutions

General Electric's application-designed capacitors are made to solve your problems. Whether you need aluminum, tantalum, or film units, GE has the right answer.

**Circuit design problems?** Many General Electric capacitors are designed by computer to optimize their electrical and mechanical characteristics. You get the highest capacitance in the least volume with electrical properties consistent to your own circuit designs. For example, if you know your installed capacitance requirements in a new power supply, our computers can quickly tell you the best capacitor combination and its electrical characteristics in your circuit.

**Product application problems?** General Electric has experienced capacitor application en-

gineers in Electronic Components Sales Offices throughout the country. These technical specialists are ready to help you select the capacitors you need and to provide specialized information about them.

**Ordering or delivery problems?** Your local Electronic Components Sales Office will be glad to furnish you price and delivery data for General Electric capacitors. We also have stocking distributors who can meet many of your immediate requirements for limited quantities of standard units.

You supply the capacitor problems. General Electric can supply 1844 application-designed solutions. Contact your local sales office, franchised distributor or **Capacitor Department, Irmo, South Carolina 29063.**

430-32

GENERAL  ELECTRIC

NEW IDEAS IN  
  
ELECTRONICS



**Aluminum High-performance Computer-grade Capacitors**  
236 standard ratings. 5 to 450 volts,  
75 to 480,000  $\mu\text{f}$ , -40  
to 85C ambient temperature



**Aluminum Miniature Tubular Capacitors**  
151 standard ratings. 3 to 150 volts, 1 to  
790  $\mu\text{f}$ , -40 to 85C ambient temperature



**Aluminum Industrial Tubular Capacitors**  
102 standard ratings. 3 to 450 volts, 2 to  
3500  $\mu\text{f}$ , -20 to 85C ambient temperature

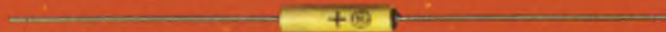

**Tantalum Sub-miniature Wet-slug Capacitors**  
59 standard ratings. 6 to 60 volts,  
0.01 to 450  $\mu\text{f}$ , -40 to 85C ambient temperature





**Metallized Film Flattened Oval Capacitors**  
102 standard ratings. 100 and 200 volts d-c, 0.01 to 10.0  $\mu$ f, -55 to 85C



**Metallized Polycarbonate Tubular Capacitors**  
57 standard ratings. 200 volts d-c, 0.010 to 10.0  $\mu$ f, -55 to 125C

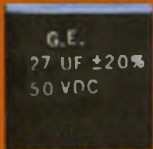

**Micro-flat Polyester Capacitors**  
78 standard ratings. 50 volts d-c, 0.0010 to 1.50  $\mu$ f, -55 to 85C



**Polyester Tubular Capacitors (left)**  
296 standard ratings. 100 and 200 volts d-c, 0.0010 to 2.00  $\mu$ f, -55 to 85C



**Black Hawk Capacitors**  
483 standard ratings. 50 to 600 volts, 0.0010 to 1.00  $\mu$ f, at 85C



**Polycarbonate Tubular Capacitors (left)**  
64 standard ratings. 100 and 200 volts d-c, 0.001 to 1.0  $\mu$ f, -55 to 85C

**Blue Jay Capacitors**  
50 standard ratings. 100 and 200 volts d-c, 0.001 to 0.47  $\mu$ f



**Aluminum Can-style Capacitors**  
43 case size and terminal combinations—thousands of ratings. 5 to 450 volts, 5 to 500  $\mu$ f, 1, 2, 3, or 4 sections



**Aluminum A-c Motor Start Capacitors**  
123 standard ratings. 110 to 330 volts a-c, 21 to 850  $\mu$ f, -20 to 65C ambient temperature



Choose from 44 styles  
of film capacitors...  
There's one to meet  
your exacting requirements

**HERMETICALLY-SEALED  
METAL CASE TUBULAR CAPACITORS**

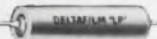

**BARE METAL CASE**

Style LP8, metallized polycarbonate film  
Style LM8, metallized PETP-polyester film  
Style LS8, metallized polystyrene film  
Style AP8, polycarbonate film  
Style AM8, PETP-polyester film  
Style AS8, polystyrene film  
Style AF8, PTFE-fluorocarbon film

**METAL CASE WITH INSULATING SLEEVE**

Style LP9, metallized polycarbonate film  
Style LM9, metallized PETP-polyester film  
Style LS9, metallized polystyrene film  
Style AP9, polycarbonate film  
Style AM9, PETP-polyester film  
Style AS9, polystyrene film  
Style AF9, PTFE-fluorocarbon film

INFORMATION RETRIEVAL NUMBER 231

**EPOXY-CASE  
RECTANGULAR CAPACITORS**

**AXIAL-LEAD**



Style LP7A, metallized polycarbonate film  
Style LM7A, metallized PETP-polyester film  
Style LS7A, metallized polystyrene film  
Style AP7A, polycarbonate film  
Style AM7A, PETP-polyester film  
Style AS7A, polystyrene film

**RADIAL-LEAD**

Style LP7S, metallized polycarbonate film  
Style LM7S, metallized PETP-polyester film  
Style LS7S, metallized polystyrene film  
Style AP7S, polycarbonate film  
Style AM7S, PETP-polyester film  
Style AS7S, polystyrene film



INFORMATION RETRIEVAL NUMBER 232

**WRAP-AND-FILL  
ROUND TUBULAR CAPACITORS**



Style LP66, metallized polycarbonate film  
Style LM66, metallized PETP-polyester film  
Style LS66, metallized polystyrene film  
Style AP66, polycarbonate film  
Style AM66, PETP-polyester film  
Style AS66, polystyrene film

INFORMATION RETRIEVAL NUMBER 233

**WRAP-AND-FILL  
OVAL TUBULAR CAPACITORS**

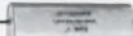

Style LP77, metallized polycarbonate film  
Style LM77, metallized PETP-polyester film  
Style LS77, metallized polystyrene film  
Style AP77, polycarbonate film  
Style AM77, PETP-polyester film  
Style AS77, polystyrene film

INFORMATION RETRIEVAL NUMBER 234

**HERMETICALLY-SEALED  
METAL CASE RECTANGULAR CAPACITORS**



Style CML, high voltage paper/PETP-polyester film, inserted tab construction.

INFORMATION RETRIEVAL NUMBER 235

**HERMETICALLY-SEALED  
CERAMIC CASE TUBULAR CAPACITORS**



Style SML, high voltage paper/PETP-polyester film, inserted tab construction.  
Style SMLE, high voltage paper/PETP-polyester film, extended foil construction.

INFORMATION RETRIEVAL NUMBER 236

**HERMETICALLY-SEALED  
GLASS CASE TUBULAR CAPACITORS**



Style GML, high voltage paper/PETP-polyester film, 85 C  
Style GTL, high voltage paper/PETP-polyester film, 125 C

INFORMATION RETRIEVAL NUMBER 237

**EPOXY CASE  
RECTANGULAR CAPACITORS**



Style EFX, high voltage paper/PETP-polyester film.

INFORMATION RETRIEVAL NUMBER 238

For engineering bulletins on the capacitor styles  
in which you are interested, write to Dearborn  
Electronics, Inc., Box 530, Orlando, Fla. 32802.

**Dearborn Electronics, Inc.**  
(a subsidiary of the Sprague Electric Company)  
**FOREMOST IN FILM CAPACITORS**

INSTRUMENTATION

**Modular generators  
vary pulse output**

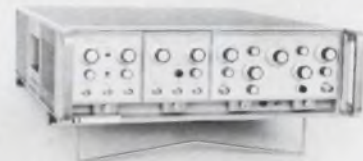

Hewlett-Packard, 1501 Page Mill Rd., Palo Alto, Calif. Phone: (415) 326-7000. Price: \$2750.

Series 1900 modular pulse-generator systems can deliver 1-A pulses into a 50-Ω load at repetition rates as high as 25 MHz and with variable rise and fall times from 7 ns to 1 ms. Besides generating pulses, these modules can be assembled into word generators, pulse shapers and variable-time-delay trigger generators. They also suppress RFI to levels below those specified by MIL-I-6181D.

CIRCLE NO. 261

**Portable multimeter  
performs 5 functions**



Data Technology Instrument Co., 1050 E. Meadow Circle, Palo Alto, Calif. Phone: (415) 321-0551. P&A: \$450; stock.

Weighing only 42 oz, an integrating digital multimeter, model DT-360, includes five ranges for each of five measurement functions. Dc and ac voltage ranges extend from 0.2 V with 100-μV resolution, to 1000 V with 1-V resolution. Current ranges, for both dc and ac, measure from 0.2 mA with 100-nA resolution, to 2 A with 1-mA resolution.

CIRCLE NO. 262



ERIE  
TECHNOLOGICAL  
PRODUCTS, INC.



LOOK FIRST TO ERIE FOR...

# CUSTOM *Hybrid* INTEGRATED CIRCUITS

*When choosing your Custom HYBRID Circuit Source...  
Check ERIE'S "Total Package" In-Plant Capability*

There are very specific reasons why ERIE is becoming a preferred source for Custom Hybrid Integrated Circuits. Our distinctly superior *resistor technology* is unique in the industry, as is our in-depth *capacitor technology*. We produce our own *precious metal formulations*, our own *substrates*, *semiconductors* and the best *protective encapsulant* available. Result? Economy, greater reliability, excellent quality control and delivery to meet your schedules. Prototypes available in about two-weeks with production quantities in about six weeks.

Look first to ERIE as *Your Custom Hybrid source*. Our total in-plant capability and expERIENCE are unparalleled in the industry.

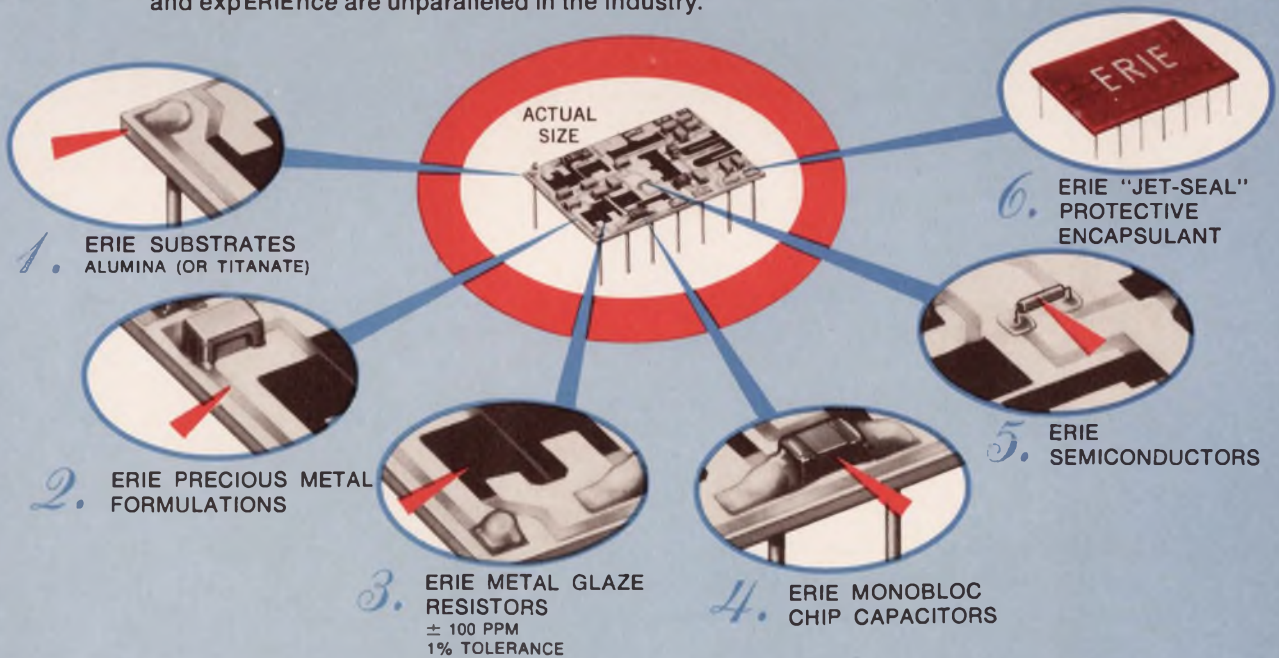

Write today for ERIE "Custom Hybrid I/C" Brochure...

ERIE TECHNOLOGICAL PRODUCTS, INC. • 644 West 12th St. • Erie, Pa. 16512 • Phone (814) 456-8592



# NEW ACTIVE FILTERS (1 Hz to 10 KHz)

## RESPONSE LIKE THIS

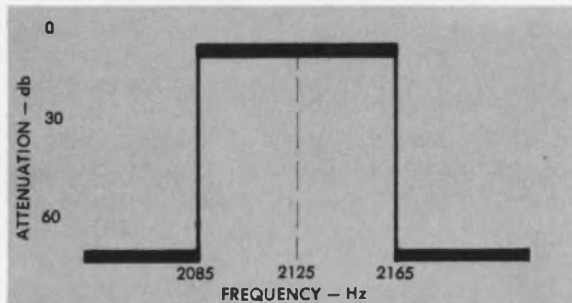

## MEANS FASTER SERIAL DATA HANDLING

**RAPID RESPONSE TIME...** equal to one cycle of input signal frequency.

**LOW PRICE...** most models are less than \$150.00

With the DE 500 series of tone filter-detectors, it takes just one cycle to recognize a frequency under 10 KHz. This new type of filter, with detected output, combines the characteristics of narrow bandwidth, sharp band rejection, and short detector response time to allow much faster tone-burst control and data transmission rates. Applications in the telecommunications field include voice coding, acoustical coupling, facsimile, and FSK.

### TYPICAL FEATURES

Input Impedance — 600 ohms  
Input Signal — 1 to 5 volts rms  
Operating Voltage — 9 to 15 volts  
DC, at 100 ma  
Size: 1 x 2 x 3 inches  
Weight: 10 ounces



For further information on low pass, high pass, and band pass models, contact our sales department.

**DIVERSIFIED**  
ELECTRONICS  
CO. INC.

154 SAN LAZARO AVENUE  
SUNNYVALE, CALIFORNIA 94086  
TELEPHONE (408) 738-3911

## INSTRUMENTATION

### Digital panel meter has separate supply

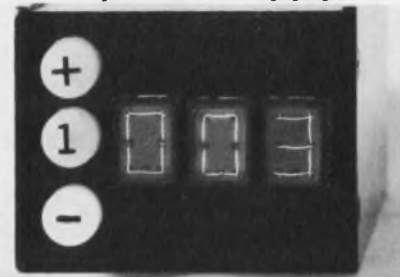

*Kay Electric Co., Maple Ave., Pine Brook, N.J. Phone: (201) 227-2000. Price: \$495.*

A miniature digital panel meter uses a power supply that can be detached from the readout section to minimize space requirements and to allow flexible panel layouts. Using incandescent readouts, model 2600 provides a three-digit display with 30% overranging. It measures 0 to 0.999 V with automatic polarity selection.

CIRCLE NO. 263

### Rf signal generators calibrate directly



*LogiMetrics, div. of Slant/Fin Corp., 100 Forest Drive, Greenvale, N.Y. Phone: (516) 484-2600. P&A: from \$2000; January, 1969.*

Direct digital calibration of Series 900 signal generation instruments increases their usable resolution and accuracy by two orders of magnitude. Each of the new instruments combines a precision rf signal generator with a high-speed counter/timer. The complete instrumentation family includes four generators and three interfacing accessories. The generators collectively span a 50-kHz-to-230-MHz range, while the companion line of accessories offers digital printout, as well as digital and analog programming of up to four digits. Frequency display is four or five digits.

CIRCLE NO. 264



**That's right. It's a commercial connector.  
Our Molex Standard. Millions are finding their  
way into some of the most exciting circuitry man  
can imagine. For that's our business: creating  
connectors that simplify  
wiring. Speed produc-  
tion. Assembly. Instal-  
lation. Servicing.**

**For the men who are  
looking for new ideas and  
ways to cut costs.**

**In the area of one circuit to sixty  
connections or more, Molex has the  
product. And the design and engineer-  
ing capabilities to solve the most com-  
plex wiring and production problems . . .  
fast! We'd like to talk to you about it.**

**If you would like a free sample of our  
Molex connector, please  
write or phone (312)  
969-4550. You  
can make con-  
nections at . . .**





# ***PICK THE TOP TEN!***

## **WIN 2 ROUND-TRIP TICKETS BETWEEN**

HERE'S ALL YOU HAVE TO DO Examine the January 4 issue of Electronic Design with extra care. Pick the ten advertisements that you think will be best remembered by your 69,000 fellow engineer-subscribers. List these advertisements (not necessarily in rank order) on the special entry blanks bound in the Jan. 4 issue, and mail to our Contest Editor. Your selections will be measured against the ten ads ranking highest in the "Recall Seen" category of Reader Recall—Electronic Design's method of measuring readership. Remember . . . in making your choices be sure to consider not only your own tastes and interests in the subject matter of each particular advertisement, but also those of the other engineer and engineering manager readers of this magazine. All Electronic Design subscribers may enter the contest (see rules in Jan. 4 issue). Good Luck! If you study the ads with care, you might wake up one morning in Paris!

### **FIRST PRIZE**

Round-trip tickets for two between New York and Paris via AIR FRANCE. You can schedule your flight anytime you wish—stay up to 21 days before returning.

### **2ND PRIZE**

**DELUXE HEATHKIT®/THOMAS "PARAMOUNT" TRANSISTOR THEATER ORGAN**

**19 Organ Voices, 200 Watts Peak Power, Chimes, Color-Glo Key Lights, Rotating Leslie Speaker, Horseshoe-Shaped Console, Plus Many Other Features.**

Here is a truly sophisticated organ with a wide variety of deluxe features to give professional playing versatility. Kit comes complete with all parts, step by step assembly instructions, and alignment tools.



# **Electronic Design 1969**



## NEW YORK AND PARIS VIA AIR FRANCE!

### 3RD PRIZE

#### DELUXE HEATHKIT® "180" COLOR TV WITH CONTEMPORARY WALNUT CABINET

Kit comes complete with all parts including chassis; hi-fi 90° 180 sq. in. rectangular color tube with anti-glare safety glass; 24,000 volt regulated picture power; rare earth phosphors; 27 tube, 10 diode, transistor circuit; automatic color control circuit; gated automatic gain control; extra B+ boost, etc. etc. All critical circuits are pre-wired and tested.



### 4TH THROUGH 10TH PRIZES

#### 7 BULOVA ACCUTRON® "SPACEVIEW" ELECTRONIC TIMEPIECES

The "Spaceview" is an ideal timepiece for electronic engineers. Its clear-view dial reveals transistorized electronic circuit and tuning fork assembly. Accuracy guarantee is 99.9977% during actual wear on the wrist. Stainless steel case with luminous hands and dots.



### PLUS 100 ADDITIONAL PRIZES

#### "ELECTRONIC DESIGN TECHNIQUES" edited by Edward E. Grazda

Contains a comprehensive collection of over 55 articles from Electronic Design covering almost all areas of interest to electronic design engineers. The articles are grouped in sections considering the use and design aspects of amplifiers, resistor networks, filters, control devices, power supplies, microwave systems, oscillators, and pulse and switching circuits. Hard cover, 312 pages.



# TOP TEN CONTEST

*WATCH FOR ENTRY BLANKS IN JAN. 4 ISSUE*



# From A to V\* about SSL's!

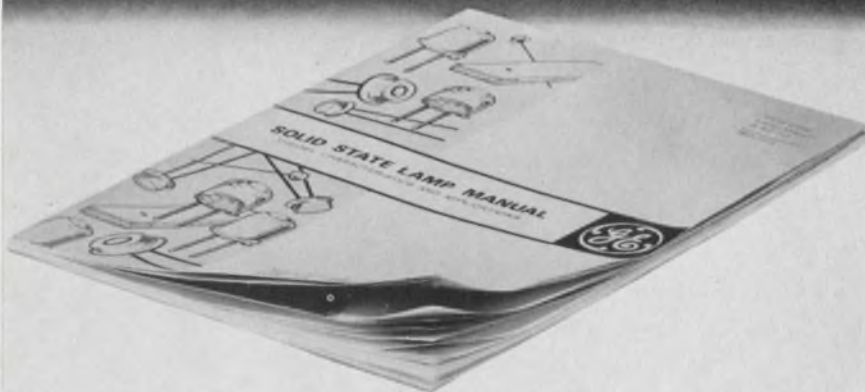

## first complete SOLID STATE LAMP MANUAL, now from General Electric

Here are 64 pages cram-packed with facts, figures and formulae about GE's growing SSL family. Over 80 diagrams, illustrations and graphs. An indispensable source book for engineers, scientists, technicians and students working with the exciting new field of solid state optics.

New *Solid State Lamp Manual* suggests dozens of immediate and future SSL applications, with particular attention to modulation, detection and control circuits. It explores solid state lamp theory and characteristics.

Also, there's a 22-page section on optoelectronics and a helpful glossary of terms. Plus, complete specifications on all GE SSL lamps.

Months in preparation by a team of General Electric scientists and engineers, this comprehensive SSL manual is now off the press. Copies are two dollars each. But supplies are limited, so mail your order today.

\*from "acceptor" to "valence band"

Please send me \_\_\_\_\_ copies of General Electric's new *Solid State Lamp Manual*. I enclose \$2 for each copy.

Name \_\_\_\_\_

Company \_\_\_\_\_

Address \_\_\_\_\_

City \_\_\_\_\_ State \_\_\_\_\_ Zip \_\_\_\_\_

To: General Electric Company  
Miniature Lamp Department, #381S  
Nela Park, Cleveland, Ohio 44112  
Attn: C. R. Dougherty

MINIATURE LAMP DEPARTMENT

**GENERAL  ELECTRIC**

## MICROWAVES & LASERS

### Silicon npn transistor delivers 1 W at 2 GHz



Mullard Ltd., Mullard House, Torrington Pl., London WC1. Phone: (01) 580-6633.

Mounted on a capstan header for use in stripline circuits, a silicon n-p-n microwave transistor is capable of providing 1-W output at 2 GHz. The 800BLY is primarily intended for use in microwave link transmitters operating in the 1.5- or 2-GHz bands. Another use is as an oscillator or power amplifier for driving a varactor-diode harmonic-generator chain.

CIRCLE NO. 265

### Varactor package lowers case capacitance



Ceramics International Corp., 39 Siding Pl., Mahwah, N.J. Phone: (201) 529-2800.

A new high-strength micropill package for microwave varactors reduces case capacitance to 30% less than that of current configurations. During high-temperature firing, metal penetration of the pre-hardened alumina ceramic is controlled to 0.0005 in. The new package is available with ceramic thicknesses (from the top of the pedestal to the top of the flange) of 0.0105 or 0.019 in.

CIRCLE NO. 266



## Who needs Sperry's new 5 ounce Ku band backward wave oscillator?

You do, if you're working on radar systems, ECM systems or test equipment with a premium on size and weight.

Sperry's remarkable new device, the SBU-4531 will give you 20 mW or more of output from 14 to 16 GHz. In the 14.5 to 15.5 GHz area, it produces 60 mW.

The SBU-4531 also features a modulating electrode that permits flexible programming of the BWO output.

The tube is PPM focused and forced air or conduction cooled. It is available with or

without an integral power supply. In its unshielded version, it weighs only 5 ounces and is approximately 6 inches long. Its low external magnetic field makes it suitable for many applications that formerly demanded shielded tubes. It is also available, as the SBU-4532, in a magnetically shielded package which weighs only 12 ounces.

Find out how the SBU-4531 and SBU-4532 can help you cut size and weight out of your Ku band system — contact your Cain & Co. representative or write Sperry Electronic Tube Division, Gainesville, Florida.

**SPERRY**  
ELECTRONIC TUBE DIVISION  
GAINESVILLE, FLORIDA



**MICROWAVE PROS!**



Tell us about your engineering degree(s) and your five or more years of microwave tube experience. Let us tell you about exciting work, educational opportunity and pleasant living in one of America's most attractive university cities. Resume, please, to Walt Thomas, Director of Industrial Relations. (An equal opportunity employer, M&F.)

INFORMATION RETRIEVAL NUMBER 51



# What can you do with a blower motor offering up to 7 stages and 3 psi?

With speeds up to 7500 rpm for the WINDJAMMER 9.5 Belt-Driven Blower, and an "airpower" range as wide as the one shown below?

You can obviously solve a wide range of air-moving problems, and fit these solutions exactly to your requirements. Which is just what Lamb Electric's new WINDJAMMER Blower line is designed to do. A stock of standard modular components allows Lamb Electric to build just the power system you need by adding stages (up to seven), with a choice of motor windings, face or foot mountings plus important optional features. These modular components are already engineered and tooled to eliminate excessive costs and to allow for rapid delivery. And expensive air valves and bleed devices are eliminated by the WINDJAMMER Blower "add on" design.

So while there are no "customizing" costs, Lamb can still exactly satisfy your air-moving requirements in a wide variety of applications. And at the same time reduce the "cost per hour of operation" in computers, business machines, magnetic tape transports, card readers and sorters, fluidic devices....

In fact, there are very few problems you can't solve with the WINDJAMMER Blower line working for you. Size problems? We've got a tough 5.7-inch model for you. Noise? The WINDJAMMER is one of the quietest blowers made. Weight? The typical five-stage unit is 18 pounds. Life? It'll go for over 20,000 hours.

For complete specifications and performance data on the entire WINDJAMMER Blower line, write us today: Ametek, Inc., Lamb Electric Division, Kent, Ohio 44240.

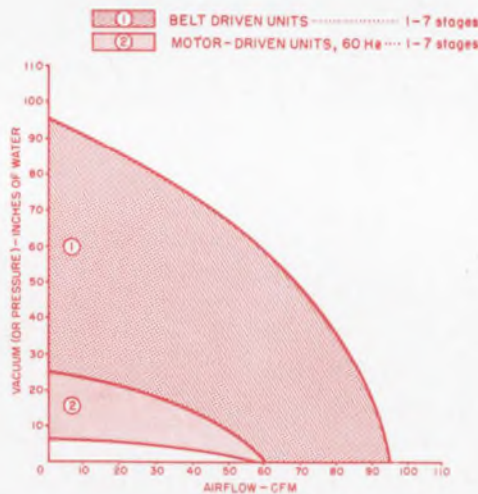
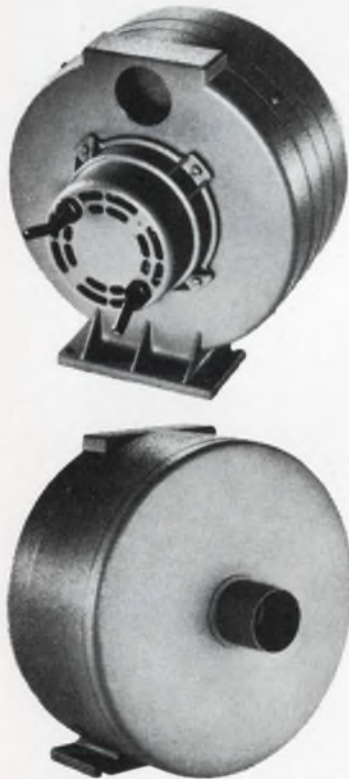

**AMETEK / Lamb Electric**



INFORMATION RETRIEVAL NUMBER 52

## MICROWAVES & LASERS

### Quad photodiode divides active area

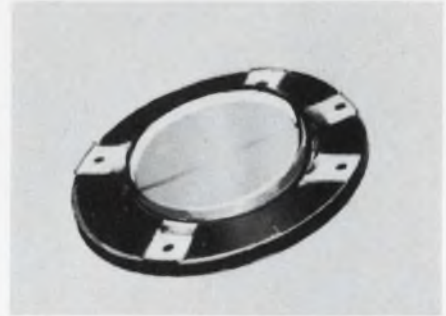

United Detector Technology, 1732 21st St., Santa Monica, Calif. Phone: (213) 393-3785.

Ideally suited for laser centering systems, a silicon Schottky photodiode has an active-area diameter of 0.45 in. that is divided into four elements with a separation spacing of 0.005 in. The PIN-Spot/8 has a noise equivalent power in the order of 0.32 pW. Capacitance of each sector at 5 to 90 V is between 15 and 50 pF.

CIRCLE NO. 267

### Cw avalanche diodes supply 0.1 W at 12 GHz



Microwave Associates, Burlington, Mass. Phone: (617) 272-3000.

Cw avalanche oscillator diodes eliminate complex circuitry by converting from dc to microwave energy in a single step. When reversed biased with 70 to 100 V dc, series MA-4900 diodes deliver power levels of over 100 mW from 8.2 to 12.4 GHz with more than 3% efficiency. They operate through a negative rf resistance resulting from the combination of the avalanche process and the carrier drift at saturated velocities.

CIRCLE NO. 268



# Our private stock isn't private any more.



## Motorola's Frequency Control Products are now on the market.

They say that if you want a thing done right, you do it yourself. And so we did. For thirty years, we've been designing and manufacturing our own

frequency control components. Because they had to be good enough to use in our own products.

We've been selfish long enough. Now our precision crystals, oscillators, filters, and tone modules are available to designers and manufacturers throughout the electronics industry. And if the mile-long list of components

isn't long enough, our designers and engineers are ready to go to work on custom projects.

For additional information on existing products and design potentials, write to Motorola Communications & Electronics Inc., 4501 W. Augusta Boulevard, Chicago, Illinois 60651. Ask for Bulletin TIC-3401.





# COMPATIBILITY

with dual in-line IC  
and discrete  
solid state devices



*New High-Speed*  
**PICOREED**  
by Clare

LOWEST PROFILE...LONGEST LIFE  
of any dry reed relay



# Exclusive new Clare Picoreed relay operates in $500\mu\text{s}$ ; permits .250" pcb mounting centers; completely compatible with IC solid-state devices

Maintenance-free, hermetically-sealed contacts in molded-epoxy modules provide positive on-off switching for 100,000,000 operations at low-level loads

Build a straight relay-switched circuit or combine relays with dual in-line integrated circuits—you'll get important plus-factors with the Picoreed. Low profile for close board spacing. Long life. Immunity to transients. Sensible cost. The Picoreed's one Form A contact solves important problems of economical and reliable input-output isolation buffering.

Outstanding characteristics of the Picoreed are:

- **High speed.** 500  $\mu\text{s}$  operate time (including bounce) and 667 Hz repetition rates at nominal coil power. Capable of following 1000 Hz with appropriate coil drive. (See response curves and scope traces.)
- **Low profile mounting.** Your choice of terminal pins for through-board connections, or axial leads for aperture mounting. Pcb mounting on .250" centers is feasible. Relays are not position sensitive.
- **Minimal size.** .187" high, .250" wide, .781" long.

- **Positive on-off switching.** ON impedance (contact resistance) 0.1 ohm initially; 1.0 ohm maximum after life. OFF impedance (insulation resistance) 10 KM ohms minimum with 0.5 pf open contact capacitance.

- **Inherent reliability.** Maintenance-free, hermetically-sealed contacts are built for 100,000,000 operations at low-level loads, 5,000,000 at 28 vdc, 0.125 amp.

- **Environmental.** Withstand vibration 0 to 5 KHz at 20g; shock 100g. Temperature range:  $-40^{\circ}$  to  $+85^{\circ}\text{C}$ .

TYPICAL RESPONSE TIMES

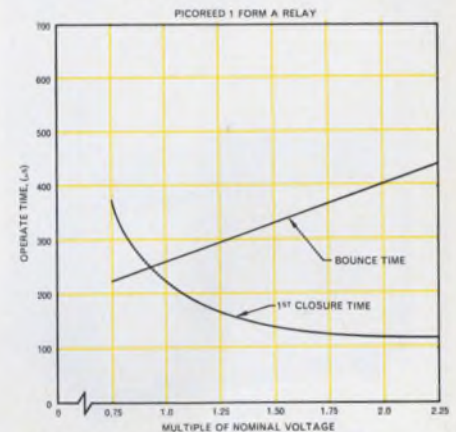

NOTES:

1. Response time measurements made at 50 Hz, 50% duty cycle square-wave coil drive.
2. With diode coil suppression (1N914 or equivalent) release time approximately 100  $\mu\text{s}$ , with nominal voltage zener diode clamping release time approximately 50  $\mu\text{s}$ .

REPETITION RATE CAPABILITIES

Oscillograms below illustrate the ability of the Picoreed to operate at 667 Hz (operate time including bounce typically 500  $\mu\text{s}$ ) and to follow 1000 Hz with an appropriate coil drive.

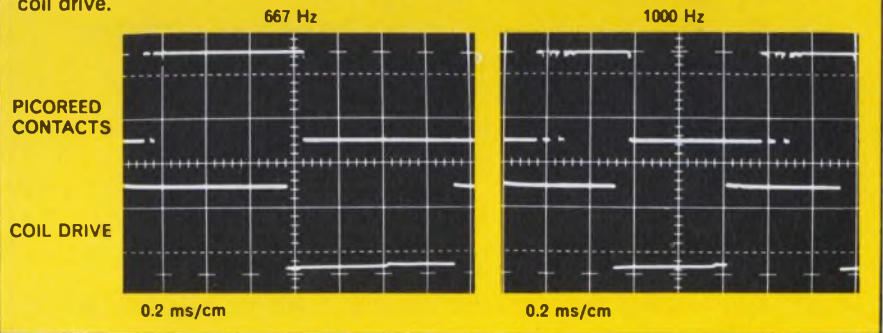

For a sample Picoreed relay, call your nearest Clare Sales Engineer:

**East.** Needham, Mass. (617) 444-4200; Great Neck, N. Y. (516) 466-2100; Syracuse, N. Y. (315) 422-0347; Philadelphia, Pa. (215) 386-3385; Baltimore, Md. (301) 377-8010; Silver Spring, Md. (Government liaison) (301) 593-0667; Orlando, Fla. (305) 424-9508

**Central.** Des Plaines, Ill. (312) 827-0151; Minneapolis, Minn. (612) 920-3125; Overland (St.

Louis) Mo. (314) 429-7372; Cleveland, Ohio (216) 221-9030; Xenia, Ohio (513) 426-5485; Cincinnati, Ohio (513) 891-3827; Columbus, Ohio (614) 486-4046; Mission, Kansas (913) 722-2441

**Southwest.** Dallas, Texas (214) 357-4601; Houston, Texas (713) 528-3811

**Pacific Coast and Mountain States.** Burlingame, Cal. (415)

697-8033; Encino, Cal. (213) 981-3323; Phoenix, Arizona (602) 264-0645; Seattle, Wash. (206) 455-2410 & 2411

For complete data, circle Reader Service Number, or write Group 12A9, C. P. CLARE & CO., 3101 Pratt Blvd., Chicago, Illinois 60645...and worldwide.

a GENERAL INSTRUMENT Company



# NEW DELTA DESIGN!

MODEL 3000 FET VOM



*A unique  
and efficient  
instrument  
bridging the gap  
between a  
multimeter and a  
digital voltmeter!*

Delta, pioneer of the famous Mark Ten® CD System, now offers a compact, versatile, and extremely sensitive VOM which combines FETs and ICs for extreme accuracy. Compact (6½" W x 8" H x 3½" D), portable, wt. 3¾ lbs. In full production at only

**\$74.95**  
ppd.

## Would you believe:

1. Mirror scale 200 $\mu$  A D'Arsonval meter
2. Integrated circuit (IC) operational amplifier for extreme accuracy
3. FET input stage with current regulator
4. Two stage transistor current regulator and Zener diode on OHMS for absolute stability and accuracy
5. Voltage clippers for protection of input stage
6. Fully temperature compensated for low low zero drift
7. Ten turns ZERO and OHMS adjust potentiometers
8. Epoxy glass circuit boards and metal case
9. Enclosed switches
10. Uses readily available type AA cells
11. Uses standard test leads for maximum flexibility and ease of measurement
12. 10 Megohms input impedance

Available in Kit form: Feedback network with pre-selected components to eliminate all final calibration. Ready to use when assembled!

Kit:  
Only **\$59.95**  
ppd.



**DELTA PRODUCTS, INC.**

P. O. Box 1147, Grand Junction, Colorado 81501

I enclose \$\_\_\_\_\_ Please send postpaid:

\_\_\_\_\_ Model 3000 FET VOMs @ \$74.95 assembled

\_\_\_\_\_ Model 3000 FET VOMs @ \$59.95 kit form

Name \_\_\_\_\_

Address \_\_\_\_\_

City/State \_\_\_\_\_ Zip \_\_\_\_\_

DP 8-7

## MODULES & SUBASSEMBLIES

### Multiplexing relay switches in 750 $\mu$ s

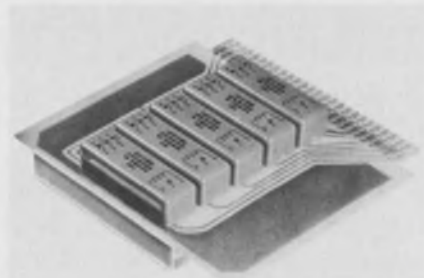

James Electronics Inc., 4050 N. Rockwell St., Chicago. Phone: (312) 463-6500. P&A: \$10/channel; stock to 6 wks.

Designed for sequential switching, a multiplexing high-speed relay switches both shield and signal contacts in 750  $\mu$ s. Called Micro-Scan, the unit closes the shield contacts 100  $\mu$ s before switching the signal contacts; it opens them 100  $\mu$ s after releasing the signal contacts. The relay can sample within 50  $\mu$ s after contact closure.

CIRCLE NO. 269

### Differential amplifier pulls signals from noise



Analog Devices, 221 Fifth Street, Cambridge, Mass. Phone: (617) 492-6000. P&A: \$75 to \$85; stock to 3 wks.

Providing size and price reductions over comparable units, a differential dc instrumentation amplifier makes accurate millivolt measurements of signals buried in large common-mode background noise. Model 602 has a stability of 2 $\mu$ V/ $^{\circ}$ C, a common-mode rejection ratio of 10<sup>5</sup>, and an input impedance of 10<sup>3</sup> M $\Omega$ . Measuring 4 by 3-1/2 by 1 in., the unit is capable of 0.25% measurements despite 10 V of common-mode noise.

CIRCLE NO. 270

Pick the  
**BEST IC**  
for the job

**Problem:** Four DC to 30 kHz signals from high impedance sources must be summed into a  $2k\Omega$ , 100 pF load. The output is to be a guaranteed minimum  $\pm 12$  volts over the full frequency and military temperature range. The logical choice would be a Radiation RA-909. But amplifier offset current drift must not exceed  $2 \text{ nA}/^\circ\text{C}$ . Pick the Best IC for the job.

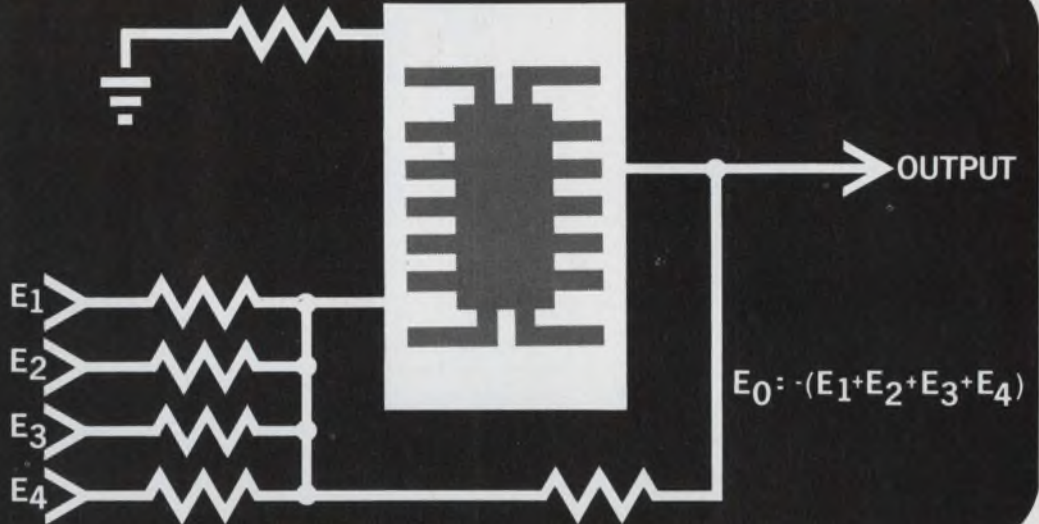

the **BEST** Solution:

### THE NEW RA-909A COMPENSATIONLESS OPERATIONAL AMPLIFIER



Drift error is very low in the new dielectrically isolated compensationless RA-909A. Between  $-55^\circ\text{C}$  and  $+25^\circ\text{C}$  offset current drift is a low  $2 \text{ nA}/^\circ\text{C}$ . From  $+25^\circ\text{C}$  to  $+125^\circ\text{C}$ ... an even lower  $0.5 \text{ nA}/^\circ\text{C}$ ! And Radiation guarantees less than  $15 \mu\text{V}/^\circ\text{C}$  offset voltage drift over the military temperature range. Compare this performance with any 709 type op amp over this extremely wide operating frequency range. You'll pick the Best op amp for the job. The RA-909A.

Like the RA-909, no external compensation is needed. Dielectric isolation and good circuit design eliminates the need for compensation. The RA-909A is in both a TO-99 package and a TO-86 flatpack configuration. A direct replacement for 709 type op amps.

Contact your nearest Radiation sales office. Let us help you pick the Best IC for the job.

WE MAKE THE **BEST IC** FOR THE JOB



**RADIATION**  
INCORPORATED

SUBSIDIARY OF HARRIS-INTERTYPE CORPORATION  
MICROELECTRONICS DIVISION

RADIATION SALES OFFICES: P.O. Box 476, Lexington, Mass. 02173, (617) 682-1055 • 600 Old Country Road, Garden City, N.Y. 11530, (516) 747-3730 • 2600 Virginia Avenue N.W., Washington, D.C. 20037, (202) 337-4914 • 6151 W. Century Boulevard, Los Angeles, California 90045, (213) 670-5432 • P.O. Box 37, Melbourne, Florida 32901, (305) 727-5430 • International Sales: Marketing Department, P.O. Box 37, Melbourne, Florida 32901, (305) 727-5412

INFORMATION RETRIEVAL NUMBER 56



**Plug-in PC card mixes 16 channels**

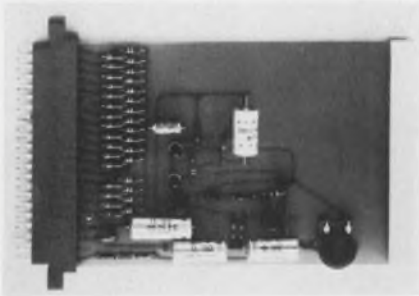

Fairchild Recording Equipment Corp., 10-40 45th Ave., Long Island City, N.Y. Phone: (212) 688-3300. Price: \$85.

A 16-channel mixing network packaged on a single plug-in card mixes up to 16 inputs into one buss, without gain loss. Model 692MNNL consists of a passive mixing network followed by an amplifier that provides gain of up to 20 dB. It accepts any source impedance of 600 Ω, or lower, and provides an interchannel separation of at least 70 dB.

CIRCLE NO. 271

**Dc-to-dc converters deliver 1 W in 1 in.<sup>3</sup>**

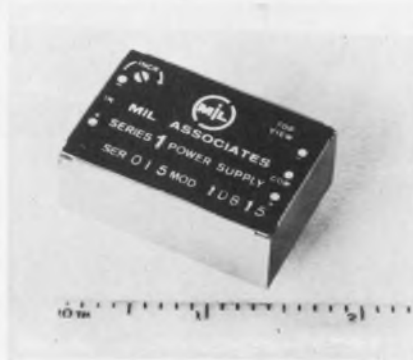

Mil Associates, Dracut Rd., Hudson, N. H. Phone: (603) 889-6671.

Supplying 1 W of power while occupying less than a cubic inch of space, dc-to-dc converters provide a single output from 4 to 100 V or dual outputs from ±4 to ±50 V. Ideal as regulators for ICs and operational amplifiers, series 1 is available with 24- or 28-V input lines. The PC-card units are supplied in sealed metal cases for protection from rfi.

CIRCLE NO. 272

**Balanced FET mixer compresses 2 dB**



Lorch Electronics Corp., 105 Cedar Lane, Englewood, N.J. Phone: (201) 569-8282. Availability: 2 wks.

Combining high power-handling capability with low intermodulation distortion, a double-balanced FET mixer operates at input powers as high as 1 W with only 2-dB compression over the frequency range of 0.2 to 100 MHz. Two-tone intermodulation ratio for model FC-351 is 140 dB, for third- and fifth-order products using two -30-dBm inputs.

CIRCLE NO. 273

Any knob will turn the equipment on. Kurz-Kasch design-oriented instrument knobs turn on the engineer, the designer, the user, 21 families, 347 stock knobs in a variety of thermosetting materials and colors brighten the products of 3,000 OEM's. You can be 3,001. Write for free catalog and samples!

**Turn yourself on with**

**FREE**

**KNOB SAMPLES**

from Kurz-Kasch

Kurz-Kasch, Inc.  
Standard Parts Division  
1415 S. Broadway  
Dayton, Ohio 45401  
(513) 223-8161

INFORMATION RETRIEVAL NUMBER 57

**10 WATTS FROM YOUR SIGNAL GENERATOR**

**RF-805 AMPLIFIER**



- 0.1 Volts In—22.5 Volts Out
- .05 MHz to 80 MHz Broadband
- Low Distortion
- Solid State
- Flat 47 db Gain

**\$980**

The RF-805 is a solid state amplifier, broadband from .05 to 80 megahertz, which produces ten watts with -30 db harmonic and intermodulation distortion. Lower distortion is available at lower output levels. Gain is 47 db minimum, constant within 1 db, so that full output is developed with less than 0.1 volt at the 50 ohm input. Accurate output metering and overload protection is provided.

The RF-805 will raise the power of most manual and swept tuned signal generators and thus extend the usefulness and versatility of available signal generators. Receiver testing, wattmeter calibration, antenna testing, RFI testing, attenuator measurements, and filter and component testing will be aided with the use of this equipment.



**R F COMMUNICATIONS, INC.**

1680 University Avenue • Rochester, N. Y. 14610

INFORMATION RETRIEVAL NUMBER 58

# Certified mix & match

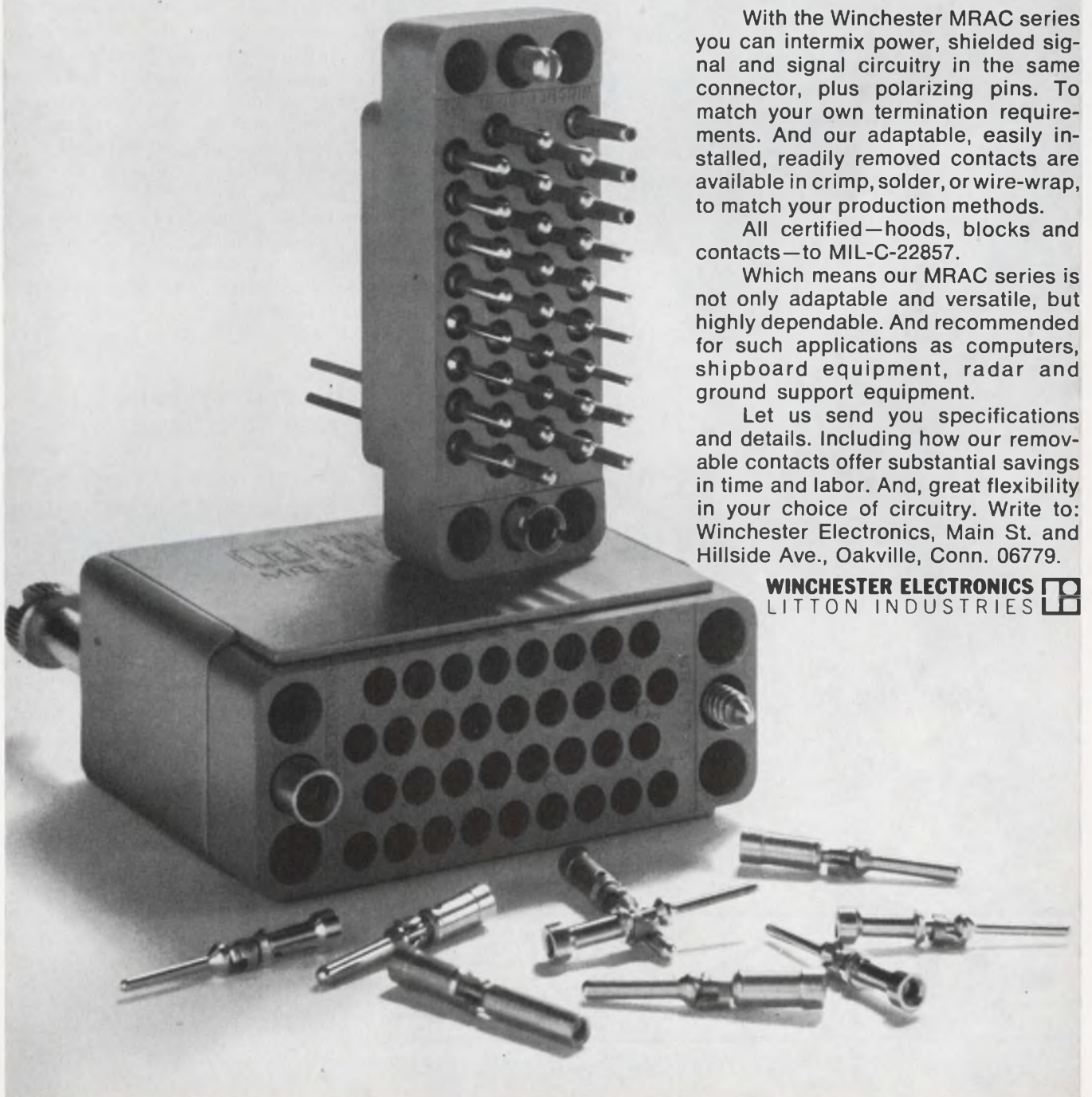

With the Winchester MRAC series you can intermix power, shielded signal and signal circuitry in the same connector, plus polarizing pins. To match your own termination requirements. And our adaptable, easily installed, readily removed contacts are available in crimp, solder, or wire-wrap, to match your production methods.

All certified—hoods, blocks and contacts—to MIL-C-22857.

Which means our MRAC series is not only adaptable and versatile, but highly dependable. And recommended for such applications as computers, shipboard equipment, radar and ground support equipment.

Let us send you specifications and details. Including how our removable contacts offer substantial savings in time and labor. And, great flexibility in your choice of circuitry. Write to: Winchester Electronics, Main St. and Hillside Ave., Oakville, Conn. 06779.

**WINCHESTER ELECTRONICS**   
LITTON INDUSTRIES



# WHICH?

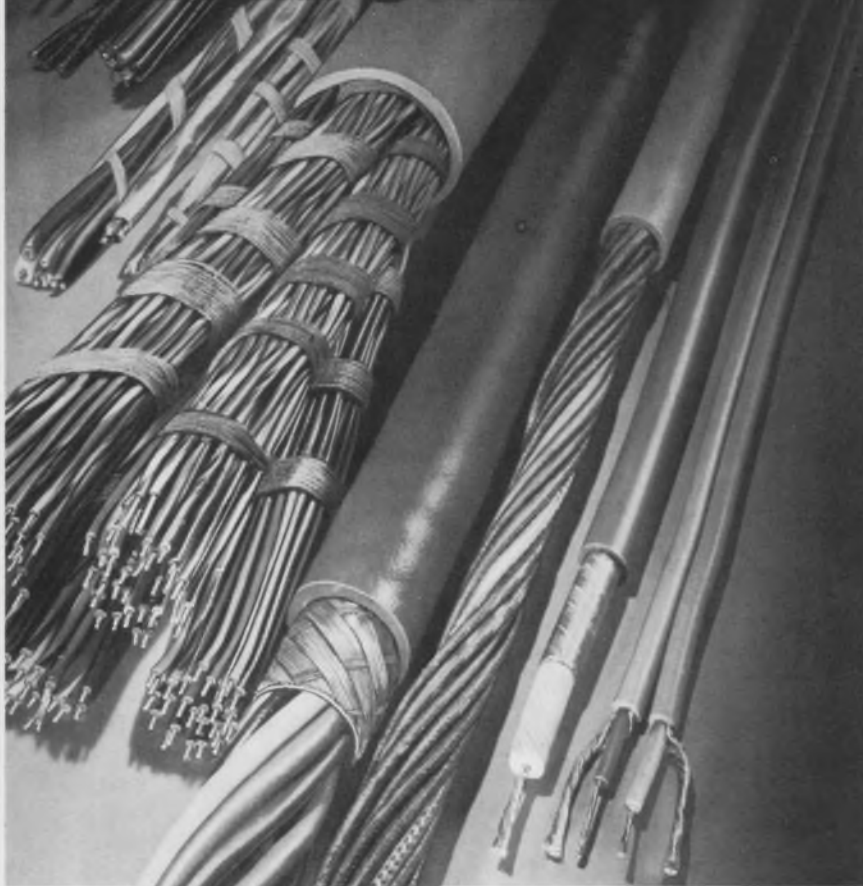

## LENZ MAKES THEM ALL... AND MORE!

No matter how sophisticated the system or how simple the device, Lenz can provide the necessary cables . . . quality-built, reliable, compact!

Lenz engineers have a broad knowledge of electronic equipment and complete familiarity with the environmental, electrical, temperature and mechanical characteristics of the wires and cables required.

Having a cable problem? Pass it along—Lenz will help find the solution, with no obligation, of course!



WRITE FOR  
NEW CATALOG!



## CABLES & WIRES

In Business  
Since 1904

LENZ ELECTRIC MANUFACTURING CO.

1755 No. Western Avenue, Chicago, Ill. 60647

INFORMATION RETRIEVAL NUMBER 60

DATA PROCESSING

### Digital comparator simplifies analysis



Computer Central, P.O. Box 5194,  
Detroit. Phone: (313) 837-5515.  
P&A: \$350; 4 to 6 wks.

Designed for use in digital feedback and servomechanism control systems, model 711 linear-range digital comparator subtracts the digital feedback quantity from the digital input and converts the difference to an analog actuating signal. The subtraction function is accomplished so quickly that sampled-data theory need not be applied to obtain predictable results. Although digital data is used and the output signal is actually discrete, it is usable as though it were continuous.

CIRCLE NO. 274

### IC a/d systems ease interfacing



Datawest Inc., 7503 E. Osborn Rd.,  
Scottsdale, Ariz. Phone: (602) 947-  
4295. Availability: stock to 60  
days.

Accommodating high or low signal levels, analog-to-digital interface systems use integrated circuits to simplify computer interface and lower interface costs. Series 370 systems are available in three versions: an a/d converter with buffer amplifier, a 96-channel single-ended or differential multiplexer with sample-and-hold and a/d converter, and a 256-channel unit with the same configuration as the 96-channel model.

CIRCLE NO. 275



You're in great shape

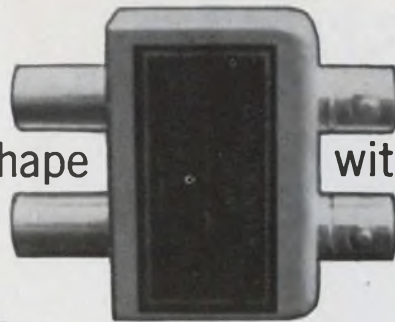

with **COTERM®**

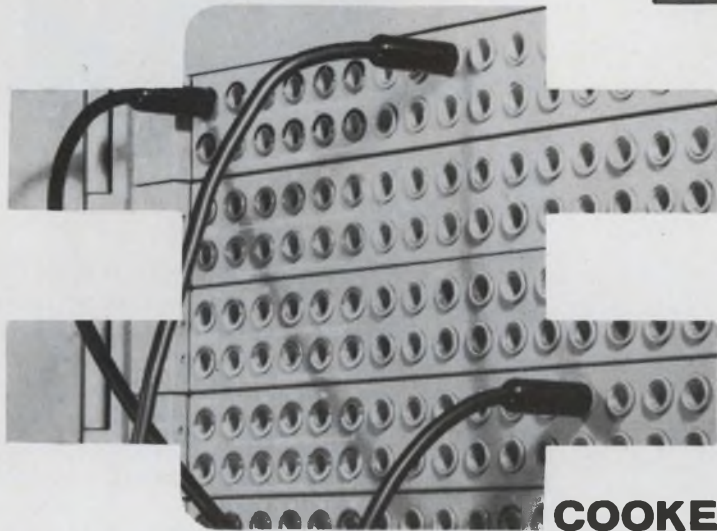

**NORMAL-THROUGH COAXIAL SWITCHING AND TERMINATING JACKS**

**COTERM®** is **COOKE**-designed so you know that it will give years of rugged use and trouble-free service. Available in 75 or 50 ohm impedances **COTERM®** provides normal-through video or other R-F circuits without patch-cords or plugs; it is completely self-terminating at the source when the load side is patched.

Find out more about **COTERM®**, send for data sheet #22T . . . no obligation of course. **COOKE** coaxial switching equipment . . . best by design.

**COOKE ENGINEERING COMPANY**

735 N. Saint Asaph St., Alexandria, Virginia 22314 (703) 548-3889

INFORMATION RETRIEVAL NUMBER 61

**NEW 20-Amp EBERT "MINIRELAY"**

Unique roto-plunger rides on modified Teflon\* TFE bearings for increased reliability! Now in all Ebert Standard Mercury Relays.

\*DuPont trademark



**free engineers' fact file**

on all-purpose Ebert Mercury Relays!

UP-DATE YOUR RELAY KNOW-HOW! Illustrated manual contains detailed data on 1, 2 and 3-pole Ebert Mercury Plunger Relays in sizes to 60 kW. FEATURES: MERCURY-TO-MERCURY CONTACTS • HERMETICALLY SEALED CONSTRUCTION • SILENT, SERVICE-FREE OPERATION.

WRITE FOR YOUR FREE COPY TODAY.



**EBERT ELECTRONICS CORP.**

130-10 JERICO TPKE., FLORAL PARK, N. Y. 11002

INFORMATION RETRIEVAL NUMBER 62

ELECTRONIC DESIGN 25, December 5, 1968

**INDICATORS**

Unlimited Variety

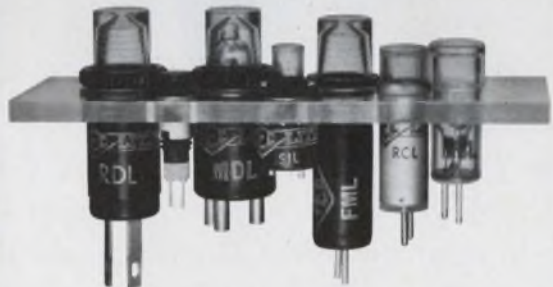

What's your need? TEC has it . . . electrically designed to cover most supply voltages. Neon or incandescent lamps; wide choice of options including integral switch. Some so compact they mount on 1/4" centers. For information about TEC's complete line of indicators and switches • readouts • display panels • data entry keyboards • CRT display terminals, call (612) 941-1100 or write:



**Transistor Electronics Corporation**

Box 6191 • Minneapolis, Minnesota 55424

INFORMATION RETRIEVAL NUMBER 63



# Digestible



Cinch-Graphik circuitry won't upset your system. Our recipe calls for liberal amounts of CARE, SKILL, and EQUIPMENT to be blended by experts into a rare treat in reliability. Cinch-Graphik knows that anything less is hard to stomach. CAUTION: A regular diet of Cinch-Graphik quality has been known to be fattening around the profits. Write for our illustrated brochure.

## CINCH-GRAPHIK

D I V I S I O N   O F   U N I T E D - C A R R



MEMBER  
200 South Turnbull Canyon Road, City of Industry (Los Angeles), Calif. 91744 • Phone (213) ED 3-1201. Sales offices in 33 principal cities throughout the United States, Great Britain, Canada, Australia and West Germany.

CONSISTING OF CINCH MANUFACTURING COMPANY, CINCH-GRAPHIK, CINCH-MONADNOCK, CINCH-NULINE, UCINITE (ELECTRONICS) AND PLAXIAL CABLE DEPT.

## DATA PROCESSING

### Data communicator selects coupling mode



*Nytron, 795 San Antonio Rd., Palo Alto, Calif. Phone: (415) 327-0490.*

Operating at a data rate of 300 baud, a data communicator transmits by acoustical coupling, and receives by switchable acoustic or magnetic coupling. Model DC-22 provides access to time-shared computers from teletypewriters or other similar data terminals via ordinary telephone lines. It links a computer in the full- or half-duplex mode, and communicates with other DC-22 units in the half-duplex mode.

CIRCLE NO. 276

### Nine-bit encoder updates Gray code



*Collectron Corp., 304 E. 45th St., New York City. Phone (212) 362-9067.*

Converting from a streamlined Gray code to binary, a nine-bit single-turn resolution encoder eliminates the unreliability of the lead-lag brush arrangement that is common to V-scan encoders. Using an internal IC package, the unit produces a high-resolution switch pattern that virtually eliminates edge noise and wiper bounce.

CIRCLE NO. 277

# THE ONLY SOLID-STATE AM/FM MODULATION METER

MODEL 2300



Carrier Frequency: 4 mc to 1000 mc

Sensitivity: 20 mV to 250 mc  
50 mV to 500 mc  
100 mV to 1000 mc

need we say more?

	<p><b>FM MEASUREMENT</b> Peak deviation in five ranges of 5, 15, 50, 150 and 500 kc. Modulating frequencies 30 cps to 150 kc. Suitable for AM or FM broadcast (mono or stereo) TV Sound, telemetry and communications.</p>		<p><b>AM REJECTION.</b> Less than <math>\pm 1</math> kc additional deviation error with 80% amplitude modulation superimposed at 1 kc using a 15 kc audio bandwidth.</p>
	<p><b>AM MEASUREMENT</b> for carriers to 500 Mc. Two ranges of 30% and 100% (usable to 95%). Peaks or troughs switch selected. Modulating frequencies 30 cps to 15 kc.</p>		<p><b>L. F. OUTPUT</b> Low distortion, low noise de-modulated signal derived from FM or AM carrier. Switchable de-emphasis 50 <math>\mu</math>sec and 75 <math>\mu</math>sec. Level 0dB into 600<math>\Omega</math> feeds distortion or wave analyser.</p>

WRITE FOR DETAILED CATALOG SHEET

## MARCONI INSTRUMENTS

DIVISION OF ENGLISH ELECTRIC CORPORATION

111 CEDAR LANE

• ENGLEWOOD, NEW JERSEY

• (201) 567-0607

INFORMATION RETRIEVAL NUMBER 65



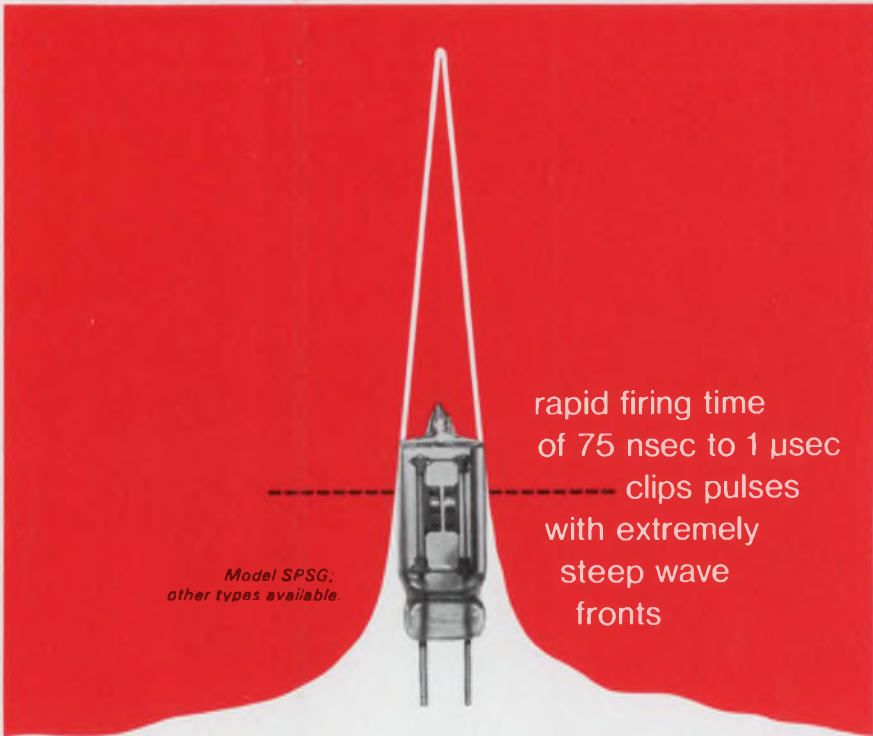

protect solid state  
circuits from  
catastrophic transient spikes  
with **VICTOREEN**  
**SPARK GAPS**

Extremely rapid firing time (as fast as 75 nsec, depending on circuit parameters) combined with excellent energy handling capabilities (100 joules for currents as high as 2000 amperes) anywhere in a broad range (85-5000 volts), including our new miniature version. And that's why they're providing sophisticated circuit designers with positive, economical protection for their solid state circuits.

Low interelectrode capacitance also makes them ideal for high frequency application where wave form must be preserved. In ignition applications, Victoreen Spark Gaps are used as hold-off devices to prevent current flow until circuit voltage reaches predetermined gap breakdown voltage. High repeatability and long service life enhance reliability of continuous duty systems in ambients from  $-65^{\circ}$  to  $125^{\circ}\text{F}$ . Shock resistance to 100g for 11 milliseconds, vibration resistance a full 10g from 55 to 2000 cps. For positive protection of exotic solid state circuits, call Applications Engineering Dept., (216) 795-8200, Ext. 306.

A-2732

**VICTOREEN INSTRUMENT DIVISION**  
10101 WOODLAND AVENUE · CLEVELAND, OHIO 44104  
IN EUROPE: GROVE HOUSE, LONDON RD., ISLEWORTH, MIDDLESEX, ENGLAND



INFORMATION RETRIEVAL NUMBER 66

PACKAGING & MATERIALS

**Two-piece harness clip  
aids heat dissipation**



*Electrovert, Inc., Components Div.,  
86 Hartford Ave., Mount Vernon,  
N.Y. Phone: (914) 664-6090.*

Because it raises a wire harness from the cabinet, Cradleclip harnessing system improves air circulation and heat dissipation while conserving space. Permitting on-the-spot wiring changes without destroying the harness, the system consists of binders and extensible clips for unsupported wiring, and cradles and extensible clips for supported wiring.

CIRCLE NO. 278

**Aerosol silicon fluid  
lubricates and protects**



*3M Co., Adhesives, Coatings and  
Sealers Div., St. Paul, Minn.  
Phone: (313) 646-5458.*

Designed for electronic applications, a spray silicone fluid lubricates, waterproofs, and protects painted surfaces, metal, rubber, plastic, wood, foam and fabrics. This heat-resistant product can lubricate moving parts, prevent sticking and freezing, protect against rust and corrosion, seal out moisture, and preserve plastic, rubber and leather.

CIRCLE NO. 279



**ATLAS**

Turned and  
Precision Ground

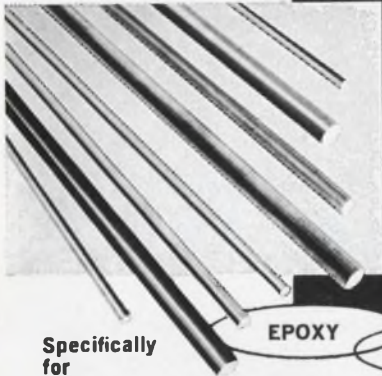

# PHENOLIC RODS

STOCK SIZES  
OR  
CUSTOM-MADE

Specifically  
for

**RELAY and SWITCH** applications

EPOXY

BAKELITE

Glass Supported  
TEFLON

- Most sizes available for immediate delivery
- Stock sizes in any diameter from 1/32" to 3/8"\*
- Increments of .001" at no extra charge
- Unsurpassed accuracy guaranteed to ±.001"\*

**COMPLETE  
FACILITIES  
FOR  
FABRICATION**

Atlas guarantees unequalled accuracy in the precision fabrication of parts from any of these materials. Send your blueprints and specifications for a prompt quote without any obligation.

\*Larger sizes and closer tolerances quoted on request.

**SEND FOR COMPLETE PRICE LIST**

**ATLAS FIBRE COMPANY**  
6970 N. Central Park Avenue  
Chicago, Illinois 60645

INFORMATION RETRIEVAL NUMBER 67

## IT'S A SNAP!

When you specify  
**CHICAGO SWITCH**  
for **LIGHTED SNAP-IN  
ROCKER SWITCHES**  
and **PANEL LIGHTS**

New snap action lighted rocker switches snap in instantly, hold securely and permanently, take less time to install, cost less to buy. Advanced design with wide application for O.E.M., industrial and military uses. Available in double and single pole, double throw and 3 position, center off, maintained or momentary. Unlighted types also available.

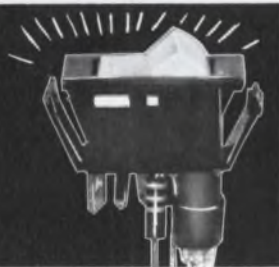

**PANEL LIGHTS**—incandescent or neon. Ideal way to indicate by color / shape—in round, square, triangular and rectangular lens. Available in Red, Green, Clear, Opal and Amber light with life span up to 25,000 hrs. Complete with lamp and slip-on spade terminals.

Want to start something?  
Send for samples and catalog.



**CHICAGO SWITCH**  
Div. of F & F Enterprises, Inc.

2035 Wabansia Ave., Chicago, Ill. 60647/Phone: (312) 489-5500 • Telex 25-3842

INFORMATION RETRIEVAL NUMBER 68

ELECTRONIC DESIGN 25, December 5, 1968

## Quickly snap PC boards on or off a chassis

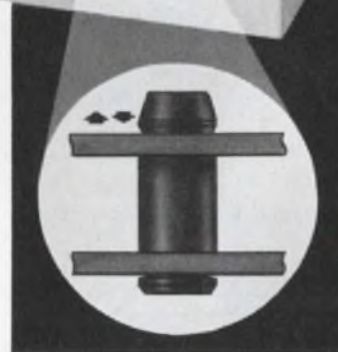
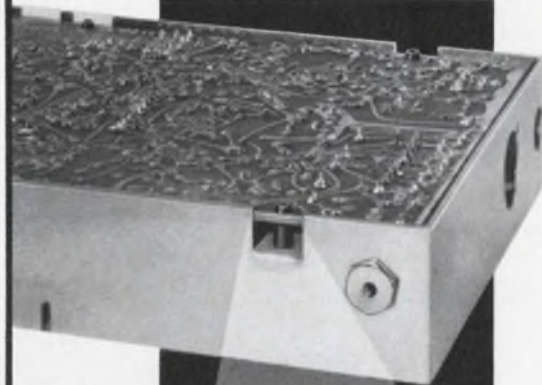

### with Johnson spacer/bushings

Now you can mount and insulate PC boards to panels or metal chassis without the use of nuts, bolts, and hollow spacers. When the grommet end of a Johnson polyamide spacer/bushing is snapped in pre-drilled or punched holes on the chassis or panel, it is in place to stay! The PC board, on the other hand, can be easily snapped on or off the opposite end of the spacer/bushings to facilitate service or modifications.

Machined from polyamide, Johnson spacer/bushings are designed for use on any 1/16" thick PC board, chassis or panel. By providing a mechanically secure, non-conductive, convenient mounting method, Johnson spacer/bushings can cut production time and costs substantially.

**FREE CATALOG** includes specs and prices on these and other high quality E. F. Johnson components. See your E. F. Johnson representative or write for your copy today.



**E. F. JOHNSON COMPANY**

3364 Tenth Ave. S.W., Waseca, Minnesota 56093

Providing nearly a half-century of communications leadership

INFORMATION RETRIEVAL NUMBER 69

133



### Lock for line plug controls equipment use



Efston Mfg. Co., Ltd., 400 Prairie Ave., Wilmette, Ill. Phone: (416) 630-3848. Price: \$2.50.

Lock-A-Plug is a device that prevents the unauthorized use of electric equipment. It functions by locking onto the prongs of an electric plug. This prevents the plug from being inserted into an electric outlet, and disables the equipment attached to it. The plug can be ejected from the lock by setting the combination dials and pressing the release button.

CIRCLE NO. 280

### Fast epoxy strippers work without heat



Kenics Corporation, One Southside Road, Danvers, Mass. Phone: (617) 774-8600.

Without requiring heat, epoxy stripping compounds completely remove most thermoset plastics from electronic modules and other devices in 2 to 24 hours without affecting circuits. Two versions are available, Kenstrip 901 and Kenstrip 902.

CIRCLE NO. 281

### Single-tier PC cards replace multilayers

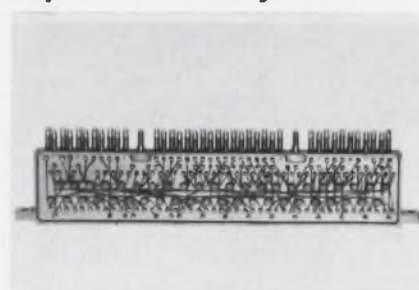

Sterling Electronics Corp., Microtechnology Div., 21525 Parthenia St., Canoga Park, Calif. Phone: (213) 385-2970.

Ideal replacements for costly multilayer cards, Micropoint printed-circuit cards permit a very high density of integrated circuits (15 per in.<sup>2</sup>) with all necessary wiring on only one layer. Twenty 14-lead flatpacks can be mounted on a standard card. Standard cards include terminals, edge gold-plated pads and 22 test points. Cards are 4.55 by 2.19 by 0.062-in.

CIRCLE NO. 282

# VARACTORS

**Silicon epitaxial abrupt junction or silicon alloy types with high voltage, high capacitance and high Q.**

Capacitances from 10 to 500 pf.  
Maximum working voltages from 15 to 200 volts.  
Figure of merit (Q) to 200 and higher.  
Power ratings from 0.5 to 2.0 watts.

Most JEDEC types available for use in telemetry and communications, electronic tuning, harmonic generation and parametric amplifiers. Available in large OEM quantities.

For free 8-page catalog (#VH-5) write at the address below. Or call 800-431-1850. (It's a local call from anywhere in the U.S.)

**Solitron** DEVICES, INC.

256 Oaktree Road, Tappan, New York 10983.

INFORMATION RETRIEVAL NUMBER 70

**Cheyenne — on target with Eastern's laser cooler**

Once it gets the range from its laser guided fire control system, the AH-56A close support helicopter can hit anything the gunner sees in his scope — with deadly accuracy.

Eastern's temperature control unit keeps the laser cool and on the job, under all flight conditions.

Today's leading military aircraft use Eastern thermal control to safeguard vital electronics. For laser cooling or other avionic temperature control equipment,

send for Bulletin 1364.



**EASTERN INDUSTRIES**

A Division of Laboratory For Electronics, Inc.  
100 Skiff Street • Hamden, Connecticut 06514

INFORMATION RETRIEVAL NUMBER 71

# 40,000 pf IN **1** SQUARE INCH

with SANGAMO

D-7 and D-10  
Dipped Mica Capacitors

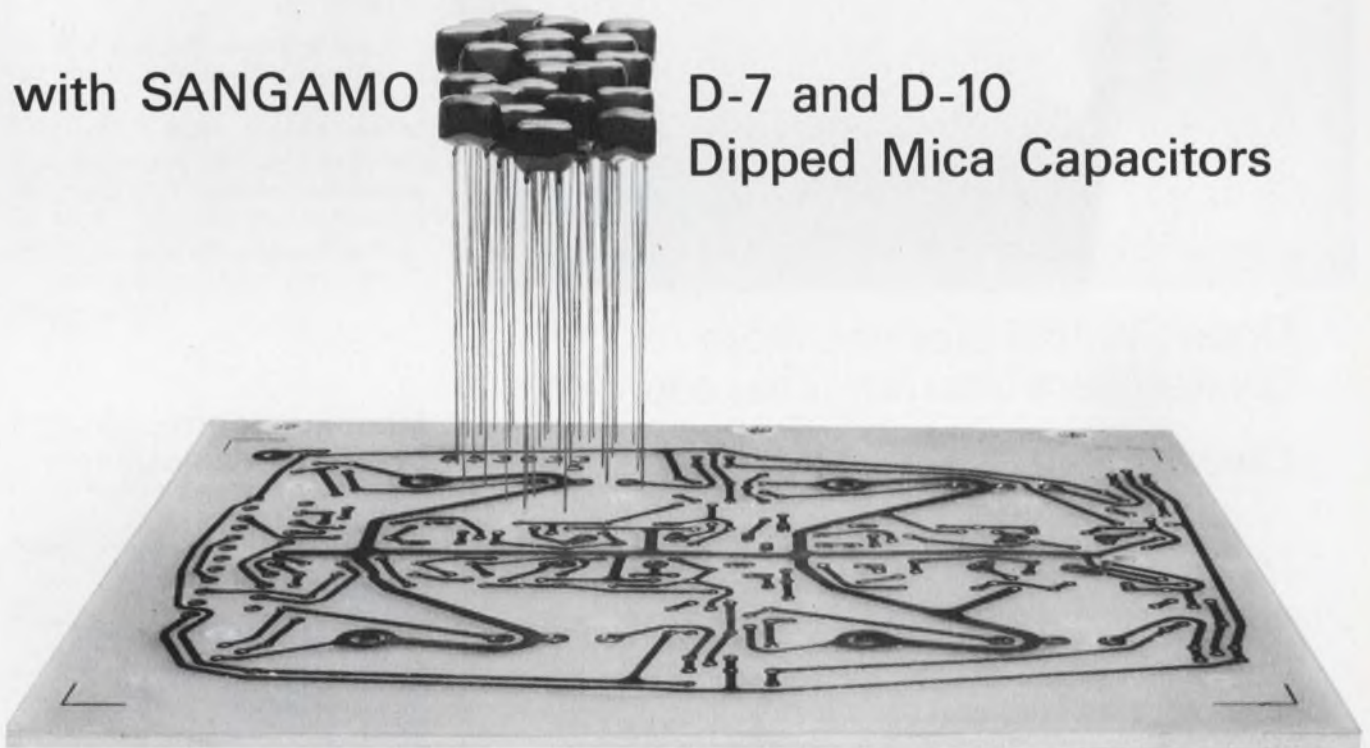

Sangamo makes these miniature dipped micas with up to 1500 pf—smallest in the industry with this much capacitance. Performance and stability are outstanding:

- T.C. retraceability as low as  $\pm .05\% + .1$  pf.
- Temperature coefficient as low as  $.007\%^\circ\text{C}$  (70 ppm).
- Q 1350 and higher above 82 pf.

These space-saving designs are the result of Sangamo's 45 years of experience in manufacturing dipped micas. We design and make them for every application—ask us for a quote!

**NEW, FASTER DELIVERY SCHEDULES**  
*Improved shipping and handling efficiency plus new production facilities assure fast delivery.*

*Dimensions as small as:*

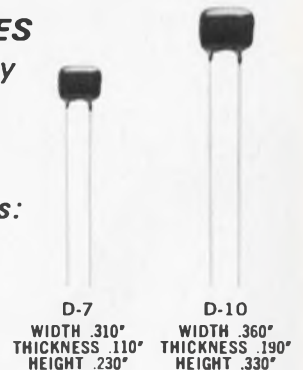

For samples and catalog, contact:

**SANGAMO ELECTRIC COMPANY**

Marketing Manager  
Capacitor Division  
Pickens, South Carolina 29671

Phone: 803-878-6311



INFORMATION RETRIEVAL NUMBER 72

EC68-2



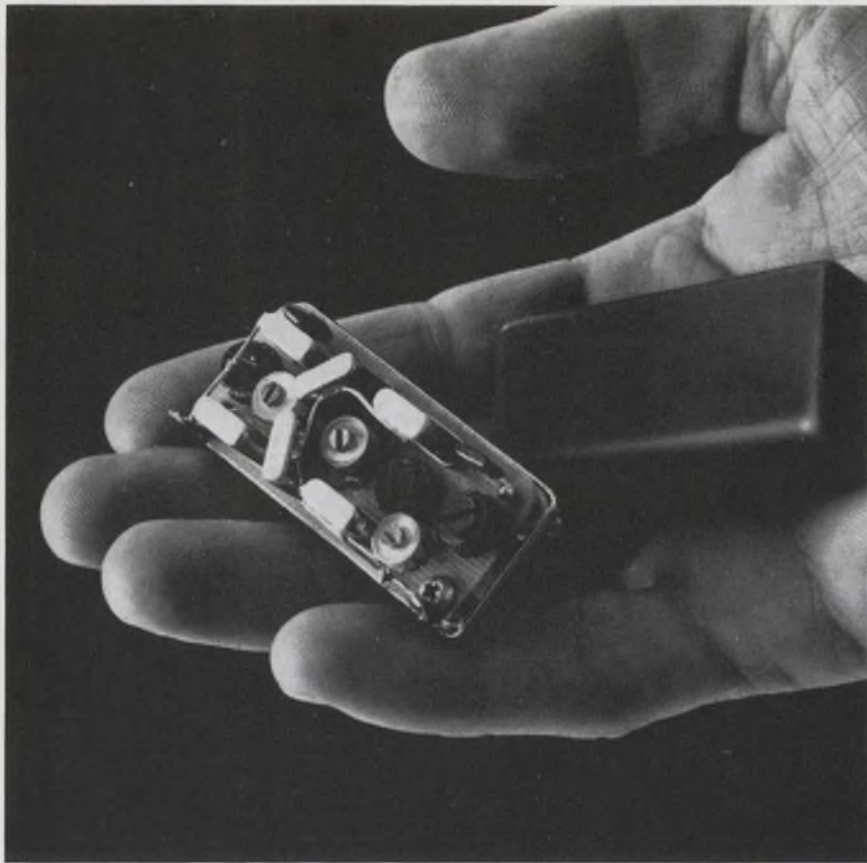

## Does Sherold produce more crystal filters than any other source?

### Clearly.

In fact, we're the largest single independent source for both crystal filters and discriminators. And we've built more PRC and VRC filters than any other company. Plus, we've got the widest range of models in production. But . . . biggest doesn't necessarily mean best, although it's a good indication. Sound out our crystal technology capabilities and you'll find Sherold has a solid reputation for being able to produce top-quality frequency selection devices in the full range from 1 to 150 megaHz. For commercial and military applications. The real proof, though, is to let Sherold tackle your frequency selection application. Send us the electrical and mechanical characteristics of your problem and we'll put our Filter Technology Department to work on it. Quickly. Write Sherold Crystal Products Group, Tyco Laboratories, Inc., 1510 McGee Trafficway, Kansas City, Missouri 64108. Or phone (816) 842-9792. TWX 910-771-2181.

# TYCO

INFORMATION RETRIEVAL NUMBER 73

## PRODUCTION

### Nylon-tipped pen controls flux flow



*BLH Electronics, Inc., 42 Fourth Ave., Waltham, Mass. Phone: (617) 894-6700.*

A nylon-tipped flux pen precisely controls the amount of flux required for all soldering tasks that involve making small connections. The liquid in the pen contains a special carrier that retards evaporation and provides even flow. In normal use and with proper care, the pen will last up to one year.

CIRCLE NO. 283

### Modular control system breadboards designs

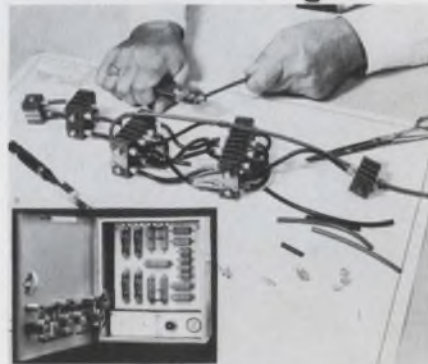

*Pnecon, Inc., 1st & Nevin Sts., Richmond, Calif. Phone: (415) 232-0476.*

Said to be compatible with, or adaptable to all electrical, hydraulic, or pneumatic controls, a modular control system with clip-together components forms an assembly that can be tested in minutes. Pressure-on and pulse indicators provide a quick visual check on system condition. The multiple-pilot unit features complete component selection of two-, three-, and four-way valves with pressure and mechanical actuators.

CIRCLE NO. 284

# 100,000 HOURS

OF BRUSH LIFE AT 3600 RPM  
WITH *Servo-Tek* TEMPERATURE  
COMPENSATED TACHOMETER

# GENERATORS



In fact, you could run these dc permanent-magnet generators continuously at 3600 rpm for the next ten years and still have a year and a half of brush life left. They boast a highly linear output and wide speed range making them ideal for velocity or integrating servos, while the low driving torque permits its use as a damping or rate signal in all types of servos. Linearity from 0 to 12000 rpm is better than 1/10 of 1% of voltage output at 3600 rpm. Various models are available with outputs as high as 45v 1000 rpm. The size is miniature. Approximate diameter is 1 1/8". Operates bidirectionally. The rpms value will not exceed 3% of the dc value at any speed in excess of 100 rpm. Single unit prices from \$25.50 with generous quantity discounts. Also available with a meter as a complete Speed Indicating System. ASK FOR CATALOG 1163.

**\$25<sup>50</sup>**

**SERVO-TEK PRODUCTS COMPANY**  
1086 GOFFLE RD, HAWTHORNE, N.J. 07506  
TELEPHONE 201-427-3100

INFORMATION RETRIEVAL NUMBER 74

# \$740

is the full price of Tenney's new  
bench type, high-low  
**SST Temperature chamber**

This sturdy new "Hermeticool" mechanically refrigerated chamber now available at a great low price. Check these features:

**Range:** -95° F to  
+350° F, ±1/2° F  
control

**Chamber Dimensions:**  
16" wide x 11" deep  
x 12" high

**Heatup:** To 350° F in  
35 minutes

**Pulldown:** From  
ambient to -95° F  
within 55 minutes

**Power:** 110 volts

**Temperature indicator**

**Available from stock**

Write or call today for complete details on  
Tenney Model SST

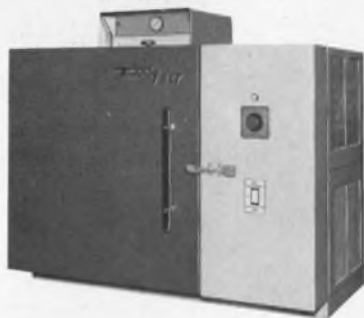

**Tenney**  
ENGINEERING, INC.

1090 Springfield Rd., Union, N.J. 07083 • (201) 686-7870  
Western Division: 15721 Texaco St., Paramount, Calif. 90723

INFORMATION RETRIEVAL NUMBER 75

ELECTRONIC DESIGN 25, December 5, 1968

# Make us put our reputation on the line.

Call up 3 relay manufacturers: Line Electric and 2 others. Ask for a quote on 1000 MK's and a sample to be sent to you. After you've made the three calls, check these simple questions.

1. Which company representative sounded the most knowledgeable?  
 Line Electric.  Company A.  Company B.
2. Which company gave you the best price?  
 Line Electric.  Company A.  Company B.
3. Which company representative was the most courteous?  
 Line Electric.  Company A.  Company B.
4. Which company said delivery would be made in six weeks?  
 Line Electric.  Company A.  Company B.
5. Which company said there was no charge for the sample, and that it would be in your hands first thing in the morning, with a letter confirming the price?  
 Line Electric.  Company A.  Company B.

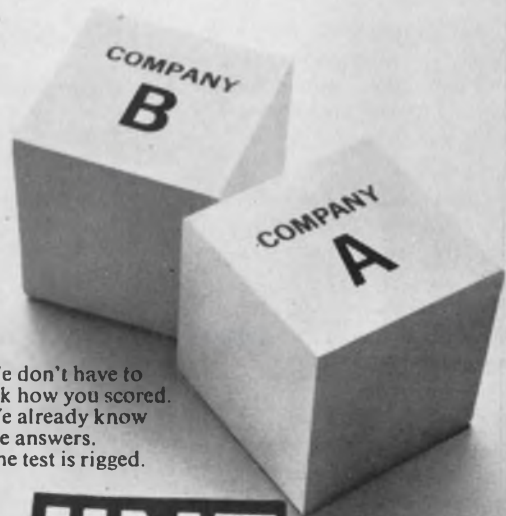

We don't have to  
ask how you scored.  
We already know  
the answers.  
The test is rigged.



The Line Electric  
Company. Manufacturers  
of Relays and the best  
service in the business.  
Send for 64 page catalog.  
U. S. HIGHWAY 287  
PARSIPPANY, N.J.  
07054  
A subsidiary of  
The Singer Company

305 U.S. Highway 287, Parsippany, N. J. 07054

INFORMATION RETRIEVAL NUMBER 76



# NEW O.E.M.

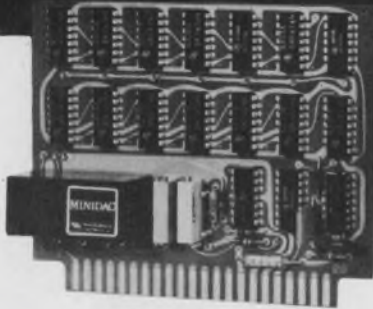

3 3/4" x 4 1/2" x 1/2"

## A-to-D Converter

Pastoriza offers the first utility converter for systems applications . . . priced for quantity sales.

Having first introduced the modular A-to-D and D-to-A converter, Pastoriza Electronics now offers an unprecedented innovation: A printed circuit card A-to-D converter featuring . . .

### High Performance

- 12 bits conversion in 8 microseconds.
- 10 bits conversion in 4 microseconds.
- 8 bits conversion in 2 microseconds.

### Low Cost

Priced competitively with any ADC available today, and designed for volume production.

### Open Book Concept

No black magic in the design — circuitry is accessible and repairable.

### User Confidence

Design and component information is supplied to insure ease and confidence in customer application.

This complete single-card A-to-D converter includes reference supply and comparison amplifier, using dual in-line integrated circuit logic with a MINIDAC D-to-A module. It accepts 0 to +10 volts input range, and provides up to 12 bits resolution.

Write for eye-opening facts on this newest modular A-to-D utility converter.

**PASTORIZA**  
ELECTRONICS, INC.

385 Elliot St., Newton, Mass. 02164 • 617-332-2131  
INFORMATION RETRIEVAL NUMBER 77

## Design Aids

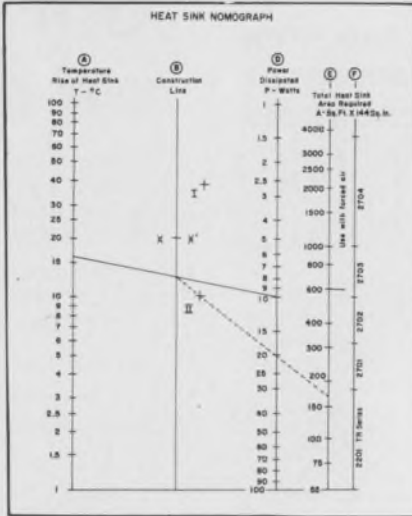

### Heat-sink nomogram

Sized and punched for insertion in standard three-ring binders, a heat-sink nomogram can be used to determine the total heat-sink area needed to cool a given semiconductor, when power dissipation and heat-sink  $\Delta T$  can be calculated from known conditions. Astrodyne.

CIRCLE NO. 285

### Letraset *instant lettering*



### Electronic symbols

A complimentary dry-transfer lettering sheet is offered as an aid to engineers and designers. Symbols, uniform and correct in each detail, conform to MIL-Std-15-1A and ASA-Std-Y32.2. The heat-resistant adhesive used permits reproduction in diazo and other high-speed printers. A short-form catalog is included with each sample. Datak Corp.

CIRCLE NO. 286



### Spectrum calculator

On one side, this new infrared calculator translates wavelength settings to other settings that represent specified organic and inorganic chemical groups. When the cursor is set to a given wavelength, the chart identifies most of the compounds that produce absorption bands at that wavelength. The flip side presents wavelengths of the main absorption bands, arranged according to 61 classes of chemical functional groups. Just match the cursor to chemical class—strong, medium or weak. Information on this nominally-priced design aid is available without cost or obligation. Barnes Engineering Co., Instrument Div.

CIRCLE NO. 287



### Connector selector

A circular slide chart is offered as a time-saving tool for designers who specify connectors. The combination of a selection chart and front-faced circular slide-rule simplifies the selection process. After setting the rule, the designer is referred to the appropriate page of an accompanying catalog for more detailed information. Thirty different lines of connectors are covered on the front and 23 PC models are detailed on the back. Winchester Electronics.

CIRCLE NO. 288

LOOK!  
we just invented  
the  
**electromechanical sequential switching device**

we just invented  
the word, that is.  
Not the product.  
It's been around for  
a long time.

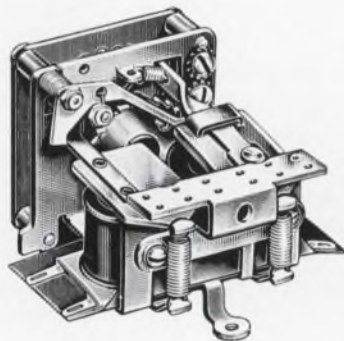

We usually call them stepping relays, or steppers for short. There's no need to re-invent them through costly scratch-design using a series of relays or circuitry. That costs lots more, and you've no guarantee of performance.

Guardian steppers are simple. They've been around for years performing all manner of sequential switching functions. And with all of the different types of steppers we offer, there's bound to be one that will do exactly what your design is attempting to do: but cheaper and perhaps better.

The types at your disposal include sequence selecting, automatic resetting, continuous rotation, circuit selecting, pulse multiplying, and counting. Also, slave and master, automatic homing, add and subtract and remote homing. They are available with up to 52 positions . . . up to 8 undivided circuits.

Ripe old engineers in dozens of equipment fields are familiar with Guardian stepper applications. We're counting on the bright young engineers to think up new ones. It helps to have our catalog F32. Why not write for it today.



**GUARDIAN<sup>®</sup>  
ELECTRIC**

**MANUFACTURING COMPANY** 1550 W. Carroll Ave. • Chicago, Illinois 60607





## New MINIDAC High-Speed D-to-A Converter in a small package

- 3/4" x 3/4" x 1 1/2"
- No Switching Transients
- Low Price

MINIDAC is an extremely versatile, UHF Digital-to-Analog converter module designed for driving into 100 ohm matching impedance. It may also be used with Operational Amplifiers for greater voltage ranges. These modules accept RTL, DTL or TTL input signals, include reference, switching, resistors, and provide currents of up to 10 ma. into resistive load.

Output voltage time constant is less than 30 nanoseconds and will settle to 0.1% in 200 nanoseconds. An external threshold adjustment permits user to adjust the actual switching threshold minimizing the variations in rise and fall times in his logic. Feed through of switching signals has been eliminated.

### APPLICATIONS

High Speed Scope Deflection Systems  
Time Compression  
High Speed A/D Converters  
Precision High Speed Test Circuits

MINIDAC units are available in up to 12 bits Binary or BCD input codes, and current output ranges of 4 and 10 ma. Maximum output voltage without amplifier is 2 volts. Custom designed D/A Converters including Buffer Storage and special output Amplifiers are available upon request.

**PASTORIZA**  
ELECTRONICS, INC.

385 Elliot St., Newton, Mass. 02164 • 617-332-2131  
INFORMATION RETRIEVAL NUMBER 79

## Application Notes



### Logic handbook

The 1969 edition of the Digital Control Handbook is aimed at anyone who specifies, designs, manufactures or uses electronic or mechanical logic for instrumentation and control. It contains useful information on the latest available techniques and products for implementing faster, cheaper and more reliable solid-state electronic control systems. Digital Equipment Corp.

CIRCLE NO. 289

### Tech note index

Over 80 technical papers, of which 35 were printed within the last year, are available at no charge. Subjects covered include semiconductors, integrated circuits, capacitors, resistors, hybrid circuits, and their applications. An index, listing titles and authors will be sent on request. Sprague Electric Co.

CIRCLE NO. 290

### Thermocouple data

A 44-page guide to the science and application of thermocouples and thermowells covers design philosophy and materials selection, and gives practical suggestions for specification. Special sections are devoted to electrical theory, circuitry, measurement standards, chemical and physical properties of materials, process connections, special coatings as well as other subjects of prime importance in this field. Pall Trinity Micro Corp.

CIRCLE NO. 291

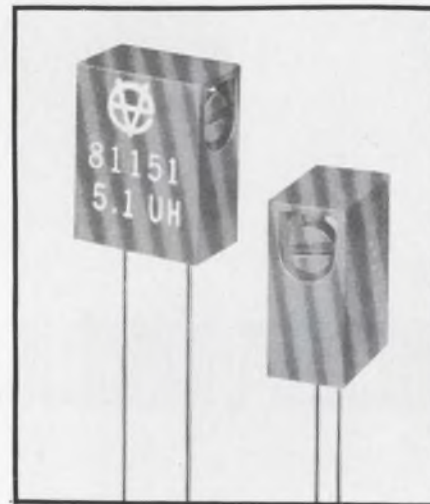

### Miniature toroids

Applications and operating characteristics of miniature high-frequency adjustable toroids are described in a new specifications brochure. Providing nominal inductance values in steps of 5%, with adjustability of  $\pm 5\%$  from nominal, the devices eliminate the need for variable capacitors in many applications. Vanguard Electronics, a division of Wyle Labs.

CIRCLE NO. 292

### Glass-to-metal seals

A series of specification sheets describes a line of hermetically sealed IC flatpacks, TO-8 and multi-pin TO-5 headers. More than 100 configurations of housings, including 45 standard flatpack designs, are described. Dimensioned component drawings with detailed specifications and application notes are presented in a three-color format that is suitable for ring binding. Veritron West, Inc.

CIRCLE NO. 293

### Thick-film hybrids

A five-page brochure discusses thick-film hybrid circuits. Ten basic steps in the thick film process are listed; thick-film components are covered, and components design criteria are tabulated. Varadyne, Inc.

CIRCLE NO. 294



### Scope news

The latest issue of "Service Scope" is available from Tektronix at no charge. The lead article explores the latest sampling techniques and discusses some recent scope accessories. The last two pages explain capacitor color codes; eight different capacitor types are covered. Tektronix, Inc.

CIRCLE NO. 295

### Cooling handbook

The "Forced Air Cooling Primer for the Electronics Engineer" is a pocket-size handbook intended primarily for the designer who must specify a forced-air cooling system for electronic equipment. Along with a basic design outline it provides checklists of those factors that affect reliability and that should be considered to achieve a sound cooling system. Henry G. Dietz Co., Inc.

CIRCLE NO. 296

### Shaft encoder primer

"Primer on Shaft Encoders" is designed to familiarize engineers with shaft encoders—what they are, how they operate, the tasks they perform, and their unique advantages. The engineer seeking shaft encoder information will find this objective booklet invaluable. Theta Instrument Corp.

CIRCLE NO. 297

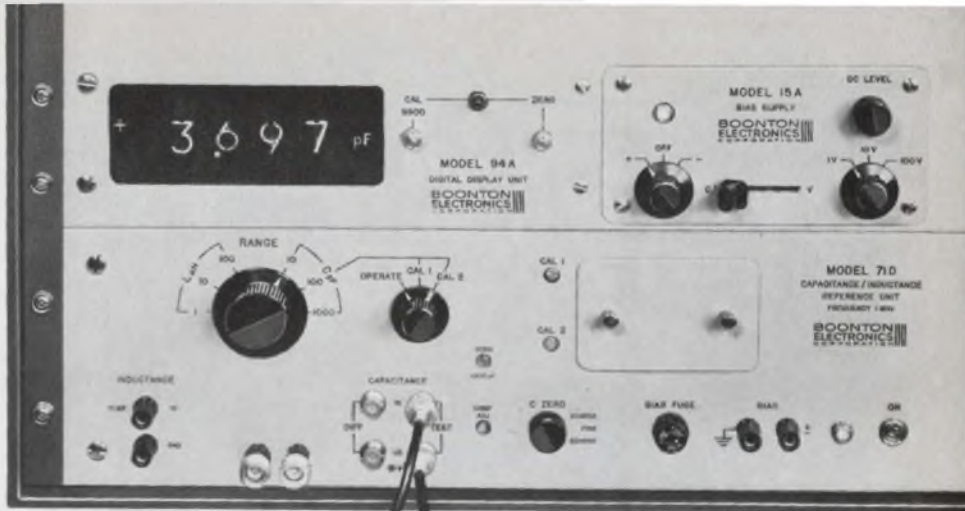

THE MODEL 700A



**NEW!**

## The First Digital 1 MHz C/L Meter

**I**t's not surprising that Boonton—No. 1 in 1 MHz capacitance measurements—would bring you a new instrument that provides digital read-out of both C (0 to 1000 pF) and L (0 to 100  $\mu$ H) with the speed (333 ms) and convenience of a DVM. And it's not surprising that with three C and three L ranges, plus 4-digit read-out and 40% overrange, you get usable .002 pF and .0002  $\mu$ H resolutions (five times better than the next best capacitance tester).

You'd naturally expect from a leader features like true, 3-terminal capacitance input which uses ground as a shield (unlike inconvenient guarded systems). And you'd expect the ability to make easy, error-free connections to jigs or component handling mechanisms to take full advantage of the 1/2% accuracy. You'd also expect built-in BCD outputs to feed a computer or printer. And digitally-displayed internal or external dc bias.

You'd likely have guessed that the Model 700A's crystal-controlled test frequency and fixed (15 mV rms) test level result in highly stable measurements (not usual with frequency shift systems). And you'd have guessed that it handles a wide range of Q (down to 3 for all capacitance and inductance values). And that it's easily self-checked with a built-in high Q and low Q, 100 pF standard.

But, after all, if you know Boonton, you've known right along that the Model 700A Digital 1 MHz C/L Meter just had to be good.

Price: \$2,500. Full specs on request, of course.

**BOONTON  
ELECTRONICS**  
CORPORATION

ROUTE 287  
PARSIPPANY, N.J. 07054  
Telephone: 201-887-5110  
TWX: 710-986-8241



# CRYSTAL FILTERS

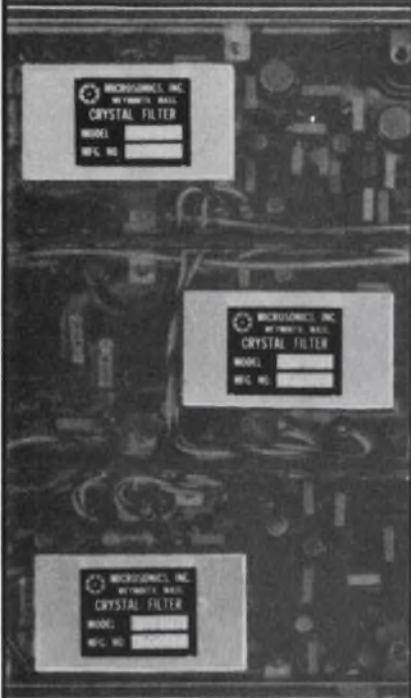

Microsonics, Inc. has designed and developed phase tracking crystal filters, in which the phase between filters will track within close tolerances, over wide temperature ranges, without temperature control. Any one of the standard multi-pole filters such as Butterworth, Tchebycheff, Bessel, etc. may be obtained with phase tracking requirements. In the event of tight tracking requirements, the filters are produced in matched sets according to the customer's requirements.

The set of 3 filters shown above have been produced in production quantities and the specifications are shown below.

## SPECIFICATIONS

**Center frequencies:** .....5MC  $\pm$ 150 cps  
**Bandwidth 3db:** .....1KC  $\pm$ 100 cps  
**Shape-factor 60/3db:** .....5:1  
**Ultimate rejection:** .....70db min.  
**Initial phase off-set:** .....1°  
**Phase tracking across the 3db bandwidth:** .....5° max.  
**Operating temperature:** -35°C to +75°C

Send for Microsonics' Brochure No. 4350



**MICROSONICS, INC.**  
 60 Winter Street  
 Weymouth, Mass. 02188  
 Tel: 617 337-4200

A subsidiary of the Sangamo Electric Company

## New Literature



### Microwave components

An 80-page catalog contains illustrations, diagrams and specifications for a broad product line of attenuators, terminations, filters, diplexers, coaxial switches, transfer switches, mixers, hybrids, directional couplers, line stretchers, and stub tuners. The catalog presents standard models, which include the specification combinations most widely used by the microwave industry. RLC Electronics, Inc.

CIRCLE NO. 321

### Antenna system

An antenna system that provides simultaneous reception from as many as 72 fixed-or-moving signal sources is described in a 6-page brochure. The system features polarization diversity reception and increases reliability under all propagation conditions, without need of additional array elements or land area. Sanders Associates, Inc., Ground Systems Div.

CIRCLE NO. 322

### Instrument knobs

Described in a 6-page catalog are machined aluminum knobs in a wide variety of shapes and sizes. These knobs are especially suited for use on expensive equipment, where appearance is a major consideration. Except for one series, all knobs are fitted with two set screws. Electronic Products, Inc.

CIRCLE NO. 323

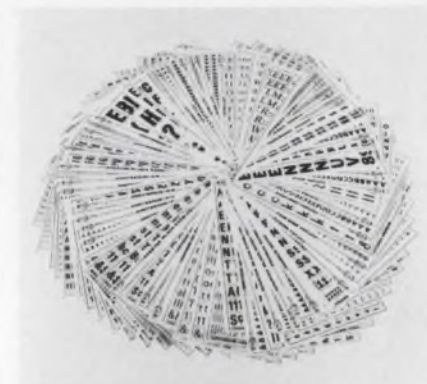

### Dry-transfer lettering

Free samples of dry-transfer lettering are offered in a package that includes a complete graphic-aids catalog. Once placed in position, this lettering can be rubbed onto any clean, dry surface. One hundred typefaces are available. Chartpak Rotex.

CIRCLE NO. 324

### Sweep generators

A 28-page catalog describes a complete line of sweep generators for testing circuits in the i-f, vhf, and uhf frequency bands. Complete descriptions and specifications on three basic series of sweep generators are included. Charts in the catalog simplify selection of the proper sweep generator and of functions for any application. Telonic Industries, Inc.

CIRCLE NO. 325

### Digital instruments

Precision industrial instruments are the subject of a 12-page illustrated catalog that gives prices and specifications of new solid-state digital equipment; these include a VOM, and a new electronic counter that is  $\pm$ 0.01% accurate up to 20 MHz. A new digital system is also shown that features plug-in modules for voltage, current and resistance measurements as well as automatic ranging. Simpson Electric Co., Div. of American Gage & Machine Co.

CIRCLE NO. 326

# The bird watchers



The modern bird needs careful tending. Minelco puts its unblinking "eyes" on guard for sure, safe, certain flight. Circuit faults must be pinpointed. Electromagnetic BITE (Built-In-Test-Equipment) indicators are there to spy. Equipment old-age must be thwarted. ECs (Events Counters) watch accumulated service; forecast remaining usefulness. Equipment over-use must be prevented. ETIs (Elapsed Time Indicators) provide valid "how long" data on equipment operation. Subminiature eyes—produced to military specifications. Eyes to measure aircraft reliability and maintenance needs; built to withstand extremes of vibration, shock, humidity, and temperature. Eyes for any type of aircraft, custom-built for any type of project. Minelco—for keeping a watch on the bird.



For additional information, contact:

## **MINELCO**

a subsidiary of



**GENERAL TIME**  
Progress in the World of Time

600 SOUTH STREET, HOLBROOK, MASS. 02343/(617) 963-7717

INFORMATION RETRIEVAL NUMBER 82



# STAMP OUT



# DAMAGED IN TRANSIT

with

## SKYDYNE CASES

Eliminate damaged equipment and costly delays

Skydyne offers a complete line of Fiberglass and A.B.S. Thermo-plastic carrying cases specifically designed to protect delicate electronic, optical, mechanical or other equipment against every hazard normally encountered in transit — Shock, vibration, moisture, and corrosive atmospheres included. Over 60 standard sizes are available from stock to meet virtually every requirement.

Let Skydyne provide you with the assurance that your equipment will arrive in one piece. Write for our complete catalog and price information.

*Skydyne, Inc.*

RIVER ROAD, PORT JERVIS, N. Y.  
Telephone (914) 856-5241

INFORMATION RETRIEVAL NUMBER 83

*WesCo*

## Aircraft and Industrial SOLENOIDS



Let WesCo engineers help solve your aircraft or industrial solenoid problem. Hundreds of proven designs available, or WesCo will design to meet your specifications.

Here are some of the features available:

- High temp units exceed 500°F.
- Adjustable plunger travel
- Units pressure sealed to 10,000 p.s.i.
- Push or pull types
- Miniature, medium and heavy duty types
- All voltages available

Please write for our latest brochure and, remember, when you think of solenoids, think of WesCo!



*The trademark  
on millions  
of solenoids  
since 1927*

**WEST COAST ELECTRICAL MFG. CO.**

233 WEST 116TH PLACE, LOS ANGELES, CALIFORNIA 90061 · PHONE (213) 755-1138

INFORMATION RETRIEVAL NUMBER 84

### NEW LITERATURE



#### Power supplies

A 64-page catalog gives complete electrical and mechanical specifications and gives prices of thousands of power supplies; these include regulated ac-dc, regulated dc-dc, and unregulated ac-dc or dc-ac. While most of those listed are of modular type for OEM applications, a line of laboratory supplies is also included. The catalog includes an extensive discussion of power supply thermal characteristics. Technipower, Inc.

CIRCLE NO. 327

#### Instruments catalog

Covering an entire line of digital instruments, a 20-page catalog gives complete technical details on digital voltmeters, multimeters, panel meters, electronic time and frequency measurement instruments, and curve tracers. Fairchild Instrumentation.

CIRCLE NO. 328

#### Capacitor bulletin

Axial-lead aluminum electrolytic capacitors that obsolete tantalum-foil capacitors are described in Bulletin 2240A. The new, 12-page booklet contains application, stability, design, and performance data for a line of capacitors. These small, low-cost units are available with capacitances that range from 3.3 to 1000  $\mu$ F. Sangamo Electric Co., Capacitor Div.

CIRCLE NO. 329

INFORMATION RETRIEVAL NUMBER 87 ►



# Cut Circuit Costs

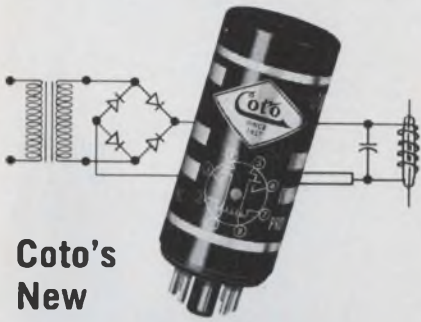

**Coto's  
New**

## A.C. Reed Relay

**Replaces Costly AC/DC Circuits!**

**Contacts:** Forms A or C with single or multiple poles.

**Ratings:** to 3 amperes or up to 5000 volts D.C.

**Inputs:** 60-800 Hz voltages available.

**Physical:** Available in 8 and 11 pin plug-in housings with electromagnetic shielding. Electrostatic shielding available on order.

Write for complete specifications. For special requirements, give complete details for quotation.

**Coto-Coil COMPANY, INC.**  
59 Pavilion Ave.  
Providence, R. I. 02905  
Phone (401) 941-3355

INFORMATION RETRIEVAL NUMBER 85



2 1/2 in. AP-2

## Snap-in Dial

2% full scale accuracy,  
self-shielded panel meters

New! Panel meters with plastic bezels give you tailor-made meters at no increase in price. Covers snap off . . . interchangeable dials snap in. High torque mechanism offers 1% linearity, 2% accuracy and sensitivity to 20 ua. Magnetic system is unaffected by external field influences, mounts on any material without interaction. Size: 2 1/2". Choice of colors and finishes. ASA/MIL 3 or 4-stud mount.

**AMMON**

AMMON INSTRUMENTS, INC.  
345 Kelley St., Manchester, N. H. 03105

INFORMATION RETRIEVAL NUMBER 86

ELECTRONIC DESIGN 25, December 5, 1968

### Military cases

A 16-page catalog lists 103 sizes of aluminum military transit and combination cases that meet MIL-C-4150, and presents detailed dimensional drawings. Cases can be modified to meet MIL-T-945, MIL-T-21200, MIL-T-4734, MIL-T-4807, MIL-E-4970, and MIL-Std-108 Class 1. These seamless cases are hydraulically deep-drawn of 6061 aluminum alloy and are heat treated to a T4 condition. Zero Manufacturing Co.

CIRCLE NO. 330

### Microwave loading

A 6-page brochure describes an iron-loaded plastic matrix. Illustrated with available shapes, sizes and technical data, the booklet provides the engineer with a design reference for terminations, attenuations and other loadings, as required for a particular system. Filmohm Division, Solitron-Microwave.

CIRCLE NO. 331

### IC hybrids

A 16-page brochure on hybrid microelectronic circuit modules explains the advantages of hybrid thick-film circuits, hybrid thin-film circuits, and silicon monolithic integrated circuits. Typical applications of hybrid technology, of packaging considerations, and methods for designing thick-film hybrid circuits are also considered. Raytheon Co., Industrial Components Operation.

CIRCLE NO. 332

### Nickel alloys

A revised 52-page booklet covers both high-nickel and nickel-containing alloys. The booklet presents each alloy's composition, its physical constants, and its thermal properties. Charts and graphs, and sections on metallography and engineering data are included. Huntington Alloy Products Div., The International Nickel Co., Inc.

CIRCLE NO. 333

INFORMATION RETRIEVAL NUMBER 87

Product of Sigmund Cohn Corp.



# Beryllium Copper "Memory" Wire

Every step of production is progressively checked under uncompromising quality-control . . .

Assurance that this Beryllium Copper Wire conforms to the high standards of performance maintained by our plant for more than 67 years . . .

Write for engineering data

**Sigmund  
Cohn Corp.**

121 So Columbus Ave.,  
Mt Vernon, N.Y. 10553



Since 1901





working with  
thin chassis  
materials?

you need  
**Sealectro**

**Riv-Loc**<sup>TM</sup>

semi-assembled  
**Teflon-Insulated  
terminals**

SIMPLE FAST ECONOMICAL INSTALLATION

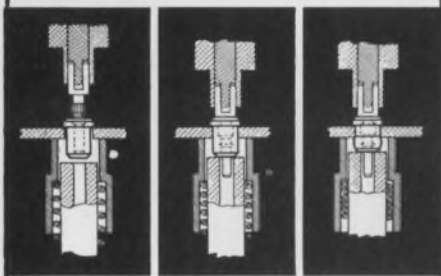

**PUSH! POP! IT'S IN!**

Riv-Loc Teflon-insulated semi-assembled terminals are specifically designed to overcome problems inherent in other types of semi-assembled terminals... especially height misalignment and faulty installation in thin chassis materials. Riv-Loc provides ease of assembly and maximum mechanical and electrical reliability. They are installed from the major diameter side requiring only the simplest of tooling and can be readily adapted to automated assembly techniques.

A complete selection of Stand-offs and Feed-thrus are included in Sealectro's Riv-Loc line. Why not check Sealectro for the solution to your requirements. Write for the complete Riv-Loc catalog.



CIRCUIT HARDWARE DIVISION

**SEAELECTRO**  
CORPORATION

MAMARONECK, N. Y. 10543

PHONE: 914 698-5600 TWX: 710-566-1110

Sealectro Ltd Portsmouth, Hants, England

Sealectro S.A. Villiers-le-Bel, Paris, France

\*Registered Trademark E. I. DuPont De Nemours & Co.

## NEW LITERATURE

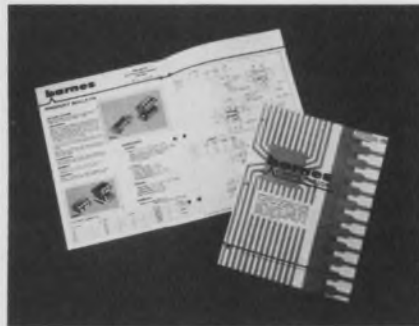

### MSI/LSI hardware

An 8-page catalog covers a complete line of stock MSI and LSI flat-pack and dual in-line sockets, carriers and contactors. Data tables list different models according to variations in package sizes and spacing and number of leads. Photographs and detailed dimensional drawings of each device show the reader what has been developed. Barnes Corp.

CIRCLE NO. 334

### Precision instruments

Catalog 600 describes precision resistance decades, decade voltage dividers, potentiometer circuits, resistance bridges and a wide variety of Wheatstone bridges for general use. Also described are bridges for such applications as fault location and testing; a megohm Wheatstone bridge assembly that measures resistances to  $10^{12} \Omega$ , given to four significant figures; and a magnetic bridge assembly for rapid measurement of either Epstein specimens or laminated cores. Shallcross.

CIRCLE NO. 335

### Panel-meter catalog

A two-color, 16-page catalog of panel and switchboard meters offers information on a full line of instruments that feature taut-band suspension systems and the transducer method of input control. Complete technical data, and physical dimensions, along with ordering information, is given for meters with knife-edge or lance-type pointers. Complete data are also given on a broad line of accessories. Voltron Products, Inc.

CIRCLE NO. 336



### Resistor catalog

Covering standard wirewound and film resistors, a 56-page catalog presents a complete range of resistive components. Included for the first time are established-reliability film and bobbin resistors, miniature epoxy-molded bobbin resistors, housed film resistors for through-chassis mounting and a complete line of wirewound, film, and cermet packaged networks. Dale Electronics, Inc.

CIRCLE NO. 337

### Light emitters

The performance and physical characteristics of light-emitting semiconductors are detailed in a new short-form catalog. Data on visible and infrared light-emitting diodes, injection lasers, photo-coupled pairs and diode arrays are presented in convenient tables and figures. Included are data on two photo-coupled pairs, one photo diode, one photo resistor, six new semiconductor injection lasers, and additional visible and infrared light emitters. Monsanto Co., Electronic Special Products.

CIRCLE NO. 338

### Answer to question 3, p. 77

No. A way to approach the problem is to substitute a small resistor for the short-circuit and thus make the admittance matrix finite.

Announcing—

**New Blu-Ray 1042  
table-top whiteprinter...  
offers dependable  
high speed production  
at a budget price!**

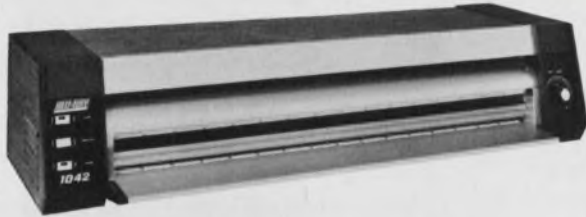

**Speeds to 22 feet/minute.**

Model 1042 is the big producer in our line of low-cost, compact whiteprinters. It challenges the output of big costly printers.

So check these 6 features—if they meet your production needs—you can save a lot of money:

1. Makes up to 400 "D" size prints per hour. Takes prints to 42" wide.
2. 4 ultra-fast fluorescent lamps—easy and inexpensive to replace.
3. Diazo materials cost only 1¢ per sq. ft.
4. Always ready to go—no waiting for warm-up.
5. Synchronized printer and developer.
6. Dependability backed by BLU-RAY's exclusive 1-year warranty.

The new 1042 has already proved its worth, which isn't surprising when you consider BLU-RAY has led in compact whiteprinter sales for 13 years!

Send for free brochure  
and a demonstration by  
one of our 600 dealers  
coast to coast.

**BLU-RAY**

INCORPORATED

3934 Westbrook Road  
Essex, Conn. 06426  
Phone (203) 767-0141

INFORMATION RETRIEVAL NUMBER 89

## CRATEX RUBBERIZED ABRASIVES

**DEBURR  
SM-O-O-T-H  
POLISH**



\$7.50 BUYS IT ALL—80 piece introductory Kit 777 equally assorted in 4 grit textures: coarse, medium, fine and extra fine. **TRY IT**—Cratex Rubberized Abrasives improve the surface while preserving critical workpiece dimensions by its unique cushioning action. **FINISH THE JOB**—to your most exacting specifications—often in a single operation. **SEND FOR KIT 777**—or your **FREE SAMPLE** and catalog illustrating the full Cratex product line and its applications.

**CRATEX<sup>®</sup> RUBBERIZED  
ABRASIVES**

1600 Rollins Road • Burlingame, California  
Sold through leading industrial distributors

INFORMATION RETRIEVAL NUMBER 90

ELECTRONIC DESIGN 25, December 5, 1968

## UP-TO-THE-MINUTE BOOKS ON CONTEMPORARY ELECTRONICS FROM MCGRAW-HILL



**1 SOURCEBOOK OF ELECTRONIC CIRCUITS.** By JOHN MARKUS. Over 3,000 different electronic circuits, each complete with values of all components, are logically arranged here in 100 chapters for easy reference. With each circuit is a concise description of its significant features, performance data, and operating characteristics, as an aid in choosing quickly the circuit that most closely meets current needs. **888 pp., \$18.50**

**2 PRINCIPLES OF DATA COMMUNICATION.** By R. W. LUCKY, J. SALZ and E. J. WELDON, JR.—NEW. This book covers such important areas as channel characterization, fundamental bounds on performance, pulse transmission and systems optimization, automatic and adaptive equalization, linear and nonlinear modulation techniques, coding theory and error-control techniques. **433 pp., \$14.50**

**3 MICROELECTRONIC PACKAGING: Interconnection and Assembly of Integrated Circuits.** By GEORGE SIDERIS—NEW. These articles cover that portion of circuit and system design concerned with device and circuit interconnection, functional division of the system into sub-assemblies that are convenient to produce and maintain, and the design and fabrication of the circuit and system interconnection structure, mechanical hardware, and cooling methods. **299 pp., \$12.50**

**4 MODERN ELECTRONIC CIRCUIT DESIGN.** By JAMES D. LONG.—NEW. From analysis to design, the practical application of circuit theory is stressed, and nearly ever design procedure is illustrated by a worked out example of a typical on-the-job problem. Use these instructions as models for your own design problems, or as tools for correct design procedures. **282 pp., \$12.50**

**5 COMPUTER-AIDED INTEGRATED CIRCUIT DESIGN.** By GERALD J. HERSKOWITZ.—NEW. This book focuses on three broad areas vital to integrated circuit design: modeling procedures, including the determination of model parameters experimentally; network and system computer techniques to the design of integrated circuits; applications of modeling and computing techniques to realize specific integrated circuit designs with the aid of a computer. **423 pp., \$15.00**

**6 TRANSFORMERS FOR ELECTRONIC CIRCUITS.** By NATHAN R. GROSSNER. This comprehensive guide concentrates on basic principles and fundamental relationships. It avoids complicated equations on the realistic assumption that most users today *select* rather than design their transformers. The book helps practicing engineers to obtain optimum performance from their transformers . . . to write specifications with greater confidence . . . and to consult a number of practical charts and tables. **384 pp., \$14.00**

At your bookstore or send coupon for

**10 DAYS FREE EXAMINATION**

McGraw-Hill Book Co., Dept. 23-ED-125  
330 West 42nd Street, New York, N. Y. 10036

Send me the book(s) circled below for 10 days on approval. In 10 days I will remit for book(s) I keep, plus a few cents for delivery costs, and return others postpaid. Include local sales tax if applicable.

1 40443-4      2 38960-1      3 57343-6      4 38670-6  
5 28395-2      6 24978-9

Name (print) \_\_\_\_\_

Address \_\_\_\_\_

City \_\_\_\_\_

State \_\_\_\_\_

Zip Code \_\_\_\_\_

Offer good in U.S. and Canada only.

23-ED-125

INFORMATION RETRIEVAL NUMBER 91



# Design Data from Manufacturers

Advertisements of booklets, brochures, catalogs and data sheets. To order use Reader-Service Card.  
(Advertisement)

## A FREE Cross Reference Guide



### to better Printed Circuit drafting

No engineer or draftsman should be without the NEW 1968 By-Buk Printed Circuit Drafting Aids P-45 Catalog with color-coded MIL-SPEC sizes. Also contains over 2000 pads, shapes, tapes, transistor tri-pads, spaced integrated circuit terminal pad sets and many other drafting aids for faster, more accurate, distortion-free printed circuit master drawings. Send for your FREE catalog.

### By-Buk Company

4326 West Pico Blvd., Los Angeles, Calif. 90019  
Telephone: (213) 937-3511

171

## NEW 28 PAGE PATCHING CATALOG



A new color coded catalog covering the latest in high performance patching equipment is available from Trompeter Electronics. Standard patch panels, miniature panels, jacks, patch cords, looping plugs, parallel networks, coax, twinax and triax connectors, cable and accessories are covered. Write for this complete catalogue today.

### Trompeter Electronics, Inc.

8936 Comanche Avenue  
Chatsworth, California 91311

172

## Latest Hybrid Microcircuit Capability



New brochure contains engineering, manufacturing and applications data on Burroughs Total Hybrid microcircuit capability. Burroughs now offers the entire circuit package\* and its components - all designed and fabricated under the eyes of experts in one complete in-house operation, providing economy, high reliability, quality control and prompt delivery. Features include hermetic packaging, MSI capability, computer test facility, and fully documented to MIL Q-9858A and MIL I-45208. Write for brochure and applications notes.

\* Circuits are available in various configurations with resistors, capacitors, and discrete IC and MSI chips, mounted.

### Burroughs Electronic Components Division

P.O. Box 1226, Dept. HI, Plainfield, N. J. 07061 Tel. 201-757-5000

173

# Electronic Design

ELECTRONIC DESIGN's function is:

- To aid progress in the electronics manufacturing industry by promoting good design.
- To give the electronic design engineer concepts and ideas that make his job easier and more productive.
- To provide a central source of timely electronics information.
- To promote two-way communication between manufacturer and engineer.

**Want a subscription?** ELECTRONIC DESIGN is sent free to qualified engineers and engineering managers doing design work, supervising design or setting standards in the United States and Western Europe. For a free subscription, use the postfree application form inside the back cover. If none is included, write to us direct for an application form.

If you do not qualify, you may take out a paid subscription for \$25 a year in the U.S.A., \$35 a year elsewhere. Single copies are \$1.50 each.

**If you change your address,** send us an old mailing label and your new address; there is generally a prepaid postcard for this inside the back cover. You will have to requalify to continue receiving ELECTRONIC DESIGN free.

**The accuracy policy of ELECTRONIC DESIGN is:**

- To make reasonable efforts to ensure the accuracy of editorial matter.
- To publish prompt corrections whenever inaccuracies are brought to our attention. Corrections appear at the end of the Letters column.
- To refuse any advertisement deemed to be misleading or fraudulent.

**Microfilm copies are available** of complete issues of ELECTRONIC DESIGN and individual articles, published since the beginning of 1961. Complete issues cost 4¢ a page, articles cost 50¢ a page; shipping and handling charges are extra. The minimum charge is \$3. For further details and to place orders, contact University Microfilms, Inc., 300 N. Zeeb Road, Ann Arbor, Mich. 48106; telephone (313) 761-4700.

**Want to contact us?** If you have any comments or wish to submit a manuscript or article outline, address your correspondence to:

Howard Bierman, Editor,  
ELECTRONIC DESIGN,  
850 Third Avenue,  
New York, N.Y. 10022.

# REED RELAYS

Certifiable to  
MIL-R-5757/29B



- Choice of 14 basic Form A, Form C, and combinations of A and C capsules in three standard-size metal cases.
- Coils: 6, 12, and 26.5 volts, or to specifications.
- Printed-circuit-type pin contacts on standard 0.1-inch grid spacing, in standoff insulating header.
- All units magnetically and electrostatically shielded.
- Resists humidity, vibration, and shock.
- Fast operate-time; long life; high reliability.

Ask for Bulletin GR-5.



Box 858, Clark, N.J. 07066 Tel. 201-382-7373  
INFORMATION RETRIEVAL NUMBER 92

## YOUR HEART FUND FIGHTS

HEART ATTACK  
STROKE  
HIGH BLOOD  
PRESSURE  
INBORN HEART  
DEFECTS



## Electronic Design

Advertising Sales Staff

New York 10022

Robert G. Drake  
Sales Manager  
Edward F. Clancy  
Sales Service Manager  
Robert W. Gascoigne  
Thomas P. Barth  
Samuel M. Deitch  
Byron Adams  
850 Third Avenue  
(212) Plaza 1-5530  
TWX: 867-7866

Philadelphia 19066

William C. Repetto  
P. O. Box 206  
Merion Station, Pa.  
(215) MA-3-5888

Boston 01945

Richard Parker  
P.O. Box 645  
Clifton Station  
Marblehead, Mass.  
(617) 742-0252

Chicago 60611

Thomas P. Kavooras  
Berry Conner, Jr.  
200 East Ontario  
(312) 337-0588

Cleveland

(216) 247-7670

Los Angeles 90303

Stanley I. Ehrenclou  
John V. Quillman  
W. James Bischof  
2930 Imperial Highway  
Inglewood, Calif.  
(213) 757-0183

San Francisco 94022

Arthur R. Shields, Jr.  
175 San Antonio Rd., S 243  
Los Altos, Calif.  
(415) 941-3084

London W. 1

For United Kingdom & Holland  
Brayton C. Nichols  
44 Conduit Street  
Tel: REGent 4714

Verviers, Belgium

For Continental Europe  
Andre Jamar  
1, Rue Mallar, 1  
(087) 253.85 Telex 41563

Tokyo

Yoshihiro Takemura  
IPS Group Ltd.  
Box 36, Ohsaki Post Office  
Phone (431) 5804



AMERICAN BUSINESS PRESS, INC.

The TRUE electronic solution to a major problem of engine operation!

## DELTA'S FABULOUS MARK TEN®



Only \$44.95 ppd.  
In easy-to-build Deltakit®  
Only \$29.95 ppd.

## CAPACITIVE DISCHARGE IGNITION SYSTEM

You've read about The Mark Ten in *Mechanix Illustrated*, *Popular Mechanics*, *Electronics* and other publications!

Now discover for yourself the dramatic improvement in performance of your car, camper, jeep, truck, boat—any vehicle! Delta's remarkable electronic achievement saves on gas, promotes better acceleration, gives your car that zip you've always wanted. Find out why even Detroit has finally come around. In four years of proven reliability, Delta's Mark Ten has set new records of ignition benefits. No re-wiring! Works on literally any type of gasoline engine.

Why settle for less when you can buy the original DELTA Mark Ten, never excelled and so unique that a U.S. Patent has been granted.

READY FOR THESE BENEFITS?

- ▲ Dramatic Increase in Performance and in Fast Acceleration
- ▲ Promotes more Complete Combustion
- ▲ Points and Plugs last 3 to 10 Times Longer
- ▲ Up to 20% Mileage Increase (saves gas)

LITERATURE SENT BY RETURN MAIL

Orders Shipped SAME DAY!

DELTA PRODUCTS, INC. <sup>DP 7-17</sup>

P.O. Box 1147 E D - Grand Junction, Colo. 81501

Enclosed is \$\_\_\_\_\_  Ship ppd.  Ship C.O.D.  
Please send:

- Mark Tens (Deltakit®) @ \$29.95  
(12 VOLT POSITIVE OR NEGATIVE GROUND ONLY)
- Mark Tens (Assembled) @ \$44.95
- 6 Volt: Negative Ground only
- 12 Volt: Specify  Positive Ground  Negative Ground

Car Year \_\_\_\_\_ Make \_\_\_\_\_

Name \_\_\_\_\_

Address \_\_\_\_\_

City/State \_\_\_\_\_ Zip \_\_\_\_\_

INFORMATION RETRIEVAL NUMBER 93



# high reliability coatings for printed circuits

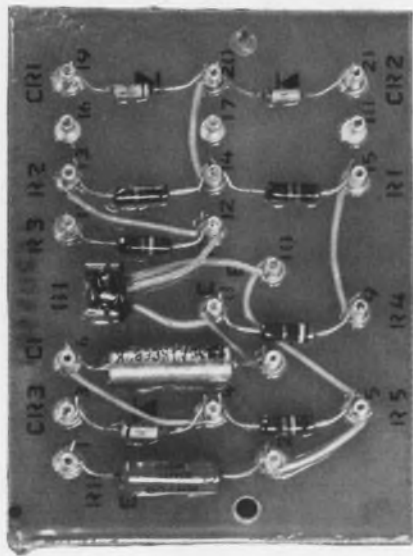

## wide range of easy-to-process economical urethanes & epoxies

CONATHANE® and CONAPOXY circuit board coatings include compounds and systems for practically any application method or property requirement.

There are formulations for dipping, spraying, brushing, flow coating, or spin coating. Solution coatings, high solids and 100% solids coatings. Screenable coatings with excellent flow control and adhesion. Coatings that cure at room temperature or elevated temperatures.

Films can be applied to meet virtually all requirements: excellent resistance to abrasion, impact, chemicals, fungus, and exterior weathering; good electrical properties; good dip-tank stability; uniformity of coating thickness. They'll protect assemblies from water, high humidity, contamination, and other severe environmental conditions, making them ideal for the most critical applications including space electronic gear. They can be provided to ruggedize units against shock and vibration and to meet MIL-1-46058, Type PUR, requirements.

Most are easily repairable. Connections can be soldered or unsoldered through these coatings without degradation or discoloration. Spot recoating is a simple matter and special kits are available for field repairs.

Request Bulletin C-110 for complete information and inquire about low cost evaluation kits. Conap, Inc., Allegany, N. Y. 14706.



Epoxies and urethanes for potting, encapsulating, insulating, bonding, sealing, and coating

INFORMATION RETRIEVAL NUMBER 94

# Advertisers' Index

Advertiser	Page	Advertiser	Page
Abbott Transistor Laboratories Incorporated	14	Leach Corporation	11
Acopian Corporation	95	Lenz Electric Manufacturing Co.	128
American Lava Corporation	43	Litton Industries, Winchester Division	127
Ametek, Inc., Lamb Division	120	Lockheed Electronics Company	4, 5
Ammon Instruments, Inc.	145		
Atlas Fibre Co.	133		
		McGraw-Hill Book Co.	147
Babcock Relays, Division of		Magnetics, Inc.	103
Babcock Electronics Corporation	31	Marconi Instruments Division of	
Beckman Instruments, Inc., Helipot Division	93	English Electric Corporation	131
Blu-Ray, Incorporated	147	MicroSwitch, A Division of Honeywell	151
Bodine Electric Company	106, 107	Microsonics, Inc.	142
Boonton Electronics Corporation	141	Minelco, A Subsidiary of General Time	143
Bourns, Inc.	32 A-H, 46	Molex Products Company	115
Burr-Brown Research Corporation	15	Motorola Communications & Electronics, Inc.	121
Burroughs Corporation	148	Motorola Semiconductor Products, Inc.	6
By-Buk Company	148		
		National Semiconductor Corporation	8, 9
Chicago Switch Division, F & F Enterprises, Inc.	133		
Cinch-Graphik, Division of United-Carr	130	Pastoriza Electronics, Inc.	138, 140
Clare & Co., C. P.	122, 123	Penny & Giles	91
Clifton, Division of Litton Industries Cover	111	Philco-Ford Corporation	12, 13
Cohn Corp., Sigmund	145		
Cohu Electronics, Inc.	100	RCA Electronic Components and Devices	48, 97, Cover IV
Colorado Hickok Corporation	34	RF Communications, Inc.	126
Conap, Inc.	150	Radiation, Incorporated	125
Cooke Engineering Company	129		
Coto Coil Company, Inc.	145	Sangamo Electric Company	135
Cratex	147	Sealectro Corporation	146
		Servo-Tek Products Company, Inc.	137
Damon Engineering, Inc.	24	Signalite, Incorporated	105
Datapulse, Inc.	2	Simpson Electric Company	41
Dearborn Electronics, Inc.	112	Singer Company, The	23
Delta Products, Inc.	124, 149	Skydyne, Inc.	144
Digital Equipment Corporation	42	Solitron Devices, Inc.	79, 134
Diversified Electronics, Inc.	114	Sperry Rand Corporation, Electronic Tube Division	119
Dow Corning Corporation	36, 37	Sperry Rand Corporation, Sperry Microwave Electronics Division	109
		Sprague Electric Company	18, 20
Eastern Industries, A Division of Laboratory for Electronics, Inc.	134	Stackpole Carbon Company	35
Ebert Electronics Corp.	129	Sylvania Electric Products, Inc.	99
Electronic Design	116, 117		
Erie Technological Products, Inc.	113	TRW, Inc., Capacitor Division	44
		Tektronix, Inc., Oscilloscopes	104 A-B
Fairchild Instrumentation, A Division of Fairchild Camera and Instrument Corporation	16, 17	Tenney Engineering, Inc.	137
		Texas Instruments Incorporated, Components Group	10
General Electric Company, Capacitor Department	110, 111	Thermal American Fused Quartz Co., Inc.	102
General Electric Company, Miniature Lamp Department	118	Transistor Electronics Corporation	129
General Radio Company	73	Trompeter Electronics, Inc.	148
General Reed Company	149	Tyco Laboratories, Inc.	136
Guardian Electric Manufacturing Company	139		
Gudebrod Bros. Silk Co., Inc.	78	United Transformer Co., Division of TRW, Inc.	Cover II
Hewlett-Packard	1, 7	Vactec Inc.	33
Honeywell, Computer Control Division	38	Varian Electron Tube and Device Group	27
Hughes Aircraft Company	29	Victoreen Instrument Division	104, 132
Industrial Condenser Corp.	88	West Coast Electrical Mfg. Co.	144
Industrial Timer Corporation	137		
		Career Advertising	
Johnson Company, E. F.	133	AC Electronics Division of General Motors	86
		Electronic Communications, Inc.	87
Krohn-Hite Corporation	108	National Cash Register Company, The	84
Kurz-Kasch, Inc.	126	Sanders Associates, Inc.	90
		Xerox Corporation	88, 89

# MICRO SWITCH

## now packs more design freedom in tiny toggles

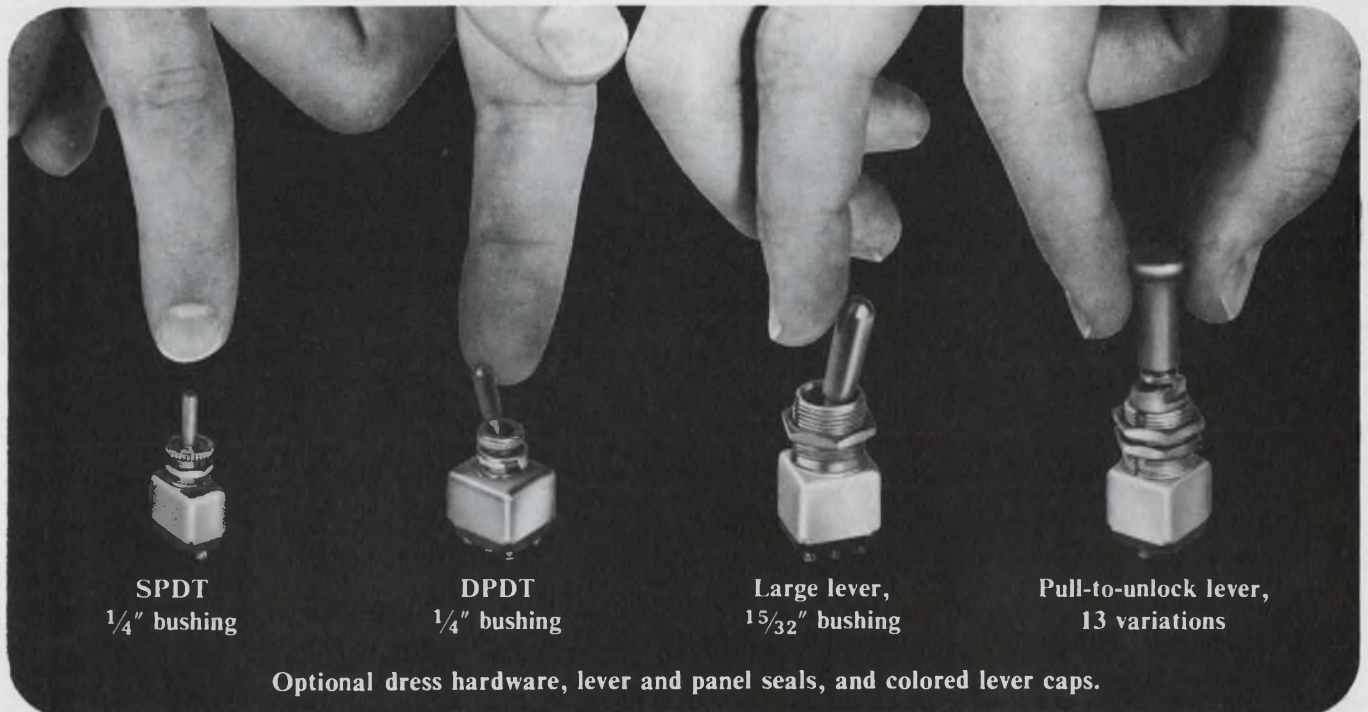

TW Miniature Toggle Switches may be peewees in size, but they are big in the features you need. Designed to meet requirements of MIL-S-3950C, they now offer new features that bring you even more design freedom than before. For example:

**NEW** large bushing (15/32") in addition to 1/4" size.

**NEW** large bat handles in addition to small types.

**NEW** pull-to-unlock levers.

**NEW** seal boots and panel seals.

**NEW** six colored lever caps, six colors for color coding.

**NEW** dress hardware.

And, consider all these features:

- Small, space-saving, weight-saving size—only 5/8" behind panel.
- Rugged, sealed, molded-in terminals.
- SPDT and DPDT.



- Outstanding combination of high capacity and low energy capabilities—5 amps. res., 2 amps ind., 30 vdc or 115 vac.
  - Long life reliability—30,000 complete cycles at full rated load.
- Outstanding toggle feel with wide 35° toggle throw—positive detents, optimum forces, 2 and 3 position, momentary and maintained, positive return spring on momentary versions and lever-lock.

For further details, call a Branch Office or Authorized Distributor (Yellow Pages, "Switches, Electric"). Or write for Product Sheet TW.

## MICRO SWITCH

FREEPORT, ILLINOIS 61032

A DIVISION OF HONEYWELL

HONEYWELL INTERNATIONAL: Sales and service offices in all principal cities of the world. Manufacturing in United States, United Kingdom, Canada, Netherlands, Germany, France, Japan.

INFORMATION RETRIEVAL NUMBER 95



# Information Retrieval Service

All products, design aids (DA), application notes (AN), new literature (NL), and reprints (R) in this issue are listed here with Page and Information Retrieval numbers. Reader requests will be promptly processed by computer and mailed to the manufacturer within three days.

Category	Page	IRN	Category	Page	IRN	Category	Page	IRN
<b>Amplifiers</b>			hybrids, thick-film (AN)	140	294	harnessing system	132	278
amplifier	124	270	light emitters (NL)	146	337	heat-sink		
amplifier, audio	102	253	logic handbook (AN)	140	289	nomogram (DA)	138	285
amplifier, in-line	104	258	op amp, monolithic	102	256	knobs, instrument (NL)	142	323
op amp, monolithic	102	256	photodiode, quad	120	267	lettering, transfer (NL)	142	324
<b>Components</b>			seals, hermetic (AN)	140	293	nickel alloys (NL)	145	333
actuator, fluidic	108	259	tech note index (AN)	140	290	package, varactor	118	266
amplifier	124	270	transistor, microwave	118	265	plug lock	134	280
amplifier, audio	102	253	UJTs, passivated	102	255	seals, hermetic (AN)	140	293
amplifier, in-line	104	258				silicone spray	132	279
antenna system, (NL)	142	322	<b>Instrumentation</b>			strippers, epoxy	134	281
capacitors (NL)	144	329	comparator, digital	128	274	symbols, electronic (DA)	138	286
cards, PC	134	282	cooling handbook (AN)	141	296			
cases, military (NL)	145	330	generator, pulse	112	261	<b>Production</b>		
connector selector (DA)	138	288	generators, rf signal	114	264	control system	136	284
converters, dc-dc	126	272	generators, sweep (NL)	142	325	cooling handbook (AN)	141	296
cooling handbook (AN)	141	296	instruments (NL)	142	326	flux pen	136	283
diodes, avalanche	120	268	instruments (NL)	144	328	lettering, transfer (NL)	142	324
encoder, 9-bit	130	277	instruments (NL)	146	335	symbols, electronic (DA)	138	286
encoders, shaft (AN)	141	297	meter, digital panel	114	263			
generator, character	102	254	meters, panel (NL)	146	335			
hardware, MSI/LSI (NL)	146	334	microwave loading (NL)	145	331			
harnessing system	132	278	multimeter, digital	112	262			
heat-sink			power supplies (NL)	144	327			
nomogram (DA)	138	285	scope news (AN)	141	295			
hybrids, IC (NL)	145	332	spectrum					
hybrids, thick-film (AN)	140	294	calculator (DA)	138	287			
knobs, instrument (NL)	142	323	thermocouples (AN)	140	291			
light emitters (NL)	146	337	transducers	108	260			
meters, panel (NL)	146	335						
microwave components			<b>Microwaves &amp; Lasers</b>					
(NL)	142	321	antenna system (NL)	142	322			
microwave loading (NL)	145	331	diodes, avalanche	120	268			
mixer, audio	126	271	generators, sweep (NL)	142	325			
mixer, balanced FET	126	273	light emitters (NL)	146	337			
op amp, monolithic	102	256	microwave components					
package, varactor	118	266	(NL)	142	321			
photodiode, quad	120	267	microwave loading (NL)	145	331			
plug lock	134	280	package, varactor	118	266			
power supplies (NL)	144	327	photodiode, quad	120	267			
relay, multiplexing	124	269	spectrum calculator					
resistors (NL)	146	337	(DA)	138	287			
seals, hermetic (AN)	140	293	transistor, microwave	118	265			
switch, rotary	104	257						
tech note index (AN)	140	290	<b>Modules &amp; Subassemblies</b>					
thermocouples (AN)	140	291	amplifier	124	270			
toroids (AN)	140	292	amplifier, plug-in	102	256			
transducers	108	260	antenna system (NL)	142	322			
transistor, microwave	118	265	converters, dc-dc	126	272			
UJTs, passivated	102	255	cooling handbook (AN)	141	296			
			hybrids, IC (NL)	145	332			
<b>Data Processing</b>			hybrids, thick-film (AN)	140	294			
communicator, data	130	276	meter, digital panel	114	263			
comparator, digital	128	274	meters, panel (NL)	146	335			
encoder, 9-bit	130	277	mixer, audio	126	271			
encoders, shaft (AN)	141	297	mixer, balanced FET	126	273			
generator, character	102	254	op amp, monolithic	102	256			
interface system, A/d	128	275	power supplies (NL)	144	327			
logic handbook (AN)	140	289	relay, multiplexing	124	269			
			tech book index (AN)	140	290			
<b>ICs &amp; Semiconductors</b>			<b>Packaging &amp; Materials</b>					
amplifier, audio	102	253	cards, PC	134	282			
diodes, avalanche	120	268	cases, military (NL)	145	330			
generator, character	102	254	connector selector (DA)	138	288			
hardware, MSI/LSI (NL)	146	334	cooling handbook (AN)	141	296			
heat-sink nomogram	138	285	hardware, MSI/LSI (NL)	146	334			
hybrids, IC (NL)	145	332						

## Application Notes

cooling handbook	141	296
encoders, shaft	141	297
hybrids, thick-film	140	294
logic handbook	140	289
scope news	141	295
seals, hermetic	140	293
tech note index	140	290
thermocouples	140	291
toroids	140	292

## Design Aids

connector selector	138	288
heat-sink nomogram	138	285
spectrum calculator	138	287
symbols, electronic	138	286

# The standard of excellence



Diamond by J. E. Caldwell Co., Philadelphia—\$60,000.

## in servo packages.

Important ingredients of every Clifton module are Clifton engineering, Clifton rotating components, Clifton gear trains. True "single source" responsibility.

The really priceless ingredient, however, is Quality. Quality borne of many years of meeting the most demanding standards of excellence—for both customers and ourselves.

A good example of Clifton excel-

lence and packaging is the Servo Repeater shown above. It can replace a size 23 torque receiver and improve accuracy by an order of magnitude. Here are some of the parameters:

- Velocity constant ( $K_v$ ) adjustable to 300 sec<sup>-1</sup>.
- Slew speed capability greater than 216 degrees per second.
- Stall torque 10 oz-in/° min.
- Torque gradient 10 oz-in/° min.
- Input voltage 115 vac ±10%,

- 400Hz ±5%.
- Synchro input 11.8 or 90 vac, 400Hz.
- Weight 18 ounces.

You expect Clifton to be better. When you select Clifton, you're getting the best.

Call your local Clifton Sales Office, or telephone (215) 622-1000 for prompt service.

**CLIFTON**   
DIVISION OF LITTON INDUSTRIES



# First Photomultiplier with a Gallium Phosphide Dynode— Offers Order of Magnitude Improvement in Electron Resolution

Electron Resolution Capability of photomultipliers formerly attainable.

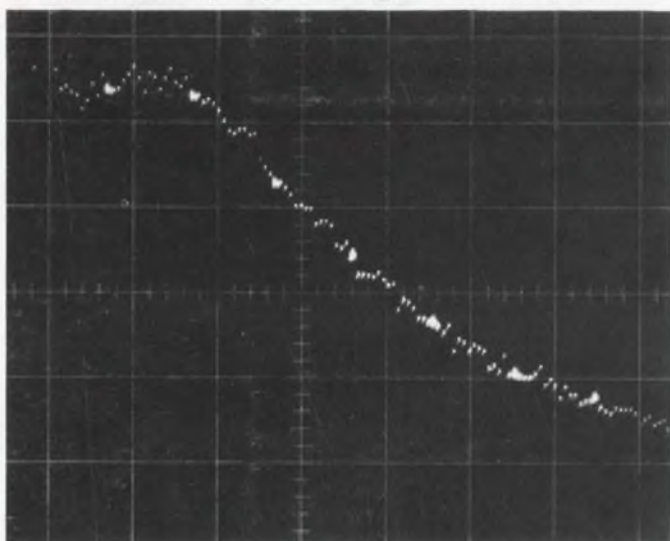

1e 2e 3e 4e 5e 6e  
Pulse Height-Photoelectron Equivalents

Electron Resolution Capability of RCA—C31000D.

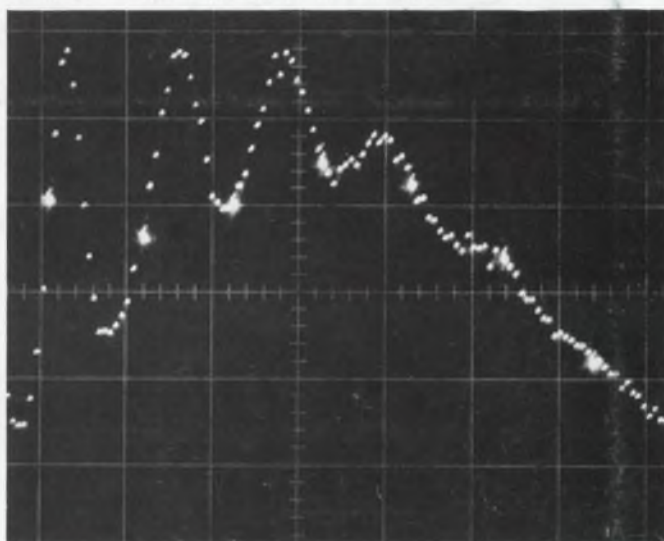

1e 2e 3e 4e 5e 6e  
Pulse Height-Photoelectron Equivalents



It's new...even revolutionary! It's the C31000D—a photomultiplier employing a new dynode material for extremely low-light-level applications, such as photon and scintillation counting, with a pulse height resolution so outstanding you can distinguish with ease single, double, triple, and quadruple photoelectron events.

Gallium Phosphide does it! Providing up to an order of magnitude increase in gain over conventional dynode materials, this gallium phosphide approach must be considered at the forefront of new photomultiplier designs for greatly improved low-light-level performance. In addition to improvements in electron resolution, Gallium Phosphide promises lower values of rise time and transit time in future photomultiplier designs.

RCA-C31000D is a 12-stage, bialkali, photocathode type photomultiplier utilizing Gallium Phosphide as the first dynode secondary emission material. At a cathode to dynode No. 1 voltage of 900 volts, the first dynode secondary emission ratio is typically 45.

For more information on RCA Photomultipliers and RCA-C31000D in particular, see your RCA Representative. For technical data, write: RCA Electronic Components, Commercial Engineering, Section No. L18P-1, Harrison, New Jersey 07029.

# RCA