

Electronic Design 23

VOL. 16 NO.

FOR ENGINEERS AND ENGINEERING MANAGERS

NOV. 7, 1968

Select clean, coherent sinusoids at microwave frequencies. Wide-band synthesizer offers extended range with counter-like accuracy. Seven digital switches resolve

frequencies in steps of 10 kHz; spectrally-pure signals from 1 to 12.4 GHz are instantly at hand. For a full readout on the specs and applications — see page 102.

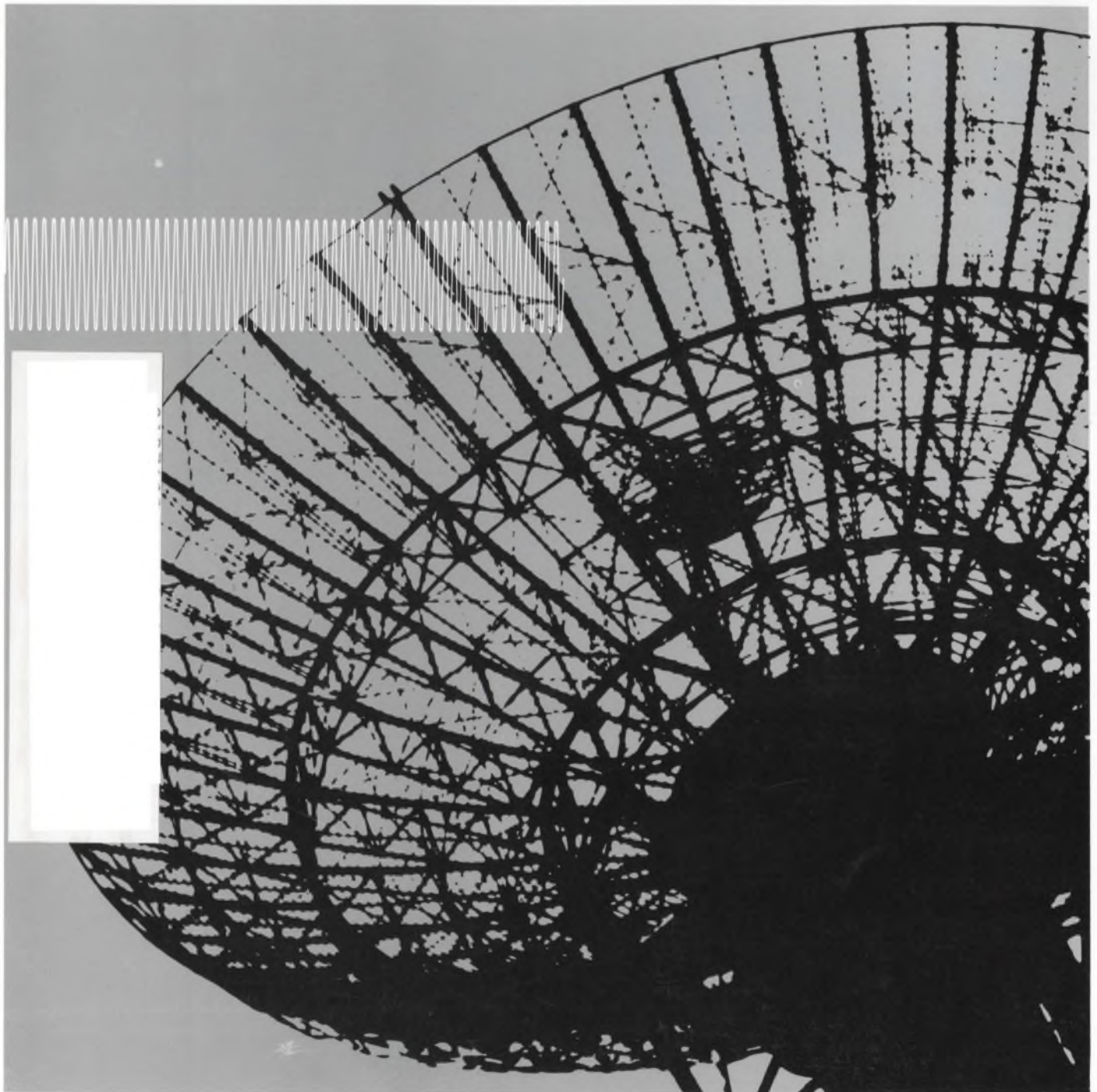



**TRW
METALLIZED
POLYCARBONATE
CAPACITORS**



TRW
X463UW
10 MFD 50V

... small enough to fit!

TRW 50-volt Metallized Polycarbonate Capacitors are made to squeeze into tight places. Imagine 10 microfarads measuring .547" x 1 1/4" long... the smallest wound capacitor on the market!

Short on size and long on reliability, the X463UW series meets all requirements of MIL-C-27287.
VOLTAGE—50V, 100V, 200V, 400V
CAPACITANCE— .001 through 10 mfd
TOLERANCE—available to $\pm 1\%$.

INFORMATION RETRIEVAL NUMBER 242

For data, write TRW Capacitor Div., Ogallala, Neb. Phone (308) 284-3611. TWX 910-620-0321.

TRW[®]

in 1-1000 MHz work

Voltage tells only half the story



The HP Vector Voltmeter tells all.

"All" means *phase*, the key to every RF measurement. Especially the tough ones like open-loop gain of feedback amplifiers, electrical lengths, resonance characteristics, or filter pass and rejection bands. And this 2-channel millivoltmeter-phasemeter makes them directly, accurately and conveniently.

The Vector Voltmeter covers the frequency range from 1 to 1000 MHz and automatically locks onto the signal anywhere within an octave—no fine tuning required. It's extremely sensitive—full scale 100 μ V. With its 90 dB dynamic range, you can easily measure high gain and high loss networks. It has a 360-

degree phase range with 0.1° resolution.

The 8405A also serves as a "frequency translator." How? By transforming the RF inputs to 20 kHz outputs whose wave shapes, amplitudes and phase relationship remain identical to the original RF signals. You can use these outputs for further analysis with low frequency scopes.

You needn't waste time making a tough RF measurement any longer. The HP 8405A does it faster and more completely than ever before. Application Note 91 tells you how. Just call your HP field engineer for details, or write Hewlett-Packard, Palo Alto, California 94304; Europe: 54 Route des Acacias, Geneva.

MAJOR SPECIFICATIONS, HP 8405A VECTOR VOLTMETER

FREQUENCY RANGE is 1 to 1000 MHz in 21 over-lapping octave bands; automatic tuning within each band.

VOLTAGE RANGE FOR CHANNEL A (synchronizing channel), 300 μ V to 1 V rms (10-500 MHz), 500 μ V to 1 V rms (500-1000 MHz), 1.5 mV to 1 V rms (1-10 MHz).

VOLTAGE RANGE FOR CHANNEL B (input to Channel A required) 100 μ V to 1 V rms, full-scale. Full-scale meter ranges from 100 μ V to 1 V in 10 dB steps. Both channels can be extended to 10 V rms with 11576A 10:1 Divider.

PHASE RANGE of 360° indicated on zero-center meter with end-scale ranges of $\pm 180^\circ$, $\pm 60^\circ$, $\pm 18^\circ$, $\pm 6^\circ$. Phase meter OFFSET of $\pm 180^\circ$ in 10° steps permits use of $\pm 6^\circ$ range for 0.1° phase resolution at any phase angle.

PRICE: \$2750.

HEWLETT  PACKARD

RF TEST EQUIPMENT

See us at NEC, Booth 1205.

NANO 2 SECOND



VARIABLE RISE PULSE GENERATOR WITH PRECISION DC BASELINE OFFSET The Datapulse Model 111 extends general purpose pulse generator technology a full octave in rise time capability, with full control over every major pulse parameter. No other pulse generator is so ideally suited for high speed integrated circuit testing and digital logic circuit design

SPECIFICATIONS — 2 ns to 500 ns linear rise, 4 Hz to 40 MHz repetition rates, $\pm 5V$ output into 50 ohms, precision baseline offset to $\pm 5V$ with $\pm 50mV$ accuracy, single or double pulse operation, 50 MHz simulated rep rates on double pulse, and 8 ns to 500 μs pulse widths. ■ **PRICE:** \$1480.00

TYPICAL APPLICATIONS —

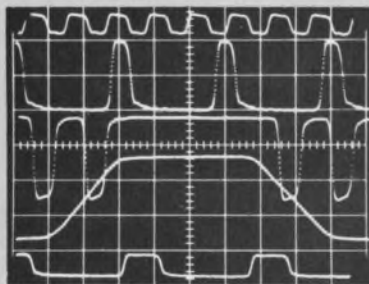

20ns/cm, 1V/cm

The 111's fully controllable fast pulses permit construction of a nearly limitless number of test waveforms for the design and test of high speed components, integrated circuits, analog devices, and other elements.

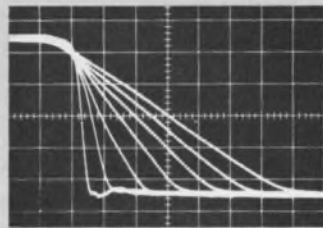

0.3V/cm, 5 ns/cm

Independently variable, linear rise and fall times permit marginal testing and exact simulation of pulse circuit rise and fall times.

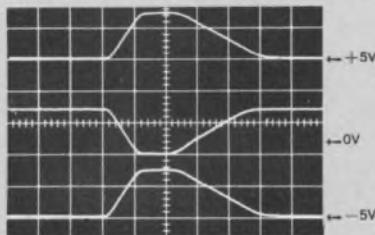

2V/cm, 20 ns/cm

Precision variable baseline level provides dc biased outputs for off-ground logic simulation; also for worst case tolerancing of logic circuitry and noise susceptibility analysis.

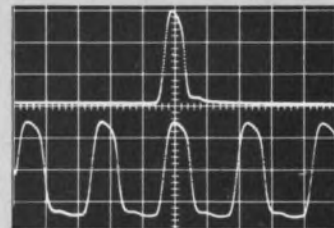

10 ns/cm, 0.5V/cm

Narrow pulse output to 8 nanoseconds provides impulse type signals for high speed circuit development, high frequency complex impedance analysis, and other transient tests.

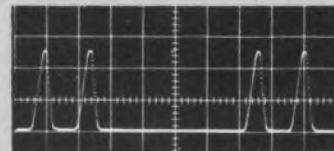

2V/cm, 0.1 μs /cm

Double pulse operation provides two identical pulses in each cycle. Ideal for flip-flop resolution checks, navigational signal simulation.

The 111 is available now! Ask your Datapulse representative for a demonstration! Write for complete technical literature!

Datapulse, Inc., 10150 West Jefferson Boulevard, Culver City, California 90230. Tele.: 213-836-6100 TWX: 910-340-6766.



NEWS

- 21 News Scope
- 25 **Parley analyzes 3 paths to the world of MICs**
Thick-film, thin-film and monolithic approaches call for trade-offs by the microwave circuit designer.
- 32 **Nose-cone antenna aids ionospheric research**
14-pound, 4-frequency, omnidirectional system is measuring rf propagation effects for Army.
- 36 Laser beats radar, tracking Mach 4.5 sled
- 39 Washington Report
- 44 Letters
- 48 Sidelights of the Issue
- 49 **Editorial: Are all designers business boobs?**

TECHNOLOGY

- 52 **Design digital comparators logically.** Use off-the-shelf ICs and limit your effort to logical design.
- 60 **Do computations at the speed of light.** Use optical processing for instant Fourier analysis. Fraunhofer diffraction is the key.
- 72 **Unsnarl your complex wiring problems** with computer-generated wiring lists. They're easy to develop, not prohibitively costly.
- 80 **Simplify selection of the critical resistor** in TTL common-collector OR drivers. Generate graphic aids.
- 90 Ideas for Design

PRODUCTS

- 102 **Cover feature:** Microwave synthesizer spans 1 to 12.4 GHz.
- 104 **Microwaves and Lasers:** Tiny hybrid shrinks attenuator size.
- 110 **Instrumentation:** Panel meters display both digital and analog readouts.
- 116 **ICs and Semiconductors:** Photoconductor arrays are custom designed.
- 122 Data Processing
- 126 Production
- 130 Packaging and Materials
- 134 Modules and Subassemblies
- 138 Components

Departments

- 14 Designer's Datebook
 - 146 Design Aids
 - 148 Application Notes
 - 150 New Literature
 - 154 Advertisers' Index
 - 160 Information Retrieval Service
- Information Retrieval Service Card inside back cover

**Today,
your I/C logic system
is only half as fast
as it could be...**

- where the priceless ingredient is care!



MECL III picosecond logic is here !

At last, fourth-generation computer designs and highly-sophisticated instrumentation designs have become a reality, thanks to the ultra-high speeds that are now possible through the current mode logic of MECL III!

Three different circuits in this new line of emitter-coupled devices are currently available for evaluation. MC1060S and MC1062S, dual 4 and quad 2-input gates, offer propagation delay times that are typically *900 picoseconds* when operated into a 510 ohm load. Reduce the load an order of magnitude and the delay time is only 1.1 nanoseconds; still twice as fast as any comparable form of logic.

In addition, MC1070S, single phase, type "D" Flip-Flop, provides a toggle/shift frequency that is typically *350 MHz*. And, it can be "tweaked" to higher frequencies by application of an external bias.

The standard MECL III package is a stud-mounted, 15-pin ceramic flat pack. The stud, connected to V_{cc} , is designed to improve heat dissipation.

For further information about MECL III or for individual evaluation units, contact us at the address below. Don't wait another day to begin designing the picosecond logic of tomorrow's fourth generation computers.



MECL III picosecond logic available in prototype kit

Six MECL III circuits plus a design information brochure are packaged in a useful, compact kit. Devices include two each of the three circuits described here. The advance information brochure contains device specifications plus design rules and applications information. The entire package is available through your Motorola Semiconductor Representative for \$154.00 (any quantity).

MOTOROLA *Integrated Circuits*

MOTOROLA SEMICONDUCTOR PRODUCTS INC./P.O. BOX 20912/PHOENIX, ARIZONA, 85036

Flexibility.

And we'll give you a good reason to buy our flexible circuits over anyone else's:

We make them with the same kind of precision our regular printed circuits are known for.

We can produce them in quantity to the most stringent specifications—single or multilayer.

We're probably the flexible circuit source you've been looking for.

For your copy of "A Designer's Guide to Flexible Circuits," write to Printed Circuits, Lockheed Electronics Company, Data Products Division, 6201 E. Randolph St., Los Angeles, California 90022.

We've added a new wrinkle to our printed circuits.



**LOCKHEED
ELECTRONICS
COMPANY**

A Division of
Lockheed Aircraft Corporation

THIS NEW ADD-ON...

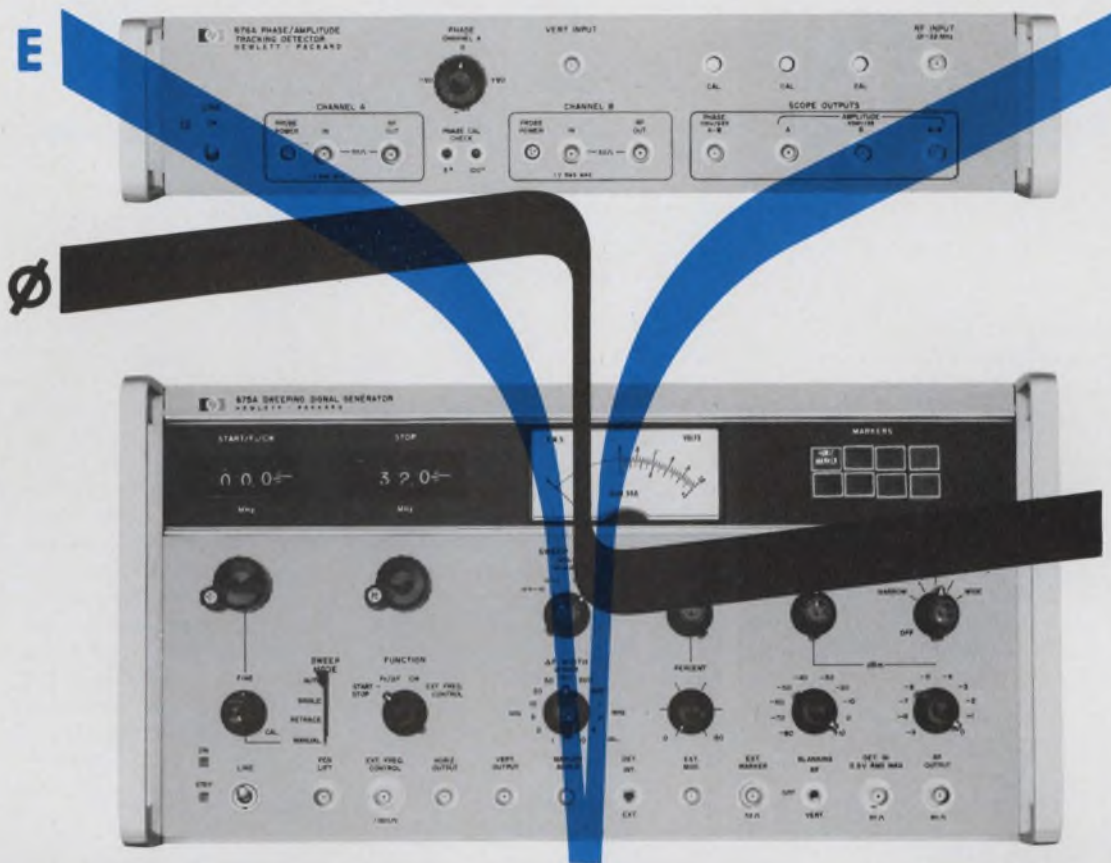

MAKES THE HP 675A SWEEPER A NETWORK ANALYZER...

Simultaneously display phase and amplitude!

Now you have *both* phase and amplitude information on a swept basis to 32 MHz. You save hours of time, see changes in phase and amplitude responses immediately as you make adjustments. This combination of instruments is oriented toward production and lab testing.

The 675A Sweeping Signal Generator has a 10 kHz to 32 MHz range with settings anywhere in this range for single or continuous sweep. The 676A Phase/Amplitude Tracking Detector adds a full 360° phase measurement capability and an 80 dB dynamic amplitude range. Combination is programmable for automatic or computerized testing.

Channel A and B outputs of the 676A provide simul-

taneous amplitude measurements of two devices for comparison. Amplitude A-B and PHASE A-B make difference measurements easy. Outputs can be easily calibrated in linear dB and linear phase on a low frequency oscilloscope or X-Y recorder. New active probe (100 k Ω , 3.5 pF) augments 50 Ω input for high impedance measurements.

Check your design and production areas for the savings you can make with the new network analyzer—the combination that makes point-to-point plotting passé. Call your local HP field engineer for complete information. Or, write Hewlett-Packard, Palo Alto, California 94304. Europe: 54 Route des Acacias, Geneva. Price: 675A, \$2250; 676A, \$1275.

HEWLETT  PACKARD

SIGNAL ANALYZERS

INFORMATION RETRIEVAL NUMBER 5

RCA Solid-State Data for Designers

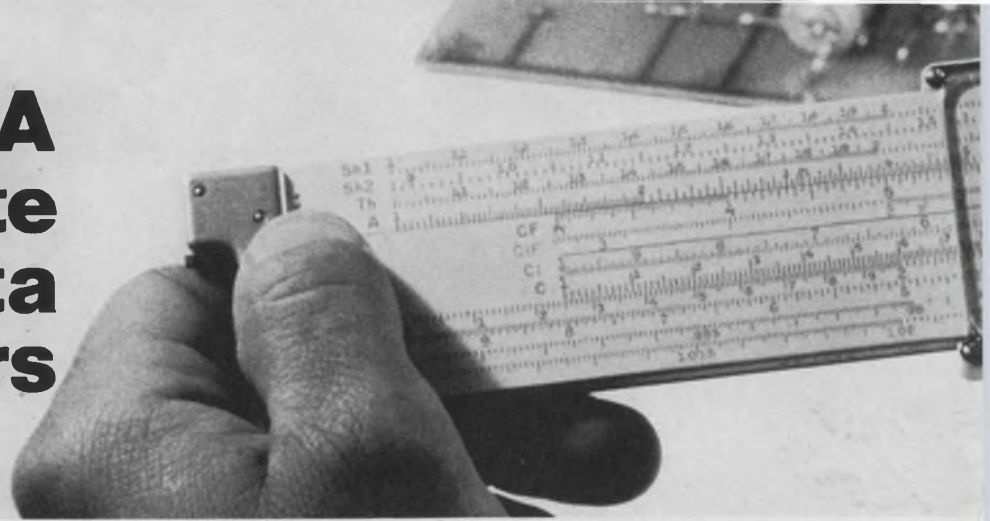
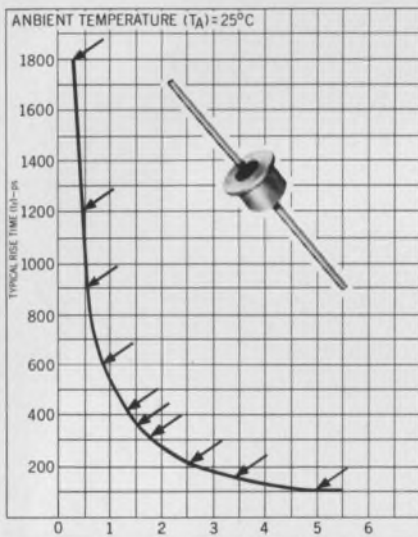

Chart Your Way to Fast Switching — RCA "TD-II" Tunnel Diodes Can Switch at From 100 to 1800 ps



Type	I _c (mA)		I _c /I _v		C (pF)		tr (ps) Typ.	I _p /C (mA/pF) Typ.
	Min.	Max.	Min.	Max.	Min.	Max.		
40561	4.5	5.5	6/1	25	1800	0.25		
40562	9	11	6/1	25	900	0.55		
40563	18	22	6/1	30	600	0.85		
40564	45	55	6/1	40	350	1.45		
40565	90	110	6/1	40	150	3.35		
40566	4.75	5.25	0/1	15	1200	0.45		
40567	9.5	10.5	0/1	15	600	0.85		
40568	19	21	0/1	20	400	1.27		
40569	47.5	52.5	0/1	25	200	2.5		
40570	95	105	0/1	25	100	5		
40571	4.75	5.25	0/1	8	600	0.85		
40572	9.5	10.5	0/1	8	300	1.67		
40573	19	21	0/1	10	200	2.5		
40574	47.5	52.5	0/1	12	100	5		

The most reliable high-speed tunnel diodes you can design around—combining speed with reliability and hermeticity—are the RCA "TD-II" family of units. Type numbers from RCA 40561 to 40574 (axial-lead version of RCA types 1N3847 to 1N3860) make up a full line covering the spectrum of your needs. The chart above gives t_r in ps (typ.) and I_p/C in mA/pF typ. Go down the line and find your exact needs!

These units are designed for extremely critical switching and signal-processing applications requiring tight control ($\pm 5\%$) of peak-point currents and rise times as fast as 100 ps (types 40570 through 40574).

Types 40566 through 40569 offer $\pm 5\%$ control of peak-point current and rise times as fast as 160 ps. The rest of the family—types 40561 to 40565—offer $\pm 10\%$ control of peak-point current and rise times in the range from 1,800 to 125 ps.

All 14 TD-II types feature RCA's unique epitaxially-grown junctions that have brought a new standard of stability, performance and reliability to tunnel diodes. Leads are gold-plated for soldering efficiency, requiring no pre-tinning. And the package configuration lends itself well to high-volume PC-board mounting operations. Circle Reader Service No. 121 for general line information.

New Design Dimension in 8-A Plastic Triacs: TA7364 Controls Up to 1,000 W, TA7365 Up to 2,000 W



Need to control ac loads in motor speed controls, heat controls, relay protection, light dimmers? Two new plastic triacs—RCA's developmental types TA7364 and TA7365—offer a

number of important circuit advantages, in addition to being small, compact, flexible, and economical.

For example, exceptionally high "static" dv/dt capability gives immunity from false turn-on caused by high noise or high transient conditions found in heavy industrial environments. Increased commutating capability assures reliable operation under heavy inductive loads such as occur in motors, solenoids, and relays. And the high 100 A peak surge current capability offers important protection in applications such as incandescent lighting controls and motor start-up, where inrush currents can be many times higher than the RMS "on-state" circuit.

As a bonus, both the 200-volt TA7364 and the 400-volt TA7365 provide long-term reliability as a result of the advantages of hermeticity made possible by RCA's glass passivation of the chip. They also have low thermal resistance (2.2°C/W junction-to-case) so you can use smaller, more economical heat sinks. And they come in a package that's so easy to mount.

We'll help you with your design problems. Circle Reader Service No. 122 for complete details.

Complement Your Power Designs with Silicon! Design Up to 300 V Capability with RCA PNP and NPN Types

Now you can meet your product needs for complementary designs that feature high-voltage capability. Commercial, military and industrial applications needing high-speed switching or linear amplifier capabilities up to 300 V are ideal for RCA's new 2N5415 and 2N5416 units in TO-5 lead packages. Audio ampli-

fier and industrial power switching circuits call for RCA's 2N5322 and 2N5323... "beefed up" versions of the popular 2N4036.

Check the tabulation for specifications. Then circle Reader Service No. 123 for full details.

There's more coming. Look for low-cost silicon power PNP audio devices with gain up to 1.5 A, P_T of 5 watts. Look, too, for types with I_C 5 A and P_T 45 W... and voltage handling capability up to 75 V.

RCA PNP Type	RCA NPN Type	V _{CEO(sus)} (V)		PNP Types	NPN Types	PNP Types	I _C (A)	NPN Types	P _T W	h _{FE}	
		PNP Types	NPN Types							@ I _C = 50 mA	@ I _C = 500 mA
2N5415	2N3440	-200	250	-1	1	1	10	30-150			
2N5416	2N3439	-300	350	-1	1	1	10	30-120			
2N5322	2N5320	-75	75	-2	2	2	10			30-130	
2N5323	2N5321	-50	50	-2	2	2	10			40-250	

*for T_c up to 25°C

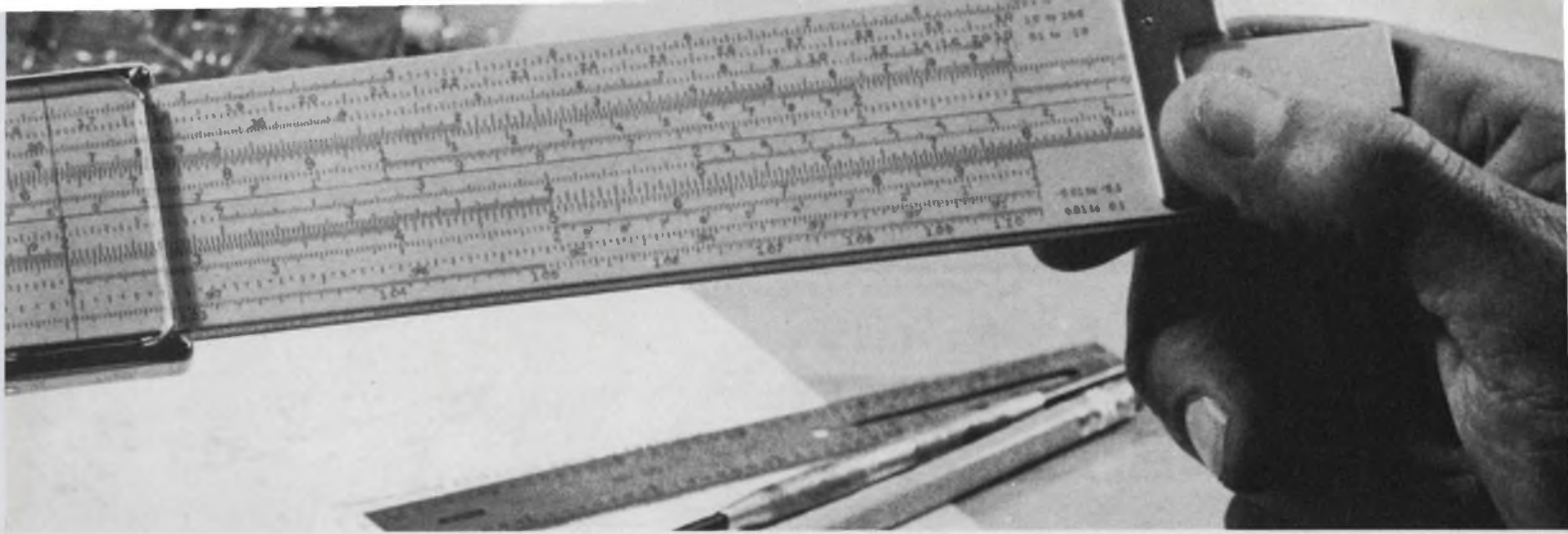

“Building Blocks” for High-Performance, Low-Cost Solid-State Circuitry

PHP

RCA's PHP MAX VALUE Silicon Signal Transistors provide an unmatched combination of Performance, Hermeticity and Price for a broad range of amplifier and switching applications. *Amplifier types*—with prices as low as 19¢ (1,000+ quantities OEM)—let you design up to 500 MHz and be-

yond. They provide low-noise, high-gain, low-capacitance performance over a wide range of voltage, current and power capabilities.

Switching types, with prices as low as 24¢ (1,000+ quantities OEM), combine high-speed performance with a voltage, power and current range covering a large percentage of high-speed switching and core driving applications.

Circle Reader Service No. 124 for cross-reference directory showing 444 industry types PHP MAX VALUE transistors can replace.

RCA CA3028A and CA3028B Integrated Circuits for Versatility and Economy in RF and IF Amplifier Designs

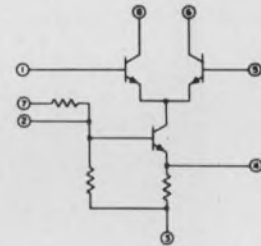

Here's true versatility for your IF designs—and more! RCA CA3028A and CA3028B integrated circuits are ideal for RF and IF amplifier designs; DC, audio and sense amplifiers; commercial FM band converter designs; oscillator, mixer and limiter applications... and much more.

RCA CA3028A is usable from DC to 120 MHz—provides a power gain of 32 dB (typ.) in differential and 39 dB (typ.) in cascode at 10.7 MHz. AGC range is 62 dB (typ.) at 10.7 MHz.

RCA CA3028B offers these big extras: tight control of input offset voltage, input offset current and input bias current for the more critical design uses. At power supply level of ± 12 V, input offset voltage is 5 mV (max.); input offset current, 6 μ A (max.) and input bias current is 80 μ A (max.). Peak-to-peak output voltage swing is 15 V (min.) with $f = 1$ KHz and R_L of 1.6 K Ω . Circle Reader Service No. 127 for full information.

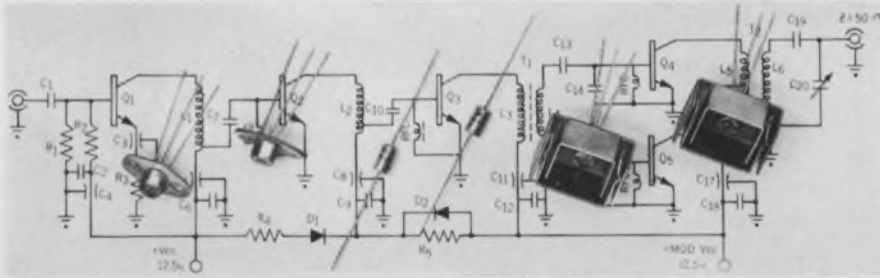

“Overlay” Transistors for Small Size, Big Power Amplifier in Aircraft AM Transmitters

Here is a simple amplifier circuit—designed around RCA “overlay” transistors. Emphasis is on ease of modification, adaptation to meet many needs, ready duplication and a minimum of adjustments in operation. The basic circuit is for a broadband amplifier for AM use in the 118-136 MHz aircraft communication band. The unit operates in low-voltage, high-power Class C service—delivers up to 40 W PEP at 95% modulation from 5 mW of unmodulated input drive, and 12.5 V power supply.

RCA devices used are RCA 1N3193 axial lead silicon diodes and RCA 2N3866, 40290, 40291 and 40292 silicon n-p-n “overlay” epitaxial planar type devices.

For a detailed Application Note, circle Reader Service No. 125.

A Simple Way of Measuring the Voltage on a Capacitor Without Significantly Disturbing the Charge!

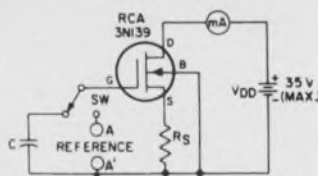

How many times have you wanted to read out the voltage on a capacitor in your circuit without disturbing the charge—or the operation of the circuit?

Here is a simple circuit-solution to the problem. It takes advantage of the high input-resistance and low input-capacitance of the RCA 3N139 MOS FET. This basic circuit may be modified in many ways to provide ultra-low (or zero) effective input-capacitance.

Circle Reader Response No. 126 for more information.

See your RCA Representative for full information on all products shown. Ask your RCA Distributor for his price and delivery. For specific data sheets, write RCA Electronic Components, Commercial Engineering, Section Q-G-11-I, Harrison, N. J. 07029.

RCA

The product improvers.

Improved N-channel FET choppers from TI feature lower capacitances for reduced feedthrough plus faster chopping and switching.



Here's the new look in FET chopper transistors from TI. A new design gives significantly lower C_{ISS} and C_{RSS} .

These lower capacitances reduce feedthrough of the input signal into the output line. Faster chopping and switching are other results.

In addition to the improved 2N4856A-61A series, this family now includes 2N3970-72, 2N4091-93, and 2N4391-93 FETs, as well.

Use of any or all of these FET "product improvers" will mean big dividends for you...in upgraded performance and reduced costs.

You won't have to wait, either, because production quantities are immediately available.

So don't put off evaluation any longer. Call your TI sales engineer or distributor now. Or, for data sheets, write on your company letterhead to Texas Instruments Incorporated, P.O. Box 5012, MS 980-A Dallas, Texas 75222.

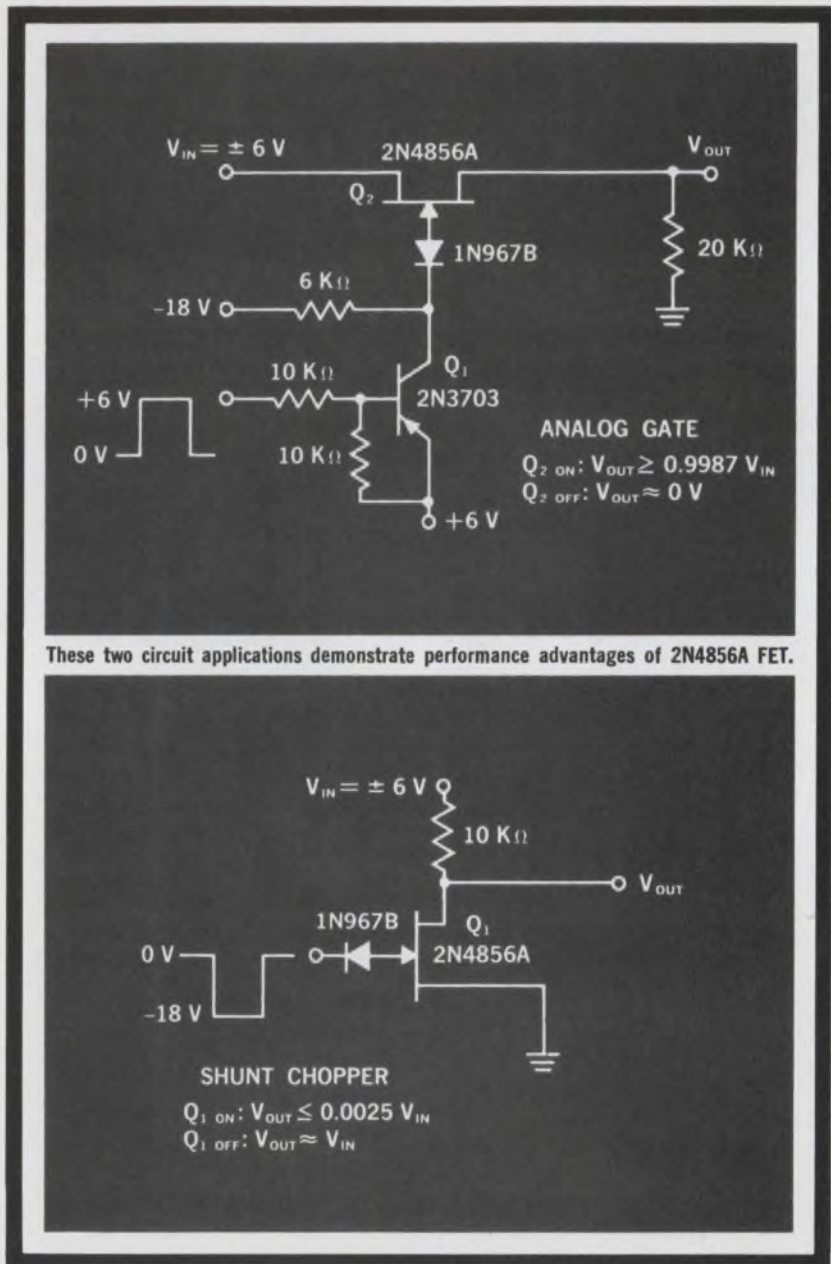

These two circuit applications demonstrate performance advantages of 2N4856A FET.

TEXAS INSTRUMENTS
 INCORPORATED

Theta Decitrak[®] puts information to work



Now, information from *your* analog sensor can command machinery, automate processes, interface computers, and provide remote digital display.

How? With a Theta Decitrak system, analog information is uniquely converted to digital format. Of course, data transmission and data acquisition applications abound. Over and above these, Decitrak delivers automatic digital-control of *your* prime mover.

The Decitrak control system will accept commands from punched cards, tape, or manual set-points. In addition, it will introduce high/low limits and arithmetical operations into the control loop. The end result is the precision control you would expect from a custom-engineered, closed-loop servo-mechanism.

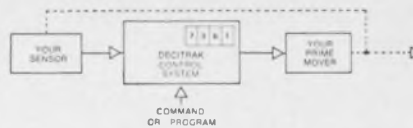

More than 1,000 of these systems are now in use in nuclear installations, satellite tracking stations, wind tunnels, and aboard ships. Theta can assemble a low-cost, customized system for *your* application from 32 basic off-the-shelf electronic modules and 27 types of shaft encoders.

Send for "Designer's Portfolio on Decitrak" — and see how Decitrak can put *your* information to work!

Theta

THETA
Decitrak

INSTRUMENT CORP • 22 Spielman Road, Fairfield, New Jersey 07006 • Phone: 201-227-1700 • TWX: 710-734-4431

INFORMATION RETRIEVAL NUMBER 6

If you're building any computer except a Computer, you need CT μ L.

CT μ L integrated circuits will give you more speed for less money than any other ICs. They're perfect for process control systems, test instrumentation, central processing units, computer peripheral equipment — just about anything short of an airborne computer.

Keep it in the family.

You can build a complete digital logic system with Fairchild's family of CT μ L devices. We have gates, flip-flops, inverters and memory circuits. A dozen different devices that make a computer easy to package. And, you'll need only about 80 percent as many packages as required with TTL.

You get out of it what you put into it.

The key CT μ L characteristic is non-saturating logic. That means you get fast gate propagation delay (typically 3nsec) with slow rise and fall times (typically 6nsec). So, there's no need for transmission lines or complex packaging. You can build an entire computer with normal two-sided circuit boards. Also, CT μ L can handle signal swings as large as 3V. It also provides typical noise immunity of 500mV.

What we'll do for an encore:

MSI CT μ L will be out before the year ends. CT μ L-II will be out even sooner, offering improvements like gate propagation delay of 1.5nsec. (typical, loaded) and a buffer and

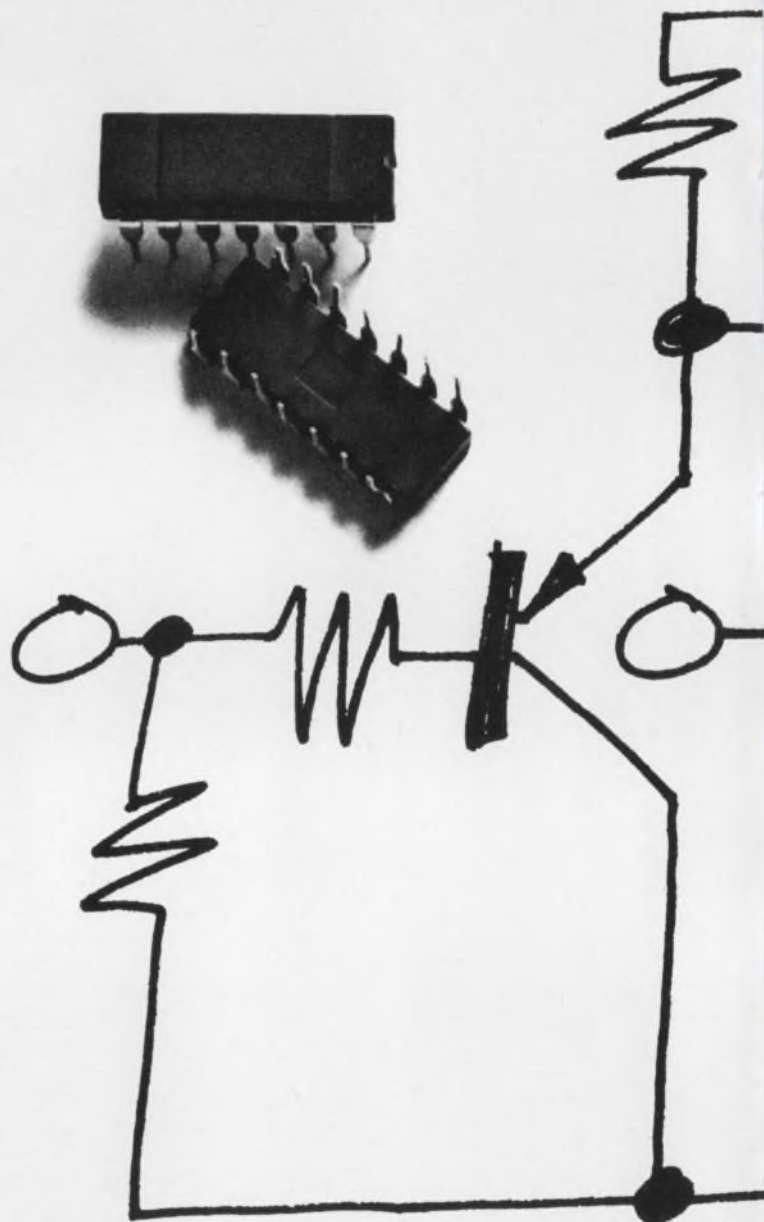

The world's largest manufacturer

inverter with propagation delays of 5nsec, compared with 12nsec in standard CT μ L. And, the new MSI and CT μ L-II circuitry will interface beautifully with all these standard CT μ L devices:

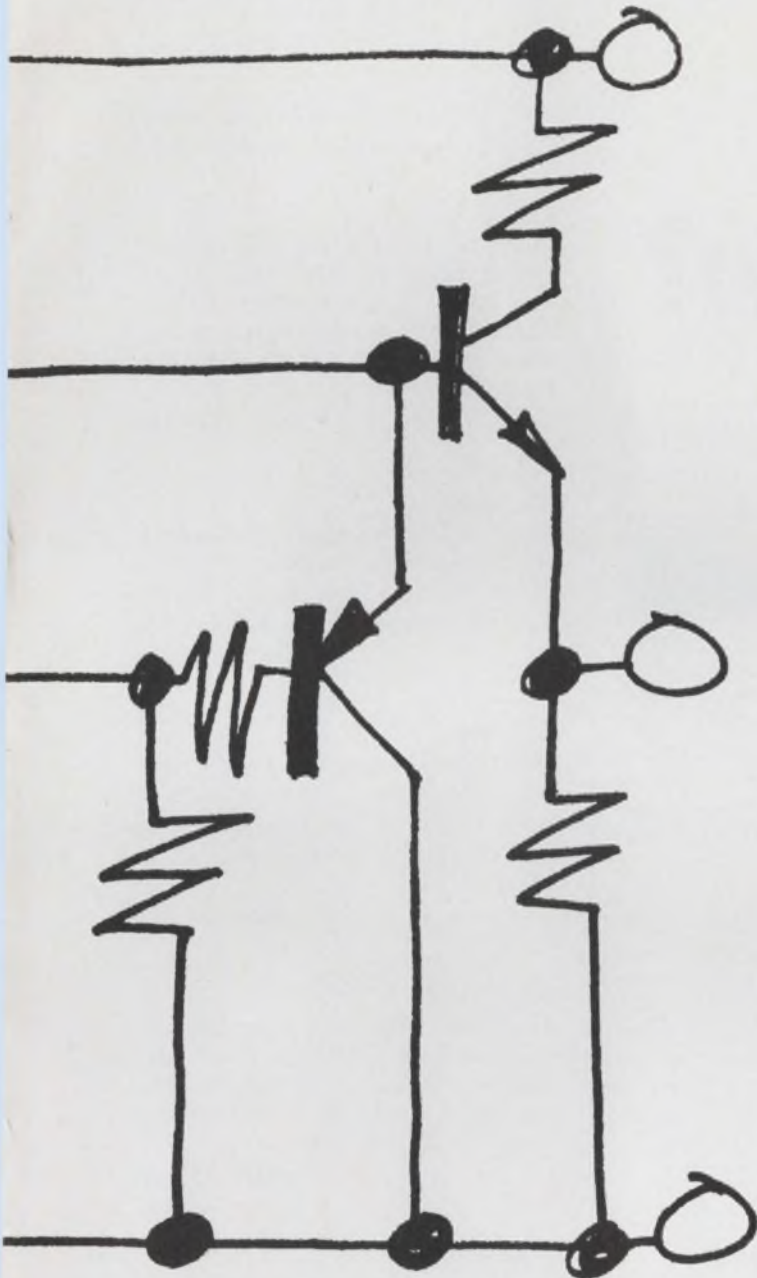

Device	Price (100-999)
9952 Dual NOR Gate	\$1.25
9953 Triple AND Gate	1.25
9954 Dual Four-input AND Gate	1.25
9955 Eight-input AND Gate	1.25
9956 Dual Buffer	1.25
9957 Dual-rank Flip-flop	2.00
9964 Dual Three-input and Single-input AND Gates	1.25
9965 Quad Single-input AND Gate	1.25
9966 Quad Two-input AND Gates, one pair with OR-tie	1.25
9967 JK Flip-flop	2.00
9968 Dual Latch	2.00
9971 Quad Two-input AND Gates with OR-tied pairs	1.25
9972 Quad Two-input AND Gates, one pair with OR-tie	1.25

If you want CT μ L-II in sample quantities, call Fairchild. If you want standard CT μ L in production quantities, call a Fairchild distributor. He has everything you need to build any computer. Even a Computer.



Fairchild Semiconductor / A Division of Fairchild Camera and Instrument Corporation / 313 Fairchild Drive, Mountain View, Calif. 94040 (415) 962-5011 / TWX: 910-379-6435

of LSI admits there's another way:

Who Built the Converter Used on the Army's Minigun?



Abbott did. Out of 931 converters delivered during 14 months, only two were returned for repair. Maybe that's the reason, Abbott's Model BL5D-11A converter was selected as a power supply for installation in the SUU-11A/A minigun system, used on helicopters in Vietnam. This system employs a 7.62 millimeter minigun pod with firing rates of 6000 rounds per minute and therefore demands high reliability. This Abbott converter has an MTBF (mean time between failures) of 129,379 hours as calculated from the MIL-HDBK-217 handbook.

Abbott power modules use only the highest quality semiconductors and MIL-T-27B transformers in their construction to obtain the high degree of reliability under tough environments demanded by today's military requirements. To withstand heat sink temperatures of 100°C all silicon semiconductors are used exclusively.

High density electronics packaging, coupled with good design, give Abbott power modules a minimum size and weight for their rated power

output. One group of Abbott's DC to DC converter line, for example, the Model B05D, is smaller than a package of cigarettes, weighs less than a pound and produces five watts of regulated output voltage. All of the models described in the Abbott Catalog have correspondingly small sizes and weights.

If you have a need for a reliable converter, inverter or modular power supply, take a look at Abbott's. There are over 3000 models listed in their new catalog. They are built to operate in military environment of MIL-E-5272C at 100°C. They include output voltages from 5 volts to 10,000 volts DC with output currents from 2 milliamperes to 20 amperes. A wide range of different types of input power is available:

- 60 ϕ to DC, Regulated
- 400 ϕ to DC, Regulated
- 28 VDC to DC, Regulated
- 28 VDC to 400 ϕ , 1 ϕ or 3 ϕ
- 60 ϕ to 400 ϕ , 1 ϕ or 3 ϕ

TO: Abbott Transistor Labs., Inc., Dept. 07
5200 West Jefferson Blvd.
Los Angeles, California 90016

Sir:
Please send me your latest catalog on power supply modules:

NAME _____ DEPT. _____
COMPANY _____
ADDRESS _____
CITY & STATE _____

Please write for your FREE copy of this new catalog or see EEM (1968-69 ELECTRONIC ENGINEERS MASTER Directory), Pages 1727 to 1740.

abbott transistor
LABORATORIES INCORPORATED
5200 W. Jefferson Blvd./ Los Angeles 90016
(213) WEbster 6-8185 Cable ABTLABS

INFORMATION RETRIEVAL NUMBER 8

Designer's Datebook

DECEMBER						
S	M	T	W	T	F	S
1	2	3	4	5	6	7
8	9	10	11	12	13	14
15	16	17	18	19	20	21
22	23	24	25	26	27	28
29	30	31				

JANUARY						
S	M	T	W	T	F	S
			1	2	3	4
5	6	7	8	9	10	11
12	13	14	15	16	17	18
19	20	21	22	23	24	25
26	27	28	29	30	31	

For further information on meetings, use Information Retrieval Card.

Dec. 9-11

National Electronics Conference and Exhibition (Chicago). Sponsor: NEC; R. J. Napolitan, NEC, Inc., Oakbrook Executive Plaza #2, 1211 W. 22 St., Oak Brook, Ill. 60521

CIRCLE NO. 424

Dec. 9-12

Electrical Insulation Conference (Los Angeles). Sponsor: IEEE; G. M. Goldenstern, 22307 Ocean Ave., Torrance, Calif. 90505

CIRCLE NO. 425

Dec. 9-11

Fall Joint Computer Conference (San Francisco). Sponsor: IEEE and AFIPS; AFIPS Headquarters, 345 E. 47 St., New York, N. Y. 10017

CIRCLE NO. 426

Dec. 16-18

Adaptive Processes Symposium (Los Angeles). Sponsor: J. M. Mendel; Douglas Aircraft Co., Inc., 3000 Ocean Pk. Blvd., Santa Monica, Calif. 90406

CIRCLE NO. 421

Jan. 21-23

Reliability Symposium (Chicago). Sponsor: J. E. Condon; Office of Reliability & Quality Assurance, NASA Hq., Washington, D. C. 20006

CIRCLE NO. 422

Jan. 28-31

International Symposium on Information Theory (Ellenville, N. Y.). Sponsor: David Slepian; Dept. of Transportation, Washington, D. C. 20006.

CIRCLE NO. 423

These new SAMPLE/HOLD MODULES from BURR-BROWN

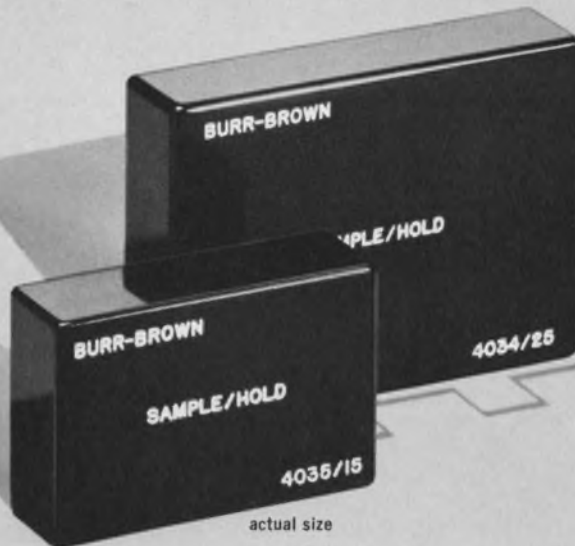

will help you build
accurate A/D conversion systems
in less time...at lower cost

Of the six Sample and Hold (or Track and Store) modules supplied by Burr-Brown, these two new units are proving to be the most popular. Why? Because they provide the type of precise, non-inverting performance that is ideally suited for highly-accurate A to D conversion systems. And, the price is reasonable. Only \$110.00 for the 4034/25 . . . \$125.00 for the 4035/15 . . . in single unit quantity.

Both units have excellent gain accuracy ($\pm 0.01\%$), low drift in the HOLD mode and a $10M\Omega$ input impedance. Size is a convenient 1.80" x 2.40" x .60" for the Model 4034/25 . . . only 1.20" x 1.80" x .60" for the Model 4035/15. Rack mount versions are also available.

FOR DETAILED INFORMATION
on the complete line of Burr-Brown Sample/Hold Modules,

simply contact your Burr-Brown Engineering Representative or use this publication's reader service card.

HIGHLIGHT SPECIFICATIONS

	4034/25	4035/15
Accuracy (0 to 60°C, 1% of f.s.)	$\pm 0.01\%$	$\pm 0.01\%$
Input Impedance	10 M Ω	10 M Ω
Aperture Time	0.05 μ s	0.05 μ s
Acquisition Time		
Settling to 0.01%	1000 μ s	100 μ s
HOLD Decay (at 25°C)	± 0.1 mV/s	± 0.25 mV/s
Power Requirements	± 15 V	± 15 V
Price, single unit quantity	\$110.00	\$125.00

BURR-BROWN

RESEARCH CORPORATION

International Airport Industrial Park • Tucson, Arizona 85706
TELEPHONE: 602-294-1431 • TWX: 910-952-1111 • CABLE: BBRCORP



Operational Amplifiers
Instrumentation Amplifiers
Function Modules
Active Filters
Power Supplies

ENGINEERING REPRESENTATIVES: ALABAMA, HUNTSVILLE (205) 534-1648 / ARIZONA, PHOENIX (602) 254-6085 / CALIF., LOS ANGELES (213) 665-5181, SAN DIEGO (714) 232-2017, SAN FRANCISCO (408) 244-1505 / COLO., DENVER (303) 399-4391 / CONN., EAST HARTFORD (203) 874-9222 / D.C., WASHINGTON (SEE MARYLAND) / FLORIDA, ORLANDO (305) 425-2764 / ILLINOIS, CHICAGO (312) 286-6824 / LA., NEW ORLEANS (504) 888-2266 / MD., SILVER SPRING (301) 588-8134 / MASS., BOSTON (617) 245-4870 / MICH., DETROIT (313) 358-3333 / MINN., MINNEAPOLIS (612) 781-1611 / MO., ST. LOUIS (314) 524-4800 / N.C., GREENSBORO (919) 273-1918 / N.J., CAMDEN (215) 925-8711 / N.M., ALBUQUERQUE (505) 255-1638 / N.Y., ALBANY

(518) 489-4777, BINGHAMTON (607) 723-9661, MT. VERNON (914) 968-2200, NEWBURGH (914) 561-4510, NEW HARTFORD (315) 732-3775, ROCHESTER (716) 473-2115 / OHIO, CINCINNATI (513) 761-5432, CLEVELAND (216) 237-9145, DAYTON (513) 277-8911 / PENN., PHILADELPHIA (SEE CAMDEN, N.J.), PITTSBURGH (412) 243-6655 / TEXAS, DALLAS (214) 357-6451, HOUSTON (713) 774-2568 / UTAM, SALT LAKE CITY (801) 466-8709 / VIRGINIA, (SEE MARYLAND) / WASH., SEATTLE (206) 767-4260 / CANADA, DOWNSVIEW, ONT. (416) 636-4910, MONTREAL, QUE. (514) 739-6776, OTTAWA, ONT. (613) 725-1288, VANCOUVER B.C. (604) 291-7161

Help Yourself To Better Power Circuit Systems With This All-New Designer's Handbook!

Two hundred and fifty information-packed pages that will help you make the best use of the best of today's power transistors, rectifiers, thyristors and regulator diodes — with proven circuits springboarding auxiliary ideas for your future requirements!

"How-to-do-it" is the keynote. Nearly 150 bread-boarded and tested designs — many of them unique and up-to-now-unpublished — point the ways to a great variety of state-of-the-art power semiconductor applications. Even for a given power system, such as dc-ac conversion multi-faceted approaches are described: low and high voltage inputs and high power outputs, 60 Hz to 15 kHz switching frequencies, unregulated and regulated output with and without overload protection and using SCR's and transistors.

Specific titled sections include:

- Motor Speed Controls
- Inverters and Converters
- Regulated Power Supplies
- Static Switching
- Servo & Audio Power Amplifiers
- Thyristor & Transistor Switches

The first of many section highlights illustrates excellent control of ac induction motors through two unique designs followed by dc motor speed controls featuring control of rotation direction, compensation for load changes and optical feedback. Other chapters are equally engrossing spotlighting series, parallel and impulse-commutated thyristor inverters; overload circuit protection with automatic reset with no series resistance to power source; triac-relays with no contact bounce or arcing; low-distortion, transformerless, load-protected power amplifiers and much, much more.

Learn the latest in power circuit designs with this invaluable technical library addition. Send for your copy today!

(To receive "Semiconductor Power Circuits," send check or money order for \$2.00 payable to Motorola, Inc., to Box 20912, Phoenix, Arizona 85036.)



MOTOROLA
Power Semiconductors
- where the priceless ingredient is care!

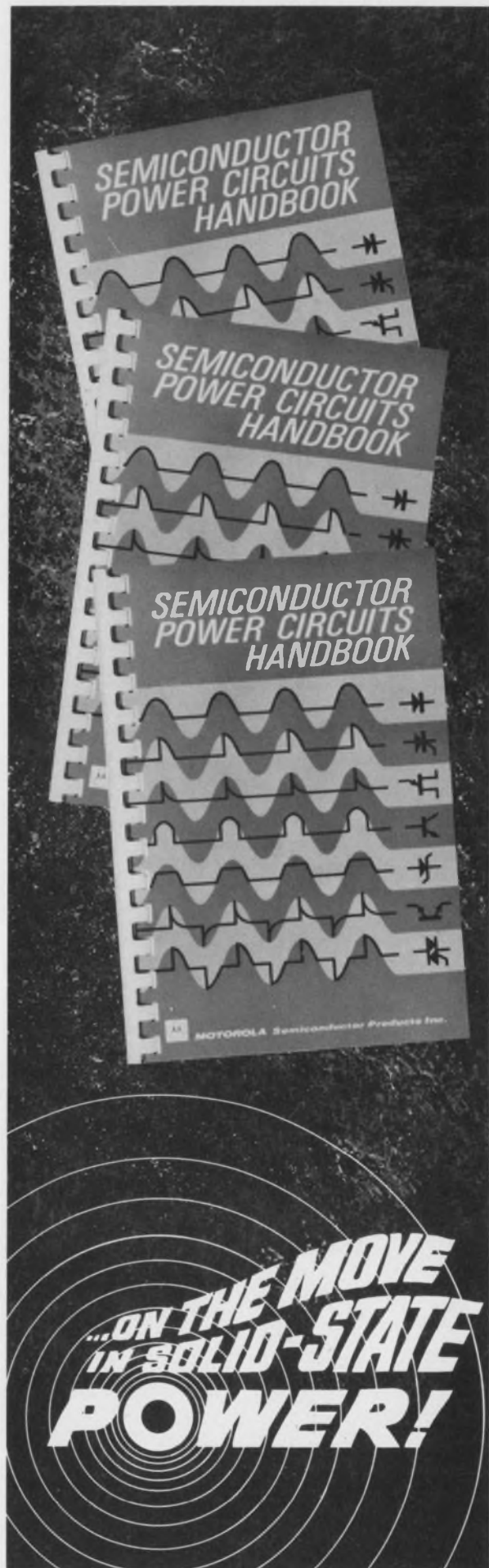

1 μ V Full Scale 10 kHz to 30 MHz Wave Analyzer



TYPE USVH

SELECTIVE MICROVOLT/AMMETER

FEATURES:

- Wide frequency range covers 10 kHz-30 MHz
- Measure Voltage: 1 μ V to 1V, f.s.d. (-118 dB to +2 dB)
- Measure Current: Clip-on current probe (optional, 0.1 — 30 MHz) 1 μ A to 1 A, f.s.d.
- Dynamic Range: 60 dB
- Fine Frequency Adjustment: \pm 2.5 kHz
- Selectable Bandwidth: 500 & 5000 Hz
- Noise Level: 0.5 μ V
- Input Impedances: 50, 60, 75, 150, 600 Ω and 500k Ω || 20 pF High impedance probe available.
- Internal reference makes unit self-calibrating.
- Demodulated phone output.
- Economically priced.

Price: \$3085.00

TYPICAL SELECTIVITY
TYPE USVH
BANDWIDTH 500 Hz

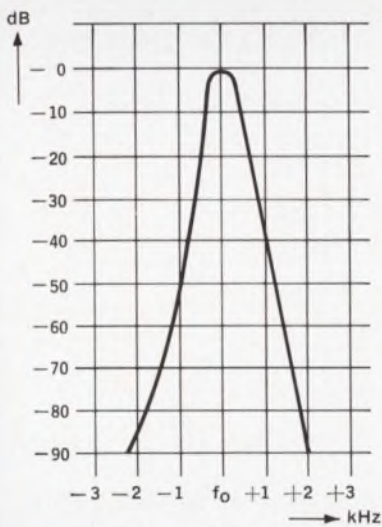

Type USVH Selective Microvolt/ammeter is continuously tunable over the wide frequency range of 10 kHz to 30 MHz. High sensitivity and selectivity are outstanding features of this superheterodyne receiver with direct readings in volts and decibels. Voltage measuring range covers from 1 μ V to 1 V f.s.d. with an accuracy of \pm 3% referred to 1 MHz & 1 V. Measurements can be made to 0.25 μ V. Frequency response is \pm 0.5 dB from 20 kHz — 10 MHz, and \pm 1.0 dB from 10-20 kHz and 10-30 MHz. Type USVH also can be used for selective current measurements using Clip-On Current Probe, BN 150013. Instrument features selectable bandwidth of 500 & 5000 Hz, and provides six switchable input frequencies.

Applications Include:

- 30 MHz Wave Analyzer
- Attenuation and frequency response measurements on networks up to 140 dB
- Null indicator for high frequency bridges
- Measurements of RF distortion as low as -60 dB
- Inter-Channel cross-talk attenuation measurements on carrier systems

Get The Extra Capability,
Greater Reliability, and
Longer Useful Life Of . . .



ROHDE & SCHWARZ

111 LEXINGTON AVENUE, PASSAIC, N. J. 07055 • 201-773-8010

INFORMATION RETRIEVAL NUMBER 11

Add Sprague Series 7400A to your prints for Series 74N TTL circuits. They're pin-for-pin identical.

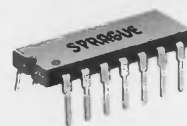

SERIES 74N	FUNCTION	SPRAGUE PART NO.
SN7400N	Quad 2-Input NAND	USN-7400A
SN7401N	Quad 2-Input NAND (No Collector Load)	USN-7401A
SN7402N	Quad 2-Input NOR	USN-7402A
SN7410N	Triple 3-Input NAND	USN-7410A
SN7420N	Dual 4-Input NAND	USN-7420A
SN7430N	Single 8-Input NAND	USN-7430A
SN7440N	Dual 4-Input NAND Buffer	USN-7440A
SN7450N	2-Wide 2-Input Expandable AND-OR-INVERT	USN-7450A
SN7451N	2-Wide 2-Input AND-OR-INVERT	USN-7451A
SN7453N	4-Wide 2-Input Expandable AND-OR-INVERT	USN-7453A
SN7454N	4-Wide 2-Input AND-OR-INVERT	USN-7454A
SN7460N	Dual 4-Input Expander	USN-7460A
SN7470N	D-C Clocked J-K Flip Flop	USN-7470A
SN7472N	J-K Master Slave Flip Flop	USN-7472A
	Dual J-K Master Slave Flip Flop:	
SN7473N	Single chip, pin 11 GND	USN-7473A
—	Single chip, pin 7 GND	USN-74107A
SN7474N	Dual D-Type Edge-Triggered Flip Flop	USN-7474A
—	Dual AC Clocked J-K Flip Flop	USN-7479A
COMPLEX ARRAYS		
SN7441N	BCD-To-Decimal Decoder/Driver	USN-7441B
SN7475N	Quadruple Bistable Latch	USN-7475B
SN7480N	Gated Full Adder	USN-7480A
SN7482N	2-Bit Binary Adder	USN-7482A
SN7483N	4-Bit Binary Adder	USN-7483B
SN7490N	Decade Counter	USN-7490A
SN7491AN	8-Bit Shift Register	USN-7491A
SN7492N	Divide-By-Twelve Counter	USN-7492A
SN7493N	4-Bit Binary Counter	USN-7493A

For complete technical data on Series 5400 and 7400A circuits, write to Technical Literature Service, Sprague Electric Co., 347 Marshall St., North Adams, Mass. 01247



SPRAGUE WORCESTER...the world's finest microcircuit facility

Sprague and ® are registered trademarks of the Sprague Electric Co.

News

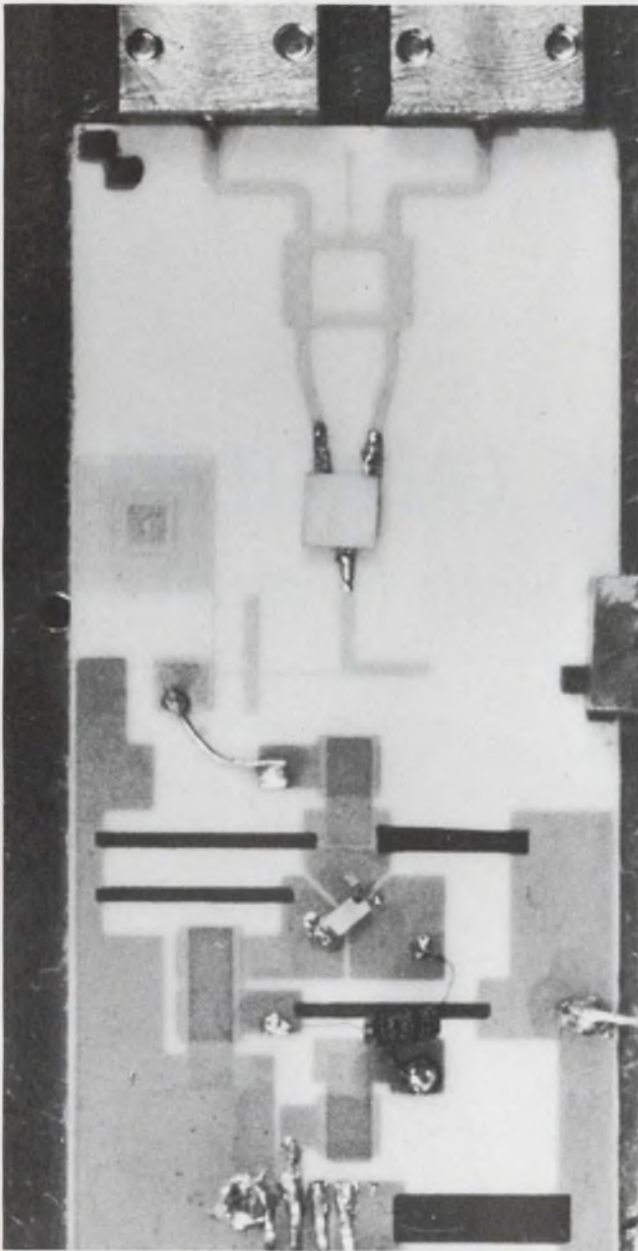

Microwave integrated circuit designers get the lowdown on fabrication techniques. P. 25

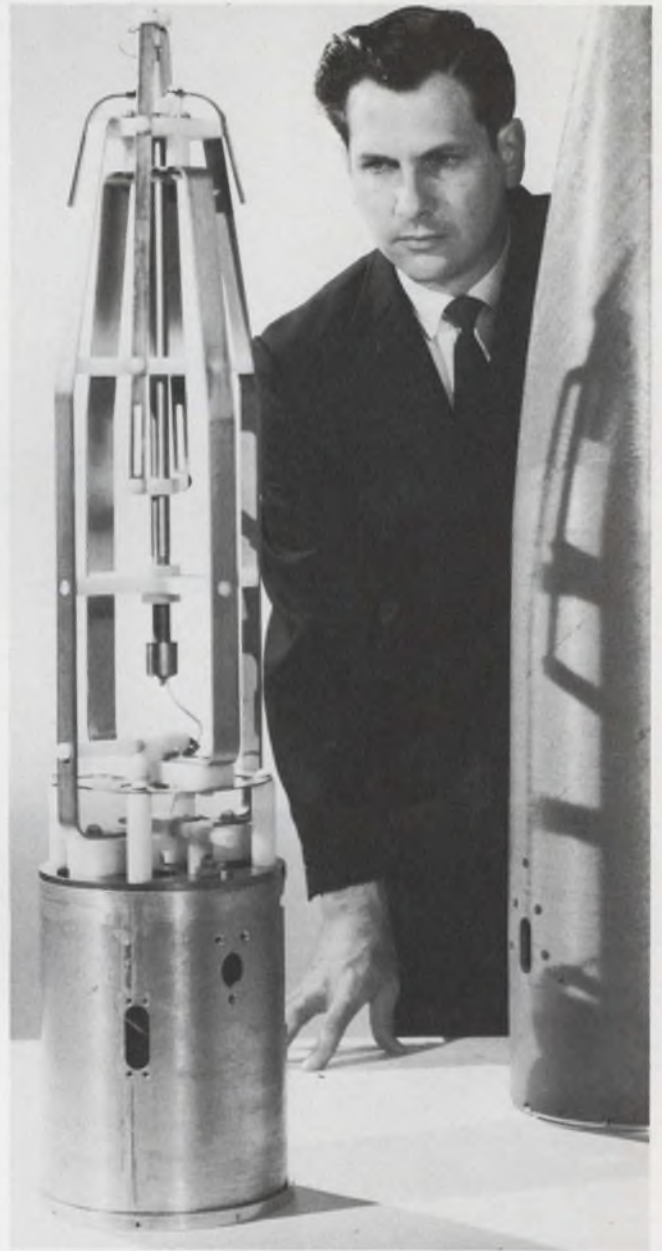

Four-frequency antenna used in ionospheric research fits into rocket nose cone. P. 32

Also in this section:

Laser tops radar in tracking Mach 4.5 sled. Page 36

News Scope, Page 21 . . . **Washington Report**, Page 39 . . . **Editorial**, Page 49

Something *New* Has Been Added!

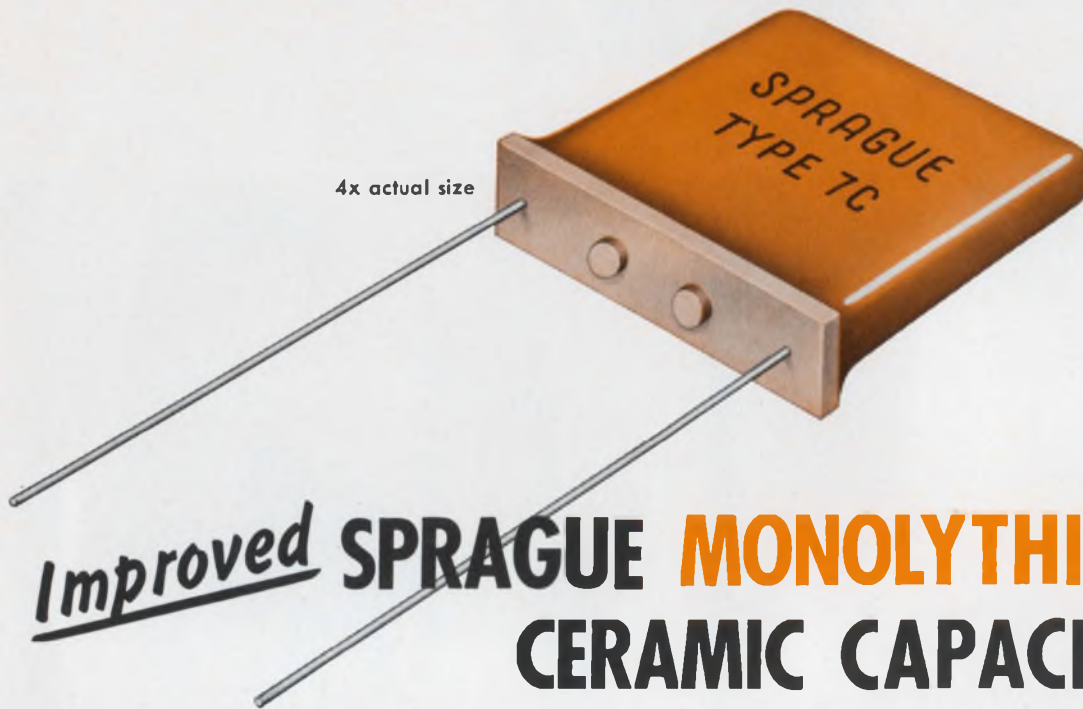

Improved SPRAGUE MONOLYTHIC[®] CERAMIC CAPACITORS

now have a phenolic terminal base

Type 7C Radial-lead Capacitors are made with alternate layers of sprayed ceramic dielectric material and screened metallic electrodes, fired into a solid homogeneous block and coated with a tough phenolic resin. Their new bossed terminal base construction provides these advantages: (1) No resin run-down on leads. (2) Uniform lead spacing is automatically maintained. (3) No dirt and moisture entrapment; degreasing fluid flows freely between capacitor and board.

Body Code	EIA Characteristic	Operating Temperature Range	Maximum Cap. Change over Temp. Range	WVDC	Capacitance Range	Capacitance Tolerance
082	N030	-55 C to +125 C	-30ppm/°C, ±30ppm/°C	50 100 200	51 pF to .024 μF	±20% ±10% ±5% ±2%
075	N750	+25 C to +85 C	Meets MIL-C-20 Char. UJ	50 100 200	.001 μF to .082 μF	±20% ±10% ±5% ±2%
		-55 C to +125 C	-750ppm/°C, ±120ppm/°C			
067	W5R	-55 C to +125 C	±15%	50 100	.0018 μF to 1.5 μF	±20% ±10%
023	Z5U	+10 C to +85 C	+22%, -56%	50	.01 μF to 3.3 μF	+80, -20% ±20%

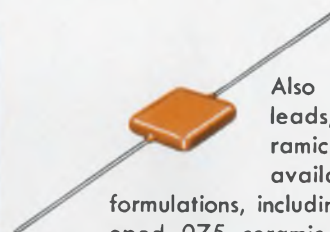

Also made with axial leads, Monolythic[®] Ceramic Capacitors are available in four body formulations, including a newly-developed 075 ceramic material, as described in the adjacent chart.



For complete technical data write for engineering bulletins on Monolythic Ceramic Capacitors to: Technical Literature Service, Sprague Electric Co., 347 Marshall St., North Adams, Mass. 01247.

SPRAGUE COMPONENTS

CAPACITORS
TRANSISTORS
RESISTORS
INTEGRATED CIRCUITS
THIN-FILM MICROCIRCUITS

PULSE TRANSFORMERS
INTERFERENCE FILTERS
PULSE-FORMING NETWORKS
TOROIDAL INDUCTORS
ELECTRIC WAVE FILTERS

CERAMIC-BASE PRINTED NETWORKS
PACKAGED COMPONENT ASSEMBLIES
BOBBIN and TAPE WOUND MAGNETIC CORES
SILICON RECTIFIER GATE CONTROLS
FUNCTIONAL DIGITAL CIRCUITS



'Sprague' and '®' are registered trademarks of the Sprague Electric Co.

Software patent debate rages despite guidelines

Can computer programs be patented? New guidelines published by the U.S. Patent Office, after several years of debate in the computer software industry, seem destined to raise more objections than they are intended to resolve.

The guidelines were announced in Washington, D. C., in a speech by Edward J. Brenner, Commissioner of Patents, before the Computers-In-Law Institute of George Washington University. They merely reaffirm in writing what has been the Patent Office's position all along:

Computer programs, as such, are not patentable. This conclusion, Brenner said, "is based on the well-established doctrine that processes which can be performed solely by mental acts do not constitute patentable subject matter."

The guidelines limit patent protection to programs that are combined with a process that alters "the form, composition, or condition of a physical substance or object."

This position of the Patent Office has stirred strong opposition among the nation's 425 software firms. Conservative estimates are that their software business will pass the \$1.5 billion sales mark by 1970 and will be absorbing up to 70 per cent of the computer industry's research dollar by then. Software developers hold that patent protection is essential to the growth of their industry.

Richard C. Jones, president of Applied Data Research of Princeton, N.J., which holds the only U.S. software patent issued so far—on a sorting system—argues that current patent laws cover software "inventions." He asks that the Patent Office give software the same treatment it does hardware—that each case be considered on its own merits. Jones is confident that the

courts will vindicate his position.

Referring to software as an engineering equivalent of hardware, Jones points out that in many applications, it is engineering considerations alone that dictate whether hardware or software is used to perform a given function.

But Commissioner Brenner warned in his speech that a policy of giving patents on computer programs alone would create long delays in an area where, because of rapid development, prompt action is imperative.

The issue seems likely to end up in the courts.

Lower costs foreseen for silicon devices

No significant innovations but considerable reductions in manufacturing costs are expected next year in silicon device technology.

That's the evaluation of Dr. Gordon E. Moore, vice president of Intel Corp., Mountain View, Calif. He spoke on trends at the 1968 IEEE Electron Devices Meeting in Washington, D.C.

Moore sees a move toward bigger wafers, bigger chips and greater complexity, a lower defect rate, good surface control in crystals, and an elimination of flying leads.

"Little wires are on the way out," he says. "Beam-leads or flip-chips, will be adopted to achieve more reliable multiple-chip structures at lower cost."

He also sees packaging as a problem, with hermetic seals at the chip level the logical solution.

"The package is a principal contributor to the cost of a circuit and has done more to down-grade semiconductor devices than anything else," he says. "Let's do away with packages and put the protection on the chip."

Moore sees dielectric films providing protection from ions and preserving surface properties in silicon devices, as well as providing mechanical and chemical protection to finished circuits. Such films are used also as insulation for multi-level interconnections and for isolation of devices in radiation-resistant circuits.

"Suitable dielectrics," Moore says, "are glass, silicon dioxide and silicon nitride. These will find increasing use in future technology. We can use sedimentation, chemical-vapor-deposition or vacuum-deposition methods for dielectric films. Investigating the possibilities for protective films that are available to us now will keep research labs going for years."

The perfection of processes will cut manufacturing costs, Moore asserts. "Present yields definitely do not approach 100%," he notes.

He looks for two separate attacks on the low-yield problem: through direct examination of failure modes and elimination of the causes of failure, and through the use of redundancy techniques in the masking process.

"Redundancy in masking," he says, "is an important trend."

As for doping, Moore says that "we still use the same three techniques"—grown-junction and solid-state diffusion methods, and a technique in which dopants are added during epitaxial growth.

"These techniques are powerful," he says, "and offer good control of impurity patterns. We can build almost any three-dimensional structure that we desire, and although we may employ many more steps, the processes are the same as they were a few years ago."

Who's who, what's what in data-processing field?

In the last decade there's been a small population explosion in the world of data processing. Who are the people in this mushrooming field? What do they do? How much money do they make?

The questions are expected to be answered in a comprehensive report, "Survey of Information Processing Personnel," which is being compiled by the American Federa-

News Scope

CONTINUED

tion of Information Processing Societies.

The federation sent long questionnaires to 90,000 people. About 40,000 replied. Along with such data as educational background and professional society memberships, the questionnaire sought details on working conditions and salary.

The society hopes to reveal part of its findings at the upcoming Fall Joint Computer Conference in San Francisco. The complete report is expected to be published in early 1969.

Electroacoustic amplifier has separate elements

A new type of traveling-wave electroacoustic amplifier that uses mutually coupled piezoelectric and semiconductor materials has been developed at the General Telephone and Electronics Laboratories, Inc., Bayside, N.Y.

As developed by Stephen Yando, senior engineering specialist, and Dr. Chava Fischler, research engineer, a wafer of silicon is bonded to a wafer of lead zirconate titanate—a piezoelectric material. Acoustic waves are launched in the piezoelectric wafer, and a parallel current of drifting carriers is set up in the close-coupled silicon wafer. Amplification takes place when the carrier drift velocity exceeds the traveling-wave velocity, and energy is transferred from the carriers to the wave.

Because the new amplifier has separate semiconductor and piezoelectric elements, it can be designed with more flexibility than older, single-crystal types which were made from a semiconductor with piezoelectric properties. Where, up to now, the designer has been locked in by the properties of the single-crystal material, with the GT&E amplifier approach the designer is free to choose materials independently of each other.

The GT&E device has reportedly achieved gains of 12 dB/cm over octave bandwidths in the range of 0.5 to 4.0 MHz. Although noise-

figure measurements have not, as yet, been made, the experimenters report that their signals appear to be much cleaner than those achieved with single-material amplifiers.

Approximately 0.5 watt of output power has been obtained so far. The researchers explain that no attempt has been made to maximize power output.

The work was described at the International Electron Devices Meeting in Washington, D.C.

U.S. to award contracts for computer interfaces

Bid proposals to build interface message processors (Imps) for a computer network for the Defense Dept.'s Advanced Research Project Agency have been narrowed down to a few. The contract winner should be announced in a few weeks.

Imps, which will be made of modified off-the-shelf equipment, are needed because many of the 35 computers at 19 sites in the U. S. don't speak a common language. Digital computers themselves, the interface message processors will translate each computer's output into one standard code for communications and display. And, when necessary, they will translate the language of one computer into the language of another.

The defense agency plans to use the network to exchange research and development information and to test new techniques for tying together military command and control networks.

Spaceborne instrument may monitor pollution

Polluted air in the earth's atmosphere may soon be monitored and measured by a new instrument—the correlation spectrometer—that will look down from space orbit.

The feasibility of monitoring, by satellite, the movement and dispersion of masses of polluted air has been demonstrated, according to the developer, Dr. A. R. Barringer, president of Barringer Research, Rexdale, Ontario.

Speaking at the 23rd annual conference of the Instrument Society

of America, the Canadian researcher cited results of measurements made during airplane flights over a dozen U.S. and Canadian cities earlier this year. These results, he maintains, demonstrated the practicality of making similar measurements from orbiting satellites.

The measuring technique, he devised, employs the characteristic spectra or "signatures" of specific pollutants which appear in the visible and near visible wavelength regions.

The Barringer Correlation Spectrometer views the atmosphere through reflected sunlight, which is dispersed by a grating onto a photographic mask. Since the mask is a photographic replica of the pollutants being sought, only light identical to that imprinted on the mask is registered. The amount of light thus passed gives a measure of the contamination present. Resolution of the measurement amounts to a few parts in a billion.

Financial support for the new development has been provided by the National Aeronautics and Space Administration and the Department of Health, Education, and Welfare.

Photomultiplier accuracy raised tenfold by RCA

A photomultiplier amplifying stage that is 10 times more efficient than previous models has been developed by RCA's Industrial Tube Div., Lancaster, Pa. The new light detector, the company says, counts the electron input inaccurately enough "to revolutionize studies of the DNA molecule, detect light from radio stars and show how green plants convert sunlight into food.

The amplifier's dynode is coated with a gallium phosphide layer that emits approximately 30 electrons for each one that reaches it from the photomultiplier. This ratio is large enough to overcome possible errors that arise when initial electron entry is counted with conventional photomultiplier materials; the latter emit electrons at the rate of only 5 or 6 to 1.

The dynode's gallium phosphide layer is deposited from hot vapors by a process known as "vapor phase growth."

How to use a Singer Model SPA-100 Microwave Spectrum Analyzer to measure close-in noise

Measuring close-in noise (noise that is close to the carrier) has always been a vital part of many laboratory and production-line tests. But today's solid state oscillators, so much noisier than klystrons or tubes, make the accurate, simple and fast measurement of close-in noise crucial to the successful operation of many systems. The Singer Model SPA-100 microwave spectrum analyzer replaces the complex microwave discriminator systems formerly required to make this measurement.

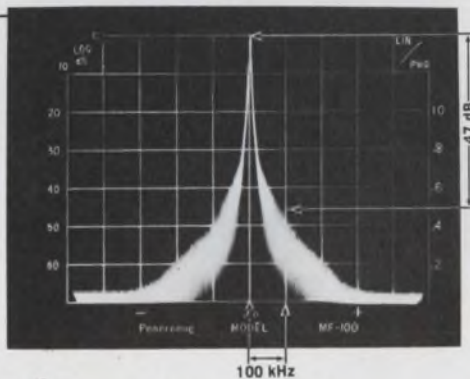
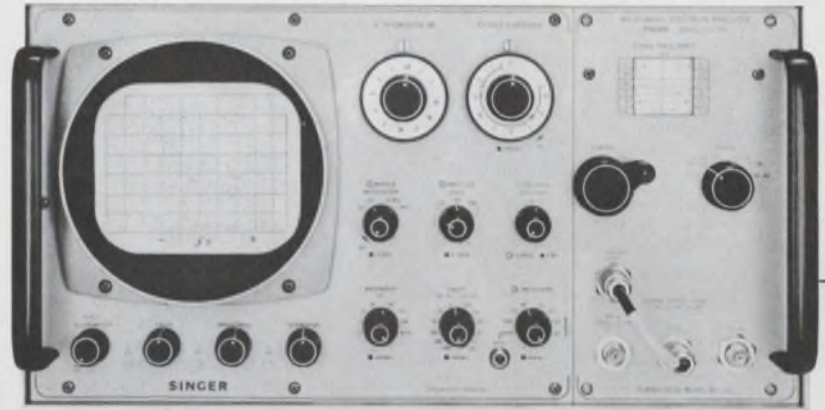

1.

This measurement of $\frac{1}{f}$ noise (noise whose amplitude is *inversely* proportional to the frequency separation from the carrier per unit of bandwidth) can be clearly seen on the analyzer's screen as 47 dB down from the carrier, 100 kHz away. The analyzer settings for this measurement were fixed at a bandwidth of 3 kHz and a dispersion of 100 kHz per division on the CRT graticule. The noise level at any other frequency is easily scaled from the display.

The simplicity of its operation makes the Singer Model SPA-100 ideally suited for the measurement of close-in noise. It has six calibrated bandwidths and a virtually noise-free triode first local oscillator. Its excellent sensitivity provides the wide dynamic range necessary for these measurements as indicated:

Signal Frequency (GHz)	Calibrated Bandwidth Setting (kHz)	Maximum Dynamic Range (dB)
0.94 - 3.5	1	80
	100	60
3.2 - 11	1	75
	100	55

Sharp skirt selectivity allows signals close to the carrier to remain unmasked and easily visible. For example, in the 1 kHz bandwidth mode, signals as close as 25 kHz away from the carrier, 60 dB down may be measured. Similarly, using 100 kHz of bandwidth, signals 175 kHz away from the carrier, 60 dB down, may also be measured.

A detailed application/data bulletin on the Model SPA-100 is now available. The bulletin covers many of the principles of microwave spectrum analysis. For your copy, use the Readers Service Card, or write on your letterhead.

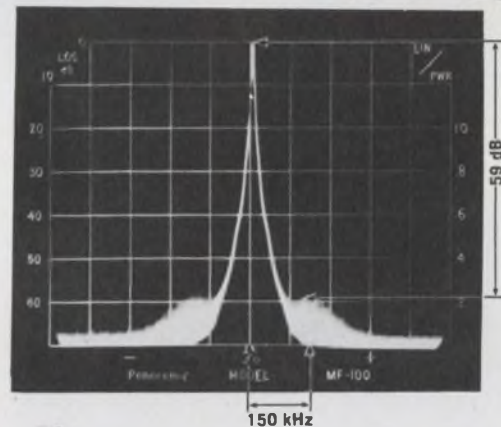

2.

White noise (noise whose amplitude is *constant* with the frequency separation from the carrier per unit of bandwidth) is often measured by the Singer Model SPA-100 spectrum analyzer. Here, with the analyzer set at a bandwidth of 3 kHz and a dispersion of 100 kHz per division, the white noise is visible at 59 dB down, 150 kHz away from the carrier.

Panoramic **SINGER**
INSTRUMENTATION

The Singer Company, Metrics Div., 915 Pembroke Street, Bridgeport, Conn. 06608 (203) 366-3201

winning form

from the
form-factor
specialists
at Damon

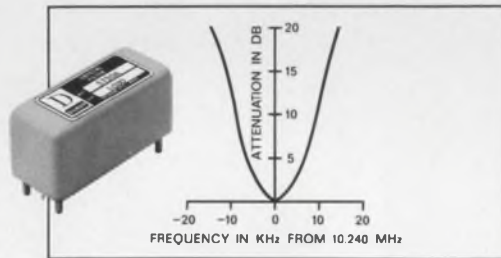

If flat time delay is a requirement in your FM communications or radar system, specify the **Damon line of Gaussian Crystal Filters**. For example, in a coherent pulsed radar system, the Damon Model 5750A can minimize return-pulse overshoot. And its well-behaved impulse response can reduce ringing in frequency scanning applications. In an FM application, the versatile 5750A provides 4-pole selectivity with a linear phase characteristic to eliminate delay distortion.

Model 5750A Specifications: Center frequency (f_0): 10.240 MHz \pm .005%. Bandwidth at 3 db: 10 KHz nominal. Selectivity: 4-pole Gaussian approximation. Pulse response: ringing at least 25 db below main response, with input pulse of 100 microseconds at nominal f_0 . Source and load impedance: 95 ohms. Insertion loss: 3 db max. Operating temperature: 0° to +55° C.

Whatever your signal-shaping needs . . . from a uniformly rounded Gaussian curve to a sharp rejection notch . . . rely on the form-factor specialists at Damon. Write: Electronics Division, Damon Engineering, Inc., 115 Fourth Ave., Needham, Mass. 02194, or call (617) 449-0800.

DAMON

AT NEREM 68

Parley analyzes 3 paths to world of MICs

Thick-film, thin-film and monolithic approaches call for trade-offs by the microwave circuit designer

Michael J. Riezenman
Technical Editor

Knowledgeable designers are no longer asking whether microwave integrated circuits (MICs) are the wave of the future. The big question today is: "How should I make them?"

There are three major approaches in MIC design: thick-film, thin-film and monolithic. Each technique has advantages and limitations, and the designer must trade off such considerations as resolution, cost of fabrication and the number of circuits needed in deciding which approach to use.

This week NEREM 68—the IEEE Northeast Electronics Research and Engineering Meeting—is devoting an entire session in Boston to a discussion of the various fabrication techniques.

Thick films offer low cost

The thick-film circuits are the easiest to manufacture, says Tom M. Hylltin, manager of microwave circuits at Texas Instruments, Dallas, and chairman of the NEREM session (No. 15) in the Sheraton-

Boston Hotel. Thick films require the least expensive equipment for fabrication, and they have the lowest cost per square inch of circuitry, according to Hylltin.

Monolithic circuits, he says, are without question the most difficult form of microwave circuitry to make, and they require the most expensive manufacturing equipment.

Thin-film circuits fall between these two extremes.

Why then use anything but thick-film MICs? The answer is resolution. Most MICs are constructed with a microstrip geometry (see box). In this configuration, the line impedance is strongly dependent on the width of the line and the thickness of the dielectric substrate. Hence, in applications where it is important that the line impedance not vary, it becomes necessary to control the line width very closely.

Similarly the lengths of the transmission lines must be controlled to within small fractions of a wavelength, since the phase shift that they introduce is usually a carefully calculated quantity in the

design of the circuit. At X-band, for example, on an alumina substrate, the phase shift is 1 degree per mil.

Good resolution is also needed to allow the fabrication of very small lumped circuit elements; this increases the density of circuits per unit area of substrate surface and thus lowers the cost per circuit.

Monolithic circuits offer the best resolution and thick-film circuits the worst. However, thick-film technology is still good enough for many applications, and efforts are under way to improve the resolution.

But monolithic circuits, in which a semiconductor is used as the substrate, are not really serious contenders at frequencies below about 10 GHz. There are two significant reasons for this: (1) Microstrip transmission lines made with a semiconducting substrate are too lossy to be used at frequencies where the lines are at all appreciably long (see Fig. 1), and (2) The large areas of substrate material that are required at the lower microwave frequencies make the cost of the semiconductor prohibitively high.

Hence, below X-band the choice is really between thin-film and

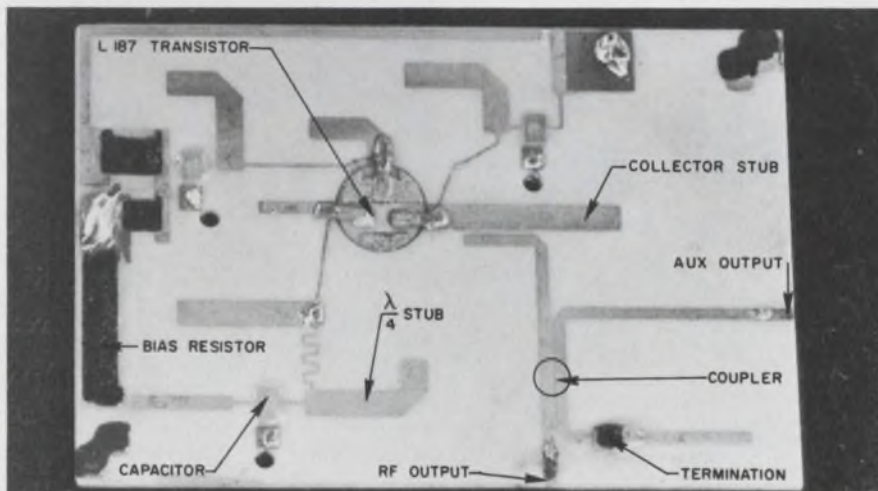

Thick-film oscillator, built at ITT Defense Communications with screen printing techniques, operates at 4 GHz. Initial tuning is accomplished by trimming the length of the collector stub.

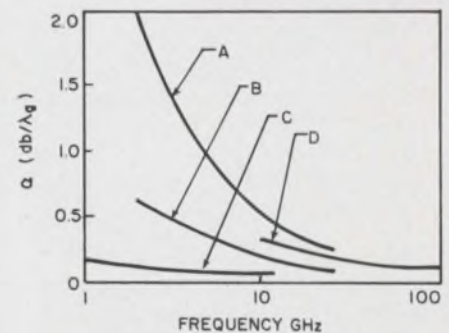

1. Line-loss per wavelength is plotted here against frequency for four different materials. Curve A is for 10-mil silicon with a resistivity of 1 k Ω -cm; curve B is for 10-mil silicon with a resistivity of 5 k Ω -cm; curve C is for 20-mil alumina; curve D is for 5-mil gallium arsenide (semi-insulating).

(MIC, continued)

thick-film circuits. The terms "thin" and "thick" are actually somewhat misleading, says Dr. Martin Caulton, a member of the technical staff of RCA Laboratories, Princeton, N.J. The thickness of the films used in MICs is determined by skin-depth considerations, and the depth is approximately the same in both technologies. Caulton, who is presenting the thin-film paper at NEREM, pointed out that the metal films should be a few skin-depths deep to avoid excessive losses. Typically, he said, line thicknesses of 5 microns (0.2 mil) are used at 2 to 3 GHz and 3 microns at X-band. This is of the same order of magnitude as the 0.5-mil thickness that has become almost standard in the

thick-film method. A more meaningful way to distinguish between thick-and thin-film circuits is suggested by Raymond K. Barcklow Jr., a member of the technical staff of ITT-Defense Communications, Nutley, N.J. Consider the way the two films are made, he says: The thin-film process is one of vacuum deposition by techniques such as evaporation and sputtering, whereas thick-film circuits are made by less exotic processes such as screen printing and spraying.

This difference is responsible for the differences in cost and resolution between the processes.

Thick films and thick inks

There are two competitive methods for fabricating thick-film circuits: screen printing and etching. In the etched approach (Fig.

2), you form a layer of metal on a dielectric substrate, such as alumina, by applying a metal solution to the substrate and firing it. The pattern on one side of the ceramic is left intact and serves as a ground plane, while the other side is etched with photolithographic techniques to form a pattern of conducting lines. These lines are then plated with gold, and uncased semiconductor chip devices can then be bonded to the conductors to form completed circuits.

The chief disadvantage of this technique is the large number of steps required to form multi-layer components, such as capacitors. Each layer of metal or dielectric must be applied, fired, masked and etched. This raises the cost above that of the competitive printed approach in which the layers are screened onto the substrate one at a time and fired individually. The etched approach does afford somewhat better resolution than the printed approach, however.

In an effort to investigate the limitations of the printed approach, Charles Greenwald, manager of advanced R&D, ITT-Defense Communications, along with Barcklow and E. Zaratkiewicz of the ITT-Avionics Div., has been building experimental circuits with the screen-printing technique. He reports that circuits operating through X-band have been successfully constructed.

To build their relatively high-resolution, screen-printed circuits, the ITT group is employing a combination of techniques to improve the resolution of the thick-film printing process. These include the use of very fine-mesh screens, thixotropic inks and slow air-drying of the patterns. The present work uses 325 mesh screens (325 lines per inch). The conductors are made from DuPont No. 8115 gold ink with a viscosity of 1000 poise. Although it has a resistivity of 0.005 ohms per square, the gold ink is preferable to silver, with 0.001 ohm per square resistivity, because of its superior printing properties. The gold ink is thixotropic, which means that it doesn't flow unless it is subjected to shear forces. This improves pattern resolution, since the ink doesn't spread after printing. After the patterns are deposited, they are dried slowly in

MICs: Hybrid devices ordinarily

The term *microwave integrated circuit* (MIC) usually describes a hybrid type of construction in which thick- or thin-film technology is used to lay out a pattern of conducting lines on a ceramic substrate, and uncased active devices are then bonded to the conductor pattern. This technique has two major advantages:

- It uses uncased chips and thus minimizes the parasitic capacitances and inductances associated with packages and long leads.
- It guarantees circuit reproducibility, because the geometry of the circuits is accurately controlled.

The hybrid technology took a step forward when beam-lead devices were invented. They provide, with small gold "beams," both the mechanical mounting and electrical connections needed for the semiconductor chips. These factors, combined with the advantages of high reliability, long life and low maintenance cost has spurred great interest in MICs throughout the microwave industry.

The microstrip circuit shown is the most widely used geometry for MICs. The bottom face of the ceramic substrate is completely coated with a metal film to form a ground plane, and the circuit conductor pattern is

laid out on top. A simple microstrip transmission line is shown. The impedance of such a line, as a function of the line width and substrate thickness, is shown in the graph for a dielectric with a relative dielectric constant of 10, which is a typical value for alumina—one of the most widely used substrate materials.

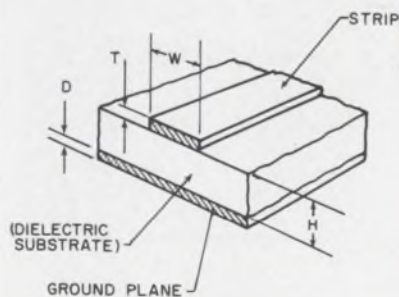
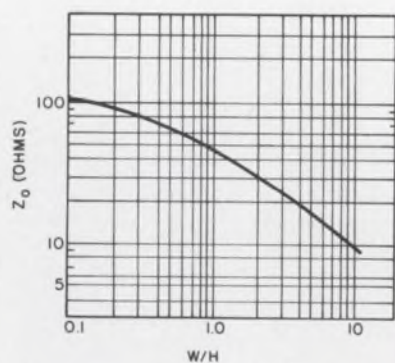

Ice maker control circuit courtesy of Gibson Refrigerator Div.

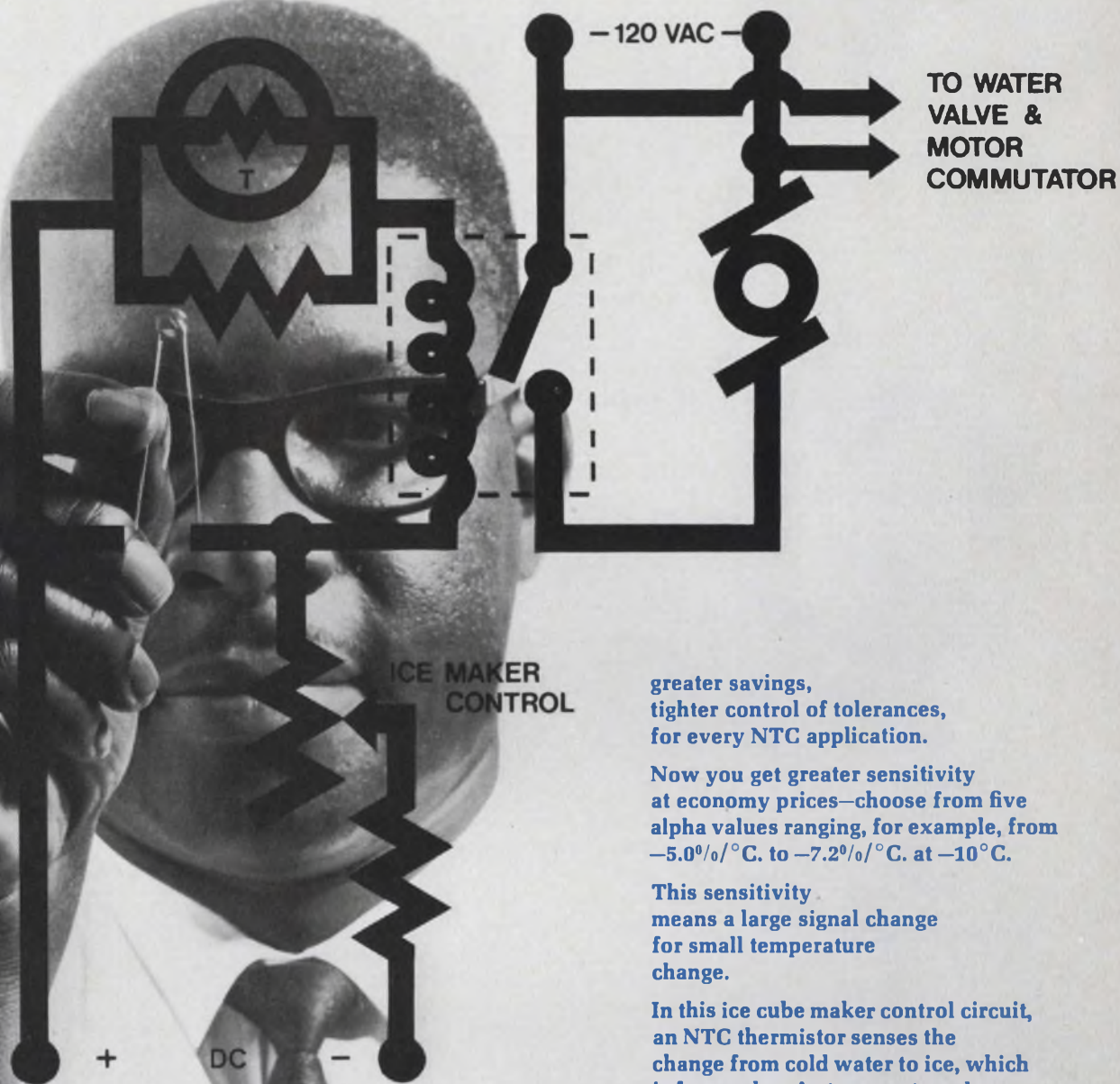

greater savings, tighter control of tolerances, for every NTC application.

Now you get greater sensitivity at economy prices—choose from five alpha values ranging, for example, from $-5.0\%/^{\circ}\text{C}$. to $-7.2\%/^{\circ}\text{C}$. at -10°C .

This sensitivity means a large signal change for small temperature change.

In this ice cube maker control circuit, an NTC thermistor senses the change from cold water to ice, which is frozen dry. As temperature drops, resistance across the thermistor increases. At the required temperature, the thermistor activates the unit's ice cube harvest/refill cycle. A second thermistor compensates the reed relay for ambient-temperature changes.

You too can simplify circuit design, cut costs, and improve temperature-sensing reliability in your solid-state design with Carborundum NTC thermistors.

For detailed information, or assistance on specific applications, write to Mr. James Battle, The Carborundum Company, Electronics Plant, Niagara Falls, N.Y. 14302.

Precisely yours . . .

Design in precise solid-state temperature sensing

... now for just pennies

Carborundum® Negative Temperature Coefficient Thermistors with resistance tolerances to $\pm 5\%$ are now available for as little as 5c per unit.

Our new automated thermistor production line means

CARBORUNDUM



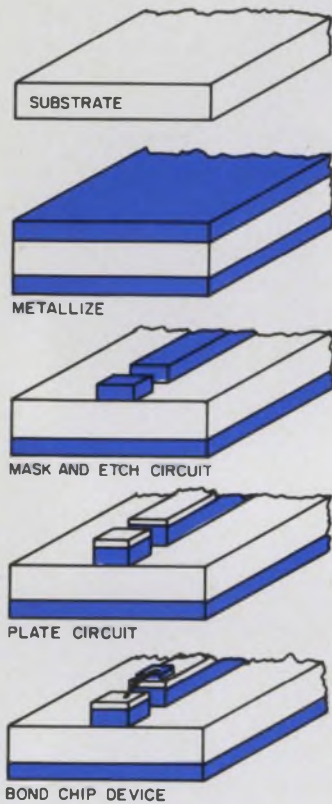

2. Etching a thick-film conductor pattern provides slightly better resolution than printing it. But it costs more.

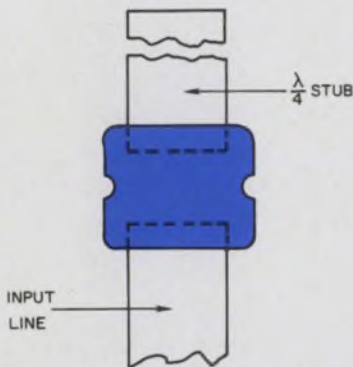

3. The trimming notches on this screen-printed 50- Ω termination have been symmetrically placed to preserve the rf impedance of the line. The lumped (less than 1/50 of a wavelength) resistor is terminated by a quarter-wave open circuit stub that presents an rf ground at the resistor edge.

air before being fired, to avoid the distortions that rapid drying under a heat lamp would cause.

It's simple and economical

The big advantages of this technique, according to Greenwald and Barcklow, are its economy and flexibility. The process is simple and inexpensive because it consists of only two basic steps: printing and firing. Conductive inks, resistive inks, high-dielectric-constant inks and encapsulating inks are all available and are simply screened onto the substrate in the appropriate order to form various devices. Since the process does not have very high resolution, some trimming is needed; but this is done automatically and doesn't add greatly to the cost (see Fig. 3). In the manufacture of capacitors, a barium titanate-based ink with a relative dielectric constant of 1600 is screened over a metal film and topped with another metal film. The high dielectric constant means that the dielectric layer can be quite thick and the breakdown voltage correspondingly high. Capacitors with 10,000 pF per square inch and 500-V breakdown have been made this way.

If very high capacitance is not needed, titania (TiO_2) can be used with some improvement in temperature stability.

Flexibility is provided by the wide range of values that can be produced in such components as resistors and capacitors. Resistive inks, for example, are available that vary in resistivity from 1 ohm per square to more than 10-k ohms per square. This can be contrasted with the thin-film approach, in which the choice of resistive materials is limited by their compatibility with a vacuum-deposition technique.

However, as Greenwald and Barcklow are careful to point out, thin-film resistors have much lower temperature coefficients than the most stable inks, although the inks are steadily improving (see "Thick films headed for wide use in the 1970s," ED 16, Aug. 1, 1968, pp 25-32).

A more important advantage of the thin-film approach is the extremely fine resolution that it provides. Caulton has fabricated lines

6 microns (0.24 mils) wide with a spacing of 6 microns, whereas thick-film technology is limited to line widths of about 2 mils and spacings of about 1 mil. Alexander T. Botka, head of IC development at Microwave Associates, Burlington, Mass., who is a co-author of the NEREM paper on etched thick-film circuits, points out that it is easier to make a narrow gap between two lines than to make a narrow line. The reason is undercutting. As seen in Fig. 4, undercutting is a problem with etched circuits because the etching solution attacks the sides of the conductors as it forms them. As a rule of thumb, the amount of undercut is about equal to the thickness of the metal. Hence, Botka says, if you try to make a very narrow line out of fairly thick material, it will fall off the substrate.

The problem of undercutting is not limited to the thick-film makers, since, as pointed out earlier, the thin films used in MIC work are actually quite thick. A partial solution to the problem—one being used in thin-film fabrication (Fig. 4)—is to deposit and etch very thin films and then, after the pattern is defined, to plate the required thickness of metal onto the pattern. This would seem to solve everything, but it does not. Caulton explains that the plated metal, unfortunately, does not always have the smoothness and conductivity of the bulk metal. Therefore it can be more lossy. Hence, in considering whether to etch the rather thick thin-films or use the plating and etching technique, the fabricator must weigh the relative importance of lossiness of the line and accuracy of its definition.

In the construction of coupled circuits, for example, it may be necessary to have line separations of less than one mil. This requires the plating and etching technique. On the other hand, a 50-ohm line on 20-mil alumina is 19 mils wide (see box). Here the etching uncertainty of, say, 0.3 mils is no problem, and the lower-loss etching method can be used.

Lumped elements save space

Traditionally the microwave circuitry is fabricated with distributed passive elements. But, as

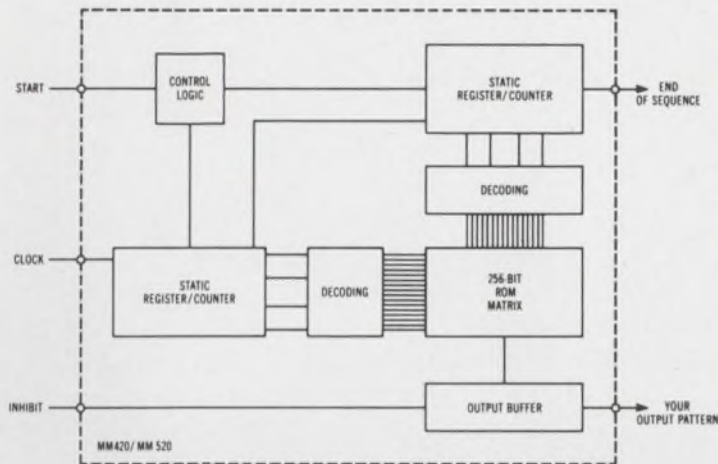

For a paltry \$38* each
 you can get a complete
 read-only memory
 system on a chip
 (made to your specs
 and delivered 4
 weeks from next Tues.)

*Buy a hundred of the MM520 commercial version at \$38 each.
 Or, better yet, buy more.

National Semiconductor

National Semiconductor, 2975 San Ysidro Way, Santa Clara, California 95051. (408) 245-4320.

INFORMATION RETRIEVAL NUMBER 17

(MIC, continued)

Caulton points out, at the lower microwave frequencies, distributed circuits take up a great deal of area, and the use of lumped elements—if they can be made small enough and with sufficiently high Q_s —is worthy of exploration. In fact, the only reason for using distributed elements in the first place is the difficulty in making miniature lumped elements. This point is recognized by Montgomery, Dicke and Purcell in a classic book¹ in which they note that the difficulties of fabricating small, high- Q components call for using distributed techniques.

But, Caulton points out, modern photolithographic techniques have removed many of the objections to the lumped approach, and it must be reconsidered in the light of present knowledge.

Caulton and his colleagues at RCA Laboratories have built and tested 2-GHz, lumped-element, thin-film transistor amplifiers with single-stage gains of 13 dB at low power levels and 4 dB at 1 watt. Cascaded operation provided more than 17 dB of gain at 0.8 watts cw.

At L- and S-bands, the savings in substrate area that can be realized by using lumped elements is on the order of 10:1. This means that the amplifiers or other microwave circuits that can be put on one substrate can be increased about ten times. Now, since the cost of integrated circuits varies inversely with the number of circuits processed at one time,² the size reduction has important economic significance. As frequency goes up, the size of the distributed circuits goes down, and the advantages of the lumped approach disappear.

In building lumped-element microwave ICs, the designer must keep the Q_s of the inductors and capacitors as high as possible, to keep losses down to a level comparable to those achieved with distributed-element circuits.

Problems with monolithics

The monolithic MIC, in which the substrate serves both as an active semiconductor and a transmission line dielectric, represents

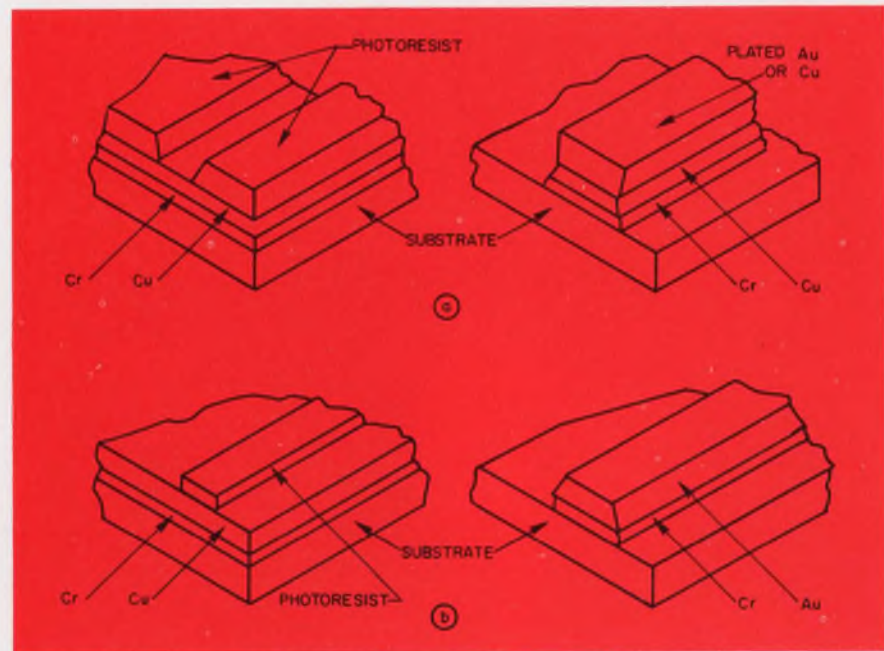

4. Under-cutting is the big problem in etched-film fabrication. One way of combating it is to deposit a thin film and then cover the film with a thick layer of photoresist (a). The required thickness of metal is then plated inside the mold which is then etched away. The undercutting caused by directly etching a relatively thin film is shown in (b).

the ultimate in line resolution and circuit reproducibility. But it also presents some very difficult fabrication problems. As is evident from Fig. 1, the ohmic losses of microstrip transmission lines with semiconducting substrates are too high to permit reasonable performance below X-band. Above those frequencies, acceptably low losses can be obtained with high-resistivity semiconductors.

However, Frank E. Emery of Texas Instruments, who is presenting the NEREM paper on monolithics, points out that at the higher frequencies great care is needed in circuit design to prevent surface-wave propagation. To avoid this problem, he says, the transverse dimensions of the microstrip must not be allowed to approach a quarter wavelength. This necessitates the use of thinner substrates and narrower lines than at the lower microwave frequencies.

The most important problem is that posed by impurities. Microwave ICs use a much higher resistivity, and hence a much purer semiconductor, than do ordinary ICs. To maintain the high-resistivity substrate characteristics while depositing impurities onto selected areas of the chip requires extreme care and special procedures. Hyllin cites the use of different oxides

and diffusion temperatures as two of the steps taken to lessen the probability of picking up impurities.

If the problems are so great, why use monolithic MICs? First of all, says Hyllin, silicon has an amazingly fixed dielectric constant. It is essentially unchanged over wide ranges of temperature and over the whole microwave frequency spectrum. This means that narrowband filters built on silicon will be very reproducible and stable. No trimming should be needed in their manufacture, and no changes should occur in the field.

A second advantage of silicon, Hyllin notes, is its high thermal conductivity. This allows it to handle much higher powers than other materials. A switching diode built into a silicon substrate, for example, could handle much more power than a similar diode mounted on alumina, Hyllin says. ■■

References:

1. C. G. Montgomery, R. H. Dicke and E. M. Purcell, *Principles of Microwave Circuits*, McGraw-Hill, New York, 1947, Chap. 1.
2. M. Caulton, S. P. Knight and D. A. Daly, "Hybrid Integrated Lumped-Element Microwave Amplifiers," (to appear shortly in a special joint issue of *IEEE Transactions on Electron Devices and Microwave Theory and Techniques*).

We have a nice way with words

Data manipulation is a breeze with our three newest MOS shift registers:

MM408/508: 8-bit static MOS shift register; serial in/parallel out. \$36.00 in 100 lots for the MM408 (-55°C to +125°C); \$16.00 for the MM508 (0°C to 70°C).

MM409/509: 8-bit static MOS shift register; parallel in/serial out. \$30.00 in 100 lots for the MM409 (-55°C to +125°C); \$12.00 for the MM509 (0°C to 70°C).

MM410/510: Dual 64-bit high-speed MOS shift register; needs only two clock phases; 5MHz operating speed; built-in accumulator; operates from 16 volts. \$40.00 in 100 lots for the MM410 (-55°C to +125°C); \$20.00 for the MM510 (0°C to 70°C).

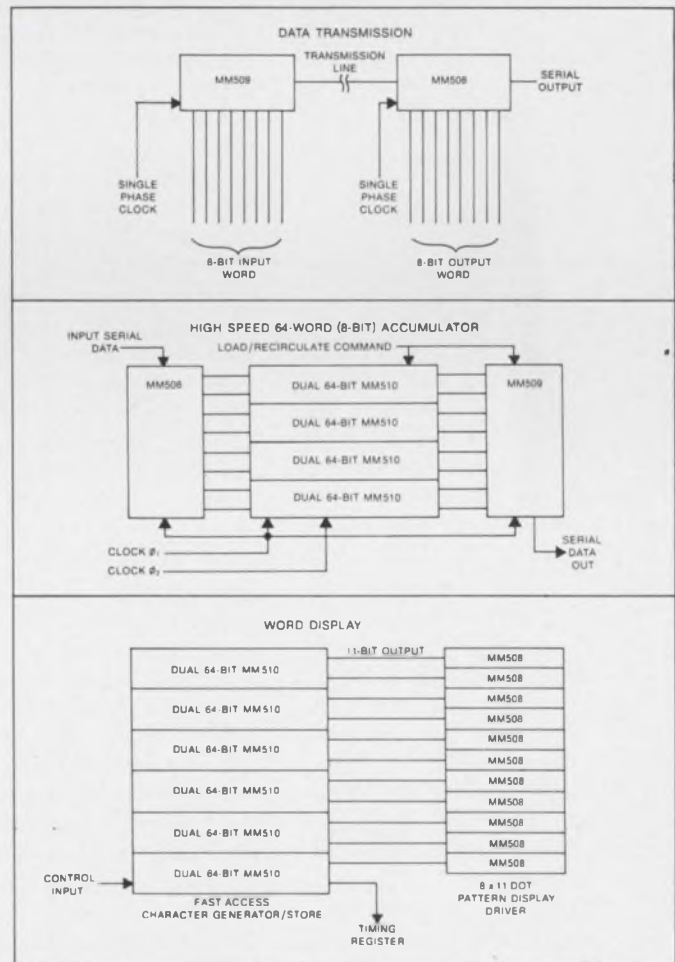

National Semiconductor

2975 San Ysidro Way, Santa Clara, California 95051. Telephone (408) 245-4320.

INFORMATION RETRIEVAL NUMBER 18

Nose-cone antenna aids ionospheric research

A four-frequency, omnidirectional antenna system, used to measure the effect of electron densities on rf propagation in the ionosphere, fits into a rocket nose cone that is only 43 inches long and 9 inches wide at the base.

The unique assembly, which weighs just under 14 pounds, has been used in Nike-Javelin III and other rocket flights from NASA's Wallops Island launching area in Virginia and from Eglin Air Force Base, Fla. While the Army has not disclosed the reasons for its ionospheric study, technical observers believe that it is in support of the development of the Sentinel anti-ballistic missile system.

The area of interest in the upper atmosphere, according to an Army spokesman, begins at 50 kilometers and extends to 640. Thus, data are being radioed, via four Army-furnished beacon transmitters, through the E- and F-layers of the ionosphere as the rockets ascend and descend.

Two major design problems

The antenna system, designed and built by the Orlando, Fla., division of Martin Marietta Corp., overcame two major design problems: the limited volume available within the nose cone of the rocket and the operational requirement for an acceptable antenna pattern from the rear of the rocket.

The minimum acceptable antenna pattern called for uniform coverage within a 90° pattern off the rocket tail and centered about its longitudinal axis. Uniform coverage was defined to mean a maximum of ± 1 dB variation. Because rocket-motor burnout occurs at approximately 20 kilometers and the measurements were to begin at 50 kilometers, transmission to Earth through the rocket plume was not a design problem.

Joseph C. Pullara, the staff engineer at Martin-Orlando who designed the antenna, describes it as a four-frequency, continuous-wave, phase-coherent system. Measurements, he says, are made by com-

paring the phase of a low-frequency carrier with the phase of a much higher frequency. The basis of this technique is that the low-frequency carrier is strongly affected by an ionized medium, while phase at the higher frequency is comparatively unaffected. Thus a "dispersive-Doppler" measurement is obtained by determining the phase difference at any given point throughout the rocket flight.

The four frequencies are 37, 74, 148 and 592 MHz, each harmonically related. The 74-MHz signal, Pullara says, is employed for propagation-attenuation measurements only, while the three others are carrier frequencies required for the Doppler measurements.

A range of sensitivity

The most sensitive and accurate measurement, Pullara reports, is between the 37- and 148-MHz signals. But, he points out, the dynamic range at 37 MHz is limited by high attenuation. The converse is true with measurements that compare the 148-MHz signal with that at 592 MHz.

In his antenna design, a 37-MHz loop is mounted orthogonally with a 74-MHz loop; the 148-MHz, folded-back dipole is mounted orthogonally to a 592-MHz, folded-back bipole. The loop subassembly is oriented at a 45-degree angle with respect to the folded-back subassembly. The whole assembly is such that feedpoints are colinear with the longitudinal axis of the radio-sounding rocket.

The two lower-frequency antennas, Pullara discloses, were designed as electrically small loops, since earlier study had shown this approach to provide the most efficient radiators for the particular application. Identical except for size, the two lower-frequency antennas are made of a brass strip, 1/8 inch thick by 1 inch wide and tapered to fit the nose-cone ogive. The loop is fed across a balanced transformer, and a shunt variable capacitor tunes out antenna reactance.

The 148-MHz antenna is de-

folded-back dipole." The radiation scribed by Pullara as "simply a pattern produced by such a configuration is very nearly isotropic, he asserts, since the swept-back dipole arms negate the effect that normally produces a null in the E-plane of a straight half-wavelength dipole. In this instance, reactance compensation is handled by an externally tuned capacitor (reactance is produced when the arms are folded back at a sharp angle).

No tuning required

The two upper-frequency antenna designs are nearly identical, except that the swept-back angle of the 592-MHz radiator is shallower. As a result, it responds electronically more like a half-wavelength dipole and exhibits no high-reactive impedance components, and it requires no tuning to meet bandwidth needs, Pullara says.

He emphasizes that the antenna does not compensate for spinning or precessing phase changes. Rather, it provides only uniform phase and amplitude coverage and pure linear polarization, thus significantly reducing phase variations caused by precessing. Phase variations resulting from rocket spin are periodic. These, says Pullara, can be subtracted from the data by receiving the linearly polarized signals through two oppositely sensed, circularly polarized antennas and, then, by processing the signals in such a manner as to leave only phase changes caused by Doppler shift.

Pullara emphasizes that the dispersive-Doppler technique is only one of several available electron-density measurement techniques. However, the approach was applied to the Army problem because it lends itself readily to the performance of attenuation measurements and still provides an extended range of electron-density measurements within a single electronic package.

Procurement was recently completed with delivery of a total of 22 systems, the Army says. ■■

IDEAS/Circuit Assemblies

Solve your noise problems with circuit modules.

We told you in the past how our circuit modules reduce noise. Now we've improved them even further.

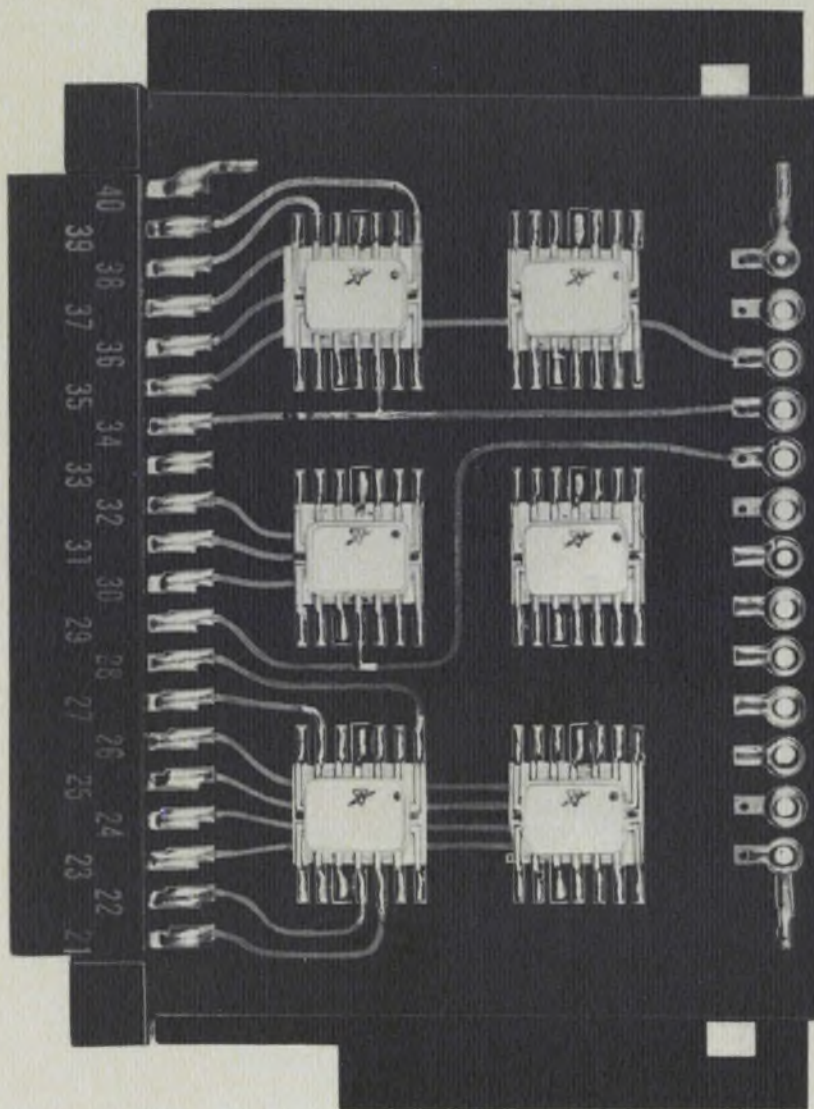

Multilayer construction of Sylvania circuit cards brings IC leads within 1/64" of power and ground planes.

An additional reduction in noise figures of from 30 to 50 percent has been obtained by circuit improvements in Sylvania's popular line of circuit modules. The 13 new modules added to the line are completely compatible with previous units.

The key to improved noise reduction is the addition of a leadless low-inductance capacitor between the power and ground planes. This improvement is in addition to the already low noise figure of our circuit card that is achieved by

Continued on next page

This issue in capsule

Information Displays

New CRT brightens picture for air traffic controllers.

Spark Gaps

Compact surge arrestors offer low-cost circuit protection.

Integrated Circuits

How to design with the SA-20 wide-band amplifier.

Microwave Diodes

For short pulse detection: Try back diodes.

EL Readouts

Electroluminescent clocks will time Apollo flights.

Manager's Corner

How synergism brings you new and better circuit assemblies.

New Circuit Module Cards

Type	Function
262	Memory card (2 bit x 64 word)
263	Memory select driver card
264	Encoder
265	Dual eight-bit register
266	Quad four-bit register
267	Quad four-bit binary divider
268	Up/down counter
269	Series/parallel converter
270	Dual four-bit/five-word storage register
271	Five-bit comparator with storage
272, 273	5.55 MHz bi-phase clock
276	13-bit digital delay generator
285	Test card

its unique construction and inherent low noise of Sylvania's SUHL integrated circuits.

Until the development of our circuit modules you couldn't take full advantage of the speed capability of our SUHL II 50-MHz logic. Noise levels limited practical operation to speeds of about 20 MHz. Now you can approach the full 50-MHz capability of these devices when you buy them on our circuit boards.

The circuit module is made up of two four-layer boards mounted on either side of an aluminum "backbone." Each board has two signal planes plus distributed power and ground planes. When necessary, the signal planes can be electrically interconnected with plated-through holes. The distributed power and ground plane construction allows every IC lead on the board to be within 1/64" of the power and ground planes. The result is extremely short lead lengths and, thus, low noise pickup.

Typical of the new circuit boards is our #262 memory card and #263 memory select driver. Here, we've done your memory design work for you. The #262 is a 128 bit card (2 bits x 64 words). Combined with the #263 memory driver, it gives you a sophisticated systems-oriented building block that can solve your memory problems with a minimum of interconnections.

CIRCLE NUMBER 300

New CRT brightens picture for air controllers.

Scan conversion system using Sylvania CRT makes airport tower radar displays visible in bright sunlight.

Airport towers, where lighting conditions can vary from darkness to 4,000 foot-candles, put tough demands on the contrast and brightness of radar displays.

As a result of considerable research and development work within the Federal Aviation Administration, bright radar displays for use by air traffic controllers have become a reality. Based on an FAA-issued specification, ITT Industrial Laboratories, Fort Wayne, Indiana has come up with an optical scan conversion system that solves the problem for FAA flight controllers. The system uses a special long-lag vidicon camera optically coupled to a Sylvania 5-inch CRT to convert the PPI radar display into a high-brightness 945-line TV display.

The high-resolution requirements put a stringent demand on the CRT used in the conversion process. To meet the need, Sylvania developed the SC-5014P31. This tube provides a 0.0015-inch line width on a 5-inch optically flat faceplate. The neutral gray non-browning faceplate is designed to give optimum photographic quality. Brightness is enhanced by the use of an aluminized screen.

In operation the PPI unit in the diagram accepts the normal radar inputs and displays the radar video on the face of the Sylvania CRT. The vidicon camera is focused on the CRT display and converts it to a uniform bright TV display. The long-lag photoconductive surface of the vidicon retains images of moving aircraft so that a minimum of five trails are visible to indicate direction of movement.

The composite EIA video signal is fed to a special 12-inch CRT for viewing by the flight controller. The display has a highlight brightness of up to 500 foot-lamberts giving the controller an acceptable display in the tower at any time of the day or night.

It is in applications like this, where the demands on CRTs are exacting, that Sylvania's experience and technical know-how really pay off.

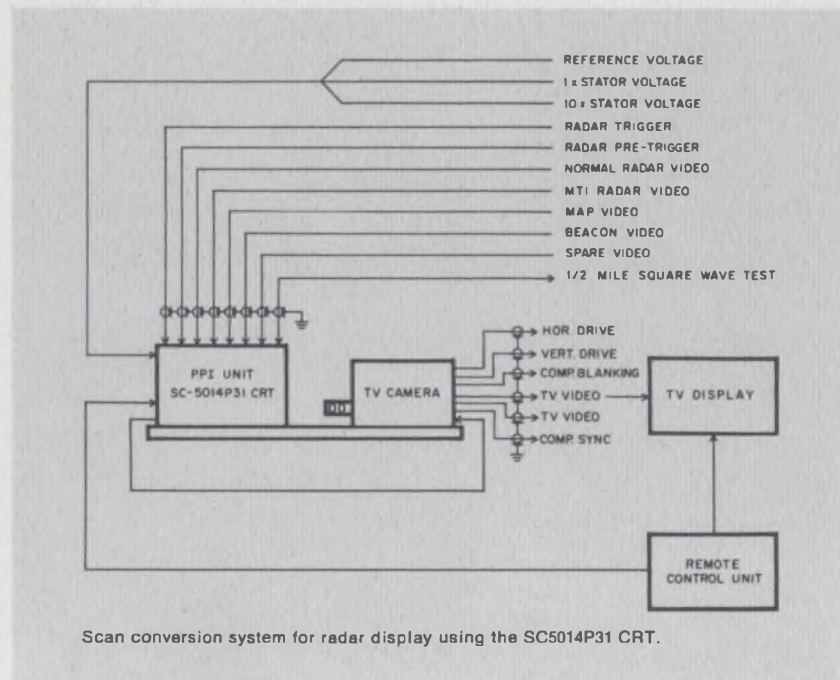

Scan conversion system for radar display using the SC5014P31 CRT.

CIRCLE NUMBER 301

How compact surge arrestors offer low-cost circuit protection.

The gas-filled spark gap surge arrestor is one of the simplest ways to protect equipment against damaging voltage surges. But just because it's simple, don't underestimate its capability.

A spark gap represents an almost ideal device for the job of protecting equipment against voltage surges. Under normal load conditions it presents a very high impedance (100 megohms). If a surge occurs, the gap breaks down and appears as a virtual short circuit. When the over-voltage drops below the extinguishing voltage of the gap, the device immediately returns to the high impedance state.

Sylvania's SG-1361 argon-filled spark gap is a miniature unit designed to protect low power components such as relays, capacitors, coils, and active devices from overloads. It has a nominal firing voltage of 600 V at 60 Hz and a firing voltage range of 500 to 900 V, 60 Hz. Maximum firing current is 25 mA.

The SG-1361 can be used with higher energy circuits if a series resistor is used to reduce the amount of energy transferred by the spark gap to ground. When used as a secondary protector, along with a primary surge arrestor, the SG-1361 can protect components against lightning strikes and other high-transient overloads.

Its small size ($\frac{3}{4}$ -inch long and 0.215-inch in diameter) and its simple economical construction make the SG-1361 an easy component to fit into any system. Since it comes with pretinned Dumet leads the device can be wired directly into the circuit without the use of adapters or clip-type holders.

SG-1361 Electrical Data

Firing Voltage at 60 Hertz	600 volts
Firing Voltage Range (at 60 Hertz)	500-900 volts
Maximum Firing Current (time duration = 30 sec. max.)	25 mA
Maximum Operating Temperature	80°C
Minimum Open Line Impedance	100 Meg.

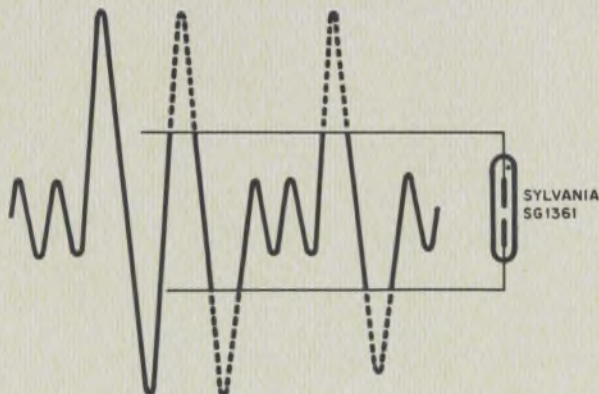

Voltage spikes are shunted to ground by Sylvania's SG-1361 spark gap.



How to design with the SA-20 wideband amplifier.

External access to every element of Sylvania's SA-20 linear amplifier makes it easy for you to modify its characteristics to fit your application.

Sylvania's SA-20 is a versatile general-purpose wideband amplifier. Its characteristics include a high gain-bandwidth product, large signal swing and excellent linearity.

The SA-20 has three direct-coupled NPN transistors in a single-ended configuration. Bias for the input transistor is established internally by divider R_1 and R_2 (Fig. 1). Zener diode D_Z raises the bias level of Q_2 to permit operation of Q_1 in the linear range. Emitter follower Q_3 buffers the output load circuit from the intermediate stage, Q_2 , thereby giving a higher total open-loop circuit gain even with low-value loads. Series DC negative volt-

age feedback is applied from the output of the emitter follower to the emitter of Q_1 by divider R_1 and R_6 .

The major power supply current path is through the output transistor, Q_3 . Total device current drain is therefore strongly related to the quiescent output voltage and the value of R_6 . The output transistor has a maximum current capability of 50 mA. Maximum junction and case temperature for the device are 200°C and 155°C, respectively. Worst-case thermal gradients of the dual inline package used for the SA-20 are $\theta_{JA} = 0.15^\circ\text{C}/\text{mW}$ and $\theta_{JC} = 0.075^\circ\text{C}/\text{mW}$.

In most instances the base current of the input tran-

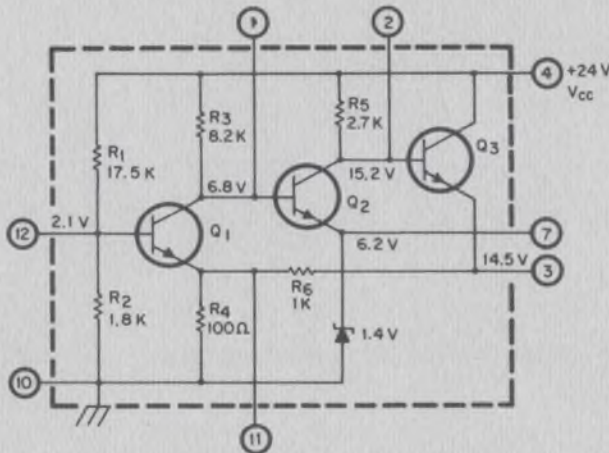

Fig. 1 Circuit of SA-20 linear amplifier.

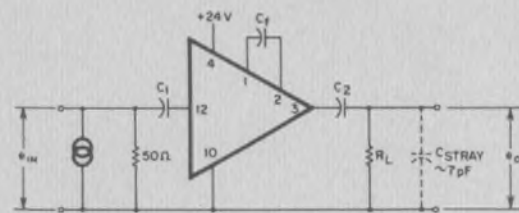

Fig. 2 Standard configuration for SA-20.

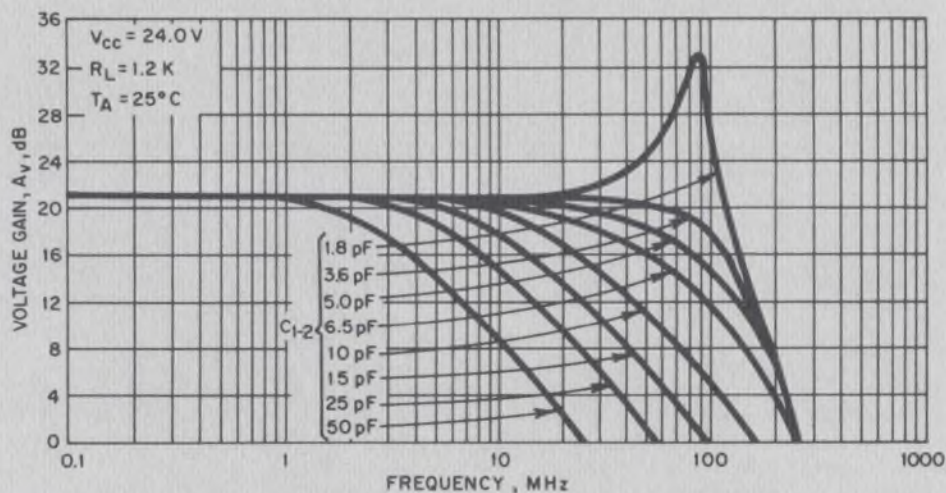

Fig. 3 Typical gain-versus-frequency curves for SA-20 in standard configuration.

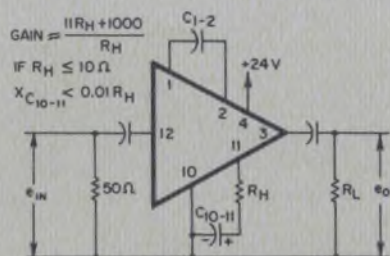

Fig. 4 High gain configuration for SA-20 linear amplifier.

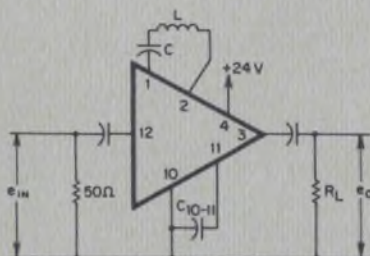
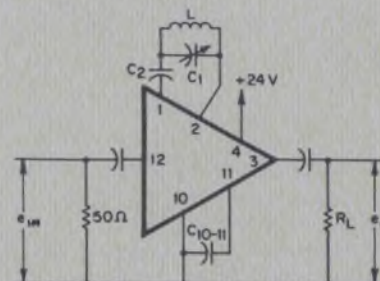

Fig. 5 Selective amplifier configuration with C and L in parallel and series connections.



sistor is small relative to the current in the input divider. Under these conditions input quiescent voltage is:

$$V_{Qin} = (V_{CC}R_2) / (R_1 + R_2)$$

Bias level of the input transistor may be varied by shunting resistors R_1 or R_2 . However, consideration must be given to the effect of a change in V_{Qin} on such factors as current drain and output quiescent voltage.

The output quiescent voltage, V_{Qout} , is:

$$V_{Qout} = \frac{R_6 + R_4}{R_4} \left[\left(\frac{V_{CC} R_2}{R_1 + R_2} \right) - (V_{BE}) \right]$$

V_{Qout} can thus be changed by external resistive shunting of any of the four resistors in the expression.

The maximum voltage swing of the device with an $R_L = \infty$ is essentially a function of the supply voltage and the zener-diode voltage. In the positive direction the voltage is limited by the voltage drop across R_5 and the base-emitter voltage of Q_3 . The voltage swing in the negative direction is limited by the zener voltage plus the saturation voltage of Q_2 minus the junction drop of Q_3 . With a high R_L the device will normally swing between 22.5 V and 6.5 V. If the quiescent output voltage is at the optimum level of 14.5 volts, the AC swing at the output, assuming negligible resistive loading, is approximately ± 8.0 V.

Current restrictions limit the maximum possible voltage swing when using AC-coupled resistive loads of more than approximately 600 ohms.

In the case, when R_L is low, the maximum output voltage is

$$e_{o \max} = \frac{V_{CC} - V_{BE} + [(R_5 V_{Qout}) / (\beta_3 + 1) (R_L)]}{1 + (R_5) / (R_L) (\beta_3 + 1)}$$

Assuming a typical device with $V_{CC} = 24$ V, an AC-coupled 50-ohm load and $\beta_3 = 100$ which is normally the case, the maximum absolute voltage level as seen at the emitter of Q_3 is $e_{o \max} = 16$ V.

The maximum positive swing as seen at the load is therefore 1.5 V. The negative-going swing from the quiescent voltage level is a function of the quiescent current of the device. In terms of absolute voltage the minimum output voltage, $e_{o \min}$, of the device with low value of AC coupled load is:

$$e_{o \min} = V_{Qout} - \left[\frac{V_{Qout} - (V_{Qin} - V_{BE})}{R_6} \right] R_L$$

Again, assuming a typical device and AC-coupled load of 50 ohms, $e_{o \min} = 14.5 - 0.675 = 13.8$ V.

The maximum linear swing with an AC coupled 50-ohm load is therefore 1.5 V above and 0.67 V below the quiescent voltage.

It is possible to increase the swing capability of the device in the negative-going direction when driving low-resistance loads by increasing the quiescent current. This may be accomplished by a DC resistive load or current source. A 1000-ohm DC resistive load increases the negative-going voltage swing across an AC-coupled load from 0.67 V to $0.67 + [(14.5 \text{ V}) 50 / 1000]$ or 1.4 V. Thus the swing can be made symmetrical.

The three-stage open-loop gain of the SA-20 is about 900. Closed-loop voltage gain is:

$$A_{VCL} = \frac{A_{VOL}}{1 + A_{VOL}\beta}$$

where $\beta = R_4 / (R_6 + R_4)$.

Resistors, R_4 and R_6 , are 100 and 1000 ohms, respectively. Since the quantity $A_{VOL}\beta$ at low and medium frequencies is significantly greater than 1, the expression for closed-loop gain simplifies to $A_{VCL} = 1/\beta = 11$. By shunting R_4 or R_6 with an external resistor, the gain of the circuit can be varied. However, as shown previously, other characteristics such as V_{Qout} and associated parameters are also changed by padding either of these resistors. To change the mid-frequency gain without affecting the quiescent level, it is necessary to shunt the internal resistor with a series RC network.

To maintain AC stability a shunt-type feedback loop using an external capacitor is required between the base and collector of Q_2 . Phase margin of a typical device is $> 45^\circ$ when the feedback capacitor is 3.6 pF.

The SA-20, when connected in the standard configuration, as shown in Fig. 2 exhibits the characteristics shown in Fig. 3. It can be seen that by varying the value of the shunt-feedback capacitor, C_1 , the bandwidth of the device can be varied considerably.

In the maximum-gain configuration shown in Fig. 4, AC series feedback is removed from the circuit by shunting R_4 with a capacitor. With the device connected in this manner, the shunt-feedback capacitor which is normally connected between pin 1 and pin 2 is not required. The gain of the amplifier with all forms of AC feedback removed, is about 60 dB up to 5 MHz. From 5 MHz to 100 MHz, the amplifier rolls off at an average rate of -8 dB/octave.

In the selective-amplifier configuration of Fig. 5, the circuit functions as bandpass and notch amplifiers. Series or parallel tuned circuits are used in the shunt feedback loop to achieve the desired response.

For short pulse detection: try back diodes.

High sensitivity, low video impedance and low 1/f noise make back diodes ideal as short pulse detectors.

Microwave designers have a wide choice of devices when it comes to video detectors. Few of these choices, however, have all of the advantages of back diodes when it comes to short-pulse response and fidelity. Among the features of back diodes are high sensitivity, low video impedance and low 1/f noise.

Sylvania's new planar germanium back diodes have all of these features plus a few others including high reliability, and improved temperature stability.

Typical values of tangential signal sensitivity range from -56 dBm (10 MHz video bandwidth) at L-band to -50 dBm at X-band. Low video impedance is a unique feature of back diodes and it is obtained without the use of any noise-generating DC bias. Impedance values in the

hundreds of ohms range are commonly obtained, and in some cases can be as low as 100 ohms. Impedance levels like these mean shorter time constants in the video output circuit, which in turn means better pulse fidelity. Noise figure is another area where back diodes shine. Even where a substantial self-bias current or a DC bias is a must, 1/f noise is minimal thanks to the low resistance and inherent physical qualities of the device.

In Sylvania back diodes, ruggedness and reliability are assured by the use of bonded, brazed and welded construction. The Sylvania diodes are available in the 048 pill package that is ideal for stripline circuitry. They are also available in other package configurations or in chip form.

CIRCLE NUMBER 304



Back Diode Electrical Characteristics

	Test Frequency GHz	Tangential ¹ Signal Sensitivity (TSS) -db min	Figure of ² Merit (M) min	Video Impedance (R _v) ohms max
D5610	2	56	400	1,000
D5611	4	52	180	1,000
D5612	8	49	85	1,000

¹Video Bandwidth = 10 MHz

$$^2 M = \frac{\gamma}{\sqrt{R_v}} \text{ where } \gamma = \text{mv/mw measured at } -20 \text{ dbm in an optimized holder.}$$

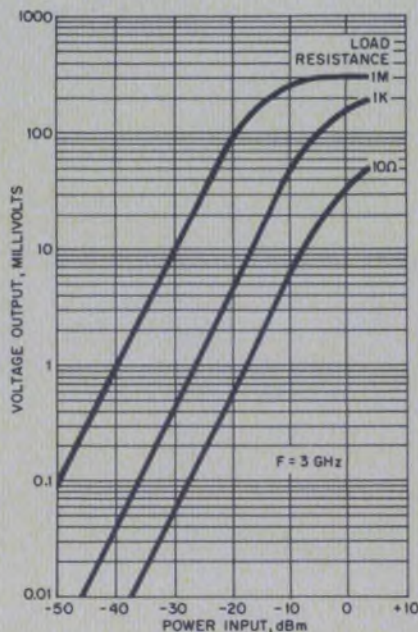

Voltage output versus power input as a function of load resistance.

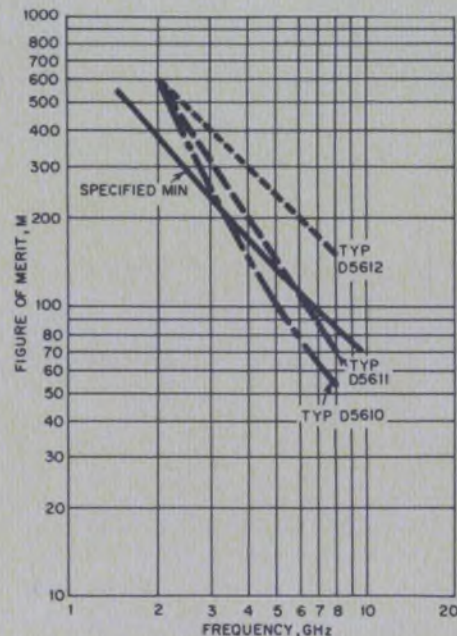

Back diode figure of merit versus frequency.

Electroluminescent clocks will time Apollo flights.

When astronauts head for the moon they'll be reading flight times from Sylvania EL displays.

A total of 46 electronic clocks have been designed and built by Sylvania Electronic Systems for use in upcoming Apollo missions. The clocks display hours, minutes, and seconds on a 2 x 4½ inch electroluminescent display panel. Two clocks are used in each Apollo command module and one is used in the lunar excursion module.

Electroluminescent readouts were selected for a number of reasons: they are not prone to catastrophic failure, they give off almost no heat and require much less power than conventional light sources. Since the EL readout is a planar display there are no parallax problems when viewed from an angle.

The clocks used in the command module are used to keep a record of mission time and provide a reference for activities prescribed in the astronaut's flight plans.

The clock in the lunar excursion module will be used to time the landing and take-off on the moon. This seven-

digit clock can display elapsed time up to 1,000 hours.

Both the clocks and the electroluminescent displays are hermetically sealed. They are designed to withstand extremes of shock and vibration over a temperature range from 0°F to 140°F.

In addition to these basic clocks, the Apollo astronauts will also carry a number of Sylvania electroluminescent timers. These are designed to time individual experiments on board the lunar module. These units display minutes and seconds on a 2 x 4 inch electroluminescent panel.

Sylvania's electroluminescent panels are available in a wide range of display patterns. The relative ease with which they can be modified makes them readily adaptable to a wide variety of display applications.

CIRCLE NUMBER 305



SEE OUR SPECIFICATIONS IN
VSMF
MICROFILM CATALOG FILE

Use Sylvania's "Hot Line" inquiry service, especially if you require full particulars on any item in a hurry. It's easy and it's free. Circle the reader service number(s) you're most interested in; then fill in your name, title, company and address. We'll do the rest and see you get further information by return mail.

FIRST CLASS
Permit No. 2833
Buffalo, N.Y.

BUSINESS REPLY MAIL

No Postage Stamp Necessary if Mailed in the United States

POSTAGE WILL BE PAID BY

Sylvania Electric Products Inc.
Sylvania Electronic Components
1100 Main Street
Buffalo, New York 14209

Dept. C 9 9 9 9

How synergism brings you new and better circuit assemblies.

A business-oriented definition of synergism might be: "The total strength of an organization is greater than the sum of its individual strengths." At Sylvania Electronic Components, this definition is continually being applied to satisfy both industry needs and company objectives. Certainly, our newest addition, the Circuit Assemblies Operation, is a perfect example of this type of synergism at work.

The key consideration in any successful product development, regardless of company goals or objectives, must be user benefit. Put in a different way, if our new products don't help solve a problem for you, then it's just a wasted effort for Sylvania.

With our new Circuit Assemblies Operation, however, we feel we're on safe grounds. Electronic circuitry is becoming increasingly more sophisticated, and bigger performance is being demanded from smaller systems. The result is that package design and density have become crucial considerations to the circuit engineer. The industry need, therefore, is for economically produced circuit assemblies manufactured with high reliability and in high volume. And that's what our new operation is all about.

In addition to user benefit, however, there are two other criteria that must be met. The new product must have profitability and viability (the ability to grow). Thus, before entering the circuit assembly mar-

ketplace, Sylvania went through several stages of product evolution.

First of all, there was an *exploration* stage which quickly showed that circuit assemblies would allow us to optimize the total spectrum of technologies within Sylvania Electronic Components. This included the capabilities to manufacture not only the basic circuit boards, single, double sided or multilayer, but also integrated circuits, diodes and rectifiers, hybrid thick-film circuits, and even vacuum tubes. These capabilities provide a giant step toward the concept of added value.

Then, a *screening* stage proved the idea to be pertinent enough to merit further study. Next was a *business analysis* stage which confirmed that the explosive growth in electronic hardware had established significant trends in the circuit assembly business.

Then *development, testing, and commercialization* were undertaken. In this case, these stages were easily achieved since a full-scale circuit-board facility was already operating as a feeder plant to Sylvania Electronic Systems. It was simply a matter of taking their products to the customer. And that's being accomplished by the efforts of the Sylvania Electronic Components sales force.

With circuit assemblies, therefore, the synergistic effect has combined the efforts of a number of strong elements within the Sylvania Electronic Components group to produce a new and better product line for you.

But the synergistic part was the easiest part to achieve—it was already there.

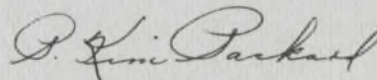

P. K. Packard
Product Marketing Manager, Circuit Assemblies

This information in Sylvania Ideas is furnished without assuming any obligations.

SYLVANIA

A SUBSIDIARY OF
GENERAL TELEPHONE & ELECTRONICS

NEW CAPABILITIES IN: ELECTRONIC TUBES • SEMICONDUCTORS • MICROWAVE DEVICES • SPECIAL COMPONENTS • DISPLAY DEVICES

C9

NAME _____ PLEASE PRINT

TITLE _____

COMPANY _____

ADDRESS _____

CITY _____ STATE _____ ZIP _____

Circle Numbers Corresponding to Product Item

300 301 302 303 304 305

Please have a Sales Engineer call



HOT LINE INQUIRY SERVICE

Need information in a hurry? Clip the card and mail it. Be sure to fill in all information requested. We'll rush you full particulars on any item indicated.

You can also get information using the publication's card elsewhere in this issue. Use of the card shown here will simplify handling and save time.

700V HIGH VOLTAGE NPN Silicon Power TRANSISTORS from Solitron

2N5467



80W @ 100°C
1.25°C per W

2N5469



40W @ 100°C
2.5°C per W

SPECIFICATION RATINGS:

- $V_{CEX} = 700V$ min
- $V_{CEO(sus)} = 400V$ min
- $h_{FE} = 15-60$ @ 3.0A
- $V_{CE(sat)} = 0.5V$ @ 3.0A

Also available in 500 Volt V_{CEX} versions, 2N5466 and 2N5468; all other specifications identical.

High voltage, triple-diffused silicon power transistors are now available from Solitron, with V_{CEX} up to 700 Volts. Typical applications include horizontal deflection circuits, ignition systems, CRT sweep systems, high voltage switching mode regulators, high voltage pulse amplifiers and high voltage pass series regulators. Priced low, they are available in TO-3 and TO-66 cases.

TYPICAL GAINS AND SATURATION VOLTAGES

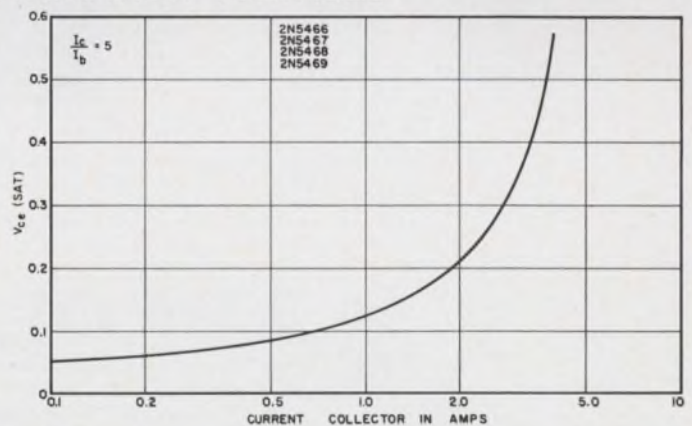
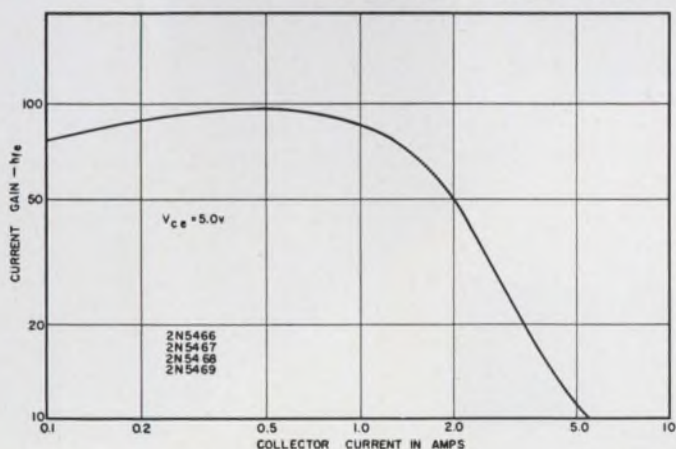

Dial 1-800-327-3243 for a "No Charge" telephone call and further information

SEMICONDUCTOR DIVISION
Solitron DEVICES, INC.

1177 BLUE HERON BLVD. / RIVIERA BEACH, FLORIDA / TWX: (510) 952-6676

INFORMATION RETRIEVAL NUMBER 19

MAGNETICS

*keep weaponry
on target!*

Unlike the cumbersome, clanking gear train of the Monitor's cannon, today's weapons are controlled by sophisticated and silent means. Artillery shells and bombs are exploded precisely on-target by delayed action fuses. A tape core in an oscillator generates pulses for a timing circuit. A bobbin core counts the pulses and actuates the explosive device at the exact instant selected by pre-setting the fuse.

Some of our best tape and bobbin cores are blown to bits this way... but they do their job. Forward-looking manufacturers with airborne problems look to Arnold for high-quality magnetic materials, design, technology, components. Magnetic cores. Powder cores. Laminations. Permanent magnets. You ask. We'll supply. The best in magnetic materials.

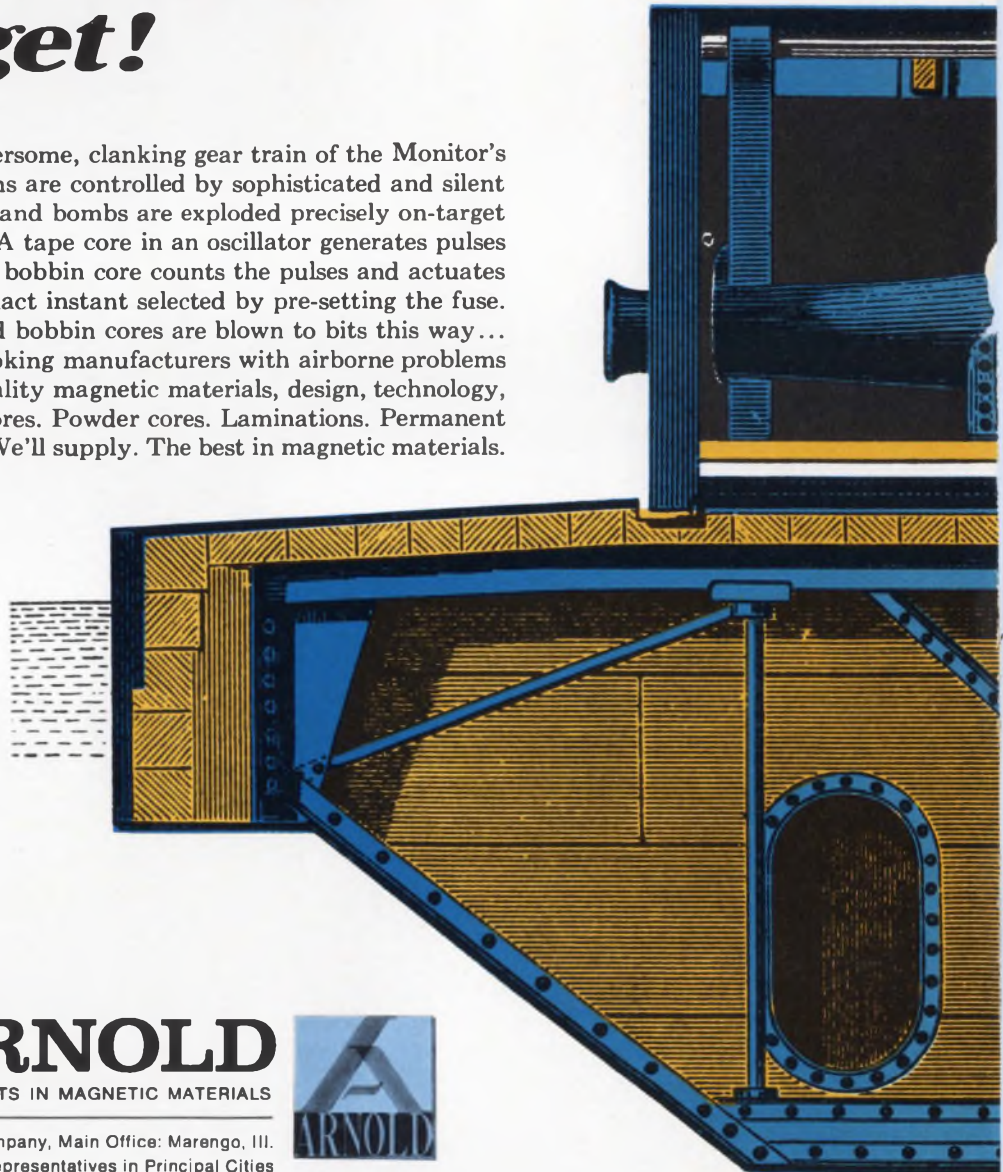

ARNOLD
SPECIALISTS IN MAGNETIC MATERIALS



The Arnold Engineering Company, Main Office: Marengo, Ill.
Branch Offices and Representatives in Principal Cities

Write for your free guide to the only complete line of magnetic materials.

Other Arnold products are up in the air too: bobbin cores and MPP cores in aerospace telemetering • Supermendur in smaller, lighter transformers for jets and aerospace • iron powder cores in radio/TV coils • Alnico and Arnox in loudspeakers for radio/TV and communications • Alnico for microwave equipment.

BY ARNOLD

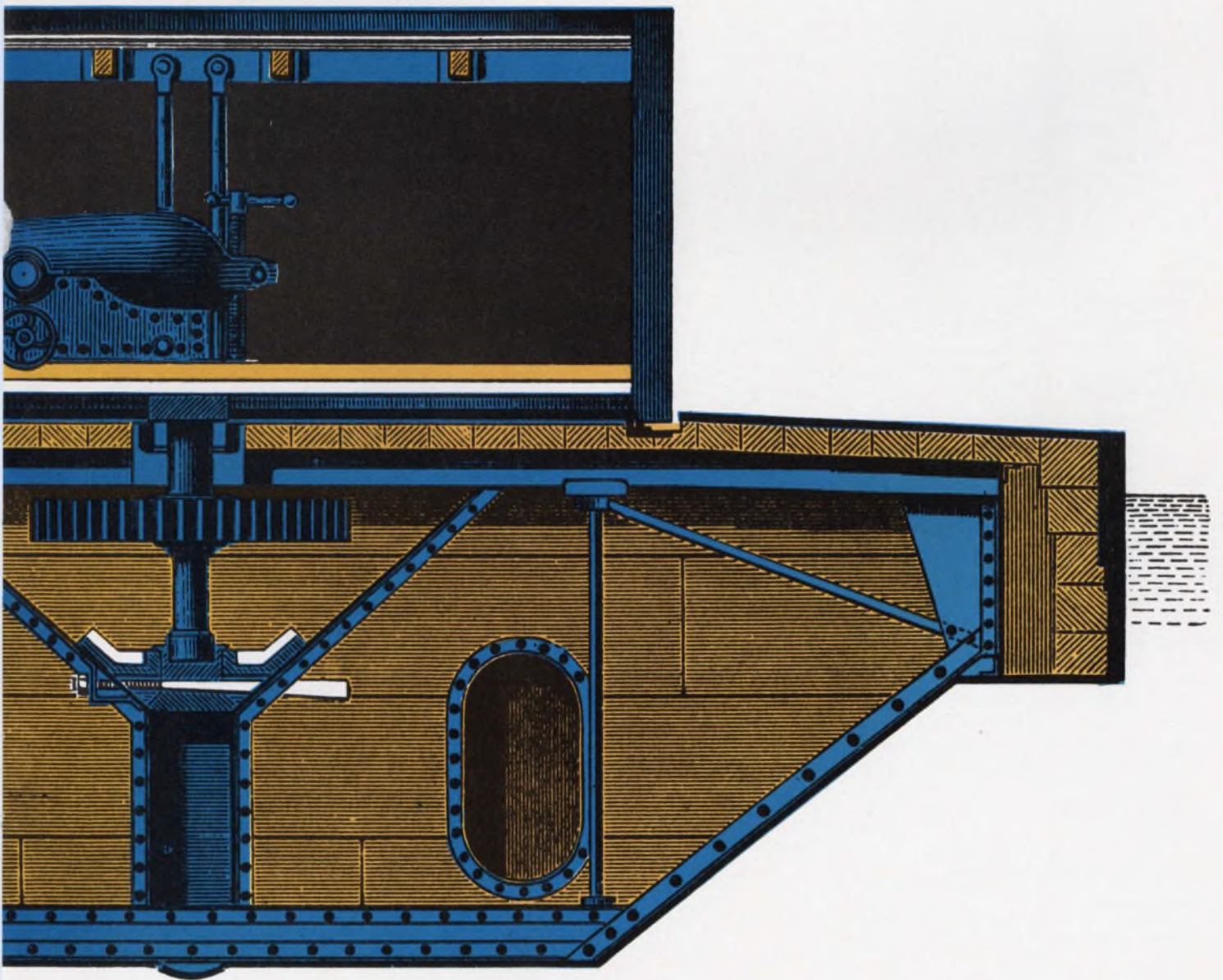

The First Authoritative Single-Volume I/C Reference

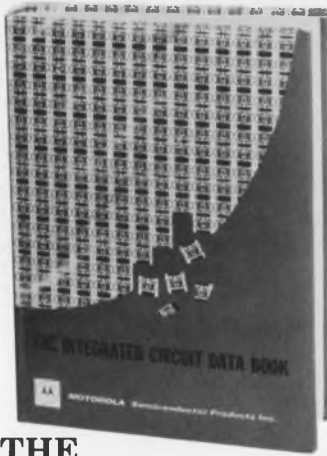

...THE INTEGRATED CIRCUIT DATA BOOK

Here is the industry's most complete data guide and the most comprehensive source of general I/C information.

Nearly 1,000 fact-packed pages contain detailed specifications for all Motorola linear and digital integrated circuits, plus:

- INTERCHANGEABILITY CROSS-REFERENCE
- DIGITAL AND LINEAR APPLICATION SELECTION GUIDES
- SELECTED KEY APPLICATION NOTES
- SUPPLEMENTS — UPDATING SERVICE SUBSCRIPTION RESERVATION
- ALPHA-NUMERIC CIRCUIT IDENTIFICATION INDEX

Individual sections of the book treat each of the Motorola I/C families: MECL, MHTL, MTTL, MDTL, mWMRTL and MRTL, MOS, Complex Arrays, and each of the linear types. No single I/C information source offers so much toward the intelligent selection of the right device for the specific job . . . yet the price is only \$3.95 per copy.

Integrated Circuit Data Book Coupon
My check (payable to Motorola Inc.) is enclosed.
(\$3.95 per copy)

Name _____
Company _____
Address _____
City _____ State _____ Zip _____

MOTOROLA
Semiconductor Products Inc.
P.O. BOX 20912 • PHOENIX, ARIZ. 85036

Laser faster than radar, tracking Mach 4.5 sled

You're tracking a rocket sled a thousand feet away. It's whizzing along a track at Mach 4.5—about 3000 miles an hour. You're interested in calculating the range to target at any given instant. How do you do it?

Sandia Corp. of Albuquerque, N. M., is faced with this problem. For its solution Sandia engineers are using a laser tracking system delivered by the Applied Research Laboratory of Sylvania Electronic Systems, Waltham, Mass. Although the tracker was developed for rocket sleds, W. D. Wright, a Sylvania development engineer, suggests that the system may also be used for tracking aircraft and targets that move in three coordinates because of the high sampling rate (1000 a second) used.

Brian P. Fitzgerald, who headed the project for Sylvania, claims that the angular tracking resolution of the system is 25 microradians. This resolution, he says, is orders of magnitude finer than a microwave radar.

The tracker (see figure) follows a cooperative target, and is insensitive to any input but the reflection of its own laser beam off glass retroprisms that are fastened to the sled. A 50-watt helium-neon cw

laser is used instead of a more powerful argon ion laser because it lessens the radiation hazard. Wright asserts that a range of "10 miles for tracking an aircraft is not unreasonable even with a helium-neon laser."

The laser output is modulated by the application of two sine waves to a Pockel cell. This electro-optic modulation permits the phase of the laser returns to be compared with the transmitted signal. Ambiguity is resolved by the use of two tones at the same time: One, at 50 kHz, corresponds to 10,000 feet, and the other, 3.2 MHz, to 153 feet. The phase data is digitized and stored on magnetic tape.

The retroprism on the rocket sled returns the laser beam to the gimbal mirror, which directs it along the receiving path. The beam is divided, and the reflected portion is collected by a 5-inch lens, collimated, passed through an interference filter and focused on the face of the image dissector.

Shaft-angle encoders on the servo-driven tracking mount convert the azimuth and elevation angles into data for storage on tape. Azimuth, elevation and range are eventually fed to a general-purpose computer. ■■

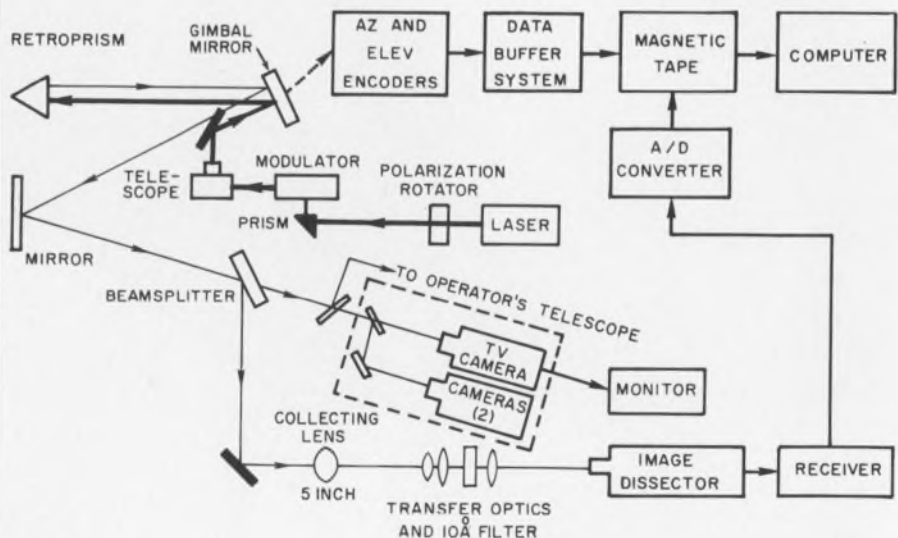

Laser system can track aircraft and other targets moving in three coordinates. Its angular tracking resolution is 25 microradians.

Our airborne switches and relays are finding a home in military systems down below.

Specifying Cutler-Hammer airborne switches and power relays is getting to be a habit with more and more designers. They're putting our equipment to work in computers, radar, shipboard electronics, tanks, trucks, power and fire-control equipment.

Good idea. After all, they're using the same components that have proved themselves for nearly 40 years—under the extreme conditions of flight.

No wonder. Cutler-Hammer switches and power relays are designed by pros.

People with a world of experience in designing these components to perform normally under some mighty abnormal conditions. They're rigorously inspected at every stage of the manufacturing process, and subjected to unbending quality control standards.

Specify Cutler-Hammer equipment on your next project—whether ground, marine or airborne. Call your local Stocking Distributor or write for new catalogs LL-291-W217 and LL-292-W217



Some of our relays and switches for ground, sea and airborne installations around the world: Miniature and standard-size, positive-action toggle switches built to the requirements of MIL-S-8834, Shallcross rotary switches (to MIL-S-3786). Hermetically sealed power relays and 175-amp generator contactor (to MIL-R-6106).

The natives are friendly.



Switch
to No. 1

More than just switches:
prompt availability,
field help, innovation,
quality assurance too.

INFORMATION RETRIEVAL NUMBER 21

CUTLER-HAMMER

Milwaukee, Wisconsin 53201



Cermet

AND THE

Model 3262

POTENTIOMETER

Meets requirements MIL-R-22097, Style RJ-26
TC 150PPM/°C* over entire resistance range 10Ω to 1 Meg.



Designed to not only meet requirements, but beat requirements! A ¼ inch square potentiometer of the highest quality available — in the tradition of excellence of design and workmanship you have come to expect from Bourns . . . the leaders in the industry. Write or call the factory, your local field office or representative today for technical data.

* 100PPM/°C AVAILABLE





Optimism plus persistence pays off

Just over 14 months ago, Honeywell's Aerospace Div. proposed development of a new satellite called Orbital Scanner, a vehicle designed to perform a comprehensive mapping of the Earth's infrared horizon (see ED 20, Sept. 27, 1967, p. 29). At that time, prospects for funding a new, unmanned, scientific satellite effort appeared dim, because of the evertightening NASA budget. Yet only last month NASA awarded Honeywell a \$1-million design-study contract to refine concepts for satellite pointing systems and infrared instrumentation.

There is no question that the project is directly related to the original proposal. Honeywell Aero. Div. general manager E. H. Olson stated that: "This development will be necessary in order to conduct future space missions, such as orbital scanner flights for mapping a new infrared horizon in the Earth atmosphere and earth resources in the 1970s."

Control Data Corp. and Lockheed Missiles and Space Company will work on the 11-month program. CDC is well along in development of star telescopes that will provide vehicle attitude determination. Designed as dual star mappers and a sun sensor, the optical units are intended to assure a 10-arc-second pointing accuracy with respect to the Earth's surface. Lockheed has been developing the IR radiometer employing cadmium-doped germanium detectors that encompass a 0.01° field of view and operate in the 15-micron range. The detectors will be neon cooled.

In July 1967, Honeywell completed a 15-month over-all program study leading to the present program for NASA's Langley Research Center. The current Langley effort could lead to a satellite program in the early 1970s. The original Honeywell proposal called for a 725-lb

Washington Report

CHARLES D. LAFOND
WASHINGTON BUREAU

spin-stabilized spacecraft to be placed in a circular, polar orbit at a 270 nautical mile altitude. The program cost was then estimated at \$10 million. In the present contract, CDC will get about \$150,000 and Lockheed some \$300,000.

RTCA releases new test "bible"

A must for those involved in aircraft avionics systems, the revised "Environmental Conditions and Test Procedures for Airborne/Electrical Equipment and Instruments" is now available. Prepared by over 150 members of the Radio Technical Commission for Aeronautics and three years in the preparation, RTCA Document #DO-138 updates current test data and allows for anticipated needs. It attempts to resolve past conflicts that existed between the subsonic environmental conditions and test procedures set forth in a previous and similar RTCA document (DO-108), and publications of other U.S. organizations. For the future, the report takes into consideration the environmental problems of solar radiation, ultraviolet radiation and acoustic noise effects, as these affect avionic systems. (Copies may be obtained at a cost of \$4.00 each through the RTCA Secretariat, Suite 302, 2000 K Street, N. W., Washington, D.C., 20006.)

Air-ground radio-telephone R&D approved

Experimental civil aircraft-to-ground radiotelephone service has been extended by the FCC. Reversing its earlier memorandum that had put a time limit on such development—which, in fact, would have killed such a program—the FCC has approved a split

Washington Report

CONTINUED

of authorized channels down to 25-kHz spacing, thus providing 12 channels in the range of the 454- and 459-MHz bands. Two companies, AT&T's Bell System and Litton's Skyphone Div. are currently involved.

Bell has 12 ground stations that are currently equipped to work with the Litton Skyphone flight equipment which links any aircraft into the conventional telephone system. The present experimental system provides only a single channel capability through any one ground station. But Bell believes it will, in time, provide full U. S. coverage on the multichannel basis.

The Skyphone equipment, including power supply, weighs about 30 lb and requires a maximum of 300 watts for an 18-watt transmitter output. Present cost for the flight system is under \$4000.

Depending largely on future FCC approval, AT&T Vice President C. L. Elmendorf predicts a need for up to 300 radiotelephone channels in the near future, to satisfy corporate and business aircraft. He proposes that such an operational system might better perform in the 900-MHz band.

Army considers new guided rocket

Early last month the Army invited over 60 aerospace firms to attend a pre-solicitation conference at the Missile Command Headquarters, Redstone Arsenal, Alabama. The classified program centered its discussion on a new "Multiple Artillery Rocket System."

The Army is seeking a mobile launcher that will also be capable of carrying some six to eight of the limited-range Mars rockets for use in area-saturation. Informants here believe the new rocket will be similar in size to the Little John battlefield support missile. Unlike Little John, however, Mars will be guided by some form of stabilization and control system. Odds are, informants

say, that a fluidic guidance and control system will be used.

Considerable testing of such a system, using a Little John as the experimental vehicle, has been performed at Redstone where fluidic subsystems developed by Honeywell, General Precision, Martin-Orlando and Corning Glass were employed. The approach taken was to provide only yaw and pitch stabilization with the airframe fins limiting roll. Also, tests that appeared to employ a similarly modified rocket were fired from a multiple launcher at Fort Sill, Okla. last year.

Industry bids for conceptual design-study contracts are expected to be submitted by the end of this year. It is doubted that this program will move to the contract definition stage before the end of 1969.

Whatever the final design, it is certain the Army will hold out for a weapon that is simple, rugged, reliable and more accurate than existing tactical weapons that are limited to a 10-to-15 mile range. Also, the Army is seeking a cost of less than \$10,000 in production quantities. Unless these basics are achieved in the conceptual design, informants here doubt that the program will obtain developmental-contract approval from the Secretary of Defense.

Explorer 38 antennas extended fully

The Radio Astronomy Explorer, RAE-1 or Explorer 38, is now operating in space with its massive X-shaped antennas fully extended (1500 feet from tip to tip). When first launched by NASA on July 4, the antennas were only deployed to a length of 455 feet each (910 feet over-all).

Although Explorer 38's mission was to map natural radio sources within our solar system and throughout the Milky Way on a round-the-clock basis, it was feared at first that full extension of the antennas might create an unstable condition that could degrade radio measurements. The partial extension was deemed sufficient to provide all the data desired despite the poorer resolution that would thus be obtained.



260[®] SERIES VOM

Every 260[®] VOM has Safe/Guard[®] meter movement protection built-in. Safe/Guard[®] ends forever the problem of bent pointers and burned out movements. Also eliminates inaccurate readings caused by the hidden damage of overheating. Safe/Guard[®] gives positive protection from overloads of over 200,000 Per Cent! Yet, it in no way affects the precise calibration of the Simpson 50-microampere movement.

Safe/Guard[®] is just one of the "extra value" features built into the 260[®]. Others include: superior linearity and dial calibration; replaceable 1-ampere input fuse; shock-proof, virtually friction-free movement; and the exclusive Adjust-A-Vue[®] handle which folds down to use as a convenient stand. Solid reasons why the 260[®] is the world's largest selling volt-ohm-milliammeter.

260-5 with built-in meter protection..... \$62.00

260-5M (mirror scale) with built-in meter protection..... \$64.00

For virtually 100% protection of the entire instrument... be sure to see the GOOF PROOF 260-5P. Button pops out to indicate overloads. Just push to re-set. Write for bulletin 2078 which lists the entire family of 260[®] VOMs.

RANGES

20,000 Ω/V DC • 5,000 Ω/V AC

DC VOLTS: 0-0.25; 0-2.5; 0-10; 0-50; 0-250; 0-1000; 0-5000

AC VOLTS: 0-2.5; 0-10; 0-50; 0-250; 0-1000; 0-5000

DC MICROAMPERES: 0-50 (250 MV Drop)

DC MILLIAMPERES: 0-1; 0-10; 0-100; 0-500

DC AMPERES: 0-10 (250 MV Drop)

RESISTANCE RANGES: RX1 0-2000 ohms (12 ohms center) RX100 0-200K ohms (1200 ohms center) RX10K 0-20 megohms (120K ohms center)

ACCURACY: DC, $\pm 2\%$ F.S.; AC, $\pm 3\%$ F.S.

Write for Bulletin 2078 showing the entire line of Simpson VOM's

*Model 260-5P has both meter and circuit protection except on the 1000V and 5000V DC and AC ranges, and the 10-amp DC range. Price \$94.00



SIMPSON ELECTRIC COMPANY

5200 W. Kinzie Street, Chicago, Illinois 60644 • Phone (312) 379-1121

Export Dept: 400 W. Madison Street, Chicago, Illinois 60606, Cable Simelec

IN CANADA: Bach-Simpson Ltd., London, Ontario

IN INDIA: Ruttonsha-Simpson Private Ltd., International House, Bombay-Agra Road, Vikhrol, Bombay

WORLD'S LARGEST MANUFACTURER OF ELECTRONIC TEST EQUIPMENT

INFORMATION RETRIEVAL NUMBER 23

**Everyone talks
correed reliability,**

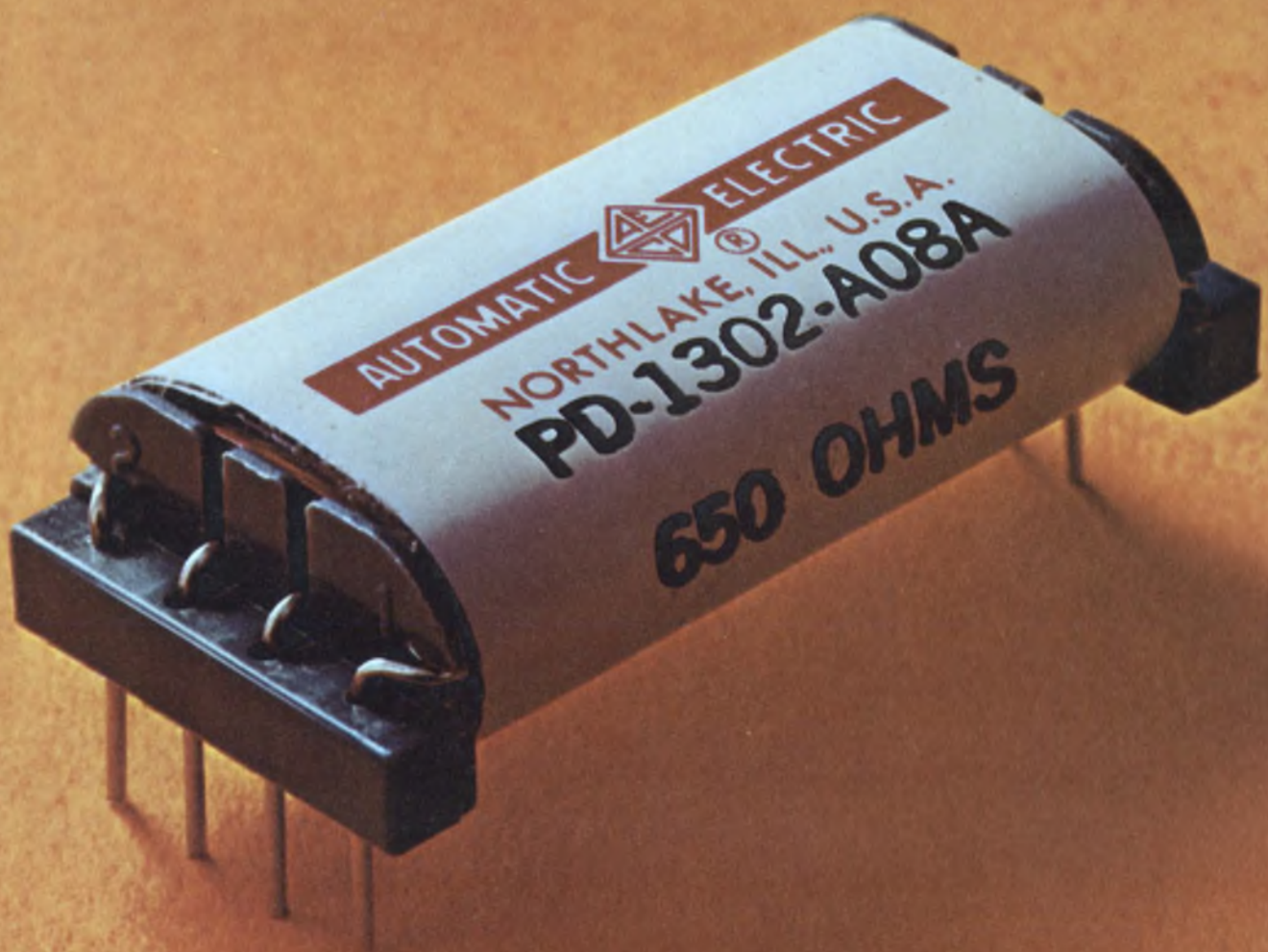

here's the way it looks.



Switches under glass.

The heart of every AE correed is a reed switch consisting of two overlapping blades. For protection, we seal them inside a glass capsule. But only after we pull out all the dirty air and pump in a special, pure atmosphere. That way there's no chance of contact contamination or oxidation. Ever.

Notice our terminals are one piece. A special machine delicately forms them to precision tolerances. It's a lot of work, but one-piece terminals have distinct advantages over the two- and three-piece kind.

For one thing, there's no extra joint so you're always assured of a positive contact. Also, one piece terminals are more reliable when the correed is used to switch low-level analog signals. That's because thermal EMF is reduced to practically zero.

A different kind of bobbin.

Since we go through so much trouble with our correed capsules, we designed a special bobbin to protect them.

It's molded of glass-filled nylon. (You know how plastic chips and cracks.) Moisture and humidity have no effect on this stubborn material. No effect means no malfunctions for you to worry about. No current leakage, either.

Running the full length of the bobbin are a series of slots. They pamper the capsules and keep them from getting damaged or jarred.

And to help you remember which terminal is which, we mold the terminal numbers into the end of the bobbin. You can read them at a glance.

Little things mean a lot.

Reliability means that we pay attention to the little things. Like the tiny pressure rods we use in every miniature correed. They're placed at

each end of the bobbin, across the one-piece terminals. What they do is prevent stresses from being transmitted from the terminals to the reed blades. This keeps the contact gap right on the button. All the time.

The contacts are normally open. To provide them normally closed, we employ another little device—a tiny magnet. It's permanently tucked into a slot next to the reedcapsule. The magnetic action keeps the contacts normally closed.

Coiled by computer.

Once all the parts are secure in the bobbin, we cover them with protective insulation. Around this, we wind the coil. You can be sure the coil winding is correct. It was all figured out for us by computer.

Our next step is to protect the coil. We do that with more protective insulation.

A coat of iron.

On top of the insulation goes a layer of annealed iron. It acts as a magnetic shield and minimizes interaction between coils. Also, it improves the sensitivity of the entire unit. A coat of iron is standard on all AE correeds.

Finally comes super wrap.

To wrap it all up, we use some very special stuff. A layer of mylar laminated material.

It's so tough we guarantee it to withstand all cleaning solvents known to man.



It's attention to detail that helps us keep our miniature relays miniature. Now we're just waiting to show you how perfectly it measures up to your specifications. Automatic Electric Company, Northlake, Illinois 60164.

AUTOMATIC ELECTRIC

SUBSIDIARY OF GENERAL TELEPHONE & ELECTRONICS

WE'RE UNVEILING



THE ALL NEW SERIES 8000 GORDON METERS



- Quality, reliability and styling from Gordon, famous for instruments since 1914!
- Tops for your OEM equipment or black-box applications, GORDON METERS feature covers of clear, high-impact G.E. Lexan®.
- Core magnets are high-coercive Alnico for the sustained accuracy you need.
- Spring-backed sapphire pivot bearings and one-piece bridge construction standard.
- Popular 2½", 3½" and 4½" models; square; edgewise; DC and AC rectifier type.
- Custom design available, too, in color masks, scales, ranges, resistances and pointer style and color.

FREE GORDON PANEL METERS BULLETIN 1-800



4042

Write Today

PDC GORDON
A SUBSIDIARY OF
PNEUMO DYNAMICS CORPORATION
5710 KENOSHA ST. RICHMOND, ILL. 60071

INFORMATION RETRIEVAL NUMBER 25

Letters

An idea for improving an Idea for Design

Sir:

In the Ideas for Design article "Long-Period One Shot Uses One UJT and Two SCRs" (ED 9, April 25, 1968, p. 88), I have an improvement for the free-running circuit.

After building the circuit, I found that if the time delays, as set by R_1 and R_6 , are very close, it is possible for both SCRs to fire at about the same time, latch and hold both sides on continuously. To correct this fault, and also to introduce a means of controlling which side fires first, I have added a capacitor, as shown in the accompanying drawing. This capacitor is placed in either position A or B,

depending upon which side is desired to conduct first. When power is initially applied, a pulse appears at the gate to which the added capacitor is connected, causing that SCR to fire immediately and insuring proper operation thereafter. This capacitor is $0.5 \mu\text{F}$, the same as C_2 , the commutating capacitor.

In addition, in Fig. 1b in the original article, R_1 is connected to the wrong point. It should tie to the bottom of R_3 and not R_4 , as shown.

I also found that economy semi-conductors such as those shown on my drawing, can be used in place of those used in the original design, if cost reduction is desired.

Harold J. Zuckerman

Electro Miniatures Corp.
South Hackensack, N.J.

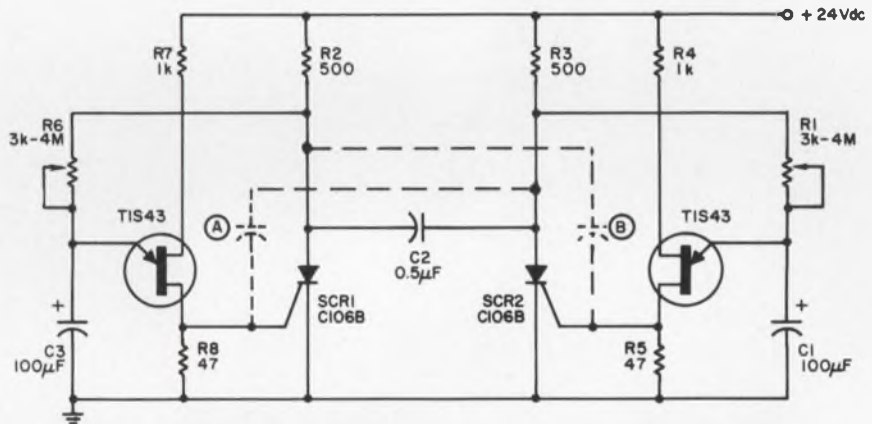

Adding a $0.5\text{-}\mu\text{F}$ capacitor to either point A or B (dashed lines) insures that the corresponding SCR will fire first.

A Word from the FAA

Sir:

With reference to "Warning System Features Equipment Compatibility" (ED 17, News Scope, Aug. 15, 1968): The article states the frequencies for the "cooperative time-frequency system" under development by the Air Transport Association (ATA) as being between 1575 and 1590 MHz. The reality is that the problems of frequency spectrum congestion are very much a fact of life in the

1540-1660 MHz band; consequently, the final determination regarding the allocation of frequencies for the ATA system, and for the other systems under development in this band, is yet to be made. In the interim, the collision-avoidance system development is being continued on frequencies between 1600 and 1615 MHz.

I hope that this will clarify the matter for you and your readers.

William B. Hawthorne
Chief, Frequency Management
Division, RD-500

first at the SUMMIT

Allen-Bradley hot-molded resistors are the *first* resistors to meet the requirements at the *S level* of the new MIL-R-39008A specification, which covers the general requirements for established reliability for Insulated Fixed Carbon Composition Resistors. ■ And Allen-Bradley provides this "peak" performance in *all three ratings*—the 1 watt, 1/2 watt, and 1/4 watt—and over the *complete resistance range* from 2.7 ohms to 22 megohms! ■ This conclusively demonstrates the superiority of Allen-Bradley's exclusive hot-molding technique. Completely automatic machines developed, built, and used only by Allen-Bradley produce such uniformity from

resistor to resistor—billion after billion—that long-term performance can be accurately predicted. And Allen-Bradley hot-molded resistors have no known incident of catastrophic failure. ■ For complete specifications on this quality line of resistors that afford tops in performance, please write to Henry G. Rosenkranz and request Technical Bulletin 5000.

Allen-Bradley Co., 1201 S. Second St., Milwaukee, Wis. 53204. Export Office: 630 Third Ave., New York, N.Y., U.S.A. 10017. In Canada: Allen-Bradley Canada Ltd.



ALLEN-BRADLEY
QUALITY ELECTRONIC COMPONENTS



STANGARD* DV SERIES

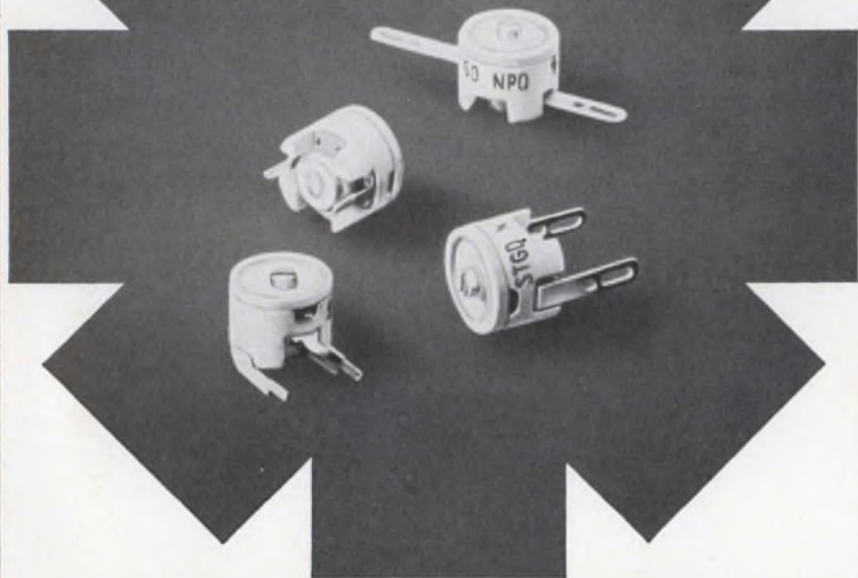

(illus. 1.5 X actual size)

MINIATURE VARIABLE CERAMIC DISC CAPACITORS

The Stangard*/DV Series, miniature variable ceramic disc capacitors, represent an optimum balance of high quality and low cost for commercial and industrial applications.

Nine wide ΔC ranges, each available in 4 versatile mounting configurations, offer high Q and excellent stability in applications such as TV, AM, FM receivers, test equipment, communications equipment, low power transmitters, filters, delay lines and other devices requiring adjustable capacitors. These $\frac{3}{8}$ " diameter Ceramic Disc Stangard capacitors meet or exceed the applicable requirements of MIL-C-81A.

Write for catalog STD-DV-67-A.

*STANGARD — A Product Line of JFD

"TODAY'S COMPONENTS BUILT FOR TOMORROW'S CHALLENGES"

JFD

JFD ELECTRONICS CO. / COMPONENTS DIVISION
15th Ave. at 62nd St. • Brooklyn, N.Y. 11219 / Phone 212-331-1000

Offices and subsidiaries in principal cities, world-wide.

"See us at the NEC Show Booth #305 and the NEREM Show Booth #2E22"
INFORMATION RETRIEVAL NUMBER 27

LETTERS

Accuracy is our policy

The following changes should be made in Les Besser's article, "Combine S Parameters With Time Sharing" (ED 16, Aug. 1, 1968, pp 62-68):

Page 62, Col. 2, last line:

Change $(h, y, z$ and $s)$ to $(x, y, z$ and $s)$.

Page 63 Box:

In Eq. 2, change s_{12} to s_{21} .

In Eq. 5, change s_{21}^2 to $|s_{21}|^2$.

In Eq. 6, change $10\log_{10}(s_{21}^2)$ to $10\log_{10}(|s_{21}|^2)$.

Page 65, Col. 1, three lines below the T -matrix:

Change s_{22} to s_{21} .

Page 65, Col. 1, bottom:

The 4×4 matrix, used to represent the real and imaginary parts of a complex 2×2 matrix, is:

$$\begin{bmatrix} r_{11} & x_{11} & r_{12} & x_{12} \\ -x_{11} & r_{11} & -x_{12} & r_{12} \\ r_{21} & x_{21} & r_{22} & x_{22} \\ -x_{21} & r_{21} & -x_{22} & r_{22} \end{bmatrix}$$

where the elements are all real.

This represents the complex 2×2 matrix:

$$\begin{bmatrix} Z_{11} & Z_{12} \\ Z_{21} & Z_{22} \end{bmatrix}$$

where the Z s are of the form defined in the equation eight lines from the bottom.

Page 66, Col. 2, second line:

Change Z_{T3} to Z_{T2} .

Same column, second line of caption 10:

Change X_0 to X_C .

Page 67, Col. 1, Step 13:

The transistor base (bottom circuit) should be connected as in Step 14.

Page 68, Col. 1, first line:

Change s_{11} to S_{11} .

Same column, third paragraph, line 3:

Change 12-dB to 1.2 dB.

Same column, six lines from the bottom: Instead of requiring that the numerator of the "above expression" be greater than zero, the quantity

$1 + |s_{11}|^2 - |s_{22}|^2 - |s_{11}s_{22} - s_{12}s_{21}|^2$ should be greater than zero.

HP application note 95 contains a corrected version of this article and additional information. For your copy, circle No. 380.

Allen-Bradley cuts space requirements with new sealed type Z cermet trimmers

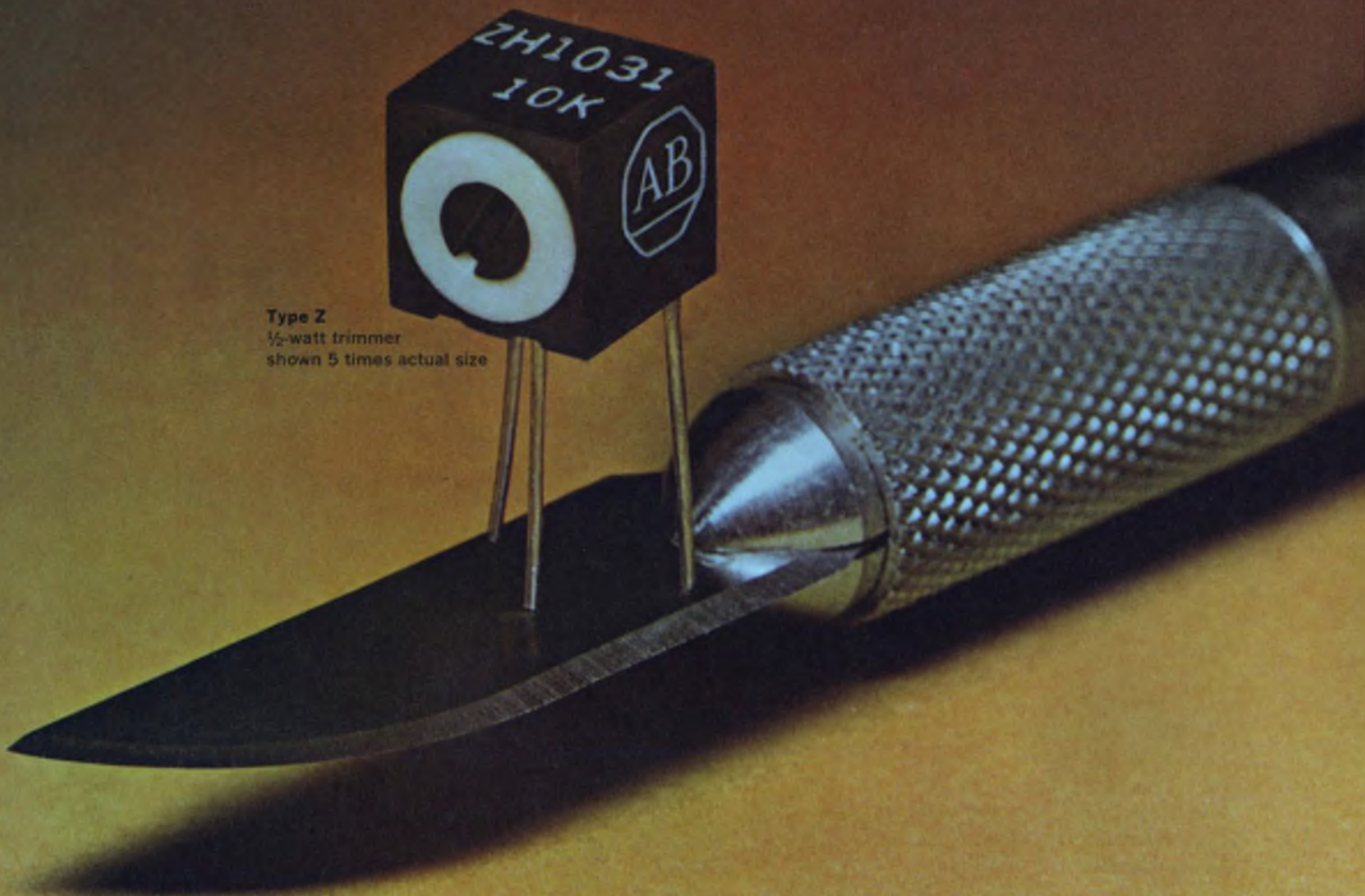

Type Z
½-watt trimmer
shown 5 times actual size

this latest addition to the Allen-Bradley line of cermet trimmers...the type Z...affords high performance in an especially compact package

The cermet material—an exclusive formulation developed by Allen-Bradley—provides superior load life, operating life, and electrical performance. For example, the full load operation (½ watt) for 1000 hours at 70°C produces less than 3% total resistance change. And the temperature coefficient is less than ± 250 PPM/°C for all resistance values and throughout the complete temperature range (-55°C to +125°C).

The Type Z is ruggedly constructed to withstand shock and vibration. The unique rotor design ensures smooth adjustment and complete stability under severe environments. The leads are permanently anchored and bonded. The connection exceeds the lead strength—opens cannot occur. Leads are weldable.

The enclosure is *SEALED*. It is both dust-tight as well as watertight, and can be potted. Mounting pads prevent moisture migration and also post-solder washout. For full specifications on this new spacesaving cermet trimmer, please write Henry G. Rosenkranz, Allen-Bradley Co., 1344 S. Second St., Milwaukee, Wis. 53204. In Canada: Allen-Bradley Canada Ltd. Export Office: 630 Third Ave., New York, N. Y., U.S.A. 10017.

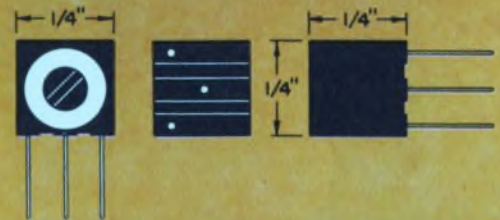

SPECIFICATIONS SUMMARY

- Adjustment:** Horizontal or vertical.
- Temperature Range:** -55°C to +125°C.
- Resistances:** 50 ohms through 1 megohm. Lower resistances available.
- Tolerances:** $\pm 20\%$ standard, $\pm 10\%$ available.
- Resolution:** Essentially infinite.
- Rotational Life:** Less than 2% total resistance change after 200 cycles.
- Rotation:** 300° single turn.
- End Resistance:** Less than 3 ohms.



ALLEN-BRADLEY
QUALITY ELECTRONIC COMPONENTS



**WHY SHOULD YOU
SPECIFY
MECATORN®
SPUN
REFLECTORS?**



The exclusive Torngren Mecatorm® hydraulically controlled spinning process has produced thousands of spun-to-specification "dishes" in use today by both military and commercial communication networks — at substantial savings over other more costly fabricating methods.

If you have a requirement for parabolic reflectors from 4 inches to 16 feet in diameter call Torngren today for complete details on the cost saving and metallurgical advantages of the Mecatorm® process.

*Send for a free copy
of our new capabilities
brochure today!*



C.W.

TORNGREN
COMPANY, INC.

INFORMATION RETRIEVAL NUMBER 29

MIC: the singular and the thick-and-thin

Microwave integrated circuits (MIC) are now in the mainstream of microwave system design. The controlled geometry and reduced parasitics offered by this technology promise to reduce costs and improve reliability. But problems remain. Development work on one of these—circuit fabrication—is underway in the labs of virtually every company in the business.

To get the lowdown, Mike Riezenman, ELECTRONIC DESIGN'S Microwave Editor, visited old friends and made some new ones—all of whom are variously involved in researching three main fabrication technologies: thick film, thin film and monolithic.

In other interviews, Mike learned about different methods for making MICs. If you can't make it to Boston for the NEREM session on the subject, turn to page 25.



ED's Mike Riezenman (left) listens as Charles Greenwald (center), an ITT research manager, details features of a screen-printed thick-film MIC, and Ray Barcklow, ITT tech staff member, holds down right field.

From Frim-to-Miller—right down the line

ED authors often share more than a by-line. Authors Albert H. Frim and Melvin M. Miller, who shared the same institute of learning (Northeastern Univ.), are still "sharing" another Massachusetts "institution"—RCA's Defense Electronics Products at Burlington. Both work on computers and controllers for automatic test equipment: Al Frim does the logic design and Mel Miller develops programing aids for Al's designs. And, no surprise, both have been with RCA for the same time. For another example of what they have in common, turn to pp. 75-76.



Portables with Performance

50 MHz

7-ns Risetime, Dual-trace

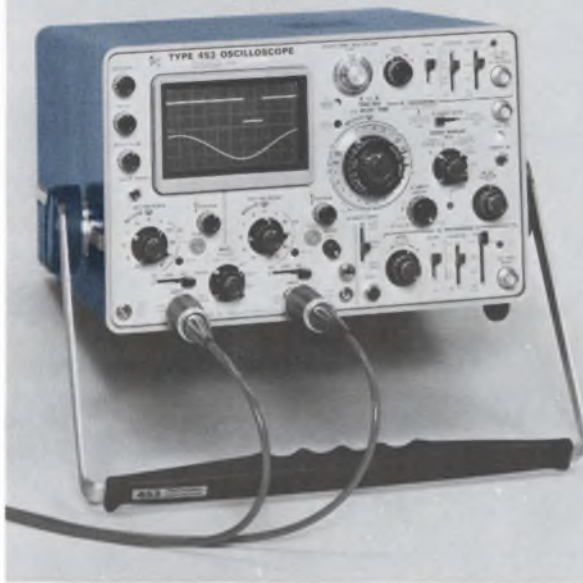

The Tektronix Type 453

Dual-trace, DC-to-50 MHz bandwidth with sweep delay in a compact 30-pound instrument. Rugged environmental capabilities are combined with performance features normally found only in multiple plug-in instruments. Vertical amplifiers provide 7-ns risetime, DC-to-50 MHz bandwidth, from 20 mV/div to 10 V/div deflection factor. At 5 mV/div deflection factor, risetime is 8.75 ns and bandwidth is DC to 40 MHz. Cascading Channel 1 and Channel 2 provides 1 mV/div deflection factor, DC-to-25 MHz bandwidth. The included Type P6010 miniature 10X probes preserve system bandwidth and risetime performance right to the probe tip. Front panel switching logic permits making 5 mV/div X-Y measurements. Jitter, time coincidence, pulse width and other measurements are easily made utilizing the calibrated sweep delay. Sweep rates are 5 s/div to 0.1 μ s/div, extending to 10 ns/div with the X10 magnifier. Solid-state design, with FET vertical inputs, provides low drift and fast stabilization time. AC powered.

Type 453 Oscilloscope \$1950

150 MHz

2.4-ns Risetime, Dual-trace

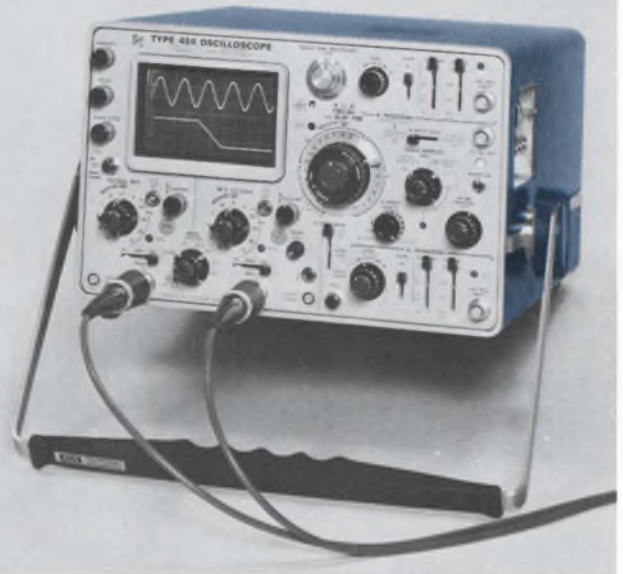

The Tektronix Type 454

DC-to-150 MHz bandwidth, 2.4-ns risetime! This oscilloscope is currently the fastest real-time, general-purpose instrument available. Dual-trace amplifiers provide 150-MHz bandwidth at 20 mV/div deflection factor. At 5 mV/div, risetime and bandwidth are 5.9 ns and 60 MHz respectively. Single-trace displays at 1 mV/div deflection factor permit viewing low level signals. The supplied P6047 10X probes preserve the 150-MHz bandwidth right to the tip of the probe. Sweep rates are 5 s/div to 50 ns/div, extending to 5 ns/div with the X10 magnifier. Calibrated sweep delay permits expanding specific portions of your waveform display for examination in detail. A photographic writing speed of 3200 div/ μ s (>2500 cm/ μ s) is provided by the Type 454 Oscilloscope, C-31 Camera, and 10,000 ASA film, without employing film-fogging techniques! X-Y displays, with calibrated deflection factors to 5 mV/div, are possible with the flick of two front panel switches. The Type 454 is mechanically designed to withstand environmental extremes and rough handling. AC powered.

Type 454 Oscilloscope \$2600

U.S. Sales Prices FOB Beaverton, Oregon

please turn page for additional information

Making the Measurement . . . with Tektronix Type 453 and Type 454 Portable Oscilloscopes

Portability

The Type 453 and Type 454 Oscilloscopes are designed to be easily transported. With the adjustable handle locked in the "carry" position, these instruments present a vertical form factor which enables them to be carried at the side using only one hand. The handle rotates to other fixed positions, providing a convenient tilt-stand for bench applications. A front cover prevents accidental damage to the operating controls and seals out dust and moisture while in transit. The cover also provides convenient storage for standard accessories. These compact high-performance instruments are lightweight—the Type 453 weighs 30 pounds and the Type 454 weighs 31 ¼ pounds, including panel cover and standard accessories. Both instruments are designed to withstand environmental extremes and rough handling. Specifications are valid over an operating temperature range of -15°C to +55°C.

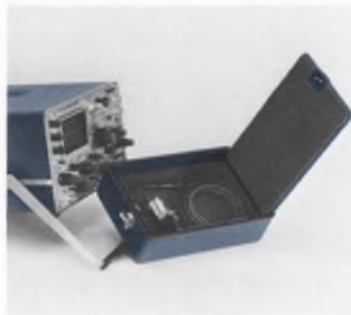

The P6046 Differential Probe and Amplifier provide a CMRR of 1000:1 at 50 MHz with 1 mV/div deflection factor. When used with the Type 454, this same probe/amplifier combination provides 1 mV/div deflection factor at ≈70-MHz bandwidth!



The Type 200-1 Scope-Mobile® Cart is specifically designed for the Type 453 and Type 454 Portable Oscilloscopes. This cart occupies less than 18 inches of aisle space and provides storage at the base for accessories or associated instruments.

Extra Performance

Dual-trace vertical amplifiers, calibrated delaying sweep, full-bandwidth triggering, and probe-tip performance are standard features offered by both the Type 453 and Type 454 Portable Oscilloscopes. To enhance these performance features and provide additional measurement value, a complete line of compatible optional accessories are available.



The new P6042 DC Current Probe permits measuring current flow with bandwidth from DC to 50 MHz and deflection factors to 1 mA/div.



Repetitive or single-event waveform phenomena may be photographically recorded using the Type C-30A or C-31 Trace-Recording Camera. A minimum photographic writing speed of 3200 div/μs is provided by the Type 454 Oscilloscope with P11 phosphor, C-31R Camera and 10,000 ASA film—without employing film-fogging techniques!

Type 453 Portable Oscilloscope	\$1950
Type 454 Portable Oscilloscope	\$2600
Type C-31 Camera	\$ 550
P6042 Current Probe	\$ 600
P6046 Differential Probe and Amplifier	\$ 690
Type 200-1 Scope-Mobile® Cart	\$ 75
<small>U.S. Sales Prices FOB Beaverton, Oregon</small>	

Your Tektronix Field Engineer will demonstrate these products on your premises at your convenience. Please call him, or write Tektronix, Inc., Box 500, Beaverton, Oregon 97005.



Tektronix, Inc.

committed to progress in waveform measurement

Publisher

Hugh R. Roome

Editor

Howard Bierman

Managing Editor

Robert C. Haavind

Technical Editors

Frank Egan
 A. Craig Reynolds, Jr.
 Michael J. Riezenman
 Raymond D. Speer

Management and Careers Editor

Bruce Trabue

News Editor

Ralph Dobriner, Chief

Washington News Bureau

Charles D. LaFond, Chief

Military/Aerospace Editor

John F. Mason

East Coast Editor

Jim McDermott

West Coast Editor

Elizabeth deAtley

New Products Editors

Robert Patton
 Lucinda Mattera

Copy Editor

Peter Irving

Editorial Production

Dollie S. Viebig
 Phyllis Gura

Art Director

Clifford M. Gardiner

Art Assistant

William Kelly

Technical Illustrators

William Alvarez
 Rita Jendrzejewski
 Barney Krochek

Production Manager

Thomas V. Sedita

Asst. Production Manager

Helen De Polo

Production Assistants

Bernard Wolinsky
 Gregory A. Bannon

Circulation Manager

Nancy L. Merritt

Information Retrieval

Genate Pazmino

EDITORIAL



**Are all designers business boobs?
 We, for one, don't think so.**

We have noticed lately a subtle and disturbing trend in management-oriented literature—sometimes expressed, sometimes implied—to the effect that design engineers know little or nothing about business.

Whether insinuated or stated, the message is clear: designers are an amorphous mass of inward-looking individuals who are more interested in design excellence than in the question, "Will it sell?"

The innocent reader is left with the impression that if left to their own devices, all designers would overdesign their company right out of business.

Of course, some of this does exist. But it is no more prevalent, and probably less so, than those cases where management or sales personnel know little and care less about technical matters.

From our experience, the majority of designers do care whether their components, devices or equipments sell profitably. They do look beyond their breadboards and consider production, packaging and field maintenance problems. And they most certainly do consider design alternatives in terms of cost.

But to expect these same designers to have the business acumen of a comptroller, the marketing insights of a sales manager, and the dollars-and-cents grasp of a cost accountant is foolish.

And to deprecate him when he doesn't is absurd.

We are not implying here that everything is rosy, or that the average engineering department is staffed with people having the business-technical expertise of a Bill Hewlett, a Dave Packard or a Varian brother.

But by the same token—to borrow an analogy from the automotive field—it would have been grossly unfair to blame Ford's experience with the Edsel on over-engineering.

Of course improvements are needed. All designers should make every attempt to keep abreast of all of their company's business, sales and production elements that affect them, and on which they in turn can have some good effect.

But this is a two-way street, and the other departments must reciprocate. Otherwise, their glass partitions may someday come under fire, from rocks thrown by an aroused design community.

FRANK EGAN

THERE'S A NEW STATE OF THE ART IN MINIATURIZED TIMERS

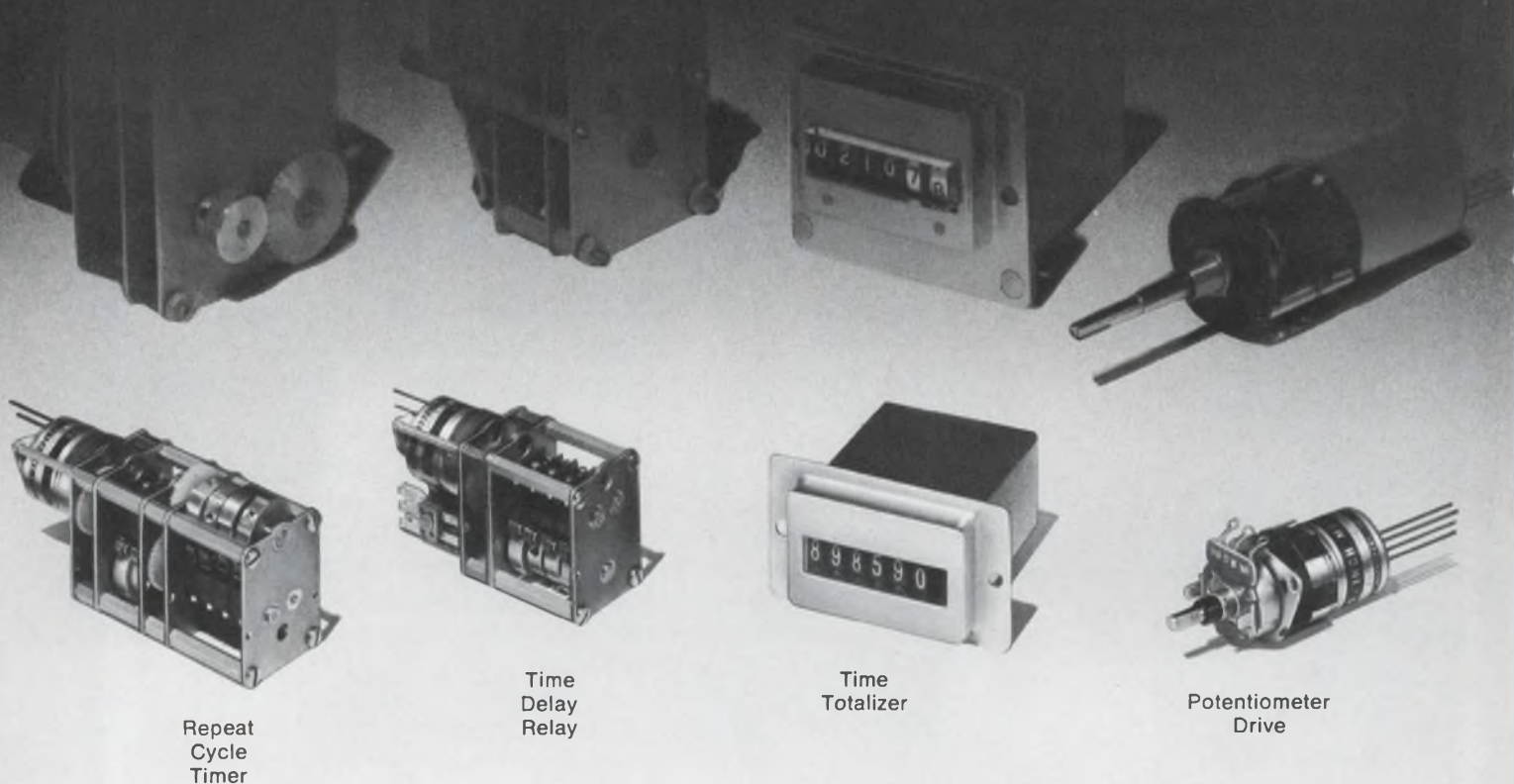

Repeat
Cycle
Timer

Time
Delay
Relay

Time
Totalizer

Potentiometer
Drive

HSI 3rd Generation Timers

MADE POSSIBLE BY HSI'S MINIATURIZED COMPONENTS:

These new type timers are smaller, lighter in weight and more versatile than other units heretofore available — **without sacrifice in performance or increased cost.**

After years of development, timers like these finally became possible by using HSI's BIG INCH™ motors. No other timing motor has ever been built that is so small yet so precise . . . so powerful . . . so efficient and so low in cost.

HSI's 3rd Generation Timers, which open up a wide new range of applications, will initially be custom-engineered for specific OEM applications. Designers may obtain basic data by writing or calling Mr. G. O. Hoffmann at HSI, Inc. 1500 Meriden Rd., Waterbury, Conn., Tel. (203) 756-7441.

... **BIG INCH™ Motors**

... **Compact, Interchangeable
Gear Trains**

... **Advanced Switches
and Counters**



HAYDON SWITCH & INSTRUMENT, INC.

The Innovators in 3rd Generation Timers

Technology

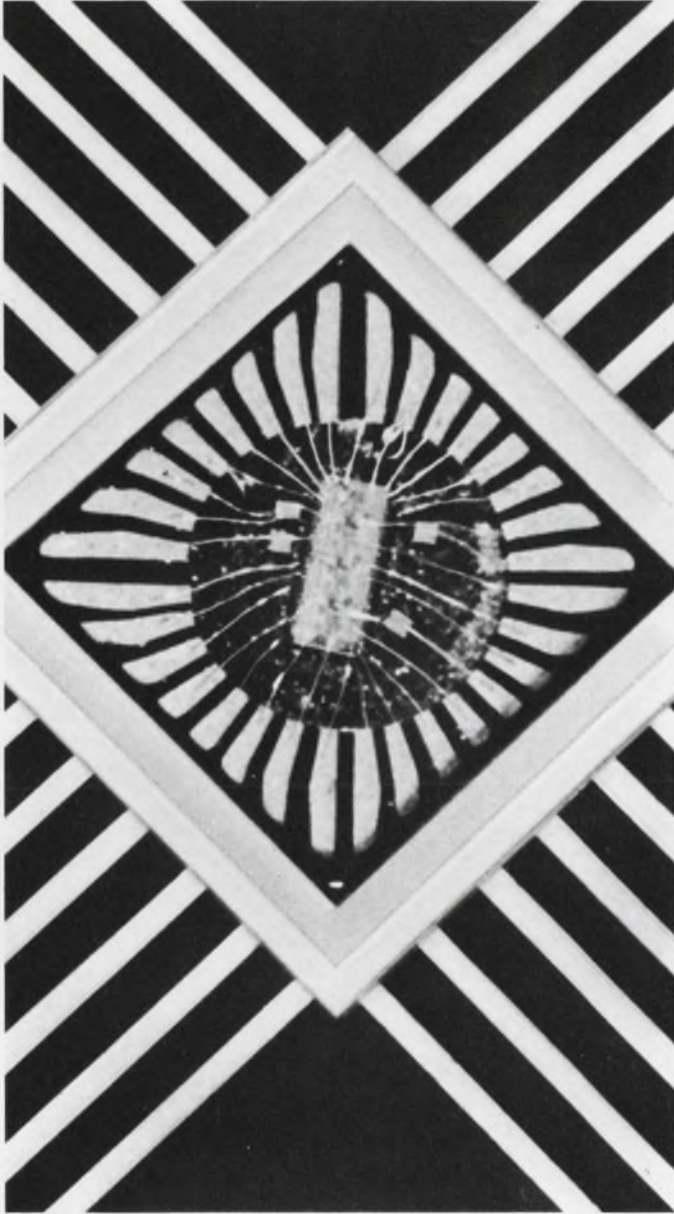

Save time in designing digital comparators, use off-the-shelf ICs. Page 52.



Optical computer uses Fourier methods, does tricks like image enhancement. Page 60

Also in this section:

Unsnarl wiring problems with computer-generated wiring lists. Page 72

Simplify selection of the critical resistor. Page 80

Ideas for Design. Page 90

Design digital comparators logically.

Use off-the-shelf ICs and limit your effort to logical design.

Part 1 of a two-part article

Digital comparators are being built to an increasing extent with off-the-shelf integrated circuits. This eliminates detailed circuit design, and reduces the design task to one of implementing the logic of a particular comparator function.

Further simplification in comparator design is possible if the designer has at his fingertips logic design information for commonly used comparator types. Such information is given here in Figs. 6 through 9. Additional comparator types will be covered in the second part of the article.

Included for each comparator are a description of operation, logic diagram, truth table, Karnaugh map and typical timing waveforms. The actual ICs used in the descriptions are Fairchild Semiconductor Type 930 DT μ L (diode-transistor micrologic) gate packages. The basic principles are easily applied to other types of ICs.

The following background material applies to all of the specific comparator types described.

Basic comparator is an identity gate

The basic digital comparator is generally an identity gate, which compares the contents of two or more stages or registers and provides an output only when all of its corresponding inputs are equal. For example, as shown in Fig. 1, an output F will be obtained only when the contents of the A Register are equal to the contents of the B Register. No output F will be obtained if any one of the stages, A_i , is not equal to its corresponding stage, B_i . These conditions are illustrated by the truth table and Karnaugh map for each stage, also shown in Fig. 1, where "1" is a logical HIGH and a "0" is a logical LOW.

For an n -stage identity comparator, the Boolean equation can thus be written as:

$$F = (A_1 B_1 + \overline{A_1} \overline{B_1}) (A_2 B_2 + \overline{A_2} \overline{B_2}) \dots (A_n B_n + \overline{A_n} \overline{B_n}) \quad (1)$$

A. H. Frim and M. M. Miller, Radio Corporation of America, Defense Electronic Products, Aerospace Systems Div., Burlington, Mass.

which states that the output F will be HIGH when A_1 and B_1 are both HIGH or both LOW, and when A_2 and B_2 are both HIGH or both LOW, and so forth.

Using inverters and passive AND and OR gates, Eq. 1 could be implemented as shown in Fig. 2. Symbolically, a dot represents an AND gate, a plus sign represents an OR gate, and an arrowhead represents an inverter for obtaining the complement of the input variable.

In addition to the identity comparator, other types of comparators find frequent usage in digital systems. These include:

- A greater than or less than B .
- A equal to or greater than B .
- A equal to or less than B .

There are also comparators which perform such functions as voting or limit determination. Typical of these circuits are the two or more out of three; the two out of four; the greater than four; the less than five, and so forth.

IC characteristics must be considered

When designing with off-the-shelf ICs, in this case Fairchild DT μ L units, the inverting action of the circuit itself must be taken into consideration. This, in effect, influences the manner in which the Boolean equations are implemented. To illustrate the point, consider a typical DT μ L 930 gate, shown in Fig. 3. It can be represented schematically as a 4-input diode network and a pair of npn transistors connected in cascade, with two such gates contained on a single chip. The input network is expandable to 8 diodes by the addition of a diode cluster, such as DT μ L 933.

Circuit operation of the gate itself is as follows: When inputs A , B , C and D are all HIGH (+5 V dc), diodes $CR1$ through $CR4$ are back biased, so that the base and collector of $Q1$ are HIGH. $Q1$ will then conduct. The resulting voltage drop across R , will cause $Q2$ to conduct and saturate, so that output F is LOW (ground potential). If any input A , B , C or D goes LOW, its associated diode will be forward biased, placing the base of $Q1$ at ground. This condition causes $Q1$ to cut off, thereby cutting off $Q2$, so that out-

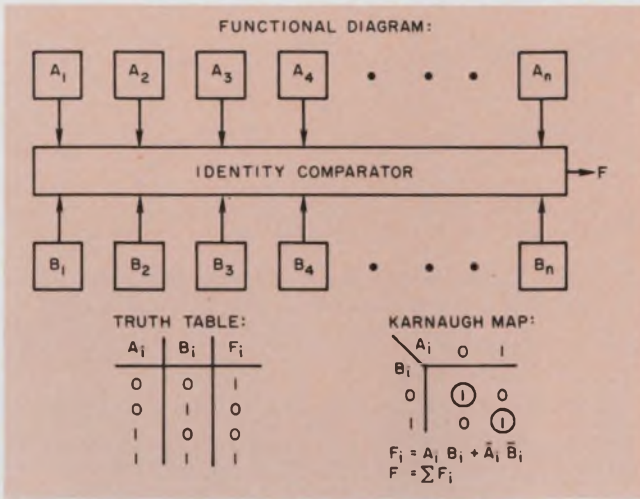

1. The basic digital comparator compares the contents of two registers and produces an output only when the contents of each are exactly equal.

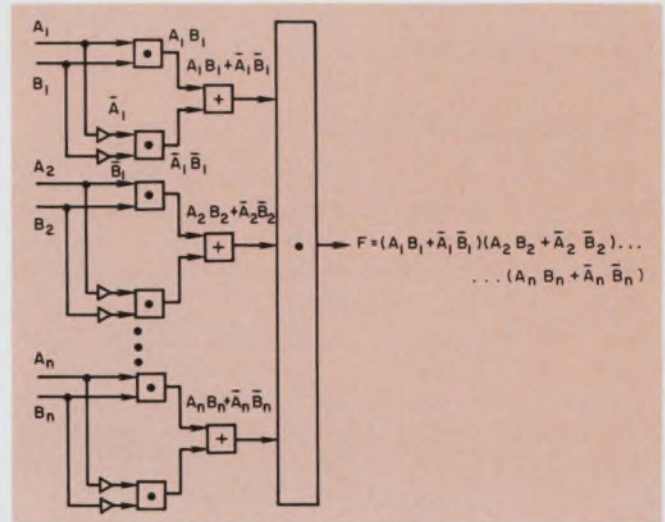

2. AND and OR gates can be used to implement the basic digital comparator.

put F goes HIGH ($+V_{cc}$). In effect, the output is LOW when all inputs are HIGH, and the output is HIGH when one or more inputs are LOW.

At 25°C , the noise immunity of the gate is approximately $+1\text{ V dc}$ and, as the temperature increases, the noise immunity decreases.

The internal logic diagram of a Type 930 gate package, with lead numbering, is shown in Fig. 4. As a rule, pin 7 is connected to ground and pin 14 is connected to a $+5\text{-V dc}$ source (V_{cc}). If an input line is unconnected, it will act the same way as if a $+5\text{-V dc}$ level were present.

In terms of logic, the DT μ L 930 can be used as a positive NAND or negative NOR, depending solely on the way in which the input and output levels are interpreted. When used as a NAND gate, the circuit provides a LOW output only when all the inputs are HIGH. If one or more inputs are LOW, then the output is HIGH. These conditions can be expressed by Boolean equations:

$$\bar{F} = A B C D \quad (2)$$

and

$$F = (\bar{A} + \bar{B} + \bar{C} + \bar{D}) + \bar{A} B C D \quad (3)$$

$$= \bar{A} + \bar{B} + \bar{C} + \bar{D} = \bar{A} B C D$$

The logic symbol for a 4-input NAND gate is shown in Fig. 5a. A "bubble" on the output line indicates a logical LOW; absence of a "bubble" on an input line indicates a logical HIGH.

When used as a NOR gate, the circuit provides a HIGH output whenever one or more inputs are LOW. If all inputs are HIGH, then and only then is the output LOW. These conditions can also be represented by Boolean equations 2 and 3 above. The logic symbol for a 4-input NOR gate is shown in Fig. 5b. In this case, the "bubble" on an input line indicates a LOW, and absence of a "bubble" on the output line indicates a HIGH.

Use of a DT μ L 930 gate as an inverter is illus-

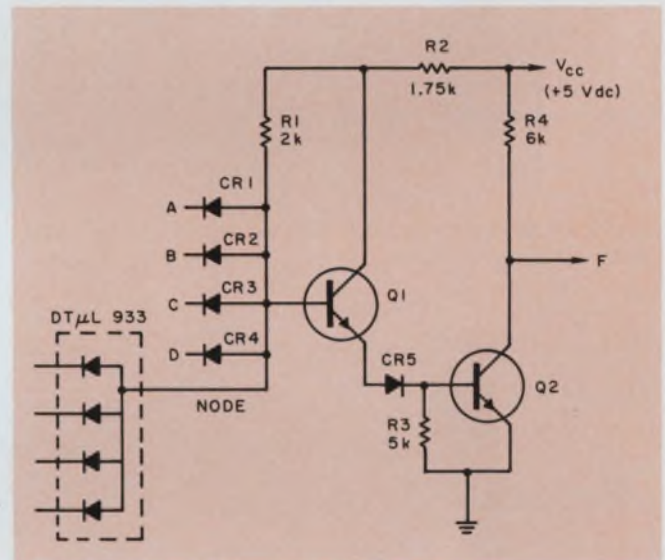

3. Two gates of the type shown are contained in a Type 930 DT μ L package.

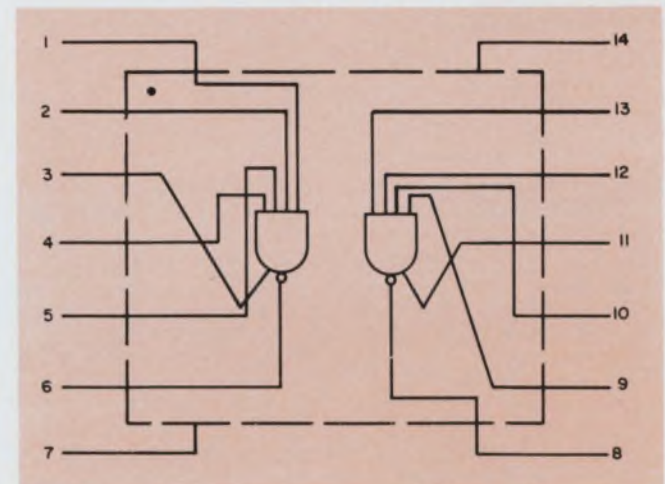

4. Lead designations shown are for the flat-package configuration of the Type 930.

trated in Fig. 5c. The output is LOW when the input is HIGH, and vice versa.

Logical designs are illustrated

Based on the foregoing material, the logical design of a variety of digital comparator types is detailed in Figs. 6 through 9. For convenience, only converters operating on a limited number of bits are illustrated. The designs, however, can be applied to any number of bits or stages, provided loading requirements are met.

When referring to the circuit descriptions given in Figs. 6 through 9, note that inputs and outputs are referred to as Z3-2, Z1-3, Z2-1 and

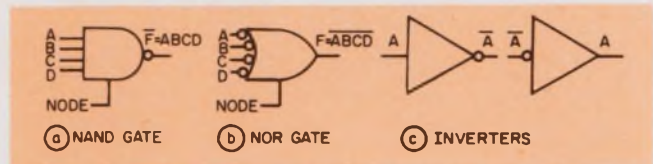

5. The NAND, NOR or inverter function can be implemented with the basic 930 gate.

so forth. These designations include both the particular gate and its input or output pin number. For example, Z3-2 refers to pin 2 on gate Z3. Similarly, Z2-1 means pin 1 on gate Z2.

Data similar to that given in Fig. 6 through 9 will be presented for a variety of other comparator types in Part 2 of this article. ■■

6. A = B comparator (2-bit)

This identity comparator provides a logical HIGH output when the two inputs, A and B, are both HIGH or both LOW. For example, If A and B are HIGH, Z2-6 will be LOW and Z3-6 will be HIGH. When A and B are LOW, Z2-8 will be LOW and Z3-6 will again be HIGH.

Logic diagram:

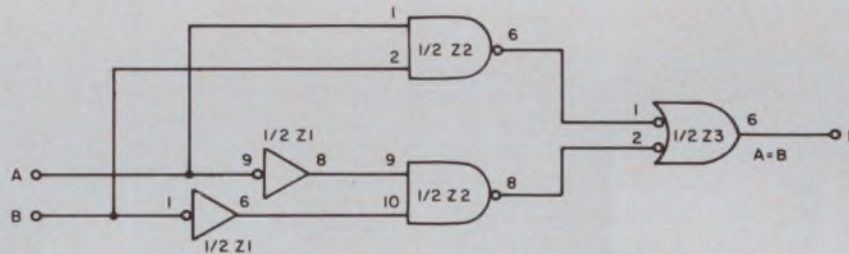

Truth table:

Inputs		Output
A	B	F
0	0	1
0	1	0
1	0	0
1	1	1

Karnaugh map:

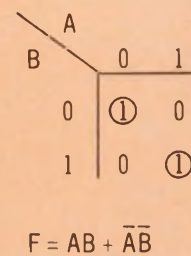

Timing diagram:

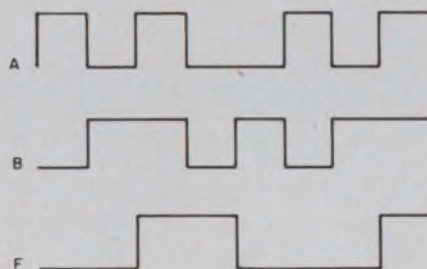

7. A = B comparator (6-bit)

This comparator provides a logical HIGH output when every A input is identical (HIGH or LOW) to its corresponding B input. For example, when A_1 and B_1 are HIGH, Z2-6 will be LOW and Z3-6 will be HIGH. To obtain a HIGH output from the comparator, the 9, 10 and 12 inputs to Z8 must all be HIGH. If any of these inputs are LOW, Z9-6 will be LOW, indicating that not all of the A inputs are equal to their corresponding B inputs.

Logic diagram:

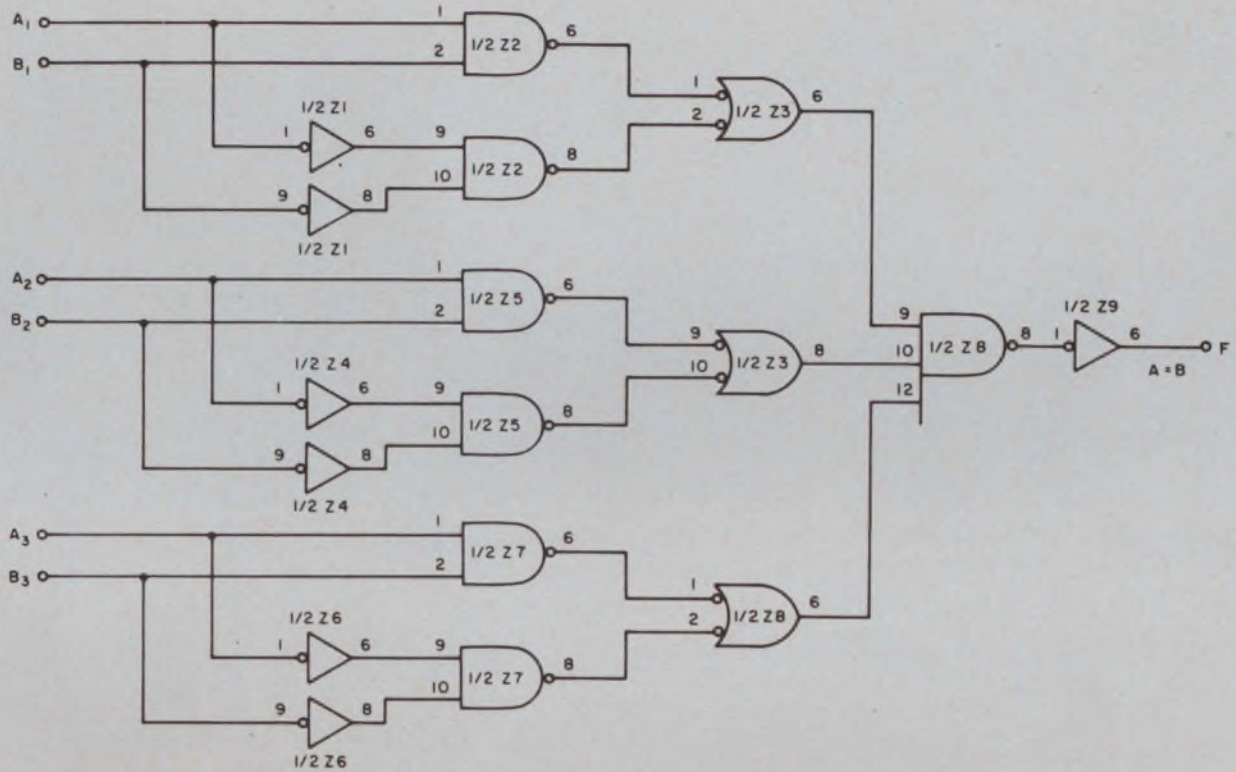

Truth table:

Inputs		Output
A_{xi}	B_{xi}	F_i
0	0	1
0	1	0
1	0	0
1	1	1

Karnaugh map:

		A_i	
		0	1
B_i	0	①	0
	1	0	①

$$F_i = A_i B_i + \bar{A}_i \bar{B}_i$$

$$F = (A_1 B_1 + \bar{A}_1 \bar{B}_1)(A_2 B_2 + \bar{A}_2 \bar{B}_2)(A_3 B_3 + \bar{A}_3 \bar{B}_3)$$

Timing diagram:

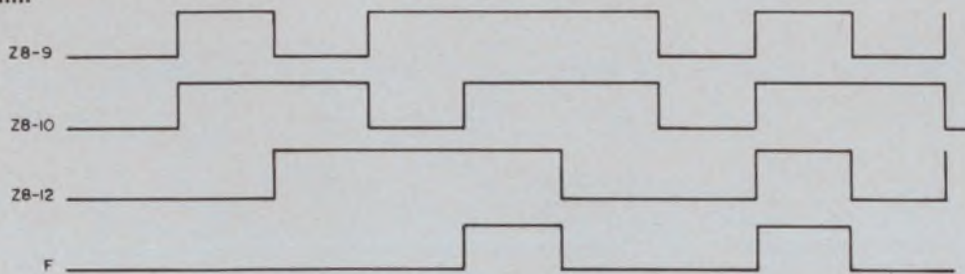

8. A > B and A < B comparator (2-bit)

This comparator provides two outputs: A > B and A < B. The "greater than" output, F_1 , is a logical HIGH if the A input is greater than the B input. Similarly, the "less than" output, F_2 , is HIGH if the A input is less than the B input. When A and B are equal, both outputs are LOW. For example, assume that A is HIGH and B is LOW. Then Z1-6 will be HIGH. With inputs 9 and 10 of Z1 HIGH, Z1-8 will be LOW and Z3-6 will be HIGH. Also, pins 9 and 10 of Z2 will be LOW, making Z2-8 HIGH and Z3-8 LOW. This is the condition for A > B.

Logic diagram:

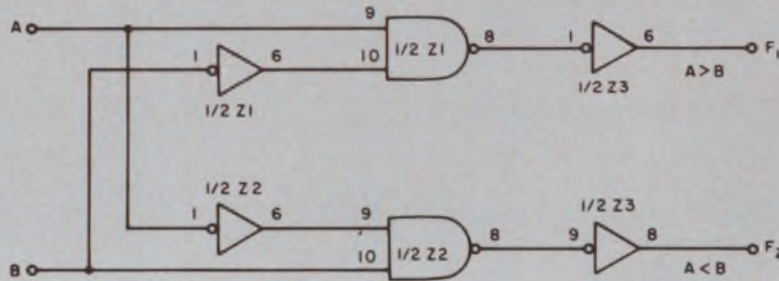

Truth table:

Inputs		Outputs	
A	B	A > B	A < B
0	0	0	0
0	1	0	1
1	0	1	0
1	1	0	0

Karnaugh maps:

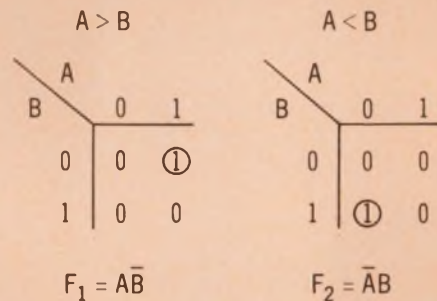

Timing diagram:

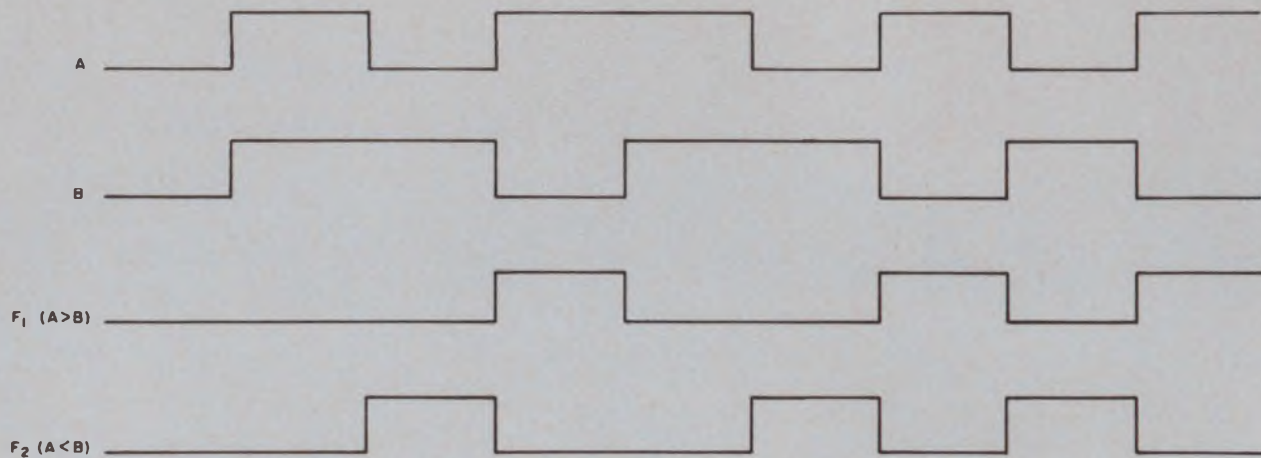

9. A > B and A < B comparator (8-bit)

This comparator compares two 4-bit numbers, starting at the highest-order bits (A_8 and B_8) and working down to the lowest-order bits (A_1 and B_1). If the numbers are identical, both comparator outputs, F_1 and F_2 , are LOW. If one of the numbers is larger than the other, its corresponding output line (F_1 for $A > B$ and F_2 for $A < B$) will go HIGH.

For example, assume the numbers 1010 and 0110 are being compared, with the leftmost digits in the numbers being A_8 and B_8 , respectively. In this case A_8 is HIGH and B_8 is LOW, so that \bar{B}_8 is HIGH. Output Z1-6 is therefore LOW, inhibiting Z2, Z3 and Z4, and causing Z6-9 to go LOW and Z6-8 to go HIGH. This is the condition for $A > B$.

If, when comparing two numbers, A_8 and B_8 are equal, Z1-6 and Z1-8 are HIGH, so that Z2-4 and Z2-9 are also HIGH. And if A_4 is LOW and B_4 is HIGH, then \bar{A}_4 is HIGH, making Z2-10 and Z2-12 HIGH. As a result, Z2-8 and Z6-4 are LOW and Z6-6 is HIGH. This is the condition for $A < B$.

Logic diagram:

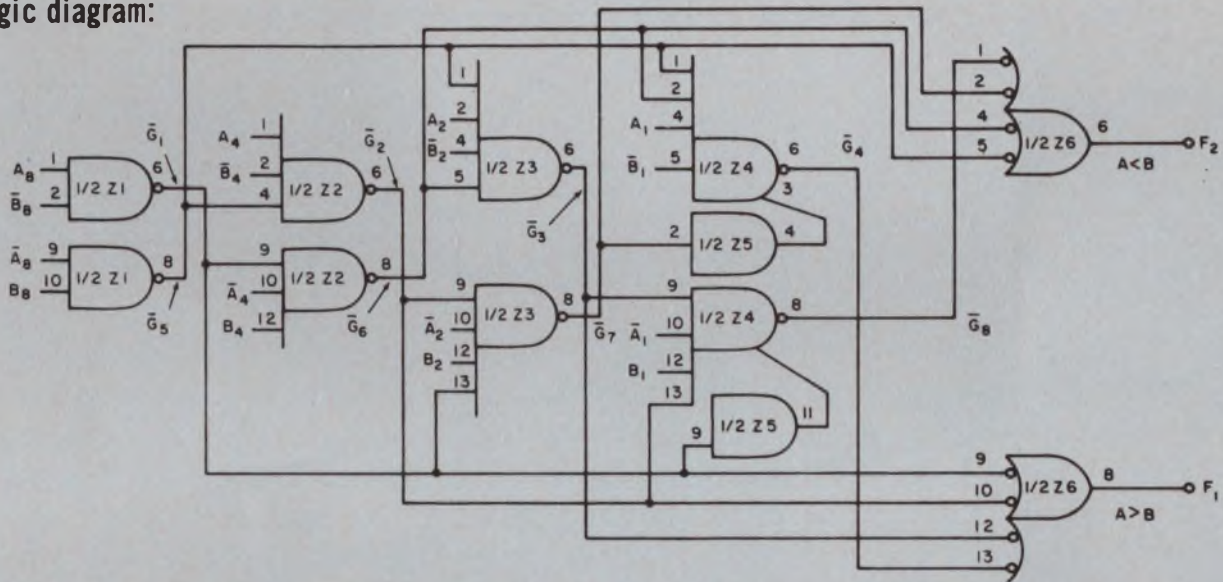

Logic equations:

$$A > B: F_1 = \bar{G}_1 + \bar{G}_2 + \bar{G}_3 + \bar{G}_4$$

$$A < B: F_2 = \bar{G}_5 + \bar{G}_6 + \bar{G}_7 + \bar{G}_8$$

where:

$$\bar{G}_1 = A_8 \bar{B}_8$$

$$\bar{G}_5 = \bar{A}_8 B_8$$

$$\bar{G}_2 = G_1 (A_4 \bar{B}_4)$$

$$\bar{G}_6 = G_1 (\bar{A}_4 B_4)$$

$$\bar{G}_3 = G_2 (A_2 \bar{B}_2)$$

$$\bar{G}_7 = G_2 (A_2 B_2)$$

$$\bar{G}_4 = G_3 (A_1 \bar{B}_1)$$

$$\bar{G}_8 = G_3 (A_1 B_1)$$

Timing diagram:

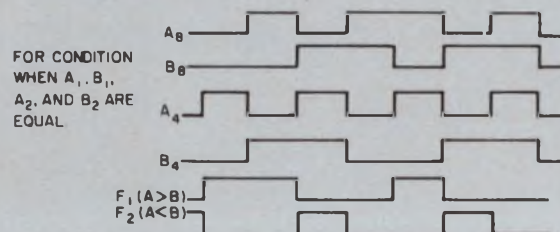



Silicones can prevent grounding

Silicones can play a vital role in assuring electronic equipment reliability — key to operational readiness. That's because they provide excellent protection against the harsh environments inherent to worldwide operations.

Silicone electronic materials from Dow Corning comprise an entire family of dielectrics: fluids, grease-like compounds, gels, rubbers, adhesive/sealants, potting and encapsulating materials, molding compounds and surface coatings.

All provide outstanding dielectric

and physical properties:

- *Resistance to moisture* — sea or fresh water and high humidity
- *Temperature stability* —60 to 300 C
- *Long term heat aging* — more than 10,000 hours at 250 C for most materials
- *Mildew resistance* — nonnutrient to fungi
- *Inertness* — to oxygen, ozone, many chemicals
- *Electrical parameters* — good volume resistivity, dissipation factor, dielectric constant, arc resistance and electric strength

Dow Corning silicone electronic materials have already proven themselves in aerospace, aviation and ground support equipment. Many typical uses are cited in our *Military Electronic Design Guide* such as filling, potting, encapsulating, embedding and other applications.

If you are involved in keeping military electronic gear airborne, write for your copy to Dept. B-8471, Dow Corning Corporation, Midland, Michigan 48640.

DOW CORNING



Shock and vibration are two of the operational environments that take heavy toll of delicate electronic gear. Improved protection is available with a new shock absorbent Dow Corning solventless silicone encapsulating resin which absorbs these forces with very little internal reaction.

Designed for electronic use, a new Dow Corning material is the first noncorrosive one-part silicone adhesive/sealant that cures without emitting by-products that can affect sensitive electronic contacts and circuits. The material cures at room temperature to provide a tough, resilient silicone rubber bond between metals, plastics, painted surfaces, ceramics and silicone coated surfaces.



INFORMATION RETRIEVAL NUMBER 851

Do computations at the speed of light.

Use optical data processing for instant Fourier analysis. Fraunhofer diffraction is the key.

To most engineers the word "computer" means electronic digital computer. However, over the past few years, a newer and, for certain important system applications, superior device has come into being—the optical data processor (ODP), or optical (or laser) computer.

Here we will discuss some of the basic operations that can be performed by optical computers. Most of these tasks can also be done with electronic systems, often to greater accuracy. But if large quantities of wideband data are to be operated upon, the electronic techniques are often prohibitively expensive and time-consuming. Here is where the laser computer shines.

The optical computer is faster than a digital computer because it operates on signals that are functions of position, not time. That is to say, the input to an optical data processor is a pattern of light intensity that varies over some area, not a light intensity that varies as a function of time. This has two important consequences:

- The optical computer is able to directly handle signals that are functions of two independent variables, because it is just as easy to make the density of an optical mask vary over two dimensions as one.
- Normally time-consuming operations, such as integration, can be performed virtually instantaneously because all of the input data is available simultaneously, the integration being over space, not time.

Thus optical data processing is most appropriate for such lengthy operations as the calculation of complicated Fourier transforms and the processing of side-looking radar signals.

Now, since most signals of interest here are electronic, the first job must be one of signal conversion. A present constraint for some applications is the lack of good converters to go directly from electronic signals to optical signals. Electronic signals must be recorded on photographic film with a cathode ray tube, and the film developed and used to read the data into the computer. The output is frequently an electrical signal generated by a

mosaic of photocells. However, if a photographic record is desired, the delays due to film processing will be doubled.

Discovery of ways to overcome this drawback and allow operation in near real-time would offer definite advantages. Toward this objective, much work is in progress in many laboratories on recording materials such as photochromics, thermoplastics and other exotic films that would instantly store image information, yet could be readily erased for reuse. There is every reason to believe that this problem will soon be solved. For many applications, though, the time needed for processing the film is small compared to the time saved by using optical processing.

As an example of the capabilities of the optical data processor consider the problem of restoring the photograph of Fig. 1 (top). The photograph is blurred because of atmospheric turbulence between the camera and the subject. As will be explained later, this blurring represents a loss of the higher spatial frequency components of the picture. To improve the picture, it is necessary to (1) form its spatial Fourier transform, (2) filter it through an appropriate high-pass filter, and (3) take the inverse transform.

These corrective procedures can, of course, be carried out on a digital computer using a Fourier transform program. Appropriate interface equipment must be used to read and digitize the photograph. Additional read-out equipment must then be provided to convert the corrected intensity values (numbers) to a light intensity that can be photographed.

A 35-mm picture with a 50 cycle per millimeter spectrum represents approximately three million bits of information. To transform, filter, and retransform so much information—even using the Cooley-Tukey fast Fourier transform algorithm—would require several hours on a high speed digital computer equipped with a large memory.

With optical data processing equipment, on the other hand, the computation time required is about 10 nanoseconds—the time it takes light to traverse the ODP. Read-in time is zero, and a read out time of several seconds would be required to record the restored image on high resolution film.

Dr. Joseph L. Horner, Research Physicist, Conduccion Corp., Ann Arbor, Mich.

On a cost basis, certainly, the arguments substantially favor the ODP.

To understand the process, we'll have to go back a few steps and begin with the fundamentals:

Fraunhofer diffraction: the basis of the ODP

Diffraction is the basic property of light that makes it appear to bend around an object placed in its path. Consider the simple experiment shown in Fig. 2. An aperture consisting of a narrow slit, *S*, is placed in a beam of parallel light. A screen, *O*, is set up behind the slit. It would seem that one should see a single sharp shadow of *S* at *O*, i.e., the geometric image. However, the pattern of light at *O* is structured as shown on the right in Fig. 2. The departure of the actual pattern from the simple sharp-edged shadow is due to diffraction.

Further experimentation would reveal that the pattern depends on the size of the slit, the wavelength of the light, and the distance between *S* and *O*. By using Huygen's principle that each point on the slit can be regarded as a secondary source of light, and integrating over the aperture, the pattern of light on *O* can be calculated. This operation is the so-called Fresnel-Kirchhoff diffraction integral.

Suppose now that the screen is moved farther and farther back from the slit. In fact, let us take the observation screen back an infinite distance from *S*. The simple way of accomplishing this in the real world is to employ a converging lens. The setup for the experiment is shown in Fig. 3. For historical reasons, this is called Fraunhofer diffraction.

Now, parallel rays of light emanating from *S* will not have to go to infinity to meet, but will meet at a distance behind the lens equal to the focal length, *f*, of the lens. It is now found that the shape of the diffraction pattern depends solely on the geometry of the input slit; only the scale of the pattern can be altered by changing the wavelength λ , of the incident light and the focal length of the lens.

Thus, two distinct classes of diffraction pattern can be obtained: the near-field or Fresnel case, and the far-field or Fraunhofer case. For Fraunhofer diffraction, the Fresnel-Kirchhoff integral reduces to:

$$G(u, v) = c \int_{-\infty}^{+\infty} \int_{-\infty}^{+\infty} g(x, y) e^{(ig\pi/\lambda f)(ux + vy)} dx dy, \quad (1)$$

where:

x and *y* are distance coordinates in the aperture (object) plane and *u* and *v* are similar coordinates in the plane of the screen, *O*, or image plane. For both coordinate systems, the origin lies on the optical axis of the system.

c = a constant.



1. Atmospheric turbulence blurred this aerial scene (top) but spatial filtering with an inverse Gaussian filter cleaned up much of the distortion (bottom). Note particularly the improvement in fine detail, such as the windows.

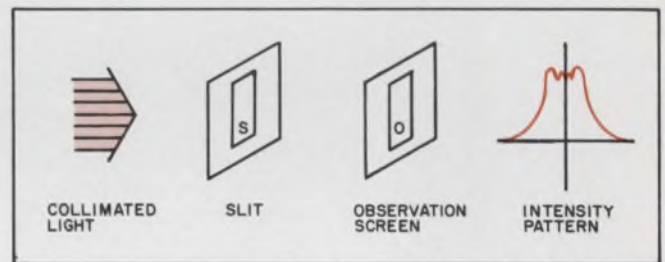

2. Fresnel, or near-field, diffraction causes the structured intensity pattern at *O*, where one might have expected to see a clean, sharp shadow of *S*.

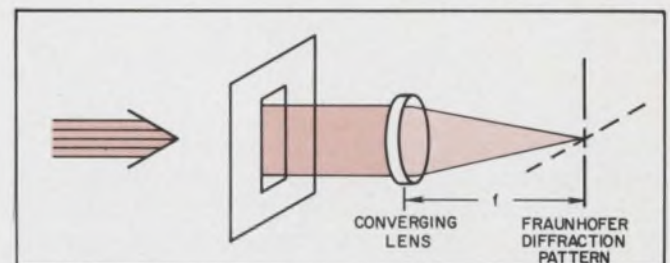

3. Fraunhofer, or far-field, diffraction is easily realized through the use of a converging lens. The pattern one focal length, *f*, behind the lens could only be obtained at infinite distance without it.

The optical computer

Light coming from the cw laser (a few milliwatts is enough for most applications) passes through a microscope objective lens and a pinhole, which form a low-pass spatial filter (see text) for expanding and cleaning up the beam, i.e., removing unwanted intensity variations or hot spots.

L_1 is a collimating lens that renders the diverging light parallel. Next in the plane P_1 is the input film, usually contained in a liquid gate assembly. A fluid whose index of refraction matches that of the film base and/or emulsion is used to eliminate phase noise—the random variation of optical phase across the film caused by variations in film thickness. Lens L_2 extracts the Fourier transform of the input film and presents it as a complex amplitude distribution in plane P_2 , the Fourier transform (F.T.) plane.

It is in plane P_2 that various spatial filters can be placed to operate on the transformed signal. The lens L_3 extracts the inverse Fourier transform and presents the processed image in plane P_3 . (Theoretically, L_3 is not really needed. The inverse transform should form in plane P_3 , located in accordance with the thin-lens formula (Eq. 7). However, practical considerations involving the characteristics of available lenses make it desirable to use a two-lens system).

Note that plane P_2 is located a distance behind L_2 equal to the focal length of L_2 ; similarly, P_3 is one focal length behind L_3 . The focal lengths

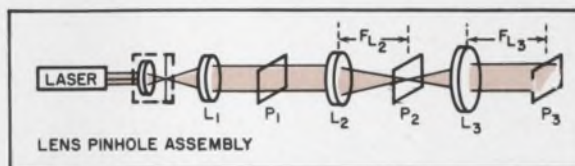
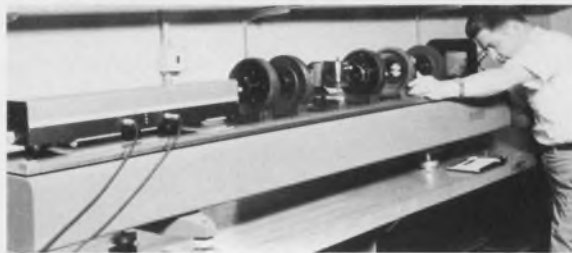

of lenses L_2 and L_3 are f_{L2} and f_{L3} respectively.

Some applications of the optical computer do not require all of the components shown here. Integration, for example, does not require L_3 . The detector is placed directly in the F.T. plane.

Note, in the photograph, that Author Horner's left hand is touching the filter holder in plane P_2 . A directional low-pass filter can be seen in the holder.

Most optical-computer-design problems arise in lens selection. However, reasonably good results can be obtained with good-quality lenses intended for photographic use. Several companies make lenses specifically for taking Fourier transforms and optical data processing.

$g(x, y)$ = an arbitrary function describing the amplitude distribution of light at the aperture.

$G(u, v)$ = the amplitude of diffracted light in the focal plane of the lens.

Eq. 1 is related in a simple way to the two-dimensional Fourier transform of the function $g(x, y)$. This transform is a more general statement of Fourier's theorem for periodic functions. The theorem states that for a function $g(x, y)$:

$$g(x, y) = \int_{-\infty}^{+\infty} \int_{-\infty}^{+\infty} G(\nu_x, \nu_y) e^{-i2\pi(\nu_x x + \nu_y y)} d\nu_x d\nu_y \quad (2)$$

and

$$G(\nu_x, \nu_y) = (1/2\pi) \int_{-\infty}^{+\infty} \int_{-\infty}^{+\infty} g(x, y) e^{i2\pi(\nu_x x + \nu_y y)} dx dy \quad (3)$$

The functions g and G are called a transform pair. Eq. 2 is frequently referred to as the inverse operation, and $G(\nu_x, \nu_y)$, the spectrum of the function $g(x, y)$. (The Fourier transform pair can also be written with the minus sign in the exponent of Eq. 3 instead of in Eq. 2.)

If we make the following substitutions:

$$\nu_x = (1/\lambda f) u \quad (4)$$

$$\nu_y = (1/\lambda f) v \quad (5)$$

Eq. 1 becomes

$$G(\lambda f \nu_x, \lambda f \nu_y) = \int_{-\infty}^{+\infty} \int_{-\infty}^{+\infty} g(x, y) e^{i2\pi(\nu_x x + \nu_y y)} dx dy,$$

which is conventionally written as:

$$G(\nu_x, \nu_y) = c \int_A \int g(x, y) e^{i2\pi(\nu_x x + \nu_y y)} dx dy \quad (6)$$

Note that the infinite limits of integration can be replaced by some finite aperture size, A , since any actual signal will be zero outside some finite region. The entire equation is a two-dimensional transformation in x, y space, with the corresponding variables ν_x and ν_y in transform space. The variables ν_x and ν_y are spatial frequencies measured in cycles per unit length. Optical signals that change drastically over short distances (in a plane) are characterized by spectra with large amounts of the higher spatial frequencies. Similarly, signals that change only gradually have low-frequency spectra.

It is clear, then, that the image formed one focal length behind any converging lens is equivalent to the Fourier transform of the input amplitude

pattern if the input object is illuminated with coherent, parallel, monochromatic light—a laser source.

This is illustrated in Fig. 4. Note that the Fourier transform is formed one focal length behind the lens, regardless of the image and object distances (d_i and d_o , respectively).

It will be noted that the optical system works as would be predicted by the simple thin lens formula, namely

$$1/f = 1/d_i + 1/d_o \quad (7)$$

The idea of the optical computer (see box) is merely to make use of the Fraunhofer diffraction pattern occurring in the transform plane by placing filters there to operate on the (spatial) spectrum of the input signal. The filtered spectrum is then converted back into the distance-domain by a second lens, which performs the inverse transformation, Eq. 2. (Actually, a lens can only take repeated Fourier transforms of a signal. But the inverse transform can be regarded as a Fourier transform in an inverted coordinate system. Hence, the image in the output plane is inverted.)

An input function can be recorded on a piece of photographic film as a density variation; the amplitude transmission, t_a , is a convenient variable. It is the fraction of light passed by the film and varies from 0.0 to 1.0.

One of the simplest mathematical operations to perform optically is the multiplication of two signals. Two pieces of film are placed in series, one behind the other, in the path of a laser beam. The amplitude of light at each point immediately behind the second transparency is proportional to the product of the signal on each transparency. For example, if t_{a1} is a gray transparency that passes 0.5 of the incident light and t_{a2} passes 0.8 of the light, the output will be $0.8 \times 0.5 = 0.4$ or 40% of the incident amplitude.

Calculus is easy with an optical computer

Differentiation and integration are easy and virtually instantaneous when performed optically. Consider differentiation. Take the first derivative of Eq. 2 with respect to one of the variables, say x .

$$\begin{aligned} & \frac{\partial g(x, y)}{\partial x} \\ &= \frac{\partial}{\partial x} \int_{-\infty}^{+\infty} \int_{-\infty}^{+\infty} G(\nu_x, \nu_y) \cdot e^{-i2\pi(\nu_x x + \nu_y y)} d\nu_x d\nu_y \quad (8) \\ &= \int_{-\infty}^{+\infty} \int_{-\infty}^{+\infty} G(\nu_x, \nu_y) (-i2\pi\nu_x) e^{-i2\pi(\nu_x x + \nu_y y)} d\nu_x d\nu_y \\ &= k \int_{-\infty}^{+\infty} \int_{-\infty}^{+\infty} G(\nu_x, \nu_y) \cdot \nu_x \cdot e^{-i2\pi(\nu_x x + \nu_y y)} d\nu_x d\nu_y \end{aligned}$$

where k = complex constant.

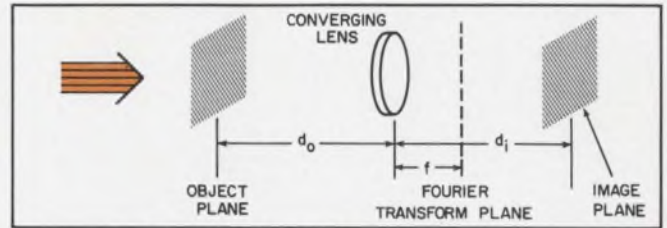

4. The Fourier transform of the two-dimensional amplitude distribution in the object plane is formed in the Fourier transform (F.T.) plane, one focal length behind the lens, regardless of the object distance, d_o . The image distance, d_i , is determined by the classical thin-lens formula (Eq. 7).

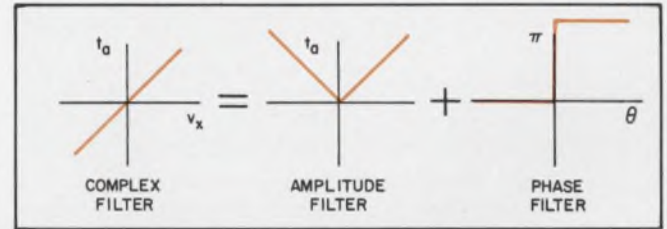

5. Optical differentiation can be performed by placing this filter in the F.T. plane of an optical computer. The filter's transmission, as a function of x , is proportional to x . Since negative transmission is not possible, a thin dielectric coating is used to provide 180° of phase shift.

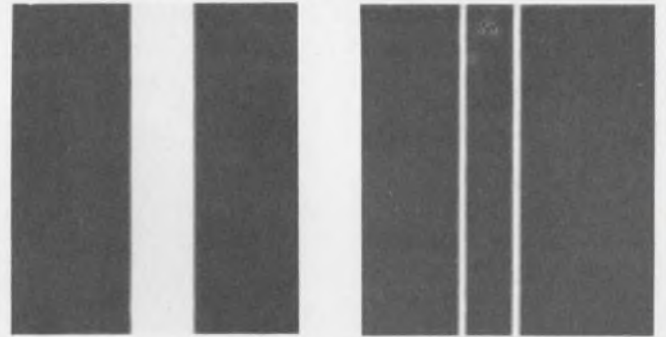

6. An example of optical differentiation: The rectangular function on the left was put in the input plane of an optical computer with a filter like that of Fig. 5 in the F.T. plane. The function on the right, its derivative, was the result.

Thus to take the derivative of a function with respect to the x -direction, multiply the spectrum, $G(\nu_x, \nu_y)$, by a filter proportional to ν_x , and then take the inverse Fourier transform. Fig. 5 shows a plot of the filter and its physical realization. Negative values of the filter are achieved by shifting the relative phase of the light by 180°, or one-half the wavelength, $\lambda/2$. This can be done by depositing a layer of clear dielectric on a glass substrate—similar to the process for putting anti-reflection coatings on lenses and optical plates. Fig. 6 shows the result when a square pulse is differentiated in the x -direction.

Consider integration. Inspection of Fourier's

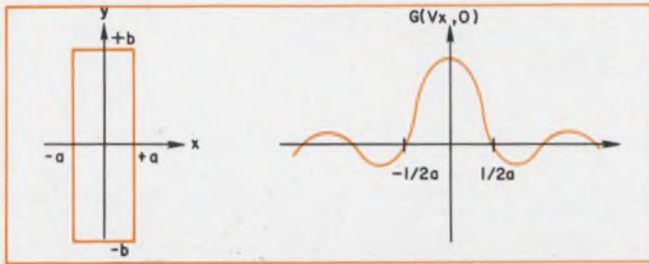

7. The $(\sin x)/x$ function on the right is the Fourier transform of the narrow slit on the left. Actually, there should be another dimension to the transform, but b is assumed so large that $1/b$ is infinitesimal. Note the inverse relationship between the slit and transform widths.

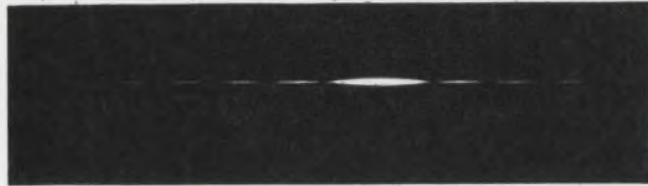

8. The Fourier transform of the narrow slit of Fig. 7 was used to make this photograph. The absolute value squared—the intensity—is what has actually been recorded.

fundamental theorem shows that the definite integral of a function is equal to the Fourier transform evaluated at $\nu_x = \nu_y = 0$.

Since the spatial frequency scale is linear (Eqs. 4 and 5), the position of $\nu_x = \nu_y = 0$ is the origin or optical axis of the system. Thus, to instantaneously integrate the two-dimensional function, one merely measures the light level on the optical axis in the Fourier transform plane. After the language of electronics, this point is often called "the dc spot" by workers in the field.

Spectrum manipulation made simple

Just as it is frequently instructive to examine the Fourier spectrum of a time-varying electronic signal, so is the optical Fourier spectrum—in terms of the spatial frequencies present—sometimes useful. The optical Fourier spectrum represents the decomposition of a complicated amplitude pattern in terms of optical sine waves.

It is instructive to compute the Fourier transform of a simple function, and compare it with the results obtained using the optical computer. For the function, consider a rectangular slit:

$$g(x, y) = \begin{cases} 1; & |x| < a, |y| < b \\ 0; & \text{otherwise} \end{cases}$$

According to Eq. 6, the Fourier transform is

$$G(\nu_x, \nu_y) = \int_A \int g(x, y) \cdot e^{i2\pi(\nu_x x + \nu_y y)} dx dy \quad (9)$$

We will assume that the slit width, $2a$, is less than the input aperture width, and that the aperture has a length $2b$. Eq. 9 becomes:

$$\begin{aligned} G(\nu_x, \nu_y) &= \int_{-b}^b \int_{-a}^a 1 \cdot e^{2\pi i \nu_x x} \cdot e^{2\pi i \nu_y y} dx dy \\ &= \frac{e^{2\pi i \nu_x a} - e^{-2\pi i \nu_x a}}{2\pi i \nu_x} \cdot \frac{e^{2\pi i \nu_y b} - e^{-2\pi i \nu_y b}}{2\pi i \nu_y} \\ &= \frac{e^{2\pi i \nu_x a} - e^{-2\pi i \nu_x a}}{2\pi i \nu_x} \cdot \frac{e^{2\pi i \nu_y a} - e^{-2\pi i \nu_y a}}{2\pi i \nu_y} \end{aligned} \quad (10)$$

This can be put into more useful form by using Euler's identity:

$$e^{\pm i\phi} = \cos \phi \pm i \sin \phi. \quad (11)$$

Equation 10 becomes:

$$G(\nu_x, \nu_y) = \frac{\sin 2\pi \nu_x a}{\pi \nu_x} \cdot \frac{\sin 2\pi \nu_y b}{\pi \nu_y} \quad (12)$$

This is a product of two functions of the type $(\sin x)/x$, called the sinc function. Figure 7 shows the computed transform and its relationship to the dimensions of the slit. Note that if the slit broadens in the x -direction, the transform will narrow.

This is analogous to the familiar property of electronic signals that sharp, narrow pulses have broad spectra and vice versa.

Since the slit is assumed very long in the y -direction, the transform, as a function of ν_y , is essentially zero except at $\nu_y = 0$. Hence only a one-dimensional plot is needed in Fig. 7.

Another property, without an analog in the world of one-dimensional electronics, is that the input signal and its transform are orthogonal. A vertical slit has its transform in the form of a horizontal slit and vice versa.

Fig. 8 is a film recording of the spectrum of a slit.

Alternatively, the output data could be recorded by a photocell scanner and strip-chart recorder. Since both film and photocells respond to energy, the absolute value squared of Eq. 12, or the intensity, i , is what is recorded.

The radial distance from the origin in the transform plane is proportional to the spatial frequency, and the intensity of light at any point is proportional to the intensity of that frequency component in the Fourier transform. Note that both positive and negative frequencies are present.

Having a plane in space where a Fourier transform is displayed allows one to duplicate many of the filtering tricks that electronics can do. For example, a sharp-cutoff, low-pass filter is constructed by simply punching a hole in an opaque card. When inserted in the Fourier transform plane, only spatial frequencies within the clear aperture can get through. This is the basis for the lens-pinhole assembly in the box. Unwanted intensity variations in the laser beam correspond to higher spatial frequencies. A small pinhole (typically 0.001 inch) allows only the very low frequencies or dc to emerge from the assembly and

be collimated by lens L_1 . This filter has nearly infinitely steep sides, a feat of optics that is difficult to do electronically. Figure 9 shows several other filter configurations and their electronic equivalents.

Such binary (because they are everywhere either clear or opaque) amplitude filters have been used by geophysicists in removing unwanted and confusing structure in seismic data. Another application (see "Optical computers poised for systems role," ED 8, April 11, 1968, pp 25-32) is the removal of the lines between individual film strips in a picture mosaic assembled from lunar orbiter probe data.

Optical correlation saves phase

For many applications it is necessary to modify the Fourier spectrum of a signal, not only in amplitude but also in phase. In other words, a complex filter is desired. A basic problem in fabricating such a filter is that a photographic emulsion (the usual medium used to record both signal and filter) responds only to intensity.

But the intensity of a complex optical signal,

$$r(x, y) e^{i\phi(x, y)}, \text{ is}$$

$$i(x, y) = [r(x, y) e^{i\phi(x, y)}] [r(x, y) e^{i\phi(x, y)}]^*, \quad (13)$$

$$= r(x, y) \cdot r(x, y)$$

where r and ϕ are real functions, and $*$ denotes the complex conjugate operation. In other words the phase information, $\phi(x, y)$, has been lost in the recording process.

A. VanderLugt, a research scientist at the Institute of Science and Technology of The University of Michigan, realized that the scheme used to record both phase and amplitude in holography could be applied to optical data processing. To see how this comes about, let us take a carrier function, $e^{i\alpha x}$ and add it to the complex signal we wish to record on film. The intensity of the resulting distribution will be

$$i(x, y) = \text{Re} \left\{ [r(x, y) e^{i\phi(x, y)} + e^{i\alpha x}] [r(x, y) e^{i\phi(x, y)} + e^{i\alpha x}]^* \right\}$$

$$= 1 + r^2(x, y) + r^*(x, y) \cos[\alpha x - \phi(x, y)] + r(x, y) \cos[\phi(x, y) - \alpha x] \quad (14)$$

Thus the amplitude and phase information have both been converted to an intensity signal to which the photographic film is sensitive. α here is the carrier frequency, and a constant.

VanderLugt incorporated his scheme in an optical computer to determine how alike are two signals. Mathematically this is the process of cross-correlation, defined as

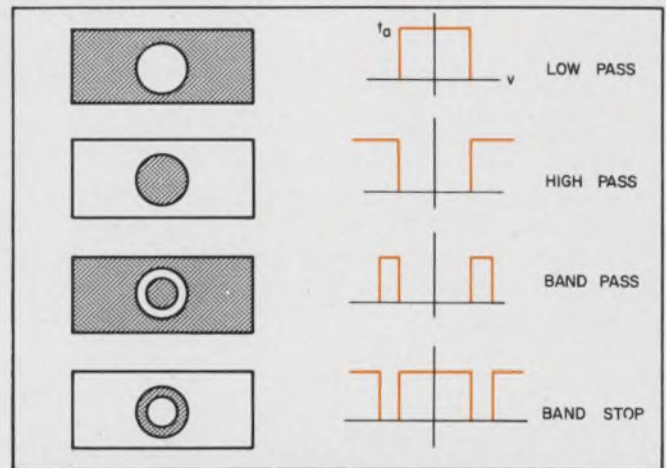

9. Almost-impossible functions, electronically speaking, are realized with ease using spatial filters like these. The shaded areas are opaque, the unshaded, clear. The distance from the center of each circular aperture corresponds to the frequency (horizontal axis) of the electronic equivalents shown alongside.

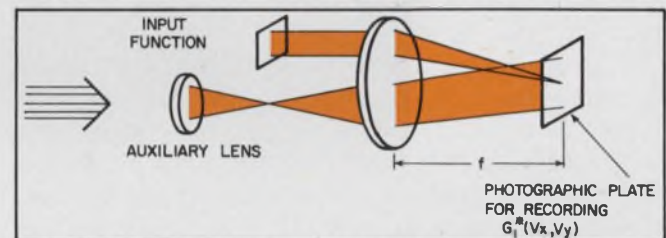

10. The complex conjugate of a function is formed by allowing a reference beam (obtained from an off-axis lens) to interfere with the main beam. Phase data are converted to intensities and, as such, can be recorded on film.

The important feature of Fourier transformation, of course, is its position invariance, i.e., the stationarity of the power spectrum with respect to translations of the imagery. Moment invariants are even better in this respect -- they are not only position invariant, but also invariant with respect to changes in size and angular orientation!

The potential of the moment-invariant technique is obvious. For suppose we wanted to look for all the airplanes in an aerial photograph. Airplanes, of course, vary in size, position and orientation, but the basic shape is always the same. Now, moment invariants depend only on the shape of the object. Thus, by examining the moment-invariant spectrum of the

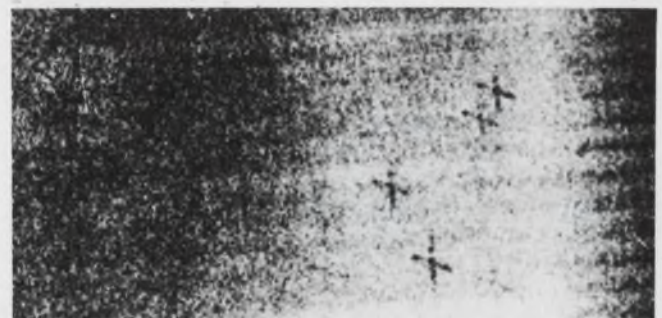

11. X marks the spot where the phase moment-invariant appears. A filter was made of this phrase and the page of the text was used as an input. The correlation peaks have an X shape because an X shaped mask was put in the beam when the filter was made.

$$\tau_{12}(x', y') = \int_A \int g_1(x + x', y + y') g_2^*(x, y) dx dy. \quad (15)$$

The correlation, τ_{12} , is a pure number, and will change for each different value of x' and y' . If the functions g_1 and g_2 are identical, τ_{11} is referred to as the auto-correlation.

It can be shown that the auto-correlation function is also equal to the Fourier transform of the power spectrum:

$$\tau_{12}(x', y') = \int_{-\infty}^{+\infty} \int_{-\infty}^{+\infty} G_1(\nu_x, \nu_y) G_2^*(\nu_x, \nu_y) e^{i(2\pi \nu_x x' + \nu_y y')} d\nu_x d\nu_y. \quad (16)$$

The way to extract the correlation is now clear: (1) Form the complex conjugate of the Fourier transform of one function; (2) multiply it by the Fourier transform of the other function; then (3) take the Fourier transform of the product. Optically, the correlation will be a spot of light whose amplitude is proportional to the correlation integral.

Figure 10 shows how to perform step 1. Steps 2 and 3 are performed in the optical computer by putting one of the functions to be correlated in the input plane, and the filter of step 1 in the F. T. plane. It happens that this filtering is identical with the theory of matched filtering when the two signals are the same (autocorrelation). Matched filtering is the technique of maximizing the ratio of peak signal value to mean square noise, when the noise is random and additive.

In this type of optical correlation, it is not necessary to move one signal relative to the other to produce the correlation. The brightest spot of light occurs in the output where the correlation is maximum. It is this unique property of the coherent optical correlator that makes the device useful for rapid automatic pattern recognition.

An example of this is shown in Fig. 11. A filter has been made of the key word, *moment-invariant*. A page of text is used for the other signal. Everywhere in the text that the key word occurs, a correlation maximum occurs in the output. The correlation peak is in the form of an **X** for easy identification. This was done by putting a mask, in the shape of an **X** in the beam while making the filter. A photocell mosaic could be used to automatically count or signal the correlation.

There are many potential applications for rapid automatic pattern recognition. For instance, aerial photographs could be routinely and automatically searched for missile sites or other strategic targets. Mail sorting as well as fingerprint identification could benefit by optical correlation techniques. Conductron Corp. is, in fact, developing a fingerprint correlator with a possible search rate of 10,000/s.

Another area where the optical computer shines

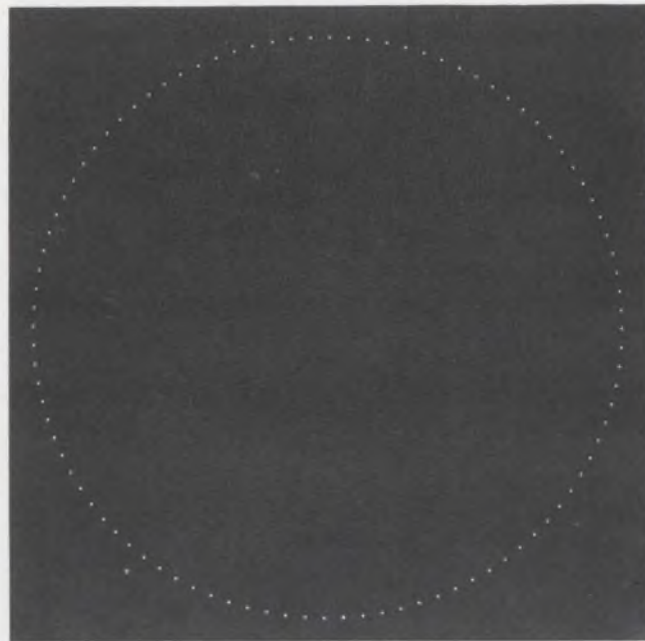

12. A mile-and-a-half-diameter antenna array was studied with this optical model. The actual size of the film transparency is 2 millimeters.

is in the modeling of antenna arrays. In designing an array, one must determine its radiation pattern. However, one would like to do this without going to the trouble and expense of actually building the array. Thus, it would be nice to have a model of the array to experiment with, perhaps one that could be conveniently set up on a table top.

One very useful piece of information about an array is its far-field or Fraunhofer diffraction pattern. This, as we have seen, is equivalent to the Fourier transform of the amplitude pattern. By scaling down the wavelength from microwaves to the laser line, a reduction in the size of the antenna of approximately $3 \text{ cm}/6328 \text{ \AA} \approx 50,000$ is possible.

Figure 12 shows the optical model of an antenna proposed by the Australian Government for scanning the sun. It consists of 96 parabolic antennas. The antennas are equally spaced on a circle one and a half miles in diameter. The size of the circle on the film transparency was 2 millimeters, giving a scale factor of about $8 \times 10^7:1$. A laser of wavelength 6328 Å was used. This is a frequency of about 4×10^8 MHz. When multiplied by the scale factor, this corresponds to 390 MHz.

Figure 13 shows the far-field Fraunhofer diffraction pattern recorded in the Fourier transform plane, P_2 , of the optical computer. Both normal exposure and long exposure are presented to show the gross pattern and the complicated detail in the side-lobes.

Of course, the same pattern could have been computed on a digital computer, or observed from a satellite at a distance of 2400 miles out in space. But pattern synthesis by optical simulation is far

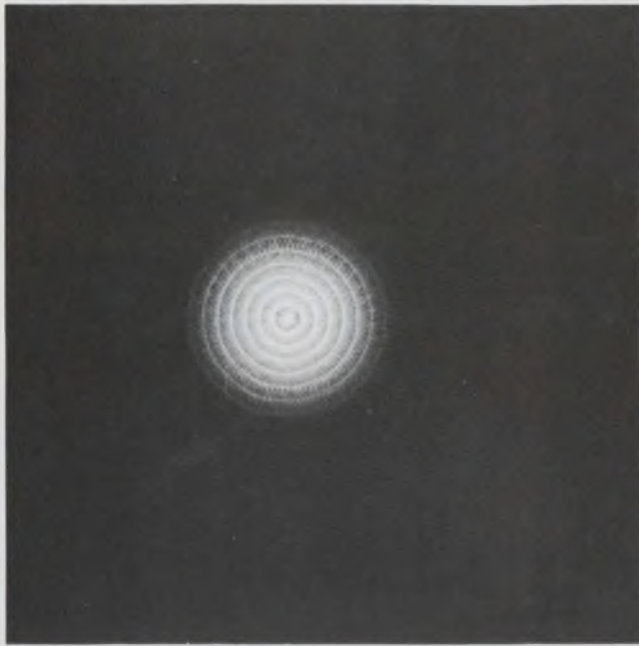

13. The far-field radiation pattern of the antenna array of Fig. 12 is shown with normal exposure (left) and long exposure (right). The patterns were recorded in the

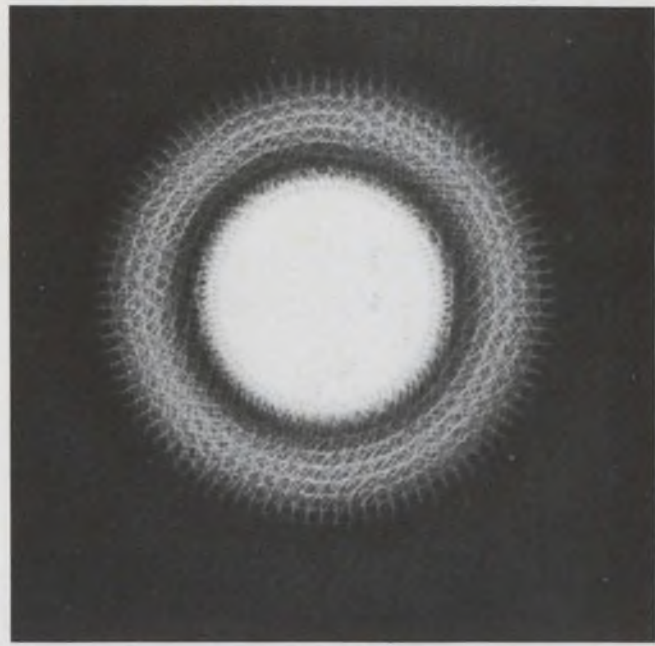

Fourier transform plane of the optical computer. The side lobes, which are too weak to show up in the normal exposure, have become visible in the overexposed picture.

easier and in this case almost incredibly simple. Phase information could be incorporated into the antenna structure by using a dielectric coating of the proper thickness to change the phase of each element by the desired amount.

Enhance images with spatial filtering

Using an optical computer, one can correct photographs suffering from such things as out-of-focus adjustment, blur caused by camera or object motion during the exposure, and loss of resolution due to atmospheric turbulence during exposure by spatial filtering techniques. All of these defects are characterized by a reduction of the higher spatial frequency spectrum in the picture. Therefore, the restoration requires basically a highpass spatial filter. To understand the technique, one must see the image-forming process as a convolution process. In incoherent light the equation for the image is

$$i'(x', y') = \int_{-\infty}^{+\infty} \int_{-\infty}^{+\infty} s(x, y; x', y') i(x, y) dx dy, \quad (17)$$

where

- i' = the light intensity in the image,
- s = the point spread function,
- i = the intensity of the original scene.

The point-spread function describes the intensity pattern in the image plane when the object is an infinitesimal point source of light. This is analogous to the impulse response function of an electrical network. Ideally, s would be a gradually vanishing narrow function determined only by the size of the lens—the so-called diffraction limit. In

practice, imperfect lens systems and external factors such as image motion and atmospheric turbulence can degrade (widen) the point-spread function. If it is translation-invariant over some region of object-image space (analogous to the time-invariant requirement in electronic filter analysis), Eq. 17 can be simplified to give:

$$i'(x', y') = \int_{-\infty}^{+\infty} \int_{-\infty}^{+\infty} s(x' - x; y' - y) i(x, y) dx dy \quad (18)$$

$$= s * i \quad (19)$$

where

* denotes the convolution operator.

The intensity pattern, i' , is used to expose a photographic emulsion. Next, the developed emulsion is placed in the input plane, P_1 , of the computer (see box). If the film exhibits a linear relation between the incident exposing light intensity and the developed amplitude transmission, then the light amplitude, $a(x', y')$, in the input plane of the computer will be

$$a(x', y') = Ks * i \quad (20)$$

In the first transform plane, P_2 , the light amplitude will be the Fourier transform of the input

$$A(\nu_x, \nu_y) = \text{F. T.} \cdot [s * i]. \quad (21)$$

A theorem that states that the Fourier transform of a convolution integral is equal to the product of the transformed functions, when applied to Eq. 21, gives

$$A(\nu_x, \nu_y) = S(\nu_x, \nu_y) \cdot I(\nu_x, \nu_y) \quad (22)$$

The right side is now a product of the spread function transform and the original *undistorted* scene spectrum. Now the trick is to synthesize a filter to be inserted in the transform plane, P_2 , whose transmission is

$$1/S(\nu_x, \nu_y) \quad (23)$$

This gives for the light behind the filter:

$$S(\nu_x, \nu_y) \cdot I(\nu_x, \nu_y) \cdot 1/S(\nu_x, \nu_y) = I(\nu_x, \nu_y) \quad (24)$$

In the output plane, P_3 , the inverse Fourier transform is produced

$$\text{F.T.}^{-1} [I(\nu_x, \nu_y)] = i(x', y'). \quad (25)$$

In other words the degraded image, i' , has been deconvolved from the point spread function, s , in the optical computer to give a reproduction of the original undistorted scene. Information theory predicts that the restored scene will not be perfect because of the noise present in any real system, but considerable enhancement of picture detail can still be accomplished.

Consider a scene blurred by atmospheric turbulence. We produced this in the laboratory by placing a hot plate under the camera lens (out of sight) and making a time exposure of an aerial photograph. The narrow point spread function of the optical system became a wide blur which, to a good approximation, can be represented by the Gaussian function

$$s(r) = e^{-(r/r_0)^2}$$

where $r = (x^2 + y^2)^{1/2}$ (26)

and r_0 is a constant which depends on the amount of turbulence in the atmosphere. To make the inverse filter we take the Fourier transform of s and invert it—Eq. 23. The Gaussian function has the property that its Fourier transform is also a Gaussian function:

$$\text{F.T.} [e^{-r^2/r_0^2}] = ke^{-(\nu/\nu_0)^2} \quad (27)$$

where $\nu = (\nu_x^2 + \nu_y^2)^{1/2}$.

Hence, the inverse filter is

$$ke^{(\nu/\nu_0)^2} \quad (28)$$

where k is a normalization constant to make the maximum value of Eq. 28 equal to unity at the highest spatial frequency in the input film.

Fig. 1 shows the blurred, unfiltered aerial scene, and also the same scene after spatial filtering. Note the improvement in fine detail, such as the windows.

With the exception of the image-enhancement application, the optical data processing techniques that we have been discussing require only reasonable mechanical tolerances in order to work as

described. Any converging lens will produce a Fourier transform, but the transforms produced by high-quality lenses will have less distortion than those produced by cheap lenses.

Precise positioning of filters along the optical axis in the transform plane is not essential for successful operation—errors of a few millimeters are usually acceptable. In fact, when using photographic transparencies as filters, it is necessary to defocus slightly to avoid burning the film with the extremely intense dc spot that exists precisely in the transform plane.

The selection of a laser for an optical computer is simple. A cw laser is needed. Since high power and efficiency are not important and spectral purity is, a gas laser is the obvious choice. Ordinary off-the-shelf gas lasers have very narrow spectra (see "Advances in Lasers," ED 19, Sept. 12, 1968, p. 49) and adequate power for this application.

As the wave of the future in computer technology we can expect to see a marriage of the optical computer with integrated circuit components to yield new speed and compactness. For example, a mosaic of IC photodetector and decision circuits could be used to process the Fourier transform data generated by optical means.

Considering that the whole field of optical data processing is less than a decade old, many advances and improvements can be anticipated. But even now, most limitations on the wider use of ODP equipment can be traced to shortcomings in the imagination of the user. ■ ■

Test your retention

Here are questions based on the main points of this article. Their purpose is to help you make sure you have not overlooked any important ideas. You'll find the answers in the article.

1. *How does the object-to-lens distance affect the location of the Fourier transform plane?*

2. *Why is the optical computer able to integrate faster than an electronic computer?*

3. *What factors determine the size and frequency scale of a model of an antenna array?*

4. *What is the principal advantage of optical correlation over its electronic counterpart?*

5. *Filters used for image enhancement are of what basic type? Why?*



New! Type 1681 Automatic Impedance Comparator — \$4975



Type 1680 Automatic Capacitance Bridge — \$4975

We've made life more difficult

Now you must choose between TWO automatic bridges

With the introduction of the 1681 Automatic Impedance Comparator, you are forced to decide whether it or the 1680 Automatic Capacitance Bridge is better suited to handle your measurement problems. You'll thank us, though, because we've made life easier for you in the long run.

Whichever instrument you choose — 1680 or 1681 — you get a true three-terminal bridge, with all the inherent accuracy and stability of a bridge. You also get BCD output data, 1/2-second (or less) automatic balance, and a choice of frequencies (120, 400, or 1000 Hz).

Like the 1680, the 1681 can be used by itself or it can form the nucleus of an automatic measuring system. Systems typically include devices such as scanners, recorders, card- or tape-punches, and even on-line computers. Call your nearest General Radio Office, or write General Radio, W. Concord, Massachusetts 01781; telephone (617) 369-4400. In Europe Postfach 124, Ch 8034 Zurich 34, Switzerland.

The 1681 is direct reading in <i>impedance-magnitude and phase angle differences</i> , and it can measure R, L, or C from 2Ω to 20 MΩ.	The 1680 is direct reading in <i>capacitance and dissipation factor</i> (or conductance) over a 0.01-pF-to-1000-μF range.
The 1681 achieves its flexibility through the use of <i>external standards</i> — precision laboratory standards or your production samples.	The 1680 contains its own highly stable internal standards.
The 1681 can read $\Delta Z $ to within <i>10 ppm</i> of your standard and $\Delta\theta$ to within <i>0.00001 radian</i> . <i>Comparison accuracy</i> is as good as 0.005%.	The 1680 reads absolute value of capacitance and loss factor to <i>five-figure resolution</i> at 0.1% basic accuracy.
The 1681 is best suited for <i>comparison measurements</i> or for measurements requiring extreme <i>resolution</i> . Typical applications are component evaluation such as temperature-coefficient measurements, receiving inspection, production testing, sorting, and precise measurement of small and low-loss capacitors.	The 1680 is best suited for <i>general capacitance measurements</i> where wide range, ease of use, and direct readout are desired. Capacitor sorting, process control, and quality control are typical applications.

GENERAL RADIO

industrious

Small wonder the Clare LB Telephone Type Relay is kept busy—at 1.33 cu. in., it is unmatched for switching capacity and contact versatility—realistically priced!

You can design around 2 amp. to low level operation . . . using up to six Form C contacts . . . or Forms A, B, or D. Twin contacts assure reliable performance . . . with no adjustment needed. Use Type LB for direct pcb mounting . . . Type LBP for mounting with socket. With quality controlled manufacture and adjustment, you can depend on these industrious relays for consistent high quality . . . maintenance-free, long life operation.

For design information, circle reader service number—or ask Clare for Data Sheet 552B . . . Write Group 11A5.

C.P. Clare & Co., Chicago, Illinois 60645



a GENERAL INSTRUMENT company

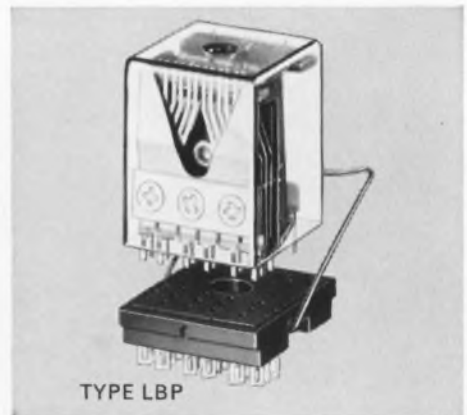

- Long life: up to 50×10^6 operations
- Contact Versatility: 2 amp. to low level . . . twin contacts for reliability . . . up to 6 Form C with A, B and D available
- Stable, adjustment-free operation
- Socket terminals—pcb or solder

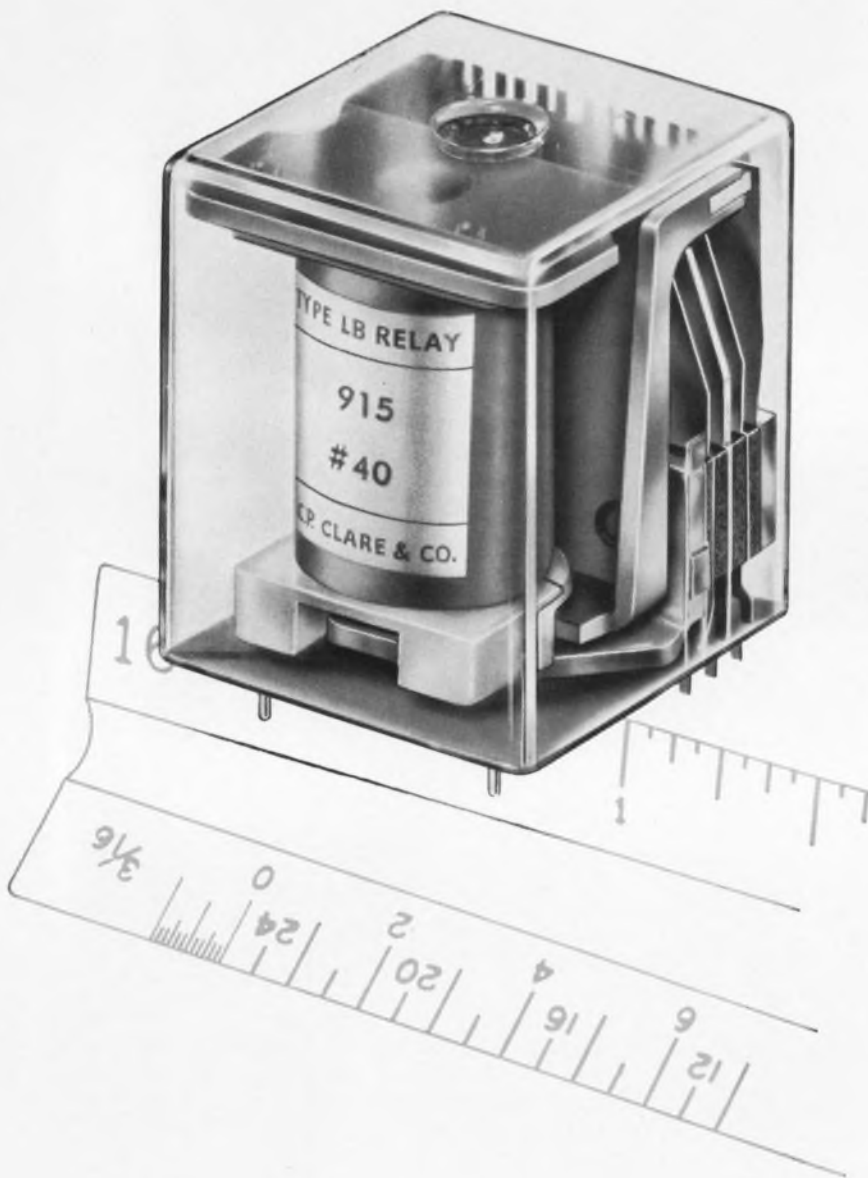

CLARE MINIATURE TELEPHONE TYPE RELAYS

for process control, computer peripheral equipment, communications,
digital instruments, business machines, ground support equipment

INFORMATION RETRIEVAL NUMBER 32

Dual 100-bit MOS... longest and lowest cost static shift registers

- 200 bits per package
...for economy and
reliability
- Lowest cost per bit
(one-tenth bipolar
registers)
- D-C to 1 MHz
operation
(no minimum
clock rate)
- Extremely low power
drain
(1.5 mW per bit)

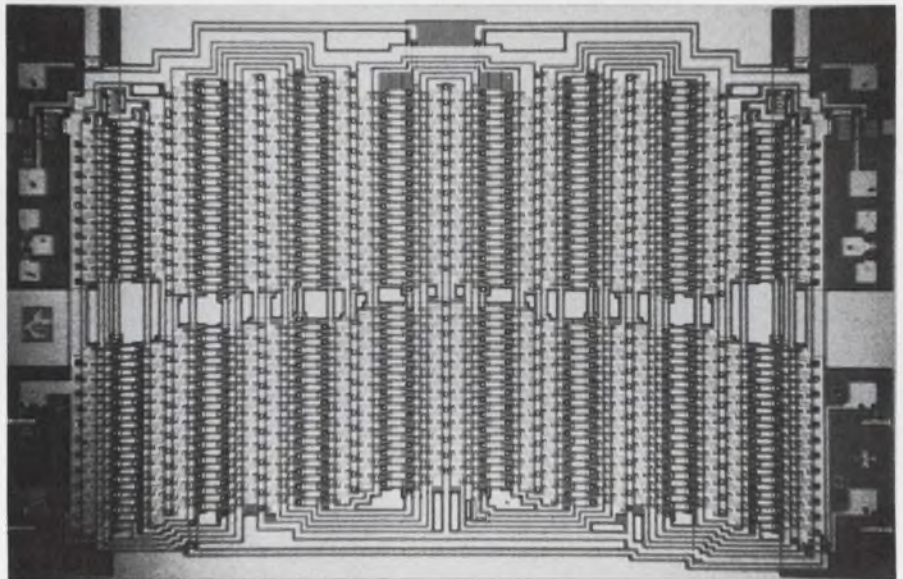

This is a photomicrograph of the longest static shift register available in a production device today. It's the new dual 100-bit MOS-LSI from Texas Instruments...the latest of a growing family of computer-designed MOS circuits. Other static shift registers include dual 50-, 32-, 25-, and 16-bit units.

In addition TI is currently producing other advanced MOS circuits including memories...random access and read only, analog switching circuits, linear circuits, and custom logic arrays.

Furthermore, TI's computer design capability reduces design lead time for custom products tailored

to your system needs.

A new MOS Static Shift Register Application Report is just off the press. For your copy—plus data sheets—write on your letterhead to Texas Instruments Incorporated, P. O. Box 5012, MS 980-C, Dallas, Texas 75222.



TEXAS INSTRUMENTS
INCORPORATED

Unsnarl your complex wiring problems

with computer-generated wiring lists. They're easy to develop and not prohibitively costly.

You are designing a relatively complex system, and the problem arises of drawing up a wire list for the many interconnections. You can do it manually, but it's drudgery. Why not use the company computer?

Great, except for one thing: The majority of engineering companies don't have access to costly sophisticated computer wire list programs. The solution: Seek out an amiable programmer in your company and, with his help, write your own computer wire-list program. Once you understand the basic technique, it can be adapted to most wiring requirements—and at a cost that's guaranteed not to bankrupt your company.

The function of the computer in these wiring-list tasks is to sort basic wiring-point information into alphanumerical lists of varying configurations and complexities.

More than one list used

The basic list and starting point from which the others are derived is called the Input Pin

List (Fig. 1). It is simply the original, unsorted listing prepared by the designer to identify the points to be wired and the signals associated with those particular points. Each entry identifies the signal and its wiring point by code names. The makeup depends upon your requirements and the programming of your company's computer.

The unsorted pin list is put onto punched cards and entered into the computer. The computer then generates a Signal Wire List (Table 1) which connects all the wiring points in the input pin list that carry the same signal. This wire list is the most convenient method of indicating the numerous interconnections in a complex system. It presents, in tabular form, connections between all the components in a unit, such as connectors, switches and bus bars.

Each entry in the wire list is composed of a signal name and two points (FROM and TO) to which the wire is connected. Additional data, such as wire number, wire size, wire color, or even circuit loading information can be printed on the wire list. However, the more complicated the listing, the more closely the designer and programmer must work together. In fact, the programmer can be a valuable aid in organizing the initial list.

Norton Markin, Research Engineer, Bendix Corp., North Hollywood, Calif.

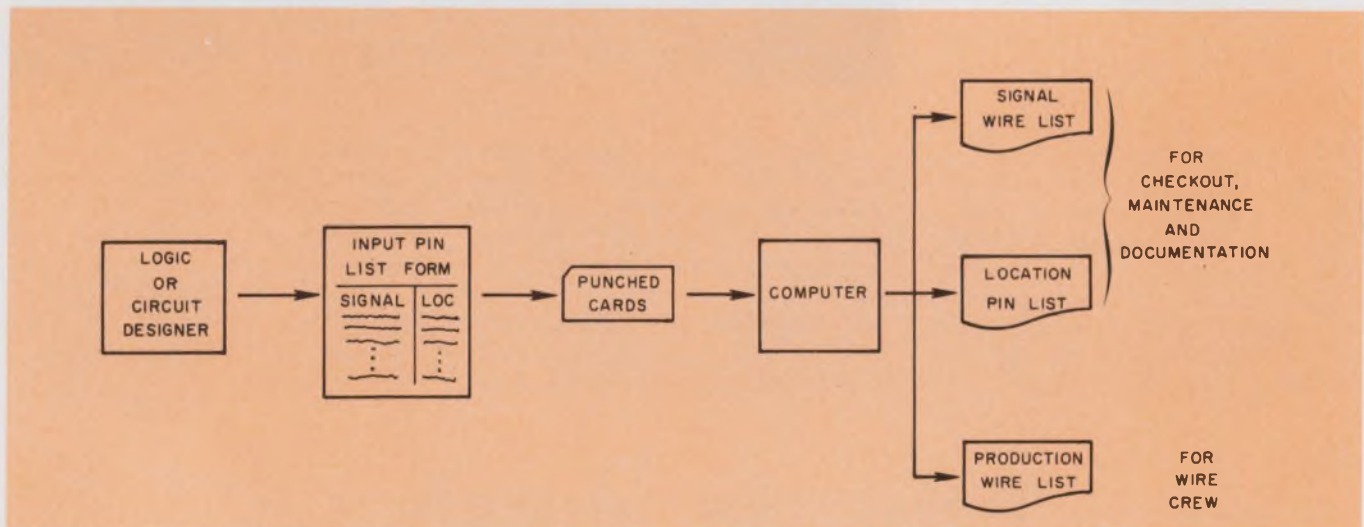

1. Simplified approach to wire listing starts with unsorted Input Pin List, prepared by designer. The listing is

put on punched cards, which are fed to the computer. Alphanumeric sorting produces the working lists.

In Table 1 the computer has made a primary alphanumeric sorting of items according to the signal name, together with a secondary sorting according to the FROM location. This list is used during checkout and maintenance to find all points connected by a common wire.

For original wiring purposes, a Production Wire List, generated from the Signal Wire List in Table 1, sorts the items in the order in which they are to be wired, as shown in Table 2. The items in this particular list are first sorted according to the hardware areas shown in Fig. 2. Then, since the card rack area is to be wire-wrapped, the wire list is sorted according to the wire-wrap levels shown in Fig. 3. The Production Wire List thus permits each area to be wired independently, and it also gives the information for interconnecting the wires between areas.

For maintenance and checkout, a Location Pin List, generated from the Input Pin List, gives an alphanumeric sorting of items according to location, as shown in Table 3.

Generating the program

To produce a simple wire-list program, a set of arbitrary, consistent rules for wire routing must first be established, based upon the hardware configuration. For example, a representative unit (Fig. 3) consists of a front panel containing switches and indicator lights, a rear panel with input-output receptacles, and a card rack into which the printed-circuit card files are inserted.

The card rack is composed of columns of card files. Each file has a number of connectors (eight in Fig. 2), and each connector has connector pins. The card files are designated alphabetically, and the card connectors and connector pins are designated numerically. Thus the location of any point in the unit can be described by its card-file letter, its connector number and its pin number. For example, pin 14 of connector 01 in card file B in Fig. 2 is designated at B01 14.

Note that in the wiring list (Table 1) it appears as B01 14 1. This last figure is the wiring level, which is 1 for soldered or taper-pin connections.

For wire-wrap connections, the location (or level) of the wire wrap on the connector pin is also included. For example, wire-wrap level 1 is closest to the connector (Fig. 3), level 2 is in the center level, and level 3 is on top. When wire-wrapping, it's best to alternate the levels (Fig. 3), so that a minimum of wires have to be removed when you make a change. To simplify programming, a wire-wrap level designation column is used throughout, even though only one area of a unit is to be wire-wrapped.

The physical location of connections to switches,

Table 1. Signal wire list

Signal name	Location
ADS00ANL	B01 12
ADS00ANL	B07 18
BGD29BBL	A03 11
BGD29BBL	B01 14
BGD29BBL	B01 15
BGD29BBL	B05 12
BGD29BBL	B06 03
BGD29BBL	B06 12
BGD29BBL	B08 16
BGD29BBL	D04 21
BGD29BBL	D06 17
BGD29BBL	J03 01
BGD29BBL	S03 A2
BGD29BBL	S05 CW
BGD29BBL	S13 05
DEF14DNH	A01 13
DEF14DNH	C03 21
DEF14DNH	J03 04

Table 2. Production wire list

Wire wrap connections			
Level 1 to Level 2			
DEF14DNH	A01 13 1	C03 21 1	
ADS00ANL	B01 12 1	B07 18 1	
BGD29BBL	B01 14 1	B01 15 1	
BGD29BBL	B05 12 1	B06 03 1	
BGD29BBL	B06 12 1	B08 16 1	
BGD29BBL	D04 21 1	D06 17 1	
Level 1 to Level 2			
BGD29BBL	A03 11 1	B01 14 2	
Level 2 to Level 2			
BGD29BBL	B01 15 2	B05 12 2	
BGD29BBL	B06 03 2	B06 12 2	
BGD29BBL	B08 16 2	D06 17 2	
Interface connections			
DEF14DNH	C03 21 2	J03 04 1	
BGD29BBL	D04 21 2	J03 01 1	
BGD29BBL	S13 05 1	A03 11 3	
Soldered connections			
BGD29BBL	S03 A2 1	S05 CW 1	
BGD29BBL	S05 CW 2	S13 05 2	

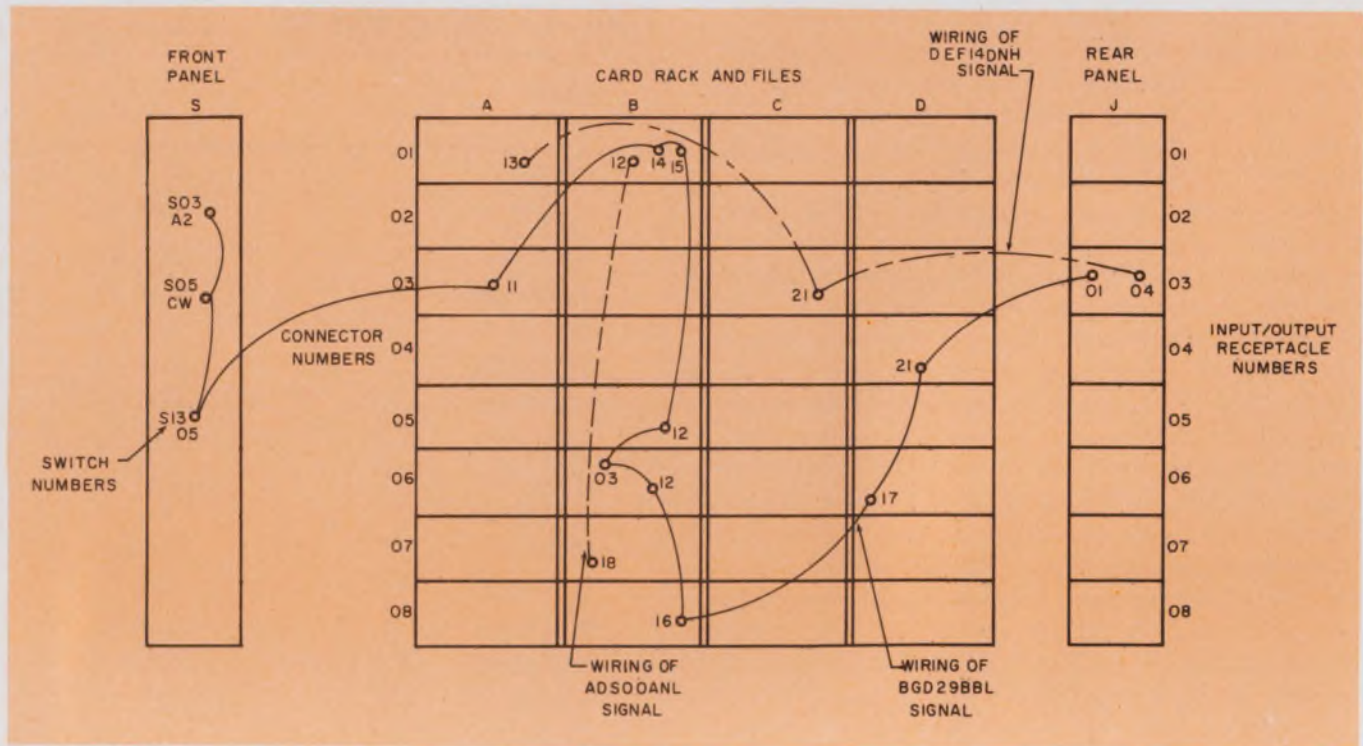

2. Complex wiring pattern is simplified by preplanning the wire routing and organizing the wiring areas, as

shown in this representative example. Wires between the front panel and card rack are stranded; rest are solid.

lights, and input-output receptacles is handled in a similar fashion. Thus, "S" is a basic switch designation, and each switch is uniquely identified by a two-digit number that is the equivalent of a connector designation. For example: S03, Figs. 2 and 3. In this case, the switch has three decks, and the connection is made to terminal 2 of deck A. The complete location designator appears in

the wiring list as S03 A2 1, since solder terminals are handled as "1" wiring levels by the computer program.

Table 3. Location pin list

Wire number	Signal name	Location	
		From	To
0000	ADS00ANL	B01 12 1	B07 18 1
0001	BGD29BBL	A03 11 1	B01 14 2
0002	BGD29BBL	B01 14 1	B01 15 1
0003	BGD29BBL	B01 15 2	B05 12 2
0004	BGD29BBL	B05 12 1	B06 03 1
0005	BGD29BBL	B06 03 2	B06 12 2
0006	BGD29BBL	B06 12 1	B08 16 1
0007	BGD29BBL	B08 16 2	D06 17 2
0008	BGD29BBL	D04 21 1	D06 17 1
0009	BGD29BBL	D04 21 2	J03 01 1
0010	BGD29BBL	S03 A2 1	S05 CW 1
0011	BGD29BBL	S05 CW 2	S13 05 2
0012	BGD29BBL	S13 05 1	A03 11 3
0013	DEF14DNH	A01 13 1	C03 21 1
0014	DEF14DNH	C03 21 2	J03 04 1

Wire routing rules

Having established the means of identifying connection-point locations, you next define the manner in which a single wire is routed between all the points that it connects. Once you determine this, you are in a position to draw up the wire-list program.

For the various interconnections, follow the philosophy of "high-high, low-low" routing, by routing all wires with the same signal name in the following way:

First, within a connector, route the wire from the pin with the lowest number to the pin with the next highest number, and so on. For example, in Fig. 2, wire between B06 03 and B06 12. A wire should enter a connector at the lowest pin number and leave it at the highest pin number with which the signal is associated.

Between connectors in the same card-file column, route the wire from the highest pin of the uppermost connector to the lowest pin of the next connector in line. (In Fig. 2, wire between B05 12 and B06 03.) Repeat this until all the connectors within the file are wired.

Between card files, route the wire from the highest pin of the highest connector in the first file to the highest pin of the highest connector in the next file to which the wire goes. (In Fig. 2,

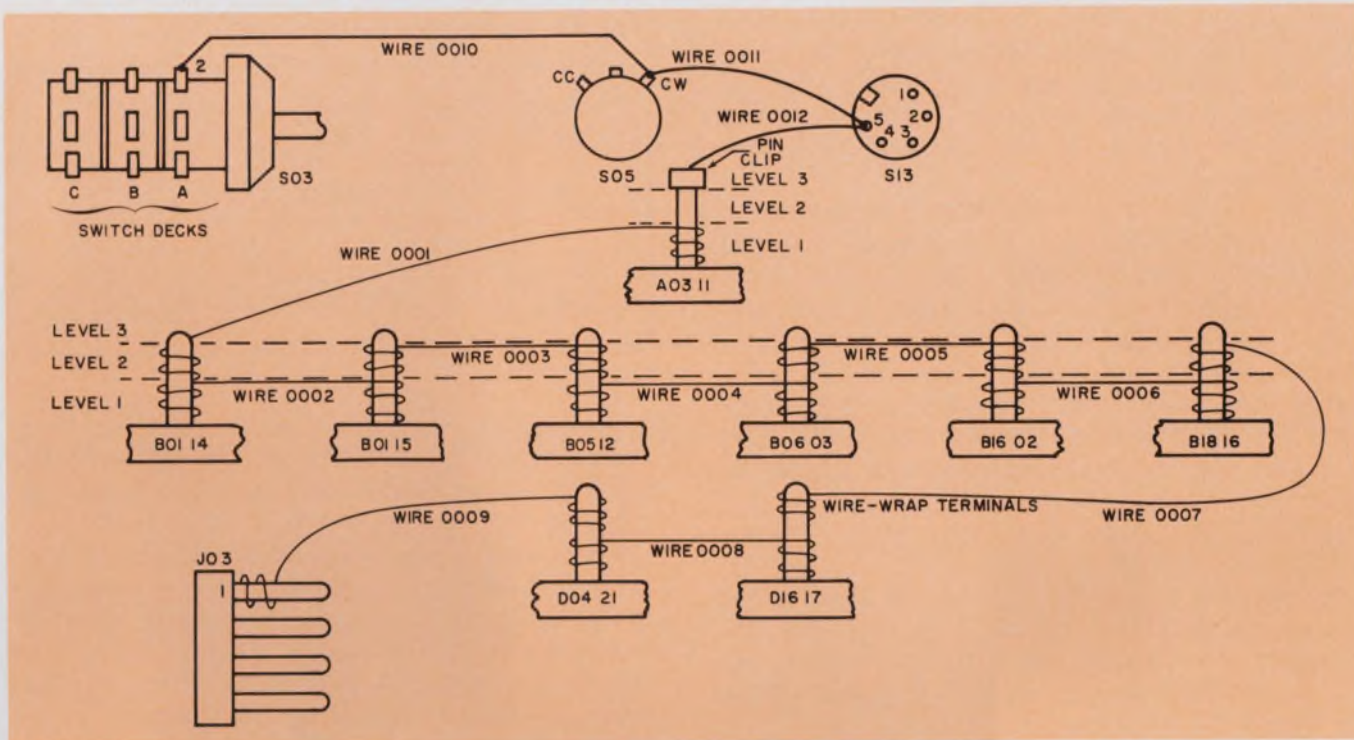

3. Wiring of BGD29BBL signal circuit shows the three-level arrangement for wire-wrap terminals. The location

of components and connections is indicated in Fig. 2, while the wires are identified in Table 1.

wire between B08 16 and D06 17.) Then connect between the lowest pin of the lowest connector in the second file to the lowest pin of the lowest connector in the third file. (In Fig. 2, wire between A03 11 and B03 14). Repeat this high-high, low-low sequence until all card files are connected.

Assigning wire-wrap levels

When connecting a group of pins with wire-wrap terminations, join the first, third, fifth, etc., wires from level 1 to level 1 (Fig. 3). The second, fourth, sixth, etc., wires go from level 2 to level 2.

The last wire of the group always ends at level 1, with the following exceptions: To connect a stranded (front panel) wire to a wire-wrap pin, use a pin clip (Fig. 3, wire 0012)). This clip is attached to level 3 in the card rack or in the rear panel area. Where another wire is connected to the same terminal, wrap it on level 1.

Another exception to ending at level 1 is this: If one of two wires terminating in the card rack comes from the rear panel area, wrap it on level 2 (see Fig. 3, wire 0009).

Specifying the wire list

Once the wire routing rules are established, you are ready to go ahead with the actual specification of a wire list. Let's use the hardware, terminations and routing in Figs. 2 and 3, and represented by Tables 1, 2 and 3, as an example.

The particular wiring requirements for the unit represented by Figs. 2 and 3 are:

1. Wrap wires at card rack locations and at the input-output receptacles on the rear panel.
2. Solder wires at the switches and lights on the front panel.
3. Terminate wires from the front panel to the rear panel or card rack with a pin clip at wire-wrap level 3.
4. To minimize wire length, wire the elements in the sequence: S to A to B to C to D to J.
5. To facilitate production wiring, terminate wires from the rear panel to the card rack at wire-wrap level 2.

As a start, prepare an original list by designating signal names and the physical locations of all components to be connected, as well as the related terminals.

The original pin list that you generate will, in general, be an unsorted version of Table 3. It may not even be necessary to prepare the list if the information is presented on diagrams or in some format that can be easily understood by the key-punch operators.

Choosing a signal name

Note that the signal names in Tables 1 and 3 have eight alphanumeric characters. (For example: BGD29BBL). But this choice is purely arbitrary and will vary with the designer's own signal identification code, with the program requirements and with computer capacity.

In general, the first alphabetic group is associated with its signal function. The next two numbers refer to a particular circuit—for example, flip-flops. The last letters of the name may indicate the signal, its location, and any other association desired.

Let's dissect the BGD29BBL signal term, which, for this example, is concerned with the wiring of a computer. The principles can, however, be applied to any other type of circuitry.

In the BGD29BBL signal, the "BGD" indicates "buffer-gate driver" circuit. The "29B" reminds the designer that these circuits are driving buffer gate No. 29. The next (seventh) character "B" indicates the circuit type (buffer) in which the logic signal is formed, while the eighth term, "L," indicates that the level on that bus is "low" under conditions established by the designer.

To produce a wire list that follows these rules, you must add further inputs to the basic list. To minimize wire length, designate the routing sequence between files as well as the area where each card file is located.

It is most convenient and advisable to enter this information into the computer program prior to entering the input pin list data. The computer will then use this "pre-information" to generate a signal wire list that complies with wiring requirements.

In addition to the signal name, it is also desirable to have the wire-list program generate a different number for each wire on the list. These numbers aid in making any future wiring changes.

With the various elements entered into the computer program, the Signal Wire List of Table 1 is generated from the unsorted version of Table 3. The list is then re-sorted to generate the Production Wire List of Table 2. The actual wiring of the BGD29BBL signal term of Table 1 is illustrated in Figs. 2 and 3.

Revising the wire list

Changes are inevitable, and it is necessary to update the wire lists. The wire number identifies any wire that is to be changed. An example of the computer inputs needed to make such changes in the wiring lists is given by Table 4.

Here, the first entry shows how wire 0014 is deleted (from Table 1). The second entry indicates that the FROM location of wire 0010 is to be changed.

An example of how to add a new wire is given in the third entry. Note that no wire number is necessary, since once all these changes have been entered, the computer produces a new, updated list that includes the new wire number. When updating, it is desirable to have the computer program determine whether the designer

Table 4. Wire-change list

Change No.	Wire Number	Signal Name	Location	
			From	To
1	0014	DELETE		
2	0010		S01 B31	
3		ADS00ANL	B11 181	D03 051

has assigned two or more signal wires to one location, or possibly has assigned two wires to the same wire-wrap level. Such errors should be indicated on the Location Pin List is produced.

Since most wiring is involved with connections between four points or less, it is not necessary, in this simplified program, to provide absolute minimization of wire length—that is, those wire lengths that must be kept to an absolute minimum can be determined by the designer ahead of time and can then be optimized after the initial wire list is generated. The routing rules presented here provide for partial minimization of wire length between card files. However, the references below describe relatively complex algorithms, designed primarily to minimize wire length. ■■

References:

1. P. C. Gilmore, "Optimal and suboptimal algorithms for the quadratic assignment problem." *J. Soc. Ind. Appl. Math.* 10, 2 (June 1962), 305-313.
2. C. Y. Lee, "An algorithm for path connections and its applications," *IRE Trans. EC* 10 (1961), 346-353.
3. H. Loberman and A. Weinberger, "Formal procedures for connecting terminals with a minimum total wire length," *J. ACM* 4, 4 (1957), 428-433.
4. T. Pomentale, "An algorithm for minimizing backboard wiring functions," *Comm. ACM* 8, 11 (Nov. 1965), 699-703.
5. Steinberg, Leon—"The backboard wiring problem: A placement algorithm," *SIAM Rev.* 3, 1 (Jan. 1961), 37-50.

Test your retention

Here are questions based on the main points of this article. Their purpose is to make sure you have not overlooked any important ideas. You'll find the answers in the article.

1. What is the principal function of a computer in generating a wire list?
2. What is the principal use of the Signal Wiring List? The Input Pin List?
3. How are the physical locations of connection points identified in computer listing?
4. What is the "high-high, low-low" method of wire routing?

Only Magnetics Inc. gives you all three of these advantages in photo-etched parts:

1. Metals processed to your specification
2. Guaranteed magnetic performance properties
3. Total quality control, raw metal to finished part

There is nothing new about chemically milling small, thin metal parts. Dozens of companies can photo-etch any part that can be drawn. What sets Magnetics Inc. apart in photo-etching is our capability of processing the metal to close tolerances.

Magnetics' completely integrated

production system for Photofab® parts is all-inclusive. We can custom blend basic metals into special alloys, or we can start with stock metal. We follow through with whatever it takes to match your specifications—precision rolling or flattening or strip annealing. As long-time specialists in magnetic materials, we have the facilities and the expertise needed to provide the ultimate in dimensional accuracies, at the same time guaranteeing the magnetic properties of your parts.

We augment our production capa-

bilities with uptight quality control. This means the most advanced laboratory and test equipment, manned by a staff of nit-picking experts. When you take delivery on Photofab parts, you can be sure that they've passed our constant surveillance, from basic metal through shipment in custom-designed packaging.

If you've been looking for a supplier who can offer single-source responsibility on photo-etched parts, you've found us. For more information, write Magnetics Inc., Dept. ED-104, Butler, Pa. 16001.



*Photofab example—
words photo-etched
in a sheet of .001
beryllium copper.*

90-second look at IEE's wonderful world of readouts

Readouts are our special craft. Using any characters you want. Any colors or color combinations. Any input, BCD or decimal. Any input signal level. Any mounting, vertical or horizontal. Five sizes,

up to 3 $\frac{3}{8}$ ". Many configurations, options and accessories. Long lamp life (to 100,000 hours; up to 175,000 hours at reduced voltage). If it doesn't exist and you need it, we'll build it.

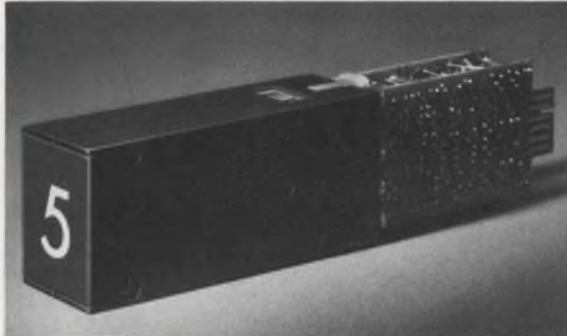

10H—World's most popular readout. And we've improved it. Double condensing lens provides exceptional character brightness. Greater clarity at wider angles and longer distances, even under high ambient light. .937" sq. viewing area. Mil-spec version available.



160H—Exceptionally large viewing area (1.56"H x 1.12"W) for overall size. 45 FL character brightness with a 6.3V \$.20 lamp. Displays messages simultaneously with symbols.



80—Large screen unit suited for annunciator applications such as factory call systems and production control. 3 $\frac{3}{8}$ " character height can easily be read at 100'. 160° viewing angle.



120H—Miniature rear-projection readout (.62" sq. screen) easily read from 30' under high ambient light. Quick-disconnect lamp assembly speeds lamp replacement.



nimo™—First 10-gun CRT single-plane display. Projects numbers, letters and words onto a fluorescent screen. No image ambiguity. No external focusing required. No ambient light worries. Exceptionally wide viewing angle. Ideal for instrument application.



875—Miniature 24-position readout assembly with a cost per display of only \$1.45 each. .620 sq. in. viewing area with overall case size of 1.39"H x .90"W x 3.095"D. Exceptional brightness, clarity. Front panel access.

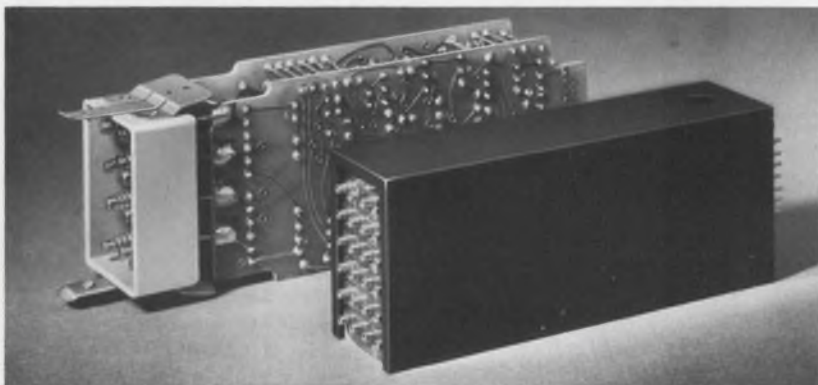

IC Driver/Decoders—Small, reliable units for driving IEE readout incandescent lamps ranging from 250 ma @ 6V to 40 ma @ 28V. Fully compatible with modern IC's. Accept a variety of binary codes for decimal conversion. Require normal signal V., draw less than 2 ma per data input. Internal data storage for pulsed oper.

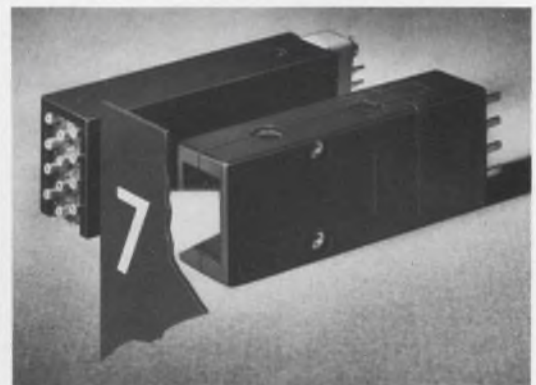

345—IEE's smallest rear-projection readout. Viewing area .38"H x .34"W. Based lamps. Low cost. Individual readouts plug into perm. wired housing for quick message change. Easy front panel access.

Industrial Electronic Engineers, Inc.



7720 Lemona Ave., Van Nuys, California

Until now, designing with mercury relays meant taking the good with the bad. The trade-off for long life, high-speed closure and no contact bounce has been a bulky package (about $\frac{3}{4}$ cu. in.) that must be babied in a vertical position.

But not any more! Now Logcell® Mercury Film Relays offer all the advantages of mercury-wetted relays . . . plus miniature size (0.06 cu. in.), operation in any mounting position, and shock and vibration resistance suitable for many airborne, marine and other mobile applications.

Whether you require the specific advantages of mercury relays for computer logic circuits, advanced instrumentation or high-speed control systems . . . or

just need a tiny rugged relay that will last and last and last, consider Logcells:

- Long life — units tested to billions of cycles
- No contact bounce
- Operation in any mounting plane
- Form "C" SPDT contacts
- Fast operating time — 2 ms
- No measurable AC contact noise
- Thermal noise less than 0.2 microvolt
- Switches dry circuits to 2 amps at 0-6 volts
- Inherent contact memory — requires no holding current (mono-stable models also available)

For complete information about revolutionary new Logcell Mercury Film Relays — and Logcell Mercury Film Switches — write Fifth Dimension Inc., Box 483, Princeton, New Jersey 08540 or call (609) 924-5990.



FIFTH DIMENSION INC.

here at last . . .

**a miniature mercury relay that operates
IN ANY POSITION**

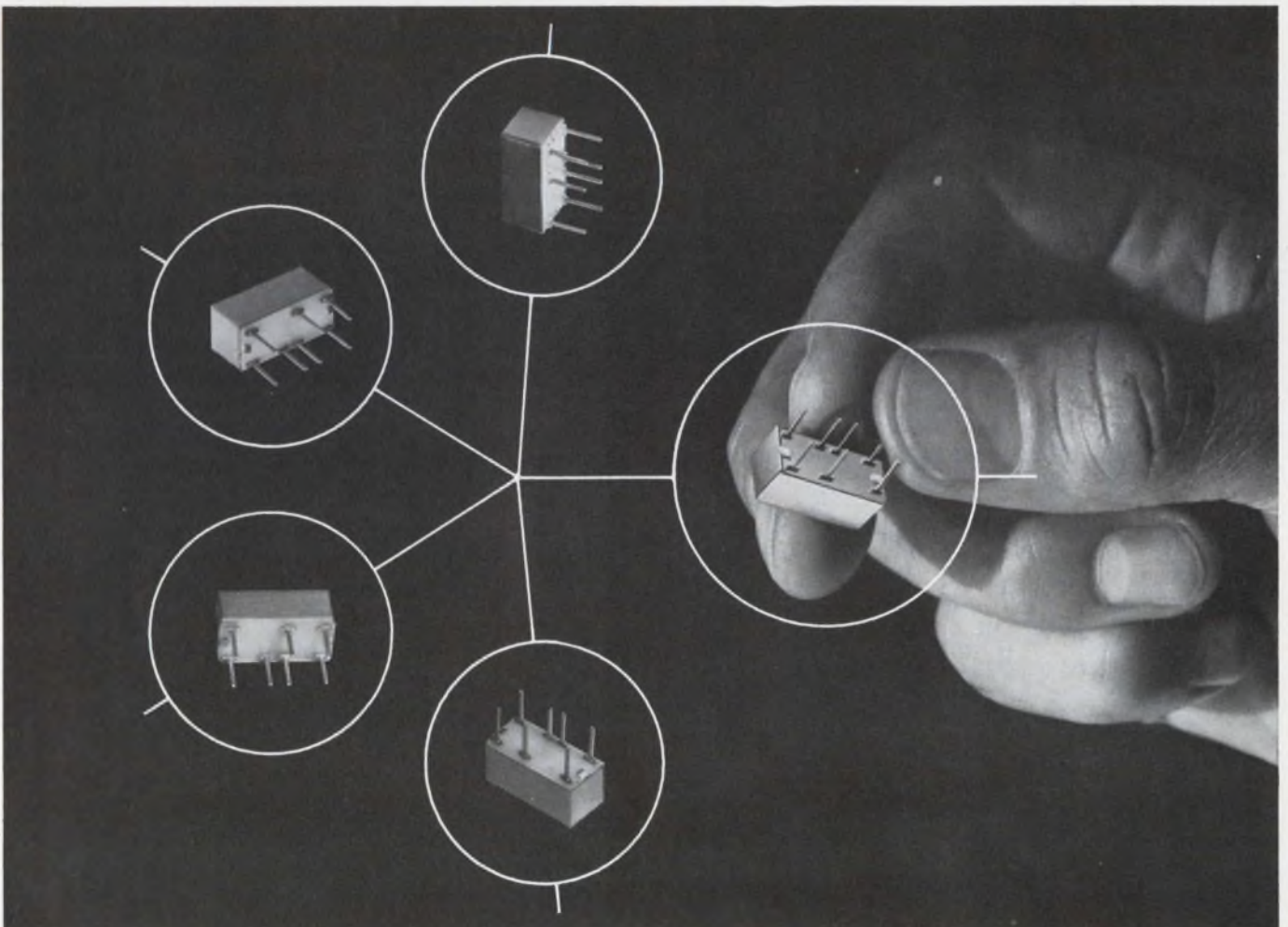

Simplify selection of the critical resistor

in TTL common-collector OR drivers. Generate graphic aids with the formulas given here.

In the design of TTL common-collector OR drivers, resistor selection can be complicated. The value depends on three interrelated factors which together can yield nine different combinations, each affecting the choice. But the selection can be simplified with the help of formulas and graphs.

A versatile type of IC output logic is a so-called "floating collector" array that can be connected to provide the "wired-OR" logic (Fig. 1) for driving data busses. But a problem arises if the collectors are connected directly to the following gate (Fig. 2a). While transistor Q_D can be turned on to provide a logic 0, it cannot be turned off to assume a logic 1 state without adding a "pull-up" resistor, R_P .

But selecting this particular resistor can be an involved process because its value depends upon three interrelated factors: (1) the number of outputs wired together; (2) the number of gates that are driven; and (3) the value of the pull-up resistor itself.

Selection of R_P is simplified by use of the formulas and graphs developed here which establish maximum and minimum limits between which R_P can lie.

The maximum allowable value of the pull-up resistor depends on three factors: the value of V_{CC} , the leakage current, I_{CEO} , of the driving stage in the OFF condition, and the leakage current of the driven gate, I_{LK} , as shown in Fig. 2b.

The minimum value of R_P is limited by the maximum (saturated) current capability of the driving transistor (I_O) and the load current, I_G , of the driven gate.

For the single driver-gate combination shown by Q_D , Q_G in Fig. 2b, the maximum value of R_P is determined by the formula given, provided Q_D is off and its collector voltage is at its highest, or "1" level. Note that the driver leakage current I_{CEO} is the only current assumed for the collector,

which means that the input of Q_D is not at a threshold condition.

The minimum value of R_P for the single driver-gate combination is obtained from the formula shown in Fig. 2c. In this case, the Q_D collector current is at its saturated value, which includes the current I_{PO} through R_P , plus the Q_G gate load current, I_G .

In actual application, the designer is interested in determining the boundary values of R_P for n driving stages and m driven gates, as indicated in Figs. 3 and 4. In general, note that each driver in the bus must be able to independently drive m gate loads. For these problems, the equations of Figs. 2b and 2c now become:

$$R_{P \text{ MAX}} = (V_{CC} - V_{1 \text{ MIN}}) / [n (I_{CEO}) + m (I_{LK})]$$

$$R_{P \text{ MIN}} = (V_{CC} - V_{0 \text{ MAX}}) / [n (I_{SAT}) - m (I_G)]$$

These equations may be solved and reduced to useful graphs, on which a range of values for $R_{P \text{ MAX}}$, $R_{P \text{ MIN}}$, n , and m are directly presented.

As an example, specification limits of a standard SUHL circuit will be applied:

$$V_{CC} = 5.0 \text{ V}$$

$$\text{Logic 1 voltage minimum, } V_{1 \text{ MIN}} = 3.0 \text{ V}$$

$$\text{Logic 0 voltage maximum, } V_{0 \text{ MAX}} = 0.4 \text{ V}$$

$$\text{Logic 0 current minimum, } I_{SAT} = 10 \text{ mA}$$

$$\text{Driver leakage current, } I_{CEO} = 250 \mu\text{A} = 0.25 \text{ mA}$$

$$\text{Driven gate input leakage, } I_{LK} = 100 \mu\text{A} = 0.1 \text{ mA}$$

$$\text{Gate load current} = 1.33 \text{ mA}$$

The general equations now become:

$$R_{P \text{ MAX}} = (5.0 - 3.0) / [n (0.25) + m (0.1)]$$

$$= 8 / (n + 0.4m)$$

$$R_{P \text{ MIN}} = (5.0 - 0.4) / [10 - m (1.33)] = 3.45 / (7.5 - m)$$

With these equations, plots of sample calculations for logic circuits having a maximum driving transistor current I_{SAT} of 10 mA and a gate load current I_G of 1.33 mA were made. They are presented in Fig. 5. The upper left-hand curve is the boundary on the minimum value of pull-up resistor R_P for the specified driver/gate characteristics.

James Sheahan, Engineer-in-Charge, Digital Applications Semiconductor Div., Sylvania Electric Products, Woburn, Mass.

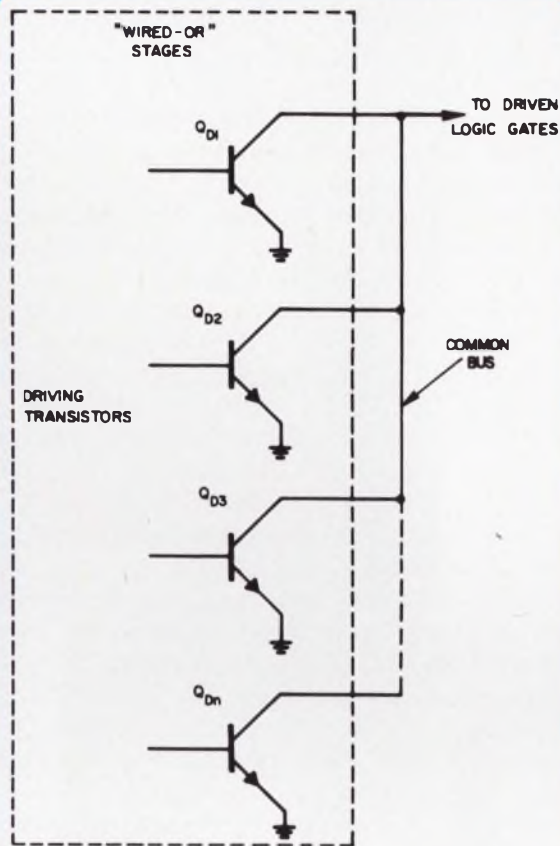

1. Floating-collector outputs of "wired-OR" TTL logic are connected together to drive logic gates.

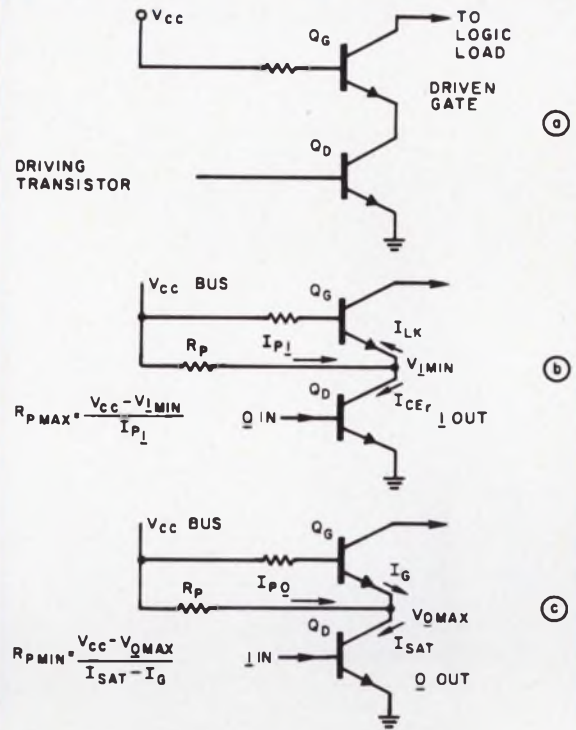

2. Simple connection of driving collector to driven gate (a) gives unreliable operation. Addition of "pull-up" resistor R_p is required for positive turn-off of Q_D . Maximum value of R_p is derived from (b), minimum from (c).

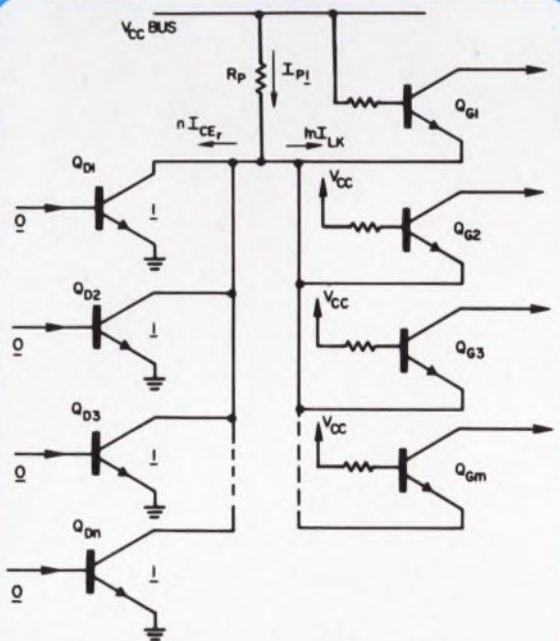

3. Current flows are multiplied as drivers and gates are added during maximum-value conditions for R_p .

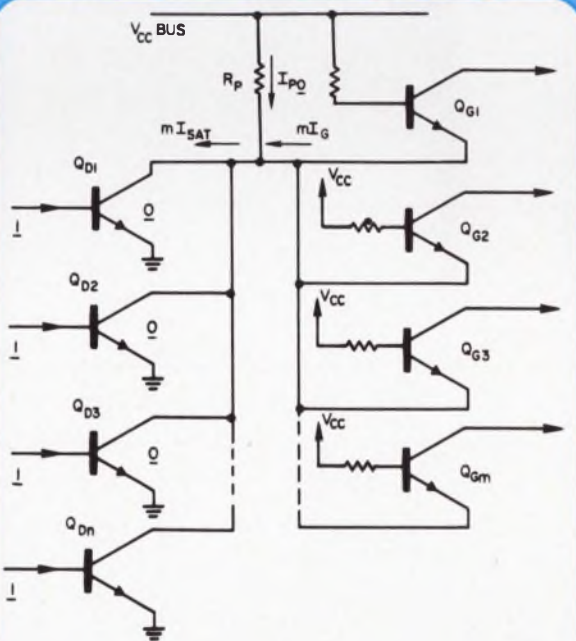

4. Saturation I_s and gate (I_G) current flows for determining minimum value of R_p .

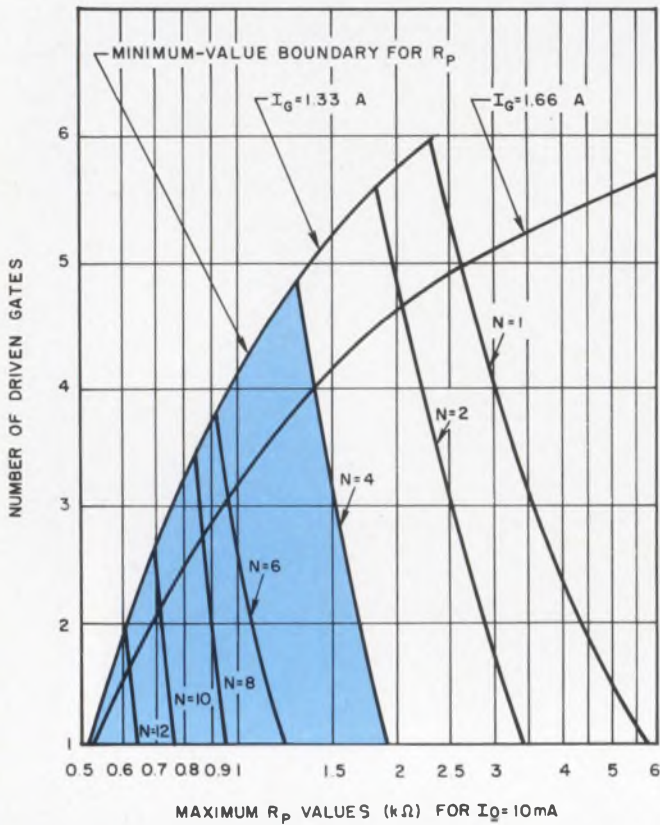

5. Minimum and maximum values of R_p are obtained from this type plot, generated from equations in text.

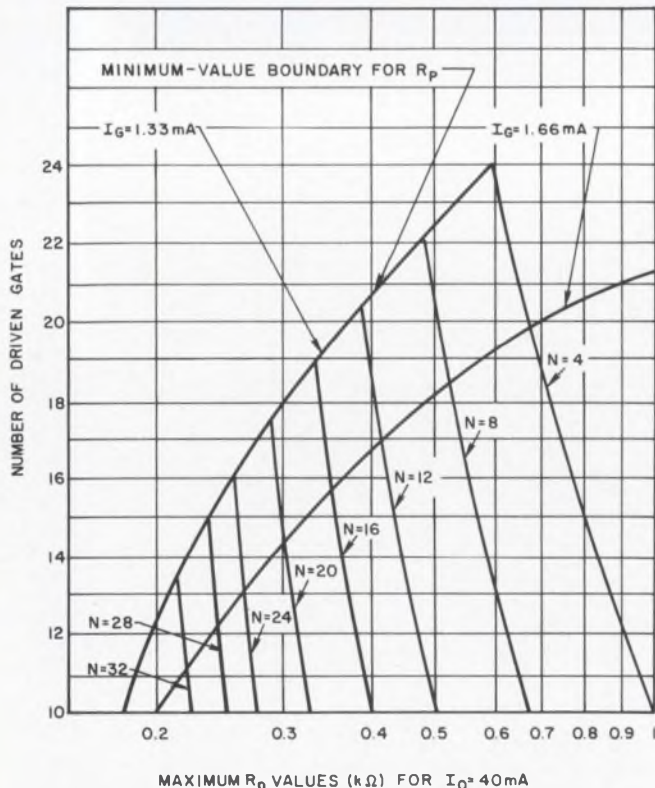

6. Method described for obtaining maximum and minimum R_p values holds good for large numbers of drivers and gates.

The vertical curves, designated n_1, n_2 , etc., are the maximum-value boundaries for R_p .

Once the number of collectors to be connected to the same bus is determined—for example, $n = 4$ —the maximum value of R_p may be determined by traversing the ($n = 4$) line to that point at which it crosses the desired number of m driven loads. The minimum value of R_p may be determined for the above conditions by traversing the horizontal line to the point at which it intersects the upper boundary, designated as 1.33 mA.

For example, assume that four drivers are connected to the same bus and three gates are driven from this bus. At the intersection of the ($n = 4$) and ($m = 3$) lines, in Fig. 5, the maximum value of R_p is found to be 1.57 k Ω . Traveling horizontally to the left of this intersection, we find the minimum value of R_p where the ($m = 3$) line intersects the lower resistance boundary. In this case, it is 730 Ω .

Should it be desired to increase the number of driven gates from three to four (with four drivers), then maximum R_p becomes 1.45 k Ω and the minimum 1.0 k Ω . If the number of drivers is increased to six ($n = 6$), the curves show that no more than three gates may be driven under the previously specified conditions.

Note that a second curve for a gate current I_G of 1.66 mA is included as a second example of typical gate requirements. Values of R_p are determined for this curve as before.

A sample plot of values obtained for gates with the same current requirements as in Fig. 5, but with a single driver current capability of $I_{SAT} = 40$ mA, is shown in Fig. 6. ■■

Test your retention

Here are questions based on the main points of this article. Their purpose is to help you make sure you have not overlooked any important ideas. You'll find the answers in the article.

1. What resistor is required to provide reliable turn-off operation of wired-OR drivers?

2. What is the formula for maximum value of this resistor? For minimum value?

3. How are basic formulas altered when numerous drivers and gates are connected in the circuit?

4. What determines boundary areas of maximum and minimum-value plots for R_p ?

By habit, precision jobs got wire wounds.

Until Corning.

Now, you have another choice.

A less expensive choice.

Glass tin oxide film.

Corning makes them.

In the precision range.

Makes them with a base of pure optical glass. And a fully oxidized metal film.

Environment can't degrade either. Film and substrate are molecularly bonded. Matching TC's do away with fatiguing stresses. Special silver-glass composition insures low termination noise.

Press-fitted end caps mean mechanical integrity. Tailored tough insulations wrap them up. It all adds up to long-term reliability.

General purpose, precision, or special, CORNING® Glass Tin Oxide Film resistors are a better buy—by design. From 1/10 watt in .150", up to 6000 watts in six feet, they're all shown in our new Resistor Design Guide.

Get your copy from:
Corning Glass Works,
Electronic Products Division
Corning, N.Y. 14830.

CORNING
ELECTRONICS



Tomorrow, Paul Barr may even get to his desk

Paul Barr is a hard man to catch. He may be at the bench sweating over a prototype circuit . . . or have his head under a car lift surveying the built-in problem. He's got lab people hopping and test drivers in and out of spins. A couple of friction experts shake their heads when they see him coming. But wherever development engineering leads on a sophisticated new braking system, Paul Barr's on his way. And no two Mondays ever start alike. The question is . . . can you say the same? Take a good look at how your career shapes up, compared with Paul's and his colleagues' at Delco. You might even call us collect. Area Code 317/459-2808. Or, write: Mr. C. D. Longshore, Supervisor, Salaried Employment, Dept. 502, Delco Radio Division of General Motors, Kokomo, Indiana.

**DELCO
RADIO**



AN EQUAL OPPORTUNITY EMPLOYER
DIVISION OF GENERAL MOTORS
KOKOMO, INDIANA

INFORMATION RETRIEVAL NUMBER 901

Free Career Inquiry Service

Absolutely Confidential

Respond to the career opportunities advertised in this issue. Fill out and send us this handy resume. **Electronic Design** will do the rest – neatly typed copies of this form will be mailed to the companies of your choice, indicated by the circled Career Inquiry Numbers at the bottom of this page.

23

Name		Home Phone	
Home Address (Street)		City	State ZIP Code
Age	U.S. Citizen <input type="checkbox"/> Yes <input type="checkbox"/> No	Security Clearance	

Prime Experience	Secondary Experience

Desired Salary	Availability Date
-----------------------	--------------------------

Employment History – present and previous employers

Company	City, State	Dates	Title	Specialty
		to		
		to		

Education – indicate major if degree is not self-explanatory

Degree	College	City, State	Dates
			to
			to

Additional Training – non-degree, industry, military, etc.

Professional Societies

Published Articles

- Career Inquiry Numbers:**
- | | | | | | | | | | |
|-----|-----|-----|-----|-----|-----|-----|-----|-----|-----|
| 900 | 901 | 902 | 903 | 904 | 905 | 906 | 907 | 908 | 909 |
| 910 | 911 | 912 | 913 | 914 | 915 | 916 | 917 | 918 | 919 |

ELECTRONIC DESIGN
850 Third Avenue
New York, New York 10022

Opportunities for

CIRCUIT DESIGNERS

Expanding activity on long-range programs and advanced projects has created many stimulating growth-assignments for Circuit Designers at Hughes.

Some of our most urgent requirements exist in the following areas:

- Development of high-power airborne radar transmitters, the design of which involves the use of the most advanced components
- Design of low-noise radar receivers using parametric amplifiers and other advanced microwave components
- Design of digital radar signal processing subsystem circuits, including range and speed trackers, doppler filter banks and a variety of display circuits
- Design of high-efficiency power supplies for airborne and space electronic systems
- Development of telemetering and command circuits for space vehicles and communications satellites

Requirements: an accredited Engineering degree, a minimum of two years of directly relatable experience and U.S. citizenship.

For immediate consideration, please airmail your resume to:

MR. ROBERT A. MARTIN
Head of Employment
Hughes Aerospace Divisions
Dept. 63.
11940 W. Jefferson Blvd.
Culver City, Calif. 90230

HUGHES

HUGHES AIRCRAFT COMPANY
AEROSPACE DIVISIONS

An equal opportunity employer—M & F



Book Reviews

second edition

HANDBOOK OF PHYSICS

prepared by a staff of specialists



Physics handbook

Handbook of Physics, E. U. Condon and Hugh Odishaw (McGraw-Hill, New York), 1680 pp. \$32.50.

A massive volume of some 1600 pages, the second edition of the *Handbook of Physics* is a major revision of this standard work. The combined effort of scores of experts in their respective fields has contributed to the success of this and past editions. Completely updated, the book presents authoritative information on all aspects of physics in its 92 chapters and offers the latest findings, theory and data. An extremely thorough 64-page index gives immediate access to information contained in the nine major sections into which the volume is divided. Since physical laws are the basis on which engineering science is built, this volume can serve the engineer as well as the physicist.

CIRCLE NO. 321

Product planning plan

Concept and Practice of Product Planning, Gerd D. Wallenstein (American Management Association, Inc., New York, N.Y.), 128 pp. \$5.25.

Long on the *Concept* side of its title. Short on the *Practice* side. Hardly a how-to-do-it for the man

 SPERRY RAND



History-making toy

The toy gyroscopes Elmer Sperry bought for his children inspired his invention of the Sperry gyro-compass and gyro-stabilizer—for naval vessels and early-day aircraft.

Sperry-developed equipment helped Lindbergh, Wiley Post and Amelia Earhart achieve their history-making flights. Many other aviation "firsts" also came from Sperry.

Today, Sperry's contribution to the safety and comfort of Jet Age pilots and passengers—civilian and military—is the greatest of any company in the world. In fact, in production of flight controls, flight instruments and displays, we lead our nearest competitors by a wide margin. We are also pacesetters in aerospace products.

If you're an engineer—and want to give your career new excitement and significance—we'd like to hear from you. **These are our current requirements:** ■ Instrument Displays ■ Auto Pilots ■ Compass Systems ■ Circuit Design ■ Advanced Avionics ■ Gyroscopics ■ Mechanisms ■ Magnetics ■ Standards ■ Product Support ■ Research & Development ■ Manufacturing Engineering ■ Industrial Engineering ■ Publications ■ Logistics

Send resume for confidential review to Charles N. Reppumer, Technical Recruitment Representative, Dept. 211

SPERRY

FLIGHT SYSTEMS DIVISION
P.O. BOX 2529, PHOENIX, ARIZONA 85002

An equal opportunity employer M/F

INFORMATION RETRIEVAL NUMBER 902

INFORMATION RETRIEVAL NUMBER 903 ►



O. R. Kirby,
Vice President—
Technical Operations,
Greenville Division,
LTV ElectroSystems, Inc.

THE
EXCITING
SURGE OF
ELECTROSYSTEMS

the head of our “what’s ahead” team

At our Greenville Division it's Oliver Kirby.

If you're considering a career move, consider LTV ElectroSystems. You'll be working with men of his caliber.

Once the assistant director of the National Security Agency in charge of worldwide operations and planning, Mr. Kirby now heads up advanced planning for the largest of our four operating units.

Intelligent planning and a “can do” attitude has helped propel LTV ElectroSystems into the big time in electronics. 1966 sales hit \$123 million. Last year, a record \$181 million. 1968 promises to be another record year.

Our main line is electronic systems—the “total package” concept developed for special mission requirements for land, sea, air and space deployment. With people like Oliver Kirby, we've done a great job for our customers. This has generated a number of outstanding career positions—particularly for talented systems experts.

Current systems programs include surveillance and reconnaissance, tracking, command and control, tactical warfare, communications, TACAN, guidance, antennas, super-power transmitters. We also design and produce much of the hardware for these systems and we manufacture many lines of standard electronic products.

Presently we are hiring specialists in artificial intelligence, RF systems analysis, RF circuits design, digital systems analysis, digital circuits design, radar systems analysis, electrical systems installations design, optics systems and aerodynamics.

What's ahead for LTV ElectroSystems? Oliver Kirby is working on it. So are planners in all our divisions. We'd like you to join us and participate in our growth and our future.

Please write or call Bill Hickey, Supervisor of Professional Placement, P.O. Box 6118, Dallas, Texas 75222. Tel. (214) 276-7111. An equal opportunity employer.

LTV ELECTROSYSTEMS, INC.
A SUBSIDIARY OF LING-TEMCO-VOUGHT, INC.

'X' marks the future.

McDonnell Douglas is involved in a number of exciting programs that, for the moment at least, are marked "X".

These include FX, VFX, and AX. And each one requires experienced electrical/electronics engineers to help us turn "experimental" into "operational."

Specifically, we now need engineers specializing in these areas:

Acoustic data processing • Radar Systems • Electronic Countermeasures • Airborne antennas & radomes • Inertial navigation systems • Transmitter-modulator • Digital computers • Infrared • Electro-magnetic compatibility.

We're also staffing up in other disciplines for our new DC-10, STOL transports, AWACS, and for new missile systems and manned spacecraft programs.

Long-term career openings are immediately available in St. Louis, Southern California, Florida, and Texas. Just put "X" in the appropriate box in the coupon to indicate your preference.

Then send it today, along with your current resume if available, to arrange for an interview.

BOOK REVIEWS

who finds he's suddenly down to the nitty-gritty of product planning and has "gotta come up with something."

The author, who has been involved in electronic product planning as a Vice President of Lenkurt Electric Co., Inc., for the last 12 years, is a strong exponent of assigning product planning responsibility to an individual on a full-time basis. And full-time it well might be under his comprehensive concept of closely involving technical, financial, marketing, manufacturing, planning, legal, and personnel operations in the product planning process.

The technical manager examining titles in search of product planning guidance may question the aptness of a reference which devotes a full 20 percent of its text to "Technical Manpower Planning" and ranges therein from manpower inventories to leadership development.

Bruce Trabue

CIRCLE NO. 322

Engineering handbook

Standard Handbook for Mechanical Engineers, Theodore Baumeister & Lionel S. Marks, Seventh Edition. (McGraw-Hill Book Company, New York City,) 2456 pp. \$29.50

This is the Golden Anniversary edition of a venerable standby that has gone through seven editions in the past fifty years. Although, as its title implies, it has been compiled for mechanical engineers, it richly deserves a place on the shelf of electronics men as well. Chapters on electrical engineering, electronics, instruments, cryogenic, automatic controls, and optics are directly relevant to the electronics field and many others are of interest to all engineering disciplines. Those sections aimed directly at the mechanical engineer can also be useful, in view of the interdisciplinary nature of many of the fastest moving areas of engineering today. A large, comprehensive index of over 100 pages serves as an effective key to the vast storehouse of information contained in this massive volume.

CIRCLE NO. 323

AXFX VFX

Mail to: Mr. W. R. Wardle, Professional Employment, Box 14308, St. Louis, Mo., 63178
or: Mr. P.E. Kilgore, Professional Employment, 3000 Ocean Park Blvd., Santa Monica, Calif. 90406

Name _____

Home address _____

City & State _____ Zip Code _____ Phone _____

Education: BS _____ MS _____ PhD _____ Major Field _____
(date) (date) (date)

Primary experience area _____

Present position _____

Area choice: East Midwest West Best Opportunity

ED-11/7

MCDONNELL DOUGLAS 

An equal opportunity employer

INFORMATION RETRIEVAL NUMBER 904

Now! Get 225 MHz for less than \$2K and add 3.3 GHz for less than \$1K!

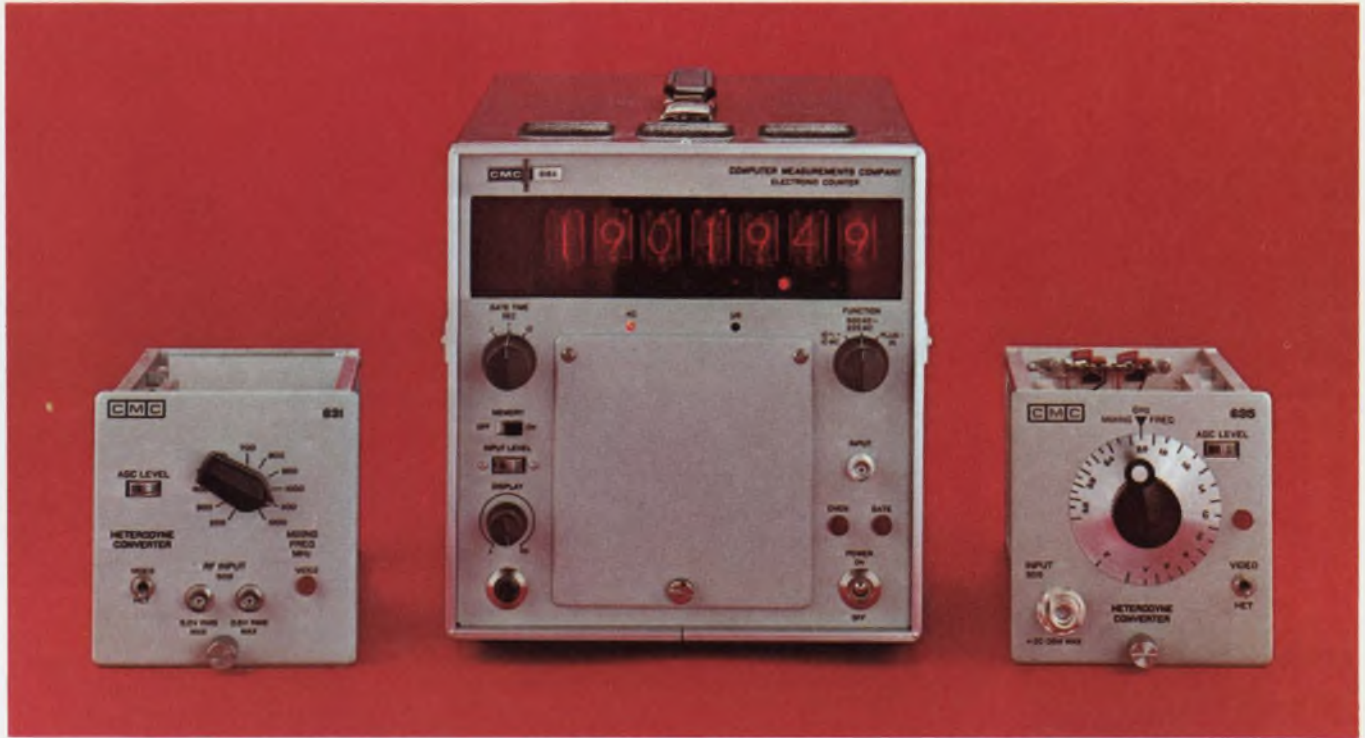

But how does the competition look?

GREEN!

Who else offers a counter that provides frequency measurements up to 225 MHz for only \$1975, plus the options of two plug-ins to boost the range to either 1.3 GHz for \$775 or to 3.3 GHz for only \$825? That's what you get from CMC with the Model 616 Counter and the new Models 631 and 635 Heterodyne Converters. But that's not all.

Look at the rugged portable design of the CMC Model 616, with its sturdy valise grip and its solid well-balanced frame. Here's an instrument that's equally at home in the lab, on the production line, or in the field. You can rack mount it, too. And its all-silicon solid-state circuitry gives it an extended operating range from -20°C to $+55^{\circ}\text{C}$.

Already a popular workhorse, the 616 is in common use for alignment of frequencies in UHF communication links, for calibration of high frequency signal generators, for

direct monitoring of radio/TV transmitter carrier frequencies, and for production checkout of radio transmitters. But now, with the addition of two great heterodyne converters—and a TIM plug-in if you want it—here's a low-cost, portable family that's hard to beat for application versatility!

For the full specs on the counter and plug-ins, just circle the reader service card. And to arrange for a demonstration, contact your local CMC representative.



A Division of Pacific Industries

12970 Bradley/San Fernando, Calif. 91342/(213) 367-2161/TWX 910-496-1487

INFORMATION RETRIEVAL NUMBER 38

The Compatibles

NEW Helipot Model 841 Miniature 4-bit Ladder Switches feature:

- unipolar or direct bipolar operation
- 350 nanosecond rise and fall time
- 0 to 2 millivolt switch offsets (at 25°C)
- 5 (± 3) ohms "on" resistance
- 0 to 5 milliamps output current
- small size (1" x 1" x 0.170" high)
- cermet thick film construction
- list price, \$100.00
- available from stock

Helipot Series 811 Precision, High Speed Binary Ladder Networks feature:

- up to $\frac{1}{2}$ bit accuracy in 12 bits from -55° to $+125^\circ\text{C}$ or from -20° to $+80^\circ\text{C}$
- 50 nanosecond settling time
- 1 ppm/ $^\circ\text{C}$ tracking
- small size (1" x 1" x 0.1" high)
- cermet thick film construction (assuring ultrastability and minimum change in performance with time)
- list prices from \$27.00
- available from stock

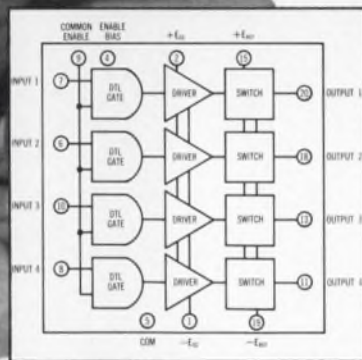
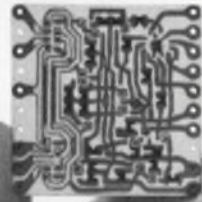

Model 841 Ladder Switch Block Diagram

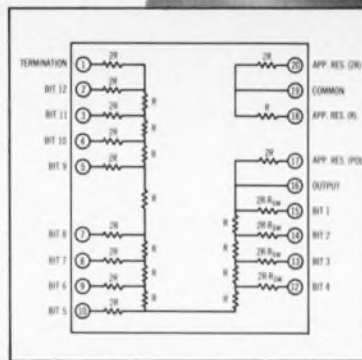

Series 811 Ladder Network Schematic

The Helipot Compatibles are designed to give you—pre-engineered and pre-packaged—a ladder system with the combination of economy, sophistication, small size, and flexibility you can't get anywhere else. ■ Check out The Compatibles from Helipot—for complete specifications, ask your local Helipot sales representative or circle the reader service number.

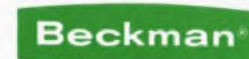

INSTRUMENTS, INC.
HELIPOT DIVISION
FULLERTON, CALIFORNIA • 92634

INTERNATIONAL SUBSIDIARIES: GENEVA; MUNICH; GLENROTHES, SCOTLAND; TOKYO; PARIS; CAPE TOWN; LONDON; MEXICO CITY

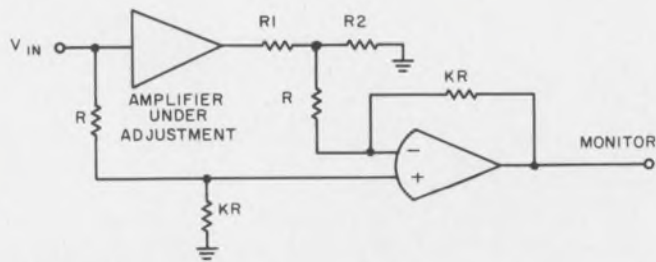

Amplifier gain can be adjusted very accurately by detecting the zero voltage at the output of the op-amp.

application of the ac meter to input and output). The use of two meters provides a check on input constancy, but introduces meter-to-meter error.

- It is difficult to adjust a voltage more precisely than a few per cent while shooting for a specific reading on a meter face.

Using an operational amplifier in the circuit shown eliminates all these inadequacies. The principle of operation is as follows. Assume that the gain of the amplifier under adjustment is in error by an amount X , so that the amplifier output is $A(1 + X)V_{in}$. The values of R_1 and R_2 are chosen to yield a voltage divider with the ratio A . If a perfect divider ratio is assumed, the output of the voltage divider is $(1 + X)V_{in}$. The operational amplifier is connected as a differential amplifier with gain K . The voltage at the "monitor" terminal is therefore KXV_{in} . When the cor-

rect value of A is attained in the amplifier under adjustment, the voltage at the "monitor" terminal will go to zero. It is thus possible to adjust the gain of the amplifier very accurately by the simple act of nulling a sensitive ac meter at the "monitor" terminal.

The only significant sources of error in this scheme are:

- Accuracy of the divider resistors R_1 and R_2 . This poses no serious problem; resistors of $\pm 0.1\%$ and better are easily obtainable.

- Loading of the divider by the differential amplifier input impedance, which is equal to $(1 + K)R$. This can be minimized either by using the largest practical values of K and R , or it may be taken into account in selecting the values of divider resistors R_1 and R_2 .

- Loading of the amplifier under adjustment by the R_1, R_2 voltage divider. This is minimized by choosing the highest practical values of R_1 and R_2 .

This gain adjustment scheme is independent of signal generator stability, is easy to implement, demands no great meter accuracy, and combines the capability of gain adjustment with extremely good resolution.

William J. Travis, Chief Design Engineer, Sprague Electric Co., North Adams, Mass.

VOTE FOR 312

Cure voltage and temperature ills in inverted chopper switches

In analog-to-frequency converters using choppers, transistor voltage drops and temperature variations constitute major sources of error. Here is a circuit (see schematic) that can circumvent them. It operates as follows.

Q_1 and Q_2 serve as chopper transistors, alternately connecting the outputs of amplifiers 1 and 2 to the input of the integrator on the alternate half-cycles of the square wave from the bistable switch. Amplifier 2 has a gain of -1 and the resultant square wave at the emitters of the choppers is symmetrical. Its magnitude is dependent on the levels at the outputs of amplifiers 1 and 2. The switching levels of the bistable switch are fixed.

Identical inverted switching transistors are added in the feedback loops of the amplifiers (Q_2 and Q_1), introducing an opposing offset voltage

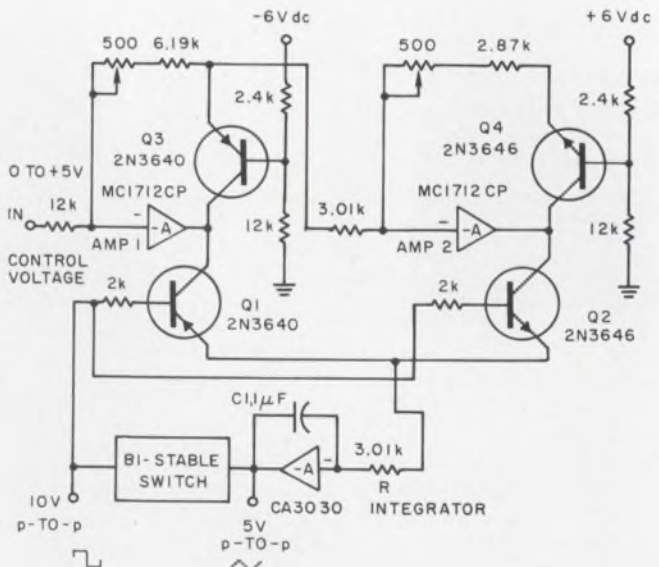

Voltage drops and temperature variations in a voltage-to-frequency converter are nulled out with the addition of Q_2 and Q_1 . These transistors are the same as the chopper transistors Q_1 and Q_2 .

ERIE

TECHNOLOGICAL

PRODUCTS, INC.



Quality **TRIMMER CAPACITORS** *by* **ERIE**

AIR • CERAMIC • GLASS • QUARTZ • PLASTIC



*Call or wire TODAY for
complete new Trimmer data.*

YOUR ERIE MAN HAS JUST THE RIGHT **TRIMMER CAPACITOR...** *AT JUST THE RIGHT TIME*

Your Erie Man won't sell you a particular type of trimmer capacitor . . . but he will help you choose the right trimmer from the world's most complete selection . . . AIR, CERAMIC, GLASS, QUARTZ, and PLASTIC — more than 1000 styles. With ERIE you save valuable time by talking with one expert rather than several representatives handling limited trimmer lines. And you know the trimmer you choose will be ideal for your application. So call in your ERIE man for your complete trimmer requirements.

ERIE is qualified to MIL-C-81 and MIL-C-14409

ERIE TECHNOLOGICAL PRODUCTS, INC.

644 WEST 12th STREET • ERIE, PENNSYLVANIA 16512 • PHONE (814) 456-8592

INFORMATION RETRIEVAL NUMBER 40

to the chopper transistors. Any changes in temperature in the chopper transistors are met by opposing changes in the compensating transistors. These transistors should be biased ON to the same level as the chopper transistors in their ON state.

This circuit approach is used in a voltage-controlled function generator.

The slope of the output from the integrator is dependent on the values of R and C , and the polarity and magnitude of voltage applied to the integrating resistor. The bistable switch has fixed firing points of ± 2.5 V. Therefore, when the output of the integrator reaches ± 2.5 V, the bistable switch functions to change the polarity of the voltage applied to the integrator. The same oc-

curs when the integrator output reaches -2.5 V.

The bistable switch output turns on Q_1 when negative and Q_2 when positive. In this way, the outputs of the two operational amplifiers are alternately connected to the integrator. The first amplifier has its gain adjusted for a given frequency out for an applied voltage. The gain of the second amplifier is set to unity. The magnitude of the square wave applied to the integrator thus is determined by the voltage levels at the outputs of the two amplifiers, and is set by the level of the positive voltage applied at the input. Since the other frequency-determining factors are fixed, the voltage at the input terminal determines the output frequency of both the triangle and square-wave outputs.

Jerry F. Foster, Chief Engineer, WAVETEK, San Diego, Calif.

VOTE FOR 313

Simple solid-state circuit detects frequency

Here is a circuit that can detect a given frequency and put out a signal whenever this frequency is applied to the input (see schematic). The frequency detectable by this circuit is determined by the values of L_1 and C_1 .

While the circuit was originally designed to detect 40 kHz, it can detect other frequencies by changing L_1 and C_1 . With the values shown, the circuit detects 19 kHz, the frequency of the so-called stereo beacon.

Here is how it works. The first stage, Q_1 , a frequency selective amplifier, is followed by a detector, D_1 . The feedback path, R_2 , assures fast

response of the output stage, Q_4 , and an increased sensitivity.

A sensitivity (adjustable with R_1) of better than 10 mV was obtained over the "capture bandwidth" of 1 kHz. It can be increased by adding another linear amplifier stage at the input.

The pilot light used as a load for the output stage can be replaced with a relay coil or other compatible load.

W. P. Beullens, Design Engineer, Louvain University, Institute of Low Temperature & Applied Physics, Leuven, Belgium.

VOTE FOR 314

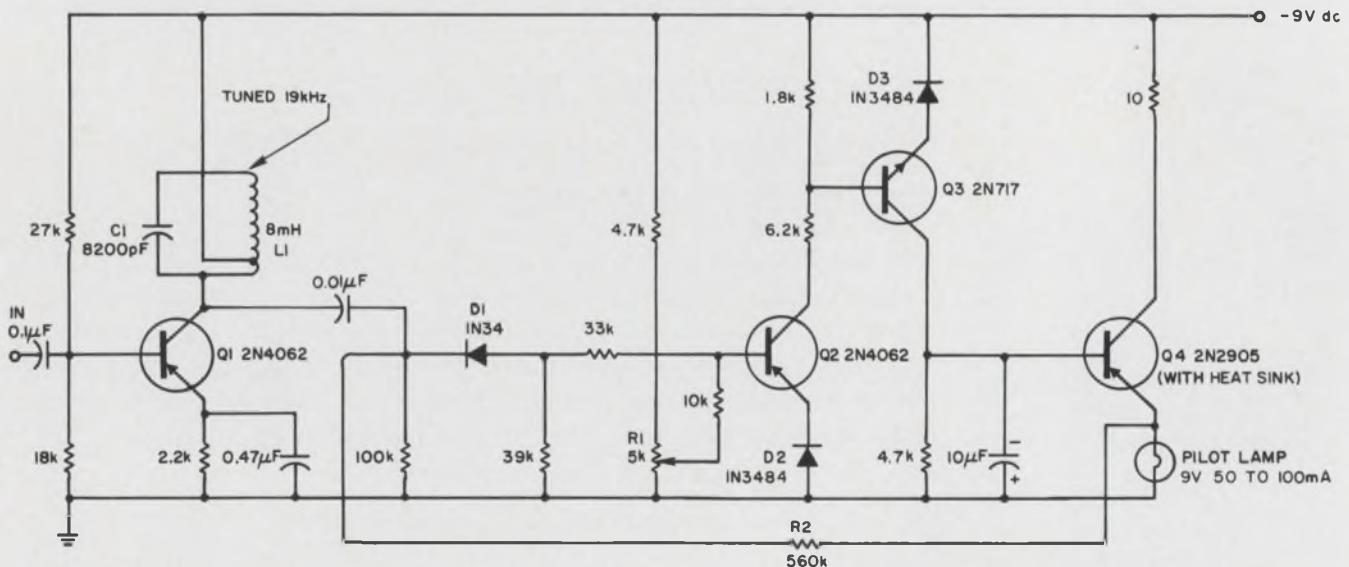

A 19-kHz detector has a sensitivity of 10 mV over its "capture bandwidth" of 1 kHz. In order to detect 40

kHz, L_1 and C_1 must be changed to 4.5 and 3300 pF, respectively. Operation otherwise is the same.

**4½-Digit DVM.
Compact flexibility:
\$1150.**

We've packed a lot of flexibility into our Model 7000 DVM. It's only half-rack size (5¼" x 8¾" x 12"), but has five big options: auto-ranging, AC volts, resistance, DC current and BCD output. Options are contained on convenient plug-in circuit boards. A front-panel function switch controls all options. The 7000 is built with integrated circuits and provides a reading accuracy of 0.01%. Resolution is 100µV. Input impedance is greater than 1000 megohms. You also get dual slope integration, automatic polarity and display storage. Low power operation means no fan and no noise. A 7000 DVM can be yours in 15 days. You can get our data sheets even faster. Write today.



Lamp and photoresistor adjust loop bandwidth automatically

A photoresistor and an incandescent lamp provided a simple solution to a tough phaselock problem that came up during the Mariner Venus 67 project. The problem was to provide a spectrally pure 1.0 MHz signal from a remote rubidium frequency standard, for use in some precision ranging experiments. Because the reference signal from the standard had to be transmitted through space, it became degraded. A phaselock "cleanup" loop (Fig. 1) was designed to extract the clean signal from the noise.

One difficulty posed by this approach was that a very narrowband loop (0.02 Hz) was needed to provide this extremely pure signal

However, a bandwidth so narrow is difficult to hold, and, when lost, very difficult to regain. The time required for phaselock with an initial offset of only 0.03 Hz, for example, was calculated to be 67 minutes, because of the slow rate of scan necessary. This time would be cut down dramatically if the bandwidth were increased. Merely opening the bandwidth to 0.08 Hz when the loop is unlocked, and then decreasing the bandwidth logarithmically toward 0.02 Hz upon achieving lock, cuts the acquisition time from 67 minutes to less than 30 seconds, for a 0.03 Hz offset.

In an application such as the Mariner Venus probe, this bandwidth variation must be done automatically.

Photocell to the rescue

The problem is solved by placing a photoresistor across the bandwidth-determining resistors, R_1 and R_2 , of the loop filter (Fig. 2), and a light source, L_1 , near it. If for any reason, the loop loses lock, a relay in the lock detector places +28 V on R_4 , activating the transistor circuit (Q_1 and Q_2) which, in turn, activates the light source. Until this point, the lamp is completely off. With the light on, the photocell resistance changes from more than 300 megohms to less than 2 kilohms. This widens the bandwidth of the acquisition circuit from 0.02 Hz to 0.08 Hz and allows the loop, which may be offset by as much as ± 0.06 Hz, to lock to the input frequency. All this can be done in one minute.

As the 1.0 MHz phase detector indicates phaselock, the relay in the lock detector drops out, removing the +28 volts from R_4 . Then, as the gate of FET Q_1 charges toward -15 volts, the photocell light source slowly dims and the resistance of the photocell increases towards 300 meg-

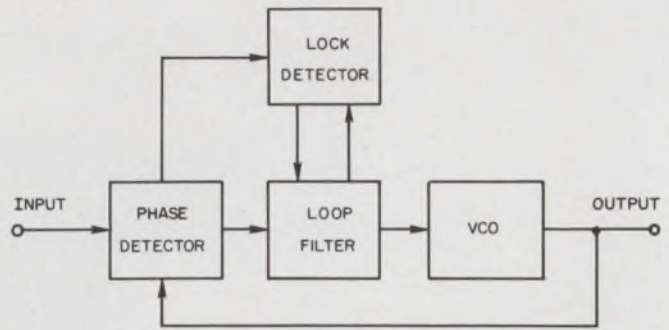

1. The very narrowband low-pass loop filter serves to lock the voltage-controlled oscillator (VCO) to the average frequency of the input signal thus eliminating most of the input noise. The VCO is an HP 106B 1.0 MHz quartz oscillator that can be pushed about ± 0.06 Hz by the signal from the filter.

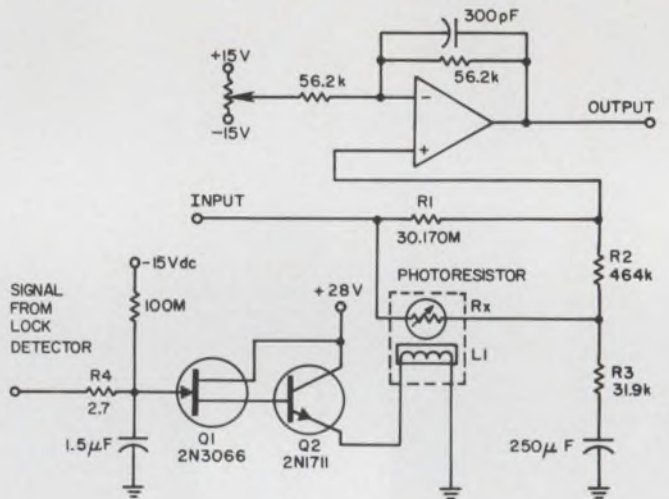

2. Automatic bandwidth control is achieved by placing a photoresistor, R_x , across R_1 and R_2 . A Clairex CL703C cadmium selenide cell was used. When lock is lost, the lamp goes on and lowers the resistance of R_x , from more than 300 M Ω to less than 2 K Ω .

ohms again. This removal of power from the light source must be done at a very gradual rate and as smoothly as possible so that the loop remains in lock. It requires approximately 3 minutes; this slow decay makes the use of a FET mandatory.

The quartz oscillator used in this loop was a precision instrument intended for use as a frequency or time standard. In actual measurements, the loop bandwidth was determined to be 0.021Hz when locked to a local rubidium frequency standard.

The operational performance of this system was proved last October when the Mariner space vehicle passed within 2500 miles of the planet Venus.

R. B. Crow, Senior Development Engineer, Jet Propulsion Laboratory, California Institute of Technology, Pasadena, Calif.

VOTE FOR 315

BOURNS NEW MODEL 3111 MIL-SPEC RELAY

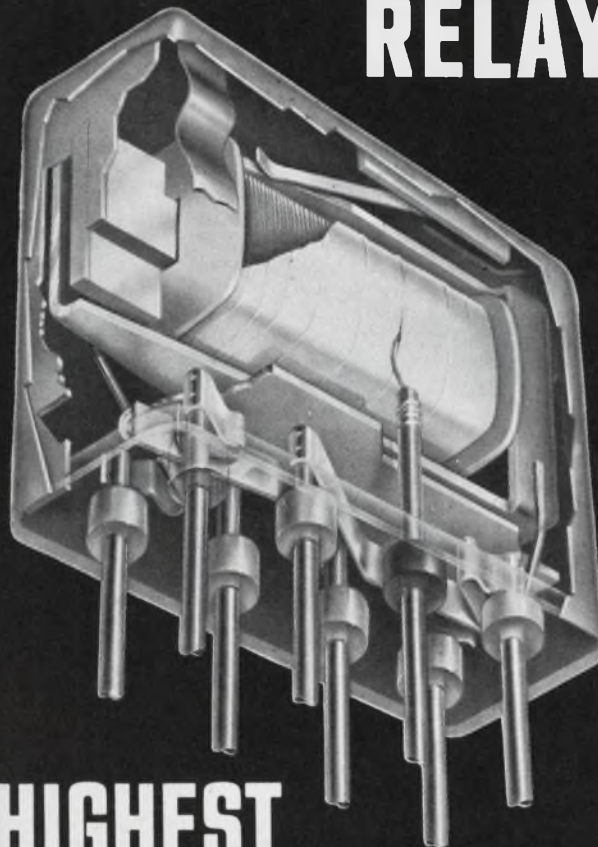

HIGHEST PERFORMANCE YET AVAILABLE

The Bourns Model 3111 TRIMPOT® Relay is a high performance, 1.0 ampere, DPDT unit that answers the demand for higher reliability and greater miniaturization. It is hermetically sealed in a 1/6 crystal can, with convenient 0.1" grid pin spacing.

The Model 3111 has an operating temperature range of -65 to +125°C. Contact rating is 1.0 ampere resistive at 28 volts D.C., with a pickup sensitivity of 130 milliwatts. Operate and release time is 4 milliseconds maximum. This model also features a self-damping return spring and balanced armature design assuring excellent shock (50G) and vibration (20G) performance. All requirements of MIL-R-5757 are met or exceeded by the Model 3111. And its price is just \$13.34*.

For further data and detailed specifications, contact your nearest Bourns sales office or representative, or write the factory direct.

* 500-piece unit price



SPECIFICATION TABLE

Size:	.23 x .50 x .40
Pickup Sensitivity:	130 milliwatts
Contacts: DPDT; Rating:	1.0 ampere at 28 volts D.C.
Operating Temperature Range:	-65 to +125°C
Standard Coil Resistance:	70 to 1500 ohms
Shock:	50G
Vibration:	20G
Life:	150,000 cycles
Pin Spacing:	0.1" grid



BOURNS, INC., TRIMPOT PRODUCTS DIVISION
1200 COLUMBIA AVENUE, RIVERSIDE, CALIFORNIA 92507
714 684-1700 • TWX: 910 332-1252 • CABLE: BOURNSINC

Line synchronized pulse unit triggers microcircuits

With most digital microcircuits, a very sharp pulse is required to assure proper operation. When it is necessary to operate from a sine-wave source, such as the 60-cycle line, it takes a lot of wave shaping to get a pulse sharp enough to trigger the microcircuits.

The circuit described produces pulses having rise times that are fast enough to trigger any microcircuit flip-flop. The operation is based on a General Electric device, the D13T1, called a Programmable Unijunction Transistor.

The D13T1 operates somewhat like an SCR. No current flows through the D13T1 until the voltage on the anode exceeds the voltage on the gate by approximately 0.5 V. The device then exhibits the typical 4-layer negative resistance action.

In this circuit, the zener diode and resistor R_1 produce a wave form that is approximately square from -0.6 V to $+12$ V. When the voltage goes to $+12$ V, capacitor C charges through resistor R_2 . The voltage on the gate of the D13T1 follows the zener voltage, while the anode voltage is delayed slightly by the RC time constant of R_2 and C . As long as the voltage on the anode is not positive with respect to the gate, the D13T1 continues to act as an open circuit.

When the input to the circuit drops below $+12$ V, the gate of the D13T1 follows the decrease. The anode, however, is held to approximately 12 V by the charge on the capacitor. When the difference-voltage from gate to anode becomes 0.5 V or higher, the D13T1 breaks down and switches to the hard ON condition. Capacitor C then discharges through resistor R_4 , developing the output pulse.

The D13T1 cuts off as soon as the capacitor is discharged, since there is no other source of sufficient current to keep it conducting. In this way, one positive pulse of about 4 V amplitude and $10 \mu\text{s}$ width is produced for each cycle of input. Two pulses per cycle could be produced by applying full-wave rectified voltage to the zener.

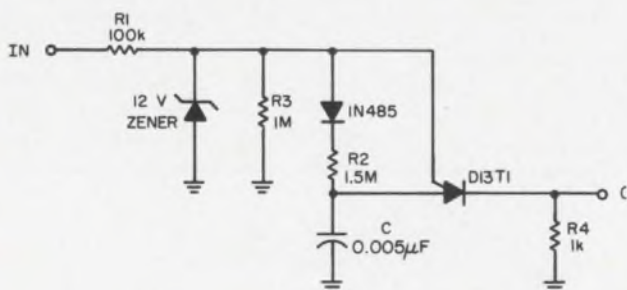

One sharp output pulse is produced for each positive excursion of the ac input.

The diode in series with resistor R_2 keeps capacitor C from tending to discharge when the input voltage drops, and thus assures the highest output pulse.

A. G. Richardson, Supervisor, Teledyne, Inc., Quality Assurance Dept., Charlottesville, Va.

VOTE FOR 316

Two op amps provide floating output circuit

Outputs from equipment are sometimes required to be floating—not related to a supply or ground level. For ac signals, a convenient solution is to use an isolating transformer. Dc outputs, on the other hand, must first be chopped and then rectified again after passing through an isolating transformer. But because miniaturization of these approaches is difficult, neither is consistent with an integrated-circuit philosophy.

A circuit that can produce a floating output for both ac and dc signals, without need for a transformer, is shown in the illustration. It employs two operational amplifiers, such as the $\mu\text{A}709$, and, as shown, is interconnected so that the differential output $C-D$ is equal to inputs $B-A$. If only one signal exists, the other input terminal can be connected to ground.

Either output lead can be connected to ground, or to any voltage level within the output range of the ICs without damaging them or disturbing the differential output relationship.

M. Stevens, Staff Engineer, Cossor Electronics Ltd., Aviation Products Div., Harlow, Essex, England.

VOTE FOR 317

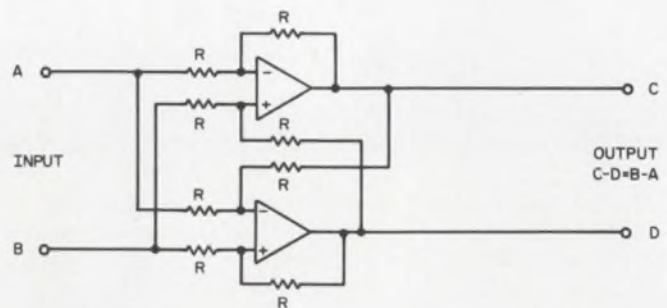

Floating output provided at C-D has the same magnitude as input B-A.

IFD Winner for August 1, 1968

Michael R. Leibowitz, Electronic Engineer, Brooklyn, N.Y. His Idea "Get better performance from a parallel-transistor stage" has been voted the Most Valuable of Issue Award.

Cast your vote for the Best Idea in this Issue.

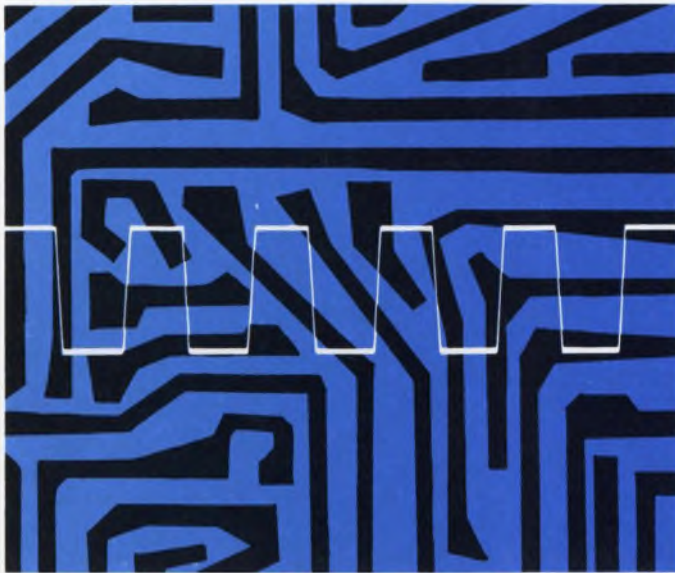

Better circuit testing requires better pulse generators.

Better check these out.

The Hewlett-Packard 8002A and the Model 8003A Pulse Generators offer you new and improved control over your input pulses for testing circuits under actual operating conditions. With clean, well-controlled and clear geometry pulses, you now have a versatile way to analyze circuit outputs without being restricted by the limitations of the pulse generator itself.

The 8002A Pulse Generator gives you excellent control of your

pulses, with rise and fall independently controllable by means of a vernier. Variable rise and fall times, 10 nsec to 2 sec, and rise/fall, fall/rise ratios up to 30:1. Repetition rate is 0.3 Hz to 10 MHz. 50 ohm source impedance, even during transitions; reflections are minimized. Price: \$700.

For the best pulses and greatest versatility for your money, the 8003A Programmable Pulse Generator is your best buy. Here you get simultaneous positive and negative outputs, 5 nsec rise time, pulse width of 30 nsec to 3 sec

and a 10 MHz repetition rate. Great for fast switching applications, wide frequency testing capability of the 8003A also makes it ideal for testing analog devices such as wideband amplifiers, filters and other linear circuits. Price: \$470.

If you've been searching for a better way to test circuits, a way to get better, more accurate results, get complete details on these two pulsers by calling your local HP field engineer. Or write Hewlett-Packard, Palo Alto, Calif. 94304; Europe: 54 Route des Acacias, Geneva.

HEWLETT  PACKARD

PULSE GENERATORS

INFORMATION RETRIEVAL NUMBER 43

18804

the one stop memory shop.

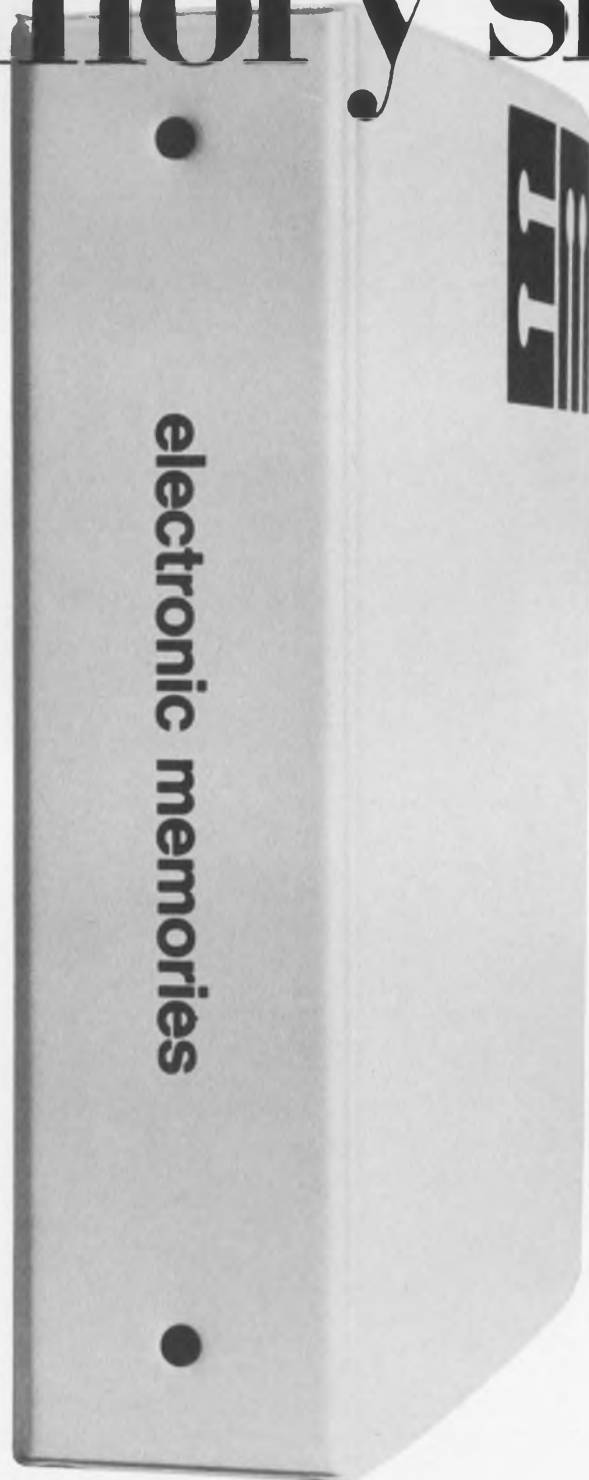

No one offers quite the range of things we do: cores, stacks and systems; aerospace, military and commercial. All here. Electronic Memories, Inc., 12621 Chadron Avenue, Hawthorne, California 90250 (213) 772-5201.

Products

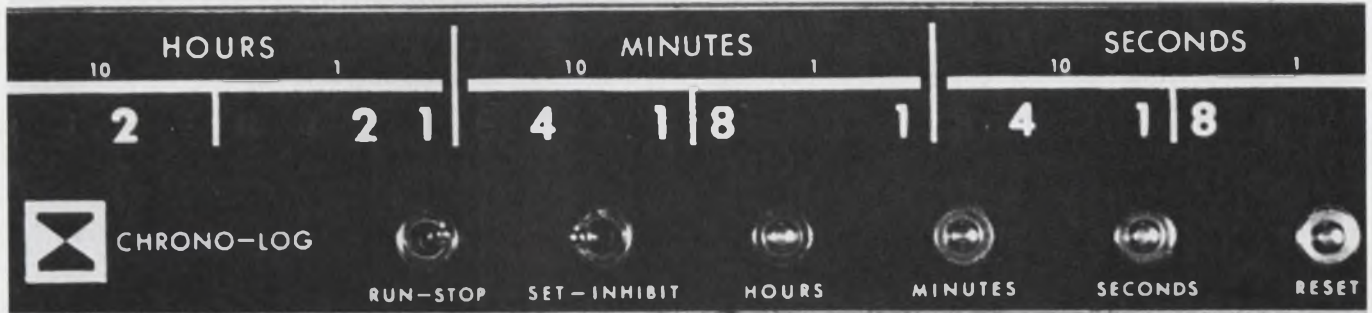

IC digital clock/calendars display time in real units or 8421 BCD format. They offer over

7000 combinations of options for exceptional systems flexibility. Page 110



Coaxial attenuator uses ultraminiature hybrid to reduce package size. Page 104



Compact panel meters combine digital and analog readouts in the same package. Page 110

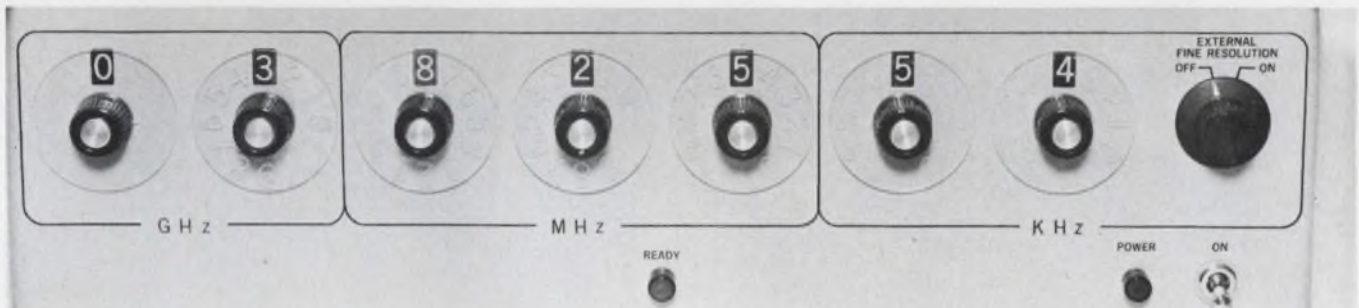

Microwave synthesizer with counter-like accuracy provides spectrally pure signals from

1 to 12.4 GHz. Seven digital switches resolve frequencies in 10-kHz steps. Page 102

Also in this section:

Photoconductor arrays come in custom-designed configurations. Page 116

Chip zener diodes for 1.8 to 91 V offer four assembly choices. Page 116

Design Aids, Page 146 . . . Application Notes, Page 148 . . . New Literature, Page 150

Microwave synthesizer has extended range; generates stable signals at 1 to 12.4 GHz

Micro-Power, Inc., 25-14 Broadway, Long Island City, N. Y. Phone: (212) 726-4060. P&A: main frame: \$6500; plug-ins: \$3900 to \$4900; 90 days.

Clean and coherent signals at frequencies to 12.4 GHz can now be digitally selected at the front panel of a new laboratory instrument. Where synthesizers have up to now been limited to 2.4 GHz, this instrument synthesizes sinusoidal waveforms in 10-kHz increments over four ranges that span the L, S, C and X bands.

With the introduction of this unit, frequency synthesis can be applied to solving design problems at substantially shorter wavelengths.

Applications foreseen by the manufacturer include frequency-standard calibration, use as a local oscillator in broadband microwave receivers, and use in military automatic test sets.

The system's coherence and low noise will facilitate the testing of high-frequency narrow-band fm receivers used by the military for voice communications. For microwave communications, frequency synthesis can help solve the spectrum-space dilemma.

Employing indirect (phase-lock) synthesis techniques, the new instrument achieves a stability of 1×10^{-9} per second and 1×10^{-8} per day; with the use of a more accurate 1-MHz external

source, stability can be extended by three orders of magnitude. Power output is 50 mW at frequencies below 4 GHz and 30 mW above 4 GHz. Non-harmonically related signals are 60 dB below the selected frequency; harmonics are at least 20 dB down. Phase noise measured in a 1-kHz band, centered 30 kHz from the selected signal, is down at least 65 dB.

Operation of the model 300A synthesizer is extremely simple. Once connections have been made to a suitable external VCO (such as Micro-Power's 221-11 sweeper), output frequency can be set in 10-kHz increments by seven digital switches provided on the front panel. External digital programming can be applied at each decade through 4-wire BCD inputs. Positive indication that the instrument is locked on the correct frequency is given by a front-panel indicator lamp, which makes it virtually impossible for false frequencies to mislead the user.

To employ the full range of the instrument, four back-panel plug-ins are required. Model 301A covers 1 to 2 GHz; model 302A, 2 to 4 GHz; model 303 A, 4 to 8 GHz, and model 304A, 8 to 12.4 GHz. Operable on either 115 or 230 V ac, at 48 to 420 Hz, the package measures 19-by-5-1/4 by 20-in. deep.

CIRCLE NO. 299



Frequency synthesizer rests neatly atop a companion sweep oscillator. Interconnections are at rear panel.

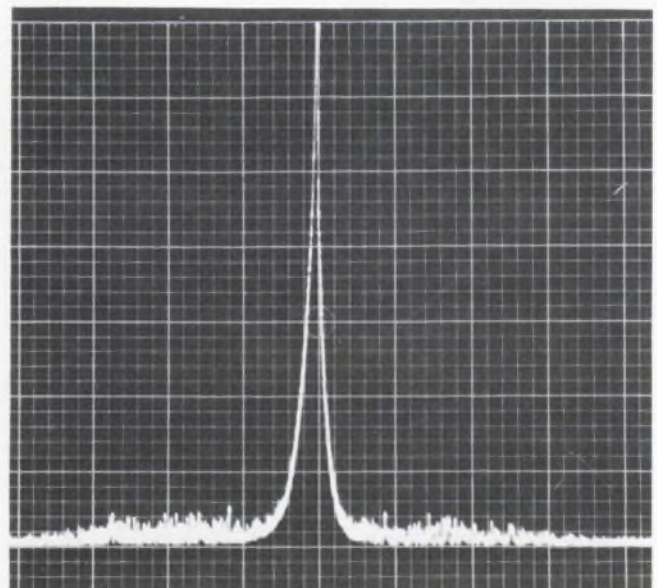

Spectrum analyzer log display of 3,141,290-kHz synthesizer signal demonstrates clean, coherent output.

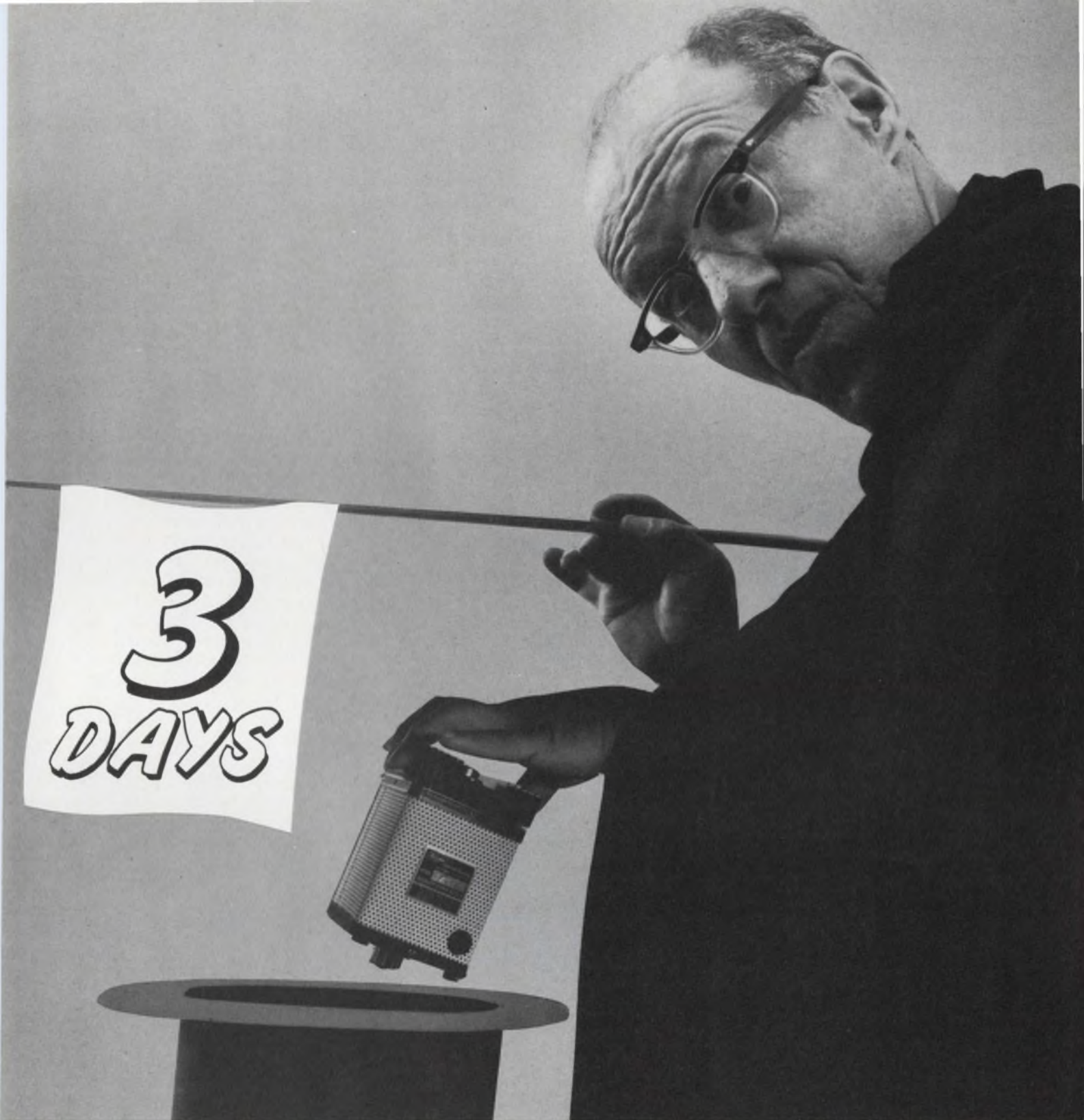

Magic... Acopian style!

We ship any of our 62,000 different AC to DC plug-in power supplies in just 3 days!

Next time you need power supplies in a hurry, contact Acopian. We offer 62,000 different AC to DC plug-in power supplies, any of which will be shipped to you in **just three days!** Choose the exact DC output you need. Singles or duals. Regulated or unregulated. Whether you need one power supply or several, your order will be shipped in just three days! That's our promise. For your copy of our latest catalog, contact your local Acopian rep, call us at (215) 258-5441, or write to Acopian Corp., Easton, Pa. 18042.

Acopian

L-band delay line loses only 50 dB



Anderson Laboratories, 1280 Blue Hills Ave., Bloomfield, Conn. Phone: (203) 242-0761. P&A: \$3000; 6 to 9 wks.

While operating at 50-W peak power in L band, a microwave acoustic delay line with a 10- μ s delay exhibits a loss of only 50 dB. In S band, its loss is 65 dB; in C band, 90 dB. The unit is designed per MIL-E-5400.

CIRCLE NO. 250

Miniature LC hybrid shrinks attenuator size



Merrimac Research and Development Inc., 41 Fairfield Pl., W. Caldwell, N.J. P&A: \$165; stock to 30 days.

Without degrading performance, an electronically controlled coaxial attenuator achieves miniaturization through the use of a lumped-element quadrature hybrid. About the size of a match head, the hybrid is an LC network that allows the attenuator to maintain constant impedance, no matter where the attenuator is set. Known as Pellet, the QHU-2-K hybrid functions independently of wavelength, unlike its distributed-component counterparts. This is the second time that Merrimac Research and Development has used the ultra-miniature network in an assembly. Balance-mixer units were the first.

The new attenuator, model AEM-2-2.2K, is about one-half the size of currently available comparable units and weighs only 1 oz. It has a center frequency of 2.2 GHz, but special versions can be supplied with center frequencies from 1 to 3 GHz. Its attenuation range covers 0 to 18 dB.

Satisfying the military's demand for smaller size, the miniature unit is expected to offer particular advantages for the aerospace and satellite applications of telemetry, radar and communications. Other uses are automatic signal leveling and control, a-m modulation, and remote signal control.

The AEM-2-2.2K can be modulated at any frequency up to 2 MHz. It accepts a maximum input signal of -15 dBm and requires a control current from 0 to 0.5 mA.

Other specifications include a bandwidth of 10% and an attenuation variation of $\pm 5\%$ with fixed bias. Insertion loss is 0.65 dB. VSWR is 1.5, and rf impedance is 50 Ω .

CIRCLE NO. 251



Custom wound bobbins are now available in an extensive range of inductance values and current ratings on many standard forms. Where space limitations dictate one or more dimensions, Miller engineers will make recommendations to help you obtain optimum performance in your circuit.

Custom Wound Bobbins and Special Coils



Screened room with precision test equipment assures close tolerance measurements for special coil characteristics. Intensive specialization in coil design and manufacture assures excellent operating results with a high degree of reliability.



Special 16 Pi/30 KV windings for oil-filled, high voltage transformers... special coil samples are shipped within 1 to 2 weeks; production coil shipments start within 3 weeks after sample approval.



"Guide to Better Coil Selection" describes major types of windings and advantages of each type; gives 10-point check list of primary considerations for use when selecting inductors. Write for your copy today.

For your bobbin and special coil requirements, call a Miller coil design specialist—(213) 233-4294.



J.W. MILLER COMPANY

5917 SOUTH MAIN STREET ■ LOS ANGELES, CALIFORNIA 90003
Get factory prices from your local distributor in quantities to 750.



PACT cuts losses in latching microstrip circulators 80% in twelve months

Engineers at work in Sperry's PACT (Progress in Advanced Component Technology) Program have announced outstanding success in an intensive 12-month campaign to cut insertion losses of external loop latching microstrip circulators.

When the effort began, the loss figure was 2.5 db at X-band; today, Sperry has built external loop latching circulators with insertion loss of only 0.5 db at the same frequency.

PACT's latching circulator work actually began with an internal loop configuration. YIG substrates were prepared with loops of .005" and .010" platinum wire fired in place. Test data were taken at substrate thicknesses of .100", .075" and .055". Results showed that, while fixed bias performance improved as thickness decreased, other factors caused latching performance to deteriorate.

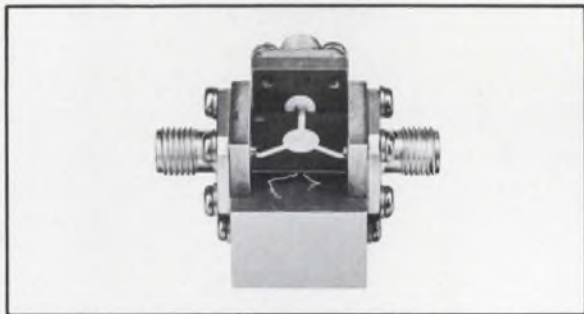

INTERNAL LOOP X-BAND LATCHING CIRCULATOR

While the test results obtained with the internal loop device were generally satisfactory, PACT engineers felt that the configuration had some inherent disadvantages. Among these were difficulty and expense of fabrication, and unsuitability for use in modules. This led to extensive investigation of the external loop design.

PACT personnel found one immediate advantage: when working with external loop, they could consider the substrate and the latching plate independently. Intrinsic and physical properties of the substrate material could be chosen for good

microwave performance, while latching plate design need only consider hysteresis and other switching parameters.

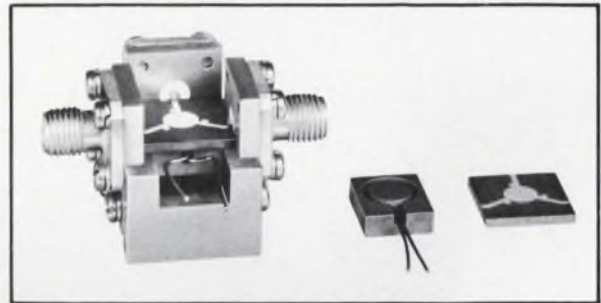

EXTERNAL LOOP X-BAND LATCHING CIRCULATOR, WITH LATCHING PLATE AND SUBSTRATE SHOWN SEPARATELY

Since temperature and high power stability are prime design parameters, the program settled on a design using .482" square x .055" thick hybrid YIG substrate. Lithium ferrite — a material with saturation magnetization of about 3500 gauss, a coercive field of 2.0 oe, and a very square hysteresis loop — was chosen for the latching plate. The switching loop was four turns of #24 copper wire.

Using this configuration, PACT engineers have achieved switching times of less than 1 microsecond, with performance as indicated in the accompanying curve.

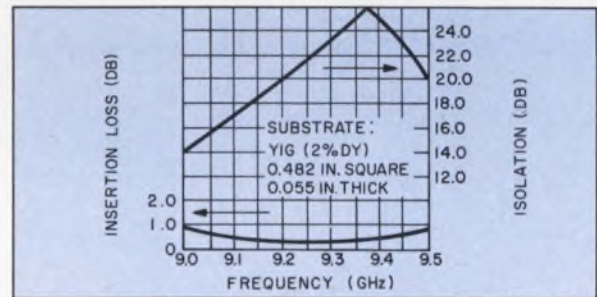

PERFORMANCE OF EXTERNAL LOOP LATCHING CIRCULATOR

For further information about PACT work on latching microstrip circulators and their coming application in microwave IC's, contact your Cain & Co. Representative, or write Sperry Microwave Electronics Division, Sperry Rand Corporation, Clearwater, Florida.

*For faster microwave progress,
make a PACT with people
who know microwaves.*

SPEERY
MICROWAVE ELECTRONICS DIVISION
CLEARWATER, FLORIDA

Delay Lines

MAGNETOSTRICTIVE
DELAY LINES

SOLID
DELAY LINES
(Glass or Quartz)

LC and DC
DELAY LINES

DISPERSIVE
DELAY LINES

DIGITAL
DELAY LINES

for proven
reliability in
Delay Lines and
Serial Memory Systems
for military and
commercial
applications, it's...



MICROSONICS, INC.
60 Winter Street
Weymouth, Mass. 02188
Tel: 617 337-4200

A subsidiary of the Sangamo Electric Company

INFORMATION RETRIEVAL NUMBER 48

MICROWAVES & LASERS

Frequency system uses standard units



Hewlett-Packard, 1501 Page Mill Rd., Palo Alto, Calif. Phone: (415) 326-7000. P&A: \$10,500; 12 wks.

Consisting of standard, general-purpose instruments which can be used separately for other tasks, type E40-5245L digital frequency measurement system operates with a transfer-oscillator technique from dc to 40 GHz. The instruments in the new system are: an electronic counter, a local oscillator, a synchronizer for phase-locking the local oscillator to cw input signals, a mixer, a 20-dB directional coupler, and a monitor tee.

CIRCLE NO. 252

Dielectric foam sheets are flexible or rigid

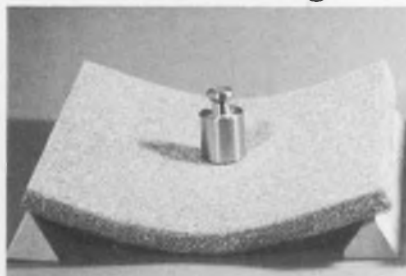

Emerson & Cuming, Inc., Canton, Mass. Phone: (617) 828-3300. Price: \$65 to \$100/sheet.

Available in either flexible or rigid sheets, Eccofoam HiK artificial foam has essentially constant dielectric properties through the microwave frequency band. Standard dielectric constants range from 1.1 to 6. Loss tangent increases with increasing dielectric constant from 0.001 to 0.031.

CIRCLE NO. 253

Portable pulse supply drives laser diodes



Laser Diode Laboratories, Inc., Metuchen, N.J. Phone: (212) 867-6062.

Driving injection laser diodes at room temperatures, a portable, solid-state, pulse power supply provides a 100-A output current with rise and fall intervals of 50 to 100 ns. Model LP11 has two triggering modes, an internal one with a continuous variable repetition rate ranging from 100 Hz to 1 kHz, and an external one allowing manual operation at repetition rates below 100 Hz.

CIRCLE NO. 254

Step-recovery diode multiplies frequency



Fairchild Semiconductor, 313 Fairchild Dr., Mountain View, Calif. Phone: (415) 962-2530. Price: \$80.

Designed primarily for use as a frequency multiplier in microwave systems, a step-recovery diode features efficiencies as high as 76% when doubling from 1 to 2 GHz. In other frequency conversions, the FGC1001 exhibits an efficiency of 55% when doubling from 4 to 8 GHz, and 57% when quadrupling from 1 to 4 GHz. The new diode operates with transition times of only 100 ps.

CIRCLE NO. 255

General Electric introduces the smallest 50mw, 2-amp relay on the market

Tiny, powerful
and turned on with the touch of a feather

This extra-small, 2-pole, 2-amp relay needs only the slightest tickle to operate—50 milliwatts. With this impulse, it performs standard high-level output switching from low-level, microelectronic input.

Size-wise, it's only 0.32" high, 0.31" wide, and 0.61" long. And, it meets or exceeds all MIL-Spec environmental and electrical requirements of relays many times larger.

Because of its low operate power and size, this relay is ideally suited for microelectronic applications. Its low profile lets you stack many more circuit boards in the same space.

Like all General Electric 150-grid relays, this new 50mw type is available with a number of options to suit your individual application. You have a choice of coil ratings for a wide range of system voltages, a choice of popular mounting forms and header types.

If this new relay tickles your fancy, contact your General Electric Electronic Components Sales Engineer. Or, write for Bulletin GEA-8589, Section 792-43, General Electric Company, Schenectady, New York 12305.



GENERAL  **ELECTRIC**

SPECIALTY CONTROL DEPARTMENT, WAYNESBORO, VIRGINIA

INFORMATION RETRIEVAL NUMBER 49

HERE'S A NEW WAY

to stabilize cabinet temperature without air conditioning!

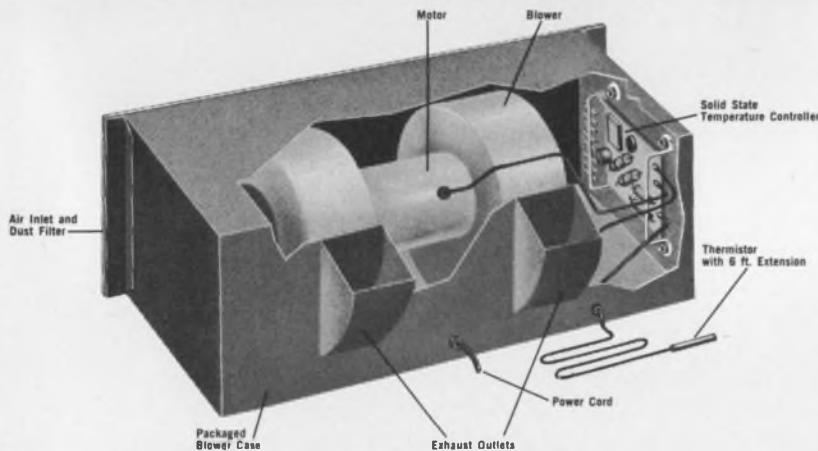
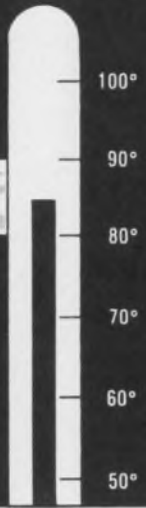

McLEAN

Solid State Temperature Controller

Modulates the Flow of Cool Air Within a Very Narrow Thermal Range

This new system employs a transistorized control and a modulating thermostatic probe to sense critical component temperature or outlet air temperature. Together these modulate the speed of the blower automatically supplying the right volume of air to maintain constant thermal stability. The Controller is preset so that the blower begins to operate at 80°F increasing in output as the temperature rises. Full output is achieved at 90°F. REQUEST DATA SHEET SSC 700.

FEATURES:

- Maintains cabinet temperature between 80°F and 90°F
- Automatically modulates blower speed
- Systems stay drift-free
- Quieter operation
- Extends life of electronic components
- Extends blower life
- Costs less than air conditioning
- More compact than air conditioning



SEND FOR
NEW CATALOG

McLEAN ENGINEERING LABORATORIES

Princeton Junction, New Jersey 08550
Phone 609-799-0100 • TELEX 84-3422



MICROWAVES & LASERS

Transistor chips build S-band hybrids

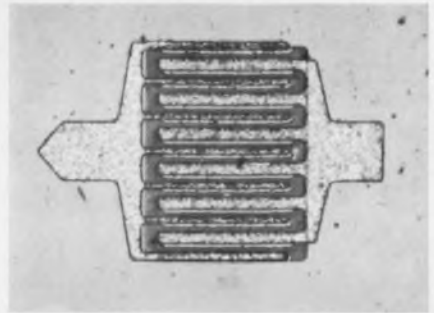

Hewlett-Packard Co., 1501 Page Mill Rd., Palo Alto, Calif. Phone: (415) 326-7000. P&A: \$65 to \$80; stock.

High-frequency characteristics are now specified and guaranteed for new transistor chips designed for microwave hybrid microcircuits. In addition, these transistor chips (35800 series) have microwave characteristics that allow use in critical oscillator and amplifier applications. Typical f_T is 3 to 4 GHz with typical f_{max} going as high as 6 GHz.

CIRCLE NO. 256

Crystal mixers operate at 90 GHz



Scientific-Atlanta, Inc., P.O. Box 13654, Atlanta, Ga. Phone: (404) 938-2930. P&A: \$600; 4 wks.

Improving sensitivity by using X band as the fundamental mixing frequency, series 17 microwave crystal mixers cover the frequency range of 26.5 GHz to 90 GHz. They are cross-waveguide units with adjustable cavity plungers for both the X-band fundamental input and the millimeter-wave input. The plunger tuning provides both fast course adjustments and fine micrometer settings for adjusting resolution of the mixer cavity.

CIRCLE NO. 257

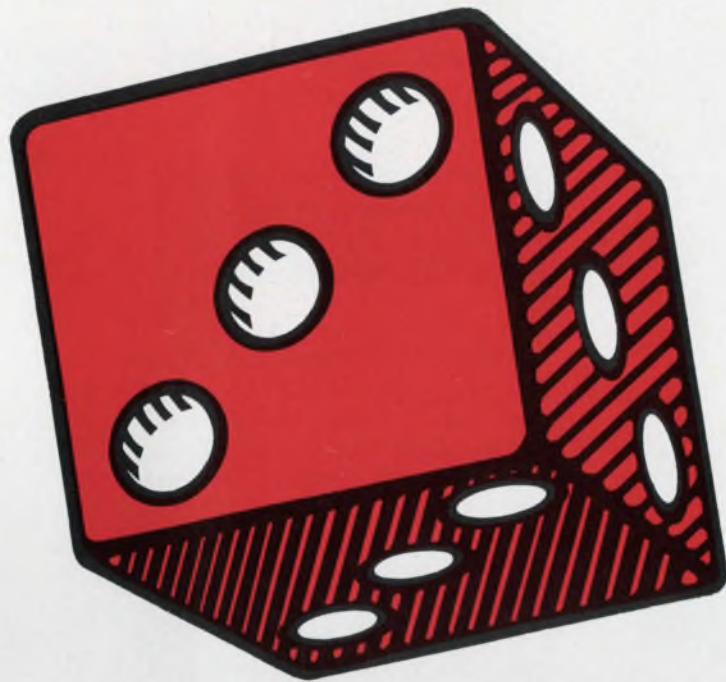

LIKE A SURE THING ?



THE ODDS ARE 36,000 TO ONE COHU HAS THE RIGHT TV SYSTEM FOR YOU! A pioneer in TV, Cohu today is the largest producer of standard, off-the-shelf TV systems in the industry. Take the standard lenses, camera controls, pick-up tubes (both vidicons and Plumbicons®) and video monitors—put these together with Cohu's various camera housings, remote controls and lens drives and you have over 36,000 possible TV system combinations. And this does not include Cohu's wide variety of quality TV accessories and switching systems.

ONE IS RIGHT FOR YOU! Whether your needs be industrial, educational or military, one of Cohu's TV combinations is right for you. Let Cohu engineering know-how design for you a custom TV system from standard, off-the-shelf components.

For details on the industry's most complete TV line, contact your nearest Cohu representative or call Bob Boulio direct at 714-277-6700 in San Diego. The odds are in your favor.

Box 623, San Diego, California 92112. TWX 910-335-1244.

INFORMATION RETRIEVAL NUMBER 51

ELECTRONIC DESIGN 23, November 7, 1968



We've just cracked the vacuum-tube rectifier market.



Now Varo has developed a new series of High Voltage Fast Recovery Diffused Silicon Rectifiers economically competitive with both vacuum tubes and selenium. And they mean improved reliability in color and monochrome receiver applications.

Peak reverse voltage rating for the series is from 5,000 Volts to 45,000 Volts, with rated output current to 25 milliAmps. And we can supply you with any shape you need. In sizes from .250" square and 1.00" long. Diode-capacitor voltage multiplier assemblies are also available.

This new series is the result of Varo's continuing R & D leadership in high-voltage rectifiers.

Varo is the same company that introduced miniature, low-cost high-voltage diodes for night vision applications: the Integrated Bridge Rectifier (IBR®) and the Epoxy Integrated Bridge Rectifier (EBR).

If you'd like to give your customers all the advantages of totally solid state TV circuitry, now you can.

In the meantime, don't feel bad if you're still using vacuum-tube rectifiers.

Up until now, it was the only choice you had.

For complete details, applications, and price list write or call.



VARO

SEMICONDUCTOR DIVISION
2203 WALNUT STREET,
GARLAND, TEXAS 75040
(214) 272-3561

INFORMATION RETRIEVAL NUMBER 52

INSTRUMENTATION

Compact panel meters display D/A data



Time Systems Corp., 265 Whitman Rd., Mountain View, Calif. Phone: (415) 961-9321. P&A: \$245 or \$320; stock.

Two new panel meters, which combine analog and digital read-out in the same package, display three full digits plus 100% over-range with a full-scale accuracy of 0.1%. Analog display is performed with 5% resolution by a lit needle that uses a horizontal row of 20 neon lamps to simulate the left-to-right action of an ordinary deflection-type meter. Two models are available, the 700 and the 710 with floating BCD output.

CIRCLE NO. 258

Audio test system combines 4 in 1



Century General Corp., 570 7th Ave., New York City. Phone: (212) 594-9368. P&A: \$48; stock.

Operating from a battery supply, a portable, solid-state, audio test system combines four basic instruments into one. Model 140 consists of an rf/i-f/af signal tracer, a tone generator, a multiple-input audio amplifier, and an oscilloscope preamplifier. The system is designed not to overload or damage transistors. Gain is 70 dB, noise is -60 dB, and frequency response is ± 3 dB.

CIRCLE NO. 259

One-hand test probe makes three contacts



Dynascan Corp., B & K Div., 1801 W. Belle Plaine Ave., Chicago. Phone: (312) 327-7270. Price: \$12.95.

Requiring only one hand to make three simultaneous touch-to-test contacts, the model FP-3 probe tests transistors, diodes, and other compact components mounted on printed boards. It has three spring-loaded needle-point tips that tilt or swivel on ball joints for adjustment to any spacing from 1/32 to 5/8 in. Three leads, color-coded to their respective tips, terminate in insulated alligator clips for easy connection to the test instrument being used.

CIRCLE NO. 260

Digital clock/calendars use integrated circuits

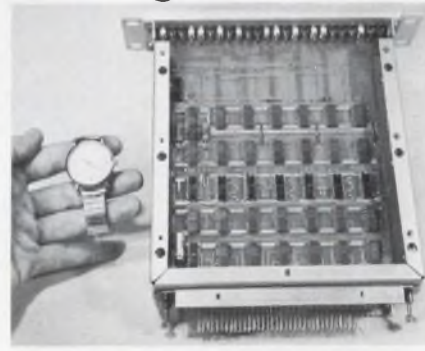

Chrono-Log Corp., 2583 W. Chester Pike, Broomall, Pa. Phone: (215) 356-6771. Price: from \$495.

Designed to provide digital display of time and date for data processors and computers, series 30,000 digital clock/calendars employ full IC construction to lower price tags and to reduce package size. Offering over 7000 combinations of options, the new units require only 1-3/4 in. of panel height, at either half-rack or full-rack width. Standard-time display is 8421 BCD; real-time units are optional.

CIRCLE NO. 261

One man's stability is another's slop.

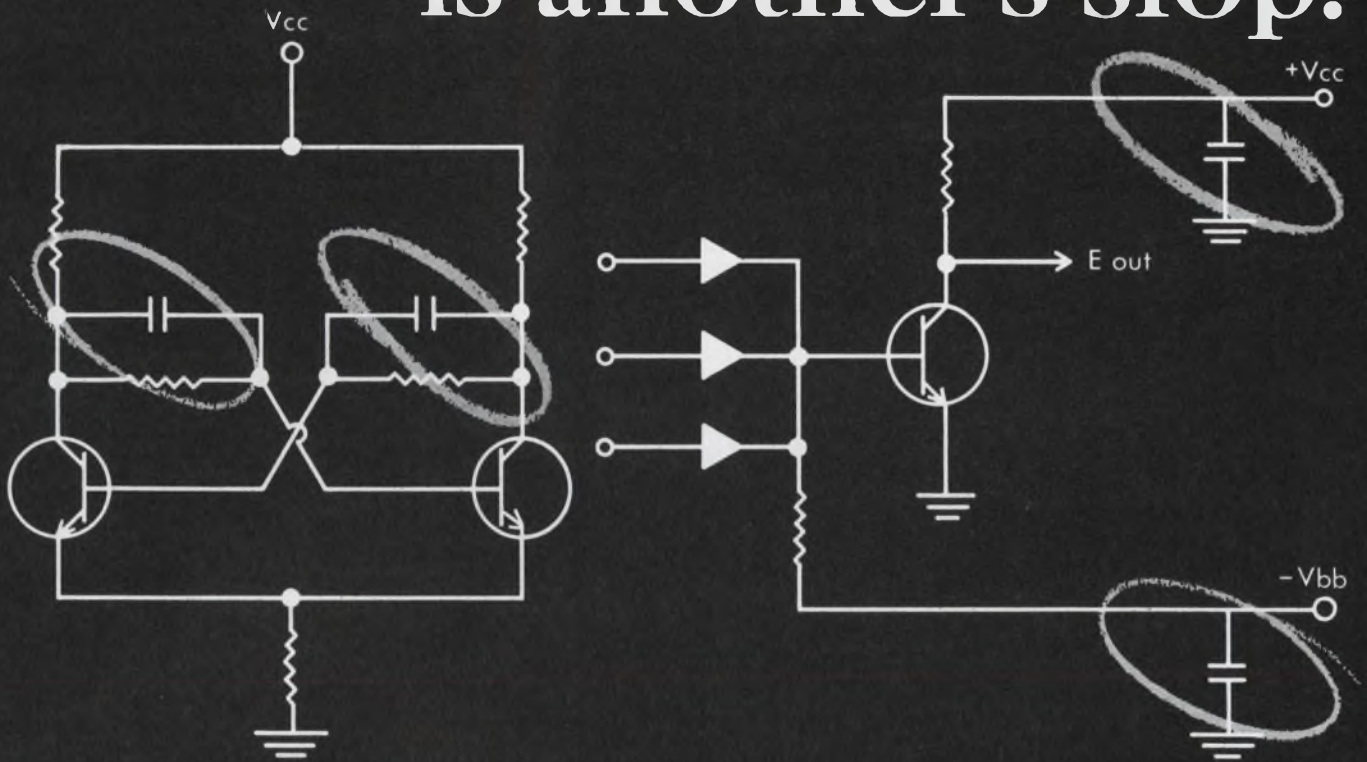

CORNING® Glass-K Capacitors provide both.

Needs vary with circuit function.

A filter can stand some slop. You buy for size and plain reliability.

But in timing or tuning, a capacitance change may not only foul up your signal, but the result may be more damaging than a total stop.

CORNING Glass-K answers both needs.

From 270 to 100,000 pf, just .250" long.

Stability? Choose from three characteristics, with ΔC with life as low as 2% max., at 125° C.

Reliability? Check Apollo, Centaur, Poseidon.

Get size, stability, sureness. Get the figures on Glass-K Capacitors.

Write: Corning Glass Works, Electronic Products Division, Corning, N. Y. 14830

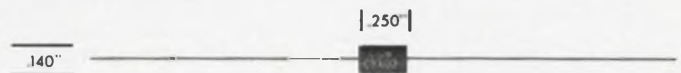

CORNING
ELECTRONICS

Choose from 44 styles
of film capacitors...
There's one to meet
your exacting requirements

**HERMETICALLY-SEALED
METAL CASE TUBULAR CAPACITORS**



BARE METAL CASE

Style LP8, metallized polycarbonate film
Style LM8, metallized PETP-polyester film
Style LS8, metallized polystyrene film
Style AP8, polycarbonate film
Style AM8, PETP-polyester film
Style AS8, polystyrene film
Style AF8, PTFE-fluorocarbon film

METAL CASE WITH INSULATING SLEEVE

Style LP9, metallized polycarbonate film
Style LM9, metallized PETP-polyester film
Style LS9, metallized polystyrene film
Style AP9, polycarbonate film
Style AM9, PETP-polyester film
Style AS9, polystyrene film
Style AF9, PTFE-fluorocarbon film

INFORMATION RETRIEVAL NUMBER 231

**WRAP-AND-FILL
ROUND TUBULAR CAPACITORS**



Style LP66, metallized polycarbonate film
Style LM66, metallized PETP-polyester film
Style LS66, metallized polystyrene film
Style AP66, polycarbonate film
Style AM66, PETP-polyester film
Style AS66, polystyrene film

INFORMATION RETRIEVAL NUMBER 233

**HERMETICALLY-SEALED
METAL CASE RECTANGULAR CAPACITORS**



Style CML, high voltage paper/PETP-polyester film, inserted tab construction.

INFORMATION RETRIEVAL NUMBER 235

**HERMETICALLY-SEALED
GLASS CASE TUBULAR CAPACITORS**



Style GML, high voltage paper/PETP-polyester film, 85 C
Style GTL, high voltage paper/PETP-polyester film, 125 C

INFORMATION RETRIEVAL NUMBER 237

**EPOXY-CASE
RECTANGULAR CAPACITORS**

AXIAL-LEAD



Style LP7A, metallized polycarbonate film
Style LM7A, metallized PETP-polyester film
Style LS7A, metallized polystyrene film
Style AP7A, polycarbonate film
Style AM7A, PETP-polyester film
Style AS7A, polystyrene film

RADIAL-LEAD

Style LP7S, metallized polycarbonate film
Style LM7S, metallized PETP-polyester film
Style LS7S, metallized polystyrene film
Style AP7S, polycarbonate film
Style AM7S, PETP-polyester film
Style AS7S, polystyrene film



INFORMATION RETRIEVAL NUMBER 232

**WRAP-AND-FILL
OVAL TUBULAR CAPACITORS**



Style LP77, metallized polycarbonate film
Style LM77, metallized PETP-polyester film
Style LS77, metallized polystyrene film
Style AP77, polycarbonate film
Style AM77, PETP-polyester film
Style AS77, polystyrene film

INFORMATION RETRIEVAL NUMBER 234

**HERMETICALLY-SEALED
CERAMIC CASE TUBULAR CAPACITORS**



Style SML, high voltage paper/PETP-polyester film, inserted tab construction.
Style SMLE, high voltage paper/PETP-polyester film, extended foil construction.

INFORMATION RETRIEVAL NUMBER 236

**EPOXY CASE
RECTANGULAR CAPACITORS**



Style EFX, high voltage paper/PETP-polyester film.

INFORMATION RETRIEVAL NUMBER 238

For engineering bulletins on the capacitor styles
in which you are interested, write to Dearborn
Electronics, Inc., Box 530, Orlando, Fla. 32802.

Dearborn Electronics, Inc.
(a subsidiary of the Sprague Electric Company)
FOREMOST IN FILM CAPACITORS

INSTRUMENTATION

Limit testers
work like DVM



James G. Biddle Co., Plymouth Meeting, Pa. Phone: (215) 646-9200. P&A: \$1885 to \$2885; 30 days.

Mentor multipurpose instruments provide the stability and accuracy of a laboratory-grade potentiometer with the operational simplicity of a digital voltmeter. Four models are available: two for dc and two for ac/dc measurements. Each model is three instruments in one: an automatic limit tester; a manual or automatic system for adjusting input parameters to preset limits; and a fast differential voltmeter.

CIRCLE NO. 262

Low-cost FET VTVM
works from ac or dc



Mercury Electronics Corp., 315 Roslyn Rd., Mineola, N.Y. Phone: (212) 755-0845. Price: \$69.95.

Model 4000 FET volt-ohm-milliammeter operates from an ac line or from its own batteries. It has a special low-voltage range of 0.5 V dc, in addition to seven ac and dc voltage ranges to 1000 V. Seven resistance ranges cover 0.2 Ω to 1000 M Ω . Five dc current ranges measures up to 1000 mA.

CIRCLE NO. 263

INFORMATION RETRIEVAL NUMBER 54 ►

110 contacts to the inch.

Socket to 'em!

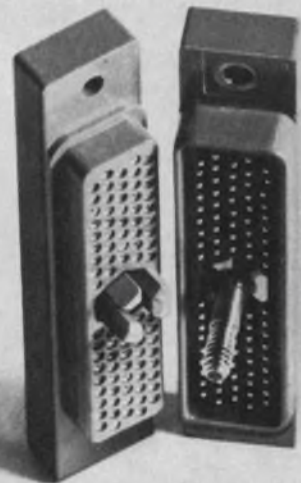

We make subminiatures so they're more subminiature.

Smaller. Lighter. More fully packed. 110 contacts to the inch, without sacrificing contact size or spacing.

It happened like most Hughes innovations. We couldn't find connectors small enough for our space jobs—so we made some small enough. Rugged enough.

That was the birth of PolarHex, our center jackscrew coupling mechanism. It insures perfect alignment, positive engaging

and polarizing.

Hughes subminiatures also feature crimp snap-in contacts with the industry's best retention system. The retaining clip is anchored to the contact, not the body—so it floats free for easy alignment.

They're available in environmental, non-environmental and potting versions. In arrangements to fit any requirement, from 14 to 244 size 22 contacts.

If you're up tight for space, write and say "socket to me."

Write Hughes Aircraft Co., Connecting Devices, 500 Superior Ave., Newport Beach, California 92663. Phone (714) 548-0671. TWX 714-642-1353.  Connecting Devices, part of Hughes Circuit Technologies. Including: Contour™ Cable; Semiconductors; Flip Chips/Equipment; Frequency Control Devices; Microelectronic Circuits; MOSFETs.

HUGHES

HUGHES AIRCRAFT COMPANY

If it's happening in connectors,
it probably started at Hughes.



E F C fiberoptics for computer applications

**Punched Card and
Tape Readers**

**Reflective Readers
Light Piping**

For designers, specifiers and buyers of fiberoptic components in the computer or peripheral equipment industries, there is now a single source of design and manufacturing capability to meet your requirements...with competitive prices, firm deliveries and conscientious service. For more information, write or call

ELECTRO FIBEROPTICS CORPORATION

45 Water Street, Worcester, Mass. 01604
Phone 617 791-7391

Write for this booklet called **Sine Waves and Light Pipes**—an introduction to Electro Fiberoptics Corporation—plus technical data sheets.

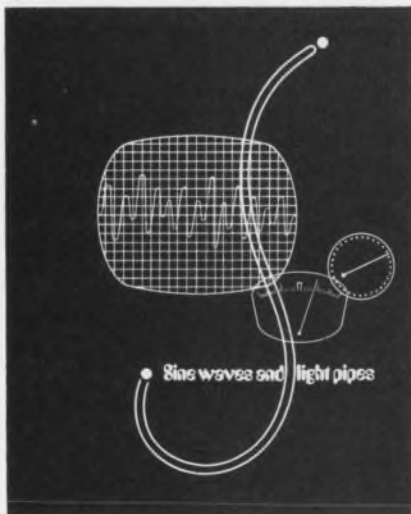

INFORMATION RETRIEVAL NUMBER 55

INSTRUMENTATION

Digital panel meter spans 0.1 to 1000 V



*Gralex Industries, Inc., 28 Di Tom-
as Court, Copiague, N.Y. Phone:
(516) 691-2502. Price: \$290 to
\$350.*

Using Nixie-type readouts, series DM-30 digital panel meters provide direct 3-digit display (with overrange and polarity) of any quantity that can be represented as a dc voltage or current. A choice of five input ranges is available for full-scale readings of 0.1, 1, 10, 100 or 1000 V dc. Gain and slope adjustments are located on the front panel, and decimal-point position is selected by simple rear connector wiring.

CIRCLE NO. 264

Digital thermometer withstands vibration



*API Instruments Co., 7100 Wilson
Mills, Chesterland, Ohio. Phone:
(216) 729-1611.*

Unaffected by vibration and capable of direct temperature readout with an accuracy of 1°F, a new digital thermometer covers -50 to +1500°F. Thermocouples are used as sensors for higher temperatures, beginning at 120°F, and platinum resistance probes are used for lower ranges. Accuracy is ±5°F with thermocouples and ±1°F with RTD probes.

CIRCLE NO. 265

Plug-in modules alter panel meters

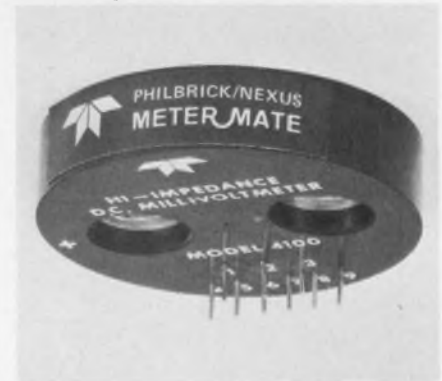

*Philbrick/Nexus Research, A Tele-
dyne Co., Allied Drive, Dedham,
Mass. Phone: (617) 329-1600.
Price: \$65 or \$90.*

When attached to the back of a panel meter, plug-in modifiers change current devices to voltage devices. There are two basic types of Meter-Mates: a high-impedance unit and a log-null unit. The high-impedance unit converts a 50-μA low-impedance meter into a high-impedance 0.1-mV voltmeter. The low-impedance unit expands a scale logarithmically for sensitive, accurate null readings.

CIRCLE NO. 266

Digital panel meter has 0.01% accuracy



*California Instruments Corp., 3511
Midway Dr., San Diego, Calif.
Phone: (714) 224-3241. Availabil-
ity: 30 days.*

Featuring 5-digit Nixie readout and automatic polarity indication, a digital panel meter provides an accuracy of 0.01% and a resolution of 0.008%. Model 8361 occupies only 2 by 3-1/2 in. of panel space, 5-1/4 in. deep. Standard full-scale ranges cover ±12, ±120 and ±1200 V. Nominal input impedance is 10 MΩ, and common mode rejection is 100 dB.

CIRCLE NO. 267

INFORMATION RETRIEVAL NUMBER 56 ►

Why take pot luck for reliability?

The Daystrom Squaretrim 318-160HS with pins, and the new Model 313-160HS with flexible leads are both designed, manufactured and tested in complete accordance with MIL-R-39015. This means you no longer have to resort to costly unmonitored programs when you need high reliability potentiometers. These new

Squaretrim models not only give you the best design and materials, but are manufactured with piece part traceability, in-process controls, and the stringent QC program defined in this Specification. So . . . our advice to you is: don't trust to luck. Specify and order Daystrom Hi-Reliability Squaretrim pots. They're available

in values from 10 ohms through 20K. Prompt delivery on orders. Write or phone today. Daystrom potentiometers are another product of: WESTON COMPONENTS DIVISION, Archbald, Pa. 18403, Weston Instruments, Inc.

a Schlumberger company

WESTON®

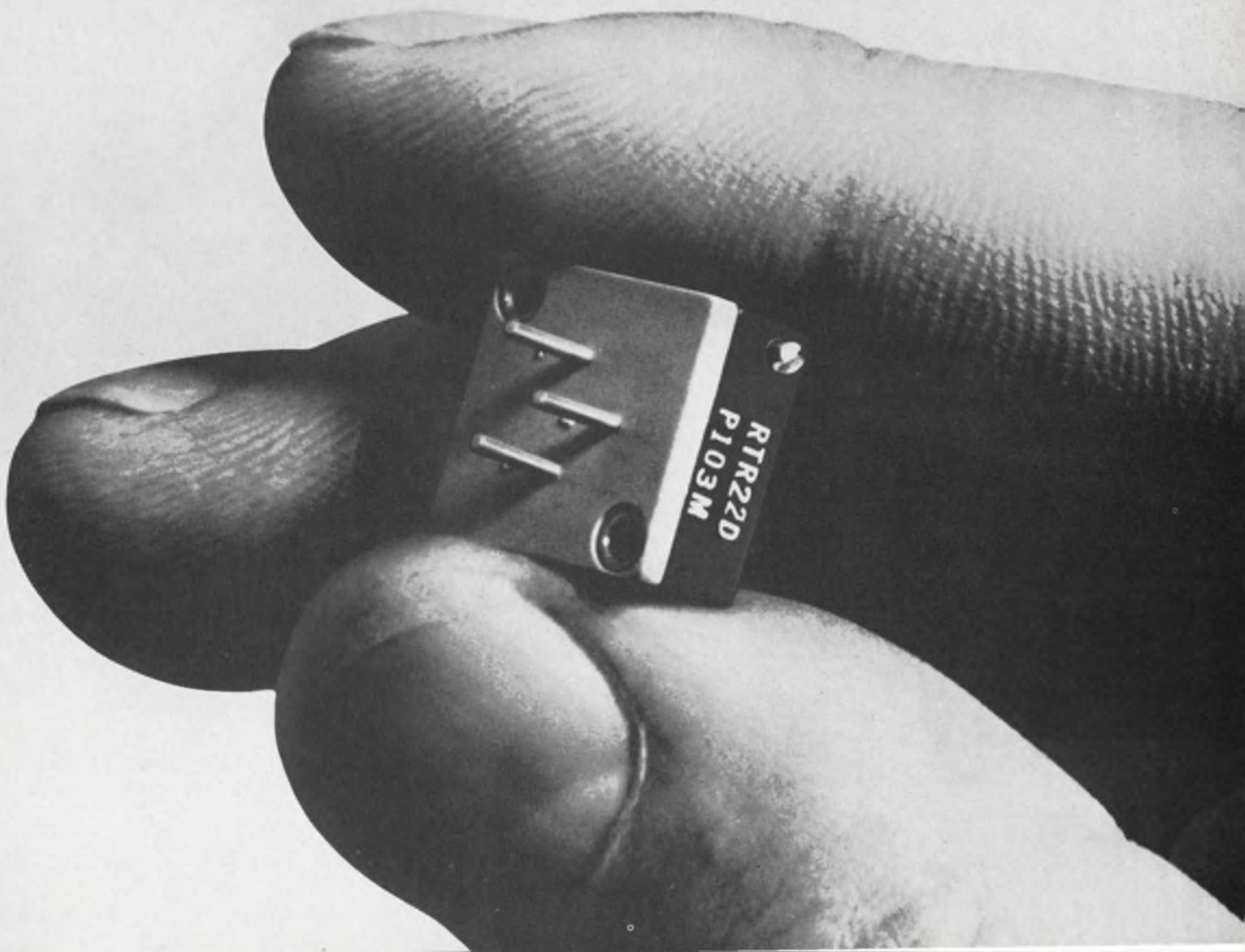

WHICH?

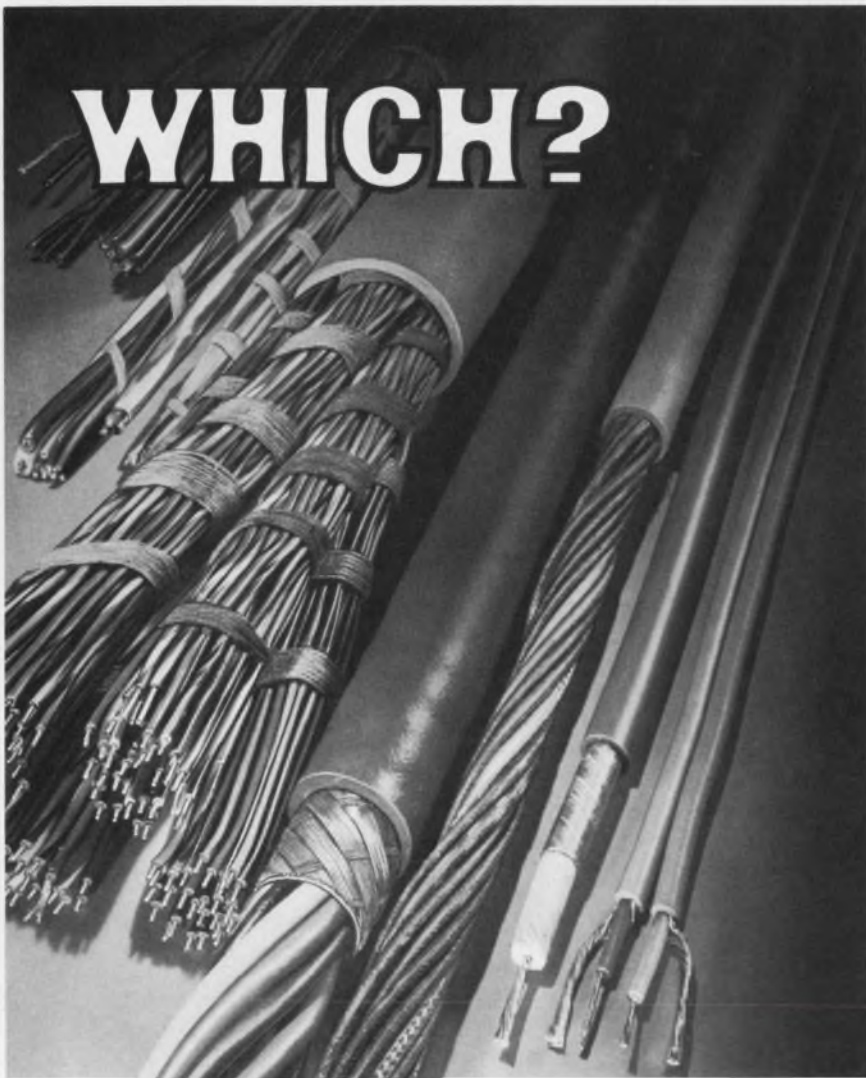

LENZ MAKES THEM ALL... AND MORE!

No matter how sophisticated the system or how simple the device, Lenz can provide the necessary cables . . . quality-built, reliable, compact!

Lenz engineers have a broad knowledge of electronic equipment and complete familiarity with the environmental, electrical, temperature and mechanical characteristics of the wires and cables required.

Having a cable problem? Pass it along—Lenz will help find the solution, with no obligation, of course!



WRITE FOR NEW CATALOG!



CABLES & WIRES

In Business Since 1904

LENZ ELECTRIC MANUFACTURING CO.

1755 No. Western Avenue, Chicago, Ill. 60647

INFORMATION RETRIEVAL NUMBER 57

ICS & SEMICONDUCTORS

Photoconductor arrays are custom designed

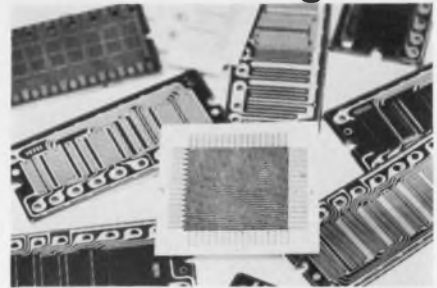

Hewlett-Packard Co., 1501 Page Mill Rd., Palo Alto, Calif. Phone: (415) 321-8510. P&A: 35¢/cell; 8 wks.

Photoconductor arrays are now available as custom-designed devices to meet special requirements for switching, coding, translating, reading, or position-sensing applications. The light-sensitive arrays are fabricated by thick-film techniques on ceramic substrates and can be produced to accept active or passive components. They can be supplied with 200 photocells grouped within 1 in.²

CIRCLE NO. 268

Chip zener diodes offer 4 assemblies

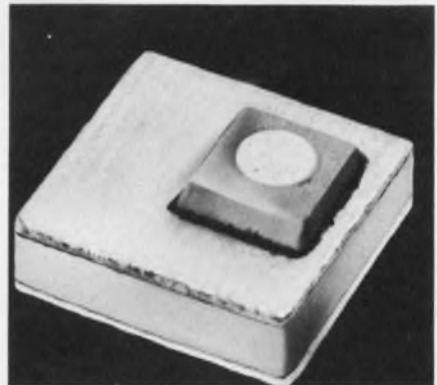

Dickson Electronics Corp., P.O. Box 1390, Scottsdale, Ariz. Phone: (602) 947-2231.

Chip zener diodes with voltage ratings from 1.8 to 91 V are available in four basic assemblies: the MA series with Kovar substrates for mounting directly on electrically active surfaces; the MB series with ceramic substrates for insulating the diode chip; the MC series which eliminates bonding directly to the diode chip; and the MD series which is packaged similarly to a leadless inverted device (LID).

CIRCLE NO. 269

For Capacitors with **GREATER RELIABILITY . . .**

Choose
EL-Menco

*The Capacitors You
Find Wherever
There's Electronics!*

EL-MENCO DUR-MICA CAPACITORS

Only 1 Failure Per 43,000,000 Unit-Hours!

- It has been computed that "debugged" DM30, 10,000 MMF units, when subjected to 257,000 hours of life at 85°C with 100% of the rated DC voltage applied, will yield only 1 FAILURE PER 43,000,000 UNIT-HOURS!
- DM15, DM16, DM19, DM20 . . . perfect for miniaturization and for new designs using printed wiring circuits. Also available in DM30, DM42 and DM43.
- New "hairpin" parallel leads insure easy application. Exceed all electrical requirements of military specification MIL-C-5A.

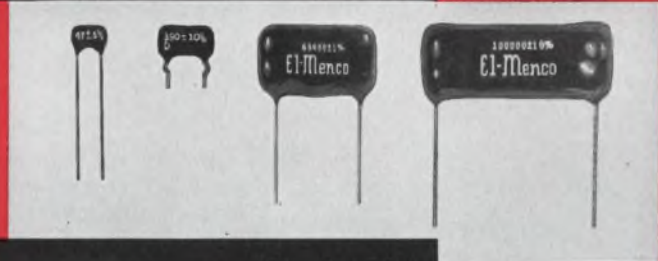

EL-MENCO TRIMMERS & PADDERS

Design Versatility!

- Available in 350 VDC and 500 VDC as well as other test voltages.
- All bases are of low-loss steatite.
- Special lugs are obtainable for printed circuitry.
- Miniature units are available.
- Solder Lugs can be bent in any position without affecting the capacity setting due to the rigid construction.
- Various types of mounting brackets are available for all trimmers.
- Units can be constructed for special applications.

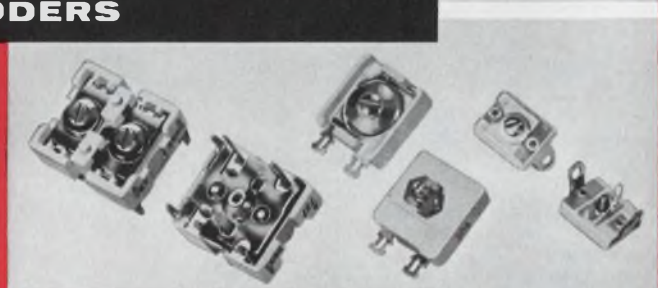

EL-MENCO *MYLAR-PAPER DIPPED CAPACITORS

Only 1 Failure in 14,336,000 Unit-Hours!

- Life tests at 105°C with rated voltage applied have yielded only 1 FAILURE PER 1,433,600 UNIT-HOURS for 1 MFD. Since the number of unit-hours for these capacitors is inversely proportional to the capacitance, 0.1 MFD Mylar-Paper Dipped capacitors will yield only 1 FAILURE PER 14,336,000 UNIT-HOURS!
- Working volts DC: 200, 400, 600, 1000 and 1600.
- Durez phenolic resin impregnated.
- Tolerances: $\pm 10\%$ and $\pm 20\%$ (closer tolerances available).
- Dielectric strength: 2 or 2½ times rated voltage, depending upon working voltage.
- Exceed all electrical requirements of E.I.A. specification RS-164 and military specifications MIL-C-91A and MIL-C-25A.

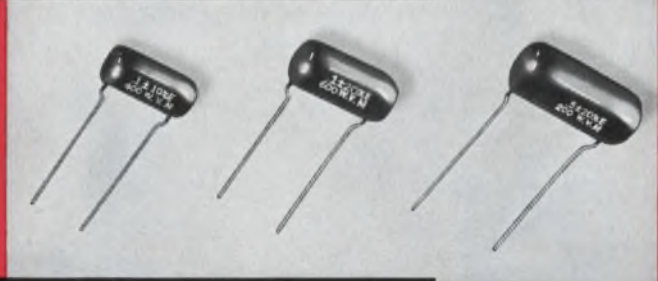

*Registered Trademark of DuPont Co.

EL-MENCO MOLDED MICA CAPACITORS

Superior Performance!

- Unmatched for excellent stability, dielectric strength, high insulation resistance, extremely high "Q" and correspondingly low power factor.
- Units can be subjected to a short "debugging" life test at elevated voltage and temperature for removal of early life failures and for improved reliability.

*Write for Free Samples and Booklets
on Any of The Above Capacitors*

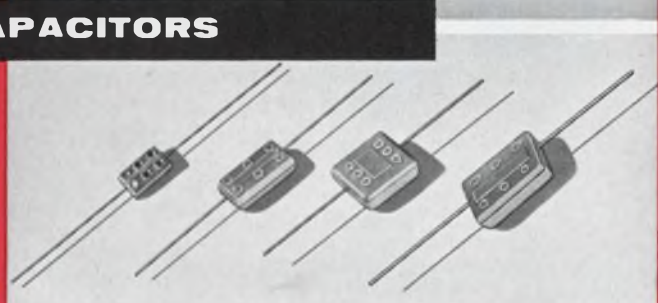

EL-MENCO OFFERS A COMPLETE LINE OF CAPACITORS . . . STANDS READY TO SERVE ALL YOUR CAPACITOR NEEDS

THE ELECTRO MOTIVE MFG. CO., INC.

WILLIMANTIC, CONNECTICUT 06226

Dipped Mica • Molded Mica • Silvered Mica Films • Mica Trimmers & Padders
Mylar-Paper Dipped • Paper Dipped • Mylar Dipped • Tubular Paper

West Coast Manufacturers contact: COLLINS & HYDE CO., 900 N. San Antonio Rd., Los Altos, California 94022
5380 Whittier Blvd., Los Angeles, California 90022

ALSO SOLD NATIONALLY THROUGH ELECTRONIC PARTS DISTRIBUTORS

INFORMATION RETRIEVAL NUMBER 58





NEW / FROM NORTRONICS



FIRST COMBO HEAD FOR 8-TRACK STEREO

MODEL Z-B2L

ELIMINATES: ASSEMBLY TOLERANCE, TRACK ALIGNMENT AND PRESSURE PAD PROBLEMS

This new Nortronics Z-Combo head — a major engineering accomplishment — reduces the spacing between erase and playback gaps from the conventional .250" to an extremely small .050"!

Because of the close tolerances required in 8-track stereo, the conventional gap-to-gap spacing creates serious problems.

A 1° azimuth correction of the R/P gap in conventional combo heads creates a vertical displacement of .004" of the erase gap. As a result, the erase gap may incompletely erase the proper tracks and at the

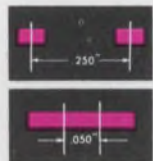

same time erase unwanted material on adjacent tracks. With the Nortronics Z-Combo heads, the equivalent displacement is less than .001".

The new head also permits simplified circuitry in the recorder, since it features internal automatic biasing.

The new Z-Combo head displays the quality, engineering, ingenuity, and responsiveness to every recording need that have made Nortronics the world's largest manufacturer of laminated core tape heads and the standard-setter for the industry.

Complete technical data is available on request.

Nortronics COMPANY, INC.

8101 Tenth Avenue North
Minneapolis, Minnesota 55427

INFORMATION RETRIEVAL NUMBER 118

ICS & SEMICONDUCTORS

Overvoltage monitors accept 10-A surges

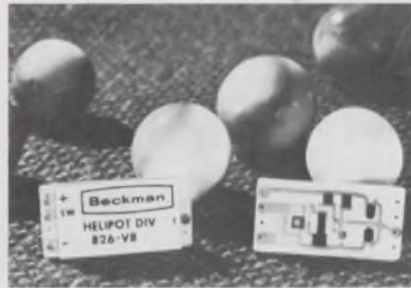

Helipot Div., Beckman Instruments, Inc., 2500 Harbor Blvd., Fullerton, Calif. Phone: (714) 871-4848. P&A: \$12.50 or \$13.50; stock.

Requiring only a low standby current, hybrid cermet overvoltage monitors protect power lines with an adjustable triggering speed and a 10-A peak surge capability. They can be used for direct control in a shunt mode or for indirect control along with SCRs. They handle 4-A continuous current and 11-W power. Series 826 has threshold points from 8 to 40 V, and series 827 covers the 5-to-7-V range.

CIRCLE NO. 270

Npn/pnp transistors dissipate 35 watts

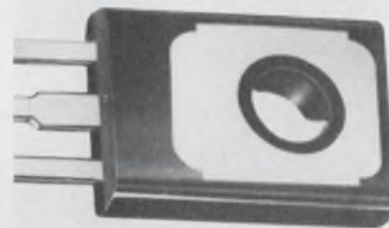

Motorola Semiconductor Products, Inc., P.O. Box 955, Phoenix, Ariz. Phone: (602) 273-6900. Price: \$1.05 to \$1.95.

Providing high performance at low cost, Thermopad complementary silicon power transistors handle 35 W of power at 4-A collector current. Types 2N5190 to 2N5195 can be used as npn/pnp pairs to gain these advantages: direct-coupled complementary symmetry and a high degree of frequency stability without the addition of expensive impedance-matching driver transformers. Collector-to-emitter sustaining voltages range from 40 to 80 V.

CIRCLE NO. 271

FET-input amplifier requires only 500 μ A

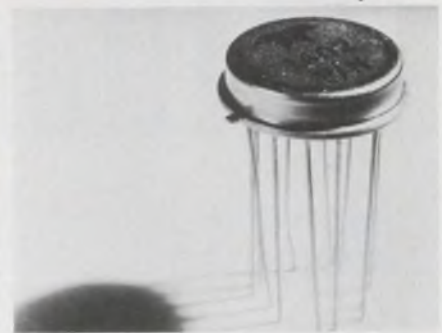

Philbrick/Nexus Research, A Tele-dyne Co., Allied Dr. at Route 128, Dedham, Mass. Phone: (617) 329-1600.

Model 1402 FET operational amplifier operates over a wide range of power supply voltages, from as low as ± 4 V up to ± 24 V, with a quiescent current of only 500 μ A. This thin-film hybrid circuit features a high input impedance of 10^6 M Ω , low bias currents of 10 pA, and low wideband noise for both voltage and current.

CIRCLE NO. 272

A-D 12-bit converter contains 150 gates

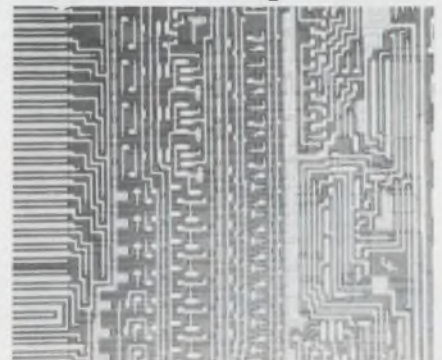

Fairchild Semiconductor, 313 Fairchild Dr., Mountain View, Calif. Phone: (415) 962-2530. P&A: \$144; stock.

Providing the equivalent of 150 gates in one 36-pin dual-in-line package, a 12-bit A-D converter performs the functions of approximately three circuit boards of integrated circuitry. It only requires the addition of an external ladder network, a comparator, and a reference voltage source. The 3751 features parallel or serial output with the option of 10-bit binary or 12-bit BCD conversion format.

CIRCLE NO. 273

***Accelerated Cathode Excitation
SCR from the Power House.**

Meet the tradeoff eliminator: our new 80-ampere-average ACE[®] SCR in a TO-94 case. Now you can toss out complex hard firing circuits, get more power output per SCR. In other words, get maximum power at lowest system cost.

The ACE SCR allows low amplitude soft firing, and has the industry's highest di/dt (800 A/ μ s per JEDEC #7) along with high frequency performance to 10 kHz (250 amperes peak at 60 Hz and 210 amperes peak at 5 kHz). It's rated to 1200 V and provides 200 V/ μ s dv/dt with 40 μ s turnoff time. Advance specifications from the Power House, 233 Kansas St., El Segundo, Calif. 90245. Phone (213) 678-6281.

INTERNATIONAL RECTIFIER



**Super
ace***

Aircraft Flight Mechanisms:

4 weeks delivery.
MIL-SPEC quality.
The industry's lowest prices.

Nobody else but Ideal brings you all these benefits. Including high torque and sensitivities, up to 80° deflection, complete shielding, low weight, synchro or standard mounting, all shapes of pointers and flags—and customizing of all parameters. American-made. We're known for experience and

promises kept. Write for free 34-page catalog. Ideal Precision Meter Co., Inc., 218 Franklin St., Brooklyn, N.Y. 11222 (212) EVergreen 3-6904.

National Master Distributor: EN-CER, Inc., 16850 So. State St., So. Holland, Illinois 60473 (312) 339-6310.



INFORMATION RETRIEVAL NUMBER 61

NATIONAL®

Regenerative Gate* SCR

lowest switching losses

Operates to 20 KHz with switching losses lower than any other high power SCR available. Ideal for inverters, choppers, DC to DC converters, cycloconverters. Only the Regenerative Gate* SCR gives 600 amperes/ μ sec. di/dt with low power gate drive. 110 ampere rating available with 200 volts/ μ sec. minimum dv/dt and 10 μ sec. maximum turn-off time.

*A NATIONAL® exclusive.
Patent Pending.

NATIONAL
ELECTRONICS, INC.

a varian subsidiary

PHONE: (312) 232-4300 • GENEVA, ILLINOIS 60134

REQUEST BULLETIN



INFORMATION RETRIEVAL NUMBER 62

ICS & SEMICONDUCTORS

Pnp power transistors
carry 1 A at 300 V

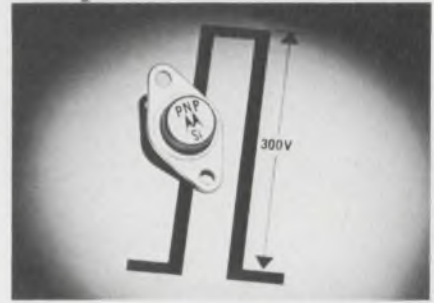

Motorola Semiconductor Products, Inc., P.O. Box 20924, Phoenix, Ariz. Phone: (602) 273-6900. P&A: \$12 or \$15; stock.

Pnp silicon power transistors, the 2N5344 and the 2N5345, are capable of carrying a collector current of 1 A when collector-to-emitter voltage is 250 and 300 V, respectively. Both transistors are fast switches with a maximum turn-on time of only 200 ns at 500 mA and 100 V. Their high-voltage rating permits direct 117-V line operation without step-down transformers.

CIRCLE NO. 274

Low-level amplifier
has beta of 500

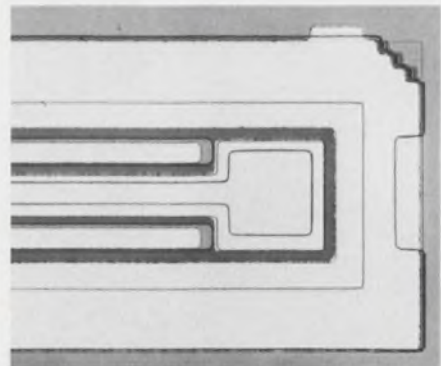

Fairchild Semiconductor, 313 Fairchild Dr., Mountain View, Calif. Phone: (415) 962-2530. P&A: \$2.40; stock.

Operating from dc to radio frequencies, a pnp low-level amplifier provides current gains from 50 to 500 at 10 μ A and a maximum noise figure of 4 dB at 1 kHz. Type 2N4359 has a minimum collector-to-emitter breakdown voltage of 45 V and a low leakage current of 10 nA. It is supplied in a TO-18 metal can.

CIRCLE NO. 275

THE OUTCLASSERS!

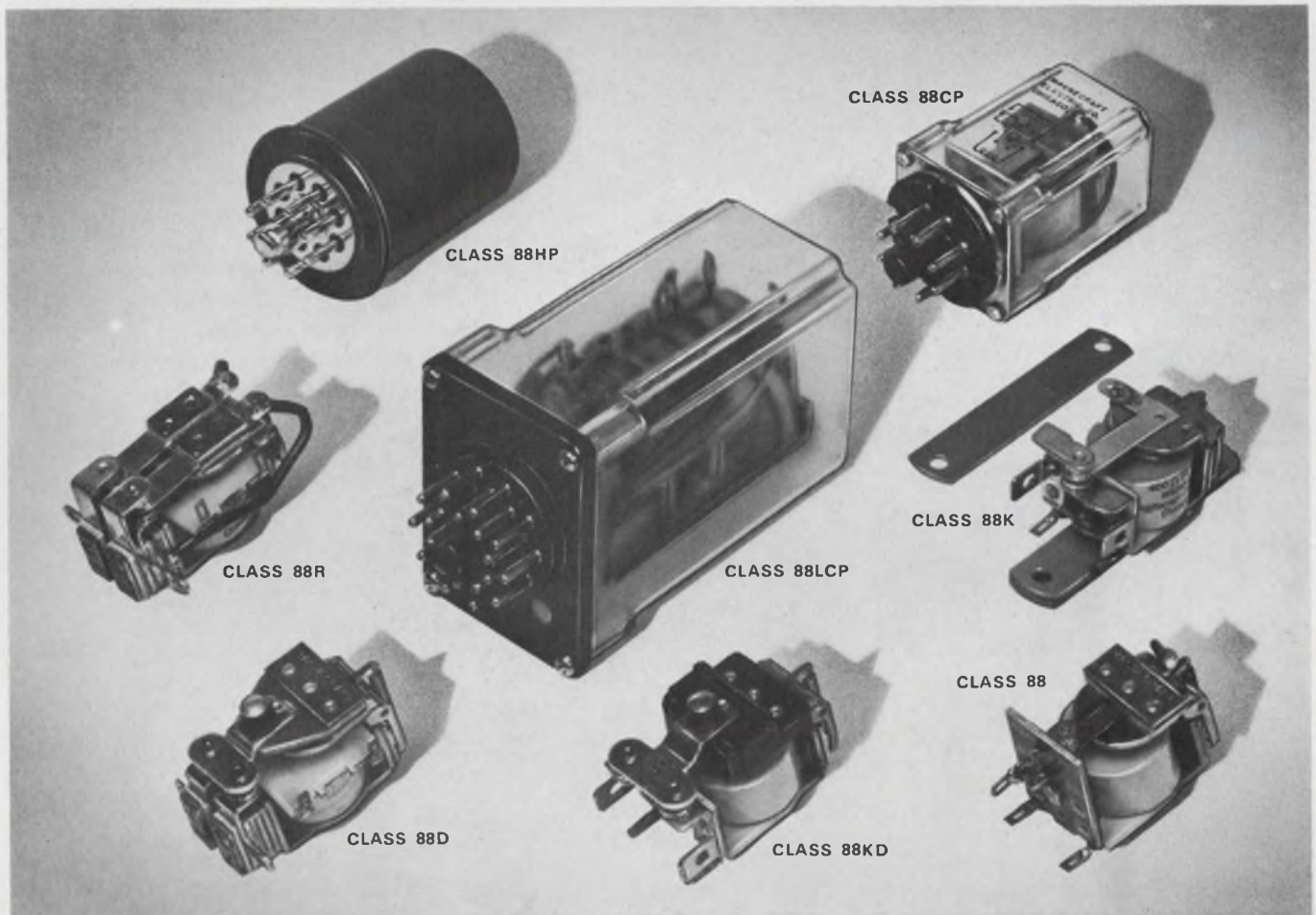

MAGNECRAFT GENERAL PURPOSE RELAYS

Our general purpose relays aren't known as the least expensive. But they have earned the reputation for reliability with the most consistent performance record of any general purpose relay on the market.

In addition, Magnecraft has more general purpose relays in stock than anyone else. This means nearly all your requirements can be filled in days—if not hours. As for variety, we have it over the others with relays such as our improved Class 88KD 50 ampere relay that's ideal for industrial switching applications. And the new Class 88LCP Latching Relay that's composed of two Class 88 Relays with interlocking latching levers mounted on a common base and a crack-proof polycarbonate cover.

If all this doesn't overcome price alone, better forget us. But if you want large silver cadmium oxide contacts, precision hinge-pin armature bearings, molded nylon bobbins and overall custom made quality, then keep us in mind for all general purpose relays. Ours outclass the others at any price.



FREE! Product File — Yours for the asking. Contains full details on all our stock relays.

Magnecraft® **ELECTRIC CO.**

5575 NORTH LYNCH AVENUE • CHICAGO, ILLINOIS 60630 • 312 282-5500

INFORMATION RETRIEVAL NUMBER 63

NEW O.E.M.

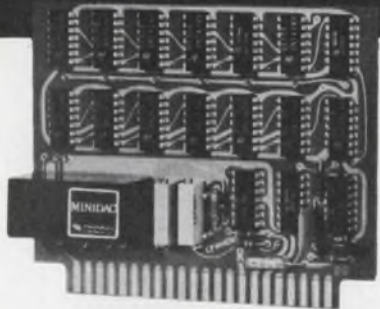

3 3/4" x 4 1/2" x 1/2"

A-to-D Converter

Pastoriza offers the first utility converter for systems applications . . . priced for quantity sales.

Having first introduced the modular A-to-D and D-to-A converter, Pastoriza Electronics now offers an unprecedented innovation: A printed circuit card A-to-D converter featuring . . .

High Performance

- 12 bits conversion in 8 microseconds.
- 10 bits conversion in 4 microseconds.
- 8 bits conversion in 2 microseconds.

Low Cost

Priced competitively with any ADC available today, and designed for volume production.

Open Book Concept

No black magic in the design — circuitry is accessible and repairable.

User Confidence

Design and component information is supplied to insure ease and confidence in customer application.

This complete single-card A-to-D converter includes reference supply and comparison amplifier, using dual in-line integrated circuit logic with a MINIDAC D-to-A module. It accepts 0 to +10 volts input range, and provides up to 12 bits resolution.

Write for eye-opening facts on this newest modular A-to-D utility converter.

PASTORIZA
ELECTRONICS, INC.

385 Elliot St., Newton, Mass. 02164 • 617-332-2131

INFORMATION RETRIEVAL NUMBER 64

DATA PROCESSING

D-A binary ladders settle in 50 ns

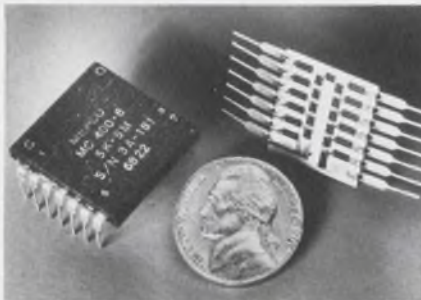

Mepco, Inc., Columbia Rd., Morristown, N.J. Phone: (201) 539-2000.

Binary ladder networks with a maximum settling time of 50 ns convert data from digital to analog to within one-half the least significant bit. Available in five resistance values from 1 to 10 kΩ, series R-2R operates over the temperature range of -55 to +125°C. Standard resistance tolerance is 5%, but 1% units are available. The networks are supplied with standard DIP mounting pins.

CIRCLE NO. 276

Glass tape reel does not deform



Corning Glass Works, Optical Products Dept., Corning, N.Y. Phone: (607) 962-4444.

Eliminating many of the problems that plague recording equipment, this glass tape reel will not warp or bend even under extreme environmental conditions. Its glass flanges cannot be dented; when squeezed together, they will return to shape immediately. Because of this reduction of flange deflection, tape edges and recorded data on the tape are protected. The smoothness of the glass flanges also serves to minimize tape-edge wear and damage.

CIRCLE NO. 277

Digital logic cards operate at 10 MHz

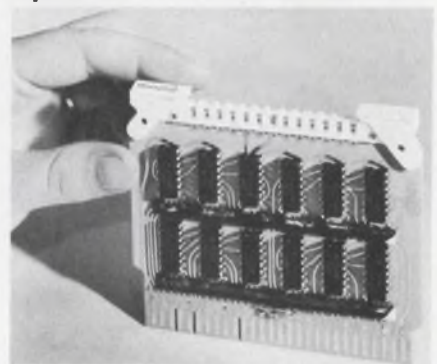

Electronic Engineering Co. of Calif., 1601 E. Chestnut Ave., Santa Ana, Calif. Phone: (714) 547-5501. P&A: \$36 to \$240; stock.

Thirteen new digital logic cards use TTL ICs to operate at speeds as high as 10 MHz. Types D-4201 to D-4213 expand the EECoLogic 2 line to 64 cards. Included are J-K flip-flops, multiple-input NAND gates, retriggerable one-shots, inverters, a shift register, dual binary and BCD counters, a NAND buffer, and a 4-bit digital magnitude comparator.

CIRCLE NO. 278

A-D converter module allows bipolar output

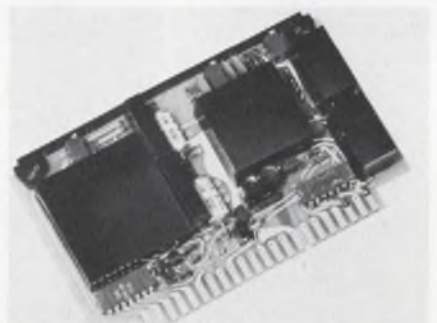

Analogic Co., 296 Newton St., Waltham, Mass. Phone: (617) 891-4708. P&A: \$275; stock.

Model AN2200-AVS plug-in module permits true bipolar operation of A-D converters that provide only complementary output codes for bipolar inputs. With a ±10-V step input, the module settles to 0.01% of its final output amplitude in 2.5 μs. It has a high transfer accuracy of 0.005% full scale, over the temperature range of 0 to 70°C.

CIRCLE NO. 279

TWO GREAT CONDUCTIVE PLASTIC PRECISION POTENTIOMETERS FROM BOURNS



MODEL
3438
SINGLE TURN
\$800*

Units Shown
Actual Size

MODEL
3501
TEN TURN
\$1375*

BOTH AVAILABLE FROM DISTRIBUTORS FOR IMMEDIATE DELIVERY

These standard models offer outstanding specifications . . . lowest priced conductive plastic . . . immediate delivery.

The 3438 and 3501 Conductive Plastic potentiometers are another indication of the depth of the Bourns line. Other models, non-linear and linear and with or without load compensation, available to your specific requirements including Mil-R-39023. If your needs call for a single-turn or a ten-turn . . . Bourns has the solution! Before you specify or buy just any conductive plastic units, take a good look at the 3438 and 3501.

Get all the data you need for a sound decision. Write today for the latest catalog sheets or call your local Bourns office, representative, or stocking distributor.

SPECIFICATIONS	Model 3438	Model 3501
Resistance Range	100Ω to 1 Meg	1K to 1 Meg
Resistance Tolerance	±20%	±10%
Linearity (Independent)	±1.0%	±0.5%
Power	1 Watt at 40°C	2 watts at 70°C
Temperature Range	-15 to +105°C	-55 to +105°C
Rotational Life	20,000,000 shaft revolutions	50,000,000 shaft revolutions
Vibration	10G	20G
Shock	15G	100G



*Price for 1-9 pcs.

BOURNS, INC., TRIMPOT DIVISION • 1200 COLUMBIA AVE., RIVERSIDE, CALIF.
TELEPHONE (714) 684-1700 • TWX: 910 332-1252 • CABLE: BOURNSINC.

TRIMPOT® and Precision Potentiometers - Miniature Relays - Electronic Modules - Microcomponents.

INFORMATION RETRIEVAL NUMBER 65



**New
MINIDAC
High-Speed D-to-A
Converter in a
small package**

- 3/4" x 3/4" x 1 1/2"
- No Switching Transients
- Low Price

MINIDAC is an extremely versatile, UHF Digital-to-Analog converter module designed for driving into 100 ohm matching impedance. It may also be used with Operational Amplifiers for greater voltage ranges. These modules accept RTL, DTL or TTL input signals, include reference, switching, resistors, and provide currents of up to 10 ma. into resistive load.

Output voltage time constant is less than 30 nanoseconds and will settle to 0.1% in 200 nanoseconds. An external threshold adjustment permits user to adjust the actual switching threshold minimizing the variations in rise and fall times in his logic. Feed through of switching signals has been eliminated.

APPLICATIONS

- High Speed Scope Deflection Systems
- Time Compression
- High Speed A/D Converters
- Precision High Speed Test Circuits

MINIDAC units are available in up to 12 bits Binary or BCD input codes, and current output ranges of 4 and 10 ma. Maximum output voltage without amplifier is 2 volts. Custom designed D/A Converters including Buffer Storage and special output Amplifiers are available upon request.



385 Elliot St., Newton, Mass. 02164 • 617-332-2131
INFORMATION RETRIEVAL NUMBER 66

DATA PROCESSING

**Fast A-D converter
resolves 15 bits**

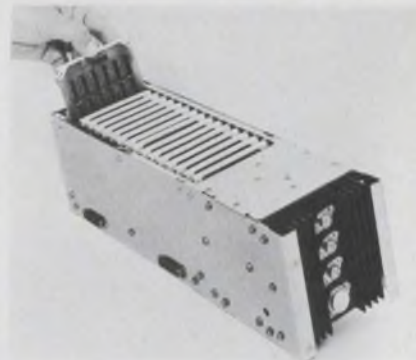

Electronic Engineering Co. of Calif., 1601 E. Chestnut Ave., Santa Ana, Calif. Phone: (714) 547-5501. P&A: \$6000 to \$7000; 60 days.

Intended as a direct computer input and for analysis of rapidly varying analog information, a high-speed A-D converter completes 250,000 conversions per second with a resolution of 15 binary bits. Model 1200 can be supplied with a single input or with an integral 4-channel multiplexer. It is isolated from other circuits to minimize noise pickup and to insure stability.

CIRCLE NO. 280

**Nylon-mesh filters
clean computer air**

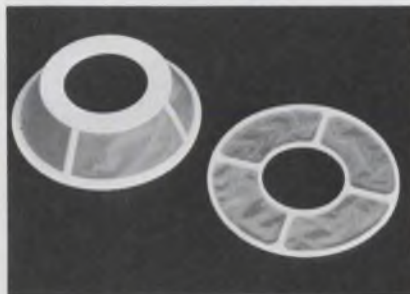

Nylon Filter Corp., Dept. EI-2, 932 W. Huron St., Chicago. Phone: (312) 321-0200.

With a nylon mesh of 44-to-48-micron fineness, a new line of air filters protect computer information storage systems from dust and contaminants. Compared to other types of filters, these permit freer air flow while performing their filtering function. Several styles and sizes are available, including the flat disc and frustum types used in disc packs.

CIRCLE NO. 281

**Transmission system
varies data speed**



Lenkurt Electric, Sub. of General Telephone & Electronics, 1105 County Rd., San Carlos, Calif. Phone: (415) 591-8461.

Designated the 25B, a low-speed data transmission system uses passive plug-in filters to vary channel spacings and data speeds from 120 Hz for 75 bits/s to 1.02 kHz for 600 bits/s. The new system will operate over most types of transmission facilities including cable, open-wire and microwave-multiplex systems, and microwave supervisory channels. It can be arranged for either 2- or 4-wire circuits.

CIRCLE NO. 282

**A-D converter
has dual output**



Theta Instrument Corp., 22 Spielman Rd., Fairfield, N.J. Phone: (201) 227-1700. P&A: from \$300; 30 days.

Using dual-slope integration, an analog-to-digital converter, which accepts inputs of 0 to 1 V dc, produces simultaneous BCD and decimal outputs. Conversion speed is 10 ms with a maximum sampling rate of 50 readings/s. Full-scale accuracy is 0.1%, and input impedance is greater than 100 MΩ.

CIRCLE NO. 283

Two
Very Handy
Alfred Detectors

10 MHz to 12.4 GHz

± 0.5 db Response

SWR Less than 1.5

Providing a full-range flat frequency response of better than ± 0.5 db, SWR of less than 1.5 and high sensitivity, new broadband Crystal Detectors ALFRED Models 1001 and 1002 are ideally suited to many applications, including:

Power Leveling. The flat frequency response of the Model 1001 coupled with ALFRED Directional Couplers provides precise power leveling to ± 0.3 db over octave bandwidths.

Power Measurements. The low SWR and exceptional stability of the Model 1001 permit accurate, long-term power measurements.

Broadband RF Detection. Characteristics of RF devices may be accurately displayed as a function of frequency using an oscilloscope or XY plotter and an Alfred sweep oscillator.

Reflectometer Measurements. The exceptionally uniform crystal characteristics provide the matched frequency and square law response required for reflectometer measurements.

Video Response. Output capacitance is low (approximately 30 pf) for outstanding video response.

BRIEF SPECIFICATIONS

Frequency Range: 10 MHz - 12.4 GHz
Frequency Response: ± 0.5 db
full range

SWR: Less than 1.4 to 10 GHz and 1.5 to 12.4 GHz

Sensitivity (no load): Power input required to produce 0.1 v rectified output—no greater than 0.4 mw

Square Law Response: Within ± 0.5 db, low level to 1 mw input when properly terminated

Maximum Input Power: 100 mw

Dimensions: 2.4" long x 0.8" diam.

Connectors: Input, Model 1001 Type N, and Model 1002 OSM; output BNC

Price: \$115 with BNC, \$160 with OSM Connector

For complete details, ask your local ALFRED representative or contact us at 3176 Porter Drive, Palo Alto, California 94304. Phone (415) 326-6496.



Model 1001
with Type N Connector



Model 1002
with OSM Connector

ALFRED ELECTRONICS

INFORMATION RETRIEVAL NUMBER 67

Hot-air gun shrinks plastic

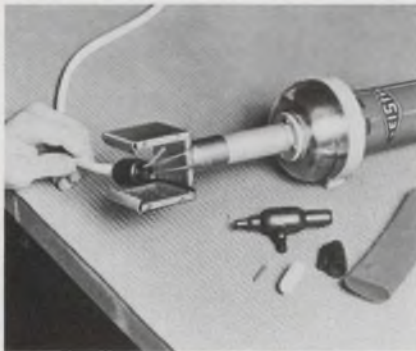

Brian R. White Co., 15158 Golden West Circle, Golden West Industrial Parks, Westminster, Calif. Phone: 681-8334.

The Leister hot-air welding gun simplifies precision heating of shrinkable-plastic encapsulating and molding materials. Working temperatures at the nozzle range from 68 to 1112°F. Temperatures are governed by a six-stage switch on the handle which also contains the blower.

CIRCLE NO. 284

Compressed-air gun neutralizes static



3M Co., 3M Center, St. Paul, Minn. Phone: (612) 733-1590. Price: \$69/year.

By supplying ionized air, the 902 portable air gun blows away dust and neutralizes static electricity in one operation. The barrel of this compressed-air device contains a nuclear source that ionizes air as it is blown out of the gun. Ready to be attached to an air line, the standard model is equipped with a 1/8-in. orifice, coupler plug, and a hose end.

CIRCLE NO. 285

Portable pump kit transfers liquids



Miller-Stephenson Chemical Co., Route 7, Danbury, Conn. Phone: (203) 743-4447.

A portable miniature pump kit uses an aerosol-type propellant to transfer liquids from one container to another. Porta-pump consists of an aerosol can fitted with a special valve head, a graduated 250-in.³ plastic bottle, and a length of plastic tubing. The valve head provides either pressure or suction, as desired, to expel or pump a liquid between the bottle and another vessel. Both actions can be controlled to an accuracy of one drop.

CIRCLE NO. 286

SLIDE-TROL® — NEW CONCEPT IN POTENTIOMETER DESIGN

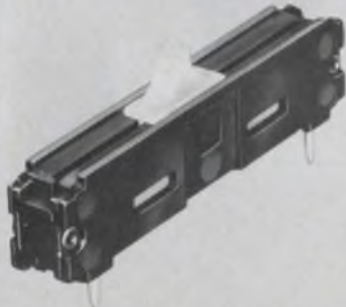

- Mount horizontally, vertically or sideways, either singly or in multiple units.
- Standard solder lug, wire wrap or printed circuit terminals available.
- Low noise and low contact resistance, plus uniform heat distribution.
- Ratings 40-500Ω 1.5 watts, 500-5KΩ 1.25 watts, 5KΩ and over 1 watt.
- Thermal expansion-contraction and shock hazard problems eliminated.
- Know resistance setting at a glance.
- Compact, lightweight, functional, attractive.
- Write for SLIDE-TROL® Brochure.



STACKPOLE
COMPONENTS COMPANY
P. O. Box 14466
Raleigh, N. C. 27610

INFORMATION RETRIEVAL NUMBER 68

UNIQUE DESIGN ADDS VALUE AND APPEAL

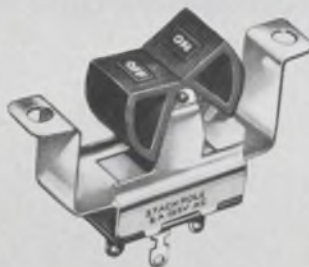

- 23 rocker switch configurations, including 2-3 positions, spring return and center-off.
- Variety of rocker designs available in a spectrum of colors and hot-stamped lettering.
- Listed by UL AND CSA, 1 to 10 amps at 125V AC.
- Solder lug, space saver, quick-connect or printed circuit terminals.
- Field-proven quality same as famous Stackpole slide switches.
- Prices start at less than 15¢.
- Write for engineering literature.



STACKPOLE
COMPONENTS COMPANY
P. O. Box 14466
Raleigh, N. C. 27610

INFORMATION RETRIEVAL NUMBER 69

ENVIRONMENT PROOF ROTARY SWITCHES

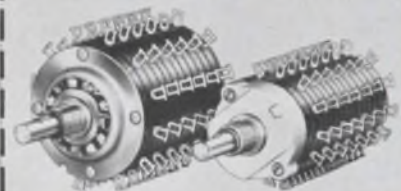

Series 600 1 1/2" Dia. — Series 100 1 1/8" Dia.

- Both index mechanism and electrical sections are completely enclosed.
- Corrosive atmospheres, dust, dirt and moisture are permanently sealed out, lubricants sealed in.
- Solder or quick-connect terminals molded permanently into position minimize production damage.
- Standard index angles include 15°, 30°, 36°, 60° and 90°, special angles available on request.
- Write for engineering bulletin.



STACKPOLE
COMPONENTS COMPANY
P. O. Box 14466
Raleigh, N. C. 27610

INFORMATION RETRIEVAL NUMBER 70

Liquid dispenser sprays and refills



Techni-Tool, Inc., 1216 Arch St., Philadelphia. Phone: (215) 568-4457.

Designed for lightweight liquids, a pressure sprayer dispenses contact cleaners or specialized lubricants with a pin-point stream or a spray mist. The unit, which is pressurized by free air, can be refilled and reused. Known as Sure-Shot, the portable sprayer is available in sizes of 6 oz or 1 quart.

CIRCLE NO. 287

Hand-held tool pigtails cable

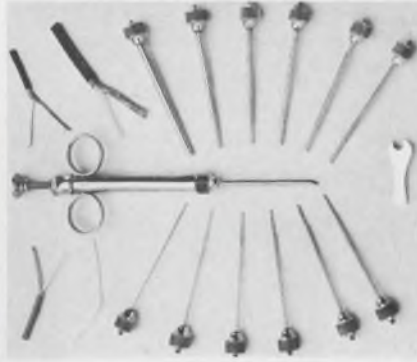

Bailey Co., 5919 Massachusetts Ave., Washington, D. C. Phone: (301) 656-2625. P&A: \$73.50; stock.

A syringe-like tool separates the core of a shielded cable from the braiding, making a neatly finished pigtail in one swift operation without breaking wires. Type GD-13 Lead Ejector includes 13 polished plungers for braided cable with inside diameters from 0.036 to 0.175 in.

CIRCLE NO. 288

Circular heater shrinks tubing



Hi-Shear Corp., 2600 W. 247th St., Torrance, Calif. Phone: (213) 775-3181.

Encircling heat-shrinkable tubing with twin rings of radiant heat, model LTH300 heating device works without shifting wire or sleeves. Its circular working area is 1 in. in diameter when the twin heating elements are closed.

CIRCLE NO. 289

SOLVE NOISE AND FILTERING PROBLEMS WITH CERAMAG® FERRITE BEADS

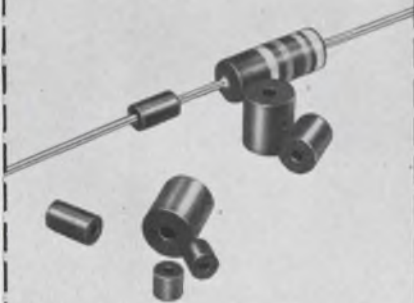

- Ceramag® ferrite beads are low cost, easy to install, and save space.
- Effective r.f. decoupling, shielding and parasitic suppression without sacrificing low-frequency power or signal level.
- Installed by simply sliding one or several over conductor leads.
- Beads can, but need not, be grounded.
- Sizes from .040" ID — .100" OD — 100" L.
- Sample quantities available.

 **STACKPOLE**
CARBON COMPANY
Electronic Components Division
St. Marys, Pa. 15857

INFORMATION RETRIEVAL NUMBER 71

GUARANTEED UNIFORMITY IN ELECTRICAL, PHYSICAL CHARACTERISTICS

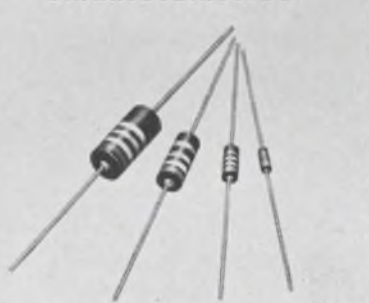

- Available in 2, 1, ½ and ¼ watt sizes.
- Uniform from resistor to resistor, order to order.
- 100% tested for resistance value.
- Same day shipment on 9 orders out of 10.
- Solderability, load life and humidity-temperature characteristic checked.
- Impregnated to assure moisture resistance.
- Write for literature.

 **STACKPOLE**
CARBON COMPANY
Electronic Components Division
Kane, Pa. 16735

INFORMATION RETRIEVAL NUMBER 72

NEW SPECIAL PURPOSE RESISTOR PROTECTION



- Currently in use on lightning arrestors, circuit breakers, spark plugs.
- Available in rods, sleeves, rings, special shapes, up to 15" in length and 5" in diameter.
- Ceramic composition favors high voltage applications with high surges.
- Organic Special Purpose Resistors are inexpensive solution where heat dissipation is necessary.
- Both ceramic and organic available in wide range of resistivity values.
- Write for technical assistance.

 **STACKPOLE**
CARBON COMPANY
Electronic Components Division
St. Marys, Pa. 15857

INFORMATION RETRIEVAL NUMBER 73

New Johanson capacitors help you make ends meet.



Solder directly on P/C board
(minimum stray capacity).



Solder one end to coupling link
and other end to cavity wall.



Solder ends to terminals of
another component.



Solder one end to P/C board
and attach lead to other end.

The new Johanson 7200 capacitor is ideal for balancing of semi-conductors and microwave components, for trimming of small fixed capacitors, for UHF oscillators, for coupling (VHF and UHF), for terminations for UHF coupling links, and for strip lines and modular blocks.

The 7200 features tubular electrodes which provide for low losses and low inductance at microwave frequencies. They also feature a low minimum capacitance 0.1 pF (10:1 tuning ratio) and Q of 500 at 200 MHz. Call or write for complete information.

Johanson

**MANUFACTURING
CORPORATION**

400 Rockaway Valley Road
Boonton, N.J. 07005 • (201) 334-2676

Electronic Accuracy Through Mechanical Precision

INFORMATION RETRIEVAL NUMBER 75

PRODUCTION

Drawing/drafting rulers measure automatically

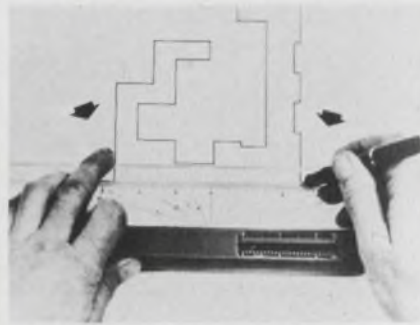

Sidney Corn Enterprises, 1317
Third Ave., Los Angeles. Phone:
(213) 985-1228. Price: \$4.95 or
\$6.95.

For drawing horizontal, vertical, or angular parallel lines in automatically measured distances, two double-scaled calibrated drawing/drafting rulers combine a T-square, a rolling ruler, and a special plastic triangle with metal roller. The Speedliner ruler has scales in 16ths and 10ths of an inch, and scribes circles and arcs to diameters of 22 in. The Line-master ruler, which has an outrigger bar, draws a variety of lines in measured distances in a single continuous unbroken line.

CIRCLE NO. 290

Handheld cutters hold snipped wires



Dentronix Corp., P.O. Box 237,
Cornwells Heights, Pa.

A feature called Shear-Hold permits stainless steel cutting pliers to retain cut wires in the jaws. The new tools avoid the possibility of injury to the operator and of damage to small components from flying wires. All cutting edges are high-speed tool steel, inserted and finished by hand for each tool. Tip alignment is continuously maintained by box joints.

CIRCLE NO. 291

Ultrasonic generators tune automatically



Phillips Mfg. Co., 7334 N. Clark
St., Chicago. Phone: (312) 338-
6200.

Featuring automatic tuning, Cavmatic 25 ultrasonic generators can be frequency and phase locked in a cascaded series. Each unit may be used as a module of an entire system with all control handled by a single unit. The generators may be used for conveyORIZED batch or manual production-line cleaning and degreasing. As the production system is expanded, units can be added to handle the new load.

CIRCLE NO. 292

Step and repeat system has 80- μ in. accuracy

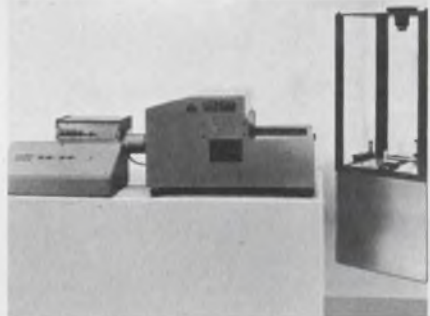

Royal Zenith Corp., 2101 Jericho
Turnpike, New Hyde Park, N.Y.
Phone: (212) 421-7800.

Designed for the reproduction of film and integrated circuits, Miso-matic 102 step-and-repeat system delivers a dimensionally stable contact print with excellent definition even at the periphery. It is capable of producing minimum steps of 0.001 in. with a guaranteed accuracy of 0.00008 in. The system features a precision camera with a fixed focus lens for 10 \times reduction in an independently suspended chassis.

CIRCLE NO. 293

New WETREED Relays eliminate reed bounce or chatter in microvolt or power switching ranges



Hathaway's new mercury-wetted reed relays give super-reliability wherever low level data is important

Super-reliable because the Hathaway WetReed's contacts are coated with a mercury film that breaks clean and cushions the reeds on contact. The mercury carries current in spite of mechanical bounce on contact and electrical chatter is eliminated. Cushioned contact also prevents arcing and reed corrosion. That's why you can expect billions of reliable operations from Hathaway WetReeds.

And they're fast—operate time as low as three milliseconds. Low contact resistance of less than 50 milliohms at the relay terminals remains constant, within a few milliohms, throughout the life of the relay. Contact rating is up to 250 volt-amperes.

Hathaway's new WetReed Relays undergo the same exhaustive production lot pre-testing that has made our DriReed line so successful. Hathaway takes extra steps to make sure the relays we ship are really reliable. Each lot performs to our exacting standards or the whole batch is scrapped.

Telemetry instruments, data control, test equipment—wherever high-speed chatter-free switching is mandatory, Hathaway has the new WetReed Relay with lot-proved reliability for you. Write for the complete Hathaway WetReed Catalog.



HATHAWAY INSTRUMENTS, INC.

5250 E. EVANS AVENUE • DENVER, COLORADO 80222 • (303) 756-8301

Established 1938

INFORMATION RETRIEVAL NUMBER 76

Wedge-Action*



Relays

Hermetically-sealed, electromagnetic relays that provide high performance and reliability under the most difficult operating conditions in dry-circuit to 2 amp applications.



2 PDT
MARK II, SERIES 500
MIL-R-5757/9



2 PDT
MARK II, SERIES 400
(1.35" high)
SERIES 410 (1" high)
MIL-R-5757/8



6PDT 4PDT
(1" x 1")
MARK II, SERIES 300
(6 PDT).
SERIES 350 (4 PDT).
MIL-R-5757/1 and
MIL-R-5757/7



6PDT
MARK II, SERIES 085
(-55°C to +85°C)
SERIES 100
(-65°C to +125°C),
SERIES 200
(-65°C to +200°C).
MIL-R-5757/1.

*Wedge-Action



The moving contacts are mounted between two stationary contacts. On actuation, they drive into the stationary contacts, creating high pressures and low

contact resistance at all current levels. In addition, wedge-action contact wipe provides self-cleaning of the precious-metal contacts.

*Patent No. 2,866,046 and others pending.

For complete data write Relay Sales and Engineering Office, P. O. Box 667, Ormond Beach, Fla. 32074, Phone 904-677-1771, TWX 810-857-0305.

Electro-Tec Corp.

A DIVISION OF KDI CORPORATION **KDI**

INFORMATION RETRIEVAL NUMBER 77

PACKAGING & MATERIALS

Portable air spray dusts confined area

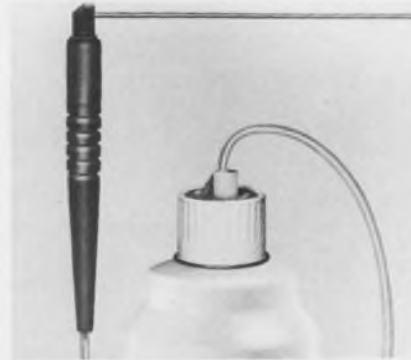

Miller-Stephenson Chemical Co., Inc., Route 7, Danbury, Conn. Phone: (203) 743-4447.

Called Extend-Air, a new aerosol source of pressurized air removes dust and other particles from hard-to-reach places in delicate assemblies. Its valve and extension nozzle are connected to the can by a length of plastic tubing. The aerosol propellant forces air to the valve where it is controlled by the user with simple fingertip pressure. One Extend-Air provides up to 30 minutes of continuous air spray.

CIRCLE NO. 294

Plastic clasp bites to lock



Robroy Industries, S. Pennsylvania Ave., Morrisville, Pa. Phone: (215) 295-4123. Price: 33¢ to 50¢.

Useful for a variety of electronic and industrial applications, a polypropylene clasp with interlocking teeth accommodates a wide variety of wire bundle diameters. Called the Hugger, the clasp is available in two sizes. These are supplied with self-adhesive backing or are predrilled for attachment with staples, nails, or screws. It is resistant to corrosive acids and caustic materials, and withstands temperatures to 225°F.

CIRCLE NO. 295

-MATSUO-

THE SPECIALIST OF FILM AND TANTALUM CAPACITORS

POLYESTER FILM CAPACITORS

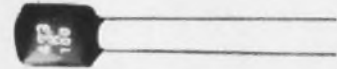

Type MFL epoxy dipped
Standard voltage rating: 35V, 50V, 100V, 200V D.C.
Standard capacitance value: .001 MFD to .22 MFD (E-6 series)



Type MFK epoxy dipped, non inductive
Standard voltage rating: 100V, 200V, 400V, 600V D.C.
Standard capacitance value: .01 MFD to .47 MFD (E-6 series)

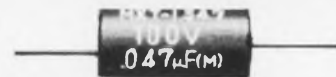

Type MXT encapsulated in plastic tube, non-inductive
Standard voltage rating: 100V, 200V, 400V, 600V D.C.
Standard capacitance value: .001 MFD to .22 MFD (E-6 series)

METALIZED POLYESTER FILM CAPACITOR

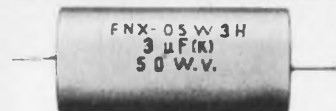

Type FNX-H mylar wrapped
Standard voltage rating: 100V, 200V, 400V, 600V D.C.
Standard capacitance value: .33 MFD to 10 MFD

SOLID TANTALUM CAPACITORS

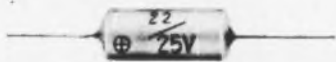

Type TAX hermetically sealed in metallic case
MIL-C-26655B
Standard voltage rating: 6V, 10V, 15V, 20V, 25V, 35V, 50V D.C.
Standard capacitance value: 1 MFD to 220 MFD (E-6 series)



Type TSX encapsulated in metallic case and sealed with epoxy resin
Standard voltage rating: 3V, 6V, 10V, 15V, 20V, 25V, 35V D.C.
Standard capacitance value: 1 MFD to 220 MFD (E-6 series)

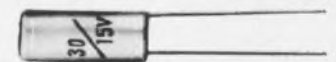

Type TSL encapsulated in metallic case and sealed with epoxy resin
Standard voltage rating: 3V, 6V, 10V, 15V, 20V, 25V, 35V D.C.
Standard capacitance value: 1 MFD to 220 MFD (E-6 series)

For further information, please write to:

MATSUO ELECTRIC CO., LTD.

Head Office: 3-5, 3-chome, Sannari-cho, Toyonaka-shi, Osaka, Japan

Cable: "MCC MATSUO OSAKA"

Telex: 523-4164 OSA

Tokyo Office: 7, 3-chome, Nishi-Gotanda, Shinagawa-ku, Tokyo

INFORMATION RETRIEVAL NUMBER 78

ELECTRONIC DESIGN 23, November 7, 1968

Conductive epoxy conserves silver

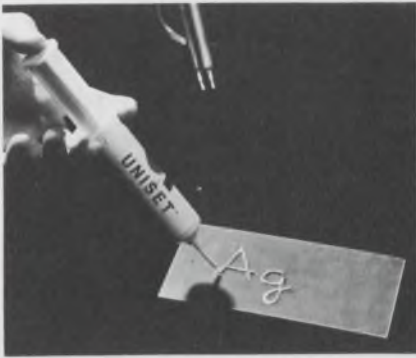

Amicon Corp., Polymer Products Div., 25 Hartwell Ave., Lexington, Mass. Phone: (617) 861-9600.

Uniset C-409 fast-curing no-mix conductive epoxy is a free-flowing paste that eliminates the waste of silver associated with 2-part epoxies. Although it has a shelf life of nine months at room temperature, the compound cures rapidly at temperatures as low as 200°F. It also retains high and stable conductivity, even after prolonged aging at over 300°F.

CIRCLE NO. 296

Resin dispenser has three parts



3M Co., 3M Center, St. Paul, Minn. Phone: (612) 733-4033. Price: \$1 to \$4.

Potting of connectors and other small devices is made simpler and easier with the use of a new 3-compartment Unipak dispensing bag containing Scotchcast 225 resin. Rupturing the seal between the two compartments, that separate parts A and B of the resin allows them to be intermixed by kneading the plastic bag. A third compartment has a removable nozzle through which the resin may be dispensed.

CIRCLE NO. 297

What can you do with a blower motor offering up to 7 stages and 3 psi?

With speeds up to 7500 rpm for the WINDJAMMER 9.5 Belt-Driven Blower, and an "airpower" range as wide as the one shown below?

You can obviously solve a wide range of air-moving problems, and fit these solutions exactly to your requirements. Which is just what Lamb Electric's new WINDJAMMER Blower line is designed to do. A stock of standard modular components allows Lamb Electric to build just the power system you need by adding stages (up to seven), with a choice of motor windings, face or foot mountings plus important optional features. These modular components are already engineered and tooled to eliminate excessive costs and to allow for rapid delivery. And expensive air valves and bleed devices are eliminated by the WINDJAMMER Blower "add on" design.

So while there are no "customizing" costs, Lamb can still exactly satisfy your air-moving requirements in a wide variety of applications. And at the same time reduce the "cost per hour of operation" in computers, business machines, magnetic tape transports, card readers and sorters, fluidic devices. . . .

In fact, there are very few problems you can't solve with the WINDJAMMER Blower line working for you. Size problems? We've got a tough 5.7-inch model for you. Noise? The WINDJAMMER is one of the quietest blowers made. Weight? The typical five-stage unit is 18 pounds. Life? It'll go for over 20,000 hours.

For complete specifications and performance data on the entire WINDJAMMER Blower line, write us today: Ametek, Inc., Lamb Electric Division, Kent, Ohio 44240.

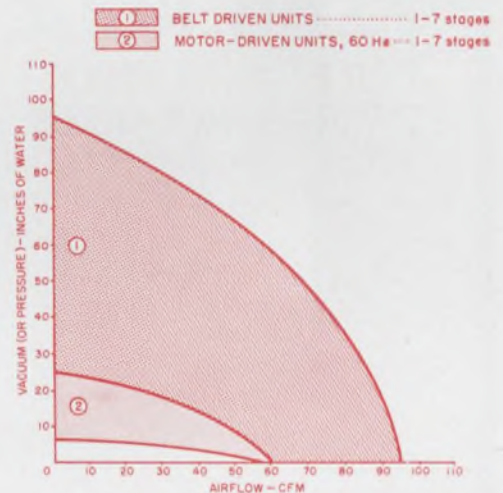
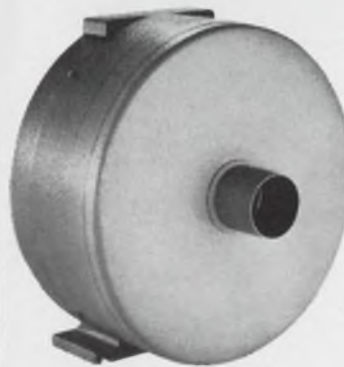
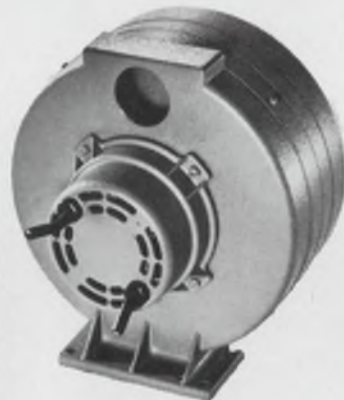

AMETEK / Lamb Electric

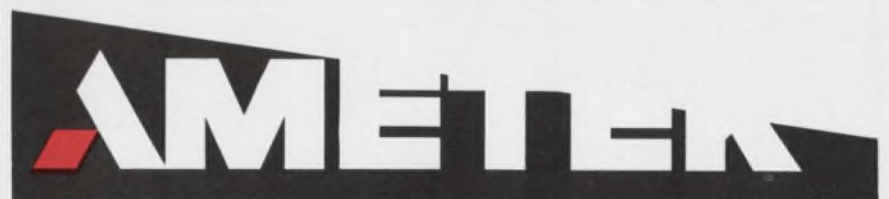

INFORMATION RETRIEVAL NUMBER 79

From I. C. Transistor and Pin Sockets,
to Terminals, Connectors and
Contacts, Robinson-Nugent means
Masters of Miniaturization!

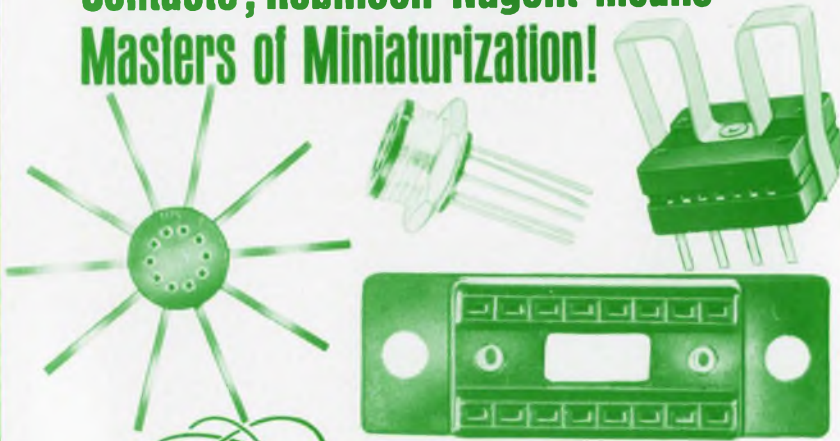

**Robinson
NUGENT
INCORPORATED**

802 EAST EIGHTH STREET / NEW ALBANY, INDIANA 47150
AREA CODE: 812-945-0211

Write or call for complete catalogs and information

MASTERS OF MINIATURIZATION

INFORMATION RETRIEVAL NUMBER 80

PLUG ACCESSORIES

FOR HIGH DENSITY
PACKAGING PANELS

(Using Dual-In-Line I C's)

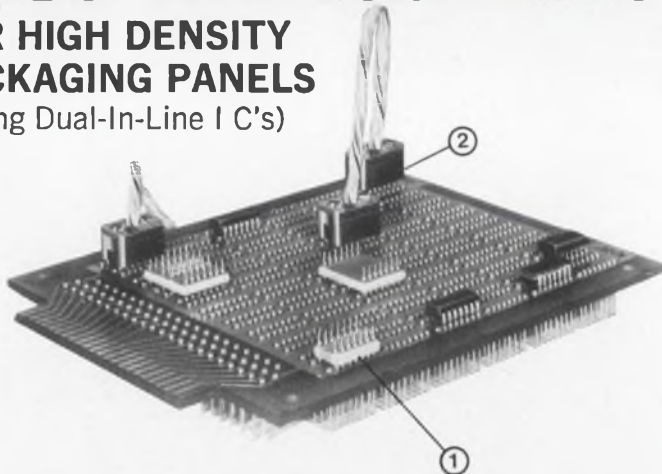

Provide greater flexibility in prototyping and packaging. Facilitate interposing of discrete components. Plugs have 14 and 16 leads with pins on .100" centers and .300" between rows.

- 1 Adaptor Plugs — in single and double pattern combinations. Also permit modular construction with P. C boards and sub-strates.
- 2 Interfacing Plug — permits combining patterns on a single board or interconnection of patterns between boards. Also used as test plug.

Contact patterns on Augat panels permit insertion of I C, adaptor plug or interfacing plug.

Request I. C. folder

AUGAT INC.

TEL: 617/222-2202
31 PERRY AVE., ATTLEBORO, MASS. 02703

INFORMATION RETRIEVAL NUMBER 81

PACKAGING & MATERIALS

Fluorocarbon solvents
exert cleaning action

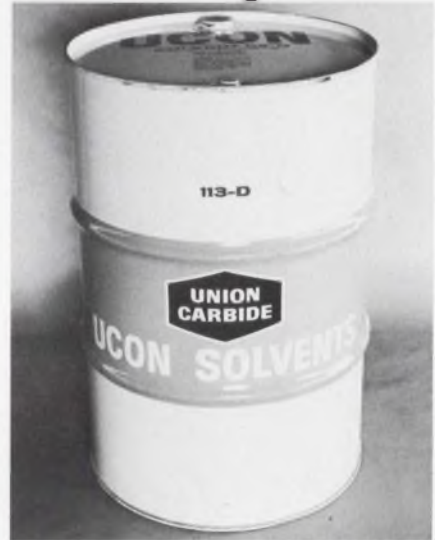

Union Carbide Corp., 270 Park Ave., New York. Phone: (212) 551-3105. Price: \$3.62 or \$5.45/gallon.

Two fluorocarbon-based solvents remove resinous contaminants from electronic equipment and printed circuits without damaging components. UCON 113-DCE is a mild-action solvent; UCON 113-MCP is a high-power solvent for both partially and highly polymerized contaminants.

CIRCLE NO. 298

Teflon bi-pin socket
holds miniature bulb

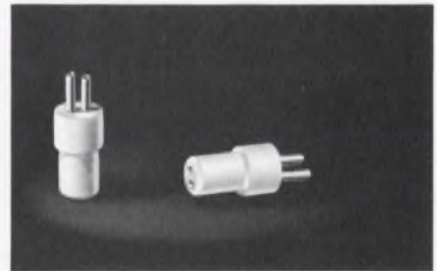

Sealectro Corp., Circuit Hardware Div., 225 Hoyt St., Mamaroneck, N.Y. Phone: (914) 698-5600.

Designated as Press-Fit RTS-261, a bi-pin socket accepts micro-miniature bulbs having two 0.017-in.-diameter leads on 0.05-in. centers. Its minor diameter is 0.135 in., and its major diameter is 0.172 in. Fabricated with Teflon, the socket features contacts with gold flash over silver-plated, rolled, beryllium copper. The Teflon body is available in 10 standard EIA colors.

CIRCLE NO. 324

100,000 HOURS

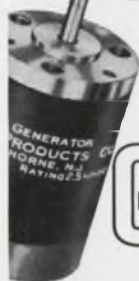

**OF BRUSH LIFE AT 3600 RPM
WITH *Servo-Tek* TEMPERATURE
COMPENSATED TACHOMETER**

GENERATORS

In fact, you could run these dc permanent-magnet generators continuously at 3600 rpm for the next ten years and still have a year and a half of brush life left. They boast a highly linear output and wide speed range making them ideal for velocity or integrating servos, while the low driving torque permits its use as a damping or rate signal in all types of servos. Linearity from 0 to 12000 rpm is better than 1/10 of 1% of voltage output at 3600 rpm. Various models are available with outputs as high as 45v 1000 rpm. The size is miniature. Approximate diameter is 1 1/8". Operates bidirectionally. The rpms value will not exceed 3% of the dc value at any speed in excess of 100 rpm. Single unit prices from \$25.50 with generous quantity discounts. Also available with a meter as a complete Speed Indicating System. ASK FOR CATALOG 1163.

\$25⁵⁰

SERVO-TEK PRODUCTS COMPANY

**1086 GOFFLE RD, HAWTHORNE, N.J. 07506
TELEPHONE 201-427-3100**

INFORMATION RETRIEVAL NUMBER 82

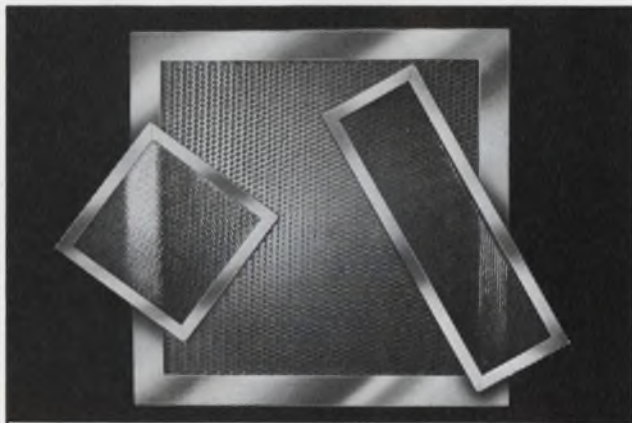

Shield-Cell®

**... removable shielded cooling cells that
install quickly, economically.**

Shield-Cell is available in 3 unique frame designs for quick, low-cost installation. Provides attenuation of up to 100 db. Its metal-to-metal permeated aluminum honeycomb panels can be removed from frames, reducing

replacement costs up to 75%. High-reliability design includes METEX electronic weatherstrip RFI gasket. Shield-Cell mounts inside enclosure for extra protection. Write for prices and literature.

METEX Corporation

970 New Durham Road, Edison, N. J. 08817
(201) 287-0800 • TWX 710-998-0578
West Coast Cal/Metex Corp., 509 Hindry Ave., Inglewood, Calif. 90301
(213) 674 0650 • TWX 910-328-6100



INFORMATION RETRIEVAL NUMBER 83

ELECTRONIC DESIGN 23, November 7, 1968

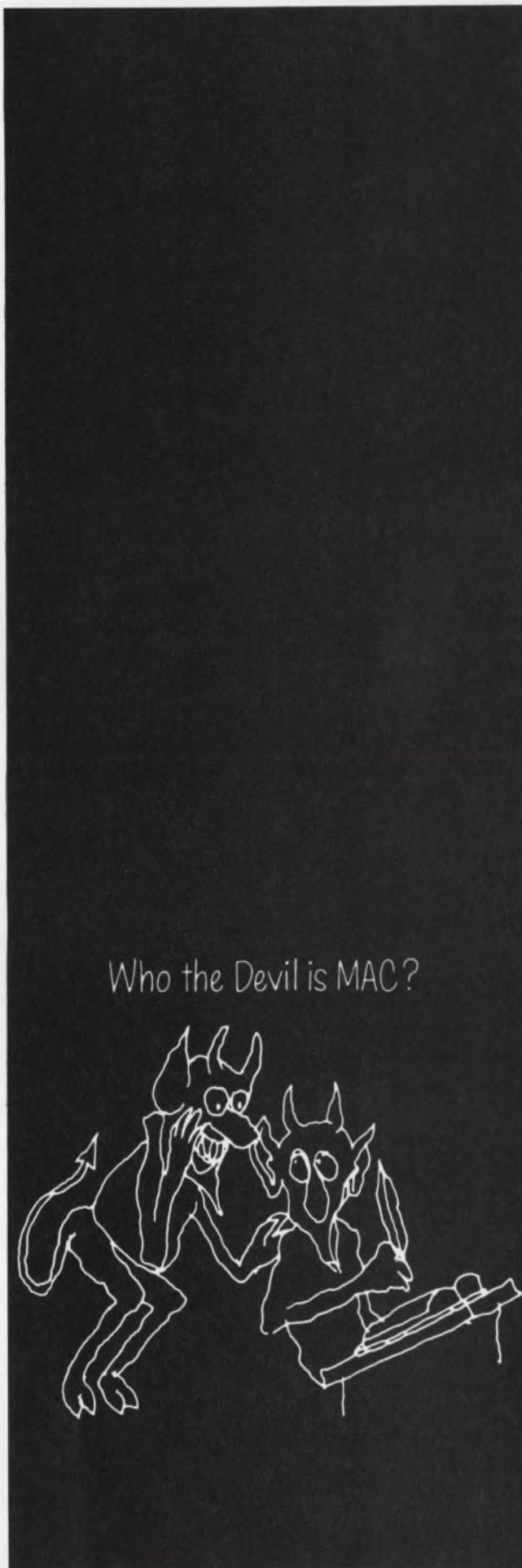

Who the Devil is MAC?

INFORMATION RETRIEVAL NUMBER 84

Operational amplifier consumes 8 mW max



Fairchild Controls, Div. of Fairchild Camera and Instrument Corp., 423 National Ave., Mountain View, Calif. Phone: (415) 962-3833. P&A: \$55; stock.

Featuring low power consumption between 1.8 and 8 mW, model ADO-39 FET-input op amp operates from any supply of ± 4.5 to ± 20 V with a quiescent current drain of less than 200 μ A. Particularly useful in battery-powered equipment, the amplifier has an input impedance of 10^4 M Ω , a minimum gain of 20,000, and a minimum output of ± 1 mA.

CIRCLE NO. 325

Logarithmic amplifier slews at 10^6 dB/s



Ithaco Inc., 413 Taughannock Blvd., Ithaca, N.Y. Phone: (607) 272-7640. P&A: \$825; 30 days.

Providing true logarithmic gain control without coupling the control signal into the output, model 316 wideband amplifier is capable of slewing at rates well over one million dB per second. Between 10 Hz and 100 kHz, a control voltage of 0 to 5 V dc adjusts gain at 12 dB/V. The control voltage/gain relationship is logarithmic over a 60-dB range, with ± 0.5 -dB accuracy. Harmonic distortion is less than 2% at maximum output.

CIRCLE NO. 326

Audio amplifier sustains 15 W rms

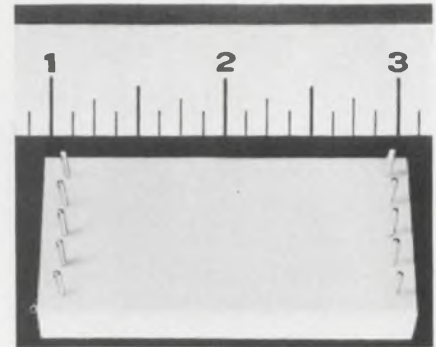

Bendix Semiconductor Div., South St., Holmdel, N.J. Phone: (201) 946-9400. P&A: \$9.40; 2 wks.

Operating from 350-mV input signals, a class-B audio amplifier is capable of sustaining an output of 15 W rms. The hybrid IC, model BHA-0002, achieves useful feedback compensation without external components, while retaining full rated output. Idle currents and crossover characteristics can be trimmed through external terminals. Frequency response is 25 Hz to 20 kHz. Power gain is 60 dB.

CIRCLE NO. 327

Diode function generator customizes gain curves

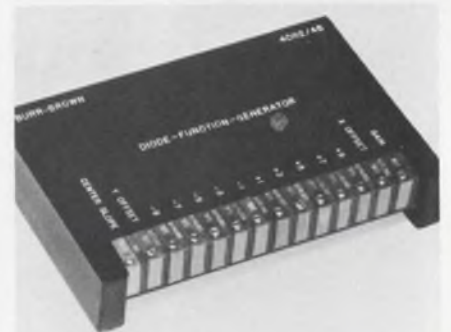

Burr-Brown Research Corp., International Airport, Industrial Park, 6730 S. Tucson Blvd., Tucson, Ariz. Phone: (602) 294-1431. Price: \$395.

Providing arbitrary nonlinear shaping of an analog input voltage, a diode function generator is now available as an encapsulated module. Model 4062/45 has slope controls for adjusting each of 11 straight-line segments. No external components are needed to achieve the desired gain curve. Compatible with IC op amps, the unit requires a supply of ± 15 V dc.

CIRCLE NO. 328

VITREOSIL[®] PURE FUSED QUARTZ CLOTH

offers the design engineer a combination of extreme heat resistance, exceptionally low coefficient of thermal expansion and excellent dielectric properties for plastic reinforcement, screening and filtration of molten, non-ferrous metals, high temperature gases and liquids. Also available are Vitreosil Quartz mat and wool of extremely fine diameter fibers which provide excellent thermal insulation barriers (to 2000° F. indefinitely with no degradation).



THERMAL AMERICAN
FUSED QUARTZ CO.
RT. 202 & CHANGE BRIDGE RD.
MONTVILLE, NEW JERSEY
ZIP CODE 07045

74

METALIZED MYLAR CAPACITORS



to your exact
specifications...
at stock prices

METALIZED MYLAR CAPACITORS

Unique, self-healing units that remain in circuit during voltage surges with little or no loss of electrical properties. Use the M2W's where size and weight are limiting factors and long life and dependability are required. The units utilize metalized Mylar* Dielectric with film wrap and custom formulated epoxy resin end fill. Available in round and flat styles.

*Du Pont Trademark for Polyester Film

Samples available on your letterhead request

Standard CONDENSER
CORPORATION

DEPT. ED-11, 1065 WEST ADDISON STREET, CHICAGO, ILLINOIS 60613

5 days

can do a lot for your next 5 years.

If you're involved in systems and equipment design, research, production or management . . . five days at one of our Seminars may make your next five years—and many more after that—much more productive.

More and more key management and high-level technical personnel from top companies all over the United States are attending RCA Institutes Seminars. Just as they are doing, you'll acquire information and techniques of immediate value in your work. You will also gain the kind of knowledge that can help build your professional standing in the years just ahead.

We believe we can increase your productivity by providing you with a firm grasp of many of the latest engineering techniques. Our experienced staff maintains constant contact with "what's happening" in industry. The texts and audio-visual materials are prepared exclusively by us for each seminar.

You can attend RCA Institutes Seminars around the country the year-round. Check your subject and send along the coupon for your brochure. Now—while you're thinking about it.

RCA

RCA Institutes, Inc. Dept. ELD-N8

Institute for Professional Development
132 West 31st Street
New York, New York 10001

For FREE descriptive brochure, check the Seminar in which you are interested:

- | | |
|--|---|
| <input type="checkbox"/> Logic Design | <input type="checkbox"/> Management Information Systems |
| <input type="checkbox"/> Digital Systems Engineering | <input type="checkbox"/> Digital Communications |
| <input type="checkbox"/> Modern Optics | <input type="checkbox"/> Digital Electronics |
| <input type="checkbox"/> Integrated Circuits | <input type="checkbox"/> Numerical Control Systems |
| <input type="checkbox"/> Reliability of Integrated Systems | |

Name _____

Title _____

Company _____

Address _____

City _____ State _____ Zip _____

Ferrite Shielded Air Core Yoke C5380. Designed for high speed precision character displays (nanosecond writing speeds). Undesirable magnetic coupling and stray fields eliminated by unique shield design.



DESIGN DEVELOPMENT FROM syntronic THE YOKE SPECIALISTS

Syntronic engineers and manufactures the most extensive line of deflection yokes available . . . and continually develops new designs to satisfy the ever increasing requirements of the display industry. For large production or custom applications get the engineering control and production experience that only SYNTRONIC, the yoke specialists, can provide.



syntronic

INSTRUMENTS, INC.
100 Industrial Rd., Addison, Ill. 60101
phone 312-543-6444

INFORMATION RETRIEVAL NUMBER 88

MODULES & SUBASSEMBLIES

FET amplifiers drift 2 $\mu\text{V}/^\circ\text{C}$



Fairchild Controls Div. of Fairchild Camera and Instrument Corp., 423 National Ave., Mountain View, Calif. Phone: (415) 962-3833. P&A: \$29 to \$98; stock.

High-stability, modular, FET operational amplifiers offer maximum drift voltages of 2 to 60 $\mu\text{V}/^\circ\text{C}$. Critical thermocouple junctions between copper input pins and Kovar FET leads are close together so that temperatures remain equal and thermal emfs cancel. Models ADO-19, -26B, -27B, and -29B have a modular construction with discrete FET input stages followed by ICs.

CIRCLE NO. 329

Programmable selector switches and trims

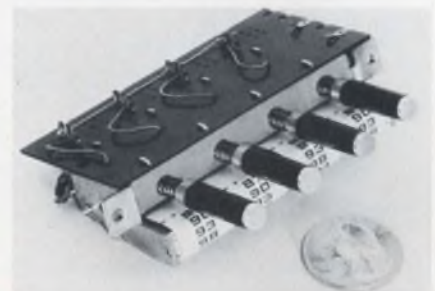

Seacor, Inc., 598 Broadway, Norwood, N.J. Phone: (212) 594-9130. Price: from 60¢/station.

Called Switchohmat, a programmable, sequential, resistor selector switch consists of one or more pushbutton switches that activate or deactivate its individual 10-turn trimmer pot. Each switch has an associated knob that serves as a fine control, and provides a means for actuating the switch that engages the trimmer circuit.

CIRCLE NO. 330

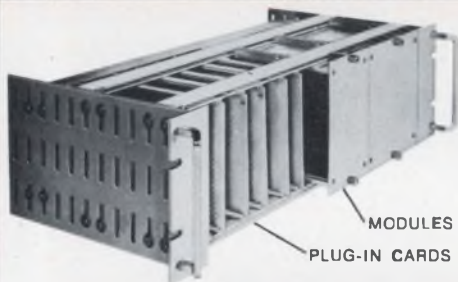

Vector-strut Cages Have Universal Adjustability

- STRENGTH
- HANDSOME APPEARANCE
- QUICK ASSEMBLY
- LOW COST

CHECK THE SPECS AND SEE:

THE VECTOR-STRUT CAGE provides an adjustable aluminum frame which through customer test has proven to be more versatile than other competitive units on the market.

- Mountable on 10", 19" or 24" racks.
- Three standard heights - 3 $\frac{1}{2}$ ", 7 $\frac{1}{2}$ ", 8 $\frac{3}{4}$ ".
- Three standard depths - 8.975", 11.975", 15.725".
- Prototype quantities shipped from stock. Production quantities in minimum time.
- Vertically slotted side walls and adjustable cross member end brackets allow universal height and depth adjustability for cards and module cases.
- Infinite adjacent positioning capability for modules, cards and connectors with extruded fastener holding ducts.

"EFP" ALUMINUM MODULE CASES[®] to fit Vector-Strut Cages

- Sixty (60) standard sizes for circuit cards, featuring $\frac{1}{16}$ " extruded grooves on .150" centers across case width for easy card mounting — no holes required in circuit board.
- Slide out side covers for quick access to cards.
- Front panels with captive thumb screws and rear panels either slotted or closed for user's connector design.

FOR HIGH FREQUENCY Vector Pak plug-in cases provide 90 to 100 DB of shielding with optional side panel gasketing.

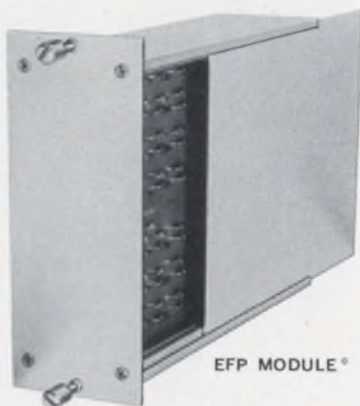

EFP MODULE[®]

* Patented Features

Write the factory for specification data and prices.



Vector ELECTRONIC COMPANY, INC.
12460 Gladstone Ave., Sylmar, Calif. 91342

INFORMATION RETRIEVAL NUMBER 89

Sample-and-hold card
decays at 15 $\mu\text{V}/\text{ms}$

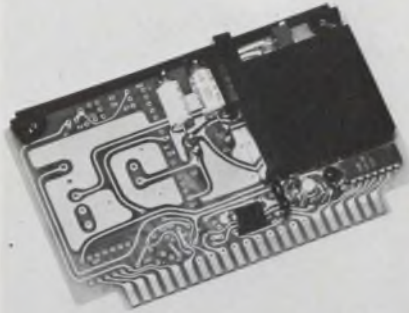

Analogic Co., 296 Newton St., Waltham, Mass. Phone (617) 891-4708. P&A: \$249; stock.

Increasing the accuracy and efficiency of conversion applications that require sampled data, a high-speed sample-and-hold module provides a decay rate of 15 $\mu\text{V}/\text{ms}$ and a full-scale accuracy of 0.01%. Model AN250-01 settles in 5 μs max with an aperture time (acquisition uncertainty) of less than 50 ns. All control inputs are DTL compatible. Optional modules include a dual configuration for parallel operation.

CIRCLE NO. 331

Booster amplifier
supplies ± 500 mA



Philbrick/Nexus Research, A Teledyne Co., Allied Drive at Route 128, Dedham, Mass. Phone: (617) 329-1600. Price: \$75.

Model 2001 modular amplifier extends the capability of operational amplifier circuits by rapidly and accurately boosting their current to ± 500 mA at ± 10 V. It has a slewing rate of 10 V/ μs and full output response to 80 kHz. Built-in overload protection prevents short-circuit damage even with maximum signal applied.

CIRCLE NO. 332

NEW VISIBLE LIGHT EMITTING DIODE with a brightness of 450 footlamberts

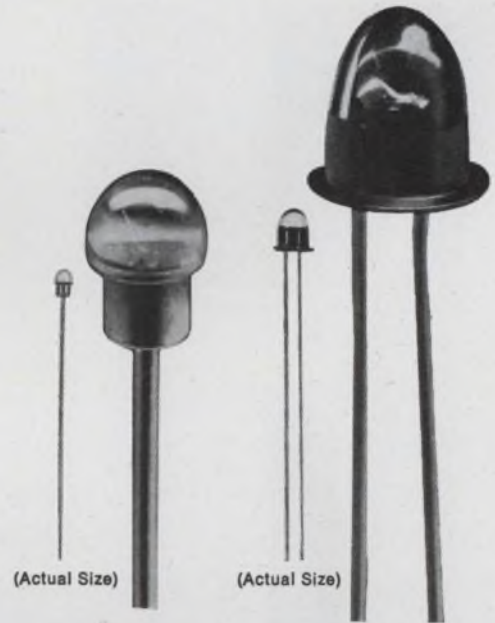

Model MV10A

Model MV10B

Forward bias ($I_f=50\text{ma}$)	1.65 volts	1.65 volts
On-off cycle time	10 nsec	10 nsec
Wavelength range	6500-7000 \AA	6500-7000 \AA
Brightness ($I_f=50\text{ma}$)	115-300 ftL	115-450 ftL
Price (In lots of 1000)	\$4.00 to \$18.00	

From film annotation to panel indicators, Monsanto's visible LEDs deliver solid state reliability, miniature size, low power consumption. And they're available off the shelf.

Other Monsanto Optoelectronic Devices

Infrared LED	MI20B — 200 microwatts radiated power
	MI20C — 1.5 milliwatts radiated power
Lasers	ML30C — 0.5 watts peak power output
Arrays	MA10A — alpha-numeric visible array

Monsanto

ELECTRONIC SPECIAL PRODUCTS

10131 Bubb Road, Cupertino, Ca. 95014 / (408) 257-2140

Interested in career opportunities? Send resumé to Manager Professional Recruiting. An equal opportunity employer.

INFORMATION RETRIEVAL NUMBER 90

We just took a great step backwards



(with three new, forward-looking unitized DVMs)

Trymetrics' new 4243 Digital Multimeter with AC, DC and OHM readings—auto polarity—full four digit—0.1% (\$850) ... a tremendous step backwards. And so are the 4240 DVM (\$695) and 4230 DVM (\$595).

We started with our Model 4100: stored display—precision .01%, four-digit DVM and its full range of plug-ins for the price of an ordinary 3-digit job—just \$740 with the $\pm 9.999v$ DC head; and eight other plug-ins to choose from. For an encore, the only way to go was down.

Down \$195 to \$850 for the versatile 4243 Digital Multimeter: DC-AC-OHMS .01% — auto polarity $\pm 999.9mv$ to $\pm 999.9v$. Same 4-digit stored display—no plug-ins. Sorry—unless you don't need plug-ins.

Down again, \$155, to \$695, for the 4240 DVM. Same high accuracy, same stored display, same $\pm 999.9mv$ DC to $\pm 999.9v$ DC 4-digit measurements. But, no AC or OHMS—unless, of course you don't need AC or OHMS.

Once more, down, to \$595 for the Trymetrics 4230 DVM. Still the same precise 4-digit unit with readings $\pm 9.999v$ DC to $\pm 999.9v$ DC. Don't buy this one if you need to measure in the low millivolts.

You don't need true 4-digit readout with .01% accuracy at a 3-digit, .05% price? Sorry—but we can't keep backtracking forever. May we send you our new catalog that shows ALL our models, all our plug-in versatility, all our reasons for going backwards?

PRICES SLIGHTLY HIGHER IN EUROPE.

TRYMETRICS
Corporation
A SUBSIDIARY OF TRYGON ELECTRONICS, INC.

204 Babylon Tpke., Roosevelt, L.I., N.Y.
Phone 516-378-2800 11575

INFORMATION RETRIEVAL NUMBER 91

COMPONENTS

Fiber-optic kit prototypes designs



Albion/Rank Taylor Hobson, 260 N. Rte. 303, W. Nyack, N.Y. Phone: (914) 358-4450. Price: \$38.

A kit of fiber-optic components includes glass fiber bundles, image conduits, and fiber-optic tape. It allows the environmental and transmission characteristics of various light guide sizes to be determined, as well as a proposed system to be breadboarded for feasibility study. The kit contains four light guides, a Y-guide for splitting a fiber bundle, and a small flashlight for use as a light source.

CIRCLE NO. 333

Switch contacts have prism shape

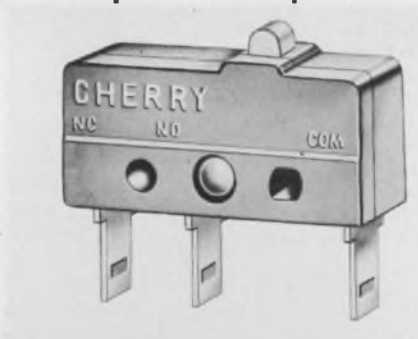

Cherry Electrical Products Corp., 1650 Old Deerfield Rd., Highland Park, Ill. Phone: (312) 831-2100. Price: \$1.86.

Series E63 switches maintain low contact resistance in low-level switching applications from 5 to 100 mA at 4 to 30 V. The switch contacts, which are made of a gold alloy, are shaped in the form of prisms and welded at right angles to each other. This configuration increases contact pressure and decreases susceptibility to contact closure interference.

CIRCLE NO. 334

Pneumatic amplifier boosts signals 300:1



Aro Corp., 400 Enterprise St., Bryan, Ohio. Phone: (419) 636-4242.

Designed to simplify pneumatic logic functions, an amplifier valve with an adjustable threshold level is capable of providing signal gains as high as 300. The new pneumatic element has a built-in variable orifice that provides a self-generating jet for back-pressure sensing. Sensing pressure ranges from 4 in. of water to 20 psig, output pressure ranges from 25 to 150 psig, and response time is 10 ms.

CIRCLE NO. 335

Photocell scanner detects 50,000/s

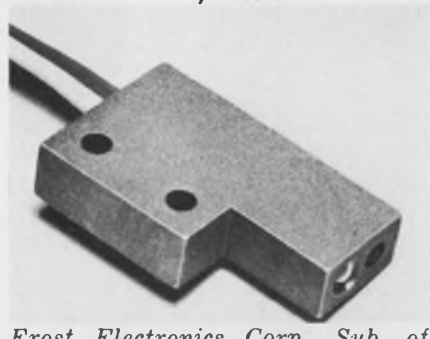

Frost Electronics Corp., Sub. of Astrosystems International, Inc., One Goddard Dr., Rockaway, N.J. Phone: (201) 625-0222.

Containing light source and photocell in a single housing, model PL-8S4 subminiature high-speed scanner detects small objects at rates above 50,000 per second. It can also accurately pick up code-mark registrations on printed film or paper webs while ignoring unrelated printed marks. Internal lamp bulbs are rated at 40,000 hours, and internal photodiodes have a risetime of only 1.5 μs .

CIRCLE NO. 336

NEW

VARIABLE RATE RASTER GENERATOR WITH BLANKING AMPLIFIER AND PHOSPHOR PROTECTION LINEAR DUAL SWEEPS

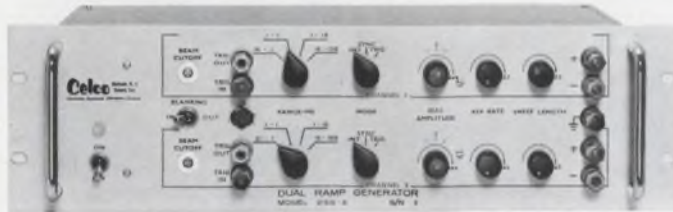

Model 2SG-4

- Wide Range of Raster Rates
- Sweeps from 20 μ sec to 100 msec
- Sweeps Available to Seconds
- 10% to 90% Duty Cycle
- Linearity Better than 0.5%
- Internal, External Trigger or Sync
- ± 5 Volt dc Bias
- 5/4" High for 19" Rack
- Compatible with CELCO Drivers

The CELCO Dual Ramp Generator provides the display designer with a versatile tool for producing a wide variety of raster or line scan CRT displays. Your answer to a need whenever linear, variable ramp lengths and rates are required — plus the convenience of blanking and phosphor protection.

Immediately available from stock.

Constantine Engineering Laboratories Company

Mahwah, N.J. 07430

Tel. 201-327-1123

INFORMATION RETRIEVAL NUMBER 92



150:1 SPEED RANGE

INFINITELY ADJUSTABLE FROM 24 RPM TO 3600 RPM IN *Servo-Tek*

ADJUSTABLE-SPEED DRIVES

WITH CONSTANT TORQUE REGARDLESS OF LOAD CHANGE OR INPUT CHANGE

Temperature-compensated feedback provides line and load regulation of better than 1/3 of 1% of rated speed ■ Uses silicon diodes, transistors and magnetic amplifier for exceptionally long service life. Modular plug-in requires only a screwdriver for servicing ■ Remote Control provides precise adjustment, monitors operation and continuously indicates speed ■ All motors totally enclosed, fan cooled, with or without gear reduction or braking and reversing ■ 1 hp model as shown \$687, 1/8 hp to 1 1/2 hp models proportionally priced ■ ASK FOR 500/600 SERIES CATALOG.



SERVO-TEK PRODUCTS COMPANY

**1086 GOFFLE RD, HAWTHORNE, N.J. 07506
TELEPHONE 201-427-3100**

INFORMATION RETRIEVAL NUMBER 93

ELECTRONIC DESIGN 23, November 7, 1968

Now Available!

New! Lightweight,
Tiny (1/64 cu. in.!)

Double-Ended Radial Inertia Switch



Calibration range of 5-300 G's with $\pm 10\%$ accuracy.

**Model
3RO-498**

For sub-miniature printed circuitry, this tiny switch provides sensitivity to forces from any direction. When 2 switches are right-angled, semi-directional response to acceleration is achieved within 1/32 cu. in. Proven performance; this magnetic restraint unit is superior to spring-mass systems.

Size: .175" dia. x 11/16" long
Weight: 1/16 oz. patented

- Operating temperature range: -55° C. to $+125^{\circ}$ C.
- Complies with Mil Specs E-5272
- Available with either momentary contact or latching.
- 3 AWG No. 26 wire leads, 1 1/2" long.

Write today for detailed information

INERTIA SWITCH Inc.
311 West 43rd Street, New York, N. Y. 10036
Phone: (212) JUdson 6-5880



INFORMATION RETRIEVAL NUMBER 94



By George... Captor sure makes small EMC Filters!

Captor subminiature EMC filters are the industry's smallest . . . 25% to 37% more compact than other popular miniatures. Volumes and weights are correspondingly reduced . . . as light as 4.9 grams for many units. Captor EMC filters maintain high published performance over full temperature range to 125° C. Their performance is equal to or better than the competition's, yet they truthfully cost less! Let Captor bid on your next EMC filter or filter assembly requirement, by George! Write for Catalog F-104 and prices today.

Captor Corporation manufactures miniature filters . . . communications and security filters... custom-design filters, and other electronic components.

CAPTOR CORPORATION
APPLICATION ENGINEERING DEPT.
5040 Dixie Highway, Tipp City, Ohio 45371

INFORMATION RETRIEVAL NUMBER 95

COMPONENTS

Elapsed-time indicator logs up to 10,000 hours



Curtis Instruments, Inc., 200 Kisco Ave., Mount Kisco, N.Y. Phone: (914) 666-2971. Price: \$5.

Meeting the requirements of MS-3311 for Weapons Replaceable Assemblies, and of other military system modules, an elapsed-time indicator records actual time in operation up to 1000, 5000, or 10,000 hours. Model 620-PC uses two columns of mercury separated by an electrolyte gap in a capillary tube. Current flow causes the gap to be displaced by electroplating the mercury as a function of time.

CIRCLE NO. 337

Trimmer resistor adjusts in-circuit



Angstrom Precision Inc., 781 Lemona Ave., Van Nuys, Calif. Phone: (213) 989-3061. P&A: \$1.80; stock.

Free of moving parts, Fix-Trim metal-film resistor can be user-adjusted before or after installation. Resistance can be varied up to five times the base value with $\pm 0.02\%$ accuracy. Measuring only 0.085 by 0.09 by 0.2 in., type V5 has a rating of 0.05 W at 125°C. Twelve base resistance values cover the range of 1 to 4600 Ω , $\pm 1\%$. Temperature coefficients to ± 25 ppm/°C are available.

CIRCLE NO. 338



APT-1; 1 cu. in.,
3.15 oz. (actual size)

More torque, Less weight in moving coil mechanism

Highly stable, linear and accurate mechanism for indicating, control or recording systems. 18-0-18° linearity is 1%. Coil design with over 75% of winding "working" in high energy, uniform field air gap assures greater accuracy. Coil system weighs 0.85 gm, develops 26.4 mmg of torque; 31:1 T/W. Mechanism offers negligible vibration pivots and jewels — custom damping — wide range of sensitivities.

AMMON

AMMON INSTRUMENTS, INC.
345 Kelley St., Manchester, N.H. 03105

INFORMATION RETRIEVAL NUMBER 96

YOUR HEART FUND FIGHTS

HEART ATTACK
STROKE
HIGH BLOOD
PRESSURE
INBORN HEART
DEFECTS



Decode/display module inserts decimal point

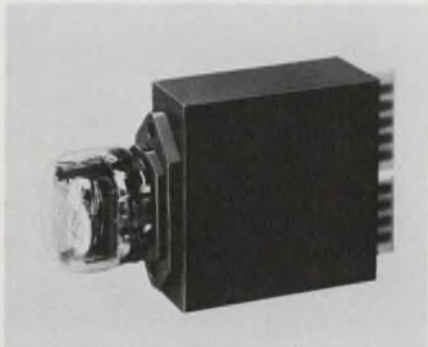

*Integrated Circuit Electronics, Inc.,
P.O. Box 647, Waltham, Mass.
Phone: (617) 899-2700.*

A new decode display module provides a cold-cathode tube with a readout that includes decimal-point presentation. Model D-101 accepts 4-line or 8-line BCD codes at typical IC voltage logic levels. It features high speed, reliability and long-life through the use of transistor-transistor-logic monolithic integrated circuits.

CIRCLE NO. 339

Fluidic OR/NOR gates isolate inputs totally

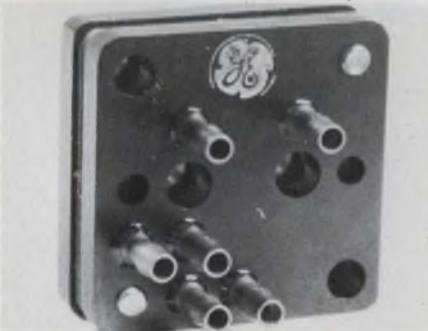

General Electric Co., Specialty Fluidics Operation, Schenectady, N.Y. Phone: (518) 374-2211.

Two OR/NOR fluidic elements feature complete noninteraction between inputs and absolute turn-off when no input signal is applied. Model DN32 is a 2-input unit; model DN33 is 3-input. Fabricated with stainless steel laminates, they feature integral course filters that increase reliability by minimizing contamination vulnerability. Response time is less than 1 ms, and fanout is 3.

CIRCLE NO. 340

FOR CONTINUOUS WEB TRANSPORT DRIVES... DC TACH TORQUER

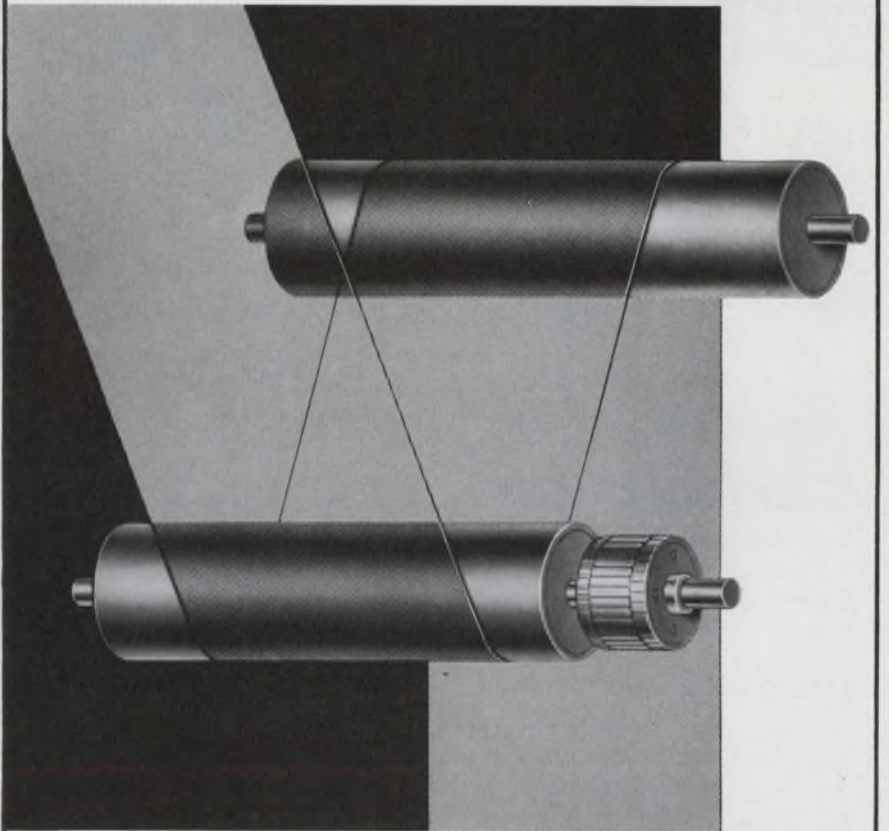

gives PRECISE VARIABLE SPEED RATE INFORMATION ACCURACY BETTER THAN 0.1%

Inland torque motor-tachometer generator units: "Tach-Torquers", use a DC direct-drive torque motor that drives the web transport reel at a precisely controlled, infinitely variable speed with constant tension throughout. The tachometer generator functions as an error sensing transducer producing a DC signal which is used in the electronic loop for immediate response.

A single unit that not only precisely drives the web at any speed in which torque can be varied as dictated by the requirements of the web in any particular station, but also provides immediate rate information with better than 0.1% accuracy.

Torque ratings available from 2.55 oz.-in. to 3,000 lb.-ft.



TORQY SAYS:

If you would like further information on designing-in a "Tach-Torquer" for your continuous web transport drive, just drop a line. No obligation, of course.



INLAND MOTOR

CORPORATION
OF VIRGINIA
RADFORD, VIRGINIA
12460

SUBSIDIARY OF KOLLMORGEN

INFORMATION RETRIEVAL NUMBER 97

**SMALL SIZE
PLUS
OUTSTANDING
PERFORMANCE**

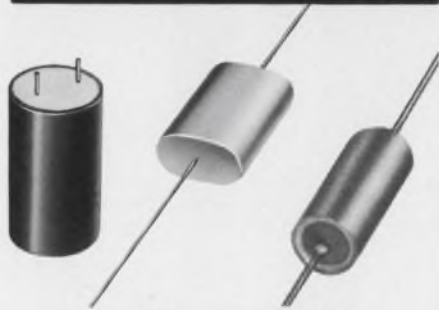

**Silverfilm
CAPACITORS**

They may look like a conventional foil capacitor, but there the resemblance ceases. Made of a synthetic film with a vaporized metal coating, they have certain highly desirable characteristics.

Silverfilm Capacitors are operable from their rated voltage down to the microvolt range—and they are smaller than capacitors now available for such applications. When subjected to over-potentials they are self healing and have no tendency to short circuit. Unlike conventional metallized film capacitors, Silverfilm insulation resistance is not reduced after capacitor healing.

In short, Silverfilm fills a need for a highly reliable, miniaturized capacitor that will operate satisfactorily over wide voltage and temperature ranges.

- Capacities from .01 to 100 mfd.
- Operating temperatures from -55°C to $+125^{\circ}\text{C}$
- Standard voltage ratings—microvolts to 600 V—others on request
- AC voltage ratings available to 330 V and 400 cycles

WRITE FOR
SILVERFILM CATALOG NO. 1195



3243 No. California Ave.
Chicago, Illinois 60618

INFORMATION RETRIEVAL NUMBER 98

COMPONENTS

**Miniature trimmer
has 0.25-in. dia**



Miniature Electronic Components Corp., Sub. of General Time, 600 South St., Holbrook, Mass. Phone: (617) 963-7717.

A metal-film trimmer potentiometer with a 0.25-in. diameter combines high-frequency response, infinite resolution, and low temperature coefficient over a full range of resistance values from $10\ \Omega$ to $100\ \text{k}\Omega$. The single-turn unit is available in two models, the MF2 without stops and MF2S with stops. It withstands the vibration, shock, and humidity conditions of MIL-STD-202B.

CIRCLE NO. 341

**Plastic potentiometer
replaces synchro**



Betatronix Inc., 35 Doyle Court, E. Northport, N. Y. Phone: (516) 368-3170. P&A: from \$35; stock to 8 wks.

Replacing the control transformer used in conventional synchro systems, a plastic potentiometer has a resistivity that varies as a trigonometric function of its wiper displacement. It is available in either standard potentiometer or synchro housing configurations with diameters ranging from 0.5 to 5 in.

CIRCLE NO. 342

**Ceramic capacitors
filter and bypass**

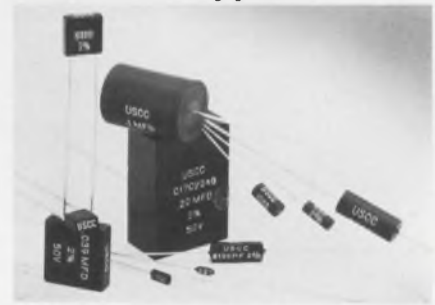

U.S. Capacitor Corp., 2151 N. Lincoln St., Burbank, Calif. Phone: (213) 843-4222. P&A: 77¢ to \$3.43; 3 wks.

Designed to replace mica, glass or porcelain capacitors, miniature ceramic chips can be used in filtering, bypass and coupling applications. These stable ceramic capacitors are available in three types: C13 series—tubular with axial leads, with a capacitance range from $0.5\ \text{pF}$ to $0.2\ \mu\text{F}$; C17 series—rectangular with radial leads, $5\ \text{pF}$ to $0.22\ \mu\text{F}$, and C18 series—rectangular with axial leads, $5\ \text{pF}$ to $0.011\ \mu\text{F}$. Working voltage ratings are 50, 100 and 200 Vdcw.

CIRCLE NO. 343

**Chip capacitors
withstand 4000 V**



Monolithic Dielectrics Inc., P.O. Box 647, Burbank, Calif. Phone: (213) 848-4465.

Currently used in photomultiplier circuits for image-intensifier optics, a 4000-V ceramic chip capacitor features a leakage current of as little as 1 nA. Dissipation factor is less than 1% at 1 kHz and insulation resistance is $100\ \text{G}\Omega$ at 25°C . Rated life is 1000 hours at 125°C . These capacitors meet the requirements of applicable sections of MIL-C-11015 and -39014.

CIRCLE NO. 344

When Only Excellent is Adequate TURN to Grayhill

for **TOTALLY ENCLOSED ROTARY SWITCHES.**
TEMPERATURE TO 125°C. MULTI-POLE.
30°, 36°, 45°, 60°, and 90° ANGLE OF
THROW. 100,000 OPERATIONS.

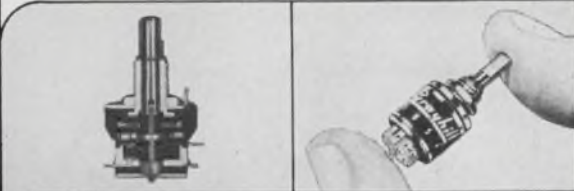

... the Difference Between
 Excellent and Adequate

Typical Specifications

- Explosion Proof
- Contact Resistance 10 Milliohms
- Make or Break 1/4 Amp. to 15 Amps., 115 VAC Resistive
- 1 to 6 Poles per Deck
- 2 to 12 Positions per Pole
- 1 to 12 Decks

Send for Engineering Catalog G-304-A



565 Hillgrove Avenue
 LaGrange, Illinois 60525
 Area Code 312, Phone 354-1040

"PIONEERS IN MINIATURIZATION"

INFORMATION RETRIEVAL NUMBER 99

DELAY TIMERS



Any mounting style; voltage specification; time cycle; operational method. No special engineering required. Good delivery schedules. Our stock is ample.

**INDUSTRIAL
 TIMER**
 CORPORATION

U.S. Highway 305, Parsippany, N. J.

Subsidiary of the Singer Company

INFORMATION RETRIEVAL NUMBER 100



You may have seen them before. You'll see these ads often this year in national media space contributed to the cause of traffic safety.

They're trying to keep your employees alive and healthy. By encouraging them to use safety belts, both in their private driving and on the job for you.

But they can't succeed all by themselves. And that's where you come in.

You can encourage every one of your employees to use safety belts regularly.

Warn about the lethal danger of making excuses. Remind them that 7000 people died last year because they weren't wearing safety belts when they ran into trouble.

If you do your part, you'll be helping your employees stay alive and well. And on the job for you.

If you don't . . . what's your excuse?



Advertising contributed for the public good.

Electronic Design

DATA-

here's how industrial advertising

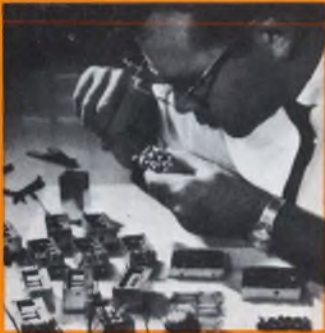

1 SELF-SERVICE BUYING— A MAJOR POTENTIAL

Now there is a bold new approach to marketing.

We call it DATA-SELL.

Its goal is to telescope the selling process so that your advertisements will bring in more orders... faster. If you are content merely to arouse interest or "communicate" with your prospects, you are missing a big potential in this industry.

Already, advanced marketers are leaping closer to the sale. Instead of inquiries, their ads often bring in immediate results! The technique works... it's being used... it's applicable to almost any advertiser, large or small... to almost any product.

DATA-SELL begins by taking a new look at the buyer and his needs in the electronic OEM, everybody knows it's the design engineer or engineering manager who specifies and buys. But how does he do it?

He sees your ad...

He inquires about your product...

You send him product information...

He compares...

He buys...

Every step takes time, every step costs money.

DATA-SELL takes advantage of the tremendous self-service buying potential in this industry. You simply give the engineer the data he needs... right away... In your ad. Impossible? Read on to see how it is being done—right now—to build sales and profits.

2 SPECIFICATION AND PURCHASE MADE WITHOUT PARTICIPATION BY SALESMEN

Self-service buying underlies the basic marketing philosophy of DATA-SELL. Research data is now available to prove that electronic design engineers and engineering managers often buy without seeing a salesman. It's obvious that this must happen because few companies' salesmen could possibly touch all the bases in this industry—keep up with all the orders. But, now there's proof!

MORE PROOF!

In June, 1968, we reported positive sales results for Electronic Design's DATA-SELL technique as surveyed by National Semiconductor Corp., and Electro Scientific Industries. Now here's more proof!

BALLANTINE LABORATORIES FOUND OUT that 19.7% of Electronic Design's primary audience had specified electronic measuring instruments within five months of the appearance, in Electronic Design, of a Ballantine ten-page DATA-SELL insert. Of the sales explored, **61.4% were made without a salesman's call**, including all of Ballantine's sales reflected by survey respondents.

SIMPSON ELECTRIC COMPANY FOUND OUT that 97% of the 1,000 Electronic Design subscribers surveyed had some degree of familiarity with Simpson's product line. (Simpson's 48-page DATA-SELL unit appeared in Electronic Design, May 8, 1968.) Of the 506 respondents, 61.1% recalled seeing Simpson's advertising. Of the 103 sales explored in the survey, **89.3% had been made without even talking to a Simpson salesman!**

UNION CARBIDE ELECTRONICS FOUND OUT that 53.4% of Electronic Design's primary audience specifies FETs. Of the 25.5% who specified or requisitioned FETs within 3 months preceding survey date, **43.4% did so without a salesman's call!**

A FOLLOW-UP STUDY OF ALL INQUIRIES TO THE FEBRUARY 1, 1968 ISSUE OF ELECTRONIC DESIGN showed that:

1. **Although 87.9% of Electronic Design's readers received the information they requested through Information Retrieval channels, only 7.3% were contacted by a salesman.**

2. **83% of the specifications of advertised products were made without a salesman's call.**

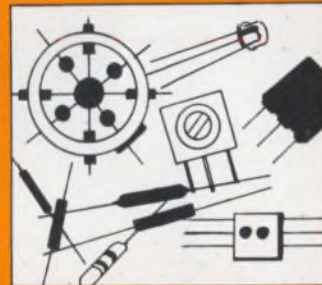

3 TELL THE ENGINEER ALL THAT HE NEEDS TO KNOW

DATA-SELL is basically a "tell-all" technique. You must anticipate the technical data *most* of your engineer-customers will need for *most* applications. The object is to avoid drawn out correspondence... eliminate questions... anticipate needs... so that engineers can even make their first communication an *order* instead of an *inquiry*. Or, if further contact is necessary, it is speeded up, simplified, easier to process.

Here are some basic examples of the kinds of information engineers often require in order to specify. (You will have to refine this list, of course, to suit your own products.)

- Operating ranges
- Key performance parameters
- Accuracy ratings
- Reliability test results
- Sensitivity
- Interconnections
- Power requirements
- Options
- Packaging
- Delivery time
- Size
- Weight
- Cube
- Cost
- MIL approval

The tell-all technique of DATA-SELL gives the engineer *all* of the information he needs to make self-service buying decisions—right now.

4 DATA-SELL WILL ALTER



Electronic Design's DATA-SELL technique urges you to turn *white* space into *selling* space. It means you must tell enough to do the job—in enough space to do the job.

Most DATA-SELL advertisers have taken advantage of multi-page advertisements as the best means of presenting their tell-all units. The technique combines the factual data of a short-form brochure with the attention-getting power of advertising. It uses color and design

BENCH MARK STUDIES PROVE DATA-SELL TECHNIQUE EFFECTIVE

To measure the impact of a series of three DATA-SELL inserts run in Electronic Design by Texas Instruments, Semiconductor Components Division, "Before" and "After" studies were conducted. The "Before" study questionnaire was mailed Aug. 24, 1967 to an nth name sample of 1,500 drawn from Electronic Design's domestic circ. list; the "After" questionnaire was mailed to a similar unduplicated sample on 3/29/68, after the appearance of the last insert. Survey results are highlighted at right. The complete survey is available on request.

SELL

can sell your products RIGHT NOW!

YOUR CAMPAIGN STRATEGY



to underscore user benefits for maximum impact and readership. However, for some advertisers it may only mean switching from a $\frac{1}{4}$ to $\frac{1}{2}$ page, or from $\frac{1}{2}$ to a full page. The extra advantages and results you can obtain from DATA-SELL make it worthwhile for you to revise older inquiry-oriented concepts. It may mean planning less units, but larger, more effective ones—units packed with immediate selling power.

TEXAS INSTRUMENTS 1968 BEFORE/AFTER INTEGRATED CIRCUIT SURVEY HIGHLIGHTS

- Present and/or intended usage of monolithic ICs increased slightly from 54.0% to 56.1% with DTL and TTL being the most widely used digital logic types
- Actual specification/purchase of monolithic ICs by potential users jumped from 77.0% to 83.7%. **Texas Instruments showed a 23% gain!**
- In both mailings, more than 4 in 10 sales explored were made without a salesman's call.
- Among the top three in supplier preference, **Texas Instruments showed the largest gain.**

5 HOW TO OBTAIN FUNDS FOR YOUR PROGRAM

If your budget has been set without an understanding of how DATA-SELL can revolutionize your advertising program, here are several ways to obtain the necessary funds. (Ideally, DATA-SELL should be planned and funded as a separate part of your marketing program.)



• **SET NEW GOALS**—Make realistic projections combining your own track record with the DATA-SELL experience of others. Set new goals and budget accordingly.



• **BORROW FROM SALES**—DATA-SELL acts like a salesman. It can even be considered as an extra salesman. Talk to your sales manager.



• **BORROW FROM DIRECT MAIL**—DATA-SELL really is direct mail—only it costs less, reaches more prospects and gets higher readership.



• **CONCENTRATE TO SELL**—Eliminate marginal publications. There's much more potential business to be found by the DATA-SELL technique in your leading magazine than you can possibly obtain by adding random circulation in lesser books.

6 SELECT THE MOST EFFECTIVE, MOST EFFICIENT PUBLICATION IN THE ELECTRONIC O.E.M. IT'S

Electronic Design

CIRCULATION MOVES UP TO 69,000 IN NOVEMBER

100% design engineers and engineering managers—more than 69,000 men responsible for the specification of electronic products. Pass-along copies swell Electronic Design's total audience to more than 213,000! (Most of the 7,000 added coverage is in the major companies where IC and LSI activity is highest.)

READERSHIP

Electronic Design has won more independent readership studies than all other electronic publications combined!

EDITORIAL

Winner of Jesse H. Neal awards, 1966 and 1967. Industrial Marketing award, 1966, Society of Publication Designers, 1966.

INQUIRIES

More than 1,200,000 last year—far more than any other publication in this field.

LOW 4-COLOR RATES

A recent survey shows that 4-color advertisements attract twice as many readers as black and white or two-color ads. These low rates mean that DATA-SELL ads in 4-color can bring 100% increase in readership for only $\frac{1}{3}$ additional cost!

MULTI-PAGE DISCOUNT RATES

To encourage DATA-SELL multi-page advertising, special Electronic Design discount rates apply. Multi-page inserts earn discounts ranging from 10% to 75% depending on frequency.

BUDGET YOUR DATA-SELL INSERTS NOW

Here's how to start: (1) Proceed with your regular campaign. (2) Pick those of your products that engineers can buy directly when complete information is furnished. (3) Budget and schedule enough multi-page DATA-SELL inserts to do the job. (4) Place your order as soon as possible—only a limited number of multi-page DATA-SELL units can be accepted for any one issue.

SEND FOR CASE HISTORIES OF SUCCESSFUL DATA-SELL CAMPAIGNS

Ask your local Electronic Design representative for more information about DATA-SELL—or contact Ed Clancy, Advertising Services Manager at (212) PL 1-5530.

Design Aids



Laser data chart

A 22 by 24-in. data compilation chart folds for insertion into a notebook. Included are formulas for wavelength and energy conversion, output wavelength and fluorescent lifetime of various lasing systems, indices of refraction, angular to linear conversion, physical constants, recommended unit prefixes; beam-shaping formulas, Xenon flashlamp approximations, and laser radar range formulas. The chart also lists designation, source and wavelength of spectral lines used in spectrometric measurements; optical transmission data; energy bank formulas; and networking formulas. Laser Nucleonics Inc.

CIRCLE NO. 345

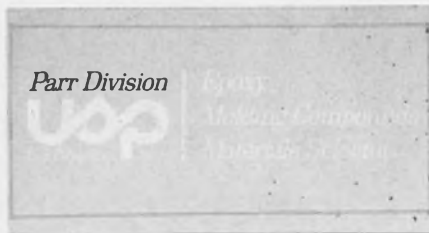

Epoxy molding selector

A vest-pocket epoxy-materials selector lists four encapsulation grades and four transfer-molding grades of granular compounds. The quick-reference table includes EMMI and mesa spiral flow, and typical applications for each material. U. S. Polymeric Inc.

CIRCLE NO. 346

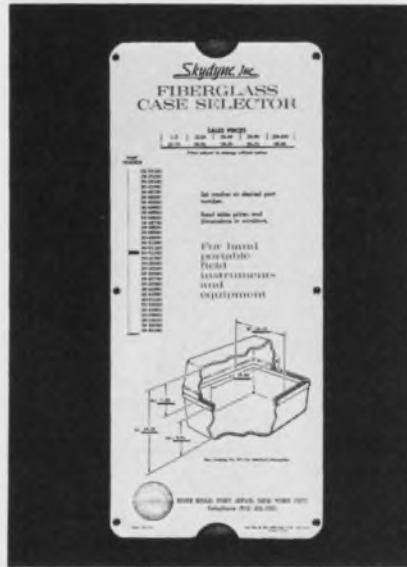

Molded case selector

Fiber glass cases can be easily specified with the aid of a special slide-rule selector. To determine the proper case for a specific application, one simply sets desired dimensions into the five windows provided, and the slide rule does the rest. Descriptive literature on a line of military and commercial cases is included with the rule. Skydyne, Inc.

CIRCLE NO. 347



Plating guide

Listing military and industrial specifications for plating with precious metals, base metals and alloys, a comprehensive handbook also discusses end-uses and gives an analysis of required metallurgical properties. Easy to read tabular charts permit the reader to match applicable specifications, end-use requirements, and recommended plating formulations. LeaRonol, Inc.

CIRCLE NO. 348

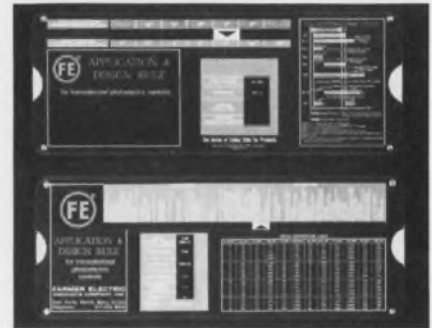

Photoelectric design rule

Specification of plug-in logic modules for industrial photoelectric applications is simplified by this application and design slide rule. When the desired application is set opposite an arrow, a choice of modules appears in a window. Also printed on the rule are a speed-conversion table, 17 applications, and a scanning-distance chart for both direct and reflected light installations. Farmer Electric Co.

CIRCLE NO. 349



Conversion formulas

Included as a bonus with a 24-page meter catalog are two pages of useful engineering data. A glossary lists and defines terms useful in specifying panel meters. A second full page is devoted to conversion factors, formulas, and tables. Included are formulas for ac and dc circuits, sinusoidal voltages and currents, reactances, impedances, conductance, susceptance and admittance. A decibel table correlates dB values with power ratio and voltage or current ratio. Weston Instruments, Inc.

CIRCLE NO. 350

Now, METAL GLAZE resistors for MIL-R-10509

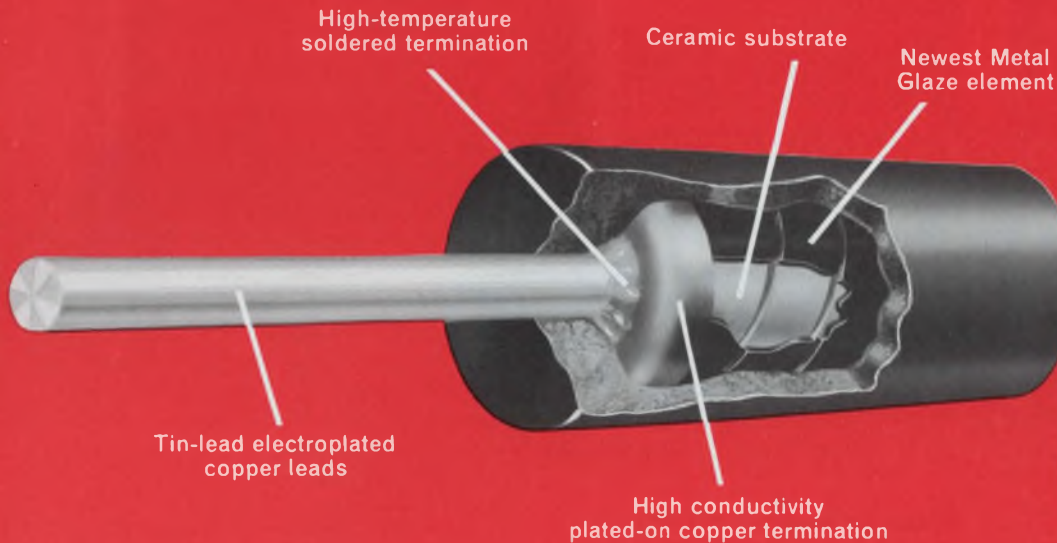

100ppm, 1% plus thick-film stability

IRC's newest Metal Glaze resistors offer the most economical approach to MIL-R-10509 requirements. They have precision performance, plus the added benefits of thick-film stability and reliability.

These resistors feature IRC's latest generation of Metal Glaze resistance material. This improved thick-film element provides the electrical stability and mechanical ruggedness that tin oxide types can't achieve. And, their tough molded bodies resist solvents and the pounding of automated inserting equipment.

Metal Glaze resistors have withstood over 15 million unit hours of testing. In addition to MIL-R-10509, they also meet or exceed MIL-R-22684 and MIL-R-39017. For complete data and prices see your IRC Qualified Industrial Distributor. Or, write IRC, 401 North Broad Street, Philadelphia, Pa. 19108.

CAPSULE SPECIFICATIONS

	Type T-55	Type T-60
MIL STYLE	RN55	RN60
RESISTANCE	10 Ω thru 90K	10 Ω thru 200K
TOLERANCE	$\pm 1\%$	$\pm 1\%$
TEMP. COEFF.	$\pm 100\text{ppm}/^\circ\text{C}$	$\pm 100\text{ppm}/^\circ\text{C}$
POWER	$\frac{1}{4}$ watt @ 70°C $\frac{1}{4}$ watt @ 125°C	$\frac{1}{2}$ watt @ 70°C $\frac{1}{4}$ watt @ 125°C (derate to zero at 165°C, no load)



DIVISION OF TRW INC.

Application Notes



Digital recording

Recently published, a technical note evaluates cost factors involved in digital recording. Various techniques of incremental and continuous IBM-compatible recording are examined and compared. A discussion of non-IBM-compatible cassette recorders is also included. Cipher Data Products, Inc.

CIRCLE NO. 351

Computer glossary

An 8-page glossary lists and defines terms for tape and transmission formats. Included are many of the most common terms used in magnetic tape data storage technology. Computer Products Div. of Tally Corp.

CIRCLE NO. 352

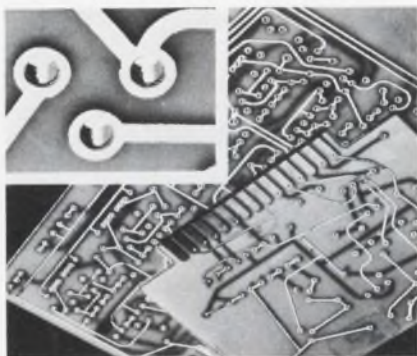

PC production data

A fully diagrammed technical data sheet covers the step-by-step production of plated-through holes in PC-board production. All eight steps are illustrated and described. London Chemical Co., Inc.

CIRCLE NO. 353

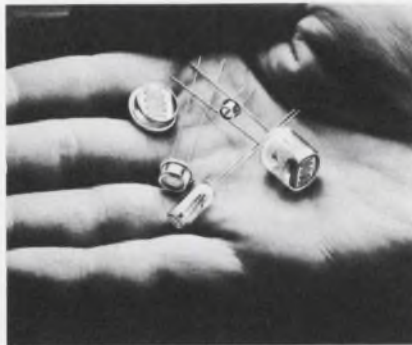

Photocell design manual

A 16-page designer's guide to photoconductive cells covers photocell theory, design, and properties from the application viewpoint. Included in the manual are sections on photocell theory, spectral and color temperature-response speed, light history effects, and maximum voltage. Clairex Corp.

CIRCLE NO. 354

Schottky-barrier diodes

Performance characteristics of silicon microwave Schottky-barrier diodes are described in an applications report. The report briefly describes metal-semiconductor theory as applied to the Schottky-barrier junction, and the importance of reducing losses of junction parasitics. The remainder of the paper describes characteristics of Schottky-barrier diodes as mixers and detectors at S- and X-bands. Microelectronics Division, Philco-Ford.

CIRCLE NO. 355

Application note catalog

Motorola Semiconductor Products Inc. has published an application note catalog listing the number, title, and a brief summary of more than 130 available papers describing circuit and system application designs. Many of the notes listed in this 11-page catalog are reprints of actual articles prepared by Motorola applications engineers and published in leading electronics magazines. Motorola Semiconductor Products Inc.

CIRCLE NO. 356

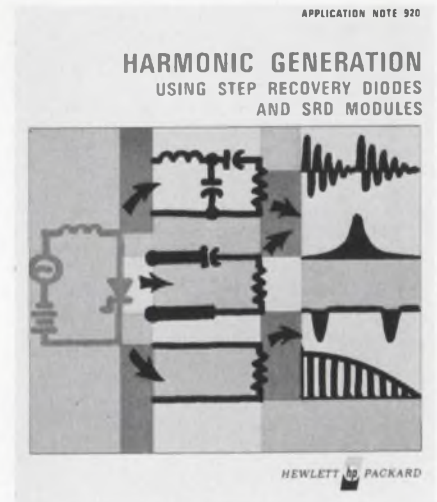

Step recovery diodes

A 32-page application note describes the theory and practice of two step recovery diodes: harmonic frequency multiplication and comb spectrum generation. The note summarizes important design criteria concerning multiplier noise, bandwidth, stability, and deficiency, and tells how to build multipliers that are stable over broad temperature ranges and under all phases of a short-circuit termination. Hewlett-Packard.

CIRCLE NO. 357



Digital logic

A new 200-page workbook contains a complete course in digital logic. Designed for use with a digital logic teaching device, the workbook contains 46 experiments and over 160 illustrations and diagrams. Digital Equipment Corp.

CIRCLE NO. 358

Centralab "Little Giant" Microglass Zener Regulators

Centralab's Little Giant zeners thrive in tight spots. Their performance and competitive pricing have opened new product miniaturization possibilities in entertainment, industrial and high reliability military and aerospace applications.

Our 400 mW regulator has a zener voltage breakdown of 6.8 through 200 volts; the 1 watt from 6.8 through 200 volts; and the 1.5 watt from 6.2 through 200 volts. So the Little Giants do a big job in cramped quarters. What else? They're tough. So tough that gruelling tests of acceleration, mechanical and thermal shock, vibration, lead and body strength, temperature, humidity, salt spray and altitude leave them unscathed. Centralab's Little Giant zeners.

Real crowd pleasers.

FOR MORE INFORMATION ON DIODES,
SOLAR CELLS AND READOUT DEVICES,
WRITE CENTRALAB TODAY. THESE

CENTRALAB PRODUCTS ARE MARKETED
DIRECT TO MANUFACTURERS AND THROUGH
CENTRALAB SEMICONDUCTOR DISTRIBUTORS;
INTERNATIONALLY THROUGH GLOBE-UNION
INC. — INTERNATIONAL DIVISION.

FIT IN ANY CROWD



CENTRALAB
Electronics Division
GLOBE-UNION INC.
5757 NORTH GREEN BAY AVENUE
MILWAUKEE, WISCONSIN 53201

M-6822

New Literature

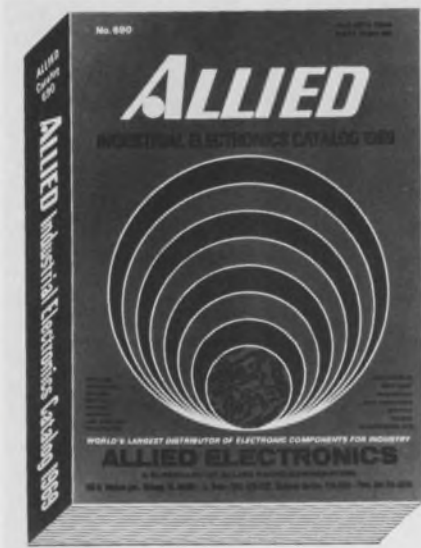

Allied industrial catalog

Allied's 1969 catalog of electronic equipment for industry and government is now available. This 600-page book, the largest issued by an electronics supply house, lists over 50,000 stock items from over 500 manufacturers for research and development, production, communications, education, controls and entertainment. Allied Electronics Corp.

CIRCLE NO. 359

Panel-light hardware

Data, illustrations and military type designations for lens-cap and base assemblies are provided by a 24-page illustrated brochure. The catalog is complete with an index and a replacement cross-reference chart that enables the user to quickly find the desired base and mating lens-cap assemblies. Dialight Corp.

CIRCLE NO. 360

Thermoplastic resins

Newly revised, this 12-page publication describes electrical/electronic uses of thermoplastic resins, including their use in radio and TV components, business machines, control equipment and switchgear, military components and appliances. General Electric Co., Polymer Products Operation.

CIRCLE NO. 361



Adhesive selector chart

An up-dated reference chart suitable for notebook or wall mounting lists the important properties of a line of adhesives. The chart is conveniently arranged to expedite the selection of the proper adhesive. Products with similar properties, such as liquid epoxies, epoxy pastes, and electrically conductive adhesives, are grouped together. For each group the important mechanical, thermal and electrical properties are described. Emerson & Cuming, Inc.

CIRCLE NO. 362

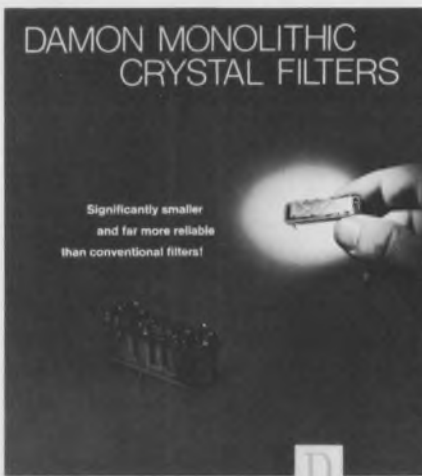

Crystal filters

A four-page bulletin describes a line of monolithic crystal filters and their components, and compares their applications and advantages with conventional crystal bandpass filters. Included are specifications for the complete line of filters. Damon Engineering, Inc., Electronics Div.

CIRCLE NO. 363



Silicon photocells

Case history studies describe the physical and electrical flexibility of silicon photovoltaic cells, and show how they provide a degree of electro-optical design freedom that can only be approached by a multiplicity of discrete devices. Sensor Technology, Inc.

CIRCLE NO. 364



Fasteners

A 20-page standards catalog provides basic information on a broad line of self-drilling fasteners, lock washers, spring washers, thread-cutting screws, locking terminals and other cost-saving fasteners. This condensed reference book contains basic catalog information, illustrations, and a bibliography. Shakeproof, Div. Illinois Tool Works, Inc.

CIRCLE NO. 365



ZELTEX Model 830, the FIRST fet 'op amp' in a dual-in-line package...

try that on for size

The big news in miniature amplifiers is the ZELTEX 830—the industry's first in a DIL package—and the first in a new ZELTEX family of DIL analog functions. What's more, the 830 is fully compensated and short circuit-proof. Performance? The spec's tell the story. ■ Voltage gain is 300,000 ■ $20\mu\text{V}/^\circ\text{C}$ drift ■ input



bias current of 15 pA ■ $6\text{V}/\mu\text{sec}$ slew rate ■ 10 volt common mode voltage, and ■ output of 10 volts at 5 mA. Available from stock, too. Size up the 830 now. Write for complete data and prices. ■ 1000 Chalomar Rd., Concord, Ca. 94520. Phone (415) 686-6660.

INFORMATION RETRIEVAL NUMBER 103

They said it couldn't be done!



**a CONTROL METER RELAY
with 50% savings and
high performance**

WELL, THEY WERE WRONG! After a year of customer use in the field, our customers report that our units are consistently providing high accuracy and high reliability — and they must be right because they are re-ordering and pocketing cost savings of up to 50%. Why not join our increasing list of satisfied customers now?

Beede's Non-Contacting Control Meter Relay was initially designed to offer a wide choice of design options for the greatest application versatility. For instance:-

- 8 or more choices of power supply
- 4 choices of fail-safe configuration
- 10 or more choices of output mode
- 9 choices of alarm lights and reset switches
- Many special features such as tamper-proof units, fixed set pointer stops, etc.
- Pyrometers and resistance thermometers

Write for complete literature today!

BUY VALUE / BUY BEEDE

BEEDE
ELECTRICAL INSTRUMENT CO., INC.
PENACOOK, NEW HAMPSHIRE
Area Code: 603-753-6362

NEW LITERATURE

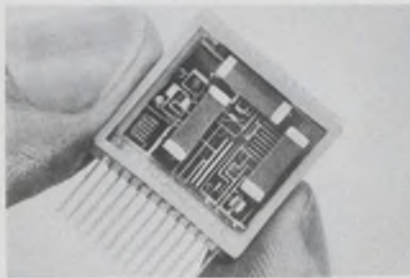

Hybrid microcircuits

The manufacturing process of a hybrid microcircuit, from the engineering drawing to the finished package, is outlined in a newly revised brochure entitled, "The Making of a Hybrid." The eight-page booklet pictorially describes the step-by-step procedures involved in the manufacturing process. A typical circuit is taken through the production cycle to illustrate how advanced techniques are employed to assure an accurate, highly reliable microcircuit. WEMS, Inc.

CIRCLE NO. 366

High-speed TTL ICs

Seventeen high-speed TTL integrated circuits with a typical gate propagation delay time of 13 ns are now in production. Complete details including parameter measurement data are given in a 48-page engineering bulletin that is available upon request. Sprague Electric Co.

CIRCLE NO. 367

Magnetic record heads

A 20-page, two-color catalog contains mechanical and electrical specifications, and typical response curves for a line of recording heads. These heads meet most requirements for full-, half-, quarter-, and eight-track units. Michigan Magnetics.

CIRCLE NO. 368

Instrument journal

The latest issue of the Hewlett-Packard Journal discusses signal generation and spectral analysis. Published monthly, the journal is offered at no charge to engineers and technical personnel. Hewlett-Packard.

CIRCLE NO. 369

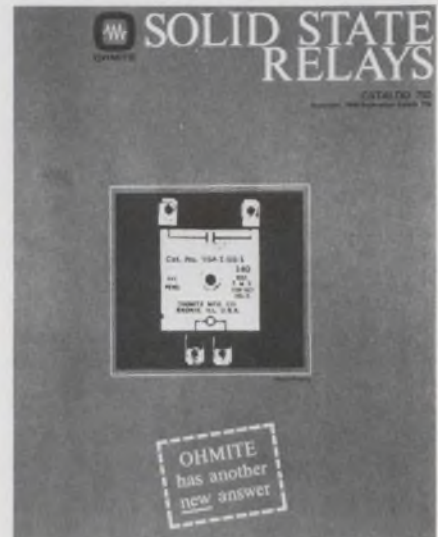

Solid-state relays

Catalog 750 describes the features of a line of solid-state relays, such as inherent contact isolation and universal operating voltage range. Application data on transient protection, surge current handling, load/current temperature derating, and turn-on sequence are presented graphically. Ohmite Mfg. Co.

CIRCLE NO. 370

Rf techniques

A 16-page catalog details many advances in rf techniques, and offers general as well as detailed specifications and descriptions for a wide range of products. These include amplifiers, attenuators, converters, filters, frequency multipliers, multicouplers and multiplexers. Applied Research Inc.

CIRCLE NO. 371

Semiconductor catalog

A 28-page catalog lists electrical specifications and ratings for the following semiconductor products: regulators, mil spec items, general purpose diodes, rectifiers, tunnel diodes, temperature-compensated reference devices, silicon controlled rectifiers, TD/SCR switching system tunnel-diode triggers, photo-voltaic components and devices, and readouts. Dimensional drawings are included for all case types. Centralab, the Electronics Division of Globe-Union Inc.

CIRCLE NO. 372

3 THUMBWHEEL SWITCHES

Digital & Binary. Meet MIL-S-22710.

- For Critical Reliability Applications.
- Available with Internal Lighting MIL-L-25467A.



Switch Modules provide Complete Protection against hostile environments because both panel and switching elements are separately sealed.

Aluminum Bezel has no visible screws when rear-mounted on miniature and standard type switches.



Permanent wafer type miniature decimal switch modules for limited panel space applications.

Removable wafer type switch modules for applications where maintenance time is valuable and rapid servicing is required.

TABET U.S. Patent 2,841,660



No down-time in rotary switches

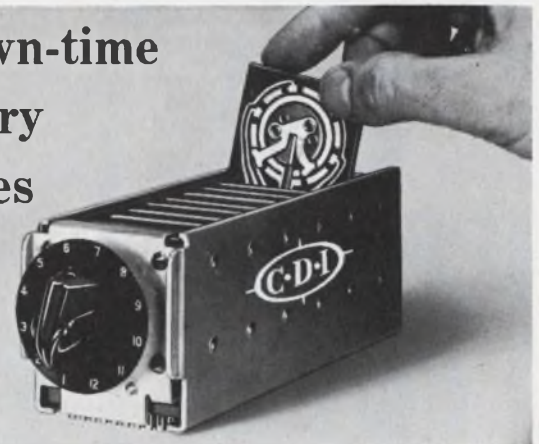

Unique 5-second water replacement obsoletes other switches. Simply lift out old wafer, slip in new wafer. No unsoldering . . . no disassembling . . . no wire removing.

CDI patented switches with dust covers are available in sizes 2" x 2", 3" x 3", and 4" x 4" with lengths to accommodate up to 36 wafers. Switches can be customized to your specifications.

Operation may be manual, motor or solenoid for use in any rotary selector switch application. Now supplied for numerous military and commercial applications.

Mfd. under Tabet U. S. Patents 2,841,660, 2,971,066, 3,015,000, 2,956,131, 2,988,607.



CHICAGO DYNAMIC INDUSTRIES, INC.

PRECISION PRODUCTS DIVISION 1725 Diversey Blvd., Chicago, Illinois 60614 Phone: WEllington 5-4600

INFORMATION RETRIEVAL NUMBER 105

NOW! 2 SUPERIOR DRY FILM LUBRICANTS tailored for your specific industrial needs!

- FEL-PRO C-300**
Air-dries and cures in 1 hour while offering -65°F. to 1200°F. protection
- FEL-PRO C-200**
Bakes on to give outstanding performance throughout -65°F. to 2400°F. range

High-temperature and low-speed lubricating problems? Forget oils, greases and other short-life lubricants! These non-corrosive FEL-PRO products brush or spray on quickly, then dry to a solid yet slick film that fights friction, wear, abrasion, fretting. Either type provides positive, long-life protection for all metals and their derivative alloys. Ideally suited for heavy-load, low-speed applications that require excellent adhesion and extreme pressure resistance. Try C-300 or C-200 once . . . and you'll never settle for less!

Write on your letterhead for free sample, technical data, and price information. Please state which product desired and intended application.



← NEW
Push Button Can



FEL-PRO FEL-PRO, INC., A Division of Felt Products Mfg. Co.
7450 N. McCormick Blvd., Dept. ED, Skokie, Ill. 60076

INFORMATION RETRIEVAL NUMBER 106

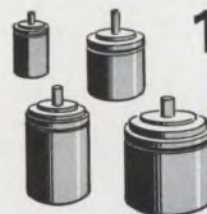

1001 uses for STEPPER MOTORS

Because their output is in discrete increments, Cedar stepper motors have many advantages over conventional motors for precise positioning applications. They are bi-directional and have high torque output. They can be run at high stepping rates or as slow as you wish. Because shaft rotation is incremental, damping is not required.

Some of the applications for which stepper motors have been used are: replace motor-tachometers in servo systems, control missile ailerons, shutter control on high-speed cameras, open loop positioner in checkout systems, high-speed counter in such applications as rapid firing weapons, replace ultra low-speed dc motors, incremental tape handlers, and digital-to-analog and analog-to-digital conversion equipment.

The uses for stepper motors are as unlimited as your imagination. New applications are constantly being discovered. What new use will you next make of stepper motors? Let us know about your ideas; we'll be happy to work with you.

Cedar Stepper Motors are available in sizes 5, 8, 11 and 15 in both permanent magnet and variable reluctance types, and with a wide variety of stepping angles. All meet the full requirements of MIL-E-5272. For free booklets on stepper motor application ideas, write or call:

CEDAR
ENGINEERING DIVISION

CONTROL DATA
CORPORATION

5806 West 36th Street, Minneapolis 16, Minnesota. Phone 929-1681

INFORMATION RETRIEVAL NUMBER 107



COMPACT POWER PACKS



The new Compact "M" Series Power Packs offer you:

- Rated output voltages from 1000 to 75,000 DC
- Rated output currents of 1.5, 5, and 10 milliamperes
- Input voltages of 118, 220, 230, and 240 volts AC
- Variable output from 0 to rated voltage
- Input frequency range 50 to 500 CPS
- output ripple 1% RMS at rated voltage
- Hermetically sealed construction

Why pay more, and settle for less... PC's new compact power packs give more quality, more versatility, more dependability, plus smaller size, and best of all, most sizes are available in stock to meet your immediate needs.

Write for complete information and new catalog today!



Plastic Capacitors, Inc.

2620 N. Clybourn • Chicago 14, Ill.
DI 8-3735

INFORMATION RETRIEVAL NUMBER 108

NEW LITERATURE



Data transmission

Applications of high-speed data transmission are discussed in an 18-page booklet that describes three such systems. Model 2056 is an asynchronous channel in which two- or three-state data streams may be transmitted. Model 3227 is a coherent channel in which two-state data streams may be transmitted along with and in synchronism with 50% clock pulses. Model 4000 is a synchronous channel in which the clock information is taken from the data set at both ends. RFL Industries, Inc.

CIRCLE NO. 373

Potentiometer brochure

An eight-page adjustment potentiometer brochure features nomenclature, dimensions, specifications, price listings, and detailed photos. Specifications given include those for resistance tolerance, power rating, maximum temperature, adjustment turns, standard resistance and humidity. Bourns, Inc.

CIRCLE NO. 374

Measuring equipment

A 35-page catalog lists and pictures all major elements of a line of electronic measuring instruments. Brief descriptions are provided with each entry, and specifications are listed for major items. B & K Instruments, Inc.

CIRCLE NO. 375

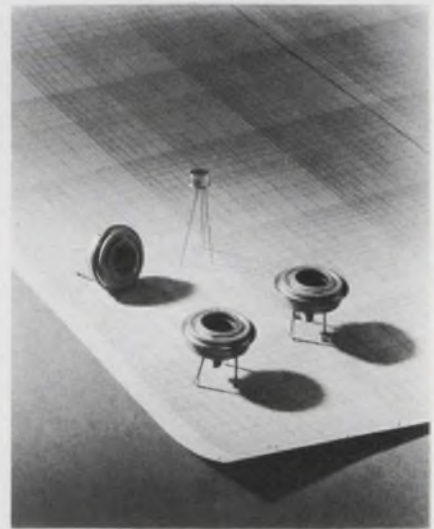

Photodiode notes

Application notes on SGD-100 and SGD-444 photodiodes describe the characteristics and operation of these high-speed, high-sensitivity devices. Both silicon photodiodes offer a planar-diffused, guard-ring construction. They feature a unique combination of high quantum efficiency (70%), wide spectral range (0.35 to 1.13 μm), nanosecond speed or response, low noise levels and high linearity. EG&G, Inc.

CIRCLE NO. 376

Laser trimming

A four-page data sheet describes the factors involved in mass producing precision-trimmed cermet resistors with an automatic laser trimming system. Laser trimming of these high-temperature resistors is fast and precise. It reduces the need for stringent control during the manufacturing process and produces toleranced resistors of exceptional quality. Spacera, Inc.

CIRCLE NO. 377

IC digital counters

A comprehensive review of characteristics, applications, detailed specifications and operation information of a series of IC digital counter/timer/frequency meters and companion plug-ins appears in this 24-page brochure. Bulletin #74-1702 covers all modes of application provided by these instruments. Monsanto Electronics Technical Center.

CIRCLE NO. 378



**New Arvin
1 MHz TCXO
off-the-shelf
for only
\$150 each**

We can manufacture and **deliver in quantity** TCXO's to these specifications:

Frequency . . . 1 MHz
Stability . . . 5 PP 10' from -40°C to +75°C
Supply Voltage . . . 12V ±1VDC
Output . . . 750mv ±10% into 1000 ohms
Packaging . . . 1.125" high x 2.00" dia.
Specs . . . designed to meet MIL Specs
Price . . . \$150 each. Less in quantity
Delivery . . . immediate.

Next time you need a proven TCXO capability, call (317) 743-9639.



ARVIN FREQUENCY DEVICES
ELECTRONIC SYSTEMS DIV., ARVIN INDUSTRIES, INC.
2505 N. Salisbury, West Lafayette, Indiana 47906

INFORMATION RETRIEVAL NUMBER 109

**"IT'S GOOD BUSINESS
TO HIRE THE HANDICAPPED."**

ISN'T THAT A GREAT IDEA, SNOOPY?



THE PRESIDENT'S COMMITTEE ON EMPLOYMENT
OF THE HANDICAPPED, WASHINGTON, D. C.

**New, smaller
air variable
capacitor**

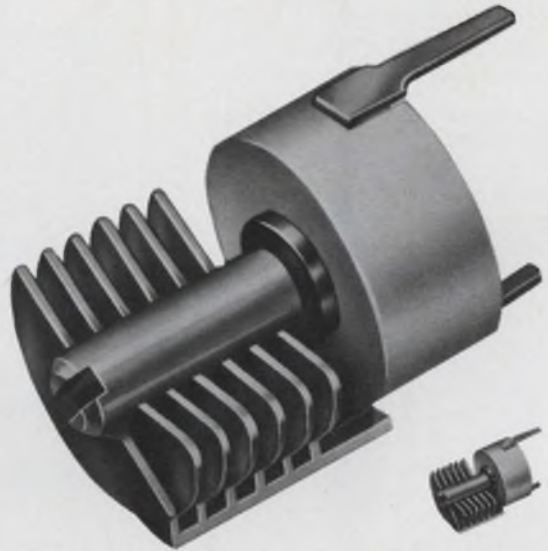

ACTUAL SIZE

**1.7 to 11 pf machined plate capacitor
for PC mounting is only .310" in diameter**

This new, sub-miniature Type "T" air dielectric trimmer capacitor from E. F. Johnson fits the limited space requirements of modern design. It is designed for VHF and UHF applications where small size (.310" diameter), high Q (greater than 1500 at 1 MHz), low TC and low cost are important considerations.

The Type "T" mounts interchangeably with widely used 3/8" printed-circuit-type ceramic disc trimmers in two .050" diameter holes on .300" centers.

Nominal capacity is 1.7 pf minimum, 11.0 pf maximum. Peak voltage breakdown is 250 VDC. End frame is 95% alumina, grade L624 or better, DC200 treated. Metal parts are silver plated and Iridited.

Johnson machined plate construction provides exceptional stability, including minimum drift over extremes of temperature and humidity.

MAY WE TELL YOU MORE? Write for detailed specs and prices on Type "T" capacitors. And ask for Components Catalog 701 covering the entire E. F. Johnson component line.



E. F. JOHNSON COMPANY

3378 Tenth Ave. S.W., Waseca, Minnesota 56093

Providing nearly a half-century of communications leadership

INFORMATION RETRIEVAL NUMBER 110

Electronic Design

ELECTRONIC DESIGN's function is:

- To aid progress in the electronics manufacturing industry by promoting good design.
- To give the electronic design engineer concepts and ideas that make his job easier and more productive.
- To provide a central source of timely electronics information.
- To promote two-way communication between manufacturer and engineer.

Want a subscription? ELECTRONIC DESIGN is sent free to qualified engineers and engineering managers doing design work, supervising design or setting standards in the United States and Western Europe. For a free subscription, use the postfree application form inside the back cover. If none is included, write to us direct for an application form.

If you do not qualify, you may take out a paid subscription for \$25 a year in the U.S.A., \$35 a year elsewhere. Single copies are \$1.50 each.

If you change your address, send us an old mailing label and your new address; there is generally a prepaid postcard for this inside the back cover. You will have to requalify to continue receiving ELECTRONIC DESIGN free.

The accuracy policy of ELECTRONIC DESIGN is:

- To make reasonable efforts to ensure the accuracy of editorial matter.
- To publish prompt corrections whenever inaccuracies are brought to our attention. Corrections appear at the end of the Letters column.
- To refuse any advertisement deemed to be misleading or fraudulent.

Microfilm copies are available of complete volumes of ELECTRONIC DESIGN at \$19.00 per volume, beginning with Volume 9, 1961. Work is now in process to complete the microfilm edition of Volumes 1-8. Reprints of individual articles may be obtained for \$2.00 each, prepaid (\$.50 for each additional copy of the same article) no matter how long the article. For further details and to place orders, contact the Customer Services Department, University Microfilms, 300 North Zeeb Road, Ann Arbor, Michigan 48106; telephone (313) 761-4700.

Want to contact us? If you have any comments or wish to submit a manuscript or article outline, address your correspondence to:

Howard Bierman, Editor,
ELECTRONIC DESIGN,
850 Third Avenue,
New York, N.Y. 10022.

Design Data from

A FREE Cross Reference Guide



to better Printed Circuit drafting

No engineer or draftsman should be without the NEW 1968 By-Buk Printed Circuit Drafting Aids P-45 Catalog with color-coded MIL-SPEC sizes. Also contains over 2000 pads, shapes, tapes, transistor tri-pads, spaced integrated circuit terminal pad sets and many other drafting aids for faster, more accurate, distortion-free printed circuit master drawings. Send for your FREE catalog.

By-Buk Company

4326 West Pico Blvd., Los Angeles, Calif. 90019
Telephone: (213) 937-3511

171

FREE CATALOG OF ELECTRONIC REFERENCES



A 92 page catalog of up-to-date, illustrated references is now available. The books described deal with electronics and microelectronics, computers and their components, semiconductors, test equipment, etc. — a broad range of principles, materials, design-data, and applications. They are designed to meet the specific needs of engineers and managers, as well as students and industrial trainees. Send today for your free copy.

Hayden Book Company, Inc.

116 West 14th Street
New York, New York 10011

173

How To Write Technical Articles



A guide for the engineer-author, "How to Write Articles for Electronic Design" shows how easy it is to write for publication—once the engineer knows what to write and how to write it. The Author's Guide includes a complete run-down of the types of articles published by Electronic Design—plus detailed instructions on how to prepare technical articles and short special features. A MUST for every "would-be-writer" in the electronics industry. Send for your complimentary copy by circling the number to the right.

Electronic Design

850 Third Avenue
New York, N.Y. 10022

175

Manufacturers

Advertisements of booklets, brochures, catalogs and data sheets. To order use Reader-ServiceCard.
(Advertisement)

Free: 2,500 Plastic Parts Catalog



New from Nylomatic, molders and fabricators of mechanical plastic components, a highly informative 48-page catalog of more than 2,500 standard parts. It can help you save time and money in design, test and production. Advantages of Nylomatic standard parts: no tooling charges, low unit costs, quick delivery, complete range of sizes. Nylomatic standard parts are made of Nylon, Delrin® and other thermoplastic materials. You'll find our new free catalog a real problem solver for designers, send for it today.

Nylomatic Corporation

Dept. P

Nolan Ave., Morrisville, Pa. 19067

172

Free Fiberfil Reinforced Thermoplastics Manual



This 32 page engineering manual gives complete data on thermoplastic injection molding compounds with fiberglass to greatly improve performance. It contains properties comparisons, including dielectric performance on all reinforced thermoplastics. Many electrical-electronic applications show how the materials are being used. Test data is included on eleven basic resins, long glass and short glass reinforced grades and many specialized materials. This is the standard reference on FRTP's, prepared by the oldest and largest maker of fiberglass reinforced thermoplastics. For a free copy circle this number.

Fiberfil Division, Rexall Chemical Co.

1701 N. Heidelberg,
Evansville, Indiana 47717

174

NEW COAXIAL SWITCHES AND MATRICES



This new colorful 12 page catalog is the most complete and technically helpful of its kind. Cable system noise reduction is covered in detail along with how to establish the best system for your application. Matrices are available with multiple inputs and outputs, with numerous paths through the matrix available simultaneously. Using the same mode of construction, single pole multi-throw, or multi-pole multi-throw coax, twinax and triax relays are available.

Trompeter Electronics, Inc.

8936 Comanche Avenue
Chatsworth, California 91311

176

Electronic Design

Advertising Sales Staff

New York 10022

Robert G. Drake
Sales Manager

Edward F. Clancy
Sales Service Manager

Robert W. Gascoigne
Thomas P. Barth
Samuel M. Deitch
Byron Adams

850 Third Avenue
(212) Plaza 1-5530
TWX: 867-7866

Philadelphia 19066

William C. Repetto

P. O. Box 206
Merion Station, Pa.
(215) MA-3-5888

Boston 01945

Richard Parker

P.O. Box 645
Clifton Station
Marblehead, Mass.
(617) 742-0252

Chicago 60611

Thomas P. Kavooras
Berry Conner, Jr.

200 East Ontario
(312) 337-0588

Cleveland

(216) 247-7670

Los Angeles 90303

Stanley I. Ehrenclou
John V. Quillman
W. James Bischof

2930 Imperial Highway
Inglewood, Calif.
(213) 757-0183

San Francisco 94022

Arthur R. Shields, Jr.

175 San Antonio Rd., S 243
Los Altos, Calif.
(415) 941-3084

London W. 1

For United Kingdom & Holland
Brayton C. Nichols

44 Conduit Street
Tel: REGent 4714

Verviers, Belgium

For Continental Europe
Andre Jamar

1, Rue Mallar, 1
(087) 253.85 Telex 41563

Tokyo

Yoshihiro Takemura

IPS Group Ltd.
Box 36, Ohsaki Post Office
Phone (431) 5804



FREE

Design Engineering Service

from

PERMACOR®

Iron Core Engineers

Only the world's largest iron core producer could offer you the qualified engineering services backed by an unequalled knowledge of iron core usage, applications, limitations, and production to quickly resolve all iron core problems.

With countless years in their research, development, and production, PERMACOR can, from experience, recommend the most efficient and economical solution to your iron core product and production problems.

We have matched over 20,000 iron cores to the needs of countless military, commercial, miniature, and specialized applications. We can do the same for you!

Send us your problems today. Let us show you how PERMACOR "Engineered Economy" can save you time and money. There's no obligation, of course.

PERMACOR®

A Division of Radio Cores, Inc.

9540 Tully Ave., Oak Lawn, Ill.

Phone: 312/GA 2-3353

INFORMATION RETRIEVAL NUMBER 111

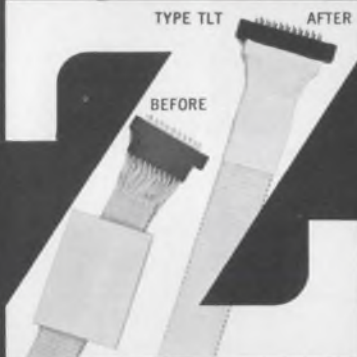

ZIPPERTUBING® TEMPLOCK THINWALL SHRINKTUBING

provides low cost, light weight PVC with better dielectric properties!

TLT is a thin wall, low cost shrink tubing of especially compounded polyvinyl chloride with a shrink capability of 45% to 55%.

Standard colors: Clear, black, white.

For full information on specialized, high-performance jacketing, contact

THE ZIPPERTUBING® CO.

CORPORATE HEADQUARTERS
13000 S. BROADWAY
LOS ANGELES, CALIF. 90061
Phone (213) 321-3901
TWX 910-346-6713

BALTIMORE • BOSTON • CHICAGO • DALLAS • NEW YORK
PHOENIX • SAN FRANCISCO • WEST GERMANY



INFORMATION RETRIEVAL NUMBER 112

Advertisers' Index

Advertiser Page

Abbott Transistor Laboratories Incorporated	14
Acopian Corporation	103
Alfred Electronics	125
Allen-Bradley Co.	45, 47
Ametek/Lamb Electric	131
Ammon Instruments, Inc.	140
Arnold Engineering Company, The	34, 35
Arvin Frequency Devices	155
Augat, Inc.	132
Automatic Electric Company	42, 43

Beckman Instruments, Inc., Helipot Division	91
Beede Electrical Instrument Co., Inc.	152
Bourns, Inc.	38, 97, 123
Burr-Brown Research Corporation	15
By-Buk Company	156

CMC, A Division of Pacific Industries	89
Captor Corporation	140
Carborundum Company, The	27
Cedar Engineering Division, Data Control Corporation	153
CELCO (Constantine Engineering Laboratories Co.)	139
Centralab, the Electronics Division of Globe-Union, Inc.	149
Chicago Dynamics Industries, Inc.	153
Clare & Co., C. P.	70
Cohu Electronics, Inc.	109
Corning Glass Works, Electronic Products Division	83, 111
Cutler-Hammer	37

Damon Engineering, Inc.	24
Datapulse, Incorporated	2
Dearborn Electronics Inc.	112
Dow Corning Corporation	58, 59

Electro Fiberoptics Corporation	114
Electro-Motive Mfg. Co., Inc., The	117
Electro Tec Corp.	130
Electronic Design	144, 145, 156
Electronic Memories, Inc.	100
Erie Technological Products, Inc.	93

Fairchild Instrumentation, A Division of Fairchild Camera and Instrument Corporation	95
Fairchild Semiconductor, A Division of Fairchild Camera and Instrument Corporation	12, 13
Fel-Pro, Inc.	153
Fiberfil Division, Rexall Chemical Co.	157
Fifth Dimension, Inc.	79

General Electric Company, Specialty Control Department	107
General Radio Company	69
Gordon, a Subsidiary of Pneumo Dynamics Company	44
Grayhill, Inc.	143

Hathaway Instruments, Inc.	129
Haydon Switch & Instrument Inc.	50
Hewlett-Packard	1, 7, 99, Cover III
Hughes Aircraft Company	113

IRC, Division of TRW, Inc.	147
Ideal Precision Meter Co. Inc.	120
Industrial Condenser Corp.	142
Industrial Electronic Engineers, Inc.	78
Industrial Timer Corporation	143
Inertia Switch, Inc.	139
Inland Motor Corporation of Virginia	141
International Rectifier Corp.	119

Advertiser Page

JFD Electronics Co./Components Division	46
Johanson Manufacturing Corp.	128
Johnson Company, E. F.	155

Lenz Electric Manufacturing Co.	116
Lockheed Electronics Company	6

MAC	133, 159
McLean Engineering Laboratories	108
Magnecraft Electric Co.	121
Magnetics, Inc.	77
Matsuo Electric Co., Ltd.	130
Metex Corporation	133
Microsonics, Inc.	106
Miller Company, J. W.	104
Monsanto Company	137
Motorola Semiconductor Products, Inc.	4, 5, 16, 36

National Electronics, Inc.	120
National Semiconductor Corporation	29, 31
Nortronics Company, Inc.	118
Nylomatic Corporation	157

Pastoriza Electronics, Inc.	122, 124
Plastic Capacitors, Inc.	154

RCA Electronic Components and Devices	8, 9, Cover IV
RCA Institutes, Inc.	135
Radio Cores, Inc.	158
Robinson Nugent, Incorporated	132
Rohde & Schwarz	17

Servo-Tek Products Company, Inc.	133, 139
Simpson Electric Company	41
Singer Company, The	23
Solitron Devices, Inc.	33
Sperry Rand Corporation, Sperry Microwave Electronics Division	105
Sprague Electric Company	18, 20
Stackpole Carbon Company	126
Stackpole Components, Inc.	127
Standard Condenser Corporation	135
Sylvania Electric Products, Inc., Electronic Components	32A-H
Syntronics Instruments, Inc.	136

TRW, Inc., Capacitor Division	Cover II
Tektronix, Inc., Oscilloscopes	48 A-B
Texas Instruments Incorporated, Components Group	10, 71
Thermal American Fused Quartz Co., Inc.	134
Theta Instrument Corporation	11
Torngren Co., Inc., C. W.	48
Trompeter Electronics, Inc.	157
Trymetrics Corporation	138

Varo Inc.	110
Vector Electronic Co., Inc.	136
Weston Instruments, Inc.	115
Zeltex, Inc.	151
Zippertubing Corp., The	158

Career Advertising

Delco Radio, Division of General Motors	84
Hughes Aircraft Company, Aerospace Divisions	86
LTV Electrosystems, Inc.	87
McDonnell-Douglas Corporation	88
Sperry Flight Systems Division	86

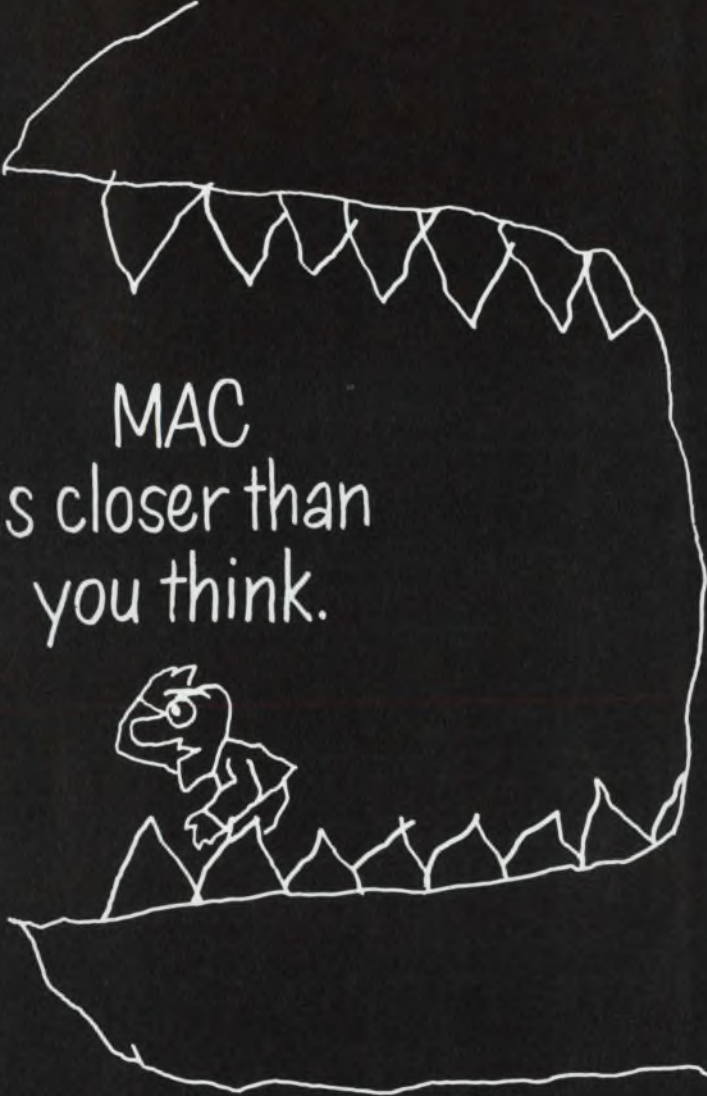

MAC
is closer than
you think.

**These
new
sub-mini
mixers**



**fit the same
hole
pattern
as your flat-pack IC's**



**and use
the same
board area
as your TO-5 cans.**



So when you're building printed circuits, you save time and money in both layout and construction. And the new HP 10534C Double Balanced Mixer has the same high performance, versatility and ruggedness as Hewlett-Packard's other models, yet is only 0.4" wide, 0.35" deep and 0.43" high when seated.

The 10534C mixer has a range of dc to 150 MHz on one port, 50 kHz to 150 MHz on the other two. Conversion loss is 6.5 dB over the HF band, 8 dB over the entire range. Typical balance is better than 15 to 35 dB, depending on frequency and test connections.

These small, high-performance mixers are available immediately at \$60 each, or at liberal quantity discounts.

HP offers a selection of five mixers with four connector options, low 1/f noise, complete testing with parameters specified in detail, and guaranteed performance over a wide environmental range. For detailed specifications, call your HP field engineer, or write Hewlett-Packard, Palo Alto, California 94304; Europe: 54 Route des Acacias, Geneva.

HEWLETT  PACKARD

SOLID STATE DEVICES

INFORMATION RETRIEVAL NUMBER 243

New...RCA-2N5497 Family Extends Your Current Choice in TO-66 Plastic Power Transistors to 3.5 A

Ruggedness, versatile configuration, high power density—these are key features of RCA's recently announced 2N5490 through 2N5497 n-p-n transistors in the highly reliable "plastic TO-66 package." Intended for a wide variety of medium-power switching and amplifier applications, this new family augments previously announced types 2N5293 through 2N5298, and extends RCA's total current handling capability with good gain over the range from 0.5 to 3.5 A... power dissipation from 36 to 50 watts.

These new power devices provide top performance. RCA mounts the silicon chip directly onto a solid copper base for better current handling, improved thermal resistance, and dissipation capabilities. Also, all units provide designs with freedom from second breakdown—the inherent advantage of RCA homotaxial-base technology.

Check the chart. For more information, see your RCA Representative or your RCA Distributor. For technical data on specific types, write: RCA Electronic Components, Commercial Engineering, Section 1-G-11-1, Harrison, N. J. 07029.

TYPE	$V_{CE(sus)**}$	h_{FE}
2N5293+	75 V	30-120 @ $I_C = 0.5$ A, $V_{CE} = 4$ V
2N5294+		
2N5295+	50 V	30-120 @ $I_C = 1$ A, $V_{CE} = 4$ V
2N5296+		
2N5297+	70 V	20-80 @ $I_C = 1.5$ A, $V_{CE} = 4$ V
2N5298+		
2N5490*	50 V	20-100 @ $I_C = 2.0$ A, $V_{CE} = 4$ V
2N5491*		
2N5492*	65 V	20-100 @ $I_C = 2.5$ A, $V_{CE} = 4$ V
2N5493*		
2N5494*	50 V	20-100 @ $I_C = 3$ A, $V_{CE} = 4$ V
2N5495*		
2N5496*	80 V	20-100 @ $I_C = 3.5$ A, $V_{CE} = 4$ V
2N5497*		

* θ_{J-C} 3.5°C/W max.

** θ_{J-C} 2.5°C/W max.

** $R_{BE} = 100$ ohms

