

Electronic Design

FOR ENGINEERS AND ENGINEERING MANAGERS

VOL. 16 NO.

8

APRIL 11, 1968

Light bounces from a bent film in this optical computer that has just emerged from security wraps. Little by little, the fog is lifting from the exotic world

of calculation with light beams and lenses. Lasers promise high-density memories. For a glimpse at the promise and problems of optical computers, see page 25.

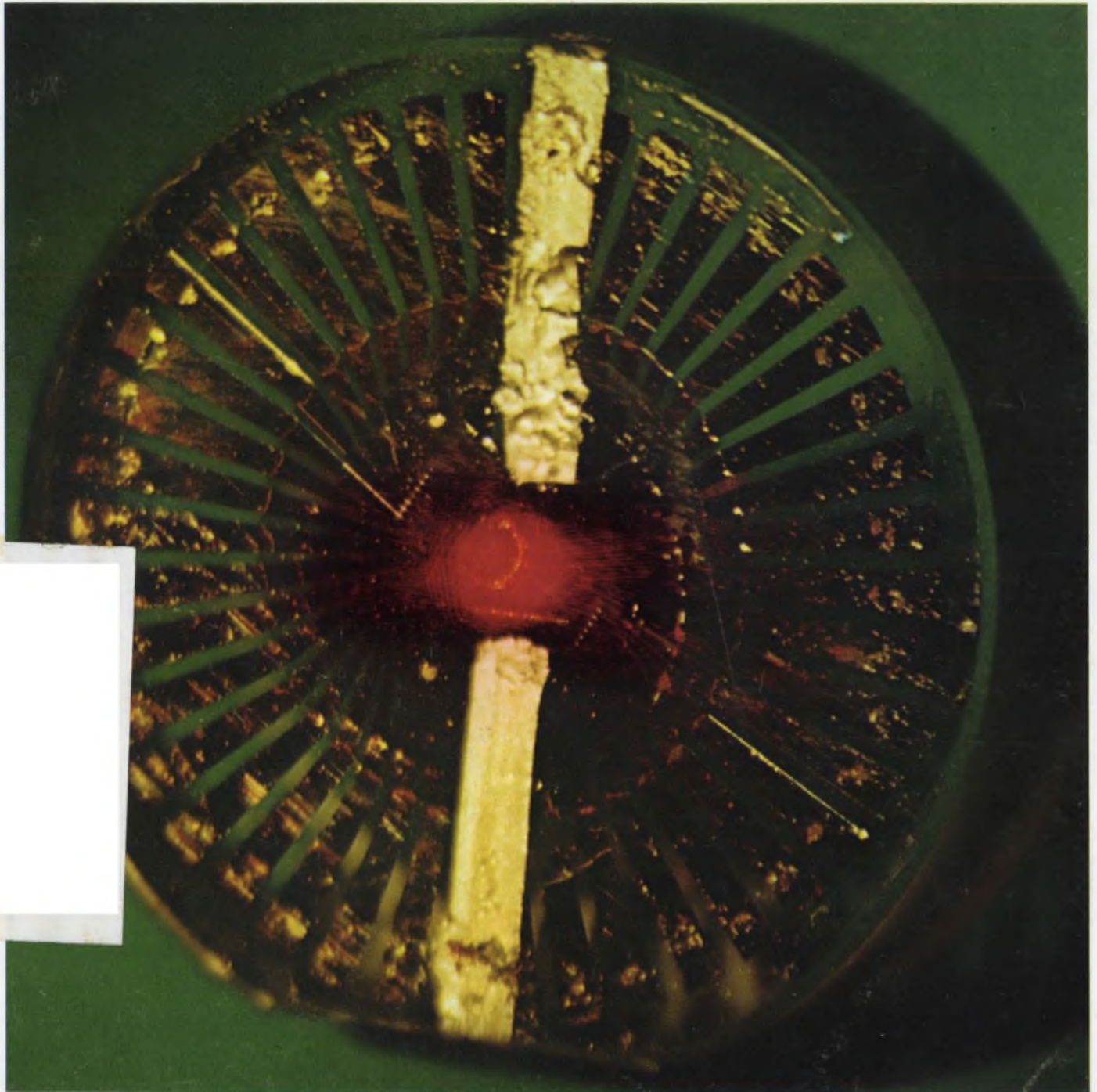

SEE MORE...DO MORE...

For the first time there's Four-Channel Capability in a Portable, All-solid-state Scope—the hp 180 Scope System

Now—*whenever* and *wherever* you need four channels of high frequency information, the new hp 1804A Four Channel Vertical Amplifier plug-in provides more than twice the measurement capability of a two-channel scope. As a part of the lightweight 30-pound 180 scope system, the 1804A gives you 50 MHz, 20 mV/cm sensitivity, with four-channel capability in your lab, in the field, or in your production area.

Use the hp 1804A amplifier with 180A mainframe for making timing comparisons or measuring relationships of up to four inputs. Use the 1804A for designing computer logic circuitry, or for checking digital logic pulse trains. You'll save time

by comparing four inputs at one time!

Use the 1804A with 181A Variable Persistence and Storage mainframe to make measurements of four low rep rate pulses. Use variable persistence to eliminate annoying flicker. For time comparison of four channels of computer logic—which often are single shot phenomena—use the storage feature to capture and hold traces for accurate comparison.

The new hp 1804A amplifier offers a choice of selectable triggering or composite triggering. When set in SELECT mode, you can trigger on any one channel and see the time relationship with each of the other channels. For composite triggering, set the SYNC MODE switch to ABCD and each channel is triggered individually.

An UNCAL indicator lights when the CAL vernier setting on any channel is out of calibration. Channels are identifiable through use of the identification button next to the position controls.

The hp 1804A amplifier is another addition to the growing group of versatile plug-ins now available for use with the

hp 180 scope system. It is compatible with either the 1820A Time Base or the hp 1821A Time Base and Delay Generator. Other plug-ins available for use with the 180A conventional display scope and the 181A Variable Persistence and Storage scope are the 1801A 50 MHz 5 mV/cm Dual Channel Amplifier, the 1802A Dual Channel Amplifier with fully usable bandwidth to > 100 MHz, the 1803A Differential/DC Offset Amplifier with its 40 MHz bandwidth and >0.5% accuracy.

Get the full story on the new hp 1804A Four-Channel Vertical Amplifier and the SEE MORE . . . DO MORE hp 180 Scope System. Contact your nearest hp field engineer. Or write to Hewlett-Packard, Palo Alto, California 94304. Europe: 54 Route des Acacias, Geneva. Price: hp 180A Oscilloscope, \$825; hp 181A Variable Persistence and Storage Oscilloscope, \$1850; hp 1804A Four Channel Vertical Amplifier, \$975; hp 1820A Time Base, \$475; hp 1821A Time Base and Delay Generator, \$800.

INFORMATION RETRIEVAL NUMBER 212

HEWLETT  PACKARD

OSCILLOSCOPE SYSTEMS





RF OUTPUT
 $Z_0 = 50 \text{ OHMS}$

1026 STANDARD-SIGNAL GENERATOR
GENERAL RADIO COMPANY
CONCORD MASSACHUSETTS USA
SERIAL 108

RF output: 1/2 watt

We've used an ordinary pilot lamp to prove a point: Our new Type 1026 Standard-Signal Generator puts out lots of power — $\frac{1}{2}$ watt into 50 ohms, 10 volts behind 50 ohms (5 volts when modulated). It also puts out as little as $0.1 \mu\text{V}$ and anything in between these limits.

The 1026 also has true single-dial tuning over its entire 9.5- to 500-MHz frequency range. There is no output trimmer control to adjust every time you change frequency. Output of the 1026 is *automatically* leveled; you can change frequency within a range or even switch ranges and maintain output level within ± 0.2 dB to 110 MHz and within ± 0.5 dB to 500 MHz. The carrier is leveled whether modulated or unmodulated. Amplitude modulation up to 95% can be imposed on the carrier from an internal, highly stable 1-kHz oscillator or from an external audio source. There are also provisions for external modulation to 1.5 MHz and for pulse modulation.

Other specifications are as much as an order of magnitude better than those of

any other signal generator you can buy. For example, envelope distortion is less than 1% for 1-kHz, 50% modulation; incidental fm accompanying this a-m is less than 1 ppm, peak; residual fm is less than 0.05 ppm, peak; residual a-m is at least 70 dB below carrier level in CW, internal 1 kHz, and external audio modes.

This instrument is made to order for a-m receiver testing, and its high-level output makes it most suitable for antenna-pattern and impedance measurements, receiver overload and cross-modulation tests, and measurements of large insertion losses. The ease of operation and outstanding performance of the 1026 in the most critical applications must be experienced to be appreciated.

For complete information or a demonstration of the 1026, write General Radio Company, W. Concord, Massachusetts 01781; telephone (617) 369-4400; TWX (710) 347-1051.



Type 1026 Standard-Signal Generator, \$6500 in U. S. A.

GENERAL RADIO
INFORMATION RETRIEVAL NUMBER 2

Little plug-ins make the big difference in 50 MHz counters



When you look only at the main frame, it's hard to find important differences between 50 MHz counters. But when you compare plug-ins, you'll find great differences and decisive advantages. Only Systron-Donner plug-ins can give you:

1. Final-answer frequency readings to 40 GHz.

A single plug-in, our Model 1292 semi-automatic transfer oscillator, boosts the counter's frequency-measuring range to 15 GHz. Measures FM and pulsed RF above 50 MHz. And the complete dc to 15 GHz system (counter with plug-in) costs only \$5250. Our new Model 1298 semi-automatic T.O. now gives you final-answer readings up to 40 GHz—a new record.

Contact Systron-Donner Corporation, 888 Galindo Street, Concord, California. Phone (415) 682-6161.

2. Automatic frequency readings to 18 GHz.

Three Acto[®] plug-ins now produce fully-automatic microwave frequency readings: 50 MHz to 5 GHz (P, L, Q, S band), 5 to 124 GHz (S, X band), and 12.4 to 18 GHz (K_u band).



Find more unique measuring capability in this catalog

3. Time readings with 10-nano-second resolution.

Our latest time interval plug-in gives you time readings with 10-nanosecond resolution—greater precision than ever before possible with a standard counter.

All this unique measuring capability can be yours today—or tomorrow—when you buy your basic counter from Systron-Donner. Sixteen different plug-ins have been especially designed to give your Systron-Donner counter more measuring power at less cost than any other system.

SYSTRON  DONNER

NEWS

- 19 News Scope
- 25 **Optical computers poised for systems role**
Powerful parallel processors, nearing practicality, could blend with electronics to solve the 'insoluble'
- 33 Gold bridge boosts isolation in ICs
- 34 **Major growth is forecast in radar market**
Panel of experts sees significant advances in four fields with total spending of about \$1 billion by 1975
- 41 Washington Report
- 46 Letters
- 50 Sidelights of the issue
- 53 **Editorial: As the pot shrinks, the snow flies**

TECHNOLOGY

- 57 **Single transistor gives uhf watts.** Learn how to design a class C output stage, using simple equations and manufacturers' data.
- 64 **Design noise out of spacecraft payloads.** Good circuit design and proper layout can avoid serious troubles at launching time.
- 70 **Analyze nonlinear systems with ECAP.** Switching features of a circuit analysis program are used to simulate control systems.
- 76 **Use ICs in your phase-locked loop.** System complexity is greatly reduced and the parts count lowered by 60 per cent in a typical circuit.
- 82 **Calculate distributed capacitance of coils** with an easy-to-make cardboard slide rule. Use it for measurements with a grid dip meter.
- 86 Test your IC IQ
- 90 **Put some life into your technical talk.** Why send your audience to sleep, when you can stimulate it with lively illustrations?
- 96 NASA Tech Briefs
- 100 Ideas for Design

PRODUCTS

- 114 **Systems:** 'Ubiquitous' spectrum analyzer works to 10 kHz with 20 kHz resolution.
- 122 **Microelectronics:** Low drift IC amplifier contains 24 active elements.
- 124 **Production Equipment:** Drilling machines use air bearings.
- 126 **Microwaves:** Hybrid microcircuits amplify microwaves.
- 134 **Test Equipment:** Photographic microscope reveals a 1/4 in. depth of field.
- 130 Components

Departments

- 16 Designer's Datebook
 - 98 Books
 - 140 Design Aids
 - 142 Application Notes
 - 144 New Literature
 - 150 Advertisers' Index
 - 152 Information Retrieval Service
- Information Retrieval Service card inside back cover



tiny, but tough,

the Clare MF relay does a *big* job in .046 cu. in.

It's built for action. Whether the job calls for one operation with certainty, or for consistent reliability over more than 150,000 operations, the MF delivers proven Clare performance.

Design around the Clare MF for space-saving efficiency in the most demanding military and industrial circuits. Provide long electrical and mechanical life under extreme conditions of shock, vibration and linear acceleration . . . and temperatures from -65°C to $+125^{\circ}\text{C}$. Meet advanced pcb circuit requirements with low profile, high-density switching you can depend on, dry circuit to 0.5 amps.

For complete design information, circle reader service number—or ask Clare for Data Sheet 756 . . . Write Group 4A7

C. P. Clare & Co., Chicago, Illinois 60645 . . . and worldwide



a GENERAL INSTRUMENT company



MF Relay: Actual size

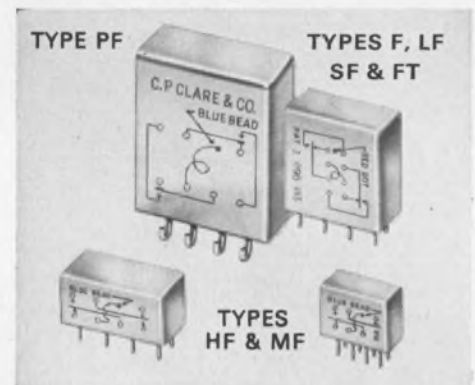

- Clare Military-Type relays include: New 10 amp Type PF, standard size Type F, latching Type LF, sensitive SF, half-size Type HF, one-sixth size Type MF, and Type FT for noise and thermal voltage problems. All meet appropriate MIL-R-5757D requirements
- Sensitivities from 40 mw
- Versatile contact capabilities . . . low level to 10 amp. Gold-plated contact areas, with high contact pressures and positive wiping action. Bifurcated contacts (F, FT, LF, SF, HF)

CLARE MILITARY-TYPE (crystal can) RELAYS

for airborne, aerospace and ground support equipment, industrial and commercial control systems

INFORMATION RETRIEVAL NUMBER 4

INFORMATION RETRIEVAL NUMBER 5 ►

Giant Killers

Second in the series.



International road racing had long been dominated by foreign automotive dynasties . . . until 1965, when the old regimes were toppled from the world racing throne by a bold Texan, Carroll Shelby, with his Cobra sports cars. In '66 and '67 Shelby Fords swept Le Mans —another American first—and a clear indication the giant was no longer king of the hill!



In the fast recovery power diode field, we knock heads with some industry giants, too. Take an example.

Our 251UL silicon diode boasts a 250-ampere forward current with recovery time of $1.5\mu\text{s}$, 600 to 1000 PRV, $2.0\mu\text{s}$ to 1300 PRV. These recovery times are tested at 785 amps peak I_F (π times the FCA rating) as recommended by JEDEC. You get microsecond recovery at operational currents.

The giants can't come near it. Brands G, W and M publish recovery times tested at I_F levels well below specified capacities—usually 1 to 5 amps or so. Try their diodes in a circuit and see how fast they recover.

If you have inverters with critical high frequency requirements, talk to the giant killer—IR—developers of the 200 ampere power logic triac. Send for 251UL bulletin plus test procedures. Or just send your order. We've been delivering them for over a year.



INTERNATIONAL RECTIFIER

COMPARE RCL's 1/2" ROTARY SWITCHES



**4 SERIES TO FIT
EVERY REQUIREMENT
PLUS
INDUSTRY'S
BEST DELIVERY!**

- ★ Shorting AND non-shorting poles may be grouped on one deck in any combination.
- ★ Up to 12 positions per deck shorting or ■ non-shorting.
- ★ Life expectancy 200,000 mechanical operations.

Write For Free Engineering Catalog

RCL
ELECTRONICS, INC.

700 South 21st Street, Irvington, N. J. 07111

U.S. Pat. 3352979

MALLORY CAPACITOR FACTFILE

How to get the most microfarads in smallest size, highest reliability

The Mallory MTP may change your ideas on how small a capacitor can get. This wet slug tantalum capacitor puts more C-V rating into miniature size than any other capacitor on the market. It's an ideal answer to the problem of squeezing microfarads into a miniaturized circuit.

In the MTP construction, you can get up to 172,000 mfd. volts per cubic inch. (Although none of the standard ratings are anything but a small fraction of a cubic inch.) This is about 5 times what you can get with CS12/13 solid tantalum types, and 3 times what you can get with CL64/65 miniature metal case wet tantalum. The chart shows comparison of sizes of typical ratings (all rat-

ings are not identical; nearest useful values are shown).

Here's another way to compare. Consider only 30 volt ratings. In three roughly comparable case sizes, you can get 120 mfd. in an MTP, 68 mfd. in a CL64, and 6.8 mfd. in a CS12 type.



Low DC Leakage

DC leakage current is considerably lower for the MTP than for solid tantalum capacitors. At higher capacitance values, the MTP has only about 10% the DCL of solid types. Because of their low leakage, you can design MTP into timing and capacitor discharge circuits and get accurately predictable performance.

No Voltage Derating Needed

Traditionally, circuit designers add a safety factor of their own by specifying capacitors with higher voltage rating than actually needed for anticipated steady state or surge conditions. You don't have to do this with MTP's. We have already built in a generous safety factor in the stated rating. And we have found by extensive tests that operating under rated voltage neither improves nor impairs life or stability of the MTP. By specifying the exact voltage you need, you can get the smallest possible case size, and generally save money.

High Reliability

The MTP is the commercial version of the MTPH capacitor produced in special "white room" facilities used for making similar capacitors for Minuteman II. Over 6 million unit test hours have been run on MTPH at full voltage at 85°C, with only one catastrophic failure. At 90% confidence level, proved failure rate is .06%/1000 hours; MTBF is 1.6×10^6 hours. Ratings cover 450 mfd., 6 volts, to 6.8 mfd., 50 volts. Temperature range is -55°C to +85°C. For data, write or call Mallory Capacitor Company, a division of P. R. Mallory & Co. Inc., Indianapolis, Indiana 46206.

Rating	MTP Size*	CL64/65 Size*	CS12/13 Size*
150 mfd., 6V	.145" x .590"	.313" x .672"	.289" x .686"
33 mfd., 10V	.115" x .400"	.219" x .485"	.185" x .474"
4 mfd., 50V	.115" x .312"	.219" x .485"	.185" x .474"

*Insulated case size

TYPICAL PERFORMANCE LIFE TEST: 300 MFD., 10V, 85°C.

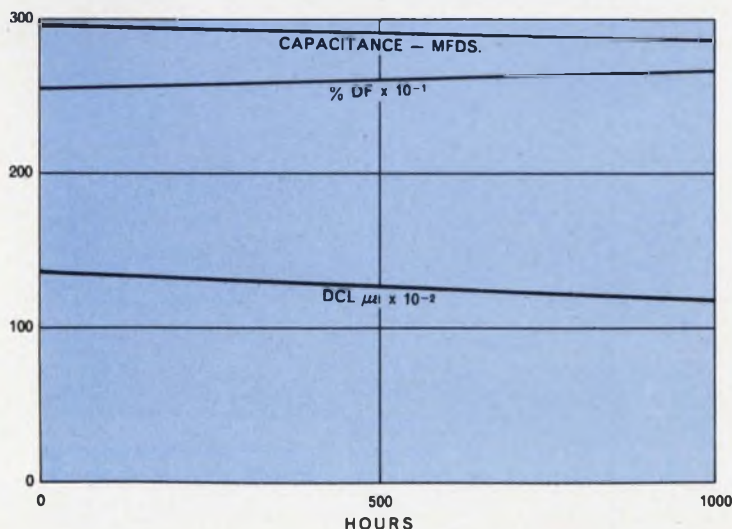

The Wait Reducers! New Active Filters from BURR-BROWN



At Burr-Brown, computer-aided design and new modular assembly techniques combine to give you faster delivery of active filters . . . in most cases within two weeks of your order. And, you specify the exact performance you want from Burr-Brown's new line of 5 Hz to 20 kHz units. Custom units are available with frequencies as low as 0.1 Hz and as high as 100 kHz.

A variety of active filter types and response characteristics are available including:

- | TYPES | CHARACTERISTICS |
|---|--|
| <input type="checkbox"/> low-pass | <input type="checkbox"/> Butterworth |
| <input type="checkbox"/> high-pass | <input type="checkbox"/> Tchebyscheff |
| <input type="checkbox"/> band-pass | <input type="checkbox"/> Bessel (linear phase) |
| <input type="checkbox"/> band-rejection | |

Since the heart of the filter is the amplifier, Burr-Brown has the very finest building blocks, including its own IC op amp (patent pending). Because of the outstanding performance of Burr-Brown op amps you get active filters with superior characteristics at the lowest possible prices.

You also benefit from Burr-Brown's industry-leading technical staff. For the same experts who authored the Active RC Network Handbook, the basic industry reference on the use of operational amplifiers in filtering applications, supervise Burr-Brown's active filter facilities.

So, if you use active filters and you want a fast, dependable source of supply, call on Burr-Brown. You'll find Burr-Brown knows a little more and does a little more, because Burr-Brown has more to work with.

NEW 12-PAGE ACTIVE FILTER CATALOG



For your copy of the new applications-oriented Burr-Brown Active Filter Product Bulletin, contact your local Engineering Representative or use this publication's reader-service card. For Immediate Applications Assistance: simply phone (602) 294-1431 and ask to talk to your Burr-Brown Applications Engineer.

BURR-BROWN RESEARCH CORPORATION

International Airport Industrial Park • Tucson, Arizona 85706
TELEPHONE: 602-294-1431 • TWX: 910-952-1111 • CABLE: BBRCORP



Operational Amplifiers
Instrumentation Amplifiers
Function Modules
Active Filters
Analog Simulators
Geophysical Instruments

ENGINEERING REPRESENTATIVES: ALABAMA, HUNTSVILLE (205) 534-1648 / ARIZONA, PHOENIX (602) 254-6085 / CALIF., LOS ANGELES (213) 665-5181, SAN FRANCISCO (408) 244-1505 / COLO., DENVER (303) 388-4391 / CONN., EAST HARTFORD (203) 874-9222 / D.C., WASHINGTON (SEE MARYLAND) / FLORIDA, ORLANDO (305) 425-2764 / ILLINOIS, CHICAGO (312) 286-6824 / LA., NEW ORLEANS (504) 888-2266 / MD., SILVER SPRING (301) 588-8134 / MASS., BOSTON (617) 245-4870 / MICH., DETROIT (313) 358-3333 / MINN., MINNEAPOLIS (612) 781-1611 / MO., ST. LOUIS (314) 524-4800 / N.C., GREENSBORO (919) 273-1918 / N.J., CAMDEN (215) 925-8711

/ N.M., ALBUQUERQUE (505) 255-1638 / N.Y., ALBANY (518) 436-9649, BINGHAMTON (607) 723-9661, MT. VERNON (914) 968-2200, NEW HARTFORD (315) 732-3775, ROCHESTER ((716) 473-2115 / OHIO, CINCINNATI (513) 761-5432, CLEVELAND (216) 237-9145, DAYTON (513) 277-8911 / PENN., PHILADELPHIA (SEE CAMDEN, N.J.), PITTSBURGH (412) 243-6655 / TEXAS, DALLAS (214) 357-6451, HOUSTON (713) 774-2568 / UTAH, SALT LAKE CITY (801) 466-8709 / VIRGINIA, (SEE MARYLAND) / WASH., SEATTLE (206) 767-4260 / CANADA, DOWNSVIEW, ONT., (416) 636-4910 — MONTREAL, QUE., (514) 739-6776 — OTTAWA, ONT., (613) 725-1288 — VANCOUVER, B.C., (604) 298-6242

**The world's smallest 10 watt zener
has a 350 watt surge capacity...**

**600% more than an ordinary one,
35% more than a 50 watt.**

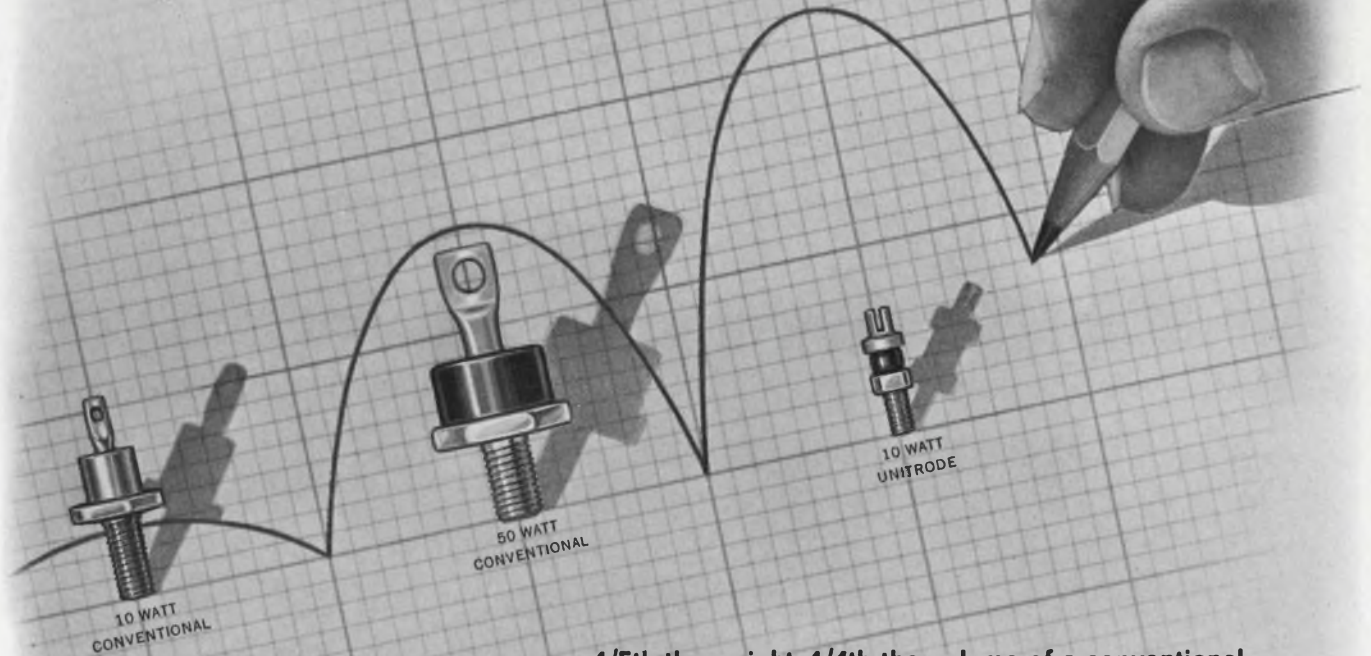

- 1/5th the weight, 1/4th the volume of a conventional 10 watt (smaller than an ordinary 400 milliwatt).
- 1/10th the weight, 1/20th the volume of a conventional 50 watt
- 10 watt continuous rating — stud mounting
- 6 watt leaded version for mounting on circuit boards, has same high surge capacity
- 6.8 to 100 volt range
- Low leakage current
- Electrical characteristics remain stable throughout life, exceeding the environmental requirements of MIL-S-19500

580 Pleasant St., Watertown, Mass. 02172, (617) 926-0404

UNITRODE 



THE UNIQUE UNITRODE CONSTRUCTION

With the silicon die metallurgically bonded between terminal pins of the same thermal coefficient, the hard glass sleeve is fused to the entire outer silicon surface. Result — a voidless, monolithic structure.

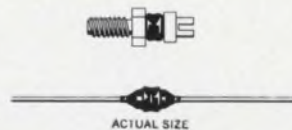

Get yourself a complete set of specs that give you all kinds of detailed information. Circle the reply card number now.



INFORMATION RETRIEVAL NUMBER 9

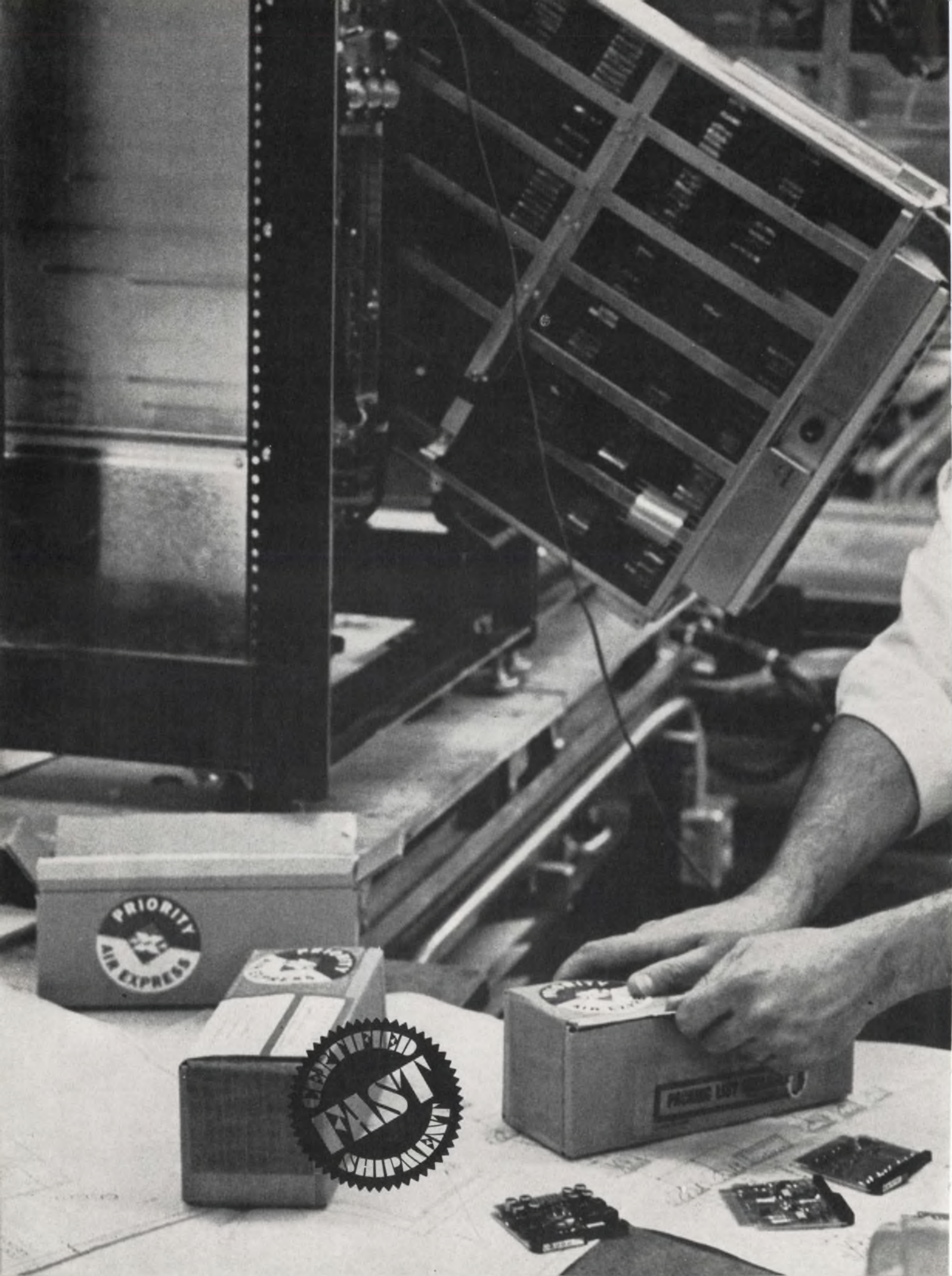



72-hour

μ -PAC logic module delivery . . .

**Special handling to make sure
you receive them on time
-even when you set
tight schedules.**

We recently reduced μ -PAC logic module prices up to 46%. Then we introduced new low-cost 2 MHz modules to let you save another 50% per average system cost.

Now . . . when you say so, we'll give you 72-hour CFS (Certified Fast Shipment). But don't be surprised if we respond to your CFS request in 40/48 hours. Bulk shipments and special logic designs take a little longer . . . but not much. (That's better turn-around time than you'd be able to get even if you owned your own production facility.)

Breadth of Line — Only one supplier is necessary when you design with μ -PACS — a complete line including interface modules, memory modules, and analog modules as well as the widest, most versatile selection of standard digital logic functions. All necessary mounting hardware, power supplies, and special wiring and design accessories are available at minimum cost. Honeywell maintains a special μ -PAC design and fabrication capability to aid the systems designer in solving custom problems.

Service — Honeywell maintains world-wide sales and service offices staffed by highly qualified applications engineers to provide technical assistance and design support. μ -PACS are fully documented by comprehensive instruction manuals, application notes, wiring and assembly notes, schematic parts lists and logic design aids.

Experience — In the past 14 years, Honeywell has delivered over a million digital logic modules. Whether your design requirements involve a one-time logic interface or volume systems assembly, you'll find μ -PACS the ideal answer to your hardware problems.

You've been watching us develop the most extensive, economical, highest quality I/C modules. Now, don't you think it's time you called us to talk about your digital logic requirements? Or, write for our new summary brochure. Honeywell, Computer Control Division, Old Connecticut Path, Framingham, Massachusetts 01701.

Honeywell

 **COMPUTER CONTROL
DIVISION**

INFORMATION RETRIEVAL NUMBER 10

Shocking . . . the way Bodine treats wound stators. We do it for your own good.



A good, stiff jolt of high voltage does wonders for the reliability you enjoy in Bodine induction motors. Wound stators get the treatment . . . because ordinary inspection techniques can't tell us whether the insulation will really stand up under transient voltage conditions, or whether windings include the correct number of turns and wire size, or whether turns are properly positioned. But surge testing can tell us these things.

It's just one of many quality controls Bodine employs in breeding the best in fhp motors. It's another reason why Bodine motors offer you ADE—

After Delivery Economies, such as—

1. Very, very few rejects in your receiving, production or final test stages.
2. Consistent performance in the field.
3. Easy-service design.
4. Reliability—few call-backs, low field service costs.
5. Enhancement of your product's quality, helping you earn customer satisfaction, repeat sales.

Doesn't your product deserve motors of such quality? Bulletin S describes over 275 stock types and sizes from 1/2000 to 1/6 hp. Write Bodine Electric Company, 2528 West Bradley Place, Chicago, Illinois 60618.



*Bodine motors wear out—
it just takes longer*

BODINE
fractional/horsepower
MOTORS

the power behind the leading products



BODINE MAKES MOTOR CONTROLS, TOO—ASK FOR BULLETIN 1050

INFORMATION RETRIEVAL NUMBER 11



Solid State Klystron replacements!

Western Microwave has now made it possible to replace many low and medium power klystrons with reliable, efficient, low cost, SOLID STATE oscillators.

Typical of the many proven designs are the following:

Solid State Oscillator Model Number	"Replaceable" Klystron Type	Frequency Range (GHz)	Minimum Power (MW)
SFL-4892	RK5981	1.24-1.46	60
SFS-4893	726C	2.7 - 2.96	120
SFC-4894	RK5976	6.2 - 6.48	110
SFX-4888	2K25	8.5 - 9.6	30*
SVC-4895	RK6037	5.1 - 5.43	20
SVX-4896	2K45	8.5 - 9.6	30*

*Tunable over any 100MHz bandwidth.

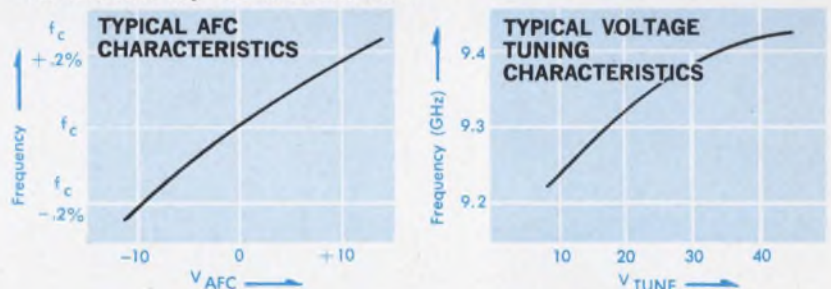

All units are voltage trimmable over 1/2 % bandwidth about center frequency for AFC.

If you have a microwave source requirement and you want to go SOLID STATE, give Western Microwave a call for fast expert engineering assistance.



Western Microwave Laboratories, Inc.

1045 DiGiulio Avenue, Santa Clara, California 95050
Telephone (408) 246-4500 / TWX 910-338-0032

This is a unique power supply designed by Acme Electric. At last count we had made only 1,127 of them.

Unique by the fact that it delivers 3.0 V. and 1.2 V. DC at 100 Amps for IC operation . . . with remarkable efficiency and regulation. But this power supply is no more unique than thousands of others we've custom built in quantity for some of the best-known and least-known names in industry.

You'll find our power supplies and Voltrol® constant voltage transformers in computers and data processing, nuclear research, communications, photography, machine tools, medical apparatus and the military.

In these and other fields we've solved such knotty power supply problems as: dynamic load regulation of 3000 DC amps at .002%; economically achieved high efficiency at extremely low voltage and high current for IC's; tough packaging problems and programming requirements; many others.

We not only have a staff of 123 engineering personnel to custom design units. We also have over 1100 experienced production people and the machines and floor space to produce power supplies and Voltrol® constant voltage transformers in pre-production quantities through full production runs.

So, if you're looking for high quality, soundly engineered custom units, yet want them made with the economy of production line efficiency, write us today on your letterhead. Our Mr. Rathbun will call you.

Acme Electric Corporation, Dept. 90.
Cuba, New York 14727

Acme Electric



INFORMATION RETRIEVAL NUMBER 13

Designer's Datebook

APRIL						
S	M	T	W	T	F	S
	1	2	3	4	5	6
7	8	9	10	11	12	13
14	15	16	17	18	19	20
21	22	23	24	25	26	27
28	29	30				

MAY						
S	M	T	W	T	F	S
			1	2	3	4
5	6	7	8	9	10	11
12	13	14	15	16	17	18
19	20	21	22	23	24	25
26	27	28	29	30	31	

For further information on meetings, use Information Retrieval card.

Apr. 23-24

Relay Conference (Stillwater, Okla.) Sponsor: National Association of Relay Manufacturers and Oklahoma State University; Dr. D. Lingelbach, School of Electrical Engineering, Oklahoma State University, Stillwater, Okla. 74074.

CIRCLE NO. 400

Apr. 29-May 1

Institute of Environmental Sciences Meeting and Exposition (St. Louis) Sponsor: D. N. Cerasuolo, Institute of Environmental Sciences, 940 East Northwest Highway, Mt. Prospect, Ill. 60056.

CIRCLE NO. 402

May 6-8

Quality Control Technical Conference and Exhibit (Philadelphia) Sponsor: American Society for Quality Control; J. Mehalek, General Chairman, ASQC, 161 West Wisconsin Ave., Milwaukee, Wis. 53203.

CIRCLE NO. 403

May 8-10

Electronic Components Conference (Washington, D.C.) Sponsor: Electronic Industries Association and the Institute of Electrical and Electronics Engineers Inc.; W. Hepner, Jr., Electronic Industries Association, 2001 1 St. N.W., Washington, D.C. 20001.

CIRCLE NO. 404

May 14-16

Quantum Electronic Conference (Miami, Fla.) Sponsor: Joint Council on Quantum Electronics, IEEE, et al. L. Winner, 152 West 42nd Street, N.Y., N.Y. 10022.

CIRCLE NO. 405

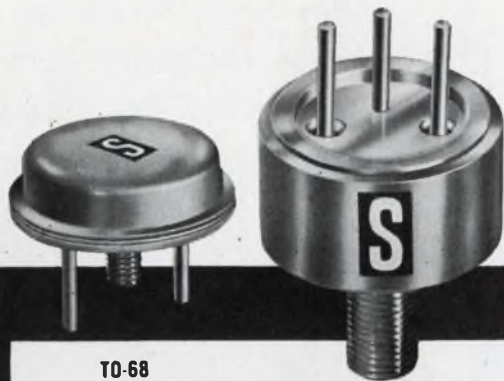

TO-68

DOUBLE-ENDED VERSION

PNP GERMANIUM ALL PURPOSE POWER TRANSISTORS UP TO 65 AMPS FROM Solitron

Solitron offers 65 Amp Germanium Power Transistors in a TO-68 case or double-ended version. Both packages provide heavier leads than the TO-36 case for more efficient use of power. These high current devices are identified as the SDT 1800 and SDT 1900 Series, and include the JEDEC registered 2N2730-35 Series. Typical uses include motor speed controls, computer printers, welder-control circuits, inverters, converters, regulators and many other high current power supply and control applications.

A wide variety of other PNP Germanium Power Transistors, with current ratings up to 25 Amps, are available in a TO-3 case. Also, many general purpose and JAN qualified devices.

Type Number TO-68	Type Number DOUBLE-ENDED VERSION	Breakdown Voltage		h_{FE}	SAT Voltage @ Max. Rated I_C	
		V_{CE}	V_{CE}		V_{BE}	V_{CE}
MHT1808	MHT1908	80V	60V	15 min @ 50A	1.25V	.45V
MHT1809	MHT1909	60V	45V	15 min @ 50A	1.25V	.45V
MHT1810	MHT1910	40V	30V	15 min @ 50A	1.25V	.45V
2N 2730	2N 2733	80V	60V	15 min @ 65A	1.25V	.45V
2N 2731	2N 2734	60V	45V	15 min @ 65A	1.25V	.45V
2N 2732	2N 2735	40V	30V	15 min @ 65A	1.25V	.45V
SDT1860	SDT1960	80V	60V	20 min @ 65A	1.25V	.30V
SDT1861	SDT1961	60V	45V	20 min @ 65A	1.25V	.30V
SDT1862	SDT1962	40V	30V	20 min @ 65A	1.25V	.30V

SOLITRON HAS COMPLETE FACILITIES FOR ALL TYPES OF ENVIRONMENTAL AND BURN-IN QUALIFICATIONS TESTING.

Dial 1-800-327-3243 for a "No Charge" telephone call and further information

*When you think of semiconductors...
think Solitron!*

Solitron

DEVICES, INC.

1177 BLUE HERON BLVD./ RIVIERA BEACH, FLA./ TWX: (510) 952-6676

Sprague delivers Tape Cores

advertisement



Our Tape Cores come in thirty sizes from $\frac{5}{8}$ to 6 inch O.D., offer a choice of core materials, and have standard phenolic or hermetically-sealed epoxy-coated aluminum cases. Most are available for off-the-shelf delivery. Shouldn't you wind up with Sprague?

For complete technical data, write for Bulletin Series 51000 to Technical Literature Service, Sprague Electric Company, 347 Marshall Street, North Adams, Massachusetts 01247

SPRAGUE COMPONENTS

MAGNETIC COMPONENTS
CAPACITORS
TRANSISTORS
RESISTORS
THIN-FILM MICROCIRCUITS
INTEGRATED CIRCUITS

INTERFERENCE FILTERS
PACKAGED COMPONENT ASSEMBLIES
FUNCTIONAL DIGITAL CIRCUITS
PULSE TRANSFORMERS
CERAMIC-BASE PRINTED NETWORKS
PULSE-FORMING NETWORKS



Sprague® and ® are registered trademarks of the Sprague Electric Co.

INFORMATION RETRIEVAL NUMBER 15

New Bridge Design For Safe, Accurate, Easy Measurement of 'Lytic Capacitors



The Sprague Model 1W7 Capacitance Bridge introduces new, improved technical refinements as well as restyling for added attractiveness and ease of operation. Built by capacitor engineers for capacitor users, it incorporates the best features of bridges used for many years in Sprague laboratories and production facilities.

Precision Measurements over Entire Range from 0 to 120,000 μF

The capacitance range of the 1W7 Bridge can be extended to 1.2F with an external standard capacitor. The internal generator is a line-driven frequency converter, and detection is obtained from an internal tuned transistor amplifier/null detector, whose sensitivity increases as the balance point is approached. It has provision for 2-terminal, 3-terminal, and 4-terminal capacitance measurements, which are essential for accurate measurement . . . $\pm(1 + D)\%$ + 10pF . . . of medium, low, and high capacitance values, respectively.

No Damage to Capacitors

The model 1W7 Capacitance Bridge will not cause degradation or failure in electrolytic or low-voltage ceramic capacitors during test, as is the case in many conventional bridges and test circuits. The 120 Hz a-c voltage, applied to capacitors under test from a built-in source, never exceeds 0.5 volt! It is usually unnecessary to apply d-c polarizing voltage to electrolytic capacitors because of this safe, low voltage.

Complete Specifications Available

For complete technical data on this precision instrument, write for Engineering Bulletin 90,011 to Technical Literature Service, Sprague Electric Co., 347 Marshall St., North Adams, Mass. 01247.

INFORMATION RETRIEVAL NUMBER 16

ELECTRONIC DESIGN 8, April 11, 1968

News

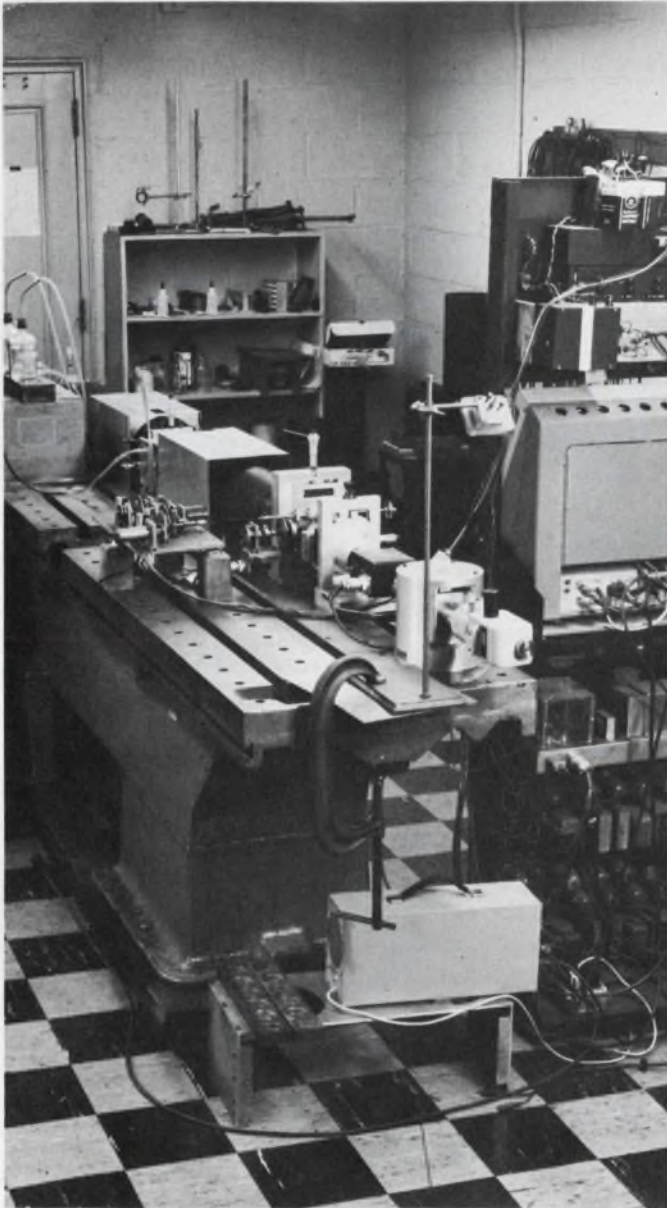

Optical computers like this one inspect entire phased array at once—only one of many jobs optics may perform in future systems. P. 25

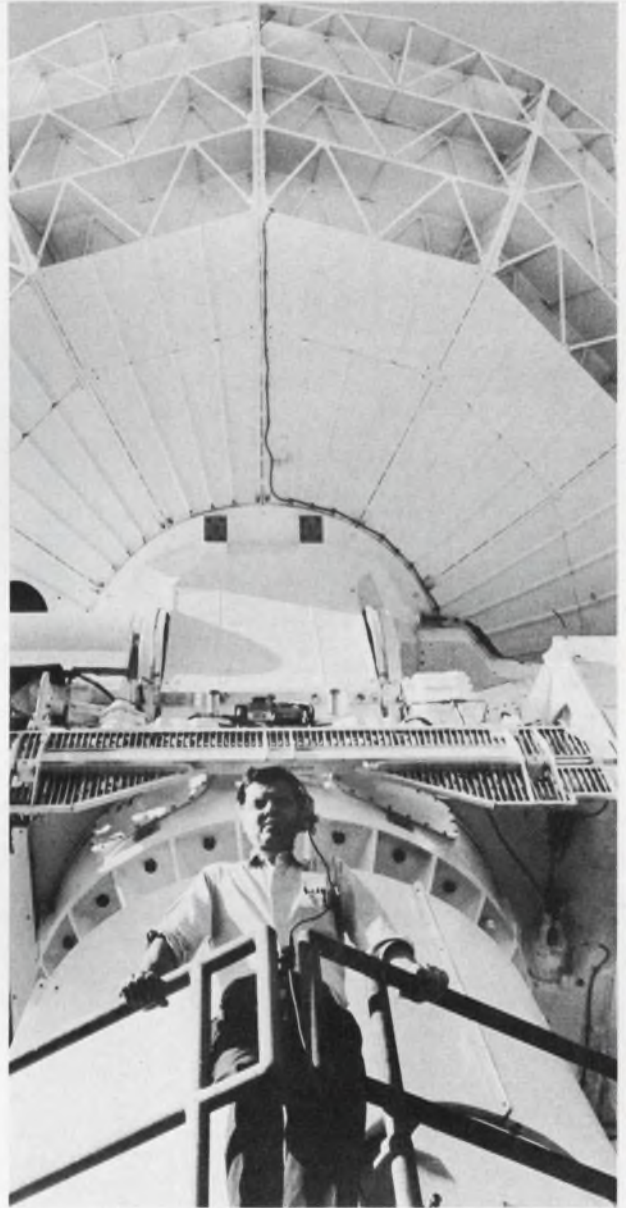

Market for large radars, such as this missile tracker at Vandenberg AFB, may increase to \$500 million by 1975. P. 34

Also in this section:

Gold bridge boosts isolation in ICs. Page 33

News Scope, Page 19 . . . **Washington Report**, Page 41 . . . **Editorial**, Page 53

The Connector thing

A periodical periodical designed, quite frankly, to further the sales of Microdot connectors and cables. Published entirely in the interest of profit.



FIND OUT MORE ABOUT THIS.



THE SUPER CABLE contest

We were salivating over a couple of particularly comely, full color gate-folds not long ago, when the product manager, the manufacturing manager and the applications manager of the cable division came in foaming at the parameters.

"Remember that mild mannered little microminiature cable?" they intoned. "We now have proof positive it is, in reality **SUPER CABLE**, on our side to wage war against the forces of high attenuation." We shoved them out and swiped a data sheet. They were right. Super Cable is just that. And it's Microdot's alone.

It's all done secretly and patently with foamed FEP and gives people who have low capacitance requirements, a capacitance that's the lowest. Just the ticket for smallest possible packages for microelectronics. The high strength cellular composition has a dielectric constant of about 1.4 and a specific gravity of close to 1.0.

GIVE 'EM THE ADVANTAGES, CHARLIE

You can start out with a micromin cable, beef up the center conductor, keep the same capacitance and impedance, but lower the attenuation without changing the O.D.

Larger center conductors make for miniature coax cables with a greatly

increased breaking strength.

Your present connector can be retained if you want to replace a standard weak conductor coaxial cable with **SUPER CABLE**

OTHER NEAT THINGS

Most conductors tend to get a little nervous working over 80°C. Our foamed FEP conductor will function continuously even at 200°C.

It's also a fantastic buy where solderability is a problem. It'll solder, not disappear.

Off the shelf you can get it in 93, 70 and 50 (VERY SMALL) ohm impedances. Custom, you can order various types of jacketing, and with centers from .003 to .025.

Of course one of the big questions is, is Super Cable really necessary? Will foamed FEP really triumph? It will wherever low capacitance, low impedance and even lower attenuation in micro-miniature cables is a requirement.

ENOUGH PITCH. WHERE DO WE COME IN?

You are going to tell us where you think a SUPER CABLE like that could and should be used.

GROSS HINT

A Redwood City, Calif. tape recorder manufacturer wanted a sub low capa-

citance cable with an extremely low DC resistance for their 3000 video tape recorder. The only cable that met their requirements was **SUPER CABLE**. Now, the contest is to tell us what to do with it. (And that, sir, doesn't win a thing.) We've got some applications, but we're looking for more. The most interesting one you send us will WIN a genuine, good sized, authentic, replica of a San Francisco cable car, measuring 12" x 6" x 8" and made of wood.

ALL ENTRIES WIN a super picture of the Polaroid proof of SUPER CABLE stripped of her mild mannered funky garb suitable for sticking on the wall.

Contest closes with a thud, Midnight May 30, 1968. Void where prohibited by the constabulary.

TELL IT TO US LIKE IT COULD BE

In 25 words or less, on your brave company's letterhead, write, "You can use SUPER CABLES as follows..." Include your name, address and what-not and send to us at:



MICRODOT INC.
220 Pasadena Ave., South Pasadena, Calif. 91030

Airlines score FAA air control electronics

Airline experts have studied the Federal Aviation Administration's system for air traffic control in the New York area and found it dependent on unreliable electronic equipment.

In a report made public by the Air Transport Association, Washington, D.C., a trade organization representing the scheduled airlines of the USA, the air traffic control system was criticized as "amazingly cumbersome" and becoming "less and less efficient with increased demand." It noted a general "lack of planning on a system basis" for the Eastern region.

Specific comments on electronics were made about two "unreliable" radars serving the New York area and "inadequate and failure-prone" communication between the control towers and air traffic control centers. The over-all lack of system planning, according to the report, made it unlikely that necessary improvements would be carried out.

The study group of airline employees conducted their investigations, with FAA cooperation, at the Newark, Kennedy and La Guardia airport control towers as well as at the regional traffic centers for New York, Boston, Cleveland and Washington.

The radars found to be unreliable are located at Palermo, N.J., and Benton, Pa. They are Air Force Radars used jointly by the FAA for traffic control and by the Air Force for air defense monitoring. Designed for air defense operations, they do not meet FAA standards for effective air traffic control in a congested airspace and are subject to failure because of inadequate maintenance, the report notes.

The radar scans at lower angles than necessary for air control thus introducing more "ground clutter." Further, the scope presentations of aircraft are too poorly defined for

the precise location required in crowded air corridors.

The number of communications channels between the airport control towers and the control centers were found to be insufficient for reliable operations. With no spare channels, radio equipment failure can only be overcome by using telephone lines, which are also inadequate.

The report recommends replacement of the military radars, better telephone backup for air traffic control communication and improved radio links between the control centers and towers.

A spokesman for the FAA said a technical staff has been assigned to review the report and determine action to be taken on the recommendations. Improvement activities antedating the report, the FAA spokesman noted, include:

- Construction of a common facility at Kennedy airport to combine in one location control of arriving and departing air traffic for the three New York metropolitan airports. New display and monitoring equipment which will be operational in July is being installed at the facility.

- Plans to replace the military radars as part of the New York air traffic control network are now being made. A possible replacement is the control radar at the FAA's National Aviation Experimental Center in Atlantic City, N.J.

Hologram self-portrait made in a hurry

History was made in 40-billionths of a second as physicist Larry Siebert pressed a button and made a hologram of himself. This is the first hologram ever made of a person, according to Conductron Corp., Ann Arbor, Mich.

A common dye-cell Q-switch (using cryptocyanine) allowed the light to build up on a two-ruby cavity so that only a 40-ns, 1/4-joule pulse was emitted. But careful optical design permitted only a single axial and single transverse mode (TEM_{00N}).

Could the technique be used for hologram movies? Repetition rates of 30 pulses a second could be achieved, says Siebert but non-symmetrical thermal gradients, especially in the ruby rods, would allow unwanted modes, thus destroying hologram quality.



Physicists criticize 'light' ballistic missile defense

Two eminent physicists with extensive nuclear weapons experience are critical of the "light" Chinese-oriented anti-ballistic missile system. They observe that new tactics and penetration aids could nullify the limited \$5 billion Sentinel system.

Doctors Hans Bethe and Richard Garwin say that the system described by former Defense Secretary Robert McNamara last September would not deter China from attacking the U.S. if that country were "insane and suicidal" enough to do so. They believe that the Chinese are capable of producing the weapon and employing counter-measures against the planned defense.

The scientists, writing in the March issue of *Scientific American*, state that the light ABM defense would only "nourish the illusion that an effective defense against ballistic missiles is possible."

The program, they assert, would

lead to a cost escalation to the \$40 to \$50 billion level and would only increase the likelihood of war with the USSR.

Dr. Bethe, a professor at Cornell University, Ithaca, N.Y., won a Nobel prize for his work on the theory of nuclear reactions last year. Dr. Garwin is director of Applied Research at IBM's Thomas J. Watson Research Center, Yorktown Heights, N.Y.

The scientists declare that complete national defense would be very costly with no assurance of reliability. Terminal defense of the 20 largest cities, for example, although less costly, would leave large population centers undefended. Multiple warheads, nuclear radar blackouts, decoys and jamming would waste our supply of defensive missiles without repelling the attack, they predict.

The physicists believe that the best deterrent is a strong offensive nuclear arsenal.

Sealab to 'hold the line' at its present 600 feet

When the Sealab III program, man's attempt to live and work for extended periods at 600 feet below the sea is completed next November, what will be the Navy's next step?

According to Capt. George Bond, the Navy's principal investigator for the man-in-the-sea, deep-submergence project, the initial step will not be to press for lower depths, but rather remain at 600 feet or even move to shallower waters to develop new tools and underwater mining equipment. Once this is accomplished, he said, the Navy will again probe deeper into the ocean.

But before it can make this move, he indicated, major improvements in equipment will be needed (see "Aquonauts' Goal: 'Cordless' Living Under Sea," ED 4, Feb. 15, 1968, pp. 25-32).

The occasion for his remarks was the unveiling two weeks ago in Anaheim, Calif., of the communica-

tions and medical monitoring stations for the Sealab III project. The vans, built by the Nortronics Div. of Northrop Corp. in Anaheim, will be the key link between the sea floor habitat and shore facilities.

Captain Bond said that Sealab needs improved equipment, better techniques and a different breathing gas if it is to go much deeper.

"Although men have made short trips to 1000-foot depths, we can't go much below 850 feet for extended periods with present equipment and techniques," he said.

Four main areas where equipment is needed, Captain Bond said, are:

- Closed-circuit breathing gas system.
- Diver navigation equipment.
- Diver propellant equipment.
- Diver-to-diver communication equipment.

Jungle foliage RFI tested by NBS

Jungle country frequently makes it impossible to use conventional radio antennas for communication. However, a research project just concluded at the National Bureau of Standards, under the sponsorship of the Navy, has taken a basic step toward a solution of the problem.

Dr. M. G. Broadhurst of the NBS Institute for Materials Research has measured living plant materials for their dielectric properties. Tests were carried out up to frequencies of about 4 GHz, and revealed remarkably similar results for such leaves as bamboo, dogwood, tulip tree, dandelion and sugar maple.

In addition to discovering the dielectric properties of a leaf when there was electromagnetic radiation present, the study was aimed to "enable the building of a mathematical model of a forest, or a tree, in order to calculate the effect of the model on electromagnetic radiation," in Dr. Broadhurst's words. "Bamboo was included in the tests," he added, "because it is so common in jungle areas; the other plants were selected at random."

Beyond the building of the mathematical model, the discovery

may have important results for the design of antennas suitable for use in heavily forested areas throughout the world, according to the scientist.

The NBS refused to elaborate on possible Viet Nam application.

Coast Guard will direct national buoy program

As a result of recommendations by the President's Council on Marine Resources and Engineering Development, the Coast Guard will be responsible for the planned National Data Buoy Systems project. A development program will begin on July 1, 1968, according to the Transportation Dept.

A study completed last October concluded that automatic data buoys to provide worldwide meteorological and oceanographic data could be developed and operational within five years. The data would be used in long-range weather and sea-state forecasting and could be utilized by other Federal agencies. According to the Coast Guard, the first systems will employ hf for direct transmission to collecting stations. Later, vhf-uhf systems will be produced for satellite relay of data. Capt. James A. Hodgman in the Coast Guard Office of R&D has been named project manager. Study reports and other information on the program are available from his office in Washington.

Honeywell announces 32-bit control computer

Honeywell Inc. announced a family of fast general-purpose computer systems for medium and large real-time control and scientific applications. The first in the line, scheduled for delivery later this year, is the H632 multi-processor. It is made up of an 8,192-word 32-bit core memory which employs ICs to perform all major functions. The memory is expandable to 131,072 words. Full cycle time is 850 ns.

The basic computer consists of one central and one input-output processor. Both are multi-programmable. The computers will sell for \$100,000 and up.



Actual Size
Series 2500

TOTALLY ENCLOSED MICRO-MINIATURE ROTARY SWITCH WITH NEW

UNITIZED CONSTRUCTION 1/2 INCH DIAMETER...

Now that's a tiger, figuratively speaking, of course. But it does sum up the tiger-like performance of this new, totally-enclosed, micro-miniature rotary switch which exceeds the requirements of MIL-S-3786. Now briefly, because we want you to send for our complete specifications, let us take a look at what selective breeding and careful training have done for this tiger. Designed into a maximum overall dimension of .62 is a 30° indexed switch, giving you 2 to 12 positions with

continuous rotation or with stops. You can even specify your own number of decks from 1 to 12. This tiger will perform at 70,000 feet and will stand its ground at temperature ranges of -55° C to +125° C. New unitized construction insures the highest level of reliability.

This is no paper tiger. It's off the boards and running, and your tiger-taming Janco representative holds the leash. Call him now! He's just back from safari with a great story.

JANCO

CORPORATION

3111 WINONA AVENUE ■ BURBANK, CALIFORNIA ■ AREA CODE 213 * 845-7473

INFORMATION RETRIEVAL NUMBER 19

you get a choice,

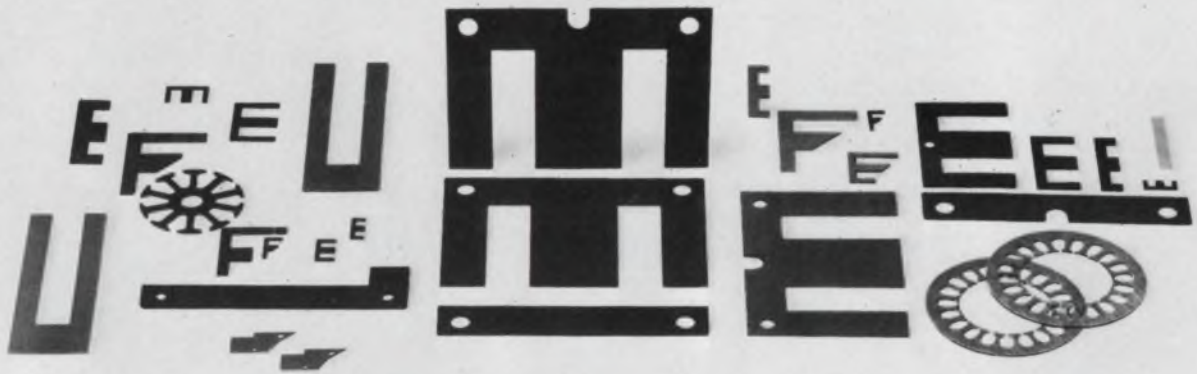

not a challenge

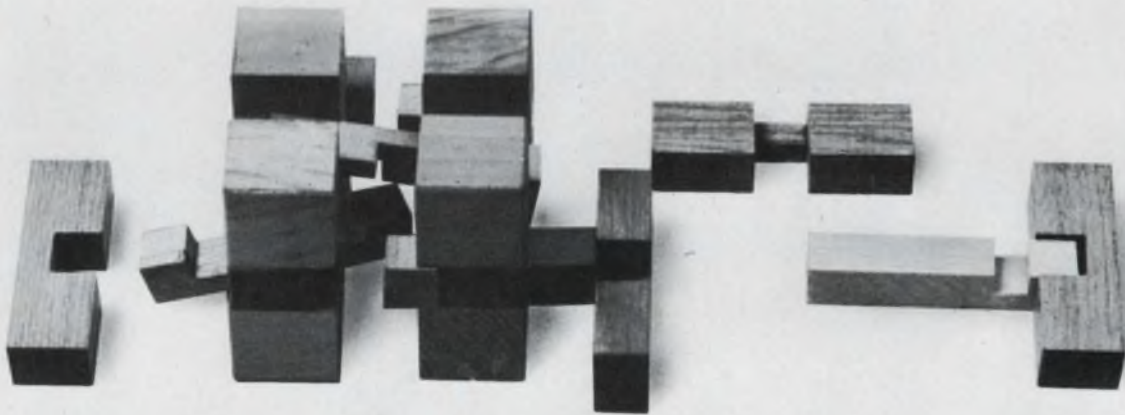

51 standard shapes of laminations simplify solid-state circuit design

Magnetics maximizes your chances of finding laminations that dovetail precisely into your designs for transformers, chokes, reactors and transistor circuits. We offer 51 standard shapes in Permalloy 80, Alloy 48 and Orthonol®. Thicknesses of 0.004", 0.006", and 0.014" are available, with sizes ranging from DU-87 and EI-12 down to the

solid-state circuitry sizes—EI-093, EE-30-31, DU-63 and F-094.

All Magnetics' laminations are hydrogen-annealed and manufactured to guaranteed minimum permeability limits. In addition to the catalog shapes and sizes, we have the capability to make special shapes to fit specific needs, including rotors, stators and recording head laminations. Our photo-etch process is ideal for making

prototype-run laminations and small intricate configurations.

Furnishing a broad spectrum of shapes, sizes and materials is Magnetics' way of saving you valuable design time—we believe in giving our customers a choice, not a challenge. Complete information on Magnetics' laminations can be had by writing today for our Catalog ML-303-R, Magnetics Inc., Butler, Pennsylvania 16001



Legerdemain with light beams and lenses

Optical computers poised for systems role

Powerful parallel processors, nearing practicality, could blend with electronics to solve the 'insoluble'

Robert Haavind
Managing Editor

Optical computers, long a laboratory curiosity, are about to move into the mainstream of electronic system technology.

These are not digital computers. Nor are they analog computers of the electronic variety.

They are, rather, a class of machines that uses lenses, masks and mirrors to perform mathematical legerdemain with beams of light. They normally take time-varying signals, shift them into the frequency domain for processing and then return them to the time domain for display. Most of the phenomena being harnessed for this forthcoming family of optical processors have been known for decades, some for centuries. The invention of the laser has spurred activity.

But the greatest impetus to the development of optical processing is the tremendous success they have achieved in solving a particularly difficult system problem—that is,

the processing of side-looking radar signals.

A big drawback to the side-looking radar processor, and to many potential optical systems, is the use of film as an input medium. It takes time to develop film. That eliminates real-time applications.

If there were no great advantage to computing optically, as opposed to electronic methods—especially with the cost of electronic circuitry steadily declining—researchers would probably leave things as they are. But this is not the case. If good, wide-bandwidth, real-time electro-optical modulators were available, optical computers would offer some big advantages.

First: They would do highly parallel processing. An electronic signal is essentially a one-dimensional function of time. Optical processors handle two-dimensional spatial functions.

Second: There are several types of mathematical operations that optical systems do with ease but are horrendously involved for electronic computers. Fourier trans-

forms, for example, are produced automatically by a lens.

Third: Some problems are naturally suited to solution in the frequency domain.

These are the main reasons why intense efforts are now being directed at the development of real-time electro-optic input modulators. Probably the most promising of these is the ultrasonic light modulator. Some other potential real-time modulators are membrane light modulators (cover), thermo-plastic tape, oil films on glass (like those used in the Eidophor color-projection system) and photo-chromic glasses.

What sorts of systems will optical processors be used for? Following is a brief listing of some of the promising applications:

- Processing phased-array radar returns. With an optical system, there is no need for scanning.

- Image enhancement. This could be useful in such diverse ways as for sharpening TV pictures from space probes or for increasing the resolution of medical X-ray images.

- Pattern recognition.

- Jamming cancellation.

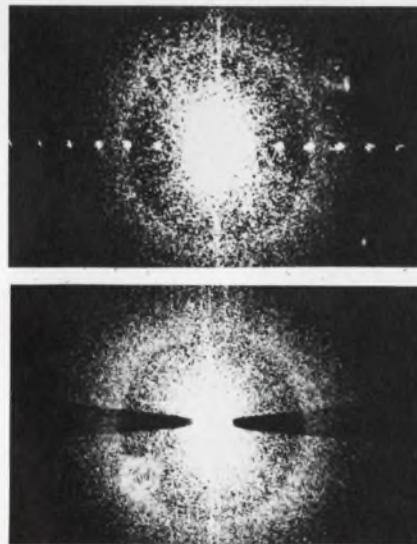

Courtesy Conduccion Corp.

Composite television picture of the moon (left) has vertical lines where strips are joined. When a positive transparency is illuminated by a laser beam, a line of dots appears in the spectrum of the photo produced by a

lens (top, center). These dots, representing the "frequency" of the lines and its harmonics, are cancelled with a prong-type mask, producing the line-free moon scene. A grey-scale mask could sharpen image.

(Legerdemain . . . , continued)

■ Secure communications. Coding and decoding masks make possible operations on the spectra of voice or other communications.

■ Radar and sonar signal processing. Auto- and cross-correlations, which will be used widely in future sonar and radar systems, can be performed at high speed.

■ Pulse compression.

Here's how they work

The basic optical system diagramed on this page illustrates several vital points in understanding how optics can accomplish some of these tasks.¹

The signal to be processed is presented at the input plane, usually in the form of a film transparency. This plane is illuminated by a coherent collimated light beam—that is, one with parallel rays and plane phase fronts. (Here only coherent, or laser, processing will be considered. Some work is also being done on incoherent systems.) A lens of focal length F forms a light pattern representing the Fourier transform of the input signal at a distance F behind the lens. The spectrum of the signal is now distributed in space, with the higher frequencies toward the outside. The central or low-frequency portion is called the zero-order term; it is analogous to the main lobe in a $\sin x/x$ distribution. A mask placed at this plane can then operate on the signal's spectrum. Thus if the

original input signal, $f(x, y)$, has a Fourier transform, $F(p, q)$, and the mask has a transfer function $H(p, q)$, these will form a new frequency function $R(p, q) = H(p, q)F(p, q)$. Now $R(p, q)$ is transformed to form $r(x, y)$ at the output. (Here p and q are radian spatial frequencies where $p = 2\pi\epsilon/\lambda F$ and $q = 2\pi\eta/\lambda F$.)

Some points worth noting are:

■ The input does not have to be at distance F . The Fourier transform will still appear at P_F , no matter where the input plane is located.

■ The spectral display is an intensity pattern in two dimensions. It is, in effect, a spatially distributed power spectrum of the input.

■ Since light cannot be negative, the input signal recorded on the film must be biased so the most negative portion does not go below zero. This bias term is dc, which lies at the center of the Fourier plane. A small opaque stop is sometimes placed at this position to block the dc.

Filtering in space

If a black spot at the center of the spectral pattern can block the dc term, then couldn't a pattern of black spots filter out undesired frequency components of any sort? And couldn't a pattern with various shades of gray modify the whole spectrum of the input?

The answer is that both of these approaches are widely used in optical-processing systems. The first, in which the spatial filter contains only completely black and complete-

ly transparent areas, is called a binary filter. A beautiful example of the use of such a filter is a composite moon television picture (page 25) that had lines where film strips had been pieced together.

An even more powerful use of the optical computer could be achieved with a gray-scale filter for image enhancement. The reason that such pictures appear somewhat fuzzy and blurred when they are first received from space is that they were obtained with an optical system with non-flat response. The high-frequency data—that is, the sharp edges between dark and light areas—have been attenuated. This occurs because the bandpass characteristic of an optical system slopes off at the high frequencies, just like those for electronic systems. If a filter can be prepared that shades the lower frequencies and passes the higher frequencies, with just the right proportions, then the fuzzy edges should become properly sharp. If the bandpass characteristic of the optical system were $H(p, q)$, then the desired mask represents $H^{-1}(p, q)$.

Such masks could also be used to modify the spectrum of an input signal. In cancelling jamming, for example, dark spots would be put at the jamming frequencies. One trouble with this is that wherever the signal to be blocked has a zero in its spectrum, a pole, or infinite value, is needed in the mask. This is impossible, so results can not be perfect.

Picking needles from haystacks

Another type of mask operation involves correlation. The frequency characteristic of the signal to be recognized is recorded and then compared with unknown images to obtain a correlation response. Unfortunately, if such a mask is prepared directly it puts unwanted responses on the optical axis along with the desired correlation term. One solution is to make a hologram of the desired pattern. That is, light from an offset reference beam is allowed to interfere with the light from the scene which is on the optical axis. The resulting interference pattern is then used as the correlation mask. The three terms in the output are then separated in space. A photosensor at the correlation point will then re-

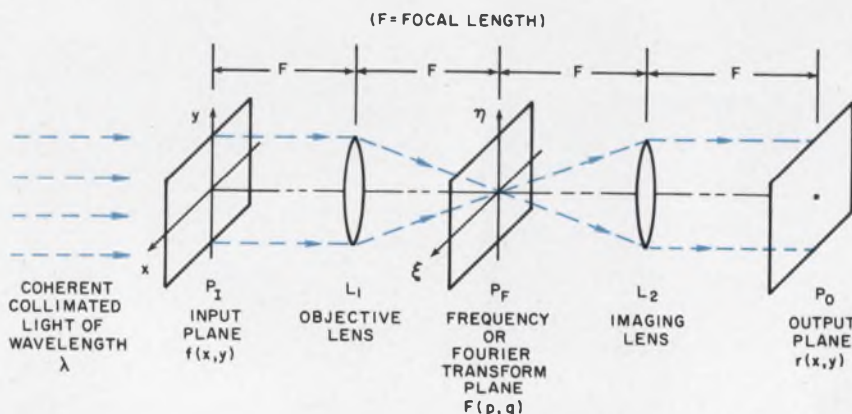

1. Basic set-up for spatial filtering. The input can be moved and the frequency plane will still remain at a focal-length distance from the objective, although it would be then multiplied by a phase factor. This would not degrade results.

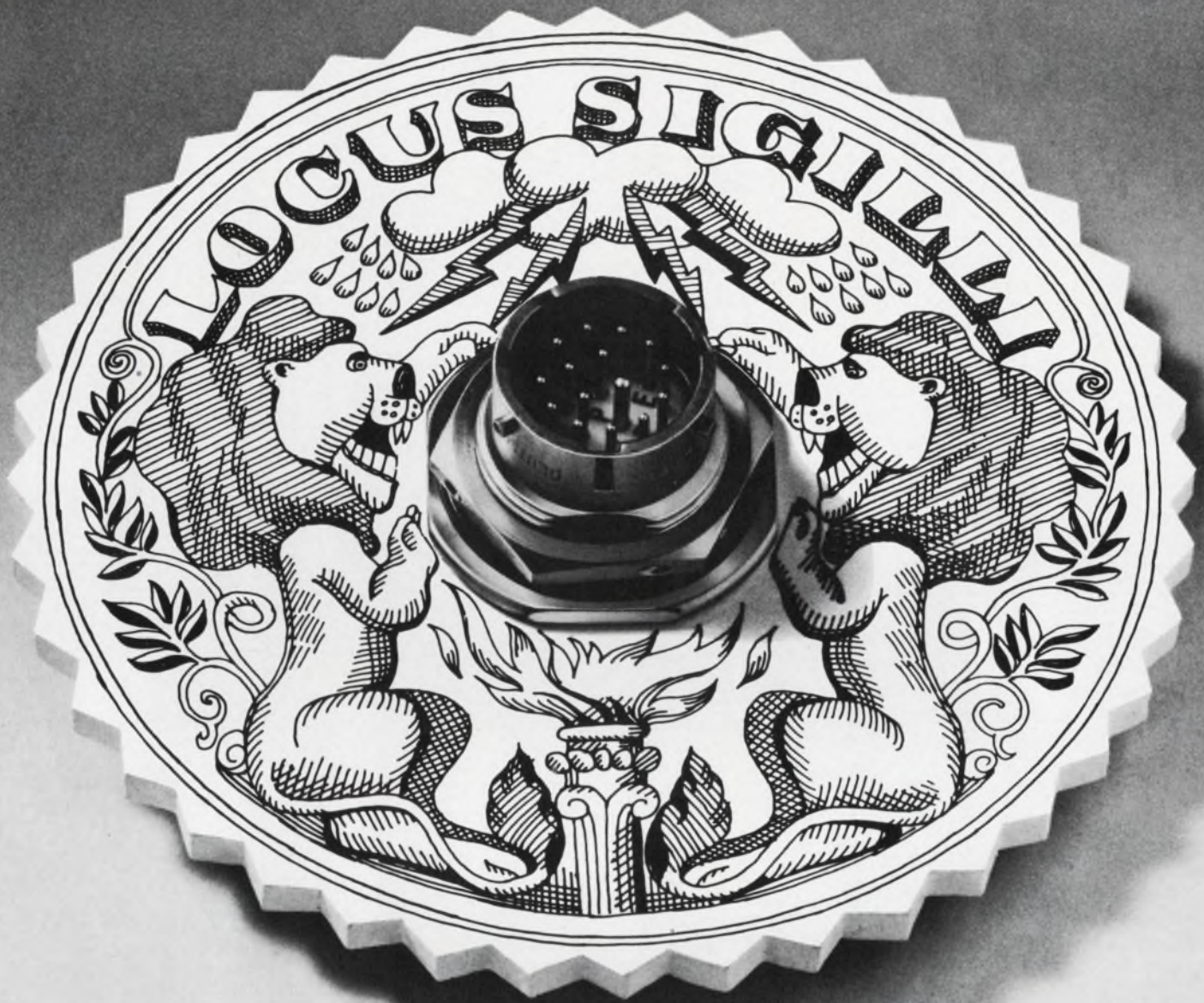

THE GREAT HERMETIC SEAL

Every part of every Deutsch hermetic seal is made and assembled in our own plants. All glass-to-metal sealing and brazing is done in the most modern automatic furnaces in the world. Every seal is checked for leakage; and every hermetic connector checked for contact positioning, polarization, high voltage capacity and precise dimensions.

This rigid quality assurance program, and 100% inspection, guarantee performance to and beyond specifications.

And this performance—and on-time delivery—is available on the widest range of hermetically sealed connectors in the industry.

Push-pull, bayonet, threaded, and specials of every description are available in a variety of insert arrangements and mounting styles. You can order them with high temperature brazed bussing strips to

provide internal circuitry; and with special shell materials or platings to meet exotic environments.

Recently developed Deutsch rear release hermetics are compatible with the Deutsch Integrated Termination System. Here, crimped rear release contacts eliminate costly soldering and increase reliability.

Rear release hermetics are available that intermate and interchange with existing Mil C 26482, NAS 1599 or Deutsch subminiature connectors.

Get all the details on the full line of Deutsch hermetic connectors by writing Deutsch, Electronics Components Division, Municipal Airport, Banning, California 92220.

DEUTSCH 
HERMETIC CONNECTORS

(Legerdemain . . . , continued)

ceive a light spot when a correlation is obtained.

This approach has successfully identified fingerprints, according to Dr. Joseph Horner, an optics researcher with Conductron. Perkin-Elmer has explored this application for some years, however, and has concluded it is not feasible. Strong auto-correlations are obtained, but cross-correlations are also strong, which causes too many false correlations, Perkin-Elmer reports.

Continuous, real-time correlation, such as that used in radar and sonar systems, might be done with a system such as that shown on page 30.² In such a system the position of the dot at the output plane is proportional to the doppler shift of the received signal with respect to the transmitted signal.

The complexity of this system is again caused by difficulties with the zero-order term at the output. This term is also sensitive to doppler, and it is so bright that doppler frequencies close to zero doppler are hidden.

One solution is to take advantage of the fact that the input medium is moving. Light interacting with a moving input is broken into the zero-order term and two sideband frequencies which are complex conjugates. By blocking the carrier and upper sideband terms, only the lower sideband—which still contains the data remains.

In the phased array application³ received signals from elements in one column of the array are fed sequentially into one column of an ultrasonic light modulator. Adjacent columns in the modulator receive signals from adjacent columns in the array. Timing is such that all the signals from the entire array are in the modulator at one instant. Plane, collimated light passing through the array at that instant is then phase-modulated by the stored image. Separate targets will cause spots to appear at different points on the output plane.

What can you modulate?

In the ultrasonic light modulator the phase of the laser light is modulated—that is, the refractive index of the medium is varied to slow the light beam at some points

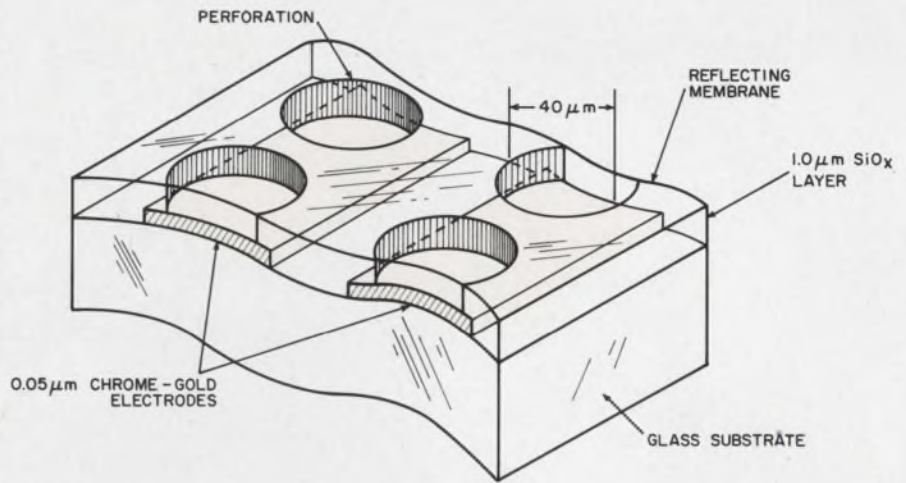

2. Top reflective film dips into a line of holes in the membrane light modulator when a voltage is applied to an electrode.

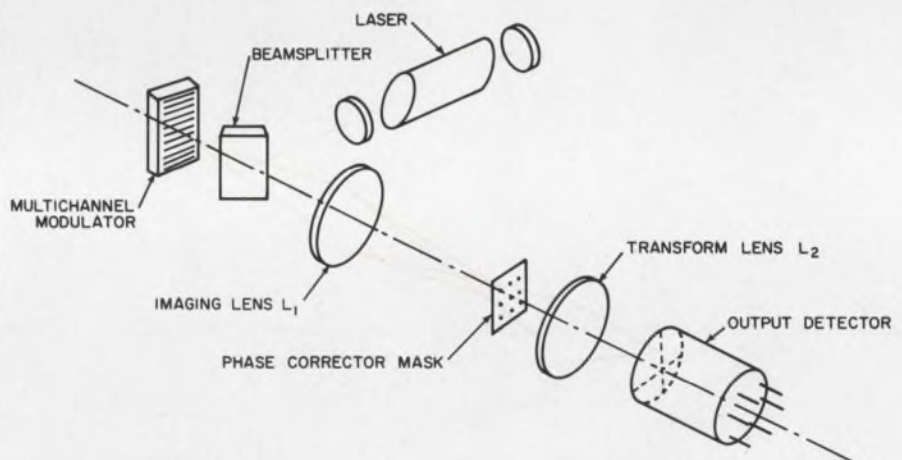

3. Optical computer configuration with an MLM input shows how a beam splitter would direct the laser light to the electrically varied modulating spots. Laser wave fronts would have parabolic "dimples" in them when sharp phase transitions would be preferred. The phase correction mask helps solve this problem by allowing only light from the centers of the deflected spots to pass through to the output.

more than at others. The wave that emerges from the modulator has a ripply surface in accordance with the pressure wave pattern within the modulator. For practical systems modulations up to about 10 degrees are feasible.

The most extensive work on this type of system has been done at Columbia University. The modulators most extensively developed are water and fused silica, or quartz. The radar signals have to be heterodyned down to work with these modulators because of bandwidth and frequency limitations.

Research going on now may overcome this limitation. Sapphire, or aluminum oxide, has been found to have much higher bandwidth capabilities for these optical-acoustic interactions. This transparent ma-

terial works well at room temperature in contrast to some earlier modulators that required liquid-nitrogen cooling. Hundreds of megahertz bandwidths can be achieved for signals in the GHz range, thus permitting direct processing of the radar returns without heterodyning. Work is going on in military laboratories, including the Naval Ordnance Test Station, China Lake, Calif., to achieve better electro-acoustic transducers, lower drive power, and purer crystals.

The membrane light modulator (MLM) developed by Perkin-Elmer Corp., Norwalk, Conn., does not achieve the bandwidth of the ultrasonic light modulators; however, it allows a full 360-degree phase modulation. Also it permits signal patterns to be stored electrically.

THIS POWER SUPPLY IS 3-WAYS* **NEW!**

PANEL HEIGHT IN INCHES.

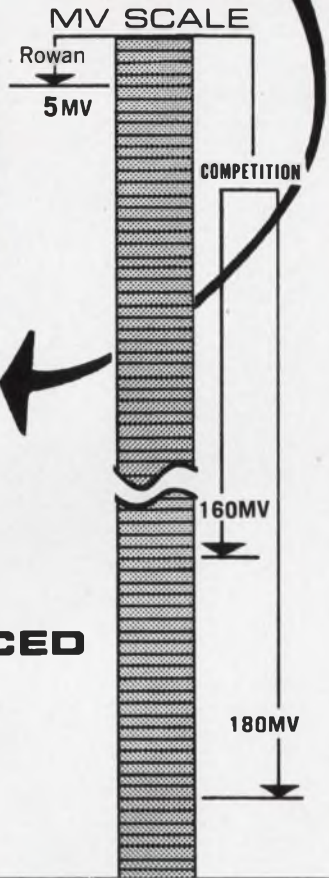
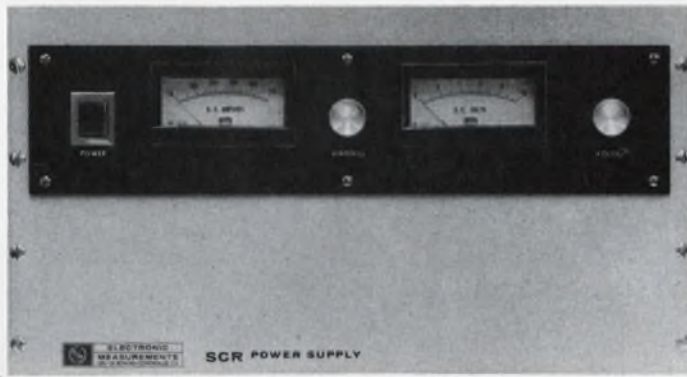

NEW* **S** MALLER SIZE
NEW* **C** OMPETITIVELY PRICED
NEW* **R** EDUCED RIPPLE

MODEL	DC OUTPUT		REGULATION				RIPPLE MV RMS	SIZE			WEIGHT	PRICE
	VOLTS	AMPS	VOLTAGE		CURRENT			H	W	D		
			%	MV*	%	MA**						
SCR10-500	0-10	500	0.1	3	0.1	150	5	8 3/4	19	20	195#	\$1700.00
SCR10-250	0-10	250	0.1	3	0.1	75	5	7	19	20	140#	1300.00
SCR20-250	0-20	250	0.1	6	0.1	75	5	8 3/4	19	20	190#	1500.00
SCR20-125	0-20	125	0.1	6	0.1	40	5	7	19	20	140#	1150.00
SCR40-125	0-40	125	0.1	12	0.1	40	5	8 3/4	19	20	185#	1375.00
SCR40-60	0-40	60	0.1	12	0.1	20	5	7	19	20	140#	925.00
SCR80-30	0-80	30	0.1	30	0.1	10	10	7	19	20	140#	900.00
SCR120-20	0-120	20	0.1	40	0.1	8	10	7	19	20	140#	900.00
SCR160-30	0-160	30	0.1	50	0.1	10	10	8 3/4	19	20	185#	1500.00
SCR160-15	0-160	15	0.1	50	0.1	5	10	7	19	20	140#	900.00
SCR250-20	0-250	20	0.1	75	0.1	8	10	8 3/4	19	20	185#	1500.00
SCR250-10	0-250	10	0.1	75	0.1	4	10	7	19	20	140#	900.00
SCR500-10	25-500	10	0.1	150	0.1	4	10	8 3/4	19	20	185#	1700.00
SCR500-5	25-500	5	0.1	150	0.1	2	10	7	19	20	140#	1300.00
SCR120-40	0-120	40	0.1	40	0.1	12	10	8 3/4	19	20	185#	1500.00

*Voltage regulation—% or MV, whichever is greater **Current regulation—% + MA total



ELECTRONIC MEASUREMENTS

2 CRESCENT PLACE | OCEANPORT, N.J. 07757

INFORMATION RETRIEVAL NUMBER 22

From the optical computer's bag of tricks

REAL-TIME TWO-DIMENSIONAL CORRELATOR

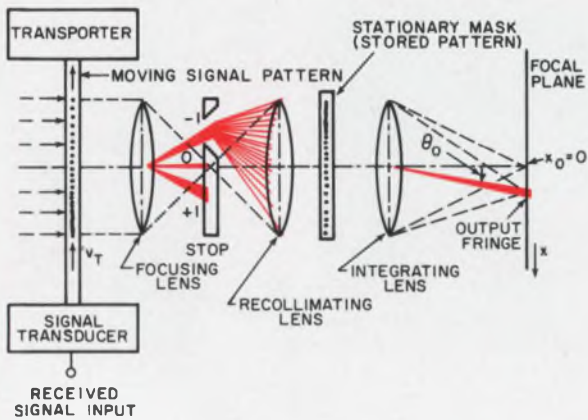

PATTERN RECOGNITION

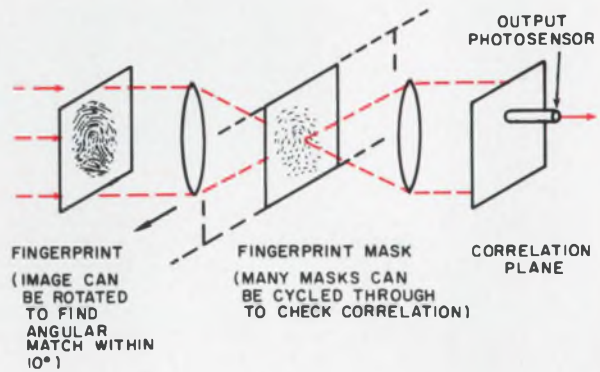
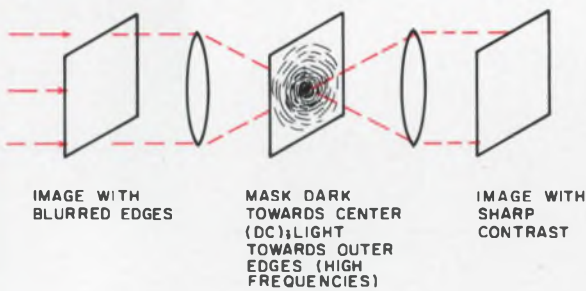
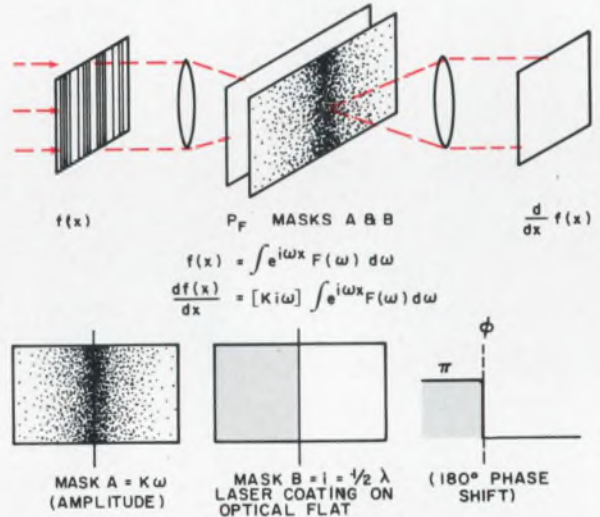

IMAGE ENHANCEMENT



DIFFERENTIATION



PHASED ARRAY PROCESSING

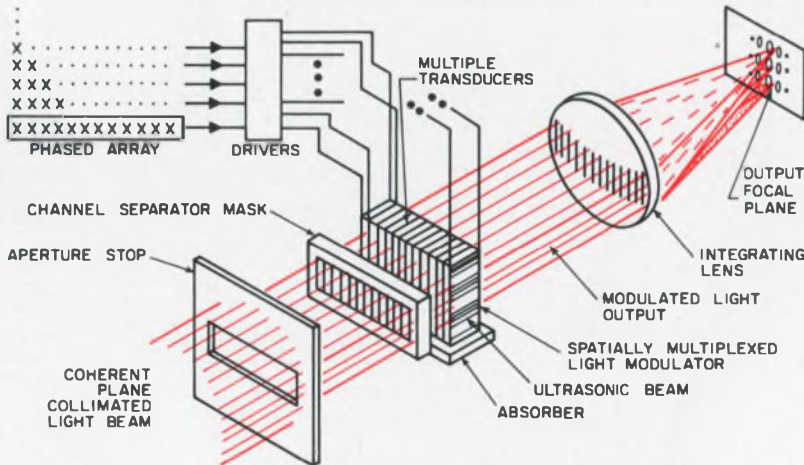

JAMMING CANCELLATION

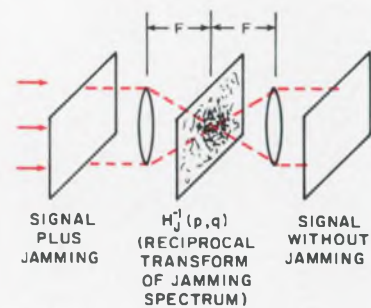

(Legerdemain . . . , continued)

On the top of the MLM is a thin membrane which adheres to a dielectric coating on glass. The dielectric layer has a pattern of rows of holes in it. Beneath the holes are electrode strips. A metallic coating over the thin collodion membrane forms a conductive, mirror surface. This surface is held at a fixed electrical potential. Then, when a different voltage is applied to one of the electrode strips, the membrane is pulled down into the holes along that strip. The deflection is proportional to the square of the applied voltage difference.

This modulator is then used at the input plane to phase-modulate the laser light. Note that since the electrodes are strips the modulator can only operate in one dimension. Perkin-Elmer is now working toward similar arrays with individually addressible elements, according to Kendall Preston, Jr., inventor of the membrane concept.

One problem with the MLM is that it oscillates when deflected. Despite this limitation, 1 MHz bandwidths have been achieved, and this is being improved by using electrical damping methods.

Thermoplastic recording tape also phase-modulates an input signal. Electrostatic signals deform a heated plastic surface on this tape, and the deformation is used to phase-modulate a coherent light beam. The biggest difficulty with this approach is that the tape must be optically flat within a small fraction of a wavelength of light.

Some magneto-optic materials also have been developed that have promise as real-time modulators. RCA, Camden, N.J., has developed a magneto-optic modulator that is being used in an optical correlator.

The side-looking story

Without years of intense development work at the University of Michigan on side-looking radar processing, all of this activity would probably not be taking place.

In side-looking radar short antennas are used on either an aircraft or satellite, but, by combining returns from several pulses as the vehicle moves along, a long antenna is "synthesized," and ex-



Stradivarius . . . and Nytronics make the difference!

A Stradivarius violin and a Nytronics High Q variable shielded inductor have much more in common than meticulous craftsmanship and quality materials. Both also have the special built-in ability to be precisely adjusted. This is a most desirable quality in an inductor, permitting the engineer to tune it accurately for most efficient performance in any given circuit simply by turning the adjusting head

Their range of 0.10uh to 12hy makes them ideal for all uses in any packaging technique. Hermetically sealed, with no physical contact between adjusting screw and the inductor itself, they provide a stepless adjustment of inductance over a minimum of $\pm 5\%$ range from nominal — and without strain on printed circuit mountings. With an operating temperature of -55°C to $+125^{\circ}\text{C}$, they meet the requirements of MIL-C-10535C, Grade 1, Class B.

Available from stock in the following package sizes:

WEE V-L — 0.300" dia. x 0.400" high; range 0.10uh to 100,000uh
 ATE-11 — 45/64" dia. x 3/4" high; range 0.01hy to 0.18hy
 ATE-0 — 1 1/16" dia. x 1" high; range 0.22hy to 1.50hy
 ATE-4 — 1 19/64" dia. x 1 1/4" high; range 1.80hy to 12.0hy

Nytronics off-the-shelf inventory also includes a wide range of capacitors, delay lines, and resistors. Write today for complete engineering data.



NYTRONICS®

...for Precision Electronic Components

550 Springfield Ave., Berkeley Heights, N.J. 07922 ■ (201) 464-9300 ■ TWX: 710-984-7977

INFORMATION RETRIEVAL NUMBER 23

(Legerdemain . . . , continued)

tremely high azimuth resolution can be obtained. The result is a radar map of the ground that looks like a high-resolution photograph.

Reflections from any range within the beam can be sorted out by the time of arrival of each portion of the return pulse. But since the beam is wide, this only sorts the return into range "strips" (see top of Fig. 4). However, each point within the strip has a different doppler shift. This is so small that it must be measured as a phase shift. A very stable continuous local oscillator is gated to provide a short transmitted pulse. A phase detector then compares the return pulse with the steady LO signal.

Since each point passed by the

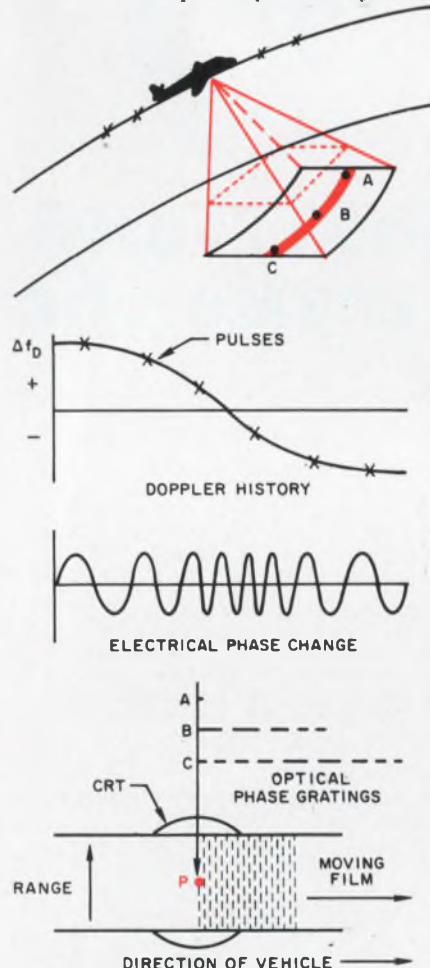

4. In side-looking radar separate pulses from a moving aircraft or satellite hit the same point on the ground. But each pulse will experience a slightly different doppler shift when it hits the point. This is observed as a phase difference between the return pulse and the short-term-coherent local oscillator signal.

beam has a certain "doppler history," that is, a slightly different doppler shift for each pulse that strikes the point as the beam passes over it (see Fig. 4), all the energy returned from that point could be stored and summed electronically. There was an attempt to do this in the early '50s, but the storage and processing of all this data was obviously a massive job. Optics provided a better solution.

In the optical approach, the doppler data is stored by summing the phase shifts from any particular range strip and intensity-modulating an electron beam in a CRT with the resulting sum. The spot sweeps across the CRT face in a straight vertical line, writing a line on a film in front of the tube face. As each line is written the film moves slightly and a new line is written for the next return pulse.

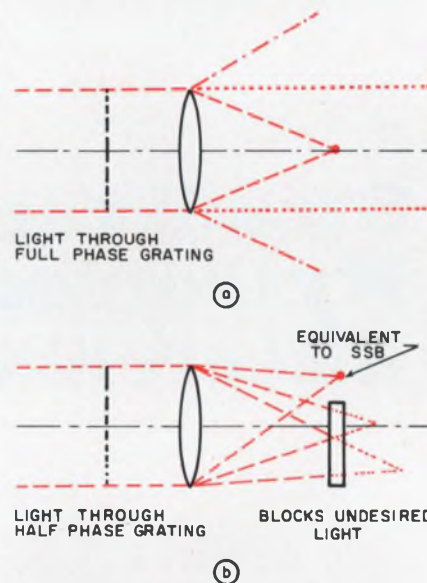

5. Three images, all with focal points on the central axis, are formed if full phase gratings are used for each point on the ground. Unwanted light couldn't be blocked. Using half gratings puts two images off-axis, so unwanted ones can be blocked.

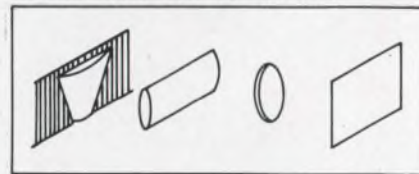

6. Lenses cure some problems. The conical one provides the different focal length required for each range. The cylindrical-spherical one gives a direct image in the vertical; a Fourier image in the horizontal. Radar observations are from such distances that equal-range arcs are effectively straight lines.

It seems at first glance that since each point, like *P* on the film, stores a portion of the doppler history from each point within the range strip shown on the diagram, it would be impossible to sort out the separate contributions from different points at the same range, say *A*, *B* and *C* in the drawing. But it happens that over the time that the beam passes each point, a separate one-dimensional Fresnel-zone pattern, is produced by it. The phase gratings formed by *A*, *B* and *C* are illustrated. Even though these phase gratings are superimposed, when light shines through a section of the film each grating causes the light representing each point to focus at a slightly different location. Thus an optical system can separate the points and form an image of the ground's radar reflectivity—a radar "photograph."

Unfortunately, as Fig. 5a shows, there are two other images formed beside the desired one. And the two unwanted images can not be blocked because their focal points are on the optical axis. However, this problem is solved when only half of the phase grating is used. This introduces an offset factor, and allows the two undesired images to be blocked out. This operation is not performed optically in the side-looking radar system. Rather, it is done by pointing the radar beam a little forward.

Another problem is that the Fresnel-zone patterns for each range have a slightly different focal length. Also, the optical system must produce a Fourier transform in the azimuth direction and a direct image in the range direction. The lenses shown in Fig. 6 perform these functions. ■■

References:

1. Vander Lugt, "A review of optical data processing techniques," *Optica Acta*, Vol. 15, No. 1, Jan., 1968, pp. 1-33, published by Taylor & Francis Ltd., Red Lion Court, Fleet Street, London, E. C. 4.
2. Lambert, "Optical Correlation," Chapter III, *Modern Radar Analysis, Valuation and System Design*, Edited by Raymond S. Berkowitz; John Wiley and Sons, Inc. 1965.
3. Lambert, Arm, Aimette; "Electro-optical Signal Processors for Phased Array Antennas," *Optical and Electro-Optical Information Processing*, MIT Press, 1965. [This book covers many other developments in the field also.]
4. Leith and Ingalls, "Synthetic Antenna Data Processing by Wavefront Reconstruction," *Applied Optics*, Vol. 7, No. 3, March, 1968.

Integrated Circuit

IDEAS

FROM SYLVANIA

**Increase computer speed and reliability...
cut size and costs at same time.**

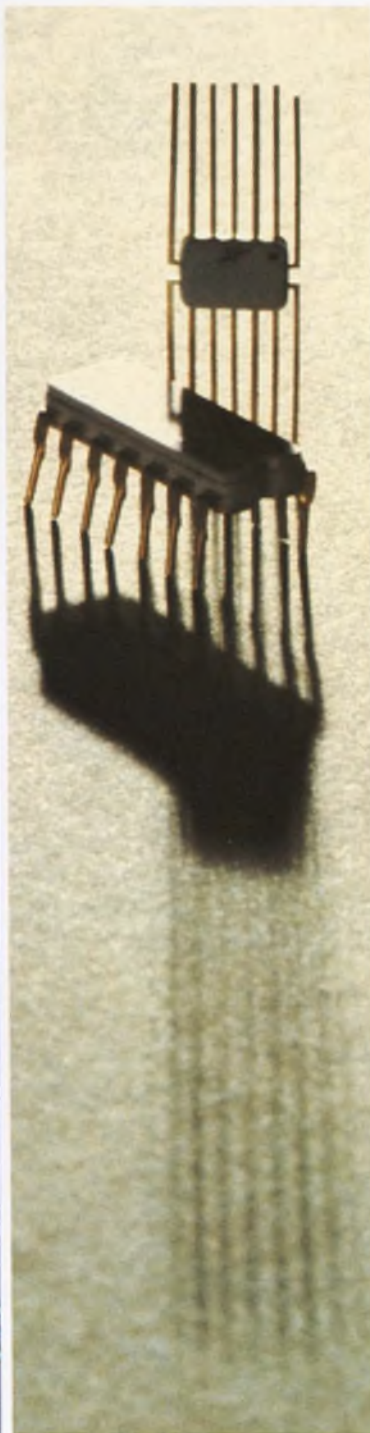
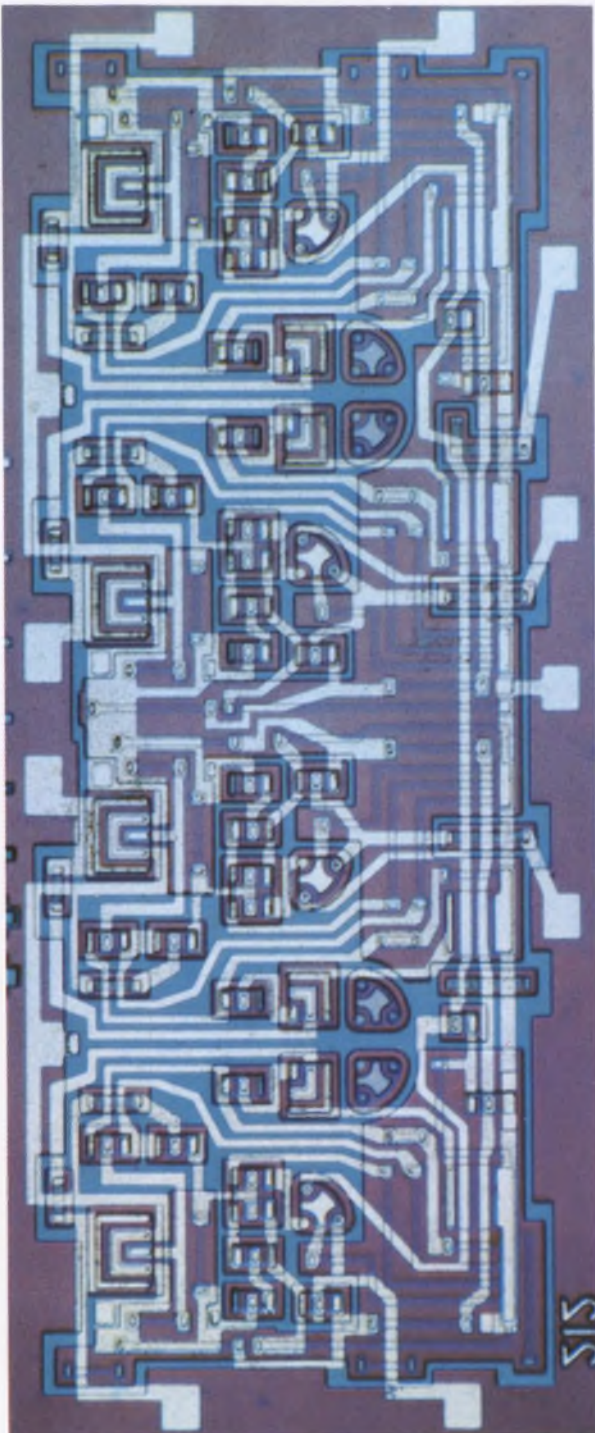

You get all these system improvements when you design around Sylvania monolithic digital functional arrays.

Sylvania monolithic arrays come in the familiar 14-lead package—in-line or flat pack—you know so well with our SUHL™ circuits. Easy to plug into conventional circuit boards.

The big difference is packaging density—more functions per package, less pins per function and higher speed. Monolithic arrays, typical of today's most modern MSI (medium-scale integration) technology, give you in single compact units such basic computer subsystems as adders, frequency dividers, registers and memories which work at faster speeds, use less power, need fewer connections and cost less than discrete IC subsystems.

Table 1 gives you an idea of the degree to which a computer can be simplified, reduced in size and made more efficient by use of Sylvania arrays.

In addition, our arrays significantly improve total system performance and reliability. Consider some of their advantages.

(Continued on next page)

This issue in capsule

IC Types

SUHL™ I and II, the industry's fastest and most complete TTL line.

IC Packaging

Molded plastic packaging lowers IC costs.

Hybrid Microcircuits

Active trim assures repeatability at low cost.

IC Applications

World's largest aircraft uses some of world's smallest IC systems.

Manager's Corner

LSI is on its way, but MSI is here today.

TABLE 1. MONOLITHIC DIGITAL FUNCTIONAL ARRAYS VS. CONVENTIONAL ICs

Typical Computer Subsystems	Sylvania Monolithic Digital Functional Arrays				Conventional Integrated Circuits			
	Number of Packages	Number of Equivalent Discrete Components	Speed (nsec)	Power (Milliwatts)	Number of External Connect'ns	Equivalent Number of IC Gates	Power (A) (Milliwatts)	(B) No. of External Connect'n
Basic Single Stage Fast Adder With Anticipated Carry	1	73	14	120	14	18	180	64
Four Bit Anticipated Carry Adder	4	292	35	480	56	72	720	252
Four Bit Ripple Carry Adder	4	264	60	400	32	36	540	132
Eight Bit Anticipated Carry Adder	12	704	45	1040	168	172	1460	602
Eight Bit Ripple Carry Adder	8	528	120	800	112	72	1080	252
Decade Frequency Divider	1	116	DC to 30 MHz	150	6	40(C)	600(C)	140(C)
Four Bit Register (Bus Transfer Output)	1	87	15	120	12	25	350	89
Four Bit Register (Cascode Pullup Output)	1	94	15	120	11	25	350	89

(A) Based on Average of 15 mw per NAND/NOR and Average of 5mw per AND-NOR Expansion

(B) Based on Average of 4 Gates per 14-Lead Package.

(C) Using 4 Sylvania JKs and a Pulse Shaping Gate, the Package Count would be 5 and Interconnections 37. Average Power Drain would be 190 mw.

FUNCTIONAL ARRAYS, TYPICAL CHARACTERISTICS (+25°C, +5.0 Volts)

Function	Type Nos.	t_{pd} (nsec)	Avg. Power (mw)	Noise Immunity + (volts)-	**Military (-55°C to +125°C)		**Industrial (0°C to +75°C)		
					Prime FO	Std. FO	Prime FO	Std. FO	
Full Adder	SM-10, SM-11, SM-12, SM-13	sum 22 carry 10	90	1.0	1.0	20	10	20	10
Dependent Carry Fast Adder	SM-20, SM-21, SM-22, SM-23	sum 22 carry 10	125	1.0	1.0	20	10	20	10
Independent Carry Fast Adder	SM-30, SM-31, SM-32, SM-33	sum 22 carry 10	125	1.0	1.0	20	10	20	10
Carry Decoder	SM-40, SM-41, SM-42, SM-43	2	25	1.0	1.0				
Decade Frequency Divider	SM-50, SM-52	30 MHz	120	1.0	1.0	15		15	
Four Bit Storage Register Bus Transfer Output	SM-60, SM-61, SM-62, SM-63	20	30/bit	1.0	1.0	20	10	20	10
Four Bit Storage Register Cascade Pullup Output	SM-70, SM-71, SM-72, SM-73	20	30/bit	1.0	1.0	20	10	20	10
16-Bit Scratch Pad Memory	SM-80, SM-81, SM-82, SM-83	25	250	1.0	1.0	40	20	40	10

*Minimum toggle frequency **Minimum fan-out

Integrated circuit structure for 8-stage fast adder.

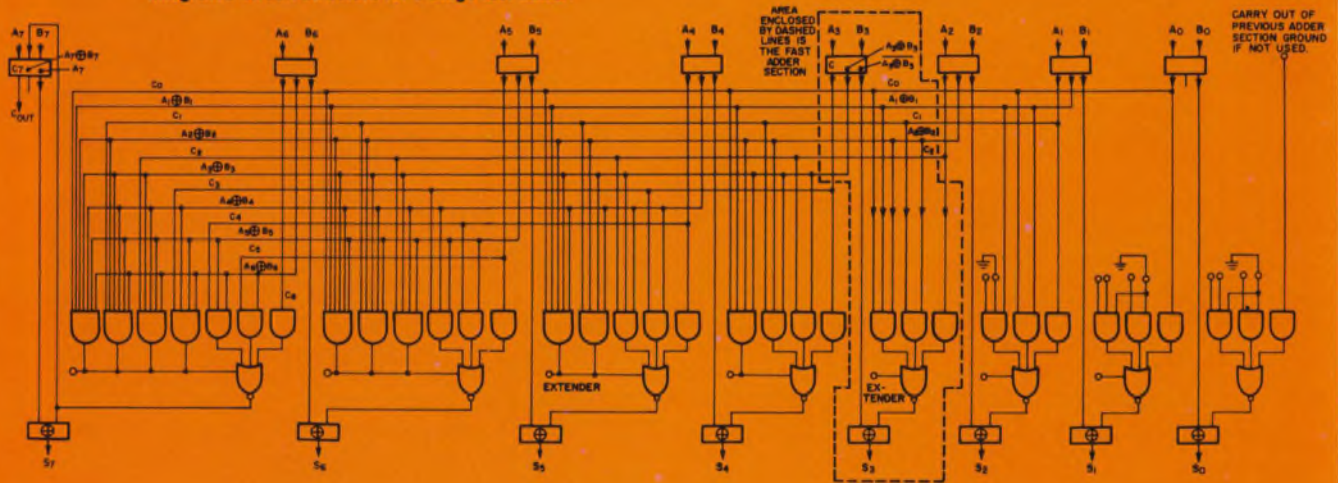

8-stage anticipated carry fast adder made from SM-20, SM-30 and SM-40 monolithic digital functional arrays.

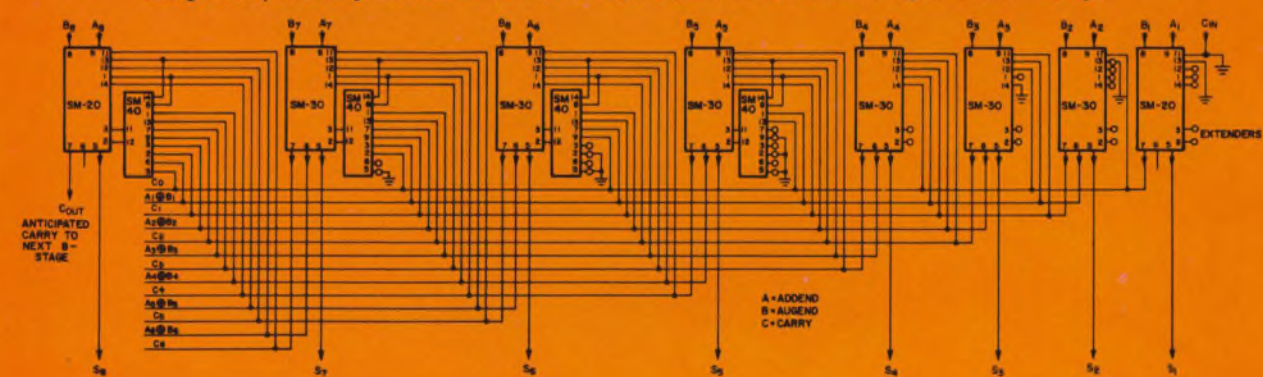

This

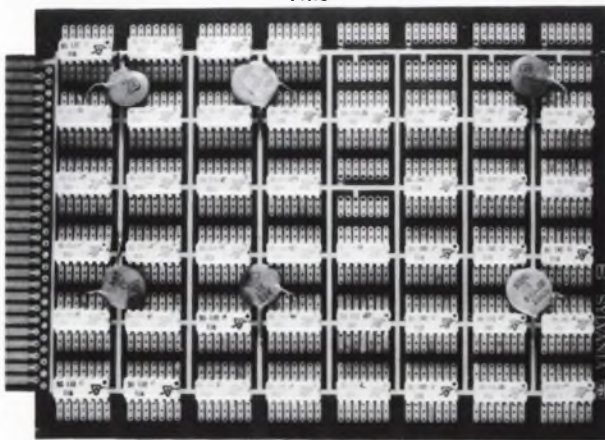

plus this

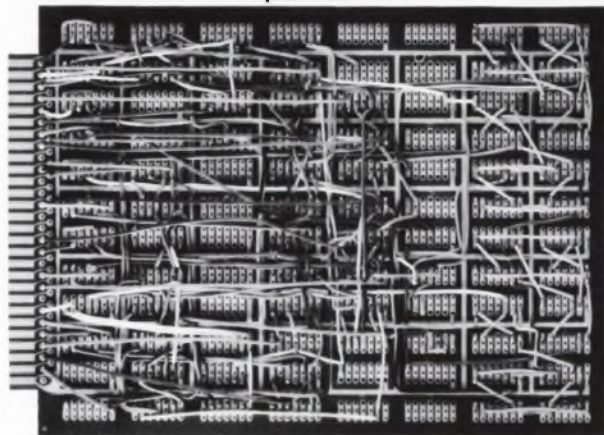

equals this



Complex Sylvania monolithic array (below, in 28-lead package) performs all the functions of the double-sided discrete-component IC circuit board, above. Available soon, it will be much more economical to produce in volume.

An array system puts more of its essential connections inside the basic 14-lead package. So there's less external wiring, and therefore a lower assembly cost, as the diagram (above) indicates.

Arrays provide more equivalent gating functions per pin: about 2 gates per pin typical in our SM-60 four-bit storage register.

Because signal paths are shorter, arrays reduce propagation-delay time and give better control of t_{pd} paths.

An array design, as opposed to a discrete-IC-board unit, has less backwiring. Shorter current paths reduce cross-talk, external noise pickup, self-induced ($L \frac{di}{dt}$) noise as well as power-supply-decoupling requirements. And metallization assures better "dress" between individual components, and thus better control of inter-component-connection electrical characteristics.

Sylvania now has, or is developing, arrays for every stage of a computer:

Arithmetic	Control	Memory	Input/Output
Adders: SM-10, -20, -30, -40 4-bit universal shift register*	BCD* counter Binary counter	16-bit scratch-pad memory, SM-80 4-bit storage register, SM-60, -70	BCD* to 7-line translator

*Presently in engineering development stage.

Our monolithic digital functional arrays—their numbers and functions—are shown on page 2 opposite. Tear it out and save it for reference.

CIRCLE NUMBER 300

Now SUHL™ ICs in molded plastic packages give you reliability plus economy.

More SUHL integrated circuits for the dollar, along with other advantages for you in performance and reliability. That's the big reason to consider these TTL's now in a new modern molded plastic package.

Our SUHL circuits are still available in ceramic flat packs and dual in-line plug-in packages. But now SUHL is available in molded plastic packages with glassivated wires and chips, providing an inert interface between the plastic and the active device... a Sylvania extra. In this package, our SUHL circuits meet the needs of design engineers more economically than ever before.

SUHL types in this newest package include the AND-NOR, NAND/NOR and J-K flip-flop families. All are temperature rated for operation over the 0-75°C range. The glass-coated chips are moisture-proof and are fully protected from contamination by foreign matter. Heat dissipation capability is equivalent to that of a ceramic flat-pack.

With the new molded plastic package, tinned rectangular leads are spaced 100 mils apart and are canted to facilitate automatic machine insertion in circuit boards.

Leads are attached to chips using aluminum-to-aluminum ultrasonic bonding methods. Because there is no trimetal interface (silicon can represent the extra metal), there is no possibility of self-generated bond failure due to "purple plague".

And where cost economy is important, these units offer dependable SUHL circuitry at the lowest prices ever. Sylvania passes along to the user the savings accrued through more efficient assembly processes. So you get our familiar high-quality SUHL circuits in an efficient package at the right price.

CIRCLE NUMBER 301

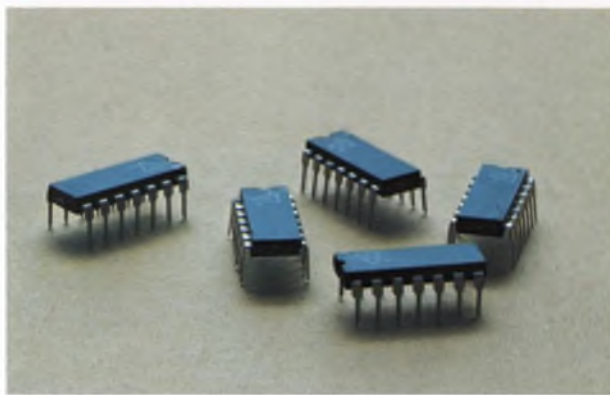
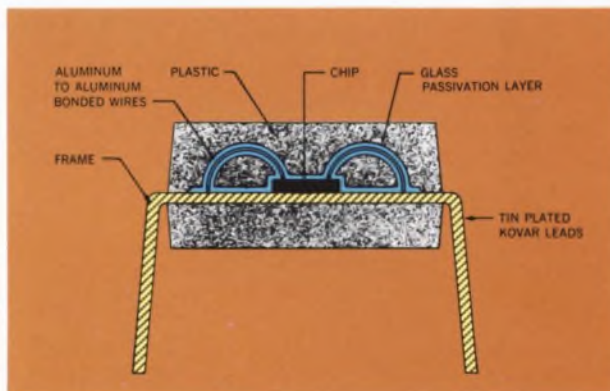

SUHL™ I and II IC's—the runaway favorites in TTL— now offer some 160 different types.

SUHL I TYPICAL CHARACTERISTICS (+25°C, +5.0 Volts)										
Function	Type Nos.	t_{pd} (nsec)	Avg. Power (mw)	Noise Immunity + (volts)–	**Military (–55°C to +125°C) Prime FO Std. FO		**Industrial (0°C to +75°C) Prime FO Std. FO			
NAND/NOR Gates										
Dual 4-Input NAND/NOR Gate	SG-40, SG-41, SG-42, SG-43	10	15	1.1	1.5	15	7	12	6	
Single 8-Input NAND/NOR Gate	SG-50, SG-61, SG-62, SG-63	12	15	1.1	1.5	15	7	12	6	
Expandable Single 8-Input NAND/NOR Gate	SG-120, SG-121, SG-122, SG-123	18	15	1.1	1.5	15	7	12	6	
Dual 4-Input Line Driver	SG-130, SG-131, SG-132, SG-133	25	30	1.1	1.5	30	15	24	12	
Quad 2-Input NAND/NOR Gate	SG-140, SG-141, SG-142, SG-143	10	15	1.1	1.5	15	7	12	6	
Triple 2-Input Bus Driver	SG-160, SG-161, SG-162, SG-163	15	15	1.1	1.5	15	7	12	6	
Triple 3-Input NAND/NOR Gate	SG-190, SG-191, SG-192, SG-193	10	15	1.1	1.5	15	7	12	6	
AND-NOR Gates										
Expandable Quad 2-Input OR Gate	SG-50, SG-51, SG-52, SG-53	12	30	1.1	1.5	15	7	12	6	
Expandable Dual Output, Dual 2-Input OR Gate	SG-70, SG-71, SG-72, SG-73	12	20/gate	1.1	1.5	15	7	12	6	
Exclusive-OR with Complement	SG-90, SG-91, SG-92, SG-93	11	35	1.1	1.5	15	7	12	8	
Expandable Triple 3-Input OR Gate	SG-100, SG-101, SG-102, SG-103	12	25	1.1	1.5	15	7	12	6	
Expandable Dual 4-Input OR Gate	SG-110, SG-111, SG-112, SG-113	12	20	1.1	1.5	15	7	12	6	
Non-Inverting Gates										
Dual Pulse Shaper/Delay-AND Gate	SG-80, SG-81, SG-82, SG-83	11	30/gate	1.1	1.5	15	7	12	6	
Dual 4-Input AND/OR Gate	SG-280, SG-281, SG-282, SG-283	11	38/gate	1.0	1.5	10	5	8	4	
AND Expanders										
Dual 4-Input AND Expander	SG-180, SG-181, SG-182, SG-183	< 1	0.9/gate	1.1	1.5					
Dual 2 + 3 Input AND/OR Expander	SG-290, SG-291, SG-292, SG-293	7	15/gate	1.0	1.5					
OR Expanders										
Quad 2-Input OR Expander	SG-150, SG-151, SG-152, SG-153	4	20	1.1	1.5					
Dual 4-Input OR Expander	SG-170, SG-171, SG-172, SG-173	3	5	1.1	1.5					
Flip-Flops										
Set-Reset Flip-Flop	SF-10, SF-11, SF-12, SF-13	20MHz*	30	1.1	1.5	15	7	12	6	
Two Phase SR Clocked Flip-Flop	SF-20, SF-21, SF-22, SF-23	20MHz*	30	1.1	1.5	15	7	12	6	
Single Phase SRT Flip-Flop	SF-30, SF-31, SF-32, SF-33	15MHz*	30	1.1	1.5	15	7	12	6	
J-K Flip-Flop (AND Inputs)	SF-50, SF-51, SF-52, SF-53	20MHz*	50	1.1	1.5	15	7	12	6	
J-K Flip-Flop (OR Inputs)	SF-60, SF-61, SF-62, SF-63	20MHz*	55	1.1	1.5	15	7	12	6	
Dual 35MHz J-K Flip-Flop (Separate Clock)	SF-100, SF-101, SF-102, SF-103	35MHz*	55/FF	1.0	1.5	11	6	9	5	
Dual 35MHz J-K Flip-Flop (Common Clock)	SF-110, SF-111, SF-112, SF-113	35MHz*	55/FF	1.0	1.5	11	6	9	5	
SUHL II TYPICAL CHARACTERISTICS (+25°C, +5.0 Volts)										
NAND/NOR Gates										
Expandable Single 8-Input NAND/NOR Gate	SG-200, SG-201, SG-202, SG-203	8	22	1.0	1.5	11	6	9	5	
Quad 2-Input NAND/NOR Gate	SG-220, SG-221, SG-222, SG-223	6	22	1.0	1.5	11	6	9	5	
Dual 4-Input NAND/NOR Gate	SG-240, SG-241, SG-242, SG-243	6	22	1.0	1.5	11	6	9	5	
Single 8-Input NAND/NOR Gate	SG-260, SG-261, SG-262, SG-263	8	22	1.0	1.5	11	6	9	5	
AND-NOR Gates										
Expandable Dual 4-Input OR Gate	SG-210, SG-211, SG-212, SG-213	7	30	1.0	1.5	11	6	9	5	
Expandable Quad 2-Input OR Gate	SG-250, SG-251, SG-252, SG-253	7.5	43	1.0	1.5	11	6	9	5	
Expandable Triple 3-Input OR Gate	SG-300, SG-301, SG-302, SG-303	7	36	1.0	1.5	11	6	9	5	
Expandable Dual Output Dual 2-Input OR Gate	SG-310, SG-311, SG-312, SG-313	7	30/gate	1.0	1.5	11	6	9	5	
AND Expanders										
Dual 4-Input AND Expander	SG-180, SG-181, SG-182, SG-183	< 1	0.9/gate	1.1	1.5					
OR Expanders										
Quad 2-Input OR Expander	SG-230, SG-231, SG-232, SG-233	2	28	1.0	1.5					
Dual 4-Input OR Expander	SG-270, SG-271, SG-272, SG-273	2	6.7	1.0	1.5					
Flip-Flops										
Dual 50 MHz J-K Flip-Flop (Separate Clock)	SF-120, SF-121, SF-122, SF-123	50MHz*	55/FF	1.0	1.5	11	6	9	5	
Dual 50MHz J-K Flip-Flop (Common Clock)	SF-130, SF-131, SF-132, SF-133	50MHz*	55/FF	1.0	1.5	11	6	9	5	
50MHz J-K Flip-Flop (AND Inputs)	SF-200, SF-201, SF-202, SF-203	50MHz*	55	1.0	1.5	11	6	9	5	
50MHz J-K Flip-Flop (OR Inputs)	SF-210, SF-211, SF-212, SF-213	50MHz*	55	1.0	1.5	11	6	9	5	

MONOLITHIC LINEAR AMPLIFIERS TYPICAL CHARACTERISTICS (+25°C)

Function	Type Nos.	Supply Voltages	Power Dissipation (mW)	Input Impedance	Output Impedance	Output Signal Swing Vp-p	–3db Freq. MHz	Voltage Gain (db)	Temperature Range
Wide Band Video Amplifier	SA-20, SA-21	+24V	450	1.6K	1.5	13.0	100	21	–55°C to +125°C
High Gain Operational Amplifier	SA-40, SA-41 SA-42, SA-43	+12 to +6 and –6 to –3	80/40	25K	125	10.0	1.2	69	–55°C to +125°C 0°C to +75°C
Amplifier/Limiter/Discriminator	SA-500, SA-501	+10 to +5.5	125	2.5K	15K	2.8	6	75	–55°C to +125°C

Our Sylvania SUHL I and II lines offer you more different types of TTLs to do more different jobs—faster and better—than any comparable TTL line in the industry. For your convenience, the list (left) is color-coded to the IC diagrams on this page. Tear it out and save it for reference.

Applications engineers estimate that 80% of new computer designs call for TTL. And our SUHL line—Sylvania *Universal High-level Logic*—is the industry's acknowledged leader in TTL, the line that other manufacturers admit to copying.

Speed is the most important advantage, of course. Our SUHL II flip-flops, for example, provide up to 50 MHz switching speed, as little as 6 nsec propagation delay time (t_{pd}) while retaining extremely high noise immunity.

Shown here is a full list of SUHL I and II TTL logic elements available to you, all color-coded to the appropriate diagrams. (The chart at bottom, listing linear amplifiers, is not color coded.) Our monolithic digital functional arrays are listed on page 2 with an article on the subject.

SUHL circuits are still the fastest TTL's; in addition to maintaining good switching speeds, they keep waveform integrity under varying loads and fluctuating temperatures.

Every Sylvania TTL element is fully and automatically tested on our specially designed *Multiple Rapid Automatic Test Of Monolithic Integrated Circuits (MR. ATOMIC)* equipment to assure that you get the performance you pay for every time. All units, except as noted, are available in 14-lead flat-pack style or dual in-line plug-in packages.

CIRCLE NUMBER 302

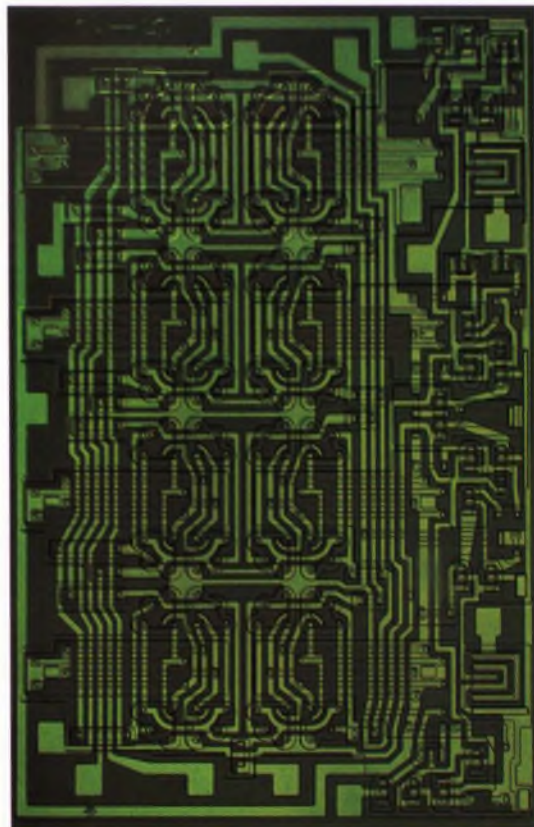

SM-80, 16-bit scratch-pad memory.

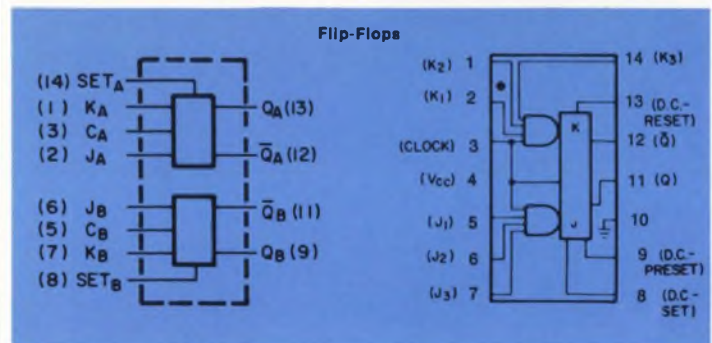
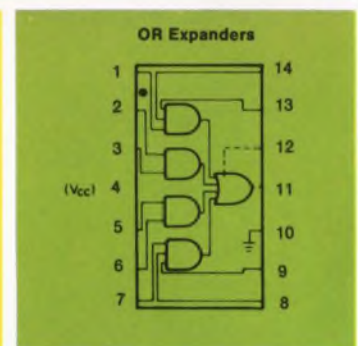
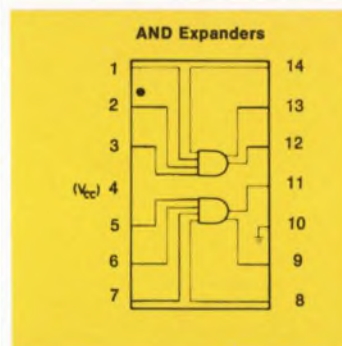
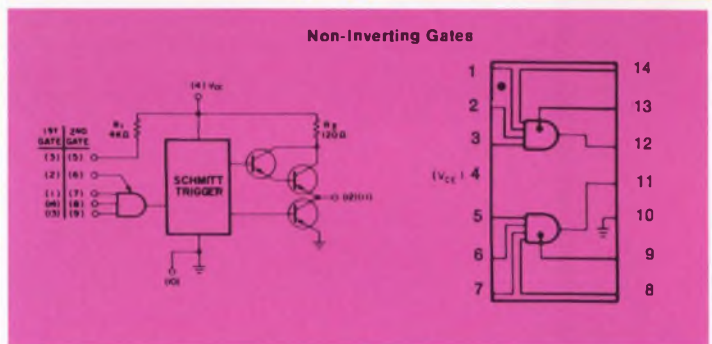
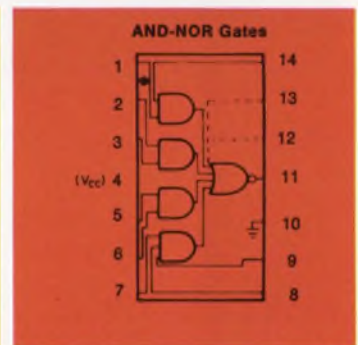
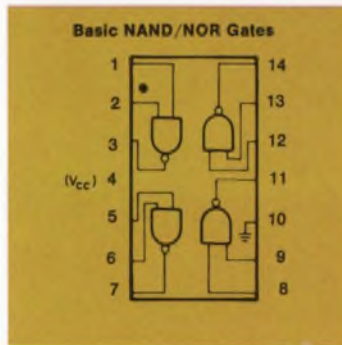
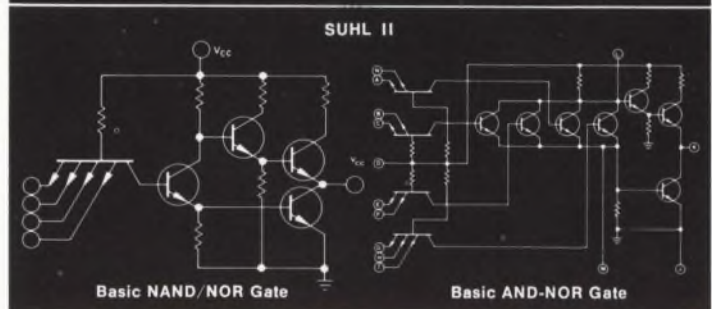
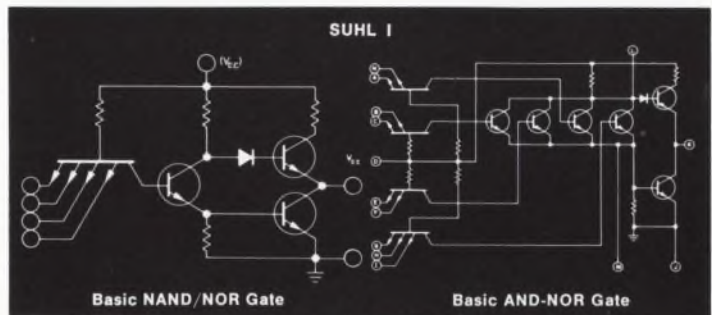

Custom microcircuits: repeatability at low cost through active trim.

Now, through active trim of hybrid microcircuits, Sylvania can meet exact requirements for repeatability of quiescent DC level balance.

Until recently, electronic circuit designers would first select circuit topology and then, to fulfill their specific requirements, would compute active and passive device values. With that approach, circuit performances could fall within a wide range of values, sometimes resulting in poor production yield.

To improve yield, previous options open to the design engineer were either to select tightly toleranced components or to specify adjustable elements to bring circuit performance within acceptable limits. These choices often lead either to relatively higher cost or to larger package size.

But now, with the conventional microcircuit, Sylvania individually trims passive components to final value through the use of a null-detecting bridge. Passive component trimming can achieve the desired circuit performance characteristics.

Final adjustment is effected after active components have been attached and after the circuit has been energized. During this final trim, the rate and amount of abrasion is controlled by monitoring the circuit characteristic of interest. This trim allows the circuit designer to work with broader tolerance of individual circuit elements. Such a technique can be cost-effective since in-process yields are substantially increased as individual component tolerances are relaxed.

As one example of an active trim application, let's take a photocell signal amplifier. It is used in a char-

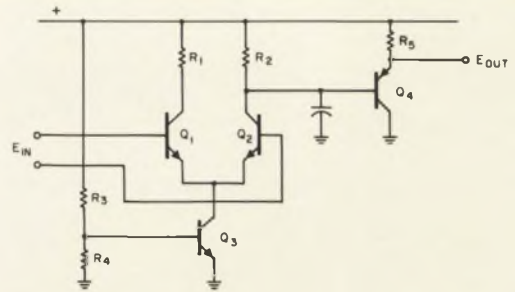

Figure 2—Equivalent circuit diagram of photocell signal amplifier.

acter recognition system where the quiescent DC level from a matrix of cells has to be balanced. A requirement is that the output of each amplifier must be held at a fixed DC value from unit to unit. The actual circuit is shown in Figure 1. Figure 2 is an equivalent schematic.

The output voltage level is established by the output of a differential amplifier. The emitters of the differential transistor pair (Q1 and Q2) are connected to a transistor current source (Q3). The level of current is fixed by the values of resistors R3 and R4 to set a bias for Q3.

After all required adjustments have been made, this circuit is energized and R4 is adjusted to a predetermined value of output voltage. Since in the thick film technology screened resistors are fired to value below the desired nominal, R4 may be increased in value by using air-abrasive trim techniques to effect a geometry change. As the value of R4 is increased, the operating point of Q3 is changed causing the increase in collector current. As the voltage drop in R2 changes, DC level at the output of the emitter follower approaches the required level.

This represents just one example of how Sylvania meets the need for inexpensive hybrid microelectronic circuits tailored to your operational requirements. CIRCLE NUMBER 303

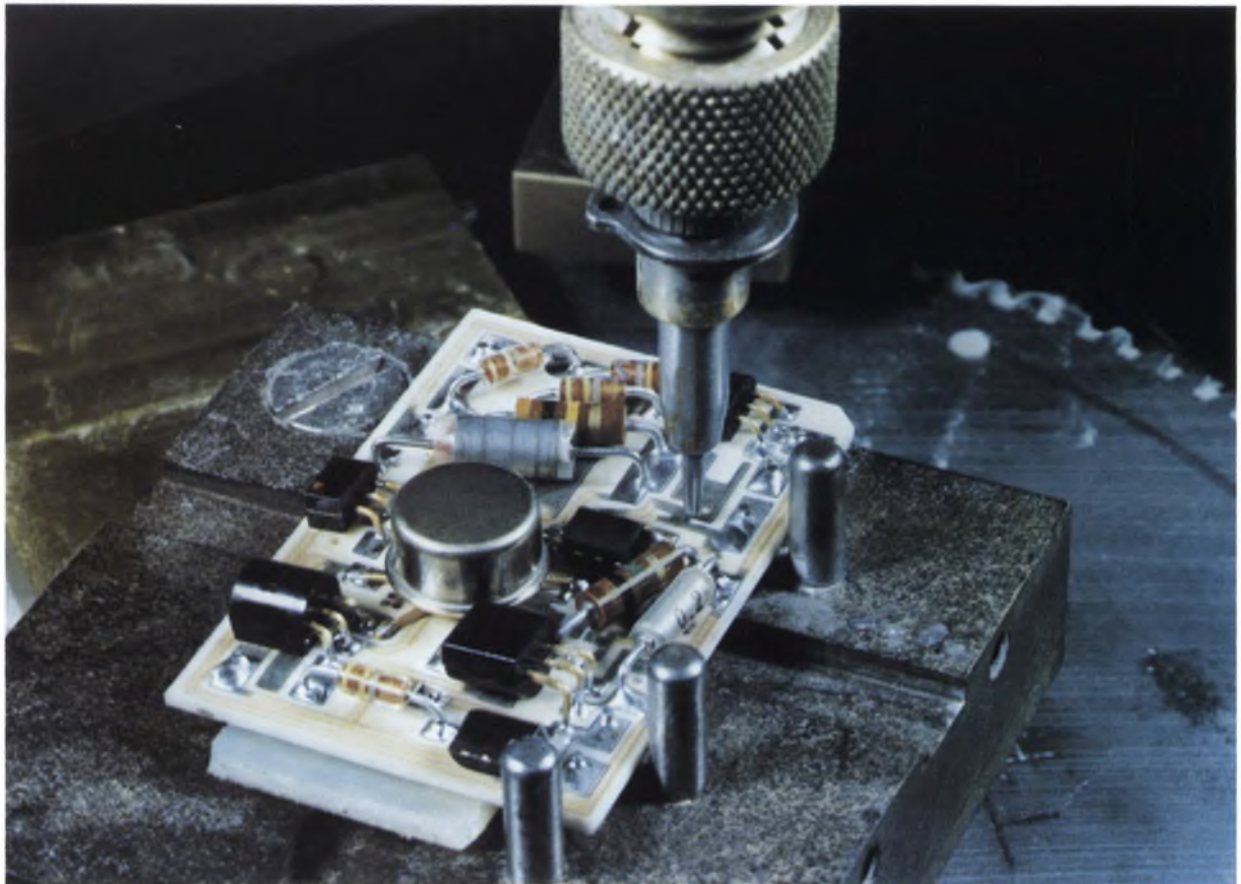

Figure 1—Air-abrasive trim techniques are used to precisely adjust circuit operating characteristics.

Largest aircraft will rely on some of world's smallest, fastest ICs: Sylvania SUHL™ II.

World's largest aircraft, U.S. Air Force C-5A Galaxy built by Lockheed-Georgia Company of Marietta, Ga., employs Sylvania SUHL II high-speed IC logic elements in its self-checking Malfunction Detection, Analysis and Recording (MADAR) subsystem, its station-keeping equipment (SKE) radar subsystem and its landing gear proximity switch control units.

The Lockheed C-5A Galaxy will not only be the world's largest aircraft. It will also be one of the world's most self-sufficient.

Through its Malfunction Detection, Analysis and Recording (MADAR) subsystem, the aircraft continuously monitors over 600 critical test points during take-off, flight and landing. If a defect occurs, the defective subsystem's number lights up on the flight engineer's instrument panel. Then for a diagnostic check, the flight engineer calls for a live waveform and views it adjacent to comparative ideal waveforms projected on a screen from a random-access memory bank, and takes corrective measures. And as he makes manual diagnoses and corrections, MADAR continues monitoring other test points automatically.

The MADAR subsystem is designed around Sylvania SUHL II ultra-high-speed integrated circuits. Our SUHL II ICs also accomplish essential logic functions in the synchronizer unit of the aircraft's station-keeping equipment (SKE) and in the landing gear proximity switch control system. The SKE system is a low-frequency (doppler) radar which automatically maintains the correct relative flight position of every aircraft in a fleet. The landing-gear proximity switch senses the position of the landing gear and landing-gear housing doors, controls their sequence of operation and informs the crew of any malfunction.

The MADAR control and sequencer uses about 450 SUHL II ICs; the SKE synchronizer has some 378.

How important are they? Says Lockheed:

"By using integrated circuits and . . . thick-film hybrid circuits, the size and weight of these systems has been greatly reduced while reliability increased. Development of either system without integrated circuits would have been impractical; the complexity of

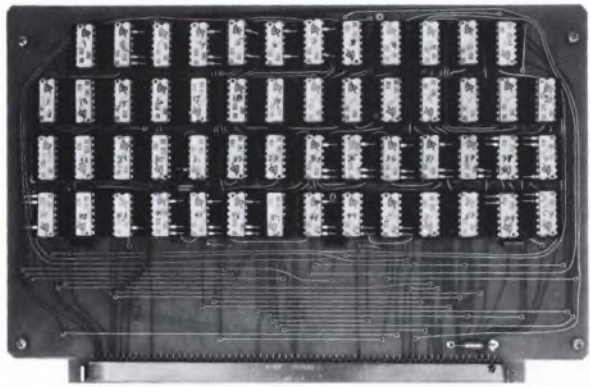

One of ten printed IC mounting boards used in Galaxy's station-keeping equipment (SKE) synchronizer.



Artist's conception of C-5A in flight. Aircraft is designed to carry 100,000 pounds of payload for 6300 miles, and up to 265,000 pounds for shorter distances. It will be 82 yards long with a wingspan of 74 yards.

discrete component designs, to accomplish the required logic functions, would have resulted in units too large and heavy and too unreliable to use on aircraft."

What more can we say?

CIRCLE NUMBER 304



Use Sylvania's "Hot Line" inquiry service, especially if you require full particulars on any item in a hurry. It's easy and it's free. Circle the reader service number(s) you're most interested in; then fill in your name, title, company and address. We'll do the rest and see you get further information by return mail.

BUSINESS REPLY MAIL

No Postage Stamp Necessary if Mailed in the United States

FIRST CLASS
Permit No. 2833
Buffalo, N.Y.

POSTAGE WILL BE PAID BY

Sylvania Electric Products Inc.
Sylvania Electronic Components
1100 Main Street
Buffalo, New York 14209

Dept. C4 4 4

LSI...around the corner. But MSI is here now.

We've all heard tales of the girl who rejects the nice boy next door while she waits for Prince Charming . . . and winds up an old maid.

Right now in the computer business, medium-scale integration (MSI)—in the form of monolithic digital functional arrays—is in the position of the nice boy next door, while LSI is Prince Charming.

MSI devices are something *we make and you can use*—today, without redesign of your present circuit configurations. LSI is still in the future both as to volume manufacture and practical application.

There's an unfortunate tendency in this industry to "announce" something when it's on the drawing board, and to say it's "in stock" when a prototype has been produced. (By that definition, Sylvania could claim we have LSI devices "in stock", because we have produced and are testing prototypes with over 100 functions on a chip.) But we don't believe in that; when we say we have something "in stock", we mean we have a device that works and that we can deliver in quantity within a matter of days.

And we *do* have MSI devices in stock. Such devices will be the basis of practical computer designs for the next five years or so. Any computer manufacturer who passes up MSI to wait for LSI is likely to find himself in the situation of the girl waiting for Prince Charming. Left out.

Our MSI monolithic arrays, available in the familiar TO-85 14-lead flat pack or 14-lead dual-in-line plug-in package, provide in general from 20 to 50 gating functions on a single chip with a single layer of metallization. These devices are fully compatible with existing monolithic logic; they interface with present-day systems without major redesign effort on your part.

Larger-scale integration—which we're working on—refers to a functional device with more than 100 functions, created by multiple-layer interconnections using metallized fixed connective patterns. This will bring

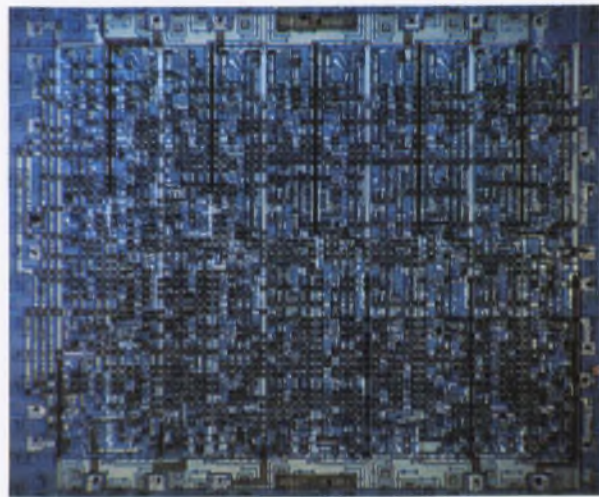

Sylvania LSI chip: over 1200 components, 100 logic functions.

about a technique in which—on a 500-gate 2-inch wafer—by selection and rejection only functioning gates are wired. This could yield 400 or more functions in a single package . . . the beginning of the "computer-on-a-wafer" concept.

But such devices—to produce in volume and to be used practically—will require much more sophistication on the part of both manufacturer and user than the present state of the art permits. To produce them will require the ability to create an extremely high yield of usable functions on a wafer, excellent control of multiple-layer interconnection techniques and very complex testing and packaging procedures. Equipment and process requirements will be elaborate and costly.

More significantly, the engineering required by the computer designer, builder and user must be advanced to a far higher level than present technologies demand. Builders must understand the importance of these differences before committing themselves to an approach.

So . . . LSI is coming. But meanwhile, MSI in the form of functional arrays is the practical solution to *today's* computer design problems.

Harry Luhrs

H. M. Luhrs
Product Marketing Manager
Integrated Circuits

SYLVANIA

A SUBSIDIARY OF
GENERAL TELEPHONE & ELECTRONICS

NEW CAPABILITIES IN: ELECTRONIC TUBES • SEMICONDUCTORS • MICROWAVE DEVICES • SPECIAL COMPONENTS • DISPLAY DEVICES

This information in Sylvania Ideas is furnished without assuming any obligations.

C4

NAME _____
PLEASE PRINT

TITLE _____

COMPANY _____

ADDRESS _____

CITY _____ STATE _____ ZIP _____

Circle Numbers Corresponding to Product Item

300 301 302 303 304

Please have a Sales Engineer call



HOT LINE INQUIRY SERVICE

Need information in a hurry? Clip the card and mail it. Be sure to fill in all information requested. We'll rush you full particulars on any item indicated.

You can also get information using the publication's card elsewhere in this issue. Use of the card shown here will simplify handling and save time.

Gold bridge boosts isolation in ICs

A new gold bridge for connecting elements of integrated circuits improves circuit isolation and reliability. It has a higher breakdown voltage and lower capacitance than conventional structures for making these connections.

The new bridge, a further advance in beam-lead technology, was devised at Bell Telephone Laboratories, Murray Hill, N.J., by Dr. Martin P. Lepselter. Beam leads are formed during the diffusion and etching processes in making integrated circuits.

Metallic surfaces are etched to form bar relief connections. Circuit elements are air isolated and can be packaged by improved methods.

If two conductors separated by a third conductor are to be joined, the 10-micron high "microbridge" is used to span the gap. The two crossing conductors are separated by a thin layer of zirconium oxide and an air gap, a combination that will withstand 200 V.

In the usual method for making this connection, a layer of insulating silicon dioxide is deposited directly over the intervening conductor and substrate between the two conductors to be connected. The bridge is then formed directly on the insulating layer.

A problem in this approach is that pinholes can develop in the insulating layer of silicon dioxide and cause shorts and leakage between the crossing conductors because of their close contact. ■■

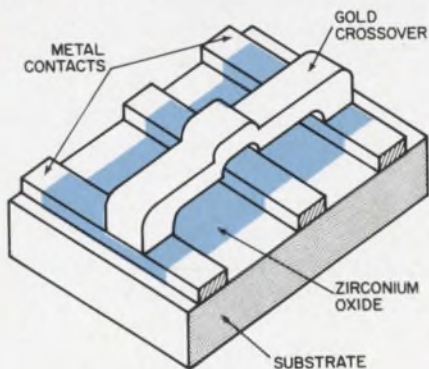

Microbridge spans conductor in IC. Air gap and zirconium oxide assure improved circuit isolation from intervening conductor.

NEW *Byne* SEMI-AUTOMATIC INTEGRATED CIRCUIT TESTERS

MODEL 715

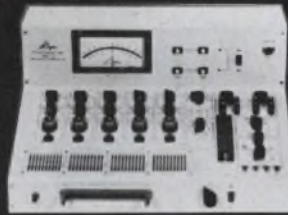

\$1695

MODEL 716

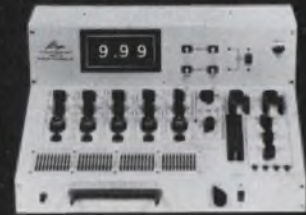

\$2195

TEST

DIGITAL

(RTL, DTL, TTL, MECL)
FOR

- INPUT LOAD CURRENT
- INPUT LEAKAGE CURRENT
- INPUT THRESHOLD
- SHORTS BETWEEN INPUTS
- OUTPUT LOGIC "1" UNDER LOAD
- OUTPUT LOGIC "0" UNDER LOAD
- TOTAL I_{cc} DRAIN
- CLOCKING FLIP-FLOPS AND COUNTERS

OR

LINEAR

(OPERATIONAL AMPLIFIERS, COMPARATORS)
FOR

- VOLTAGE GAIN
- INPUT OFFSET VOLTAGE
- INPUT OFFSET CURRENT
- OUTPUT VOLTAGE
- OUTPUT CURRENT
- TOTAL I_{cc} DRAIN
- BANDWIDTH (VIA SPECIAL ADAPTER)
- INPUT BIAS CURRENT



MODEL 701 \$545.



MODEL 710 \$995.



MODEL 711 \$1495.

Byne MICRODYNE INSTRUMENTS INC., 225 Crescent St., Waltham, Mass. 02154 (617) 893-8210

Major growth is forecast in radar market

Panel of E.I.A. experts sees steady advances in 4 fields, with total spending of about a billion by '75

Charles D. LaFond
Chief, Washington News Bureau

Changing military requirements and critically needed advances in technology have forced a significant cyclic rise in the U.S. radar market.

Dr. Leland D. Strom, former staff scientist of the Institute for Defense Analyses and now a consultant, suggests four factors that are influencing the growth; the impact of the Southeast Asia conflict; a redistribution of funds (and emphasis) for R&D, production; and operation and maintenance efforts; the impact of new electronic technology; and the Defense Dept. decision to deploy the Sentinel antiballistic missile system—the new “thin” network formerly called Nike X.

A forecast for 1967-1975 by experts of the Electronic Industries Association indicates, conservatively, total radar spending of from \$700 million to over \$1.1 billion. The spread reflects uncertainties over defense policies, Congressional appropriations, and the ultimate end of the war in Vietnam. It also depends on how well industry ex-

ploits technological advances, the experts declared.

The forecast emerged last fall when the Requirements Committee of EIA sponsored a panel report on “The Radar Market, 1967-1975” during a major meeting of the organization in Los Angeles. The report, published only recently, contains the views of four market study groups, with comments by the panel moderator, Dr. Strom, then associated with the Institute for Defense Analyses.

Because of the expertise of the industry participants, the forecast is considered a practical guide to what probably will occur rather than what a parochial industry might wish to see happen. Advances were forecast in these areas:

- Large surface radars.
- Tactical ground radars.
- Shipboard radars.
- Aircraft and spacecraft radar.

Following are the major findings:

LARGE SURFACE RADARS

The large-surface-radar market should grow from a present level of \$200 million a year to about

\$500 million by 1975, according to Clifford A. Bean, manager for market planning and development of Sylvania Electronics Systems. He defines the systems that will be affected as large, fixed installations employed in air, missile and space defense; aircraft and missile range instrumentation; air-traffic control; and weather-data collection.

In essence, Bean suggests a cyclical repetition of the radar market that peaked during the 1950s—also at about \$500 million. That period was highlighted by a build-up of military aircraft and ballistic-missile defense radar systems, and by the opening of national missile-space ranges.

However, Bean sees a different change in the 1967 to 1975 period. The principal procurement role, he says, will shift from the Air Force to the combined efforts of the Army and the Advanced Research Projects Agency of the Defense Dept. With the U.S. decision to embark on a “thin” continental antiballistic missile defense program, the Sylvania specialist says, the nation has “crossed the threshold into the next generation” for heavy radars. Bean estimates that nearly 40 per cent of the total market by 1975 will be accounted for by operation and maintenance contracts to industry.

Scatter techniques emphasized

Three system design approaches are currently receiving the most R&D attention: frequency scan, forward-scatter and back-scatter, and phased-array. Frequency scan, Bean suggests, appears most significant today for such functions as ground-control approach radars, where accurate guidance information is required.

Forward-scatter and back-scatter techniques are receiving more and more emphasis because of the need for extended-range, over-the-horizon systems for aircraft and missile detection. The military, for example, is attempting to apply forward-scatter techniques in an

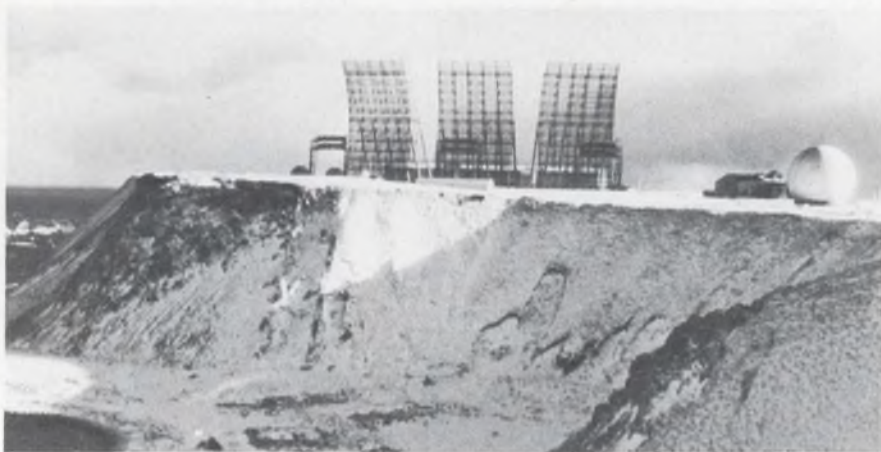

Large-surface tracking radars such as this one at Shemya, Alaska, are typical of major surface radar systems procured in recent years. For the near future, emphasis will be on over-the-horizon scatter systems, anti-ballistic missile trackers and large phased arrays for space surveillance. The system above is part of the nation's defensive satellite-tracking network.

New Bomac VTM's deliver 1 watt in X band.

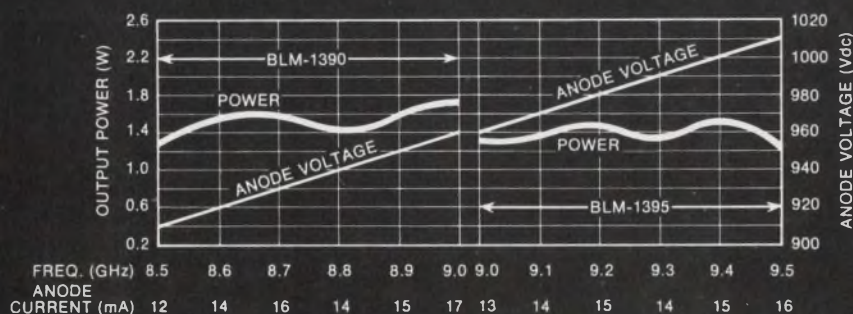

Bomac introduces the only Voltage Tunable Magnetrons operating between 8.5 and 9.5 GHz. Models BLM-1390 and BLM-1395 deliver 1 watt minimum (1.5 watts typical), with flat power output and linear voltage tuning.

Anode voltage is only 1200 Vdc, allowing use with simplified power supplies.

High FM sensitivity — 10 MHz/V — and linear tuning make modulation easier in electronic warfare and fuze applications.

The units are about 2 by 2½ by 3 inches, weigh only 1½ pounds. Efficient shielding permits them to contact other ferromagnetic materials without degrading their performance, making these VTM's ideal for compact packaging.

For more data, contact Bomac Division, Salem Road, Beverly, Massachusetts 01915, or any of the more than 30 Varian Electron Tube and Device Group Sales Offices throughout the world.



(radar market, continued)

hf system that employs multi-megawatt power to transmit from one station, via the ionosphere, to a receiving station halfway around the world. The system aims to detect missile-launching atmospheric and rf perturbations between the two stations. The Radio Corp. of America, on the other hand, recently received Air Force approval to develop and test the AN/FPS-95, a back-scatter, over-the-horizon radar. The hope, in this instance, Bean says, is to provide more tracking data about the target than that furnished by existing forward-scatter approaches.

The greatest emphasis, however, will be on phased-array radars, Bean says. Efforts will concentrate on finding the best and most economical of three basic types: a single power tube driving many array elements; separate power tubes driving each antenna element, or the use of transmitting tubes to drive multi-element sub-arrays.

Other recent developments, such as high-powered avalanche diodes and Gunn-effect devices, could move radar technology to the threshold of the long-sought, high-power, solid-state, microwave oscillator, Bean contends. Increased funds for the development and application of integrated-circuit technology are fostering the reality of

a microwave transmitting-receiving module, he says. While most of the functional elements of such subsystems probably could be monolithic, he adds, it appears that the needs for high power and good amplification, with low loss, will force the evolution of hybrid circuitry.

Future phased-array radars, Bean suggests, probably will result from combining the outputs of many hybrid solid-state modules. For vhf-uhf operation, 40-watt outputs can be obtained now from single-transistor output stages. In the microwave region, 1-2 watts at 2 GHz is feasible, he says. Tens of watts at this frequency and above, or 1 watt at 10 GHz, can be obtained with vhf-uhf amplifiers through the use of varactor frequency multipliers.

The dominant factor, Bean points out, is not technical feasibility alone but also cost effectiveness. Practical module prices of about \$10 a unit in large quantity should be reached within two to three years, he says, but until that time, system designers will use conventional design—gridded tubes for vhf-uhf transmitters and traveling-wave tubes and klystrons for the higher frequency operation.

Weapons systems dominate

Up to 90 per cent of the near-future, large-surface-radar market will be dominated by aerospace,

surveillance and defense needs. Bean concludes. Much of this effort will be derived from the Sentinel anti-ballistic missile system deployment. A new growth area is forecast within the next five years for space surveillance and associated target detection and tracking.

In examining future markets, the Sylvania expert says: "Probably the most significant factor impacting on the heavy radar market is the threat from air, missile and space weapons systems. The recognition of this threat and the development of defensive systems against it have provided the impetus to launch this market into a period of significant growth."

Six years ago EIA predicted a shakeout within the ranks of the then leading radar manufacturers. This did not occur. The principal radar suppliers continue to reign: Avco, Bendix, GE, Westinghouse, Sperry, RCA, Raytheon and Sylvania. Three newcomers round out the top companies: LTV, Hughes and Sanders. In dollar volume, Bean states, RCA tops the list, while Raytheon, GE and ITT provide close competition.

Bean estimates that 60 per cent of the total Sentinel program will be for electronics, while 20 per cent of the total expenditures will be for radar alone—or over \$1 billion, based on thin deployment and only experimental installation of the tactical, multi-function array radar Tacmar. Sentinel, or Nike-X, radar system awards from 1965 to 1967—from the Army through Western Electric and Bell Telephone Laboratories—totaled \$90 million.

Closely associated with the Sentinel system is the Project Defender program. Budgeted at about \$120 million a year, Defender expenditures are largely for advanced radar experimentation in missile warhead signatures, missile interception, decoy discrimination, target measurement, phased arrays and associated technologies. The Defender program is expected to spend from \$50 million to \$60 million a year directly for advanced radar technology.

While the figure is expected to decline somewhat over the next few years, the Air Force spent some \$250 million for heavy radars from 1965 to 1967. Much of this was for over-the-horizon radars

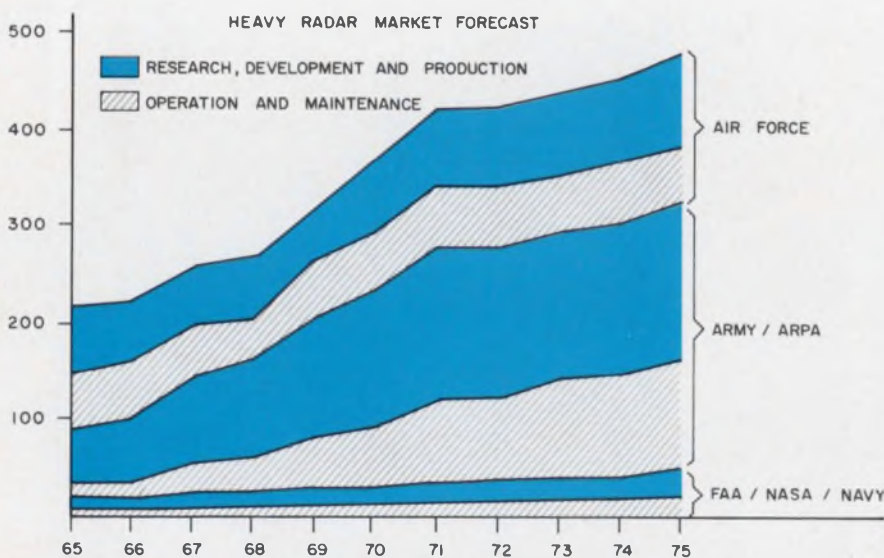

An upward shift in radar expenditures is forecast by Electronic Industries Assoc. over the next few years, with Army and Advanced Research Projects Agency spending exceeding that of the Air Force. Sentinel anti-ballistic missile funds provide the major impetus as space-surveillance needs grow.



If you can't find the difference in our new 7/8" pot here



look here.

The difference is price. Under \$4 for the new Amphenol ten turn, 7/8" pot in production quantities.

The reason for the low price is inside. A totally new shaft and carrier design eliminates seven separate parts. Manufacturing and material costs are reduced—reliability improved.

Test the 4100 pot with Amphenol's new 7/8", 1370 concentric scale counting dial. Outer vernier dial mounts directly to pot's shaft providing index accuracy of one part in a thousand.

Ask your local Amphenol distributor or sales engineer for the full story. Or write us: Amphenol Controls Division, Janesville, Wisconsin.



Compare our high precision 4100 model to other 7/8" pots:

Length1 3/16"	Maximum temp.125°C
Shaft diameter 1/4"	Power dissipation2 watts @ 40°C
Resistance range100 to 100k	Resistance tolerance5%
Standard linearity (Ind.)0.25%	Electrical rotation	..3600 +10°-0°



AMPHENOL

Specify Amphenol electronic components . . .
produced in Canada, England, France, Japan,
Mexico, United States, West Germany.

(radar market, *continued*)

that used scatter techniques and for more conventional operation and maintenance contracts.

In summary, the Sylvania expert estimates a 10-year heavy radar market total of \$1.8 billion just for the Sentinel, Defender, Air Force Spacetrack (including the over-the-horizon follow-on program 68-H) and the Army Missile Command's Hardsite program (follow-on to the present Sentinel radar projects).

TACTICAL GROUND RADARS

Steady but relatively slow growth is anticipated for what might be termed the tactical, ground-radar market. It includes primarily military radars that are mobile or portable. According to Robert L. Higginbotham, a Westinghouse market analyst in the Surface Div., the market has seen a slight but steady increase over the past six years and is expected to grow from the present \$100 million a year to approximately \$130 million by 1975. Expenditures by the Air Force are expected to remain constant, while those of the Marine Corps decrease somewhat and the Army's grow steadily. This

radar market segment is heavily influenced by the war in Vietnam.

Higginbotham defines the market as one involving lightweight, rugged, versatile, reliable, low-power, easy-to-operate equipment. It is made up of five functional categories: air-traffic control, air surveillance, ground surveillance, counter mortar battery, and weapons control systems. An end to the conflict in Vietnam, the Westinghouse official says, will affect only the annual total of expenditures in this field. They may be as much as \$20 million less, he predicts, but the field will continue to grow.

The development of solid-state devices capable of handling higher power levels, particularly through integrated and thin-film circuit techniques, has had a distinct impact on tactical radars that offer higher reliability and significant reductions in size and weight. Higginbotham sees continued stress on electronically scanned antennas, multi-functional systems, functional flexibility through modular construction, and an improved ability to detect very slow moving targets.

The highest priority now and in the near future, he says, will be for perimeter defense, battlefield surveillance and mortar and artillery site-detection systems. Equipment programs not marked

for Southeast Asia are expected to be either deferred or stretched out.

Of some 29 major suppliers in this market area, Higginbotham lists seven who account for 73 per cent of the business: Westinghouse, ITT-Gilfillan, Raytheon, Airborne Instruments Lab, Sperry, Sanders, and General Electric, in that order.

SHIPBOARD RADARS

The radar market for the Navy's shipboard systems is expected to plod along, as it has for some years, at about \$70 million a year. It likely will dip to a low of \$60 million in the next few years, according to Donald B. Stillman, Raytheon expert, but it should return to the low \$70-million range by 1975. Stillman, marketing manager in the Equipment Div., says the market breaks down into four functional areas: surface search and navigation, air search, fire control, and special purpose. For the latter, he includes such systems as aircraft-carrier control approach systems and missile and space vehicle support systems.

The Raytheon expert stresses that changes in shipboard radars continue to be evolutionary rather than revolutionary. The future of such radars is tied rigidly to the ups and downs of the Navy's new-ship construction. Thus, while a tapering off is occurring with Navy nuclear submarine and existing-class destroyer construction, new programs will come to fruition during the next few years. These will be highlighted by the newly approved DX and DXG classes of high-speed destroyers, the Fast Deployment Logistic ship project and the new Landing Helicopter Assault amphibious ships.

The trend, according to Stillman, is toward phase-phase steering rather than phase-frequency. Current efforts are geared toward use of the following:

- Up to 5000-element arrays, each element using digital phase shifters.
- Diode and ferrite phase shifters, with emphasis on the latter.
- Quad arrays to assure hemispherical coverage.

Efforts are being pressed, Stillman says, to reduce element costs significantly.

(*continued on p. 44*)



The Vietnam conflict has shown the need for improved types of small tactical radars for detecting personnel movement and for enemy mortar and artillery location. Shown is the AN/PPS-5 built by Airborne Instruments Laboratory.

at
\$1.22*

*you have
no choice of
color...*

black



MODEL
3305P

also black



MODEL
3305W

but...

the specs are better than "those other makes" that cost more! The Model 3305 TRIMPOT® potentiometer has been designed from the ground up as a **commercial**.

Here are the facts on the 3305 . . . besides the price, that is!

The unit is sealed to prevent contamination from fluxing, soldering, and cleaning . . . in addition our pins can be used on boards using 0.1" grid spacing. This small $\frac{5}{16}$ " dia. unit has a resistance range of 50 Ω to 25K Ω , with standard resistance tolerance $\pm 5\%$. Being a wirewound unit, it provides plus features such as low temperature coefficient . . . better resistance tolerance . . . and superior noise characteristics. Operating range is -55°C to $+125^{\circ}\text{C}$. . . temperature coefficient is only ± 70 PPM/ $^{\circ}\text{C}$. . . power rating $\frac{1}{2}$ watt and noise is negligible at 100 ENR.

***500 piece price**

Check into our one color—basic black—Model 3305 for the best . . . at a low-low price. For complete technical data contact your nearest Bourns office, representative or write the factory direct.

FREE

Exploded-view drawing and
new informative specification
comparison chart



BOURNS, INC., TRIMPOT DIVISION • 1200 COLUMBIA AVE., RIVERSIDE, CALIF.
TELEPHONE (714) 684-1700 • TWX: 910 332-1252 • CABLE: BOURNSINC.

TRIMPOT® and Precision Potentiometers - Miniature Relays - Electronic Modules - Microcomponents.

IF YOU GET CONSTANT VOLTAGE WHEN YOU VARY CURRENT IN ANY OF OUR ZENER DIODES, WHAT DO YOU GET WHEN YOU VARY TEMPERATURE?

MOTOROLA TEMPERATURE-COMPENSATED ZENER REFERENCE DIODES

Series	Voltage Change Over Temp. Range ΔV_z (Max)
1N821-29A ^{•†}	0.096 to 0.005
1N4565-84A	0.099 to 0.002
1N3154-57A ^{•†}	0.172 to 0.013
1N4775-84A	0.132 to 0.003
1N935-939B [•]	0.184 to 0.003
1N4765-74A	0.141 to 0.003
1N941-45B [•]	0.239 to 0.004
1N2620-24B	0.191 to 0.003
1N2163-71A	0.115 to 0.004
1N4896-15A	0.198 to 0.010
1N4916-32A	0.298 to 0.014
1N3580-83B	0.239 to 0.009
1N429 ^{**}	0.050
1N1735-42A ^{**}	0.400 to 0.050
1N1530-30A ^{**}	0.014 to 0.007
1N2767-70A	0.316 to 0.079
1N4057-85A	1.550 to 0.038

[•]Available to MIL-S-19500 and Meg-A-Life II
^{**}Available to MIL-S-19500
[†]Precision reference availability

ONE OF THESE.

It takes a particular kind of Zener Diode — namely a temperature-compensated device — to lock in voltage stability and equilibrium under any fluctuating temperature conditions you might encounter. The Motorola oxide-passivated, 1N945B reference diode, for example . . . allowing reference voltage change of less than 12 millivolts from -55° to 150°C and featuring RamRod* construction for lower operating junction temperatures and safe, sure, lead-to-die contact.

It and a complete line of TC voltage reference devices for 6.2 to 200 V applications are available from your franchised Motorola distributor — including top-of-the-line Precision Reference units capable of voltage deviation of less than 5 ppm/1,000 hours!

We've prepared a special TC reference diode application package including a brochure and five new Designers Data Sheets* which discuss important considerations like the three most critical device selection parameters, results obtained when altering test currents, and special applications. It permits design of most circuits entirely from the data presented. Send for it — it's as complete and accurate as we could make it.

So you'll get the right idea about the kind of devices we furnish.

*Trademark Motorola Inc.

— where the priceless ingredient is care!



MOTOROLA
Semiconductor Products Inc.

P. O. BOX 955, PHOENIX, ARIZONA 85001

A radiation hazard?

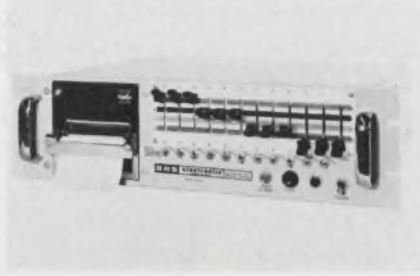

Washington Report

CHARLES D. LAFOND
WASHINGTON BUREAU

Anti-radiation bill clears committee

A bill that would give the Dept. of Health, Education and Welfare control over the manufacture of radiation-emitting equipment has been approved by the House Interstate and Foreign Commerce Committee. The bill, now ready for discussion on the floor of the House, is intended to protect the public health from excessive radiation, such as emitted from color TV sets (see item below).

Under the proposal (HR 10790), the Federal department would have the right to test electronic products for dangerous radiation and require the manufacturers to meet safety standards. A maximum civil penalty of \$1000 would be set for each unsafe unit, with a maximum total of \$200,000 for a series of such units.

The Public Health Service, as part of Health, Education and Welfare, would be specifically charged with enforcing the controls. If the bill passes, the service is expected to establish a nine-member National Advisory Committee on Electronic Product Radiation Standards. Committee representatives would be drawn from industry and interested technical organizations. The Electronic Industries Association's laser subdivision has expressed approval of the pending legislation and has pledged to campaign for industry self-regulation of laser safety. Experts within the EIA Consumer Products Div. are believed to have been a major influence in writing the legislation.

X-ray hazard in TV color sets

Approximately 6 per cent of 1124 color television sets examined in the Washington area emit dangerously high levels of X-radiation, the U.S. Public Health Service has revealed. It made public the results of a survey conducted in the past few

months by experts of the National Center for Radiological Health and representatives of TV color set manufacturers. On-the-spot measurements were taken to determine the extent of X-ray emission by the sets.

In addition to 66 sets that produced dangerous amounts of radiation, 268 produced some X-ray emission, and two TV sets emitted radiation in excess of 12.5 milliroentgens—25 times the maximum permissible dose.

The radiological center revealed no brand names or identification of models. It did indicate, however, that three groups of manufacturers produced sets responsible for 74 per cent of the hazardous equipment. Of 360 sets in one group, 20 produced excessive radiation; in a second group of 165 sets, 19 unsafe sets were found, and in a third group, of 69, there were 10 excessively radiating TVs. All of the sets found to produce unsafe radiation levels were corrected by reduction of the high voltage or by replacement of tubes. The results of the survey may lead to recommendations for manufacturers' set testing procedures.

Reduced space effort questioned

"The exception has been found, it appears, to the rule 'Nothing succeeds like success'. The exception is the American space program."

So began a highly critical review of the current U.S. attitude toward the space program by retired Air Force Gen. Bernard A. Schriever. In the 1968 Goddard Lecture before the National Space Club last month, the former head of the Air Force Systems Command seriously questioned the re-examination and de-emphasis of the nation's space R&D effort. The U.S., he declared, has every right to celebrate its achievement, during the last ten years, of 500 successful launches and almost 2000

hours of manned orbital flight. Yet, he remarked, the nation's space program is being reviewed, questioned and criticized.

Schriever pointed out that, although the U.S. began its rocket program after the Soviet Union, "the nation quickly moved into a commanding lead in both land and sea-based ballistic missiles. Our missiles," he asserted, "gave us overwhelming strategic superiority."

However, Schriever stated that the most significant aspect of today's strategic forces has been the development by the Russians of the orbital missile. Although referred to by ex-Secretary of Defense McNamara as a "Functional" Orbital Bombardment System, the Soviet spokesmen have never called the weapon anything less than an "orbital missile."

In addition to its expanding ICBM force and the orbital system, the Soviet strategic threat is supported by an anti-ballistic missile system, said Schriever. The latter is based on considerable data about high-altitude X-ray and electromagnetic pulse effects collected in the 1961-1962 Soviet nuclear tests, which, he disclosed, featured the detonation of one device rated at 58 megatons. Also included were a series of experiments relative to anti-ballistic missile defenses.

"By comparison, U.S. missile force is declining steadily. We have not initiated an advanced ICBM program despite the technology potential for such a weapon," Schriever declared. "Our most advanced military space effort is the Manned Orbiting Laboratory, and this program is at least three years behind schedule."

Admirals trying to scuttle F-111B

In secret testimony, not yet cleared by the Pentagon for public release, two admirals are believed to have expressed serious doubts about the advisability of continuing development of the Navy's F-111B fighter. The two officers, Adm. Thomas H. Moorer,

Chief of Naval Operations, and Vice Adm. Thomas F. Connelly, who directs naval aviation, accompanied their boss, Secretary of the Navy Paul R. Ignatius, during hearings on March 4 before the Senate Armed Services Committee.

Connelly, reportedly, was most outspoken in urging that the F-111B be dropped as an operational aircraft and that the Navy rapidly begin developing a replacement. Moorer is believed to have been more cautious in his statement but to have said under questioning that if he had to make a choice, he, too, would scuttle the program.

In a prepared statement, Secretary Ignatius reiterated the accepted Defense Dept. and Navy position that the F-111B still is the best aircraft available to meet fleet air defense needs by the early 1970s.

The Navy's version of the F-111 variable geometry fighter is now under test for carrier operations at the Patuxent Naval Air Station in Maryland. Meanwhile the Air Force has deployed a squadron of F-111A's at Tak Lhi Air Field in Thailand; they are expected to see action soon in Vietnam.

Omega contract awarded to Nortronic

The Nortronic Division of Northrop Corp. has won a hotly contested contract from the Naval Air Systems Command, to design and develop the airborne equipment for use with the Omega Navigation System.

First announcement of the award was made by Rep. Charles H. Wilson (D-Calif.). The initial contract exceeds \$1 million, and Wilson estimates that commercial and international sales for an operational Omega system could go as high as \$500 million.

The Navy's Omega system, as previously reported here, is intended to ultimately employ eight hyperbolic, low-frequency, long-range transmitting stations for nearly global coverage. Just recently the four existing experimental stations were given limited operational status.

Nortronic has indicated that the in-flight Omega receiver will be combined with a digital computer similar to the one produced by the division for the Air Force C-5A Galaxy. (Two variations of the computer are used in the C-5A Doppler inertial guidance and the MADAR in-flight checkout system.)

GOOF-
PROOF

VOM



Here's the most foolproof volt-ohm-milliammeter ever made. Protection approaches 100%. It's the VOM you will want to have on hand where inexperienced people are running tests . . . or will reach for yourself on those days when you're all thumbs. The 260-5P will save you all kinds of headaches from burned out meters and resistors, bent pointers, and inaccuracies caused by overheating.

**Combined Protection You Won't Find
In Any Other VOM**

1. Reset button pops out to indicate overload.
2. You cannot reset circuits while overload is present.
3. Protective circuit does *not* require massive overloads which can cause hidden damage to the instrument.
4. All ranges are protected except those not feasible in a portable instrument—1000 and 5000 volts DC and AC; 10 amp DC.

SIMPSON
260-5P

ONLY \$94.00

Write for Bulletin 2078

Ranges—The 260-5P has the same ranges and takes the same accessories as Simpson's famous 260-5 volt-ohm-milliammeter.



DIVISION

Simpson
INSTRUMENTS THAT STAY ACCURATE

SIMPSON ELECTRIC COMPANY

5200 W. Kinzie Street, Chicago, Ill. 60644 • Phone: (312) 379-1121

Representatives in Principal Cities . . . See Telephone Yellow Pages

Export Dept.: 400 W. Madison St., Chicago, Ill. 60606 Cable: Simelco

In Canada: Bach-Simpson Ltd., London, Ontario

In India: Ruttonsha-Simpson Private Ltd., Vikhroli, Bombay

WORLD'S LARGEST MANUFACTURER OF ELECTRONIC TEST EQUIPMENT

INFORMATION RETRIEVAL NUMBER 29

Buying Power?

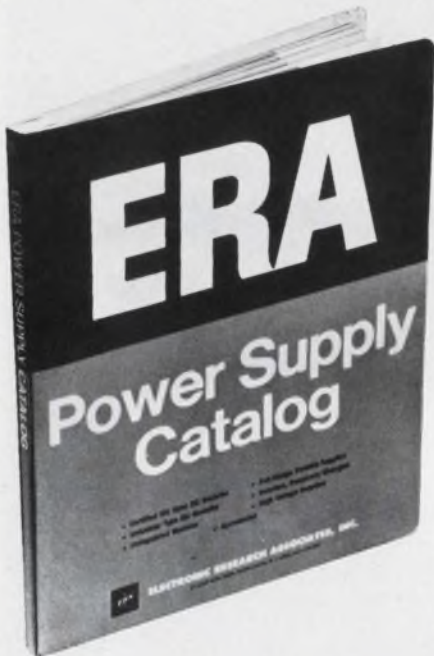

Here's the new, single source for all your power needs.

- Certified Mil Spec Transpac® DC Modules
- New Low-Cost Silicon Transpac DC Modules
- Full-Range Variable Supplies
- Inverters, Frequency Changers
- High-Voltage Supplies

**AC to DC • DC to AC
AC to AC • DC to DC**

Send for Your Free Copy TODAY!



ELECTRONIC RESEARCH ASSOCIATES, INC.

Dept. ED-4, 67 Sand Park Road
Cedar Grove, N. J. 07009 • (201) 239-3000
Subsidiaries: ERA Electric Co. • ERA Acoustics Corp.
ERA Dynamics Corp. • ERA Pacific, Inc.

INFORMATION RETRIEVAL NUMBER 30

NEWS

(radar market, *cont'd from p. 38*)

Other major trends for shipboard radars include the use of high-power (tens of kilowatts) coherent transmitters with instantaneous bandwidths of 10-50 kHz, increased use of digital techniques for signal processing and weapons control, further use of multi-mode or multi-function radars, and greater use of microelectronic techniques, wherever applicable.

A major Navy need is to improve shipboard radars to permit a multiple-engagement capability. Existing systems operate on a one-to-one ratio, thus limiting engagements to only four targets at any given time, Stillman indicates.

The top R&D and radar system suppliers currently are ITT-Gilfillan, Sperry, Raytheon, Bell Aerospace, Hughes, and Westinghouse, in that order, Stillman reports. R&D awards are presently dominated by advanced development for fire-control systems, with the current leaders being Raytheon, Sperry and Westinghouse. Gilfillan is by far the leader in production awards, with its three-dimensional, long-range, air-search radar.

AIRCRAFT AND SPACECRAFT RADAR

The largest radar market segment today, because of the need for high production, is that of the aircraft onboard radars. By contrast, radars for space vehicles seldom require more than pilot production, but they do demand relatively heavy R&D funds. Today's market, according to Kenneth A. Homon, market analyst at International Business Machines Federal Systems Div., is in the range of \$250-300 million and is expected to peak in the 1973-to-1974 period at more than \$400 million, then level out at about \$400 million in 1975. Today's space market is about \$20 million a year and will probably continue at that rate or slightly higher, he says.

The IBM expert defines the airborne radar market as consisting of three functional hardware types: radar altimeters, Doppler systems, and radar systems. The latter include all the variations of air-to-air tracking, ground detection, terrain following and avoid-

ance, ground mapping, beacon illumination, and weapons delivery. As with the other radar segments, airborne radars are heavily influenced by technology advances, the Vietnam conflict and, nearly equally important, the increasing move toward multifunctional aircraft, Homon declares.

He sees several trends that will influence radar design and the market picture. In particular, he cites the need for improved sensor resolution for better target identification. Advances are also sought in standoff missile guidance for both air-to-air and air-to-surface applications. In the planned Airborne Warning and Control System, increased range, good discrimination, will be required.

Several approaches are cited by Homon for improved design, including molecular electronic radars that use integrated arrays and the use of a synthetic aperture to improve sensor resolution. Homon also points out that while the need is apparent for the increased use of microelectronic components and techniques, industry must avoid the "trap" of increasing complexity in signal processing just because of the gains in size and weight possible with microminiaturization.

Homon suggests that sensor integration and the application of competitive techniques, such as lasers and infrared systems, will have an increasing impact on the radar market. While both IR sensors and laser radar have inherent problems for atmospheric operation, they do provide unique performance not obtainable with conventional radar, he notes.

He predicts further that in the next eight to nine years the radar altimeter market will drop 50 per cent, Doppler systems will grow 50 per cent and other radar systems will hold at about the same level. For the latter, he predicts a marked change in product mix in which side-looking radar and phased-array systems will grow rapidly.

In space, Homon pictures ever increasing use of laser ranging systems for the traditional use of radar for rendezvous and other guidance techniques.

The largest area of opportunity for space radars, the IBM specialist says, is in earth-orbiting craft for cloud penetration. ■■



Illustration is 1400X magnification cross-section through selectively plated contact at point shown

CINCH PUTS THE GOLD ONLY WHERE YOU NEED IT

IN THE AMOUNT YOU WANT—With Cinch selective plating you benefit from reduced gold content and the absolute control of gold thickness at the contact area. The result is a better connector at lower cost . . . that also helps reduce the U.S. gold drain.

In conventional barrel plating, the amount of gold deposited at any point is a function of the geometry of the part and cannot be accurately controlled from part to part. To compensate, excessive gold deposits must be used, but there is still no guarantee that every part will receive the minimum gold plate specified, due to the random nature of the process.

Cinch continuous process selective plating deposits the same controlled amount of gold on every contact. Only the contact area is plated, reducing gold consumption as much as 60%.

A wide range of Cinch connectors is available with selectively plated contacts. For information on how selective plating can provide you with a better product at lower cost, write to Cinch Manufacturing Company, 1501 Morse Avenue, Elk Grove Village, Illinois 60007. C-6814

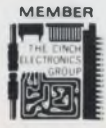
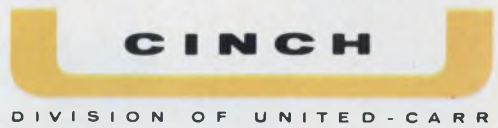
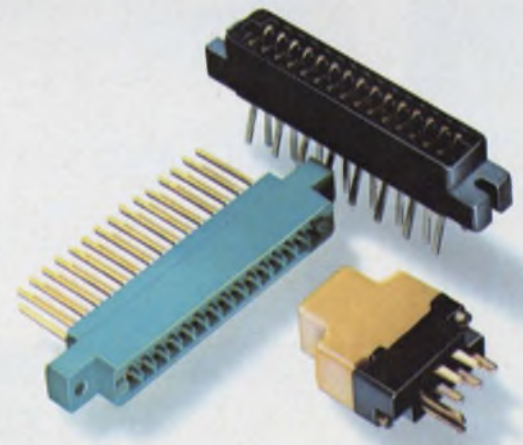

CONSISTING OF CINCH MANUFACTURING COMPANY, CINCH-GRAPHIK, CINCH-MONADNOCK, CINCH-NULINE, UCINITE (ELECTRONICS) AND PLAXIAL CABLE DEPT.

which pot... has infinite resolution?



PT/112 SERIES POTENTIOMETERS

Alike as the proverbial peas in a pod you'd need X-Ray vision to tell which of the potentiometer-twins can resolve to infinity.

But one of them does. And we turn this neat trick with the use of our own exclusive MystR[®] as the resistance element. Excellent stability, indefinite storage life are dividends in the PT/112M.

The resistance element in its companion PT/112W is a continuously wound non-phenolic winding terminated with thermo-welded leads.

The PT/112's make a pretty versatile pair of potentiometers for just about any of your ground-environment potentiometer applications. Perfectly matched, they can be ganged (up to 3 cups) in combination or separately. With Waters ball bearing bushings, the PT/112M (MystR[®]) has a rotational life in excess of 2,000,000 cycles.

You'll want the whole story of the PT/112 series. We'd like to send it to you.

NEED A PARTICULAR POT..?

If you have a worthwhile need for the potentiometer that doesn't exist . . . could be Waters has the engineering know-how to do something about it.



WATERS
MANUFACTURING INC.
WAYLAND, MASS. 01778

EXPORT: Charles H. Reed, Export Director, Waters Manufacturing, Inc.,
Wayland, Mass. 01778 U. S. A.

Letters

A resounding cheer for quality control

Sir:

Your provocative editorial, "Come Out of the Clouds, Get Down to Brass Tacks" [ED 2, Jan. 18, 1968] contained some basic common sense, but basically it reeked with generalities and innuendos.

Because of the complex, advanced technologies encompassing all phases of the space program, both militarily and in space exploration, the degree and depth of reliability and quality controls are vital to assure equipment integrity, reliance and safety. Product credibility and quality is achieved with the essentials of quality assurance/controls, value engineering, reliability, zero defects.

There are no restrictions for being cost conscious and for judicious uses of standard components, but what is their impact on reliability? Common sense has its place, but the quality control function in industry is here to stay and *will not* disappear altogether.

A. M. DeMark
Quality Control & Retrofit
Supervisor Specialist
General Electric Co.
Philadelphia, Pa.

Reactances can be paralleled graphically

Sir:

In reference to Richard E. Johnson's article "Draw your network's impedance," in ED 1, Jan. 4, 1968 [pp. 102-103], I should like to bring to your attention the fact that a capacitive reactance can be paralleled with an inductive reactance by the described graphical technique.

Consider first the problem of finding in Fig. 1 of the article an unknown R_2 that will produce a given R_p when it is connected in parallel with a given R_1 . One can erect R_p and R_1 (lines CA and EP on Fig. 1), extend line CE until it intersects the extended baseline AP, draw a line perpendicular to the baseline at this intersection, B,

Our Ice-A-Box.

Keeps the sandwiches from getting soggy and even doubles as a temperature cycling chamber for relays.

Environmental testing is a "special service" according to most relay manufacturers. At Comar,

it's a way of life. We use temperature chamber as a basic design tool . . . like a drafting board. Just to make sure Comar relays can take any environmental punishment you specify.

But, there's more to ensuring a good relay or Prozutto sandwich than a temperature chamber.

Let's discuss it in detail the next time you have a tough relay application. You'll find that Comar has the experience and facilities to solve your problems. Fast and economically.

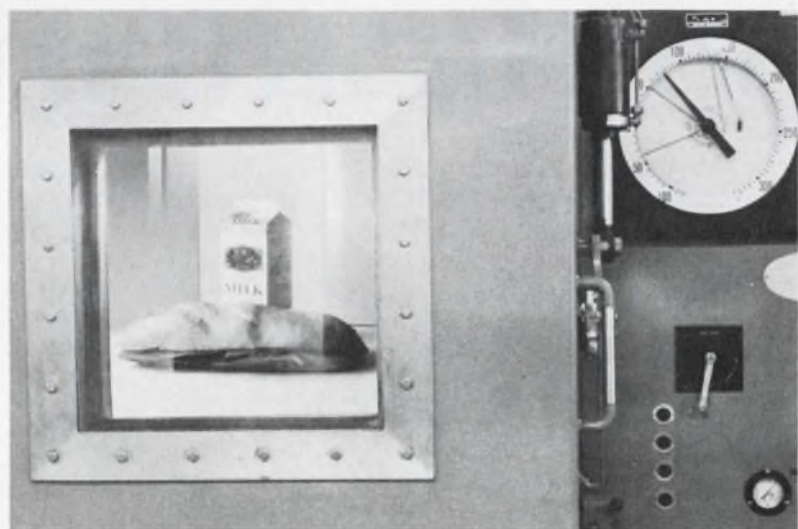

COMAR ELECTRIC COMPANY 3349 Addison Street Chicago, Illinois 60618

INFORMATION RETRIEVAL NUMBER 33

Wheelock's 442 SERIES RELAY 700% SMALLER

THAN
BRAND E

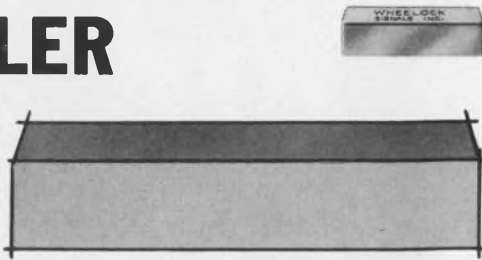

420% SMALLER
THAN BRAND I

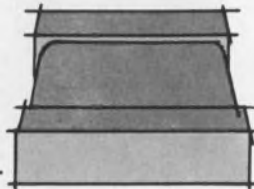

400% SMALLER
THAN BRAND D

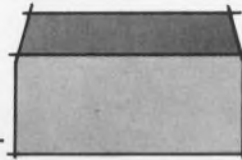

with no trade off in specifications

Wheelock's 442 reed relays are the smallest, most sensitive multi-pole relays of their kind in the industry. Available in 1 thru 4 poles, the 442 series occupies only 0.055 cu. in. per pole, making it possible to mount 25 4-pole relays on a 3½" x 4½" pc board. Outstanding features: coil voltages, 6, 12, 18, 24 VDC; Contact Rating, 7 Watts; Weight, 1.9 grams per pole; Power Rating, as low as 35 mw.

Write for literature!

WHEELOCK SIGNALS INC.

273 Branchport Ave. • Long Branch, N. J. 07740 • (201) 222-6880

LETTERS

then extend a line AE till it intersects the perpendicular at D . The resulting section BD will be the sought R_2 .

The algebraic expression for R_2 is $R_p R_1 / (R_1 - R_p)$, which has the same form as Eq. 1 in the article. Hence the paralleling of the example reactances, 50 and -10 in Fig. 3b in the article, can be graphically computed, as shown by the accompanying figure, where $AC = 50$, $BD = 10$, and $PE = 12.5$ and is the sought parallel reactance. It is capacitive; if EP appeared on the other side, it would be inductive.

G. Richwell

Staff Engineer
Reflectone Electronics
Stamford, Conn.

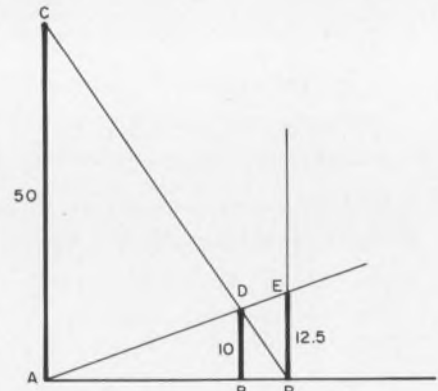

Differential dc op amp for D/A or A/D converters settles to within 0.01% of its final value in 1 μ s while slewing at 50/ μ s.

It's a con-fuzing business at times

Sir:

Page 33, column 3 of your Feb. 1 issue reports an Air Force-sponsored contract for an optical proximity fuze for fire bombs.

The problem, as reported, sounds quite similar to one that was evidently recognized by the Imperial Japanese armed forces during World War II. I happened to see, and to help take apart, a captured Japanese photoelectric proximity fuze for bombs in 1945, while working as an engineer for a major laboratory run by one of the U.S. armed services. The principles involved in this de-

precision R-C-L measuring

workhorse impeded. bridge now smaller, more refined, less expensive

Better performance in less space at less cost sum up the major reasons for buying our new workhorse Universal Impedance Measuring System, the Model 293. Accuracy is every bit as good as most single function bridges— $\pm 0.05\%$ for resistance and conductance measurements and $\pm 0.1\%$ for inductance and capacitance—and incorporation of a new solid-state AC/DC generator-detector has resulted in smaller over-all size and several input-output improvements. Among them:

The unit provides DC, AC at 1kHz plus other plug-in switchable frequencies as well; it has continuously

variable 0 to ± 6 volts output, power limited to 1 watt; and its detector is internally tuned to generator frequency with continuously variable sensitivity in two ranges (minimum detectable signal 10 microvolts).

The Model 293 is designed for maximum versatility. Terminals are provided so that ranges may be extended and special circuit connections made. A four-terminal Kelvin connection can be made to increase the accuracy of low resistance measurements, for example, while three-terminal connections remove the effects of stray shunt circuits when measuring high resistance, inductance, or low capacitance. Among the system's applications:

Low resistance measurements, high resistance measurements, AC resistance measurements, resistance limit checking, inductor measurement (series and parallel), inductor measurements with DC, measurements with AC voltage or current applied to unknown, capacitor measurements (series and parallel), capacitor measurements with DC, measurements with extended leads.

Cost of the Model 293 is \$1,100.

CIRCLE NO. 241

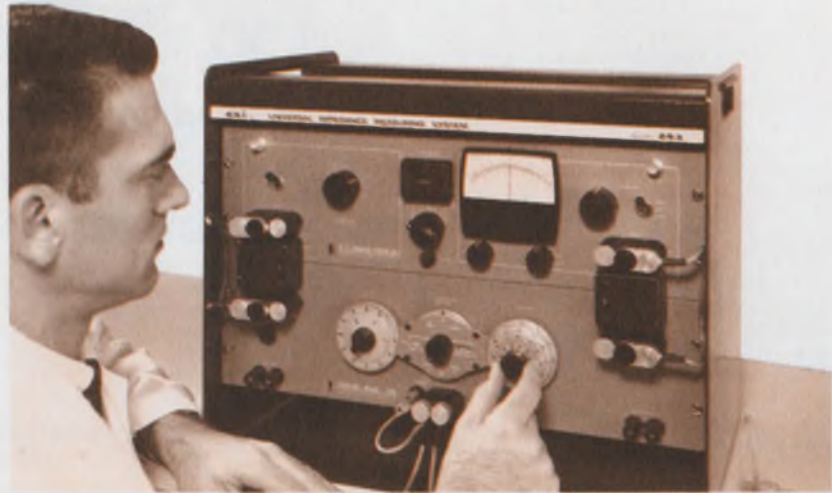

news and innovations in metrology

esi

precision components

3 decades in 2 inches ...at 0.02% accuracy



ESI has responded to the call for miniaturization with pint-sized versions of their well-known precision decades.

Shown here are the DS 1365 DEK-ASTAT[®] and its miniature cousin, the DS 325A. Both of these precision decade resistors are available in 1, 10, or 100 ohm steps, with total values of 1.2, 12, or 120 k ohms. Their only difference is the DS 325A's decreased size—2" diameter—and slightly lower power rating, 250 mW.

This is just one example of the models available. We can also provide the DS 326, a miniature 2 decades plus rheostat in the higher values mentioned above; or the DS 625A, a smaller 6-dial double-stack miniature.

All models use ESI professional-grade, wire-wound resistors which account for guaranteed 2-year accuracy of $\pm 0.02\%$; comparable performance using AC also.

CIRCLE NO. 242

up to 0.01%. The guarded, four-terminal Kelvin bridge design assures reliable measurements even at range extremes.

This kind of speed with total reliability is now possible with our new automatic sorter accessory, which dispenses tested resistors into three different limit bins.

The Model 500 is a rugged, solid-state system that gives you precise measurements every time; it checks resistance values between 0.1 ohm and 111 megohms, with adjustable deviation settings from plus-and-minus 0.01% to 10% end scale.

The complete package includes a KELVIN KLAMP[®] four-terminal holding jig, foot pedal and instruction manual, for just \$2,750. The automatic sorter is additional.

CIRCLE NO. 243

production/quality control

automatic resistor sorting 1 per second—at 0.01%



Production test, quality control and incoming inspection personnel are finding ESI's Model 500 Resistance Deviation Bridge a great new answer to resistor sorting.

The semi-automatic system cranks out the measured resistors at the rate of one every second—with accuracies

Electro Scientific Industries, Inc.

design engineers

capacitance bridge acquires new accuracy in high value range

Now comes our new solid-state Capacitance Bridge, the Model 273, designed to measure "direct" capacitance over a wide range with special capability for high values.

The new unit is far more compact than previous models, yet it operates on 9 ranges—from zero through 120 pF to zero through 12,000 μ F. Accuracy is $\pm 0.1\%$ on middle ranges, $\pm 0.3\%$ at the highest. It's priced at \$875.

Effects of lead resistance are eliminated through a four-terminal Kelvin connection and a high value internal standard reduces the effects of shunt capacitance. The Model 273 there-



fore is ideal for measuring electrolytics. The instrument also features a maximum voltage across the unknown of 0.5 volts, allowing measurements of tantalum capacitors with specified accuracy.

Features include two built-in frequencies of 120 Hz and 1kHz, log-linear meter response, and added terminals for DC bias, range extension, or external generator and detector.

CIRCLE NO. 244

esi

news and innovations in metrology



precision temperature

new speed, reliability in measuring temp at highest accuracy

Our new Model 951 Temperature Measurement System not only provides state-of-the-art accuracy in one console over the entire range of resistance thermometry (0 ohms to 1000 ohms), but it greatly improves operational convenience, speed and reliability. And for just \$6,000.

The Model 951 System captures the accuracies of both the Mueller bridge method and low-temperature potentiometric system—better than

10 ppm of resistance ratio measured—while at the same time eliminating virtually all their operational problems.

You read R/R. directly off the dials without computation. There are no separated instruments, no cumbersome leads; detector and current supply are built-in.

The System is free of lead resistance and thermal emf problems, external thermal electric voltages are checked by a single polarity reversal.

It's all accomplished by combining three basic ESI instruments: a nanovolt galvanometer, a nanovolt potentiometer and the 7-dial passive divider from our most advanced DC voltage-measuring system.

CIRCLE NO. 245

lab calibration/test

"everybody wants it," complain users of PVB

As applications increase for our 19-lb. portable calibration "lab"—the Model 300 PVB®—customers report

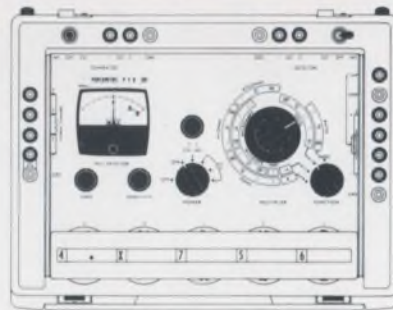

problems keeping it in their department.

In a single battery-operated unit, the PVB combines the functions of a potentiometric voltmeter, voltage source, ammeter, guarded Kelvin double bridge, resistance comparison bridge, ratiometer and electronic null detector. With accuracy of 0.02% (0.01% on Model 300A) and numerous accessory adapters, its applications are almost endless.

"We can hardly keep it in the lab," complained Signetics. So we sold them another system . . . bigger and better, but non-portable. The PVB costs \$940.

CIRCLE NO. 246

esi

Electro Scientific Industries, Inc.

13900 N.W. SCIENCE PARK DRIVE
PORTLAND, OREGON 97229

vice were not unlike those reported in ED. They were sophisticated.

After World War II there were two Government laboratories working on proximity fuzes. Their names, along with the gist of their work, were published in the electronic engineering press in the late 1940's. I worked for both. In the second laboratory I realized that many expensive problems at hand could be solved by looking up the microfilm reports of tests made by the other lab, and I asked permission to go over and look through them. Permission was not granted.

Shortly after, I gained the impression (which I cannot, unfortunately prove) that there was roughly a three-year cycle for doing over about the same development work that had been done before. The causes were (a) a rough three-year turnover rate in employed engineering and physics personnel, and (b) the difficulty of getting reports out of the classified files in the lab library.

This was many years ago. I sincerely hope that the efficiency of using existing data has improved in 23 years. The best hope should be in the Government labs, because the labs of private contractors tend to have poorer libraries.

Incidentally, *fuzze* is spelled with a z when it refers to military ordnance.

Lawrence Fleming

Innes Instruments
Pasadena, Calif.

Accuracy is our policy

In "Computers of the '70s Given a Sneak Preview," ED 3, Feb. 1, 1968, p. 24, the paper by M. O. Paley of International Business Machines Corp. was said to discuss computer X—a fourth-generation computer using LSI. Computer X was incorrectly stated to be 1000 times superior to IBM's 360 series in calculating ability. The comparison should have been to the 7090. Also, the term "computer X" is a hypothetical one, referring to general capabilities for future LSI computers, and not to any specific product.

McDonnell Phantom: the hot one

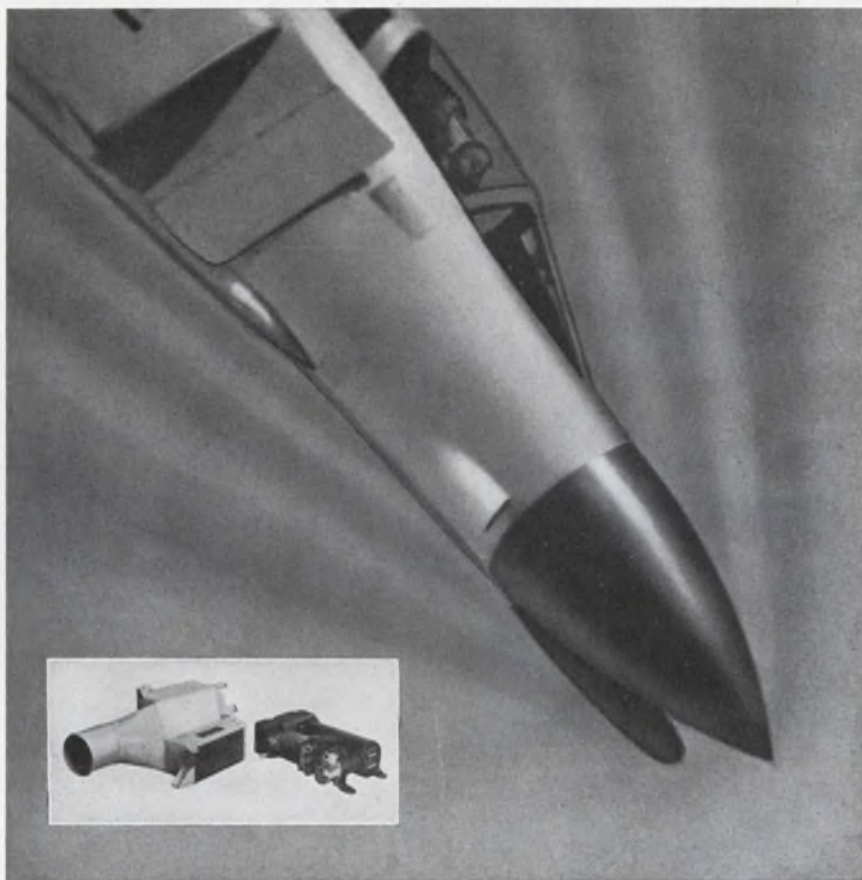

Eastern keeps its radar cool

Each day of flight operation continues to confirm the McDonnell "Phantom" as the most advanced all-around fight aircraft in the world today. But high density electronics and the heat loads of high speed flight would soon put the radar nose of the Phantom out of business.

That's where Eastern Industries' cooling systems come in. A liquid-to-air heat exchanger and hydraulic pack combine to remove over 8 KW from the radar, keeping it within safe temperature limits under all flight conditions. For all its performance, the total system weighs less than 17 lbs. and is remarkably compact (hydraulic pack: 3 $\frac{1}{16}$ " x 6 $\frac{1}{16}$ " x 11" and exchanger: 6 $\frac{5}{8}$ " x 8" x 17".)

Other Eastern cooling systems are now under development or in production for such aircraft as the Lockheed AH-56A, North American RA5C and F-104.

Write for new literature on Eastern capabilities in thermal control — or for the answer to your particular problem. We may have some cool answers.



EASTERN INDUSTRIES

A Division of Laboratory For Electronics, Inc.
100 Skiff Street • Hamden, Connecticut

INFORMATION RETRIEVAL NUMBER 35

the most
comprehensive
specimen book
in its field
free!



When it comes to saving you time and making your job easier, we weren't interested in cutting corners. We went first class and you benefit. The new Prestype catalog illustrates the largest selection of dry-transfer type faces available anywhere, reproduced in their actual size. Makes layouts and copy fitting so much easier and more accurate.

FREE Send for the colorful 74-page Prestype catalog and make life easier.

Prestype, Inc.
136 W. 21st Street, New York 10011

INFORMATION RETRIEVAL NUMBER 36

Probing for optical allusions

In the early days of analog computers, engineers went through mechanical analogies to see how electronic circuits performed the same functions as vibrating strings, bouncing springs and similar systems. This helped to clear up the way in which differential equations, simulating all types of physical phenomena, might be easily set up by twiddling potentiometers in operational amplifiers.

In researching the story on optical computers starting on page 25, Managing Editor Robert Haavind found that a similar set of analogies could clarify a lot of the concepts tossed about by optical system designers. Furthermore a good grasp of some of the analogies between optics and such things as Fourier spectra, modulation theory and radar analysis might easily lead to a number of new uses for light, lenses and films in electronic systems. The deeper he probed, the more he found that some of the best work in the optical data-processing field is being done by the engineers who have a nice feel for the close coupling between electronics and optics.

Many of the possibilities are important ones, as Haavind's article points out. For example, the granddaddy of optical processing systems—side-looking radar—is a blend of solutions from both fields.

In the photo below, Haavind is examining an optical computer on a tiny glass disc, while the inventor, Kendall Preston (standing next to him) and Fremont Reizman, both of the Perkin-Elmer Corp., look on. For a glimpse yourself at this optical computer—called a membrane light modulation—examine the spectacular cover photo taken by George Pennell, staff photographer of Perkin-Elmer. The computer is in the center of the red disc. The black lines are interference patterns from a laser beam that is being reflected from the computer in several directions at once. The spotted gold lines are ambient light reflections from the tiny computer elements.





This is our Molex 1175. A lighted push button switch. Snap mounts. Spade or wire terminals make assembly easy. In quantity, costs about sixty cents.

You could pay more, but that's the point. Men who use switches have told us, "enough is enough". We take that seriously. By creating switches that do the job right, yet aren't over-engineered to the point that costs wind up in left field.

So this switch is available in nine colors, 500 variations, and is built to go on and off—and on and on. For about sixty cents.

If that makes sense to you, and you would like a free sample of our 1175 switch, write or phone (312) 969-4550.



TRW
announces

**50 W at
500 MHz**



ACTUAL SIZE

28 Volts...5dB Gain...60% Efficiency!

TRW announces a major breakthrough in communication transistor technology with the introduction of this high efficiency, high gain 50 watt/500 MHz device.

In high power military aircraft transmitters, a single 2N5178 will do the job formerly requiring vacuum tubes or multiple-transistor circuits. The 2N5178 is also

well suited for use in radar pulse circuits.

This state-of-the-art device employs a patented cellular construction in a grounded emitter strip-line package comparable in size to the TO-37. A 25-watt version, type 2N5177, is also available.

For evaluation quantities and complete technical details, con-

INFORMATION RETRIEVAL NUMBER 38

tact any TRW distributor or TRW Semiconductors, 14520 Aviation Blvd., Lawndale, Calif. 90260. Phone: 679-4561, TWX: 910-325-6206. *TRW Semiconductors Inc. is a subsidiary of TRW INC.*

TRW[®]

ELECTRONIC DESIGN 8, April 11, 1968

Publisher

Hugh R. Roome

Editor

Howard Bierman

Managing Editor

Robert C. Haavind

Technical Editors

Jeffrey N. Bairstow
Peter N. Budzilovich
Raymond D. Speer
David H. Surnan

Management and Careers Editor

Howard S. Ravis

News Editors

Ralph Dobriner, Chief
Richard N. Einhorn

Washington News Bureau

Charles D. LaFond, Chief

Military/Aerospace Editor

John F. Mason

East Coast Editor

Neil Sclater

West Coast Editor

Ron Gechman

New Products Editors

Steven B. Futterman
Robert Patton

Copy Editor

Rose Jacobowitz

Editorial Production

Dollie S. Viebig
Phyllis Gura

Art Director

Clifford M. Gardiner

Art Assistant

William Kelly

Technical Illustrators

Cheh Nam Low
Sheila F. Ward
William Alvarez

Production Manager

Thomas V. Sedita

Asst. Production Manager

Helen De Polo

Production Assistants

Bernard Wolinsky
Gregory A. Bannon

Circulation Manager

Nancy L. Merritt

Information Retrieval

Diane Mandell

EDITORIAL



As the pot shrinks, the snow flies

As R&D money gets tighter, certain methods of the wise old engineers are becoming more common. To equalize things somewhat and give everyone an equal crack at the shrinking pot, we will outline some techniques that are second-nature to the old pros but may be unfamiliar to newcomers.

The first subject to be attacked is curve plotting. Choosing scale factors—even the scale itself—should be done so as to optimize the interpretation. If, say, we wish to show a flat response of something between 3 dB points:

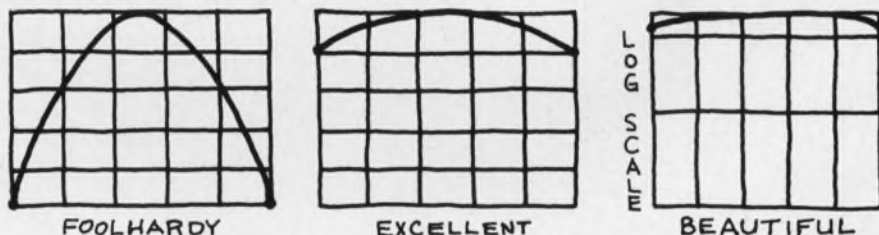

Now, say it was cost and price that were to be considered. Normalized curves are shown. One simply tailors them to the problem at hand, staying just within the realm of believability of the boss, contracting agency, management, or etc. A figure of three to five years is generally safe for the knees of the curves; by that time the contract will be running out, you will have another job, or the boss, contracting officer or management will have been removed.

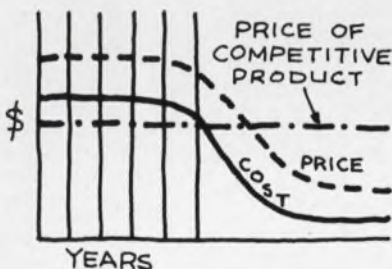

Assuming the general principles of curve plotting have been mastered, we will tackle the subject of charisma. Charisma is the ability of a properly selected name for something to cause a glowing feeling to swell up within any listener who hears it. Say, for example, that you're working on doppler-shifted, ultrasonic, holographic in-

terference effects. This is obviously some sort of blue-sky effort of little potential use to anyone, even if you perfect it. Call it "U-lography." Or "HOLOSOUND." These principles were well known in the early days when money was scarcer and tunnel diodes, bionics and cybernetics were highly charismatic.

Tabulation of comparative performance is a further art of the old pro. Boil down the data to the simplest form possible, leaving out such trivia as test conditions, relation between the theoretical figures given and what might actually be achieved in practice, and modes of operation of the various competitive devices. If this is done properly, your own approach will prove far superior.

Now that everyone knows what's up, all are running with the same handicap. And let the eye and the ear of the beholder beware.

ROBERT HAAVIND

Pulse Fidelity

This double-exposure photograph shows the same 12-ns-wide pulse displayed by the Tektronix Type 454 (upper trace) and by a 7-ns, 50-MHz oscilloscope (lower trace). Note the difference in detail of the pulse characteristics displayed by the Type 454 with its 2.4-ns risetime performance.

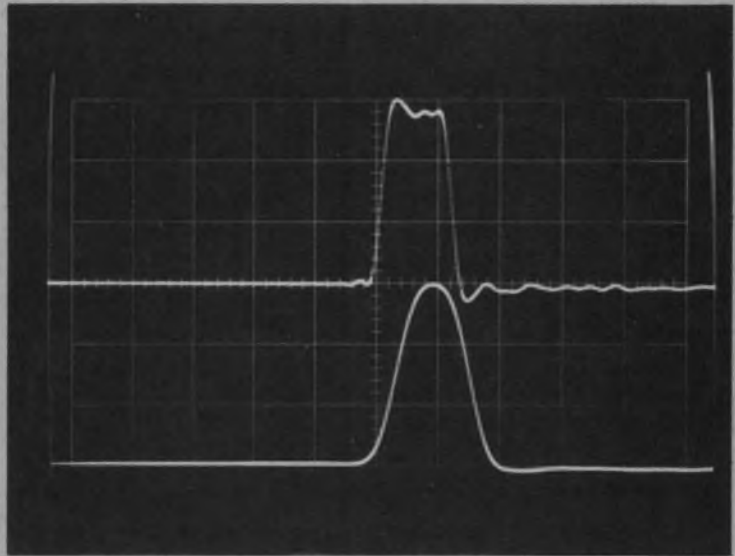

10 ns/div

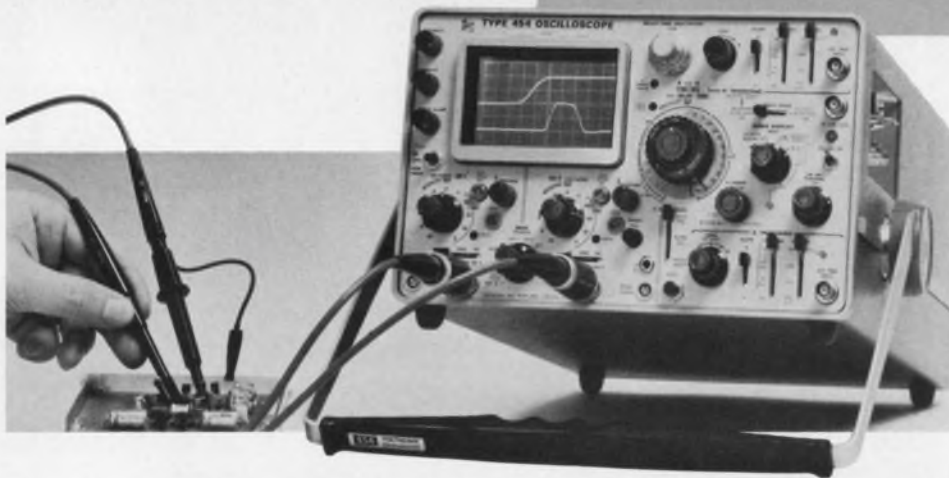

**150 MHz,
2.4 ns
with or
without
probes**

The Tektronix Type 454 is an advanced portable oscilloscope with DC-to-150 MHz bandwidth and 2.4-ns risetime performance where you use it—at the probe tip. It is designed to solve your measurement needs with a dual-trace vertical, high performance triggering, 5-ns/div delayed sweep and solid state design. You also can make 1 mV/div single-trace measurements and 5 mV/div X-Y measurements.

The vertical system provides the following dual-trace performance, either with or without the miniature P6047 10X Attenuator Probes:

Deflection Factor*	Risetime	Bandwidth
20 mV/div to 10V/div	2.4 ns	DC to 150 MHz
10 mV/div	3.5 ns	DC to 100 MHz
5 mV/div	5.9 ns	DC to 60 MHz

*Front panel reading. With P6047 deflection factor is 10X panel reading.

The Type 454 can trigger internally to above 150 MHz. Its calibrated sweep range is from 50 ns/div to 5 s/div, extending to 5 ns/div with the X10 magnifier on both the normal and delayed sweeps. The delayed sweep has a calibrated delay range from 1 μ s to 50 seconds.

- Type 454 (complete with 2 P6047 and accessories)..... \$2600
- Rackmount Type R454 (complete with 2 P6047 and accessories) \$2685
- Type 200-1 Scope-Mobile® Cart \$ 75

U.S. Sales Prices FOB Beaverton, Oregon

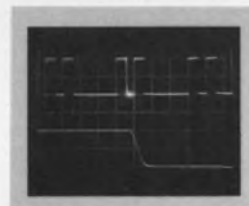

Double Exposure

5 ns/div delayed sweep

The delayed sweep is used to measure individual pulses in digital pulse trains. The Type 454 with its 1 μ s-to-50 s calibrated delay time, 5-ns/div sweep speed and 2.4-ns risetime permits high resolution measurements to be made. Upper trace is 1 μ s/div; lower trace is 5 ns/div.

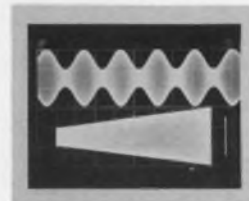

150 MHz AM

X-Y

The upper display is a 150-MHz signal that is 50% modulated by a 2 kHz signal. The lower display is an X-Y trapezoidal modulation pattern showing the 150-MHz AM signal vertically (Y) and the 2 kHz modulation signal horizontally (X). Straight vertical line is the unmodulated carrier. Multiple exposure.

For a demonstration, contact your nearby Tektronix field engineer, or write: Tektronix, Inc., P. O. Box 500, Beaverton, Oregon 97005.



*Coordinated research,
design and manufacturing*



*... part of the Tektronix commitment
to progress in the measurement sciences*

Technology

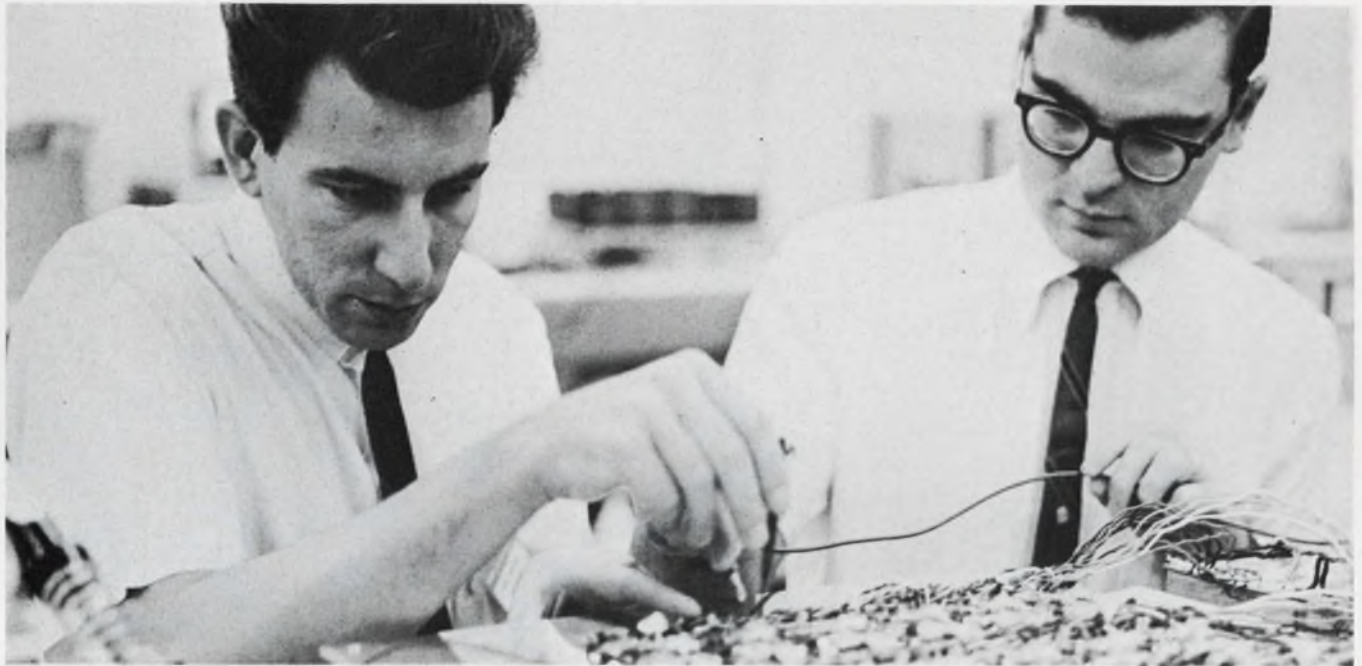

You can get a few watts of power at 400 MHz out of a single transistor. And, required bias-

ing, impedance-matching and suppression of oscillations are not too difficult. Page 57

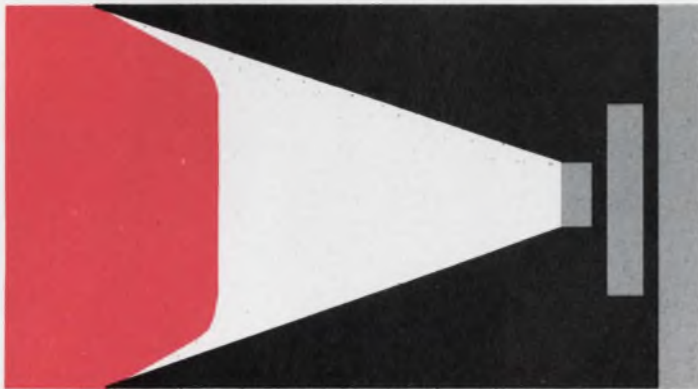

Spark up your technical presentations with well-made slides. How? Get some hints on page 90

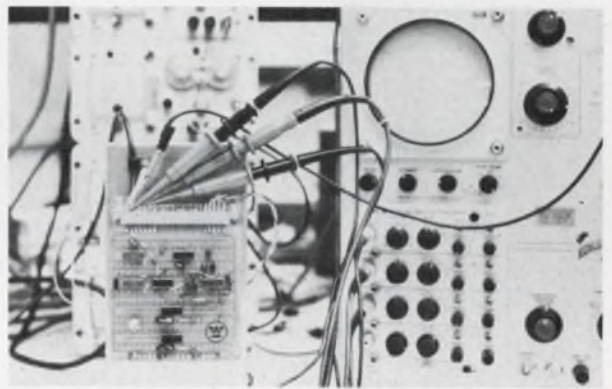

Build digital phase-locked loops with ICs, cut parts count and complexity. Page 76

Also in this section:

Keep spacecraft electronics noise-free through proper interconnection. Page 64

Even nonlinear systems can be simulated using ECAP. Page 70

'Do-it-yourself' slide rule finds coil distributed capacitance. Page 82

Test your IC IQ, Page 86 . . . Ideas for Design, Page 110

Protect transistors against overheating... and save

You can use a Carborundum® Positive Temperature Coefficient Thermistor to give thermal protection to an expensive transistor circuit. If the ambient temperature increases or the transistor overheats, the resistance of the PTC increases, protecting the transistor.

The result: more stable output over the operating range of the circuit in communications equipment and computers—extra insurance against transistor failure.

Because of their very high temperature coefficient—up to 10% per °C—precision Carborundum PTC's also can be used to simplify circuit design, cut costs, and improve reliability in applications involving time delay, current limiting, temperature control, and liquid-level/flow control.

In cases where small amounts of heat and fast response are required, PTC's can be used as solid-state, self-limiting heaters to maintain temperature without additional circuitry.

A circuit-design kit containing 16 popular PTC's at half price is yours for \$20.

For the kit, or for detailed information, write Mr. Harry Emes, The Carborundum Company, Electronics Plant, Niagara Falls, N. Y. 14302.

Precisely yours . . .

CARBORUNDUM



Single transistor gives uhf watts.

Learn how to design a class C output stage, using simple equations and manufacturers' data.

Problem: Design an amplifier to get several watts of power at 400 to 2000 MHz from a single output transistor. **Solution (until recently):** Forget it. A selection of suitable transistors just wasn't around.

Things are different now. Good transistors are becoming available. But to gain the full benefit of this advance, the designer needs a practical background in high-frequency design.

The techniques described here were used to build a 400-MHz, 8-W class C output stage. Since the design of class C amplifiers requires solid knowledge of class A operation and biasing, we can begin by examining the three major factors that must be taken into account when biasing a transistor, class A:

- Transistors that operate above 1000 MHz have extremely high gain below 500 MHz, and, when they are biased class A, may tend to oscillate at some lower frequency.

- The bias mode should be independent of the transistor's dc current gain—that is, when transistors are interchanged, a device with a beta of 20 should draw about the same collector current as a device with a beta of 200.

- The operating point and the dynamic load line should be designed so that, with no drive signal or an ac open or shorted output, the bias point is still inside the safe operating region.

Prevent failures due to oscillation

Anyone who has ever experienced a failure due to low-frequency oscillation in a class A circuit knows that the result is usually complete destruction, with little or no forewarning. There are, however, several techniques that can be used to protect a transistor during initial breadboarding. First, the common-emitter mode of operation inherently produces negative feedback from output to input, provided that the input and output circuits offer a conjugate impedance match. Common base should be avoided, if

possible, since the output-to-input feedback is generally positive.

Secondly, before an attempt is made to operate the transistor at the desired voltage and current, it is advisable to use a resistor in the collector circuit, to limit the collector current. Using an oscilloscope connected to the collector of the transistor, observe the waveform as the desired voltage and current are applied to the circuit. Next, abruptly switch the collector voltage on and off while observing the transient response in the collector. If the response looks normal and no spurious oscillations occur as the collector voltage and current are varied, the limiting resistor can be removed and normal operation tried. It is unlikely that oscillation problems will occur now, but should some appear, check these common problem areas:

- The resonance of rf chokes.
- A bypass capacitor that appears inductive at the frequency of oscillation.
- A low-frequency modulation caused by rf



"You can easily get several watts out of a single transistor at 400 to 2000 MHz," says Dick Battisti (right), shown here with the co-author, Ken Morey, examining the breadboard of their amplifier.

Richard A. Battisti, Chief Engineer, and **Ken O. Morey**, Applications Engineer, Advanced Technology Div., TRW Semiconductors, Inc., Lawndale, Calif.

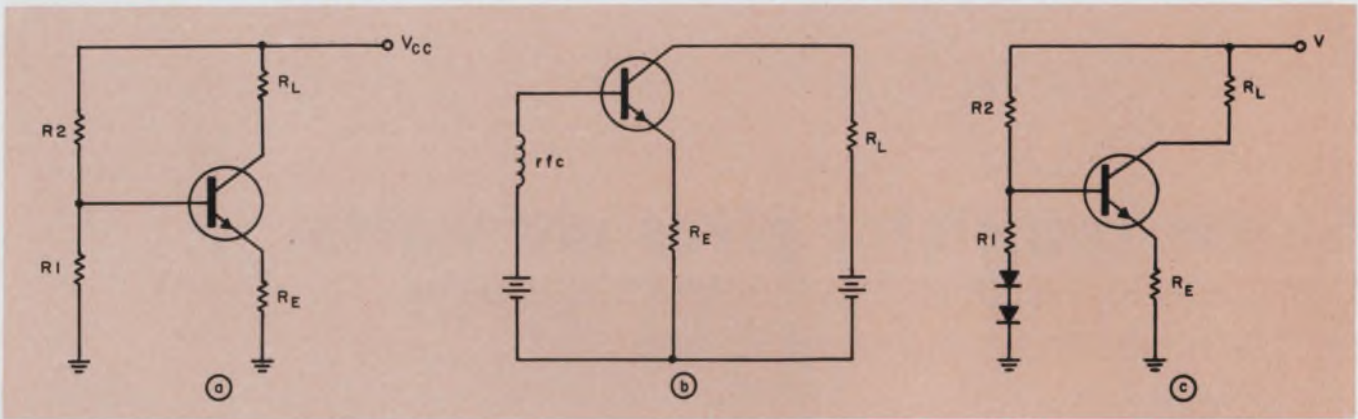

1. **Biassing a class A amplifier** can be done either by using a resistive divider network (a) or two supplies (b). The first method is preferred, in spite of the fact that changes in collector current up to 10 per cent can result

when transistors with beta ratio of 10:1 have to be accommodated. Temperature stabilization may be achieved with one or two diodes (c). Their temperature characteristic should be equal to that of the emitter-base junction.

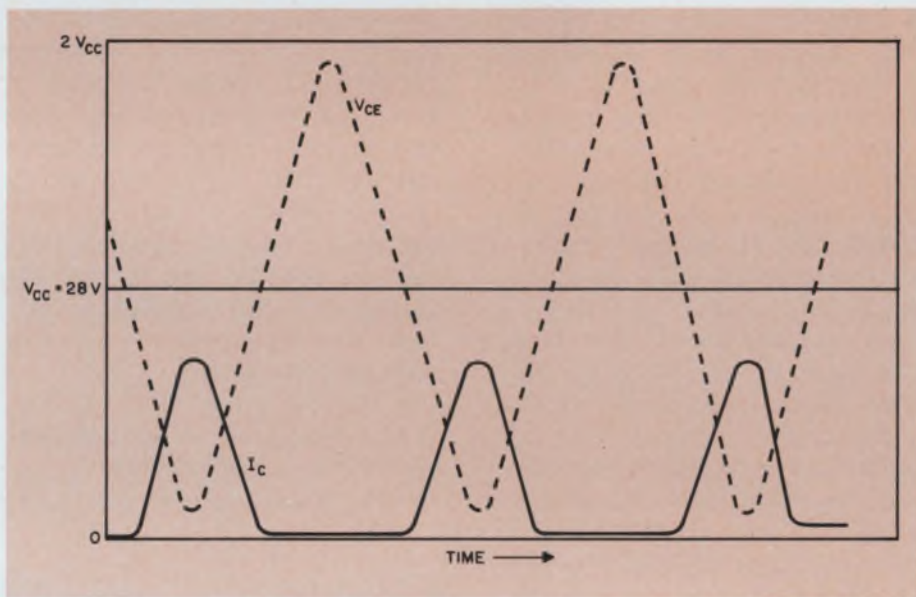

2. **Transistors with $BV_{CE0} = 2V_{CC}$** should be used to avoid collector-to-emitter breakdowns. The phase shift between collector current and voltage is about 180° .

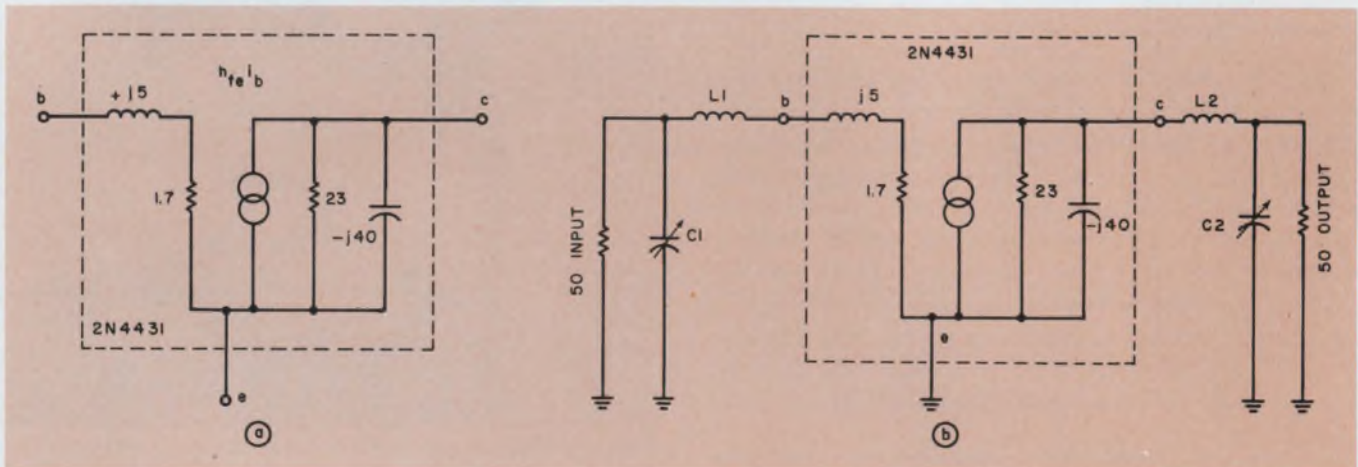

3. **400-MHz equivalent transistor circuit (a)** can be readily obtained directly from the manufacturer's spec

sheets. The input and output networks can then be determined for a given performance (b).

power entering the power supply and creating a sawtooth supply voltage variation.

■ Feedback caused by multistage class A operation, where the most likely problem may be decoupling of the common power supplies.

Change transistors without affecting bias

To maintain the same bias level, when transistors are interchanged, the bias mode must be independent of the device's beta. This can be accomplished in several ways.

The practical, commonly used method is the voltage divider (see Fig. 1a). The ratio of $R1$ to $R2$ determines a voltage, which forward-biases the transistor until the voltage drop across $R_E + V_{BE}$ is equal to the voltage drop across $R1$. This is a popular class A bias scheme. The values of $R1$ and $R2$ should be such that the divider current is at least five times the base current of the lowest-beta transistor. This bias technique provides approximately a 10 per cent change in collector current when devices with betas varying from 20 to 200 are interchanged.

Another method is to use the classic two-supply method (see Fig. 1b). The value of R_E is selected so that the voltage drop is approximately five times V_{BE} . A variation in the collector current, I_C , between a beta of 20 and 200 is only 5 per cent.

While this method is probably the best for constant collector current when devices are interchanged, it requires an additional power supply. This method is, therefore, a laboratory tool rather than a production design.

If low- and high-temperature (-55°C to 120°C) stabilization is required, a diode can usually be added in series with $R1$ (Fig. 1c). This diode should have the same temperature characteristics as the emitter-base junction of the transistor. In some cases, where extreme temperature variation is encountered, the transistor operates better if the collector current is reduced at high temperatures and increased at low temperatures. This can be accomplished by using two or more diodes in series with $R1$.

Determining operating point

When everything is optimized, so far as dc bias is concerned, the rf operating points must be determined.

In small-signal amplifiers (20 mW output or less), the bias point will not usually shift when a signal is applied or removed. If the circuit nears the large-signal condition, it is quite possible that the bias will shift. If a class A amplifier is driven with too large a signal, the amplifier will begin to act as a class C amplifier, and this will clip the output. To determine if this is

occurring, measure the voltage drop across $R1$ with and without an input signal. If the input signal is too large for the application, the bias voltage drop across $R1$ should be greatly reduced and may even look negative.

If the collector current decreases when the input signal is applied, the values of $R1$ and $R2$ should be reduced, to increase the divider current. Never depend on the input signal to decrease the collector current to the desired value. If the signal is not present, it is possible to destroy the transistor from excessive dissipation.

Look at important class C parameters

For large-signal, class C amplifier applications, the most important transistor specifications are these:

- BV_{CEO} .
- BV_{CBO} .
- Power gain.
- Maximum dissipation.

Let's consider these one at a time.

In any class C or B large-signal amplifier, the lowest breakdown voltage is BV_{CEO} . It doesn't matter whether the actual circuit has a resistor, a choke or a combination of these in parallel with the emitter and base. Once the emitter-base junction is forward-biased, the transistor experiences a V_{CEO} breakdown. For 28-V operation, it is best to use a transistor with a V_{CEO} of greater than 35 V. It is not required that this breakdown be higher than $2 V_{CC}$ (56 V in case of the 28-V supply).

This can be explained by analyzing the current and voltage through the transistor at some uhf application (Fig. 2).

The diagram of Fig. 2 is not completely correct, since there is something less than a 180° shift between the collector voltage and current. The actual amount of phase shift is dependent upon the drive signal, the frequency, voltage and circuit tuning, and it cannot generally be measured accurately. However, it can serve for a qualitative description of the currents and voltages occurring in the transistor.

In analyzing this diagram, you can assume that since the transistor draws current only when the collector voltage is minimum or very near minimum, a device with a V_{CBO} just in excess of 28 V can be used. This is not true. If the input or output tuning were varied, the phase shift introduced by this tuning would destroy the device. At the same time there can never be a phase shift of 180° either, which indicates that a 35-V to 40-V V_{CEO} is safe for 28-V operation, even with open or shorted load conditions.

When the transistor draws no collector current and has a negative voltage on the base, the breakdown that occurs is BV_{CBO} (collector-base break-

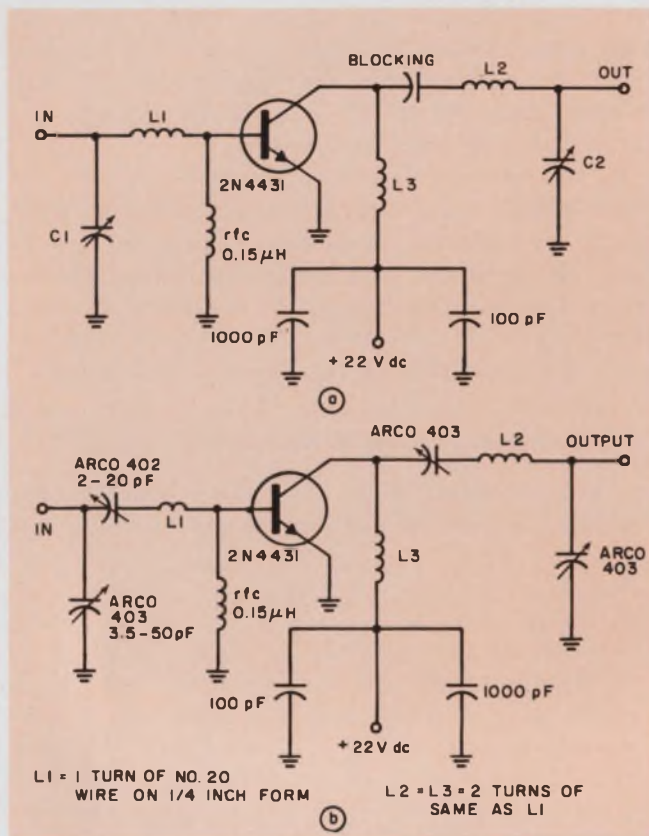

4. 400-MHz amplifier is shown in (a). Because the calculated values for both L1 and L2 turned out to be in the pH range, they have been replaced by the Q-multiplied L sections (b). Inclusion of the trimmer capacitors provides the adjustment.

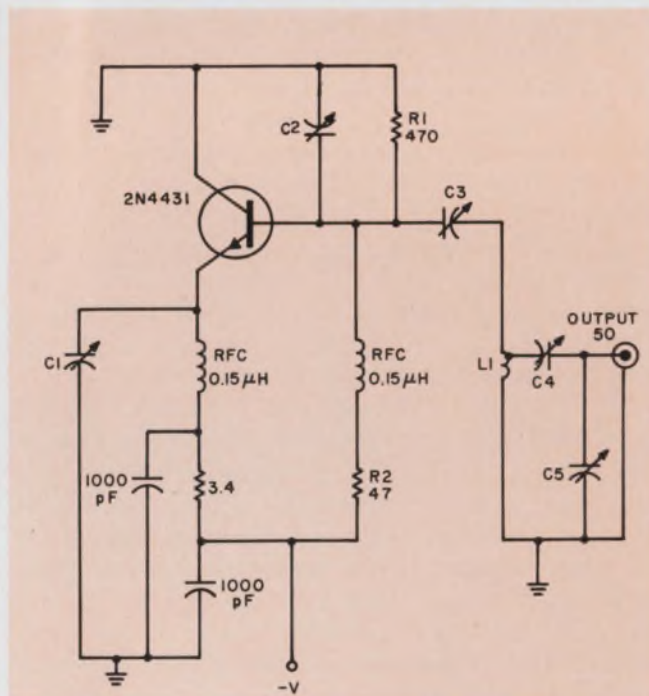

5. Power oscillator can put out 400 to 1000 MHz signal, depending on L1 (see text). C1 and C2 are Arco 402; C3, C4, C5 are Arco 400s. The same circuit can use a 2N4430 if R1 is changed to 940 ohms and R2 is changed to 94 ohms.

down). The saturation voltage of a transistor above 400 MHz is approximately 3.5 V, and the peak-to-peak voltage at these frequencies is on the order of 50 V. It is therefore recommended, for 28-V operation, that a transistor with a BV_{CBO} of 55 V or greater be chosen.

Of all tests on a transistor, the power gain is the most important specification. No other test describes the transistor's capability better.

Below is a simplified expression for large-signal power gain:

$$PG = 10 \log_{10} [R_{out} (h_{fe})^2 / R_{in}],$$

where R_{out} = large signal output resistance,

R_{in} = large signal input resistance,

h_{fe} = large signal current gain measured at πI_c average or calculated from power gain (at the operating frequency).

It can be seen that even with an h_{fe} of 1/2, the transistor would have a power gain at 1000 MHz. For example:

For 2N4431 at 1000 MHz,

$$R_{out} = 36 \Omega \quad PG = 10 \log_{10} [(36) (1/2)^2 / 3]$$

$$R_{in} = 3 \Omega \quad = 4.78 \approx 5 \text{ dB.}$$

The maximum dissipation defines the amount of power a transistor can dissipate when the stud is at 25°C. At elevated stud temperatures, this is linearly derated to zero at 200°C.

It is possible, in some cases, to obtain as much rf power from a transistor as the maximum rating indicates. Even though the efficiency is greater than 50 per cent and the junction temperature is less than 200°C, this condition must be avoided, except in pulsed applications, because should the load be removed or the output circuit be detuned, the transistor would fail due to excessive dissipation. Good engineering practice dictates using the transistor at an output power of $\leq 2/3$ maximum dissipation, if the collector efficiency is greater than 50 per cent.

While f_T (the gain-bandwidth product) is always specified for a good rf device, its importance has been overemphasized, except in the case where the device is used as an rf current amplifier.

In general, a transistor can be operated at two to three times the frequency of its large-signal f_T and at about 1.5 times its small-signal f_T . This is true because the input and output impedance largely determines the power gain, especially at, or near, f_T .

Designing the class C amplifier

Suppose we want to build a class C amplifier with these performance specifications:

Operating frequency = 400 MHz.

$V_{cc} = 22 \text{ V.}$

$P_{in} = 1.6 \text{ W.}$

Desired Output = 5-10 W.

First, jot down some parameters given in the manufacturer's data. From the specification sheet on the 2N4431, we see that it puts out about 10 W at 400 MHz with 1.5 W input. Furthermore:

$$\text{Re}(h_{ie}) = 1.7 \text{ ohms,}$$

$$\text{Im}(h_{ie}) = +j5,$$

$$1/\text{Re}(y_{22}) = 32 \text{ ohms,}$$

where $\text{Re}(h_{ie})$ and $\text{Im}(h_{ie})$ are real and imaginary parts of the transistor hybrid input impedance, h_{ie} , and $\text{Re}(y_{22})$ is the real part of the output admittance with the input short-circuited.

First, $1/\text{Re}(y_{22})$ is a small-signal, class A measurement and is not valid for class C design. If it is assumed that the collector voltage swing is approximately 40 V from a 22-V supply, about 8 W output can be expected. We first find R_{out} and X_c , the resistive and reactive components of the output impedance, respectively.

$$R_{out} = E^2/\text{power} \approx [(V_{cc} - V_{SAT})^2/P_{out}] (\sqrt{2}/2)^2 \\ \approx [V_{cc} - V_{SAT}]^2/2P_{out}.$$

At 400 MHz V_{SAT} is about 3 V, so that $R_{out} = (19)^2/2P_{out} \approx 23 \text{ ohms}$.

The open-circuit output capacitance, C_{ob} , for 2N4431 $\leq 10 \text{ pF}$, and for the V_{cc} of 22 V, it is approximately 10 pF.

Therefore:

$$X_c = 1/2 \pi fC = 40 \text{ ohms,}$$

which means you cannot resonate the collector capacitance at this power level because of the very low Q. The Q is given by $23/40 = 0.57$. This insures unconditionally stable operation.

Starting with the simplified equivalent model of the transistor (Fig. 3a) and then adding simple L-section matching networks to it (Fig. 3b), you can calculate the values of L_1 , C_1 , L_2 and C_2 , since both impedance levels are known. Here is how to go about it:

Assuming a 50-ohm source impedance and looking into the input, we get for the matched condition:

$$(X_{c1})(X_{Lt} + 1.7)/(X_{c1} + 1.7 + X_{Lt}) = 50, \quad (1)$$

where $X_{Lt} = X_{L1} + j5$.

Rearranging, we get

$$X_{c1} X_{Lt} + 1.7 X_{c1} = \\ 50 X_{c1} + (1.7)(50) + 50 X_{Lt}. \quad (2)$$

Equating real and imaginary terms separately, we have:

$$X_{c1} X_{Lt} = (1.7)(50) = 85.0, \text{ and} \quad (3)$$

$$1.7 X_{c1} = 50 X_{c1} + 50 X_{Lt}. \quad (4)$$

We proceed to solve Eqs. 3 and 4 for X_{Lt}

$$48.3 X_{c1} = -50 X_{Lt}, \quad (5)$$

$$X_{c1} = (-50/48.3) X_{Lt}, \\ -50 (X_{Lt})^2/48.3 = 85.0, \quad (6)$$

$$X_{Lt} = j9.1 = j2\pi fL_t,$$

so that L_t , at 400 MHz, is

$$L_t = 3.62 \text{ nH.}$$

Then:

$$X_{c1} = (-50)/48.3 (j9.1) = j/2\pi fC_1,$$

and the value for C_1 becomes

$$C_1 = 42.3 \text{ pF.}$$

The procedure for calculating the output circuit values is the same and, consequently, is omitted here.

Connecting the required components results in the circuit of Fig. 4a. In the base return to ground, an 0.15- μH choke was selected, since it is nearly an open circuit at 400 MHz.

In the output circuit, L_3 can be any value, since the parallel-combination of C_{ob} , L_3 and R_{out} has a Q of about 1. By experience, it is best for stability reasons to use a small inductor 0.01 μh , since this appears as a short circuit to lower frequencies and it tends to suppress lower frequency spurious oscillations and to yield a better transient response. Since the chances of selecting an inductor with the calculated inductance is almost nil, it is advisable to use a Q multiplied L section with an impedance of about 3 times the calculated value on the input and output matching networks. The combinations of L and C are selected above series resonance, and the adjustment of C produces the effect of having a variable L . This is desirable, since variable inductors at this frequency are quite lossy and very limited in range. This, finally, gives the complete circuit shown in Fig. 4b.

General considerations related in the preceding discussion can be readily extended to other high frequency circuits. Figure 5 depicts an oscillator circuit from the frequency range of 400 to 1000 MHz. A resistor is placed in the emitter to provide stability at a slight loss in output. All capacitor leads are made as short as possible to eliminate parasitic inductance.

At 400 MHz, $L1$ is three turns of #14 wire, 0.5 inch in diameter. At 1000 MHz, $L1$ is a 1/4-inch copper tube one inch long. The transistor is mounted so that the collector can be grounded with leads as short as possible to minimize collector lead inductance. ■■

Test your retention

Here are questions based on the main points of this article. They are to help you see if you have overlooked any important ideas. You'll find the answers in the article.

1. What are the major factors in designing bias for a class A rf amplifier?

2. How can you test quickly for spurious oscillations?

3. How do you begin an amplifier design?

We've got op amps like nobody's got op amps.

1. VERY LOW POWER

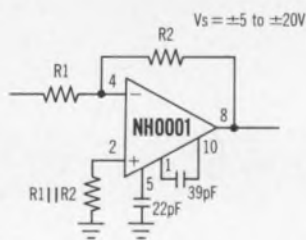

The typical dissipation of the NH0001 is but 1.8mW at $V_s = \pm 15V$ and 0.6mW at $V_s = \pm 6V$. Something of a record, no? And further, the mighty NH0001 will deliver over $\pm 10V$ into a 2K load from $V_s = \pm 15V$ supplies. It's priced at \$48.00 in 100 to 999 quantities.

2. GENERAL PURPOSE

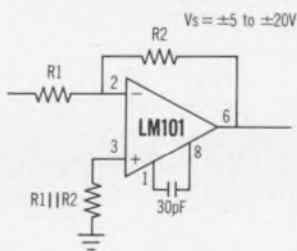

Old faithful LM101 is both general purpose and no-sweat in operation. It's short-circuit proof and has a large differential input voltage allowance. Moreover, frequency compensation is simple, and there is no latch-up problem. The price is \$40.00 in 100 to 999 quantities. (There is also a commercial version, the LM201, priced at \$8.80.)

3. FULLY COMPENSATED, GENERAL PURPOSE

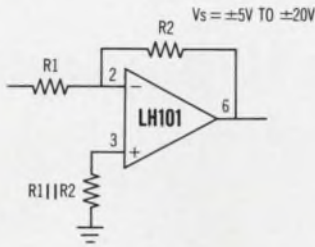

The LH101 is kin to the LM101. The essential difference is that all the required frequency compensation is *inside* the package. Current drain is low, even with the output saturated. There is no latch-up when common mode range is exceeded and there's continuous short circuit protection. Price for 100 to 999 is \$48.00. The commercial version LH201 is \$11.40.

4. HIGH SLEW RATE VOLTAGE FOLLOWER

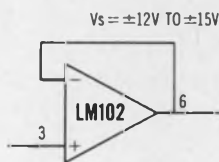

The LM102 voltage follower is the first monolithic amplifier that has combined low input current with high speed. Slew rate is $10V/\mu s$. The maximum input current is an incredible $10nA$. Input currents better than $10nA$ at $125^\circ C$ are guaranteed. The price: \$30.00 each in 100 to 999 quantities. The $-25^\circ C$ to $+85^\circ C$ LM202 is priced at \$12.00, LM302 commercial at \$5.40.

5. HIGH OUTPUT CURRENT

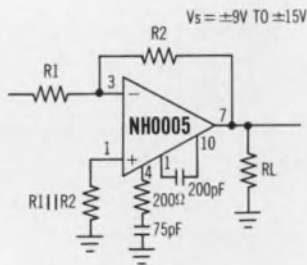

When we say high output current, we *mean* high. The output current on this, the NH0005, is $\pm 50mA$ into a 100Ω load. The price in 100 to 999 quantities is \$45.00. And there's a commercial version, the NH0005C, priced at \$22.50.

6. VERY HIGH OUTPUT, WITH BUFFER

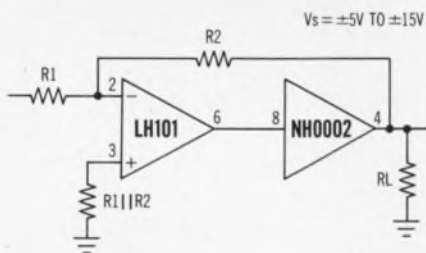

The NH0002 is something else. It has an output current of $\pm 300mA$ into a load of 50Ω . The NH0002 buffer is useful in the loop in all your high current op amp applications. The price is \$20.00 in 100 to 999 quantities.

For more on op amps, write National Semiconductor Corporation, 2975 San Ysidro Way, Santa Clara, California 95051.

National Semiconductor

INFORMATION RETRIEVAL NUMBER 41

Design noise out of spacecraft payloads.

Good circuit design and proper layout can avoid serious troubles at launching time.

No matter how immune your electronic systems are to noise in the laboratory, the inside of a spacecraft is another story. The frame of the craft is the hardest source of noise to control for such experiments or payloads as a camera or telemetry setup. And the best time to control this noise is when these payloads are connected to power, signal and chassis commons.

Launching time is too late

Most noise problems that occur when a payload is integrated into the space vehicle are a result of improper circuit layout and design. This can be a very serious problem, because the troubles are usually not discovered until the integration takes place. And launching schedules generally do not include time to make basic design changes to correct the problems. Stopgap solutions are generally tried. Filters may be added to the interface wires, or the complete experiment may be placed in a shielded container and certain ends of the shields of particular shielded interface cables disconnected. Anything that will reduce the noise to an acceptable level is tried. The only trouble is that the basic cause of the problems is seldom found. The installation conditions may change at a later date, and the noise may then reappear.

A major source of noise is brought about by the signal and power interfaces between experiments and the spacecraft. A separate signal and power common is generally available, and the metal frame of the vehicle is not deliberately used as a return path. However, fast signal and power transients on unbalanced lines can be injected as noise into the vehicle frame, into adjacent conductors and into vulnerable payload circuits. Whether intentional or not, the vehicle frame is a potential source of noise on any unbalanced signal and power system.

A minimum rise time of transients that will, in fact, be injected as noise is hard to define. Rise times of a fraction of a microsecond to

several microseconds have been observed. All have a characteristic damped wave train shape, which seems to indicate that the leading and trailing edges of square waves from the digital data system and dc-to-dc converters are being differentiated by stray capacitance. The energy of the spike thus formed is stored in the stray inductance of the system. In turn, it alternates back and forth from the inductance to the capacitance, producing a damped wave train as the energy decays. This can cause trouble because a fast-pulse amplifier and pulse-counting string, responding to this type of noise, may end up producing five or six counts at each transient as the damped wave train swings back and forth about the zero axis. The resulting apparent counting rate may be many times the fundamental square wave frequency that produced the original transient. In some satellites 1-MHz sine waves have been observed on common instrument returns. These signals originate in the data-handling system with the high-frequency clock that is counted down to produce the necessary low-frequency gate and clock signals.

Amplifiers most susceptible to noise

In a typical experiment, the most vulnerable circuits are the high-gain amplifiers. Figure 1, an amplifier connected to a detector and power source, shows how noise on the chassis can couple into an amplifier. Chassis connections C through H can be conductive, or more generally, capacitive reactances between various components close to any of the chassis. The impedances are those of interconnecting wires or those between chassis. All can develop noise pulse voltages across them that can couple into the amplifier. The value of these impedances can be arranged to minimize the amplitude of noise voltage across points A and B, the signal high and low. Impedances Z_1 , Z_2 , Z_3 , and Z_4 should be as small as possible. (This is accomplished when experiments are connected correctly, as in Fig. 3). Impedances Z_5 , Z_6 , Z_7 , Z_8 and Z_9 should be made as large as possible by electrically insulating the chassis from the frame.

Joseph C. Thornwall, Chief, Environmental Systems Section, Solar Physics Branch, Laboratory for Space Sciences, NASA, Goddard Space Flight Center, Greenbelt, Md.

Of all the chassis impedances, only one— Z_1 between point B and the chassis—should be made small. This is the connection made to the common input of the amplifier. By making Z_1 as small as possible, the signal high input at point A will be surrounded by an enclosure at the same relative noise signal potential as the signal low input at point B. If a noise signal should then appear on the chassis, both the signal high and low will follow in common mode and minimize the difference of potential between A and B.

Figure 2 is a simplified block diagram of the area around the input of the amplifier—another vulnerable part of the circuit. It shows what can happen if the signal and various power commons are not properly connected at the input. Assume that point J is some convenient point in the system to which all of the commons are connected. Impedances Z_7 and Z_3 represent the impedances of the wires connected between the detector and amplifier signal low. Also assume that there is some high-frequency power supply ripple or other noise on the low-voltage dc input.

The amplifier incorporates a low-pass filter, R_1 and C_1 , to bypass this noise so that it will not be introduced into the input. The only trouble is that the noise pulse currents flowing through C_1 must return through Z_3 as it flows back to the power-supply common. Instead of decreasing the noise on the input of the amplifier as the value of C_1 is increased, the noise input will actually increase. To eliminate this voltage source, Z_3 must be made as small as possible. A similar noise source from bypass capacitor C_2 conducts noise currents through impedance Z_7 . This also introduces a noise signal to the amplifier input. If all commons were connected together at point B instead of point J, and at no other point, none of the noise voltage drops would appear at the amplifier input. Further, if there are several amplifiers in a system operating from the same low-voltage power supply, a flat braid (low-inductance strap) should be used to connect their B points together.

Figure 3 shows the correct way to connect the amplifiers and detectors into a system. All of the common returns originate at point B of the amplifier. This arrangement has the effect of reducing impedances Z_1 , Z_2 , Z_3 and Z_4 (Fig. 1) to a negligible value. Except for the impedance of the connection between all of the B points in a multiple-amplifier system, all of the wires connecting the common returns can have noise-voltage drops across them. However, none of these voltage drops are in the connection made from the detector to the amplifier, so that they will not be introduced as noise to the amplifier input.

There are many other ways that noise can enter an amplifier. Fortunately, however, many of them can be eliminated with an isolation

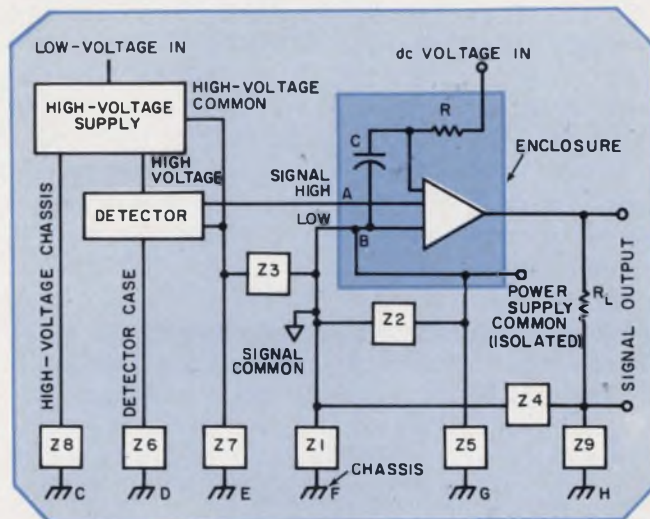

1. To minimize noise coupled into the amplifier, impedances 1 through 4 should be made as small as possible. Impedances 5 through 9 are made large by electrically insulating the payload chassis from the vehicle frame.

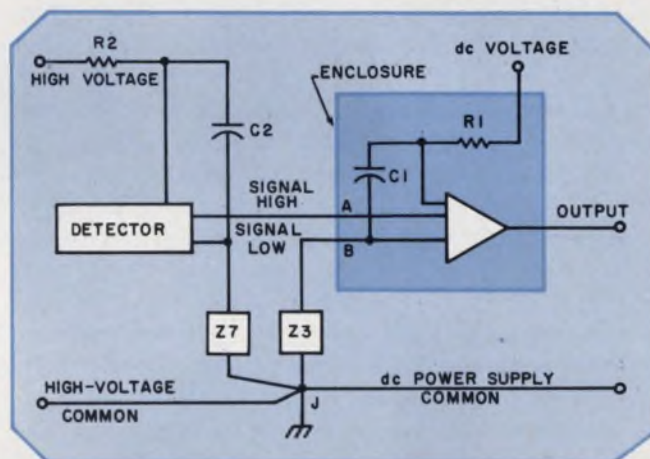

2. Connect signal and power commons improperly, and you'll get noise at the amplifier input. Here, J is any convenient point. Noise currents from C_1 and C_2 through Z_3 and Z_7 become noise at the input. By connecting commons at point B, you eliminate these noise sources.

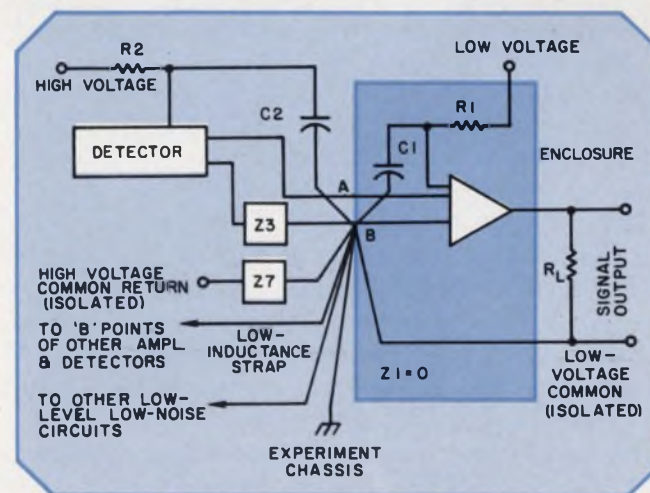

3. Connecting all commons at point B has the effect of minimizing impedances 1 through 4 (Fig. 1). This minimizes the noise appearing at the amplifier input.

power supply. Fig. 4 is a schematic of the power supply common between the experiment and the vehicle. The vehicle power common (point F) is generally connected to the spacecraft frame at a point far removed from the chassis of the experiment (point E). If the experiment does not have an isolation power supply to break this path, a chassis ground loop will be present through impedances Z_1 , Z_3 and Z_7 . Any noise pulse currents flowing over this path will cause noise signals to be introduced into the amplifier input by the voltage drops across these impedances.

Signal isolation circuits can help

Figure 5 shows signal isolation techniques used in a camera and sequence timer on Aerobee rockets. (A sequence timer is used to start and stop several experiments, initiate camera timers at the proper time and perform other in-flight control functions. The initiation of the timing sequence is started at T-15 seconds. From that time on, during the launching, powered and coasting phases of the flight, this timer must operate without a single response to external noise.)

All power and signal connections to the timer were conductively isolated. The circuit shown in Fig. 5a is a complementary symmetry flip-flop connected as a free-running multivibrator. It drives four of the output circuits shown in Fig. 5b. A separate such output circuit was used to control each remotely located relay, camera solenoid and control mechanism. The output circuit is a push-pull transformer-coupled amplifier with gate transistors Q_3 and Q_4 connected in series with the emitter returns of push-pull transistors Q_1 and Q_2 . The secondary of the transformer is segment-wound from the primary to minimize interwinding capacitance. The transformer used has an interwinding capacitance of approximately 15 pF and an output impedance of 30 Ω . Transistors Q_3 and Q_4 comprise a two-input AND gate. As many as four series-connected transistors have been used to provide more complicated logic. The circuit operates very simply: transistors Q_1 and Q_2 conduct through the series-connected gate transistors Q_3 and Q_4 when inputs A and B are both positive. This causes a 50-kHz signal to appear on the isolated secondary of the transformer. To achieve a maximum of noise immunity, this output signal is conducted on a twisted-pair balanced-line, which is enclosed in a shield. This carrier scheme is an excellent way to reject noise induced in the output line, between the experiment and the load, or on the common return of the load circuit. One side of the secondary can be connected to any power common in a system, no matter how noisy. Any noise signals present on both conductors

(unbalanced noise voltages) must pass through the very small 15-pF interwinding capacitance to gain access to the experiment. Any balanced noise signal voltages must be large enough to couple into the 30- Ω twisted-pair shielded line.

Transformer circuits, both linear and non-linear core types, are very useful for signal and power isolation in experiment design. Figure 6 illustrates conductive isolation with the use of a nonlinear core transformer. Here, three commons are isolated in one transformer. This circuit was used in an experiment in which a standard robot camera was used to take pictures of the sun. The camera had a solenoid for operating its shutter and a dc motor for driving a 35-mm film transport. The solenoid required 0.68 A dc, and the motor 0.4 A. Because of a variable motor load and commutator and brush arcing during opera-

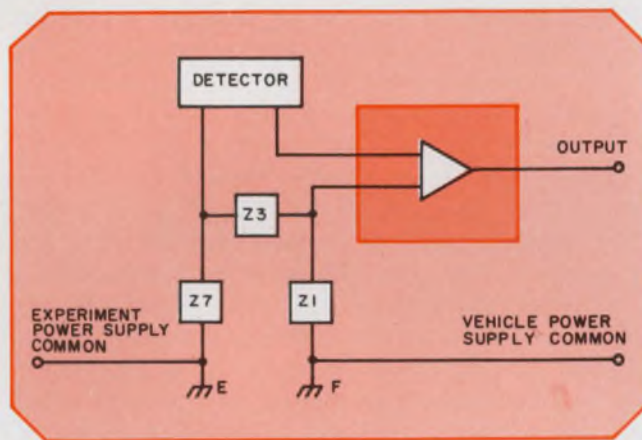

4. An isolation power supply can do away with the chassis ground loop through impedances 1, 3 and 7. Any noise currents flowing over this path would cause corresponding noise voltages to be introduced at the input of the amplifier.

tion in a vacuum environment, the motor generated considerable noise. To keep the noise from being introduced into the telemetry common return and the signal-carrying circuits of the experiment, a separate power common lead was provided for the motor and solenoid (point A).

The problem with this setup is that a signal is required for telemetering a record of the solenoid closure and motor operation time back to the ground. The most obvious way to do this would be to drop a small portion of the voltage applied to the motor and solenoid across a resistor in the common return, and then apply this voltage to the telemetry input. Unfortunately this would mean connecting the telemetry signal common, point B, together with the noisy motor and solenoid common, point A. And this would cause the

Ten steps to a noise-free payload

1. Use an isolation power supply.
2. Connect the experiment isolation power supply common return to the lowest-level amplifier in the system.
3. In a multiple-amplifier system, connect all amplifier common returns with a flat braid.
4. If possible, conductively isolate the signal outputs and inputs, to further remove conductive paths between the experiment and the craft.
5. Electrically insulate the experiment chassis from the spacecraft.
6. Do not allow current from pulsed electromechanical devices in the experiment to flow on the experiment chassis.
7. Provide isolated, balanced-pair conductive paths for all pulsed devices within the experiment (stepping motors, relays, calibrators).
8. Connect the experiment chassis common to the same point as the experiment isolation power supply common.
9. Connect the detector signal common to the same point as the experiment power supply common at the amplifier input.
10. Connect the shields on all shielded wires to the chassis at as many points as possible.

tion showed that a relay at a distance from the timer package, part of the vehicle electronics, was opening at this time. And, since there was no diode across the relay coil, a 600-to-1000-V spike was produced during the collapse of the relay's magnetic field. This transient was coupling into the output flip-flop via the output signal line, or power supply common to the flip-flop, and back to the chassis.

A diode was placed across the relay coil (to eliminate the noise at the source), and the timer chassis was insulated from the vehicle. The flip-flop did not respond spuriously when the relay transient was removed, and it would not even have been necessary to insulate the chassis. However, since the unit was not being tested under flight conditions, it did no harm to insulate the chassis. This just might prevent a spurious response during the actual flight. A 50-kHz carrier signal scheme was incorporated into subsequent units, and there has never been a spurious response.

The accompanying box lists the most important points to be observed to minimize noise pulses coupling into payload circuits. It is interesting to note that if noise is introduced into a payload when signal cable shields are tied to the chassis (Item 10), it is a good indication that amplifiers are improperly connected. This is especially troublesome if the interface signals have not been conductively isolated. Without this isolation, the vehicle and experiment chassis will be connected

together through the interface. And an unbalanced shielded cable that has one end of the shield floating will radiate. It is essential that the shield be tied to the chassis to eliminate this radiation. One end of the shield should never be removed from the chassis, just because it reduces the noise in an experiment. It is much better to locate the point at which the noise is introduced into the system and find some method to remove this path. Or, better still, the circuit layout or cabling within the experiment should be changed so that it does not respond. This is very important, because there is no assurance that conditions will remain the same during the actual flight. And if a circuit has been found to be vulnerable to noise on the ground, it may well respond under flight conditions.

Finally, the data and power systems of a space vehicle should use low-impedance, balanced, twisted-pair, transformer-coupled and properly terminated lines to connect black box to black box. This greatly reduces the coupling of noise into the frame of the vehicle and eliminates the need for a common return in which signal and power transients are present from all the black boxes. And shielded wires are not needed. This cuts weight and cost. Uniformity of results from one craft to the next are improved, since small changes in capacitance and inductance do not cause large signal changes that now occur with an unknown-impedance, unbalanced system. ■■

The techniques described in this article are the result of six years of work at the Goddard Space Flight Center in designing and building the electronics for scientific payloads for an OAO and several OSO satellites, Aerobee rockets, and balloons.

Test your retention

Here are questions based on the main points of this article. They are to help you see if you have overlooked any important ideas. You'll find the answers in the article.

1. How does a spacecraft frame become a noise source on an unbalanced system.

2. What is the best practical method of minimizing the first four impedances and maximizing the last four?

3. Why should an isolation power supply be used?

4. If signal cable shields are tied to the chassis and noise appears, what does this indicate?



Prefer specs
to
speculation?

Want a *quality* product with *complete* specs? WIN WITH STEWART-WARNER DUAL J-K FLIP-FLOPS!

As the industry's finest DTL house, we won't give you a fast shuffle in the old spec game. Our products are top quality and we spec them out in detail, so why gamble on products that are poorly spec'ed?

Think we're bluffing? Take a look at our four-page data sheet on DTL dual J-K clocked flip-flops. Compare our detailed specs with anyone else's (if you find anyone else who publishes theirs). You'll like the way our products look in fan-out, in lower power dissipation, and in lower input loading across the full temperature range. You'll also like the

way we test our input diodes for minimum breakdown. And who else subjects their finished packaged circuits to 100% electrical testing—*twice*—before shipment?

Our customers already know how good our SW945 and SW948 single units are—and now we are offering our new, SW705-series, dual circuits on a passivated die of the same size. These new DTL dual J-K's are better than twice as good as singles at less than twice the cost. They improve reliability and reduce external wiring and mounting time. They are available in hermetically sealed, 14-lead,

ceramic flat packs or dual in-lines, and they can be ordered to meet either industrial or military temperature ranges.

Send for your copy of the industry's most complete spec sheet on DTL dual J-K flip-flops, or call your local Stewart-Warner Microcircuits distributor for immediate off-the-shelf product delivery. You can't lose with this pat hand!

STEWART  WARNER
MICROCIRCUITS, INC.
SUBSIDIARY OF STEWART-WARNER CORPORATION

Analyze nonlinear systems with ECAP.

Switching features of a circuit analysis program are used to simulate control systems.

Part 2 of a two-part series

Part 1 of this series* showed how the ECAP standard branch elements can be used to model operational amplifiers. Using these amplifiers as summing or integrating elements, an analog model of a transfer function can be set up and analyzed with ECAP.

ECAP is also capable of simulating nonlinear systems because the ECAP transient analysis program allows the use of switched network elements. Thus the switching of a resistor in the feedback loop of an amplifier can change the gain of that amplifier to simulate saturation or any other piecewise linear gain characteristic.

Simulate nonlinear functions with analog models

The ECAP modeling of discontinuities requires the use of switching methods. Simple switching circuits in the input and/or feedback circuits of the basic operational amplifier equivalent circuit can be used to simulate the characteristics of saturation, threshold, hysteresis, on-off devices, etc. They also can be used to compute specific mathematical functions, such as the absolute-value function and many decision or logic functions based upon inequalities.

The output of an amplifier, for example, may be limited to values determined by the supply voltages. There are a number of ways in which diode switching circuits can be used to enforce a condition such as $V \leq \text{constant}$. The simplest method is to use switching circuits as feedback elements in an operational amplifier equivalent circuit (Fig. 1). In this circuit the summing junction voltage, $V2$, of the amplifier is not affected by switches 1 and 2 until the output voltage, $V3$, exceeds ± 1.75 V, forcing current in one of the switch-sensing branches to reverse direction. When $V3$ tends to exceed ± 1.75 V, switch 1 or 2, depending on the

sign of $V3$, switches in the small $10\text{-}\Omega$ feedback resistance, preventing the output from increasing.

An asymmetrical limit can be just as easily simulated by the proper selection of the battery voltages in the switching branches. Such an asymmetrical limit can also be set to limit on two levels of positive or negative voltages, if desired, by making the battery voltages the same polarity.

Also, a piecewise linear gain characteristic can be simulated by the proper selection of resistor values in the feedback switching branches. More than two switching branches may be used.

A bang-bang characteristic is obtained from Fig. 1, by eliminating the 100-k feedback resistor.

A commonly encountered nonlinearity associated with on-off devices is that of hysteresis. An example of a simple switching circuit appropriate for the ECAP simulation of a bistable switching device with hysteresis is shown in Fig. 2. Note that switches 1 and 2 serve the dual function of controlling the $\pm 5\text{-V}$ switching level in the feedback circuit and the $\pm 1\text{-V}$ hysteresis level in the summing circuit. Plots of a computer solution of

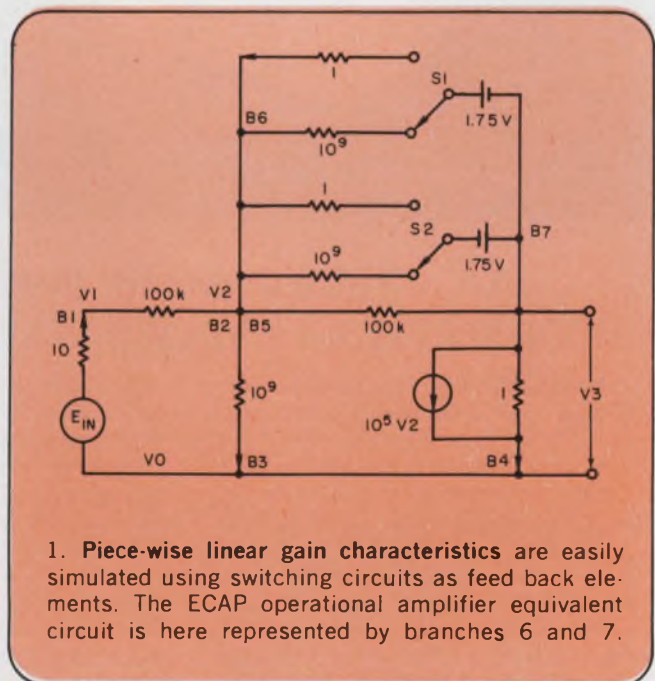

1. Piece-wise linear gain characteristics are easily simulated using switching circuits as feedback elements. The ECAP operational amplifier equivalent circuit is here represented by branches 6 and 7.

*D. B. Herbert, "Simulate transfer functions digitally," ED 7, April 1, 1968, p. 72.

Donald B. Herbert, Reliability Engineer, General Dynamics, Pomona, Calif.

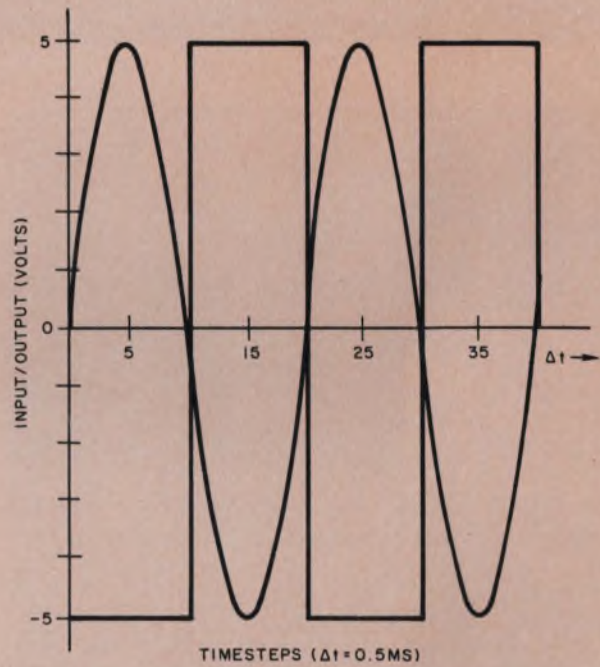
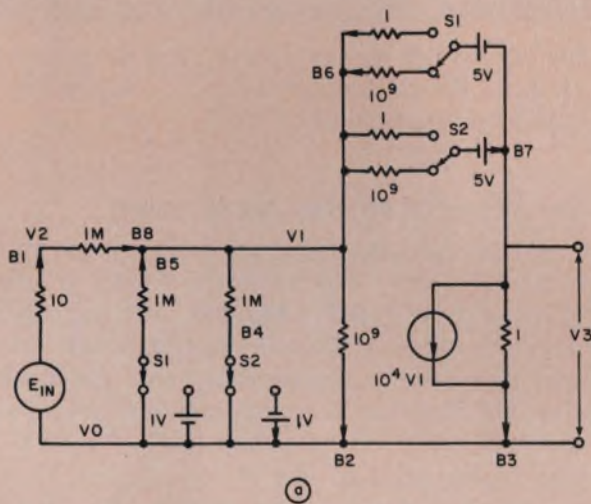

2. **Hysteresis is simulated** by switching double-pole switches in both the feedback path and the input resistance (a). The dc sources in the input branch provide a hysteresis level of ± 1 volt, as shown by the computer plots (b).

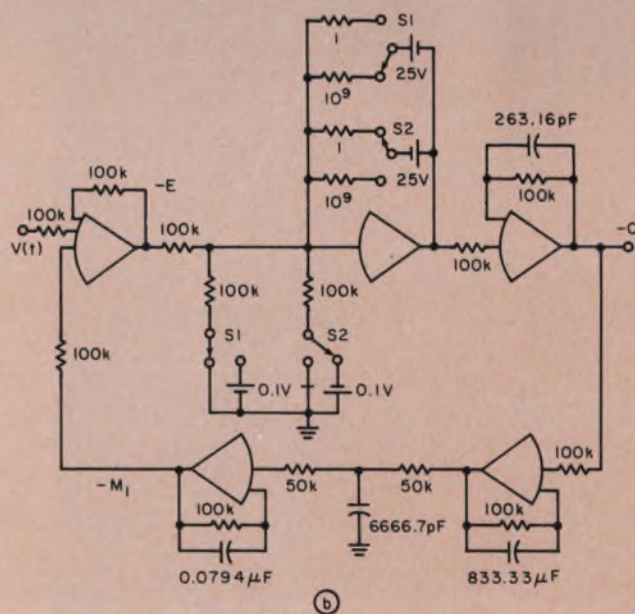
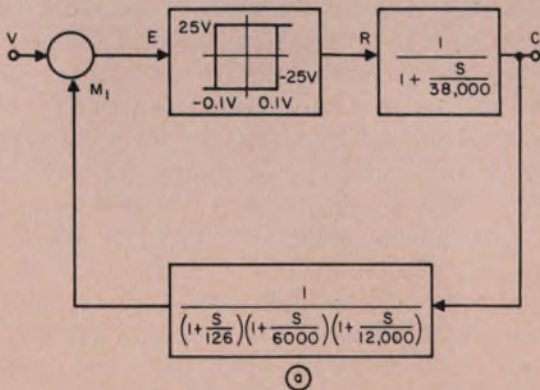

3. **A hydraulic valve controller** has a set of transfer functions (a) that can be simulated by an analog computer-type diagram (b). The forward loop contains a nonlinearity simulated by the bistable section of switches 1 and 2.

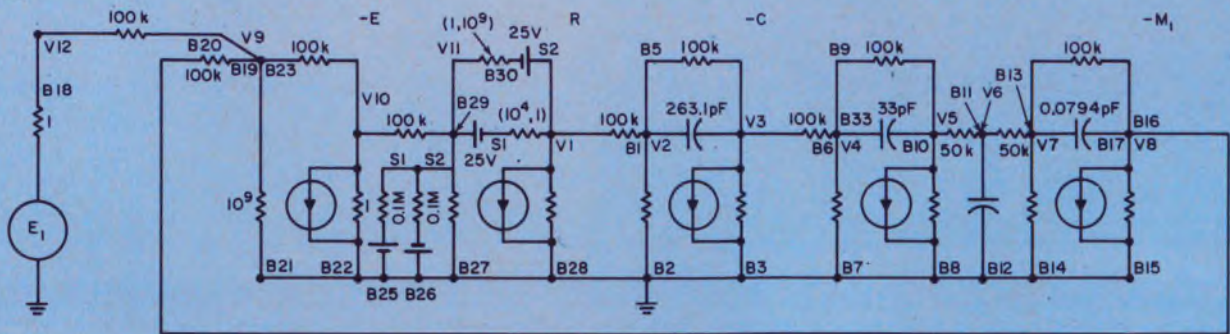

4. The final ECAP equivalent circuit uses five amplifier elements to model the entire control system.

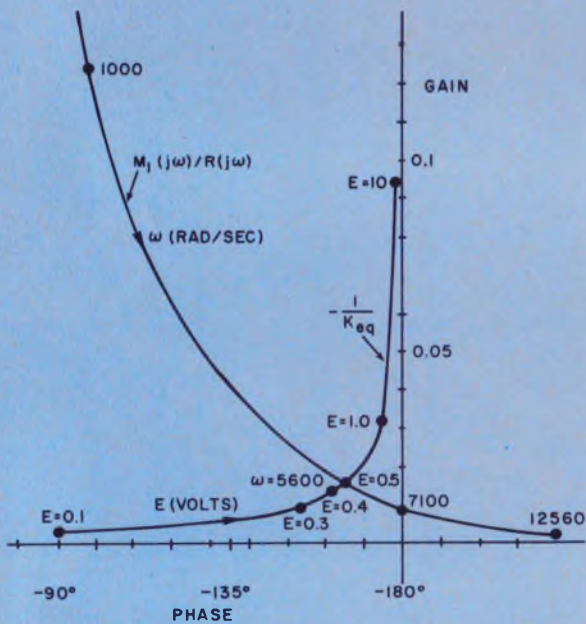

5. The open-loop frequency response and the negative reciprocal of the bistable element describing function gain show that the system has a stable limit cycle at 5600 rad/sec with an input amplitude of 0.5 volt.

the output voltage waveform (Fig. 2b) caused by an input stimulus of the form $E_{in} = 5 \sin 628t$ indicate a hysteresis level of ± 1 V.

Simulation of a bistable control system

A bistable control system, designed to control a hydraulic valve,¹ illustrates the ECAP simulation of a nonlinear system (Fig. 3a). The forward loop linear transfer function is the bistable element lag resulting from imperfections, and the feedback transfer function is a shaping network. The bistable element has an output level of ± 25 V with a hysteresis level of ± 0.1 V.

The recommended first step in the simulation procedure is to generate an analog computer diagram from the control system block diagram (Fig. 3b). Note that this simulation diagram provides for the generation of all of the system's internal functions. And, the output of each linear amplifier represents the solution to a linear first-order differential equation.

The second step is to generate an equivalent circuit from the analog computer diagram. Then an ECAP equivalent circuit of the bistable control system block diagram is generated (Fig. 4).

A set of solutions in the frequency range of 0.1 to 62,800 rad/s was obtained for the open-loop linear portion of the system in one computer run with ECAP's modify capability. The open-loop system solution was obtained for use in a describing function analysis. The complete set of frequency solutions required 0.78 minutes of CDC 3400 computer time, for a total of 11 solutions. The computer printed out the node voltages and branch currents in the open-loop equivalent circuit, including magnitude, phase and dB.

Fig. 5 shows the open-loop frequency response ($M_1(j\omega)/R(j\omega)$) and the negative reciprocal ($-1/K_{eq}$) of the bistable element describing function gain.² The intersection of the two plots indicates that the system possesses a stable limit cycle at a frequency of about 5600 rad/sec with an input amplitude of 0.5 V.

For further illustration of the use of ECAP for

6. The transient analysis of the whole system (a) confirmed the result of the describing function analysis. Plots of the transient analysis (b) show a limit cycle at 5690 rad/sec with an amplitude of 0.47 volt.

bistable system simulation, the limit-cycle oscillation of the closed-loop system was also assessed in the time domain. The ECAP transient analysis program input data coding is shown in Fig. 6a for the nonlinear model of Fig. 4. A computer solution for this model was obtained (Fig. 6b). These results indicate that the nonlinear system possesses a stable limit cycle at a frequency of about 5690 rad/s with an amplitude of 0.47 V. The time-domain solution is in quite close agreement with the describing function analysis, thus validating the ECAP simulation approach. The transient response solution used 2.1 minutes of CDC 3400 computer time for a total printout of 65 time solutions. ■ ■

References:

1. Wayne C. Foster, "The Frequency Response Of A Bi-Stable Oscillating Control System." Presented at the 1963 Western Electronic Show and Convention, San Francisco, August 20-23, 1963.
2. John E. Gibson, *Nonlinear Automatic Control*, McGraw-Hill Book Company, Inc. New York (1963).

Test your retention

Here are questions based on the main points of this two-part series. They are to help you see if you have overlooked any important ideas. You may have to refer to Part I (ED 7, April 1, 1968) to find all the answers.

1. List the main features of ECAP programming that make it simpler than straight-forward analog computer programming.

2. What precautions are necessary when parameter values are selected for the ECAP operational amplifier model?

3. How are unit impulse and step function responses obtained from ECAP?

4. Why is ECAP particularly suited to the modeling of nonlinear functions?

```

C      BI-STABLE SWITCHING SYSTEM
C
      TRANSIENT ANALYSIS
B1    N(1,2),R=1E5
B2    N(2,0),R=1E9
B3    N(3,0),R=1.0
B4    N(3,2),C=263.16E-12
B5    N(3,2),R=1E5
B6    N(3,4),R=1E5
B7    N(4,0),R=1E9
B8    N(5,0),R=1.0
B9    N(4,5),R=1E5
B10   N(4,5),C=833.33E-12
B11   N(5,6),R=5E4
B12   N(6,0),C=6666.7E-12
B13   N(6,7),R=5E4
B14   N(7,0),R=1E9
B15   N(8,0),R=1.0
B16   N(7,8),R=1E5
B17   N(7,8),C=0.0794E-6
B18   N(0,12),R=1.0
B19   N(8,9),R=1E5
B20   N(9,12),R=1E5
B21   N(9,0),R=1E9
B22   N(10,0),R=1.0
B23   N(10,9),R=1E5
B24   N(10,11),R=1E5
B25   N(11,0),R=1E5      ,E=(0,-0.1)
B26   N(11,0),R=1E5      ,E=(0.1,0)
B27   N(11,0),R=1E9
B28   N(1,0),R=1.0
B29   N(1,11),R=(1E9,1)  ,E=25
B30   N(11,1),R=(1,1E9)  ,E=25
T1    B( 2, 3),GM=1E5
T2    B( 7, 8),GM=1E5
T3    B(14,15),GM=1E5
T4    B(21,22),GM=1E5
T5    B(27,28),GM=1E5
S1    B=29(25,29),ON
S2    B=30(26,30),OFF
      TIME STEP=2.63E-6
      FINISH TIME=8E-2
      OUTPUT INTERVAL=30
      SHORT=1.0
      PRINT,VO,CU
      PLOT(V1,V3,V8,V10)
      EXECUTE
  
```

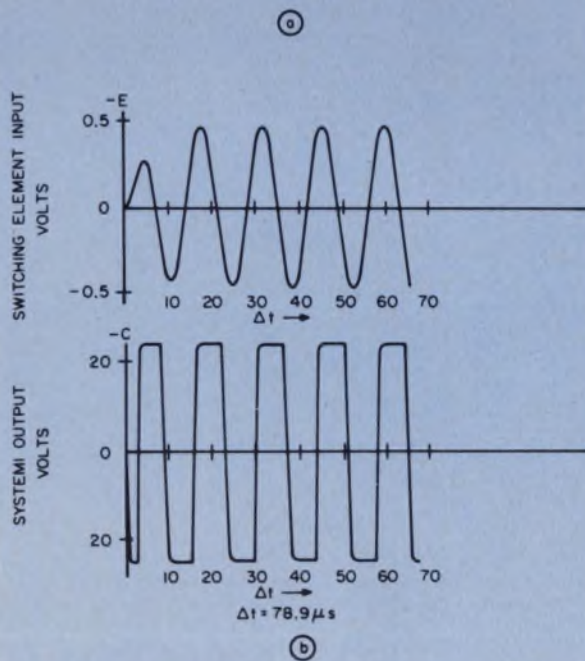

NEW
CORNING[®]
C3 Resistor.

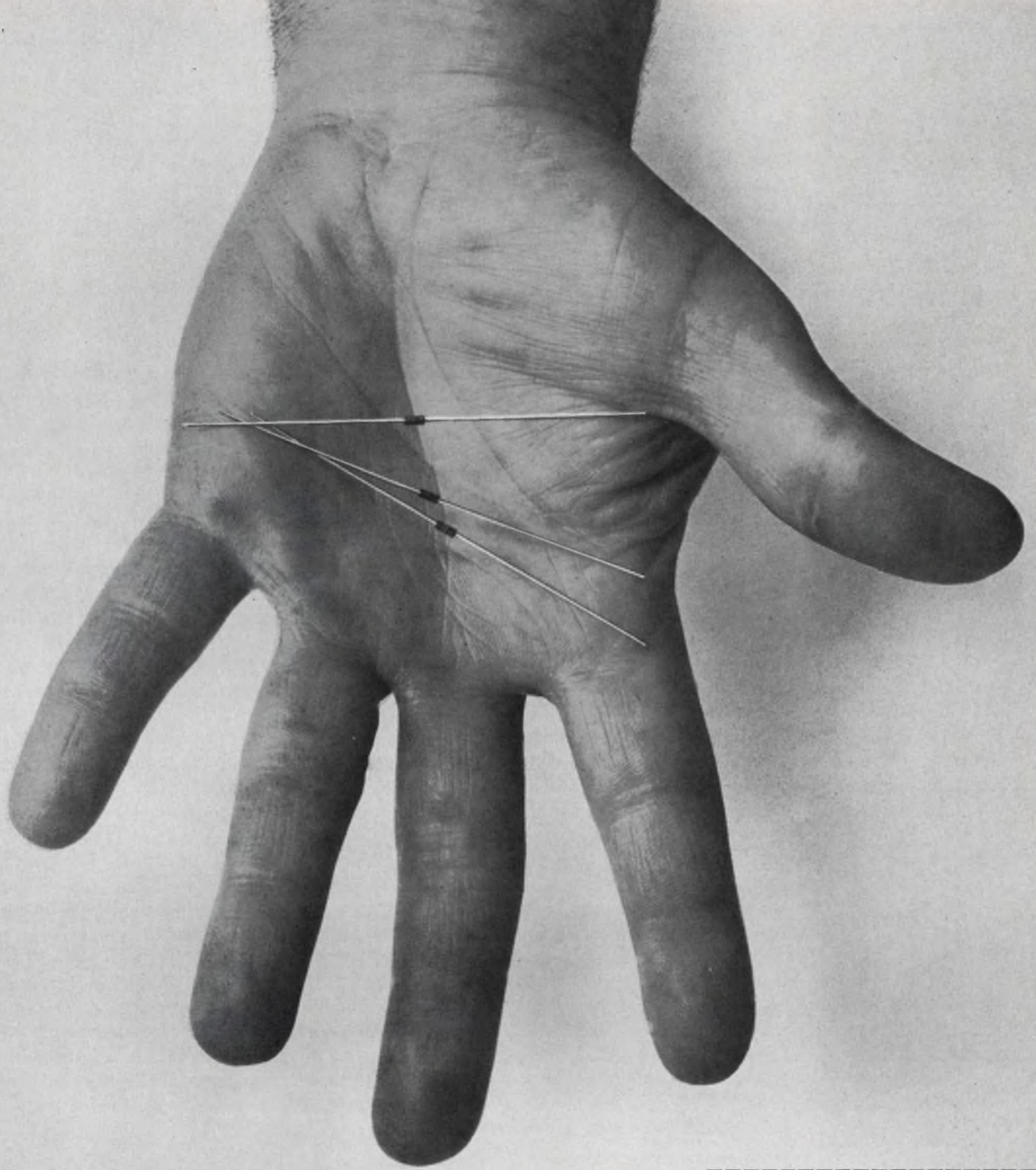

Small.
RN50/RC05 size. Clean lead length .150". Diameter 0.066" maximum. Put more per board.

Stable.
The proven, long-term stability of CORNING Glass Tin Oxide Film Construction.

Rugged.
Leads are beefy .020" dia. Eliminate handling and automatic insertion problems.

Terminated.
With reliable cap construction, not just soldered.

Performs.
Power ratings to 1/8 watt, 70°C. T.C.'s of 100 and 200 ppm. Values from 10 ohms to 150 K. Tolerances of 1, 2, 5 and 10%.

Handy.
Leads are 1½" for easier handling. Reeling is available.

Corning Glass Works
Electronic Products Division
Corning, N. Y. 14830

Gentlemen:

- Please forward data on new C3 Resistor.
 Please send samples of new C3 Resistor.

Name _____

Title _____

Firm _____

Address _____

City _____ State _____ Zip _____

CORNING
ELECTRONICS

INFORMATION RETRIEVAL NUMBER 43

Use ICs in your phase-locked loop.

Complexity is greatly reduced and the parts count is lowered by 60 per cent in a typical circuit.

Integrated circuits are being used to reduce complexity and to lower the parts count in phase-locked loops. In a typical phase-detection system, the parts count can be dropped from 134 (if built with discrete components) to 33.

A sawtooth-characteristic phase detector can be assembled from standard IC flip-flops. The voltage-controlled oscillator (VCO) is made from cross-connected monostable multivibrators. An operational amplifier, with a suitable feedback network, forms the low-pass filter, used in such loops to control frequency jitter in the VCO. The result is a complete phase-locked loop on a 4-by-5-inch circuit board.

The phase-locked loop is, of course, a means of accurately controlling the frequency of a local oscillator. This control is accomplished by comparing, by means of a phase detecting circuit, the oscillator output phase and the phase of an input reference frequency in a closed loop servo system. The oscillator frequency is made to be exactly equal to the input reference frequency.

A common application of phase locking is in the reception of signals in the presence of noise. Here, the input "reference" is a signal that carries information in its phase or its frequency. This signal is invariably accompanied by noise. Properly designed, the loop will lock onto the signal and reproduce it faithfully, but will remove the noise. It will act as a very selective filter and will automatically track the signal frequency.

The basic components of an elementary phase-locked loop are shown in Fig. 1. The phase detector produces an output voltage that is proportional to the phase difference between the input reference frequency and the output frequency of the voltage-controlled oscillator. The low-pass filter smooths the output of the phase detector, amplifies this signal, and applies it to the input of the VCO, causing the VCO frequency to change. Thus, if the zero bias frequency of the VCO (the frequency for zero signal output from the phase detector) differs from the input fre-

quency by a fixed amount, the output voltage of the phase detector will adjust to that value required to make the VCO output frequency equal to the input reference frequency.

IC blocks replace discrettes

One type of phase-locked loop, employing sawtooth-characteristic digital phase detectors, can easily be built with ICs (Fig. 2). The result is a dramatic decrease in parts count. The particular circuit built for testing was made as follows:

The voltage-controlled oscillator was made by cross-coupling two monostable multivibrators and modulating the voltage that their timing capacitors charged toward. The monostable package used contained independent inverters that provided positive feedback for oscillation. The frequency of the VCO was found to be approximately $1.3 C_T R_T$ at zero error signal. The observed transfer characteristic is shown in Fig. 3. The phase-locked loop was designed for the VCO to track directly the input reference frequency; therefore a divider chain was not included in the feedback path.

To minimize phase jitter in the VCO output, the loop bandwidth should be made as narrow as possible. However, to minimize transient error due to modulation of the input signal frequency, and to obtain the best frequency-tracking and capture properties, the loop bandwidth should be made as

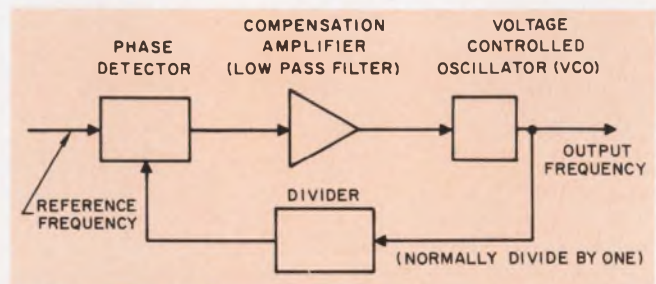

1. The phase-locked loop is used in a variety of applications, including frequency demodulation, frequency multiplication and division, synchronization and the filtering of noisy signals. The output frequency of the voltage-controlled oscillator is made to equal exactly the input reference frequency.

William L. Gill, Senior Digital Application Engineer, and A. Deene Ogden, Advanced Digital Development Engineer, Westinghouse Molecular Electronics Div., Elkridge, Md.

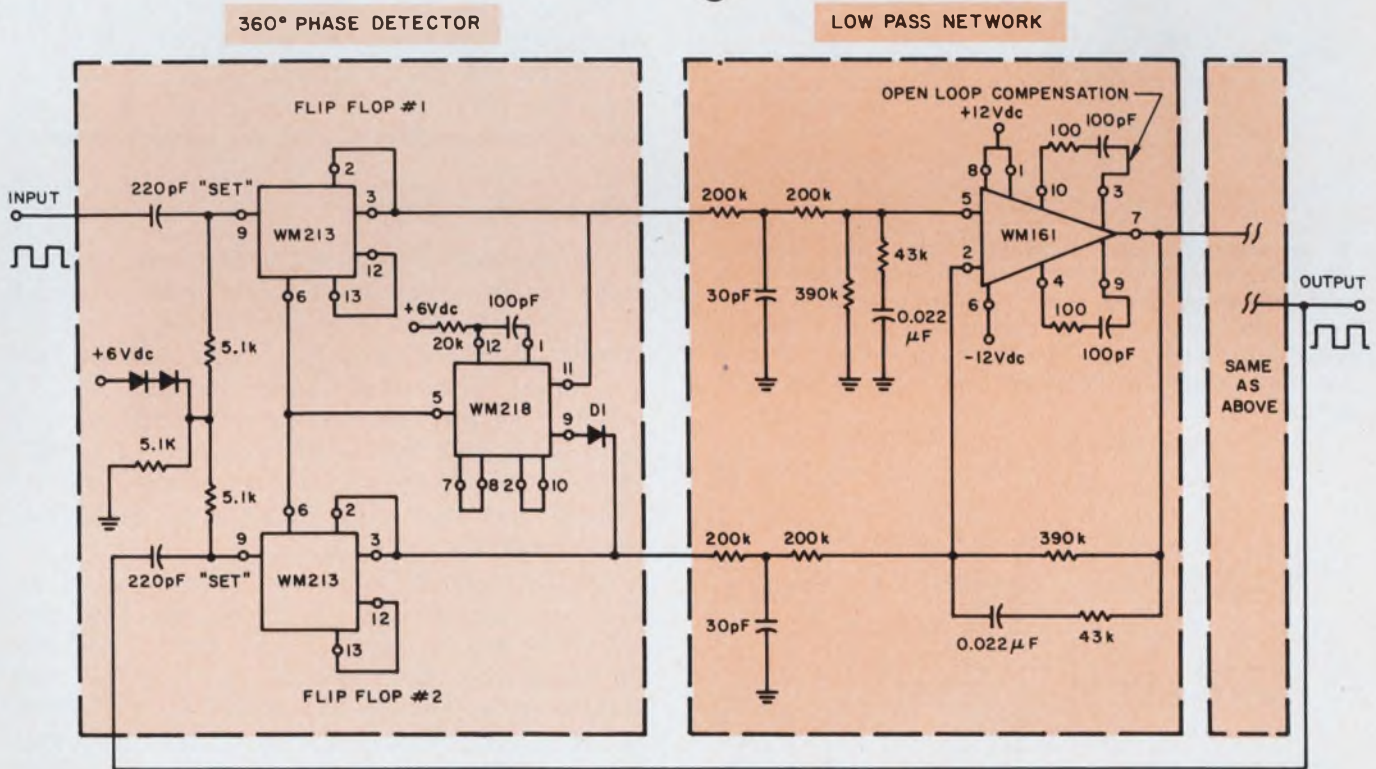
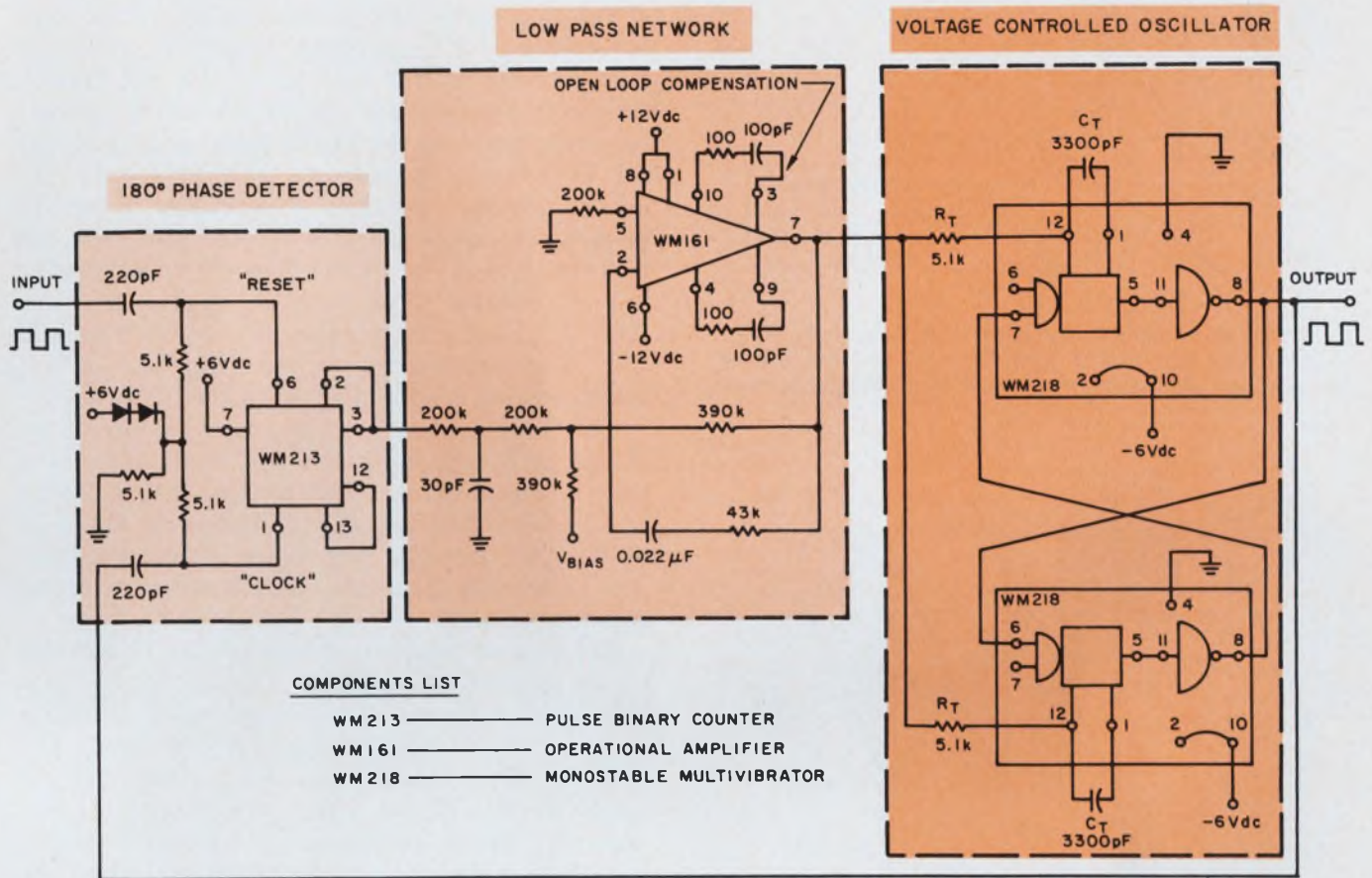

2. Two sawtooth-characteristic digital phase-locked loops were built by the author. The 180° phase detector (a) provided a linear error-signal vs phase-error relationship

over a ±180° phase-error range. The 360° phase detector (b) required more components, but it provided a linear characteristic over a ±360° phase-error range.

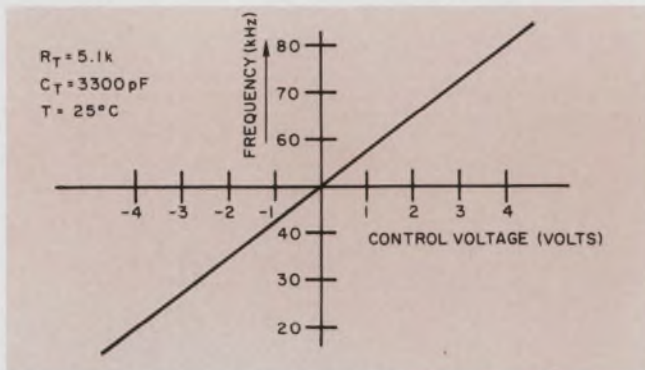

3. A voltage-controlled oscillator was formed by cross-coupling two monostable multivibrators and modulating the voltage that their timing capacitors charged toward.

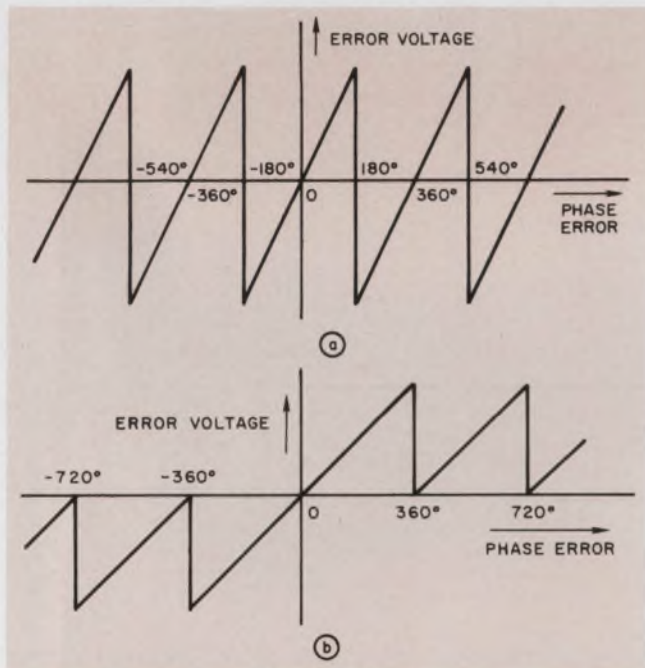

4. The error-voltage vs phase error for the 180° detector (a) is linear over an error range of ±180° and cyclic with increasing phase error. The error voltage for the 360° detector (b) is not continuously cyclic. Positive phase error always gives positive error voltage. Capture and lock ranges are improved over those of the 180° detector.

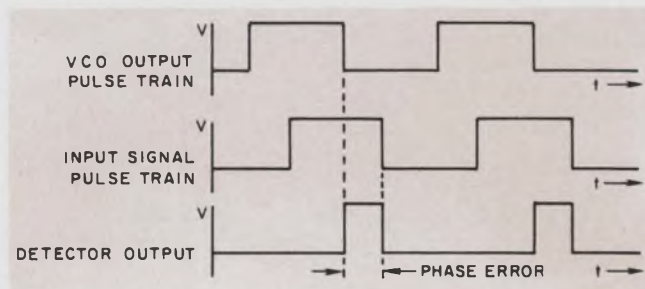

5. The detector flip-flop is set by the VCO feedback pulses and reset by the input reference pulses. The output from the flip-flop is a series of pulses with width proportional to phase error.

wide as possible. These requirements are contradictory, and a compromise is always necessary.

The loop bandwidth was controlled by the low-pass filter. An operational amplifier, with the proper feedback, was used to provide the desired frequency response and also to provide the necessary gain between the phase detector output and the VCO input. In this case, the unity gain frequency for the open loop was chosen to be approximately 4300 rad/s, a figure that provided adequate smoothing of the detector output pulses.

Two different filter circuits were built. The first (Fig. 4a), was an unbalanced version for the 180° detector, and the second (Fig. 4b), a balanced version for the 360° detector.

The filter used in the 180° detector circuit included provision for a dc bias input. This was used to cancel the dc offset present in the output of the 180° detector at zero error. In the case of the 360° detector, the phase detector output was inherently balanced, and such adjustment was unnecessary.

The proper open-loop compensation to provide an operational amplifier depends on the particular op-amp used. The compensated amplifier should have a cutoff frequency well above the intended filter cutoff frequency, so that the op-amp roll-off will not affect the filter performance. The proper component values for the compensation network can be obtained from the manufacturer's data sheet.

During tests, the operational amplifier in the filter circuit was supplied with ±12 V, to avoid saturation effects for output voltage swings approaching 10 V. A ±6-V supply could have been used at some sacrifice of detector voltage range.

Choice of characteristic

Two sawtooth-characteristic phase-detector designs—a 180° detector and a 360° detector—were built with standard IC digital blocks. The 180° detector provided an output error voltage that was linear with phase error over a range of ±180°. The 360° detector provided an identical function over a phase error range of ±360° (Fig. 4). The principles involved in the design of the 360° and 180° phase detector can be utilized with any DTL or TTL logic.

Flip-flop circuits were used in both detectors. The input signal—and, of course, the VCO output—were square waves. Trains of pulses suitable for triggering the phase-detector circuits were derived from these square waves by RC differentiation. The time constants of the RC differentiator networks were chosen to be approximately 100 ns to provide reliable triggering of the flip-flops used.

Both detector types provided fixed-amplitude output pulses, with the width of the pulses pro-

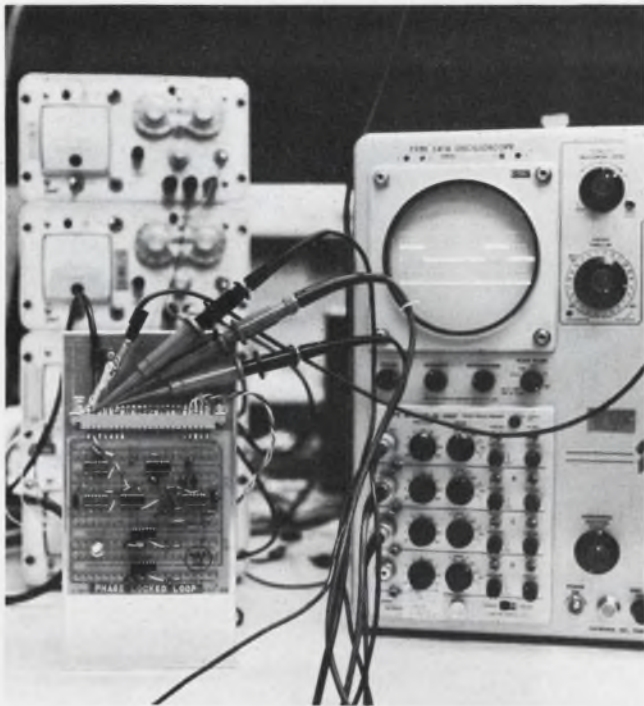

The input signal, a pulse train, is applied to the 360° phase-locked loop (top trace). The resulting error signal is a dc voltage (bottom trace) that tunes the voltage-controlled oscillator to the frequency of the input signal.

portional to the phase difference between compared signals. The sawtooth-characteristic was then obtained by passing these pulses through an RC integrator. The component values used in the RC network were chosen so that the time constant of the network was approximately equal to the period of the VCO at zero error input. In this way pulse integration was provided without affecting loop stability, since the corner frequency of the network was much higher than the closed-loop cutoff frequency.

The minimum measurable phase error was determined by the minimum achievable output pulse width. This, in turn, was dictated by the capabilities of the flip-flop circuits. In general, it is desirable that the propagation delay of the flip-flop be as low as possible. The exact value of minimum pulse width required in a particular application depends on the frequency of operation and on the maximum allowable "dead zone" for that application.

Most system noise was found to originate in the operational amplifier. This noise level was inversely proportional to the value of the op-amp input resistor. This resistor should be held to a low value. Most op-amp manufacturers will specify the lowest permissible value on their data sheet, and this is the value to use.

The first detector built—the 180° detector—required only one flip-flop (Fig. 2a). The operation of this type of circuit is as follows:

The flip-flop is set by the VCO feedback pulses and reset by the input reference pulses. As the

phase difference between the VCO feedback and the input reference signal varies, the pulse width at the flip-flop output varies (Fig. 5). These pulses are passed through an RC integrator, yielding an output voltage directly proportional to phase error (Fig. 4a).

In this case, "zero error" corresponds to a 180° phase difference between the VCO and reference inputs, for which the flip-flop output is a square wave at one-half the VCO frequency. This signal has an average "bias" of $E/2$ V, which is the zero-error output of the detector.

The 180° detector is an economical circuit, requiring only one flip-flop and a few discrete components, but it has some shortcomings:

- The VCO output signal and the reference frequency are 180° out of phase for zero error signal conditions. This can be a disadvantage in some control circuits.

- The tolerable phase-error range is limited by the design to $\pm 180^\circ$.

- The output waveform is a fixed amplitude square wave for zero error conditions. This square wave has to be heavily filtered before application to the VCO to prevent excessive frequency jitter.

360° detector found superior

The basic deficiencies in the 180° detector circuit are overcome by the 360° circuit. Two flip-flops are required, connected as shown in Fig. 2(b). Flip-flop 1 is set by a pulse derived from the input reference signal. The output of flip-flop 1 remains in the high state until the next pulse, from the VCO feedback, sets flip-flop 2. With both flip-flops 1 and 2 in the high state, the monostable multivibrator is triggered, resetting both flip-flops simultaneously. Diode D1, attached to the expander node of the inverter gate of the monostable, is used to expand the inverter gate into a two-input NAND gate, to detect the presence of an input from both flip-flops. The output of the detector is therefore a fixed-amplitude output pulse with a width proportional to the phase difference between the VCO feedback pulse and the input reference frequency, as shown in Fig. 5.

The error signal is then produced by subtracting the outputs of flip-flops 1 and 2 with an operational amplifier. As the system approaches zero error, the pulses generated by this detector circuit become more and more narrow, until at zero error there is no signal output. As the phase error becomes negative, flip-flop 2 is set first, since the pulse derived from the VCO signal is the first to enter the detector circuit. Detector action is unchanged, but the output is inverted by the action of the differential amplifier in the filter circuit. The error voltage for negative phase

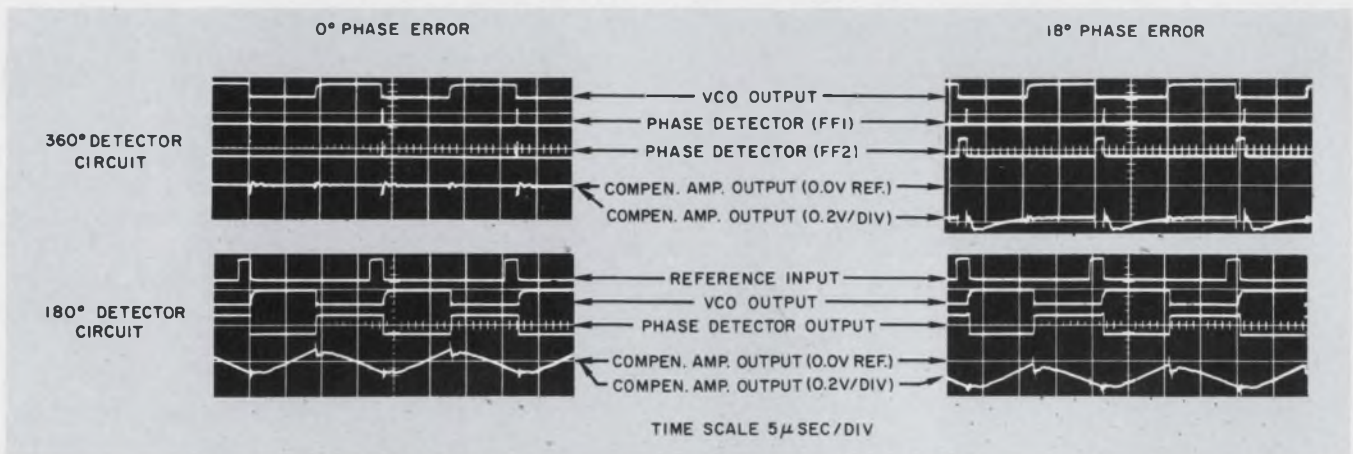

6. Waveforms observed during circuit operation show that error-voltage fluctuations under zero-error conditions

are much greater for the 180° detector circuit. These fluctuations cause jitter in the VCO output.

error is thus negative. The transfer characteristic is as shown in Fig. 4b.

The 360° detector is an improvement on the 180° type for the following reasons:

- The VCO signal is in phase with the reference signal for zero-error signal output.
- The tolerable phase error range is $\pm 360^\circ$.
- The output of the detector is a pulse train that is integrated to yield the sawtooth characteristic. As the phase error approaches zero, the output pulse width approaches zero, until at zero phase error there is no error signal output. Jitter of the VCO for zero phase error conditions is thus negligible.

The phase-locked loop was tested with both detector types. The open-loop gain and phase characteristics were held constant for the tests. Loop performance was not limited by saturation of the compensation amplifier nor by the dynamic range of the VCO. Thus differences in closed-loop performance characteristics were a direct consequence of differences in phase detector characteristics.

Of particular interest in these tests were the "capture" and "lock" ranges of the phase-locked loops. The lock range is the total drift in signal frequency from zero bias frequency that can be compensated for by the phase-locked loop under operating conditions. The capture range of a phase-locked loop is the largest unlocked frequency difference over which the system can obtain lock.

The results of the laboratory tests are tabulated in Table 1. The 360° phase-detector system was found to have the largest lock and capture ranges by a significant margin.

Shown in Fig. 6 are circuit waveforms for the 180° and 360° detector. These correspond to an 18° error and zero error. It is important to note that the output of the compensation amplifier for the 180° phase detector system contains a much larger quasi-steady state transient than that for

Table 1. Capture and lock ranges

Item	180° Detector	360° Detector	360° Advantage
Capture range	± 8 kHz	± 27.1 kHz	3.4 : 1
Lock range	± 17.9 kHz	± 36.6 kHz	2.0 : 1

the 360° phase detector system. The amplitude of this "transient" determines the amount of frequency jitter present in the VCO output. Again, the 360° detector system is superior.

Table II is a parts list of the number of components required to make the 360° and the 180° phased-lock loops. Also included is an estimate of the number of parts it would take to fabricate the systems with discrete components. The replacement of discrete components with integrated circuits reduced the total parts count of both loops by approximately 60%. Use ICs in your phase-locked loop! ■■

Test your retention

Here are questions based on the main points of this article. They are to help you see if you have overlooked any important ideas. You'll find the answers in the article.

1. Which type of detector—the 180° or the 360°—provides a "zero error" signal when the input signal and VCO signal are 180° out of phase?

2. Why is the error signal from the 180° detector more difficult to filter than that from the 360° detector?

3. Which type of detector has the largest capture and lock ranges?

...and switch to the highest quality switches ever made: Shallcross!

These are the switches designed for function and performance, not to low price. Yet they're priced competitively!

They give you a quality "feel." A solid feel. The kind you don't get in cheaper switches.

Not surprising. Because we use only the best materials and conservative design standards in creating Shallcross rotaries. For both commercial ratings and switches designed to MIL-S-3786.

All this pays-off for you. With Shall-

cross switches, you get lower initial contact resistance. So you can use them on more exacting applications.

You get better contact-resistance stability, so your equipment holds calibration better.

And you get better voltage and current ratings for a given size. More switch per volume.

You get versatility, too. Select from 1" wafer, 1 $\frac{3}{4}$ " deck, and 2 $\frac{1}{2}$ " deck configurations, plus round and oval ceramics —for every rotary application.

Join our rotary club. Switch to the Number One rotary switch: Shallcross. See your local Cutler-Hammer Sales Office or Shallcross Stocking Distributor. Or write for catalog LA-163-G217.



Cutler-Hammer offers a complete selection of other quality switches. Commercial forms are covered in catalog LL-290, Military ratings in Catalog LL-291.



CUTLER-HAMMER
Milwaukee, Wisconsin 53201

Join our rotary club



Switch
to No. 1

More than just switches:
prompt availability,
field help, innovation,
quality assurance too.

INFORMATION RETRIEVAL NUMBER 44

ON READER-SERVICE CARD

Calculate distributed capacitance of coils

with an easy-to-make cardboard slide rule. Use it whenever measurements are made with a grid dip meter.

Sometimes *Q*-meters don't work out too well in distributed-capacitance measurements. The capacitance may be too small, the error introduced by the *Q*-meter too large, and the meter itself may be inconvenient. Your best bet then is a grid dip meter. It can be brought right up to the chassis and detect extremely small values of capacitances, for errors in absolute meter calibration are cancelled by reliance on the ratio of two results.

The illustrated slide rule is handy when the ratio that yields a coil's distributed capacitance has to be computed. This ratio is formed by the results of two measurements. First the coil's resonant frequency is measured with an arbitrary capacitance connected across the coil, then with the capacitor removed. Finally the two detected values of resonant frequencies are then set on the slide rule and the coil's capacitance is found.

Build the slide rule

Building the slide rule is almost as easy as using it. All you need is some cardboard, some rubber cement and the cutouts on the opposite page. Follow the illustration below. Call the capacity slide *A*, the frequency slide *B* and the front panel of the slide rule *C*.

Cut out the two slides (*A* and *B*) and the front (*C*). Cement each of the three to a piece of cardboard, and cut out the windows on *C*. Trace the outline of the front onto another piece of cardboard to be used as a back piece, and cut it out.

Take a piece of heavier cardboard and cut out spacers of the same length as the slide rule. Cut one spacer 3/16-inch wide and two spacers about 9/16-inch wide. If heavier cardboard is not available, use the same material from which you are making the slides and shim each spacer with thin cardboard from a manila file folder.

Hold the frequency slide behind the lower cutout on *C* and the capacity slide behind the upper cutout so that both pairs of baselines are together. Cement the 3/16-inch spacer to the back of *C* to

form a guide between the two slides. Cement the two wider spacers to the front, to complete the slide guides. Cement the back of the frame to the spacers, trim up the edges, and the slide rule is ready to use.

How to find the ratio

Set the two resonant frequencies, determined with the grid dip meter, opposite each other in the lower window. Using the vertical lines between windows as guides, set the arrow of the top slide directly over the place where the lower slide's diagonal line crosses the top of the lower window. Opposite the value of capacitance added to obtain the first resonant frequency, read the coil's distributed capacity.

For example, a grid dip meter near a coil shows that its self-resonant frequency is 38 MHz; the addition of 21 pF across the coil shifts the resonant point to 22 MHz. When these two values are set opposite each other in the lower window, the diagonal line will cross the upper side of the window a little past the tenth vertical line. Set the arrow of the upper slide directly over that same point. Above an added capacity of 21, read the coil's distributed capacity of 6.

The ranges of values shown on the rule can be extended by moving the decimal point the same number of places, as required, on either or both pairs of scales. ■■

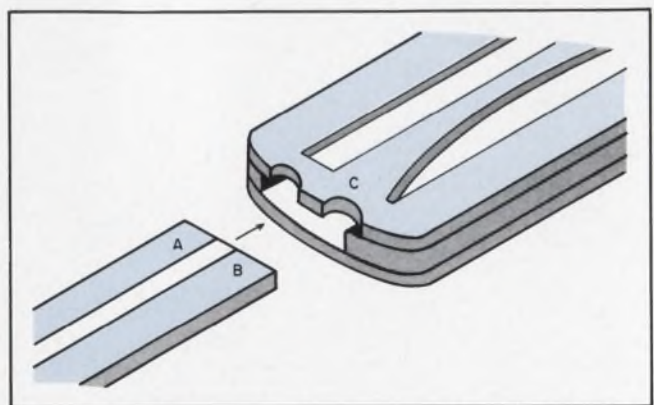

Donald W. Moffat, Consultant, San Diego, Calif.

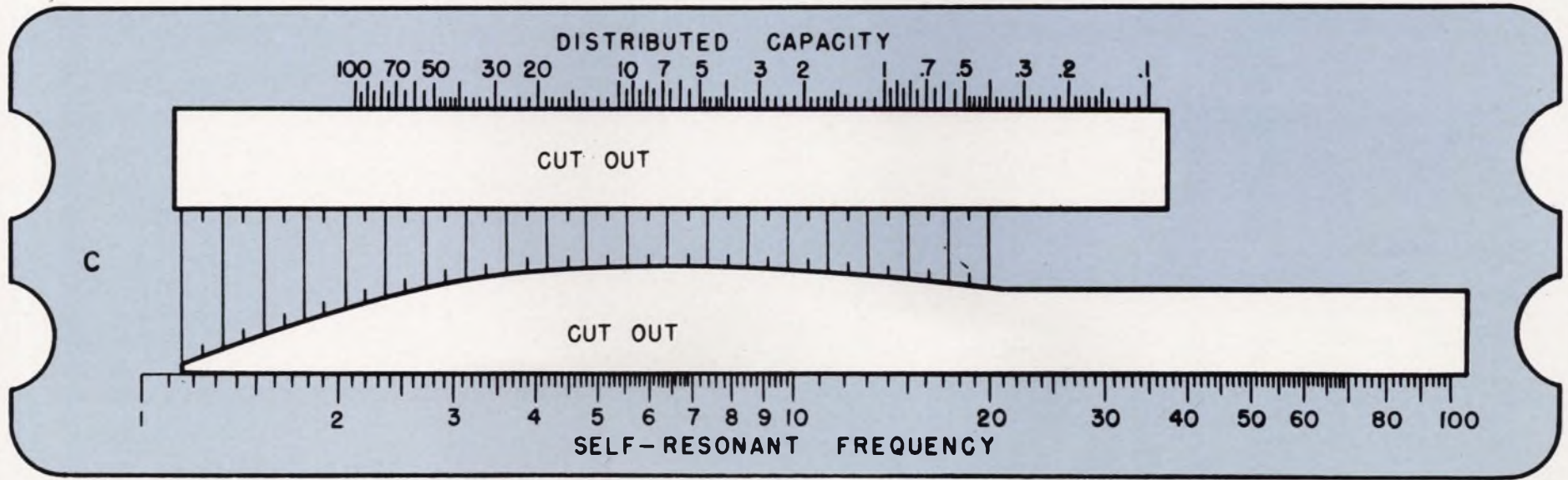
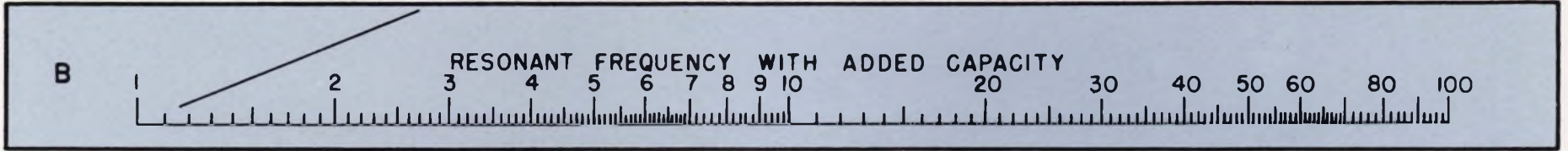
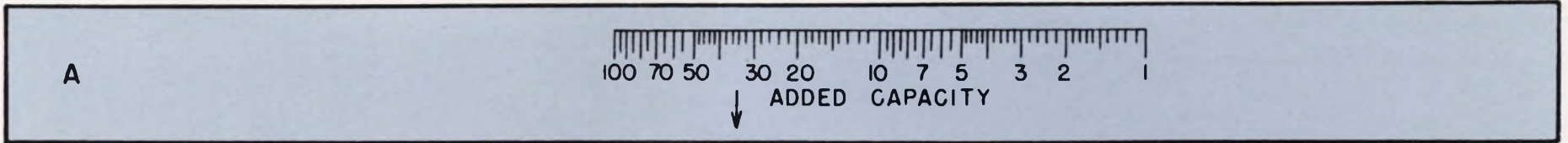

Announcing the Winners of 'Top Ten' Contest

Winners among Readers:

- 1st Prize: 2 Round Trip NY-Paris** R. Thompson, Westinghouse R & D
2nd Prize: HeathKit-Theater Organ Raymond S. Turgel, NBS
3rd Prize: HeathKit-Color TV Joe W. Hutchins, Phillips Petroleum

4th-11th: Stereo Amplifier Kits:

- 4th:** Satoshi Ito, Air Research Mfg. Co.
5th: J. F. Kalinowski, General Electric Co.
6th: William Wheaton, Univ. of Calif. at San Diego
7th: Roy Larsen, Trans-R-Ducer
8th: Lauren G. Fischer, Comm. & Systems Inc.
9th: J. R. Prokop, Automatic Electric Labs.
10th: Anthony De Berardis, Unitrode Corp.
11th: Donald Kimmel, Westinghouse R & D Center

12th-62nd prizes: Copies of "Microelectronic Design"

James Husty
IIT Research Inst
Jerome F. Lowenstein
Motorola Inc
Ben Nilsson
IBM Corp
Frank Furstinger
Bendix Corp
Rod P. Attwooll
Plessey Radar
F. Chethik
Hughes A/C
C. Helgesen
Vega Veieteknikk a/s
Kenneth S. Burgess
Aro Inc
R. E. Wilson
Spectral Dynamics Corp.
T. Chellstorp
John Fluke Mfg. Co.
J. B. Williams
U.S. Army-SENSCOM
U. Hamalainen
Geological Survey of Finland
Paul A. Bannister
Autonetics

Ronald Speirs
Sperry Flight Systems Div.
J. R. Lane
General Electric
Douglas R. Myhre
Honeywell, Inc.
Fred James
Sandia Corp
C. P. Germano
Clevite Corp.
Ronald L. Tovsen
Sylvania Electronic Systems
Ronald L. Spencer
E. I. duPont de Nemours & Co
David A. Beckman
NASA
Robert L. Shaltde
Mandrel Ind
Wayne F. Miller
Caltech. Seismological Lab.
Vernon J. Laurie
Fairchild-Hiller
Charles J. Kring
Comcor, Inc.
R. J. Moreau
General Electric Ordnance Dept

K. Stockhoff
Litton Ind.
George Mistic
Motorola Inc
John Petranic
Brush Instruments
R. W. Reiner
Hughes Aircraft Co
David W. Phillips
IBM
Gene West
AC Electronics
J. S. Dailey
Control Data Corp
M. H. Tang
NASA
Philip H. Noll
Emerson Electric Co.
Christian J. Simonsen
Tempo Instrument Inc
Sam J. Gozzo
Dept. of Interior
William H. Watson
Zenith Radio Corp
Capt. James F. Reilly
USAF

Paul C. Wade
Lockheed Electronics Co
Warren Hendryx
Magnavox
John B. MacLead
NASA
Lawrence Kirk
NASA/MSC
P. A. Espen
Sperry Flight Systems Div
B. N. Satian
Triad Transformer Corp.
Ken Feige
Specialized Area Consultants
B. Sebestyen
Institute of Nuclear Research
Ronald T. Miyahira
Hawaiian Telephone Co.
Ralph U. Moody
Aerospace Corp.
Jack Shirman
Stromberg-Carlson
A. M. Eisner
Western Union Tele Co.

Winners among Marketing Group:

- 1st Prize: Closed Circuit TV** Gerry Heagney, Thomas & Betts
2nd Prize: 2 Round Trip NY-Paris Thomas S. Jones, Jones, Mather, Roberts Inc.
3rd Prize: 70-Watt Stereo Amplifier Robert E. Insley, General Electric Co.



*In days of old, when swains were bold,
 Before the electronic computer;
 The "electric kiss" was a test of love
 To match a lass and suitor.*

One of a series of...
Vignettes in Electronic History

The "electric kiss" was a romantic 18th Century fad, but it produced no practical results even for that early period. Today, ardor and zeal alone are even less likely to produce significant technological innovation. Now, only the companies with the most modern facilities and the best people and machines can maintain technical leadership. That's why a visit to Spectrol's new facility in the City of Industry has turned many a skeptic into a fervent customer. Quote from a large user of potentiometers: "What impressed me most wasn't just the large, modern, R&D, fabrication, and assembly areas; but also the orderly

layout and the efficient way people went about their jobs. It looked to me like good management as well as a fine facility —and that's what makes for reliable products." But why not? Spectrol designed and built this plant from the ground up for the sole purpose of producing the quality components you need, at competitive prices. Of course, we're not perfect yet but we're working at it! (Perhaps you'd like to be working with us.)

Spectrol Electronics Corporation

*A subsidiary of the Carrier Corporation
 17070 E. Gale Ave., City of Industry, Calif. 91745
 Copyright ©1967*



Better Components for Better Systems: precision potentiometers • trimming potentiometers • turns-counting dials • miniature switches

A limited number of full-color reproductions of the "electric kiss" painting, along with the story of the experiment, are available upon request.

Is transistor-transistor logic a fad?

Why do many people specify TTL when they don't need the speed or drive capability? Is it a fad?

Yes. In part, the widespread popularity of TTL is the latest fad. Recently TTL has become the most highly touted type of logic, and many engineers are influenced simply by this advertising. Many designers are employing this logic form in preference to lower-speed logic forms, which would satisfy their requirements as well. However, there is now a good economic reason for specifying TTL. Since it is becoming the most popular commercially available form of logic, it has the potential of developing the greatest production volume, the largest number of suppliers, and thus the lowest potential cost.

Question submitted by Amaury Piedra, Senior Development Engineer, ITT Semiconductors, West Palm Beach, Florida

Can a high-frequency amplifier, mixer and i-f amplifier be fabricated on the same wafer?

Yes. Not only can these circuits be fabricated on the same wafer, but even on the same chip. RCA, Westinghouse and several other manufacturers have made commercially available a series of linear circuits in which these functions are combined on a single chip. Built with basic planar technology in silicon monolithic form, these products are finding application in television, particularly in color sets. They are also employed in more sophisticated airborne radar applications where their small size and high reliability are attractive features.

Question submitted by Ted Gill, Research Engineer, Lockheed Missiles and Space Co., San Jose, Calif.

Test your IC IQ is a collaboration between the editors of ELECTRONIC DESIGN and the staff of the ICE (Integrated Circuit Engineering) Co., Phoenix, Ariz. Readers of this new column are invited to submit their questions to Test your IC IQ, ELECTRONIC DESIGN magazine, 850 Third Ave., New York, N.Y. 10022. Those who submit questions chosen for publication will receive a complimentary copy of **Microelectronic Design**. (Earliest postmark wins in the event of identical questions.)

Why don't manufacturers state the maximum allowable junction temperatures for their ICs?

Maximum allowable junction temperatures are usually of little interest to designers. A specification of maximum power dissipation is easier to work with, and it amounts to the same thing. If the maximum junction temperature were to be used as a design limitation, the engineer would need detailed knowledge of the junction-to-case thermal resistance for each circuit type that he used. Instead, he is provided with a power dissipation limit for the device, this being a quantity that he can measure directly. In this limit, the manufacturer includes sufficient derating to allow for variations in thermal resistance between the junction itself and the ambient temperature of the IC's environment.

Question submitted by Francis A. Shukis, Senior Engineer, Raytheon Co., Bedford, Mass.

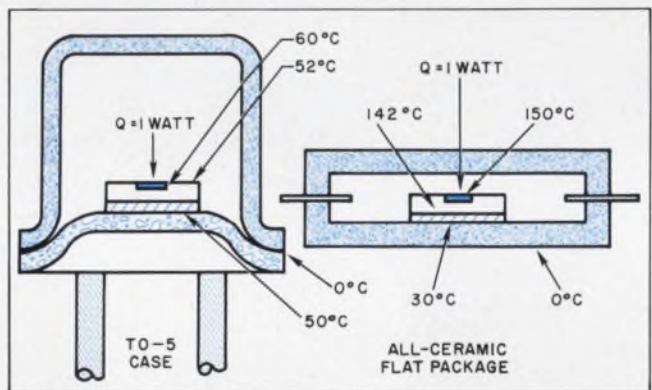

1. These typical temperature distributions were measured on operating IC units for two common IC packages. In each case the package was held at 0°C.

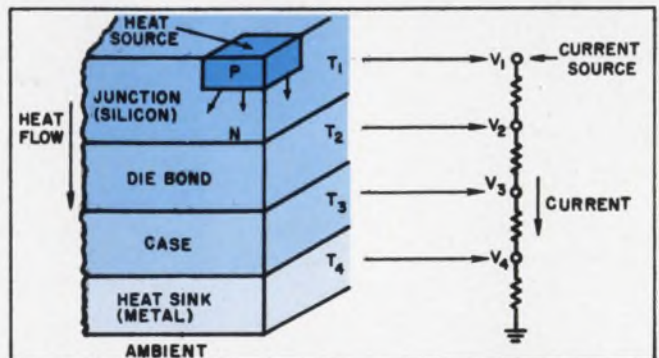

2. Complex intrachip and intracase thermal resistances can be simplified to a series of lumped equivalent resistances. Junction temperature is directly proportional to the power dissipated in the IC device.

Will LSI be limited to custom systems?

Virtually all applications of LSI in the immediate future will be in custom configurations. Large-volume applications for the inherently complex LSI modules are difficult to find.

System designers are presently studying system partitioning in attempts to develop high-volume requirements for basic building blocks. Standardization on these building blocks will be a necessary part of LSI development. This standardization can be expected to proceed slowly—more slowly than it did with integrated circuits.

Although LSI offers the system designer a potential increase in reliability and a potential decrease in cost the latter will be realized only when large-volume markets are found.

In the immediate future, manufacturers will approach LSI by using one of several multi-chip assembly techniques.

What is the maximum temperature that an integrated circuit can stand without deterioration?

Most silicon transistors and integrated-circuit assemblies will withstand temperatures of up to 300°C. Above this, the gold alloy used to bond the die to the package begins to soften.

If an IC is held at above 100°C for long periods, however, reactions within the package may become a problem. Purple plague formation, for instance—a reaction of gold and aluminum with silicon—is greatly accelerated at high temperature.

What construction techniques will be used for microwave ICs in the immediate future?

The more advanced segments of the industry are concentrating on thick-film techniques. By using film resistors and conductors on ceramic substrates, and adding high-frequency active components or ICs, they obtain high-performance circuits with existing technology. Flip-chip assembly techniques are the most popular at present.

The major limitation of IC application to microwave circuits is the lack of standardization of microwave functions and the lack of potential market volume. ICs are best suited to applications involving the use of large quantities of identical circuits.

Will MOS LSI outsell bipolar LSI if MOS device speeds are increased?

It seems quite likely. If MOS speeds were comparable to those of bipolar devices, MOS techniques would probably be the better choice for LSI.

Existing MOS switching circuits are about an

order of magnitude slower than bipolar circuits. Normally, smaller size implies greater speed, but the MOS operates at a comparatively high impedance level and its circuit time constants are therefore larger.

MOS transistors internal to an array occupy about 1 square mil of area compared to 30 to 50 square mils for a conventional bipolar transistor. This space saving cannot be used to advantage in simple devices, because interconnections and bonding pads cannot be reduced accordingly. In small circuits, such a three-input gate, the MOS version occupies approximately 1/10 of the area of the bipolar circuit. In large, complex arrays, however, the small size of the MOS device becomes an attractive feature.

Why has the CTL family not been very popular?

The complementary transistor logic family relies upon the use of npn and pnp transistors in its circuit structure. This type of structure requires more processing steps than most other logic families, and thus it is difficult to produce with high yield. The CTL family is therefore relatively expensive. In addition to this, it is difficult to produce high-performance npn and high-performance pnp transistors within a single monolithic circuit structure. CTL has been designed into only one major computer system.

What effect does circuit layout have on leakage currents?

In general, there should be little relationship between leakage currents and the layout of an integrated circuit. An exception, of course, is the obvious relation of the junction area to the theoretical leakage value. The multiple emitter transistor is also an exception. Here, each pair of emitters, with the base, can act as a separate transistor. This configuration can, unless correctly designed, provide effective leakage paths through unintended transistor action. In many of the new multiple emitter structures, the geometry has been carefully designed to minimize such lateral action.

What is the major cause of integrated circuit failures?

Data indicate that either surface problems or wire-bond problems are the major cause of field failures. Surface problems usually involve the effect of inversion layers, leakages, etc., which are caused either by poor processing or by ionic contamination problems on the surface of a silicon device. The failures caused by the wire bonding are simply mechanical problems relating to the repeatability and uniformity of bond strengths under all environment conditions.

NO OTHER COMPANY CAN

66

MTOS SILICON P-CHANNEL ENHANCEMENT MODE FIELD EFFECT TRANSISTORS (T _A = 25°C, BODY GROUNDING)										
TYPE	V _{GS} (VOLTS TYP)	I _D (mA TYP)	I _{SS} (mA TYP)	I _{DS} (mA TYP)	BV _{DS} (VOLTS)	BV _{GS} (VOLTS)	V _{GS} (μmhos TYP)	C _{iss} (pF TYP)	I _{FS} (Ω TYP)	I _{FS} (Ω TYP)
MEM 511	4.0	-6.0	-0.5	-0.1	-30	-30	2,500	2.0	150	
2N4353	4.0	-6.0	-0.5	-0.1	-30	-30	2,500	2.0	150	
MEM 517	-3.5	-60	-0.8	-0.1	-30	-25	12,000	10	30	
MEM 517A	-3.5	-60	-0.8	-0.1	-30	-25	12,000	10	30	
MEM 517B	-3.5	-60	-0.8	-0.1	-30	-25	12,000	10	30	
MEM 520	4.0	-6.0	-0.5	-0.3	-30	NA	2,500	2.0	150	
MEM 550*	4.0	-5.0	-0.1	-0.1	-30	-25	1,400	1.1	250	
3N151*	4.0	-7.0	-0.2	-0.5	-30	-30	2,000	NA	250	
MEM 551*	4.0	-5.0	-0.5	-0.3	-30	NA	1,400	1.1	250	
MEM 556	4.0	-7.0	-0.1	-0.1	-65	-70	950	0.3	700	

*Dual Device

MTOS SILICON N-CHANNEL DEPLETION MODE FIELD EFFECT TRANSISTORS (T _A = 25°C, BODY GROUNDING)										
TYPE	APPLICATION	FEATURES	V _{GS} (μmhos TYP)	C _{iss} (pF TYP)	C _{oss} (pF TYP)	NF (dB TYP)	V _{GS} (VOLTS TYP)	BV _{DS} (VOLTS)	I _{FS} (Ω TYP)	I _{FS} (Ω TYP)
MEM 554	LINEAR VHF AMP & MIXERS	DUAL GATE CASCODE	12,000	02	18 @ 200 MHz	3.2 @ 200 MHz	-1.5	-20	50	
MEM 554C	LINEAR VHF AMP & MIXERS	DUAL GATE CASCODE	10,000	02	17 @ 200 MHz	3.7 @ 200 MHz	-1.5	-20	50	
MEM 557	VHF AMP	SINGLE GATE	10,000	40	16 @ 200 MHz	3.2 @ 200 MHz	-1.5	-20	25	

MTOS SILICON N-CHANNEL ENHANCEMENT MODE FIELD EFFECT TRANSISTORS (T _A = 25°C, BODY GROUNDING)										
TYPE	APPLICATION	V _{GS} (VOLTS TYP)	I _D (mA TYP)	I _{SS} (mA TYP)	I _{DS} (mA TYP)	BV _{DS} (VOLTS)	V _{GS} (μmhos TYP)	I _{FS} (Ω TYP)	C _{iss} (pF TYP)	I _{FS} (Ω TYP)
MEM 562	GEN PURPOSE SWITCH	1.2	20	1.0	.01	30	4000 @ 10 mA	150	1.0	
MEM 563	HIGH GAIN SWITCH	1.2	60	1.0	.01	20	7000 @ 10 mA	50	1.0	

LOGIC CIRCUITS		POWER CONSUMPTION (mW MAX)	SUPPLY VOLTAGE (VOLTS)	PROPAGATION DELAY (ns TYP)	LOGIC LEVELS				FREQUENCY
TYPE	FUNCTION				"1"	"0"	"1"	"0"	
MEM 1000	DUAL FULL ADDER	55	-13V ± 1V -27V ± 1V	350	-10V	-2.0V	-11V	-1.0V	—
MEM 1002	DUAL 3-INPUT NOR GATE	35 per Gate	-27V ± 1V	200	-10V	-2.0V	-11V	-1.0V	—
MEM 1005	R-S-T FLIP-FLOP	70	-27V ± 1V	950 (Max)	-10V	-2.0V	-11V	-1.0V	dc to 500 kHz
MEM 1008	DUAL EXCLUSIVE OR/NOT GATE	60 per Gate	-27V ± 1V	300	-10V	-2.0V	-11V	-1.0V	—
MEM 1013	QUAD 2 INPUT NOR GATE	13 per Gate	-13V ± 1V -27V ± 1V	200	-10V	-2.0V	-11V	-1.0V	—
MEM 1014	QUAD 2 INPUT AND GATE	14 (Circ 1,2,3) 42 (Circ 4)*	-13V ± 1V -27V ± 1V	250	-10V	-2.0V	-11V	-1.0V	—
MEM 1015	DUAL J-K FLIP-FLOP	82 per Flip-Flop	-13V ± 1V -27V ± 1V	300	-10V	-2.0V	-11V	-1.0V	dc to 1.0 MHz
MEM 1022	9 BIT PARALLEL PARITY DETECTOR	80	-27V ± 1V	500	-10V	-2.0V	-11V	-1.0V	dc to 500 kHz
MEM 1050	4 STAGE BINARY UP-DOWN COUNTER	300	-27V ± 1V	—	-10V	-2.0V	-11V	-1.0V	dc to 160 kHz
MEM 1050B	4 STAGE BINARY UP-DOWN COUNTER	300	-27V ± 1V	—	-10V	-2.0V	-11V	-1.0V	dc to 2.5 MHz
MEM 1051	BUFFERED D/A CONVERTER	35	-13V ± 1.5V -25V ± 3V	—	-10V	-2.0V	-11V	-1.0V	dc to 500 kHz
MEM 1055	4 STAGE BINARY UP-DOWN COUNTER WITH RESET	300	-27V ± 1V	—	-10V	-2.0V	-11V	-1.0V	dc to 2.5 MHz

* The MEM 1014 provides Four 2-Input AND Gates (Circuits 1,2,3,4). Circuit 4 also provides a NAND Output

MULTIPLEXER CIRCUITS		OFF RESISTANCE (Ω TYP)	ON RESISTANCE (Ω TYP)	CAPACITANCE (pF C ₉₀)	BV _{DS} (VOLTS)	BV _{GS} (VOLTS)
TYPE	FUNCTION					
MEM 2002	5 CHANNELS (4 Channels -Common Drain)	10 ^M	200	1.1	-30	-30
MEM 2003	4 CHANNELS (Protective Diodes)	10 ^M	200	1.1	-30	-30
MEM 2004	4 CHANNELS (No Diodes)	16 ^M	200	1.1	-30	-60
MEM 2005	4 CHANNELS (Dual 2 Channel)	10 ^M	200	1.1	-30	-30
MEM 2006	3 CHANNELS (2 Channels -Common Drain)	10 ^M	200	1.1	-30	-30
MEM 2009	6 CHANNELS (Protective Diodes)	10 ^M	150	1.9	-30	-30
MEM 2017	6 CHANNELS (Protective Diodes)	10 ^M	700	0.5	-50	-50

MAKE THIS STATEMENT:

SERIES SHUNT CHOPPER		OFFSET VOLTAGE	CLOCK ϕ	FREQUENCY (MHz)	ON RESISTANCE PER UNIT (SERIES OR SHUNT) (Ω TYP)	OFF RESISTANCE PER UNIT (SERIES OR SHUNT) (Ω TYP)	SIGNAL VOLTAGE HANDLING RANGE (TYP)
TYPE	FUNCTION						
MEM 2008	INTEGRATED SERIES SHUNT CHOP CIRCUIT	0	1	100	6K	10^{11}	$1\mu\text{V} - 10\text{V}$

SHIFT REGISTERS		STATIC	DYNAMIC	FREQUENCY	NUMBER OF BITS	INPUT		OUTPUT		NO. OF CLOCKS	SUPPLY VOLTAGE (VOLTS)
TYPE	FUNCTION					PARALLEL	SERIES	PARALLEL	3-STATE		
MEM 3005PP	5-BIT PARALLEL IN/PARALLEL OUT	X		dc to 1.0MHz	5	X	X	X	X	2	-13V - 1V
MEM 3005SP	5-BIT SERIAL IN/PARALLEL OUT	X		dc to 1.0MHz	5		X	X	X	2	-13V - 1V -27V - 1V
MEM 3008PS	8-BIT 2/4 PARALLEL IN/SERIAL OUT	X		dc to 1.0MHz	8	X	X		X	2	-13V - 1V -27V - 1V
MEM 3012SP	12-BIT SERIAL IN/PARALLEL OUT	X		dc to 100kHz	12		X	X	X	1	-27V - 1V
MEM 3016-2	DUAL 16-BIT	X		dc to 1.0MHz	32 (16,16)		X		X	2	-13V - 1V -27V - 1V
MEM 3020	20-BIT	X		dc to 1.0MHz	20		X		X	2	-13V - 1V -27V - 1V
MEM 3021	21-BIT	X		dc to 500kHz	21 (1,4,16)		X		X	1	-27V - 1V
MEM 3021B	21-BIT	X		dc to 250kHz	21 (1,4,16)		X		X	1	-27V - 1V
MEM 3032	6-14 BINARY WEIGHTED	X		dc to 1.0MHz	32 (1,1,2,4,8,16)		X		X	1	-13V - 1V -27V - 1V
MEM 3040	40-BIT	X		dc to 1.0MHz	40 (4,4,16,16)		X		X	1	-13V - 1V -27V - 1V
MEM 3050	DUAL 25-BIT		X	10kHz to 500kHz	50 (25,25)		X		X	2	-27V - 1V
MEM 3064	64-BIT SERIAL ACCUMULATOR		X	10kHz to 5.0MHz	64		X		X	4	NONE
MEM 3064B	64-BIT SERIAL ACCUMULATOR		X	10kHz to 2.0MHz	64		X		X	4	NONE
MEM 3064-2B	DUAL 64-BIT SERIAL ACCUMULATOR		X	10kHz to 2.0MHz	128 (64,64)		X		X	4	NONE
MEM 3100	DUAL 50-BIT		X	10kHz to 2.0MHz	100 (50,50)		X		X	2	-18V - 1V
MEM 3128	128-BIT		X	10kHz to 2.0MHz	128		X		X	2	-18V - 1V
MEM 3198	TRIPLE 66-BIT		X	10kHz to 1.0MHz	198 (66,66,66)		X		X	2	-27V - 1V

LARGE DIGITAL SUBSYSTEMS		POWER CONSUMPTION (mW)	SUPPLY VOLTAGE (VOLTS)	CLOCK RATE	DESCRIPTION
TYPE	FUNCTION				
MEM 5014	A/D-D/A CONVERTER ELEMENT	135	-27V - 1V	dc to 200 kHz	Complete logic and analog switching for 10 bit successive approximation A/D converter.
MEM 5015	16 CHANNEL RANDOM ACCESS MULTIPLEXER	80	-27V - 1V	dc to 100 kHz	Sixteen Channel Multiplexer with address storage and decoding.
MEM 5021	DDA ELEMENT	100	-13V - 1V -27V - 1V	dc to 500 kHz	Ternary type DDA performing rectangular integration.
MEM 5031	SERVO ADDER	25	-13V - 1V -27V - 1V	dc to 1.0 MHz	Shift Register content decision unit used in conjunction with the MEM 5021.
MEM 5035	2 INPUT DELTA "Y" SUMMER	80	-13V - 1V	10 kHz to 500 kHz	2 Input Delta "Y" Summer used in conjunction with the MEM 5021.
MEM 5116	16 CHANNEL RANDOM SEQUENTIAL ACCESS MULTIPLEXER	100	-27V - 1V	dc to 500 kHz	Sixteen Channel Multiplexer with parallel access counter and decoding.
MEM 5132	RANDOM ACCESS MEMORY CELL	100	+5V - 0.5V -12V - 1V	dc to 500 kHz	32 BIT Random Access Memory Cell for large and small Memory Systems.

4th GENERATION SYSTEMS		POWER CONSUMPTION (mW)	SUPPLY VOLTAGE (VOLTS)	CLOCK RATE	DESCRIPTION
TYPE	FUNCTION				
S-C-100	MINIATURE A/D CONVERTER SYSTEM	300	-27V - 2V -15V - 2V -15V - 2V REF. VOLT	dc to 100 kHz	Complete 10 BIT A/D Converter System
S-C-101	MINIATURE D/A CONVERTER SYSTEM	300	-27V - 2V -15V - 2V +15V - 2V REF. VOLT	dc to 200 kHz	Complete 10 BIT D/A Converter System

”

All 61 MTOS devices listed are available off-the-shelf from your authorized General Instrument distributor.



Write for complete information. (In Europe contact General Instrument Europe, Via Turati 28, Milano, Italy.)

GENERAL INSTRUMENT CORPORATION • 600 WEST JOHN STREET, HICKSVILLE, L. I., NEW YORK

INFORMATION RETRIEVAL NUMBER 46

Put some life into your technical talk.

Why lose your audience, when it's easy to keep it with meaningful and lively visual aids.

When was the last time you fidgeted in your seat during a technical talk or conference?

Chances are that the talk was poorly illustrated, or not illustrated at all.

The value of visual material is readily apparent to anyone who has tried to communicate with an audience or anyone who has tried to sit through a dull technical presentation. In most instances, words alone cannot get the total message across. A skillful blending of words and illustrations is a good way to guarantee success in presenting a technical paper.

The problem for most engineers is that they don't know how to prepare the slides, if their company doesn't have an art department to help them. Even some art departments, accustomed to turning out technical drawings or wiring diagrams may produce very poor slide copy. Many are accustomed to producing blueprints or fine-line drawings, which may be 8-1/2 × 11 inches or even two or three feet wide, for reading at a distance of 10 to 18 inches. The requirements for slides differ markedly from these specifications.

It never hurts to learn to do it yourself.

There are five stages in producing effective slides for a technical talk:

1. Organize the presentation.
2. Select the method to be used.
3. Prepare the material.
4. Produce the slides.
5. Evaluate the results.

Organize the presentation

A good presentation with slides requires a careful analysis of the material to be communicated. It calls for selecting only the pertinent portions of the technical presentation for illustration. Keep these basic points in mind:

- All the the narrative and all of the slides must be functional. Every word, idea or point—everything that will be seen or heard—must blend with the whole.

B. A. Aumuller, Photography Manager, and **H. E. Marrows**, Technical Information Manager, Western Electric Co., New York City.

- A visual aid is used because it helps get the point across better than words alone. The most beautiful, technically perfect slide is a time-waster unless it has a specific purpose in your talk.

It's a good idea to tape your talk and listen to it. Then ask yourself these two questions: What are the key points I want to get across? What points in my talk will benefit by illustration?

In planning your slides, use one 3 × 5 card for each slide as a planning guide. Clip out the illustration you want or make a rough drawing of what you want the slide to show and paste it on the card. Beside the drawing, list the instructions in preparing the slide. In the lower lefthand corner cite the page and paragraph in the manuscript to which the slide alludes (see Fig. 1 for examples of these cards).

At this stage of your planning, aim for the maximum. Pick out as many potential illustrations as possible, even if you are positive that you have selected more than your talk can possibly absorb without turning your technical talk into a slide show with accompanying text. Then review your text again and trim, if necessary.

In choosing material, remember that copyrights must be observed. Permission to use material, especially if it is an excerpt, is easy to obtain, provided credit is given. Allow yourself enough time to get this permission.

Select the method to be used

Now that you have decided *what* you want to illustrate, you are ready for the "how" of your preparations. How can you best illustrate the points? Photographs, diagrams, sketches, statistical displays, even words—all are potential slides.

Photographs lend a feeling of reality, even though it may be difficult to see the technical aspects of the subject matter under discussion.

Discussing the selection of slides for a technical talk are B. A. Aumuller (left) and Gabe Pellicciotti, a Western Electric engineer.



“The success of your presentation may well hinge on the quality of your visual material.”

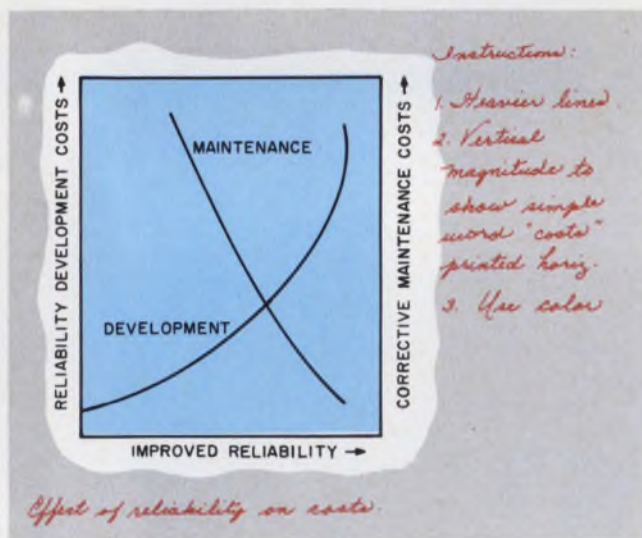
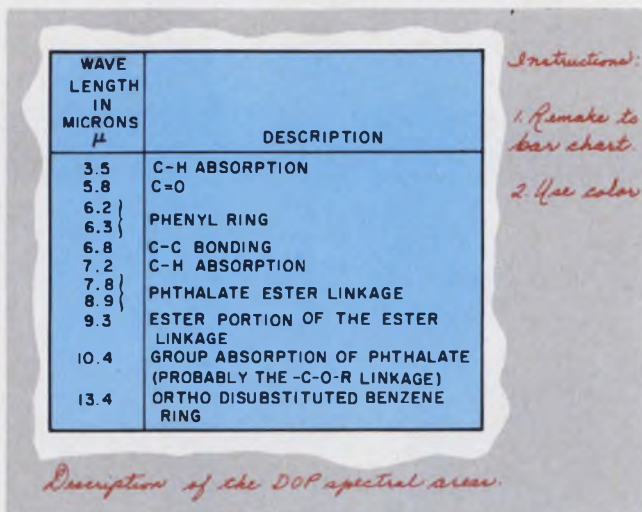

1. An initial step in planning your slides is preparing a series of index cards listing what you want the slide to show. As shown in the two examples above, you clip out the illustration you want or make a rough drawing. Then list the instructions for preparing the slide and cite the page and paragraph in the lower left-hand corner.

Diagrams and sketches can be used to show the makeup of an item, or how it works. Often a diagram or sketch can demonstrate the functional aspects of items better than a photograph. With a sketch or diagram, for example, you can use different colors on different components to illustrate your points more clearly (see Fig. 2). Usually you cannot achieve this color breakdown in a photograph.

Statistical displays, which can take many pictorial forms, are useful in showing relative quantities, qualities, trends, peculiarities of cycle, etc. A comparison figure—a bar chart, a pie chart, etc.—often gets the point across more clearly and succinctly than a photograph, drawing or mere words.

Words on a slide can help emphasize a key point you are making. By showing just a word

or phrase in big letters on a screen, the seed is planted firmly in your viewer's mind.

Prepare the material

If you are going to use photographs, select the subjects and get the photographic equipment ready. But keep one basic rule in mind: Don't over-estimate your ability or the capability of your camera. Taking color slides of the kids is one thing; preparing professional-looking slides for a technical presentation is another.

For example, you cannot get a top-quality close-up of a small component without the proper camera attachments. Not even the possession of a telephoto lens will insure the desired results. Many telephoto lenses will not focus closer than several feet.

In this instance, it may be best for you to make a drawing or sketch. Or see a professional photographer.

Incidentally, here is where your company art department can be helpful to you. While it may not be expert in actually making the slides for you, it should be able to prepare the sketches, drawings and diagrams that will be made into slides.

Here are some guidelines in preparing material to be photographed:

- Crop the art work in proportion to the slide format. This will obviate the need for cropping later, which means more time and money in producing new slides from slides. Here are the sizes that scale to 35-mm dimensions:

3 x 2	10 x 6-3/4	15 x 10-1/8
4 x 2-3/4	11 x 7-1/2	16 x 10-7/8
6 x 4	12 x 8-1/8	18 x 12
8 x 5-3/8	13 x 8-3/4	20 x 13-1/2
9 x 6-1/8	14 x 9-1/2	24 x 16-1/4

- Avoid confusing the viewer's eye with repeated changes from vertical to horizontal slides. If you have a choice, prepare your material for horizontal slides.

- Try to make all your drawings, sketches and charts the same size. This will save considerable time when it comes to photographing them. You will be able to set up your camera equipment once and take all the photographs without having to move and readjust the equipment or subject each time.

- Trim or mask to exclude all extraneous materials. This not only avoids cluttering the slide, but it also saves the extra time of having to crop and then remake the slide.

- Include only the essential details. The simpler the slide, the better its effect. If you want to show one component or a piece of equipment, sketch just that one part, not the whole thing.

- Use glossy paper, mounted perfectly flat.

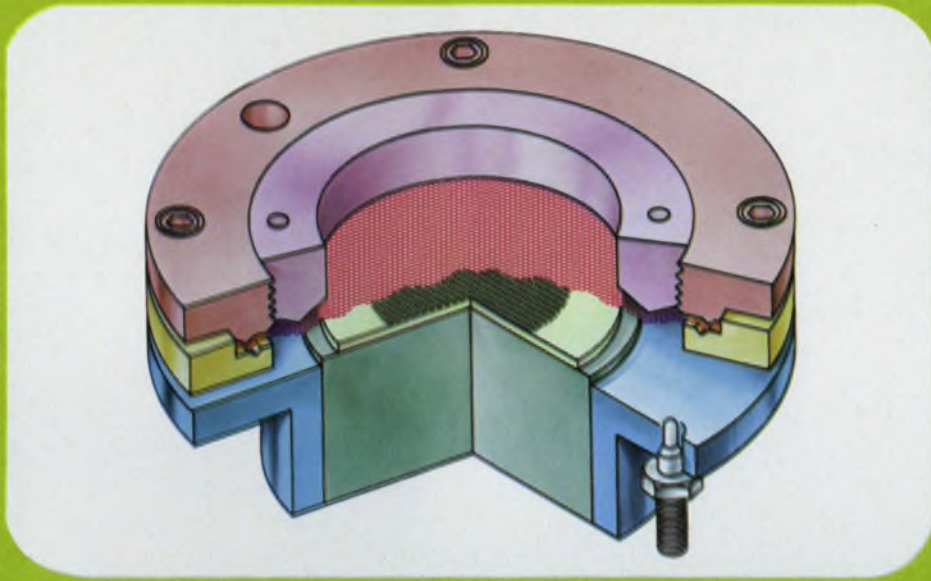

2. Notice how much more effective the diagram at the top is in illustrating the operation of this wafer matrix transfer than the photograph

below it. The photograph is an example of a technically excellent slide that really doesn't serve any functional purpose.



3. Chances are very slim that a slide such as this would contribute very much towards at-

tracting listeners' attention. Your audience would find such a slide difficult to read.

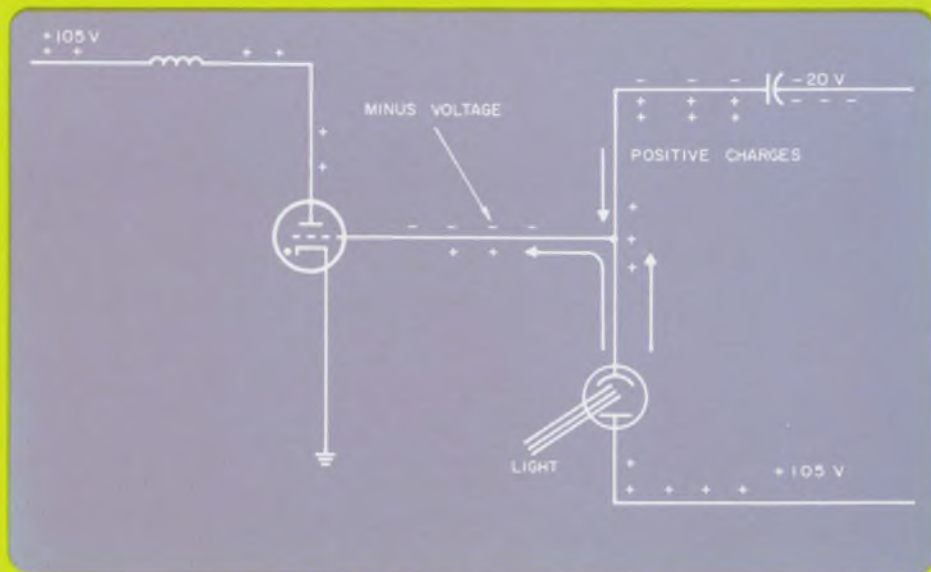

4. This diagram helps you avoid the confusion that befalls many speakers. Regardless of the

technical competence of your audience, the meaning should come across.

Non-glossy surfaces tend to desaturate colors in the finished slides.

- Do not use paper with a watermark. It may reproduce on the slide.

- If your drawing is on paper, mount it smooth on cardboard, using rubber cement or dry mounting tissue. Do not use ordinary water soluble glue or library paste; they tend to cause wrinkles and bulges that will show up on the slides.

- Restrict the use of words to basic titles or nomenclature where possible. A slide filled with words is difficult to read.

- Type-set words—those set by a professional printer, that is—give good results. When you must use typewritten material, use an electric typewriter if possible. If the words are hand lettered, make the letters thick.

- Words and messages should be centered on the paper within an area proportional to the slide format (see table on p. 92).

- Use brightly colored drawings for best results. Pastel shades often give the appearance of being washed out on a slide.

Produce the slides

If you have never done this type of photographic work before, don't start now. Unless you are extremely lucky, you will not get the desired results the first or second time; and you probably haven't got sufficient time to experiment.

For the engineer who plans to do his own photography, here are some guidelines:

- Use color film. Not only are the results better, but the cost will be less than for black and white slides. Even if some of your material to be photographed is black and white, such as lettering, use color film anyway. This will obviate the need for changing film or for using more than one camera.

- Stay with one type of film. You will get to know its capabilities faster, thus ensuring better slides. If you are not certain which type is best, a camera shop should be able to advise you.

- A 35-mm single lens reflex camera, with interchangeable lenses, is by far the most suitable for making slides.

- For copying indoors, use 3200K lamps for Type B color film and 3400K lamps for Type A; or you can use practically any color film with either light source by using the proper filters over the lights or over the camera lens.

- Avoid any outdoor copying work, because you must have your camera at an exact angle to get good results. Otherwise, you will get glare on the photograph in direct sunlight. If you use daylight film and do not photograph in direct sunlight, the results will be too blue on a sunny day, because film is balanced for an average mixture

of warm sunlight and blue sky light.

- Once you get the reading from your light meter, take one shot at the prescribed setting and then take two more—one at 1/2 *f*-stop above and one at 1/2 *f*-stop below. Between the three, you should get just what you want in terms of exposure. Even the best photographer rarely takes just one shot of anything.

- Keep a record of the camera settings, lighting conditions, etc., of each slide you take. It will save you considerable time later if you have to retake the slide.

- If you want to photograph a piece of equipment, make certain the background doesn't compete with the item you want to show. A blank wall is probably best as a background. But make certain the color of the wall doesn't compete!

- If you want to show just one component or section of a piece of equipment, photograph just the part and not the whole product. If the component is too small, it probably will be better to make a sketch rather than go through the frustration of not getting what you want.

Once your finished slides are at hand, try them out. Set up the slide projector, play the tape of your speech and flash each slide at the proper point. This will show if your slides are doing the intended job. ■■

Suggested reading:

The following are published by Eastman Kodak Co.:

1. *Producing Slides and Filmstrips*
2. *Effective Slide Lectures*
3. *More Here's How*
4. *Legibility Standards for Projected Material*
5. *Artwork Size Standards for Projected Visuals*
6. *Planning and Producing Visual Aids*
7. *Basic Copying*

Test your retention

Here are questions based on the main points of this article. They are to help you see if you have overlooked any important ideas. You'll find the answers in the article.

1. *What criteria should you use in determining whether or not to illustrate a point made in your text?*

2. *Cite an advantage for using each of the following to illustrate a given point—photographs, diagrams and sketches, statistical displays, words.*

3. *Why is it important to make art work in proportion to 35-mm slides? Why is it vital to make all your art work the same size?*

4. *What is the surest way to determine if your visual aids will achieve the desired result when you give the formal talk?*

Laboratory pulse modulator uses minority carrier storage diodes

Problem: Design a solid-state modulator capable of producing high peak power and using neither magnetic compression techniques nor pulse-forming networks that are restricted to operation at a single pulsewidth and pulse repetition rate.

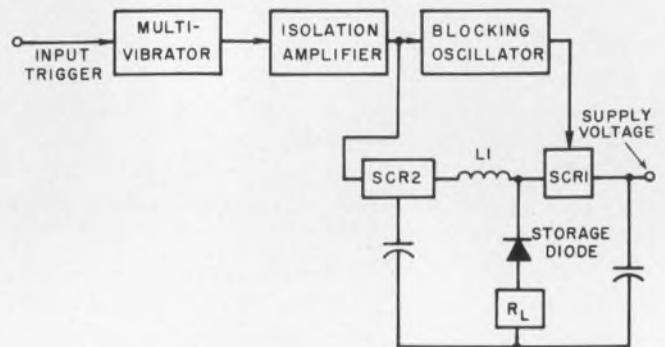

Solution: A pulse modulator capable of continuously variable pulsewidth over a 10-to-1 range of $1.0 \mu\text{s}$ to $0.1 \mu\text{s}$ and operation over a wide range of pulse repetition rates. Pulsewidth diversity is obtained by operating step-recovery diodes in the reverse-conduction mode.

The first stage of the storage-diode modulator is a multivibrator turned on by a 3.5-volt, $1\text{-}\mu\text{s}$ system input trigger. The multivibrator output pulse, variable in width from 5 to $50 \mu\text{s}$, is coupled to an emitter-follower type of isolation amplifier with an output directly coupled to SCR2, which controls the charging current for the storage diode. The amplitude level of the gate trigger is approximately 5 volts, or about twice the minimum amplitude required. A second output from the isolation amplifier is inverted, differentiated, and used to trigger a blocking oscillator which has an output coincident with the multivibrator output trailing edge. Collector-base feed design of the blocking oscillator allows heavy loading without suppression regeneration. The output winding of the blocking oscillator is referenced to the cathode of the main discharge switch, SCR1, which provides the reverse storage-diode current (load current). The gate output to SCR1 is 10 volts to ensure rapid turn-on.

Inquiries concerning this invention may be directed to Technology Utilization Officer, Marshall Space Flight Center, Huntsville, Ala. 35812 (B67-10226).

Inquiries about obtaining rights for the commercial use of this invention may be made to NASA, Code GP, Washington, D.C. 20546.

if...

you are involved with systems and equipment design, research, production or management—RCA Institutes seminars can help in your field!

The RCA Institute for Professional Development offers Seminars that will provide you with information, knowledge and techniques you can put into immediate practical application . . . and prepare you for tomorrow's developments. Seminars are held throughout the year, throughout the country. Accomplished Lecturers present each program with an exclusively written text and modern audio-visual equipment. Look over the list below, and send coupon today for brochure explaining full details.

RCA

RCA Institutes, Inc. Dept. ELD-48
Institute for Professional Development
132 West 31st Street
New York, New York 10001

For free descriptive brochure, check the Seminar in which you are interested:

- | | |
|---|--|
| <input type="checkbox"/> LOGIC DESIGN | <input type="checkbox"/> INTEGRATED CIRCUITS |
| <input type="checkbox"/> DIGITAL SYSTEMS ENGINEERING | <input type="checkbox"/> RELIABILITY OF INTEGRATED SYSTEMS |
| <input type="checkbox"/> DIGITAL COMMUNICATIONS | <input type="checkbox"/> NUMERICAL CONTROL |
| <input type="checkbox"/> DIGITAL ELECTRONICS | <input type="checkbox"/> MODERN OPTICS |
| <input type="checkbox"/> MANAGEMENT INFORMATION SYSTEMS | |

Name _____

Title _____

Company _____

Address _____

City _____ State _____ Zip _____

Please send information on in-plant Seminars.

INFORMATION RETRIEVAL NUMBER 47

Free Career Inquiry Service

Absolutely Confidential

Respond to the career opportunities advertised in this issue. Fill out and send us this handy resume. **Electronic Design** will do the rest – neatly typed copies of this form will be mailed to the companies of your choice, indicated by the circled Career Inquiry Numbers at the bottom of this page.

8

Name		Home Phone	
Home Address (Street)		City	State
			ZIP Code
Age	U.S. Citizen	Security Clearance	
	<input type="checkbox"/> Yes <input type="checkbox"/> No		

Prime Experience	Secondary Experience

Desired Salary	Availability Date
-----------------------	--------------------------

Employment History – present and previous employers

Company	City, State	Dates	Title
		to	
		to	
		to	

Education – indicate major if degree is not self-explanatory

Degree	College	City, State	Dates
			to
			to
			to

Additional Training – non-degree, industry, military, etc.

Professional Societies

Published Articles

- Career Inquiry Numbers:**
- | | | | | | | | | | |
|-----|-----|-----|-----|-----|-----|-----|-----|-----|-----|
| 900 | 901 | 902 | 903 | 904 | 905 | 906 | 907 | 908 | 909 |
| 910 | 911 | 912 | 913 | 914 | 915 | 916 | 917 | 918 | 919 |

ELECTRONIC DESIGN
 850 Third Avenue
 New York, New York 10022

Lockheed's electronics engineers have a lot of fingers in the...



It figures. The scope of production, development and study programs now under way at Lockheed-California range from "A" (ASW)...to "V" (V/STOL); with many stops in between, such as Military Rotary Wing Aircraft; Commercial Aircraft; Fighter Bombers and Hypersonic Aircraft. They all have one thing in common: sophisticated electronic systems...and you can help to provide them.

The variety of projects at Lockheed have created openings for Electronics Engineers in the areas of Sensors; Data Processing; Navigation; Communications; Armament and Electrical Installation. □ If you're an electronics engineer equally at home with a formula or an idea...look into Lockheed-California. Send your resume to Mr. E. W. Des Lauriers, Professional Placement Manager, Department 1304 2402 North Hollywood Way, Burbank, California 91503. Lockheed is an equal opportunity employer.

LOCKHEED-CALIFORNIA COMPANY

A group division of Lockheed Aircraft Corporation

INFORMATION RETRIEVAL NUMBER 901

Book Reviews

Communications guide

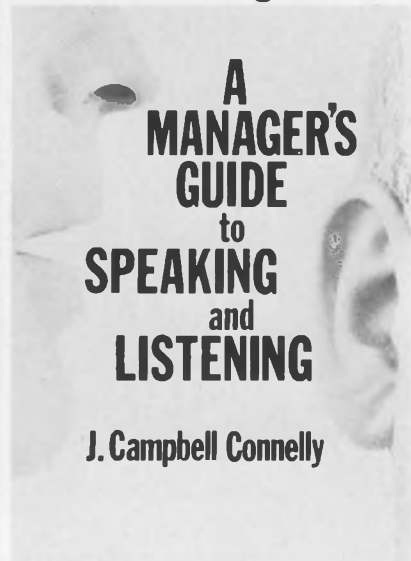

A Manager's Guide to Speaking and Listening, J. Campbell Connelly (American Management Association, New York), 125 pp., \$6.

If you want a practical method of improving your speaking and listening skills, this is the book for you. Its 125 pages contain more practical advice for becoming a better talker and listener than most books three, four and five times its size.

Do you have "lazy lips" when you speak? Author Connelly gives you exercises to do. Is your uvula limber? It should be if you want to be an effective listener.

Do you have "mental dissipation" when you listen? You can learn how to program your mind, which, in Connelly's words, is "the oldest computer."

If you practice what the author preaches, there should be a noticeable improvement in your communications habits.

—Howard S. Ravis

CIRCLE NO. 250

As a further service to our readers, ELECTRONIC DESIGN is now including an Information Retrieval Service number with book reviews. Publishing companies have agreed to supply information about their books to interested readers.



ELECTRICAL ENGINEERS

HIGH VOLTAGE—Will design and develop high voltage power supplies, perform vendor liaison and work with Xerographic Development Engineers in translating machine requirements to high voltage systems.

CONTROL SYSTEMS—Will design and develop electrical control systems involving integrated circuits, instrumentation and testing of circuits and related processes.

SOLID STATE—Will design analog/digital circuits for the development of solid state integrated circuits and other applicable microelectronic components.

COMMUNICATIONS/COMPUTER ENGINEERS—Will design graphic information, distribution, switching, and storage systems devices for digital communications and switching systems.

COMPUTER PERIPHERAL ENGINEER—Will design and develop computer related peripheral equipment involving modern data recording methods including magnetic disc, drum or tape systems for video or digital recordings.

BS or MS in EE required for the above positions.

ELECTRICAL TECHNICIANS

Assist engineering staff in the design, breadboard construction, testing from breadboard through prototype and evaluation of electromechanical/optical equipment and materials. A two-year A.A.S. degree in Electronic, Mechanical or related technology, or at least 5 years' industrial experience is required.

INFORMATION RETRIEVAL NUMBER 902

ELECTRONIC DESIGN 8, April 11, 1968



Can there be this kind of excitement in engineering?

Try Xerox and see



An engineer operates the keyboard of an experimental information storage and retrieval system.

The water's cold, insistent rush... surface dappled by a late sun. A brown hackle* touches down, lightly, perfectly, bobs briskly for a moment and—bam! That indescribable minor explosion that means you've hooked into something big.

Nobody can really define the excitement of trout fishing. It is highly personal, unstructured, yet unmistakable. And so it resembles, we think, the excitement an engineer should find in doing what he has been highly educated to do...but which so many engineers, apparently miss.

At Xerox, the exciting professional environment is real. Proof? See what it has done for our growth. In 1960, we had 3000 people on our payroll. As we entered 1968, the number exceeded 24,000. We earned 14¢ a share in '60. In '67, it rose to \$4.45.

Find out for yourself. Specific openings at our suburban Rochester, New York facilities are outlined at the left. Please forward your resume to Mr. R. W. White, Dept. MZ-32-D1. Xerox Corporation, P.O. Box 1995, Rochester, New York 14603. An Equal Opportunity Employer (m/f)

XEROX

An Equal Opportunity Employer (m/f)

*Half an hour from Rochester are some of the world's finest trout streams. Also abounding: lake trout, bass, walleyed pike and muskie.

High-frequency oscillator uses single $\mu A703$ and an LC tank circuit

The symmetrical limiting properties of the $\mu A703$ integrated-circuit i-f amplifier make it an ideal device for use in oscillators. With a large input signal, the circuit operates in a switching mode where transistor Q1 chops the current from Q3 into Q2. The output of Q2 is a switched current with amplitude fixed by the supply voltage and the biasing arrangement. This current, I, is given by:

$$I = (V_{CC} - V_{BE4} - V_{BE5}) / R2 \cong (V_{CC} - 1.5) / R2$$

for $V_{CC} = 10 \text{ V}$ $I \cong 3.4 \text{ mA}$

A parallel tuned tank converts the current pulses into a sine wave that is attenuated and fed back to the input of the circuit. The rf choke between the bases of Q1 and Q2 supplies the proper bias voltage and current to Q1 to insure symmetrical limiting.

A necessary condition for the oscillator to start is that the small signal gain of the feedback loop must be greater than unity. The loop gain is given by:

$$A_v = kY_{21} R'_L$$

where: $Y_{21} = 35 \mu\mu\text{ho}$ for $\mu A703$

$R'_L =$ effective load resistance at collector of Q2

$Y_{21}R'_L =$ voltage gain of 703

$k =$ attenuation ratio of tap on tank.

For oscillation, $R'_L > A_v / kY_{21} \cong 30 \Omega / k$.

This condition is readily met, since for low dis-

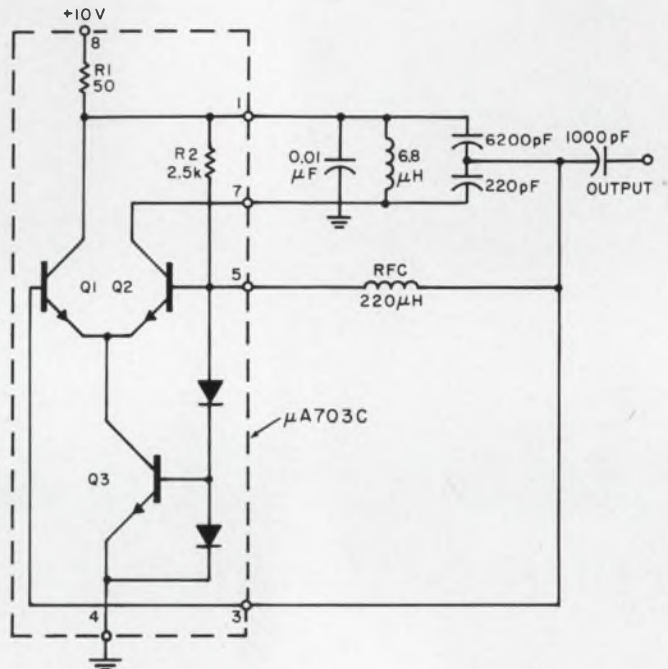

4.5-MHz oscillator uses a single IC and a simple tank circuit with high loaded Q.

tortion, the loaded Q of the tank should be high, and this governs the choice of a load. For the values shown, the minimum load is 10 Ω but for low distortion, the load should be larger than about 50 Ω .

The circuit will operate well over a wide range of supply voltages and at frequencies up to 150 MHz, with suitable changes in the tank circuit.

Carl Andren, Johns Hopkins University, Applied Physics Laboratory, Silver Spring, Md. 20910.

VOTE FOR 311

Square-wave generator is stable and simple

An ultrastable square-wave generator uses an RC bridge as timing element, a voltage comparator, k , and two switches, $S1$, $S2$, (Fig. 1 a). The operating frequency is determined by the bridge network and the comparator which operates the switches. The switching command is always obtained at the moment when the potentials at the points A and B are equal.



VOTE! Go through all Idea-for-Design entries, select the best, and circle the appropriate number on the Reader-Service-Card.

SEND US YOUR IDEAS FOR DESIGN. You may win a grand total of \$1050 (cash)! Here's how. Submit your IFD describing a new or important circuit or design technique, the clever use of a new component or test equipment, packaging tips, cost-saving ideas to our Ideas-for-Design editor. You will receive \$20 for each accepted idea, \$30 more if it is voted best-of-issue by our readers. The best-of-issue winners become eligible for the Idea Of the Year award of \$1000.



V-Scan Binary.

Memorandum

To: Systems engineers who keep their files of the world's finest encoders up to date.
From: Norden.
Re: Our latest list of versatile encoders for all your systems—magnetic, optical or contacting.

	Total Count	Revolutions for Full Count	Diameter"	Model Number	
External Logic V-Scan Binary Encoders	128 or 256	1	1.750	ADC-7/8-BNRY-XB	
	8,192 or 16,384	64	1.750	ADC-13/14-BNRY-XB	
	524,288 or 1,048,576	4,096	1.750	ADC-19/20-BNRY-XB	
High Reliability, Long-Life, Self-Contained Logic Binary Encoders	128	1	1.750	ADC-ST7-BNRY-E	
	8,192	64	1.750	ADC-13-BNRY-E	
	524,288	4,096	1.750	ADC-19-BNRY-E	
Single Turn Gray Code Encoders	256	1	1.066	ADC/11/8/GRAY	
	256	1	1.750	ADC-ST8-GRAY	
	512	1	2.250	ADC-ST9-GRAY	
	1,024	1	3.062	ADC-ST10-GRAY	
Multiturn Gray Code Encoders	1,024	4	1.062	ADC-11/10GRAY256	
	1,024	16	1.062	ADC-11/10GRAY 64	
The above encoders are available with various levels of RFI suppression.					
Binary-Decimal Code Encoders Self-Contained Logic	100	1	2.250	ADC-ST2-BCD	
	1,000	10	2.250	ADC-3-BCD	
	10,000	100	2.250	ADC-4-BCD	
	100,000	1,000	2.250	ADC-5-BCD	
	1,000,000	10,000	2.250	ADC-6-BCD	
Degree Counting Binary-Decimal Encoders Self-Contained Logic	100	1	2.250	ADC-ST2-BBCD	
	1,000	10	2.250	ADC-3-BBCD	
	10,000	100	2.250	ADC-4-BBCD	
	100,000	1,000	2.250	ADC-5-BBCD	
	1,000,000	10,000	2.250	ADC-6-BBCD	
Latitude-Longitude Binary-Decimal Encoders, Self-Contained Logic	360	1	2.250	ADC-3-36BCD-E-360L	
	3,600	10	2.250	ADC-4-36BCD-E-360L	
	360	1	3.250	ADC-ST3-36-BCD	
	3,600	36	2.250	ADC-4-36-BCD	
	36,000	360	2.250	ADC-5-36BCD	
Beacon Altitude Reporting Encoders	360,000	3,600	2.250	ADC-6-36BCD	
	3,600	36	2.250	ADC-4-36BBCD	
	36,000	360	2.250	ADC-5-36BBCD	
Binary-Decimal Encoders with Extended Environmental Capability	360,000	3,600	2.250	ADC-6-36BBCD	
	100	1	2.250	ADC-ST2-BCD-A	
	10,000	100	2.250	ADC-4-BCD-A	
Optical Incremental Encoders	360,000	3,600	2.250	ADC-6-36BCD-A	
	500	1	2.250	OADC-23/500/INC	
	512	1	2.250	OADC-23/512/INC	
	1,000	1	2.250	OADC-23/1000/INC	
	1,024	1	2.250	OADC-23/1024/INC	
	2,000	1	2.250	OADC-23/2000/INC	
Low-Cost Magnetic Noncontacting Encoders	2,048	1	2.250	OADC-23/2048/INC	
	All optical incremental encoders are available with index marker, quadrature outputs and internal squaring circuit options. Other counts available on special order.				
	Incremental	128	1	1.750	MADC-18/128/INC
	Gray	16	1	1.750	MADC-18/4/GRAY
	Gray	256	1	1.750	MADC-18/8/GRAY
	Binary	128(V scan)	1	1.750	MADC-18/7/BV
Binary	8,192(V scan)	64	1.750	MADC-18/13/BV	
Binary	524,288(V scan)	4,096	1.750	MADC-18/19/BV	
All magnetic encoders are normally furnished with sleeved leads. Terminal header or Cannon connector options are available for all units. Non-standard counts within the capabilities of the encoder are available on special order.					

For more information and detailed specs on Norden encoders, write Components Department, Norden Division, United Aircraft Corp., 1475 Barnum Ave., Bridgeport, Conn. 06610. Or phone (203) 366-4531. TWX: 710/453/1855.

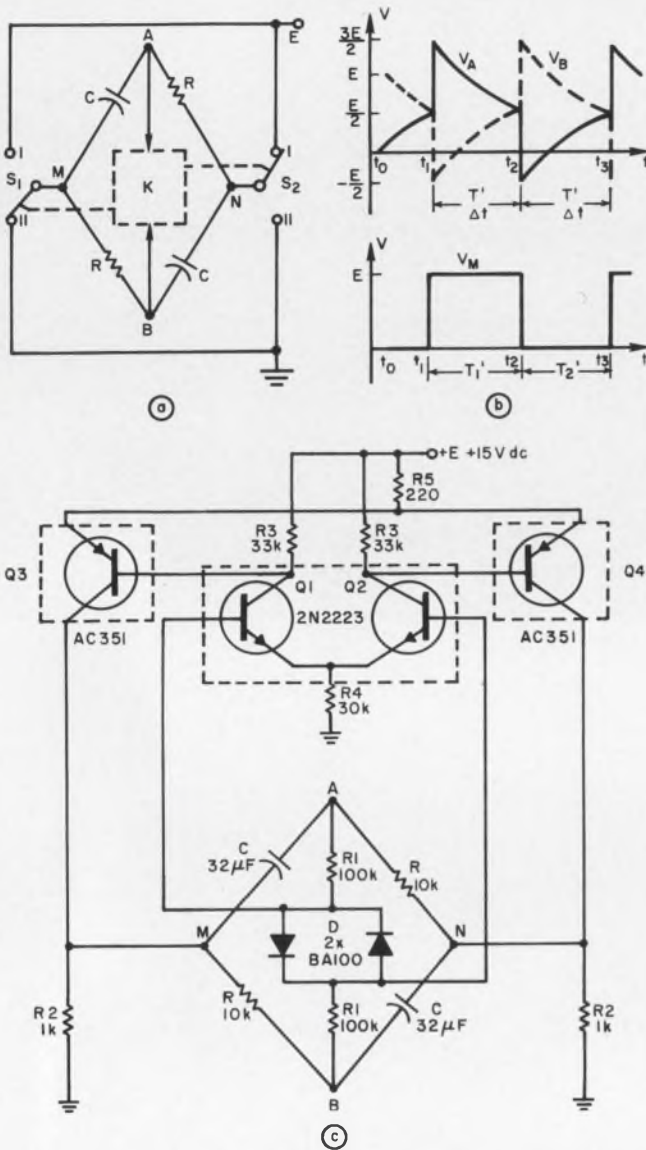

Stable square-wave generator results when a bridge (a) is used as a timing element. Circuit action is shown in (b). With the values shown (c) the period of oscillation is 0.677 s.

The pulse generator outputs are M and N nodes of the bridge. They are complementary and according to the switch position they are either at potential E or at ground.

If supply voltage E is switched on at the instant t_0 (Fig. 1b) and switches S1 and S2 are in position I, the potential at point A starts to increase and the potential at point B starts to decrease. The change in the potentials is an exponential with a time constant RC. At t_1 , the potentials at A and B become equal ($V_A = V_B = E/2$) and the comparator places the switches into the position II. Potentials V_A and V_B become $V_A = 3E/2$, $V_B = -E/2$. After a time T' , at the instant t_2 , potentials V_A and V_B are equal again, and the switches reverse, bringing the potentials

V_A and V_B to $V_A = -E/2$ and $V_B = 3E/2$, respectively.

The time interval T' , i.e., the half period of the generator oscillation is given by:

$$t_2 - t_1 = T' = RC \ln 3, \quad (1)$$

so that the period becomes:

$$T = 2T' = RC \ln 9 \quad (2)$$

Fig. 1c illustrates one possible square-wave generator circuit. Transistors Q1 and Q2 constitute the voltage comparator of the differential amplifier type, and Q3 and Q4 are electronic switches S1 and S2.

The comparator is not coupled directly into the A-B leg of the bridge, but through the diode-resistance chain, R1, D. Direct connection of the comparator is not convenient because of the effect of its finite input impedance on the oscillation period.

Testing the circuit indicates that the stability depends exclusively on the stability of time constant, so that a stability of 10^{-1} can be easily realized.

Borislav M. Stajanovic and Toma I. Cakulev, Research Associates, Mihajlo Pupin Institute for Automation and Telecommunications, Belgrade, Yugoslavia.

VOTE FOR 312

Long-pulse-width multi has short recovery time

In conventional one-shot multivibrators, the recovery time is dependent on the timing period. Most one-shots, including integrated types, have a typical recovery time of 100% of their period. This limitation is based on the time required to restore the capacitor of the RC timing elements to the initially charged or discharged condition, depending on the type of one-shot.

The circuit in the accompanying figure is a one-shot with a very low percentage of recovery time to period. The major elements are a level detector operating from a ramp generator that is reset from a triggered blocking oscillator. The output pulse width is determined by the ramp voltage slope and the threshold voltage setting of the level detector.

A positive pulse greater than 0.7 V is applied to the base of transistor Q1 through R1. Q1 and transformer T1 form an 8- μ s blocking oscillator. A positive pulse from T1 is fed into the base of Q2 which saturates and discharges C2 to the $V_{CE(sat)}$ of Q2.

When 8- μ s blocking-oscillator pulse is not present, C2 is charging linearly from the tran-

For micro-accuracy... Starrett measures up

When it comes down to the ultimate in measurement control, or even for fine increments of movement with or without linear measurement, it's time for Starrett. Starrett micrometer heads are precision built to give you the preciseness that your design requires. Starrett is world-known as the leader in precision tools. When you just can't afford to be wrong, be precision-perfect with Starrett.

Starrett micrometer heads are stocked in a wide range of standard designs, and custom-built heads can be manufactured for special applications.

Write today for additional information about what Starrett can do for you to make your design better.

The L. S. Starrett Company,
Athol, Massachusetts.

Starrett®
WORLD'S GREATEST TOOLMAKERS

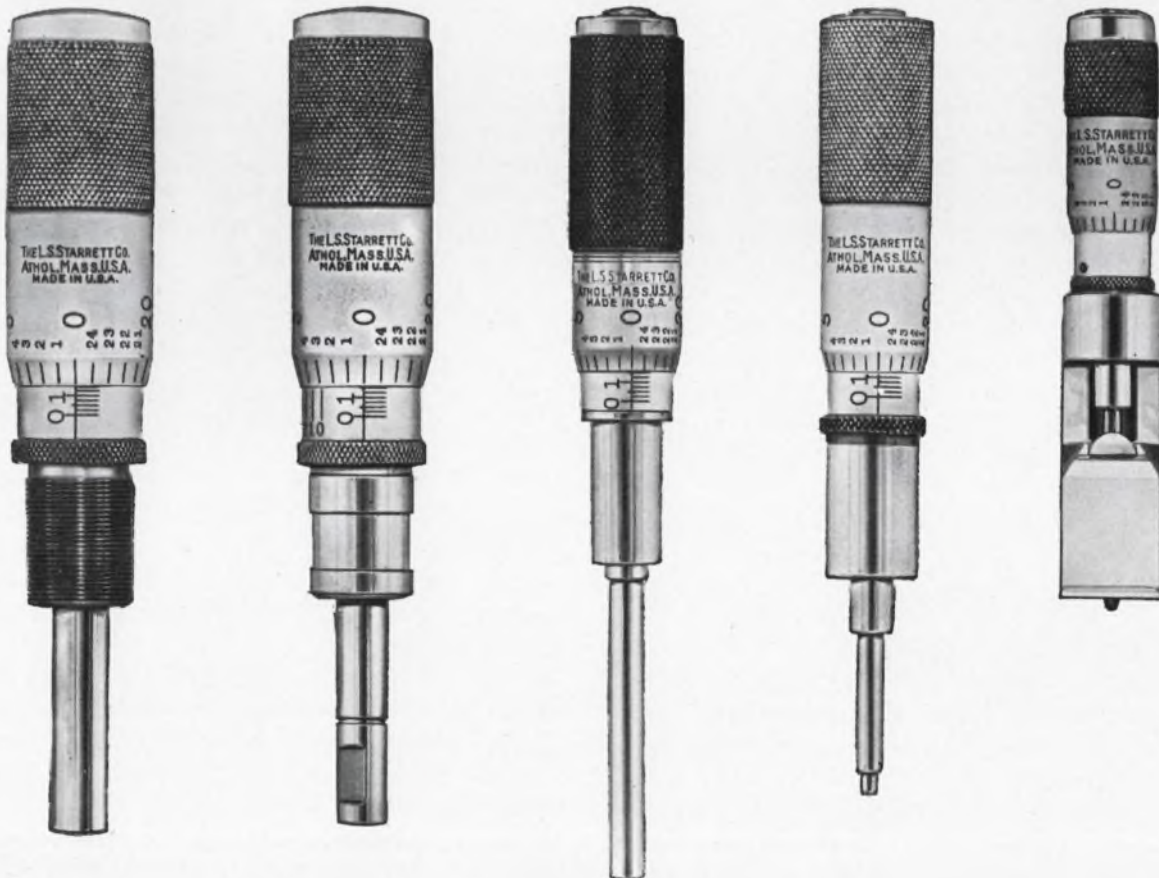

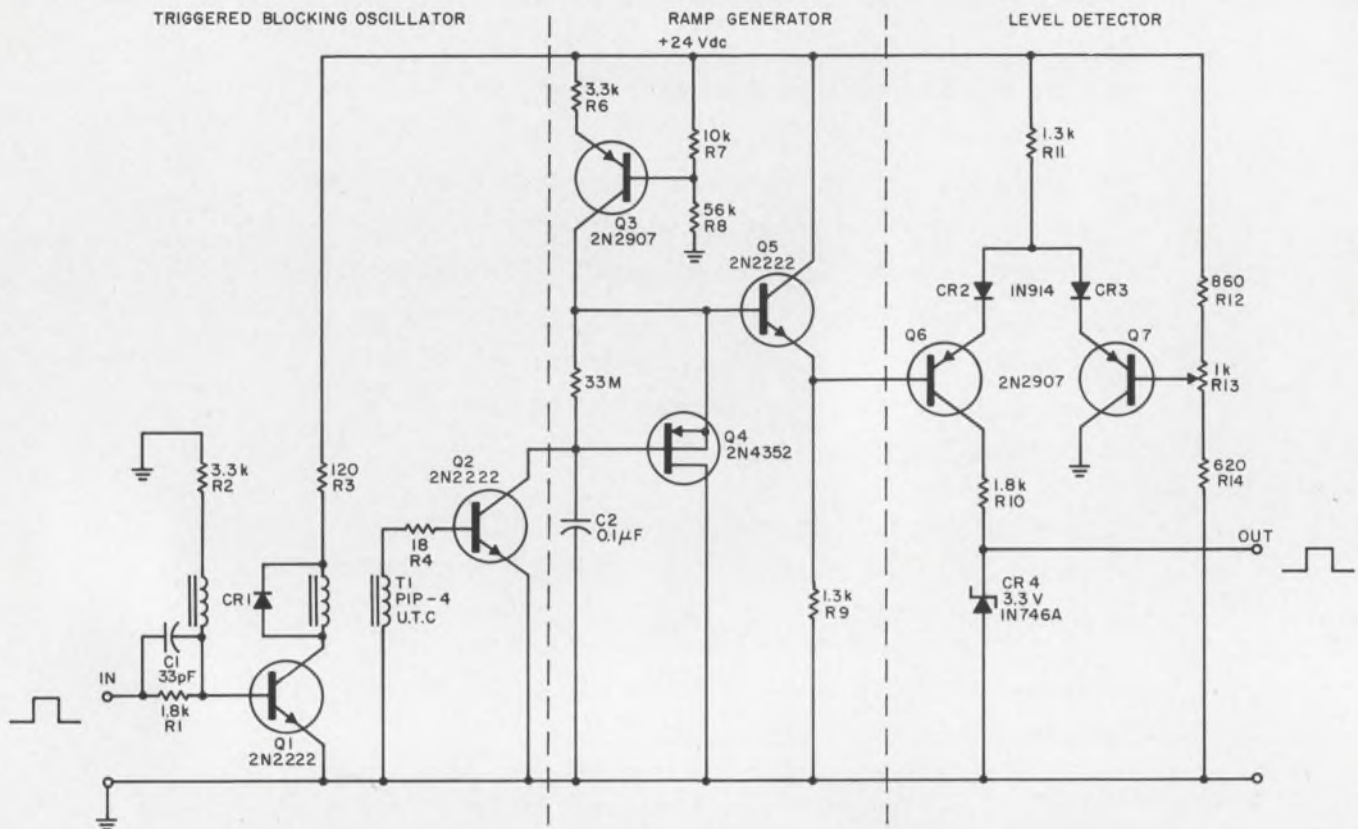

Short-recovery-time multi can put out pulses from 10 μs to 10 s in width depending on the value of C2. With the

values shown, the output pulse is 10 s wide with a recovery time of 8 μs.

sistor current source Q3 to +18 V. Q4 not only provides source-follower action for C2 but, in addition, further stabilizes the capacitor charge rate for variations in I_{CQ3} . The very linear ramp voltage at the source of Q4 is coupled through emitter follower Q5 to the base of Q6. Q6 and Q7 form a level detector. The threshold voltage is established at the base of Q7 by adjusting potentiometer R13. Q6 remains cut off as long as its base is more positive than the established threshold voltage. When C2 is discharged, the base of Q6 becomes more negative than the threshold voltage, and Q6 saturates allowing a +3.3-V step to appear at the output. Q6 will

remain saturated until the positive-going ramp exceeds the threshold voltage. Q6 then returns to cutoff, allowing the output to return to zero. Diodes CR1, CR2 and CR3 provide punch-through protection for Q1, Q6 and Q7.

A broad range of pulse widths from 10 μs to 10 s can be generated with capacitor values of 10 F to 0.1 μF. These must be low-leakage capacitors. The adjustable threshold voltage p provides an approximate 10 to 1 pulse-width adjustment. The required recovery time for a 10-s pulse is 8 μs.

David A. Sands, Engineer, EG&G, Inc., Boston.
VOTE FOR 313

Simple test circuit matches FETs quickly

Tests for the differential gate voltages ($V_{GS1} - V_{GS2}$) between two devices for matching purposes are often time-consuming and cumbersome. The drain currents for each device must be individually adjusted to the desired measuring value as in Fig. 1a; or, if a common-current source is used, the gate bias must be individually adjusted for a

drain current balance as in Fig. 1b. This same procedure must be followed through for each measuring current level.

The entire procedure can be automated with only single adjustment and still maintain a 0.01% drain current match. This is accomplished by using two μA-709 operational amplifiers and two matched resistors as in Fig. 1c.

Q1 and Q2 are the devices under test. Resistors R1 and R2 are matched to 0.01% and serve as con-

Progress Report

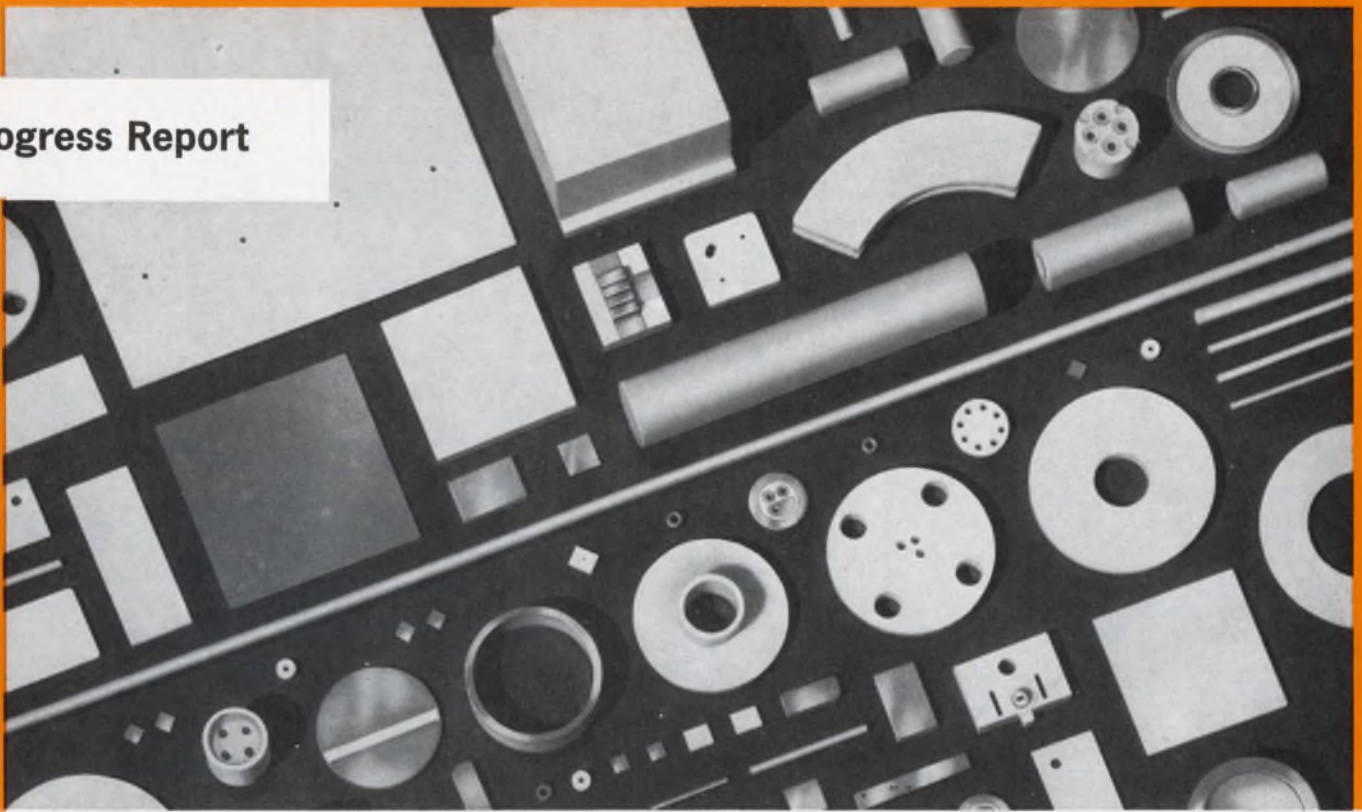

The high thermal conductivity of AlSiMag Beryllia Ceramics is coupled with electrical properties in the same range as alumina ceramics. Beryllia ceramics have high dielectric strength and low dielectric constant. Their high melting point also means high plastic deformation. High thermal conductivity gives superior resistance to thermal shock. The material is chemically stable and has high modulus of elasticity.

Advances in processing AlSiMag Beryllia Ceramics continue to widen their usefulness. In general, AlSiMag Beryllia Ceramics are now fabricated in the same wide range as AlSiMag alumina ceramics. This includes small precision parts, small rods and tubes such as helix rods, cores for carbon deposited, metal deposited or wire wound resistors, substrates, base for composite substrates, packages and other applications where heat dissipation is important.

Unusual requirements including improved strength and controlled dielectric constant can be met in some designs. American Lava offers single-source responsibility on a wide range of processes on AlSiMag Beryllia Ceramics including precision fabrication, grinding, lapping, metallizing and plating.

Outline your requirements. Prototypes can be furnished promptly for your evaluation.

ALSiMAG[®]

BERYLLIA (Heat Conductive) CERAMICS

Bulletin
675
on AlSiMag
Beryllia
Ceramics
sent on
request.

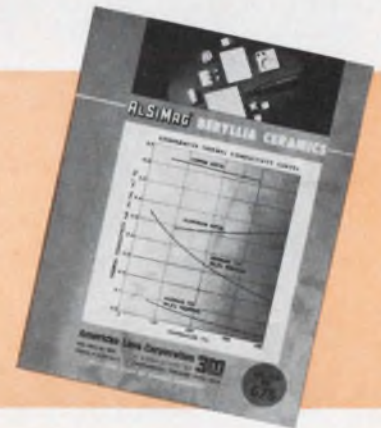

CODE IDENT. NO. 70371

PHONE 615 265-3411, CHATTANOOGA, TENN. 37405

American Lava Corporation **3M**
A SUBSIDIARY OF COMPANY

For service, contact American Lava representatives in Offices of Minnesota Mining and Manufacturing Company in these cities (see your local telephone directory): Boston: Needham Heights, Massachusetts • Chicago: Elmhurst, Illinois • Dallas, Texas Elyria, Ohio • Laurens, S. C. • Los Angeles, California • Metropolitan New York: Ridgefield, N. J. • Up-State New York and Canada: Phoenix, New York • Orange, Conn. • Philadelphia, Penn. • Roanoke, Va. • St. Louis: Lee's Summit, Mo. South San Francisco, Calif. • 3M International: c/o American Lava Corp., Chattanooga, Tenn. 37405, U.S.A., 615/265-3411.

67th
YEAR
OF
CERAMIC
LEADERSHIP

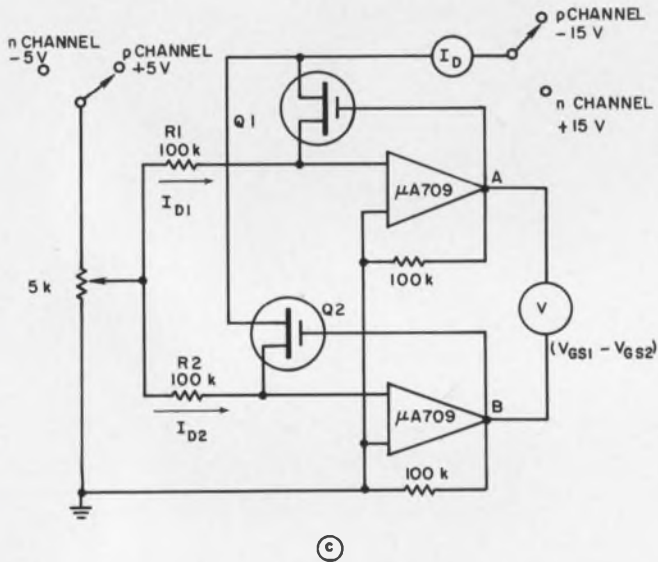
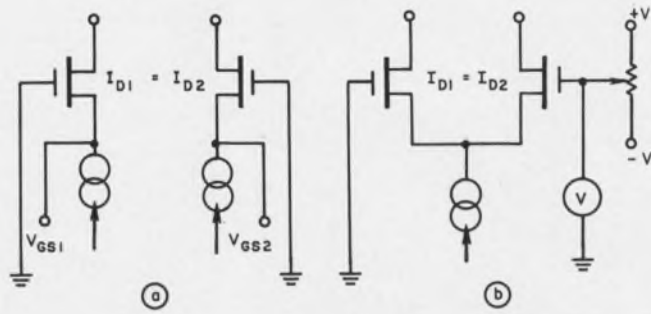

Fast matching of two FETs can be obtained with simple test circuit (c). Use of circuits (a) and (b) is time-consuming and requires several adjustments rather than just a single one as in (c).

stant-current sources, so I_{D1} and I_{D2} are also matched to 0.01%. The corresponding values of V_{GS} are read at points A and B, where connecting a differential voltmeter across them gives the desired $(V_{GS1} - V_{GS2})$ readings. The different current levels are adjusted with the potentiometer. The ammeter reads the total current or twice the drain current of each device.

Henry Wu, Transistor Engineer, Fairchild Semiconductor, Mountain View, Calif.

VOTE FOR 314

Get uhf transistor parameters with 8-ohm slotted line

High-power, uhf transistors have operating impedances in the 1-to-10-ohm range. When measuring their characteristics on conventional 50-ohm test equipment, a small measurement error readily leads to gross errors of 3 or 4 to one in the desired parameter. These errors come

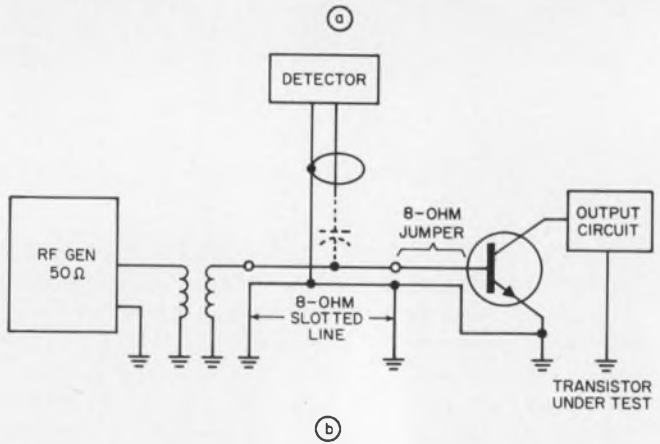
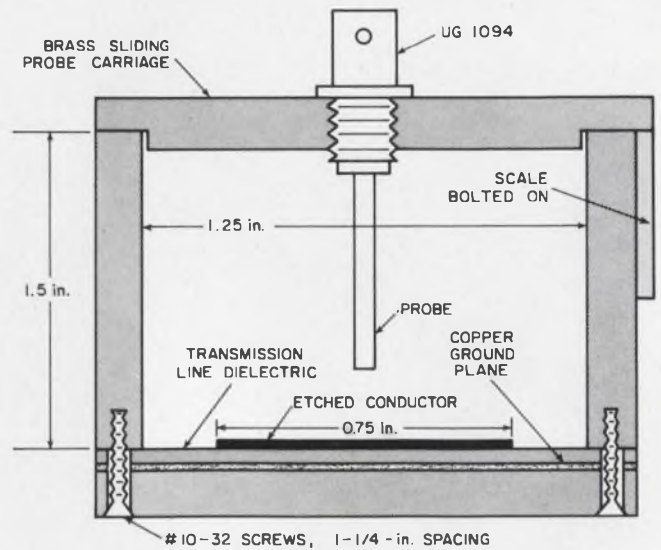

Impedance match between standard 50-ohm test gear and low-impedance, high-power uhf transistor is obtained with a home-made slotted line (a) hooked up as shown in (b). The rf generator is connected by means of a broad-band ferrite transformer or double-stub tuner.

from coupler directivities and stray leakage pick-up, which normally distort the data taken on a 50-ohm high-VSWR system. A home-made 8-ohm slotted line makes possible more accurate measurements under actual operating conditions.

A cross section of a readily constructed low-impedance slotted line is shown in Fig. 1a. A 36-inch line, made from 1/4-in. aluminum required 1-1/2 days' more model-shop time for construction. The transmission line is 0.75 in. wide etched from a 0.032-in. double-sided printed-circuit board, GE 11711 L2 PPO, and gives 8 ohms impedance. This material has 0.0264-in. dielectric and two 0.0028-in. copper layers.

The semiflexible 8-ohm jumper which connects the slotted line to the circuit under test is sheared from 0.016-in. PPO double-sided printed-circuit board. A 0.31-in. wide strip of GE 0.015-in. 11711 L2 gives 8 ohms characteristic impedance. Standard slotted-line impedance-measuring (see

how big *is a micron?*

This page
could hold
6,914,128,443.75
round dots
one micron
in diameter

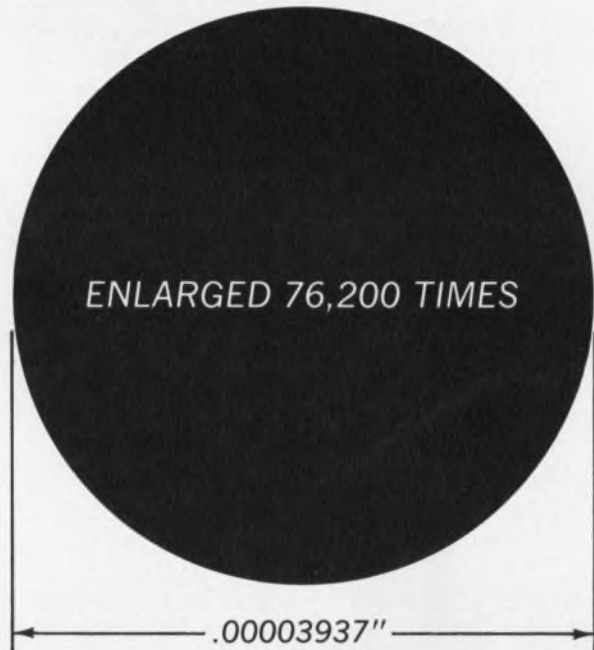

We etch metal to micron tolerances every day

Ultra-precise photomechanical reproduction of metal and glass parts is our business. We're very good at it. We've been precision etching on a quantity production basis since we made fire control reticles and other parts for the military in World War II. Now, with equipment like our new BMAPS computer-plotter system, we do it better and faster.

We picture a micron dot because we do work regularly to tolerances of microns, or even millionths of inches. As an example, with Buckbee-Mears electroforming we produce standard stock sieves down to 5 micron hole sizes, guaranteed accurate within ± 2 microns. These are shelf items, quantity produced. On hand-picked spe-

cial we can do better.

If you need a little less precision—for fewer dollars, of course—check our prices and delivery times for more routine etched metal or glass parts. We can make virtually any part that can be drawn on paper. Our prices are fair, and we think 10 days is long delivery.

Ask us about your requirements. We look upon ourselves as professional problem solvers. We have an impressive list of companies we have helped, and we'd like to add your name to the list. Call or write us today. The first man to talk to is Bill Amundson, our industrial sales manager.



BUCKBEE-MEARS CO.

245 E. 6th St., St. Paul, Minnesota 55101 / (612) 227-6371

The world leader in *precision photomechanical reproduction*

INFORMATION RETRIEVAL NUMBER 51

Fig. 1b) techniques are used, but the 66% wavelength shrinkage by the PPO dielectric must be borne in mind.

Robert H. Merriam, Design Engineer, General Electric Company, Syracuse, N.Y.

VOTE FOR 315

Extra transformer windings increase rectifying efficiency

Efficient thermoelectric cooling modules generally require low voltage at high amperage. But these requirements, particularly in high-power devices, can result in inefficient power-supply operation, because of the large voltage drops across the rectifying elements relative to the output voltage.

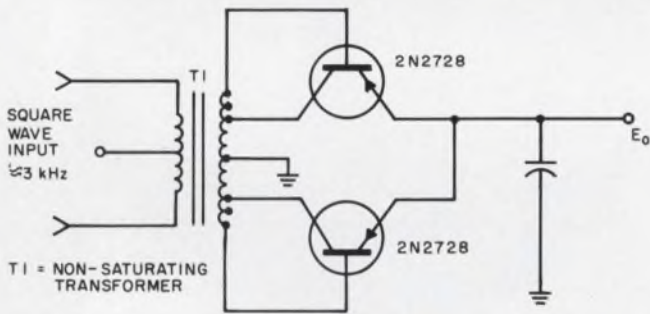

A five- to tenfold efficiency is obtained in a low-voltage rectifying circuit when the transistors are driven by additional transformer windings.

The rectification efficiency is improved when germanium power transistors are connected as diodes in place of the usual silicon rectifiers. A way to reduce the rectifier power loss further, by a factor of 5 to 10, is shown.

Tapped end windings are added to the transformer secondary to supply the base drive to operate the transistors in the saturated switching mode. An end winding voltage of about 0.9 V peak at 4 to 5 A (worst case transistor) is required for a maximum output load current of 54 A (2N2728). The total rectifier power loss is then less than 10 W. End winding taps provide for optimizing the saturation characteristics and allow "tuning" the rectifier circuit for minimum power dissipation.

A free-running multivibrator, operating at the highest possible frequency commensurate with good transistor switching times and low transformer core losses, supplies the square-wave power to be rectified.

W. F. Ball, Engineering Physicist, Kitt Peak National Observatory, Tucson, Ariz.

VOTE FOR 316

Simple slide screw tuner uses an eccentric screw

An eccentric screw mechanism (see figure), consisting of a large screw and an eccentrically located small screw, can act as a limited range slide screw tuner in a rectangular waveguide. The offset of the small screw from the center line (C/L) of the large screw determines the range

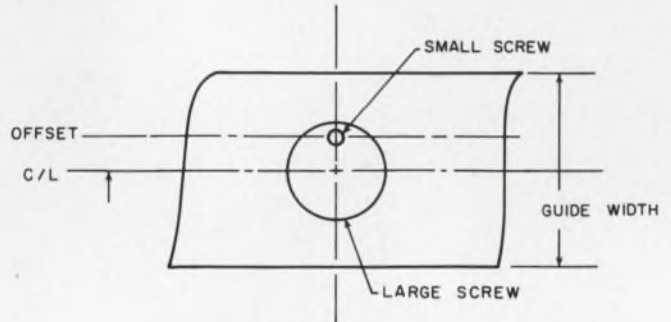

Limited-range waveguide tuner is obtained by combining two screws.

of the tuner. This offset should not exceed about one-quarter the width of the waveguide, to avoid inserting the small screw in regions of weak electric field. Both the large and small screws are equipped with hex nuts and curved washers, so that that tuner screws can be locked.

The practical dimensions for the eccentric screw mechanisms for several guide sizes are:

Guide Width in.	Offset in.	Large screw	Small screw
4.300	0.375	1-32	8-32
1.872	0.281	3/4-32	4-40
0.900	0.187	1/2-32	2-56

The data in the table are for the waveguide types RG-104/U, RG-49/U, RG-52/U and for the frequencies of 2, 5 and 9 GHz, respectively.

The eccentric screw mechanism permits building an inexpensive, limited-range tuner.

Richard M. Kurzrok, Consulting Engineer, New York City.

VOTE FOR 317

IFD Winner for January 4, 1968 **Robert Billon**, Design Engineer, UNITEC, Grenoble, France. His Idea "Zero-crossing detector needs no supply voltage" has been voted the Most Valuable of Issue Award. **Cast your vote for the Best Idea in this issue.**

NO CONTEST

if you're looking for 1 to 2 watts
of continuous audio power

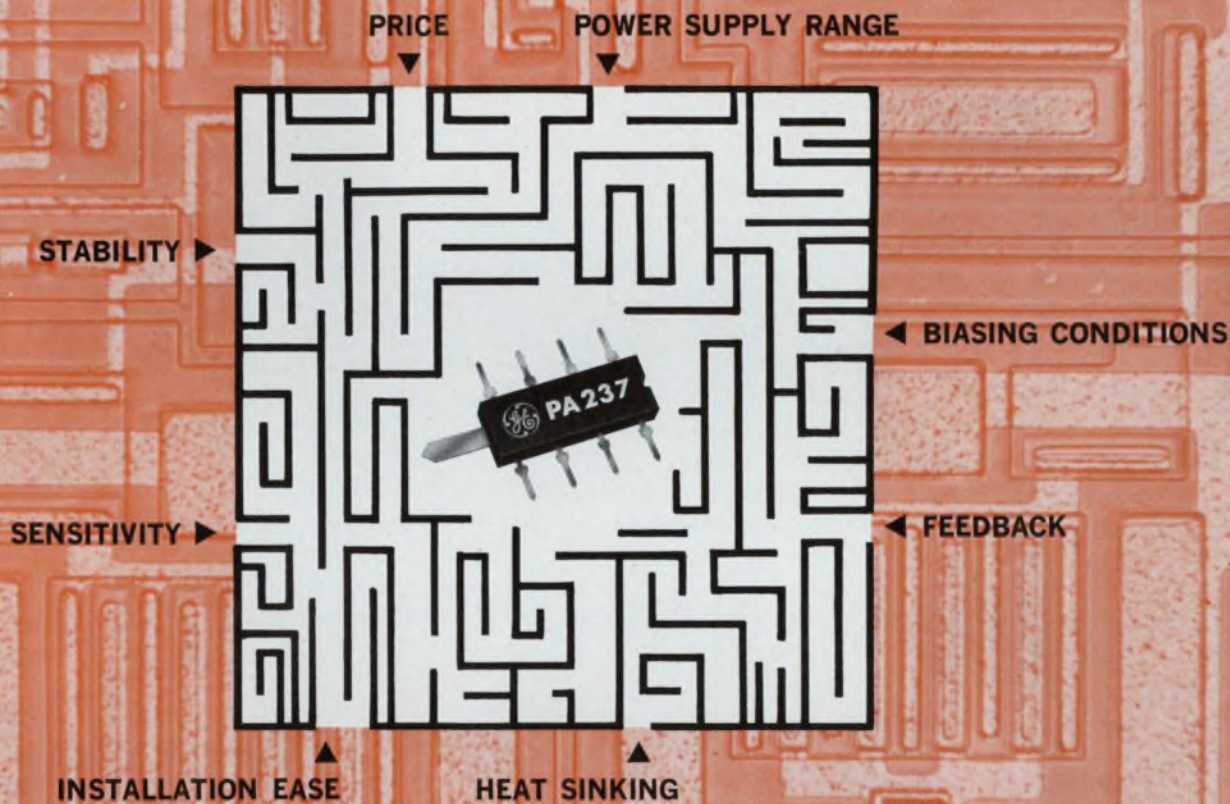

**See for yourself why General Electric's silicon monolithic IC's
can't be beat.**

No matter what your application, the PA234 or PA237 probably fits . . . and you save on design expense. See if you can draw a path from the feature most important to you, to the PA237 amplifier in the center of the puzzle. If you can get to the center, the PA237 is right for you. If you want to prove it to yourself, tell us your expected application and we'll send you a free PA237 to put to the test. Simply tear out this page and send it with your name, address, title, company, and PA237 application to Product Manager, Monolithic Audio Amplifiers, General Electric Company, Northern Concourse Office Bldg., North Syracuse, N.Y.

For more facts, turn the page. ▶

SEMICONDUCTOR PRODUCTS DEPARTMENT

GENERAL  ELECTRIC

Save design expense. Take advantage of the PA237's application versatility.



Because General Electric's PA237 operates over a supply voltage range of 9 to 27 volts, you can probably use this one circuit for most of your applications and save money. It is capable of delivering up to two watts of power to resistive or inductive loads. (Pictured actual size.)

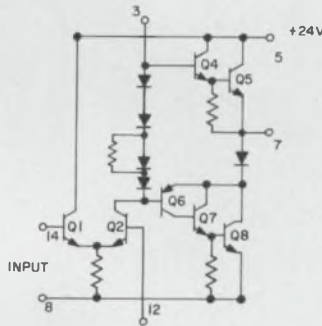

The PA237, shown in this circuit diagram, converts 8 mV of input signal to 2W of continuous, low distortion output power.



General Electric's PA234 gives you the lowest total cost for a 1-watt amplifier function through a combination of low device cost and minimum number of outboard components. (Shown actual size.)

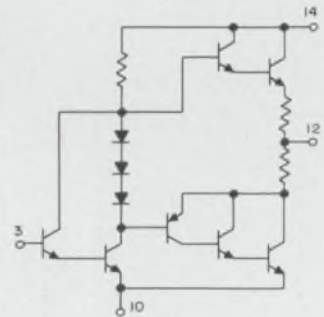

PA234 audio amplifier delivers 1 watt of continuous power to a 22-ohm load from a 22-volt supply.

Now you can use a single IC for most of your audio applications by simply varying its bias.

General Electric PA237 silicon monolithic audio amplifier is designed to have its biasing network external to the chip. Thus appropriate biasing for any power supply from 9- to 27-volts is readily achieved.

External biasing permits operation with Class A, Class A-B, or Class B output modes. The input may be biased for voltage or current sources as well as differential signals.

In addition to the PA237's wide range of supply voltage and bias alternatives, feedback may be applied to the amplifier to allow adjustment of stability, input and output

impedance and amplifier sensitivity. Simple AC and DC feedback networks are employed to provide excellent stability with frequency and temperature.

General Electric's 1- and 2-watt low-distortion amplifiers are packaged in an 8-lead dual-in-line plastic package with a tab for transferring heat to a printed circuit board. This means easy insertion into the P.C. board and easy heat sinking too. **General Electric's PA234** is the ultimate in low cost 1-watt monolithic audio IC's. Its low cost plus the least number of outboard components of any audio amplifier on

the market makes the PA234 the most economical alternative for achieving one watt of audio power.

Both General Electric's PA234 and PA237 offer you outstanding performance and top reliability in a wide range of circuit applications. These varied uses include phonographs, dictating equipment, tape player/recorders, and TV, AM, and FM receivers. Plus: the PA237 can drive inductive loads or provide voltage regulation for 1% typical over a 9- to 27-volt range. For more information on how GE can save you design expense and cash outlay **circle number 811**.

Here are some other outstanding GE semiconductors on which you can depend.

Industry's most predictable UJT saves time and money.

Stand-off ratio spread $\pm 3\%$!
Oscillator frequency shift .6% max!
(-15°C to $+65^{\circ}\text{C}$)

GE's D5K1 and D5K2 planar complementary unijunction transistors offer greater stability and uniformity than any UJT previously available. They have characteristics of standard unijunction transistors except that, being complementary, their currents and voltages are of opposite polarity. For most applications, polarity is unimportant.

The D5K1 and D5K2 combine planar and integrated circuit techniques resulting in a much tighter intrinsic-standoff ratio distribution and lower saturation voltage. This gives them both a new high level of performance predictability versus temperature.

Timing stability of 0.5% is achievable without the necessity of expensive temperature testing on individual devices to determine the compensating resistor. For more details circle number 812.



1200-volt, 400-amp

PRESS PAK

silicon rectifier costs less.

If you want a high power silicon rectifier diode with the same proved, all-diffused construction of the A90 series, General Electric offers the A390 PRESS PAK. The package innovation delivers far more continuous current than comparable stud-mounted devices, and it's smaller, too.

The new PRESS PAK package, using pressure contacts, allows double-side cooling to significantly reduce thermal resistance and, therefore, increase current ratings about 60%. Result: You get more average amps per dollar.

Light weight, hermetically-sealed PRESS PAK also features reversibility of mounting, thus eliminating the need for special reverse polarity units. And it complements many SCR's already in the PRESS PAK package. For more details, circle number 813.



Now you can custom tailor UJT characteristics to meet your specific needs.

With General Electric's D13T1 and D13T2 programmable unijunction transistors (PUT) you can now program unijunction characteristics such as η , R_{BB} , I_p , and I_v to your specific needs by adding two external resistors.

Generally, the D13T gives programmability without increasing circuit complexity. In fact, it often reduces circuit cost. And the PUT offers tight parameter specifications, high sensitivity, low unit cost, low leakage current, low peak point current, low forward voltage, and fast, high-energy trigger pulse too.

D13T2 is specifically characterized for long interval timers and other applications requiring low leakage and low peak point current. The D13T1 has been characterized for general use where low peak point current is not essential. Circle number 814.



For more information on these and other General Electric semiconductor products, call or write your GE sales engineer or distributor, or write General Electric Company, Section 220-63, 1 River Road, Schenectady, N. Y. 12305. In Canada: Canadian General Electric, 189 Dufferin St., Toronto, Ont. Export: Electronic Component Sales, IGE Export Division, 159 Madison Ave., New York, N. Y. 10016.

SEMICONDUCTOR PRODUCTS DEPARTMENT

GENERAL  **ELECTRIC**

Look for us at 3:20

or...Components, Inc. helps solve a problem in space-time

If you look closely, just after 3 o'clock, you can see one of the world's most compact capacitors, there in one of the world's most remarkable timepieces.

When they designed the unique Accutron® timepiece, Bulova engineers came up with elegant solutions to some perplexing problems in space as well as time. Not the least of these was the question of how to squeeze a relatively large (.22 mfd) electrical capacitance into a space somewhat smaller than the lead point in a pencil. This capacitance, part of the tiny pulse-generating circuit which controls the critical vibration amplitude of the Accutron tuning fork, had to be extremely stable and completely reliable.



solid-tantalum Minitans are substantially smaller than any other type of capacitor available . . . yet provide highest possible performance, minimum leakage, and (although most Accutron timepiece owners won't particularly care) full reliability up to 125°C.



They found precisely what they needed for the Spaceview model (illustrated), in C.I.'s Econotan line of miniaturized solid-tantalum electrolytics. Providing excellent electrical characteristics and unusually high capacity/volume ratios, these metal can, epoxy-sealed units remain completely imperturbable in the face of passing time. They maintain high stability under shock, vibration and temperature change.

Thinking Super-Small . . . For the thinner Accutron date models, where space is really tight, the C.I. subminiature Minitan series was selected. No bigger than a gnat's kneecap, these

When the squeeze is on . . .

call Components, Inc. If you have a space problem, C.I. has the capacity to solve it. We offer more subminiature case styles and ratings than anyone in the business. We welcome requests for samples, performance and reliability data, and application assistance. Standard prototypes normally shipped within 24 hours. Write or call today for data or samples.

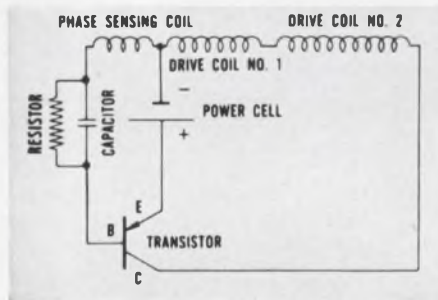

Schematic diagram of Accutron circuit

ECONOTAN		MINITAN CORDWOOD	
	CT		Y
	CM		P
	CL		B
	CB		A
			G
.0047 MFD @ 35 VDC to 68 MFD @ 4 VDC		.001 MFD @ 50 VDC to 47 MFD @ 3 VDC (modular series available to 220 MFD.)	

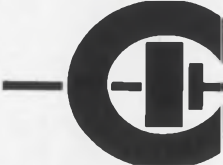

COMPONENTS, INC.
MAINE DIVISION
 BIDDEFORD, MAINE 04005 — TEL: (207) 284-5956 — TWX: 710-229-1559

Products

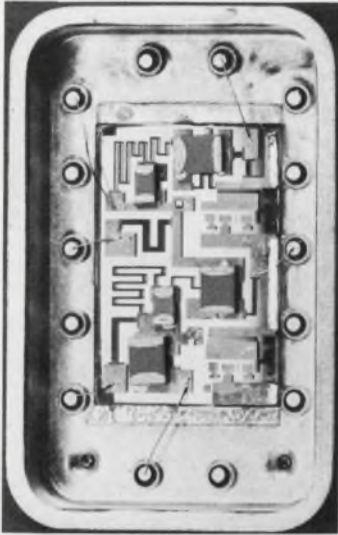

Hybrid ICs can amplify microwaves. Page 126



Photographic microscope reveals a 1/4-in. depth of field and will take pictures up to 500 × magnification. Page 114

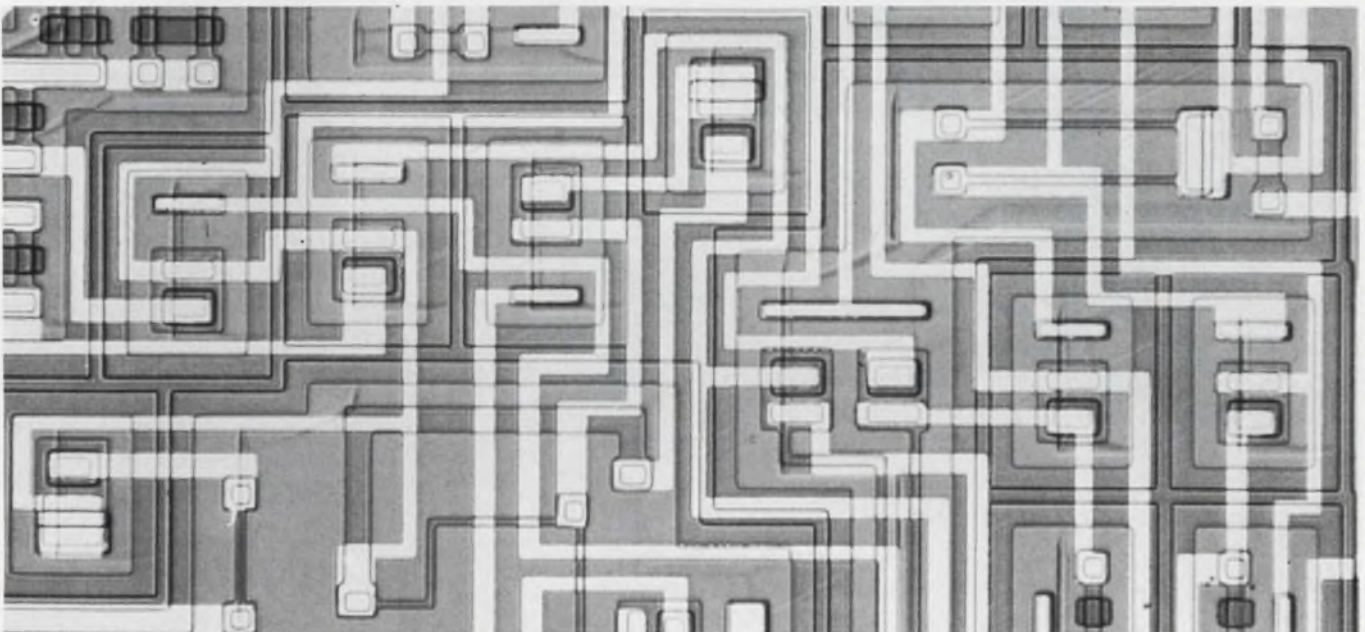

Low-drift IC amplifiers contain 24 active elements. Input-offset voltage and current drift

are $0.3 \mu\text{V}/^\circ\text{C}$ and $2 \text{ pA}/^\circ\text{C}$ respectively with gains of up to 140 dB. Page 122

Also in this section:

Drilling machines use air bearings to obtain high accuracy and long life. Page 125

Ubiquitous spectrum analyzer handles 10 kHz signals in real time. Page 134

Design Aids, Page 140 . . . **Application Notes**, Page 142 . . . **New Literature**, Page 144

Photographic microscope shows a 1/4 in. depth of field

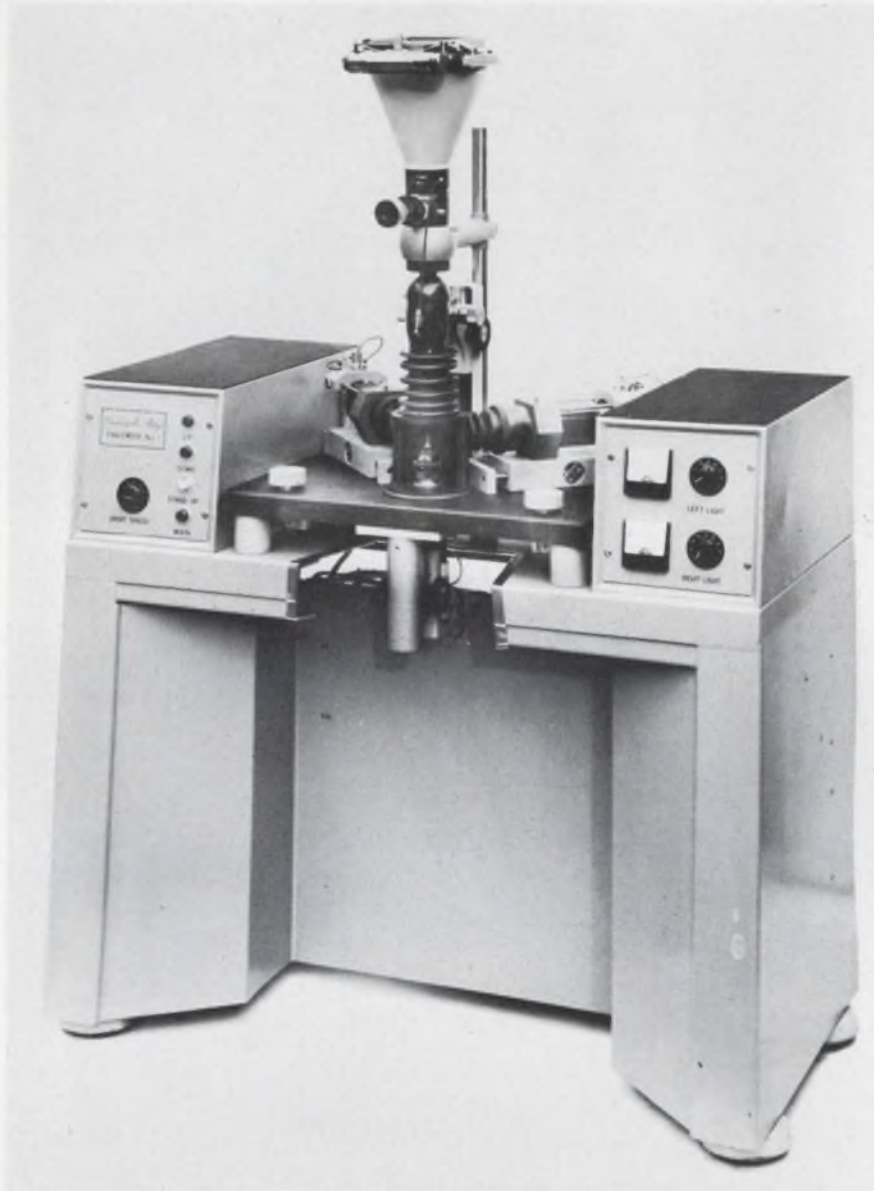

Electronics & Alloys Inc., 145 S. Dean St., Englewood, N.J. Phone: (201) 568-6820. Price: \$6900.

A photographic microscope that can magnify 500 times also has a depth of field capability of 1/4 in. Pictures taken by the unit can be either black and white or color.

The instrument, according to its inventor, Dr. Dan McLachlan, Jr., "does something never before possible with either a conventional optical microscope or a conventional electron microscope. It is capable

of magnifying in the same way that a conventional microscope does, but with a depth of field many orders of magnitude greater than standard microscopes."

The first problem to be overcome was that of specimen illumination. In conventional microscopic practice, the specimen is flooded with light and every part of it disperses light throughout the optical system; all the transmitted light falls on the photographic film or the eye, whether or not that particular part of the specimen is in focus.

On this microscope, however, the entire specimen is in darkness except for a thin horizontal zone which precisely corresponds to that of a selected focal depth range. Those parts of the specimen which are out of focus are in darkness and cannot scatter light to diminish the sharpness of the in-focus image being recorded on photographic film.

The light sources are two 50-W tungsten lamps which are used with horizontal collimating slits and condensing lenses with adjustable f /stops. Voltage controls and meters are provided for each lamp.

The specimen is illuminated only within the depth-of-field of the lens system, and it is moved into range on a rising specimen platform, which is in a plane perpendicular to the illuminated zone. The photographic image is built up by what might be described as a modified scanning process.

The specimen, which may possess irregular surface features, is mounted on a miniature eucentric goniometer that provides for precise positioning and orienting to the light beams. In operation, the scanning mechanism is thrown out of gear, the specimen is mounted and the translating system positioned near its lower limit. The microscope is then focused on the topmost part of the specimen and manually scanned to the lower limit.

Any necessary adjustments to place the image in the desired position on the film are made by viewing the upper and lower scan limits on the camera's ground-glass plate. The limit switch is set for the point at which the scan is complete and the illumination adjusted to the desired depth of beam and intensity.

A test exposure on Polaroid film, made with the scanning mechanism gear, is usually taken to determine the correctness of position, illumination, and depth of scan. Following this, the camera is loaded with either color or black-and-white sheet film and a final exposure is made. Depending on film speed, the exposure may require from a few minutes to an hour. The microscope need not be attended during the exposure.

CIRCLE NO. 251

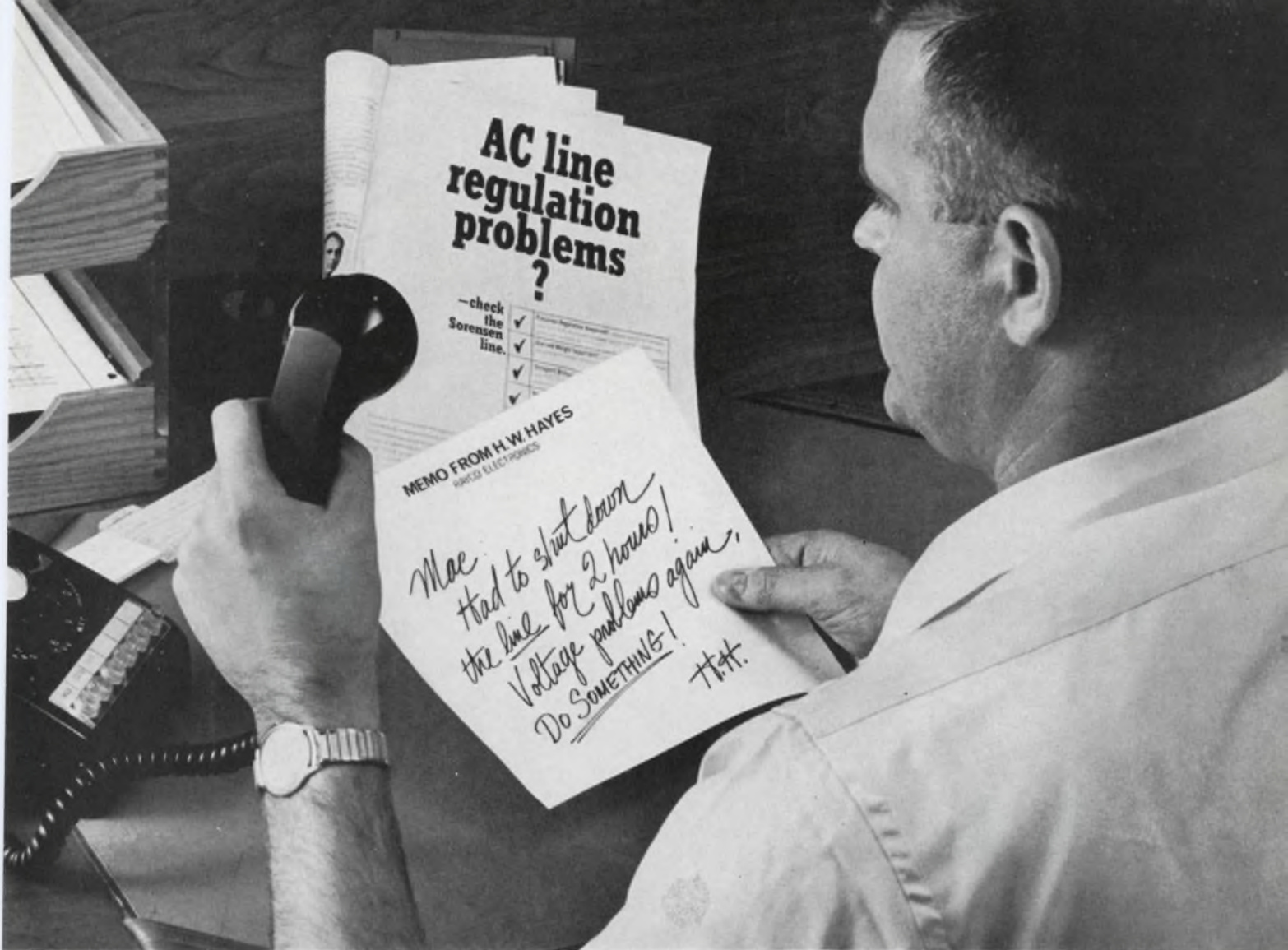

Call Sorensen 203-838-6571



... for the solution to your voltage problems! As you know, AC line regulation is the single, most effective preventive maintenance measure you, or any other engineer can specify. Regulation reduces costly production line down-time, and insures precision laboratory instrument performance. Whether your problem is on the production line or in the laboratory, there are Sorensen regulators, available from 150 VA to 45 KVA, that will more than satisfy those "DO SOMETHING" demands.

The Sorensen ACR Series combines SCR regulation, printed circuit maintainability, with up to 60% size and weight reduction over conventional units. The 0.01 Series provides $\pm 0.01\%$ precision regulation for problems de-

manding the strictest accuracy and stability. Where fast response and high accuracy is important, models of the FR Series respond to line and load changes within 50 μsec —considerably less than one cycle. Where size is not a factor, Sorensen's magnetic-amplifier S Series offers most effective, low-cost regulation. Each of Sorensen's 27 models have been expertly designed to solve specific voltage problems. We've been experts at solving regulation problems for over a quarter of a century.

For details on AC Line Regulators or DC Power Supplies, call or contact your local representative, or: Raytheon Company, Sorensen Operation, Richards Avenue, Norwalk, Connecticut 06856.

Telephone: 203-838-6571; TWX 710-468-2940.

RAYTHEON

STANDARD FREQUENCY RECEIVERS

FREQUENCY STANDARDIZATION TO THE
NATIONAL BUREAU OF STANDARDS



Model T-60 60 KHZ Time Code Receiver
Round The Clock WWVB 60 KHZ Binary Time Code Broadcasts • Most Accurate Time Signal Available • Can Be Recorded Continuously
Radio Station WWVB is broadcasting complete time information using a level shift carrier time code (10 db level changes). This code, which is binary coded decimal (BCD) is broadcast continuously and is synchronized with the 60 khz carrier signal. \$480.00

Model T-60A Rack Model (3½" H x 19" W x 5" D)



Model SR-60 Price: \$850.00
Model SR-60. WWVB-60 khz. Will calibrate any local standard up to 5-10' within a short period. Can be easily operated by any technician and performs in any part of the Continental United States.



Model SFD-6R Modular Construction:
A complete system for distribution of standard frequency throughout a plant. All solid State—fail safe—reasonably priced. Price depends upon Modules selected (\$90.00 each). Several Modules available.



Model WVTR Mark II All Silicon Transistor
Five different models of Receivers for WWV and WWVH are available. They receive all frequencies transmitted by WWV and are all crystal controlled double conversion superheterodynes. \$590.00

Special Antenna Assemblies for both VLF and HF are in stock.

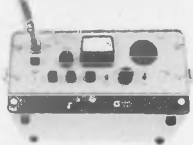

Model WWVT \$590.00
Mark II
All Silicon Transistor
Overall Size
7¼" x 9½" x 5"
Approx. Weight—7 lbs.

MODEL SR-7H
\$345.00

Crystal controlled front end receiver covering 2.5, 5, 10, 15, 20 and 25 MHz with double conversion 2 MHz first I.F. and 175 kHz second I.F. Also available in rack model.

Send for complete specifications. Prices and specifications subject to change without notice. F.O.B. Woodland Hills, Calif.

SPECIFIC PRODUCTS

P.O. Box 425 / 21051 Costanzo Street
Woodland Hills, California
Area Code: 213 340-3131



INFORMATION RETRIEVAL NUMBER 54

SYSTEMS

High-speed reader handles 200 ft-tape

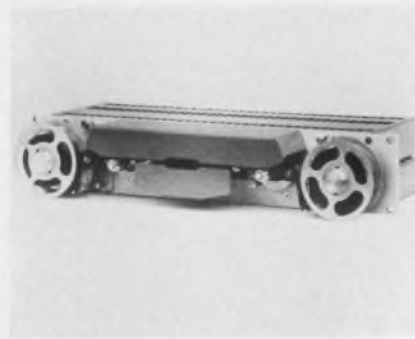

Chalco Engineering Corp., 15126 S. Broadway, Gardena, Calif. Phone: (213) 321-0121.

A high-speed tape handler and reader occupies only 3.5 in. of rack space. The transport mechanism will handle 200 ft of tape bidirectionally. Operating at any rate from 0 to 150 characters per second, the unit slews at 500 Hz and stops on character. Electrical adjustments, clutches and gear trains have been eliminated.

CIRCLE NO. 252

Phase-lock receiver has 5 vhf channels



Data-Control Systems, Inc., Danbury, Conn. Phone: (203) 743-9241.

Operating in the 125-to-155 MHz range, a 5-channel, crystal-controlled, phase-lock vhf receiver is designed for high dynamic range and stability. I-f image rejection is 100 dB minimum, and over-all system distortion is less than 1%. The front panel houses a lock-loss indicator, a signal strength meter, a zero level control, an audio level control and a video level control.

CIRCLE NO. 253

Plug-in modules accommodate ICs

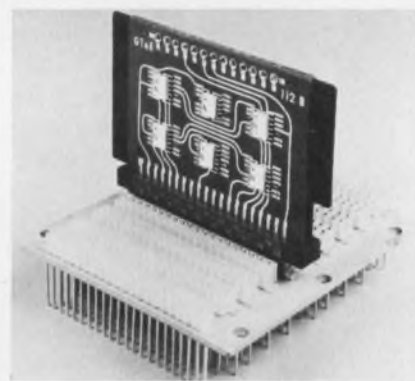

Sylvania Electric Products Inc., 730 Third Ave., New York. Phone: (212) 551-1693.

A series of double-sided, multi-layer, printed-circuit modules will accommodate high-speed logic functions utilizing integrated circuit assemblies. The basic card can also accommodate discrete components and film-hybrid microcircuits. Available in 78 basic circuit configurations, the 40-pin modules are 1.8 in. high by 2.84 in. wide by 0.281 in. deep.

CIRCLE NO. 254

Paper tape system prints teletype code



Kurt Weiss/Prodata, 2 Hamburg 70 Postfach 13389. Telex 02-13426.

A portable data-acquisition system with a rechargeable nickel-cadmium battery will record international teletype code on paper tape. Information is stored by electromechanical counters and, after transfer into four-decade temporary storage counters, may be read out in variable intervals of 1, 5, 10, 15, 20, 30 and 60 minutes, or in pre-programmed intervals selected by the user.

CIRCLE NO. 255

New Sperry reflex klystrons provide added flexibility for Ka-band systems

 SPERRY RAND

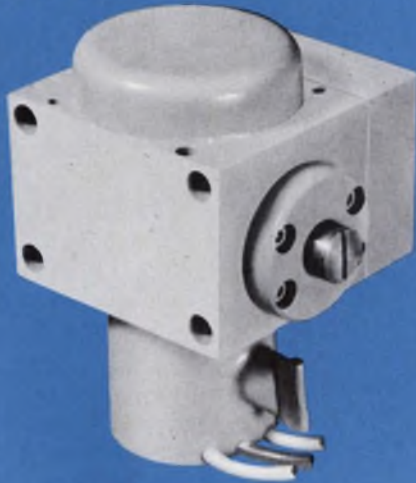

	TYPICAL OPERATION BROAD BAND	TYPICAL OPERATION HIGH POWER	
Beam Voltage	425	500	Vdc
Beam Current	30	40	mAdc
Reflector Voltage	Constant *	Constant *	Vdc
Heater Voltage	6.3	6.3	V
Heater Current	0.6	0.6	A
Electronic Tuning Range	100	60	MHz
Power Output	30	100	mW
Mechanical Tuning Range	±500	±500	MHz
Frequency	35.0	35.0	GHz
Reflector Modulation Sensitivity	6.0	3.0	MHz/V
Weight	3	3	Oz
Dimension (Max)	2.14x1.63x1.34	2.14x1.63x1.34	In

* Voltage to be constant from tube to tube at specified customer frequency

Sperry announces a new family of reflex klystrons — the SRV-5250 Series — which promises unprecedented flexibility for system designers working in the 26.5 to 40 GHz range. The basic design may be readily modified to meet specialized requirements.

Among the more important design features of the series are:

- 1000 MHz tuning range anywhere in the 26.5-40 GHz band.
- A unique adjustable reflector which assures peak performance at specified reflector voltage. This eliminates

costly variable power supplies.

- Single-knob tuning which prevents spurious modes through use of an integral cavity dielectric tuner.
- A new, low-temperature cathode which prolongs operating life even under the most severe conditions.

The series is available with matching power supplies tailored to specific system requirements. For more details, contact your Cain & Co. representative or write Sperry Electronic Tube Division, Sperry Rand Corporation, Gainesville, Florida 32601.

SPERRY
ELECTRONIC TUBE DIVISION
GAINESVILLE, FLORIDA

INFORMATION RETRIEVAL NUMBER 55

CRYSTAL FILTERS

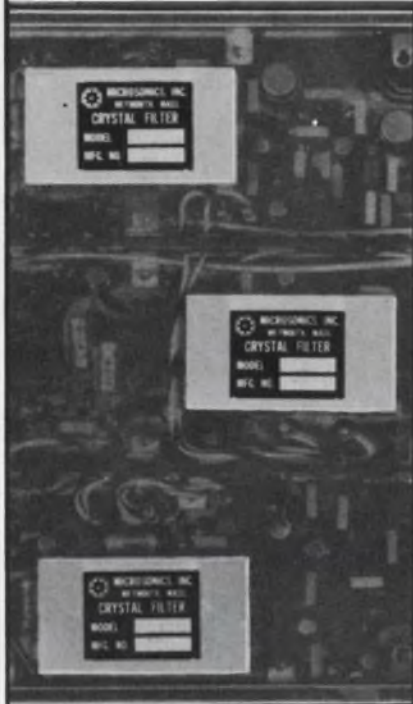

Microsonics, Inc. has designed and developed phase tracking crystal filters, in which the phase between filters will track within close tolerances, over wide temperature ranges, without temperature control. Any one of the standard multi-pole filters such as Butterworth, Tchebycheff, Bessel, etc. may be obtained with phase tracking requirements. In the event of tight tracking requirements, the filters are produced in matched sets according to the customer's requirements.

The set of 3 filters shown above have been produced in production quantities and the specifications are shown below.

SPECIFICATIONS

Center frequencies:5MC \pm 150 cps
Bandwidth 3db:1KC \pm 100 cps
Shape-factor 60/3db:5:1
Ultimate rejection:70db min.
Initial phase off-set:1°
Phase tracking across the 3db bandwidth:5° max.
Operating temperature: -35°C to +75°C

Send for Microsonics' Brochure No. 4350



MICROSONICS, INC.

60 Winter Street
 Weymouth, Mass. 02188
 Tel: 617 337-4200

A subsidiary of the Sangamo Electric Company

INFORMATION RETRIEVAL NUMBER 56

SYSTEMS

Magnetic tape system sends 100 characters/s



Community Corp., 292 Madison Ave., N.Y. Phone: (212) 532-4870. Price: \$18,000.

A 6000-characters/min-magnetic-tape-transmission-system provides economical offline data receiving and sending facilities for a computer operation. The system will receive and batch magnetic tape data and translate it to computer-compatible codes recorded on magnetic tape. It will also send computer-prepared data at 1200 bits/s.

CIRCLE NO. 256

A-D conversion system has modular design



Canoga Electronics Corp., Digital Products Div., 8966 Comanche Ave., Chatsworth, Calif. Phone: (213) 341-3010. Price: \$3750-\$5780.

All of the units in a line of A-D converters are based on a basic 5-bit printed-circuit card. Additional cards can be integrated with the basic card to obtain 9-, 12- and 15-bit converters, packaged as separate instruments or in printed-circuit card assemblies that can be incorporated directly into a rack-mounted system.

CIRCLE NO. 257

Discriminator system handles 15 channels

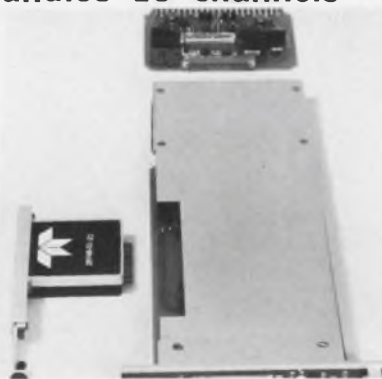

Geotech, a Teledyne Co., 3401 Shiloh Rd., Garland, Texas. Phone: (214) 271-2561. Price: \$700/channel.

Up to 15 plug-in solid-state filters and tuning units are accommodated by a discriminator system designed for multiple data, low-frequency telemetering applications. The discriminator has a dynamic range of 54 to 80 dB depending on selected deviation. Noise level is less than 1 mV pk-pk and linearity is better than 0.5%.

CIRCLE NO. 258

AEC instrument module delays from 1 to 63 ns

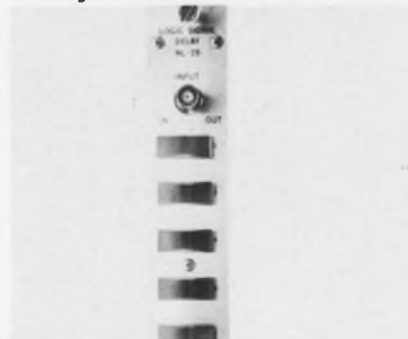

Hamner Electronics Co., Inc., 1945 East 97th St., Cleveland. Phone: (216) 721-8300.

A precision logic signal delay unit provides delay from 1 to 63 ns in 1-ns increments. The unit is a passive cable delay in a single-width AEC standard nuclear instrument module. It can be used to balance parallel timing channels, to maintain proper time relationship between logic signals or as a calibration standard.

CIRCLE NO. 259

MICROWAVE IC PROGRESS REPORT #1

Sperry PACT program carries avalanche transit time oscillator past 5,000 hours of life testing

Sperry's PACT (Progress in Advanced Component Technology) Program now offers more than 5000 hours of life test data on an X band Avalanche Transit Time Oscillator. With a test history dating from July 6, 1967, the device has not yet shown a measurable change in characteristics.

A direct result of PACT, Sperry's intensified effort to accelerate the development of microwave integrated circuits, the ATTO is believed to be the smallest device of this type available anywhere for the direct conversion of DC to a microwave signal. Its outline dimensions are identical with that of a DO-5 diode package.

In developing the device, PACT engineers attacked the following requirements:

- Relatively high power output in microwave IC size packages.
- Electronic tunability over 5 to 50% bandwidths.
- Frequency modulation capability without excessive spurious amplitude modulation.
- Minimum AM and FM noise characteristics.

Success of the project depended largely on Sperry's in-house capability for development and production

of avalanche diodes. This capability met the challenge, and ATTO's are now produced entirely within Sperry's Clearwater, Fla., facility.

As soon as PACT had demonstrated its ability to deliver the diodes required, the other technical problems came under staff scrutiny. One of the first developments was an "upside-down" diode mounting technique which puts the heat dissipating region of the silicon mesa chip as close as possible to the heat sink. Resulting reduction of thermal resistance between junction and heat sink enabled



PACT engineers to handle current densities as high as 850 amps/cm². Power outputs have reached 380 mW CW.

Both frequency and phase locking techniques have been demonstrated.

Tuning requirements were met by utilizing mechanical, varactor or YIG techniques. Magnetic tuning across a 40% bandwidth is a reasonable expectation, and Sperry's experience in stalo design has permitted FM noise reduction by a factor of 30.

In summary, PACT has now demonstrated the feasibility of ATTO power output from 20 to 350 mW at specified frequencies between 5 and 10 GHz; inputs would vary from 80 to 110 VDC at 30 - 50 mA. These forerunners of true microwave IC's will deliver conversion efficiency as high as 5%, and

SPURIOUS AMPLITUDE MODULATION

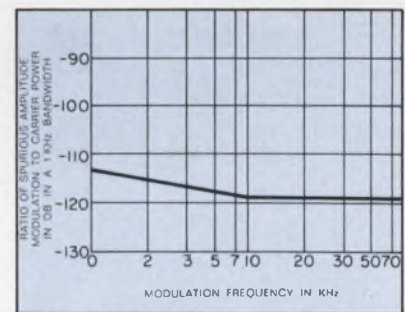

frequency stability of 4.5 ppm/°C between -10 and +50/°C.

In its ATTO effort, the PACT program has already proved its ability to provide direct DC to microwave conversion for the most demanding of custom specifications. Chances are that the technology required for your application is already in existence. And, PACT's achievements in ATTO development foreshadow a quickening pace in the refinement of microwave integrated circuits.

To learn more about an ATTO for your application or the coming impact of PACT, contact your Cain & Co. representative or write Sperry Microwave Electronics Division, Sperry Rand Corporation, Clearwater, Florida.

*For faster microwave progress,
make a PACT with people
who know microwaves.*

SPERRY
MICROWAVE ELECTRONICS DIVISION
CLEARWATER, FLORIDA



Cool De-Fog Exhaust Circulate

with Sanders MINICUBE®
Subminiature Blowers

Missile-bred reliability . . . space-saving one cubic inch size . . . 1.25 ounce lightweight . . . 2.2 cfm rated output . . . 6.3, 26 or 115 vac, 400 cps. Sanders MINICUBE Blower eliminates hot spots around electronic components . . . prevents fogging of optical devices. Solves a variety of problems in both military and commercial applications. Write for free literature. Sanders Associates, Inc., Instrument Division, Grenier Field, Manchester, New Hampshire 03103. Phone: (603) 669-4615.

TWX: (710)
220-1845.



1" x 1" x 1";
2.2 cfm nominal; 1.25 ounces;
operating temperature range: -55°C to 125°C; typical life: 5000 hours; three models available.

Creating
New Directions
In Electronics

SA SANDERS ASSOCIATES, INC.

SA  **SANDERS ASSOCIATES, INC.**

INSTRUMENT DIVISION
GRENIER FIELD, MANCHESTER, NEW HAMPSHIRE

INFORMATION RETRIEVAL NUMBER 58

SYSTEMS

Low-speed reader scans punched tape



*Digitronics Corp., Albertson, N.Y.
Phone: (516) 484-1000.*

A low-speed tape reader reads any EIA standard 11/16-(5 channel) to 1-in. (8 channel) punched tape and operates at speeds up to 60 characters/s. By means of solenoids which do not require lubrication, a simple drive is used to move tape. For high reliability, bifurcated contacts are employed to perform the read function. A tape handler for feeding and collecting tape is optional.

CIRCLE NO. 260

Differential amplifier has fifteen options

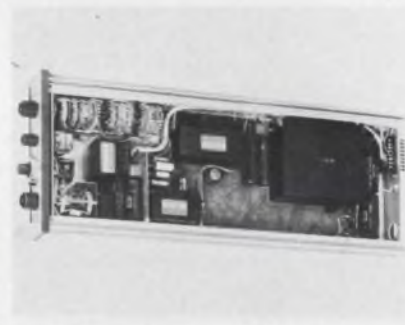

*Dynamics Instrumentation Co., 583
Monterey Pass Rd., Monterey Park,
Calif. Phone: (213) 282-3161.*

A differential dc amplifier features a 300-V common-mode operating level and fifteen options for maximum versatility. These options include six gain step sequences, $\pm 0.01\%$ accuracy, single and dual outputs (± 100 mA), five- and seven-position selectable filters and fixed or variable current limiting settings.

CIRCLE NO. 261

Data system has three parts



*Hewlett-Packard, 1501 Page Mill
Road, Palo Alto, Calif. Phone:
(415) 326-7000. P&A: \$12,240; 8
wks.*

A data-acquisition system includes a scanner, a digital voltmeter and a digital recorder. The scanner connects up to 200 3-wire inputs one at a time to the DVM for measurement. The recorder prints the measurement result along with channel identification data.

CIRCLE NO. 262

Counting modules make 200 counts/s

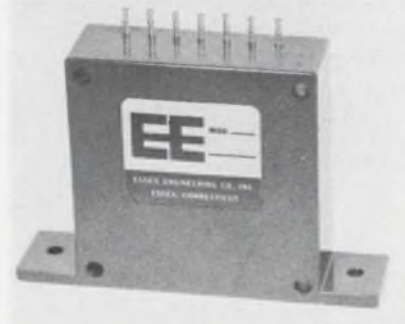

*Essex Engineering Co., P.O. Box
28, Essex, Conn. Phone: (203) 767-
8221. Price: \$5-\$20.*

Using relay-capacitor logic, a line of binary, BCD and decimal units are capable of counting at rates up to 200 counts/s. These units are adaptable to counting applications at line frequency and may be used for frequency dividers, timing, or counting applications. The units are packaged in $2 \times 2 \times 3/4$ -in. modules.

CIRCLE NO. 263

Six-pen recorder tracks at 18 speeds



Houston Instrument, Div. of Bausch & Lomb, Inc., 4950 Terminal Ave., Bellaire, Tex. Phone: (713) 667-7403. P&A: \$8500; 60-90 days.

Featuring 6-pen X-Y or T-Y recording capability, this instrument offers speeds from 0.05 in./s to 2 in./h in 18 ranges. The X-axis can be driven with analog input or on a pushbutton-selected time base. The six pens are positioned in pairs, each capable of traversing the entire Y-axis. Each pen axis has 36 voltage ranges from 0.2 mV/in. to 100 V/in. Accuracy is $\pm 0.2\%$ and repeatability is $\pm 0.1\%$ of full scale.

CIRCLE NO. 264

Tape-data converter feeds analog inputs

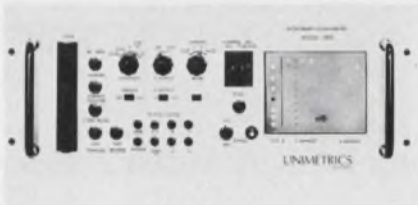

Unimetrics Corp., 2712 Southwest Freeway, Suite 107, Houston. Phone: (713) 524-3157. P&A: \$2675; 60 days.

Transforming perforated-tape data into analog voltages for plotting on X-Y or incremental-advance recorders, a converter contains all logic and controls for the read-converter-plot-advance cycle. Featuring logarithmic conversion of linear data, the instrument has facilities for overlays of data for comparison and analysis.

CIRCLE NO. 265

Parametric amplifier covers 2.2 to 2.3 GHz

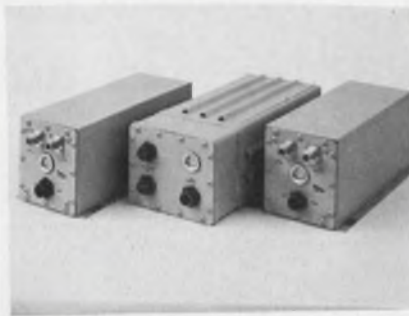

Melabs, 3300 Hillview Ave., Stanford Industrial Park, Palo Alto, Calif. Phone: (415) 326-9600.

A broadband, low-noise parametric amplifier for airborne or ground-station uhf telemetry applications covers the 2.2- to 2.3-GHz range with a 2-dB maximum noise figure and 22-dB gain. This fixed-tuned unit handles inputs up to 100 mW, is 4-1/2 by 5-3/32 by 12-1/16 in. in size and weighs 8-1/2 lb.

CIRCLE NO. 266

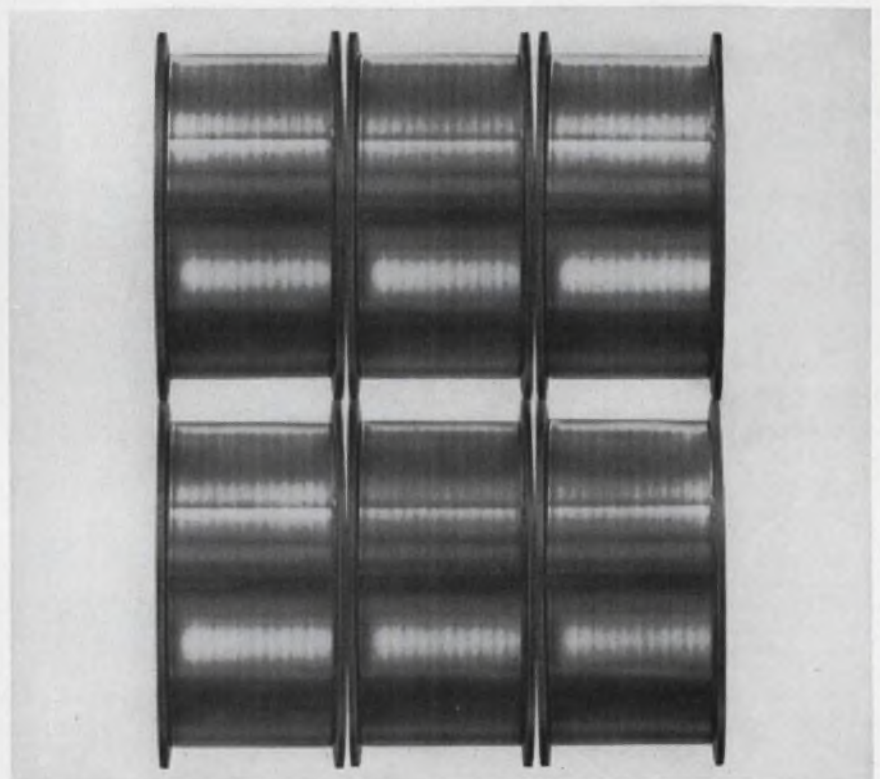

NEW SECON type "5" ultra quality lead bonding wire for semiconductors

The new Secon type "5" technique produces wire that is more uniform and reproducible than ever before. Type "5" also handles more smoothly in wire feed mechanisms. Secon now supplies *all* lead bonding wire to its customers in the type "5" quality classification.

This new level of controlled quality is the culmination of over a year

of intensive technical and metallurgical research in cooperation with several of the semiconductor industry's largest consumers of finely engineered wire. If you haven't sampled type "5", it's time you did.

For additional information, or technical assistance, please write on your letterhead to — Secon Metals Methods Engineering Department.



7 INTERVALE STREET, WHITE PLAINS, NEW YORK 10606 • (914) 949-4757
INFORMATION RETRIEVAL NUMBER 59

high reliability coatings for printed circuits

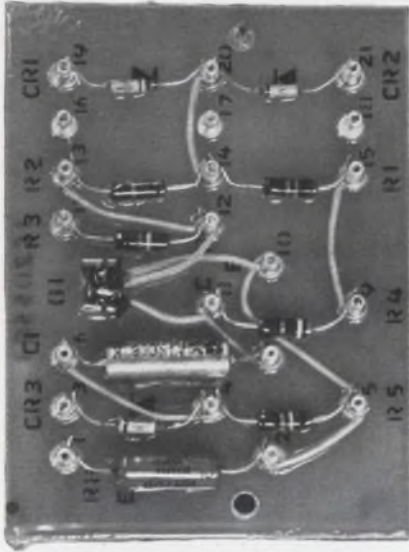

wide range of easy-to-process economical urethanes & epoxies

CONATHANE® and CONAPOXY circuit board coatings include compounds and systems for practically any application method or property requirement.

There are formulations for dipping, spraying, brushing, flow coating, or spin coating. Solution coatings, high solids and 100% solids coatings. Screenable coatings with excellent flow control and adhesion. Coatings that cure at room temperature or elevated temperatures.

Films can be applied to meet virtually all requirements: excellent resistance to abrasion, impact, chemicals, fungus, and exterior weathering; good electrical properties; good dip-tank stability; uniformity of coating thickness. They'll protect assemblies from water, high humidity, contamination, and other severe environmental conditions, making them ideal for the most critical applications including space electronic gear. They can be provided to ruggedize units against shock and vibration and to meet MIL-1-46058, Type PUR, requirements.

Most are easily repairable. Connections can be soldered or unsoldered through these coatings without degradation or discoloration. Spot recoating is a simple matter and special kits are available for field repairs.

Request Bulletin C-110 for complete information and inquire about low cost evaluation kits. Conap, Inc., Allegany, N. Y. 14706.



Epoxies and urethanes for potting, encapsulating, insulating, bonding, sealing, and coating

INFORMATION RETRIEVAL NUMBER 60

Low-drift IC amplifiers contain 24 active elements

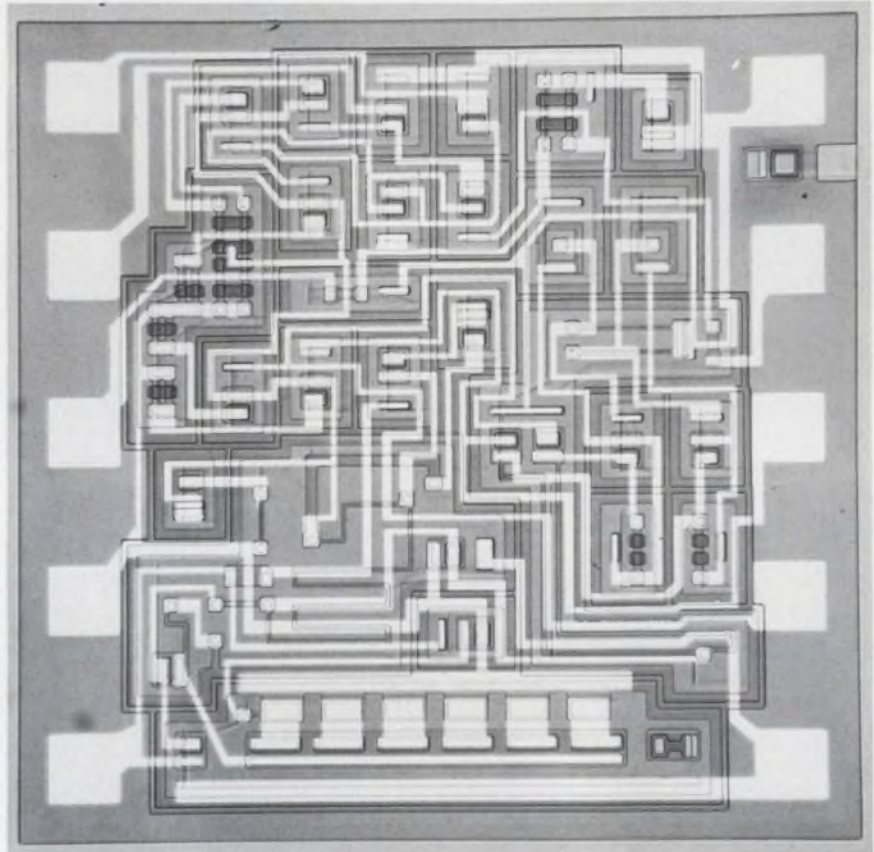

Fairchild Semiconductor, 313 Fairchild Dr., Mountain View, Calif. Phone: (415) 962-5011. Price: $\mu A727$ —\$34 (100 lots); $\mu A727-B$ —\$12.50 (1000 lots).

Engineers can now build high gain op amps using a linear IC. A temperature-controlled differential amplifier, the $\mu A727$, features input-offset voltage and current drifts of $0.3 \mu V/^{\circ}C$ and $2 pA/^{\circ}C$ respectively. Input impedance is a steady $300 M\Omega$ at temperatures between -55 to $+125^{\circ}C$. A second unit known as the $\mu A727-B$ offers lower price with an operating temperature range from -20 to $+85^{\circ}C$.

The $\mu A727$ is one of the small but growing family of microcircuits that are characterized by die sizes of 4000 to 10,000 mils² with 20 to 100 elements on a single chip. With 24 active elements, the $\mu A727$ uses a symmetrical geometry input

stages to obtain two dimensional cancellation of thermal gradients. This minimizes input-offset voltage drifts.

Low current drift and further improvement of the offset voltage drift are obtained by using active regulator circuitry to maintain the amplifier at a constant temperature. Temperature gradients are reduced by using multiple emitters on the 1.5 W power transistor with multiple diffused emitter resistors.

The $\mu A727$ is a monolithic, fixed-gain amplifier constructed by the Planar epitaxial process and mounted in a high thermal resistance package. It is intended as a self-contained input stage in low-drift dc instrumentation amplifiers. Its output will couple directly to differential input, single-ended amplifiers, and discrete or module amplifiers to obtain massive forward gains up to 140 dB.

CIRCLE NO. 272



The new Fluke 853A: The only complete multimeter.

Accuracy, measurement capability, and low cost have been a long time coming in the multimeter field. Now, they're here with the introduction of the new Fluke 853A. □ These specs are guaranteed for one year without recalibration. DC volts, 0.2%. AC volts, 0.5%. Range, 0 to 1.1 kv. DC amps, 0.2%. AC amps, 0.5%. Range, 0 to 11 amps. Ohms, 0.2%. Range, 0 to 110 megohms. All this plus complete overload protection. Price, \$445. □ Does this data bit give you just a hint why we also call the Fluke 853A, "the only complete multimeter"? Write or call for complete information.

Fluke, Box 7428, Seattle, Washington
98133. Phone: (206) 774-2211.
TWX: (910) 449-2850.



In Europe, address Fluke International Corporation, P. O. Box 5053, Ledeborstraat 27, Tilburg, Holland. Telex: 844-50237. In U.K., address Fluke International Corporation, P. O. Box 102, Watford Herts, England.

ANALOG



DEVICES

\$49

OP-AMP POWER SUPPLY

Dual ± 15 VDC @ 40mA
Direct Operation from 115 VAC
Modular for PC mounting
Small Size 2.5" x 3.5" x .87"



MODEL 901

SPECIFICATIONS:

Input	105 to 125 VAC, 60 to 400 Hz
Output Voltages	$\pm (15.1$ to $15.3)$ VDC
Output Current	40mA, each output
Load Regulation	0.2%, NL-FL
Line Regulation	0.1%, 105 to 125 VAC
Temp. Coeff.	0.03%/°C
Ripple and Noise	2mV, rms
Dynamic Output Z	2 ohms @ 10kHz
Output Protection	Short circuit proof
Operating Temperature	0 to 71°C
Derate 1.5mA/°C above 60°C	
Derate 0.5mA/°C below 15°C	
Storage Temperature	-25 to +85°C
Price (1-9)	\$49.
(10-24)	\$39.

ANALOG DEVICES INC.
221 FIFTH STREET,
CAMBRIDGE, MASS. 02142
PHONE: 617/492-6000
TWX: 710/320-0326

PRODUCTION EQUIPMENT

Nondestructive tester gauges plating

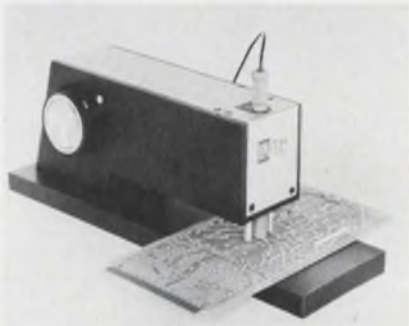

Unit Process Assemblies, Inc., 53-15 37th Ave., Woodside, N.Y.
Phone: (212) 899-9090.

A probe system nondestructively measures plating thickness in the holes of printed circuit boards. Used with a direct-reading thickness gauge, the system eliminates destructive examination by microscopic cross-sectioning. Accurate measurements of copper thickness from 1/2 to 3 mils are rapidly made without requiring any specific preparation of the circuit board.

CIRCLE NO. 267

Pneumatic press exerts 42 tons



Airam Inc., 16760 Stagg St., Van Nuys, Calif. Phone: (213) 875-5186.

A 42-ton press can produce 12 circuit boards per minute. Epoxy-glass boards are pierced and blanked after printing. The press is 30 x 26 x 36 in. Increased die life is claimed as the result of the ability to control impact pressures to suit the work. Virtually any tonnage up to the unit's limit can be achieved by adjusting a valve that controls the air pressure fed into the press.

CIRCLE NO. 268

Automatic masker makes ICs accurately



Jade Corp., 3063 Philmont Ave., Huntingdon Valley, Pa. Phone: (215) 947-3333.

Completely automatic, the 4M-10AXYL microcircuit mask making machine is available in four models for producing step and repeat photomasks. It will accept any microscope objective lens in addition to the Ultra-Micro-Nikkor f 1.8 1/10X magnification lens which is provided as standard equipment. The unit delivers image placement repeatability to an accuracy of ± 0.00001 in. (1/4 micron).

CIRCLE NO. 269

Thread clippers are Teflon-coated



Clauss Cutlery Co., Div. of Alco Standard Corp., Fremont, Ohio. Phone: (216) 696-0330. P&A: \$4; stock.

A thread-wire clip has replaceable blades and Teflon-coated spring-return handles. The blade inserts are hard cutlery steel and are sharp enough to cut multiple thicknesses of heavy materials. Blade removal and installation is performed with a screwdriver at the work station. Either sharp points or rounded safety points can be used.

CIRCLE NO. 270

Drilling machines use air bearings

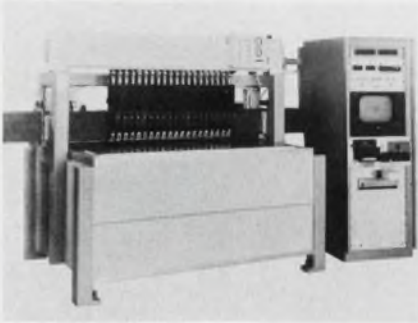

Elpac, Inc., 3760 Campus Dr., Newport Beach, Calif. Phone: (714) 546-8640.

Two machines combine granite and air bearings for improved accuracy and productivity. The granite floats on the air bearings which minimizes wear and allows the machines to operate without maintenance at much greater speeds for longer periods. The machines maintain an accuracy of ± 0.0003 in. because of the air-granite combination.

One model is equipped with from 4 to 20 drill heads. Up to five different drill sizes may be used and independently set up for feed rate, rpm, drill length and depth. The number of heads and the large table on which the boards are placed make it possible to drill a number of boards at one time. The programming technique uses a television system which magnifies the negative of the printed circuit artwork 50 times; this feature, with a joystick, enables the operator to position the table to an exact location for drilling the hole. When the table is positioned, a command causes paper tape to be punched, identifying the hole position. After all holes have been located and their positions recorded on the paper tube, the machine automatically drills the printed circuit boards.

Another model, an optical scan machine, is supplied with 42 drill heads and is used to drill complex multilayer circuit boards automatically. The optical scan machine requires no paper tape programming for drilling. A negative of the circuit board artwork is placed directly in the machine, automatically scanned and the boards drilled.

CIRCLE NO. 271

MODULAR TYPE IC PACKAGING PANEL

For High Density Panel

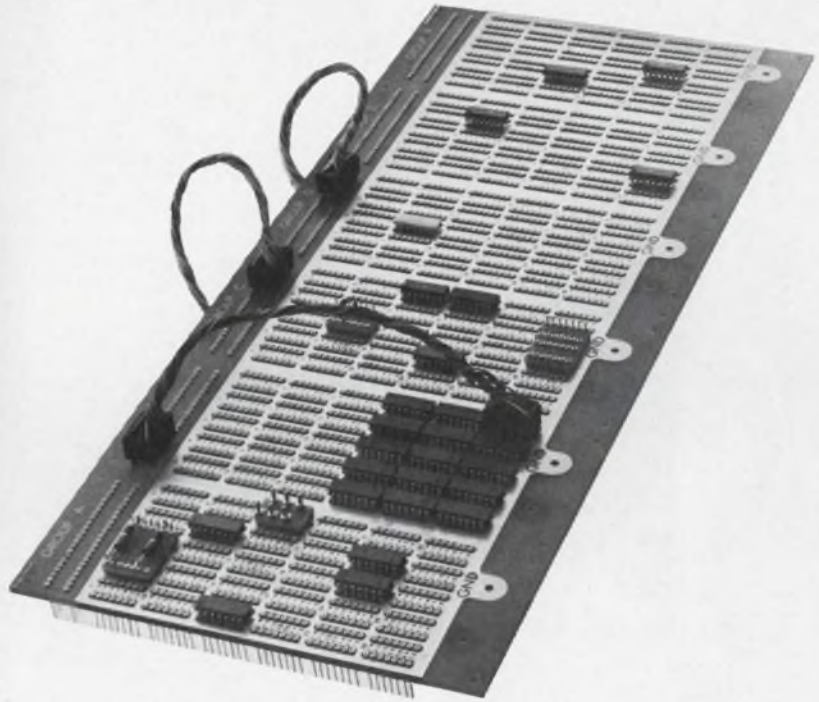

Simplifies design and production operations. Saves time and space. Direct mounting chassis eliminates need of logic cards — increases flexibility in prototyping, production and field service. A unique two dimensional approach to IC packaging with these outstanding features:

Multiple of 30 pattern sections, up to 180 patterns.

Two pins of each pattern tied directly to power and ground planes.

Provisions for input-output plugs and adaptor plugs for discrete components.

Excellent contact retention of flat lead dual-in-line (.022 max.) with machined closed entry design.

Choice of Wire-Wrap® or solder pocket terminations.

Three levels of connection on Wire-Wrap pins.

®Trademark Gardner-Denver Co.

Request Complete I. C. Folder

AUGAT

TEL: 617/222-2202

INC. 31 PERRY AVE., ATTLEBORO, MASS. 02703

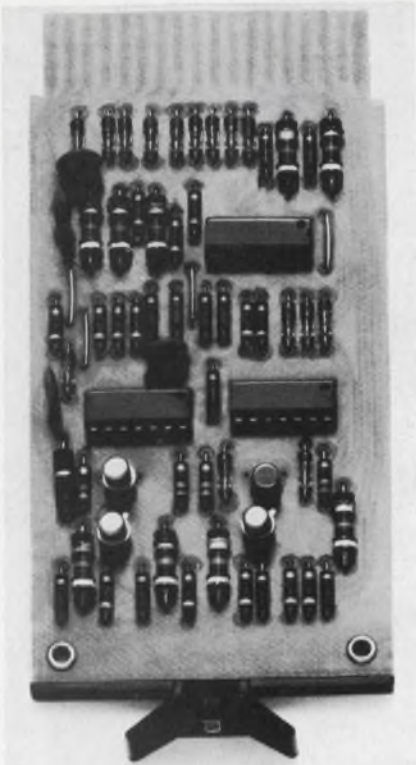

K604 Matches Solid State Logic to 120 volt AC Coils

The solid state K604, one module of our K Series line, interfaces sophisticated logic controls to the real world of 115 V. pilot circuits, motors, AC solenoids, hydraulic and air valves. It can control a type K size 3 motor starter for switching up to 50 H.P., for example, functions that mechanical relays handled until now.

The compatibility of the K604 permits updating to solid state logic without replacing solenoids, valves, contactors, etc. K604 can, in fact, be used in series with relay contacts.

The module's triac switches are totally isolated from ground, permitting switching on the hot side of the line. At about \$25 per line, including clamp-type terminals for wires up to 14 AWG.

Our K Series line is designed specifically for industrial control applications and features high noise immunity, ease of design and installation, and hardware compatible with standard NEMA enclosures and 19" electronic racks. Write for a free copy of our Industrial Handbook.

digital
MODULES · COMPUTERS

Maynard, Mass. Tele: (617) 897-8821

MICROWAVES

Hybrid microcircuits amplify microwaves

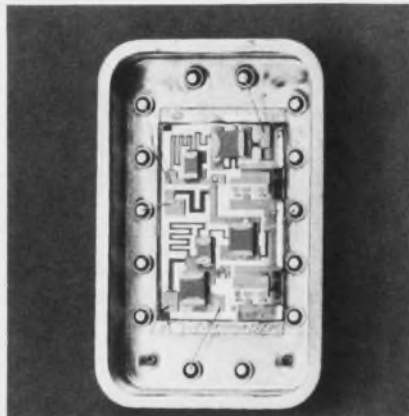

Hewlett-Packard Co., 1501 Page Mill Rd., Palo Alto, Calif. Phone: (415) 326-7000.

Hewlett-Packard is using the hybrid-microcircuits approach in a line of microwave amplifiers. The use of both lumped- and distributed-parameter circuit elements has been found to contribute to optimum performance by eliminating isolation problems. These devices cannot be produced on a monolithic chip, because the yield for each would be prohibitively low.

An insulating substrate of single-crystal sapphire forms the foundation of these devices. The C-axis is oriented in the plane of the substrate, thus maintaining an equal dielectric constant for the dominant TEM mode traveling in any direction on the substrate.

Since the expansion coefficient parallel to the surface is close to that of the materials used for both resistors and capacitors, resistance to thermal shock is very high. Substrates of this type have been heated to 500°C and then plunged into liquid nitrogen without impairing the adhesion of the components.

Numerous thin-film resistors provide a wide range of values but capacitors larger than a few thousand pF are applied in discrete form. Conductors are gold; molybdenum is used for adherence and as a diffusion barrier. Interconnections, bonding pads and strip lines are plated-up gold. Active devices are bonded on the circuit as discrete components. Power handling capability is enhanced by direct bonding to the substrate.

CIRCLE NO. 273

Pockels-cell assembly uses KDP crystal



Korad Dept., Union Carbide Corp., 2520 Colorado Ave., Santa Monica, Calif. Phone: (213) 393-6737. Price: \$1300.

A Pockels-cell plug-in assembly can serve as the heart of a complete Q-switch. It consists of a potassium - dihydrogen - phosphate (KDP) crystal with circular electrodes, cell container with end windows, and index-matching dielectric fluid. The assembly can withstand laser pulses of greater than 200 MW/cm² and is capable of a rise time of less than 10 ns.

CIRCLE NO. 274

GaAs emitter peaks at 9000 Å



General Electric Co., Miniature Lamp Dept., P. O. Box 2422, Cleveland. Phone: (216) 266-2121.

A gallium-arsenide infrared emitter hits its peak wave length at 9000 Å, making it useful for triggering action rather than for visual indication. It is mounted on a standard transistor base and capped by a top-hat capsule and lens. The unit is intended for use in card readers and other photoelectric applications. Other uses can include counting devices, machine controls and tape readers.

CIRCLE NO. 275

Report from

**BELL
LABORATORIES**

The Anatomy of Vibrating Crystals

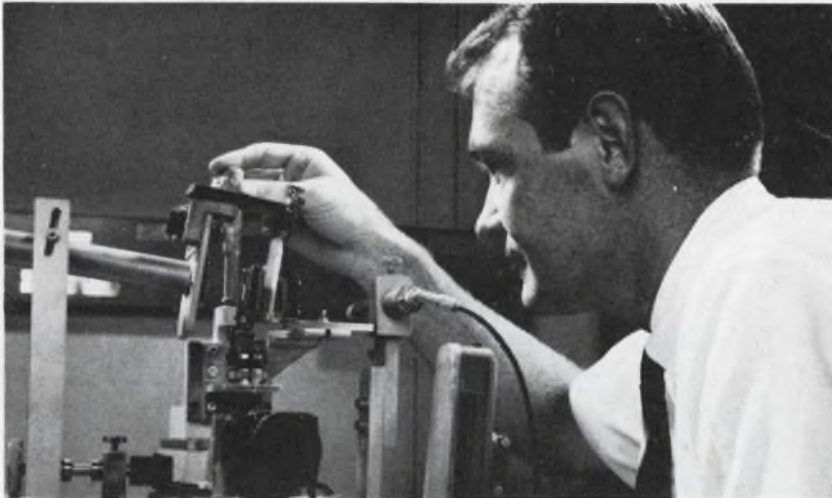

William J. Spencer with equipment for detecting vibrational modes. Through sloped tube, left, X-rays strike crystal (in frame at center of apparatus). A portion of beam is diffracted by the crystal (drawing, right) and passes through the slit. The main X-ray beam is stopped at the edge of the slit. During exposure, crystal and film are driven from left to right so that entire crystal area is photographed. The X-ray beam is set at a particular angle to the crystal (the Bragg angle), which for good crystals produces a diffracted intensity greater than at other orientations. Vibrating the crystal reduces destructive interference and increases diffracted-beam intensity.

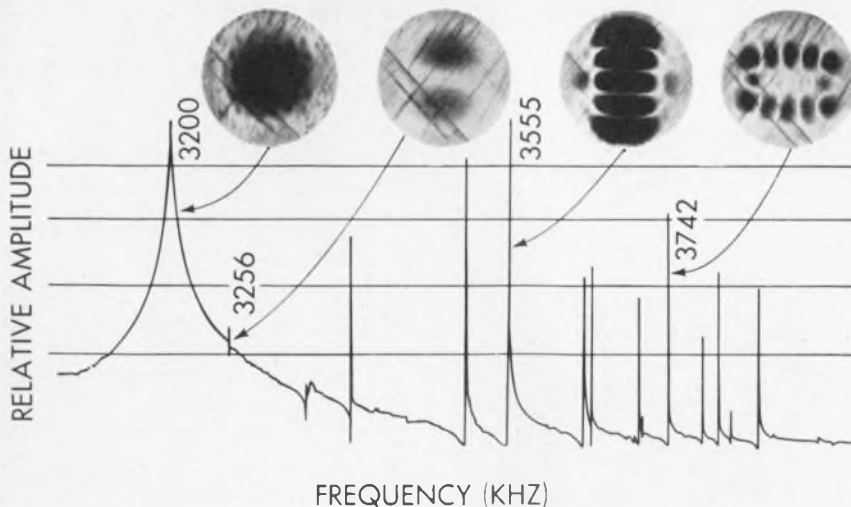
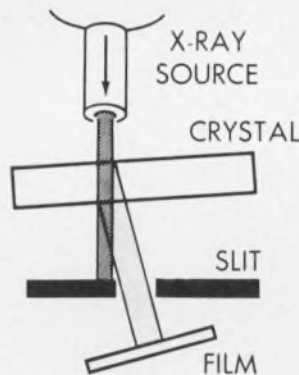

X-ray photographs of a crystal showing four modes of vibration selected from the many modes indicated by the resonance peaks on the curve. Dark areas are due to displacement antinodes in the vibrating quartz disk. Diagonal lines are intrinsic crystal-lattice defects.

In modern amplifiers, filters, and oscillators, piezoelectric crystals are widely used to select signals at certain frequencies. Such crystals — of quartz, for example — provide electronic selectivity because of their ability to convert electric waves into mechanical waves, and mechanical waves back into electric waves, at certain resonant frequencies. For any particular application, the principal resonant frequency is determined by the size and geometry of the crystal, but in addition to this principal vibrational mode, the crystal will vibrate in a number of other modes.

To suppress these unwanted resonances, they must first be identified. And until recently we did this by observing patterns created when a crystal, coated with a fine powder, is vibrated at high intensity. Since the powder collects where the crystal surface is stationary, a vibrational pattern or mode is revealed. But the pattern at such high signal levels may not correspond to the modes produced at the lower signal levels of actual operation.

Recently, however, W.J. Spencer, at the Bell Telephone Laboratories location in Allentown, Pa., has used X-ray diffraction as an accurate and flexible method of observing vibrational amplitude under realistic conditions. The new method depends on the fact that the intensity of diffracted X-rays is extremely sensitive to distortion of the crystal lattice. The transmission of the rays is greater through vibrating regions of a crystal, and this darkens such areas on the X-ray film. Stationary regions are light.

Vibration amplitudes of less than a millionth of an inch are easily observed. Thus, we obtain a quick, sensitive photographic record of displacement associated with any crystal resonance under conditions simulating actual use. This technique helps us design better filters for the Bell System.



Bell Telephone Laboratories
Research and Development Unit of the Bell System

MULTI-CAP[®]

CERAMIC CAPACITORS

SAVE SPACE
AND MONEY

ALSiMAG[®]

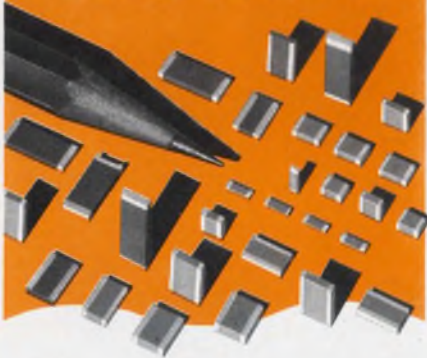

8 STOCK SIZES

Experience shows that these 8 sizes from .085 x .055 to .380 x .157 cover most requirements for high capacitance-to-volume ratio units. Readily solderable silver terminations are standard. Other metals are available. Stocked in both Low Loss High Stability NPO and in K-1300 Temperature Stable materials. Other materials available with K to 8000 and TC from P120 to N5600 ppm/°C. American Lava offers the widest range of materials in the industry.

CUSTOM DESIGNS

Prototypes for your evaluation can be made in a wide range of ceramic materials, sizes and capabilities. Outline your needs and let us suggest solutions.

Bulletin 682 gives charts, graphs, data on standard and special sizes. Sent on request.

American Lava Corporation 
A SUBSIDIARY OF

Chattanooga, Tennessee 37405
Sixty-Sixth Year of Ceramic Leadership

INFORMATION RETRIEVAL NUMBER 65

MICROWAVES

TWT amplifier accepts 7-11 GHz

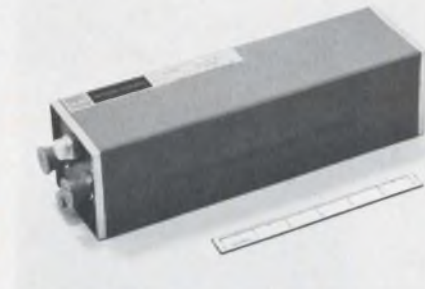

Watkins-Johnson Co., 3333 Hillview Ave., Stanford Industrial Park, Palo Alto, Calif. Phone: (415) 326-8830.

A traveling-wave-tube amplifier operates between 7 and 11 GHz with a noise figure of 6 dB. The 8.5 lb unit will withstand vibrational forces of over 5 g at frequencies up to 500 Hz. Shielded permanent-magnet focusing is unaffected by adjacent ferromagnetic material. Power consumption is under 30 W.

CIRCLE NO. 276

Solid-state oscillator tunes a full octave

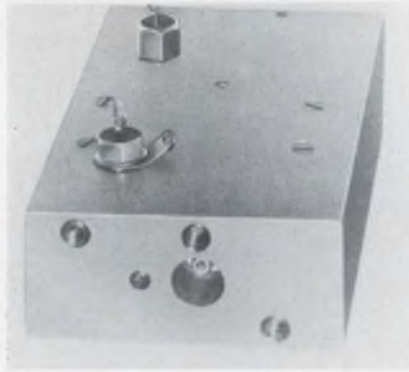

Raytheon Company, Lexington, Mass. Phone: (617) 862-6600.

A solid-state octave bandwidth oscillator requires only single polarity voltage to tune over a full octave bandwidth. It has fm modulation capability, and its linearizing network produces control over the 600-to-900-MHz portion of the octave when driven from 0-20 V (± 0.01). When driven from 0-85 V, linearity over the full 500-to-1000-MHz octave is produced, ± 0.03 MHz.

CIRCLE NO. 277

Broadband power limiter operates at 2 to 8 GHz

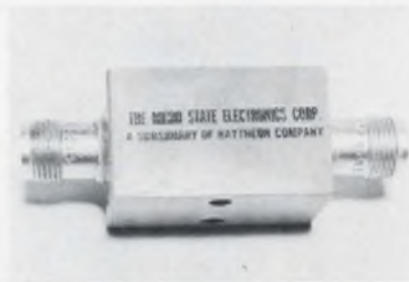

Micro State Electronics, 152 Floral Ave., N.J. Phone: (201) 464-3000.

A broadband, high-power limiter operates over the frequency range of 2 to 8 GHz. The device can limit peak rf input powers up to 500 W and average power up to 5 W. Maximum rf power output is 100 mW. Power insertion loss is 1.25 dB max and input VSWR is 1.75.

CIRCLE NO. 278

Bandpass filters span 225-400 MHz

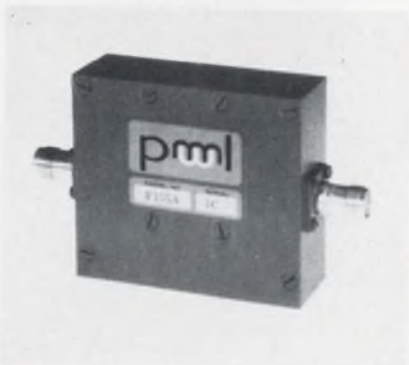

Peninsula Microwave Laboratories, 855 Maude Ave., Mountain View, Calif. Phone: (415) 969-3303.

A new line of bandpass filters has been developed for use in the 225-400 MHz, uhf band. Transmission line elements have been combined with lumped constants to provide high quality performance in a compact package. Typical is a unit with a four-pole Bessel response, centered at 330 MHz. Transmission phase is linear to within one degree over the 18-MHz, 3-dB bandwidth.

CIRCLE NO. 279

**FREE BULLETINS
OFFER YOU A CHOICE OF
315 OFF-THE-SHELF FERRITES.**



Indiana General has the most complete line of ferrite materials and shapes in the world. Including materials, core sizes, and shapes not available as standard from any other manufacturer.

In all, we list 15 ferrite materials in 315 standard shapes and sizes including: cup cores; toroids; transformer C cores; rods and strips; E, I, U, and C cores; the international series of cup cores, and cross cores.

Chances are, any size, shape, or ferrite material you need is already listed in our Ferramic® Materials Bulletins. For your copy, write Mr. K. S. Talbot, Manager of Sales, Indiana General Corporation, Electronics Division/Ferrites, Keasbey, New Jersey.

INDIANA GENERAL 

INFORMATION RETREVAL NUMBER 66

**DOWN
THE
HATCH!**

**New 5 KVA
audio power amplifier**

Designed to go down the hatch of submarines, the model S5K is a workhorse audio source for ship or shore. The unit delivers 5 KVA CW and 15 KVA instantaneous peak power from 100 to 10,000 cps. Full power is available into reactive loads . . . **no power factor correction needed.**

Another CML exclusive: selectable output taps for wide range load matching.

Other power sources from 70 VA to 200 KVA.

Call or write today.



CML, Inc.

A subsidiary of Tenney Engineering, Inc.
350 Leland Avenue • Plainfield, New Jersey
(201) 754-5502 • TWX: 710-997-9529

87A

INFORMATION RETREVAL NUMBER 67

ELECTRONIC DESIGN 8, April 11, 1968

**Is the World
Ready for an
\$88 Analog
Multiplier?**

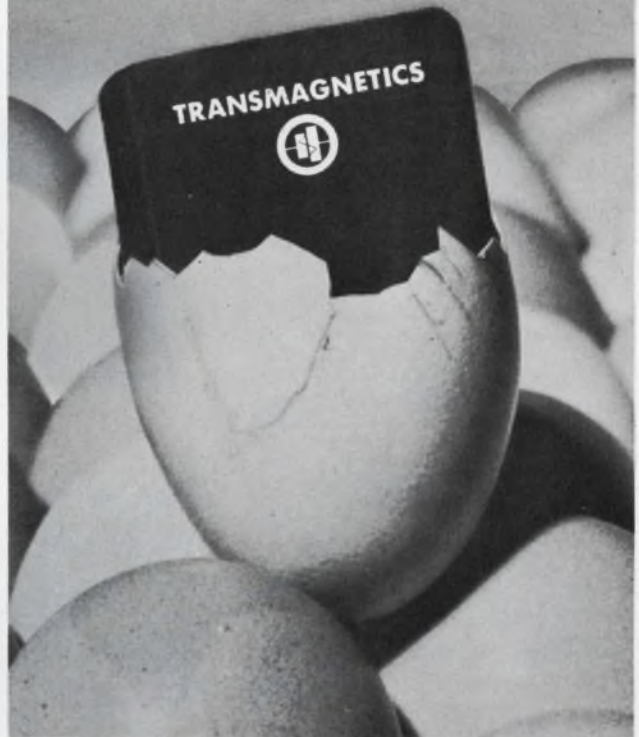

- 1% FS Linearity ■ 0.4" High for PC Mounting
- DC X 200 HZ-100 KHZ ■ No External Amplifiers

Model 365 multiplying modulator was specifically created to satisfy the requirements for variable gain control, non-linear correction, squaring, and audio attenuation in flight control, fire control radar and similar systems. The price of \$88 each (in 100 piece lots) for the first time enables the production-oriented engineer to take an economical approach to accurate control. Other specs include DC input 0 to $\pm 10V$; AC input 0 to 7.07 V RMS; Bandwidth 200 HZ to 100 KHZ; Phase shift—constant to $\pm 1^\circ$ over 380-420 HZ; Null 5 MV max at 400 HZ.

For other multipliers ranging from DC to 4 MHZ write for bulletin 1167.



Transmagnetics, Inc.

134-25 Northern Blvd. / Flushing, New York 11354
Phone: 212 539-2750 / TWX: 710 582-2472

INFORMATION RETREVAL NUMBER 68

129



NEW / FROM NORTRONICS



HIGH PERFORMANCE PROFESSIONAL AUDIO TAPE HEADS

FOR 1/4" TAPE

20 Hz to 20 KHz Response

The new Nortronics PR Series tape heads provide a new standard of audio reproduction for broadcast equipment and other critical applications. Frequency response is within *one* DB from 20 Hz to 20 KHz in a mu-metal case. Even better response can be obtained with modified case shielding. In 7.5 and 15 ips playback applications the PR Series extends the usable low frequency response a full octave.

The PR Series is available in production quantities for full track and half track stereo, with other types supplied on special order. All heads feature the Nortronics deposited quartz gap

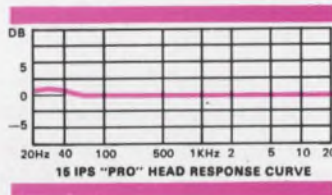

and laminated precision-lapped, low loss cores. They can be provided in a broad range of electrical specifications.

Standard "B" cases and terminal pin arrangements are used in the PR Series. Thus they are compatible with existing Nortronics mounting accessories and connector plugs.

Complete technical data is available on request.

Nortronics

COMPANY, INC.

8101 Tenth Avenue North
Minneapolis, Minnesota 55427

INFORMATION RETRIEVAL NUMBER 69

COMPONENTS

Op amp power supply delivers 40 mA



Analog Devices, 221 Fifth St., Cambridge, Mass. Phone: (617) 491-1650. P&A: \$49; stock.

Designed for energizing operational amplifiers, a dc power supply is encapsulated into a 2-1/2- by 3-1/2- by 7/8-in. module. The ± 15 -V, 4-mA unit can drive several operational amplifiers simultaneously. A 40-mA supply can power four amplifiers, each with a 10-mA full-load rating.

CIRCLE NO. 280

Termination system speeds wire-wraps

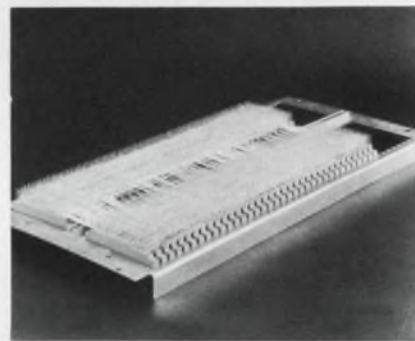

Winchester Electronics, Div. of Litton Industries, Main & Hillside, Oakville, Conn. Phone: (203) 274-8891. P&A: 5.5¢/contact; stock.

A printed-circuit connector with solderless wrap post terminations is the basic building block of an automatic wire-wrap system. The system is a simple reliable method of positioning discrete connectors for automatic termination as opposed to similar systems using precision drilled or punched plates.

CIRCLE NO. 281

Trimmer capacitors bolt to chassis



Voltronics Corp., West St., Hanover, N.J. Phone: (201) 887-1517.

Precision trimmer capacitors can be bolted directly to a chassis and tuned on the inside of the panel. They are available with ranges from 0.8-4.5 to 1-36 pF. These units feature nonrotating piston design. The tuning screw does not move axially but remains in position for blind-hole tuning. Linearity is better than $\pm 1\%$ with no capacitance reversals.

CIRCLE NO. 282

Dual-lamp indicators operate on 4 to 48 V

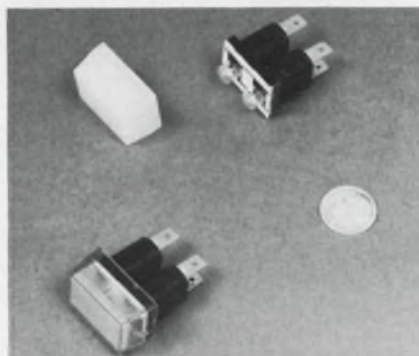

Sylvania Electric Products Inc., 730 3rd Ave., New York City. Phone: (212) 551-1000.

Dual-lamp circuit indicators are available in three versions for 4- to 48-V operation. The units measure approximately 1 inch in over-all length, including their 1 x 0.5-in. lens covers. Interchangeable lenses are available in red, white, green, amber and blue with legend imprints on lens faces for those applications requiring positive identification.

CIRCLE NO. 283

SYNTRON Series

150 C-B

(Silicon Controlled Rectifiers)

235 Amperes RMS
25 to 1200* PRV

FORWARD CONDUCTING

$I_{t\text{ avg}}$	—AVERAGE FORWARD CURRENT.....	150 A.
V_{tm}	—MAXIMUM PEAK FORWARD VOLTAGE DROP AT 25°C. AT 500 A. PEAK 180° CONDUCTION ANGLE.....	1.7 V.
I_h	—TYPICAL HOLDING CURRENT AT 25°C.....	100 MA
$I_{t\text{ sm}}$	—MAXIMUM PEAK ONE CYCLE SURGE CURRENT.....	3000 A.
I_{T^2}	— I^2t FOR FUSING (FOR TIMES \geq 1.5 MILLISECONDS).....	37,000 A ² SEC.
I_{dm}	—MAXIMUM FORWARD LEAKAGE CURRENT AT 125°C. AND EBO.....	25 MA
t_{off}	—MAXIMUM OFF TIME AT 125°C.....	40 μ SEC.
t_{on}	—TYPICAL ON TIME.....	10.5 μ SEC.
t_r	—TYPICAL RISE TIME.....	3.25 μ SEC.
t_d	—TYPICAL DELAY TIME.....	7.25 μ SEC.
Θ_{J-C}	—MAXIMUM THERMAL RESISTANCE, JUNCTION TO CASE (DC).....	0.2°C./W
T_j	—OPERATING JUNCTION TEMPERATURE.....	125°C.
T_{strg}	—STORAGE TEMPERATURE.....	—40°C. to 150°C.

BLOCKING

I_{rm}	—MAXIMUM REVERSE LEAKAGE CURRENT AT 125°C. AND PRV.....	25 MA
dv/dt	—MINIMUM CRITICAL EXPONENTIAL RATE OF RISE OF FORWARD BLOCKING VOLTAGE.....	100 V./ μ SEC.

TRIGGERING

V_{gt}	—MAXIMUM GATE VOLTAGE TO TRIGGER AT 25°C.....	2.5 V.
V_{gt}	—TYPICAL GATE VOLTAGE TO TRIGGER AT 25°C.....	1.3 V.
V_{gt}	—TYPICAL GATE VOLTAGE TO TRIGGER AT 125°C.....	0.9 V.
I_{gt}	—MAXIMUM GATE CURRENT TO TRIGGER AT 25°C.....	200 MA
I_{gt}	—TYPICAL GATE CURRENT TO TRIGGER AT 25°C.....	100 MA
P_{gm}	—MAXIMUM PEAK GATE POWER.....	10.0 W.
$P_{g\text{ avg}}$	—AVERAGE GATE POWER.....	2.0 W.
I_{gm}	—MAXIMUM PEAK GATE CURRENT.....	2.0 A.
V_{gm}	—MAXIMUM PEAK GATE VOLTAGE (FORWARD).....	10.0 V.
	—MAXIMUM PEAK GATE VOLTAGE (REVERSE).....	5.0 V.

*1300 Volt Transient Rating

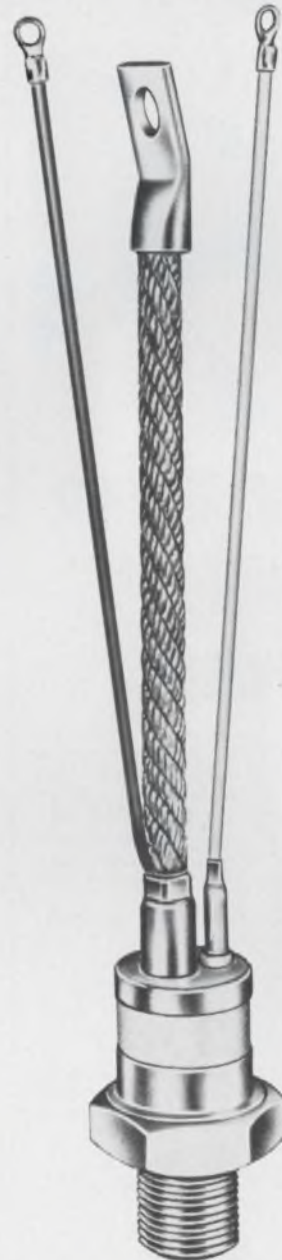

SYNTRON
A DIVISION OF
FMC CORPORATION
283 Lexington Ave.
Homer City, Pa. 15748
Telephone 412-479-8011

Name/Title _____
Company _____
Street _____
City/State _____ Zip _____

Please send information on:

- Series 150 C-B Silicon Controlled Rectifiers
- Silicon Rectifiers
- Selenium Rectifiers
- Selenium Surge Suppressors

68R2

you can't beat this drum



because it's an unbeatable test system

Delta's **CHARGER** is a new concept in manual testing of your integrated circuits.

Versatility is unbeatable; simply by changing test heads the **CHARGER** handles all common devices. A wide temperature range, -65°C to $+150^{\circ}\text{C}$, is equalled only by much larger, more expensive testing units.

Accuracy is unbeatable; the same test position for each part insures only $\pm 0.25^{\circ}\text{C}$ deviation.

Repeatability is unbeatable; identical electrical parameters are guaranteed because every integrated circuit is measured from the same test socket.

Continuous throughput is unbeatable in an environmental manual handler; only the **CHARGER** lets you test an impressive 500 parts per hour!

You'll beat the drum, too, when you use a **CHARGER**. For the latest information, mail the request card today.



Delta Design, Inc.
8000 Fletcher Parkway
La Mesa, California 92042
Telephone (714) 465-4141

INFORMATION RETRIEVAL NUMBER 71

COMPONENTS

Parametric transformer operates on 115-V

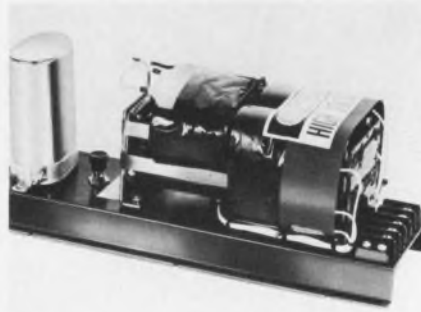

Wanlass Electric Co., 2175 S. Grand Ave., Santa Ana, Calif. Phone: (714) 546-7650. P&A: \$150; stock.

A 150-VA power conversion unit called the Paraformer is designed for use at 115 V ac 60 Hz. Designated the PEC-150, it is entirely passive and gives bilateral transient noise rejection over 50 dB for frequencies up to 1 MHz. The unit also provides line voltage regulation $\pm 0.25\%$ and has overload protection.

CIRCLE NO. 284

High-power resistors have low ohmic values

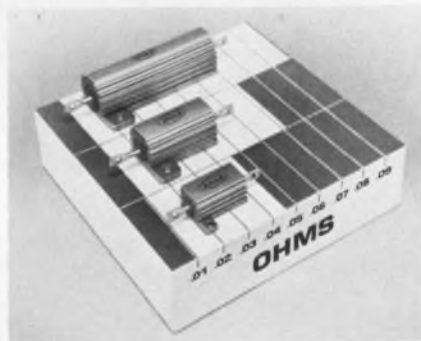

Dale Electronics, Inc., P.O. Box 488, Columbus, Neb. Phone: (402) 564-3131. Price: \$3.50.

A precision power resistor offers a range of 0.008 to 0.099 Ω . It is available in 10-, 25- and 50-W models for use in circuits which require minimum resistance at close tolerances. These resistors exceed MIL ratings for chassis-mounted resistors in both power and dielectric strength. Standard tolerances range from 0.1 to 5%.

CIRCLE NO. 285

Transformer module drives memory switch

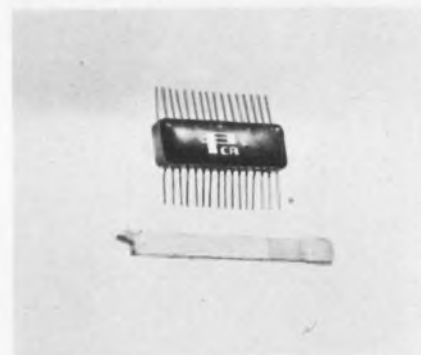

PCA Electronics, Inc. 16799 Shoeborn St., Sepulveda, Calif. Phone: (213) 892-0761. P&A: \$15; 4 wks.

A miniature transformer unit consists of four encapsulated transformers designed to drive a transistorized switch on memory cores. Encapsulated in a $7/8 \times 1/4 \times 3/16$ -in. epoxy case, the transformer features a primary sine-wave inductance of 400 μH min. and a rise-time of 8 ns, max. Maximum primary-to-secondary leakage inductance is 1.5 μH .

CIRCLE NO. 286

Voltage reference regulates to 0.0001%



Stable Dynamics Corp., 2738 Chauncey Dr., San Diego. Phone: (714) 277-8656. P&A: \$34; 4 wks.

A family of stable voltage reference supplies is designed to operate over the temperature range of -55 to $+100^{\circ}\text{C}$. Typical specifications include 0.0001% constant load regulation, 0.0001%/ $^{\circ}\text{C}$ temperature coefficient and output ± 5 to ± 15 V dc at 2-200 mA. Models incorporating output amplifiers are available offering voltage options to 50 V dc and current to 2 A.

CIRCLE NO. 287

Thermal resistor
is rated at 0.7%/°C

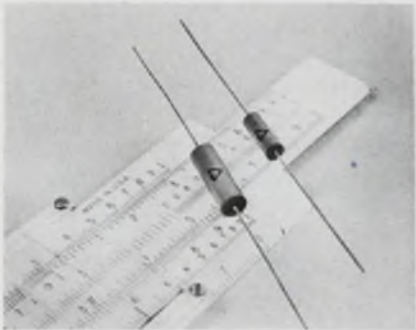

Delta Semiconductors, P.O. Box 2177, 225 Paularino Ave., Costa Mesa, Calif. Phone: (714) 540-4160.

A thermal resistor that features a positive temperature coefficient of 0.7%/°C is available in resistances of 10 Ω to 10 k Ω and tolerances of 5 to 10%. Available in 1/8 or 1/4 W ratings, these units meet the specifications of MIL-T-23648A. Matched pairs and nonstandard values are available on special order. Applications are in the area of temperature compensation and sensing.

CIRCLE NO. 288

Log video amplifiers
have ± 0.5 -dB ripple

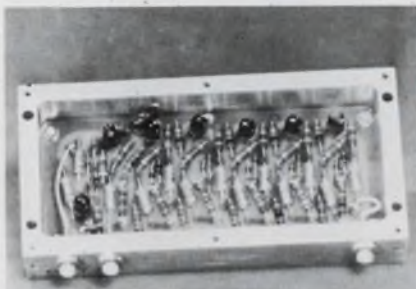

TRF, Inc., 6627 Backlick Rd., Springfield, Va. Phone: (703) 451-5131.

Miniature logarithmic video amplifiers are specifically designed for crystal video receiver and pulse amplifier applications. The logarithmic characteristic is less than ± 0.5 dB ripple over a 60-dB dynamic range, and the units track within ± 0.2 dB for use in multi-channel systems. Bandwidth of 2 MHz is standard for these 0.6 x 1.3 x 3 in. packages, and modified versions are available with video bandwidths to 10 MHz.

CIRCLE NO. 289

this receiving system covers

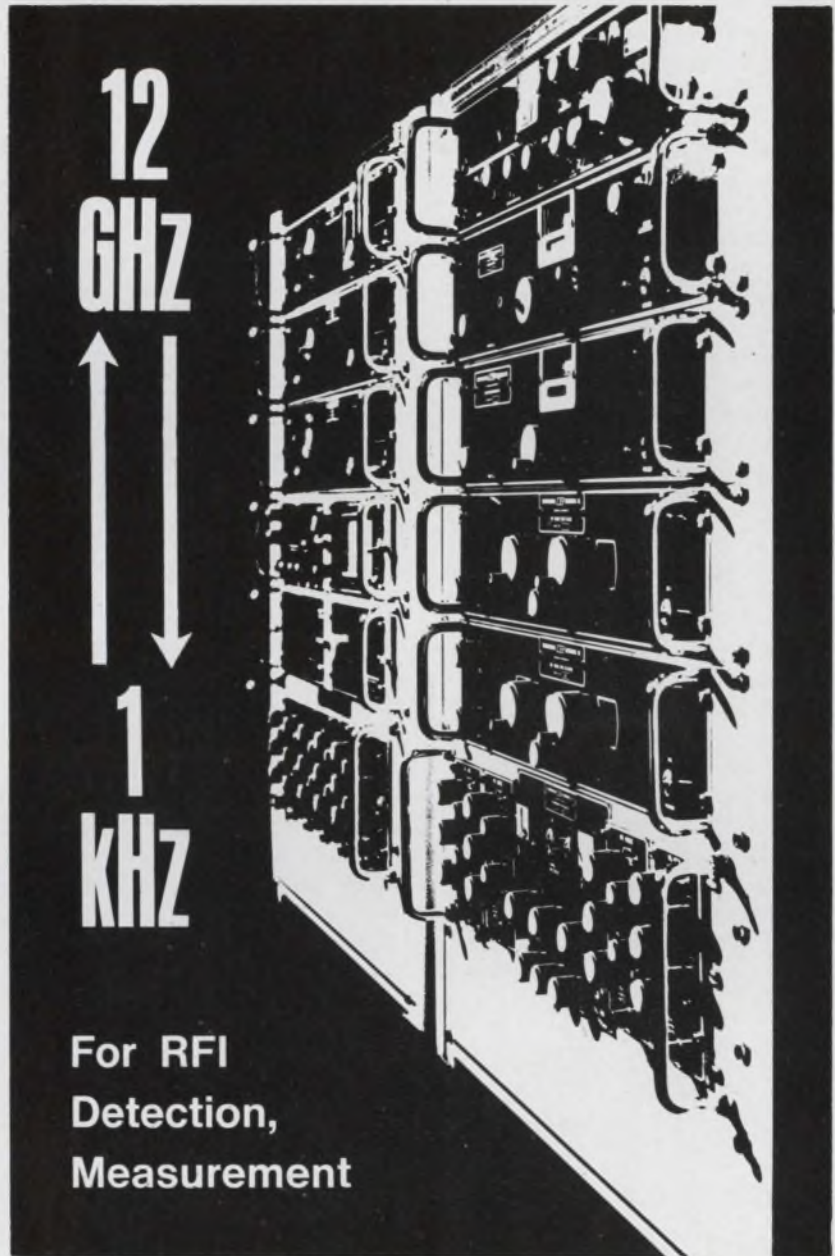

Eleven bands . . . receiver and seven tuners . . . IF demodulation bandwidths from 150 Hz to 8 MHz . . . signal monitoring. . . Call or write for specifications.



SUBSIDIARY OF WATKINS JOHNSON



COMMUNICATION ELECTRONICS

6006 Executive Boulevard, Rockville, Md. 20852 • 301/881-3300 • TWX: 710-824-9603

INFORMATION RETRIEVAL NUMBER 72

'Ten-kHz' spectrum analyzer can pick signals from noise

Federal Scientific Corp., 615 W. 131st St., New York, N.Y. 10027. Phone (212) 286-4400. P&A: Model UA-7B, \$25,850; 90 days.

The Ubiquitous spectrum analyzer gets its name from its ability to derive a spectrum based on simultaneous observation of a whole ensemble of samples of a time-varying signal. In effect, it duplicates the characteristics of a set of narrowband contiguous filters. For the 0-to-10-kHz range, each simulated filter has a bandwidth of 20 Hz.

The operation of the spectrum analyzer is based on the use of a recirculating delay-line memory. The samples are "speeded up" in the memory, and thus the output waveform, as illustrated in the diagram, is an accelerated version of the original waveform. In the continuous mode, new samples from the input are sequentially fed into the memory, replacing previously stored samples. In the hold mode, to observe transients or selected segments of a waveform, the most recent 1500 samples are continuously circulated and their spectrum displayed. No matter how long it took to accumulate the samples, they are time-compressed to 100 μ s in the memory.

The accelerated waveform, when restored to analog form, is hetero-

dyned with a stepped local oscillator. Because the signal has been shifted to a higher frequency, a fairly wideband crystal (10 kHz) filter in the MHz range gives results equivalent to those obtainable with a narrowband filter in the signal's actual lower frequency band. The local-oscillator stepping is synchronized with the memory recirculation period. Thus, each time the 1500 samples in the memory loop cycle once, the local oscillator is advanced 10 kHz. This action is repeated until the entire spectrum has been scanned.

Note in the block diagram that a shaping function is used to amplitude-modulate the local-oscillator signal. In the heterodyner, this function is multiplied by the signal from the D/A converter. The result is that the filter output appears as if it had passed through a filter whose characteristic is a product of the crystal filter's actual impulse response and the shaping function. Thus a simple output filter can be used, and its characteristics modified by the shaping function chosen.

A triplet function is used in the Ubiquitous analyzer. The resulting spectral response has a broader main lobe than some other alternate functions would produce, but it rolls off more sharply. The triplet is expressed as $\omega(t) = [\exp$

$(-\pi t/P)] [\sin^2(\pi t)/P]$ where $t \leq P/2$. The reason for the use of the triplet is that it can resolve closely spaced spectral components of greater difference in amplitude than alternate functions would achieve.

This "speed-up" type analyzer allows the user to trade off between analysis frequency range and bandwidth of the simulated filter bank by simply turning a knob. For the 0-to-5-kHz range, for example, 10-Hz filters are synthesized. Also, spectrum display periods can be selected. Twenty analyses per second provide a flickerless oscilloscope display, while longer periods can be chosen for recorder or plotter outputs.

Although the accuracy does not match that possible with fully digital Fast-Fourier Transform analyzers (see "The FFT computer; Designers' 'missing link'," ED 25, Dec. 6, 1967, pp. 25-30), it operates at considerably higher speed than any commercial FFT machine. Real-time processing is provided with 1-dB amplitude accuracy and with 50-dB dynamic range. However, only power spectra, without phase information, are produced.

Applications include radar and sonar signal processing, vibration and noise analysis, speech studies, interferograms and medical diagnostics. The analyzer can be used to perform single- or dual-channel Fourier analyses, cross-spectrum or transfer-function analysis, and auto- and cross-correlations.

CIRCLE NO. 290

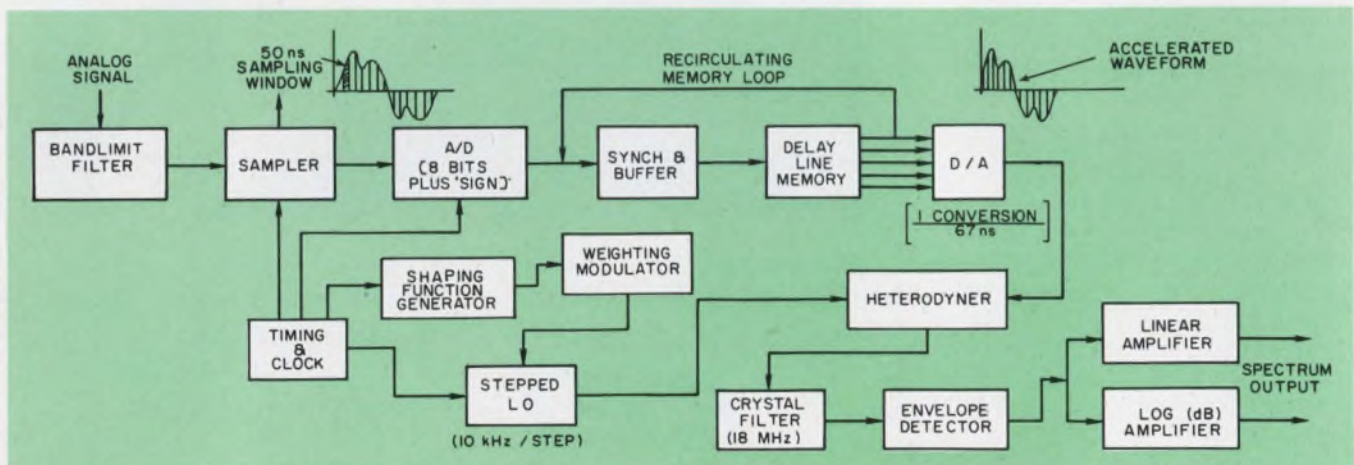

Speed-up-type spectrum analyzer combines digital and analog techniques. Low frequency signals are shifted to

higher frequencies for spectral analyses. Text explains operation of the instrument.

We're generations ahead on the relay circuit



Everyone else is having trouble with their first. Once in a while we still find an engineer who hasn't been exposed to the TELEDYNE TO-5 breakthrough in the relay revolution. Some of the hesitance is understandable. It wasn't too

very long ago when mechanical defects and poor reliability made relays a bit unpopular. To those who have been skeptical the TELEDYNE TO-5 provides real amazement — how the world's smallest relay can be so reliable, long lasting, and do so much.



TELEDYNE RELAYS A TELEDYNE COMPANY

3155 West El Segundo Boulevard,
Hawthorne, California 90250 Telephone (213) 679-2205

IN JUST

3

DAYS

ACOPIAN WILL SHIP ANY OF 62000 DIFFERENT POWER SUPPLIES

This catalog lists 62,000 models of AC to DC plug-in power supplies available for shipment in just three days. Choose the exact outputs you need. Singles or duals, regulated or unregulated. Write or phone for your free copy.



Name _____
 Title _____
 Company _____
 City _____
 State _____ Zip _____

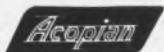

Acopian Corp., Easton, Penna. 18042
 Phone: (215) 258-5441

INFORMATION RETRIEVAL NUMBER 74

TEST EQUIPMENT

Digital voltmeter ranges automatically



Dana Laboratories, Inc., 2401 Campus Drive, Irvine, Calif. Phone: (714) 833-1234. Price: \$1345.

A 4-digit instrument with a fifth digit and a 20% overrange, makes ac or dc measurements automatically on 1, 10, 100 and 1000-volt scales. The 1-volt range affords 100- μ V resolution. A broadband input filter gives the instrument a noise rejection capability of 60 dB at 60 Hz. Linear protection against noise at all frequencies above 40 Hz is provided.

CIRCLE NO. 292

Sampling phase meter spans 10 Hz to 400 MHz

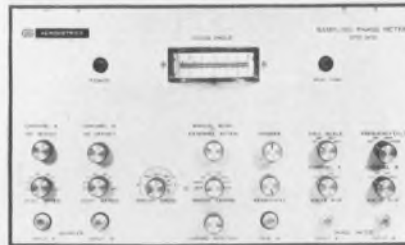

Aerometrics General Corp., Aerometrics Div., P.O. Box 216, San Ramon, Calif. Phone: (415) 837-5343.

A sampling phase meter making phase measurements from 10 Hz to 400 MHz, offers a coverage of from 0 to 360° in four ranges. For measurements above 1 MHz a positive triggering indicator lamp is utilized to assure proper sampling of the signals. The device can be used in observing high frequency repetitive phenomena on low-frequency readout devices such as X-Y recorders and oscilloscopes.

CIRCLE NO. 293

DID YOU SAY INSIDE?

YES!

Delevan will put MICRO*i*™ Inductors & Transformers

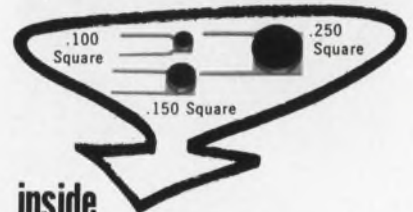

inside IC's

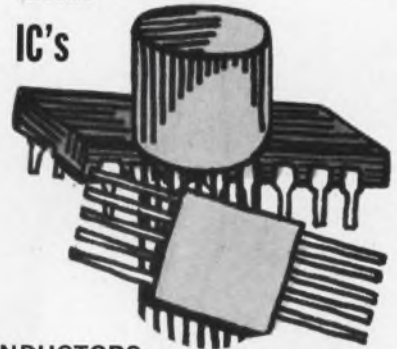

INDUCTORS

- Size .100, .150, .250 SQ x .065 HIGH
- L Range .015 uH to 1000 uH
- Shielded, Encapsulated, Excellent T. C.
- Meet MIL-C-15305C Grade 5 and Class 5

TUNABLE INDUCTORS

- Size .150, .250 SQ x .125 HIGH
- L Range .10 uH to 1,300 uH
- Tuning Range 1.7 to 1
- Excellent Resolution, Non-Retractable Tuning

RF TRANSFORMERS (FIXED AND TUNABLE)

- Size .100, .150, .250 SQ x .125 HIGH MAX.
- Frequency Operation — 500 KHz to 50 MHz
- IF & Wideband Designs Available
- 30 MHz & 60 MHz IF Designs in stock

HI-Q COILS

- Size .250 SQ x .125 HIGH
- L Range .12 uH to 1000 uH
- Q values in area of 100
- Direct replacement for toroids
- L tolerances as low as $\pm 1\%$

Delevan Electronics / Division AMERICAN PRECISION INDUSTRIES INC.

270 QUAKER RD. / EAST AURORA, N. Y. 14052
 TELEPHONE 716/652-3600 TELEEX 91-293

OTHER DIVISIONS OF AMERICAN PRECISION INDUSTRIES INC.:
 BASCO • DUSTEX • ELECTRO-MECHANICAL PRODUCTS

INFORMATION RETRIEVAL NUMBER 75

ELECTRONIC DESIGN 8, April 11, 1968

Viscofilm CAPACITORS HOLD THEIR CHARGE!

1%
VOLTAGE
LOSS
IN
ONE HOUR

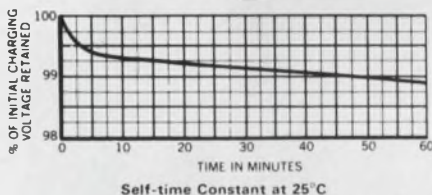

VISCOFILM capacitors are impregnated with a unique plastic dielectric that remains permanently liquid. Its properties are such that it provides exceptionally high insulation resistance and, consequently, a long self-time constant for VISCOFILM capacitors.

This makes them especially suitable for applications requiring the storage or transfer of energy plus replacement of conventional oil filled capacitors.

- Excellent capacitance stability
- Temperature range -75°C to $+125^{\circ}\text{C}$
- Voltage ratings from 100 VDC up.
- Capacitance ratings from .004 MFD to 100 MFD.

Write For
VISCOFILM Catalog No. 1255

INDUSTRIAL
CONDENSER CORPORATION

3243 No. California Ave.
Chicago, Illinois 60618

INFORMATION RETRIEVAL NUMBER 76

TEST EQUIPMENT

IC logic test set tells go or no-go



Optimized Devices, Inc., Pleasantville, N.Y. Phone: (914) 769-6100. Price: \$4850.

A logic circuit test set, Module LT101, will test either IC or discrete component digital current, such as gates, flip-flops, shift registers and decade counters, with up to 10 outputs and eight inputs for conformance to the correct truth table as well as for the correct voltage levels for "0" and "1" levels. Go-no-go tests are performed at the rate of 1000/s.

CIRCLE NO. 294

Electron microscope scans specimens

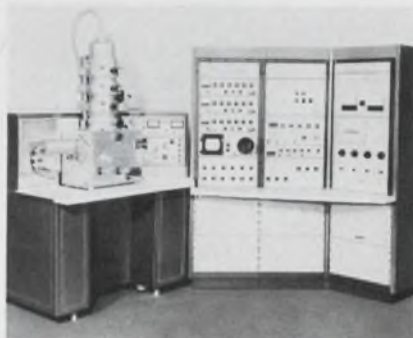

K Square Corp., Pittsburgh. Phone: (412) 241-5500.

A versatile electron-scanning microscope bridges the gap between optical and electron transmission microscopes. Utilizing a scanning raster that traverses the surface of a specimen, the instrument provides a resolution of 200 Å and magnifications up to 100,000 diameters. Depth of field is as much as 500 times that obtainable with conventional optical microscopes.

CIRCLE NO. 295

INFORMATION RETRIEVAL NUMBER 77 ▶

Product of
SIGMUND COHN CORP.

No. 479*

*Reg. Trade Mark

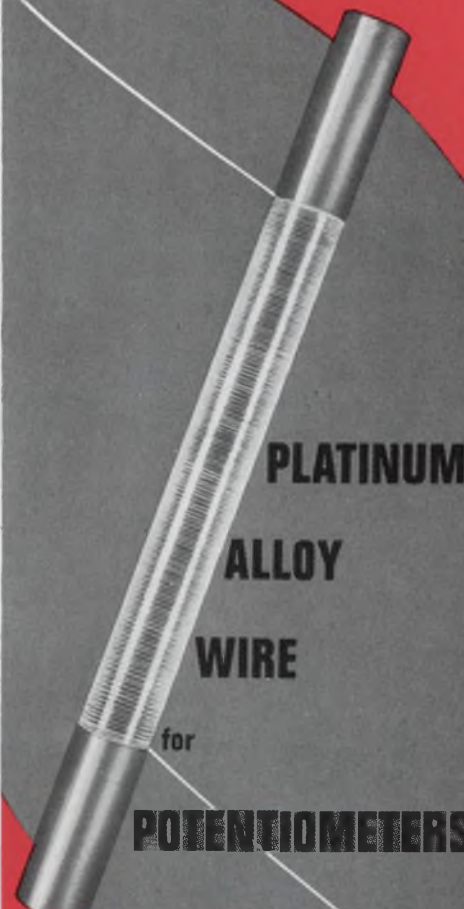

PLATINUM
ALLOY
WIRE

for

POTENTIOMETERS

Developed
and Manufactured
in the
Sigmund Cohn Plant...

No. 479 Platinum Alloy Wire is produced specifically for low-noise precision potentiometers. This high tensile strength, long-life alloy wire contains 92% Platinum, 8% Tungsten. It is exceptionally round, linear, strong and corrosion-resistant. Potentiometers wound with it have very low noise limits—shelf-life unlimited. Available bare or enamelled.



SINCE 1901



Sigmund Cohn Corp.
121 So. Columbus Avenue,
Mount Vernon, N.Y. 10553

LET'S GET TECHNICAL!



KEPCO POWER SUPPLIES

PROGRAMMING SPEED

With the advent of fast-programming d-c power supplies (pioneered by Kepco three years ago), there has arisen a problem about how best to describe the speed with which a power supply's voltage can be switched from level to level. Properly stated, this rather vital parameter becomes, also, the measure of sinusoidal amplitude-frequency bandwidth—in the frequency domain, and the response time of a current regulator's recovery from a step load change.

Unfortunately, there is yet little agreement among the manufacturers of fast programming equipment on measuring technique—or even the units.

On the theory that a possible user, informed of the method, can easily ascertain for himself the probable performance in his application. The following is offered:

KEPCO'S PROGRAMMING SPEED MEASURING PROCEDURE:

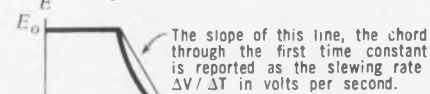
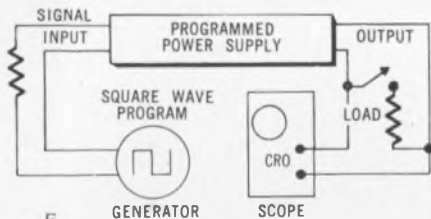

RISE AND FALL. NO LOAD AND FULL LOAD ARE MEASURED. THE NO LOAD FALL (SLOWEST) RATE IS REPORTED AS THE POWER SUPPLY'S SLEWING RATE

Our reader's comments are invited.

If you'd like the specs on our various high speed power supplies, circle the number below or write Dept. AB-5



131-38 SANFORD AVENUE • FLUSHING, N.Y. 11352
(212) 461-7000 • TWX #710-582-2631
Telex: 12-6055 • Cable: KEPCOPOWER NEWYORK

INFORMATION RETRIEVAL NUMBER 78

TEST EQUIPMENT

Transistor analyzer tests sequentially



Test Equipment Corp., 2925 Merrell Rd., Dallas, Tex. Phone: (214) 357-6271.

An automatically sequencing transistor tester makes 19 different measurements and automatically sequences through five tests, indicating results by meter readings, indicator lights and contact closures. The 135-lb instrument is 19-in. wide, 28-in. high and 12-in. deep when rack mounted. An optional bench cabinet is available at extra cost.

CIRCLE NO. 296

Miniature meter monitors battery



Bureau of Engraving, Inc., Industrial Div., 500 S. 4th St., Minneapolis. Phone: (612) 339-8001. P&A: \$.96 to \$3; 10-12 wks.

A miniature battery meter for use with portable equipment is available with full-scale voltage ranges from 1.5 to 48 V. Scale ends are compressed and center scale is expanded. Accuracy at center scale is 3%. Coil resistance is temperature compensated. The unit may also be used as a linear current meter with ranges of 1 to 10 mA.

CIRCLE NO. 297

free! new

1968 NEWARK INDUSTRIAL ELECTRONICS CATALOG

- Industry's Most Complete Buying Guide
- Over 70,000 items—500 Standard Brand lines
- 700 Pages
- Over \$7,000,000 Industrial Electronics Inventory—your assurance that NEWARK has it now.

NEW P&B

CH SERIES SOLID STATE TIME DELAY RELAYS

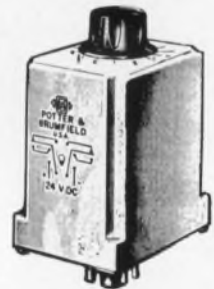

Cost saving answer to many industrial timing applications. Dial setting reference scale; operating temperature range of -10°C to $+55^{\circ}\text{C}$ with $\pm 10\%$ accuracy. Reset time in 100 milliseconds and repeatability is $\pm 2\%$. 24 types in stock.

Immediate delivery from stock—factory OEM prices—fast efficient service from 10 Newark warehouses.



New Main Office & Warehouse

NEWARK 500 North Pulaski
Chicago, Illinois 60624

ELECTRONICS CORPORATION

AUTHORIZED P & B WAREHOUSES IN

- ✳ Chicago, Illinois (312) 638-4411
- ✳ Cincinnati, Ohio (513) 421-5282
- ✳ Denver, Colorado (303) 757-3351
- ✳ Detroit, Michigan (313) 548-0250
- ✳ Los Angeles Area (213) OR 8-0441
- ✳ Grand Rapids, Michigan (616) 452-1411
- Other Newark Warehouses in:
- ✳ New York City (212) 255-4600
- ✳ Dallas, Texas (214) BR 2-3571
- ✳ Houston, Texas (Opening Soon)
- ✳ New Orleans, Louisiana (504) 834-9470

INFORMATION RETRIEVAL NUMBER 79

ELECTRONIC DESIGN 8, April 11, 1968



COMPACT POWER PACKS



The new Compact "M" Series Power Packs offer you:

- Rated output voltages from 1000 to 75,000 DC
- Rated output currents of 1.5, 5, and 10 milliamperes
- Input voltages of 118, 220, 230, and 240 volts AC
- Variable output from 0 to rated voltage
- Input frequency range 50 to 500 CPS output ripple 1% RMS at rated voltage
- Hermetically sealed construction

Why pay more, and settle for less... PC's new compact power packs give more quality, more versatility, more dependability, plus smaller size, and best of all, most sizes are available in stock to meet your immediate needs.

Write for complete information and new catalog today!



Plastic Capacitors, INC.

2620 N. Clybourn • Chicago 14, Ill.
DI 8-3735

INFORMATION RETRIEVAL NUMBER 80

ELECTRONIC DESIGN 8, April 11, 1968

TEST EQUIPMENT

Digital voltmeter has five ranges



United Systems Corp., 918 Woodley Rd., Dayton, Ohio. Phone: (513) 254-6251. Price: \$195; stock.

A miniaturized digital voltmeter features 0.05%-plus-1-digit accuracy on five extended ranges. This DVM measures $3 \times 5\frac{1}{2} \times 5\frac{3}{4}$ in. and weighs less than 3-1/2 lb. It covers five decades from 0.1 to 1000 V dc full scale with 50% over-range. The instrument is readable to 20 μ V on the 100-mV range. A detented slide switch selects range and locates the decimal point simultaneously.

CIRCLE NO. 324

Hand-held instrument tests tape tension



Tensitron, Inc., Box 185, Harvard, Mass. Phone: (617) 456-3511.

Tape tension is a critical factor in the design of tape-handling mechanisms in audio and data recording. A tension meter that measures this parameter is made with cylindrical rollers that turn freely on ball-bearings. When the rollers are clamped from the side on a taut section of tape, tension, in grams, can be read on a 360° meter that faces the operator.

CIRCLE NO. 325



IN HIGH-SPEED PROGRAMMABLE POWER SUPPLIES

First There Was One, Then Two, Now Three Manufacturers

All Offering "Fast Slewing" Equipment.

But Kepeco is still the only one offering high speed power supplies in the operational format — with patch panel access to all nodes.

Offering the ultimate flexibility in programming choices, the Kepeco OPS-TA models permit an infinite selection of input signals and impedances with unrestricted feedback. For scaling, summing, integrating, sampling, amplifying, you name it! It's named KEPCO.

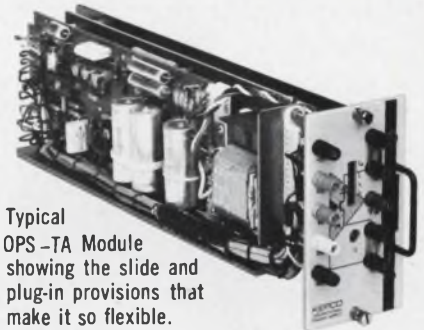

Typical OPS-TA Module showing the slide and plug-in provisions that make it so flexible.

Ratings available:

- 0- 7 volts @ 0-2 amperes
- 0- 15 volts @ 0-1.5 amperes
- 0- 21 volts @ 0-1 ampere
- 0- 40 volts @ 0-0.5 ampere
- 0- 72 volts @ 0-0.3 ampere
- 0- 100 volts @ 0-0.2 ampere

GAIN: >80db

SPEED: >500,000 volts/ second.

Adjustable offsets, phase and current limiting.

FOR COMPLETE SPECIFICATIONS AND APPLICATIONS NOTES WRITE DEPT. AC-5



131-38 SANFORD AVENUE • FLUSHING, N.Y. 11352
(212) 461-7000 • TWX # 710-582-2631

Telex: 12-6055 • Cable: KEPCOPOWER NEWYORK
INFORMATION RETRIEVAL NUMBER 81

Introducing the newest LC filter in the world:



Type _____
 Insertion loss _____ db maximum at reference frequency of _____
 Attenuation characteristics _____
 Temperature range _____ Voltage level _____
 Dimensions _____ Quantity required _____

Exactly what you're looking for...
 Vanguard will design, manufacture and deliver within 60 days the filters you need, between 20 Hz and 100 mHz, with impedances up to 40 kilohms. And they'll be designed to applicable standard specs, whether Mil, DCA, or any others required.

Clip this ad. Fill in the blanks. Put it with one of your business cards in an envelope addressed to Vanguard. You'll hear from us regarding competitive pricing without delay. Vanguard Electronics, Division of Wyle Laboratories, 930 W. Hyde Park Blvd. Inglewood, California 90302.



VANGUARD/WYLE

INFORMATION RETRIEVAL NUMBER 82

Design Aids

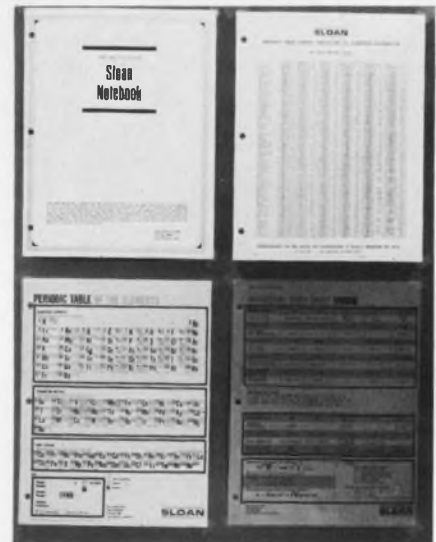

Vacuum deposition notes

A notebook offers pertinent data for those in the vacuum-deposition thin-film field. It contains a chart of characteristics and source preferences for 79 evaporants. Also included is a periodic table of the elements and useful facts and formulas about vacuum. The notebook folds to 9-3/4 by 12 in. and is punched for a 3-ring binder. Sloan Instruments Corp.

CIRCLE NO. 298

Rugged... Reliable HIGH BRIGHTNESS NEON INDICATOR LIGHTS

with built-in Resistor
 (a patented DIALCO feature)

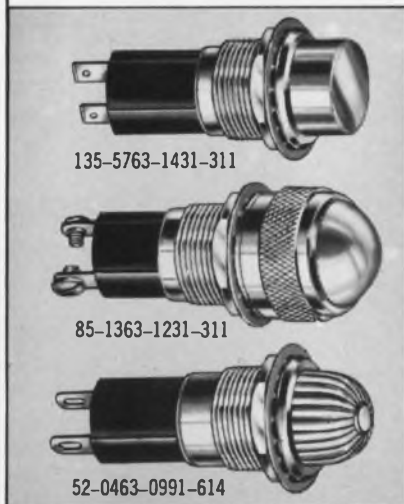

135-5763-1431-311

85-1363-1231-311

52-0463-0991-614

(Illus. approx. 75% actual size)

Dialco indicator lights accommodating high brightness NE-51H lamps can solve many indication problems for you!

Rugged and reliable: The NE-51H lamp is made to resist shock and vibration...and is not subject to sudden failure.

High brightness neon lamps are up to 8 times brighter than standard NE-51 lamps. Dialco makes the required resistor an integral part of the unit—built-in (a patented DIALCO feature—U.S. Pat. No. 2,421,321). This feature is provided with indicators on 110-125V AC or 210-250V AC-DC circuits.

Among the many other features to choose from are: assemblies mount in 9/16" or 11/16" clearance hole; offer a wide selection of lens shapes, colors and finishes; and are available with water-tight construction too! All assemblies are recognized under the component program of Underwriters' Laboratories Inc.—and meet CSA requirements.

Get all the data. Write for our new catalog today!

SAMPLES ON REQUEST—AT ONCE—NO CHARGE

Foremost Manufacturer of Indicator Lights

DIALIGHT CORPORATION

60 STEWART AVE., BROOKLYN, N.Y. 11237

DIALCO

AREA CODE 212 497-7600

INFORMATION RETRIEVAL NUMBER 83



Purchase planner

Engineers as well as procurement people normally look for lead dates several weeks in advance of planning schedule. With this slide-rule device, one merely sets the red arrow on the current date and looks ahead the number of weeks to the target date. Thermalloy Co.

CIRCLE NO. 299

Now Hysteresis Motors Cost Less.

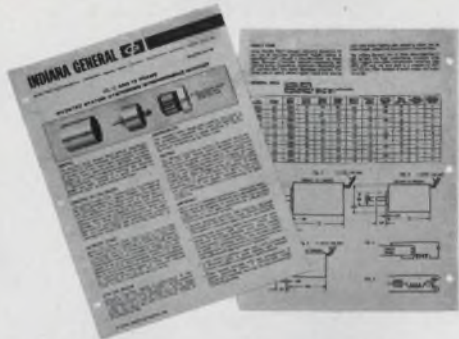

Get the Facts.

Indiana General's "Family Plan" (standard parts concept) and a new inverted stator design have lowered the cost of hysteresis synchronous motors. And there are plenty of other advantages. Flutter problems in voice/data recording applications, always inherent in conventional hysteresis motors, are virtually eliminated with the inverted design. Rotor inertia is six times that of conventional design.

The lower cost also makes IGC hysteresis motors practical for many induction motor applications. Moreover, you get significant reduction in input power at start-up and high operating efficiency with low slip characteristics. They are available in 10, 11, 13, and 15 frame sizes, and designed to meet Mil Specs. For free engineering data, write Indiana General Corporation, Electro-Mechanical Division, Oglesby, Illinois.

INDIANA GENERAL 

INFORMATION RETRIEVAL NUMBER 84

COMPACT NUMERIC READOUTS AT REASONABLE PRICES

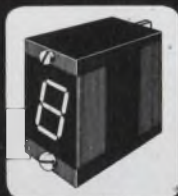

Displays 0-9 numerals by illuminating miniature lamps. Combination of lamps can be controlled with a matrix circuit (not supplied). Decimal points can be used as colon when 2 units are placed together. Indicator provides high illumination with a low voltage and current. Colored filters available. 6 & 12V. Figures 25/32" high. 20,000 hr. bulb life.

ALCO® ELECTRONIC
PRODUCTS, INC.
LAWRENCE, MASSACHUSETTS

PRICES
start at
\$9.95
Quantity
prices
available

INFORMATION RETRIEVAL NUMBER 85

MODERN DESIGN SERIES MINIATURE Neon Pilot Lights



1-piece body ideal for space limitations. BNE SERIES has compact lens system protruding slightly above panel. BNF SERIES' lens system extends more for greater illumination. BND SERIES' pilot assembly protrudes beyond panel to provide maximum light intensity.

Write for details.

ALCO® ELECTRONIC
PRODUCTS, INC.
LAWRENCE, MASSACHUSETTS

INFORMATION RETRIEVAL NUMBER 86

ELECTRONIC DESIGN 8, April 11, 1968

only
hallicrafters
offers complete
frequency
control and
instrumentation
capability!

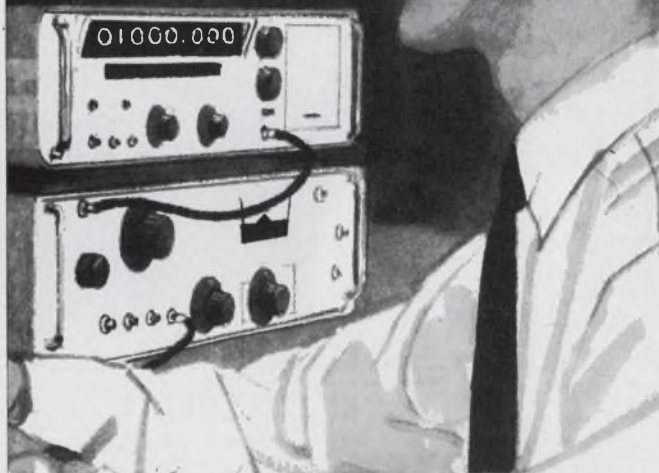

- PRECISION CRYSTAL OSCILLATORS**
1 Hz to 100 MHz, 2.5×10^{-9} (-20°C to $+65^{\circ}\text{C}$)
 5×10^{-10} aging/day
- VOLTAGE CONTROLLED OSCILLATORS**
2 to 20 MHz, 0.2% deviation, 2% linearity
- PROPORTIONAL OVENS**
1 millidegree short term variation,
10 millidegrees under all environments
- TEMPERATURE CONTROLLED OSCILLATORS**
No heaters, 5×10^{-6} stability (-20°C to 71°C)
- FREQUENCY STANDARDS**
 1×10^{-11} aging/day
- FREQUENCY SYNTHESIZERS**
2 to 34 MHz, Spurious -120 db

Only Hallicrafters offers you this extensive line of frequency equipment backed by over 20 years of precision engineering know-how and accomplishments. Any of these items can be readily custom designed to your specific requirements, with six week delivery of prototypes.

For information on products detailing variations in frequency, stability, etc., send for: Guide to Specifying Frequency Products. Department 4532.

316

the hallicrafters CO.
A Subsidiary of Northrop Corporation
600 Hicks Road, Rolling Meadows, Illinois 60008



INFORMATION RETRIEVAL NUMBER 87

141

Aircraft Flight Mechanisms:

4 weeks delivery.

MIL-SPEC quality.

The industry's lowest prices.

Nobody else but Ideal brings you *all* these benefits. Including high torque and sensitivities, up to 80° deflection, complete shielding, low weight, synchro or standard mounting, all shapes of pointers and flags — and customizing of all parameters.

American-made.

We're known for experience and promises *kept*. Write for free 32-page catalog. Ideal Precision Meter Co., Inc., 218 Franklin St., Brooklyn, N.Y. 11222. (212) EVergreen 3-6904.

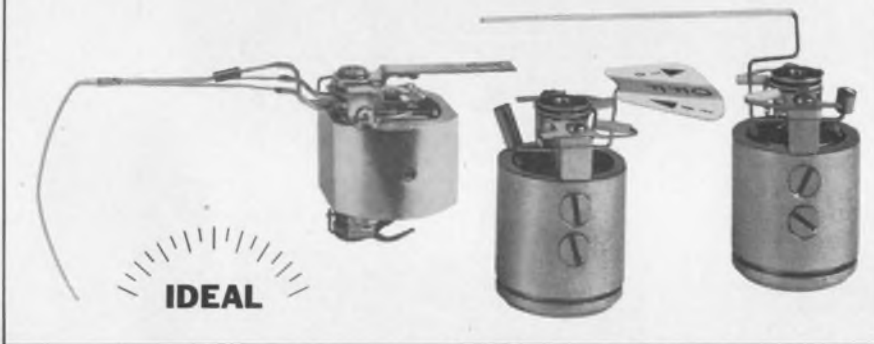

INFORMATION RETRIEVAL NUMBER 88



PLAY IT SAFE:
Start now
to save
their hearts

Help your children form good health habits now to reduce risk of heart attack later:

- Encourage normal weight; obesity in youth may persist throughout life;
- Build body health through regular physical activity;
- Serve them foods low in saturated fats;
- Teach them that cigarette smoking is hazardous to health;
- Make medical check-ups a family routine.

Set a good example. Follow the rules yourself and guard your heart, too.

GIVE...
so more will live
**HEART
FUND**

Contributed by the Publisher

Application Notes

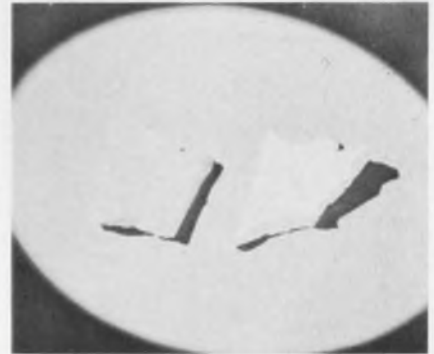

Circuitry glazes

Dielectric glazes for cross-over and multi-layer screened circuitry are described in a 12-page paper by Dr. Sidney J. Stein. Included are a number of illustrations and tables showing the glass-ceramic glazes that are compatible with conductive glazes. The glazes provide a rapid means of preparing multi-layer interconnections for larger scale integrated circuitry. Electro-Science Laboratories, Inc.

CIRCLE NO. 321

Null detectors

A 64-page, illustrated booklet discusses the selection of null detectors for various applications. A preface reviews the problems encountered in designing these instruments. Diagrams show in detail the connection and operation of null detectors with a number of commercially available, high-resolution potentiometers and bridges. Keithley Instruments, Inc.

CIRCLE NO. 322

Engineering handbook

A tabulation of engineering data, functions and formulas includes tables for logarithms, trigonometric functions and useful conversion factors. Compilations of radio formulas and nomograms also add to the utility of this handbook. Included is a complete listing, with specifications, of a broad range of precision components, ranging from capacitors and trimmers to tuners and delay lines. JFD Electronics Co.

CIRCLE NO. 323



for **\$195***, get the highest accuracy (.05%) per dollar from this newest, smallest 5 range

DIGI-EC® dvm

Test drive  the newest **DIGI-EC** compact

Want to take a test drive? Circle the reply card number below

ACCURACY of .05% plus 1 digit is unparalleled by any instrument in its price field. High stability circuits provide the "confidence factor" so often lacking in DVM's.

VERSATILITY of measurement. This new compact cruises the broad spectrum of 5 decades from 100 MV to 1 KV DS full scale with a bonus of 50% overrange.

RELIABILITY is proven by over 20,000 instruments that have travelled in the field providing MTBF in excess of 24 months. Simplicity of design and dramatic reduction of components is made possible by the utilization of the latest semi-conductor art. This instrument is warranted for one year (or 24,000 miles).

READABILITY is enhanced by combining the non-ambiguous presentation of digital readout with the resolute qualities of analog display. Typically, instrument is readable to 20 μ V on 100 MV range.

DIGI-EC by **UNITED SYSTEMS CORPORATION**

Stocking representatives throughout the world

*for quantity 10 to 49 for 1 to 9—\$225

918 Woodley Road, Dayton, Ohio 45403

INFORMATION RETRIEVAL NUMBER 89



free engineers' fact file

on all-purpose Ebert "Hi-power" Mercury Relays!

Up-date your relay know-how with this comprehensive manual on Ebert mercury-to-mercury relays.

FEATURING: Ratings to 60 kW • 1, 2 and 3-pole models • Hermetically sealed metal tube construction • Silent and Service-free operation.

SEND FOR YOUR FREE COPY TODAY.
EBERT ELECTRONICS CORP.

130-10 JERICHO TPKE., FLORAL PARK, N.Y. 11002

INFORMATION RETRIEVAL NUMBER 90

SPRING BUYERS DESIGN ENGINEERS MAINTENANCE ENGINEERS

FREE



Our new Catalog has over 2500 spring designs. IMMEDIATE DELIVERY Compression — Extension — Torsion. Complete engineering data on each spring. All orders received by 2 pm EST will be shipped same day.

OVER 2500 STOCK SPRINGS with complete Engineering data on each spring.

LEE SPRING COMPANY
DIVISION OF LEETRONICS, INC.

30 MAIN STREET, BROOKLYN, N.Y. 11201 212-855-7163 TWX 212-643-9349

50 YEARS OF EXPERIENCE

INFORMATION RETRIEVAL NUMBER 91

GOOD

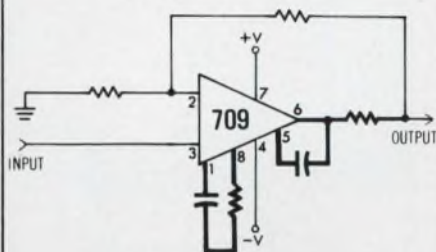

This buffer has a 10M Ω input . . .

BETTER

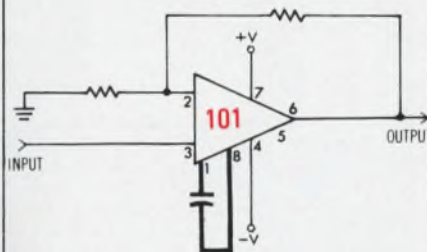

but the circuit can be improved . . .

BEST

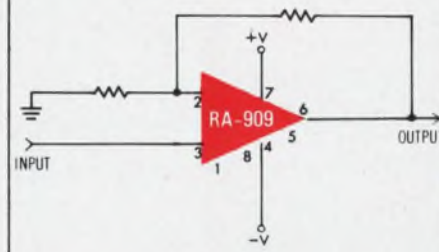

or it can be optimized!

Now all 709 circuits can be optimized by using the NEW compensationless RA-909.

This pin-for-pin replacement eliminates extra components and offers performance better than the very latest versions of the 709.

It's possible to achieve an equivalent input impedance of 10M Ω or better and provide unity gain with a maximum error of .004% with the buffer illustrated on the left above. But why not get the same performance with less components? Use the new RA-909.

Design it in or use it as a replacement. Available in the popular eight pin TO-5 configuration and the TO-86 flatpack, both having blank pins where the 709 and 101 require compensation so that existing compensation networks will not affect the

RA-909. Eliminate possible failure sources and get better performance for a comparable price. You can expect improvements such as a slew rate of 5 volts per microsecond; power dissipation of only 52 milliwatts; transient response of 40 nanoseconds (10 to 90% points) with a 200 millivolt output into a 2K Ω , 100pF load in the worst-case unity gain configuration; and a maximum equivalent input noise of 5 microvolts rms. Yes, five microvolts!

Contact your nearest Radiation sales office for further information.



RADIATION
INCORPORATED

SUBSIDIARY OF HARRIS-INTERTYPE CORPORATION
MICROELECTRONICS DIVISION

Sales Offices: 600 Old Country Road, Garden City, N.Y. 11530, (516) 747-3730 — 2600 Virginia Avenue, N.W., Washington, D.C. 20037, (202) 337-4914 — 6151 W. Century Boulevard, Los Angeles, Calif. 90245, (213) 670-5432 — P.O. Box 37, Melbourne, Florida 32901, (305) 727-5430 — International Sales Marketing Department P.O. Box 37, Melbourne, Florida 32901, (305) 727-5412

INFORMATION RETRIEVAL NUMBER 92

Size 9 DC Motor State-of-the-Art is off the shelf at AEI



The size 9 DC Permanent Magnet Motor, .875 in. dia x 1.375 in. length, is available open with Terminals or closed with Leads or Terminals.

Frame is Aluminum, finish Alodine per MIL-C-5541, with Armature supported in Ball Bearings.

Mounting either by Servo Clamps or Face Mounting by screws. Performance speeds are available from 5000 RPM to 20,000 RPM, at a continuous running torque of .21 in. oz. with an operating voltage of 6-50 VDC.

The Size 9 will meet all of the requirements of MIL-M-8609. Available accessories include Planetary Gearheads, RF Filter and Speed Governor.

Complete literature is available by writing Electro-Mechanical Group, American Electronics, Inc., 1600 East Valencia Drive, Fullerton, Calif. 92634, (714) 871-3020, TWX 910-592-1256

Electro-Mechanical Group AEI
AMERICAN ELECTRONICS INC.

Please rush checked item(s)
 DC Motor Design Manual
 DC Motor Technical Catalog

NAME _____

TITLE _____

COMPANY _____

ADDRESS _____

CITY _____

STATE _____

ZIP _____

INFORMATION RETRIEVAL NUMBER 93

NEW LITERATURE

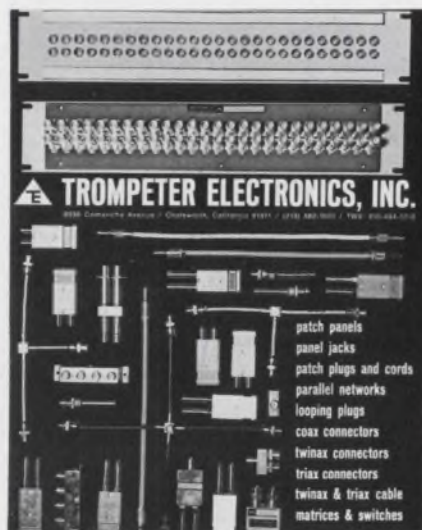

Patching systems

A color catalog describes a complete line of coax, triax and twinax patching systems and components. The brochure lists patch panels, jacks and cords, cable connectors, looping and terminating plugs, multiple parallel networks, and power dividers. The catalog also contains a technical discussion of noise and cross-talk in coaxial cable and the use of triax and twinax to improve communication and data transmission. Trompeter Electronics, Inc.

CIRCLE NO. 332

Ultrasonic equipment

A comprehensive line of ultrasonic cleaning equipment is described in five product data sheets. Ultrasonic cleaners, generators, system components, vapor degreasers, and ultrasonic soldering systems are included. Self-contained ultrasonic cleaners, with power ratings from 175 to 600 W are shown. The Redford Co.

CIRCLE NO. 333

Quartz catalog

A new catalog offers a complete line of quartz products with related components and hardware for the semiconductor industry. The 12-page brochure lists quartz furnace tubes, epitaxial reactors, diffusion carriers, washing racks and boat holders. It includes all related hardware and accessories, such as flange clamps, rf coils, stopcocks, adapters, flowmeters and clamps. Berkeley Quartzlab, Inc.

CIRCLE NO. 334

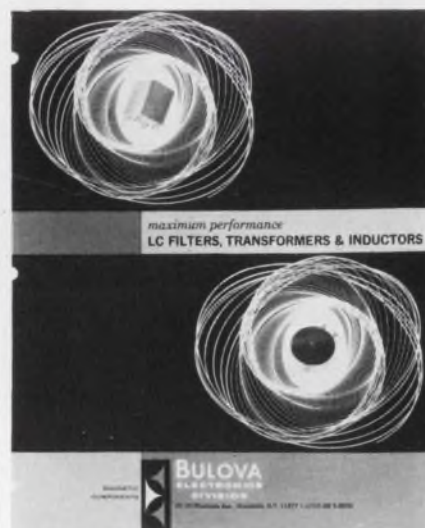

Magnetic Components

A new illustrated catalog on magnetic components for aerospace, industrial, communications and defense applications details Bulova's facilities for the production of LC filters and related networks, transformers, toroidal inductors and pot core coils. Included is a special section on high-reliability filters made to the requirements of NASA NPC-200 for advanced communications and aerospace applications. Also included are descriptions of comb filters, linear phase filters and IRIG and tone channel filters. Bulova Watch Company, Inc.

CIRCLE NO. 335

Ceramic data chart

A four-color chart gives a wealth of information on the mechanical and electrical properties of various ceramic materials. Too numerous to list, these properties include specific gravity, hardness, tensile strength, thermal conductivity, dielectric constant and dissipation factor (60 Hz to 25 GHz). American Lava Corp.

CIRCLE NO. 336

Wire and cable

A 40-page catalog contains complete data on 44 types of insulated wire and cable. Nearly 600 separate items are included. Each wire type is pictured and complete data including gauge, stranding, diameters, weights and insulating materials is given in chart form. Radix Wire Company.

CIRCLE NO. 337

WHO'S NEW ON THE CIRCUIT?

ON YOUR MARK . . . Meet the Diceon Super-Sprint. He's the sales engineer on your circuit with quality printed circuit boards and Diceon split-site savings.

GET SET . . . He's something new . . . a neighbor, yours for immediate professional at-your-site decision. He offers top-Mil. Spec. quality Diceon boards with a new extra: Super-Sprint service. See for yourself.

GO! . . . Call collect (714) 642-7100, and steal a start.

DICEON ELECTRONICS, INC.

644 TERMINAL WAY
COSTA MESA, CALIFORNIA 92627
TELEPHONE: (714) 642-7100

COSTA MESA
CALIFORNIA



© Copyright 1968 Diceon Electronics, Inc.

INFORMATION RETRIEVAL NUMBER 94

"IT'S GOOD BUSINESS
TO HIRE THE HANDICAPPED."

ISN'T THAT A GREAT IDEA, SNOOPY?



THE PRESIDENT'S COMMITTEE ON EMPLOYMENT
OF THE HANDICAPPED, WASHINGTON, D. C.

specify
CHICAGO SWITCH
for
Reliability, Repeatability and
Ingenuity

New



MINI-SLIDE SNAP

does 10 times as many jobs in 1/4 the space!

Computer Grade Reliability & Quality in a Rugged, Sub-Sub-miniature Switch. For transistor and integrated circuits applications, for "dry" circuit and moderate power use.

FEATURES: • Smallest in its field (next size available 4X larger) • NEW Anti-tease design • 4 pin 1A, 1B, 1C circuits • Contact rating: 2 amps at 120 VAC, 1/2 amp at 120 VDC • Panel mount or printed circuit • Thermoset base and slide block • All metal parts corrosion proof • Life: 250,000 operations.

Sound good . . . Want to learn more?
Send for Technical Bulletin and free sample!



CHICAGO SWITCH DIVISION • F & F ENTERPRISES, INC.
2039 Wabansia Avenue • Chicago, Illinois 60647 • 312/489-5500

INFORMATION RETRIEVAL NUMBER 95

Electronic Design

ELECTRONIC DESIGN's function is:

- To aid progress in the electronics manufacturing industry by promoting good design.
- To give the electronic design engineer concepts and ideas that make his job easier and more productive.
- To provide a central source of timely electronics information.
- To promote two-way communication between manufacturer and engineer.

Want a subscription? ELECTRONIC DESIGN is sent free to qualified engineers and engineering managers doing design work, supervising design or setting standards in the United States and Western Europe. For a free subscription, use the postfree application form inside the back cover. If none is included, write to us direct for an application form.

If you do not qualify, you may take out a paid subscription for \$25 a year in the U.S.A., \$35 a year elsewhere. Single copies are \$1.50 each.

If you change your address, send us an old mailing label and your new address; there is generally a prepaid postcard for this inside the back cover. You will have to requalify to continue receiving ELECTRONIC DESIGN free.

The accuracy policy of ELECTRONIC DESIGN is:

- To make reasonable efforts to ensure the accuracy of editorial matter.
- To publish prompt corrections whenever inaccuracies are brought to our attention. Corrections appear at the end of the Letters column.
- To refuse any advertisement deemed to be misleading or fraudulent.

Microfilm copies are available of complete issues of ELECTRONIC DESIGN and individual articles, published since the beginning of 1961. Complete issues cost 4¢ a page, articles cost 50¢ a page; shipping and handling charges are extra. The minimum charge is \$3. For further details and to place orders, contact University Microfilms, Inc., 300 N. Zeeb Road, Ann Arbor, Mich. 48106; telephone (313) 761-4700.

Want to contact us? If you have any comments or wish to submit a manuscript or article outline, address your correspondence to:

Howard Bierman, Editor,
ELECTRONIC DESIGN,
850 Third Avenue,
New York, N.Y. 10022.

Design Data from

Free Electronic Circuit Symbol Catalog



Save artwork and drafting time. Cut costs with thousands of electronic drafting aids and symbols featured in the new 28-page Catalog No. 102 from Bishop. In it is the industry's only complete selection of predrawn circuit component symbols: integrated circuits, logics, semiconductors, flat-packs, transistors, printed circuits, welded modules, etc. Also: tapes, pads, corners, connectors, schematic symbols, reference numbers and more. Included are illustrations, range of sizes and complete price information. Send today for your free copy.

Bishop Industries Corp.
11728 Vose Street
North Hollywood, California 91605

171

Total System Power Supply Capability



Dynage manufactures three different standard styles of equipment. The voltage references and standards are packaged for circuit board and chassis mounting. The low current power supplies (Dynage "D" series up to 1.0 amperes) are packaged for chassis mounting in Mil-T-27A cans. The highest current power supplies (H series up to 60 amperes) are racked type modules. The advantages to the Dynage approach are repairability, service, cost, delivery, (72 hours on standard D & H series power supplies), flexible packaging, color coordination and an extremely wide selection of voltages and currents.

Dynage, Inc.

1331 Blue Hills Avenue
Bloomfield, Connecticut 06002

172

ELECTRONIC DESIGN TECHNIQUES



In this outstanding reference book, leaders in electronic design demonstrate for your immediate use new ideas and proven techniques that have solved difficult problems for themselves and their firms. Over 55 practical design studies selected from **Electronic Design** are presented. Vital sections of the book cover the use and design aspects of amplifiers, resistor networks, filters, control devices, power supplies, microwave systems, oscillators, and pulse and switching currents. Edited by Edward E. Grazda. Just published. 312 pages. 352 illustrations. Large format. 8 1/2 x 11. \$12.75, clothbound. Examine for 15 days without obligation or ask for details.

HAYDEN BOOK COMPANY, INC.

116 W. 14 St.
New York, N.Y. 10011

173

Manufacturers

Advertisements of booklets, brochures, catalogs and data sheets. To order use Reader-Service Card.
(Advertisement)

Terminal Block Selector



A new 24-page, completely illustrated catalog contains photos, descriptions, ratings, engineering drawings, and prices of the complete line of Curtis terminal blocks. Included are printed circuit, insulated feed-thru, quick disconnect, track type, and high current terminal blocks. Handy selection chart quickly locates the perfect block for your particular requirements. Send today for your free copy.

Curtis Development & Mfg. Co.

3236 North 33rd Street
Milwaukee, Wisconsin 53216
See us at: Booth 724, Design Eng. Show

179

Bus Bars For Noise Reduction



A 16 page Technical Bulletin is now available, describing a new concept in power or signal distribution. Basic mechanical and electrical design principles, along with descriptive pictures and diagrams, are included in this bulletin. These compact buses can replace bulky cable harnesses and repetitive wiring for computer or modular application. This method of construction satisfies the demanding requirements of low inductance and resistance of high speed, solid state systems, while controlling electrical noises.

Eldre Components, Inc.

1239 University Avenue
Rochester, New York 14607

175

Ferrites For Electronics

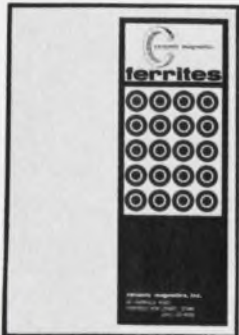

This new catalog provides detailed engineering information pertaining to ferrite materials, their inherent magnetic characteristics and recommended applications for their optimum usage. Offered are specific materials designed for:

- Low and Medium Frequency Small Signal Devices.
- Medium to High Frequency Devices.
- High and V.H.F. Devices.
- U.H.F. Microwave and Millimeter Wave Devices.
- Magnetostrictive and Electromechanical Transducers, Couplers and Filters.

Ceramic Magnetics, Inc.

87 Fairfield Road
Fairfield, New Jersey 07006
(201) 227-4222

176

Electronic Design

Advertising Representatives

New York 10022

Robert W. Gascoigne
Thomas P. Barth
Samuel M. Deitch
Byron Adams
850 Third Avenue
(212) PLaza 1-5530
TWX: 867-7866

Philadelphia

William C. Repetto
P. O. Box 206
Merion Station, Pa. 19066
(215) MO 4-1073

Boston

Richard Parker
40 Webb Street
Salem, Mass. 01970
(617) 742-0252

Chicago 60611

Thomas P. Kavooras
Berry Conner, Jr.
720 N. Michigan
(312) 337-0588

Cleveland

(216) 247-7670

Los Angeles 90303

Stanley I. Ehrenclou
Terrence D. Buckley
W. James Bischof
2930 W. Imperial Highway
Inglewood, Calif.
(213) 757-0183

San Francisco

Ashley P. Hartman
175 South San Antonio Rd
Ste. 243
Los Altos, Calif. 94022
(415) 941-3084

Southwestern 75206

Tommy L. Wilson
6200 North Central Expressway
Dallas, Tex.
(214) EMerson 1-2311

London W. 1

Brayton C. Nichols
44 Conduit Street

Verviers, Belgium

Andre Jamar
1, Rue Mallar, 1
(087) 253.85

Tokyo

Yoshihiro Takemura
IPS Group Ltd.
Box 36
Ohsaki Post Office
Phone (431) 5304





1 1/2 in. AM-1 (actual size)

Distinctively Styled high torque, self-shielded panel meters

Smart, sophisticated styling . . . easy reading scale . . . sizes 1 1/2 to 4 1/2". Rugged, high torque mechanism offers 1% linearity, 2% accuracy and sensitivity to 20 ua. Completely shielded to eliminate error from magnetic panels. Mounts bezel-to-bezel on any material without interaction or effect on calibration. Choice of colors or finishes, custom dials — ASA/MIL 4-stud mounting.

AMMON

AMMON INSTRUMENTS, INC.
345 Kelley St., Manchester, N.H. 03105

INFORMATION RETRIEVAL NUMBER 97

Not the Great American Novel but a **FREE** COMPREHENSIVE



GUIDE TO

- Battery Holders
- Terminals
- Terminal Boards
- Pre-Punched Boards
- Plug-in Housings
- Bushings
- Staking Tools

SEND FOR IT



STANDARD FROM
STOCK OR
CUSTOM MADE

Battery
Holders

Plug-in
Housings

Terminal
Boards

designed and manufactured by



KEYSTONE

ELECTRONICS CORP.

49 Bleeker Street, N.Y., N.Y. 10012

INFORMATION RETRIEVAL NUMBER 98

Advertisers' Index

Advertiser	Page	Advertiser	Page
Acme Electric Corporation	16	International Rectifier, Semiconductor Division	5
Acopian Corporation	136	Janco Corporation	23
Alco Electronic Products, Inc.	141	Kepeco, Inc.	138, 139
American Electronics, Inc.	146	Keystone Electronics Corp.	150
American Lava Corporation	105, 128	Lee Spring Company	143
Ammon Instruments, Inc.	150	Magnetics, Inc.	24
Amphenol Controls Division,		Mallory Capacitor Company	7
Amphenol Corporation	37	Microdyne Instruments, Inc.	33
Analog Devices, Inc.	124	Microdot, Inc.	20
Augat, Inc.	125	Microsonics, Inc.	118
Bell Telephone Laboratories	127	Molex Products Company	51
Bishop Industries Corp.	148	Motorola Semiconductor Products, Inc.	40
Bodine Electric Company	14	National Semiconductor Corporation	62, 63
Bourns, Inc.	39	Newark Electronics Corporation	138
Buckbee Mears Co.	107	Nortronics Company, Inc.	130
Burr-Brown Research Corporation	10	Nytronics, Inc.	31
CML, Inc.	129	Plastic Capacitors, Inc.	139
Carborundum Company, The	56	Prestype, Inc.	50
Ceramic Magnetics, Inc.	149	RCA Electronic Components and Devices	Cover IV
Chicago Switch Division,		RCL Electronics, Inc.	6
F & F Enterprises, Inc.	147	RCA Institutes, Inc.	96
Cinch, Division of United Carr	45	Radiation, Incorporated	145
Clare & Co., C. P.	4	Raytheon Company, Sorensen Operation	115
Cohn Corp., Sigmund	137	Rowan Controller Company, The	29
Comar Electric Company	47	Sanders Associates, Inc.	120
Communication Electronics, A subsidiary of Watkins—Johnson	133	Secor Metals Corp.	121
Components, Inc. Maine Division	112	Simpson Electric Company	43
Conap, Inc.	122	Solitron Devices, Inc.	17
Corning Glass Works, Electronic Products Division	74, 75	Specific Products	116
Curtis Instruments, Inc.	149	Spectrol Electronics Corporation	85
Cutler-Hammer	81	Sperry Rand Corporation,	
Dale Electronics, Inc.	Cover III	Electronic Tube Division	117
Delevan Electronics, Division of American Precision Industries Inc.	136	Sperry Rand Corporation,	
Delta Design, Inc.	132	Microwave Electronics Division	119
Deutsch, Electronics, Components Division	27	Sprague Electric Company	18
Dialight Corporation	140	Starrett Company, The L. S.	103
Diceon Electronics, Inc.	147	Stewart Warner, Microcircuits Inc.	69
Digital Equipment Corporation	126	Sylvania, Subsidiary of General Telephone & Electronics	32A—H
Dynage, Inc.	148	Syntron, A Division of FMC Corporation	131
ESI/Electro Scientific Industries, Inc.	48A-B	Systron-Donner Corporation	2
Eastern Industries, A Division of Laboratory for Electronics, Inc.	49	TRW Semiconductors, Inc.	52
Ebert Electronics Corp.	143	Tektronix, Inc., Oscilloscopes	54
Eldre Components, Inc.	149	Teledyne Relays, A Teledyne Company	135
Electronic Design	84, 151	Transmagetics, Inc.	129
Electronic Research Associates, Inc.	44	United Aircraft Corporation,	
Fairchild Semiconductor, A Division Fairchild Camera and Instrument Corporation	8, 9	Norden Division	101
Fluke Mfg. Co., Inc., John	123	United Systems Corporation	143
General Electric Company, Semiconductor Products Department	109, 110, 111	Unitrode Corporation	41
General Instrument Corporation	88, 89	Vanguard Wyle	140
General Radio Company	1	Varian, Bomac Division	35
Hallicrafters, Co., The	141	Waters Manufacturing, Inc.	46
Hayden Book Company, Inc.	148	Western Microwave Laboratories, Inc.	15
Hewlett-Packard	Cover 11	Wheelock Signals, Inc.	48
Honeywell, Computer Control Division	12, 13	Career Advertising	
Ideal Precision Meter Co. Inc.	142	Lockheed-California Company	98
Indiana General Corporation	129, 141	Xerox Corporation	98, 99
Industrial Condenser Corp.	137		

FIVE GOOD WAYS TO LEARN ALL
ABOUT THE LATEST IN MICROWAVES

- *By visiting all the leading microwave plants and interviewing their best designers and researchers.
- *By attending all major conferences on the subject.
- *By developing and editing state-of-the-art articles covering latest design techniques.
- *By writing extensively about new developments and trends.
- *By working for Electronic Design... the magazine whose editors make it their business to know.

Good salary,
excellent benefits, and
association with top professional
engineer-writers can be yours.
If you are an engineer with
experience in microwaves or
communications systems, and are
interested in the possibilities,
call or write Robert Haavind,
Managing Editor, Electronic
Design, 850 Third Avenue,
New York, New York 10022,
(212) PL 1-5530

Information Retrieval Service

All products, design aids (DA), application notes (AN), new literature (NL), and reprints (R) in this issue are listed here with Page and Information Retrieval numbers. Reader requests will be promptly processed by computer and mailed to the manufacturer within three days.

Category	Page	IRN	Category	Page	IRN	Category	Page	IRN
Amplifiers			Integrated Circuits			modules, plug-in	116	254
amplifier,			IC amplifier,			parametric amplifier,		
differential dc	120	261	24-element	122	272	microwave	121	266
amplifier, TWT	128	276	Materials			reader, punched tape	120	260
amplifier, hybrid			ceramic data chart (NL)	146	336	reader, 200-ft tape	116	252
microwave	126	273	circuitry glazes (AN)	142	321	receiver, vhf		
amplifier, IC,			quartz catalog (NL)	146	334	phase-lock	116	253
24-element	122	272	resin selection			recorder, six-pen	121	264
amplifier, log video	139	289	chart (NL)	144	328	transmission system,		
Circuit Modules			vacuum deposition			tape	118	256
amplifier,			notes (DA)	140	298	Test Equipment		
differential dc	120	261	Microwave Devices			meter,		
converter, A-D	118	257	amplifier, hybrid			battery-condition	138	297
counting modules	120	263	microwave	126	273	microscope, electron	137	295
delay, module, NIM	118	259	amplifier, TWT	128	276	phase meter,		
IC amplifier,			filters, uhf bandpass	128	279	sampling	136	293
24-element	122	272	infrared emitter,			spectrum analyzer	134	290
modules, plug-in	116	254	GaAs	126	275	tension gauge, tape	139	325
power supply, op amp	130	280	limiter, broadband	128	278	tester, IC logic	137	294
transformer, miniature	138	286	oscillator,			transistor tester	138	296
voltage reference	138	287	voltage-tuned	128	277	voltmeter, digital	139	324
Communications Equipment			Q-switch, Pockels-cell	126	274	voltmeter, digital	136	292
receiver, vhf			Microwave Equipment			Wire and Cable		
phase-lock	116	253	amplifier, TWT	128	276	wire and cable (NL)	146	337
Components			amplifier, hybrid			New Literature		
amplifier, log video	139	289	microwave	126	273	ceramic data chart	146	336
capacitors, trimmer	130	282	receiver, vhf,			computer-designed		
lamps, indicator	130	283	phase-lock	116	253	motors	144	329
power supply, op amp	130	280	parametric amplifier,			crystal detection		
resistors, low-ohmmage	138	285	microwave	121	266	data	144	327
resistor, thermal	139	288	Power Supplies			drafting system	144	326
transformer, miniature	138	286	power supply, op amp	130	280	magnetic components	146	335
transformer,			transformer, miniature	138	286	patching systems	146	332
parametric	138	284	Production Equipment			positive followers	144	331
voltage reference	138	287	clipper, wire-thread	124	270	quartz catalog	146	334
wire-wraps, automatic	130	281	drilling machine	124	271	resin selection		
Control Devices			microcircuit			chart	144	328
infrared emitter,			mask-maker	124	269	torque motors	144	330
GaAs	126	275	press, pneumatic	124	268	ultrasonic equipment	146	333
lamps, indicator	130	283	tester, plating	124	267	wire and cable	146	337
Q-switch, Pockels-cell	126	274	Semiconductors			Design Aids		
resistor, thermal	139	288	infrared emitter,			purchase planner	140	299
Data Processing			GaAs	126	275	vacuum deposition		
converter, A-D	118	257	transistor tester	138	296	notes	140	298
converter, tape to			Systems			Application Notes		
analog	121	265	amplifier,			circuitry glazes	142	321
counting modules	120	263	differential dc	120	261	engineering handbook	142	323
data system,			converter, A-D	118	257	null detectors	142	322
teletype code	116	255	converter, tape to			Reprints Available		
data-acquisition			analog	121	265	Buying a spectrum analyzer?	473	
system	120	262	counting modules	120	263	Interpreting spectrum		
discriminator,			data system,			analyzer displays	472	
15-channel	118	258	teletype code	116	255	Try this integrated-circuit		
reader, punched tape	120	260	data-acquisition			digitizer	474	
reader, 200-ft tape	116	252	system	120	262	Hardware & Packaging		
recorder, six-pen	121	264	delay, module, NIM	118	259	modules, plug-in	116	254
transmission system,			discriminator,			wire-wraps, automatic	130	281
tape	118	256	15-channel	118	258	Information Retrieval Service		
Hardware & Packaging			microscope, deep					
modules, plug-in	116	254	field	114	251			
wire-wraps, automatic	130	281						

Figure on faster rise time!



New FREE* SLIDE RULE proves you can do more with DALE bobbin resistors!

Dale Bobbin Wirewounds have the performance you need plus good delivery at competitive prices. Prove it with our new free* slide rule. It puts at your finger tips valuable design information on rise time plus inductance/capacitance readings from .5 to 50 MHz. Choose from 14 Dale bobbins from .1 to 1 watt with fast, non-ringing rise times as low as .003 microseconds (10%-90% - 100 KC pulse). All are available with the accuracies and/or matching you need for switching in digital to analog converters and other high frequency, low reactance applications.

*To Get Your Free Bobbin Slide Rule, write us on your company letterhead, including your job title or function.



DALE BOBBIN SPECIFICATIONS

Power Rating: .1 watt to 1 watt in 14 sizes. Power may be doubled for commercial applications.

Resistance Range: .1 ohm to 23 Megohms

Tolerances: 1%, .5%, .25%, .10%, .05%

Mil. Spec.: Meet applicable requirements of MIL-R-93 and MIL-R-39005

Construction: Molded. Pass salt water immersion test

Load Life: .5% Max. ΔR in 1500 hours at MIL-R-93 conditions

Operating Temperature: -55° C to +145° C

Reactance & Rise Time: Write for slide rule or consult factory.

Special Modifications Available: Tolerances to .005%; Tolerance Matching to .001%; Special T.C.'s to ± 2 PPM/° C; Matched T.C.'s to 1 PPM/° C accuracy.

For complete information, write Dale Electronics or phone 402-564-3131.

For Catalog A, Circle No. 181



DALE ELECTRONICS, INC.

1328 28th Ave., Columbus, Nebraska 68601
In Canada: Dale Electronics Canada, Ltd.





Specify RCA-8507A Vidicon for Black-and-White or Color

For the best picture in closed-circuit applications, specify RCA-8507A... for tube-to-tube uniformity and the optimum combination of size, price, and performance.

Typically, under ordinary lighting conditions, you'll get improved resolution at high-voltage conditions of operation, a limiting center resolution of 1100 TV lines, and an amplitude response of 60% at 400 TV lines. Sensitivity is equivalent to photographic film with 1200 ASA exposure index—producing high quality pictures under virtually all operating conditions. The 8507A employs RCA's high-sensitivity, low-lag photoconductor, has separate

mesh connection, and will provide more uniform signal output than other high-sensitivity, low-lag vidicons.

RCA has a wide range of vidicons for you to choose from: ½", 1", 1½" diameter, using all four combinations of focus and deflection means, with heater power requirements as low as 0.6 watt. RCA Vidicons have environmental capabilities meeting the most severe military and space requirements. They offer high-quality picture capabilities for every TV

function—live, film, or VTR, black-and-white or color, in broadcast or closed circuit systems.

Whatever your application, see your RCA Representative. Ask him about the RCA-8507A... and the other RCA Vidicons, both regular line and custom designed.

For technical booklet CAM-700, "RCA Vidicons," write RCA Commercial Engineering, Section D184-2, Harrison, N. J. 07029.



RCA