

New All-Solid-State hp 1200 Scope System Sets New Standards of Performance for Your dc-500 kHz Measurements

Now you can upgrade your low frequency measurements with the new hp 1200 scope system for better performance, greater sensitivity and improved accuracy in the dc to 500 kHz range.

The hp 1200 scope system has an all-new design from the inside out to provide all-solid-state reliability and stability. Drift has essentially been eliminated to allow accurate measurements—even in the 100 μ V dc area. Controls on the front panel have been grouped to give faster measurements, quicker set-up, direct dial readout even when using the magnifier.

Choose from four models to get single or dual trace 100 μ V/cm sensitivity, or single or dual trace 5 mV/cm sensitivity. The 100 μ V scopes have 17 calibrated ranges in 1-2-5 sequence with vernier for continual adjustment between ranges. (The 5 mV scopes have 12 calibrated ranges.) All four

models have large 8 x 10 cm internal graticule CRT's, single-ended or differential input on all ranges, complete triggering versatility, external horizontal input, dc-coupled Z-axis, beam-finder—many of the features you normally associate only with high frequency scopes.

All four models are available as lightweight (< 25 pounds) cabinet or 5 $\frac{1}{4}$ " high rack mounts. Power consumption of 33 watts eliminates need for cooling fans.

For details on how you can increase your measurement confidence and your measurement accuracy in the low frequency range, contact your nearest hp field engineer. Ask him about the new hp 1200 scope system. Or, write to Hewlett-Packard, Palo Alto, California 94304. In Europe: 54 Route des Acacias, Geneva.

	1200A/AR*	1202A/AR*	1205A/AR*	1206A/AR*
Number of Channels	2	1	2	1
Maximum Vertical Sensitivity	100 μ V/cm	100 μ V/cm	5 mV/cm	5 mV/cm
Common Mode Rejection (Differential)	100 dB	100 dB	50 dB	50 dB
X-Y Capability	Identical Amplifiers (17 ranges)	17 vertical vs. 4 horizontal ranges	Identical Amplifiers (12 ranges)	12 vertical vs. 4 horizontal ranges
Price	\$990	\$790	\$875	\$715

* AR indicates 5 $\frac{1}{4}$ " rack mount model

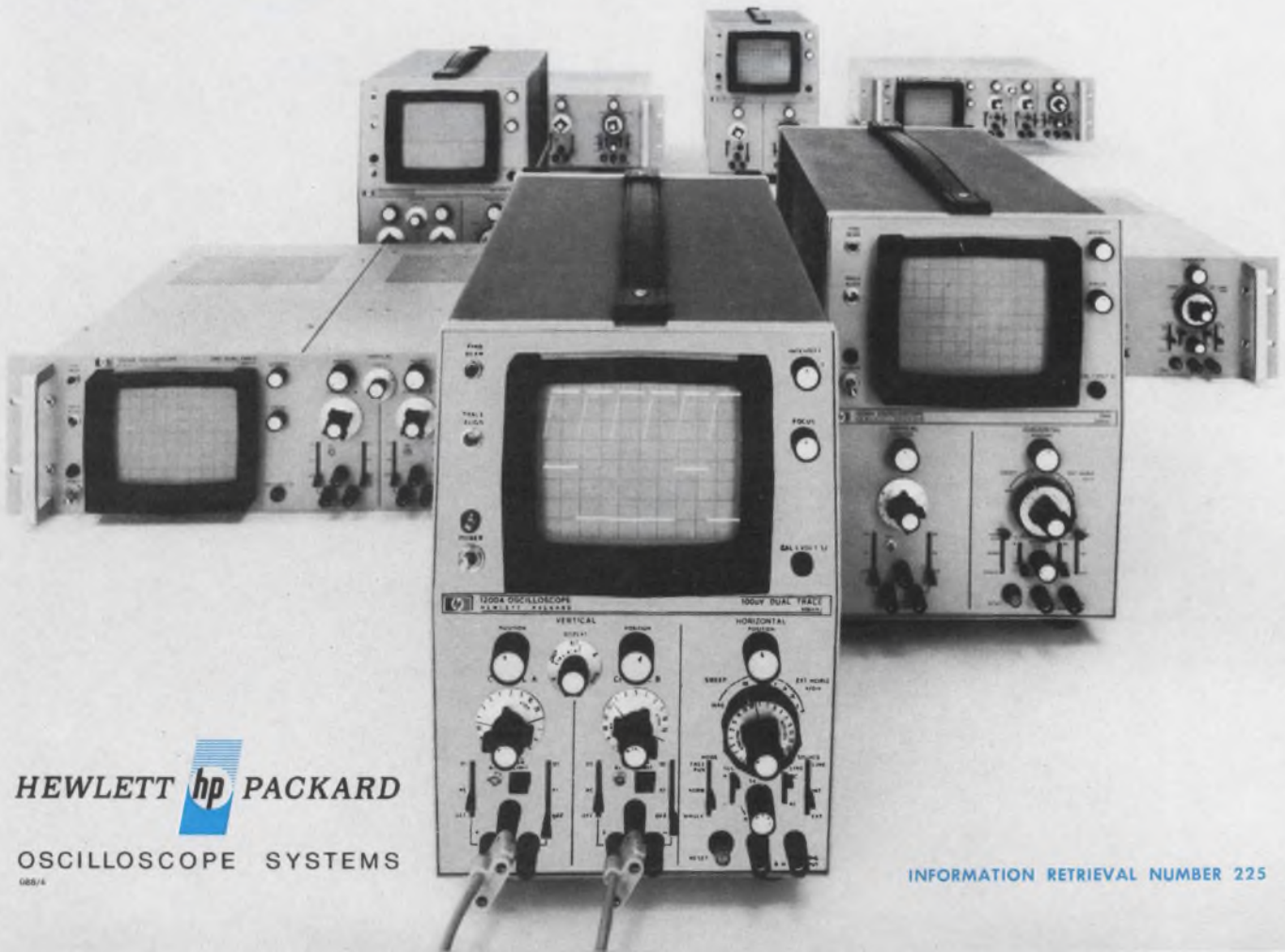

HEWLETT  PACKARD
OSCILLOSCOPE SYSTEMS

INFORMATION RETRIEVAL NUMBER 225

Little plug-ins make the big difference in 50 MHz counters



When you look only at the main frame, it's hard to find important differences between 50 MHz counters. But when you compare plug-ins, you'll find great differences and decisive advantages. Only Systron-Donner plug-ins can give you:

1. Final-answer frequency readings to 40 GHz.

A single plug-in, our Model 1292 semi-automatic transfer oscillator, boosts the counter's frequency-measuring range to 15 GHz. Measures FM and pulsed RF above 50 MHz. And the complete dc to 15 GHz system (counter with plug-in) costs only \$3250. Our new Model 1298 semi-automatic T.O. now gives you final-answer readings up to 40 GHz—a new record.

Contact Systron-Donner Corporation, 888 Galindo Street, Concord, California. Phone (415) 682-6161.

2. Automatic frequency readings to 18 GHz.

Three Acto® plug-ins now produce fully-automatic microwave frequency readings: 50 MHz to 3 GHz (P, L & S band), 3 to 12.4 GHz (S & X band), and 12.4 to 18 GHz (Ku band).



Find more unique measuring capability in this catalog

3. Time readings with 10-nanosecond resolution.

Our latest time interval plug-in gives you time readings with 10-nanosecond resolution—greater precision than ever before possible with a standard counter.

All this unique measuring capability can be yours today—or tomorrow—when you buy your basic counter from Systron-Donner. Sixteen different plug-ins have been especially designed to give your Systron-Donner counter more measuring power at less cost than any other system.

SYSTRON  DONNER

Do you want to go LSI now?

If you really want LSI now, grab the next plane to Mountain View. (It lands in San Francisco.) It's the quickest, least expensive way to get LSI into your system.

Plan to bring along your blueprints. And be ready to answer a lot of questions. We'll need to know what you have in mind for sub-systems, functions and specs. And, don't be surprised when we ask "why" a couple of times. It's all part of Fairchild's systems approach to complex circuitry.

We'll take your requirements and match them against our family of fundamental building blocks. We've got LSIs (and MSIs) that work in any digital logic system. The most advanced circuitry on the market. Offspring of computer-aided design and double-layer metal technology. And, they're all so versatile, we can probably give you a counter that has a dozen other applications in your system.

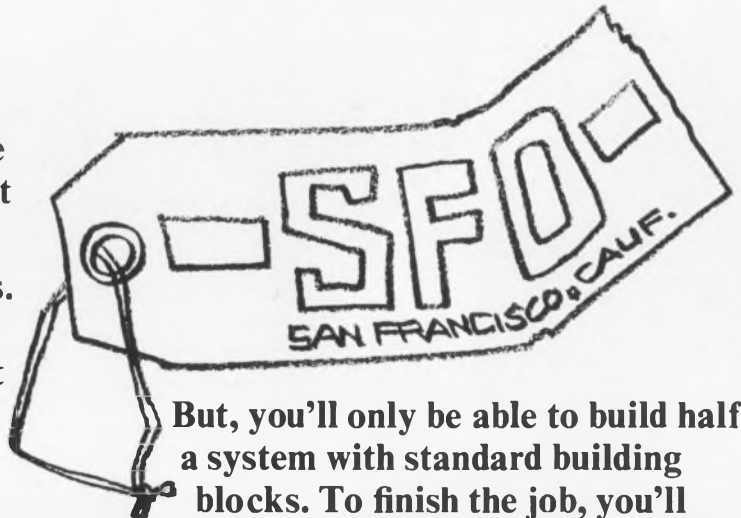

But, you'll only be able to build half a system with standard building blocks. To finish the job, you'll need interface devices to tie the whole thing together. And, here's where Fairchild can really save you time and money. We don't have to custom design each LSI interface circuit. We use Micromatrix™—a unique cellular array that's completed when we add your specific interconnection pattern. Your specs customize the entire array for your system.

Of course, there's a lot more to the story. But, you ought to hear it in person. Just call your Fairchild salesman. He knows the flight schedule to San Francisco.

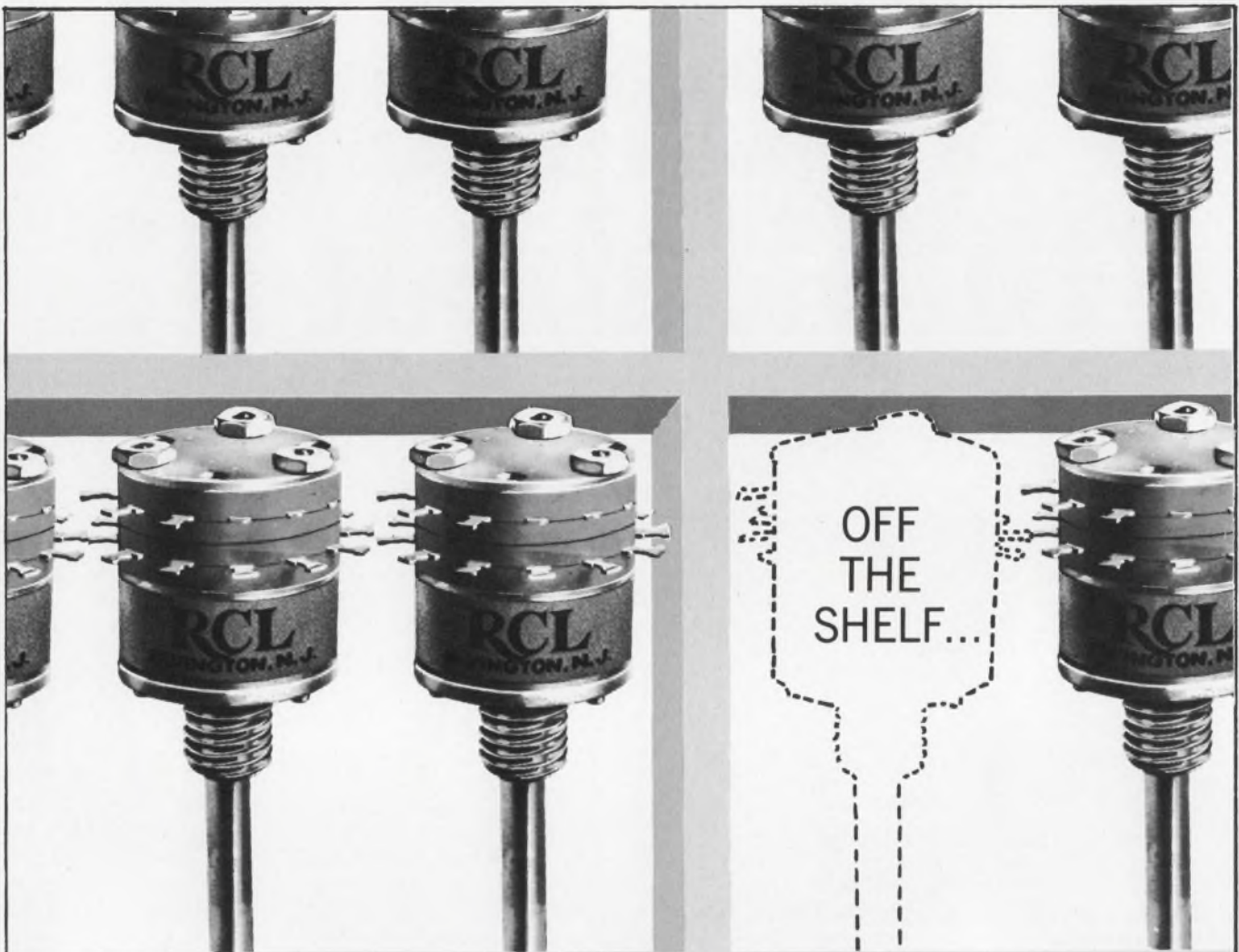

INDUSTRY'S
BEST DELIVERY...
1/2" MINIATURE
ROTARY SWITCHES

Write For Engineering Catalog



- Shorting **AND** non-shorting poles may be grouped on one deck in any combination
- Up to 12 positions per deck, shorting **OR** non-shorting
- As many as 6 poles per deck
- Life expectancy 200,000 mechanical operations
- All individual deck parts are self-contained, and are permanently molded into place

RCL ELECTRONICS, INC.

General Sales Office: 700 South 21st Street, Irvington, New Jersey 07111

U.S. Pat. 3352979

SHOWTIME! WRITE



Kearfott Products Div., Dept. S, General Precision Systems Inc.
Kearfott Group, Little Falls, N.J.
 Please send me a copy of your booklet on KEARFOTT SERVOS.

Name _____
 Company _____
 Address _____
 City _____ State _____ Zip _____
 (Circle Reader Service Number 231)



Kearfott Products Div., Dept. EC, General Precision Systems Inc.
Kearfott Group, Little Falls, N.J.
 Please send me a copy of your booklet on KEARFOTT ELECTRONIC COMPONENTS.

Name _____
 Company _____
 Address _____
 City _____ State _____ Zip _____
 (Circle Reader Service Number 232)



Kearfott Products Div., Dept. MTG, General Precision Systems Inc.
Kearfott Group, Little Falls, N.J.
 Please send me a copy of your booklet on KEARFOTT MOTOR TACH GENERATORS.

Name _____
 Company _____
 Address _____
 City _____ State _____ Zip _____
 (Circle Reader Service Number 233)



Kearfott Products Div., Dept. SR, General Precision Systems Inc.
Kearfott Group, Little Falls, N.J.
 Please send me a copy of your booklet on KEARFOTT SYNCHROS/RESOLVERS.

Name _____
 Company _____
 Address _____
 City _____ State _____ Zip _____
 (Circle Reader Service Number 234)

It took the old pros to give you what you wanted in an IC op amp

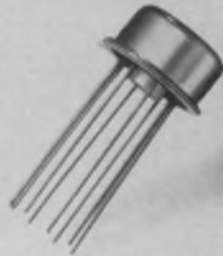

- * guaranteed maximum values for the 20 key parameters. 100% tested!
- * only two external components required for phase compensation.
- * low bias current drifts, less than 0.6 nA/°C, guaranteed.
- * 0.8 μ V and 0.03 nA input noise, guaranteed.
- * 20 kHz full power response with unity gain phase compensation.
- * input overvoltage protection to ± 15 V.
- * output short circuit protection.
- * uniform stability and performance from lot to lot — *guaranteed*.
- * package interchangeable with standard 8 pin 709 type amplifiers.

These new IC op amps were designed from the users viewpoint. After all, their family line stretches all the way back to the very beginning of solid state operational amplifier development. So, the BBICs (Burr-Brown Integrated Circuits) have the performance and application advantages you expect from Burr-Brown . . . the old pros in op amp technology.

Burr-Brown's unique, proprietary design (patent pending) overcomes the limitations of other monolithic IC units on the market to cut your incoming test and inspection cost, simplify your system design work, reduce the number of external components required, eliminate time-consuming hand-tuning . . .

and give you superior performance, stability and uniformity in the bargain.

Both Military and Commercial temperature ranges are included in the 8-unit series. BBIC prices start at \$8.00 in 100 unit quantities. And, they are available, now, from stock.

Sound good? Then use this publication's reader service card for your copy of the six page specification and application bulletin on the BBICs. Better yet, get hold of your local "old pro", your Burr-Brown Representative. His phone number is listed below. Demonstrator units available in case you're a skeptic.

BURR-BROWN

RESEARCH CORPORATION

International Airport Industrial Park • Tucson, Arizona 85706
TELEPHONE: 602-294-1431 • TWX: 910-952-1111 • CABLE: BBRCORP



Operational Amplifiers
Instrumentation Amplifiers
Function Modules
Analog Simulators
Geophysical Instruments

ENGINEERING REPRESENTATIVES: ALABAMA, HUNTSVILLE (205) 534-1648 / ARIZONA, PHOENIX (602) 254-6085 / CALIF., LOS ANGELES (213) 665-5181, SAN FRANCISCO (408) 244-1505 / COLO., DENVER (303) 388-4391 / CONN., EAST HARTFORD (203) 874-9222 / D.C., WASHINGTON (SEE MARYLAND) / FLORIDA, ORLANDO (305) 425-2764 / ILLINOIS, CHICAGO (312) 286-6824 / LA., NEW ORLEANS (504) 888-2266 / MD., SILVER SPRING (301) 588-8134 / MASS., BOSTON (617) 245-4870 / MICH., DETROIT (313) 358-3333 / MINN., MINNEAPOLIS (612) 781-1611 / MO., ST. LOUIS (314) 524-4800 / N.C., GREENSBORO (919) 273-1918 / N.J., CAMDEN (215) 925-8711

/ N.M., ALBUQUERQUE (505) 255-1638 / N.Y., ALBANY (518) 436-9649, BINGHAMTON (607) 723-9661, MT. VERNON (914) 968-2200, NEW HARTFORD (315) 732-3775, ROCHESTER (716) 473-2115 / OHIO, CINCINNATI (513) 761-5432, CLEVELAND (216) 237-9145, DAYTON (513) 277-8911 / PENN., PHILADELPHIA (SEE CAMDEN, N.J.), PITTSBURGH (412) 243-6655 / TEXAS, DALLAS (214) 357-6451, HOUSTON (713) 774-2568 / UTAH, SALT LAKE CITY (801) 466-8709 / VIRGINIA, (SEE MARYLAND) / WASH., SEATTLE (206) 767-4260 / CANADA, DOWNSVIEW, ONT., (416) 636-4910 — MONTREAL, QUE., (514) 739-6776 — OTTAWA, ONT., (613) 725-1288 — VANCOUVER, B.C., (604) 298-6242

The great linear IC

National Semiconductor Corporation
2975 San Ysidro Way, Santa Clara, California 95051
(408) 245-4320

Gentlemen: Please send me complete specs on the following Linear IC's that I've checked:

PROPRIETARY LINEAR IC's:

- | | | |
|--|--|---|
| <input type="checkbox"/> LM 100 Voltage Regulator
<i>Output adjustable from 2V to 30V, full military temperature range.</i> | <input type="checkbox"/> LM 101 Operational Amplifier
<i>Eliminates application problems of most IC amplifiers.</i> | <input type="checkbox"/> LH 201 Operational Amplifier
<i>Industrial/commercial version, 0 to 70°C.</i> |
| <input type="checkbox"/> LM 200 Voltage Regulator
<i>Industrial/commercial version, 0 to 70°C.</i> | <input type="checkbox"/> LM 201 Operational Amplifier
<i>Industrial/commercial version, 0 to 70°C.</i> | <input type="checkbox"/> LM 102 Voltage Follower
<i>10nA maximum input current, 10V/μs slewing, full MIL temperature range.</i> |
| <input type="checkbox"/> LM 300 Voltage Regulator
<i>Industrial/commercial version, 2V to 20V.</i> | <input type="checkbox"/> LH 101 Operational Amplifier
<i>Complete with internal frequency compensation.</i> | <input type="checkbox"/> LM 202 Voltage Follower
<i>-25°C to +85°C.</i> |
| <input type="checkbox"/> LM 103 Zener Diode
<i>Extremely sharp knee in 2.4V to 5.6V range.</i> | | <input type="checkbox"/> LM 302 Voltage Follower
<i>Industrial/commercial version, 0 to 70°C.</i> |

I further understand that by the time I mail this coupon, you may have more new Linear IC's, since an innovator is never satisfied.

NAME _____ TITLE _____

COMPANY _____ PHONE _____ EXT _____

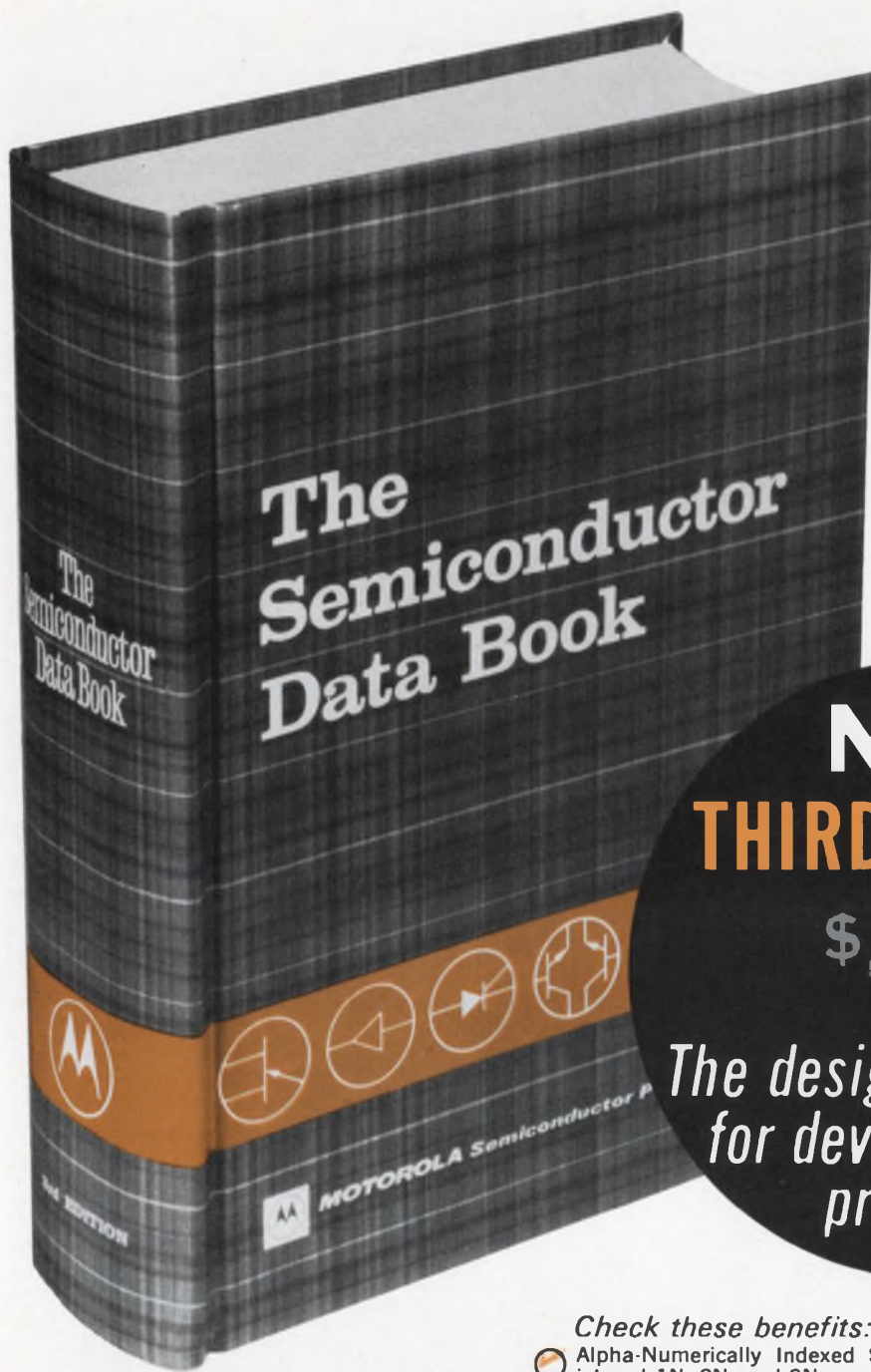

**NEW
THIRD EDITION**

\$4.95
PER COPY

*The designers' solution
for device selection
problems*

Check these benefits:

- Alpha-Numerically Indexed Short-Form Specifications for all* EIA registered 1N, 2N, and 3N numbered devices
- Complete Data for all Motorola devices including house-number types
- Special Index sections with short-form specs for Tunnel Diodes, Varactor Diodes, 4-Layer Diodes, Thyristors, FET's, Reference Amplifiers, Unijunction Transistors
- Twelve separate, logically grouped discrete device data sheet sections
- Separate digital and linear integrated circuit data sections
- Edge-Referenced Quick Selection Guide with each regular product section
- Sixteen valuable "How To" Application Notes
- 1750 pages of data and general information — big enough for easy readability — compact enough to go anywhere.

And For The First Time

- Data Book Updating Service—subscription blank in book—Receive all supplements automatically

*as of close date for publication

Please send my copy of Motorola's new Semiconductor Data Book, Third Edition.

Name _____

Address _____

City _____

State _____ Zip _____

My check or money order for \$4.95 (payable to Motorola Inc.) is enclosed.

-where the priceless ingredient is care!



MOTOROLA
Semiconductor Products Inc.

P. O. BOX 955, PHOENIX, ARIZONA 85001



AUGAT offers easier, more efficient methods of Packaging, Testing and Breadboarding IC's

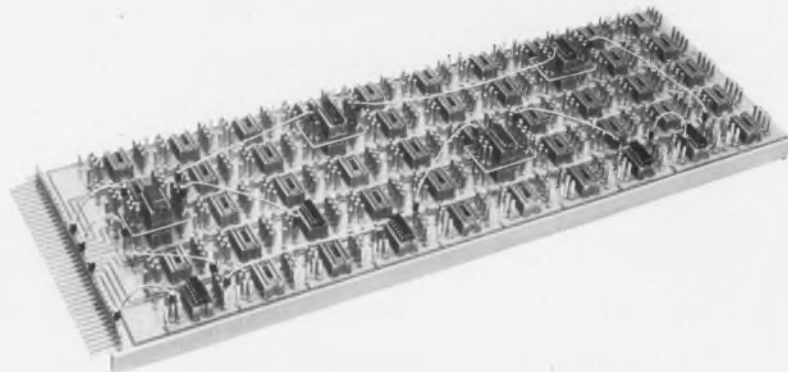

Outstanding flexibility in panel for simulated circuit construction testing, and breadboarding.

50 pattern panel illustrated; also available with fewer patterns. Solderless jumpers permit unlimited interconnections and fast change of circuitry.

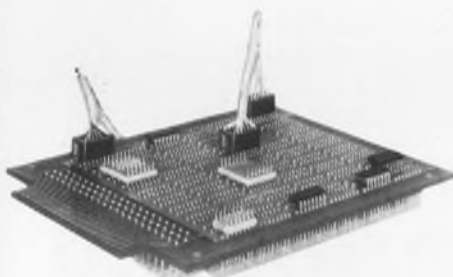

High Density Dual-In-Line Packaging Panel with Connector Take-Off. Available in 60 and 30 patterns and with Wire-Wrap[®] terminals. Also without connector take-off.

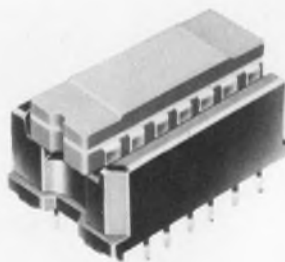

Low Profile Packaging Socket. Directly interchangeable. Exclusive socket configuration, identical to IC package, simplifies mounting. Also permits card stacking on 1/2" centers.



Test Socket
for rapid testing of IC's

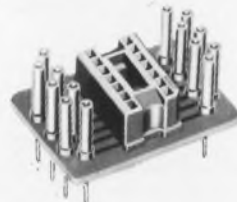

Single Breadboard Unit
may be used as an individual unit or for "stacking" on multi-station panels.

All units with sockets are available for 14 and 16 lead plug-in IC's. Available with gold or tin plated contacts. Similar panel units available for Flat Pack and TO-5 IC's.

Request Complete IC Folder

©Trademark Gardner-Denver Co.

AUGAT INC.

Tel. 617-222-2202
31 PERRY AVE., ATTLEBORO, MASS. 02703
Booth 4H12-14 IEEE

Designer's Datebook

APRIL						
S	M	T	W	T	F	S
	1	2	3	4	5	6
7	8	9	10	11	12	13
14	15	16	17	18	19	20
21	22	23	24	25	26	27
28	29	30				

MAY						
S	M	T	W	T	F	S
		1	2	3	4	
5	6	7	8	9	10	11
12	13	14	15	16	17	18
19	20	21	22	23	24	25
26	27	28	29	30	31	

For further information on meetings, use Information Retrieval card.

Apr. 3-5

International Conference on Magnetism (INTERMAG) (Washington, D.C.) Sponsor: IEEE; Philip Cohen, Magnetism, Inc., Butler, Pa. 16001, or J. M. Lommel, General Electric R&D Center, Schenectady, N.Y. 12301.

CIRCLE NO. 491

Apr. 9-11

National Telemetry Conference (Houston) Sponsor: IEEE; Lewis Winner, 152 W. 42 St., New York, N.Y. 10036.

CIRCLE NO. 492

Apr. 16-18

National Symposium on Law Enforcement Science and Technology (Chicago) Sponsor: U.S. Dept. of Justice: S. A. Yefsky, IITRI, 10 W. 35 St., Chicago, Ill. 60616.

CIRCLE NO. 493

Apr. 22-24

Frequency Control Symposium (Atlantic City, N.J.) Sponsor: U.S. Army Electronics Command; M. F. Timm AMSEL-KL-ST, Director Electronic Components Lab., U.S. Army Electronics Command, Fort Monmouth, N.J. 07703.

CIRCLE NO. 494

Apr. 29-May 1

Process Automation Symposium (Anaheim, Calif.) Sponsor: Beckman Instruments, Inc., and others; B. Stewart, Beckman Instruments, Inc., 2500 Harbor Blvd., Fullerton, Calif. 92634.

CIRCLE NO. 495

Apr. 29-May 1

Institute of Environmental Sciences Meeting and Exposition (St. Louis) Sponsor: D. N. Cerasuolo, Institute of Environmental Sciences, 940 East Northwest Highway, Mt. Prospect, Ill. 60056.

CIRCLE NO. 496

15339

HUGHES NPN SILICON POWER TRANSISTORS ... A TYPE FOR EVERY APPLICATION

2 AMP... A new family type of 2 amp devices with medium power capabilities, unusually broad current gain range, and excellent high-frequency response. Specific family types include the 2N4862, 2N4863, and 2N4864 and their derivatives in TO-48, TO-5, TO-66 packages.

5 AMP... Series 2N2657-8, 2N3469, 2N2697-8, 2N2632-3-4, 2N2877-8-9, 2N2880, 2N3744 through 52, and their house types are represented as well as several industrial and commercial types. All are available in TO-5, TO-62, TO-66, TO-111, MT-9, and MT-42 packages.

3.5-5 AMP... Featuring the replacement types for the former Honeywell 1001 through 1017 series. All are available in the TO-5 package.

10 AMP... Represented are 2N2811-12-13-14, 2N4150, 2N4070-1 types in TO-5, TO-41, TO-61, and TO-66 packages. High reliability versions of the 10 amp family, sustaining voltages to 200 volts are available in TO-3 packages.

15 AMP... Features the 2N3055 and ten comparable house types of outstanding quality, all in the TO-3 package with a copper base.

15-30 AMP... All are popular JEDEC registered devices—the 2N3771, 2N3772, and 2N3773. All are given a free-air power test of 150 watt-seconds to insure reliability. Each of these types is available in the TO-3 package.

20 AMP... The replacement types for the Honeywell 8801 through 8805 series. These special

devices are an industry first—a transistor with usable gain at over 20 A, sustaining voltage of up to 300 V, and a frequency cutoff of at least 30 MHz.

20-30 AMP... 2N types 3597, 8, and 9 are featured with their relative house types in the TO-63 package.

60 AMP... These high voltage devices are capable of switching over 15,000 watts with high efficiency. A current capability of over 60 amps combined with sustaining voltages of up to 300 V make these units ideal for inverter, converter, and switching regulator applications.

70-100 AMP... Available in both the TO-68 package and a hex-case. 2N numbers include the 2N4865-6 and 2N3149-50 and 51.

SILICON INTEGRATED AMPLIFIERS... Fully integrated, Darlington connected amplifiers designed for applications requiring very high gain, high input impedances, high frequency and fast switching. Three former Honeywell types in TO-5, TO-18, and TO-47 packages are featured.

POWER DARLINGTONS... The practical HSM2000, 2100, and 2200 series are available in special packages—RO-89a, MT-42, and MT-53d with gains up to 100,000.



Specify your particular NPN silicon power transistor requirement—there is a Hughes device for almost every application.

Hughes Semiconductors

500 Superior Avenue, Newport Beach, California 92663

For "immediate ordering" call toll free the Hughes HOT LINE (800) 854-3280... or if located in California dial (714) 548-0671.

HUGHES CIRCUIT TECHNOLOGIES: Flip Chips/Equipment • Connecting Devices • Contour Cable™ • Semiconductors • Frequency Control Devices • Microelectronic Circuits • MOSFETs



SPRAGUE

THE MARK OF RELIABILITY

DCL^{*} WARRANTY

With your purchase of Sprague Series 8000 DCL integrated circuits you are guaranteed...

Worst case DC noise margins

Worst case DC loading

Worst case AC loading

Min/Max propagation delay limits

Power consumption per gate limits

Absolute maximum ratings

*Designers Choice Logic—
the circuits you can count on*

Semiconductor Division
SPRAGUE ELECTRIC COMPANY

*Trademark of Signetics Corp.

For further information call your Sprague District Office or Sales Representative, or write Technical Literature Service, Sprague Electric Company, 347 Marshall Street, North Adams, Mass. 01247

The connector thing

A periodical periodical designed quite frankly to further the sale of Microdot Inc. connectors and cables. Published entirely in the interest of profit.



Give me your tired, your froze, your thirsty masses...

and we will rescue you brothers, from the tremors, shakies, vapors, chills, and foot sore wearies of the IEEE marathon.

Let Microdot rescue you from New York.



There'll be a beacon in the New York sky overlooking the Avenue of the Americas. (Sixt Evenuh t' New Yawkuhs.)

That's where our Rescue Mission is. In the modestly opulent east penthouse suite of the New York/Hilton just five blocks over (and a block-and-a-half up) from the Coliseum where you-know-who will be shuffling in and out of all those booths.

Throughout IEEE days, we will be looking down from this exquisite hospitality suite daily from 4 in the afternoon on. We hope you'll be there at least once.

You may stop in for a stirrup cup with us, or stay for the whole saddle. If pressed, we will regale you with per-

formance anecdotes on the you-know-whats that we make.

Your Rescue Mission button retained and worn at all times, is your ALL TIME PASS any time during IEEE. In real life the badge is neat tin, attractively painted in plain color and will go with most wardrobes, except puce glen plaid suits.

Your Rescue Mission button is your constant passport. So to obtain yours, write now, right now.

See you, starting the eighteenth of March at 53rd or 54th and Avenue of the Americas (depending on which direction you're cabbng or walking) which is another way of saying top o' the New York/Hilton.

Incidentally, it's only fair to warn you that as you're relaxing about our lush little paradise, that you can and indeed must expect to be pitched. Which is really all to your benefit because we have a lot of keen connectors to talk about. And, so you won't have to just take our word for it, we'll just happen to have inspectable proofs of what we're talking about.

High density packing is available in our connectors. It's done with Twist/Con,* a principle of getting rid of the

standard contact spring member and replacing it with our unique breathing helical spring. This makes for very high density.

There's a variety of push-pull, thread or bayonet hermetic seal connectors to Mil-Specs.

Lepra/Con* mini-minis (5/32" o.d. and 3/8" to 7/16" long) all crimp, no solder connectors in seven configurations with screw-on or slide-on designations.

Standard coaxial connectors, slide-on, screw-on, hermetically sealed, with bend-relief caps and enough combinations to give you hundreds of variations.

Golden Crimp,* a solderless miniature coax cable with a fast, four step, double crimp assembly that's completely moisture and humidity proof.

And **Microcrimp,*** the tiny crimp type coax connector in line-cable, bulkhead or snap-lock mounting. An easy crimping method eliminates soldering, burning or miscrimping.

The MARC 53.* A multi-unlimited-application type high density, cylindrical, multi-pin connector with front insertable contacts. It's the only one in that category to meet the USAF spec MIL-C-38300A. No insertion or removal tools needed.

What could be better than that? Maybe **MARC 53 RMD.** Same as the MARC 53, but with rear insertable and removable pins and sockets.

All these great things add up to better deals for you. Old homilies like greater reliability, longer life, more raises, bigger promotions and a blow for freedom.

Please buy.

Now that you've read this, fill in the request for your Rescue Mission button, so that you can join us and luxuriate where Heads of State have romped.

*Registered trademarks of Microdot Inc.

REQUEST FOR RESCUE

NAME _____

ADDRESS _____

CITY _____

STATE _____

ZIP _____

Incidentally, you could unload a
 sales rep. or literature on
MARC 53 **Lepra/Con** **Standard**
Connectors **Pin and socket**
connectors whatever.



MICRODOT INC.

220 Pasadena Ave.
 South Pasadena, Calif. 91030

INFORMATION RETRIEVAL NUMBER 14

ator of corrugated copper to air-cool the oscillator.

The oscillator, with an expected life of 1000 hours, is designed to sell for less than \$60 after quantity production has been reached.

Liquid crystals stir application activity

New uses and new companies are merging to exploit the unusual properties of cholesteric liquid crystals.

A modified electron beam scanner has been used on a liquid-crystal screen to produce video test patterns in "living color."

The development was reported by J. R. Hansen, an electrical engineer in the Applied Physics Dept. of Westinghouse Research Laboratories, Pittsburgh. Hansen said he had carried out the experiment to prove that the concept of an electronic imaging system that used liquid crystals was fundamentally sound. The work was partly supported by an Air Force Avionics Laboratory contract at Wright-Patterson AFB, Ohio. It may result eventually in X-ray, radar-surveillance and reconnaissance displays, according to Hansen.

In a separate development, a new firm was formed to offer liquid-crystal products and services. The firm, Liquid Crystal Industries, 402 Princeton Drive, Pittsburgh, was created by Frederick Davis of Westinghouse. Davis' firm now joins the Vari-Light Corp. of Cincinnati as the only two that not only sell the material to desired temperature specifications but also offer application assistance.

Navy strengthening its missile defense

What if a Soviet surface-to-surface missile—of the type, say, that the Egyptians used to sink the Israeli destroyer *Elath*—turns up in the Vietnam War?

The question has haunted the U.S. Navy for some time.

Possibly because of this, and certainly because of growing war tensions around the world, full-scale production has been ordered for the *Sea Sparrow*, a shipboard defensive missile.

The *Sea Sparrow*, a Navy spokesman says, "will intercept anything that flies that it can get to." It will knock down not only surface-to-surface missiles but also enemy aircraft and air-to-surface missiles.

So great is the urgency for it that the Navy has ordered the *Sea Sparrow* installed on all ships of the destroyer class and larger as the missiles are turned out. Prime contractor for the work is Frequency Engineering Laboratories, a subsidiary of Harvard Industries, Inc., in Farmingdale, N.J.

Two *Sea Sparrow* prototypes, now on duty in the Gulf of Tonkin on the aircraft carrier *Enterprise*, were developed by Raytheon Co.'s Missile Systems Div. in Bedford, Mass.

The *Sea Sparrow* system is similar to Raytheon's *Sparrow 3*, an air-to-air missile.

The missile is guided by a semi-active, continuous-wave radar system. A radar on the ship illuminates the target. A radar receiver in the missile's nose receives and homes on the radar return. The missile is 12 feet long, eight inches in diameter and weighs 380 pounds.

Raytheon developed the fire-control system, which includes the radar and the missile. The Navy provided the launcher and systems integration.

Business computer built with a 'rod' memory

The National Cash Register Co. has introduced a new line of business data-processing systems, the *Century 100*, with deliveries scheduled to begin in September. A second line, the *Century 200*, is to be ready in February, 1969.

The new series uses a thin-film "rod" memory, consisting of thousands of hairlike, cylindrical rods, 1/10 inch long, coated with a thin film of magnetic material.

The same basic memory module is used throughout the entire computer family. It operates at 800 ns

cycle time, expandable with additional modules. The basic *Century 100* has a memory of 16,000 characters, expandable to 32,000. The *Century 200* will have a capacity of up to 524,000 characters.

Every system includes two discs, metal-plated instead of oxide-coated, "to provide a clean, long-wearing surface," the company says.

Monolithic integrated circuits are used throughout the system, including peripheral units as well as the central processor. Only one type of IC is used in the new family. The circuits are mounted in standardized cards, and six different types of cards make up 80 per cent of the logic circuitry.

The *Century 100* will rent for \$2250 a month, or \$1910 with a five-year contract; the *Century 200* for \$3950 a month, or \$3355 with a five-year contract.

Brighter TV color tubes introduced by Sylvania

Color television tubes with improved resolution and 23 per cent higher brightness have been introduced by Sylvania Electric Products. The performance gains according to the company president, Gene K. Beare, are based on (1) improved phosphors, (2) a new, sharp-spot electron gun design, (3) a reflex-control temperature-compensated shadow mask, and (4) use of Sylvania's patent dusting process for applying the phosphor powders to the glass screen.

The tubes will be available to all set manufacturers in 14- to 25-inch rectangular sizes. Current Sylvania color receivers are being manufactured with the new tube.

C-5A being groomed for first flight in June

The world's biggest bird, the Air Force's recently unveiled *C-5A Galaxy* military air transport, is now being instrumented for its first flight in June. Flight testing of the Northrop doppler inertial-guidance system, including United Aircraft Corp.'s multi-mode radar, began in January aboard a *C-141* transport. The GE engines are already in flight test on a *B-52* bomber at Edwards Air Force Base, Calif.

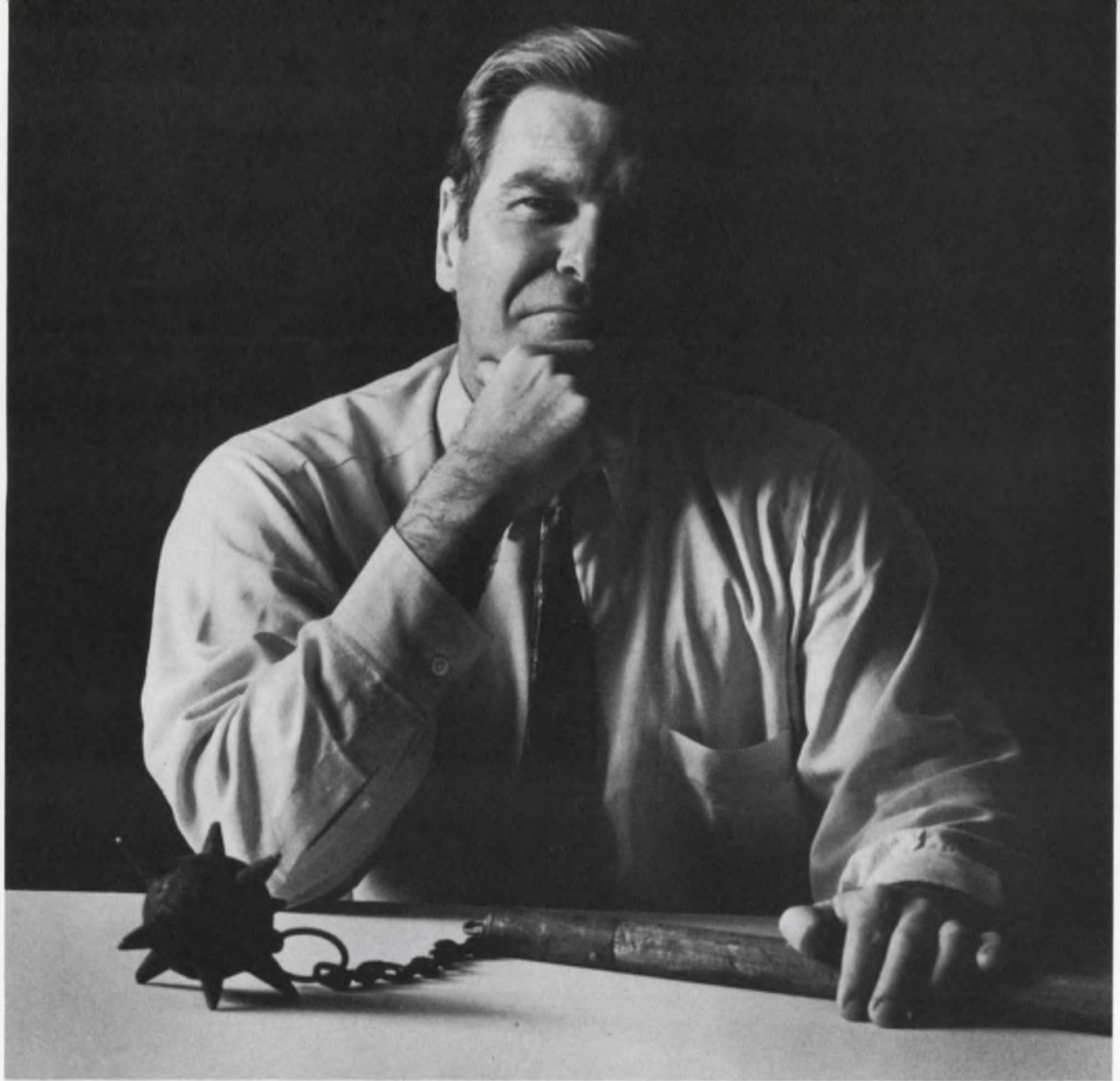

To meet—and exceed—the toughest standards of IC acceptability in the business takes tough people with tough ideas. Raytheon Semiconductor's Reliability and Quality Assurance Manager is a very tough man.



(407L program, continued)

tronics by cables. When the structure has to be moved, the consoles can be packed together without time-consuming care, while the electronic racks can be handled with caution.

High reliability standards

Redundancy in circuitry of all kinds is receiving careful attention in 407L. When reliability has been increased sufficiently with solid-state devices and integrated circuits, redundancy has often been eliminated.

The Air Force has set high reliability standards for the complex system. The mean time between failures for the entire system is 200 hours, which means that each subsystem must have an MTBF of 2000 to 10,000 hours.

Space for equipment and personnel—which might appear to be a problem in such a weight-conscious

Masterminding 407L

The Air Force Systems Electronic Systems Div. at Hanscom Field, Mass., near Bedford, is the contracting agency for the 407L tactical air control system. Technical and engineering assistance is being provided by the Rome Air Development Center, Griffiss Air Force Base, N.Y. Tests are being handled by the Air Proving Ground, Eglin Air Force Base, Fla.

Mitre Corp. at Bedford provides systems engineering to the

Electronic Systems Div., and TRW Systems Group, Systems Engineering and Integration Div., Redondo Beach, Calif., is under contract to help integrate the system and to be the final arbiter on problems of interface. If two items do not mesh, TRW decides which must be modified or changed. The company is also working up a standard testing procedure for reliability, maintainability and human factors.

program—will be far more adequate than in the modules that were sent in by ship for Vietnam and Thailand. This is being achieved by using inflatable structures whenever several men will be working in one structure.

Program 407L is not a one-shot affair. The Electronic Systems Div. began shipping individual items for the network to Eglin Air Force Base, Fla., for testing in 1965 and will probably continue deliveries through 1972. "After that, who knows?" an official said. There are 49 contracts out now for different end items.

The network, which consists of 10 "elements," as the Air Force calls them, is so big that when Eglin tests the whole complex, it will spread out from South Carolina to Texas (see diagram and box on page 28).

Five networks planned

The final production goal is five complete electronic networks, costing about \$500 million each. Three will go to the Tactical Air Command, two to the Air Force in Europe and one to the Pacific.

The equipment for a network can be broken down into four principal categories:

- Radar for detecting enemy planes and guiding friendly planes to intercept targets; for air-traffic control and for ground-controlled-approach landings.
- Communications between elements of the network and with aircraft.
- Switchboards for channeling the large communications traffic.

■ Operations centers for housing the equipment and personnel.

The first complete element set up at Eglin for tests, is the Forward Air Control Post, a lightweight, highly mobile radar surveillance and control facility that provides extended radar coverage for tactical missions. Displays and a communications central pass the information on to the Tactical Air Control Party.

Radar set up in minutes

The radar for the forward post, designated the AN/TPS-44, was built by Cardion Electronics of Woodbury, N.Y., a unit of General Signal Corp. Equipped with a folding 10-by-16-foot dish antenna, mounted on a separate pallet, the radar can be set up in 20 minutes and operating in less than an hour.

Frequencies are 1250 to 1350 MHz, in the L band, with pulse widths of 1.4 and 4.2 microseconds. Receiver sensitivity is 110 dBm.

One of the most challenging design problems was to develop a high-power pulse transformer, small and light enough to satisfy the transport requirements of the network. The initial pulse transformers worked for a while, but after 300 to 600 hours of operation, they began to burn out.

Axel Electronics, also a unit of General Signal, which supplied the pulse transformer to Cardion, diagnosed the failures as breakdowns from high-voltage points due to corona deterioration. Investigation revealed that a protective spark gap from the pulse transformer secondary to ground



Antenna of the AN/TPS-44 search radar collapses, making the lightweight system air transportable in two neat modules.

(407L program, continued)

was worthless, because of erratic firing characteristics; it was providing little or no protection against 100 per cent over-voltage during magnetron misfiring.

After attempts to provide effective protection proved fruitless, it

was decided to upgrade the pulse transformer to a voltage rating compatible with the repetitive fault condition. This was done without changing the unit's size or electrical parameters.

Axel replaced the liquid dielectric with one of a higher strength and a higher corona start level. Unfortunately, the new fluid was of a lower temperature class,

which required more efficient heat-transfer techniques.

One technique was to use heavy copper heat conductors from the core to the outer case.

Although Axel will not disclose the fluids it used or all the heat-transfer techniques, company officials say the new approach has eliminated corona deterioration, thermal instability and the result-

How tactical air network divides the work

An elaborate network is needed to organize and coordinate the different forces needed to wage war by air. The Air Force has broken the network down into 10 elements. Each has its mission, its pecking order and its facilities for communication.

Although the network might be scattered over a thousand-mile stretch, a forward con-

troller can spot an enemy target, relay his request for an air strike to the top command and watch the fighter-bombers streak to his aid—all within minutes.

Here are the elements in the air-transportable network:

Air Force Component Command Post and the **Tactical Air Control Center** are at the same

site. The post is the field headquarters, and the center is its operations arm. The center controls the war. For constant communication with all elements in the system, there is high-frequency/ssb, uhf, vhf, troposcatter and microwave equipment. An elaborate operations center, with data processor, displays and telephone

407L TACTICAL AIR CONTROL SYSTEM

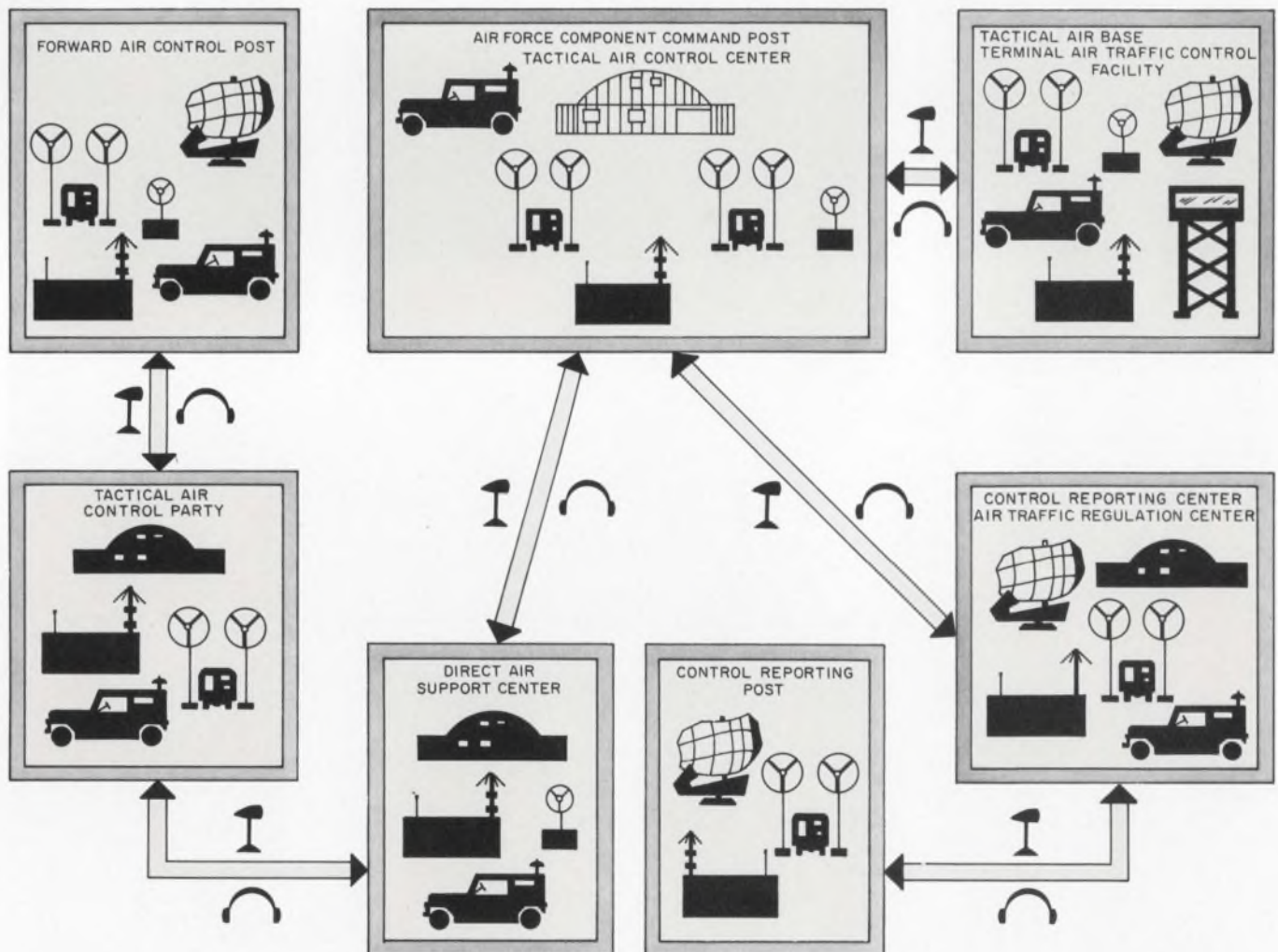

The 407L network is composed of air-transportable modules. The entire network or any portion of it, depending

on the nature of the conflict—can be flown anywhere in the world and be set up and ready to operate in hours.

(407L program, continued)

Program 407L was the AN/TPS-27, weighing in at 50,000 pounds. It was built for a predecessor program that literally never got off the ground because of its weight.

To slim it down, TPS-27 was almost completely overhauled. New materials, new components and packaging were used, plus a different point of view. The engineers thought of the radar as if it were going to be used on an aircraft instead of on the ground. Aluminum and magnesium replaced steel. The antenna became tubular rather than solid. Lightening holes were bored, and boxed-beam construction was used instead of solid members. Solid-state devices replaced tubes wherever possible.

The result brought the 50,000-pound radar down to 15,000 pounds. The new designation is the AN/TPS-48. One TPS-48 is at Eglin now, and seven more will be built. The TPS-48 will be used until the AN/TPS-43, which was designed from scratch, is ready. The latter uses all the newer techniques plus integrated circuits. It weighs 7000 pounds, and its range is 120 miles.

The two other radars in the 407L network will be part of the ground-controlled-approach landing system in the Terminal Air Traffic Control Facility. This base facility, which will probably be one of the last portions of the network to be ready, is in the contract-definition phase, with three companies looking at the problem: Westinghouse; ITT-Gilfillan, Inc., in Los Angeles and Raytheon Co.'s Equipment Div., in Wayland, Mass.

The design problem is a result of the frequency allocated to the precision-approach radar. Although the X-band frequencies—9100 to 9200 MHz—provide accurate range information, they are attenuated by precipitation (see "Radar specs come with built-in headaches," ED, 1, Jan. 4, 1968, p. 22).

The performance specifications, nevertheless, call for the radar to monitor approaching planes through a storm five miles in diameter, with rain falling at the rate of two inches an hour.

The search radar, which will be in the S-band region, should not

present any problem.

To get the network working, all 407L elements will be equipped with high-frequency, single-side-band radios. Later, for greater reliability, more circuit capacity will be installed, along with broadband troposcatter and microwave links for more flexibility in routing. Once the broadband links are set up, the high-frequency ssb units will be used for backup.

Radio families planned

A family of solid-state, micro-miniaturized, high-frequency ssb radios, designated AN/TSC-60, 60A and 60B, is planned. Each unit will consist of two full duplex radio sets. The TCS-60 will have a 1-kW output and the 60A, 2.5 kW. The B model will consist of an A model plus a 10-kW amplifier. The units are to be capable of both digital and voice high-speed transmission.

A family of microwave modules, designated AN/GSQ-119(V), will perform as a data-transfer central. The units will be built to operate radar and communication transmissions from a remote site where cables for this purpose are not practical. The communications will include voice and teletypewriter. Although funding has been put off until fiscal 1970, a performance-requirements package will be ready next month.

The tropo communications will

be handled by the AN/TRG-97A, built originally for the Marine Corps by the Radio Corp. of America's Communications Systems Div., Camden, N.J., and modified by the Air Force.

Packaged in a weather-proof shelter 6 by 6 by 6 feet, the facility provides space for the solid-state radio equipment plus an area for maintenance and an operator's position, equipped with a desk, control panel and a telephone handset. Two eight-foot antennas are used.

The 97A can also be used as a relay link between other, similar units. A remote-performance monitor kit, equipped with a telephone, can be connected to the radio facility within a half-mile radius.

The equipment is considered good, but it weighs 2000 pounds. The Air Force had hoped to replace it with a lighter unit, but the performance of two contenders fell so short of expectations that the 97A will continue to be part of 407L.

The contender units were developed by Motorola's Government Electronics Div., Chicago, and Tectron's Bell Aerosystems Div., Niagara Falls, N.Y.

"The next basic step forward in communications for the 407L will be in time-division multiplexing, to save weight and volume," according to Col. Franklin J. Hickman, chief of the Engineering Div. and deputy for tactical systems at Hanscom.



The radar operator inside the AN/TSQ-61 van spots approaching aircraft on the AN/TPS-44 search radar's remote indicator and passes position data on to an assistant, who plots the coordinates.

(407L program, continued)

Two jeep-mounted communications centrals, the AN/MRC-108 and AN/MRC-107, delivered in that order, provide high-frequency ssb, vhf and uhf communications. The 108 was built by Collins Radio Co., Cedar Rapids, Iowa, and the 107 by the Electronics Div. of General Dynamics Corp., Rochester, N.Y.

Right after delivery, it became evident that the 107 had a poor uhf antenna pattern. The hood of the jeep, over which the antenna was mounted, was acting as part of the antenna's ground plane. Since the hood was not designed for this role, the resulting ground plane was irregular. Engineers at Eglin solved this by moving the antenna to the rear bumper and making a "coolie hat" ground plane for the antenna. The results were good.

Vhf/fm radios for crash and rescue work, designated AN/FRC-110 and AN/FRC-116, have been built by Avion Electronics, a unit of General Signal Corp., Paramus, N.J., for use at the tactical air bases in conjunction with man-carried AN/PRC-58 and PRC-78 sets built by Motorola's Government Electronics Div. The FRC-110 operates between 144 and 174 MHz, and the FRC-116 at 70 to 80.

Avion is to begin testing the FRC-110 and FRC-116 radios in August. Motorola is to deliver the portable units in June.

Several communications centrals are being built by Stelma, Inc., of Stamford, Conn. One includes an

electronic switching center for telephone communications; another is a telegraph facility providing torn-tape equipment to terminate 24 full duplex teletype circuits, 18 of which are cryptographically secure.

Automatic switching used

A new electronic switching and subscriber set designated the AN/TTC-30, using integrated circuits, is being built by North Electric Co., of Galion, Ohio, a subsidiary of United Utilities, Inc.

By using solid-state, time-division switching and electronic common control, the TTC-30 provides fully automatic switching of up to 460 four-wire lines and trunks with dual-tone, key-call subscriber signaling; priority-call handling with pre-emption; automatic alternate routing between switching centers; stored address; and conference service.

A new element in the system is its 40-line, electronic, cordless switchboard. It automatically rings the called party for local and two-wire lines, performing the proper back-to-back signaling and providing automatic release on a line when the subscriber disconnects.

To keep size and weight down, linear and digital integrated circuits and miniature relays were used, as was a resistance hybrid form of matrix employing operational amplifiers. Discrete circuits are used only for current drivers and audio detectors. All circuits are modular and are mounted on double-sided printed-wiring boards and housed in three separate units. A silver-zinc battery in the switch-

board is approximately one-third the weight of a nickel-cadmium battery of equal capacity.

Probably the most complicated portions of the 407L are the decision-making operational centers where radar and communications data will be received, digested by computers, displayed and stored. Hughes Aircraft Co.'s Ground Systems Group, Fullerton, Calif., is prime contractor for the centers.

Although the initial displays will still be hand-written, a large automatic display is being sought.

For data processing, Hughes believes the system can be adequately handled by its HM-4118 micro-electronic computer. The system has a basic storage capacity of 49,000 18-bit words, expandable to 131,000. The central processor is capable of a half million operations a second. This speed can be doubled by adding a second processor unit.

Not only is the computer modular, but so is the software. Portions of it can be changed without affecting the rest. While this leaves some of the memory idle, which might be considered inefficient use of the computer, it nevertheless simplifies changes in the field.

The voice communications subsystem in the operations centers at both the Control and Reporting Center and the Control and Reporting Post brings in high-frequency/ssb channels from the TSC-60A, from the TRC-97A troposcatter receiver, and from the TRC-87 uhf transceiver.

All these are fed into the AN/TSC-62 control center, which feeds out the appropriate channels to the telephone switchboard and radio patch station. ■■



"Coolie hat," fabricated at Eglin Air Force Base, Fla., solved a poor uhf antenna pattern caused by an irregular ground plane. The irregularity was created by the hood of the jeep on which this AN/MRC-107 is mounted.

Continued.

Applications

We recommend them for:

- Air traffic control systems
- Military identification systems
- Stock market quotation units
- Teaching machines
- Electronic test equipment
- Computer displays
- Airline and other transportation-status boards
- Any application requiring discrete-color information display.

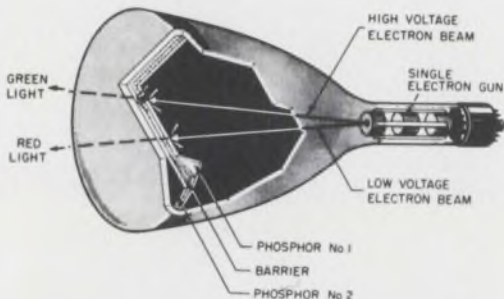

CRT employs two phosphor layers—red and green or other combination—and one electron gun. Rapid switching from high to low voltage actuates one phosphor or the other; midrange voltages mix the basic phosphor light output to produce different colors.

with a slight green admixture: orange.

By rapid voltage switching, all four colors can be displayed sequentially, but fast enough that they can be viewed visually simultaneously.

And the tube can be supplied with other basic phosphor-color combinations: red and blue, for example.

Because the tube has no shadow mask, brightness and resolution are extremely high.

We offer commercially a 19" round 35° deflection angle type (SC-4852), with electrostatic focusing and magnetic deflection, and a 21", 72° deflection angle rectangular type (SC-4876) with electrostatic focusing and magnetic deflection. In addition we have previously announced a 10" tube (SC-4827, electrostatic focusing and magnetic deflection) and a 5" tube (SC-4689, electrostatic focusing and deflection). On special order we can make color tubes in any screen diameter.

In air-traffic control displays, for example, these CRTs could be used to provide quick and positive information on different altitudes or stacked aircraft problems. Different colors could be used to indicate various runways, holding patterns or air traffic lanes.

In computer displays, color can be used to indicate particularly significant data or newly changed, added or deleted data. For alphanumeric stock quotation displays, red could be used to indicate a stock which has declined since the last quotation, and green to indicate a stock which has gone up.

Come see them demonstrated at IEEE. We're sure you'll think of many other IDEAS for using them.

CIRCLE NUMBER 300

Specify your own EL readout brightness levels up to 50 fL.

Hermetically sealed all-glass or metal-glass electro-luminescent readout panels provide initial brightness of up to 50 footlamberts—readily visible even at high ambient light levels.

Brighter phosphors in Sylvania "P-Series" hermetically sealed all-glass and metal-glass EL panels provide intrinsic brightness levels of up to 50 fL at 250 V, 400 Hz, or 25 fL at 115 V, 400 Hz.

Contrast may be increased by changing the transmission characteristics of the glass faceplate. A panel with an intrinsic brightness level of 50 fL would still provide a useful light output of 25 fL with 50% transmission glass for higher contrast, and about 15 fL with 30% transmission glass for extremely high contrast.

These bright, high-contrast panels are available in two basic types of construction: all glass or metal glass (see Fig. 1).

The ideal visual display

From the point of view of design, operational and human engineering considerations, EL panels offer distinct advantages over conventional display devices. When required, they display information faster than the human eye can respond, yet can retain it for as long as necessary. They are highly immune to catastrophic failure. They have the widest viewing angle of any display device: almost 180°, and all in the same viewing plane.

They readily display any type of information de-

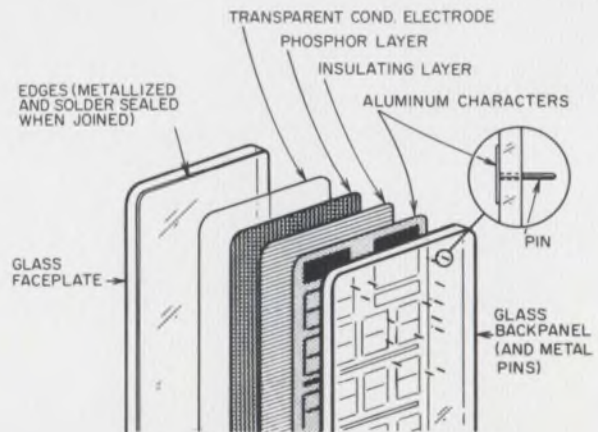
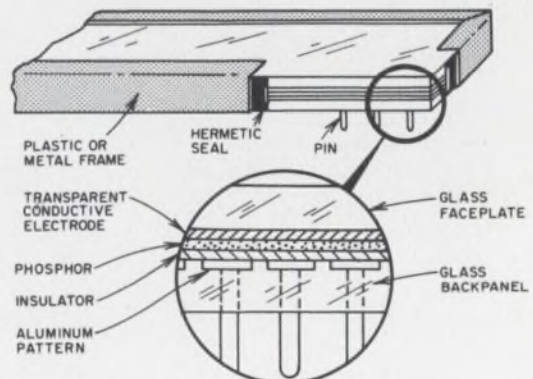

Fig. 1. Top, exploded view, all-glass EL readout panel. Below, sectional view of metal-glass construction.



Now you can get high sensitivity, low 1/F noise and microphonics in a video detector.

Schottky barrier diodes, when used in video detector circuits in electronic countermeasures systems, provide broadband detection capability to 40 GHz, yet assure high sensitivity with low microphonics in such applications.

Manufacturing technology for low-noise Schottky barrier diodes has progressed so rapidly over the past few years that it is now possible to fabricate, on a production basis, true metal-to-semiconductor junctions having the extremely small areas necessary to achieve maximum tangential signal sensitivity (TSS).

TSS is a measure of small signal sensitivity in a diode, and high TSS levels are essential to proper performance of electronic countermeasures systems (detection of hostile aircraft and radars), doppler radars, military aircraft beacons and electronic surveillance systems.

Sylvania now offers a new line of Schottkys with TSS levels of better than -50 dBm at X-band and better than -40 dBm at 40 GHz—virtually a flat response over the entire frequency range as illustrated in Fig. 1.

Diode bias is required if maximum sensitivity is to be attained. Both bias and video bandwidth must be specified if the TSS measurement is to have any significance. Fig. 1 indicates the relative TSS with a 50 μ A bias. Reducing the bias to about 30 μ A will improve the TSS, but will also increase the video impedance to a level that may not be desirable in certain applications. Fifty microamps was chosen to provide a more reasonable impedance match with the video amplifier.

Video impedance variation (R_v) vs dc bias is shown in Fig. 2. Under normal conditions, R_v is specified at about 6000-8000 ohms at 50 μ A.

A low noise level—particularly at low 1/F envelope frequencies—is another vital characteristic which is also affected by bias level. Fig. 3 compares noise output of a point-contact diode and a Schottky diode from 1 to 1000 KHz—typical doppler-radar envelope frequency ranges. Each is measured at 20 and 50 μ A bias current. As the figure indicates, at 1 KHz the Schottky diode exhibits about $\frac{1}{4}$ the noise output of the point-contact device.

In addition to the advantages of high sensitivity (TSS) and low 1/F noise (flicker noise), Schottky barrier diodes offer low microphonic noise output (see Fig. 4), high burnout resistance and uniform performance characteristics.

CIRCLE NUMBER 302

	D5754	D5754A	D5691	D5691A	D5733	Unit
Test Frequencies	5 and 12	5 and 12	5 and 12	5 and 12	35	GHz
Minimum TSS with a 10 MHz bandwidth at 50 μ amp bias	TSS 47	50	47	50	45	-dbm
Video Impedance R_v at 50 μ amp bias	6.5	6.5	6.5	6.5	7.3	kohms
Breakdown Voltage V_B at 10 μ amp	7	7	7	7	7	volts
Package	013	013	075	075	013	

Fig. 1. Tangential signal sensitivity vs frequency for three types of Sylvania Schottky barrier detector diodes. Note virtually flat response from 1.0 to 40.0 GHz carrier frequencies.

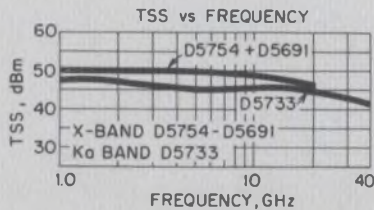

Fig. 2. Video impedance variation (R_v) vs dc bias, for X-band and Ka-band Schottky diodes.

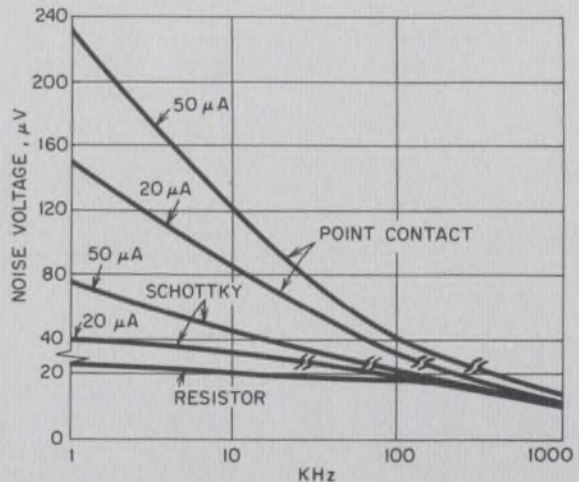
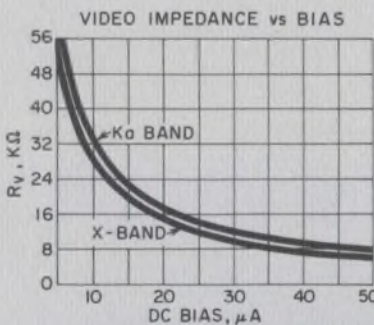

Fig. 3. Noise ratio vs bias current. Sylvania Schottky barrier diodes exhibit much lower noise voltage levels at low 1/F frequencies when used in video detector applications than point-contact diodes.

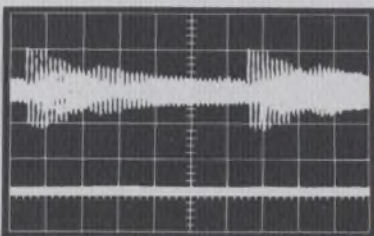

Fig. 4. Sylvania Schottky diodes exhibit much lower microphonics than point-contact diodes. Upper trace is microphonic response of a point-contact diode when subjected to a mild shock; lower trace shows the lack of microphonic response of a Sylvania Schottky D5754 when subjected to the same shock.

New 16-diode arrays can drive cores more efficiently—save labor and space.

With Sylvania's newest 16-diode core driver in either a single plug-in or flat package, you gain many significant advantages. Obviously, higher reliability and packaging density. Also, reduced labor assembly time and costs—because there are fewer external connections and fewer components to handle. Our SID-16E arrays also give you these advantages without sacrificing switching speed.

Our 16-diode arrays, such as shown in the diagram at right, reduce labor costs, shorten assembly time and cut external wiring in the manufacture of a computer memory-core-driving system. They have a bank of both common anode and common cathode diodes interconnected in the classic core driver circuit.

Ideally suited for core driving applications, they combine high forward conductance, fast recovery,

low capacitance and tight performance tolerances.

These new units include the SID-16E-2 in a hermetically sealed flat package and the SID-16E-20, electrically the same device but enclosed in a 14-lead plug-in package. Both have forward current ratings of 300 mA and power ratings of 300 mW per diode. This power drive capability, together with ultra-fast recovery, gives design engineers diode arrays which meet the demanding requirements for memory drivers in military and aerospace computers as well as commercial computers.

Reverse recovery time of these diodes is a maximum of 60 nsec, even at such extreme switching conditions of a forward current of 300 mA and an I_r of 30 mA. Typical values for the recovery time of I_r and I_f switching from 300 mA to 30 mA in 35 nsec.

Like the SID8A-2 (common cathode) and SID8B-2 (common anode) 8-diode arrays, these 16-diode arrays

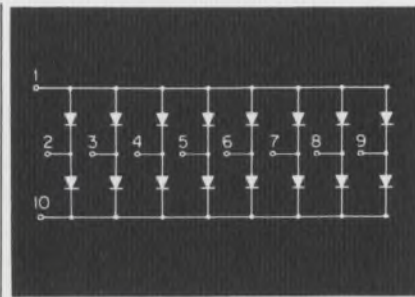

feature silicon dioxide passivated construction. They are fabricated on a high resistivity layer which is epitaxially grown on a low resistivity substrate. Passivation insures that performance remains stable over a long operating life. Manufactured to standard MIL quality assurance requirements, these packaged arrays meet MIL-S-19500.

The 8-diode arrays are now also available in dual-in-line plug-in packages, in addition to the hermetically sealed flat packs (0.250" x 0.175").

CIRCLE NUMBER 304

Maximum Ratings at 25°C (each junction):

Reverse Voltage, V_R	40 volts
Forward Current, I_F	300 mA
Peak Forward Current, I_{FP}	1.0 amp (0.0 μ sec, 25% D.C.)
Average Power Dissipation, $P_D(2)$	300 mW (500 mW total package)
Junction Temperature, T_J	-65°C to +150°C
Storage Temperature, T_{stg}	-65°C to +300°C

Notes:

1. Pulse test $\leq 300 \mu$ sec, $\leq 2\%$ duty cycle.
2. $\theta_{JC} 0.1^\circ\text{C}/\text{mw}$; $\theta_{CA} 0.2^\circ\text{C}/\text{mw}$. Linear-derating $+25^\circ\text{C}$ to $+150^\circ\text{C}$.

Electrical Characteristics at 25°C (each junction):

Conditions	Min	Max	Unit
Forward Voltage Drop, V_F (Note 1)		1.25	V
$I_F = 300 \text{ mA}$	—	1.40	V
$I_F = 500 \text{ mA}$	—	2.00	V
$I_F = 800 \text{ mA}$	—	0.1	μ A
Reverse Current, I_R	40	—	V
$V_R = 30 \text{ V}$	—	8.0	pF
Peak Inverse Voltage, PIV	—	50	nsec
Capacitance, C	—	—	—
Reverse Recovery, t_{rr}	—	—	—
$I_F = 300 \text{ mA}$	—	—	—
$I_R = 30 \text{ mA}$	—	—	—
$i_r = 3 \text{ mA}$	—	—	—
$R_L = 100 \text{ ohm}$	—	—	—

TYPICAL CHARACTERISTICS
FORWARD CURRENT vs FORWARD VOLTAGE
(EACH DIODE)

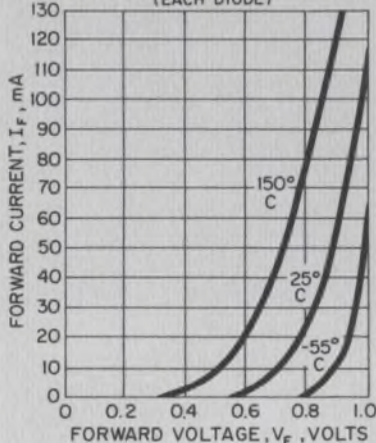

TYPICAL CHARACTERISTICS
CAPACITANCE vs REVERSE VOLTAGE
(EACH DIODE)

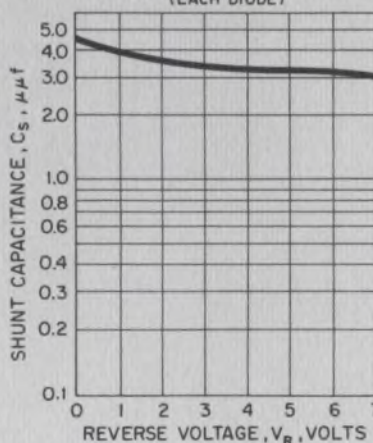

TYPICAL CHARACTERISTICS
REVERSE CURRENT vs TEMPERATURE
(EACH DIODE)

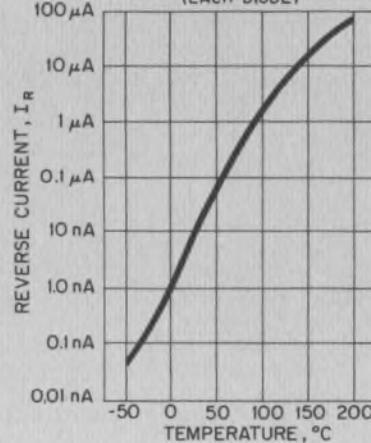

Field Engineering: What it can do for you.

It's not enough to offer good electronic components to a customer.

His needs must be served—both on today's production line and during development of tomorrow's equipment.

He must keep his line rejects and field returns low and at the same time seek improved performance and reliability in his products at competitive prices.

This is a tough job.

Sylvania's field engineers make his job easier. For example, if a customer's production line rejects are high for one of our tubes, it costs him money—and us too. Our field engineers, in cooperation with our field salesmen, assist the customer in analyzing the problem and determine if the fault is really with our tube or with some other component. If our tube is at fault, the field engineer immediately informs the Sylvania Plant Quality and Product Engineering Departments. He then seeks help from the Sylvania Applications Laboratory and Division Quality Staff. Our customer saves time and minimizes lost business.

If a production change is made to correct a field problem it's field engineering's responsibility to insure that *only* the revised product will be shipped to his customer.

Similar action is necessary to help keep our customers "in-warranty" cost low. This is a critical situation involving life and consumer acceptance of our products; it demands closely coordinated evaluation between our customers and ourselves.

To further assure customer satisfaction and to see that our production will match customer needs, field engineering plays a major role in the initiation and approval of testing specifications and published data. What electronic components will our customers need next year—and the years after? Here too we provide

a strong market-oriented authority for our customers' benefit. In conjunction with our marketing people, the field engineers participate in customers' plans for new equipment and guide our resultant developmental and production activity. This involves planning meetings between customer engineers and Sylvania engineers, as well as continuous monitoring of our mutual progress.

SEC field engineering is a unique group in the industry. Its responsibility covers receiving tubes, picture tubes, semiconductor devices, and other special products in the entertainment, industrial and government equipment market and in the distributor and renewal markets as well. We believe this group has helped to establish Sylvania's leadership in electronic components.

In receiving tubes we have long had a reputation for supplying the most reliable horizontal deflection tubes and high voltage rectifiers in the business. Our new 6LR6 and 6JE6C deflection tubes and our posted filament 3CU3 are prime examples.

In semiconductors, Sylvania has pioneered fast switching diodes, UHF mixers, video detectors, glass rectifiers and much more. Our latest developments in this area are variable voltage capacitance diodes for a multitude of electronic tuning applications.

We believe Sylvania has a most effective concept of technical liaison with our customers, and our customers firmly support this belief. Why? Because we have effectively accomplished our goal: serving our customers.

A W Peterson

A. W. Peterson
SEC Field Engineering

This information in Sylvania Ideas is furnished without assuming any obligations.

SYLVANIA

A SUBSIDIARY OF
GENERAL TELEPHONE & ELECTRONICS

NEW CAPABILITIES IN: ELECTRONIC TUBES • SEMICONDUCTORS • MICROWAVE DEVICES • SPECIAL COMPONENTS • DISPLAY DEVICES

C3

NAME _____
PLEASE PRINT

TITLE _____

COMPANY _____

ADDRESS _____

CITY _____ STATE _____ ZIP _____

Circle Numbers Corresponding to Product Item

300 301 302 303 304 305

Please have a Sales Engineer call



HOT LINE INQUIRY SERVICE

Need information in a hurry? Clip the card and mail it. Be sure to fill in all information requested. We'll rush you full particulars on any item indicated.

You can also get information using the publication's card elsewhere in this issue. Use of the card shown here will simplify handling and save time.

WE HAVE A TENDENCY TO OVERSIMPLIFY



Before

try this for size...

there's no doubt about performance!

Sized right for high density pcb switching—as small as .145 cu. in.—the MicroClareed MR Relay adds a new dimension to Clare Sealed Contact Reed Relay capabilities. Design around 1 to 5 contacts in epoxy sealed and open coil modules—take advantage of all of the inherent reliability and performance achievements of CLAREED Relays in only 1/5th the size.

Super-clean in construction, the 100% operation-tested, glass-encapsulated contacts never need maintenance or adjustment. Fast... with switching speeds in the low millisecond range. On the job, insensitivity to electrical transients... and complete input/output isolation... provide high reliability with maximum circuit simplicity.

For complete design information, circle reader service number—or ask Clare for Data Sheet 961... Write Group 3A9.

C. P. Clare & Co., Chicago, Illinois 60645



a GENERAL INSTRUMENT company



Length: 1¹⁵/₆₄" max.

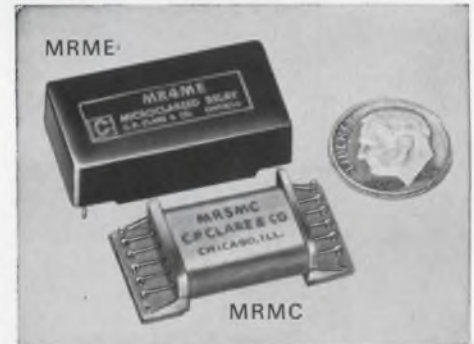

- Inherent reliability with no maintenance (Contacts sealed in glass)
- Switching times 0.5 to 2 ms
- Insensitive to transient electrical/electronic noises
- Contact load versatility—low level to 10 va
- Life:
 .125 amp., 28 v: 10 x 10⁶ operations
 low level: 100 x 10⁶ operations
- 1 to 5 contacts per module—open coil or molded epoxy modules

MICROCLAREED SEALED-CONTACT REED RELAYS

for industrial control, data logging and instrumentation,
communication switching, ground control, checkout systems

INFORMATION RETRIEVAL NUMBER 21

Solid-state triode operates like a vacuum tube

High-input JPL device is also similar to a FET, with better defenses against radiation and noise

Ron Gechman
West Coast Editor

A solid-state triode that is said to be similar to the thermionic vacuum-tube triode in operation has been developed by the Jet Propulsion Laboratory in Pasadena, Calif. Its basic characteristics are somewhat like those of a FET.

According to its developer, Dr. Alex Shumka, senior scientist, the device utilizes the modulation of space-charge-limited current in semiconductor materials and offers several attractive features not found in other semiconductor devices, such as bipolars. The triode has an input impedance of 1 to 2 Mhos, a frequency response of 200 MHz and an operating temperature of 100°C.

In addition, Dr. Shumka said in an interview, the triode has a low noise figure and is not susceptible to radiation damage. He added that "thermal runaway" in the triode should not occur, as it does in a transistor. As the temperature of the device increases, the current tends to decrease slightly, which is just the opposite of what happens in a transistor.

Germanium wafer cut

The triode is made from a wafer of high-purity germanium, with two channels cut into the base to form a mesa (see Fig. 1). The emitter and collector are alloyed to opposite surfaces, and the gates (or grids) are alloyed at the bottom of each channel. A multi-element device can be made, Dr. Shumka said, by cutting more channels in the base, to form additional mesas, and by properly alloying the additional emitters, collectors and gates.

The device, being directly analogous to the thermionic vacuum tube has three electrodes, Dr. Shumka explained. The emitter injects the charge carriers into the

base, the collector receives the injected charge, and the gate electrode modulates or controls the number of carriers that flow to the collector. The applied potential, the scientist noted, may be 100 V or more, as in a thermionic triode.

During operation the emitter (or electron) current is directly related to the number of field lines terminating on the emitter (see Fig. 2). The number of lines can be modulated by varying the gate voltage. If the voltage between the collector and gate is increased while that between the emitter and collector is kept constant, fewer field lines will terminate on the emitter.

Dr. Shumka noted that the amount by which the emitter current changed for a given change in gate voltage would depend largely on the position of the gate electrode with respect to the emitter,

and also upon the separation distance between the gate conductors. He explained that the gate was neither a source nor a sink for the injected carriers but was capacitively coupled with the emitter, and it is through this coupling that modulation takes place.

Dr. Shumka developed a special "sabre saw" to cut the channels in the germanium base. The saw has a reciprocating blade with a rectangular cross-section. A very sensitive dial gauge accurately monitors the channel depth. By ganging several saws, he said, one can cut all of the channels in one operation. His experimental triode has a 10-mil-wide channel, cut to a depth of 2.5 mils, and the mesa is 4 mils wide. The JPL scientist feels that the channel width of a more practical device could be reduced to 1 or 2 mils.

Germanium was first selected as the base material because it was suitable and readily available; how-

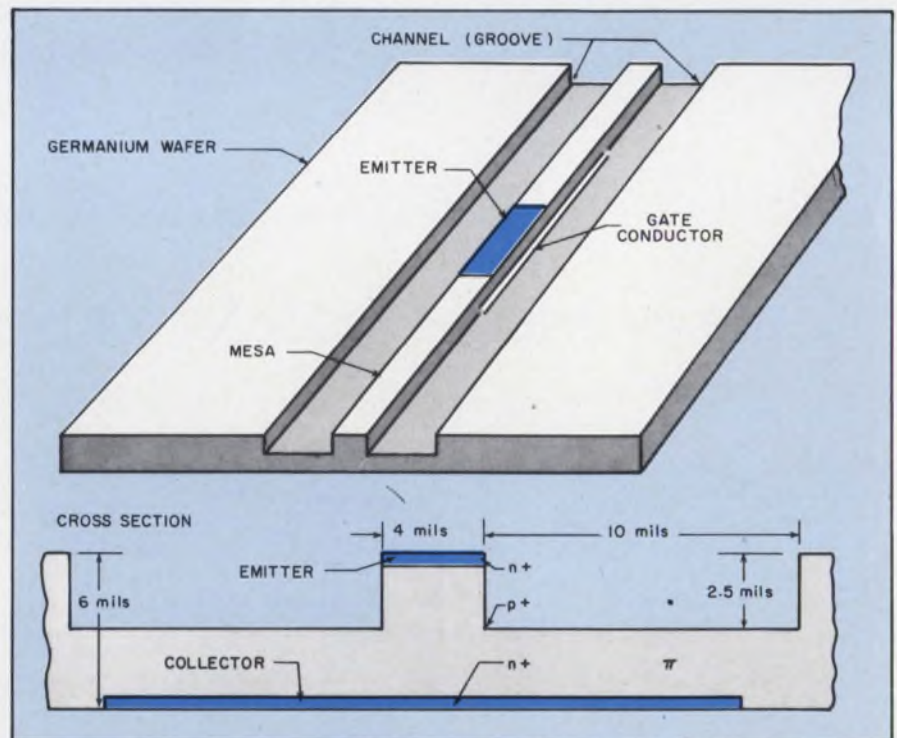
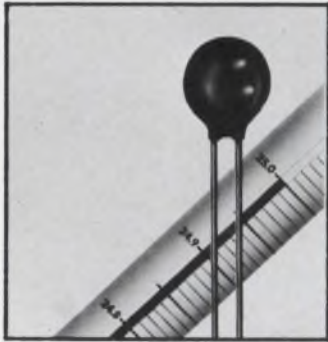

Fig. 1. Single-element, solid-state triode developed by Jet Propulsion Laboratory. Additional triodes may be formed on the same wafer by cut-

ting more channels and alloying the necessary emitters, collectors and gates to the wafer. π refers to germanium material.

Newest in Thermistors



1%

- Resistance Tolerance $\pm 1\%$ (0.2°C) $0^\circ\text{--}80^\circ\text{C}$
- Development for Extended Performance
- Fast Time Response
- Exceptional Stability
- Meets Performance Requirements of MIL-T-23648

CAL-R thermionics has available a large selection of . . .

THERMOCERAM compositions to meet all circuit design requirements. A variety of physical configurations, lead materials and protective coatings supplied upon request are options available to further aid you in your specific application.

A continuous program of materials research and new product development have made available an extensive inventory of thermistor experience that can be applied directly to your application.

Our applications engineering department will be happy to discuss your requirements with you. Send for complete product data and application information.

CAL-R INC.
thermonetics DIVISION

1823 Colorado Avenue
Santa Monica, California 90404
(213) 451-9761
TWX 910-343-6966
a subsidiary of CapTech inc.

NEWS

(solid-state triode, *continued*)

ever, silicon could also be used. Gallium phosphide would be a very desirable base material, Dr. Shumka said, because it would raise the operating temperature of the device from its present limit of 100°C to 500°C . He cannot use this material at present because it is not available with the required purity.

Previous work in what might be considered solid-state triode development has been limited to low-voltage, thin-film devices, field-effect transistors, and field-effect epitaxial devices. In the higher voltage domain, triple-diffused junction transistor structures have been developed, Dr. Shumka explained, but none of these devices shows operating characteristics directly analogous to those of thermionic vacuum-tube triodes. In particular, he said, no three-element, solid-state device has been developed that can be operated in either polarity by simply interchanging the collector and emitter elements and utilizing hole space-charge current or electron space-charge current for operation.

FET similarities noted

In comparing the triode to a FET, Dr. Shumka described their similarities and differences. They are similar in that both have a high input impedance and employ capacitance modulation. In the triode, the capacitance modulates the space-charge current, and in the FET the capacitance modulates

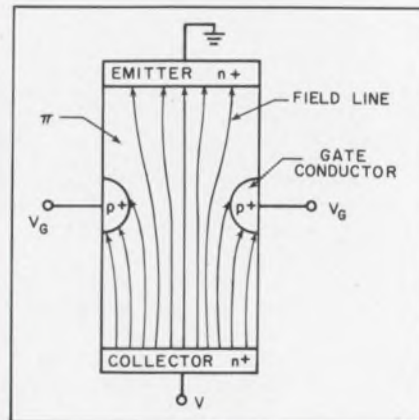

Fig. 2. Field lines in the JPL solid-state triode show its similarity to a thermionic tube. Field lines emanating from the collector terminate on the emitter and gate when $V_0 \leq 0\text{ V}$.

the ohmic current (or channel width).

The differences are as follows:

- The triode has a lower noise figure. The FET has a layer of insulation on top of the semiconductor material that creates an interface, which is a source of noise.
- The triode can withstand larger amounts of power.
- The triode can operate at higher temperatures.
- The triode has a higher radiation resistance, some three to four orders of magnitude better than that of transistors.
- The triode has a higher frequency response. A FET has stray capacitance between the gate, source and drain that tends to reduce its frequency response.

Dr. Shumka hesitated to estimate the cost of the triode compared with other devices. With a reasonable market, he believes the triode would probably compare with the cost of a vacuum tube—about \$2 or \$3.

Microcircuit version sought

Can the triode be made in microcircuit form? Dr. Shumka says not with present technology.

The major problem, he noted, is that it requires the cutting of grooves in the base, which, in effect, is one violation of the commonly used planar technology.

"Using the epitaxial process," the scientist said, "the near-intrinsic material could be grown as part of the region through which space-charge-limited current would flow. However, the base must be maintained as pure as possible, and with epitaxial means, this is not yet possible."

With the extension of present technology or the development of a new approach, he sees microcircuit configuration of the triode as a possibility.

What kind of yield can be achieved on a production basis? Dr. Shumka isn't sure.

"The yield is pretty well tied to the technology used, and we have not yet developed a technique for producing the device on a production basis," he said.

The California Institute of Technology, JPL's parent organization, has asked NASA for commercial rights to the device. ■■

NEW Lambda dual output lab the power plus output ranges



LPD-421-FM
5 1/4" 1/2-rack metered

plus-

5 Models with two independent DC outputs offer widest choice—Up to ± 250 VDC, up to 1.7 amps. Either output may be + or -, or both outputs may be + or -.

Series/Parallel operation of both outputs yields two times the voltage or two times the current—up to 500 volts or up to 3.4 amps.

Auto Series/Auto Parallel (master slave) permits tracking to a common reference.

4 Meters provide simultaneous monitoring of both voltage and current.

Most power in a half-rack package.

Overvoltage Protection as an accessory.

Compatible with LP, LH and LK Series rack adapters and other accessories.

Multi-Current-Rated—Only dual power supplies on market with this advanced design feature.

Regulation: .01% + 1mV.

Ripple: 500 μ VRMS (1.5mVp-p).

Size: 5 3/16" x 8 3/4" x 10 5/8" 1/2 Rack • LPD Series

Model ⁽²⁾	Voltage Range Per output/ Outputs in series	I MAX AMPS AT AMBIENT OF: ⁽¹⁾ Per output/Outputs in parallel				Price ⁽²⁾ US and Canada
		30°C	40°C	50°C	60°C	
LPD-421-FM	0- ± 20 /0-40	1.7A/3.4A	1.5A/3.0A	1.3A/2.6A	0.9A/1.8A	\$325
LPD-422-FM	0- ± 40 /0-80	1.0A/2.0A	0.85A/1.7A	0.7A/1.4A	0.55A/1.1A	260
LPD-423-FM	0- ± 60 /0-120	0.7A/1.4A	0.6A/1.2A	0.5A/1.0A	0.4A/0.8A	325
LPD-424-FM	0- ± 120 /0-240	0.38A/0.76A	0.32A/0.64A	0.26A/0.52A	0.20A/0.40A	325
LPD-425-FM	0- ± 250 /0-500	0.13A/0.26A	0.12A/0.24A	0.11A/0.22A	0.10A/0.20A	350

⁽¹⁾ Current rating applies over entire voltage range. Ratings based on 57-63 Hz operation.
⁽²⁾ Prices are for metered models. LPD Series models are not available without meters.

Overvoltage Protection

Available as bolt-on accessory for all LP and LPD models and LK-LH models with suffix (A). For LPD models, each output requires separate OV accessory.

For use with	Model	Adj. Volt Range	Price
0-10, 0-20 V Models ^o	LH-OV-4	3-24V	\$35
0-36, 0-40 V Models ^o	LH-OV-5	3-47V	35
0-60 V Models ^o	LH-OV-6	3-70V	35

^o Except for Full-Rack LK models. Overvoltage protection for full-rack models to 70 VDC is available as a built-in option. To order add suffix (-OV) and add \$90 to the price of models LK-350-352; add \$120 for models LK-360-FM-362-FM.

L A M B D A

Premium-engineered ERA Transpac® Inverters convert low voltage DC to 115 VAC, 60 or 400 cps. Solid-state designs assure high shock and vibration resistance, high conversion efficiency, stable operation and minimum maintenance. New ERA Transpac® Frequency Changers convert any 115 VAC, 50-1000 cps source to 115 VAC output, 60 or 400 cps at power levels.

DC to AC INVERTERS

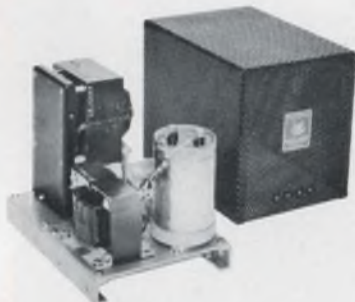

AC to AC FREQUENCY CHANGERS

These highly stable Inverters or Frequency Changers are ideal for the exacting requirements of AC-operated equipment in lab, military or industrial applications, providing high reliability at moderate cost. *Types available:* non-regulated square-wave output; regulated square-wave output; regulated sine-wave output.

Write Today for Catalog #138



ELECTRONIC RESEARCH ASSOCIATES, INC.

Dept. EP-1067 Sand Park Road
Cedar Grove, N. J. 07009 • (201) 239-3000
Subsidiaries: ERA Electric Co. • ERA Acoustics Corp.
ERA Dynamics Corp. • ERA Pacific, Inc.

INFORMATION RETRIEVAL NUMBER 27

NEWS

Electronics brings some life into physics teaching

Electronic designers are providing the next generation of physicists with a new set of tools for learning basic concepts.

But the builders of electronics for the physics laboratory are finding that novel gadgetry is not enough. To be successful commercially, the apparatus is accompanied by detailed experiment manuals. These manuals include some technical discussion of how the electronic gadgetry produces its results, along with numerous diagrams to help the student. References are supplied to pertinent literature for a more complete discussion, if desired.

The laser appears to be the most popular of the new educational tools. Light beams from a laser can be directed through all kinds of media, and because they are easily visible, they can illustrate the deflections obtained. A new demonstration kit introduced by American Instrument Co., Buffalo, illustrates the range of optical principles that can be demonstrated.

The photograph below shows how the laser is integrated with an optical bench, including a beam splitter and labeled slots into which various accessories can be

mounted. The system allows a student to play with the "rays" he sees drawn in his physics text.

The plastic lens shown here bends the light beams as we would normally expect a convex lens to bend them. When another lens with an index of refraction equal to that of air is substituted for the red lens shown, however, the beams travel straight through. When the student puts the same lens in place in the liquid tank (the tank contains a colloidal silica suspension in water), he finds that the rays diverge sharply. Two principles of ray optics are thus illustrated. One is that the shape of the lens is not the critical factor in determining the direction of bending. The other is that bending occurs at interfaces because of the differences between indices of refraction of the lens and surrounding medium. In addition, when a diverging beam strikes the air-liquid surface at the top of the tank, it is bent back into the liquid. The same thing happens at the tank bottom which is made of plastic with an index of refraction equal to air.

Over 20 demonstrations along these lines can be performed with the American Instruments kit, which sells for \$645. It includes a

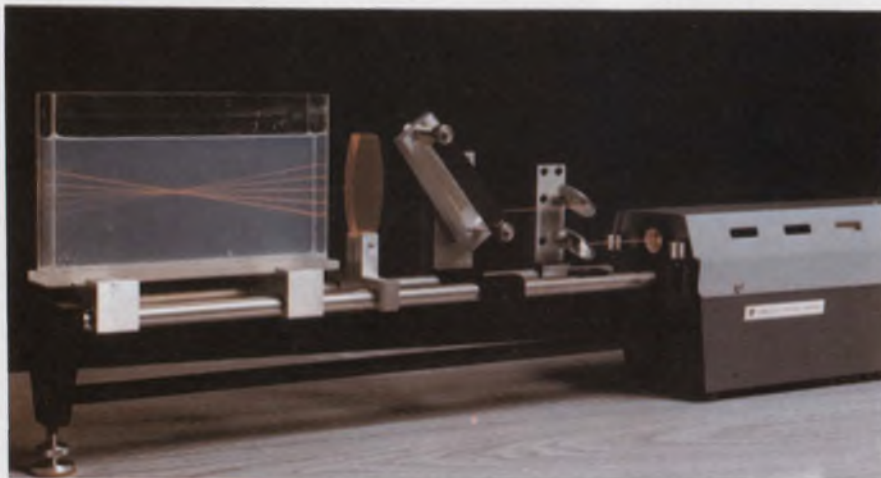

Light rays come to life in this laser-optical bench setup with interchangeable lenses and other parts to illustrate some of the laws of optics. Experiments allow the student to "discover" the laws for himself. A beam splitter divides the laser beam into five rays. Lenses and mirrors can be inserted at different points in the optical path.



UNI-POWER

UNIVERSAL WIDE-RANGE
POWER SUPPLIES



WHERE ELSE CAN YOU GET...

- SAME DAY DELIVERY**
- WIDE RANGE**
- LOW PRICE**
 - UNI-76 — 0-34 volts at 0.5 amps \$ 76.00
 - UNI-88 — 0-34 volts at 1.5 amps \$ 88.00
 - UNI-128-16—0-16 volts at 4 amps \$128.00
 - UNI-128-34 — 15-34 volts at 4 amps \$128.00
 - UNI-TWIN-164 — dual output — 0-25 volts at 0.75 amps \$164.00
- UN-MATCHED PERFORMANCE** — Meet MIL-E-5272 Environmental Specs, MIL-1-6181 RFI Specs and have MTBF in excess of 100,000 hours per MIL HDBK 217.
- FULLY PROTECTED** — Overload and Short Circuit Proof. Instantaneous recovery and auto-reset.
- REGULATION** — better than $\pm 0.005\% + 1 \text{ uv}$. ($\pm 0.01\%$ on the UNI-TWIN 164).
- RIPPLE** — less than 250 uv (500 uv on the UNI-TWIN 164).
- TEMPERATURE COEFFICIENT** — $0.01\% + .5 \text{ uv}/^\circ\text{C}$.
- COMPLETE SELECTION** — Rack and metered accessories available.

If all this seems hard to believe, why not let us prove it. Write today for **FREE LITERATURE** describing these and many other POWER/MATE CORP. Power Supply Modules.



POWER/MATE CORP.

163 Clay Street, Hackensack, New Jersey 07601
Phone: (201) 343-6294

INFORMATION RETRIEVAL NUMBER 30

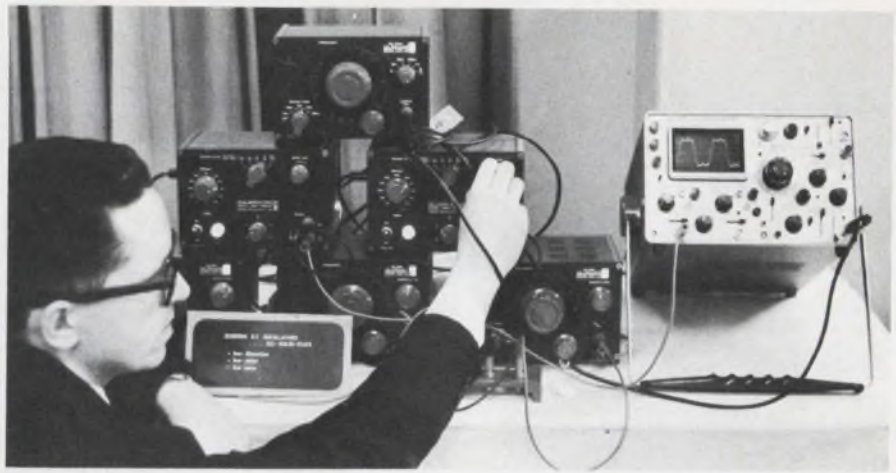

Fourier synthesis of a square wave from sine waves is achieved in this experiment by using the synchronizing feature of General Radio's RC audio oscillators and tapping the 1-kHz calibration signal from a Tektronix 454 oscilloscope. The fundamental oscillator is on top and odd harmonics are set on the oscillators below.

NEWS

(physics, continued)

helium-neon gas laser that provides a 2 milliwatt output at 6328 Å.

The laser hologram has also entered the school laboratory.

For \$195 a school can buy a lens, mirrors, a beam-splitter, spectrographic plates (36), chemical supplies, photographic equipment, stands and holders to make holograms. All this, plus an experiment manual telling how to build a stable platform and how to make and view holograms. The only other thing you need, says University Laboratories, Inc., 733 Allston Way, Berkeley, Calif., is a laser. The kit-maker suggests that the user buy one of its helium-neon gas lasers, which emit 6328 Å in the visible red. The model 200, with 0.6 mW output, costs \$195; the model 240, with 1.0 mW output, is \$295.

The spectrographic plates are Kodak type 649 F, which has a very slow emulsion and offers resolution of 2000 line pairs per mm.

Standard instrument adapted

In one case, an addition of a simple feature to a standard instrument resulted in the ability to use it for a quite informative experiment. Fourier synthesis is demonstrated with a series of audio RC oscillators by adding a synchronization feature to them.

General Radio Co., West Concord, Mass., has done this by allowing a set of oscillators, representing a fundamental and odd harmonics, to be synchronized by the calibration signal from an oscilloscope. The photograph shows the results obtained with the third, fifth, seventh, ninth and eleventh harmonics. As each harmonic is added, or removed, the student can see the results clearly on the oscilloscope face. Each of the audio oscillators shown sells for \$325.

Activity in electronic instruments for teaching was spurred with the passage of two pieces of Federal legislation in fiscal 1966. Because of the Vietnam War, how-

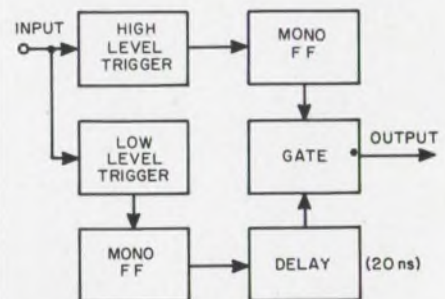
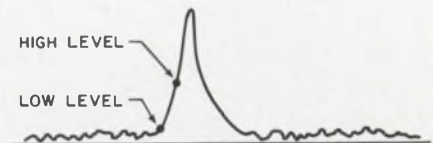

Pulse time resolution is increased in a pulse amplifier and discriminator by combining low-level and high-level triggers. The low-level one is triggered often by noise. Its output is delayed and only gated when the high-level trigger is also exceeded.

NO. 2, 3, & 4 WILL CONCEDE*

We're No. 1 in RF Voltmeters



So, you better believe it. We've sold more sensitive RF Voltmeters than anyone else because we've been doing a lot of things right. We've given you 2% accuracy. We've given you the highest input impedance to make that accuracy meaningful. We've given you the highest ac and dc overload protection (probe diodes last longer that way). We've given you the fast response you need for peaking and nulling (sluggish sampling voltmeters can't make the grade). We've given you a well-mannered probe which works without any "back-talk" pulses pumped into your circuit (again, sampling voltmeters flunk out)! We've given you a clean, trouble-free design with a choice of features in three models ranging from \$550 to \$700. Why not send for all the specs and see for yourself why our competitors always end up Nos. 2, 3, & 4.

* Alphabetically speaking (and when pressed) Ballantine, Hewlett-Packard, Millivac.

BOONTON
ELECTRONICS
CORPORATION

ROUTE 287
PARSIPPANY, N.J. 07054
Telephone: 201-887-5110
TWX: 710-986-8241

"IEEE: Booths 2E46-50"

INFORMATION RETRIEVAL NUMBER 31

NEWS

(physics, continued)

ever, the expected rise in Government funds to help schools buy instruments has not come about.

Nevertheless, some manufacturers report, interest among educators has been so high that some markets are developing anyway.

"Most of our sales have not been under Government matching grants," says one engineer for a company that sells hologram kits to schools.

Colleges can buy instruments under Title 6 of the Higher Education Act. The school must match the Government funds. Originally the bill called for spending to start at \$15 million in 1966 and to increase to \$60 million a year by fiscal '68. Actually only \$14.5 million was allocated in fiscal '67, and the same amount this fiscal year. Some instruments are also being purchased under Title 3 of the National Defense Education Act for elementary and secondary schools.

Physicists need training

All of the newer educational instruments were on display at the annual meetings of the American Physical Society and the American Association of Physics Teachers in Chicago. It was clear from the instrumentation on display that it is a good thing that physics students are learning something about electronic instruments. As the use of electronics increases, the versatility of the instrumentation is also being extended.

In the past the design of instruments for the particle and event-counting measurements of the physicist has been a province somewhat apart from the mainstream of electronics. But recently the speeds of some computer circuitry are moving into the same range. Thus some manufacturers are being approached for equipment to help check out high-speed memory circuits, for example.

Designers of these instruments are constantly being required to come up with special tricks to make the kinds of measurements physi-

How TTL helped slim fat counters

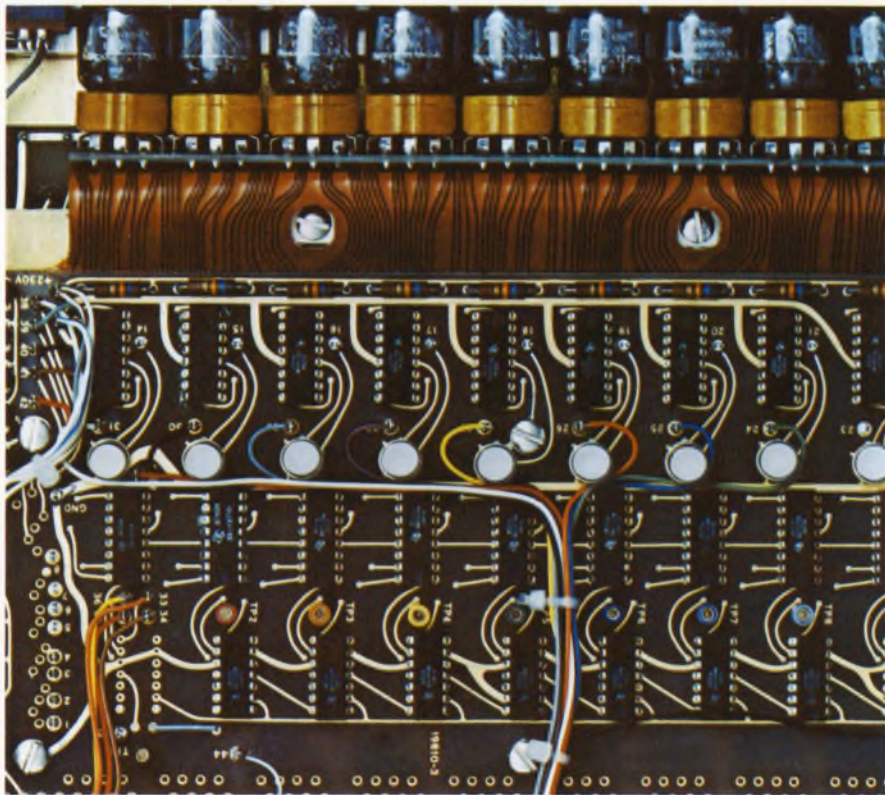

Twenty-six TI Series 74 complex-function integrated circuits form the decade chain and decoder-driver section of this Systron-Donner Thin Line counter. Without circuits such as SN7441N BCD-to-decimal decoder-drivers, hundreds of separate transistors and simple integrated circuits would have been necessary to perform the required functions.

Mission impossible? It may have seemed so to project engineers at Systron-Donner Corp. They had the assignment of designing a radically new line of high-frequency counters—one that would give them a big jump on competition.

A key requirement was reduced panel height. Systron-Donner engineers wanted a *skinny* counter — one only 1¾" high.

But, they also wanted nine-digit readout for top resolution.

Plus a 100 MHz direct counting range.

And greater freedom from repairs than ever before possible.

Integrated circuits were the obvious solution. But *which* ICs posed the tough question. Answering it triggered a two-year search that covered all major IC suppliers as well as many smaller producers. Systron-Donner's analysis included RTL and ECL logic types, in addition to TTL and DTL. Breadth of product line, depth of manufacturing facilities and competence of personnel were considered—along with price, service and performance—before the final selection was carefully made.

3 new shift registers expand industry's broadest logic line

These complex-function TTL shift registers are far more than basic registers. Applications include shift counters, Johnson and ring counters, and shift-register generator counters.

These registers incorporate additional gating as well as input and output connections, and are recommended for many storage and counting applications in addition to such shift functions as serial-to-parallel, parallel-to-serial, right-shift and left-shift operations. In all cases, substantial savings in packages, interconnections, design time and overall costs will be realized.

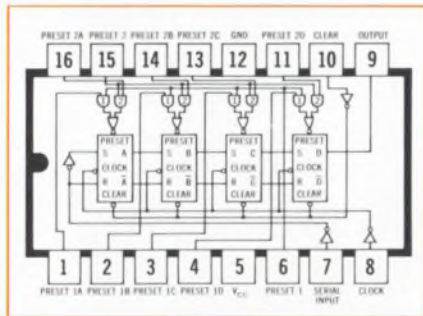

SN7494 4-bit shift register

This parallel entry, serial shift register includes four AND-OR-INVERT gates, four inverter drivers, and four R-S master-slave flip-flops. The result is a versatile circuit which performs right-shift operations as a serial-in, serial-out register or as a dual source parallel-to-serial converter.

All flip-flops may be cleared simultaneously – independently of

clock input. Also, the circuit has asynchronous loading capability from two strobe-controlled sources.

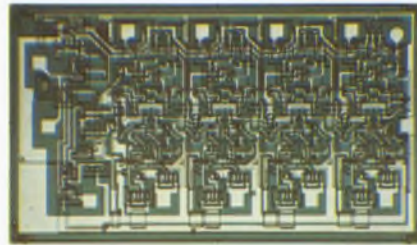

SN7495 4-bit shift-right, shift-left register

This parallel or serial-input shift register incorporates four AND-OR-INVERT gates, one AND-OR gate, six inverter-drivers, and four R-S master slave flip-flops.

This versatile register can be used in a wide variety of applications, including serial-in, right-shift/left-shift, and parallel loading operations.

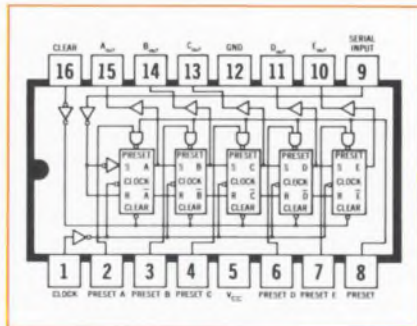

SN7496 5-bit shift register

This register consists of five R-S master/slave flip-flops, with gates and inverter drivers, connected

as a shift register to perform parallel-to-serial or serial-to-parallel conversion of binary data. Since both inputs and outputs to all flip-flops are accessible, parallel-in/parallel-out and serial-in/serial-out operations may be performed.

A common clear line and strobe-controlled, individual presets permit loading of any binary information into the register. Preset is independent of the state of the clock input.



A note from you, on your company letterhead, will bring this goldmine of information . . . data sheets on these 3 new shift registers plus application information on all our 54/74 counters and shift registers...a data book on the entire 74 N complex-function family ...and finally, an in-depth 48-page brochure covering all 54/74 TTL integrated circuits. Just address your letterhead request to Texas Instruments, Incorporated, MS980, P.O. Box 5012, Dallas, Texas 75222.



TEXAS INSTRUMENTS
INCORPORATED

Tomorrow morning you can build a system with compatible digital hardware from Raytheon Computer and enjoy your coffee break.

You'll have it made. 1. 703—the \$15,000 IC Computer with \$1.50 spares.

The 703 is the small systems computer built like third-generation million dollar computers. The CPU is wire wrapped with plug-in IC's on one motherboard. A unique CPU self-diagnosis solves its own circuit malfunctions. When necessary, you can simply plug-in a new IC. Time: about 30 seconds. Cost: about \$1.50.

The 703 is a 16-bit machine; 1.75 μ sec cycle time; and expandable from 4K to 32K.

Software includes an executive and real-time FORTRAN IV.

All Raytheon Computer products are compatible with the 703 for easy, economical and flexible systems expansion.

2. The MINIVERter™ approach to A/D conversion. The MINIVERter is a multi-channel multiplexer, sample and hold amplifier and 10, 12 or 13-bit A/D converter prewired and installed in your package or ours. We have several to choose from.

3. You do the system design; we've done the rest. Raytheon Computer offers a complete range of analog and digital IC modules. Mounting hardware and accessories have analog and digital power and grounding built in. For fast turn around, you can send us a wire list and we'll send you an automatically wired and assembled system within 4 weeks. And our application engineers are the best in the business.

Our literature is helpful, our representatives even more so. Write or call today for Data File CB-150. Raytheon Computer, 2700 South Fairview St., Santa Ana, California 92704, phone (714) 546-7160.

**Raytheon
Computer
...the company
that gives you
a break.**



1.



2.

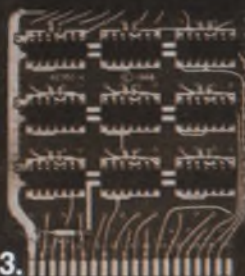

3.



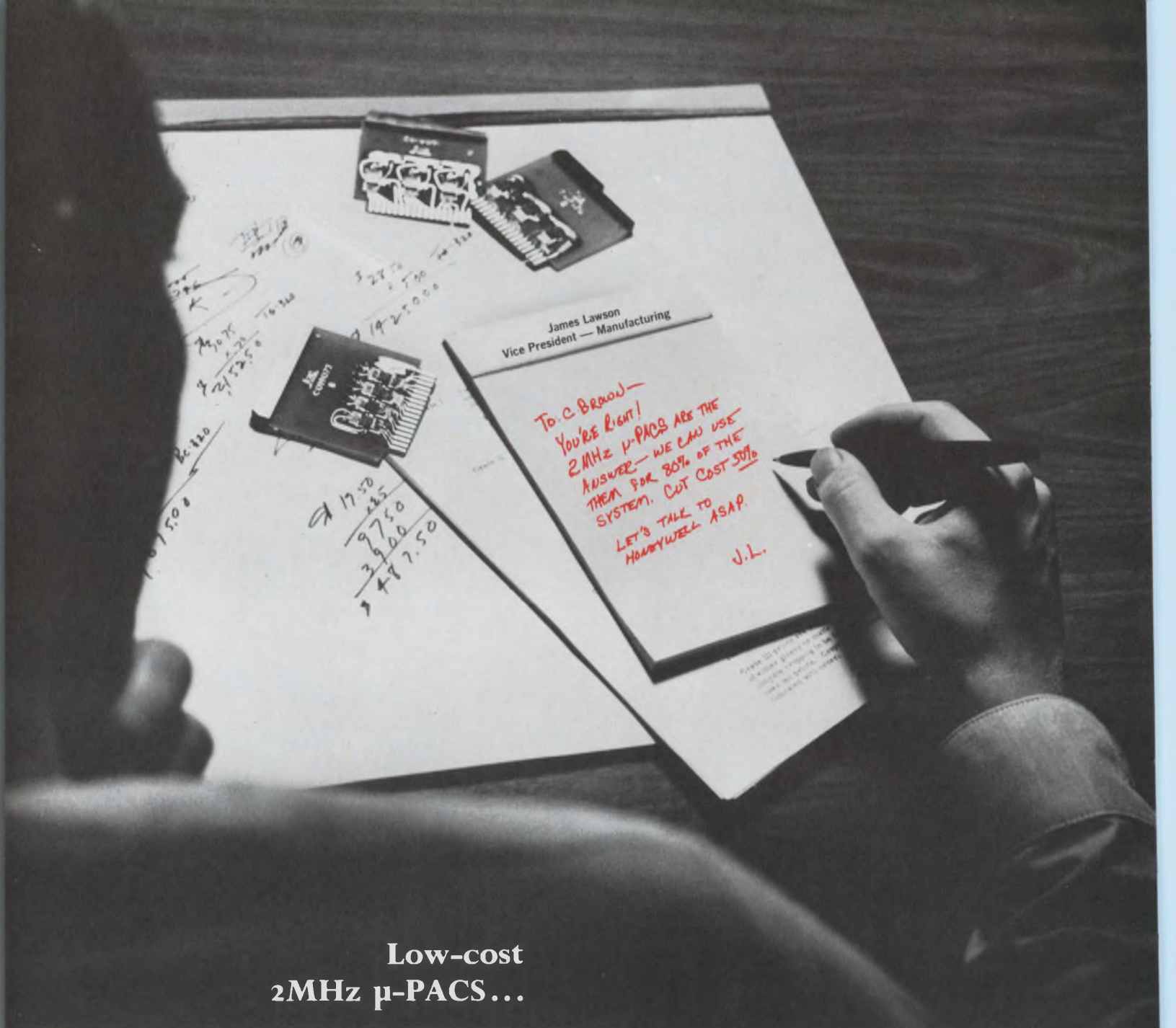

Low-cost 2MHz μ -PACS...

**...let you save
up to half the cost
of system logic.**

If you face a make-or-buy evaluation for system logic, maybe you've considered μ -PACS. Now, you can use new I/C 2MHz μ -PACS for up to 80% of your logic needs. Cut costs as much as 50%.

Take another look at your make-or-buy: Think μ -PACS at half the cost. Add more savings for volume discounts. Forget the people and equipment you'd need just to begin making your own. Remember μ -PAC quality and reliability. (Both 2MHz and 5MHz μ -PACS are compatible.) If this changes your cost analysis, write for new spec/price brochure. Honeywell, Computer Control Division, Old Connecticut Path, Framingham, Massachusetts 01701.

Honeywell

 **COMPUTER CONTROL**
DIVISION

Washington Report

CONTINUED

taking strong exception to the decision. Withdrawal by the military, they argue, will weaken the impetus for participation by major U.S. airframe and electronics manufacturers and could cost the national economy more in overseas sales than the expense of participating in the show.

Commerce Dept. figures indicate that aerospace systems and equipment make up 10 per cent, or \$2.5 billion, of all U.S. exports each year. About \$200 million in sales may result directly from the Paris Air Show, critics of the Defense Dept. policy contend. Estimates are that it cost the U.S. Government less than \$1.5 million to participate in the air show last year.

Now it appears that the Defense Dept. may reconsider; so the whole issue is again back up in the air.

Meanwhile a bill sponsored by Rep. L. Mendel Rivers (D-S.C.) calls for Federal sponsorship of a U.S. international air show. His measure would appropriate \$5 million as a start for such an exposition, to be held no later than 1969. Interested Federal agencies have been queried for comment, but hearings have not yet been held on the measure.

Dulles International Airport, situated in Virginia near Washington, has been suggested as a potential site for an international air show. Last summer a one-day air show there drew 75,000 persons. Sponsored by the National Aviation Club and the Federal Aviation Administration, the success has led to plans for an even larger two-day show at Dulles Airport this August.

Comsat pinch-hits for broken cables

At just about the time that an official of the Federal Communications Commission revealed his agency would probably grant American Telephone & Telegraph's request to install a new transatlantic cable (TAT-5), two existing Atlantic cables broke and went out of operation. The odds against such a failure are at least 1000 to 1 according to one Washington expert. The first cable to go was TAT-4, which extends from New Jersey to St. Hilaire-de-Riez, France. The other cable, TAT-3, extends

from New Jersey to Cornwall, England. Both breaks occurred off the U.S. coast.

With understandable delight at both the timing and the opportunity, the Communications Satellite Corp. sought and received permission from the FCC to provide temporary assistance. In the end, a total of 177 circuits were provided by the INTELSAT communications satellites Early Bird and Atlantic II. Comsat Operations has reported "both satellites and satellite earth stations functioned precisely." The same news release pointed modestly to the reliability of the satellite system during 1967: no service failures attributable to the satellites; 99.37% reliability for earth-station operations, 99.14% reliability for land lines between earth stations and international switching centers.

Electric thrusters for new satellites

NASA's new Applications Technology Satellites, ATS-D and -E, scheduled for launching over the next two years, will have small electric engines to provide the thrust to anchor each spacecraft in a fixed synchronous earth orbit. Called resistojets, each tiny eight-pound engine will provide a thrust of from 10 to 20 micropounds. The jets were developed by NASA and tested on the ATS-III, launched last November.

Each unit employs electric resistance to heat liquid-ammonia propellant, and, through the resulting expansion, it generates a reaction thrust through a jet nozzle. The very low thrust will be used to counteract torque disturbances to the gravity-gradient booms used for primary attitude control.

Requests for proposals were sent out by NASA a month ago to 20 aerospace manufacturers for development of a final design of both ATS satellites. Two contractors are to be selected for a competitive design, and one will be chosen later to build both spacecraft.

ATS-D is scheduled for launching in June, 1968, and ATS-E in mid-1969. Each will carry advanced communications, navigation and weather experiments, along with other scientific and technical experimental packages. The primary experiment will involve radio communications from 400 MHz to 8 GHz through a 30-foot antenna. The project is directed by the Goddard Space Flight Center.

FASTEST RESISTOR IN THE WEST



Do your requirements demand immediate delivery plus precision craftsmanship?



IF SO . . . LOOK INTO THE

CAL-R INC.

LINE OF PRECISION AND POWER RESISTORS.

CHECK THESE FEATURES:

- Meets or exceeds all MIL - SPECS
- Proven reliability
- Superior performance
- Miniaturization



WRITE OR CALL FOR . . .
COMPLETE DATA



CAL-R INC.

CALIFORNIA RESISTOR
DIVISION

1631 Colorado Avenue
Santa Monica, California 90404

[213] 451-9761

TWX 910-343-6966

a subsidiary of CapTech inc.

Letters

Editorial spurs readers to react

Sir:

Congratulations on your Jan. 18th editorial ["Come out of the clouds, get down to brass tacks," ED 2, p. 75]. I have long maintained and advocated the idea that all these "new-fangled" words like zero defects, quality assurance, reliability, value engineering . . . are nothing but warmed-over names for basic truths in engineering philosophy.

My engineers are all human engineers, value engineers, reliability engineers, etc. Occasionally we might seek consultation from an expert on a particularly deep problem, but on a day to day basis . . . this is the stuff engineering design should be made of.

As you aptly point out, this philosophy is not taught in our schools . . . nor was it when I was an undergraduate. Somehow the academicians remain aloof to the problem of indoctrinating their end product to the realities of the cruel world of realism that exists outside their walls.

M. H. Sluis
Manager, Product Engineering
General Railway Signal Co.
Rochester, N.Y.

Sir:

Your recent editorial on the subject of training engineers in the art of using common sense and practicality in addition to the more sophisticated Laplace endeavors looks to me like the classical complaint of many. The question often arises, "Why not etc., etc.?" and in this case I think the answer is simple.

There is only limited time to teach and train our engineers, and our colleges and universities must allocate this time to produce not only highly practical graduates but also, to an ever greater extent, engineers who have a large degree of fundamental theoretical knowledge. Therefore those courses that stress the kinds of proficiency you want must take a lower priority, because it can be learned on the job later

while theory and fundamentals generally cannot.

I favor the present mix of fundamentals first and practical efficiency second, unless the course time were extended to five or six years.

Harry Levinson
Harry Levinson Co.
Seattle

Sir:

Really, there are plenty of experienced engineers who have a solid record of successful, practical, low-cost designs—including the most modern components and techniques.

Many of them are looking for jobs. This is no secret. Why try to mislead your readers?

Lawrence T. Fleming
Thomas & Wittrig
Pasadena, Calif.

Electronic thermometer has high sensitivity

Sir:

We have a thermometer circuit that offers advantages over some of those previously published, such as "Simple thermometer converts temperature into voltage," ED 3, Feb. 1, 1967, p. 92. Our circuit uses the emitter-base voltage change with temperature as the temperature-sensitive parameter.

In Fig. 1 Q1 is the sensing transistor ($I_{CBO} \ll 1$ mA at the temperature of interest). Q2 is a 1-mA

(continued on p. 58)

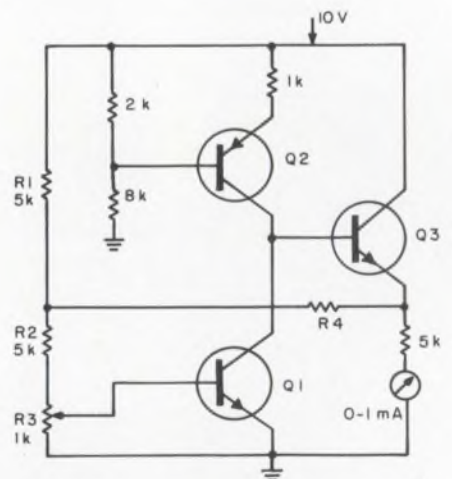

ΔT	R4	R5	PNP	2N3906
40°F	27k	5k	NPN	2N3904
5°F	100k	20k		

1. Thermometer circuit uses emitter-base voltage change of Q1 to sense temperature. A 100°C change in its zero setting introduces a 10% full-scale error.

**This is our 3 step.
Give us a call and see all
the steps in our routine.**



If you really want to swing you can also step 4, 8, 12, 24, 48, and 200 increments without gears.

Or to Indicate, Measure and Control using flag and remote angle indicators, synchros, resolvers, steppers, or solenoids. They are in stock at IMC Magnetics Corp., Western Division. For quick service contact the Applications Section at Western Division, 6058 Walker Ave., Maywood, Calif. 90270. Phone 213 583 4785 or TWX 910 321 3089.

If you need data sheets for references or consideration for future projects, write IMC's Marketing Division at 570 Main Street, Westbury, New York 11591.



INFORMATION RETRIEVAL NUMBER 38

**Why you won't get burned
with an IMC vaneaxial fan.**



Airmoving capability. A vaneaxial fan is the most versatile of all the airmovers. It has a high aerodynamic efficiency over a wide range of specific speeds and offers the lowest noise level of any airmover when used properly. Primarily because of high efficiency. Delivers exceptionally well against high back pressures. **Mechanical** and other advantages. Long life—the motor is cooled by the air passing over it. Exceptionally good resistance to shock and vibration because there are no overhanging

parts. Good mechanical balance. Because of the rigidity of the moving parts and easy mounting in duct work (can be flanged at both ends). **Cost** is competitive with other types. **Competence.** IMC designs and produces the entire airmover (motors, impellers, housings, gas bearings) to the demanding requirements of the Minuteman, TFX, and other advanced projects. We also produce standard vaneaxials ranging from the IMCube (1-inch cube) to real big blasters, producing thousands of cfm.



IMC Magnetics Corp., Eastern Division, 570 Main St., Westbury, N.Y. 11591
Phone (516) 334-7070 or TWX 510 222-4469

INFORMATION RETRIEVAL NUMBER 39

LETTERS

(continued from p. 56)

constant-current source for the $Q1$ collector current and presents a very high resistance to the $Q1$ collector. $Q3$ is an emitter follower to supply the output signal to the meter. $R4$, $R1$, $R2$ and the top part of $R3$ form a feedback network which sets the full-scale sensitivity of the meter. The setting of $R3$ sets the zero. As the zero set is changed by 100°C , the full-scale calibration will shift approximately 10%. If this error is unacceptable, the circuit in Fig. 2 can be used. It will lower the error to

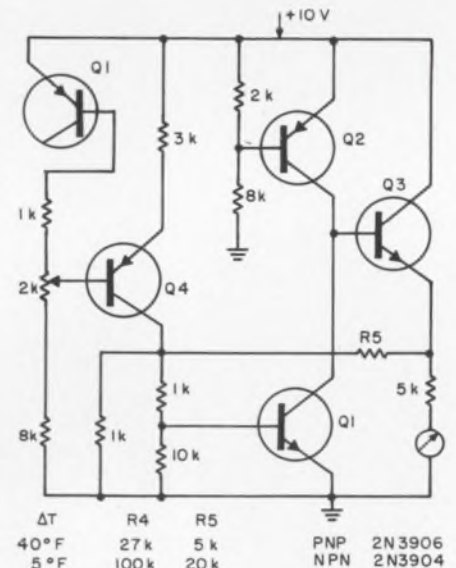

2. **Full-scale error** is nearly nil in this thermometer circuit, but $Q4$ must be kept at fairly constant temperature.

nearly zero, but $Q4$ must remain at a fairly constant temperature.

Both circuits have the advantages of large output signal and high sensitivity and can easily be adjusted over 100°C . A well-regulated power supply or battery is necessary.

John L. Menke
J. K. Whittaker

National Bureau of Standards
Washington, D.C.

**Bidirectional counter
won't count as shown**

Sir:

I wish to call your attention to the synchronous bidirectional

(continued on p. 60)

INFORMATION RETRIEVAL NUMBER 40 ►

CHUBBY IS CHEAPER!

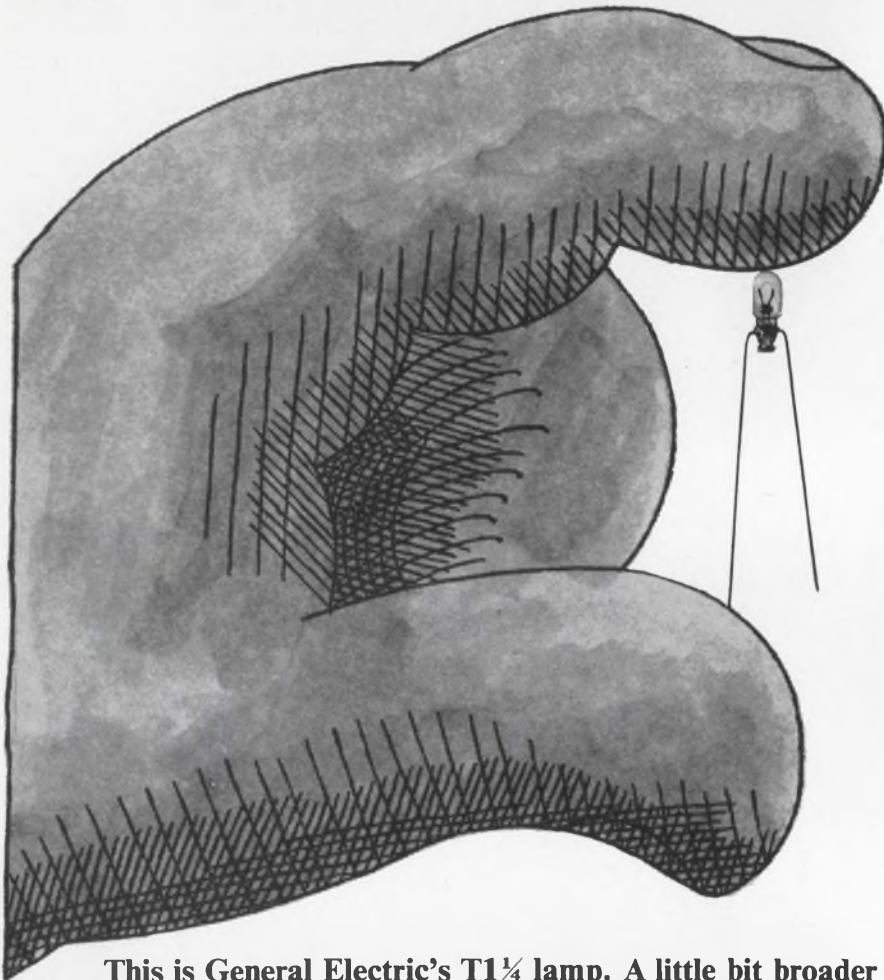

This is General Electric's T1 $\frac{1}{4}$ lamp. A little bit broader around the middle than the GE T1. Just about 40 thousandths broader. Otherwise, identical in nearly every way. Except price. The General Electric T1 $\frac{1}{4}$ costs just one-third as much as the T1! So if you've got space in your design for a little bit of extra bulk, you can save a bundle. For aircraft indicators, computers, photo-chopper and photoexcitation jobs, check up on the chubby T1 $\frac{1}{4}$. Economy-rated General Electric performing T1 $\frac{1}{4}$ lamps:

GE Lamp Number	Design Volts	Design Amps	Approx. Mean Spherical Candlepower	Filament Designation	Max. Overall Length (Inch)	Rated Average Lab. Life (Hours)
583	5	.06	.05±25%	C-2R	.438"	100,000+
580	5	.06	.03±25%	C-2R	.438"	100,000+
515	5	.115	15±25%	C-2R	.438"	40,000+

Miniature Lamp Department

GENERAL  ELECTRIC

INFORMATION RETRIEVAL NUMBER 41

LETTERS

(continued from p. 58)

counter for which a corrected scheme was published in ED 17, Aug. 16, 1967, p. 66 ["Bidirectional counter is completely synchronous"].

The suggested carry function is still not correct when three or more decades are used. Because of the synchronous design, the *Advance* input, which is the count input, is common to every decade; decades higher than the units' are prevented from counting by the *Inhibit* input, which is connected to the carry of the preceding decade. The value of S. Iannazzo's carry, when it opens the *Inhibit* gate, remains at logic 1 during ten pulses for the second decade, 100 pulses for the third, and so forth, so that every decade higher than the second will count wrongly. The *Inhibit* level must always return to logic 0 after the pulse that produces the carry.

This it is possible to achieve by modifying the carry function. For DT μ L micrologic, the correct carry function is:

$$C_n =$$

$$(F \cdot a_n \cdot d_n + R \cdot \overline{a_n} \cdot \overline{b_n} \cdot \overline{c_n} \cdot \overline{d_n}) C_n - 1,$$

where C_n is the carry function of the n^{th} decade.

This can be realized very simply if the decoder outputs are used as follows:

$$C_n = F \cdot \overline{9}_n + R \cdot \overline{0}_n + \overline{C_n} - 1.$$

A counter I have built according to this design works very well.

Dr. Franco Pavese
Italian Thermometric Institute
Turin, Italy

Accuracy is our policy

In "Radiation-hardened ICs still unproved," ED 4, Feb. 15, 1968, p. 40, the next-to-the-last paragraph incorrectly states: "The TRW structures are only 34 μ M deep." It should have read: "3.4 microns deep."

In "Test your IC IQ," ED 25, Dec. 6, 1967, p. 100, right-hand column, ninth line, the reference should be to silicon, which is a semiconductor, not to silicon dioxide, which is an insulator.



“Four to six weeks for power supply delivery?

Forget it!

Acopian will ship any of their 62,000 different AC to DC plug-in power supplies in just 3 days!”

This catalog lists 62,000 models of AC to DC plug-in power supplies available for shipment in just three days. Choose the exact outputs you need. Singles or duals, regulated or unregulated. Write or phone for your free copy.



Name _____
 Title _____
 Company _____
 City _____
 State _____ Zip _____



Acopian Corp., Easton, Penna. 18042
 Phone: (215) 258-5441

What's at the IEEE show for you?

Every year cases of “show shock” are reported at the New York Coliseum during IEEE week. Some engineers, bewildered by the jungle-like maze of exhibits, wander “lost” for days, morosely hunting the technical trophies that might be of use to them. Some roam gleefully up and down the stairs, back and forth and across the gaily cluttered aisles, like kids at a carny, only to develop guilt feelings when the show is over: They have nothing to show for their efforts but a blur of broad impressions. Some show visitors, pondering how best to tackle the ordeal, never make it past the Lowenbrau booth.

ELECTRONIC DESIGN has a better way: IEEE-USA. Calmly, calculatedly, sit at your ease and flip open the magazine. Pick your field of interest: IEEE-USA is categorized by engineering specialties. Start your “tour” of the show. It's fast; it's incisive. And you can check other fields, other interests as you move along. Do it *before* you go to the Coliseum. This tour starts on page U65.

Is IEEE doing a good job?

How well does IEEE serve its members? For six weeks, ELECTRONIC DESIGN's Management and Careers Editor, Howard S. Ravis, sought the answer in a nationwide survey of design engineers. He also interviewed IEEE Manager Donald G. Fink, Government representatives and other engineering society officials. He even spent three hours with Internal Revenue Service experts in Washington, just to have one sub-subsection of the IRS code explained. The in-depth view of IEEE starts on page U68.



Rep. Emilio Daddario (right), chairman of the House Subcommittee on Science, Research and Development, tells Editor Howard S. Ravis how engineering societies can aid the Government.

4 breakthroughs: new NIXIE® tube

1

size

.530" dia. x 1.5" for IC compatibility — largest numeral height provides best readability.

2

anode strobing

new design permits all like-numerals to be driven in parallel for time sharing operation with improved brightness.

3

pin spacer

simplifies both PC board layout and tube insertion.

4

price

in quantities of 1,000 — only **\$395** each.

This new tube, type B-5750, has been engineered to achieve all these outstanding breakthroughs in a single design. The new slim-line tube not only has two internal decimal points but also has an "in-line" lead arrangement which is compatible with dual in-line IC's. In addition, the numeral aspect ratio has been designed to provide the optimum in readability and viewing distance.

The movable pin spacer — standoff, which is used to align the tube pins for ease of PC layout and insertion, is part of the tube assembly.

The anode strobing/time sharing operation permits substantial reduction in driver costs for many multi-digit display applications. For more information on these and other features contact your nearest Burroughs representative or sales engineer, or write: *Burroughs Corporation, Electronic Components Division, P.O. Box 1226, Department N6, Plainfield, New Jersey 07061 TEL: (201) 757-5000.*



INFORMATION RETRIEVAL NUMBER 45

Burroughs

1968 IEEE Show...

For the first time, too, four special microwave sessions are being held at the Coliseum. Another first is an expanded film theater, in which two technical papers will be presented. You can even start breakfast with a choice of tutorial seminars—one on integrated circuits, the other on computer-aided design.

The show runs from March 18 through 21. Come along on ELECTRONIC DESIGN's tour.



Is the IEEE helping you?

Designers rate society's technical competence high, but say it could do more in other professional areas

Howard S. Ravis,
Management and Careers Editor

For \$25 a year any electrical or electronic engineer can join the Institute of Electrical and Electronic Engineers—familiarly, the IEEE. Is it worth it?

One of every eight design engineers in a national survey conducted by *ELECTRONIC DESIGN* didn't think it was. They reported they left the society because they felt they weren't getting their money's worth.

These are other findings:

- Half of the design engineers in the survey did not belong to IEEE—the society that purports to serve the engineer's technological needs the best.

- IEEE does a reasonably competent job of being the acknowledged expert in its field, thanks to a massive publications program. Most design-engineer members believe this. But one-third have doubts.

- IEEE recognizes that it must provide tutorial services for engineers, but it has been very slow to carry out its good intentions. A majority of designers rate the society's program deficient.

- IEEE sees its sole function as that of serving its members in a technical sense, with the engineer reaping nontechnical rewards—improved status, better pay, etc.—as automatic by-products. Most design-engineer members disagree; they feel the society should be doing more in the nontechnical area.

The sampling on which these findings are based was 1000 readers of *ELECTRONIC DESIGN*, drawn by computer for a geographic distribution. A total of 289 answered the questionnaire by the deadline. The respondents, whose average age was 36.5, represented 31 states and the District of Columbia. Their opinions are likely to coincide with those of any group of design engineers chosen at random.

Besides the conclusions about IEEE, the survey uncovered these findings about engineering societies in general:

- Three of every 10 design engineers score the societies' total performance as poor or useless. Fewer—about one-fourth—say the societies

are doing an exceptional or good job (see Question 1 on p. U70).

- A Congressman who specializes in the science and technology area says the societies could be of more help to the Government, if they weren't so conservative in their interpretations of Internal Revenue Service regulations for non-profit organizations.

Two basic questions raised

To assess the job that IEEE is doing, the *ELECTRONIC DESIGN* survey sought the answers to two basic questions:

1. What does the society see as its function in serving its members and others?

2. What do design engineers expect from their society?

Donald G. Fink, IEEE general manager, looks at the society's role this way: "In today's electronics world, a number of important jobs have to be done. At the center of those jobs is advancing with and keeping up with technology. That is our job . . . There is a need for someone who can be called upon for technological facts and be believed."

The answers to Questions 2, 3 and 4 in the survey confirm that most design engineers believe the society should compile and supply the latest technical data and offer updating courses for engineers so they can keep abreast of changing technologies.

What does IEEE actually do in these technical areas?

Variety of publications offered

IEEE does a competent job of providing the "technological fact." It publishes 42 periodicals and 16 other publications each year, with a combined circulation of 3.8 million copies. In 20 years the number of editorial pages has risen tenfold—from 3,000 to 30,000 a year.

"Our aim is to have our combined publications be the publications of record in our field," Fink says. "At least one-third of the prime information in the electrical engineering field is pub-

changes and policy statements needed to implement those activities.”

Board action awaited

In August, 1967, the IEEE board of directors approved the committee's recommendations and named an Educational Activities Board to use the recommendations as guidelines in launching a program of continuing education for members.

The committee report admitted that “the tutorial services of IEEE, at the present time,

are inadequate.” It recommended additional services in four general areas:

1. Published monographs and course material in new technological areas.
2. Slide-tape lecture series.
3. Information on courses and materials.
4. Workshops.

No specific action programs along these lines have begun yet, however, because the Educational Activities Board, established last August, just held its organizational meeting last month.

A total of 21 slide-tape lecture series are avail-

Sample questions from ELECTRONIC DESIGN survey

Here are some of the questions ELECTRONIC DESIGN asked design engineers throughout the country about technical societies. Take the test and see how your attitudes compare with the responses of engineers in the survey.

The answers to Questions 2, 3, 4, 8, 10, 11 and 12—general questions about all engineering societies—include both IEEE members and non-members, whose attitudes never varied by more than 5 per cent.

1. In your opinion, which of the following ratings best describes engineering societies today?

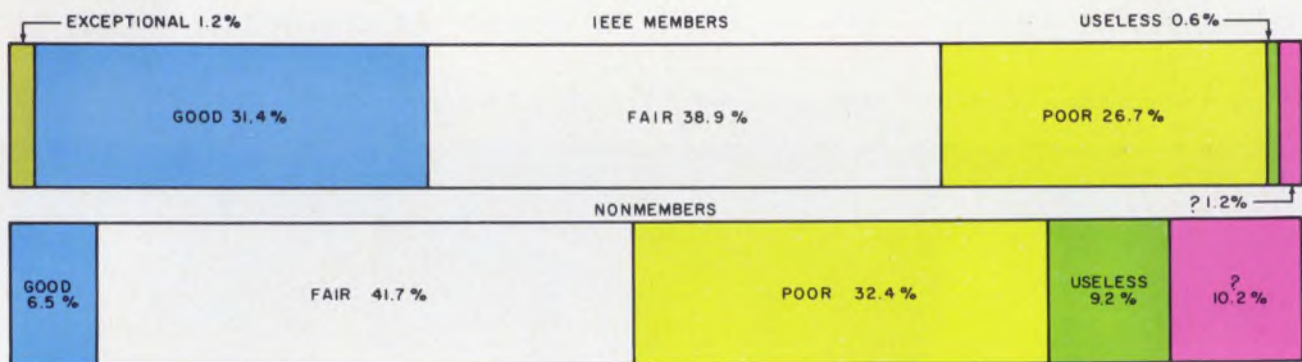

2. Should societies *compile* the latest technological data in the field?

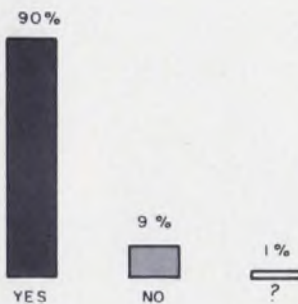

3. Should societies *supply* the latest technological data in the field?

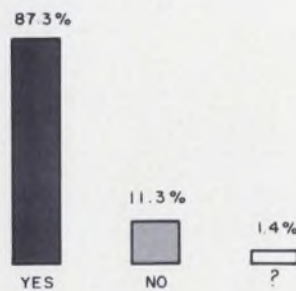

4. Should societies sponsor updating courses for engineers?

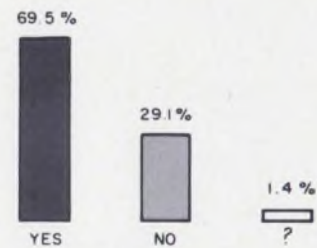

5. Rate the performance of your society in *compiling* the latest technological data in the field.



grow into an information retrieval system, and the co-publication of an abstract service with London's Institute of Electrical Engineers.

IEEE President Seymour W. Herwald, a Westinghouse vice president, sees the information retrieval service as one example of "how we will enhance our communications function in the future."

"By incorporating the best of what is now known about information retrieval," he says, "we have started a 'kernel' system that can grow and evolve in the ever-shifting real-world scene. By relying on IEEE authors and editors, we should get the best possible indexing of our own

literature, which constitutes a good proportion of that published in the world."

This indexing will be put on computer tapes in a master file. At first, Herwald says "this file will be used for things like computer-controlled printout of indexed material."

The file will be extended to include all IEEE-sponsored courses this year. "In due course," Herwald continues, "this master file will form the core of an information retrieval system that is appropriate to IEEE's unique needs."

Nontechnical gaps conceded

When the nontechnical areas are probed, IEEE falls wide of the mark, in the eyes of many members. IEEE Manager Fink readily concedes that the society does not get deeply involved in nontechnological pursuits, nor does it intend to.

"We don't say that engineers shouldn't be interested in higher salaries and other things not strictly technological," he says. "But we feel that if we do our part of the job, we will give the engineer the material—the technical capability—for getting better salaries, etc."

IEEE members—and nonmembers—in the ELECTRONIC DESIGN survey tend to disagree. As the response to Question 8 indicates, the overwhelming majority feel societies should work to improve the professional status of engineers. But only a third of the IEEE members in the survey said the society did a good job or exceptional job of actually enhancing the professional status of engineers (see response to Question 9).

Even if IEEE leadership suddenly did an about-face in this respect, the mere structure of the society undoubtedly would delay the incorporation of the change for many years. Fink frankly suggests that an engineer who belongs to his society would also have to join a group such as the National Society of Professional Engineers (NSPE) to have these nontechnical needs met more fully.

'Unionism' strongly opposed

While there is strong disagreement between the society and its members concerning IEEE activities in the nontechnical area, there is one subject upon which nearly all engineers and the society concur. Nearly four of every five engineers polled—both IEEE members and nonmembers—said IEEE should *not* work to "organize engineers into a strong body capable of demanding general salary levels, layoff and hiring policies, pension plans, etc." (see response to Question 10). They rejected out of hand this hint of "unionism."

"We do not and never will serve this purpose," Fink says. "We cannot get involved in pitting



Major program: More than 60,000 visitors attend IEEE's convention and exhibition in March each year.

few years ago. Despite this, 10 per cent of its members in the survey said it did a good job of serving them in this area! Perhaps they interpreted this as meaning the classified advertisement section in the IEEE publication *Spectrum*. However, since one must pay for these ads, can it really be termed a "service" for members in the pure sense?

The table on this page shows how IEEE's attitude toward operating an employment service compares with three comparable engineering societies in other disciplines—the American Institute of Chemical Engineers, American Society of Civil Engineers and American Society of Mechanical Engineers.

IEEE and ASME offer no employment services for engineers, while the AIChE has an active program and ASCE provides some services.

Aid to Government backed

Should IEEE's technical services and advice be made available outside the "family"—to the Federal Government, say? There is general agreement here. Most engineers in the survey—both IEEE members and nonmembers—felt engineering societies should perform this service (see response to Question 12). IEEE believes it should perform the service. And the Government concurs.

IEEE Manager Fink, in discussing IEEE's involvement, will mention the 20-year-old Joint Technical Advisory Committee, comprised of representatives of the IEEE and the Electronics Industries Association. The committee's function is to work with Government agencies.

Fink also cites many other instances of how IEEE advises the Government. He points out that the technical competence and reputation of many of its members is so great that Government agencies automatically seek them out, without the need for IEEE to make the offer.

Fink indicates that he definitely feels IEEE does a competent job in this area. However, only one of every 10 IEEE members in the survey rated the society's performance as good or exceptional in advising the Government. Three in 10 said it is poor, and the remaining six in 10 said the society does nothing, or they did not or could not rate the performance (see response to Question 13).

This raises the question: Do the members give the low rating because they don't approve of the way IEEE operates in this area, or are they ignorant of the fact that the society does work in this area?

Is it a case of ineffective communication between IEEE and its members?

The latter question seems to hit at the heart of the matter. Nearly one-fourth of the IEEE members in the survey left this question unanswered. This lack of response was at least twice as great as that for any other question in the survey.

Congressman criticizes societies

On the Government's side, Representative Emilio Daddario (D-Conn.), chairman of the House Subcommittee on Science, Research and Development since it was formed in 1963, has actively promoted closer ties between the techno-

Table. Do you provide an employment service for your members?

YES		NO	
Society	Service Offered	Society	Reason for Inaction
AIChE	Every member gets a free listing in society magazine when he is job-hunting; also, a bulletin listing members looking for jobs is sent to companies looking for engineers.	IEEE	Eliminated service. "We are not in the employment business. If we are to put our stamp of approval on an employee-employer relationship, we'd have to know a lot more than we do about both. One or two mistakes, and we would really suffer. Also, our technical lives are made easier by not having to render personal judgments."* (Members pay for classified ads in monthly magazine.)
ASCE	Offer employment guidance and provide facilities to assist employees and employers.	ASME	Formerly sponsored Engineering Societies Personnel Service. Organization no longer exists, "primarily because the technical explosion has and continues to render a demand for engineers which is greater than the supply available from colleges and universities."**

* Statement by Donald Fink, IEEE general manager.
 ** Statement by O. B. Schierzsd, ASME executive director.



Directs operations: As IEEE general manager, Donald G. Fink administers all society activities. He is shown above conferring with Dr. James H. Mulligan (center), vice president for technical activities, and Dr. R. E. Emberson, director of technical activities.

we ought to be getting from them.”

Summing up what he believes the relationship between Government and societies should be, Daddario asserts: “Our objective is to get the best possible advice we can about important national objectives, important goals, important problems. The objectives of a society certainly are to develop their own internal capabilities so that they can do the same things. We in Congress feel that we can’t do our job in the best possible way unless we get the best possible advice. The societies are the source of this best possible advice.”

Society slow to change

Is IEEE geared to respond to pleas for change—from its members, as well as outsiders? The record indicates that it isn’t. Even if IEEE leadership wanted to change policies or improve the society’s performance, its very structure precludes anything resembling fast action.

For example, IEEE officials seem oblivious to the fact that many engineers no longer belong to IEEE because they felt they were not getting their money’s worth. There is no formal provision for feedback within the society. If there had been, IEEE might have received comments like these volunteered by dissidents in the survey:

“Dues kept going up. Services kept going down.”

“Too expensive for what I received.”

“I could not justify the cost versus receipt of good usable information on everyday problems.”

“I derived no benefit, other than having the society’s initials on my resume.”

One of every four design engineers responding to the ELECTRONIC DESIGN survey indicated they once belonged to IEEE but left the society for these or other reasons.

IEEE officials do not express any visible concern over the loss of members like these. Instead, they point to a membership total of 160,000 (including 15,000 student members), which makes IEEE the largest technical society in the world. They do not question how many of these members have their dues subsidized by their companies, or whether they would remain members of they had to pay their own dues.

IEEE throws the ball back to the engineers, as in this statement by President Herwald:

“It is my feeling that there are many individuals in IEEE who have not sufficiently appreciated that it is a voluntary organization and that, as such, communications within it go along a two-way street. To get more out of the enhanced communications that are made available to him, the individual must put more in . . . If you feel you are not getting enough out of your membership in IEEE, it may well be that you are not using the resources of the institute that really are available. It is up to you to seize the value of enhanced communications that our institute provides.”

Few engineers would not agree that communication is a two-way street. But some are inclined to wonder whether the IEEE leaders have asked themselves the same question they so readily ask the members: “Are you doing your part?” ■■

The engineer looks at technology

Scan this summary of significant papers and trends at the IEEE show, arranged by engineering specialties

Aerospace

Space designers urged to help exploit earth

The aerospace engineer is invited to look earthward from space for new worlds to conquer rather than toward space itself in the highlight session, "New Directions in Space."

Satellites, for example, could be very useful to fishing fleets, says Dr. G. C. Ewing of the Woods Hole Oceanographic Institute in Massachusetts. He describes the great riches in the seas and the difficulties in extracting them. Satellites, Dr. Ewing believes, might be used to spot surface conditions that point for the presence of schools of fish 100 feet below the surface.

Other speakers advocate the use of elaborate sensing devices on satellites to locate other natural resources on the earth and to make maps. Meteorological satellites and super-pressure balloons monitored by earth stations and satellites are cited as ways to improve business through better weather forecasts to fishing fleets, farmers, airlines and ships. Oceanographic data collections by satellites from transmitting buoys and the measurement of air pollution by laser beams are further advances envisioned.

The super-pressure balloons, which are described by W. W. Kellogg of the National Center for Atmospheric Research, University of Colorado in Boulder, would be sturdy enough to last a year, circling the earth once every week or two. Transducers and a telemetry system would send back temperatures and other measurements, and the ground or satellite stations would determine the direction and speed of the wind affecting the balloon.

To cope with the data from satellites and balloons, according to Kellogg, a new-generation computer is needed with a speed 100 times greater than any now available.

New electronic equipment will be required to handle the new projects, according to J. C. Elms of the NASA Electronics Research Center, Cam-

bridge, Mass. Highly responsive sensors are needed to measure the temperature of ocean from a satellite and the ocean's color and the surface roughness. Color sensing, for example, would require scanning and precise amplitude recording at three or more optical or near-optical regions. The measurement of sea roughness would call for active radar techniques at one or more microwave frequencies with one or more polarizations.

Oceanographic data could be collected from buoys by existing communications techniques, but the data rate called for would create a problem in communications bandwidth, Elms says. The problem might be solved by data selection and compression at the beacon or in the satellite, or by the development of very broadband communications links.

The problem of software would be formidable. The interpretation of meteorological data for fishermen, for example, is different from providing farmers with the information they need.

Integration versus confederation for aerospace systems is getting a thorough going-over by a high-level group in Session 6G. Integration, in the sense used in the session, means the communal use of one element by several subsystems. For example, all the black boxes in a plane might use a common power supply, or the computer in the inertial navigation system might also solve problems for the fire-control system. Confederation, on the other hand, means that every black box would have its own power supply, or that there would at least be several power supplies for the group of black boxes.

The chairman of Session 6G is Eugene Fubini, formerly director of defense research and engineering and now a vice president and group executive at International Business Machines. The origins of the integration-confederation controversy are described by R. A. Frosch, Assistant Secretary of the Navy for Research and Development. R. D. O'Neal, who holds the same position for the Army, discusses the Army's stand for "graceful degradation and growth potential." Harry Davis, Deputy Assistant Secretary of the Air Force for Special Programs, states his conviction that the mission itself has taken a back

seat to the preoccupation with avionics integration. W. T. Carnes, manager of avionics for Aeronautical Radio, Inc., gives the air transport industry's point of view. And T. P. Cheatham Jr., formerly Deputy Director of Defense Research and Engineering for Tactical Systems and now vice president for future systems at the Grumman Aircraft Engineering Corp., Bethpage, N. Y., advocates both integration and confederation.

—John Mason

Circuit Designer

The pickings are lean for circuit designers

The long-heralded era of systems design, coupled with the tendency of IEEE papers toward the vague and theoretical rather than the specific and practical, has finally resulted in a convention program that has little specific to offer the circuit designer. Practically every speaker is out to solve big, impressive system problems. The circuit designer assumes the role of a necessary bother: He merely comes up with the stuff that goes into the "black boxes" that make up system block diagrams.

In this context, the circuit designer can find something of interest in practically the whole convention. But the interpretation of his role in each case is up to him. By and large, the circuit problems will be only implied rather than stated directly.

With this in mind, then, how should a circuit designer tour the technical side of the show?

As far as the papers are concerned, the best bet is to look at the program, pick a session of general interest and then, after listening to all the system-design talk, nail the speaker with some specific questions. Like: "How are you going to measure your error signal in the presence of all that noise, so the system will operate effectively?" This, hopefully, will steer the discussion to the "bolts and nuts" level, and some useful circuit information may be salvaged.

As far as the exhibits are concerned, the solution is more cumbersome. Humorous as it may seem, one suggestion is for the circuit designer to equip himself with a suitcase and make the rounds of the booths, picking up spec sheets and samples, wherever they are available. The reason for this is that, by and large, it is futile to talk to the exhibitors' representatives at the show, because they know very little, from an engineer's point of view, about the products they are exhibiting. Very few companies assign knowledgeable applications engineers to the show. The most frequent answer that a designer is apt to get to

a technical question at a booth is: "Gee, I am awfully sorry, but I'm not a technical man myself. What I could do, though, is to take down your name and . . ." Meaningful dialogue on the spot is impossible.

Possibly in the remote future this will change, and more companies will come to realize that the man buying their products is, in the final analysis, the design engineer and that providing him with a competent, on-the-spot answer is good business.

Technical seminars sponsored by several companies during the show can be of interest to the practical designer. Such seminars are usually announced at the booths, and quite often they are very informative. General Electric, for example, is presenting a seminar on linear IC applications. While most of the practical examples presented at the seminar involve, understandably, GE products, the related design techniques can be extended to other products.

All in all, it's a bleak prospect for the circuit designer this year. All of a sudden he takes a back seat to the system designer (who, in many cases, has come from the ranks of circuit design). The circuit designer is left pretty much to his own resources, both at the technical sessions and at the exhibits.

—Peter Budzilovich

Communications Engineer

Ways explored to utilize the cluttered spectrum

Communications engineers and scientists are always seeking better ways to use the electromagnetic spectrum that will conserve this vital but limited natural resource.

Session 3F, "Recent Advances in Radio Wave Propagation," considers "some of the vagaries of propagation, including those that cause interference to the user," says Joseph T. de Bettencourt, an engineer with Raytheon at Norwood, Mass., and the session's organizer.

Among the schemes being explored in the session are ones for using the ionosphere for transmission between satellites at high and very high frequencies, and others for employing propagation through the earth's crust at low frequencies.

Dr. Mario Grossi of Raytheon's Sudbury, Mass., laboratory explains in a paper that his organization has demonstrated the practicality of the so called "short wave ionospheric whispering gallery." This, he says, is the electromagnetic analogy of an acoustic phenomena that was explained many years ago by Lord Rayleigh, the English physicist.

respective satellites.

Grossi says that if the satellite moves above the F-layer (about 150 miles), the propagation once again becomes line-of-sight. On the other hand, he explains, unless the satellite is above the D-layer, the propagation reverts to conventional multihop.

Earth-crust transmissions

While some investigators are looking at new uses for the ionosphere, others are looking at the earth's crust, which can act as a waveguide for low frequencies.

A. Donald Watt of the Westinghouse Environmental Science and Technology Dept. at Boulder, Colo., discusses "Notes Regarding Possible Field Strength vs Distance in Earth Crust Waveguides." One of the researchers on this subject, Watt says that significant results have been achieved in the radio frequency range of 100 to 1000 Hz with use of the earth's lithosphere as a waveguide. The Westinghouse study has shown that intelligence can be transmitted through certain layers in the earth if enough rf power is used. It is possible to obtain useful ranges on the order of miles, he says.

Transmission through the lithosphere is usually accomplished with buried monopoles, excited from the surface. Watt says that the monopoles are normally placed in wells, with the water acting as an impedance-matching medium.

Because of the low frequencies used in the signaling, Watt says, the mode suffers from narrow bandwidth. Most of the intelligence transmitted is in a digital or code format to overcome this handicap.

Jungle communications

Other problems being considered in Session 3F include communicating in the jungle. Ray Vincent of the Stanford Research Institute tells of the difficulties in sending radio signals through dense foliage at sites where conventional antennas cannot easily be deployed. New experimental results obtained from propagation measurements made at hf, vhf, and uhf over rough ground are described by Robert S. Kirby of the Institute for Telecommunication Science at Boulder.

Terrestrial interference caused by atmospheric effects, such as forward scatter, ducting and rain scatter, are being evaluated by Dr. Hayden Evans of Bell Telephone Laboratories, Holmdel, N.J. His paper, "The Satellite Propagation Problem," is concerned primarily with the uhf and microwave frequencies.

Another complete session, 2F, is devoted to the problems of propagation in higher microwave

and millimeter wavelength communications.

And still another session, 7E, is devoted entirely to satellite communications.

—Neil Sclater

Computer Engineer

Computer designers look to 4th generation

Now that development of the third generation of computers is well under way, both designers and users are asking when the research breakthrough will be made that will herald the fourth generation. The third-generation machines use the same basic principles of stored programs and sequential execution that were used in Eckert and Mauchly's original designs.

Session 1D is gazing into the crystal ball for systems and hardware designers of tomorrow's computers. Dr. Brian Gaines of Standard Telephone and Cables Telecommunications Laboratories Ltd., Harlow, England, points the way with stochastic computers.

Stochastic, or statistical, computers represent variables by the average frequency of random pulses. They could lead to enormous simplifications of the arithmetic processor needed for numerical computations, according to Dr. Gaines. His paper discusses the principles of stochastic representation, as well as the trade-offs to be obtained between precision and averaging time.

If tomorrow's computers rely on electronics for the logic elements of their processors, high speed will be an absolute necessity. To increase the speed above today's nanosecond levels without severe transmission-line problems will require the use of large-scale integrated circuits. Even with the advantage of small size that LSI will bring, the choice of the proper topology will be a major problem. As an example of the needs of LSI, David Chung of Texas Instruments, Dallas, describes a special topology, chosen for a nanosecond read-only memory, that makes extensive use of LSI.

However, electronics may not be the solution for the high speed and large capacities that will be required of the computer of the future. Optical computers promise both speed and capacity. Supporters of this approach are Gabor Kalman of Carson Laboratories, Bristol, Conn., with a paper on holographic storage and C. J. Koester of the American Optical Co., Framington, Mass., with a paper on information transfer and processing in fiber optics.

Computer-aided design is hardly a new concept for the design engineer. According to Dr. William H. Ninke, leader of a computer-aided design group

Also users of a graphic console are the authors of a third paper in this session, A. G. Liddell and E. A. Peresich of the Boeing Co., Huntsville, Ala. They are reporting on Boeing's use of a flight data conditioning system for Saturn V post-flight performance evaluation.

Portrait of the computer artist

A bombardment of visual output is promised in Session 5A, "Computer Output as Art." With a thousand slides at his disposal, the session chairman, Oliver G. Selfridge of the MIT Lincoln Laboratories, Lexington, Mass., defines computer art as any visual output with artistic intent. He admits that most of the "art" produced by computers has plenty of artistic intent but little art. He hopes that his session will stimulate collaboration between artists and technologists to begin to use the computer as a creative tool rather than as an imitative device.

For the technologists, Kenneth C. Knowlton of Bell Telephone Laboratories, Murray Hill, N. J., draws a picture of the software trends for graphical and pictorial computer output. Hardware trends in artistic visual displays are being shown by George Michaels of Lawrence Radiation Laboratories, Livermore, Calif.

The real battle at the session is likely to be stirred by the art experts—Prof. G. Mezei, professor of visual design at the University of Toronto, and Mrs. K. M. Bell, an art critic.

Mrs. Bell acknowledges that technologists are showing a very real interest in producing art. Can technologists and artists agree on what constitutes art? Does the computer, as it is designed today, really give the artist significant possibilities? Few artists appear to realize the abundant creative possibilities of a computer, and the art so far produced by the technologists has been mainly imitative or representational, according to Mrs. Bell.

Tutorial session presented

A better understanding between engineers and programmers is the goal of Dr. F. A. Russell, chairman of electrical engineering at the Newark (N.J.) College of Engineering. He is chairman of a tutorial session on modern algorithmic methods for the computer solution of electrical engineering problems.

A first priority, according to Dr. Russell, is that the engineer be aware of the range of programs available. Too much effort is being spent on writing basically similar programs, he says.

Backing this thesis is W. M. Gentleman of Bell Telephone Laboratories, Murray Hill, N.J., who is setting up a program library service at Bell. He supports the modular concept of building an engineering program from a whole series of different

subroutines. These black-box subroutines can be assembled in much the same way as an engineer assembles logic modules for a digital system.

Dr. R. W. Hamming, head of the Numerical Methods Research Dept. at Bell Telephone Laboratories, warns of "Pitfalls in the Indiscriminate Use of Algorithmic Methods." Dr. Hamming notes in this paper that a library of subroutines in the hands of a naive user can lead to serious trouble. He contends that the real world of the engineer and the abstract world of the computer programmer do not combine efficiently.

An algorithmic method that receives much attention in this session is the Fast Fourier Transform (FFT). One of the originators of this method, J. W. Cooley of IBM's Watson Research Center, Yorktown Heights, N. Y., gives a tutorial description of its basic concepts. He gives examples of its use, particularly for filter design and Laplace transforms.

Because FFT reduces the order of the number of calculations required for a Fourier Analysis, the way has been opened for using Fourier transform analyzers on-line in production applications. The results of an on-line testing program for digital filters are described by a group of engineers from the Defense and Electronic Products Div. of the Radio Corp. of America, Camden, N.J.

—Jeffrey Bairstow

Industrial Electronics

Industrial engineering shows steady gains

For the industrial engineer—one who designs production and process-control equipment—there are quite a few interesting papers at this year's IEEE convention. Data handling, large control systems and the general application of electronics in a variety of industrial areas are discussed.

Consider Session 7A, for instance. Under the provocative title "Marconi's Impact on Gutenberg," five speakers outline the application of electronics to typesetting, printing and associated instrumentation and control.

In "Electronic Typesetting," J. J. Boyles of the United States Government Printing Office discusses major reasons for the rapid advances in the electronic typesetting: direct conversion of the computer-stored information to a copy of good quality and the elimination of keyboarding. Aspects of optical character recognition are covered.

Measurement and control techniques in the printing process are discussed by E. W. Harselm, in "Instrumentation and Control—Electronics in the Printing Process." Of particular interest here is the measurement and control of the ink-water

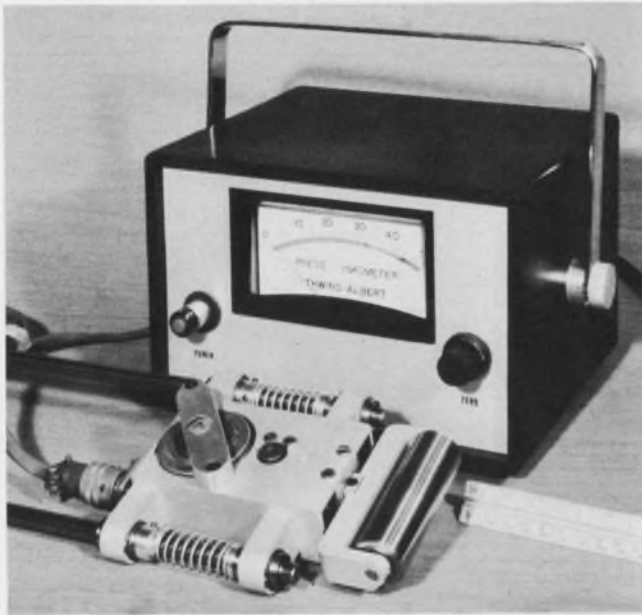

Ink-water balance on a printing-press roller is maintained by sensing the "stickiness" of the roller through torque measurement. Deviations in the proper degree of stickiness are converted to an error signal, and the relative amounts of ink and water are adjusted automatically.

balance by continuous monitoring of the degree of "stickiness" of the printing roller through torque measurement. The resulting electrical error signal is used to adjust the relative amounts of ink and water.

H. F. George, in "Electronics in Imaging and Printing," discusses a new electrostatic ink transfer technique. A charge is induced in the ink by putting about 1000 V on the impression roller, made of semiconductive rubber. This makes possible more complete and cleaner transfer of the ink on the paper, with resultant improvement in the printing quality.

A seemingly routine, yet surprisingly eye-opening session on fuse characteristics should be of interest to all users of high-power semiconductors (Session 5F). The over-all aim is to show the designers how to protect their high-priced semiconductors with the judicious use of fuses.

Recent developments in active ultrasonic transducers are being presented in the Session 4F, "High Power Ultrasonics." Unlike passive ultrasonic devices, which do not use the ultrasonic energy to do something (sonar, for example, is a passive ultrasonic system) active devices use ultrasonic energy to perform some work. A familiar example is the ultrasonic cleaner. Session 4F is considering the application of active ultrasonic devices to a number of industrial processes—such as metal and plastic welding, with power ratings from 20 to 4000 watts rms, and metal stamping, with power ratings to 10 kW.

A session on the present and future state of solid-state materials—magnetics, piezo- and fer-

ro-electrics, superconductors and semiconductors—offers insight into the applications of these materials in future electronic components.

Anyone with a tricky problem in voltage measurements may find the answer in Session 3B, "The Op Art of Voltage Measurement." The emphasis here is on the use of operational amplifiers and general feedback techniques in voltage measurements. In addition the design of accurate voltage standards with Zener diodes is being presented in a paper, "The Zener Diode, a Working Direct Voltage Standard," by W. G. Eicke Jr. of the National Bureau of Standards.

—Peter Budzilovich

Materials Engineer

The practical lowdown on materials offered

Last year's premiere session on materials is being repeated at this year's show.

Once again the session, No. 7D, is organized by Gustave Shapiro, chief of the engineering electronics section of the National Bureau of Standards, Gaithersburg, Md. And again it is stressing "uses instead of physics." It avoids futuristic and R&D materials and sticks to the applications of what's available today.

Materials merge into microcircuits

The session zeroes in on a particular problem area in materials applications—microelectronics. In "Systems, Materials and Packaging Disciplines: Merging Technologies," Alfred Levy of the Radio Corp. of America, Van Nuys, Calif., recognizes that growth in microelectronic "support" areas has not paralleled the almost exponential growth of microcircuits themselves. Monolithic circuits have evolved into medium and large-scale integration. Yet such related disciplines as intraconnection and interconnection methods have lagged far behind the developments in active elements.

The four papers of session 7D treat four different aspects of the problem.

Madhu Desai and William Koelsch of Fairchild Semiconductor probe the package densities to be achieved with a hybrid, rather than a discrete or integrated, circuit system.

Leonard Katzin of the Jet Propulsion Laboratory, Pasadena, Calif., takes a look at materials requirements for spacecraft electronics, where some packaging problems are insoluble with "land-based" materials and conventional designs. Spacecraft electronics are subject to extremes of heat, impact radiation, voltage, interference—just to name a few trouble spots. And, to com-

the Z-transform, its description of the discrete systems involved in digital filtering, and analogies between digital and continuous system treatment. The paper is tutorial in nature and provides a good introduction to digital filter design.

The well-established design techniques developed for continuous filters are used to advantage in digital filter design. Digital approximations to continuous-filter functions can be found by applying appropriate sampled-data transformations to the continuous-filter transfer functions. Roger Golden of Autonetics, Anaheim, Calif., in the second paper of the session, discusses the most frequently used Z-transformations—the “standard,” the “bilinear” and the “matched” types.

In some particular digital filtering applications, notably cases in which signals have not been additively combined, a special approach to design is used. It is termed homomorphic filtering. Alan Oppenheim and Tom Stockham of the Lincoln Laboratory describe homomorphic filtering and details of its applications in the fourth paper of the session. They discuss applications involving signals that have been convolved. These types of filtering problems can arise in automatic gain control, in speech and picture processing, and in echo removal.

Having developed the necessary theory, the engineer is faced, as always, with the problem of implementation. How does he build the hardware?

Leland Jackson, James Kaiser and Henry McDonald of Bell Telephone Laboratories, Murray Hill, N. J., describe their technique for constructing very complex and exacting filters from a small set of basic digital circuitry. They describe the problems they encountered with special-purpose hardware. Mention of actual hardware in this field is new and should prove interesting.

LSI applications pondered

Computer designers are understandably preoccupied with the implications of advancing LSI technology. They are inclined to listen attentively to the guardians of this technology, the semiconductor manufacturers.

Fairchild's director of research, Gordon E. Moore, discusses, in session 3D, the changes to be expected in computer design.

“Unless drastic changes are made in computer design to accommodate large-scale integration,” he says, “it will be necessary to generate many more different LSI functions than have been required with conventional integrated circuits.”

Moore points out that a given special function might be employed only once in each system. To serve these special needs, a means for building custom configurations quickly and cheaply will have to be developed.

On the other hand, there are considerable gains to be realized from the development of standard functional LSI products. Clyde Thornton of Philco-Ford's Microelectronics Div., Blue Bell, Pa., feels that standard functional assemblies will evolve from today's custom designs, which will permit orders-of-magnitude reductions in cost per function.

Manufacturers of computer equipment have, in general, expected LSI to be applied first to large, high-speed, digital equipment. Lester Spandorfer of Sperry Rand's Univac Div., Blue Bell, Pa., notes trends toward LSI in the design of large computers, but he describes difficulties in the technological systems and economic areas. Manufacturers are having processing difficulties that show up in low yields. LSI circuits should provide a speed advantage in large systems, where performance is the primary issue, but until the technology is developed, the economic picture will remain unclear. Spandorfer feels that these difficulties provide a basis for skepticism concerning the early use of LSI in conventional large-scale processors.

Another manufacturer, however, Paul Low of International Business Machines, Fishkill, N.Y., attempts to show that a substantial market for logic circuits exists in terminals and peripheral gear. He feels that LSI can help fill the needs of this market area.

—Raymond Speer

Microwave Engineer

Explore the heights of microwave design

Did you ever wonder what it's like to design really high-frequency circuits and systems—up there in the microwave region? Four special sessions present papers that explain the basics of microwave design: components, circuits and systems.

“These papers,” says Leo Young, organizer of the sessions, “are not research-oriented. They discuss materials, components, instruments and techniques currently in use.”

The papers and demonstrations are being presented, on invitation, by major suppliers of microwave equipment. Represented are Monsanto, Trans-Tech, Microwave Associates, RCA, Sperry Rand, Ewen-Knight, Martin Marietta, Philco-Ford, Systron-Donner, Omni-Spectra, and Hewlett-Packard.

In the past some of these microwave houses have provided lectures or demonstrations of one sort or another on their own. But the IEEE organizers feel that it's to the engineers' advantage to coordinate the effort.

"We hope," says Young, who represents the Stanford Research Institute, "that this type of session will stop the trend on the part of the suppliers to provide independent lectures and displays in hotel suites. Such showings are inconvenient and haphazard; they are not organized on an over-all basis. Lectures are frequently a distance apart, and they often overlap in time."

How has Young organized the sessions?

Technical orientation offered

The first, "Materials for Microwaves," as its name implies, features discussions of the basic materials: semiconductors and ferromagnetics. Semiconductors, for example, are used in two ways with microwaves. High-frequency semiconductor circuits amplify, switch or process microwaves, just as their slower counterparts do with audio, IF or RF. And bulk semiconductor devices, usually made with gallium arsenide, are used to generate microwave signals.

For the low-frequency circuit designer, micro-

waves present two important new twists. It is not always easy to keep the signal contained, as microwaves will readily radiate from conductors in the circuit. On the other hand, the short wavelengths make possible miniaturized transmission lines. Properly used, these transmission lines can provide inductance or capacitance, and both effects can be quite useful in microcircuitry, where space is always at a premium. Stripline circuits are the subject of a tutorial talk by Harlan Howe of Microwave Associates, who demonstrates how computer terminal equipment can be used in such a design.

Stripline techniques provide passive components for microwave circuits, but striplines must be used with active components to build a working system.

"Components for Microwave Integrated Circuits" are discussed in Session 2. Many components are presently available in a form suitable for IC design, but little work has been done to date to build complete systems on one integrated circuit. This area is thoroughly explored by

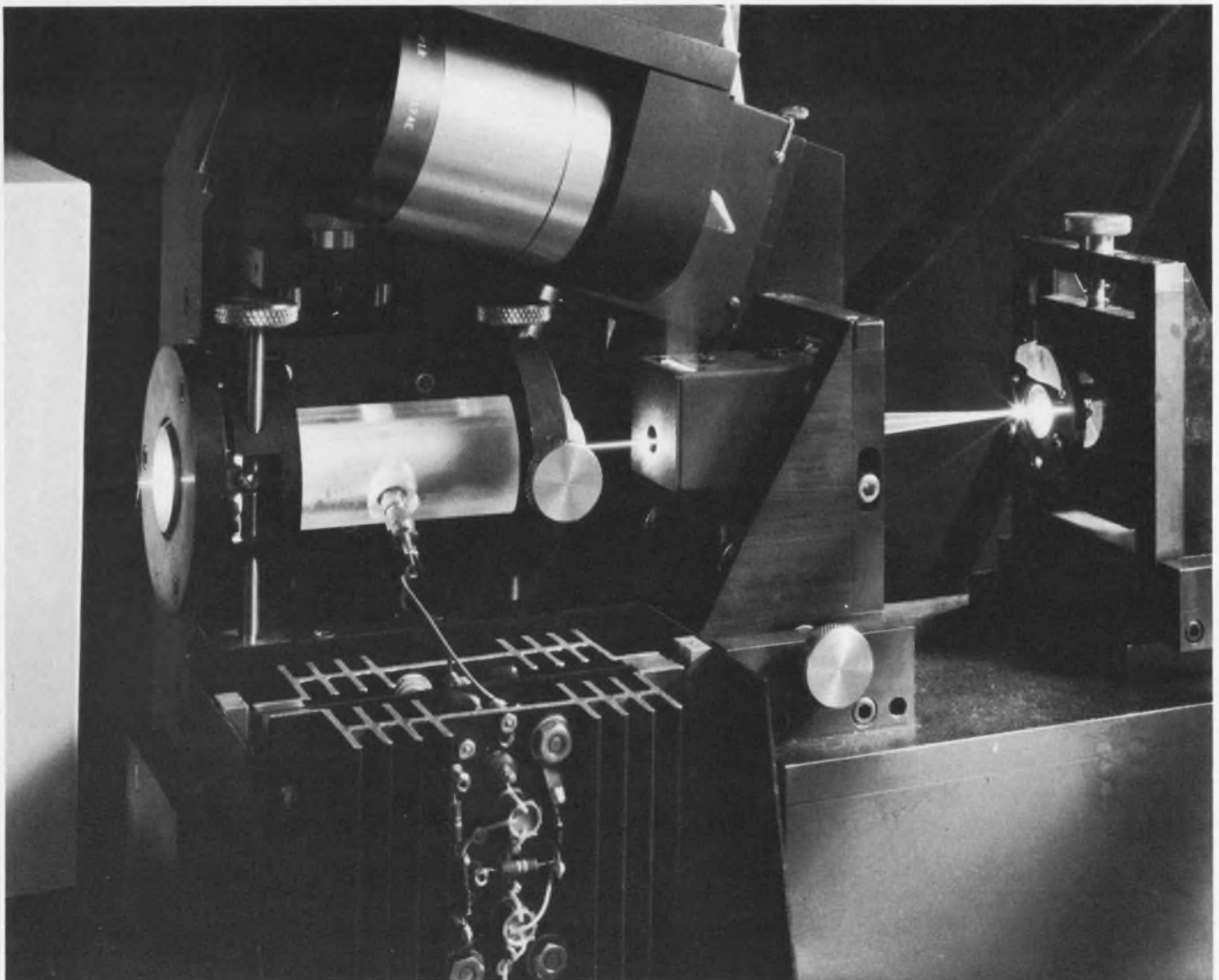

Laser beam is modulated by a video signal, then passed through horizontal and vertical moving-mirror scanners

to generate a television-like image in laser display unit. Standard television raster is achieved (Session 4D).

The basis for the system is four groups of remote sensors, or modules, suspended with equal vertical spacing in 60 feet of water. The modules clamp to a sea cable and receive power and synchronizing signals by inductive coupling from a single-conductor cable. A power winch positions the modules above the sea floor.

The terminal equipment on the platform consists of timing, signal-processing and recording units in a large cabinet and a command and display unit used for manual operation, checkout and maintenance. The system was built by the Amecom Div., Litton Systems, Inc., Silver Spring, Md.

Terminals above water

Power and frequency shift keying synchronization pulses from the terminal equipment are inductively coupled to the sensor modules, according to Dr. Hill. The sync pulses cause the module digitizer to convert sequentially the transducer output signals to serial 12-bit numbers. These numbers are returned to the surface by FSK modulation of a subcarrier multiplexed on the sea cable.

All four sensor modules transmit the same parameter information simultaneously. The data are separated by filtering, converted to dc binary code, and recorded in real time on magnetic tape.

Dr. Hill says each tape record contains a station code, the day and time of the record, followed by data points in a manually selected program.

Tape yields the data

At regular intervals the tape is returned to the

Institute of Ocean Technology for computer processing. This converts the serial binary recording, computes salinity and makes calibration corrections.

"Only a relatively few stations now permit in-depth recording of oceanographic behavior at the same time and place over long spans of time," Dr. Hill says. "This kind of information, in an easy-to-handle form is necessary to permit oceanographers to make meaningful long-term predictions about the ocean, not now possible because so few permanent stations exist."

Tricky communication problems

The ocean engineer will be concerned with unusual communications problems in exploiting the seas. In addition to conventional radio communications over the expanse of ocean, there is a need for improved wire and acoustic communications down to depths of thousands of feet.

General Electric has been studying the engineering problems of ocean exploration at these depths. It has considered power systems, structures, communications and the environmental monitoring and control necessary to sustain men and equipment.

"We are going to run into communications problems as we ambitiously pursue deep ocean programs," says Philip Staas a systems analysis engineer, who is presenting a paper, "Communications Requirements for Ocean Based Systems. He says his is an analytic approach to the problem in terms of range, signal-to-noise ratio, information bandwidth and degree of security required.

One oceanographer, Robert E. Stevenson of the



Computers and automatic control techniques will play a key role in future high-speed rail transportation systems.

The equipment carried by the man above operates the locomotive by remote radio control (Session 1E).

When, Where and What's New

Check the complete technical program at the show, by session, with the time and place for each paper

Airborne Electronics

Origins of the Controversy—Hon. R. A. Frosch, Assistant Secretary of the Navy (R&D), Washington, D.C. (6G. 1, Wed./p.m./M)

Which Path to Graceful Degradation and Growth Potential—Hon. R. D. O'Neal, Assistant Secretary of the Army (R&D), Washington, D.C. (6G. 2, Wed./p.m./M)

The Mission: Stepchild of Avionics Integration—H. Davis, Deputy Assistant Secretary of the Air Force (Special Programs), Washington, D.C. (6G. 3, Wed./p.m./M)

Functional Independence: By Choice, Not Chance!—W. T. Carnes, Aeronautical Radio, Inc., Annapolis, Md. (6G. 4, Wed./p.m./M)

Integration and Confederation: Complementary Tools for Progress—T. P. Cheatham, Jr., Grumman Aircraft Engineering Corp., Bethpage, N.Y. (6G. 5, Wed./p.m./M)

The World Weather Program—R. E. Hallgren, Environmental Science Admin., Rockville, Md. (8E. 1, Thurs./p.m./RS)

Suprapressure Balloon System—V. Lally, Jr., National Center for Atmospheric Research, Boulder, Colo. (8E. 3, Thurs./p.m./RS)

Antennas and Scattering Techniques

Jungle Radio Propagation—R. Vincent, Stanford Research Institute, Calif. (3F. 1, Tues./a.m./RN)

Notes Regarding Possible Field Strength vs Distance in Earth Crust Waveguides—A. D. Watt, G. F. Leydorf, A.N. Smith, Westinghouse Electric Corp., Boulder, Colo. (3F. 2, Tues./a.m./RN)

Short-wave Ionospheric Whispering Gallery—B. M. Langworthy, M. D. Grossi, Raytheon Co., Sudbury, Mass. (3F. 3, Tues./a.m./RN)

Vhf/uhf Propagation Between Low Antennas Over Irregular Terrain—R. S. Kirby, Institute for Tele-Communication Science, Boulder, Colo. (3F. 4, Tues./a.m./RN)

The Satellite Propagation Problem—H. W. Evans, Bell Telephone Labs. Inc., Holmdel, N.J. (3F. 5, Tues./a.m./RN)

Electro-optical Signal-Processing Techniques—L. B. Lambert, Columbia University, New York (4D. 1, Tues./p.m./G)

Adaptive Antenna Systems—B. Widrow, L. J. Griffiths, Stanford University, Calif.; P. E. Mantey, IBM, San Jose, Calif.; B. Goode, Navy Electronics Lab., San Diego, Calif. (7C. 4, Thurs./a.m./MH)

Circuits

Protection Against Internal Faults of High-Power Rectifier Equipment—M. Goldstein, Carbone Corp., Boonton, N.J. (5F. 2, Wed./a.m./RN)

Some Considerations for Coordinating Fuses and Power Semiconductors—M. Smith, The Bussman Mfg. Co., St. Louis (5F. 6, Wed./a.m./RN)

Surveillance Equipment—B. Jamil, Continental Telephone Supply Co., New York (6D. 1, Wed./p.m./G)

Overview of Digital Processing—C. M. Rader, MIT Lincoln Lab., Lexington, Mass. (7F. 1, Thurs./a.m./RN)

Implementation of Digital Filters—L. B. Jackson, J. F. Kaiser, H. S. McDonald, Bell Telephone Labs., Inc., Murray Hill, N.J. (7F. 3, Thurs./a.m./RN)

Applications of Homomorphic Filtering—A. V. Oppenheim, T. G. Stockham, MIT Lincoln Lab., Lexington, Mass. (7F. 4, Thurs./a.m./RN)

Circuit Theory

Methods for Processing Complex Waveforms Through Filters for Use in Monte Carlo Noise Studies—M. S. Corrington, T. C. Hilsinki—W. B. Schaming, RCA, Camden, N.J. (4E. 2, Tues./p.m./RS)

Pitfalls in the Indiscriminate Use of Algorithmic Methods for the Solution of Engineering Problems—R. W. Hamming, Bell Telephone

Labs., Inc., Murray Hill, N.J. (4E. 3, Tues./p.m./RS)

The Fast Fourier Transform and Its Applications—J. W. Cooley, P. A. W. Lewis, P. D. Welch, IBM, Yorktown Heights, N.Y. (4E. 4, Tues./p.m./RS)

Telecommunication System Design—D. C. McNelis, American Can Corp., New York (5B. 1, Wed./a.m./N)

Simulation of the Design of a Multiprocessing Computing System—F. C. Holland, The Mitre Corp., Bailey's Crossroads, Va.; N. A. Merikallio, IBM, Washington, D.C. (5B. 3, Wed./a.m./N)

A Three-Valued Computer Design Verification System—J. A. Jephson, P. McQuarrie, IBM, Endicott, N.Y. (5B. 4, Wed./a.m./N)

The Need for Current-Limiting Fuses in Circuits Containing Power Semiconductors—K. Lipman, Westinghouse Electric Corp., Buffalo, N.Y. (5F. 5, Wed./a.m./RN)

Communications

Nature—The New Interface in Electronics—R. Daniels, Interference Consultants, Boston (1F. 1, Mon./a.m./RN)

Hazards of Electromagnetic Radiation to Ordnance—C. M. Cormack, Naval Air Systems Command, Washington, D.C. (1F. 2, Mon./a.m./RN)

Radio Noise Predicts Inversions and Forecasts Smog—W. E. Buehler, Boeing Co., Seattle (1F. 3, Mon./a.m./RN)

Atmospheric Effects at Micron Wavelengths—D. C. Hogg, Bell Telephone Labs., Inc., Holmdel, N.J. (2F. 1, Mon./p.m./RN)

The Effects of the Atmosphere on Earth-to-Space Propagation at Millimeter Wavelengths—E. Altshuler, V. Falcone, K. Wulfsberg, Air Force Cambridge Research Labs., Bedford, Mass. (2F. 2, Mon./p.m./RN)

Rain Attenuation at Millimeter Wavelengths—R. Crame, MIT Lincoln Lab., Lexington, Mass. (2F. 3, Mon./p.m./RN)

Possible Terrestrial Common-Carrier

(2C.2, Mon./p.m./MH)

COMMEND 1—A Two-Dimensional Evaluation of Its Use.—F. Anderholm, IBM, Rochester, Minn. (2C.3, Mon./p.m./MH)

An On-Line Flight Data Conditioning System for SATURN V Post Flight Performance Evaluation—A. Liddell, E. Peresich, Boeing Co., Huntsville, Ala. (2C.4, Mon./p.m./MH)

Computer Assistance in the Layout of Integrated-Circuit Masks—W. Sutherland, MIT Lincoln Lab., Lexington, Mass. (4A.2, Tues./p.m./SN)

Telecommunication System Design—D. McNelis, American Can Corp., New York. (5B.1, Wed./a.m./N)

Telephone Transmission Performance Evaluation—M. Mugglin, Bell Telephone Labs., Inc., Holmdel, N.J. (5B.2, Wed./a.m./N)

Simulation of the Design of a Multiprocessing Computing System—F. Holland, The Mitre Corp. Bailey's Crossroads, Va.; N. Merikallio, IBM, Washington, D.C. (5B.3, Wed./a.m./N)

A Three-Valued Computer Design Verification System—J. Jephson, P. McQuarrie, IBM, Endicott, N.Y. (5B.4, Wed./a.m./N)

Dynamic Models of Power Systems: A Survey—A. El Abiad, Purdue University, Lafayette, Ind. (5B.5, Wed./a.m./N)

Computers

Hybrid Techniques for Computer Graphics—T. Hagan, Adage Ltd., Brighton, Mass. (1D.2, Mon./a.m./G)

Foundations of Stochastic Computing Systems—B. Gaines, Standard Telecommunication Labs., Ltd., Harlow, England (1D.3, Mon./a.m./G)

Information Transfer and Processing in Fiber Optics—C. Koester, L. Smith, E. Snitzer, American Optical Co., Framington, Mass. (1D.4, Mon./a.m./G)

Planning for High-Speed Ground Transportation—R. Hansen, MIT, Cambridge, Mass. (1E.1, Mon./a.m./RS)

A Case History—In-Depth Study of Error Characteristics in the Baudot Teletype System—C. Edwards, New York Central Railroad, New York (1E.2, Mon./a.m./RS)

Genie, A Dynamically Routed Taxi Bus—J. Brenand, General Research Corp., Santa Barbara, Calif. (1E.3, Mon./a.m./RS)

Trends in Rail Transportation—S. McElhenny, P. Ryan, GE, Erie, Pa. (1E.4, Mon./a.m./RS)

Highlight symposium: New Directions in Space (Tues./8:00-10:30 p.m./Grand Ballroom)

Keynote address: Dr. Robert C. Seamans, Jr., NASA consultant, will discuss the space agency's future plans emphasizing how we can better understand our total environment and better utilize the resources of the world by means of electronics in space.

Other speakers at the session:

Vast Potential in Ocean Resources, G. C. Ewing, Woods Hole Oceanographic Institute, Mass.

Infinite Variety of Land Resources, W. A. Fischer, U.S. Geological Survey, Dept. of the Interior, Washington, D.C.

Understanding the Atmosphere and Its Impact on Earth Economy, W. W. Kellogg, National Center for Atmospheric Research, University of Colorado, Boulder.

Electronics: The Technological Key, J. C. Elms, NASA Electronics Research Center, Cambridge, Mass.

A Rapid Synchronous-Logic Tenary Simulator—F. Fowler, Jr., North American-Rockwell Corp., Anaheim, Calif. (2C.1, Mon./p.m./MH)

Small-Card Wiring Changes on a Graphic Console—J. Lafuente, S. Plumb, IBM, Poughkeepsie, N.Y. (2C.2, Mon./p.m./MH)

COMMEND 1—A Two-Dimensional Evaluation of Its Use—F. Anderholm, IBM, Rochester, Minn. (2C.3, Mon./p.m./MH)

An On-Line Flight Data Conditioning System for SATURN V Postflight Performance Evaluation—A. Liddell, E. Peresich, Boeing Co., Huntsville, Ala. (2C.4, Mon./p.m./MH)

Evolution Potential for Automated Highways—S. Bruening, MIT, Cambridge, Mass. (2E.1, Mon./p.m./RS)

An Approach to Highway Automation—R. Fenton, K. Olson, J. Bender, Ohio State University, Columbus; R. Cosgriff, University of Kentucky, Lexington. (2E.2, Mon./p.m./RS)

The Metropolitan Toronto Traffic Control Signal System—J. Hewton, Toronto, Canada. (2E.3, Mon./p.m./RS)

Modern Developments in Intersection Control—R. Dobel, Philco-Ford Corp., Palo Alto, Calif. (2E.4, Mon./p.m./RS)

Computer Graphics in Acoustics Research—A. Noll, Bell Telephone Labs., Inc., Murray Hill, N.J. (3A.1, Tues./a.m./SN)

The Control of Human Learning—B. Gaines, Standard Telecommunication Labs., Ltd., Harlow, England. (3A.2, Tues./a.m./SN)

Where People Look and Why—J. Senders, Brandeis University, Waltham, Mass. (3A.3, Tues./a.m./SN)

LSI and Small Computers—P. Low, IBM, Hopewell Junction, N.Y. (3D.3, Tues./a.m./G)

LSI and Large Computers—L. Spandorfer, Sperry Rand Corp., Blue Bell, Pa. (3D.4, Tues./a.m./G)

Applications of Large-Scale Time Sharing—M. Spierer, Systems Development Corp., Santa Monica, Calif. (4A.1, Tues./p.m./SN)

Computer Assistance in the Layout of Integrated-Circuit Masks—W. Sutherland, MIT Lincoln Lab., Lexington, Mass. (4A.2, Tues./p.m./SN)

The Computer as a Mathematical Assistant—J. Moses, Project MAC, MIT, Cambridge, Mass. (4A.3, Tues./p.m./SN)

On Interactive Computer Networks—L. Roberts, Advanced Research Projects Agency, U.S. Dept. of Defense, Washington, D.C. (4A.4, Tues./p.m./SN)

Visual Perception of Computer-Generated Patterns—B. Julesz, Bell Telephone Labs., Inc., Murray Hill, N.J. (4C.4, Tues./p.m./MH)

Laser Display Technology—C. Baker, Texas Instruments, Dallas. (4D.4, Tues./p.m./G)

Off-the-Shelf Black Boxes for Programming—W. Gentleman, Bell Telephone Labs., Inc., Murray Hill, N.J. (4E.1, Tues./p.m./RS)

Methods for Processing Complex Waveforms Through Filters for Use in Monte Carlo Noise Studies—M. Corrington, T. Hilsinki, W. Schaming, RCA, Camden, N.J. (4E.2, Tues./p.m./RS)

Pitfalls in the Indiscriminate Use of Algorithmic Methods for the Solution of Engineering Problems—R. Hamming, Bell Telephone Labs., Inc., Murray Hill, N.J. (4E.3, Tues./p.m./RS)

The Fast Fourier Transform and Its Applications—J. Cooley, P. Lewis, P. Welch, IBM, Yorktown Heights, N.Y. (4E.4, Tues./p.m./RS)

Software Trends for Graphical and Pictorial Output—K. Knowlton, Bell Telephone Labs., Inc., Murray Hill, N.J. (5A.1, Wed./a.m./SN)

Hardware Trends for Artistic Visual Displays—G. Michaels, Lawrence Radiation Labs., Livermore, Calif. (5A.2, Wed./a.m./SN)

A Critic's View of Computer Art—K. Bull, Lexington, Mass. (5A.3, Wed./a.m./SN)

Simulation of the Design of a Multiprocessing Computing System—F. Holland, The Mitre Corp, Bailey's Crossroads, Va.; N. Merikallio, IBM, Washington, D.C. (5B.3, Wed./a.m./N)

A Three-Valued Computer Design Verification System—J. Jephson, P. McWuarrie, IBM, Endicott, N.Y. (5B.4, Wed./a.m./N)

Relationships of Elements to Systems in Brains and Computers—E. Lewis, University of California, Berkeley. (6A.3, Wed./p.m./SN)

What is the Ethical Responsibility of the Engineer in the Design of Privacy Safeguards in Information Processing Systems?—P. Baran, The Rand Corp., Santa Monica, Calif. (6D.3, Wed./p.m./G)

Reliability Modeling of Automatically Repaired Computers—W. Bouricius, W. Carter, P. Schneider, IBM, Yorktown Heights, N.Y. (7B.1, Thurs./a.m./N)

Functional Techniques for Efficient Digital Fault Simulation—E. Manning, Y. Chang, Bell Telephone Labs., Inc., Naperville, Ill. (7B.2, Thurs./a.m./N)

Application for Concurrent Diagnosis and Replacement in a Self-Repairing Computer—A. Avizienis, University of California, Los Angeles; D. Rennels, J. Rohr, Jet Propulsion Lab., Pasadena, Calif. (7B.3, Thurs./a.m./N)

Automatic Fault Isolation Techniques for Nondigital Applications—R. Ranalli, North American-Rockwell Corp., Anaheim, Calif. (7B.4, Thurs./a.m./N)

Learning Adaptive Curve-Fitting and Stochastic Tracking—S. Chang, T. Peng, State University of New York, Stony Brook. (7C.1, Thurs./a.m./MH)

Self-Learning Systems — What Are They?—Y. Tsytkin, Institute of Automatics and Telemechanics Academy of Sciences of the USSR, Moscow (7C, Thurs./a.m./MH)

An Adaptive Search Technique for Multi-model Surfaces—J. Hill, Battelle Memorial Institute, Columbus, Ohio (7C.3, Thurs./a.m./MH)

Adaptive Antenna Systems—B. Widrow, L. Griffiths, Stanford University, Calif; P. Mantey, IBM, San Jose, Calif.; B. Goode, Navy Electronics Lab., San Diego, Calif. (7C.4, Thurs./a.m./MH)

Four Basic Concepts for On-Line Learning Control—J. Mendel, Douglas Missile and Space Systems Div., Santa Monica, Calif. (7C.5, Thurs./a.m./MH)

Logic Organization — Its Impact on Interconnection Density—R. Farquharson, RCA, Camden, N.J. (7D.3, Thurs./a.m./G)

Automatic Fault Detection—J. Lawrence, T. Urben, General Post Office, London (8B.1, Thurs./p.m./N)

Problems of and Solutions to Automatic Testing Equipment for Switching Installations—M. Waitz, Standard Elektrik, Stuttgart, Germany (8B.2, Thurs./p.m./N)

Sample Tests in Telephone Switching Systems Will Replace Preventive Maintenance by Corrective Maintenance.—H. Hochmuth, Siemens AG, Munich, Germany (8B.3, Thurs./p.m./N)

Automatic Maintenance of a Universal Electronic Switching System—C. Richmond, C. Atwater, A. Hocht, W. Hastings, Stromberg-Carlson Corp., Rochester, N.Y. (8B.4, Thurs./p.m./N)

Maintenance of a Large Electronic Switching System—S. Tsiang, G. Haugk, H. Seckler, Bell Telephone Labs., Inc., Naperville, Ill. (8B.5, Thurs./p.m./N)

Cybernetics

Introduction—L. Harmon, Bell Telephone Labs., Inc., Murray Hill, N.J. (6A.1, Wed./p.m./SN)

Images and Models of the Brain—J. Cowan, University of Chicago (6A.2, Wed./p.m./SN)

Relationships of Elements to Systems in Brains and Computers—E. Lewis, University of California, Berkeley (6A.3, Wed./p.m./SN)

Coding, Flow and Use of Information in Nervous Systems—L. Lipetz, Ohio State University, Columbus. (6A.4, Wed./p.m./SN)

Engineering Education

A System for Individualization and Optimizing Learning Through Computer Management of the Educational Process—A. Schure, New York Institute of Technology, Old Westbury (1A.1, Mon./a.m./SN)

Engineering and the Technological Society—R. C. Dorf, University of Santa Clara, Calif. (1A.2, Mon./a.m./SN)

Graduate Engineering Education Via Television—M. Forsman, University of Florida, Gainesville (1A.3, Mon./a.m./SN)

Toward an Individualized Education—E. Shelley, E. F. Shelley & Co., Inc., New York (1A.4, Mon./a.m./SN)

An Empirically Designed High-School Program—R. Morgan, U.S. Office of Education, Washington, D.C. (1A.5, Mon./a.m./SN)

Merits of Blackboard by Wire on the

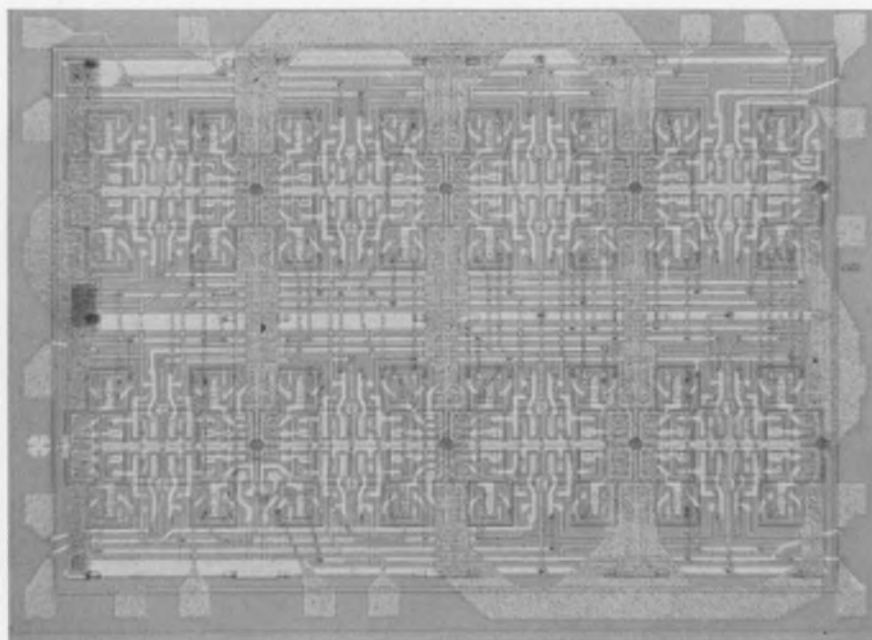

Two-layer bipolar LSI chip from Fairchild semiconductor is made from eight standard diffused cells (Session 3D).

Special Microwave Presentations Coliseum, Microwave Hall (South American Room)

Session I. Materials for Microwaves

Monday and Wednesday mornings, March 18 and 20, 10:30 A.M.-1:00 P.M.

10:30 A.M. Semiconductor Materials for Microwave Devices, F. Williams, Monsanto Co., St. Louis, Mo.

11:20 A.M. Ferrimagnetic Materials for Microwave Devices, R. West, A. Blankenship, Trans-Tech, Gaithersburg, Md.

12:10 P.M. Tutorial on Stripline, H. Howe, Microwave Associates, Burlington, Mass.

Session II. Components for Microwave Integrated Circuits

Monday and Wednesday afternoons, March 18 and 20, 2:30-5:00 P.M.

2:30 P.M. Microwave Solid-State Sources-Trends and Applications,

R. Lorentzen, RCA, Harrison, N.J.

3:20 P.M. Application of Integrated Circuit Techniques at UHF and Microwave Frequencies, A. Botka, M. Gilden, R. Blight, C. Buffler, Microwave Associates, Burlington, Mass.

4:10 P.M. Integrated Circuit Technology Applicable to Functional Microwave Modules, G. Harrison, J. Allen, Sperry Rand Corp., Clearwater, Fla.

Session III. Microwaves for Space

Tuesday and Thursday mornings, March 19 and 21, 10:30 A.M.-1:00 P.M.

10:30 A.M. Exploration and Exploitation of the 3 cm-to-3 mm Wavelength Region, H. Ewen, Ewen-Knight Corp., East Natick, Mass.

11:20 A.M. A Millimeter Wave Propagation Experiment from the ATS-E Spacecraft, J. Dees, J.

King, J. Wiltse, Martin Marietta Corp., Orlando, Fla.

12:10 P.M. Low-Noise Receivers for the Reception of Signals from Space, C. Cuccia, Philco-Ford, Palo Alto, Calif.

Session IV. Microwave Frequency Control Measurements

Tuesday and Thursday afternoons, March 19 and 21, 2:30-5:00 P.M.

2:30 P.M. A Comparison of the Various Techniques for the Accurate Measurement of Microwave Frequencies, R. Voyles, Systron-Donner Corp., Concord, Calif.

3:20 P.M. Electronically Tuned Oscillators, F. Voorhaar, Omni Spectra, Farmington, Mich.

4:10 P.M. Computer-Controlled Network Analyzer for Microwave Measurements, J. Cardoza, R. Hackborn, Hewlett-Packard, Palo Alto, Calif.

Educational Scene—M. Ristenbatt, University of Michigan, Ann Arbor (2A.1, Mon./p.m./SN)

Conceptual Design of a Television System for Continuing Education—A. Morris, Genesys Systems, Inc., and Consultant to School of Engineering, Stanford University, Calif. (2A.2, Mon./p.m./SN)

The Curriculum — A Continuing Transient—N. Balabanian, Syracuse University, N.Y. (2A.3, Mon./p.m./SN)

Factors Affecting the Choice of Instructors for Continuing Engineering Studies Programs—I. Katz, Northeastern University, Boston (2A.4, Mon./p.m./SN)

An Observer's View: Continuing Engineering Education — Today and Tomorrow—H. Ravis, Electronic Design, New York (2A.5, Mon./a.m./SN)

Revolution in Patents — The International View—A. Bogesch, United International Bureau for the Protection of Intellectual Property, Geneva (2B.1, Mon./p.m./N)

Revolution in Patents — The United States' View—F. Neuhauser, GE, Washington, D.C. (2B.2, Mon./p.m./N)

Role in Business of Engineering Economy—A. Froggatt, AT&T, New York (3C.1, Tues./a.m./MH)

Tutorial Session on Engineering Economy—A. Lesser, Stevens Insti-

tute of Technology, Hoboken, N.J. (3C.3, Tues./a.m./MH)

Engineering Economy Problems of Integrated Circuit Applications—B. List, Texas Instruments, Dallas (3C.3, Tues./a.m./MH)

Engineering Economy Decision in Large System Applications—E. Greene, GE, Erie, Pa. (3C.4, Tues./a.m./MH)

The Education and Training of Engineers for Effective Use of Computers—J. Aronofsky, Mobil Oil Corp., New York; M. Tayyabkhan, Realtime Systems, Inc., Fullerton, Calif. (5C.1, Wed./a.m./MH)

Computer Graphics as a Tool for Engineering Development and Design—J. Malakoff, Beckman Instruments, Inc., Fullerton, Calif. (5C.2, Wed./a.m./MH)

Computers as a Tool for Managing the Functions of Engineering—G. Rath, Northwestern University, Evanston, Ill. (5C.3, Wed./a.m./MH)

Computers as a Tool for Managing the Information Explosion—W. Carlson, IBM, Armonk, N.Y. (5C.4, Wed./a.m./MH)

Latin American Technology—G. Andrews, Compania Standard Electric Argentina, Buenos Aires (6C.1, Wed./p.m./MH)

Japanese Technology—K. Kobayashi, Nippon Electric Co., Ltd., Tokyo (6C.2, Wed./p.m./MH)

European Technology—M. Ponte, Compagnie Generale de Telegraphie sans Fil, Paris (6C.3, Wed./p.m./MH)

Human Engineering

Computer Graphics in Acoustics Research—A. Noll, Bell Telephone Labs., Inc., Murray Hill, N.J. (3A.1, Tues./a.m./SN)

The Control of Human Learning—B. Gaines, Standard Telecommunication Labs., Ltd., Harlow, England (3A.2, Tues./a.m./SN)

Where People Look and Why—J. Senders, Brandeis University, Waltham, Mass. (3A.3, Tues./a.m./SN)

Application of Large-Scale Time Sharing—M. Spierer, Systems Development Corp., Santa Monica, Calif. (4A.1, Tues./p.m./SN)

What Psychophysics Has to Offer the Electronics Engineer—C. Hirsch, Princeton, N.J. (4C.1, Tues./p.m./MH)

The Perception of Color—R. Evans, Eastman Kodak Co., Rochester, N.Y. (4C.2, Tues./p.m./MH)

The Waveguide Theory of Color Vision—A. Schroeder, RCA Labs., Princeton, N.J. (4C.3, Tues./p.m./MH)

Visual Perception of Computer-Generated Patterns—B. Julesz, Bell

Telephone Labs., Inc., Murray Hill,
N.J. (4C.4, Tues./p.m./MH)

Industrial Electronics

The Zener Diode, a Working Direct Voltage Standard—W. Eicke, Jr., National Bureau of Standards, Washington, D.C. (3B.1, Tues./a.m./N)

The New Generation of Digital Voltmeters—D. Johnson, Lear Siegler, Inc., San Diego, Calif. (3B.2, Tues./a.m./N)

Active Direct Voltage Standards—J. Kimball, Cohu Electronics, Inc., San Diego, Calif. (3B.3, Tues./a.m./N)

Generation of Precision Alternating Voltages—P. Richman, Lexington, Mass. (3B.4, Tues./a.m./N)

The Industrial Future of Sonic Power—R. McMaster, C. Libby, Ohio State University, Columbus (4F.1, Tues./p.m./RN)

The Design of High-Power Ceramic Transducer Assemblies—N. Maropis, Aeroprojects, Inc., West Chester, Pa. (4F.2, Tues./p.m./RN)

The Design and Application of High-Power Sonic Transducers—H. Minchenko, W. White, The Ohio State University, Columbus (4F.3, Tues./p.m./RN)

A Calorimetric Apparatus and Method for Evaluation of Transducer Assemblies—J. Jones, Aeroprojects, Inc., West Chester, Pa. (4F.4, Tues./p.m./RN)

Recent New Application for High-Power Ultrasonic Systems—R. Soloff, Branson Sonic Power Co., Danbury, Conn. (4F.5, Tues./p.m./RN)

Protection Against Internal Faults of High-Power Rectifier Equipment—M. Goldstein, Carbone Corp., Boonton, N.J. (5F.2, Wed./a.m./RN)

Fundamental Behavior of High-Speed Fuses for Protecting Silicon Diodes and Thyristors—E. Jacks, The English Electric Co., Ltd., Liverpool, England (5F.3, Wed./a.m./RN)

Fuse Characteristics Essential to the Protection of Thyristors—P. Jacobs, The Chase-Shawmut Co., Newburyport, Mass. (5F.4, Wed./a.m./RN)

The Need for Current-Limiting Fuses in Circuits Containing Power Semiconductors—K. Lipman, Westinghouse Electric Corp., Buffalo, N.Y. (5F.5, Wed./a.m./RN)

Some Considerations for Coordinating Fuses and Power Semiconductors—M. Smith, The Bussman Mfg. Co., St. Louis (5F.6, Wed./p.m./RN)

Electronic Typesetting—J. Boyle, U.S. Government Printing Office, Washington, D.C. (7A.1, Thurs./a.m./SN)



Long-term changes in vegetation, such as in the Florida Everglades above, can be spotted by aircraft and satellite infrared color photography. Numbers help identify various land features (Highlight session).

Electronics—Reproduction Photography—H. Phillips, Rochester Institute of Technology, N.Y. (7A.2, Thurs./a.m./SN)

Electronics in Imaging and Printing—H. George, Gravure Research Institute, Port Washington, N.Y. (7A.3, Thurs./a.m./SN)

Instrumentation and Control—Electronics in the Printing Process—E. Harselm, Graphic Arts Technical Foundation, Pittsburgh (7A.4, Thurs./a.m./SN)

Electronic Distribution of Graphic Materials—J. Tewlow, American Newspaper Publishers Association Research Institute, Easton, Pa. (7A.5, Thurs./a.m./SN)

Management

Management of Technical and Intellectual Resources—Albert Shapero, University of Texas, Austin (1C.1, Mon./a.m./MH)

Project Management in Research and Development—Irwin Rubin, MIT Sloan School of Management,

Cambridge, Mass. (1C.2, Mon./a.m./MH)

Technological Forecasting: The Exploratory and Normative Approaches—M. J. Cetron, U.S. Naval Material Command, Washington, D.C. (1C.3, Mon./a.m./MH)

The Information-Seeking Behavior of Researchers—G. J. Rath, Northwestern University, Evanston, Ill. (1C.4, Mon./a.m./MH)

Revolution in Patents—The International View—Arpad Bogsch, United International Bureau for the Protection of Intellectual Property, Geneva (2B.1, Mon./p.m./SN)

Revolution in Patents—The United States' View—Frank Neuhauser, GE, Washington, D.C. (2B.2, Mon./p.m./SN)

Role in Business of Engineering Economy—A. M. Froggatt, AT&T, New York (3C.1, Tues./a.m./MH)

Tutorial Session on Engineering Economy—Arthur Lesser, Stevens Institute of Technology, Hoboken, N.J. (3C.2, Tues./a.m./MH)

of Semiconductors and Related Hardware (paper includes a film), F. Davis, Westinghouse Research Labs., Pittsburgh; M. Lauriente, Westinghouse Aerospace Div., Baltimore (4B.3, Tues./p.m./N)

Recent Advances in Materials for Electrical Insulation—J. Swiss, Westinghouse Electric Corp., Pittsburgh (5D.1, Wed./a.m./G)

Chemistry in Solid-State Devices—F. H. Horn, GE, Schenectady, N.Y. (5D.2, Wed./a.m./G)

The Chemistry of Fuel Cell Energy Processes—G. R. Frynsinger, U. S.

Army Electronics Command, Ft. Monmouth, N.J. (5D.3, Wed./a.m./G)

The Lead and Zinc Industries' Interest in the Electric Vehicle—A. R. Cook, International Lead Zinc Research Organization, Inc., New York (5D.4, Wed./a.m./G)

The Chemistry and Technology of Batteries for Today and Tomorrow—R. C. Shair, Gulton Industries, Inc., Metuchen, N.J. (5D.5, Wed./a.m./G)

Hybrid System Integration—M. Desai, W. A. Koelsch, Fairchild Semi-

conductor, Palo Alto, Calif. (7D.1, Thurs./a.m./G)

Packaging for Spacecraft Application—L. Katzin, Jet Propulsion Lab., Pasadena, Calif. (7D.2, Thurs./a.m./G)

Logic Organization—Its Impact on Interconnection Density—R. Farquharson, RCA, Camden, N.J. (7D.3, Thurs./a.m./G)

Multilayer Ceramic Interconnection Substrates—E. G. Fagersten, Dielectric Systems, Inc., San Diego, Calif. (7D.4, Thurs./a.m./G)

Medical Electronics

Nature—The New Interface in Electronics—R. Daniels, Interference Consultants, Boston (1F.1, Mon./a.m./RN)

Patient-Oriented Delivery of Health Services—C. Caceres, U.S. Public Health Service, Washington, D.C. (8A.1, Thurs./p.m./SN)

Why Plan for Payoff—G. B. Devey, National Academy of Engineering, Washington, D.C. (8A.2, Thurs./p.m./SN)

On Beating Swords into Plowshares—A. Kahn, Hoffman-LaRoche, Nutley, N.J. (8A.3, Thurs./p.m./SN)

BME—Its Brawn-Brain Barrier—Charles Ray, Johns Hopkins School of Medicine, Baltimore (8A.4, Thurs./p.m./SN)

Beating Plowshares into Swords—J. H. U. Brown, National Institutes of Health, Bethesda, Md. (8A.5, Thurs./p.m./SN)

Microelectronics

Considerations of Large-Scale Integration of High-Speed Circuits—D. Chung, Texas Instruments, Dallas (1D.1, Mon./a.m./G)

Engineering Economy Problems of Integrated-Circuit Applications—B. H. List, Texas Instruments, Dallas (3C.3, Tues./a.m./MH)

Customized LSI Technology—G. E. Moore, Fairchild Camera & Instrument Corp., Palo Alto, Calif. (3D.1, Tues./a.m./G)

The Evolution of LSI Technology to Standard Products—C. G. Thornton, Philco-Ford Corp., Blue Bell, Pa. (3D.2, Tues./a.m./G)

LSI and Small Computers—P.R. Low, IBM, Hopewell Junction, N.Y. (3D.3, Tues./a.m./G)

LSI and Large Computers—L.M. Spandorfer, Sperry Rand Corp., Blue Bell, Pa. (3D.4, Tues./a.m./G)

Computer Assistance in the Layout of Integrated Circuit Masks—W. R. Sutherland, MIT Lincoln Lab., Lex-

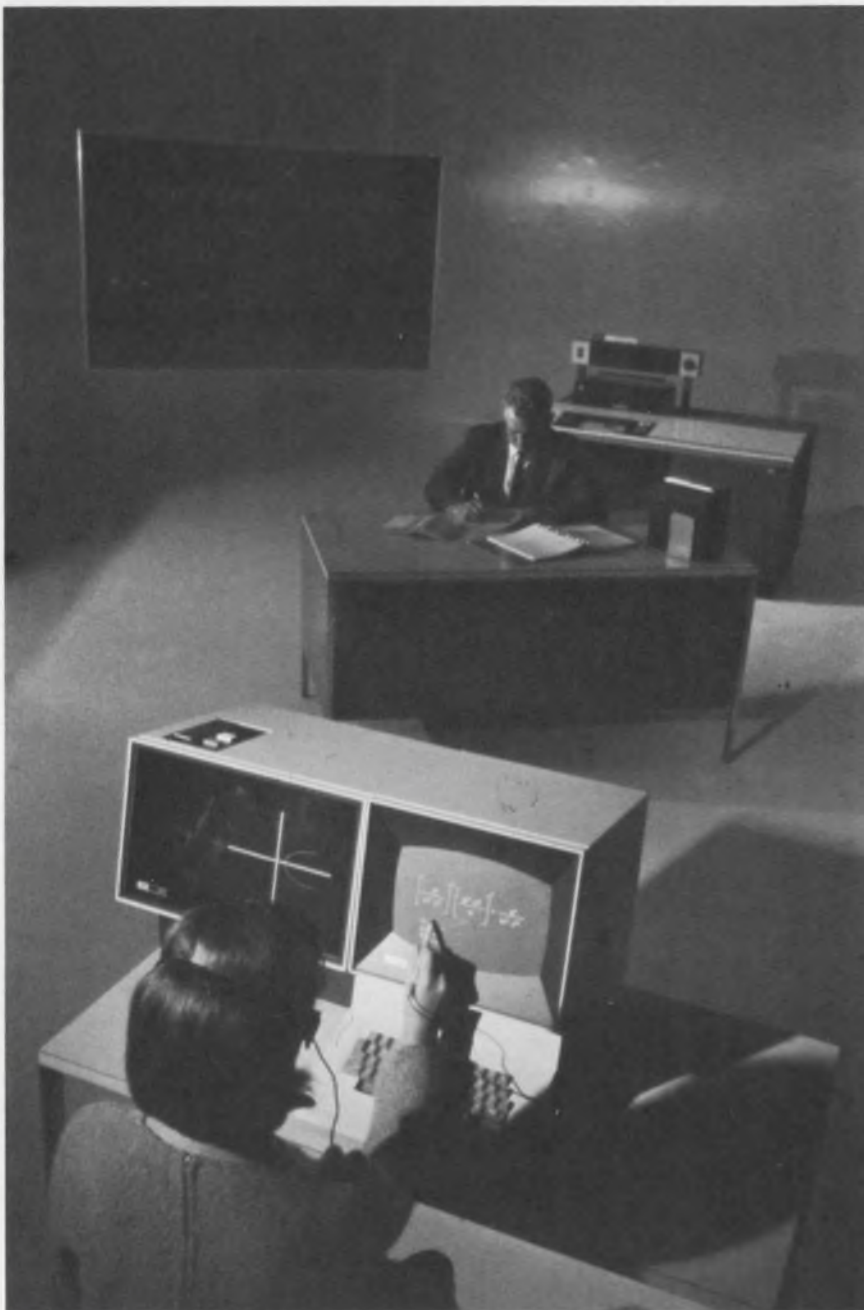

Men and computers, how they communicate and interact on-line and at the console—is the subject of Session 4A.

ington, Mass. (4A.2, Tues./p.m./SN)

Microwaves

Atmospheric Effects at Micron Wavelengths—D. C. Hogg, Bell Telephone Labs., Inc. Holmdel, N.J. (2F.1, Mon./p.m./RN)

The Effects of the Atmosphere on Earth-to-Space Propagation at Millimeter Wavelengths—E. E. Altshuler, V. J. Falcone, K. N. Wulfsberg, Air Force Cambridge Research Labs., Bedford, Mass. (2F.2, Mon./p.m./RN)

Rain Attenuation at Millimeter Wavelengths—R. K. Crane, MIT Lincoln Lab., Lexington, Mass. (2F.3, Mon./p.m./RN)

Possible Terrestrial Common-Carrier Applications Above 10 GHz—S. D. Hathaway, Bell Telephone Labs., Inc., Holmdel, N.J. (2F.4, Mon./p.m./RN)

Electro-optical Signal-Processing Techniques—L. B. Lambert, Columbia University, New York (4D.1, Tues./p.m./RS)

Modern Holography—E. N. Leith, University of Michigan, Ann Arbor (4D.2, Tues./p.m./RS)

Optical Nonlinear and Parametric Devices—J. E. Geusic, Bell Telephone Labs., Inc., Murray Hill, N.J. (4D.3, Tues./p.m./RS)

Laser Display Technology—C. E. Baker, Texas Instruments, Dallas (4D.4, Tues./p.m./RS)

The Laser Gyro—F. Aronowitz, Honeywell, Inc., St. Paul, Minn. (4D.5, Tues./p.m./RS)

Keynote to the Session—D. Silver-

man, Pan American Petroleum Corp., Tulsa, Okla. (5E.1, Wed./a.m./RS)

Optical Processing in the Earth Sciences—M. B. Dobrin, United Geophysical Co., Pasadena, Calif. (6E.5, Wed./p.m./RS)

A Conditional Probability and Statistical Study of Crop Discrimination with Radar Images—F. Caspall, R. Haralick, R. Moore, D. Simonett, University of Kansas, Lawrence (6E.6, Wed./p.m./RS)

Military Electronics

Hazards of Electromagnetic Radiation to Ordnance—C. M. Cormack, Naval Air Systems Command, Washington, D.C. (1F.2, Mon./a.m./RN)

Jungle Radio Propagation—R. Vincent, Stanford Research Institute, Calif. (3F.1, Tues./a.m./RN)

Origins of the Controversy—Hon. R. A. Frosch, Assistant Secretary of the Navy (R&D), Washington, D.C. (6G.1, Wed./p.m./M)

Which Path to Graceful Degradation and Growth Potential?—Hon. R. D. O'Neal, Assistant Secretary of the Army (R&D), Washington, D.C. (6G.2, Wed./p.m./M)

The Mission: Stepchild of Avionics Integration—H. Davis, Deputy Assistant Secretary of the Air Force (Special Programs), Washington, D.C. (6G.3, Wed./p.m./M)

Functional Independence: By Choice, Not Change!—W. T. Carnes, Aeronautical Radio, Inc., Annapolis, Md. (6G.4, Wed./p.m./M)

Integration and Confederation: Complementary Tools for Progress—T. P. Cheatham, Jr., Grumman Aircraft Engineering Corp., Bethpage, N.Y. (6G.5, Wed./p.m./M)

Nuclear Electronics

The 200-GeV Accelerator—M.S. Livingston, National Accelerator Lab., Oak Brook, Ill. (1B.1, Mon./a.m./N)

The Stanford Two-Mile Linear Accelerator—R. B. Neal, SLAC, Stanford University, Calif. (1B.2, Mon./a.m./N)

New Accelerators for Nuclear Research—R. S. Livingston, Oak Ridge National Lab., Tenn. (1B.3, Mon./a.m./N)

The Impact of Computers on The Control of Particle Accelerators—H. S. Butler, Los Alamos Research Lab., N.M. (1B.4, Mon./a.m./N)

The Superconducting Linear Accelerator—A Step Into the Future—H.A. Schwettman, Stanford University, Calif. (1B.5, Mon./a.m./N)

Oceanography and Underwater Systems

Geologically Affected Variations of the Earth—Patrick Thaddeus, Columbia University, New York (5E.3, Wed./a.m./RS)

Navocean Calibration Maintenance—M. L. Sims, U.S. Naval Oceanographic Office, Washington, D.C. (6B.5, Wed./p.m./N)

Design of Synoptic Oceanographic Data System—R. F. Hill, K. E.



Concorde 001, the first model of the Anglo-French supersonic airliner is scheduled for its maiden flight later

this spring. European technology compared with that in the U.S. will be covered in Session 6C.

PLUG-IN RF MODULES		K10237		K10324	K10325-6	K10327-8
MODULE	FREE RUNNING	STABILIZED	STABILIZED	STABILIZED	STABILIZED	STABILIZED
FREQUENCY RANGES VARIABLE:	.05-110MHz	1-10MHz	10-70MHz	0.1-1.0MHz	1.0-5.0MHz 5.0-10.0MHz	10-30MHz 30-70MHz
RESIDUAL FM LINE RELATED: RANDOM:	500Hz pk 100Hz pk	100Hz pk 50Hz pk	400Hz pk 100Hz pk	5Hz pk 5Hz pk	5Hz pk 5Hz pk	20Hz pk 20Hz pk
SWEEP WIDTH RANGES VARIABLE:	0-100MHz	 <ul style="list-style-type: none"> ■ 50 KHz to 110 MHz ■ 100 KHz to 70 MHz Stabilized Narrow Sweep and CW ■ Wide Sweep ■ Markers 				
AM SPURIOUS HARMONIC: NON-HARMONIC:	below—30 db below—30 db					
SWEEP LINEARITY 100 MHz SWEEP: (WIDE) 0-4% SWEEP: (MEDIUM) 0-1% SWEEP: (NARROW)	±5% (of sweep width)					
STABILIZED OUTPUT FREQUENCIES	FREQUENCY SETTABILITY FIXED STEPS: VERNIER:	10KHz 20Hz	100KHz 200Hz	1KHz 2Hz	10KHz 20Hz	100KHz 200Hz
	FREQUENCY CALIBRATION FIXED STEPS: FIXED plus vernier:	± .002% Accuracy (% of indicated frequency) ± .01% Accuracy (% of indicated frequency)				
	FREQUENCY DRIFT ONE MINUTE ONE HOUR 10 VOLT LINE VAR. PER °CENTIGRADE	± 5ppm on 0—1% Sweep Range; ±20ppm on 0—4%. ± 20ppm on 0—1% Sweep Range; ±80ppm on 0—4%. ± 10ppm on 0—1% Sweep Range; ±20ppm on 0—4%. ± 30ppm on 0—1% Sweep Range; ± 120ppm on 0—4%. (AFTER 10 MINUTE WARMUP)				

Sweep-synthesizer performance at far from "synthesizer" cost.

BOOTH 2D25-2D31 AT IEEE.

The Syntha Sweep 101-A offers not only 100 MHz wide sweeps, versatile pulse and birdie marker plug-ins, and sophisticated sweep and manual frequency controls; but also superb, low residual and narrow-sweep capability. It brings a new order of swept and CW stability, of narrow band frequency marking, of calibrated CW output frequencies, and of programmable swept and CW operation through the use of newly developed IC synthesizer circuitry.

NEW MODEL 101-A

Solid-state wide sweeps now locked for STABLE narrow sweeps and CW ■ direct reading digital frequency dial now .01% accurate for CW and narrow sweeps ■ voltage-controlled sweeps now precision controlled for computer control ■ Horizontal and vertical pulse markers spaced only cycles apart.

Complete systems for less than \$2,900.00

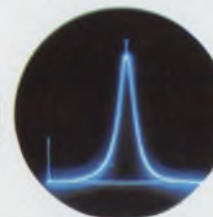

KAY

ELECTRIC COMPANY

MAPLE AVENUE, PINE BROOK, NEW JERSEY 07058 • 201 / 227-2000

Digital Filter Synthesis by Sampled-Data Transformation—R. M. Golden, Autonetics, Anaheim, Calif. (7F.2, Thurs./a.m./RN)

Implementation of Digital Filters—L. B. Jackson, J. F. Kaiser, H. S. McDonald, Bell Telephone Labs., Inc., Murray Hill, N.J. (7F.3, Thurs./a.m./RN)

Applications of Homomorphic Filtering—A. V. Oppenheim, T. G. Stockham, MIT Lincoln Lab., Lexington, Mass. (7F.4, Thurs./a.m./RN)

Processing for Digital Transmission—T. Sekimoto, Nippon Electric Co., Ltd., Kawasaki, Japan (8F.1, Thurs./p.m./RN)

Basic Issues in PCM Switching—W. T. Duerdoth, L. R. F. Harris, H. B. Law, General Post Office, London (8F.2, Thurs./p.m./RN)

Multiplexing in a Digital Transmission Hierarchy—R. A. Kelley, Bell Telephone Labs., Inc., Holmdel, N.J. (8F.3, Thurs./p.m./RN)

Problems and Opportunities in Digital Transmission—K. W. Cattermole, Standard Telecommunication Labs., Ltd., Harlow, England (8F.4, Thurs./p.m./RN)

Solid-State Devices and Theory

Magnetic Devices—R. Barker, Yale University, New Haven, Conn. (2D.1, Mon./p.m./G)

Piezoelectric and Ferro-Electric Devices—D. Berlincourt, Clevite Corp., Cleveland (2D.2, Mon./p.m./G)

Superconductor Devices—K. Rose, Rensselaer Polytechnic Institute, Troy, N.Y. (2D.3, Mon./p.m./G)

Semiconductor Devices—E. O. Johnson, RCA, Harrison, N.J. (2D.4, Mon./p.m./G)

Transient Infrared Radiation: Promising New Approach to Probe Semiconductor Performance—W. Lurie, NASA-ERC, Cambridge, Mass.; R. Vanzetti, Raytheon Co., Wayland, Mass. (4B.1, Tues./p.m./N)

Implementation of IR Diagnosis Techniques for Solid-State Circuits (an AF-APL film)—Wright Patterson Air Force Base, Dayton, Ohio (4B.2, Tues./p.m./N)

Chemistry in Solid-State Devices—F. H. Horn, GE, Schenectady, N.Y. (5D.2, Wed./a.m./G)

Power Semiconductor I²t Ratings—F. B. Golden, GE, Auburn, N.Y. (5F.1, Wed./a.m./RN)

Protection Against Internal Faults of High-Power Rectifier Equipment—M. M. Goldstein, Carbone Corp., Boonton, N.J. (5F.2, Wed./a.m./RN)

Some Considerations for Coordinating Fuses and Power Semiconductors—M. Smith, The Bussman Mfg. Co., St. Louis.

Hybrid System Integration—M. Desai, W. A. Koelsch, Fairchild Semiconductor, Palo Alto, Calif. (7D.1, Thurs./a.m./G)

Packaging for Spacecraft Application—L. Katzin, Jet Propulsion Lab., Pasadena, Calif. (7D.2, Thurs./a.m./G)

Logic Organization—Its Impact on Interconnection Density, R. Farquharson, RCA, Camden, N.J. (7D.3, Thurs./a.m./G)

Space Electronics

The Satellite Propagation Problem—H. W. Evans, Bell Telephone Labs., Inc., Holmdel, N.J. (3F.5, Tues./a.m./RN)

Geologically Affected Variations of the Earth's Magnetic Field—Measurements and Inferences—H. Jensen, Aero Service Corp., Philadelphia (5E.3, Wed./a.m./RS)

The View of the Ocean from Space—R. E. Stevenson, Bureau of Commercial Fisheries, U.S. Dept. of Interior, Galveston, Tex. (5E.4, Wed./a.m./RS)

Space Applications of Sequential Decoding—G. D. Forney, Jr., Codex Corp., Watertown, Mass. (6F.1, Wed./p.m./RN)

Packaging for Spacecraft Application—L. Katzin, Jet Propulsion Lab., Pasadena, Calif. (7D.2, Thurs./a.m./G)

A Brief History of Satellite Communications—W. H. Watkins, Federal Communications Commission, Washington, D.C. (7E.1, Thurs./a.m./RS)

Design Considerations for Spaceborne Communication Equipment—W. L. Glomb, ITT Defense Communications, Nutley, N.J. (7E.2, Thurs./a.m./RS)

Earth Stations for the Global Satellite Communications Systems—H. Prescott, Communications Satellite Corp., Washington, D.C. (7E.3, Thurs./a.m./RS)

Single-Sideband Communications with the ATS Satellite—R. J. Darcey, NASA, Greenbelt, Md. (7E.4, Thurs./a.m./RS)

Plans for Future Commercial Communications Satellites—R. D. Briskman, Communications Satellite Corp., Washington, D.C. (7E.5, Thurs./a.m./RS)

The World Weather Program—R. E. Hallgren, Environmental Science Admin., Rockville, Md. (8E.1, Thurs./p.m./RS)

System Engineering

Engineering Economy Decision in Large System Applications—E. E. Greene, GE, Erie, Pa. (3C.4, Tues./a.m./MH)

A Three-Valued Computer Design Verification System—J. A. Jephson, P. McQuarrie, IBM, Endicott, N.Y. (5B.4, Wed./a.m./N)

Dynamic Models of Power Systems: A Survey—A. H. El Abiad, Purdue University, Lafayette, Ind. (5B.5, Wed./a.m./N)

Comparison of Methods for Systems Synthesis—G. L. Hollander, Hollander Associates, Fullerton, Calif. (8C.1, Thurs./p.m./MH)

System Synthesis by Digital Simulation—J. Reitman, United Aircraft, Norwalk, Conn. (8C.2, Thurs./p.m./MH)

Systems Synthesis by Design Indices—K. Sargent, Arinc Research Corp., Santa Ana, Calif. (8C.3, Thurs./p.m./MH)

System Synthesis Using Bayesian Probability as a Basis for Design Methodology—M. Asimov, University of California, Los Angeles (8C.4, Thurs./p.m./MH)

Test Equipment and Techniques

The Zener Diode, a Working Direct Voltage Standard—W.G. Eicke, Jr., National Bureau of Standards, Washington, D.C. (3B.1, Tues./a.m./N)

The New Generation of Digital Voltmeters—D.L. Johnson, Lear Siegler, Inc., San Diego, Calif. (3B.2, Tues./a.m./N)

Active Direct Voltage Standards—J. L. Kimball, Cohu Electronics, Inc., San Diego, Calif. (3B.3, Tues./a.m./N)

Generation of Precision Alternating Voltages—P. L. Richman, Lexington, Mass. (3B.4, Tues./a.m./N)

Transient Infrared Radiation: Promising New Approach to Probe Semiconductor Performance—W. Jurie, NASA-ERC, Cambridge, Mass.; R. Vanzetti, Raytheon Co., Wayland, Mass. (4B.1, Tues./p.m./N)

Implementation of IR Diagnosis Techniques for Solid State Circuits (an AF-APL film), Wright-Patterson Air Force Base, Dayton, Ohio (4B.2, Tues./p.m./N)

Liquid Crystals for Thermal Mapping of Semiconductors and Related Hardware (paper includes a film)—F. Davis, Westinghouse Research Labs., Pittsburgh; M. Lauriente, Westinghouse Aerospace Div., Baltimore (4B.3, Tues./p.m./N)

Touring the Exhibit Area

Seven hundred firms to visit? Tour the exhibit areas here. Show products listed are grouped under eight headings. From transformers and relays in packages 0.25 inches high, to production equipment that fills a room, shop with us.

Components U114
 Test equipment U134
 Production equipment U140
 Systems U144
 Semiconductors U148
 Microelectronics U154
 Microwaves U158
 Materials U166



Resolver/synchro-to-digital converter tracks to 2000°/s. The six digit instrument has an updating time of 125 ms (for a 180° input step). In addition, the unit has a Velocity Constant of 20,000 to 1, a variable 0.3 to 3 second display time and three operating modes. Page U134.

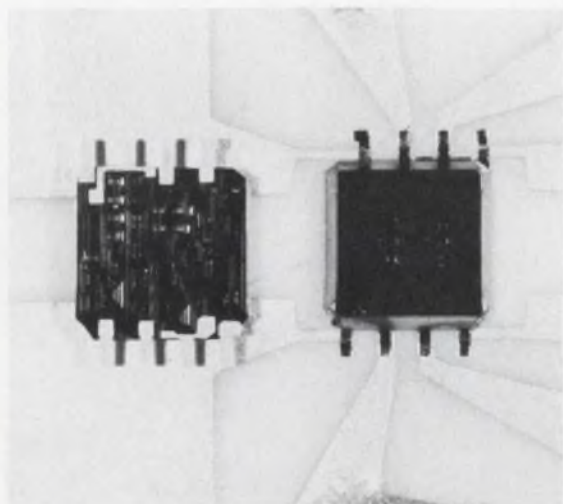

Flip-tab fabrication techniques for monolithic ICs have electroformed gold beams that extend beyond the edges of the chip. The mechanical strength of the bond will survive a force of more than 100,000 g. Page U154



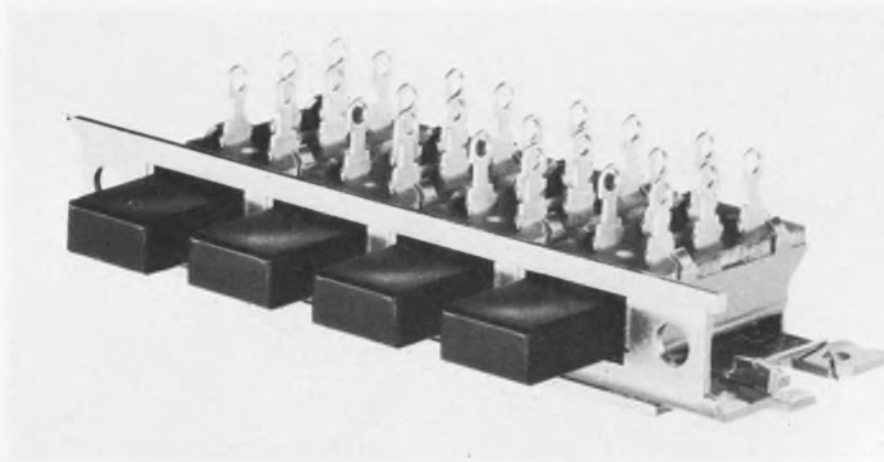

Multiple action switches are pushbutton controlled

Switchcraft, Inc., 5555 N. Elston Ave., Chicago. Phone: (312) 774-1515. P&A: Type 65000, 30¢ to 35¢; Type US, 42¢; Type LUS, 44¢; 4 wks.

The series 65000, multiple-station pushbutton switch features double-wipe bifurcated contacts. This double-wipe switch is available with up to 18 stations in a single row depending on switch functions. Maximum switching per station is 2 C contacts (dpdt). Each station utilizes switching modules that consist of a switch housing, pushbutton actuator, thermal board assembly and switching contactors. These contactors are U-shaped to assure continuity between contactor and terminal.

Designed to meet the requirements of such equipment as analog and digital computers, analyzers, transmitters and receivers, inter-

coms, numerical control and ground support systems, the switch requires 1-1/16 in. behind the panel. Overall switch height is 27/32 in. The switch mounts directly to any control panel and may be mounted horizontally or vertically using two screws.

Standard assemblies are available in single row assemblies with interlock and all-lock functions from one to 12 stations; and with non-lock function up to 18 stations, with up to 2-pole double-throw action per station. Special mixed functions are also available.

The series 65000 switches consist of a switch frame, latch bar for functional control and a spring return for the latch bar. Switch modules are added to the basic frame assembly depending on contact configurations needed. Switch modules may be removed, as a

module, from the frame at any time without disturbing wiring or other switch modules.

Status indication of individual switch stations may be provided by the use of varied colored pushbutton actuators, or engraving or hot stamping on the pushbutton face.

Solder-lug terminals are standard on this switch; however, printed circuit terminals in 11 varying lengths are available on special order.

Standard silver-plated contactors are rated at 3 A, ac. 0.5 A, dc. 125 V, non-inductive load.

Two momentary action pushbutton switches called "Uniswitch" are completely enclosed in a molded plastic housing, 11/16 in.². Their 1/2 in.² concave button is available in a standard color of white on both series. One "Uniswitch," series US, is non-illuminated, the other, series LUS is illuminated through the use of one 6 V, 1/2 W, T 1-3/4, Bi-Pin Lamp. The button on this switch has special slots on the button edges for front-of-panel-removal when replacing the lamp.

A feature on both series of these switches allows "snap-lock" installation of the switch from the front panel. The clip may be set in the proper position to accommodate any mounting panel from 3/65 in. to 17/64 in. thick. These switches mount in matrices on 11/16-in.-centers in either of two planes and take only 1-3/64 in. minimum to 1-17/64 maximum depth behind the panel. Both have a button stroke of 0.071 in. and handle one A. Switch terminals on both series are extruded for use with #5-40 machine screws, or if desired, as solder lug types. Lighting terminals on the series LUS are solder lug only.

Contact terminals are brass, silver plated and are rated at 250 A, 30 W max, ac, non-inductive load.

Also on view will be an electromagnetically operated annunciator that provides a highly visible color-legend display without the use of lamps or other electrical illumination. Called the "Glo-Annunciator," series GA, this device is designed for use in industrial and commercial equipment applications, such as status or circuit conditions.

Booth No. 4G30 Circle No. 330

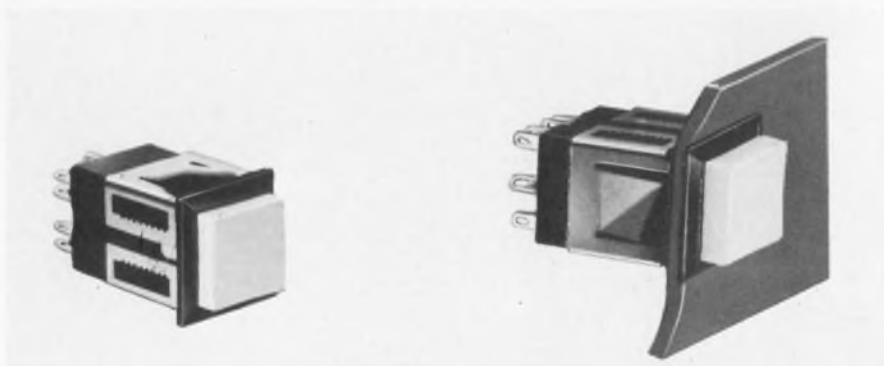

Momentary action switches models US and LUS are enclosed in a molded plastic housing. The LUS is an illuminated version while the US is non-illuminated. An "Adjusto-Clip" provides snap-lock installation.

COME... ...HEAR The Latest in Power Supply Technology



KEPCO, INC.

will again present its popular lecture/film series at the New York Coliseum (second floor) during the IEEE Show. The theatre entrance is adjacent to Kepco's display, Booth No. 2F51-2F53. Come hear qualified engineers and scientists discuss the new operational analog for power regulators, offset ratings and applications data. We'll also have new product seminars, demonstrations, and films.

Find out about:

- Precision Power Regulators
- Fast Programming
- Digital Techniques
- Quick Recovery Current Regulators
- Computer Power Supplies
- Redundant Overvoltage Protectors

All at the **KEPCO
POWER SUPPLY THEATRE**



BOOTH 2F51



131-38 SANFORD AVENUE • FLUSHING, N.Y. 11352

INFORMATION RETRIEVAL NUMBER 55

U116

Multi-stage blower has fan-stage flexibility

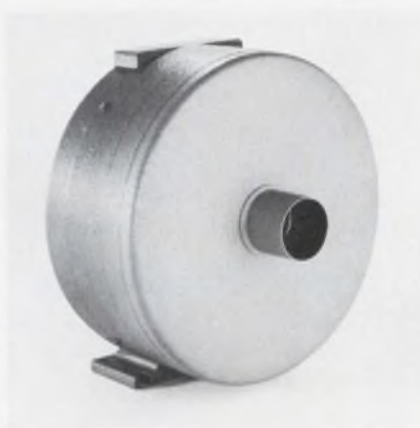

AMETEK/Lamb Electric, Kent, Ohio. Phone: (216) 673-3451. Price: \$20 to \$50.

By adding or deleting fan stages AMETEK/Lamb can now supply a motor blower unit having a specific air flow without resorting to air valves and bleed devices for air flow control.

The basic model is a 9.5-in. dia blower unit, operating at 3450 rpm. Air flow is determined by the number of fan stages: adding more stages increases the amount of vacuum (or pressure). The blowers are available with from one to seven stages.

Many different combinations of

stages, motor windings and such optional features as inlet tubes, exhaust tubes, thermal protectors and various mounting configurations are available.

The blowers run cooler in operation than other similar types because the air flow is not circulated through the motor. Quiet operation is designed into the unit.

A compact 5.7-in. dia blower is also available for applications requiring greater air flow or where space limitations preclude use of the standard unit. The 5.7 in. models can be equipped with either a 400-Hz motor or a belt-drive assembly, as the application dictates.

These units will supply power for vacuum buffer chambers in computer peripheral equipment, such as magnetic tape decks. Other applications include the handling of cards in readers and sorters, removal of paper lint, chaff and punchings in computer paper tape or data processing card operations, cooling of electronic equipment and circuit components and the feeding of plastic particles into injection molding equipment.

Booth No. 4F35 Circle No. 386

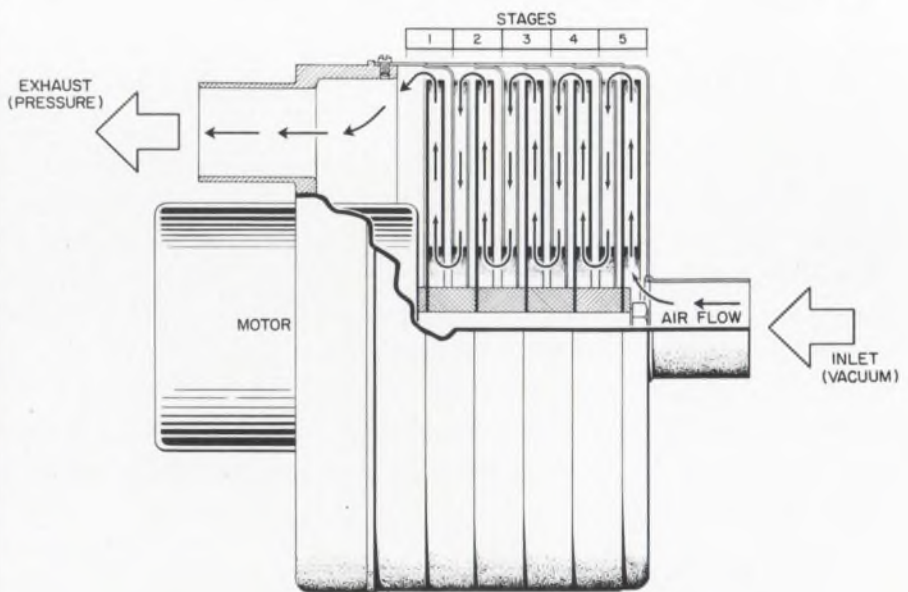

Multi-stage blower can be built with up to seven stages. Adding more stages increases the amount of vacuum (or pressure). The blower also runs cool because the air flow is not circulated through the motor.



HANOVER FAIR

April 27-May 5, 1968

A CONCENTRATION OF MANY FAIRS
PRESENTING THE MOST ADVANCED
PRODUCTS, METHODS AND IDEAS

- Electrical and Mechanical Engineering
- Power Generating Machinery & Equipment
- Construction Machinery, Equipment and Supplies; Oil-field and Mining Machinery, Equipment and Supplies
- Iron, Steel and Non-Ferrous Metals
- Metal Surface Treatment; Anti-Pollution Devices
- Welding and Cutting
- Heating, Cooling, Air Conditioning
- Business Machines incl. EDP Equipment, Office Supplies and Furniture
- Vending Machines
- Precision and Optical Goods
- Chemical and Plastics Machinery and Products
- Electronics: Measuring and Testing Equipment, Components, Assemblies and Supplies
- China - Ceramics - Glassware - Gifts - Decorative Accessories - Metalware - Handicrafts - Jewelry - Silverware - Watches - Clocks - Radio, Television and Phonographs - Household Appliances - Lamps - Fixtures

Almost 6,000 exhibitors from all over the world exhibiting on more than 9.5 mil. sq. ft., more than 500,000 visitors

For information, room reservation forms and tickets, call or write:

GERMAN AMERICAN CHAMBER OF COMMERCE

New York: 666 Fifth Ave. (212) 582-7788
Chicago: 77 E. Monroe St. (312) 782-8577

COMPONENTS

Miniature transformer weigh only 1.1 grams



United Transformer Co., Div. of TRW, 150 Varick St., New York. Phone: (212) 255-3500. Price: \$6.35 (500 lots).

A line of ultraminiature transistor transformers and inductors weighs 1.1 grams making the devices compatible in size with transistors and ICs. A substantial size reduction (profile height 0.25 in.) is obtained through a cylindrical winding technique used to make the devices.

All BIT-250 units are manufactured to MIL-T-27B, Grade 4 standards. The line contains 17 stock units. Characteristics and the range of parameters constituting the stock line include a primary impedance of 150 to 25,000 Ω center tapped, a secondary impedance of 3 to 10,000 Ω , a power level of 45 to 80 mW and a frequency range of ± 2 dB from 300 Hz to 250 kHz.

Terminations available include gold-plated ribbon-style leads, gold-plated straight pin leads, or ribbon-style leads perpendicular to the terminal board to fit dual-in-line patterns.

The transformers are 7-terminal types with center-tapped primaries and split secondaries. The inductors are made in two styles. There are the single-winding types for economy and the split-winding types which, connected in parallel give 1/4 the inductance and twice the current of units connected in series.

Booth No. 4F25 Circle No. 289

Vacuum capacitors are motor-tuned

International Telephone & Telegraph Corp., 6842 Van Nuys Blvd., Van Nuys, Calif. Phone: (213) TR3-5357.

A high-speed combination motor drive and variable vacuum capacitor is packaged as a sealed unit to eliminate contamination problems and is offered with a wide choice of vacuum capacitors. A dc stepping motor directly coupled to a ball screw is used. The actuator assembly is hermetically sealed to provide rfi shielding and an internal-ground connection is included in the receptacle.

Booth No. 3C01 Circle No. 383

Illuminated switch meets rfi MIL-spec

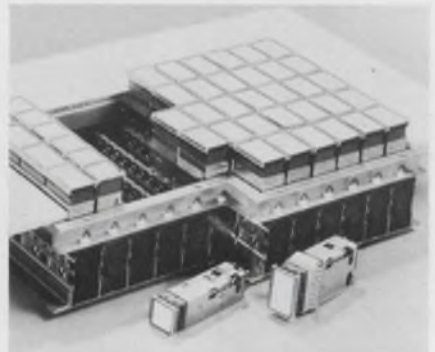

Micro Switch, A Div. of Honeywell Inc., Freeport, Ill. Phone: (815) 232-1122.

Designed to meet the requirements of MIL-S-22885, a line of illuminated pushbutton switches meets most standards of rfi suppression. Matrix-mounted, they are available in unit (3/4 in.²) and 1-1/2-unit sizes. These modular type switches are available with either momentary or maintained action. The switch unit is designed for trouble-free performance in over 100,000 operations in the presence of wide temperature variations, salt fog, moisture, shock and vibration. The switches may be installed from the panel front in less than a minute; lamps are replaceable without tools. Both transmitted and projected colors are available to illuminate up to four individual button sections.

Booth No. 2G47 Circle No. 253

High-density connector inserts easily

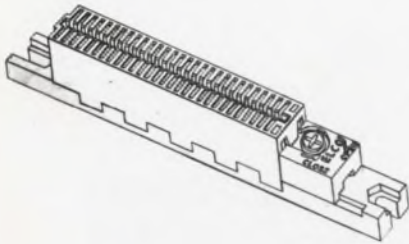

Elco Corp., Willow Grove, Pa. Phone: (215) 659-7000.

Requiring virtually no insertion force because the printed circuit board does not deflect the contacts during insertion, this connector accommodates standard 1/16-in. thick printed circuit boards and is suitable for systems incorporating IC or LSI devices. It is available in multiple sizes with up to 200 dual-readout contacts spaced on 0.05-in. centers.

Booth No. 4G26 Circle No. 327

Rotary stepping switch made on circuit board

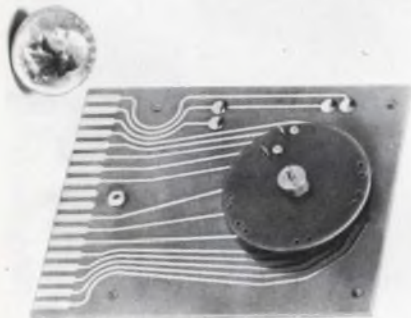

A. W. Haydon Co., 232 North Elm Street, Waterbury Conn. Phone: (203) 756-4481.

A printed-circuit rotary stepping switch designed for sequential circuit switching, pulse counting, and programing operates on 12 or 28 V dc or rectified 115 V, 60 Hz. The power requirement is 5 W. Step rate is up to 15 steps per second, and 3, 4, 5, 6, 10 and 12-position switches are available.

Booth No. 4K03 Circle No. 292

Five pushbuttons actuate counter

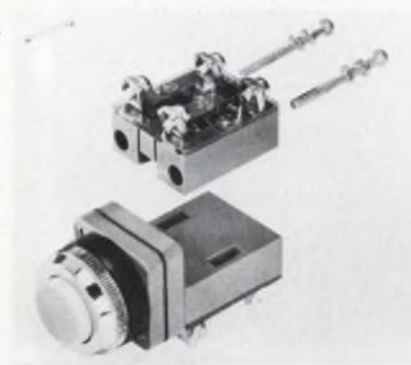

Hecon Corporation, 31 Park Road, New Shrewsbury, N.J. Phone: (201) 542-9200.

This counter features pushbutton selection. Rapid reset and a ball-bearing drive capable of handling 6000 rpm are standard and positive electrical knock-off is assured. The unit can actuate an spdt switch wired to control numerous manufacturing processes. The counter is dust-proof and will operate at low or high temperatures (-40° to +140°F).

Booth No. 2J44 Circle No. 325

Miniature pushbutton controls 5 A



Micro Switch, a Div. of Honeywell Inc., Freeport, Ill. Phone: (815) 232-1122.

A miniature unlighted pushbutton switch is available in spdt and dpdt versions with ratings of 125 or 250 V dc at 5 A. The switches are characterized by low operating force, long life (100,000 mechanical operations) and light weight. A variety of button color options is available.

Booth No. 2G47 Circle No. 254

Miniature relay has TO-5 housing

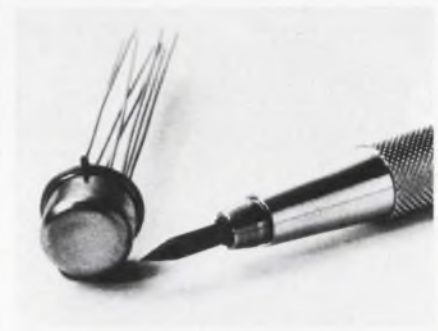

Deutsch, Filtrors Relay Div., 65 Daly Rd., E. Northport, N.Y. Phone: (516) 266-1600.

A transistor-sized relay will be initially available in a dpdt version with five standard coil-voltage ratings of 6, 9, 12, 18 and 26.5 V. With a rated contact load of 1 A at 28 V dc, the units have a rated life of 100,000 operations. Characteristics of the relay include a contact resistance of 100 mΩ, operating time of 2 ms and release time of 1.5 ms max.

Booth No. 4H31 Circle No. 328

Photon counter tube has 1-in. diameter

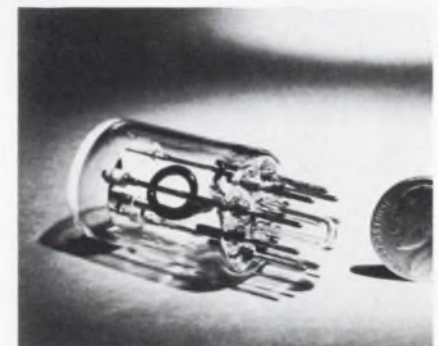

The Bendix Corp., Bendix Research Laboratories, 20800 10-1/2 Mile Road, Southfield, Mich. Phone: (313) 353-3500.

This photon counter tube, only 1.8 in. long and 1 in. in diameter, generates an output charge pulse for each photon detected. It ensures output counts for 99% of all pulses at an output discrimination threshold of 50 mV. Dark output counts of 10 events/s and less are achieved without photo-cathode cooling by using an effective photo-cathode of only 0.04 in. diameter.

Booth No. 3B48 Circle No. 367

Save design expense. Take advantage of the PA237's application versatility.



Because General Electric's PA237 operates over a supply voltage range of 9 to 27 volts, you can probably use this one circuit for most of your applications and save money. It is capable of delivering up to two watts of power to resistive or inductive loads. (Pictured actual size.)

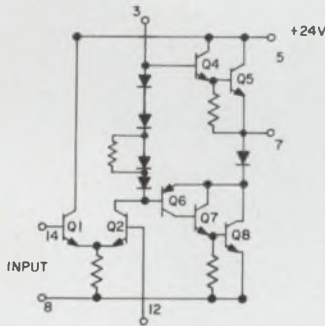

The PA237, shown in this circuit diagram, converts 8 mV of input signal to 2W of continuous, low distortion output power.



General Electric's PA234 gives you the lowest total cost for a 1-watt amplifier function through a combination of low device cost and minimum number of outboard components. (Shown actual size.)

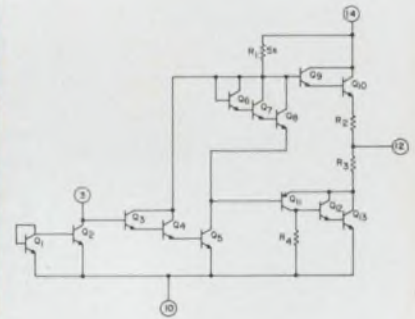

PA234 audio amplifier delivers 1 watt of continuous power to a 22-ohm load from a 22-volt supply.

Now you can use a single IC for most of your audio applications by simply varying its bias.

General Electric PA237 silicon monolithic audio amplifier is designed to have its biasing network external to the chip. Thus appropriate biasing for any power supply from 9- to 27-volts is readily achieved.

External biasing permits operation with Class A, Class A-B, or Class B output modes. The input may be biased for voltage or current sources as well as differential signals.

In addition to the PA237's wide range of supply voltage and bias alternatives, feedback may be applied to the amplifier to allow adjustment of stability, input and output

impedance and amplifier sensitivity. Simple AC and DC feedback networks are employed to provide excellent stability with frequency and temperature.

General Electric's 1- and 2-watt low-distortion amplifiers are packaged in an 8-lead dual-in-line plastic package with a tab for transferring heat to a printed circuit board. This means easy insertion into the P.C. board and easy heat sinking too.

General Electric's PA234 is the ultimate in low cost 1-watt monolithic audio IC's. Its low cost plus the least number of outboard components of any audio amplifier on

the market makes the PA234 the most economical alternative for achieving one watt of audio power.

Both General Electric's PA234 and PA237 offer you outstanding performance and top reliability in a wide range of circuit applications. These varied uses include phonographs, dictating equipment, tape player/recorders, and TV, AM, and FM receivers. Plus: the PA237 can drive inductive loads or provide voltage regulation for 1% typical over a 9- to 27-volt range. For more information on how GE can save you design expense and cash outlay **circle number 811**.

Spdt coaxial relay has 500-W rating



ITT Jennings, P.O. Box 1278, San Jose, Calif. Phone: (408) 292-4025.

This spdt coaxial relay offers a power rating of 0.5 kW at 30 MHz using BNC-type rf connectors. Its active elements are two vacuum relays. VSWR is 1.1 max over a frequency of 0 to 750 MHz. Operating time is 13 ms and insertion loss is 0.1 dB. Vacuum construction gives the unit low, stable contact resistance.

Booth No. 3C01 Circle No. 354

Shaft encoder is one-in. long



Norden Div. of United Aircraft, Norwalk, Conn. Phone: (203) 838-4471.

This subminiature shaft encoder is designed for navigation, fire control, stabilization and display systems in ground, shipborne and airborne applications. The encoder is 1.062 in. in dia by 1 in. long. It is available with either 256 or 64 counts per turn resolution. Total count is 1024. No active electronics are required for switching or rfi suppression. The unit is guaranteed for 2 million turns.

Booth No. 4G25 Circle No. 323

Thumbwheel switches make three ways



A. W. Haydon Co., 232 North Elm St., Waterbury Conn. Phone: (203) 756-4481.

Thumbwheel switches for use in single-pole, double-pole, or 4-pole switch applications may be used for binary decimal coding or decoding, or for straight decimal circuitry. A built-in decoding diode gate in the rotor eliminates the need for extra equipment.

Booth No. 4K03 Circle No. 291

Transistor heat sinks cool plastic types

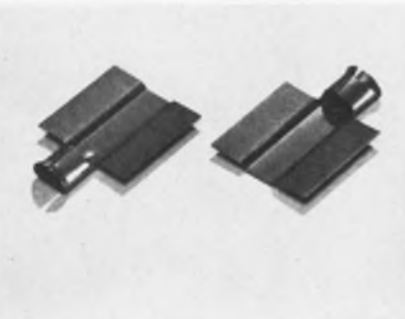

Wakefield Engineering, Inc., Wakefield, Mass. Phone: (617) 245-5900.

A new addition to a heat sink line is the type 292 circuit board heat sink for TO-92 plastic transistors. For power dissipation of 0.2 W, natural convection characteristics show that collector lead temperature rises only 18°C above ambient with black immersion, or 20°C with iridite finish.

Booth No. 4B06 Circle No. 298

Bat-handle switch toggles 10⁵ times

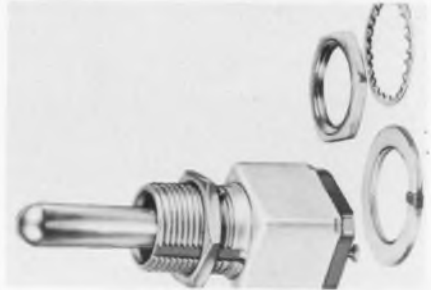

Micro Switch, A Div. of Honeywell Inc., Freeport, Ill. Phone: (815) 232-1122.

Featuring a 15/32 in. bushing, large bat handle, level lock capabilities, bushing seal and high operating force for firm tactile feedback, a series of toggle switches offers long life (100,000 mechanical cycles) in both spdt and dpdt versions. Toggle throw of 28° maximizes positive control and visual monitoring. The switches operate within an ambient temperature range of -85°F to +185°F. Small diameter, quick connect terminals will be available. The complete series meets the requirements of MIL-S-3950C.

Booth No. 2G47 Circle No. 256

Nickel-cadmium cell takes fast charge

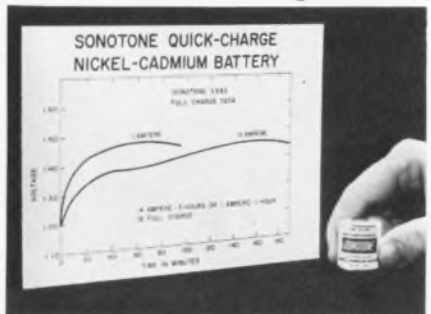

Sonotone Corporation, Elmsford, N.Y. Phone: (914) 592-9600.

A sealed, rechargeable nickel-cadmium battery cell that is capable of taking a quick charge can be fully charged in one hour or charged to a sufficient capacity in a few minutes to operate a cordless device, such as a toothbrush, slicing knife or shaver. The quick-charge device is built into the battery cell, and is also capable of accepting overcharge.

Booth No. 4E16 Circle No. 321

Solid-state switch operates at 250°F

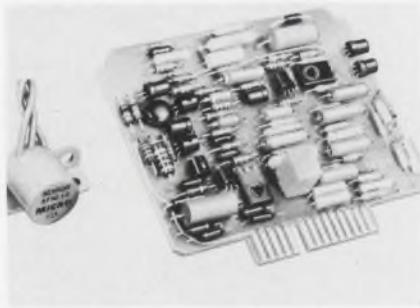

Micro Switch, a Div. of Honeywell Inc., Freeport, Ill. Phone: (815) 232-1122.

Designed to provide reliability and long life, a miniature solid-state proximity switch operates from -106°F to $+250^{\circ}\text{F}$ for 85,000 hours. The 3-oz. device includes a shielded sensor and a solid-state switch. System response time is 20 ms and standby power consumption is limited to 2 W.

Booth No. 2G47 Circle No. 255

One MHz oscillator holds to 10^{-3} ppm/day



Vectron Laboratories, Inc., 146 Selleck St., Stamford, Conn. Phone: (203) 324-9225. P&A: \$200-\$400; stock.

Operating from a 5-6 V dc source for compatibility with integrated-circuit systems, a crystal oscillator provides a stability (aging rate) better than 10^{-3} ppm/day. The $2 \times 2 \times 4$ in. package employs an IC proportional oven control system to provide stable operation over the -20°C to $+70^{\circ}\text{C}$ temperature range.

Booth No. 2F07 Circle No. 251

Oil-tight pushbuttons mount in a 1-in. hole

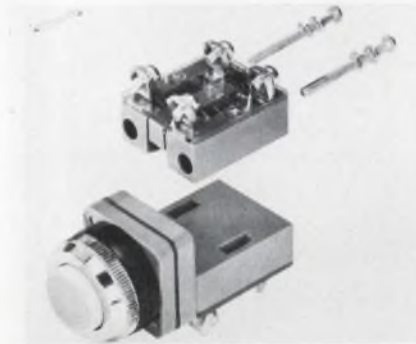

Alcoswitch, Div. of Alco Electronic Products, Inc., Lawrence, Mass. Phone: (617) 688-1821. Price: \$3.25.

These miniature oil-tight push-button switches mount in a 1-in. hole. Rated to carry 6 A at 230 V ac, they feature double-break silver contacts. All models are supplied with a single block. An additional contact block can be supplied to convert these switches to a double unit.

Booth No. 4G23 Circle No. 385

Tin-oxide resistor dissipates 1/8 W

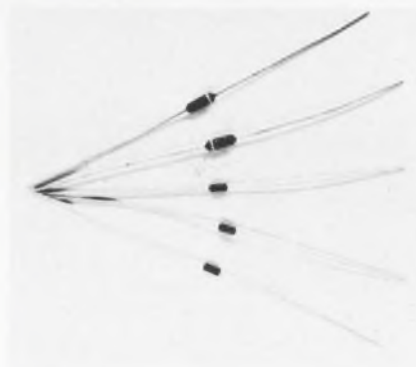

Corning Glass Works, Corning, N.Y. Phone: (607) 962-4444.

A miniature tin-oxide resistor is offered in tolerances of 1, 2, 5 and 10%, temperature coefficients of either 100 or 200 ppm and power ratings up to 1/8 W. Ranging in value from 10Ω to 140 k Ω , they are not more than 0.15 in. long and 0.065 in. in dia. To facilitate the use of automatic insertion equipment, leads of 0.02-in. dia are provided. The leads are connected with press-fitted end caps.

Booth No. 4C04 Circle No. 346

Power relay weighs 1-3/4 oz

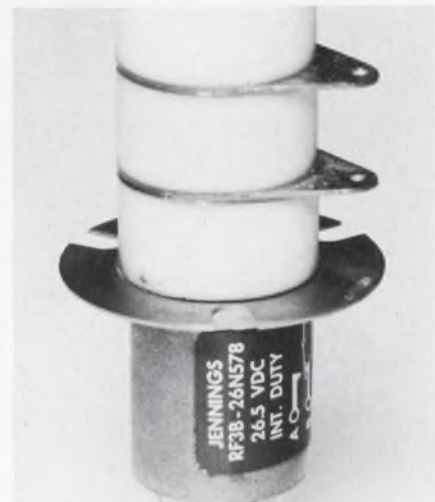

International Telephone & Telegraph Corp., 6842 Van Nuys Blvd., Van Nuys, Calif. Phone: (213) TR3-5357

This 2-1/4-in., 1-3/4-oz relay will interrupt 20,000 W of dc power. It will also carry 17 A rms and withstand 7500 V at 16 MHz. Aided by a vacuum dielectric the relay will handle 60 Hz peak voltages of 12,000 V. Its rated service life is more than a million operations. Typical uses include antenna switching, rf-coil tapping, grid- and plate-circuit switching and motor control.

Booth No. 3C01 Circle No. 382

Aluminum extrusions house small devices

Vector Electronic Co., Inc., 1100 Flower St., Glendale, Calif. Phone: (213) 245-8971. Price: \$3-\$10.35.

A line of extruded aluminum cases is suitable for housing instruments, circuitry and miscellaneous small equipment. The cases consist of a wrap-around extrusion, a bottom plate and two aluminum panels. Screws are absent on five of the six surfaces and case joints overlap to improve rf shielding. Interior surfaces are provided with parallel 0.07 in. grooves which may be used to hold circuit boards running the long dimension of the cases. Special hardware is available for mounting components internally without drilling through the case.

Booth No. 4F09 Circle No. 350

New, miniature Teflon[®] trimmers

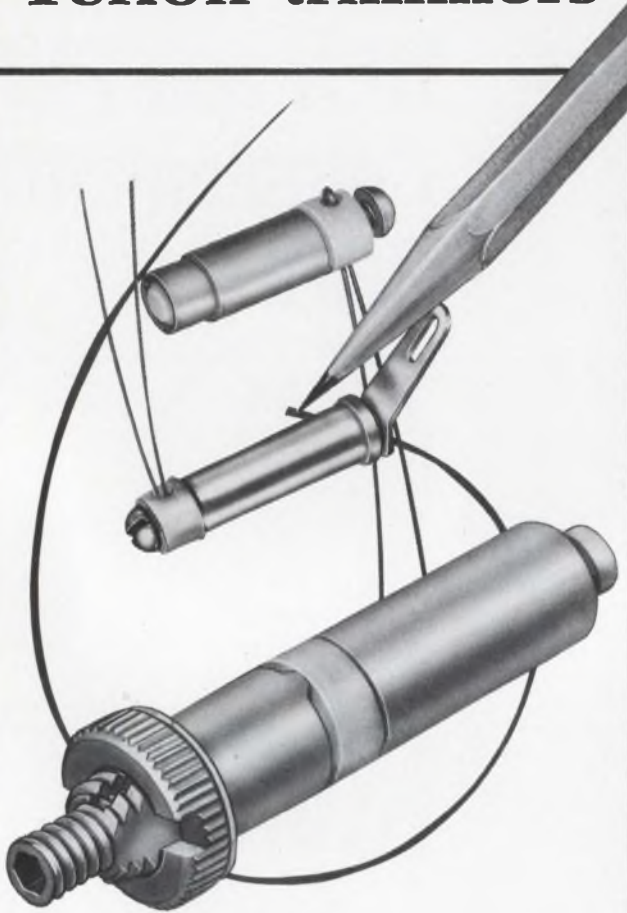

These new trimming capacitors are ideally suited for VHF and UHF applications requiring low minimum capacity and delta C. They provide high resolution and are electrically stable. Tuning is linear. High Q (2000 at 1 MHz typical). Insulation resistance 10^6 megohms. Temperature range— -55° to $+150^\circ\text{C}$. Voltage breakdown 2000 VDC. Part numbers 273-1-1 and 273-1-2 nominal capacity .25 pf min., 1.5 pf max.; part 273-15-1 nominal .30 pf min., 2.9 pf max.

Metal parts are gold plated on PC and solder lug mounting types, silver plated on panel mount. Insulation is Teflon.[®] Rotor screw threaded 80 turns to the inch on PC and solder lug types, 40 turns per inch on panel mount version. Resistant to shock and vibration.

See your Johnson representative or write for complete information.

®Teflon is a registered trade name of DuPont Co.



E. F. JOHNSON COMPANY

3358 Tenth Ave. S.W., Waseca, Minnesota 56093
Providing nearly a half-century of communications leadership

INFORMATION RETRIEVAL NUMBER 63

COMPONENTS

Transformer-inductors for microcircuit use

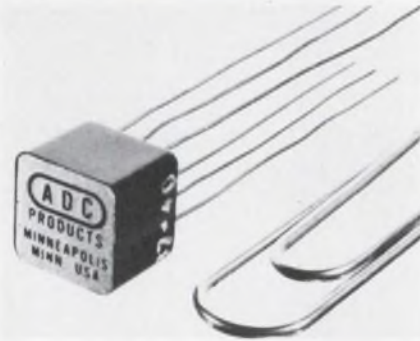

ADC Products, Div. of Magnetic Controls Co., 6405 Cambridge St., Minneapolis. Phone: (612) 929-7881.

Subminiature transformers and inductors for microcircuit applications occupy a volume of 0.015 in.³ (0.25 in. \times 0.25 in. \times 0.25 in.). The units pass the requirements of MIL-T-27B, grade 5, class S. The transformer features an impedance range of 600 Ω to 100 k Ω with a frequency range of 400 Hz to 250 kHz. Its power range is 2 mW at 400 Hz to 50 mW at 1 kHz. The inductor has an inductance range of 0.1 H to 65 H at 1 kHz with a dc resistance range of 50 to 2000 Ω .

Booth No. 4G12 Circle No. 282

Numeric readout draws 8 mA/segment

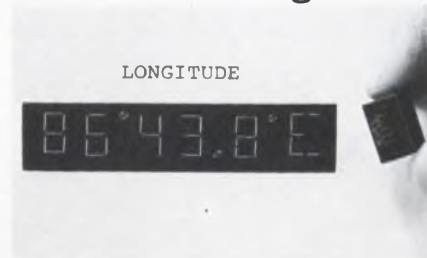

Pinlites Inc., 1275 Bloomfield Ave., Fairfield, N.J. Phone: (201) 226-7724. Price: \$12.95.

With a character height of 5/16 in., this miniature readout occupies a space only $1/2 \times 5/16 \times 3/16$ in. Drawing 8 mA per segment, the unit dissipates 168 mW to print a figure 8. At a 3-V operating potential, readability is adequate for viewing in direct sunlight. Rated life is 100,000 hours and, by a reduction in operating voltage to 2 V, can be increased to an estimated million hours.

Booth No. 4J26 Circle No. 329

Delta Launches the

COMPUTACH®*

The
Great
One!



*An exclusive computer-tachometer for precise RPM measurement in easy-to-build Kit form!



ONLY
\$29.95
ppd.

Delta, pioneers in CD ignition who produced the fabulous MARK TEN®, now offer a precise computer-tachometer which obsoletes any type tachometer on the market today! You achieve unbelievable accuracy in RPM readings due to the advanced, solid-state electronic matched components used in the computer, coupled with the finest precision meter in the world. In kit only for all 12V, 8 cyl. cars.

Check these Deltafeatures:

- ▲ 0-8000 RPM range
- ▲ Perfect linearity — zero paralax
- ▲ Adjustable set pointer
- ▲ Wide angle needle sweep
- ▲ Translucent illuminated dial
- ▲ Chrome plated die-cast housing
- ▲ All-angle ball & socket mounting
- ▲ Use it with any ignition system
- ▲ Meter: 3 1/8" dia. X 3 3/8" deep
- ▲ Kit complete, no extras to buy

Orders shipped promptly.
Satisfaction guaranteed.
Send check today!



DELTA PRODUCTS, INC.

P.O. Box 1147 ED / Grand Junction, Colo. 81501
Enclosed is \$ _____ Ship ppd. Ship C.O.D.
Please send:
 COMPUTACH® Kits @ \$29.95 ppd
(12 VOLT 8 CYLINDER VEHICLES ONLY)

Name _____
Address _____
City/State _____ Zip _____

INFORMATION RETRIEVAL NUMBER 65

U130

COMPONENTS

Reed proximity-switch is magnet-actuated

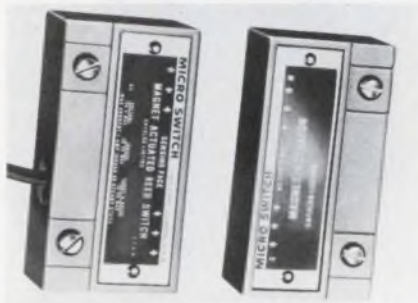

Micro Switch, A Div. of Honeywell Inc., Freeport, Ill. Phone: (815) 232-1122.

This magnet-actuated reed proximity-switch has no moving parts. Its ceramic magnet offers improved resistance to demagnetization. At the rated contact load, between -30 and +200°F, the switch is capable of over 10⁶ operations. Its continuous rating is 6-120 V ac at 0.16 A.

Booth No. 2G47 Circle No. 252

Rotary attenuators use film resistors



Texscan Component Div., Sales Dept., 2446 N. Shadeland Ave., Indianapolis. Phone: (317) 357-8781. Price: \$125.

Film resistors are used throughout in this line of miniature turret attenuators. Static contacts are silver and moving contacts are nickel-silver. Positive action detents have stainless or cadmium-plated steel shafts. Housings are of lightweight iridited aluminum. Connectors are silver-plated brass or gold-plated stainless.

Booth No. 2K15 Circle No. 358

Indicating device is easily serviced



Ideal Precision Meter Co., 214 Franklin St., Brooklyn, N.Y. Phone: (212) 383-6904.

These aircraft instrumentation indicating devices offer easy accessibility for servicing. In manufacture, the device's pole-piece configuration remains open until the last production step. In servicing, loosening one screw on the pole-piece exposes the entire mechanism for inspection, cleaning and testing.

Booth No. 2G33 Circle No. 347

Tantalum capacitors come in 5 styles

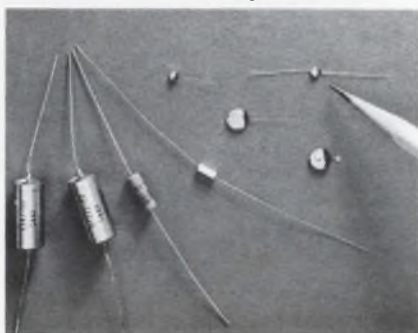

Tansistor Electronics, Inc., West Road, Bennington, Vt. Phone: (802) 442-5473.

Five types of solid tantalum capacitors include the XS series, the MM type, in a metal case with epoxy end seal, the SL variety, which are designed for commercial and industrial applications, high temperature solid type (HTS) designed for operation at 200°C and a disc type which is an unencapsulated solid for IC use.

Booth No. 4E29 Circle No. 295

FIVE GOOD WAYS TO LEARN ALL
ABOUT THE LATEST IN MICROWAVES

- *By visiting all the leading microwave plants and interviewing their best designers and researchers.
- *By attending all major conferences on the subject.
- *By developing and editing state-of-the-art articles covering latest design techniques.
- *By writing extensively about new developments and trends.
- *By working for Electronic Design... the magazine whose editors make it their business to know.

Good salary,
excellent benefits, and
association with top professional
engineer-writers can be yours.
If you are an engineer with
experience in microwaves or
communications systems, and are
interested in the possibilities,
call or write Robert Haavind,
Managing Editor, Electronic
Design, 850 Third Avenue,
New York, New York 10022,
(212) PL 1-5530

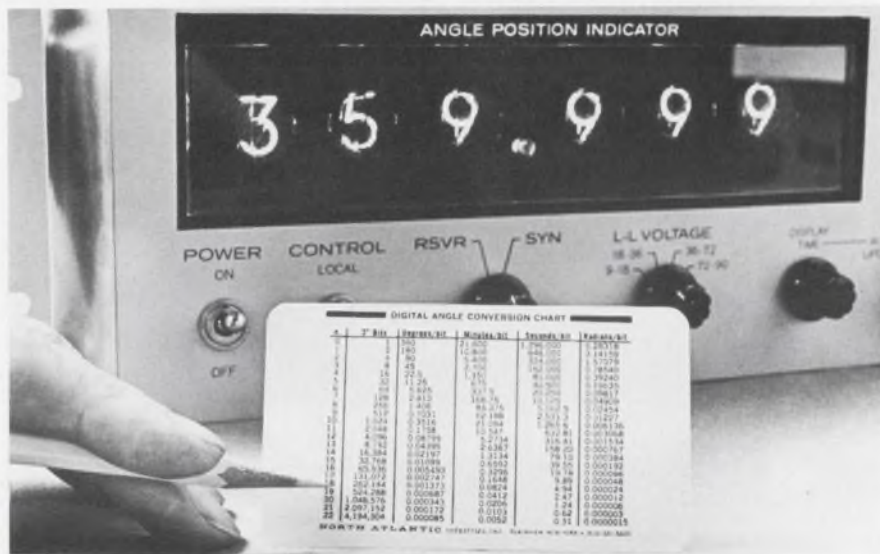

Resolver/synchro converter tracks input data to 2000°/s

North Atlantic Industries, Inc., 200 Terminal Dr., Plainview, N.Y. Phone: (516) 681-8600. P&A: \$7000; 4-5 wks.

During the summer of 1967, North Atlantic announced a 5-digit model 545 Resolver/Synchro-To-Digital Converter (R/S-To-D) whose nulling principle enabled it to track angular input data at speeds up to 2000°/second.

Dynamic accuracy of the 1967 model was defined, by a velocity constant, $V_k = 2000$, that related conversion lag (error) to tracking rate, by: $ERROR = TRACKING SPEED/V_k$.

Now a 6-digit instrument still designated model 545 with a new level of velocity constant, $V_k = 20,000$, can track at 2000°/second despite the extra tenfold resolution, and simultaneously give tenfold better accuracy at any speed. Photo indicates resolution between 18 and 19 bits!

Preserving the 2000°/second tracking rate with the extra decade of resolution actually means that the unit handles data ten times faster. The tenfold higher accuracy at any tracking rate means that the over-all speed-accuracy capability has been improved 100-fold over the earlier model.

There are two major groups of applications for R/S-to-D convert-

ers, occurring respectively in process control and automatic checkout systems. The converters are used on-line to interface between radar antennas, machine tools, aircraft and satellite simulators, astronomical telescopes, theodolites and other precision computer-controlled mechanisms

When the converter is used in checkout applications, converting analog readings into digital language for computer evaluation, the sample-and-hold modes are widely used. Frequently, one converter is multiplexed to receive analog data from several units under test. In such applications, the fast updating capability is at a premium.

Worst-case updating time for the new instrument is 125 ms (for a 180° input step), versus 200 ms for the previous 5-digit unit.

Major specs include 000.000° through 359.999° continuous range, 0.003° ±1 digit (0.001° maximum error), 6-digit illuminated display plus digital outputs for computer interfacing, 2000°/second tracking rate, 20,000:1 Velocity Constant, variable 0.3 to 3 seconds display time, 0.3 mΩ resolver and synchro input impedance, and three different operating modes: Automatic Update, Tracking and Sample-And-Hold.

Booth No. 2B12 Circle No. 290

Capacitance bridge reads within 0.3%



Electro Scientific Industries, Inc. 13900 N. W. Science Park Drive, Portland, Ore. Phone: (503) 646-4141. P&A: \$875; 30 days.

A capacitance bridge measures capacitance over a wide range with special capability for high values. The unit operates on 9 ranges—from 0-120 pF to 0-12,000 μF. Accuracy is ±0.1% on middle ranges and ±0.3% on the highest. A maximum voltage across the unknown capacitor of 0.5 V allows measurements of tantalum capacitors without bias.

Booth No. 2B02 Circle No. 349

Remote preamplifier connects to RG/U coax



Unholtz-Dickie Corp., 2994 Whitney Ave., Hamden, Conn. Phone: (203) 288-3358.

Inserted as a line driver between an accelerometer and a signal-conditioning amplifier, this preamp is packaged as a BNC to Microdot adapter unit and is powered by the signal-conditioning amplifier. Up to 2000 ft of RG/U coaxial cable may be connected between the remote preamp and a rack-mounted instrument without cable-loading effects. An input impedance of 1 GΩ is converted to a low output impedance of less than 50 Ω by the device. A mounting block permits attachment to a fixed object.

Booth No. 2C09 Circle No. 270

Time-signal receiver offers CRT display



General Radio Co., West Concord, Mass. Phone: (617) 369-4400. Price \$3250.

A time-signal receiver for Loran-C, WWV and CHU transmissions consists of a storage oscilloscope with rf and time-base plug-ins for quick, visual time comparisons between frequency standards and transmitted time signals. A 100-kHz loop antenna is supplied with the receiver for Loran-C reception.

Booth No. 2E26 Circle No. 366

Versatile meter works 3 ways



Technology/Versatronics, Inc., 506 South High Street, Yellow Springs, Ohio. Phone: (513) 767-7365. P&A: \$950; 4 wks.

Capable of performing all specified functions without additional plug-ins or adapters this unit is a digital dc voltmeter, an electronic integrator, and an electronic counter. In the counter mode, three functions are provided: rate or frequency measurement, period measurement, and event counting.

Booth No. 4A38 Circle No. 359

Incremental gaussmeter utilizes Hall effect



F. W. Bell, Inc., 1356 Norton Ave., Columbus, Ohio. Phone: (614) 294-4906.

A prefabrication technique employed in an incremental gaussmeter takes advantage of the Hall effect and allows direct interchangeability of probes without recalibration. With built-in calibration accuracy of $\pm 0.3\%$, the instrument's accuracy is at least $\pm 1\%$ when used with high-linearity probes.

Booth No. 2J15 Circle No. 297

Pulse generator has burst capability



Datapulse Inc., 10105 West Jefferson Blvd., Culver City, Calif. Phone: (213) 836-6100. P&A: \$3375; 90 days.

Two repetition rate oscillators are used in a pulse generator that has built-in burst capability. A high-frequency oscillator provides repetition rates from 500 kHz to 250 MHz and a low-frequency oscillator is used for gating 10-ns-to-10- μ s bursts or as a trigger for low repetition rates.

Booth No. 2B44 Circle No. 339

Potentiometric device measures Hz and volts



Wavetek, 8159 Engineer Rd., San Diego. Phone: (714) 279-2200. P&A: \$1520; 30 days.

A potentiometric/null-balance measuring device can be used to measure, monitor or tune any phenomenon that can be converted into a dc voltage or dc voltage ratio. A six-digit readout and non-saturating null amplifier make finding a null or tracking an unknown a simple, quick operation. Various plug-ins can give measurement capabilities that include dc volts, ratio and frequency.

Booth No. 3A42 Circle No. 355

Oscilloscope plug-in features FET input



Tektronix, Inc., P.O. Box 500, Beaverton, Ore. Phone: (503) 644-0161. P&A: \$440; 3 months.

All solid-state with protected FET input stages, this plug-in amplifier has a basic deflection factor of 10 μ V/cm, dc coupled, with a bandwidth of dc to 1 MHz. Trace drift is specified at 10 μ V/h with constant line voltage and temperature. Displayed noise is 16 μ V or less, tangentially measured at full bandwidth. Common mode rejection ratio is 100,000:1 from 10 μ V/cm to 10 mV/cm with a dynamic range of 400 mV.

Booth No. 2E39 Circle No. 348

Wide frequency range
in neat, compact,
easy to read case



The Anritsu MG41A frequency synthesizer offers continuous coverage of frequencies from 200Hz to 30MHz, yet takes up little space on the bench. The MG41A provides 5×10^{-8} /day frequency stability, amplitude modulation, and output level may be varied in 1dB, between ± 15 and -50 dBm. It is a general purpose variable oscillator and is capable of measuring exact frequency characteristics, sharp frequency response, has a 1MHz reference oscillator for calibrating absolute values of carrier waves, and offers a remarkably low noise figure. It is ideal for use on HF bands and is precisely adjustable in 10MHz and 1MHz increments for direct scale readings down to 10Hz. Size; 520mm wide, 370mm high and 315mm deep. Price \$4,229 f.o.b. Yokohama. And, we promise delivery dates. For more complete information, write.

Anritsu Electric Co., Ltd.

4-12-20, Minamiazabu, Minato-ku, Tokyo
cable address ANRITDENKI TOKYO

TEST EQUIPMENT

Test sets have 4 ranges



Honeywell Test Instruments Div.,
Honeywell Inc., P.O. Box 5227,
Denver, Colo. Phone: (303) 771-
4700.

Portable potentiometric test sets offer four measurement ranges (from ± 5 mV to ± 1.61 V) with manual reference junction calibration for thermocouple applications and voltage source capabilities for calibrating strip chart recorders, X-Y plotters, digital voltmeters and other such instruments. The sets operate face-up or face-forward.
Booth No. 2G39 Circle No. 268

IC digital printer records 10 lines



The Hickok Electrical Co., 10514
Dupont Ave., Cleveland. Phone:
(216) 541-8060. P&A: \$695; 6
months.

An IC digital printer may be used with any device that provides 10-line decimal or BCD coded data. Up to ten lines of numeric and coded data can be printed from one or even two independent digital systems. Print command can be remote, local or at calibrated time intervals.
Booth No. 2C25 Circle No. 368

Sweep generator delivers 8 W



Telonic Instruments, 60 N. First
Ave., Beach Grove, Ind. Phone:
(317) 787-3231.

Capable of delivering swept outputs of over 8 W, a series of sweep generators comprising four instruments covers frequencies of 20 to 100 MHz, 100 to 250 MHz, 200 to 375 MHz, and 375 to 1000 MHz respectively. These instruments feature continuously variable sweep width and automatic level control.
Booth No. 2H12 Circle No. 369

Preset controller counts to 1000/s



Veeder-Root, Hartford, Conn.
Phone: (203) 527-7201. P&A:
\$485; 4 wks.

Utilizing ICs and silicon solid-state components this instrument operates at up to 1000 counts per second. Numerical display is presented in large, in-line illuminated tubes, and the circuit design assures continuous counting. A number is set into the counter by means of rotary switches.
Booth No. 2H40 Circle No. 260

Engraving machine scribes 5-ft panels



Scripta Machine Tool Corp., 575 E. Linden Ave., Linden, N.J. Phone: (201) 925-1950.

This engraving machine will reproduce size-for-size or reduce down to better than 100:1. With a throat depth of 34 in., the equipment will engrave panels up to 64 in. wide and of any length. Work pieces up to 12-1/2 in. in height and 1100 lb in weight can be accommodated.

Booth No. 1J12 Circle No. 294

Single operation clamps and severs

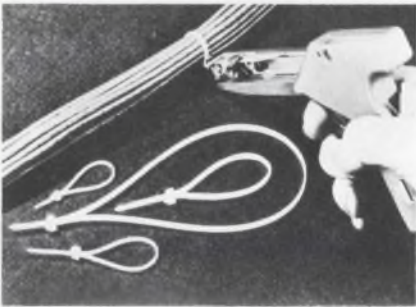

Panduit Corp., 17301 Ridgeland Ave., Tinley Park, Ill. Phone: (312) 532-1800.

A cabling tool incorporates a three-position knob which can be adjusted to suit any cable tying job. Tension is adjustable and remains constant from one operation to the next. Operation is simple. Just insert the cable tie, squeeze the trigger and the tie is cut off flush at the pre-set tension.

Booth No. 1C14 Circle No. 374

Pantograph engraver covers 5-1/2 in. circle

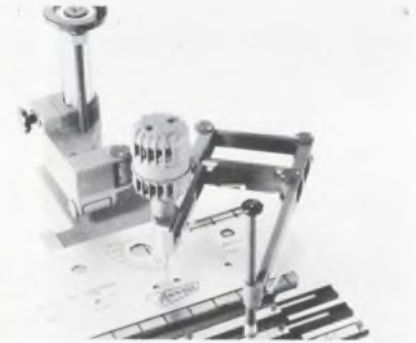

Scripta Machine Tool Corp., 575 E. Linden Ave., Linden, N.J. Phone: (201) 925-1950.

Covering a 5-1/2 in. dia circle at a 2:1 reproduction ratio, this pantograph engraving machine features a wide range of accessories for increased versatility. Clearance between the work table and the cutter is adjustable from 0 to 6-1/2 in. Reduction ratios may be set from 2:1 to 6:1 and spindle speed can be varied up to 20,000 rpm.

Booth No. 1J12 Circle No. 296

Soldering conveyor works vertically



Hollis Engineering, Inc., P.O. Box 742, Nashua, N.H. Phone: (603) 889-1161.

Rotary horizontal/vertical conveyors (model RHV) for automatic soldering have been designed because many components and parts require vertical dipping into solder rather than being conveyed horizontally through a solder wave. This vertical withdrawal prevents solder buildup or flags on long leads and terminals where they cannot be tolerated.

Booth No. 4L05 Circle No. 351

Manual digitizer displays coordinates



The Gerber Scientific Instrument Co., P.O. Box 305, Hartford, Conn. Phone: (203) 644-1551.

Manual operation of a large-area coordinate digitizer enables the operator to read, measure and automatically record sequence numbers and XY coordinate information on punched cards for eventual computer use.

This digitizer has applications covering readout from engineering drawings, charts, maps, printed circuit layouts, IC layouts and other graphical data sources. Modular construction allows the addition of all system options without changing the basic control configuration. The electronic circuitry is IC type. Digitizing area is a usable 48 x 60 in. surface. Clear buttons return each of the coordinate displays being used by the operator to zero, enabling the operator to set zero at any desired point on full working area.

Options include punched paper tape output, flexowriter and magnetic tape output. The XY counter can be preset manually to any value from 00000 to 99999 without moving the reading head. Output scaling of the system is switch-selectable. A grid recognition option allows operator to select rounded-off grid factors 0.005, 0.01, 0.025, 0.05, 0.1 or 0.25, switch-selectable as required. Individual, plug-wired patchboards are available for altering the output data block format. An alphanumeric keyboard, similar to a standard typewriter keyboard, that inserts data directly into the output device is also available as an option.

Booth No. 4A00 Circle No. 280

*if you don't like
to compromise...*

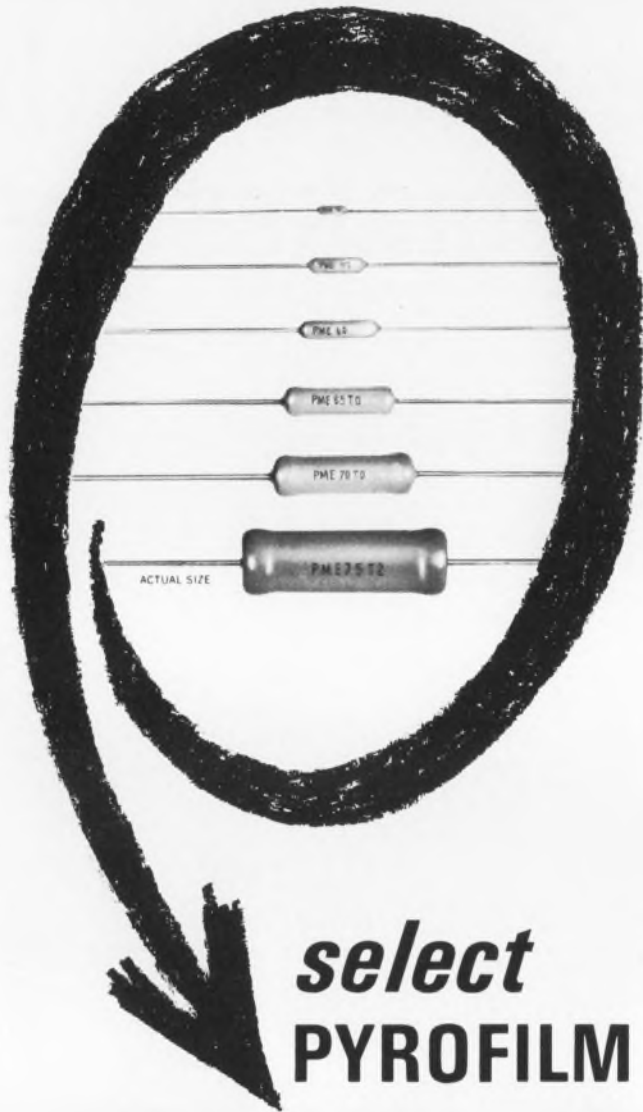

select

**PYROFILM
HIGH VALUE
METAL FILM
RESISTORS**

Part No.	R/N	Power	Ohms	Temp. Coef.
PME 50	50	1/20W	1M	T-0 to T-9
PME 55	55	1/10W	3M	
PME 60	60	1/8W	8M	
PME 65	65	1/4W	15M	
PME 70	70	1/2W	30M	
PME 75	75	1W	50M	

Send for fact-filled literature sheet 71

**PYROFILM RESISTOR
COMPANY, INC.**

3 SADDLE ROAD • CEDAR KNOLLS, N. J. 07927 • 201-539-7110

See us at the IEEE Show-Booth 3K01

INFORMATION RETRIEVAL NUMBER 76

PRODUCTION EQUIPMENT

**Production furnace
fires thick films**

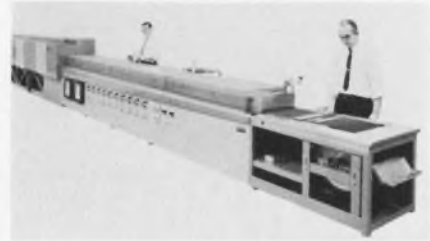

*BTU Engineering Corp., Bear Hill,
Waltham, Mass. Phone: (617) 894-
6050.*

Thick-film production furnaces can deliver up to 12,000 circuits per hour based on a 40-minute heating cycle. Equal time/temperature profile from load to no-load condition is provided. Solid-state controls ensure repeatable temperature profiles along and across the belt up to 1000°C with control accuracy of $\pm 1^\circ\text{C}$ and maximum variation of $\pm 1^\circ\text{C}$ across the belt.

Booth No. 1G26 Circle No. 409

**Coil-winding machine
spins 2000 turns**

*International Wire Machinery
Corp., 16 W. 46th Street, New
York. Phone: (212) 582-0330.
P&A: \$4500-\$8000; 3 months.*

Sequential coil-winding machine handles automatic and semi-automatic winding of coils with up to approximately 2000 turns of 46 to 18 AWG wire. The machine is equipped with tooling designed for the customer's particular requirements. Some examples of the many different types of coil that can be wound include field coils, loud-speaker coils, meter movement coils, miniature motor armatures, a wide variety of formed and self-supporting coils and wire-wound resistors. The machine can be fitted with automatic stations for carrying out many operations normally done manually by the operator. These include taping, cutting, heat- and wax-bonding and welding. The rotating table carrying the tooling is removable, thus allowing the same machine to be used for a variety of coil-types. A dual-head version is available.

Booth No. 4L04 Circle No. 342

Parallel-storage unit accepts 11 digits



General Radio Co., West Concord, Mass. Phone: (617) 369-4400. Price: \$2600.

Accepting up to 11 digits of time-of-day information in 2 μ s, this parallel-storage unit will store and display the information and transfer it to card and tape punches or printers. Stored time data can be read to the nearest 10 μ s. Both data input and output are in 4-line BCD, 1-2-4-8 format.

Booth No. 2E26 Circle No. 380

Static card readers accept IBM format



Scalestro Corp., Mamaroneck, N.Y. Phone: (914) 698-5600.

Two static card readers are designed for IBM format. One reads all 960 points simultaneously and the other reads 612. Both units sense punched holes mechanically with remote contacts that are protected from dust, lint and dirt. The bifurcated, rhodium-plated contacts feature double-contact wiping surfaces and a contact resistance of 30 m Ω max after 1×10^6 operations.

Booth No. 4C20 Circle No. 324

Coaxial matrix has 7 modules

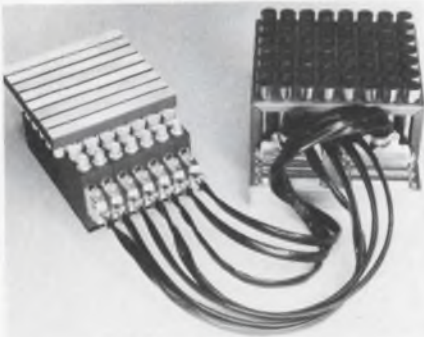

Matrix, Div. of Schafer Electronics, Chastworth, Calif. Phone: (213) 882-2000. P&A: \$1960; 30 days.

A 7 \times 8 coaxial matrix consists of 7 modules in a 1 \times 8 configuration. Because of the modular construction, any format matrix can be built by cross-strapping a number of individual modules. Each switch point is replaceable by unsoldering the bottom lead and unscrewing the connector.

Booth No. 4H29 Circle No. 362

Electrometer amplifier has MOSFET input



Keithley Instruments, Inc., 28775 Aurora Road, Cleveland. Phone: (216) 795-2666. Price: \$200.

Featuring a differential MOSFET input, current offset of 10^{-14} A, and common mode input resistance of $5 \times 10^{12} \Omega$, an electrometer amplifier operates as a current modifier for signals in the 10^{-14} to 10^{-2} A range. Maximum output is ± 11 volts at 11 mA, and open-loop gain is 50,000. Voltage regulation is built-in.

Booth No. 2F04 Circle No. 343

Thermal regulator controls to 1/4°F



Honeywell Apparatus Controls Div., 2727 S. Fourth Ave., Minneapolis. Phone: (612) 322-5222. Price: \$350-\$400.

A solid-state temperature controller that offers two proportional current outputs can hold a set temperature within 1/4°F. Either output, 0.5-5 or 4-20 mA dc, can be selected. An odometer-type set-point permits dialing any desired temperature within 1°F. Once set, the unit locks in at this point, maintaining the entire control loop within a degree. Any deviation is indicated on a front-panel meter.

All electronic components are solid-state; FETs and ICs are utilized for optimum reliability. Key components, such as amplifiers and bridge circuits, are on special field-replaceable modules that plug into the chassis. The chassis simply slides into the rugged heavy-duty case, automatically plugging into contact terminals.

This is a potentiometer-type instrument with temperature control entirely independent of indication. In contrast, conventional controllers rely on the meter movement itself to control temperatures. Therefore any vibration that disturbs the meter also affects the temperature. Thus vibration and shock that would throw a conventional unit out of control do not affect this controller.

Control temperatures range from 0 to 3000°F in 1000° spans. Controllers are available with either manual or automatic reset. These controllers operate on 12-240-V ac at 50-60 Hz. Supply voltage is field-selectable (at the case back).

Booth No. 2K39 Circle No. 273

$\pm 1/4^\circ\text{F}$ control (SCR solid state) -120°F to $+350^\circ\text{F}$

with improved Tenney Jr. "Hermeticool" refrigerated bench-top test chamber

Better than ever! The Tenney Jr. now features more precise control while providing 40% expanded work space and faster cooling. Inside area has been enlarged to $1\frac{1}{4}$ cu. ft. without increasing outside dimensions. New, faster pull-down is from $+75^\circ\text{F}$ ambient to -100°F in just 35 minutes. Delivered for immediate 115 volt plug-in operation, Tenney Jr. requires no special piping, no accessories. And because of Hermeticool refrigeration and Vapor-weld construction, Tenney Jr. is as maintenance free as your home refrigerator. Still only \$990/ Available immediately from stock.

Write or call for complete information.



Tenney
ENGINEERING, INC.

1090 Springfield Rd. • Union, N. J. 07083 • (201) 686-7870
Western div.: 15721 Texaco Street • Paramount, Calif. 90723



SYSTEMS

Strip-chart recorder sensitive to 1 mV/in.

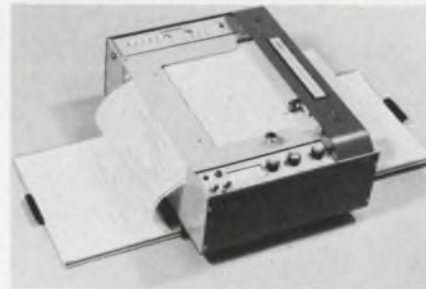

Houston Instrument, Div. of Bausch & Lomb, Inc., 4950 Terminal Ave., Bellaire, Tex. Phone: (713) 667-7403. P&A: \$2950; 30 days.

A strip-chart recorder with 1 mV/in. sensitivity covers a speed range of 144,000:1 and is capable of making X-Y plots with dc inputs of the Y-axis and step inputs on the X-axis. It can also make a sequence of records of any variable vs. time on standard 8-1/2 by 11-in. or 11 by 17-in. charts. Five continuously variable ranges from 0.001 to 10 V/in. are provided for Y-axis input. Slewing speed is 40 in./s and accuracy is $\pm 0.2\%$ with a repeatability of $\pm 0.1\%$ of full scale.

Booth No. 2H25 Circle No. 274

Differential amplifier operates in two modes

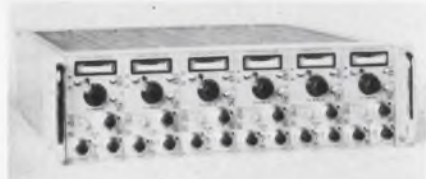

Unholtz-Dickie Corp., 2994 Whitney Ave., Hamden, Conn. Phone: (203) 288-3358.

A dual-mode amplifier conditions both charge and voltage-generating transducers that may be either grounded or floating. Differential operation provides rejection of ground-loop signals by a factor of 1000 or more for the most sensitive gain settings. A front-panel pilot light indicates proper operation of the float/ground selector switch. Operation in the voltage mode with a remote impedance converter combines 1 G Ω input impedance with a low impedance, 2-wire output connection to the signal conditioning amplifier.

Booth No. 2C09 Circle No. 276

CUSTOM-MADE

R-C Networks

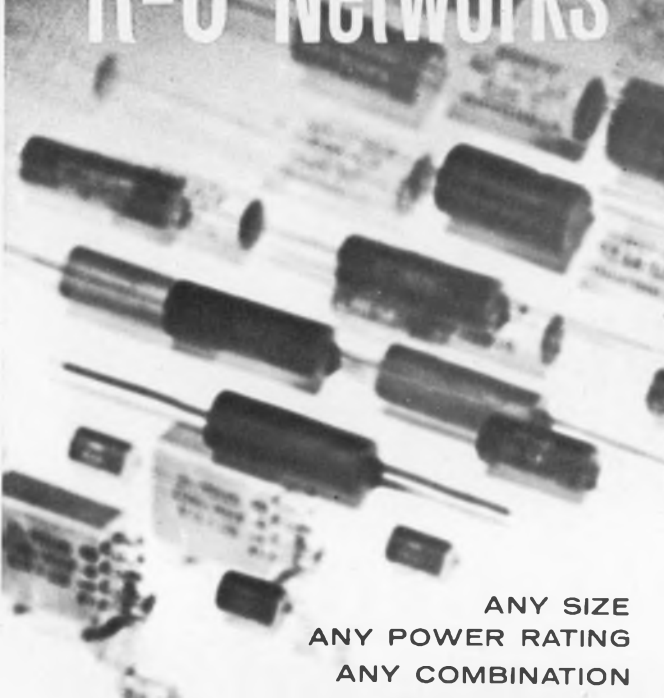

ANY SIZE
ANY POWER RATING
ANY COMBINATION
ANY CONFIGURATION

- For • RFI Suppression • Arc Suppression
 • Relay Contact Protectors • Noise Filters
 • Spark Suppression

R-C Networks available in any combination, for example:

Capacitor Section can be . . . Mylar, Metalized Mylar, Polystyrene, Polycarbonate . . . any voltage or tolerance.

Resistor Section can be . . . Composition, Wire-wound, Metal Film, Deposited Carbon . . . in any wattage or tolerance.

Total Networks available in tolerances as close as $\pm 1\%$.

All Networks are manufactured under rigid Quality Control to meet your specific requirements.

Send us your specifications for quotation. Prototype quantities furnished prior to production.

For Complete details write Dept. ED-3



1065 W. Addison Street, Chicago, Illinois 60613

INFORMATION RETRIEVAL NUMBER 81

SEMICONDUCTORS

Thyristor SCR handles 5000 A surges



Westinghouse Semiconductor Div., Youngwood, Pa. Phone: (412) 925-7272. P&A: \$440 (25 lots); stock.

A thyristor SCR with a 5000 A surge current rating is designed for cycling loads, making it suitable for applications such as motor control, starters, primary controlled power systems, and inverters where high inrush currents are encountered.

Designated type 2248, the thyristor passes a forward current of 475 A rms and 300 A half-wave average. Forward and reverse blocking voltages are available through 1500 V with 20 percent transient voltage above blocking voltage. The I²t rating for fusing is 100,000 A²/s. With its high current and voltage ratings, the type 2248 thyristor makes it unnecessary to connect many smaller devices in series or parallel arrangements.

A flat base and bolt-down mounting construction is ideal for forced air, water, or oil cooling. The junction, which is positioned close to the base, is thus able to gain maximum thermal conduction from the cooling medium.

Other features include compression-bonded encapsulation (CBE) and a lifetime guarantee. The CBE construction, exclusive with Westinghouse, eliminates failures due to thermal stresses by avoiding use of solder joints.

The device is held together by spring pressure.

Booth No. 3H02 Circle No. 401

SPEAK UP, MAN!

I was just saying . . . I've been published and I'm an engineer, not a writer. I've had three articles published in *Electronic Design*, the industry's most respected publication, and each one has earned me and my company lots of professional recognition. If you'd like to learn how to write for publication, attend one of the following "How to Write" seminars during IEEE.

The Times: 8:30 to 12:00 A.M., March 19, 20, or 21
(Coffee and danish will be served)

The Place: Henry Hudson Hotel, 353 West 57th Street
(Adjacent to the Coliseum)

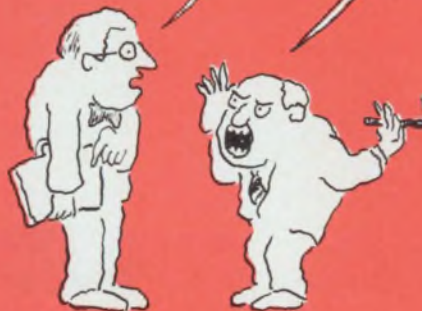

An avionics builder discovered Harowe when he needed a gearhead servo motor that never lost its cool

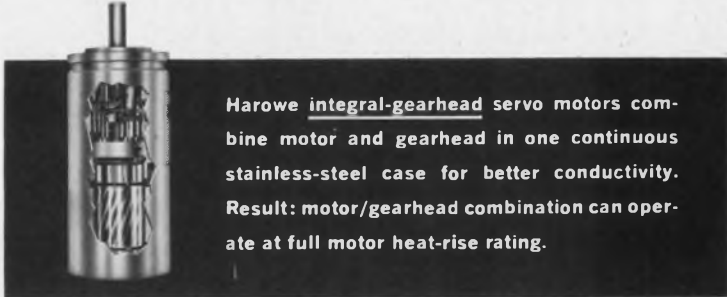

Harowe integral-gearhead servo motors combine motor and gearhead in one continuous stainless-steel case for better conductivity. Result: motor/gearhead combination can operate at full motor heat-rise rating.

Then he discovered he could get synchros with 10x normal life from the same place

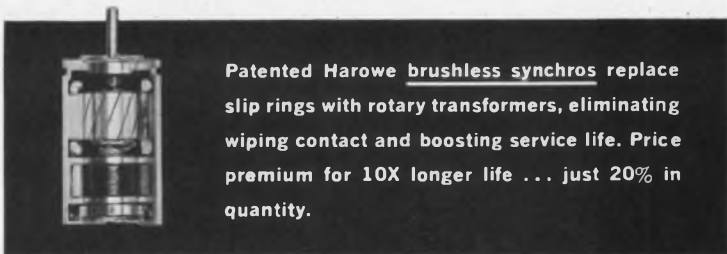

Patented Harowe brushless synchros replace slip rings with rotary transformers, eliminating wiping contact and boosting service life. Price premium for 10X longer life ... just 20% in quantity.

Discover some new solutions to your servo problems:



Harowe SERVO CONTROLS, INC.

22 Westtown Road • West Chester, Pa. 19380

RUSH technical data on . . .

	Reader Service No.
<input type="checkbox"/> Brushless Synchros & Resolvers —last up to 10X longer	241
<input type="checkbox"/> Conventional Synchros & Resolvers —all sizes; all types	242
<input type="checkbox"/> Servo Motors —with low starting voltage; high torque—including stepper and synchronous	243
<input type="checkbox"/> Motor-Generators —damping, rate, and integrating	244
<input type="checkbox"/> Integral-Gearhead Servo Motors —built together in one-piece case	245
<input type="checkbox"/> Size 5 Components —for lowest space and weight	246

Name _____ Title _____
 Company _____
 Address _____

See us at Booth 4E28

SEMICONDUCTORS

S-band mixer diodes use Schottky barrier

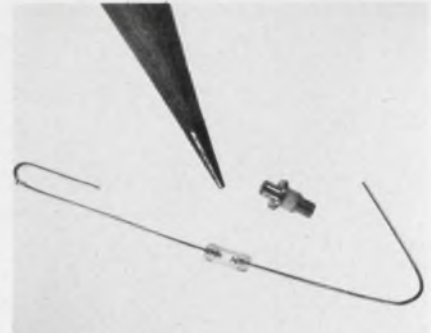

Philco-Ford Corp., 3939 Fabian Way, Palo Alto, Calif. Phone: (415) 326-4350.

All-bonded construction Schottky-barrier mixer diodes are designed for low-noise operation in S band where units with noise figures of 6 dB to 7 dB maximum are offered. Both pill-prong and axial-lead packages are available. In order to obtain reliability in both package styles all contacts are made by thermal compression bonds. In this manner, the undesirable aspects of pressure contacts are avoided. These units have been designed for local oscillator power levels of 1 mW and provide an i-f impedance of 230 Ω. They may be operated at frequencies into X band with a typical noise figure increase of 1.5 dB.

Booth No. 3B16 Circle No. 372

Power transistor handles 25 A

Solitron Devices, Inc., 1177 Blue Heron Blvd., Riviera Beach, Fla. Phone: (305) 848-4311.

This 25-A pnp germanium power transistor comes in a TO-36 case. Other devices are available in the same configuration at any current rating up to 65 A. Typical specifications of the 25 A unit include a minimum gain of 10 V_{CE0} of 40 to 80 V, V_{CEX} of 40 to 80 V and V_{CEO} of 30 to 50 V. The device is useful in applications requiring up to 170 W dissipation. It is a general purpose transistor for use in military and industrial inverters, converters, switches, regulators, control circuitry and audio amplifiers.

Booth No. 4G20 Circle No. 375

Flip-tab fabrication helps mounting of ICs

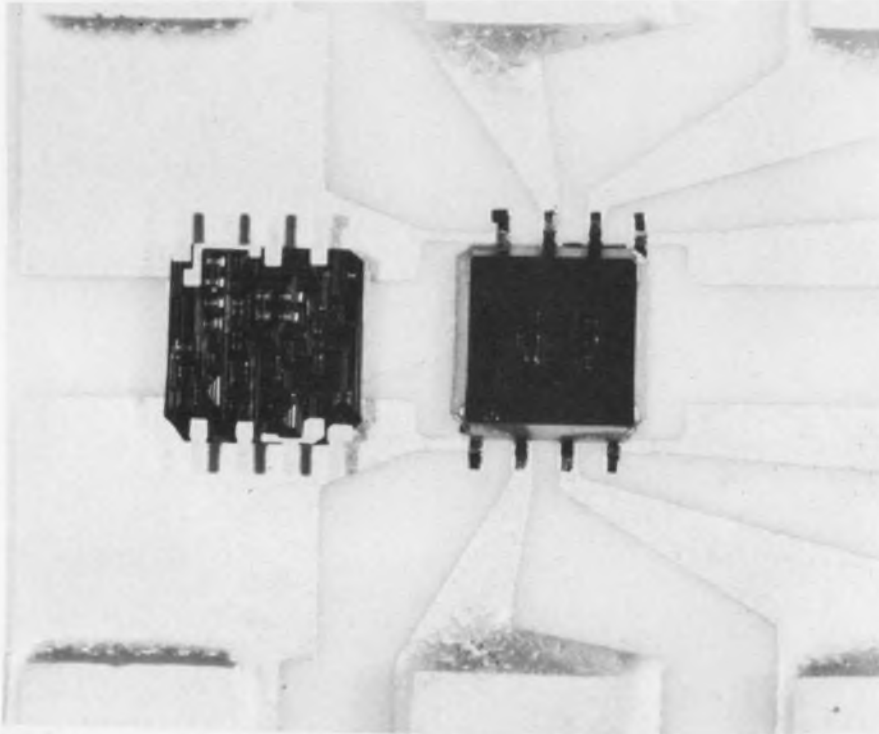

Raytheon Company, Semiconductor Div., 350 Ellis St., Mountain View, Calif. Phone: (415) 968-9211.

A fabrication method for monolithic ICs called the flip-tab technique will be announced at the IEEE show by the Raytheon Co. Units produced by this method differ from conventional ICs in having electroformed gold beams that extend beyond the edges of the chip.

Conventional integrated circuits are provided with metallized areas on the face of the chip to which electrical wiring is bonded. The protruding gold beams of the flip-tab device replace these metallized areas.

A flip-tab device would typically be used in a hybrid integrated circuit in which patterns of conducting metals have been laid down on a ceramic substrate. The flip-tab unit is mounted on the substrate by inverting it and visually positioning its protruding leads over the connecting metal pattern to which it will be bonded.

Flip-tab technique differs from

conventional "beam-lead" technology as originally developed by Bell Labs in that it does not include air gap isolation of the individual elements in the integrated circuit. It is similar in the use of relatively heavy metallic leads extending beyond the edge of the chip, and in the separation of chips on the silicon wafer by chemical milling instead of by scribing and breaking.

Flip-tab units are easier to mount and bond than their counterpart in hybrid circuit technology, the flip chip. The latter are supplied with raised bumps on the face which are bonded beneath the inverted chip to metal patterns on the substrate. Positioning is difficult and trouble is encountered in getting all the bumps bonded at the same time.

By contrast flip-tab devices permit visual alignment of the chip on the board, visual inspection of bond quality and individual bond repairability. The metal bonding system gold-on-gold is compatible with most hybrid designs.

Booth No. 3F01 Circle No. 376

Low power DTL ICs ceramic/metal cloaked

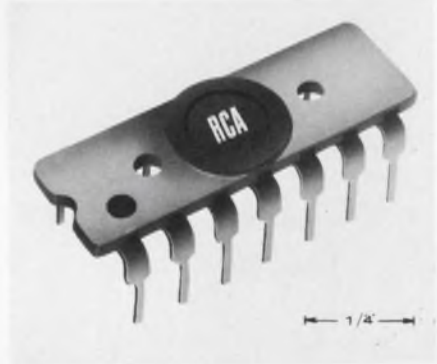

Commercial Engineering, RCA Electronic Components & Devices, Harrison, N.J. Phone: (201) 485-3900. Price: \$2.25 to \$4.20; (1000 lots).

Low power DTL ICs are available in a ceramic-and-metal dual in-line package. The 14-lead IC employs a 100-mil lead spacing and 300-mil spacing between rows.

The hermetically sealed ceramic units are designed for application in aerospace and airborne computers, portable military equipment, instrumentation and industrial control equipment and other applications where circuits with low device dissipation and high noise immunity are primary design requirements.

Some of the features of these DTL ICs include their low device dissipation of 2.3 mW per gate or 7 mW per flip-flop; a full military operating temperature range of -55°C to $+125^{\circ}\text{C}$; a noise immunity of 1200 mV typical at 25°C ; and typical flip-flop clock frequencies of 3 MHz for a fan-out of 5.

The following devices are available in the ceramic-and-metal dual in-line package: the CD 2200D is a dual four-input expandable NAND gate, CD 2201D is a quadruple two-input NAND gate, the CD 2202D is a dual four-input expandable NAND buffer gate, the CD 2203D is a J-K flip-flop with set-reset capability, the CD 2204D is a dual four-input gate expander and the CD 2205D is a dual three-input expandable AND/OR/NOT gate.

Additional technical information is available on the LD 2200D series. Booth No. 3D01 Circle No. 402

**if you're using
any other
miniature fan
in your equipment,
you're getting
less efficient cooling...
and paying more dollars to do it!**

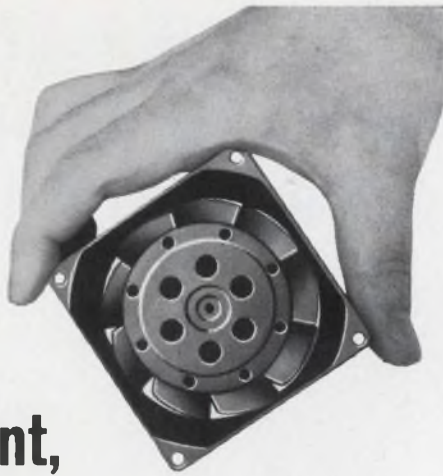

THE NEW ALL-METAL MODEL 8500 IS...

THE QUIETEST...

(Unmatched low noise level of 28.8 dB SIL.)

THE MOST COMPACT...

($\frac{1}{8}$ " thinner than conventional $3\frac{1}{8}$ " fans. Standard mounting dimensions for EIA $3\frac{1}{2}$ " rack panels.)

THE MOST EFFICIENT...

(Delivers 45 cfm at zero static pressure ... up to 50% more air than other $3\frac{1}{8}$ " fans.)

$3\frac{1}{8}$ " FAN YOU CAN GET YOUR HANDS ON

(Immediate delivery through leading electronic distributors or directly from factory stock.)

**IF THIS SEEMS TOO GOOD TO BE TRUE,
FILL IN THE COUPON AND WE'LL MAKE YOU A BELIEVER!**

OK, so prove to me that the new Model 8500 offers better performance at a lower cost than *any other* $3\frac{1}{8}$ " fan.

Have sales representative call Send me complete data

Name.....Title.....

Company.....Phone.....Ext.....

Address.....City.....State.....Zip.....



312 Seventh Street, San Francisco, Cal. 94103

INFORMATION RETRIEVAL NUMBER 87

MICROELECTRONICS

**Power booster
for IC op amps**



Helipot Div., Beckman Instruments, Inc., 2500 Harbor Blvd., Fullerton, Calif. Phone: (714) 871-4848. P&A: \$35; stock.

A miniature power amplifier can boost power of IC op amps to 2.5 W, without affecting other performance capabilities. The unit is a hybrid, cermet thick-film device. In addition to its 2.5-W output, special features include unity voltage gain, 30-MHz bandwidth, ± 16 -V swing, less than 90° phase shift and -55° to $+125^\circ\text{C}$ operating temperature range. The unit is short-circuit proof and keeps overload reflections from reaching the IC amplifier and power supply. This prevents heat-generated errors in the IC amplifier and permits immediate recovery after overload removal. The unit is 0.17 in. high, occupies 0.5 in. board space, and is compatible with both flat pack and dual-in-line IC packages.

Booth No. 2G25 Circle No. 373

**30,000 capacitor chips
occupy 1 in.³**

American Components, Inc., Eighth Ave. at Harry St., Coshohocken, Pa. Phone: (215) 828-6240. Price: 22¢-\$4.11.

These chips, which are so small that it takes 30,000 units to fill 1 in.³, are available for microcircuit applications. Uncased type U chips are available in twenty sizes, and other sizes can easily be customized. Sizes range from $0.025 \times 0.025 \times 0.065$ in. up to $0.4 \times 0.15 \times 0.7$ in. and cover capacitance values to 680,000 pF. Lower values are available in a choice of working voltage of 50 or 100 V dc. A choice of tolerances is available, ranging from as low as $\pm 1\%$ for certain types to as wide as $+80 - 20\%$ for others. Tolerances of $\pm 10\%$ and $\pm 20\%$ are standard.

Booth No. 4G15 Circle No. 363

I-f amplifier rejects 100 dB

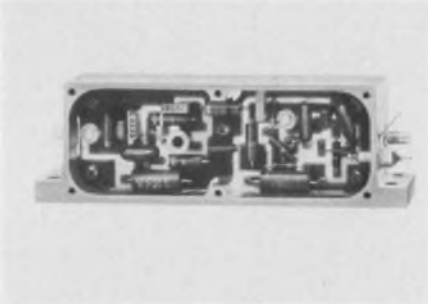

RHG Electronics Laboratory, Inc., 94 Milbar Blvd., Farmingdale, L.I., N.Y. Phone: (516) 694-3100.

An i-f amplifier is capable of greater than 100 dB of intermodulation rejection. Typical specifications for this FTM series include a center frequency of 40 MHz, a bandwidth of 20 MHz, gain of 35 dB and a noise figure of less than 4 dB. The saturated output capability is greater than +25 dB.
Booth No. 3L07 Circle No. 410

Parametric amplifier for C-band radar

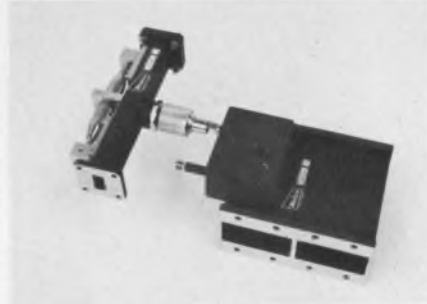

Melabs, 3300 Hillview Ave., Stanford Industrial Park, Palo Alto, Calif. Phone: (415) 326-9500.

A tunable, low-noise parametric amplifier compatible with C-band radar systems operates in the 5.4 to 5.9 GHz range. It is designed for use in single-or multi-channel radar systems. The amplifier has a 20 MHz instantaneous 3 dB bandwidth. Noise figure is 3 dB maximum with 18 dB of gain. Calibrated gain and frequency controls permit tuning across the operating range.
Booth No. 3K27 Circle No. 412

Chebyshev filters weigh under 1 oz



Telonic Engineering Co., Box 277, Laguna Beach, Calif. Phone: (714) 494-9401. P&A: \$95; 6 wks.

A series of bandpass filters with center frequencies ranging from 400 to 2300 MHz uses the 0.05-dB Chebyshev design. A typical 5-section unit, with miniature connectors, measures 4-1/4 in. long and weighs 1/2 oz. The filters are available with a 3 dB bandwidth of 2 to 15%, in 2- to 6-section versions. Insertion losses are specified at less than 1 dB.
Booth No. 2H12 Circle No. 257

Miniature oscillator generates 100 mW



Omni Spectra, Inc., 24600 Hallwood Ct., Farmington, Mich. Phone: (313) 255-1400.

Electrically tunable from 500-1000 MHz, this 1.3-oz oscillator develops a power output of better than 100 mW. Measuring 0.75 x 1 x 1.5 in., the package employs an npn transistor in a grounded collector configuration and uses a high-Q varactor as the frequency tuning element. Power requirements are 20 V at 150 A.
Booth No. 3L01 Circle No. 331

Antenna feed assembly covers 2.2 to 2.3 GHz

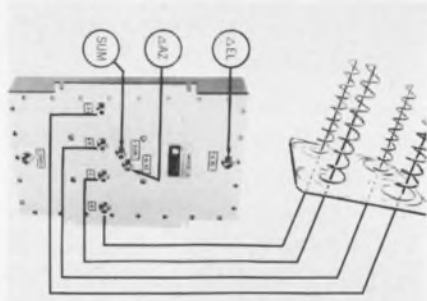

Alford Manufacturing Co., 120 Cross St., Winchester, Mass. Phone: (617) 729-8050. P&A: \$2075; 35 days.

Useful at from 2.2 to 2.3 GHz, a tracking antenna feed assembly provides a 40 dB minimum null depth and less than ±1° null shift over the entire frequency range. The units offer greater than 40 dB isolation and less than 0.2 dB insertion loss. They are constructed of non-corrosive materials and are hermetically sealed in an aluminum case. Outline dimensions are 18 x 13 x 4 in. and weight is 15 lb.
Booth No. 2D46 Circle No. 414

Traveling wave tube amplifies 1000 MHz



Microwave Associates, Burlington, Mass. Phone: (617) 272-3000.

A compact, lightweight continuous-wave TWT operates in the 550-1000-MHz frequency range. The new device features metal-ceramic construction and utilizes a hollow electron beam coupled with a solenoid to provide high gain in a small package. Power output is 2 W with a saturation gain of 33 dB.
Booth No. 3K18 Circle No. 338

THE BEST?

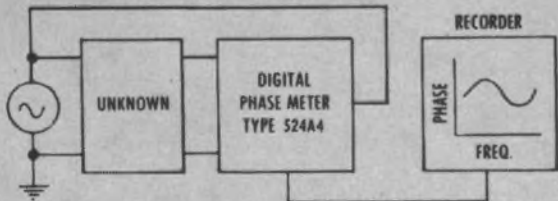

Read phase angle in 4-digits and automatically plot phase curve vs. frequency from 10 Hz to 500 KHz

Do You Have Phase Problems?

Why not try AD-YU Type 524A4 Digital Phase Meter and see what happens? Phase angle in degrees directly represented in four digits. No frequency adjustment. Analog output available for external recorder or programmable systems. Accuracy $\pm 0.03^\circ$. Phase response from 5 Hz to 500 KHz.

Write for free technical bulletin—
"DIGITAL PHASE MEASUREMENT"



WORLD FAMOUS IN PHASE-TIME MEASUREMENT

ADYU **ELECTRONICS, INC.**
249 TERHUNE AVE., PASSAIC, N. J.
PHONE: (201) 472-5822
CABLE: ADYU PASMAIC

"Visit our Booth 2J43-2J45 at the IEEE Show"

INFORMATION RETRIEVAL NUMBER 90

MICROWAVES

High-resolution CRT has 0.45 mil spot size



Westinghouse Electronic Tube Div., Elmira, N.Y. Phone: (607) 739-7951.

A high-resolution, electrostatically focused CRT, made up in an assembly of matched tube, yoke and shield, provides a 0.00045-in. (0.45 mil) dia spot size for aerial photographic recording and other single-line scan data-processing applications. The 11-1/4 lb package is ready to install and operate with no further engineering or designing. The CRT features a 3-in., optically ground flat faceplate and magnetic deflection reduced to 40° . Normally the faceplate is coated with P11 phosphor, but other standard JEDEC phosphors can also be supplied.

Booth No. 3H02 Circle No. 413

Spst diode switch turns on in 1 ns

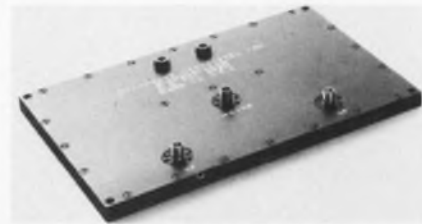

Microwave Associates, Burlington, Mass. Phone: (617) 272-3000.

An 800-MHz spst switch turns on or off in less than 1 ns. The device is constructed in stripline in order to utilize advanced filter techniques. The basic switch structure consists of two bandpass filters, impedance transformers, a diode section and a low-pass filter. Drive pulse rise time is 2 ns and fall time is 1.5 ns. Across a 200-MHz bandwidth there is less than 1.5 dB insertion loss.

Booth No. 3K18 Circle No. 333

**CHOOSE DEL PRODUCTS FOR HIGH
QUALITY PERFORMANCE & RELIABILITY**

**FREQUENCY
CONVERTERS**

**SOLID
STATE:** Stable 400 Cycle
Power Sources
INPUT: 105-125 VAC, 50-
70 CPS
OUTPUT: 100 VA to 1000
VA Models



FEATURING

Adjustable output voltage, Excellent frequency characteristics, Waveform purity, Voltage regulation, and Low dynamic output impedance.



100 to 1000 VA DC/AC
Power Inverters
INPUT: 22 - 30 VAC
Regulated and Non-
Regulated Models
Fully protected against
overvoltage, reverse
polarity, overload
short circuit and
over-temperature.

**AC/DC
INVERTERS**

Write for bulletin



Del Electronics Corp.

Mt. Vernon, N.Y.

250 E. SANDFORD BLVD.

TEL: 914-699-2000

See us at IEEE show. Booths 3K28-3K29
INFORMATION RETRIEVAL NUMBER 92

**PRETTY SMALL
FUSE**



Picofuses by Littelfuse.
Available from 1/8 thru
15 amps, 125V.
Weights only 1/6 gram.

LITTELFUSE

DES PLAINES, ILLINOIS

INFORMATION RETRIEVAL NUMBER 93

MICROWAVES

**Mixer/preamp
weighs 2.5 oz**

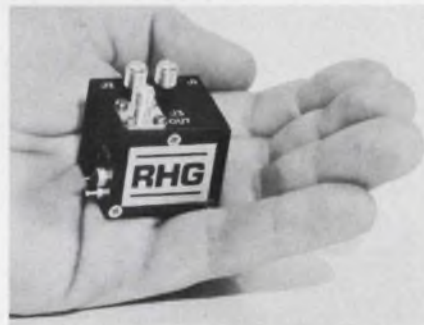

*RHG Electronics Laboratory, Inc.,
94 Milbar Blvd., Farmingdale, N.Y.
Phone: (516) 694-3100. P&A:
\$595; 4-6 wks.*

Each unit in a line of ultramini-
ature mixer/preamplifiers occupies
less than 2 in.³ and weighs under
2.5 oz. Small size and low power
drain suit these devices to air-
borne and portable applications.
Four units cover the rf frequency
range of 1 to 8 GHz. i-f frequen-
cies of 30, 60 or 70 MHz are stand-
ard. Other rf and i-f frequencies
are available upon request.

Booth No. 3L02 Circle No. 411

**Tunable magnetron
develops 1 kW**



*Microwave Associates, Burlington,
Mass. Phone: (617) 272-3000.*

A positive pulse beacon magne-
tron provides 1 kW peak output
and is tunable from 16 to 16.5
GHz. Its output is level (± 1 dB)
while temperature coefficient varies
with tuning from -60 to -85
kHz/ $^{\circ}$ C. Duty cycle is 0.005 and
operation at pulse widths as short
as 50 ns is possible. Operation at
longer pulse widths is limited only
by maximum average power dissipa-
tion requirements.

Booth No. 3K18 Circle No. 334

MIL SPEC CASES

★ FIBERGLASS ★



★ SANDWICH PANEL ★



★ THERMOFORMED PLASTIC ★



No matter what your Mil Spec Transportation Case, Combination Case, or Custom-designed Structural Container requirement might be, Skydyne offers industry's most complete line meeting MIL-T-21200, MIL-T-945 and MIL-C-4150. Over 60 standard sizes are available in Fiberglass and ABS Thermoplastic. Standard components and materials assure the fastest possible delivery on Aluminum-faced Sandwich cases and containers. When the design calls for a Military Specification Case, check with Skydyne. Chances are we have an off-the-shelf case that will do the job. Write for our complete catalog file.

Skydyne, Inc

River Road, Port Jarvis, N. Y. (914) 856-5241

INFORMATION RETRIEVAL NUMBER 95

72 HOUR DELIVERY

ON THESE



REGULATED DC POWER SUPPLIES

- Fully accessible, fully repairable
- Low Cost—Large quantity discounts
- 0.5 to 250 vdc coverage
- Combined regulation from 0.5% to 0.01%
- Temperature coefficient from 0.04%/°C to 0.001%/°C
- Stability—To 0.005%/Month
- Two year warranty
- Many optional modifications

See EEM for power supplies and voltage references



DYNAGE inc.
1331 Blue Hills Ave., Bloomfield
Conn. 06002 • (203) 243-0315

Booth 2J42 at IEEE Show

INFORMATION RETRIEVAL NUMBER 96

YOUR HEART FUND FIGHTS

HEART ATTACK
STROKE
HIGH BLOOD PRESSURE
INBORN HEART DEFECTS



MICROWAVES

Two switches isolate 40 to 60 dB



Microwave Associates, Burlington, Mass. Phone: (617) 272-3000.

A compact, lightweight X-band high power double-throw switch has been designed for time-sharing the input signal. The switch's output channels are phase balanced and provide 40-dB isolation with only 1 dB loss.

The MA-8319-2X4 has a high power capability of 4 kW at an 0.001-duty cycle and the switching time is 1 μ s. VSWR at -25 V is 1.4. The switch is recommended for radar and communication systems applications.

Booth No. 3K18 Circle No. 417

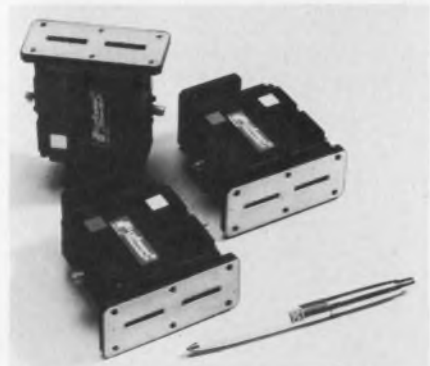

Subminiature switches are available with performance ratings to 18 GHz. This rating widens the switches' applicability to include the Ku-band installations. Electrical ratings from 12.4 to 18 GHz are as follows: VSWR: 1.70 max; insertion loss: 0.9 dB max; isolation remains at 60 dB. Power output is 15 W and rfV capacity is 350 V max.

The MA-7530 series is available with fail-safe, latching (remote control), or manual actuation. The fail-safe version weighs less than 1.2 oz.

Booth No. 3K18 Circle No. 418

Conductor composition uses palladium-gold

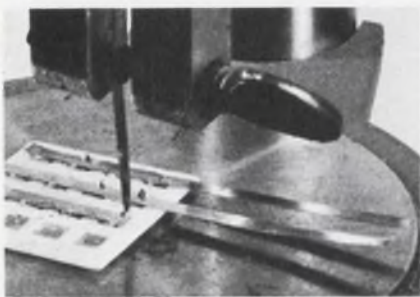

Du Pont Company, Wilmington, Del. Phone: (302) 774-8631. Price: \$40.60 (troy oz).

A palladium-gold conductor composition for thick film microcircuits provides good adhesion to ceramic substrates. Designated Palladium-Gold #8227, the new composition reaches maximum adhesion at a peak firing temperature of 850°C. Because solderability is excellent across a firing range from 850°C to 925°C, it is no longer necessary to balance adhesion and solderability with firing temperature, Du Pont said. In addition to advantages in adhesion and initial solderability, Palladium-Gold #8227 has excellent acceptance to solder after multiple firings. It is also compatible with thick-film resistors, readily accepts thermo-compression bonding and has low sheet resistivity. In addition to Palladium-Gold #8227, Du Pont also announced two other new high-adhesion conductors, one in platinum-gold and the other in platinum-palladium-gold. These are designed for specialized microcircuit use where properties of these metals are required.

Booth No. 1D10 Circle No. 403

Beryllia substrates conducts 2.6 W/cm/°C

National Beryllia Corp., Haskell, N.J. Phone: (201) 839-1600.

BERLOX-STRATE is the trade name for Beryllia substrates offered for all types of IC components. Having a thermal conductivity of 2.6 W/cm/°C, BERLOX-STRATE has more than seven times the thermal conductivity of the usual Alumina substrate.

Booth No. 4F43 Circle No. 404

Zip-on sleeving blocks rfi



The Zippertubing Co., 13000 S. Broadway, Los Angeles. Phone: (213) 321-3901.

Zip-on sleeving provides electrostatic and rfi shielding of multi-conductor wiring and cables. A laminate of vinyl-impregnated nylon and aluminum foil, with a tinned copper braid attached to the inside overlap, provides a gasket-type seal and a solderable termination point. The material has a temperature range of -20 to +150°F and is resistant to oil, solvents, alcohol and acids. The tubing is available in diameter sizes from 1/2 in. to 4 in. with 2- or 4-ply shielding mesh.

Booth No. 1B28 Circle No. 371

Stripline materials are aluminum-backed



The Polymer Corp., Reading, Pa. Phone: (215) 929-5858.

Dielectric materials of polyphenylene oxide for stripline microwave circuits are aluminum-backed. The material is offered in cut-to-size boards in any practical combination of aluminum and dielectric substrate thickness, with or without copper laminate. Polyphenylene oxide maintains the low-electrical-loss, high-frequency characteristic of thermoplastic olefins, along with a similarity to thermosets in strength, rigidity and stability.

Booth No. 1A12 Circle No. 361

Noble metal formulation saves space on IC

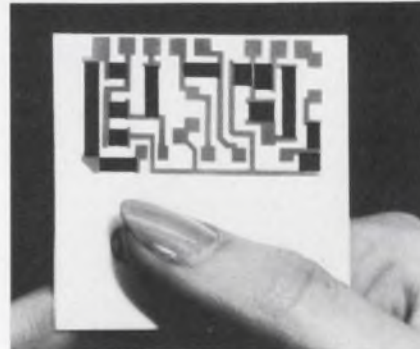

Method Electronics, Inc., 7447 W. Wilson Ave., Chicago. Phone: (312) 867-9600.

Resistance materials that will reduce the complexity of manufacturing hybrid microcircuitry are in the form of noble metal formulations. The composite metal compounds are represented to be superior to those now on the market because of greater environmental stabilities and exceptionally low temperature coefficients. The materials permit one-coat system for manufacturing resistor networks and offer resistance coverage up to 5 MΩ per square. More than 375,000 hours of test data have gone into developing the materials. The dispersion pastes are available to manufacturers of ceramic substrate resistors and hybrid micro-circuit networks. The resistive networks replace a number of individual resistor components, each requiring two wire leads and a separate molded enclosure. Thus, they save space.

Booth No. 3A31 Circle No. 405

Presoldering chemical restores solderability

Alpha Metals, Inc., 56 Water St., Jersey City, N.J. Phone: (201) 434-6778.

Nickel wet No. 994, a fumeless aqueous solution containing an effective etching agent, is designed to restore the solderability of tarnished nickel and nickel alloy surfaces. The solution is recommended for use on nickel and tin/nickel printed circuit boards. It can also be used on wires and terminals.

Booth No. 1F08 Circle No. 406

Resistor pastes of thallium oxide

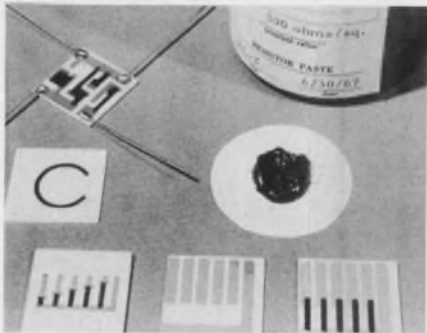

Airco Speer, St. Mary's, Pa. Phone: (814) 834-2801.

Airco Speer will show a series of thallium oxide resistor pastes. The composition comes in two forms. The type TGF paste, compatible with forsterite, steatite and titanate-type substrates, is available with sheet resistivity levels (Ω/mil^2) of 300 Ω , 5, 20 and 100 k Ω and 1 M Ω . Type TGA, compatible with alumina and other substrates, has a sheet resistivity level of 100 Ω and 1, 10 and 100 k Ω .

Booth No. 4K15 Circle No. 281

Wiring devices fill many needs

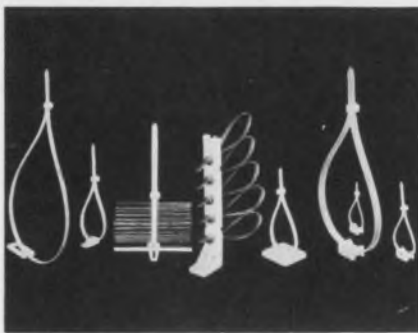

Panduit Corp., 17301 Ridgeland Ave., Timely Park, Ill. Phone: (312) 532-1800.

These mounting devices add versatility to existing harness-tying systems. At left are two adaptors for offset mounting. Next is a mount which is used to secure large wiring harnesses up to 4 in. in diameter. In the center is a bracket that will support wiring harnesses away from a surface. The four devices on the right are for use with bolts and adhesives for mounting on walls.

Booth No. 1C14 Circle No. 407

Ceramic terminal strip can mount up or down

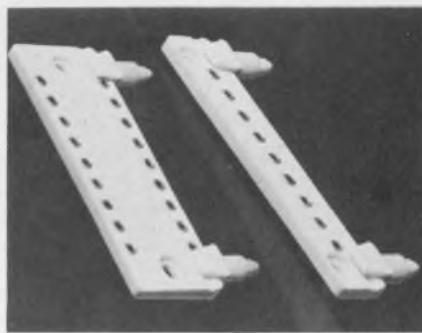

Alcoswitch, Div. of Alco Electronic Products, Inc., Lawrence, Mass. Phone: (617) 686-3888. Price: 80¢-\$2.20.

Suitable for both horizontal and vertical mounting, a ceramic terminal strip is designed for high-density packaging. The low-loss ceramic material is superior in longevity and temperature resistance to plastics. Round silver-plated copper eyelets are swaged to the ceramic base and up to 40 of these terminals can be supplied on a single strip.

Booth No. 4G23 Circle No. 408

Let's keep electronics clean

Here are some of the products that help keep electronic devices clean during production and in use. You'll find them on assembly lines and flight lines, in laboratories and on launch pads... wherever dirt, grease or foreign matter could degrade the quality or performance of electronic hardware.

If you'll tell us (on your letterhead) which of them you'd like to evaluate, we'll send you a free sample. For literature only, use the bingo card.

ms miller-stephenson chemical co., inc.
Route 7, Danbury, Conn.



Lockheed stacks stack up.



Precisely.

Core after core, plane after plane ...the only difference between Lockheed stacks is the serial numbers. This precision means memory systems using Lockheed stacks are more reliable.

Reliability begins with each core's production and placement. Lockheed design and quality standards for cores are so high, many are rejected that would be acceptable to other producers. And our exclu-

sive bonding technique, plus rigid manufacturing controls, makes core positioning precise...permanent.

Testing is another way Lockheed assures reliability. An average plane in a stack must pass 260,000 performance tests (based on an average of 16K words per plane) before the stack can be shipped.

Lockheed also knows your business. We make memory systems, too. So our stack designs are

systems-oriented...and perform that way. Plus, Lockheed offers you a large library of standard stack designs covering the entire range of memory systems technology.

■ For stacks of additional technical material, promptly mailed, write to: Memory Products, Lockheed Electronics Company, 6201 E. Randolph Street, Los Angeles, Calif. 90022. Or save a stamp and call (213) 722-6810.

LOCKHEED ELECTRONICS COMPANY

A DIVISION OF LOCKHEED AIRCRAFT CORPORATION
INFORMATION RETRIEVAL NUMBER 101

Pulse Fidelity

This double-exposure photograph shows the same 12-ns-wide pulse displayed by the Tektronix Type 454 (upper trace) and by a 7-ns, 50-MHz oscilloscope (lower trace). Note the difference in detail of the pulse characteristics displayed by the Type 454 with its 2.4-ns risetime performance.

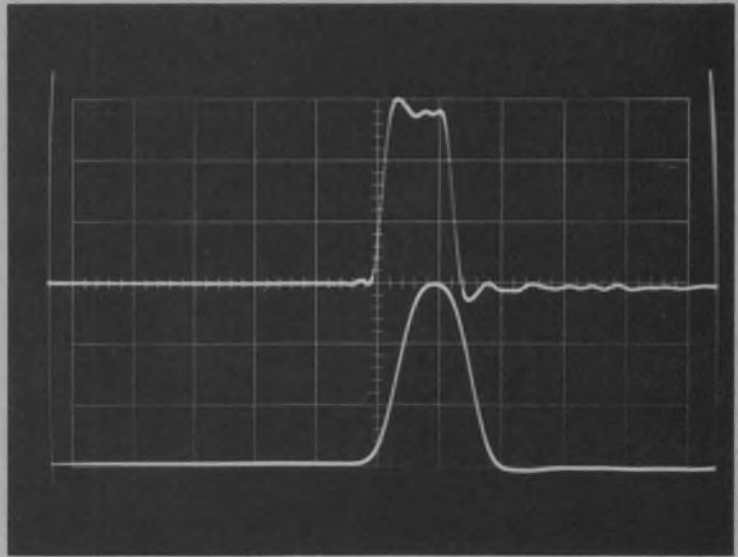

10 ns/div

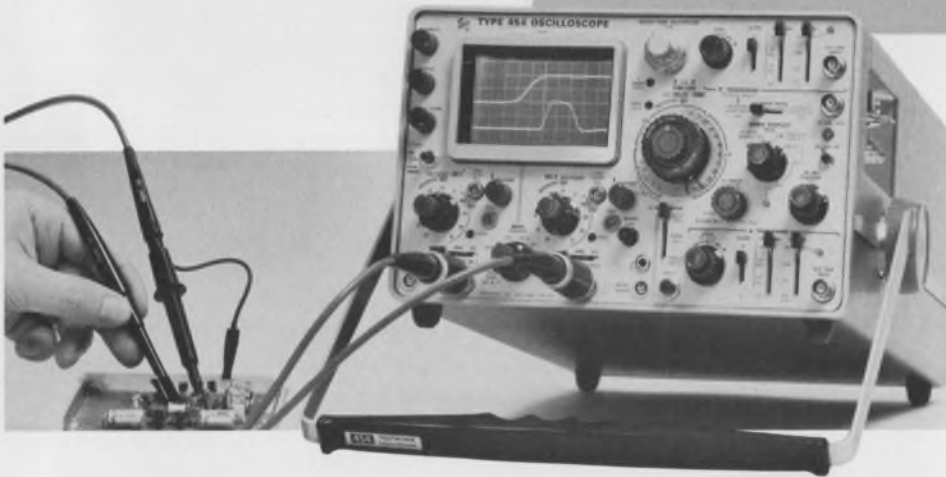

**150 MHz,
2.4 ns
with or
without
probes**

The Tektronix Type 454 is an advanced portable oscilloscope with DC-to-150 MHz bandwidth and 2.4-ns risetime performance where you use it—at the probe tip. It is designed to solve your measurement needs with a dual-trace vertical, high performance triggering, 5-ns/div delayed sweep and solid state design. You also can make 1 mV/div single-trace measurements and 5 mV/div X-Y measurements.

The vertical system provides the following dual-trace performance, either with or without the miniature P6047 10X Attenuator Probes:

Deflection Factor*	Risetime	Bandwidth
20 mV/div to 10V/div	2.4 ns	DC to 150 MHz
10 mV/div	3.5 ns	DC to 100 MHz
5 mV/div	5.9 ns	DC to 60 MHz

*Front panel reading. With P6047 deflection factor is 10X panel reading.

The Type 454 can trigger internally to above 150 MHz. Its calibrated sweep range is from 50 ns/div to 5 s/div, extending to 5 ns/div with the X10 magnifier on both the normal and delayed sweeps. The delayed sweep has a calibrated delay range from 1 μ s to 50 seconds.

Type 454 (complete with 2 P6047 and accessories).....	\$2600
Rackmount Type R454 (complete with 2 P6047 and accessories)	\$2685
Type 200-1 Scope-Mobile® Cart	\$ 75

U.S. Sales Prices FOB Beaverton, Oregon

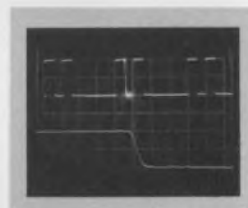

Double Exposure

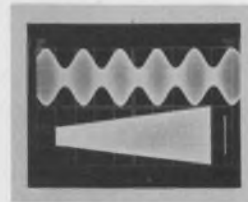

150 MHz AM

5 ns/div delayed sweep

The delayed sweep is used to measure individual pulses in digital pulse trains. The Type 454 with its 1 μ s-to-50 s calibrated delay time, 5-ns/div sweep speed and 2.4-ns risetime permits high resolution measurements to be made. Upper trace is 1 μ s/div; lower trace is 5 ns/div.

X-Y

The upper display is a 150-MHz signal that is 50% modulated by a 2 kHz signal. The lower display is an X-Y trapezoidal modulation pattern showing the 150-MHz AM signal vertically (Y) and the 2 kHz modulation signal horizontally (X). Straight vertical line is the unmodulated carrier. Multiple exposure.

For a demonstration, contact your nearby Tektronix field engineer, or write: Tektronix, Inc., P. O. Box 500, Beaverton, Oregon 97005.



*Coordinated research,
design and manufacturing*



*... part of the Tektronix commitment
to progress in the measurement sciences*

Follow a logical sequence to synthesize circuits.

All-logic flip-flop design is based on a flow-table method that can be applied to many digital circuits.

Today's demands for speed in digital systems has increased the emphasis on compatibility between logic gates and flip-flops. The best way to achieve this is to use the gates to construct flip-flops. NAND and NOR gates are most commonly used. These all-logic flip-flops are trickier to design than regular ones.

The following six-step method, using a series of flow tables, will minimize the designer's work and eliminate troubles that might result from a "hammer and tongs" approach. The approach usually involves the use of several timing diagrams and a series of mental exercises, referred to as "chasing 1s and 0s," to achieve a design. The sequential circuit synthesis procedure is not new; it is covered in detail in the bibliography. What is offered now is a simple summary of the design steps for two specific types of all-logic flip-flops. The discussion does not probe theoretical side issues, but sticks instead to the basic design rules.

The first example is a delay, or *D*, flip-flop that can be implemented by NAND gates. It is easily built with DTL or TTL logic elements. A J-K flip-flop is the second example.

The sequential circuit synthesis approach demonstrated in these examples is applicable to any logic family. Implementation of the functions, once the sequential circuit synthesis procedure has been carried out, is limited only by the design engineer's ingenuity.

Delay flip-flop design

The delay flip-flop is shown in general form in Fig. 1. Any input at *D* will appear at the output, *Q*, whenever the clock makes a transition from 0 to 1. The truth table for the flip-flop, Table 1, bears out this mode of operation. In the table t_n represents a time before a clock pulse occurs, and t_{n+1} represents a time one clock cycle later. Any change in data that occurs after the clock pulse makes a positive transition does not effect

the output. Also the clock's transition from 1 to 0 does not change the output.

The feedback paths *X* and *Y* in the black-box diagram for the circuit are necessary for the logic elements to produce the desired function. More complicated sequential circuits may use many more feedback paths, but two suffice for flip-flop operation. The *C* and *D* inputs are called primaries because they are the only ones that can initiate changes in the internal states that may cause *Q*, *X* or *Y* to change state. Any changes in *X* and *Y* are in turn fed back to inputs *x* and *y*, which may then cause further changes. The system becomes stable only when $x = X$ and $y = Y$. If $x \neq X$ or $y \neq Y$ the system is considered unstable, or in transition.

Step 1: Making a primitive flow table

With the basic concept of the delay flip-flop in mind, the designer now develops a primitive flow table (Table 2). The stable states are numbered arbitrarily and are circled. For example, the condition where *C* and *D* are 0 and *Q* is also 0 is numbered ①. When *C* and *D* are 0 and *Q* is 1, number ⑤ is used.

The rest of the spaces in the flow table are filled in by observing the operation of the flip-flop. The shifts from one column to another column are defined by the primary inputs. The shifts from one row to another are defined by the secondaries.

An example of a transition will help to clarify the procedure. Suppose the *C* and *D* inputs are

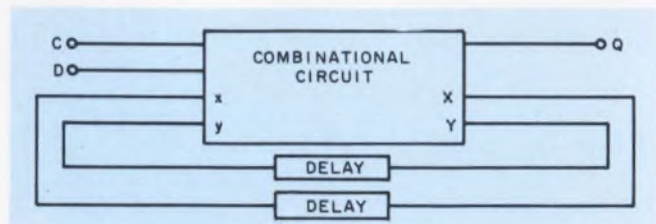

1. In a sequential circuit the output *Q*, is a function of the present inputs, *C* and *D*, and also the past circuit states. This memory characteristic is realized by secondary circuits (*X* and *x*, *Y* and *y*).

Ron Treadway, Applications Engineer, Motorola, Inc., Phoenix, Ariz.

	$\bar{C}\bar{D}$	$\bar{C}D$	CD	$C\bar{D}$	
$\bar{x}\bar{y}$	0	0	0	0	a
$\bar{x}y$	0	0	1	1	b
xy	1	1	1	1	c
$x\bar{y}$	1	1	0	0	d

$$X = \bar{C}x + Cy + xy$$

(a)

	$\bar{C}\bar{D}$	$\bar{C}D$	CD	$C\bar{D}$	
$\bar{x}\bar{y}$	0	1	0	0	a
$\bar{x}y$	0	1	1	1	b
xy	0	1	1	1	c
$x\bar{y}$	0	1	0	0	d

$$Y = \bar{C}D + Cy + yD$$

(b)

2. The Karnaugh maps for the external and internal inputs are derived directly from the division of Table 5

and X (a) and Y (b) components. Grouping all 1 squares gives the logical equations for X and Y.

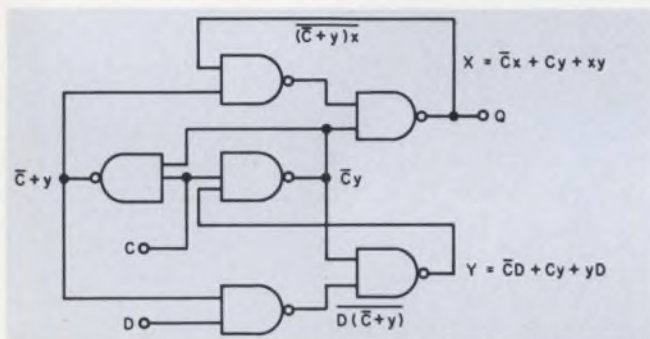

3. No decoding is needed to derive the output of this NAND gate implementation of the D flip-flop. The output is taken directly from the gate used to realize X.

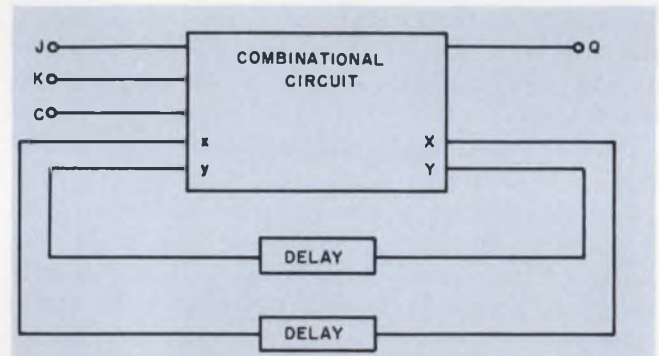

4. The sequential circuit for the J-K flip-flop has two inputs plus the clock. The number of secondaries needed is dependent on the number of secondary states.

secondary states. This generally leads to greater circuit economy. Two or more rows may be merged if, within the rows, there are no conflicting-state numbers in any column. In Table 2, for example, rows I, III and IV may be merged to give the first row of Table 3.

Step 3: The transition map

The next step is to make secondary-state assignments from the rows of the merged flow table. To prevent critical races, a transition map is helpful (Table 4). Row *a* is arbitrarily assigned the 00 state. There is a transition between row *a* and row *b* (stable states ① or ③ to ②), so *b* must take position 10 or 01. This condition, or adjacency, shows that row *a* must be adjacent to row *b*. At least one transition like this is necessary to determine adjacency. A transition is then noted between rows *b* and *c*, that is, a shift from ② to 7 and then to ⑦ can occur, so row *b* must be adjacent to row *c*, which is adjacent to row *d*, which is adjacent to row *a*. No adjacency is required of rows *a* and *c* or rows *b* and *d*, since no transitions are possible between these rows.

Step 4: The secondary excitation map

From the transition map, the secondary excitation, or *Y* map is derived (Table 5). As stated, to have a stable state, the inputs and outputs of the secondary states must be equal. Therefore each of the stable states must have the same state as determines the row. The unstable states must have the same state as the row to which they are going. Thus in row *a* of Table 5 columns 1, 3 and 4 representing stable states ①, ③ and ④ are assigned 00, and column 2 representing an unstable state is assigned 01, since stable state ② is in row *b*, the assigned internal input of which is 01. The map is now separated into its *X* and *Y* components and solved (Fig. 2). The NAND logic form is shown in Fig. 3.

Step 5: The output map

The output map uses the same primary and secondary inputs as the flow table. The values placed in the map for the stable states are now the desired output of the circuit (Table 6).

For a stable state, if the initial and final states are the same, the output state is assigned that same condition. For example, if a change is initi-

Table 8. Primitive flow table for J-K flip-flop

	<i>CJK</i> 000	<i>CJK</i> 001	<i>CJK</i> 011	<i>CJK</i> 010	<i>CJK</i> 110	<i>CJK</i> 111	<i>CJK</i> 101	<i>CJK</i> 100	<i>Q</i>
I	①	2	3	4	—	—	—	8	0
II	1	②	3	4	—	—	7	—	0
III	1	2	③	4	13	14	—	—	0
IV	1	2	3	④	13	14	—	—	0
V	1	2	3	4	⑤	6	7	8	0
VI	1	2	3	4	5	⑥	7	8	0
VII	1	2	3	4	5	6	⑦	8	0
VIII	1	2	3	4	5	6	7	⑧	0
IX	⑨	10	11	12	—	—	—	16	1
X	9	⑩	11	12	—	6	7	—	1
XI	9	10	⑪	12	—	6	7	—	1
XII	9	10	11	⑫	13	—	—	—	1
XIII	9	10	11	12	⑬	14	15	16	1
XIV	9	10	11	12	13	⑭	15	16	1
XV	9	10	11	12	13	14	⑮	16	1
XVI	9	10	11	12	13	14	15	⑯	1

Table 9. Merged-flow table for J-K flip-flop

		<i>CJK</i> 001	<i>CJK</i> 001	<i>CJK</i> 011	<i>CJK</i> 010	<i>CJK</i> 110	<i>CJK</i> 111	<i>CJK</i> 101	<i>CJK</i> 100	<i>Q</i>
(I, II, V, VI, VII, VIII)	a	①	②	3	4	⑤	⑥	⑦	⑧	0
(III, IV)	b	1	2	③	④	13	14	—	—	0
(IX, XII, XIII, XIV, XV, XVI)	c	⑨	10	11	⑫	⑬	⑭	⑮	⑯	1
(X, XI)	d	9	⑩	⑪	12	—	6	7	—	1

RECAP:

Starting October 6, 1967, Fairchild
promised to introduce a new integrated
circuit each week for 52 weeks.
This is number **17.**

9620 DUAL DIFFERENTIAL LINE RECEIVER

The 9620 is designed to have differential logic from transmission lines and convert it to CMOS levels. It also has the capability for conversion to higher levels. It is ideal for use in data link collectors, or in data processing applications where the central processor and data source are in separate locations. The 9620 can also be used as a CMOS-compatible differential comparator.

Each section of the dual IC consists of a differential amplifier driving a saturating inverting DTL gate with uncommitted collectors. Maximum differential threshold voltage is ± 100 mV in the presence of a 10 volt common mode rejection is also provided.

The 9620 comes in a 16-pin hermetic DIP and will operate in both military and commercial temperature ranges -55°C to 125°C and 0°C to 70°C . It is available in volume quantities. Your Fairchild distributor has it in stock now. Write for complete specs and applications information. Ask about our other new products, too.

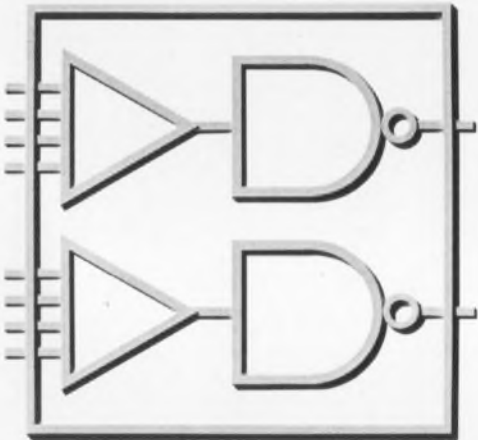

FAIRCHILD SEMICONDUCTOR CORPORATION • Division of Fairchild Camera and Instrument Corporation • 201 Woodside Drive, Mountain View, California 94039 • Tel. 415/961-0000

CIRCLE READER SERVICE NUMBER 117

Starting October 6, 1967, Fairchild
promised to introduce a new integrated
circuit each week for 52 weeks.
This is number **18.**

9621 DUAL LINE DRIVER

Fairchild's 9621 is used to transmit CMOS-level logic direct transmission lines. It can also be used to drive high capacity loads, in consist of a input inverting DTL gate and a 2-input inverting DTL gate. There is a termination resistor available on each stage which permits use to terminate 150-ohm lines, either directly or differentially. An add-on is available on the 2-input gate which allows you to add additional external loads, and thus obtain more inputs. The 9621 can also be used as a low impedance driver. Each stage provides maximum output current of 20mA at 0.4V. Drive strength is provided for direct connection to the load.

Maximum power dissipation for the new IC is 250mW. Power supply should be from maximum to 5V. The 9621 is available in a 16-pin hermetic DIP and will operate in both military and commercial temperature ranges -55°C to 125°C and 0°C to 70°C .

Applications for the 9621 include data processing and computer peripheral equipment. It is designed specifically to operate in conjunction with our 9620 dual differential line receiver. (See Product No. 17). Both devices are available in volume quantities. Your distributor has them in stock now. Write for complete specs and applications information. Ask about our other new products, too.

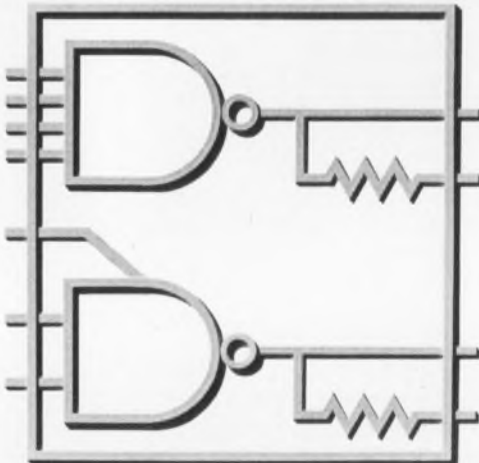

FAIRCHILD SEMICONDUCTOR CORPORATION • Division of Fairchild Camera and Instrument Corporation • 201 Woodside Drive, Mountain View, California 94039 • Tel. 415/961-0000

CIRCLE READER SERVICE NUMBER 118

Starting October 6, 1967, Fairchild
promised to introduce a new integrated
circuit each week for 52 weeks.
This is number **19.**

3300 25-BIT MOS STATIC SHIFT REGISTER

The 3300 is the 16th MOS device we've introduced since October 11, 1967. The first four were the 3701 six-channel multiplexer switch, 3702 channel gate, 3703 normal multiplexer switch, and the 3305 dual 20-bit dynamic shift register. The 3300 is a monolithic IC utilizing Phase Shift (PS) channel multiplexed MOS technology. It is designed to be used for digital data shift and static memory storage in test systems and computers. It is also applicable for data storage in laboratory systems.

The 25-bit device comes in a 28-pin can and will operate over the entire commercial temperature range -55°C to 125°C . There are two versions: 16- and 4-bit data strings within the package. Power dissipation is typically 200mW per bit. Speed is typically 100ns. The clock drive circuit is simplified by a single-phase clock input. The output is suitable for memory drive capability. Volume quantities of the 3300 are now available. Fairchild distributor has it in stock. Write for complete specs and applications information. Ask about our other new products, too.

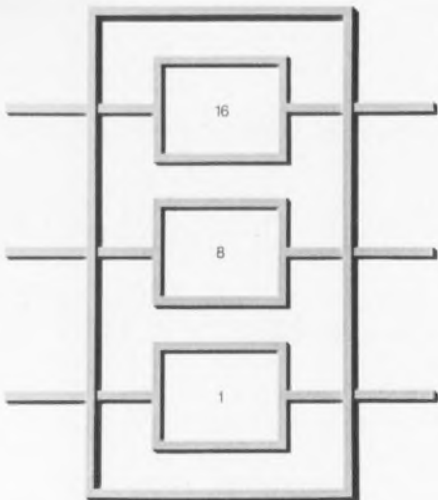

FAIRCHILD SEMICONDUCTOR CORPORATION • Division of Fairchild Camera and Instrument Corporation • 201 Woodside Drive, Mountain View, California 94039 • Tel. 415/961-0000

CIRCLE READER SERVICE NUMBER 119

Starting October 6, 1967, Fairchild
promised to introduce a new integrated
circuit each week for 52 weeks.
This is number **20.**

9110 HIGH LEVEL LOGIC HEX INVERTER

The 9110 is the functional element of our new high-level logic family. It features a wide range of DC input impedance of 0.5 to 10 kΩ. Each AC input impedance is even better. It can resist pulses of 100 nanoseconds duration and 10 volts amplitude minimum. Other members of the family provide interfacing capability to make the 9110 compatible with CMOS levels.

The 9110 consists of a high-level DTL gate with uncommitted collectors. It can be expanded with external diodes on the input. There is a series pull-up on the output for great driving capability. Propagation delay is typically 20 ns. The 9110 is available in volume quantities in both hermetic and plastic packages. Output voltage swing is typically 0.5 to 10 volts. The 9110 operates over the entire range of -55°C to 125°C and 0°C to 70°C . It is available in volume quantities. Your distributor has them in stock now. Write for complete specs and applications information. Ask about our other new products, too.

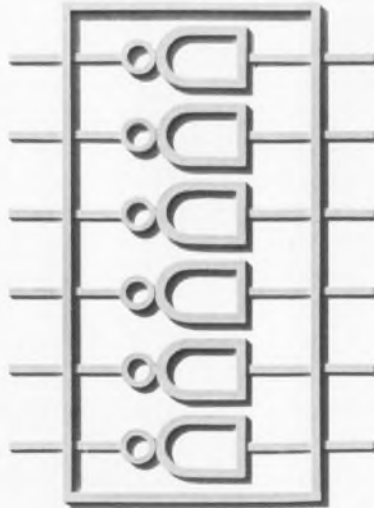

FAIRCHILD SEMICONDUCTOR CORPORATION • Division of Fairchild Camera and Instrument Corporation • 201 Woodside Drive, Mountain View, California 94039 • Tel. 415/961-0000

CIRCLE READER SERVICE NUMBER 120

Extend audio-amplifier performance

with limit-condition analysis and active bias for complementary, low-cost, efficient circuits.

Part 1 of a two-part article

The advantages of direct-coupled, transformerless transistor audio amplifiers over their more familiar RC and transformer-coupled counterparts include lower cost, better frequency response and improved efficiency. Till now their use, however, has often been limited by two shortcomings: their excessive dependence on a regulated supply voltage, and their restricted output voltage swing due to excessive internal amplifier losses.

The first part of this article describes a circuit that overcomes the first problem. It also shows how careful design by limit-condition analysis with newly available complementary devices can reduce or even eliminate the second problem without significantly increasing parts count or cost.

The second part of the article, which will appear in the next issue, will give a design example to illustrate how limit-condition analysis is used, not only to develop the basic circuit, but also to yield a design that is insensitive to the effects of the normal transistor-parameter variations encountered in typical mass-production situations. The new circuitry will finally be examined to see whether it can be adapted to integrated-circuit fabrication.

Before beginning the actual circuit analysis, take a quick look at some of the advantages of transformerless design. They include:

- Expanded bandwidth.
- Simplified feedback circuitry.
- Minimal and uniform phase shift.
- Reduced size and weight.
- No transformer fields.

The basic circuit and terminology in review

Figure 1 shows the fundamental complementary-symmetry design that is the basis of virtually every high-efficiency, transformerless circuit now in use. It consists of a direct-coupled amplifier driving complementary emitter-follow-

ers connected back to back. The output stage operates in a push-pull manner, with $Q2$ carrying the load on the positive half cycle and $Q3$ carrying the load on the negative half cycle. $R2$ will be neglected for a moment and the output of a single supply amplifier will be taken from the connection between the emitters of the two output transistors. It is coupled to the load through an electrolytic capacitor, $C2$. (In split-supply designs, the dc output voltage corresponds to ground and the capacitor can be eliminated.) The emitter-follower action of the output stage sets the maximum limit on output voltage swing.

The no-signal current through $Q2$ and $Q3$ is set by a combination of diodes $D1$ and $D2$ and resistor $R2$. The quiescent current is maintained over the operating temperature range by choosing diodes $D1$ and $D2$ so that the voltage drop across them is slightly greater than the voltage drop across the emitter-base diodes of $Q2$ and $Q3$ and tracks it with temperature. $R2$ is then chosen to provide the required quiescent current and stability factor.

The output stage is driven by $Q1$, which develops its signal across resistor $R1$. The current through $Q1$ controls the voltage drop across $R1$, which in turn sets the operating point for the output transistors. The low impedance of diodes $D1$ and $D2$ ensures that the same ac signal is supplied to the bases of $Q2$ and $Q3$. In the absence of an ac signal, the collector current $Q1$ should set the emitter of $Q2$ at approximately half the supply voltage. The direct coupling between stages causes $Q1$ to act as a dc bias amplifier as well as an ac signal amplifier. This characteristic is the source of one of the major problems in many existing designs. Because of it, any variation in the bias of $Q1$ that adversely affects its collector current will also upset the quiescent operation of $Q2$ and $Q3$. The resulting unsymmetrical clipping can substantially reduce the undistorted power output available.

Ac feedback is accomplished with $C3$ and $R3$, which are chosen to provide the desired frequency response for the amplifier.

An effective circuit analysis of limiting conditions can be developed by considering three

David J. Bernays, Staff Engineer, Automatic Radio Manufacturing Co., Melrose, Mass.

lossless at the lowest frequency of interest. (Whether or not this is actually true is more a matter of economics than circuit design.)

Peak-point analysis begins with examination of the positive (relative to the quiescent voltage) half cycle of the signal voltage swing at the emitter of Q_2 .

The positive peak output voltage (V_{s1} in Fig. 3) developed across the load before clipping occurs will be achieved when Q_1 is cut off and R_1 is conducting only base current for Q_2 . This base current is given by:

$$i_{bQ_2} = V_{s1}/R_L h_{FEQ_2}. \quad (1)$$

The difference—positive peak loss, L_P —between the supply voltage and the positive peak of the output voltage is:

$$L_P = R_1 i_{b(max)Q_2} + V_{EBQ_2} \quad (2)$$

$$= R_1 V_{s1}/R_L h_{FEQ_2} + V_{EBQ_2}. \quad (3)$$

Negative-peak-point analysis

The point at which the signal begins to clip on the negative half cycle can be determined in a similar manner. In this case Q_1 will be saturated and so able to conduct a very high current. The collector current of Q_1 will then consist of two components: the current through R_1 and base current to Q_3 . Current through R_1 has no effect on the lower clipping point and serves only to increase the load on Q_1 . The difference—negative peak loss, L_N —between the minimum signal voltage and ground is:

$$L_N = V_{CE(sat)Q_1} + V_{EBQ_3} + V_{s2}R_2/R_L, \quad (4)$$

where V_{s2} is the maximum negative signal excursion at the start of clipping.

The maximum peak-to-peak signal swing, V_s —that is, $V_{s1} + V_{s2}$ —that can be developed across the load is obtained by combining Eqs. 3 and 4:

$$V_s = V_{CC} - R_1 V_{s1}/R_L h_{FEQ_2} - V_{EBQ_2} - V_{CE(sat)Q_1} - V_{EBQ_3} - V_{s2}R_2/R_L. \quad (5)$$

The importance of minimizing the losses, especially when operating from low supply voltages, is underlined by the fact that the amplifier power output is proportional to the square of the maximum output voltage swing:

$$P_{O(max)} = V_s^2/8R_L. \quad (6)$$

Examination of Eq. 5 not only defines the individual losses but also shows several qualitative factors associated with the basic complementary-symmetry circuit. First, the current swing required from Q_1 between positive and negative signal peaks far exceeds the linear range of most practical devices. This alone will cause severe distortion (Figs. 4 and 5). Second, for any practical value of R_1 the voltage drop across it at the positive peak becomes excessive if significant power output is required from the amplifier.

The equations also indicate that the output device parameters of primary importance to the designer are those associated with high currents

and low collector voltages verging on saturation. Power transistors intended for this application will usually have h_{FE} specified at a collector voltage of 1 volt and collector current of 1 to 4 amperes. Examination of device collector curves in the saturation region can provide the required design information when a specific 1-volt h_{FE} figure is missing.

The foregoing circuit is unmanageable for more than a few hundred milliwatts output. The easiest way to improve the situation would be to substitute Darlington circuits for Q_2 and Q_3 , as in Fig. 6. This requires additional temperature-compensating bias diodes and increases the voltage loss associated with the combined emitter-base contact potentials of the two added transistors. The voltage loss associated with current through R_1 on the positive cycle, however, will be reduced significantly, as will the dynamic collector current swing of Q_1 .

Consider practical design refinements

The effect of losses in the output stage, especially the voltage drops inherent in the output stage, becomes increasingly significant as the supply voltage is reduced. Their reduction requires careful attention in automotive applications, for instance.

The first improvement is aimed at the voltage drop in R_1 and the nonlinear operation of Q_1 . The addition of one capacitor and one resistor (C_4 and R_4) in the bootstrap connection shown in Fig. 7 will provide R_1 with an essentially constant-voltage source.¹ That eliminates the R_1 term from Eqs. 2, 3 and 5, significantly increasing the maximum possible signal swing. It also changes the drive required by the output stage from voltage drive to current drive. That raises load impedance seen at the collector of Q_1 and makes truly linear operation possible. For the circuit to be effective, C_4 must be chosen so that the time constant associated with R_1 , R_4 and C_4 is considerably greater than the period of the lowest frequency that the amplifier is expected to handle. The same effect may be obtained without adding components in circuits where the driver emitter is returned to the positive supply bus instead of to ground by returning R_1 to the load side of C_2 .^{2, 3}

The circuit of Fig. 7 has several additional advantages. The combination of R_4 and C_4 provides sufficient filtering between the supply bus and R_1 to eliminate any need for further driver supply filtering. Moreover, the charging time required by C_4 lengthens the turn-on transient and thus softens the objectionable turn-on thump. The circuit shown is usable, although the gain from the input of Q_1 to the output is relatively low since Q_1 is required to drive the bases

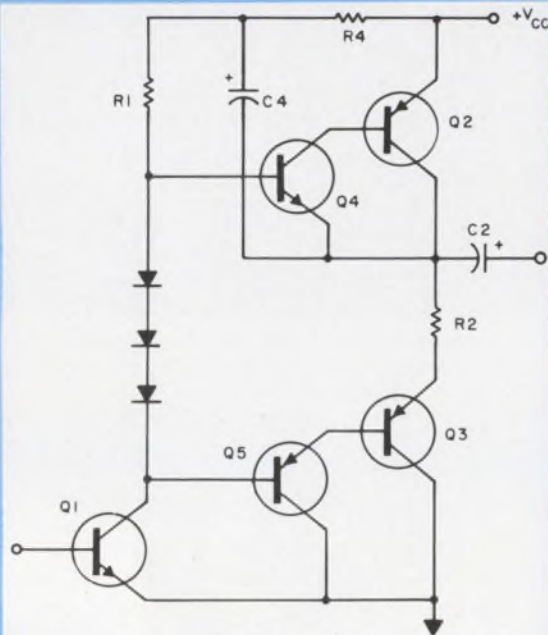

8. Using an "inverted Darlington," Q2 and Q4, in the circuit of Fig. 7 results in further performance improvement. In addition to the increased gain (up to two orders of magnitude), the total positive peak voltage loss for Q2 and Q4 combined will be slightly greater than the emitter-base potential of Q2 alone.

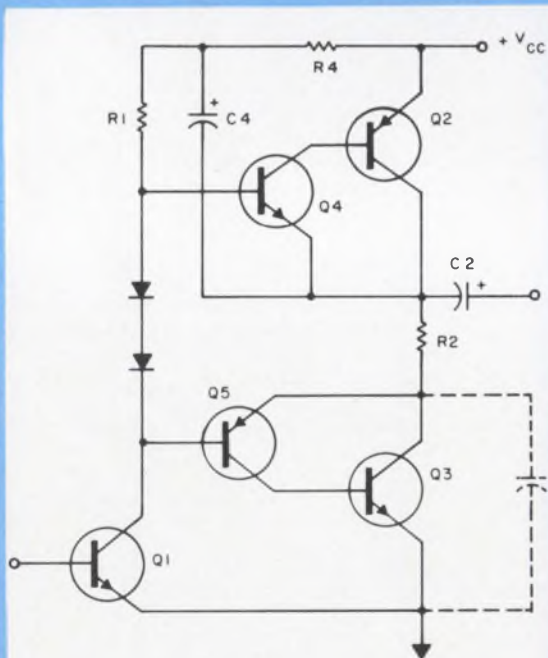

9. Negative peak voltage loss is reduced by changing Q5 and Q3 into an inverted Darlington, too. High-frequency parasitic (12-MHz) oscillations can be eliminated by connecting a small (0.1- μ F) capacitor across Q3 (dashed lines). This completely corrects the problem without affecting normal amplifier operation in any way.

cycle, for instance, Eq. 1 may be rewritten to show the new drive requirement:

$$i_{b(max) Q_3} = V_{S1}/R_L h_{FEQ_2} h_{FEQ_1} \quad (8)$$

$R1$ and $R4$ will also be increased, allowing a significant reduction in the size of the bootstrap electrolytic, $C4$. The maximum peak-to-peak output voltage swing is:

$$V_s = V_{CC} - V_{CE(sat) Q_4} - V_{EBQ_2} - V_{CE(sat) Q_1} - V_{EBQ_3} - V_{EBQ_3} - V_{S2} R_2/R_L \quad (9)$$

While Fig. 8 is an excellent circuit, performance can be improved without increasing the parts count by changing $Q5$ and $Q3$ also into an inverted Darlington (Fig. 9). This reduces the negative peak voltage loss, L_N by an amount equal to $V_{CE(sat) Q_1} + V_{EBQ_5} - V_{CE(sat) Q_5}$. At room temperature with silicon transistors, the resulting improvement in available clean output voltage swing is approximately 0.5 volt.

In certain circumstances this connection may develop spurious oscillations owing to the very high alpha cutoffs often associated with modern npn silicon power transistors. Severe 12-MHz oscillations, for instance, were experienced when a Fairchild 2N3638-SE3030 combination was used in this manner. Connecting a 0.1- μ F capacitor from collector to emitter of the SE3030 ($Q3$) completely corrected the problem without affecting normal amplifier operation. The peak-to-peak output voltage swing possible with this connection is:

$$V_s = V_{CC} - V_{CE(sat) Q_4} - V_{EBQ_2} - V_{CE(sat) Q_5} - V_{CE(sat) Q_1} - V_{EBQ_3} - V_{S2} R_2/R_L \quad (10)$$

Since $V_{CE(sat)}$ of most silicon transistors is typically less than one or two tenths of a volt, Eq. 10, for practical purposes, may be simplified to:

$$V_s = V_{CC} - V_{EBQ_2} - V_{EBQ_3} - V_{S2} R_2/R_L \quad (11)$$

That simplification points to the one remaining voltage loss that may be significantly reduced, but only when silicon output transistors are used. The thermal stability and low I_{CBO} of silicon transistors are such that, when the output biasing circuitry has been properly designed, $R2$ may be eliminated and the combination of $R5$ and $C5$ substituted to perform the same function (Fig. 10). $R5$, unlike $R2$, is large enough to be effectively bypassed, so cutting the dynamic or peak voltage loss associated with the thermal stability resistor to its quiescent-current value. When this circuit is used, the transistors for $Q2$ must be chosen to have a close h_{FE} spread, to maintain output-stage quiescent current within design limits. The technique should not, however, be tried when germanium devices are used for $Q2$ and $Q3$ because $R5$ will provide no protection against thermal runaway arising from excessive $Q2$ and $Q3$ leakage currents. The simplified equation for the maximum possible output voltage swing with the circuit of Fig. 10 is:

$$V_s = V_{CC} - V_{EB Q_2} - V_{EBQ_3} - i_{b(quiescent)Q_2} R_5 \quad (12)$$

ing current to flow through $R6$ into $C6$ at a rate determined by the time constant of $R6$, $C6$, $R7$ and $R8$. The time constant should be at least one, and preferably two, orders of magnitude greater than the period of the lowest ac frequency of interest. The voltage across the emitter-base junction of $Q6$ then increases, causing an increase in base current to $Q1$. This in turn increases collector current in $Q1$ until the voltage drop across $R1$ is increased to return the quiescent operating point to the set percentage of the output supply voltage. A decrease in supply voltage will initiate a reverse sequence to restore the optimum quiescent voltage. Temperature-sensitive parameter variations in the driver and output stages, which cause changes in the quiescent voltage, will also be sensed and corrected by $Q6$ in a similar manner. The clamping action of $C6$ is required to prevent $Q6$ from developing undesirable feedback when an ac signal is applied. It has no effect on compensation for long-term changes, such as supply voltage variations and temperature shifts.

When an ac signal is present, the instantaneous ac output voltage is divided between $R6$ and the combined parallel impedances of $R7$ and $R8$. The emitter-base voltage drop across $Q6$, remains clamped by $C6$ so the collector current of $Q6$ remains essentially constant, even when the output voltage point is swung from the positive to the negative clipping points. The voltage variation appearing at the base of $Q6$ can be considerable, but because of the clamping action of $C6$ it will cause negligible current variation at the base of $Q1$. Described differently, the collector curves of a modern silicon transistor closely resemble those of a pentode tube, so large collector-voltage changes cause very small collector-current changes, provided the transistor is operated in its "pentode" region at a constant emitter-base potential, as $Q6$ is. This may be verified by bypassing the base of $Q6$ to ground with a large-value electrolytic capacitor and observing the results when the amplifier is driven by an ac signal. No measurable change occurs.

The collector impedance of $Q6$ is high enough for any ac loading effect it may have on the base of $Q1$ to be safely ignored.

Diodes $D3$ and $D4$ provide reference voltage compensation, which is needed only when the circuit is to be operated over an extremely wide temperature range (in this case, 200°F). Under temperature variations of this magnitude, the emitter-base contact potential of $Q6$ changes at least 0.7 volt. That in turn shifts the quiescent operating voltage a like amount, causing a symmetrical clipping at the temperature extremes. Whether one or more diodes is required depends on the exact output-stage configuration chosen. When a completely symmetrical output (Fig. 9 or

10) is needed, the quiescent voltage should be held constant with respect to temperature, since both L_P and L_N will always be changing by like amounts. In these circuit $D4$ and $D3$ will both be required. The circuit of Fig. 8, on the other hand, is not a completely symmetrical configuration. L_N contains two emitter-base potentials; L_P contains only one. In this case L_P and L_N will not change equally with temperature so, if V_{S1} is to remain equal to V_{S2} over the operating temperature range, the quiescent voltage must shift with temperature. Using one diode instead of two provides the required temperature-controlled quiescent-voltage drift. If npn output transistors were used, inverting the output circuit, L_P instead of L_N would contain the two emitter-base diodes requiring compensation, and three diodes would be needed for reference compensation. Mixing germanium and silicon transistors in the output stage will also affect the exact reference voltage compensation required.

In the second part of this two-part series the detailed circuit performance of various configurations that were built and tested will be given. A step-by-step design of a 5-watt amplifier using the configuration of Fig. 9 will be included. An integrated circuit adaption of the circuit will also be described. ■■

References:

1. Fisher, RCA Application Note AN-3185, June 1966.
2. "Complementary Symmetry Circuits and Data," Amperex Electronic Corp. brochure.
3. Motorola Semiconductors, MJE370, 371 Preliminary Specification, Sept. 1966.
4. Blaser and Franco, "Push-Pull Class-AB Transformerless Power Amplifiers," Fairchild Application Note APP-51, Feb. 1955 and *IEE Trans. on Audio*, Jan.-Feb. 1963.

Test your retention

Here are questions based on the main points of this article. They are to help you see if you have overlooked any important ideas. You'll find the answers in the article.

1. *What is meant by limit-condition analysis.*
2. *What are the advantages of a transformerless design?*
3. *What primarily contributes to the power losses in the output stage? How can they be reduced?*
4. *What aspect of bias-circuit design permits the use of an unregulated supply?*
5. *How can distortion be reduced?*

new ideas for
moving electrical energy

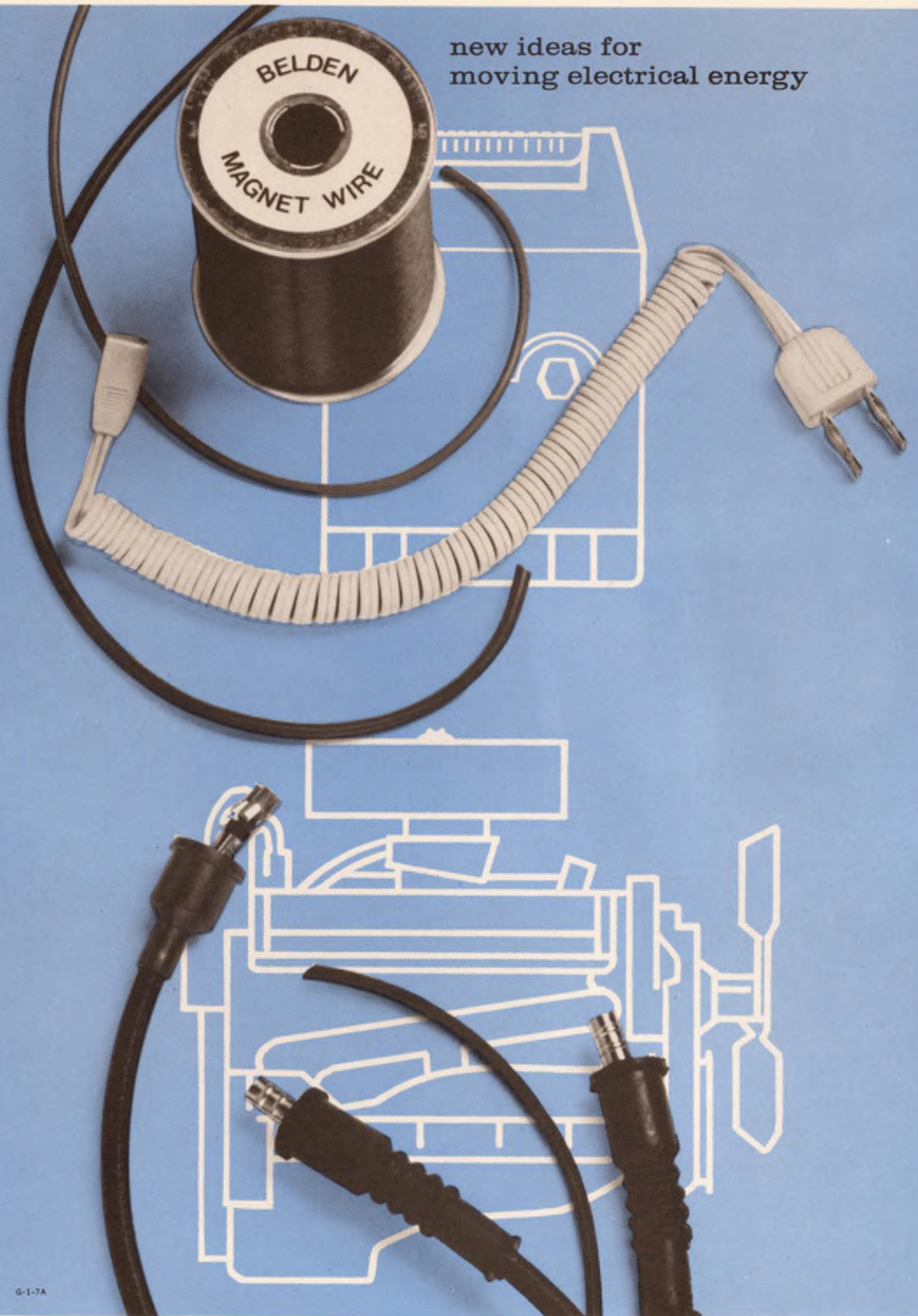

G-1-7A

Get near-infinite input impedance

in a dc amplifier with four low-cost, high-beta transistors and a few simple equations.

A very high-input-impedance dc amplifier with excellent linearity and stability is of great value in electronic instrumentation circuits. Although junction and metal-oxide-semiconductor field-effect devices (J-FETs and MOSFETs) could be used in it, both have disadvantages. J-FETs are unstable with variations in temperature; MOS devices need protection to prevent the insulated gate from breaking down when even moderate overvoltages are accidentally applied to it, as often happens during voltage measurements, testing or troubleshooting.

The circuit described below achieves the desired characteristics without FETs. It uses instead four conventional, low-cost, high-beta silicon transistors.

Circuit operation is simple

The basic circuit consists of four silicon npn transistors, connected as in Fig. 1. When a dc voltage, e_{in} , is applied across the bases of the two input transistors (so that a positive signal is applied to the base of $Q1$ and a negative signal to base of $Q3$), an input current, i_{in} , flows from the base of $Q1$ through its emitter to the base of $Q2$, through the emitter of $Q2$ and then the emitter resistor R_{e2} to point A. Because $Q3$ and $Q4$ are forward-biased, the signal continues to flow through R_{e4} to the emitter of $Q4$, through the base of $Q4$ to the emitter of $Q3$ and so to the base of $Q3$. $Q1$ and $Q3$ could be mounted on a common heat sink. The same is true for $Q2$ and $Q4$.

Because $Q1$ and $Q3$ are matched, the offset voltage between the input bases is zero when the circuit is properly balanced in its quiescent state. When e_{in} is applied to the two bases, the base of $Q1$ becomes $+e_{in}/2$ and the base of $Q3$ becomes $-e_{in}/2$, with respect to point A. In other words, the signal $+e_{in}/2$ is amplified through $Q1$ and $Q2$, and the signal $-e_{in}/2$ is amplified through $Q3$ and $Q4$.

$Q1$ and $Q3$ serve two major purposes. First, each introduces a controlled positive feedback

from the collector to the base of the other transistor through cross-coupling. In this way, a near-infinite impedance is provided at the input. Second, they serve as preamplifiers: the current developed at their emitters drives the bases of $Q2$ and $Q4$.

$Q2$ and $Q4$ also serve two purposes. First, they introduce a negative feedback through emitter resistors R_{e2} and R_{e4} , producing a high input impedance at their bases and preventing the emitters of $Q1$ and $Q3$ from loading. They also serve as amplifiers for driving the meter or other suitable loads.

Designing the circuit

The following assumptions are made in deriving the equations for this amplifier and proving the manner in which infinite input impedance is obtained:

$Q1, Q3$ and $Q2, Q4$ are matched within 10%.

$$\beta_1 \cong \beta_3 \text{ and } h_{ie1} \cong h_{ie3}.$$

$$\beta_2 \cong \beta_4 \text{ and } h_{ie2} \cong h_{ie4}.$$

$$R_{b1} = R_{b3} = R_b.$$

$$R_{c1} = R_{c3} = R_c.$$

$$R_{e2} = R_{e4} = R_e.$$

These symbols are shown in Fig. 1.

The current gain, β_3 , at the collector of $Q3$ is given by:

$$i_{c3} = \beta_3 i_{in}. \quad (1)$$

The portion of this current, i_{FB} , that is fed back through R_b to the base of $Q1$ is given by:

$$i_{FB} = i_{c3} R_c / (R_c + r_{in} + R_b). \quad (2)$$

Substitution of Eq. 1 into Eq. 2 yields:

$$i_{FB} = \beta_3 i_{in} R_c / (R_c + r_{in} + R_b). \quad (3)$$

If both the numerator and the denominator of Eq. 3 are divided by R_c , the equation for i_{FB} becomes:

$$i_{FB} = \beta_3 i_{in} / \{ 1 + [(r_{in} + R_b)/R_c] \}. \quad (4)$$

By definition, infinite input impedance results when the positive feedback current, i_{FB} , returned to the input is equal to the input current, i_{in} —that is, $i_{FB} = i_{in}$. If the value of i_{FB} in Eq. 4 is replaced by i_{in} , then:

$$\beta_3 i_{in} / \{ 1 + [(r_{in} + R_b)/R_c] \} = i_{in}. \quad (5)$$

Dividing both sides of Eq. 5 by i_{in} yields:

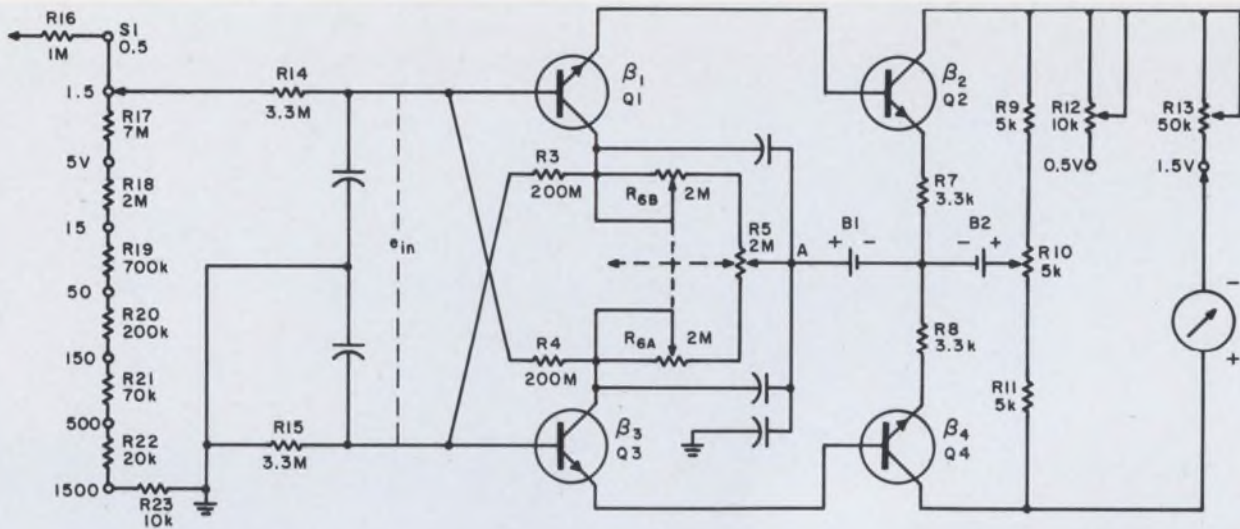

2. Practical high-input, stable dc amplifier operates on two dry cells drawing only a total of 1.2 mA at 9 V. Here it is used as dc voltmeter. S1 is the range selector switch, R17 through R23 are range resistors, R16 is the probe resistor, R14 and R15 are protection and isolation resistors,

capacitors bypass ac and rf, R9 through R11 are the output bridge resistors with R10 serving as the meter zero potentiometer, R12 and R13 are the 0.5- and 1.5-V calibration potentiometers, respectively. B1 and B2 are dry cells. All transistors are 2N3242, all capacitors are 0.01 μ F.

predetermined transistor beta. If, for instance, a single 6-M Ω potentiometer is used ($R_c = 3$ M Ω each side) and the matched transistors used for input and output have a beta range from 200 to 500, the input impedance may range from 1 G Ω to infinity with the input open.

Theory agrees with predictions

Some of the advantages obtained from the breadboard of this circuit are:

- Since the input signal is applied directly to the bases of the input transistors Q1 and Q3, maximum advantage is taken of the high collector-to-base insulation and low leakage property of the silicon npn transistors.

- Unlike conventional differential amplifiers, this circuit in its balanced condition has zero offset voltage at the input, which is independent of the output circuit. It is possible to offset the output balance with the zero potentiometer in order to shift the meter pointer, or a recorder pen driven through the output of the amplifier, to a zero center position without affecting the input impedance or balance.

- Use of high-beta, low-leakage transistors Q1 and Q3 at the input makes it possible to bias and cross-couple these two transistors through very high-value resistors (on the order of 200 M Ω). The application of positive feedback through such high resistance eliminates the danger of oscillation due to excessive feedback when the input is open. It thus simulates a condition at the input of the amplifier very similar to that of an open-grid vacuum tube or an open-gate

MOS amplifier, and can be treated as such.

- The cross-coupling of the collectors to bases in combination with the variable-collector resistors furnishes the input circuit with a balanced and controlled positive feedback, which makes it possible to approach infinite input impedance.

- The stability and accuracy of this circuit depends primarily on the preamplifier circuit, Q1 and Q3. Because the current drain in this preamplifier is only about 3 μ A at 9 volts, use of a separate battery, B1, independent of the output supply battery, B2 makes it possible to obtain near-shelf-life service from a set of fresh batteries. B2 may drop from 9 to 7 volts without any change in circuit or instrument accuracy. ■■

Test your retention

Here are questions based on the main points of this article. They are to help you see if you have overlooked any important ideas. You'll find the answers in the article.

1. What are the disadvantages of J-FETs and MOSFETs in high-input-impedance circuits?
2. How is very high input impedance obtained in this circuit?
3. Which part of the circuit accounts for its accuracy and stability?
4. What makes it possible to cross-couple the two input transistors through large resistors?

Now- Count to 150 MHz for \$640!

See it at IEEE
Booth 2H07 – 2H09.



With the new trio/lab Universal Frequency Scaler

Forget the cost of a new high frequency counter – for a modest \$640 it is now possible to extend the useful range of your old low frequency counter – *any* counter – to 150 MHz! The unique, extremely easy-to-use trio/lab Model 556 Scaler performs simultaneous scaling functions of divide-by-100 and divide-by-10 over the range of 1 MHz to 150 MHz.

A remarkable instrument that demands demonstration – at your convenience.

• Truly universal – Scales *any* counter • No controls – Power switch only • High sensitivity – 50 MV at 150 MHz • Large output swing – 1 V drives any counter • Self-powered – All solid-state.

Trio Laboratories, Inc. • 80 DuPont St., Plainview, L. I., N.Y. 11803
Tel.: 516-681-0400 • TWX: 510-221-1861



Original Concepts in Instrumentation

What do you do with unused leads?

Is there a rule of thumb to help us decide what to do with 'extra' leads on digital ICs?

What is done with unused leads often depends on the particular circuit application. In general, it is safe to leave unused output leads open. Unused input leads, on the other hand, should be tied to ground or some other potential point to prevent parasitic transistor action or leakage under any possible signal combination. The best potential point to use will depend upon the circuit geometry, and in most cases will be apparent from the circuit schematic, which can be obtained from the manufacturer.

Question submitted by L. A. Gordon, Chief Engineer, Midland Standard Inc., Elgin, Illinois

Is an integrated circuit laboratory for small-scale production economically feasible?

A small integrated circuit production house or laboratory is now quite feasible at moderately low cost. Equipment prices are steadily decreasing, and process technology is becoming standardized and easily duplicated.

A good laboratory with considerable versatility but limited production capability can be set up for as little as \$200,000 in capital equipment investment. This laboratory could be expected to produce 5000 circuits per week, of complexity equivalent to a dual op-amp or a J-K flip-flop. It would employ perhaps 10 people in the production area. Set-up time, allowing for training of personnel and proving-out processes, would be about 14 months. All of these figures are, of course, approximate.

What is a suitable method for protecting MOS devices from accidental punch-through? Is it possible to provide this protection and still maintain input impedance in the order of $10^{14} \Omega$?

A Zener diode can be used as a protective device. At present, however, there is no low-cost

diode which has a reverse impedance as high as $10^{14} \Omega$. Typical small geometry planar silicon diodes have room temperature reverse currents in the order of 0.1 nA. For the type of protection required, the diode might have a Zener breakdown of approximately 6.5 V, and its equivalent resistance just below that voltage would be about $3 \times 10^9 \Omega$. This is typical of the Zener diodes (emitter-base diodes) readily fabricated in integrated circuit form. The lowered input impedance of the protected MOS device represents the usual compromise between performance and reliability.

Question submitted by R. C. Dennison, TV Advanced Development, RCA, Camden, New Jersey

What is the washout emitter process?

This is a process in which the same mask is used for both the emitter diffusion and the ohmic contact deposition. The aluminum metalization for the contact is allowed to form in the same hole that was used for the diffusion. The aluminum is prevented from shorting the junction because the junction has in fact spread sidewise approximately two microns under the oxide. This is a critical area in the process, and an area which causes a yield problem. With excessive alloying, the aluminum can short the junction.

The washout emitter process is sometimes called the buffered etched emitter technique.

Question submitted by A. A. Vacca, Advanced Electronics Dept., Control Data Corp., Arden Hills, Minn.

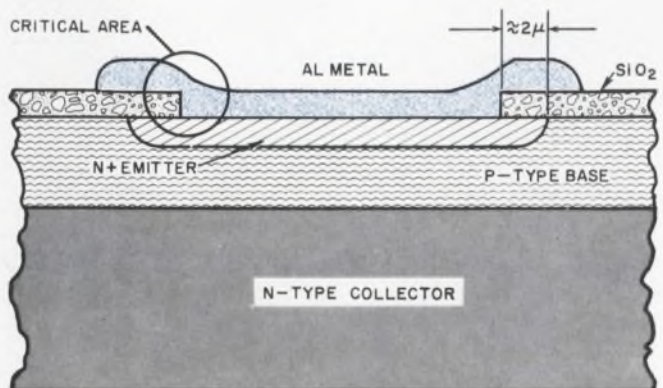

In the washout emitter process, a thin film of aluminum is deposited in the same hole used for the emitter diffusion.

Test your IC IQ is a collaboration between the editors of ELECTRONIC DESIGN and the staff of the ICE (Integrated Circuit Engineering) Co., Phoenix, Ariz. Readers of this new column are invited to submit their questions to Test your IC IQ, ELECTRONIC DESIGN magazine, 850 Third Ave., New York, N.Y. 10022.

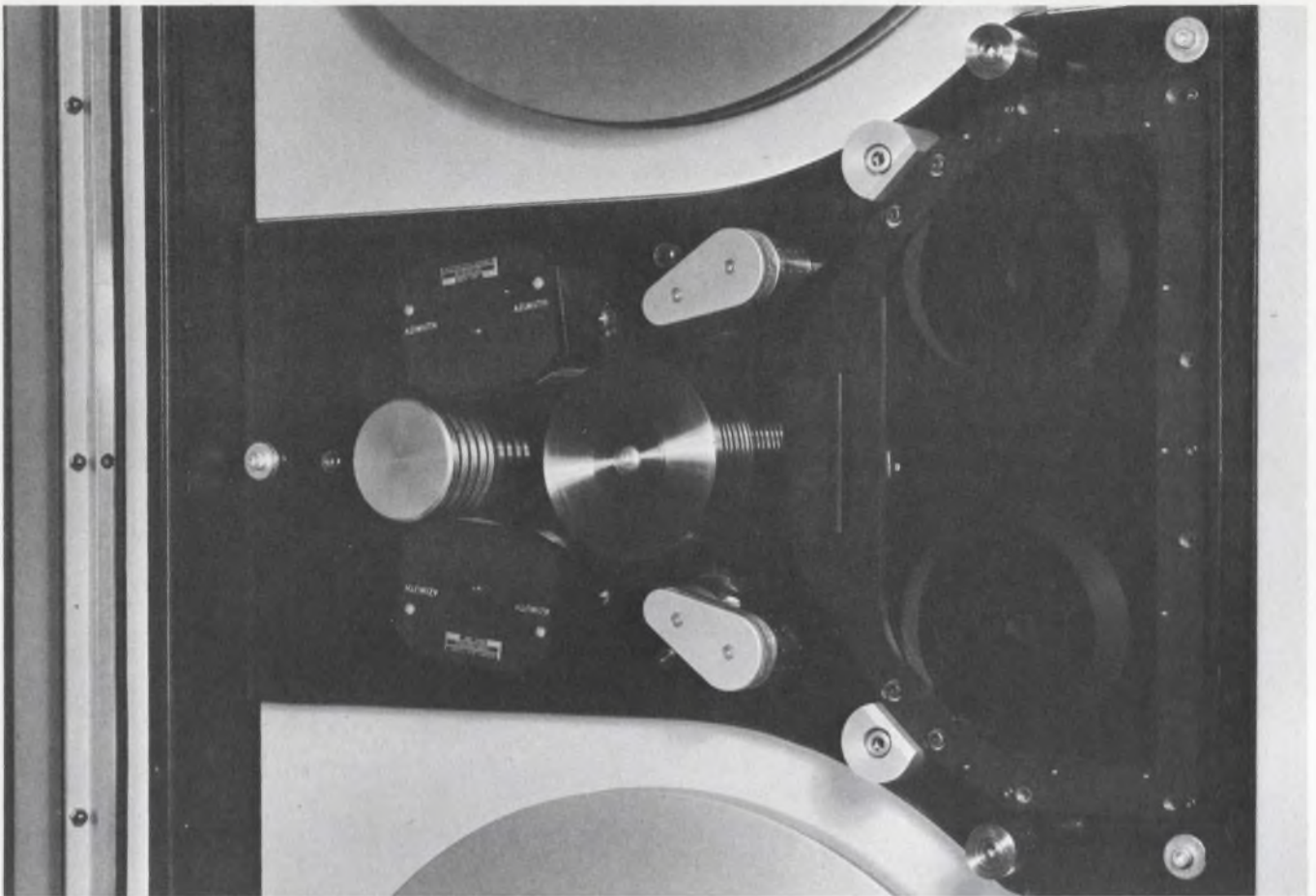

DUAL INERTIA DRIVE, INERTIA DISENGAGED

CEC announces the most important recording advance in years... a time base error of ± 400 nanoseconds maximum



The recorder is CEC's new 2.0 MHz VR 5000. Because of its improvements in time base error, the ultimate in real-time restoration of data is now possible. Tapes made on conventional data acquisition recorders under severe environmental conditions can be successfully reduced with correct time base restored.

To some, however, there is another achievement of the VR 5000 which may be even more significant. It has a flutter correction capability *five times more effective* than that of our nearest competitor.

Reason: the VR 5000 is the only recorder that offers Dual Inertia* drive, translating the ideal system concept into a working reality—*high mass recording and low mass reproduce.*

CEC also offers a complete line of other analog recorders for mobile, laboratory and aerospace use at considerable savings.

Comparative performance report on VR 5000 now available.

For your copy, call your nearest CEC Field Office. Or write Consolidated Electrodynamics, Pasadena, California 91109. A subsidiary of Bell & Howell. Ask for Bulletin VR 5000-X12. *Patent Pending

CEC/DATAPE PRODUCTS

 **BELL & HOWELL**

Avalanche transistors give fast pulses

of high current and high voltage. Once he grasps how they work, the designer should have no difficulty in using them.

Avalanche transistors can be used in many situations that call for extremely high-voltage and high current pulses. Their operation, however, depends heavily on the design of the driving circuit. Many engineers who are not well informed about them therefore shy away and rely instead on more familiar, less elegant techniques.

To remedy this, the characteristics and laws of operation of these transistors, with specific circuit examples, will be explained in detail. Once the fundamentals have been grasped, the engineer should find the design of practical high-power pulse circuits much less formidable.

How do they work?

Although similar to ordinary transistors, avalanche transistors operate in regions beyond the normal range of transistor operation. As shown in Fig. 1a, the normal range of transistor operation is in the area enclosed by $O C D E O$, sometimes called the safe operating active region (SOAR). The avalanche transistor operates outside this area in the region $A B F E$. Careful circuit design is needed to ensure that it operates clear of the normal transistor region, to avoid misfiring or latch-up.

Figure 1b shows a very simple circuit that will be used to describe the operation of avalanche transistors. Upon application of supply voltages, capacitor C_o will charge through R_C and R_L until the voltage at the collector reaches BV_{CEX} (see box and Table 1). The transistor will then begin conducting current and a stable operating point A will be obtained (Fig 1c). The circuit will remain in this condition until a trigger is supplied. Application of a positive trigger pulse to the base will cause the transistor to begin to conduct. Owing to the dynamic load, C_o and R_L , the operating point for rapid changes lies along the line $A Y$ (Fig. 1c). Since this line lies completely outside the stable region, the collector voltage will collapse very rapidly along $A Y$ until the stable point F is reached (this point is typically 10 to 20 volts and 1 to 3 amperes). Switch-

Glossary of symbols

I_H	Hold-off current—the maximum current that can be put into the collector (in a specified circuit condition) in the breakdown region and not cause avalanche (Point B in Fig. 3).
I_C	Collector current.
V_A	Avalanche voltage—voltage across the transistor during avalanche at a specified current.
BV_{CEX}	Collector-to-emitter breakdown voltage measured at a current smaller than I_H .
V_{BA}	The voltage between base and emitter that will cause avalanche.
V_{CE}	Collector-to-emitter voltage drop.
t_d	Delay time—the time measured from when the input pulse reaches V_{BA} to when the output changes 10% of its value.
t_r	Rise time—the time required to reach 90% of the final output pulse amplitude.
t_f	Fall time.
t_{on}	Turn-on time— $t_D + t_R$.
t_j	Jitter—the time variation of t_D .
R_C	The dc collector supply resistor.
R_L	Output load resistor.
C_o	Output coupling capacitor.
C_{in}	Input coupling capacitor.

W. B. Mitchell, Manager of Electronics, National Semiconductor Corp., Danbury, Conn.

ing times during this collapse are in the region of 1 nanosecond or less.

Capacitor C_o will then discharge through R_L and the transistor, and the operating point will follow the line FE until a level is reached below which there is insufficient current to maintain the avalanche condition. The transistor will subsequently cut off and the operating point will fall to point G . Capacitor C_o will begin recharging and the operating point will move out on the BV_{CEX} curve until point A is again reached, completing the cycle. Figure 1d shows the collector voltage waveform and Fig. 1e the output voltage, V_{out} , for the circuit of Fig. 1b. During the turn-on times, dv/dt of 10^{11} V/s and dI/dt of 10^9 A/s are easily obtained.

Once the avalanche cycle begins, it is independent of the input, and external means must be provided to stop the avalanche. This is accomplished in Fig. 1b by the proper choice of C_o as a limited-energy storing element.

Watch the temperature

The avalanche transistor is fairly sensitive to temperature variations, and unless proper care is taken, misfiring or free-running will occur. The following characteristics are generally the most important:

- BV_{CEX} has a positive temperature coefficient of about 0.15%/°C. Care must be taken in choosing V_{CC} and R_C to ensure an adequate quiescent operating point over expected temperature excursions.

- V_{BA} has a negative temperature coefficient of about 2 mV/°C. The base bias should be maintained at least 2.0 volts below V_{BA} to prevent free-running.

- V_{out} , since it is a function of BV_{CEX} , will vary with temperature, increasing at higher temperatures.

The operation of an avalanche transistor is, furthermore, almost completely circuit dependent, as will now be explored in detail.

Power dissipation is a factor

There are two power-dissipating phases in an avalanche circuit. The first is the quiescent power, equal to the collector bias current times BV_{CEX} . This should be held to the 50-mW area if possible; bias currents are typically 200 to 300 μ A.

The second power-dissipating phase occurs during the avalanche mode. Here the power dissipation can be very high (more than 20 watts), so care must be taken in selecting pulse width and duty cycle. In general, pulse widths should be kept less than 10 μ s and duty cycles less than 1% for the TO-18 package.

Good wiring techniques are extremely important in avalanche circuits. With the high rate of change of current (better than 10^9 A/s), even the smallest

Table. Typical characteristics

Different types of avalanche transistors are available. The TO-18 versions provide the following range of characteristics:

BV_{CEX}	The general range is from 70 to 190 V, with special selection in that range of any voltage plus or minus 10 V.
I_H	This will range from less than 1 mA to over 20 mA. Typical specifications would be greater than 0.5 mA.
$I_{A(min)}$	This will vary from 100 mA to 500 mA with a typical value of 300 mA.
V_A	This is current-dependent, but will generally be between 10 and 20 V at 1.0 A.
V_{BA}	Typically +0.4 V.
t_R	Less than 1.0 ns.
t_D	Less than 2.0 ns.
t_J	Less than 0.1 ns.

inductance is prohibitive. A transistor lead wire 1 inch long may have over 20 volts induced across it. That will considerably increase the turn-on time, and if it is in the emitter return, excessive base voltages will occur. This may damage a preceding stage, or charge the base capacitor and cause free-running. In a grounded-emitter circuit, the emitter should be connected to a good ground with a maximum of a 0.25-inch lead length.

Excess inductance in the collector circuit or coupling capacitor will cause slow rise times, reduced pulse outputs and possible ringing. In general, low-inductance disk capacitors should be used. In extreme cases they can be soldered directly to the top of the TO-18 can with low-temperature solder. Alternatively, a plug-on heat sink with the capacitor directly connected to it can be used.

How to select the load line

Problems often occur in selecting the optimum load line, since there is a maximum and minimum allowable value. The minimum impedance is governed by the maximum peak current allowed and by power dissipation. Peak theoretical load currents should be held to 5 amperes maximum for standard TO-18 avalanche transistors. This is given by $(BV_{CEX} - V_A/R_L)$.

This current will not be achieved since there will be losses due to stray inductance, but pulses of 70% of this value are easily achieved and 85% can be obtained under ideal conditions.

The maximum impedance load is governed by the second break in the BV_{CE0} curve (Fig. 1c). If the

base voltage to be held negative with respect to V_{BA} by at least 2 volts for reliable operation over a wide temperature range. Figure 1b shows a typical input network composed of C_{in} , R_B and V_{BB} . During the quiescent state, the current flow is from V_{CC} through R_C , through the collector-base junction of the avalanche, through R_B to $-V_{BB}$ supply. Thus, when calculating the base bias, the IR drop in R_B due to the quiescent current must be taken into account. For most circuits, R_B is chosen to be less than 1 k Ω preferably in the 200-to-400-ohm range, and V_{BB} to be between -2 and -4 volts.

Figure 4, which is an expanded curve of the low-current region of BV_{CBO} , helps to explain why such a large negative bias is chosen. As is true with most high-voltage diodes, there is noise at the knee. This can give pulses of a few tenths of a volt at 25°C, increasing to 0.5 to 1 volt at -55°C . At high temperatures, the curve becomes slightly "soft" and this noise problem lessens. In Fig. 1b, since the collector dynamic load is effectively R_L , the noise pulse will divide across R_B and R_L . As R_L is usually equal to or less than R_B , much of that pulse will appear as a positive voltage applied to the base of the transistor. If the pulse brings the base-emitter voltage up to V_{BA} , the circuit will self-avalanche. For safety, therefore, V_{BB} of at least -2 volts should be used. Figure 5a shows the collector waveform observed where insufficient V_{BB} is used. The triggered pulses are *A* and *D*; the free-run pulses are *B* and *C*. Since the noise pulses are somewhat random, *B* pulses will usually occur only for a small portion of the time and *C* pulses quite seldom. The occurrence of these pulses will increase with decreasing temperature, but a V_{BB} of -2 volts suffices to prevent free-run to -55°C .

Figure 5b shows the type of free-run that occurs if R_B is too high in value and the quiescent current is enough to bring V_{BE} up to V_{BA} . *A* and *E* are the desired pulses, and *B*, *C* and *D* are free-run pulses. Pulse *E* may occur at any point in the cycle and may be a full pulse or only a partial pulse. This type of free-run is more prevalent at higher temperatures, especially if R_B is returned directly to the emitter instead of a negative supply.

It is also possible to trigger an avalanche transistor by introducing a positive-pulse at the collector. This pulse is effectively coupled back to the base through the transistor collector-base junction, and if the base is brought up to V_{BA} , an avalanche will occur. This type of triggering is seldom used, but in specific cases may be convenient (Fig. 17).

Emitter output is available

If a positive output pulse is desired, it is possible to take the output from the emitter instead of the collector. Figure 6 shows a typical avalanche cir-

cuit delivering a positive output pulse. This circuit has a greater tendency to latch up in the BV_{CEO} mode than the grounded-emitter configuration, especially if R_L is greater than 100 ohms. If R_L must be large, a 150-pF capacitor from collector to emitter of the transistor will eliminate the problem at the expense of a longer recharge cycle.

Another potential problem occurs at the input, since the emitter voltage rises to a high level during avalanche. If a coupling capacitor is connected directly to the base, a charge can be put on the capacitor during avalanche. For this reason, a diode is used in the input circuit to isolate the avalanche from the drive circuit (Fig. 6). The quiescent base voltage is determined in this circuit by $-V_{BB}$ and the divider R_B , $D1$ and R_G . As in the grounded-emitter circuit, the fast-recharge circuit of Fig. 3 can be incorporated in this circuit.

Collector turn off sharpens pulses

If the avalanche transistor of either Fig. 1b or Fig. 6 is allowed to complete the entire cycle, output pulses with very fast turn-on times but poor tops and turn-off times will be generated. If flat pulses with fast turn-on and turn-off times are required, a collector energy supply capable of collapsing rapidly is required.

The standard way of achieving this is to replace the energy supplying capacitor C_o with an open cable (Fig. 7). An important point in this circuit is to ensure that during avalanche the dynamic loading of the cable is equal to or is slightly less than the characteristic impedance of the cable. This can be done by varying R_L . A fine rise-time adjustment can be made by putting a small trimmer capacitor from collector to ground. As in Fig. 6, a small capacitor may be required from collector to emitter, and the fast-recharge circuit of Fig. 3 may be used. Figure 8 shows the same technique as Fig. 7, but supplying a negative pulse.

The circuits of Figs. 7 and 8 have one major drawback — the pulse width is fixed as a function of the cable length. Although artificial, adjustable delay lines can be used, it is more convenient to use another avalanche transistor to turn off the collector supply of the first avalanche transistor very rapidly. Figure 9 shows a typical method of doing this. The NS1111 is used in a normal emitter-output avalanche circuit, except that the load resistor is split into two parts, R_L and R_X . The output voltage will be attenuated by the ratio of these resistors. The turn-off transistor, NS1110, is in a standard grounded-emitter avalanche circuit, delivering a negative output pulse to *D1*. This voltage is coupled through *D1* and C_o to the collector of the first transistor, driving the voltage to approximately zero and turning the avalanche off. In this circuit, C_o is usually made quite large to obtain a relatively flat-

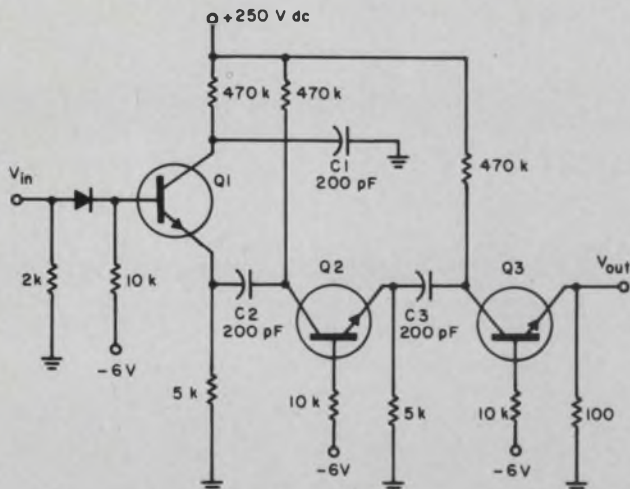

11. High-voltage pulses (higher than the single avalanche transistor voltage rating) can be obtained by putting two or more transistors in series. The capacitors are charged in parallel, discharged in series.

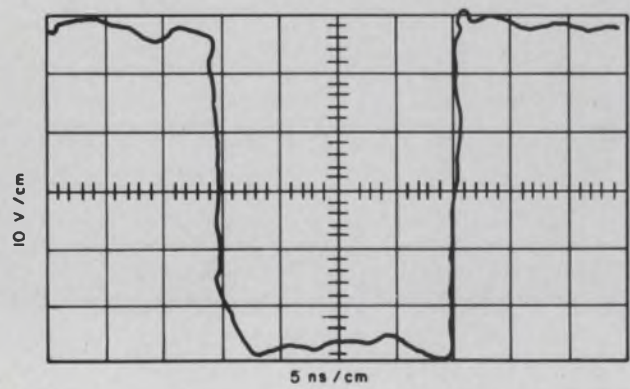
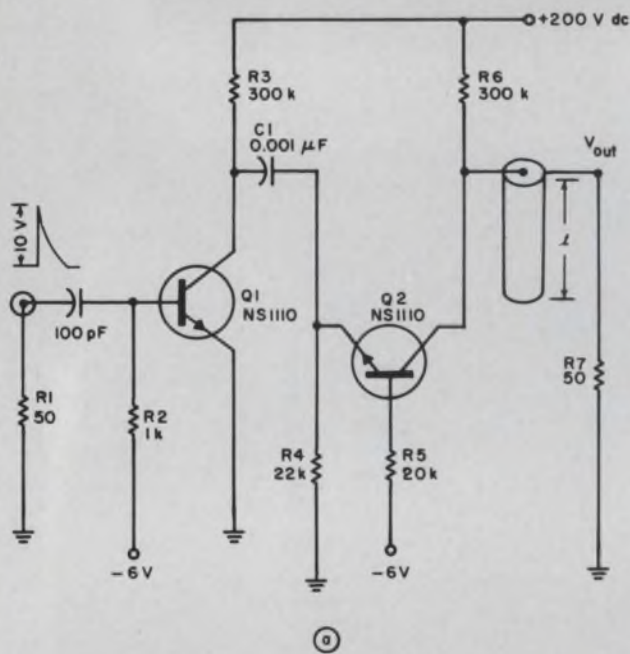

12. 55 V across a 50-Ω load (a) give 20-ns negative-going pulses (b). The coaxial cable is 7 feet of RG 180 B/U cable.

top pulse. A value of $0.1 \mu\text{F}$ is typical. With such a large value of C_o a stop pulse must occur within $10 \mu\text{s}$ or the first transistor may be damaged by excess heating.

Different types of avalanche transistors are used in this circuit, because it is desirable for the turn-off transistor to supply a larger output than the turn-on transistor, to give a sharp turn-off.

Build a comparator circuit

Avalanche transistors make good high-speed comparators, providing a sharp output pulse when the effective input level equals V_{BA} . Figure 10a shows a typical comparator circuit that will deliver an output pulse when the input ramp approximately equals the reference voltage. In this circuit, $Q2$ is the avalanche transistor, and $Q1$ a similar transistor used as a normal emitter follower. $Q2$ avalanches in the collector-base mode instead of the collector-emitter mode of the previous examples. This method of operation is used to maintain constant collector-to-base bias in $Q2$ during the ramp input and to obtain more predictable and constant V_{BA} values than can be obtained in the grounded-emitter case. Figure 10b shows the variation of V_{BA} with temperature and quiescent bias current for this type of circuit. Another advantage of this circuit is that the variation of $Q2$'s V_{BA} with temperature is compensated for by the V_{BE} variation of $Q1$ over nominal temperature ranges. It is important to provide a good ac ground at the base of $Q2$, to keep the common-emitter point from rising high enough to damage the emitter-to-base junction of $Q1$.

High-voltage pulses are no problem

Output voltage pulses are often required to be greater than can be obtained with a single avalanche transistor. Figure 11 shows a very effective method of obtaining high-voltage pulses. The energy-storing capacitors, $C1$, $C2$ and $C3$, are charged in parallel and discharge through avalanche transistors $Q1$, $Q2$ and $Q3$ in series. In this circuit, $Q1$ is triggered as a normal emitter output avalanche, and $Q2$ and $Q3$ are collector-triggered, causing the entire string to avalanche. If a short, flat-top pulse is desired, the last coupling capacitor (in this case, $C3$) can be replaced with a delay line, since the output pulse is determined by the smallest capacitor (or line) in the string.

If a negative-going output pulse is required, the circuit of Fig. 11 is modified by grounding the emitter of $Q3$, applying the input pulse to the base of $Q3$, and taking the output off a load resistor in series with $C1$ to ground. Although only three stages have been shown, more or fewer stages may be used to obtain the desired outputs.

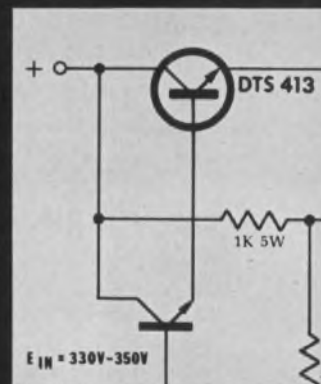

The Kokomoans'



Power semiconductors. And that knowledge can help you solve your most intricate problems in power. Our applications experience began the moment the power industry was born. Grew with it. And comes to you in Delco applications engineers stationed in nearby offices throughout the country. Engineers who've worked with people in everything from TV to space technology. Engineers who'll work with you to help take your pro-

gram from concept into production. Help you simplify circuits, lower costs or take care of most anything that might be short-circuiting your operation.

Prompt delivery's no problem because the Delco Radio organization is keyed 100% to mass production: mass production of components to meet customer production schedules. And mass production of our own end products—car radios and automatic temperature control systems. StereoTape systems. Portable military communications equipment.

When a company is geared like this, you know you'll get your parts on time.

You'll find that Delco devices come with conservative specs. Plus the uniform high quality and reliability gained through our precision high-volume production. So you can design with confidence.

SEMICONDUCTOR DISTRIBUTORS: EAST—BALTIMORE, MD. 21201, Radio Electric Service Co., 5 North Howard Street, (301)-539-3835 BINGHAMTON, N.Y. 13902, Federal Electronics, Inc., P. O. Box 1208, (607)-748-8211 CLIFTON, N.J. 07015, Eastern Radio Corporation, 312 Clifton Avenue, (201)-471-6600 NEWTON, MASS. 02195, The Greene Shaw Co., Inc., 341-347 Watertown St., (617)-969-8900 NEW YORK, NEW YORK 10036, Harvey Radio Co., Inc., 2 West 45th St., (212)-582-2590 PHILADELPHIA, PENN. 19123, Almo Industrial Electronics, Inc., 412 North 6th Street, (215)-922-5918 PITTSBURGH, PENN. 15206, Radio Parts Company, Inc., 6401 Penn Ave., (412)-361-4600 WOODBURY, L. I., N.Y. 11797, Harvey Radio Company, Inc., 60 Crossways Park West, (516)-921-8700 **SOUTH**—BIRMINGHAM, ALA. 35233, Forbes Distributing Company, Inc., 1416 Fourth Ave., South, (205)-251-4104 MIAMI, FLORIDA 33142, Mountain Electronics, Division of Mountain National Co., 3730 Northwest 36th St., (305)-634-4556 RICHMOND, VA. 23220, Meridian Electronics, Inc., 1001 West Broad Street, (703)-353-6648 WEST PALM BEACH, FLA. 33402, Mountain Electronics, Division of Mountain National Co., 1000 N. Dixie Highway, (305)-833-5701 **MIDWEST**—CINCINNATI, OHIO 45237, United Radio, Inc., 7713 Reinhold Drive, (513)-761-4030 CLEVELAND, OHIO 44125, The W. M. Pattison Supply Co., Industrial Electronics Division, 4550 Willow Parkway, (216)-441-3000 INDIANAPOLIS, IND. 46225, Graham Electronics Supply, Inc., 122 South Senate Avenue, (317)-634-8486 KALAMAZOO, MICH. 49005, Electronic Supply Corp., P. O. Box 831, (616)-381-4626 KANSAS CITY, MO. 64111, Walters Radio Supply, Inc., 3635 Main

Mix and mate type-N connectors

from different manufacturers, and you have problems
— unless you know which designs are compatible.

Type-N coaxial connectors are better than ever. The supply is wider than ever. As a result, design and systems engineers are having more headaches than ever.

The seeming paradox stems from the fact that in 1964 the military scrapped specification MIL-C-71 and substituted MIL-C-39012. Equipment based on the now-obsolete military specification is still in use, however. To compound the confusion, many manufacturers offer modified designs based on the newer specification.

Where does this leave the engineer who is trying to mate a new male coaxial connector with a female unit installed before 1964? He must take into account the mechanical incompatibilities between the two standards and between the equipment of different manufacturers. If this is done accurately, his headache is eased.

Higher VSWR with MIL-C-71 uni

In the older MIL-C-71 specification, all dimensions and tolerances are specified. The newer MIL-C-39012 only specifies the critical center conductor interface dimensions in terms of maxima and minima. Tolerances are fixed by desired rf performance. Accordingly manufacturers are allowed a certain amount of flexibility in construction in the interests of improved rf performance.

A connector pair built to MIL-C-71 is shown in Fig. 1. Both the male outer conductor and the female inner conductor are slotted, a mandatory requirement of the specification. The male outer conductor has a diameter of 0.328 ± 0.002 inch before slotting, so that mating with the 0.318-inch inside diameter of the female shell involves severe compression of the contact fingers and substantial encroachment on the interior air space of the female unit. The inside diameter of the female inner conductor is specified as 0.071 ± 0.001 inch before slotting. It must be closed down to provide a spring contact with the male inner conductor, and this causes a distortion of

the nominal 0.120-inch inner conductor diameter. The effect of this discontinuity is to alter the characteristic $50\text{-}\Omega$ impedance of the line, sometimes by as much as $\pm 1\ \Omega$ or 2%. Because of the longitudinal tolerances permitted, the gap between inner conductors can vary from 0.006 to 0.046 inches. This gap variation accounts to a large extent for the difficulty in predicting the VSWR that will result from unions of MIL-C-71 connectors.

To minimize electrical mismatch at the gap, MIL-C-71 specifies the use of a compensating ring located in the inside diameter of the outer male conductor. This ring has a nominal width of 0.026 inch and so cannot compensate for the full range of possible gap variations. These connectors are not therefore suited for devices where the over-all VSWR must be kept low, or in systems where the total mismatch losses and phase shift over a number of components must be held to a minimum.

MIL-C-39012 fixes VSWR under 1.35

The new MIL-C-39012 defines two classes of type-N connectors. Class-I connectors are intended to provide superior rf performance at frequencies up to 10 GHz. All rf characteristics are to be defined completely, but at present this specification has still not been enforced.* Class-II connectors, on the other hand, are specified only for their mechanical connection capability. They are required only to provide "reasonable" rf performance, which the specification defines as a maximum VSWR of 1.35. Most general-purpose connectors fall into this class. In both classes, connectors may be made of either brass alloy or stainless steel. Stainless construction is generally used in most precision equipment where long-term dimensional stability is needed.

The interface dimensions called out in MIL-C-39012 are shown in Fig. 2. This specification makes the slotting of the outer male and inner female conductor optional. The male compensat-

Salvatore Ammirati, Microwave Section Head, Narda Microwave Corp., Plainview, N.Y.

*Presently one of the tasks of the USASI C83.2 Committee on Rf Connectors.

rf performance superior to that of the general-purpose military types. Although some of these modified designs may use basic MIL-C-39012 specifications, they can differ in the extent to which they adopt the construction options and dimensional tolerances. Intermating capability among the various designs is then an important consideration when specifying equipment for systems use, or when the equipment may be used with devices from several manufacturers. The dimensions involved in a Narda modified design are shown in Fig. 3.

Among the precision type-N connectors used in modern coaxial equipment are the Weinschel Engineering types 1510 to 1512, designed for low VSWR up to 18 GHz. They are incorporated in Weinschel's attenuators and similar components. Type 1510 holds VSWR to a maximum of 1.12; types 1511 and 1512 specify VSWR at 1.25 or less. These connectors have an unslotted tubular body as the outer male contact. The female inner conductor is an unslotted tube containing a special contact mechanism designed to accept any male shank with a diameter from 0.063 to 0.072 inch. Critical interface dimensions of Weinschel's (and other) modified designs are given in Table 1. It will be seen that the interface dimensions limit the gap variation at the inner conductors from 0.000 to 0.006 inch. Weinschel will also soon introduce its model 1518 precision connector, with VSWR specified at less than 1.05 at 18 GHz. The diameter of the male shank may vary around 0.065 ± 0.003 inch. The center conductor gap is the same as that of the 1510. Weinschel's 1510 and 1518 will mate mechanically with all connectors designed to MIL-C-71 and MIL-C-39012.

Another precision type has been used by Hewlett-Packard. Its older models 805A and C slotted lines (0.5 to 4 GHz) and coaxial directional couplers (0.216 to 4 GHz) were designed for use with MIL-C-71 connectors, with the male and female inner contact dimensions equal to the cor-

responding MIL-C-71 mating connector dimensions. The purpose was to eliminate inner conductor discontinuities at the junction. The mating of two instruments that have this type of connector gives an interference fit.

A newer Hewlett-Packard slotted section, model 816A (1.8 to 18 GHz), uses modified type Ns (see Table 1) patterned to MIL-C-39012. These are used on all post-1966 Hewlett-Packard coaxial equipment.

Narda Microwave Corp. offers a choice of two modified type-N connectors in its equipment. As Table 1 shows, one of them has interface dimensions essentially the same as the Weinschel and Hewlett-Packard types and is comparable in performance. Narda instruments with these connectors mate and perform well with either of the other two manufacturers'. Narda's second type is equivalent to the military version of the MIL-C-71 connector, but differs in some of the critical dimensions to facilitate intermating.

Various combinations of performance and mating capability are available within a family of type-N connectors offered by Alford Manufacturing Co. Their type-NR connectors will perform best with MIL-C-71 connectors with nominal dimensions (that is, with zero tolerances). They will mate with any MIL-C-71 connector with a dimension B (see Table 1) of $0.197 + 0.008$ -inch female, and $0.223 - 0.001$ -inch male. However, they will not mate with each other. Types NB/P and NS, for use with MIL-C-39012 connectors, can be mated mechanically with MIL-C-71 units, but with reduced electrical performance. Type NB/L is designed for special testing applications where a high-precision connector with a smooth outer conductor is desired. It is not recommended for general use with either of the MIL types, because outer conductor contact is not always assured unless the male outer conductor fingers are spread before joining.

Mechanical compatibility among the various

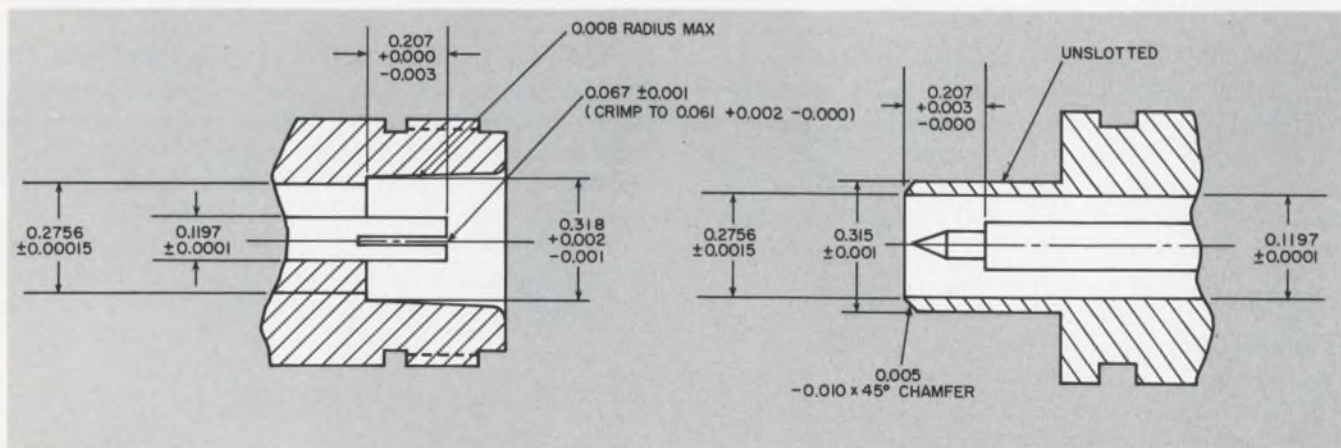

3. Modified versions of the type-N connector use MIL-C-39012 construction and design options to improve rf

performance. Critical interface dimensions of this typical unit are defined to optimize VSWR characteristics.

Table 2. Interface compatibility of modified designs

Male Female	Narda fixed atten. (prior to 1967)	HP 806B slotted section	MIL-C-71 (prior to 1964)	Weinschel 1020-N slotted line	Amphenol APC-N 131-10003	MIL-C- 39012 Class II	MIL-C-71 (after 1964)	Narda precision	PRD 215 slotted line	General Radio 900-QNP	Alford NB/P	Alford NR	Alford NS	Alford NB/L	HP 816A slotted section
Narda fixed atten. (prior to 9-67)															
HP 806B slotted section															
MIL-C-71 (prior to 1964)															
Weinschel 1020-N slotted line															
Amphenol APC-N 131-10004															
MIL-C-39012 Class II															
MIL-C-71 (after 1964)															
Narda precision															
PRD 215 slotted line															
General Radio 900-QNJ															
Alford NB/P															
Alford NR															
Alford NS															
Alford NB/L															
HP 816A slotted section															

 Mechanically possible

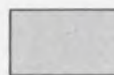
 Destructive interference possible

 Will mate mechanically, however, chamfer radii dimensions and lack of concentricity may degrade VSWR performance in mated pairs involving different manufacturers.

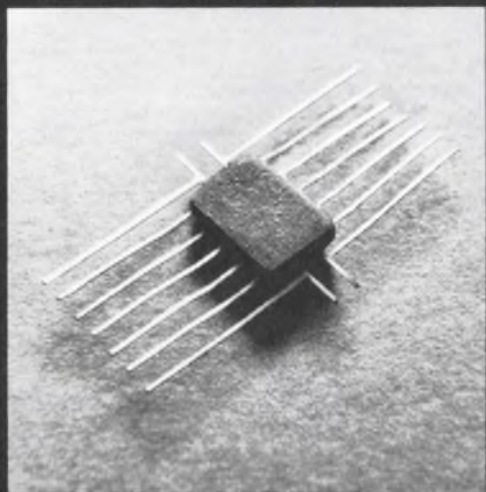

Transistor serves as a dc coupler, simplifies amplifier design

Variable-voltage direct coupling between successive stages of a transistor amplifier is easy with an active dc coupler. Cost is substantially less than using Zener diodes, which are not variable, and the noise level due to coupling is lower.

The dc coupler circuit shown in the accompanying figure shows utter simplicity. The signal and bias current for the following transistor base are supplied through the collector resistance of the coupling transistor. Variations in collector voltage in the preceding stage are translated to the variations in base current to the following stage.

Except for the following-stage base bias and the coupling-transistor base bias, the collector voltage of the preceding stage appears across the coupler base bias resistor, $R1$. Changes in voltage across $R1$ vary the coupler-transistor forward bias. Output current of the coupler transistor therefore varies with applied voltage. If the base bias current of the coupler transistor were fixed, it would simply look like a resistor. Under the operating conditions outlined, it appears that some gain occurs. For small-signal transistors with very little base current, the coupling transistor gain will be very small.

Noise generated in the coupling transistor is less than that of a Zener diode. Furthermore, it is attenuated by the negative feedback. There is a direct collector-to-base feedback path through the bias resistor $R1$. No noise measurements, however, have been made.

Base bias currents required by the following coupled stage will vary with transistor beta and

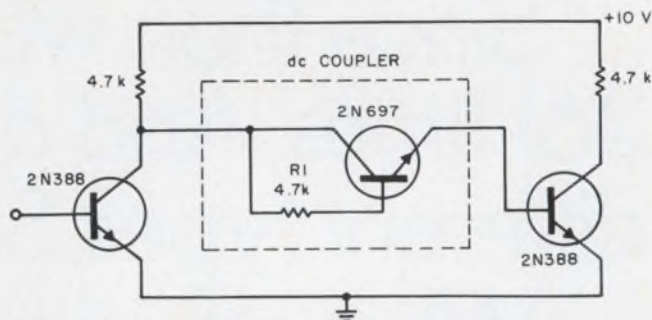

Dc coupling of transistor stages with a transistor and resistor simplifies dc amplifier design.

power level. For low-level operation, collector currents in the coupler transistor will be on the order of a few microamperes. The coupler-transistor beta under these conditions will be quite low.

Germanium transistors have substantial leakage current compared with silicon types. For this reason, silicon transistors are much more appropriate.

Use of this dc coupler circuit will simplify design of dc amplifiers. This coupler can compete in price with tantalum electrolytic capacitor coupling. The variability of the collector-to-emitter voltage drop by varying the bias resistor makes it a boon to breadboard development.

Harvey L. Morgan, Engineering Specialist, LTV Electrosystems, Inc., Dallas.

VOTE FOR 311

Single FET solves problem of interfacing p-MOS to DTL

As combining MOS logic and DTL in one integrated digital system becomes more popular, there is a need to interface one logic level to another, since the output voltage level for p-MOS integrated circuits is from 0 volts to a negative level, while that of the DTL circuit input requirement is 0 volts to some positive level. The simplest way to solve the problem is to use a single n-channel J-FET between the two systems. An example is shown in the accompanying figure.

The p-MOS integrated-circuit device has an output stage, typically an inverter, which feeds into the gate of 2N4392, an n-channel depletion-mode J-FET. Because the n-J-FET conducts



VOTE! Go through all Idea-for-Design entries, select the best, and circle the appropriate number on the Reader-Service-Card.

SEND US YOUR IDEAS FOR DESIGN. You may win a grand total of \$1050 (cash)! Here's how. Submit your IFD describing a new or important circuit or design technique, the clever use of a new component or test equipment, packaging tips, cost-saving ideas to our Ideas-for-Design editor. You will receive \$20 for each accepted idea, \$30 more if it is voted best-of-issue by our readers. The best-of-issue winners become eligible for the Idea Of the Year award of \$1000.

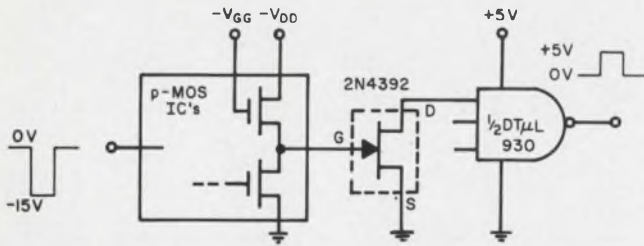

p-MOS logic is coupled to a DTL gate by means of a single n-channel J-FET.

when its gate is at 0 volts and turns off when the gate reaches the pinch-off, V_p or $V_{GS(off)}$, voltage, it will then turn the DTμL930 gate element off and on accordingly. Since the FET employed in this scheme requires only some pinch-off voltage, V_p , to insure its turn-off and some relative low $R_{d(on)}$ at about 2 mA, a reasonably inexpensive system can be realized.

Shao-Han Shou, Senior Engineer, Union Carbide Corp., Mountain View, Calif.

VOTE FOR 312

Field-effect diode simplifies regulator

The field-effect current-regulator diode (CRD) can be used to simplify the basic feedback voltage regulator. The CRD serves as the pre-regulator section of the voltage regulator and, as illustrated in the accompanying schematic, one CRD can eliminate four components, so reducing layout size, cost, and increasing reliability.

The CRD is a FET operated with $V_{GS} = 0$. Normal operation is beyond pinch-off, where the

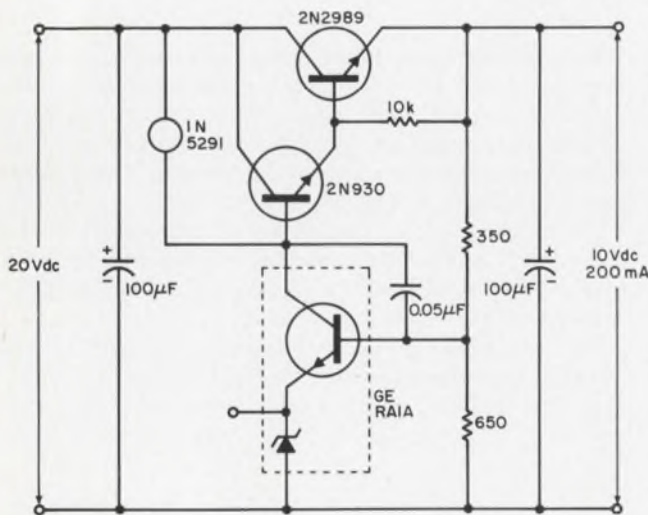

Simpler voltage regulator uses a field-effect current regulator diode, 1N5291. 2N2989 should be heat-sunk with a Wakefield NF209 heat sink.

CRD operates as a constant-current source with high dynamic impedance. This high impedance, which is a function of pinch-off current, greatly attenuates input ripple from the output. The CRD (1N5291) used in the regulator is made by Motorola and has a nominal pinch-off current of 0.56 mA. Other CRDs are available with nominal pinch-off currents ranging from 0.22 to 4.7 mA.

The voltage regulator supplies 0 to 200 mA at 10 volts. Load regulation is 0.1% for zero to full load and line regulation is 0.02% at an input ripple of 400 Hz.

A. P. Butvidas, Engineer, Martin Marietta Corp., Denver.

VOTE FOR 313

Nanosecond pulse shaper uses five components

A device, consisting of a network of three resistors together with two lengths of 50-ohm coaxial cable, can shape a subnanosecond-rise step-function voltage into any desired output pulse width.

The primary consideration in preserving the quality of a fast pulse through a transmission line¹ is proper matching of the source, cable and termination impedances. Ideally, in a 50-ohm system, the source, cable and termination impedance should be 50 ohms. If it is wished to reshape a pulse by means of a transmission line, proper matching of the shaping network junctions is necessary. In the schematic (Fig. 1) the input is a step-function voltage, $-e_{in}$, as shown in Fig. 2a. To minimize the reflection back into the source, the impedance at the junction of R_{in} and

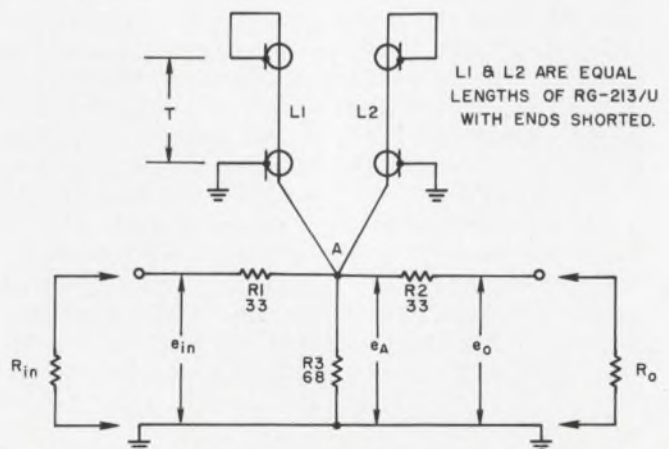

1. Matched 50-ohm nanosecond pulse shaper consists of only three resistors and two short coaxial cables, L1 and L2.

IDEAS FOR DESIGN

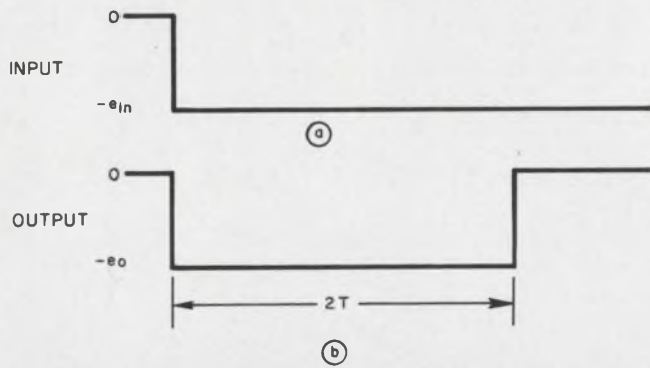

2. Input (a) and output (b) of the pulse shaper demonstrate the idea: the reflected voltage cancels the output voltage after a time, 2T.

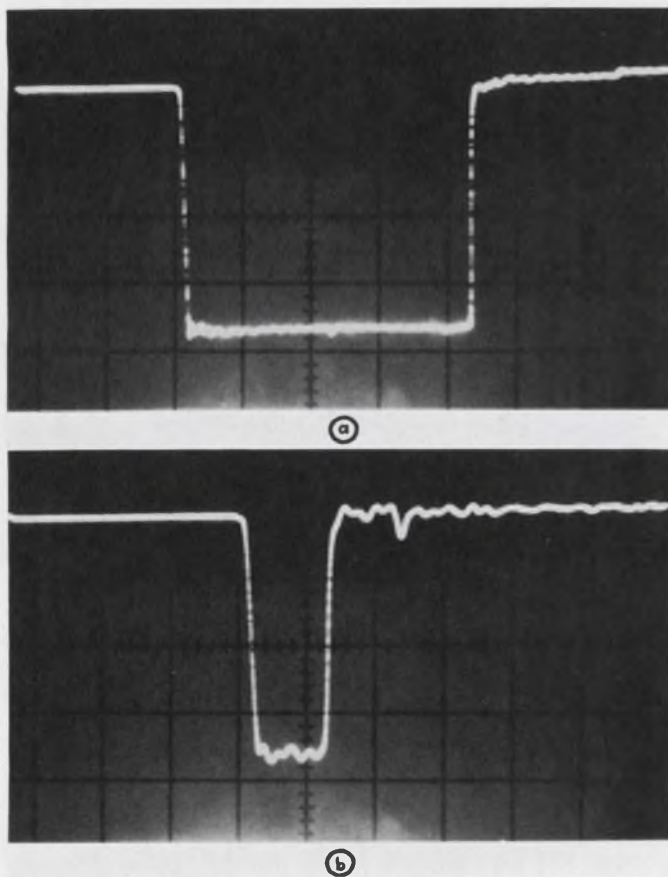

3. Pulse shaper response for different lengths of RG-213/U cable. In (a) the response is for 2-m cables, in (b) the cables are 20 cm. In both cases, vertical scales are 0.5 V/cm. Horizontal scale in (a) is 5 ns/cm, in (b) it is 2 ns/cm.

R_1 , with R_o connected, must be equal to 50 ohms, or:

$$R_1 + \frac{Z_{L_1} Z_{L_2} R_3 (R_2 + R_o)}{\left\{ \begin{array}{l} Z_{L_2} R_3 (R_2 + R_o) + Z_{L_1} R_3 (R_2 + R_o) \\ + Z_{L_1} Z_{L_2} (R_2 + R_o) + Z_{L_1} Z_{L_2} R_3 \end{array} \right\}} = 50, \quad (1)$$

where: Z_{L_1} = impedance of L_{11} ,
 Z_{L_2} = impedance of L_{12} ,

R_{in} = input source impedance,
 R_o = output termination impedance.

In this case, $Z_{L_1} = Z_{L_2} = R_{in} = R_o = 50$ ohms. The second condition that must be met is that L_1 and L_2 must each look into 50 ohms when the input and output are terminated:

$$\frac{Z_{L_1} Z_{L_2}}{(Z_{L_1} + Z_{L_2})} = R_3 \frac{(R_1 + R_{in})(R_2 + R_o)}{[R_3(R_1 + R_{in}) + R_3(R_2 + R_o) + (R_1 + R_{in})(R_2 + R_o)]} \quad (2)$$

Since the input and output terminals are reciprocal, R_2 must equal R_1 . Simplifying Eq. 2 gives:

$$\frac{R_3(R_2 + R_o)}{[2R_3 + (R_2 + R_o)]} = 25. \quad (3)$$

Combining Eqs. 1 and 3 gives $R_3 = 68$ ohms and $R_2 = 33$ ohms for the closest EIA $\pm 5\%$ resistor values.

After satisfying the impedance criteria, the problem of shaping a step-function voltage into a rectangular pulse can be considered. Let the step function voltage amplitude be $-e_{in}$. The voltage amplitude at junction A of Fig. 1 is:

$$e_A = -e_{in} [50 - R_1] / 50 = -0.34 e_{in}$$

The voltage with amplitude e_A travels down cables L_1 and L_2 of length T . Since L_1 and L_2 are terminated with a short, the reflected voltage will be $-e_A$. This reflected voltage will appear at junction A at $2T$ later, thus returning junction-A voltage back to zero (see Fig. 2b).

The output of this pulse shaper is:

$$e_o = e_{in} [50 - R_1] / 50 [R_3 / R_2 + R_o] = e_{in} (0.34) (50/83) = 0.202 e_{in}$$

Typical output waveforms are given in Figs. 3a and 3b.

(This work was performed under the auspices of the United States Atomic Energy Commission.)

Reference:

1. J. Millman and H. Taub, *Pulse and Digital Circuits* (New York: McGraw-Hill Book Co.), pp. 295-305.

Robert C. Der, *Electronics Engineer, Physics Dept., Lawrence Radiation Laboratory, University of California, Livermore, Calif.*

VOTE FOR 314

Frequency divider built with a novel technique

To divide frequencies in a binary manner (by 2, 4, 8, etc.) flip-flops may be used. To divide by a number that is not binary, however, the design becomes complex, since feedback must be employed to reset the counter at the proper time. This leads to complex circuit designs that vary widely for each factor of division.

Using logic gates to sense a particular state that will reset the counter to an earlier state

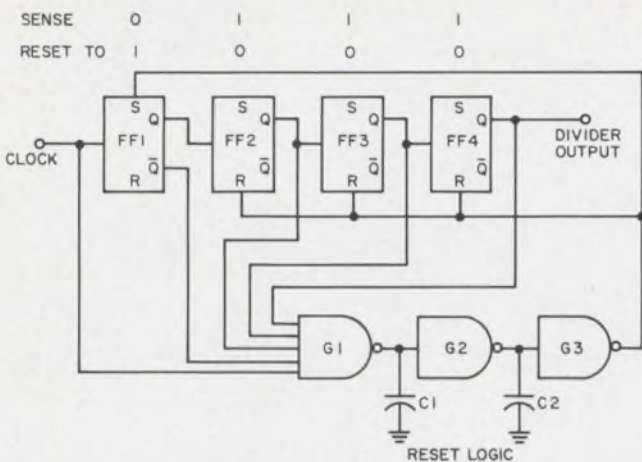

1. For a count of thirteen, 6-1/2 clock periods are measured either side of the transition FF4: 6-1/2 periods ahead of the transition gives the sense state for each flip-flop, 6-1/2 periods prior to the transition gives the states the flip-flops are reset to.

leads to a general technique for dividing a frequency by an integer. The method involves determining the binary half-count state of a normal binary counter and the flip-flop states at plus or minus half the desired count above the binary half-count rate.

As an example, consider dividing a frequency by 13. First, the output waveforms of each flip-flop are compared in time along with the input clock (Fig. 1). Binary division will cause a transition in the output of FF4. Counting 6-1/2 clock periods to the right of this transition reveals the state that will reset the counter. Counting 6-1/2 clock periods to the left reveals the state to which the counter is set. Since the 1 and 0 levels of the output are each 6-1/2 clock periods long, the output is a square wave.

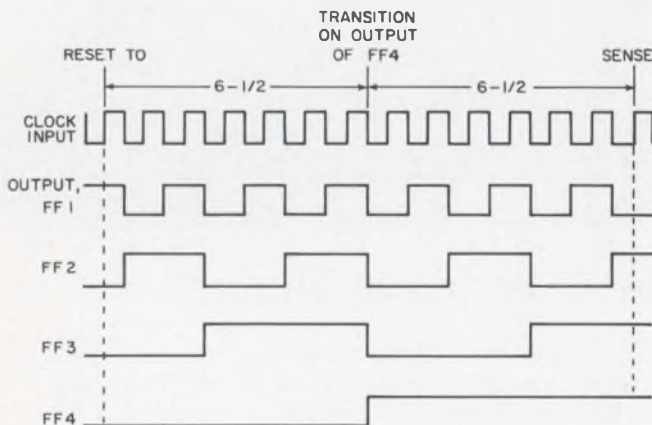

2. Divide by thirteen counter uses a four-stage binary counter. Sense state is determined by the inputs to G1. Reset states are determined by the outputs of G3. A delay is required to prevent the resetting from removing the sense state.

In the circuit (Fig. 2) NAND gate G1 senses state 1110 and the logic level of the clock. This resets the divider to state 0001 through G2 and G3. Since the loop would remove the sensed state as soon as it occurs, capacitors C1 and C2 are used to provide the time lag necessary to reset the flip-flops fully.

Instead of having to draw the timing diagrams for the divider, the sense and reset states can be determined from two sets of simple formulas shown in the table.

N	SENSE STATE	RESET TO STATE	SENSE CLOCK ?	NUMBER OF FLIP-FLOPS
ODD	$B + \frac{N-1}{2}$	$B - \frac{N+1}{2}$	YES	$X \geq \log_2 N$
EVEN	$B + \frac{N}{2}$	$B - \frac{N}{2}$	NO	$X \geq \log_2 N$

N = DIVISOR
 B = HIGHEST BINARY NUMBER IN THE DIVIDER
 X = NUMBER OF FLIP-FLOPS IN THE DIVIDER

In dividing by 13, N is 13 and B is 2³ or 8. Because N is odd, the state to sense is $B + (N - 1) / 2$, or 14, which in binary form is 1110.

As an example of an even frequency divider, let N = 30, so that B = 16 and the sense state will be 31 or 11111. The reset state will be 1 or 00001.

The time lag consists of two parts. The time constant formed by capacitor C2 and the pull-up resistor in gate G3 provides sufficient time for the state to be sensed before reset occurs. The time constant formed by capacitor C1 and the pull-up resistor in gate G2 provides the duration of reset. External resistive loads may be used to swamp out time-constant variations between gates G2 and G3.

For odd division, the time lag must be less than one-half the clock period, because the reset time is half a period before the next clock pulse. For even division, the time lag must be less than a full clock period.

Robert I. Serody, Engineer, Raytheon, Inc., Lexington, Mass.

VOTE FOR 315

Transistor switch provides low output impedance

In order to feed voltage pulses to such low-impedance loads as the motor armature in bang-bang servos, Darlington pairs with low emitter resistances are normally used in the output stage. In a typical circuit (Fig. 1a), Darlington T1 draws a

quiescent pulse current of about 2 amperes when a negative pulse is applied to $B1$, but nearly one-third of the input pulse is lost as a drop across R_{e2} when load resistance R_L is connected. Any attempt to reduce R_e below the value shown in Fig. 1a to minimize the drop across it would require a proportional increase in the quiescent pulse current, which serves no useful purpose for the load.

A scheme where load current is supplied by transistors instead of the emitter resistances of Darlington pairs is shown in Fig. 1b. Initially Darlington pairs $T1$ and $T2$ and transistor switches $Q5$ and $Q6$ are reverse-biased by the heavily conducting driving stages. A positive pulse at $A1$ cuts off transistor $Q1$ and feeds a negative pulse to Darlington $T1$. The same pulse cuts off $Q3$ to bring into saturation transistor $Q5$, which will thus offer negligible resistance to the load current. Darlington $T2$ stays reverse-biased to ensure that the saturated current of $Q5$ flows through only the load.

Thus the load pulse voltage is approximately equal to the input pulse voltage. Since fairly large values of R_{e1} and R_{e2} can be used in this scheme, very little quiescent current flows and the power supply current is very nearly equal to the load current.

AD 149 is a power transistor made by Mullard, Ltd., of London; AC 128 is made by Philips, N.V., of Eindhoven, Netherlands.

T. R. Narang, Senior Scientific Assistant, Central Electronics Engineering Research Institute, Pilani (Rajasthan), India.

VOTE FOR 316

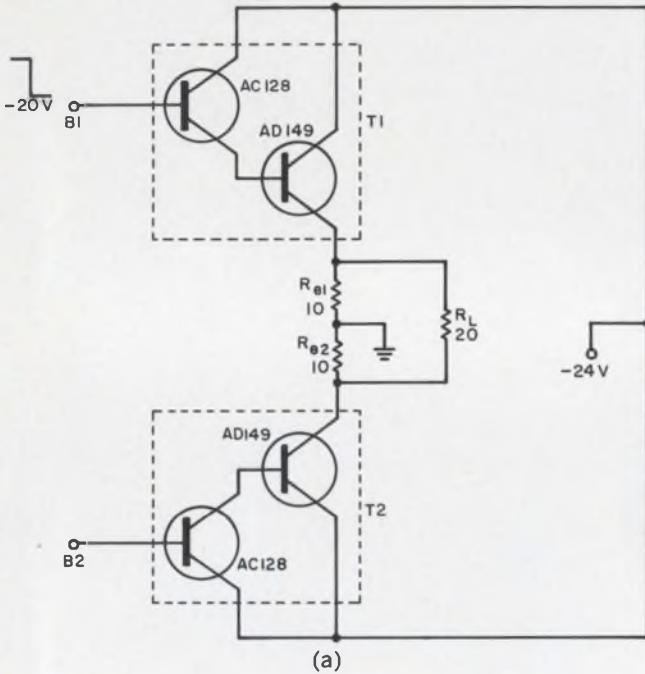

High-efficiency amplifier for driving low-impedance loads result when a conventional circuit (a) is modified (b). This is achieved by adding $Q5$ and $Q6$ to conduct the load current instead of R_{e1} and R_{e2} .

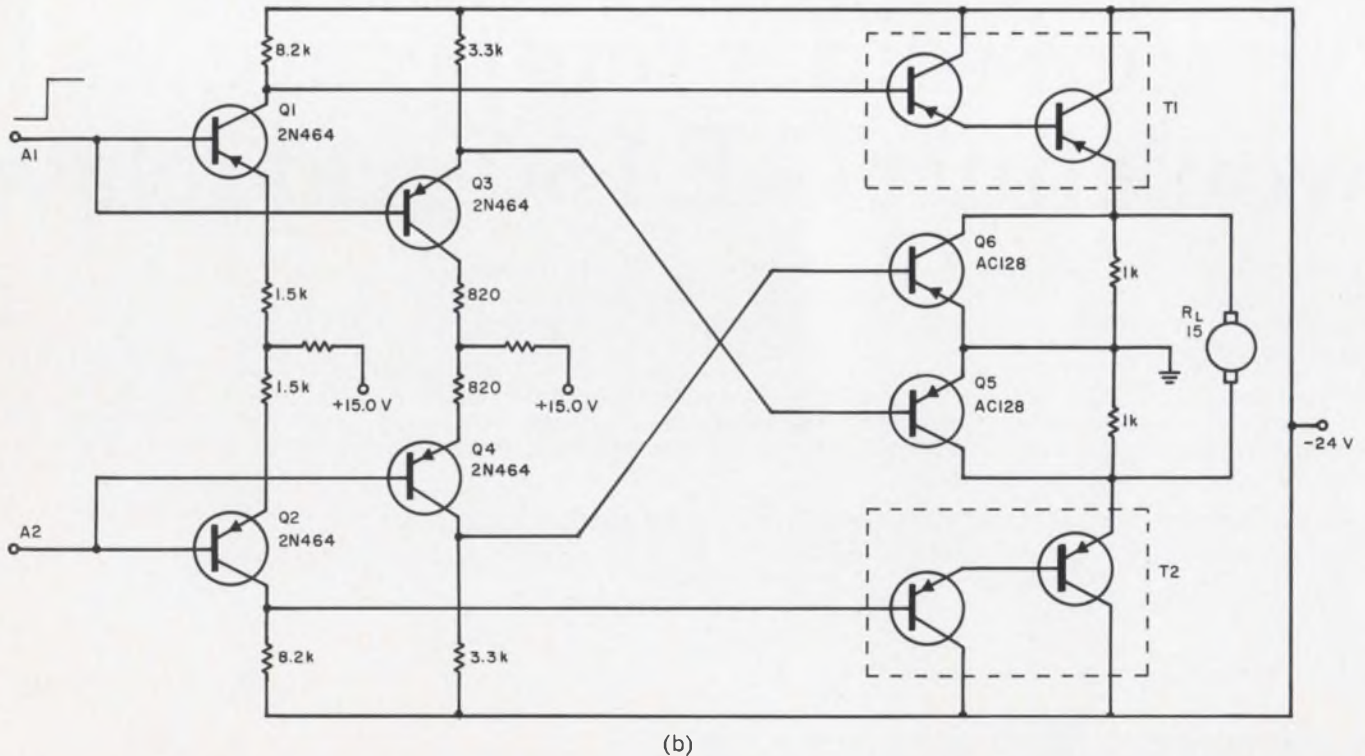

Diode improves performance in superregenerative circuit

The dual problems of hangover and receiver radiation, which characterize the self-quenched superregenerative detector, can be minimized by addition of a diode (see figure).

The first of the problems consists of residual oscillation that persists in the tank after the period of active oscillation has terminated. This effect, commonly known as hangover, gives rise to spurious responses and can block detection by effectively forcing the receiver to listen to its own residual rf signal. Shunting a germanium diode, CR1, across a portion of the tank inductance dissipates unwanted energy immediately after the circuit oscillation burst, eliminating hangover effects during the remaining sensitive portion of the decay slope. The diode is connected so as not to affect required positive feedback.

Receiver radiation is also reduced since the diode damping action lowers the amplitude and shortens the duration of the radiated pulse.

Receiver sensitivity is not affected by the diode since the barrier potential (approximately 0.2 V in the case of germanium diodes) prevents con-

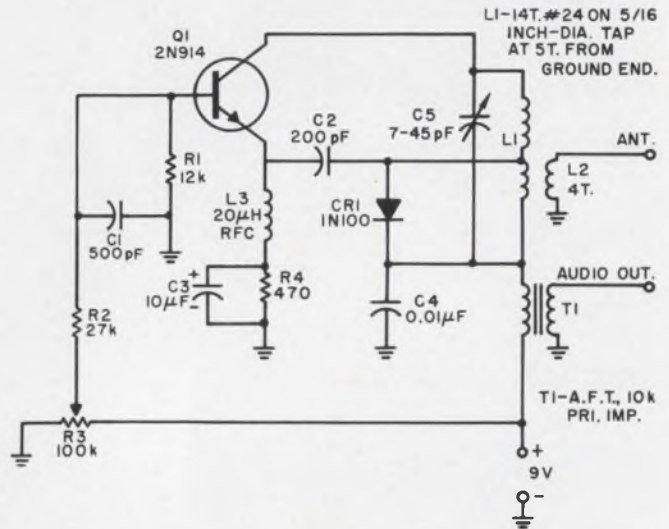

Residual oscillations are eliminated by adding a diode, CR1, to the conventional 27-MHz superregenerator. T1 is an audio transformer with 10-k Ω primary.

duction and consequent tank loading with respect to normal signal input.

Charles L. Ring, Technical Writer, Bell Telephone Lab., Inc., Whippany, N.J.

VOTE FOR 317

Triac, UJT and FET give linear ramps

A negative ramp of good linearity is generated by this circuit. An np complementary unijunction relaxation oscillator determines the

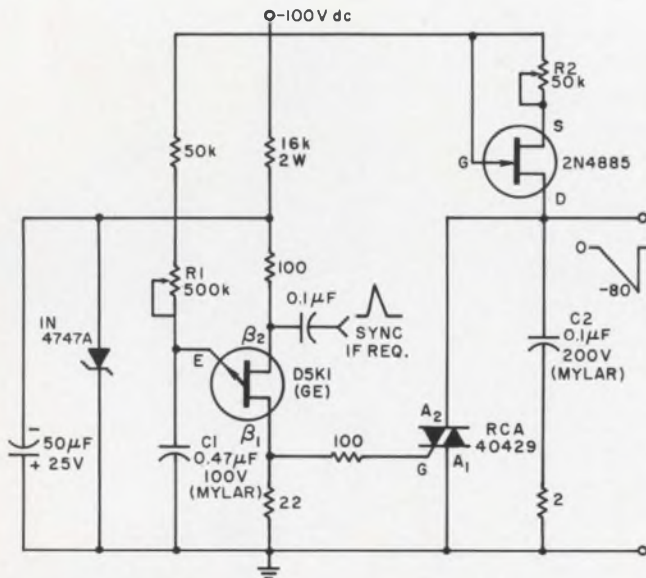

High-voltage linear ramp is obtained from this circuit using a Triac, UJT and FET.

period of the ramp. The unijunction circuit operates from -20 volts Zener-regulated from the -100-volt supply. The negative pulse from the unijunction section triggers the Triac gate, discharging C2, which has been constant-current-charging through the FET. R2 controls the slope of the ramp and R1 controls the period, giving a degree of control not found in simpler circuits. Ramps of 80 volts can be easily produced with this arrangement. As higher-voltage FETs and Triacs become available, the technique can be extended to nearly 1000-volt ramps.

Henry D. Olson, Research Engineer, Radio Physics Lab., Stanford Research Institute, Menlo Park, Calif.

VOTE FOR 318

IFD Winner for December 6, 1968

S. G. Johnson, Physicist, Regional Medical Physics Dept., Sheffield, England. His Idea "Voltage-to-frequency converter built with one UJT oscillator," has been voted the Most Valuable of Issue Award. Cast your vote for Best Idea in this Issue.

Pulse autocorrelator improves laser measurement accuracy

Problem: Develop a method that permits the dispersion effect of a disturbed laser signal to be detected against background noise. Laser signals are of very short duration. As they travel through mediums of varying refractive index, they may undergo multipath dispersion at the receiver and the disturbed pulses become difficult to distinguish from a noisy background.

Solution: A pulse autocorrelator that is an electronic multiplier and integrator network, based on the autocorrelation mathematical function and designed to detect multipath arrivals of gaussian-shaped signal pulses. The autocorrelation function is time-dependent and can be differentiated from noise by integrating the products of received pulses and their delayed replicas. A single pulse, on the other hand, cannot be so resolved. This electronic system represents a convenient method for accurately determining important parameters of a transmitted pulsed-laser signal.

The autocorrelator is constructed to detect the multipath arrivals of laser signal pulses. The modules (attenuator, multipliers, integrators, etc.) electronically perform the arithmetic operations that are required to evaluate the autocorrelation integral.

Two conditions are assumed in the operation: Only positive signals are autocorrelated, and the integrators of the practical autocorrelator have finite storage times (4 μ s) that are long in comparison with the duration of the individual signal

pulses (100 n) but short compared with the pulse repetition rate (100 pulses/s). Each incoming signal pulse is therefore individually autocorrelated, and the autocorrelation coefficient outputs for a particular pulse are not functions of the autocorrelation coefficients of any previous pulses.

The incoming signal enters the autocorrelator at the gate circuit drive amplifier. The purpose of this emitter-follower amplifier is to present a high-impedance load to the signal source. The signal then passes into the gate circuit, which gives free passage to signal pulses but blocks noise pulses.

The signal continues through the square-root driver amplifier and square-root circuit, and is amplified to a high level by the grid driver amplifier. At this point, part of the signal is attenuated and fed to the delay line, where it is tapped off at various delay points and fed to the low-level control grids of the multipliers. The main output of the grid driver amplifier is fed directly to the high-level screen grids of the multipliers.

The multiplier outputs are fed to the integrators, which in turn produce output pulses of a height proportional to the integral of the multiplier outputs. To record integrator outputs by audio fm machines, the integrator output pulses are stretched by the amplification and detection circuits.

Inquiries about this innovation may be directed to: Technology Utilization Officer, Manned Spacecraft Center, Houston, Texas 77001 (reference B67-10338).

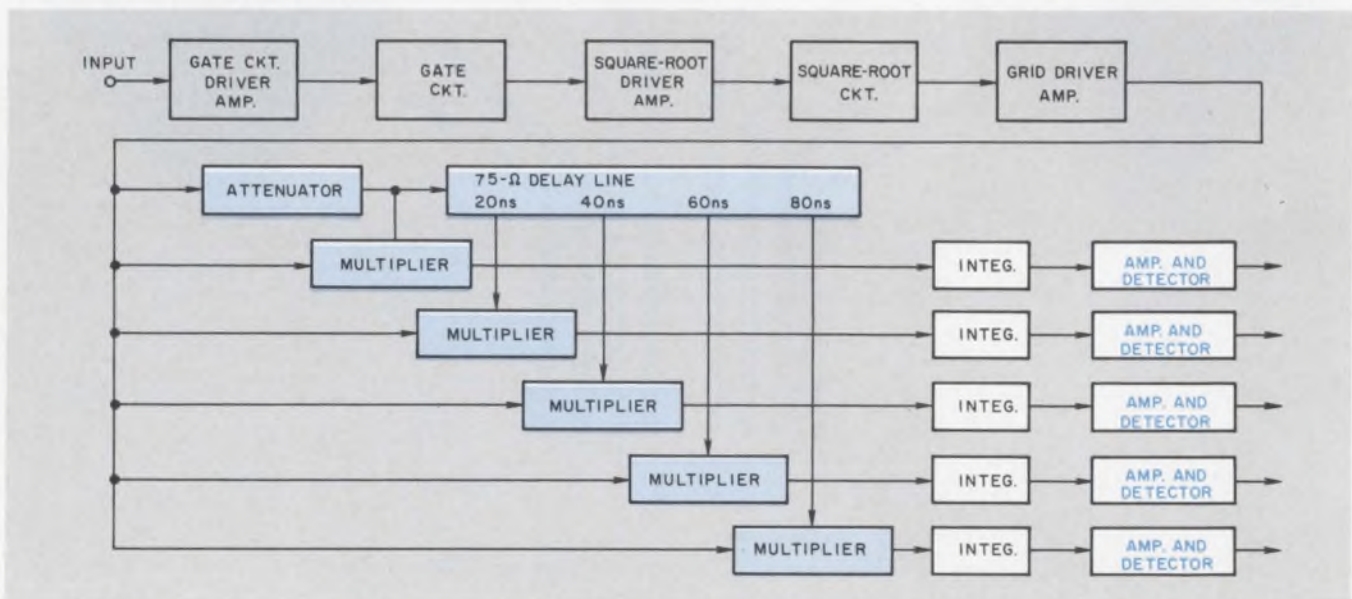

lab null detector
gives a nanovolt resolution
without jiggle

unique feedback control
allows new nanovolt
galvanometer to
ignore source resistance

Annoying meter bounce caused by source resistance or stray 60 Hz pickup is virtually eliminated in the new ESI Model 900 Nanovolt Galvanometer, by the use of a unique feedback control circuit. The circuit, a major design innovation, controls the galvanometer's damping and speed of response, giving optimum performance regardless of source resistance level.

The Model 900 is a calibrated electronic null detector that can accurately measure extremely small voltages and currents, from 10 nanovolts (10 picoamperes) to 3 millivolts (3 nanoamperes) with 2-nanovolt resolution regardless of source resistance. Accuracy is 2% of end-scale on all ranges.

Ideal for use with many laboratory measuring devices, the Model 900 is especially useful as a detector for resistance measuring systems, direct-reading and universal ratio sets, and high-accuracy, high-resolution potentiometers. As the Model 900 R it is now available for rack mount. A guarded and isolated recorder output is available on both bench and rack models.

Specifications: **Ranges:** 10 nV (10 pA) end-scale to 3 mV (3 μ A) end-scale on zero-centered meter; 12 overlapping ranges in 1, 3, 10 sequence. **Input Resistance:** 1 k Ω (on all ranges) \pm 2%.

Accuracy: 2% of end-scale value for voltage or current change (except when limited by noise). **Minimum Detectable Signal:** 2 nV or 2 pA. **Noise:** Less than 2 nV or 2 pA peak-to-peak. Price: \$2,175.

Circle No. 212



esi[®]



precision measurement

general purpose
resistance bridge now 5
times better...10 ppm

To meet a demand for increased accuracy in resistor production and quality control we are introducing the Model 242C Resistance Measuring System — a resistance bridge with five times closer measuring capability than any other comparable instrument.

Accuracy is rated at 10 ppm, yet the 242C maintains the outstanding range, reliability and — above all — simplicity of the predecessor models in this series.

Direct reading accuracy is maintained over all ranges without the use of correction tables or computations of any kind. Ratio resistors in the Kelvin bridge and each resistor in the first four decades are adjustable to 1 ppm of nominal. Calibration accuracy can be checked and adjustments reset in a matter of minutes on a normal 90 day cycle.

Other new improvements have been added to the 242C: yoke balance and lead compensation in the Kelvin bridge, for more accurate resistance measurements below 10 ohms; and an additional range on the deviation dial gives resistance standards comparison to 0.1 ppm. The resistors now have a tighter temperature coefficient too, for the reduction of temperature change effects.

You'll find the 242C a much more versatile unit for your resistance measurements. All the way from 10 m Ω to 120 M Ω . Price: \$5,500.

Circle No. 213

A revelation is in store for those of you familiar with the working problems of the traditional Mueller bridge method or potentiometric methods used for low temperature measurements. The Model 951 System captures the accuracies of both approaches—better than 10 ppm of the resistance ratio — (R_1/R_0) — while at the same time eliminating virtually all their unwieldiness.

precision temperature

**new speed, repeatability
in measuring temp
at highest accuracy**

Anyone working at present limits of accuracy in temperature measurement—whether in high or low ranges—should be interested in our new Model 951 Temperature Measurement System.

Not only does it provide state-of-the-art accuracy in one console over the entire range of resistance thermometry (0 ohms to 1000 ohms), but it revolutionizes operational convenience, speed and repeatability. And for just \$6,000.



You read R_1/R_0 directly off the dials without computation. There are no separated instruments with cumbersome connection leads; detector and current source are built-in.

The System is free of lead resistance problems, since measurement of the thermometer resistance is potentiometric. This eliminates lead commutation.

There's no need to reverse both current and potentiometer to check thermal electric voltages; a single polarity reversal does it.

There are no messy mercury cups, no worry about detector sensitivity and shielding.

It's all accomplished by combining three basic ESI instruments: a nanovolt galvanometer, a nanovolt potentiometer and the 7-dial passive divider from our most advanced dc voltage measuring system.

Circle No. 216

esi news and innovations in metrology

process control

**new "runup" adapter
makes PVB® a portable
recorder calibrator**

ESI's Model 1310 Precision Voltage Source now makes meter and recorder calibration a truly portable operation. This new accessory for the PVB 300 Potentiometric Voltmeter-Bridge converts the high-impedance PVB output to low-impedance, and provides from 50 nanovolts to 5 volts of precision calibration voltage.

The battery-operated PVB previously needed a separate power source as a drive signal for the recorder or meter being calibrated. With the 1310, however, each of the PVB's three potentiometric voltage ranges are buffered and the current boosted to handle the requirements.

The 1310 attaches permanently to the inside of the PVB lid, and its battery-powered operation gives about 200 hours use without attention. You can still use the PVB separately as a portable precision voltmeter-bridge, or use them together for recorder and meter calibration. You'll find 0.05% accuracy on the millivolt ranges and above.

Price on the Model 1310 is just \$300. Its parent 300 PVB costs \$940.

Circle No. 217



First Class
Permit No. 5454
Portland, Oregon

BUSINESS REPLY MAIL
No Postage Stamp necessary if mailed in the United States

Postage will be paid by

Electro Scientific Industries, Inc.

13900 N.W. Science Park Drive

Portland, Oregon 97229

esi

Electro Scientific Industries, Inc.

13900 N.W. SCIENCE PARK DRIVE
PORTLAND, OREGON 97229

see us at IEEE—booth 2B02

LMI

Shielded
rooms won't
let
obsolescence
box you in



Design • Changes in Government and Industry RF shielding specifications can quickly obsolete costly shielded rooms. That's why LMI RF shielded rooms are designed with built-in capability for upgrading. Any of the seven standard rooms designed and manufactured by LMI can be upgraded with appreciable savings over the cost of a new room. LMI designs utilize solid membrane, clamp-together or all-MIG-welded seams and provide maximum shielding over the widest frequency range.

Upgrade • For example, Class D Rooms can be upgraded by MIG welding all seams and/or adding an additional shield.

All-welded Class C and higher rooms can be upgraded by the addition of an inner shield, acoustic and microwave anechoic material at any future date.

Class AA and AAA are all-welded dual wall, solid shielded rooms for the highest performance from low audio to highest microwave frequencies.

Cost • The initial low cost and final costs are one and the same with LMI all-seams-welded rooms. There is no seam leakage nor any maintenance requirements over the life of the shielded room.

Technical Bulletin • For a complete description on all classes of LMI shielded rooms, write for your complimentary copy of Technical Bulletin (TB-101) "Technical Discussion and Specifications for Electro-magnetic Shielded Rooms."

Quick Reaction • For fast personal service on your shielding problems telephone or write direct to Fred J. Nichols, Carl T. Luce or James C. Senn.

LectroShield Division
LectroMagnetics, Inc.

6056 West Jefferson Boulevard
Los Angeles, California 90016
Area Code 213 870-9383

INFORMATION RETRIEVAL NUMBER 130

Frequency synthesizer is a digitally controlled oscillator

Problem: Design a digital oscillator for pulse-frequency-modulated telemetry systems. Previous oscillators used magnetic-core oscillators to provide output frequencies that were only approximately known. Output frequencies of such oscillators are prone to drift, either separately or together, making exact frequency detection difficult under conditions of poor signal-to-noise ratio.

Solution: A device that provides a better means of converting digital data from the format of binary information at several input terminals to the format of discrete frequencies at the output terminals. Each possible state of the input levels corresponds to one, and only one, frequency that can appear at the output.

The circuitry includes a common-clock source which drives

a first binary counter and several logic gates. This counter produces a number of pulse trains (one pulse train for each stage) with repetition rates related by the power of 2 in such a way that no pulses in any of the pulse trains occur simultaneously. The pulse trains are selectively gated through the logic gates to a combining circuit, with selection made by a binary number applied to terminals A through F.

The resulting combined-pulse train drives a second binary counter. The first stage of the second counter generates a square wave, irregular in width, and the subsequent stages of the counter produce similar irregular square waves that have been divided down in frequency. As a result, the average period of the irregular square wave is increased while the ab-

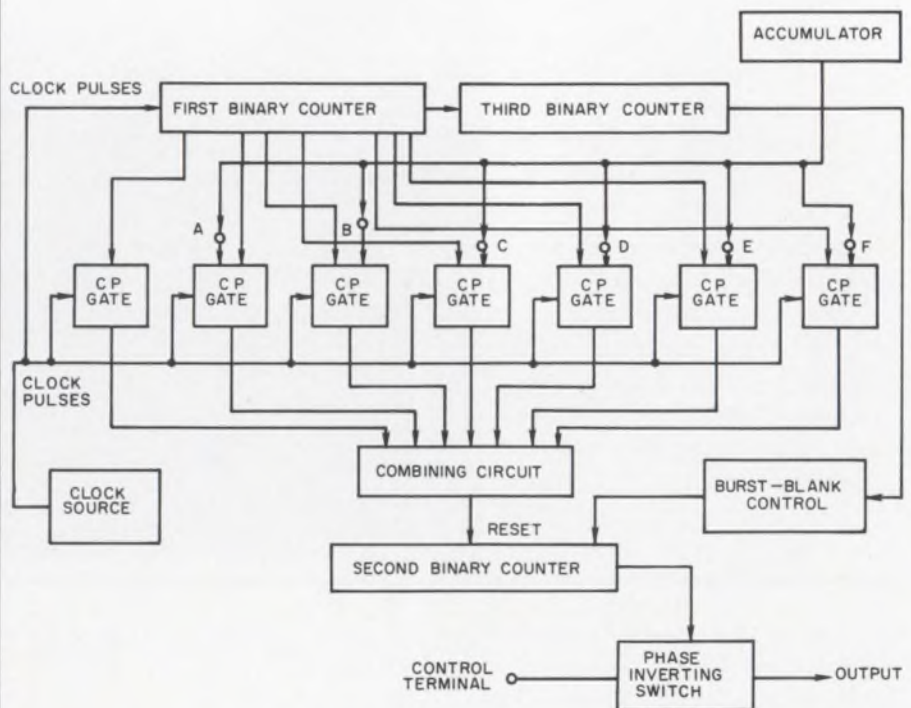



VOMs



RANGES and SPECIFICATIONS	160	230	240	250	255	260-5	260-5M	260-5P	261	270-3	
DC Volts	0-0.25/1.0/2.5/10/50/250/500/1000	0-10/50/250/1000	0-15/75/300/750/3000	0-0.05/0.25/2.5/10/50/250/500/1000	0-0.05/0.25/1/2.5/10/50/250/1000	0-0.25/2.5/10/50/250/1000/5000					
AC Volts	0-2.5/10/50/250/500/1000	0-10/250/1000	0-15/150/750/3000	0-2.5/10/50/250/500/1000	0-2.5/10/50/250/1000	0-2.5/10/50/250/1000/5000					
DC Microamperes	0-50 (250 mV drop)	NONE	NONE	0-50 (Both 50 and 250 mV drop)		0-50 (250 mV drop)					
DC Milliamperes	0-1/10/100/500 (250 mV drop)	0-10/50/250 (150 mV drop)	0-15/150/750 (150 mV drop)	0-1/10/100/500 (50 mV drop)		0-1/10/100/500 (250 mV drop)					
DC Amperes	NONE	NONE	NONE	0-10 (50 mV drop)	NONE	0-10 (250 mV drop)					
AC Amperes	NONE	NONE	NONE	NONE*	0-5/25/100/250 (w/ adapter No. 0531)	NONE*	NONE*	NONE*	NONE*	NONE*	
DB Scale ("0" = 1 mw into 600)	-20 to +10/-8 to +22/+6 to +36/+20 to +50	NONE	NONE	-20 to +10/-8 to +22/+6 to +36/+20 to +50	NONE	-20 to -10/-8 to -22/-6 to -36/-20 to -50					
Output Ranges	NONE	NONE	NONE	NONE	NONE	0.1 ufd in series with all AC voltage ranges through 250 volts.					
Resistance Ranges	RX1 (30 Ω ctr.)/RX10/RX100/RX1K/RX10K	RX1 (12 Ω center)/RX100	RX1 (30 Ω center)/RX100	RX1 (12 Ω center)/RX100/RX10K							
Temperature Range	NONE	NONE	NONE	NONE*	+100°F. to +1050°F.	NONE*	NONE*	NONE*	NONE*	NONE*	
Accuracy (% of Full Scale)		±3% DC, ±4% AC			±2% DC, ±3% AC			±1.5% DC, ±3% AC			±1.25% DC, ±2% AC
Temperature Compensated	NO	NO	NO	NO	NO	NO	NO	NO	NO	YES	
Meter Movement Protection	YES	NO	NO	YES	YES	YES	YES	YES	YES	YES	
Resettable Tester Circuit Protection	NO	NO	NO	NO	NO	NO	NO	YES	NO	NO	
Mirror Scale	NO	NO	NO	NO	NO	NO	YES	NO	YES	YES	
Scale Length	2.9 inches	2.36 inches			4.2 inches						
Dimensions	4 7/16" x 3 3/16" x 1 1/4"	3" x 5 1/4" x 2 1/2"			5 1/4" x 7" x 3 1/8"						
Net Weight	12 oz.	1 1/2 lbs.			3 1/2 lbs.						
Price	\$53.00	\$43.00	\$43.00	\$68.00	\$90.00	\$62.00	\$64.00	\$94.00	\$70.00	\$75.00	
Movement Type	Self Shielding Annular—Taut Band	Self Shielding Annular—Pivot and Jewel		Self Shielding Annular—Taut Band		Self Shielding Annular—Pivot and Jewel					Self Shielding Annular—Taut Band
Sensitivity	20,000 Ω/V DC, 5000 Ω/V AC	1000 Ω/V DC, 1000 Ω/V AC			20,000 Ω/V DC, 5000 Ω/V AC						

*Temperature, AC current, and other ranges can be added with exclusive Simpson Add-A-Tester adapters.



makes other specialized VOMs, adapters and accessories, too! And if we can't fill your needs from stock . . . we'll build it! Send your specifications, or write for test equipment brochure 2076.

Quick guide to bright, legible, wide angle readouts



Series 360H Displays 2" high characters easily read from over 50'. Yet unit is just 3" H x 2" W x 7.75" D. New lens system provides bright, crisp display.



CRT Display 10-gun CRT projects single-plane digital or word displays onto fluorescent screen. Easy reading, even in direct sunlight. Wide viewing angle. Ideal for instrumentation applications.



Series 160H Exceptionally large viewing area (1.56" H x 1.12" W for overall size. New lens system increases character brightness; reduces chance of reading error. Message lines may be displayed simultaneously with symbols.

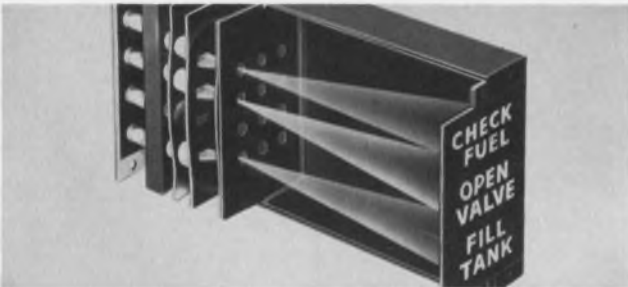

Series 80 Large screen unit particularly suited for annunciator applications . . . factory call systems, production control boards, etc. Message or character 3 $\frac{3}{8}$ " high; can easily be read at 100', 160° viewing angle.

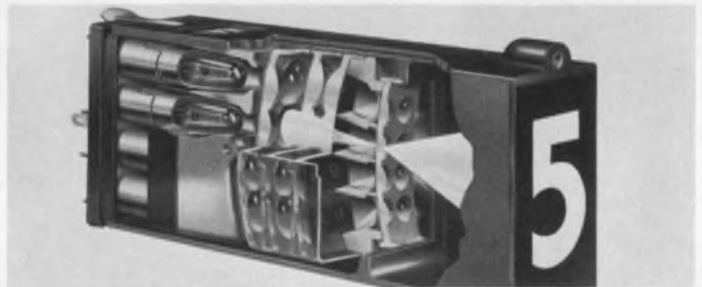

Series 10H It's the world's most popular readout. And we've improved it. New lens system increases character brightness 4 times. Greater clarity at wider angles and longer distances, even under high ambient light. .937" H x .937" W viewing area. Mil-spec version also available.



Series 345 IEE's smallest rear-projection readout. Viewing area .38" H x .34" W. Based lamps. Low cost. Individual readouts plug into permanently wired housing for quick message change. Easy front panel access.



Series 120H Miniature (.62" H x .62" W) rear-projection readout. New lens system increases character brightness 50%. Easily read from 30' even with high ambient light. Quick disconnect lamp assembly for speedy lamp replacement.



Series 220H Miniature, plug-in, rear-projection readout meets MIL-R-39027. .62" H x .62" W viewing area. Special lens system increases character brightness 50%. Excellent readability from wide angles and long distances.



Series 875 Miniature, 24-position, rear-projection readout with .62" H x .62" W viewing area. Overall size just 1.39" H x .90" W x 3.095" D. Exceptional character brightness and clarity. Quick disconnect lamp assembly for easy replacement.



IC Driver/Decoders Small, solid-state units for IEE Series 10H, 120H, 220H, 340 and 360 readouts. All models accept a variety of binary codes for decimal conversion. Take normal signal voltage. Draw less than 2 ma. (Many options, including memory.)

Any characters desired. Any colors or combinations. Any input, BCD or decimal. Any input signal level. Any mounting, vertical or horizontal. Many sizes. Many configurations. Many options and accessories. Many brightness choices. Long lamp life (to 100,000 hours).

See them all at the IEEE Show, March 18-21, Booth 3B22-23



Industrial Electronic Engineers, Inc., 7720 Lemona Ave., Van Nuys, California

INFORMATION RETRIEVAL NUMBER 133

No.1 in display

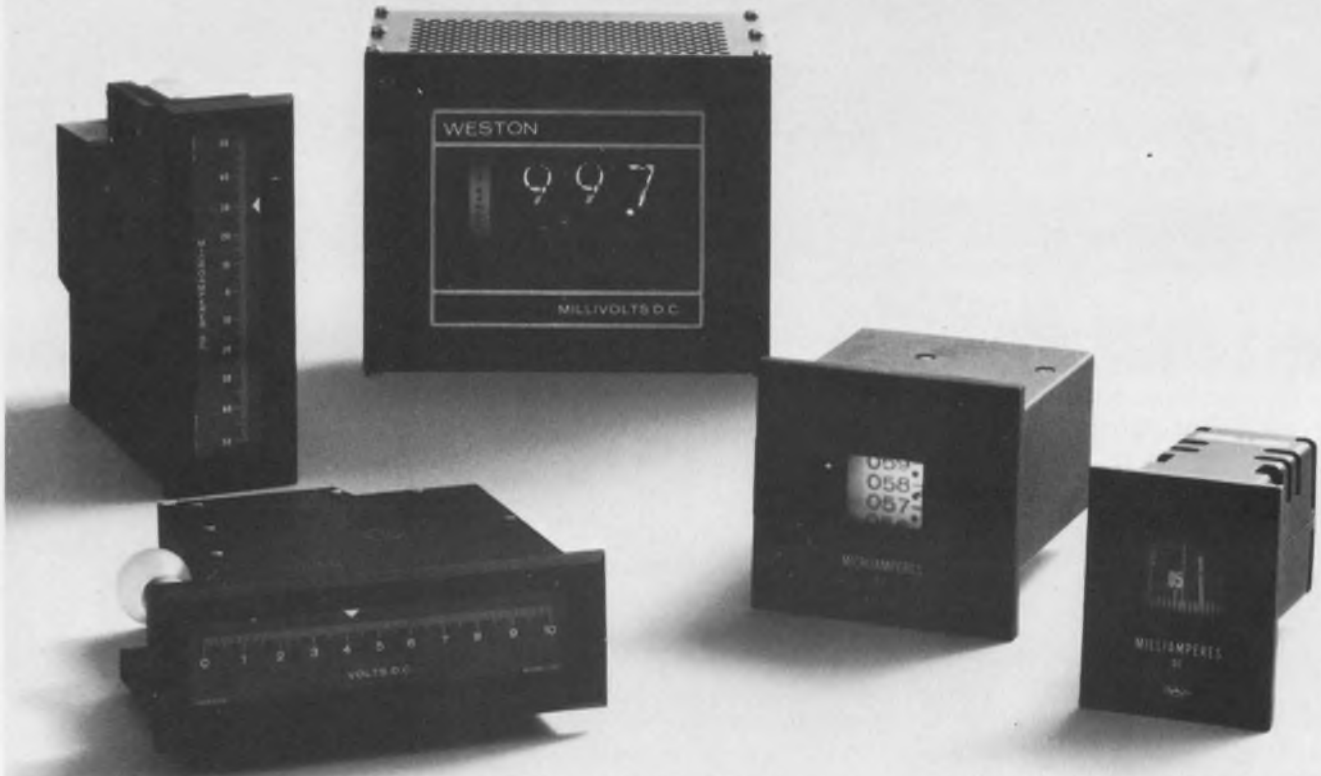

First with projected pointer meters

First with digital panel meters

First with projected scale meters

These panel meters represent the three most significant advances in meter design made in recent years. It is no coincidence that they are products of Weston, undisputed leader in display. Weston developed the projected moving pointer which did away with parallax and gave you full scale readings as low as 2 microamperes for the first time in an edgewise meter. Then came the projected moving scale

by Weston, offering 1% accuracy, hairline resolution and 8 inches of scale in a 2½-inch case. And in a slightly larger case, we offer the equivalent of a 30-inch scale with digital readout (analog motion). The latest Weston achievement is the all-electronic digital panel meter, providing unprecedented accuracy and solid-state reliability in a compact OEM styled package. Anticipating industry's needs in

precision measurement, products like these have earned Weston a reputation as "the number one innovator" in display technology. **WESTON INSTRUMENTS DIV.**, Weston Instruments, Inc., Newark, N.J. 07114, a Schlumberger company.

See the forward look in display at IEEE Booth 2C40-50

WESTON®
PRIME SOURCE FOR PRECISION... SINCE 1888

NEW MAGNETIC RELAY plugs into your PC board!

NO Springs, NO Wiring,
NO Sockets, NO Soldering,
NO Mechanical Linkage

Printact®

Standard Series G
Latching Series LS/LD

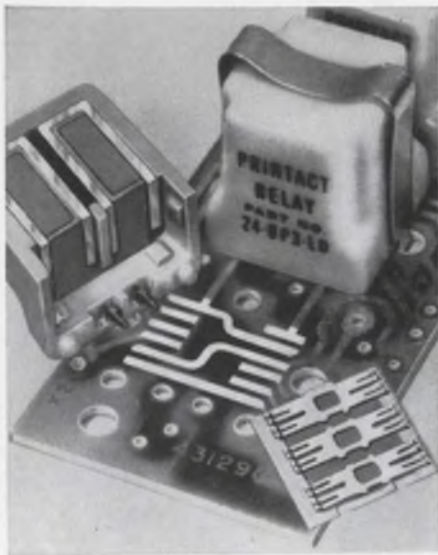

(actual size)

Plated Conductors on Your PC Board are the Fixed Contacts

Save SPACE, MONEY and MANHOURS with these new small, lightweight, highly reliable Standard and Latching PRINTACT Relays.

Available with Bifurcated Palladium or Gold Alloy contacts for more than 10 million cycle 2 to 4* pole switching. Handles up to 2 amp. res. loads. Coils for 6, 12, 24 and 48 vdc at 500 mw. Operating temperature -30°C to $+95^{\circ}\text{C}$. Operate time 7 ms. The little gem is an 0.8 oz. $\frac{7}{8}$ " cube.

Quality features include: double-break contacts; balanced armature, enclosed housing, plug-in application; encapsulated coil; self-wiping contacts and inherent snap-action — saves sockets soldering, and wiring and the cost is lower than you think!

*Switches up to 4 form A plus B, or 4 form C.

For data and prices write or call:
212-EX2-4800

Executone

PRINTACT RELAY DIVISION
47-37 Austell Place
Long Island City, N.Y. 11101

INFORMATION RETRIEVAL NUMBER 103

240 B

NASA TECH BRIEFS

Multiplexer samples with 0.2% accuracy

Problem: Design a highly accurate and reliable multiplexer of small size and weight for telemetry applications. The multiplexer must repetitively sample up to 234 separate data lines and time-share them on a single output line to allow single-line transmission.

Solution: A multiplexer incorporating insulated-gate field-effect transistors for all digital logic functions, including the internally generated 3.6-kHz clock. Transistors of this type are also used for analog data switching.

The multiplexer basically consists of 30 primary channels, each of which is sampled 120 times per second. Twenty-three data channels may be submultiplexed to 10 subchannels, sampled at 12 times per second. Four other data channels are sampled only 120 times per second. The three remaining primary channels are used for amplitude reference and frame identification.

The multiplexer accepts 0 to +5 volts and provides two parallel pulse-amplitude-modulated wave-train outputs, one with a 1.2-volt pedestal inserted during on time and one without. An internal calibration unit provides calibrated output levels equal to percentage values of 0, 25, 50, 75, and 100 within 0.2 per cent of an externally applied voltage reference.

The multiplexer uses 15 different printed-circuit boards, making a total of 35 boards, each 2 inches \times 1 inch in size. Each board is completely encapsulated in epoxy resin. The individual encapsulated boards are stacked to form a compact, rugged unit occupying a volume

of 29 cubic inches and weighing 1.3 pounds.

The high accuracy and low output impedance of the multiplexer suit it for driving either modulators or analog-to-digital converters. The system can also be used as a general-purpose multiplexer in any application where time-sharing or sampling is required.

Inquiries concerning design and performance details may be directed to: Technology Utilization Officer, Marshall Space Flight Center, Huntsville, Ala. 35812 (B67-10396).

Limit circuit prevents op amp overdriving

Problem: Design a circuit for an operational amplifier that limits the output. The operational amplifier should have a hard limit, that is, one with an output that is clamped to within 0.002 V of a desired set limit.

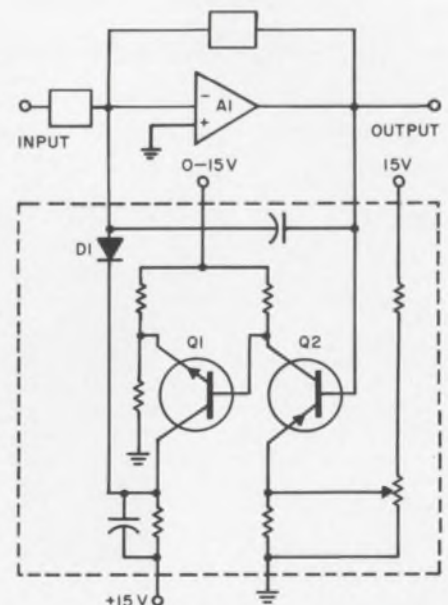

ELECTRONIC DESIGN 6, March 14, 1968



COMPUTER POWER SOURCE



Not just another computer power supply but a complete computer power system. Designed for critical applications in main frame and peripheral equipment which require:

- Maximum Line Isolation
- EMI Reduction
- Positive Protection Against Voltage Overshoot
- Highest Reliability
- Minimum Maintenance
- Short Circuit Protection

All these features are inherent in a NOBRUSH[®] Power System. Combines the unique qualities of a "Nobrush" Permanent Magnet Generator and solid state rectifiers. Get the complete facts. Write or call:

GEORATOR CORPORATION

315 Tudor Lane, Manassas, Va. 22110
Phone: (703) 368-2101

See us at
IEEE BOOTH 2A03-2A05

INFORMATION RETRIEVAL NUMBER 106

240 D

NASA TECH BRIEFS

Solution: A cutoff-type high-gain amplifier coupled by a diode around the operational amplifier. A standard 15-volt powered transistorized operational amplifier will usually hold the output to within 0.3 to 0.5 volt of a desired limit by means of a simple diode clamp even though the input is being over-driven.

The gain of the feedback circuit is high, and whenever the output of the amplifier reaches a preset limit, any excess is amplified and fed back to the input side of the amplifier. The amplified feedback signal offsets the excess input signal that tends to cause the amplifier to exceed its present limit. The output is, therefore, held to the set clamp level.

The circuit limits output to less than 2 mV for a 14-volt overdrive on the input. The figure shows a negative-going signal output clamp. For a positive going signal output clamp, Q1 and Q2 should be interchanged and diode D1 polarity reversed.

Inquiries concerning this innovation may be directed to: Technology Utilization Officer, AEC-NASA Space Nuclear Propulsion Office, U.S. Atomic Energy Commission, Washington, D.C. 20545 (B67-10343).

Controls impurities in silicon wafers

Problem: Devise a process to control the concentration of lithium diffused as a dopant, or impurity, into the base region of an n-on-p silicon solar-cell wafer.

Solution: A modified three-step process in which part of the surface layer of the base region of the p-type silicon containing the diffused lithium is removed be-

fore the remaining portion of the dopant is redistributed into the bulk of the silicon wafer.

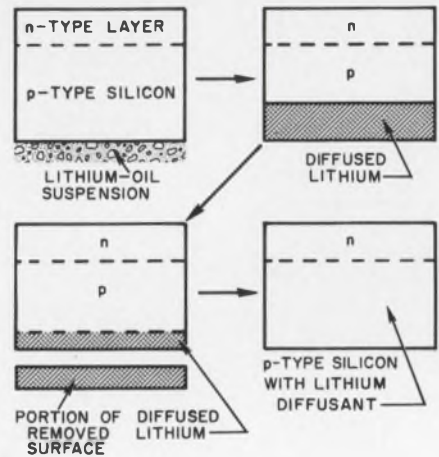

Lithium is diffused into the base region of the silicon wafer by using a coating of lithium suspended in oil as the diffusant source. Part of the surface layer on the base region is then chemically or mechanically removed to a depth less than that of the total penetration of the diffused lithium. The diffusant in the remaining portion of the surface layer is redistributed through the bulk of the wafer by heat treatment.

The advantages of this process are that the final impurity concentration in the wafer can be closely controlled by adjusting the amount of surface layer removed, and that the effects of surface alloying generally encountered in the diffusion of such metallic impurities as lithium are eliminated. This process, which has been specifically used for lithium doping of diffused n-on-p solar-cell wafers, can be applied to other dopants and semiconductor materials.

Inquiries about this innovation may be directed to: Technology Utilization Officer, Goddard Space Flight Center, Greenbelt, Md. 20771 (reference B67-10303).

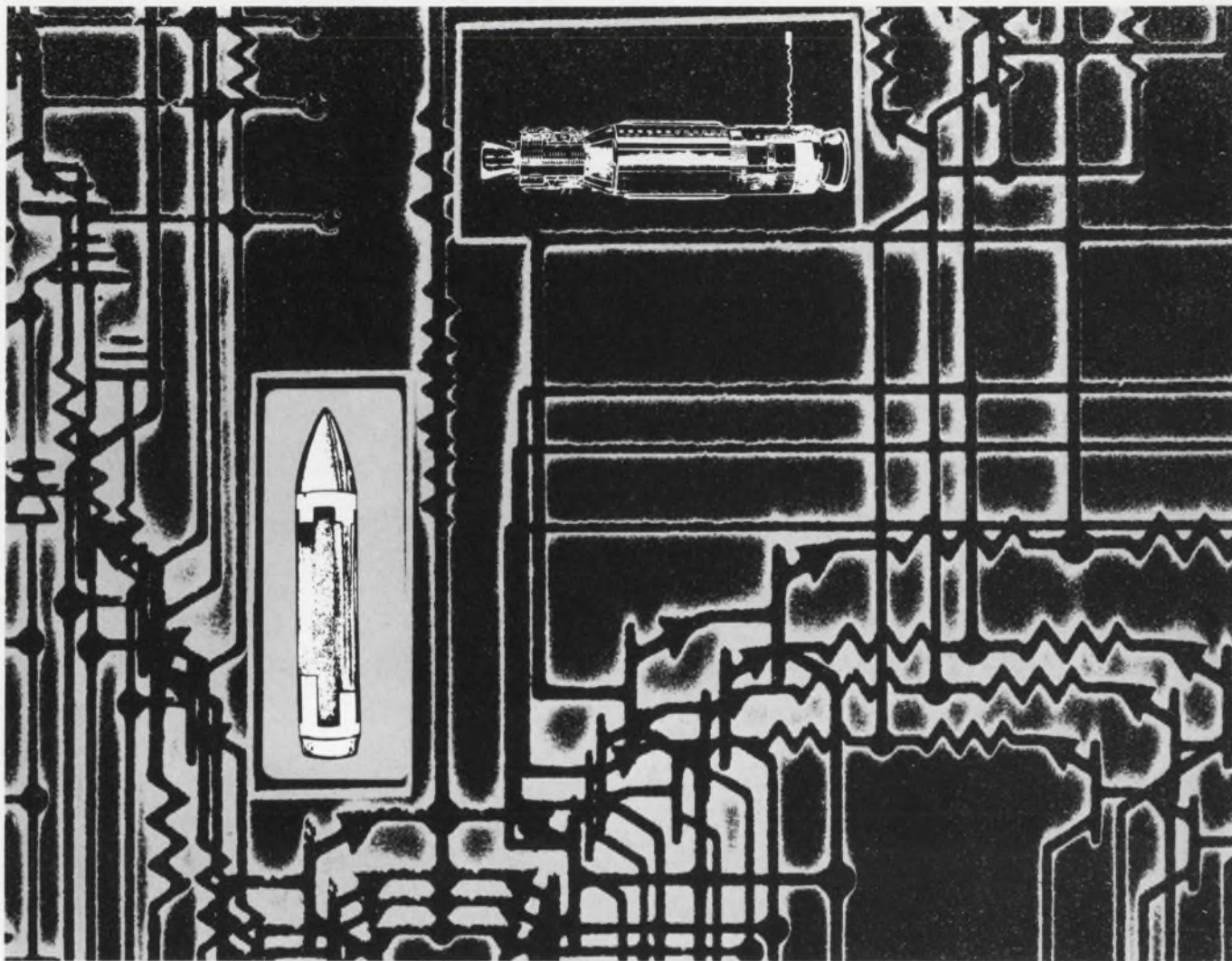

*up.
down.
on the ground.
the place for new electronics advances is Lockheed.*

Whatever environment you now work in—land, sea, or space—you'll find it to your advantage to look into opportunities at Lockheed. Take Agena and Poseidon for example. Major technical expansion is under way on both of these vital programs. And both Agena and Poseidon share the need for new concepts and major technical advances. □ Typical Agena assignments will include: digital communication systems for data transmission and command, digital and analog flight control systems, optical and infrared sensors, solar power panels, and power conditioning. □ Poseidon's general area of requirements ranges from weapon effects on electronics to the design and use of state-of-the-art test check-

out equipment in one of the largest checkout programs ever mounted. □ Undersea, Lockheed is active in the expanding field of deep submersibles and ocean mining. Now under way—the Navy's unique Deep Submergence Rescue Vehicle and Lockheed's Deep Quest research vehicle designed to operate down to 8000 feet. □ On land, Lockheed is engaged in the development of unique land vehicle systems, information systems for states and hospitals, and many other important programs. □ For more complete information, you are invited to write Mr. R. C. Birdsall, Professional Employment Manager, P.O. Box 504, Sunnyvale, California. Lockheed is an equal opportunity employer.

LOCKHEED
MISSILES & SPACE COMPANY
A GROUP DIVISION OF LOCKHEED AIRCRAFT CORPORATION

"VISIT LOCKHEED'S SUITE DURING IEEE"

INFORMATION RETRIEVAL NUMBER 901



We can't kick the habit

When the Air Age was still fluttering on fragile wings, Elmer Sperry foresaw the need for the development of flight controls and flight instruments and displays. His inventive genius soon won the Aero Club of France's First Award for the Sperry Gyro Stabilizer; two Collier Trophies, for gyroscopic controls and aircraft instruments; and the Grand Prize Award of the 1915 Panama Pacific Exposition for the Sperry Gyro Compass.

We blushing point out that Sperry's collection of trophies and awards grew even faster than the aviation/aerospace industries in which its major roles are of vital importance. And in today's fast-moving jet age, Sperry is lengthening the leadership gap over all its competitors.

At Sperry there is opportunity for engineers who take pride in the work they do — whose creativity triumphs over the toughest technical problems. **These are our current requirements:**

- Instrument Displays ■ Auto Pilots ■ Compass Systems ■ Circuit Design ■ Advanced Avionics
- Gyroscopics ■ Mechanisms ■ Magnetics ■ Standards ■ Product Support ■ Research & Development ■ Manufacturing Engineering ■ Industrial Engineering ■ Publications ■ Logistics

Send resume for confidential review to Darrell Jordan, Supervisor, Technical Recruitment, Dept. 203 .

SPERRY

FLIGHT SYSTEMS DIVISION
P.O. BOX 2529, PHOENIX, ARIZONA 85002
An equal opportunity employer M/F

INFORMATION RETRIEVAL NUMBER 902

Book Reviews

Mathematics

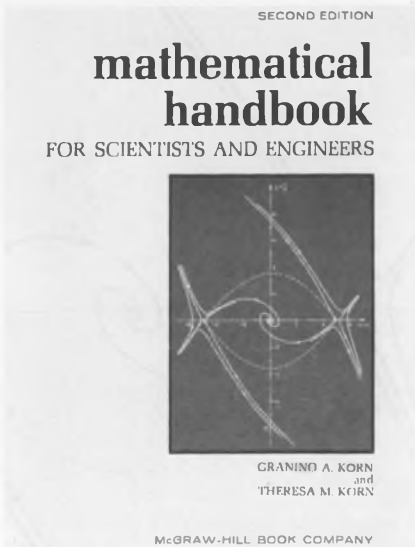

Mathematical Handbook for Scientists and Engineers, Granino A. Korn, PhD, and Theresa M. Korn (McGraw-Hill Book Co., New York, N.Y.), 1095 pp. \$25.

Presenting a brief, thorough digest of mathematical reference material, this handbook includes handy tabulations of important formulas and definitions. The text presents a succinct review of basic material and goes on to more detailed discussion of advanced topics. Collected in the appendices are mensuration formulas, plane and spherical trigonometry, combinatorial analysis, Fourier and Laplace transforms, an integral table and tables of sums and series. The focus of the authors has been practical rather than theoretical. All proofs have been omitted, to allow the inclusion of as much reference data as possible.

Robert Patton

CIRCLE NO. 497

Transistor theory

Electrical Characteristics of Transistors, R. L. Pritchard ("Electronic Science Series," McGraw-Hill Book Co., New York), 715 pp. \$19.50.

This book devotes practically all its 700 expensive pages to a thoroughly impractical treatment of



ELECTRICAL ENGINEERS

HIGH VOLTAGE—Will design and develop high voltage power supplies, perform vendor liaison and work with Xerographic Development Engineers in translating machine requirements to high voltage systems.

CONTROL SYSTEMS—Will design and develop electrical control systems involving integrated circuits, instrumentation and testing of circuits and related processes.

SOLID STATE—Will design analog/digital circuits for the development of solid state integrated circuits and other applicable microelectronic components.

COMMUNICATIONS/COMPUTER ENGINEERS—Will design graphic information, distribution, switching, and storage systems devices for digital communications and switching systems.

COMPUTER PERIPHERAL ENGINEER—Will design and develop computer related peripheral equipment involving modern data recording methods including magnetic disc, drum or tape systems for video or digital recordings.

BS or MS in EE required for the above positions.

ELECTRICAL TECHNICIANS

Assist engineering staff in the design, breadboard construction, testing from breadboard through prototype and evaluation of electro-mechanical/optical equipment and materials. A two-year A.A.S. degree in Electronic, Mechanical or related technology, or at least 5 years' industrial experience is required.

INFORMATION RETRIEVAL NUMBER 903

ELECTRONIC DESIGN 6, March 14, 1968

ELECTRONICS ENGINEERS

You can make tomorrow's memories today. How? Come to Lockheed Electronics Company in Los Angeles... where the world's fastest 2½D memory system is already in production. Lockheed engineers conduct research in all phases of memory systems technology. Not only do they develop advanced memories, but also what memories are made of—the finest printed circuits, stacks and ferrite cores. With such a large number of successful projects underway, Lockheed Electronics has become the country's fastest-growing company in the memory system field. □ To continue growing, Lockheed needs talented engineers in logic design, circuit design and magnetic memory design. There are also openings for engineers with managerial experience. □ Tomorrow's memories can't wait. Send your resume today to Professional Employment Group, Lockheed Electronics Company, 6201 East Randolph Street, Los Angeles, California 90022. **LOCKHEED ELECTRONICS COMPANY** Lockheed is an equal opportunity employer.

A Division of Lockheed Aircraft Corporation

INFORMATION RETRIEVAL NUMBER 904

 SPERRY RAND

Wanted: Hardware people for our R&D

Univac offers physicists, electrical and mechanical engineers—especially those with computer experience—unique opportunities for both individual and team achievement. Because Univac is no giant, but big enough for unlimited challenge and personal progress, R&D is wide open today, particularly in these areas:

electro-mechanical devices	computer memories
rotary equipment	solid state devices
computer peripherals	optics
circuit design	pattern or character recognition
logic design	recording circuits
systems design	
thin film	

These challenging projects are located at Univac world headquarters in Blue Bell, Pa. in the choice rural suburbs of Philadelphia. Benefits include security and medical plans—plus a mutual investment retirement program. Please write, in confidence, including resume and salary requirements, to: R.W. Jones, Staff Employment Representative, Univac Data Processing Division, Dept. B116, P.O. Box 8100, Philadelphia, Pa. 19101.

UNIVAC

An Equal Opportunity Employer

INFORMATION RETRIEVAL NUMBER 905

BOOK REVIEWS

transistors. While interesting from the standpoint of describing transistor electrical characteristics, the book is almost useless to a practicing circuit designer.

Practically all conceivable characteristics of transistors are discussed in great detail. Their meaning, however, is left entirely "as an exercise for the student."

All in all, it is difficult to comprehend what kind of audience the book is intended for. It is certainly not the kind of book that any designer will need to find room on his shelves for.

—Peter Budzilovich

CIRCLE NO. 498

Dolphins

The Mind of the Dolphin, John C. Lilly (Doubleday, New York), 310 pp. \$5.95.

In this book, Dr. John C. Lilly, director of the Communication Research Institute, Miami, Fla., one of the major centers of dolphin research, sets forth his theories on this remarkable animal's intelligence, behavior and capacity for communication. Since the author is a Cal Tech graduate as well as a doctor of medicine, his research relies heavily on such electronic gear as hydrophones, tape recorders, telemetry transmitters and receivers, sonic and spectrum analyzers and computers. Dr. Lilly uses man-to-dolphin and dolphin-to-man electronic converters, which operate on Vocoder principles.

He has concentrated on the complex vocal production of the dolphin. He concludes that the sounds are used for both echo-locating and communicating, and that the dolphin can learn to mimic human speech.

In addition, Dr. Lilly attributes intelligence, sensitivity and even moral qualities to dolphins. In one experiment he had a young woman assistant live in isolation with a dolphin for 2-1/2 months in a specially constructed laboratory, so that the two species could learn to interact.

This book should be read in conjunction with *Man and Dolphin*, a 1961 book in which the author expressed himself less philosophi-

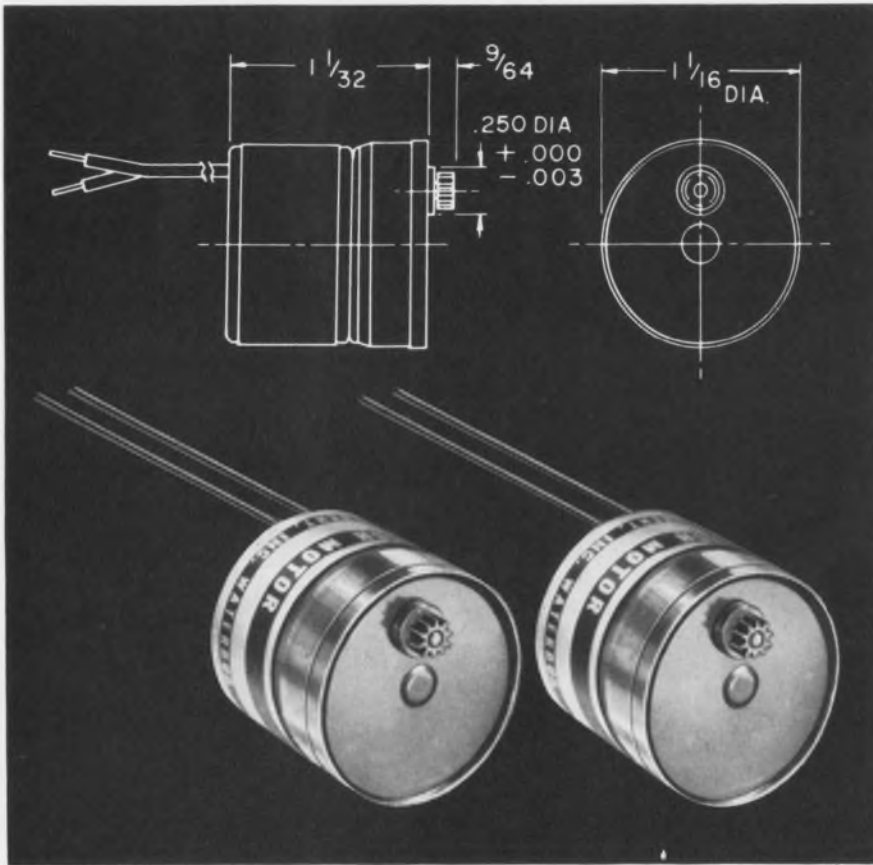

big inch!

New BIG INCH™ Synchronous Integrating Motors

Like peas in a pod but available in different speeds and voltage ratings. The HSI Series 33000 is approximately 1" x 1" small, yet unmatched for its size in precision, power, efficiency and low cost. It's the ideal drive for elapsed time indicators, stop clocks, pulsers, interrupters, timing devices, chart drives — and many other applications. Outstanding features include . . .

Fast Start/Stop: From dead stop to full speed in $\frac{1}{100}$ sec., stops instantly without coast.

High Torque: Higher than many motors twice its size.

Low Wattage: Only 1 watt input at rated voltages.

Sealed Gears: Permanently lubricated for long life.

Low Cost: Tooled for mass production.

Available in speeds of 360, 300, 60 and 3.6 RPM, 20V and 115V 60Hz.

SEND FOR NEW BULLETIN NO. 33-1



HAYDON SWITCH & INSTRUMENT, INC.

Where Optimum Performance is Standard

1500 Meriden Road, Waterbury, Conn. 06720 / Area Code (203) 756-7441

INFORMATION RETRIEVAL NUMBER 136

BOOK REVIEWS

cally.

The crux of the matter is this: Dr. Lilly has gone out on a limb with his speculations. If his theories about interspecies communications are verified, he will be hailed as a prophet. If not, then he will be put down as a maverick. Scientists in all ages have had to face this ordeal.

Richard N. Einhorn

Engineering handbook

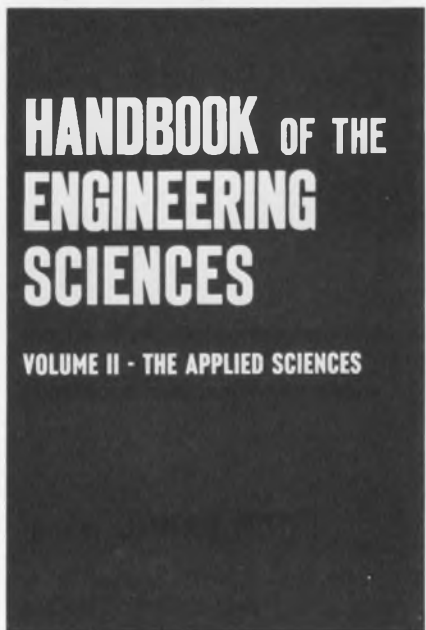

Handbook of the Engineering Sciences, Vol. II, The Applied Sciences, edited by James H. Potter, (Van Nostrand, New York), 1428 pp., \$37.50.

Most of the material in this handbook is on the first-year-graduate-student level. Only the more basic facts, techniques and methodology are presented. If you need advanced information, look elsewhere, but if you simply want to look up data you don't quite remember, it's a very useful reference.

Of the 18 major divisions, those dealing with electronic circuits, materials science and computers are perhaps the most interesting. The section on preparation of reports will also prove helpful.

CIRCLE NO. 499

**TURN
TO
DELEVAN**



as the industry leader
for inductive components.

Delevan's engineers provide a flow of newly developed products which continually push the state-of-the-art on inductive devices. Combine this know-how with large volume production experience and a world-wide distribution organization and you have a company that you can depend on for quality and service. Shouldn't you be buying from Delevan?



Delevan Electronics

Division



**AMERICAN
PRECISION
INDUSTRIES INC.**

270 QUAKER ROAD / EAST AURORA, NEW YORK 14052 / 716 652-3600

OTHER DIVISIONS OF AMERICAN PRECISION INDUSTRIES INC. • BASCO • DUSTEX • ELECTRO-MECHANICAL PRODUCTS

INFORMATION RETRIEVAL NUMBER 137



Laser light modulators utilize new crystal material

Isomet Corp., 433 Commercial Ave., Palisades Park, N.J. Phone: (201) 944-4100. P&A: EOLM-400, \$385; VPA-500, \$2700; MD-10, \$2200; 4 wks.

A new line of laser light-modulators is being manufactured with barium sodium niobate, a nonlinear electro-optic crystal discovered recently by Bell Telephone Laboratories.

Barium sodium niobate ($Ba_2NaNO_5O_{15}$) was used initially as a harmonic generator for the efficient conversion of 1.06 micron laser radiation into coherent green light. The electro-optical and nonlinear properties of the material will make possible such devices as electro-optic modulators and optical parametric oscillators, according to Isomet Corp. of Palisades Park, N.J., maker of the new light-modulators. The company is also producing the barium sodium niobate.

Unlike lithium niobate, barium sodium niobate does not exhibit any optical damage from laser irradiation at high-power levels. A variety of sizes, including 5-millimeter and 10-millimeter cubes are now available. As-grown boules, including annealing, are available on a two-week delivery basis. Fabrication of blanks, which includes poling, detwinning and X-ray orientation to plus or minus 10 minutes,

can be supplied within 30 days. Optically polished pieces with entrance and exit faces, finished flat to one-fifth wave length and parallel to 10 seconds of arc, are available within 45 days.

Utilizing the newly developed electro-optical crystal, one light-modulator, model TFM-510, needs only 75 V for 100% beam modulation at 6328 Å. In addition to 75-V driving levels, the material utilized in the device eliminates piezoelectric resonance effects over the total operable electrical bandwidth, from dc to greater than 100 MHz. Optical performance features of the unit include better than 90% transmission over the range of 250 to 1175 nanometers. A contrast ratio exceeding 70 to 1 is exhibited by this modulator with an unprocessed laser beam; the ratio is better than 200:1 with collimating optics.

Laser light-modulator model EOLM 400 operates over an optical bandwidth from 200 to 1800 nanometers and has an optical power-handling capability of 100 W cw. The device is 1-1/3 in. in dia by 2-1/2 in. long.

Two electronic drivers for use in conjunction with the laser beam-modulators are the model VPA-500 and the MD-10. VPA-500 is a video power amplifier, designed express-

ly to drive the TFM series of light-modulators. The amplifier delivers over 40 dB of gain with a video bandwidth from 100 Hz to 6 MHz. When used in conjunction with the TFM-502 light-modulator, a nominal signal of 2.5 V pk-pk will provide an output of 250 V pk-pk, more than sufficient to produce 100% modulation of the light signal. The amplifier also serves as the source of a well-regulated bias voltage, adjustable from 0 to 320 V dc. A dc restorer that references the output video signal to the bias signal is incorporated in the amplifier.

The second driver package (MD-10) is a tunable video amplifier, designed to cover a frequency range from 10 kHz to 10 MHz. When used in conjunction with the TFM-503 light-modulator, a nominal input signal of 1 V pk-pk will provide 320 V pk-pk output, which corresponds to 100% modulation of a 6328 Å laser beam. Signal distortion is less than 1% at the maximum output and rated load. A continuously adjustable bias voltage from 0 to 320 V dc is also provided. The solid-state designed the low-level stages and the single metal ceramic output tube are packaged within 6-3/8 × 5-3/16 × 3-1/4 in.

CIRCLE NO. 430

thinking about multilayer circuit boards?

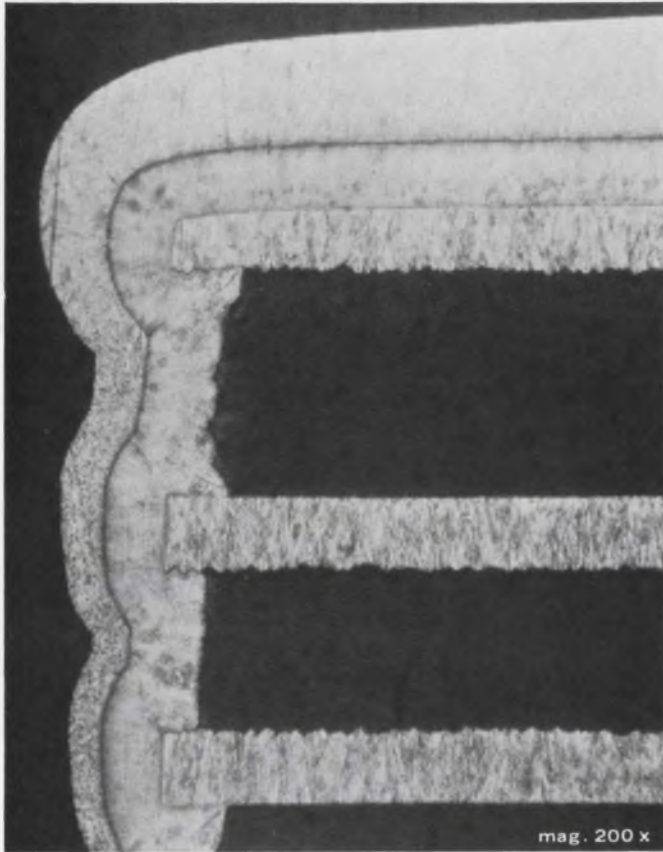

take a look at no. 1

Take a close look at this actual micro-cross-section.

It's from a 17-layer circuit board recently manufactured from scratch by National Technology for an advanced Navy computer development program.

Check the layer-to-layer registration and drill-hole patterns—both within .002" to .003" throughout.

And our proprietary etch-back method that insures maximum electrical and mechanical contact, and highest reliability.

And our copper thru-hole plating technique that beats even the toughest specs.

National Technology is one of the largest, most versatile and most experienced manufacturers of precision multilayer circuit boards for both aerospace and private industry. Complete multilayer capability from artwork to finished product—all available under one roof, along with rigid clean room conditions and efficient production planning.

We have a brochure that tells the whole story—write for it.



NATIONAL TECHNOLOGY, INC.
220 W. CENTRAL AVE. SANTA ANA, CALIF. 92707
(714) 546-6186 (213) 625-1065

INFORMATION RETRIEVAL NUMBER 138

MICROWAVES

Coaxial diode limiters recover in 50 ns max



Microwave Associates, Burlington, Mass. Phone: (617) 272-3000.

A series of broadband, fast-recovery coaxial diode limiters offers complete passive receiver protection. One model covers the frequency range of 1 to 1000 MHz with peak power of 1 kW. Pulse width is 4 μ s, maximum insertion loss is 0.6 dB and peak leakage is 100 mW. All models have spike leakage less than 0.2 ergs and recovery time in 50 ns max. These diode limiters are ideally suited for passive and broadband tracking radar receivers, where they protect against spike leakage from existing gas-type duplexing circuits. The limiters may be installed behind T-R tubes, ferrite circulators, and duplexing networks which permit enough rf leakage to damage mixer diodes.

Booth No. 3K18 Circle No. 332

X-band signal source utilizes Gunn effect

Chemical and Metallurgical Div., The Plessey Co., Towcester, England.

A miniature microwave source incorporating a GaAs diode makes use of the Gunn effect to generate frequencies in the 7-to-12-GHz range. Power output is 2 mW min, with a typical value of 5 mW. Current drain is approximately 70 mA and bias voltage may be varied to allow a maximum dissipation of 1 W. Operating temperature range is -55°C to $+85^{\circ}\text{C}$. The device makes possible new types of microwave equipment, including hand-held radar speedometers and compact shipdocking radars.

CIRCLE NO. 431

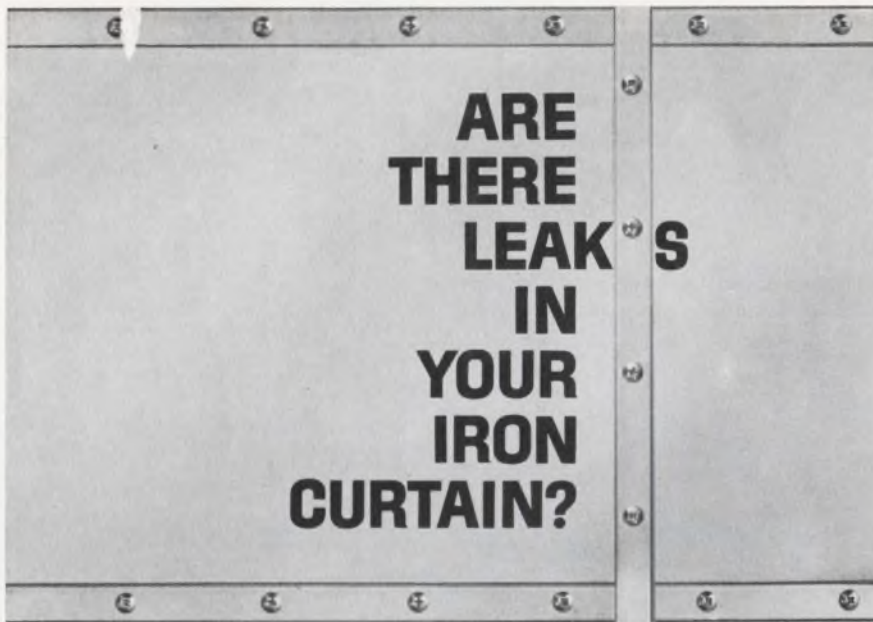

STODDART SNIFFS 'EM OUT!

RIGHT!

The problem is all too familiar. The RF shielded enclosure looked great on paper. And you erected it with utmost care. But what have you got? Leaky seams. Microscopically mismatched joints. Pinhole perforations. High resistance regions. Right?

So you set about testing for RF leaks. And you're stuck with some expensive, time-wasting method. So your project comes in late, and way over budget. Right?

WRONG!

Because now, for less than \$700, you can get a Stoddart RF Sniffer. A complete detection system, you can use it to improve enclosure attenuation by 20 to 40 Db, in a fraction of the former time.

THE SNIFFER

The sniffer receiver is solid-state and self-powered. No adjustments or calibrations are required prior to use for either the transmitter or the hand-held receiver. And the instrument detects leakage to frequencies greater than 10 GHz. You don't even have to watch the meter until you hear a leak-indicating audible tone.



If the Sniffer smells good to you, get in touch with us today!

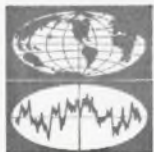

STODDART ELECTRO SYSTEMS

A Division of Tamar Electronics, Inc.

2045 West Rosecrans Avenue · Gardena, California 90249

Phone (213) 770-0270

INFORMATION RETRIEVAL NUMBER 140

MICROWAVES

Microwave sources develop 7-1/2 W



Applied Research Inc., 76 S. Bayles Ave., Port Washington, N. Y. Phone: (516) 767-8707.

A series of solid-state voltage-tunable signal sources generates signals with a long-term stability of 0.005%/°C from L through Ku band. Power output is from 7-1/2 W in the L band to 350 mW in the Ku band. The output frequency is tunable over a range as great as ±100 MHz from center frequency. Tuning sensitivity is 1 MHz to 16 MHz per volt.

CIRCLE NO. 419

Multiplier chains for X-band use

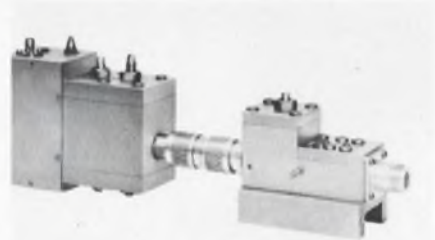

RHG Electronics Laboratory, Inc., Farmingdale, N.Y. Phone: (516) 694-3100.

Solid-state X-band multiplier chains provide a multiplication of 25 times and output powers of up to 1 W. Known as series MX, these RHG multiplier assemblies are designed for use in wide-band fm relay transmitters. The use of step recovery multiplier diodes, coupled with integral cavity filter assemblies, provides high efficiency with low spurious content. A typical chain consisting of two cascaded X5 multipliers, takes a 384-MHz 10-W signal and multiplies it to 9.6 GHz at 0.5 W. Conduction-cooled diode mounts and two-pole cavity filters are used in both multiplier sections.

Booth No. 3L07 Circle No. 390

Waveguide switches channel 40 GHz

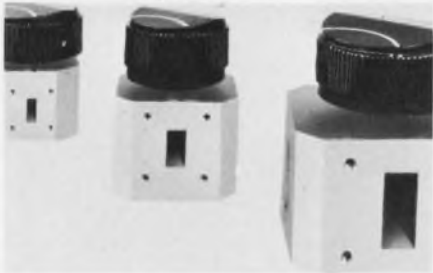

E & M Laboratories, 7419 Greenbush Ave., North Hollywood, Calif. Phone: (213) 983-0912.

Manual waveguide switches that cover the frequency range of 2.6 to 40 GHz in 11 waveguide sizes incorporate precision bearings and a spring-loaded detent mechanism. They feature a maximum VSWR of 1.1. Insertion loss is 0.2 dB max and crosstalk is 50 dB min.

CIRCLE NO. 420

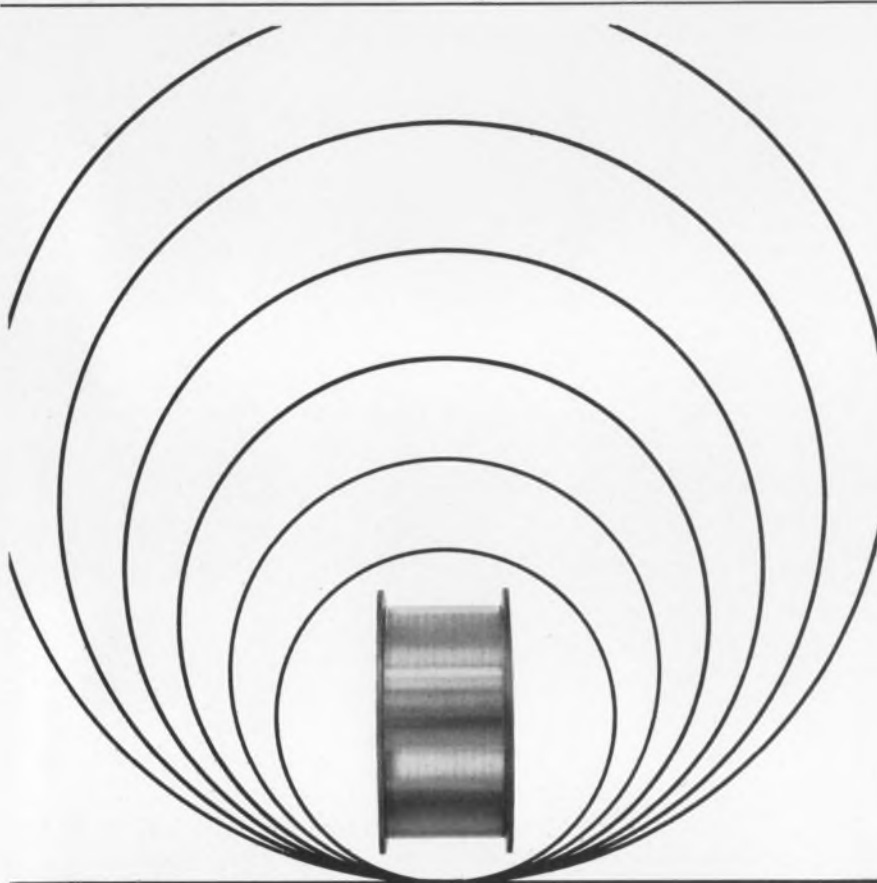

NEW SECON U.B.G. GRADE WIRE

A technological breakthrough for Ultrasonic Bonding

1% Silicon Aluminum wire specifically engineered for Ultrasonic Bonding. Designated as U.B.G. grade, this wire has a high uniform elongation and a high consistent tensile strength. The 1% Silicon Aluminum wire has exceptional Ultrasonic Bonding characteristics; a constant reproductibility and an almost infinite homogeneity. U.B.G. grade 1% Silicon Aluminum is composed of semiconductor purity materials. This purity is maintained during alloying and fabrication. It can be supplied to as fine as .0005" diameter.

If you want more information about our highly engineered whisker wire — please write to our Methods Engineering Department on your letterhead describing your requirements. No obligation, of course.



7 INTERVALE STREET, WHITE PLAINS, NEW YORK 10606 • (914) 949-4757

INFORMATION RETRIEVAL NUMBER 142

Pulsed TWT amplifier delivers 5 kW peak

Varian, TWT Div., 611 Hansen Way, Palo Alto, Calif. Phone: (415) 326-4000.

Suited for service as driver or output tube in pulsed radar systems, a grid-pulsed traveling-wave-tube amplifier will deliver, without adjustment, a peak saturation output of 5 kW or more at frequencies of 1.2 to 1.5 GHz. For a gain of at least 50 dB, less than 50 mW of drive is required. In the standard model, the traveling-wave tube employs permanent-periodic-magnet focusing and is forced-air cooled. Liquid-cooled models are available. Grid bias voltage is specified at -125 Vdc and capacitance between grid and all other electrodes is 70 pF. Heater voltage and current are 12.6 V and 4 A respectively for a warm-up time of 3 minutes. The unit weighs 20 lb.

CIRCLE NO. 421

Two preamplifiers span 250 MHz and 1 GHz



Raytheon Co., Lexington, Mass. Phone: (617) 862-6600.

Two octave transistor preamplifiers cover 250 to 500 MHz and the other 500 MHz to 1 GHz. The low-noise preamplifiers have noise figures of 7.5 and 10.5 dB, respectively. Both have input and output impedances of 50 Ω and gain of 13 to 17 dB. Each unit contains its own limiter and features VSWR input and output of 2.3 to 1 maximum. Two octave postamplifiers are also available. They cover the frequency ranges of 250 to 500 MHz and 500 MHz to 1 GHz respectively. Impedance is 50 Ω, noise on the low-frequency unit is 8.5 dB and on the high-frequency unit is 10.5 dB. Gain for both is 16 to 20 dB, with VSWR of 2.3 to 1 maximum.

Booth No. 3F01 Circle No. 398

INFORMATION RETRIEVAL NUMBER 143 ►

μsec/millisecond delays

VIDEO

5 to 500 MHz

MULTI-CHANNEL

TRIPLE

TRAVEL

PROPORTIONAL CONTROL

Analogs

ISOTHERMAL

WIDEBAND

AMPLIFIERS

LOW LOSS

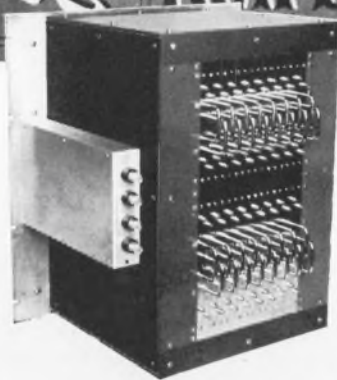

In a word, LFE

for quartz or glass ultrasonic delay lines

You'll find the complete text — applications information — theory — technical data — specifying information for standard and custom delay lines for your application — in these authoritative LFE Catalog-Handbooks. Get them, now!



ELECTRONICS DIVISION

Laboratory For Electronics, Inc.
WALTHAM, MASSACHUSETTS 02154
Tel: 617-894-6600 • TWX: 710-324-0681

INFORMATION RETRIEVAL NUMBER 144

MICROWAVES

Portable laser weighs 6 lb

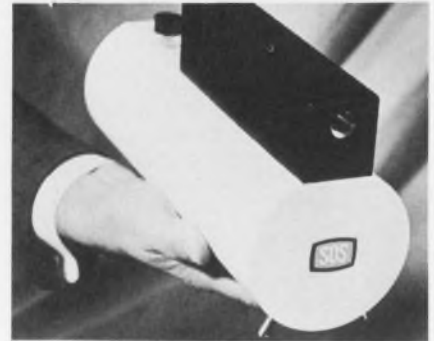

Space Ordnance Systems, Inc., 122 Penn Street, El Segundo, Calif. Phone: (213) 772-5461.

Including self-contained head and power supply, this portable neodymium laser occupies only 140 in.³. It weighs approximately 6 lb. Emission at a wavelength of 1.06 μm produces an output of 5 J max. The laser head is contained in an aluminum housing containing the neodymium rod, flash lamp, and the focusing cavity. No external cooling is required.

CIRCLE NO. 422

Low-pass filters reject 100 dB



American Electronic Laboratories, Inc., Lansdale, Pa. Phone: (215) 822-2929.

High-frequency coaxial low-pass filters provide rejection levels of 100 dB or greater to 11 GHz. The two model series are available with cut-off frequencies ranging from 2 MHz to 50 MHz. All models in both series are of tubular construction characterized by low pass band insertion loss (0.2 dB typical) and steep skirt selectivity (100 dB from 30 MHz to 11 GHz).

Booth No. 3K21 Circle No. 393

Ferrite coaxial device offers 10-dB isolation



E & M Laboratories, 7419 Greenbush Ave., North Hollywood, Calif. Phone: (213) 983-0912.

A ferrite coaxial isolator that comes in a 6-5/8-in., 24-oz package achieves a minimum isolation of 10 dB. Usable in the frequency range from 3.8 to 11.7 GHz at temperatures from -50° to +50°C, the unit has a maximum VSWR of 11.3. Insertion loss is under 1.2 dB.

CIRCLE NO. 423

Subminiature filter handles 30 watts



Telonic Engineering Co., Box 277, Laguna Beach, Calif. Phone: (714) 494-9401. P&A: \$150-\$300 8 wks.

A subminiature filter of 0.01-dB Chebyshev design, with center frequencies from 200 to 600 MHz, is offered with peak power ratings up to 30 W. The filter, a magnetically-coupled-resonator type, may be specified with from 2 to 8 sections. It measures 1/4 x 9/16 in. and is from 2 to 3-1/2 in. long, depending on the number of sections and the bandpass.

CIRCLE NO. 424



Expanded Series (.01 uh to 100 mh) Subminiature RF Chokes

Ideal for network, filter, delay line and computer applications, 70F Series RF chokes give designers high reliability in a small package. Coils are impregnated with moisture resistant lacquer; can be fungus proofed or encapsulated on special order.



70F Series RF chokes are stocked in 88 standard inductance values to cover the .01 uh to 100 mh range completely. To insure fast delivery, J. W. Miller Company stocks the industry's widest line of RF chokes and RF & IF coils in depth. Virtually all orders are shipped on the same day the purchase order is received.



Screened room with precision test equipment assures close tolerance measurements for special coil characteristics. Special coil samples are shipped within 2 weeks; production coils are shipped within 3 weeks after sample approval.



Catalog 67 gives specifications and prices for the full line of J. W. Miller RF chokes, RF and IF coils, transformers, filters, coil forms and components ... write for your copy today.

For your special coil requirements, call a Miller coil design specialist—(213) 233-4294.



J. W. MILLER COMPANY

5917 SO. MAIN STREET • LOS ANGELES, CALIFORNIA 90003

GET FACTORY PRICES FROM YOUR LOCAL DISTRIBUTOR IN QUANTITIES TO 750

Coaxial adapters span 2.6 to 26 GHz



American Corp., 87 Rumford Ave., Waltham, Mass. Phone: (617) 891-5230.

Available with either miniature or 7mm connectors for laboratory or system, a series of waveguide to coaxial adapters covers the frequency range of 2.6 to 26 GHz. Models 7000-6254 and 7000-6255 adapt waveguides to 7mm coaxial lines and cover the frequency ranges of 8.2 to 12.4 GHz and 12.4 to 18 GHz respectively. Models 2000-6250 thru 2000-6256 adapt waveguides to miniature coaxial line sizes and cover the frequency ranges between 2.6 and 26 GHz.

CIRCLE NO. 425

We custom-design and produce DC power supplies and constant voltage transformers for everything from office copiers to electron accelerators.

Which means we have a variety of experience you can use to good advantage. And the people and facilities to back it up.

If you require regulated AC or DC voltages, we can tailor-make power supplies and constant voltage transformers to fit your specs. Exactly, economically. In pre-production quantities or full production runs.

For us, tackling tough custom design problems is second nature. We've solved them in such diverse fields as data processing, communications, air purification, nuclear research, photography, medicine, and many others. We're also specialists at designing and manufacturing CVT regulated power supplies.

So, whatever your power supply and constant voltage transformer requirements, whatever size or complexity, let us show you how Acme Electric can do the job effectively and economically.

Just write us on your company letterhead. Our Mr. Rathbun will call you back.

Acme Electric Corporation, Cuba, New York

Acme Electric

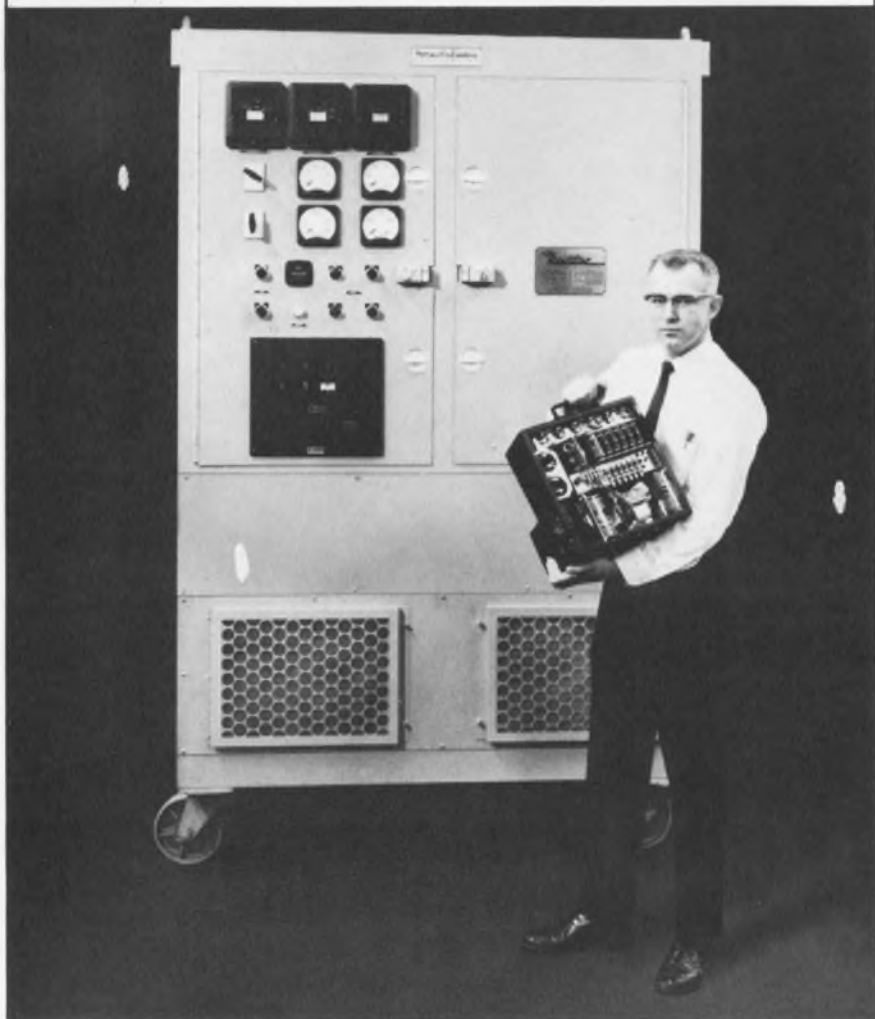

INFORMATION RETRIEVAL NUMBER 148

MICROWAVES

Power dividers split at 18 GHz



Microlab/FXR, 10 Microlab Rd., Livingston, N.J. Phone: (201) 992-7362.

A line of resistive power dividers is available for use up to 18 GHz. Their nickel-finished symmetrical housings contain resistors that have been matched at both junction and terminal arms for precise performance characteristics. Available with all major connector types, these units feature a VSWR as low as 1.5 at 12.4 GHz.

CIRCLE NO. 246

L-band amplifier has 6-dB noise figure



Watkins-Johnson Co., 3333 Hillview Ave., Stanford Industrial Park, Palo Alto, Calif. Phone: (415) 326-8830.

An L-band amplifier that covers the frequency range 1 to 2 GHz offers a guaranteed noise figure of 6 dB and a typical noise figure of 5 dB. Saturated power output is 3 dBm minimum, gain is 25 dB minimum and VSWR is 2:1 maximum. The amplifier weighs 10 oz and measures 1.25 x 1.25 x 2.5 in. A P-band unit with a 4 dB noise figure is also available.

CIRCLE NO. 247

CEDAR

Servo Packages



DATA CONVERTER



IN-LINE SERVO



SYNCHRONIZER



FOLLOW-UP SERVO

...like getting a Servo Engineer free

On your next make-or-buy decision, give careful consideration to the benefits of putting Cedar's servo experience to work for you in engineering your servo package. It's like getting the services of a highly experienced servo design engineer free.

Cedar servo packages have been successfully used on leading missiles and aircraft, ranging from the LTVA7A autopilot synchronizer to the Polaris A3 pulse sum-to-analog converter. Write or give us a call on your next servo package problem. You'll be glad you did.



5806 W. 36th St., Minneapolis, Minn. 55416 • Phone (612) 929-1681

INFORMATION RETRIEVAL NUMBER 150

MICROWAVES

Harmonic generators tune up to 4.2 GHz



Watkins-Johnson Co., 3333 Hillview Ave., Palo Alto, Calif. Phone: (415) 326-8830.

A line of solid-state, electronically tunable harmonic generators has been designed for use as digitally-tuned local oscillators and microwave test-signal sources. These generators offer linear tuning characteristics over octave frequencies from 500 MHz to 4.2 GHz. Less than 1 W of 100-MHz fundamental drive signal is required.

CIRCLE NO. 428

Antenna covers from 25 to 76 GHz

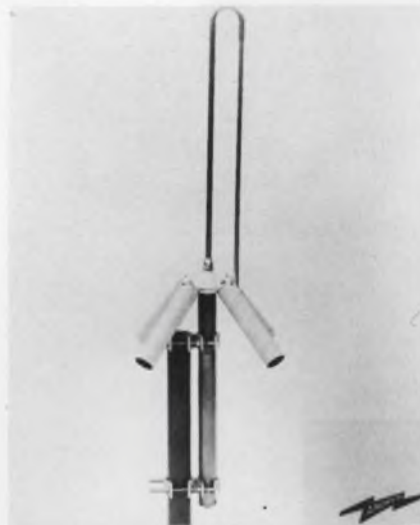

Andrew Corp., P. O. Box 807, Chicago. Phone: (312) 349-3300. 349-3300.

Covering the 25-to-76 GHz communications bands, the Type 903 omnidirectional antenna consists of a folded radiating element and four helical ground rods encased in Fiberglas. The unity-gain antenna exhibits a maximum VSWR of 1.5. For coastal areas, a hurricane model is also available.

CIRCLE NO. 429



Where other relays have fallen by the wayside, American Zettler's Series AZ-420 miniature relays have been the wonder of the decade. For more than 10 years, over 12 MILLION of these small wonders have been the industry standard in controls and business data systems the world over. The AZ-420 relay requires less than ONE CUBIC INCH of space and offers a life expectancy of up to 100 MILLION operations. And wonder of wonders, they're priced from **\$1.80 EACH** in production quantities!

Among other outstanding features are:

- International standard-type relay
- Available with plug-in, solder or pc terminals
- Balanced spring-held armature allows same operating data in any mounting position
- Lower cost per unit from mass production techniques
- Available from stock in all common contact and coil configurations

Write today for your free evaluation sample and complete technical information on AZ's relays, switches and miniature solenoids. Find out why American Zettler can handle all of your switching requirements... from A to Z!



**American
Zettler,
inc.**

697 RANDOLPH AVENUE
COSTA MESA, CALIFORNIA 92626
PHONE (714) 540-4190 • CABLE: ZETELEC

SEE US AT IEEE BOOTH #4E33

INFORMATION RETRIEVAL NUMBER 152

TEST EQUIPMENT

Dc bias supply is stable to 0.01%



Keithley Instruments, Inc., 28775 Aurora Road, Cleveland. Phone: (216) 795-2666. Price: \$450.

A regulated dc supply, with an output capability of 0 to 3100 V and a stability of 0.01% is suited for use with photomultiplier tubes, ion gauges, solid-state radiation detectors, photocells, and other current detectors. Direct-readout dials permit selection of outputs from 0 to 3100 V in 10-V steps, with an accuracy of $\pm 1\%$.

Booth No. 2F04 Circle No. 344

Spectrum analyzer handles 40 GHz

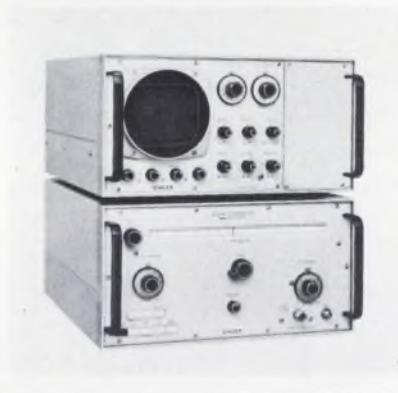

The Singer Company, 915 Pembroke St., Bridgeport, Conn. Phone: (203) 366-3201. Price: \$9900.

Microwave spectrum analyzer offers better than 2-GHz dispersion with no in-band multiple responses for frequencies up to 40 GHz. Rf sensitivities are from -105 dBm at 1-kHz bandwidth. Calibrated dispersion ranges are provided as low as 10 kHz and full dispersion capability is available on all 9 bands. The instrument is a solid-state swept front end analyzer.

Booth N. 2B25 Circle No. 353

Rf wattmeter weighs 1 lb

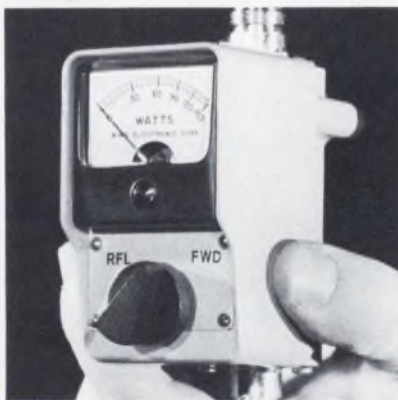

Bird Electronic Corp., 30303 Aurora Rd., Cleveland. Phone: (216) 248-1200. P&A: \$93; 90 days.

Palm-sized power meters designed for servicing equipment in the 2 to 175 MHz range weigh 1 lb. Built to instrument specs with 1 and 2% components, these rf directional wattmeters are accurate to $\pm 5\%$. Measuring only $2 \times 3 \times 4\frac{1}{2}$ in., the 50- Ω instruments are completely self-sufficient—without batteries, line power, charts or plug-ins.

Booth No. 2E40 Circle No. 365

Zero-to-100-V supply reads out in 4 digits



Kepco, Inc., 131-38 Sanford Ave., Flushing, N.Y., Phone: (212) 461-7000. P&A: \$795; 60 days.

A precision voltage source offers a four-place digital display of output voltage (0 to 100 V). Four rotary voltage selectors offer 0.02% of full scale accuracy, with 0.001% combined line and load regulation. Display logic also signals crossover into current limited mode.

Booth No. 2F51 Circle No. 267

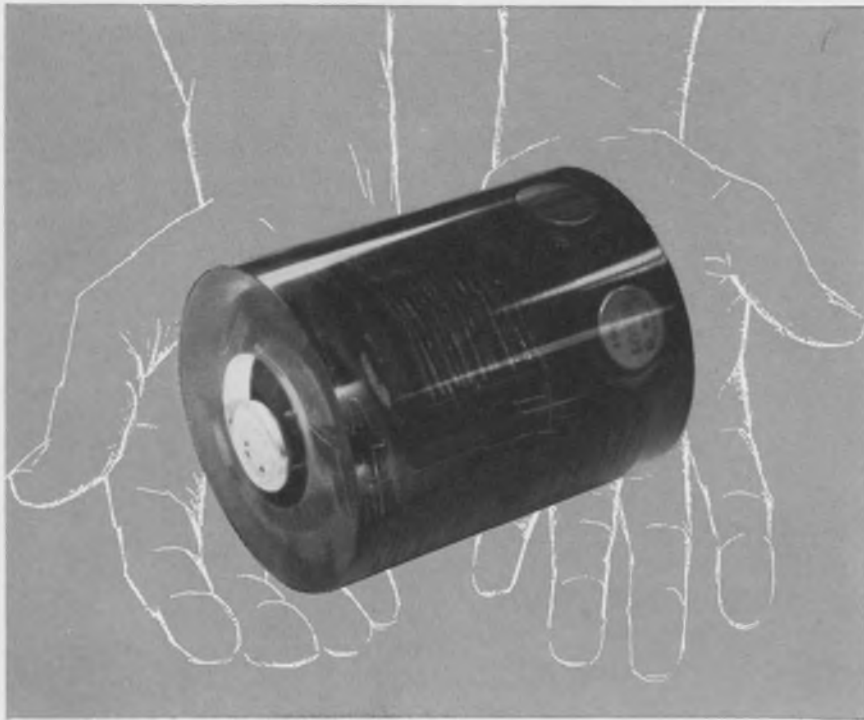

50 to 100 kvdc Output? Yes.

MINIATURE HIGH VOLTAGE POWER SUPPLIES

Designed and Fabricated
for your Application
by Sippican

- TYPICAL SPECIFICATION**
- Input voltage:
+89 to -100 VDC
 - Output voltage:
-50 to -100 KVDC
 - Operating temperature:
-15° to +40°C
 - Size:
3.1" dia. x 4.5" long

The basic power supply design employs a low-voltage inverter oscillator driving capacitor multipliers thru medium voltage isolation transformers to produce the stipulated voltage. Six taps are available for output range selection. Vernier control of B+ is used for high resolution output voltage trimming.

For more information contact:
Marketing Department
The SIPPICAN Corporation

SIPPICAN

Marion, Massachusetts 02738 • Tel. 617 748-1160

INFORMATION RETRIEVAL NUMBER 154

TEST EQUIPMENT

Oscilloscope views swept displays



*Texscan Technical Products Div.,
4610 N. Franklin Rd., Indianapolis.
Phone: (317) 545-6481. P&A:
\$1495; 30 days.*

This transistorized large-screen (6 × 8 in.) multichannel oscilloscope permits the display and resolution of frequency response curves when used in conjunction with a sweep generator. A scanning system and three identical directly-coupled Y amplifiers with 1 mV/cm sensitivity permit the simultaneous display of response curves at three different points of the circuit under test.

Booth No. 2K15 Circle No. 357

Television test set analyzes PAL signal



*Tektronix, Inc. P.O. Box 500, Beaverton, Ore. Phone: (503) 644-0161.
P&A: \$1850; 3 months.*

Designed to measure luminance hue and saturation of the PAL color television signal, this instrument has dual inputs that permit time-shared displays for comparison of input-output phase- and gain-distortion. Pushbutton controls permit rapid selection of displays for quick analysis of television color signal characteristics. Differential gain and differential phase measurement capabilities are provided.

Booth No. 2E39 Circle No. 345

Programmable source sweeps to 1 GHz

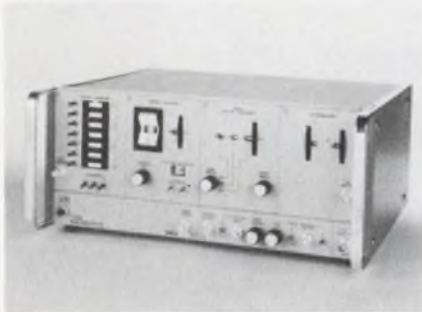

Sweep Systems Inc., 3000 Shelby St., Indianapolis. Phone (317) 787-8275. P&A: \$995-\$1575; 45 days.

This 0.5-MHz-to-1-GHz sweep generator is fully programmable. The instrument will accept analog dc programming to control center frequency, sweep width, output level and markers. A modular front panel design enables the user to purchase a stock instrument suited to his requirements.

Booth No. 2J18 Circle No. 364

Solid-state switch provides dual trace



Jerrold Electronics Corp., 401 Walnut St., Philadelphia. Phone: (215) 925-9870.

A solid-state rf coaxial switch permits simultaneous viewing of two separate traces on an oscilloscope, with or without a zero base line. Mercury-wetted switch contacts insure high reliability. The instrument is available in two separate housings which can be mounted either stacked or side-by-side.

Booth No. 2J25 Circle No. 337

Function generator selects digitally



Wavetek, 8159 Engineer Road, San Diego. Phone: (714) 279-2200 P&A: \$595; 30 days.

A precision function generator, offering pushbutton convenience, generates sine, square, triangle, and ramp waveforms over the frequency range of 0.001 Hz to 1 MHz. The output amplitude is selectable in six 10 db steps from 0.1 to 30 V pk-pk. The digital controls are supplemented by verniers allowing continuous variability.

Booth No. 3A42 Circle No. 379

CROSSTALK

100db DOWN! With VPC SHIELDED PATCHCORD PROGRAMMING SYSTEMS

"YES" Crosstalk can be reduced over 100db using frequencies up to 5 Mgs., with voltages as high as 100 volts peak to peak. At lower frequencies crosstalk and false signals are practically eliminated. This is achieved efficiently and inexpensively by shielding each individual contact spring and using coaxial wire for the patchcords. The patchcords are designed with a snap detent. This guarantees that the patchcord will be properly inserted and cannot be pushed out.

120 to 6500 contacts available. Write today for test data and catalog.



Virginia Panel Corp.

1400 New Hope Road P. O. Box 1106
Waynesboro, Virginia 22980 Tel. No. 703-942-8376

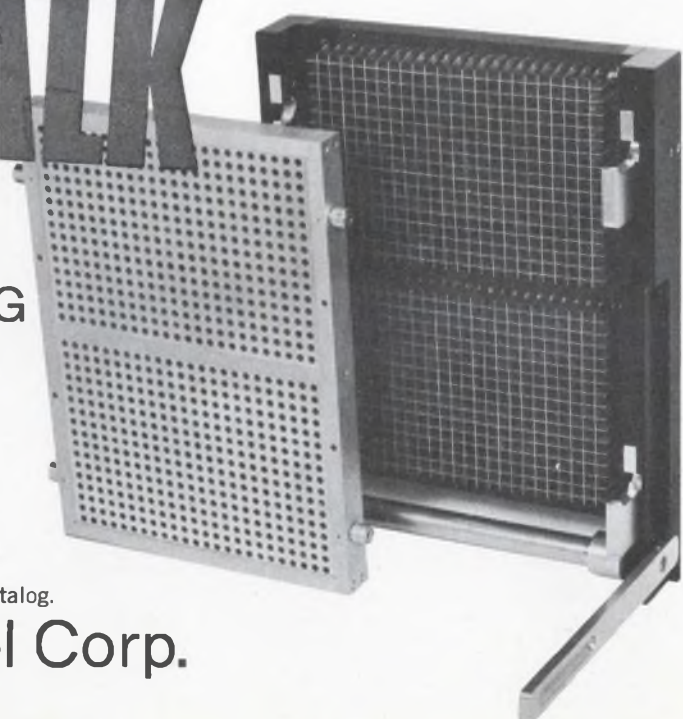

WHAT'S A LAMINAR HYPERBOLOID?

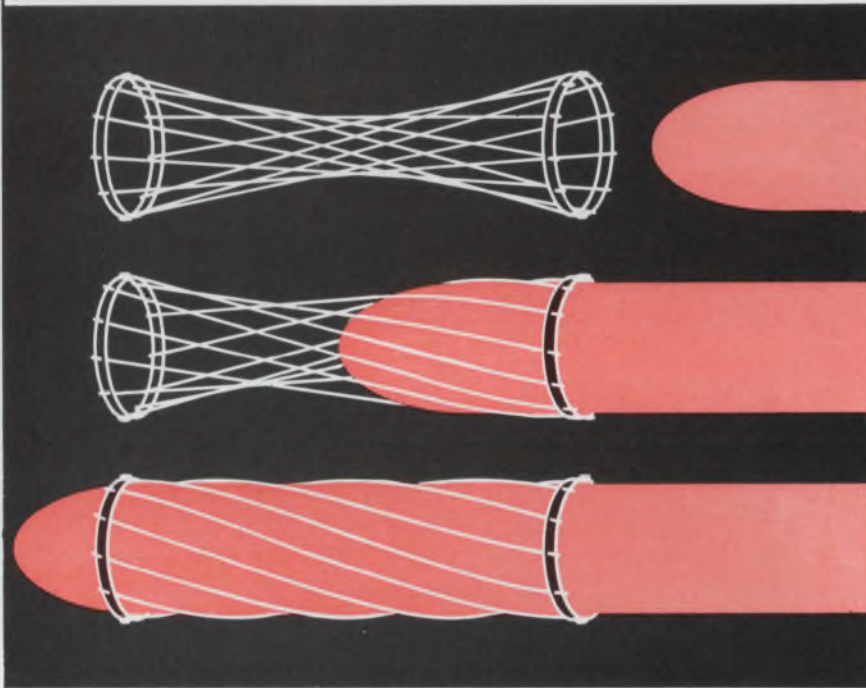

THE PRINCIPLE BEHIND HYPERTAC—™ THE LATEST ADVANCE IN CONNECTOR CONTACT DESIGN

More reliable and efficient connectors are now available with this new concept in contact design. HYPERTAC's geometrical socket construction is achieved by stringing a set of fine wires inside a tube at an angle. The wires "hug" the inserted pin in a taut grip, providing a number of lines of contact. There is no noticeable deterioration in operation after testing for over 100,000 operating cycles—surpassing anything in today's state-of-the-art. This patented "wire trap" design affords many advantages for high performance industrial or military applications:

Closed entry construction ★ Large contact area assures very low contact resistance ★ Reliability due to multiplicity of contact points and smooth pin entry ★ Very low insertion/extraction forces ★ Long life, low rate of wear with uniform characteristics ★ Withstands shock and vibration without noise or discontinuity ★ Easy manual insertion of high density, multiple pin connectors ★ Pre-assembly plating permits highly uniform thickness of finishes.

In both standard and non-standard configurations, HYPERTAC connectors can be customized to your specifications for insertion force, contact resistance and durability. Get complete information from your local IEH sales representative or contact:

INDUSTRIAL ELECTRONIC HARDWARE CORPORATION
109 Prince Street, New York, N. Y. 10012, (212) 677-1881.

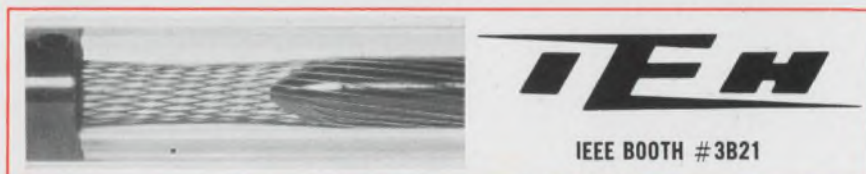

INFORMATION RETRIEVAL NUMBER 158

TEST EQUIPMENT

Video sweep generator spans 25 MHz



Texscan Corp., 2446 N. Shadeland Ave., Indianapolis. Phone: (317) 357-8781. P&A: \$1095; 3 wks.

Covering the audio and video bands, this solid-state generator sweeps from 500 Hz to 25 MHz. Sweep width is continuously adjustable in the same range and the 1-V rms output is specified to a flatness of ± 0.25 dB. The unit can be ordered with a variable marker covering the center frequency range of the instrument. Provision for up to eight crystal-controlled plug-in markers is included.

Booth No. 2K15 Circle No. 258

Grid-dip meter goes solid-state



James Millen Mfg. Co., Inc., 150 Exchange St., Malden, Mass. Phone: (617) 324-4108. Price: \$90.

A grid-dip meter has a solid-state dc amplifier for increased sensitivity. It provides full scale readings from 1.7 to 300 MHz on a taut-band meter. The unit contains a stable oscillator, transformer-type power supply and seven coils protected by form fitting molded covers. A polypropylene carrying case keeps the coil/probes with the instrument and protects both. Five additional coils are available for extending the range to 165 kHz. The frequency-determining coil plugs into the unit for use as a probe. A set of terminals on an internal printed circuit board provides connections for battery operation.

Booth No. 2D35 Circle No. 262

Big Capacitance

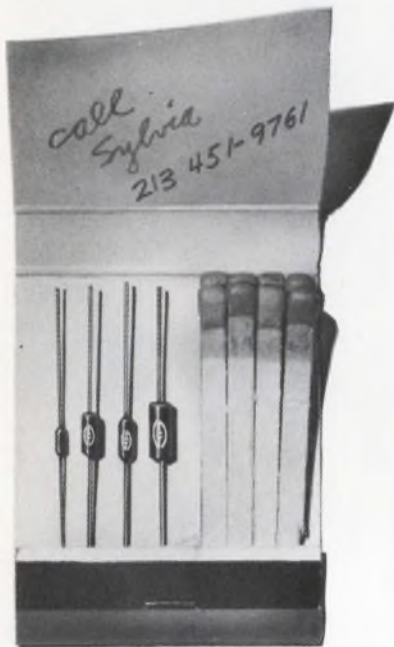

Small Package

If large capacitance in a small package is your problem, specify SCIONICS axial lead CERAMIC CAPACITORS. These microminiature ceramic capacitors are uniquely designed to solve the smallest cordwood or microminiature packaging problems.

Designed to meet the industry's highest reliability requirements, Scionics capacitors are backed by years of proven experience. Scionics offers dipped and molded

ceramic capacitors. Available in values of 1 pf to 1,000,000 pf and a variety of style configurations including a complete line of microminiature ceramic pellet capacitors.

Special capacitor designs are available to solve unique circuit problems created by advanced concepts in military and aerospace applications.

Stocked by:

Tomelco/Moulton — Los Angeles, Cal.

Dart/Hamilton — Syracuse, New York

GAL-R, INC.

SCIONICS CAPACITOR DIVISION

1631 Colorado Avenue

Santa Monica, California 90404

[213] 451-9761

TWX 910-343-6966

a subsidiary of CapTech inc.

INFORMATION RETRIEVAL NUMBER 160

276

TEST EQUIPMENT

Transfer standard measures rms to 0.01%



The Singer Co., Metrics Div., 915 Pembroke St., Bridgeport, Conn. Phone: (203) 366-3201. P&A: \$3500; 120 days.

An ac/dc transfer standard provides 0.01% true rms measurements in approximately 10 to 15 seconds. The instrument is operated automatically and reads the dc equivalent of the true rms value of an unknown ac signal. Readout may be made on a dc digital voltmeter, potentiometer or any dc measuring system.

Booth No. 2B25 Circle No. 326

Dc power supply is SCR-regulated



Christie Electric Corp., Box 43187, 3410 W. 67th St., Los Angeles. Phone: (213) 750-1151.

A 0 to 37 V, 0 to 50 A dc power supply is SCR-regulated and provides $\pm 0.25\%$ voltage regulation against line and load changes, with less than 1% ripple. It is continuously adjustable and includes $\pm 3\%$ current regulation down to 0 V. Suited for automatic battery charging, it can be furnished for bench, wall or rack mounting.

Booth No. 2A06 Circle No. 335

Chart recorder includes amplifier

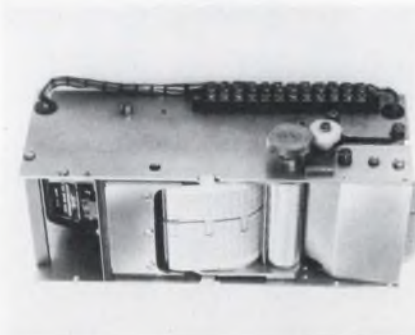

Computer Instruments Corp., 92 Madison Ave., Hempstead, N.Y. Phone: (516) 483-8200.

A strip-chart recorder module combines a chart drive assembly, transistorized amplifiers and a closed-loop servo-driven pen motor. Packaged in a compact assembly, it requires a panel opening 4 by 10 in. Other features include rectilinear hot-stylus writing, base or side mounting, dual-speed motor (25 and 50 mm/s) and controls for stylus heat and centering.

CIRCLE NO. 438

Impedance bridge tests passive devices



Electro Scientific Industries, Inc., 13900 N.W. Science Park Dr., Portland, Oregon. Phone: (503) 646-4141. P&A: \$1100; 30 days.

A lab or production-line instrument provides measurements of resistance, capacitance, inductance and conductance. The impedance bridge and ac/dc generator-detector, permits accuracies of $\pm 0.05\%$ for resistance and conductance and $\pm 0.1\%$ for inductance and capacitance.

Booth No. 2B02. Circle No. 356

INFORMATION RETRIEVAL NUMBER 161 ►

Get a complete Electronic Package from Chassis-Trak of Indianapolis

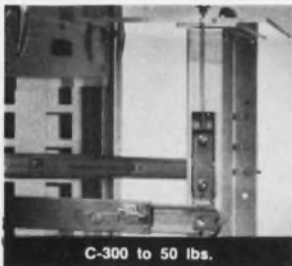

C-300 to 50 lbs.



C-230 to 100 lbs.



CTB to 175 lbs.



CB to 1000 lbs.

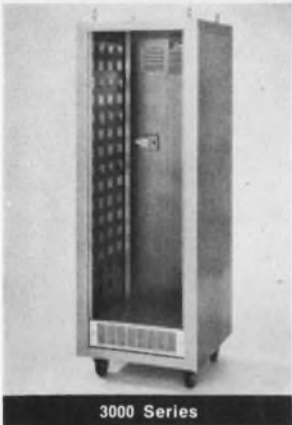

3000 Series



5000 Series



D-600 to 125 lbs.



VENT-RAK Modular Chassis



1000 Series



5050 Series

"See you at
IEEE
Booth 1F02"



Whatever your electronic packaging needs, military or commercial, light-weight or heavy-duty, Chassis-Trak offers a complete line of slides in capacities from 50 lbs. to 1,000 lbs., hardware, and cabinets in a wide range of styles, sizes and materials. The *Chassis-Trak* of Indianapolis name on your electronic package is your assurance of quality and economical *versatility*.

To learn more about *total electronic packaging* write Chassis-Trak, Inc.

525 South Webster Avenue, Indianapolis, Indiana 46219

INFORMATION RETRIEVAL NUMBER 162

TEST EQUIPMENT

Rf sweep generator tunes 0.3 to 100 MHz



Texscan Corp., 2446 N. Shadeland Ave., Indianapolis. Phone: (317) 357-8781. P&A: \$895; 3 wks.

A solid-state sweep generator, covers a frequency range of 300 kHz to 100 MHz. Sweep width is continuously adjustable from 200 kHz to 100 MHz and rf output is specified for a flatness of ± 0.25 dB at maximum sweep width. Built in are provisions for eight plug-in crystal-controlled markers, a variable marker and sweep-rate controls from 60 Hz to 5 Hz. A step attenuator and vernier offer a combined range of 0-105 dB.

Booth No. 2K15 Circle No. 259

Auto-ranging meter seeks the unknown



Aerojet-General Corp., Aerometrics Div. P.O. Box 216, San Ramon, Calif. Phone (415) 837-5343.

An auto-ranging multimeter performs operations in the analog measurement of voltage, current and resistance. With its inputs connected to the unknown source, it will automatically select the proper range and indicate on the panel meter the correct reading. The unit ranges cover from 5 mV to 1500 V, 5 nA to 150 mA and 5 Ω to 15 M Ω . The total weight of the MM-110 is approximately 12 lb.

Booth No. 3A34 Circle No. 397

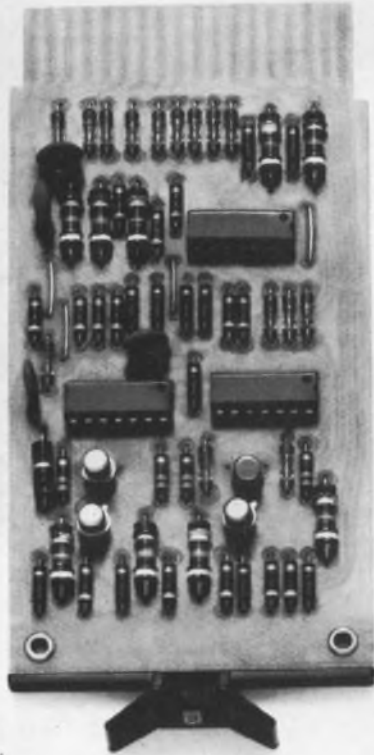

K Series Modules are Built Tough—Used Easily!

K Series solid state modules are built for a tough environment. A glass-epoxy board so strong it won't break even if you step on it. No moving parts, of course, and all outputs are short-circuit proof.

And K Series modules are easy to use. Only a few different module types do the vast majority of industrial or laboratory control functions. A lot of logic is on the circuit cards, and minimum wiring makes all the connections. In the K220, only two wires per decade are needed to interconnect into a BCD up/down counter. A companion module is available to display the contents of the register. K220 sells for \$52.00.

K Series modules have consistent pin assignments so that you don't have to look at the drawing all the time.

They're noise-immune, shielding becomes no problem; they work with 115 ac pilot circuits (indicator lights are on all AC pilot circuits). A test probe is available for troubleshooting and adjustment without a scope.

The hardware is designed to fit NEMA and standard 19" enclosures — and, of course, the modules plug in.

DIGITAL is the leading producer of modules for industrial and laboratory applications. These and other series are fully described in our Industrial Control and Logic Handbooks. Write for free copies.

digital

MODULES · COMPUTERS

Maynard, Mass. Tele: (617) 897-8821

TEST EQUIPMENT

Battery or ac power drives sweep source



Jerrold Electronics Corp., 401 Walnut St., Philadelphia. Phone: (215) 925-9870.

A solid-state sweep generator can use battery power to facilitate field testing. Covering the frequency range from 500 kHz to 300 MHz, the package includes a marker generator and a detector system. The unit features start-stop frequency tuning with good sweep linearity and automatic leveling without frequency shift.

Booth No. 2J25 Circle No. 336

Rf attenuators handle dc to 500 MHz

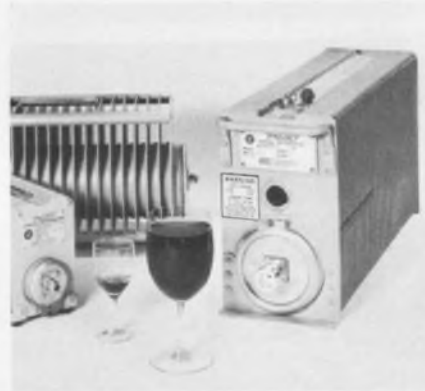

Bird Electronic Corp., 30303 Aurora Rd., Cleveland. Phone: (216) 248-1200.

With their 30-dB attenuation and wide range from dc to 500 MHz, each of these three attenuators can replace four or more directional couplers of one octave each and add dc verification. The attenuator curve is flat and VSWR is low in both input and output. Electrically equivalent to symmetrical T-pads, these attenuators are unidirectional. Models from 50-2000 W are available.

Booth No. 2E40 Circle No. 381

Compact counters record to 10 MHz



Hewlett-Packard, 1501 Page Mill Rd., Palo Alto, Calif. Phone: (415) 326-7000.

Electronic counters, each only 3 in. high and 7-3/4 in. wide, count at rates up to 10 MHz. One model measures frequency with 0.1 or 10-second gates and totalizes. Another has a quartz crystal time-base that is stable to 1 ppm/month. It measures frequency, time interval and frequency ratio and has BCD output for digital recording.

Booth No. 2F25 Circle No. 269

VSWR tester resolves to 1%

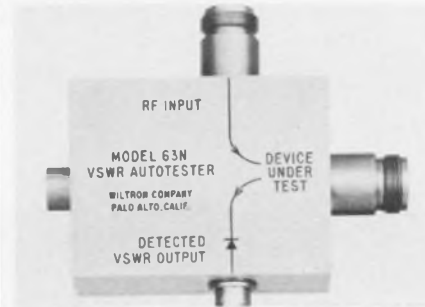

Wiltron Company, 930 East Meadow Drive, Palo Alto, Calif. Phone: (415) 321-7428.

An instrument that combines the directional features of a hybrid with a built-in rf detector and precision reference termination measures the reflected signal from a device under test. The unit covers the 10-MHz-to-3-GHz frequency range and has 40-dB directivity. This means that a reflection of 1% can be resolved.

*small
but
versatile
members
of*

THE BIG FAMILY



**BROADBAND MINIATURE
PLUG-IN HYBRID JUNCTIONS**



A/R Anzac's miniature 180° hybrids afford you unique design freedom in solving signal processing problems in telemetry, communications, command guidance, radar and pulse circuits. The units are packaged on TO-5 headers and weigh less than 5 grams. They are easily incorporated into stripline and printed-circuit boards. They cover multi-octave bandwidths in the frequency range of 1-400 MHz. And they meet the requirements of MIL-E-5400. Typical applications include . . .

- Producing two equal-amplitude, identically-phased, isolated outputs.
- Producing two equal-amplitude, oppositely-phased, isolated outputs.
- Combining two non-coherent signals while maintaining source isolation.
- Antenna beamforming networks for airborne, missileborne and satellite phased arrays.

TYPICAL SPECIFICATIONS

Isolation >30 dB Insertion Loss <0.5 dB
Amplitude Balance <0.2 dB
Phase Balance <2° VSWR <1.3:1

These plug-in hybrids can be combined with A/R-Anzac mixers, quadrature hybrids, directional couplers and other members of The Big "A" Family as prepackaged sub-systems to satisfy your specific needs. Phone or write describing your requirements and you will receive a complete proposal.

A-R•ANZAC electronics co.

"the **ULTRA-BROAD** line"



DIVISION OF THE ADAMS-RUSSELL CO., INC.
121 WATER STREET, NORWALK, CONN. 06854
CALL WALTHAM (617) 899-3145 OR NORWALK (203) 853-9411
INFORMATION RETRIEVAL NUMBER 166

TEST EQUIPMENT

**Time-delay generator
is frequency divider**



General Radio Co., 22 Baker Avenue, West Concord, Mass. Phone: (617) 369-4400. Price: \$1775.

A high-resolution programmable digital delay generator also serves as a frequency divider. With the unit's internal 10-MHz clock, time delays are available from 0.3 μs to 10 s in increments of 0.1 μs. When the internal clock signal is replaced by an external signal between 100 Hz and 13 MHz, the instrument acts as a frequency divider, providing frequency ratios of from 3:1 to 99,999,999:1.

Booth No. 2E26 Circle No. 377

**Seven power supplies
range from 6-100 V**

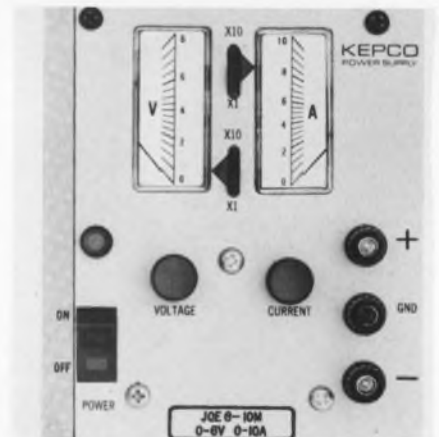

Kepco, Inc., 131-38 Sanford Ave., Flushing, N.Y. Phone: (212) 461-7000. P&A: \$285; 60 days.

A line of power supplies, encompassing seven models is offered in ranges from 0-6 V dc at 0-10 A to 0-100 V dc at 0-1 A. A dual-range voltmeter, ammeter, 10-turn voltage control, current limit adjustment and output terminals are front-panel mounted. Specifications include 0.005% line regulation, 0.01% load regulation and 0.2 mV rms output ripple. All units are capable of external control using a voltage, current or variable resistance signal.

Booth No. 2F51 Circle No. 265

Always connect subminiatures with Winchester Electronics.

Take cable and panel mounted rectangulars. We've got them with solder or crimp removable contacts. From 4 to 50 contacts with current ratings of 3 to 7.5 amps. Standardized high-density rectangulars also, that allow you three current ratings — 3, 5, or 7.5 amps — with one size connector and one size panel cutout.

Need pc connectors? We've got edge-board, right-angle or flat-mounted pc's on .050, .078 or .100 contact centers. With solder, eyelet or dip solder terminations for 1/32 to 1/4-inch boards. And we've got micro-miniature pc connectors for use

with integrated thin film and semi-conductor circuitry.

If you're looking for circular cable or panel mounted connectors, you'll find them with 1 to 12 contacts. Contact centers from .025 to .040 with current ratings of 3 to 7.5 amps.

They're all on the shelf of



Function generator sweeps to 100 kHz



Honeywell Test Instrument Div., Honeywell Inc., P.O. Box 5227, Denver, Colo., Phone: (303) 771-4700.

A function generator with a million-to-one continuous sweep capability has 12 overlapping, 2-decade ranges and the capabilities of an automatic ramp generator. The result is a programmed, automatic sweep-frequency source with an operating range of 0.01 Hz to 100 kHz. The unit provides a logarithmic sweep spanning 6 decades, and a linear sweep over 2 decades of frequency. Logarithmic or linear voltage proportional to the chang-

ing frequency is produced to drive associated recording devices. The auto-range feature of this model permits a linear voltage-to-frequency relationship to within 1% and a logarithmic analog voltage-to-frequency relationship accurate to within 0.3 dB. In addition to the unit's sine, square and triangular wave-shape capability, its dc ramp logarithmic converter permits dc-to-log conversion over a 40-dB range. Wave forms are automatically or manually swept with an output voltage level constant to within ± 0.1 dB. Programmable upper and lower frequency selection permits automatic sweeps over any increment within the million-to-one range without overlapping manual range switch points. Jogging or repetitive sweeps over a narrow frequency limit can be obtained by operating the reverse control push button intermittently. *Booth No. 2G39 Circle No. 712*

Component comparator makes vector analyses

The London Company, 811 Sharon Dr., Cleveland. Phone: (216) 871-7980. P & A: \$535; 30 days.

This component comparator provides rapid and accurate vector measurements of components or networks with reference, basic or production standards. Accuracy is 0.05% of standard value for resistance (10 Ω to 1 M Ω), capacitance (200 pF to 20 μ F) and inductance (1 mH to 10 H) at a 1 kHz test frequency. Magnitude deviation is from $\pm 1.5\%$ full scale to -50% and $+100\%$, in four ranges. Phase angle deviation is ± 0.015 radians to ± 0.6 radians full scale, also in four ranges. Outputs for limit sensing and fast system response allow semiautomatic or automatic operation at speeds up to 10 measurements per second.

Booth No. 2K25 Circle No. 277

When Only Excellent is Adequate TURN to Grayhill

WHAT'S NEW ABOUT THIS SWITCH?

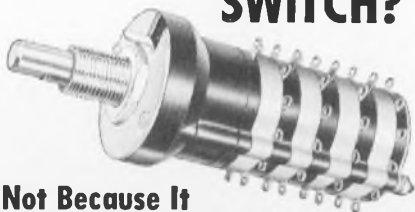

It's Not Because It

- 1) is explosion proof.
- 2) has up to 12 positions/deck.
- 3) could have up to 6 poles/deck.
- 4) comes in shorting or non-shorting versions.
- 5) is available in sealed, military or standard versions.

No...These are Standard Grayhill Rotary Switch features.

IT'S NEW BECAUSE

one or more positions may be ISOLATED from normal shaft turning techniques. It has its own built-in shaft turning SAFETY feature.

For details on this and other Switches Ask for Catalog G-304-A



565 Hillgrove Avenue
LaGrange, Illinois 60525
Area Code 312, Phone 354-1040

The Difference Between Excellent and Adequate

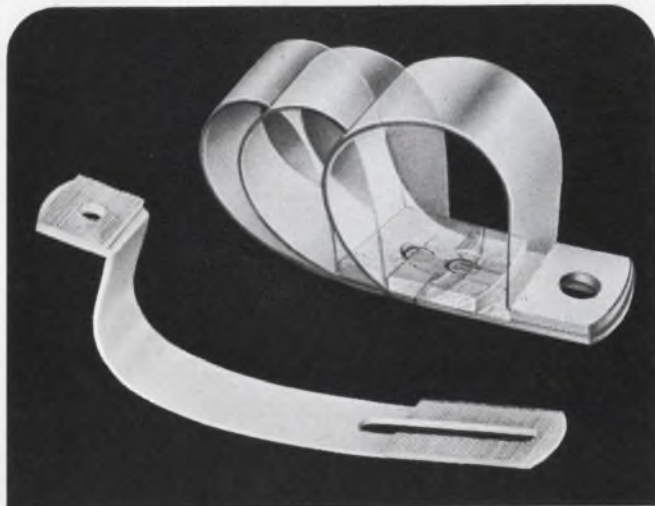

ADJUSTABLE P-CLIPS

Only nine sizes provide controlled tension for all bundle and cable diameters from $\frac{1}{8}$ " thru 2". Add or remove wires and the same clip can be adjusted to the new bundle diameter. Molded nylon ratchet teeth provide positive locking action — no slip, no slide — even under vibration or shock. Adjustable P-Clips simplify work, ordering, and inventories.

Send for Free Samples

ELECTROVERT INC.

Components Division
86 Hartford Ave., Mt. Vernon, N. Y. 10553
Milwaukee, Wis. • Burbank, Calif.



SOLD COAST-TO-COAST THROUGH AUTHORIZED DISTRIBUTORS

See Us At Booth #1D16

HERE'S A NEW WAY

to stabilize cabinet temperature without air conditioning!

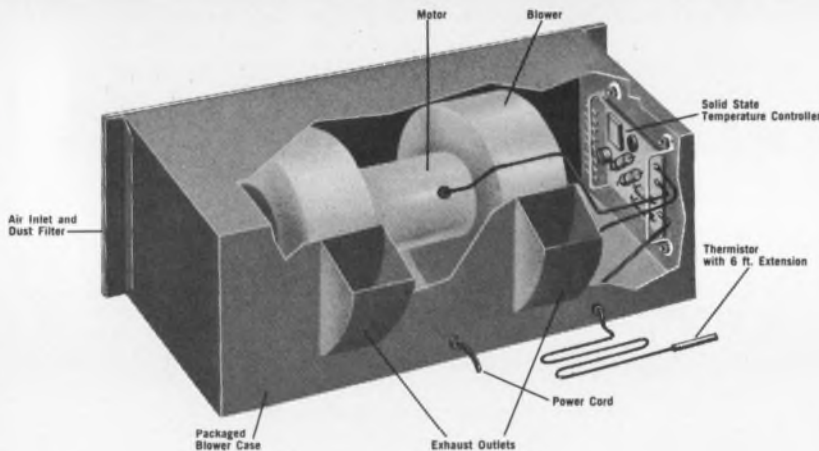
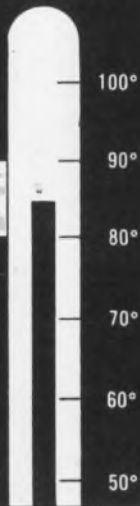

McLEAN

Solid State Temperature Controller

Modulates the Flow of Cool Air Within a Very Narrow Thermal Range

This new system employs a transistorized control and a modulating thermostatic probe to sense critical component temperature or outlet air temperature. Together these modulate the speed of the blower automatically supplying the right volume of air to maintain constant thermal stability. The Controller is preset so that the blower begins to operate at 80°F increasing in output as the temperature rises. Full output is achieved at 90°F. REQUEST DATA SHEET SSC 700.

FEATURES:

- Maintains cabinet temperature between 80°F and 90°F
- Automatically modulates blower speed
- Systems stay drift-free
- Quieter operation
- Extends life of electronic components
- Extends blower life
- Costs less than air conditioning
- More compact than air conditioning

SEND FOR
NEW CATALOG



McLEAN ENGINEERING LABORATORIES

Princeton Junction, New Jersey 08550
Phone 609-799-0100 • TELEX 84-3422

Visit us at the I.E.E.E. Show, Booth 4K12



TEST EQUIPMENT

Phase meter spans 2 MHz

Wiltron Company, 930 E. Meadow Dr., Palo Alto, Calif. Phone: (415) 321-7428. P&A: \$1190; 6 wks.

A differential-input phase meter covers the frequency range of 10 Hz to 2 MHz with a two channel sensitivity of 1 mV. The differential input minimizes extraneous signals entering the input leads. By subtracting the voltage on one lead from the voltage on the other, the interfering signal that is common to both leads is eliminated. Differential input is achieved by means of a FET-input arrangement. Using silicon semiconductors throughout, the instrument will work over the entire range of 1 mV to 100 V without external preamplifiers, attenuators or periodic calibration.

Booth No. 2C30 Circle No. 288

A-m/fm/audio source covers 220-410 MHz

Wiltron Company, 930 E. Meadow Dr., Palo Alto, Calif. Phone: (415) 321-7428. P&A: \$4650; 8 wks.

Frequency coverage of this generator is from 220 to 410 MHz and its maximum rf level is 2 V into 50 Ω . Frequency stability is 0.001% per 10 minutes of operation after 30-minute warm-up. Spurious fm is less than ± 30 Hz. This performance is achieved using a low noise push-pull FET oscillator circuit that eliminates rf wiping contacts and minimizes rf distortion. A 75-MHz crystal controlled a-m signal generator is included in the package. The modulation oscillator doubles as a general purpose audio frequency signal generator, since it covers 20 Hz to 20 kHz and has a metered output. It can be used for simultaneous internal and external modulation. A modulation monitor is provided to measure a-m modulation on uhf transmitters. Plug-ins permit extended use of all the general purpose circuitry of the main frame and provide for later extension of the frequency range.

Booth No. 2C30 Circle No. 284

RC oscillator puts out 5-V sine waves



Hewlett-Packard, Palo Alto, Calif.
Phone: (415) 326-7000.

A direct descendant of Hewlett-Packard's first product, this RC Wien bridge oscillator produces 5-V sine waves flat ± 0.5 dB from 5 Hz to 1.2 MHz with total harmonic distortion $< 0.1\%$. The dial is recessed for no-parallax setting. Complete disassembly for maintenance is a two-minute operation.

Three plug-in interchangeable power supplies are offered—ac line-operated, battery, and rechargeable battery. When fed to the instrument's front-panel sync input, any waveform in the 5 Hz - 1.2 MHz range will produce a sine-wave oscillator output synchronized in phase. The oscillator can thus function as a tunable filter, or it may be phase-locked to a frequency standard. A sync output, independent of oscillator output, supplies a signal for oscilloscope or counter inputs, or to synchronize another oscillator. Long-term frequency stability is specified at 0.02%, amplitude stability 0.2%.

The oscillator-amplifier uses a FET input, and a FET automatic gain control in the feedback loop to stabilize output and to reduce distortion. Amplifier frequency response is independent of transistor parameters so transistors may be changed without recalibration.

Booth No. 3K18 Circle No. 437

Dual-trace scope views tv waveforms

Tektronix, Inc., P.O. Box 500,
Beaverton, Ore. Phone: (503) 644-0161. Price: \$2035.

A 50-MHz, dual-trace, portable oscilloscope with built-in tv sync separator may be used to view waveforms from standard broadcast or closed-circuit tv systems with up to 1201-line, 60-Hz field rates. The $7\frac{1}{4} \times 11\frac{5}{8} \times 20\frac{1}{2}$ in. package weighs 30 lb and is equipped with front panel cover and carrying handle. Dual-trace sensitivity and bandwidth is 5 mV/div with 40-MHz bandwidth. Channel 1 and 2 amplifiers can be cascaded to obtain 1 mV/div sensitivity at 25 MHz, single-trace. Signal delay allows viewing the leading edge of the triggering waveform. Calibrated sweeps extend from 5 s/div to $0.1 \mu\text{s}/\text{div}$, the fastest sweep to $10 \mu\text{s}/\text{div}$.

Booth No. 2E39 Circle No. 261

Sulfides, Selenides & Phosphors

Want high purity *electronic chemicals*? General Electric provides zinc and cadmium sulfides and selenides for preparation of photoconductors, sintered powders, thin films, and single crystals—produced to very low impurity levels. GE's *custom doping* service prepares chemicals to your exact specs through custom-controlled amounts of copper, chloride, or other chemicals. GE *phosphors* for industrial and military applications offer exceptional properties . . . available in JEDEC grades including P-1, P-7, P-31, P-36, P-37 and P-39. Prompt delivery! Send for physical data and price information. General Electric Company, Lamp Metals & Components Dept., 21800 Tungsten Road, Cleveland, Ohio 44117. Tel: (216) 266-2451.

GENERAL  ELECTRIC

INFORMATION RETRIEVAL NUMBER 186

- 400 cycle power
- 1% distortion
- .5% frequency and voltage regulation



The completely transistorized model CRS-100A frequency converter (100VA output) offers all this in only $3\frac{1}{2}$ " panel height . . . and high reliability, too!

Others are available rated at 30 VA to 15 KVA with fixed or adjustable output frequencies. Call or write today for complete details.

CML, Inc. 

A subsidiary of Tenney Engineering, Inc.
350 Ieland Avenue, Plainfield, New Jersey 07062
(201) 754-5502 • TWX: 710-997-9529

INFORMATION RETRIEVAL NUMBER 187



COMPACT POWER PACKS



The new Compact "M" Series Power Packs offer you:

- Rated output voltages from 1000 to 75,000 DC
- Rated output currents of 1.5, 5, and 10 milliamperes
- Input voltages of 118, 220, 230, and 240 volts AC
- Variable output from 0 to rated voltage
- Input frequency range 50 to 500 CPS
- output ripple 1% RMS at rated voltage
- Hermetically sealed construction

Why pay more, and settle for less... PC's new compact power packs give more quality, more versatility, more dependability, plus smaller size, and best of all, most sizes are available in stock to meet your immediate needs.

Write for complete information and new catalog today!



Plastic Capacitors, INC.

2620 N. Clybourn • Chicago 14, Ill.
DI 8-3735

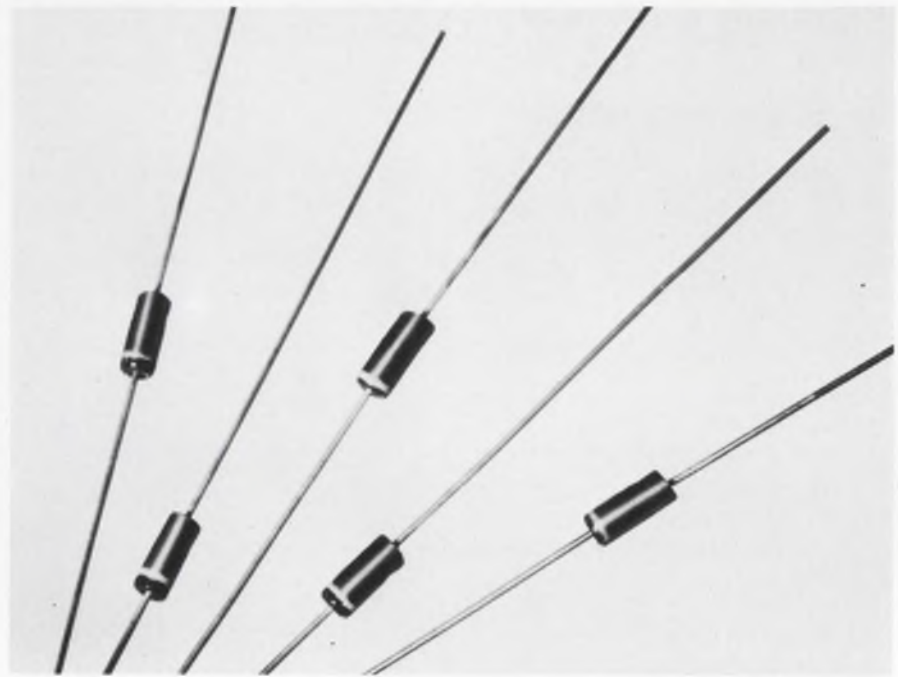

Hot-carrier junction diode has a 100 ps carrier life

Hewlett-Packard, 1501 Page Mill Rd. Palo Alto, Calif. Phone: (415) 326-7000. P&A: 48¢ (5000 lots); stock.

A new type of semiconductor diode incorporates the advantages of hot-carrier diodes with those of conventional pn junction diodes. This device has a breakdown voltage of 70 V. The minority-carrier lifetime of the new diode, which ultimately determines switching speed, is like that of hot-carrier diodes: less than 100 ps. By comparison, the fastest available silicon pn junction diodes have a minority-carrier lifetime of 450 ps.

The 70-V breakdown voltage of the new diode makes it possible to use it in high-level uhf mixers and detectors and in other applications where signals having a wide dynamic range are encountered, or where high burn-out capabilities are required.

The low turn-on (or threshold) voltage of the hybrid hot-carrier diode (< 410 mV at $I_F = 1$ mA) is comparable to that of germanium diodes. Silicon junction diodes have threshold voltages on the order of 700 mV.

The hybrid's operating and stor-

age temperatures range from -65°C to $+200^\circ\text{C}$. In tests, the diodes have shown no change in characteristics after heating many hours at 300°C .

The Schottky barrier, which accounts for the diode's fast switching performance, is formed by evaporating molybdenum onto the n-doped silicon substrate. The design differs from earlier planar hot-carrier diodes in that a p-doped ring is around the periphery of the metal barrier. This ring prevents the formation of high-density electric fields, which caused "soft" breakdown characteristics (higher than normal leakage currents) in earlier planar hot-carrier diodes. The reverse breakdown characteristics of the earlier planar hot-carrier diodes were also unreliable.

The use of molybdenum for the Schottky barrier is also a new development. This permits reliable operation at temperatures to 200° . Earlier hot-carrier diodes were limited to temperatures below 125°C . The diode is packaged in a glass envelope and can withstand accelerations of 20,000 G's for 1 ms.

CIRCLE NO. 432

Multiplier rectifiers range to 6000 V

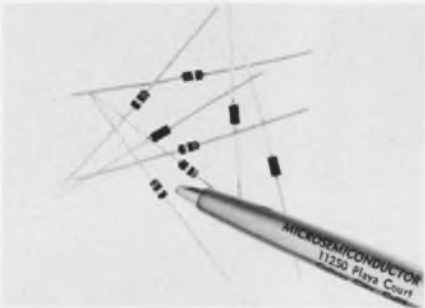

Micro Semiconductor Corp., 11250 Playa Court, Culver City, Calif. Phone: (213) 391-8271.

Multiplier rectifiers—high-voltage devices—are available for use in cascade multiplier designs, such as electro-optical imaging and infrared search and tracking systems. Voltage ranges of 1000-6000 V, leakage of less than $0.2 \mu\text{A}$ and capacitances of less than 1 pF are standard. The devices are 0.075 in. in dia by 0.15 in. long with 0.02-in. -dia leads.

CIRCLE NO. 433

N-channel FET has low noise

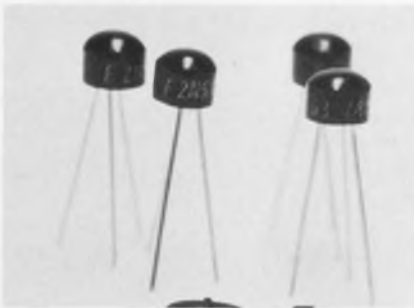

Fairchild Semiconductor, 313 Fairchild Dr., Mountain View, Calif. Phone: (415) 962-2530. P&A: 25-50¢; stock.

An N-channel epoxy field-effect transistor has low noise and high gain characteristics. It has the equivalent of a 0.6-dB noise figure at a source resistance of $1 \text{ M}\Omega$. The device has a forward transadmittance of 2000 to 9000 μmhos and an on-resistance of 500Ω max. Applications include: amplifiers, switches and choppers.

CIRCLE NO. 434

Silicon rectifiers cover 50 to 150 kV



Semtech Corp., Newbury Park, Calif. Phone: (805) 498-2111.

Silicon rectifiers for high-voltage applications are available in five voltages: 50, 75, 100, 125 and 150 kV. Called Sticpac, its dimensions are: diameter, 0.695 in. ; length, from 3.38 to 8.50 in. The Sticpac's design incorporates a unitized construction encapsulated in a high-temperature compound for maximum mechanical, thermal and electrical reliability. The average output is $100 \text{ mA}/55^\circ\text{C}$.

CIRCLE NO. 435

Designed with a particular type of Customer in mind

 A collection of images showing various Howard Industries products: a fan, a large motor, and a smaller motor.

Total quality control, advanced engineering and long field experience combine to give Howard customers the superior performance, longer life and insurance against costly breakdowns that they look for in motors, gear motors, fans and blowers.

For immediate delivery of Cyclohm fans and blowers, contact Standard Motor Product Sales, 23 Broadway, Des Plaines, Ill. 60016.

For complete information on the Howard motor, gear motor, fan and blower lines, address

HOWARD INDUSTRIES
MSL Industries, Inc./Motor Group
2420 18th St., Racine, Wis. 53403

INFORMATION RETRIEVAL NUMBER 192

 A diagram showing the assembly of a resistor bobbin. It includes labels A through F pointing to different parts: A (Lead), B (Weld), C (Evanohm Ribbon), D (4-Slot Bobbin), E (Case), and F (Finished Unit).

NEW! Bobbins ready for winding - with ribbons now welded to leads!

- A** Lead
- B** Weld
- C** Evanohm Ribbon
- D** 4-Slot Bobbin
- E** Case
- F** Finished Unit

Designed for use in printed circuits, these molded resistor bobbins speed up winding operations because Evanohm ribbons are welded directly to No. 22 gauge tinned copper leads. Case size: $.275 \text{ in.}$ diam. x $.330 \text{ in.}$ high. Lead spacing $.200 \text{ in.}$ Other sizes available.

Send for free samples today!

PI Plasmetex Industries, Inc.
8217 Lankershim Blvd., North Hollywood, Calif. 91605
Phone: (213) 767-1532

INFORMATION RETRIEVAL NUMBER 191

ELECTRONIC DESIGN 6, March 14, 1968

SPECIAL or STOCK BLOWERS

Call Ripley!

Designing, development and production of precise air-moving units to fit your performance requirements and your budget. Stocked units available from 4 to 145 CFM for immediate delivery. For fast action, call Sales Dept., (203) 346-6678.

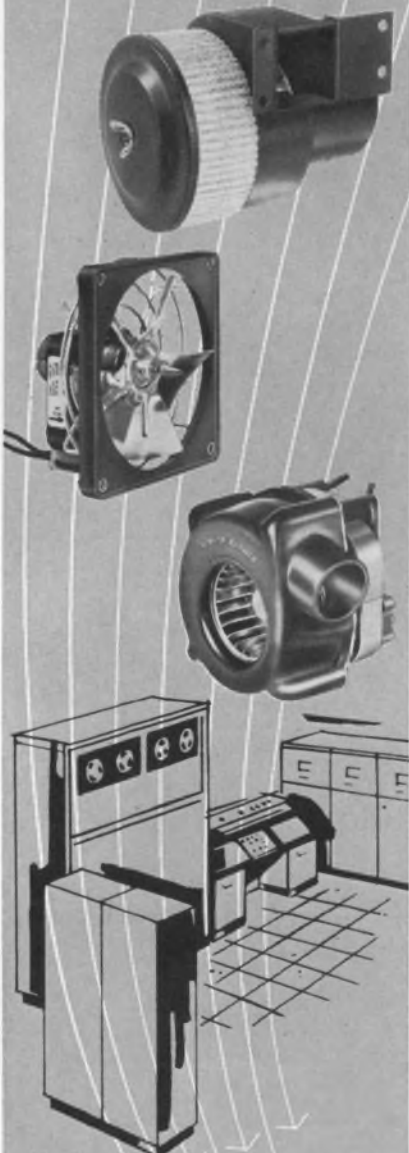

RIPLLEY
COMPANY, INC.
MIDDLETOWN, CONNECTICUT

MICROELECTRONICS

Dual-in-line ICs will function eleven ways

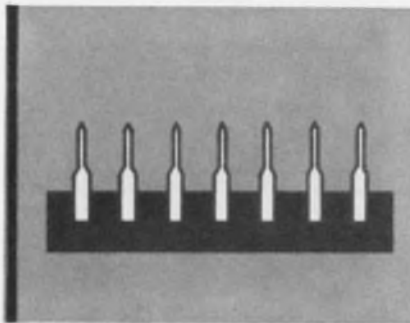

Signetics Corp., 811 Arques Ave., Sunnyvale, Calif. Phone: (408) 739-7700. P&A: 75¢ to \$1.92; stock.

ICs called Utilogic II are priced as low as 20¢ a gate function. Seven of the circuits are multifunctional units, including dual J-K binaries and triple and quad gates. Utilogic II devices are being offered in two temperature ranges, the LU-series to operate at from 15°C to 55°C and the SP-series from 0°C to 75°C. Both have 1-V ground-line noise immunity—5 to 10 times better than comparable RTL circuits. In addition, Utilogic II has a fan-out of 17 compared with a fan-out of 3 for RTL. Signetics also adds a new package for the dual master-slave flip-flop (322B), it is a 16-lead dual in-line silicone package.

CIRCLE NO. 713

4-bit binary counter supplies 3.6 to 5.5 V

Fairchild Semiconductor, 313 Fairchild Dr., Mountain View, Calif. Phone: (415) 962-2530. P&A: \$7.50 ea. (100 lots); stock.

A 4-bit binary counter with a typical power dissipation of 130 mW is a negative true logic and is compatible with RTL circuitry. Power supply voltages of 3.6 V to 5.5 V are available. The C μ L 9989 typically delivers a 15-MHz counting frequency and employs a weighted count sequence consisting of four cascaded binary triggered flip-flops. It is a straight binary divider, capable of dividing the input frequency by 16. A master reset can return all 4 flip-flops to the 0 state. Presetting to the 1 state is done by reducing the output.

CIRCLE NO. 442

MOS analog switch has 300 Ω R_{ON}

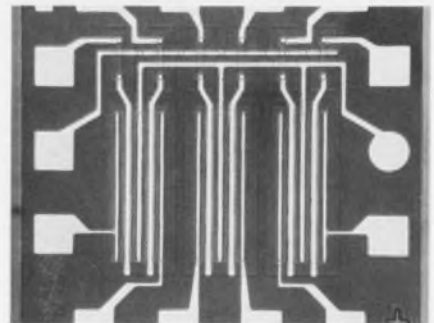

Fairchild Semiconductor, 313 Fairchild Dr., Mountain View, Calif. Phone: (415) 962-2530. P&A: \$40; stock.

A MOS 6-channel analog switch featuring a low ON resistance ($R_{ON} = 300 \Omega$) is an enhancement mode IC well suited as a basic switching element for airborne or ground instrumentation, telemetry or other analog or digital data transmission applications. The 3701 updates Fairchild's 5-channel multiplexer switch by providing a sixth channel.

CIRCLE NO. 443

FET hybrid IC for analog gating

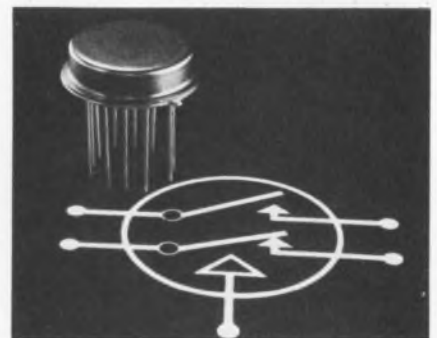

Crystalonics, a Teledyne Co., 147 Sherman St., Cambridge, Mass. Phone: (617) 491-1670. P&A: \$39.70 (100-999); stock.

The CAG7 is a FET analog gate containing a low R_{on} FET and a gate coupling diode with a pnp driver. Performance features include an R_{on} (6 Ω max), and zero offset voltage. This circuit operates directly from logic. This hybrid uses all military grade semiconductors. High component density is achieved by bonding chips directly to the substrate.

CIRCLE NO. 444

Microcircuit bonder solders chips to film



General Micronetics Ltd., London.
Price: \$1500.

A bonding machine, consisting of vacuum chuck, movable substrate holder and controlled heater, facilitates the attachment of small leadless devices and flip chips to microcircuits. Controls position the substrate beneath the chuck while the chuck is rotated to align the device with the circuit. A binocular attachment permits continuous inspection of the process.

CIRCLE NO. 445

Drafting machine has 5-digit readout



Development Associates Controls,
725 Reddick, Santa Barbara, Calif.
Phone: (805) 963-3708.

A precision layout and drafting machine, designed for the electronics industry, is available with 5-character digital readout indicating to 0.0005 in. The basic machine can cut or scribe artwork within ± 0.001 in. over 48-in.² back-lighted table. The electronic readout is effected by rotary shaft encoders and digital counters.

CIRCLE NO. 446

Microfurnace heats to 2400°C



Tem-Pres Research, 1401 S. Ather-
ton, State College, Pa. Phone:
(814) 237-7631.

This furnace will heat a sample to 2400°C in 4 to 10 s. The sample can be observed through a transparent enclosure and can be quenched instantaneously. The complete assembly consists of a power supply housed in a desk-height console and two miniature furnace units that can be changed by simply unplugging.

CIRCLE NO. 447



SYNCHRO-TO-DC CONVERTER

Natel Engineering has designed a Solid State Synchro-To-DC Converter that you should know more about. Why? Here are just a couple of reasons . . . Accuracy: ± 6 minutes, Output: DC voltage linearly proportional to rotor shaft angle 0-360°, Size: 4" x 5" x 6". Synchro/Digital models also available. To receive further technical data and prices promptly, write today on your company letterhead. For data on your immediate application, telephone collect to Phil Diamond, V.P., Marketing.

APPLICATIONS MODEL 406 — Major aerospace/electronic firms throughout the U.S. have now standardized on Natel Model 406 for: Ground radar antenna sites Ship and airborne heading indicators And wherever a smaller and lower cost replacement for electro-mechanical systems is needed.



7129 Gerald Ave., Van Nuys, Calif. 91406/(213) 782-4161/TWX (910) 495-1765

MINIATURIZATION MADE EASIER

With

**Dual Knobs
That Take
Half the
Space!**

PROMPT
SHIPMENT
•
NO
TOOLING
COSTS



FREE
CATALOG
•
SAMPLES
On
Request

HARRY DAVIES MOLDING COMPANY
4920 W. Bloomingdale Avenue • Chicago, Ill. 60639

NEW! low cost direct viewing filament readout

A major advance in production techniques is responsible for this low cost, micro-miniature numeric readout — Model M6-30. □ High in reliability, low on power, small in size and long on life, it withstands extreme shock and vibration conditions, uses only 8ma/segment at 3 volts, is only 1/2" high x 5/16" wide x 3/16" deep with a character height of 5/16" and lasts 100,000 hours/segment. □ By viewing the filament directly, excellent readability is provided even in direct sunlight. It can be plugged into a connector or wired directly into printed circuit logic. □ Commercial unit, in large quantities, only \$12.95.



SEE A DEMONSTRATION AT THE IEEE EXHIBITION, MARCH 18-21, BOOTHS 4J26-4J28

Pinlites Inc. 1275 Bloomfield Ave., Fairfield, N. J. 07006
201-226-7724

INFORMATION RETRIEVAL NUMBER 201

RECORD VIBRATION WITH GROUNDED ACCELEROMETERS

no insulating studs yet no ground loops



New Unholtz-Dickie D11 charge amplifier effectively rejects ground loop voltages without insulating devices.

■ If you want to record vibrations with a grounded accelerometer — and do it without having to mess around with insulating blocks, etc. — the new D11 charge amplifier is for you. Noise levels are approximately equal to those obtained when you used studs. Flick one switch to choose either grounded or ungrounded operation. For complete technical information, write today.

manufacturers of shaker systems, advanced instrumentation, and accelerometers

UNHOLTZ-DICKIE CORPORATION

3000 WHITNEY AVE. / HAMDEN, CONN. 06516 / (203) 286-3356

"See Us at IEEE, Booth 2C09"

INFORMATION RETRIEVAL NUMBER 202

PRODUCTION EQUIPMENT

Punched data cards program coil winder



Eubanks Engineering Co., 225 W. Duarte Rd., Monrovia, Calif. Phone: (213) 358-4531.

Programed by a punched IBM card, this machine will wind coils at up to 8000 turns per minute. Wire in sizes from 16 to 50 AWG can be spun in a variety of linear or random windings. Winding pitch, speed and density are closely controlled. Coils with outside diameters of up to 5 in. can be wound.

Booth No. 1J13 Circle No. 451

Diffusion furnace heats to 1200°C



Electroglas, Inc., 150 Constitution Dr., Menlo Park, Calif. Phone: (415) 325-1536.

This diffusion furnace is designed for high-volume three-shift operation. Heat-up time from cold start to 1200°C is less than 70 minutes. Solid-state controllers produce rapid temperature response and stability. Temperature variations of $\pm 1/4^\circ\text{C}$ have been achieved in stability tests of up to 170 hours.

Booth No. 1F26 Circle No. 452



**NOBODY
ELSE
WOULD TRY
TO CREATE
A SOLID STATE
TIME
DELAY RELAY
UNAFFECTED
BY
RADIATION**



ARTISAN TRIED, and did it! We know there's not a large market for this equipment — but when an important customer asked us to try, the challenge was too much to resist.

Maybe it's this "can do" attitude that's turning more and more companies to Artisan when they have an important electronic timing problem.

Did you know our Universal Time Delay Relay Model 416, used for ground support or in airborne systems, is rated the most reliable and the least costly of any existing model by actual test and cost evaluation studies?

If you're cost conscious — and who isn't — investigate our Industrial Control Time Delay Relay Model 428, which offers the maximum in flexibility and economy on the market today.

Whatever your electronic timing needs, you'll get them solved faster and for less money if you call Artisan first. There are regular "off the shelf" devices, plus nearly 1,000 proven Specials, and an engineering capability to handle all beyond.

Write today for our Timing Products Catalogue, and to be placed on our Timing Tips mailing list.

Artisan Electronics

Electronic Timing Devices/Relays and Solenoids
Communication and Control Subassemblies.

Artisan Electronics Corporation
5 Eastmans Road, Parsippany, N. J. 07054
(201) 887-7100

INFORMATION RETRIEVAL NUMBER 203

302

PRODUCTION EQUIPMENT

Wave soldering unit forms 3-in. wave

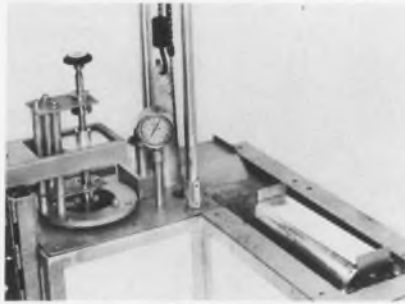

Electrovert Inc., 86 Hartford Ave., Mt. Vernon, N.Y. Phone: (914) 664-6090.

A wave soldering unit is designed to form a smooth wave of molten solder 3 in. long in the direction of board conveyance. The unit forms a smooth, laminar, double-sided wave. Wave height is adjustable to 5/8 in. within a tolerance of $\pm 1/32$ in. Standard wave widths are 12, 15, 18 and 24 in.

Booth No. 1B19 Circle No. 453

Bonding console welds beam leads



Wells Electronics, Inc., 1701 S. Main St., South Bend, Ind. Phone: (219) 288-4651. P&A: \$3975; 8 wks.

Beam lead devices can be joined to their metallic substrates or carriers using a new bonding console. The bonder can also be used to join small gold wires or ribbons to thin or thick film circuits and to other solid-state devices by means of a pulse-heated tip. The console consists of a bonding head, a 10 to 1 micropositioner, a B & L Stereo-zoom scope and an ac power supply.

Booth No. 1J10 Circle No. 454

Stripper tool skins flat cable



Carpenter Manufacturing Co., Inc., Fairground Dr., Manlius, N.Y. Phone: (315) 682-9176.

Designed to end-strip flat cables, a production tool employs a counter-force stripping principle that eliminates cable clamping devices. The cable is simply passed through the unit and is stripped. The insulation shoulder is clean and square.

Booth No. 1H07 Circle No. 455

Wafer tester also sorts



Advanced Technology & Systems Corp., 199 Sound Beach Ave., Old Greenwich, Conn. Phone: (203) 637-4337. P&A: \$23,000; 45 days.

An automatic system will test and classify semiconductor wafers according to their thickness or specific resistivity. One component of the system will classify wafers into 10 tolerances plus high and low in accordance with their thickness. Thickness variations of 0.5 μm can be detected.

CIRCLE NO. 456

Micropositioner hits 8- μ m target

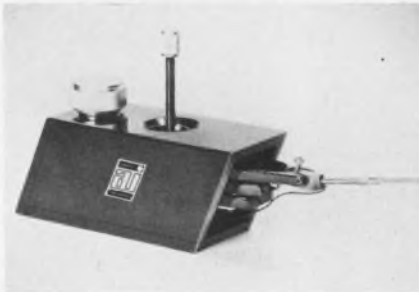

Alessie Industries, 418 Main St., El Segundo, Calif. Phone: (213) 322-6690. P&A: \$217; stock.

A precision micropositioning instrument will traverse 360° in a horizontal plane to scan and probe areas as large as 0.3 in. in diameter. Contacting of a point 8 μ m in diameter is made possible by the spring-loaded, joystick positioner and the compound-point, precision ground and polished probe points supplied with the instrument. Probe pressure on contact is adjustable.

CIRCLE NO. 464

Drilling machines punch etched boards

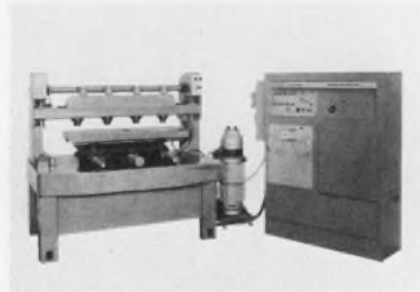

Digital Systems, 1078 E. Edna Place, Covina, Calif. Phone: (213) 966-8631.

A series of accurate, high-production circuit board drills features high drilling speeds and good over-all accuracy. The drill is hydraulic, has a 0 to 300 in. per minute feed rate, drilled hole accuracies greater than ± 0.001 in. and a production rate greater than 96,000 holes per hour. Numerical control helps to eliminate drilling errors.

CIRCLE NO. 465

Miniature torch heats 6300°F



Tescom Corp., Instrument Div., 2633 Southeast Fourth St., Minneapolis, Minn. Phone: (612) 331-1311.

A miniature torch for welding metal thinner than 0.002 in. or as thick as 16 gauge, is ideal for heat-bonding, welding and soldering applications requiring a small, intense flame. It uses oxygen and fuel gas (acetylene, hydrogen, LP-gas, or natural gas) to produce a flame temperature of 6300°F, operates at 2 to 4 lb/in.² and uses gas at 0.023 to 2.54 ft³/h.

CIRCLE NO. 466

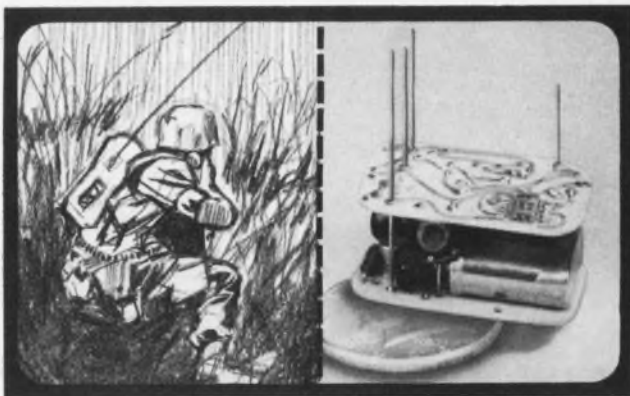

TC/VCXO

TEMPERATURE COMPENSATED VOLTAGE CONTROLLED CRYSTAL OSCILLATORS

New Arvin TC/VCXOs for miniaturized communications equipment generate frequencies to 50 MHz with oven-like accuracy. Typical TC/VCXO specifications:

- 5 MHz ± 2 PPM from -40° C to $+70^{\circ}$ C
- Power Input 60 MW ■ Power Output 1 MW
- Deviation ± 25 PPM ■ Deviation Rate DC to 5 KHz
- Deviation Sensitivity 5 PPM/volt ■ Linearity 2%

Units with other frequencies and stabilities can be designed. TC/VCXOs can be manufactured to conform to all applicable NASA or MIL specs.

ARVIN FREQUENCY DEVICES



2505 North Salisbury Street, West Lafayette, Indiana 47906

INFORMATION RETRIEVAL NUMBER 207

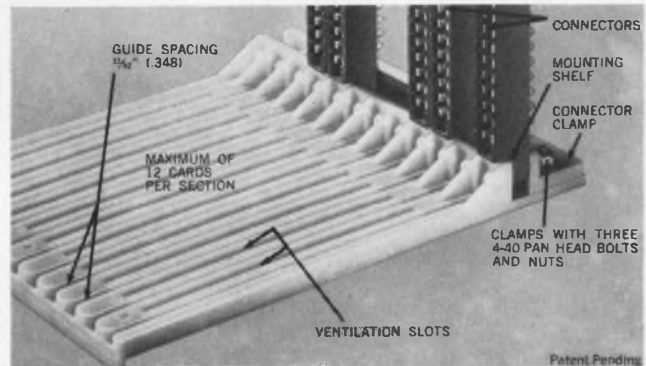

BUCKEYE bord-pak

EASIER PACKAGING OF PRINTED CIRCUIT CARDS

Write Today For Catalog No. 1267



Bord-Pak Circuit Board Guides are Cyclocol modules with 12 tracks, spaced 1/32" apart for maximum density of circuit board packaging. Connectors mounted and self-adjusting with one-piece clamp. Available in 4 1/2" and 6" length and rack mounted in tiers or stacked — or packaged in standard instrument case. Saves assembly time. Special spacing on quantity orders.

the BUCKEYE stamping co.
555 Marion Road
Columbus, Ohio 43207
"Quality Products Since 1902"

INFORMATION RETRIEVAL NUMBER 208

ELECTRONIC DESIGN 6, March 14, 1968

-MATSUO-

THE SPECIALIST OF FILM AND TANTALUM CAPACITORS

POLYESTER FILM CAPACITORS

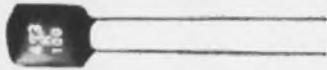

Type MFL epoxy dipped
Standard voltage rating : 35V, 50V, 100V, 200V D.C.
Standard capacitance value : .001 MFD to .22 MFD (E-6 series)



Type MFK epoxy dipped, non inductive
Standard voltage rating : 100V, 200V, 400V, 600V D.C.
Standard capacitance value : .01 MFD to .47 MFD (E-6 series)



Type MXT enclosed in plastic tube, non-inductive
Standard voltage rating : 100V, 200V, 400V, 600V D.C.
Standard capacitance value : .001 MFD to .22 MFD (E-6 series)

METALIZED POLYESTER FILM CAPACITOR



Type FNX-H mylar wrapped
Standard voltage rating : 100V, 200V, 400V, 600V D.C.
Standard capacitance value : .33 MFD to 10 MFD

SOLID TANTALUM CAPACITORS

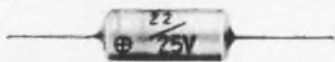

Type TAX hermetically sealed in metallic case
MIL-C-26655B
Standard voltage rating : 6V, 10V, 15V, 20V, 25V, 35V, 50V D.C.
Standard capacitance value : 1 MFD to 220 MFD (E-6 series)



Type TSX enclosed in metallic case and sealed with epoxy resin
Standard voltage rating : 3V, 6V, 10V, 15V, 20V, 25V, 35V D.C.
Standard capacitance value : 1 MFD to 220 MFD (E-6 series)

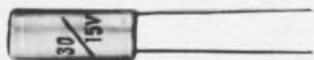

Type TSL enclosed in metallic case and sealed with epoxy resin
Standard voltage rating : 3V, 6V, 10V, 15V, 20V, 25V, 35V D.C.
Standard capacitance value : 1 MFD to 220 MFD (E-6 series)

For further information, please write to:

MATSUO ELECTRIC CO., LTD.

Head Office: 3-5-3-chome, Sennari-cho, Toyonaka-shi, Osaka, Japan
Cable "NCC MATSUO OSAKA" Telex: 523-4164 USA
Tokyo Office: 7, 3-chome, Nishi Gotanda, Shinagawa-ku, Tokyo

SYSTEMS

Telemetry system functions with ICs

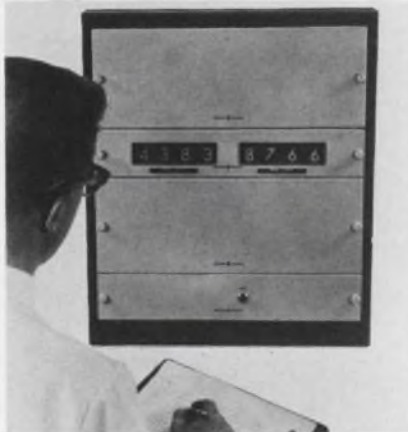

General Electric, Schenectady,
N.Y. Phone: (518) 374-2211.

A compact digital telemetering system designed for transmitting accumulated pulse count data has been designed with integrated circuits. The system, called TD-7010, consists of a transmitter, receiver and various optional input-output devices, such as a digital data display. The use of IC design permits reduced size and power requirements and increased reliability.

The system's accessories include an on-line logging capability and dual display up to a maximum of 10 readings transmitted from a remote location.

Integrated measurements, such as kilowatt hours and accumulated flow, are transmitted with a digital code, which is displayed on a digital readout at the receiving site.

The transmitter is capable of accepting up to 10 four-digit pulse accumulation counters, equipped with or without auxiliary storage for operation with a two-wire or three-wire contact device. A wide range of operating speeds (18-9600 bits/s) allows the system to take advantage of available channel characteristics and to meet varying data-acquisition rate requirements. In addition the system can be arranged to share a channel with a previously existing analog telemetering system.

The TD-7010 is the first in a series of IC telemetering devices to be manufactured by GE. Future systems will incorporate supervisory functions.

CIRCLE NO. 457

Power supply delivers 2400 V

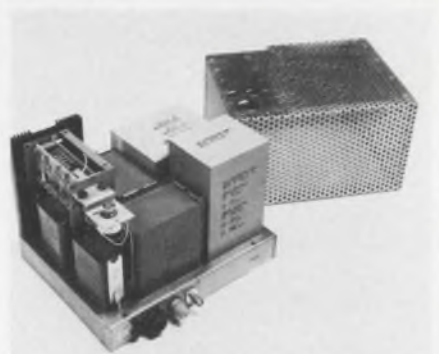

DEL Electronics Corp., Mount Vernon, N.Y. Phone: (914) OW 9-2000.

Operating from an input of 115 V, 60 Hz, this power supply has an output of 2400 V regulated to $\pm 0.05\%$ with a maximum 10 mV peak to peak ripple at a rated load of 20 mA. It has the ability to limit current to 28 mA while withstanding a direct shorted output for an indefinite period, returning to normal operation when the short is removed. Typical applications include its being used as a helix high dc voltage source for backward wave oscillators in frequency converters or to meet other close regulated low ripple requirements.

Booth No. 3K28 Circle No. 399

Synchronizer tunes from 1 Hz to 100 kHz

Stellarmetrics, Inc., 416 E. Cota St., Santa Barbara, Calif. Phone: (805) 963-3566.

A 100-kHz PAM/PDM decommutator has as its basis an analog programmable synchronizer that is continuously tunable from 1 Hz to 100 kHz. The programmable synchronizer accepts PAM and PDM wave trains, programmed by either front-panel controls or by computer through an accessory program control unit. The output of the synchronizer is fed to an A/D converter, whose digital output is available for direct computer data-processing, data compression, or other digital handling. The synchronizer output also is fed to a D/A converter.

CIRCLE NO. 458



NEW / FROM NORTRONICS

EXTENDED POLE PIECE TAPE HEADS

FOR READING SOUND FROM FILM



Nortronics extended pole piece record/play heads read sound from 8 mm or 16 mm film without touching the film's optical or sprocket areas. This avoids scratching of the optical surfaces and eliminates possible picture bounce or sound flutter from sprocket hole-to-head contact. The extended tip on these heads is available with Alfenol laminations for long wear or Mu-metal laminations for maximum sensitivity.

These heads are also appropriate for a variety of other applications requiring a projecting track, such as card readers, drums and discs. As small as a 1/4 inch cube, the heads can be supplied with track widths from .006" to .070", with a choice of sizes and case styles. Complete technical data is available upon request.



Like all Nortronics tape heads, the extended pole piece type has a fine laminated, precision lapped core structure for low loss, a deposited quartz gap for optimum high frequency resolution, and superb shielding for protection from external magnetic fields. The world's largest manufacturer of tape heads and pace-setter for the industry, Nortronics offers a complete line of heads, including many for replacement and prototype applications off-the-shelf from your local distributor.

Nortronics
COMPANY, INC.

8101 Tenth Avenue North
Minneapolis, Minnesota 55427

INFORMATION RETRIEVAL NUMBER 755

SYSTEMS

PCM system has 32 channels



Teledyne Telemetry, A Teledyne Co., 9320 Lincoln Blvd., Los Angeles. Phone: (213) 670-7256. P&A: \$10,000; 90 days.

Extensive use of analog ICs, in addition to digital ICs, has led to a 32-channel pulse-code-modulation (PCM) system housed in a chassis requiring approximately 15 in.³. The CT-100 system comprises a 32-channel time-division multiplexer, sample-and-hold, 8-bit analog-to-digital converter, system clock, power supply, and serial NRZ-C or NRZ-M output logic. Other features include throughput rates up to 1.4 megabits accuracy of 1%, back currents below 50 nA, offset and scatter below 0.05% of full scale, low-power requirements of less than 230 mA at 28 V dc, a high input impedance of 5 M Ω minimum, and linearity better than 0.1% deviation from best straight line. Applications include all PCM system requirements, especially those requiring high-speed data rates and minimum size and weight.

CIRCLE NO. 462

Inverted microscope enlarges 1500 times



Multiplex system stacks in 10.5 in.

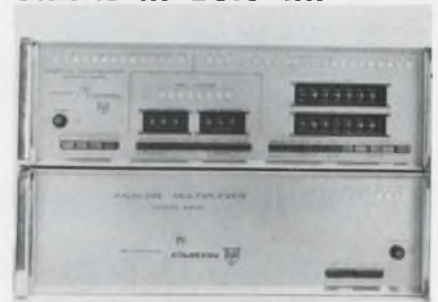

Lear Siegler, Inc., Cimron Div., 1152 Morena Blvd., San Diego. Phone: (714) 276-3200.

Designed to meet numerous data acquisition applications, a multiplex A/D conversion system consists of off-the-shelf units that combine to form a complete system in 10.5 in. of rack space. One component, an analog multiplexer, performs low-level multiplexing of 128 channels using one amplifier and 3-wire, FET switching. Its three full-scale ranges are ± 11 , ± 1.1 and ± 0.11 V dc. Up to two of these multiplexers may be controlled by a companion system-scanner. Where sequential scan can be employed, this unit acts as system control. Upper and lower limits are controlled from front-panel thumbwheel switches or from a remote position. Scan modes are continuous, single and single step. An optional digital comparator compares measured data with preset limits of up to 16 bits plus sign. An A/D converter completes the line.

Booth No. 2B31 Circle No. 271

William J. Hacker & Co., Inc., P.O. Box 646, West Caldwell, N.J. Phone: (201) 226-8450.

An inverted metallurgical microscope allows inspection of samples at magnifications from 42x to 1500x. The stand of the instrument rigidly supports the vertical column. An optical unit on the quadruple revolving nose-piece includes four achromatic objectives and three sets of paired plane eyepieces. Binocular observation tubes are rotatable and are quickly interchanged.

CIRCLE NO. 463

**SUPERIOR
COAXIAL
ATTENUATORS**

**continuously
variable
broadband**



attenuators

Each Model in Series 953 and 973 operates in frequency ranges up to 3½ octaves wide with only small changes in characteristics.

MODEL	RANGE FREQ. (GHz)	RANGE IN dB
953-3	1-11	3
953-10	2.5-11	10
953-20	4-11	20
973-10	1.3-11	10
973-20	2.5-11	20
973-40	4-11	40

They are available as either level set or calibrated units. The direct reading insertion loss scales are individually calibrated. They also feature . . .

- Non-contacting control device
- Stainless steel connectors
- Small phase shift
- High stability
- Optional panel mounting versions

Using the simple control, insertion loss is continuously variable, and the scale is almost linear in dB.

Designers and
Manufacturers of Precision
Microwave Equipment

**WEINSCHEL
ENGINEERING**
Gaithersburg, Maryland

SYSTEMS

**Tape recorder
weighs 5.5 lb**

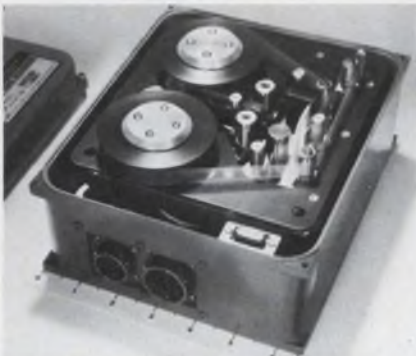

Kinelogic Corp., 29 S. Pasadena Ave., Pasadena, Calif. Phone: (213) 449-8707.

The types of data the model LR tape recorder can store includes digital, analog, fm, and PDM. Head configurations for IRIG IBM-compatible playback during recording are available. The unit weighs 5.5 lb and measures 7 x 6 x 3.5 in. It accommodates up to 650 ft of 1.1-mil tape 0.5 in. wide. Also included within the recorder housing are the control logic electronics and the dc-to-ac motor drive inverter. The inverter has an electrically selectable dual-frequency output to provide a two-speed capability. Standard speed pairs available are 60:30 or 15:7.5 in./s. A low-speed pair of 3.75:1.875 in./s is available on special order, as also are fast forward and rewind applications. The unit requires 18 W of power from a 28-V dc line.

CIRCLE NO. 459

**Analog computer
uses 167 amplifiers**

Simulators, Inc., 3611 Commercial Ave., Northbrook, Ill. Phone: (312) 272-6310. Price: \$8000 to \$65,000.

This equipment is suitable for solving complex problems in the high-speed iterative mode under logical control. An expanded 720 simulator and desk-top computer contain 167 amplifiers (72 of which are uncommitted), 36 integrators, 12 arbitrary function generators, 24 multipliers, additional nonlinear devices, 30 hybrid elements, operational synchronous and asynchronous logic, and a general-purpose hybrid interface unit.

CIRCLE NO. 460



2½ in. AP-2

Snap-in Dial
2% full scale accuracy,
self-shielded panel meters

New! Panel meters with plastic bezels give you tailor-made meters at no increase in price. Covers snap off . . . interchangeable dials snap in. High torque mechanism offers 1% linearity, 2% accuracy and sensitivity to 20 ua. Magnetic system is unaffected by external field influences, mounts on any material without interaction. Size: 2½". Choice of colors and finishes. ASA/MIL 3 or 4-stud mount.

AMMON

AMMON INSTRUMENTS, INC.
345 Kelley St., Manchester, N.H. 03105

INFORMATION RETRIEVAL NUMBER 758

**TERMINAL
HEADACHES?**

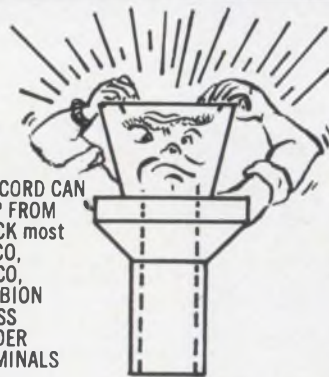

CONCORD CAN
SHIP FROM
STOCK most
LERO, U.S.E.C.O.,
CAMBION
BRASS
SOLDER
TERMINALS

plus
PRINTED CIRCUIT, MS STD.,
Mil-T-55155, Fed. Spec. Nos.
& Crack Proof terminals.

"We completely manufacture everything we sell"

— Certified Plating to ALL MIL-Specs.

SEND FOR LATEST CATALOG

CONCORD ELECTRONICS CORPORATION
37 Great Jones St., New York, N. Y. 10012
212 — 777-6571

INFORMATION RETRIEVAL NUMBER 759
ELECTRONIC DESIGN 6, March 14, 1968

Size 9 DC Motor State-of-the-Art is off the shelf at AEI



The size 9 DC Permanent Magnet Motor, .875 in. dia x 1.375 in. length, is available open with Terminals or closed with Leads or Terminals.

Frame is Aluminum, finish Alodine per MIL-C-5541, with Armature supported in Ball Bearings.

Mounting either by Servo Clamps or Face Mounting by screws. Performance speeds are available from 5000 RPM to 20,000 RPM, at a continuous running torque of .21 in. oz. with an operating voltage of 6-50 VDC.

The Size 9 will meet all of the requirements of MIL-M-8609. Available accessories include Planetary Gearheads, RF Filter and Speed Governor.

Complete literature is available by writing Electro-Mechanical Group, American Electronics, Inc., 1600 East Valencia Drive, Fullerton, Calif. 92634, (714) 871-3020, TWX 910-592-1256

Electro-Mechanical Group AEI
AMERICAN ELECTRONICS INC.

- Please rush checked item(s)
- DC Motor Design Manual
 - DC Motor Technical Catalog

NAME _____

TITLE _____

COMPANY _____

ADDRESS _____

CITY _____ STATE _____ ZIP _____

INFORMATION RETRIEVAL NUMBER 762

312

COMPONENTS

Plug-in board accepts dual-in-line packages

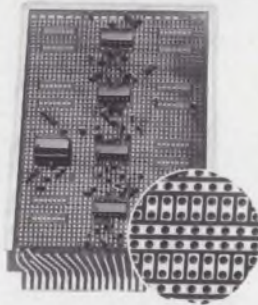

Vector Electronic Co., Inc., 1100 Flower St., Glendale, Calif. Phone: (213) 245-8971.

These plug-in circuit boards are 4-1/2 x 6-1/2 in., with an overall pre-punched grid of 0.041 in. holes on 0.1 in. centers. Copper etched lines 0.07 in. wide run vertically on one side of the boards and horizontally on the other. The boards provide an easy, fast method of mounting integrated circuits for experimental, prototype or small production runs.

Booth No. 4F09 Circle No. 378

Voltage regulator tames transients

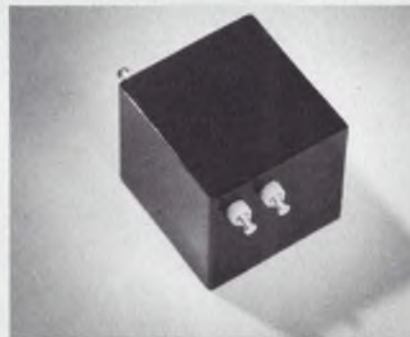

Polyphase Instrument Co., E. 4th St., Bridgeport, Pa. Phone: (215) 279-4660. Price: \$75.

A 400-Hz solid-state, line-voltage regulator developed for use with airborne electronic equipment operating from aircraft power sources meets the requirements of MIL-STD-704A. When connected between the power source and load, voltage transients present in such systems are suppressed and limited to safe peak values compatible with normal operation of the load equipment.

Booth No. 4E30 Circle No. 322

Flat pack relay stands 0.34 in. high



Electronic Controls, Inc., Danbury Rd., Wilton, Conn. Phone: (203) 762-8351. Price: \$5.35 to \$6.85 each.

Flat pack relays are available in a 4-pole make or transfer arrangement that stands 0.34 in. off the board. Designed for computer interface, automatic test or communications switching, the relays allow printed circuit boards to be mounted on 1/2 in. centers. The units may use an electromagnetic arrangement that permit them to transfer 3 A at 28 V dc or interrupt up to 1000 V ac at 100 mA. Typical dry circuit resistance is from 10 to 20 mΩ at 1 mV and 1 mA. Life at 100 mA is 100 million cycles. The unit mounts on a 0.1 x 0.1 in. grid.

Booth No. 4H07 Circle No. 283

Thick-film resistors use metal-oxide glaze

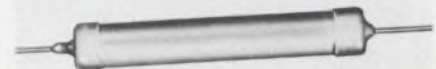

Victoreen Instrument Co., 10101 Woodland Ave., Cleveland. Phone: (215) 795-8200.

Metal-oxide glaze resistors based on thick-film techniques offer values from 10 kΩ to 500 MΩ. There is less than 1% full-load drift in 2000 hours and shelf drift is less than 0.1% per year. The tolerances are 1 to 2% in all types and values, with 0.5% for limited values. Power ratings to 5 W and voltage ratings to 15,000 V are available.

Booth No. 3B08 Circle No. 299

A-to-D Converters

... up to 12 bits
... loaded with options



4½" x 2½" x ¾"

- High-frequency FET input amplifier.
- Bipolar or unipolar input signals of varying ranges.
- Parallel and serial outputs of binary or BCD codes.
- TTL logic for high speed and fanout drive capability.
- Resolution up to one part in 4096 (12 bits)
- Extended temperature capability.

Get any of these options easily in the Pastoriza Model ADC-12_{ic} analog-to-digital converter — without the usual delays and extra cost that "specials" always involve.

The 12-bit Model ADC-12_{ic} is a single-card, general purpose, integrated circuit A-to-D converter that accepts input voltages on command and converts them to a 12-digit binary code in 25 microseconds. The single card contains an input amplifier, precision reference supply, logic, weighing network, switching, comparison, and internal clock. Only external DC power is needed.

The Model ADC-12_{ic} 12-bit converter is just one of Pastoriza's many competitively priced A-to-D and D-to-A converters. All are available with a variety of different input options, resolutions, and output codes.

Write or call for more information on ADC TTL Series.

PASTORIZA
ELECTRONICS, INC.
385 Elliot St., Newton, Mass. 02164 • 617-332-2131

COMPONENTS

Indicator lights are neon or incandescent

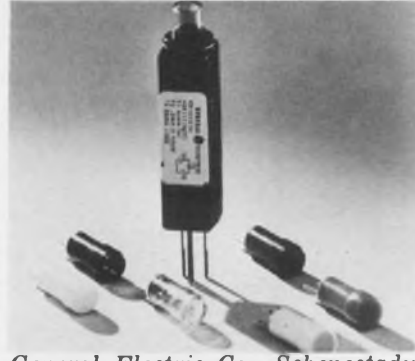

General Electric Co., Schenectady, N.Y. Phone: (312) 354-8585.

Fixed neon and removable cartridge incandescent indicating lights meet the application requirements for computers, data processing equipment, communications and control systems using printed or integrated circuits. The lights require very low input signal power to turn the indicator on or off. Input signals required to actuate the lights are: neon—ON, 0 to 2 V; OFF, 3.6 to 6 V. Incandescent—ON, 0 V at 1.4 mA; OFF, 6 V. The lights may be mounted from the rear of the panel with a single knurled nut and backwasher. Lights mount in a 3/8-in. dia hole on centers as close as 19/32 in. on panel thicknesses from 1/6- to 3/16-in. Both the incandescent and neon lights will operate in temperatures ranging from -40°C to 65°C at 95% humidity. Removable color lamp cartridges are available for the incandescent form in amber, red, blue, green, clear, and white translucent or white transparent.

Booth No. 3E11 Circle No. 400

Machined metal knobs have broached knurl

Control Corp., 530 Burnside Ave., Inwood, N.Y. Phone: (212) 471-9800.

Of all-metal construction, the control knobs feature a broached knurl that affords a crisper feel than one produced by die-casting. Various colored discs in the front face of the knobs may be ordered to harmonize with escutcheon plates or instrument exteriors. The knobs themselves can be anodized virtually any color.

Booth No. 4H25 Circle No. 293

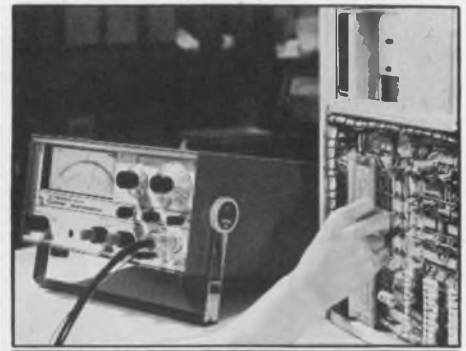

**EXTREMELY
HANDY,
TAKEDA'S
-TR-8651
ELECTROMETER
IS BOTH
ACCURATE AND
ECONOMICAL**



FEATURES:

-TR-8651 ELECTROMETER is conveniently used for:

Measurements of ● Semiconductor resistivity ● Insulation ● Piezo-electric charge ● Photo-electric current

-TR-8651 ELECTROMETER measures:

● Voltage from 1 mV to 100 V f.s. (11 range) with ±0.5% accuracy ● Charge from 10⁻¹² to 10⁻⁵ coulomb f.s. ● Current from 10⁻¹⁴ to 0.3 A f.s. ● Resistance from 100 to 10¹⁴ Ω f.s.

SPECIFICATIONS:

RANGE:

● Voltage: 1, 3, 10, 30 mV, 0.1, 0.3, 1, 3, 10, 30 and 100 V f.s. ● Charge: 10⁻¹² to 10⁻⁵ coulomb f.s. (1× and 3× overlapping ranges) ● Current: 10⁻¹⁴ to 0.3 A f.s. (1× and 3× overlapping ranges) ● Resistance: 10² to 10¹⁴ Ω f.s. on linear 1× and 3× overlapping ranges.

For further details, write to:



**Takeda Riken
Industry Co., Ltd.**

285, Asahi-cho, Nerima-ku, Tokyo, Japan.
Cables: TRITRONICS TOKYO Phones: 930-4111

INFORMATION RETRIEVAL NUMBER 767
ELECTRONIC DESIGN 6, March 14, 1968

new IC test instruments



Circle Card #221

IC LOGIC TEST SET — LT 101

Functionally tests digital IC's for conformance to truth table and also for proper values of "0" and "1" voltage levels. Test rate = 1000 tests/sec. Includes 2 variable power supplies, "0" and "1" input levels and clock generator programmed by plug-in circuit or direct reading dials (optional) \$4,850*

IC TEST SET — IC 102



Circle Card #222

20 line matrix with transference of readout line permits sequential testing without reprogramming \$5,000 (Approx.)*

For evaluation and test of all types of IC's. Includes voltage/current measurement, plug-in modules for d.c. voltage/current and pulse generator, R/C loads. 20 line matrix with transference of readout line permits sequential testing without reprogramming \$5,000 (Approx.)*

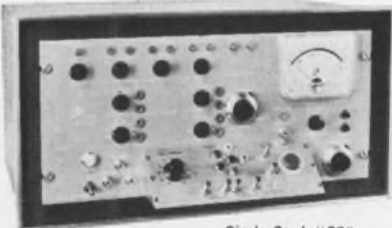

Circle Card #223

OP-AMP TEST SET — OPT 101

Tests op-amps for offset voltage, open loop d.c. gain, input current, voltage swing, input voltage range, power supply current. Includes direct readout of parameters, dual power supply and test adapter. \$1,950*

*F.O.B. Pleasantville, New York.



OPTIMIZED DEVICES, INC.
220 MARBLE AVENUE, PLEASANTVILLE, N. Y. 10570
(914) 769-6100/TWX: 914-769-7212

Visit us at NY-IEEE Booth 2C-13

COMPONENTS

Display indicator mounts flush

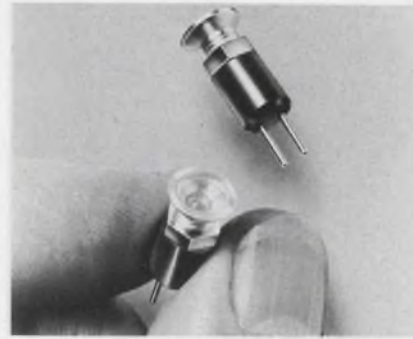

Display Devices, Inc., 2928 Nebraska Ave., Santa Monica, Calif. Phone: (213) 393-0385.

A relampable miniature indicator light that utilizes a standard T-1 lamp has a 0.312-in. lens dia that is flush with the panel in which it is installed. The over-all length, including terminals, is 0.78 in. The polycarbonate lens, available in clear or standard colors, fits a 100° countersunk hole in panels as thin as 0.062 in.

CIRCLE NO. 469

Miniature switch measures 4 mm wide

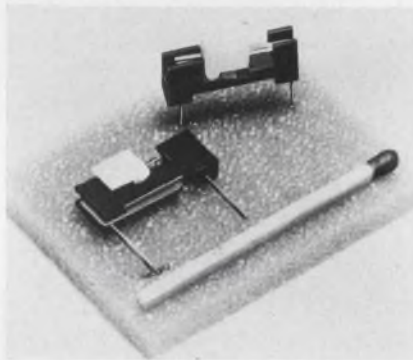

ITT-Standard S.A., 120 Rue de la Loi, Brussels 4, Belgium. Telex 23.276.

With an over-all width of only 4 mm, a new switch for printed-circuit boards can be positioned on individual circuit paths. Over-all dimensions of the switch assembly are 21 × 11 × 4 mm. The switch consists of a molded body, two separate contact springs, a tension spring and a sliding knob. Contacts and terminals are phosphor-bronze with precious metal plating.

CIRCLE NO. 470

Marker plates identify cables



Panduit Corp., 17301 Ridgeland Ave., Tinley Park, Ill. Phone: (312) 532-1800.

Identification marker plates, for identifying wire bundles of up to 4 in. dia, are 3/4 in. wide and available in lengths of 1-1/2, 1-3/4, 2, 2-1/2 and 3-1/2 in. They are all-nylon and can be hot-stamped or marked with a nylon-tip pen. All five sizes are easily secured to wire bundles using standard harness ties—two for each marker. Color is natural nylon white.

Booth No. 1C14 Circle No. 471

Proximity switches handle 300 V

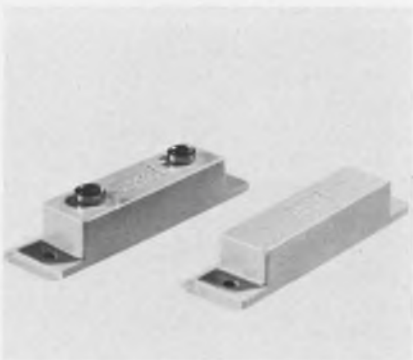

Alco Electronic Products, Inc., Lawrence, Mass. Phone: (617) 686-3888. P&A: \$2.85; stock.

Featuring the simplicity of the basic dry reed switch, an improved proximity switch has an expected life of 18 million operations at 48 V. An encased Alnico-5 permanent magnet provides the force to actuate the reed switch within distances of 1 in. (center to center). The current rating is 0.5 A with a voltage breakdown of 300 V dc. The unit is supplied as a normally open, unmagnetized switch. Booth No. 4G23 Circle No. 472

new IC test systems

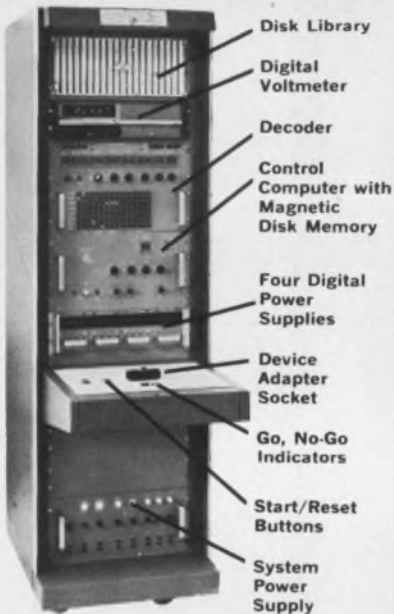

- Model 5000E (shown above)
20 Tests/Sec — \$29,900
- Model 5000H
100 Tests/Sec — \$36,900

For:

- INCOMING INSPECTION
- PRODUCTION TESTS
- RELIABILITY STUDIES
- QUALITY CONTROL

Both systems feature:

- High Speed Programming with Interchangeable Magnetic Disks
- Four Digit Readout and GO, NO-GO Digital Comparison to Dual Limits
- Alpha-Numeric Readback of all Program Conditions
- Four Digital Power Supplies, Constant Voltage/Constant Current
- Options for Data Logging, Device Classification Multiplexing, Linear Circuit Tests, and Dynamic Tests
- Direct Entry of New Programs or Changes in Existing Programs without specialized Machine Language



OPTIMIZED DEVICES, INC.
220 MARBLE AVENUE, PLEASANTVILLE, N. Y. 10570
(914) 769-6100/TWX: 914-769-7212

Visit us at NY-IEEE Booth 2C-13

INFORMATION RETRIEVAL NUMBER 773

MATERIALS

Epoxy-based adhesive is metal filled

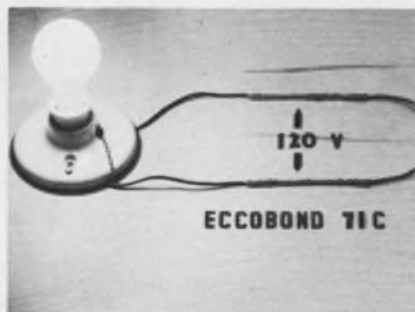

Emerson & Cuming, Inc., Canton, Mass. Phone: (617) 828-3300. Price: \$10/lb.

The high cost of pure silver has prompted the development of a metal filled epoxy-based adhesive which has a high conductivity. Eccobond solder 71C is a two component adhesive with a volume resistivity below $0.001 \Omega \text{ cm}$. It can be cured at room temperature and develops bond strength of 1000 lb/in.^2 and is supplied as two components which you mix yourself.

CIRCLE NO. 473

Spun shields are weld-free



Amuneal Manufacturing Corp., 2042 W. Jefferson St., Philadelphia. Phone: (215) 236-6800.

Spun magnetic shields, of weld-free seamless construction, are made by spinning the shield over a chuck of the exact configuration of the cathode ray tube or other component to be shielded. All shields are formed of Mu-metal (or equivalent) and all are hydrogen-annealed, after fabrication, to insure optimum magnetic shielding properties.

CIRCLE NO. 474

Adhesive heat sink cools transistors



Raiko Products, P.O. Box 375 Farmingdale, N.Y. Phone: (212) 224-9448. Price: \$3.25.

A one component heat sink and adhesive for transistors, SCRs, and other electronic components can be used for direct bonding to a metal chassis. This new product has many times more thermal conduction than silicone greases, requires no mica, and retains high electrical insulation. It is a one component system. Measuring and mixing are avoided.

CIRCLE NO. 475

Thixotropic coating provides rf shield

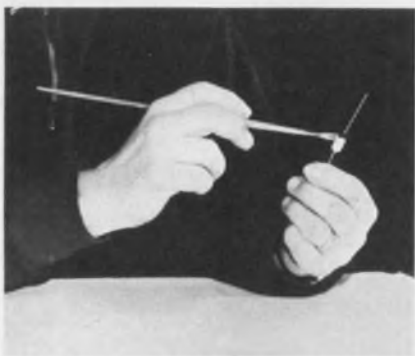

Epoxy Technology, Inc., 65 Grove St., Watertown, Mass. Phone: (617) 926-1949. Price: \$13/2 oz. kit.

A two-component, 100% solids, thixotropic paste containing pure silver for coating resistors and other electronic components, provides highly efficient, low-cost shielding. The epoxy compound is non-flowing and has good handling characteristics, a 4-hr. pot life, and curing cycles ranging from 10 minutes to 1-1/2 hours.

CIRCLE NO. 476

COLUMBIA WIRE

the name *QUALITY*
made famous servicing the
wire needs of industry!

Consistent quality, prompt delivery. From a miniature wire to a multiconductor cable — have established Columbia's leadership.

Regardless of your electrical or electronic need, for automated systems, instrumentation, communications or aerospace, military or consumer oriented, there is a Columbia wire, cable or power supply cord.

Columbia can ship from stock. Normal inventory of over 100 million feet stock cords for every application.

Columbia Custom Services

For special cords or cables, count on Columbia for the finest service possible. To your specifications—any combination of conductors up to 2" in diameter, and the largest variety of molds.

braiding,
shielding,
cabling,
cutting,
stripping,
termination,
stripping,
custom cord
molding
with our
own production
facilities . . .

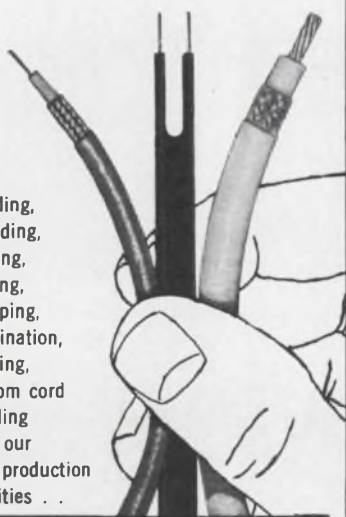

COLUMBIA

WIRE PRODUCTS COMPANY

4045 N. Rockwell Ave. • Chicago 60618
Phone: 312/267-3160

INFORMATION RETRIEVAL NUMBER 777

MATERIALS

Bolts and screws of molded nylon



Gries Reproducer Co., 125 Beechwood Ave., New Rochelle, N.Y.
Phone: (914) 633-8600.

Two lines of molded nylon machine screws and bolts are an addition to GRC's line of molded nylon fasteners. The screws come in four standard thread sizes, 6-32, 8-32, 10-32 and 1/4-20 with pan, flat or fillister heads. Formerly molded in lengths up to 1 in. they are now available up to 1-1/4 in. for the 6-32 size and 1-1/2 in. for the 8-32, 10-32 and 1/4-20 sizes. The molded nylon bolts are available in 5/16-18, 5/16-24 and 3/8-16 thread sizes. Lengths are 3/8, 1/2 and 1 in. for the 5/16 thread size and 1/2, 3/4 and 1 in. for the 3/8-in. thread size.

Booth No. 1C09 Circle No. 396

Ceramic fiber cement handles 2300°F

Babcock & Wilcox, 161 E. 42nd St., New York. Phone: (212) 687-6700.

A new ceramic fiber cement adds strength, abrasion resistance and insulation to a wide variety of materials, and will withstand continuous exposure to temperatures up to 2300°F. The cement sets with a strong hard film, which will develop a ceramic bond above 1000° F but still maintain excellent resistance to thermal shock. Resembling white paint, the cement is mildly alkaline and insoluble in water after drying. It is applied easily by brushing, spraying or dipping. A 0.010-in. coating covers 120 ft² per gallon.

CIRCLE NO. 477

Replace Costly AC/DC Circuits!

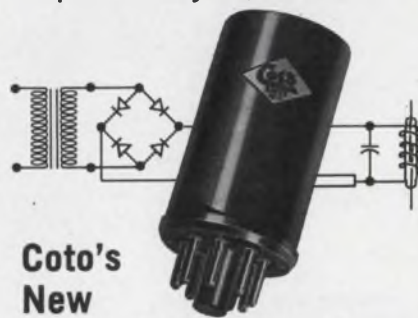

Coto's
New

A.C. Reed Relay

Designed to Operate on
Standard 60 Hz input

Contacts: Forms A, B, C with single or multiple poles.

Ratings: To 3 amperes or up to 5000 volts D.C.

Inputs: 50-400 Hz voltages available.

Physical: Available in steel or plastic octal base housings for plug-in mounting.

Write for complete specifications. For special requirements, give complete details for quotation.

Coto-Coil COMPANY, INC.
59 Pavilion Ave.
Providence, R. I. 02905
Phone (401) 941-3355

INFORMATION RETRIEVAL NUMBER 778

ACTIVE: PASSIVE
1 Hz to 1 MHz

FILTERS

SHIPPED
IN
7
DAYS

Active - Passive High Pass; Low Pass; Bandpass; Notch (optional power supply for active designs).

P. C. Mount - Chassis Mount Diallyl Pthalate Modules - Hermetically Sealed Cans.

A fast, dependable Engineering Service at competitive prices.

call 516-289-0066 or write

John M. Beukers Laboratories, Inc.
3205 Horse Block Road,
Medford, N.Y. 11763

INFORMATION RETRIEVAL NUMBER 779
ELECTRONIC DESIGN 6, March 14, 1968

The original lacing tape
is still the best...

... and saves money too!

That's
GUDELACE® 18

You ought to try
a sample...



GUDELACE
ties tight, makes
firm harnessing—fast!

It is important, of course, for you to use tape that complies with military specs, or commercial stipulations, but the usual allowances for wax content in such specs give no consideration to the best lacing conditions. Gudebrod GUDELACE is made within the specs—BUT, it's made too, for easy handling, tight knotting, firm harnessing. THAT'S WHERE IT SAVES MONEY, in the harnessing operation. GUDELACE, the original harness lacing tape, is manufactured under strict control. Every yard is impregnated exactly the same, exactly right. You can count on that—and on getting better harnessing—fast—with minimum rejects. Why not send for a sample, test it any way you want. Let your harness crew try it. You'll be glad you did! (Remember, the Gudebrod Lacing Tape line includes tape for nearly every special situation—ask for The Product Data Book.)

NOW—GUDEBROD HAS
TWO AIDS TO FASTER—
BETTER HARNESSING



**CABLE-LACER®
& GUDE-SNIPS®**

The production tested Cable-Lacer is now reduced in price—only \$9.95. Holds bobbin of tapes—makes tight knots. The palm held GUDE-SNIPS provide convenient tape cutting—using either right- or left-hand, \$3.75.



GUDEBROD

GUDEBROD BROS. SILK CO., INC.

Founded 1870

12 SOUTH TWELFTH STREET
PHILADELPHIA, PA. 19107

Electronics Division

INFORMATION RETRIEVAL NUMBER 783

Design Aids

Frequency computer

This computer greatly simplifies problems in frequency, inductance and capacity. It correlates the natural frequency and wave length of a circuit comprising a coil and a condenser, with the physical dimensions of the coil and the capacity of the condenser. Its range covers frequencies from 400 kHz to 3000 MHz. It handles capacitors of capacity between 1 and 1000 $\mu\mu\text{F}$.

Available for \$5.95 from INFO, Inc., Box 305, Newton, Mass.

Noise calculator



Ten scales are incorporated in this slide-rule type of noise calculator, to enable the user to perform various noise computations. Included are scales to determine thermal noise voltage and current developed by a resistor; shot noise voltage and current developed by a transistor or diode junction; and noise figure for a given source resistance from its spectral density.

Available on company letterhead from Quan-Tech Laboratories, Inc., 43 S. Jefferson Rd., Whippany, N.J.

Conversion table

From 1/2	Standard Conversion	Sign Conversion	% Resolution	Milliampere Conversion
1	1.0000	1.0000	1.0000	1.0000
2	2.0000	2.0000	2.0000	2.0000
3	3.0000	3.0000	3.0000	3.0000
4	4.0000	4.0000	4.0000	4.0000
5	5.0000	5.0000	5.0000	5.0000
6	6.0000	6.0000	6.0000	6.0000
7	7.0000	7.0000	7.0000	7.0000
8	8.0000	8.0000	8.0000	8.0000
9	9.0000	9.0000	9.0000	9.0000
10	10.0000	10.0000	10.0000	10.0000
11	11.0000	11.0000	11.0000	11.0000
12	12.0000	12.0000	12.0000	12.0000
13	13.0000	13.0000	13.0000	13.0000
14	14.0000	14.0000	14.0000	14.0000
15	15.0000	15.0000	15.0000	15.0000
16	16.0000	16.0000	16.0000	16.0000
17	17.0000	17.0000	17.0000	17.0000
18	18.0000	18.0000	18.0000	18.0000
19	19.0000	19.0000	19.0000	19.0000
20	20.0000	20.0000	20.0000	20.0000
21	21.0000	21.0000	21.0000	21.0000

An angular correlation table is displayed on a wallet-sized plastic card. The tabulation will be useful to personnel working in the areas of A/D conversion, D/A conversion or digital computer equipment. General Precision Systems Inc.

CIRCLE NO. 478

New Literature

ENGLISH
ELECTRIC
VALVES



VIDICONS



Vidicon guide

A leaflet describing vidicons contains 12 pages which give brief data for current 1-in. types, some with electrostatic- and others with magnetic-focusing. The range of vidicons described covers monochrome and color tv applications. English Electric Valve Co. Ltd.

CIRCLE NO. 481

Mylar capacitors

Operating characteristics of the 4M/200 V dc and 4M1/100 V dc series of metallized mylar capacitors for soldered or welded micro-module assembly are covered in a four-page brochure. Special and general features of the 4M/4M1 series highlighted in the brochure include: operating temperature, -65°C to $+125^{\circ}\text{C}$ with no voltage derating; dielectric strength, 200% of rated voltage; positive temperature coefficient; self healing even at extremely low voltage, and long-life construction with materials that do not deteriorate with time. The 4M/4M1 capacitors are designed to meet applicable portions of MIL-C-18312. Capacitance and tolerance for each case size in both the 4M1/100 V dc and 4M/200 V dc series, with nominal capacitance values in micro-microfarads, is provided in tabular form in the brochure. Case dimensions and lead-spacing schematics and three tables showing capacitance change, insulation resistance and dissipation factor versus temperature are also included. West-Cap Div., San Fernando Electric Manufacturing Co.

CIRCLE NO. 482



Aerospace computers

A 24-page catalog describes nine different aerospace digital computers and their variations. Replete with descriptive text, pictures and other features, the catalog details a variety of general-purpose and special-purpose navigation and guidance computers designed for more than 25 different applications aboard aircraft, missiles, boosters and spacecraft. General Precision Systems Inc.

CIRCLE NO. 483

Tools and machinery

A 68-page catalog describes assembly tools and machinery such as pliers, tweezers, wire strippers, cutters, benders and soldering aids. The machinery section describes miniature as well as standard drill presses, jeweler's lathes and other machine and hand tools. AAA Machinery & Tool Company.

CIRCLE NO. 484

Electronic countermeasures

A 12-page, 2-color brochure briefly outlines electronic countermeasures systems and includes a description of available services that includes program management operation, research system analysis, mechanical engineering, production, and environmental measurement facilities. Examples of recent countermeasure systems designed by the firm are described. American Electronic Laboratories, Inc.

CIRCLE NO. 485



Components catalog

A revised catalog on electronic components describes in detail more than one hundred different units. Component categories include miniature transistorized servo-amplifiers, quadrature rejection circuits, solid-state choppers, resolver buffer amplifiers, summing amplifiers, signal sensors, gyro erection amplifiers, magnetic amplifiers and stepper motor driver and logic circuits. New additions to the catalog are dc to ac modulators, ac to dc demodulators, 16 W and 50 W, 400 Hz servo amplifiers having 90° phase shift and a complete new series of stepper motor driver and logic electronic packages suited to a wide variety of permanent magnet, bifilar permanent magnet and variable reluctance stepper motors. General Precision Inc.

CIRCLE NO. 486

Adhesives and cements

A 32 page catalog provides technical information on specialty cements and industrial bonding compounds. The booklet details 33 products which are widely used in the ceramic, chemical, electrical, metal finishing, power and steel industries. A special feature of the catalog is a two-page fold-out characteristics chart which gives specific information on type, form, color, application, setting time, curing time, weight, heat limit, and resistance qualities of these products. Sauereisen Cements Co.

CIRCLE NO. 487

**Backlighted
Multi-Colored
Modular**

Graphic Display System

Please Check ✓

A System? —

Mass-produced assembly of standardized precision components, wired to terminal blocks in our factory.

Graphic Display? —

Reports completely on the status of any process system.

Modular? —

Panels interchangeable for easy modification or enlarging as required by varying applications; only simple hand tools needed.

Multi-Colored? —

Eight colors, four for any given symbol.

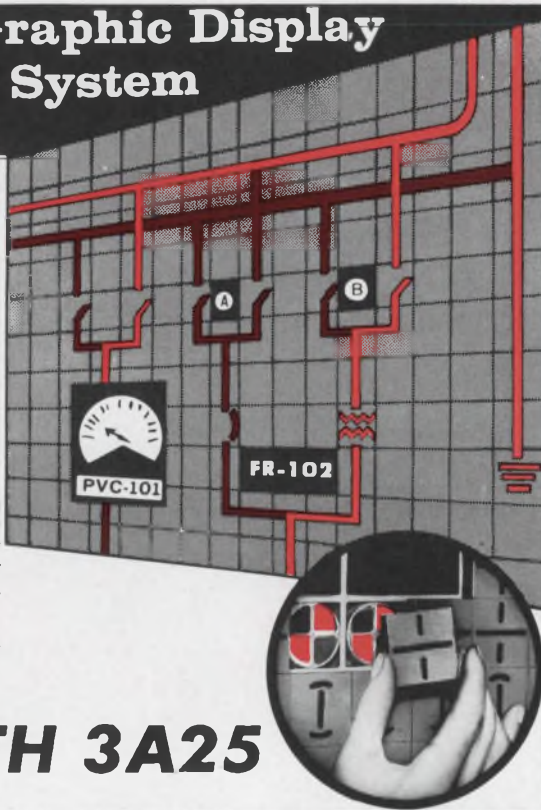

IEEE BOOTH 3A25

KCC SHOKAI LTD.



4-71 Kita-dori, Nada-ku,
Kobe, Japan
Cable: Wmkcc Kobe

U.S.A.-Canada:
Gail B. Rathbun Co., Inc.
1250 Space Park Way
Mountain View, Calif. 94040
Tel: 415-969-1155

"Booth No. 3A25 at IEEE"

INFORMATION RETRIEVAL NUMBER 786

NEW FROM AUSTRON



TFO-22 Series



PMC Series

Tuning-Fork Oscillators

Your low-frequency control requirements can be met most economically with Austron's TFO-22, designed to drive latest TTL or DTL micrologic devices. Features include wide temperature range and frequency range from 360 Hz to 10 kHz. The PMC is a rugged control device meeting severe shock and vibration MIL-SPEC requirements. Frequency range is from 2 kHz to 10 kHz. Write for details on Austron's complete oscillator line.

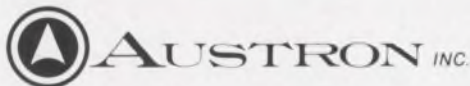

10214 NORTH INTERREGIONAL HIGHWAY, AUSTIN, TEXAS 78753 TELEPHONE (512) 454-2581

INFORMATION RETRIEVAL NUMBER 787

NEW LITERATURE



Spraying techniques

Six easy steps are the key to successful spray application described in this 8-page brochure. Magnified photographs show both good and bad spray patterns. The techniques described will be useful to anyone concerned with spray application of materials such as contact adhesives. Armstrong Cork Company.

CIRCLE NO. 488

Data directory

A tri-state directory of technical information sources including Washington, D. C., has been compiled. The directory shows more than 150 governmental, industrial, and institutional sources in New Jersey, New York, Pennsylvania and Washington, D.C., giving the type of information available and a summary of services, borrowing and purchase details. The complete range of technical information categories includes pollution, cryogenics, desalination, nuclear science and technology. Available for \$5, from New Jersey Council for Research and Development, Suite A, Hotel Robert Treat, 50 Park Place, Newark, N.J.



General catalog

A 75-page general catalog includes complete information on a commercial product line of antennas, solid state switches, detector mounts, and diodes. Information on filters, frequency multiplexers and instruments is also included. Parametric amplifiers, pulse generators, video and TWT amplifiers are covered in the comprehensive catalog. Data on a line of infrared detectors is also given. American Electronic Laboratories, Inc.

CIRCLE NO. 489

TWISTING TOROIDS ISN'T NECESSARY



Instead, choose the toroid configuration to fit your circuit design: radial-lead () or side-lead (). Saves assembly time. Halts lead breakage, during installation and when equipment is in use. Vanguard has your choice of styles with inductive values from 0.01 microhenries to 10 millihenries—all immediately available for the roughest environments, from -55°C to $+125^{\circ}\text{C}$. And thanks to the toroid's low external magnetic field, you can package units closer than

with other types of inductive devices.

While we can't say which lead type is best for your design, we do have a pair of suggestions. (1) Use side lead toroids for your prototype. They mount fast and are quickly removable. (2) Before starting on your breadboard, write for data on Vanguard's broad toroid line. You might find it necessary.

Vanguard Electronics/A Division of Wyle Laboratories/930 West Hyde Park Blvd./Inglewood, Calif. 90302/(213) 678-7161/TWX: 910 328-6126.



VANGUARD/WYLE

INFORMATION RETRIEVAL NUMBER 790

CUT CONSTRUCTION DELAY

with pre-punched
**VECTORBORD,*
PLUGBORDS and
Push-in TERMINALS**

Make circuits the fast, easy way . . . simply insert Vector push-in terminals (wide variety available) and component wires into pre-punched Vectorbord, or use punched copper clad for do-it-yourself etching; and, for production, we're geared to omit the holes not required and assemble terminals, eyelets, etc. to your specifications. Eleven patterns available with .025", .040", .062", .093" holes in XXXP phenolic, glass silicone, glass or paper epoxy and copper clad. Plugbords supplied in many sizes with etched pads, .040" dia. Edge-Pins or Elco Varicon* contacts.

Save time — Save work — Save money!

*TRADE MARK

Send for complete literature
VECTOR ELECTRONIC CO., INC.
1100 Flower St., Glendale, Calif. 91201 Area 213 Phone 245-8971
"See our Booth #4F09 at the IEEE Show"

INFORMATION RETRIEVAL NUMBER 791

NEW LITERATURE

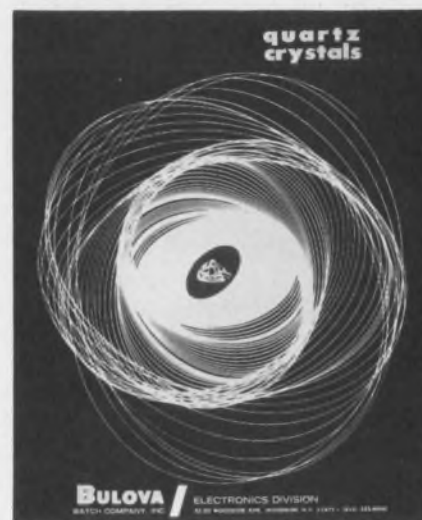

Quartz crystal catalog

An illustrated quartz crystal catalog includes a full line of quartz crystal resonators from 1 kHz to 150 MHz. Crystals may be obtained in solder-seal, cold-weld or precision glass sealed enclosures. In addition to standard military crystals produced to MIL-C-3098D specifications, many special designs for both filter and oscillator use are offered. Special high-vibration and shock mounts are available. Bulova Watch Company, Inc.

CIRCLE NO. 707

Broadband antennas

A technical data sheet discusses crossed planar log periodic antennas. Featuring a broad bandwidth with simultaneous horizontal and vertical polarization, these antennas have applications in ECM as well as other areas. Four standard models are described in the data sheet. American Electronic Laboratories, Inc.

CIRCLE NO. 708

Undersea research

A new eight page, full-color illustrated booklet gives details about ocean engineering activities. Some of the subjects detailed in the booklet are the Cachalot prolonged submergence diving system, Deepstar submersibles, sonar and the Ocean Research and Engineering Center with its 1500-test facility. Westinghouse Electric Corp.

CIRCLE NO. 709

Electronic Design

ELECTRONIC DESIGN's function is:

- To aid progress in the electronics manufacturing industry by promoting good design.
- To give the electronic design engineer concepts and ideas that make his job easier and more productive.
- To provide a central source of timely electronics information.
- To promote two-way communication between manufacturer and engineer.

Want a subscription? ELECTRONIC DESIGN is sent free to qualified engineers and engineering managers doing design work, supervising design or setting standards in the United States and Western Europe. For a free subscription, use the postfree application form inside the back cover. If none is included, write to us direct for an application form.

If you do not qualify, you may take out a paid subscription for \$25 a year in the U.S.A., \$35 a year elsewhere. Single copies are \$1.50 each.

If you change your address, send us an old mailing label and your new address; there is generally a prepaid postcard for this inside the back cover. You will have to requalify to continue receiving ELECTRONIC DESIGN free.

The accuracy policy of ELECTRONIC DESIGN is:

- To make reasonable efforts to ensure the accuracy of editorial matter.
- To publish prompt corrections whenever inaccuracies are brought to our attention. Corrections appear at the end of the Letters column.
- To refuse any advertisement deemed to be misleading or fraudulent.

Microfilm copies are available of complete issues of ELECTRONIC DESIGN and individual articles, published since the beginning of 1961. Complete issues cost 4¢ a page, articles cost 50¢ a page; shipping and handling charges are extra. The minimum charge is \$3. For further details and to place orders, contact University Microfilms, Inc., 300 N. Zeeb Road, Ann Arbor, Mich. 48106; telephone (313) 761-4700.

Want to contact us? If you have any comments or wish to submit a manuscript or article outline, address your correspondence to:

Howard Bierman, Editor,
ELECTRONIC DESIGN,
850 Third Avenue,
New York, N.Y. 10022.

Design Data from

FREE REFERENCE LETTERS AND NUMBERS CATALOG



Bishop Industries now offers the only complete catalog of sequential reference designations, letters and numbers, especially developed for the electronics industry. The new 12-page Catalog No. SRD-1, features the time saving, easy to use, StikOn drafting aids in the most commonly used sizes for electronic circuit and assembly layouts. Individually precut symbols are available in opaque black, transparent red and blue. Also reverse black, red and blue for absolute registration on two sided boards from single art. Included are illustrations, range of sizes and complete price and ordering information. Send today for your free copy.

BISHOP INDUSTRIES CORP.
11728 Vose Street
North Hollywood, California 91605

171

Clamp or Tie Wire Bundles In Seconds!



Six-page catalog contains complete ordering information for CAB-L-TITE® clamps and BUND-L-TITE® straps, devices which provide a fast and reliable means of securing wires and wire bundles. Units withstand loadings greater than 50 G's, are removable in seconds for re-routing wires, and are self-locking—no tying, no knots, no hitches to come loose. Lightweight Du Pont Zytel meets MIL-P-17091 and MIL-P-20693. Proved in aircraft and missiles. Photos, dimensional drawings, tables, physical properties, specifications, price list. Request catalog A.

Dakota Engineering, Inc.
4315 Sepulveda Blvd.
Culver City, California 90230

172

Ferrites For Electronics

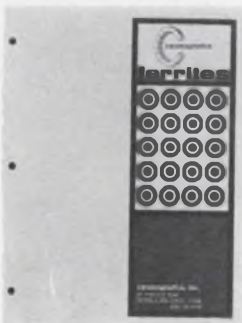

This new catalog provides detailed engineering information pertaining to ferrite materials, their inherent magnetic characteristics and recommended applications for their optimum usage.

Offered are specific materials designed for:

- Low and Medium Frequency Small Signal Devices.
- Medium to High Frequency Devices.
- High and V.H.F. Devices.
- U.H.F. Microwave and Millimeter Wave Devices.
- Magnetostrictive and Electromechanical Transducers, Couplers and Filters.

Ceramic Magnetics, Inc.
87 Fairfield Road
Fairfield, New Jersey 07006
(201) 227-4222

173

Advertisers' Index

Advertiser	Page	Advertiser	Page	Advertiser	Page
ACDC Electronics, Inc.	297	Duncan Electronics, Inc.	299	Kings Electronics Co., Inc.	U111
Acme Electric Corp.	264	Dynage, Inc.	U164	Kistler Instrument Corporation	331
Acopian Corporation	62			Krohn-Hite Corporation	279
Adams & Westlake Company, The	U141				
Ad-Yu Electronics, Inc.	U160				
Airpax Electronics, Cambridge Division	U129	EMN Company	319	LFE Electronics, Division of	
Aladdin Industries, Inc.	U117	Electro Scientific Industries, Inc. 232 A-B-C-D		Laboratory of Electronics, Inc.	260
Alfred Electronics	265	Eldre Components, Inc.	333	Lambda Electronics Corp.	42, 43
Allen-Bradley Co.	39, 41	Electro Materials Corp.	255	Lectro Magnetics, Inc.	234
American Electronics, Inc.	312	Electronic Design	U132, U150	Lee Spring Company	317
American Monarch, A Rowan Affiliate	U155	Electronic Engineering Co. of California	259	Lenox Fugle Electronics, Inc.	329
American Zettler, Inc.	268	Electronic Research Associates, Inc.	44	Licon, Division Illinois Tool Works, Inc.	34, 35
Ammon Instruments, Inc.	310	Electrovert, Inc.	286	Line Electric Company	319
Amphenol Controls Division,		Executone, Inc.	240B	Littlefuse	U162
Amphenol Corporation	223			Litton Industries, Encoder Division	325
Anzac Electronics, Inc.	282			Litton Industries, Winchester Division	284, 285
Anritsu Electric Co., Ltd.	U138	Fairchild Instrumentation, A Division of		Lockheed Electronics Company	37, 170
Art Wire and Stamping Co.	U137	Fairchild Camera and Instrument Corporation	45		
Artisan Electronics Corporation	302	Fairchild Semiconductor, A Division			
Arvin Frequency Devices	304	Fairchild Camera and Instrument Corporation	4, 5, 180, 181	McLean Engineering Laboratories	288
Atlas Fibre Co.	303	Federal Scientific Corp.	309	Mallory Capacitor Company	267
Augat, Inc.	16			Mallinckrodt Chemical Works	U161
Austron, Inc.	326			Master Specialties Company	240C
				Matsuo Electric Co., Ltd.	306
				Metex Corporation	313
B & B Motor & Control Corp.	307			Microdot, Inc.	20
Bel Fuse, Inc.	315	Gardner-Denver Company	U143	Miller Company, J. W.	262
Belden Corporation	190, 191	General Cable Corporation	275	Miller-Stephenson Chemical Co., Inc.	U168
Beta Instrument Corp.	329	General Electric Company, Lamp Metals & Components Dept.	290	Molex Products Company	269
Beuker Labs, Inc. John	320	General Electric Company, Miniature Lamp Dept.	60	Mosiac Fabrications, Division, The Bendix Corporation	11
Birnback Brand Rex	U147	General Electric Company, Semiconductor Products Department	U121, U122, U123	Motorola Semiconductor Products, Inc.	14, 61
Bishop Industries Corp.	330	General Electric Company, Specialty Control Dept.	227		
Boonton Electronics Corp.	48	General Instrument Corporation	U107	NJE Corporation	U135
Borden Chemical Co., The Mystic Tape Division	281	General Precision Systems, Inc., Kearfoot Products Division	8, 9	Natel Engineering Co. Inc.	298
Bourns, Inc.	27	General Radio Company	U77	National Semiconductor Corporation	12, 13
Buckeye Stamping Co., The	304	Georator Corporation	240D	National Technology, Inc.	254
Burdny Corporation	261	German American Chamber of Commerce	U118	Northern Natural Gas Co.	273
Burr-Brown Research Corporation	10	Grayhill, Inc.	286	Nortronics Company, Inc.	308
Burroughs Corporation	64	Gudebrod Bros. Silk Co., Inc.	322, 323	Nyrnoics, Inc.	29
		Guardian Electric Manufacturing Company	U153		
				Oak Manufacturing Co.	231
CML, Inc.	290	Harowe Servo Controls, Inc.	U152	Ohio Semiconducting Inc.	313
Cal-R, Inc.	40, 56, 276	Haydon Switch & Instrument Inc.	248	Ohmite Manufacturing Company	257
Cambridge Communications Corp.	321	Hewlett-Packard	Cover II, 55, 307	Optimized Devices, Inc.	316, 318
Cedar Engineering Division, Data Control Corporation	266	Hi-G, Inc.	334		
Centralab, the Electronics Division of Globe-Union, Inc.	63	Honeywell, Computer Control Division	52	Pamotor, Inc.	U156
Ceramic Magnetics, Inc.	330	Houston Instruments, A Division of Bausch & Lomb	283	Pastoriza Electronics, Inc.	314, 315
Chassis-Trak Inc.	278	Howard Industries, A Division MSL Industries, Inc./Motor Group	294	Philbrick/Nexus Research, a Teledyne Corporation	195
Chemical Division of 3M Company	7	Hudson Tool & Die Company, Inc.	U105	Philco-Ford Corporation	221
Cinch, Division of United Carr	229	Hughes Aircraft Company	16A-B-C, 31, 59, 291	Pinlites Inc.	300
Clairex Electronics, Inc.	311			Plas Metex Industries, Inc.	294
Clare & Co., C. P.	36	IBM Data Processing Division	241	Plastic Capacitors, Inc.	292
Clifton, Division of Litton Industries	331	IMC Magnetics Corporation	58	Potter & Brumfield Division of American Machine & Foundry Company	U99
Cohn Corp., Sigmund	321	Ideal Precision Meter Co. Inc.	311	Power/Mate Corp.	46
Columbia Wire Products Company	320	Industrial Electronic Engineers, Inc.	238, 239	Pulse Engineering, Inc.	333
Comar Electric Company	U157	Industrial Electronic Hardware Corporation	274	Pyrofilm Resistor Co., Inc.	U142
Components, Inc., Arizona Division	U151	Industrial Timer Corporation	317		
Components, Inc. Maine Division	U139	Intercontinental Instruments, Inc.	U167	RCA Electronic Components and Devices	1, 189, Cover IV
Concord Electronics Corporation	310	Interdata Corp.	23	RCL Electronics, Inc.	6
Consolidated Electrodynamics, A Subsidiary of Bell & Howell	200	Interelectronics Corp.	303	RFL Industries, Inc.	285
Control Logic, Inc.	235	International Electronic Research Corporation	293	Radiation, Incorporated	U125
Coto Coil Company, Inc.	320	JFD Electronics Co. Components Division	317	Radio Cores, Inc.	321
Curtis Development & Mfg. Co.	333	Johnson Company, E. F.	U128	Raytheon Computer	50, 51
				Raytheon Company, Sorensen Operation	253
				Raytheon Company, Semiconductor Operation	24
Dakota Engineering, Inc.	330	K.K.C. Shokai Ltd.	326	Reeves Hoffman Division of DCA	17
Dale Electronics, Inc.	Cover III	Kay Electric Company	U108	Ripley Co., Inc.	296
Davies Molding Company, Harry	298	Keithley Instruments, Inc.	33		
Dearborn Electronics Inc.	49	Kepeco, Inc.	U116	Sage Electronics Corporation	313
Del Electronics Corporation	U162			Scientific Atlanta, Inc.	U101
Delco Radio, Division of General Motors	210, 211				
Delevan Electronics Corporation	250				
Delta Products, Inc.	U130				
Deutsch Electronic Components Division	201				
Dialight Corporation	307				
Diamond Tool and Horseshoe Co.	319				
Digital Equipment Corporation	280				
Digitran Company, The	327				

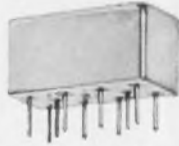

2 Amps.
All Welded

NEW  **LATCHING RELAY**

DPDT
0.37 oz.

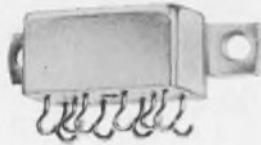

The new KL Series combines the proven performance of Hi-G 1/2 size crystal can relays with a unique new latching design. These relays meet all the applicable requirements of MIL-R-5757 and are available for fast delivery in all standard configurations and header styles.

Write or call Hi-G for Bulletin #103. If you need applications engineering assistance, an experienced Hi-G representative awaits your call. Telephone: (203) 623-2481



SPRING STREET & ROUTE 75 / WINDSOR LOCKS, CONNECTICUT 06096

The new SERIES KL Relays are available at the following DISTRIBUTORS

Angus, Incorporated, Pleasant Valley Avenue, Moorestown, N.J. 08057 TEL: 609-235-1900

Federal Electronics, P.O. Box 1208, Vestel Parkway E., Binghamton, New York 13903 TEL: 607-748-8211

Lelectronix, Incorporated, 214 North 2nd Street, P.O. Box 188, St. Charles, Missouri 63301 TEL: 314-723-1122

Moulton Electronics Distributors, Inc., 1058 Terminal Way, San Carlos, California 97078 TEL: 415-591-8292

Moulton Electronics, c/o Banks Sales Corp., 2785 N. Speer Blvd., Denver Colorado 80211 TEL: 303-433-5455

Tomelco/Moulton, 531 N. Brown Avenue, Scottsdale, Arizona 85251 TEL: 602-945-5030

Tomelco/Moulton, 15846 Pacific Highway South, Seattle, Washington 98188 TEL: 206-246-1727

Radio Products Sales, Inc., 1501 South Hill Street, Los Angeles, California 90015 TEL: 213-748-1271

R and D Electronics, Inc., 71 Pearl Street, Cambridge, Mass. 02139 TEL: 617-864-0400 and 8401; ENTERprise 7135 in Major Cities

Solid State Electronics Co. of Texas, 2643 Manana, P.O. Box 20299, Dallas, Texas 75220 TEL: 214-352-2601

Westates Electronics Corp., 20151 Bahama Street, Chatsworth, California 91311 TEL: 213-341-4411

Information Retrieval Service

(continued)

All products, design aids (DA), application notes (AN), new literature (NL), and reprints (R) in this issue are listed here with Page and Information Retrieval numbers. Reader requests will be promptly processed by computer and mailed to the manufacturer within three days.

Category	Page	IRN	Category	Page	IRN	Category	Page	IRN
Power supplies			tape recorder	310	459	vector voltmeter	287	278
fast-charge battery	U124	321	telemetry system	306	457	voltmeter counter	U136	359
IC compatible						VSWR tester	280	341
transformers	U118	289	Test equipment			Electronic Design Test		
power supply, 2400 V	306	399	amplifier plug-in	U136	348	Instrument Directory (R)		704
transformer-inductors	U128	282	audio source	288	284	constant current (AN)	323	479
			auto-ranging			conversion table (DA)	322	478
Production equipment			multimeter	278	397	frequency computer (DA)	322	
beam-lead welder	302	454	capacitance bridge	U134	349	noise calculator (DA)	322	
cable clamping tool	U140	374	chart recorder	276	438	counters and readouts		
cable stripper	302	455	coaxial rf switch	272	337	(NL)	327	706
coil-winding machine	300	451	component comparator	286	277			
coil-winding machine	U142	342	controller	U138	364			
coordinate digitizer	U140	280	counter	280	269			
counter pushbutton	U120	325	dc amplifier	285	264			
diffusion furnace	300	452	dc bias supply	268	344			
drafting machine	298	446	dc power supply	276	335			
drilling machine	304	465	differential amplifier	U146	276			
engraving machine	U140	294	digital multimeter	291	440			
mask-making metal-clad			digital printer	U138	368			
plates	321	392	dual-trace					
micropositioner	304	464	oscillator	290	261			
microsolderer	299	450	electrometer op amp	315	467			
microcircuit bonder	298	445	frequency selector					
microfurnace	298	447	plug-in	287	285			
miniature torch	304	466	function generator	286	712			
pantograph engraver	U140	296	function generator,	272	379			
photon counter tube	U120	367	gauss meter	U136	297			
polymer 360 extrusions	299	448	grid-dip meter	274	262			
soldering conveyor	U140	351	harmonic generators	266	428			
timer-counter	299	449	impedance bridge	276	356			
thick-film furnace	U142	409	logarithmic detector	283	360			
wafer tester-sorter	302	456	microscope, 1500 power	308	463			
wave solderer	302	453	multichannel					
tools and machinery			oscilloscope	270	397			
(NL)	324	484	oscillator, adjustable	290	437			
			oscillator, 1 MHz	U126	251			
Semiconductors			oscillator, 100 mW	U158	331			
FET op amp	U149	279	phase meter	288	288			
junction diodes,			portable laser	260	422			
L-band	U149	370	potentiometric device	U136	355			
junction diodes	292	432	potentiometric meter	U138	268			
multiplier rectifiers	294	433	power supply, 100 V	268	267			
n-channel FET	294	434	power supplies					
power transistor, 25 A	U152	375	to 100 V	282	265			
S-band mixer diode	U152	372	programmable source	272	364			
silicon rectifiers	294	435	pulse generator	U136	339			
thyristor 5000 A	U148	401	refrigeration chamber	283	340			
transistor, switch or			remote preamplifier	U134	270			
amplifier	295	436	resolver-synchro					
Electronic Design			converter	U134	290			
Semiconductor Directory (R)		703	rf attenuators	280	381			
thermistor notes (AN)	323	480	rf sweep generator	278	259			
			rf wattmeter	268	365			
Systems			spectrum analyzer	268	393			
analog computer	310	460	step attenuators	279	263			
analog synchronizer	306	458	strip-chart recorder	U146	274			
A to D converter	308	271	sweep generator	291	439			
bidirectional counters	311	461	sweep generator	274	258			
coaxial matrix	U144	362	sweep generator	U138	369			
electrometer amplifier	U144	343	sweep source	280	336			
microscope, 1500 power	308	463	taut-band meter	279	287			
PCM multiplexer	308	462	ten-channel recorder	285	286			
parallel-storage unit	U144	380	time-delay generator	282	377			
photoelectric reader	311	272	time-signal receiver	U136	366			
power supply, 2400 V	306	399	transfer standard	276	326			
static card reader	U144	324	TV test set	270	345			

New Literature

adhesive and cements	324	487
aerospace computers	324	483
broadband antennas	328	708
ceramic data chart	329	710
coaxial magnetrons	329	711
components catalog	324	486
counters and		
readouts	327	706
data directory	326	
electronic		
countermeasures	324	485
general catalog	326	489
microwave devices	327	490
mylar capacitors	324	482
quartz crystals	328	707
spraying techniques	326	488
tools and machinery	324	484
underseas research	328	709
vacuum capacitor		
data	327	705

Design Aids

conversion table	322	478
frequency computer	322	
noise calculator	322	

Application Notes

constant current	323	479
thermistor notes	323	480

Reprints Available

Digital chips shift into		
analog territory		700
Practical guide to threshold		
logic		701
The tiny, exploding world		
of linear microcircuits		702
Electronic Design		
Semiconductor Directory		703
Electronic Design Test		
Instrument Directory		704

RCA hard-tube modulators... for nanosecond service

Now, nanosecond switching time, low inductance, and low capacitance come naturally for L-, C-, X-, and S-band radar with RCA-4630 and 4634 Cermolox® tubes. Representative of RCA's capability in hard-tube modulator service, these conduction-cooled, beam power tubes are especially suitable for high-package-density airborne applications where μ sec modulation of reactive loads is required at high duty factors. Cermolox construction achieves a new high in tight characteristic control for ultra-reliable systems.

RCA-4630 is rated for 17 kV DC plate voltage. Its reliable matrix cathode permits a peak plate current rating of 40.0 amperes at a duty factor of 12.5 per cent and a pulse duration of 2 μ sec. RCA-4634 is rated for 7000 volts. Its peak plate current rating ranges from 8.0 amperes at 2 μ sec pulse length and 0.05 per cent duty factor to 0.6 amperes at a DC level.

Your RCA Representative can tell you more about these hard-tube modulators and how their characteristics and cooling methods can be tailored to your space configurations. Technical data from Commercial Engineering, Section C18-Q, RCA Electronic Components, Harrison, New Jersey 07029. Also available from your RCA Industrial Tube Distributor.

RCA



RCA-4630 and 4634 are typical of the compact, rugged units available from RCA for use as hard-tube modulators.