

Electronic Design 22

VOL. 15 NO.

FOR ENGINEERS AND ENGINEERING MANAGERS

OCT. 25, 1967

Come in. Let's talk threshold logic the way we would talk about, say, amplifier design. That is, let's not use a mathematician's approach and get bogged down quickly on

the way to plus or minus infinity. Instead, we'll work out a practical, easy-to-follow set of logic-circuit design procedures that can be readily used. Join us on page 65 for details.



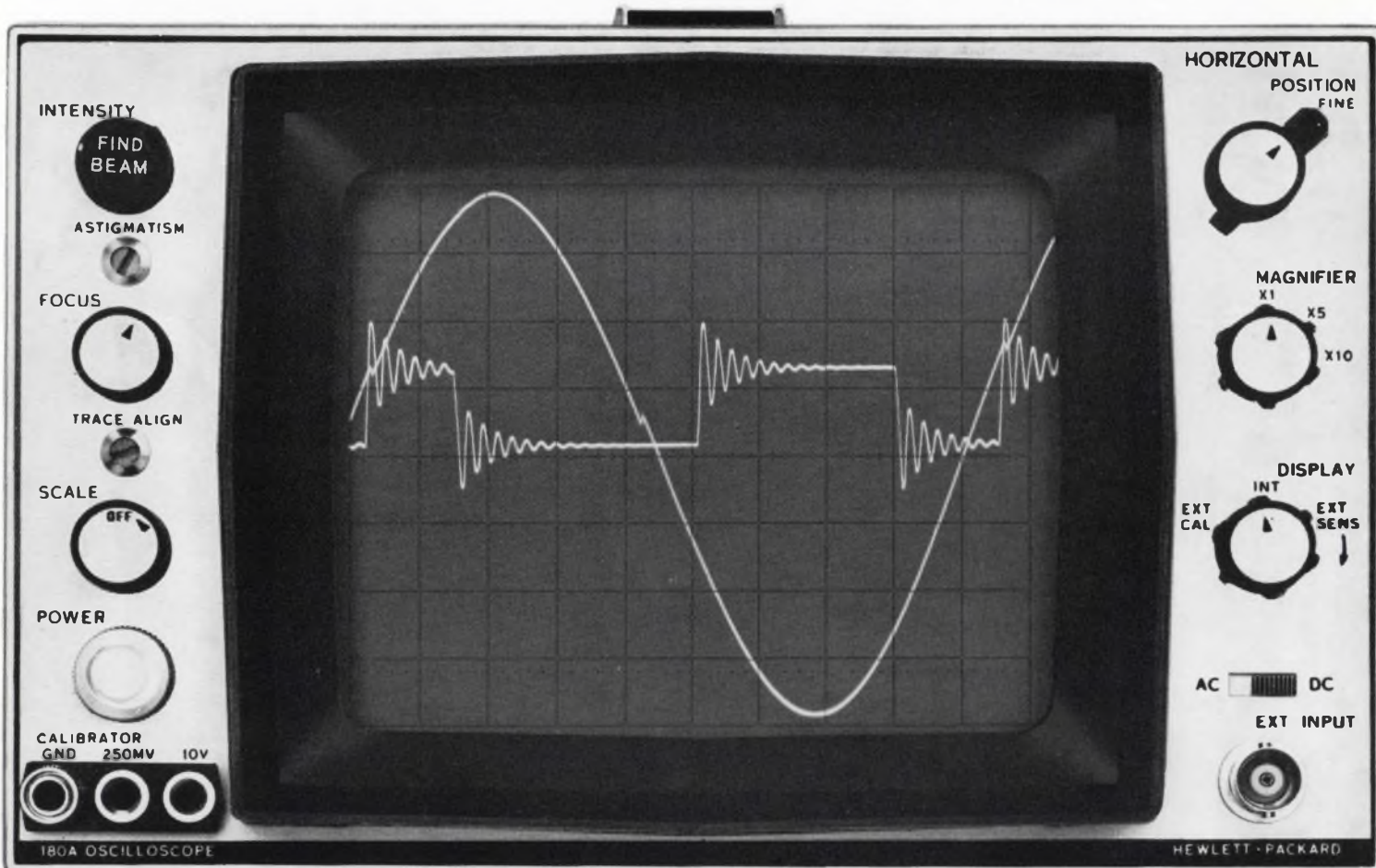

See More! Do More! With the hp 180A — the scope with room to grow!

The hp 180A—the new concept in overall scope design—is destined to be the industry standard. All solid-state circuitry gives you the big advantages of state-of-the-art technology, now! With plug-in capability, your 180A scope system has room to expand for tomorrow's demands!

All-solid-state design in the 180A gives sweep speeds and sensitivities that are easier to get and hold, easier to calibrate—better all-around reliability. All-solid-state design eliminates the need for fans, troublesome heat-producing vacuum tubes, excessively high current power supplies, and bulky, heavy cabinets. Get all the performance and versatility inherent in new solid-state technology . . . get the new hp 180A, the scope with room to grow!

Mainframe of the 180A lab/field scope has a big-picture 8 x 10 cm CRT for easier-to-see traces, readable to greater accuracies. Power supply and CRT have capability of handling existing and future solid-state plug-ins. Special internal phase bandwidth switch matches phase shift of horizontal to phase shift of vertical for accurate phase measurements.

Three plug-ins are currently available. The 1801A Dual Channel Amplifier plug-in allows you to plot A and B traces for accurate comparison. It gives you dc to 50 MHz bandwidth with 7 nsec rise time, on all ranges from 5 mV/cm to 20 V/cm. Use convenient internal Channel B trigger in ALT or CHOP modes for easy time correlation of traces.

The 1821A Time Base and Delay Generator provides slow/fast sweep displays. Exclusive hp mixed sweep features com-

bine display of first portion of trace at normal sweep speeds, and simultaneously expands trailing portion of trace at faster delayed sweep speed to allow magnified examination. The 1821A triggers to >90 MHz, sweeps from 1 sec/cm to 10 nsec/cm.

The 1820A Time Base has a variable holdoff to permit variation of time between sweeps to allow triggering on asymmetrical pulse trains. Triggers to beyond 90 MHz, sweeps from 2 sec/cm to 5 nsec/cm.

Specify the rugged hp 180A Oscilloscope to get the complete versatility you need for general laboratory and field work. Ask your hp field engineer for data sheet. Or, write to Hewlett-Packard, Palo Alto, California 94304. Europe: 54 Route des Acacias, Geneva. Price: hp 180A Oscilloscope, \$825; hp 180AR (rack) Oscilloscope, \$900; hp 1801A Dual Channel Vertical Amplifier, \$650; hp 1820A Time Base, \$475; hp 1821A Time Base and Delay Generator, \$800.

087/32

HEWLETT  PACKARD

OSCILLOSCOPE SYSTEMS

ACTUAL SIZE

OSCILLATOR 10 Hz-50 kHz

E 1313-A

SERIAL 125

L RADIO
MASS USA



10 Hz to 50 kHz with one dial turn



With our new Type 1313-A Oscillator, you can manually sweep through its entire frequency range with one turn of the main dial. There are no range-switching transients or ambiguous dial multipliers to contend with; frequency changes can be made quickly and conveniently. The all-solid-state 1313-A provides both sine- and square-wave outputs, has a calibrated 60-dB step attenuator with a zero-volts-behind-600 Ω output position, and a 20-dB continuously adjustable attenuator. Distortion is only 0.5% from 100 Hz to 10 kHz.

The 1313-A is the fourth in our new line of "sync-able" oscillators. Like

the others, the 1313-A has a SYNC jack for external synchronization, is completely self-contained, and is small and lightweight (8 by 6 by 8 in, 7 lb). Even the price is a feature — it's only \$325*!

For complete information, write General Radio Company, W. Concord, Massachusetts 01781; telephone (617) 369-4400; TWX 710 347-1051.

*Price applies in USA only.

GENERAL RADIO

ON READER-SERVICE CARD CIRCLE 3

If you buy HP counters, we have news for you.

Systron-Donner makes advanced counter instrumentation that has no equivalent in the HP catalog. That's why it pays to check with Systron-Donner before you buy. You'll find equipment with unique capability like:

1. A plug-in that will extend your counter's frequency range to 15 GHz – measuring FM and pulsed RF as well as CW and AM. The only way to get the full dc to 15 GHz range in one cabinet. No calculations. Displays final answer.



3. "Thin Line" counters that take only 1 3/4" of rack space. Built with ultra-reliable integrated circuits to give you automatic frequency measurements – dc to 100 MHz or 0.3 to 12.4 GHz.

These are the highlights of expandable systems that will make just about any measurement possible with counters. The accuracy of our basic 50 MHz and 100 MHz counters is unsurpassed. (Time base aging rate is only 5 parts in 10¹⁰ per 24 hrs.) All devices to extend the range or add functions are convenient plug-ins – not rack mounts. The newest are a prescaler to extend counter range to 350 MHz and a heterodyne converter to measure noisy signals in the 0.2 to 3 GHz range.

Are you surprised that Systron-Donner is a step ahead of HP in counter technology? How else could we stay in business?

Systron-Donner Corporation, 888 Galindo Street, Concord, California 94520

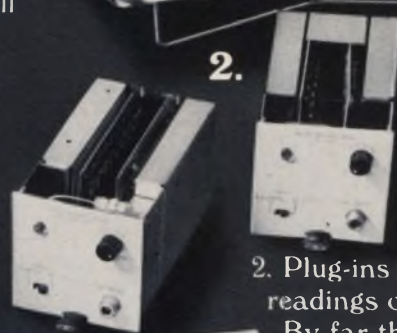

2. Plug-ins that produce automatic readings of microwave frequencies. By far the most compact and economical equipment for producing automatic readings in the 0.3 to 3 GHz band or the 3 to 12.4 GHz band.

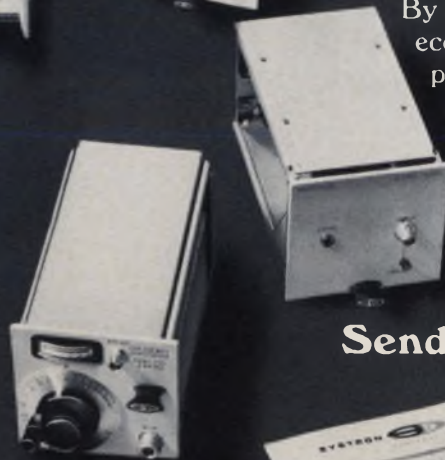

Send for catalog.



SYSTRON  DONNER

NEWS

- 13 News Scope
- 17 **News Feature: Nike-X: A merger of radars and computers**
U.S. defense to use phased arrays under digital control.
- 26 Integrated-circuit reliability: fact or myth?
- 29 Washington Report
- 33 Satellite memory goes to sea on a buoy.
- 40 Picosecond diode takes a 450-volt jolt.
- 48 Letters
- 61 **Editorial: The great American brain drain: It's time to stop.**

TECHNOLOGY

- 65 **Special Report: The promise of threshold logic**—neglected design tool that is capable of drastic gate reductions in future logic systems.
- 90 **Design a high-speed counter** that achieves eight-place accuracy and high stability over a wide frequency range.
- 98 **Destroy your microwave transistors** with a few common tools—an ohmmeter, a soldering iron, your fingers and transistor test sets.
- 104 **Graphs speed two-section filter design** by providing the exact pole positions, the attenuation and the component values at any angular frequency.
- 110 **Check cabinet requirements** before buying standards or specials. Here are guidelines to simplify your selection.
- 114 **'Let's smooth the path to management.'** Survey shows managers believe that colleges, concerns and professional societies can do more.
- 126 NASA Tech Briefs
- 130 Ideas for Design

PRODUCTS

- 144 **Semiconductors:** Gallium arsenide phosphide used in 450-fL diode.
- 150 Materials
- 160 Microwaves
- 164 Production Equipment
- 167 Microelectronics
- 168 Test Equipment
- 176 Components
- 194 Systems

Departments

- 122 Book Reviews
- 200 Design Aids
- 202 Application Notes
- 204 New Literature
- 210 Reprints
- 212 Advertisers' Index
- 214 About the Magazine
- 215 Designer's Datebook

Now that you're going to buy a multi-function meter, get hp's extra measure of

Performance

Step-ahead design, extra attention to construction, use of premium components throughout – these are the features that give you an extra measure of performance in hp Multi-Function Meters!

Step-Ahead Design. – Here are four of hp's most popular multi-function meters. Each of them has contributed to the state-of-the-art of multi-function meter design. One of the first meters in this line, the *hp Model 410B* was the first to offer high accuracy, sensitivity and stability over a wide frequency range. The *hp Model 410B* still warrants high preference because the circuit performs better than its predecessors or any of its later copiers. The *hp Model 412A* was the first multi-meter to use a photo-chopper to make a dc amplifier stable enough to eliminate the necessity for a front panel zero control. The *hp Model 410C* was the first multi-meter design to adapt solid-state circuitry for better performance, increased reliability and compactness of size. The 410C also utilized the first hp taut-band meter – now used in all hp multi-function meters. The *hp Model 427A* is the first multi-function meter to combine use of the inherent advantages of all-solid-state, ultra-low current circuitry with battery operation.

Extra Attention to Construction. – Reliable, glass-epoxy circuit boards with extra-heavy copper etch are used throughout hp multi-function meters. These instruments will withstand rugged use and tolerate wide fluctuations in temperature and humidity. Exclusive hp-made taut-band suspension meters give excellent repeatability with friction completely eliminated. Each meter scale is individually calibrated for accurate readings over the entire range.

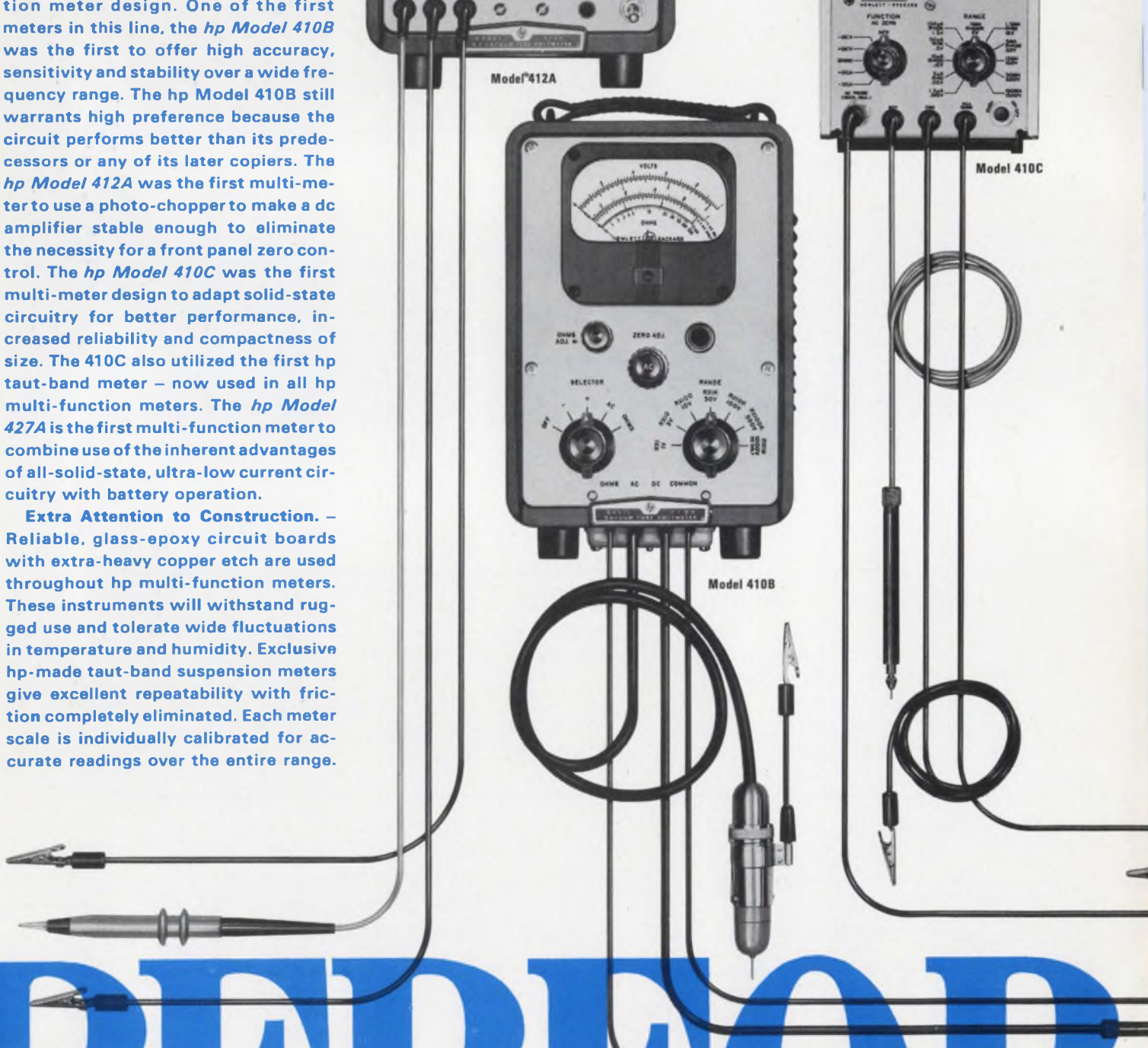
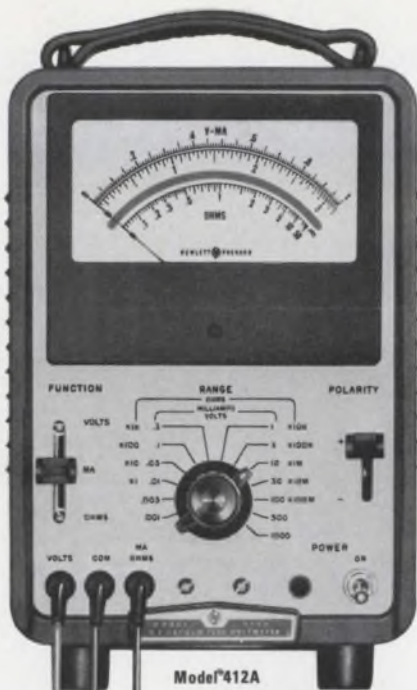

PREFERRED

Premium Components Used Throughout. — Only premium high reliability components are used throughout hp multi-function meters. When hp can't get components necessary to meet the high hp quality standards, they are manufactured "in-plant." Resistors, taut-band meters, and even the exclusive hp photo-chopper are manufactured "in-plant."

Now that you're going to buy a multi-function meter, get step-ahead design, extra attention to construction, premium components — get the hp extra measure of performance!

*hp Model 410B
for Wide Frequency Range*

Performance

Since the 410B Vacuum Tube Voltmeter was first introduced, it has proved to be an outstanding instrument because of the large number of tasks it will perform, and its frequency range of 20 Hz to 700 MHz. Use the 410B in laboratory, broadcast stations or production testing department—wherever you need a broad frequency range instrument.

The wide frequency range is made possible by the exclusive Hewlett-Packard high-frequency diode used in the probe. The probe gives low inductance, low input capacitance (1.5 pF) so it won't affect the circuit under test. Total input impedance at low frequencies for ac measurements is 10 mΩ shunted by the 1.5 pF.

When you need a reliable, broad frequency range voltmeter with ohms capability, the hp Model 410B Vacuum Tube Voltmeter is your No. 1 choice! See the table for specifications.

*hp Model 412A
for DC and Ohm Sensitivity*

Performance

Model 412A DC Vacuum Tube Voltmeter was the first multi-function meter to incorporate the exclusive hp photo-chopper design. The photo-chopper gives you an acoustically and electrically noise-free design for low drift dc amplification.

The 412A has a four-terminal ohmmeter for highly accurate resistance/current measurements. The four-terminal system greatly minimizes resistance lead loss.

Because of its high sensitivity, you can use the Model 412A as a high gain dc amplifier—a sensitive bridging amplifier, or output for a dc recorder.

Check the 412A dc and ohm sensitivities in the table. Note the 1 mV FS dcV sensitivity, and 1Ω midscale ohms sensitivity. Pick the 412A for laboratory accuracy and a simplicity of operation that makes the instrument ideal for production line testing!

*hp Model 427A
for High AC Sensitivity*

Performance

High ac sensitivity in a general-purpose, fully portable multi-function meter—that's what you get in the all-solid-state battery-powered hp Model 427A. Option 01, (price \$25.00) gives you both battery and line operation.

This small, light-weight, multiple function instrument has field effect transistors in the input circuit to give a 10 MΩ input impedance. Specifically designed temperature compensating circuitry minimizes zero drift. You can make ac and dc volts and ohms measurements and expect an extremely stable reading.

The versatile hp Model 427A Voltmeter is your choice when you need 10 mV FS, with 100 μV resolution in a general purpose fully-portable instrument—best for field use!

Condensed specifications are given in the table.

*hp Model 410C
for All-Purpose Meter*

Performance

If you have to limit your choice to only one instrument, hp Model 410C Multi-Function Voltmeter is your No. 1 preference! This one compact, easily portable instrument measures just about everything... nanoamps, millivolts and ohms with laboratory precision!

The exclusive hp high-sensitivity photoconductor chopper amplifier makes the 410C suitable as a pre-amplifier for data recording on analog recorders. The photo-chopper eliminates need for zero adjustment.

The hp taut-band meter gives you reliability and repeatability possible only with a friction-free hp meter!

For a high-sensitivity, broad band, easily portable all-purpose meter, you'll get best performance from the 410C! Check the specifications in the table.

	410B	410C	412A	427A
DCV	1— 1000 V	15 mV— 1500 V	1 mV— 1000 V	100 mV— 1000 V
Accuracy	± 3%	± 3%	± 1%	± 2%
ACV	1—300 V	.5 V— 300 V	—	10 mV— 300 V
Accuracy	± 3%	± 3%	—	± 2%
DCI	—	1.5 μA— 150 mA	1 μA— 1 A	—
Accuracy	—	± 3%	± 2%	—
Ohms	10 Ω— 10 MΩ	10 Ω— 10 MΩ	1 Ω— 100 MΩ	10 Ω— 10 MΩ
Accuracy	± 5%	± 5%	± 5%	± 5%
Zdc	122M	10—100 M	10—200 M	10M
Zac	10 M//1.5pF	10 M//1.5pF	—	10 M//40pF
BW	20 Hz— 700 MHz	20 Hz— 700 MHz	—	10 Hz— 1 MHz
Price	\$275	\$425	\$450	\$225
Amplifier	—	Yes	Yes	—
AC Response	Peak	Peak	—	Avg
Power	50—1000 Hz	50—1000 Hz	50—60 Hz	Battery (Line Optional)

Get full specifications on these four hp Multi-Function Meters from your nearest hp field engineer. Or, write to Hewlett-Packard, Palo Alto, California, 94304. Europe: 54 Route des Acacias, Geneva.

097/58

HEWLETT *hp* PACKARD
An extra measure of performance

ON READER-SERVICE CARD CIRCLE 5



MANI



**Good things do
come in small
packages!**

**ALL THE FEATURES
FOUND IN
LARGER SIZE**

SWITCHES... *except the larger size*

1/2" ROTARY SWITCHES

INDUSTRY'S MOST COMPLETE SELECTION

Up to 12 positions per deck SHORTING OR NON-SHORTING / Up to 6 poles per deck / Shorting and NON-SHORTING poles can be grouped in any combination on one deck / Individual deck parts self-contained and permanently molded into place / Extremely low and uniform contact resistance (.004 Ω average) / Life expectancy 200,000 mechanical operations minimum / "Off-The-Shelf" Delivery

RCL.

ELECTRONICS, INC.

General Sales Office
700 So. 21st Street
Irvington, New Jersey 07111

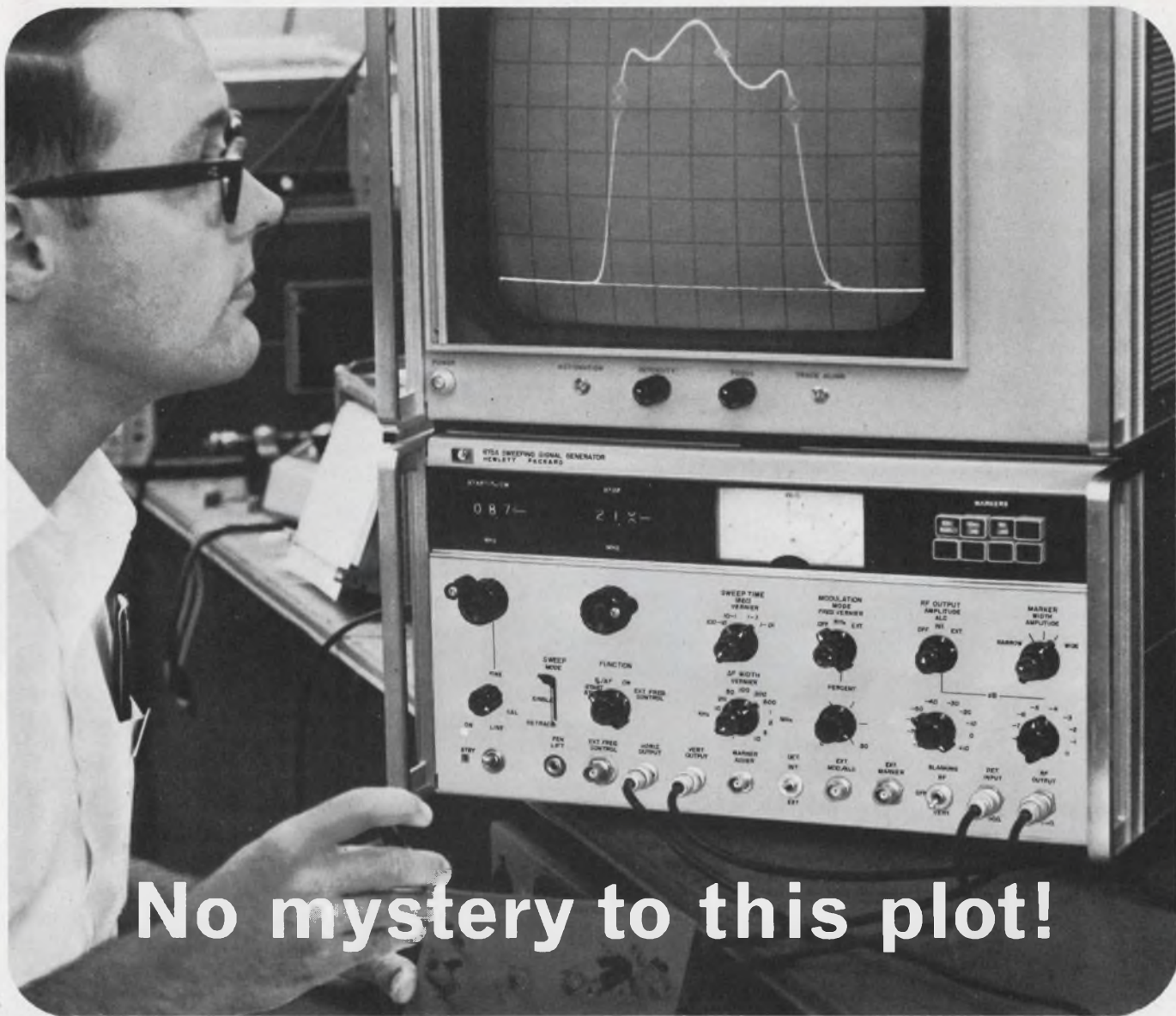

No mystery to this plot!

*Not with the linearity and flatness of the new
hp 675A Sweeping Signal Generator!*

SWEPPER—You know the swept response you're getting is the true picture—because the hp 675A provides you with a linearity of <math><0.5\%</math>, output flatness of .15 dB, low residual FM of <math><70</math> Hz peak, and a continuous range of 10 kHz to 32 MHz!

The start-stop sweep has $\pm 1\%$ end point accuracy and the center frequency sweep has calibrated ΔF steps up to 10 MHz. The low frequency drift of <math><1</math> kHz/hr. eliminates the need to individually calibrate each sweep setting. The 99 dB calibrated output has 1 dB step resolution.

If you need crystal marker accuracy in your display, you can get optional fixed frequency crystal and crystal controlled harmonic (comb) markers. The 675A has horizontal tilt and marker width and amplitude controls. With both external and internal detectors, markers are added after the signal has passed through the device under test.

Unique vertical blanking eliminates RF switching transients that could affect your device response.

SIGNAL GENERATOR (CW)—The 675A has CW dial accuracy of $\pm 0.5\%$ of full scale, <math><60</math> Hz rms spurious FM, 1 kHz settable, calibrated output in 10 and 1 dB steps, and an output monitor for an ideal signal generator. It can be amplitude mod-

ulated internally or externally from 0 to 50%. External FM has a sensitivity of 1 MHz/V.

PROGRAMMABILITY—The external frequency control permits analog programming of discrete frequencies, swept frequencies and frequency modulation over the entire band. Amplitude can also be externally controlled over a 6 dB range.

Take the mystery out of your plots. Get the complete story on the new hp 675A Sweeping Signal Generator from your hp field engineer! Or, request a copy of our data sheet from Hewlett-Packard, Palo Alto, California 94304. Europe: 54 Route des Acacias, Geneva. Price: hp 675A, \$2250.00; markers and detectors optional.

097/16 A

HEWLETT  PACKARD

S I G N A L S O U R C E S

ON READER-SERVICE CARD CIRCLE 7

Connector set.



Vibration-proof modules.
Environmentally sealed.
Modules removable singly.
Minimum contact interfaces.

ON READER-SERVICE CARD CIRCLE 8

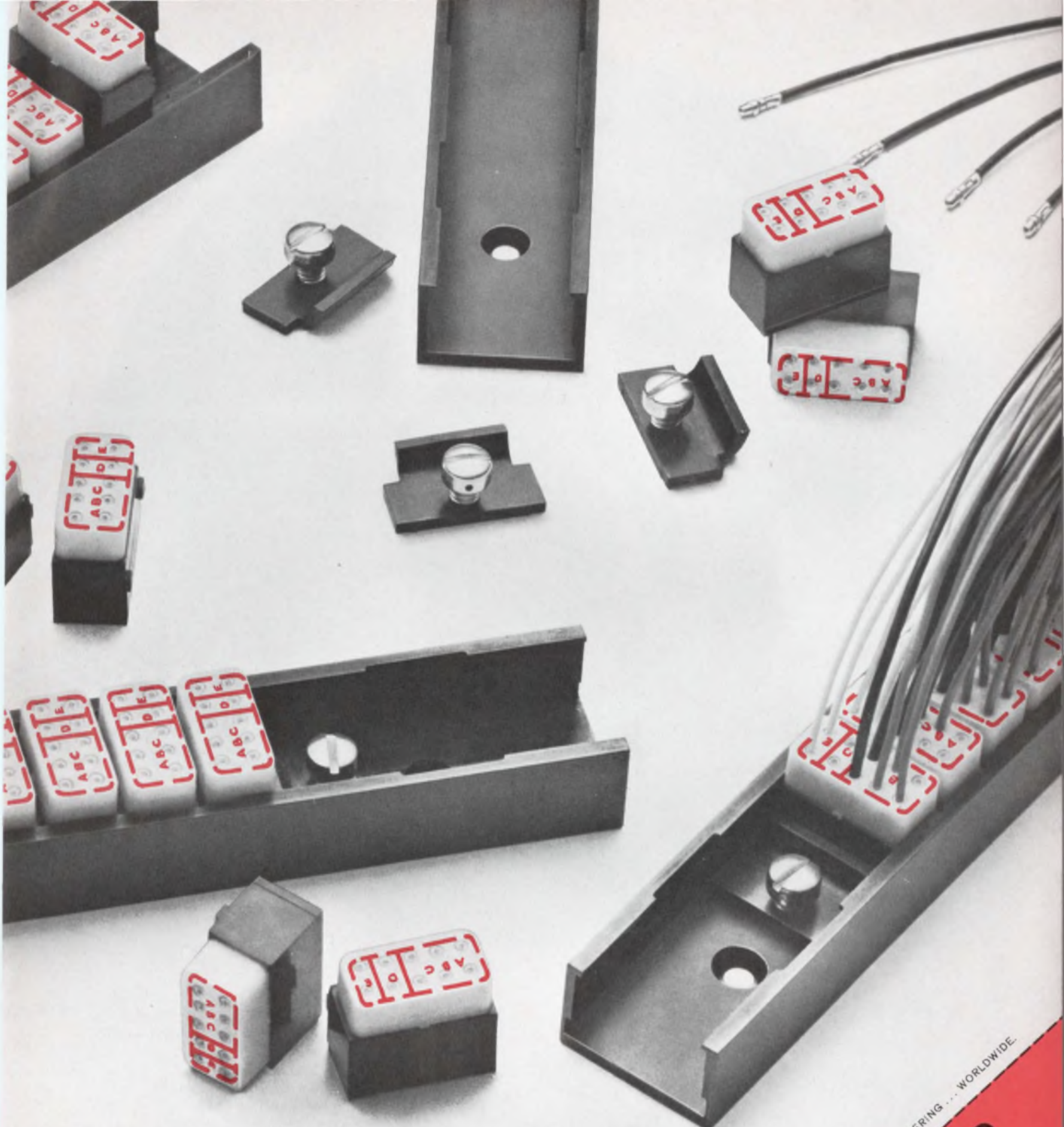

Less resistance than wire.
Standard MIL crimp tooling.
Rugged one-unit track.
High density. **AMP**

PUT YOUR IDEAS INTO ACTION WITH THE HELP OF AMP ENGINEERING ... WORLDWIDE.

AMP INCORPORATED
Harrisburg, Pa. 17105

Send me information on the Modular Connector Block now.

NAME _____
COMPANY _____
ADDRESS _____
CITY _____
STATE _____
ZIP _____

SPRAGUE SSL^{*}

(Super-Speed Logic)

IS THE BEST DOGGONE TTL



^{*} Trademark

**DON'T BE DOGGED
BY CIRCUIT SPEED**

**SPRAGUE SSL
TO THE RESCUE!**

PROPAGATION DELAY	5 nsec*
POWER DISSIPATION	25 mW*
NOISE IMMUNITY	1.0 V
FANOUT	11
FLIP-FLOP TOGGLE FREQUENCY	60 MHz

* As faithful as our four-footed friend, these values are typical, NOT exceptions.

*For additional information on
Sprague SSL Super-Speed Logic,
write to:
Semiconductor Division
Sprague Electric Company
115 Northeast Cutoff
Worcester, Mass. 01606*



SPRAGUE WORCESTER ... the world's finest microcircuit facility

'Sprague' and '®' are registered trademarks of the Sprague Electric Co.

News



The 'thin' Nike-X system relies on a marriage of phased arrays and computers to detect, identify and track approaching warheads

and guide intercepting missiles onto target. The system's electronics and budgeting are tied in a major feature that opens on p. 17

Also in this section:

Satellite memory used to store information on floating buoy. Page 33

The reliability of ICs is bone of contention at IEEE symposium. Page 40

News Scope, Page 13 . . . **Washington Report**, Page 29 . . . **Editorial**, Page 61

THE CONNECTOR THING

A periodical periodical, designed to further the sales of Microdot Inc. connectors and cables. Published entirely in the interest of profit.

DICK TRUMMER WINS MICRODOT

You've thrilled to the fabled romances of Damon and Pythias, Pyramus and Thisbe, Procter and Gamble. Now, grab a hankie and read the tale of Trummer and Microdot.

BOY MEETS CONNECTOR

Once upon a time, as they say, there was a young Wisconsin lad with two compelling interests — space technology and rowing. Richard Owen Trummer pursued both interests at the University of Wisconsin, where he received his B.S.M.E. and coached the rowing team. Later, as a components engineer at AC Electronics, part of his job was to recommend the right components for inertial guidance systems. But an equally important part of the job was helping the people who make those components to do a better job for AC.

One component category of concern to Dick was connectors. That's how Dick Trummer came to know of Microdot. But wait! Even more breathtaking is the saga of how Microdot came to know Trummer.

ALL-TIME CHAMPION CONTEST WINNER!

Our current series of ads is now more than two years old; and almost every ad offers an opportunity to enter some sort of contest. For example, our very first ad in the series asked readers to compete in assembling our Microcrimp connectors in record time. Winners received prizes such as a Honda, a Schwinn bike and an Irish Mail.

That's when we first heard of Dick



Trummer. His speed in assembling our Microcrimp connector beat out all but two other contestants — and made him the proud owner of an Irish Mail. The fact that Dick didn't

even know what an Irish Mail was, gave birth to a second contest in which we awarded lapel buttons reading "I know what an Irish Mail is!"*

After that, Trummer was hooked. In a way, so was Microdot. Every contest brought a Trummer entry. Most of them were excellent. And since we're honest folk, we had to judge without partiality. Result: Trummer also won a whole stack of Capitol record albums for a new idea on what to do with our Twist/Con concept. And by June of this year, the word was out among our loyal readers and contest entrants: GET TRUMMER!

And that's what we did.

As of September 1, Richard Owen Trummer has been appointed Military Products Manager of Microdot's Connector and Cable Products.

In this capacity, Dick will act as technical liaison man between Microdot and many of its most important customers. (For one of Dick's new winners, see box on this page.)

Most important benefit: as a bona fide permanent employee of Microdot Inc., Dick Trummer is now *ineligible* to enter any of our "Connector Thing" contests. Once again, there's room at the top! So take pen in hand with renewed hope. With Trummer out of the way, anything is possible. Who knows. If you win enough contests, we may hire you.

RECENT CONTEST WINNERS (Other than Dick Trummer)

CARY A. MATUSZAK, R&D Technician at the Republic Division of Rockwell Mfg. Co., is the winner of our "Great American Cable" Contest. Happy viewing on your new Sony TV.**

WINNERS of our "Let Microdot Take You To The Movies" contest:

1. Grand Prize: ROBERT H. AILOR, NASA Redstone Arsenal
2. Runner Up: MARVIN SENTER, Litcom Division, Litton Industries

Honorable mention awards in the form of imitation "Oscars" go to—

R. H. KLEMM (Bethpage, N.Y.), G. E. FOGLEMAN (Washington, D.C.), PAUL KURLAND (Lansdale, Pa.), R. R. RIEBSAMEN (W. Palm Beach, Fla.), P. W. LANCASTER (Philadelphia), and—guess who—yep—RICHARD OWEN TRUMMER, formerly of Wisconsin. (That's it, Dick.)

*If you know, please write. We still have some buttons left.

**Winning slogan: "Microdot cable withstands the test of time."

MICRODOT INC. 
220 Pasadena Ave., S. Pasadena, Calif. 91030



TRUMMER'S NEW WINNER: THE HIGH DENSITY MULTI-PIN MARC 53

Here's why Dick Trummer considers MARC 53 a winner: It's the smallest and most flexible high density multi-pin on the market. It meets MIL-C-38300 Rev. A (USAF) and is NASA approved for manned space flight applications. It features "Posilock," the finest blind mating coupling mechanism ever devised, and "Posiseal"—the best environmental seal. (Ask Dick what we mean by the floating interfacial seal concept.) Contacts are completely scuff-proof. Our new MARC 53 RMD gives you a genuinely field serviceable version that takes mass-produced pre-crimped wires and requires neither insertion nor extraction tools for assembly. A color-sound film that tells you all about the assembly of MARC 53 is now available.

ON READER-SERVICE CARD CIRCLE 10

Comsat ready to give up ruling vote in global body

The Communications Satellite Corp. (Comsat) has made the first two proposals aimed at a permanent agreement on the operations of the 59-nation International Telecommunications Satellite (Intelsat) consortium.

Under one of them, Comsat agrees to relinquish its controlling vote in the group. The other would allow member nations to launch domestic communications satellites with Intelsat's approval.

Both proposals were put forward at last month's meeting of the Interim Communications Satellite Committee, the ruling body of the present global communications system. This was set up in August, 1964, as an interim body. A final agreement for a permanent organization must be signed in 1969. The U.S. proposals were the first put forward by any member nation to give the consortium a permanent footing.

Comsat proposed that the final agreement should be based on the interim accord. Displaying readiness to play a less dominant role, it argued that in the permanent consortium no nation should have a weighted vote in excess of 50 per cent and that the voting distribution should depend on member nations' use pattern: the greater a nation's contribution to the system, the larger its vote. The Comsat vote would thus drop from its present 53.5 per cent to not more than 50 per cent and could conceivably be lower than 40. A two-thirds majority would be required in all votes on the consortium's activities.

Comsat's other suggestion would set up a new category-B satellite series for domestic use by member nations. Intelsat would sanction their launching. Such an arrangement would overcome bones of contention like France's proposal to launch its own satellite system. It

would also ensure an effective allotment of the frequency spectrum to avoid interference.

Comsat finally proposed that it should remain manager of the Intelsat system, but on a contractual basis.

Comsat proposes to orbit four satellites in 1970, four in 1973, and four in 1978. The 1970 models with a life of five years would be capable of providing 48 television channels or 84,000 point-to-point message channels. When all for 1970 satellites are in service, Comsat proposes to have 180 ground stations in operation.

New camera system for geophysical satellites

The Radio Corp. of America is trying to interest NASA in a satellite camera-laser image-reproducing system it has developed for the proposed Earth Resources Observation Satellite (EROS).

The camera system contains a new tube called a return-beam vidicon, which is reported to have a 5000-TV-line resolution capability—about 6 times that of any TV camera so far used in space. This will enable it to resolve terrestrial features 100 feet across, according to RCA scientists.

The camera would radio stored information to a ground station where it would be recorded on a new RCA device called laser image reproducer. Conventional recording methods, such as a kinescope or cathode-ray tube, cannot reproduce the high-resolution picture of the return-beam vidicon. The laser device converts the vidicon's signals into a picture by scanning conventional photographic film with a modulated helium-neon laser beam. The picture is recreated at the rate of 1200 lines per second.

The return-beam vidicon operates like a standard vidicon in that a photoconductor is charged by light and discharged by a scanning beam. It differs from it in that the return beam is utilized as a signal path rather than as in an image orthicon. RCA says the camera could be capable of providing up to 8000 TV lines of resolution.

The company has suggested that several of the new vidicon cameras could be carried in a satellite to sample several areas of light spectrum. Three cameras, they point out, would allow the satellites' view to be reproduced in color.

The laser reproducer is being studied by RCA for use in other areas of image reproduction where great reduction is required from a photographic laser, such as in the manufacture of ICs.

Computers enlisted for weather research

The World Meteorological Organization will use computers for studying the equatorial regions, to find out more about the breeding and growth of hurricanes and typhoons.

Plans for a Global Atmospheric Research Program were presented in October in Zürich, Switzerland, in belated response to two United Nations General Assembly resolutions of 1961.

The weather scientists want to concentrate their observations in 2000-by-1000-mile rectangular regions near the equator. If instrumentation shows phenomena of special interest, they will focus on smaller regions a few hundred miles square.

The computers will be expected to digest numerous readings and translate them for use in predicting long-range weather trends.

During a two year effort, that may start before 1972, as many as 15 aircraft will launch instrumented balloons to obtain wind direction, temperature and humidity profiles of the selected region. The balloons will be set to float indefinitely at preset altitudes. These may be supplemented by observations collected from ships, buoys and free-drifting balloons.

The international scientists want first to investigate an area in the western Pacific, but a region in Africa has also been proposed and

News Scope

CONTINUED

may be the site of their initial efforts.

In later stages of the research program, after 1973, the effort will become global. As many as four synchronous satellites would extract information from thousands of balloons adrift at various levels of the atmosphere.

Satellites in polar orbits would furnish atmospheric temperature, humidity and precipitation profiles and ground temperatures by optical and rf measurements. These satellites would be in orbits similar to those of the Tiros and Nimbus satellites that are already circling the Earth. The Nimbus satellites are research platforms designed to develop atmospheric sensors and techniques for polar-orbiting satellites.

Meteorologists say that at present the best weather satellites give essentially two-dimensional information but the third-dimension data are also needed.

The long-term objective of the program is systematic weather prediction. The computer, it is hoped, will eventually have a program that will enable it to forecast the general weather pattern as much as three weeks in advance.

The scientists say, however, that computers 500 times faster than those now in existence will be needed to handle all the data for such forecasts. They hope computers capable of this will be available in five years.

NASA's Goddard Space Flight Center Greenbelt, Md., recently awarded a contract for an advanced data collection system for worldwide weather readings. The electronic equipment for this Nimbus-D research satellite will be built by Radiation, Inc., Melbourne, Fla. The contract calls for interrogation, recording and location equipment to be launched in 1970. Basic equipment has already been designed and built by Radiation for a Nimbus-B test launching next January.

This earlier equipment is designed to make 20 interrogations per orbit but the newer equipment will raise that number to 370.

As the Nimbus satellites orbit the earth, the onboard electronics

will gather and store data collected by automated ground, balloon and sea-buoy stations. When the satellites pass over the stations in Alaska and North Carolina, the stored information will be telemetered to the ground.

NASA joins battle against air pollution

The National Aeronautics and Space Administration has offered its help with U.S. cities' bid to combat air pollution. NASA representatives have shown New York City officials how spacecraft might give more precise information on where air pollutants come from and go to.

The assistance would come under the Apollo Applications Program and could take one of two likely forms. Detectors aboard a satellite may be cameras from which photographs could be relayed to Earth by television; or they may be electronic sensors that can determine what is in the air by the nature of the reflected light.

Cameras in orbit can clearly trace smoke plumes in the upper air, a task that is difficult to perform with ground equipment. Such pictures would enable New York for instance, to test the recent contention that 15 per cent of the pollutants in the air over Washington, D.C., come from New York. They would also help the city to keep an eye on the open burning of waste materials, to ensure that it is done only when the wind will carry the smoke out to sea.

Electronic sensors would give a more detailed picture of air pollution. Since different compounds reflect light differently, they would not only detect the presence of air pollution, but also permit the pollutants to be identified.

PHS may pool data on hospital computers

The Public Health Service (PHS) is considering setting up a clearinghouse for information on automated hospital communication systems. Surgeon General William H. Stewart said such a center would gather and analyze data so that government consultants will be better able to advise hospitals on their computer applications.

A six-month study to determine the technical and management requirements for the center is being supported by a \$29,386 contract from the Div. of Hospital and Medical Facilities. The work is being undertaken by Herner and Co., of Washington, D.C.

Dr. Stewart noted that the growing use of computers to store data on such matters as admitting, nursing, pharmacy, business, and to speed information between hospital departments can greatly increase hospital efficiency and effectiveness. "If public funds are to be prudently expended," he commented, "a comprehensive source of information on these systems and the current state of the art is essential. Our objective is to help hospitals avoid the many problems and pitfalls to be encountered in this fast-moving science."

MBA degree shown to be most rewarding

Thinking of going back to school? Then maybe an MBA course is your best bet.

An undergraduate degree combined with a master of business administration offers the engineer the highest financial rewards, according to a College Placement Council study. It shows that the 1967 college graduate with this combination wound up with the highest average monthly salary offer—\$869. This was a dollar more than offered those with master of electrical engineering degrees. It is believed to be the first time an MBA average topped an engineering master's average, the council reports.

At the bachelor's level, the electronics industry offered new graduates the highest monthly salary average (\$718) of all industries, closely followed by aerospace (\$716).

The study also shows that engineers are still in heavy demand. Aerospace and electronics continue to make the most offers to new graduates.

By curriculum, chemical engineers attracted the highest offers with a \$733 average. Next were electrical engineering, \$728; aeronautical engineering, \$724, and mechanical engineering, \$720.

The average dollar value offered technical graduates with bachelor's degrees was \$720, while the non-technical average was \$614.



For hot and cold insulation...Mystik 7000!

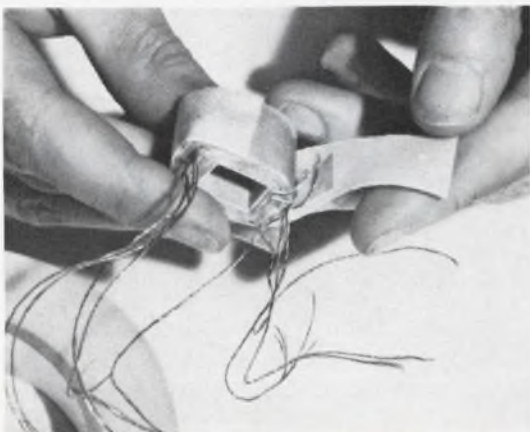

Superior thermal and electrical properties make Mystik 7000 suitable for an unusual range of cryogenic and elevated temperature applications. Uniquely inorganic, it has a tightly woven high tensile glass cloth backing with a pressure-sensitive silicone adhesive. Mystik 7000 has exceptionally high dielectric strength and offers high conformability and excellent shear resistance.

Here is a remarkable tape, perfect for insulating motors, generators or other components which must perform in critical operating environments.

This is only one of the Mystik family of tapes for the electrical industry. If you have an insulating problem or extreme temperature requirement, call your Mystik distributor. He's in the Yellow Pages under "Tape". Or write: The Borden Chemical Company, Mystik Tape Div., 1700 Winnetka Ave., Northfield, Illinois.



**BORDEN
CHEMICAL**

ON READER-SERVICE CARD CIRCLE 11

Another new (MOS) FET from RCA... 3N142



100 MHz
65¢
(1000+)

- ✓ **100 MHz power gain 17 dB typ.**
- ✓ **feedback capacitance 0.2 pF max.**
- ✓ **transconductance 7,500 μ mho typ.**
- ✓ **for military/industrial applications**

RCA's GROWING FAMILY OF N-CHANNEL, DEPLETION TYPE (MOS) FET's
FOR INDUSTRIAL & MILITARY APPLICATIONS

Single-Gate Types	Typ 200MHz G_{21}	Typ 200MHz N.F.	Typ G_{11} (μ mho)	Max C_{11}	Max I_{CSS}	Min V_{DS}	Case	Price (1000+)	Applications
3N128	18dB	3.5dB	7,500	0.2pF	50pA	20V	TO-104	.88	RF Amplifier, Mixer, Osc. High Input Impedance Timing Circuits, Electrometers, Instrumentation & Controls
3N138	(Zero offset)		6,000	0.25pF	10pA	35V	TO-72	2.00	Chopper and Multiplex Equipment, Transmission Gates
3N142	17dB*	2.5dB*	7,500	0.2pF	1nA	20V	TO-104	.65	RF Amplifier, Mixer, Osc. and General Purpose Amplifier
Dual Gate Types									
3N140	18dB	3.5dB	10,000	0.03pF	1nA	20V	TO-72	.98	200MHz RF Ampl.
3N141	18dB	—	10,000	0.03pF	1nA	20V	TO-72	.94	200MHz Mixer and Product Detector

* unneutralized power gain
* 100MHz

The new RCA 3N142 N-channel depletion type insulated-gate (MOS) FET offers complete versatility from DC to 100 MHz and beyond. Its high input resistance (10^{12} typ.) and low gate leakage current make it ideal for low frequency timing circuits, industrial controls and instrumentation equipment. High transconductance and low feedback capacitance, coupled with excellent thermal stability, provide outstanding performance in RF amplifier, mixer and oscillator applications up to 175 MHz. Because it features low cross modulation, reduced spurious responses, minimum oscillator feedthrough and large signal handling capability with-

out diode-current loading, the 3N142 offers today's greatest value in MOS transistors.

Why not get the complete story of the price and performance advantages of the RCA 3N142 (MOS) FET? Your RCA Field Representative will be glad to answer your questions and supply information on other single and dual-gate (MOS) FET's. For additional technical data, write RCA Commercial Engineering, Section EG10-2, Harrison, N.J. 07029. See your RCA Distributor for his price and delivery.



RCA Electronic Components and Devices

The Most Trusted Name in Electronics

ON READER-SERVICE CARD CIRCLE 12

Nike-X: A merger of radars and computers

U. S. defense to use phased arrays under digital control to track missiles and guide interceptors

Charles D. LaFond, Washington Chief, and Neil Sclater, East Coast Editor

"The purpose of Nike-X is defense against a threat of the size we anticipate the Chinese to be able to achieve in the next five to 10 years. It provides an essentially complete defense against their ability to hurt this country"—Lt. Gen. Austin W. Betts, Nike-X system manager.

When Defense Secretary Robert S. McNamara announced on Sept. 18 this country's intention to deploy a "thin defense" against ballistic missiles, he set in motion plans for computers and radars to perform tasks that formerly were impossi-

ble. In the Nike-X system the management of radar operations, the identification of warheads and decoys speeding at 18,000 miles an hour, and the tracking and guidance of supersonic antimissile missiles will all fall to the computer.

Before this integration of radars and computers, each had pursued essentially independent paths of development. Early radar systems used little or no data processing, other than what was done in the receiver. The human operator detected targets and determined heading,

time of arrival and velocity by crude graphic methods.

The introduction of the Semi-Automatic Ground Environment radar system (SAGE) in the late 1950s was a major step in combining the two technologies. This early-warning equipment, which ties together mechanically scanned radars and computers, was able to detect and track aircraft automatically, identify them as friendly or hostile and direct interceptor aircraft to destroy hostile planes.

The data potential rises

But with the advent of electronically scanned phased arrays, the data-handling potential of radar increased tremendously. And with fast data processing by a digital computer to match this gain, systems like the Nike-X became feasible. Arrays in the Nike are so complex that the computer must not only manage the radar subsystems; it must also maintain communication with other radars and weapons in the defense network.

Such capability does not come at discount prices. Over the last 10 years \$3 billion has been spent to plan an unabridged, or "thick defense," Nike-X system. The figure of \$5 billion spread over the next five to six years has appeared frequently of late, but it ignores annual support costs (upward of \$500 million) and research, engineering and facility costs that will push the figure to a more realistic \$11 billion by 1973.

Two interceptors used

The thin Nike-X system will assign defense against enemy warheads to two interceptor missiles with nuclear warheads. The primary defender, Spartan, is a three-stage missile with a range reputed to exceed 400 miles. It is designed to intercept warheads high above the earth's atmosphere. The second defense missile, called Sprint, is a high-acceleration, short-range, two-stage interceptor that is intended

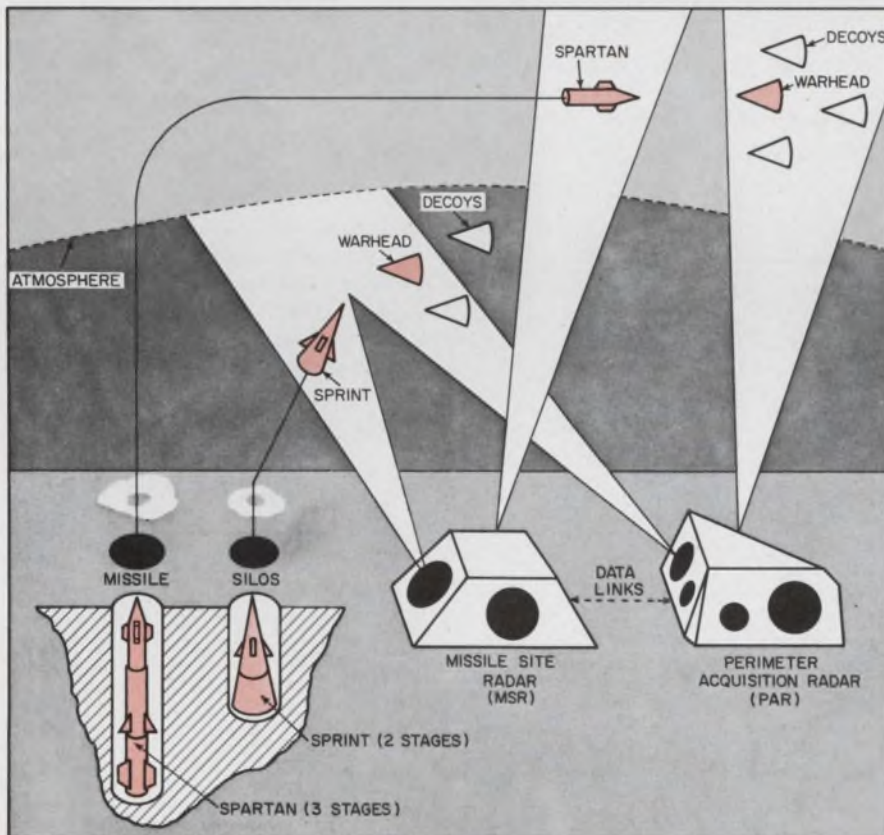

Elements of a "thin" Nike-X defense system. Nuclear-tipped Spartan missiles are designed to intercept enemy ICBMs at long range (more than 400 miles). Sprint missiles, also with nuclear warheads, can intercept those ICBMs that have evaded the Spartans. Perimeter Acquisition Radar sorts out warheads from decoys and begins tracking them. Missile Site Radar takes over the Perimeter Radar data and guides the interceptor missiles. Computer-controlled phased arrays will be used in both radars.

(Nike-X, continued)

for use against warheads that might evade the Spartan and plunge into the earth's atmosphere.

Spartan and Sprint will be capable of knocking out land-launched intercontinental ballistic missiles and sea-launched intermediate-range ballistic missiles. Both are designed to destroy or immobilize warhead subsystems by means of thermal radiation, particle radiation, high-intensity X-rays or combinations of these effects. The nuclear weapons used in both missiles reportedly have low fallout, but at low altitude a burst from Sprint could present a radiation danger.

A typical example

In a hypothetical situation, as projected for the thin Nike-X defense system, assume that an enemy has launched two or three intercontinental ballistic missiles along with a dozen decoys. Assume, too, that the warheads and decoys approach over the North Pole and have as their mission the destruction of a city in the United States.

The first indication of the enemy

attack would be noted by a Perimeter Acquisition Radar, in this case deployed on the Alaskan frontier. All other defensive radars would be alerted as a result, and target tracking and warhead identification would begin.

Warhead identification would be made by the Perimeter Radar computer as it compared the ICBM radar "signatures" with the characteristics of true warheads determined from previous studies. This would be done automatically, with human operators notified only after target tracking had begun.

Data on target course, speed and time of arrival within the defensive missile range would also be calculated by the Perimeter Radar computer and sent to Missile Site Radars in the continental United States. These radars would then lock onto the true warheads during their regular scanning functions. Computers linked to the Site Radars would select both the best missiles to intercept the warheads and the optimum firing times.

Ordinarily the Spartan long-range interceptor would be used first, and the short-range Sprint would be called on if the enemy warheads evaded the Spartans. Each Missile Site Radar would also

continue regional surveillance to guard against any simultaneous threat from intermediate-range ballistic missiles.

In the original Nike-X concept, three radars were planned: the Perimeter Acquisition, the Missile Site and one called the Multi-Function Array Radar. The latter, like the Missile Site Radar, was intended to perform all the functions of target detection, identification, discrimination and tracking, along with an ability to track and guide interceptor missiles. This radar-computer combination was to have been the most sophisticated part of the Nike system, and the Missile Site Radar was to have had a secondary backup role.

Switch in emphasis

But with the announcement of the thin defense system, the Defense Dept. said that research on the Multi-Function Array Radar was being reduced to a mere subsistence level. The switch in emphasis to tactical versions of the two other radars is apparently the most significant change in technical approach between the so-called thick and thin Nike-X defenses.

Drawings released so far by the Army show that all tactical versions of the phased-array radars incorporate electronic beam steering to scan large areas of space in nanoseconds. The housings will be built of reinforced concrete and will have deep foundations. Most internal electronic equipment will be mounted on blast-isolating spring suspensions.

Three faces for scanning

The Perimeter Acquisition Radars to be deployed reportedly will be multi-megawatt (pulse) units operating in the uhf range. Each radar, according to the Army, will employ three array faces. The radars, it is believed, will be capable of reliable target acquisition beginning at about 10° to 15° above the horizon and to ranges of nearly 1,000 miles. After detection of a target, the radar computer will be used to define the target's trajectory, its expected impact area, and the physical characteristics of the reentry body. These data will be fed in real time to a computer center, and the entire sequence for continued track-

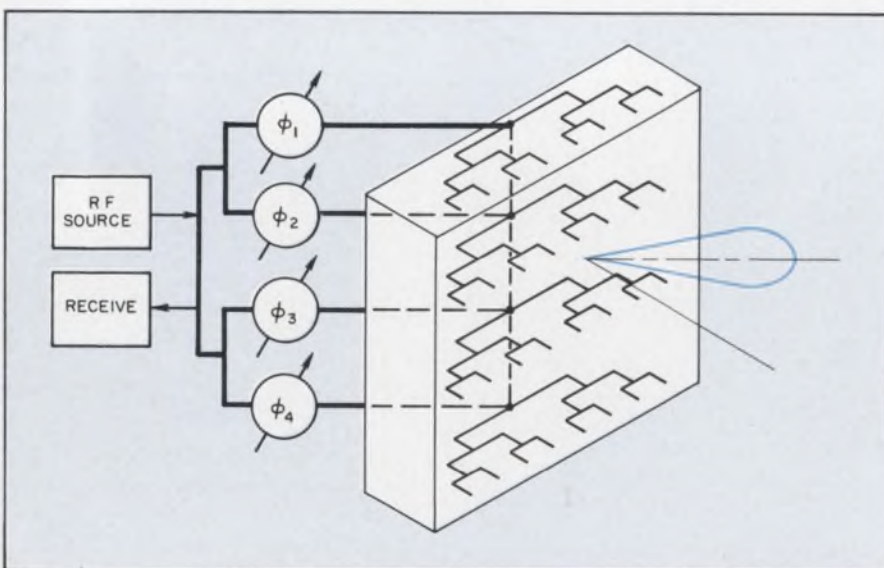

A basic antenna module for a planar corporate array. Nike-X radars will use many of these arrays, each with separate transmitting tubes. The many antenna elements of the complete phased array form a beam when they are energized. If all the elements are in phase, a planar phase front is created, forming a beam perpendicular to the array. When incremental phase differences are introduced between adjacent antenna elements, by adjustment of the phase shifters, a plane phase-front is created at an angle to the plane of the elements. The beam formed is perpendicular to the phase-front but angled with respect to the array.

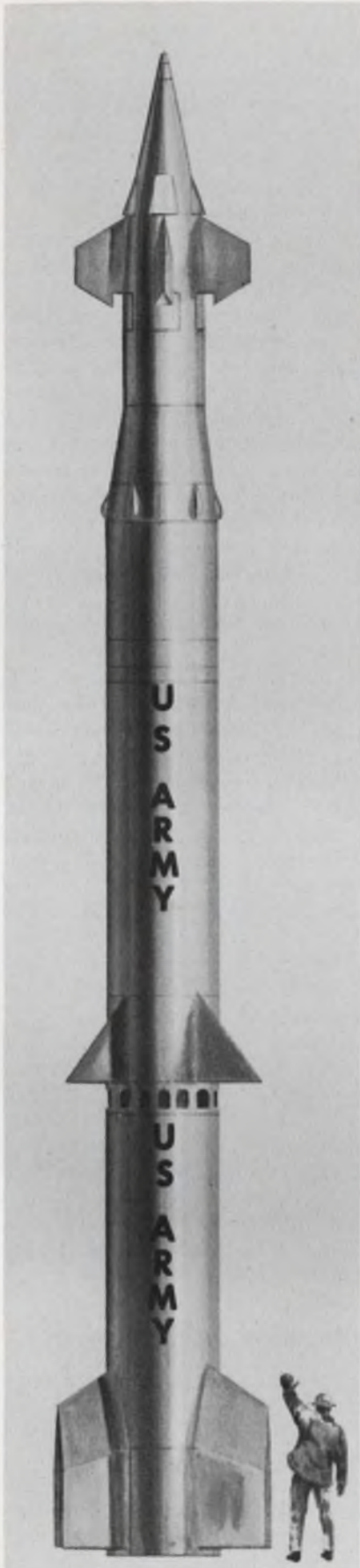

The Spartan missile, now under development, will be the primary interceptor in the thin Nike-X system. Developed from the Zeus, the missile has three stages.



A Sprint roars skyward in a test, scattering bits of debris from its silo cover. It was popped from its silo by a propellant gas before its first stage ignited. Acceleration of the 27-foot long missile is over 100 G's.

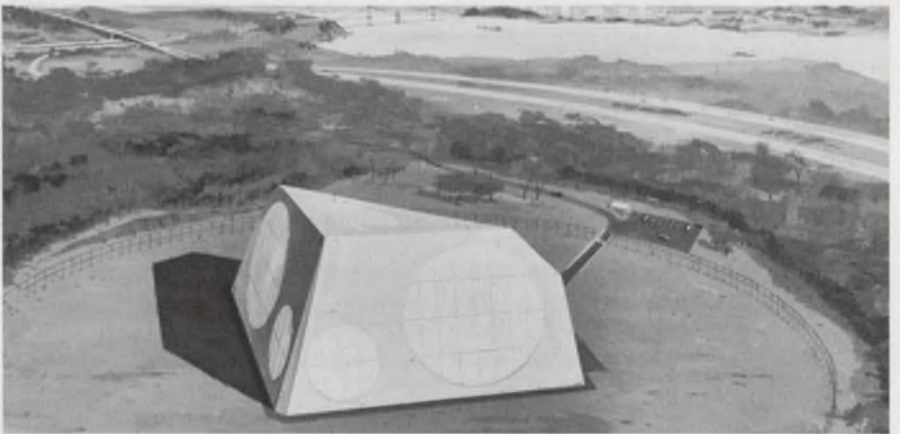

The Perimeter Acquisition Radar will perform long-range, early-warning target identification and tracking of intruder missiles. In the hardened configuration shown in this Army drawing, the transmitting arrays are smaller than the receiving arrays. The three faces will provide omnidirectional coverage. The radar will detect incoming missiles at nearly 1000-mile slant range.

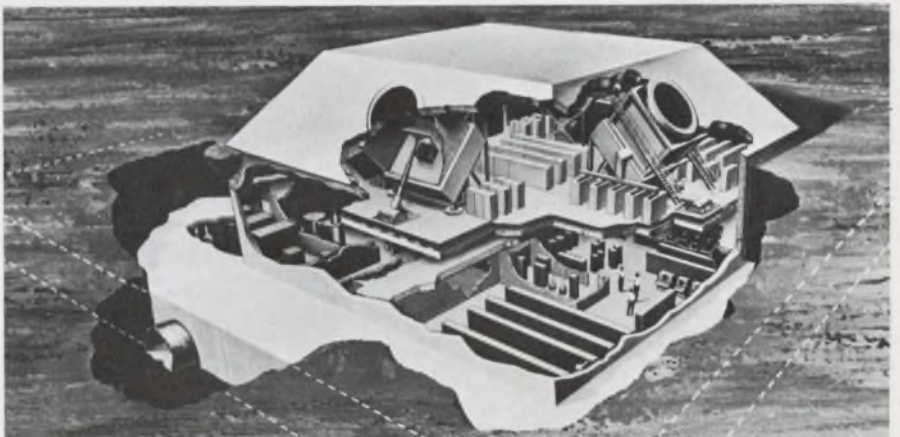

The Missile Site Radar will guide and control intercepting missiles. This Army drawing shows the hardened emplacement with blast-isolation suspension of internal electronic equipment and four dual-purpose antenna arrays for omnidirectional coverage. The radar is expected to operate at S-band.

(Nike-X, continued)

ing, missile-battery assignment and missile-interception control will be provided automatically.

The General Electric Co. of Syracuse, N. Y., is the subcontractor for the Perimeter Acquisition Radars.

The Missile Site Radars will be housed in hardened pyramidal shelters. Combination transmitting and receiving arrays on each of their four faces will furnish nearly complete omnidirectional coverage. The radars reportedly will transmit power in the megawatt range but at S-band. Through the data transmission link, the Site Radar computer will be alerted to the number, course and expected time of arrival of the targets. This information is fed to the Site Radar, so it can track incoming targets when they come within operating range—believed to be better than 800 miles.

The Raytheon Co. of Lexington, Mass., will build the Missile Site Radars.

The Army made a major engineering decision when it elected to use electronic scanning in its missile defense system. All arrays will have many transmitter tubes feeding planar branching antenna ele-

ments for beam formation. It is expected that this scheme will follow closely the approach used in Space Tracking Radar AN/FPS-85, built by the Bendix Corp. of Baltimore under Air Force sponsorship. The Air Force says this system is now undergoing final tests and has been used to track satellites manually. Later this year it will be operational, and, under computer control, it will track and catalog all space vehicles.

It will be able to detect sea-launched intermediate-range missiles, but the Air Force says there are no plans to tie it in directly to the Nike-X system. But the lessons learned through development of the FPS-85 will prove invaluable.

Many tubes employed

The system employs many low power, identical rf power tubes rather than one large rf power source to feed its many dipole transmitting elements. The receiving array, which is separate in this system, also has many redundant dipole receiver modules. Both the transmission and receiving functions will be directed by two general-purpose IBM 360/65-1 digital computers. The phase shifters—ele-

ments used to form and shape the transmitted pencil beam—are set digitally to sweep the transmitting beam electronically. The computer also sets the receiver phasers, so that the received echoes are collected in the proper phase. It transmits in the uhf band at 439 MHz.

Redundancy preferred

The Army argues that redundancy, as employed in the FPS-85, offers greater reliability than is possible if only one large power source is used. This comes at a higher price, but the Army believes that the Nike-X mission is important enough to justify the additional cost. It says that this approach permits "graceful degradation" rather than catastrophic failure of the system. Even if many of the individual rf sources fail or are destroyed by nearby explosive bursts, the system can still function.

The alternative scheme is exemplified by Sperry Gyroscope's Hardpoint Demonstration Array Radar (Hapdar) now operational at the Missile Command's White Sands, N. M., range. It uses one 5 MW-klystron transmitter tube to illuminate one passive array that acts as both transmitter and receiver. The array, a giant lens in an optical feed arrangement, uses three-bit digital rf diode phase-shifters for beam steering and collimation.

Hapdar has, however, demonstrated the effectiveness of computer-controlled radar. A Univac 1218 digital computer controls the diode phase-shifting network and gives Hapdar rapid scanning and multiple target acquisition and tracking ability. It also provides for data recording, self-testing and target simulation.

Conventional radar inadequate

The Univac Div. of the Sperry Rand Corp. in St. Paul, Minn., has disclosed some of the interaction between computers and radar in technical papers cleared by the Army. Univac says that conventional radars are no longer capable of collecting and handling data at rates required to cope with high-velocity ballistic missiles. The requirements of extended range coverage, high target densities and fast reaction call for sophisticated

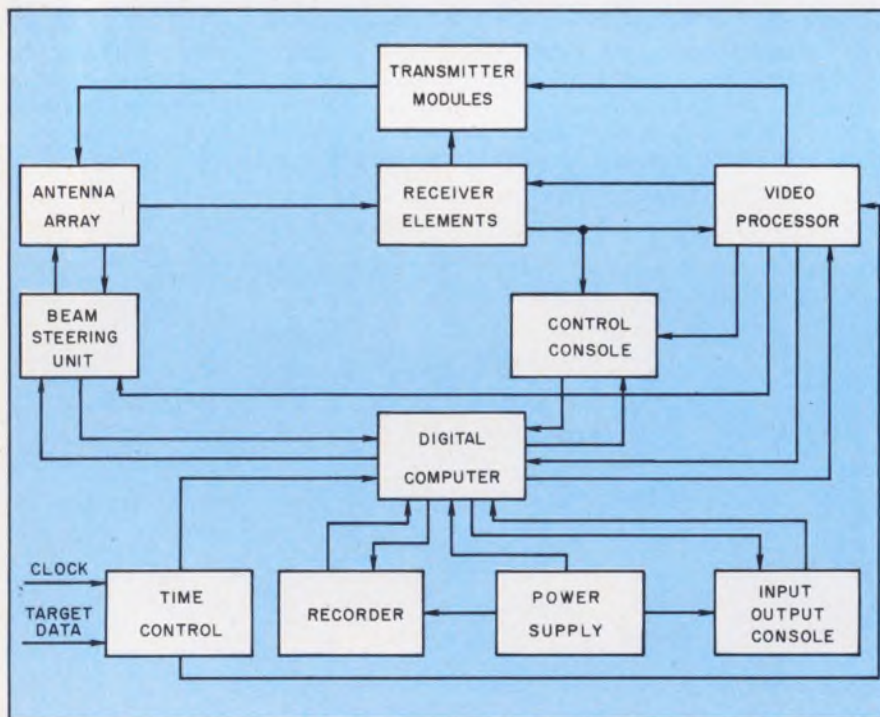

The computer is the central controller in the phased-array radar. The beam-steering unit converts the geographic coordinates of the radar site into antenna element phase-shifting directions. All arrays in the system use the same time base and target designation data for exact coordination.

New Generation

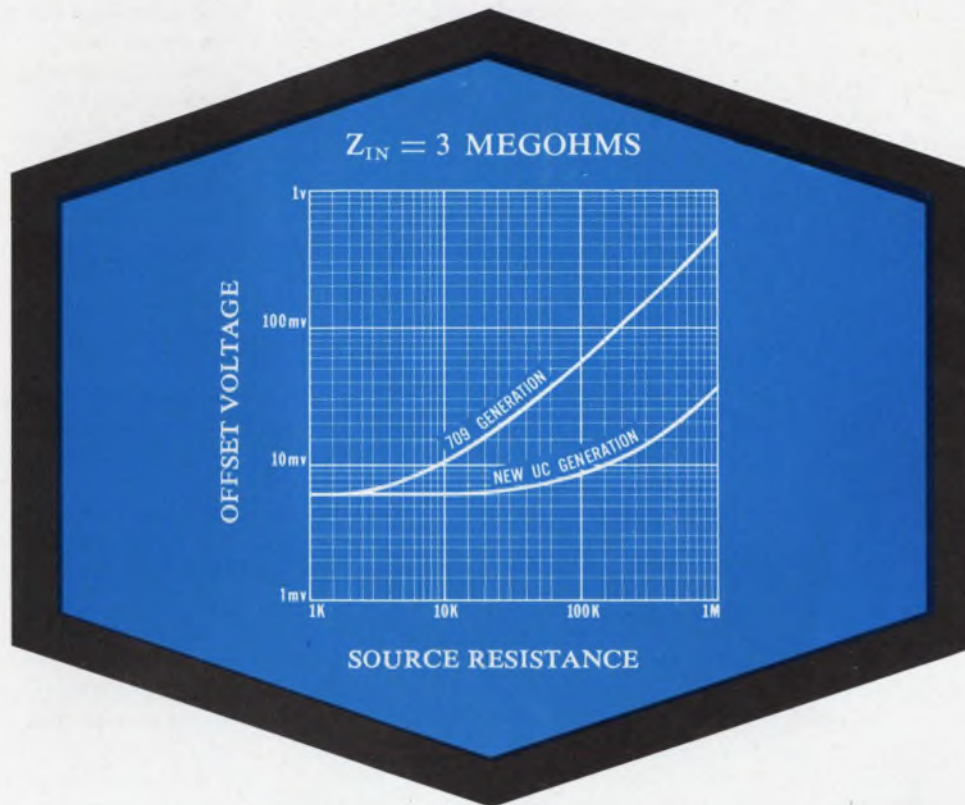

in IC op amps!

 UC709/ $\pm 15\text{V}$ POWER SUPPLY

 UC4200/ $\pm 24\text{V}$ POWER SUPPLY

- High Input Impedance: 3 megohms (typ)
- Output is short circuit proof
- Low power dissipation
- Balanced supply current
- Temperature coefficient: $6\mu\text{V}/^\circ\text{C}$ (typ)
- Output Swing: $\pm 10\text{V}$ (UC709); $\pm 20\text{V}$ (UC4200)
- Gain: 25K min (UC709); 50K min (UC4200)
- Output current: 5 mA min (UC709); 4 mA min (UC4200)
- Operating Temperature: -55°C to $+125^\circ\text{C}$
- Package: 8-lead JEDEC TO-99

Applications: Ideal for airframe and aerospace use • Infrared sensors
PM sensors • Piezoelectric transducers • Ionization gauges • EEG and EKG pre amps
Analog integrators and electrometric type voltage followers.



ELECTRONICS

Semiconductor Department/365 Middlefield Road, Mountain View, California 94040, (415) 961-3300

ON READER-SERVICE CARD CIRCLE 14

NEWS

(Nike-X, *continued*)

time-sharing techniques for beam scanning.

Univac engineers say that the raw data furnished by the radar is not as useful as the information that can be derived from the raw data. The initial data, they say, contain random errors caused by the noise mixed with the signals as it is processed through the receiver. Correlation of the results of many observations reduces these errors.

Raw data contain only range and angle information, but other quantities are needed: altitude, heading, velocity and time of arrival. The computer can process the basic radar data to furnish this information, in addition to its internal management and communication functions.

Instructions via computer

A digital data-processing system for an array radar sends instructions to the transmitter to control the pulses to be sent, and then it transmits instructions to the receiver, where they are converted to an intermediate frequency. The video processor performs the remaining analog processing and encodes the information in digital form.

The computer receives manual-control information from the operations-control console and translates

the control information to radar instructions. It can also process information for display and can change the display information, if it is requested to do so by the operator.

To measure events in nanoseconds, the computers are expected to use a buffer storage and timing unit. These units will accept many instructions and timing signals for the radar and assign them to the appropriate subsystems.

With the digital computer, the radar can perform many functions automatically. Among those expected to occur in all Nike-X radars are:

- **Target search**—Each face in an array searches for targets within its scanning limit. The computer commands the transmitter to sweep the beam (or beams) systematically for full 360° coverage and organizes the receivers to process the return signals.

- **Target identification and verification**—The computer can compare returns with the signatures of true warheads and command more observations of suspected targets.

- **Target tracking**—After establishing that it has a true target or targets, the computer can direct the compiling of target position and velocity data, along with such information as apparent size, identity code, heading, altitude and observation time.

- **Radar management**—The com-

puter can adjust receiver gain control, optimize the transmitter power, establish pulse widths, control the time-sharing of transmitting and receiving functions, set the array phaseshifters, shape the transmitted beam and synchronize all system functions.

- **Communication**—The computer can exchange data between the radar stations, so they can assist one another in locating and tracking targets, identifying them and indicating the probable time of entry into radar and interceptor missile range.

- **Display data generation**—The high data rate from an array radar requires that display and control be carried out by computer. The computer can sort and evaluate returns in a manner that can be comprehended by a human operator. It can, on demand, furnish extra information if it is required.

- **System checkout and evaluation**—The computer can locate and diagnose faults, evaluate antenna patterns and monitor system accuracy, range and sensitivity.

- **Simulation**—The computer can provide real-time simulation with artificial data, generated by the computer or by the replay of digitally recorded data from real situations. This can be used for training and test and checkout procedures.

Early computers improved

Univac developed the first general-purpose computer for use with the Multi-function Array Radar. It had a data-handling ability of about 325,000 instructions per second. Improved versions for Nike-X are expected to be able to handle more than 4 million instructions a second with a single processor.

The computers are expected to incorporate the latest in destructive and nondestructive memories.

One engineer in commenting on the computer radar interrelation said that the real limit to the ability of the radar was no longer the radar itself but the ability of the computer specialists to write the programs.

Both Control Data Corp. in Minneapolis and Univac are writing programs for all of the Nike-X radar computers. The Burroughs Corp. of Paoli, Pa., will subcontract for data displays.



The Multi-function Array Radar at the Army's White Sands, N. M., range is the test bed for radar development. Development of the Multi-function Radar has been downgraded in favor of tactical versions of Nike-X radars.

More than 3000 companies in the United States will help develop the thin Nike-X system. The key contractors are the same ones who led the early development phases. The Western Electric Co. in New York remains the prime contractor. Bell Telephone Laboratories of Whippany, N. J. will continue to direct design and development.

With Secretary McNamara's decision to deploy a thin missile defense system, spending has jumped dramatically. Last year's appropriation for the Nike-X Project Office at Huntsville, Ala., was \$447 million. The money available now approaches \$1 billion. Fiscal 1968 financing is as follows:

- \$298 million for production to support deployment.
- \$85 million for construction of sites and facilities.
- \$421 million for continued research and development.

In addition \$168 million and \$11.5 million remain from last year's appropriations for production and development, respectively. Thus the total funds for continued R&D deployment approach \$984 million, with \$550 million of this planned directly for deployment.

\$3 billion spent so far

So far in fiscal 1968, Western Electric has received incremental contracts totaling \$275 million, and most of this will be distributed in the next five months to second- and third-tier subcontractors. With current expenditures included, the amount spent so far on the Nike-X program, since 1957 tops \$3 billion.

Industry sources foresee total program development expenditures through 1973 at about \$5.5 billion excluding nuclear-warhead costs. The breakdown is as follows:

- Fiscal 1968—\$0.5 billion.
- 1969—\$1.0 billion.
- 1970—\$1.3 billion.
- 1971—\$1.2 billion.
- 1972—\$1.0 billion.
- 1973—\$0.5 billion.

In addition it is expected that \$500 million will be required each year to continue advanced Nike-X development and to press the Advanced Research Projects Agency's Defender Program. This program is exploring various methods for detecting ballistic missile warheads amid a cover of decoys or in the

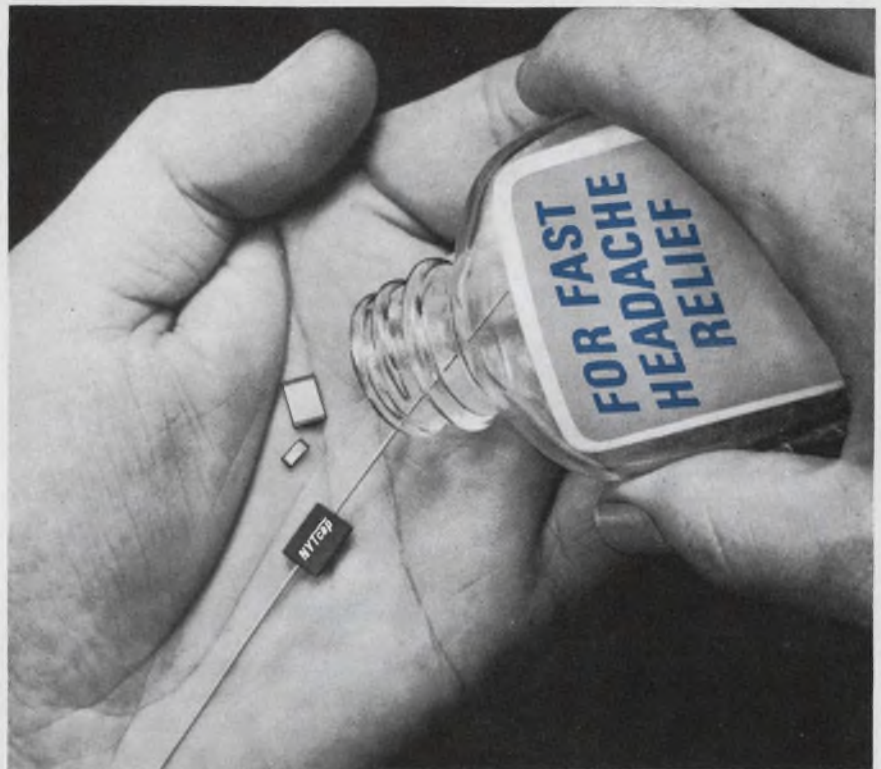

Cure for circuitry headaches

Solve your critical circuitry problems with two extraordinary new miniaturized ceramic capacitors — the product of Nytronics research and development in the continuing pursuit of excellence.

New NYT-CHIP, an ultra-stable chip capacitor, has such advantages as superior packaging flexibility and mounting versatility, particularly for onboard mounting on integrated, thick and thin film circuitry. Dimensions, with tinned terminals, 0.170" x 0.065" x 0.070", with capacitance range of 4.7 pf through 220 pf, and 0.280" x 0.195" x 0.070" for 270 pf to 4700 pf.

NYT-CAP, an ultra high stability ceramic capacitor series is packaged in a miniature molded epoxy tubular package 0.1" diameter by 0.250" in length, with capacitance range of 4.7 pf to 220 pf. The remainder of series in miniature, molded epoxy case 0.350" long by 0.250" wide by 0.1", with a range of 270 pf to 4700 pf.

Both NYT-CHIP and NYT-CAP have a temperature coefficient that does not exceed ± 40 ppm/ $^{\circ}$ C over temperature range of -55° C to $+125^{\circ}$ C, and working voltages of 200 D.C.

As a pioneer in the concept of standardization, Nytronics maintains large volume inventories of these two products, as well as of many other standardized high quality components: inductors, delay lines, and resistors. Write for complete engineering data.

 **NYTRONICS**[®]

...for Precision Electronic Components

550 Springfield Ave., Berkeley Heights, N.J. 07922 ■ (201) 464-9300 ■ TWX: 710-984-7977

ON READER-SERVICE CARD CIRCLE 15

NEWS

(Nike-X, *continued*)

presence of electronic countermeasures. It is also studying the effects produced by clusters of missiles as they penetrate the atmosphere.

The Defense Dept. has estimated that \$500 million will be needed annually to operate and maintain test sites for Nike-X. The total cost of the thin missile defense, industry observers believe, could easily exceed \$11 billion in the next five to six years.

Component costs estimated

The actual production costs for the major system components have not been stated. However, the best estimates for the missiles (without warheads) and for radars are as follows:

Spartans—\$1.25 million apiece.

Sprints—\$1 million apiece.

Perimeter Acquisition Radars—\$85 million each.

Missile Site Radars—\$125 million each.

Approximately \$1.5 billion to \$2 billion will be spent for the missile systems, and about \$3.5 billion for radars, computers, communications links and electronic support equipment.

The Raytheon Co. of Lexington, Mass., will probably receive most of the deployment funds, because its area of responsibility—the Missile Site Radar—accounts for the largest single cost. One of these radars will be required for each missile complex.

The types of missiles in launching cells at each complex will be mixed, and it is believed that from 15 to 20 missile complexes will be deployed throughout the continental United States. Those sites used for the defense of the Air Force's Minuteman ICBM sites are expected to use only Sprint missiles. Seven to eight Perimeter Acquisition Radar sites are reportedly planned.

Directed by Army

The entire program is directed by the Nike-X Project Office, a separate element of the Army Materiel Command at the Redstone Arsenal, Huntsville, Ala. Employing a staff of some 325, the Nike-X Project Office also operates the Kwajalein

Test Site in the Pacific Ocean and maintains a major field office at the White Sands Missile Range, N. M. The Nike-X system manager in Washington is Lt. Gen. Austin W. Betts, and his project manager at Redstone is Brig. Gen. Ivy D. Drewry.

The program was begun in 1957 as the Nike-Zeus antimissile missile system. From this 10-year R&D program evolved all the fundamentals, radars and missiles now to be integrated as an operational system. The program claims at least two major firsts: the successful interception of an ICBM reentry vehicle in July, 1962, and the interception of an earth-orbiting satellite in May, 1964.

The program was reorganized as the Nike-X project in 1963, and the Sprint missile was added. The Nike-Zeus missile was renamed the Spartan last year.

A better "Zeus" made

Spartan is an improved version of the original Nike-Zeus. With greater thrust, it can carry a larger nuclear warhead than the Zeus over greater distances. Each of its three stages is solid-fuel propelled, and the total launching weight exceeds 25,000 pounds.

It is 54.4 feet long and 3.6 feet in diameter across its first stage body. It measures 10 feet across the tail fins. The slant range is believed to be from 400 to 600 miles, and its maximum velocity is expected to exceed Mach 4.

The McDonnell Douglas Corp. of Santa Monica, Calif., is the missile builder. The solid propellant motors are being supplied by the Thiokol Chemical Corp. of Bristol, Pa.

Spartan will have a three-axis inertial autopilot and will be guided by radar command. Honeywell, Inc., of Minneapolis is building the autopilot, and Western Electric's Burlington, N. C., plant is making the guidance system.

The first flight tests for the Spartan are scheduled for early next year. Launching facilities are now under construction at Meck Island, 17 miles north of Kwajalein.

Spartans will be stored vertically in buried, hardened silos. The environmentally controlled silos will be covered with large breakable lids. Since it is solid-fuel propelled and

all electronic equipment will be kept on a standby status, no preflight preparations are needed. When the firing order is received, ignition occurs within the cell, and the missile nose breaks through the silo cover as it leaves the ground. The guidance system takes over once the Spartan is airborne and the controls are set for interception.

Studies by Bell Telephone Laboratories in 1962 showed the need for an interceptor missile that could back up the main missile defense and knock out warheads that had evaded the main defense ring. Sprint was designed to fulfill this requirement.

A conical-shaped, 27-foot long missile, Sprint has two solid-fuel propelled stages. Its 4.5-foot base tapers to a pointed, nuclear-warhead nose. The launching weight is 7500 pounds.

Designed for interception within the atmosphere, Sprint is said to be able to accelerate to more than 100 G's on its way to targets that may be 15 to 25 miles away. Sprint missions will probably be completed in less than five seconds.

Sprint operates hot

The Martin Marietta Corp.'s Orlando, Fla., division has been building the missile since 1963 and will continue to produce it. Hercules, Inc., of Wilmington, Del., furnishes the solid-fuel motors.

The extremely high velocity of Sprint creates a number of operational and guidance problems. The rocket's skin temperatures are reported to soar higher than those in any other rocket. This has raised serious thermal problems with the on-board electronics, but Martin Marietta engineers say they have solved them. Guidance commands must be complete before the second stage motor burns out, because the plasma sheath around the warhead section is so great that it blacks out communications before the intercept.

Sprints are housed in vertical silos, like Spartans, but the launching procedure is different. The missile sits atop a solid propellant charge that literally blows it out of the silo after the firing command is given. It pops right through the frangible cell cover, and rocket ignition occurs when the missile is above the ground. ■ ■



RE SERIES POWER SUPPLIES

HIGH PERFORMANCE — LOW COST POWER SUPPLY
 ... for system and laboratory applications

The Rowan RE series is designed for both precise laboratory and systems applications. The units are convection cooled and use all silicon semi-conductors throughout. The RE series can be operated in either a constant voltage mode or a constant current mode and features circuitry providing automatic crossover to either mode.

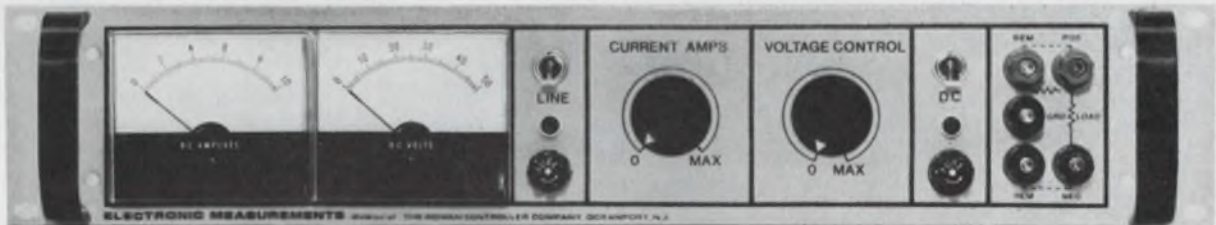

RE 40 - 5ML

FEATURES:

- All silicon semi-conductors
- Convection cooled
- Automatic E/I crossover
- Constant voltage/constant current operation
- Series master-slave operation
- Remote sensing
- Remote programming
- Single knob voltage control with dual knob resolution

RE SERIES SPECIFICATION TABLE

Model	Output volts	amps	Regulation line or load %*	Ripple MV RMS	Meters Ammeter Voltmeter	Terminals F - front R - rear	Size 19" panel	Weight	Price
RE 40 — 5	0 - 40	5	.01 or 2 MV	0.5	No	R	3½ H x 17¼ D	36#	\$290.00
RE 40 — 5M	0 - 40	5	.01 or 2 MV	0.5	Yes	R	3½ H x 17¼ D	36#	315.00
RE 40 — 5ML	0 - 40	5	.01 or 2 MV	0.5	Yes	F & R	3½ H x 17¼ D	36#	320.00
RE 60 — 2.5	0 - 60	2.5	.01 or 2 MV	0.5	No	R	3½ H x 17¼ D	36#	290.00
RE 60 — 2.5M	0 - 60	2.5	.01 or 2 MV	0.5	Yes	R	3½ H x 17¼ D	36#	315.00
RE 60 — 2.5ML	0 - 60	2.5	.01 or 2 MV	0.5	Yes	F & R	3½ H x 17¼ D	36#	320.00

*whichever is greater. Input for all models 105-125, 50-63 HZ

ELECTRONIC MEASUREMENTS

division of THE ROWAN CONTROLLER CO. | 2 CRESCENT PLACE | OCEANPORT, N.J. 07757

ON READER-SERVICE CARD CIRCLE 16

Integrated-circuit reliability myth or fact?

How reliable are integrated circuits?

Nowhere near as reliable as manufacturers claim, according to military and space systems buyers.

Ten times better than discrete-component counterparts that have less sophisticated requirements, according to systems designers.

The question was argued bitterly in Garden City, N. Y., at an IEEE Aerospace and Electronic Systems Group Symposium on Microelectronic Applications. Comparisons were drawn between IC deficiencies today and the reliability headaches that were encountered with receiving tubes a decade ago.

Military and space systems buyers were outspokenly critical of the failure of IC equipment to meet highly touted performance promises. Boasts of hundredfold increases in systems MTBF (mean time between failure) have been bandied about with subsequent disappointment in field performance, they indicated.

Customers blamed

Systems designers, on the other hand, argued that the MTBFs of ICs had indeed improved. They blamed the customers for demanding of integrated circuits more functions and higher performance than they did of discrete components. One defender of ICs, Frank McGinnis, director of reliability for the Sperry Gyroscope Co. of Great Neck, N. Y., said that military and space customers were pushing the IC technology too hard by rushing to put the circuits in their aircraft and weapons systems.

The systems customers, represented by the Navy, Air Force and NASA, were unmoved. Ed O'Connor, a reliability engineer with the Air Force's Rome Air Development Center, contended that there were order-of-magnitude differences between expected failure rates for ICs and the results achieved to date. Further, he complained, the specifications are so broad that precise

information on device performance cannot be tracked down. The customer cannot even rely on getting the same device in the second shipment from a supplier, he reported, since process steps are often changed without notification. And as if that were not enough, O'Connor said that one manufacturer, had informed him that IC prices were not based on supply and demand but on a structure designed to keep competitors off balance.

Construction flaws cited

Flaws in workmanship, rather than variations in processing steps, are the major cause of IC unreliability, both sides in the debate agreed. Poor bonding in the form of overwelds and underwelds and foreign particles inside the sealed headers were described as most common assembly problems.

A. J. Finocchi, director of reliability engineering for ITT in Nutley, N. J., noted that the major causes of receiving-tube unreliability a decade ago were overwelds, underwelds and foreign particles inside the tube envelope. The increased application of flip-chip devices in system assemblies should reduce errors stemming from workmanship, Glen Madland, president of the Integrated Circuit Engineering Co., Phoenix, Ariz., said.

Both military customers and their systems suppliers expressed concern over the shift in attention by major IC manufacturers from the high-price, low-volume military market to the low-price, massive-volume industrial and consumer markets. Air Force, Navy and NASA spokesmen, as well as systems engineers at major Long Island aerospace companies, lamented that the IC devices that they had to accept for their high-reliability programs seemed to be similar to those shipped to industrial and commercial users.

Finocchi pointed out once more that the situation was analogous to the military-consumer tube hassle

of years ago. He recalled a session in Washington, D. C., where 50 representatives of receiving-tube manufacturers met with about 100 systems engineers who were designing for military customers. Following a strong demand by the systems engineers for more reliable tubes, he said, the representative of a major tube supplier calmly estimated the number of tubes that the military market could be expected to buy that year. He then proceeded to illustrate that the dollar volume was only 1 per cent of the total expected market for tubes that year. Further, he added, military customers were taking up 16 per cent of the tube makers' engineering time.

Today's ICs manufacturers, the symposium was told, are seeking markets that will lead to high-quantity output; few feel that the low-volume custom specials of the military represent long-term gains. A solution to the military-space problem, one systems engineer suggested, might be to offer a bonus to IC suppliers whose devices meet premium performance specs and perform with low failure rates in the field.

Corrective steps urged



To spot defective ICs stemming from poor workmanship, Madland proposed the use of headers with plate glass lids. Inspectors could then visually examine devices and cull out units with poor connections, foreign particles and other defects. But, he went on, the key to over-all IC reliability improvement is in the hands of the IC manufacturers themselves. Remove the myth of the proprietary process, he suggested, and drop the notion that each company must closely guard its processing procedure. Then, he went on, competitive companies can openly exchange information on failure modes and establish industry-wide life-testing methods that will be meaningful for a generic product line and not for just one particular supplier's devices. ■ ■

Designed Sealed Delivered



Helipot's New Model 77P Cermet Trimming Potentiometer

Here's the new Model 77P, the first low-cost, general purpose trimmer with a sealed housing and cermet resistance element! DESIGNED to wider performance parameters than any other adjustment potentiometer in its price range. It is directly interchangeable with competitive Models 3067 and 3068—SEALED to permit p.c. board solvent cleaning and potting without trimmer contamination or failure—DELIVERED from local stock at the low list price of \$1.95. In large quantities, Model 77P sells for as little as \$1.10. ■ Compare Model 77P specifications with those of unsealed trimmers, then call your local Helipot representative for an evaluation sample.

	 Helipot Model 77P	 Model 3067 Wirewound	 Model 3068 Carbon
Resistance Range, ohms	10 - 2 meg	50 - 20K	20K - 1 meg
Resolution	Essentially Infinite	1.7 (100) to 0.3 (20K)	Essentially Infinite
Sealing	Yes	No	No
Power Rating, watts	0.75	0.5	0.2
Maximum Operating Temp. °C	105	85	85



Beckman INSTRUMENTS, INC.
HELIPOT DIVISION
FULLERTON, CALIFORNIA • 92634

INTERNATIONAL SUBSIDIARIES: GENEVA; MUNICH; GLENROTHES, SCOTLAND; TOKYO; PARIS; CAPETOWN; LONDON; MEXICO CITY

ON READER-SERVICE CARD CIRCLE 17



In-depth software...

...at your fingertips
for the finest 24-bit
I/C computer buy

...DDP-124

NOW—
60 DAY DELIVERY
ON BASIC SYSTEMS
NEW LOW PRICES

Every μ -COMP DDP-124 includes 253 field-proven software programs, FORTRAN IV compiler with Boolean capabilities, compatible symbolic assembler . . . and more. That's a lot of 24-bit software strength at your fingertips to help solve your programming problems.

Hardware? DDP-124 features I/C μ -PAC logic modules for high reliability, high performance, high speed at low cost . . . and its specs make it an ideal computer for flight simulation, message switching, physics research, radar tracking, data acquisition, scientific computation, missile tracking, impact prediction.

Interested in the finest 24-bit I/C computer? Write today for new DDP-124 brochures with complete software listing. Honeywell, Computer Control Division, Old Connecticut Path, Framingham, Massachusetts 01701.

Honeywell

 **COMPUTER CONTROL**
DIVISION

TFX wins grudging acceptance



TFX: Air Force—yea, Navy—nay

Despite the Congressional hue and cry over the F-111 swing-wing fighter/bomber's suitability, the F-111A was quietly accepted formally late last month by the Air Force's Tactical Air Command at Nellis Air Force Base, Las Vegas, Nev. Further certification has still to be obtained. There reportedly remain design problems affecting operational performance, and the aircraft is six tons heavier than desired. Nevertheless the Air Force has indicated that it can live with the aircraft in its inventory.

The Navy has more serious problems with its F-111B version; yet it, too, has learned either to keep silent or to do its fighting on the quiet, out of range of Defense Secretary Robert McNamara's ears. It has good reason. According to Washington informants, three top Navy officials and many of lesser rank have been summarily removed from office for publicly stating their disapproval of the F-111B.

Among those retired well before statutory age are Admirals George Anderson, Robert Perry and William Scoech.

Aside from many technical problems such as gross instability on landing, certain basic deficiencies for a Naval carrier role are hard to overlook. Industry and military informants state unequivocally that the F-111B can operate from only one existing carrier, the U.S.S. "Enterprise," because of its great weight—more than 15 tons above specifications. Besides not fitting the elevators of other carriers, the aircraft's great weight would buckle their deck plates on landing. Furthermore, they claim, even on the Enterprise, the F-111B will require 40 men to maneuver it onto an elevator, since it leaves no room for a "mule" tow vehicle.

Pentagon nails overpricing

Deputy Secretary of Defense Paul H. Nitze, in a memorandum dated Sept. 29, has ordered all military service assistant secretaries to audit

Washington Report

CHARLES D. LAFOND
WASHINGTON BUREAU

contractors once awards have been made. In an attempt to reduce overpricing on noncompetitive fixed-price contracts, he has ordered performance records, including both actual cost and actual profits, to be made subject to full government review. A clause will henceforth be inserted in these Defense Dept. contracts stating the government's right of access to contractors' performance records.

Nitze's directive emphasized that such auditing will be "limited to the single purpose of determining whether or not defective cost or pricing data were submitted." Access to a contractor's records, said Nitze, is not intended to evaluate cost-profit relationships nor will contracts be repriced if the realized profit was greater than forecast. The audit must show that cost and pricing data certified by the contractor were in fact defective before the Pentagon may seek a contractual repricing.

Lesson learned from Apollo accident?

How much does it take to convince contractors working on NASA's lunar spacecraft program that man-rated systems must approach perfection? The discovery during a test countdown early this month of a malfunctioning power supply, wiring problems, and engine plumbing difficulties in the massive Saturn 5 space booster have again introduced unnecessary delay in the vehicle's flight test.

Following NASA's announcement of these deficiencies in America's largest launch vehicle, Rep. William P. Ryan (D-N.Y.) showed Congress a Feb. 15 letter from Dr. Wernher von Braun, upbraiding the rocket-engine subcontractor for slipshod manufacturing and quality control. He warned Rocketdyne Div. of North American Aviation that deficiencies could "cause a serious accident if this situation is allowed to continue."

Rep. Ryan, who has loudly opposed further large appropriations for NASA, also made public a Sept. 14 letter to him from NASA

Washington Report

CONTINUED

Administrator James E. Webb. It gave details of additional engine problems, chiefly foreign matter discovered after testing and cleaning the engines.

In the wake of Ryan's disclosures, Webb, supported by von Braun and top officials from NASA and the Saturn contractors, held a press conference. All echoed von Braun, who stated emphatically that "all three types of engines are in very good shape now."

Chrysler Corp. is the contractor for Saturn's stages; Boeing is the prime contractor for Saturn 5. The principal problems have centered on the H-1 engine in the Saturn 1B, which will orbit three astronauts next year, and the J-2 upper-stage engine common to both the Saturn 1B and Saturn 5 launch vehicles.

Army data system to exceed \$100 million

First elements of the Army's Combat Service Support System are due for testing at Fort Hood, Tex., early next spring. Under a \$5 million contract awarded last June to IBM, three complete mobile data-processing and communications systems will be built for the so-called CS3 program. Due to be operational in 1968, the system uses off-the-shelf hardware and is designed to pool logistical and combat personnel records. These are to provide both field equipment and manpower readiness data for personnel and supply staffs whenever needed. CS3 will be deployed at Army corps and division headquarters, so operational-system expenditures could easily exceed \$100 million over the next few years.

Each system consists of four 35-foot military vans and the use of remote substations for input/output units. The latter will be contained in portable shelters mounted on trucks.

Two additional systems will be delivered under the same contract to the U.S. Seventh Army in Europe (one fixed and one mobile). They do not form part of the CS3 program.

CS3 is part of the Army's long-range plans to have an integrated Automatic Data System for the Army in the Field (ADSAF) by the 1970's. A comprehensive effort, this is expected ultimately to cost close to \$1 billion. The two other elements that make up ADSAF are a tactical automatic system for artillery fire

control, dubbed TacFire, and a Tactical Operations Support System (TOSS), to provide digital computer and communications services for supply and operations staffs. Control Data Corp. has provided off-the-shelf hardware for TOSS field-testing by the Seventh Army. Three firms—IBM, Litton Systems and Burroughs Corp.—are now competing for the production phase of Tac Fire.

Each of the CS3 mobile vans will be equipped with:

- An IBM model 360/40 computer.
- An IBM model 2314 direct-access eight-disk storage unit.
- Digital communications equipment.
- Maintenance equipment and key punches.
- IBM has also stated that a pair of its new data correction devices, called Dacor, will be tested with one of the mobile field systems.

Senate reinstates NASA funds

For a while at least, NASA can count on an additional \$96 million in appropriations—the Senate Appropriations Committee has restored Voyager funds, to continue work on the unmanned exploration of Mars, and Nerva II funds, to sustain the pace of development of the nuclear rocket program. The full Senate must vote on the bill before it goes back to the House, where another fight is anticipated.

The restored funds break down as follows: \$36 million for Voyager, \$35 million for the Apollo Applications Program (the post-Apollo effort), \$29.5 million for Nerva II and \$15 million for NASA's global tracking network. About \$20 million was also included for NASA administering funds. The money reinstated comes to \$116 million. Thus the total bill that the Senate will vote on will amount to \$4679 million.

Alaskan Communications System for sale

By a vote of 357 to 1, the House has passed a bill authorizing the Dept. of Defense to dispose of that portion of the U.S.-owned long-lines Alaskan Communications System that is not essential to the integrity of military communications. The system includes both radio and hard-line communications circuits within Alaska and terminals connecting circuits to the continental U.S.

Originally established by the Army and now under the control of the Air Force, the Alaska Communications System initially cost \$200 million. Fair market cost of the portion to be sold is now estimated at \$20 million.

FIVE GOOD WAYS TO LEARN ALL
ABOUT MICROELECTRONICS

- *By interviewing the top integrated circuit designers in the country.
- *By attending conferences devoted or related to microelectronics.
- *By developing and editing state-of-the-art articles covering the latest design techniques.
- *By writing extensively about the subject.
- *By working for Electronic Design... the magazine that makes it their business to know.

Good salary,
excellent benefits,
pleasant atmosphere, and
association with top professional
engineer-writers are yours.
Interested? Write or call Robert
Haavind, Managing Editor, Electronic
Design, 850 Third Avenue, New York,
New York 10022 (212) PL 1-5530.

Color TV equipment drops 90% in price

Closed-circuit color television equipment of broadcast quality at a cost comparable with that for monochrome systems has been announced by International Video Corp., of Mountain View, Calif.

Donald F. Eldridge, president of IVC, said the complete system consisting of a color camera, video tape recorder and monitor sells for \$15,000 and produces closed-circuit television color pictures equivalent to those from a \$150,000 professional system.

This major reduction in price was achieved through the development of an inexpensive optical system. Conventional optics account for a significant portion of the total cost of a three-vidicon color television camera. The optical system must separate a scene into its three primary colors and focus each color on the proper vidicon tube. The company simplified the design for the normally complex optical system, but declined to give details of its newly developed design.

The company claims the camera has excellent color fidelity and quality pictures with light levels of 250 footcandles. Resolution is 400 lines at center and corners. The camera is self-contained with a built-in integrated-circuit synchronous generator and color encoder with encoded output from a coaxial connector.

A camera viewfinder is available with pushbutton switches to allow viewing of the red, blue or green separately, or any combination of these primary colors. A Y matrix permits viewing of the luminance signal.

Eldridge anticipates sales of the color system will reach \$5 million within the next 5 years. He predicts that it will take about 5 years for the price of color systems to decline to a point where closed-circuit color TV systems would become attractive for home use.

The color camera alone is priced, at \$9850 without the CRT viewfinder. This contrasts with a typical broadcast camera, which costs about \$80,000, and the least expensive closed-circuit color TV camera available hitherto, which sold for about \$30,000. ■ ■

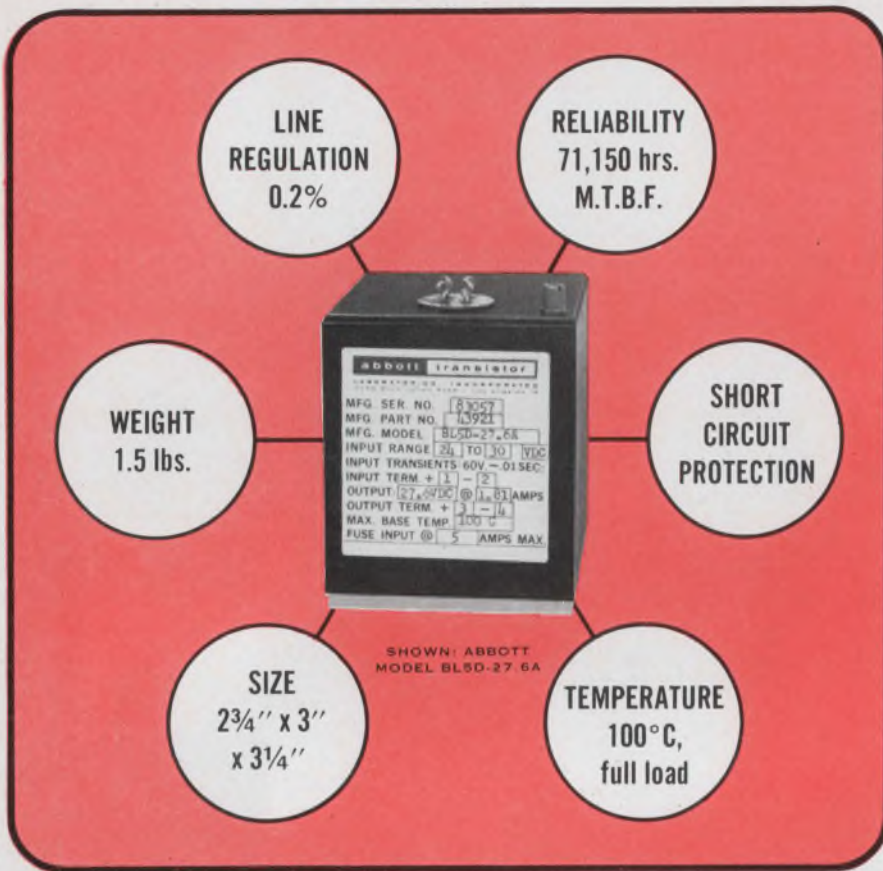

What are Engineers Saying About Abbott's Power Supply Modules?

Saves Space – Abbott Power Supply Modules save chassis space in missile systems where space is at a premium. Some DC to DC modules are as small as a package of cigarettes—yet rugged enough to meet MIL specs.

Reliable – Space and missile systems must first be reliable. Abbott Power Modules are reliable. According to an analysis by a leading prime contractor, the Abbott units have an expected M.T.B.F. (mean time between failure) of 71,150 hours.

Saves Weight – Since every ounce of weight in a missile system is worth more than gold, we have designed the Abbott modules for minimum weight. For example, one model has a 120 watt power output in less than three pounds. Other models weigh less than a pound yet still have this high performance.

High Temp. Operation – The new Abbott Hi-Temp models will operate continuously at 100°C at full load. They use all silicon semiconductors. Good thermal design allows heat to flow into the heat sink by conduction.

Good Regulation – When a missile system's line voltage is varying, the power supply output voltage must usually be constant. Abbott Power Supplies have line regulation as close as 0.2%. (Regulations of 0.005% have been designed when required.)

Protects Circuitry – No short circuit damage to an expensive missile system occurs when an Abbott Power Module is used. Special Short Circuit Protection works automatically to deactivate the power supply when it senses a short circuit in the system.

Most models are listed in EEM (ELECTRONICS ENGINEERS MASTER Directory) on Pages 1665 to 1678. For our complete line of power modules covering voltages between 4.7 and 10,000 volts, send for your FREE catalog.

abbott transistor
LABORATORIES INCORPORATED
5200 W. Jefferson Blvd. • Los Angeles 90016
Area Code 213 • WEbster 6-8185

TO: Abbott Transistor Labs, Inc., Dept. 42
5200 W. Jefferson Blvd.
Los Angeles, California 90016

Sir:
Please send me your latest catalog on power supply modules:

NAME _____ DEPT. _____
COMPANY _____
ADDRESS _____
CITY & STATE _____

Component
and
Circuit
Design

IDEAS

from SYLVANIA Electronic Components Group

CRTs

3" x 5" CRT prints out signal records up to 1 MHz



Video pictures
printed out in a series
of individual frames

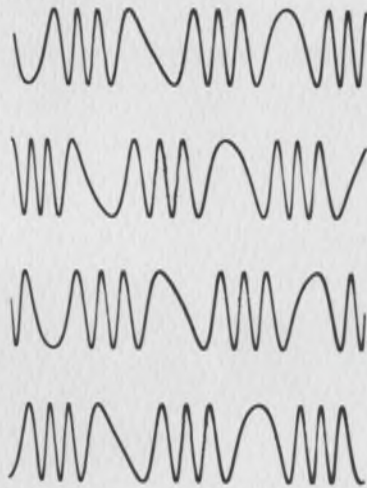

Continuous record,
transverse signal pattern

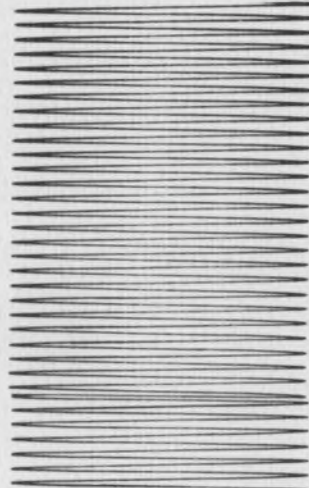

Continuous record,
longitudinal waveform



Printout of simultaneous
X-Y plot and Lissajous pattern

Photos courtesy of Honeywell Inc. Test Instrument Division

Direct printout speeds 100 times faster than previously available in commercial oscillographs . . . Spot resolution of less than 0.008-in. diameter . . . Recording of both black-and-white and halftone data . . . Signal recording and printout from dc to 1 MHz . . . Waveform or alphanumeric printout . . .

All of these are well within the capability of the Sylvania SC-4082E fiber-optic cathode-ray tube, which has the largest fiber-optic faceplate commercially available today: 3" x 5".

The faceplate consists of more than 35 million light-conductive fibers, each only 10-15 microns in diameter, fused into one bundle about 1/2-inch thick and coated on the back with Sylvania P16 high-output phosphor.

The small diameter of the faceplate fibers, combined with an improved electron gun, assures extremely fine spot resolution on the output side of the faceplate: 4 to 7 mils as opposed to the 15 to 30-mil range of typical laboratory oscilloscopes.

As shown here, this fiber-optic CRT is used in Honeywell Test Instrument Division's Model 1806 Visicorder, which combines a precision oscilloscope for visual signal monitoring with a high-speed oscillograph recorder.

The Visicorder is a single-channel, 4-axis unit which uses the light output from the fiber-optic CRT faceplate to record continuous transient data directly on standard ultra violet-sensi-

(continued)

This issue in capsule

Integrated Circuits—Tailor amplifier response without complex networks.

Readouts—"Bar-graph" analog indicators with resolution to 30 lines per inch.

Rectifiers—50-amp glass rectifiers absorb 1000-watt reverse transients.

Microwave Components—High-power avalanche diode oscillators open new application areas.

Manager's Corner—Thick-film microcircuits: reliability at low cost.

Television—New, more economical 15" and 19" color picture tubes.

CRTs (continued from page 1)

tive oscillograph paper. Signal variations are recorded as the paper passes over the faceplate. Low-level ultraviolet light develops the paper as it comes out of the Visicorder to give a permanent record within seconds.

Thanks to the speed, light output and resolution of this fiber-optic CRT (and with a well-deserved bow to the ingenuity of Honeywell's design engineering staff), the Visicorder records signal responses from dc to 1 MHz, on either the vertical or the horizontal axis or simultaneously on both, and has continuous or intermittent chart-drive modes.

In addition, video pictures can be recorded as a continuous series of individual 3" x 4" frames on the direct-record paper at the rate of 30 pictures per second.

The SC-4082E fiber-optic CRT uses electrostatic focus and deflection, although Sylvania makes many fiber-optic CRTs with magnetic focus and deflection. Helical-resistor post-deflection acceleration is employed to get a high writing rate, high deflection sensitivity and freedom from pattern distortion.

Unique and specialized as it is, the SC-4082E represents only a tiny part of Sylvania's full capability in fiber-optic cathode ray tubes. Sylvania can make them in circular or rectangular configurations, and with wide, shallow faceplate strips for alphanumeric readout exclusively. CIRCLE NUMBER 300

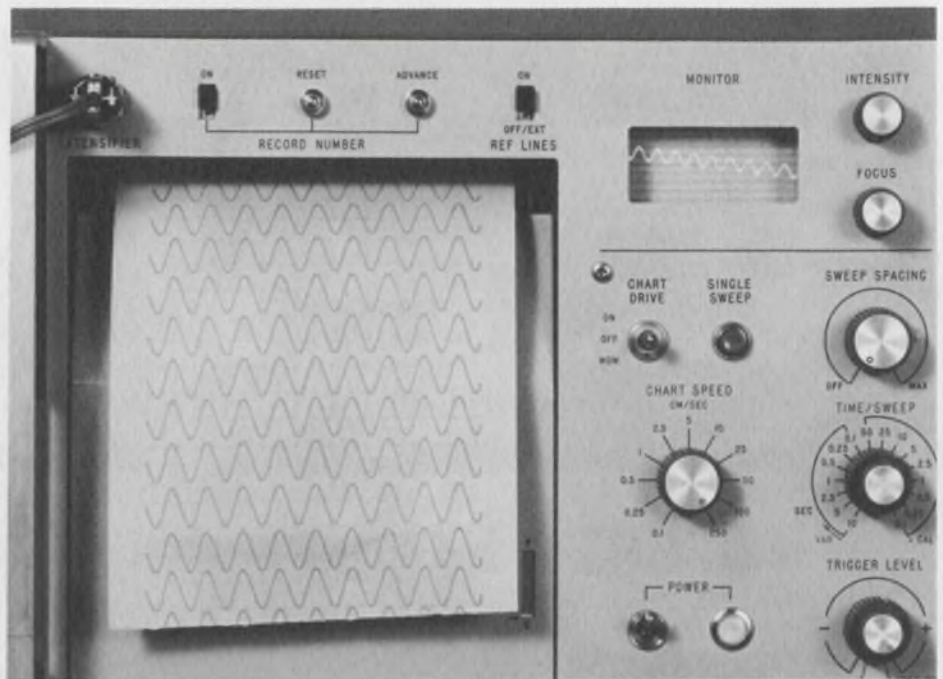

Honeywell Model 1806 CRT Visicorder

BASIC CHARACTERISTICS OF TYPICAL FIBER-OPTIC CRTS

Tube Type	Fiber Strip Size	Focus	Bulb Size
SC-3304	2 3/4" x 1/4"	magnetic	3" x 1 1/2"
SC-3507	8 11/16" x 1/2"	magnetic	10" x 3 1/2"
SC-3800	8 11/16" x 1/2"	electrostatic	10" x 3 1/2"
SC-3850	4 1/2" x 1/2"	magnetic	5" dia.
SC-3876	8 11/16" x 1/2"	magnetic	10" x 3 1/2"



Sylvania fiber-optic CRT Model SC-4082E as used in Honeywell Visicorder above

INTEGRATED CIRCUITS

You can tailor amplifier response without complex networks

Sylvania's SA-20 series of linear ICs offers more than just an excellent wideband amplifier. The ability to externally control the amplifier's gain and bandwidth means this device can be easily tailored to meet specific system needs. Electrical performance is not sacrificed to obtain this external flexibility. The SA-20 is characterized by stable voltage gain, high output voltage swings, low output impedance, excellent frequency and pulse response, excellent intermodulation product and high linearity.

Now you can get a wideband, bandpass, or notch amplifier simply

by changing a simple external network connected between two terminals of an IC. Sylvania's SA-20 integrated circuits (Figure 1) are basically wide band video amplifiers consisting of three direct-coupled linear amplifier stages. Frequency response characteristics are determined by a simple external network connected between the collector (pin 2) and base (pin 1) of the second stage. The complex external networks often needed with other ICs are not required when designers use these Sylvania units.

How the value of a compensating

capacitor between terminals 1 and 2 influences broadband characteristics is indicated in Figure 2.

The selective amplifier configurations of Figure 3 show how notch and bandpass characteristics are obtained with simple L-C feedback networks. In the notch configuration, there will be a dip in the gain-frequency characteristics at the resonant frequency. Very narrow notch bandwidth can be obtained by operating in the series resonant mode.

In the bandpass option, maximum gain is obtained at the resonant frequency of L and C. Capacitor C

INTEGRATED CIRCUITS (continued)

blocks dc. When the SA-20 is connected in this way, the gain approaches the maximum open loop gain at the resonant frequency. The response curves shown were obtained with components listed. Using higher-Q inductors and series tuning L with C_2 at a frequency below F_0

would improve circuit selectivity. Using a crystal operating in a parallel resonant mode will give a more selective bandpass characteristic.

If precise matching of the amplifier gain to a specific application is required, external resistance is added in parallel with an internal feedback

resistor R4 or R6. Padding R4 increases the gain, and padding R6 decreases the gain. Padding resistors should be DC-isolated from the circuit with capacitance to prevent a shift in DC quiescent levels.

CIRCLE NUMBER 301

Figure 1

SYLVANIA WIDEBAND AMPLIFIER

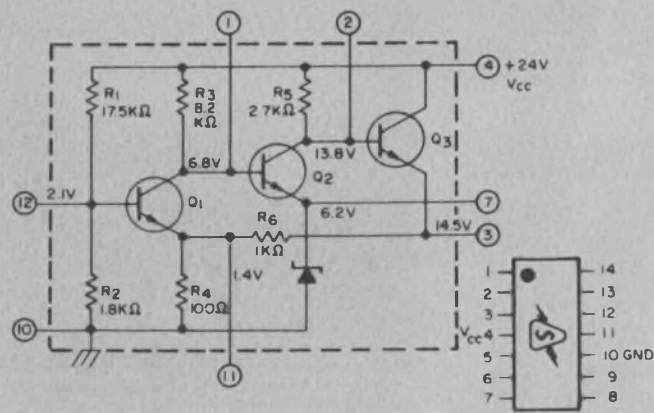

NOTE:
VOLTAGES DENOTED ARE NOMINAL QUIESCENT VALUES AT 25°C, AND ARE SHOWN FOR INFORMATION ONLY

Figure 2

TYPICAL GAIN vs FREQUENCY OF SA-20

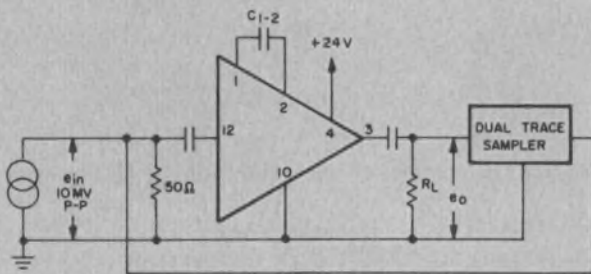
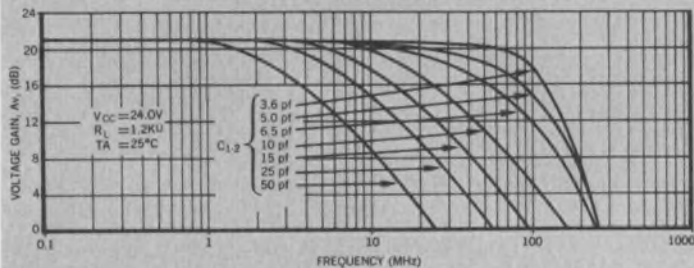

C_{1-2} * INCLUDES SOCKET CAPACITY BETWEEN PIN 1 AND 2

Figure 3

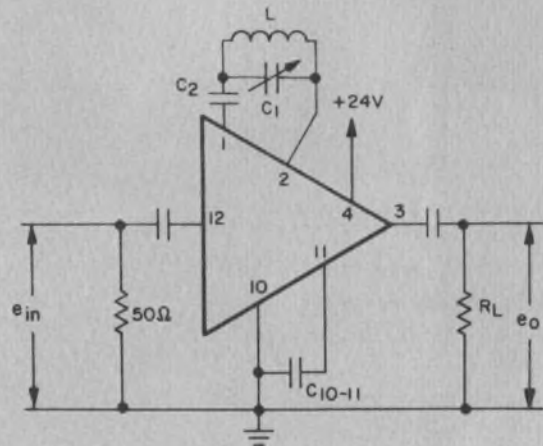
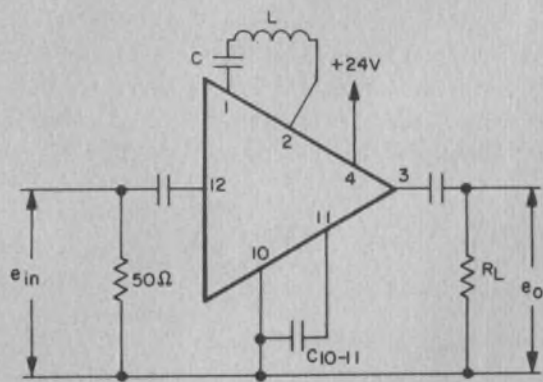

TYPICAL SA-20 BANDPASS CHARACTERISTICS

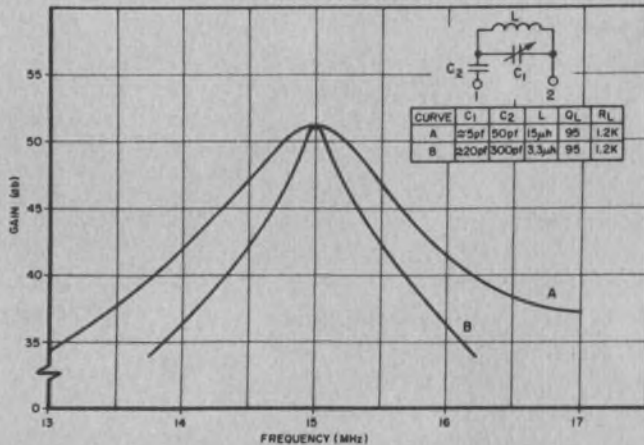

EL "bar-graph" analog indicators, now with resolution to 30 lines per inch

The effectiveness of any analog indicator is measured in terms of how accurately it displays the information and how immediately comprehensible the information is to the viewer. Sylvania has developed a plug-in EL bar-graph indicator which we consider a major advance in instrumentation.

Let's take a typical application for our EL bar-graph indicators: a tachometer array for a 4-engine jet aircraft.

A metered display would look like this:



Our EL bar-graph display of the same input data would look like this:

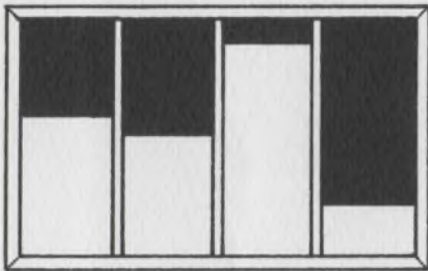

Notice how much more quickly and easily the comparative speed of the engines may be seen on the bar-graph display.

EL bar-graph analog indicators can be used for general instrumentation, aircraft, spacecraft and shipboard applications—anywhere that quantitatively variable input data must be monitored.

How they work

Each indicator consists of an array of horizontal parallel EL lines deposited on a glass film. The devices—in standard or custom design—can be provided with from 8 to 30 lines per inch, depending on the resolution required. And they are available in hermetically sealed construction. Sylvania bar-graphs offer the inherent design advantages of all EL readout units: solid-state reliability, low power consumption, wide viewing angle, light weight, low reflection, stable performance, freedom from catastrophic failure, and rapid information display.

These bar-graph analog indicators are available in 115 V and 250 V versions: our "P" Series and "C" Series respectively.

The "P" Series is designed for low voltage operation—115 volts RMS, 400 Hz with a peak voltage rating of 300 volts over the temperature range of -55 to +71°C. This series yields a higher average initial brightness of 15 foot-lamberts at the lower voltage of 115 volts RMS, 400 Hz.

The "C" Series is designed to operate typically at 250 volts RMS, 400 or 800 Hz with a peak voltage rating of 420 volts over the temperature range of -55 to +94°C. This series yields an average initial brightness of 8 foot-lamberts operating at 250 volts RMS, 400 Hz and 12 foot-lamberts at 250 volts RMS, 800 Hz. CIRCLE NUMBER 302

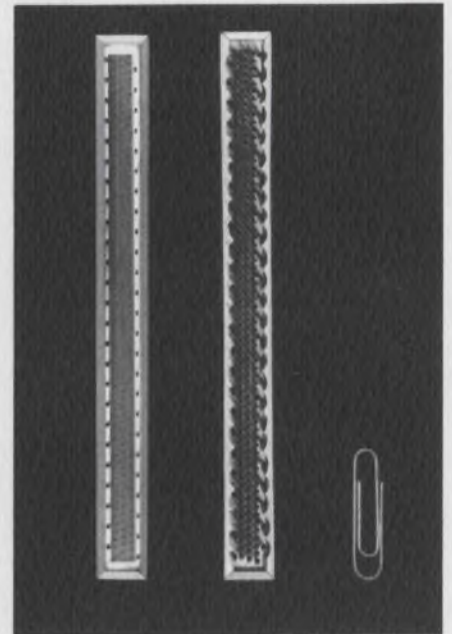

Sylvania electroluminescent bar-graph-type plug-in analog indicators.

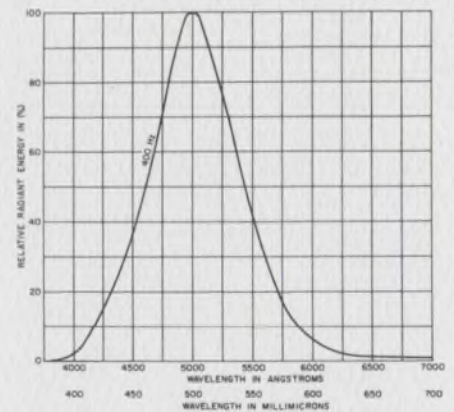
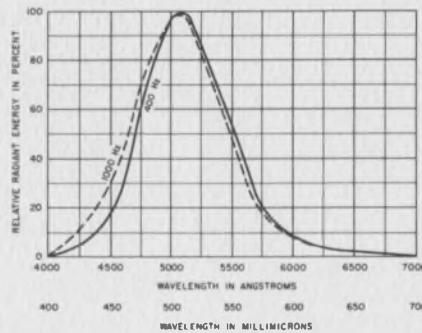
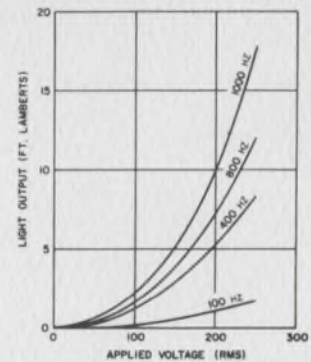
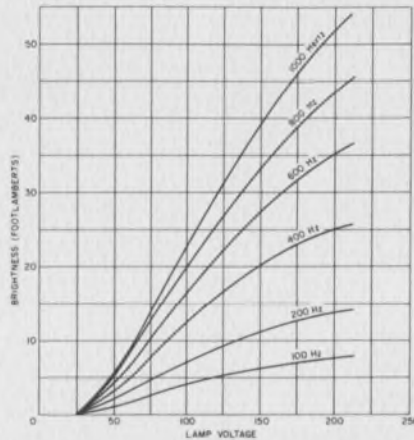

TYPICAL OPERATING CHARACTERISTICS AND MAXIMUM RATINGS (All Segments Lighted)

Type	OPERATING CHARACTERISTICS				MAXIMUM RATINGS						
	Light Output		V-AC RMS	F Hz	Maximums			Peak Voltage	RMS Voltage	Peak Transient Voltage	Operating Temperature Range (°C)
	Brightness (Initial) FL	Wavelength Angstroms			I Ma	P Mw	Pf				
C-Series	6-10	5100	250	400	1.0	50	.50	420	300	500	-55 to +94
	10-14	5100	250	800	1.2	85	.50	420	300	500	-55 to +94
P-Series	12-18	5100	115	400	1.1	55	.85	300	210	350	-55 to +71

Sylvania 50-amp glass rectifiers withstand 1000-watt reverse transients

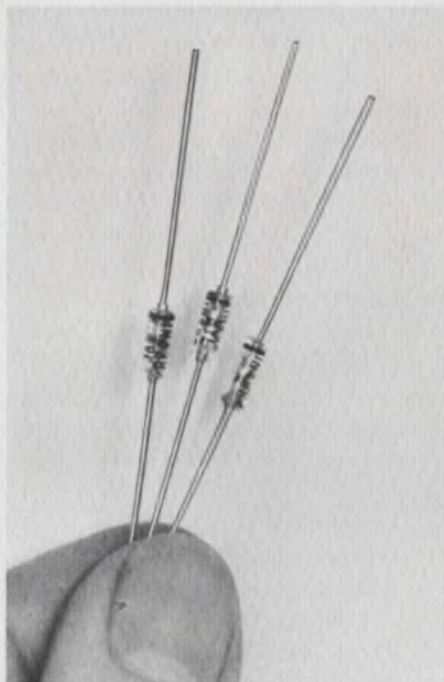

Circuit designers are finding that Sylvania's glass rectifiers are better than other glass rectifiers. In this instance, the improved characteristics result in enhanced circuit performance and increased device reliability. Sylvania has coupled the inherent advantages of glass encapsulation with superior device design to make these glass diodes rugged enough for military applications. This designed-in dependability also makes this line of glass units an excellent choice for many other uses in computer, industrial and communications equipment. It is the improvements in device design that make Sylvania's glass silicon rectifier line stand out from other glass units.

In the improved devices, a large double diffused junction allows handling of 1000-watt reverse power transients while still maintaining the standard 50-amp forward surge capability. Sylvania's first glass rectifiers can take outputs of up to 1 amp at reverse working voltage of 1000 volts without damage.

Heat dissipation is aided by welding a solid high conduction power lead to an oversized heat conduction stud. This enhances power handling capability while extending device life by keeping the unit cooler. The glass package is electrically neutral and smaller than many metal rectifiers,

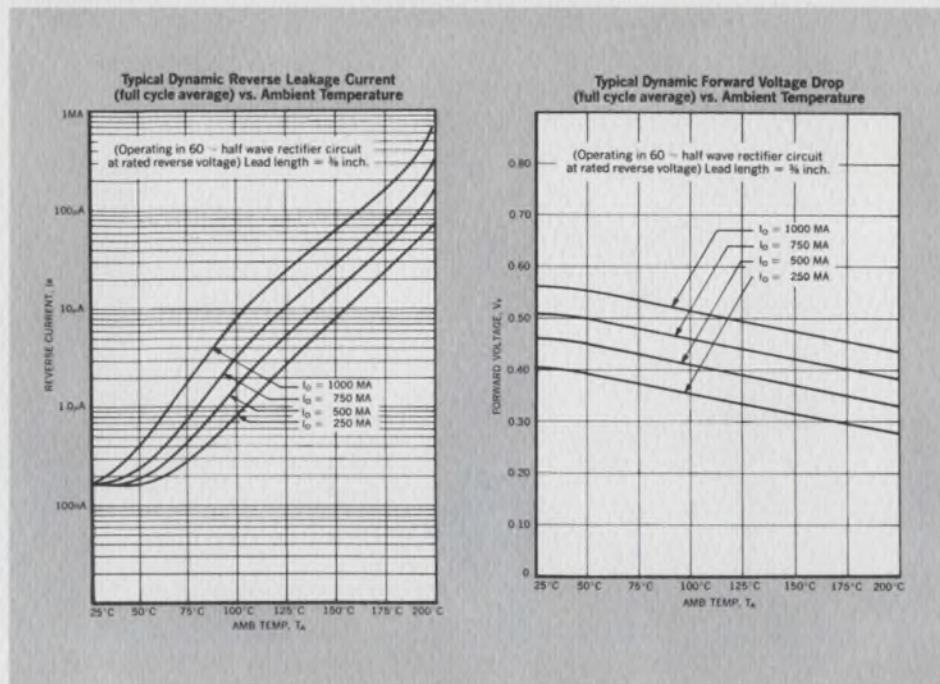

thus permitting greater stacking and card densities. With Sylvania's sealing techniques, the designer gets the benefits of improved device design without sacrificing any of the advantages of glass encapsulation. Use of a glass package means not only improved insulating characteristics but units that can be hermetically sealed. Radiflo leakage rate for these devices is less than 1×10^{-10} cc/sec. Low leak rates extend life and increase reliability. The glass body also enhances the thoroughness of in-process quality control by allowing visual inspection during production.

In addition to the ability to handle

high reverse pulses, these rectifiers have low reverse leakage current. Typical rating is 10 na at 25°C ambient and rated reverse voltage. The high voltage rating and wide temperature operating range (-65°C to 175°C) capability of these units can't be matched by ordinary non-hermetically sealed devices.

All units in the Sylvania series are packaged in the conventional DO-29 outline. They are replacing existing glass, epoxy or top hat types in applications which demand higher reliability levels. These devices meet or exceed all the standard life and design requirements of MIL-S-19500.

CIRCLE NUMBER 303

ABSOLUTE MAXIMUM RATINGS:						
-65°C to +175°C — Resistive and Inductive Loads — Single Phase, half wave at 60 cps.						
	Units	1N4383	1N4384	1N4385	1N4585	1N4586
Continuous Reverse Working Voltage, V_R	volts	200	400	600	800	1000
RMS Input Voltage, V_{rms}	volts	140	280	420	560	710
Average Forward Current, I_o	amps					
@ 50°C		1.0	1.0	1.0	1.0	1.0
@ 100°C		1.0	1.0	1.0	0.6	0.6
@ 150°C		0.3	0.3	0.3	0.2	0.2
Forward Surge Current, 1 cycle — $I_{F sur}$	amps	50	50	50	50	50
Forward Surge Current, Recurrent, $I_{F sur}$	amps	6	6	6	6	6
ELECTRICAL CHARACTERISTICS:						
Typ. Dynamic Forward Voltage Drop, V_F @ 1.0 amp	volts					
@ 50°C						
@ 100°C		.52	.52	.52	.56	.56
Typ. Dynamic Reverse Current, I_R @ V_R	μA @ 1.0 amps					
@ 50°C		8	8	8	.55	.55
@ 100°C						
Typ. Reverse Current, I_R @ V_R and +25°C	na	10	10	10	10	10
Typical Junction Capacitance — All Types —	@ 0 V 80 picofarads					
	@ 10 V 21 picofarads					

Thick-film microcircuits: Reliability at low cost

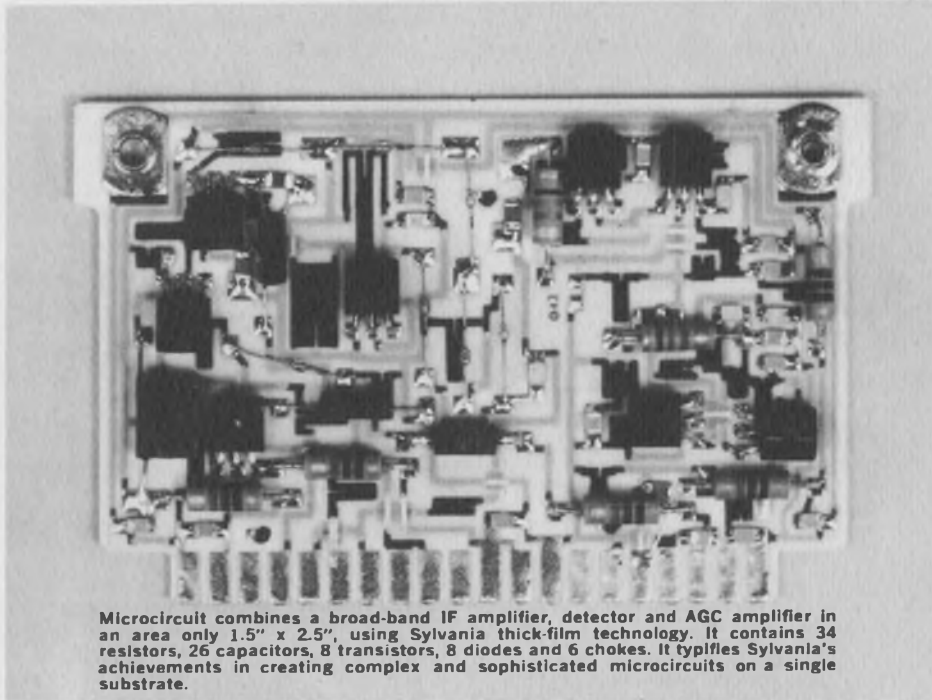

Microcircuit combines a broad-band IF amplifier, detector and AGC amplifier in an area only 1.5" x 2.5", using Sylvania thick-film technology. It contains 34 resistors, 26 capacitors, 8 transistors, 8 diodes and 6 chokes. It typifies Sylvania's achievements in creating complex and sophisticated microcircuits on a single substrate.

It's a truism that electronics has had to shrink rapidly in order to grow.

Because as systems became more complex, they grew larger, heavier . . . and less reliable.

(And slower. What profiteth man to switch in a picosecond when it may take the switching signal a thousand times longer to get where it's going?)

Hence the proliferating technology of microelectronics.

While space, weight and speed are important, no less so is reliability. Most of the many approaches to microelectronics have aimed at improving reliability at the same time they cut bulk and increased speed.

So a major problem facing the design engineer today is the bewildering variety of microelectronic technologies available to him: thick-film circuits, thin-film circuits, monolithic IC's, MOS units and many combinations.

The role of Sylvania

Sylvania has been involved in microcircuit R & D for about 7 years. We've looked into just about every major technology: vacuum-deposited films, sputtered films, active thin-film semiconductors, screened-and-fired or thick-film microcircuits . . . you name it.

But since we can't be all things to all people, we concentrated, starting in 1964, on thick films because this

technology is most applicable to automation and low-cost microcircuitry.

Why hybrid microcircuits?

For one thing, they are economical. They can be packaged in virtually any size or shape.

They make it practical and economical to produce prototype-quantities of modules containing complex circuit configurations.

In addition, they can handle high voltages, currents and frequencies and have capability of producing high resistances and capacitances.

Sylvania has not only demonstrated all these advantages of microcircuitry, but has cut costs enough to make microcircuits competitive with many discrete-circuit components.

Microcircuit capabilities

Sylvania has designed and manufactured microcircuits ranging from simple resistor matrices to complex digital, analog and RF circuits operating up to 250 MHz.

We produce networks of conductors, resistors and capacitors by successively screening and firing conductive, resistive and dielectric compounds onto a single substrate. Our dielectric materials provide 0.001 to 0.5 μ fd per square inch; resistive materials cover the range from 10 ohms to 1 megohm.

In the thick-film technique, successive layers are sequentially fired in

the temperature range of 600°C to 1000°C. This high-temperature stabilization, combined with the molecular codiffusion that occurs at the layer interfaces, yields microcircuits with high inherent stability, ruggedness and reliability. All film elements are protected by two layers of glass fired in place to assure additional long-term stability.

Reliability standards

Because most of our microcircuits so far have been designed for military use, reliability standards are stringent. Our units have survived (and thrived on) such typical torture tests as:

Shock—100 G

Vibration—15 G; 20 to 2,000 cps

Humidity—95% relative humidity at 85°C

Drop Test—36 inches onto concrete floor

Temperature Shock—125°C to -54°C in two minutes

Low Pressure—3.44 inches of mercury at -54°C

Accelerated Life Tests—elevated temperatures and voltages used as stresses

Non-military applications

There is now a growing trend toward use of hybrid microcircuits, like the one above, in industrial and consumer applications. We feel that as we continue to bring costs down, hybrid microcircuits will soon be used, for example, in television, hi-fi, automotive and appliance control systems.

And finally—asking for the order

The unit above is unique, custom-built to a specific customer requirement. Par for the course in the microcircuit business.

We'd expect to do the same for you.

We offer you a fully systems-oriented design and manufacturing capability, staffed to provide cost-effective microcircuits designed to your specific needs. Whether you need a few prototypes or volume production quantities, we'd like to work with you to develop exactly the microcircuits you require.

Irving Greenberg

IRVING GREENBERG
PRODUCT MANAGER, MICROELECTRONICS

High power avalanche diode oscillators open new application areas

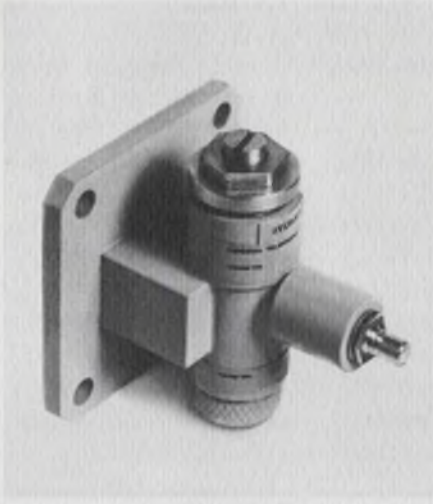

When Sylvania introduced its SYA-3200 avalanche diode oscillator a few months ago, we said continued development was expected to lead to improved devices with higher output power. We were right. Power levels have now been raised by a factor of five. And there's a total of three units with waveguide outputs, and three to come with coaxial outputs, to make it even easier to convert dc to rf directly at X-band frequencies.

Now there are even more reasons for using solid-state avalanche diode oscillators—with new devices from Sylvania. Our new units have a minimum power output rating as high as 50 mW and are available in waveguide configuration (now) and coaxial (soon). Type SYA-3200A is rated at 25 mW, Type 3200B at 50 mW. Both these units, and the original 10 mW Sylvania avalanche diode oscillator (Type SYA-3200), are for

use in waveguide systems.

Soon we'll announce three coaxial versions with electrical characteristics similar to the 3200, -A and -B.

Use of the SYA-3200 series as pumps for parametric amplifiers reduces the size and complexity associated with klystron drivers without degrading performance.

In addition to providing direct dc to rf conversions, other advantages of this line include: only one dc input required, small size and light weight (less than 5 ounces), lower dc power consumption (60 to 90 V, 10 to 20 mA), and no spurious outputs up to twice output frequency. Operating temperature range is -40 to $+85^{\circ}\text{C}$. These new sources are mechanically tunable by a single screw adjustment over a range of at least 200 MHz and have a typical temperature coefficient of frequency of 200 KHz/ $^{\circ}\text{C}$.

Tests show that parametric amplifiers pumped by these avalanche diode oscillators exhibit performance which is indistinguishable from that obtained with conventional klystrons. In one application, a parametric amplifier operating in L-band was pumped at 11 GHz by a SYA-3200.

The noise figure was 1.8 dB, exactly that obtained using a klystron. Saving in power supply, size, and weight reduced the overall weight and size of the amplifier by fifty percent. Gain, bandwidth, and stability were unchanged from that obtained with a klystron.

Particularly suited for use in doppler radar, these oscillators can function as local oscillators in heterodyne receivers as well as beacon transponder sources.

Continued device development is expected to result in devices with even higher output power and additional frequency-band coverage. Sylvania's application specialist will work with designers in tailoring these new devices to meet specific system requirements. The aim is to be able to use these devices as direct replacements for many of the reflex klystrons now in use.

CIRCLE NUMBER 304

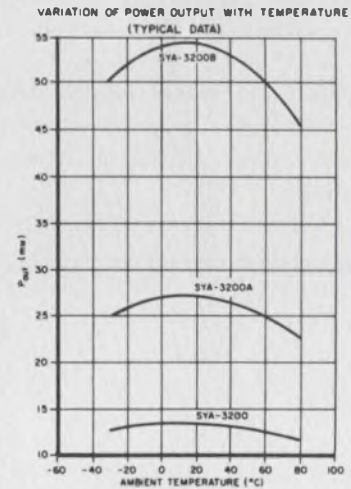
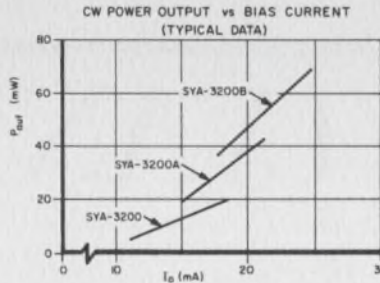

FIRST CLASS
Permit No. 2833
Buffalo, N. Y.

BUSINESS REPLY MAIL
No Postage Stamp Necessary if Mailed in the United States

POSTAGE WILL BE PAID BY

SYLVANIA ELECTRONIC COMPONENTS GROUP

Sylvania Electric Products Inc.
1100 Main Street
Buffalo, New York 14209

Use Sylvania's "Hot Line" inquiry service, especially if you require full particulars on any item in a hurry. It's easy and it's free. Circle the reader service number(s) you're most interested in; then fill in your name, title, company and address. We'll do the rest and see you get further information almost by return mail.

New, more economical 15" and 19" color picture tubes

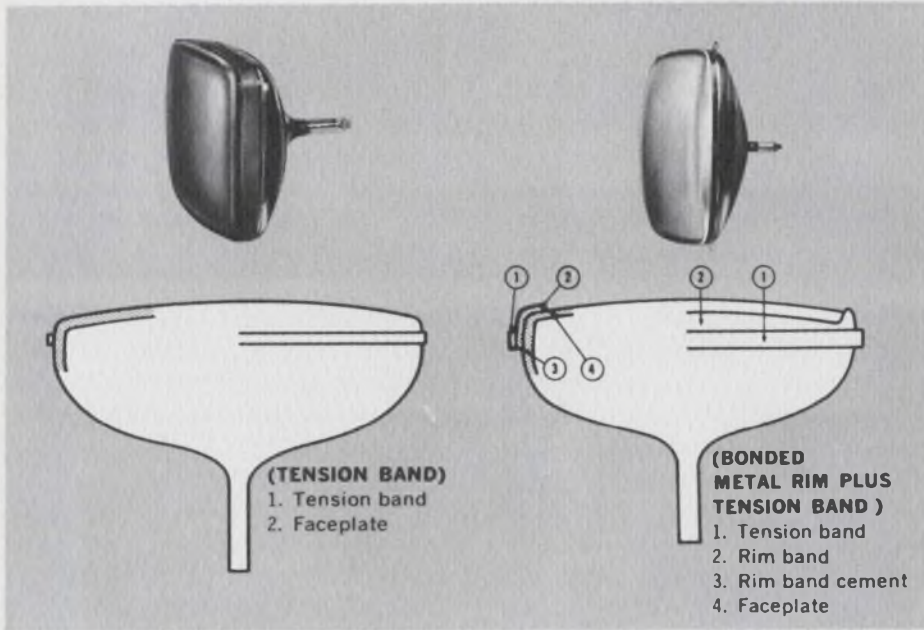

Sylvania offers these two new color picture tubes in the popular 15" and 19" shadow-mask styles. Their integral implosion protection systems eliminate the need for separate safety glass in the set chassis or heavy, plastic-laminated bonded-shield tubes.

On the 15" tube, the weight saving is approximately 1½ lbs; on the 19" tube, the weight saving is approximately 3 lbs.

Proven through years' use in black-

and-white picture tubes, the T-band and Kimcode systems are available now for the first time in Sylvania 15" and 19" color tubes. For manufacturers who prefer it, however, tubes will still be available with the familiar PPG safety system.

The RE-ST4561A, for the first time in a shadow-mask color tube, offers a low focus voltage (-75 to +400 volts), and is a 15" size. This eliminates the need for a separate high-voltage focus rectifier circuit, permit-

ting lower set design costs.

Both new tubes are manufactured with spherical faceplate and have dark-tint glass for high contrast. Each uses three electrostatically focused electron guns spaced 120° apart, with axes tilted to facilitate convergence of the three beams at the shadow mask. Each uses magnetic deflection and convergence, an aluminized screen and is capable of producing high-resolution pictures in both color and black-and-white. The screen incorporates the unique Sylvania screening process and high light-output rare-earth phosphor system.

SPECIFICATIONS

	15"-TYPE RE-ST4561A	19"-TYPE RE-ST4562A
Implosion Protection	T-Band	Kimcode
Glass transmission characteristic	52%	43.5%
Minimum useful faceplate area	11.689 x 9.139 in.	15.585 x 12.185 in.
Deflection Angles (approx)		
Diagonal	90 deg.	89 deg.
Horizontal	79 deg.	78 deg.
Vertical	63 deg.	63 deg.
Minimum projected picture area	102 sq. in.	180 sq. in.
Phosphors	Sylvania P22 Rare-Earth Type	

Sylvania designed these new tubes to help you broaden your set line and cut set costs. Complete specifications are available from your Sylvania representative.

CIRCLE NUMBER 305

This information in Sylvania Ideas is furnished without assuming any obligations.

SYLVANIA

A SUBSIDIARY OF
GENERAL TELEPHONE & ELECTRONICS

NEW CAPABILITIES IN: ELECTRONIC TUBES • SEMICONDUCTORS • MICROWAVE DEVICES • SPECIAL COMPONENTS • DISPLAY DEVICES

NAME _____

TITLE _____

COMPANY _____

ADDRESS _____

CITY _____ STATE _____

Circle Numbers Corresponding to Product Item

300 301 302 303 304

305

Please have a Sales Engineer call



HOT LINE INQUIRY SERVICE

Need information in a hurry? Clip the card and mail it. Be sure to fill in all information requested. We'll rush you full particulars on any item indicated.

You can also get information using the publication's card elsewhere in this issue. Use of the card shown here will simplify handling and save time.

Satellite memory goes to sea on buoy

A ferrite-core memory designed originally for the Pioneer spacecraft is in use on a buoy for storing information on the ocean environment.

The equipment requirements for ocean and space environments are similar in several respects, according to the Bissett-Berman Corp. of Santa Monica, Calif., builder of the unmanned, instrumented buoy called SEAS (Sea Environmental Acquisition System). The company installed the 1.7-pound, 32-cubic-inch memory on the buoy to store sensor inputs recording air temperature, current speed and direction, wind speed and direction, sea surface temperature and wave height.

John Clark, electrical engineer for Electronic Memories of Hawthorne, Calif., builder of the memory, said that it used magnetic current steering switches, which offer a number of advantages for this unmanned operation.

No power drain between pulses

Unlike conventional addressing and sequencing circuits, no power is consumed in the addressing and selection circuits between pulses or during nonoperational periods.

Components have been substantially reduced with only a core, transistor, resistor and capacitor needed for each address switch.

In a typical SEAS installation, wave height is sampled every two seconds for a 40-minute period twice daily. All other sensors are interrogated every 20 minutes. Data are stored in the memory system and transmitted to shore every six hours.

The storage capacity of 15,323 bits is read serially at 10 characters a second. Only 80 milliwatts of power are used. The readout is destructive. The memory, however, is nondestructive in the event of power loss; it retains all data and the next address.

One test SEAS unit, installed in the Pacific Missile Range, remained on station for eight months gathering information for missile recovery operations. The Navy expects to install two more buoys in the Pacific Range and two near Hawaii. ■ ■

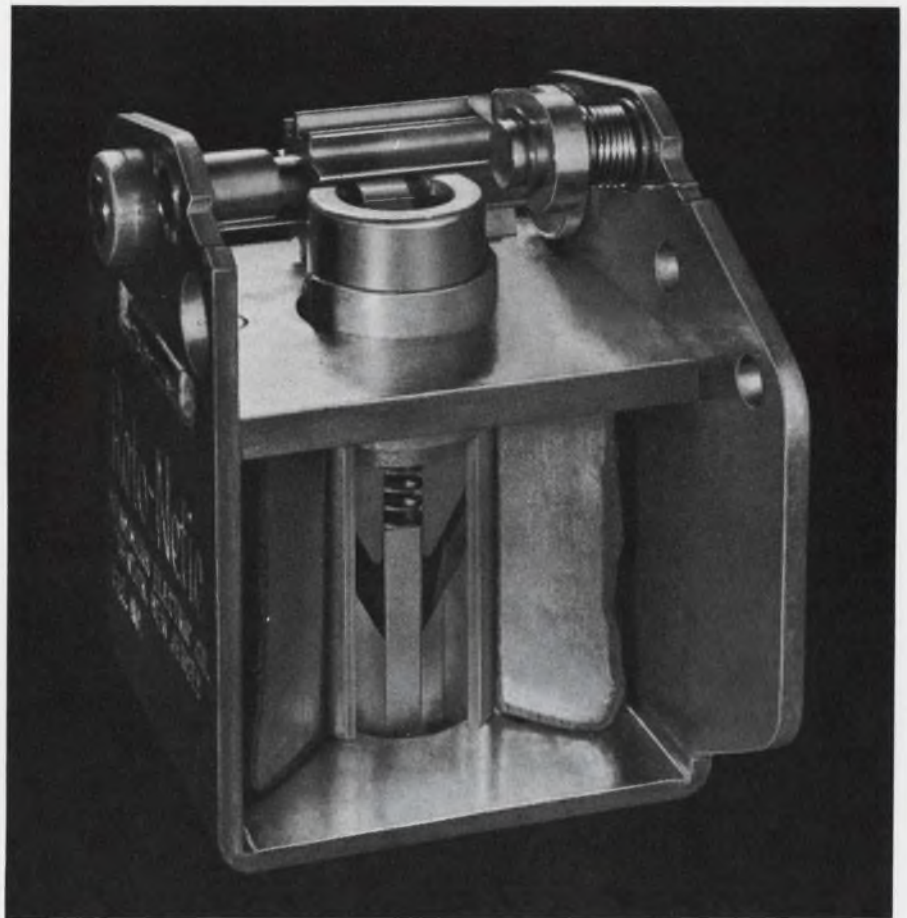

Nobody ever built a stepping motor this way before.

Or sold one for so little.*

A stepping motor has always been a rotary motor that steps. With all the design and manufacturing difficulties that implies. Precision bearings, dynamic balance, and the like. Incremental rotation calls for detents, springs, balls. Or magnetic braking. Then there's the axial thrust problem. Not surprisingly, you pay a lot of money for a rotary motor that steps.

Our picture shows a stepping motor that is not a rotary motor. It's a solenoid in disguise. A spring-loaded armature actuates a ratchet and pawl mechanism. Mechanically, that's all there is to it.

But functionally, there's a great deal more. For example, there's a double-ended shaft that lets you choose the direction of output rotation. An output torque of 0.1 inch-pounds. A ten-step star wheel (very handy for decade functions). A standard stepping speed of 600 steps/min.

There's more: nine standard stock models. Six DC models from 6V to 110V; three AC models from 24V to 240V 60 Hz. Non-standard models can be built to virtually any specs. Facts and figures are in Bulletin 701. Send for a copy. Heinemann Electric Company, 2616 Brunswick Pike, Trenton, N.J. 08602.



*\$8. to OEM's, in quantities of 100 to 499.



HEINEMANN

3657 A

ON READER-SERVICE CARD CIRCLE 21

Magnetic eyes...exciting new



Direct traffic. Vickers magnetic probes can be below grade, damage- and tamper-proof.

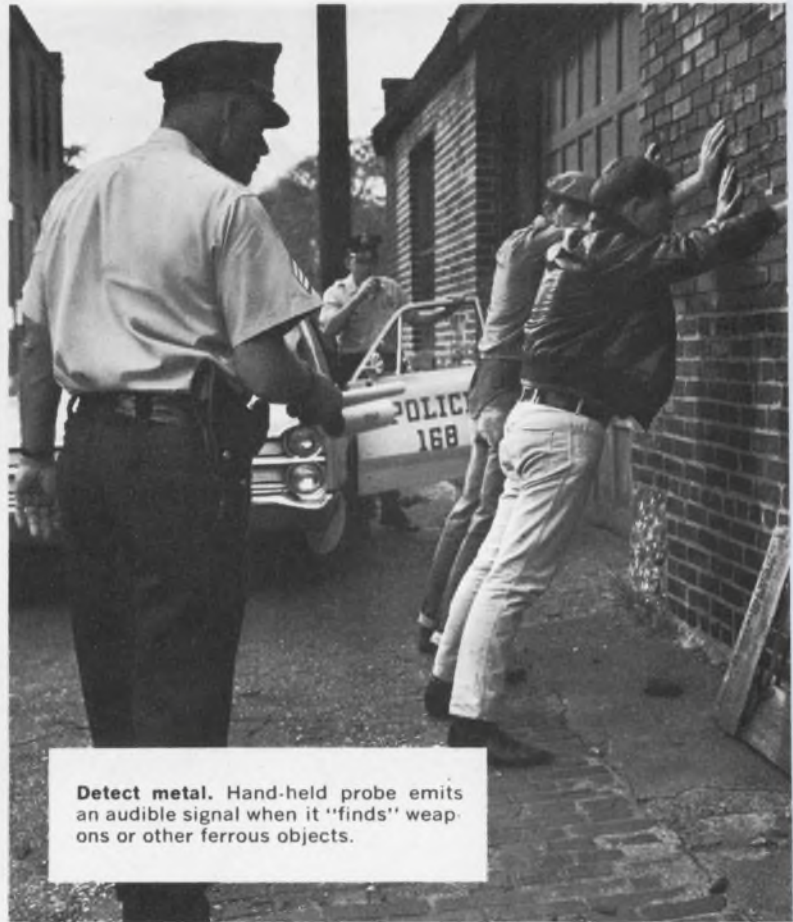

Detect metal. Hand-held probe emits an audible signal when it "finds" weapons or other ferrous objects.



Count, route, sort. With instant response, Vickers magnetic transducers can detect speed, motion, volume of even tiny ferrous objects—or magnetically coded material.

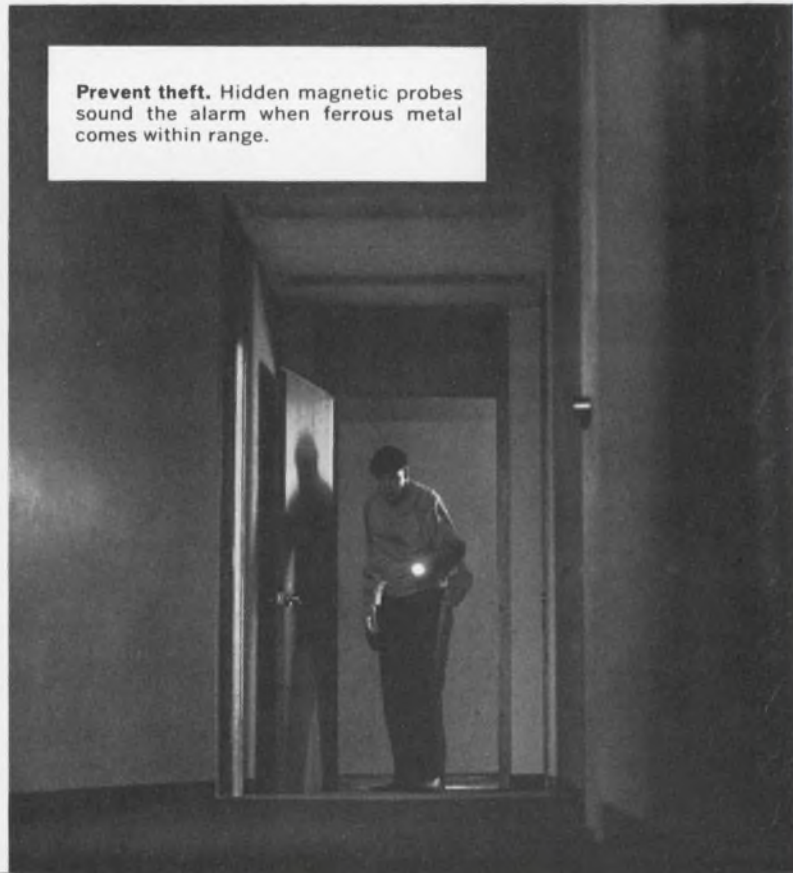

Prevent theft. Hidden magnetic probes sound the alarm when ferrous metal comes within range.

Vickers transducers

Vickers challenges your imagination with a new generation of magnetic transducers. More precise. More reliable. Free from wear! Vickers magnetic transducers are helping to create new, higher-performance equipment. They're replacing older, bulkier, more complex transducers in numerous industries. Perhaps yours.

Without physical contact, Vickers sensors can transduce the presence, speed, motion or mass of any ferrous object, part or material. No mechanical linkages. No moving parts or maintenance.

Our transducers simply read the changes in the low-intensity magnetic ambient and amplifies it. Instantly. Out of our solid-state amplifier comes a useful analog signal that can trigger alarms, operate recorders or digital counters, run heavy equipment, make precise measurements, govern sensitive controls—the possibilities are endless.

HOW VICKERS UNITS WORK

Sensitive gradiometer or magnetometer, combined with a solid-state amplifier, reads the weak-field magnetic environment, producing an analog signal. Any change in the magnetic environment, no matter how small or brief, results in an instant, proportional change in the signal. This effect is produced by such diverse things as metal in pockets, the passage of automobiles or metallic parts, miniscule shifts in magnetic ambients and other phenomena. Units can be made as sensitive as the application requires.

It's time you put this challenging new tool to work. For more detail, contact Magnetic Products Department, Vickers, 1815 Locust Street, St. Louis, Mo. 63103.



VICKERS
ELECTRIC PRODUCTS DIVISION

ON READER-SERVICE CARD CIRCLE 22



Find, measure, survey. Vickers equipment reads magnetic ambient, detects changes in increments as low as 0.01 millioersteds.



Control environment. Vickers Dycome systems maintain precise magnetic ambients in research areas and critical electronic instrumentation.

tiny, but tough,

the Clare MF relay does a *big* job in .046 cu. in.



MF Relay Actual size

It's built for action. Whether the job calls for one operation with certainty, or for consistent reliability over more than 150,000 operations, the MF delivers proven Clare performance.

Design around the Clare MF for space-saving efficiency in the most demanding military and industrial circuits. Provide long electrical and mechanical life under extreme conditions of shock, vibration and linear acceleration . . . and temperatures from -65°C to $+125^{\circ}\text{C}$. Meet advanced pcb circuit requirements with low profile, high-density switching you can depend on, dry circuit to 0.5 amps.

For complete design information, circle reader service number—or ask Clare for Data Sheet 756 . . . Write Group 10A7
C. P. Clare & Co., Chicago, Illinois 60645 . . . and worldwide

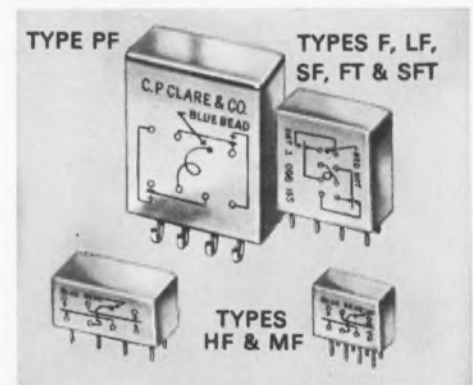

- Clare Military-Type relays include: New 10 amp Type PF, standard size Type F, latching Type LF, sensitive SF, half-size Type HF, one-sixth size Type MF, and Types FT & SFT for noise and thermal voltage problems. All meet appropriate MIL-R-5757D requirements
- Sensitivities from 40 mw
- Versatile contact capabilities . . . low level to 10 amp. Gold-plated contact areas, with high contact pressures and positive wiping action. Bifurcated contacts (F, FT, LF, SF, HF)

CLARE MILITARY-TYPE (crystal can) RELAYS

for airborne, aerospace and ground support equipment,
industrial and commercial control systems

ON READER-SERVICE CARD CIRCLE 23

THREE PNP TRANSISTORS NOW GIVE YOU HIGHER CURRENT, HIGHER VOLTAGE, AND LOWER NOISE AT LOW COST



...ALL 3 ARE GERMANIUM.

When you are looking for state-of-the-art performance in many key areas of semiconductor design, there's still a lot to be said for Germanium devices: 60 amperes in a TO-3 or TO-36 case; 320-volt operation at less than 0.5¢/ volt; 1.6 dB maximum noise figure at 200 MHz for less than \$3.00! For a complete report on Motorola's three new breakthrough Germanium types, write Box 955, Phoenix, Arizona 85001. We'll include a new Germanium Transistor Selection Guide.

There's no end to Motorola Germanium Semiconductors!

2N4048-53 2N4276-83	20-60 V V_{CE0}	0.30 V $V_{CE(sat)}$ @ 50A	As Low As \$2.35, 100-up*
MP3730/MP3731	200-320 V_{CE}	0.5 V $V_{CE(sat)}$ @ 6.0 A	5 · 10 A_{dc} I_c max
MM5000-02	1.6 · 2.2 dB NF @ 200 MHz	20-24 dB Min G_{re} @ 200 MHz	\$1.50-2.95

*And substantially lower in larger quantities.

-where the priceless ingredient is care!



MOTOROLA
Semiconductors

ON READER-SERVICE CARD CIRCLE 24

DYNAMIC DUO!

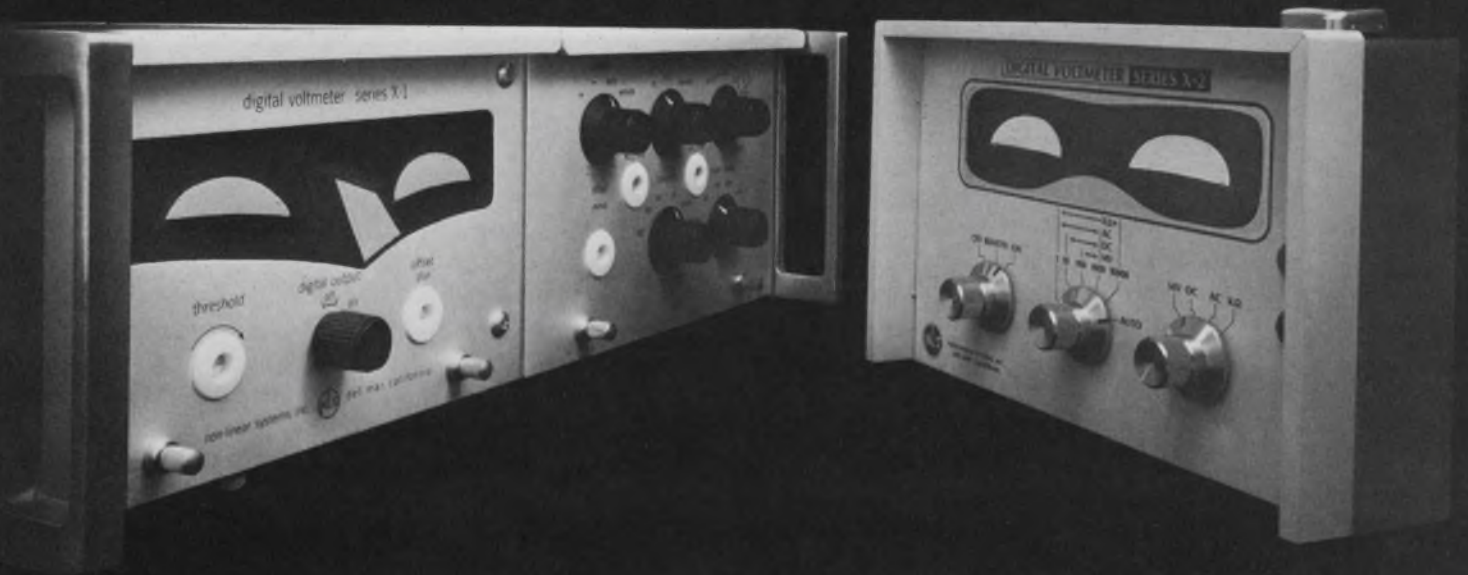

- X-2:** *Holy Accuracy, X-1, how do you do it? . . .*
- X-1:** *Fear not, X-2, if you don't become a college dropout, you too, can achieve .005% Accuracy.*
- X-2:** *You were designed to compete with those \$4,000 voltmeters, but I've got IC's.*
- X-1:** *When I was in school, X-2, those IC's were costly and unavailable; however, with all your IC's, you can't give 23 millisecond readings!*
- X-2:** *Well, X-1, I haven't had my logic courses yet. Can you integrate?*
- X-1:** *I don't need to integrate, X-2, because I have an Active Filter that saves customers (who think they need a 5-digit integrator) \$1,700.*
- X-2:** *You got me there, X-1, but if the customers don't need your .005% accuracy and high speed for \$2,450, they can buy me for \$980, and I'm half rack size too!*
- X-1:** *Naturally, you're half rack size because you don't have Scan Counter, Range Memory, Range Hysteresis, Range and Polarity memory logic, and my Exclusive Threshold control.*
- X-2:** *Holy features, X-1! Those other DVM's must be overpriced!*
- X-1:** *We must not cast moral judgments on the integrity of our competition, X-2.*
- X-2:** *You're such a good teacher, X-1 . . .*
- X-1:** *Remember, X-2, that together, that is, you at \$980, and me at \$2,450, can conquer 80% of the requirements in DVM city.*



NON-LINEAR SYSTEMS, INC.
DEL MAR, CALIFORNIA 92014
[714] 755-1134/TWX: 910-322-1132

\$695.00

(and at last)

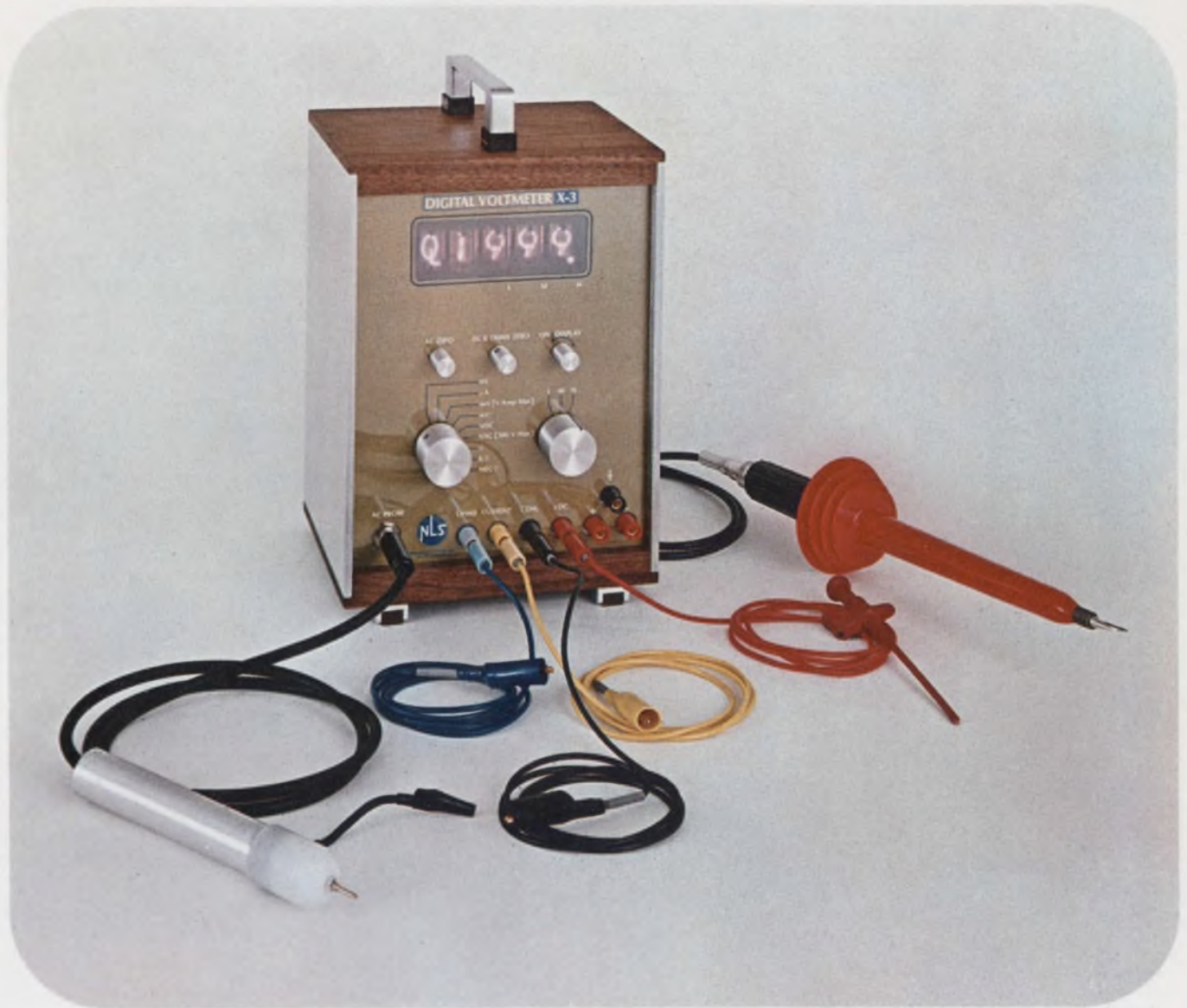

No Needless Needles

WHY?

Because Non-Linear Systems introduces (X-3), a solid-state integrated circuit DVM "(VTVM)" with extras for \$695.

DC Volts:

10 mv to 10K v
.1% = 1 digit
100 Megohm input impedance, entire range
10 Microvolts resolution

AC Volts:

200 Millivolts to 300 volts

10 Millivolts resolution
3% Accuracy
20 Hz to 500 MHz
10 Megohms Input Impedance

Resistance:

10 Ohms to 2000 Megohms
.1% = 1 digit to 200K

Current:

10 Nano Amps to 200 Milliamps
.1% = 1 digit

Yes, all these extras for \$695 (including probes)

LOOK AT THESE EXTRAS

100% Over-range Digit
Over-load Indicator
Over-load Protection
Automatic Polarity
Display Storage
High CMR
Unique Low, Medium, and High Range Selector



Originator of the Digital Voltmeter
NON-LINEAR SYSTEMS, INC.
DEL MAR, CALIFORNIA 92014
[714] 755-1134/TWX: 910-322-1132

Picosecond diode takes a 450-volt jolt

Bell Lab's beam-lead Schottky barrier has ideal back-bias characteristics over wide current range

Roger Kenneth Field
Microelectronics Editor

Two scientists at Bell Telephone Laboratories, in Murray Hill, N. J., have made a diode that withstands 450 volts, and has a picosecond recovery time. So fast is the device that its speed cannot be measured by even the fastest sampling scopes.

It is a Schottky barrier diode, formed at the junction of a semiconductor and a metal. Its breakdown voltage can be accurately controlled during processing, and it follows precisely the ideal diode current-voltage curve from 10^{-3} to 10^{-12} A. What is new is not the Schottky barrier diode but rather its ability to exhibit ideal back-bias and forward-bias characteristics and to withstand breakdown voltages that equal the theoretical breakdown voltage of a silicon p-n junction of the same impurity concentrations.

Last February a tall, slender expert on Schottky barriers, Simon Sze, took a three-second walk down the corridor from his office at Bell Laboratories to that of Martin Lepselter, a scientist who is best known for his invention of the beam-lead microcircuit—a packaging technique in which thick gold leads are formed right on the chip.

They reasoned that Lepselter's metal-silicon beam-lead junction would make an ideal Schottky diode, if only the silicon could be cleaned thoroughly prior to deposition of the metal and the edge effect could be eliminated.

So Lepselter did it this way:

First he formed a hole in the passivating oxide where he wanted an ideal Schottky diode.

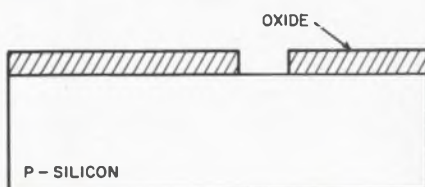

Then he bombarded the wafer with fast-moving ions. This process, called back-sputtering, leaves the surface of the silicon automatically clean.

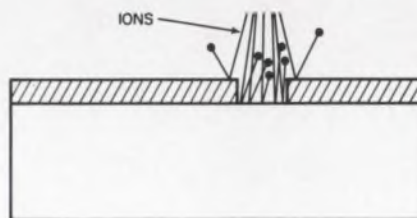

Immediately after bombardment, he formed platinum silicide in the diode hole.

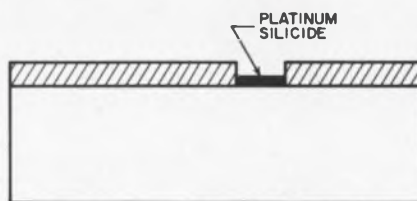

Then Lepselter put titanium into the hole to form a metallurgically sound bond with the silicide and the oxide.

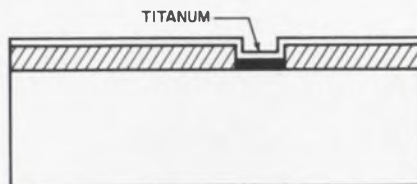

A layer of platinum then covered the titanium, and on it was formed the solid gold beam lead.

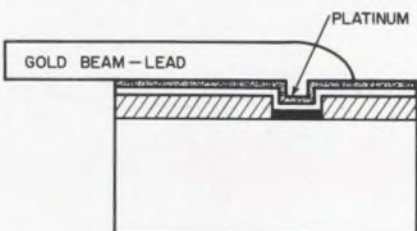

Finally Lepselter once again bombarded the wafer with ions to remove the excess thin layers of platinum and titanium.

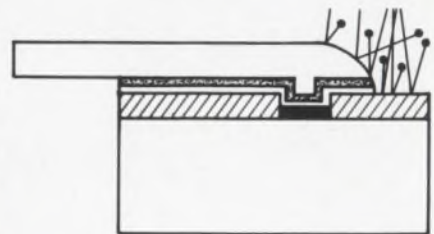

"This metallurgy," says Lepselter, "assures ohmic contact to an atomically clean surface. Our group specializes in the design of devices like these that have mean-time-between-failure rates better than that of the sun."

Improving the breakdown voltage of the diode was a little trickier. In theory, it should be able to handle voltages up to those that produce field intensities sufficient to break down the silicon p-n junction. But at about one-third that voltage, the greater field intensity at the edges of the diode's rectifying surface caused breakdown. Lepselter and Sze needed something that would counteract this peripheral electrostatic field. Since diffusions are used anyway in standard transistor processing, they designed a field of reverse polarity for the periphery of the diode by embedding a p-n junction just below the surface of the silicon. This p-n "guard ring" (see Fig. 1), counteracted the high-intensity peripheral field and allowed the diode to operate at its theoretical breakdown voltage.

The breakdown of up to 450 volts in the diode built by Lepselter and Sze can be accurately predetermined. And if it's made on a beam-lead microcircuit, it requires no extra processing steps. But what can you do with it?

"You can keep a transistor from saturating," Lepselter points out, "and the diode is so fast, its response doesn't detain the recovery of the transistor. So by sticking a Schottky under a collector lead, you

SCAT-28

can test anything
the mind can conceive



...from Diodes to Integrated Circuits
to Large Scale Integration in one machine with reliability.

...from Modules through PC cards to complete Sub-
assemblies in one machine with dependability.

The SCAT-28 measures in an excitingly new way. Here we use a 20-line Co-Axial switch, new oscillographic techniques, high speed A to D converters, along with Programmable Power Sources that "sink" and "load"; Programmable Pulse generators and complete random access techniques. DC to 10 GHZ, dynamic all the way, with sources that can stay up between measurements to solve those special shift register and memory test problems. SCAT-28 can measure all types, shapes & lead configurations of electronic parts. *Try us and see!*

CHECK THESE SCAT-28 STANDARD FEATURES & CAPABILITIES:

DC Tests AC Tests RF Tests Tape Programmed DC Parameters & switching time in same socket All relays dry switched Stop on failure Go-No-Go Random access to 20 scope probes Random access of any connection on the DUT to any stimulus supply Programmable vertical amplifier Programmable time-base Maximum number of tests unlimited Programmable pulse generator fully automatic Kelvin connections.

CHECK THESE OPTIONS:

Data output Disc Program 1% reading .1% reading .05% reading additional scope probes Real time measurement capability Probe reference choppers Programmable probe attenuators Adaptable to high temperature measurements Expand greater than 20 levels Computer control Auto transport Auto temperature control Auto segregation Automatic failure analysis Auto part failure location.

No other expandable auto testing system gives you as much (for less), than the CDC SCAT-28. Unconditionally Guaranteed for Five Years. Ask CDC to give you a demonstration. Phone CDC Apparatus Division, or write CDC for complete information and data sheets. *Do it Today!*

reliability... our first responsibility

CONTINENTAL DEVICE CORPORATION

APPARATUS DIVISION

12515 Chadron Avenue, Hawthorne, California 90250

Phone: (213) 772-4551 • TWX: 910-325-6217

SEE US AT THE AEREMA SHOW, Booth 1-577-70



Viscofilm CAPACITORS HOLD THEIR CHARGE!

1%
VOLTAGE
LOSS
IN
ONE HOUR

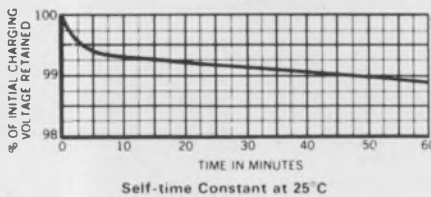

VISCOFILM capacitors are impregnated with a unique plastic dielectric that remains permanently liquid. Its properties are such that it provides exceptionally high insulation resistance and, consequently, a long self-time constant for VISCOFILM capacitors.

This makes them especially suitable for applications requiring the storage or transfer of energy plus replacement of conventional oil filled capacitors.

- Excellent capacitance stability
- Temperature range -75°C to $+125^{\circ}\text{C}$
- Voltage ratings from 100 VDC to 6000 VDC
- Capacitance ratings from .004 MFD to 24 MFD

Write For
VISCOFILM Catalog No. 1255



3243 No. California Ave.
Chicago, Illinois 60618

NEWS

(diode, continued)

can make subnanosecond, nonsaturating logic elements."

The diode is compatible with any microcircuit technique, particularly with that of the beam-lead microcircuits that presently hold the most promise for extremely high speed. The capacitance of 0.05 pF associated with a beam lead is not nearly as deleterious to high-speed performance as the several picofarads associated with the leads of a flat pack, a dual in-line or a TO-5.

The superiority of the device's performance over that of a conventional Schottky diode can be seen from the logarithm of-current-versus-voltage plot in Fig. 2 and from the current-versus-voltage oscilloscope traces in Fig. 3.

"Of course," muses Lepselter, "you might use them at low speeds, simply because you'd like to design with diodes that'll last as long as the sun." ■ ■

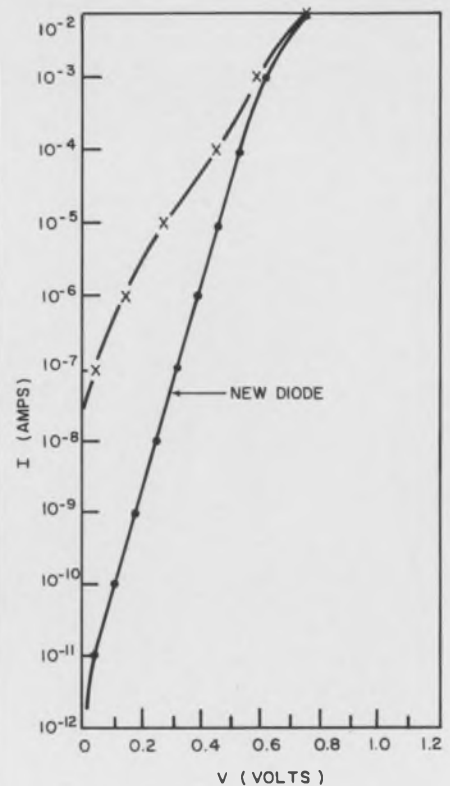

2. A completely linear relationship between voltage and the logarithm of current that is four orders of magnitude greater than that of other diodes is obtained with the new device.

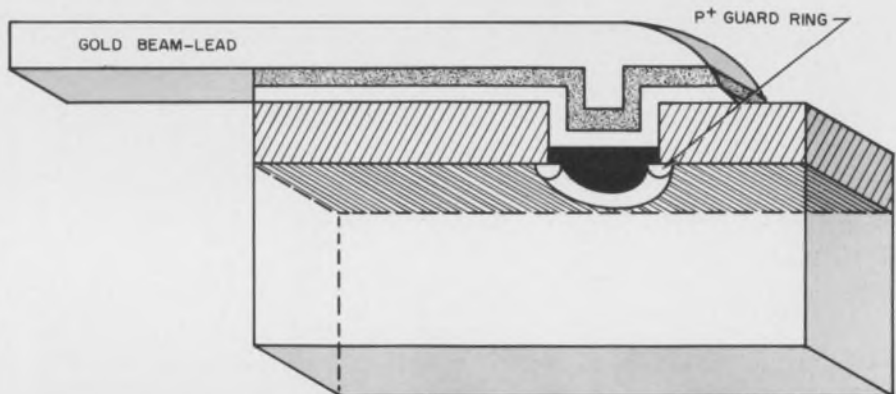

1. This little guard ring protects the diode from breakdown at its edge due to electrostatic fields of high intensity. The guard ring is formed by a p⁺ diffusion just prior to the series of steps that results in the formation of the beam leads and the Schottky barrier.

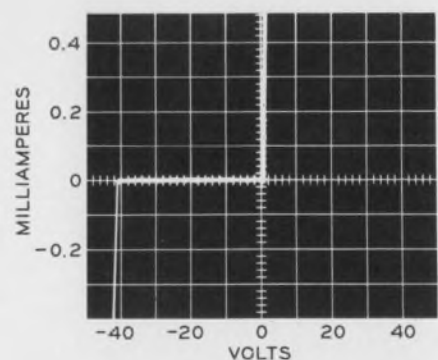
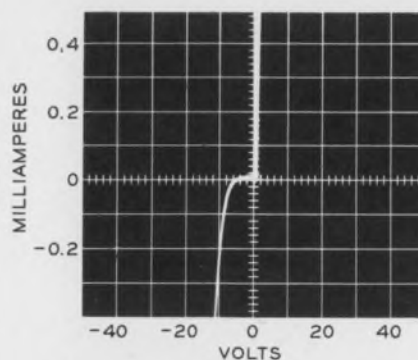

3. The sharpness of the characteristics of the new diode is demonstrated by these two current-versus-voltage scope traces. The left-hand trace is from a conventional Schottky diode; the right-hand trace is that obtained from the new unit.

Latest in the line of Monsanto IC counter/timers.



AVAILABLE PLUG-INS: TWO FREQUENCY CONVERTERS (50 MHz TO 500 MHz; 100 MHz TO 3 GHz); PRESCALER (dc TO 1 GHz); PRESET UNIT (20 Hz TO BEYOND 10 MHz); VIDEO AMPLIFIER (1 mV SENSITIVITY, 10 Hz TO 200 MHz); TIME INTERVAL UNIT (100 ns RESOLUTION); NON-COMMITTED PLUG-IN.

With 90% integrated circuit construction this new "4th generation" instrument is the most advanced plug-in counter/timer yet.

Our new model 1500A takes full advantage of IC capabilities to bring you: main-frame counting range from dc to over 125 MHz; to 3 GHz with a single plug-in. Remote programmability by either contact closure or voltage level. Provision for external time base up to 10 MHz. And nat-

urally, the inherent stability and reliability of integrated circuit construction, as indicated by our two-year warranty. All this for only \$2,850*. Call our field engineering representative in your area for full technical details, or contact us directly at: Monsanto Electronics Technical Center, 620 Passaic Avenue, West Caldwell, N. J. 07006. Phone: (201) 228-3800; TWX 710-734-4334. *U. S. Price, FOB West Caldwell, N. J.

Monsanto
ELECTRONICS

No Comment.

LM 101

Voltage Follower

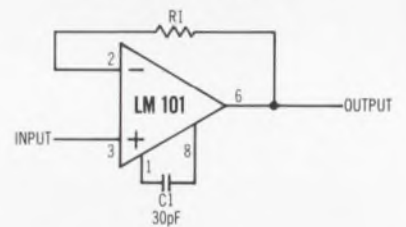

Inverting Amplifier with Balancing Circuit

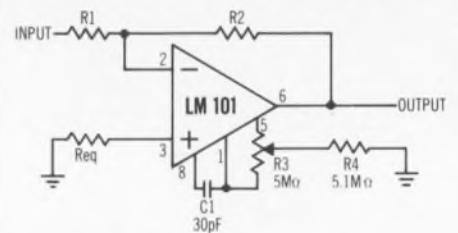

Unity Gain Inverting Amplifier

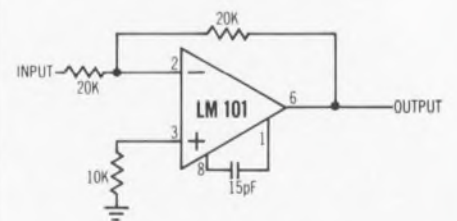

Voltage Comparator for Driving DTL or TTL Integrated Circuits

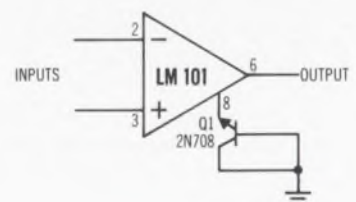

709

Voltage Follower

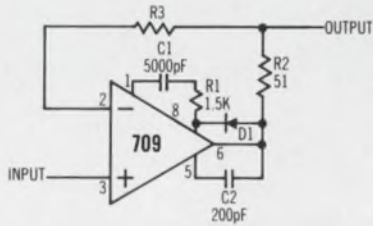

Inverting Amplifier with Balancing Circuit

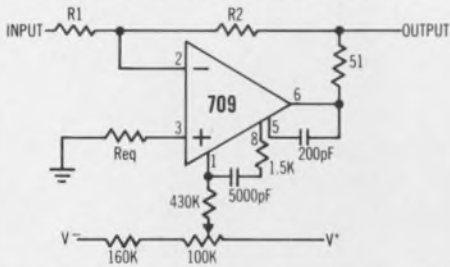

Unity Gain Inverting Amplifier

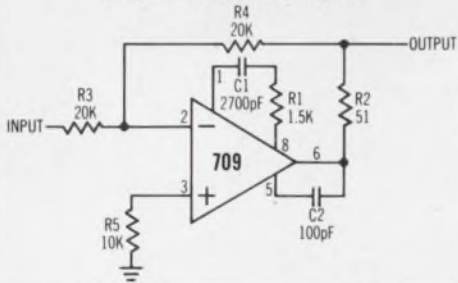

for comment, write:
2975 San Ysidro Way, Santa Clara,
California 95051, (408) 245-4320

National Semiconductor

ON READER-SERVICE CARD CIRCLE 30

Will a bargain bypass/filter capacitor jeopardize your entire system?

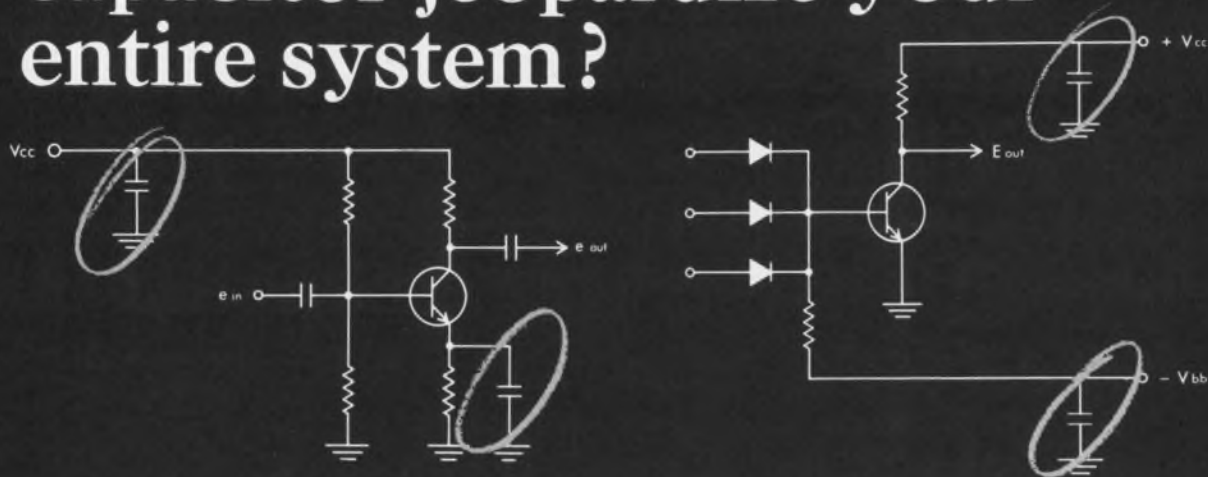

Specify CORNING® Glass-K Capacitors... for confidence

Considering the finality of bypass failure, anything less than the reliability of glass is false economy.

CORNING Glass-K Capacitors guarantee that reliability in two case sizes.

Get 1000 to 51,000 pF in .250" x .100", and 12,000 to 100,000 pF in .250" x .140".

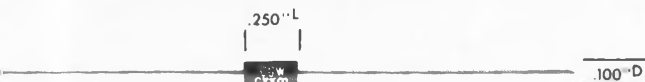

Specify CORNING Glass-K Capacitors when you need:

- bulk capacitance in minimum case size
- the total design flexibility of three stability characteristics, T, U, and V
- capacitor A to track capacitor B with the positive retraceability of glass
- minimum power attenuation and phase error with CORNING Glass-K Capacitors' low power factor

- tight end of life design with the guaranteed low capacitance change of CORNING Glass-K Capacitors
- adaptability to cordwood, printed circuit, and point-to-point packaging.

Get all this in a competitively priced unit that gives ΔC with life as tight as 2%, IR greater than 100,000 megohms, D. F. as low as 1%, and standard item delivery of two weeks or less.

Tell us what you want a bypass/filter capacitor to do, and we'll tell you which CORNING Glass-K Capacitor will give you the confidence you need.

For complete data, write to:
 Corning Glass Works,
 Electronic Products Division,
 3909 Electronics Drive, Raleigh, N. C.

CORNING
 ELECTRONICS

Which one SCR combines high reliability with lowest cost?

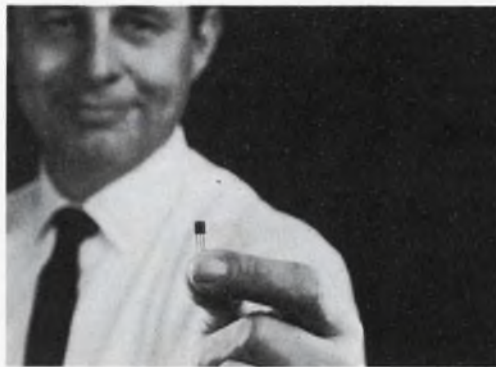

The planar one from TI, the Solid-State Power People

When you need to control 120 watts or less, you might remember what we say about TI's Silect™ SCR.

Its planar wafer gives highest reliability. Economy plastic packaging means lowest cost. And this package is backed by over 10 million hours of reliability data.

All this adds up to big benefits for you.

TIC44-47 SCRs are rated at 600 mA continuous dc at 30, 60, 100 and 200 volts. Peak anode surge current is 6 amps; peak gate power dissipation is 4 watts. Triggering current

is optimized for maximum gain and for the high transient levels encountered in industrial circuitry.

Who's saving money and improving their products with these SCRs?

People who make computers.

And military fuzes.

And power tools.

And home appliances.

And pinball machines.

And automobiles.

The list goes on and on.

To show you how and

where you can use TI's SCRs, we've put together three thyristor application reports, reliability data, plus a new thyristor selection guide.

They're yours free. Simply circle 32 on the

Reader Service Card or write to P.O.

Box 5012, Dallas, Texas 75222.



TEXAS INSTRUMENTS
INCORPORATED

ON READER-SERVICE CARD CIRCLE 32

25 AMPS OF REGULATED DC FOR INTEGRATED CIRCUITS

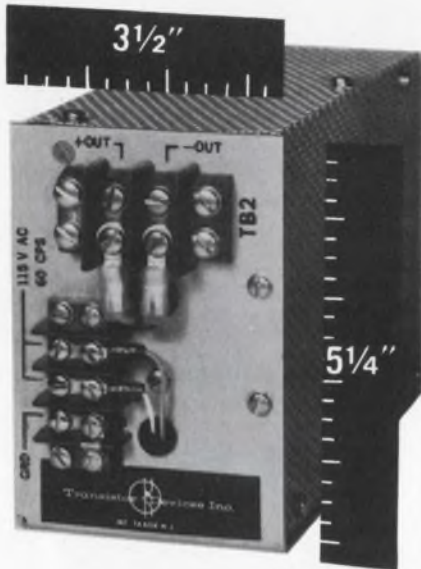

INPUT: 105-120 VAC at 50, 60 or 400 Hz
WEIGHT: Only six pounds

Here's a new series of high efficiency power supplies specifically designed to meet the regulation, ripple, noise and RFI requirements of all commonly available integrated circuits, and deliver more watts of regulated power per cubic inch than previously available from any module of its size.

For example, Model IC5-25 measuring only 5 1/4" x 3 1/2" x 7 1/2" and weighing only six pounds, delivers 5 VDC at 25 AMPS with regulation of 125 MV and RMS ripple of 15 MV.

This high efficiency and package density creates new design flexibility and capability for applications where space is at a premium, or power distribution a problem. Low RFI and noise add to the suitability of this series for Integrated Circuits and similar applications.

All models have full isolation between line and load, automatic short circuit protection and operate in ambient temperatures between 0 and 55°C. Higher temperature operation is available with forced air cooling or derating. Military Grade and other units are available on special order.

Model	Output Adj. Range	Load Current	Regulation Line & Load	Ripple RMS
1C4-25	3-4 V	0-25 A	± 125 MV	15 MV
1C5-25	4-5 V	0-25 A	± 125 MV	15 MV
1C6-20	5-6 V	0-20 A	± 125 MV	15 MV
1C10-13	6-10 V	0-13 A	± 200 MV	20 MV

For complete technical data write to:

**Transistor
Devices Inc.**

ROUTE 53, MT. TABOR, N. J. 07878
TELEPHONE (201) 625-0250

ON READER-SERVICE CARD CIRCLE 33

Letters

Motorola simplifies plastic device numbering

Sir:

We certainly share the sentiments expressed by George Skoblin in the Letters column of *ELECTRONIC DESIGN* ["Epoxy device numbering praised for simplicity," *ED* 15, July 19, 1967, p. 40] in favor of a simple system for indicating a similarity between metal- and plastic-packaged transistors. That such a logical and clear system is a definite benefit to the user is the primary reason why Motorola adopted it more than two years ago.

The nomenclature adopted by Motorola was to replace the 2N prefix of the item with MPS (Motorola Plastic Silicon) for the plastic-encapsulated devices. An example is the MPS706, which is the plastic replacement for the popular 2N706 in a metal can.

Furthermore, all MPS devices introduced by Motorola that are not exact equivalents of a 2N device are assigned numbers over MPS6500—substantially out of the range of present 2N number assignments.

Reed Neddermeyer

Manager

Silicon Transistor Marketing
Motorola Semiconductor Products
Phoenix, Ariz.

Private handling of mail supported

Sir:

I wish to comment on two News Scope items which appeared in *ELECTRONIC DESIGN* 18 [Sept. 1, 1967, "USPO drives to streamline nation's mailing operations," p. 13, and "LBJ orders full review of U.S. telecommunications," pp. 13-14].

The Post Office's mail-handling problem would not be nearly so severe if the Government removed its dictatorial restrictions, which prohibit private companies from entering the mail-carrying business. In spite of these restrictions some companies have found it advantageous to pay the regular postage

fees to the Post Office in order to be allowed to carry their own mail. I cannot see how this transaction differs from extortion. In a free country private companies who are eager to carry mail should be allowed to do so. This would relieve the taxpayer from his burden of supporting the inefficient Post Office Department.

Similarly, the communications situation could be vastly improved by free enterprise rather than monopoly operation and by the restoration of price competition by the removal of "Federal control of rates and practices." Governmental efforts should then be concentrated on the legitimate function of protecting the rights of private citizens engaged in a competitive communications industry, both as businessmen and as customers.

Nationalization or government control should never be considered as the solution to any economic or technological problem, since, if so desired, a solution can always be found within the framework of freedom and man's natural rights to life, liberty and property. Laissez-faire capitalism is the only practical and the only moral form of government.

Ernst F. Germann

Houston

Engineering offices suffer from noise pollution

Sir:

Your editorial on noise pollution ["Let's raise our voices against noise pollution," *ED* 17, August 16, 1967, p. 79] was very timely. I suppose this is one of the prices we must pay for increased population density and mobility. I wish, however, you had directed your article more specifically at the noise level which exists in engineering offices throughout much of the industry.

It continues to amaze me that industrial management so generally fails to recognize the deleterious effects of noise upon the productivity of professional employees. In too many plants the only thing separating the engineering area from the laboratory is a thin plywood partition about head high. This ar-

(continued on p. 54)

tricky tapers...

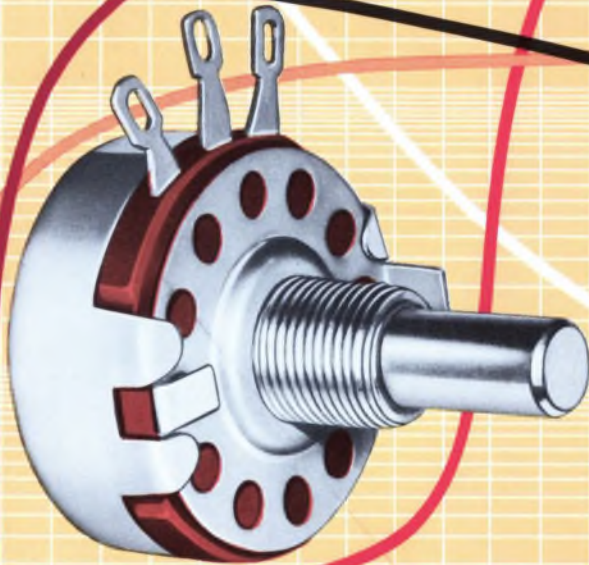

Allen-Bradley Type J
hot molded variable resistor
shown twice actual size

Allen-Bradley Type J potentiometers offer tapers designed to your special needs!

■ When standard tapers fail to provide the control you desire, Allen-Bradley Type J potentiometers have the unique capability to provide a virtually limitless variety of curves to meet your specialized requirements. While not a precision device that is continuously taper-trimmed to very close tolerances, Allen-Bradley's control of the resistance-rotation characteristics during production assures a high degree of conformity.

Allen-Bradley Type J potentiometers have a solid hot molded resistance track made by an exclusive process which was pioneered and perfected by A-B. This solid resistance track assures smooth adjustment at all times—with none of the discrete changes in resistance that are encountered in wire-wound units. And being essentially noninductive, Type J controls can be applied in high frequency circuits where wire-wound units are useless.

Furthermore, A-B's solid molded resistance track assures low noise and long life. On accelerated tests, Type J potentiometers exceed 100,000 complete operations with less than 10% change in resistance.

For more complete details, please write: Allen-Bradley Co., 222 W. Greenfield Ave., Milwaukee, Wis. 53204. In Canada: Allen-Bradley Canada Limited. Export Office: 630 Third Ave., New York, N.Y., U.S.A. 10017.

ADDITIONAL ALLEN-BRADLEY HOT MOLDED VARIABLE RESISTORS

TYPE G CONTROLS are only $\frac{1}{2}$ " in diameter. Quiet, stepless operation. Rated $\frac{1}{2}$ watt at 70°C. Values to 5 megohms. Type L are similar in construction but rated $\frac{1}{2}$ watt at 100°C.



TYPE F TRIMMERS are for mounting directly on printed wiring boards by means of their terminals. Rated $\frac{1}{4}$ watt at 70°C. Values to 5 megohms. Type O are similar but rated 0.4 watt at 70°C.



TYPE R ADJUSTABLE RESISTORS for trimming applications are built to withstand environmental extremes. Only $1\frac{1}{4}$ " in length. Have stepless adjustment. Watertight and can be encapsulated. Rated $\frac{1}{4}$ watt at 70°C. Values to 2.5 megohms. Type N for less severe environments are rated $\frac{1}{3}$ watt at 50°C.



ALLEN-BRADLEY
QUALITY ELECTRONIC COMPONENTS



CERAMIC MAGNETS

Remington takes advantage of the high energy of Allen-Bradley ceramic permanent magnets to achieve the small size required for the ideal performance of their 500 *Selektronic* shaver

This custom designed ceramic magnet is the result of cooperative efforts by Remington and Allen-Bradley engineers. Despite the complex geometry of the magnets, Allen-Bradley was able to achieve high volume production at reasonable cost.

Allen-Bradley MO5-C ceramic permanent magnets are radially oriented and can be furnished in segments for d.c. motors measuring no more than $\frac{3}{4}$ " diameter up to a maximum rating of 10 hp. Coordinated and adequate manufacturing facilities at Allen-Bradley and tight quality control assure delivery in quantity —on time!

Allen-Bradley application engineers will be pleased to cooperate in the design of your motor magnets to obtain optimum performance. Allen-Bradley Company, 222 W. Greenfield Ave., Milwaukee, Wis. 53204. In Canada: Allen-Bradley Canada Limited. Export Office: 630 Third Ave., New York, N. Y., U.S.A. 10017.

A-B ceramic magnets
used in the 500 *Selektronic* shaver
shown actual size.

TYPE MO5-C CERAMIC PERMANENT MAGNETS Typical Characteristics—stated values have been determined at 25° C.

Property	Unit	Nominal Value
Residual Induction (B_r)	Gauss	3300
Coercive Force (H_c)	Oersteds	2300
Intrinsic Coercive Force (H_{ci})	Oersteds	2400
Peak Energy Product ($B_d H_d \text{ max}$)	Gauss-Oersteds	2.6×10^6
Reversible Permeability	—	1.09
Curie Temperature	+°C	450
Temperature Coefficient of Flux Density at B_r	%/°C	-0.20
Specific Gravity	—	4.85
Weight per Cu. In.	Lb.	0.175



The 500 *Selektionic* shaver features a unique dial which adjusts the shaving heads to four shaving positions for any combination of skin and beard, plus TRIM position for sideburn trimming and CLEAN position for instant cleaning. The shaver operates on its rechargeable energy cells or from an electric cord.



ALLEN-BRADLEY
QUALITY MOTOR CONTROL
QUALITY ELECTRONIC COMPONENTS

circuit problems?

***Signalite Glow Lamps have
solved problems in these areas:***

- Voltage Regulation & References • Photo-Cell Drivers • SCR Triggering
- Timing • Photo Choppers • Oscillators • Indicator Lights • Counters
- Voltage Dividers • Surge Protectors • Logic Circuits • Flip-Flops
- Memory • Switching • Digital Readouts

Signalite glow lamps combine long life, close tolerance and economy, and are manufactured with a broad range of characteristics to meet individual application requirements. For a creative approach to your design problem . . . contact Signalite's Application Engineering Department.



PHOTO-CELL APPLICATIONS

The A074 and A083 have been designed for use with Cadmium Sulfide or Cadmium Selenide photocells. Applications include photo choppers, modulators, demodulators, low noise switching devices, isolated overload protector circuits, etc. Speed of operation is limited only by the photo-cells.

**SEE Signalite Application News
for TYPICAL APPLICATIONS**



VOLTAGE REGULATORS BETTER THAN 1% ACCURACY

These subminiature voltage regulators are used in regulated power supplies, as reference sources, photomultiplier regulators, oscilloscope calibrators, etc. They are available in voltages from 82 to 143 V. They are used in multiples as regulators in KV ranges.

**SEE Signalite Application News
for TYPICAL APPLICATIONS**

SIGNALITE APPLICATION NEWS

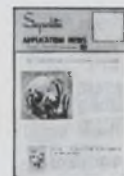

is used to communicate new and proven techniques and applications of Signalite's neon lamps and gas discharge tubes. Signalite Application News provides a forum for an exchange of ideas to keep the design engineer aware of the versatility of neon lamps and their many applications. Copies are available from your Signalite representative or by contacting Signalite.

ON READER-SERVICE CARD CIRCLE 248



NEON TIMERS The bi-stable characteristics and high leakage resistance of Signalite's special glow lamps make them ideal as a component for timing circuits. The basic circuit resembles a relaxation oscillator network.

**SEE Signalite Application News
for TYPICAL APPLICATIONS**



MEMORY SWITCHES Neon lamps have proven to be an excellent memory switch since they store information and provide visual indication. The properties of neon lamps provide a large differential between breakdown and maintaining voltages, stable electrical characteristics and high "off" resistance (20,000 meg ohms). Other applications include switching, information storage, timing circuitry, etc.

**SEE Signalite Application News
for TYPICAL APPLICATIONS**

Signalite

INCORPORATED

NEPTUNE, NEW JERSEY 07753

(201) 775-2490



**SUBSIDIARY OF
GENERAL INSTRUMENT CORPORATION**

ON READER-SERVICE CARD CIRCLE 249

◀ ON READER-SERVICE CARD CIRCLE 242

49

What Kind of Panel Meter Do You Need ?



**crisp, classic
Horizon Line?**

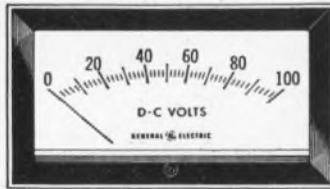

**trim, built-in
Horizon Line?**

Built-in or front-mounted, General Electric HORIZON LINE® panel meters add quiet sophistication that accents, never dominates your electronic equipment. Check these distinctive HORIZON LINE features: smart, low-profile; clean, soft line; fine-precision markings. All ratings are available in 2½", 3½", and 4½".

**distinctive
Big Look?**



Add bold, exciting, truly distinctive styling to your electronic equipment with General Electric BIG LOOK® panel meters. Panels take on added flair with such BIG LOOK features as . . . big, bold numerals, uncluttered display, tapered pointer, stylish shape, plus many others. All ratings are available in 1½", 2½", 3½", 4½".

Besides saving you valuable panel space, General Electric slim-line Type 185 EDGEWISE panel meters add exceptional styling and readability to your electronic equipment. These 2¼" Type 185 EDGEWISE panel meters can be mounted individually or in space-saving clusters of two, three, or more. All ratings are available for vertical or horizontal mounting, with or without bezels.

smart, slim edgewise?

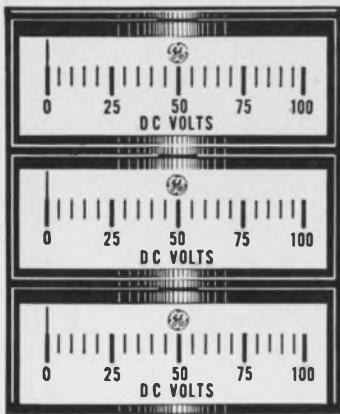

style-matched time meters?



Distinctive BIG LOOK styling is yours with General Electric BIG LOOK elapsed time meters. These "look-alike" time meters combine to give your equipment uniformity and beauty. G-E elapsed time meters measure either hours or minutes with or without a reset knob. All ratings are available in 2½" and 3½".

bright, bold meter relay?



Add years ahead BIG LOOK styling to your equipment with General Electric Type 195 contactless meter relays, featuring a totally new, solid-state, light-sensitive switch for the ultimate in control simplicity and readability. "Piggyback" control modules make for faster, easier installation. Companion pyrometers are also offered. All ratings are available in three sizes (2½", 3½", 4½") with single or double setpoints.

You can get it...from General Electric's full line

And, of course, General Electric's full line of panel meters is unmatched for accuracy and reliability. They're as near as your dependable G-E electronic distributor or sales office. You get fast delivery, too. For free descriptive bulletins describing G.E.'s full line of panel meters, write General Electric Co., Section 592-25A, Schenectady, New York 12305.

GENERAL  ELECTRIC

ON READER-SERVICE CARD CIRCLE 35

Introducing a new circuit element:

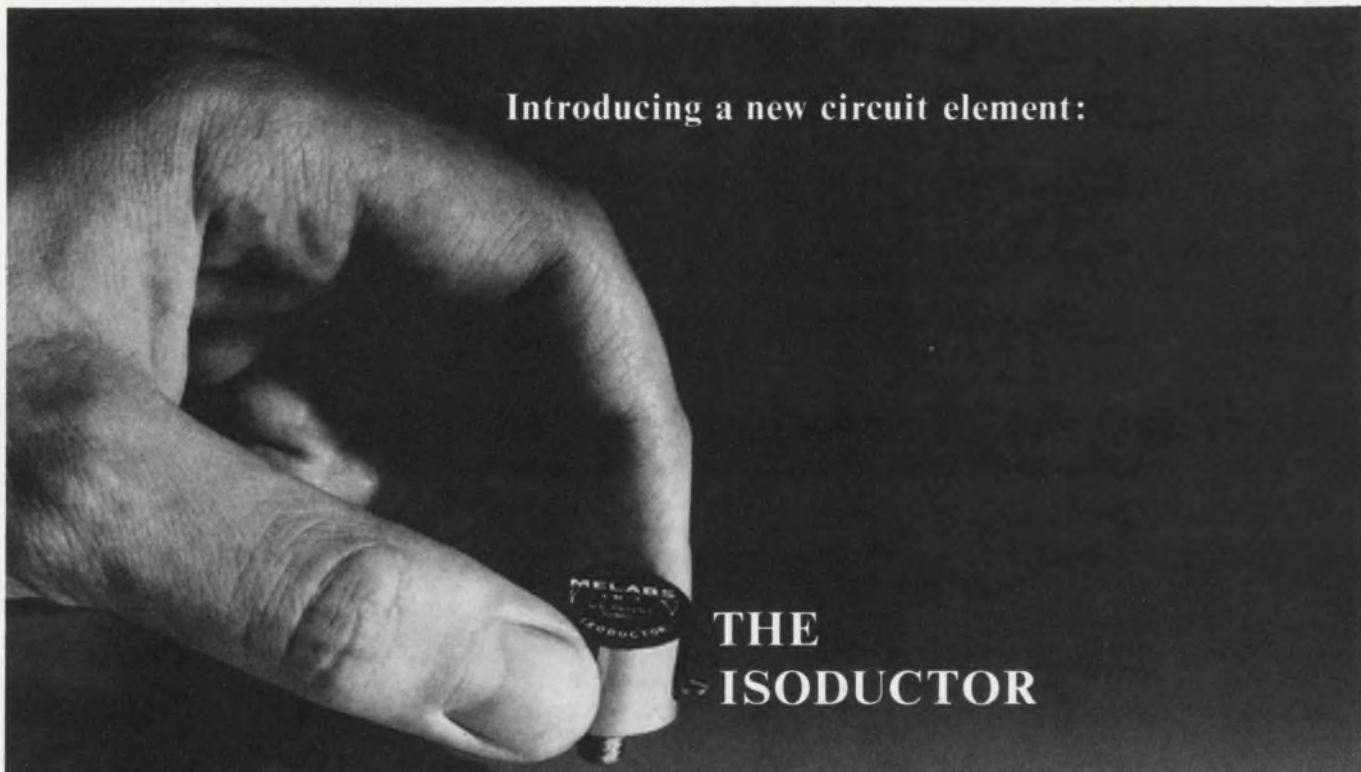

THE ISODUCTOR

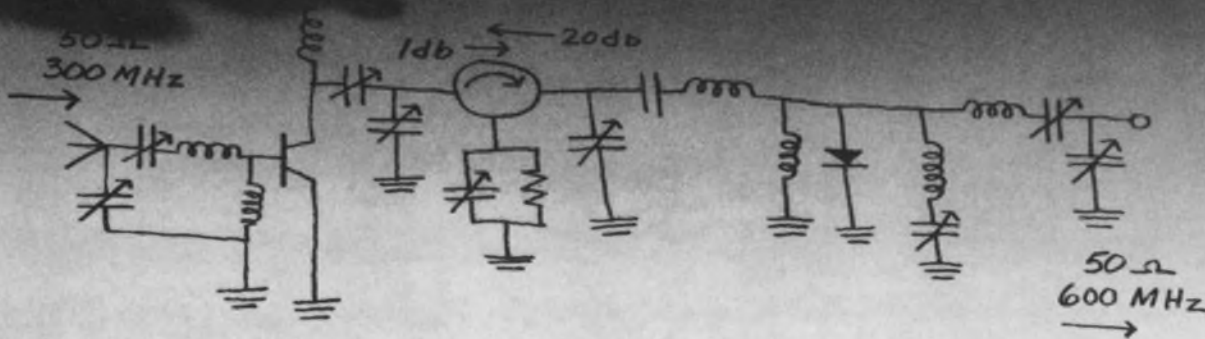

For improved solid-state circuit stability in the 100-600 MHz band.

For the first time a non-reciprocal, passive, low loss circuit element—the ISODUCTOR—is available to solid-state-circuit designers. ISODUCTORS function like one-way pads. When used with power transistors (both are about the same size and cost), ISODUCTORS' non-reciprocal attenuation characteristic make transistors insensitive to load variations assuring stability with virtually no loss in power output. □ ISODUCTORS are a major breakthrough in component technology, and will eliminate some of the most frustrating circuit stability design problems. Typical performance at 300 MHz is illustrated at the right. □

Our 7-page Application Bulletin, #7-182, fully details the theory and performance of these unique devices. Send for your copy or call your local Melabs representative for a demonstration.

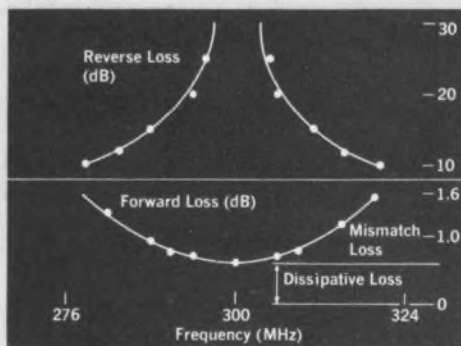

Insertion loss vs. frequency for ISODUCTOR terminated for 300 MHz operation.

3300 Hillview Avenue • Stanford Industrial Park • Palo Alto, California • (415) 326-9500 • TWX: (910) 373-1777
 MELABS, S. A. • 43 Rue De Namur • Brussels, Belgium • Telephone 12-17-23 • TELEX MELABS BRU 23281 □ Exceptional opportunities exist on our technical staff for qualified engineers and scientists. Melabs is an equal opportunity employer.

Ho-hum, another Forum. What have you got to say about "Multi-Switch" switches that's new and exciting? Frankly, I get tired of just rehashing old product specs.

So do we. But, just the other day we discovered that

The increased size of the "Multi-Lite" pushbutton would be ideal for a cancel bar on our new check-



SWITCH CRAFT FORUM

a long standing customer of ours didn't know about our "Multi-Lite" pushbuttons that can couple two adjacent stations on a "Multi-Switch" switch.

Two stations?

Right. But, maybe we ought to start from the beginning. A single station can accommodate up to 6PDT circuitry. The "Multi-Lite" arrangement mechanically interlocks two adjacent stations for twice the switching capability without adding to the overall height of the switch stack. And, each station has a total of four lamps for sectionalized or redundant lighting, since we have combined two, dual lighted pushbuttons. Fig. 1. gives a good example of the flexibility we're talking about.

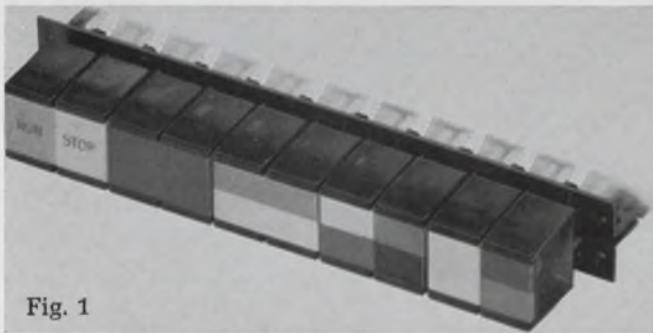

Fig. 1

How does the "Multi-Lite" arrangement tie into the mechanics of your switch? I'm talking about lighting circuitry and switch functions.

Lighting circuitry on the Series 37000 & 38000 little "Multi-Switch" switches is accomplished by means of a lighting stack of the type shown in Fig. 2. The extra-long lighting springs extends the lighting circuit from the lamp terminal to the rear of the switch for convenient wiring to the N.O. or N.C. contacts on the lighting switch stack. Naturally, direct wiring to the pushbutton lights is another alternate.

Regarding switch functions, the coupled stations can be furnished for interlock, momentary, push-to-lock,

Fig. 2

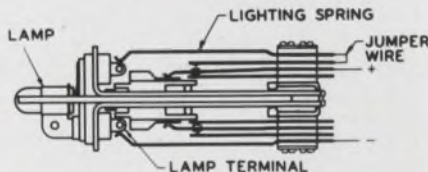

push-to-release, and all-lock operation. Of course, the all-lock arrangement will require a single button for a release station. (Forum readers may obtain complete info on switch functions from our engineering specification catalog. Just circle the reader service number below.)

writer, but we'll need smaller pushbuttons for most of the other functions. How much legend information can I get on either type? And what about display screen colors and lamps?

The "Multi-Lite" pushbuttons will accept up to 4 lines of 11, $\frac{1}{8}$ " high characters per line. The smaller pushbuttons provide a $3\frac{1}{32}$ " x $1\frac{19}{32}$ " rectangular area for hot stamping or engraving. This should accommodate any of your legend requirements for each station. We have nine standard display screen colors plus color inserts to give you unlimited color flexibility.

As a convenience, Switchcraft has available, standard industry lamps #328 (6v.), #718 (6v.) or #327 (28v.). Or if you need zero power consumption on an "illuminated" switch, why not use the Switchcraft "Glo-Button." Available on certain switches, the "Glo-Button" produces a highly visible illumination change by strictly mechanical means without consuming any power.

I must admit we've learned something, but I suspect the Forum won't be dismissed until we've heard a "life & versatility" pitch.

Our catalog tells all about "life & versatility" and how you can specify a "Multi-Switch" switch anywhere from 1 to 18 stations in a row or up to 100 stations in ganged and coupled matrixes. The almost unlimited adaptability of this switch to countless applications is difficult to express. When we sit down to discuss your requirements in detail, the value of a "Multi-Switch" switch will become more apparent. We've dwelled on lighting pretty much, but the total versatility of these units doesn't begin to "shine" until you can see it solving your particular application problems.

Forum dismissed, but but don't forget that we have extra bound copies of "FORUM FACTS on 'Multi-Switch' Switches", that describes these units, their accessories and applications. Just have your engineers drop us a line on your company letterhead, asking for this handbook. We'll also place their name on our mailing list for TECH-TOPICS, our semi-monthly application engineering magazine. Ten-thousand engineers already receive TECH-TOPICS and tell us that the technical stories are interesting and useful.

SWITCHCRAFT
INC.

5529 North Elston Avenue • Chicago, Illinois 60630

ON READER-SERVICE CARD CIRCLE 37

YTTRIUM AND RARE EARTHS

High purity
oxides, metals,
salts
from the world's
largest
ion-exchange
facility

APPLICATIONS:

Phosphors
Electronic Ceramics
High Temperature
Refractories
Ceramic Control
Materials
Metallurgy
Coloring Agents
Permanent Magnets
Lasers
Catalysts
Glass, Lenses
Metal Halide Lamps

Like technical data on
any of the above oxides
or metals? Write, wire
or call us about your
specific interest.

**MICHIGAN
CHEMICAL
CORPORATION**



RARE EARTH SALES
2 North Riverside Plaza
Chicago, Illinois 60606
312-263-0580

Copyright 1967 by Michigan Chemical Corporation RE-57-1

ON READER-SERVICE CARD CIRCLE 38

LETTERS

(continued from p. 48)

management provides some privacy but does almost nothing to shield the engineers from the sounds of electric drills, grinders, saber saws, air hoses, blowers, and whistling and loud talk among the technicians (and some other engineers). A couple of years ago I set up a sound level meter in the office where I was working. The average level of noise during the working day was about 73 dB. It is difficult to do much creative thinking in an environment as cacophonous as that.

Eliminating noise from engineering areas is best done during design of the plant. Given existing conditions, however, any office can be made more pleasant to work in, and productivity increased, by taking steps to decrease the noise level. Soundproof booths can be installed in the laboratory for the use of personnel operating power tools. The loudness control on telephone handsets can be turned to the lowest position. And loud talk can be discouraged by means of proper management methods.

The biggest hurdle is convincing management that the effort is

worth while.

R. G. Johnson

Senior Engineer
Space and Information Systems Div.
Raytheon Co.
Goleta, Calif.

FAA denies masking Vietnam war costs

Sir:

The "Washington Report" article on FAA activities in Vietnam ["FAA masks Vietnam war costs," ED 15, July 19, 1967, pp. 29-30] is erroneous in its assumptions. The military is reimbursing the Federal Aviation Administration for the equipment [air traffic control systems] and ancillary services being provided by the agency. Moreover, the Civil Aviation Assistance Group in Saigon is supported with AID (Agency for International Development) funds. The only person paid by the FAA in Vietnam is the air carrier operations inspector who monitors the safety of Military Air-lift Command charter flights.

Charles G. Warnick
Director, Information Services
Federal Aviation Agency
Washington, D. C.

Accuracy is our policy

Owing to a printer's error, the wrong block diagram was published on p. 26 of ED 19, Sept. 13, 1967, in

the box headlined, "Adding the 'chirp' to transmitter-receiver." The correct diagram is reproduced below:

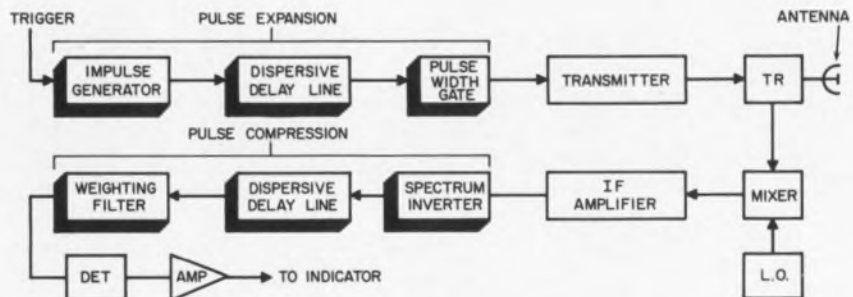

In "Versatile pulse generator made by combining three ICs," in the Ideas for Design of ED 18, Sept. 1, p. 82, in the figure *K* output of the SG-130 driver should be independent, not connected to output *L*.

In the Idea for Design headlined

"Voltage follower has high impedance, can handle large signals," ED 19, Sept. 13, 1967, p. 124, the author reports a typographical error in Fig. 1a. The collector of *Q1* should not be connected to the collector of *Q2*, but should cross over and connect only to the base of *Q2*.

ON READER-SERVICE CARD CIRCLE 39 ➤

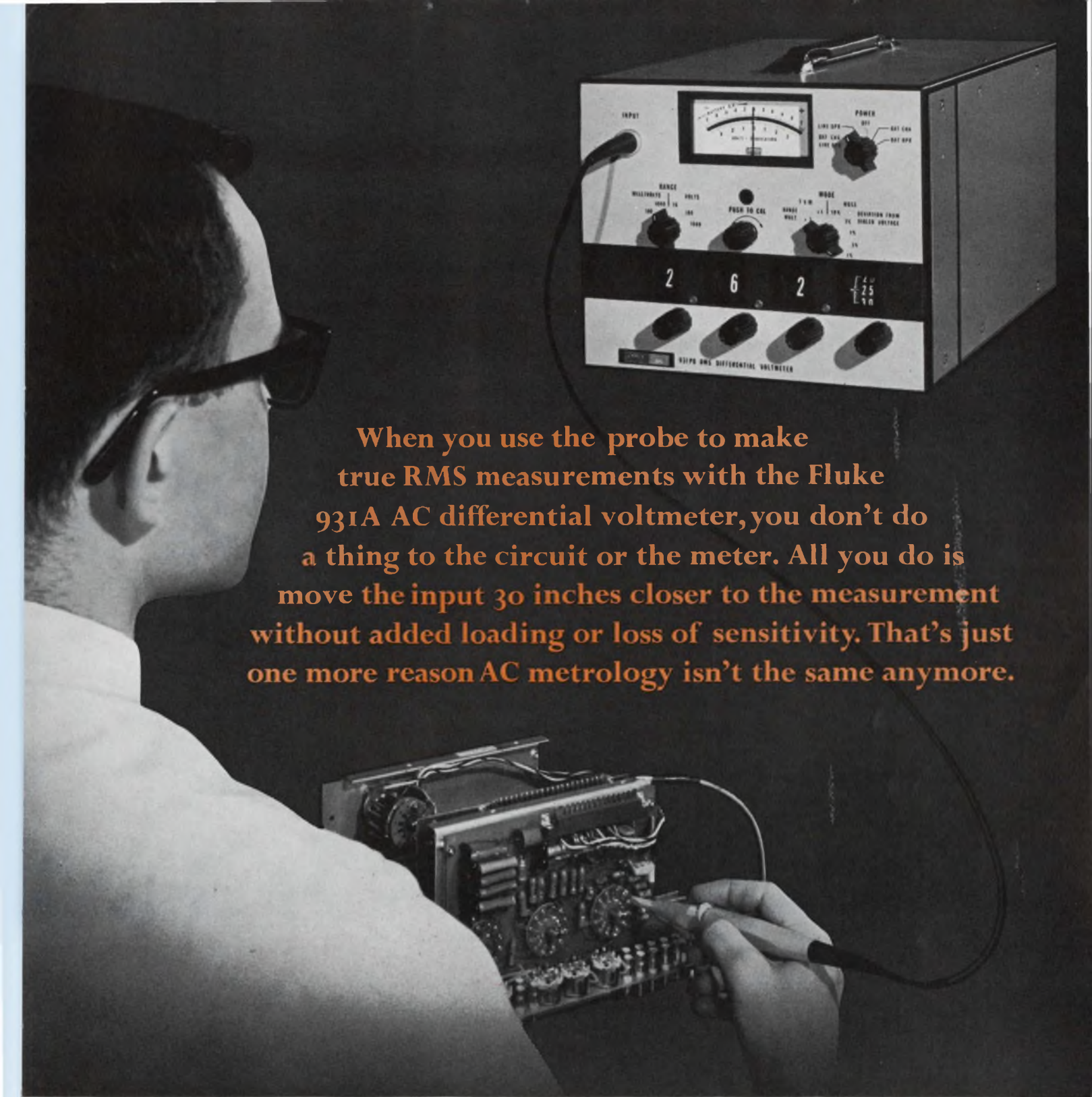

When you use the probe to make true RMS measurements with the Fluke 931A AC differential voltmeter, you don't do a thing to the circuit or the meter. All you do is move the input 30 inches closer to the measurement without added loading or loss of sensitivity. That's just one more reason AC metrology isn't the same anymore.

Use the new Fluke 931A to measure virtually any waveform within 0.05% from 30 Hz to 50 KHz. Make these measurements without losing null sensitivity as the voltage decreases. For in the Fluke 931A, the null meter indicates percent deviation from the dialed voltage. Overall frequency response is 10 Hz to 1 MHz. Range is 0.01 to 1100 volts. Ten to one crest factor takes care of effects caused by voltage spikes and pulse trains. Other features include low capaci-

tance, high resistance input, inline digital readout with lighted decimal point, all solid state design, and linear recorder output. Meets MIL-SPEC shock and vibration requirements. Ten percent overranging cuts down range changing. Available with or without probe in both line and combination line rechargeable battery powered versions. Base price \$895. Call your full service Fluke sales engineer (see EEM) for a demonstration or write us for full information.

Fluke • Box 7428, Seattle Washington 98133
Phone: (206) 774-2211 • TWX: (910) 449-2850 • In Europe,
address Fluke International Corporation, P.O. Box 5053,
Ledeboerstraat 27, Tilburg, Holland. Telex: 844-50237.



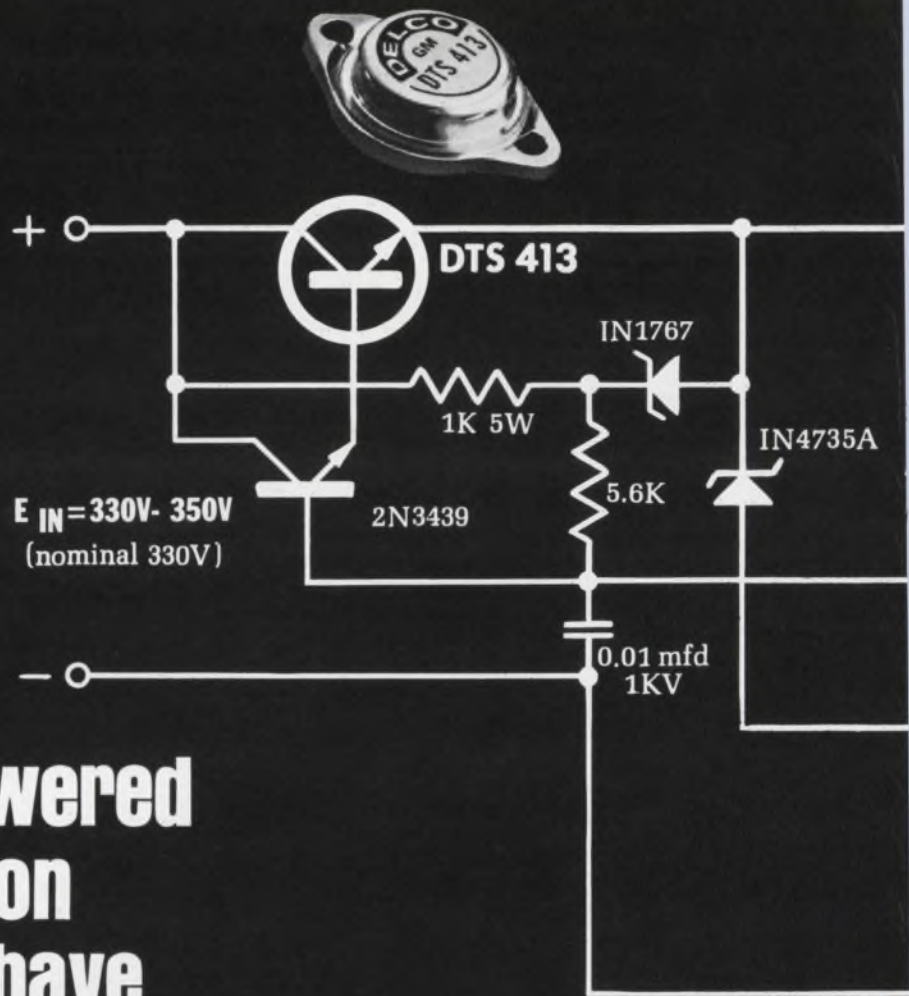

High-powered regulation doesn't have to carry a high-powered price!

The simple DC regulator shown supplies 290 volts to a load of 50 to 600 milliamperes. Regulation is better than $\pm .05$ percent with an input voltage variation of 15%. Delco high voltage silicon makes this possible with just one series transistor—the DTS-413—priced at just \$3.95 each in 1000-and-up quantities.

This circuit also can be scaled to the capabilities of any of the other cost saving Delco DTS transistors, including the new DTS-424 and DTS-425. And no matter which Delco high voltage transistor you use, reduction of weight, size, and component cost is part of the bargain. Circuit complexity and number of components are reduced and so assembly costs go down, too. And fewer components mean higher reliability.

Right now, Delco silicon power transistors are adding these benefits in such high energy circuits as: DC-DC converters, ultrasonic power supplies, VLF class C amplifiers, off-line class A audio output and magnetic CRT deflection (several major TV manufacturers use them in big screen horizontal and vertical sweep circuits).

How soon can you get Delco silicon power transistors? How soon do you need them? With our experience and new plant facilities, samples or production quantities can be shipped promptly. Call one of our distributors or a Delco sales office now.

For full details on the DC regulator circuit, ask for application note number 38.

Application of Delco high voltage silicon power transistors: a DC voltage regulator.

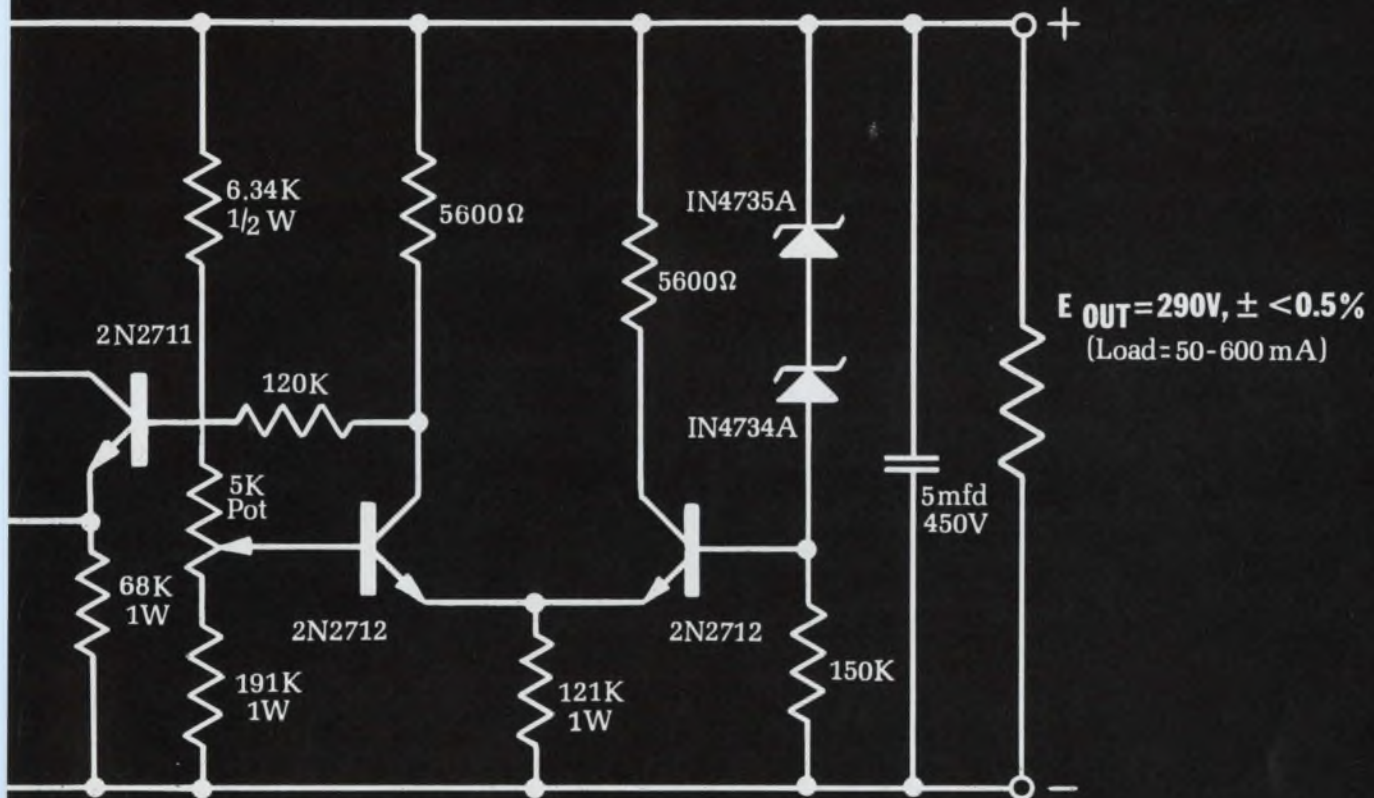

TYPE	V _{CEX}	V _{CEO} (sus) min.	I _C max.	h _{FE} min. V _{CE} =5 V @ I _C	P _D max.	PRICE 1000 and-up QUANTITIES
DTS-413	400V	325V	2.0A	15 @ 1.0A	75W	\$3.95
DTS-423	400V	325V	3.5A	10 @ 2.5A	100W	\$4.95
DTS-424	700V	350V	3.5A	10 @ 2.5A	100W	\$7.00
DTS-425	700V	400V	3.5A	10 @ 2.5A	100W	\$10.00
DTS-430	400V	300V	5.0A	10 @ 3.5A	125W	\$17.49
DTS-431	400V	325V	5.0A	10 @ 3.5A	125W	\$25.00

NPN silicon transistors packaged in solid copper TO-3 case.

Field Sales Offices: Union, New Jersey* 07083 Box 1018 Chestnut Station (201) 687-3770; Detroit, Michigan 48202 57 Harper Avenue (313) 873-6560; Santa Monica, Calif.* 90401 726 Santa Monica Blvd. (213) 393-1465; Syracuse, New York 13203 1054 James Street (315) 472-2668; Chicago, Illinois* 60656 5151 N. Harlem Avenue (312) 775-5411; General Sales Office: 700 E. Firmin, Kokomo, Ind. 46901 (317) 459-2175

*Office includes field lab and resident engineer for applications assistance.

DELCO RADIO
DIVISION OF GENERAL MOTORS • KOKOMO, INDIANA

ON READER-SERVICE CARD CIRCLE 40

Support your local Resistance.



	Multi-purpose instruments			Resistance Bridges			Ratio/Deviation Bridges		
Model	250 DE	292	300	231	232	242	122	500	261
Range	.1 Ω -12M Ω	.1 Ω -1.2M Ω	.01 Ω -500M Ω	.01 Ω -12G Ω	.1 Ω -500M Ω	.001 Ω -120M Ω	.001 Ω -100M Ω	.1 Ω -111M Ω	10 Ω -2M Ω
Accuracy	.1%	.05%	.02%	.01%	.01%	50ppm	0.2ppm	.01%	.1%
Price	\$475	1380	875	2050	1075	3500	4000	2595	Appr. 250
Comments	R, C and L	R, C, L and G	R, E, I and Ratio			Ratio and deviation ranges	1:1, 10:1 ratios	Deviation ranges \pm 10% to \pm .01%	1:1 ratio, \pm 1%, 5%, 20% ranges

Resistance measurement is very much a local matter, requiring resistance measuring instruments designed to match your local needs. Whether the job is production testing, on-line inspection, or laboratory calibration and certification—you want an instrument specifically tailored to the task.

The chart illustrates the wide range of approaches ESI can offer to meet your resistance measuring needs. Among them, you're sure to find the ranges, accuracies and special features that suit your particular application. In many cases, you may be able to answer a number of different electronic measurement requirements in a single multi-purpose instrument.

It's not by chance that every major manufacturer of precision resistors uses an ESI measuring instrument. You'll find, as they have, that ESI instruments are fast and easy to use. And they give you the greatest reliability and accuracy for your dollar. That's a good local cause to be supporting, ESI, 13900 NW Science Park Drive, Portland, Oregon 97229.

Electro Scientific Industries Inc. **esi.**
ON READER-SERVICE CARD CIRCLE 41

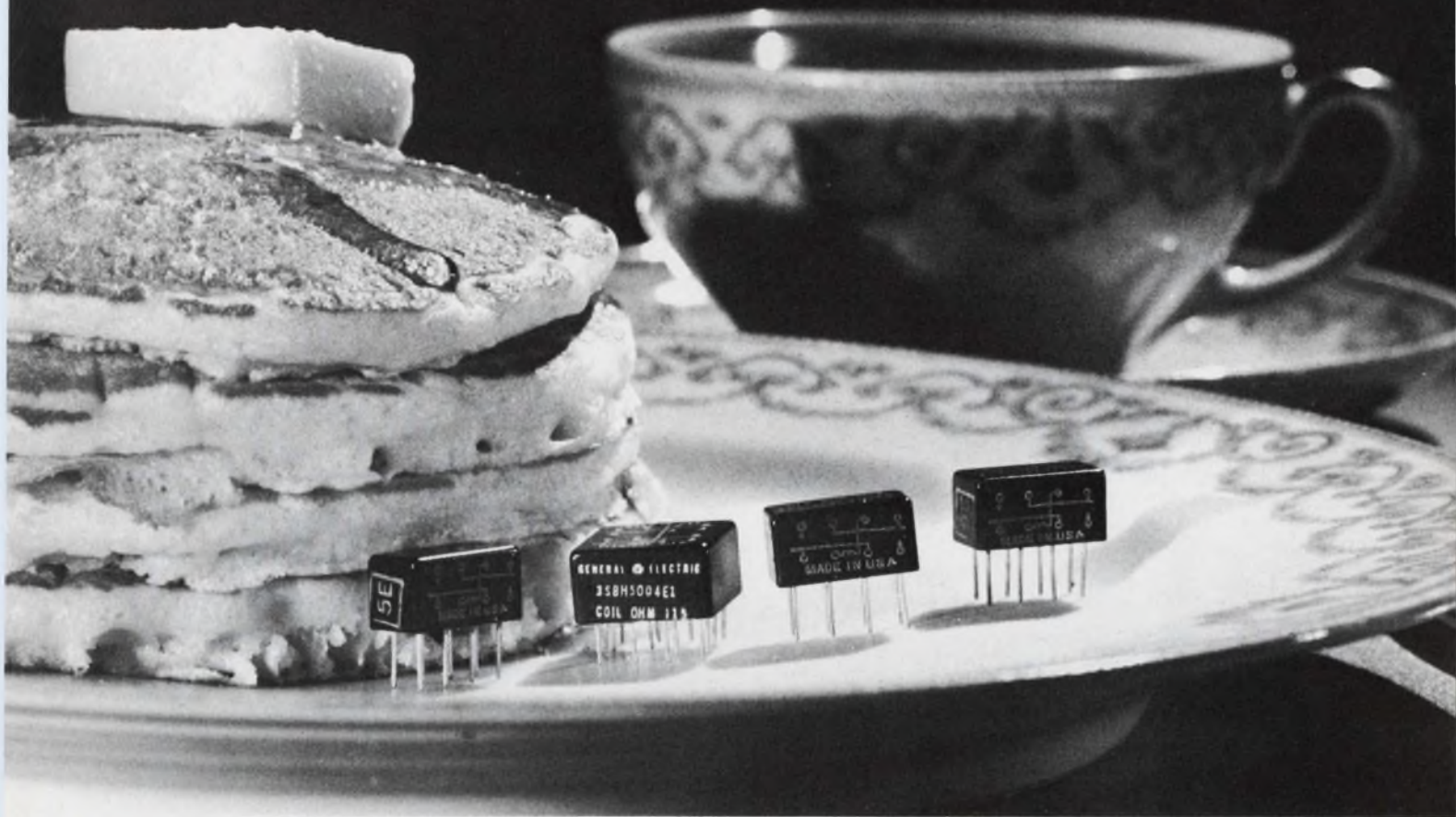

Flat as a pancake... and selling like hotcakes

And why not?

General Electric's new high performance 150-grid sealed relays are smallest where it counts most—only 0.320" high. What's more they come in 4 versions: 4 Form C, 2 Form C, 4 Form C AND-logic type, and a 50 milliwatt sensitivity 1 Form C (or 1A+1B).

Result: for the first time you can get really small size, a variety of forms to choose from, and exceptional performance all in one relay type.

These General Electric 150-grid space relays meet or exceed the environmental and mechanical specs of much larger Mil Spec micro-miniature relays. And compared to relays of comparable size, GE 150-grid space relays have 3 times the magnetic force and over twice the contact force of the nearest competitor.

Outstanding features include:

- High vibration capability
- Excellent minimum current switching ability
- Excellent thermal resistance
- High overload capability—can withstand 5 amps each contact and make and carry 10 amps for short periods
- No flux contamination because of all-welded construction and design.

For more information on the small relay that's going over big, contact your General Electric Electronic Components Sales Engineer. He can tell you more about them and help with your individual application. Or write for bulletin GEA-8042B, Section 792-41, General Electric Company, Schenectady, New York 12305.

Specialty Control Department, Waynesboro, Virginia

GENERAL  **ELECTRIC**

TRW METALLIZED POLYCARBONATE CAPACITORS



... small enough to fit!

TRW 50-volt Metallized Polycarbonate Capacitors are made to squeeze into tight places. Imagine 10 microfarads measuring .547" x 1¼" long... the smallest wound capacitor on the market!

Short on size and long on reliability, the X463UW series meets all requirements of MIL-C-27287.
VOLTAGE—50V, 100V, 200V, 400V
CAPACITANCE—.001 through 10 mfd
TOLERANCE—available to $\pm 1\%$.

ON READER-SERVICE CARD CIRCLE 43

For data, write TRW Capacitor Div., Ogallala, Neb. Phone (308) 284-3611. TWX 910-620-0321.

TRW®

Co-Publishers

James S. Mulholland, Jr.
Hugh R. Roome

Editorial Director

Edward E. Grazda

Editor

Howard Bierman

Managing Editor

Robert C. Haavind

Technical Editors

Jeffrey N. Bairstow
Peter N. Budzilovich
Maria Dekany
Roger K. Field
David H. Surgan

Careers and Management Editor

Howard S. Ravis

News Editors

Ralph Dobriner, Chief
Richard N. Einhorn

Washington News Bureau

Charles D. LaFond, Chief

East Coast Editor

Neil Sclater

West Coast Editor

Ron Gechman

Copy Editor

Peter Beales

New Products Editor

Steven B. Futterman

Directory Editor

William Alvarez

Washington Editor

S. David Pursglove

Editorial Production

Dollie S. Viebig
Marian Arkin

Art Director

Clifford M. Gardiner

Art Assistant

William Kelly

Technical Illustrators

Cheh Nam Low
Sheila F. Ward
Richard Hartman

Production Manager

Thomas V. Sedita

Asst. Production Manager

Helen De Polo

Production Assistants

Bernard Wolinsky
Robert M. Henry
Murray Friedman

Circulation Manager

Nancy L. Merritt

Reader Service

Diane Mandell

EDITORIAL



The great American brain drain: It's time to stop

Congress has been trying mightily in recent weeks to locate soft spots in our burgeoning public expenditures. With sound justification, we believe, they are trying to make sure the budget is fat-free before approving a 10% tax surcharge for next year.

Is it possible, though, that abuses of public spending—particularly on defense and space projects—have become so widespread, yet so well concealed, that for the most part they are invisible to the budget-cutters? As soon as cuts were called for, the Defense Dept. contended that supplies to Vietnam would be endangered. Space officials said the Apollo timetable would be delayed to the early Seventies.

Is this scare talk? Could some defense and space programs be trimmed without causing either war-supply shortages or delays?

Congress can't answer these questions, but it's time that answers were sought. Congress should immediately form a sort of "Hoover Commission" to delve in detail into some common practices on large defense and space contracts.

In the late 1940s the Hoover Commission probed government waste and made many useful recommendations for improving efficiency and reducing costs.

Would such a commission today find many cases of overstaffing on defense contracts so that higher profits can be obtained without taking too high a percentage of the total contract? Would it find that military and space agencies are willing to spend heavily just to keep their own budgets large? Are engineers who are skillful at "milking" contracts getting promotions and raises? Congress will have to get out into the industry—and away from "Washington representatives"—to find the true story.

Many of the engineers we have talked to in industry report that such practices are common. Some have left defense or space work because of these practices, they say. They speak confidentially, though, because no one wants to see thousands of workers—many of them engineers—suddenly out of jobs.

The fact of the matter is that mass unemployment need not occur. We must revise our economic structure anyway once the Vietnam conflict is settled. Why not start now?

Too much public money, we believe, is going into projects carried along by inertia or empire-building, rather than into projects that meet the nation's true needs. Let's look at some of these needs: Our cities are facing decay. Social problems are multiplying. Public transportation is inadequate. Our water and air are becoming polluted. Hospitals are overcrowded, understaffed and underequipped. Crime is rampant.

Yet many bright people, including engineers capable of helping to solve these problems, may be wasting their time on "featherbed" projects. The nation has too much at stake to allow this situation to continue. Congress should get the facts, and then get action.

ROBERT HAAVIND

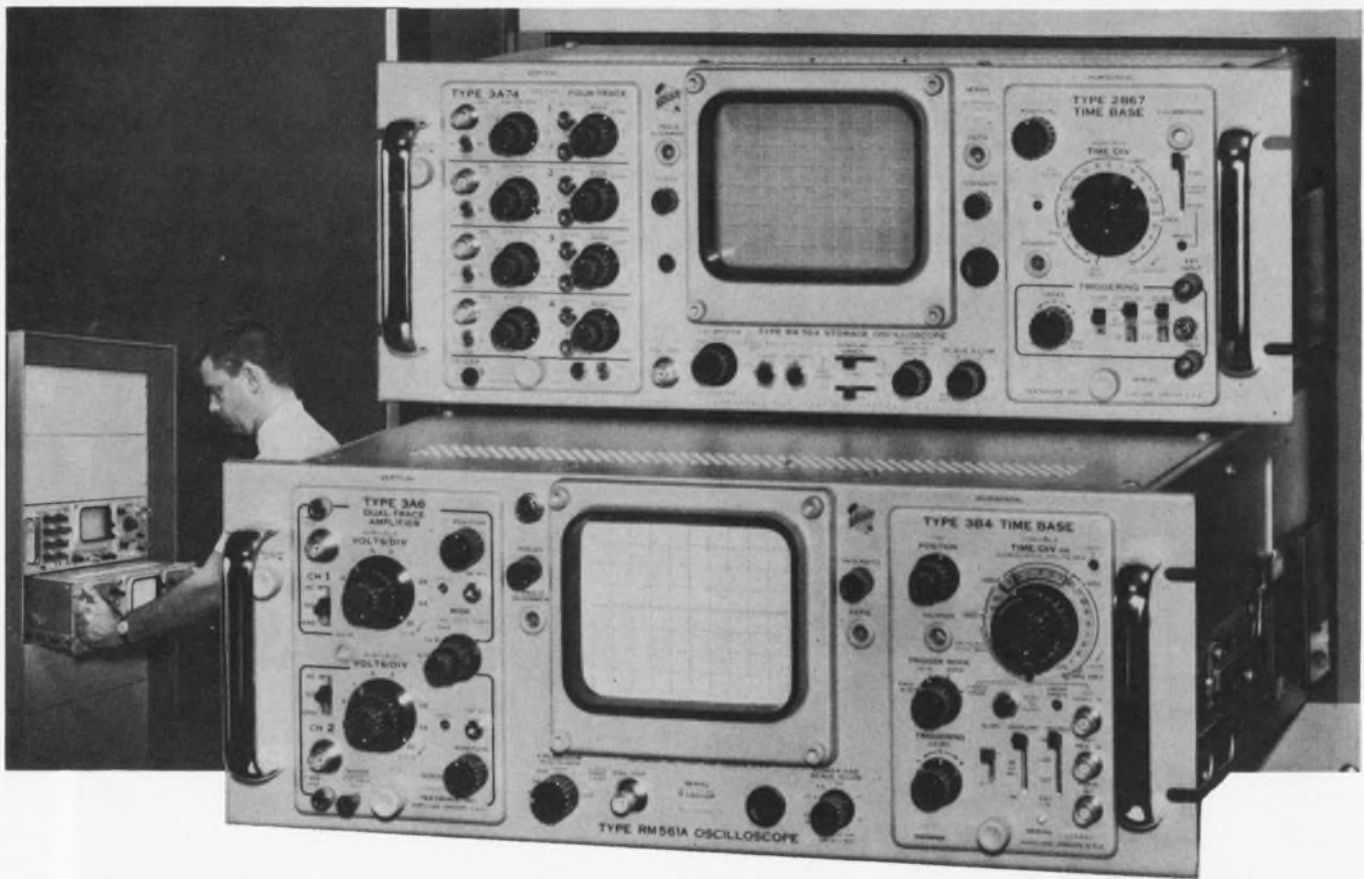

plug in a Tektronix rack-mount oscilloscope

- Conventional or storage
- Multi-trace, differential, sampling and spectrum analyzer plug-ins
- 7 inches of rack height

The **Type RM561A** 7-inch high rack-mount oscilloscope provides conventional oscilloscope performance with measurement capabilities extending from DC through 1 GHz with appropriate plug-in units. It has an 8 by 10-cm CRT with a bright P31 phosphor and an illuminated, internal graticule.

The measurement system illustrated consists of the Type RM561A with the Type 3B4 Time-Base Plug-in and the Type 3A6 Dual-Trace Amplifier. The Type 3B4 provides versatile triggering and calibrated sweep speeds from 5 s/div to 50 ns/div. A direct-reading magnifier provides up to X50 magnification about the center of the CRT. The Type 3A6 Dual-Trace Amplifier has DC-to-10 MHz bandwidth and 35-ns risetime over its 10 mV/div to 10 V/div deflection range.

Type RM561A Oscilloscope	\$ 580
Type RM561A MOD 171A (Includes slide-out tracks)	\$ 630
Type 3B4 Time Base	\$ 425
Type 3A6 Dual Trace Amplifier	\$ 525

The **Type RM564** split-screen storage oscilloscope is virtually two instruments in one. It offers all the advantages of a storage oscilloscope plus those of a conventional plug-in oscilloscope. The contrast ratio and brightness of stored displays are constant and independent of viewing time, writing and sweep speeds, and signal repetition rates. The entire screen or either half can be used for storage and/or conventional displays. In the stored mode, either half of the screen can be erased independently of the other half. A rear panel connector permits remote erasure of either or both halves of the display.

The plug-ins shown in the Type RM564 are the Type 2B67 Time-Base Unit that has calibrated sweep speeds from 5 s/div to 1 μ s/div extending to 200 ns/div with the X5 magnifier, and the Type 3A74 Four-Channel Amplifier that provides DC-to-2 MHz bandwidth over its 20 mV/div to 10 V/div calibrated deflection range.

Type RM564 Storage Oscilloscope	\$1025
Type RM564 MOD 171A (Includes slide-out tracks)	\$1075
Type 2B67 Time-Base	\$ 225
Type 3A74 Four-Channel Amplifier	\$ 625

U. S. Sales Prices FOB Beaverton, Oregon

For a demonstration, contact your nearby Tektronix Field Engineer or write: Tektronix, Inc., P. O. Box 500, Beaverton, Oregon 97005.



*Conventional or storage
oscilloscopes*

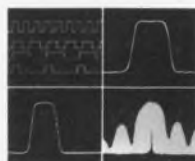

*...with multi-trace, differential,
sampling and spectrum analyzer plug-ins*

Technology

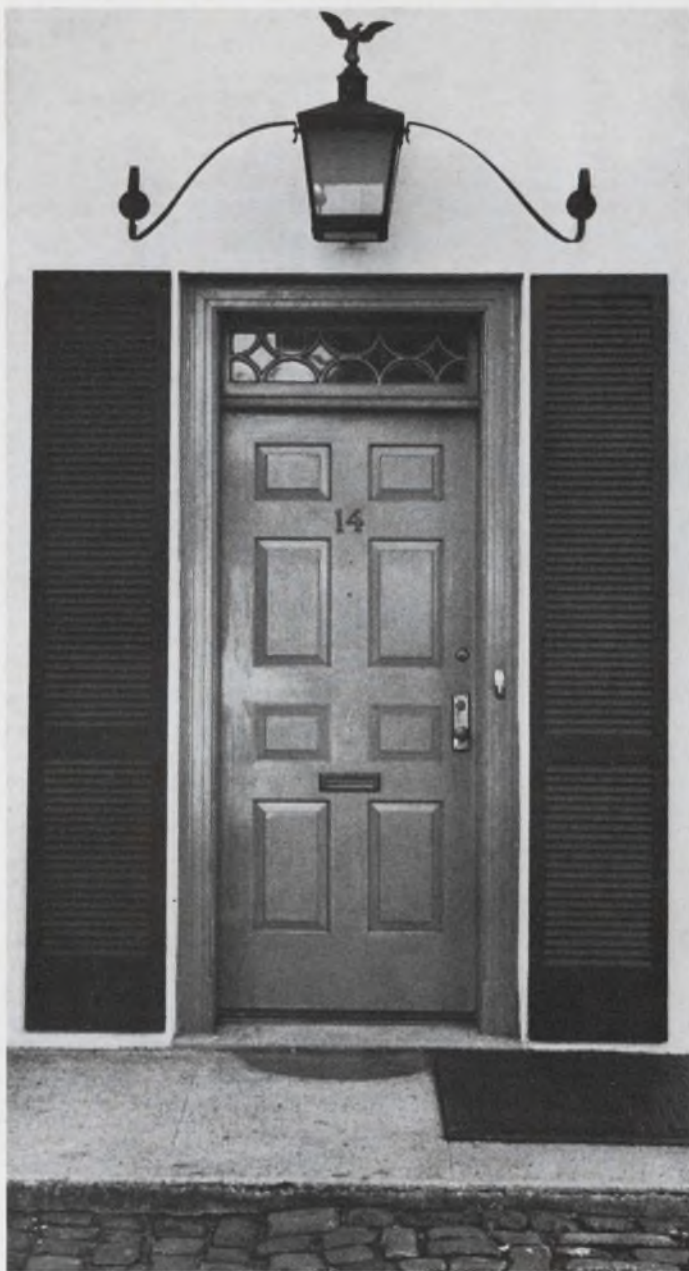

Threshold logic can drastically reduce the number of gates in future logic systems. Page 65



Engineers' training and experience fails to prepare them for management. Page 114

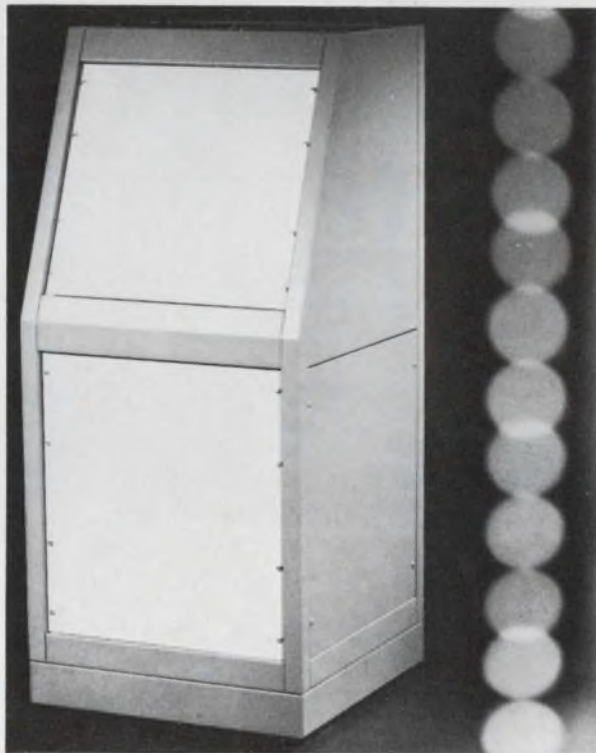

Cabinet requirements should be carefully checked before buying units. Page 110

Also in this section:

A high-speed counter gives good accuracy and stability over wide frequency. Page 90

Microwave transistors are easy to destroy by careless use of common tools. Page 98

Filter design can be speeded by use of a few graphs. Page 104



TWO DUAL R-S FLIP-FLOPS COMBINE TO FORM A 6 ns MASTER-SLAVE SHIFT REGISTER!

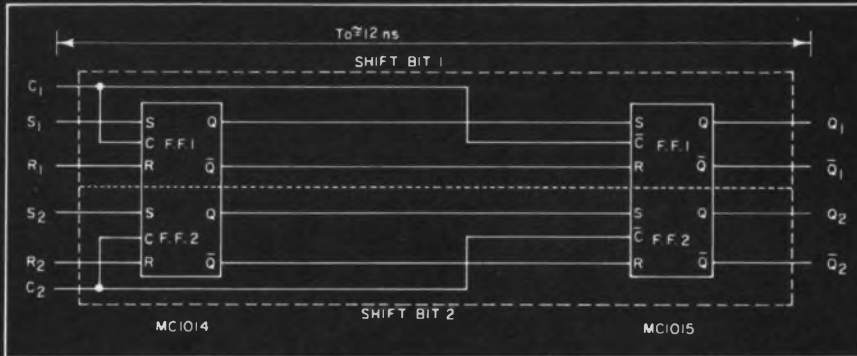

(MECL II MAKES IT POSSIBLE!)

Two new additions to the growing MECL II line of integrated circuits, MC1014P and MC1015P, can be used as positive-gated and negative-gated R-S flip-flops, respectively. Two levels of gating are accomplished with only 2 ns increase in propagation delay. As a result, a single phase, clocked Master-Slave type of shift register with a 6 ns total propagation delay may be obtained as shown.

The MC1014P, in addition to teaming with MC1015P for shift register functions, is also useful as a dual storage element. It contains two dc Set-Reset flip-flops with a positive clock input provided for each flip-flop. MC1015P operates with a negative clock input.

Both new circuits exhibit typical propagation delays of 5.0 ns, operating over the 0 to +75°C temperature range. Both provide typical power dissipa-

tion of 125 mW at an operating frequency of 80 MHz. Minimum dc fan-out of 25 for each output is guaranteed!

Available in the 14-pin Unibloc* plastic package, these circuits bring to 27 the total number of MECL II functional elements — in the fastest, most flexible logic line available. All are fully compatible with the MECL 300/350 series; and, have the same logic levels and power supply requirements as the coming, ultra-high-speed MECL III line.

For data sheets and application notes, circle the reader service number or write to us on your company letterhead.

*Trademark of Motorola Inc.



MOTOROLA
Semiconductors

—where the priceless ingredient is care!

AN ELECTRONIC DESIGN

practical guide to

THRESHOLD LOGIC

Written by: **Dr. Philip M. Lewis 2d**, Research Scientist,
General Electric Research and Development Center, Schenectady, N. Y.

Edited by: **Peter N. Budzilovich**, Technical Editor

The literature on threshold logic is generally theoretical and written so that only mathematicians can understand it. Here, in one 24-page four-part report, is the industry's first practical guide to basic threshold logic concepts and design procedures. Although this new switching theory can result in large cuts in gate numbers, little hardware has been built with it because of the tight component tolerances required.

Now IC gates offer closely matched values at reasonable cost. Integrated threshold gates will soon be on the market. Be ready to apply them in your system designs by reading these articles. They cover:

1. Basic concepts and definitions	66
2. Design procedures	72
3. The majority gate	78
4. Advanced concepts	83

Use threshold logic:

with it you can cut gate count drastically in your future logic systems.

Most digital computers are made of such basic building blocks as AND, OR, NAND or NOR gates. These are embodiments of the well-known basic Boolean algebra connectives, and they are perfectly natural choices. But there is a more powerful basic logic building block: the threshold gate.

Many engineers have shied away from using the threshold gate because they have lacked formal knowledge about it, and because early threshold gates required tight component tolerances. Yet, used properly, it is a powerful tool that promises significant reductions in numbers of gates, numbers of interconnections and total cost of logic systems of the future.

Recent advances in integrated-circuit technology¹ indicate that stable, reliable threshold gate circuits can be mass-produced inexpensively. What is needed now is more widespread knowledge about design procedures that use threshold gates. These four articles will help to fill this gap.

What is a threshold gate?

Figure 1 shows the schematic of a typical threshold gate. It has n binary inputs, x_1, x_2, \dots, x_n , and one binary output, y , which can take on the values 0 or 1. Associated with each input x_i is a coefficient, (or

weight), a_i , and associated with the entire gate is a threshold, t . The threshold and each weight, a_i , can be any real number—positive, negative or zero. The law or operation of the gate is:

$$y = 1 \text{ if } \sum_{i=1}^n a_i x_i \geq t,$$

and:

$$y = 0 \text{ if } \sum_{i=1}^n a_i x_i < t.$$

In other words, the value of y is 1 whenever the weighted sum of the inputs equals or exceeds the threshold; otherwise it is 0. It is convenient to use the following shorthand notation for the output of the gate:

$$y = (a_1 x_1 + a_2 x_2 + \dots + a_n x_n)_t. \quad (1)$$

The threshold gate is a generalization of both an OR and an AND gate. If all the weights are 1 and the threshold (or t) is 1, the gate becomes an OR gate, and if the weights are all 1 and the threshold n , the gate is an AND gate. The generalization* results when the weights and threshold are chosen differently. The gate can then realize more complicated logical functions.

Consider, for example, the logical function:

$$y_1 = x_1 \dot{+} x_2 x_3. \quad (2)$$

(The sign $\dot{+}$ is used for OR and Boolean addition and $+$ for ordinary arithmetic addition.) This function can be realized by a single threshold gate with $t = 2$:

$$y_1 = (2x_1 + x_2 + x_3)_2. \quad (3)$$

This can be verified by observing that the weight of x_1 alone is sufficient to equal the threshold and that the sum of the weights of x_2 and x_3 also equals the threshold. To realize this same function with AND/OR logic would require two gates, one to form the AND of x_2 and x_3 , and one to OR the output of the first gate with x_1 .

As a slightly more complicated example consider:

$$y_2 = x_1 x_2 \dot{+} x_3 x_4, \quad (4)$$

which would require three gates of the AND/OR type. A threshold-gate realization of this function can be obtained in two steps. First observe that $x_1 x_2$ is a

*Some threshold gate circuits give outputs complementary to those specified by Eq. 1 and are thus generalizations of NOR and NAND gates.

simple AND function that can be realized by the threshold gate:

$$y_3 = x_1 x_2 = (x_1 + x_2)_2. \quad (5)$$

The original function y_2 can then be expressed in terms of y_3 as:

$$y_2 = y_3 + x_3 x_4, \quad (6)$$

and can thus be realized as in Eq. 3:

$$y_2 = (2y_3 + x_3 + x_4)_2. \quad (7)$$

Substitution of the realization for y_3 yields the two-gate realization

$$y_2 = (2(x_1 + x_2)_2 + x_3 + x_4)_2, \quad (8)$$

which is shown in Fig. 2.

In both these examples, a significant percentage savings resulted from using threshold gates rather than AND/OR gates. This is the attractive feature of this new type of logic. However, some of these advantages of gate reduction are bought at the expense of tighter tolerances on components. For this reason, sensitivity considerations are an important part of the theory and practice of threshold logic.

Sensitivity defined

In building the circuit that will serve as a logic gate, the engineer can expect the circuit parameters

(such as voltages, resistance values, transistor characteristics) to vary from their nominal values. These variations must remain within specified tolerances if the circuit is to operate correctly. The tolerances on circuit parameters imply corresponding limitations on certain logic parameters of the gates that can be built from the circuits. For AND and OR gates, these logic parameters are fan-in (the number of inputs to the gate) and fan-out (the number of outputs that can be driven by the gate). Thus specifying tolerances on the circuit parameters of an OR gate implies a maximum fan-in and fan-out for that gate.

For threshold gates, the logic parameters are slightly more complicated and, in fact, depend to some extent on the way in which the circuit is built. However, for the class of circuits in which all of the weights are positive[†] (for example, those circuits that use resistors), there are only three logic parameters: relative gap, normalized fan-in and fan-out.

Relative gap defined

The gap of a threshold gate is the interval in which the threshold may lie. In the gate of Eq. 3, for exam-

[†]This is not a serious restriction, as the following article shows.

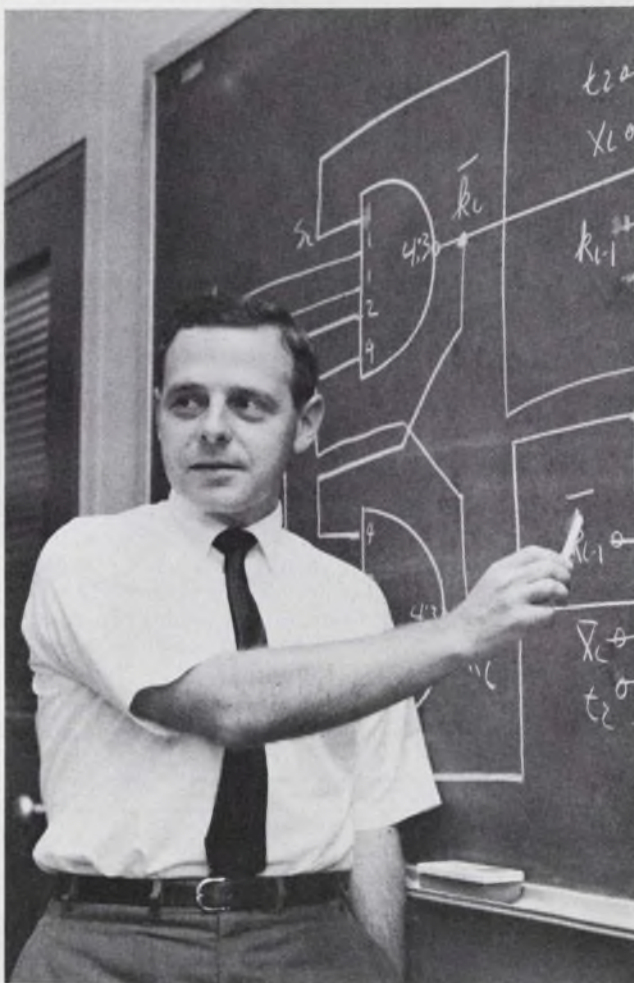

"Reliable threshold gate IC's are practically here; learn how to use them," says Dr. Lewis, the author.

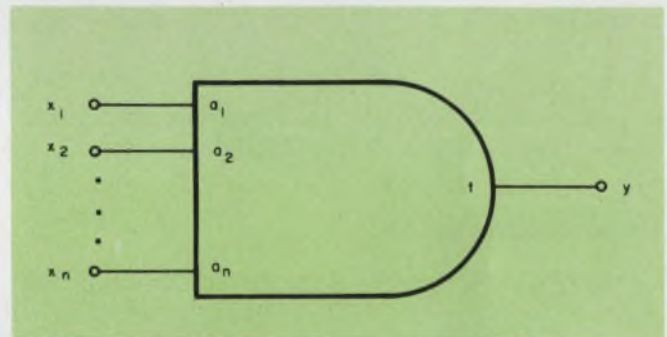

1. Logic Representation of a threshold gate is simple. x_1, x_2, \dots, x_n denote inputs; a_1, a_2, \dots, a_n denote corresponding weights; t stands for the threshold value of the gate, and y denotes the output.

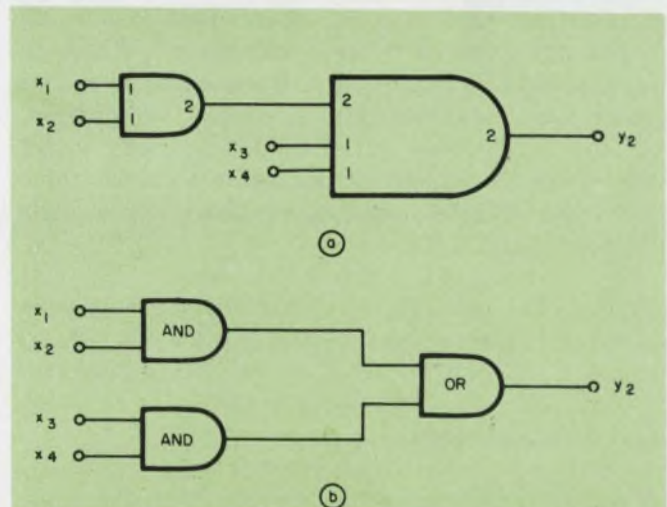

2. Two threshold gates (a) replace three standard AND/OR gates (b) to realize the function of Eq. 4.

ple, the threshold may have any value greater than 1 and less than or equal to 2, and this interval is called the gap. More precisely, for any threshold gate, let u be the smallest value of $\sum_{i=1}^n a_i x_i$ for which the gate is to have unity output, and let l be the largest value of $\sum_{i=1}^n a_i x_i$ for which the gate is to have zero output. The gap in which the threshold may lie is then the interval specified by z , where $l < z \leq u$. The shorthand notation $u:l$ can be used to denote the gap. Using this notation to write the gate of Eq. 3 yields:

$$y_1 = (2x_1 + x_2 + x_3)_{2:1} \quad (9)$$

The gap length is $u - l$. The relative gap is defined as $(u - l)/(u + l)$. For the gate of Eqs. 3 and 9, the relative gap is:

$$(2 - 1)/(2 + 1) = 0.33.$$

It is clear that the smaller the relative gap, the more difficult it is to build the gate—that is, it is harder to build a gate with a gap of 100:99 than one with a gap of 1:0.

What is normalized fan-in?

The fan-in of a threshold gate is the sum of the (positive) weights on its input—that is, $\sum_{i=1}^n a_i$. The normalized fan-in is that normalized by the gap length—that is:

$$\sum_{i=1}^n a_i / (u - l).$$

It is intuitively clear that the larger the normalized fan-in, the more difficult it is to build the gate.

Understanding fan-out

The fan-out is the sum of the weights driven by the gate.

Informally it is sometimes assumed that the gap length is normalized to 1, in which case these sensitivity parameters can be expressed as threshold, fan-in and fan-out.

Specifying tolerances for the circuit parameters implies corresponding limitations on the sensitivity parameters—that is, a minimum relative gap and maximum normalized fan-in and fan-out. These, in turn, affect the number of gates required to realize given logic functions. For example, the function:

$$y = x_4(x_1 + x_2x_3), \quad (10)$$

which can be realized in the obvious way by three AND and OR gates, can also be realized with a single threshold gate:

$$y = (3x_4 + 2x_1 + x_2 + x_3)_{5:1}. \quad (11)$$

This can be easily verified. (Start with the realization of Eq. 3.) However, the relative gap for this realization is:

$$(5 - 4)/(5 + 4) = 1/9,$$

and the normalized fan-in is:

$$(3 + 2 + 1 + 1)/(5 - 4) = 7.$$

If these parameters are not feasible, then this function cannot be realized with one gate; it requires at least two gates. For example, we might let:

$$y_1 = x_1 + x_2x_3, \quad (12)$$

which can be realized as in Eq. 3:

$$y_1 = (2x_1 + x_2 + x_3)_{2:1} \quad (13)$$

Then y is realized as follows:

$$\begin{aligned} y &= x_4 y_1 \\ &= (x_4 + y_1)_{2:1} \\ &= (x_4 + (2x_1 + x_2 + x_3)_{2:1})_{2:1} \end{aligned} \quad (14)$$

Thus, in this example, the gate reduction, compared with AND/OR gates, is a factor of 3, if the relative gap of 1/9 and normalized fan-in of 7 is feasible. But it is only a factor of 1.5 if these parameters are not feasible.

Checking the gate reduction

The gate reduction that can be achieved with threshold gates is dependent not only on the sensitivity parameters of the gates in the circuit, but also on the particular logic function being realized. It is easy to find logic functions with quite impressive gate reductions, but it is just as easy to find other examples where the saving is minimal. It is important therefore to have some idea what the average savings would be over a large number of practical logic functions.

To accomplish this, the logic design of a small general-purpose computer (the DONUT computer² in

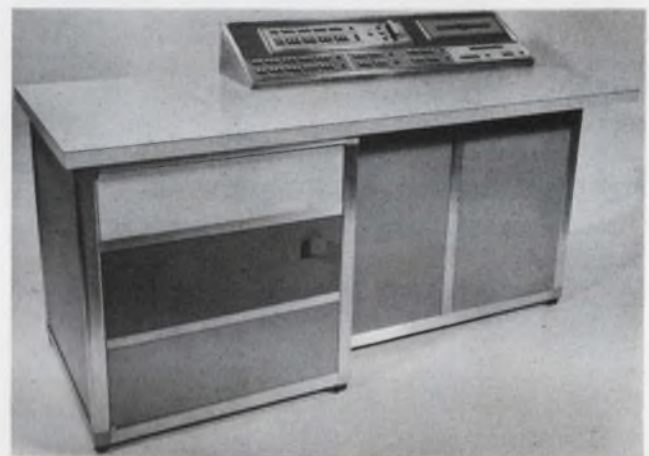

3. Gate reduction possible through the use of threshold logic was demonstrated in the design of this small, general-purpose computer built in 1964 at General Electric Research Laboratories. The results are summarized in the Table in terms of the gate requirements.

Table. DONUT gate requirements

gate parameters	gap	5:4		3:2		1:0-NOR gate	
	fan-in	15	15	5	15	4	4
	fan-out	5	5	5	5	5	5
normalized numbers of gates	whole computer	.29	.42	.50	.80	1	
	accumulator only	.19	.29	.39	.73	1	

Fig. 3) was carried out for five different tolerance constraints, and the tightest tolerance version was constructed.

The computer contained a fairly representative spectrum of logic circuits: a 14-bit accumulator, about 70 bits of flip-flop registers and the control logic to perform about 15 instructions.

The entire logic design of the computer (excluding memory but including registers and accumulator) was carried out for the five limiting values of relative gap, fan-in and fan-out shown in the Table. In each case the same switching functions were realized but with the different sensitivity constraints. The comparative number of gates (again excluding only memory) is shown in the Table, with the number for the NOR gate realization normalized to 1.

The Table also shows the comparative number of gates required for the accumulator alone. Threshold gates appear to be particularly efficient for realizing arithmetic circuits.

Some circuits for threshold gates

The threshold gate circuits used in the DONUT computer were resistor-transistor logic circuits, as shown in Fig. 4a. A resistor adding network is used to compute the weighted sum and a transistor sup-

plies the threshold. Diodes can be placed in the input leads to allow increased fan-in. Some other circuits that have been used for threshold gates are parametrons (Fig. 4b) and magnetic cores (Fig. 4c). In each of these, the weighted sum is computed by summing ampere turns in a magnetic circuit. (In fact, a commercial computer³ has been constructed in Japan with parametron threshold gates.)

Of particular interest is the recent announcement by the Radio Corp. of America that it has developed an integrated-circuit threshold gate¹ (Fig. 5). It is compatible in power, signal levels and packaging, and comparable in noise immunity, speed and power consumption with conventional current-mode OR/NOR gates.

The RCA circuit is shown in Fig. 6. Each input x_i switches a unit of current, weighted by resistor R_i , to the summing points V_B or V_S , depending on whether the input is 0 or 1. The weights are determined by the emitter resistors. The two summed currents at V_B and V_S develop a voltage across the upper current comparator, which in turn determines the two output levels (-1.60 and -0.85 volt) through emitter followers.

The logic circuit realized on the chip is shown in Fig. 7. It consists of two gates, each of which has a normal and a complemented output. One of the gates

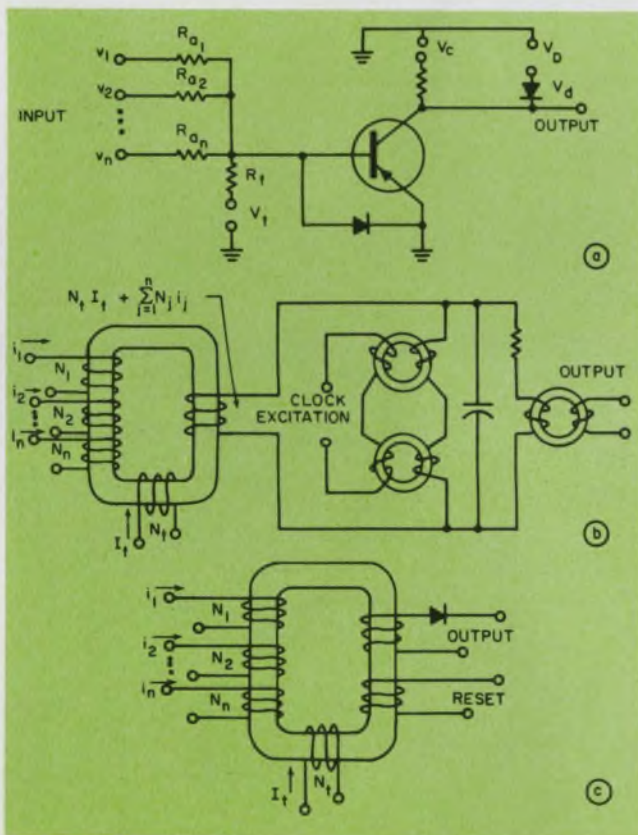

4. **Threshold gate circuits** can be built in several ways. Resistor-transistor circuits (a) were used in the DONUT computer shown in Fig. 3. Parametron and core logic gates are shown in (b) and (c), respectively.

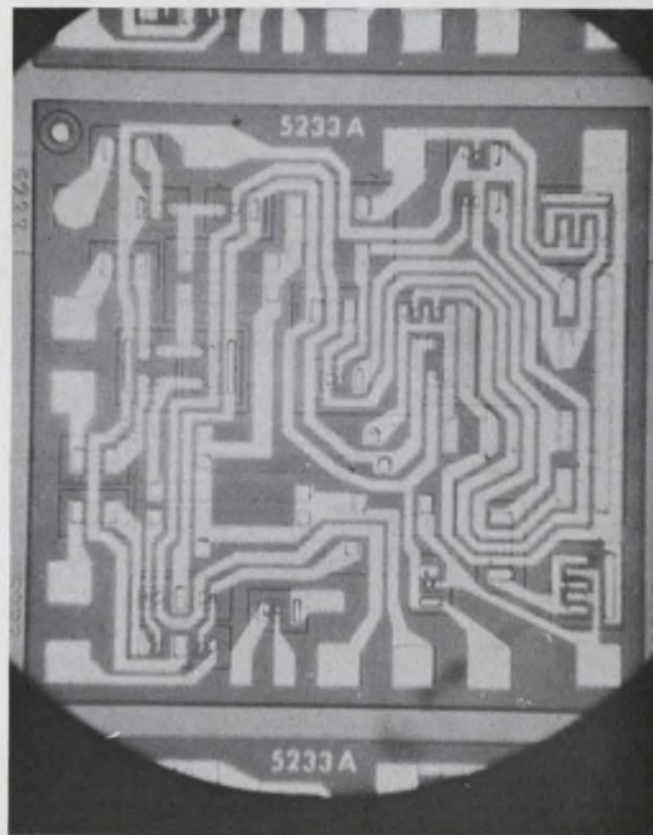

5. A **practical integrated-circuit** threshold gate under development at RCA indicates the possibility of a 50% cost reduction. This figure is obtained by comparing all production costs, including interwiring of the packages.

Photo by RCA

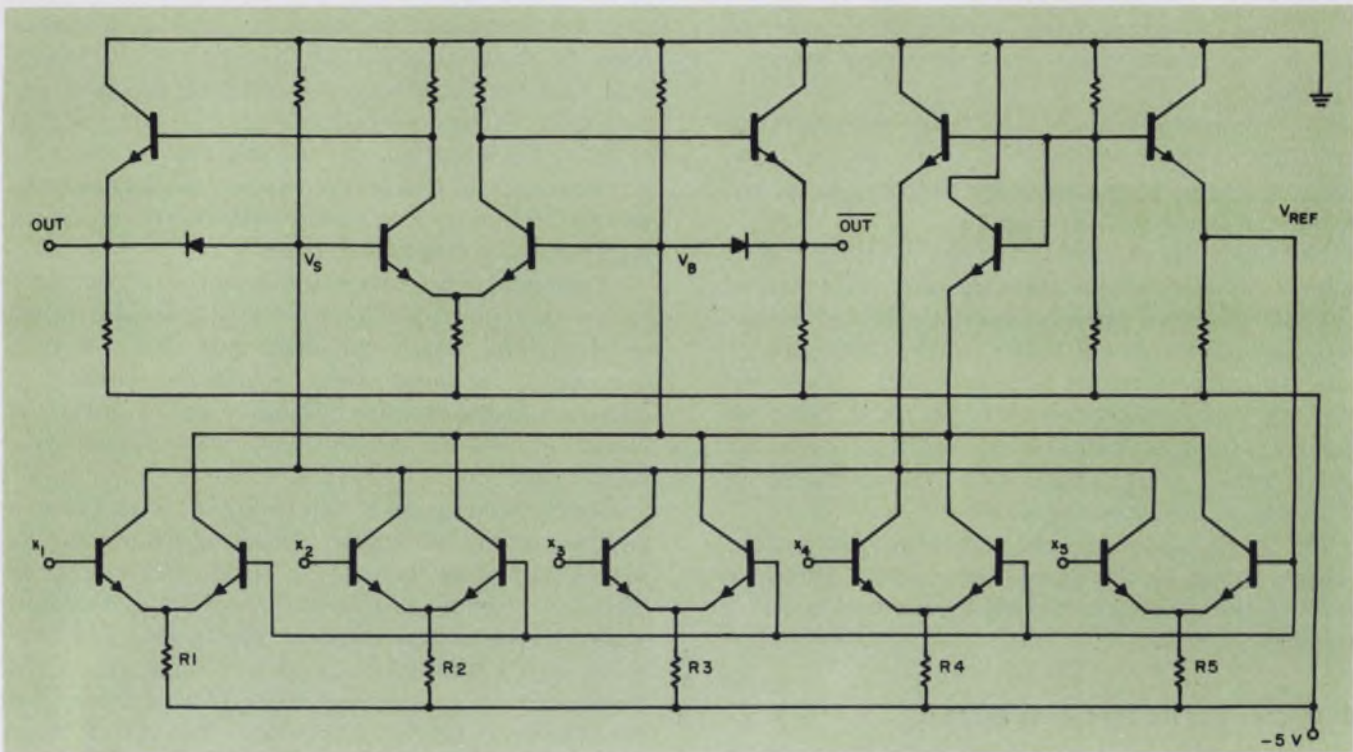

6. Schematic of the five-input threshold gate shown in Fig. 5. The weights are determined by the emitter resistors. Unloaded and loaded stage delays are 8 and 12 ns,

respectively. Output levels are -1.60 and -0.85 V. The circuit is packaged into a 14-pin flat pack and is compatible with conventional current-mode gates.

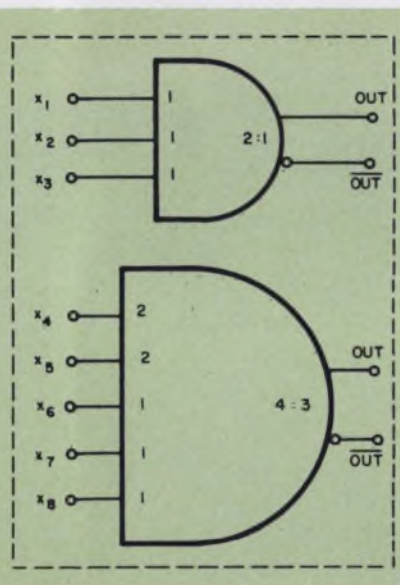

7. Logic circuit of the chip in Fig. 5 indicates that it consists of two gates. Each has both normal and complemented outputs.

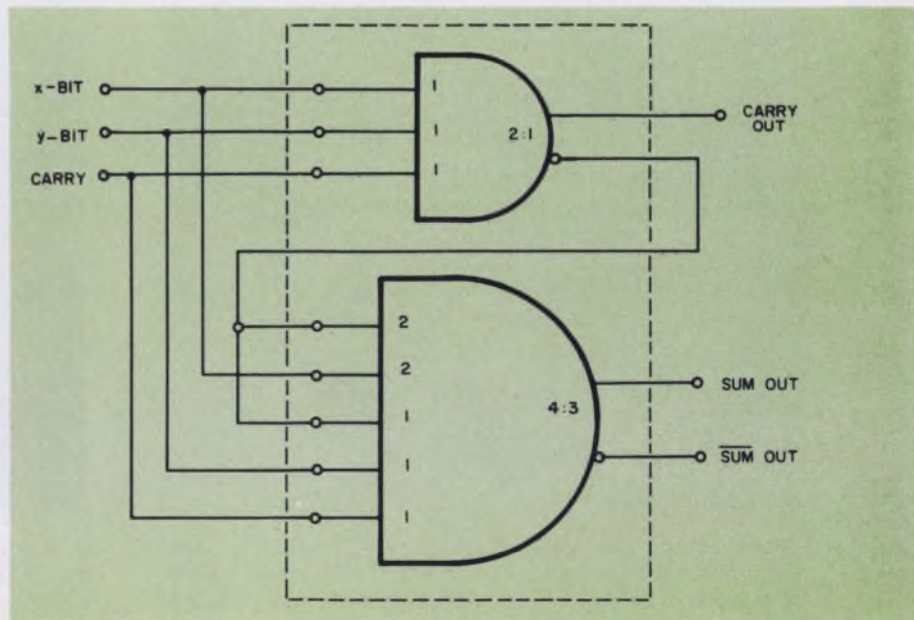

8. Full binary adder can be realized with the use of the two threshold gates of Figs. 5 through 7.

is a two-out-of-three majority gate:

$$x_1 x_2 + x_1 x_3 + x_2 x_3 = (x_1 + x_2 + x_3)_{2:1} \quad (15)$$

The other is a more complex gate:

$$(2x_4 + 2x_5 + x_6 + x_7 + x_8)_{4:3}, \quad (16)$$

which realizes the logic function:

$$x_4 x_5 + (x_4 + x_5)(x_6 x_7 + x_6 x_8 + x_7 x_8). \quad (17)$$

This second gate can be made to realize a large class of logic functions by connecting some of its input leads permanently to 1 or 0 or by tying two or more input leads together. For example, setting $x_4 = 1$ and $x_6 = 0$ gives:

$$(2[1] + 2x_5 + 1[0] + x_7 + x_8)_{4:3},$$

which is equivalent to:

$$(2x_5 + x_7 + x_8)_{2:1} = x_5 + x_7 x_8. \quad (18)$$

Similarly, setting $x_4 = x_6$ gives:

$$(3x_4 + 2x_5 + x_7 + x_8)_{4:3},$$

which realizes the logic function:

$$x_4(x_5 + x_7 + x_8) + x_5 x_7 x_8.$$

As a practical example of the use of these gates, we now realize one stage of a full binary adder (Fig. 8). Assume the inputs are x and y and the input carry is k . The sum output will be denoted by S and the carry output by k' . Then the logic functions to be realized are:

$$k' = xy + xk + yk \quad (19)$$

and:

$$S = \overline{k}(xy + \overline{xy}) + k(\overline{xy} + xy). \quad (20)$$

The carry is a simple majority function and can be realized by the majority gate as:

$$k' = (x + y + k)_{2:1}. \quad (21)$$

To realize the sum function, write it in the equivalent form:

$$S = \overline{k'}(x + y + k) + xyk, \quad (22)$$

which can be realized as:

$$S = (2\overline{k'} + x + y + k)_{3:2}.$$

Unfortunately this particular realization for S cannot be obtained from the gate of Eqs. 16 and 17. However, another realization of S that can be achieved is:

$$S = (3\overline{k'} + 2x + y + k)_{4:3}. \quad (24)$$

To obtain this realization, set:

$$k = x_4 = x_6$$

$$x = x_5$$

$$y = x_7$$

$$k = x_8.$$

The entire full binary adder stage can be realized on the one chip, as shown in Fig. 8. Both the complemented and uncomplemented outputs of the carry gate are used.

The designers of the RCA gate estimate that the gate savings with the use of their chip will be a factor of about 2.5. They further estimate that the cost of the dual threshold gate package will be 25% greater than the conventional current-mode OR/NOR dual-gate package, if equal production volumes are assumed. When these two factors are taken together, a 50% reduction in the cost is the result.

Since the number of interconnections required (and hence the cost of printed-circuit boards and plug-ins) also decreases by about 50%, the total cost

of the logic system can be halved when these threshold gates are used.

Threshold logic state of the art

The advantages of threshold gates have been fairly well documented. Practical circuits exist in the laboratory but are not yet in production. The only remaining obstacle to widespread acceptance of these gates may very well be lack of knowledge about how to use them in efficient logic design. Unfortunately much conventional switching theory, based on Boolean algebra, is not applicable to these gates. A new branch of switching theory is required; it has been called threshold logic, linear input logic and majority logic, among other names. A large number of technical papers have been written on the subject. Recently three books have appeared,^{4,5,6} all with the same title: *Threshold Logic*.

To summarize the current state of threshold logic: Not all of the problems have been solved by any means, but enough is now known for practical logic circuits to be designed, with significant gate reductions. A number of general synthesis algorithms exist, but, as in AND/OR logic, the designer who is fairly familiar with the theory frequently finds it more convenient to design by informal methods. ■ ■

References:

1. J.J. Amodei et al., "An Integrated Threshold Gate," 1967 *International Solid-State Circuits Conference Digest of Tech. Papers* (New York: Lewis Winner), X (1967), 114-115.
2. C.L. Coates and P.M. Lewis, "DONUT: A Threshold Gate Computer," *IRE Trans. on Electron Computers*, Vol. EC-13, No. 3 (June 1964), 240-247.
3. S. Muroga and K. Takoshima, "The Parametron Digital Computer MUSASINO-1," *IRE Trans. on Electron Computers*, Vol. EC-8, No. 3 (Sept. 1959), 308-316.
4. M. Dertouzos, *Threshold Logic: A Synthesis Approach* (Cambridge, Mass.: MIT Press, 1965).
5. S.T. Hu, *Threshold Logic* (Univ. of Calif. Press, 1966).
6. P.M. Lewis and C.L. Coates, *Threshold Logic* (New York: John Wiley & Sons, 1967).

Are you ready for Part II?

Test your knowledge of the fundamentals of threshold logic before attempting to move on to Part II of this four-part series. If you have trouble with any of the concepts, reread the appropriate portions of Part I until you have mastered them.

Here are the test questions:

1. Can you draw a typical threshold gate with n inputs and a threshold t ? Can you write the law of operation of a threshold gate?
2. Can you say in words what the expression $y = (2x_1 + x_2 + x_3)_{2:1}$ means? Can you draw a single gate realization for this function?
3. What does the relative gap mean to you? Sensitivity? Fan-in and fan-out?
4. What does a two-out-of-three majority gate mean? Can you write the function for it and draw a gate for it?

Design logic circuits

with ease using practical step-by-step procedures and straightforward tables.

The previous article outlined the fundamentals of threshold gates, with particular emphasis on their contribution to cutting costs in logic circuits. The definitions, notation and laws of operation are summarized in the threshold gate depicted in Fig. 1.

One of the theory's most useful results has been the compilation of tables that enable the engineer to design threshold-gate circuits with the use of practically no theory at all. The tables list realizations for all the functions of a fixed number of variables possible with a single threshold gate.

Functions that can be realized with a single threshold gate are called threshold functions (or linearly separable functions). Only a small percentage of the functions of a given number of variables are in fact threshold functions, but once these threshold functions have been identified, it is relatively easy to make simple combinations of them in order to realize nonthreshold functions.

Examine functions of three variables

Table 1 shows all the threshold functions of three or fewer variables, together with their maximally reliable realizations—those with maximum relative gap and minimum normalized fan-in. This table can, of course, still be used even if the variables are re-

named. For example, the Boolean function:

$$y = A \dot{+} \bar{B}\bar{C} \quad (1)$$

(i.e., "output y " is obtained in the presence of A OR in the presence of NOT B AND NOT C) can be recognized as the next-to-last entry in Table 1 and realized as:

$$(2A + \bar{B} + \bar{C})_{2:1}, \quad (2)$$

where all the complemented variables are used as inputs. (Bars over symbols mean NOT; a dotted plus sign means OR, the undotted plus sign indicates arithmetic addition.)

As a more complicated example of the use of the table, consider:

$$y = x_1 x_2 \dot{+} x_1 x_3 \dot{+} x_2 x_3 \dot{+} \bar{x}_2 \bar{x}_3. \quad (3)$$

Since this function is not in Table 1, it cannot be realized with one gate. However, the first three terms can be realized as in the fifth table entry:

$$y_1 = x_1 x_2 \dot{+} x_1 x_3 \dot{+} x_2 x_3 \quad (4)$$

$$= (x_1 + x_2 + x_3)_{2:1}. \quad (5)$$

The entire function can be expressed as:

$$y = y_1 \dot{+} \bar{x}_2 \bar{x}_3, \quad (6)$$

which can also be realized from the table:

$$y = (2y_1 + \bar{x}_2 + \bar{x}_3)_{2:1}. \quad (7)$$

Substitution of the realization of y_1 gives the final two-gate realization:

$$y = (2(x_1 + x_2 + x_3)_{2:1} + \bar{x}_2 + \bar{x}_3)_{2:1}. \quad (8)$$

What about more than three variables?

As the number of variables increases, two difficulties complicate listing all threshold functions:

The number of threshold functions of n variables increases exponentially with n . The list of threshold functions of three variables shown in Table 1 is, say, about the size of a sentence. A similar list for four variables would be the size of a paragraph; for five variables, a page; for six variables, a chapter; for seven variables, a book, and eight variables, an encyclopedia. Thus the practical limit for such tables appears to be six or seven variables. Tables for six variables have been published.^{1,2,3} A table for seven variables appears in a paper by R.O. Winder.⁴ The space limitation confines this article to the table for five or fewer variables.

For n larger than three, the number of terms in the

sum-of-products expression for the threshold function becomes quite large. For this reason, it would be cumbersome to list the functions and difficult to find a particular function in such a table. A simpler representation of the function is needed. This new representation is called the Chow parameters. The Chow parameters for a function are computed from its truth table. For example, the truth table for the function: $y = \bar{x}_1 x_2 + x_2 x_3 + x_2 x_4 + \bar{x}_1 x_3 x_4$ (9) is given in Table 2. The term $\bar{x}_1 x_2$, for instance, means that $y=1$ for the four-input combinations where $x_1=0$ and $x_2=1$ —namely those table entries denoted by 0100, 0101, 0110 and 0111.

How to compute the Chow parameters

The Chow parameters, for a function of n variables, are labelled $b_0, b_1, b_2, \dots, b_n$. They are computed as follows:

1. Let m_1 be the number of truth-table entries for which $y=1$. Let m_0 be the number of entries for which $y=0$. Then:

$$b_0 = m_1 - m_0. \quad (10)$$

2. For x_1 , let m_{x_1} be the number of entries for which $y=1$ and $x_1=1$. Let $m_{\bar{x}_1}$ be the number of entries for which $y=1$ and $x_1=0$. Then:

$$b_1 = 2(m_{x_1} - m_{\bar{x}_1}). \quad (11)$$

3. Similarly for each x_i , let m_{x_i} and $m_{\bar{x}_i}$ be the number of entries for which $y=1$ and $x_i=1$ and 0, respectively. Then:

$$b_i = 2(m_{x_i} - m_{\bar{x}_i}). \quad (12)$$

For the function given in Table 2, the Chow parameters are:

$$\begin{aligned} b_0 &= 8 - 8 = 0. \\ b_1 &= 2(3 - 5) = -4. \\ b_2 &= 2(7 - 1) = 12 \\ b_3 &= 2(5 - 3) = 4. \\ b_4 &= 2(5 - 3) = 4. \end{aligned} \quad (13)$$

These parameters characterize the function as far as its single-gate realizability is concerned, and can be conveniently used to tabulate threshold functions.

Use the Chow parameter tables

Table 3 lists all threshold functions of five or fewer variables. The procedure for using the table is as follows.

1. Given a function of five or fewer variables, compute the Chow parameters as described previously.
2. Considering only magnitudes of the parameters and temporarily neglecting their signs, place them in numerical order, putting the largest number on the left, then the second largest, etc.
3. Look up this sequence of numbers in the left-hand columns of the table, labeled $|b_i|$. If they do not appear, the given function is not a threshold function. If they do appear, the given function is a threshold function, and the realization can be obtained in the following manner.

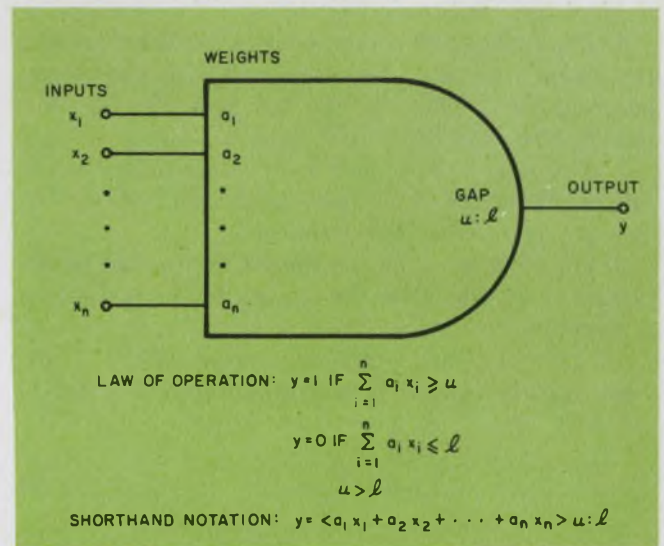

1. Basic threshold gate together with its input-output relation shows the inadequacy of Boolean algebra as a design tool for these gates and hence the need for a new switching theory.

Table 1. All 1-, 2-, and 3-variable threshold functions.

Switching function	Realization
$y = x_1$	$y = \langle x_1 \rangle_{1;0}$
$y = x_1 + x_2$	$y = \langle x_1 + x_2 \rangle_{1;0}$
$y = x_1 x_2$	$y = \langle x_1 + x_2 \rangle_{2;1}$
$y = x_1 + x_2 + x_3$	$y = \langle x_1 + x_2 + x_3 \rangle_{1;0}$
$y = x_1 x_2 + x_2 x_3 + x_1 x_3$	$y = \langle x_1 + x_2 + x_3 \rangle_{2;1}$
$y = x_1 x_2 x_3$	$y = \langle x_1 + x_2 + x_3 \rangle_{3;2}$
$y = x_1 + x_2 x_3$	$y = \langle 2x_1 + x_2 + x_3 \rangle_{2;1}$
$y = x_1 (x_2 + x_3)$	$y = \langle 2x_1 + x_2 + x_3 \rangle_{3;2}$

Reprinted from Lewis and Coates *Threshold Logic*.

Table 2. The truth table for Eq. 9

Variables				Function Value
x_1	x_2	x_3	x_4	y
0	0	0	0	0
0	0	0	1	0
0	0	1	0	0
0	0	1	1	1
0	1	0	0	1
0	1	0	1	1
0	1	1	0	1
0	1	1	1	1
1	0	0	0	0
1	0	0	1	0
1	0	1	0	0
1	0	1	1	0
1	1	0	0	0
1	1	0	1	1
1	1	1	0	1
1	1	1	1	1

4. The right-hand columns of the table are labeled $|a_i|$. Each $|a_i|$ is to be associated with the corresponding $|b_i|$. Thus, if the leftmost $|b_i|$ is $|b_3|$, then the leftmost $|a_i|$ is $|a_3|$, etc.

5. For $i=1, 2, 3, 4$ and 5 the value of $|a_i|$ is the magnitude of the weight of x_i in the realization. The sign of a_i is the same as the sign of b_i .

6. For $i=0$, let a_0 be the weight that would be obtained by step 5. Then the gap $u:l$ in the realization is given by:

$$u:l = (\sigma - a_0 + 1)/2 : (\sigma - a_0 - 1)/2, \quad (14)$$

where σ is the sum of the weights computed in step 5:

$$\sigma = \sum_{i=1}^5 a_i. \quad (15)$$

As an example of the use of the tables, we will realize the function of Eq. 9 and Table 2.

In step 1 the Chow parameters are computed. This has already been done in Eq. 13.

In step 2, the magnitudes of these parameters are placed in numerical order and associated with their

corresponding $|b_i|$ to obtain:

$$12 \quad 4 \quad 4 \quad 4 \quad 0$$

$$|b_2| \quad |b_1| \quad |b_3| \quad |b_4| \quad |b_0|. \quad (16)$$

In step 3, this function is found listed as number 3 in the table for $n \leq 4$. The given function, then, is indeed a threshold function.

In step 4, the $|a_i|$ is selected from the appropriate columns:

$$2 \quad 1 \quad 1 \quad 1 \quad 0, \quad (17)$$

and associated with the corresponding $|b_i|$:

$$2 \quad 1 \quad 1 \quad 1 \quad 0 \quad (18)$$

$$|a_2| \quad |a_1| \quad |a_3| \quad |a_4| \quad |a_0|.$$

Step 5 shows that:

$$a_2 = 2$$

$$a_1 = -1 \quad (19)$$

$$a_3 = 1$$

$$a_4 = 1$$

By step 6 it is determined that $a_0=0$ and that:

$$\sigma = 2 - 1 + 1 + 1 = 3. \quad (20)$$

Then the gap is:

$$u:l = (3 - 0 + 1)/2 : (3 - 0 - 1)/2 = 2:1. \quad (21)$$

Hence:

$$y = (-x_1 + 2x_2 + x_3 + x_4)_{2,1}, \quad (22)$$

which is a valid realization.

Table 3. Threshold functions of five or fewer variables

Number	$ b_i $	$ a_i $
≤ 3	1 8 0 0 0	1 0 0 0
	2 6 2 2 2	2 1 1 1
	3 4 4 4 0	1 1 1 0
≤ 4	1 16 0 0 0 0	1 0 0 0 0
	2 14 2 2 2 2	3 1 1 1 1
	3 12 4 4 4 0	2 1 1 1 0
	4 10 6 6 2 2	3 2 2 1 1
	5 8 8 8 0 0	1 1 1 0 0
	6 8 8 4 4 4	2 2 1 1 1
	7 6 6 6 6 6	1 1 1 1 1
≤ 5	1 32 0 0 0 0 0	1 0 0 0 0 0
	2 30 2 2 2 2 2	4 1 1 1 1 1
	3 28 4 4 4 4 0	3 1 1 1 1 0
	4 26 6 6 6 2 2	5 2 2 2 1 1
	5 24 8 8 4 4 4	4 2 2 1 1 1
	6 24 8 8 8 0 0	2 1 1 1 0 0
	7 22 10 10 6 2 2	5 3 3 2 1 1
	8 22 10 6 6 6 6	3 2 1 1 1 1
	9 20 12 12 4 4 0	3 2 2 1 1 0
	10 20 12 8 8 4 4	4 3 2 2 1 1
	11 20 8 8 8 8 8	2 1 1 1 1 1
	12 18 14 14 2 2 2	4 3 3 1 1 1
	13 18 14 10 6 6 2	5 4 3 2 2 1
	14 18 10 10 10 6 6	3 2 2 2 1 1
	15 16 16 16 0 0 0	1 1 1 0 0 0
	16 16 16 12 4 4 4	3 3 2 1 1 1
	17 16 16 8 8 8 0	2 2 1 1 1 0
	18 16 12 12 8 8 4	4 3 3 2 2 1
	19 14 14 14 6 6 6	2 2 2 1 1 1
	20 14 14 10 10 10 2	3 3 2 2 2 1
	21 12 12 12 12 12 0	1 1 1 1 1 0

Reprinted from Lewis and Coates *Threshold Logic*.

What to do with negative weights

The realizations obtained from the table will often have negative weights. Many circuit implementations of threshold gates, however, do not allow negative weights (the weights for example, may be implemented as resistors).

In these cases a threshold gate with negative weights must be converted into an equivalent one with all positive weights. This is easily done with the identity:

$$x = 1 - \bar{x}. \quad (23)$$

This is an arithmetic identity which is satisfied for both $x=1$ and $x=0$. Thus $1-\bar{x}$ can be substituted for x in the equation of the threshold gate. This will have the effect of changing the sign of the weight of x .

For example, in the realization of Eq. 22:

$$y = (-x_1 + 2x_2 + x_3 + x_4)_{2,1}, \quad (24)$$

the expression $(1-\bar{x}_1)$ can be substituted for x_1 , yielding:

$$y = -(1 - \bar{x}_1) + 2x_2 + x_3 + x_4)_{2,1}. \quad (25)$$

Removing the parenthesis yields:

$$y = (-1 + \bar{x}_1 + 2x_2 + x_3 + x_4)_{2,1}. \quad (26)$$

The weight of \bar{x}_1 is now positive. There is, however, a constant on the left side which can be removed by the following procedure.

Recall that Eq. 26 is just shorthand for:

$$y = 1 \quad \text{if} \quad -1 + \bar{x}_1 + 2x_2 + x_3 + x_4 \geq 2, \quad (27)$$

$$y = 0 \quad \text{if} \quad -1 + \bar{x}_1 + 2x_2 + x_3 + x_4 \leq 1. \quad (28)$$

Thus the constant -1 can be brought from the left to the right side of the inequalities:

$$y = 1 \quad \text{if} \quad \bar{x}_1 + 2x_2 + x_3 + x_4 \geq 3 \quad (29)$$

$$y = 0 \quad \text{if} \quad \bar{x}_1 + 2x_2 + x_3 + x_4 \leq 2 \quad (30)$$

The shorthand notation for this is:

$$y = (\bar{x}_1 + 2x_2 + x_3 + x_4)_{3:2} \quad (31)$$

Obviously Eq. 31 could have been written directly from Eq. 26.

Thus if a function has a single-gate realization, that realization can always be converted into an equivalent one with all positive weights.

Now suppose a multigate realization with some negative weights, for example:

$$y = (-2(2x_1 + x_2 + x_3)_{2:1} + \bar{x}_3 + x_4)_{0:-1} \quad (32)$$

having the configuration shown below. The output

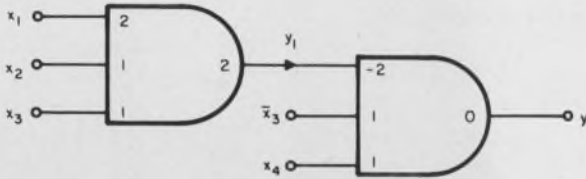

from the first gate has a negative weight. If the output of the first gate is called y_1 , then the expression for y can be written as:

$$y = (-2y_1 + \bar{x}_3 + x_4)_{0:-1} \quad (33)$$

and the procedure already described can be used to obtain the positive weight realization:

$$y = (2\bar{y}_1 + \bar{x}_3 + x_4)_{2:1} \quad (34)$$

Although the weight of the first input has been made positive, the function that must be supplied to that input by the first gate is no longer y_1 but \bar{y}_1 . A realization for y_1 is known:

$$y_1 = (2x_1 + x_2 + x_3)_{2:1} \quad (35)$$

It must now be used to obtain a realization for \bar{y}_1 . This can always be done.

Recall that Eq. 35 is just shorthand for:

$$y_1 = 1 \quad \text{if} \quad 2x_1 + x_2 + x_3 \geq 2. \quad (36)$$

$$y_1 = 0 \quad \text{if} \quad 2x_1 + x_2 + x_3 \leq 1. \quad (37)$$

Suppose that both sides of these inequalities are multiplied by -1 . This requires changing the direction of the inequality sign. Suppose also that $y_1 = 1$ and 0 is replaced by $\bar{y}_1 = 0$ and 1. Then:

$$\bar{y}_1 = 0 \quad \text{if} \quad -2x_1 - x_2 - x_3 \leq 2, \quad (38)$$

$$\bar{y}_1 = 1 \quad \text{if} \quad -2x_1 - x_2 - x_3 \geq 1. \quad (39)$$

Any input combination of the x s that satisfies Eq. 36 will satisfy Eq. 38 and any that satisfies Eq. 37 will satisfy Eq. 39. Thus Eqs. 38 and 39 describe a realization for \bar{y}_1 which has the shorthand description:

$$\bar{y}_1 = (-2x_1 - x_2 - x_3)_{-1:-2}. \quad (40)$$

This is the desired realization.

Thus if a function has a single-gate realization, the complement of that function also has a single-gate realization. It can be obtained from the given realization by changing the signs of all the weights and of u and l and interchanging the new values of u and l .

If a positive weight realization for \bar{y}_1 is required, then the procedure just described can be used to change the sign of the weights. Applying that procedure to Eq. 40 gives:

$$y_1 = (2\bar{x}_1 + \bar{x}_2 + \bar{x}_3)_{3:2}. \quad (41)$$

This realization can be substituted into Eq. 34 to

give a positive weight realization for y :

$$y = (2(2\bar{x}_1 + \bar{x}_2 + \bar{x}_3)_{3:2} + x_3 + x_4)_{2:1}. \quad (42)$$

If y_1 itself had had a multigate realization, the process could have been repeated to obtain a complete positive weight realization for an arbitrary function.

ORing and ANDing realizations

Starting with the realizations given by the tables, it is possible to obtain other realizations by simple techniques based on ORing and ANDing.

Consider the last function in Table 1:

$$y = x_1(x_2 + x_3) = (2x_1 + x_2 + x_3)_{3:2}, \quad (43)$$

and suppose we are interested in the realization for $x_4 + y$:

$$y_1 = x_4 + y = x_4 + x_1(x_2 + x_3). \quad (44)$$

One such realization is:

$$y_1 = (3x_4 + 2x_1 + x_2 + x_3)_{3:2} \quad (45)$$

A new input x_4 has been added to the gate with a weight equal to u . When $x_4 = 0$, the gate operates as before. When $x_4 = 1$, its weight alone is sufficient to equal u .

The process can be repeated:

$$y_2 = x_5 + y_1 = x_5 + x_4 + y \\ = (3x_5 + 3x_4 + 2x_1 + x_2 + x_3)_{3:2}. \quad (46)$$

This is a perfectly general procedure. Thus we have shown:

Given any single-gate, positive-weight realization for y :

$$y = (\sum_{i=1}^n a_i x_i)_{u:l}, \quad (47)$$

then a realization for:

$$y_1 = x_{n+1} + y \quad (48)$$

is:

$$y_1 = (u x_{n+1} + \sum_{i=1}^n a_i x_i)_{u:l} \quad (49)$$

The same idea can be applied to multigate realizations. The function:

$$y = x_1 + x_2 x_3 + x_4(x_5 + x_6) \quad (50)$$

can be recognized as the OR of the last two functions in Table 1:

$$y = y_1 + y_2, \quad (51)$$

where:

$$y_1 = x_1 + x_2 x_3 = (2x_1 + x_2 + x_3)_{2:1}, \quad (52)$$

$$y_2 = x_4(x_5 + x_6) = (2x_4 + x_5 + x_6)_{3:2}. \quad (53)$$

Using y_2 for x_{n+1} yields the realization:

$$y = (2y_2 + 2x_1 + x_2 + x_3)_{2:1} \\ = (2(2x_4 + x_5 + x_6)_{3:2} + 2x_1 + x_2 + x_3)_{2:1}. \quad (54)$$

A very similar technique is useful for ANDing variables and realizations. Consider the next-to-last realization in Table 1:

$$y = x_1 + x_2 x_3 = (2x_1 + x_2 + x_3)_{2:1}, \quad (55)$$

and suppose we are interested in a realization for $x_4 y$:

$$y_1 = x_4 y = x_4(x_1 + x_2 x_3). \quad (56)$$

One such realization is:

$$y_1 = (3x_4 + 2x_1 + x_2 + x_3)_{3:4}. \quad (57)$$

Note that the gap was changed from $u:l$ to:

$$(\sigma + (u-l)):\sigma, \quad (58)$$

where:

$$\sigma = \sum_{i=1}^3 a_i, \quad (59)$$

and a new input x_4 was added with weight:

$$a_4 = \sigma - l. \quad (60)$$

When $x_4=0$, the gate can never have an output of 1 since, even if all the other variables are equal to 1, their weighted sum can never exceed the threshold. When $x_4=1$, the weight 3 is always added to the left side of the inequalities. As was shown in Eqs. 26

through 31, this is equivalent to decreasing the threshold by three, which makes the realization equivalent to the original one. Thus, when $x_4=0$, the realization of Eq. 57 always has an output of 0; when $x_4=1$, the realization has output 1 whenever the realization of Eq. 55 has output 1. Hence Eq. 57 is the desired realization. This, once again, is a perfectly general result:

Given any single-gate, positive-weight realization for y :

$$y = \left(\sum_{i=1}^n a_i x_i \right)_{u,l}, \quad (61)$$

then a realization for:

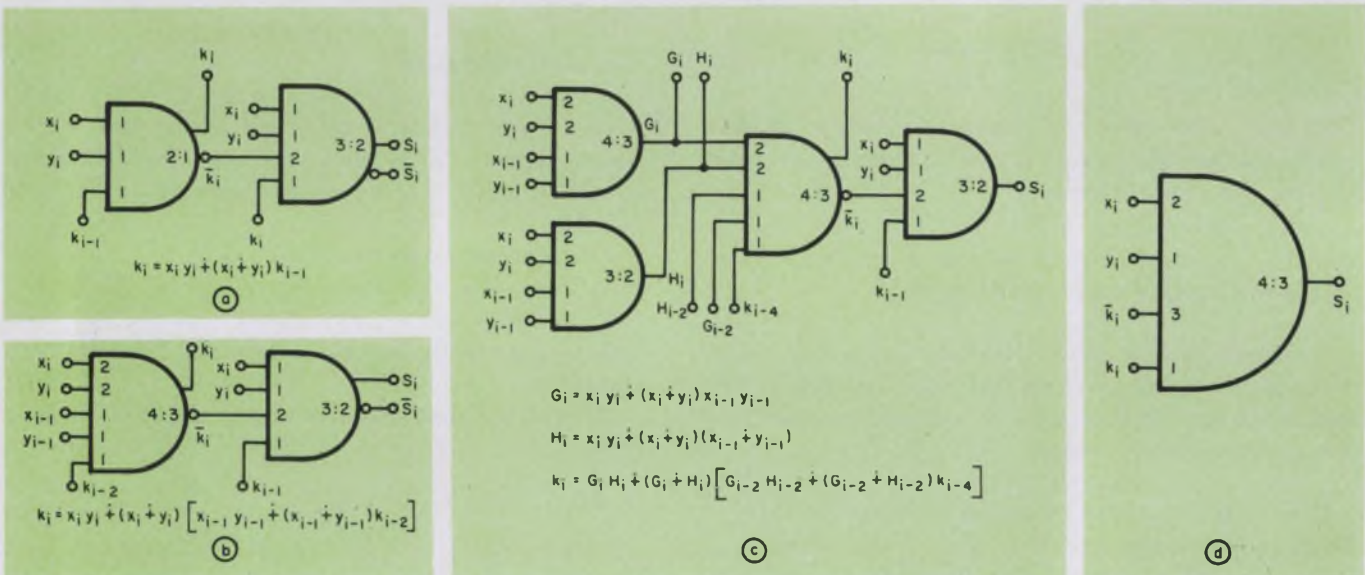

2. **Adder circuits** built with threshold gates demonstrate their versatility. Basic adding circuit (derived in Fig. 8 of the previous article) is shown in (a). An adder with one-bit look-ahead carry (b) can be derived from (a) by substituting the expression for k_{i-1} into the expression for

k_i . A four-bit look-ahead carry adder is shown in (c). An alternative sum-gate (d) can be used in the circuits of (a), (b), and (c) so that these circuits can be realized with the IC threshold gate described in the previous article, i.e., a circuit on a single chip.

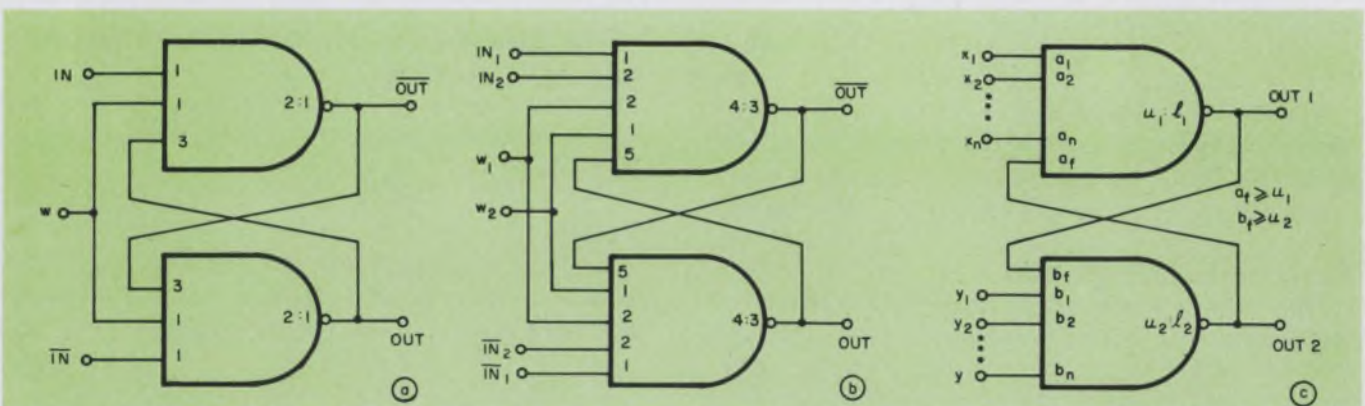

3. **Threshold-gate flip-flops** using complementing gates operate as follows. In (a) the data inputs are IN and \overline{IN} and the gating or control input is w . As long as $w=0$, the data inputs have no effect on the flip-flop. When $w=1$, then if $IN=x$ and $\overline{IN}=\overline{x}$, the value of x will be set into the flip-flop. (b) shows somewhat more complex threshold logic performed on the input to the flip-flop. Here $IN_1, IN_2, \overline{IN}_1,$ and \overline{IN}_2 are data inputs and w_1 and w_2 are control inputs. If w_1 and w_2 are both 0, then the data inputs can

have any values without setting the flip-flop. Data can be stored from either IN_1 and \overline{IN}_1 or from IN_2 and \overline{IN}_2 . To store data from IN_1 and \overline{IN}_1 , set $w_1=1, w_2=1, IN_2=0, \overline{IN}_2=0, IN_1=x,$ and $\overline{IN}_1=\overline{x}$. To store data from IN_2 and \overline{IN}_2 , set $w_1=1, w_2=0, IN_2=x$ and $\overline{IN}_2=\overline{x}$; IN_1 and \overline{IN}_1 can have any arbitrary values. (c) shows the general flip-flop of this type. Arbitrary threshold logic can be performed on the gate inputs. The only restriction is that the feedback weights must equal or exceed their respective thresholds.

$$y_1 = x_{n+1} \vee \quad (62)$$

is:

$$y_1 = ((\sigma - 1)x_{n+1} + \sum_{i=1}^n a_i x_i) \sigma + \sigma - 1 : \sigma. \quad (63)$$

This technique can be used, as described previously, to obtain new realizations starting from those in the tables. What is particularly useful is to apply the ORing and ANDing results alternately. For example, starting with:

$$x_2 \dot{+} x_1 = (x_2 + x_1)_{1:0}, \quad (64)$$

apply the AND result:

$$x_3(x_2 \dot{+} x_1) = (2x_3 + x_2 + x_1)_{3:2}, \quad (65)$$

then the OR result:

$$x_4 \dot{+} x_3(x_2 \dot{+} x_1) = (3x_4 + 2x_3 + x_2 + x_1)_{3:2}, \quad (66)$$

then the AND result:

$$x_5 [x_4 \dot{+} x_3(x_2 \dot{+} x_1)] = (5x_5 + 3x_4 + 2x_3 + x_2 + x_1)_{8:7}, \quad (67)$$

and finally the OR result twice:

$$x_7 \dot{+} x_6 \dot{+} x_5 [x_4 \dot{+} x_3(x_2 \dot{+} x_1)] = (8x_7 + 8x_6 + 5x_5 + 3x_4 + 2x_3 + x_2 + x_1)_{8:7}. \quad (68)$$

Of course, this realization is probably not feasible because of tolerance considerations. The main point is that complicated realizations can be obtained by repeated use of the AND and OR techniques. In fact all the realizations in Table 1 can be obtained by these methods.

If the tolerances in Eq. 68 are exceeded, as indicated by the relative gaps being too small and the fan-in too large, then the AND and OR technique can also be used to obtain a feasible multigate realization.

One such two-gate realization is:

$$x_7 \dot{+} x_6 \dot{+} x_5 y_1 = (2x_7 + 2x_6 + x_5 + y_1)_{2:1}, \quad (69)$$

where:

$$y_1 = x_4 \dot{+} x_3(x_2 \dot{+} x_1) = (3x_4 + 2x_3 + x_2 + x_1)_{3:2}. \quad (70)$$

If the fan-in of these gates is still too high, the process can be repeated to give a four-gate realization.

What we have shown here is our ability to realize most any function to meet any tolerance requirements that may exist.

Applications including adders and flip-flops

By the foregoing methods, many simple logic circuits can be designed from the tables or by judicious trial and error. Even such simple circuits have some useful applications.

The details of the circuits often depend on whether the gates are the conventional type described by Fig. 1, the complementing types which give outputs complementary to that of Fig. 1, or the types which give both outputs, as in the current-mode gates described in the previous article.

Figure 2 shows adder circuits. The one-bit look-ahead carry can be performed with no more gates than is required for the basic adder. In fact, look-ahead carries with any number of bits can be performed with only one gate,⁹ but tolerance considerations make these circuits infeasible. Moreover, all these circuits can be constructed on the integrated-circuit threshold-gate chip described in the previous article.

For flip-flops, the principal advantage of threshold gates is that they allow logic to be carried out on the input to the flip-flop gates in addition to their usual function of storage.

Figure 3 shows flip-flops constructed from complementing gates. Each flip-flop consists of two gates connected in the usual feedback arrangement, which leads to bistable operation, provided the feedback weights are equal to or exceed the thresholds. Various types of gating logic can be performed on the gate inputs.

As an example of more general input logic, Fig. 4 shows a small accumulator that can perform the functions of addition and storage and requires only four gates per stage. A similar but more complete accumulator was built as part of the DONUT project.⁶

Other circuits such as registers can also be built. For example, (see the first article) the RCA integrated-circuit threshold-gate chip can be used to realize a complete register stage including input and output gating. ■ ■

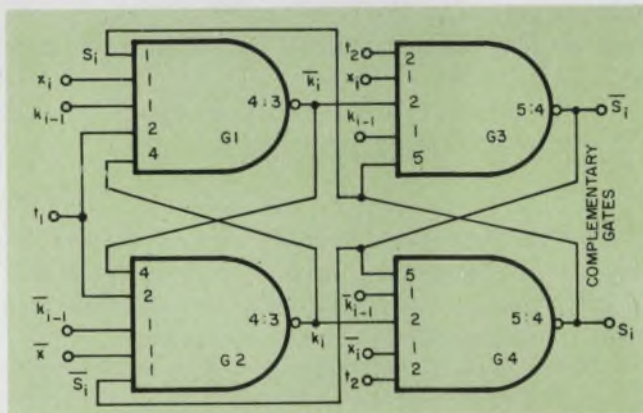

4. A simple accumulator is based on the two-gate adder circuit of Fig. 2a. Gates G₁ and G₂ form the carry flip-flop while gates G₃ and G₄ form the sum flip-flop. The circuit operates in two clock periods. During the first clock period (t₁=1 and t₂=0), the carry is computed by G₁ and G₂ and stored in the carry flip-flop while the sum flip-flop is unchanged. During the second clock period (t₁=0 and t₂=1) the carry flip-flop is unchanged and the sum is computed by G₃ and G₄ and stored in the sum flip-flop.

References:

1. M. Dertouzos, "An Approach to Single Threshold Element Synthesis," *IRE Trans. on Electronic Computers*, Vol. ED-13, No. 5 (Oct. 1964), 511-528.
2. M. Dertouzos, *Threshold Logic: A Synthesis Approach* (Cambridge, Mass.: MIT Press, 1965).
3. P.M. Lewis II and C.L. Coates, *Threshold Logic* (New York: John Wiley & Sons, 1967).
4. "Enumeration of Seven Argument Thresholds," *IEEE Trans. on Electronic Computers*, Vol. EC-14, No.3 (June 1965), 315-325. See also AFCRL Report 64-925.
5. Lewis and Coates, *op. cit.*
6. C.L. Coates and P.M. Lewis II, "DONUT: A Threshold Gate Computer," *IRE Trans. on Electronic Computers*, Vol. EC-13, No. 3 (June 1964), 240-247.

Here are majority gates:

the fundamental building blocks that give versatility to threshold systems.

The majority gate offers many of the advantages of gate reduction inherent in all threshold gates. It is also relatively easy to construct, since in many cases, it uses virtually the same circuits as AND and OR gates. Moreover, majority gates seem to lend themselves particularly well to array networks, which are important in large-scale integration.

The simplest and most useful majority gate is the so-called two-out-of-three majority gate, which means that the gate will have an output of unity whenever two or more of its inputs are unity. The rest of this section will be devoted to such three-input gates and they will be referred to as "majority gates". Their versatility will become apparent as the examples of these gates are discussed.

The following shorthand notation can be used for the majority gate of Fig. 1, which has a threshold of 2 and a fan-in of 3:

$$M(x_1, x_2, x_3) = x_1 x_2 + x_1 x_3 + x_2 x_3. \quad (1)$$

The majority gate is a simple generalization of both the OR and the AND gate. If one of its inputs is set equal to 1, the result is an OR gate:

$$M(x_1, x_2, 1) = x_1 x_2 + x_1 \cdot 1 + x_2 \cdot 1 \\ = x_1 + x_2. \quad (2)$$

If one of the inputs is set equal to 0, the result is an AND gate:

$$M(x_1, x_2, 0) = x_1 x_2 + x_1 \cdot 0 + x_2 \cdot 0 \\ = x_1 x_2. \quad (3)$$

For a free reprint of this report circle 250.

The use of inputs equal to 1 and 0 is a necessary part of general majority-gate design.

A similar kind of ANDing and ORing with majority gates can be used in a number of design situations. For example, let:

$$y = x_4(x_1 x_2 + x_1 x_3 + x_2 x_3). \quad (4)$$

This is seen to be of the form:

$$y = x_4 y_1, \quad (5)$$

where:

$$y_1 = x_1 x_2 + x_1 x_3 + x_2 x_3. \quad (6)$$

The function y can then be realized as:

$$y = M(x_4, y_1, 0), \quad (7)$$

and y_1 as:

$$y_1 = M(x_1, x_2, x_3). \quad (8)$$

Substitution of the realization for y_1 into Eq. 7, gives the final two gate realization:

$$y = M(x_4, M(x_1, x_2, x_3), 0). \quad (9)$$

Using complements and duals

Often it is easier to realize the complement of a function rather than the function itself, as the following procedure will demonstrate. Once a majority gate realization has been obtained for any function:

$$y = F(x_1, x_2, \dots, x_n), \quad (10)$$

the realization for the complement of y can be obtained. The function realized by the majority gate is:

$$y = M(x_1, x_2, x_3) = x_1 x_2 + x_1 x_3 + x_2 x_3. \quad (11)$$

The complement of that function, \bar{y} , is:

$$\bar{y} = \bar{x}_1 \bar{x}_2 + \bar{x}_1 \bar{x}_3 + \bar{x}_2 \bar{x}_3 \\ = \bar{x}_1 \bar{x}_2 + \bar{x}_1 \bar{x}_3 + \bar{x}_2 \bar{x}_3. \quad (12)$$

Thus the output of a majority gate can be complemented by complementing each of its inputs. If this result is applied to each gate of a majority-gate network, the following rule can be formulated:

Given a majority gate network that realizes y , then a network that realizes \bar{y} can be obtained by complementing all the inputs to the network, including the constant inputs 1 and 0.

For example, the complement of the realization of Eq. 9 is:

$$y = M(\bar{x}_4, M(\bar{x}_1, \bar{x}_2, \bar{x}_3), 1). \quad (13)$$

Many design procedures such as the Akers procedure¹ are based on the concept of dual functions. A result similar to that given for complementing re-

alizations can be used to obtain the dual of a given realization. Given a function:

$$y = F(x_1, x_2, \dots, x_n), \quad (14)$$

the dual of that function is defined as:

$$y^d = F(\bar{x}_1, \bar{x}_2, \dots, \bar{x}_n). \quad (15)$$

In other words the function is first complemented and then each of the variables is complemented. For example, if:

$$y = x_1 + x_2, \quad (16)$$

first y is complemented:

$$\bar{y} = \bar{x}_1 \bar{x}_2. \quad (17)$$

Then each of the variables is complemented, to obtain the dual:

$$y^d = x_1 x_2. \quad (18)$$

In general, given any function expressed in sum-of-products form, the dual can be obtained by replacing all ORs by ANDs and all ANDs by ORs.

If this procedure is applied to the majority gate of Eq. 11, the result is:

$$y^d = (x_1 + x_2)(x_1 + x_3)(x_2 + x_3), \quad (19)$$

which reduces to:

$$y^d = x_1 x_2 + x_1 x_3 + x_2 x_3. \quad (20)$$

Thus the dual of this function equals the function itself. Such functions are known as *self-dual functions*.

For a network of majority gates, the dual function can be obtained by the following rule:

Given a majority gate network that realizes y , then a network that realizes y^d can be obtained by complementing all constant inputs.

For example, the dual of the realization of Eq. 9 is:

$$y^d = M(x_4, M(x_1, x_2, x_3), 1) \quad (21)$$

Compare Eq. 21 with Eq. 13. As expected from Eq. 15, the realization for y^d can be obtained from that for \bar{y} by complementing all the input variables except for the constant input 1.

How to design majority-gate networks

A number of special design procedures have been developed for majority-gate networks because of their particular importance. Once such procedure for arbitrary functions and one for symmetric functions will be considered, and then their implications for array networks will be discussed.

The first procedure is based on a particular way in which all switching functions can be factored. Assume, for example, that the given function is:

$$y = x_1 x_2 + x_1 x_3 \bar{x}_4 + \bar{x}_1 \bar{x}_2 \bar{x}_3 + \bar{x}_1 x_4 + \bar{x}_2 x_5 x_6 + x_7 x_8 x_9. \quad (22)$$

The function has been written as the sum of six terms. These terms can be divided into three groups:

- The first group consists of all those terms that include x_1 as one of their variables. In the example, this group comprises the first two terms.

- The second group contains all terms that include \bar{x}_1 as one of their variables. In the example, this group comprises the third and fourth terms.

- The third group contains all the terms that include neither x_1 nor \bar{x}_1 . In the example, this group accounts for the last two terms.

Now consider a term in the third group, say, $\bar{x}_2 x_5 x_6$. This term can be written as the sum of two terms:

$$\bar{x}_2 x_5 x_6 = x_1 \bar{x}_2 x_5 x_6 + \bar{x}_1 \bar{x}_2 x_5 x_6. \quad (23)$$

To verify this, observe that the equation is satisfied for both $x_1 = 1$ and $x_1 = 0$, and so it is satisfied for all input combinations.

Each term in the third group, then, can be written as the sum of two terms, one of which includes x_1 and so would be placed in the first of the three groups of terms, and the other includes \bar{x}_1 and so would be in the second of those groups.

If this is done for the example, and the terms are rearranged so that those in the first group precede those in the second, the result is:

$$= x_1 x_2 + x_1 x_3 \bar{x}_4 + x_1 \bar{x}_2 x_5 x_6 + x_1 x_7 x_8 x_9 + \bar{x}_1 \bar{x}_2 \bar{x}_3 + x_1 x_4 + \bar{x}_1 \bar{x}_2 x_5 x_6 + \bar{x}_1 x_7 x_8 x_9. \quad (24)$$

The function can be further rewritten as:

$$y = x_1(x_2 + x_3 \bar{x}_4 + \bar{x}_2 x_5 x_6 + x_7 x_8 x_9) + \bar{x}_1(\bar{x}_2 \bar{x}_3 + x_4 + \bar{x}_2 x_5 x_6 + x_7 x_8 x_9), \quad (25)$$

where x_1 has been factored out of all the terms of the first group and \bar{x}_1 has been factored out of all the terms in the second group.

The sum of the four terms between the first parentheses makes up another switching function that will be called F_1 :

$$F_1 = x_2 + x_3 \bar{x}_4 + \bar{x}_2 x_5 x_6 + x_7 x_8 x_9. \quad (26)$$

Similarly the sum of terms of the second parentheses will be called F_0 :

$$F_0 = \bar{x}_2 \bar{x}_3 + x_4 + \bar{x}_2 x_5 x_6 + x_7 x_8 x_9. \quad (27)$$

The total switching function can then be written as:

$$y = x_1 F_1 + \bar{x}_1 F_0. \quad (28)$$

This is the desired factoring that will be used in later procedures. A similar process can be applied to any switching function, using any variable instead of x_1 .

Miyata's tree procedure^{1,4}

The basic idea of the tree procedure is this: Given a function F that may be difficult to realize, it is broken up into two smaller functions, F_1 and F_0 , which may be easier to realize. If necessary, F_1 and F_0 , too, may be broken up into smaller functions, and so on until the realization can be completed. This is the step-by-step procedure.

1. Given a function:

$$y = F(x_1, x_2, \dots, x_n), \quad (29)$$

select any variable, say x_1 , and factor F as:

$$y = x_1 F_1 + \bar{x}_1 F_0. \quad (30)$$

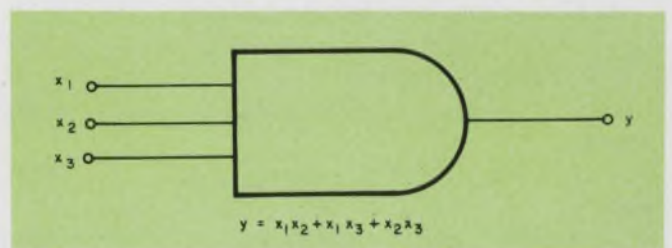

1. **Three-input majority gate** has the output equal to 1 whenever two or more of the inputs also are equal to 1.

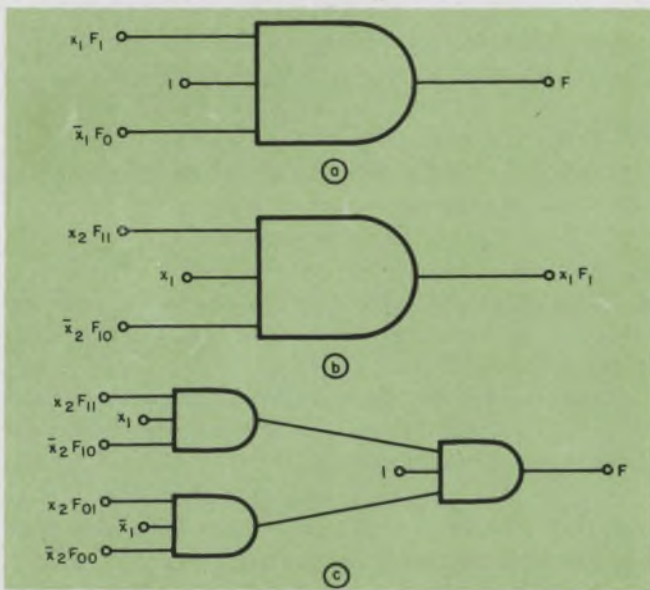

2. Derivation of the tree procedure is carried out in three steps: (a) the final gate; (b) the realization for $x_1 F_1$; (c) the first two levels of the tree.

This factoring determines the final gate in the realization. This gate is just the OR of the functions $x_1 F_1$ and $\bar{x}_1 F_0$ and, in terms of majority gates, is given by:

$$y = M(x_1 F_1, 1, \bar{x}_1 F_0), \quad (31)$$

as shown in Fig. 2a.

2. The functions $x_1 F_1$ and $\bar{x}_1 F_0$, which are inputs to the final gate, must now each be realized by majority-gate networks. Consider first $x_1 F_1$ and factor F_1 as:

$$F_1 = x_2 F_{11} + \bar{x}_2 F_{10}. \quad (32)$$

The function $x_1 F_1$ can then be written as:

$$x_1 F_1 = x_1(x_2 F_{11} + \bar{x}_2 F_{10}), \quad (33)$$

for which a majority gate realization is:

$$x_1 F_1 = M(x_2 F_{11}, x_1, \bar{x}_2 F_{10}), \quad (34)$$

as shown in Fig. 2b.

Similarly, $\bar{x}_1 F_0$ can be factored as:

$$\bar{x}_1 F_0 = \bar{x}_1(x_2 F_{01} + \bar{x}_2 F_{00}), \quad (35)$$

and realized as:

$$\bar{x}_1 F_0 = M(x_2 F_{01}, \bar{x}_1, \bar{x}_2 F_{00}). \quad (36)$$

3. Substitution of the realizations of Eqs. 34 and 36 into that of Eq. 31 gives the network of Fig. 2c.

The same procedure can now be applied to each of the functions $x_2 F_{11}, \bar{x}_2 F_{10}, x_2 F_{01}$ and $\bar{x}_2 F_{00}$ and so on. At each step one of the variables is removed, so that eventually no more variables remain and the realization is complete.

As an example, consider the function:

$$y = x_1 x_2 + x_1 x_3 + x_1 x_4 + x_2 x_3. \quad (37)$$

The first step is to form:

$$y = x_1 F_1 + \bar{x}_1 F_0, \quad (38)$$

where:

$$x_1 F_1 = x_1(x_2 + x_3 + x_4), \quad (39)$$

and:

$$\bar{x}_1 F_0 = \bar{x}_1(x_2 x_3). \quad (40)$$

This factoring implies the network of Fig. 3a.

Factor $x_1 F_1$ as:

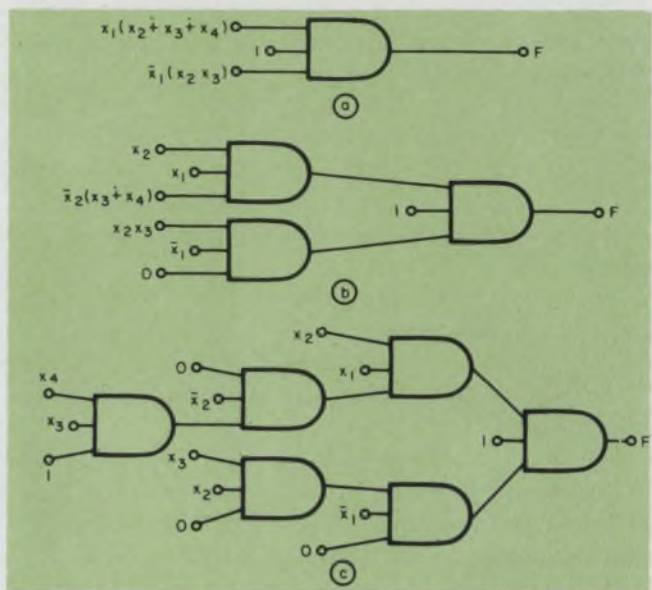

3. The realization of Eq. 37 is accomplished as follows: (a) the first step; (b) the first two layers; (c) the complete realization.

$x_1 F_1 = x_1 [x_2(1) + \bar{x}_2(x_3 + x_4)]$, (41)
and $x_1 F_0$ as:

$$\bar{x}_1 F_0 = \bar{x}_1 [x_2 x_3 + \bar{x}_2(0)]. \quad (42)$$

Observe that the constant 1 appears in Eq. 41 because, as shown in Eq. 39:

$$F_1 = x_2 + x_3 + x_4, \quad (43)$$

and the set of terms multiplied by x_2 is just 1—in other words, F_1 can be written as:

$$F_1 = x_2 1 + \bar{x}_2(x_3 + x_4). \quad (44)$$

Similarly the 0 appears in Eq. 42 because, as shown in Eq. 40:

$$F_0 = x_2 x_3, \quad (45)$$

and there are no terms multiplied by \bar{x}_2 —in other words, F_0 could be written as

$$F_0 = x_2 x_3 + 0 = x_2 x_3 + \bar{x}_2 0. \quad (46)$$

These constants appear in the realization as constant inputs to the gates, as shown in Figs. 3b and 3c. Continuing the procedure leads to the final realization shown in Fig. 3c.

Look at symmetric functions^{2,4}

Symmetric switching functions are those where the value of the function is unchanged if the values of any two variables are interchanged. In other words, the value of the function is determined solely by the number of inputs that have unit values. The majority gate realizes a symmetric function, for example, since its value is unity whenever two or more inputs have unit values. Symmetric functions occur quite frequently in practical logic design.

One important class of symmetric function is represented by:

$$y = M_k(x_1, x_2, \dots, x_n), \quad (47)$$

which has unit value whenever k or more of its vari-

able inputs have unit value.

This $M_k()$ notation is a shorthand representation of the function, used instead of writing all the product terms of k or more variables. One way to realize an $M_k()$ function would be with a single k -out-of- n -majority gate—that is, a gate with n inputs and with an output of unity whenever k or more of its inputs are unity. Such gates are rather difficult to build, however, and are beyond the scope of this article. The focus here is on two-out-of-three majority gates, which for brevity's sake are referred to merely as majority gates.

We first show how networks of majority gates can be used to obtain a realization for these $M_k()$ functions. Consider the network of Fig. 4a. The half circles represent majority gates, where each has one input that is the constant 1 function and the other two are variables. In all but the leftmost gate, one input is an input variable to the network; the other is the output of the preceding gate. If any one of the input variables has unit value, the output of the corresponding gate is unity because of the constant-1-function input. Moreover, all gates to the right of this one also have unity output. As a result, the network realizes the switching function:

$$y = M_1(x_1, x_2, \dots, x_n). \quad (48)$$

Consider now the network of Fig. 4b, which consists of two layers of gates. The bottom layer is the same as the network of Fig. 4a and its output is $M_1(x_1, x_2, \dots, x_n)$. The top layer is similar to the bottom layer (ignoring the leftmost gate for the moment), except that the third input of each gate is connected to the output of the preceding bottom-layer gate instead of to the constant 1 function. Consequently, if any input variable has value 1, then the output of the top-layer gate for which it is an input will be 1 if, and only if, a variable to its left also has value 1.

This is true because, if the variable to the left has value 1, then it causes its bottom-layer gate and all bottom-layer gates to its right to have output 1. Thus two of the inputs to the second-layer gate in question have value 1 and its output is 1. Furthermore, if any top-layer gate has output 1, then all top-layer gates to its right have output 1 because of the input from the bottom gate that is also value 1. The left-most gate has output 1 if, and only if, x_1 and x_2 both have value 1. Therefore the output of the top-layer is the function $M_2(x_1, x_2, \dots, x_n)$.

Additional layers can be added in the same way, so that the network simultaneously realizes the functions:

$$M_1(x_1, x_2, \dots, x_n), M_2(x_1, x_2, \dots, x_n), \dots, M_n(x_1, x_2, \dots, x_n). \quad (49)$$

Figure 4c shows the complete network for $n=7$. In general, the number of gates required for the complete network is:

$$\lceil n(n+1)/2 \rceil - 1. \quad (50)$$

Thus far it has been shown how to realize all the $M_k(x_1, x_2, \dots, x_n)$ functions for $k=1, 2, \dots, n$. Now it

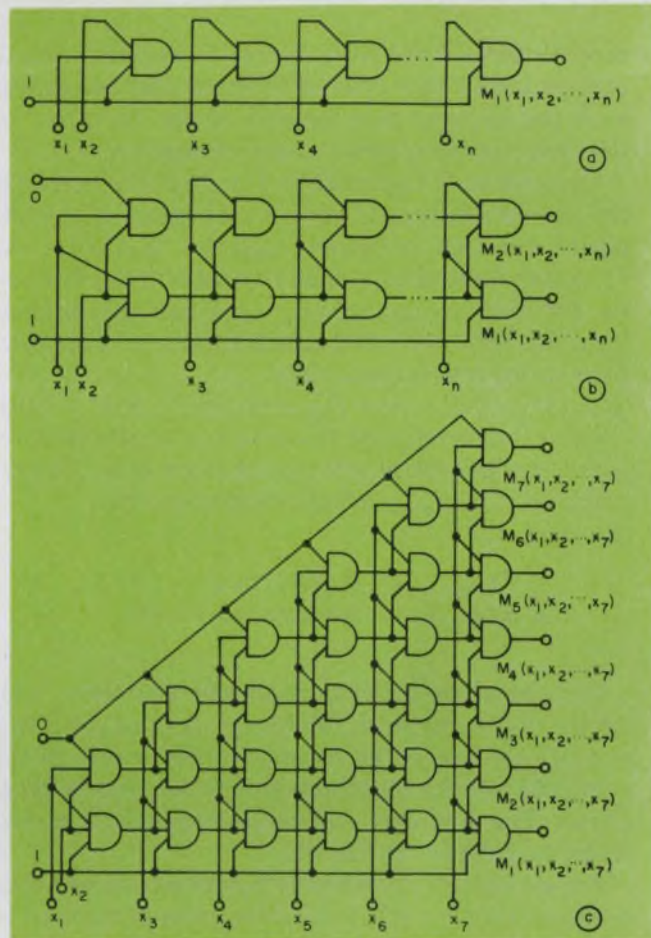

4. The general realization for seven M_k -type symmetric functions: (a) the realization for M_1 ; (b) the realization for M_1 and M_2 ; (c) the realization for M_1 through M_7 .

will be shown how to realize the symmetric functions that are not of the $M_k(x_1, x_2, \dots, x_n)$ class.

The most general class of symmetric functions is represented by:

$$S_{a_1, a_2, \dots, a_k}(x_1, x_2, \dots, x_n). \quad (51)$$

This function equals unity when exactly a_1 or exactly a_2 or ... exactly a_k of its input equals unity. As an example, the function $S_{1,3}(x_1, x_2, x_3)$ equals 1 when exactly one or three of its inputs equal 1.

$$S_{1,3}(x_1, x_2, x_3) = x_1 \bar{x}_2 \bar{x}_3 + \bar{x}_1 x_2 \bar{x}_3 + \bar{x}_1 \bar{x}_2 x_3 + x_1 x_2 x_3. \quad (52)$$

The procedure for S functions is to express the given symmetric function:

$$S_{a_1, a_2, \dots, a_k}(x_1, x_2, \dots, x_n), \quad (53)$$

as a Boolean function of the $M_k(x_1, x_2, \dots, x_n)$ functions. For example:

$$\begin{aligned} S_{1,3,5,7}(x_1, x_2, \dots, x_7) &= M_1(x_1, x_2, \dots, x_7) \bar{M}_2(x_1, x_2, \dots, x_7) \\ &+ M_3(x_1, x_2, \dots, x_7) \bar{M}_4(x_1, x_2, \dots, x_7) \\ &+ M_5(x_1, x_2, \dots, x_7) \bar{M}_6(x_1, x_2, \dots, x_7) \\ &+ M_7(x_1, x_2, \dots, x_7). \end{aligned} \quad (54)$$

Translated into English this equation says that $S_{1,3,5,7}(x_1, x_2, \dots, x_7)$ has value 1 if one or more AND NOT two or more of the variables have value 1 OR if

three or more AND NOT four or more have value 1, and so forth. This type of function can be realized with the majority gate network of Fig. 5a. The * on the input leads denotes a complementation.

Connecting the network of Fig. 5a to the output of the network of Fig. 4c gives a realization of the odd parity function of seven variables $S_{1,3,5,7}(x_1, x_2, \dots, x_7)$ that requires 31 majority gates. The even parity function $S_{0,2,4,6}(x_1, x_2, \dots, x_7)$ can be obtained from the odd parity realization by the rules for complementing realizations, since:

$$S_{0,2,4,6}(x_1, x_2, \dots, x_7) = S_{1,3,5,7}(x_1, x_2, \dots, x_7). \quad (55)$$

Any other symmetric function can be similarly realized and in general will require fewer gates. For example, $S_{1,4}(x_1, x_2, \dots, x_7)$ can be expressed as:

$$S_{1,4}(x_1, x_2, \dots, x_7) = M_1(x_1, x_2, \dots, x_7) \overline{M}_2(x_1, x_2, \dots, x_7) + M_4(x_1, x_2, \dots, x_7) \overline{M}_5(x_1, x_2, \dots, x_7). \quad (56)$$

Thus only two majority gates are required to realize the output network. Moreover, only M_1 , M_2 , M_4 , and M_5 are needed as inputs, so only a part of the complete network for all the M functions has to be realized. The complete realization requires 25 majority gates, as shown in Fig. 5b.

For an arbitrary symmetric function of n variables, a maximum of $(n+1)/2$ majority gates is required[†] in the output network. Adding this number to the bound of Eq. 50 gives an upper bound on the total number of majority gates that are needed to realize any n -variable symmetric function:

$$\lceil (n+1)/2 \rceil - 1 + \lceil (n+1)/2 \rceil = \lceil (n+1)^2/2 \rceil - 1. \quad (57)$$

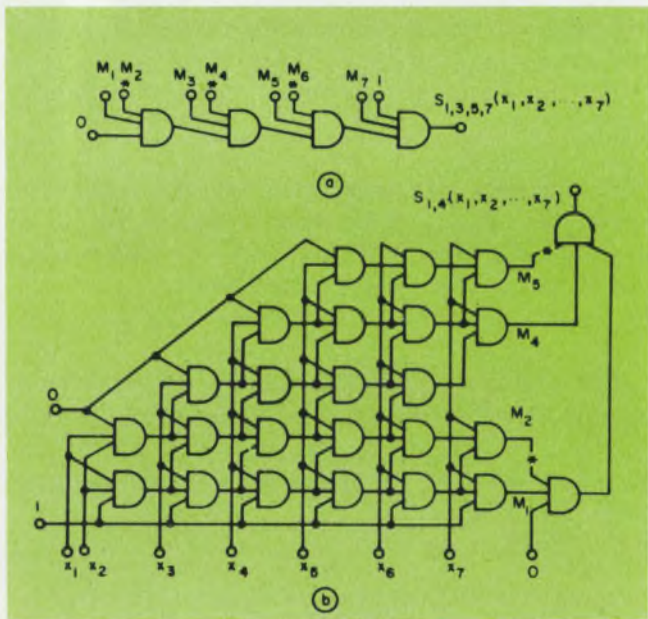

5. The realization for S-type symmetric functions: (a) majority gate realization of $S_{1,3,5,7}(x_1, x_2, \dots, x_7)$; (b) the general realization for $S_{1,4}(x_1, x_2, \dots, x_7)$.

[†]Frequently a saving in gates can be achieved by realizing the complement function and then using the usual rules for complementing realizations.

Pros and cons of majority-gate arrays

Integrated-circuit technology promises the mass fabrication of large numbers of gates on a single silicon chip. At present, the number of input-output leads that can be fitted on a chip appears to be a greater constraint than the number of gates. In this new technology, therefore, large numbers of gates must be interconnected on the chip into an array and each chip must realize a fairly complicated logic function, with relatively few input-output leads.

Each of the majority-gate realizations that have been discussed has advantages and disadvantages in terms of its suitability for array networks.

The tree array is regular and easy to construct—for instance, there are no crossovers. The tree is quite general. A single tree can be constructed to realize all functions of n variables. For this, the entire tree is laid out—one gate on the first level, two on the second, four on the third, etc. Then by varying the inputs on the bottom level, all functions of n variables can be realized in only n logic levels. This general array, however, requires about 2^n gates and this seems a rather large number.

It can be shown that for large n there exist functions that require essentially this number of majority gates for their realization. This casts considerable doubt on the practicality of such arrays for large numbers of variables.

A different approach to the majority gate array problem has been taken by Akers^{1,4} and Canady^{3,4}. Instead of realizing all functions of a given number of variables, this approach attempts to realize all functions of a given number of terms. In general, fewer gates are required, but the arrays include crossovers and so are more difficult to build.

The procedure for S-type functions is not quite as general as the others. In order to realize different S functions, different networks must be used for that part of the array that collects the M functions and forms the S functions. Various techniques are available for producing these different networks and undoubtedly others will be developed. At present, however, this is somewhat of a drawback.

The ideal procedure for arrays has probably not been developed, but majority gates do seem a likely candidate for it. ■ ■

References:

1. Akers, S. "Synthesis of Combinatorial Logic Using Three-Input Majority Gates." *Proc. of Symposium on Switching-Circuit Theory and Logical Design*, 1962.
2. Amarel, S., Cooke, G., and Winder, R. "Majority Gate Networks," *IRE Trans on Electronic Computers*, Vol. EC-13, No. 9 (Feb., 1964), 4-13.
3. Canady, R.H. "Two-Dimensional Iterative Logic." PhD dissertation, Engineering Dept., MIT issued as report ESL-R-210.
4. Lewis, P.M., and Coates, C.L. *Threshold Logic*. New York: John Wiley & Sons, 1967.
5. Miyata, F. "Realization of Arbitrary Logical Functions Using Majority Elements," *IRE Trans. on Electronic Computers*, Vol. EC-12, No. 30 (June 1963), 183-191.

Know the theory well.

Here is some background for the simple procedures developed previously.

The potential advantages of threshold gates compared with AND and OR gates include significant reductions in number of gates, number of interconnections, and total cost. The preceding articles show how to achieve some of these advantages with simple design procedures that require little or no new theory. These procedures have their limitations, however. This article presents some of the more general theory of threshold gates and shows how to use it for practical design problems. This will enable the designer to apply the procedures described in the previous three articles more intelligently and will broaden their range of application. The foundation will also be laid for the more sophisticated and efficient procedures that appear in the literature on threshold logic.

Some parts of the theory have already been derived previously. Most of them deal with the properties of the class of functions that can be realized with a single threshold gate—the threshold functions. This is perfectly natural. Any design theory requires a fundamental understanding of the basic building blocks used in the design. So, even though most practical design problems will require more than one threshold gate, the theory of threshold logic must begin with the study of single-gate networks (that is, threshold functions). The more advanced parts of the

theory can then cover the more interesting multigate situation.

Know the signs of the weights

Much of the single-gate theory deals with relating the form of the threshold function expressed as a sum of Boolean products to the weights and threshold of the threshold gate that realizes it. One Boolean form of particular importance is the *minimum-sum-of-products form* (also known as the disjunctive irredundant normal form).

In this form the function is represented as a sum of products which is irredundant in that no term or variable in any term can be deleted without changing the function represented. For example:

$$y_1 = x_1 x_2 + \bar{x}_1 x_4 \quad (1)$$

is a minimum-sum-of-products form, while:

$$y_2 = x_1 x_2 + \bar{x}_1 x_2 \bar{x}_3 \quad (2)$$

is not, since it can be represented by:

$$y_2 = x_1 x_2 + x_2 \bar{x}_3. \quad (3)$$

Similarly:

$$y_3 = x_1 x_2 \bar{x}_3 + \bar{x}_1 x_2 x_4 + x_2 \bar{x}_3 x_4 \quad (4)$$

is not a minimum-sum-of-products form since the last term is redundant.

To verify this, observe that the last term implies that $y_3=1$ for the two input combinations, $x_1=1, x_2=1, x_3=0, x_4=1$ and $x_1=0, x_2=1, x_3=0, x_4=1$. The first of these combinations is also implied by the first term, $x_1 x_2 \bar{x}_3$, and the second combination by the second term, $\bar{x}_1 x_2 x_4$. The last term thus gives no additional information and can be omitted without changing the function being represented. When this term is deleted, the minimum-sum-of-products form is:

$$y_3 = x_1 x_2 \bar{x}_3 + \bar{x}_1 x_2 x_4. \quad (5)$$

Now the form of a threshold function expressed in minimum-sum-of-products form can be related to the sign of the weights in its realization.

Let the threshold function be:

$$y = F(x_1, x_2, \dots, x_n), \quad (6)$$

and let its realization be:

$$y = \left(\sum_{i=1}^n a_i x_i \right), \quad (7)$$

Assume the minimum-sum-of-products expansion of

For a free reprint of this report circle 250.

F is:

$$y = T_1 \dot{+} T_2 \dot{+} \dots \dot{+} T_n, \quad (8)$$

where the T s are the terms. Let T_1 be any term, say:

$$T_1 = x_1 x_2 x_3. \quad (9)$$

This certainly implies, from the realization of Eq. 7 that:

$$a_1 + a_2 + a_3 > t. \quad (10)$$

Consider now the combination of input values:

$$x_1 = 0, x_2 = 1, x_3 = 1. \quad (11)$$

For this input combination F must be equal to zero; otherwise $x_2 x_3$ would be a term of F contrary to the assumption that F is in minimum-sum-of-products form. Thus this input combination implies, from Eq. 7, that:

$$0 + a_2 + a_3 < t. \quad (12)$$

Together, Eqs. 10 and 12 imply that:

$$a_1 > 0. \quad (13)$$

This shows that, if x_1 appears in the minimum-sum-of-products form, a_1 is positive. Similar reasoning shows that, if \bar{x}_1 appears in the minimum-sum-of-products form, then a_1 is negative.

Thus, the sign of each weight can be easily determined from the minimum-sum-of-products form. If the same line of reasoning is carried one step further, it is clear that a weight cannot be both positive and negative. A variable therefore cannot appear uncomplemented in one term of the minimum-sum-of-products expansion and complemented in another. Functions that have this property are called *unate* and all threshold functions have just been shown to be unate. In sum:^{2,1}

All threshold functions are unate. If a variable appears uncomplemented in the minimum-sum-of-products form, then its weight is positive. If a variable appears complemented, its weight is negative.

As an example of the use of this result, consider the threshold function:

$$y = x_1 \dot{+} \bar{x}_2 x_3. \quad (14)$$

It is known that a_1 and a_3 will be positive and a_2 negative. One such realization is:

$$y = (2x_1 - x_2 + x_3)_1. \quad (15)$$

If the negative weight is not desirable, the procedure of Part II can be used to obtain the positive weight realization:

$$y = (2x_1 + \bar{x}_2 + x_3)_2. \quad (16)$$

This realization does not contradict the result, since the x_2 variable in the realization is complemented.

As another example, consider:

$$y = x_1 x_2 \dot{+} \bar{x}_1 x_3. \quad (17)$$

Since this function is not unate, it is not a threshold function. Thus if a two-gate realization can somehow be found, it will be known that this is the realization with the fewest gates. This is easily done by the methods described in the previous articles. Let:

$$y_1 = x_1 x_2 = (x_1 + x_2)_2, \quad (18)$$

and express y as:

$$y = y_1 \dot{+} \bar{x}_1 x_3 = (2y_1 + \bar{x}_1 + x_3)_2. \quad (19)$$

From this the final realization becomes:

$$y = (2(x_1 + x_2)_2 + \bar{x}_1 + x_3)_2. \quad (20)$$

Although all threshold functions are unate, all un-

ate functions are not threshold functions. For all functions of three or fewer variables, however, it is true that all unate functions are threshold functions. This can be verified just by enumerating all such unate functions. This can be done with the tables in the second article.

Reduced functions and coefficient signs

Many of the properties of threshold functions can be determined from their associated *reduced functions*. Given any switching function a reduced function is formed by setting some of its variables equal to 1 or 0. For example, if:

$$y = F(x_1, x_2, x_3) \\ = x_1 x_2 \dot{+} x_1 x_3 \dot{+} x_1 x_4 \dot{+} x_2 x_3 x_4 x_5, \quad (21)$$

then a reduced function can be formed, for instance, by setting $x_1 = 1$ and $x_2 = 0$. This would be denoted by $F(x_1 = 1, x_2 = 0)$ and written:

$$F(x_1 = 1, x_2 = 0) = 1 \cdot 0 \dot{+} 1 x_3 \dot{+} 1 x_4 \dot{+} 0 x_3 x_4 x_5 \\ = x_3 \dot{+} x_4. \quad (22)$$

Similarly, we might form:

$$F(x_1 = 0, x_2 = 1) = x_3 x_4 x_5. \quad (23)$$

The *containment* or *comparability* of these reduced functions is of particular interest. Function F_1 is said to contain F_2 , written:

$$F_1 \geq F_2, \quad (24)$$

if, whenever F_2 equals 1, F_1 also equals 1. In other words, the set of inputs for which F_1 equals 1 contains the set of inputs for which F_2 equals 1.

Two functions are said to be comparable if either contains the other. For example, from Eqs. 22 and 23, $F(x_1 = 1, x_2 = 0)$ and $F(x_1 = 0, x_2 = 1)$ are comparable and:

$$F(x_1 = 1, x_2 = 0) \geq F(x_1 = 0, x_2 = 1). \quad (25)$$

To verify this, substitute the Boolean form of these functions:

$$x_3 \dot{+} x_4 \geq x_3 x_4 x_5. \quad (26)$$

Whenever the right side equals 1, then $x_3 = 1$ (in addition to x_4 and x_5). But x_3 's equaling 1 implies that the left side also equals 1, thus showing that the containment exists.

Now we relate the comparability of the reduced functions of a threshold function to the sign of its weights.

Consider a threshold function:

$$y = F(x_1, x_2, \dots, x_n), \quad (27)$$

with the realization:

$$y = (a_1 x_1 + a_2 x_2 + \dots + a_n x_n)_t, \quad (28)$$

and form the reduced functions:

$$y(x_1 = 1) = F(x_1 = 1), \quad (29)$$

$$y(x_1 = 0) = F(x_1 = 0). \quad (30)$$

We first see that both reduced functions are threshold functions with the realizations obtained

A procedure for ordering the weights

In practical design problems, the switching function is usually given in the form of a Boolean sum of products. Unfortunately, it is not always a simple matter to go directly from this Boolean form to a threshold-gate realization. When the given function is a threshold function, however, there is an easy way to determine the ordering of the weights—that is, whether a_1 is greater than a_2 and a_2 is greater than a_3 , etc.

Once this ordering is known, then the complete realization can often be guessed, as shown in the text. As the text also shows, the weight-ordering procedure can often be used to demonstrate that the given function cannot be realized with one gate but requires at least two gates.

Given a threshold function in a minimum-sum-of-products form with all uncomplemented variables, such as:

$$y = x_1 x_2 + x_1 x_3 + x_1 x_4 x_5 + x_1 x_4 x_6 + x_1 x_5 x_6 + x_2 x_3 x_4 + x_2 x_3 x_5 + x_2 x_4 x_5 + x_3 x_4 x_5 x_6.$$

To determine the order of the weights:

1. Consider those terms containing the fewest number of variables. In the example, these are the terms with two variables, $x_1 x_2$ and $x_1 x_3$. Order the variables according to the number of appearances in these terms. In the example:

$$x_1 > (x_2, x_3) > (x_4, x_5, x_6),$$

since x_1 appears twice, x_2 and x_3 each once, and x_4, x_5 and x_6 no times. It is now known that a_1 is greater than both a_2 and a_3 , and that these in turn are both greater than a_4, a_5 and a_6 . The relative ordering of a_2 and a_3 or of a_4, a_5 and a_6 is still not known.

2. Consider next those terms with the next fewest number of variables. In the example, these are the six terms with three variables. For those variables whose

order is not known from step 1, order the variables according to their appearance in the terms of step 2. In the example:

$$x_2 > x_3,$$

since x_2 appears three times and x_3 twice. Similarly:

$$(x_4, x_5) > x_6,$$

since x_4 and x_5 appear four times and x_6 appears twice. The orderings obtained in steps 1 and 2 can be combined. In the example:

$$x_1 > x_2 > x_3 > (x_4, x_5) > x_6.$$

3. The procedure is now repeated on those variables whose ordering is still not known, using the terms with the next fewest number of variables and so on.

Eventually either the variables will be completely ordered or all the terms will be used up and the procedure will be completed. In the example, the only variables whose ordering is not known are x_4 and x_5 . There is only one term with four variables and x_4 and x_5 each appear once in that term. Thus the procedure is completed and no further ordering can be obtained. However, it can be concluded that the function is symmetric in x_4 and x_5 , so their coefficients can be equal. Thus the complete ordering is:

$$a_1 > a_2 > a_3 > (a_4 = a_5) > a_6.$$

Assuming $a_6 = 1$, an obvious single gate configuration for this case can be:

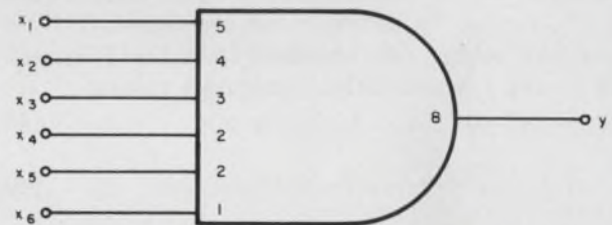

from Eq. 28 by setting $x_1 = 1$ and 0, respectively:

$$y(x_1 = 1) = (a_1 + a_2 x_2 + \dots + a_n x_n)_t, \quad (31)$$

$$y(x_1 = 0) = (0 + a_2 x_2 + \dots + a_n x_n)_t. \quad (32)$$

In Eq. 31, the same reasoning as in Eq. 26 of the second article can be used to bring the a_1 to the other side of the inequality and change the threshold:

$$y(x_1 = 1) = (a_2 x_2 + \dots + a_n x_n)_{t-a_1}. \quad (33)$$

From Eqs. 32 and 33 it can now be seen that not only are $F(x_1 = 1)$ and $F(x_1 = 0)$ both threshold functions, but they can also both have the same weights but with a different threshold. Moreover, these weights can be the same as those for F with a_1 deleted.

Now consider Eqs. 32 and 33 and assume for the moment that a_1 is positive. Then $t - a_1$ is less than t , and the threshold for $F(x_1 = 1)$ is less than that for $F(x_1 = 0)$. Therefore any input that exceeds the threshold for $F(x_1 = 0)$ must certainly exceed the smaller threshold of $F(x_1 = 1)$. Thus we have shown that when a_1 is positive, then:

$$F(x_1 = 1) \geq F(x_1 = 0). \quad (34)$$

Similar reasoning shows that when a_1 is negative

$$F(x_1 = 1) \leq F(x_1 = 0). \quad (35)$$

In short:^{3,1}

For any threshold function F , the reduced functions $F(x_1 = 1)$ and $F(x_1 = 0)$ are both threshold functions and can be realized with the same set of weights, but with different thresholds. This set of weights can be the same set as that for F with a_1 deleted. Moreover $F(x_1 = 1)$ and $F(x_1 = 0)$ are comparable, and if $a_1 > 0$, then:

$$F(x_1 = 1) \geq F(x_1 = 0); \quad (36)$$

and if $a_1 < 0$, then:

$$F(x_1 = 0) \geq F(x_1 = 1). \quad (37)$$

As an example, consider the function:

$$y = x_1(x_2 + x_3 + x_4) + x_2 x_3 x_4, \quad (38)$$

with the realization shown in Fig. 1 as:

$$y = (2x_1 + x_2 + x_3 + x_4)_3. \quad (39)$$

The reduced functions $y(x_1 = 1)$ and $y(x_1 = 0)$ are:

$$y(x_1 = 1) = x_2 + x_3 + x_4; \quad (40)$$

$$y(x_1 = 0) = x_2 x_3 x_4. \quad (41)$$

These are threshold functions and their realizations can be obtained from Eq. 39 as:

$$y(x_1 = 1) = (2 + x_2 + x_3 + x_4)_3 \quad (42)$$

$$= (x_2 + x_3 + x_4)_1 \quad (43)$$

$$y(x_1 = 0) = (x_2 + x_3 + x_4)_3. \quad (44)$$

The two reduced functions are comparable:

$$F(x_1 = 1) \geq F(x_1 = 0), \quad (45)$$

as was expected since a_1 is positive.

The relative sizes of the weights.

The reduced function comparability can also be used to obtain information about the coefficient ordering—that is, whether or not a_1 is larger than a_2 . Consider the threshold function:

$$y = F(x_1, x_2, \dots, x_n), \quad (46)$$

with its realization:

$$y = (a_1 x_1 + a_2 x_2 + a_3 x_3 + \dots + a_n x_n)_t, \quad (47)$$

and form the reduced functions $F(x_1 = 1, x_2 = 0)$ and $F(x_1 = 0, x_2 = 1)$. As before, these are threshold functions with realizations obtained from Eq. 47 by setting x_1 and x_2 equal to the appropriate values:

$$y(x_1 = 1, x_2 = 0) = (a_1 \cdot 1 + a_2 \cdot 0 + a_3 x_3 + \dots + a_n x_n)_t \quad (48)$$

$$= (a_3 x_3 + \dots + a_n x_n)_{t - a_1}, \quad (49)$$

$$y(x_1 = 0, x_2 = 1) = (a_1 \cdot 0 + a_2 \cdot 1 + a_3 x_3 + \dots + a_n x_n)_t \quad (50)$$

$$= (a_3 x_3 + \dots + a_n x_n)_{t - a_2}. \quad (51)$$

From Eqs. 49 and 51 it can be seen that both reduced functions can be realized with the same set of weights but different thresholds. Moreover, this set of weights can be the same as that used for F with a_1 and a_2 deleted.

Now assume that:

$$a_1 > a_2. \quad (52)$$

Then $t - a_1$, the threshold for $F(x_1 = 1, x_2 = 0)$, is less than $t - a_2$, the threshold for $F(x_1 = 0, x_2 = 1)$. Therefore any input that exceeds the threshold for $F(x_1 = 0, x_2 = 1)$ will certainly exceed the threshold for $F(x_1 = 1, x_2 = 0)$. And we have shown that if $a_1 > a_2$, then:

$$F(x_1 = 1, x_2 = 0) \geq F(x_1 = 0, x_2 = 1). \quad (53)$$

Thus it is known that these two reduced functions must be comparable.

Now assume that:

$$F(x_1 = 1, x_2 = 0) > F(x_1 = 0, x_2 = 1).$$

In other words, assume $F(x_1 = 1, x_2 = 0)$ contains $F(x_1 = 0, x_2 = 1)$ but that they are not equal. Applying the same reasoning as before to the realization of

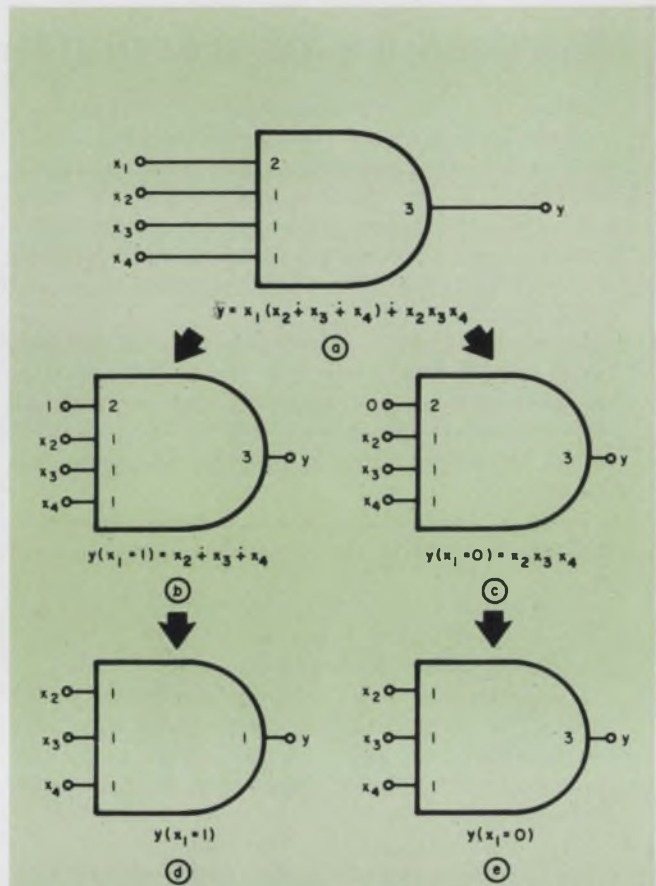

1. How the reduced functions determine the sign of the weights: (a) gives the realization of y ; to obtain the realizations for the reduced functions $y(x_1 = 1)$ and $y(x_1 = 0)$ set the input x_1 equal to 1 and 0, respectively, as in (b) and (c). The 0 input in (c) has no effect and can just be removed to give the realization in (e) for $y(x_1 = 0)$. The 1 input in (b) has the effect of always adding its weight of 2 to the weighted sum of the other inputs; this effectively lowers the threshold by 2. Thus the weight can be removed by reducing the threshold by 2, giving the realization of (d) for $F(x_1 = 1)$. Observe that the realizations of (d) and (e) have the same weights but that the threshold in (d) is less than that for (e). Thus any input combination with a weighted sum above the threshold in (e) and which causes $y(x_1 = 0) = 1$ will certainly have a weighted sum above the threshold of (d) and so will cause $y(x_1 = 1) = 1$. From this we can conclude that: $y(x_1 = 1) \geq y(x_1 = 0)$.

But recall that the threshold of (d) is equal to the threshold of (e) minus the weight of x_1 . In other words, the threshold of (d) is less than that of (e) precisely because the weight of x_1 is positive.

Now what conclusions can we draw from all of this? Suppose y is given, but not its realization, and the reduced function is computed to be:

$$y(x_1 = 1) = x_2 + x_3 + x_4$$

$$y(x_1 = 0) = x_2 x_3 x_4,$$

by inspection it can be seen that:

$$y(x_1 = 1) \geq y(x_1 = 0)$$

and can therefore be concluded that in the realization (when it is found) a_1 must be positive.

Eqs. 49 and 51, it can be concluded that:

$$a_1 > a_2. \quad (55)$$

In summary:

For any threshold function F , the reduced functions $F(x_1 = 1, x_2 = 0)$ and $F(x_1 = 0, x_2 = 1)$ are both threshold functions and can be realized with the same set of weights, namely, those for F with a_1 and a_2 deleted. Moreover, these reduced functions are comparable, and if:

$$F(x_1 = 1, x_2 = 0) > F(x_1 = 0, x_2 = 1), \quad (56)$$

then:

$$a_1 > a_2 \quad (57)$$

in all realizations.

As an example, in the function of Eq. 38:

$$y = x_1(x_2 \dot{+} x_3 \dot{+} x_4) \dot{+} x_2 x_3 x_4, \quad (58)$$

the appropriate reduced functions (Fig. 2) are:

$$y(x_1 = 1, x_2 = 0) = x_3 \dot{+} x_4, \quad (59)$$

$$y(x_1 = 0, x_2 = 1) = x_3 x_4. \quad (60)$$

These functions are comparable and, since:

$$y(x_1 = 1, x_2 = 0) > y(x_1 = 0, x_2 = 1), \quad (61)$$

it can be concluded that:

$$a_1 > a_2. \quad (62)$$

As another example, consider:

$$y = x_1(x_2 \dot{+} x_3 x_4) \dot{+} x_3 x_4 \dot{+} x_2 x_4 x_5. \quad (63)$$

If this is to be a threshold function, then, first of all, the reduced functions $y(x_1 = 1)$ and $y(x_1 = 0)$ must be comparable. Computing these reduced functions:

$$y(x_1 = 1) = x_2 \dot{+} x_3 x_4, \quad (64)$$

$$y(x_1 = 0) = x_3 x_4 \dot{+} x_2 x_4 x_5, \quad (65)$$

shows this is, in fact, the case. However, it must also be true that both reduced functions are threshold functions and can have the same set of weights. Computing the appropriate reduced functions we find that for $y(x_1 = 1)$:

$$a_2 > a_4 \quad (66)$$

in all realizations, while for $y(x_1 = 0)$:

$$a_2 < a_4 \quad (67)$$

in all realizations. Thus the reduced functions $y(x_1 = 1)$ and $y(x_1 = 0)$ cannot possibly have the same set of weights. Consequently the given function, y , of Eq. 63 cannot be a threshold function.

Consider symmetric variables

When the two-variable reduced functions are equal, that is, when:

$$F(x_1 = 1, x_2 = 0) = F(x_1 = 0, x_2 = 1), \quad (68)$$

then the function is symmetric in x_1 and x_2 .

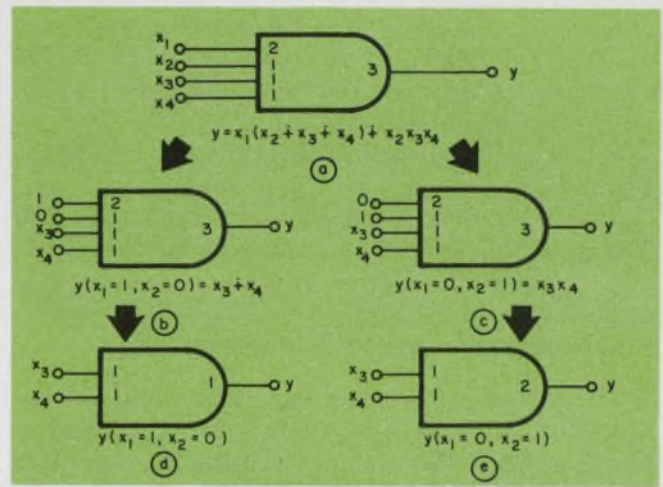

2. How the reduced functions determine the ordering of the weights (that is whether or not $a_1 > a_2$ etc.). (a) gives the realization for y and (b) and (c) give the realizations of the reduced functions $y(x_1 = 1, x_2 = 0)$ and $y(x_1 = 0, x_2 = 1)$. When the weights of the 1 inputs are used to reduce the thresholds, as in Fig. 1, the result is the realizations of (d) and (e). These realizations have the same weights, but the threshold of (d) is less than that of (e). Using the same reasoning as in Fig. 1, it can be concluded that:

$$y(x_1 = 1, x_2 = 0) \geq y(x_1 = 0, x_2 = 1).$$

Recall now that the threshold of (d) equals the threshold of y minus a_1 and that the threshold for (e) equals the threshold for y minus a_2 . Therefore, the threshold for (d) is less than that for (e) precisely because $a_1 \geq a_2$.

For example, consider:

$$y = x_1(x_2 \dot{+} x_3 \dot{+} x_4) \dot{+} x_2(x_3 \dot{+} x_4). \quad (69)$$

The corresponding reduced functions are:

$$y(x_1 = 1, x_2 = 0) = x_3 \dot{+} x_4, \quad (70)$$

$$y(x_1 = 0, x_2 = 1) = x_3 \dot{+} x_4. \quad (71)$$

Observe that y is, in fact symmetric in x_1 and x_2 . In other words, the literals x_1 and x_2 can be interchanged, without changing the function being represented.

In this situation, the previous reasoning does not imply an ordering for a_1 and a_2 . Suppose, however, that there exists some realization for y in which a_1 and a_2 are not necessarily equal:

$$y = (a_1 x_1 + a_2 x_2 + a_3 x_3 + a_4 x_4)_t. \quad (72)$$

Because y is symmetric, the literals x_1 and x_2 can be interchanged to obtain another realization for y :

$$y = (a_1 x_2 + a_2 x_1 + a_3 x_3 + a_4 x_4)_t. \quad (73)$$

Recall now that this $()_t$ notation is shorthand for a set of inequalities that define the realization. Since the equalities can be appropriately added, another realization can be obtained by "adding" the realization of Eq. 72 and 73, i.e.:

$$y = ((a_1 + a_2)x_1 + (a_1 + a_2)x_2 + 2a_3 x_3 + 2a_4 x_4)_{2t}. \quad (74)$$

Then all weights and the threshold can be divided by 2 to obtain:

$$y = (1/2(a_1 + a_2)x_1 + 1/2(a_1 + a_2)x_2 + a_3 x_3 + a_4 x_4)_t, \quad (75)$$

in which the weights of a_1 and a_2 are equal.

In summary:^{4,1}

Let y be a threshold function which is symmetric in some set of variables. Given any arbitrary realiz-

ation of y , it is possible to find another realization in which the weights of the symmetric variables are all equal. Furthermore, the fan-ins and relative gaps of the two realizations are equal.

For example, one realization of the function of Eq. 69 is:

$$y = (2 \frac{1}{4}x_1 + 1 \frac{3}{4}x_2 + x_3 + x_4)_{2 \frac{3}{4}} \quad (76)$$

The equal-weight realization given by Eq. 75 is:

$$y = (2x_1 + 2x_2 + x_3 + x_4)_{2 \frac{3}{4}} \quad (77)$$

How to determine the order of the weights

The previous comments on two-variable reduced functions can be used to obtain a complete ordering of the weights. For example, considering every pair of variables in the function of Eq. 69 leads to the conclusion that:

$$(a_1 = a_2) > (a_3 = a_4) \quad (78)$$

Knowing the ordering of the weights is often quite helpful in "guessing" at realizations. For example, if the function of Eq. 69 is given, then it is easy, after the coefficient ordering of Eq. 78 is determined, to guess first at the realization of Eq. 77 and then to verify that it is in fact valid.

For functions with large numbers of variables, however, it is quite tedious to compare all pairs of reduced functions. A computationally simpler ordering procedure that can be derived from reduced-function comparability is shown in the box.

General reduced-function comparability

The same reasoning can, in fact, be used for functions reduced with any number of variables. Any reduced function is a threshold function whose realization can be easily obtained from the realization of the given threshold function.

For example, consider the threshold function:

$$y = x_1 + x_2x_3 + x_2x_4 + x_2x_5 \quad (79)$$

The ordering procedure shown in the box can be used to determine that:

$$a_1 > a_2 > (a_3 = a_4 = a_5) \quad (80)$$

Suppose now that we wish to determine how a_2 compares with $a_3 + a_4$. On the assumption that y has the realization:

$$y = (a_1x_1 + a_2x_2 + a_3x_3 + a_4x_4 + a_5x_5)_t \quad (81)$$

we form the reduced functions $y(x_2=1, x_3=x_4=0)$ and $y(x_2=0, x_3=x_4=1)$. Their realizations are:

$$y(x_2=1, x_3=x_4=0) = (a_1x_1 + a_2 + a_5x_5)_t \quad (82)$$

$$y(x_2=0, x_3=x_4=1) = (a_1x_1 + a_3 + a_4 + a_5x_5)_t \quad (83)$$

From Eqs. 82 and 83 it can be seen that the comparability of a_2 and $a_3 + a_4$ is determined by the comparability of $y(x_2=1, x_3=x_4=0)$ and $y(x_2=0, x_3=x_4=1)$. From Eq. 79 it is seen that these reduced functions are:

$$y(x_2=1, x_3=x_4=0) = x_1 + x_5 \quad (84)$$

$$y(x_2=0, x_3=x_4=1) = x_1 \quad (85)$$

Since:

$$y(x_2=1, x_3=x_4=0) > y(x_2=0, x_3=x_4=1) \quad (86)$$

it can be concluded that:

$$a_2 > a_3 + a_4 \quad (87)$$

in all realizations of y .

One such realization is:

$$y = (4x_1 + 3x_2 + x_3 + x_4 + x_5)_4 \quad (88)$$

Realization procedures

The ultimate goal of any switching theory is synthesis. All the results discussed in these articles lead naturally in this direction. Realization procedures can be of two types: the informal methods that have been demonstrated with the examples, and the formal methods or algorithms, which guarantee to produce a realization with certain desirable properties if one exists. An algorithm, for example, might yield the realization requiring the fewest gates where each gate has to meet specified tolerance constraints.

For the single gate case, informal methods and available tables, such as those contained in these articles, will yield realizations in the overwhelming majority of cases, where the fan-in and threshold of the gate meet reasonable tolerance constraints.

For the multigate case, the situation is less clear. It has been the author's experience, based on the design of the DONUT computer, that informal design of multigate networks will usually lead to realizations that are reasonably efficient. However, the designer often wishes that there were more theory, tables and design procedures to help him, just as he might do when dealing with conventional AND and OR design.

Available algorithms are discussed in detail in Lewis and Coates¹. In summary, however, for the single-gate case, there are a number of algorithms that will test a given function, to determine whether or not it is a threshold function. If it is, they will produce a realization that is optimum in a certain sense—for example, one that has minimum normalized fan-in or maximum relative gap. For the multigate case, a number of algorithms exist for certain special cases, but none is completely satisfactory.

Although not all the problems of threshold logic have yet been solved, it is hoped that it has been demonstrated that practical circuits can now be designed with reasonable efficiency.

This, together with the imminent appearance of threshold-gate integrated circuits, may very well signal the beginning of the large-scale use of this new tool in logic design. ■ ■

References:

1. P.M. Lewis, and C.L. Coates, *Threshold Logic*. New York: John Wiley & Sons, 1967
2. R. McNaughton, "Unate Truth Functions," *IRE Trans. on Electronic Computers*, Vol. EC-10, March 1961, 1-6
3. MC. Paull, and E.J. McCluskey, "Boolean Functions Realizable with Single Threshold Devices," *Proc. IRE*, XLVIII, July 1960, 1335-1337.
4. R.O. Winder, "Threshold Logic." Unpublished PhD dissertation, Mathematics Dept., Princeton University, 1962.

General Instrument proudly announces the industry's first silicon nitride computer diodes now in production

It has long been generally recognized that semiconductor devices passivated with silicon nitride rather than with silicon dioxide would demonstrate unprecedented reliability.

Until now, however, the problem to be overcome was the difficulty of adequately handling and controlling the nitride process in mass production. General Instrument has solved that problem and is producing the industry's first line of silicon nitride passivated diodes.

The inherent reliability of silicon nitride is derived from its total imperviousness to the movement of sodium ions and extreme chemical inertness. Therefore, many of the most common modes of diode failure are eliminated. Unstable reverse breakdowns, excessive leakage currents and contamination occurring during chip handling and packaging no longer present reliability problems.

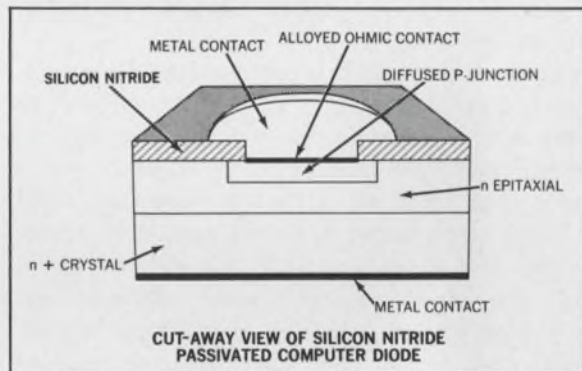

Superior electrical characteristics are now combined with this built-in reliability in General Instrument's line of high-speed silicon nitrided diodes in miniature DO-35 or DO-7 packages for computer applications.

Write for full information. (In Europe, to: General Instrument Europe, Via Turati 28, Milano, Italy).



GENERAL INSTRUMENT CORPORATION · 65 GOUVERNEUR STREET, NEWARK, NEW JERSEY

ON READER-SERVICE CARD CIRCLE 46

Design a high-speed counter

that achieves eight-place accuracy and high stability over a wide frequency range.

Operating today's complex communications systems calls for sophisticated instruments. Precise measurements must be made continually to keep the systems "on frequency" and peaked for best performance. Frequency counters are a mainstay of the new generation of test equipment that has evolved to do this job. Accuracy demands on these counters are steadily rising, calling for improved designs.

This design problem was faced in a recent project that called for a high-accuracy counter capable of operating over a frequency range from 10 Hz to 135 MHz, with a ± 1 count accuracy and an eight-place resolution. In addition, the warm-up time to an accuracy of 1 part in 10^7 had to be less than an hour and the long-term stability better than 1 part in 10^7 per year. Until recently these figures were unobtainable commercially.

An analysis of the methods used in digital frequency measurement was first required to determine which one was most appropriate to such a system. The general principle behind all of these counters is to convert an input signal into a pulse train, and then to count the number of pulses passed by a gate that is open for a precise time interval. In direct counting, the most straightforward method, one pulse is generated for each cycle of the input signal. This works well, except that when the input signals are at very high frequencies the counting flip-flops and associated circuits pose a difficult design problem.

In cases like this, one of two alternative approaches can be used. One approach, called prescaling, is to divide the input frequency by some number N . If an input signal of 100 MHz were to be measured, and $N=2$, then the 100-MHz signal would be divided down to 50 MHz. This could be handled by a 50-MHz counter.

Another approach is to heterodyne the input signal with a standard frequency to generate a lower-frequency signal for counting. Thus, using the example above, signals in the 50-to-100-MHz range could be heterodyned with a 50-MHz local oscillator to generate difference signals in the 0-to-50-

MHz counting range of the counter.

Direct counting and heterodyning have an inherent resolution advantage over prescaling. To illustrate this, some simple examples will be considered.

First, a 10-Hz signal is fed into a direct counter. The gate is opened for one second and 10 pulses are counted. Now a prescaler with $N=2$ is fed the same 10-Hz signal. In this case two seconds will be required to count 10 pulses. Twice the time is required to get the same number of pulses.

To compare the direct counting and the heterodyne scheme a 110-MHz signal will be considered. If this is mixed with a 100-MHz local oscillator, a 10-MHz signal will result. Thus with the heterodyne approach, 10 million cycles would be counted in a one-second period. When the 100-MHz mixing frequency is added, the reading is 110,000,000—that is, a 9-figure resolution. In a direct counter 110 million pulses would be counted in the same one-second interval, also indicating a 9-figure resolution.

But the heterodyne method will not easily cover the frequency range without band-switching, which was not allowed by the specifications. Thus, the advantage of the direct-counting method for this specification is apparent.

A look at the circuitry involved in each of these methods further clarifies the differences.

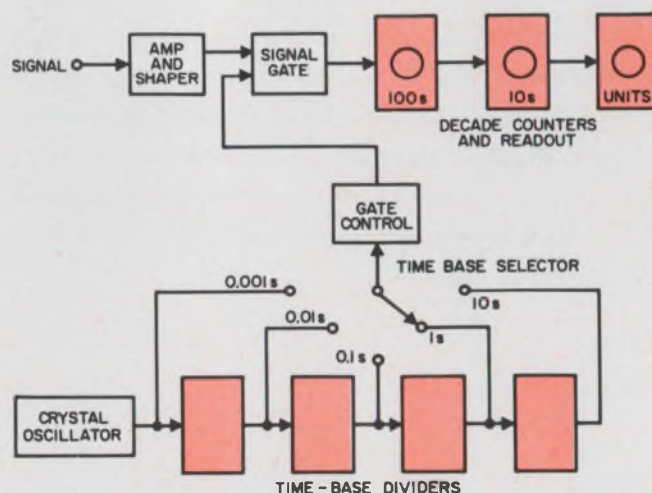

1. **High resolution** is the strong point of the direct-count method. The accuracy is determined by the precision of the time intervals and the stability of the gate circuits.

Seymour N. Rubin, Design Engineer, Datapulse, Inc., Culver City, Calif.

In a direct-counting frequency meter the input signal is amplified, shaped and fed into a signal gate that is opened for very precise time intervals determined by an oscillator and a chain of decade dividers (Fig. 1). A decade counter counts the number of cycles, or pulses, occurring in the time period chosen and displays the results. For very high-frequency operation, the amplifier-shaper, signal gate and control circuits must be fast and stable. Also, the gate times selected by the control circuits must be precise to ensure that the proper number of pulses from the amplifier-shaper will be counted by the decades.

In addition to its resolution advantage, the direct-counting system will usually react very well to aperiodic signals.¹

Prescaling uses simple circuitry

The prescaling scheme is similar to the direct-count method except that the frequency is divided by some number N (called the prescale ratio) before the signal is gated² (Fig. 2). Because of this frequency division, the oscillator frequency must also be divided by N to make the time intervals selected the proper value to obtain a correct reading. The disadvantage of this technique is that it reduces the information rate by the prescale ratio—that is, it takes N times as long to obtain a given resolution with the prescale method as it would with the direct-count technique. The prescale method does have the advantage that usually more simple circuitry can be used because lower frequencies are being handled.

Heterodyne method can be ambiguous

In the heterodyne method³ the input signal is shifted in frequency to a more easily handled and measured range. As in Fig. 3, a standard frequency output from the counter is multiplied to a higher reference frequency which is determined mainly by the

frequency-handling capabilities of the counter being used. Harmonics of the multiplied signal are then generated and fed into the harmonic mixer. In the mixer, the incoming signal is heterodyned with the desired harmonic to give the difference frequency which drives the amplifier and low-pass filter. The filter portion rejects all signals but the desired one, which is used by the counter.

As an example, assume that the counter available covers 0 to 50 MHz, and it is desired to measure frequencies in the 100-to-200-MHz range. To accomplish this the frequency standard of, say, 1 MHz is multiplied to 50 MHz and harmonics are generated.

The 100-to-150-MHz portion is covered by selecting the 100-MHz harmonic in the mixer, and difference frequencies of between 0 and 50 MHz are generated. All other spurious signals are filtered by the low-pass filter, which in this case must have sharp attenuation above 50 MHz. To get the proper answer, the reading in the 0-50-MHz range is added to the frequency of the harmonic selected—100 MHz.

If the 150-200-MHz band is to be used, the 150-MHz harmonic is selected and difference frequencies of 0-50 MHz again result. A danger here is that if the user does not know the approximate frequency being measured, it is possible to get an incorrect answer by using the image, or sum, instead of the desired difference frequency. In the previous example, if the signal were at 110 MHz, and the 150-MHz harmonic were used, the answer would be an incorrect 40 MHz, whereas if the proper 100-MHz harmonic were used, the answer would be the correct 10 MHz.

Some of these difficulties can be overcome by proper operating techniques. But, in general, the operator of a heterodyne counter must know when the reading must be added to or subtracted from the mixer frequency. The operator-knowledge problem can be solved by making the readout automatic; this has been done, but at a large increase in complexity and cost. Despite its drawbacks, the basic heterodyne

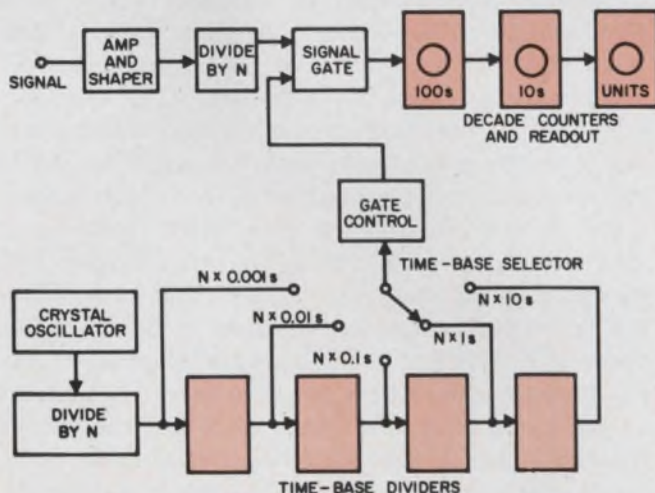

2. The prescaling counter divides both input and oscillator frequencies by the same ratio. This results in lower frequencies but long resolving times.

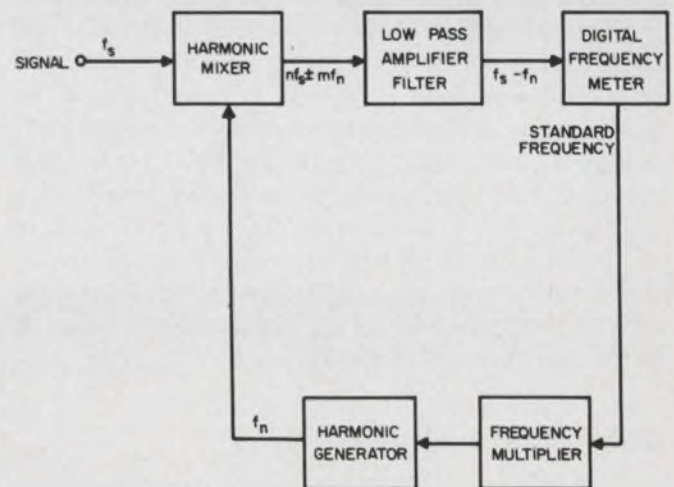

3. Incorrect answer from a heterodyne counter is obtained if a harmonic higher than the input frequency is used. The counter is very suitable for high frequencies.

technique can be useful, for it allows the digital counter accuracy to be maintained to very high frequencies and it can be implemented fairly simply.

Direct counter covers wide range

In the design considered here all but one of the techniques described were eliminated by the specification. The heterodyne scheme was out because the counter had to respond to very low frequencies (in the 10-Hz region) and this cannot be done readily. Prescaling was eliminated simply because the information rate would be reduced by a prohibitive amount; it takes one second to obtain eight digits of resolution on a 100-MHz signal by the direct-count method. But if a prescale ratio of 10 were used, a reading with the same resolution would take 10 seconds.

Thus, only the direct-count method allows for the wide frequency coverage and the required information rate.

In addition, the specification called for an oscillator stability of 1 part in 10^7 per year with any number of power interruptions and one-hour maximum warm-up time. Initially, it seemed that only two unsatisfactory solutions were available. One-MHz-fundamental-cut crystal oscillators may warm up fairly rapidly, but cannot meet the stability requirements, while 5-MHz fifth-overtone crystals can meet the stability requirements, but tend to take days to warm up.

The solution was a 3-MHz-fundamental-mode crystal oscillator in a double proportional controlled oven.⁴ This oscillator exhibits a typical aging rate of approximately 1.5 parts in 10^{10} per day (less than 1 part in 10^7 per year) after several months of burn-in. The crystal frequency initially rises and then reaches a final drift rate in a negative direction (Fig. 4a). This characteristic allows the crystals to be put into the field with a minimum of pre-aging—they meet the over-all aging rate the first year because of the change in direction of the aging characteristics, and in later years, their drift rate is less than the required value. These crystal oscillators also have exceedingly fast warm-up times—they reach their specified frequency stability of 1 part in 10^7 in a maximum of five minutes, and are within 1 part in 10^9 in 30 minutes. Warm-up measurements are referred to the frequency of the crystal one hour after turn-on, but the drift in the succeeding 24 hours is only one part in 10^9 , (Fig. 4b).

Gate control has high accuracy

To use a direct counter reliably at 100 MHz and higher frequencies, the gate control pulse must be accurate to within 2 ns and the transition times should be less than 2 ns. This precludes the use of a simple

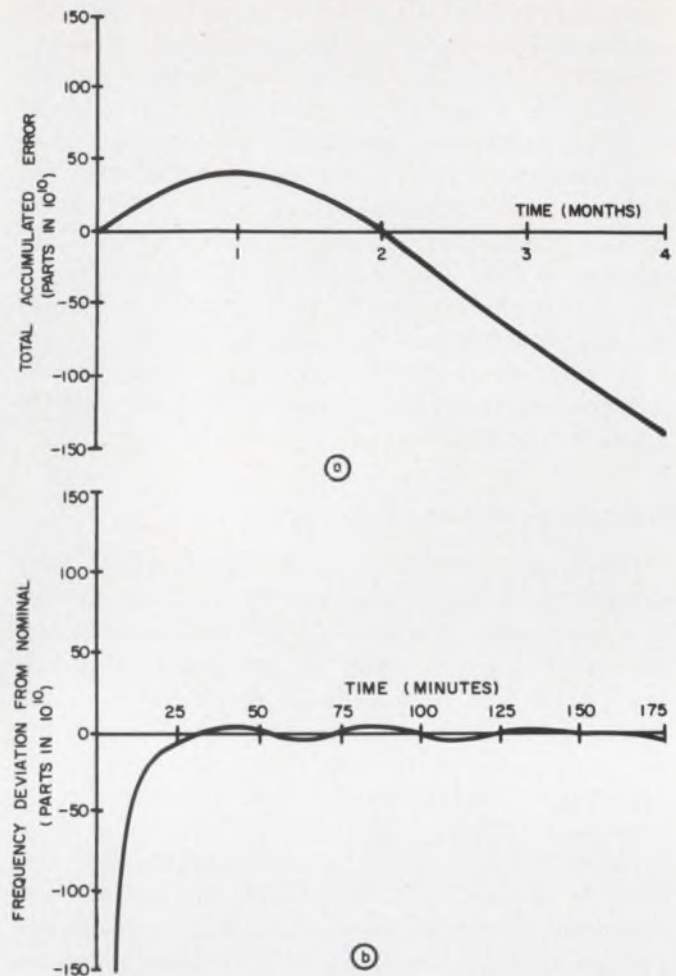

4. Long-term oscillator stability (a) is needed for equipment used outside the laboratory. A short warm-up time (b) is also vital for much used test equipment.

cascade of decade dividers for the time base selection and puts stringent requirements on the gate generation circuitry.

To maintain the accuracy of the 3-MHz oscillator, the method shown in Fig. 5 was chosen. The oscillator output is amplified and formed into a very fast-rise-time square wave of the order of 2 ns. This signal is one input to a three-input AND gate. It also drives a divide-by-three circuit. The output from this divider is also an input to the AND gate. For the fastest gate time, the third input is not used and the output from the gate is a pulse occurring at a 1-MHz rate corresponding to one-third of the 3-MHz square wave. To obtain the slower gate times, the selected time base output is used to set the latch flip-flop and its output is the third input to the AND gate. When the latch flip-flop is set, the first coincidence between a 1-MHz and a 3-MHz-signal causes an output from the gate. At the negative edge of the selected pulse, the latch flip-flop is reset and the gate is disabled until the next time-base pulse occurs. As a result, the output of the AND gate is a selected pulse of the 3-MHz square wave occurring at the repetition rate of the selected time base. This pulse has all the time position accuracy of the oscillator and

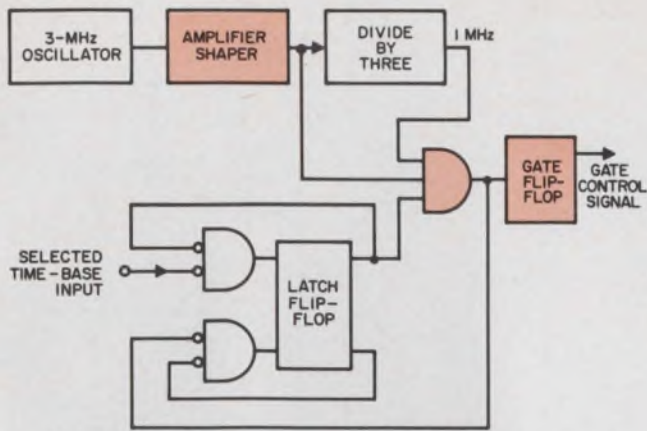

5. **Gate generation circuitry** requires pulses with a rise time of 2 ns. At the fastest gate time, the divider produces a 1-MHz gate pulse corresponding to one-third of the 3-MHz square wave. At slower speeds, the gate is latched by the time-base input.

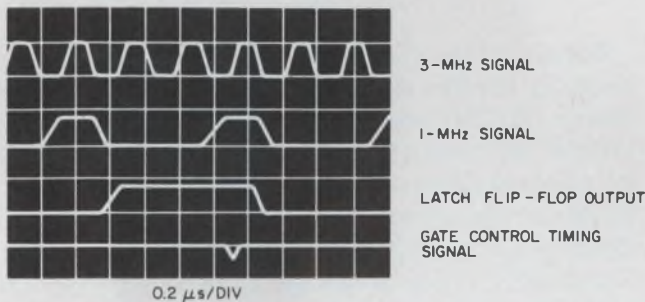

6. **The gate control signals** are determined by the latch flip-flop. When the flip-flop is set, the first coincidence of the 3-MHz crystal-oscillator signal and the 1-MHz signal cause a gate signal, shown as a differentiated pulse. The trailing edge of the 1-MHz pulse resets the latch flip-flop.

the fast rise and fall times of the shaper circuit output (Fig. 6).

Another requirement is that the gate flip-flop (Fig. 6) must have turn-on and turn-off delays that are very nearly identical, and must have output transition times as fast as possible. Referring to Fig. 7a, transistors $Q1 - Q4$ form the set-reset flip-flop with inputs at the bases of $Q1$ and $Q4$. These inputs are derived from current-mode gates A and B. The operation of the circuit can be described by assuming that transistor $Q2$ is on and $Q3$ is off so that the base of $Q2$ is more positive than that of $Q3$.

With the input at its normal positive state, the outputs of both gates will be low, because at least one of the inputs in each gate has its base voltage high. However, when the input goes to its low state during a trigger pulse, the gate with two low inputs (in this example it would be Gate B because $Q3$'s base is low) will pass and invert the pulse. The other gate will still have one input high because one base ($Q2$ in this case) will still have a positive voltage and the output voltage will therefore remain low. So when the trigger pulse arrives, the base of $Q4$ goes positive causing $Q4$ to conduct. This lowers the base voltage of $Q2$, resulting in a regenerative change of state. The

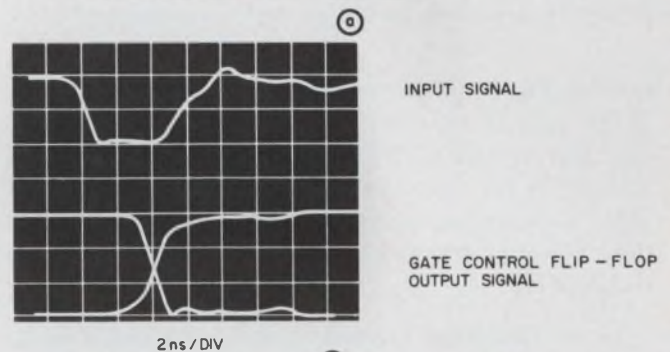
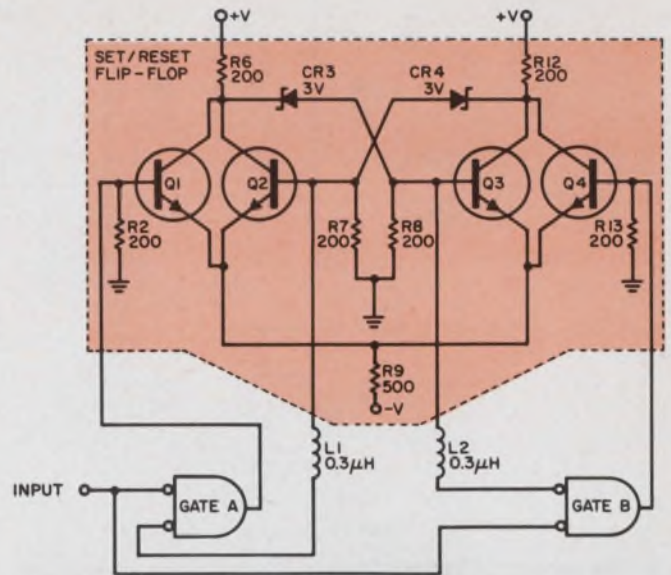

7. **To prevent saturation** of the gate control flip-flop transistor (a), the two inductors delay the changeover until the input pulse is terminated. This results in nearly identical turn-on and turn-off delays (b).

change is delayed by inductors $L1$ and $L2$ so that the input pulse is terminated before the gate inputs change state. This delay of less than 2 ns sets the maximum allowable pulse width.

In a similar manner, the next negative pulse at the input will cause the flip-flop to return to its original state. Because none of the transistors saturates, and the two trigger paths are the same, the turn-on and turn-off delays are almost precisely the same.

Figure 7b shows the output from the gate flip-flop (taken from either $R7$ or $R8$) and the input signal driving it. The double trace is due to the oscilloscope triggering on the input waveshape and therefore being triggered at each of the transitions of the flip-flop. The indicated switching time of the flip-flop is less than 2 ns and the timing accuracy is such that the difference in delay for the two transitions is not detectable.

Signal amplifier must be wideband

The input amplifier also has its problems. Because of the wide frequency and input-amplitude ranges that must be handled, two trigger circuits are re-

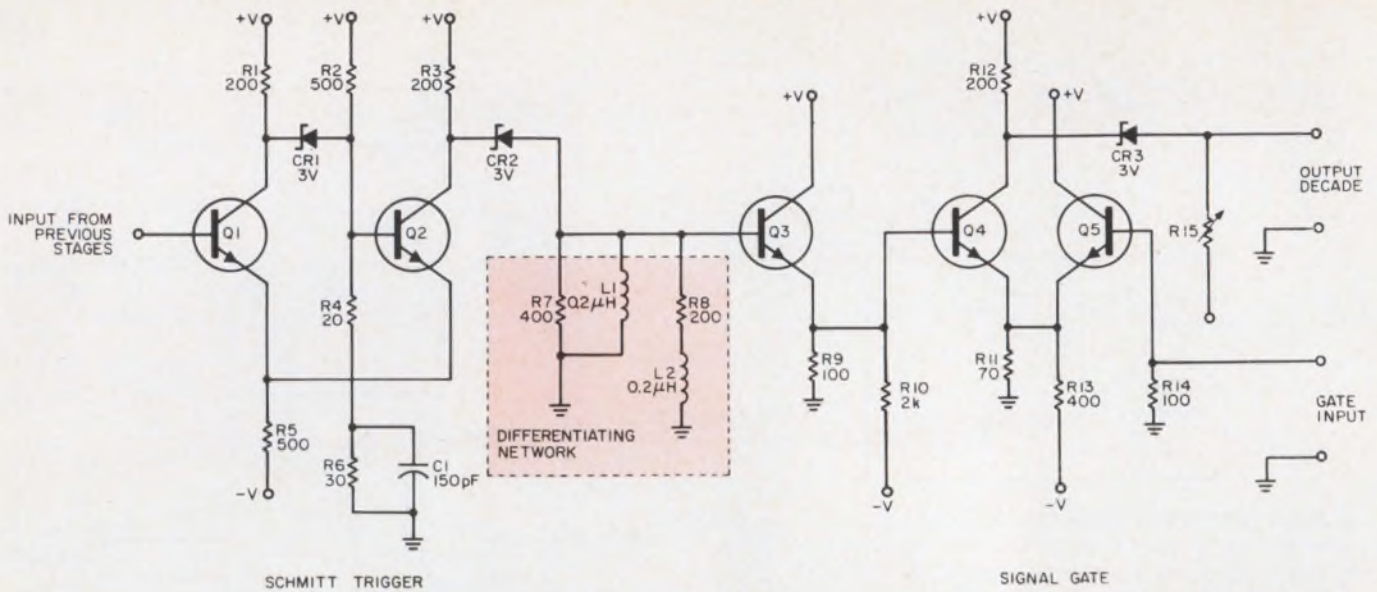

8. The second Schmitt trigger in the input amplifier chain is needed to provide an output that is independent of in-

quired (Fig. 8). If there were to be no signals below 10 MHz, only one Schmitt trigger would be necessary but the rise time of the first trigger circuit would slow slightly at the very low frequencies. The second circuit, however, has an output that is quite independent of input frequency and amplitude from 10 Hz to 150 MHz.

In the simplified schematic of Fig. 8 transistors Q1 and Q2 are the second Schmitt trigger, which is conventional except for the addition of C1 and R6. These components are added to make the hysteresis of the circuit more constant with frequency. They can be used here only because all signals are cw—no pulses need be handled. The extra components result in a lowering of the normal hysteresis at high frequency by changing the bias of Q2 as a function of frequency. The differentiating network shapes the output of Q2 into short pulses of about 1.5-ns duration. Transistor Q3 buffers the network from the following circuitry and effectively blocks the negative peaks from passing to the gate circuit formed by transistors Q4 and Q5.

In the off conditions, the gate input is positive and Q5 is conducting all the current supplied by R13—the peaks of the pulses from Q3 are below the positive gate input level so that Q4 never conducts. In this state, the output to the decade is always positive and no count occurs. When the gate signal becomes low, the base of Q5 is lowered to a level only slightly more positive than that of Q4. Thus when a pulse from the emitter of Q3 drives the base of Q4 positive, it will conduct all the emitter current of the pair and its collector voltage will drop. In this manner, each positive pulse at the base of Q4 causes a negative drive pulse to the decade. These pulses are 2 ns in duration, one volt in amplitude, and remain almost unchanged to a frequency of 150 MHz.

put frequency and amplitude from 10 Hz to 150 MHz. Hysteresis variation is reduced by R1 and C6.

Because of the very high response rate that is necessary for the first decade of the counter, the method chosen (Fig. 9a) uses five flip-flops, connected in an inverted shift-register configuration instead of four as for a normal decade, but has no delays due to permutations or logic operations. Referring to Fig. 9b, all flip-flops are initially reset to their zero state. At the first pulse, flip-flop A changes state because the last in the chain of flip-flops has its output twisted, that is the E output is connected to the reset flip-flop A and the E output is connected to the set input. At the second pulse, flip-flop A does not change state, but the set input of flip-flop B is now high and it changes state. In this manner, the first five pulses cause a 1 to propagate down the chain. At the sixth pulse, the set input of flip-flop A is 0 and it changes to a zero state. As in the 1 case, the 0 now propagates down the chain so that at the tenth pulse, the original all-0 state has been reached.

Therefore, for a continuous signal, the output of any one of the flip-flops is a square wave at 1/10 the frequency of the incoming signal. For a number of pulses not equal to a multiple of 10, the decade will stop in one of the intermediate stages shown in Fig. 9b. In this condition, each of the flip-flops has a well-defined state and the outputs may easily be decoded to the normal 1-2-4-8 BCD code for driving the readout circuits.

The flip-flops used in this decade must be triggered set-reset types (Fig. 10). Transistor Q5 provides the triggering function⁵ and CR4, CR5, and CR6 prevent transistors Q1, Q4, and Q5 from turning completely off,⁶ thereby increasing their average gain-bandwidth product. If point A is connected to Q and \bar{A} to Q as shown, a toggle binary is obtained. Transistor Q5 is normally on because its base is biased more positive than those of Q1 and Q2. Thus only the current used to hold CR3 on is "robbed" from the

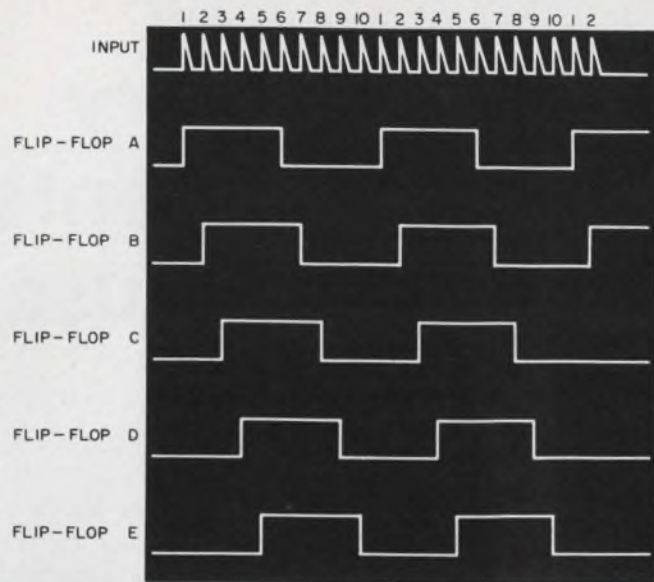

(b)

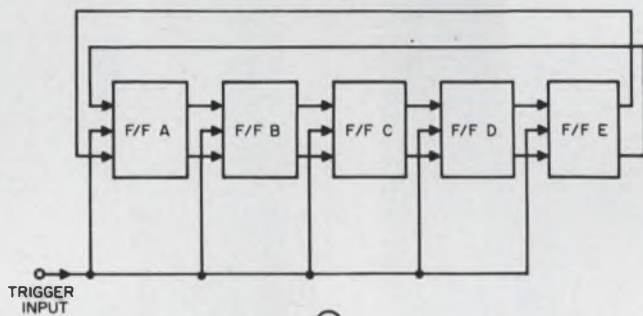

(a)

9. To achieve a high response rate, a gateless inverted shift register is used (a). Each condition has a well-defined state for decoding to drive the readout circuits (b).

emitter circuit of Q_2 and Q_3 . When the trigger input becomes less positive, Q_5 will turn off and all the current previously conducted by Q_2 or Q_3 will flow in CR_3 and R_7 , turning off both Q_2 and Q_3 . Also, when Q_5 turns off, its emitter current flows in either Q_1 or Q_4 , depending upon which base is more positive.

Diodes CR_4 , CR_5 , and CR_6 in conjunction with R_4 , R_9 and R_{12} provide the cutoff prevention. If Q_2 is on when the trigger pulse arrives, the base of Q_4 will be more positive than that of Q_1 and Q_4 will conduct the current switched from Q_5 , while both Q_2 and Q_3 will be turned off. As Q_4 conducts, the base of Q_2 goes negative. Since both Q_1 and Q_2 are off, the base of Q_3 goes positive. The transition is delayed from the bases of Q_1 and Q_4 by L_1 and L_2 until the input pulse has ended, so that multiple transitions do not occur. At the end of the input pulse, the base of Q_2 has been changed to low, the base of Q_3 is high, causing Q_3 to conduct, and the flip-flop has changed state. In addition, the base of Q_5 is again high and that transistor conducts, allowing emitter current to flow in Q_3 .

The next input pulse will cause the flip-flop to change stage again and it will return to its original state. To connect the flip-flop into the inverted shift

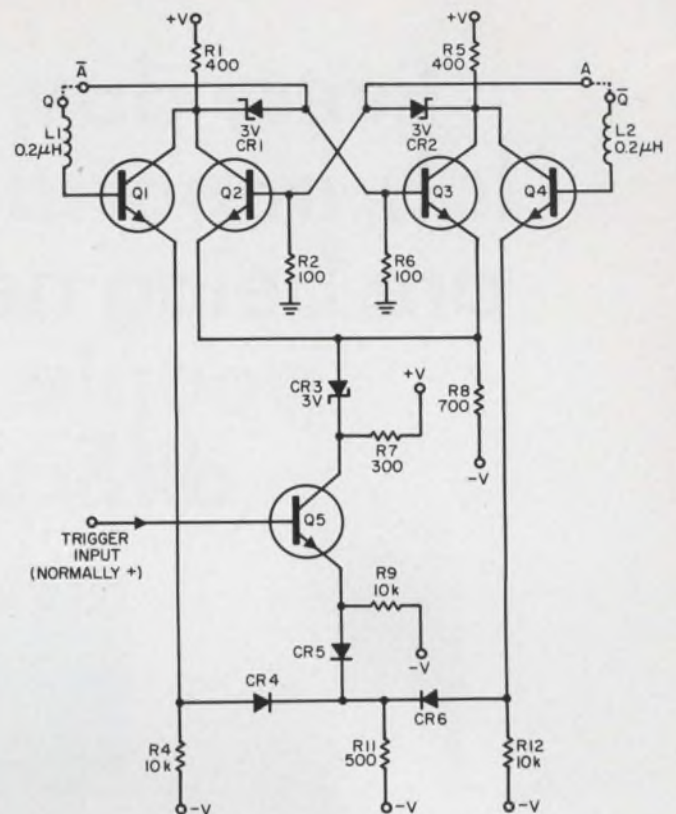

10. The high-speed decade flip-flops use diodes CR_4 , CR_5 and CR_6 to prevent Q_1 , Q_4 , and Q_5 from turning off completely, thus increasing the response of the decade.

register, Q and \bar{Q} become the outputs, and A and \bar{A} the inputs. The flip-flop then becomes a clocked set-reset type and Q is high only when A is high.

The remainder of the counter circuits utilize standard counter technology and are not especially noteworthy. These include the time-base decade dividers, the slower decade counters, the readout and memory circuits, and the power supply.

Of the units built to date, all responded to frequencies in excess of 180 MHz and some as high as 210 MHz with ± 1 count accuracy maintained to well above 135 MHz. The 1 hour warm-up time to an accuracy of 1 part in 10^7 has been reduced to only five minutes. ■ ■

References:

1. Gray J. Himler and R.L. Chafin, "Digital Measurements of Frequency and Time," *Electro-Technology*, LXXIII, No. 5 (May, 1963).
2. R.L. Chafin and J. Ahlstrom, "Measurements Using Counting Techniques," *Instruments and Control Systems*, XXXVII, No. 6 (June, 1964).
3. *Ibid.*
4. R.J. Munn, "Warm-Up Characteristics of Oscillators Employing 3 Mc Fundamental Crystals in HC-27/U Enclosures," *Proceedings of the 9th Annual Symposium on Frequency Control* (April, 1965).
5. A.K. Rapp and J.L. Robinson, "Rapid-Transfer Principles for Transistor Switching Circuits," *IRE Transactions on Circuit Theory* (December, 1961), pp. 454-461.
6. R.W. Long and S.N. Rubin, "A Digital Technique for High Resolution Radar Range Measurement," *Solid State Design*, V, No. 11 (November, 1964).

Every day, in almost every lab, important measurements are being neglected because people think they're difficult to make.

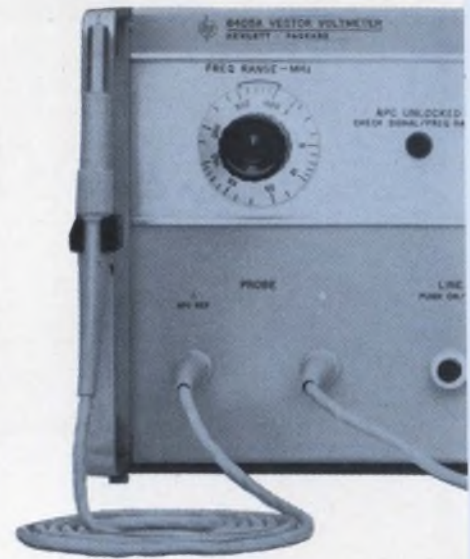
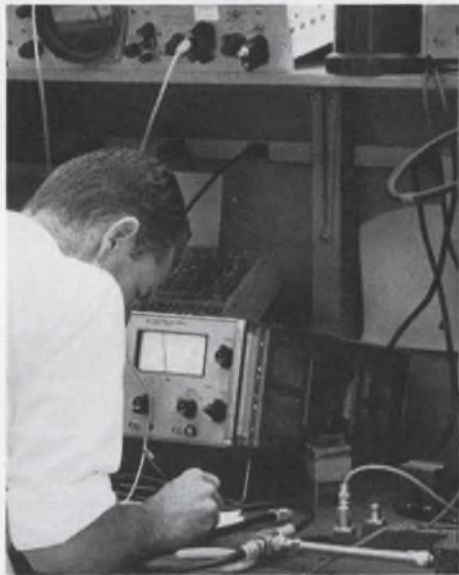

This RF vector voltmeter proves they're wrong.



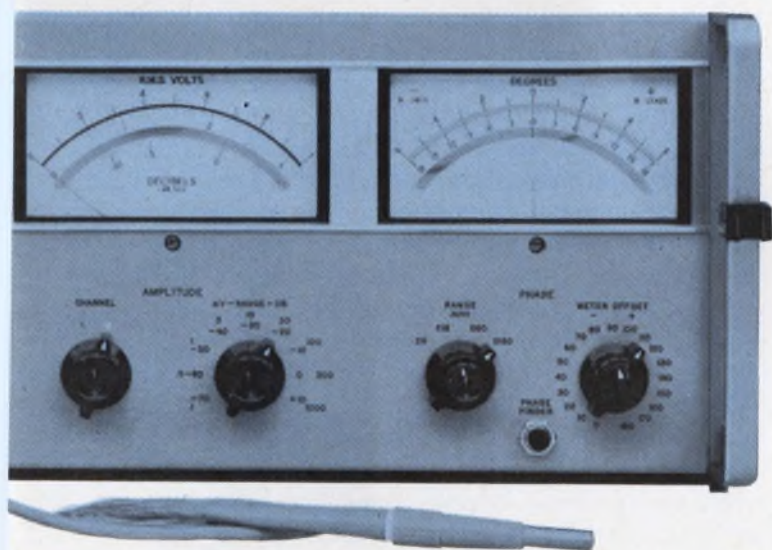

From 1 to 1000 MHz, this 2-channel rf millivoltmeter-phasemeter provides simultaneous measurement of voltage and phase. Just think of the numerous situations where these measurements will enable you to evaluate your design efforts quickly, easily and thoroughly.

What measurements? Well, take open-loop gain of feedback amplifiers. The Hewlett-Packard 8405A Vector Voltmeter makes it easy to design feedback amplifiers because it can give you both amplitude and phase of open-loop gain *simultaneously* and *fast*. The wide frequency range of 1 MHz to 1000 MHz, 100 μ V full-scale sensitivity and 95 dB dynamic range all contribute to simplicity in these important measurements. Just connect the probes to your circuit, the 8405A *automatically* tunes and locks to the test signal, and your measurement results are presented on the meters.

Or take measurement of electrical lengths such as cable matching or phase-tracking between signal paths. The 8405A, used as a phasemeter, does each simply and quickly with 10° offset steps permitting high resolution of 0.1° on the $\pm 6^\circ$ scale. And this same capability can easily be applied to making group delay measurements.

In filter design and evaluation, phase characteristics readily disclose resonances—and the 8405A Vector Voltmeter's high sensitivity and wide dynamic range permit measurements in the filter's *rejection* band, as well as in the pass band.

Though wideband in coverage—1 to 1000 MHz—the 8405A is nevertheless a *tuned* or frequency-selective

voltmeter with 1 kHz measurement bandwidth which makes it especially valuable for accurate measurement of fine-grain phenomena such as "notches," filter skirts, etc.

Many other examples of the 8405A's applications for what previously were considered awkward or complex measurements are available. The ubiquitous nature of the 8405A as a fundamental design tool is fully described in HP Application Note #91, "How Vector Measurements Expand Design Capability—1 to 1000 MHz."

Get it and more information about the Vector Voltmeter by calling your local HP field engineer or writing Hewlett-Packard, Palo Alto, California 94304; Europe: 54 Route des Acacias, Geneva.

HEWLETT  PACKARD
RF TEST EQUIPMENT

ON READER-SERVICE CARD CIRCLE 47

Destroy your microwave transistors

with a few common tools—an ohmmeter, a soldering iron, your fingers, and transistor test sets.

The rapid increase in the use of transistors at microwave frequencies, where the average unit price is around \$100, dictates the need to understand how to avoid unnecessary failures.

While the microwave transistor obeys the same laws of physics as lower-frequency devices, some of the rules must be observed more closely. Here are a few of the don'ts:

- Never use an ohmmeter for continuity checks.
- Never pick up a unit by its leads.
- Never use a constant-current bias.
- Don't use transistor test sets without proper precautions.
- Don't solder leads unless you can do it fast.
- Don't use a supply that has high-voltage spikes.

An ohmmeter does it easily

"Hello, vendor, listen, I just bought some of your microwave transistors and they don't work!"

"Well, what seems to be the problem?"

"They are all open."

"I can't understand that, every device is completely checked before it is shipped and . . ."

"Oh they were all right when they got here, but when I plugged them in nothing happened."

"What do you mean, 'nothing happened'?"

"Well, I had my breadboard ready to go; I set the collector-base voltage to its proper value, then started to run up the emitter current very slowly, but nothing happened. The emitter current wouldn't budge. So I pulled the transistors out and checked them, they were all open. And I *know* they weren't open before, because I checked all of the diodes with an ohmmeter just before I plugged them in. . . ."

And another group of "dead bodies" joins the growing list of fatalities caused by the number one killer—the simple ohmmeter (Fig. 1).

Semiconductor manufacturers seldom recommend that an ohmmeter be used to test transistors; however, it has long been a recognized method for swiftly and conveniently determining if certain types of transistors are open or shorted. It is also one of the easiest ways of destroying a high-frequency transistor. The diode characteristics of a transistor can

be represented by two diodes in a back-to-back configuration with the base lead of the transistor representing the common junction of the diodes. The engineer or technician who suddenly has a circuit malfunction, can be 90% sure that the transistor is not the culprit if both diodes look like diodes when tested with an ohmmeter. Simple and neat; so why not check a microwave transistor with an ohmmeter?

The typical ohmmeter supplies at least 1.5 volts dc to the ohmmeter probes; the typical reverse breakdown voltage between emitter and base of a microwave transistor ranges from 0.2 to 1.0 volt. On the low ranges, an ohmmeter may be capable of supplying greater than 250 mA into a small load, while the absolute maximum emitter current in many small-signal microwave transistors ranges from 20 mA to 50 mA. When testing a microwave transistor with an ohmmeter, the first check (regardless of probe polarity) will normally indicate a short; reverse the ohmmeter leads, and the transistor will probably indicate an open—and in all likelihood, it's absolutely right, the transistor *is* now open. The best way to avoid this type of failure is to take time to check the transistor on a curve tracer or transistor test set where current and voltage are adjustable and limited.

Know how to handle them

Static discharges are a potential danger to any transistor. This failure mode is seldom seen, however, in lower-frequency transistors because the emitter area and junction capacitance is usually large enough to overcome any potential danger. Several factors add significantly to the dangers of static discharge in microwave transistors:

The emitter area is extremely small, so for a given discharge the emitter current density may be orders of magnitude greater than the current density of lower-frequency transistors.

Due to the mechanical configuration of the microwave packages, the most common resting position will be inverted with the leads pointing up. Most microwave breadboarding and testing is done on a copper-topped table or bench to provide a good ground plane. If a microwave transistor is lying on this ground plane in the inverted position, the emitter of the transistor is in direct electrical contact with the ground plane through the transistor case.

Since the transistor case is inverted, any attempt to pick the transistor up will result in contact with the leads prior to contact with the case, unless deliberate precaution is taken to prevent lead contact. A static potential of several thousand volts is not unusual in a relatively dry atmosphere. Accumulation of the static charge can be aggravated by the type of clothing worn, and potentially dangerous charges can be built up within seconds after complete discharge to the ground plane. If a person with a high static charge attempts to pick up the microwave transistor, it is probable that two out of three times his first contact will be with either the collector or base lead. The instantaneous emitter current caused by such a discharge could cause permanent damage to the transistor junction (Fig. 2).

Reasonable care, such as taking the precaution of placing one hand on the ground plane prior to picking up the transistor, can totally eliminate such failures. The possibility of damaging the transistor through static discharge after initial contact is virtually nonexistent—that is, holding the devices by the leads or between the hands will not harm the devices. There is some danger when placing the device back on the ground plane, but it is not so great because physical contact with the emitter lead or the case will put the case at the same static charge as the holder, and any discharge will normally be through the case rather than through the junction. At least one company is said to foil the static-charge problem by requiring production workers to wear a conductive bracelet connected to the ground plane by a conductive, flexible cable. Another company demands non-conductive bench tops in all areas where this type of transistor is handled.

Bias them into destruction

In many cases, particularly in breadboard work, great care is taken in designing the microwave portion of the circuit while the dc biasing is completely neglected. The microwave performance is very important, but not at the expense of destroying the transistor. A high-impedance or constant-current-bias (Fig. 3) configuration should never be used with microwave transistors. In this configuration, the transistor can go into strong oscillation and develop sufficient forward self-bias to cause destruction. This configuration also invites self-destruction from thermal runaway. Even when used with current-limiting, small changes in temperature are capable of so shifting the operating points that microwave performance is impaired. A constant-bias configuration (Fig. 4) is recommended for microwave amplifiers and oscillators.

High stability factor can do it

A dc stability factor, $R_1 R_2 / [(R_1 + R_2) R_E]$, of greater than 5 is an open invitation to trouble, for the



1. "I'll never buy another transistor from this outfit," says Joe Doe, the ohmmeter whiz. "I just went through the whole dozen and every one of them is open."



2. Pick up a microwave transistor by its leads from a copper-topped bench and you have an excellent chance to heave it directly into the garbage can: the static charge of your body was enough to destroy it.

circuit begins to assume the characteristics of constant-current biasing above this value. The constant-voltage biasing introduces another potential transistor-killer into the microwave circuit. To obtain a very low stability factor, emitter resistor R_E is normally bypassed, as shown by C_1 in Fig. 4. If the transistor is removed from the circuit while voltage is applied, C_1 will charge to the value of the emitter supply voltage through R_E . When the transistor is reinserted into the circuit, C_1 will discharge through the transistor and, depending on the value of C_1 and the resistance in the discharge path, the result is generally another dead transistor. The obvious way to prevent this failure mode is never to insert a microwave transistor into a circuit when voltages are already applied.

Use two power supplies

When breadboarding microwave circuits, it is recommended that a two-supply system should be used with the transistor dc-biased in the common-base configuration (Fig. 5) and operated in the common-emitter configuration. This confers the advantages of a constant-voltage bias but allows both V_{CB} and I_E to be adjusted independently of each other. It is still necessary, however, to remove all voltages from the

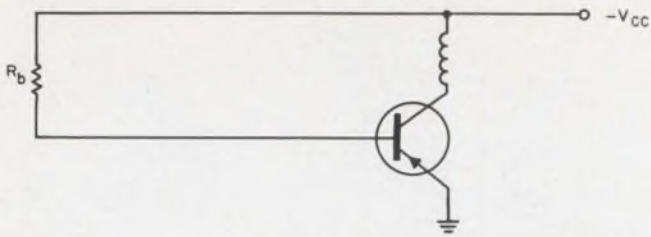

3. **Transistor destruction** can easily result from oscillations or a thermal runaway when a constant-current bias is used.

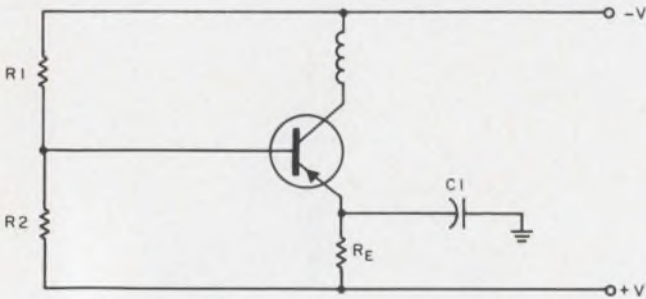

4. **Constant-voltage bias** should be used in microwave amplifiers and oscillators.

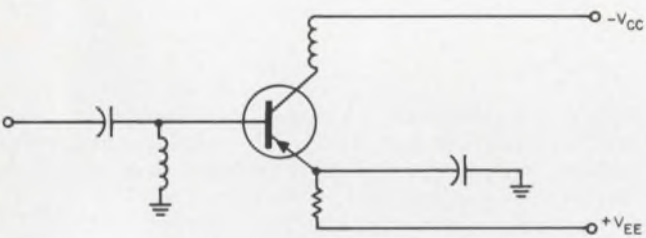

5. **Use two power supplies** to get the constant-voltage bias and independent control of V_{CB} and I_E .

circuit before plugging a transistor in. A good-quality microwave capacitor must be used as the emitter bypass, to ensure a good ac ground at the emitter.

Check your test sets

Conventional transistor test sets, including curve tracers, were designed for transistors that were not capable of amplification or oscillation at microwave frequencies. Very few commercial transistor testers are built to suppress oscillations at frequencies above 1 GHz. When testing the dynamic characteristics of microwave transistors on commercial transistor test sets, extreme care must be taken to prevent the devices under test from bursting into oscillation. A transistor which has an f_T of 2500 MHz is probably capable of oscillating at frequencies in excess of 3 GHz and could possibly oscillate as high as 7 GHz, depending on the transistor type and the material from which it is built. A conventional transistor test set simply cannot detect oscillations in this frequency range.

The primary danger from oscillation is, of course, overheating due to excessive power dissipation. Secondary dangers include voltage and current swings

that exceed the maximum ratings (particularly when measuring common-emitter parameters), and erroneous test equipment readings which may indicate that a good transistor is bad.

Another problem area in standard test equipment as well as breadboarding techniques is that of plugging transistors into sockets with bias voltages already on the socket. This failure mode is difficult to identify because the failure is generally blamed on something else. Experience indicates that, whenever an emitter-base short or seriously degraded emitter performance occurs with microwave transistors, a closer inspection of test equipment and techniques should be made. A transistor curve tracer is one of the safest ways to test a microwave transistor if all normal precautions are used.

Look out for power supply transients

A significant number of microwave transistor failures have been traced to high-voltage transients riding on the bias voltages. In most lower-frequency circuits and/or transistors, sufficient stray capacitance exists to shunt submicrosecond transients around the transistor junction effectively enough to prevent transistor damage. Such capacitances obviously cannot be tolerated in a transistor designed to operate at frequencies above 1 GHz. Therefore deliberate transient suppression *must* be incorporated into microwave circuit design.

While on this subject, the microwave engineer should keep in mind that a rather large (hundreds of volts) transient is associated with gas-tube ignition. If a gas tube used for noise generation is ignited with the transistor connected to the noise output of the tube, almost certain death for the transistor will accompany ignition!

If you can't "zap" it, cook it!

For every advantage, there is a disadvantage and this is particularly true of microwave transistor packages. The most popular microwave package uses gold-plated pure silver leads to reduce parasitics; the transistor wafer, however, is sitting on the internal end of the collector lead. Apply a large soldering iron to the silver lead less than 1/4 inch away from the transistor chip and hold for 10 seconds. You can be reasonably sure that the transistor chip is now at the same temperature as the tip of the soldering iron. If, by chance, this did not destroy the device, you are bound to have better luck when you unsolder the device to test it, since it always takes longer to get the device out and so you can get it hotter. Recognizing that silver does not bend well, you can also bend the leads several times as you unsolder and be reasonably sure that at least one will break off on the third or fourth bend. This method of destroying microwave transistors is unsportsmanlike but astoundingly successful. ■ ■

When you've got to put out a fire...



nobody comes to the rescue like AE.

Got a burning question...like which relay is exactly right for a critical circuit?

Sound the alarm, and your AE man will speed you the answer. This is what he's trained to do. If your problem is a real four-alarmer, your AE representative can call upon a staff engineer from our district office nearest you. This relay expert has thousands of relay application experiences to help him help you.

Nobody else in the relay business can offer this kind of "firehouse" service. AE can, because we're in the

telephone business, too. We know relays and switches and how to use them.

You'll find your AE man in the Yellow Pages, under "Relays." Call him, next time the heat's on. Or drop a line to Director, Relay Control Equipment Sales, Automatic Electric, Northlake, Illinois 60164.

AUTOMATIC ELECTRIC
SUBSIDIARY OF
GENERAL TELEPHONE & ELECTRONICS **GTE**

ON READER-SERVICE CARD CIRCLE 48



Precision

Precision trimmers in all 4 popular styles

RECTANGULAR

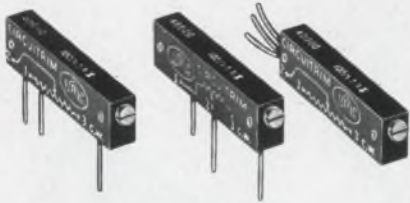

Series 400. Wirewound RT-12 case size with one extra model having staggered RT-11 P.C. pin placement for direct, space savings substitution.

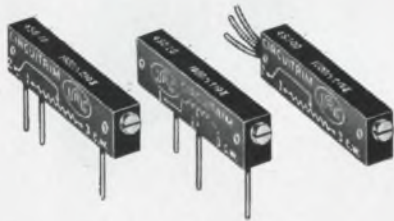

Series 450. Metal Glaze element provides essentially infinite resolution output. RJ-12 size to MIL-R-22097 requirements. Resistance values from 50Ω to 1 Meg. Standard tolerance is ±10% with 20% available for cost-saving applications.

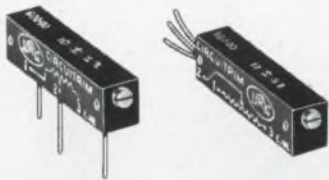

Series 600. RT-11 case size. Wirewound stability and military quality at industrial prices. Well-sealed lightweight diallyl phthalate case.

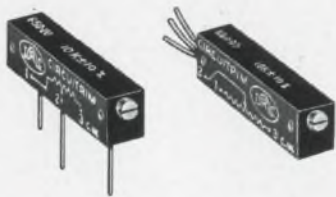

NEW Series 650. Metal Glaze resistive element built to MIL-R-22097, Characteristic C capability. ±250ppm/°C over range of 100Ω to 10K. Std. tol. ±5%.

½-INCH SQUARE



Series 205. Standard wirewound units for high-quality industrial needs in all four RT-22 styles. Built, tested and marked to MIL-R-27208 specifications.



Series 251. RJ-22 styles. Metal Glaze infinite resolution from 100Ω to 1 Meg. Offered in ±5, 10 and 20% tolerances to provide exact performance requirements.

½-INCH ROUND



Series 100. Largest ½" round selection in the industry. Well-sealed for critical industrial or military use. Single turn, positive stops. Long (0.9") winding provides superior resolution and closer settings.



Series 150. Metal Glaze companion to wirewound model 100 above. Available in same configurations. 100Ω to 1 Meg. with choice of ±5, 10 and 20% tolerances.



NEW Series 500. Most economical for commercial and industrial use. Two most popular adjustment and mounting configurations. Best wirewound resolution at lowest price.

MINIATURE 5/16" CUBE



Series 300 wirewound and 350 Metal Glaze provide space savings in all P. C. board applications. Panel mount also available.

PANEL MOUNTING

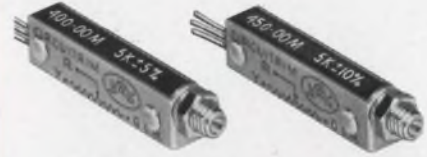

For wirewound Series 400 and Metal Glaze Series 450



For wirewound Series 600 and Metal Glaze Series 650



For ½" square series

For ½" round series

For 5/16" cube series

SINGLE TURN ROTARY

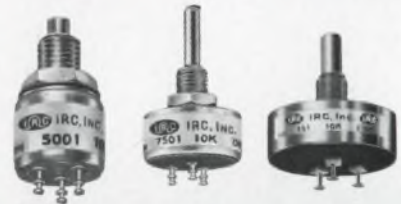

Sturdy metal-cased units for severe environmental conditions. Wirewound stability and ±5% resistance tolerance. Excellent linearity for close setting of comparison and control instrumentation.

Mod.	Case Diam.	Res. Range (Ω)	Power @ 40°C	Linearity
5001	½"	10 to 50K	2 W	±5%
7501	¾"	50 to 50K	2½ W	±1%
151	1¼"	100 to 100K	3½ W	±0.5%

MOUNTING VARIATIONS

IRC offers hundreds of different terminals, terminations, mounting variations and adjustments. Unique in the industry, they provide economy and unequalled design flexibility.

Potentiometers

Precision multi-turns for all applications

LOW-COST COMMERCIAL/INDUSTRIAL

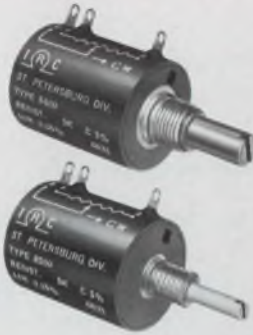

High performance and long life at lowest cost. 10 turns, $\frac{1}{8}$ " diameter with only $\frac{1}{16}$ " behind the panel. 2 watts @ 25°C., derates to zero @ 105°C. 100Ω to 100K, with all popular intermediate values. $\pm 5\%$ tolerance and $\pm 0.25\%$ linearity. Side terminals accept to #14 wire. Model 8400 has $\frac{3}{8}$ "-32 bushing, $\frac{1}{4}$ " shaft. Model 8500 has $\frac{1}{4}$ "-32 bushing, $\frac{1}{8}$ " shaft.



Model 7300 has 100 oz.-in. patented stop system and space-saving rear terminals. 10 turns, 2 watts @ 40°C., derates to zero @ 85°C. 100Ω to 100K. $\pm 5\%$ tolerance, $\pm 0.25\%$ linearity.

MINIATURE HIGH PERFORMANCE



Industry's only $\frac{1}{8}$ " metal-cased multi-turn trimmer with 100 oz.-in. stop system and $\frac{1}{8}$ " diameter shaft. Maintains settings to $\pm 0.1\%$ under severe shock and vibration. Rear terminals for closest packaging. Many shaft and bushing variations.

Model 5000: 10 turns, 1.5 watts, 25Ω to 100K. $\pm 5\%$ tolerance

Model 5005: 5 turns, 1.0 watt, 15Ω to 50K. $\pm 5\%$ tolerance

METAL-CASED STANDARD PRECISION

IRC's exclusive line of metal-cased multi-turn potentiometers offer rugged protection and superior shielding. Field tested and approved in every phase of the electronics industry, their case sizes and power handling capabilities are based on widely accepted standards for good design and packaging. Hermetically sealed, panel sealed and moisture sealed versions are also available.



Model	Case Dia.	Turns	Resistance Range (Ω)	Linearity Std. (±)	Power @ 40°C
7500	$\frac{3}{4}$ "	10	50 to 250K	0.5%	3 W
7505	$\frac{3}{4}$ "	5	25 to 125K	0.5%	2 W
1000	1"	10	500 to 250K	0.5%	3 W
1005	1"	5	250 to 125K	0.5%	2 W
1215	1"	15	500 to 450K	0.1%	4 W
1220	1"	20	750 to 600K	0.1%	5 W

Standard tolerance: $\pm 5\%$. Temperature range: -55°C to 125°C. Closer tolerances and linearity available.

RUGGED STOP MECHANISM

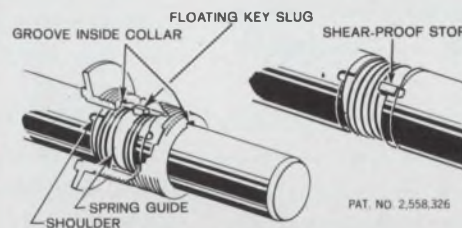

Electrical and mechanical functions of IRC metal-cased multi-turns are separate. Positive 100 oz.-in. patented stop mechanism in the shaft and bushing prevents damage to internal parts and catastrophic failure. The wiper contact assembly is relieved of stopping action. This assures setting accuracy, stability and long rotational life.

REVODIX DIALS ELIMINATE READING ERRORS

IRC has a full line of turns counting dials for use with 3, 5, 10 and 15 turn potentiometers. Only 1 inch in diameter, they fit $\frac{1}{4}$ -inch and $\frac{1}{8}$ -inch diameter shafts. Choice of black or clear anodized aluminum finish.



• Easy reading—angular surface gives maximum numeral size. Primary and secondary scale.

- Full range—000 to 999 to indicate up to 10 full turns (to 1499 for 15 turns).
- Accurate reading—reproducible to one part in a thousand. Can estimate to a fraction of a thousandth.
- Easy mounting—set-screwed directly to potentiometer shaft, there is no backlash and no need for extra panel holes.
- Long life—tested to 250,000 cycles with no appreciable wear.

WRITE FOR NEW PRECISION POTENTIOMETER CATALOG



IRC, Inc., 401 N. Broad St., Phila., Pa. 19108

ON READER-SERVICE CARD CIRCLE 49

Graphs speed two-section filter design

by providing the exact pole positions, the attenuation and the component values at any angular frequency.

Two-section RC filters offer better cutoff characteristics with a given bandwidth than single-section filters. But, though it appears simple to add a second section, the design task can be considerably more complex. The difficulty stems from the loading effect of the additional section—a factor that cannot always be neglected. A nomograph, however, simplifies the calculation of the component values.

Why go through the tedium of designing a two-stage filter? Because when the virtues of a single stage (low cost and easy construction are combined with the sharp attenuation of the two stages (a 6-dB-per-octave improvement over a single stage) the combination becomes highly attractive in many applications: noise filtering in process-control systems, ripple removal, demodulation in voice communication systems, to mention just a few.

The typical circuit configuration for a two-section low-pass RC filter is shown in Fig. 1. The transfer function of this circuit is:

$$\frac{E_o}{E_{in}} = \frac{1}{(R_1 C_1 R_2 C_2) s^2 + (R_1 C_1 + R_2 C_2) s + 1} \quad (1)$$

This equation takes into account the interaction of the two sections. If, however, the addition of the second section does not significantly load the interaction can be neglected and the transfer function is the product of the two single-section transfer functions:

$$\frac{E_o}{E_{in}} = \frac{1/(R_1 C_1 R_2 C_2)}{(s + 1/R_1 C_1)(s + 1/R_2 C_2)} \quad (2)$$

$$\frac{E_o}{E_{in}} = \frac{1}{R_1 C_1 R_2 C_2 s^2 + (R_1 C_1 + R_2 C_2) s + 1} \quad (3)$$

A comparison of Eqs. 1 and 3 shows that the $R_1 C_2$ term in the coefficient of s in Eq. 1 represents the loading effect between the two sections. If $R_1 C_2$ is small in relation to the other terms in the coefficient, Eq. 1 will approximate the transfer function of Eq. 3, and the problem is reduced to the design of two single-section filters

which are then cascaded. This approximation is valid if $C_1 \gg C_2$ and/or $R_2 \gg R_1$.

Graduated scale gives pole position

In the exact design, the two pole positions from Eq. 1 are given by:

$$s_1, s_2 = (\omega_1 \omega_2 / 2) \left\{ - \left[\frac{1}{\omega_1} + \frac{1}{\omega_2} + \frac{1}{\omega_3} \right] \pm \left[\left(\frac{1}{\omega_1} + \frac{1}{\omega_2} + \frac{1}{\omega_3} \right)^2 - 4/\omega_1 \omega_2 \right]^{1/2} \right\}, \quad (4)$$

where $\omega_1 = 1/R_1 C_1$, $\omega_2 = 1/R_2 C_2$, and $\omega_3 = 1/R_1 C_2$. The attenuation function of the filter is:

$$T(\omega) = 10 \log \left[\frac{\omega_3^2 (\omega_1 \omega_2 - \omega^2)^2 + \omega^2 (\omega_1 \omega_2 + \omega_2 \omega_3 + \omega_1 \omega_3)^2}{(\omega_1 \omega_2 \omega_3)^2} \right] \quad (5)$$

Given a particular set of values for the filter components, Eqs. 4 and 5 can be used to calculate the exact pole positions and attenuation at any angular frequency, ω . Given the design requirements, the component values can be determined with these same equations and a "trial and error" process. A set of graduated scales and a nomogram can ease this process.

The graduated scales of Fig. 2 determine the pole positions when specific attenuation requirements are given. Knowing the pole positions, the designer can find the component values from the nomogram of Fig. 3. The frequencies are normalized to the 3-dB bandwidth on the graphs.

When to apply the nomogram

The nomogram can be applied to filter-design problems in two cases:

- When the maximum obtainable attenuation is desired at a frequency ω' which is greater

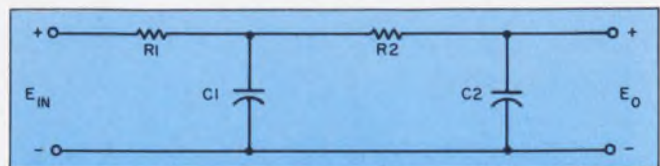

1. **Two-stage filter design can become complicated** when the loading effect of the second stage cannot be neglected. Component selection and synthesis are simplified with a nomogram.

Dr. Thomas J. Harrison, Manager of Analog Technology, and Gerald R. Bernacchi, Associate Engineer, IBM, San Jose, Calif.

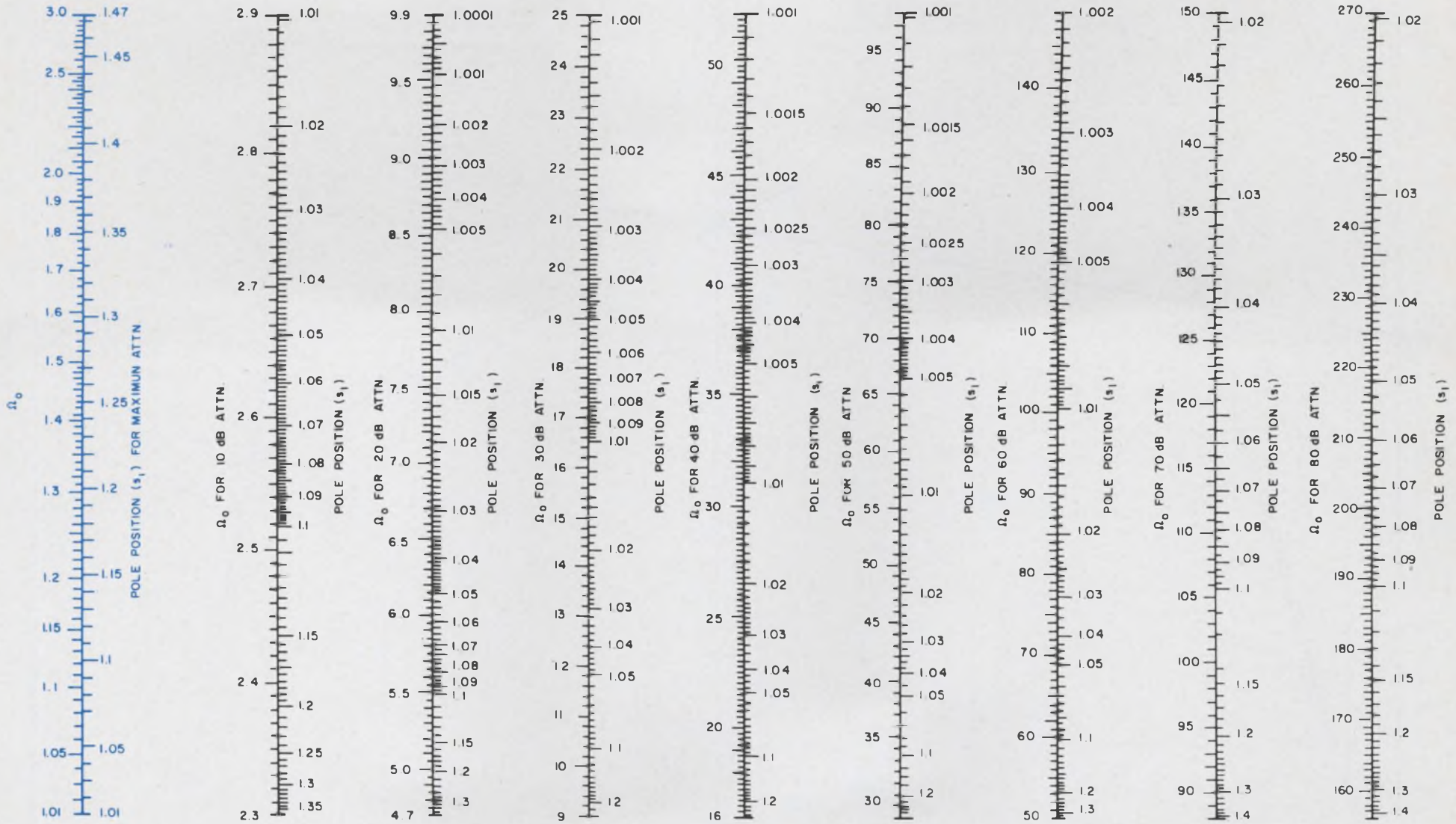

2. The first pole position for a two-stage filter depends on the required attenuation, once the normalized Ω_0 , has been calculated. For maximum attenuation, use the scale in color. The other scales apply to attenuation ranging from 10 to 80 dB in 10-dB steps.

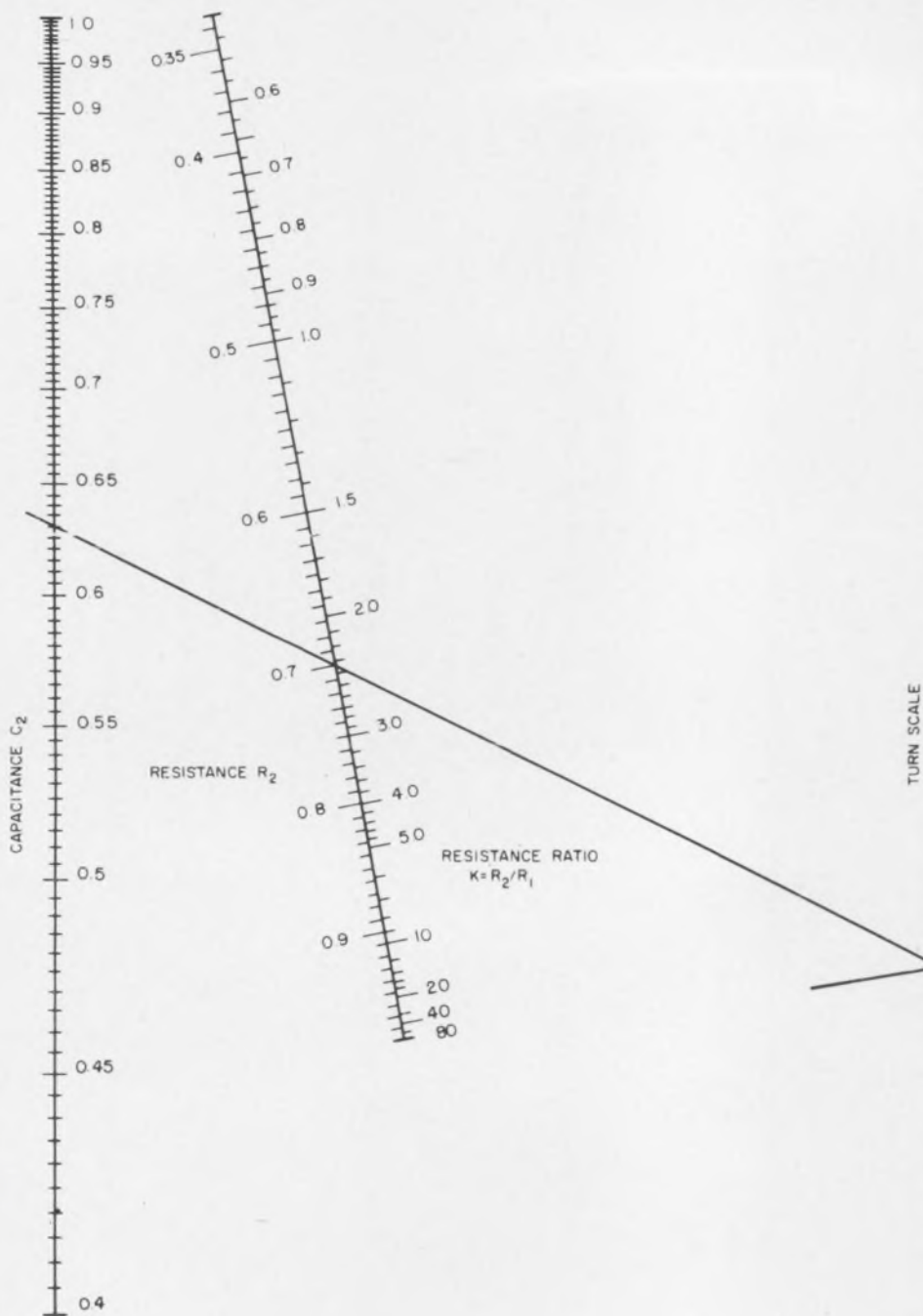

3. **Nomogram locates the second pole, s_2** and the component value of the circuit in Fig. 1. The usual design starts with an assumed value for C_2 , which yields C_1 ; if the resultant components are impractical, a new value of C_2 is assumed.

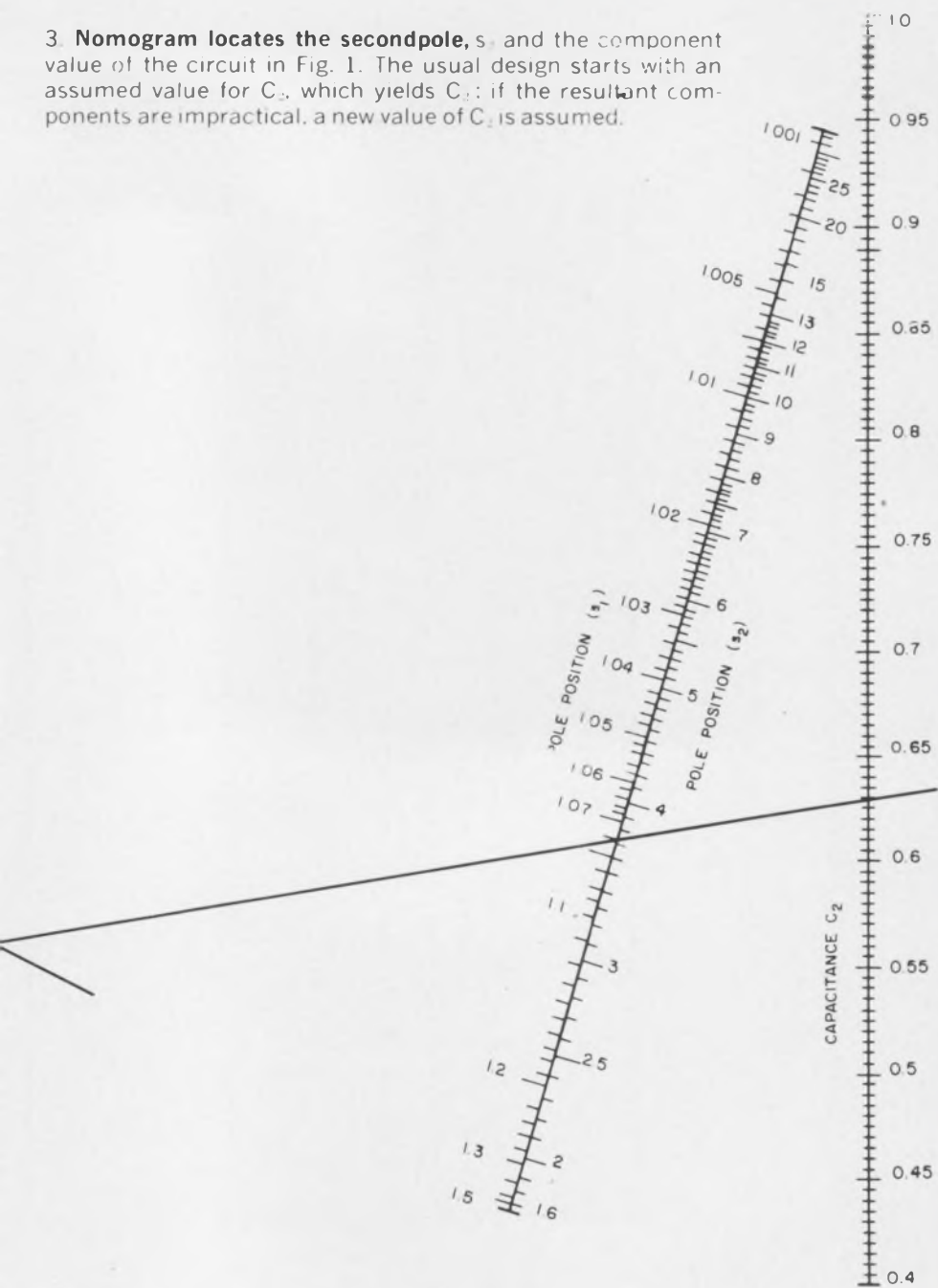

than the 3-dB bandwidth, ω_0 , under one of the following constraints:

- (A) $R_1 + R_2 = \text{constant}$.
- (B) $R_2/R_1 = \text{constant}$.
- (C) $C_1 + C_2 = \text{constant}$.
- (D) $C_1/C_2 = \text{constant}$.

■ When a specific attenuation, $T(\omega')$, is desired at a frequency ω' that is greater than the 3dB bandwidth, ω_0 , under one of the same constraints as in the first case.

To design a filter, calculate first the normalized frequency parameter, $\Omega = \omega'/\omega_0$, and determine the pole position of s_1 . For the first case, use the scale in color in Fig. 2; for the second case, the scales in black. Next, determine the component values with the aid of Fig. 3, bearing in mind that each of the four design constraints involves a different approach. These are the major steps of design under each of the constraints:

(A) $R_1 + R_2 = \text{constant}$

1. Define $R_0 = R_1 + R_2$.
2. Select a value for C_2 and calculate its normalized value C_2' , according to $C_2' = C_2 R_0 \omega_0$.
3. Draw a straight line through the values of C_2' and s_1 on the two right-hand scales of Fig. 3, so that the line intersects the turn scale.
4. Draw another straight line from the intersection on the turn scale through the *same* value of C_2' on the left-hand C_2' scale.
5. Read the value of R_2/R_1 from the resistance scale.
6. If the ratio R_2/R_1 is acceptable, proceed with Step 7. If the ratio is not desirable, return to Step 2 and select another value for C_2 .
7. Calculate the component values from:

$$R_2 = R_2' R_0$$

$$R_1' = 1 - R_2'$$

$$R_1 = R_0 - R_2.$$

$$C_1 = 1/(s_1 s_2 C_2 R_1' R_2 \omega_0), \text{ where Fig. 3 yields } s_2.$$

(B) $R_2/R_1 = \text{constant}$

In this instance, a "trial and error" procedure is employed. A straight line is passed through the pole position s_1 and some value of C_2' . A second straight line is passed through the desired ratio R_2/R_1 , the intersection of the first line with the turn scale, and the *same* value of C_2' on the *left-hand* scale. Since C_2 cannot be picked arbitrarily, a solution may not be possible for some values of R_2/R_1 . The sum, $R_1 + R_2 = R_0$, is picked arbitrarily, to find the component values, as in (A).

(C) $C_1 + C_2 = \text{constant}$

1-6. This procedure is identical to (A) through Step 6, except that the following substitutions must be made:

Replace C_2' (left and right) with R_1' .
 Replace R_2' with C_1' .
 Replace $K = R_2/R_1$ with $K = C_1/C_2$.
 Replace R_0 with C_0 .

7. The unnormalized values of the components are calculated from:

$$C_1 = C_1' C_0.$$

$$C_2' = 1 - C_1'.$$

$$C_2 = C_0 - C_1.$$

$$R_1 = R_1' / (C_0 \omega_0).$$

$$R_2 = 1 / (s_1 s_2 R_1' C_1 C_2' \omega_0).$$

(D) $C_1/C_2 = \text{constant}$

This method is identical to (B) except that the substitutions and component calculations listed in (C) must be used.

How to apply the graph

Suppose that a filter is required with a bandwidth of 1.0 Hz, a 50-dB attenuation at 35 Hz, and a total resistance less than or equal to 1000 ohms.

The bandwidth in radians is $\omega_0 = (2)(\pi)(1) = 6.28$ rad. The normalized frequency variable, Ω_0 , is:
 $(35)(6.28) / 6.28 = 35.$

From Fig. 2 pole position s_1 is 1.08 and from Fig. 3, s_2 is 3.6. Using method (A), choose C_2 arbitrarily to be 100 μF , so that $C_2' = (0.0001)(1000)(6.28) = 0.628$. The construction lines are drawn in Fig. 3 and yield $K = 1.77$ and $R_2' = 0.707$. The component values are:
 $R_2 = (0.707)(1000) = 707$ ohms.
 $R_1' = 1 - 0.707 = 0.293$
 $R_1 = 1000 - 707 = 293$ ohms.
 $C_1 = 1 / (1.08)(3.6)(0.628)(0.293)(707)(6.28) = 315 \mu\text{F}$.
 $C_2 = 100 \mu\text{F}$.

Should these values prove impractical, a new C_2 must be chosen and the design repeated.

Once the pole positions are known, the attenuation at other frequencies can be found without difficulty. Each graduated scale of Fig. 2 will give the value of Ω_0 for a given pole position s_1 and for the attenuation listed on the scale. Therefore, the frequency at which the filter has an attenuation of 10, 20, 30 up to 80 dB can be calculated by reading off the value of Ω_0 for the given pole s_1 on the desired attenuation scale, and multiplying it by the 3-dB frequency.

In the foregoing example the value of s_1 is 1.08; the frequency at which the filter has 60-dB attenuation is determined by reading off the value of Ω_0 on the 60-dB scale, and multiplying it by $\omega_0 = (2)(\pi)(1)$. Thus $\Omega_0 = 62.2$, giving 60-dB attenuation at an angular frequency of $(62.2)(2)(\pi)(1)$ radians, or 62.2 Hz. ■ ■

Acknowledgment

The authors thank Mr. Merwyn Arthur for his assistance in preparing the nomographs.

Major Price/Performance Breakthrough
for New Economy
in Industrial, Military, and Commercial Equipment

RCA's MAX VALUE PHP LINE

Performance/Hermeticity/Price

High-Performance
Silicon N-P-N Amplifiers
and Switches
in High-Temperature,
High-Dissipation
Hermetic Packages

at prices
as low as

19¢ 1000+
2N5183









A large pile of coins, likely pennies, is shown in the lower half of the advertisement. On top of the pile, the letters 'PHP' are prominently displayed in a large, white, three-dimensional font. A small, dark object, possibly a coin or a small component, is visible on top of the 'P' in the 'PHP' letters.

PHP

RCA's MAX VALUE line now brings you the results of RCA's most successful silicon planar and epitaxial technologies at unprecedented savings... Performance/Hermeticity/Price. Contact your RCA Field Repre-

sentative for more information. Or write RCA Commercial Engineering, Section CG10-2 RCA Electronic Components and Devices, Harrison, N.J. 07029. Check your RCA Distributor for his price and delivery.

†1000 plus quantities, OEM prices shown.
*RCA's MAX VALUE line offers military-type reliability control. For each type marked with the asterisk, production lots are subjected to and meet the mechanical, environmental, and life-test requirements of Military Specification MIL-S-19500.

 <p>2N5179 PHP Price 39¢† LOW-NOISE UHF AMPLIFIER TO-72</p> <p>20mW min oscillator output @ 500 MHz; 4.5 dB max NF @ 200 MHz; 15 dB min neutralized power gain @ 200 MHz; $f_T = 1\text{GHz}$ min $C_{cb} = 1\text{ pF}$ max. *Plus RCA Reliability Control</p>	 <p>2N5180 PHP Price 29¢† LOW-NOISE VHF AMPLIFIER TO-104</p> <p>4.5 dB max NF @ 200 MHz; 12 dB min unneutralized power gain @ 200 MHz; $f_T = 900\text{ MHz}$ typ; $C_{cb} = 1\text{ pF}$ max.</p>	 <p>2N5181 PHP Price 27¢† HIGH GAIN RF AND IF AMPLIFIER TO-104</p> <p>Max usable gain = 24 dB typ @ 200 MHz (neutralized); 3.5 dB typ NF @ 200 MHz; $f_T = 700\text{ MHz}$ typ; $C_{cb} = 0.34\text{ pF}$ max; new terminal arrangement for max isolation between collector and base terminals.</p>
 <p>2N5182 PHP Price 24¢† HIGH-GAIN RF AND IF AMPLIFIER for low-current applications TO-104</p> <p>Max usable gain = 24 dB typ @ 200 MHz (neutralized); 4.5 dB typ NF @ 200 MHz; $f_T = 700\text{ MHz}$ typ; $C_{cb} = 0.34\text{ pF}$ max; new terminal arrangement for max isolation between collector and base terminals.</p>	 <p>2N5183 PHP Price 19¢† 1-AMPERE GENERAL PURPOSE AMPLIFIER TO-104</p> <p>$h_{FE} = 50$ min @ $V_{CE} = 1\text{V}$, $I_C = 300\text{ mA}$; $V_{CE0} = 18\text{ V}$ max; $V_{CE}(\text{SAT}) = 0.5\text{ V}$ max @ $I_C = 300\text{ mA}$, $I_B = 15\text{ mA}$; $f_T = 200\text{ MHz}$ typ; Planar epitaxial construction.</p>	 <p>2N5184† PHP Price 27¢† HIGH-FREQUENCY HIGH-VOLTAGE AMPLIFIER TO-104</p> <p>$V_{CE0} = 120\text{ V}$ max; $I_C = 50\text{ mA}$ max; $f_T = 100\text{ MHz}$ typ; $C_{cb} = 3.5\text{ pF}$ max.</p>
 <p>2N5185 PHP Price 31¢† HIGH-FREQUENCY HIGH-VOLTAGE AMPLIFIER TO-104 with integral radiator</p> <p>1 watt dissipation capability; $V_{CE0} = 120\text{V}$ max; $I_C = 50\text{ mA}$ max; $f_T = 100\text{ MHz}$ typ; $C_{cb} = 3.5\text{ pF}$ max.</p>	 <p>2N5186 PHP Price 24¢† HIGH-SPEED SWITCH TO-52</p> <p>$V_{CB0} = 10\text{V}$ max; $t_{on} = 25\text{ ns}$ max @ $I_C = 10\text{ mA}$, $I_B = 1\text{ mA}$; $t_{off} = 25\text{ ns}$ max @ $I_C = 10\text{ mA}$, $I_B = 1\text{ mA}$; $V_{CE}(\text{SAT}) = 0.3\text{V}$ max @ $I_C = 10\text{ mA}$, $I_B = 1\text{ mA}$. *Plus RCA Reliability Control</p>	 <p>2N5187 PHP Price 27¢† MEDIUM-CURRENT HIGH-SPEED SWITCH TO-52</p> <p>$V_{CB0} = 25\text{V}$ max; $t_{on} = 18\text{ ns}$ max @ $I_C = 100\text{ mA}$, $I_B = 10\text{ mA}$; $t_{off} = 21\text{ ns}$ max @ $I_C = 100\text{ mA}$, $I_B = 10\text{ mA}$; $V_{CE}(\text{SAT}) = 0.5\text{V}$ max @ $I_C = 100\text{ mA}$, $I_B = 10\text{ mA}$. *Plus RCA Reliability Control</p>
 <p>2N5188 PHP Price 33¢† HIGH-SPEED HIGH-VOLTAGE 1/2-AMPERE SWITCH TO-39</p> <p>$V_{CB0} = 60\text{V}$ max; $t_{on} = 35\text{ ns}$ max @ $I_C = 150\text{ mA}$, $I_B = 15\text{ mA}$; $t_{off} = 50\text{ ns}$ max @ $I_C = 150\text{ mA}$, $I_B = 15\text{ mA}$; $h_{FE} = 20$ min @ $V_{CE} = 1\text{V}$, $I_C = 500\text{ mA}$ (pulsed). *Plus RCA Reliability Control</p>	 <p>2N5189 PHP Price 39¢† HIGH-SPEED HIGH-VOLTAGE 1-AMPERE SWITCH Similar to TO-39</p> <p>$V_{CB0} = 60\text{V}$ max; $t_{on} = 40\text{ ns}$ max @ $I_C = 1\text{A}$, $I_B = 100\text{ mA}$; $t_{off} = 70\text{ ns}$ max @ $I_C = 1\text{A}$, $I_B = 100\text{ mA}$; $h_{FE} = 15$ min @ $I_C = 1\text{A}$, $V_{CE} = 1\text{V}$. *Plus RCA Reliability Control</p>	<p>RCA'S MAX VALUE SAMPLER</p> <p>22 PHP Transistors for only \$3.95. (Optional distributor resale price). 2 evaluation samples of each transistor in RCA's new MAX VALUE line, packaged to let you check the outstanding performance of this economy line at your RCA distributors from Sept. 5, 1967 for a limited time only. Order your QK2100 Sampler today. This offer is limited to an evaluation quantity.</p> 

RCA Electronic Components and Devices



The Most Trusted Name in Electronics

ON READER-SERVICE CARD CIRCLE 50

Check cabinet requirements

before buying standards or specials. Here are guidelines to simplify your selection.

Choosing a cabinet large enough to hold all the components of a system is just not enough. A little prior study in selecting a line of cabinets can pay dividends in ease of installation, accessibility and even money. Questions that may never occur to the designer as he leafs through a catalog may become vitally important once the components have been installed or are to be moved. Bone up on them.

Western Electric's original relay racks set the standards for dimensions and hole locations that have been codified by the EIA and are now incorporated in a military specification (MIL-Std.-189). As a result, certain internal dimensions and hole spacings are common to all manufacturers. Standard panel opening widths are 19 and 24 inches; holes are spaced 5/8, 5/8 and 1/2 inch apart in 1-3/4-inch vertical increments. Even so, all cabinets are not the same. Exterior dimensions, styling and optional extras vary widely among the more than 50 manufacturers. *

First decide on over-all configuration

Apart from the standard 19- and 24-inch panel openings, some manufacturers also offer a 30-inch cabinet. This wider cabinet may be a "best buy" in many applications, since it gives 25% more volume at less than 25% additional cost. The larger cabinet may likewise obviate a need for a second cabinet. Nevertheless, since some 80% of rack-mounted equipment is designed for 19-inch mounting,¹ the wider cabinets are mostly practical only for custom components.

Standard cabinet depths are 22 and 25-1/2 inches but many manufacturers offer a 30-inch depth. Unless external space requirements are unusually critical, it is better to buy the added depth.

Standard cabinet heights range from about 24 inches to more than 80 inches. While cabinet openings from different manufacturers may be identical,

height ranges generally are not. If additional cabinets are likely to be needed in the future, carefully check the manufacturers' catalogs to make sure enough options (dimensions, accessories, lines) are available to handle future requirements compatibly.

Unless components are exceptionally heavy, standard cabinets should be strong enough. They are generally rated for an 800-pound load; heavy-duty cabinets, costing some 50% more, are rated for 1200 pounds. Although the cabinets may take a heavy load without collapsing, the load should still be placed as low as possible in the cabinet. Power supplies, transformers, blowers² and other hefty items should be mounted on the cabinet base. With hats, angles or channels as reinforcement, cabinet doors can also carry loads up to 200 pounds. Thus equipment that must be frequently checked or changed can be mounted right on the door for easy access.

RFI-shielded cabinets are often required. Where several cabinets are needed, it may be cheaper to install the critical components in one RFI cabinet and put the others in standard cabinets. Alternatively, it may be possible to isolate critical components individually. Bear these possibilities in mind for RFI cabinets are priced at about twice as much.

The more interchangeability you order, the greater the flexibility of the cabinetry. Doors, panels and struts should be interchangeable between cabinets of the same size. They should also be interchangeable in the same cabinet. If, for example, the be mounted on the side or back, it affords greater cabinet versatility. Some manufacturers even offer a door that can be turned upside-down for hinging either on the left or on the right. Similarly, flat panels that can be replaced with louvered panels, panels that can be easily removed so that cabinets can be installed side by side, panels that can be replaced with doors all offer added convenience. Inside the cabinet, horizontal and vertical struts should be movable for easier installation and greater accessibility. ■ ■

* Borg-Warner Emcor Div., Chicago; Honeywell Apparatus Control Div., Minneapolis; Amco, Chicago; Bud Radio, Cleveland; Zero Manufacturing, Los Angeles; Electronic Enclosures, Los Angeles; are among the major manufacturers.

References:

1. Charles H. Daniel, "Design Black Boxes for Systems Integration." *ELECTRONIC DESIGN* VX, No. 5 (March 1, 1967), 76-80.
2. Bernard J. Braganza, "Beat the Heat in Electronic Systems." *ELECTRONIC DESIGN* XIV, No. 21 (Sept. 13, 1966), 58-63

Will McLaughlin, Senior Design Engineer, Honeywell, Apparatus Controls Div., Minneapolis.

Standard options can customize your cabinetry

□ **Antitilt bases** — These prevent the entire cabinet smashing over when a heavy top drawer is pulled out. An extended base not only gives the cabinet more stability but can serve as a platform.

□ **Writing shelves** — Laminated plastic is preferable to painted metal because it will neither scratch nor scar. Retractable shelves slide out of the way but may interfere with air circulation inside the cabinet. Another good idea is to cover cabinet tops, especially low ones, with laminated plastic so they can double as a writing surface.

□ **Casters** — Larger caster wheels will not carry a heavier load, but will make a cabinet more prone to tip. Small casters may not roll quite so easily but usually carry as much weight as larger casters with more safety. For heavy loads select heavy-duty casters. Swiveling casters are fine for maneuverability, but can be annoying if the cabinet is moved any distance. A good solution is fixed casters in back, swiveling casters in front.

□ **Wedges**—Available in 30°, 45°, 60° and 90° angles, wedges "turn the corners of the room" on long cabinet runs. Small doors open up this "waste" space so it can be put to work. Turrets (horizontal wedges) are best limited to 15° from the horizontal for switch operations, 15° from the vertical for maximum viewing comfort.

□ **Common bases**—For handling up to five standard cabinets, a common base looks better, keeps the cabinets in rigid alignment and furnishes a convenient trough for wiring and cables.

□ **Louvers, filters and perforations**—Available

in front, side, back, top or bottom panels, louvers let cool air in and heat out. Filters strain the incoming air to prevent component contamination. Holes and cutouts bring wiring, cable and other lines to and from the cabinet.

□ **Holes** — Mounting rail holes come either tapped or pierced. In virtually every case, tapped holes (at 2 or 3 cents a hole) are not worth the cost. Only a few will ever be needed, yet hundreds of holes will be tapped. Nut clips, which lock in place and cannot be turned or lost, eliminate the need for tapping.

□ **Special air**—Where excessive heat will be given off or precise temperature control is needed, cabinets are available with a self-contained air-conditioning system. Generally one cabinet will supply conditioned air to other cabinets; otherwise each cabinet can have its own compact air-conditioning unit in the base. For normal cooling, rack-mounted packaged fans and blowers are available. Where clean air is needed, special filters or electronic air cleaners can supply it. Electronic air cleaners take up less than 1 cubic foot of interior space.

□ **Snap-in replacement panels**—Fitted with spring-loaded catches, these blank panels cover holes left when equipment is removed, preventing dust, dirt and other contaminants from drifting into the cabinet.

□ **Separable hinges** — With these, doors can be lifted off without the need to unbolt hinges or straps.

□ **Drawers**—These store miscellaneous items or built-in electronic components. Many units have drawers with hinged writing surfaces.

One dozen reminders simplify ordering

□ Buy more space than you need. Extra space does not increase cost proportionally and almost always turns out to be needed.

□ Remember that electronic units give off heat. Specify louvers so that the cabinet can "breathe", and leave space for a blower.

□ Order an antitilt base if the cabinet will be filled with weighty or especially costly devices.

□ Order writing surfaces if needed, but remember that retractable trays and drawers may interfere with cooling air flow.

□ Cover tops of low cabinets with laminated plastic for longer wear and better appearance.

□ Consider doors on side and rear openings for easier access.

□ Consider how power will be brought into the cabinet. Order holes or cutouts. Leave space for cables at the rear of the cabinet.

□ Gang cabinet orders to save money. Get together with other departments and take advantage of volume discounts.

□ Choose a cabinet that will look modern five years from now. The cabinet will help to sell your electronics. Specify tough vinyl finishes.

□ Order snap-in replacement panels to fill the holes lest equipment be repaired or replaced.

□ Consider filters or self-contained electronic air cleaners, if cleanliness is a problem.

□ Don't be adamant about dimensions, colors, accessories. Small compromises which will not affect cabinet utility can save money.

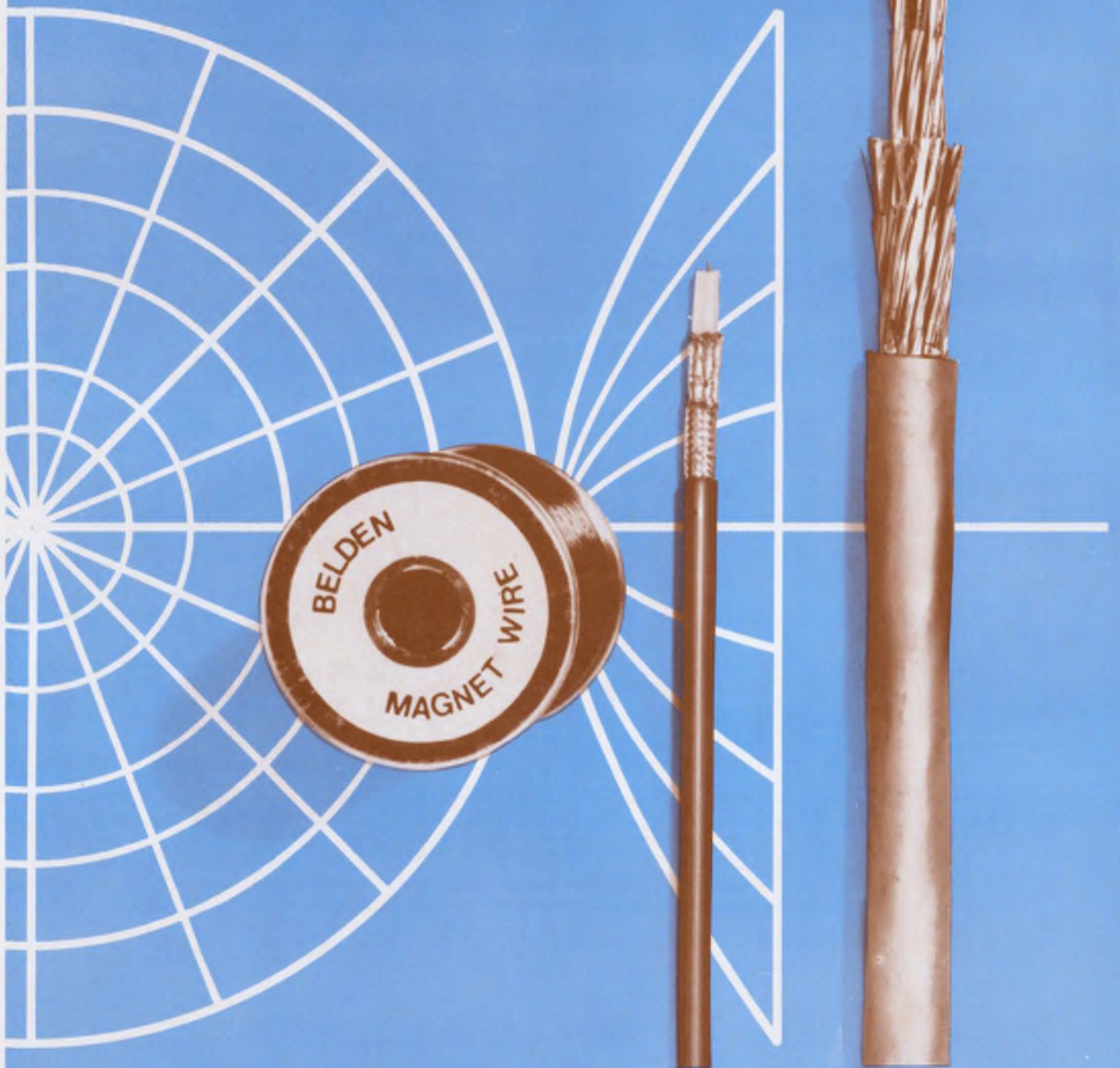

Belden's Wire Specialists know that as systems become more exotic and their functions more difficult, wire becomes more important. Wire carries the messages...conveys the power...links components into true systems. And they know that wire can make a big difference in how well the completed product operates. They know that by prescribing the right wire or cable to



new ideas for moving electrical energy

Belden thinks systems

link each component, they can help simplify designs, enhance reliability, save internal space, even reduce assembly costs. That's worth investigating, isn't it? Then get together with the wire men who think systems. You can reach them at the place that makes all kinds of wire for all kinds of systems — Belden Corporation, P.O. Box 5070-A, Chicago, Illinois 60680.

G-3-7

ON READER-SERVICE CARD CIRCLE 51

Chief engineers urge:**'Let's smooth the path to management'**

Survey shows managers believe that colleges, concerns and professional societies can do more.

Second of two articles

The engineering field does a poor job of preparing men for careers in management, and it's about time it started shaping up.

This is the consensus of engineering managers throughout the nation, a survey by ELECTRONIC DESIGN shows. While recognizing that not every engineer wants to, should or even can move to top management, chief engineers feel that engineering colleges, companies and societies can do more to help those who do want to move up the ladder.

Most chief engineers queried feel that they were not well prepared to move into management. And they say that today's potential chief engineers won't fare any better than they did.

The ingredients for a successful career in engineering management (as disclosed in the first article in this series, "How Can You Become a Chief Engineer?"—ED 21, Oct. 11, pp. 86-91) are as follows:

- Training in business administration and other non-engineering areas of company operation. These include budgeting, cost analysis, marketing and product technology.
- Training in psychology and human relations.
- Continual updating in engineering and technology.
- A broad liberal arts background.

The chief engineers in the survey believe that the engineering field is failing to provide these essentials in sufficient depth, both while the prospective engineer is in college and after he graduates. Chief engineers would like to see many improvements. Let's examine some of their suggestions.

What can engineering colleges do to help engineers prepare for management?

Most chief engineers are sympathetic to the plight of engineering schools today for these major reasons:

- Technology is advancing so rapidly, it is often difficult for colleges to keep up to date from week to week.
- It might be realistically impossible for colleges to offer a range of management, business and liberal arts courses and still give engineers and potential

engineers meaningful technological training in the allotted time.

Despite the sympathetic attitudes, however, most chief engineers feel that schools can do a better job. These are some of their suggestions.

1. *Colleges and institutes should offer more short-term intensive courses, seminars and workshops, as well as semester-long evening courses for engineers.*

These courses should be both in engineering subjects, to keep the engineer technically current, and in business, finance and other management areas, to prepare the engineer for a move into management.

Full-semester or year-long courses during the day obviously are impractical for most employed engineers, both from the standpoint of time and cost.

Today some colleges recognize that the engineer must keep abreast of technology, and they are offering short-term and evening courses. However, most chief engineers feel that neither the number of colleges nor the courses available are sufficient.

ELECTRONIC DESIGN queried all 217 accredited engineering colleges, universities and institutes in the United States and found that only about 10 to 15 per cent plan to offer any type of short-term engi-

Accent on the wide view

ELECTRONIC DESIGN questioned engineering managers across the country to elicit their views on whether engineers are being trained adequately for managerial careers. Care was taken to obtain a diversified distribution of responses, from the standpoint of geography, company size and type of electronics company.

The term "chief engineer" refers to the top engineering manager of the companies queried, regardless of job title. Thus, the survey interviewed men with such titles as chief engineer, vice president of engineering and engineering manager.

The engineering managers quoted and shown on the opposite page are: top left—Robert M. Janowiak (center), Assistant Director, Electronics Research, ITT Research Institute, Chicago; top right—Robert Pease (right), Chief Engineer, Philbrick Research, Inc., a Teledyne Co., Dedham, Mass.; bottom—Richard Harder (left), Vice President, Engineering, Lear Siegler, Inc., Anaheim, Calif.



“Societies have done little in creating the true image to the public of the engineering profession. A concerted public relations effort should be started.”

“Industry should make a greater effort to give engineers an opportunity to learn what management is about before they actually make the move.”

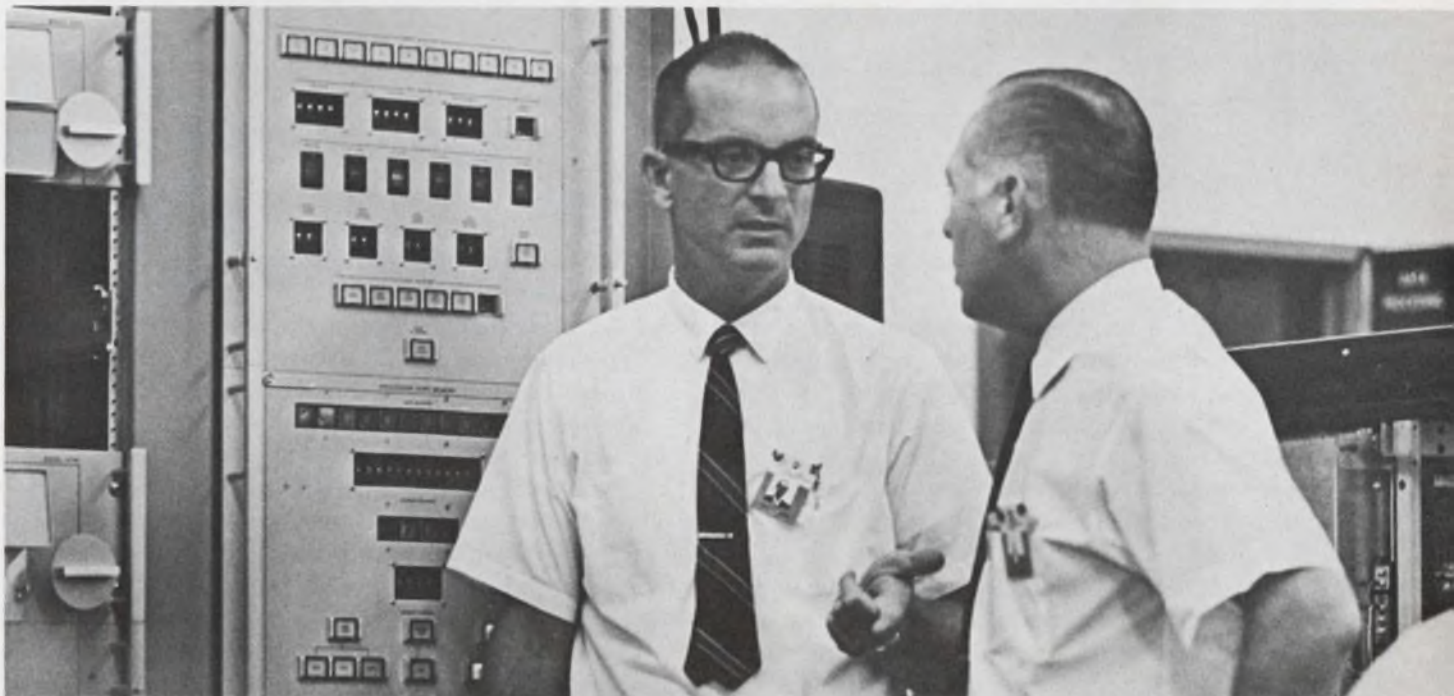

“Engineers are becoming too specialized in their work. A small company or division can’t afford many specialists.”

Colleges, industry and societies can smooth the path to management



neering course during January-May, 1968.

2. *Undergraduate training should be less specialized.*

Chief engineers feel that schools should place more stress on fundamentals and leave the specialization until their students are in industry.

"Too many young engineers become specialists too soon," says one manager. "This is a definite handicap when it comes time for a move into management. Diversification usually is preferred to specialization."

Another chief engineer concurs: "Specialization is not always good. I've seen a lot of engineers with fancy initials after their names who were useless when they came to work for us. They are specialists and couldn't adapt to an environment that required more technical versatility."

In a small firm, especially, specialization can



lead to a dead end. "We have no room for specialists," comments one respondent. "We're too small."

3. *There should be more training in non-engineering subjects.*

There is near-unanimity that the future engineer is not receiving a well-rounded education in college, and this lack seems to continue once he is in the field, chief engineers say.

In general, chief engineers recommend that colleges teach only the fundamentals of technology and devote the rest of the curriculum to such non-engineering areas as business, management and the liberal arts.

"The engineer is not equipped to communicate with other people," says one chief engineer. "He is being educated in the narrow world of technology and nothing else."

Most engineering managers feel that colleges should make some basic management and finance courses requirements for a bachelor's degree.

"Most young engineers are not economically minded," comments one manager. "Schools fail to emphasize economic factors. Only technology is

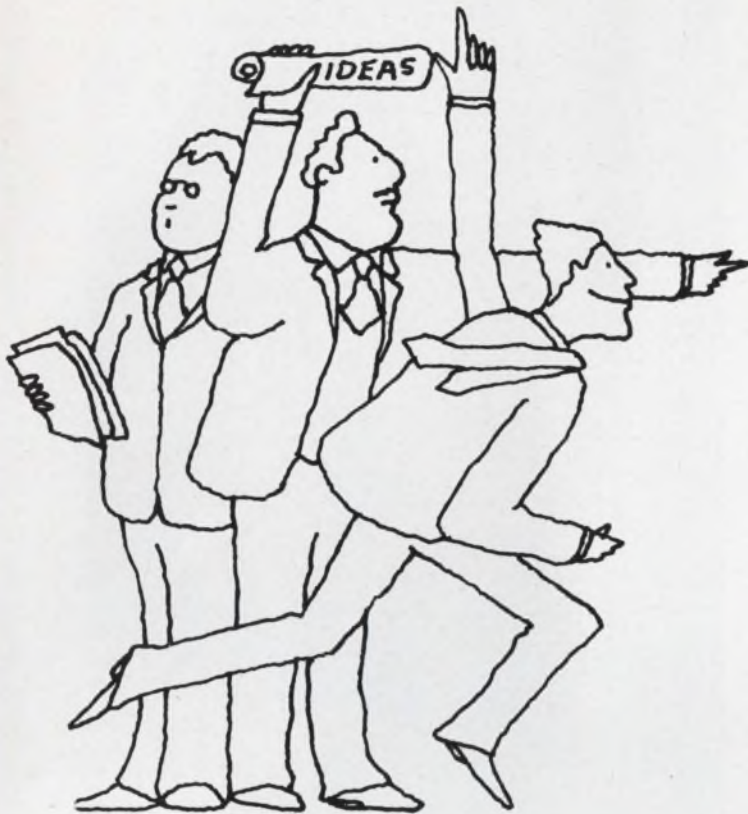

stressed. Thus when the engineer gets into industry, he is ignorant of anything but his own little world of technology."

About 10 per cent of those questioned decry the lack of liberal arts training. They feel most engineers should have a richer cultural background.

What steps can electronics companies take to prepare engineers for management?

Chief engineers cite these areas for improvement:

1. *Electronics companies should offer more internal training programs both in technology and management.*

No matter how many short courses are made available by colleges and institutes, they will never be the complete solution. Many engineers do not have easy access to the schools. And companies cannot always find a specific course that satisfies a particular company need.

A company training program offers these advantages:

- It is physically convenient.
- It can be carried out economically.
- It can be tailored to suit the company's needs.
- It can utilize company personnel who know the specific needs, or bring in the "right person" to do the instructing.

"Too many companies don't realize the full value of their human resources," comments one manager. "We have talented men in a number of areas—both in technological and management terms—and we

take advantage of this fact by having them teach others."

Another observes: "When I want some information about budgeting, I go to the finance department. So if a manager wants his men to learn about finance, why not have the company finance expert teach them?"

2. *Companies can do more to provide engineers with the management "tools" in anticipation of their moves into management.*

"It is not uncommon for a firm to be oblivious to the engineer's future in management until the actual time for promoting someone arrives," says one manager. "While it is true that the engineer must take some of the initiative to improve his management techniques, it is also a responsibility of the company to train its men to become managers. It's a two-way street."

Further, managers say that most companies do not encourage the engineers to gain this management training in advance of their promotions.

As one chief engineer notes: "It is unfortunate that engineers are forced into management when they don't want to or aren't prepared to. I have seen tragic results of this—tragic for both the engineers involved and the company."

How can engineering societies smooth the path to management?

The overwhelming majority of chief engineers are critical of the role that engineering societies are playing today. The managers charge that the societies are not taking the lead in improving the lot of the engineer—a role, they feel, that should be inherent in the societies' existence.

"Engineers don't really regard themselves as professionals, and the societies are at fault," says one chief engineer. "We need stronger engineering societies. They have outdated standards. A more active role by the societies is urgently needed."

I'm not at all happy with the role they play," comments one manager. "There was a time when societies were in a position to present state-of-the-art technical dissertations. They've been watered down over the years and now are nothing."

“Industry should encourage engineers to learn what a business is all about. Too many move into management with narrow technological viewpoints.”

“Engineering students are not learning enough about people. Schools do not have enough time and students would rather deal with things than people.”



Milton Rosenberg, Vice President, Engineering, Electronic Memories, Hawthorne, Calif.



Ervin Leshner, Manager, Value Systems and Controls, Defense Electronic Products, RCA, Camden, N. J.

Another notes: “The engineering societies should be in the forefront in leading the profession, in helping the engineer become a better engineer, in helping the engineer become an engineering manager. Engineering societies have been watered down over the years and now are nothing but prestige factors and sponsors of social functions.”

Chief engineers feel that the societies should encourage the engineer to work toward a managerial career. Specifically, they say, the societies should tell the engineer how it can be done, where he can get the training.

“The societies too often are more concerned with the corporate organization than with the welfare of the individual members,” says one critic.

“The societies are weak,” charges one manager. “They should expend considerably more effort towards improving communications between engineers rather than seeing how high they can sound in their papers. This is generally true with all societies in engineering. We find it hard to find anything that applies to our work.”

And another: “For the most part, engineering

societies have fostered non-professionalism. They claim they’re trying to overcome this by attempting to establish the role of the engineer as somehow similar to the role played by a doctor or lawyer. This is not realistic, as the doctor and lawyer are self-employed. There is a completely different set of ground rules. I don’t know how it can be done, but one way is not by comparing engineers with doctors and lawyers.”

And what can the engineer do himself?

Though much remains to be done by others, top managers are also aware that the engineer must help himself up the managerial ladder.

One respondent sums up the feeling of chief engineers in the survey: “All the efforts of colleges, industries and societies will be wasted unless the engineer realizes and recognizes where and how he must grow—not only technologically but in the other areas which make up the intelligent professional man. And too many engineers don’t regard themselves as professionals. Perhaps this is the starting point for the engineer.” ■ ■

Lockheed's, "secret weapon" for winning electronics engineers

It's scope. A unique range of projects and assignments at Lockheed, covering the entire spectrum of electronics from major systems to solid state devices.

Programs include:

Poseidon and
Advanced

Polaris, strategic
ballistic missiles; P-3C Orion, the U.S.
Navy's foremost ASW search plane and
other airborne anti-submarine

systems; YF-12, the
world's fastest jet,
now in major develop-
ment phase; airborne monitoring
systems; gunfire control systems;
electronic sub-systems; MADAR (Mal-
function Detection Analysis and Record-
ing) equipment; computer-aided design;
memory devices and systems; advanced
3D radar systems; and many more.

Immediate openings at Lockheed include:
Circuit design, hardened circuitry,
metrology, flight control electronics,
reentry electronics, reentry elec-
tronics systems design, underwater
instrumentation, optical/radar
systems, airborne electrical power
systems, hybrid microelectronics,
electromechanical packaging, radar
communications, RF and solid

state circuit design, CRT
and solid state displays,
real-time programming,
memory core design, elec-
tronics systems design, antenna systems,
phased array antennas, microwave de-
vices, and others.

To summarize: Electronics engineers at
Lockheed find themselves in a "choice"
position. With a choice of projects,
assignments and geographic locations
from coast-to-coast.

Address inquiries to Electronics
Engineering
Employment
Manager
at the Company
of your choice.

*Lockheed-California
Company, Burbank,
California. Lockheed Electronics
Company, Plainfield, New Jersey—
for locations in Plainfield as well as
Houston, Texas, Los Angeles, California,
Greenbelt, Maryland. Lockheed-Georgia
Company, Atlanta, Georgia. Lockheed
Missiles & Space Company, Sunnyvale,
California—for locations in Sunnyvale
and Palo Alto, California, or Huntsville,
Alabama. Lockheed is an equal
opportunity employer.*

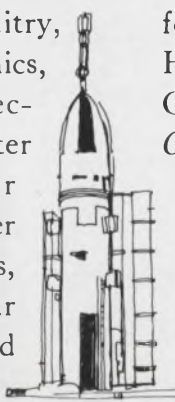
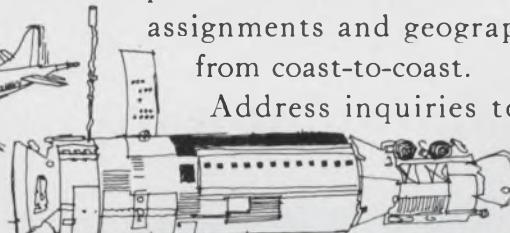
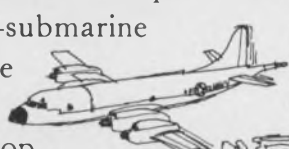
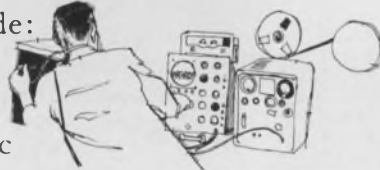
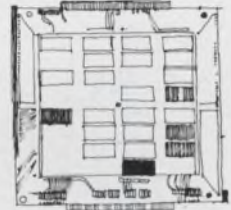

LOCKHEED
LOCKHEED AIRCRAFT CORPORATION

ON CAREER-INQUIRY FORM CIRCLE 901

EE openings on SRAM, Minuteman and other Boeing programs

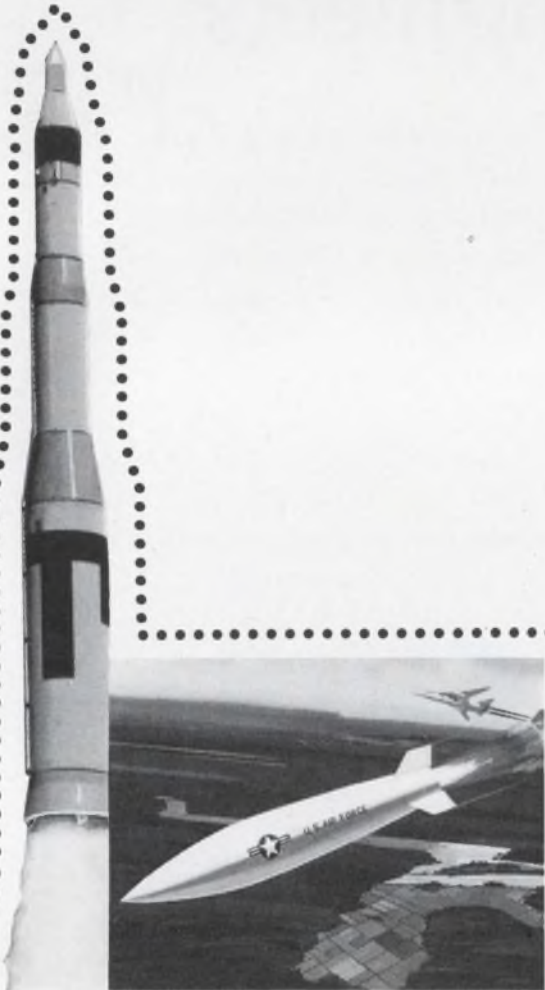

I'm interested in a Boeing career; please contact me with details.

Name _____

Address _____

Phone (incl. area code) _____

City _____ State _____ Zip _____

I'm usually home between _____ and _____ (hours) on _____ (days)

Degree/Field of Interest _____

Please mail to the location of your choice and qualifications: SEATTLE: Mr. J. T. Cartwright, The Boeing Company, P.O. Box 3999-EDG, Seattle, Washington 98124. HUNTSVILLE: Mr. Lee Batt, The Boeing Company, P.O. Box 1680-EDG, Huntsville, Alabama 35807. KENNEDY SPACE CENTER: Mr. G. S. McDaniel, The Boeing Company, P.O. Box 1698-EDG, Cocoa Beach, Florida 32931.

Boeing's deep involvement with the nation's major missile and space programs provides immediate career opportunities for electrical/electronic engineers at Seattle, Huntsville, and Kennedy Space Center.

Boeing is system integration contractor for SRAM, the U.S. Air Force's new Short-Range Attack Missile. The company also is weapon system integrator for the USAF advanced Minuteman II ICBM. In space, Boeing is prime contractor for the National Aeronautics and Space Administration's Lunar Orbiter, the moon-circling spacecraft which is helping NASA scientists select the best landing sites for Apollo astronauts. In addition, Boeing is a major mission-support contractor to NASA on the Apollo/Saturn V program, and is building the first stage of the Saturn V launch vehicle.

Immediate openings exist at Seattle on the SRAM, Minuteman and Lunar Orbiter programs. Assignments in test technology include data systems and instrumentation and test data handling and processing. Qualifications include a B.S. or M.S. in electrical engineering and two to five years applicable experience. Flight technology positions are available in flight control and flight mechanics. Qualifications include a B.S. or M.S. in electrical engineering with two to five years experience.

Additional Seattle openings exist in developmental design and electronic packaging. Design assignments are in airborne control systems, ground system electrical power systems, and environmental control, and require a B.S. degree in an applicable discipline plus related experience. Electronic packaging qualifications include a B.S. in electrical engineering plus applicable experience.

A number of openings also exist on the Apollo/Saturn V program. At Huntsville, assignments in flight mechanics and flight evaluation include operational trajectories, mission analysis, trajectory analysis, post-flight trajectories, flight simulation development, and flight dynamics. Qualifications include a B.S., M.S. or Ph.D. in electrical engineering. Openings also exist for electrical/electronic engineers at Kennedy Space Center.

Salaries are commensurate with experience and educational background. Moving and travel allowances are paid to newly employed personnel. Boeing is an equal opportunity employer.

Please fill in and mail the coupon to the location of your choice and qualifications. A Boeing representative will get in touch with you.

BOEING

MISSILE & INFORMATION SYSTEMS DIVISION
SPACE DIVISION

Other Divisions: Commercial Airplane • Vertol • Wichita
Also, Boeing Scientific Research Laboratories

Free Career Inquiry Service

Absolutely Confidential

Respond to the career opportunities advertised in this issue. Fill out and send us this handy resume. **Electronic Design** will do the rest – neatly typed copies of this form will be mailed to the companies of your choice, indicated by the circled Career Inquiry Numbers at the bottom of this page.

22

Name		Home Phone	
Home Address (Street)		City	State
			ZIP Code
Age	U.S. Citizen	Security Clearance	
	<input type="checkbox"/> Yes <input type="checkbox"/> No		

Prime Experience	Secondary Experience

Desired Salary	Availability Date
-----------------------	--------------------------

Employment History – present and previous employers

Company	City, State	Dates	Title	Specialty
		to		
		to		
		to		

Education – indicate major if degree is not self-explanatory

Degree	College	City, State	Dates
			to
			to

Additional Training – non-degree, industry, military, etc.

Professional Societies

Published Articles

Career Inquiry Numbers:

900	901	902	903	904	905	906	907	908	909
910	911	912	913	914	915	916	917	918	919

ELECTRONIC DESIGN
 850 Third Avenue
 New York, New York 10022

RF CIRCUIT ENGINEERS
SYSTEMS ANALYSIS ENGINEERS
SYSTEMS INTEGRATION ENGINEERS
INDUSTRIAL ENGINEERS
DIGITAL ENGINEERS

SEARCHING FOR

OPPORTUNITY instead of promises?

We can't promise you'll realize all your career objectives at ECI, but we will give you every opportunity. And we'll help you every way we can. The rest is up to you.

CHALLENGE instead of a chance?

Challenges lead to accomplishments. Chances don't necessarily lead to anything. If you like the satisfaction of accomplishing things, you'll like working at ECI. We're objective oriented.

GROWTH instead of a groove?

In our business you can't afford to stop learning . . . to stop growing. At ECI you'll be pushing the state-of-the-art. There are few confining grooves when you explore the unknown.

And LOCATION too?

If you're going to like your job, you might as well like where you're living. We'll pit the St. Petersburg area against anyplace in the U.S. for stimulating, comfortable living.

INVESTIGATE ECI!

We have immediate openings in design and supervision. You'll work on systems and equipment in satellite communications, multiplexing, electronic switchboards, and advanced VHF/UHF communications using microcircuitry and state-of-the-art techniques.

Send your resume, in confidence, to K. S. Nipper, Supervisor of Professional Placement, Electronic Communications, Inc., Box 12248D, St. Petersburg, Florida 33733. (An equal opportunity employer.)



St. Petersburg Division
Electronic Communications, Inc.

ON CAREER-INQUIRY FORM CIRCLE 902

Book Reviews

As a further service to our readers, *ELECTRONIC DESIGN* is now including a Reader's Service number with book reviews. Publishing companies have agreed to supply information about their books to interested readers.

Thinking Course

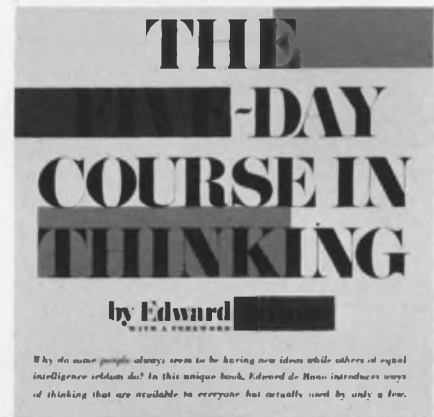

The Five-Day Course in Thinking, Edward deBono (Basic Books, New York), 209 pp. \$5.95.

As self-improvement books go, this is the cleverest, most stimulating and most engrossing to be published in recent years. It doesn't read like a textbook. Talk about reader involvement—this demands it.

Edward deBono challenges the reader with a series of problems which—whether solved or not—makes the reader more aware of how he thinks. His thinking strategies, his strengths and weaknesses—all are revealed.

Ironically, by making his book so fascinating, the author makes one bit of advice impossible to follow: He suggests that the reader work on just one problem at a time and then reflect on it for a day before going on to the next one. Stern will power is needed to stop after working on the first problem. Many will find themselves reading the book at one sitting.

Here are two suggested guidelines for readers:

1. Assuming you can't resist reading it all at once, go ahead. Then read the book a second time and follow the author's recommen-

*Its digital mind,
its analog environment:*

Opportunities for EEs to grow on

... all in a tightly-integrated, multi-disciplinary environment ... for our major product—today's and tomorrow's nuclear submarine—is probably the most sophisticated vehicle extant—bar none.

Which places a lot of responsibility on the architects of her 'nervous system': our electrical and electronic engineers. For without their efforts, a submarine would be merely a pressure-proof hull containing an incredible assortment of complex hardware, instead of a smoothly functioning network of systems, capable of many diverse missions.

If you're getting the idea that being an engineer here is like being an EE nowhere else, you're beginning to see things the way we do. The difference starts with the building blocks you work with—which are in themselves systems. One of the main tasks you'll tackle is interfacing a variety of sub-systems ... which can have you running the gamut from liaison with subcontractors to installation supervision and checkout, to designing A/D or other hardware. Or participating in setting the parameters for systems so advanced you'll be making more precedents than following them.

And this is only the beginning. What makes things even more interesting is the elasticity or nonexistence of interdisciplinary barriers. In a setup where one

Here you'll
find the excitement
of electronics,
navigation,
fire control,
guidance;
nuclear propulsion;
systems analysis;
radar,
radio,
sonar and ECM
systems;
advanced electrical
power and
control systems

PhD astronomer can and does do systems analysis, modelling and feasibility studies, you can expect—and find—the transdisciplinary growing room of a research organization combined with a competitive industry's advancement potential.

If these sound like promises you've heard before, look again. We have a policy—in writing—that mandates this idea to every manager. To move up, he has to develop his own replacement. And to give you a better crack at the job, we back up your talent with the money for advanced-degree education—and with a variety of in-house courses as well.

There's more, too, but we'd like to tell you about it face-to-face. If you're interested in the areas of solid state low frequency circuits; the design of servomechanism and computer circuitry; military applications of digital computers; systems analysis; integration and test development of shipborne radio, radar, sonar and ECM; and the design of low-voltage power plant systems and associated shipborne equipment, we'd like to talk to you about them—and us. Send a resume now to Mr. Frank L. Whitman. U.S. Citizenship is required.

GENERAL DYNAMICS

Electric Boat Division

159K Eastern Point Road, Groton, Connecticut

An Equal Opportunity Employer (M&F)

Major Southern California Aerospace Company, located in the Los Angeles area, has immediate openings for:

TECHNICAL SPECIALIST

Will be responsible for the Systems Engineering that will functionally integrate a large, high-speed data processing laboratory with a space born sensor.

The position will involve developing criteria for integrating a variety of data into a suitable transmission format, specifying adequate error protection, setting overall performance requirements for the processing laboratory, and evaluating subsequent accomplishments.

Pertinent experience would include a direct background in both systems engineering and digital data processing.

SENIOR SYSTEMS ENGINEER

To direct System Design and Analysis of complex visual electro-optical aerospace systems. Will be in charge of a small group of analysts and technical specialists which translates overall requirements into engineering terms.

Should be familiar with optical systems, atmospheric effects and visual detectors such as phototubes, image orthicons and image dissectors.

Will work in the development of state-of-the-art improvements in detection techniques on programs of national significance.

Send resume, including salary requirements to:

**ELECTRONIC DESIGN
BOX 100 ED
850 THIRD AVENUE
NEW YORK, N. Y. 10022**

an equal opportunity employer

**"IT'S GOOD BUSINESS
TO HIRE THE HANDICAPPED."
ISN'T THAT A GREAT IDEA, SNOOPY?**



THE PRESIDENT'S COMMITTEE ON EMPLOYMENT
OF THE HANDICAPPED, WASHINGTON, D. C.

BOOK REVIEWS

dation—a problem a day. In that way, you'll gain the full value.

2. You'll get much more enjoyment and knowledge from the book if you use the equipment cited for each problem, rather than trying to solve the problems in your mind or on paper without props.

Howard S. Ravis

Control Systems

Automatic Control Systems, Second Edition, Benjamin C. Kuo, (Prentice-Hall, Inc., Englewood Cliffs, N. J.), 523 pp., \$13.50.

Principles of analysis and the techniques for design of control systems are presented for use in an undergraduate course. But this updated edition can prove helpful to the practicing engineer as well as a reference in designing and analyzing automatic control systems.

Mathematical preliminary concepts, such as Fourier transform, Laplace transform and Z-transform, make up the first chapter. Thereafter Kuo analyzes the basics of linear systems, using impulse response and transfer functions. The state variable description of linear systems is developed and compared with the transfer function approach.

Time response, stability, root locus and frequency response receive a thorough coverage. How the design of control systems is effected by the frequency domain and root-locus techniques is also discussed.

The final chapter introduces optimal control theory.

CIRCLE NO. 251

Thin-Film Volume

Thin Film Microelectronics, Edited by L. Holland (John Wiley & Sons, New York), 284 pp. \$9.

Six authors have contributed to this volume on thin-film technology as it applies to microelectronics. The two major aspects considered are the electrical properties of passive and active thin-film components and the vacuum apparatus and instruments used in their production.

CIRCLE NO. 252

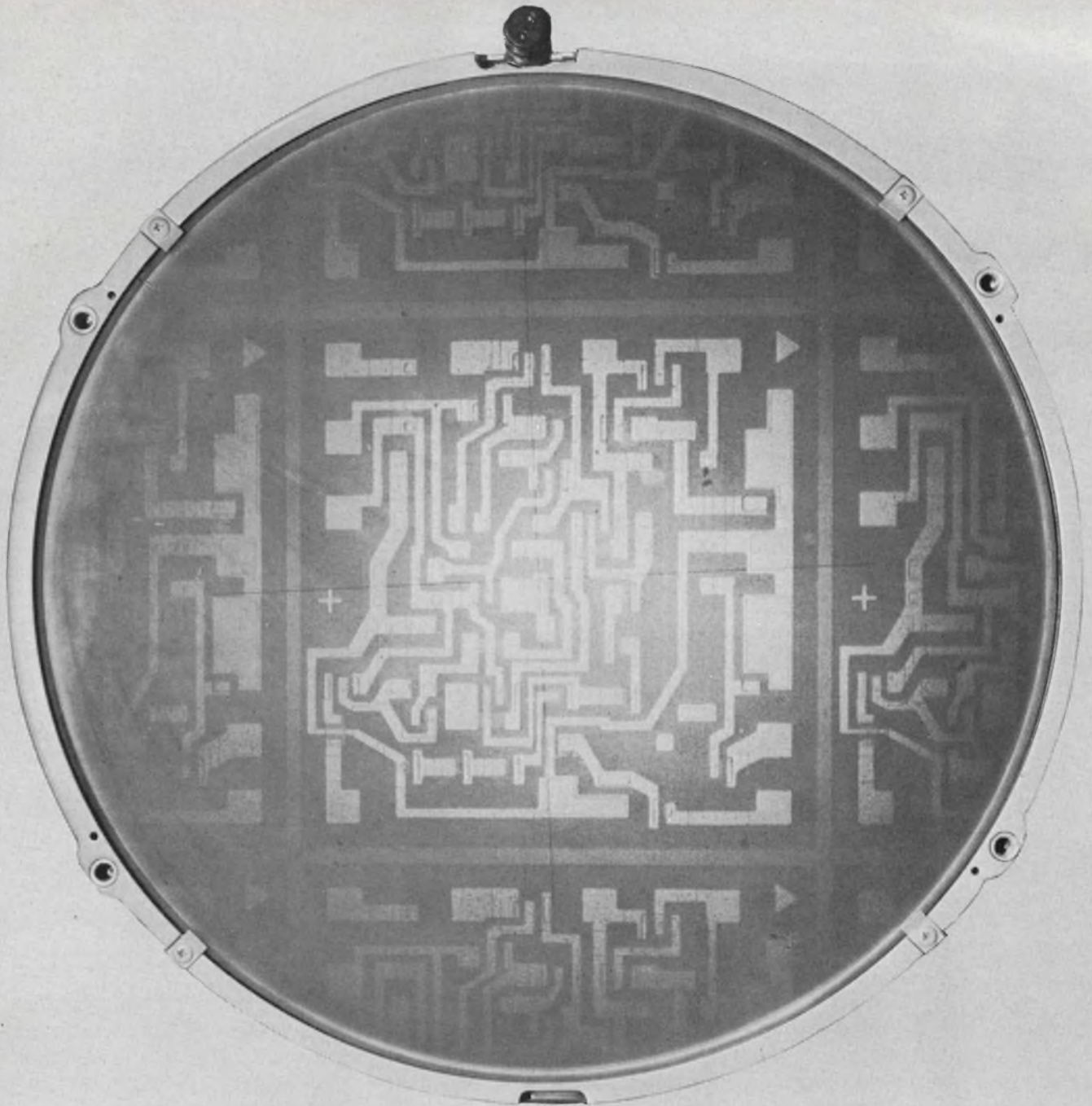

Challenge In Microelectronics

You'll find it at Delco Radio in a variety of research/development and manufacturing programs. Rapid expansion of microelectronics and silicon device projects has created new career opportunities for the B.S., M.S., Ph.D. in Chemistry, Electrical Engineering, Mechanical Engineering, Metallurgy, Physics, Physical Chemistry, and related fields.

Research and Development Programs in:

Linear and digital circuitry, embracing monolithic . . . thick film . . . thin film . . . and hybrid microcircuits

Silicon transistors from low power 10 milliampere through 25 ampere; voltages to 1200

High frequency transistors to 1gHz

Thyristors from 50 milliampere through 500 ampere, 2000 volts

Silicon rectifiers from milliampere through 250 ampere, 3000 volts

Process Engineering Positions:

Unlimited opportunities in this area to develop and create new processes for manufacturing germanium and silicon semiconductor devices, integrated circuits, and automobile radios. Includes development of automatic and semiautomatic fabrication equipment, pilot line operation and general cost savings investigations pertinent to semiconductor manufacturing.

Call us collect for an interview or more information. Area Code 317/459-2808. Ask for C. D. Longshore. Or send your resume to Mr. Longshore, Supervisor, Salaried Employment, Dept. 103, Delco Radio Division of General Motors, Kokomo, Indiana.

DELCO RADIO

DIVISION OF GENERAL MOTORS • KOKOMO, INDIANA

An equal opportunity employer



MARK OF EXCELLENCE

Parallel approach to data-compression

Problem: Devise a faster approach to data processing. Ever-increasing bit rates in telemetry communication have caused processors to become more bulky and complex, due to their serial operation at relatively low speed.

Solution: A novel data-compressor processor concept wherein the system is, at the same time, a zero-order processor, a floating aperture, a variable aperture and a binary integer aperture with a decoded buffer fullness counter directly constituting the aperture.

At the start, two samples are assumed to be available from the same channel in parallel at the analog-to-digital converter (ADC) input-output (I/O) register. One is the present sample, and the other is the last-accepted sample, which is assumed to be available in parallel at the PM (process memory) I/O register. The relative magnitudes of the two samples are to be compared. The amount of the aperture is then added to the smaller one, and the two samples are again compared with the same relative-magnitude comparator. If the result of the second comparison is the same as that of the first, the difference between the two samples is equal to or greater than the amount of the aperture, indicating that the sample is accepted.

Each of the two I/O registers is followed by a copy register, so that the original value can be re-

covered if the outcome of the comparison between the altered and unaltered sample is inconclusive. These copy registers are connected as unidirectional binary counters, with entries at each bit. Connected between the copy registers is a comparator with a single output that is pulsed only when the ADC sample is greater than the PM sample.

The output from the comparator at time t_1 controls the adding of the aperture to either copy register. Because the aperture control is a binary integer, its addition to either copy register is simply a one-term entry to the specific register at the proper position. The copy registers are connected as binary counters with regular forward carries. After the aperture has been added to either copy register, the comparator output at time t_2 will control the transfer of the number from the ADC I/O register to the PM I/O register.

Such a fixed-aperture processor may be modified to provide an exponentially variable aperture that would be a function of the process memory fullness. This requires a shift-right, shift-left shift register that contains all zeroes at any time, except for one "1". These shift-right, shift-left pulses derive from the process memory fullness level markers. The position of the "1" indicates the aperture size 1, 2, 4, 8, 16, 32, etc.

This development is in the conceptual stage only, and neither a model nor prototype has

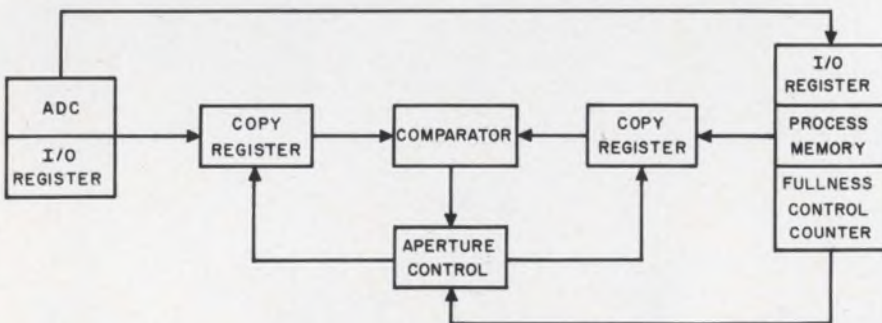

yet been constructed.

Source: Tage O. Anderson, Jet Propulsion Laboratory, (NPO-10068).

Solid-state phase detector replaces transformer circuit

Problem: Design a miniature phase detector to be used in a phase-lock loop of a sub-bit detector in an integrated data-link circuit. The phase detector is to be used in lieu of a bulky transformer circuit commonly incorporated in phase-lock loops. Input requirements must be compatible with standard logic levels.

Solution: Build a solid-state phase detector that uses MOS-FETs (metal oxide semiconductor field-effect transistors) in

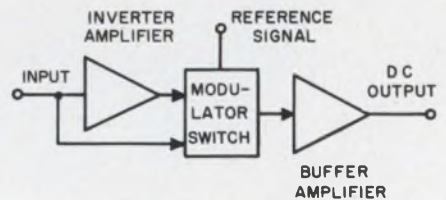

the modulator switch. The detector consists of an inverter amplifier, a modulator switch and a buffer amplifier. The output of the inverter amplifier is a signal 180 degrees out of phase with respect to the input.

The modulator switch performs a mixing function. It provides a signal of fixed amplitude, but opposite polarity, every half cycle at a rate determined by the reference switching frequency. This switching function is accomplished by two MOSFETs, one of which is connected to the input signal and the other to the inverted signal.

Inquiries concerning this invention can be directed to: Technology Utilization Officer, Manned Spacecraft Center, Houston, Tex., 77058. Reference: 67-10253.



**This Babcock
10 amp. relay
also
switches
dry circuit
with the
same contact set**

Now, your Babcock 10 amp. full size crystal can relay will also switch dry circuit with the same set of contacts. These exclusive universal contacts have greatly simplified your relay stocking requirements. You can order one model to meet a given set of performance parameters without concern for load requirement — *at no cost premium*. Get complete information about this versatile relay, and the entire Babcock line, all with universal contacts.

Write Babcock Relays, Division of Babcock Electronics Corporation, 3501 Harbor Boulevard, Costa Mesa, California 92626; or telephone (714) 540-1234.

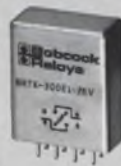

The Babcock Model BR7 relay will perform from dry circuit to 10 amps., with universal contacts, and is designed to meet critical aerospace applications.

SPECIFICATIONS

SIZES
1.300" h. x 1.075" l. x .515" w

WEIGHT:
Approx. 1.0 oz.

CONTACT ARRANGEMENTS:
SPDT and DPDT

PULL-IN POWER:
Low as 80 mw.

LIFE:
100,000 operations, min.

TEMP. RANGE:
-65°C to +125°C

FROM THE BABCOCK FAMILY OF CRYSTAL CAN RELAYS



**TWICE SIZE
4PDT**
dc to 10 Amps.



**FULL SIZE
DPDT**
dc to 10 Amps.



**HALF SIZE
SPDT & DPDT**
dc to 2 Amps.



**SIXTH SIZE
SPDT & DPDT**
dc to 1 Amp.

WATCH FOR BABCOCK RELAYS ON THE EDN MOBILE DISPLAY — SOON IN YOUR AREA.

OSCILLATORS

< 1 Hz to 125 MHz



**FOR
INTEGRATED
CIRCUIT
APPLICATION
COMPATIBILITY**

If your new system is utilizing integrated circuits, let Accutronics assist you with your oscillator requirement. Operating on voltages as low as 3 volts the I.C. Series can provide an output level to drive all forms of gates, flip-flops, multivibrators, etc. Typical output levels would be 2 volts to 2.8 volts peak to peak with a 3 volt supply. Rise and fall times of <20 nanosec. are typical. Sine wave outputs can be provided with <5% distortion and frequency stabilities from $\pm 0.0001\%$ to $\pm .5\%$. Can we be of service? Call collect Area 312, 232-2600.

HG Series



PRICE: \$115.00 to \$185.00

FREQUENCY: 1 MHz to 45 MHz
FREQUENCY TOLERANCE: $\pm 0.005\%$ over temperature range
FREQUENCY ACCURACY: $\pm 0.002\%$ or better at 25°C
TEMPERATURE RANGE: 0°C to +75°C
OUTPUT POWER: Will provide outputs to work into T²L, RTL, DTL, etc. circuitry when specified. Sine wave, 1V rms into 1K with 3 to 15% distortion depending on frequency.
OSCILLATOR VOLTAGE: 3 volts to 30 volts DC as specified
DIMENSIONS: 1½x3½x½" high

NJ Series



PRICE: \$122.00 to \$197.00

FREQUENCY: 500 KHz to 50 MHz
FREQUENCY TOLERANCE: $\pm 0.005\%$ or better over temperature range
FREQUENCY ACCURACY: $\pm 0.002\%$ or better at 25°C
TEMPERATURE RANGE: -20°C to +60°C
OUTPUT POWER: Will provide outputs to work into T²L, RTL, DTL, etc. circuitry when specified. Sine wave, 1V rms into 1K with 3 to 15% distortion depending on frequency.
OSCILLATOR VOLTAGE: 3 volts to 30 volts DC as specified
DIMENSIONS: 1½x1½x½ to 1½" high depending on frequency

accutronics, inc.

628 North St., Geneva, Illinois
Area 312, 232-2600.

ON READER-SERVICE CARD CIRCLE 53

NASA TECH BRIEFS

Light system counts dust to clean up clean rooms

Problem: Develop an instrument for monitoring particles in a clean room. The system must count, categorize and record the particles in the air according to size, and be able to function simultaneously in three separate areas.

Solution: A light-scattering particle counter in which a transducer head transforms light signals into electrical signals. The size-count data are coded at each of three samplers and conveyed by cable to a central data station, where the information is decoded and printed out on paper tape.

The counter consists of a light source, an optical lens arrangement and a photo-multiplier tube. In operation the filament of a lamp is focused on an opening, or slit, of known size in a light-shielding plate. The illuminated slit is imaged, by the optics, into the center of an aerosol stream.

Lenses view air stream

The light, scattered by the particles in the aerosol stream, is collected by a receiving lens arrangement that has a slit of the same size as the slit in the light-shielding plate. The center of the receiving slit is at the center of the aerosol stream. This arrangement examines the air in a cube in space. The photo-multiplier tube only "sees" light when a particle passes through this "viewing volume." The light intensity is a function of particles; the larger the particle, the greater the intensity.

The photomultiplier converts the scattered light into an electrical pulse. The voltage level of the pulse is directly proportional to the intensity of the light. Thus the pulses can be directed to specified channels according to voltage level and can be calibrated for particle size.

The aerosol stream is conveyed through the transducer by a pumping system. A concentric arrangement of two tubes permits the air to travel down the annular space at the same linear velocity as the sample in the inner tube. This arrangement prevents loss of particles into the sample chamber, ensuring that they are counted only once and that the lenses remain clear.

Three samplers were placed inside a clean room. Each transmitted particle-sized data to the data center, placed outside the room.

Inquiries concerning this invention may be directed to: Technology Utilization Officer, Marshall Space Flight Center, Huntsville, Ala., 35812. Reference: B67-10076.

ON READER-SERVICE CARD CIRCLE 54 ➤

The simpler the better.

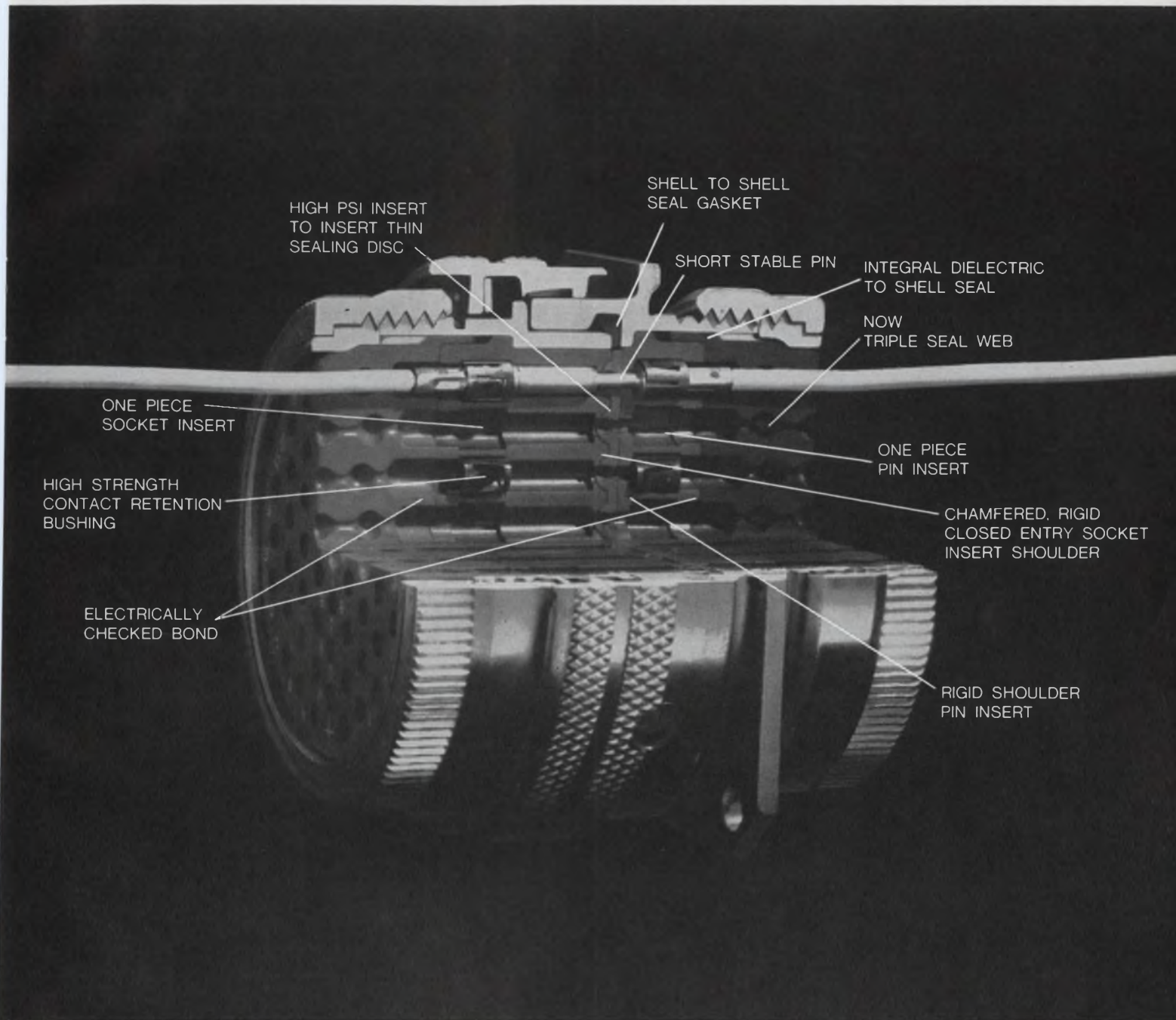

Design simplicity. That's what makes Bendix® JT connectors so reliable. As you can see, Bendix JT connectors have plenty to show: One-piece socket inserts. One-piece pin inserts. Single-piece interfaces. Shell-to-shell sealing without extra

components. Plus other features, shown above, that speak for themselves, purely and simply.

What about versatility? Choose from a host of options. Crimp, solder, standard temperatures, high temperatures, grommeted and potted

versions. Hermetic seals in 8 shell types, 9 shell sizes. Choose, too, from 35 insert patterns, 16-, 20-, 22- and 22M-contact sizes that will accept a wire range of 16 through 28 gage. Contact **Electrical Components Division** in Sidney, New York.

Bendix **Electronics**

Multioutput phase shifter uses one transistor

Figure 1a shows a standard phase-shifting circuit which develops a constant-amplitude, variable-phase voltage, e_3 , which is adjustable in phase from 0° to 180° by varying R_3 from zero to infinity. The open-circuit gain of Q_1 is given by:

$$G = e_2/e_{in} = (1 + R_2/R_1) = 2.$$

It is not generally realized that the collector-to-emitter output impedance, Z_2 , is very low, and hence the phase of e_2 is practically independent of the phase of Z_L . Z_2 is given approximately by:

$$Z_2 = (1 + R_2/R_1)R_e = 2R_e = 40 \text{ ohms,}$$

where

$$R_e = 30/I_{dc} \text{ mA.}$$

The collector-emitter impedance for Q_1 is only twice the output impedance of the same transistor used as an emitter follower.

The fact that the phase of e_2 is nearly independent of Z_L is reasoned as follows. The emitter signal voltage is always within a few per cent of e_{in} , because of the low value of R_e . From this it follows that the collector voltage is always within a few per cent of its open-circuit value, because of

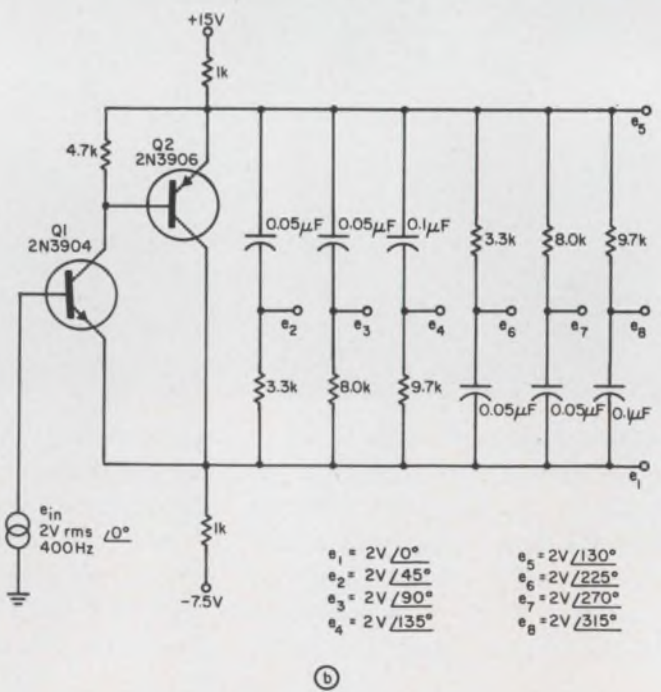
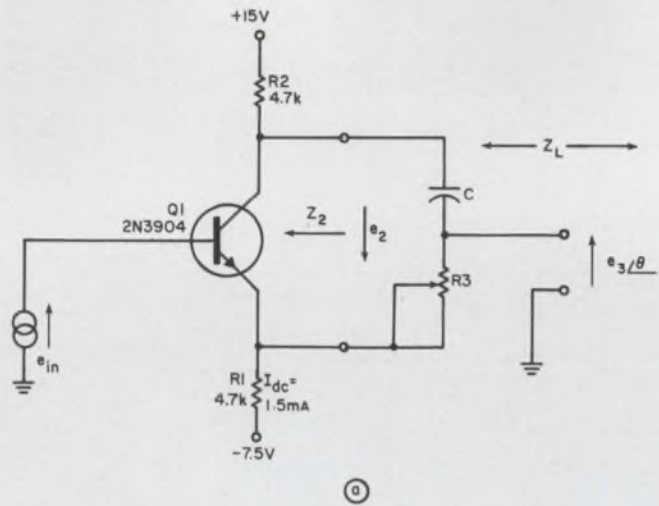



VOTE! Go through all Idea-for-Design entries, select the best, and circle the appropriate number on the Reader-Service-Card.

SEND US YOUR IDEAS FOR DESIGN. You may win a grand total of \$1050 (cash)! Here's how. Submit your IFD describing a new or important circuit or design technique, the clever use of a new component or test equipment, packaging tips, cost-saving ideas to our Ideas-for-Design editor. You will receive \$20 for each accepted idea, \$30 more if it is voted best-of-issue by our readers. The best-of-issue winners become eligible for the Idea Of the Year award of \$1000.

1. Low output impedance, Z_2 , of only 95 ohms is obtained in the phase-shifter circuit (a). Multiple-output phase shifter uses two transistors to obtain output impedance of 2 ohms and eight independent phase-shifted outputs.

What are you looking for in low-cost counters?

It's probably in one of these.



The HP 5221A is the lowest cost frequency counter with a 5 Hz to 10 MHz counting range, and it's perfect if you only want to measure frequency or totalize. Time base is controlled by power line frequency. Gate times are 0.1 and 1 second. Maximum input sensitivity is 100 mV, with sensitivity control on the front panel. Input impedance is 1 M Ω /30 pF. It's only 6¼"Hx5⅛"Wx11"D. Four-digit readout is standard. Price: \$350. Add \$75 and \$125 for 5- and 6-digit versions, respectively.

The new HP 5221B is a more accurate and versatile version of the 5221A. Five-digit readout is standard, and the time base is a crystal oscillator. Gate times are 0.01 to 10 seconds, and BCD output (for printers, etc.) is standard. For added convenience, there's a front-panel stepped attenuator for counting higher input voltages. Counting range is 5 Hz to 10 MHz. Price: \$700. Add \$75 for 6-digit version.

The HP 5216A offers a great versatility in an economical instrument. It measures frequency, time interval, period, multiple period average, frequency ratio, multiple ratios, and will totalize. It has 7-digit readout, 3 Hz to 12.5 MHz frequency range, 10 mV input sensitivity, 1 M Ω /50 pF input impedance and a crystal time base. Size is 6¼"H x 7¾"W x 11"D. Price: \$925.

All models have readout storage for a non-changing display during each gate interval. And, for speed in reading, needless zeros to the left of the first significant figure are automatically suppressed by unique, HP integrated circuits.

For more information call your local HP field engineer or write Hewlett-Packard, Palo Alto, Calif. 94304; Europe: 54 Route des Acacias, Geneva.

HEWLETT  PACKARD

ELECTRONIC COUNTERS

ON READER-SERVICE CARD CIRCLE 55

the low value of Z_2 . This means that any number of phase-shifting networks, Z_L , can be connected in parallel across the output and adjusted independently to any desired angle with no interaction. Their number is limited only by the amount of load current that can be delivered by the transistor. Figure 1b shows an eight-output phase shifter with outputs every 45° . The two-transistor driver has an internal impedance of 2 ohms. All outputs should work into open-circuit loads. Each output can be independently adjusted for its proper phase without affecting any other output.

Allan G. Lloyd, Project Engineer, Avion Electronics, Inc., Paramus, N. J.

VOTE FOR 110

Single class-B stage yields low-distortion 500-mA drive

During an investigation of magnetic properties of ferrite cores to be used as analog memories, the need arose for a low-distortion sinusoidal-current core drive.

The single-stage class-B amplifier in Fig. 1a was built and performed better than expected with respect to distortion, even without feedback. In the photo (Fig. 1c) the waveforms of the output current and of a half wave of this current at 3 kHz and 500 mA peak to peak are shown. The results of tests made with the model 330-B HP distortion analyzer over a range of 20 Hz to 20 kHz are given in the table. These results were

obtained by adjusting potentiometers $R1$ and $R2$ for an output current of 80 mA pk-pk and a frequency of 3 kHz and then varying the amplitude and frequency of the input voltage to the amplifier. By adjusting the circuit at each particular condition of operation, results even better than those listed can be obtained.

If lower distortion is needed, a somewhat more complex circuit show in Fig. 1b can be used. Within this circuit a distortion of less than 0.3%

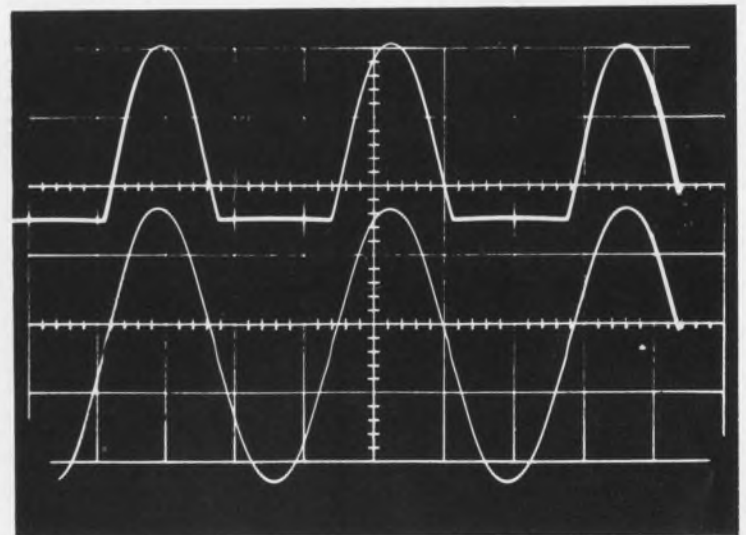
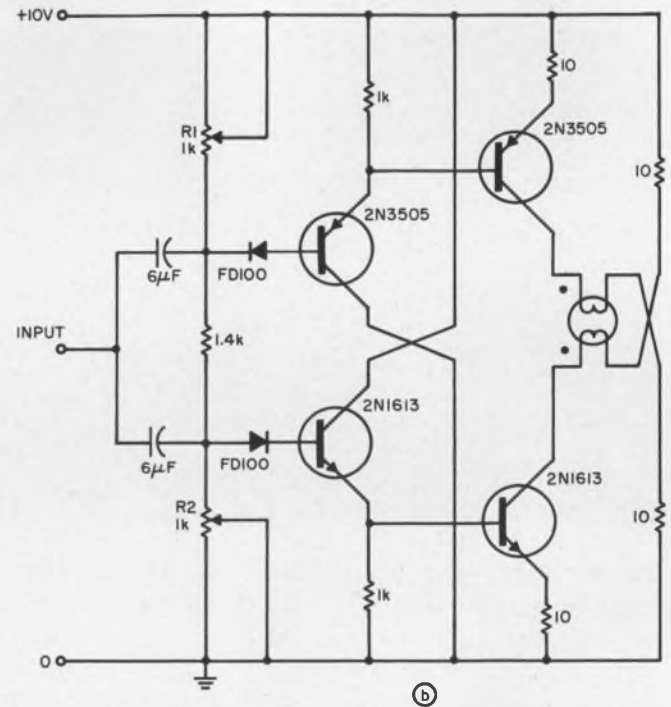
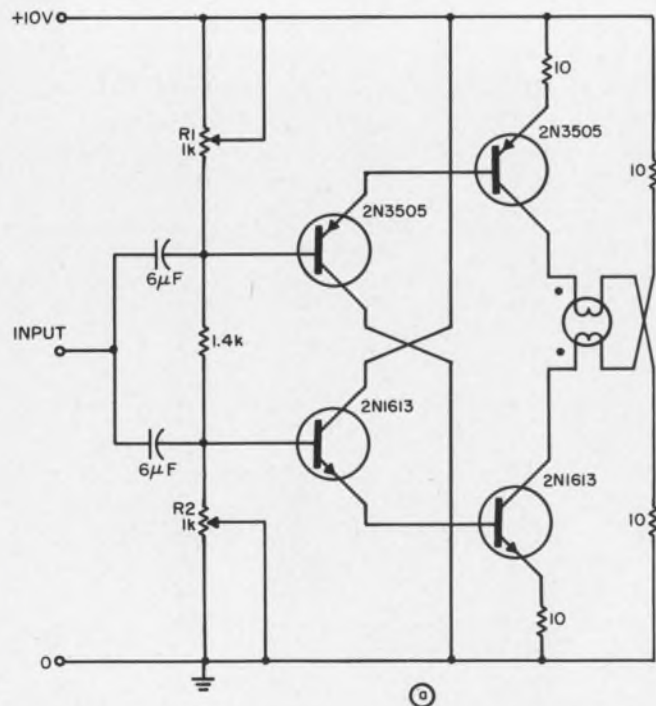

1. High-current and low-distortion core driver is possible with a single class-B stage (a). Test results appear in the table and current waveforms in (c). Even lower distortions can be obtained with the circuit (b).

Designed AS An Industrial...

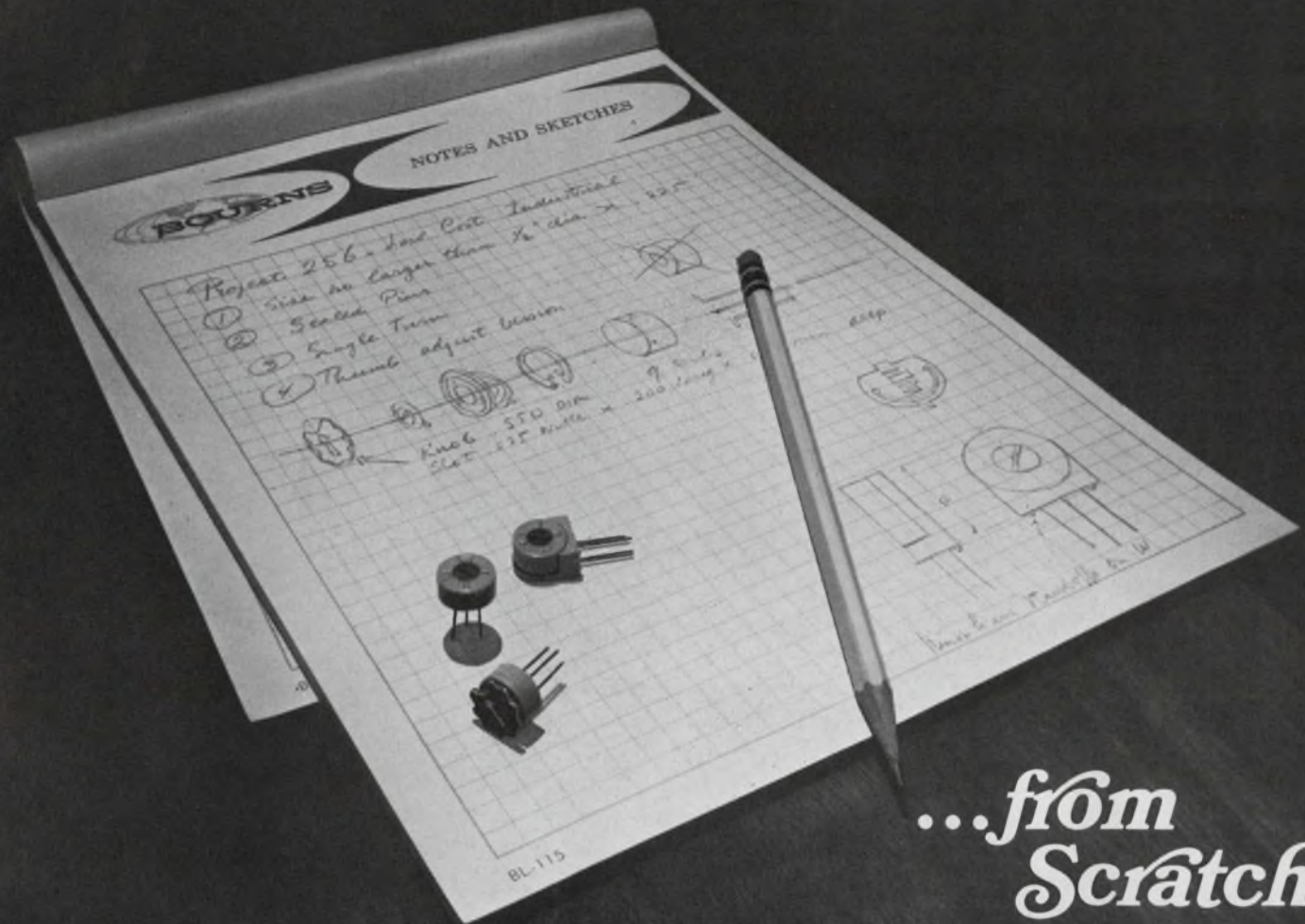

...from
Scratch

The Model 3365 TRIMIT[®] adjustment potentiometer is an industrial unit . . . designed from the ground up for industrial applications. It is brand new! This low cost single-turn wirewound unit is available in two printed circuit styles . . . each style is also available with thumb adjustment knob. Standard and special resistances are from 10 ohms to 50K. Resistance tolerance is $\pm 5\%$. It is small . . . $\frac{1}{2}$ " diameter by less than $\frac{1}{4}$ ". It is light weight . . . approximately 0.05 oz., in an all-plastic case.

There are several other points we would like to mention about the Model 3365. Its pins are sealed, its terminals gold plated, making it suitable for production fluxing and soldering processes employed on printed circuit boards. The exclusive SILVERWELD[®] process is used, thus eliminating vulnerable single wire terminations.

We think you will be even more impressed when you have read the complete, detailed specifications and technical data . . . they are available to you by contacting your nearest Bourns office or representative, or writing the factory direct.

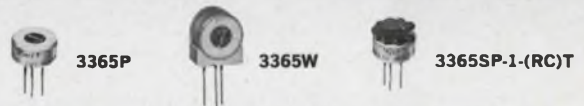

SPECIFICATIONS:

Standard Resistance Range	10 to 50K ohms
Resistance Tolerance	$\pm 5\%$ standard
Resolution	0.08 to 0.88%
Power Ratings:	
40°C Ambient	0.5 watt
105°C Ambient	0 watt
Operating Temperature Range	-55 to +105°C
Temperature Coefficient	70 PPM/°C
Humidity, MIL-STD-202, Method 103	100 megohms min. insulation resistance
Shaft Torque	8 oz-in max.
Mechanical Adjustment	280° nominal

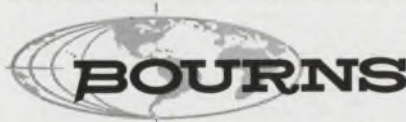

BOURNS, INC., TRIMPOT DIVISION • 1200 COLUMBIA AVE., RIVERSIDE, CALIF.
TELEPHONE 714 684-1700 • TWX: 910-332 1252 • CABLE: BOURNSINC.

OUTPUT CURRENT pk-pk(mA)	FREQUENCY (Hz)	DISTORTION (%)
500	20	1.50
"	400	1.30
"	3000	0.88
"	20000	0.92
80	20	2.50
"	400	1.15
"	3000	0.90
"	20000	0.80

was obtained at 20 kHz with the output current of 500 mA pk-pk.

M. Minuti and G. V. Pallottino, Electronics Laboratory, National Committee for Nuclear Energy, Rome, Italy.

VOTE FOR 111

Constant-pulse-width generator is built with integrated circuits

In applications requiring the generation of a constant-width pulse (such as a frequency-to-dc converter), a common technique is to trigger a monostable multivibrator to generate the constant pulse width. For moderate accuracy, this approach is satisfactory. For accuracies better than 0.1% the monostable multivibrator falls short because of the effects of temperature and power supply variations.

The circuit shown is a simple way to obtain an accurate pulse width. It is designed to generate a constant-width negative pulse for each trigger

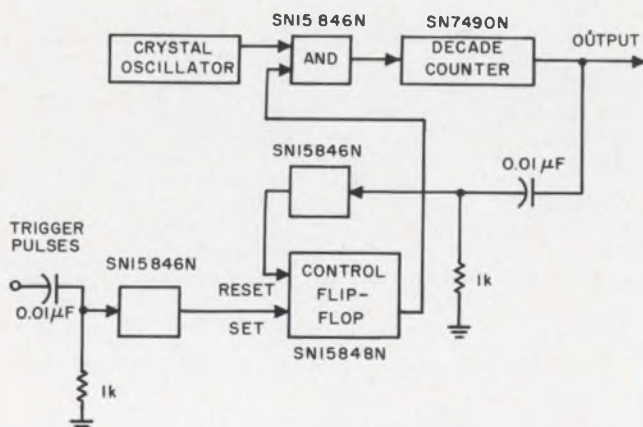

A constant-width negative pulse is generated for each trigger pulse. The accuracy of the circuit is a function solely of the crystal oscillator.

pulse. The accuracy and stability is a function only of the crystal oscillator. Oscillators with 0.001% stability characteristics are relatively inexpensive and readily available.

Initially the decade counter and the control flip-flop are in a reset state. The clock pulses are blocked by the AND gate. An input trigger sets the flip-flop, enabling the AND gate and permitting the clock pulses to feed the counter. After 5 clock pulses, the counter output swings negative. After another 5 clock pulses, the counter output swings positive. The positive-going edge resets the control flip-flop, blocking clock pulses. The counter is also in its reset state at this time, and the circuit is now ready for the next trigger pulse.

The negative output pulse is always exactly 5 clock periods wide, regardless of the timing of the trigger pulse with respect to the clock pulse. The initial time from the trigger pulse to the leading edge of the output pulse can vary as much as one clock period, but is of no consequence, since the aim is only to produce one constant-width pulse for every trigger pulse.

Any clock frequency and divider combination could be used, provided that the clock period be related to the minimum trigger period by the following:

$$\text{Clock period} \leq \frac{\text{Minimum signal period}}{\text{Counter capacity} + 1}$$

In the circuit shown, the clock period is equal to 1/11 of the minimum period of the triggers.

Albert S. Palatnick, Designer, Jericho, N. Y.

VOTE FOR 112

Band-pass filter has asymmetrical response shape

For applications such as sideband selection or duplexing, the use of bandpass filters with asymmetrical response shapes might be desirable. This can be achieved readily by substituting the modified shunt section of Fig. 1b for the conventional shunt section of Fig. 1a. This substitution is made for all resonant circuits in a multiresonator band-pass filter network. The tank inductance, L_r , of the conventional section is replaced by the series resonant circuit LC . This circuit resonates on the low-frequency skirt of the filter stopband and is inductive in the filter passband. This net inductance achieves antiresonance with tank capacitance C_r , providing a frequency of complete transmission.

A popular lumped-circuit bandpass filter used for small-percentage bandwidths is shown in Fig. 1c. Conventional shunt sections have been re-

ARNOLD IS

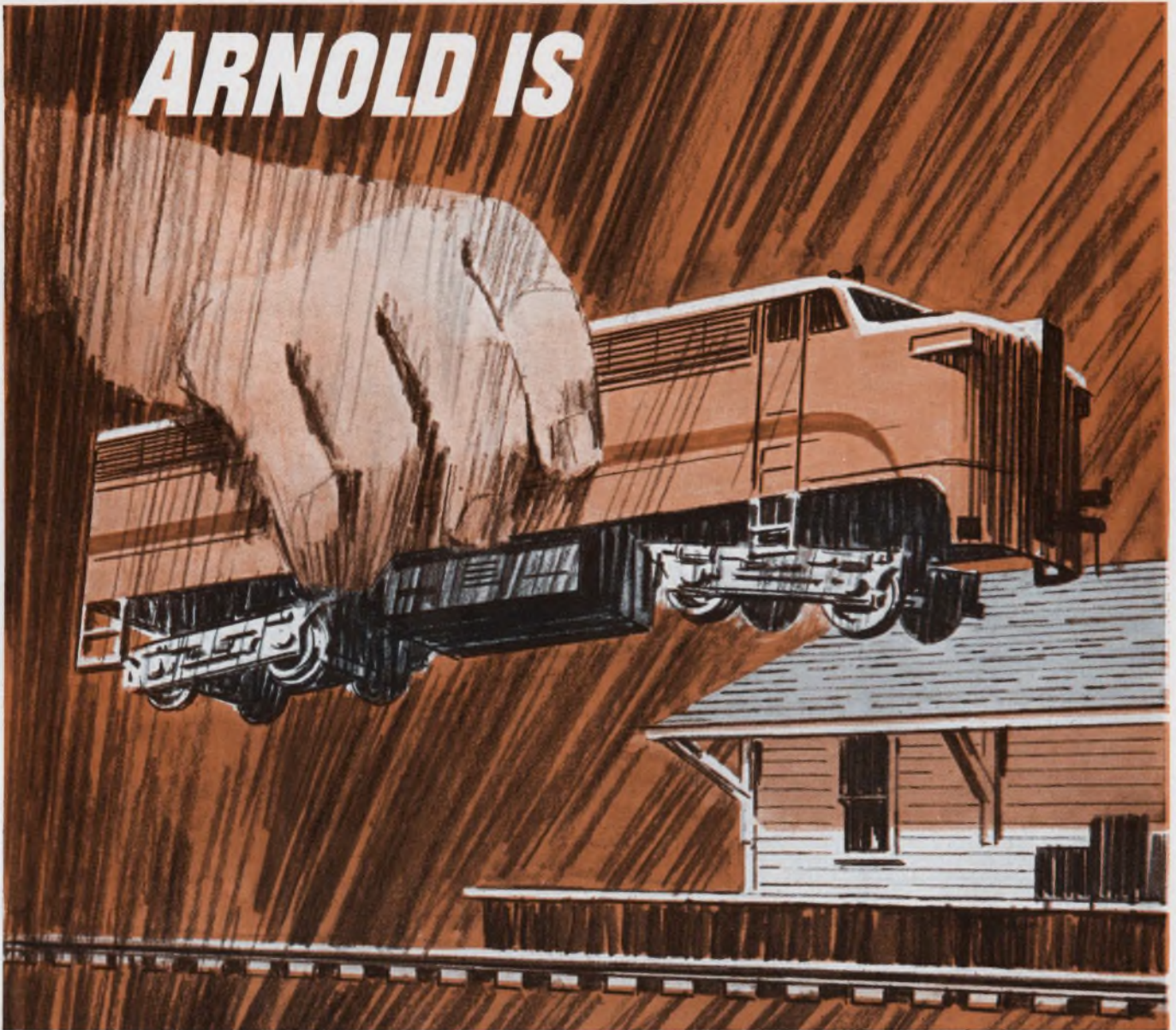

ELECTRICAL ALLOY TRANSFORMER LAMINATIONS

Our transformer laminations are used in every conceivable application from toys to sophisticated military space equipment.

We stock standard sizes in DU, E, EE, EI, F, LE, L, UI. We also have facilities for custom designs to your specifications. Chemically milled ultra-thin laminations and parts are also available. Silicon laminations only available west of the Rocky Mountains. Write for Catalog PD-122A.

Arnold is also ■ Permanent Magnets ■ Tape Wound Cores ■ MPP Cores
■ Magnetic Shielding ■ Transformer Cans and Hardware ■ Bobbin Cores
■ Silectron Cores ■ Special Magnetic Materials.

 **ARNOLD**
SPECIALISTS in MAGNETIC MATERIALS

THE ARNOLD ENGINEERING COMPANY, Main Office MARENGO, ILL.
BRANCH OFFICES and REPRESENTATIVES in PRINCIPAL CITIES

ON READER-SERVICE CARD CIRCLE 57

placed by modified shunt sections. Capacitors C_{01} are input/output couplings and capacitor C_{12} is the interstage coupling. When C approaches infinity, the modified section reduces to a conventional section.

If conventional sections are used, the bandpass filter can be designed for a Butterworth response shape described by:

$$L = 10 \log [1 + x^4], \quad (1)$$

where:

- L = insertion loss in dB,
- $x = 2 (f - f_0) / \Delta f$ = normalized frequency variable,
- f = frequency,

f_0 = center frequency,
 Δf = 3-dB bandwidth of Butterworth prototype.

Using modified sections, Eq. 1 becomes:

$$L = 10 \log \{1 + \langle x / [1 - (f_p/f)^2] \rangle^4\}, \quad (2)$$

where f_p = frequency of peak rejection—that is, series resonant frequency of LC . The series resonant circuits are designed to give the same net inductance at f_0 as the Butterworth prototype.

The response shapes of various two-resonator bandpass filters are plotted in Fig. 1d. The quantity Δf , wherever used, is the 3-dB bandwidth of the Butterworth prototype. The actual 3-dB bandwidth using modified shunt sections is:

$$\Delta fm \cong \Delta f / [1 - (f_p/f_0)^2]. \quad (3)$$

Richard M. Kurzrok, Consultant, New York.

VOTE FOR 113

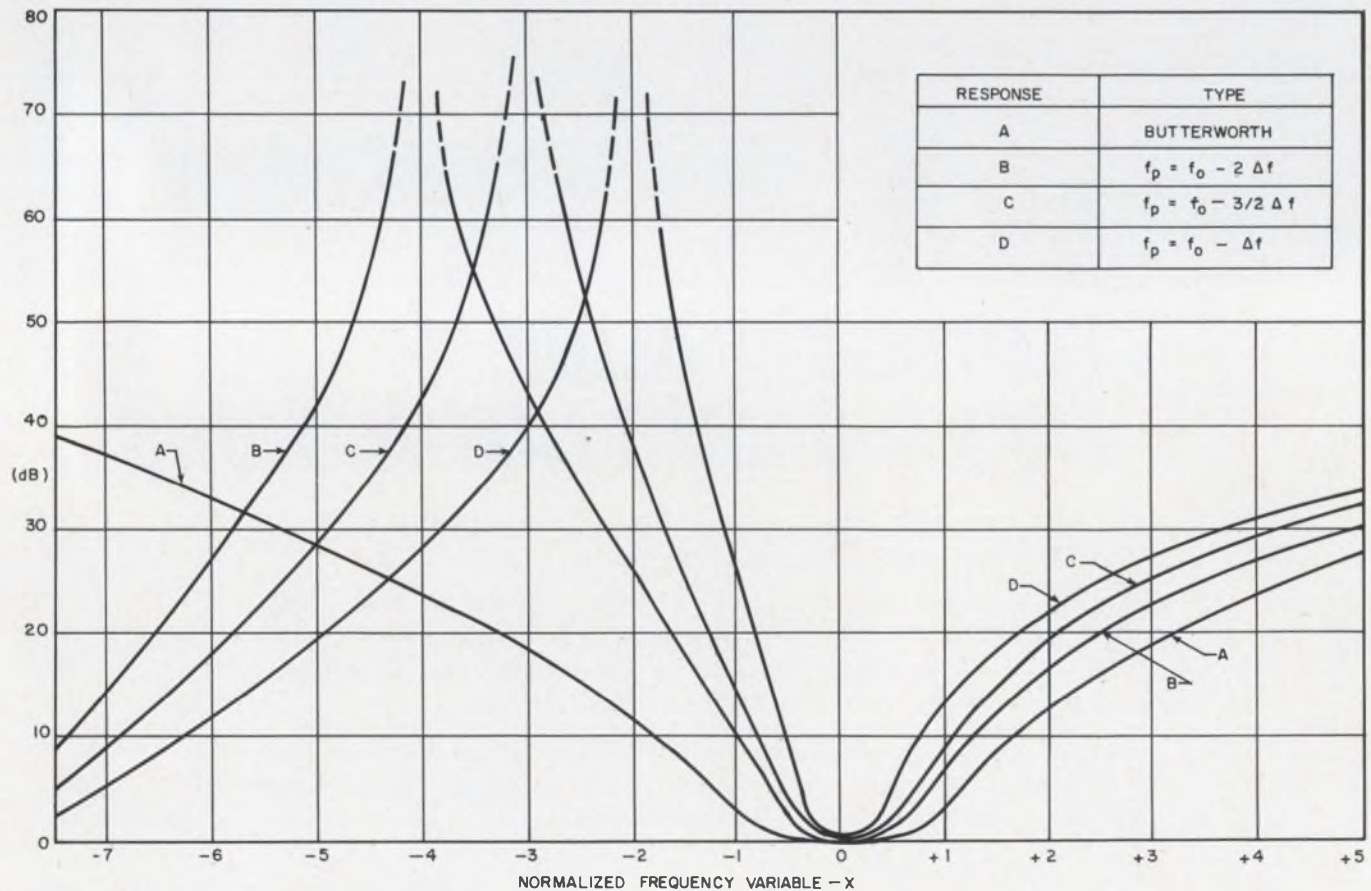
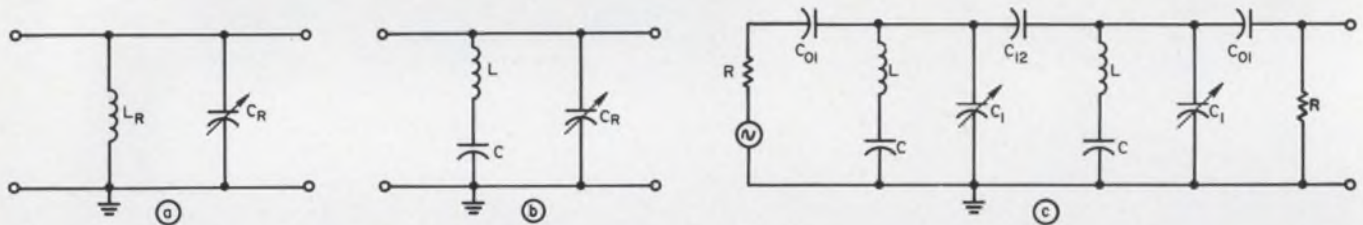

1. **Asymmetrical response shapes** can be obtained by replacing conventional bandpass-filter shunt section (a) with a modified one (b). A two-resonator, capacitively-

coupled bandpass filter with a modified shunt section is shown in (c); its response curves appear in (d) for several values of frequency of peak rejection, f_p .

Our I.C. digital modules reject more noise than anybody's.

Integrated flip-flops, inverters and buffer amplifiers in T Series modules are made to our proprietary design and hermetically sealed in TO-5 cans.

Full-width copper ground plane sandwiched between epoxy-glass boards minimizes circuit inductances and discourages noise spikes. Mounting cases also have full-width shield planes to retard noise coupling between logic wiring.

T Series input and load resistors, made to much tighter tolerances than can be attained with integrated components, are mounted outside the integrated circuit containers, eliminating power dissipation problems.

Discrete input diodes enable us to place the switching threshold right in the middle of the logic swing.

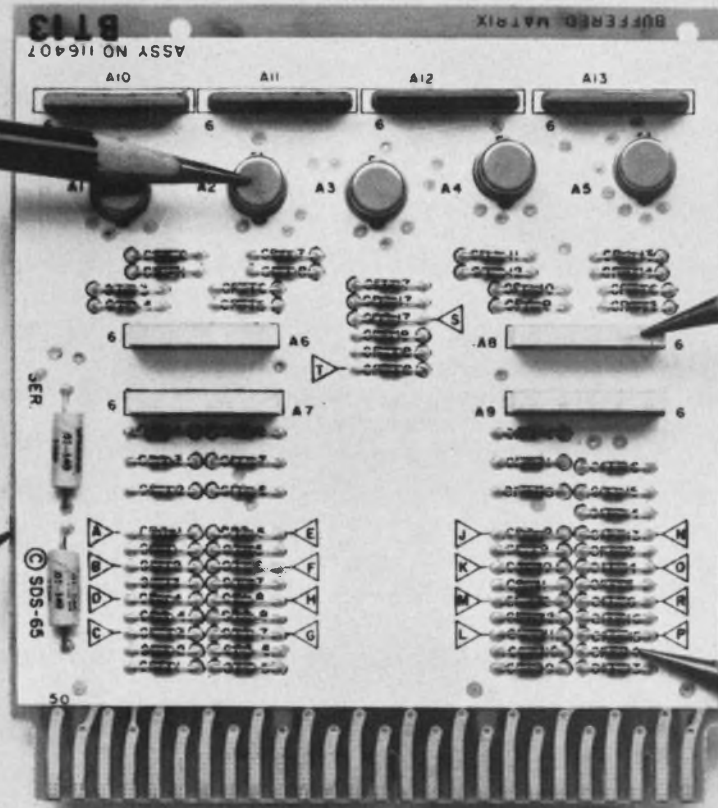

The payoff.

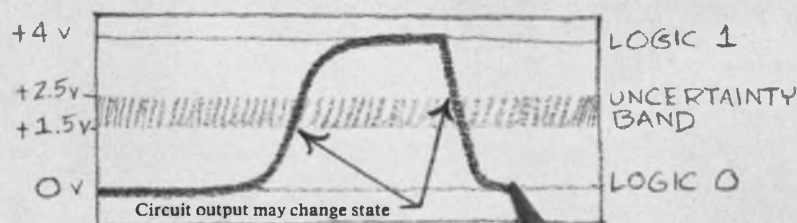

T Series logic levels are 0 and +4 volts, and noise rejection is 1.5 volts minimum, leaving a maximum uncertainty band only one volt wide within which noise can trigger the circuit output. This uncertainty band of 25% is far narrower than those of other I.C. modules on the market.

SDS
Scientific Data Systems,
Santa Monica, California

An 'operational' peak detector captures very narrow pulses

There are some inherent disadvantages in the common methods of peak detection with a capacitor and diode (Fig. 1a) or an emitter follower (Fig. 1b) to create a dc voltage proportional to the peak amplitude of a signal. If a diode is used, severe loading of the signal occurs as the diode becomes forward-biased and the capacitor is charging. In order partially to overcome this loading effect, an emitter follower is often used in place of the diode. If the need arises for greater signal isolation or faster response, emitter followers can be cascaded to obtain the necessary gain. But this "stacking" also has its drawbacks. Because of the increased voltage drop of base-emitter junctions in series, the circuit loses its sensitivity to small peaks. The resulting offset in the output also destroys the linearity between input and output if both large and small increases in peak amplitude are to be detected.

The "operational" peak detector (Fig. 1c) was developed to perform the same task as the ordinary diode or emitter-follower peak detector, but in a more refined manner. The design combines switching techniques with feed back, to obtain fast response and an exact proportionality of the

dc output to the input signal peaks. A circuit of this type can be made to exhibit a very low threshold, so that it can respond to very slight increases in peak amplitudes.

This circuit offers a solution to the sometimes stringent requirements of peak detection. The bench model of the circuit captured pulse widths as narrow as 0.2 μ s, using a repetitive signal with a duty cycle much less than 1%. The relationship of output to input was constant, regardless of amplitude. On a single-pulse basis, the storage capacitor will charge to -5 volts in about 12 μ s from a fully discharged state.

The heart of the detector in Fig. 1c is an integrated-circuit differential comparator (Fairchild μ A-710), which samples the peak amplitude of the incoming signal and compares it with the existing dc output voltage. The comparator drives a level shifter, which is used to control the transistor switch that supplies current to the storage capacitor.

The charge on the capacitor is isolated from the output by a field-effect transistor (FET), used as a source follower, to obtain a long discharge time. The FET then drives an emitter follower to provide a lower-impedance output.

The output is brought back to the other input of the comparator to provide a sample of the dc level.

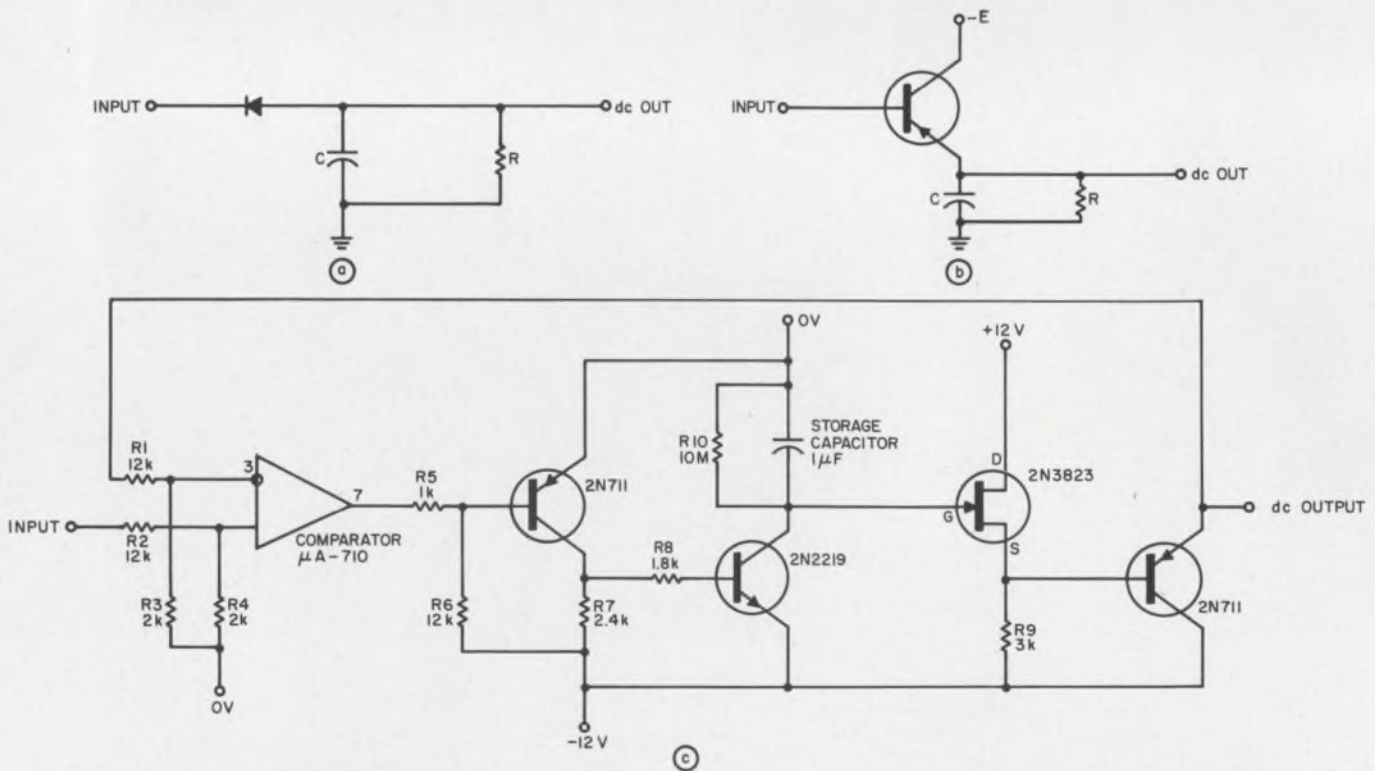

1. "Operational" peak detector circuit (c) is superior to either of the common detectors (a and b). It can detect

repetitive pulses with duty cycle of less than 1% as narrow as 0.2 ms.

IF RACK-AND-PANEL CONNECTORS DISTURB YOUR PEACE-OF-MIND...

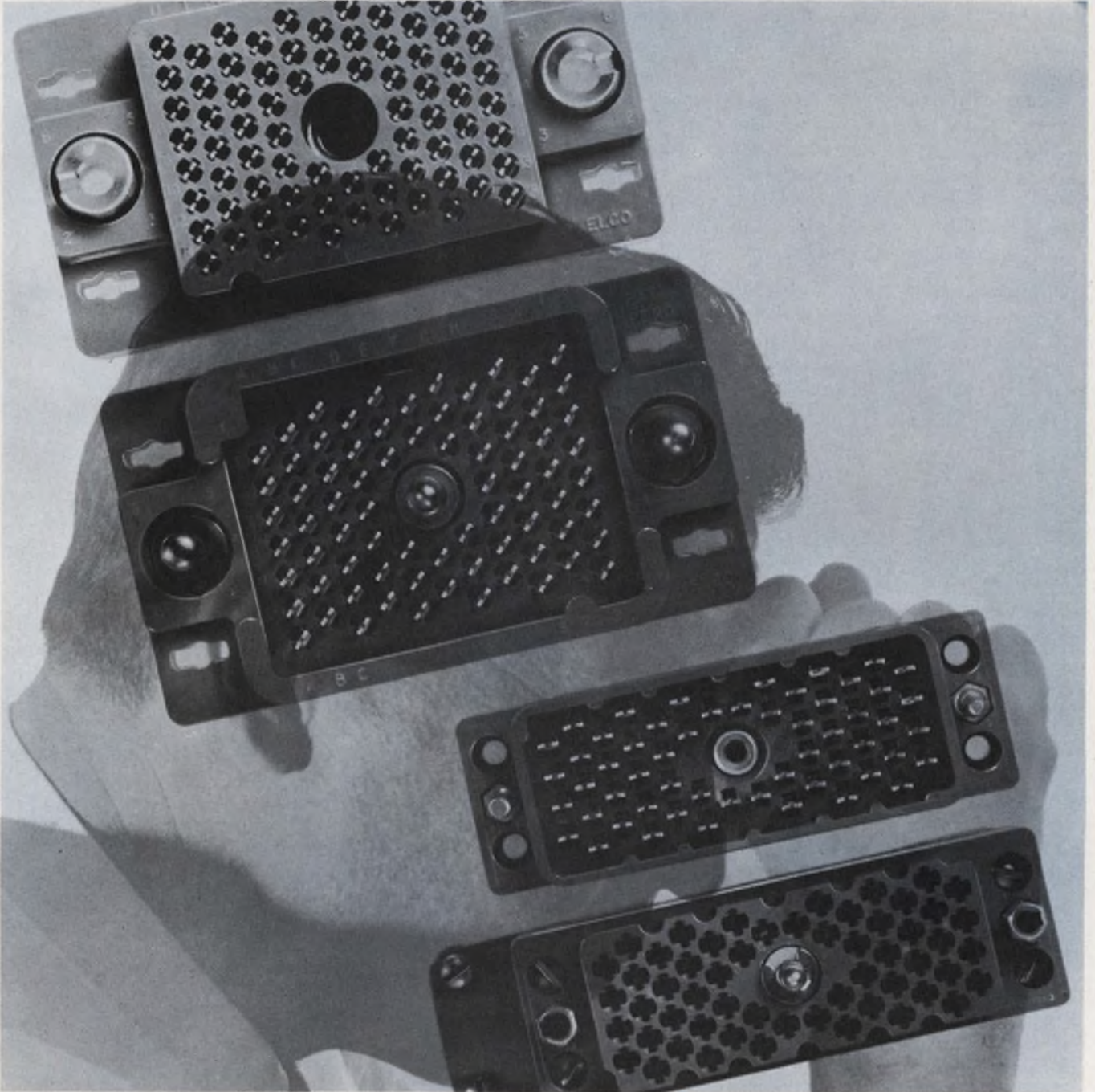

*TRADE-MARK

MIND A PIECE OF ADVICE ABOUT OURS?

First, list your own requirements. Then, check all the others. Next, measure them against the performance-proven record of Elco Rack-and-Panel Connectors. Then, when you add the fact that our Rack-and-Panels are much lower in price, your decision is made.

Elco's miniature size and design gives you greater contact density in less space.

You can have as few as 6 or as many as 140 contacts, depending on the model.

The contacts aren't just "me too" types. They're Elco Varicon* Contacts, the industry's most reliable and simple to use.

The contact tails come in 6 different styles for the terminating technique you want, including the versatile Varilok* crimp and insert contact.

You also receive polarizing guide pins, sockets, actuating screws, locking nuts, cable clamps and we'll even install the contacts for you.

Surprised at all you can get in just one of our countless lines? Then we ought to talk to you about our complete connector capability. Or forward you the facts to rid your medicine cabinet of the tranquilizers. Elco Corporation, Willow Grove, Pa. 19090; (215) 659-7000.

*Elco
Connector
Technology...
20 Years
Young*

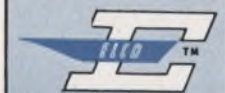

ON READER-SERVICE CARD CIRCLE 59

When the dc thus fed back is equal to the input peak, the comparator switches to its positive state and shuts off the current to the storage capacitor.

This closed-loop system (along with the switching transistor which charges the capacitor) has the advantage of allowing the capacitor to charge as rapidly as possible, regardless of the amplitude to which it is being charged. This is inherently fast. The loading on the signal also remains very nearly constant over the entire operating range.

Acknowledgement:

This work was done under the auspices of the U.S. Atomic Energy Commission.

Walter C. Dillon, Principal E.T., Lawrence Radiation Laboratory, University of California, Berkeley, Calif.

VOTE FOR 114

Amplify photo cell output with a FET source follower

The amplifier is a conventional source follower, where the FET and source resistance $R3$ form part of a bridge loop, $R3, R4, R5$. Selection of a suitable value for $R3$ is based on the impedance requirements to drive a 0-1 mA meter. A convenient operating load line and bias point are established to control one arm of the low-impedance bridge. Proper selection of $R2$ will null the bridge for any subsequent variations in the photo cells ΔR . It may also be convenient to series or parallel combinations of resistors with the photo cell for various response curves.

The bridge output can be directly amplified by conventional operational amplifiers. Ac operation is quite possible with a few circuit modifications.

David Hanning, Project Engineer, Hartman Electrical Manufacturing Co., Mansfield, Ohio.

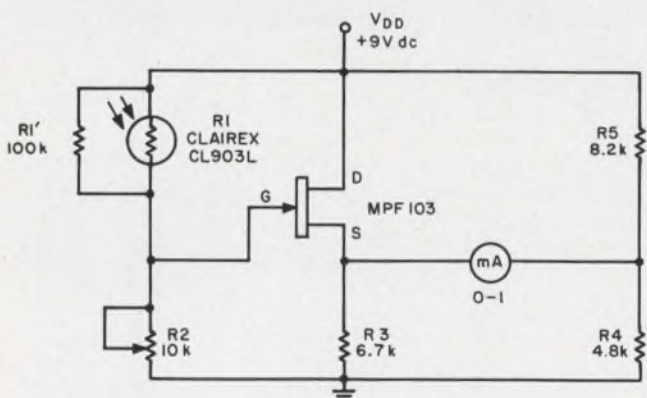

High sensitivity is obtained from a photo cell by combining it with a FET in the bridge circuit.

Simple Zener-diode tester uses single transistor

If one has unmarked Zener diodes of unknown characteristics or if reverse-biased transistor junctions are to be used as Zener diodes, the Zener voltage and the performance of the devices can be checked with this simple circuit. It can also be used to check the forward drop across diodes.

By forcing a stable and known current through the diode, the voltage across it can be measured, and when this current is varied the pertinent voltage variations can be gauged from the sharpness of the knee of the characteristic curve.

The circuit consists of a single-stage current generator, the output resistance of which is increased by the current feedback caused by the emitter resistor.

The four variable resistors must be adjusted until the desired values of current (0.2, 1, 5, 20 mA) flow through a current meter connected at the output of the instrument.

The variation of the output current as a function of the output voltage (in the range 0-15 volts) is reasonably small, that is, less than 1% at 0.2, 1 and 5 mA, and less than 5% at 20 mA.

The inexpensive germanium transistor must be furnished with the heat sink.

G. V. Pallottino, Electronic Engineer, Rome, Italy.

VOTE FOR 115

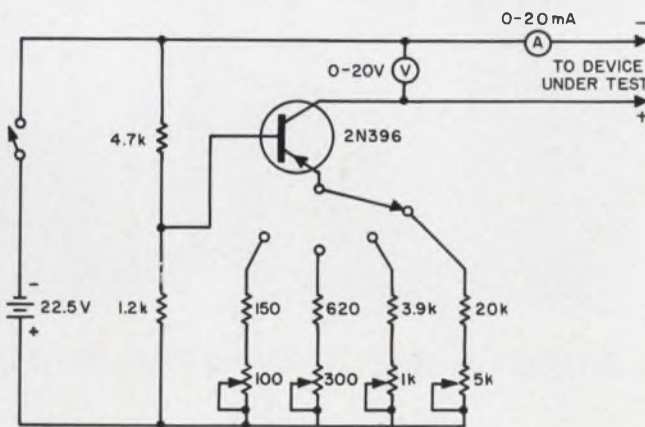

Diode characteristics can be checked quickly with this simple circuit which provides nearly constant current.

IFD Winner for July 19, 1967

Steven E. Summer, Engineer, EDO Corporation, College Point, N. Y.

His Idea, "Voltage-controlled oscillator uses an integrated circuit," has been voted the \$50 Most Valuable of Issue Award.

Cast Your Vote for the Best Idea in this Issue.

New Stauffer Si-O-Flex™

RTV silicones with these electrical properties . . .

	Dielectric Strength (v/mil)	Dielectric Constant @			Dissipation Factor @			Volume Resistivity (ohm-cm)
		60 cps	10 ³ cps	10 ⁶ cps	60 cps	10 ³ cps	10 ⁶ cps	
Si-O-Flex SS-831	630	3.3	3.2	3.1	0.013	0.010	0.006	23°C: 6.0 x 10 ¹⁴ 150°C: 4.8 x 10 ¹³
Si-O-Flex SS-832	550	4.0	3.9	3.8	0.018	0.011	0.003	23°C: 2.0 x 10 ¹⁵ 150°C: 1.8 x 10 ¹⁴
Si-O-Flex SS-833	550	4.1	4.0	3.9	0.022	0.016	0.004	23°C: 3.0 x 10 ¹⁵ 150°C: 4.5 x 10 ¹⁴

Have you ever seen RTV's with this *balanced property profile*?

- Low viscosity for easy handling
- Excellent electrical insulation
- Good physical properties
- 24-hour cure in any thickness
- Outstanding thermal stability
- Curing not inhibited by common materials
- Cure even at low humidity
- Short tack-free time plus long working time

This *balanced property profile* makes Stauffer RTV silicone rubbers especially useful for all electrical and insulation applications . . . potting, encapsulation, embedding, sealing, and caulking. Si-O-Flex SS-831, SS-832, and SS-833 RTV's are commercially available, backed by Stauffer's knowledgeable technical service. Want more information? Just complete the coupon.

Stauffer Chemical Company, Silicone Division,
P.O. Box 428, Adrian, Michigan 49221.



STAUFFER CHEMICALS . . . at work everywhere

STAUFFER CHEMICAL COMPANY
Silicone Division, Adrian, Michigan 49221 Dept. E. D.
Please send me data on Si-O-Flex SS-831, SS-832,
SS-833 RTV silicone rubbers. My special interest is:

Name: _____

Company: _____

Address: _____

City: _____ State: _____ Zip: _____

ON READER-SERVICE CARD CIRCLE 60

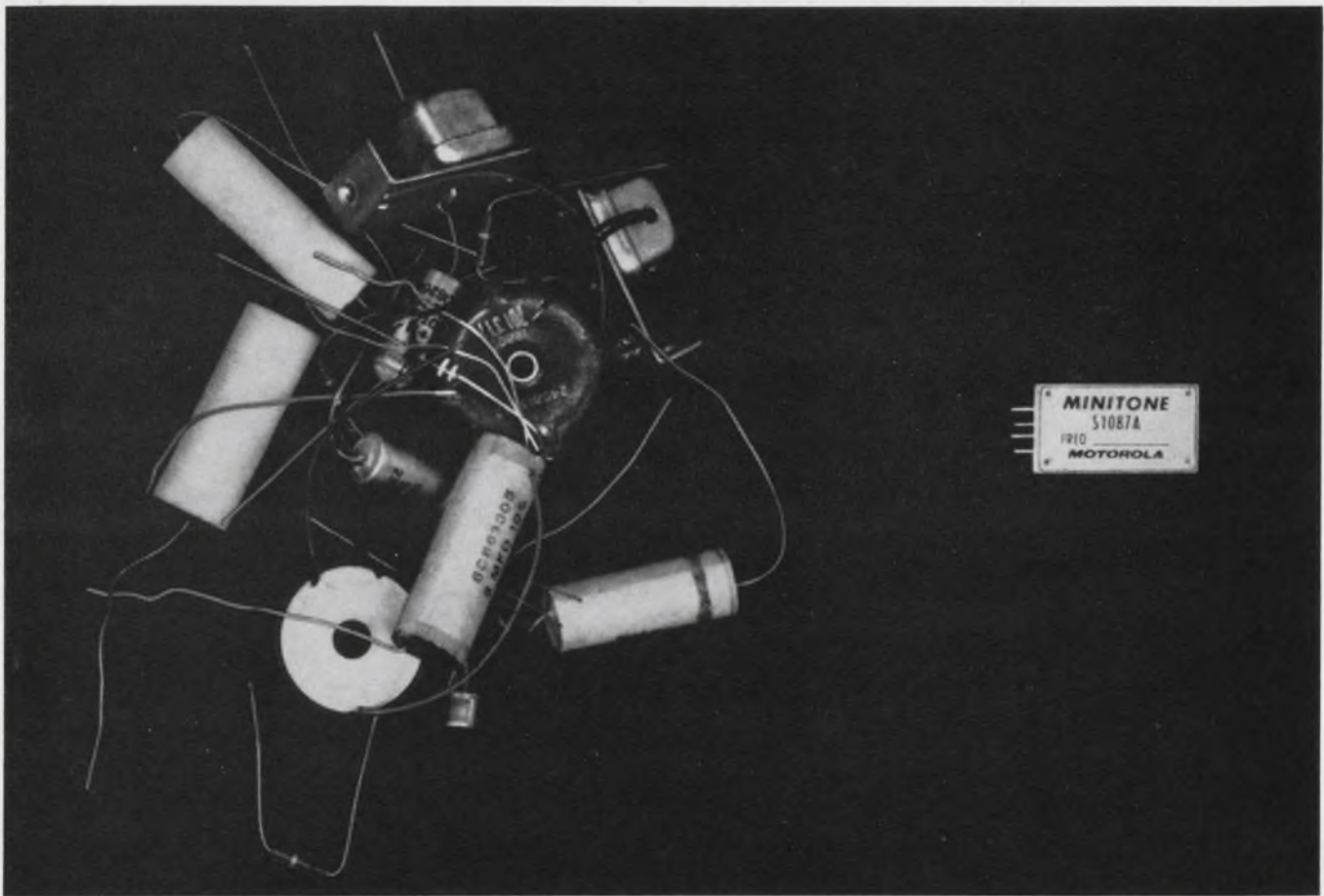

Two ways to achieve selective signaling

The MINITONE reed on the right does it better

Motorola's new miniaturized resonant reed either generates a highly stable audio tone, or provides very selective decoding. It does the job better because it's small, has excellent stability, and contains no contacts to wear out. And the MINITONE resonant reed is more economical; it eliminates the expense of extra components and design time needed to build highly selective tone oscillators and associated compensating circuits. Take a look at these facts:

SMALL SIZE: About 1/4 of a cubic inch in volume. Measures only 1.11" x 0.619" x 0.393".

LONG LIFE: No contacts to wear out or cause malfunctions; life comparable to solid-state devices. Plus 3-year warranty.

HIGH STABILITY: Frequency tolerance $\pm 0.1\%$. Temperature stability better than $\pm 0.001\%$ per $^{\circ}\text{C}$ between -30°C and $+100^{\circ}\text{C}$ (25°C reference).

WIDE FREQUENCY RANGE: From 67 Hz up to 3150 Hz.

QUICK DELIVERY: Over 200 standard frequencies available from stock.

RUGGED CONSTRUCTION: Exceeds E.I.A. standards for shock and vibration.

PROVEN PERFORMANCE: Reeds have been proven in thousands of demanding situations, such as in aviation, control systems and radio communications applications.

FOR MORE INFORMATION contact your Motorola representative. Or write for bulletin TIC-3214

MOTOROLA COMMUNICATIONS AND ELECTRONICS INC.

Dept. ED, 4900 West Flournoy Street

Chicago, Illinois 60644. A subsidiary of Motorola Inc.



MOTOROLA

**PRECISION
INSTRUMENT
PRODUCTS**

Products

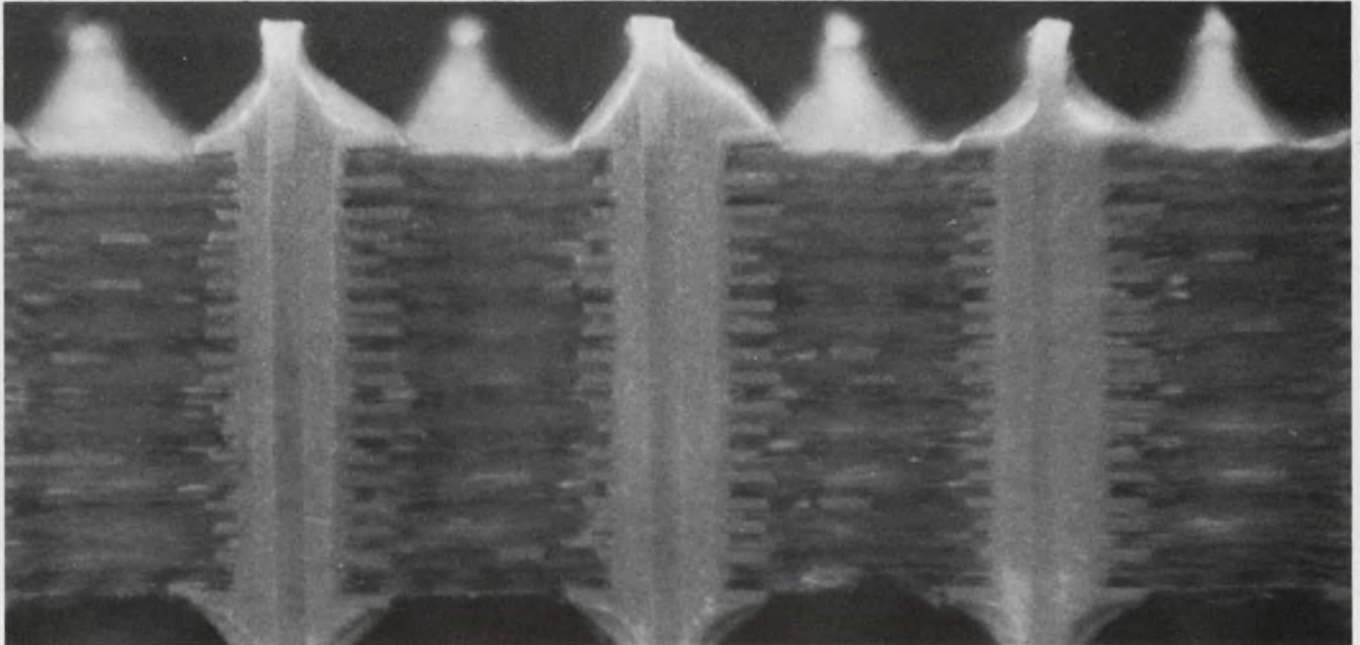

Magnified cross-section of terminations made with a predetermined amount of solder. Every

joint is uniform and each hole is completely filled with solder. Page 150

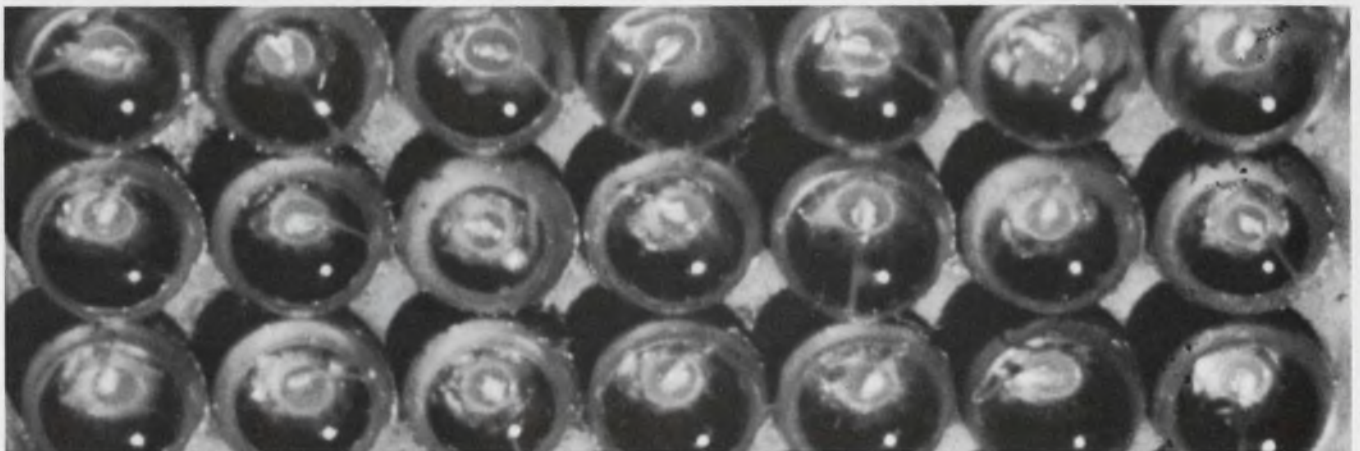

Array uses light-emitting diodes for alpha-numeric display. Operating alone, diodes are

available that develop 120, 300 and 450 foot-lamberts at 50 mA current. Page 144

Also in this section:

Manganesed phospholene, a chemical treatment prevents rust and corrosion. Page 152

Sweep oscillator uses available plug-ins to cover 200 MHz to 40 GHz. Page 160

Touchdown! Up to 100 probe contacts can be made on MOS ICs at one time. Page 164

Design Aids, Page 200 . . . **Application Notes**, Page 202 . . . **New Literature**, Page 204

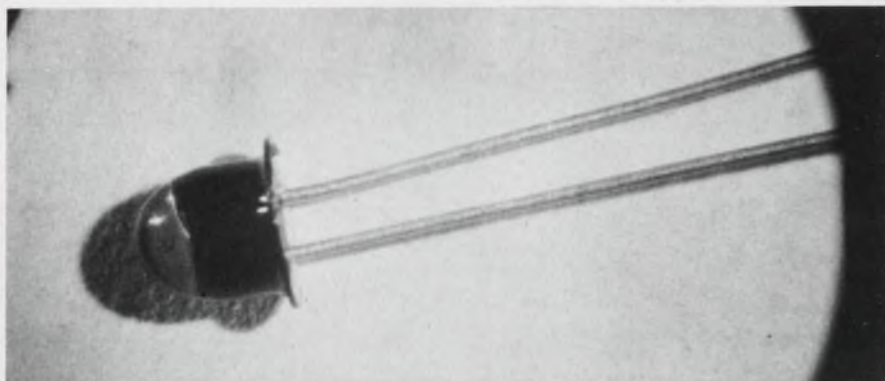

Gallium arsenide phosphide used in 450-fL diode

Monsanto Co., 800 N. Lindbergh Blvd., St. Louis. Phone: (314) 694-1000. Price: (1000 lots) \$4 (120 fL), \$6.60 (300 fL), \$18 (450 fL).

Solid-state light-emitting diodes (LED) that emit visible red light in excess of 450 footlamberts at 50-mA forward current make use of gallium arsenide phosphide and are about 10 times brighter than previously available units, according to their manufacturer.

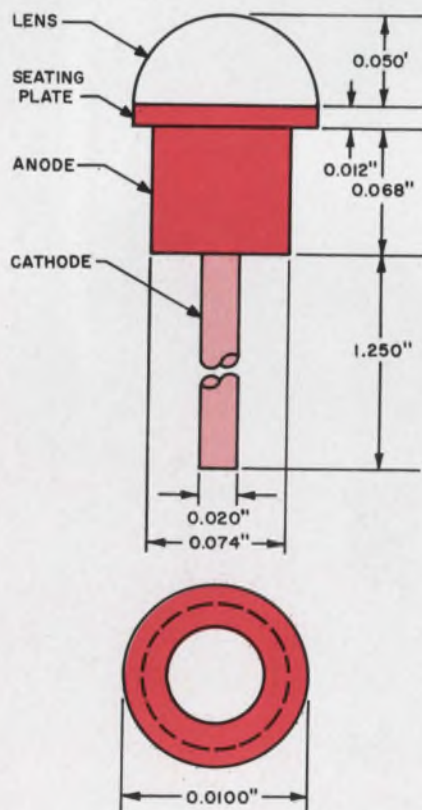

LEDs can produce 450 fL at 50 mA using gallium arsenide phosphide.

These Monsanto Co. light sources have a spectral bandwidth of 400 Å and can be selected to provide peak wave lengths over the range of 6000 to 7000 Å. First models of the gallium arsenide phosphide visible LEDs had a nominal brightness of 50 fL at 50 mA. New units are being offered in three categories of brightness: 120, 300 and 450 fL at 50 mA forward current. For applications where low input-current is more important than maximum brightness, the two classes of diodes will produce 50-fL average brightness with 20- and 10-mA forward current, respectively.

Available singly in either a TO-18 header or a smaller coaxial package for higher packing density, the diodes are protected with an epoxy lens. The lens serves as a window for the radiation, which is concentrated into a narrow cone of emission.

LEDs are suited for such applications as film data encoders, graticule illumination, long-life indicator lights and companion light sources for light-sensitive semiconductor detectors. The low input-current requirements of the new models make them compatible with microcircuitry, where they can be used as diagnostic indicators, driven directly by the microcircuit power supply without a buffer amplifier.

Monsanto's diode development program has been partially supported by the Air Force Materials Lab, Manufacturing Technology Div., Wright Patterson AFB, Ohio.

Discrete transistors use thin film resistors

Fairchild Semiconductor, a div. of Fairchild Camera and Instrument Corp., Box 1058, Mountain View, Calif. Phone: (415) 962-5011. Available for \$18 to \$50 depending on configuration and amperage capability.

Three npn-pnp families of power transistors that incorporate a series of discrete emitters in combination with an integrated-feedback-resistor system employs from 62 to 262 discrete emitter sites connected in parallel by buss bar metalization. This design provides a greater emitter-base peripheral area thus raising the emitter injection efficiency resulting in improved beta linearity. The nickelchromium resistors are integrated into each emitter site between the active emitter area and the buss bar. This extends the second breakdown-voltage capability by diverting excessive current to adjacent emitter sites thus distributing the current evenly across the entire chip. These thin-film resistors are deposited rather than diffused into the chip. Thus if an overload occurs, one or two of the sites may open up but the device will not fail catastrophically. The 2-A series is available in four-package configurations as either npn's or pnp's and with a capability of 60 to 80 V. This power device (6 to 30 W) features a frequency response of 50 to 60 MHz with beta guaranteed at three points (50 mA, 1 A and 2 A). The device, designed for military usage, offers an isolated collector package so that no isolating hardware is required. The second group of these new power devices is a 5-A series available in three package configurations as either npn's or pnp's. These units offer 10 to 50 W of power and two separate high-frequency classes, 60 and 70 MHz. Voltage is specified at 80. The final npn-pnp series is a 10-A device featuring 100 W of power. It is available in the isolated collector, 11/16-inch hex stud package. The series is rated at 80 V with two high frequency classes, 30 and 40 MHz. With the advent of this construction technique and thin-base widths, a compromise of frequency and beta linearity no longer exists.

CIRCLE NO. 253



RAYTHEON

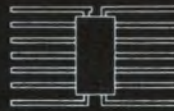

RAYTHEON

RAYTHEON

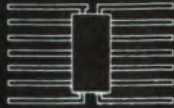

RAYTHEON



RAYTHEON

High Alumina Seal

A little something you can depend on!

We guarantee our MIL Spec glass to Kovar seals to 5×10^{-8} cc/sec Helium. You see, our Raytheon developed high alumina glass has the same coefficient of thermal expansion as Kovar. And since both expand and contract alike with temperature change, they permit a matching seal rather than a compression seal. That's just one of the little things you can depend on when your IC's come from Raytheon Company, Semiconductor Operation, 350 Ellis Street, Mountain View, California 94040.

RAYTHEON



we aren't kidding when we say rugged!

Reinforced, unique cross-section frame posts provide *exceptional strength* and resistance to crush, twist and sway stresses. Heli-arc welded throughout, the heavy-duty Vent-Rak 1000 Series Electronic Cabinet meets or exceeds all commercial or military specifications.

And . . . *versatility* is unequalled! Select all aluminum or steel construction for single, multiple or custom installations. Choose from a wide range of options and accessories . . . heavy-duty 1000 Series Cabinets can be specified to meet your *exact* electronics packaging needs.

For complete information on the 1000 Series, or on the full line of Vent-Rak electronic packaging components, write:

VENT-RAK, INC.
 625 South Webster Avenue
 Indianapolis, Indiana 46219



ON READER-SERVICE CARD CIRCLE 63

SEMICONDUCTORS

Small-signal transistors dissipate 1.6 W

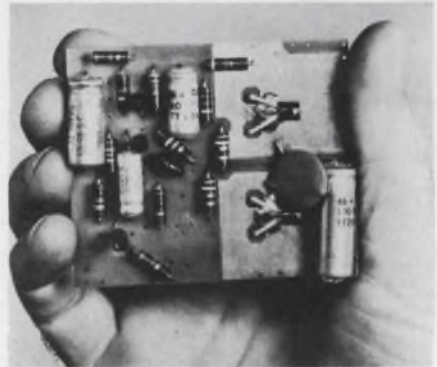

Texas Instruments, Inc., 13500 N. Central Expressway, Dallas, Tex. Phone: (214) 238-3741. Price: 39¢ to 50¢.

A series of small-signal transistors in plastic packages features power dissipation of 1.6 W at 25° C case temperature. The silicon planar epitaxial transistors are designated as npn types TIS90 and TIS92, and pnp types TIS91 and TIS93. They are available in matched complementary pairs—TIS90M/TIS91M and TIS92M/TIS93M and can be supplied within color-coded brackets of 3 dB maximum range for low-distortion output. Electrical characteristics include a minimum 40-V breakdown voltage (collector base and collector emitter), and a maximum 400-mA continuous collector current. The maximum collector-emitter saturation voltage is 0.25V.

CIRCLE NO. 255

Solid-state relay withstands 80 g

Bristol Co., Waterbury, Conn., Phone: (203) 756-4451.

The single-pole, double-throw or double-pole-throw models are available in a TO-5 case. The relay can be spaced 7/16 in. on center. It is only 0.265 in. in height. The enclosure is hermetically sealed. It is able to withstand a shock of 80 gs for 11 ms and offers high resistance to vibration. Contract rating is 10 million operations at low level, 1 million operations at 0.5 A, 28-V-dc resistive load, and 100,000 operations at 1-A, 28-V dc. The relay operates within a temperature range of -65° to 125°C.

CIRCLE NO. 256

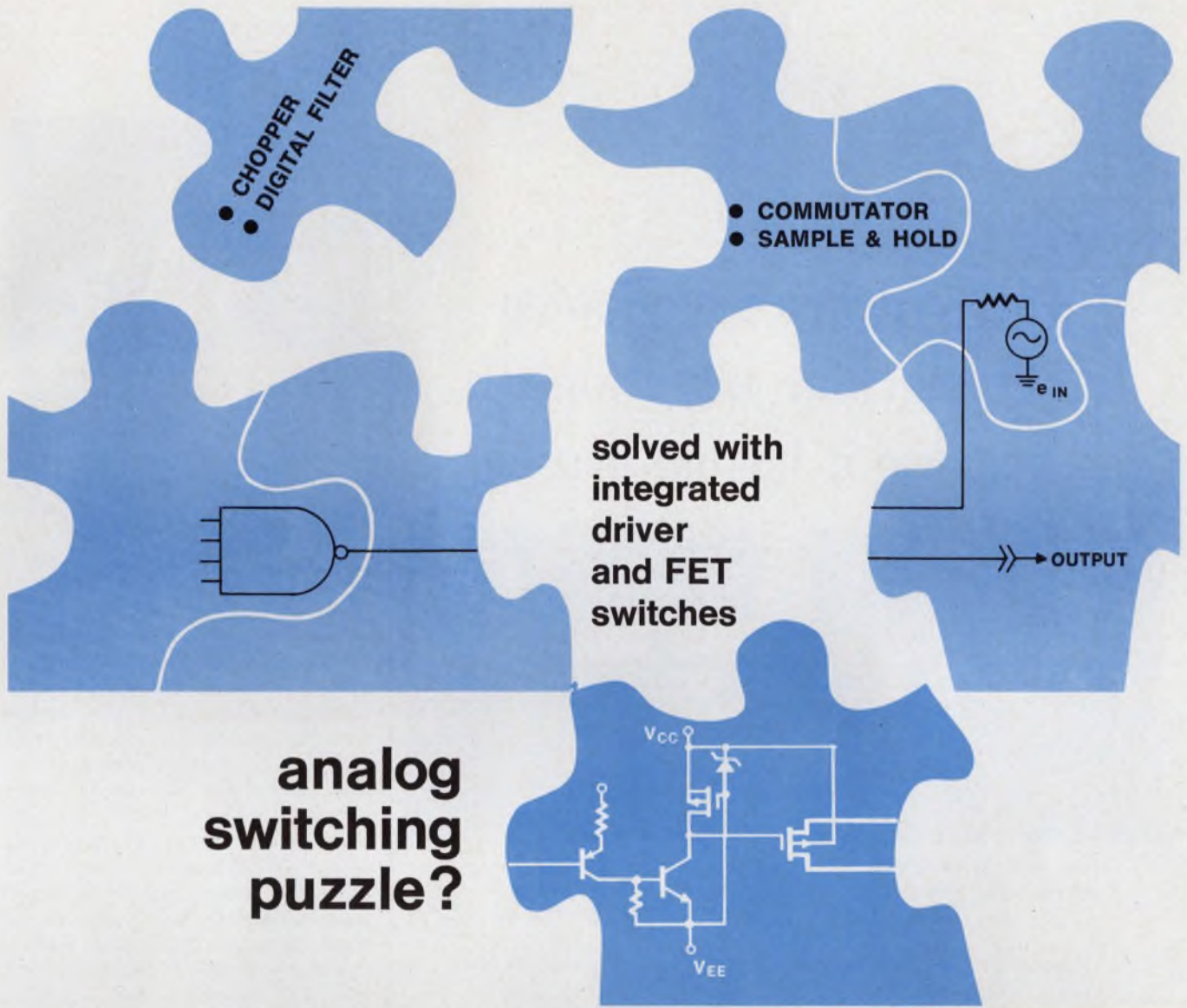

solved with
integrated
driver
and FET
switches

analog switching puzzle?

Analog switching got you puzzled? Here's the answer — an integrated circuit with drivers and FET switches all in one package. Drive the input with almost any integrated logic — only 0.8 volt swing is required. The output FET with ON resistance as low as 80 ohms and leakage less than 1 nA can switch plus or minus 20 volt signals.

Pick the driver-switch combination for your application: 2 to 5 channels; inverting drivers or not; MOS or junction FETs — see table. These products add to the wide variety of Siliconix drivers and FET switches that are now available from your distributor. Write or check inquiry card for data.

SILICONIX DRIVER-FET SWITCHES

Type	No. of Channels	Logic Input for ON Switch	Type FET Switch
DG102F	2	0	Jct
DG103F	2	1	Jct
DG104F	2	0	Jct
DG110F	2	1	MOS
DG111F	2	0	MOS
DG112F	2	1	MOS
DG126F	2*	1	Jct
DG116F	4	1	MOS
DG118F	4	0	MOS
DG123F	5	1	MOS
DG125F	5	0	MOS
DG122F	2*	1	MOS
DG132F	2*	1	MOS
DG120F	3*	1	MOS
DG121F	3*	0	MOS

* Differential — two common gate switches with common output.

NEW LOW COST FET TESTER

The SI200 Semiconductor Tester features plug-ins for expandable test capability, simplicity of operation, and low cost.

Price: SI200 Tester — \$960.

Price: SI201 (DC & g_{fs})

Plug-in Module — \$1335.



Franchised Distributors

ALABAMA Cramer Electronics, Inc.
Huntsville (205) 536-4493

ARIZONA Kierulff Electronics, Inc.
Phoenix (602) 273-7331

CALIF. Hollywood Radio & Elec.
Hollywood (213) 466-3181
Menlo Park (415) 322-3431
Kierulff Electronics
Los Angeles (213) 685-5511
San Diego (714) 278-2112
Elmar Electronics, Inc.
Mountain View (415) 961-3611
Oakland (415) 834-3311
Electronic Supply, Inc.
Riverside (714) 683-8110

COLORADO Kierulff Elec., Inc.
Denver (303) 825-7033

CONNECTICUT Cramer Elec., Inc.
Hamden (203) 288-7771

FLORIDA Perrott Associates, Inc.
Clearwater (813) 446-2535
Orlando (305) 275-1132
West Palm Beach (305) 585-7761

ILLINOIS Semiconductor Spec.
Chicago (312) 279-1000

MARYLAND Milgray Elec., Inc.
Hyattsville (202) 864-6330

MASS. Cramer Electronics, Inc.
Newton (617) 969-7700

MICH. Semiconductor Spec., Inc.
Detroit (313) 255-0300

MINN. Semiconductor Spec., Inc.
Minneapolis (612) 866-3434

MISSOURI Semiconductor Spec.
St. Louis (314) 521-8866

NEW JERSEY Tech. Elec. Dist.
Bergenfield (201) 384-3643

NEW MEXICO Kierulff Elec., Inc.
Albuquerque (505) 268-3901

NEW YORK Summit Dist., Inc.
Buffalo (716) 884-3450
Milgray Electronics, Inc.
New York City (212) 989-1600
East. Semiconductor Sales, Inc.
Syracuse (315) 455-6641

NORTH CAROLINA Kirkman Elec.
Winston-Salem (919) 724-0541

OHIO Alpine Industries, Inc.
Dayton (513) 278-5861

OKLA. Oil Capitol Elec. Corp.
Tulsa (918) 836-2541

PENNSYLVANIA Milgray Elec., Inc.
Philadelphia (215) 228-2000

TEXAS Sterling Electronics, Inc.
Austin (512) 452-0271
Dallas (214) 357-9131
Houston (713) 666-4061
Lenert Company
Houston (713) 225-1465

WASHINGTON Washington Elec.
Seattle (206) 682-8981



Siliconix incorporated

1140 W. Evelyn Avenue, Sunnyvale, California 94086
Telephone (408) 245-1000 TWX: 910-339-9216

ON READER-SERVICE CARD CIRCLE 64



This synchro isn't fooled by machine vibrations ...because it has no brushes

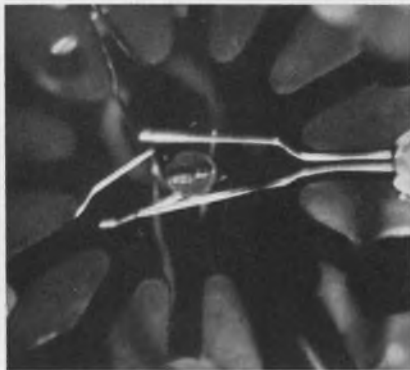

Brush bounce in conventional synchro under shock loading

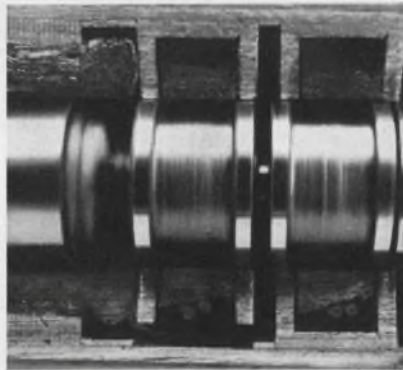

Harowe rotary transformers maintain constant coupling under shock loading

Harowe brushless synchros respond only to the motion of table or tool—not to the shock of machine vibrations. That's because they use patented rotary transformers to couple signals to rotors. There are no brushes to bounce; thus no false signals or noise spikes—even under shock loads up to 50 g's.

Using higher feed speeds to boost production? Brushless synchros deliver full performance at 12,000 rpm. Working in explosive atmospheres? Brushless synchros can't arc. Monitoring from a central panel? Brushless synchros cut indicator friction $\frac{2}{3}$ for more accurate readout. And their average life expectancy is 10,000 hours—ten times conventional synchros.

You can get this premium performance in all common synchro and resolver functions, in sizes 8 through 11 as standard, larger sizes as special. Write for complete specs—



Harowe SERVO CONTROLS, INC.

20 Westtown Road • West Chester, Pa. 19380

Servo, Stepper & Synchronous Motors • Motor Generators
Synchros • Resolvers • Pancakes • Gearheads

ON READER-SERVICE CARD CIRCLE 65

SEMICONDUCTORS

Zener diodes Range to 200 V

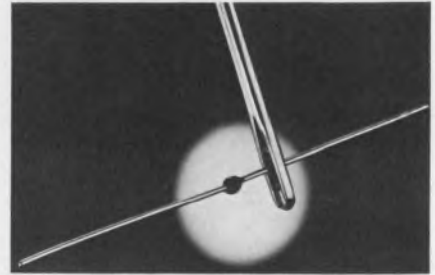

Computer Diode Corp., Pollitt Dr.
South, Fair Lawn, N. J. Phone:
(201) 797-3900.

Measuring 0.075 in. in diameter and 0.125 in. long, the reference elements, designated the MTC series, are encapsulated in high-temperature epoxy. Standard units cover the voltage range from 5 V to 12 V with similar electrical characteristics to EIA types 1N821, A through 1N829, A and 1N935, A, B through 1N946, A and B. The temperature-compensated zeners are constructed on a high strength "unibody" principle which takes advantage of the best properties of alloyed and diffused construction. The standard units contain up to four integrated silicon junctions. Non-standard units can be provided to customer specifications to meet any voltage requirements up to 200 V or higher.

These units are extremely rugged and will maintain their stability under the most severe environmental conditions.

CIRCLE NO. 257

Plastic SCR tames 6 A peak

Motorola Semiconductor Products,
P. O. Box 955, Phoenix. Phone:
(602) 273-6900. P&A: 51¢ (100
up); stock.

A sensitive-gate SCR series is rated at 800 mA (forward current rms) and is designed for low-level power control circuits. The series consists of four device types—2N5060 through 2N5063 with voltage ranges from 30 to 150 V in a TO-92 plastic package. Gate current requirement for these units is 200 μ A. The devices are for application in fractional horsepower motor controls, sensing and detection circuits, warning systems and alarms.

CIRCLE NO. 258

ON READER-SERVICE CARD CIRCLE 66 ➤

200 amp logic + triac



World's first 200 amp logic-triac is in pilot production at International Rectifier in voltage ratings from 400 to 1000 Volts. This unique "logic" capability allows the selection of the conduction direction as a function of the gate signal. The logic-triac is an advanced development made possible by IR's exclu-

sive epitaxial process. Send your purchase order today for immediate delivery: 200AC100, 1000 Volts, \$850; 200AC80, 800 Volts, \$625; 200AC60, 600 Volts, \$352; 200AC40, 400 Volts, \$270. Or ask for complete technical data via inquiry card, letter, or telephone.

INTERNATIONAL RECTIFIER



SEMICONDUCTOR DIVISION □ 233 KANSAS STREET, EL SEGUNDO, CALIF. 90245 □ PHONE (213) 678-6281
FIELD OFFICES AND DISTRIBUTORS IN MAJOR CITIES AROUND THE WORLD

TRANS- (trans) 1. To pass over the disk of another heavenly body. 2. To change out of its natural position. 3. In the natural disposition and change the elements, flesh and blood of Christ. 4. To change the contents of a substance, by which it is the divine nature. 5. A transition into another of equal value. 6. To be changed in form; to transform. 7. The act or operation of external appearance. 8. To change of form in insects. 9. Change of one metal into another. 10. The change of the soul into a divine being. 11. Transubstantiation, a change of heart disposition and temper are in image. 12. In algebra, to change into one of a different class. 13. (trans-form'd) *pp.* Changed in form; metamorphosed; transformed.

TRANS- (trans) *v. i.* To pass over. [*L. trans and fretum.*] *vt.* To narrow sea. [*Little L. transfunda.*] To transform. [*trans.*] 1. To pour, send into another. 2. To pass from one animal to another. 3. To pass from one to another; to cause a change. [*trans-*] *pp.* Poured from one vessel into another. That may be transfused. [*trans-*] *v. i.* To pass out of one vessel into another. [*trans-*] *v. i.* The act of one vessel into another. [*trans-*] *v. i.* To pass over the disk of another heavenly body.

TRANS- (trans) *v. i.* To pass over the disk of a heavenly body. TRANS- (trans) *v. i.* To pass over the disk of another and larger. 3. The passage of one heavenly body over the meridian of another. TRANS- (trans) *v. i.* To pass over the disk of a heavenly body. TRANS- (trans) *v. i.* To pass over the disk of another and larger. 3. The passage of one heavenly body over the meridian of another. TRANS- (trans) *v. i.* To pass over the disk of a heavenly body. TRANS- (trans) *v. i.* To pass over the disk of another and larger. 3. The passage of one heavenly body over the meridian of another.

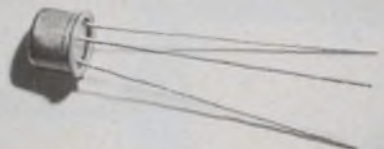

TRANS- (trans) *v. i.* To pass over the disk of a heavenly body. TRANS- (trans) *v. i.* To pass over the disk of another and larger. 3. The passage of one heavenly body over the meridian of another. TRANS- (trans) *v. i.* To pass over the disk of a heavenly body. TRANS- (trans) *v. i.* To pass over the disk of another and larger. 3. The passage of one heavenly body over the meridian of another.

TRANS- (trans) *v. i.* To pass over the disk of a heavenly body. TRANS- (trans) *v. i.* To pass over the disk of another and larger. 3. The passage of one heavenly body over the meridian of another. TRANS- (trans) *v. i.* To pass over the disk of a heavenly body. TRANS- (trans) *v. i.* To pass over the disk of another and larger. 3. The passage of one heavenly body over the meridian of another.

MATERIALS

Soldering circuit boards using the "Dimple Strip"

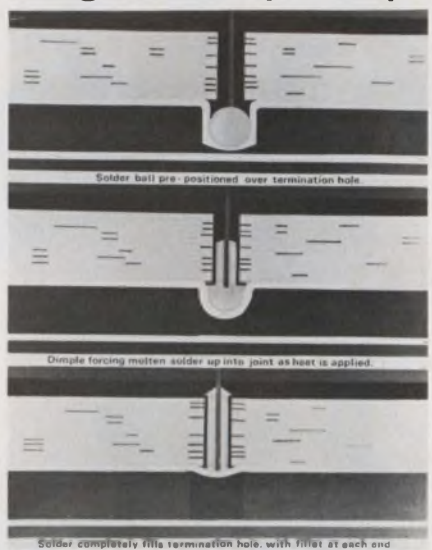

Raychem Corporation, 300 Constitution Drive, Menlo Park, Calif. Phone: (415) 369-7171.

The Dimple Strip is a radiation cross-linked polyolefin sheet with pockets containing precisely measured solder balls. When subjected to heat, the pockets shrink and flatten, forcing molten solder into minute termination points. This process provides for good solder penetration because of the "pumping action" of the radiation cross-linked, heat-shrinkable sheet containing the solder.

CIRCLE NO. 259

Insulation material uses polyester film

Hitco, 1600 W. 135th, Gardena, Calif. Phone: (213) 321-8080.

Dimplar is a multi-layer thermal radiation-shield type of cryogenic insulation, consisting of alternate layers of flat metalized polyester film reflectors and dimpled separators. This material is designed to provide effective and economical insulation for all spherical and cylindrical vessels, and is particularly effective for applications on vacuum-jacketed transfer lines, storage vessels and space vehicles. Standard Dimplar is metalized on both sides with high-purity aluminum, but for special applications, it is also available with a gold coating.

CIRCLE NO. 260

Mr. Webster didn't have a word for it... but we do!

Three authoritative dictionaries for today's technologies:

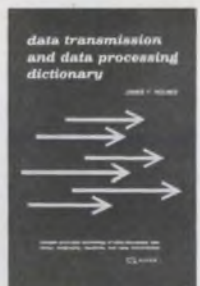

- Radio-Television-Electronics Dictionary. National Radio Institute Staff. Over 5000 terms. 168 pages. #0307, paperbound, \$3.50
- Missile Technology Abbreviations & Acronyms. Arthur T. Cartier. 8000 entries and 12,000 definitions. 130 pages. #5539, paperbound, \$3.95; #5540, clothbound, \$5.95
- Data Transmission & Data Processing Dictionary. James F. Holmes. More than 3000 terms. 103 pages. #0396, paperbound, \$2.50

SPECIAL 30-DAY EXAMINATION OFFER! Dept. ED-4, HAYDEN BOOK COMPANY, INC.

116 West 14th Street, New York, N.Y. 10011

Send me the book(s) checked below and bill me. At the end of 30 days I will either remit payment plus a few cents postage or return the book(s).

#0307 #5539 #5540 #0396 Free 1966 Catalog Name _____

Street _____

City _____ State _____ Zip _____

You pay postage. I enclose payment of \$..... Same return privileges.

The hole advantage of our wire-wrap connector.

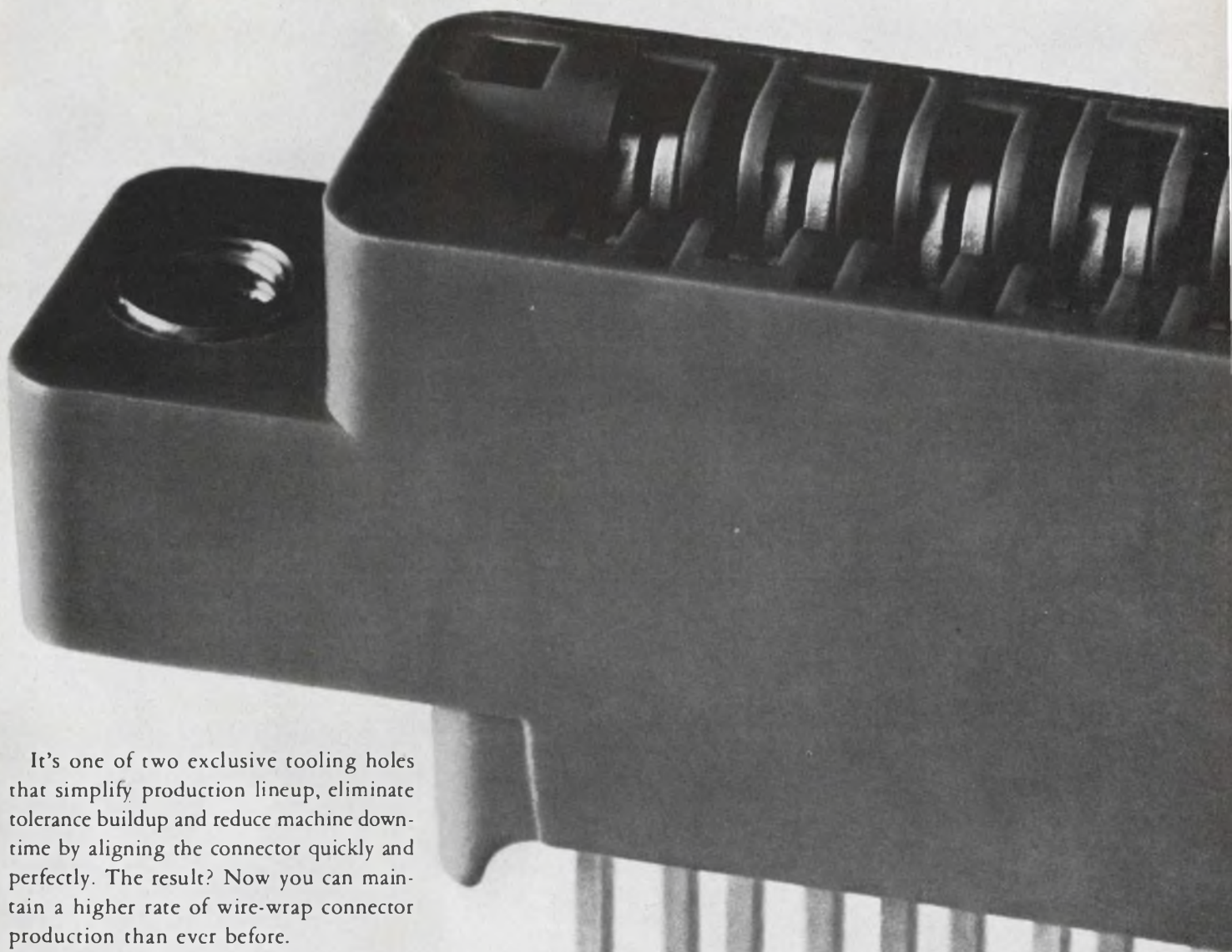

It's one of two exclusive tooling holes that simplify production lineup, eliminate tolerance buildup and reduce machine downtime by aligning the connector quickly and perfectly. The result? Now you can maintain a higher rate of wire-wrap connector production than ever before.

Winchester Electronics wire-wrap connectors have other desirable features, too, like a configuration specifically designed for automatic equipment, high strip force retention, and bifurcated spring contacts for superior interfacing. These connectors are available in 28, 40, 49, and 50 double row sizes. Standard contact spacing is 0.125 center to center, 0.25 between rows. Molding is Diallyl Phthalate SDG-F. Contacts are plated to MIL-G-45204 Type II. To find out the whole advantage of our wire-wrap connectors for your application contact your distributor or Winchester Electronics, Main Street & Hillside Avenue, Oakville, Connecticut.



WINCHESTER ELECTRONICS
DIVISION OF LITTON INDUSTRIES

control/alarm short-cut

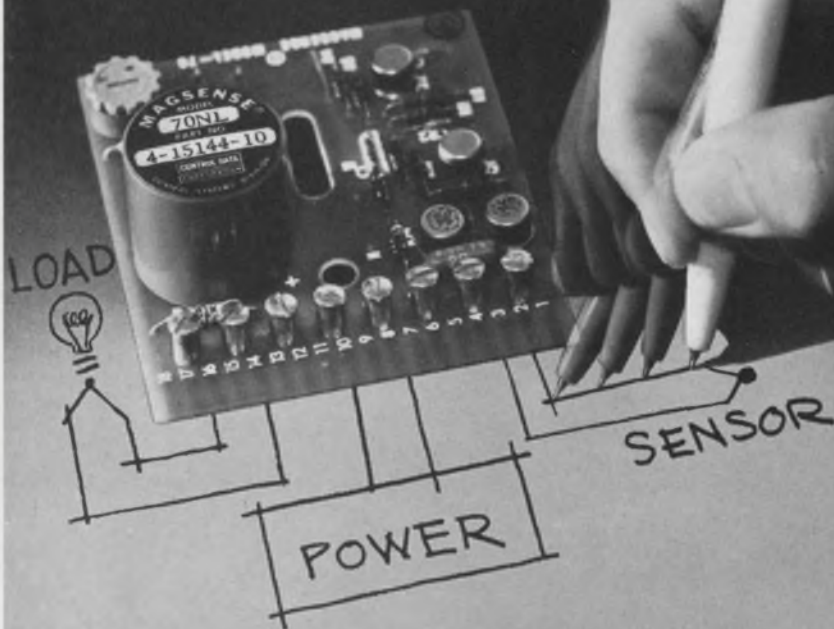

MAGSENSE

control/alarm for temperature, pressure, speed, flow

Here's the fast, easy way to solve your control/alarm problem. Hook up sensor, load and power source to a MAGSENSE® control/alarm module and adjust the setpoint. That's it. No time wasted designing and debugging a circuit. And while you're saving time you'll be saving money, getting *proven-in-service* reliability.

Capabilities? All MAGSENSE modules offer 100-billion power gain, accept inputs as low as 10 microvolts or 1 microamp *directly* without preamplification. Completely isolated inputs are unaffected by common mode voltages as high as 110vac, 60Hz or overloads as large as 1000-times full scale input. Typical accuracy is $\pm 0.5\%$ full scale. And they all

operate from a *single* DC power source (either 28v or 12v).

Options? The list includes remote and dual setpoints, adjustable hysteresis, choice of output action, transducer excitation voltage, and cold junction and copper compensation on thermocouple models. There's a MAGSENSE model for your application.

Price? Get MAGSENSE control/alarm modules for as little as \$35 in quantity. Compare that with the cost of developing and building your own circuit.

More information? Write or call, or circle the reader service number and we'll send you complete specifications and prices.

CONTROL DATA

CORPORATION

4455 Eastgate Mall, La Jolla, Calif.

MAGSENSE Sales, Dept. 212
Analog-Digital Systems Division
Control Data Corporation
4455 Eastgate Mall
La Jolla, Calif. 92037
Phone 714/453-2500

ON READER-SERVICE CARD CIRCLE 69

MATERIALS

Chemical process helps prevent rust



The Coulter Co., 6220 N. Golden West, Temple City, Calif. Phone: (213) 286-5220.

Manganese phospholene #7, a chemical process for dissolving and preventing rust and corrosion on both ferrous and non-ferrous metals, combines chemically with iron, steel or zinc to form a non-metallic moisture and waterproof coating. This coating is suitable for either rust-free storage, plating or painting. The material is not harmful to the skin, and is mildly toxic. The material will chemically clean aluminum, and when used on galvanized steel, prepares the surface for painting without a primer coat.

CIRCLE NO. 261

Ceramic transducers exhibit many shapes



Transducer Products, 95 Wolcott Ave., Torrington, Conn. Phone: (203) 482-7485.

Available are piezoelectric ceramic transducer elements in all shapes such as spheres, hemispheres, toroids, cylinders, discs, plates and focusing elements for use in electro-mechanical and ultrasonic applications. Parts are available from 1/32-in. diameter and 0.006-in. thick to audio frequencies.

CIRCLE NO. 262

ON READER-SERVICE CARD CIRCLE 244 ➤



Don't risk it!

These wires were subjected to a transient current overload in a normal atmosphere. The insulation smoked, then burst into flame. This won't happen with insulation of Du Pont TEFLON® fluorocarbon resins.

TEFLON will not propagate flame. It is *nonflammable* . . . by all recognized vertical and horizontal flame tests. The point is simply this: for proven reliability you need the combined benefits offered *only* by TEFLON. Nonflammability is just one. Among others: • *TEFLON is rated for continuous use from -450°F. to +500°F. (TFE)* • *Inert to virtually all chemicals and corrosives* • *Provides space and weight savings without sacrificing performance or long-term reliability.*

It comes as no surprise, then, that when reliability is considered, TEFLON answers the need. Its reliability has been proven in use for more than 20 years.

We'd like to send you detailed performance data on nonflammability. Write Du Pont Company, Room 5268, Wilmington, Del. 19898.
TEFLON®...for an extra measure of reliability!



Better things for better living
...through chemistry

Mixer Gems



QUALITY FREQUENCY CONVERTERS from a DEPENDABLE SOURCE

Lorch Electronics manufactures a series of broad band frequency converters (double balanced mixers) for applications requiring high isolation, low intermodulation distortion and high signal handling capability. Although these mixers measure typically as little as 0.17 cubic inches (some considerably less), they have RF power handling capability to 16 dbm, dynamic range to 135 db and excellent isolation characteristics (50 db to 400 MHz). And conversion loss is only 6-8 db, depending on model and frequency.

Careful manufacturing techniques and painstaking

quality control assure the reliability of Lorch frequency converters in mixer, phase detector, product detector, switch, attenuator and modulator applications. For printed circuit use they are furnished as miniature pin packages, for laboratory or systems work, with BNC or TNC connectors. Other connector types are available.

Tabulated are seven of the many models we manufacture and stock for immediate delivery. We have many more... on our shelves and in our heads. Among them is one suited to your particular needs.

And our prices are right.

SPECIFICATIONS

Model No. Pin Package Connector Version	FC-200 FC-201	FC-200R FC-201R	FC-200T FC-201T	FC-200W FC-201W	FC-200Y FC-201Y	FC-200Z FC-201Z	FC-210* FC-211*
Frequency Range*	0.25 to 225 MHz	0.2 to 500 MHz	0.2 to 600 MHz	0.2 to 600 MHz	0.05 to 200 MHz	2 to 1000 MHz	0.25 to 120 MHz
Conversion Loss	0.4-150 MHz: 6db Total range: 7db	0.4-150 MHz: 6db Total range: 8db	0.4-150 MHz: 6db Total range: 8db	0.4-150 MHz: 6db Total range: 9db	0.2-100 MHz: 6db Total range: 8db	50-400 MHz: 7db Total range: 8db	0.4-50 MHz: 7db Total range: 7.5db
Isolation LO at RF	50db to 10 MHz 40db to 40 MHz 25db to 225 MHz	60db to 10 MHz 50db to 50 MHz 35db to 500 MHz	60db to 10 MHz 50db to 50 MHz 30db to 600 MHz	50db to 400 MHz 40db to 600 MHz	50db to 30 MHz 35db to 200 MHz	40db to 500 MHz 30db to 1000 MHz	25db
Isolation LO at IF	50db to 10 MHz 40db to 40 MHz 25db to 225 MHz	60db to 10 MHz 50db to 50 MHz 25db to 500 MHz	60db to 10 MHz 50db to 50 MHz 25db to 600 MHz	50db to 40 MHz 40db to 200 MHz 30db to 600 MHz	40db to 30 MHz 25db to 200 MHz	30db to 500 MHz 25db to 1000 MHz	25db
Isolation RF at IF	35db to 100 MHz 25db to 225 MHz	20db to 500 MHz	25db to 50 MHz 15db to 600 MHz	30db to 50 MHz 20db to 600 MHz	20db to 30 MHz 15db to 200 MHz	25db to 500 MHz 12db to 1000 MHz	25db
Compression Level (for 2db compression)	-6dbm	-6dbm	+6dbm	+6dbm	+6dbm	+6dbm	+16dbm
LO Power	+7dbm	+7dbm	-7dbm	-7dbm	+7dbm	+7dbm	+20dbm
Dynamic Range (in 3KHz Bandwidth)	125db	125db	125db	125db	125db	125db	135db

*On all models except FC-210 and FC-211 one of the ports goes down to DC. Special versions of these two models are available with a DC port as Models FC-210DC and FC211DC.

Also available are Lorch broad band hybrid junctions and power splitters, from 80 KHz to 400 MHz, featuring low insertion loss, high isolation, low VSWR and good balance. These components can also be supplied from stock.

Want to know more about Lorch frequency converters and companion devices? Ask for our latest literature.



LORCH ELECTRONICS CORP.

105 Cedar Lane, Englewood, N.J. 07631 • 201-569-8282

ON READER-SERVICE CARD CIRCLE 245

Ceramic rods in diameters to 7 in.



Aremco Products, Inc. P. O. Box 145, Briarcliff Manor, N. Y. Phone: (914) 762-0685. P&A: \$8.25 to \$68; stock.

Machinable ceramic rods in sizes to 7 in. in dia. can be used to temperatures of 2500°F. A range of dia. have been tooled including 1/2, 1, 1-1/2, 2, 2-1/2, 3, 4, 5, 6, and 7 in. dia. These are all machinable, using carbide tipped tools. Pricing varies from \$8.25 for 1/2 in. dia. x 6 in. long rod to \$68 for a 7 in. dia. x 2 in. long rod. Aremcolox 502-1300 low expansion machinable ceramics, find applications where high heat resistance is required.

CIRCLE NO. 263

Torque limiting nut prevents stripping



Industrial Devices, Inc., Edgewater, N. J. Phone: (201) 343-4084.

Self-locking torque-limiting nuts made of nylon protect threads from stripping or breakage due to excessive torque. This nut is for use with male threads on plastic, ceramic or thinwall metal parts. When the nut is tightened beyond its "limit" it flexes and jumps the threads, then recovers to permit retightening. It can be used with any thread or nut geometry over a wide range of pre-set torque limits. The nut is produced by injection molding, so it is strong and corrosion-resistant.

CIRCLE NO. 264

Specified More Than Ever Before!

Methode

FORK CONTACTS AND CONNECTORS

Dependable, precision made Methode fork contacts in a variety of sizes and configurations are universally interchangeable.* Available with 3 to 51 contacts, and in all popular termination styles, Methode has resolved the termination problems of leading manufacturers everywhere. Invariably, we can meet these needs from stock, or from production facilities geared to fill special requirements promptly. We invite your inquiry.

Write for illustrated catalog with full engineering specifications.

Connector Division
Methode Electronics, Inc.
 7447 W. Wilson Ave.
 Chicago, Illinois 60656 • 312/867-9600

*Fork Contacts licensed under Elco Patents

ON READER-SERVICE CARD CIRCLE 70

GCC makes every type of Teflon coated wire you need today. And some you may need tomorrow.

Everyone agrees Teflon® insulated wire is more than a match for outer space. But, can you depend on getting it to your plant on time to meet your production schedule?

GCC is ready to meet your needs, wherever your plant happens to be. 51 GCC distributing centers and a nationwide network of manufacturing facilities are ready, willing and able to back up every order. GCC's delivery

policy goes one step further; tell us your needs and we'll be sure to stock your most popular items, so you'll always have a readily available source close by.

For specific data on the scope of our Teflon insulated product capabilities, drop us a line.
General Cable Corporation,
730 Third Avenue,
New York, New York 10017.

GCC



**WE'RE IN THE TEFLON
 INSULATED WIRE BUSINESS.
 AND WE'RE IN IT BIG.**

Teflon® is a DuPont trademark

ON READER-SERVICE CARD CIRCLE 73

MATERIALS

Wiring clip formed of ABS plastic

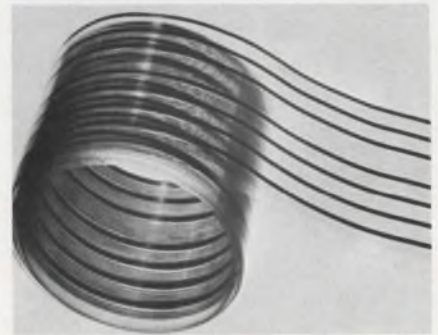

Dek, Inc., 117 W. St. Charles Rd., Lombard, Ill. Phone: (312) 629-5580.

A latching-wire clip bonds to carrying surface without tools, even in the most hard-to-reach locations. The clip is made of extruded ABS plastic and has a special adhesive backing on the mounting surface. Both clip and adhesive will hold indefinitely at 180°F. and are impervious to most environmental conditions. A special tab backing protects the adhesive until application and can be removed with practically no effort.

CIRCLE NO. 265

Flexible cable withstands 20 million flexes



Method Electronics, Inc., 7447 West Wilson Ave., Chicago, Ill. Phone: (312) 867-9600.

Plyo-duct, a flexible multiconductor wiring cable, withstood over 20-million flexes with no effect to its current carrying capacity. Consisting of a flat-conducting medium, usually copper, encapsulated between two layers of an insulating material, it is approximately 1/5 the weight of equivalent current carrying capacity cable, and represents a 2/3 savings in space over conventional wiring.

CIRCLE NO. 266

ON READER SERVICE CARD CIRCLE 74 ➤

**Back up data on the
smallest, fastest military memory weighs
more than the
smallest, fastest military memory.**

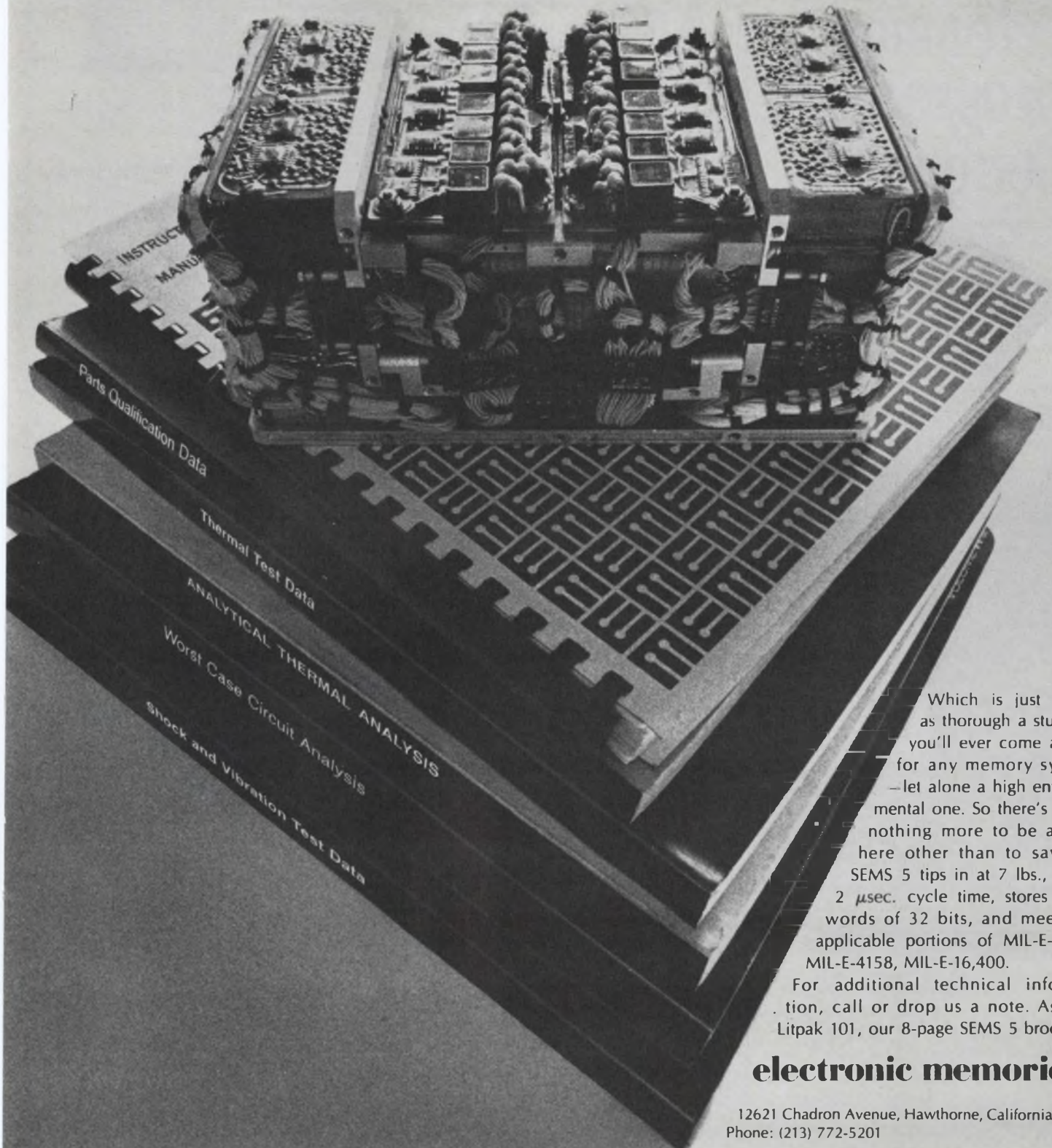

Which is just about as thorough a study as you'll ever come across for any memory system —let alone a high environmental one. So there's really nothing more to be added here other than to say our SEMS 5 tips in at 7 lbs., has a 2 μ sec. cycle time, stores 4096 words of 32 bits, and meets all applicable portions of MIL-E-5400, MIL-E-4158, MIL-E-16,400.

For additional technical information, call or drop us a note. Ask for Litpak 101, our 8-page SEMS 5 brochure.

electronic memories

12621 Chadron Avenue, Hawthorne, California 90250
Phone: (213) 772-5201

To provide you with a practical way of increasing your technical knowledge,

CREI now offers extension programs in Computers

Not simply courses, but complete programs in advanced electronics with Computers as a major elective. One program is for engineers who need updating, the other for high school graduates eager to move ahead in electronics.

CREI's industry-approved home study method permits you to study at your own pace, on your own schedule. Our free book gives full information and details on technical material covered. For your copy use coupon below, or write: CREI, Dept. 1910E, 3224 Sixteenth Street, N.W., Washington, D.C. 20010.



Founded 1927
CREI
 Accredited Member of the National Home Study Council

THE CAPITOL RADIO ENGINEERING INSTITUTE
 A DIVISION OF McGRAW-HILL, INC.
 Dept. 1910E 3224 16th St., N.W.
 Washington, D.C. 20010

Please send me FREE book describing CREI Programs in Electronics and Major Elective in Computers.

I am interested in Updating Program for Engineers
 Regular Program for men working in electronics

Name _____ Age _____
 Address _____
 City _____ State _____ Zip Code _____
 Employed by _____
 Position _____

ON READER-SERVICE CARD CIRCLE 75

MATERIALS

Tungsten carbide attains 70 Rockwell C

International Tungsten Carbide, 1651 Placentia, Costa Mesa, Calif. Phone: (714) 962-2172.

Depositing tungsten carbide at high speeds will fuse all conductive material with a layer controllable in build-up from 0.0002 to 0.003 of an in. at rates up to 6 in. per min. Applicable to all types of cutting edges (tools and dies) and wearing surfaces (frictional and erosion), the finish closely matches the original surface finish of the part. Hardness developed is at a minimum of 70 Rockwell C; higher Rockwell C's are possible depending upon the base material.

CIRCLE NO. 267

Epoxy systems are electrically conductive

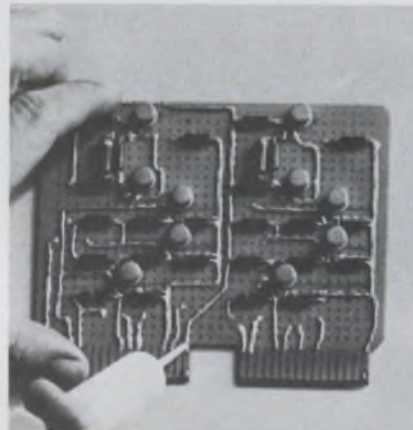

Epoxy Technology, Inc., 65 Grove St., Watertown, Mass. Phone: (617) 926-1949 P&A: \$12 evaluation kit.

A family of pure silver epoxy compounds offers versatility in electronic packaging techniques. This includes ground planes, shielding, microminiaturization, multi-layer circuits, and direct silk-screen application to complex circuits. The new epoxies are 100% solids in a soft-flowing paste form. Pot life is at least eight hours. The volume resistivity is 0.0001 to 0.0005 Ω /cm, and is reproducible. Elevated temperature tests of 1000 hours at 150° C showed no change in adhesion or conductivity.

CIRCLE NO. 268

Metalizing beryllia bars for easy soldering



Ceramics International Corp., 39 Siding Pl., Mahwah, N. J. Phone: (201) 529-2800. P&A: \$1 ea; stock.

These beryllia bars, measuring 0.050 in. square and 0.250 in. long have been metalized in isolated areas on both sides. The bars are molybdenum-coated and nickel-plated and then top-coated with 50 microns of high-purity gold. As a result, leads may be easily welded or soldered to the surfaces. The leads may also be removed and re-soldered, and the metalized area maintains its strength. Pull tests prove that a wire soldered to the metalized surface will break without weakening the metalizing.

CIRCLE NO. 269

Crystal wire in 0.005 in. diameter

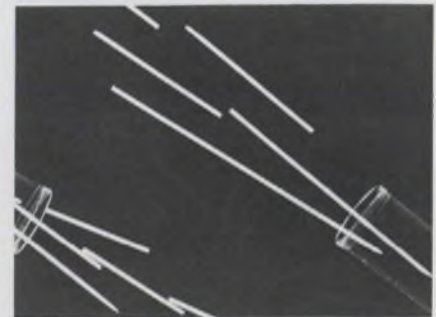

Aremco Products, Inc., P. O. Box 145, Briarcliff Manor, N. Y. Phone: (914) 762-0685. P&A: \$330.

Single crystal wire is offered in tungsten, rhenium, molybdenum, tantalum, nickel and platinum. The materials are available in diameters from 0.050 in down to 0.005 in diameter in standard 2 in. lengths. Tungsten, rhenium and molybdenum are also available in various orientations such as 110, 100 and 111. Tantalum, nickel and platinum are available only random oriented.

CIRCLE NO. 270

Solve any CCTV problem with one of these seven basic systems from Cohu.



High-fidelity color

1000 Series system includes the first CCTV camera with built-in references for correct registration and color balance. Compact, light, low-priced and easy-to-operate.

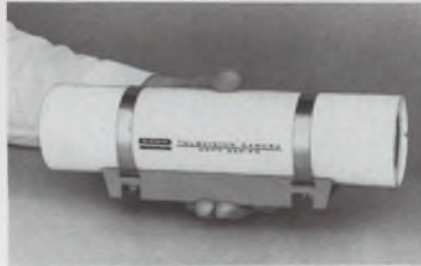

Miniaturized

Series 2000 cameras feature 3" outside diameter cylindrical housings that will accommodate remote-controlled 4:1 zoom lens. Many lens options available, including 10:1 zoom. Operate on 10 or 20 megahertz bandwidths.



High-resolution self-contained

Modular-designed 3200 Series offers choice of plug-in sync generators for EIA 525 or 729, 873 or 945-line scan rates. Compensates for light level variations to 10,000:1. Optional viewfinder.



Industrial self-contained

Complete with all camera control circuits, Model 20/20 cameras need only video cabling and any standard TV monitor to make a complete CCTV system. Highly versatile.



Radiation-tolerant

Get top quality TV pictures from radiation environments up to a cumulative dosage of 10^8 roentgens and/or 10^{12} neutrons/cm² with 3-inch diameter 2500 Series cameras. Readily de-contaminated.



Underwater

Tested to 10,000 PSI and up to 20,000 foot depth. Neutral buoyant. 70° view lens. Camera and cable independent.

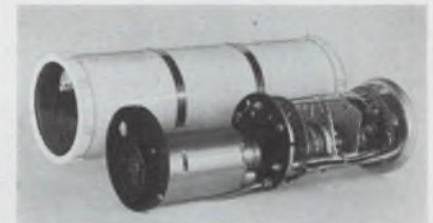

Environment-resistant

3000 Series cameras provide continuous-duty operation in up to 100% humidity, at temperatures from -20°C . to $+60^{\circ}\text{C}$., ocean depths to 250 feet and altitudes out to deep space. Meet military explosion-proof specifications. Operate on 10 or 20 megahertz bandwidths.

Which one solves yours?

For details on the industry's most complete CCTV line—including monitors, accessories and video switching systems—contact your nearest Cohu representative or call Bob Boulio direct at 714-277-6700 in San Diego.

COHU
ELECTRONICS, INC.
SAN DIEGO DIVISION

BOX 623 · SAN DIEGO, CALIFORNIA 92112 · TWX 910-335-1244

ON READER-SERVICE CARD CIRCLE 76

Miniature, dual channel YIG filter with two poles per channel and featuring excellent temperature stability for airborne applications.

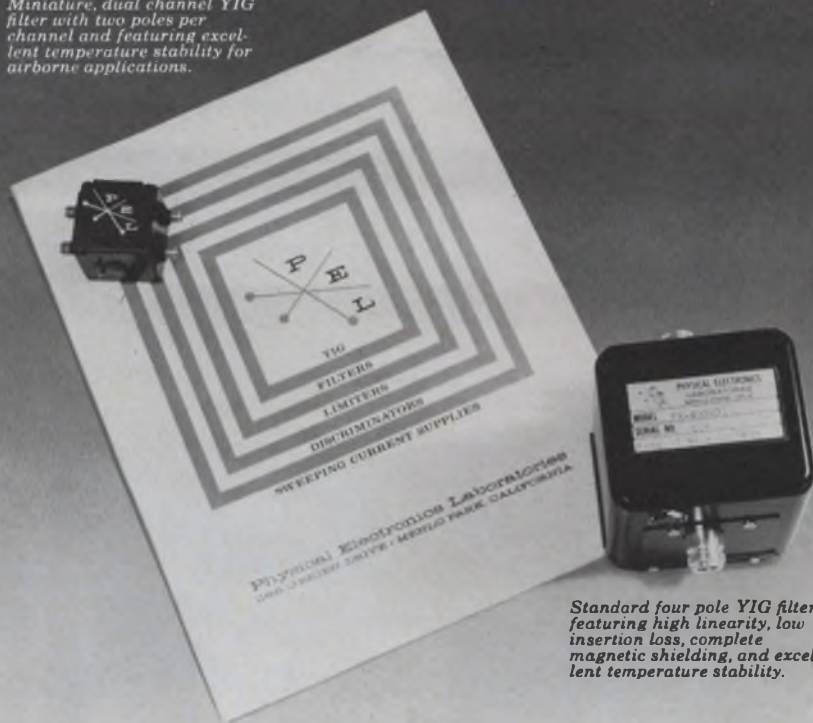

Standard four pole YIG filter featuring high linearity, low insertion loss, complete magnetic shielding, and excellent temperature stability.

Our catalog only tells part of the story...

... but some factors such as non-competitive and confidential handling of applications information, on-time deliveries, and the willingness to quote on modified or non-standard versions on a quick reaction basis have to be experienced to get the complete story.

As a result of continuing developmental programs, some of our latest products are not listed. However, every product has a complete data bulletin which fully outlines its performance. There is enough detail in the catalog and data bulletins for an engineer to make a decision on all performance characteristics such as tuning, linearity, and selectivity. And because all specifications are guaranteed, decisions can be made with confidence.

Send for copies of the latest PEL product literature. It's the best way to become familiar with the industry's most complete line of YIG devices.

The PEL line of YIG devices includes both standard size magnetically shielded units and partially shielded miniature models. We have a size and specification for most requirements. Our technical staff will be pleased to review your applications.

Representatives in all major cities in the United States.
International sales through Microwave International Corp.,
111 High Ridge Road, Stamford, Connecticut 06905 • (203)348-7704

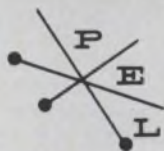

Physical Electronics Laboratories
1185 O'Brien Drive • Menlo Park, California 94025,
(415) 323-9092

ON READER-SERVICE CARD CIRCLE 77

MATERIALS

Pre-soldered boards ease mounting

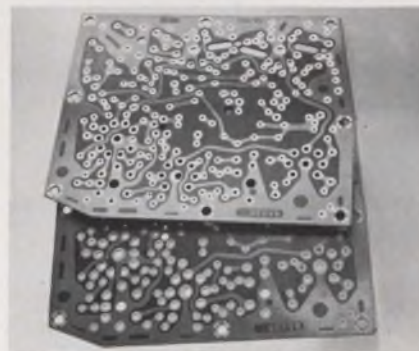

Croname, Inc., Chicago, Ill. Phone: (312) 774-2100.

A pre-soldered circuit-board system provides a solder-wetter copper surface. The solder, which can cover the entire circuit configuration or be applied selectively on pads or connector tabs, creates a solid bond at the interfaces between solder and copper. The system can substitute in most instances for silver plating, tin-nickel electroplating and for most fused solder requirements.

CIRCLE NO. 271

Terminal Groov-Pin eases circuit assembly

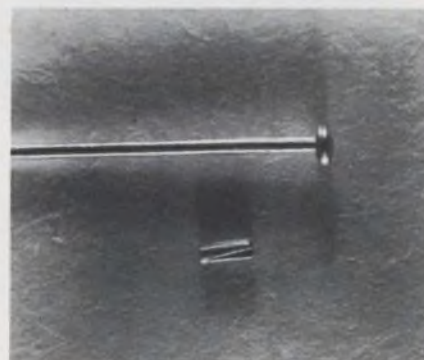

Groov-Pin Corporation, 1125 Hendricks Causeway, Ridgely, New Jersey. Phone: (201) 945-6780.

The item shown in the photo beside an ordinary dressmaker's pin is only 0.020 in. in diameter by 0.312 in. long. The pin, when forced into a drilled hole of the proper size, remains securely in place, helping protect the hair-like lead wires from damage or displacement, from normal vibration or shock. The pins, can be furnished in any size and material to suit conductive requirements.

CIRCLE NO. 272

The Authority.

Free.

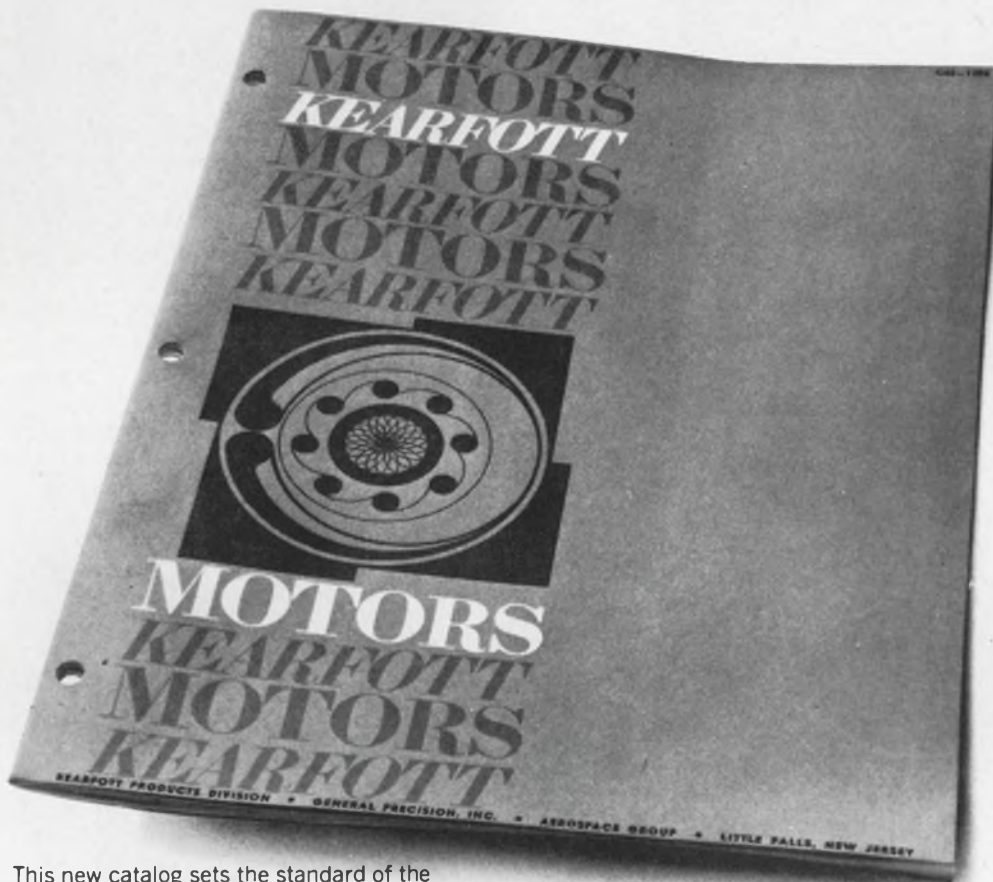

This new catalog sets the standard of the industry.

It thoroughly describes the finest motors you can buy. All types of Kearfott motors.

Open it and look at the listing. We offer stepper motors, drivers and logic. Synchronous motors. Viscous-damped, inertial-damped and braked servo motors in sizes 5 through 23. Special-purpose AC motors that meet some really way-out application needs.

Some of the designs we call standard others might call extraordinary.

Take our permanent magnet stepper motors. They're as much as 40% shorter than conventional units with no sacrifice in torque. Which means you can keep your designs small.

Our variable reluctance stepper motors are the shortest per unit torque

available. They require the least power for rated operation, and they're non-resonant without using external resistive or mechanical damping circuits.

Our standard hysteresis synchronous motors are the most stable for those applications where hunting and jittering can't be tolerated.

No other source offers such a complete variety of motors providing precision and reliability developed during 20 years of experience.

You'll find all the details in our comprehensive 32-page brochure. Pictures. Descriptions. Tables of characteristics. Dimensional drawings. Wiring schematics. Even a summary of design formulas.

Free. Write for it today. Kearfott Products Division, General Precision Systems Inc., Kearfott Group, 1150 McBride Ave., Little Falls, New Jersey 07424. Dept. 3-1450.

**GP GENERAL
PRECISION
SYSTEMS INC.**

KEARFOTT PRODUCTS DIVISION
A SUBSIDIARY OF GENERAL PRECISION EQUIPMENT CORPORATION

ON READER-SERVICE CARD CIRCLE 78

1200 CFM FAN



McLEAN REVERSIBLE REVERSIBLE

Three Mil-Spec models in this series offer air deliveries of 275, 725 and 1200 CFM. Use them for cooling and ventilating electronic cabinets, military and electronic field vehicles, and mobile power generating systems. Mount them in any position, vertical, horizontal, backwards, frontwards, for either push or pull airflow. Mechanical changes or field modifications are unnecessary! They're compact, quiet, easy to install, low cost, and rugged.

Complete engineering details on this and other McLean cooling equipment available in our new 1967 Catalog.

McLEAN ENGINEERING LABORATORIES

Princeton Junction, N. J. 08550
Phone 609-799-0100
TELEX 84-3422

MICROWAVES

Sweep oscillator covers 200 MHz to 40 GHz



*Micro Power, Inc., 25-14 Broadway,
Long Island City, N. Y. Phone:
(212) 726-4060.*

Features of the model 221 include a remote symmetrical sweep control, remote power-level control, manual sweep mode and a time delay at the beginning of each sweep to stabilize rf power. Existing oscillator plug-ins can be used with the basic unit. Frequency coverage of the sweeper, utilizing various available plug-ins, is 200 MHz to 40 GHz.

CIRCLE NO. 273

Helium-neon laser emits light at 6328 Å

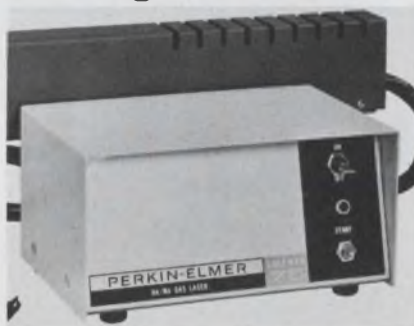

*Perkin Elmer, Norwalk, Conn.
Phone: (203) 762-6972. Price: \$295*

A low-powered helium-neon gas laser is designed for coherent light applications. The unit emits a continuous, single-frequency, single-mode, red (6328 Å) beam of light in the visible spectrum. One mW output allows for safe operation while producing a bright spot several hundred feet away. The actual beam divergency is less than 0.4 m rad. The list of possible applications includes mechanical and optical alignment, surveying, construction, laboratory research and quality control.

CIRCLE NO. 274

Radiation sources provide up to 1200°C

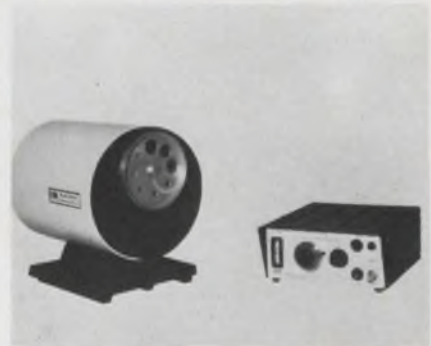

*Infrared Industries, Inc., Santa
Barbara, Calif. Phone: (805) 684-
4181.*

Blackbody radiation sources are for use in infrared calibration and studies. Temperatures to 1200°C with a stability of 0.1°C are available in 12 different models. Cavity diameters from 0.080 to 3 in. on emissivity of 0.99, reference thermocouple, and selectable precision apertures are features of the new series.

CIRCLE NO. 275

Laser-detonated device uses fiber optics

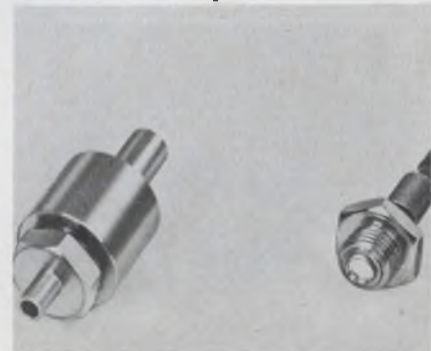

*Space Ordnance Systems, Inc., 122
Penn St., El Segundo, Calif. Phone:
(213) 772-5461.*

Electro-explosive devices are detonated by laser light conveyed along fiber-optic bundles. Because there are no electrical leads into the SOS explosive devices, the pyrotechnic compounds are effectively enveloped in a Faraday shield. The units allow complete end-to-end inspection and checkout of the system including the explosives. Simultaneous initiation of several units in salvo or sequence can be accomplished with precise simultaneity.

CIRCLE NO. 276

automate
your
DVM

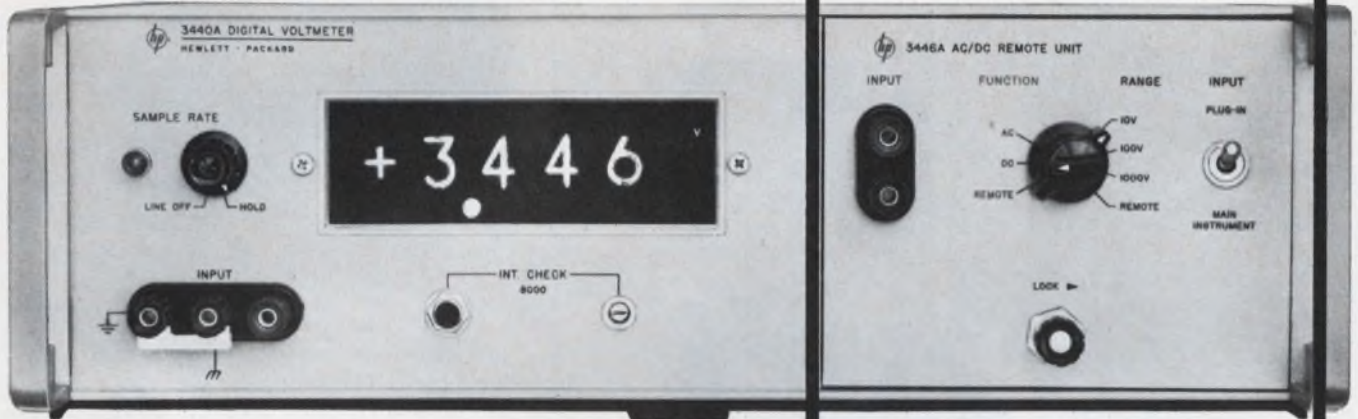

with remote
function,
range plug-in

The new 3446A AC/DC Remote Plug-in unit lets you automate your Hewlett-Packard 3439A or 3440A Plug-in Digital Voltmeter by permitting remote programming of function (ac or dc measurements) and/or range (10, 100, 1000 v full scale). An ideal instrumentation package for automatic test stations, programmable routine measurements, measurements required at a distance from the DVM.

The DVM's themselves are compact instruments with a selection of plug-ins to provide the choice of manual, automatic and remote ranging, extra-high sensitivity, ac/dc voltage/current/resistance measurements; dc accuracy better than $\pm 0.05\%$ of reading ± 1 digit; 4-digit readout; 30 db ac rejection at 60 Hz; capability of floating input pair up to 500 v above chassis ground. The 3440A (\$1160) is systems oriented. The 3439A (\$950) is a bench model. Both use the same plug-ins.

The specifications tell the performance story of the DVM's and this new plug-in. Ask your Hewlett-Packard field engineer for a demonstration of the voltmeter most useful for your application, or write for full specifications to Hewlett-Packard, Palo Alto, California 94304, Tel. (415) 326-7000; Europe: 54 Route des Acacias, Geneva.

Data subject to change without notice. Prices f.o.b. factory.

SPECIFICATIONS, 3446A

Voltage range (ac and dc):	4-digit full-scale readings of 9.999, 99.99 and 999.9 v; 5% overrange capability, indicator.
Voltage accuracy (ac):	50 Hz-20 kHz, $\pm 0.1\%$ of reading ± 2 counts. 20 kHz-50 kHz, $\pm 0.1\%$ of full scale ± 2 counts. 50 kHz-100 kHz, $< \pm 0.3\%$ of full scale ± 2 counts, from 20°C to 30°C, including $\pm 10\%$ line variations. Temperature coefficient = $\pm 0.005\%/^{\circ}\text{C}$ from 0-20°C and 30-50°C.
Voltage accuracy (dc):	$\pm 0.05\%$ of reading ± 1 digit, including 10% line variation, +15°C to +40°C ($\pm 0.1\%$ ± 1 digit 0°C to +50°C).
Range selection (ac):	Manual, remote; auto reading < 2 sec; max. remote ranging time 40 msec.
Range selection (dc):	Manual, remote; auto reading < 1 sec; max. remote ranging time 40 msec.
Function selection (ac or dc):	front panel or remote.
Input impedance:	10 megs shunted by < 35 pf, all ac ranges; 10.2 megs, dc.
Price:	\$575

HEWLETT  PACKARD
An extra measure of quality

ON READER-SERVICE CARD CIRCLE 80

1187

NEW!

Lens End Cartridge Lamp

for close proximity photosensor applications

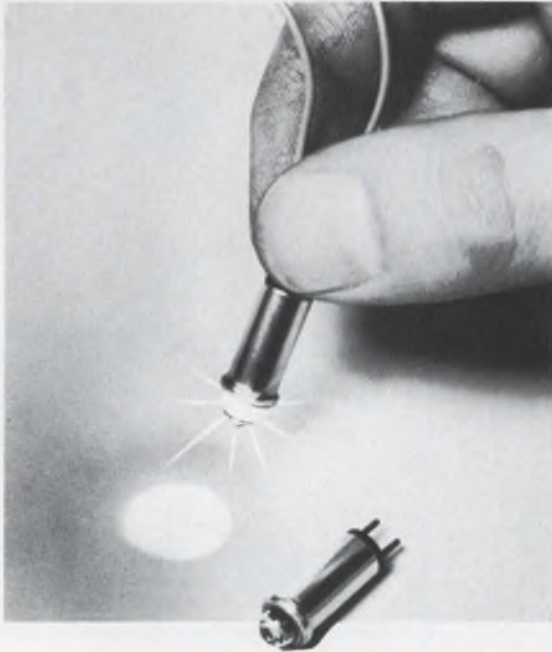

- ◆ Condensed Beam of Energy
- ◆ Ease and Versatility of Mounting
- ◆ Controlled Spot Characteristics
- ◆ Axial Alignment of Spot
- ◆ Ease of Replacement

Both infrared (80%) and luminous energy emitted is condensed by the integral lens of this lamp envelope and projected into a defined spot. This axially aligned beam of energy will saturate photosensors responding to the near infrared spectrum.

The long-life lamp is mounted in an easily installed or replaced bi-pin cartridge with several mounting devices available that permit close adjustment of the light beam.

This is just another example of Chicago Miniature's unique talent for developing lamps to suit a specific need.

For complete information,
write for Product Bulletin No. 100B.

CHICAGO MINIATURE LAMP WORKS

4433 Ravenswood Ave., Chicago, Illinois 60640

MICROWAVES

Spectrum analyzer covers 0.5 to 100 kHz



Specialty Electronics Development Corp., 70-31 84th St., Glendale, N. Y. Phone: (212) 582-2288.

The instrument uses a single tuning control to search for signals and has plug-in tuning heads with digital dials. A plug-in synthesizer assures stable performance. Sweep rates and resolution are calibrated for spectrum widths from 0.5 to 100 kHz. Other features are 10-Hz resolution, rf attenuator, X-Y recorder output, and front-panel line-voltage indicator and adjustment.

CIRCLE NO. 277

Directional detector spans 0.95 to 2.11 GHz



Narda Microwave Corp., Plainview, L. I., N. Y. Phone: (516) 433-9000.

The model 3142 is an integrated package which combines a flat directional coupler with a high sensitivity crystal detector. This design provides low input VSWR, high directivity and maximum flatness. The frequency sensitivity is limited to ± 0.2 dB from 0.950 to 2.11 GHz with a minimum directivity of 25 dB. Since the crystal detector is an integral part of the sampling device total ± 2 dB flatness can be guaranteed.

CIRCLE NO. 278

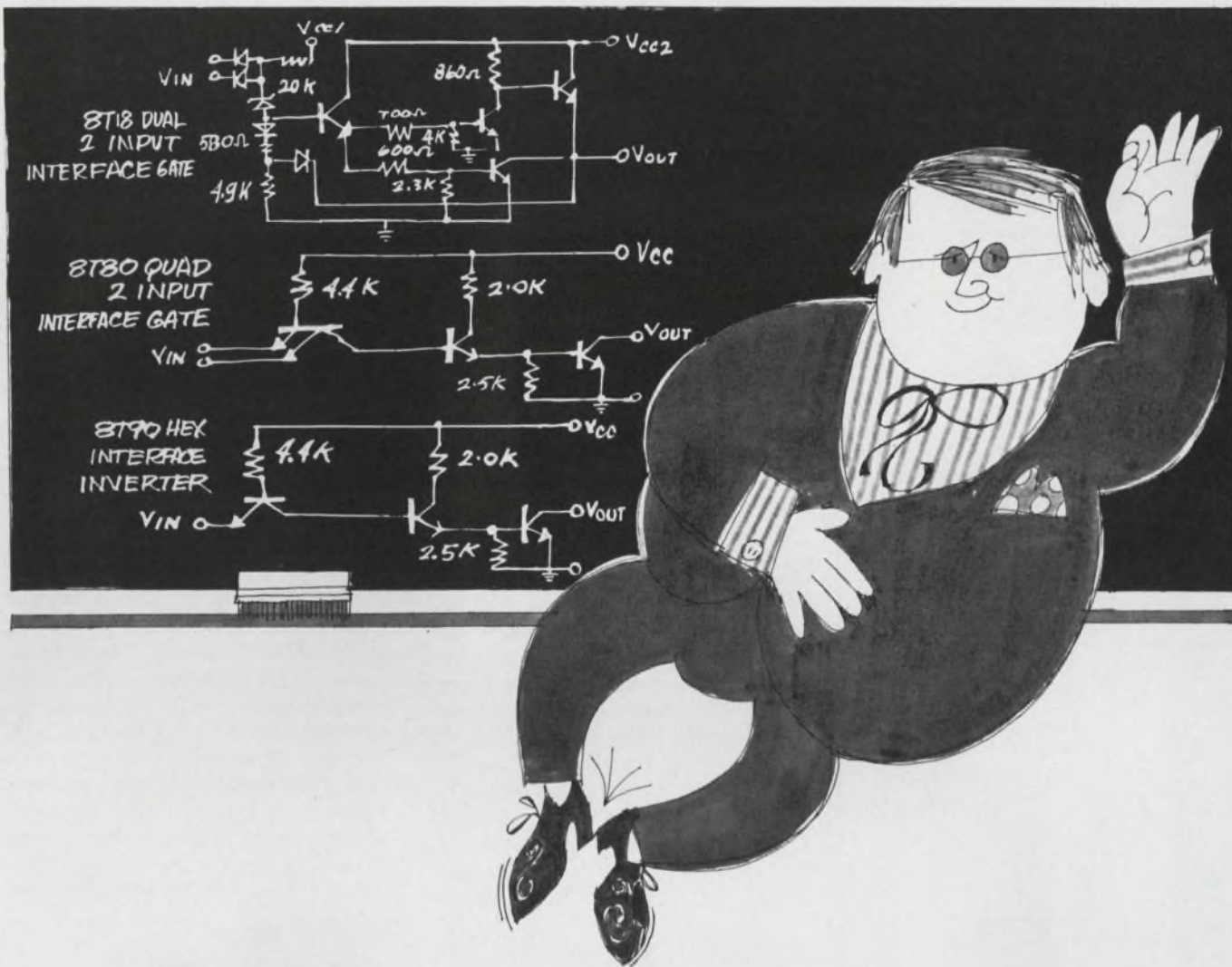

EUREKA! Signetics solves the IC interface problem.

We've just saved you time and money and simplified your system design procedures. There are three *new* interface elements in the DCL series. They are designed specifically to match system levels of up to 30 volts with DCL levels of 5 volts. In addition to their obvious application in level translation and buffering, they may be used as lamp, relay and line drivers.

Hooray! No more special discrete component designs at interfaces. Signetics has done it again! Just circle the number on the bingo card, or write, and we'll be happy to send you the data sheets on the 8T18 Dual 2-Input Interface Gate, 8T80 Quad 2-Input Interface Gate, 8T90 Hex Interface Inverter.

**SIGNETICS
INTEGRATED
CIRCUITS**



A SUBSIDIARY OF CORNING GLASS WORKS
811 EAST ARQUES, SUNNYVALE, CALIFORNIA 94086

SIGNETICS SALES OFFICES: Metropolitan New York (201) 992-3980; Upper New York State (315) 469-1072; Southwestern (214) 231-6344; Western Regional (213) 272-9421; Eastern Regional (617) 245-8200; Mid Atlantic (609) 858-2864; Southeastern (813) 726-3734; Midwestern Regional (312) 259-8300; Northwestern (408) 738-2710.

DISTRIBUTORS: Compar at all locations listed below. Semiconductor Specialists, Inc. (312) 279-1000; Terminal Hudson Electronics (212) 243-5200; Wesco Electronics (213) 684-0880; Wesco Electronics (405) 968-3475; Hammond Electronics (305) 241-6601; Avnet Electronics Corp. of Massachusetts (617) 272-3060.

DOMESTIC REPRESENTATIVES: Jack Pyle Company (415) 349-1266. Compar Corporation at the following locations: Alabama (205) 539-8476; Arizona (602) 947-4336; California (213) 245-1172; California (415) 697-6244; Colorado (303) 781-0912; Connecticut (203) 288-9276; Florida (305) 855-3964; Illinois (312) 775-5300; Maryland (301) 484-5400; Massachusetts (617) 969-7140; Michigan (313) 476-5758; Minnesota (612) 922-7011; Missouri (314) 428-5313; New Jersey (609) 429-1526; New Mexico (505) 265-1020; New York (518) 436-8536; New York (607) 723-8743; New York (716) 684-5731; New York (201) 471-6090; North Carolina (919) 724-0750; Ohio (216) 333-4120; Ohio (513) 878-2631; Texas (214) EM 3-1526; Texas (713) 649-5756; Washington (206) 725-7800.

INTERNATIONAL SALES: France, Germany, Italy, Belgium, Holland, Luxemburg, Spain - Sovcor Electronique, 11, Chemin de Ronde, Le Vesinet, (S. & O.) France. United Kingdom, Ireland, Sweden, Denmark, Norway, Switzerland, Austria, Portugal - Electrofil Ltd., Lakeside Estate, Coinbrook By Pass Slough, Buckinghamshire, Great Britain. Australia - Corning, 1202 Plaza Building, Australia Square, Sydney, N.S.W. 27-4318. Canada - Corning Glass Works of Canada, Ltd., Leaside Plant, Ontario, Canada (416) 421-150. Israel - Optronix, P.O. Box 195, Ramat Gan, Israel 724-437. Japan - ASAHII Glass Co., Ltd., Corning Products Sales Dept. No. 2, 3-Chome Marunouchi, Chiyoda-ku, Tokyo, Japan.

ON READER-SERVICE CARD CIRCLE 82

MODEL CS-60 60 KHZ TIME CODE RECEIVER

HIGH POWER • LOW CURRENT

A new, low current drain time code receiver, so sensitive that it will receive NBS signals from 2,000 or more miles away. Original and unique circuitry developed at the Seismological Laboratory in Pasadena, California. The unit will receive Radio Station WWVB signals, considered to be the most accurate time

signals available. Intermediate frequency is 2kHz. It is designed for long term, remote, unattended operation as it requires power of only ± 12 vdc ± 1 vdc at 1.5 ma without audio (35 ma with audio).

PRICE: MODEL CS-60A \$540.00
Battery powered portable field unit available.

Write, wire or phone for complete information.



SPECIFIC PRODUCTS

P. O. Box 425 / 21051 Costanzo Street / Woodland Hills, California 91364 / Phone: (Area Code 213) Diamond 0-3131



PRODUCTION EQUIPMENT

Micro probe permits 100 contacts

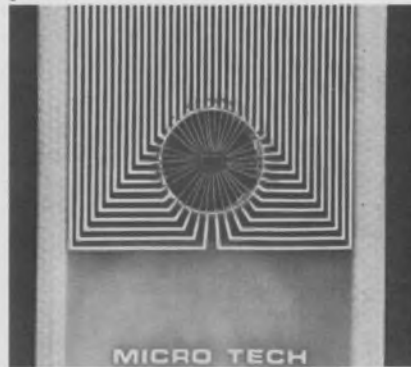

Micro Tech Mfg., Inc., 703 Plantation St., Worcester, Mass. Phone: (617) 755-5215.

A method of probing multiple-contact MOS-type integrated circuits in wafer form permits as many as a hundred contacts at one touch-down. Life testing data indicates that contact life exceeds 100,000 contacts. Model 4303 has a contact capability of up to 40, Model 4304 probe has a capability of up to 20 contacts, and the Model 4305 can probe from 40 to 100 contacts.

CIRCLE NO. 279

Assembly clamp handles 1/2 in. objects

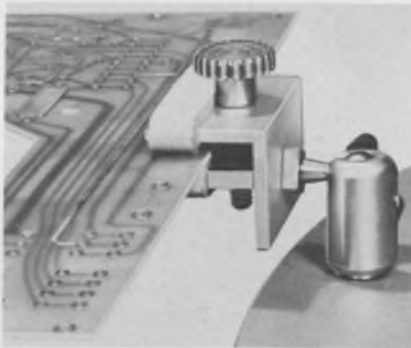

Production Associates, Inc., Box 5093, Madison, Wisc.

Small modules, circuit boards, and other flat pieces are held securely for assembly operations. The jaws of the clamp accept work to 1/2 in. thick. Jaws open and close through thumb-screw adjustment. A 1/2 in. wide rubber band protects both sides of the assembly from marring. A swivel mount gives flexibility in positioning work. It allows full 360° rotation in a horizontal plane, and 130° in a vertical plane.

CIRCLE NO. 280

Launder ferrite cores for testing or stringing



Computer Test Corp., 3 Computer Dr., Cherry Hill, N. J. Phone: (609) 424-2400.

The ramsey model CL-500 core laundry increases core handler efficiency by cleaning and deburring cores before handling. The cleaning removes die fins and burrs from cores by means of a polishing station consisting of a vibrating bowl partially filled with abrasive powder. After deburring, the cores are sieved to remove the abrasive, washed in an organic solvent, then dried in a moving air stream.

CIRCLE NO. 281

Wafer dicer cuts in 1.5 min.



Micro Tech Mfg., Inc., 703 Plantation St., Worcester, Mass. Phone: (617) 755-5215.

The model 3312 is a tool for the sawing of materials such as glass, silicon, and germanium into miniature dice-shaped pieces. The unit uses fine diameter steel wires combined with an abrasive slurry, to saw through the materials. There are straight cuts on every die with no bevels, or broken edges. Wafers with center-to-center spacing as little as 0.101 in. can be cut. Cutting rates of 1.5 min per wafer include loading and unloading of the wafer.

CIRCLE NO. 282

250-600 VOLTS IN A LEADLESS PACKAGE

HELP FOR
HYBRID CIRCUITS

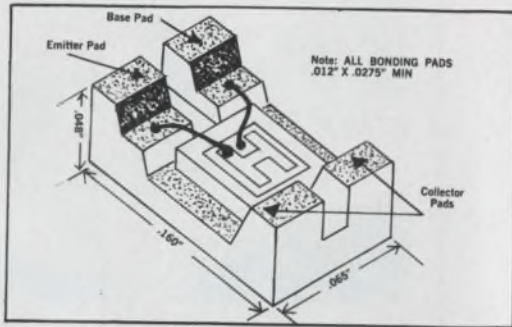

High Energy Leadless Package (HELP) devices make possible the assembly of high voltage hybrid circuits. The full line of  high voltage NPN and PNP silicon transistors are now available in the new *HELP* form. These fully passivated devices can be assembled by standard bonding and wiring techniques or by "flip-chip" soldering techniques. Currently available with the specifications described below, they can also be built to custom requirements.

NPN	BVCER RBE 1KΩ @200 uA VOLTS	BVCBO @200 uA VOLTS	BVEBO @100 uA VOLTS	HFE IC=50MA VCE=5V	VCE. SAT. IC=50MA IB=5MA VOLTS	VBE. SAT. IC=50MA IB=5MA VOLTS	ICBO @25°C <uA	VCB VOLTS	GBW IC=50MA VCE=10V @20MC	MAX COB uuf IE=0 VCB=15V f=2 MC
TRH-250	250	250	6	30	1.0	1.0	150	5.0	2.5	15
TRH-300	300	300	6	30	1.0	1.0	200	5.0	2.5	15
TRH-350	350	350	6	30	1.0	1.0	250	5.0	2.5	15
TRH-400	400	400	6	30	1.0	1.0	300	5.0	2.5	15
TRH-450	450	450	6	30	1.0	1.0	350	5.0	2.5	15
TRH-500	500	500	6	30	1.0	1.0	400	5.0	2.5	15
TRH-550	550	550	6	30	1.0	1.0	450	5.0	2.5	15
TRH-600	600	600	6	30	1.0	1.0	500	5.0	2.5	15
TRH-700	700	700	6	30	1.0	1.0	550	5.0	2.5	15
TRH-800	800	800	6	30	1.0	1.0	600	5.0	2.5	15

*BVCEO @IC=25MA Sustained										
BVCEO (SUSTAINING) TYPES										
TRH-250S	250	300	6	30	1.0	1.0	250	5.0	2.5	15
TRH-300S	300	350	6	30	1.0	1.0	300	5.0	2.5	15
TRH-350S	350	400	6	30	1.0	1.0	350	5.0	2.5	15
TRH-400S	400	450	6	30	1.0	1.0	400	5.0	2.5	15
TRH-450S	450	500	6	30	1.0	1.0	450	5.0	2.5	15
TRH-500S	500	550	6	30	1.0	1.0	500	5.0	2.5	15
TRH-550S	550	600	6	30	1.0	1.0	525	5.0	2.5	15
TRH-600S	600	650	6	30	1.0	1.0	550	5.0	2.5	15

PNP	BVCER RBE 1KΩ @200 uA VOLTS	BVCBO @200 uA VOLTS	BVEBO @100 uA VOLTS	HFE IC=25MA VCE=10V	VCE. SAT. IC=25MA IB=2.5MA VOLTS	VBE. SAT. IC=25MA IB=2.5MA VOLTS	ICBO @25°C <uA	VCB VOLTS	GBW IC=10MA VCE=20V @20MC	COB uuf IE=0 VCB=15V f=2 MC
TRHP-250	250	250	5	25	3.0	1.0	150	5.0	1.0	20
TRHP-300	300	300	5	25	3.0	1.0	200	5.0	1.0	20
TRHP-350	350	350	5	25	3.0	1.0	250	5.0	1.0	20
TRHP-400	400	400	5	25	3.0	1.0	300	5.0	1.0	20
TRHP-450	450	450	5	25	3.0	1.0	350	5.0	1.0	20
TRHP-500	500	500	5	25	3.0	1.0	400	5.0	1.0	20

*BVCEO @IC=25MA Sustained										
BVCEO (SUSTAINING) TYPES										
TRHP-250S	250	250	5	25	3.0	1.0	150	5.0	1.0	20
TRHP-300S	300	300	5	25	3.0	1.0	200	5.0	1.0	20
TRHP-350S	350	350	5	25	3.0	1.0	250	5.0	1.0	20
TRHP-400S	400	400	5	25	3.0	1.0	300	5.0	1.0	20
TRHP-450S	450	450	5	25	3.0	1.0	350	5.0	1.0	20
TRHP-500S	500	500	5	25	3.0	1.0	400	5.0	1.0	20

*Pulse Width: 300μsec, Duty Cycle <2%



INDUSTRO TRANSISTOR CORPORATION
35-10 36th AVENUE/LONG ISLAND CITY, NEW YORK 11106, (212) EX 2-8000

ON READER-SERVICE CARD CIRCLE 84

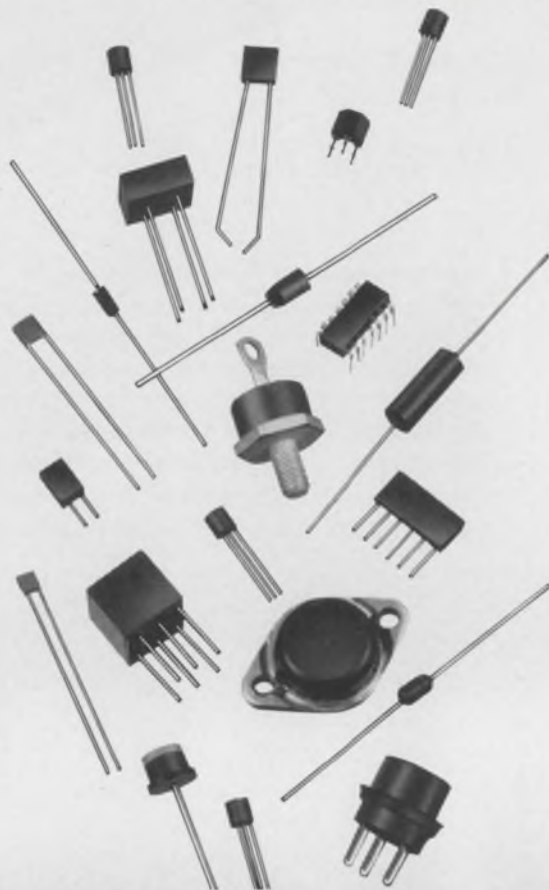

NEW

Unequaled Electronic Grade Epoxy Molding Powder from HYSOL

Now HYSOL has a specially formulated hi-grade electronic molding powder for use in applications where high quality and reliability are a must.

HYSOL recommends using these soft flow molding powders for transfer molding, encapsulation of transistors, integrated circuits, diodes, critical resistors, capacitors, inductors, as well as the more sophisticated semiconductors that demand super quality control, moisture resistance and a broader range of compatibility.

The HYSOL laboratories located in the East and West, have the test equipment procedures and personnel to supply you with test data on the effect of encapsulation on your products. HYSOL can solve your problems now. Write, wire or phone HYSOL, Dept. ED-107, Olean, New York 14760.

PROGRESSIVE PRODUCTS
HYSOL HYSOL CORPORATION • OLEAN, NEW YORK 14760
THRU CHEMICAL RESEARCH LOS ANGELES, CALIFORNIA/HYSOL (CANADA) LTD., ONTARIO/LONDON, ENGLAND

ON READER-SERVICE CARD CIRCLE 85

PRODUCTION EQUIPMENT

Die-bonder designed for dual-in-line IC's



Sola Basic Industries, Marine Plaza, Milwaukee, Wis. Phone: (414) 276-1480. Price: \$7500-\$7900; 4 to 6 wks.

A floor-model die bonder that will accommodate dual in-line ICs is designated model 1212. The bonder has a carrier that holds four tiers of 1-5/8 in. wide indexing belts and each belt accommodates 16 lineal in. of dual-in-line strips. The unit has the ability to hold 64 in. of dual-in-line strips in one carrier. Vacuum creates the bonding force.

CIRCLE NO. 283

Deflashing machine cleans plastic parts



Wells Electronics, Inc., 1701 S. Main St., South Bend, Ind. Phone: (219) 288-4651.

The model BLM-C will deflash, clean, or deburr fragile plastic parts, with or without inserts. This blasting equipment has a chain conveyor outfitted with mandrels that accept and hold the fragile parts as they are transported through the deflashing chamber. With manual feed alone, it is capable of deflashing up to 5000 pieces without damaging leads or inserts, the plastic finish, or fine molded details in the parts.

CIRCLE NO. 289

709 op amp in plastic case

Texas Instruments Inc., 13500 N. Central Expwy., Dallas, Tex. Phone: (214) 238-3741. Price: \$4 up.

The 709 integrated-circuit operational amplifier is available in a plastic package. Two versions are available—one for economy and one for performance. The economy models are the SN72702N and SN72710-N circuits, while the performance models are the SN52702N and SN52710N versions. Operating temperature for the plastic-encapsulated series 52 versions is the full military range from -55 to $+125^{\circ}\text{C}$.

CIRCLE NO. 285

Hybrid regulator offer 3 outputs

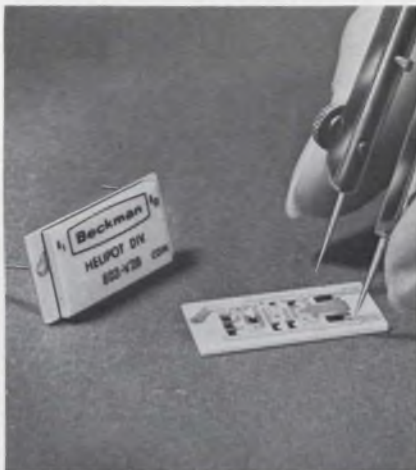

Beckman Instruments, Inc., 2500 Harbor Blvd., Fullerton, Calif. Phone: (714) 871-4848. P&A: \$30; stock.

The series-803 regulators permit $\pm 0.5\%$ regulation for both line and load variations. Standard models offer fixed outputs of 24, 28 or 32 V. Special models with any other fixed output in the 21 to 32 V range may also be ordered. The regulators will supply up to 7.6 W to load at $+25^{\circ}\text{C}$ in free air, or up to 16 W when used with a heat sink. They operate over a temperature range of -55 to $+125^{\circ}\text{C}$.

CIRCLE NO. 286

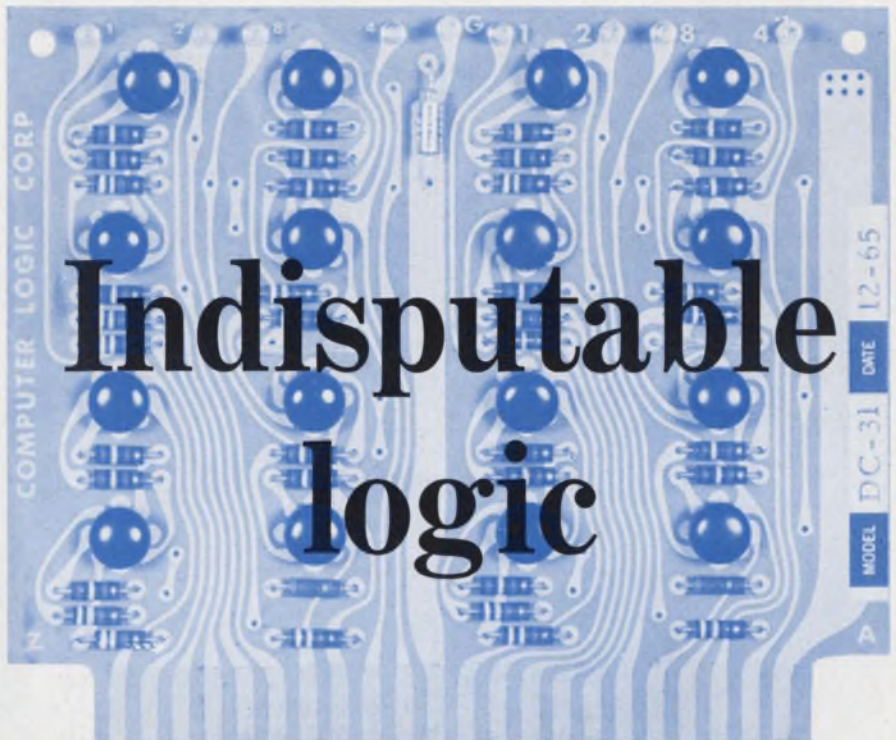

You can't beat Computer Logic Corp.'s complete family of integrated circuit DC to 5 MC DTL cards. So why not join them and put these advantages to work in your system.

**3 times
greater fan-out,
greater
performance
per dollar**

■ Fan-out is 30 from all sources without power drivers. Why pay for unnecessary cards? You can drive 20 flip-flops and 10 gates directly. How? CLC unit load is only 0.35 ma or less. Thus IC's are loafing well within device ratings. If your fan-out is typically 10, then MTBF jumps 3 to 1 due to lowered internal dissipation.

**Eliminate inverters,
simplify design,
pack maximum logic
in minimum space**

■ Only CLC offers *both* HIGH-NAND and LOW-NAND gates in one IC card family. Your AND-TO-AND, OR-TO-OR, AND-OR, OR-AND gating no longer requires costly inverters. This simplifies design and saves card space and power.

**Higher noise
rejection,
greater reliability**

■ Everyone claims good noise rejection at inputs. Ours is 1 volt. But only CLC specifies noise rejection at outputs of 4V. You can wire gate and flip-flop outputs directly together to save more cards. And large output rejection prevents costly noise-chasing during checkout. This adds to reliability as does the low dissipation and 100% final test before shipment.

**Fast delivery
response**

■ CLC will not be beat on delivery, price, or service. At CLC, it's performance that counts. Write or order directly now.

Silicon and Germanium discrete cards are also available from CLC.



COMPUTER LOGIC CORP.

1528 20TH ST., SANTA MONICA, CALIF. 90404/TELEPHONE (213) 451-9754

ON READER-SERVICE CARD CIRCLE 86

HIGH STYLE FOR
HIGH PERFORMANCE



**THE NEW
CENTURION
LINE...**

**with
the Proven
Beede
Taut Band
Movement...**

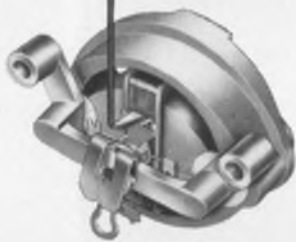

The clean custom appearance of the new "CENTURION" line will contribute to the quality appearance of any fine instrument. A durable compression molded phenolic construction permits rugged handling and lasting design appearance. Also available in a behind-the-panel model.

This new "CENTURION" line employs the high performance Beede Taut Band movement with $\pm 1\%$ or $\pm 2\%$ tracking, excellent balance, good damping and response, and no drift.

Send for our complete meter catalog today.

BUY VALUE / BUY BEEDE



ON READER-SERVICE CARD CIRCLE 87

TEST EQUIPMENT

Two power supplies used in IC tester



Microdyne Instruments, Inc., 225 Crescent St., Waltham, Mass. Phone: (617) 893-8210.

This tester may be used as a manually-operated instrument or as a programed functional tester. All dc parameters of micrologic circuits and most microlinear circuits may be tested, using the front panel controls of the model 710. Functional tests may be made by patch-plug programing and keyboard control. Lamps indicate the output condition of gates and flip-flops, while inputs are controlled by the keyboard switches.

CIRCLE NO. 287

Tension dial gauges determine force



Jonard Industries, Precision Tools Div., 3047 Tibbett Avenue, Bronx, N. Y. Phone: (212) 549-7600.

Tension dynamometer gauges determine force required to actuate sensitive mechanisms. Measurements can be made in two directions both clockwise and counter-clockwise. All gauges are equipped with maximum reading pointer. Dynamometers are available in 3 models, 0-50, 5-150, and 100-1000 grams. They are packaged in a rigid plastic case to protect movement.

CIRCLE NO. 288

Adjustable power supply span 0-1000 V dc



NIMCO, 2076 American Ave., Hayward, Calif.

The basic supply may be switched internally to either of two BNC outlets, each of which may also be arranged for positive or negative polarity. The two branches are independently adjustable over a 0-1000 V dc range with output voltage readout available directly from settings on the individual 10 turn dials. Output branch currents are indicated on the 0-50 μ A panel meter.

CIRCLE NO. 289

Laboratory preamplifier responds to 500 kHz



Applied Cybernetics Systems, Inc., 880 Bonifant St., Silver Spring, Md. Phone: (301) 588-4873.

Featuring all-silicon solid-state components, low noise, a small package and one year of continuous operation from internal mercury cells, these preamplifiers are suited for both laboratory and field applications. Their specifications include input impedances up to 1000 M Ω , gains up to 40 dB, frequency response to 500 kHz and noise levels of 3 μ V broad band.

CIRCLE NO. 290

**Design with
confidence...**



**with
Centralab's
"Little Giant"
Zeners
up your sleeve**



- Microminiature • High Rel
- High Wattage • Competitively priced

With Centralab Little Giant 1 watt zeners up your sleeve, regulators will be the least of your problems in circuit design. Though microminiature in size (actual size in above illustration), Centralab's Little Giant replaces larger zeners*, in entertainment, industrial and high reliability applications. Rugged tests the Little Giant is subjected to and passes include acceleration,

mechanical shock, vibration, lead and body strength, temperature, thermal shock, humidity, salt spray and altitude. If you need a tough zener regulator, drop us a line on your letterhead and we'll send you complete specifications and a sample *free*, which is better than on-the-cuff.

Centralab's Little Giant is available from the factory and through our Semiconductor Products Distributors. Use the readers service card for location of your nearest distributor and additional technical data.

*The Centralab 1 watt zener regulator (HW6.8 through HW91.0) will replace any zener regulator that has a wattage rating of 1 watt or less within zener voltage breakdown of 6.8 to 91.0 volts, including aluminum can units, epoxies or other glass units. Here are the JEDEC types it will replace and outperform:

150mW	400mW	400mW	¼ watt	¼ watt	1 watt	1 watt
1N1313	1N754	1N957	1N710	1N764	1N1767	1N3016
through	through	through	through	through	through	through
1N1326	1N759	1N984	1N737	1N769	1N1794	1N3043

NOTE: Also available in 1.5 watt, in solderable and weldable lead styles.



CENTRALAB

Electronics Division
GLOBE-UNION INC
5757 NORTH GREEN BAY AVENUE
MILWAUKEE WISCONSIN 53201

M-6722

ON READER-SERVICE CARD CIRCLE 88

any
way
you
look
at it,
the
TO-87
FLAT
PACK RELAY
IS THE
SMALLEST

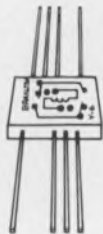

This TO-87 size relay creates new design flexibility and capability in low profile applications including circuit boards, packaging with semiconductors, part of integrated circuits and hybrid devices, etc. The TO-87 DPDT relay, rated at 1/4 amp. at 28 volts, measures 3/8" x 1/4" x 1/10" and weighs 1 gram. It is hermetically sealed and exceeds all applicable MIL specifications.

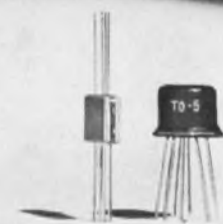

COMPARE

Relays... Our Only Business

BRANSON CORP.

VANDERHOOF AVENUE • DENVER, NEW JERSEY 07834 • 201-625-0600

ON READER-SERVICE CARD CIRCLE 89

TEST EQUIPMENT

Multiple-wave generator provides 3 waveforms



Beckman Instruments, Inc., 2200 Wright Avenue, Richmond, Calif. Phone: (714) 871-4848. P&A: \$495; 30 days.

The Model-9010 Function Generator provides three basic signal waveforms sinusoidal, square and triangular. All outputs are available simultaneously at the front panel, with variable frequencies from 0.005 Hz to 1 MHz in eight ranges. In addition to the waveform outputs a selectable, 30-V output is provided, with variable level and dc offset controls.

CIRCLE NO. 291

Dielectric strength tester for current leakage



Associated Research, Inc., 3777 W. Belmont Ave., Chicago, Ill. Phone: (312) 267-4040. P&A: \$495; stock.

This test unit is designed for manufacturing, repair and quality-control checks of electronic components, wiring harnesses, motors, appliances and transformers. Designated the model 4030, this portable test set has a two-range kilovoltmeter and three-range microammeter, both accurate to within $\pm 3\%$ of full scale. Output voltage is variable from 0 to 4000 V ac.

CIRCLE NO. 292

**IC multimeter
samples at 1000/s**



Cimron Div., Lear Siegler, Inc. 1152 Morena Blvd., San Diego, Calif. Phone: (714) 276-3200. Price: \$1965.

The Cimron 6652 is systems-oriented with three dc voltage and ratio-meter ranges, DTL logic level, 1-2-4-8 BCD outputs and multimeter mainframe with function controls and programming capability. The unit interfaces with small computers and data logging systems. This 1000 sample per second, programmable digital voltratiometer has accuracy to $\pm 0.01\%$ of full scale +0.01% reading.

CIRCLE NO. 293

**Electronic thermometers
tell all in 0.5 s**

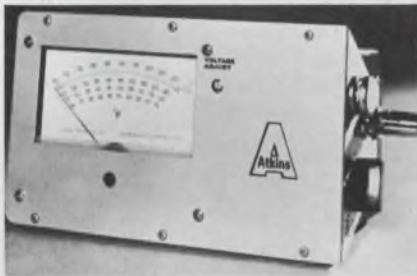

Atkins Technical Inc., Box 14404, U. of Florida Station, Gainesville, Fla. Phone: (305) 372-3518. P&A: \$260; stock.

With 0.09 in. dia. semiconductor probes, the portable testing or laboratory electronic thermometers feature up to six overlapping ranges chosen from more than 200 standard ranges. The scale illustrated covers from 29 to 215°F in 0.5 divisions on four ranges of 50° each. Other ranges cover fixed decimal spans between -150 and +575°F (-100 and +300°C), with sensitivities to 0.1. Accuracy is $\pm 1\%$ of each scale range, normally one scale mark.

CIRCLE NO. 294

New

96 db Slope

0.001 Hz to 100 KHz

Line/Battery Operation

Low Distortion

*NEREM Booth
1D22 and 1D23*

**NEW KH ALL-SILICON
DIGITALLY TUNED
VARIABLE FILTER**

FEATURES

**ULTRA LOW FREQUENCY
96 DB/OCTAVE SLOPE**



MODEL 3342 DUAL-CHANNEL, MULTI-FUNCTION FILTER provides low-pass and high-pass operation with 96 db attenuation slope or 48 db slopes as band pass or band reject filter. The digital frequency control provides cut-off frequencies from 0.001 Hz to 100 kHz with 2% calibration accuracy and excellent resettability. Size: 5¼" H x 19" W x 16½" D.

The new Krohn-Hite Series 3300 operates on either line or batteries, with 0.1% distortion and provides gain of 20 db.

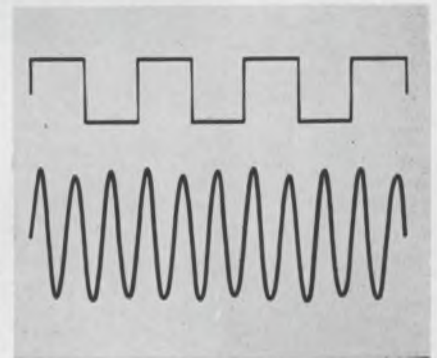

RECORDING ILLUSTRATES gain and selective response of Model 3342, in minimum band-pass operation, to a 0.01 Hz square wave. Output consists primarily of third harmonic component of input.

This kind of low-frequency performance is backed by other important specifications. Examples are:

Filter Characteristics: Either 4 or 8-pole Butterworth (maximally flat) and R-C for transient-free operation.

Digital Tuning: Six bands, 3 digits; rotary switches.

Maximum Attenuation: 80 db.

Dynamic Range: 80 db.

Input Impedance: 10 megohms.

Output Impedance: 50 ohms.

Write for Data

KH KROHN-HITE CORPORATION
580 Massachusetts Avenue, Cambridge, Mass. 02139
Telephone: 617/491-3211

ON READER-SERVICE CARD CIRCLE 90

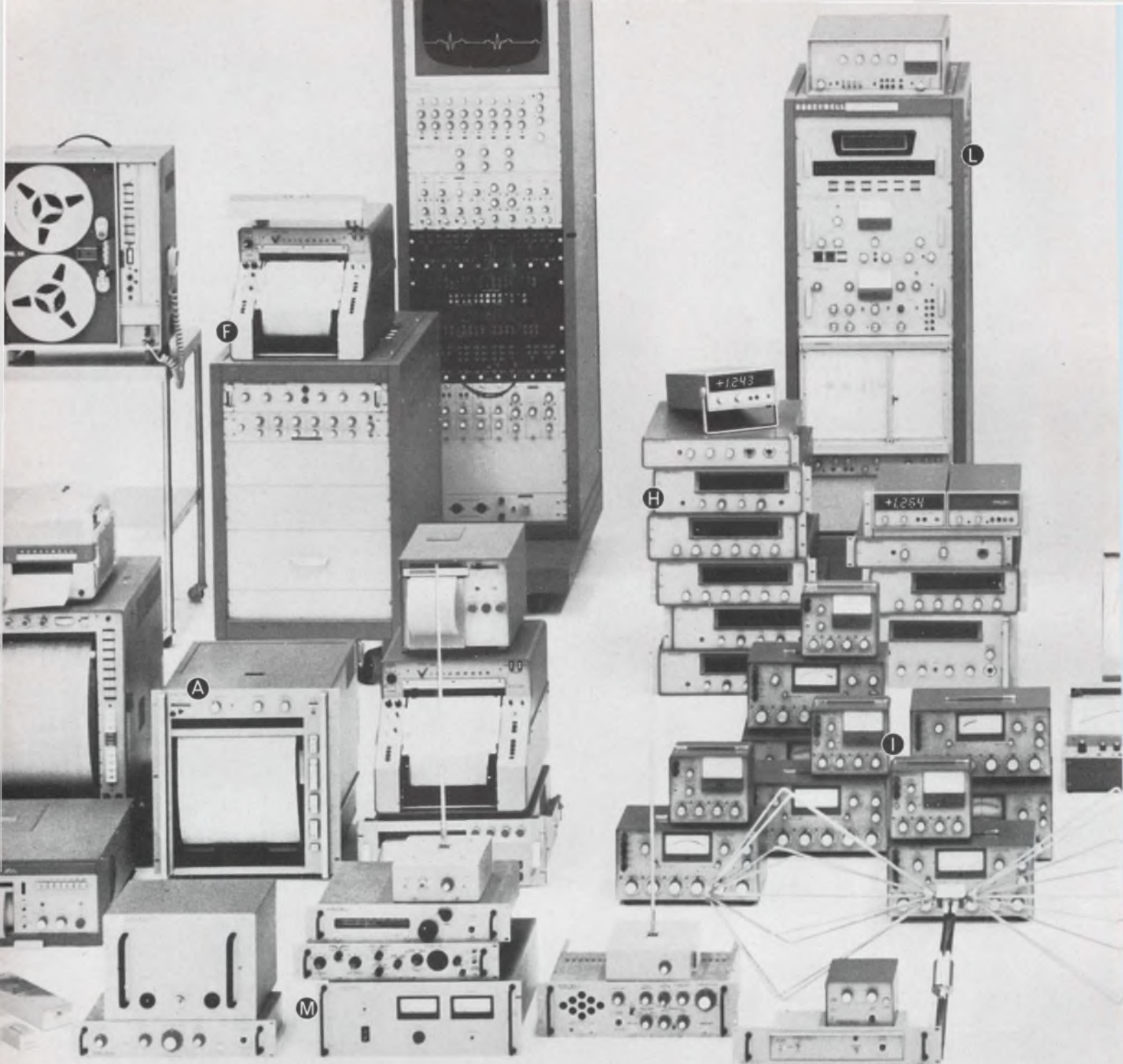

Here's just part of the full Honeywell line, which includes: **A** 117 Visicorder direct-recording oscillographs in 6", 8", and 12" models; **B** 2 Model 1806 fiber-optics CRT Visicorder oscillographs; **C** 26 magnetic tape systems, including the 7600 Series in 10½" and 15" reel versions; **D** 84 amplifiers and other signal-condi-

We build **847**
instruments to be sure we
have the exact **1** you need.

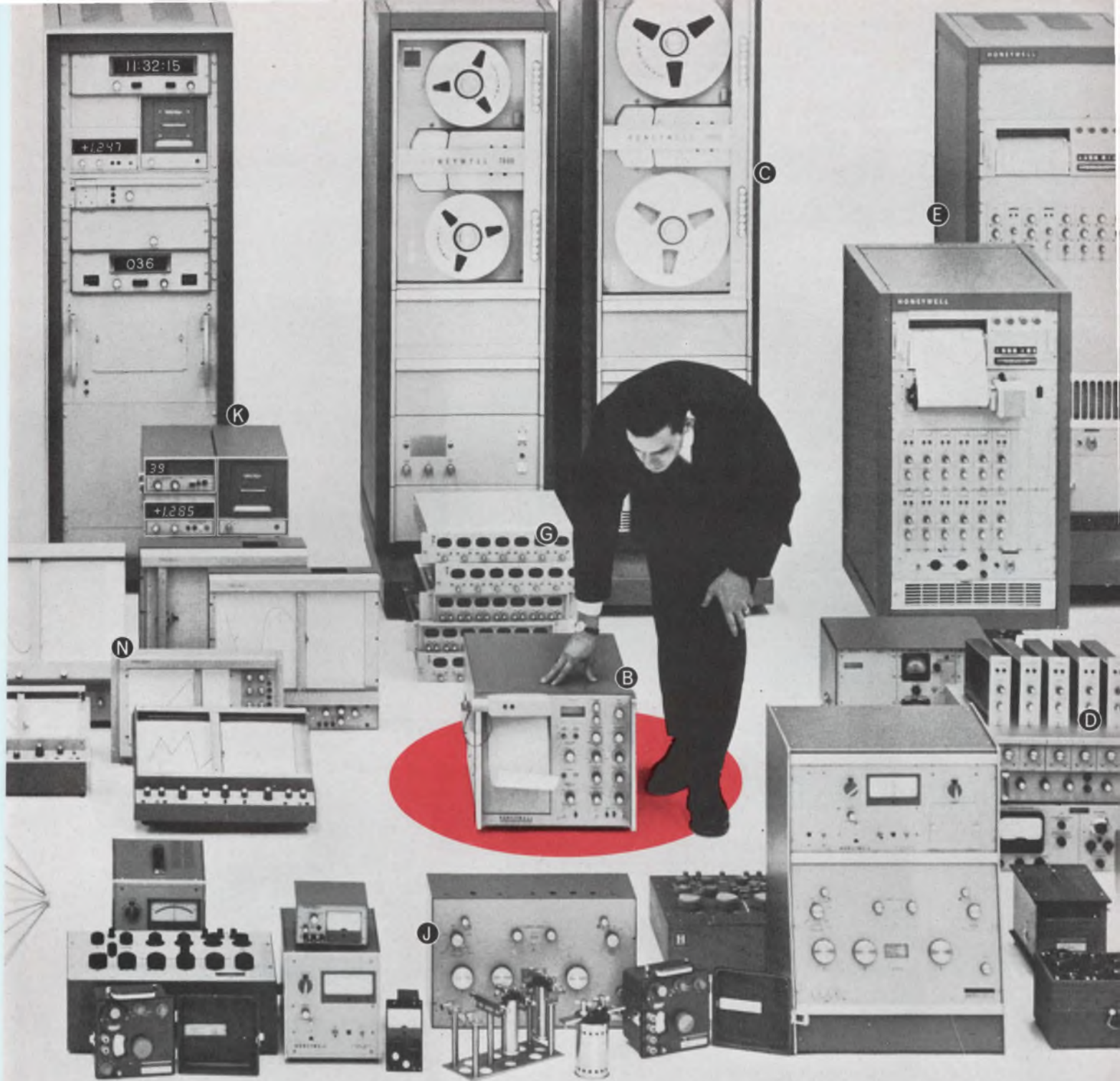

tioning units; **E** 78 analog recording systems; **F** 46 electronic medical systems; **G** 14 oscilloscopes; **H** 37 digital multimeters; **I** 29 differential voltmeters; **J** 179 precision laboratory standards and test instruments; **K** 128 data loggers; **L** 9 analysis systems; **M** 61 EMI products; **N** 37 X-Y graphic recorders.

Your Honeywell sales engineer can zero in on the *precise* solution to your instrumentation problems. Quickly and efficiently. You won't have to settle for "almost" what you need because the Honeywell sales engineer isn't handicapped by a limited line. He can choose from 847 basic instruments whose combinations and permutations approach the infinite.

The solution might be a Visicorder recording oscillograph. Or one of our modular magnetic tape systems. Or an X-Y recorder, a digital multimeter, or a portable potentiometer. But whether it's a single instrument or a complete data system, you can be sure the solution will be the right one, carefully thought out with your future requirements considered as well as your current needs.

Local service and nationwide metrology facilities back up your Honeywell instrument or system. And, we can even provide factory training courses for *your* operating personnel. For the full story on how Honeywell can help you, call your local sales engineer or write: Honeywell, Test Instruments Division, Denver, Colorado 80217.

Honeywell

Honeywell engineers
sell solutions

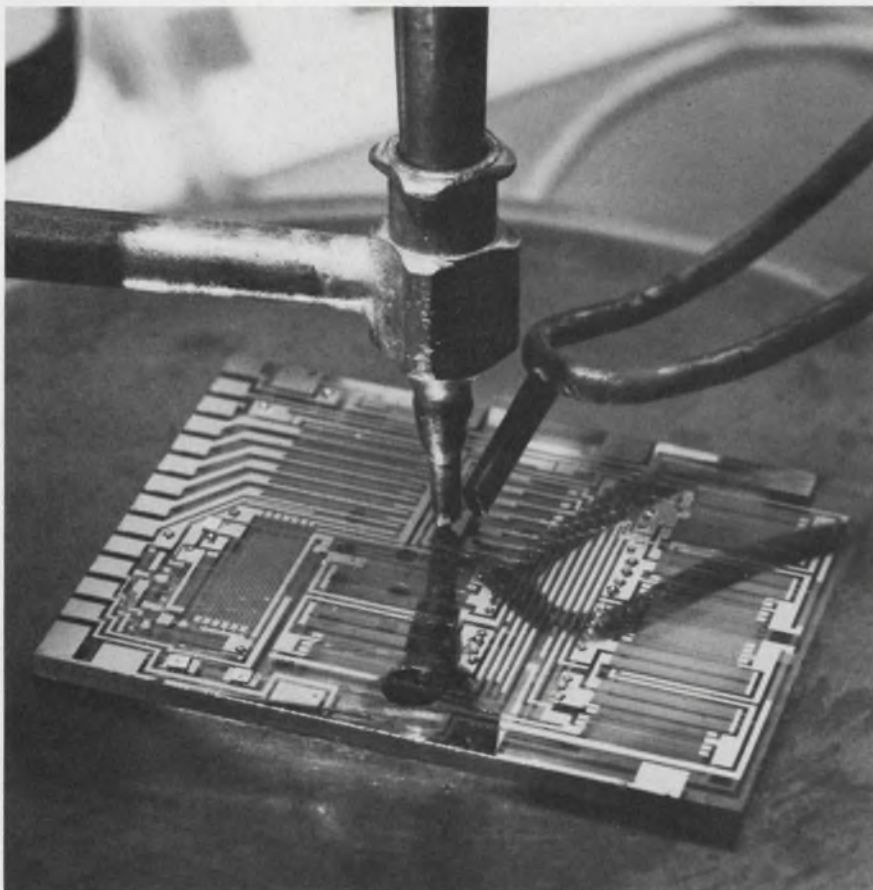

UNUSUAL REQUIREMENTS CALL FOR UNUSUAL TALENTS

In the seven years we've been in business we've concentrated on providing the best technical performance in certain specialized areas.

For instance, using a proprietary process we trim resistors to .01%. We specialize in meeting unique function and packaging requirements by combining chips, LIDS, and flip-chips on thin-film substrates with a variety of discrete components. And we adjust and match the temperature coefficient of resistance to track to within $\pm 5\text{ppm}/\text{C}^\circ$. Complete environmental facilities allow us to test your finished circuit under almost any required environmental conditions.

Naturally we have the latest equipment, but so does everybody else who is really serious about being in the hybrid microcircuit business. What we're offering you is the unique technical know-how that allows you to get exactly the precision you want in the package that meets your needs. And that means we don't cut corners on costs at the expense of performance. Why not give us a call. We'll be glad to tell you more about our approach to hybrid microcircuit technology.

Contact Joe Crist, Sales Manager, Microelectronics Operation, (213) 346-6000, Extension 546, or write to:



THE BUNKER-RAMO CORPORATION
DEFENSE SYSTEMS DIVISION
8433 FALLBROOK AVENUE • CANOGA PARK, CALIFORNIA 91304

ON READER-SERVICE CARD CIRCLE 92

TEST EQUIPMENT

Rf sniffer detects leaks

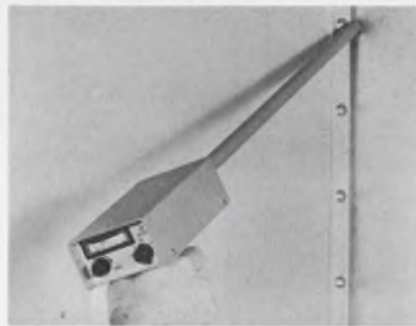

Tamar Electronics, Inc., 2045 West Rosecrans Ave., Gardena, Calif. Phone: (213) 770-0270. P&A: \$700; 30 days.

Designated model 500, and dubbed the rf Sniffer, this system is portable, solid state, and has a high order of sensitivity. It can be used in conjunction with MIL-spec methods to ensure continuous integrity of an enclosure. Use of the unit can improve the attenuation of a shielded enclosure by 20 to 40 dB; this helps detect seam leakage, poorly-mated joints, minute construction flaws, and high resistance regions.

CIRCLE NO. 295

Sweep test set exhibits 1 mV/cm



Sweep Systems, Inc., P. O. Box 616, Indianapolis, Ind. Phone: (317) 787-8275.

The instrument provides a transistorized high-quality laboratory-type 5-in. oscilloscope display system, in addition to solid-state sweep generation functions. The display unit provides vertical sensitivities of 1 mV per centimeter with band pass to 500 kHz. The grid and cathode circuits are specifically designed for optimum performance.

CIRCLE NO. 296

Surface pyrometer has optional probes



Pyrometer Instrument Co., Inc.,
110 Portland Ave., Bergenfield, N. J.
Phone: (201) 384-5140.

In addition to measuring the temperature of all kinds of surfaces, interchangeable thermocouples allow for instant, accurate temperature measurement of fluids, semifluids, plastics, rubber and molten-soft metals. The meter is equipped with a 4-3/4 in. direct reading scale. A selection of models is available with standard temperature ranges from 0 to 300°F and 0 to 1500°F. Special units are available for sub-zero and high-temperature applications.

CIRCLE NO. 297

Biased amplifier has linear gate

EG&G, Inc., 35 Congress St., Salem, Mass. Phone: (617) 745-3200.

The AN109 biased amplifier, part of the M100 system of modular high-speed nuclear instrumentation, is characterized by linearity down to the bias level, temperature insensitivity, and clean gating characteristics. This module can be used to expand the effective resolution of a multichannel pulse-height analyzer by an order of magnitude. Bias is controlled with a ten-turn calibrated potentiometer, and post-bias gain is switch-selected.

CIRCLE NO. 298

Did You Know Sprague Makes 32 Types of Foil Tantalum Capacitors?

125 C TUBULAR TANTALEX® CAPACITORS



Type 120D polarized plain-foil
Type 121D non-polarized plain-foil
Type 122D polarized etched-foil
Type 123D non-polarized etched-foil

ASK FOR BULLETIN 3602C

ON READER-SERVICE CIRCLE 821

85 C TUBULAR TANTALEX® CAPACITORS



Type 110D polarized plain-foil
Type 111D non-polarized plain-foil
Type 112D polarized etched-foil
Type 113D non-polarized etched-foil

ASK FOR BULLETIN 3601C

ON READER-SERVICE CIRCLE 822

RECTANGULAR TANTALEX® CAPACITORS



Type 300D polarized plain-foil
Type 301D non-polarized plain-foil
Type 302D polarized etched-foil
Type 303D non-polarized etched-foil

ASK FOR BULLETIN 3650

ON READER-SERVICE CIRCLE 823

TUBULAR TANTALUM CAPACITORS TO MIL-C-3965C



CL20, CL21 125 C polarized etched-foil
CL22, CL23 125 C non-polarized etched-foil
CL24, CL25 85 C polarized etched-foil
CL26, CL27 85 C non-polarized etched-foil
CL30, CL31 125 C polarized plain-foil
CL32, CL33 125 C non-polarized plain-foil
CL34, CL35 85 C polarized plain-foil
CL36, CL37 85 C non-polarized plain-foil

ON READER-SERVICE CIRCLE 824

RECTANGULAR TANTALUM CAPACITORS TO MIL-C-3965C



CL51 polarized plain-foil
CL52 non-polarized plain-foil
CL53 polarized etched-foil
CL54 non-polarized etched-foil

ON READER-SERVICE CIRCLE 825

For comprehensive engineering bulletins on the capacitor types in which you are interested, write to:

Technical Literature Service
Sprague Electric Company
347 Marshall Street
North Adams, Mass. 01247

45C-5161

SPRAGUE®
THE MARK OF RELIABILITY

Sprague and ® are registered trademarks of the Sprague Electric Co.

Panel-mounted timer spans 0.05 to 500 s



Instrumentation & Control Systems, Inc., 723 N. Addison Ave., Villa Park, Ill. Phone: (312) 279-6400. Price: \$40.

The K66 series of panel-mounted timers provide solid-state output for 50-million operations. The unit's five time ranges cover from 0.05 to 500s with eight different timing actions. Any operating voltage from 12 to 220 V ac or dc can be provided.

CIRCLE NO. 299

Coaxial attenuator span dc to 4 GHz

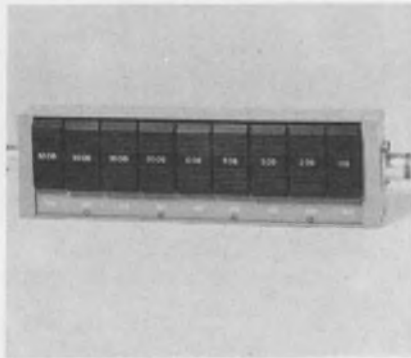

Kay Electric Co., Maple Ave., Pine Brook, N. J. Phone: (201) 227-2000.

An in-line, coaxial attenuator features a sliding switch arrangement. The unit, model 110-0 provides an extensive range of control of 132 dB in 1-dB steps. The attenuator operates at frequencies from dc to 4 GHz. Its operating power is 1 W. Accuracy is 0.3 dB from dc to 2 GHz and 0.5 dB at 4 GHz.

CIRCLE NO. 311

2.5-W network resistors come 64 to a sandwich

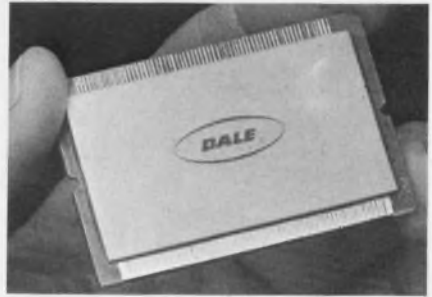

Dale Electronics, Inc., P. O. Box 488 Columbus, Nebr. Phone: (402) 564-3131.

Sixty-four parallel 2.5-W resistors form a sandwich 2.2 in. long and 0.105 in. thick. With 64 terminals at one end and a common terminal at the other, the resistor network is used to terminate word lines in a computer's memory core. The SPR-291 contains no magnetic materials. Resistance is $20 \Omega \pm 2\%$ over an ambient temperature range of 0 to 50°C.

CIRCLE NO. 312



APT-1; 1 cu. in., 3.15 oz. (actual size)

More torque, Less weight in moving coil mechanism

Highly stable, linear and accurate mechanism for indicating, control or recording systems. 18-0-18° linearity is 1%. Coil design with over 75% of winding "working" in high energy, uniform field air gap assures greater accuracy. Coil system weighs 0.85 gm, develops 26.4 mmg of torque; 31:1 T/W. Mechanism offers negligible vibration pivots and jewels — custom damping — wide range of sensitivities.

AMMON

AMMON INSTRUMENTS, INC.
345 Kelley St., Manchester, N. H. 03105

ON READER-SERVICE CARD CIRCLE 94

TOTALLY ENCLOSED ROTARY SWITCHES. TEMPERATURE TO 125 C. MULTI-POLE. 30°, 36°, 45°, 60°, and 90° ANGLE of THROW. 100,000 OPERATIONS.

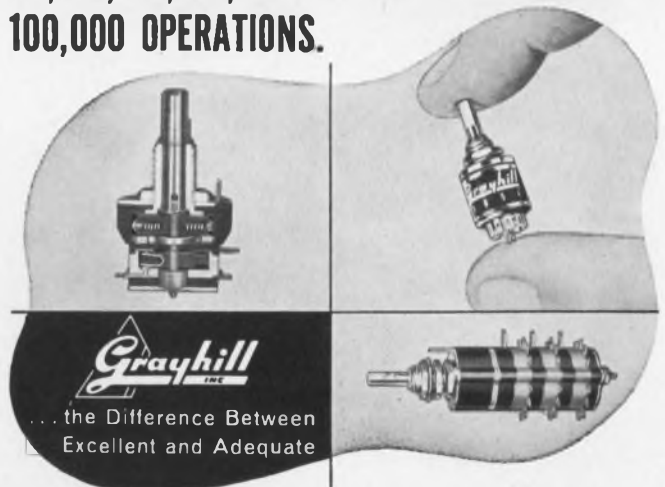

... the Difference Between Excellent and Adequate

Typical Specifications:

- Explosion Proof
- Contact Resistance 10 Milliohms
- Make or Break 1/4 Amp. to 15 Amps., 115 VAC Resistive
- 1 to 6 Poles per Deck
- 1 to 12 Decks
- 2 to 12 Positions per Pole

Send for Engineering Catalog G304



565 Hillgrave Avenue
LaGrange, Illinois 60525
Area Code 312, Phone 354-1040

"PIONEERS IN MINIATURIZATION"

ON READER-SERVICE CARD CIRCLE 95

ELECTRONIC DESIGN 22, October 25, 1967



fire them this flexible, economical, precise, fail-safe way

... with Aladdin pulse transformers ... allows triggering from a high impedance control circuit ... provides isolation from the trigger source; permits triggering through the use of fewer components (reducing overall circuit cost). Applicable to both closed and open loop systems; gate isolation permits use of both AC and DC circuits. Precise firing depends on characteristics of the pulse transformer and semi conductor elements—the extensive Aladdin transformer line affords maximum “trading” of characteristics for optimum results. Readily available—the chart lists some of the most common ratios of 1:1 and 1:1:1.

For other applications, consult our applications engineers. Meanwhile send for bulletin 195 listing other standard SCR transformers and additional performance data.

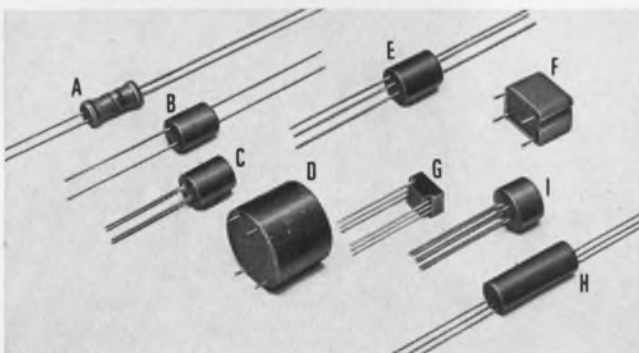

Part Number	Package Style	OCL (mh)	Turns Ratio (± 10%)	High Potential Test Voltage
307-102	A	.2 min.	1:1	1600
90-2569	B	1.3 min.	1:1	550
306-136	C	1.3 min.	1:1	550
314-162	D	3.5 min.	1:1	550
90-2510	B	5.0 min.	1:1	550
72-2040	F	5.0 ± 20%	1:1	1750
314-141	D	6.6 ± 20%	1:1	1000
02-1864	E	6.0 ± 20%	1:1	700
90-1055	B	6.0 ± 20%	1:1	700
90-2364	B	8.5 ± 20%	1:1	700
90-2555	B	24.0 ± 20%	1:1	700
314-142	D	41.0 ± 20%	1:1	1000
314-143	D	162 ± 20%	1:1	1000
307-101	H	.045 ± 10%	1:1:1	700
78-2028	G	.7 min.	1:1:1	1000
90-2397	B	1.3 min.	1:1:1	550
312-114	I	1.3 min.	1:1:1	550
90-2398	B*	5.0 min.	1:1:1	550
90-2362	B*	6.0 ± 20%	1:1:1	700
02-2062	E*	6.0 ± 20%	1:1:1	1250
314-144	D*	6.6 ± 20%	1:1:1	1000
02-2066	E*	14.0 min.	1:1:1	1000
02-1861	E*	15.0 ± 20%	1:1:1	700
314-139	D*	21.0 ± 20%	1:1:1	700
314-170	D*	28.0 ± 20%	1:1:1	1000
314-145	D*	41.0 ± 20%	1:1:1	1000

Aladdin Electronics can custom design to individual needs for higher interwinding voltage strengths.

*Package configuration are same as shown except for the additional leads required for 1:1:1 transformers.

where the magic of magnetics is a science...

Aladdin
electronics

Nashville 10, Tennessee

ON READER-SERVICE CARD CIRCLE 96

COMPONENTS

A breath (1-1/4 grams) will actuate switch



Cherry Electrical Products Corp., 1650 Old Deerfield Rd., Highland Pk., Ill. Phone: (312) 432-8182. Price: about 63¢ ea., (in 2000 lots).

A miniature switch features an operating force so low that a breath of air will actuate it. It requires only 1-1/4 grams of pressure to operate. The E22-55HLX, extended lever version is so sensitive the actuator is made of aluminum.

CIRCLE NO. 313

Push-button switches for circuit boards

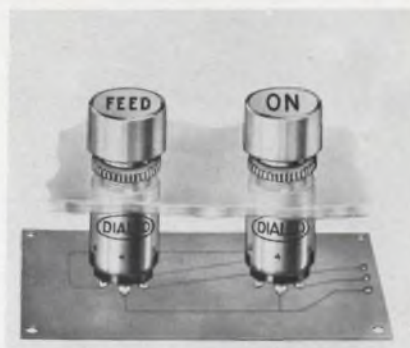

Dialight Corp., 60 Stewart Ave., Brooklyn, N. Y. Phone: (212) 497-7600. P&A: \$208 in 1000 lots; stock.

The printed circuit terminals, which are now available on the 513-series switch is designed for either single- or double-sided copper-clad printed circuit boards up to 0.90-in. thick. The momentary action switch ratings are 3, 125 V ac or 3 A, 30 V dc. It accommodates T-1 3/4 in. incandescent bulbs with flanged bases in a range of voltages from 1.35 to 28 V.

CIRCLE NO. 314

Crystal oscillator range from 2 to 100 MHz



Bulova Watch Co., Inc., 61-20 Woodside Ave., Woodside, N. Y. Phone: (212) 335-6000.

One-half in.³ crystal oscillators are designed for industrial and military applications on printed-circuit boards. The new unit, designated as model XO-105, may be ordered in the frequency range of 2 MHz to 100 MHz. The new model's frequency stability versus temperature varies from plus-or-minus 0.0005% (in the range of plus 20° to plus 30° C) to plus-or-minus 0.005% (in the range of -55° to +85° C).

CIRCLE NO. 315



EXCLUSIVE!

(you can't get it from anyone else!)

Secon's way out front this time. This wire and insulation are designed for the resistance thermometer field.

We are the only producer of reference grade platinum that can supply it with a ceramic insulation, that allows the wire to be fully recrystallized without harm to the insulation. The ceramic insulated wire can be supplied as small as .0007". The ceramic insulation handles temperatures in excess of 1500°F. We also straight-draw bare reference grade platinum

wire to a diameter of .0005". Conventional insulations are also available.

If your requirements are for high quality, reference-grade platinum, bare or insulated, you will want a copy of our brochure on wire products for resistance thermometers. It lists the physical and electrical properties of available materials.

Please write on your letterhead; no obligation of course.



7 INTERVALE STREET, WHITE PLAINS, N.Y. 10600 ■ (914) WH 9-4757
ON READER-SERVICE CARD CIRCLE 97

Revolution counter uses 4-digit display



Ebauches SA, Service PR, Publi-cite, CH 2001 Neuchatel Suisse. Tel- ex: 3 51 63.

The type-B 128 Ob revolution counter is a digital measuring instrument intended for industrial applications. The unit can be connected to all types of available transducers (photoelectric, magnetic, etc.) that convert mechanical events into electrical pulses. The applications for the B-128 Ob are not restricted to revolution counting but can be extended to totalize events, count parts and measure frequencies.

CIRCLE NO. 316

Fast recovery rectifier to 200 V



Unitrode Corp., 580 Pleasant St., Watertown, Mass. Phone: (617) 926-0404. P&A: \$4.05 (100 quantity); stock.

Fast recovery rectifiers capable of operating at full power to 100 kHz square wave are available in 3- and 4-A ratings to 200 V. These devices have a typical recovery time of less than 100 ns. They can withstand surges to 80 A for 8.3 ms. The body size is less than 1/4 in. long with a maximum dia. of 0.145 in. The outer structure is hard glass which forms a void-free hermetic seal around the junction.

CIRCLE NO. 317

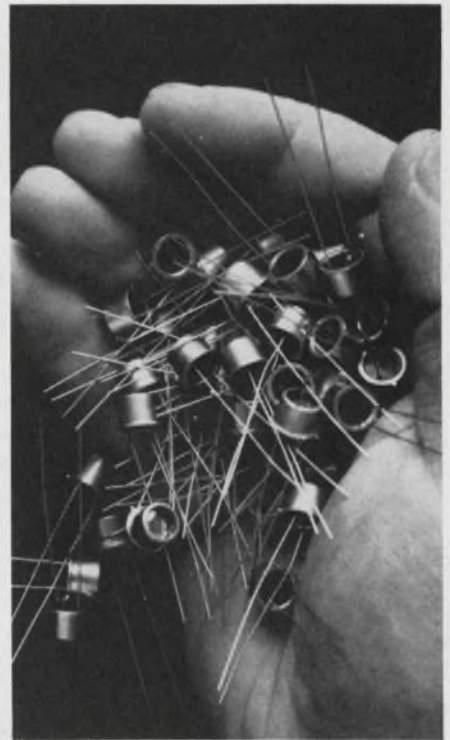
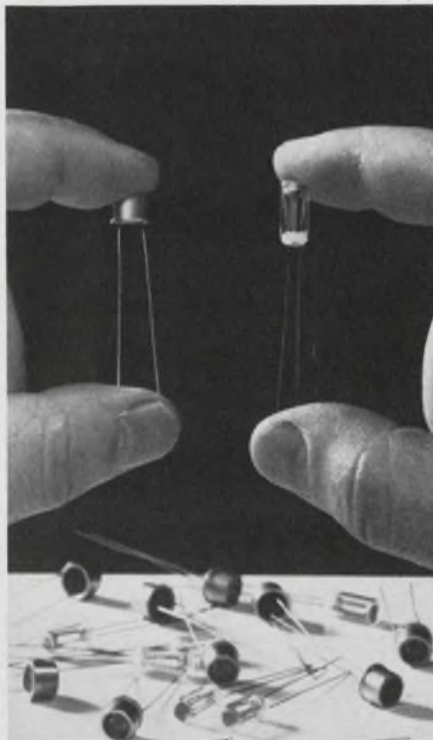

Need thirty different photocells? Or thousands exactly alike?

In either case, specify "Raytheon." Raytheon now offers standard and special types with cadmium sulfide or selenide sensors, TO-5 case or glass vial packaging, and a wide range of operating characteristics. These photocells are interchangeable with competitive types, available to MIL specifications, priced from 90¢ to \$1.60 in production quantities.

All Raytheon photocells feature: rugged mechanical construction, small size, light weight. Low noise, completely ohmic light-dependent vari-

able resistors, their characteristics and high voltage capabilities ensure fast switching, temperature stability and linear response to illumination.

Wide range of characteristics. Our CK1201, for example, features 150 ohms resistance at 100 ft. candles, rise-fall time of 3 and 60 ms, 75 mw power dissipation (maximum). And our CK1266 features 2500 ohms resistance at 100 ft. candles, rise-fall time of 1.5 and .6 seconds, and power dissipation of 100 mw maximum.

Send reader service card for data on the complete line of standard Raytheon photocells. Or tell us about your special requirements.
Raytheon Company, Components Division, Quincy, Mass. 02169.



RAYTHEON

Industrial Components Operation — A single source for Circuit Modules/Control Knobs/Display Devices/Filters/Hybrid Thick-Film Circuits/Industrial Tubes/Optoelectronic Devices/Panel Hardware

ON READER-SERVICE CARD CIRCLE 98

COMPONENTS

Differential dc amplifier has 100 to 110,000 gain



Dynamics Instrumentation Co., 583 Monterey Pass Rd., Monterey Park, Calif. Phone: (213) 282-3161.

Key feature of this dc differential amplifier is a base-line correcting circuit providing an automatic offset capability. The automatic correcting circuit functions in ms to provide constant data collection. Dc instrument performance is guaranteed without phase lead and without overload problems. Typical specifications include a gain range of 100 to 110,000 and an output capability ± 10 V, at 100 mA.

CIRCLE NO. 318

Broadband mixers cover 1 kHz to 500 MHz

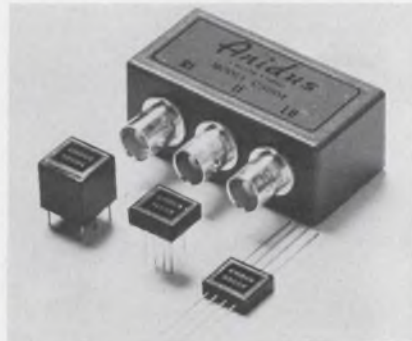

Anidus Engineering, Box 8, Arlington, Mass. Phone: (617) 646-2121. P&A: \$48 (1-9 quantity); 1 week.

These units feature hot-carrier diodes, 6-dB typical conversion loss (SSB), and package volumes as low as 1/25 cubic in. Frequency operation ranges from 1 kHz to 500 MHz. Available with BNC connectors or with pins for printed circuits, the mixers achieve minimum conversion loss with levels as low as 3 mW and provide rejection of up to 45 dB.

CIRCLE NO. 319

12-channel programmer operates on 28-V dc



A. W. Haydon Co., 4060 Ince Blvd., Culver City, Calif. Phone: (213) 870-546.

Model 35038 is a compact, lightweight programmer with 12 sets of dpdt relay contacts. The time is programmable in one-second increments from 1 to 1999 seconds in any channel by jumper wiring of a BCD encoded terminal board, accessible through the bottom cover. Accuracy of timing is 2% under all conditions. Repeatability is 1% or better. Control signals provide run, hold, and reset functions.

CIRCLE NO. 320

TERMINAL BLOCKS

CURTIS

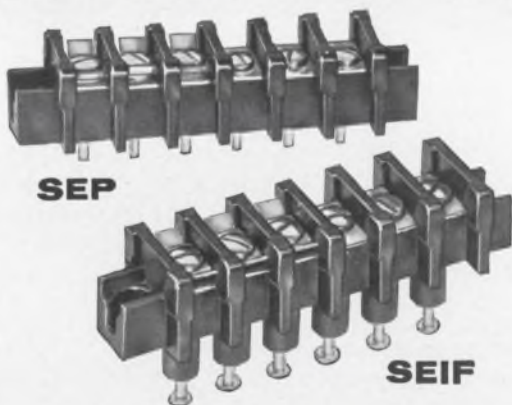

- SEP** - for connections to printed circuits
- SEIF** - for miniature insulated feed-thru
- SEF** - for miniature feed-thru
- SES** - for miniature surface contacts

All types of "SE" blocks include:

- Only 1/4" center-to-center terminal spacing
- Bright tin plated screw machine inserts
- #2-56 terminal screws for up to 16 #AWG wire
 - Molded black phenolic base
 - Choice of 1-18 poles
 - 300 volts — 5 amps

Send Today for Further Information
CURTIS DEVELOPMENT & MFG. CO.
 3236 N. 33rd St. • Milwaukee, Wis. 53216



ON READER-SERVICE CARD CIRCLE 99

Get high power, low noise from 10 to 500 MHz

The Hewlett-Packard Model 230A Signal Generator Power Amplifier provides more than 4.5 watts power from 10 to 500 MHz. It is the ideal solution to high rf power requirements for applications such as receiver testing, wattmeter calibration, antenna testing, filter and component testing and attenuation measurements. The amplifier may be driven with any conventional signal source and will reproduce AM, FM and pulse modulation characteristics of the driver generator with minimum distortion. The instrument employs three tuned, cascaded stages of grounded-grid amplification fed from a regulated power supply. Price \$1350. Application Note 76 discusses high and low-level applications of the amplifier. For your copy of this application note or more information about the amplifier, contact your local Hewlett-Packard field engineer or write: Hewlett-Packard, Green Pond Rd., Rockaway, N. J. 07866.

HEWLETT  PACKARD
 1075 SIGNAL SOURCES

ON READER-SERVICE CARD CIRCLE 100

With
BOMAC
 you can
 get as
 sophisticated
 as you
 want
 with
TR's

(or you can buy what you need to economically meet your transmit-receive switching needs)



RELIABLE BOMAC TR's • long life: warranty, 2000 hours • high reliability: proven performance, over 5000 hours • high ambient operating temperatures: to 150°C • phase control: to $\pm 0.5^\circ$ • recovery time: less than 0.4 μ seconds between -55°C and 150°C with leakage power less than 0.1 ergs • insertion loss: less than 0.3 dB (very low TR noise) • economy: lowest operating cost/hour.



RELIABLE BOMAC TR's WITH POSITIVE OFF PROTECTION • adding a hermetically-sealed shutter



RELIABLE BOMAC TR's FOR T.D.A. PROTECTION • adding a solid state limiter to get Tunnel Diode Amplifier protection with leakage less than .05 ergs . . . flat leakage less than 20 milliwatts



RELIABLE BOMAC CAPABILITY • passive TR-limiter capability • TR and solid state limiter without keep-alive operation • all solid state switching



A HERITAGE of practical, economical solutions to Radar system design problems • performance reliability backed by proven data covering a wide range of system applications • don't wait for a "continuing" story . . . write today for today's answers to your transmit-receive switching needs.



varian

BOMAC DIVISION
 Salem Road
 Beverly, Massachusetts

Columbia Components Thick-film hybrids.

Send us your specs for fast action.

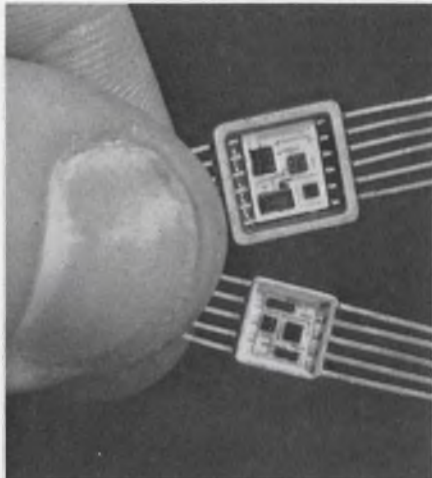

The answers to your micro-packaging problems are as close as this coupon.

The hybrid circuit is a versatile tool in the hands of the design engineer faced with problems in high power ratings, thermal tracking, precision component tolerances, intermixing monolithic IC's and other interfacing circuitry and components. In applications where the design may undergo changes up to the first production article, the hybrid offers the designer freedom to institute necessary changes with minimal cost and time.

Columbia Components Corporation's Thick-Film Hybrid Circuits are capable of reproducing any given circuit without degradation in circuit functions. These hybrids also present the most economical approach to most problems.

COMPONENTS

Dc amplifier shows 20,000 gain



Electron Corp., 8070 Engineer Rd., San Diego, Calif. Phone: (714) 278-0600. P&A: \$600; 30 days.

Combining extremely low noise and drift with a completely isolated input (100 MΩ minimum) this amplifier allows the amplification of μV level signals. The all solid-state design, plus encapsulated construction provides immunity to airborne or missile-borne environments. Performance features of the model A525-14 include a zero stability of better than $0.5 \mu\text{V}/^\circ\text{C}$, a linearity within $\pm 0.1\%$ and noise of 1 μV pk-pk.

CIRCLE NO. 321

Thin pots need one turn

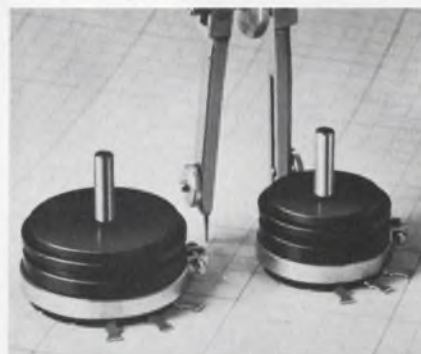

Beckman Instruments, Inc. 2500 Harbor Blvd., Fullerton Calif. Phone: (714) 871-4848.

Designated models 3103 and 3203, these general-purpose standard servo-mount models respectively have 7/8 in. and 1-1/16 in. diameters and are less than 1/2 in. long. Infinite resolution cermet elements are available in resistance values of 1 MΩ with standard resistance tolerance of $\pm 5\%$ and a linearity of $\pm 0.5\%$.

CIRCLE NO. 322

Please sketch schematic (or print, if available) and attach.

Application _____

Customer Print # _____

Rev: _____ Lead Forming _____

Is qualification acceptance required? _____

Is lot acceptance required? _____

Package style & size: _____

Body Material _____

Lead materials _____

MAXIMUM RATINGS

Storage Temp. Range _____ Operating Temp. _____

Ambient Temp. _____ Power Dissipation of 25°C _____

- Have your engineer call.
 Send descriptive literature.

R	Value	Tol.	T.C.	Wattage	Q	Generic Type	Tol.
R1					Q1		
R2					Q2		
R3					Q3		
R4					Q4		
R5					Q5		
R6					Q6		
R7							
R8							
R9							
R10							

C	Value	Tol.	Rated Voltage	CR	Generic Type	Tol.
C1				CR1		
C2				CR2		
C3				CR3		
C4				CR4		
C5				CR5		
C6				CR6		
C7						
C8						
C9						
C10						

Environmental Specifications _____

Military Specs., if any _____ Frequency _____

Other applicable specs _____

Voltages _____

Name _____

Title _____

Company _____

Address _____

Telephone _____

City _____

State _____

Zip _____



COLUMBIA COMPONENTS CORP.

A Subsidiary of Computer Instruments Corp.,
Woodside, N. Y. 11377. Tel: (212) 726-2600

ON READER-SERVICE CARD CIRCLE 102

Op amp module is a 15 V/ μ s unit



Fairchild Instrumentation, 475 Ellis, Mountain View, Calif. Phone: (415) 962-2076. P&A: \$35 (1-9); 2 to 4 wks.

The ADO-52A is a 15 V/ μ s, military grade uA702 with built in frequency compensation and guaranteed stability at unity gain. It includes internal biasing for ± 3 -V common mode voltage and current sinking to provide 8-V pk-pk output with a 10 K Ω load. The unit operates over the -55 to $+125^\circ\text{C}$ temperature range.

CIRCLE NO. 323

Dc to dc converter runs at 75% efficiency



Crestronics, 744 Rocky Loop, Crestline, Calif. Phone: (714) 338-1722. P&A: \$190; 2 to 5 days.

This 3-W converter has an average efficiency of 75%. With output voltages from 200 to 1000-V dc, the efficiency is 80%. At 6.3 and 6000-V dc it is 70%. The conversion frequency is approximately 30 Khz. The output ripple is 0.1%, and conductance interference is less than 10 mV across a 1 Ω resistor in series with the input.

CIRCLE NO. 324



Build reliability into every connection with GARDNER-DENVER *Wire-Wrap*® tools

Reliability is an inherent characteristic of solderless wrapped connections made with Gardner-Denver "Wire-Wrap"® tools. It does not depend on the skill and judgment of the operator . . . or on complex quality control procedures.

Proof: More than 37 billion such wrapped connections have been made . . . without a reported electrical failure.

Why? "Wire-Wrap" tools are simple to use. Connections are permanently tight . . . withstand severe temperature changes, atmospheric corrosion and vibration.

Send for Bulletins 14-1, 14-3, and 14-5 on Gardner-Denver "Wire-Wrap" tools. Air- or electric-powered models.



SEE WHAT AIR IS DOING NOW...SEE

GARDNER - DENVER

Gardner-Denver Company, Quincy, Illinois

ON READER-SERVICE CARD CIRCLE 103

Wide-band transformers for video applications



North Hills Electronics, Inc., Alexander Place, Glen Cove, N. Y. Phone: (516) 671-5700. P&A: \$17.95 (100 lots); stock.

Designed for medium video frequency applications, the series covers frequency ranges as wide as 1 kHz to 20 MHz. A number of standard impedance ratios are available including unbalanced primary to balanced, center-tapped secondary with dc isolation. Also available are units with unbalanced primary to unbalanced secondary. Other ratios are furnished on special order.

CIRCLE NO. 325

Proportional controller has 0.25% accuracy



Thermo Electric, Saddle Brook, N. J. Phone: (201) 843-5800.

The controller's set point accuracy is $\pm 0.25\%$ of scale span with repeatability of 0.1% of scale span. Setpoint temperature is dialed with a thumb wheel and read on a calibrated scale measuring 23.6 in. long. The solid-state controller is available from stock in three thermocouple calibrations: J, K, or T and twelve setpoint temperature

ranges; seven in degrees F (0 to 2400), five in degrees C (-175 to +1300). Controller input power requirements are selectable between 115 and 220 V ac.

CIRCLE NO. 326

Interface valves for fluidic logic

Fluid Power Div. Westinghouse Air Brake Co., Lexington, Kentucky. Phone: (502) 582-1347.

The interface valve is a 3-way, piston-operated poppet valve. For pressure actuation, it provides power amplification at the output of a fluidic-logic circuit. It operates at a supply pressure of from 1/2 to 125 psi. The two models, high and low capacity, have an approximate control pressure of 8% and 6% supply, respectively, and a flow capacity of 0.205 and 0.147 diameter equivalent orifice. They both have a cyclic response over 40 Hz. These fluidic valves have no movable parts and require little or no lubrication.

CIRCLE NO. 327

DRAMATIC REDUCTION

formerly 77" h. x 33" w. x 33" d.

now only

29" h x 17" w x 17" d

(5 KW Audio Power Amplifier)

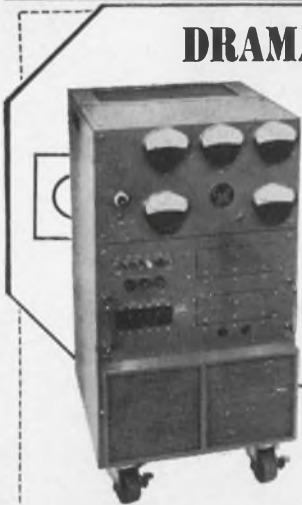

All other models similarly reduced... (but in size only!) For instance, 10 KW Model, formerly 78" h. x 78" w. x 36" d., now only 48" h. x 34" w. x 24" d. CML Audio Power Amplifiers produce tremendous power in the smallest packages. Wide frequency range. Low distortion. Ideal for CW and pulsed operation;

acoustic testing, vibration testing, plasma tubes, ion propulsion engines. Perfect for marine installations. All units with wide range of output impedance taps. Air-cooled and vapor-cooled units. Full power available into low power factor loads. Call or write today for details.

CML, Inc.

A subsidiary of Tenney Engineering, Inc.
350 Leland Avenue - Plainfield, New Jersey
(201) 754-5502 - TWX: 201-756-2064



ON READER-SERVICE CARD CIRCLE 104

Signal distortion between racks*

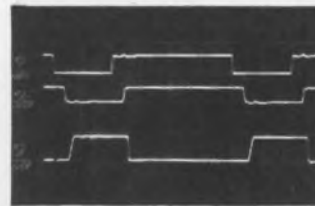
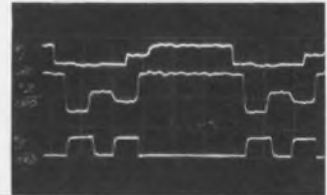

is now a thing of the past.**

MONITOR offers a new line receiver card which terminates long transmission lines in their characteristic impedance for higher frequencies. Regardless of transmission line length, you can now have pulses as clean at the destination as they were when transmitted. You get four line receivers on one L-57 card.

The L-57 is just one of over 140 MONILOGIC™ IC cards, in both DTL and TTL logic, all completely compatible. For more information write to us.

*Scope photo shows (top) transmitter output into 40-foot twisted pair; (middle) output of line; (bottom) output of gate. Reflections return to transmitter output, produce distortion in line, erroneous pulses at gate output.

**With L-57 Line Receiver terminating same line, reflections are eliminated. Transmitter output, line output, gate output are all clean, undistorted, and correct.



MONITOR
SYSTEMS INC.

3868

Fort Washington, Pa. 19034 • A Subsidiary of Epsco, Inc.

ON READER-SERVICE CARD CIRCLE 105



Not in the same league... New Varactor Bridge Op Amps Achieve 10 Fold Improvement Over the Best FET's

- Bias Current — 0.5 pA max.
- Noise Current — 0.01 pA, p-p
- Comm. Mode Impedance — $10^{13}\Omega$
- Price (1-9) — \$110.00

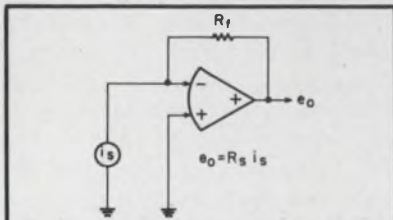

**Measure Picoamp
Current Signals**

With bias current drift of only 0.05 pA/°C and noise of 0.01 pA the 302 can resolve signal currents as low as 10^{-14} amps. Applications include flame detectors, phototubes, nuclear detectors, semiconductor testing, measuring insulation resistance and capacitor leakage, ion gauges, and ion chambers.

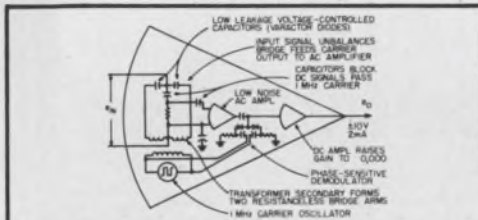

How Model 302/303 Works

Amplifier input, e_{IN} , varies varactor capacitance, unbalances bridge and develops carrier voltage output proportional to bridge unbalance. After AC amplification, carrier voltage is phase sensitively demodulated to restore correct polarity, then further boosted by DC amplifier. Matched varactor diodes operated with low level carrier signal give extremely small bias current (0.5 pA). High quality capacitors and high transformer insulation gives 10^{13} ohms common mode impedance.

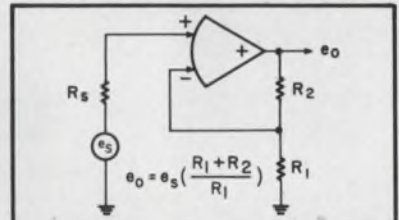

**Measure Voltage Signals
from Megohm Sources**

Model 303 achieves input impedance of 10^{13} ohms for measuring voltage signals from source impedances (R_s) as high as 10^{10} ohms. Low bias and noise currents give negligible errors with large source impedance. Applications include measuring potentials from pH electrodes, electrochemical cells, vacuum tubes, piezo-electric crystals and high resistance potentiometers.

Models 302/303 reduce the varactor bridge circuit to a practical electrometer operational amplifier and offer you the advantages of this circuit technique in a reasonable price range. The primary benefits of the varactor bridge circuit are the ultra low bias current (0.5 pA) and noise current (0.01 pA), which are ten to one hundred times lower than the best FET op amps. Input impedance is also extremely high — 10^{13} ohms.

The varactor bridge circuit provides the only solid state amplifier which approaches the performances of vacuum electrometer tubes and yet does not suffer the excessive voltage drift and noise, aging, microphonic and overload recovery problems usually associated with these tubes.

You will be hearing more and more about varactor bridge amplifiers. Send for six (6) page brochure and application note telling what these new amplifiers can do for you.

Specifications

Bias Current, max.*	0.5 pA
Current Drift, max.*	0.05 pA/°C
Current Noise, p-p, dc to 1 Hz	0.01 pA
Input Impedance, CM.	$10^{13}\Omega$
Voltage Noise, p-p, dc to 1 Hz	2 μ V
Voltage Drift, max.	60 μ V/°C
Rated Output, min.	$\pm 10V@ 2 mA$
Open Loop Gain, min.	10,000
Unity Bandwidth	20 kHz
Price (1-9)	\$110.00

*doubles each 10°C



ANALOG DEVICES, 221 FIFTH STREET, CAMBRIDGE, MASS. 02142 617/492-6000

This is the smallest optical encoder that can resolve 14 bits in one revolution under avionics conditions. It's one example of what Datex offers you in optical encoders. We'll send you others in return for your name and address. Write:

Datex Division / Conrac Corporation
1911 Walker St., Monrovia, California
(213) 359-5381

Dallas, Texas (214) EM 3-6417
Dayton, Ohio (513) 253-1104
Des Plaines, Illinois (312) 827-8141
Huntsville, Alabama (205) 539-9396
New York, New York (212) 661-4070
Pasadena, California (213) 681-7152
Washington, D.C. (202) 244-8700



Model 01-809
Actual Size

COMPONENTS

Dc power supply ranges to 20 V

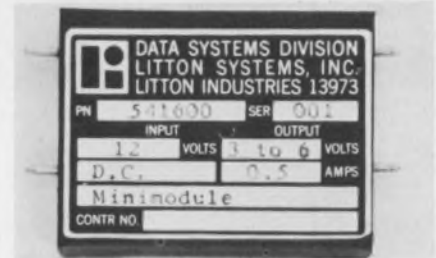

Litton, Data Systems Div., 8000 Woodley Ave., Van Nuys, Calif. Phone: (213) 781-8211. P&A: \$100; 30 days.

A "minimodule" power supply no larger than a box of matches has a predicted reliability in excess of 100,000 hours between failures. The module is completely encapsulated in plastic. It is small and light enough to be mounted on a regular circuit board, and does not require special provision for cooling. Designed for dc-to-dc operation, the unit can operate from an unregulated input source of up to 28-V dc. It can provide a regulated output voltage of 3-to-6 dc, and up to 20-V dc with minor modifications. Maximum output current for the unit is 0.5 A with a maximum power rating of 10 W. It has automatic current protection so that the power supply will shut down and reset on overload. The power supply weighs 2 ounces. Its dimensions are 2 x 1.5 x 0.5 inches. The unit meets MIL-E Class 2 specifications.

CIRCLE NO. 328

400-cycle motor torques 3 oz/in.

Magneddyne, Inc., 5580 El Camino Real, Carlsbad, Calif. Phone: (714) 729-7191.

This general-purpose motor measures 1-1/8 x 1-3/8 in. and produces a maximum torque of 3 oz/in. The model 210 is available in three versions: a two-phase, 6-pole, servo motor; a single-phase, 6-pole, capacitor-type general-purpose induction motor and a 3-phase, 4-pole general-purpose induction motor. All versions can be supplied with a double disc clutch which isolates the rotor inertia from the shaft.

CIRCLE NO. 329

High-intensity mike vibration compensated



Gulton Industries, Inc., 212 Durham Ave., Metuchen, N. J. Phone: (201) 548-2800.

This high-intensity microphone measures 1/4 in. in diameter. The piezoelectric transducer is specially vibration-compensated for measurement of high-intensity acoustic noise in severe environments. These environments typically include high-vibration levels which would obscure the acoustic output from a microphone without such effective vibration compensation. Designated MVA-2400, the miniature microphone operates in a temperature range of -100 to $+500^{\circ}\text{F}$ with ± 2 -dB change from corresponding room-ambient response. The instrument has a mounted resonant frequency of 100 kHz and capacitance of 1000 pF. Its weight is 3.5 grams.

CIRCLE NO. 330

Multiposition stepper has 300 contacts

Kinetics, 410 S. Cedros Ave., Solana Beach, Calif. Phone: (714) 755-1181.

A multiposition, multipole stepper switch is offered with as many as 300 points of contact at 5 A. Current ratings range up to 300 A at 115 V dc. The switches will operate reliably in sinusoidal vibrations of 28 to 2000 Hz at a 40-G peak, a shock of 100 G for 11 ms and an acceleration of 20 G for 10 minutes in each of three mutually perpendicular axes. The internal control logic of the switches is easily programmed by external connections. Applications for the unit include instrumentation monitoring in both space and deep-ocean vehicles.

CIRCLE NO. 331



LOOK WHAT'S HAPPENED TO HIGH-VACUUM EVAPORATION



YOU CAN NOW...

- Deflect electron beams 270° to put the emitter out of the range of evaporants and falling particles.
- Focus bent electron beams of 2 to 150 KW power with pinpoint accuracy.
- Operate electron-beam guns at peak efficiency for periods of 75 or more hours.
- Operate several electron-beam guns in one or in different vacuum chambers from a single constant-voltage power supply.
- Depend on electron-beam systems to evaporate or purify metallic and non-metallic substances on a commercial scale at costs competitive with other systems.

If you are using induction or resistance heated sources, or electron-beam gun systems more than two years old, you should read Temescal's new brochure, "The Electron Beam... A New Super Heat Source For Modern Industry." Write or telephone for your copy today. It will help guide you in selecting the system best suited to your operation.

AIRCO Temescal

A DIVISION OF AIR REDUCTION COMPANY, INCORPORATED

2850 SEVENTH STREET, BERKELEY, CALIFORNIA 94710 • TELEPHONE 415 841-5720

ON READER-SERVICE CARD CIRCLE 123

Module links control systems and computers



Consolidated Electrodynamics Corp., 706 Bostwick Ave., Bridgeport, Conn. Phone: (203) 368-6751. P&A: \$250; stock.

This pneumatic to electric converter module provides high accuracy and signal quality for computer inputs. The building-block approach to control problems is now extended to pneumatic systems by this versatile module. It is available in 0 to 5 and 0 to 10 V range models and in the 1 to 5, 4 to 20 and 10 to 50 mA range.

CIRCLE NO. 395

Chronometric accuracy in a cyclic timer



General Oceanographic Co., P. O. Box 66006, Los Angeles. Phone: (213) 398-8790.

Designated the model 6500, the cyclic timer provides a basic timing cycle of one hour and operates an internal switch for a predetermined fraction of an hour. The cycle is repeated as long as power is applied to the instrument. The cyclic timer is powered by a brushless dc motor and regulated by a temperature-compensated escapement. The duration of switch operation is determined by a field-replaceable cam.

CIRCLE NO. 396

Transistor amplifier functions at 60 MHz

Somerset Radiation Lab., Inc., 2060 North 14th St., Arlington, Va. Phone: (703) 525-4255. P&A: \$120; 10 days.

Designed to operate at 60 MHz, this transistor amplifier is capable of accepting a wide range of power inputs by incorporating a variable bias control. For inputs below 10 mW, setting the bias control for maximum power output results in optimum class AB operation. For inputs above 10 mW the bias control is rotated counter-clockwise for Class B or Class C operation to peak the power output. The model G260 delivers 1 W to a 50Ω load with an input of 20 mW for a gain of 17 dB. A single negative-ground power supply furnishing 28 V at 150-mA maximum is the only external dc requirement. Applications include amplifying the output of a low-level crystal-controlled oscillator to drive a step-recovery diode multiplier, 60-MHz laboratory-distribution amplifier and an i-f power amplifier.

CIRCLE NO. 397



TC/VCXO

TEMPERATURE COMPENSATED VOLTAGE CONTROLLED CRYSTAL OSCILLATORS

New Arvin TC/VCXOs for miniaturized communications equipment generate frequencies to 50 MHz with oven-like accuracy. Typical TC/VCXO specifications:

- 5 MHz ± 2 PPM from -40°C to +70°C
- Power Input 60 MW ■ Power Output 1 MW
- Deviation ± 25 PPM ■ Deviation Rate DC to 5 KHz
- Deviation Sensitivity 5 PPM/volt ■ Linearity 2%

Units with other frequencies and stabilities can be designed. TC/VCXOs can be manufactured to conform to all applicable NASA or MIL specs.

ARVIN FREQUENCY DEVICES



2505 North Salisbury Street, West Lafayette, Indiana 47906

ON READER-SERVICE CARD CIRCLE 124

EMI/RFI SHIELDING/VENT PANELS PLATED ALUMINUM OR STEEL COOL - FILTER - SCREEN

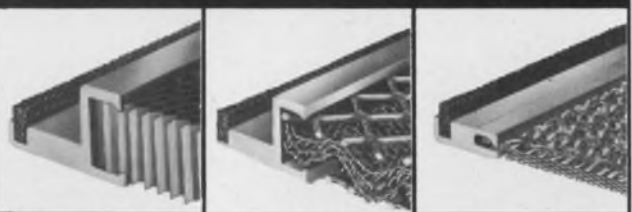

TECKCELL

Honeycomb panels provide extremely effective EMI/RFI shielding... yet permits unrestricted air flow through enclosure opening. Wide selection available.

TECKSCREEN

Effective dust filtration plus EMI/RFI shielding. All-metal filter medium is easily cleaned. Tested for shielding effectiveness and air flow (dry and wet operations).

TECKAIRE

Only 3/16" thin... filters large particles with minimal restriction of air flow. Multilayer design and aluminum extrusion with EMI/RFI gasketing gives max. shielding performance.

Write today for Information No. 101.

TECHNICAL WIRE PRODUCTS, INC.



East Division • 129 Dermody St., Cranford, N.J. 07016 (201) 272-5500
West Division • 427 Olive St., Santa Barbara, Calif. 93101 (805) 963-1867

"SEE US IN THOMAS REG. AND EEM."

ON READER-SERVICE CARD CIRCLE 125

ELECTRONIC DESIGN 22, October 25, 1967

Flat drawer cables have 80 pF/ft capacitance

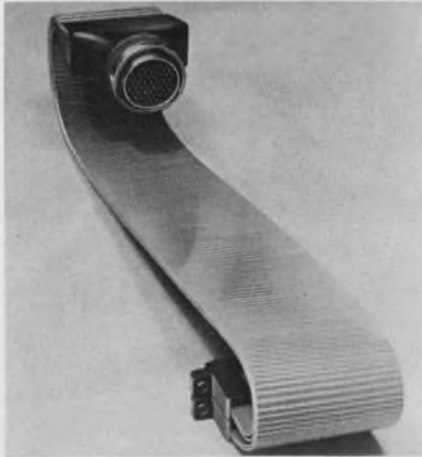

Digital Sensors, Inc., 4127 N. Figueroa St., Los Angeles. Phone: (213) 223-2333.

Shielded, thin, flat, flexible, drawer cables designed to fit available space without system modifications have welded through-insulation terminations and permit a long flex-life. Any type of connector may be used to suit military or commercial applications. No cable-retracting devices are required. A variety of sizes and physical configurations are available in either single or multilayer types. The shielded drawer cables are designed to provide less than 80 pF/ft capacitance from any conductor to the shield and less than 1 pF/ft between adjacent conductors. End requirements govern the choice of materials and construction details.

CIRCLE NO. 398

Locking mechanism cures vibration

Methode Electronics, Connector Div., 7447 W. Wilson, Chicago. Phone: (312) 867-9600.

A locking mechanism package for the multi-stacking of plug-in PC boards is used by the Navy on aircraft-mounted communication equipment. While primarily a locking device, the two, board-mounted spring-loaded disconnect levels also facilitate the removal of the board from its receptacle for inspection service. The amount of travel caused by the ejector level action is more than sufficient to lift the board free of the receptacle's spring contact.

CIRCLE NO. 399

General Electric's sub-miniature Bi-Pin lamps have slimmed down a bit about the midsection. Now the base is no bigger around than the bulb. So you can locate GE's Bi-Pins on ¼ inch centers. Set them up more precisely, put light right where you want it.

GE Bi-Pin lamps plug in from the front and stay put. For printed circuits, indicator and switching applications, they do the same job as screw base, grooved base, midget flanged base or wire terminal lamps. And often save you money because they eliminate more expensive sockets.

Lamp type identification is clearly printed on the tough plastic base of every GE Bi-Pin lamp. No confusing color codes, no delays or chance for error. Another GE extra: a soldering vent slot for tighter, trouble-free contact.

You can get this base on any lamp in the T-1¼ size. For complete specifications, send for free illustrated data, #3-5593. General Electric Co., Miniature Lamp Department, M7-6, Nela Park, Cleveland, Ohio 44112.

THE NEW SLIM GE BI-PIN

its loss is your gain

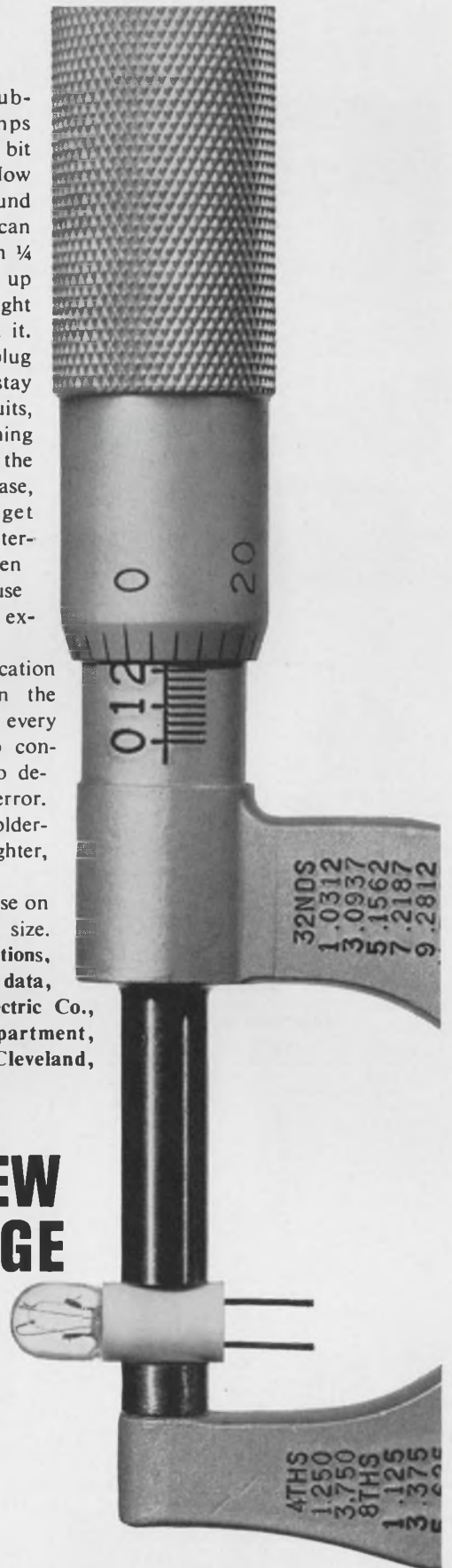

Miniature Lamp Department

GENERAL  ELECTRIC

ON READER-SERVICE CARD CIRCLE 126

DESIGN PROBLEMS?

solve them with

PIONEER PHOTOCELLS



CDS-9

A 1" photocell, especially designed for numerous applications in outside or inside lighting, flame control, and relay applications where the light source is incandescent. Proven by hundreds of thousands of photocell years of service.

hundreds of thousands of photocell years of service.



CDS-7

Has the same general characteristics as the CDS-9 but a smaller size (1/2") for use where space is at a minimum.



CDS-5

A very compact unit with a T.O. 5 housing, produced to your specifications.

Our engineering department will work with you on any special application of photosensitive layers.

STANDARD MODELS

Curves for load line design available for each model.

CDS Type No.	1 FC Simulated Daylight 50 V AC Mean* Output	Nominal Resistance 50 FC 2800° K Incand.	Max. Dark Current** or Min. Dark Resistance	Max. Dissip.	Max. Volt Dark
701	1.5 ma		25 ua		500 V
702	3 ma		25 ua	all rated	500 V
703	6 ma		40 ua	1/4 watt continuous	350 V
710		1330 ohms	4 meg.	1 watt	500 V
711		670 ohms	4 meg.	1 minute	500 V
712		330 ohms	2.5 meg.		350 V
901	1.5 ma		25 ua	All rated	1000 V
902	3 ma		25 ua	1/2 watt	1000 V
903	6 ma		40 ua	contin-	700 V
904	12 ma		200 ua	uous	500 V
910		1330 ohms	4 meg.		1000 V
911		670 ohms	4 meg.	2 watts	1000 V
912		330 ohms	2.5 meg.	1 minute	700 V
913		165 ohms	0.5 meg.		500 V

*Range of values in any category equal to ±33% of mean.
 **Measured at 100 V, 5 seconds after 50 FC light extinguished.

THE **PIONEER**
 ELECTRIC & RESEARCH CORPORATION
 Subsidiary of **QORON** Controls, Inc.
 743 Circle Ave., Forest Park, Ill. 60130
 Telephone: (312) 771-8242

ON READER-SERVICE CARD CIRCLE 127

Dynage power supplies display 3 different styles



Dynage, Inc., 390 Capitol Ave., Hartford, Conn. Phone: (203) 249-5654.

Dynage manufactures 3 different package styles. The voltage references and standards are packaged for circuit-board mounting and chassis mounting. The low current power supplies D series is available up to 1 A, and is packaged for chassis mounting in MIL-T-27A type deep-drawn cans. The higher-current power supplies (H series up to 60 A) are packaged in rack-type modules requiring no external heat sink or forced air and on use for bench and rack supplies. Supplies from 25 mA to 6-A are available.

CIRCLE NO. 366

Lightweight commutator displays 16-channels



Stellarmetrics, Inc., 416 E. Cota St., Santa Barbara, Calif. Phone: (805) 963-3566.

This miniature electronic commutator features 16-channel input and operates on less than 15 μA at 12 V. It weighs under three oz and measures 1-11/8 x 2-1/8 x 15/16 in. The single-pole commutator has a 16-channel capacity. Sample-rate stability over entire range of operating conditions is ±3%. It will operate from -40 to 85°C and withstand 600 G.

CIRCLE NO. 367

Binary system displays 12 bits/turn



Baldwin Electronics, Inc., 1101 Mc-Almont St., Little Rock, Ark. Phone: (501) 735-7351.

A natural binary encoder system uses a Baldwin Photoelectric encoder that has a reported lamp life in excess of 50,000 hours. The system has a capacity of 12 bits per turn, outputs compatible to most D.T.L. and T.T.L. IC logic and requires two supply voltages including the lamp voltage. The system was developed to fit a choice of commercial applications including automatic drafting machines, map readers, x-y plotters and numerical controlled feedback loops.

CIRCLE NO. 368

Overvoltage module protects sensitive loads



Dynage, Inc., 1331 Blue Hills Ave., Bloomfield, Conn. Phone: (203) 243-0315. P&A: \$40 to \$75 (1 to 4 quantity); stock.

The OVF overvoltage protector module is designed for the protection of voltage-sensitive loads. It has been observed from experimental data on various overvoltage packages that the worst case transient is 0.5 V for 8 μs. By setting the overvoltage package between 1 and 1.5 V below the critical voltage, the critical voltage will not be reached at any time. The modules are available from 1 to 100 A with voltage levels up to 70 V dc. The package size is 4-15/16 by 2-5/8 by 2 in.

CIRCLE NO. 369

X-band oscillator operates at 9.2 GHz



Microwave Associates, Burlington, Mass. Phone: (617) 272-3000.

The X-band local oscillator and its power supply is only a fraction of the size of the combined power supply and klystron. A simplified design concept—one transistor and diode—provides solid-state reliability.

CIRCLE NO. 370

Fast recovery rectifiers from 50 to 600 Vdc



Motorola Semiconductors, P. O. Box 955, Phoenix. Phone: (602) 273-6900. P&A: \$.40-\$16.20; stock.

This line contains 54 different types and offers a choice of rectifiers from 3/4 to 30 A current ratings. Reverse voltage (V_R) ratings are from 50 to 600 V dc. Two reverse recovery speed ranges are available: 200 ns(max) for applications up to 250 kHz and 1 μ s (max) for applications up to 50 kHz. Circuit applications include high frequency inverters, choppers, switching regulators, high voltage series strings, and fast voltage clamps. Fast recovery rectifiers with up to 1 A ratings are encapsulated in a "Surmetic" silicon-polymer case and a high-temperature, high-humidity resistant package. The die within this package is hermetically sealed by means of a silicon passivation that has proved highly effective.

CIRCLE NO. 371

Instant Circuit Design

with BARNES
BREADBOARD/
TEST ASSEMBLIES
FOR TO's, FLAT-
PACKS and DIP's

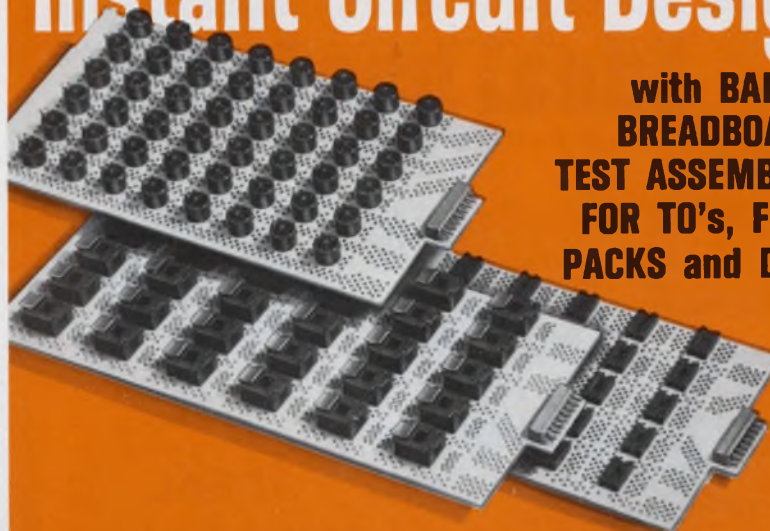

Tired of circuit designing that requires slow, tedious I.C. mounting and interconnection? Barnes breadboard/test assemblies make circuit design fast and easy . . . speed power aging too. For flat-packs, dual-in-lines or TO-5's, standard boards provide 10, 20 or 30 sockets. Wiping action spring jacks allow simple plug-in interconnection with no necessity for pre-cut jumper wires. Specials are available in any configuration. Write for data or call us collect.



Lansdowne, Pa. 19050 • 215/MA2-1525

barnes / THE FIRST WORD IN CARRIERS, CONTACTORS AND SOCKETS FOR I.C.'S

ON READER-SERVICE CARD CIRCLE 128

Ever need plug-in power supplies in a hurry?
Send for our 1967 catalog.
It lists 62,000 different types.
The one you need will be shipped in 3 days.

(We've never failed to make good on this promise)



Acopian Corporation, Easton, Pennsylvania, (215) 258-5441

ON READER-SERVICE CARD CIRCLE 129

You name the meter. Ideal has it.

(or we'll make it for you)



If one concentrates long and hard enough on panel meter development and engineering, one becomes expert.

IDEAL meters are used by all the Military and by leaders in defense and industry. For everything in meters—ruggedized or commercial, custom and stock, 1/2" to 7"—you can count on IDEAL, the proven leader.

Write for free 32-pg. catalog. Ideal Precision Meter Co., Inc., 218 Franklin St., Brooklyn, N.Y. 11222. (212) EVergreen 3-6904.

ON READER-SERVICE CARD CIRCLE 131

it costs you nothing to call on experience:

Reeves-Hoffman design and manufacture is 100% custom...
let us quote your needs!

★ quartz crystals

★ crystal filters

★ oscillators

★ discriminators

★ standards

★ ovens

REEVES-HOFFMAN

DIVISION OF **DCA**
400 W. NORTH ST., CARLISLE, PA. 17013
TELEPHONE • AREA CODE 717 • 243-5929



Md., D.C., Va., W.Va., N.C.
Valley Electronics, Inc.
Baltimore, Maryland
(301)668-4900; (202)659-1760

New England
Howard Jappe Company
Wakefield, Mass.
(617)245-9359

Pa. (not western), Del., So.N.J.
Eastern Components, Inc.
Philadelphia, Pa.
(215)927-6262

New York (except N.Y.C.)
Midstate Research Sales Co.
Syracuse, New York
(315)478-8314; (315)478-0715

New York City, No.N.J.
G. M. Moch Company
Ridgefield, New Jersey
(201)945-0080; (212)279-6758

So. California
Ash M. Wood Company
Arcadia, California
(213)283-1201; (213)287-0449

No. California
L & M Engineering
Santa Clara, Cal.
(408)243-6661

Ill., Ind., Wisc., Minn.
PGM Sales, Inc.
Chicago, Illinois
(312)622-8183

Ohio, W.Pa., Mich., Ky.
Tri-State Marketing, Inc.
Cincinnati, Ohio
(513)631-5060

Texas, Okla., Ark.
Carter Associates, Inc.
Gerland, Texas
(214)276-7151

Ariz., N.M., Las Vegas
Carter Associates, Inc.
Scottsdale, Arizona
(602)947-4355

ON READER-SERVICE CARD CIRCLE 132

COMPONENTS

Photodetector responds at 1.06 microns

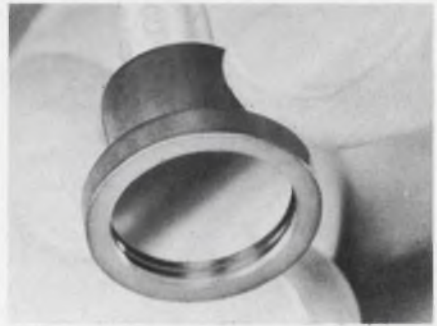

United Detector Technology, P. O. Box 2251, Santa Monica, Calif. Phone: (213) 393-3785.

Low-capacity photodetector designed for high-speed applications operates at a laser wavelength of 1.06 microns. The unit has an active area of 1 cm² and a minimum capacitance of 40 pF. Rise time to a light pulse is 5 ns. The PIN-8LC has a quantum efficiency of 30% at 1.06 microns; 70% quantum efficiency at 5500 Å; and a quantum efficiency of 40% at 3800 Å.

CIRCLE NO. 371

Pressure transducer in TO-46 can



Stow Laboratories, Inc., Barton Rd., Stow, Mass. Phone: (617) 562-9347. P&A: \$75, prototype quantities; 3 wks.

This tiny solid-state component used for converting forces and pressures into electrical signals operates so that transduction takes place entirely within the transistor junction. It is a silicon planar transistor that has its emitter-base junction mechanically coupled to a diaphragm located in the top of the TO-46 can. When a pressure or point force is applied to the diaphragm, a large, reversible change is produced in the transistor's characteristics. A linear output range of at least 2 V can be achieved without external amplification.

CIRCLE NO. 372

Dual-in-line filters range from 10 to 30 MHz

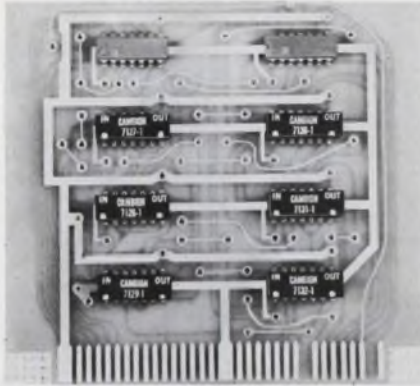

Cambridge Thermionic Corp., 445 Concord Ave., Cambridge, Mass. Phone: (617) 491-5400. P&A: \$42.50 up; stock.

Two series of dual-in-line package filters are available. Each series consists of low-pass, high-pass and bandpass filters in 10 MHz and 30 MHz frequencies. Interconnection pins are located on 0.1 in. centers with 0.3 in. between pin contact rows. Model numbers assigned to these filters are 7127, 7128 and 7129 for the low-pass, high-pass and bandpass 10 MHz filters. The 30 MHz units are 7130, 7131 and 7132 respectively.

CIRCLE NO. 374

Ball-bearing blower cools card arrays

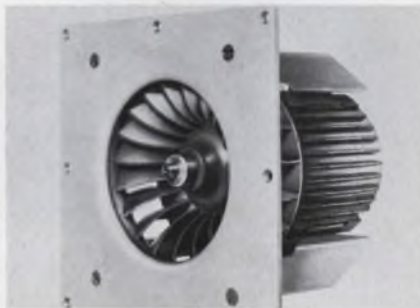

Rotron Manufacturing Co., Inc. Hansbrouck Lane, Woodstock, N. Y. Phone: (914) 679-2410.

The Model-G blowers make use of mixed-flow impellers which provide the high pressures normally available only from conventional squirrel-case designs. Designed with long-life ball bearing induction motors, the low-noise Centraxial G blowers can be used advantageously in memory stacks, specialized heat exchangers and other applications.

CIRCLE NO. 375

Dc time delay is epoxy encapsulated



Universal Technology Corp., 107 New Street, Pittston, Penna. Phone: (717) 654-7385. P&A: \$25.65 to \$42.75; stock

This fixed time delay relay is designed specifically for printed circuit applications and the aerospace industry. The unit uses a reed relay with all silicon timing circuitry to give it a life expectancy of 4-million cycles at rated load and 15-million cycles at 1/2 rated load. It is available in 21 different time delays.

CIRCLE NO. 376

Low-frequency filter spans 9 to 50 KHz

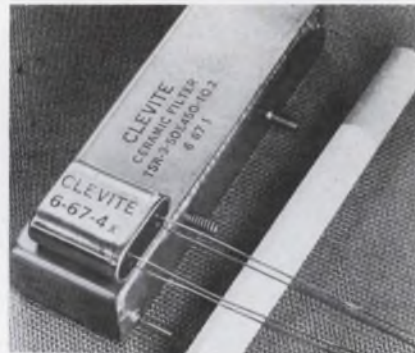

Clevite Corporation, Piezoelectric Division, 232 Forbes Road, Bedford, Ohio. Phone: (216) 232-3473.

In the 9 to 50 KHz range, the filter combine narrow bandwidths (1/2)% and 90 dB rejection with small size and weight. Performance is achieved with cascaded combinations of 4-terminal ceramic elements. The individual element is a split-ring filter with 1 per cent bandwidth at 3 dB and 13% at 20 dB packaged in an HC-6/U crystal can. Overall weight is less than a quarter ounce.

CIRCLE NO. 377

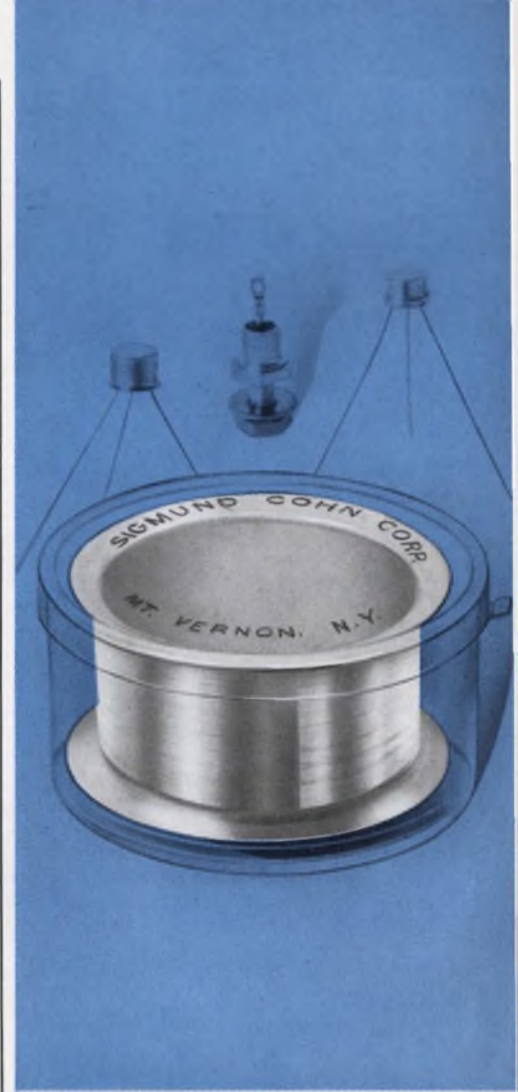

Sigmund Cohn Corp. Offers Fine Sizes in High Quality

Aluminum Alloy Bonding Wires

for Thermo-Compression and Ultrasonic Bonding

- Good bonding characteristics
- Excellent reproducibility
- Maximum homogeneity

In a variety of alloys, such as Aluminum 1% Silicon; Aluminum 1% Magnesium; No. 1100 Aluminum

Write for New Engineering Bulletin

Sigmund Cohn Corp. 121 So. Columbus Ave., Mount Vernon, N.Y. 10553



Since 1901

**Most Precise
Highly Dependable
Extremely Compact**



MATSUO ELECTRIC COMPANY LIMITED, guided by the abovementioned qualifications, have been able to produce capacitors, which have proven to be satisfactory in every respect. MATSUO capacitors, widely used for measurement equipment, computers and automatic controllers, enjoy great popularity among their numerous consumers.

METALLIZED POLYESTER FILM CAPACITOR

Type FNX-H

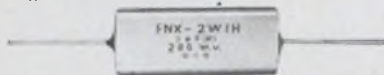

Operating temperature range: -40°C to $+85^{\circ}\text{C}$
Standard voltage rating: 100V, 200V, 400V, 600V D.C.
Standard capacitance value: .33 MFD to 10 MFD
Standard capacitance tolerance: $\pm 20\%$, $\pm 10\%$

SOLID TANTALUM CAPACITOR

Type TAX hermetically sealed in metallic case

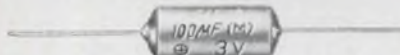

Operating temperature range: -55°C to $+85^{\circ}\text{C}$
($+125^{\circ}\text{C}$ with de-rating voltage)
Standard voltage rating: 6V, 10V, 15V, 20V, 25V, 35V D.C.
Standard capacitance value: 1 MFD to 220 MFD (E-6 series)
Standard capacitance tolerance: $\pm 20\%$

Type TSX encased in metallic case and sealed with epoxy resin

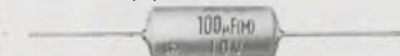

Operating temperature range: -55°C to $+85^{\circ}\text{C}$
Standard voltage rating: 3V, 6V, 10V, 15V, 20V, 25V, 35V D.C.
Standard capacitance value: 1 MFD to 220 MFD (E-6 series)
Standard capacitance tolerance: $\pm 20\%$

Type TSL encased in metallic case and sealed with epoxy resin

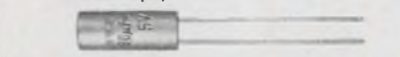

Operating temperature range: -55°C to $+85^{\circ}\text{C}$
Standard voltage rating: 3V, 6V, 10V, 15V, 20V, 25V, 35V D.C.
Standard capacitance value: 1 MFD to 220 MFD (E-6 series)
Standard capacitance tolerance: $\pm 20\%$

for full details, contact :

**MATSUO
ELECTRIC CO., LTD.**

3-chome, Sennari-cho, Toyonaka-shi, Osaka, Japan.
Cable Address: NCC MATSUO OSAKA

ON READER-SERVICE CARD CIRCLE 134

SYSTEMS

**Light source
delivers 2500 W**

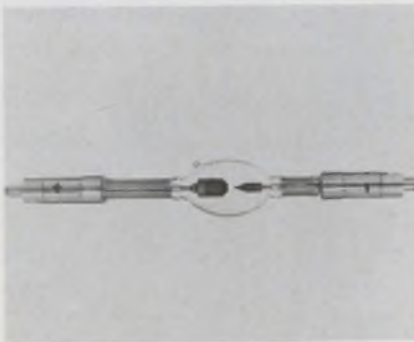

Pek, Inc., 825 E. Evelyn Ave., Sunnyvale, Calif. Phone: (408) 245-4111.

Designated Model X-2500A the 2500-W xenon arc lamp features ribbon seal construction to provide protection from damage by vibration and heat. The lamp is dc operated and provides continuous, modulated and pulsed-operation capabilities. The unit delivers a rated average brightness of 62,000 CD/cm². Life at the rated 2500 W is 15 hours.

CIRCLE NO. 378

**Reed switch
rated at 5 W**



General Electric, 2100 Gardiner Lane, Louisville, Kentucky. Phone: (502) 459-4323.

General Electric's Tube Dept. has announced the availability of a single-pole, double-throw reed switch named the DR138. The device is for applications involving both resistive and inductive loads. With a contact rating of 5 W (50 V at 100 mA) dc resistive, the reed switch has a life expectancy of 20-million operations. The unit has a contact resistance limit of 100 $\mu\Omega$.

CIRCLE NO. 379

**Modular power supplies
produce 5 V**

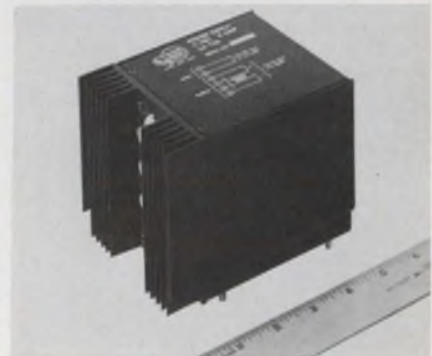

Engineered Electronics Company, 1441 East Chestnut Ave., Santa Ana, Calif. Phone: (714) 547-5651, Price: 737-\$160, 738-\$275.

Two 5 V modular power supplies for powering IC logic cards are available. The model ZA-738 fits into a card file or mounts on a chassis—its overall 3-7/8 x 4-3/8 x 5 in. size requires only 8 card spaces. The unit provides power for up to 150 cards and is rated at full output current of 8 A at 71°C. Model ZA-737 is rated at 2 A and provides for up to 40 cards.

CIRCLE NO. 380

**Rotary-push switch
handles 10 A**

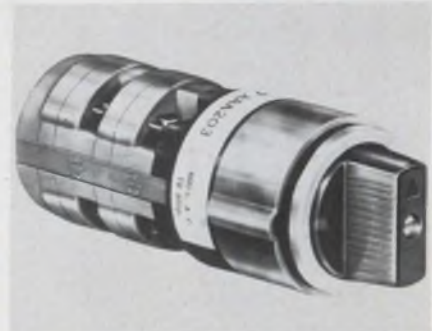

American Solenoid Co., Inc., 245 East Inman Ave., Rahway, N. J. Phone: (201) 381-5100.

The D 10 provides both lateral and rotary operation permitting a number of pushbutton and selector functions into a single switch. For example, an application requiring "start," "stop," "reverse" and "jog" functions can utilize a single D 10 Rotary-Push Switch to control all these functions including an emergency "push-to-stop" function. The unit measures 1.48 in. in diameter.

CIRCLE NO. 381

Liquid level detector weighs 3 oz.



Smiths Industries, 172-76 Baisely Blvd., Jamaica, N. Y. Phone: (212) 528-1900.

A miniature liquid level detector has been designed to replace the mechanical float switch. It is used to provide a signal when liquid in a container, such as fuel in a tank, has reached a predetermined level. It may be set to operate on a rising or falling level and can be fitted with a time-delay circuit, if required. Advantages offered by the detector include its ability to operate at extremes of temperature (-76 to $+257^{\circ}\text{F}$) and its avoidance of moving parts inside the tank.

CIRCLE NO. 382

Ionization detector senses 1 part per million

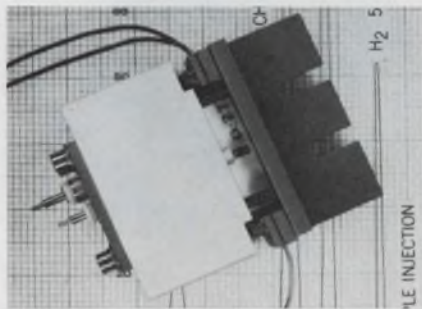

Beckman Instruments, Inc., 2500 Harbor Blvd., Fullerton, Calif. Phone: (714) 871-4848.

Helium ionization detector for process gas chromatographs offers sensitivities to non-hydrocarbon gases that are equivalent to those obtained for hydrocarbons with hydrogen-flame ionization techniques. Typical sensitivities in the order of 1 to 2 parts per million full scale can be obtained for inorganics such as carbon monoxide, carbon dioxide, oxygen, nitrogen and hydrogen.

CIRCLE NO. 383

The incomparably incomparable comparator

OK, so it's redundant, it got you to this point, didn't it? Small and quick, that's Redcor/Modules' 770-724 Comparator. 1.4 cu. in., and five times faster than any 1 mv comparator made. (Sure, you might find some guy who made one in his garage that's almost as fast. But will he sell it to you for 59 dollars American?) You also might as well know that our en-

tire line of modules has a great new pin layout that lets you easily interconnect with dual in-lines. Well, don't stand there gaping. Demand complete data and we'll arrange for a representative of the U.S. Government to deliver it to you.

REDCOR
7800 DEERING AVENUE
CANOGA PARK,
CALIFORNIA 91304
(213) 348-5832 • TWX 910-494-1228

ON READER-SERVICE CARD CIRCLE 135



POSITION PRESS PEEL TRANS-PAK Die-Cut SYMBOLS THE FASTEST METHOD OF PREPARING PRINTED CIRCUIT MASTERS

NOW IN
A NEW
HANDY
DISPENSER



Yes, here is the original TRANS-PAK "Position . . . Press . . . Peel" method with a brand new twist . . . a new, handy dispenser that makes the preparation of printed circuit masters easier than ever before. No inking, no cutting, no stripping. One convenient package gives you terminal pads, elbows, connectors, teardrops or any other symbol, die-cut to exacting tolerances for dimensional stability and distortion-free placement. Just reach for the dispenser and "press down" a perfect symbol. Takes just seconds.

TRANS-PAK pressure-sensitive die-cut symbols are available in black crepe paper and red translucent material. Never a die-charge for special orders.

POSITION TITLES, WORDS, LETTERS, NUMBERS IN SECONDS, TOO!

deca-dry[®] ELECTRONIC MARKING KIT

Kit contains all the standard titles, codes, words, letters and numbers in dry transfer form. Rub lightly with a pencil and instantly they transfer onto schematics, terminal boards, printed circuit masters with ease. Elements appear crisp, sharp . . . look just like the finest printing. Won't move, crack or peel. Produce razor sharp copies in most reproduction processes.

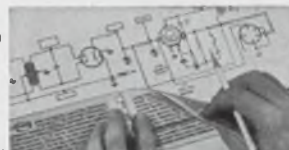

Chart-Pak Inc. A subsidiary of Avery Products Corp. 344 River Rd., Leeds, Mass. 01053



Please send catalog describing TRANS-PAK Printed Circuit Symbols.
 I am interested in Deca-Dry Electronic Marking Kit!

Name Title

Company

Address

City State Zip

Look in the Yellow Pages under Art Supplies, Drafting Supplies, Charts-Business, Tapes for your dealer's name.

ON READER-SERVICE CARD CIRCLE 136

R-3000

SOLID STATE AC VOLTAGE REGULATORS

Write
today
for new
Brochure



Designed Especially for OEM Application.
Two Lines Available.

SPECIFICATIONS

	R-3100	R-3200
Type of Voltage Regulation	True RMS	Peak
Regulation Technique	Peak Clipping	Peak Clipping
Type of Reference Input	RMS Sensor	Zener Diode
Input	100-130 VAC	100-130 VAC
	47-63 Hz	47-63 Hz
Output	115 VAC	115 VAC (RMS)
Line Regulation ($\pm 10\%$ line variation)	$\pm 0.5\%$	$\pm 1.0\%$
Load Regulation (10% to Full Load)	$\pm 0.5\%$	$\pm 1.0\%$
Frequency Regulation (47-63 Hz)	$\pm 0.5\%$	$\pm 1.0\%$
Power Factor Regulation ($+0.7$ to -0.7)	$\pm 0.5\%$	$\pm 1.0\%$
Phase Shift	None	None
Response Time	10-50 μ sec.	10-50 μ sec.
Models Available	15-1000 va	15-1000 va

WANLASS ELECTRIC CO.



A Subsidiary of American Bosch Arma Corporation
2175 South Grand Avenue/Santa Ana, California 92705

ON READER-SERVICE CARD CIRCLE 137

FIVE GOOD

WAYS TO

LEARN ALL

ABOUT MICRO-

ELECTRONICS . . .

SEE PAGE 31.

SYSTEMS

Projection readouts have 24-message positions



Industrial Electronic Engineers,
Inc., 7720 Lemona Ave., Van Nuys,
Calif. Phone: (213) 787-0311. P&A:
\$49.50; 6 wks.

Significant in this unit are the 24-message positions. The series 860 is for data-entry applications where switch closure is required in response to one of twenty-four messages, conditions or numerals displayed on the transparent switch key. The over-all display area is 0.62 in.² with a character size of 0.59 in. standard.

CIRCLE NO. 254

High-speed printer records 6000 line/min

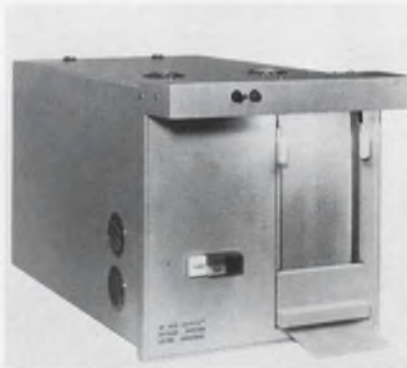

Litton Industries, 343 Sansome St.,
San Francisco, Calif. Phone: (415)
397-2813.

By use of ICs, a cathode-ray tube and fiber optics, the Datalog MC 4600 records 600 lines/min with 32 alphanumeric characters in each line. Data are accepted serially. The unit features either synchronous or asynchronous operation. It is silent, since the only moving parts are for the paper drive.

CIRCLE NO. 392

Linearizing network accepts nonlinear input

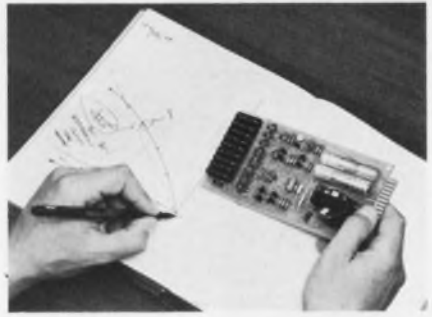

Industrial Scientific Research
Corp., 2220 Howell Ave., Anaheim,
Calif. Phone: (714) 633-7907.

A line of analog linearizing networks is now available mounted on printed-circuit boards or in a flush mounting case. These devices take a nonlinear input and offer a linear output compatible with standard recorders. Input may be as low as 0-10 mV. Discrete adjustments are available permitting the apparatus to be used in a wide variety of applications.

CIRCLE NO. 393

Tape recorder requires only 300 in.³



Kinelogic Corp., 29 S. Pasadena
Ave., Pasadena, Calif. Phone:
(213) 449-8707.

The model L offers a tape capacity of 1100 ft in a volume of 300 in.³ and weight of 11 lbs. A recording time of one hour at 3-3/4 ips is provided with any number of tracks up to 28 on 1-in. wide tape in direct, fm, or digital format. IRIG, IBM, or other computer compatible recording is available. The unit will withstand 70,000 feet altitude, 50 g shock, 25 g acceleration on any axis, ± 10 g vibration to 2000 Hz and an operation range of -54 to $+71^\circ\text{C}$.

CIRCLE NO. 394

Laser interferometer detects displacements



Heidenhain Corp., 7952 N. Waukegan Rd., Niles, Ill. Phone: (312) 967-5979.

The laser interferometer is intended for the measurement of displacements, such as that of the table of a machine tool with respect to the machine bed. This measurement is made by comparing the displacement with multiples of half the wave length of a frequency-stabilized gas laser. The laser beam is separated by a beam splitter into a measuring beam and a reference beam. Both beams are combined again and produce interference phenomena depending on the difference between the optical paths traveled by them.

CIRCLE NO. 384

Lab recorder weighs 13 pounds



Corporate Scientific Apparatus Dept., Van Water & Rogers Inc., P. O. Box 3200, Rincon Annex, San Francisco. Phone: (415) 467-2600.

A portable strip chart recorder designed for a variety of laboratory applications is available in two models. The Vanlab recorder provides full-scale operation at 1, 5, 10, 50, 100 and 500 mV with chart speeds of 1/2, 1, 2-1/2, 5 and 10 in. per minute. Response time is 0.5 s with accuracy to 1/4%.

CIRCLE NO. 385

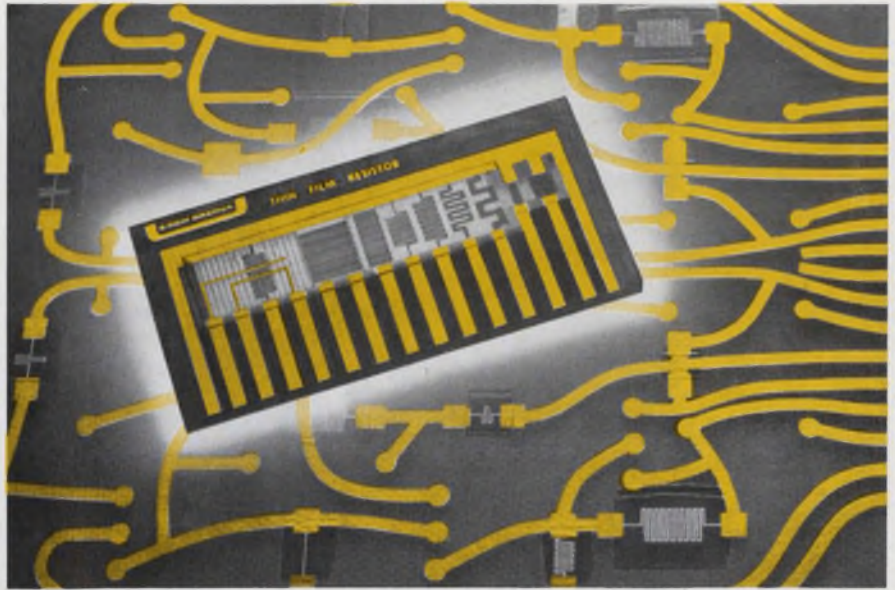

Now... Thin Film Resistors from Cinch-Graphik

Now you can order thin film resistors as an integral part of the world's finest printed circuits. This Cinch-Graphik innovation offers packaging design flexibility and economy never before possible. These electronically deposited resistance patterns are only 2 millionths of an inch thick. They occupy virtually no space, weigh practically nothing, and are competitive in price and performance with discrete resistors. In addition, Cinch-Graphik's thin film resistors are stable, reliable and have electrical characteristics as good as ordinary resistors. Available in resistance values from 10Ω to $150K\Omega$, these resistors can be utilized in single or multilayer circuits on standard printed circuit laminates. Other components or conductor paths can be placed directly on top of the thin film resistors.

Specifications:

Value Range on Single Resistivity	10 ohms-150,000 ohms	(5000 hours @ 75°C @ 2 watts/in ²)	Drift	always positive Less than 2%
Sheet Resistivity	10 ohms-50 ohms/sq.	Resistor line width and spacing	5 mils min.	
Resistor Tolerances	5%, 10%, 20%	Resistor thickness	600 angstroms @ 50 ohms sheet resistivity.	
Temperature coefficient of Resistance	+80 ppm	Power dissipation	2-4 watts/in ²	

For additional details or specifications, call, write or wire:

CINCH-GRAFIK

DIVISION OF UNITED-CARR



200 South Turnbull Canyon Road, City of Industry (Los Angeles), Calif. 91744 • Phone (213) ED 3-1201. Sales offices in 33 principal cities throughout the United States, Great Britain, Canada, Australia and West Germany.

CONSISTING OF CINCH MANUFACTURING COMPANY, CINCH-GRAFIK, CINCH-MONADOCK, CINCH-NULINE, UGINITE (ELECTRONICS) AND PLAXIAL CABLE DEPT.

ON READER-SERVICE CARD CIRCLE 138

Convenience.

Color Coding Eases db Value Reading

These miniature fixed attenuator pads are color coded for db values of 1, 2, 3, 6, 10 and 20. An easy-to-read quality pad at the practical price of \$12.50. The model FP-50 pads are designed for operation from DC to 2000 MHz. Accuracy is better than ± 0.3 db to 500 MHz and ± 0.5 db to 1 GHz. Each pad is calibrated at two frequencies, 30 MHz and 1 GHz, with the calibration recorded on the body of the attenuator. Impedance of the FP-50 is 50 ohms and the FP-75 is 75 ohms. A wide range of connector types can be provided with BNC, TNC and type N. Units available from stock.



Specialists In Electronic Instrumentation

Texscan
CORPORATION
tc

51 Koweba Lane
Indianapolis, Indiana 46207
Ph. (317) 632-7351

ON READER-SERVICE CARD CIRCLE 139

SYSTEMS

Random data generator displays 10-stage shift

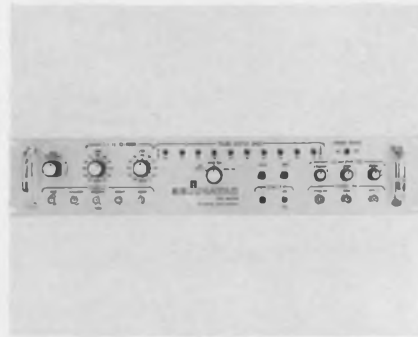

Datapulse, Inc., 10150 W. Jefferson Blvd., Culver City, Calif. Phone: (213) 836-6100.

This 10-stage shift register operates with feedback into the first stage selectable from any two of the stages in the register. Feedback provides a pattern up to 1023 bits long; two units provides over a million bits; three over a billion bits, and may also be controlled from an external source. The patterns generated are reproducible. Using patterns of sufficient length, the 213 can be used to uncover any worst-case patterns which might exist for the element or system under test.

CIRCLE NO. 386

Digital computer offers 8-K memory



Hewlett Packard, 1501 Page Mill Rd., Palo Alto, Calif. Phone: (415) 326-7000. Price: \$16,500.

Digital computers have 4K memory (8K memory alternately available), 16-bit word and 2 μ s cycle-time and teleprinter. Its basic input/output structure is 8 channels, each with automatic priority interrupt (expandable to 40 channels). Additional equipment to expand the power and versatility of the computer is available on a plug-in basis.

CIRCLE NO. 387

Stereoscopic microscope displays 210 power



American Optical Co., Instrument Div., Buffalo, N. Y. Phone: (716) 895-4000.

A zoom system permits the user to zoom up and down the entire magnification range without refocusing. The stereoscopic optical system is enclosed in the zoom power body, with magnification controlled by knobs at both sides. The field of view is 1-1/8 in. at 7X. Stereopsis is maintained at all magnifications. A constant working distance of 4 in. is maintained on all models without special stands.

CIRCLE NO. 388

Strain gauge transducer responds up to 1500 lb



Dentronics, Inc., 60 Oak St., Hackensack, N. J. Phone: (201) 343-9405. Price: \$325 each.

Featuring a built-in amplifier, this unit gives a repeatability of 0.2%, hysteresis of 0.25%, and linearity of 0.25%. The maximum output at full scale pressure is 4 V into 400 Ω .

CIRCLE NO. 389

Pulsed laser system drills and welds



Raytheon Co., Lexington Mass.
Phone: (617) 862-6600. P&A: \$25,000 up; 90 days.

Included in the system is a laser head with protective covers and safety enclosures, a power supply, an optical system with closed-circuit television for monitoring the operation, and a closed-cycle cooling system. Output from the laser is variable to 20 joules to cover a wide range of work materials.

CIRCLE NO. 390

Motor-driven parts marker



Faradan, 2245 S. Grand Ave., Santa Ana, Calif. Phone: (714) 540-6171. P&A: \$595; stock.

This parts marker is for short-run printing on curved, irregular, or flat parts. The marker features a force-limiting safety device, 4-point pad adjustment, ink roller adjustment, roller arm hold-down latch, "jog" switch, resettable counter, 25-rpm operation, and footswitch actuation. Printing is done either direct or offset. Furnished with the marker are a holder for use with rubber or metal plates, 2 x 3 in. offset marking pad, and complete operating instructions. Ball bearings are used at wear points.

CIRCLE NO. 391

VACTEC announces a new line of VACTROL Lamp-Cell Controls

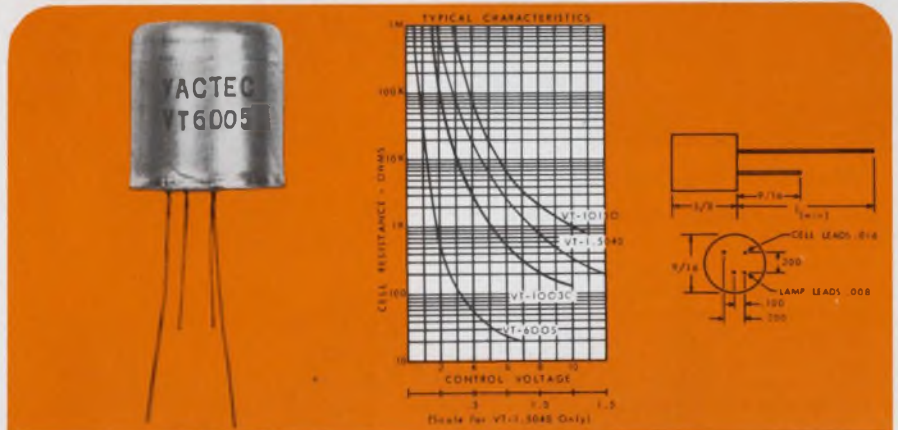

Now 1.5v, 6v, and two 10-volt Vactrols are available for electronic amplifier applications. Combines a dependable Vactec photocell with the proper long-life incandescent lamp in a complete low-cost module.

Provides noiseless, trouble-free volume and

tone control for TV, radio, guitars, organs, and other musical instruments.

Unit is protected by an epoxy sealed metal enclosure. Leads are spaced on .100" centers for circuit board mounting. Special characteristic designs available for unique applications. Write for Vactrol Bulletin PDC-4C 1.



VACTEC, INC.

2423 Northline Ind. Blvd. • Maryland Hts., Mo. 63042 • AC 314, 432-4200

See Vactec's listing in EBG under "Semi-Conductors," and in EEM, Sec. 3700.

ON READER-SERVICE CARD CIRCLE 140

ATTENTION SYSTEMS ENGINEERS

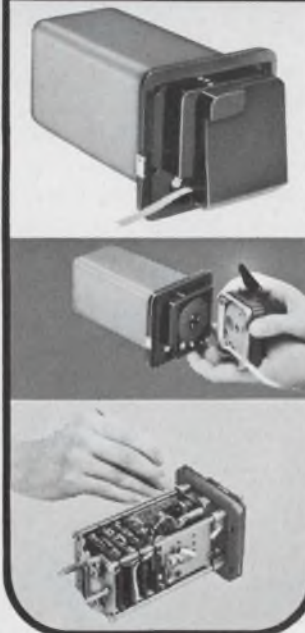

NOW AVAILABLE! CLARY MODEL AN16

Alpha-Numeric Strip Printer for Digital Systems

— with all of these features:

- **COMPACT** only 78 cubic inches
- **SOLID STATE** integrated circuitry
- **HIGH RELIABILITY**
- **ONLY 14 MOVING PARTS**
- **SPEED**, 1500 characters per minute up to 25 characters per second
- **WEIGHT**, less than 4 pounds
- **CHARACTER SELECTION** 64 characters, alpha-numeric
- **PAPER TAPE** 5/16" wide pressure sensitive
- **TAPE CAPACITY** 75 feet
- **INPUT CODE** 6 bit parallel B.C.D.
- **TAPE TAKE-UP**, Spooler available as accessory



CLARY CORPORATION
MILITARY PRODUCTS DIVISION
320 West Clary Avenue • San Gabriel, California 91776
Phone (213) 287-6111 • TELEX 674604

ON READER-SERVICE CARD CIRCLE 141

MINIATURE ANGULAR POSITIONING ASSEMBLY



Accurately and continuously measures synchro shaft position

The MAPA's principal use is to simulate synchro inputs for testing systems. Calibration of the units correlates electrical and mechanical errors to give minimum possible error between electrical output and dial indication.

This miniature mechanical indexing device increases the resolution of the precision rotating component to which it is coupled by amplifying the angular motion of the synchro rotor shaft through a gear mechanism.

PHASE SHIFTER



The Model 445 Phase Shifter is a device to vary the phase of a fixed frequency signal through 360°. It consists of a resolver and associated network mounted on a Clifton Miniature Angular Positioning Assembly as described above. The phase shift of the output signal is within 0.25° of the dial indication. Model 445-1 provides a 29V rms output signal with 30V rms input at 400 Hz. The magnitude of the output signal is constant to within ±2% through 360° displacement.

Available in a variety of frequencies and mounting configurations.

Write for our free Catalog describing Clifton Test Equipment to 5050 State Road, Drexel Hill, Pa. 19026, or call 215 622-1000.

TEST EQUIPMENT CATALOG

CLIFTON 
DIVISION OF LITTON INDUSTRIES

ON READER-SERVICE CARD CIRCLE 142

200

Design Aids

DANDY FOR DOODLING

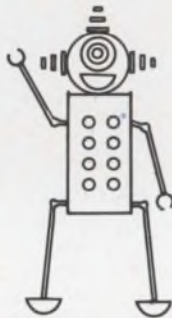
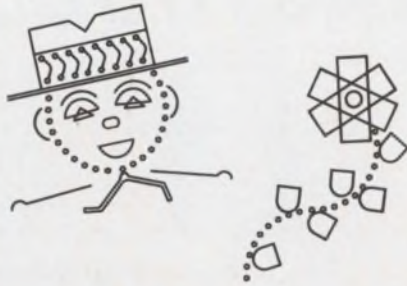

**BUT
de rigueur
FOR DESIGNING**



Dandy for doodling

Offered is a circuit-symbol template that can find wide use with designers and draftsman. Some of the cutouts are specialized; some serve multiple purposes. Indicated on the template are symbols that generally apply to the industrial application of relays and rotary stepping switches. Automatic Electric.

CIRCLE NO. 332

Engineering handbook

A pocket-size, 96-page handbook presents engineering data from a variety of original sources for use by engineers and designers. Information on anthropometry, motor and force capabilities, vision, audition, environmental tolerances, panels and labeling, light and color, etc., is presented, whenever possible, in the form of graphs, tables, nomographs, and formulas. The handbook includes the maximum amount of its most often used data in a single easy-to-use reference work. All data is completely indexed, and sources are cited to anyone who wants further explanation of the data. Tad Products.

CIRCLE NO. 333

PRODUCT DESIGN IDEAS by TITCHENER

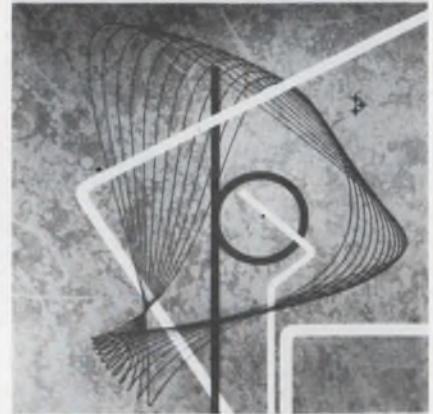

Skeletonizing

Skeletonizing for product improvement is described in a brochure entitled "Product Design Ideas by Titchener." The six-page brochure includes product-design ideas, wire-design tips that help keep costs down and wire-design basics for product designers. E. H. Titchener & Co.

CIRCLE NO. 334

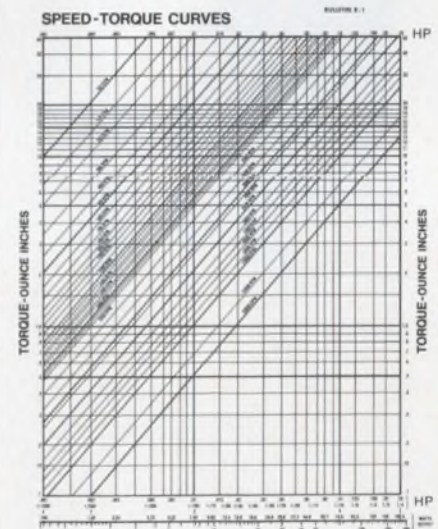

Motor measurements

Available is a handy guide for determining which motor to use for which application. Included is a speed and torque graph, metric conversion factors, motor formulae and an altitude-pressure chart. If specifying a motor has you dizzy, this conversion table is as good as two aspirin. Globe Industries.

CIRCLE NO. 335

Should you buy

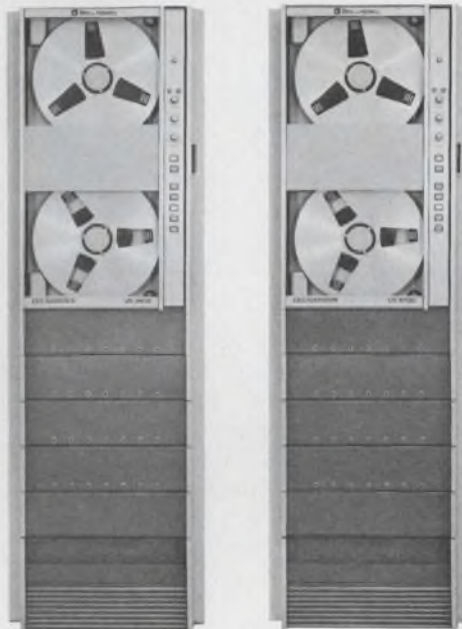

the new VR-3400? Or the new VR-3700?

Both recorders deliver superb laboratory response. Both are unsurpassed for reliability. Both are sold at a budget price.

Then what's the difference?

The VR-3700 includes state-of-the-art magnetic heads which extend its frequency range to 2.0 MHz. Also available is 500 KHz FM and all have the highest available SNR.

However—should you purchase the VR-3400, and later data handling requirements call for a 2.0 MHz response, you may *convert* it to a VR-3700 by a simple exchange of heads and electronics.

So whichever you choose today, you need have no regrets tomorrow.

Now consider the other advantages offered by *both* recorders:

☐ Magnetic recording heads guaranteed to exceed 1000 hours. CEC's unique, solid metal pole-tip design has eliminated the inherent deficiencies of lamination and rotary head design.

☐ Failsafe DC Capstan Drive assures dramatically-improved flutter and TDE performance.

☐ All-Electric Tension Control. Solid-state amplifiers for improved linear tension control and greater reliability.

☐ Photo End-of-Tape sensing included in all systems, complete with automatic transfer.

☐ Automatic 8-speed transport electrically selectable.

☐ Phase-lock capstan control electronics included for improved speed accuracy.

☐ Direct electronics phase equalized for best pulse response.

For complete information, call or write Consolidated Electroynamics, Pasadena, California 91109. A subsidiary of Bell & Howell. Bulletin 3400-X10 and Bulletin 3700-X4.

CEC/DATATAPE PRODUCTS

 **BELL & HOWELL**

ON READER-SERVICE CARD CIRCLE 143

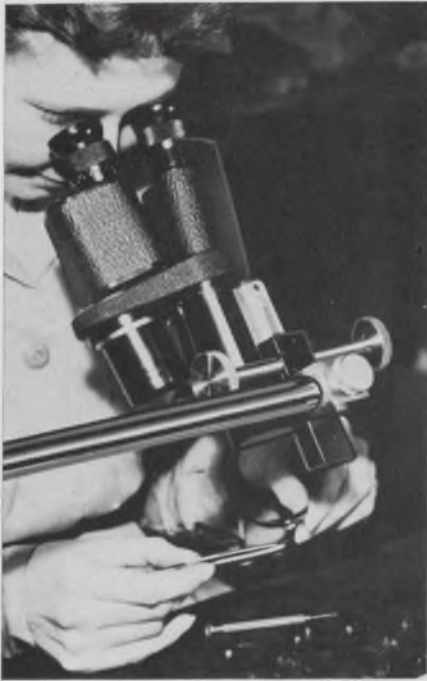

*to assemble,
inspect, or
check your
very small
components—*

WRAY 10X BINOCULAR MAGNIFIER

The Wray 10X Binocular Magnifier is available with a working clearance of 7" and a field of view of approximately 1". The precise optical system is especially suitable for the manipulation and working of very small parts; for the examination of minute detail; for the inspection of fine movements.

The image is erect and special illumination is not required when used at the work bench or in a laboratory. The instrument was originally designed for and is still used with the electron microscope. The magnification, combined with the precision optics of the viewing system, eliminates eye strain and minimizes the possibility of error in inspection.

The binoculars have independent eyepiece focusing. Special measuring gratitudes can be incorporated into the system.

For complete details of this important optical aid, ask for Catalog BE-107

ENGIS

**EQUIPMENT
COMPANY**

8035 AUSTIN AVE.
MORTON GROVE, ILL.

ENGINEERING
INSTRUMENTS
DIVISION

ON READER-SERVICE CARD CIRCLE 144

Application Notes



RC networks

A brochure on precision RC networks for contact protection and noise suppression has been published. The catalog presents specification tables, circuit diagrams, dimensional outline drawings, definitions, common properties application recommendations, and test instrumentation. Electro Cube, Inc.

CIRCLE NO. 336

Power supply handbook

The full benefits of the engineering which has gone into a modern dc regulated power supply cannot be realized unless the user recognizes its inherent versatility and high performance capabilities, and understands how to apply these features. These are the two objectives of this 44-page handbook, which includes an extensive coverage of power-supply circuitry, features, specifications, measurement methods, and application tips. Hewlett Packard.

CIRCLE NO. 337

Oscilloscope primer

Workers in an increasing number of fields are faced with measurement problems that can be solved only by electronic means. Electronic tools become more valuable to the user who is willing to expend some effort in understanding their operation. This booklet is a digest of lecture notes that experience indicates have been most helpful to those making their first acquaintance with a laboratory-type oscilloscope. Tektronix.

CIRCLE NO. 338

Thermocouples

"What is a thermocouple?" is the first point taken up in a 24-page booklet that presents an extensive review of the thermocouple principles, materials of construction and general application rules. Compiled from various sources, the explanatory material includes various diagrams, tables and photos. Topics include laws of thermoelectricity, alloying of metals, polarity, and development of temperature scale. Pyrometer Co. of America.

CIRCLE NO. 339

Polyurethane resins

An 8-page illustrated brochure contains information on polyurethane resins for electrical and electronic applications. Included in the presentation are physical and electrical properties, handling instructions, curing guides, application suggestions, pigmenting, priming etc., for other resins. 3M Company.

CIRCLE NO. 340

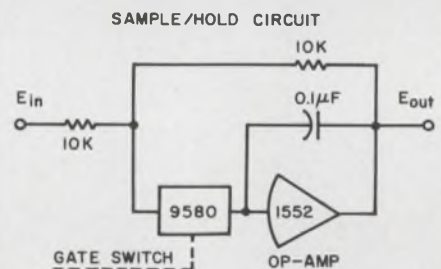

Sample/hold circuits

"Designing Sample/hold circuits" is written by Tom Cate, a Burr-Brown Product Marketing Engineer. Very often an inexperienced engineer will overlook the advantages of current amplification when he designs his Sample/hold circuits. In writing his article, Mr. Cate compares the response rate of a sample/hold circuit using a relay or FET switch and the same circuit using a Burr-Brown model-9580 current-amplifying sample/hold switch. Burr-Brown Research Corp.

CIRCLE NO. 341

ON READER-SERVICE CARD CIRCLE 145 ➤

Any way you figure it...

you can count on Beckman EiD.

We back this claim with a new line of modular counting instruments that can take the measure of any man's business.

For the first time, you can tailor your cost of a frequency-and-time measuring system to suit your desired function and frequency. These new all-integrated circuit counters employ a unique *duo-module* technique—utilize dual sets of interchangeable, plug-in modules you specify and use as your needs dictate. You change the single- or dual-channel input module to change frequency range (0Hz – 20MHz single; 0Hz – 200MHz dual). You change the function module to change measurement criteria. Three basic models offer choice of 6-, 7- or 8-digit display with an optional 9th.

This new two-module concept lets you buy for today's need, expand for tomorrow's. Any way you figure it, EiD's up front with what counts. To button down the details, contact your local EiD Sales Representative...or write direct to our nearest regional office, listed at right.

EiD more than measures up.

Beckman

INSTRUMENTS, INC.

ELECTRONIC INSTRUMENTS
DIVISION

2400 Harbor Blvd., Fullerton, Calif. 92634,
(213) 691-0841

7360 N. Lincoln Ave., Lincolnwood, Ill.
60646, (312) 583-1020

12051 Tech Rd., Montgomery Ind. Park,
Silver Spring, Md. 20904, (301) 622-2500

International Subsidiaries: Geneva;
Munich; Glenrothes, Scotland; Tokyo; Paris;
Capetown; London; Mexico City

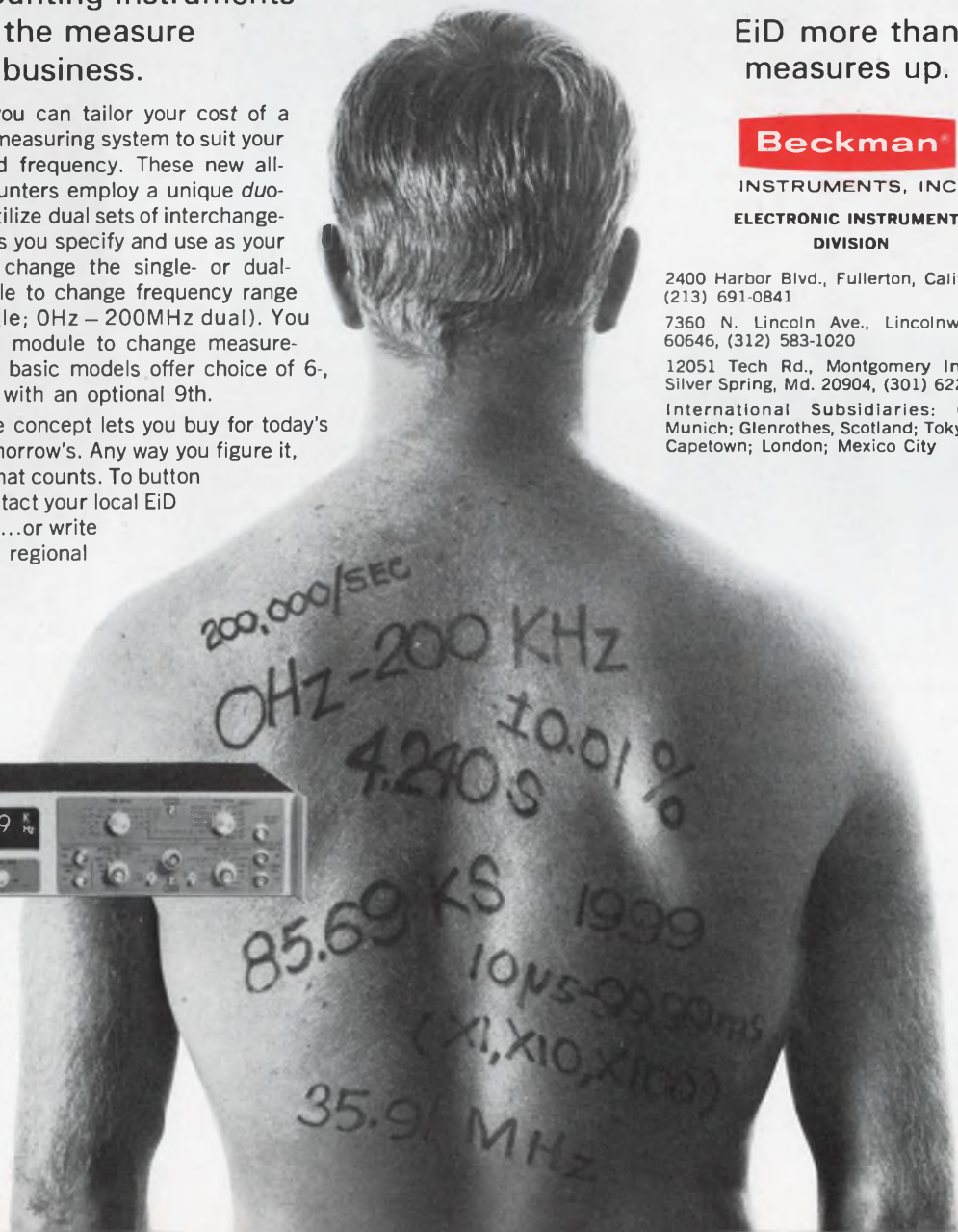

New Literature

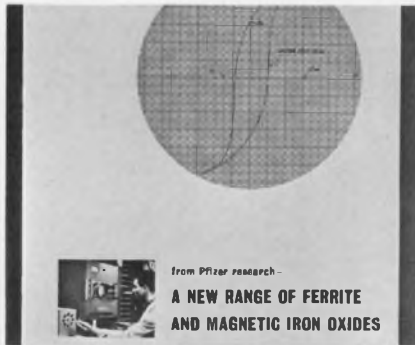

Applications for iron oxides

High-purity iron oxides with mounting application in ferrites, recording tapes and magnetic inks are described in an 8-page illustrated booklet. Details are given for both soft ferrites (those temporarily magnetic) and hard ferrites (those permanently magnetic) and their use in products such as television sets, refrigerator door seals, electric toothbrushes, windshield wipers, and memory cores. A listing of IRN magnetic iron oxides and iron oxides for ferrites is provided. Pfizer Minerals.

CIRCLE NO. 342

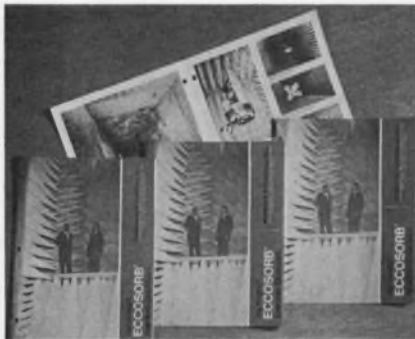

Microwave anechoic chambers

Recent advances in the design and construction of microwave anechoic chambers are covered in this brochure. Photographs showing recently-built chambers in the U.S. and Europe and a fiberglass laminate floor supported on the top of six-foot-high pyramids of eccosorb HPY-72 in a box-shaped chamber 30 by 27 by 27 ft., which is used for impedance and RFI measurements on the nimbus weather satellite, are included. Emerson & Cuming, Inc.

CIRCLE NO. 343

Ceramics capabilities

Capabilities in industrial ceramics, involving high-alumina bodies, are outlined in a 12-page booklet. The catalog describes the company's research and development center and prototype shop, as well as production machinery, including equipment for metalizing and plating. Silk City Industrial Ceramics.

CIRCLE NO. 344

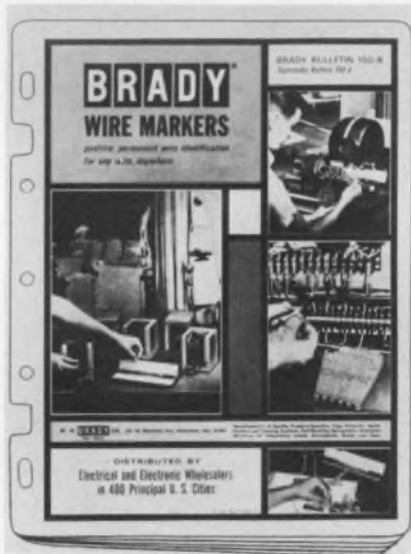

Wire-marking methods

A 20-page wire-marker catalog lists over 5,000 self-sticking wire markers and several dispensing methods to speed wire identification. Featured is a high-speed wire-marking machine that identifies up to 1,000 or more wires per hour. It automatically removes markers from 2 x 9 in. dispenser cards and wraps them around wires from 20 gauge to 1/2 in. in dia. W. H. Brady Co.

CIRCLE NO. 345

Connector catalog

A 20-page brochure covering the manufacturer's line of miniature microwave coaxial connectors, cable assemblies and components has been published. The presentation includes miniature receptacle connectors, flexible and semi-rigid cable connectors, cable assemblies, stripline connectors, terminations and other products. American Corp.

CIRCLE NO. 346

Electronics equipment

A 10-page semiconductor and scientific encapsulation equipment brochure includes descriptions and illustrations of a line of flat-pack perimeter sealers, infrared multi-speed sealers, standard and vacuum sealers, super-dry box sealers and accessories. A brief company description and its research and development service is included in the presentation. GTI Corp.

CIRCLE NO. 347

Capsules compendium

Advantages of sensing pressure with diaphragms, capsules, and capular elements are discussed in a 16-page bulletin. Operating characteristics of capsules made from Inconel-X, Ni-span C, phosphor bronze, and stainless steel are tabulated and application requirements are discussed. A comprehensive section about end fittings is also included. The Bristol Co.

CIRCLE NO. 348

Thermal relays

A folder on a line of industrial thermal relays includes specifications and application information on the manufacturer's red-line DT-series octal-base time delays. Also discussed in the literature are type DM instant reset thermal timing element used in communication systems and data processing equipment, and the JT-series thermal timing relays designed for printed circuit-board mountings. G-V Controls, Inc.

CIRCLE NO. 349

Fluorosilicones brochure

Fluorosilicones—a family of engineering materials—combines the best properties of fluorocarbons and silicones and offers outstanding resistance to fuels, oils, solvents and harsh environments. They are available in rubbers, adhesive/sealants, lubricants and mechanical fluids. Included in the discussion are properties, applications and illustrations. Dow Corning Corp.

CIRCLE NO. 350

VERSATILE

You name it

CAPABLE

The Paul Bunyan of 3M Recorders

AFFORDABLE

We're almost
ashamed of the
low price

MODEL 34



VERSATILE — With direct frequency response to 600 kHz, and IRIG FM to 80 kHz, the Mincom Model 34 does many things in many ways. Rack-mounted or in

easily portable carrying cases. $\frac{1}{4}$, $\frac{1}{2}$ or 1-inch tape. 10 $\frac{1}{2}$ -inch or 7-inch reels. Speed options: $\frac{1}{16}$, $\frac{1}{8}$, $\frac{3}{4}$, $7\frac{1}{2}$, 15, 30, 30 or 120 ips.

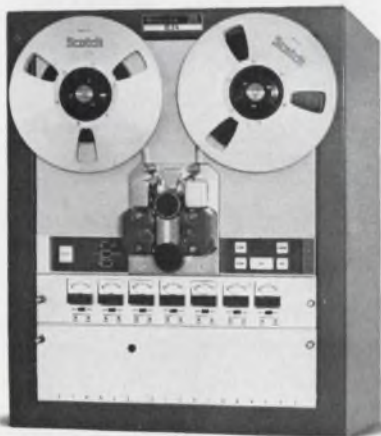

CAPABLE — Practically the only thing that's *not* an option is 3M quality — that's standard on all configurations of the Model 34. Starting with the Isoloop Drive® on the tape transport (the same as on recorders costing several times as much), Model 34 can record 7 or 14 channels of the cleanest data for over twelve hours. All types of record/reproduce modules are interchangeable, allowing any channel combination desired. Push-button controls. Dynamic braking in all modes. Fail-safe braking for AC failure. End-of-tape sensing. Solid state electronics. Input/output meters.

AFFORDABLE — As you can see, there are a lot of different ways to configure a Model 34 — and there are just as many prices.

But this we can be definite about: Model 34 is *the* recorder for people who've always wanted 3M quality — but couldn't afford it *before*. Give us a call.

Mincom Division **3M**
COMPANY
300 SOUTH LEWIS ROAD • CAMARILLO, CALIFORNIA 93010

Johnson Introduces Two NEW Components to save space, cut costs!

1. Save space with new, horizontal-mounting, printed circuit, type "U", machined-plate capacitors. Available in various sizes, with capacity values ranging from 1.2 pf to 24.5 pf, these tiny trimmers provide tuning accessibility from edge of board. Printed circuit boards can be close-spaced, resulting in compact equipment designs. TC—plus 45 ± 15 PPM/ $^{\circ}$ C. "Q"—greater than 1500 at 1 MHz. All metal parts silver plated. Famous Johnson quality throughout.

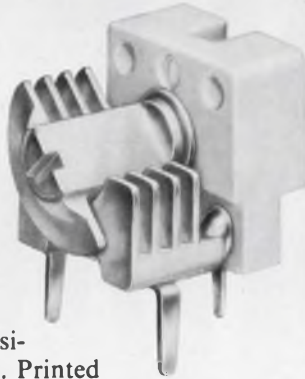

2. Cut costs with new, Johnson RIB-LOC™ Tip Jacks that save production line time with *press-in* design. No mounting hardware to assemble or handle. Simple insertion tool presses Tip Jack into pre-drilled chassis hole for a secure mount that resists loosening and turning. Jack accepts 0.080" tip plug in a recessed, closed-entry type contact. Insulating body is molded of low-loss polyamide. Brass solder terminal is silver-plated and Iridited. Low cost.



**Write today for details
and complete specifications
on these new Johnson Components!**



E. F. JOHNSON COMPANY
3346 Tenth Ave. S.W., Waseca, Minnesota 56093

ON READER-SERVICE CARD CIRCLE 147

NEW LITERATURE

Sputtering conference

A volume of the 15 papers presented at June, 1967's Symposium on the Deposition of Thin Films by Sputtering is available. The subjects dealt with in the catalog include nichrome alloy sputtering, laboratory-to-production problems, in-line sputtering, beam-lead technology, ion etching, rf sputtering of metals, and sputtering onto large substrate areas.

Available for \$16.50 from Consolidated Vacuum Corp., 1775 Mt. Read Blvd., Rochester, N. Y.

Foam for electronics

A technical bulletin describes a rapid, high-rising foam flux for printed circuits and other electronic assemblies. When this flux is used, boards can be trimmed and electronically balanced while still warm from soldering. Suitable for use on a variety of metallic surfaces, Reli-foam has instant wetting characteristics, leaves a minimum amount of residue, and retains its effectiveness during exposure to aeration. Alpha Metals, Inc.

CIRCLE NO. 352

Automatic molding

To aid users of molds, bobbins, cases and other plastic components, a brochure showing major production steps from tooling to semi-automatic and automatic molding has been published. In addition to information on materials, the catalog includes photos of firm's custom-made and proprietary resistor bobbins with molded-in leads, as well as cups, cases and a variety of other plastic components. Plasmatrix Industries.

CIRCLE NO. 353

Engineering data

Engineering data and specification charts on the B-cap connector and nylon block line, are major features in this 38-page catalog. It includes a fold-out page containing NEC tables for terminal block-current ratings and product selection for specific applications. Buchanan Electrical Prod. Corp.

CIRCLE NO. 354



Dial indicators

Purchasing information for ordering of dial indicators is contained in a 40-page presentation. The catalog describes balanced, continuous and long-range dial indicators in all American gauge design groups, including Group I (1-11/16 in. dia.), Group 2 (2-1/4 in. dia.), Group 3 (2-3/4 in. dia.), Group 4 (3-5/8 in. dia.). Graduations meet tolerance requirements from 0.0001 to 0.025 in. Indicators are available as plain, jeweled or impact cushioned, assuring accuracy, sensitivity, and reliability. Chicago Dial Indicator Co.

CIRCLE NO. 355

Potentiometers available

A 16-page bulletin describes a three-week delivery program for models of the company's potentiometer line. The catalog contains technical specifications, prices and optional convenience features for instruments included in the program. Round and strip-chart recorders in both 12-in. and 7-in. models, and pneumatic, electric and solid-state recorder-controllers can be specified. The Bristol Co.

CIRCLE NO. 356

Mineral molding compound

A 6-page bulletin describing the properties of a type of mineral-filled thermosetting alkyd molding compound is available. Formulated to meet the requirements of MIL-M-14F, Type MAG the compound exhibits dimensional stability under prolonged heat tests of up to 1000 hours at 400°F. Hooker Chemical Corp.

CIRCLE NO. 357

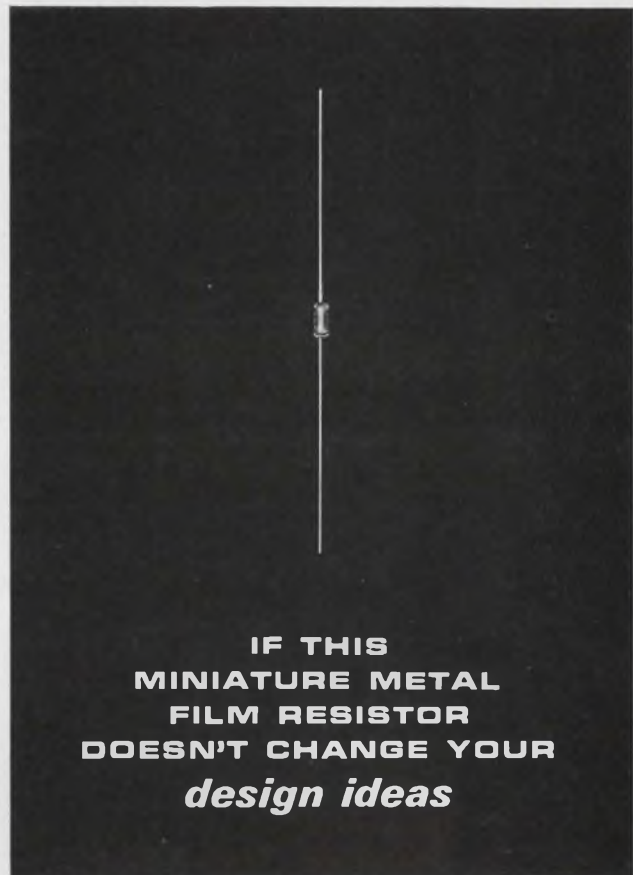

IF THIS
MINIATURE METAL
FILM RESISTOR
DOESN'T CHANGE YOUR
design ideas

...try one of these



Part No.	Power	Ohms	Tol.	Temp. Coef.
PME 50	1/20 W	10Ω to 1M	±1% to .1%	T-0, T-2, T-9
PME 55	1/10 W	10Ω to 3M	±1% to .1%	T-0, T-2, T-9
PME 60	1/8 W	49Ω to 7.5M	±1% to .1%	T-0, T-2, T-9
PME 65	1/4 W	49Ω to 20M	±1% to .1%	T-0, T-2, T-9
PME 70	1/2 W	24Ω to 30M	±1% to .1%	T-0, T-2, T-9
PME 75	1 W	49Ω to 50M	±1% to .1%	T-0, T-2, T-9

The stability and accuracy of Pyrofilm's PME metal film resistors makes their use ideal in applications where before only wire wound resistors could be used. These resistors are virtually unaffected by environmental conditions and withstand constant exposure to high moisture conditions without change in specifications. PME resistors meet or surpass all requirements of MIL-R-10509F.

Send for fact-filled literature sheet!

**PYROFILM RESISTOR
COMPANY, INC.**

3 SADDLE ROAD • CEDAR KNOLLS, NEW JERSEY • 201-539-7110

ON READER-SERVICE CARD CIRCLE 148

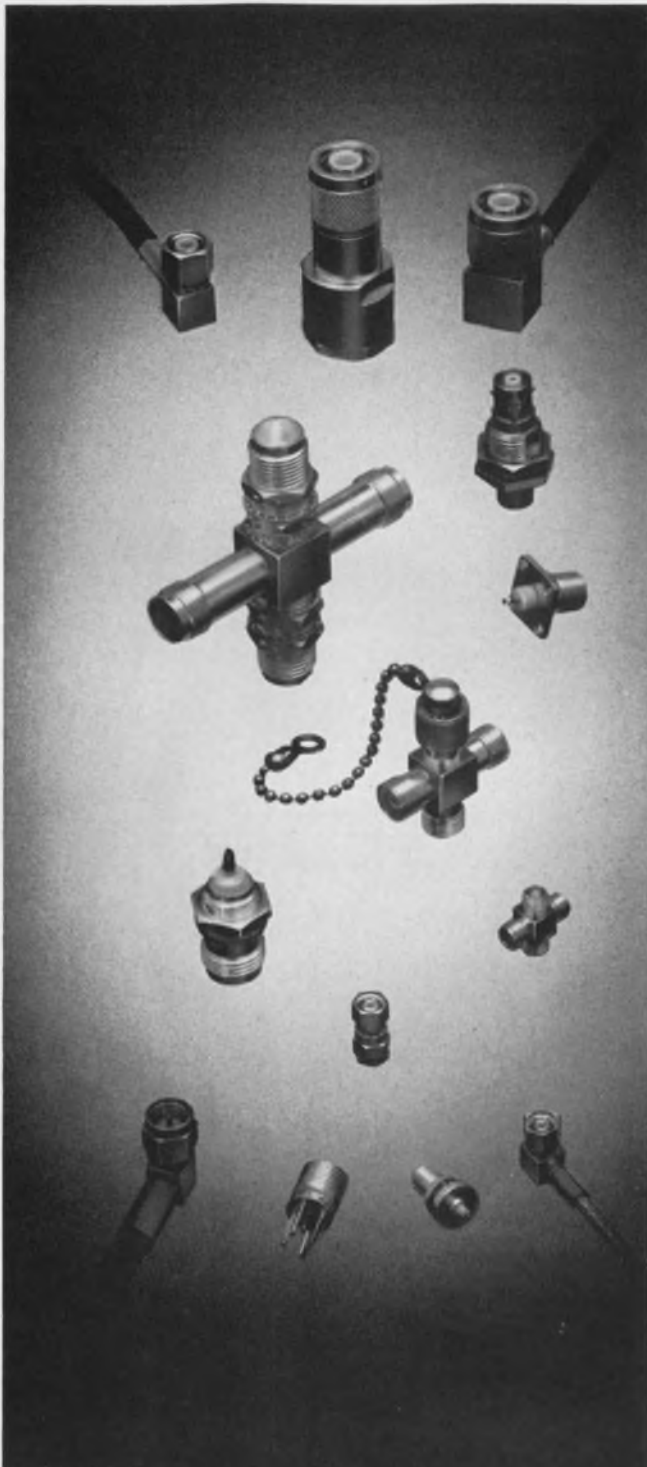

THE SPOTLIGHT IS ON...

...GENERAL RF FITTINGS precision coaxial connectors! The finest available anywhere! GRFF Manufactures TNC, TM, GM, TPS, and SERIES 2900 (which mate with OSM and BRM types) connectors in a wide range of standard and crimp configurations.

GRFF also manufactures a completely NEW line of PRECISION MICROWAVE COMPONENTS. Complete descriptive literature is immediately available.

General RF Fittings, Inc.

702 BEACON ST. / BOSTON, MASS. 02215
Telephone: 617 267-5120

ON READER-SERVICE CARD CIRCLE 149

NEW LITERATURE



Power-supply reference

A catalog containing various power-supply design groups, including seven which are described for the first time, is available. Included is an application section explaining a concept in specification and use and a five-page glossary which defines the terms employed in the data and applications section. Kepco, Inc.

CIRCLE NO. 358



Aluminum alloy bulletin

A bulletin on aluminum-alloy bonding wire has been prepared. This 8-page brochure covers the subject with discussions about composition, mechanical properties, breaking load, elongation and ductility. It tabulates suggested specifications for various types of aluminum alloys currently in demand, carries a graph on range of breaking load of aluminum wire for ultrasonic bonding. Sigmund Cohn Corp.

CIRCLE NO. 359



Pushbutton switches

A brochure which is graphically illustrated by a "pop-up" of a 800-sq tellite switch and a preassembled matrix-type mounting rack is available. It explains how customers can save time while reducing labor costs of wiring and panel installation. Advantages are given of this design in comparison with conventional switch types. Master Specialties Co.

CIRCLE NO. 360

PCM telemetry

A bulletin describing aerospace/weaponry systems for linking sensors to PCM transmitters shows how standard, compatibly-designed modules can be combined in solid-state, hybrid-component systems. Each series of modules—converters, multiplexers and commutators, track-and-hold units, etc.—is described with accompanying photographs. A system performance analysis presents in tabular form the contribution of each type of module to system limit of error (less than $\pm 0.005\%$ for the convertors). RC-95 Inc.

CIRCLE NO. 361

Electronic components

A fully-illustrated catalog of electromechanical components and equipment has been published by the Electronics Division of American Relays. The 72-page catalog lists components of all major manufacturers and features such items as accelerometers, counters, meters, motors, precision potentiometers, selsyns, servo motors, test equipment and timers. Special complete sections are included on relays, pressure transducers and gyros. Electronics Division of American Relays.

CIRCLE NO. 362

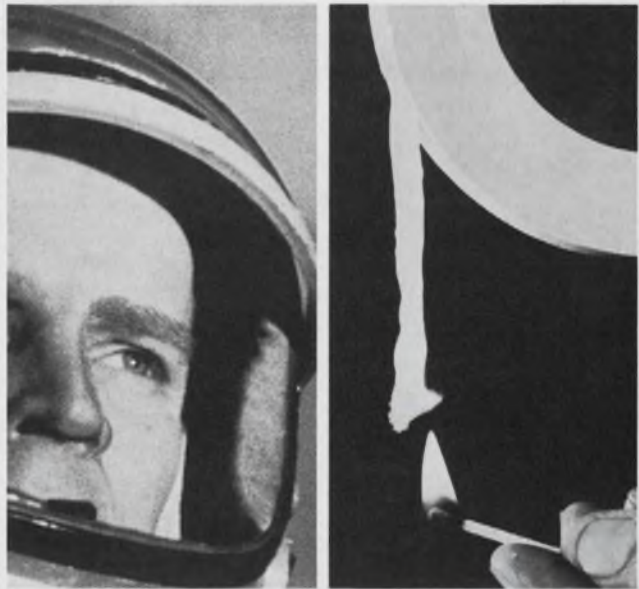

THIS ELECTRICAL TAPE COULD SAVE HIS LIFE

*It will not burn —
when exposed to flame*

Non-combustible E-125 PTFE eliminates the possibility of a fire hazard. It has no adhesive backing either, to break down with age, heat, or oxygen and become gooey or lose its grip.

When used at temperatures between -400 F and 500 F to wrap coils, cables, or other electrical components, it is extremely conformable, self sticking, an excellent dielectric, mechanically stable, and impervious to all acids, gases, solvents.



That's not all! When heated above 621 F, Type E-125 PTFE tape sinters to form a rigid, tough, hermetic seal around any object.

It's available in thicknesses from 0.002 " to 0.010 " and widths from $1/8$ " to 3 " with tensile strengths from 1100 to 1800 PSI and dielectric strength from 700 to 800 VPM. Interested?

Interested? Complete data and samples are available from Dodge Industries, Fluorglas Division, Hoosick Falls, N.Y. 12090.

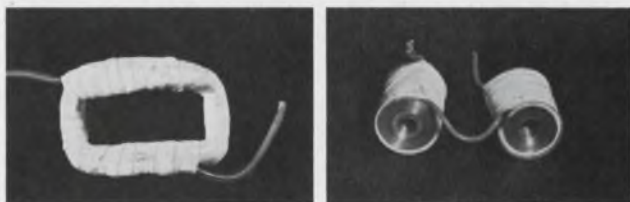

Dodge Industries

ON READER-SERVICE CARD CIRCLE 150

MIL SPEC EQUIPMENT PROTECTION



MIL-T-21200, MIL-T-945, MIL-C-4150 . . . You name the specifications and Skydyne can supply a combination, transportation, or operating case that will meet every requirement. Whether you select sandwich construction, fiberglass construction, or ABS thermoplastic construction, you can be sure that your valuable and delicate equipment will be 100% protected against vibration, shock, moisture, and other adverse environments. And, with Skydyne's large assortment of standard cases and components, you can be sure of the fastest possible delivery.

Write for a complete set of our MIL SPEC, Case Design Manuals, prices and standard case information.

Skydyne, Inc

RIVER ROAD, PORT JERVIS, N. Y.
Telephone (914) 856-5241

ON READER-SERVICE CARD CIRCLE 151

NEW LITERATURE



Npn and pnp transistors

A 12-page catalog featuring the manufacturer's line of small-signal npn and pnp transistors used for military, industrial and commercial applications also includes small signal devices. Contained in the brochure is material on silicon transistors constructed by alloy, epitaxial-base and planar techniques. Among the various types listed are discrete transistors, choppers, differential amplifiers, darlington amplifiers and duals. Complementary npn and pnp planar transistors are also listed. Each transistor has a summary of its primary specifications for quick reference. Solitron Devices, Inc.

CIRCLE NO. 363

MEET THE HEAD

that solved the problem
for \$41.75

Double, multi-diameter heads with nib for precision positioning040", 18 gauge copper wire . . . nominal tolerances: $\pm .0003$ " wire diameter . . . $\pm .002$ head concentricity . . . $\pm .001$ distance between heads . . . $\pm .001$ nib length . . . 8 times actual size.

What's your problem . . . design . . . material . . . plating . . . production . . . For precision formed wire heads that withstand . . . pulling . . . bending . . . twisting, contact . . .

EMPORIUM SPECIALTIES INC.
Wire Forms Division

Plant and Engineering: Austin, Pennsylvania
General Sales Office: 2800 East 116th Street
Cleveland, Ohio 44120
Telephone: (216) 795-1640

ON READER-SERVICE CARD CIRCLE 152

Magnet conducting systems

A 12-page brochure outlines design and fabrication techniques used in manufacturing magnets with field strengths of 50 Kgauss and upward. In addition, the brochure lists specifications of standard superconducting magnets and custom-designed magnets including split pairs. Gardner Cryogenics Corporation.

CIRCLE NO. 364

Reprints Available

The following reprints are available free and in limited quantities. To obtain single copies, circle the number of the article you want on the Reader-Service Card.

Ten Steps to Multilayer board Design (No. 400)

Simplify NAND-circuit synthesis (No. 401)

Need a circuit design program? (No. 402)

Advertisements of booklets, brochures, catalogs and data sheets. To order use Reader-Service Card.

Advertising Representatives

New York 10022

Robert W. Gascoigne
Thomas P. Barth
Samuel M. Deitch
Byron Adams
850 Third Avenue
(212) PLaza 1-5530
TWX: 867-7866

Philadelphia

William C. Repetto
P. O. Box 206
Merion Station, Pa. 19066
(215) MO 4-1073

Boston

Richard Parker
7 Redstone Lane
Marblehead, Mass. 01945
(617) 742-0252

Chicago 60611

Thomas P. Kavooras
Berry Conner, Jr.
720 N. Michigan
(312) 337-0588

Cleveland

(216) 247-7670

Los Angeles 90303

Stanley I. Ehrenclou
Terrence D. Buckley
W. James Bischof
2930 W. Imperial Highway
Inglewood, Calif.
(213) 757-0183

San Francisco

Ashley P. Hartman
175 South San Antonio Rd
Ste. 243
Los Altos, Calif. 94022
(415) 941-3084

Southwestern 75206

Tommy L. Wilson
6200 North Central Express-
way
Dallas, Tex.
(214) EMerson 1-2311

London W. 1

Brayton C. Nichols
44 Conduit Street

Verviers, Belgium

Andre Jamar
1, Rue Mallar, 1
(087) 253.85

Tokyo

Yoshihiro Takemura
International Planning
Service, Inc.
Room 231 Tokyu-Mita Bldg.
1, Shiba-Mita Koun-cho
Minato-ku, Tokyo



Free Electronic Circuit Symbol Catalog



Save artwork and drafting time cut costs with thousands of electronic drafting aids and symbols featured in the new 28-page Catalog No. 102 from Bishop. In it are the industry's only selection of predrawn complete circuit component symbols; integrated circuits, logics, semiconductors, flatpacks, transistors, printed circuits, welded modules, etc. Also: tapes, pads, corners, connectors, schematic symbols, reference numbers and more. Included are illustrations, range of sizes and complete price information. Send today for your free copy.

Bishop Industries Corp.

11728 Vose Street
North Hollywood, California 91605

171

Laminated and Molded Bus Bars For Power Distribution



A 16 page Technical Bulletin is now available, describing a new concept in power distribution. Basic mechanical and electrical design principles, along with descriptive pictures and diagrams, are included in this bulletin. These compact buses can replace bulky cable harnesses and repetitive wiring for computer or modular application. This method of construction satisfies the demanding requirements of low inductance and resistance of high speed, solid state systems while controlling electrical noises.

Eldre Components, Inc.

1239 University Avenue
Rochester, New York 14607

172

Your New Electronics Hand Tool Catalog



The finest Peer Swiss made tweezers for all micro-miniature work. 42 different patterns in all alloys. SWEDISH PLIERS that feature the "Box Joint" construction by Lindstrom, for all your precision work.

CUTTING TWEEZERS, NIPPERS AND SCISSORS for special wire cutting problems in different areas.

Many other useful tools.

Write today—for your Catalog 167.

Hammel, Riglander & Co., Inc.

P. O. Box 222
New York, N. Y. 10014

173

Advertisers' Index

Advertiser	Page	Advertiser	Page	Advertiser	Page
AMP, Incorporated	8, 9	Dzus Fastener Co., Inc.	214	National Semiconductor Corporation	44, 45
Abbott Transistor Laboratories, Incorporated	32	ESI/Electro Scientific Industries, Inc.	58	Non-Linear Systems, Inc.	38, 39
Accutronics, Inc.	128	Elco Corporation	139	Nytronics, Inc.	23
Acopian Corporation	191	Eldre Components, Inc.	211	Philips Electronic Measuring Instruments	31
Airco Temescal, A Division of Air Reduction Company	187	Electronic Design	31	Physical Electronics Laboratories	158
Aladdin Electronics, A Div. of Aladdin Industries, Inc.	177	Electronic Memories, Inc.	155	Power/Mate Corp.	215
Alfred Electronics	216	Emporium Specialties, Inc., Wire Forms Division	210	Pioneer Electric & Research Corp.	190
Allen-Bradley Co.	48 A-B	Engis Equipment Company	202	Pyrofilm Resistor Co., Inc.	207
Ammon Instruments, Inc.	176	Fluke Mfg. Co., Inc., John	55	RCA Electronics Components and Devices	16, 108, 109, Cover IV
Analog Devices, Inc.	185	Gardner-Denver Company	183	RCL Electronics, Inc.	6
Arnold Engineering Company, The	135	General Cable Corporation	154	Raytheon Company, Industrial Components Division	179
Arvin Frequency Devices	188	General Electric Company	50, 51, 59	Raytheon Company, Semiconductor Operation	145
Automatic Electric, A Subsidiary of General Telephone & Electronics	101	General Electric Company, Miniature Lamp Dept.	189	Redcor Corporation	195
Babcock Relays, Division of Babcock Electronics Corporation	127	General Instrument Corporation	89	Reeves Hoffman Division of DCA	192
Barnes Development Company	191	General Precision Systems, Inc., Kearfott Products Division	159	Rowan Controller Co., The	25
Beckman Instruments, Inc. Electronic Instructions Division	203	General R. F. Fittings Inc.	208	Schweber Electronics	215
Beckman Instruments, Inc., Helipot Division	27	General Radio Company	1	Scientific Data Systems, Inc.	137
Beebe Electrical Instrument Co., Inc.	168	Grayhill, Inc.	176	Secon Metals Corporation	178
Belden Corporation	112, 113	Hammel Riglander & Co. Inc.	211	Signalite, Incorporated	49
Bendix Corporation, The Electrical Components Division	129	Harowe Servo Controls, Inc.	148	Signetics Integrated Circuits, A Subsidiary of Corning Glass Works	163
Bishop Industries Corp.	211	Hayden Book Company, Inc.	150, 215	Siliconix Incorporated	147
Borden Chemical Co., The Mystic Tape Division	15	Heinemann Electric Company	33	Skydyne, Inc.	210
Bourns, Inc.	133	Hewlett-Packard	Cover II, 4, 5, 7, 96, 97, 131, 161, 180	Specific Products	164
Branson Corp.	170	Honeywell, Computer Control Division	28	Sprague Electric Company	10, 175
Bunker-Ramo Corporation	174	Honeywell Test Instrument Division	172, 173	Stauffer Chemical Company	141
CML, Inc.	184	Hysol Corporation	166	Switchcraft, Inc.	53
Capitol Radio Engineering Institute	156	IRC, Inc.	102, 103	Sylvania Electric Products, Inc., Electronic Tube Division	32A-H
Centralab, the Electronics Division of Globe-Union, Inc.	169	Ideal Precision Meter Co., Inc.	192	Systron-Donner Corporation	2
Chart-Pak, Inc.	195	Industrial Condenser Corporation	42	TRW Capacitors, Inc.	60
Chicago Miniature Lamp Works	162	Industro Transistor Corporation	165	Technical Wire Products, Inc.	188
Cinch-Graphik, Division of United-Carr	197	International Rectifier	149	Tektronix, Inc., Oscilloscopes	62
Clare & Co., C. P.	36	Johnson Company, E. F.	206	Texas Instruments Incorporated	47
Clary Corporation	199	Krohn-Hite Corporation	171	Texscan Corporation	198
Clifton, Division of Litton Industries	200	Litton Industries, Winchester Division	151	Transistor Devices, Inc.	48
Cohn Corp., Sigmund	193	Lorch Electronics Corp.	152B	Uniform Tubes, Inc.	214
Cohu Electronics, Inc.	157	McLean Engineering Laboratories	160	Union Carbide Corporation	21
Columbia Components, Inc.	182	Matsuo Electric Co., Ltd.	194	Vactec Inc.	199
Computer Logic Corporation	167	Melabs, Inc.	52	Varian Associates, Bomac Division	181
Consolidated Electrodynamics, A Subsidiary of Bell & Howell	201	Method Electronics, Inc.	153	Vent Rak, Inc.	146
Continental Device Corporation	41	Michigan Chemical Corporation	54	Vickers, Incorporated, Magnetics Division	34, 35
Control Data Corporation	152	Microdot, Inc.	12	Wanlass Electric Co.	196
Corning Electronics, Division of Corning Glass Works	46	Microwave Expositions, Inc.	213	Career Advertising	
Curtis Development & Mfg. Co.	180	Mincom Division, 3M Company	205	Aerojet General	124
Dale Electronics, Inc.	Cover III	Monitor Systems, Inc.	184	Boeing Company, The	120
Datex Division/Conrac Corporation	186	Monsanto	43	Delco Radio, Division of General Motors	125
Delco Radio, Division of General Motors	56, 57	Motorola Communications & Electronics, Inc.	142	Electronic Communications, Inc.	122
Dodge Industries, Fluorglas Division	209	Motorola Semiconductor Products, Inc.	37, 64	General Dynamics	123
Du Pont Co.	152A			Lockheed Aircraft Company	119

If your exhibit wasn't on display in the New York Coliseum at the recent Microwave show...

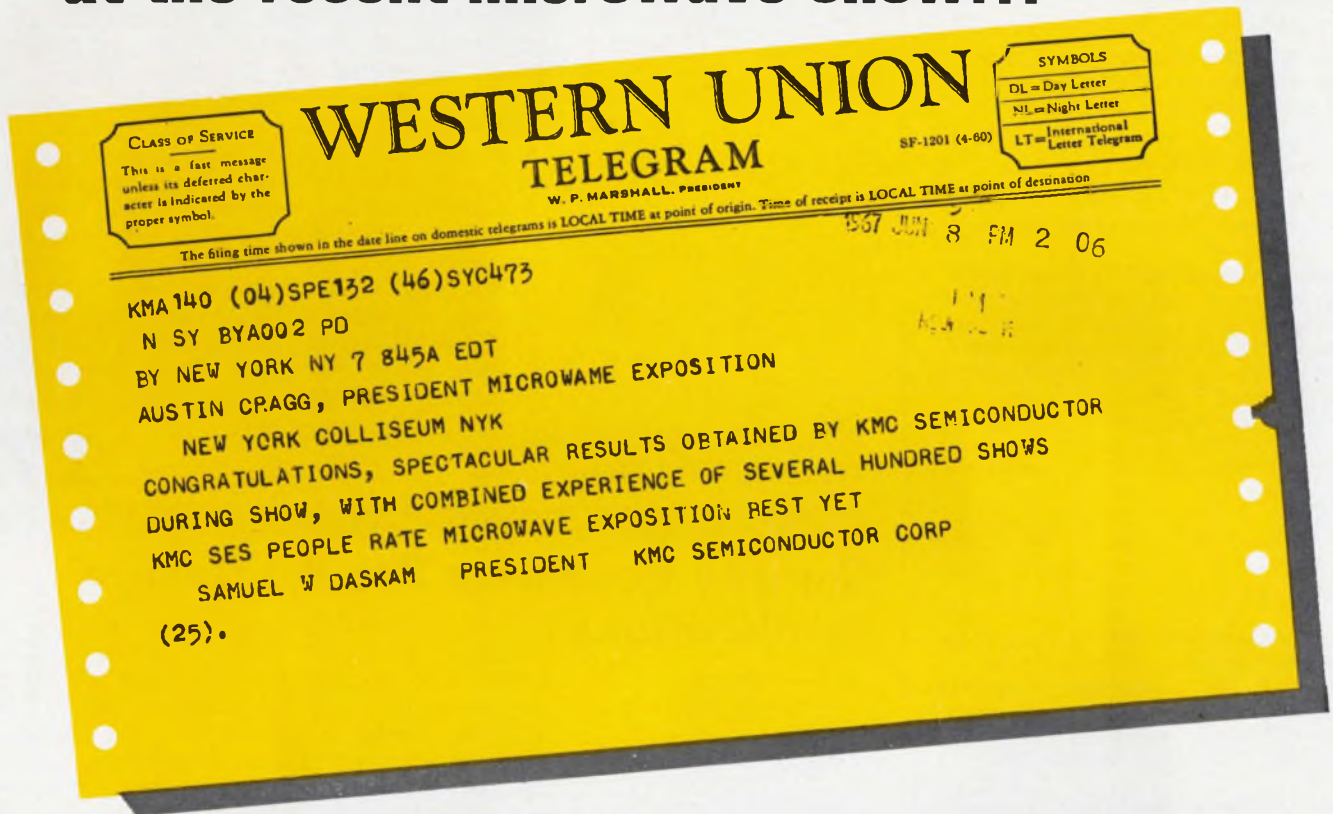

You missed a great opportunity to increase your share of the market!

Reserve space today for MICROWAVE EXPOSITION/68

PLACE: San Francisco Hilton

DATES: June 4, 5 and 6 (Tuesday, Wednesday and Thursday)

COST: \$600 per 10' x 10' space

CO-SPONSORED BY: Hayden Publishing Co.

ANTICIPATED ATTENDANCE: 4,000 microwave engineers
who can make on-the-spot decisions!

CALL OR WRITE OR WIRE

MICROWAVE EXPOSITIONS, INC.

100 Avenue of the Americas • New York, New York 10013 • 212-925-1200

ELECTRONIC DESIGN's function is:

- To aid progress in the electronics manufacturing industry by promoting good design.
- To give the electronic design engineer concepts and ideas that make his job easier and more productive.
- To provide a central source of timely electronics information.
- To promote two-way communication between manufacturer and engineer.

Want a subscription? ELECTRONIC DESIGN is sent free to qualified engineers and engineering managers doing design work, supervising design or setting standards in the United States and Western Europe. For a free subscription, use the postfree application form inside the back cover. If none is included, write to us direct for an application form.

If you do not qualify, you may take out a paid subscription for \$25 a year in the U.S.A., \$35 a year elsewhere. Single copies are \$1.50 each.

If you change your address, send us an old mailing label and your new address; there is generally a prepaid postcard for this inside the back cover. You will have to requalify to continue receiving ELECTRONIC DESIGN free.

We strive for accuracy, but despite our efforts, an occasional error does slip through. Whenever this occurs and it comes to our attention, we publish a correction. Corrections appear at the end of the Letters column.

We will not knowingly accept advertisements that make false claims. Readers are asked to bring any misleading or fraudulent data they see in advertisements in ELECTRONIC DESIGN to the attention of the Editor.

Microfilm copies are available of complete issues of ELECTRONIC DESIGN and of individual articles published since the beginning of 1961. Complete issues cost 4¢ a page, articles cost 50¢ a page; shipping and handling charges are extra. The minimum charge is \$3. For further details and to place orders, contact University Microfilms, Inc., 300 N. Zeeb Road, Ann Arbor, Mich. 48106; telephone (313) 761-4700.

Want to contact us? If you have any comments or wish to submit a manuscript or article outline, address your correspondence to:

Howard Bierman, Editor,
ELECTRONIC DESIGN,
850 Third Avenue,
New York, N.Y. 10022.

Design Data from

X-Band Waveguide Delay Lines



Bulletin 201 describes fixed-length and tapped waveguide delay-lines for X-band (8.2-12.4 Gc) frequencies. Constructed of thin-wall aluminum tubing supported by an alloy casting. MicroDelay lines are compact, rugged and light in weight. Any number of delay values can be obtained from a tapped delay line, depending on total overall delay. Fixed-length delay lines are available for delay values from 0.02 to 1.5 microseconds in 0.1 microsecond increments. Attenuation can be as low as 20 db per microsecond. VSWR input values are low, and all MicroDelay lines are supplied with bilateral, full bandwidth, input VSWR test data. MicroDelay lines have no moving parts nor any electrically controlled switches to mar their reliable performance.

MicroDelay Division / Uniform Tubes, Inc.
Collegeville, Pa. 19426

174

Quality Fasteners For All Design Applications



This 8-page catalog provides design data on the complete group of DZUS 1/4-turn self-locking fasteners for standard, high speed and panel applications, as well as universal high strength multiple thread fasteners for high tensile and shear stresses. Dzus stud assemblies, wire forms and receptacles offer an exceptional, wide variety of combinations from stock to fit specific fastening requirements. Diagrams and tables give full details for rapid, unlimited design selection. Condensed Catalog No. S-2 or comprehensive Catalog No. D-3 are available on request.

Dzus Fastener Co., Inc.
Division 32
425 Union Boulevard
West Islip, L. I., N. Y. 11795

175

How To Write Technical Articles



A guide for the engineer-author, "How to Write Articles for Electronic Design" shows how easy it is to write for publication—once the engineer knows what to write and how to write it. The Author's Guide includes a complete run-down of the types of articles published by Electronic Design—plus detailed instructions on how to prepare technical articles and short special features. A MUST for every "would-be-writer" in the electronics industry. Send for your complimentary copy by circling the number to the right.

Electronic Design
850 Third Avenue
New York, N.Y. 10022

176

Manufacturers

Advertisements of booklets, brochures, catalogs and data sheets. To order use Reader-ServiceCard (Advertisement)

How To Get The Right I/C Every Time

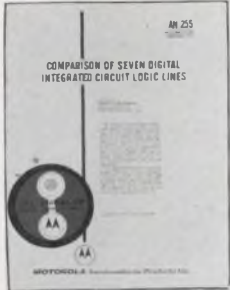

No one logic line is clearly superior to all others for all applications. Each logic line has certain applications for which it is ideally suited. For each application the user must select the integrated circuit line which best meets his total systems requirements. To help you select the right I/C every time, Schweber offers this Motorola application paper which discusses the relative trade-offs of seven different I/C logic lines.

Schweber Electronics

WESTBURY, NEW YORK 11590
PHONE 516-334-7474

177

Equipment Under Test Sign



Bright red and white signs to attach to equipment while it is under test to forestall accidental interference are available from POWER/MATE CORP., Hackensack, N. J. The company is offering these heavy cardboard signs along with their new Power Supply Module Catalog No. 117. The Catalog lists all of the many supplies available from PMC. The package will also include information about their new Uni-88—a 0-34 volt, 1.5 amp. supply that sells for only \$88.00. Racks and other accessories are also available. Write today.

Power/Mate Corp.

163 Clay St.
Hackensack, N. J. 07601

178

Engineers' Relay Handbook



A definitive work that is fast becoming a standard reference text for the relay user. Prepared and edited by the National Association of Relay Manufacturers, this book is a complete guide to the principles, properties, performance characteristics, application requirements, specifications, and testing of relays. Systems and product engineers will find the Handbook an indispensable help in determining the correct types of relays for their applications. For further information about this unique sourcebook, write Dept. ED.

Hayden Book Co., Inc.

116 W. 14th Street
New York, N. Y. 10011

179

Designer's Datebook

OCTOBER						
S	M	T	W	T	F	S
1	2	3	4	5	6	7
8	9	10	11	12	13	14
15	16	17	18	19	20	21
22	23	24	25	26	27	28
29	30	31				

NOVEMBER						
S	M	T	W	T	F	S
		1	2	3	4	
5	6	7	8	9	10	11
12	13	14	15	16	17	18
19	20	21	22	23	24	25
26	27	28	29	30		

For further information on meetings, use Reader Service card.

Nov. 1-3

Northeast Research and Engineering Meeting (NEREM) (Boston)
Sponsor: IEEE; IEEE Boston Office, 31 Channing St., Newton, Mass. 02158.

CIRCLE NO. 472

Nov. 6-8

Applied Superconductivity Conference and Exhibition (Austin, Tex.)
Sponsor: U.S. Atomic Energy Commission, University of Texas; G. D. Cody, RCA Laboratories, Princeton, N. J. 08540.

CIRCLE NO. 473

Nov. 6-8

Reliability Physics Symposium (Los Angeles) Sponsor: IEEE; A. Coppola, Rome Air Development Center (EMERS), Griffiss Air Force Base, New York 13440.

CIRCLE NO. 474

Nov. 7-8

Automatic Support Systems Symposium (Clayton, Mo.) Sponsor: IEEE; L. L. Reed, P. O. Box 4124, Jennings Station, St. Louis, Mo. 63136.

CIRCLE NO. 475

Nov. 13-16

Engineering in Medicine & Biology Conference (Boston) Sponsor: IEEE; T. B. Sheridan, Room 3-453A, MIT, 77 Massachusetts Ave., Cambridge, Mass. 02139.

CIRCLE NO. 476

Nov. 14-16

Fall Joint Computer Conference (Anaheim, Calif.) Sponsors: IEEE, AFIPS; AFIPS Headquarters, 345 E. 47 St., New York, N. Y. 10017.

CIRCLE NO. 477

The Alfred 650: The only anti-confusion, utterly reliable sweep oscillator.

All controls, indicators, and r.f. plug-in on front panel.
Alfred "total protection" circuitry used throughout.

Unique Alfred three story slide rule dial with 5 CW frequencies and 3 markers.

Internal or external leveling... PIN diode or grid leveling.

11 plug-ins cover total 250 MHz to 40 GHz. Plug-ins covering intermediate ranges available.

Front plug-in convenience eliminates additional wasteful handling and useless accessories required with now obsolete rear plug-in sweepers.



Unique F_0 control which serves as a frequency marker, the center of the symmetrical sweep, and as a single frequency.

Broad band F_1 F_2 sweep and narrow band symmetrical sweep, $F_0 \pm F$.

Operates from 50 to 400 Hz 115/230 volt power for convenient air, sea, or ground application.

Rugged construction. There is no sturdier sweeper on the market. Ask your Alfred sales engineer to demonstrate the 4" drop test.

Ask for the six-page data pack.

A six-page data pack describing the Alfred 650 Sweep Oscillator and associated plug-ins is yours for the asking. Ask your full service Alfred sales engineer for a copy or write to Alfred Electronics, 3176 Porter Drive, Palo Alto, California 94304. Phone (415) 326-6496.

Project responsibility opportunities are available for qualified engineers on Alfred Electronics' growing technical staff. An equal opportunity employer.

ALFRED ELECTRONICS

ON READER-SERVICE CARD CIRCLE 153

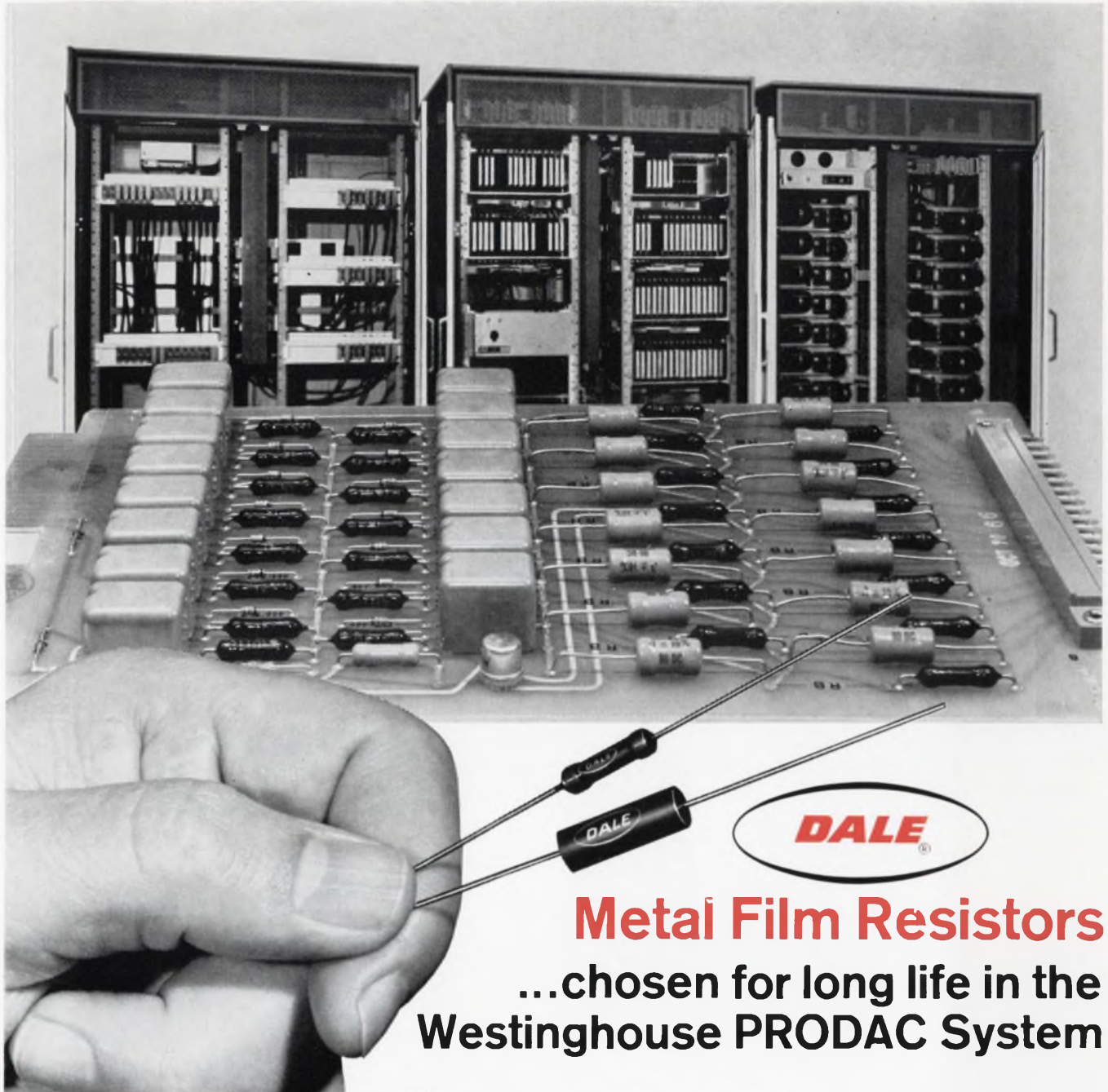

Metal Film Resistors

...chosen for long life in the Westinghouse PRODAC System

**GENERAL SPECIFICATIONS
TYPE MF* MIL-R-10509F**

DALE TYPE	MIL. TYPE	125° C RATING (Char. C & E)	70° C RATING (Char. D)	RESISTANCE RANGE (Ohms)
MF50	RN-50	1/20 w	1/10 w	30.1 to 80.6K
MF-1/10	RN-55	1/10 w	1/8 w	30.1 to 301K
MF-1/8	RN-60	1/8 w	1/4 w	10 to 1M Ω
MF-1/4	RN-65	1/4 w	1/2 w	10 to 1 M Ω
MFS-1/2	RN-70	1/2 w	3/4 w	10 to 1.5 M Ω
MF-1	RN-75	1 w	—	25 to 2.6 M Ω
MF-2	RN-80	—	2 w†	100 to 10 M Ω

*Also available in conformal coated (MFF) styles. †Char. B.
Tolerance: $\pm 1\%$, $\pm 5\%$, $\pm 25\%$, $\pm 10\%$ standard.
Characteristics D, C, or E apply depending on T.C. required.

Computers for industrial process control demand long resistor life. To insure this, Dale Metal Film resistors are used extensively in the versatile Westinghouse PRODAC System. Value analysis dictated the choice—with the long life characteristics of metal film winning over the lower price of carbon and carbon composition types. Dale verifies this reliability with long-term load life tests (see below). Delivery is reliable, too. Expanded production facilities can put quantities up to 50,000 in your plant in 2 weeks (1% tolerance units). We'll prove it—call 402-564-3131 today.

NEW METAL FILM LOAD LIFE DATA

Dale MF resistors have undergone 16,320,000 hours of load life testing without a failure (100% rated power, 70°C; failure defined as $\Delta R > 1\%$). Based on these tests, the MF resistor has a proven failure rate of .004% per 1,000 hours (60% confidence at 50% power, 70°C ambient). Write Dale for complete test data.

WRITE FOR CATALOG A



DALE ELECTRONICS, INC.
1328 28th Avenue, Columbus, Nebraska 68601
In Canada: Dale Electronics Canada, Ltd.



ON READER-SERVICE CARD CIRCLE 246

How to eliminate a transformer, two SCR's and a triggering device...

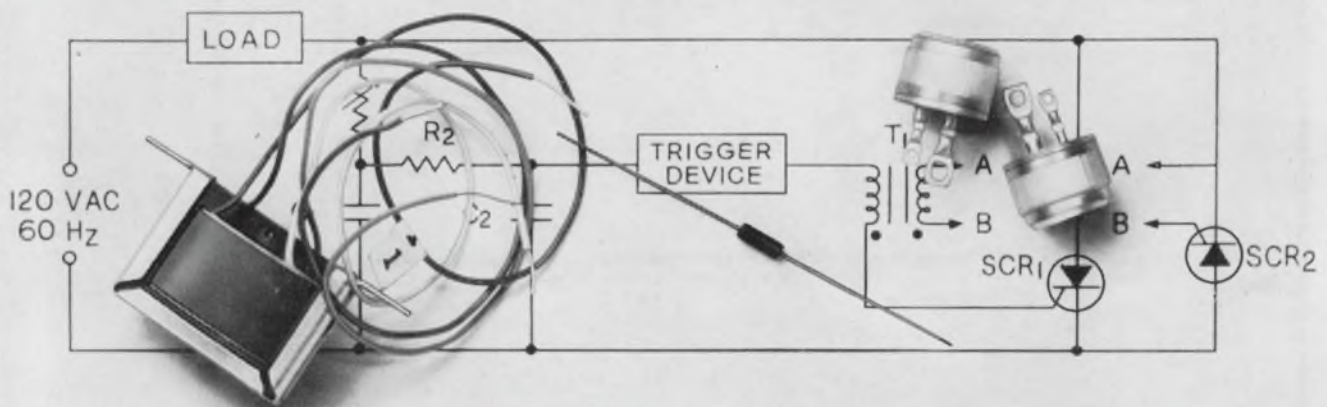

use one of RCA's new 6A Triacs with integral trigger!

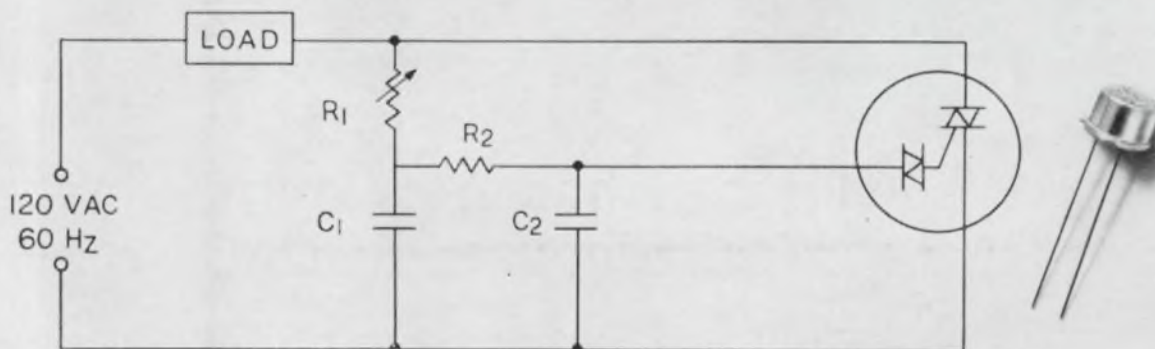

Why design in RCA's new 6A Triacs? Here are just a few of the more important reasons:

Because the triggering device and the firing characteristics of the 40431 and 40432 Triacs are integrated inside the compact TO-5 case by RCA before they sell you the device... you don't have to worry about designing in additional triggering components.

Because a Triac, by its very nature and construction, can replace two SCR's and a pulse transformer in ac circuits... you achieve significant savings in engineering and manufacturing costs, and you improve packing density.

And because RCA's 40431 and 40432 have excellent gate symmetry and surge current protection up to 100 amps... you get top circuit performance and reliability.

The 40431 controls 720 watts at 120 volts, 60 Hz. It costs only \$1.80°. The 40432 controls 1440 watts at 240 volts, 60 Hz. It costs only \$2.28°. So for modern, efficient phase control of ac loads in applications such as light dimming, universal and induction motor control, and heater control, specify RCA's new Triac with built-in trigger. Your RCA Field Representative can give you complete information, including price and delivery. Or for additional technical data, write RCA Commercial Engineering, Sec. RG10-2, Harrison, N.J. 07029. See your RCA Distributor for his price and delivery.

*Prices in quantities of 1,000 and up.

RCA Electronic Components and Devices



The Most Trusted Name in Electronics

ON READER-SERVICE CARD CIRCLE 247