

# Electronic Design 26

VOL. 14, NO.

THE MAGAZINE OF ESSENTIAL NEWS, PRODUCTS AND TECHNOLOGY

NOVEMBER 22, 1966

**Digital ICs can switch FETs** if integrated drivers are put between the chips and switches. For analog signal multiplexing, just connect multi-driver flat-

packs, like the one illustrated symbolically below, to similar FET-packs. For step-by-step driver design, see p. 50. For off-the-shelf driver data, p. 106.

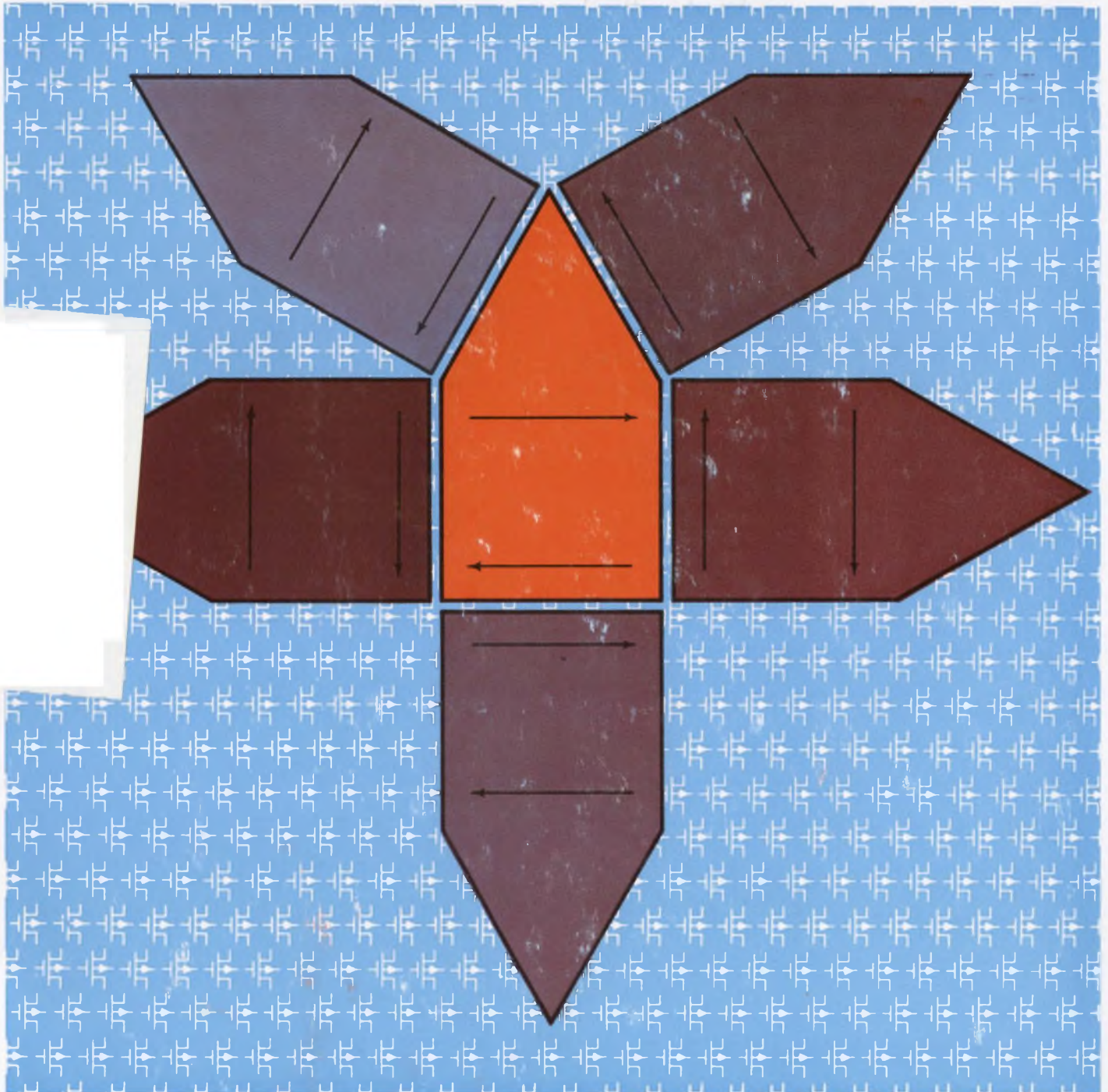

**Only 5 1/4" high! 50 MHz at 5 mv/cm! 8 x 10 CRT! All solid-state! Plug-in versatility! 95 watts—no fan!**

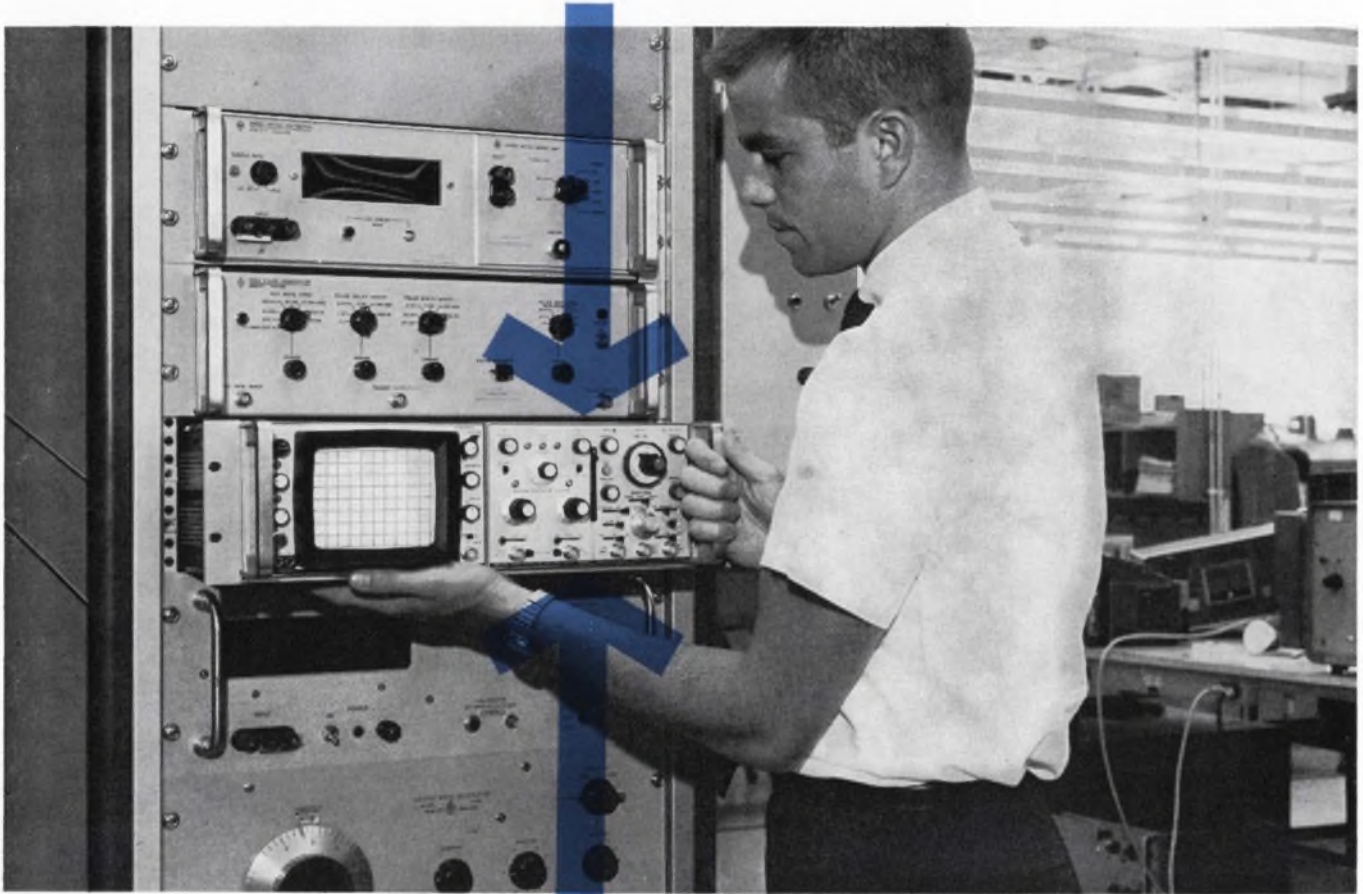

## **NEW hp 180AR OSCILLOSCOPE CUTS SIZE OF TEST CONSOLES!**

Your scope no longer has to be the biggest instrument in your test console when you use the new hp Model 180AR Oscilloscope! Although its rack height is only 5 1/4", this scope has an extra-large 8 x 10 cm CRT display area to give you 30% to 100% greater viewing area than any other high-frequency scope. Add to this feature the all-solid-state circuitry in mainframe and plug-ins for greater reliability and cooler operation (no fans needed, 95 watts), 50 MHz at 5 mv/cm, and plug-in versatility—and you get *more total performance, more usability than any other rack mount scope on the market!* Rugged design, all-solid-state and specified performance at -28°C to +65°C makes the 180AR ready to go anywhere!

Accurate measurements are easier to read and make on the new hp 180AR scope, because a new design breakthrough offers a compact 17-inch long, high-frequency 8 x 10 cm CRT. With the black internal graticule calibrated in centimeters, the bright trace, and a 12 kv accelerating potential, you get sharp, crisp traces for accurate resolution of waveform details—even at 5 nsec/cm sweeps.

Mainframe is the first with power supplies specifically designed for solid-state circuitry—to give you full performance benefits from solid-state devices in all present and future plug-ins. New horizontal amplifier has wide bandwidth with X10 magnification to provide linear 5 nsec/cm sweeps, giving you greater resolution of high frequency signals and fast pulses.

The dual channel 50 MHz at 5 mv/cm vertical amplifier has low-drift FET input stages for accurate DC measurement . . . plus quick, 15-second warm-up. Ver-

tical attenuation, which sets vertical deflection factor, is ahead of the amplifier. This prevents trace jump as you change ranges; bandwidth is maintained on all ranges even when verniers are used.

Time base plug-ins offer new easy-to-use delayed sweep for examining complex waveforms in detail. Tunnel diode triggering circuits lock-in waveforms to beyond 90 MHz. Exclusive hp mixed feature combines display of first portion of trace at normal sweep speeds, and simultaneously expands trailing portion of trace at faster delayed sweep speed to allow magnified examination.

To see how the new hp Model 180AR Oscilloscope can help you reduce the size of your test consoles and give you greater total performance, call you nearest hp field representative. Or, write to Hewlett-Packard, Palo Alto, California, 94304. Tel (415) 326-7000; Europe: 54 Route des Acacias, Geneva. Price: hp Model 180AR Rack Mount Oscilloscope, \$900.00; hp Model 180A Oscilloscope, \$825.00; hp Model 1801A Dual Channel Vertical Amplifier, \$650.00; hp Model 1820A Time Base, \$475.00; hp Model 1821A Time Base and Delay Generator, \$800.00.

**HEWLETT  PACKARD**  
An extra measure of performance



# Why do TEKTRONIX,

# TEXAS INSTRUMENTS,

# E G & G and others



## use **GR874 Coaxial Connectors** on their products?

### Because GR874 Coaxial Connectors are good for pulses

GR874 Coaxial Connectors are wide-bandwidth, low-reflection devices that are made-to-order for fast-rise-time, high-frequency pulse systems. VSWR is less than 1.02 up to 7 GHz, less than 1.08 to 9 GHz for the rigid air-line locking version, which means that these connectors pass pulses faithfully without ringing or deterioration of rise/fall times.

The GR874 is a versatile coaxial system with a wide variety of elements and components . . . power dividers, air lines, trombones, tees, elbows, pads, terminations, adaptors, etc.

The GR874 offers high performance at low cost . . . price of a basic GR874 Coaxial Connector is \$2.25, and purchases in quantity yield discounts.

The GR874 saves setup time . . . it is both a hermaphroditic (no male or female versions) and quick-connect/ -disconnect connector.

Here is an example of how GR874 Coaxial elements can be used to produce bursts of high-rep-rate pulses with a low-frequency, fractional-nanosecond pulse generator.

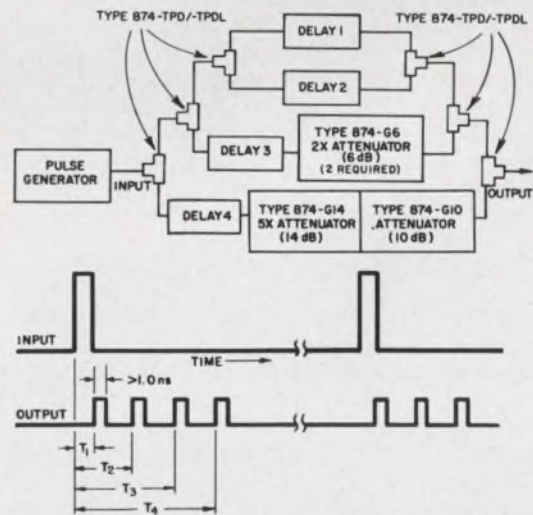

The cascaded GR874-TPD Power Dividers first reproduce the original pulse many times and, later, recombine the individually delayed signals into a higher-rep-rate pulse burst. Rep rates up to several hundred MHz can be obtained by this technique.

GR874 Air Lines can be used to provide small delays (up to 1 ns). GR874 Attenuators can be used when compensatory reductions in amplitude are required (the GR874-TPD Power Divider has a port-to-port insertion loss of 6 dB).

BOSTON • NEW YORK • CHICAGO • PHILADELPHIA • WASHINGTON, D.C.  
SYRACUSE • DALLAS • SAN FRANCISCO • LOS ANGELES • ORLANDO  
CLEVELAND • TORONTO • MONTREAL

BOURNE END, ENGLAND      ZURICH, SWITZERLAND

## GENERAL RADIO

WEST CONCORD, MASSACHUSETTS

ON READER-SERVICE CARD CIRCLE 3

# An oscilloscope picture in 10 seconds: any longer is a waste of time.

Polaroid Land films don't make you wait to see if your trace zigged when it should have zagged.

They let you know in ten seconds.

They give you an oscilloscope picture you can study, attach to a report, send as a test record with a product shipment, or file for future reference.

You have a choice of 5 films for oscilloscope recording.

The standard film has an A.S.A.

equivalent rating of 3000. It comes in both roll film [Type 47] and pack film [Type 107]. They both give you 8 pictures  $3\frac{1}{4} \times 4\frac{1}{4}$  inches. This emulsion is also available in 4 x 5 sheets [Type 57].

For extremely high-speed recording, there's Polaroid PolaScope Land film [a roll film, Type 410]. It has an A.S.A. equivalent rating of 10,000.

It can take pictures of traces too fleeting for the human eye: such as a scintillation pulse with a rise time of less than 3 nanoseconds.

One thing all these films have in common is a sharp, high-contrast image that's easy to read. Because the films are so sensitive, you can use small camera apertures and low-intensity settings.

To put these films to work on your scope, you need a camera that will take a Polaroid Land Camera Back.

Most oscilloscope camera manufacturers have one. For instance: Analab, Beattie-Coleman, BNK Associates, Fairchild, EG&G, General Atronics, Hewlett-Packard, and Tektronix.

You can get complete information by writing to Polaroid Corporation, Technical Sales Department, Cambridge, Massachusetts 02139, or by writing to one of the manufacturers mentioned above.

It will probably take a little longer than 10 seconds, but we promise the information won't be a waste of time.

"Polaroid" and "PolaScope"<sup>™</sup>

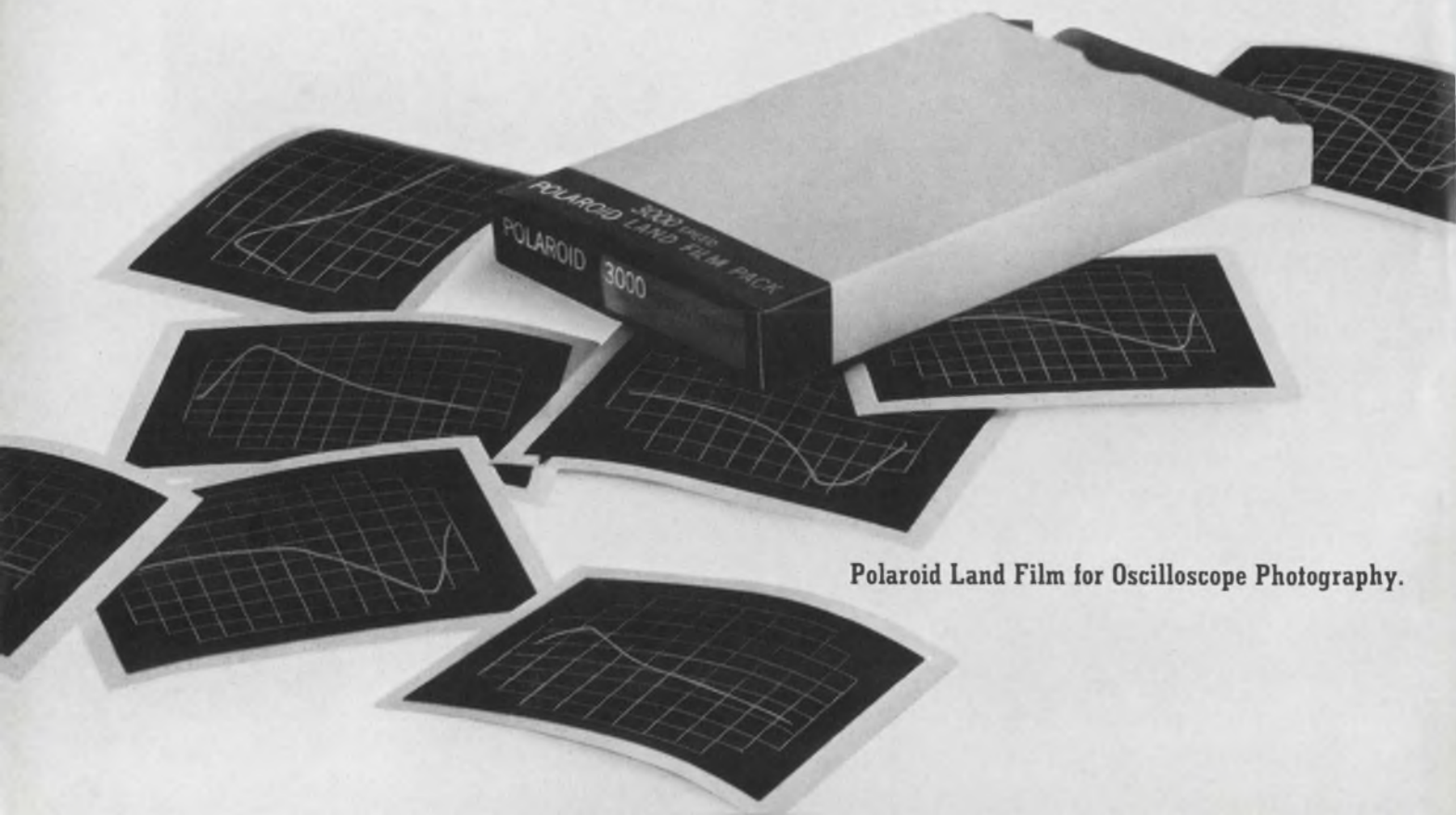

Polaroid Land Film for Oscilloscope Photography.

# Electronic Design 26

VOL. 14, NO.

THE MAGAZINE OF ESSENTIAL NEWS, PRODUCTS AND TECHNOLOGY

NOVEMBER 22, 1966

---

## NEWS

- 13 News Scope
- 17 **Researchers push IC performance higher**  
Focus is on isolation methods, complementary transistors and small geometries.
- 21 **Mighty SCEPTRE analyzes any circuit**  
Flexible computer program uses ordinary language, accepts any circuit model.
- 25 Washington Report
- 30 Function generator on a chip.
- 32 Laser replaces umbilical cord in spacecraft.
- 33 Mechanical filters move between crystal and LC.
- 34 Letters
- 47 **Editorial: Saga of a systems man—or, meetings, shmeetings.**

---

## TECHNOLOGY

- 50 **ICs end the 'driver gap'** in FET analog signal switching. These circuit designs permit the use of junction and MOS devices as switches with low-level logic.
- 58 **Tackle delay-line circuits** graphically. These plots, tailored to frequency-modulated radars, relate critical parameters.
- 64 **Take the easy road to logic design.** Use the Karnaugh map to help minimize logic equations. Here's an example of its use in counter design.
- 70 **Precision digital clock uses ICs** and a crystal oscillator to develop signals that are accurate to 10 parts in a billion.
- 76 **Try solid-state regulators** for your high-voltage dc power requirements. You get big performance in a compact package.
- 82 **Simplify vector analysis.** Use this set of nomographs to eliminate those time-consuming computations.
- 86 **Evading radar detection is a cinch** for aircraft equipped with EASY—a system that takes advantage of a radar's blind spots.
- 88 Ideas for Design
- 96 **Bits and Pieces:** The nontechnical side of engineering.

---

## PRODUCTS

- 106 **Microelectronics:** Integrated drivers level-shift and amplify low-logic signals.
- 110 **Test Equipment:** Integrating meter is 75% integrated.
- 118 Microwaves
- 122 Semiconductors
- 126 Components
- 132 Materials
- 134 Systems
- 136 Production Equipment
- 138 Power Equipment

---

## Departments

- 100 Book Reviews
- 148 Application Notes
- 150 New Literature
- 156 Reprints
- 158 Advertisers' Index
- 160 Designer's Datebook

---

**ELECTRONIC DESIGN** is published biweekly by Hayden Publishing Company, Inc., 850 Third Avenue, New York, N. Y. 10022. James S. Mulholland, Jr., President. Printed at Poole Bros., Inc., Chicago, Ill. Controlled-circulation postage paid at Chicago, Ill., Cleveland, Ohio, and New York, N. Y. Application to mail at controlled postage rates is pending at St. Louis, Mo. Copyright © 1966. Hayden Publishing Company, Inc. 60,412 copies this issue.

## NEW FET CHOPPER-MFE2133 FOR MILITARY/INDUSTRIAL DESIGNS

... featuring low  $r_{ds}$  "on" — 60 ohms (max)

Here is *one* high-impedance device that can dissipate 1.5 watts. In addition, Motorola's TO-39 package — with low thermal resistance ( $6.7 \text{ mW}/^\circ\text{C}$ ) — keeps the junction relatively free of troublesome temperature swings. The MFE2133 also offers low transfer capacitance ( $5 \text{ pF}$ ) in proportion to the low drain-source resistance. And, the combination makes for better all-around switching performance.

The MFE2133 is suitable for large gate voltage swings as a chopper. The circuit as shown allows input voltages of 10 volts. No transformer is required. The result, of course, is circuit simplicity and savings in component costs.

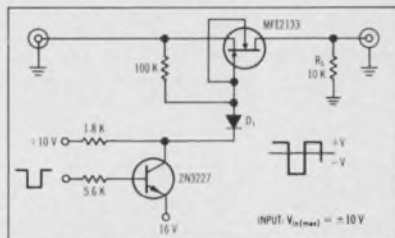

ON READER-SERVICE CARD CIRCLE 101

## MEDIUM-POWER AMPLIFIER JFETs FOR INDUSTRIAL & CONSUMER USES

The industry's first medium-power, high-gain, economical JFETs are Motorola types MFE2097 & MFE2098. Because of their natural high impedances, combined with a medium-power capability, you can often eliminate one transformer as well as large coupling and bypass capacitors in most designs. Even greater savings result from the low 100-up price of \$4.90 — *less than half the price of comparable devices!* While these new FETs are ideal for driver stages of audio amplifiers and other audio communications equipment, they are also well-suited for use in analog control systems.



- Medium-power capability results from large geometry with many current paths.
- $I_{DSS}$  ranges from 15 to 50 mA — MFE2097  
40 — 100 mA — MFE2098
- $|y_{fs}| = 10,000 \mu\text{mhos (min)} — \text{MFE2097}$   
 $14,000 \mu\text{mhos (min)} — \text{MFE2098}$   
... for extremely high gain.
- High-dissipation package — TO-39 with  $1\frac{1}{2}$ " leads.

ON READER-SERVICE CARD CIRCLE 102



MAKE  
YOUR MOVE  
TO FETs  
WITH  
ANY ONE OF  
FIVE  
NEW PIECES  
FROM  
MOTOROLA



## GUARANTEED LOW-NOISE FET FOR VHF AMPLIFIERS AND MIXERS

Now, RF receivers, including high-quality FM sets, can be virtually free from spurious responses, if you specify Motorola's new 2N3823 state-of-the-art JFET. An extremely low 100-MHz noise figure of 2.5 dB (max) is complemented by low cross-modulation and intermodulation distortion.

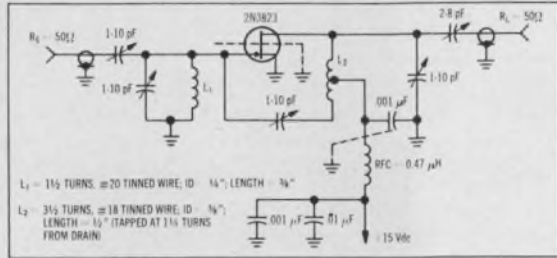

200 MHz Low-Noise Amplifier Circuit

- Symmetrical geometry in TO-72 package — can plug right into existing sockets.
- Also useful in UHF applications — up to 500 MHz.
- Low transfer and input capacitance . . .  $C_{in} = 2$  pF (max).
- $C_{out} = 6$  pF (max).

ON READER-SERVICE CARD CIRCLE 103

## GENERAL PURPOSE JFETs OFFER LOW-NOISE & LOW-COST FOR INDUSTRIAL & CONSUMER USES

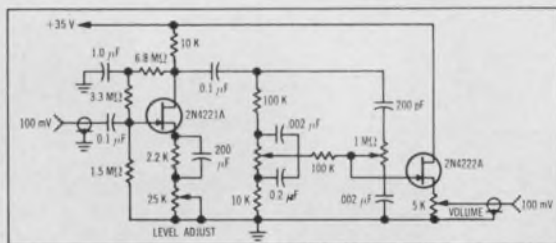

Tone Control for High-fidelity Audio Amplifiers

Ease of converting audio preamplifiers to FET designs with Motorola types 2N4220A-22A has excited the imaginations of engineers. The high input-resistance allows for "vacuum-tube" design principles in selection of tone control elements — permitting use of small, low-cost capacitors.

The low guaranteed noise figure of 2.5 dB (max) at 100 cycles/sec. provides a definite advantage over bipolar transistors. For additional savings, the cost is only \$2.90 (100-up), even lower in larger production quantities.

- N-channel for high gain  $|y_{fs}| = 1,000$   $\mu$ mhos (min) 2N4220A  
2,000  $\mu$ mhos (min) 2N4221A  
2,500  $\mu$ mhos (min) 2N4222A

ON READER-SERVICE CARD CIRCLE 104

## N-CHANNEL IGFET OFFERS HIGH GAIN FOR GENERAL PURPOSE APPLICATIONS

Motorola's new MFE3001 IGFET operates in both the enhancement and depletion modes, for a broad range of applications in industrial, military, and consumer equipment. And, the 100-up price of \$3.90 makes it practical for most applications. Typical uses are audio amplifiers, switches and controls. A low drain current results from its small geometry, and the n-Channel construction provides high gain indicated by the  $|y_{fs}|$  specification of 1,800  $\mu$ mhos (typ).



- Extremely high input resistance  
 $I_{GSS} < 10$  pA at 10 Vdc
- High signal-handling capability at low drain currents.  $I_{DSS} = 0.5$  mAdc (min).

ON READER-SERVICE CARD CIRCLE 105

## FOUR MOTOROLA APPLICATIONS NOTES EXPLAIN NEW FET TECHNOLOGY

To explain the advantages of field-effect transistors in both digital and analog systems, Motorola's Applications Engineers prepared a series of technical papers. The information covers a broad range of applications, and includes sample circuit designs as well as operational theory. Any one or all of them can be added to your semiconductor library, simply by completing and mailing the coupon below, to Dept. T.I.C., Motorola Semiconductors, Box 955, Phoenix, Arizona 85001.

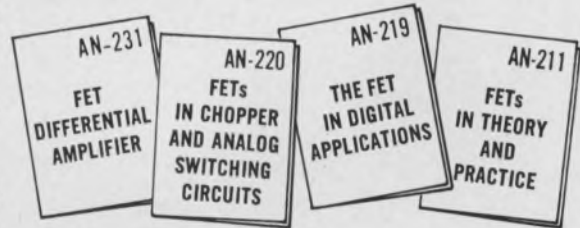

YES, I am interested in learning more about field effect transistors. Please send me the following Motorola Application Notes:

\_\_\_\_\_

\_\_\_\_\_

\_\_\_\_\_

\_\_\_\_\_

Name \_\_\_\_\_ Title \_\_\_\_\_

Company \_\_\_\_\_ Address \_\_\_\_\_

City \_\_\_\_\_ State \_\_\_\_\_ Zip \_\_\_\_\_

**MOTOROLA Semiconductors**  
— where the priceless ingredient is care!

**RCL OFFERS "OFF-THE-SHELF"**

# **1/2" ROTARY SWITCHES**

**INDUSTRY'S BEST DELIVERY**

Up to 12 positions per deck . . . up to 6 poles per deck . . . shorting and non-shortng poles can be grouped in any combination on one deck . . . individual deck parts self-contained and permanently molded into place. Extremely low and uniform contact resistance:  $.0025\Omega$  average. Life expectancy: 200,000 mechanical operations.

# **RCL**

Write for complete engineering information

**ELECTRONICS, INC.**

General Sales Office: One Hixon Place, Maplewood, New Jersey



Available With:

- .. Spring Return
- .. Adjustable Stops
- .. Coned Terminals  
for critical space  
requirements, etc.

Pat. Pend.



# New Computer Grade Capacitors with proved high ripple ratings



The new line of Mallory CGS Aluminum Electrolytic filter capacitors, designed for 65°C ambient, looks the same as our present CG family . . . same case and top construction, but they're different inside.

A completely new set of specifications for ripple current has been established for this line. The new values are based on Mallory tests of many hundreds of capacitors under a variety of environmental conditions and ripple currents. Maximum ripple values stated for the CGS are the proved currents to which you can design with full confidence of long, reliable life. And they are *higher* than our previous values: for identical case size, about four times higher . . . for identical C-V ratings, over twice as high. ESR specifications are also lower.

Furthermore, you can now get about *twice as much* capacitance in a given case size as was formerly available in Mallory capacitors. Maximum capacitance is now 280,000 mfd at 3 WVDC or 1,800 mfd at 450 WVDC, in the 3" diameter by 5 $\frac{7}{8}$ " case. And there are 880 other standard ratings from which to choose. For complete data, write for your copy of new Bulletin 4-80. Mallory Capacitor Company, a division of P. R. Mallory & Co. Inc., Indianapolis, Indiana 46206.

**50<sup>th</sup>**  
ANNIVERSARY

**MALLORY**

ON READER-SERVICE CARD CIRCLE 7

# NOW THERE'S PLANAR II.

Fairchild has now added refinements to its patented Planar\* process, which result in improved device stability, longer life, and greater reliability without 100% burn-in.



Fairchild invented the Planar process, and by doing so revolutionized the semiconductor industry. Without Planar the reliability of transistors would still be questionable, integrated circuits would not be where they are today, and the whole structure of the electronics industry would be different. But current requirements for ever more reliable systems and components have created a need for a better, purer manufacturing process. No doubt some manufacturers will soon find ways to improve the basic Planar process. We already have.

**What is Planar II?** Planar II is a refinement of the original Planar process. It is essentially aimed at controlling the behavior of free positive ions in the oxide layer which characterizes the Planar process. Concentration of free ions in the oxide can lead to problems that result in unstable MOS-FET devices, and to outright failure in transistors. The Planar II process keeps the number of these impurity ions to a minimum by using only ultra pure materials, utilizing better metalizing and bonding techniques, and by adding a few steps to the basic process which result in a much purer oxide layer. How does this work?

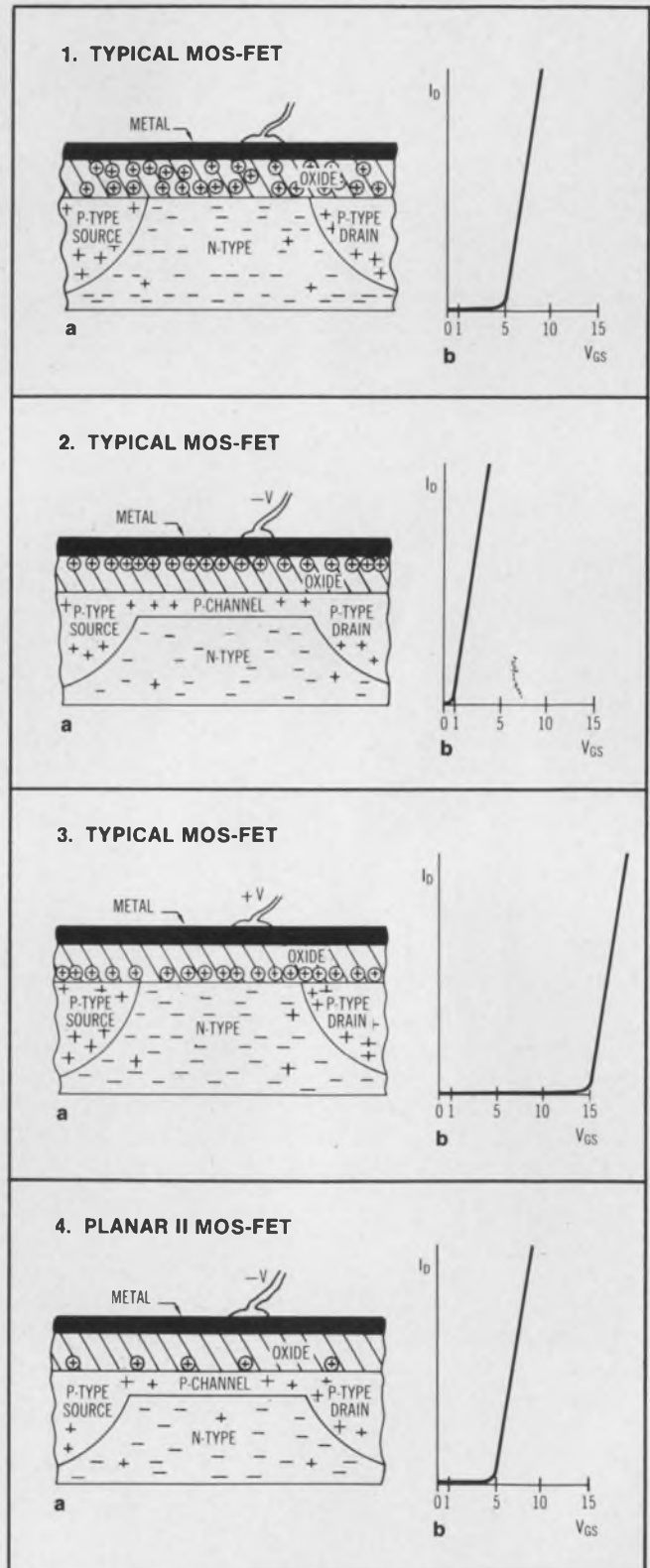

### 5. PLANAR II PNP TRANSISTOR

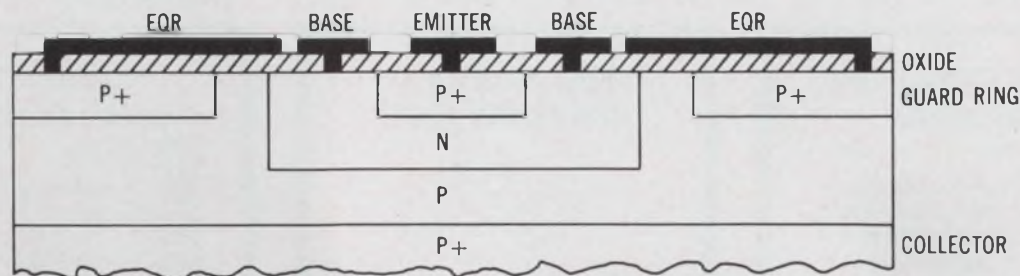

**Stable MOS devices:** In a typical P-channel MOS-FET (Fig. 1a) free positive ions are randomly distributed throughout the oxide layer. If a negative voltage is applied to turn the device on, it repels the free electrons in the N material and allows a P-channel to be formed and current to flow from source to drain. Initially such a voltage could be 5V (Fig. 1b).

As you can see in figure 2a, the negative voltage also attracts the free positive ions, and they concentrate near the oxide-metal interface. When a negative voltage is again applied, a much smaller voltage (about 1V) is required to form the P-channel, since the ions are already concentrated at the metal-oxide interface (Fig. 2a, 2b). Conversely, if a positive voltage preceded the negative turn-on signal, a much higher voltage (15V) is required to form the channel, since the positive ions will be at the bottom of the oxide layer, and will be attracted to the top (Fig. 3a, 3b). Thus, the threshold of the device is degraded and fluctuates between 1-15 volts, depending on the polarity of the previously applied signal.

Figures 4a and 4b show how the Planar II process helps to alleviate this problem. In the Planar II device the number of impurity ions is kept to a minimum, and the effects of their migrations is so small as to be negligible. The result is a threshold voltage that is stable and constant.

**Stable PNP devices:** To combat ion migrations in PNP transistors we use an equipotential ring (EQR) and a guard ring in addition to controlling the impurities (Fig. 5). The EQR and guard ring prevent the formation of inversion layers which can lead to channeling and device failure. This is accomplished by reshaping the electrical field distribution within the oxide layer to eliminate the lateral component. Ions are inhibited from moving laterally within the oxide layer, thus preventing inversion layers from forming.

The results were dramatically demonstrated in a recent test under severe High-Temperature Reverse Bias (HTRB) conditions. Epoxy devices without EQR and guard ring were subjected to conditions of  $T_A = +125^\circ\text{C}$ ,  $V_{CB} = 80\text{V}$ . Over a 1000 hour period, more than 40% of the devices tested had  $I_{CBO}$  changes greater than 1000nA. An identical sample of PNP epoxy devices *with* EQR and guard ring went through the same test for the same time period. Not one of these transistors had an  $I_{CBO}$  change greater than 1nA.

**Higher Voltage, lower cost:** Because of the Planar II process you can now get high voltage PNP's from Fairchild. Our Series 2N4357, for example, features voltages up to 240V  $V_{CEO}$ . Even in epoxy, high voltages are now practical. Our PNP epoxy series SE7501 features collector-emitter voltages of 140V. This means you can get high voltages at lower epoxy prices. Furthermore, Planar II eliminates the need for 100% burn-in on PNP transistors. This is translated into both lower prices and faster deliveries.

**Planar II summary:** The benefits of Planar II processing can be summed up as follows: it allows us to make stable MOS field-effect transistors. It allows us to make reliable, high voltage, high performance PNP devices with the flexibility of low cost epoxy packaging. It even improves the stability with time (resulting in longer life) of NPN transistors and integrated circuits. In a word, it allows us to offer you better, more reliable solid-state devices at less cost. Planar II is the purest manufacturing process ever used in mass production. We suspect that in a few years everyone will be using it. You can wait. Or, get it now, from Fairchild.

**FAIRCHILD**  
SEMICONDUCTOR

\*Planar is a patented Fairchild process

# You Can Get All These Microcircuits from Sprague Electric:

## \*SERIES SU300, LU300 UTILOGIC\*



K Package

For use in commercial, industrial, ground support applications. Available in two operating temperature ranges,  $-20^{\circ}\text{C}$  to  $+85^{\circ}\text{C}$ , and  $+10^{\circ}\text{C}$  to  $+55^{\circ}\text{C}$ . Propagation delay of 15 to 40 nanoseconds.

\*Trademark of Signetics Corp.

ON READER-SERVICE CIRCLE 883

## \*SERIES SE400, NE400 LOW POWER LOGIC



J Package

Operating temperature ranges:  $-55^{\circ}\text{C}$  to  $+125^{\circ}\text{C}$ , and  $0^{\circ}\text{C}$  to  $+70^{\circ}\text{C}$ . For use in Aerospace and other applications where low power drain is required. Optimized speed, noise margin.

ON READER-SERVICE CIRCLE 884

## \*SERIES SE500 LINEAR AMPLIFIERS



K Package

Operating temperature range:  $-55^{\circ}\text{C}$  to  $+125^{\circ}\text{C}$ . Two linear circuits available in 10-lead low silhouette TO-5 case. SE501K is a video amplifier, SE505K is a general purpose differential amplifier.

ON READER-SERVICE CIRCLE 885

## \*SERIES SE800, NE800 TTL LOGIC

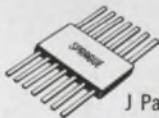

J Package

Designed for high-speed avionics systems. Eight high level circuits including four NAND Gates, Power Gate, Exclusive-OR Gate, Input Expander, J-K Flip-Flop.

ON READER-SERVICE CIRCLE 886

## UNICIRCUIT® RCTL LOGIC

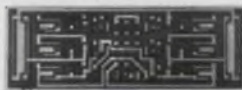

(8x actual size)

Sprague Series US-0100 . . . a complete line of silicon monolithic digital building blocks featuring low power consumption (2 mW typ.)

ON READER-SERVICE CIRCLE 887

## UNICIRCUIT® mW RTL LOGIC



TO-5 Case

Types US-0908 through US-0921 . . . Fully interchangeable mW digital building blocks featuring power consumption of 2 mW/node and propagation delay of 40 nsec.

ON READER-SERVICE CIRCLE 888

## UNICIRCUIT® CUSTOM HYBRID CIRCUITS

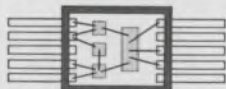

Combine monolithic silicon circuits with tantalum or Ni-Cr alloy resistors. Close resistance tolerances, low temperature coefficient. Resistor matching,  $\pm 1/2\%$ .

ON READER-SERVICE CIRCLE 889

## DIGITAL-TO-ANALOG CONVERSION CIRCUITS



UT-1000—Four-bit ladder network  
UD-4001—Ladder switch for driving resistor ladder networks  
UD-4024—Buffer amplifier

ON READER-SERVICE CIRCLE 890

\*Series SE100, NE100, CS700, SU300, LU300, SE400, NE400, SE500, SE800, NE800 are all available from Sprague Electric under technology interchange with Signetics Corp.

For data sheets on the microcircuits in which you are interested, write to: Technical Literature Service, Sprague Electric Company, 347 Marshall St., North Adams, Massachusetts 01247

### SPRAGUE COMPONENTS

INTEGRATED CIRCUITS  
THIN-FILM MICROCIRCUITS  
TRANSISTORS  
CAPACITORS  
RESISTORS

PULSE TRANSFORMERS  
INTERFERENCE FILTERS  
PULSE-FORMING NETWORKS  
TOROIDAL INDUCTORS  
ELECTRIC WAVE FILTERS

CERAMIC-BASE PRINTED NETWORKS  
PACKAGED COMPONENT ASSEMBLIES  
BOBBIN and TAPE WOUND MAGNETIC CORES  
SILICON RECTIFIER GATE CONTROLS  
FUNCTIONAL DIGITAL CIRCUITS

**SPRAGUE®**  
THE MARK OF RELIABILITY

\*Sprague and ® are registered trademarks of the Sprague Electric Co.

# News



**Materials and process research zeroes in on integrated circuits, where advances are being**

**made in complementary transistors, and isolation and fabrication methods. Page 17**

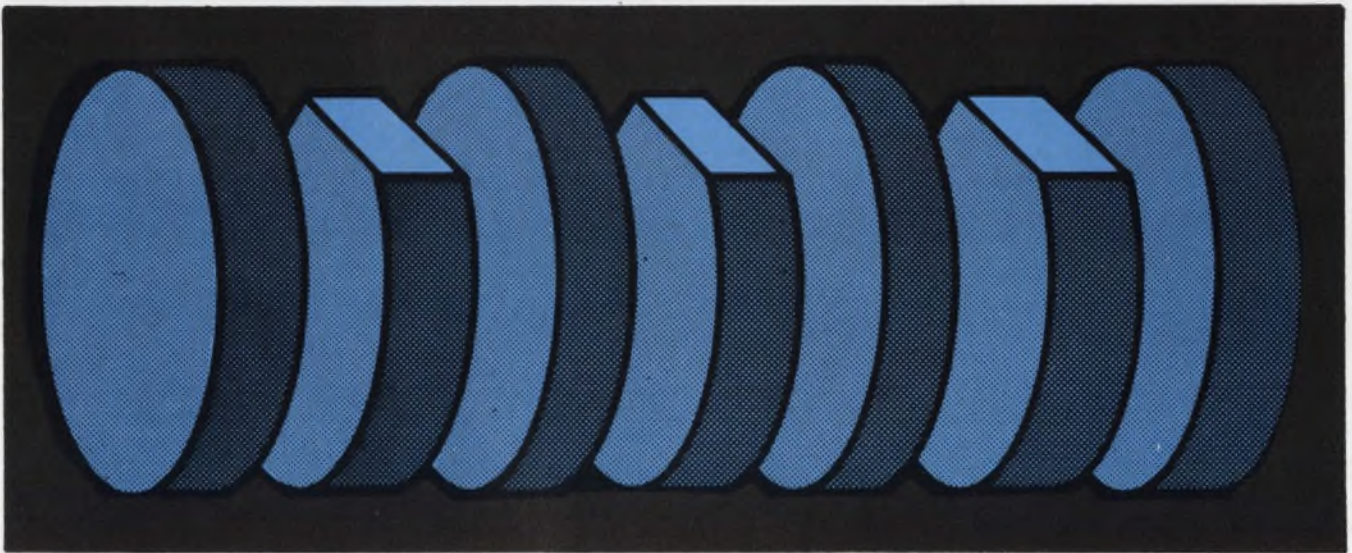

**Improvements in mechanical filters reduce their insertion losses and enable them to**

**start competing with inexpensive LC filters and highly selective crystal filters. Page 33**

## Also in this section:

**Flexible new computer program uses ordinary language for circuit analysis. Page 21**

**Laser system replaces umbilical cords used during spacecraft launchings. Page 32**

**News Scope, Page 13 . . . Washington Report, Page 25 . . . Editorial, Page 47**



## Go 1, Go 2, Go 3 . . . with Series "G"!

As you can see, something new has been added to our connector line. They've gone modular. Now you can stylize your electronic equipment from front to back, get all three kinds of service—signal, power, coaxial—from one basic housing style. You no longer need a different connector for each type of circuit in your product. AMP's Series "G" Connectors are designed so you can "go" with one, two, or three modular inserts for the exact combination of contact types you want. Inserts are available in either diallyl phthalate or general purpose phenolic with numbered cavities for one or more of these types:

- Type I—#12 screw machine pin and socket power contact
- Type II, III and III(+)—regular signal circuit pin and socket contacts
- Type IV—miniature coaxial contact
- Type XII—new 35-amp stamped and formed power contact
- New subminiature COAXICON\* contact

Designed for rugged, dependable performance as well as flexibility, Series "G" Connector shells are two-piece cast aluminum. They consist of a polarized two-piece shell and retainer plate for easy, drop-in assembly of the modules. And, they're available with floating bushings or locking springs, so you can use them equally well for rack-and-panel mounting, service drops, and in-line hook-up applications.

Try this new connector concept in your engineering designs. You'll get all kinds of service . . . with style! It's the practical way to cut inventory costs, too. Write today for complete details.

★Trademark of AMP INCORPORATED

**AMP**  
**INCORPORATED**  
 Harrisburg, Pennsylvania

A-MP\* products and engineering assistance are available through subsidiary companies in: Australia • Canada • England • France • Holland • Italy • Japan • Mexico • Spain • West Germany

ON READER-SERVICE CARD CIRCLE 10

## Hewlett-Packard breaks into computer market

Exhibition at this month's Fall Joint Computer Conference in San Francisco of a small, rugged instrumentation computer marked Hewlett-Packard's first entry into the computer market.

The 225-pound unit, which uses integrated circuits, accepts and manipulates data from counters, nuclear scalars, thermometers, voltmeters, ac/ohms converters, data amplifiers and input scanners, and many others.

Commands are fed into the computer by typing them on a teletype keyboard. The unit, housed in a 32-in.-tall rolling frame, processes the commands, controls the intended measurements, and finally delivers the data in standard forms, such as magnetic or punched tape or typed message.

The new instrumentation computer's main advantage is that it provides built-in interfaces with standard test instruments, according to Noel Eldred, vice-president of marketing, Hewlett-Packard's Dymec Div., Palo Alto, Calif.

The computer can also tolerate the same working environment as

that in which test instruments commonly operate. This includes temperatures ranging from 0°C to 55°C, line voltages that vary  $\pm 10\%$ , line frequencies between 40 and 70 Hz and humidity up to 95%. The unit has a 4096-word memory and a 1.6- $\mu$ s memory cycle.

The new instrumentation computer (designated HP Model 2116A) is an important step toward freeing engineers and production workers from the task of monitoring test instruments. Such easily relocated small computers can be expected to present an attractive alternative to the consoles of large time-shared computers.

### Poseidon okay means millions for electronics

Secretary of Defense Robert S. McNamara's recent announcement that the U.S. will begin production of the Poseidon missile will entail an estimated federal outlay of almost \$2 billion. The weapon's deployment may cost "several additional billions," according to McNamara. A large part of this total is likely to be spent on electronic equipment.

His announcement that he would recommend to Congress that the U.S. should employ the Poseidon comes in the face of "considerable evidence" that the Soviet Union is busy building an antimissile network. Despite this, McNamara has still taken no decision on whether to go ahead with the United States' Nike-X antiballistic missile system.

Poseidon is a large, submarine-launched missile able to penetrate sophisticated defense systems better than the Polaris missile, which it will eventually replace. Poseidon would be able to carry roughly twice the payload of a Polaris, and could thus be packed with a variety of

penetration devices designed to evade an enemy's defenses and slip through to its target.

The Defense Secretary said that deployment of Poseidon would mean completely re-engineering the firing tubes of the Polaris fleet. This and other "refitting" would cost "somewhat in excess" of 60 per cent of the initial cost of the Polaris submarines (about \$106 million each), McNamara said.

More than \$2 billion has been spent so far on developing the Nike-X missile defense system. Total deployment of an operational system could cost upwards of \$20 billion. The Administration defense planners are still not convinced that such a system is worth the money, since it would not prevent an all-out nuclear attack from killing tens of millions of U.S. citizens.

### Gemini-12 shows man can work in space

The signal for Project Apollo is green now that the successful four-day Gemini-12 mission has proved conclusively that, with proper equipment and by pacing himself, man can work efficiently in the weightlessness of outer space.

Major Edwin Aldrin, Jr., spent more than two hours outside his spacecraft. He plugged in electrical connections, turned bolts, cut cables, looped a tether around the nose bar, wiped his windshield and snapped a series of pictures.

Unlike previous astronauts, Maj. Aldrin did not become exhausted, did not perspire heavily and his helmet visor did not fog up. His task was made easier by frequent rest periods, and by the use of handrails for moving from place to place and of restraining tethers to keep him in position while he worked.

The first three-man Apollo space flight is now scheduled to be launched early next year.

### New Gatling gun shoots laser beams, not bullets

A four-barrel one-of-the-kind device with four neodymium lasers was delivered recently to Bethesda National Cancer Institute, Md., by the U.S. Army Missile Command from the Redstone Arsenal Center, Huntsville, Ala.



HP's latest progeny—a computer.

The four lasers are placed in a rotating head, driven by a servo motor. Knife switches make and break contact between each laser and a 5-kV charging capacitor. The speed of rotation is such that each laser is fired once every minute, achieving a total repetition rate of four 800-joule pulses per minute.

The laser beam is then guided through a series of mirrors and lenses which are installed in a flexible arm that covers an area roughly equivalent to a human body. Hence the laser beam used in treating malignant cancer, can scan a patient without moving either the patient or the laser source.

## Computer trainer solves problems, teaches users

A digital computer trainer, said to be the first to incorporate a full-scale, general-purpose computer rather than simulating the computer, is being used by the Army to train operators, technicians and programmers. The system actually performs a dual role. When it is not in use in the classroom to demonstrate the operations of military, scientific and business functions, it can be used as a normal general-purpose computer.

The basic system, which was built by Data Machines, Inc., of Newport Beach, Calif., consists of a 4- by 6-foot dynamic display, a Data/620 computer, and an input/output teletype unit.

The computer is a 16-bit, 4096- or 8192-word system-oriented machine. Contents of all the registers are displayed by illuminated push-buttons. Pushing a button will alter the contents of a register with visible results. An internal maintenance panel makes the data bus and critical timing and control signals available for observation on an oscilloscope.

The large display panel, easily visible up to 30 feet away, contains a color-coded computer organization diagram. As each instruction is executed, lighted areas of the display

show the register contents information flow and the cycle, phase and mode of operation.

The manufacturer says that the system incorporates the concepts of many general-purpose computers to make it an effective training aid, no matter what computer the student will eventually be working with. Operations that can be visually demonstrated include program interrupt applications and common addressing modes including direct, indirect, immediate, indexing, and relative addressing. Available options permit the demonstration of byte and extended addressing.

Basic software of the system includes assembler, library subroutines, AID, maintain diagnostics and Fortran.

Five systems were delivered to the Army under a development contract and are being used in a pilot program to develop a curriculum for a regular Army course. Another system was installed at Arizona State University.

## Gunn-effect device taken off market

International Semiconductor, Inc. Newburyport, Mass., has halted production of its gallium arsenide Gunn-effect oscillators, and has put the device back into the development laboratory.

None of the devices put on the market has lasted beyond 24 hours of operation, the company said.

The company reported that it has been unable to find suitable uniformly doped gallium arsenide material that could reproduce the oscillator's earlier test results. The oscillator was announced last August as the first commercially available Gunn-effect device.

## Cantilevered transducer to power pacemakers

A tiny ceramic wafer shaped like a cantilever beam may soon be powering implanted cardiac "pacemakers" with electrical energy derived from the heart itself.

The piezoelectric transducer, described at last week's Engineering in Medicine and Biology Conference in Cleveland, is unique in that the wafer does not need to be in contact with the heart.

The device, housed in a package only 10 cm<sup>3</sup> in volume, consists essentially of a beam weighted at one end and anchored at the other to a crystal operating in the resonant, rather than the deflection, mode.

The mechanical motion of the heartbeat causes the beam to vibrate and thus generate a train of electrical impulses.

At a rate of 80 pulses per minute, with a movement equivalent to that of a dog's heart, the maximum output from the experimental device is 4 volts and 160  $\mu$ w.

Professor Ko, director of Case Institute's Microelectronic Laboratory for Biomedical Sciences in Cleveland, which developed the energy conversion device, said the power output is more than enough to drive over long periods the "pacemakers" that have been developed to stimulate electrically the activity of a failing heart.

## Superconductive magnet on sale off the shelf

Radio Corporation of America has announced that it is offering the industry's first off-the-shelf line of superconductive magnets.

Ranging in field strengths from 60 to 125 kilogauss, the high-field superconductive magnets will be marketed for research in such areas as high energy physics, plasma phenomena, medicine and biology.

The starting price of the new magnets, which use RCA's Vapodep niobium tin superconductive ribbon, is about \$8500.

## Satellite-to-aircraft communications tested

The practicability of satellite-to-aircraft communications is under investigation by the U. S. Air Force.

Experiments to determine the atmosphere's effect on radio signals transmitted from an orbiting satellite to an airborne receiver at rates from 128,000 to billions of impulses per second have been undertaken by the Air Force Systems Command at Wright-Patterson AFB, Ohio. Special radio receiving equipment aboard a KC-135 jet aircraft will intercept 360-MHz signals transmitted continuously from the two-year-old orbiting geophysical observatory.





# mark it well

This is a new sign of leadership in the electronics industry. And part of an old story, too. For when commercial radio broadcasting was making its first feeble sounds over 40 years ago, General Instrument Corporation was already being heard from. Even in those days, GI was a principal designer and manufacturer of quality electronic components for the industry.

Today, virtually every kind of electronic equipment operating on earth, flying around it, or beneath its seas contains General Instrument designed and manufactured component parts. But in an industry that has only now really begun to exercise its full potential, leadership demands even more... It demands the ability not only to keep abreast of change, but constantly to initiate it. And GI is doing just that.

For example, we are today pioneering a revolutionary new concept in microcircuit technology (MOS) which is already beginning to change the shape of electronic things to come.

Our new mark is for the years ahead... a time that will be marked by change as it has never been before. We hope that those who know General Instrument and those who will come to know us will also come to recognize our mark. For we intend it to represent a company constantly in the forefront of change... constantly making its mark of leadership on the electronic future.



MODEL SELECTION CHART

Voltage	Amps.	Model	Price	Amps.	Model	Price	Amps.	Model	Price	Amps.	Model	Price
5-9	4	QSB 6- 4	\$115	8	QSB 6- 8	\$170	15	QSB 6-15	\$225*	6	QSB 6-30	\$295*
9-18	2	QSB 12- 2	115	4	QSB 12- 4	170	8	QSB 12- 8	225*	15	QSB 12-15	295*
13-26	1.5	QSB 18-1.5	115	3	QSB 18- 3	170	6	QSB 18- 6	225*	12	QSB 18-12	295*
18-36	1	QSB-28- 1	115	2	QSB 28- 2	170	4	QSB 28- 4	225*	8	QSB 28- 8	295*

\* For optional voltmeter and ammeter add \$30.

# Sorensen OEM/Lab. Power Supply

**New Sorensen QSB's give you OEM prices with laboratory performance.**

The Sorensen QSB Series, medium range power supplies available in 25, 50, 100 watt models (6, 12, 18 and 28 Vdc nominal) provide laboratory performance in compact bench or rack packages that are ideally suited for budget-type OEM computer, communications and test instrumentation applications. Features such as: precise regulation ( $\pm .005\%$  line and load for most models), low ripple (250  $\mu\text{V}$  rms, 1 mV peak to peak), response time (30  $\mu\text{s}$ ), all combined with prices starting at \$115. Other features include: inputs

105-125/200-240/210-250 Vac, 47-420Hz; current regulation  $\pm .01\%$ ; temp. range 0-71°C; temp. coefficient .015%/°C; stability .025%/8 hrs.; remote programming and sensing; series/parallel operation. For additional QSB details, or for data on other standard/custom power supplies, AC line regulators or frequency changers, contact your local Sorensen representative, or Raytheon Company, Sorensen Operation, Richards Ave., Norwalk, Connecticut 06856. Telephone: 203-838-6571. TWX 710 468-2940.



ON READER-SERVICE CARD CIRCLE 12

# Researchers push IC performance higher

Focus is on isolation techniques, complementary transistors, small geometries and electron guns.

**Rene' Colen**  
Microelectronics Editor

Today's integrated circuits may not be sophisticated enough, fast enough or have high enough voltages to satisfy many designers, but the gap is being closed fast.

Though much of the work is still in the laboratory stage, material and process researchers are making major headway in the areas of multidevice manufacture, techniques and isolation methods.

Progress in these three areas drew considerable attention at the recent International Electron Devices Meeting in Washington, D. C.:

■ **Multidevice manufacture**—Devices, previously separated by process incompatibilities, are now being effectively mated. Complementary pnp and npn transistors are diffused on the same chip; unipolar (MOS-FET) transistors are combined with bipolars; and thin-film resistors are deposited on monolithic chips. The result gives the microcircuit designer more flexibility.

■ **Manufacturing techniques**—Devices are becoming so small that more complex lithographic techniques are necessary. Electron and ion bombardment of materials may resolve resolution and processing problems.

■ **Isolation methods**—Parasitics, generally associated with junction isolation, are now being eliminated

with new isolating techniques that employ glass and ceramic insulators. Key advantages are higher operating speeds, voltages and power dissipations.

## Npn-pnp pairs make great strides

Lateral pnp transistors, like the Westinghouse device that is representationally shown in Fig. 1, provide greater design flexibility for the integrated circuit designer. As a result, an unusual amount of attention was centered on the manufacture of integrated circuits with complementary transistors. In summary, the devices range from the practical to the promising, depending on process sophistication, and thus cost. Typical specifications for lateral pnps varied from  $h_{FE} \approx 200$  and  $f_T \approx 4$  MHz (Westinghouse) to  $h_{FE} \approx 23$  and  $f_T \approx 225$  MHz (Radiation Inc.).

Some of the circuit advantages of using complementary transistors were discussed at length in a paper from Texas Instruments.

One example, a J-K flip-flop, dissipates less than 300 microwatts with rise and fall times less than  $1 \mu s$  and  $1.5 \mu s$ , respectively. To achieve this, transistor-transistor logic (TTL) was used with multiple emitter inputs and the complementary pairs at the outputs.

A few papers also took note of recent work on complementary uni-

polar pairs. One described a Westinghouse 32-bit memory prototype that uses complementary metal-oxide-silicon field-effect transistors (MOS-FETs). Even after a 5000-hour life test at  $150^\circ C$ , the devices (Fig. 2) were found to be stable. Gate threshold voltages are 3.8 V for the n-channel MOS-FET and 6.4 V for the p-channel device.

Fairchild stirred interest with a discussion of the relative merits of double-diffused, pinched-base, MOS and thin-film resistors. The conclusion was that for high resistance ( $25 \text{ k}\Omega/\text{square}$ ) and high resistance-to-capacitance ( $50 \text{ k}\Omega/\text{pF}/\text{mil}^2$ ) ratios, the MOS resistor is the optimum choice because of its high reproducibility and low temperature coefficient. A circuit that combines MOS resistors with bipolars was constructed with good results. One particular advantage of this method is that MOS resistors can be changed in value by varying their gate supply voltage. Thus, the power-speed trade-off of the circuit can be optimized to fit over-all system requirements.

## Devices become smaller yet

As device size dwindles, severe limits are imposed on present process technology.

Npn silicon transistors with an  $f_T$  of 7 GHz in which the emitter stripe width was 1 micron and the base thickness less than 0.15 micron were reported by Bell Telephone Laboratories. In the account it was stressed that a major fabrication

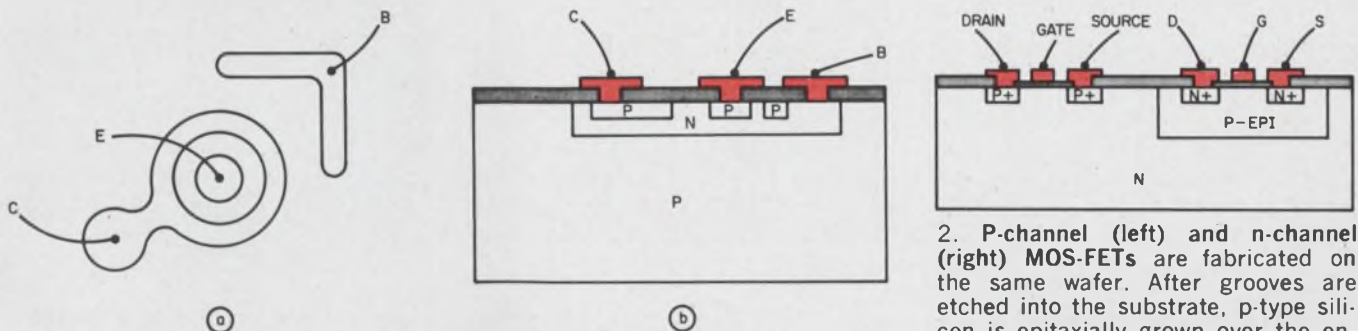

1. Lateral pnp transistor showing top (a) and representational cross-sectional (b) views. This one is made with existing semiconductor processes and no additional fabrication steps.

2. P-channel (left) and n-channel (right) MOS-FETs are fabricated on the same wafer. After grooves are etched into the substrate, p-type silicon is epitaxially grown over the entire surface. Lapping and polishing are followed by two diffusions to form the respective drains and sources.

(better ICs, *continued*)

problem was the inadequate resolution of the photoresist (KTRF). This was partly due to the creation of standing-wave patterns by light reflecting from the silicon surface. It was overcome by depositing a thin metal layer beneath the photoresist to absorb the light energy.

Meanwhile, scientists at Westinghouse propose to eliminate the photoresist completely. They have found that electron bombardment of thermally grown silicon dioxide increases the etching rate of silicon dioxide by a factor of three. Ten transistors were fabricated on a 1/4-in. silicon chip. The n-type silicon substrate, coated with silicon dioxide, was exposed to a flood-type electron gun through a set of simple

metal masks. The process, shown in Fig. 3, resulted in transistors with a  $\beta$  spread of 20 to 100 (not optimized).

Other Westinghouse researchers have used electron beams to expose the photoresist. Small-geometry transistors were formed with emitter-contact areas no larger than 1 micron by 1 micron. This work eliminates the use of photomasks and yet does not depend on complex optical-mechanical systems.

Ion bombardment of silicon, as described by Hughes Research Laboratories, simplifies fabrication of MOS devices. The process calls for growing the  $\text{SiO}_2$  insulation, depositing a metalization layer over the entire surface, and then etching away the source and drain areas to expose the silicon to the ion bombardment. After bombardment, the

source and drain contacts are deposited. The resulting devices exhibit extremely low gate-to-drain capacitances, since the gates do not overlap the diffused regions.

### Circuits are faster and faster

Few circuits were discussed. Most of them were not at a production stage, but they do indicate future possibilities. For example, a logic gate with switching speeds in excess of 400 picoseconds was reported on by IBM Components. The circuit (see photo), uses regular junction isolation, small geometries and two-level metalization. Important in this work is the fact that the transistors themselves have cut-off frequencies of 7.15 GHz when  $I_C = 20$  mA and  $V_{CE} = 2.0$  volts. Little more than a year ago, discrete transistors in the laboratory had barely attained such characteristics.

High-frequency transistors in integrated circuits seemed to be the order of the day. Philco-Ford reported on complex arrays that use 3-GHz transistors in the basic cell. Each cell consists of two 3-input ECL gates. The gates have a propagation speed of 0.4 ns with average power dissipation of 60 mW.

### New isolation methods take a bow

Among the various new isolation techniques are Fairchild's Mesa (glass), Motorola's Epic-G (glass), and Texas Instruments' ceramic dielectric isolation. All of them may lead to the virtual elimination of the parasitic problems associated with junction-isolated devices (see

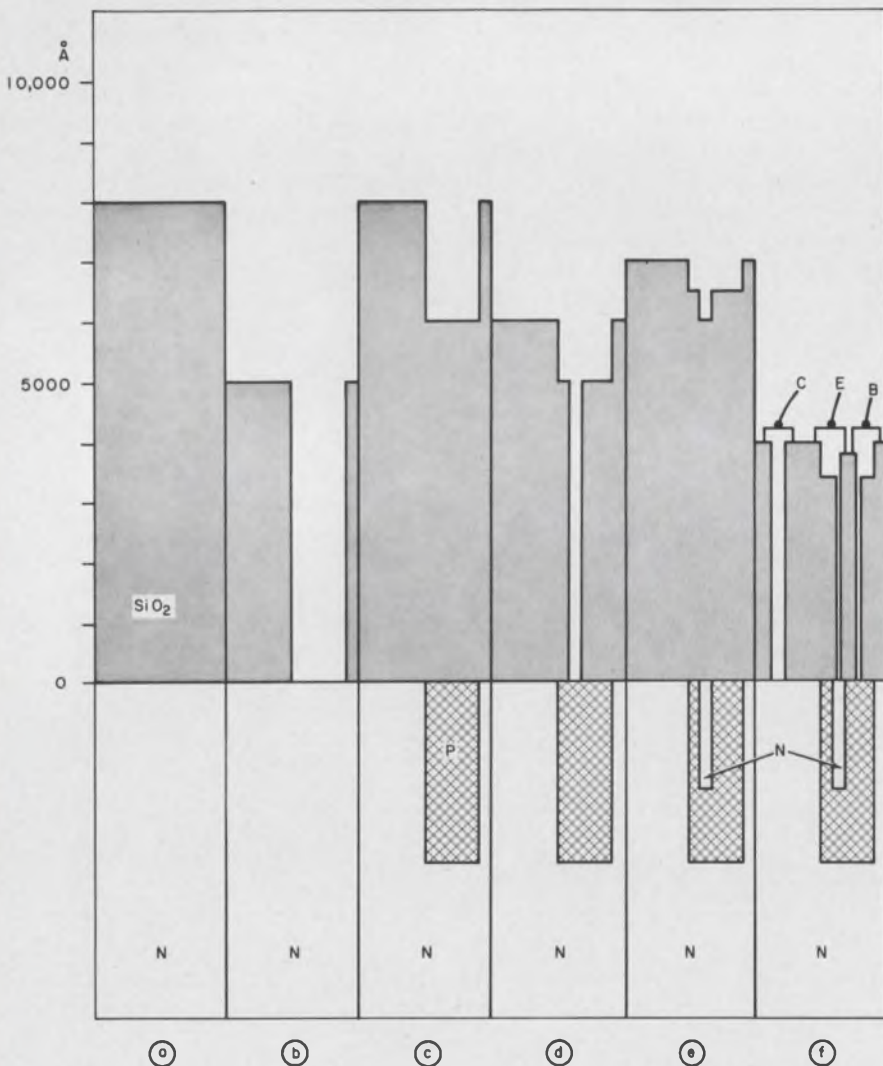

3. Electron bombardment of silicon dioxide eliminates photoresist. The steps are (a) grow oxide layer over substrate; (b) cover with base mask (metal), bombard and etch; (c) dif-

fuse-in base and regrow insulation; (d) cover with emitter mask, bombard and etch; (e) diffuse-in emitter and regrow insulation; (f) cover with metalization mask, bombard, etch, and metalize.

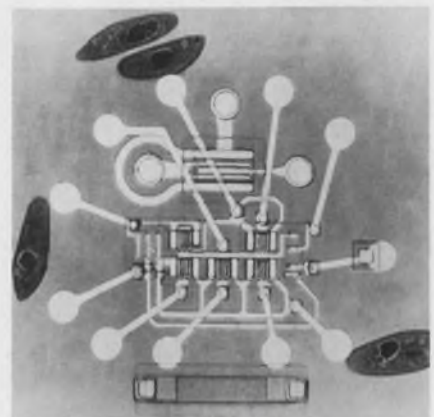

Paramecia, single-celled animals, dwarf the small-geometry transistors that make up this high-speed logic circuit with a switching speed of 400 ps, that was developed by IBM Components Div. researchers.

# When reliability is the rule

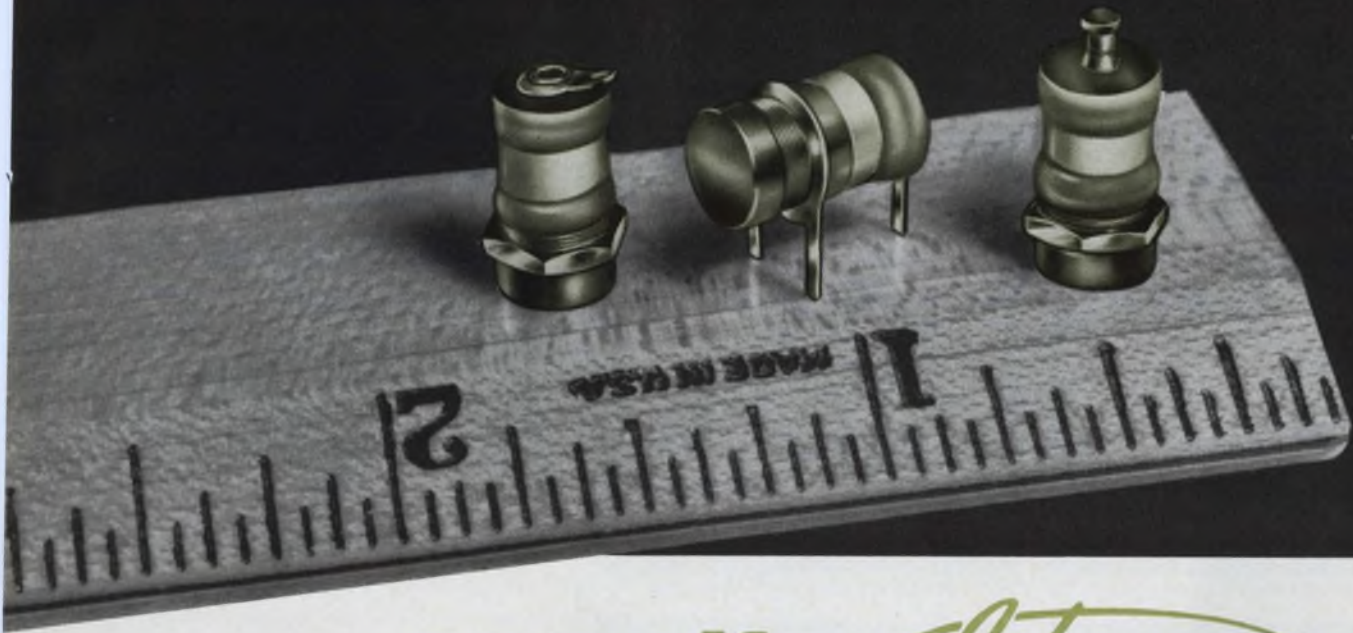

...specify *Johanson*

## HIGH Q, HIGH FREQUENCY VARIABLE AIR CAPACITORS

An extra margin of reliability is built into Johanson Miniature Variable Air Capacitors.

This versatile series provides, in miniature size, exceptionally high Q, superior ruggedness for protection against shock and vibration,  $-55^{\circ}\text{C}$  to  $+125^{\circ}\text{C}$  operating temperature range, protection against fungus, salt spray and humidity . . . plus all the other construction and performance features that have made Johanson capacitors the industry standard for excellence.

No compromise is made in materials, design or workmanship assuring, in all cases, the finest performance available for the price.

Test Johanson capacitors yourself — under your worst-case test conditions.

**Write Today for Complete Catalog, Prices.**

**Features 570° Solder  
Prevents distortion. Not affected by  
conventional soldering temperatures.**

**THE JOHANSON  
2950 SERIES  
VARIABLE AIR CAPACITORS  
(ILLUSTRATED)**

**SPECIFICATIONS:**

CAPACITANCE RANGE: . . . 0.8 — 10.0 pf.  
DIELECTRIC  
WITHSTANDING VOLTAGE: Rating 250 vdc  
Breakdown  $> 500$  vdc  
Q: . . . . .  $> 2000$  @ 100 mc  
TEMPERATURE  
COEFFICIENT: . . . . .  $0 \pm 20$  ppm/ $^{\circ}\text{C}$   
INSULATION RESISTANCE:  $> 10^4$  megohms @  
500 vdc  
ROTATIONAL LIFE: . . . . .  $> 800$  revolutions  
rotor screw  
THERMAL SHOCK: . . . . .  $65^{\circ}\text{C}$  to  $+125^{\circ}\text{C}$   
SHOCK: . . . . . 50 g's 11 millisecc.  
VIBRATION: . . . . . 15 g's 10-2000 cps

Complete data available on request.

The Complete Johanson line includes variable air capacitors ranging from .1-1 pf to 6.0 — 325 pf. also high-reliability and non-magnetic types.

*Johanson* **MANUFACTURING CORPORATION**

400 Rockaway Valley Road, Boonton, N. J. 07005

Phone (201) 334-2676

# Did You Know Sprague Makes 32 Types of Foil Tantalum Capacitors?

## 125 C TUBULAR TANTALEX® CAPACITORS



- Type 120D polarized plain-foil
- Type 121D non-polarized plain-foil
- Type 122D polarized etched-foil
- Type 123D non-polarized etched-foil

ASK FOR BULLETIN 3602C

ON READER-SERVICE CIRCLE 821

## 85 C TUBULAR TANTALEX® CAPACITORS



- Type 110D polarized plain-foil
- Type 111D non-polarized plain-foil
- Type 112D polarized etched-foil
- Type 113D non-polarized etched-foil

ASK FOR BULLETIN 3601C

ON READER-SERVICE CIRCLE 822

## RECTANGULAR TANTALEX® CAPACITORS



- Type 300D polarized plain-foil
- Type 301D non-polarized plain-foil
- Type 302D polarized etched-foil
- Type 303D non-polarized etched-foil

ASK FOR BULLETIN 3650

ON READER-SERVICE CIRCLE 823

## TUBULAR TANTALUM CAPACITORS TO MIL-C-3965C

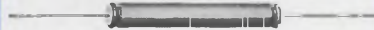

- CL20, CL21 125 C polarized etched-foil
- CL22, CL23 125 C non-polarized etched-foil
- CL24, CL25 85 C polarized etched-foil
- CL26, CL27 85 C non-polarized etched-foil
- CL30, CL31 125 C polarized plain-foil
- CL32, CL33 125 C non-polarized plain-foil
- CL34, CL35 85 C polarized plain-foil
- CL36, CL37 85 C non-polarized plain-foil

ON READER-SERVICE CIRCLE 824

## RECTANGULAR TANTALUM CAPACITORS TO MIL-C-3965C



- CL51 polarized plain-foil
- CL52 non-polarized plain-foil
- CL53 polarized etched-foil
- CL54 non-polarized etched-foil

ON READER-SERVICE CIRCLE 825

For comprehensive engineering bulletins on the capacitor types in which you are interested, write to:  
Technical Literature Service  
Sprague Electric Company  
347 Marshall Street  
North Adams, Mass. 01248

45C-1165

**SPRAGUE**  
THE MARK OF RELIABILITY

Sprague and ® are registered trademarks of the Sprague Electric Co.

## NEWS

(better ICs, continued)

"Better isolation boosts IC performance," ED 21, Sept. 13, 1966, pp. 17-23).

In the Mesa process, a completed wafer and a compatible substrate material sandwich a thin, high-purity glass layer. The back of the wafer is coated with photoresist, masked, exposed, and etched. Isolating moats are etched in the silicon down to the interconnecting metallization and the glass. The result (Fig. 4a) is a series of active-device islands. These are electrically interconnected and are mounted face-down on a glass layer that is supported by the substrate. Contacts can be made down on the original metallization or, for the collector, directly to the back of the chip. This produces a lower  $V_{SAT}$  and collector resistance. An additional advantage is the increased thermal dissipation due to the conductive paths along the top and bottom surfaces of the devices.

In the TI (Fig. 4b) and Epic-G processes, the completed wafers are first etched to form islands of active devices and then a layer of dielectric material—ceramic for TI and glass for Motorola—is used to fill the moats around each island. ■ ■

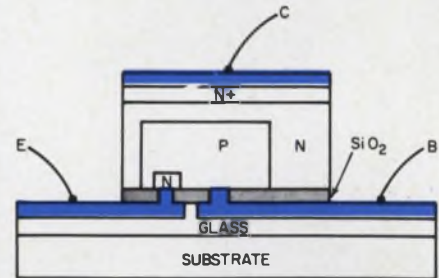

(a)

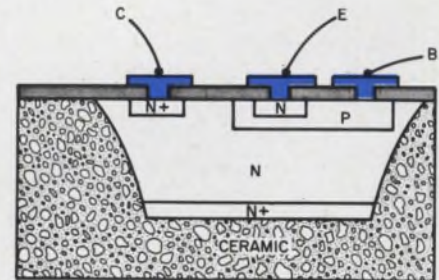

(b)

4. Mesa isolated device (a) is shown with its collector contact on top, while the ceramic dielectric isolated device (b) uses the more standard collector connection. Actually, each can be interchanged as circuit needs dictate.

# Mighty SCEPTRE analyzes any circuit

## A computer program for automatic analysis of simulated circuits is disclosed at NEREM.

Roger Kenneth Field  
News Editor

Two years ago Bill Bohan and three colleagues at IBM set out to create an extremely flexible computer program for the automatic analysis of circuits. It was to analyze transient responses and steady-state operation of any circuit precisely; yet it was to require absolutely no knowledge of programming on the part of its user. Last month they delivered the program to their customer, the Air Force Weapons Laboratory. Next month it will be made available to the engineering community.

The program, called SCEPTRE (Systems for Circuit Evaluation and Prediction of Transient Radiation Effects), uses an ordinary language, not Fortran and not a complicated machine-code. In using SCEPTRE, the designer does not have to know the design equations of the circuit that he wishes to analyze; he simply chooses a circuit configuration, and inserts arbitrary component values. The computer, presently an IBM 7094, then writes the design equations for the circuit and solves them.

Its output can be presented as either a tabular listing of data or a graph made by a plotter. The output can be any variable versus time, or even any variable as a function of any other variable.

### A simple input tells all

Thus SCEPTRE's input could be nothing more complicated than a schematic with assigned component values. Yet its output could be the circuit's gain, the power dissipated in any of its elements, the transfer function of the circuit, or almost anything the designer can define. Of course, like other programs, it can determine the voltage across, or current through any element. In each case the user simply defines the parameter that he wants, such

as  $V_{in}/V_{out}$ , and then the program automatically calculates it.

Says Bohan: "This could be quite useful, for instance, in analyzing an inverter circuit under an intense pulse of radiation. Here, the leakage current,  $i_{pp}$ , depends on the reverse bias of a particular transistor. If that current is analyzed simply as a function of time, the circuit appears to saturate for roughly 200 ns. But if the current,  $i_{pp}$ , is a function of both time and voltage, it barely saturates at all and then it promptly tails off. This cannot be done in the programs that preceded SCEPTRE."

### Active components from passive

However, SCEPTRE doesn't do everything. It directly accepts only resistors, capacitors, inductors, mutual inductors, and current and voltage sources. Transistors, diodes, vacuum tubes and all other active components must be specified by equivalent circuits made of the com-

ponents that the program will accept. The program will, however, store for instant use equivalent circuit models, which can be altered or replaced at will. Thus SCEPTRE can never become obsolete simply because somebody decides on a better equivalent circuit model for a transistor.

### No dead models

In many other circuit-analysis programs, such as CIRCUS (by Boeing) and NET-1 (Los Alamos), fixed-topology equivalent circuit models for transistors, diodes (and in CIRCUS, for four-layered devices) were built into the program. In those programs the user might direct the computer to insert the model of transistor 2N7115 into the circuit. The computer then instantly calls up its model of that transistor, but such a model always makes a number of simplifying assumptions. And these models are an integral part of those programs, and, as such, they are exceedingly hard to change.

In SCEPTRE, model-making is

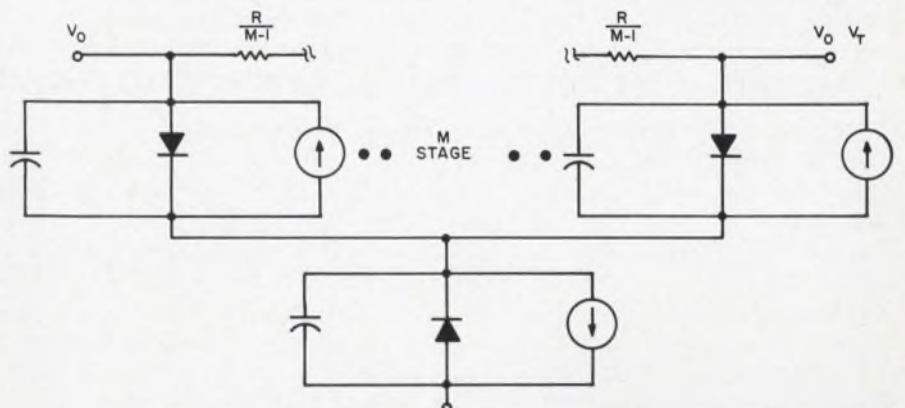
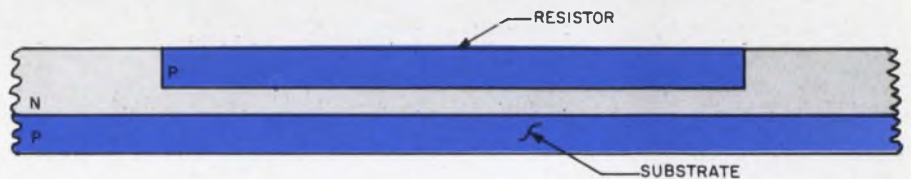

SCEPTRE can precisely simulate an integrated circuit resistor. The diffused resistor (above) is represented by M stages (below) of simulated diodes. Each contains a resistor, capacitor, diode and current source.

(SCEPTRE, *continued*)

left to the user, but once he makes a model he can store it and retrieve it at will. And he can update it to match actual improvements in the devices or he can refine the model to suit his particular problem. The models are defined according to the same rules that define the program. They allow an arbitrary configuration and the user controls it. This could be enormously useful in integrated circuits where the user might want to define and store a model of an entire monolithic chip.

According to Bohan, SCEPTRE's creators have eliminated virtually all restrictions on the circuit configuration. For example, in SCEPTRE's predecessor, PREDICT, every current or voltage source had to have an associated element either in series or shunt. In NET-1, nonlinearities must take place within the equivalent circuit model. These restrictions do not exist in SCEPTRE. On the contrary, it allows a variety of source dependencies: the user can make a current or voltage source linearly dependent on the current through, or voltage across, a resistor somewhere else in the circuit. This allows the circuit designer to use the small-signal family of equivalent circuits, such as the h- or y-parameter equivalent circuits. "The earlier programs handled these with something called a computational delay. But that method introduced inaccuracies, inaccuracies that were often catastrophic, into the answer," says Bohan. SCEPTRE is free of these inaccuracies. He also noted that SCEPTRE can digest the Linvill model equivalent circuit.

These source dependencies can also make analysis of logic circuits swift and clean. For example, the computer can be instructed to stop when  $V_1$  exceeds two volts and  $V_2$  exceeds five volts. Alternatively, it can stop when either  $V_1$  exceeds two volts or  $V_2$  exceeds five volts.

#### Fortran helps

Although the SCEPTRE user need not know machine codes and special computer languages, the more knowledgeable user can create his own subprograms to be used in conjunction with the main program, if he is versed in Fortran. This could be handy, says Bohan, for the analysis of otherwise awkward problems. For example, suppose a train of pulses is to be analyzed:

"Each pulse in the pulse train can be characterized by a set of parameters," Bohan comments. "The voltage source can be entered in a subprogram, which is written in Fortran. Let's say you wish to analyze the circuit's response to pulses of various widths. Rather than rerun your program at each of a number of pulse widths, you can simply make the pulse width a variable in the subprogram. One uninterrupted run then yields information about the effects of a broad range of pulse widths."

#### Easy as child's play

SCEPTRE embodies a number of features that make it extremely easy to use:

- It accepts inputs in a variety of forms (tables, graphs, charts, etc.).
- Elements can have arbitrary names (i.e.; a resistor can be labelled  $R_1$ ,  $R_A$ ,  $R_{im}$ , etc. . .).
- Component values can be specified in a variety of forms (i.e.; 10a, E1a, 2x5a, etc. . .).

- The user can select any system of units.

- Frequently used equations can be couched in a set of dummy variables and used by simply calling out these variables.

- The program contains a "diode" defined by the standard diode equation:  $j = i_s(e^{qV} - 1)$ . To use it, the diode is merely called up, given a name, a value of the saturation current,  $i_s$ , and a value of  $\theta$ .

- SCEPTRE automatically calculates the initial conditions for its user.

SCEPTRE will be available for the IBM 7094 around January 1, 1967, to users who get clearance from:

*Lt. Gary Pritchard, WLRET  
U.S. Air Force Weapons Lab  
Kirtland Air Force Base  
Albuquerque, N. M. 87118*

After obtaining this permission, the tape and manuals can be obtained from:

*Harry Mathers  
IBM  
Radiation Effects Department  
Owego, N. Y. 13126*

A version of SCEPTRE for the IBM 360 should be ready by the end of 1967.

Bill Bohan exudes confidence when he discusses SCEPTRE: "I feel certain that the next generation of circuit designers will use SCEPTRE and similar programs as routinely as present designers use slide rules. SCEPTRE can be a powerful tool in the hands of a good designer, but it still takes a good designer to get good circuits."

This program was described in detail recently at NEREM, Boston. The NEREM Record, a compilation of the conference papers, is available from its publisher, Ernest Witschi, Jr., Newton, Mass. ■ ■

## Josephson effect measures physical constant

A group of scientists at the University of Pennsylvania, Philadelphia, are planning to use the Josephson effect\* to measure accurately a fundamental physical constant. The constant is  $e/h$ , the ratio of the charge on an electron to Planck's constant.

The phenomenon that makes this measurement possible is an effect described by Brian Josephson to explain the action of currents through and voltages across hair-like gaps in

superconductors.

Josephson, on the basis of theoretical considerations, predicted that, if two superconductors could be brought close enough together, a current could be made to flow across the gap between them. Under certain conditions a voltage appears across the gap and high-frequency radiation emanates from it.

This radiation, he predicted, would have a frequency precisely equal to  $2eV/h$ , where  $V$  is the

measured voltage across the gap. Messrs. Langenberg, Parker and Taylor, working at the University's Laboratory for Research on the Structure of Matter, are using a Hewlett-Packard counter to measure the frequency, and a Julie potentiometer to measure the voltage. ■ ■

\*See Donald N. Langenberg *et al.*, "The Josephson Effects," *Scientific American*, CCXIV, No. 5 (May, 1966), pp. 30-39.





This is a naked YAES terminal.



We've stripped it to show why Burndy YAES Insulug<sup>®</sup> terminals are unique.

Once the insulation is off, it's easy to see that this terminal is a one-piece unit. That's a Burndy exclusive. Look closely and you'll see that the seam on the terminal body has been brazed. Another unique Burndy feature. And all YAES terminals are *fully* plated. You won't find any exposed copper edges. In fact, there are no unplated edges where the terminal is separated from the carrier. Look inside the terminal body, too. The surface has been serrated to insure intimate contact.

Additionally, each terminal is marked with the range of wire acceptable. As a double check, the tough, nylon insulation is color-coded to indicate wire size.

Installation is quick and easy with either MS 25037 or MR 8-83 ratchet-controlled hand tools.

Automatic installation tools are available, too. Burndy's Bandolug<sup>®</sup> equipment, the SME and the SME 10, handles wire ranging from 22 to 10. And they handle them quickly, simply and inexpensively. More so than any other tools.

Burndy YAES terminals meet both the Class I and II requirements of MIL-T-7928 when installed with appropriate tools.

There really is more than meets the eye when it comes to Insulug terminals and tools. Write for Bulletin YAES-66 and see for yourself.



INTERNATIONAL SALES HEADQUARTERS AND MANUFACTURING FACILITIES:

CANADA: Scarboro, Ontario / ENGLAND: St. Helens, Lancs. / BELGIUM: Mechelen / MEXICO: Naucalpan de Juarez / BRAZIL: Sao Paulo / JAPAN: Tokyo / Sales Offices in Other Major Cities

ON READER-SERVICE CARD CIRCLE 14

# The connector Thing

A periodical periodical designed, quite frankly, to further the sales of Microdot connectors and cables. Published entirely in the interest of profit.

# WIN

a pot of gold!



## Lepra/Cons Unite!

In celebration of the introduction of the highest density coax rack and panel and multi-pin connectors on the market today (the broadened Lepra/Con line), Microdot is awarding to five lucky winners (see contest rules below) five simulated gold pots (of the chamber variety) with your, repeat your, name emblazoned thereon. Perfect for desk top decoration. First, let's talk Lepra/Con.

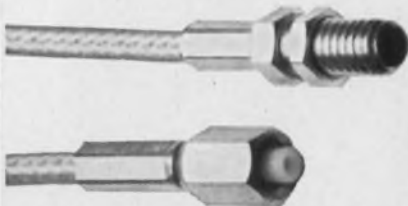

Through its stringent policy—"Never Look Back, They May Be Gaining On You"—Microdot has expanded its Lepra/Con line of ultraminiature connectors... tiny little coax jobs with an OD of only  $\frac{1}{8}$  inch and a mated length of only one inch. But why stop there.

Now there's the Lepra/Con multi-pin... all crimp, no solder; high density; uses Twist/Con pin contacts; low cost; and it's the smallest full 50 ohm coax available today.

Now there's the Lepra/Con Twist/Con (say it fast fifty times) which combines all of the above advantages in a rack and panel coax connector.

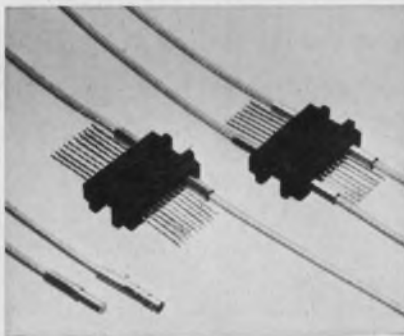

Now there's the slide-on Lepra/Con for singular ease of installation.

And, of course, there is still the old Lepra/Con (if you can call six months old).



## HOW TO WIN YOUR POT OF GOLD

1. First, of course, decide whether you actually want a pot of gold. In all likelihood, your place of employment has far more up-to-date facilities. However, if you decide a pot is for you, go to step two.
2. Write down all the applications you can think of for the Lepra/Con line on your job. And think about it. There are probably more than the twelve you can jot down immediately without hardly thinking at all.
3. Call your Microdot representative directly or drop him a note giving him all your suggested applications, your name, company, title, address and telephone number. Do not call or write Microdot. We only make connectors. Our reps sell them. Hopefully.
4. A jury of six will judge all entries for originality, number of applications and neatness. The five best will each be awarded the simulated gold pot (of the chamber variety).
5. All entrants will win a free picture of our beloved Candy inscribed passionately and personally to you.
6. This whole shoddy affair draws to an end on December 31, 1966. Happy New Year!
7. This entire offer is not valid in any state, county, township or ward where such carryings-on are generally frowned upon.



**Alabama, Tennessee**  
REP. INC.  
8100 South Memorial Parkway, Huntsville, Ala.  
205-881-9270

**Arizona**  
COMPAR ROCKY MOUNTAIN AGENTS, INC.  
84 West First Street, Scottsdale  
602-947-4336

**California (Northern), Nevada**  
PETERS-de LAET INC.  
1606 Rollins Road, Burlingame, Calif.  
415-697-1800

**California (Southern)**  
Do call MICRODOT: 213-682-3351

**Canada**  
DOUGLAS RANDALL (CANADA) LTD.  
126 Manville Road, Scarborough, Ontario  
416-421-5970

**Colorado, Utah**  
COMPAR ROCKY MOUNTAIN AGENTS, INC.  
300 E. Hampden, Suite 315, Englewood, Colo.  
303-781-0912

**Florida**  
GEARTNER ASSOCIATES, INC.  
235 Lincoln Road, Miami Beach  
305-531-0200  
GEARTNER ASSOCIATES, INC.  
2101 Mohawk Trail, Maitland  
305-647-4000

**Georgia**  
REP. INC.  
1483 Monroe Drive, N.E., Atlanta  
404-876-1591

**Illinois, Wisconsin**  
CARLSON ELECTRONIC SALES  
7448 North Harlem Avenue, Chicago  
312-774-0277

**Indiana**  
O. E. M. SALES COMPANY  
4165 Millersville Road, Indianapolis  
317-545-1267

**Kansas**  
IMPALA, INC.  
6917 W. 76th Street, Overland Park  
913-648-6901

**Long Island**  
MICRODOT INC. (Philip J. Dolan)  
P. O. Box 815, Westbury, L.I., N. Y.  
516-333-4664

**Maryland, Virginia, Washington D. C., Carolinas**  
WARREN MOUNT CO.  
7735 Old Georgetown Road, Bethesda, Md.  
202-657-9312

**Michigan**  
ROMARC  
696 Adams, Plymouth  
313-455-0300

**Minnesota, Iowa**  
HOWARD W. CARLSON  
100 N. 7th Street, Room 606, Minneapolis  
612-336-2236

**Missouri**  
IMPALA, INC.  
47 Village Square Shopping Center, Hazelwood  
314-522-1600

**New England**  
MICRODOT INC. (Ernest W. Smith)  
P.O. Box 309, Bedford, Mass.  
617-244-8434

**New Mexico**  
COMPAR ROCKY MOUNTAIN AGENTS, INC.  
2125 San Mateo Boulevard N.E., Albuquerque  
505-265-1020

**New York**  
ADVANCED COMPONENTS CORP., INC.  
119 Luther Avenue, Liverpool  
315-472-7880

**Ohio**  
RICHARD P. CALVIN & ASSOCIATES  
40 Southmoor Circle, Dayton  
513-299-4144

**Pennsylvania**  
WARREN MOUNT CO.  
837 State Road, Andalusia, Pa.  
215-788-2272

**Texas, Arkansas, Louisiana, Oklahoma, Miss.**  
ROBERT R. THOMAS CO.  
8616 Northwest Plaza Drive,  
Suite 207, Dallas  
214-363-9591  
ROBERT R. THOMAS CO.  
4031 Broadway, Suite 105,  
Houston / 713-644-2369

**Washington, Oregon**  
RAY OVER SALES  
1615 103rd Avenue, S.E.,  
Bellevue, Wash.  
206-454-9187



## MICRODOT INC.

220 Pasadena Avenue  
South Pasadena, Calif. 91030

*Twist/Con and Lepra/Con are registered trademarks of Microdot Inc.*

ON READER-SERVICE CARD CIRCLE 15

Defense spending leveling off



### Survey confirms federal R&D trends

A National Science Foundation (NSF) survey of federal and some industrial spending and planning for research and development in Fiscal 1965-1967 has largely confirmed what was foreshadowed in the budget for Fiscal 1967. All the major trends predicted then have been proved correct. The big spenders on R&D will still be the Defense Department, NASA and the Atomic Energy Commission, though their funding is leveling off. Twenty-eight other agencies account for only 16 per cent of federal R&D funding, "but there is an underlying growth trend in the R&D activities of these 28 agencies," the survey says. Federal research and development emphasis is growing in the areas of health, transportation, environmental pollution control, development of natural resources and education technology, the survey says. The bulk of the nation's money on R&D comes from Washington (64%), but most of the work is performed outside the Government—63 per cent by industry, 16 per cent by educational and nonprofit institutions. This may be compared with 1956, when a third of the Government's research and development was done on its own facilities, and underlines the Government's increasing tendency to "contract out."

The NSF, itself a government agency, points out that though the amount of federal R&D performed by the Government has dwindled since the end of World War II, so too has industry's share of federal R&D dropped slightly from a 1956 high point of 80 per cent of all its extramural work. What the raw figures, however, do not show is that this year, for the first time, as industrial contracts partly replace the more traditional grants to colleges and universities, industry is becoming a major factor in several growing areas of research and development, such as air pollution control and education technology. Individual NSF officials rather than the survey itself back up statements by agency spokesmen to the effect

# Washington Report

S. DAVID PURSGLOVE,  
WASHINGTON EDITOR

that industry will be playing an ever greater role in the once small, university-oriented programs that are now destined to accelerate rapidly.

The demands of the war in Vietnam do not seem to be affecting the general pattern, but have had some effect on federal R&D programs. This has been confined mostly to the activities of the military and space agencies, where funds have been shifted from long-range or unessential projects or strategic-weapons development to programs of more immediate application to the needs of Vietnam. Though the war has also had its impact on the work of the 28 smaller agencies, this is much less clear from the survey.

The survey, which is based on the budget of last January, reflects fairly fully administrative actions since then, but does not take into account the effect of legislation by the last session of the Congress.

### What follows Apollo keeps D. C. a-buzz

Almost every quarter in Washington, technical and nontechnical alike, is intrigued to know whether the Budget Bureau knows what NASA will do after Apollo. If it does, it is part of a very select group that includes only the topmost three officials of NASA, and the two highest executives of the Space Council, Vice President Hubert Humphrey and Council secretary Edward C. Welsh. According to the letter of Presidential order, the budgeters should know, but there is speculation that they might not, because NASA was specifically excluded from the order that requires all agencies to use the PPBS to help plan the budget that goes into effect next July.

The PPBS (Program Planning and Budgeting System) stemmed from Defense Secretary Robert McNamara's ideas on using advanced management concepts to plan ahead and determine the future of each agency. One aspect of this involves five-year advance

# Washington Report

CONTINUED

forecasting. Each agency was by now to have prepared a draft budget and a five-year plan. Most of these were due at the Budget Bureau weeks ago, and unless excused, NASA should have had to include its post-Apollo plans. Normally talkative officials are silent on whether NASA has even sent in a Fiscal 1968 budget, let alone a five-year plan.

However, there seems to be a major effort under way to prepare industry and NASA personnel—already practically flocking from the agency—for a jolt. Welsh has recently been saying—after first stating that he is not discussing a formal post-Apollo program—that the major emphasis on space after 1970 will be on the application of satellites to weather observation and communications. He repeatedly points out that Apollo will not involve merely a single trip to the moon and then nothing more. His obvious urgency in making the point leads many to feel that he is trying to soften the impact of a drastic cutback in manned space programs and an anticipated announcement that the U. S. will not undertake in the near future any gigantic R&D programs oriented to deeper space exploration.

The other fact that is seen as an effort to cushion bad news is the Administration's "peaceful engagement with the East" concept. This envisions replacement of shooting wars by heavy and formal competition in technological areas. The arena of contest most often cited is that of applying satellites to weather observation and control, navigation, and to agricultural, conservation and educational uses. NASA funding and programs have been shrinking, and the pressures of Vietnam indicate to most observers, including many NASA officials, that this trend will continue.

## Congress gets R&D guidelines

The Congressional committees with authority over research and development programs have now been given a fair idea of what direction Congress should be taking in funding and in stimulating new programs. The guidelines, contained in a report by a key Capitol Hill committee, generally urge action in those areas which the NSF's survey show to be already on the upswing, such as air and water pollution, health, transportation and education

technology. The report comes from the House Science and Astronautics Committee's subcommittee on science, research and development under the chairmanship of Emilio Q. Daddario (D-Conn.). The report would also have the downward trend noticeable in some areas reversed, by having more funds allotted for information systems development and the use of cybernetics. The emphasis throughout, moreover, is on increased participation in R&D by industry and more liberal spending by industry for R&D.

For the past two years members of most of the committees involved with R&D have felt that Congress itself should be generating programs and should have more to say in guiding the nation's technological activities, rather than merely rubber-stamping the Administration's initiatives or withholding funds. Some new national commissions with some measure of real authority have been set up that are answerable to Congress as well as to the White House. The National Science Foundation is itself due for an overhaul at the behest of Congress, as are several other agencies concerned with health and education. Organization of a large technical staff to give Congress professional guidance is in the works.

A data-collection and -compiling system to help Congress to evaluate R&D programs, spot technological gaps and predict technology change will be authorized within two years.

Daddario's subcommittee has been the inspiration for most of these innovations and its reports are respected by both sides on Capitol Hill. It has issued exhaustive analyses of fiscal trends in federal research and development, the geographical distribution of R&D monies, almost all aspects of aeronautics, air and water pollution, and technology's role in reshaping the nation. Now, after three years' study, the subcommittee has brought out this report listing 12 areas where Congress should be more active. Many of these areas heavily involve the electronic industry and will require creative thinking by electronic designers.

The 12 areas, listed "without attempting to ascribe priorities" are: strengthening information management, providing new sources of energy, application of cybernetics, protecting the natural environment, stimulating transportation innovations, diminishing urban congestion, enhancing adequate housing, improving food production and distribution, alleviating crime, upgrading the quality of education, protecting the nation's health, and fostering industrial R&D.

Once in a blue moon you'll find a superior solid-state S-Band transmitter with high reliability, superior performance, small volume and light weight. One that's compatible with both SGLS and Unified S-Band systems. One that's built by specialists in RF equipment, a true telemetry house fully experienced in S-Band operations.

Well, Vector has this superior UHF transmitter in stock.

One model is the Vector TWB-1167 wide-band transmitter, for frequency range 2200-2300 MHz, frequency stable to  $\pm 0.002\%$ , with 5 watts output. With a negative grid tube amplifier, it delivers 10 to 25 watts at S-Band. Vector's complete range of RF equipment includes VHF, L- and S-Band transmitters, Beacon transmitters, modulators, power amplifiers and airborne command receivers for all aerospace environments including high radiation. For more information, call or write Vector, (215) 355-2700.

**Vector** DIVISION OF UNITED AIRCRAFT CORPORATION  
SOUTHAMPTON, PENNSYLVANIA

U  
A

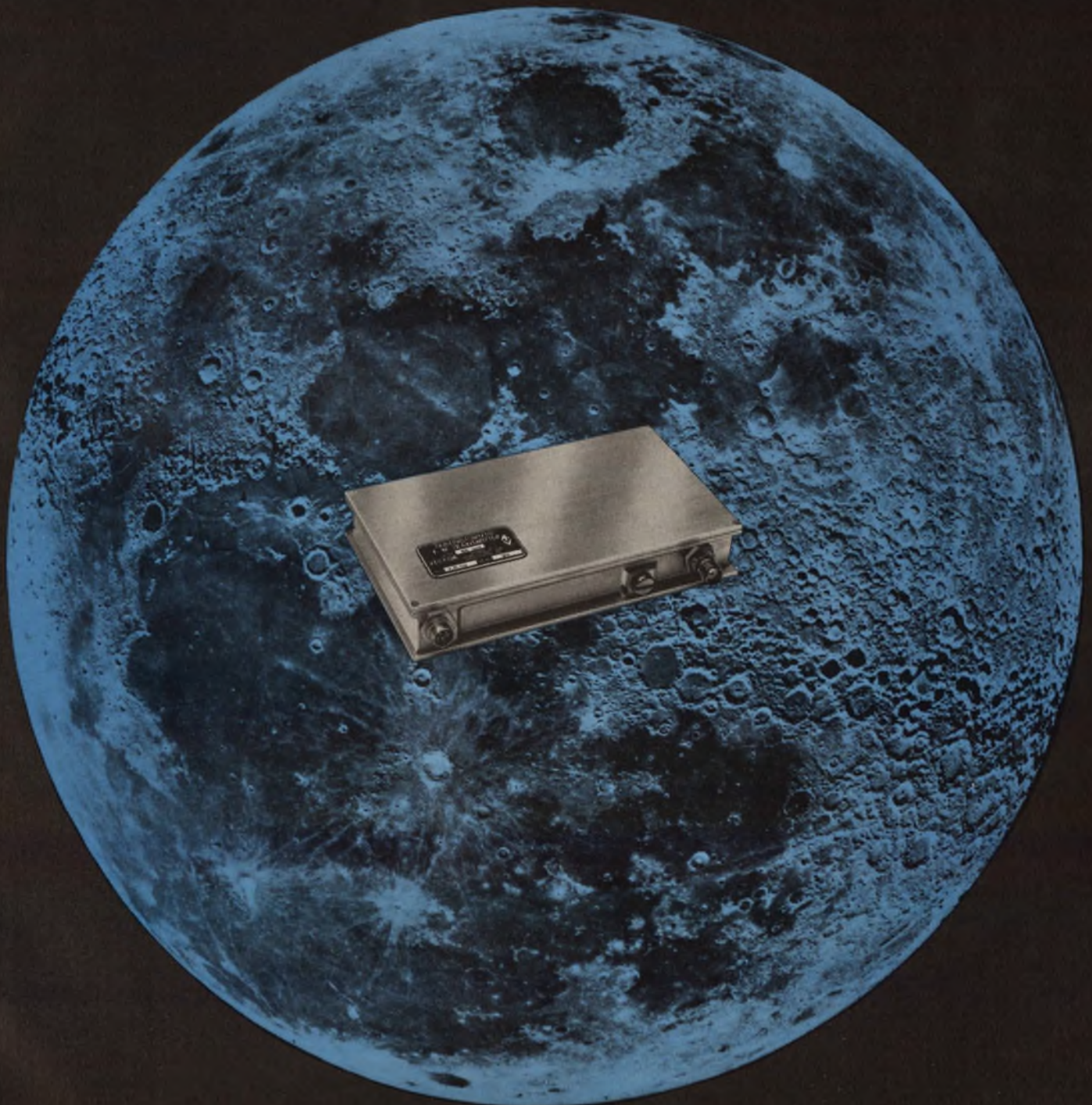

# Analog Computing

## Micro "Mag Mods"®

SINE WAVE OUTPUT—NO TUNED FILTERS!



"MAG MODS"® provide four quadrant operation, extreme stability with negligible change of phase, gain and zero position over a wide temperature range. Design is simple, featherweight and rugged—with no vacuum tubes, semiconductors or moving parts to limit life. These Modulators are available in micro, miniaturized and standard sizes depending on requirements, and feature an essentially drift-free, wide-band width circuit with superior phase and gain stability.

### FEATURES:

- Greatest Reliability—Unlimited Life
- Repeatable Data over Years of Continuous, Unattended Operation
- High Shock and Vibration Proof
- Low Milliwatt Power Consumption
- Wide Band Width
- Clean Sine Wave Output without Resonant Filtering

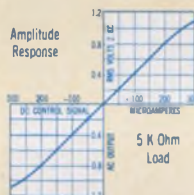

REQUEST BULLETIN MM 101X

G, M Magnetic Components have been proven superior in thousands of commercial, space and military applications. They conform to MIL-T-27A and MIL-E-5400 specifications and provide a ready solution to problems involving solid state, micro circuit, analog computer design. Call or write for Bulletins.

## Magnetic Division Modules

ACCURACY OF 1% OR BETTER!



### FEATURES:

- Micro-miniature Size
- Completely Solid State
- Low Power Consumption
- Wide Numerator and Denominator Ranges

These Analog Division Modules employ a concept which eliminates high gain operational amplifiers and logarithmic circuitry used in electronic dividers. The result is fewer components, excellent stability, micro-miniature size, lower cost. The combination of magnetic and semiconductor circuitry results in analog division accuracy of 1% or better.

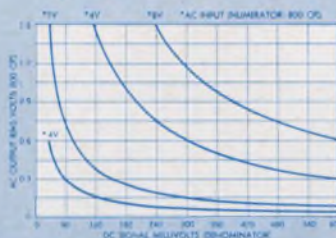

REQUEST BULLETIN MM 110

THERE IS NO  
SUBSTITUTE FOR  
RELIABILITY



Circuit and Fundamental Principles of Magnetic Modulators are covered by U.S. Pat. No. 2758162

## Gunn oscillators power modular phased arrays

Gunn-effect oscillators appear to be the key to making inexpensive, small, efficient phased arrays. Conversely, the need for good phased arrays speeds up the development of reliable, medium-power bulk oscillators. It also gives impetus to the integration of the Gunn oscillator into ICs by a monolithic deposition process.

Motorola Government Electronics Div. (formerly known as Military Electronics Div.) in Scottsdale, Ariz., is conducting a study of phased arrays, where each antenna is powered by a Gunn-effect oscillator. Engineers plan to come up with a 1-in<sup>3</sup> module that contains the printed circuit antenna and front end, including the oscillator, mixer, phase control and IF amplifiers, as shown in the figure.

A master oscillator, that controls the stability of each module by phase-locking the Gunn oscillators,

is external to the module.

The advantages of this design approach may be evaluated from both the system and the component point of view, according to project-engineer James A. Higgs.

From the system angle, the bulk device is a low-power one; it can be phase-locked for stability with very weak signals (40 dB below the actual signal level), says Higgs.

The device is very convenient, Higgs continues, because it is easy to modulate, small, inexpensive and can provide the necessary power.

### Research faces many problems

Research and development work at Motorola mainly concentrates on the bulk oscillator. "We want to get out 10 watts from it," says Higgs. "Now we are around 1 watt." The efficiency needs to be improved, too. Observed levels range from 2% to

20%, while predictions are around 30%, according to Higgs.

However, there are more fundamental problems to be solved before large-scale production can start, according to Tony Kallas, project leader of Gunn-effect research work at Motorola. The research effort centers on three major areas:

- Determine the influence of the external circuitry.
- Devise good mounting methods for the ohmic contacts for high-power and cw operations.
- Learn how to specify the gallium arsenide material so that it will provide good oscillators every-time. Now it is largely a matter of luck.

"The first two points pose less difficulties," said Kallas, "than the last." He describes their line of attack on the latter as an attempt to find a group of measurable param-

# with Magnetic Microblocks

ALL UNITS SHOWN ACTUAL SIZE

## Analog Voltage Multiplier

**WORLD'S SMALLEST, MOST RELIABLE!**



Available as small as 0.1 cubic inch and weighing as little as 0.1 ounce, Micro Magnetic Multipliers feature extreme stability with negligible change of product over wide temperature range, high shock and vibration proof. Band-width may be extended into the kilocycle range. Low milliwatt power consumption; four quadrant operation.

### FEATURES:

Four Quadrant Multiplication or Squaring Monolithic Micro Circuit Block for Analog Voltage Multiplying of DC and AC Voltages

Addition, Subtraction, Multiplication, Division and Extracting a Root of Many Voltage Variables may be Handled by one G/M Magnetic Microblock

Product Accuracy of up to 0.2% of Full Scale, with very slight Derating over a Wide Temperature Range

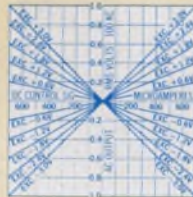

REQUEST BULLETIN MM 109

## Magnetic Demodulators

**HIGH RELIABILITY — SMALL SIZE!**



The new G/M Magnetic Demodulator is a solid state circuit for converting phase reversing AC signal voltages into phase detected polarity reversing DC voltages. The amplitude and polarity of the DC output are directly proportional to the phase and amplitude of the AC signal. High reference impedance results in very small reference power requirements.

### FEATURES:

- Output as High as  $\pm 10$  v. DC in Present Units
- Very Low DC Offset Null Voltages (As low as 0.1% of full scale)
- Operation Over Wide Environmental Conditions
- Completely Solid State-No Moving Parts

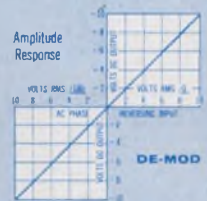

REQUEST BULLETIN MM 108

## General Magnetics • Inc

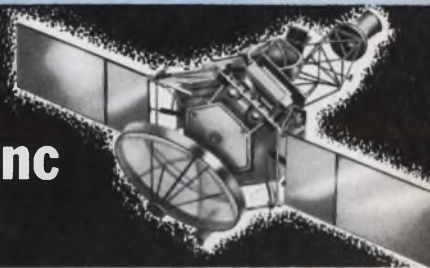

135 BLOOMFIELD AVENUE, BLOOMFIELD, N. J. 07003—Tel. (201) 743-2700

ON READER-SERVICE CARD CIRCLE 17

ters and relate them to the performance of the material.

There are some temperature problems too, mainly because the material has a negative temperature coefficient, according to Kallas. High-current densities at the projected power levels will require effective heat sinks.

"It will take at least another year before these questions are answered in a reliable and fully satisfactory way," concluded Kallas.

### IC Gunn-effect devices?

The suitability of gallium arsenide to monolithic processes also plays an important role in the research efforts.

Texas Instruments, Inc., is already investigating monolithic versions of the Gunn-effect oscillator. At the present they are trying to find out whether or not the oscillator can be formed with the monolithic process, according to Larry Levieux, press relations, TI. ■ ■

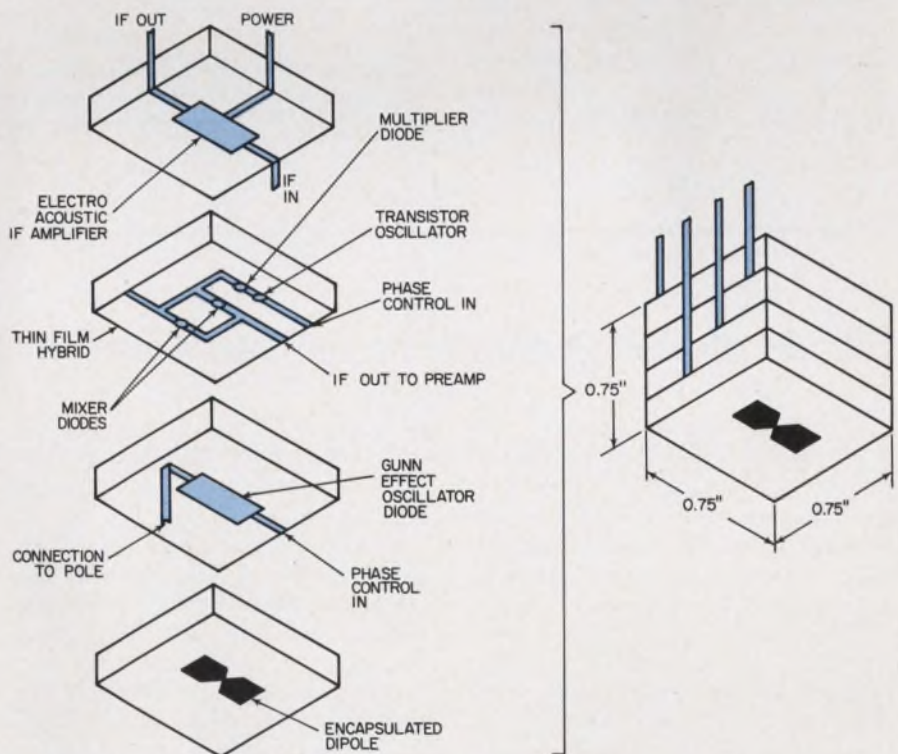

Phased-array module is built by a thin-film hybrid method. The phase control is provided by an external master oscillator.

## Function generator diffused on a single chip

A function generator can now be deposited on a single chip by means of standard planar integrated-circuit fabrication techniques, according to P. Post, Norden Div., United Aircraft Corp., Norwalk, Conn.

Semiconductor manufacturers have developed an expertise in fabricating components which they only rarely use to make unusual configurations such as this arbitrary function generator. Yet everything in semiconductor life is not necessarily composed of resistors, diodes, transistors and capacitors. The shape is the secret.

The geometry of the working surface, controlled during manufacture by a computer, determines just which one of a variety of functions the chip will generate.

The device can be made to generate log-arithmetic, sinusoidal and square-law functions, and even completely arbitrary functions. Thus it could serve as a fixed operator in an analog computer.

The generator consists of two passive elements: a fixed resistor and a nonlinear resistor. Fabricated on a single chip of silicon, they are connected in series to form a voltage divider. The nonlinear resistor is actually a continuous diode-resistance network and the shape of the network determines its electri-

cal characteristic.

The generator's output is a function of both a reference current and a signal current. A reference voltage,  $+E_r$ , on an evaporated metal strip in ohmic contact with a thick n-doped substrate, maintains a uniform reference electric field in that substrate. If the instantaneous voltage,  $C_s$ , is zero, the pn junction, between the signal region and the reference region, is back-biased and n current flows to ground. If  $C_s$  exceeds  $+E_r$ , the whole device con-

ducts much like a large-area diode.

If, however, the value of  $C_s$  is between  $+E_r$  and zero, the signal current flows along the p-doped resistive (shaped) surface. But as this p-doped surface narrows, and the current density increases in proportion to this narrowing, the signal current spreads down into the n-doped region and on to ground. Thus, the active length of the shaped resistor is a function of the signal.

Used in conjunction with an operational amplifier having a differential input, the unit can impose its particular function on any analog signal impressed on its input. ■ ■

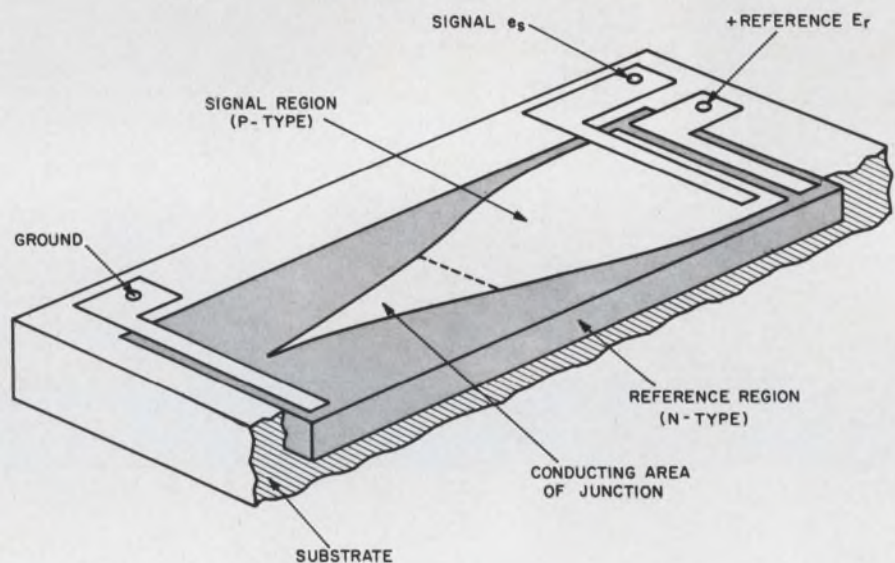

A tapered resistor of p-doped silicon is the heart of this function generator. This nonlinear resistor's effective length varies as an inherent function of the applied signal. Its shape determines the response of the generator.

## Silicon diodes generate more than a watt at 12 GHz

Silicon diodes that generate 1.1 watts of cw power at 12 GHz—said to be the highest cw power reported at this frequency for semiconductor microwave oscillators—have been developed at Bell Telephone Laboratories.

The continuous-wave power generated by these experimental pn junction diodes, according to BTL scientist Dr. Toshio Misawa, is twice as great as previously reported at 12 GHz for silicon pn junction diodes. The 8 per cent

efficiency achieved at this frequency is about 2 per cent higher than that of previous silicon diodes, Misawa said.

The scientist credits the better performance of the devices primarily to improvements in mounting and bonding, and closer control of processing techniques.

More specifically, Misawa cited a major improvement in heat flow, which was achieved by mounting the diodes upside down in their metal housings—a complete depar-

ture from conventional diode-mounting practices. This upside-down arrangement places the pn junction closer to the metal mount, thus reducing thermal resistance between the junction and the metal.

Better device efficiency was achieved by controlling the impurities or doping profile of the semiconductor and by reducing the n-type region of the diode to the minimum necessary thickness. This cuts the diodes' resistance. ■ ■





NSC GEM  
ACTUAL SIZE

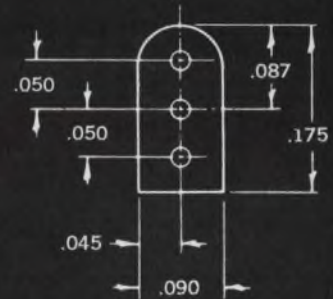
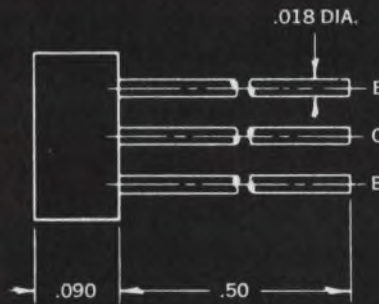

## Quick way to buy smallest, low cost silicon molded epoxy transistors



NATIONAL SEMICONDUCTOR CORPORATION  
DANBURY, CONN.

AVAILABLE FROM YOUR LOCAL NSC DISTRIBUTOR.

2N3793	NPN	Medium Power
2N3704	NPN	Medium Power
2N4284	PNP	Small Signal
2N4285	PNP	Small Signal
2N4286	NPN	Small Signal
2N4287	NPN	Small Signal
2N4288	PNP	Small Signal
2N4289	PNP	Small Signal
2N4290	PNP	Medium Power
2N4291	PNP	Medium Power
2N4292	NPN	UHF
2N4293	NPN	UHF

### WESTERN DISTRIBUTORS:

Moltronics of Arizona  
2746 West Palm Lane  
Phoenix, Arizona 85009  
(602) 272-7951

Fortune Electronics  
695 Veterans Blvd.  
Redwood City, California  
94063  
(415) 365-4000

Kierulff Electronics  
3969 East Bayshore Road  
Palo Alto, California 94303  
(415) 968-6292

Liberty Electronics Corp.  
339 South Isis Avenue  
Inglewood, California  
(213) 678-8111

Spectronics  
131 Garnet  
Ridgecrest, California 93555  
(714) 378-2831

Western Electronic  
Components  
4301 Birch St.  
Newport Beach, California  
(714) 540-1322  
(Orange County)  
(213) 631-6119  
(Los Angeles County)

Newark-Denver Electronics  
Supply Co.  
P. O. Box 22045  
Denver, Colorado  
(303) 757-3351

Pacific Electronics  
1336-4 Dillingham Blvd.  
Honolulu, Hawaii 96817  
817-118

Sterling Electronics, Inc.  
1712 Lomas Blvd., N.E.  
Albuquerque, New Mexico  
(505) 247-2486

Kierulff Electronics  
2585 Commerce Way  
Los Angeles, California 90022  
(213) 685-5511

Ballard Supply Company  
3109 Washington Blvd.  
Ogden, Utah 84400  
(801) 394-5541

Ballard Supply Company  
44 East 6th Street, South  
Salt Lake City, Utah 84100  
(801) 364-6541

Kierulff Electronics  
6133 Maynard Ave., S.  
Seattle, Wash. 98108  
(206) PA 5-1550

Kierulff Electronics  
8137 Engineer Road  
San Diego, California  
(714) 278-2112

ON READER-SERVICE CARD CIRCLE 19

# Laser replaces umbilical cord in spacecraft

**Time-sharing lasers take the place of wires for carrying data to and from spacecraft during launching.**

**Maria Dekany**  
Technical Editor

"Five, four, three. . . . Stop countdown. The umbilical cord did not disconnect. . . . Launching will be postponed till the disconnect mechanism is repaired."

You may not have to hear this again. IBM Federal Systems Div. has designed and tested a laser system that can take the place of umbilical cords used for communications, telemetry and data transmission during space launches. It will not replace wires for prime powers, fuels and oxygen, but these leads are usually disconnected at a relatively early stage of a countdown.

The tests, completed a couple of weeks ago, proved the feasibility and practicability of the design, says Dwight Divine, senior associate engineer for IBM at Cape Kennedy.

According to him, the advantages of optical systems over conventional hardware are:

- No disconnect problems.
- Totally isolated grounds. Electrically shifting grounds in wire systems may introduce errors.
- Ease of use in space launches. Thick bundles of cables may upset the stability of a launching platform in space.

## System works without tracker

The 0.9- $\mu$  two-way communication system, linking the launch umbilical tower and the space vehicle, uses 12 gallium arsenide injection laser diodes at room temperature as transmitters: four at the tower and eight in the vehicle. The receiving systems consist of focusing lenses, silicon photodetector diodes, amplifiers and demultiplexing circuitry.

The system offers wide-angular view of the field and has a range up to 1000 ft. At the launching tower, two lasers provide a short-range (10 to 60 ft) link with  $\pm 3$  ft horizontal and  $\pm 1$  ft vertical

view. Two more lasers are used for the long-range link, with the same angular coverage from 60 up to 1000 ft. A similar technique is applied in the vehicle, except that four lasers are used in a time-sharing mode in each link, explains Divine. The two optical paths are separated by 3 ft.

This approach eliminates the need for tracking and cuts the cost considerably, compared with other optical communication systems, according to Divine.

Transmission to the vehicle is performed by pulse-code modulation. From the vehicle, pulse-position modulation is used. "The type and amount of data require different modulating schemes," says Divine. "Much more information is collected from the vehicle and ppm can handle higher average data than pcm. For example, we can transmit 41 analog signals, a voice channel and 47 discrete on-off type signals from the vehicle. To the vehicle, we have a voice channel, a pcm channel and some on-off type information. Since the pcm channel has the highest data rate, we choose the pcm scheme."

The pcm system can transmit 44 thousand pulses per second with two diodes. The ppm system can handle 90 thousand pulses per second, with four diodes in a time-sharing mode. These data rates were observed when the diodes operated at power levels from 0.2 to 0.5 volt and at room temperature.

## Tests show small error rates

The system was tested twice over a range of 28 ft for 1.6 hours of continuous operation. The total bit error rates were  $3.7 \times 10^{-6}$  and  $2.7 \times 10^{-8}$ .

The system was also tested in a simulated foggy environment. A CO<sub>2</sub> fire extinguisher was used to fog up the transmitting windows and the path. However, the error rate remained unchanged. "It

worked like a charm," comments Divine.

Speed of data transmission and output power are the areas where improvements will have to be made to make the system fully competitive with wire types, Divine adds.

Higher data rates can be achieved by either using more lasers in a time-sharing mode or by cooling the lasers down to cryogenic temperatures, he states. He points out that cryogenic cooling is more economical and also reduces the size and weight of the system by cutting back the number of lasers needed.

Since demonstration of the feasibility model did not require higher data rates, no tests were performed with cooled diodes.

The range, limited by the available peak power at room temperature, can also be extended by cryogenic cooling, according to Divine.

## Receiver uses Si diodes

Both long- and short-range transmitters can be picked up by the same receiver, since the optical paths are fairly close together, Divine notes. Only the focusing lenses are different: for the long-range link, a 5-in.-diameter one is used; for the short-range, a 1.5-in. is sufficient. The photodetector is a back-biased silicon diode, followed by a 3.5-MHz video amplifier and a threshold detecting circuit.

When asked about avalanche silicon diodes\* as detectors, Divine points out that the project was started before the avalanche effect became generally known. "We are interested in it," he says, "but the state of the art has not advanced far enough to make the change imminent." He feels that their production is a little uncertain at the present. However, if the production problem is overcome "it looks like the case of getting something for nothing," he concludes.

NASA is reported to be studying the test results and actual applications will depend on the outcome of its evaluation. ■ ■

\*See "Solid state competes with lasers . . ." ELECTRONIC DESIGN, XIV, No. 22 (Sept. 27, 1966), p. 63

# American Bosch

## uses Allen-Bradley Oriented Ceramic Permanent Magnets...

because of their uniformity in staying within specifications,  
and delivery schedules—though tight—are kept!

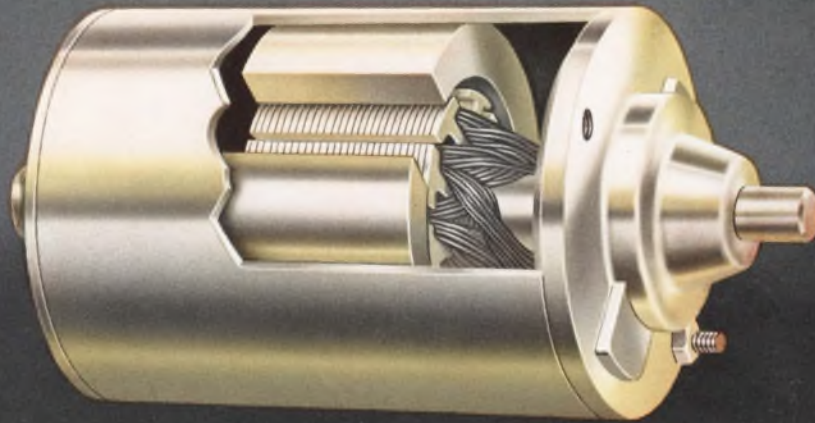

American Bosch permanent magnet motors are used for...

power windows

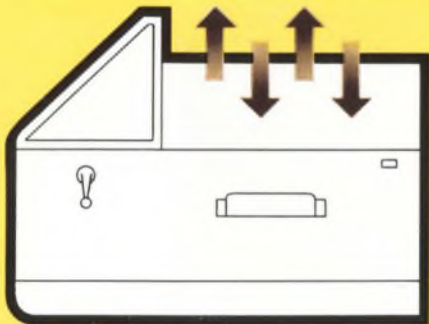

electric windshield wipers



power seats



■ Allen-Bradley's quality control procedures assure the continuously uniform properties—both electrical and physical—that are essential to profitable large volume motor production. The most modern manufacturing facilities in the hands of technically experienced craftsmen produce the highest quality, radially oriented ceramic permanent magnet segments that are presently available.

Allen-Bradley ceramic permanent magnets can be furnished for a wide range of motor sizes—from 3/4" diameter up to a 10 hp motor rating. They are available in a variety of types—having different properties—to satisfy your specific requirements. A-B application engineers will be happy to consult with you in developing your dc motors for maximum motor performance. Allen-Bradley Co., 1316 S. Second St., Milwaukee, Wis. 53204. In Canada: Allen-Bradley Canada Limited. Export Office: 630 Third Ave., N.Y., N.Y., U.S.A. 10017.

Properties of typical Allen-Bradley ceramic permanent magnets

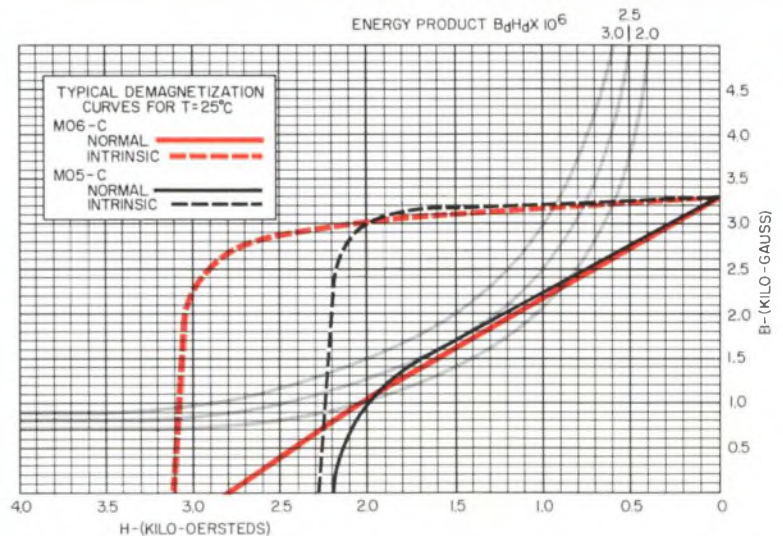

# ALLEN-BRADLEY

QUALITY MOTOR CONTROL  
QUALITY ELECTRONIC COMPONENTS

# announcing...

Allen-Bradley Active Filters, which offer a 60 db attenuation over the range of 10Hz (3Hz\*) to 100KHz



Allen-Bradley active filters can provide as much as a 50 to 1 reduction in size and a corresponding reduction in weight over conventional passive elements.

The diagram below and performance curve at right illustrate how Allen-Bradley active filters prevent current fluctuations in the power distribution system above 10Hz (3Hz\*), developed by pulse modulated communications equipment, such as teletypewriters and other randomly varying loads.

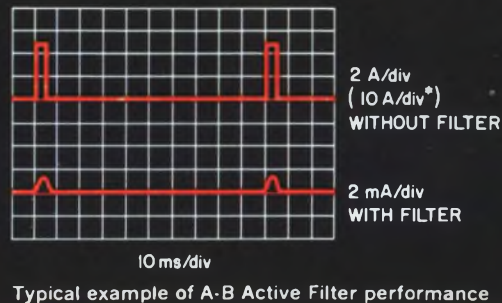
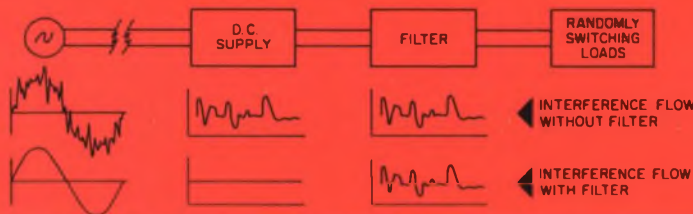

Typical example of A-B Active Filter performance

■ Directly as the result of some new ideas applied to the field of ElectroMagnetic Compatibility, Allen-Bradley has been able to produce a new *active* low pass filter that provides an attenuation of greater than 60 db over the range of 10Hz (3Hz\*) to 100KHz. The maximum dc component of the load current is 5 amperes.

The primary purpose of this filter in the above application is to prevent impulses generated by rapid load fluctuations, which may be carrying information of a confidential nature, from being reflected back through the power supply and into the power distribution system.

These new filters are designed to satisfy specific requirements. For instance, power line filters are under development for 60Hz and 400Hz power frequencies. Here, a sharp pass band is afforded the power frequency while greatly attenuating all other frequencies.

\* WITH EXTERNAL CAPACITOR

Allen-Bradley active filters produce a far greater attenuation of unwanted signals than is possible with a filter composed of conventional passive elements, occupying the same volume. By using the A-B *active* filter, a size reduction of 50 to 1 is attained, together with corresponding savings in weight. These filters employ solid-state circuitry. No external power source is required other than that supplying the power to the load. In addition, complete inrush and short circuit protection is provided.

Allen-Bradley specialists in filter engineering are available to discuss with you such problems for which these new active filters might offer the best solution. Please write: Allen-Bradley Co., 222 West Greenfield Avenue, Milwaukee, Wis. 53204. In Canada: Allen-Bradley Canada Limited. Export Office: 630 Third Ave., New York, N. Y., U. S. A. 10017.



**ALLEN-BRADLEY**  
QUALITY ELECTRONIC COMPONENTS

## Improved mechanical filters compete with crystal and LC

For 20 years the mechanical filter has offered the circuit designer a small, rugged frequency selector that has been relatively temperature-stable. But insertion losses, often running upwards of 20 dB, have prevented the mechanical filter from seriously challenging either the inexpensive LC filter or the highly selective crystal filter.

Recently, however, new nickel-alloy disks have reduced the mechanical filters insertion losses to less than 15 dB for simple filters and as low as 2.5 dB for multiple element units, according to William Carnes, Collins Radio Co., Newport Beach, Calif. And these rugged devices can maintain a temperature stability of better than one part per million per degree centigrade at 455 kHz over a 100-degree range.

Operating up to one MHz, the filters are particularly useful in citizens' band receivers and transmitters and many single-sideband applications. The mechanical filters have a higher  $Q$  than comparable LC filters and are often cheaper and more rugged than crystal filters.

This is how the devices work: The mechanical energy produced by the signal in a magnetically biased ferrite core travels through a series

of metal alloy disks. Variations in the number and shapes of the disks and in the lengths and locations of the connecting rods determine the frequency response. At the other end of the filter, another ferrite core surrounded by magnetic flux converts the filtered mechanical motion back into an electrical signal.

Although a mechanical filter can have as few as two thick metal disks, the more sophisticated pass-band, side-band and stop-band filters can contain from four to seven. In the seven-disk stop band illustrated below, the insertion loss with ferrite cores is merely 2.5 dB with a pass-band ripple of  $\pm 0.15$  dB at 78 kHz. (With ordinary nickel-steel cores the insertion loss is 8 dB.)

Though the seven-element filters with ferrite-core transducers are, quite naturally, more expensive than less complex types, Collins reports very good yields in production. This, it says, is due to the simplicity and stability of the metal and ferrite machined parts. And apparently the price edge enjoyed by the LC filters does not deter sales: "I show designers 50-cent LC filters," says Carnes, "and I tell them they're going to pay \$12 for the mechanical version. And they do." ■ ■

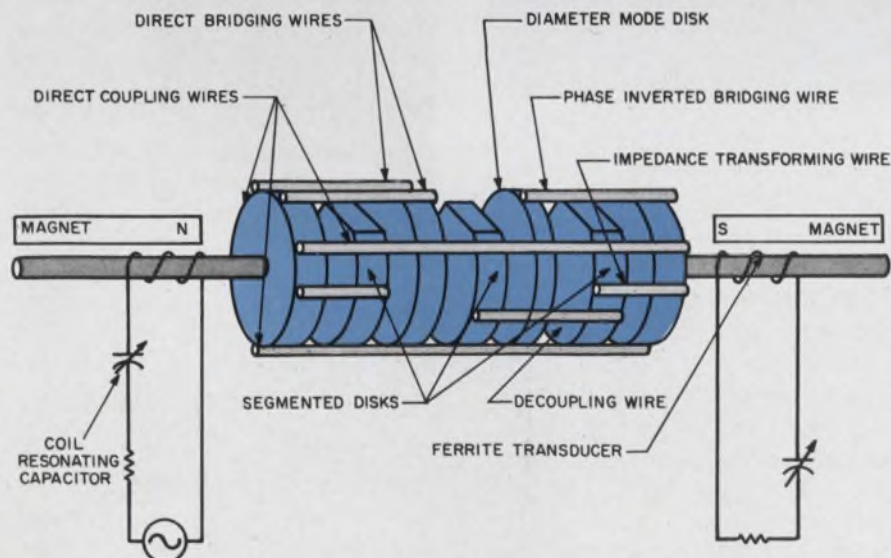

An insertion loss of only 2.5 dB can be attained with this ferrite-transducer seven-disk mechanical filter. The segmented disks reduce the amplitude of spurious responses. Thus, unwanted resonances are not propagated through the filter by either the circular or the segmented disks.

# HATHAWAY

## NO.1 DRIVE RELAY



## can take it

Predictable performance through the spectrum is made possible by our Controlled Reed process. Whether single function or in multiple form applications, these relays will contribute greatly to optimum system performance. To 300 MHz— $\mu$ A to .5A in the same integrated switching package if desired. Write for new condensed catalog.

**HATHAWAY INSTRUMENTS, INC.**

5250 EAST EVANS AVENUE  
DENVER, COLORADO 80222  
(303) 756-8301 • TWX 282-2935

*Distributed Nationally by*  
**COMPAR CORPORATION**



**The new, improved model of our Type A time-delay relay has gold-diffused contact surfaces, heavier contact blades, and a more efficient magnetic circuit. Performance is better, but the price is still remarkably low. Our enclosed and plug-in time-delay relay models have been similarly upgraded. All can be had in a diversity of standard timings from 1/4 to 120 seconds, with SPDT or DPDT switching. All have continuous-duty coils and can thus be used without an auxiliary load relay for the majority of applications. Our Bulletin 5006 will give you full technical information on the entire line. Write us for a copy. Heinemann Electric Company, 2604 Brunswick Pike, Trenton, N.J. 08602.**



**HEINEMANN**

ON READER-SERVICE CARD CIRCLE 24

## LETTERS

### More research needed into UFO phenomena

Sir:

I noted with interest your comments on the UFO puzzle in the August 16 issue ["The UFO puzzle: time for a technical evaluation," ED 19, p. 63], and further data on ball lightning investigations in the issue of Sept. 13 [ED 21, p 14].

The theory of Philip J. Klass and the work of Drs. Uman and Moruzzi may well make a useful contribution to this field of investigation by eliminating one more natural source of UFO phenomena. However, I think it is unlikely to provide a universal explanation of some of the unusual sightings reported by many reliable witnesses. Reports of large metallic objects resting on the ground, which have subsequently taken off, leaving a depression in the ground and scorched grass, cannot very well be reconciled with ball lightning.

A very persistent phenomenon, which could be regarded as a giant form of ball lightning, has been reported by many observers in the USA and in France. This takes the form of a large glowing object usually found at night on or near a roadway. The effect of this object on an automobile is to extinguish the lights, cut out the engine, and blank out the car radio. The occupants sometimes report a tingling or paralyzing feeling. What we would like our theoretical physicists to explain is what sort of field would produce these effects, and how would it be generated by ball lightning.

I have recently helped to investigate the sighting of an unusual object, seen at night in the area of Reading and Oxford [England] this summer. It took the form of a cluster of points of light which moved rapidly across the sky together. The individual lights moved about relative to one another in a curious jerky manner. All observers were convinced that it was not an aircraft (no sound), a satellite (moving too fast) or a meteorite.

*(continued on p. 38)*

# QUALITY, VARIETY SERVICE

...that's the story of "Ohmitran" v. t.<sup>®</sup> variable transformers

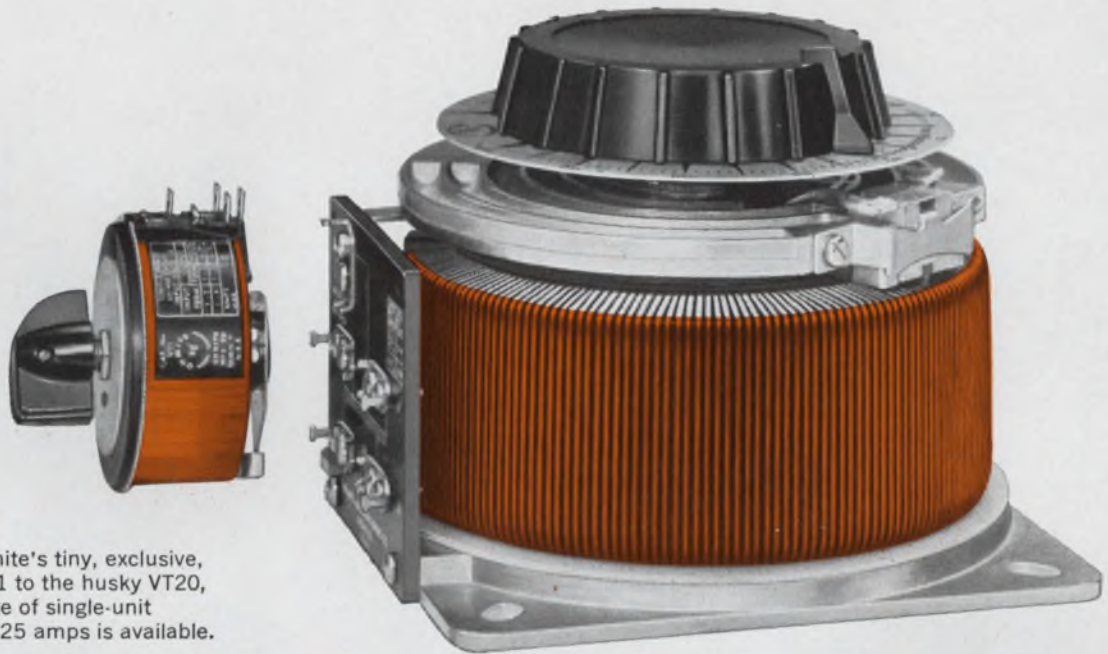

From Ohmite's tiny, exclusive, 1-amp VT1 to the husky VT20, a full range of single-unit ratings to 25 amps is available.



**SATISFY** yourself . . . eliminate irritating variable transformer difficulties with Ohmite's famed reliability and long service life. In any piece of equipment, an Ohmite component indicates that there has been no compromise with quality.

**MEET** virtually all your requirements from Ohmite's big selection. Single units start with a tiny (and exclusive) 1-amp model, extend through heavy-output models of 25 amps. For single and/or ganged models,

voltage inputs begin below 40 volts, run to 480 volts. There are assemblies for 3-phase applications, too, plus models in stationary or portable cases—with meters if you like. Most are stocked for fast delivery.

**EASE** engineering headaches by taking advantage of Ohmite's ready-to-ship stock of standard units, or willing advice and service on units for special applications. Bone up on the broad aspects of Ohmite's complete variable transformer service by requesting *Catalog 500*.

**RHEOSTATS • POWER RESISTORS • PRECISION RESISTORS • VARIABLE TRANSFORMERS • RELAYS  
TAP SWITCHES • TANTALUM CAPACITORS • SEMICONDUCTOR DIODES • R.F. CHOKES**

# OHMITE

MANUFACTURING COMPANY  
3643 Howard Street • Skokie, Illinois 60076  
Phone: (312) ORchard 5-2600



ON READER-SERVICE CARD CIRCLE 25

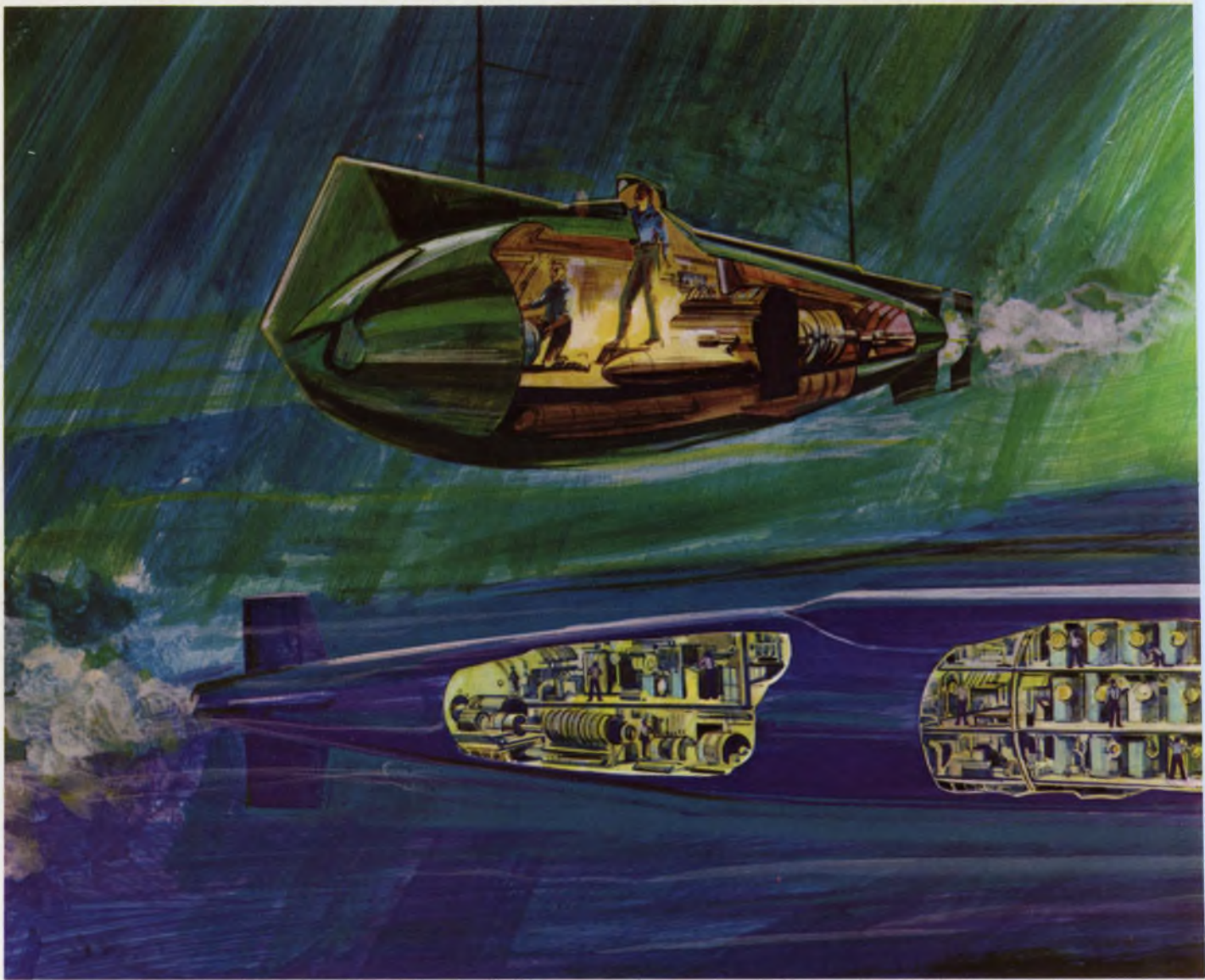

## The Kind of Knowledge that makes progress possible...

During the 1890's, a Paterson, N. J. schoolteacher named John P. Holland was busy perfecting a submarine. It was the ninth underwater vessel he had built in over thirty years, and his eight previous attempts had taught him well. This ship was motor-driven and carried torpedos within its hull. It could travel submerged for fifty miles. In 1900, the U.S. Navy not only commissioned the vessel, but honored its inventor by naming it after him.

Since the *Holland*, men have piled fact upon fact in an unending scientific quest to improve the materials, the propulsion, the range, the striking power, the defenses and the livability of submarines. Today's nuclear-powered submarines are marvels of engineering, controlled by a maze of intricate electronic





## IS THE KIND OF KNOWLEDGE YOU GET FROM KESTER

systems. They can launch missiles while submerged. They can roam the seas for months without resurfacing, while their crews live in a cleaner atmosphere than do most city dwellers. The modern submarine is an amazing example of man's application of accumulated knowledge.

This knowledge of experience is the kind of knowledge you get from Kester. Even before the Holland sub was commissioned, Kester Solder products and soldering knowledge were serving industry. And as technology accelerated, Kester kept pace.

Today, after 67 years of working with development engineers in the technology of solders, fluxes and their applications, Kester stands ready to serve you. Write, phone or wire for specific information.



## KESTER SOLDER COMPANY

4201 Wrightwood Avenue, Chicago, Illinois 60639 • Newark, New Jersey 07105 • Anaheim, California 92805 • Brantford, Ontario, Canada

1899-1966—67 years devoted to production of products of the highest reliability—solders and fluxes

ON READER-SERVICE CARD CIRCLE 26

# DIRECT DRIVE TORQUE MOTORS WHAT, WHY AND WHERE

The direct drive torque motor is a servo actuator that can be directly attached to the load it is to drive. It converts electrical signals directly into sufficient torque to maintain zero error in a positioning or speed control system. Most torque motors are frameless and require very little space, offering the greatest flexibility and adaptability in application. They are thin compared to diameter and have relatively large axial holes through the rotor for easy application to shafts, hubs and bosses. In general, torque motors are designed essentially for high torque, "stand still" operation (for positioning systems) and for high torque at low speeds (for speed control systems).

Direct drive torque motors are particularly suited for servo systems where size, weight, power requirements and response times must be minimized and where position and rate accuracies are desirable. Torque motors have these important advantages over other servo system actuators:

**high torque-to-inertia ratio:** a direct drive motor has the highest practical torque-to-inertia ratio. To respond to an input signal, it must overcome only the inertia of its own, slowly turning rotor and the driven load. Since it is directly coupled to the load, it has no gear train. A gear train increases inertia by a multiple equal to the square of the gear train ratio, resulting in sluggish response.

**high coupling stiffness:** the direct drive torque motor is attached directly to the load itself — therefore no gears, no backlash errors, no mechanical resonance problems.

**fast response:** since it produces higher torque for its size than any other electromagnetic device, and since its torque is a direct function of applied current independent of speed (a function of voltage), the torque motor's response is absolute and instantaneous at all operating speeds.

**high resolution:** the same characteristics

that result in fast response from stand still to maximum operating speeds result in "locked-on" resolution. The torque motor is limited only by the sensitivity of the error sensing circuits that command it. **reliability and long life:** the basic simplicity and absolute minimum of moving parts makes a torque motor inherently reliable. Extensive design and production experience have put Inland torque motors in most major defense programs of the last decade. These include widely ranging applications under all conditions and environments from thousands of feet underwater to years of unattended operation in outer space.

The variety and number of applications of Inland direct drive torque motors are increasing rapidly in both industry and government. Some typical applications are in:

- stable platforms for inertial guidance
- antenna and telescope drives
- filament winding constant tension drive
- space probe solar cell orientation
- X-Y plotter drives
- precision welding rod drives
- gyro test table rate and tracking
- magnetic tape transport
- submarine periscope power assist
- star tracker optics positioning

Inland Motor Corporation specializes in direct drive torque motors and servo subsystems. Having originated most of the designs available today, Inland makes available a design library of over 600 torque motor models. Catalog items range from a small 0.03 lb-ft unit to those that are capable of 3000 lb-ft of torque. Inland also produces rotary and solid state amplifiers, tachometer generators and other units which give them the unique capability to design and deliver complete direct drive servo subsystems for positioning, rate and tensioning applications. Inland's experience, production capacity and complete prototype facilities are distinct advantages to the customer.



**INLAND MOTOR**

CORPORATION  
RADFORD, VIRGINIA

703-NE9-3973

SUBSIDIARY OF **KOLLMORGEN**

## LETTERS

(continued from p. 34)

The same, or similar, object was seen in different places at different times over a period of days, ruling out the meteorite explanation. One observer was an amateur astronomer, and has never seen anything like it before.

I think that very much more investigation is needed and scientists have spent too long with their heads in buckets of sand. We need more practical efforts like those of Drs. Uman and Moruzzi, but on a much greater scale. I suspect that spectroscopic tests are only just beginning to scratch at the problem.

G. Elliott

Director  
Elliott Electronics  
Reading  
England

## More on the great Mho, recognized at last

Sir:

I was very pleased to find that another reader knows of the eminent Mho Wang Fu (Roger T. Stevens, ED 22, Sept. 27, 1966, pp. 40 & 42). As Mr. Stevens pointed out, the career of this distinguished Chinese philosopher is virtually unknown in the West today.

Mr. Stevens also neglected to mention, undoubtedly through an oversight, that Mho formulated the laws known today to the engineering profession as Murphy's Laws (or Finagle's Laws). These resulted from Mho's battery experiments with a shorting bar across the electrodes. Crudely translated, Mho's Law comes out as: "Watch it, men, I think the infernal thing is going to burn up again." In the time since 1161 B.C., naturally there have been many chances for engineers to refine and expand this basic law.

I concur heartily in the protest against this unseemly drive to eliminate the sole remembrance of this great philosopher and experimenter by dropping his name as the unit of conductance. Can't the siemens be reserved for the unit of conductor

(continued on p. 40)

NEW-

# THE SEMICONDUCTOR DATA BOOK

... includes major specs for all (10,500) EIA registered 1N, 2N, and 3N numbered types!

*Plus these features:*

- Complete data on 2,800 types (including curves)
- 16 categories of special and standard device types
- Complete cross-reference guides
- Complete "how to use" information
- Alpha-numeric device indexing
- Application note section
- Information on "How to get more value out of a device data sheet"
- Over 200 pages of data on digital and linear integrated circuits

... and much, much more!

Here's a new 1500-page all-industry reference text that is the most complete volume of semiconductor information ever published by a semiconductor manufacturer. Designed to overcome the major problems of device identification and selection for the engineer, this comprehensive one-of-a-kind manual will save you hours previously wasted looking through multiple references for semiconductor device data.

Priced within the range of every engineer, this all-in-one text will more than pay for itself the first few times you use it. Fill out and mail the coupon below for your copy today!

**SHOULD BE ON EVERY ENGINEER'S DESK!**

Please send me \_\_\_\_\_ copies of the new Semiconductor Data Book. My check (payable to Motorola Inc.) for \$ \_\_\_\_\_ is enclosed (\$3.95 per copy).

NAME \_\_\_\_\_ TITLE \_\_\_\_\_

COMPANY \_\_\_\_\_ DIV/DEPT \_\_\_\_\_

ADDRESS \_\_\_\_\_

CITY \_\_\_\_\_ STATE \_\_\_\_\_ ZIP \_\_\_\_\_

Mail to:



**MOTOROLA**  
Semiconductor Products Inc.  
BOX 955, PHOENIX, ARIZONA 85001

*- where the priceless ingredient is care!*

ON READER-SERVICE CARD CIRCLE 28

# These choppers work in any position

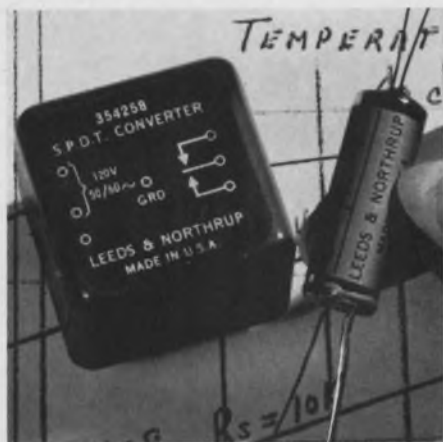

If you're looking for exceptional reliability, look at the life ratings of these two photo-choppers from L&N—25,000 to 50,000 hours.

They're designed to operate with good efficiency into a wide range of circuit impedances, especially at high impedances. Efficiency goes beyond 95% when load is in the megohm range. And they're not as sensitive to shock and vibration as mechanical choppers.

For SPST application, we provide a tubular chopper with CdSe cell. For SPDT application, the chopper is in a flat package, plug-in configuration with two lamps and two CdS cells. A unique electrostatic shield is used between lamp and cell, reducing interaction and giving better noise characteristics.

Features include low d-c voltage offset—less than 1  $\mu\text{V}$  and low microvolt noise levels.

Applications? The SPST chopper can be used to stabilize high-gain amplifiers, cutting drift to negligible levels. The SPDT design can profitably replace an electromechanical chopper in a low-level, d-c servo amplifier circuit. Both have excellent capability for handling low-level signals.

They're so good, we use them in our latest Speedomax recorders and other L&N instruments.

They're the newest in our family of choppers, which includes mechanical, photo-conductive and — soon — solid-state types.

To learn more about these choppers and how to order, write or call Components Division, Leeds & Northrup, North Wales, Pa. 19454. (212) 699-5353.



**LEEDS & NORTHRUP**  
Philadelphia 44 • Pioneers in Precision

ON READER-SERVICE CARD CIRCLE 29

## LETTERS

(continued from p. 38)

area, eliminating the circular mil, for example?

Eli Silverman

Consulting Engineer

Hempstead, L. I., N. Y.

## Biology inspires fluidic design

Sir:

Your interesting article on fluidics, which appeared in the Aug. 30 issue of *ELECTRONIC DESIGN* [ED 20, pp. 17-21], has prompted me to jot down a few ideas which I have not seen in print and which may be relevant to the subject.

With the present emphasis on fluidics, it appears strange—to me, at least—that the analogy has not been drawn between man-made fluidics and natural fluidic systems, such as the vascular system of animals. From such an analogy much could be learned and exploited: for one thing, new models—both mathematical and functional—of the vascular system could be elaborated; and second, new and useful hardware directly based on biological models might be created. This note is primarily concerned with the second of these two alternatives.

The basic fluidic circuit is that of the bistable amplifier illustrated in Fig. 2 of your article [p. 18]. The major difference between natural and man-made fluidics is that the latter are rigid-walled structures. By contrast, the walls in the former are free to respond to a variety of stimuli by either contracting or expanding. This property can thus channel flow selectively from partially "obstructed" channels to unobstructed, or even actively opened, channels. This suggests that flexible-walled models of a bistable amplifier could be made out of compressible plastic Y-shaped pieces interconnected by conventional plastic tubing. Compression at the branches of the junction could be achieved by a variety of mechanical means, such as electrically activated solenoids, or by control tubes wrapped around the arms of the junction in such a way that fluid flow in the control tube will constrict the walls of the main

channel. Among the attractive features of such a scheme is cost, since the major components of the system could be made with cheap plastics by conventional molding and extrusion techniques. Another attraction is that linear as well as nonlinear characteristics are achievable; hence analog as well as digital operation appears feasible.

A device similar to the turbulence amplifier in your Fig. 4 [p. 21], but not dependent on changes from laminar to turbulent flow, can be made with collapsible-wall fluidics. In this case, the inlet orifice of the output tube would be contractile and changes in its diameter would control the output flow.

Pursuing the analogy between living and nonliving systems still further, one could create a fluidic diode, employing the same principle as venous valves, which permit blood flow in one direction only.

Still another useful analogy would permit control of fluidics by use of phenomena similar to clotting, which by formation of an obstructing plug allows blood flow to be diverted to uninjured channels. A properly chosen circulating fluid could be caused to interact with a suitable coagulant at given branches, forming a plug and causing diversion through other branches. For some susceptible liquids (i.e., heat-labile) this coagulation could be produced by localized heating.

R. M. Zilberstein

Sharon, Mass.

## Critic replies to critic on war and peace

Sir:

Donald Davidson criticized me [ED 21, Sept. 13, 1966, pp. 42-44] for defending hecklers during an anti-Vietnam-war march who were dubbed "neo-Nazis" in an ED editorial.

I have been in two shooting wars so far, and while I did not see the incident referred to in the editorial and am willing to concede that the hecklers were neo-Nazis, I cannot

(continued on p. 44)



Technically speaking, men who know meters say nothing in the industry can measure up to the new Auto-Torque. It's built to take it. The

first and only band-type meter built by automated machines for reliability never before possible in conventional meters.

More reliable because Auto-Torque meters have half as



many parts. No screws. No nuts. No hairsprings. No pivots and jewels. And best of all, no "sticks". The mechanism is self-shielded, too, so it can be mounted on any panel without special calibration. Accuracy is unaffected by external fields.

Another thing. The moving system of the Auto-Torque mechanism is suspended on metal bands under tension. So there's no friction and wear.

What's more, (and this may surprise



you) new Auto-Torque meters can actually save you money! Prices to volume buyers are below those for comparable pivot and jewel meters. And there are all kinds of styles to choose from — in fact, the widest selection of band-type meters available today. And they're all a knockout. If you want more information, write to Honeywell Precision Meter Division in Manchester, New Hampshire 03105.

## **Honeywell Auto-Torque Meters**

# Auto-Torque is a technical knockout.



# State of the monolithic art

Logic function  
generator  
is simplified with  
Radiation's 6 x 8  
Monolithic  
Diode Matrix

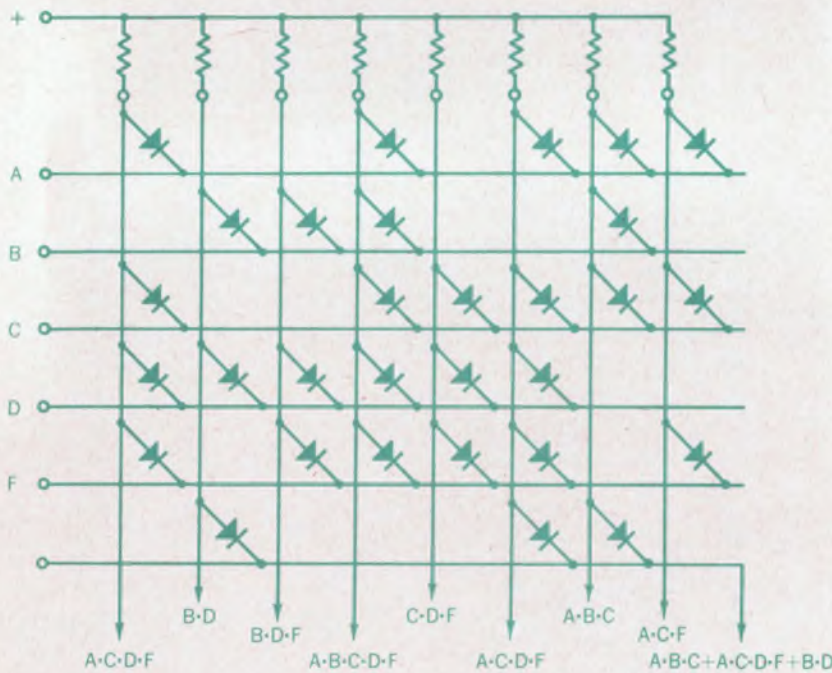

Note: true logic positive

Radiation's RM-30 Monolithic Diode Matrix allows design engineers to: Generate logic functions for data transfer and operational control — Eliminate unnecessary logic gates — Reduce delay time — Save space by reducing package count — Increase speed of performance — Boost fan-out capability through duplicate function generation — Combine matrices to produce many AND/OR logic circuits.

The circuit at left illustrates one of the many uses for Radiation's 6 x 8 Monolithic Diode Matrices. In this example, nine logic functions are generated from five variables.  $A \cdot C \cdot D \cdot F$  is generated twice, to indicate the extended fan-out capability inherent in the matrix approach. This is only one application in which the Radiation Matrix offers the most reliable—often the most economical—approach to diode logic!

# State of the design art

Radiation's popular dielectrically isolated matrices provide an unusual degree of flexibility. (1) They contain 48 active devices per chip. (2) A fusible link in series with each diode permits unlimited matrix patterns to be formed. And (3), circuits can be combined to produce an infinite variety of configurations.

In addition to flexibility, Radiation 6 x 8 Matrices offer the increased reliability of monolithic construction. Size and weight requirements are slashed through reduced package count. Further, cost of matching, testing and assembly of discrete diodes is eliminated.

Production has been expanded to guarantee fast shipment of ma-

trices "customized" to your exact requirements. In fact, most orders are shipped on a 24-hour basis.

Write for data sheets on the entire line of Radiation Monolithic Diode Matrices. *Worst-case* limits are included, as well as all information required by design engineers. We'll also be glad to supply our new manual "Monolithic Diode Matrix Technical Information and Applications." For your copy, request publication number RDM-T01/A01 from our Melbourne, Florida office.

*A new low cost RM-34 design is immediately available in volume at a new unit price of less than \$5.00—and can be supplied to any code configuration that you may want.*

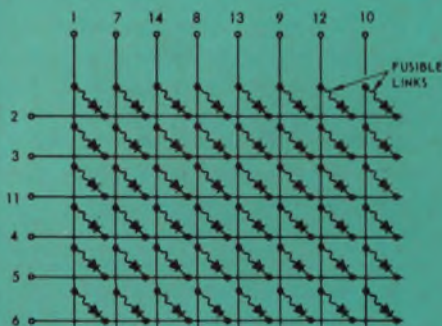

BEFORE "CUSTOMIZING"



Radiation 6 x 8 Monolithic Diode Matrices\*

Characteristic	Symbol	RM-30 (Typ limits)	RM-31 (Typ limits)	RM-34 (Typ limits)	Unit	Test conditions ( $T_A = +25^\circ\text{C}$ )
Forward drop	$V_F$	1.0 0.7	1.3 0.75	1.0 0.7	V	$I_F = 20 \text{ mA}$ $I_F = 1 \text{ mA}$
Reverse breakdown	$BV_R$	60	60	50	V	$I_R = 100 \mu\text{A}$
Reverse current	$I_R$	7	25	70	nA	$V_R = 25 \text{ V}$
Reverse recovery	$t_{rr}$	7	11	30	ns	$I_F = 10 \text{ mA to}$ $I_R = 10 \text{ mA}$
Crosspoint capacitance	$C_{cp}$	1.9	1.9	2.0	pf	$V_R = 5 \text{ V}; f = 1 \text{ MHz}$
Coupling coefficient	$I_{CL}$	20	20	20	$\mu\text{A}$	See data sheet

\*Supplied in TO 84 packages. Detailed data sheets available on complete line.

All Radiation integrated circuits are dielectrically isolated.



**RADIATION  
INCORPORATED**  
MICROELECTRONICS DIVISION

Sales offices: Suite 622, 650 North Sepulveda Blvd., El Segundo, Calif. (213) 772-6371—Suite 438, 600 Old Country Road, Garden City, N. Y. (516) 747-3730—Suite 201, 1725 Eye Street, N. W., Washington, D. C. (202) 337-4914—P.O. Box 37, Dept. ED-11, Melbourne, Florida (305) 723-1511, ext. 554

More IC developments from Radiation! Our new line of Operational Amplifiers now opens the door for integration of systems requiring high performance analog circuitry. These amplifiers are designed to provide the ideal 6db per octave high frequency roll-off required for unconditional stability in operational feedback connections *without* use of external compensation . . . even in the critical unity gain configuration.

Three types are immediately available in TO-84 flat packages: general-purpose, broadband, and high-gain circuits. All offer outstanding performance characteristics. For example, major parameters for Radiation's RA-239 Broadband Operational Amplifier are:

$TC_{A_{vg}}$ :

Input Offset Voltage:  $\pm 5 \mu\text{V}/^\circ\text{C}$

Input Offset Current:  $\pm 5 \text{ nA}/^\circ\text{C}$

Undistorted Output

Voltage Swing: 21.6  $V_{p-p}$

Unity Gain Bandwidth: 15 MHz

Open Loop Gain: 2700

Power Dissipation: 160 mW

UNCOMPENSATED UNITY GAIN  
TRANSIENT RESPONSE:

Output Voltage 1.0 V

Rise Time: 25 ns

Overshoot: 15%

Slew Rate: 30 V/ $\mu\text{s}$

Further application information will appear in our ELECTRONICS advertisement of December 12. We'll be glad to send data sheets which include worst-case limits, and a copy of our manual, Operational Amplifier Technical Information and Applications, ROA-T01/A01. Write or call our Melbourne, Florida office.



ON READER-SERVICE CARD CIRCLE 31

# MODEL T-60 60 KHZ TIME CODE RECEIVER



Write, wire or phone for complete catalog information.

**SPECIFIC PRODUCTS** P. O. Box 425 / 21051 Costanzo Street / Woodland Hills, California 91364 / Phone: (Area Code 213) Diamond 0-3131

45 degrees forward at exactly 10 minutes after each hour and the reverse shift at exactly 15 minutes after each hour.

The Schmitt BCD output can be completely automated for continuous monitoring of extremely accurate real time and time interval information.

**MODEL T-60A** \$480.00  
3 1/2" x 19" rack panel with 5" depth behind panel. Includes 117v, 50 to 400 cps supply, or an external 12 to 16 volts may be used.

- Round The Clock WWVB 60 KHZ Binary Time Code Broadcasts
  - Most Accurate Time Signal Available
  - Can Be Recorded Continuously
- Radio Station WWVB is broadcasting complete time information using a level shift carrier, time code (10 db level changes). This code, which is binary coded decimal (BCD) is broadcast continuously and is synchronized with the 60 khz carrier signal. The station identification is provided by a phase shift of



## LETTERS

(continued from p. 40)

condemn their actions in this instance.

When you were in the service, Mr. Davidson, were there any groups trying to undermine your positions and possibly get you killed? And if there were, what did you think of them? Why weren't the Nazis in the service? Why aren't the marchers? "Practice what you preach" indeed works both ways, Mr. Davidson.

We are at war. If you feel that you cannot help your country, don't hinder it. The hecklers may not have been very commendable types, but what were the marchers?

Paul Doerr  
San Francisco Bay Naval Shipyard  
Vallejo, Calif.

## Power supplies are complete V and I sources

Sir:

As one involved in the specification of dc power supplies and the generation of meaningful specifications about them, I should appreciate the opportunity to reply to reader Kestenbaum's letter in your Sept. 12 issue [ED 21, p. 34].

Mr. Kestenbaum's complaint is that modern series-regulated power supplies will not sustain overloads, even momentary ones, as their self-protecting circuits invariably act to limit overload current. He describes power supplies made and rated this way as "highly unrealistic" in terms of his particular application (involving audio or pulse loads).

The term power supply is an unfortunate misnomer, as it tends to imply a *power* capability in some users' minds, an implication which is perhaps derivative from a simpler era, when power supplies were limited fundamentally by thermal considerations. Then it was possible to speak of a "power-limited" circuit for which peak values and duty cycle were subordinate to average and rms numbers.

Modern series-regulated supplies, on the other hand, are *voltage* and *current* sources in the complete sense of the word. No longer are mere thermal conditions the sole

limiting factor in output ratings. The supplies are designed for, and deliver, certain specific maxima in terms of both voltage and current. These characteristics require manufacturers to specify and describe their product in terms of the absolute values of voltage and current, defining, thus, an operating region or area on the volt/ampere plane.

Far from being "unrealistic" or failing to give the user a true appraisal of the unit in the user's circuit, such ratings are entirely real, referring to easily duplicated test conditions and specified in easily measured maximum volts and amperes. Of course, they do force the user to re-evaluate his circuit requirements in terms of absolute (peak) volts and amperes, and do not permit the sort of time-averaging which describes a 300-volt, 10-ampere pulsed load as "300 volts at 10 milliamperes." This latter specification is the unrealistic one. . . . Properly stated, peak and average values of an ac load should be given, together with a duty cycle and waveform. Whatever the description, a series-regulated power supply must always be rated for the peak load conditions. It matters not that a particular load draws only 10 amperes for a very short time, only once a year (a minuscule average); its power supply must be rated to deliver the 10 amperes or the circuit will be starved, and will not perform properly.

A proper understanding of the equipment ratings, the units, terms, and methods, is essential to the application of such equipment in an engineering sense. Your magazine is to be commended for furthering that vital understanding.

Paul Birman

Sales Engineer  
Kepeco, Inc.  
Flushing, N. Y.

## Accuracy is our policy

In "Try the hybrid-pi," ED 21, Sept. 13, 1966, pp. 66-68, author Robert Mammano points out that the test equipment input capacity,  $C_{in}$ , in Fig. 2, p. 67, should read 7.5 pF, not 2.0 pF as printed.





3 times out of 4  
our distributor has your  
switch order in the bag.

The bag  
we call  
Uni-Pak.

Your Cutler-Hammer Distributor sells more than 10,000 different commercial switches and military switches. One of these will do your job, or we're ready to design the special that will.

More often than not, he can fill your switch order from right off his shelf. Because of unit pack.

What's unit pack all about?

First, it covers the 350 basic commercial and military switch models that account for 75% of our Distributors' orders. Next, it is convenient packaging: one switch with mounting hardware per sealed plastic bag; 25 bags per carton.

Most important, unit pack provides immediate local availability of all these popular, conveniently packaged switches. Your Distributor's stocks are substantial. Our factory back-up stocks truly enormous.

Now you have immediate switch selection without tying up dollars in inventory. For prototype production. To cover unexpected rush orders. The switches you need today, you order today. Or yesterday at the earliest.

Chances are excellent our unit pack switch program can pay-off in better service for you. Plan to discuss it soon with your nearby Cutler-Hammer Distributor.

**CUTLER-HAMMER**

Milwaukee, Wisconsin 53201





**TRW CAPACITORS...  
IN SPACE-SAVING  
SHAPES**

14-60

**The 601 PE... a particular shape for a particular need.**

Design with Mylar reliability in the size and shape of a disc! The slim, compact type 601 PE is tailored for printed circuits in military or industrial applications.

In all you will find more than 200 design variations of reliable TRW Capacitors. Round or oval cross-sections. Axial

or radial leads. Dipped, tape-wrapped, or metal enclosed cases. Essentially all these constructions are available in film-foil, in metalized Mylar\* and polycarbonate dielectric.

In a tight spot? There's a TRW Capacitor to help you. Contact TRW Capacitors, Box 1000, Ogallala, Nebraska.

\*Du Pont Trademark

**TRW** CAPACITORS

ON READER-SERVICE CARD CIRCLE 34

**Co-Publishers**

James S. Mulholland, Jr.,  
Robert E. Ahrensdorf

**Editorial Director**

Edward E. Grazda

**Editor**

Howard Bierman

**Managing Editor**

Robert C. Haavind

**Technical Editors**

Peter N. Budzilovich  
Joseph J. Casazza  
Rene Colen  
Maria Dekany  
Frank Egan

**News Editors**

Ralph Dobriner, News Chief  
Roger K. Field

**East Coast Editor**

Neil Sclater

**West Coast Editor**

Ron Gechman

**Copy Editor**

Peter Beales

**New Products Editor**

David Sorgan

**Washington Editor**

S. David Pursglove

**Editorial Production**

Dollie S. Viebig  
Karen L. Sherman

**Art Director**

Clifford M. Gardiner

**Art Assistant**

William Kelly

**Technical Illustrators**

Cheh Nam Low  
Douglas Luna

**Production Manager**

Thomas V. Sedita

**Asst. Production Manager**

Helen De Polo

**Production Assistants**

Bernard Wolinsky  
Robert M. Henry

**Circulation Manager**

Nancy L. Merritt

**Reader Service**

Diane Pellechi

## EDITORIAL



## Saga of a systems man — or meetings, shmeetings

Dr. Perry Asymptote, Chief Systems Scientist for Analysis and Reanalysis, Inc., was preparing his briefcase for his 17th technical meeting of the year.

The renowned systems specialist was heading this time for the Poconos—"Vacationland of Pennsylvania," the flyer said. "Too warm for skiing and too cold for fishing at this time of the year," Dr. A. mused, but at least he would get to bend an elbow with some old friends. Memories of meetings in Las Vegas, Miami, Paris and Disneyland waltzed through his mind.

*(Are resort locations truly necessary for the exchange of ideas? Or do they offer, instead, a number of interfering distractions?)*

Then, as Dr. A. shuffled through his morning's mail, he spotted a curious letter. It read:

"All Government agencies are seeking ways of reducing expenditures in order to relieve pressures on the economy, while giving strong support to our efforts in Vietnam. To that end the Air Force is deferring or eliminating all conferences or meetings which are not of immediate necessity. I have, therefore, decided to postpone the Congress on . . . ."

Signed by an Air Force general, the letter went on to explain that the papers scheduled for the meeting would be published and delivered to all who had been invited.

*(It's really true. The letter was sent out Oct. 31—the most efficient time-saver for meetings attendance we've heard of yet.)*

The sudden turn of events meant that Dr. A. would have to sit in the home plant, pursuing some sort of activity for the next three weeks—until the next conference was scheduled.

Just then, a junior systems man, looking a bit sheepish, appeared at the office door.

"Sorry to bother you, Dr. Asymptote. I know you've been busily traveling to important conferences, but do you remember that design problem I mentioned as you were rushing to catch a plane six months ago? Well, we're still stuck . . . ."

Dr. A. realized that this time there was no escape. He pushed a pile of analyses, reanalyses and memoranda aside and invited the young engineer to sit down. In a few minutes he was enmeshed in a difficult technical quandary—and found that his problem-solving apparatus had become distinctly rusty.

On the following Thursday afternoon, Dr. A. went through his meetings schedule and crossed out over half the entries. For the next few days he plunged deeper and deeper into the problem.

"It hurts," he mumbled, "But the Air Force was right."

ROBERT HAAVIND



## AND STRIP!

Our new Mallinckrodt organic photoresist stripper needs no added chemicals, and it works hot or cool.

Here's the organic stripper that eliminates the mess of mixing and, in many cases, the need for heating. New Photostrip 66 TransistAR®. You just pour it out and put it to work at room temperature. Or heat it up where the application requires.

Photostrip 66 is non-flammable and non-alkaline. It softens and removes resist quickly.

Give our new Photostrip 66 a whirl. It works beautifully and it's a step faster than anything you've ever used before. For product data, write Electronic Chemicals, Mallinckrodt Chemical Works, St. Louis, Mo. 63160.

**Mallinckrodt**

**MALLINCKRODT CHEMICAL WORKS / Electronic Chemicals**

® St. Louis • New York • Los Angeles

ON READER-SERVICE CARD CIRCLE 35

# Technology

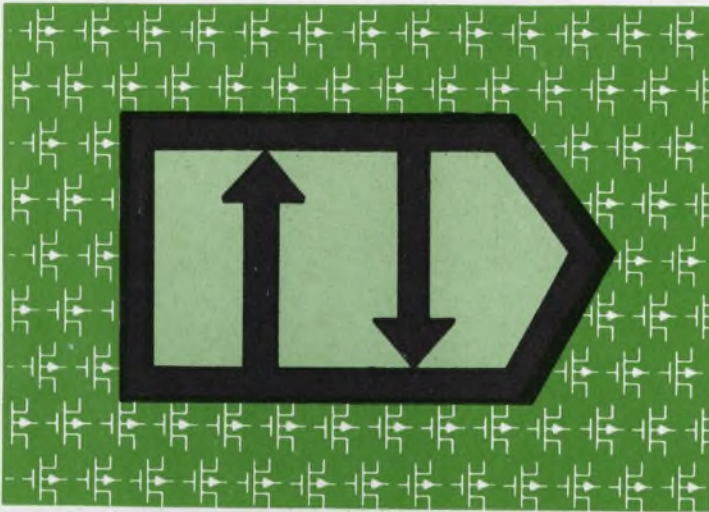

FETs function with low-level logic, so bridging the 'driver gap' in analog signal switching. Page 50

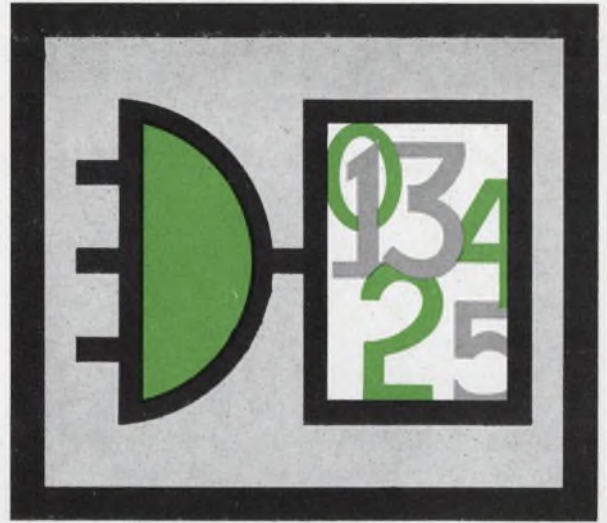

Karnaugh map eases Boolean equations and helps simplify logic design. Page 64



A digital clock built with integrated circuits and a 1-MHz crystal-controlled oscillator will

develop signals that have an accuracy better than one part per 100 millions. Page 70

## Also in this section:

Design moving-target indicating radars rapidly using two graphs. Page 58

Solid-state regulators fulfill high-voltage dc power requirements. Page 76

Vector analysis is simplified by a set of nomographs. Page 82

Evading radar detection is EASY if your aircraft is nimble enough. Page 86

# ICs end the 'driver gap' in FET analog signal switching. These circuit designs permit the use of junction and MOS devices as switches with low-level logic.

From the time they were first introduced, junction field-effect transistors (J-FETs) and metal-oxide semiconductor types (MOS-FETs) have always been excellent for analog signal switching.\* But they could never be used directly with low-level logic circuits, because of the relatively large voltages (both positive and negative) required for their control.

Now the problem can be solved. Several integrated circuits have been developed to bridge this "driver gap." These circuits, available commercially, can amplify low-level signals and also shift levels. The considerations that went into their design should prove useful in selecting the right circuit. They also would apply to discrete-circuit design.

The circuits can be used in any application where good isolation of the switched signal from the driving source is required. For example:

- Sequential switching (commutation) of many signals into a single output.
- Analog-to-digital converters.

Starting with a step-by-step description of J-FET and MOS-FET fundamentals as switches, let us consider input-output driver circuit requirements and how to integrate the J-FET and MOS-FET analog switches and drivers.

## FETs are switches

Figure 1 shows three types of FETs as they are commonly used for analog switching. Figures 1a and b are n-channel and p-channel junction-FETs (J-FETs), respectively. Figure 1c is a p-channel MOS-FET. Each can be used to perform a single-pole, single-throw switch function. Figures 1d, e and f show the functional symbols used in this article to represent the three FETs in Figs. 1a, b

\*See ELECTRONIC DESIGN issues 12, 13, 14, 15, all Vol. 14, 1966.

Arthur D. Evans, Vice President, Engineering Manager, Siliconix, Inc., Sunnyvale, Calif.

and c. The n- and p-channel J-FETs are normally ON switches; hence their symbols are shown with the contacts closed. The p-channel MOS-FET is normally an OFF switch; its symbol has open contacts.

Also indicated in Fig. 1 is the gate voltage  $V_G$  polarity needed to turn the switch OFF or ON. For example, an n-channel J-FET is turned ON when  $V_{GS}$  swings positive with respect to the OFF gate voltage. This fact may be indicated in the switch symbol by placing an arrow pointing upward at control terminal G. Following this new sign convention, both p-channel FET switch symbols have downward pointing arrows at terminal G, to indicate that the ON gate voltage level is negative with respect to the OFF voltage.

The FET source and drain terminals are internally connected by the channel. When the FET is ON, the channel conducts current in either direction between them. Therefore the analog signal can be fed into either the drain or source and taken out of the opposite terminal. Since the FET is usually symmetrical, the drain and source terminals may be interchanged without affecting

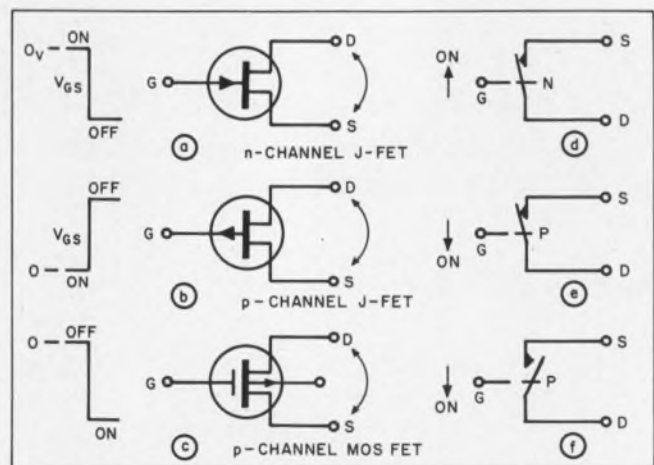

1. J-FETs as switches (a, b) are normally closed (d and e) while MOS-FETs (c) are open (f). The arrows are used to indicate the gate voltage polarity required to turn the switch ON, positive-up, negative-down.

performance. For the purpose of this discussion, let us assume that the analog input signal is connected to the source terminal, designated the analog input terminal; thus the drain becomes the output terminal.

### Know your n's and p's

Channel conduction, or channel resistance, is a function of gate-to-channel voltage ( $V_{GS}$ ). The graphs in Fig. 2 show channel conduction  $1/r_{ds}$  vs voltage  $V_{GS}$  for the three FET types. Note that, for both p- and n-type J-FETs, the conduction is high (switch is ON) with zero gate voltage. When the gate is made negative for the n-channel, or positive for the p-channel, conduction decreases to approximately zero for a gate voltage equal to pinch-off  $V_p$ . The n-channel J-FET requires a gate-to-channel voltage more negative than  $V_p$  to hold it OFF. For example, assume the analog signal at the source is +5 volts and the drain is -3 volts. If  $V_p = -8$  volts, the gate voltage must be equal to or more negative than -11 volts to hold the J-FET switch OFF. For similar analog signal conditions (+5 and -3), a p-channel J-FET with  $V_p = +8$  volts would need a gate voltage equal to or greater than +13 volts to hold it OFF.

The operation of the p-channel MOS-FET differs a little from that of the p-channel J-FET. As shown in Fig. 2, the conduction of the MOS-FET channel is approximately zero in the absence of a gate voltage—that is, the device is normally OFF. When the gate is made more negative than threshold voltage  $V_{th}$ , with respect to either source or drain terminal, the channel begins to conduct. Again, if we assume the same analog signals as above (+5 and -3 V) and assume  $V_{th} = -6$  volts, the gate voltage should be more positive than -1 volt to hold the switch OFF.

When switched ON, FET source and drain

terminals are approximately at equal potential. In addition, with J-FETs the gate-to-channel voltage ( $V_{GS}$ ) should be approximately zero. Although a forward-biased gate will produce higher channel conduction, it also may result in excessive current being forced into the channel and hence into the analog signal path from the gate control circuit. This may be permissible, if the analog signal disturbance is very small, but usually it should be avoided.

For the p-channel MOS-FET, gate voltage should be much more negative than  $V_{th}$  to obtain high channel conduction. A typical value of ON gate voltage for the MOS is -15 volts plus the most negative analog signal to be switched. If the analog signal is expected to swing down to -5 volts, then a gate drive voltage of -20 V should be provided to turn the switch ON. If the analog signal is expected to swing up to +5 volts and the MOS has a  $V_{th}$  (minimum) of -3 volts, then the gate voltage must go up at least +2 volts to turn the switch OFF.

### Drivers amplify and shift levels

In many applications the gate control signals originate in low-level logic stages with outputs of less than 5 volts. The foregoing examples indicate that gate control signals of 10 to 30 volts are needed to turn FET switches OFF and ON; hence an amplifier is needed. Also, the logic signal is usually referenced to ground (logic 0) and swings positive (logic 1), whereas the analog-switch gate may need to swing from -20 volts to +10 volts. Thus the gate driver must provide both amplification and level-shifting functions. For flexibility, the output reference level (0) should be fairly independent of the driver input reference level.

The driver circuit in Fig. 3a accomplishes these

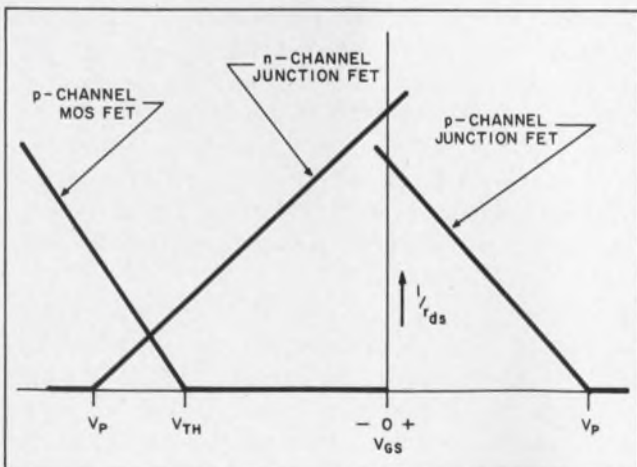

2. J-FET channel conduction vs gate voltage is easy to remember: n-channel (negative  $V_{GS}$ ) = OFF; p-channel (positive  $V_{GS}$ ) = OFF; for MOS-FETs this is reversed. All voltages are from gate to channel.

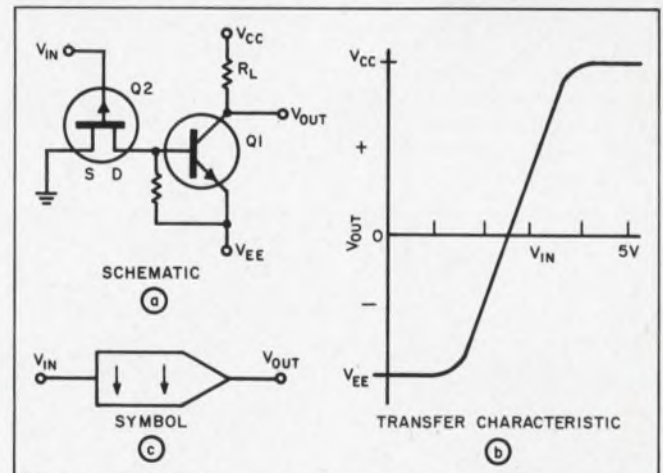

3. One J-FET and one transistor (a) amplify and shift levels (b) in response to a low-level input. Note the new logic symbol (c), with the arrows of Fig. 1 used to indicate the signal polarities when the driver is ON.

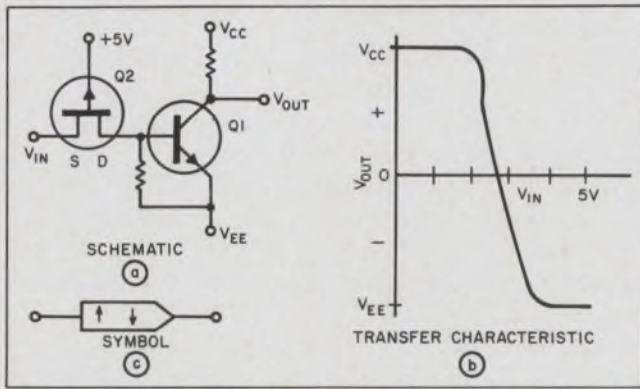

4. Invert function of circuit of Fig. 3 results if the input leads are rearranged.

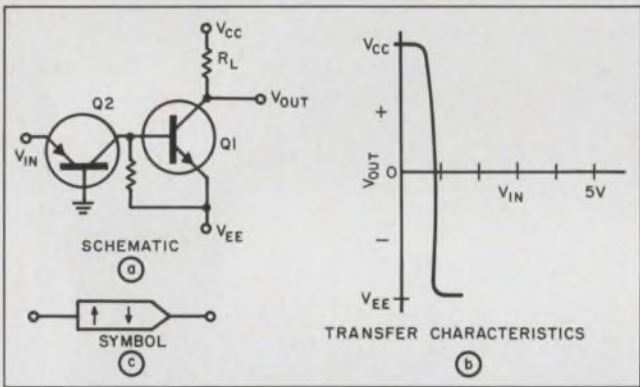

5. A two-transistor driver (a) can accept even lower inputs (b) than the circuit of Fig. 4. A pnp transistor, Q2, shifts the levels.

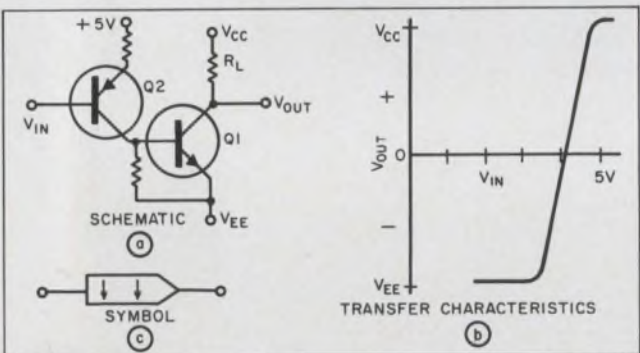

6. Invert function of circuit of Fig. 5 results through additions of a resistor and rearrangement of the input. The function is the same as that of Fig. 3.

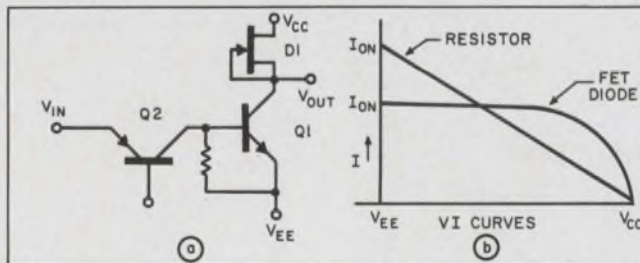

7. Replacing  $R_L$  in the circuit of Fig. 6 with a FET diode (a) results in ON power saving (b). Note that since the areas under the two curves are about the same, the switching time is not affected.

goals. Fig. 3b shows the transfer characteristics of this driver. When input FET Q2 is ON ( $V_{IN} = 0$ ), the output stage Q1 is saturated and the output voltage is approximately  $V_{EE}$ . As  $V_{IN}$  is made positive, the channel conduction of Q2 begins to decrease, and Q1 begins to come out of saturation. Further increase in  $V_{IN}$  results in turning OFF both Q2 and Q1.  $V_{OUT}$  then rises to  $V_{CC}$ . For this driver, a logic 0 at the input turns the driver ON. In the ON condition the output is low as indicated by the new symbols defined below.

A symbol, shown in Fig. 3c, has been devised to represent the analog gate driver function. The arrows at the input and output sides indicate the voltage condition at the terminals when the driver is ON. When Q2 in Fig. 3a is ON, the output voltage is down (to  $V_{EE}$ ); therefore the output arrow in the symbol points down. For the output to be ON, the input  $V_{IN}$  must be at logic 0 (down); hence the input arrow also points down.

The circuit of Fig. 4a is the same as Fig. 3a, except the source of Q2 is the input terminal and the gate is referenced to the logic voltage supply, +5 V. In this case a logic 0 at the input turns the output OFF, and a logic 1 (+5 V) turns the output ON. Fig. 4b shows the transfer characteristic and Fig. 4c the symbol for this driver. Note that the input arrow points up. This circuit has an invert function, in addition to amplifying and level-shifting.

The circuit of Fig. 5a has a function similar to that of 4a. However, as indicated by its transfer characteristic, it will switch with a lower input voltage. A pnp transistor Q2 provides the level-shifting function. Fig. 6a shows that a noninvert function can be achieved by interchanging the input and reference voltage terminals. In this case a current limiting resistor has been added to the emitter of Q2. Fig. 6b shows the transfer characteristic and Fig. 6c the symbol for this driver.

The external load on an analog-gate driver is usually light and consists primarily of the capacitance of the gate or gates being driven. The  $R_L$  values in Figs. 3, 4, 5 and 6 will be determined, in part, by the required switching speed. As the value of  $R_L$  is made smaller, the gate capacitance can be charged up faster and the turn-off time will decrease. Since this also results in an increase in ON power, a trade-off is now possible between speed and ON power.

As shown in Fig. 7a, a FET current-limiter diode may replace resistor  $R_L$  to decrease ON power without decreasing speed. Diode D1 has a volt-amp characteristic, as shown in Fig. 7b. Since areas under the two curves are about equal, the turn-off time (capacitor charging time) is about the same. The FET diode, however, limits the ON power to about 60% of that resulting when the resistor is used. In Fig. 8a, the MOS-FET Q3 is



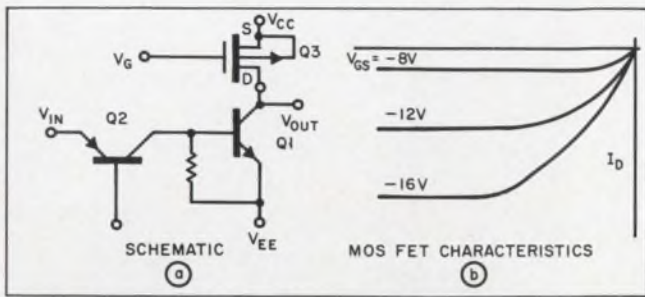

8. Output current can be "pulled up" if  $R_L$  of the circuit of Fig. 6 is replaced with MOS-FET (a). Note the effect of  $V_{GS}$  on the current for a given  $V_{ds}$  (b).

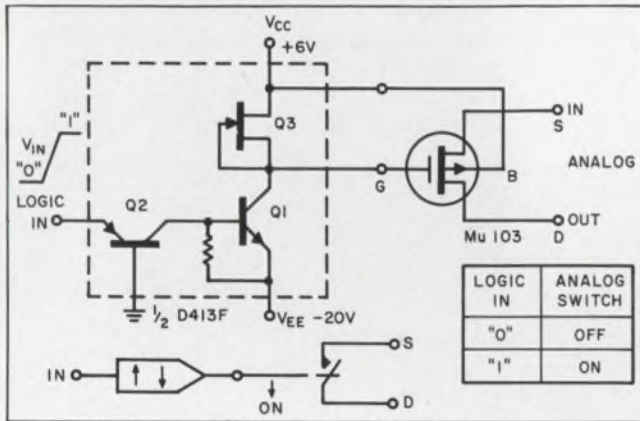

9. Integrated driver can provide  $-20$  V to operate the MOS-FET analog switch. The power consumption is minimum when the switch is OFF.

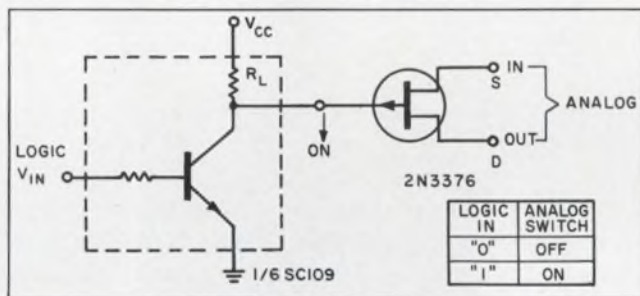

10. Low-level analog signals can be switched with a single transistor integrated driver and a J-FET. Analog signals exceeding  $0.5$  V cannot be handled by the switch.

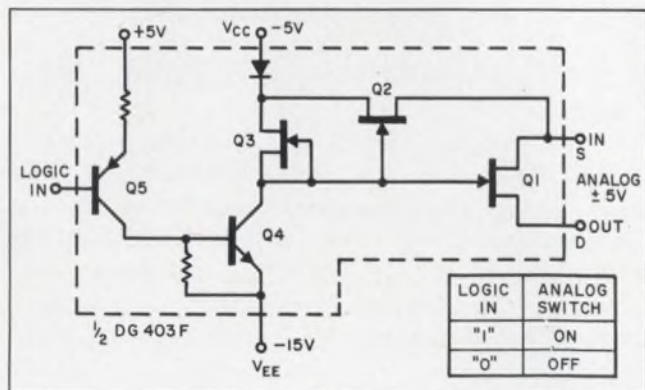

11. An integrated driver-FET switch dissipates minimum power in the ON condition.

used for the output "pull-up." With this addition, the gate of Q3 is available to set the pull-up current level. Fig 8b shows the output characteristics of the MOS-FET as a function of  $V_G$ .

Any of the foregoing driver circuits can be used to control a p-channel MOS-FET switch. Fig. 9 presents the schematic and symbol for a typical integrated driver and switch. To turn the switch ON, the driver must pull the switch gate down to  $-20$  V. The switch is held ON over the full analog signal range of  $\pm 5$  V. When the driver is OFF, pull-up FET Q3 clamps the switch gate to  $+6$  V ( $V_{CC}$ ), which holds the switch OFF over the full analog signal range. In the ON condition, switch conduction varies with analog voltage, because channel conduction is a function of gate-channel voltage (see Fig. 2). In most cases this modulation of channel conduction by the analog voltage is not serious.

A simple integrated driver and J-FET switch are shown in Fig. 10. The advantages of the circuit, other than simplicity, are that dissipation in the OFF condition is very low, and the required gate voltage swing is only slightly greater than  $V_p$ . Though the analog voltage range in the ON condition is limited, this circuit is excellent for switching low-level signals. In the ON condition, the FET gate is held at about  $0.2$  volt. If either source or drain is allowed to become more than a few tenths of a volt positive with respect to the gate, gate-current flow will decrease gate isolation and disrupt switching action. As a result, analog signals of greater than  $0.3$  to  $0.5$  V cannot be handled by this circuit.

In the circuit of Fig. 11, the gate of the n-channel J-FET switch Q1 is clamped to its source in the ON condition and clamped to  $-15$  V in the OFF condition. The voltages used in this illustration assume that: (1)  $V_p \leq -10$  volts for all the FETs, and (2) the analog signal is  $\pm 5$  volts. This circuit functions as follows:

If Q4 is ON, the gate of Q1 is clamped to  $-15$  volts, and switch Q1 is turned OFF. FET Q2 is also turned OFF, disconnecting the driver circuit from the analog switch source. To turn the analog switch ON, Q4 is turned OFF. With Q4 OFF, the voltage drop across Q3 is reduced to zero, thus permitting Q2 to turn ON. With Q2 ON and zero drop across Q3,  $V_{GS}$  of Q1 is zero; therefore Q1 is ON. Note that this circuit uses minimum power when the switch is ON. The circuits of Figs. 9 and 10 use minimum power when the analog switches are OFF.

In Fig. 12, when Q3 is OFF, Q1 is OFF because its gate is at  $+15$  volts. When Q3 is ON,  $V_{GS}$  of Q1 becomes negative, and the gate pulls a certain amount of current from the analog input terminal. The amount of current is limited to the saturation current of FET diode Q2. For this switch the saturation current is limited to  $6 \mu A$ . Fig.

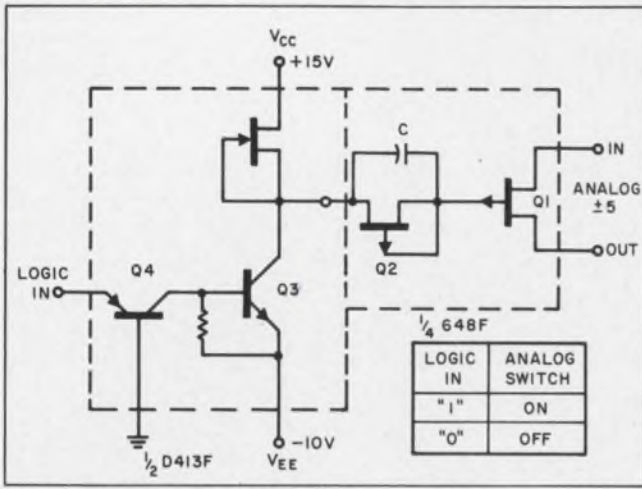

12. Only 6  $\mu\text{A}$  of current are drawn from the analog input terminal when the switch is ON.

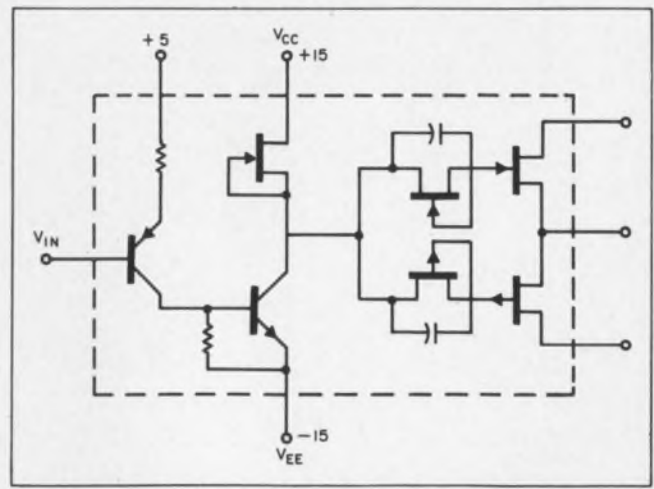

13. An SPDT switch results with addition of three components to the circuit of Fig. 12.

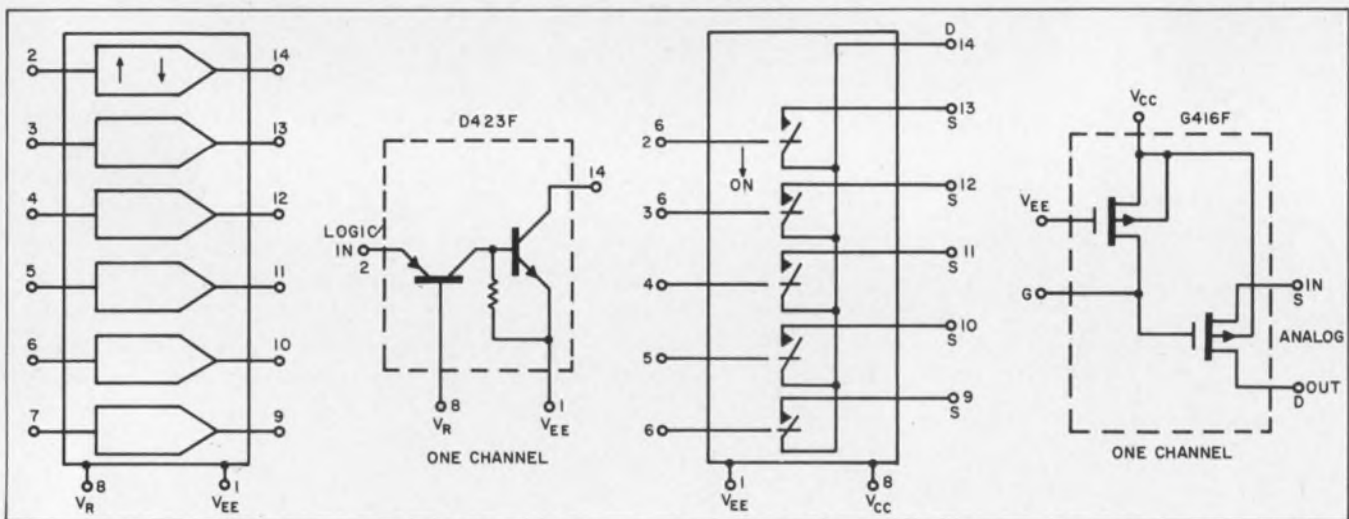

14. Six drivers and five gates are packaged separately in 14-lead flat packs.

13 is similar to Fig. 12, with an n-channel switch added to provide a SPDT switch function. The n-channel and p-channel J-FET switches should have comparable  $V_p$ .

### How to integrate

Many of the driver and gate circuits discussed above are suitable for integration onto a single chip. In fact some of the drivers are so simple that as many as six may be placed in a single package. Though integrated drivers can be built with both J-FETs and bipolar transistors on a common substrate, the same circuits with FETs and bipolars on separate chips are more economical. For example, the circuit of Fig. 7a may be separated into two parts: pull-up FET D1 on one chip and the rest of the circuit on another. A pair of drivers may be packaged in a single 14-lead flat-pack or in a 12-lead TO-5.

The driver and gate circuit of Fig. 9 (with a MOS-FET substituted for Q3) may also be sepa-

rated into two parts: one chip includes all MOS-FETs and the other the rest of the circuit. In this case, a pair of drivers plus gates may be packaged in a single 14-lead flat-pack or in a 12-lead TO-5. An alternate approach is to package six drivers, less the pull-up FETs Q3, in a single 14-lead flat-pack. Five MOS analog switches plus the five pull-up FETs are mounted in another flat-pack (Fig. 14). This arrangement increases the number of circuits per package. The use of one driver to control several MOS switches results in fewer packages.

In general, the exact circuit packaging depends on the application. Cost considerations also play an important part in determining the packaging configuration. Thus, if one designs a multiplexer with a large number of inputs, the maximum number of circuits per package is desirable to reduce the number of packages. For example, a 25-channel multiplexer has been constructed utilizing only eight flat-packs of the type shown in Fig. 14, i.e., six-gate and two-driver packages. ■ ■

# Westinghouse makes IC's faster than you can buy them



18 gate circuits with 1 to 6 gates per package in a variety of input arrangements, 3 RS flip-flops, 2 JK flip-flops, 1 pulse binary counter, plus diode expanders, and a variety of interface circuits...all available in dual-in-line pack, flat-pak, or TO can. For technical data, write Westinghouse Molecular Electronics Division, P.O. Box 7377, Elkridge, Maryland 21227.

**Call your Westinghouse Electronic Distributor now.**

You can be sure if it's Westinghouse

J-09136



# Systron-Donner takes all the fuss out

## Instant readings to 12.4 GHz with ACTO<sup>®</sup> plug-ins



Quick as you couple the signal, a microwave reading appears. Notice the reading is "11,659.219 Mc.," an actual microwave frequency—presented with counter accuracy because the input is phase locked. No calculations. No risk of human error. You simply plug in the ACTO for the range you're working in, then use the instrument just as though it were a simple frequency counter.



### ACTO's for HP counters?

People keep asking us if ACTO's will work with Hewlett-Packard Model 5245L frequency counters. The answer is **yes**. We didn't build our ACTO for HP counters, but it turns out that a slightly modified ACTO (our Option W) will slip into the HP plug-in cavity and perform beautifully. So if you already have an HP 5245L, we won't insist that you buy another counter to get ACTO performance. You can have ACTO's for your HP counter to cover the full 0.3 to 12.4 GHz range.

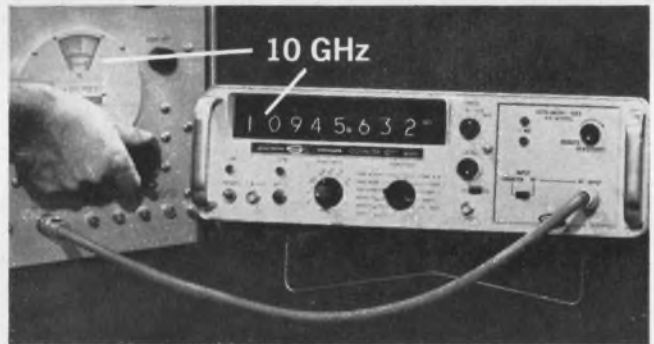
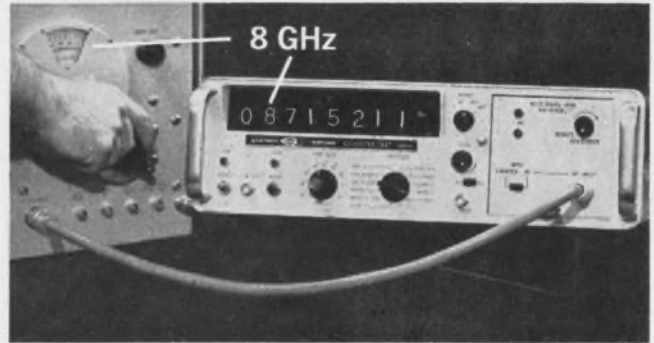

When you change the input frequency, the reading changes right along with it. All automatically. No operating adjustments whatever. That's why we call our plug-in "ACTO" for "Automatic Computing Transfer Oscillator." It enables people with very little technical skill to make precise measurements rapidly and without mistakes.

Systron-Donner Corporation 888 Galindo Street Concord, California  
Phone: (415) 682-6161 TWX: 415-687-3200 Cable: SYSTRONDONNER



Solid-state counter takes all plug-ins at right. Choice of counter-timer, 50 MHz, \$2450 (100 MHz, \$2950) or simple frequency counter, 50 MHz, \$1925 (100 MHz, \$2525)



ACTO, 0.3 to 3 GHz, \$975



ACTO, 3 to 8 GHz, \$1,950



ACTO, 8 to 12.4 GHz, \$1,975

# of microwave frequency measurement.

## Simple 2-step readings to 15 GHz with one transfer oscillator plug-in

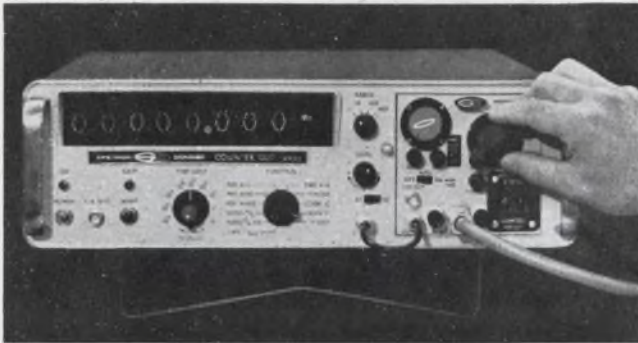

**1.** Tune transfer oscillator until a zero beat—any zero beat—appears on the built-in scope. The transfer oscillator is now phase-locked to the input.



**2.** Adjust harmonic preset until the reading appears. Notice the counter reads "10,803.722 Mc," an actual microwave frequency presented with counter accuracy.

Transfer oscillator plug-in gives you the enormous range from dc to 15 GHz in a single cabinet plus the ability to measure pulsed rf, FM center frequency and FM deviation.

The harmonic preset on the Systron-Donner transfer oscillator eliminates all need to calculate the harmonic number if you have even a rough idea of the frequency of the signal—as is nearly always the case. In the example above the frequency was known to be about 10.8 GHz. The following readings appeared as the harmonic preset was increased:

Harmonic preset number	Reading
84	10,676.634 Mc (Far too low)
85	10,803.722 Mc (Obviously correct)
86	10,928.860 Mc (Far too high)

The center reading was obviously the correct indication—located quickly, unambiguously and without calculation.

### Send for instructive brochure:

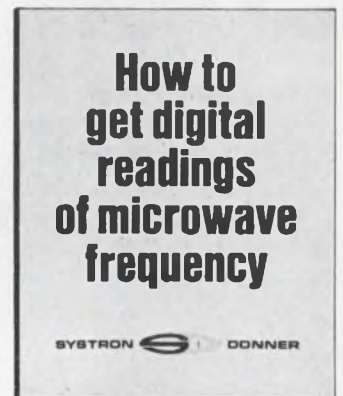

## SYSTRON + DONNER



50 MHz to 15 GHz transfer oscillator, \$1,500



Transfer oscillator 50 MHz to 26 GHz with external mixers, \$1,550



50 to 500 MHz heterodyne frequency extender, \$550



Input video amplifier, \$350



Integrating DVM, \$575

CN READER-SERVICE CARD CIRCLE 37

# Tackle delay-line circuits graphically.

These plots, tailored to frequency-modulated radars relate critical parameters.

The interpretation of signals and the design of delay-line circuits for frequency-modulated radars can be performed rapidly with the aid of the two graphs presented here. The graphs are tailored to systems with linearly modulated FM pulses, where the frequency changes linearly with time. Similar curves may easily be prepared for other systems.

The actual circuit, shown in Fig. 1, illustrates the operating principle of a typical system: The instantaneous phase of the IF input signal from the receiver is compared with the phase of the same signal, displaced in time by a delay of  $\Delta T$ , which is determined by the delay line. The resulting interference pattern causes the output to vary as a function of frequency, with nulls appearing at frequencies differing by  $1/(2\Delta T)$  cycles. The delay may be as large as the pulse repetition rate of the radar. In general, a larger delay makes the discriminator more sensitive to frequency changes, provided that the input and delayed signal overlaps.

For example, a  $1\text{-}\mu\text{s}$  delay line stores 30 cycles of a 30-MHz signal, 31 cycles of a 31-MHz signal, and so on. The phase difference between the input and the output of the delay line therefore varies by 360 degrees for each megahertz change of the

input frequency. The minima and the maxima of the output alternate at every 180 degrees. Similarly, a  $2\text{-}\mu\text{s}$  line would cause the output to repeat every half megahertz.

Other major components of the discriminator include a limiting amplifier to remove amplitude variations, a separate amplitude detector, and a Schmitt circuit to provide synchronization with an oscilloscope and to operate the IF switch, which removes limiter noise when the signal is not present.

The output of the phase detector and the pulse envelope from the amplitude detector appear in Fig. 2. The actual circuit includes a delay line with a  $10\text{-}\mu\text{s}$  delay and an oscilloscope with a  $5\text{-}\mu\text{s/division}$  trace speed. The input pulse width is  $30\text{ }\mu\text{s}$ . The photograph shows that, with linear FM, 10 uniformly spaced beat cycles are generated during the latter  $20\text{ }\mu\text{s}$  of each  $30\text{-}\mu\text{s}$  input pulse.

With these values, the designer can use the graphs to analyze the output or to redesign the system.

The graphs relate beat frequency, FM rate, frequency deviation, and time-bandwidth product to the number of beat cycles, pulse width and delay time. They are based on the following mathematical expressions:

$$\text{Beat frequency } (f_b) = N / (T_p - T_d); \quad (1)$$

$$\text{FM rate } (R) = N / [(T_p - T_d) T_d] = f_b / T_d; \quad (2)$$

$$\text{Deviation } (f_d) = N T_p / [(T_p - T_d) T_d] = R T_p; \quad (3)$$

David Cohen, Consultant, Data Systems, and Richard L. Heimer, Engineer, Space Systems Div., Cutler-Hammer Airborne Instruments Laboratory, Deer Park, L. I., N. Y.

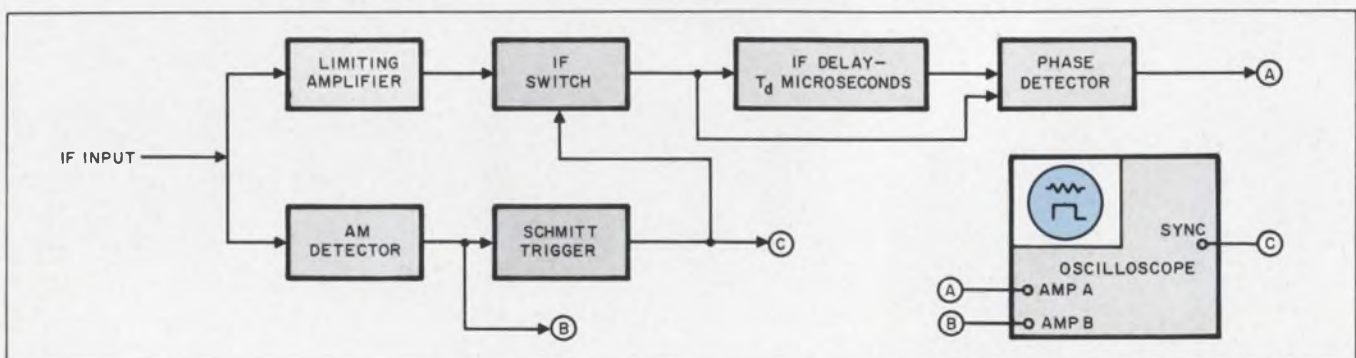

1. A frequency discriminator is used to analyze the characteristics of linearly modulated FM pulses of frequency-

modulated radars. Graphs simplify the interpretation of its output and the needed design changes.

$$\text{Time-bandwidth} = NT_p^2 / [(T_p - T_d)T_d] = RT_p^2$$

$$\text{product } (\beta\tau) = f_b T_p^2 / T_d; \quad (4)$$

where  $N$ =beat cycles,  $T_p$ =input pulse width, and  $T_d$ =delay time.

Of course, it is possible to devise short cuts even with the mathematical approach. For example, the beat frequency may be deduced from the oscilloscope traces by taking the reciprocal of the time of one cycle of the beat signal. In the long run, however, the alignment diagram (Fig. 3) and the four-dimensional chart (Fig. 4) considerably simplify analysis and design.

### Graphs complement each other functionally

The alignment diagram will, with a little practice, provide relatively accurate answers. However, it gives no insight into the consequences of any change of the initial conditions. The four-dimensional chart overcomes this by allowing curves to be drawn.

To illustrate the use of the alignment diagram, consider the previous example, where  $N=10$ ,  $T_d = 10 \mu\text{s}$ ,  $T_p = 30 \mu\text{s}$ .

Align  $N=10$  on the  $N$  scale with  $T_p - T_d = 20 \mu\text{s}$  on the  $T_p - T_d$  scale, and read off  $f_b = 0.5 \text{ MHz}$  on

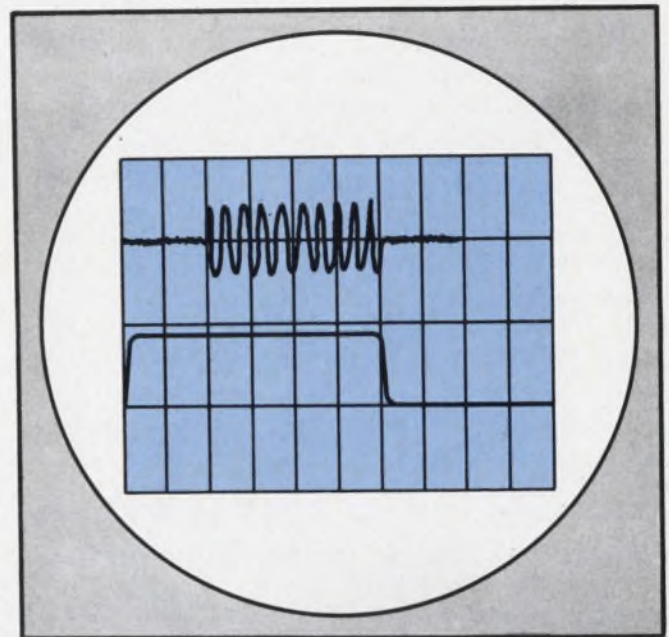

2. Typical display of a discriminator shown in Fig. 1. The lower trace is the pulse envelope from the amplitude detector, the upper trace is the output of the phase detector. The delay line has a  $10\text{-}\mu\text{s}$  delay, therefore, the beat cycles do not start for  $10 \mu\text{s}$ . (Each division on the horizontal scale represents  $5 \mu\text{s}$ .) The  $30\text{-}\mu\text{s}$  input pulse yields 10 uniformly spaced beat cycles.

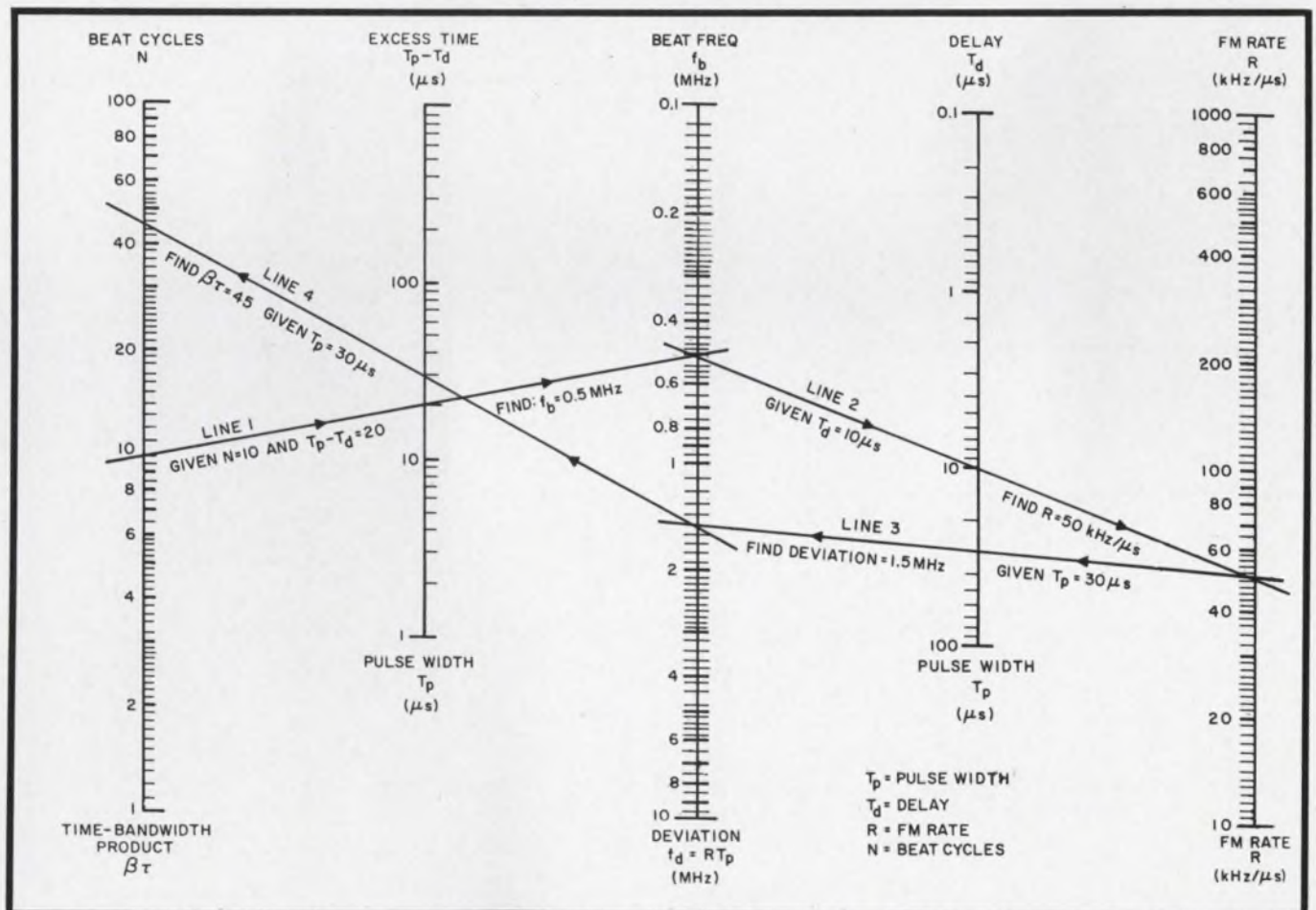

3. Alignment chart provides rapid solutions for the values of the beat frequency, FM rate, deviation and time-band-

width product once the performance of the circuit has been specified.

the beat frequency scale. Align this result with  $T_d = 10$ , and find  $R = 50 \text{ kHz}/\mu\text{s}$  on the FM-rate scale at the right. Now, referring to the lower scale labels, line up this result with the right-hand pulse-width scale, marking  $T_p = 30 \mu\text{s}$ , and note that deviation  $f_d = 1.5 \text{ MHz}$ . Finally, project a straight line from this result through  $T_p = 30 \mu\text{s}$  on the left-hand pulse-width scale to the  $\beta\tau$  scale at the left, and observe that the time-bandwidth product is 45.

The same results are obtained with the four-dimensional chart of Fig. 4. In the example, the excess time of  $20 \mu\text{s}$  intersects with 10 beat cycles at a beat rate of  $0.5 \text{ MHz}$ . This beat rate intersects with the delay time of  $10 \mu\text{s}$  at an FM rate of  $0.05$

$\text{MHz per } \mu\text{s}$ . Extending this FM rate to a pulse width of  $30 \mu\text{s}$  yields a point on the graph that contains the over-all pulse parameters including the total deviation,  $1.5 \text{ MHz}$ , and the time-bandwidth product of 45.

By varying the pulse width, a locus of pulse parameters yielding 10 beat cycles with a  $10\text{-}\mu\text{s}$  delay line can be drawn. Curves of varying pulse widths or delay times or beats may be similarly drawn, holding the remaining two parameters constant. In fact, any one of the seven variables involved may be plotted with any two others held constant, and the necessary curves may thus be obtained for the solution of any particular design problem. ■ ■

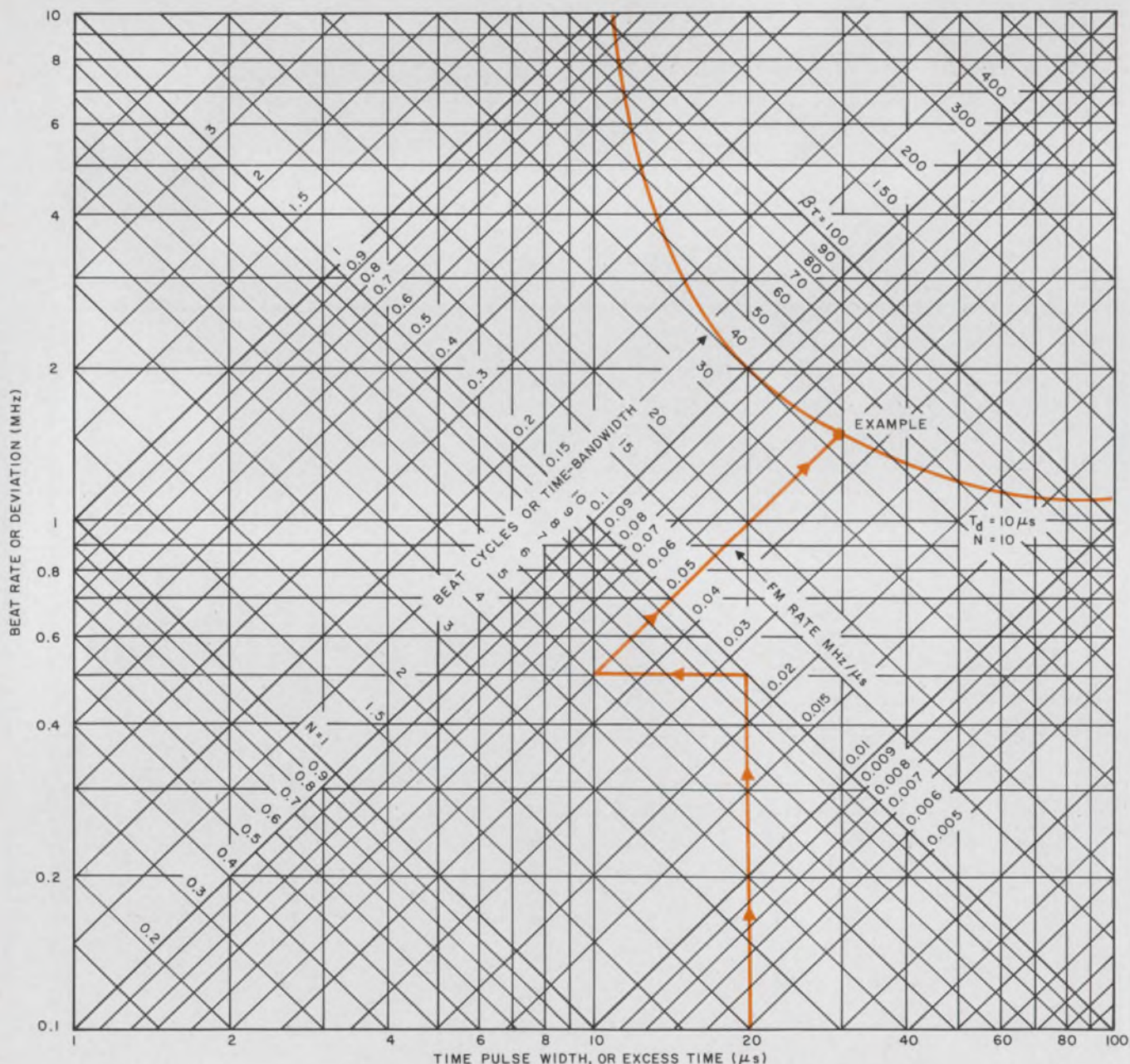

4. Four-dimensional chart permits the evaluation of changes in the design parameters or in the initial conditions. For example, the variation of the pulse width

results in a curve (color) which is the locus of all points having 10 beat cycles with a  $10\text{-}\mu\text{s}$  delay line. Any one of the seven variables may also be plotted.



If we made only digital IC's, what would we try to sell you?

If we made only linear IC's, what would we try to sell you?

If we made only hybrid IC's, what would we try to sell you?

If we made only MOS devices, what would we try to sell you?

If we made only transistors, what would we try to sell you?

But since we make **all** these, what will we try to sell you?

Only what you need.

Philco has the broadest line of products in the microelectronics industry. We make everything from epoxy transistors to MOS IC's, and we can show you how to use all these products to your advantage. Because our capability is the most diversified in the industry, we make an excellent source for all your present—and future—systems requirements. We offer you economy, unbiased service, and the finest products available today. Here are a few examples of Philco's broad capability.

**DTL:** We make both SE and the 930-Series standard DTL families. Our E-line 930 Series in dual inline packages guarantees the same levels of fan-out and noise immunity over 0° to 75°C available in hermetically-sealed packages.

**Super RTL:** For high-speed, medium-power logic systems. Typical propagation delay of 8 ns per logic level and power dissipation of 3.5 mW per gate.

**Milliwatt III:** For high-speed, low-power, applications. Typical propagation delay of 13 ns per logic level and power dissipation of 3 mW per gate.

**Linear:** PA 7600 RF/IF video amplifier, with highest gain

bandwidth available today. PA 7601 RF/IF bandpass amplifier, with medium gain and bandpass of 40 to 150 MHz. PA 7602 utility amplifier, high gain, for use in analog guidance, computer, and instrumentation.

**Hybrid:** Compatible hybrid circuits; PNP, NPN, FET, and MOS FET—all on the same substrate. Packaged in: epoxy for industrial uses; low-cost conformal for consumer products; hermetically-sealed in TO-5 or flat packs for reliability optimization.

**Transistors:** PNP and NPN planar and planar epitaxial silicon transistors.

**Picologic (Large-scale Integration):** Integrated MOS subsystems include the pL4000 Series (gates, counters, etc.) at speeds from DC to 100 Kc and the pL5R shift register series with speeds from 10 Kc to 1 Mc.

Call for the name of your nearest distributor. **Philco Microelectronics Division Sales Offices:** 2920 San Ysidro Way, Santa Clara, California (408-245-2966) / 999 North Sepulveda, El Segundo, California (213-772-6226) / 594 Marrett Road, Lexington, Mass. (617-862-6000) / Benson Manor, Suite 114B, Washington Lane, Jenkintown, Pa. (215-885-0430) / 1215 Drew Street, Clearwater, Florida (813-446-0124) / 815 Connecticut Avenue, N. W., Washington, D. C. (202-965-0903).



PHILCO-FORD CORPORATION  
Microelectronics Division  
Santa Clara, California • 95051

ON READER-SERVICE CARD CIRCLE 38

# Silicon or Bendix delivers

**Bendix has the plus to remember. And exclusive SOAR protection lets you forget about secondary breakdown.**

But it's more than just another plus. You'll find Bendix germanium and silicon power transistors for *every* need. With quality and performance capabilities at prices hard to believe.

Examples: Our B-5000 low-cost plastic silicon power units: 25 watts at 2.5 amps, 10 volts, 100°C—priced at less than 40¢ in volume. Or our standard commercial 2N3055; or our ultra-high reliability, radiation resistant NPN power units like the BR101.

Our germanium types—3 to 50 amps—are just as impressive. With high DC current gain, low collector cutoff current, low saturation voltage and remarkably fast switching times. Look at the charts and see.

And then there's exclusive SOAR protection—clearly defined Safe Operating AREA envelopes for hundreds of these power units. As long as a given device is operated within its SOAR envelope, secondary breakdown cannot occur. There's no easier way to pick the *right* transistor.

Reliability, performance, quality of construction and price—you'll find them built into every package. Call or write your nearest sales office for full information.

**700 W DC-DC CONVERTER**

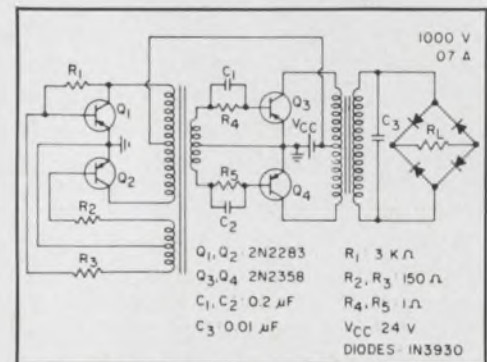

Baltimore (Towson), Md.—(301) 828-6877; Chicago—(312) 637-6929; Dallas—(214) 357-1972; Detroit—(313) Jordan 6-1420; Holmdel, N. J.—(201) 946-9400; Los Angeles—(213) 776-4100; Miami Springs, Fla.—(305) 887-5521; Minneapolis—(612) 926-4633; Redwood City, Calif.—James S. Heaton Co., (415) 369-4671; Seattle—Ray Johnston Co., Inc., (206) LA 4-5170; Syracuse, N. Y.—(315) 474-7531; Waltham, Mass.—(617) 899-0770; Export—Cable: "Bendixint," 605 Third Avenue, New York, (212) 973-2121; Ottawa, Ont.—Computing Devices of Canada, P.O. Box 508—(613) TAibot 8-2711.

# Germanium. the power-plus.

## 2N3055 SILICON NPN POWER TRANSISTOR

$V_{CB0} = 100\text{ V}$   $V_{CE0} = 60\text{ V}$   
 $I_C = 15\text{ A}$   $P_{peak} = 900\text{ W}$   
 $V_{CE(s)} = 0.4\text{ V Typ at } I_C = 4\text{ A, } I_B = 0.4\text{ A}$   
 $t_r = 5\text{ }\mu\text{s Typ}$  at  $I_C = 7.5\text{ A}$   
 $t_f = 1\text{ }\mu\text{s Typ}$

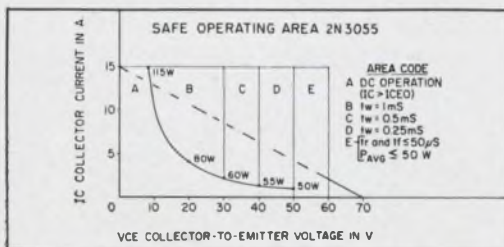

## GERMANIUM PNP ALLOY POWER TRANSISTORS

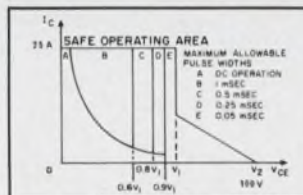

TYPE NUMBER	$I_C$ MAX A	$V_1$ V	$V_2$ V	$P_{peak}$ W	$\theta_{J-C}$ $^{\circ}\text{C/W}$
2N514B	25	45	70	1750	0.5
2N677C, 2N678C,					
2N1031C, 2N1032C	25	60	80	2000	0.8
2N1120	15	35	60	900	0.5
2N1136B-2N1138B	10	50	80	800	1.2
2N1146C, 2N1147C	20	45	70	1400	0.8
2N1166A, 2N1167A	25	45	75	1875	0.8
2N1365	6	70	100	600	0.8

## DAP<sup>®</sup> GERMANIUM PNP POWER TRANSISTORS

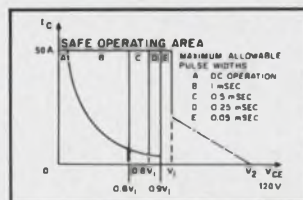

TYPE NUMBER	$I_C$ Max A	$V_1$ V	$V_2$ V
2N2284, 2N2469	3	70	110
2N1073B, 2N2290	10	70	110
2N1430	10	80	120
2N1653, 2N2287	25	60	100
2N2638	25	80	120
2N2359	50	50	90

**Bendix Semiconductor Division**  
 HOLMDEL, NEW JERSEY



ON READER-SERVICE CARD CIRCLE 39

# Take the easy road to logic design. Use the Karnaugh map to help minimize logic equations. Here's an example of its use in counter design.

The Karnaugh map offers an easier and more positive way of minimizing logic equations than Boolean algebra. Because there is usually more than one solution to a Boolean equation, experience and intuition are usually necessary to obtain as simple a solution as possible. On the other hand, the Karnaugh map clearly shows the minimum equation required.

To see how this approach can be used to handle a practical design problem, the Karnaugh map will be used to determine the simplest Set and Reset equations for each flip-flop of a synchronous binary-coded decimal counter (Fig. 1).

The first step in the design is to determine the code that will be used for the decimal counter. A four-flip-flop counter can result in 16 possible code combinations. Any ten of these combinations could be used; let us select the first ten.

The code in the table shows the state of each changes or "ripples" at every count. Cross-coupling the outputs  $Q$  and  $\bar{Q}$  (1 and 0) of flip-flop A, shown in Fig. 1, to its Set and Reset inputs will cause it to "toggle," or change states, for each clock pulse.

In a *synchronous* counter, the clock pulse is tied in parallel to all flip-flops of the counter, so that the clock pulse is applied to all flip-flops simultaneously. Gating at the Set and Reset inputs is required to ensure that the flip-flop will change state only at the time or count shown in the table. This is done to improve the counter's operating speed.

In a *ripple* counter, the speed is limited by the propagation delay through all four flip-flops.

## Design one flip-flop at a time

*Set/reset for flip-flop A* : The first step is to set flip-flop A of the decade counter. The equation is: Set  $A = \bar{A}$  (or  $A = 0$ ) on the Karnaugh map (see the map labeled "Set A"). The two columns enclosed are adjacent when the map is folded into a cylinder.

Note that A will be set by the next clock pulse when the counter is at states (in order of DCBA) 0000, 0010, 0100, 0110, 1000, 1010, 1100, and 1110.

---

C. J. Grandmaison, Manager, Semiconductor Applications Engineering, Sprague Electric, Worcester, Mass.

However, states ten through fifteen cannot occur, and thus are "don't-care" conditions. Place a 1 in all squares where A is set, and X in every "don't-care" square. Enclose as large an even-numbered group of adjacent 1 squares as possible. "Don't-cares" are "wild" like jokers in a pack of cards and may be included wherever advantageous (See map above). There are eight squares that can be so enclosed.

The logic equation for the Set input to flip-flop A is determined by using only the letters that do not change state for any square in the enclosure.  $A = 0$  is the only bit that satisfies this requirement. B is both 0 and 1 within the enclosure, as are C and D. They are not required as inputs to control the Set input of flip-flop A, because they can be in any state and flip-flop A will still be set when it should. Thus, the Set A will be true when  $\bar{A}$  output is coupled to the Set input of flip-flop A.

A must now be reset (See map labeled "Reset A"). The equation for this condition is: Reset = A (or  $A = 1$ ).

Flip-flop A becomes reset, or "0", whenever the following states of the BCD counter occur: 0001, 0011, 0101, 0111, 1001, 1011, 1101, and 1111. As in the previous instance, "don't-care" states are 1010 through 1111. Enter the 1's and X's on the Karnaugh map and the result will be the equation for resetting A. Because  $A = 1$  is the only condition that is constant in the grouping, it is the only bit needed to ensure the resetting of A.

Here the Q output is also called A and the  $\bar{Q}$  is called  $\bar{A}$ . In a synchronous counter, the clock is simultaneously coupled to all flip-flops.

*Set/reset for flip-flop B*: Now the Set equations for flip-flop B can be obtained. From the code chart, we see that B is set when the following counter states are present: 0001, 0101, 1001, and 1101. Because 1101 (13) and 1010 (10) are greater than nine, we must not allow B to be set after count 1001 if we wish to ensure that only 10 different counter states will occur. Thus, 1001 must not be allowed to set B, as it would have in a binary counter (see table). The Karnaugh map for this condition is labeled "Set B." Only 2 squares may be enclosed. It is of no value to enclose the 4 squares of "don't cares," which are shown dotted. The two 1's enclosed are adjacent when the map is folded.

It is also of no added value to enclose the 1 and

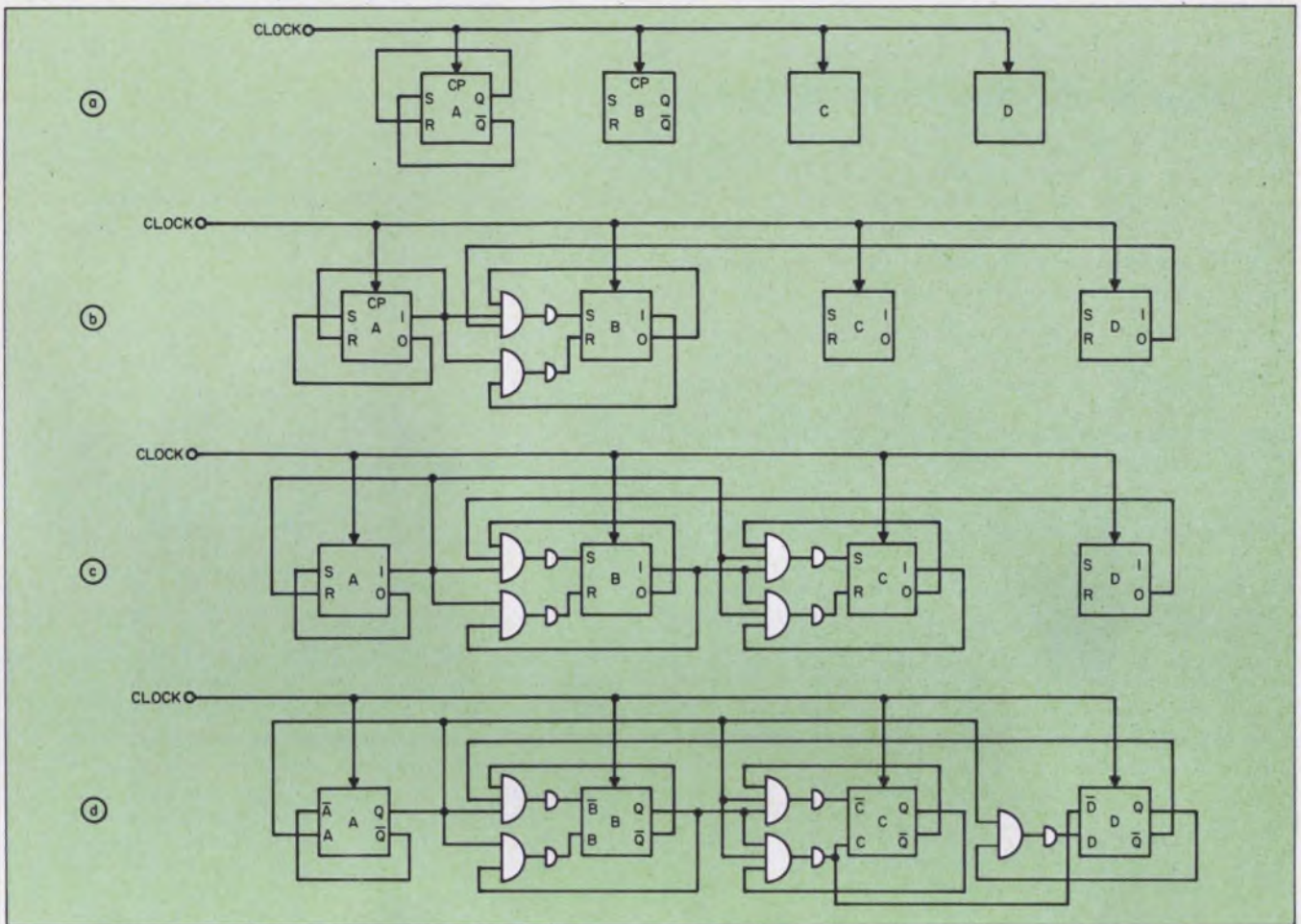

1. Karnaugh maps simplify BCD counter design by eliminating the need for manual simplification of Boolean equations. The design proceeds step-by-step by obtaining

the individual Set/Reset equations for flip-flops A, B, C and D in that order, as shown in (a) (b) (c) and (d) respectively. The completed design appears in (d).

SET A

SET A	A	0	1	1	0
	B	0	0	1	1
DC					
00		1			1
10		1		X	X
11		X	X	X	X
01		1			1

RESET A

RESET A	A	0	1	1	0
	B	0	0	1	1
DC					
00			1	1	
10			1	X	X
11		X	X	X	X
01			1	1	

SET B

SET B	A	0	1	1	0
	B	0	0	1	1
DC					
00			1		
10				X	X
11		X	X	X	X
01			1		

RESET B

RESET B	A	0	1	1	0
	B	0	0	1	1
DC					
00					1
10				X	X
11		X	X	X	X
01					1

adjacent X, because the enclosure shown already includes all the 1's necessary to reset B. The equation takes the form:

$$\text{Set } B = A \bar{B} \bar{D}$$

From the table, the clock pulse will reset flip-flop B in order to decade-count when the counter is at 0011 and 0111.

The equation is:

$$\text{Reset } B = A B$$

The BCD counter form is now as shown in Fig. 1b. The gates shown utilize negative NAND logic. It is necessary to invert the gate output so that the proper voltage will be present at the Set or Reset inputs. Ground potential is required to

POSSIBLE COUNTER STATES

DIGIT	FLIP-FLOP			
	D	C	B	A
0	0	0	0	0
1	0	0	0	1
2	0	0	1	0
3	0	0	1	1
4	0	1	0	0
5	0	1	0	1
6	0	1	1	0
7	0	1	1	1
8	1	0	0	0
9	1	0	0	1
10	1	0	1	0
11	1	0	1	1
12	1	1	0	0
13	1	1	0	1
14	1	1	1	0
15	1	1	1	1

TEN COMBINATIONS FOR OUTPUT FROM FOUR FLIP-FLOPS

THESE CODES WILL NOT BE ALLOWED TO OCCUR AT ANYTIME

# How to use the Karnaugh map

Rules for applying Karnaugh maps in solving and minimizing Boolean equations and logic are:

1. Only one bit is allowed to change in each adjacent column or row heading.
2. The outside squares are assumed to be adjacent as in a cylinder or globe. All four corner squares are adjacent; i.e., the matrix could have been shown in either of the forms below. (1 is the true state, and 0 is the false or "not" state.)

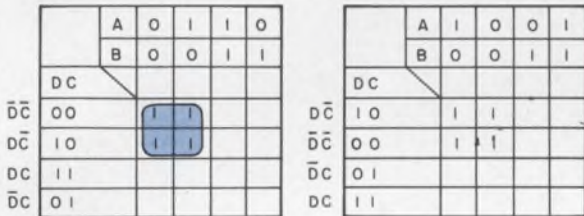

3. Logic minimization is possible when there is a symmetrical grouping of 2, 4, 8, or 16 squares that have a 1 or an X marked in them. The enclosing of a group of squares allows the writing of an equation that is composed of flip-flop states (such as A, B, C or D) which remain constant within the enclosure. In the example shown above, the four upper left squares have 1 marked in them. The enclosure is square and groups the four squares. Note that the B and the C states are consistently 0. The Boolean expression  $\overline{B}\overline{C}$  (i.e., not-B and not-C) is shown on the Karnaugh map.

NOTE: Marking each of the squares that have  $\overline{B}, \overline{C}$  ( $B=0, C=0$ ) in common will result in the Karnaugh map shown above. Only rectangular enclosures are allowed. L or T shapes are not valid as a whole; that is, the equation must be written for each leg. The larger the square or rectangular enclosure, the more simple the equation becomes.

In the following example, there is a 1 in the squares where the equation  $A\overline{C}D + \overline{A}B\overline{C}D$  is satisfied. To satisfy the equations:  $A=1, \overline{A}=0$ . Then  $A\overline{C}D$  will be true for 1X01 (in order of ABCD), where X indicates that B can be either 0 or 1; hence it is not needed in the equation. Therefore, on the Karnaugh map, mark 1 in squares where  $A=1$ , but only where the squares are also in line with  $\overline{C}D$  (where  $C=0$  and  $D=1$ ) as shown in the circled squares upper right.

To finish the equation, write 1 in the square that has  $\overline{A}B$  and  $\overline{C}D$  in common. The resulting map is shown below.

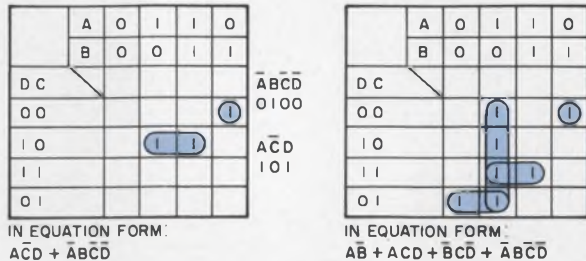

The equation for the Karnaugh map on the right could have been as complex as:  $\overline{A}B\overline{C}D + \overline{A}B\overline{C}\overline{D} + \overline{A}B\overline{C}D + \overline{A}B\overline{C}\overline{D} + \overline{A}B\overline{C}D + \overline{A}B\overline{C}\overline{D} + \overline{A}B\overline{C}D + \overline{A}B\overline{C}\overline{D}$ . Note that the equation below the map will put a 1 in all required squares and is less complex.

Note that there are two places where a 1 is enclosed by more than one enclosure. Remember that the least complex equation will be found when the enclosed groups are symmetrical and still enclose as many 1 or X terms as possible. Terms that are enclosed in more than one group can be factored using Boolean algebra. For example:

$$A(\overline{B} + CD) + \overline{D}(\overline{B}C + \overline{A}B\overline{C})$$

4. A "don't-care" condition is said to exist when there are codes that do not occur, such as the last six codes in binary when a four-flip-flop decimal (10-count) counter is designed. A "don't-care" may be enclosed in a grouping as though it were a 1. The "don't-care" is symbolized by an X.

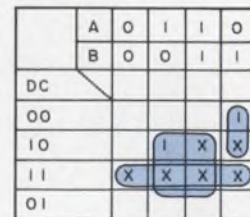

Using the example given in Rule 3, the equation  $A\overline{C}D + \overline{A}B\overline{C}D$  becomes  $AD + \overline{A}B\overline{C}$ .

Note that only groupings which also include 1s are used in forming equations. Thus  $CD$  is not a useful equation.

SET C

SET C	A	O	I	I	O
	B	O	O	I	I
DC					
00			I		
10			X		X
11	X	X	X	X	
01					

RESET C

RESET C	A	O	I	I	O
	B	O	O	I	I
DC					
00					
10				X	X
11	X	X		X	X
01				I	

RESET D

RESET D	A	O	I	I	O
	B	O	O	I	I
DC					
00					
10			I	X	X
11	X	X	X	X	X
01					

allow the Set or Reset inputs to operate.

*Set/reset for flip-flops C and D:* To determine the Set equation for flip-flop C, note that C is set only at count 0011. The Karnaugh map, "Set C," is shown below:

Therefore:

$$\text{Set } C = A B \bar{C}$$

Reset C occurs at count 0111, so the equation is: Reset C = A B C and the map is shown labeled "Reset C."

Note that on each map, the "don't care" conditions (10 through 15) are marked X.

The binary-coded decimal counter is now as shown in Fig. 1c:

Checking over the counter code table shows that the setting of flip-flop D occurs only at 0111, which is the same time that flip-flop C is reset. This means that the gate output for resetting C can also be used to set D.

Therefore:

$$\text{Set } D = A B C$$

Reset D occurs at count 1001 only. The equation is:

Reset D = A D and the map is labeled "Reset D." The counter is now completely designed.

For the binary-coded decimal counter, some decoding matrices and other simple logic forms, the equations may be converted directly from the table of code combinations merely by inspection. Nevertheless, this exercise in the conversion from codes to equations to logic should help the reader to understand the process of digital design. Using the three basic steps—code-equation-logic—we can now design and solve other logic problems from beginning to end. We could count to any selected number, simply by writing the equations for setting and resetting and then implementing the equations with logic circuits. ■ ■



# Take a good look...

TELEDYNE TELEMETRY COMPANY  
DYNAPLEX DIVISION • AEROSPACE  
TELEDYNE TELEMETRY COMPANY  
DYNAPLEX DIVISION • AEROSPACE  
TELEDYNE TELEMETRY COMPANY  
DYNAPLEX DIVISION • AEROSPACE  
TELEDYNE TELEMETRY COMPANY  
DYNAPLEX DIVISION • AEROSPACE  
TELEDYNE TELEMETRY COMPANY  
DYNAPLEX DIVISION • AEROSPACE  
TELEDYNE TELEMETRY COMPANY  
DYNAPLEX DIVISION • AEROSPACE  
TELEDYNE TELEMETRY COMPANY  
DYNAPLEX DIVISION • AEROSPACE  
TELEDYNE TELEMETRY COMPANY  
DYNAPLEX DIVISION • AEROSPACE

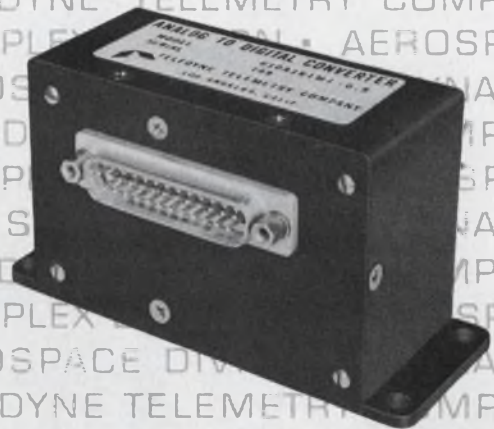

## at our TYPE 610 MICROCIRCUIT AIRBORNE A-D CONVERTER

Space age designed . . . for space age applications, Type 610 Analog-to-Digital Converters use only reliable integrated circuits and military approved parts to provide the optimum in performance for critical missile, satellite, space probe or aircraft A-D conversion requirements.

- Throughput rates from 1 to 100,000 words per second
- Up to 10-bit resolution
- Overall accuracy up to ±0.1 percent
- Choice of output formats, parity and synchronization codes
- Lightweight-small size
- High reliability under extreme environmental conditions

Next time you have an analog-to-digital conversion requirement, contact your local TELEDYNE TELEMETRY COMPANY Sales Representative or contact us directly . . . and TAKE A GOOD LOOK AT OUR TYPE 610 MICRO CIRCUIT AIRBORNE A-D CONVERTER.

## TELEDYNE TELEMETRY COMPANY

A Division of Teledyne, Inc.

### AEROSPACE DIVISION

12964 Panama Street  
Los Angeles, California 90066  
Telephone (213) 870-9831  
TWX: 910 343 6855

### DYNAPLEX DIVISION

P.O. Box 341 Alexander Road  
Princeton, New Jersey 08540  
Telephone (609) 452-2550  
TWX: 510 685 2379

ON READER-SERVICE CARD CIRCLE 40



With  
**cdc**  
 it's #4  
 that makes  
 it a  
 game!

*Whether it be in golf  
 or in business,  
 never ignore player #4*

Through the sheer impact of overwhelming advertising, many engineers and purchasing people are misled into believing there are only three broad based silicon semi-conductor manufacturers. Today, however, Continental Device Corporation can provide that essential competitive edge needed to assure high quality, low-cost semiconductor devices on firm delivery schedules.

Failure to utilize number 4 has caused many manufacturers to struggle against slow delivery and poor service. Start looking to number 4 to make it the game you would like to play.

*#4 is the name of the game.*

## 1 WATT/400 mw



CDC Zener Diodes established the standard for the first military zener specifications. If stability and low leakage are essential, price and delivery paramount, check CDC.

JAN 1N746A-	1-99	100-999
JAN 1N759A	\$2.00	\$1.59

1 Watt Zeners are available to Mil specifications at comparable savings.

## FAST SWITCHING INTEGRATED POWER DARLINGTON CIRCUIT



This device is an epitaxial integrated power circuit with all aluminum ultra-sonic bonded leads. This circuit is usable as a commutating diode, high speed power switch, regulator, high gain power gate and inverter, and linear or servo amplifier. Packaged for 20 watts rated power. Minimum gain of 1000 at 1 ampere.

2N998	1-99	100-999
2N999	\$12.00	\$ 8.05
	24.00	16.00



## SIZE UP YOUR NEEDS MINI-MONO/Mono Diode

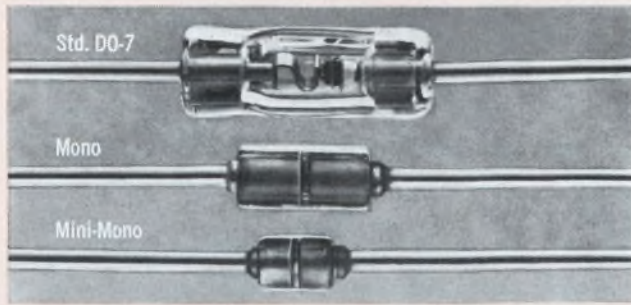

CDC's subminiature dual stud hermetic glass packaged unit is an extremely sophisticated device. Considerable dimensional and electrical flexibility exists. Units are available in O.D.'s from .060 to .100 and overall lengths from .090 to .265. Electrically, the range is from 1N457 to 1N3600.

DEVICE	STANDARD DO7		MONO-DIODE EQUIVALENT		MINI-MONO EQUIVALENT	
	1-99	100-999	1-99	100-999	1-99	100-999
JAN 1N914	\$.35	\$.24	\$.40	\$.27	\$.70	\$.57
JAN 1N916	.52	.35	.65	.43	.95	.73

## EPOXY/METAL CAN TRANSISTOR

With CDC the chip's the thing! Only the package changes. CDC uses the same stringent process controls in manufacturing dice for epoxy transistors as are used for all military and high reliability metal packaged devices.



METAL CAN TRANSISTOR			EPOXY EQUIVALENT			
Device	1-99	100-999	Device	1-99	100-999	1000
JAN 2N697	\$1.00	\$.67	CS 697	\$.60	\$.40	\$.28
JAN 2N1613	1.50	1.00	CS 1613	.70	.47	.30

## PORTABLE IC TESTER... \$995.00

Model 9522 tests all DC E&I characteristics for any 2 to 14 lead integrated circuit. It is a solid state, short circuit protected device. It measures from 0-30V and from 1nA to 100mA. Also, it is adaptable for measuring switching characteristics. Has four 0 to  $\pm 15V$  power supplies with vernier control and two fixed 24V power supplies. Small, compact, easy to carry. Weighs a mere 25 lbs. Immediate delivery. \$995.00.



## RTL Mono Circuit

Continental Device Corporation's RTL family of monolithic circuits is really an extension of CDC's proven ability in the manufacture of hi-rel volume components. And when it comes to prices, CDC wins the game.



OPERATING RANGE:  $-55^{\circ}C$  to  $+125^{\circ}C$   
 $0$  to  $+100^{\circ}C$   
 $+15^{\circ}C$  to  $+55^{\circ}C$

To-5 metal can  
 To-5 metal can  
 Epoxy equivalent

DEVICE	PART NO.	PACKAGE	1-99	100-999	1,000
Buffer	CMC219001	Epoxy TO-5	\$.80	\$.54	\$.36
Dual 2-Input Gate	CMC219141	Epoxy TO-5	.80	.54	.36
JK Flip-Flop	CMC219231	Epoxy TO-5	1.50	1.00	.67

Write for  
**FREE**  
data sheets  
and new  
24-page color  
catalog!

**FREE** sample  
devices sent  
on request.

Contact your  
CDC representative or write the factory direct.



reliability...  
our first  
responsibility

# cdc

CONTINENTAL DEVICE CORPORATION  
 12515 Chadron Ave., Dept. D, Hawthorne, Calif. 90250  
 Phone: (213) 772-4551 • TWX: 910-325-6217

# Precision digital clock uses ICs and a crystal oscillator to develop signals that are accurate to 10 parts in a billion.

An ordinary alarm clock that can be bought for less than \$5 has an accuracy level of about one part in 1000. A fine watch, costing \$100 or more, may be accurate to one part in a million. But for the engineer who has everything, there is an even more accurate timing device: a digital clock built with integrated circuits (Fig. 1).

Though it costs considerably more than other timepieces, it achieves an accuracy that exceeds one part in  $10^8$ .

A 1-MHz crystal-controlled oscillator serves as the basic timing source. At this relatively high frequency, crystals achieve a greater degree of stability and accuracy than at lower frequencies. The oscillator output is coupled directly to the first stage of a series of six decade counters. These counters divide the 1-MHz timing signal by one million. The resulting one-hertz signal is the basic reference for all further timing in the clock.

## System is iterative by nature

A general block diagram of the clock is shown in Fig. 2. Notice the iterative nature of much of

---

Jack Irwin and Robert Jensen, Applications Engineers, Fairchild Semiconductor, Mountain View, Calif.

the circuitry; i.e., the logic circuits for seconds, minutes and hours are all alike, as are the circuits for tens of seconds and tens of minutes. As it results in simpler circuitry, the clock follows the traditional United States method of keeping time and recycles to 01:00:00 o'clock at 12:59:59 o'clock plus one second. The Continental method, going from 0 hours to 24 hours, would require additional circuits in the last two stages.

Using an integrated decade counter drastically reduces the actual number of elements needed for implementation: Only six packages are needed to form the basic frequency divider network. The particular counter used (Fairchild  $C_{\mu}L$  958) is functionally shown in Fig. 3a; the relative position of the waveforms at the output appears in Fig. 3b. A positive transition occurs at output *D* as the count goes from nine to zero. Since this is the only positive transition at this terminal, this output can be coupled directly into the input of the next stage.

Because this counter provides a decimal output (through a binary code), it is also used as the units' counter circuit for seconds, minutes and hours.

To count tens of seconds and tens of minutes, a modulo-6 counter is required. The choice of possible circuitry for this is wide, so that selection



1. Digital clock built with 90 integrated circuits uses a 1-MHz oscillator as a basic timing source and achieves an

accuracy of one part in one-hundred million. The basic timing source is a 1-MHz crystal-controlled oscillator.

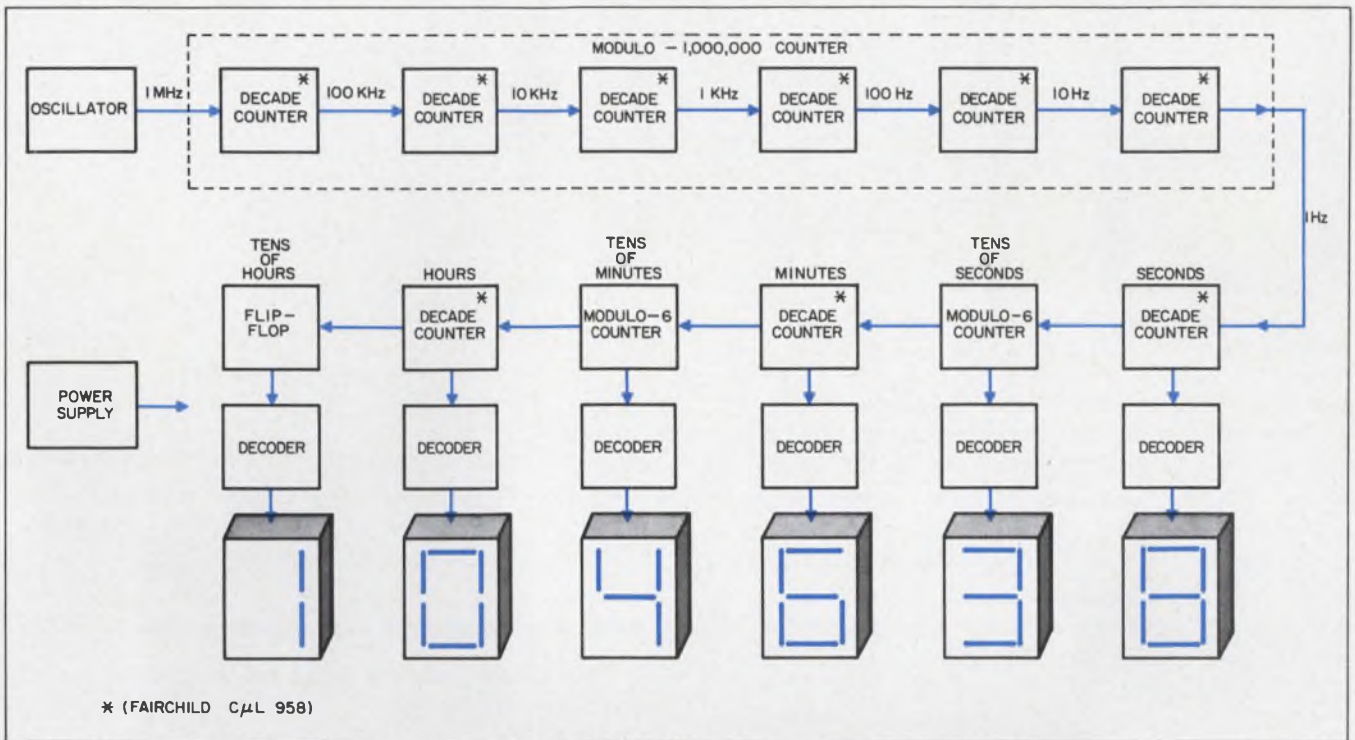

2. The four fundamental units of the clock are the oscillator, counters, decoders and displays. Note the iterative

nature of the count-decode-display combination for the seconds', minutes' and hours' sections.

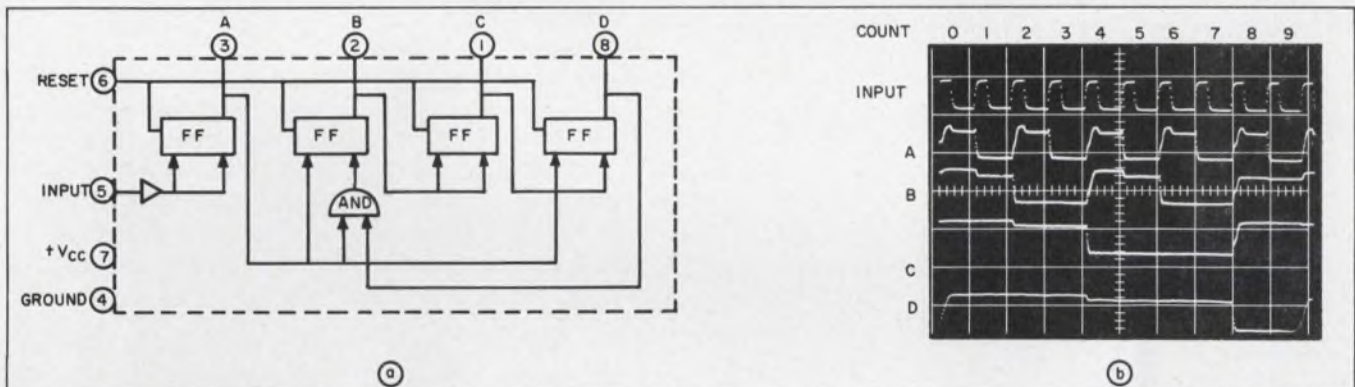

3. Complete integrated decade counter greatly reduces the component density; six of these make up the complete

modulo-1,000,000 counter. The functional diagram is shown in (a) and the output waveforms in (b).

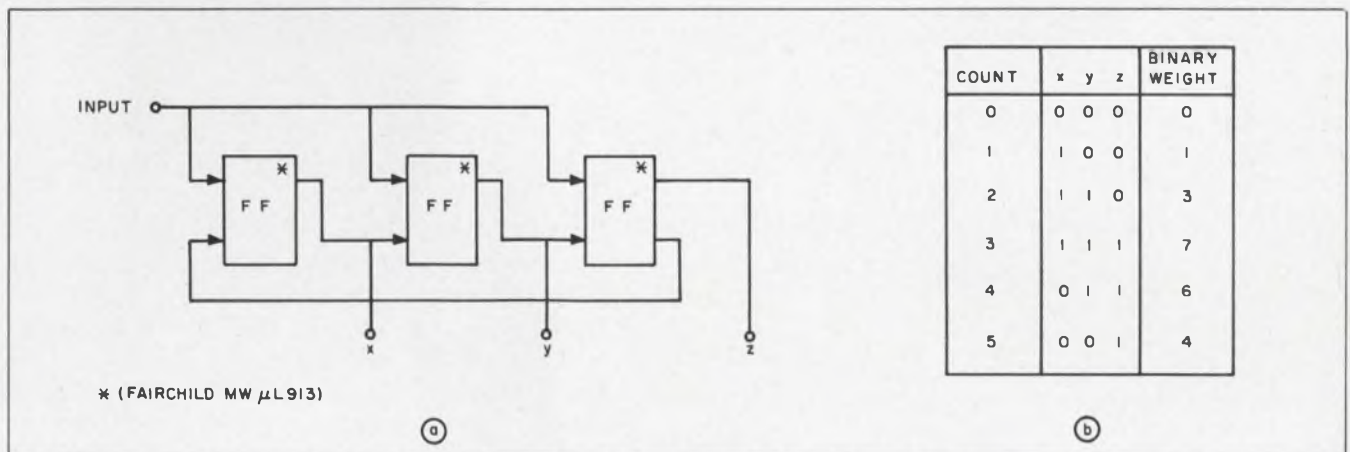

4. Modulo-6 counter uses three flip-flops in a shift-mode arrangement (a). The truth table is shown in (b).

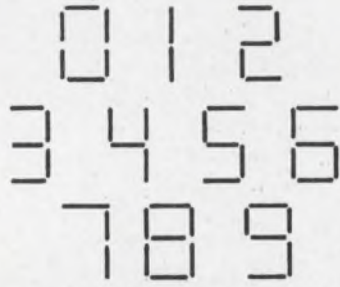
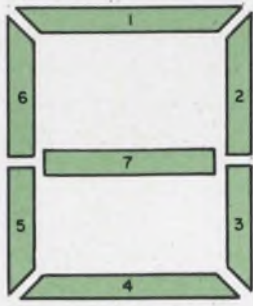

5. Incandescent display has seven segments and these form the numbers from zero to nine as shown.

becomes highly subjective. Because of its low power-dissipation rating, high fan-out, and ready availability, an RTL-type flip-flop (Fairchild MW $\mu$ L 913) was used as the basic element for the modulo-6 counter. This counter, functionally shown in Fig. 4a, is a shift-mode counter, known also as a "walking clock" or "twisted-ring counter." The timing chart for this counter is given in Fig. 4b; on the sixth count, all outputs return to their initial state.

For the displays, six incandescent indicators were selected. Use of an incandescent display, as opposed to a gas-tube display, simplified the power supply design. This includes a direct connection to a set of rechargeable batteries so that stand-by power is available. The segmented indicator layout is illustrated in Fig. 5, along with the segmented display of the numerals 0 through 9.

#### Developing the logic for the units' decoders

The states of the units' counters are decoded as the counters progress through their cycles so that the appropriate indicator segments may be lit or extinguished. Since more segments are generally ON than OFF, the better method of indication is to extinguish superfluous lights rather than to illuminate needed lights. Note also that the numbers 6 could be represented with or without segment 1, and likewise the numbers 9, with or without segment 4; inclusion of these bars, however, lessens the amount of extinguishing that has to be done.

A set of logic equations, as a function of each segment, can be written for the numbers that have to be displayed. These take the form:

$$\begin{aligned}\overline{f_1} &= (1+4+10+11+12+13+14+15), \\ \overline{f_2} &= (5+6+10+11+12+13+14+15), \\ \overline{f_3} &= (2+10+11+12+13+14+15), \\ \overline{f_4} &= (1+4+7+10+11+12+13+14+15), \\ \overline{f_5} &= (1+3+4+5+7+9+10+11+12+13+ \\ &\quad 14+15), \\ \overline{f_6} &= (1+2+3+7+10+11+12+13+14+15), \\ \overline{f_7} &= (0+1+7+10+11+12+13+14+15).\end{aligned}$$

The symbol for negation above ( $\overline{\quad}$ ), means extinction as opposed to ignition. Because all four binary variables are being dealt with, there is a

possibility of sixteen states (0-15); but as the decade counter completes its cycle on the tenth count, states 10-15 will never occur and can thus be included as "don't cares" in our logic. The Boolean equations governing the decoding are:

$$\begin{aligned}\overline{f_1} &= \overline{B}(A \cdot \overline{C} \cdot \overline{D} + \overline{A} \cdot C), \\ \overline{f_2} &= C(A \cdot \overline{B} + \overline{A} \cdot B), \\ \overline{f_3} &= (\overline{A} \cdot B \cdot \overline{C}), \\ \overline{f_4} &= \overline{B}(A \cdot \overline{C} \cdot \overline{D} + \overline{A} \cdot C) + A \cdot B \cdot C, \\ \overline{f_5} &= A + f_4, \\ \overline{f_6} &= \overline{C} \cdot \overline{D}(A + B) + A \cdot B \cdot C, \\ \overline{f_7} &= (\overline{B} \cdot \overline{C} \cdot \overline{D} + A \cdot B \cdot C).\end{aligned}$$

These reduced equations can be implemented as shown in Fig. 6. Because certain logic combinations occur often, three new terms are created:

$$\overline{U} = A \cdot B \cdot C; \quad V = \overline{C} \cdot \overline{D}; \quad \overline{W} = \overline{A} \cdot B.$$

#### Tens' display requires a modulo-6 counter

The tens' counters have to display only the numerals 0 through 5, so that the question of whether the 6 and 9 should have "bars" does not apply. It was consequently felt that in this case it was better to switch on the segment lights required than to extinguish those not required in the display indicator.

Figure 4b shows that the binary progression of the counter is actually: 0 - 1 - 3 - 7 - 6 - 4. Since it does not matter to the displays what the input to the decoder is, these values can represent the numbers 0 - 1 - 2 - 3 - 4 - 5, respectively. Only three variables are involved and thus eight distinct states are possible. Of these, the states 2 and 5 never occur, so they may appear as "don't cares" in our prime implicants. The functions governing the seven segments are as follows:

$$\begin{aligned}\overline{f_1} &= (1+2+5+6), & \overline{f_5} &= (1+2+4+5+6+7), \\ \overline{f_2} &= (2+5+6), & \overline{f_6} &= (1+2+3+5+7), \\ \overline{f_3} &= (2+3+5), & \overline{f_7} &= (0+1+2+5). \\ \overline{f_4} &= \overline{f_1},\end{aligned}$$

When algebraically reduced, the equations become:

$$\begin{aligned}\overline{f_1} &= \overline{X} \cdot Y + X \cdot \overline{Y}, & \overline{f_5} &= \overline{Z} + X \cdot \overline{Y}, \\ \overline{f_2} &= \overline{Y} \cdot Z, & \overline{f_6} &= X, \\ \overline{f_3} &= Y \cdot \overline{Z}, & \overline{f_7} &= \overline{Y} \cdot \overline{Z}. \\ \overline{f_4} &= \overline{f_1},\end{aligned}$$

Implementing these equations yields the logic configuration in Fig. 7.

The hours' tens' circuit is a completely different circuit from the other tens' counters. Since a new cycle starts on the count of 12:59:59 + 1 second, a single flip-flop may be used. The hours' tens' flip-flop is turned ON at 9:59:59 + 1 second and remains ON until the new cycle is started. During this time, segments 2 and 3 of the hours' tens' indicator are illuminated. At all other times this indicator is extinguished. ■ ■

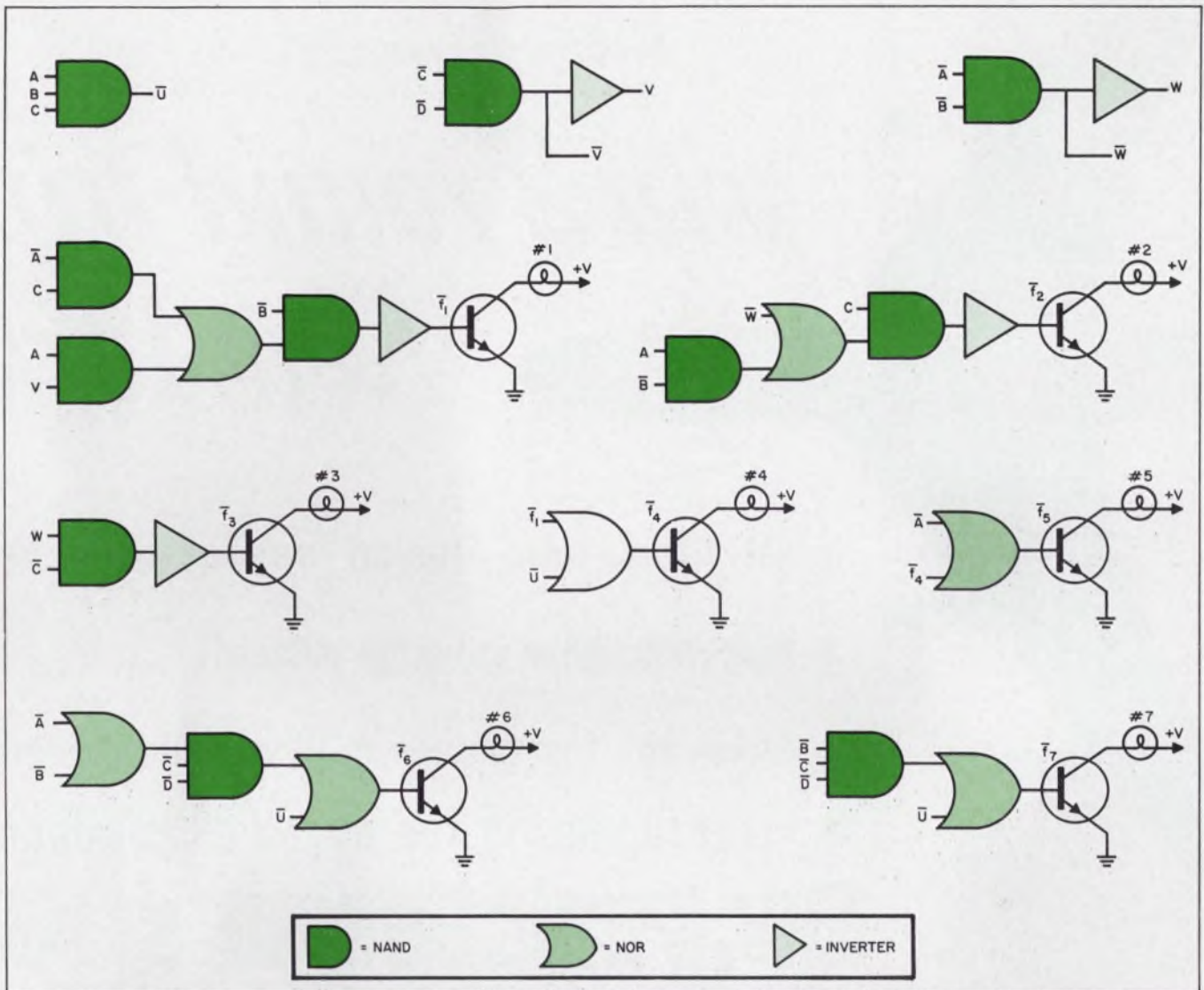

6. **Decoding circuits for the units' sections.** The fact that certain combinations appear often makes it possible to achieve some simplification by creating sublogic, such as

$\bar{U}$ ,  $V$  and  $\bar{W}$ . The functions (NAND, NOR, invert, etc.) are generally available from all integrated-circuit manufacturers.

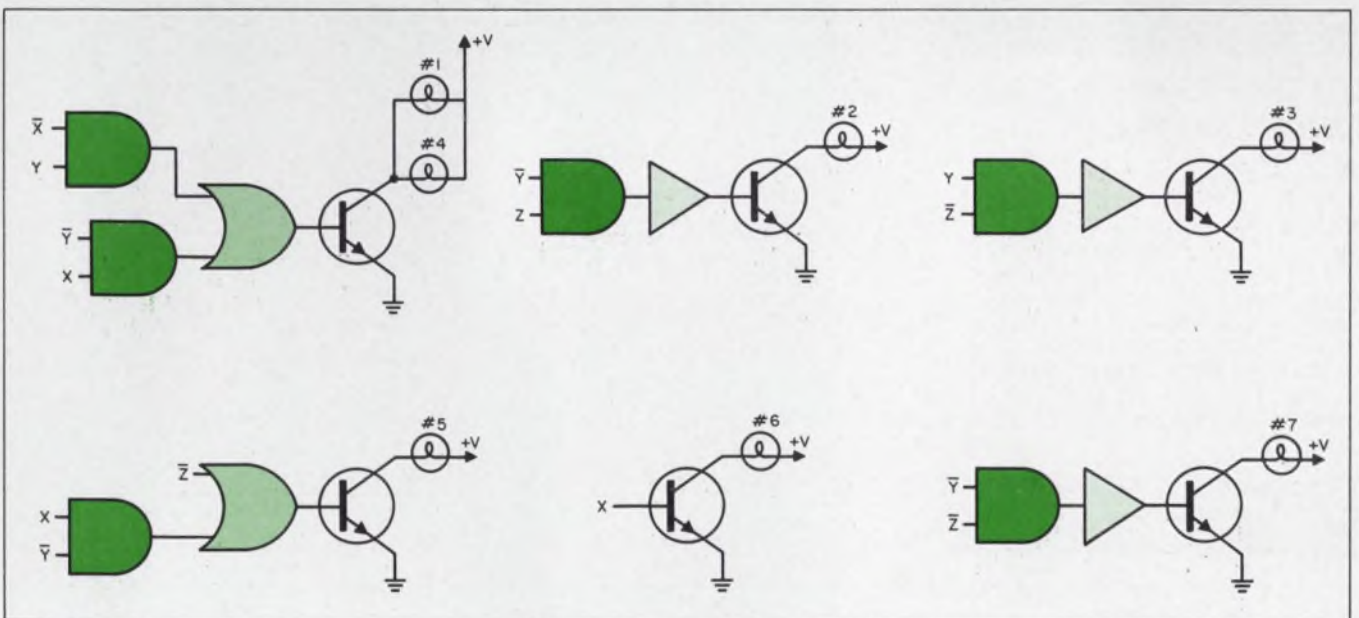

7. **Decoding circuits for the tens' sections.** Some manufacturers offer multifunction integrated circuits, so that

the circuits above can frequently be combined within one package.

**FIRST PRIZE:**

*win 2 round-trip  
New York*

- ▶ All Electronic Design subscribers are
- ▶ Over 100 other valuable prizes!
- ▶ Guess the top ten ads in Electronic Design's
- ▶ "ELECTRONICS IN THE WORLD OF TOMORROW"

## Electronic Design's 1967

### SEPARATE CONTEST FOR MANUFACTURERS AND ADVERTISING AGENCIES

Not forgotten in the "Top Ten" contest, advertisers and their agencies may also enter. In addition to prizes of a **flight to Paris, color TV, and electronic timepiece**, the top 10 ads, and the winning advertiser's ad (if run January 4, 1967) will be re-run in the April 1st issue. Watch for the special "Top Ten" contest rules and entry blanks appearing January 4, 1967



### 2ND PRIZE HOFFMAN COLOR TV CONSOLE

Hoffman 23" console, featuring 26,000 volts of picture tube power . . . 4" x 6" front-firing speaker . . . easy vision camera control for sharp color movies and positive, black and white picture shading . . . InstaVision on-off control . . . 32" x 29" x 19 1/8" cabinet. (Retail value: \$600.00.)



### 3RD TO 8TH PRIZES BULOVA ACCUTRON® ELECTRONIC TIMEPIECES

The "Spaceview" is an ideal timepiece for electronics engineers. Its clear-view dial reveals transistorized electronic circuit and tuning fork assembly. The tuning fork, advertising symbol and unique frequency standard of Accutron® timepieces, is the reason Bulova guarantees an in-use, on-the-wrist accuracy of within 60 seconds a month. (Retail value: \$150.00.)



### PLUS 100 ADDITIONAL PRIZES MICROELECTRONIC DESIGN

This clothbound, 8 1/2 x 11, 320-page, 1966 edition will be given free to 100 winners. "Microelectronic Design" offers a thorough overview of the field in six sections—has almost 90 outstanding articles compiled from the pages of *Electronic Design*. Edited by Howard Bierman. (Retail value: \$11.50.)

The background of the advertisement features a large, stylized white Air France logo on a blue background. To the right, a black and white photograph of the Eiffel Tower in Paris is visible, extending from the top to the bottom of the page. The text is overlaid on the left side of the image.

# *tickets between* *and* **PARIS**

**VIA AIR FRANCE**

**eligible!**

**January 4 issue**

## **“Top Ten” contest**

### **HERE'S ALL YOU HAVE TO DO TO ENTER:**

Rate the ads appearing in the January 4, 1967 issue of *Electronic Design*. Select the “Top Ten” . . . the ads that, in your opinion, will be best remembered by readers. Your choices will be measured against the 10 ads ranking highest in the “Recall-Seen” category of Reader Recall—Electronic Design’s scientific method of measuring readership. In making your predictions, be sure to consider your 54,000 fellow engineers’ interest in the subject matter of the ads, their effectiveness, impact, and attention-getting values.

Entry blanks and complete contest rules will appear in the January 4th issue. Don’t miss this opportunity to win one of the many valuable prizes shown at left. The first prize winner will receive round-trip tickets for two, between New York and Paris via Air France!

# Try solid-state regulators for your high-voltage dc power requirements. You get big performance in a compact package.

Try designing your own solid-state high-voltage dc regulator the next time you require a long-life unit. Solid-state units in high-voltage applications have demonstrated useful lifetimes several times greater than that of vacuum-tube regulators. You can tailor your own regulator circuit quite easily with a step-by-step design procedure.

A typical regulator circuit providing a nominal output of 290 Vdc at loads of 50 to 600 mA is shown in Fig. 1. Regulation is better than  $\pm 0.5\%$  with a 15% change in input voltage over a load variation of 50 to 600 mA.

The complete regulator consists of three major stages:

- *Series control element* (Fig. 2)—Essentially a two-element voltage divider network used to maintain the load voltage within desired limits. The input voltage is divided between  $V_{CE}$  of the series transistor and the load. The series element must be capable of adjusting its voltage drop,  $V_{CE}$ , to compensate for the change in input voltage. A similar condition exists when the input voltage is constant and a variable output is required.  $V_{CE}$  is defined as  $E_{in}$  less  $E_{out}$ .

- *Preregulator* (Fig. 3)—In regulator design it is common practice to return the base of the series element through a resistor to the positive side of the unregulated supply (Fig. 3a). In this case, ripple current from the unregulated supply is injected into the base of the series control element and amplified. This amplified ripple appears in the output and may be overcome by the use of a preregulator (Fig. 3b).

The preregulator consists of two resistors,  $R1$  and  $R2$ , and a Zener diode,  $D1$ . The Zener tends to keep a constant voltage across  $R2$  and therefore supplies a constant current,  $I_z$ , to the collector of

DTS-413 operating limits

Operating points	Input		Output		$V_{CE}$ $I_E$	
	$E_{in}$	$I_{in}$	$E_{out}$	$I_{out}$		
1	min	max	max	max	min	max
2	min	min	max	min	min	min
3	max	max	min	max	max	max
4	max	min	min	min	max	min

the sensing amplifier and to the base of the series element. The reference voltage of  $D1$  may be any value less than  $E_{in} - E_{out}$  that will supply sufficient current to  $Q2$  and  $Q3$ .

- *Sensing amplifier* (Fig. 4)—The sensing element samples the output voltage, compares it with a reference voltage and produces an error signal that is proportional to the difference. The emitter-coupled differential amplifier is used as a sensing element because of its high sensitivity and good thermal stability.

The current through  $R7$  must supply the collector of  $Q4$  and the base current for the dc amplifier. Resistor  $R8$  is not critical, but should be almost the same value as  $R7$  in order to keep the differential amplifier balanced. With an understanding of the functional requirements of each regulator stage, the designer can now proceed with calculation of circuit values. Design of the regulator begins with the series control element (Fig. 2). In this particular circuit the DTS-413 transistor was chosen, but the same design approach could be taken with other devices, such as the DTS-423 or the 2N2580 series.

## Design series control element first

The area of operation for the series element can be defined by four points which can be plotted on the safe-operating-area curves (Fig. 5). The characteristics of each of these points are shown in the table above.



Each of these four points has its particular limitations with respect to the operation of the transistor. Care must be taken that the maximum ratings of the transistor are not exceeded.

**Point 1.**  $V_{CE}$  is minimum and  $I_C$  is maximum. The point must not exceed the maximum allowable  $I_C$ . Sufficient base drive must be available to produce the desired  $I_C$  but the transistor must not be driven to saturation.

**Point 2.**  $V_{CE}$  is minimum and  $I_C$  is minimum. This point should not lie in the nonlinear saturated region.

**Point 3.**  $V_{CE}$  is maximum and  $I_C$  is maximum. This point must not exceed the maximum dc dissipation rating of the series transistor.

**Point 4.**  $V_{CE}$  is maximum and  $I_C$  is minimum.

This point must not exceed the maximum  $V_{CE}$  rating of the transistor.

Heat sink design is an important factor to consider in a Class-A series regulator. For example, assume the following conditions:

- The application requires a maximum ambient temperature ( $T_{A\ max}$ ) of 75°C.
- Heat sink 7281366\* has a surface area of 165 in<sup>2</sup> and a thermal resistance,  $\theta_{hs}$ , of 1.5°C/W to ambient air for free-air convection.
- The DTS-413 has a maximum thermal resistance (junction to heat sink),  $\theta_{jhs}$ , of 1.0°C/W and a maximum allowable junction temperature of 150°C.

The maximum allowable dissipation,  $P_{max}$ , may

\*Delco Radio data sheet 7281366.

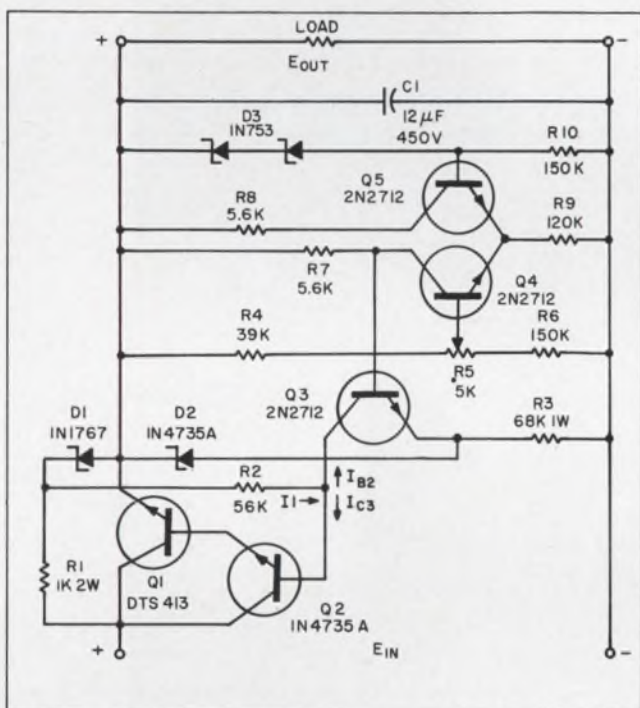

1. High-voltage silicon transistors make a compact regulator that can handle high currents while providing tight output voltage regulation. Step-by-step procedure simplifies the design of the regulator circuit.

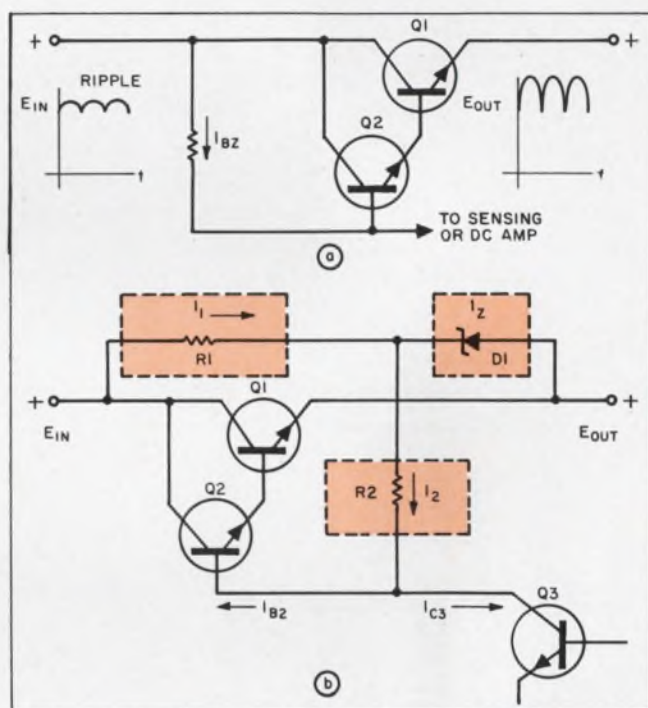

3. The preregulator filters ripple current from the input supply. The ripple is amplified by the series control element Q1 (a). Resistors R1 and R2 together with Zener diode D1 (b) make up the preregulator.

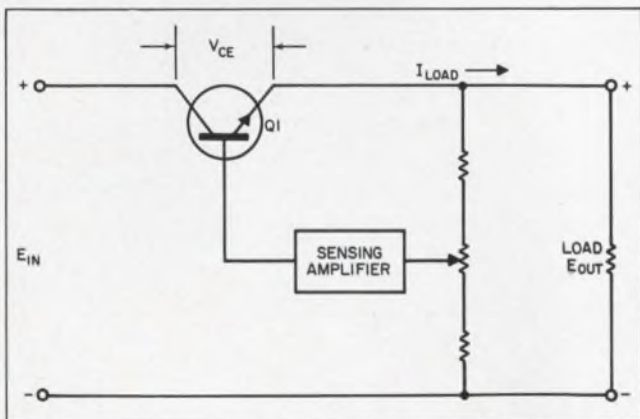

2. Series control element maintains output voltage within desired limits. The circuit is basically a two-element voltage divider.

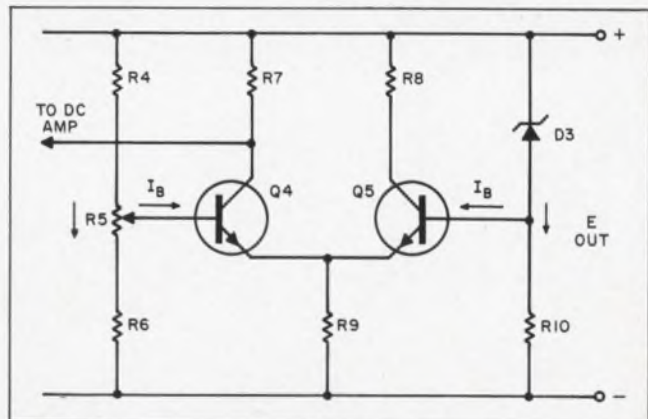

4. The sensing amplifier samples the output voltage, compares it with a reference (D3) and produces an error signal proportional to the difference.

be calculated by:

$$\begin{aligned}
 P_{max} &= (T_{j\ max} - T_{A\ max}) / (\theta_{hs} + \theta_{jhT}) \\
 &= (150^\circ\text{C} - 75^\circ\text{C}) / (1.5^\circ\text{C/W} + 1.0^\circ\text{C/W}) \\
 &= 30\ \text{W}.
 \end{aligned}$$

Thus it can be seen from the 30-W curve in Fig. 5 that the heat sink is a factor limiting the operating area of the series element. This area may be extended by limiting the maximum ambient temperature or by improving the heat sink (for instance, with forced-air cooling or liquid cooling†).

In order to minimize power dissipation in the sensing circuit, the output current to the series element should be kept small. Additional gain may be obtained by using a compound, or Darlington, driver for the series control element, as shown in Fig. 6. Allowable base currents for both transistors are calculated by using the maximum allowable collector current for Q1 (Fig. 5) and the transistor characteristics:

$$\begin{aligned}
 Q1\ (DTS-413) &- h_{FE} = 25\ \text{min where } I_C = 500\ \text{mA}, \\
 \therefore I_{B1} &= I_C / h_{FE} = 500\ \text{mA} / 25 = 20\ \text{mA}; \\
 Q2\ (2N3439) &- h_{FE} = 40\ \text{min where } I_C = 20\ \text{mA}, \\
 \therefore I_{B2} &= I_C / h_{FE} = 20\ \text{mA} / 40 = 0.5\ \text{mA}.
 \end{aligned}$$

The Darlington driver must have a voltage capability equal to the main series element.

The 2N3439 was selected for the drive transistor

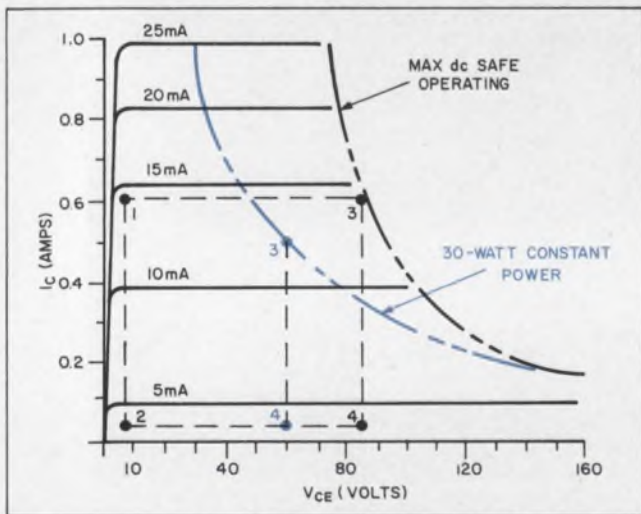

5. Operating characteristics of the DTS-413 transistor show safe operating range of the device.

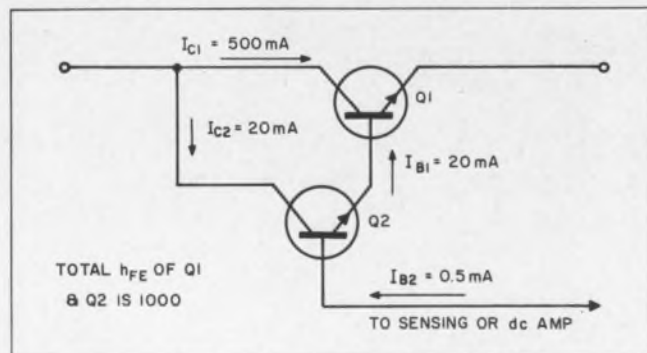

6. Addition of a compound, or Darlington, amplifier provides additional gain for the series control element.

because of its gain distribution at 20 mA ( $h_{FE} = 40$  min). Its high-voltage characteristics are similar to the DTS-413's.

### Preregulator uses Zener diode

Component values for the regulator stage are calculated in the following manner.

We start with  $I_{B2} = 0.5$  mA, and assume that  $I_{C3} = I_{B2}$ . Then  $I_2 = I_{C3} + I_{B2} = 0.5 + 0.5 = 1.0$  mA.

Since  $V_{Z1}$  may be any value less than  $E_{in\ min}$  that will supply sufficient current to Q2 and Q3, a 6.8-V Zener (D1) was chosen.

R2 is now calculated:

$$\begin{aligned}
 R2 &= [V_Z - (V_{EB1} - V_{EB2})] / (I_{B2} + I_{C3}) \\
 &= 6.8 - (0.7 - 0.7) \text{V} / 1.0\ \text{mA} \\
 &= 5.4\ \text{k}\Omega.
 \end{aligned}$$

A 5.6-k $\Omega$  resistor was used.

To calculate R1 we use:

$$R1 = [(E_{in\ min} - E_{out\ max}) - V_{Z1}] / I_1,$$

where  $I_1 = I_2 + I_Z$ . The Zener diode (1N1767) that was chosen has a dissipation of 0.7 W at 70°C and therefore:

$$I_Z\ max = 0.7\ \text{W} / 6.8\ \text{V} \approx 100\ \text{mA}.$$

†See "Beat the Heat in Electronic Systems," ELECTRONIC DESIGN, XIV, No. 21 (Sept. 13, 1966), 58-63.

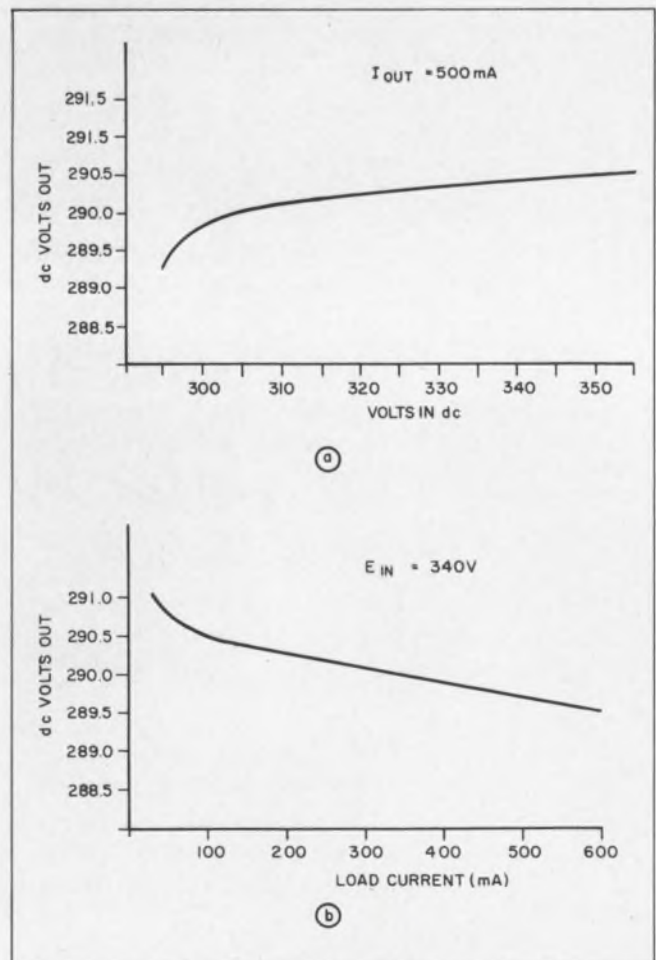

7. Varying inputs and loads are easily handled by the regulator as shown in the performance curves above.

Thus  $I_1 = 1 + 100 = 101$  mA. Then:

$$R1 = [(340 - 280) - 6.8] V / 101 \text{ mA} \\ = 520 \Omega.$$

This value of  $R1$  results in a dissipation of 5.2 W; this was considered excessive, so a 1-k $\Omega$  resistor was used.

### Sensing amplifier completes design

In the sensing amplifier (Fig. 4), silicon Zener diode  $D_2$  is used as the reference element. The breakdown voltage of a Zener is reasonably constant over a range of reverse currents. The temperature coefficient of a Zener diode approaches zero where  $V_Z$  is between 5 and 6 V. When breakdown voltages are less than 5 V, the coefficient is usually negative. As breakdown voltages increase above 6 V, the temperature coefficient becomes increasingly positive. To minimize the effects of temperature, two 1N753A (6.2 V) Zeners are used in series. The sum of the two series units (12.4 V), in addition to providing the reference voltage, allows the transistors  $Q_4$  and  $Q_5$  to operate at low voltage. The current through reference element  $D_3$  and the divider ( $R_4$ ,  $R_5$  and  $R_6$ ) must be much greater than the base currents required by  $Q_4$  and  $Q_5$ . Transistors  $Q_4$  and  $Q_5$  are 2N2712s biased to an emitter current of approximately 1 mA each.

Finally the value of Zener  $D_2$  in the complete circuit (Fig. 1) should be chosen not to exceed the voltage rating of  $Q_3$ . As a rough approximation, the value should be about one volt greater than the voltage drop across  $R_7$  when the differential amplifier is balanced.

The dc supply used to provide power for the regulator is usually some form of rectified ac source. For this design, the supply should have a nominal value of 320 V and must be capable of supplying a minimum of 300 V under full load and a maximum of 340 V under light conditions. The regulator should not be operated under a no-load condition. If this is a requirement, a bleeder resistor should be added across the output to maintain a stand-by current of 40 to 50 mA. The 12-pF capacitor across the output provides stability under light-load conditions.

Performance curves showing the effectiveness of the circuit are shown in Fig. 7.

An important advantage of this particular regulator is that, through the use of a so-called crowbar circuit (SCR overload-sensing circuit), the regulator may be made short-circuit-proof. In the foregoing example, in the case of a short circuit,  $Q_1$  must withstand a collector-to-emitter voltage of 300 V simultaneously with a collector current of 1 A or more. The DTS-413 can withstand this overload for 500 ms. The crowbar circuitry would therefore have to be capable of operating in less than 500 ms. ■ ■



Samuel Guagliardo, Design Engineer  
Milwaukee Transformer Company, Milwaukee, Wisconsin

## T & S Lamination Certifications Prove Value In Transformer Design

"The Certification of Magnetic Quality supplied with each shipment of Thomas and Skinner laminations helps bridge the gap from theory to practice in transformer design," says Samuel Guagliardo, Design Engineer, Milwaukee Transformer Company.

"We file the Certifications by lamination size, grade and gauge of metal. This enables me to set up design criterias by averaging the practical values certified by T & S for any given size lamination."

Milwaukee Transformer produces specialty transformers, like the one shown here. Quality components and workmanship assures the reliability and performance required in Milwaukee transformers.



### CERTIFICATION OF MAGNETIC QUALITY



Thomas and Skinner is the first manufacturer to provide certification of magnetic quality with each lamination shipment. All T & S laminations are tested and certified under ASTM A-346-64 specification. The T & S material certifications provide volt amperes per pound, core loss and material lot number. The material lot number identifies and serves as a control

on each lot. The material certification is forwarded with the invoice, and a duplicate copy is included with the packing slip covering the shipment.

### T & S LAMINATIONS ASSURE UNIFORMITY

Because they are rigidly inspected throughout every step of production under a Quality Control System conforming to Mil-T-9858. Send for your sample copy of a typical T & S Material Certification. See for yourself how it could help you with your transformer design problems. Write to:



Mr. Magnetician, symbol of over 60 years  
T & S experience in the field of magnetics.



*Thomas & Skinner, Inc.*

Box 120 1120 EAST 23rd STREET  
INDIANAPOLIS, INDIANA 46207 PHONE 317- 923-2501

ON READER-SERVICE CARD CIRCLE 42

# Self-protection built in



## Low-cost G-E Selenium Encapsulated Rectifiers

■ Self-protection against transient voltage is built into all General Electric low-cost, low-current Miniature Selenium Encapsulated Rectifiers.

Ideal for light electronics applications, these little wonders (the largest is less than five-eighths inch in diameter) are available with current ratings from 2 ma. to 150 ma. Input voltage can be as high as 540 volts. Frequency capability stretches up to 25 kHz.

G-E selenium miniatures are packed with application potential. Use them for toys and electric razor motor control, electric cigarette lighters, lamp dimmers, and TV antenna boosters. They're also being used in nickel-cadmium battery chargers, and the full wave control circuit shown here is ideal for heaters, fans, and limited

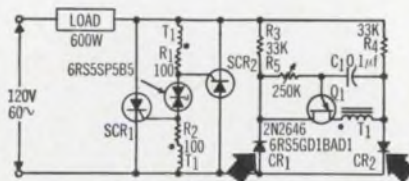

Full wave control circuit using General Electric 6RS5GD1BAD1 Miniature Selenium Encapsulated Rectifier.

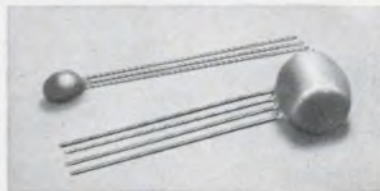

Actual typical size of General Electric Miniature Encapsulated Rectifiers.

range control of lamps.

Self-protecting G-E rectifiers are available in a variety of circuit configurations including single phase half wave, center tap, doublers, and bridges—plus special types.

Low cost? Sure. A completely assembled encapsulated bridge can be purchased and wired into the circuit at less cost than four surplus silicon diodes.

For further information on Miniature Selenium Encapsulated Rectifiers—or on G.E.'s total electronic capability—write to Section 220-44, General Electric Company, Schenectady, New York. In Canada: Canadian General Electric, 189 Dufferin St., Toronto, Ont. Export: Electronic Components Sales, I.G.E. Export Division, 159 Madison Ave., New York, N. Y.

SEMICONDUCTOR PRODUCTS DEPARTMENT

GENERAL  ELECTRIC

ON READER-SERVICE CARD CIRCLE 43

ELECTRONIC DESIGN 26, November 22, 1966

# Are you haunted by these recording nightmares?



1. Big moment — wrong instrument?



2. Chart paper feedback?



3. Smeared traces — inky hands?



Then — you're ready for CEC's 5511.

## Because...

**1. You don't need separate recorders for separate jobs.** CEC's portable, 2-channel 5511 features the versatility of plug-in signal conditioners for a wide range of voltage inputs. And you may convert from high-level signal inputs to low-level inputs by a simple change of plug-in attenuator/amplifier units.

**2. You don't need four hands to load paper.** CEC's foolproof 5511

eliminates those problems with its unique snap-in, front chart loading.

**3. You can wear ink-free shirts again.** CEC's thermal-writing 5511 guarantees you consistently clean traces with a high degree of resolution on heat-sensitive paper.

The 5511 is another reason why CEC is known as the leader in data recording — from event to readout.

For your permanent recording panacea, call the nearest CEC Field Office, or write for CEC Bulletin 5511-X35.

# CEC

Data Instruments Division

**CONSOLIDATED ELECTRODYNAMICS**

A SUBSIDIARY OF BELL & HOWELL/PASADENA, CALIF. 91109  
INTERNATIONAL SUBSIDIARIES: WOKING, SURREY, ENGLAND  
AND FRIEDBERG (HESSSEN), W. GERMANY

ON READER-SERVICE CARD CIRCLE 44

# Simplify vector analysis.

Use this set of nomographs to eliminate those time-consuming computations.

The addition and subtraction of vectors is usually a tedious computational process. You can eliminate these arithmetic steps by using nomographs.

Given the magnitude and direction of a set of vectors in a three-dimensional system, the first step is to reduce them to their co-ordinate components. Arithmetic operations are then performed, and the resultant set of co-ordinate components can be reconverted to a single vector of the correct magnitude and direction. This can be done more quickly by the use of these nomographs than by actual calculation.

To see how the nomographs work, start with the graphical representation of a vector,  $V$ . In spherical co-ordinates this vector may be written as:

$$V = |V| \cdot \underline{\phi, \theta},$$

where

$V$  is the vector,

$|V|$  is its scalar magnitude,

$\phi$  is its angular displacement from the  $k$  vector, and  $\theta$  is its angular displacement from the  $i$  vector.

In rectangular coordinates it may be written as:

$$V = ai + bj + ck,$$

where

$i$ ,  $j$  and  $k$  are unit vectors in their respective planes.

$a$ ,  $b$  and  $c$  are scalar quantities in their respective planes.

## Determining co-ordinate components

If  $|V|$ ,  $\phi$  and  $\theta$  are known for a given vector, then the nomographs can be used to break the vector down to its co-ordinate components, as follows:

(1) Determine  $|V|$ ,  $\phi$  and  $\theta$ . Annotate  $|V|$  in unit decimal terms ( $2400 = 2.4 \times 10^3$ ).

(2) Determine  $a$ . Enter  $|V|$ ,  $\phi$  and  $\theta$  on Fig. 1. Connect  $|V|$  and  $\phi$  to intersect the Index Line. Connect this index point with  $\theta$  to intersect the right-hand line. This intersection will give the value of  $a$ .

(3) Determine  $b$ . Enter  $|V|$ ,  $\phi$  and  $\theta$  on Fig. 2. Connect  $|V|$  and  $\phi$  to intersect the Index Line. Connect this index point with  $\theta$  to intersect the right-hand line. This intersection will give the value of  $b$ .

(4) Determine  $c$ . Enter  $|V|$  and  $\phi$  on Fig. 3. Connect these points to intersect the right-hand

line. This intersection will give the value of  $c$ .

## Determining the new vector

This process is then repeated for as many vectors as are involved in the operation, until they have all been broken down to their component parts. They may then be added or subtracted simply by adding or subtracting their components as follows:

$$V_1 = a_1i + b_1j + c_1k.$$

$$V_2 = a_2i + b_2j + c_2k.$$

$$V_t = V_1 \pm V_2 = (a_1 \pm a_2)i + (b_1 \pm b_2)j + (c_1 \pm c_2)k.$$

$$V_t = a_i i + b_i j + c_i k.$$

Enter  $a_1$ ,  $b_1$  and  $c_1$  on Fig. 4. Connect  $a_1$  and  $b_1$  to intersect the Index Line. Connect this index point with  $c_1$  to intersect  $|V_t|$ . This intersection will give the value of  $|V_t|$ .

$\phi_1$  may then be determined by using Fig. 3 as follows:

(1) Enter  $|V_t|$  on the  $|V|$  line.

(2) Enter  $|c_1|$  on the  $c$  line.

(3) Connect the two to intersect the  $\phi$  line.

Read out the value  $\phi_1$ .

$\theta_1$  may now be determined from Fig. 5 as follows:

(1) Enter  $a_1$  on the  $a$  line.

(2) Enter  $b_1$  on the  $b$  line.

(3) Connect the two to intersect the  $\theta$  line and read out the value  $\theta_1$ .

## A practical example

A simple example is worked out where it is desired to resolve the sum of two vectors, such as:

$$V_t = V_1 + V_2.$$

Assume:

$$|V_1| = 500 (5 \times 10^2), \phi_1 = 45^\circ, \theta_1 = 30^\circ.$$

$$|V_2| = 500 (5 \times 10^2), \phi_2 = 45^\circ, \theta_2 = 60^\circ.$$

Using Figures 1, 2 and 3 for  $a$ ,  $b$  and  $c$  respectively, we get:

$$a_1 = 3.06 \times 10^2; b_1 = 1.77 \times 10^2; c_1 = 3.54 \times 10^2.$$

$$a_2 = 1.77 \times 10^2; b_2 = 3.06 \times 10^2; c_2 = 3.54 \times 10^2.$$

$$a_t = 4.83 \times 10^2; b_t = 4.83 \times 10^2; c_t = 7.08 \times 10^2.$$

Using Fig. 4, we get:

$$|V_t| = 9.8 \times 10^2.$$

Using Fig. 3, we get:

$$\phi_1 = 44^\circ.$$

Using Fig. 3, we get:

$$\theta_1 = 45^\circ.$$

It can be seen that these graphs eliminate the large number of trivial computations that would have been required for even this simple problem. The same nomographs can be used for a two-dimensional system by merely setting either  $\phi$  or  $\theta$  to zero. ■ ■

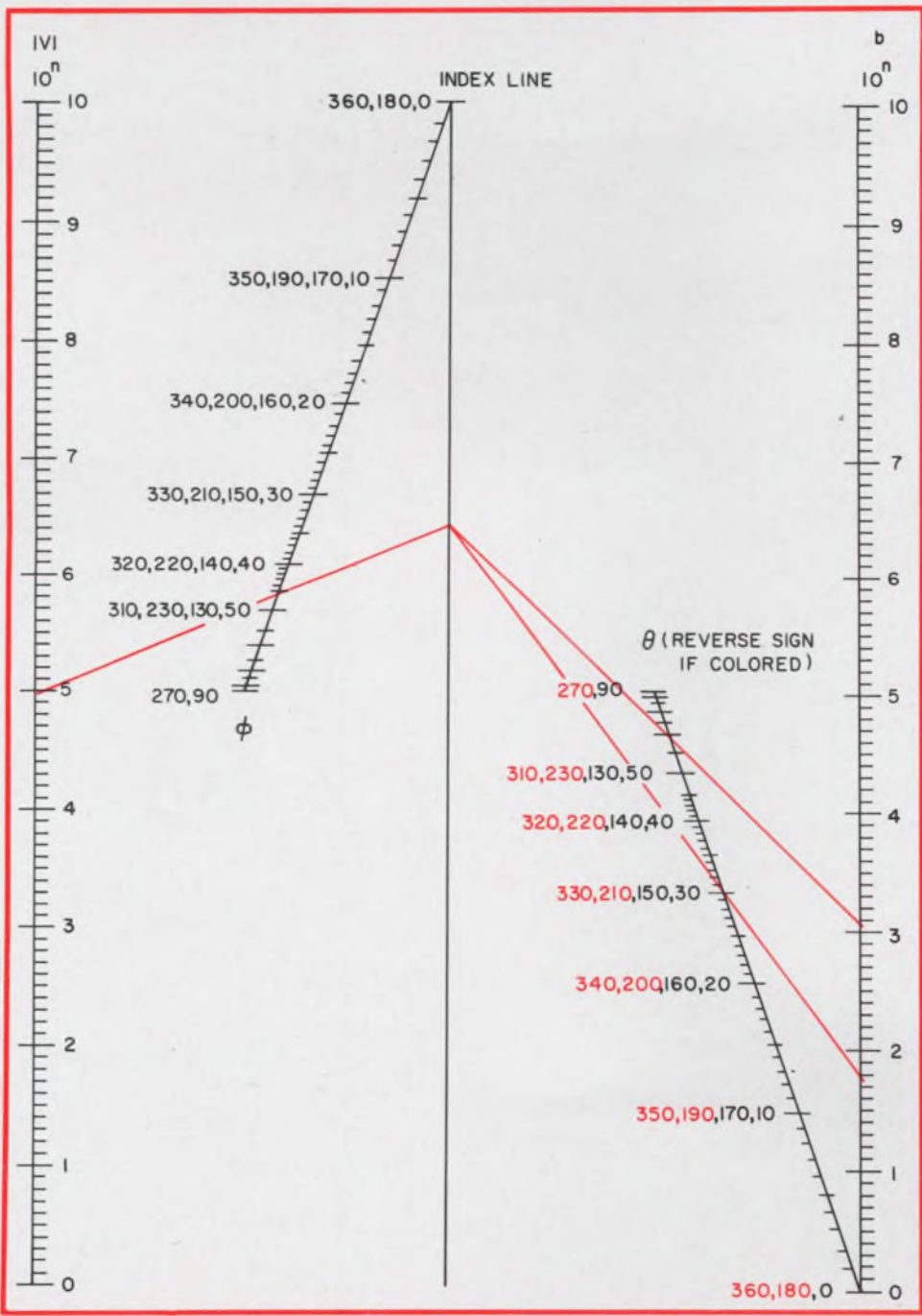

(Illustrations continued on p. 84)

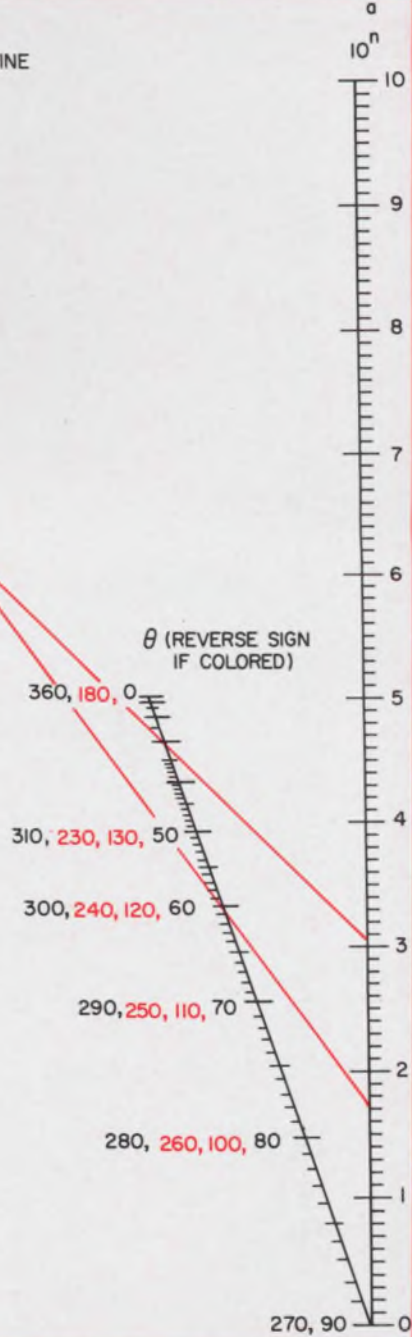
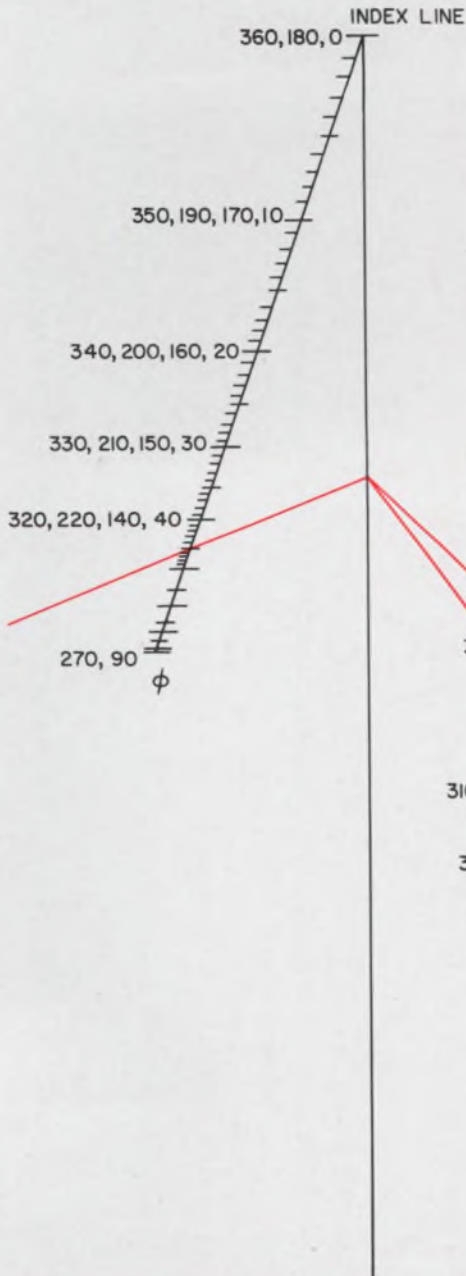
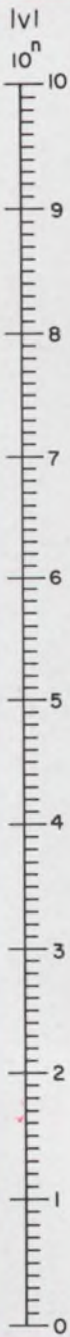



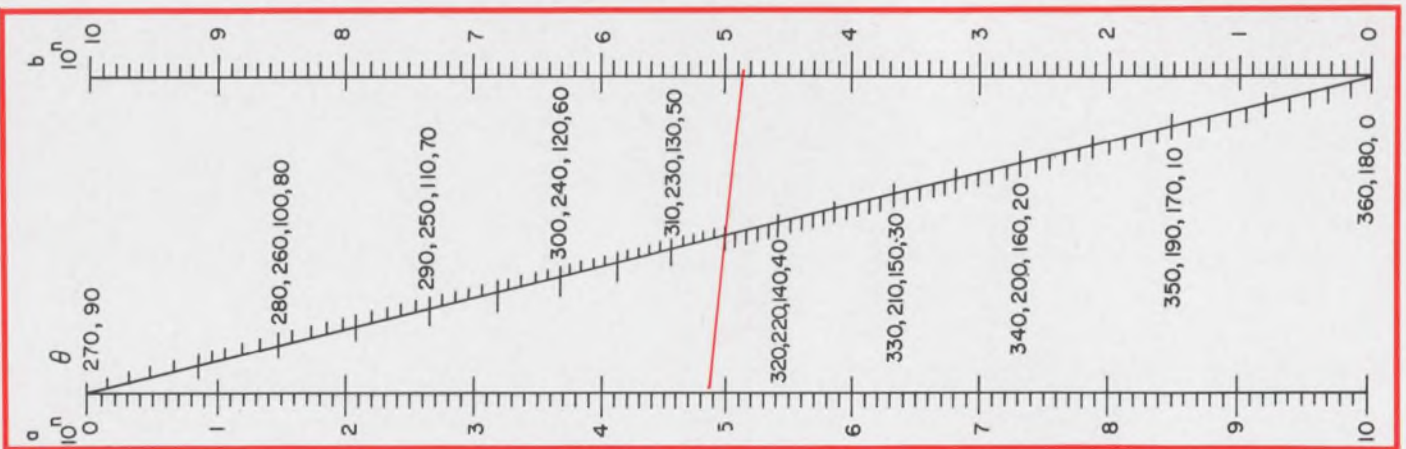
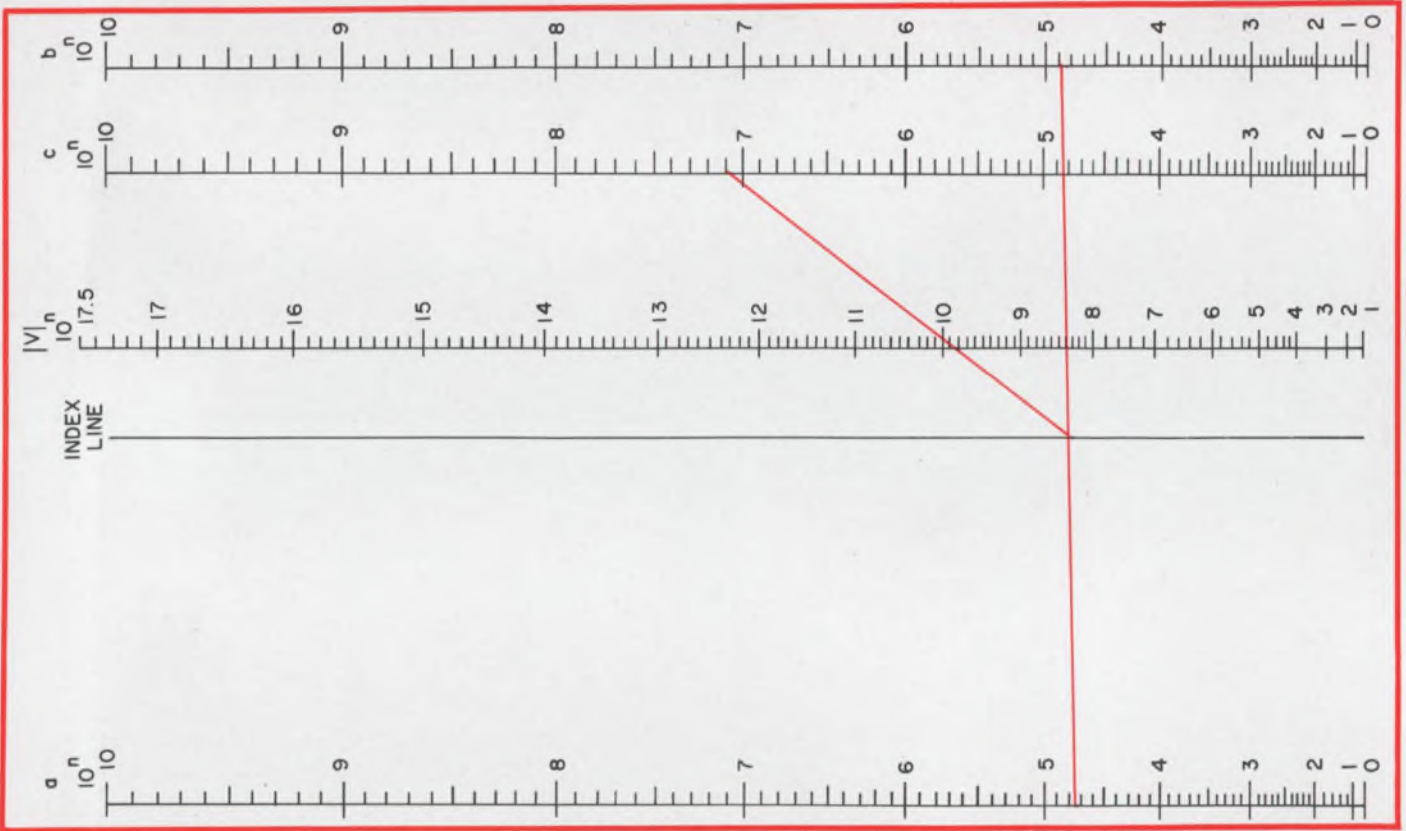
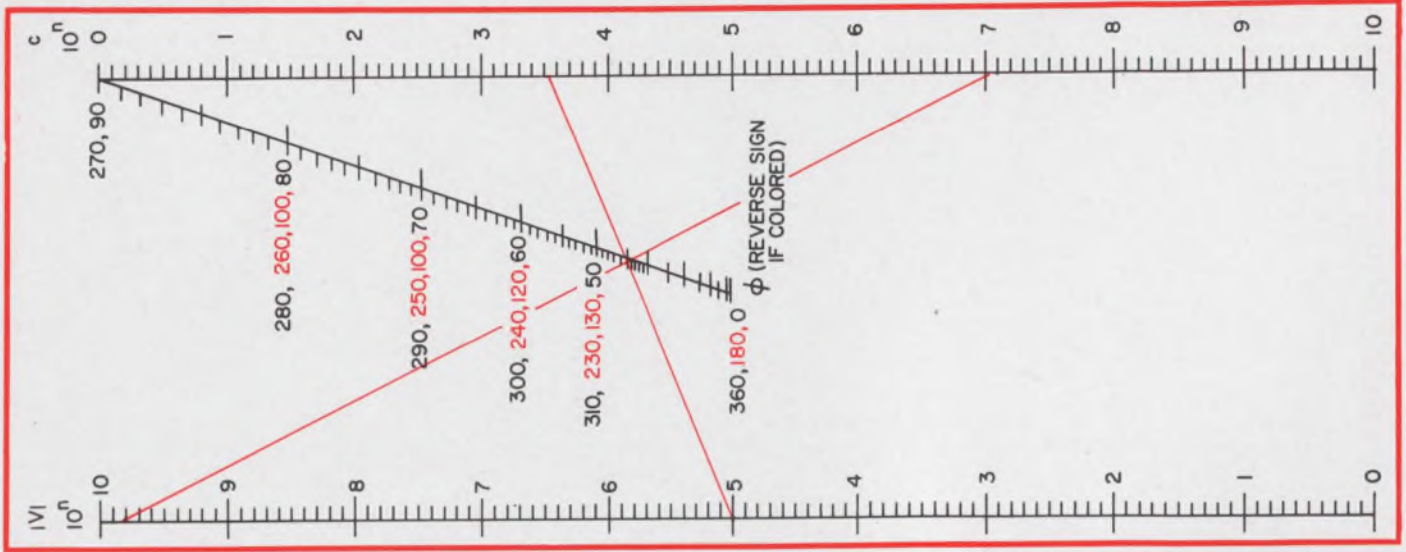



No ordinary  
silicone rubber  
could pass the UL  
vertical flame test



until G.E. developed  
SE-9041

Ordinary silicone rubber wire insulation was only half-safe. It met Underwriters' Laboratories requirements when held *horizontally* over a flame, but flunked UL's *vertical* flame test. That's why General Electric developed SE-9041—the first economical silicone rubber insulation to pass *both* UL flame tests. New SE-9041 meets UL specifications as insulation for any size conductors without flame-retardant exterior braids or saturants.

**SE-9041 is versatile too.** Although it was originally developed specifically for television wiring, this new

silicone compound can be used in any high voltage circuit from ignition wiring to klystron wiring. In electrostatic precipitators or magnetrons, for example.

**But that's only part of the story.** SE-9041 is also superior in dielectric strength. A No. 22 AWG conductor insulated with a 75 mil wall of SE-9041 would have a typical breakdown voltage of 500 volts/mil a-c. About 50% higher than values obtained with previous silicone rubber compounds! We especially formulated this new silicone rubber insulation to hold high-voltage stresses for prolonged periods of time.

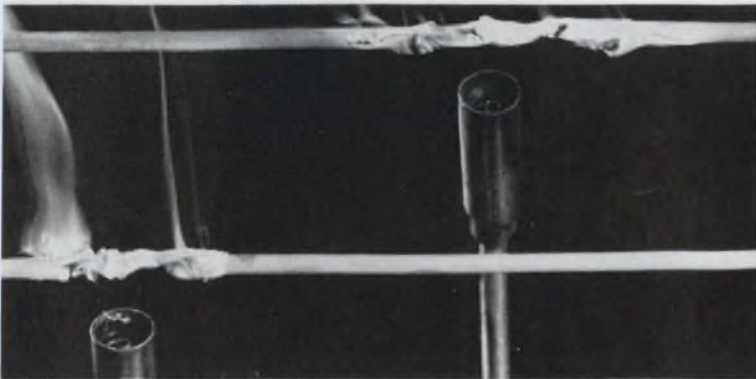

For horizontal wiring requirements, any silicone rubber insulation provides superior resistance to flame propagation. It's on the vertical jobs that SE-9041 built a reputation as a firefighter. First among lower-priced silicone insulations to pass the demanding UL vertical flame test.

Want a sample for evaluation? Be our guest.

Section L11236, Silicone Products Dept.  
General Electric Co., Waterford, N. Y. 12188

Send me a free sample of SE-9041, plus all the literature you can put your hands on.

Name \_\_\_\_\_

Title \_\_\_\_\_

Company \_\_\_\_\_

Address \_\_\_\_\_

City \_\_\_\_\_ State \_\_\_\_\_ Zip \_\_\_\_\_

GENERAL  ELECTRIC

Now it can be told . . .

## Evading radar detection is a cinch

for aircraft equipped with EASY—a system that takes advantage of a radar's blind spots.

While novel in concept, this radar evasion system has a somewhat restricted range of application. In fact, it can be used only against a low-budget aggressor, who has placed all his defense dollars into the construction of moving-target radars. In the context of a limited war fought against such a shortsighted enemy, the Evasive Aircraft System (EASY) offers tremendous potential. Before proceeding with a detailed description of EASY, it is necessary to appreciate fully those characteristics of certain radar systems that make EASY possible.

### Moving target radar has blind spots

Pulse radar detection systems operate by periodically transmitting pulses of electromagnetic energy in a narrow beam. Energy, reflected by a target in the beam, is received after a propagation delay and is processed for an optimum measurement against background noise. If the reflected energy (return) from a target is great enough to trigger a threshold device, the presence of a target is indicated, at a range determined by the propagation delay and at an azimuth corresponding to the beam pointing angle. Figure 1 shows a block diagram of this simple radar.

Radars which are equipped with a moving target indicator (MTI) provide enhancement for the return from moving targets. The return from fixed targets differs from that of targets moving radially with respect to the radar. Since signal phase (that is, time delay) is proportional to the distance between the radar and the target, the phase of fixed targets remains constant between pulses. The phase of moving targets varies from pulse to pulse with the distance that the target has moved. If a target has a constant radial velocity, there is a constant rate of change of target return phase, that is a Doppler-shifted return signal. The effect of target radial motion is, more generally, both a frequency shift and a broadening of the target return spectrum. The difference in the return spectra for fixed and moving targets is shown in Fig. 2. The spectrum for fixed targets is

centered at  $f_0 \pm nf_r$ , where  $f_0$  is the transmitted frequency and  $f_r$  is the pulse repetition rate.

An MTI radar has provision for comparing successive target returns, and in so doing, canceling the return from fixed targets. A typical cancellation characteristic is seen in Fig. 2. A property of such systems is the periodic nulls, which occur at multiples of the radar repetition rate, and the aircraft radial speeds, which produce corresponding Doppler shifts. The existence of these "blind" speeds is the basis for the EASY system.

### EASY system fools the MTI

The EASY system is based on varying the radial speed of an aircraft so that the aircraft will always be traveling at a blind speed of the enemy's radar. Consider a simplified model, which might be applied to a ship or other ground vehicle:

A vehicle travels at constant speed, greater than or equal to the first blind speed, and in the plane of the radar. Where vehicle speed equals blind speed, the proper course is a radial line toward the radar. If vehicle speed is greater than first

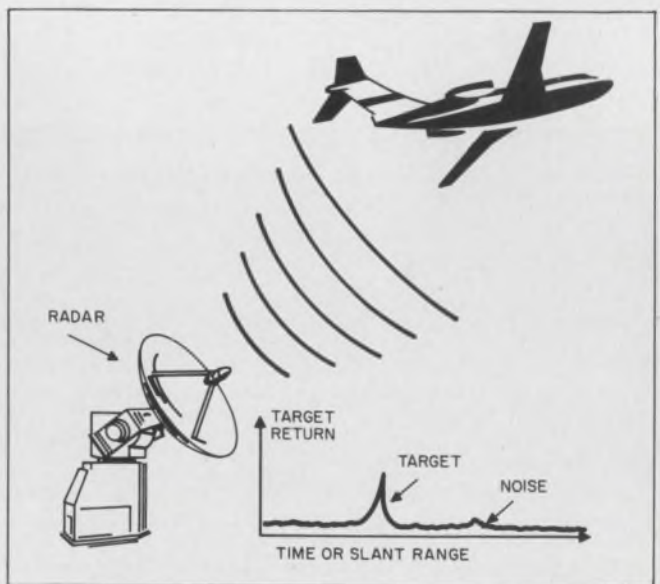

1. Radar detection of an airborne target is accomplished by the fairly well-known technique of transmitting radio-frequency energy and monitoring any echoes, which result from the reflection of a portion of the transmitted energy from a target object.

Robert M. Goldberg, Staff Engineer, General Instrument Corp., Radio Receptor Div., Hicksville, N. Y.

blind speed, the proper path is a logarithmic spiral. This spiral has a constant angle between its tangent and a radial line to the origin. Clockwise or counterclockwise paths are equivalent. Since radial speed and total speed are constants:

$$dr/dt = K_1 = f_r \lambda / 2 \text{ (blind speed)}$$

and

$$ds/dt = K_2 = [r^2(d\theta/dt)^2 + (dr/dt)^2]^{1/2} \text{ (vehicle speed),}$$

then slant range:

$$r = \epsilon^C \epsilon^{0/K}, \quad (1)$$

where  $K = [(K_2/K_1)^2 - 1]^{1/2}$ ,

$\theta$  = target bearing, and  $C$  is an integration constant.

If the radar has maximum and minimum coverage ranges of  $r_1$  and  $r_2$ , respectively, then  $C = \ln r_1$ . It is then necessary to circle the radar by  $N$  revolutions to reach safety, i.e.,  $r = r_2$ , where:

$$N = 1/2\pi [(K_2/K_1)^2 - 1]^{1/2} \ln r_2/r_1, \quad (2)$$

where  $1 < K_2/K_1$ .

Figure 3 shows the number of revolutions required to penetrate the radar as a function of the ratio of vehicle speed to blind speed.

The problem in three dimensions is formulated in cylindrical co-ordinates in Eq. 3. The conversion to spherical is straightforward. In order to keep radial speed constant, the rates of change of total aircraft speed, aircraft altitude, and turning angle with respect to the radar can be varied separately and in conjunction:

$$\begin{aligned} (ds/dr)^2 &= (dz/dt)^2 + (r d\theta/dt)^2 + (dr/dt)^2 \\ &\text{(vehicle speed);} \\ dR/dt &= K_1 \text{ (blind speed);} \\ R^2 &= r^2 + z^2 \text{ (slant range);} \\ (ds/dt)^2 &= [(1 + z^2/R^2 - z^2) dz/dt \\ &\quad - 2RzK_1/R^2 - z^2] dz/dt + (R^2 - z^2) \\ &\quad + (d\theta/dt)^2 + R^2 K_1/R^2 - z^2. \end{aligned} \quad (3)$$

A block diagram of an EASY system instrumentation appears in Fig. 4. As shown in the figure, it is necessary to monitor the enemy radar continuously in order to determine its operating parameters and relative position. The EASY computer compares the relative aircraft-radar position against a desired target location and selects a suitable flight path. Command signals are sent to the autopilot continuously to direct the path of the aircraft.

A reduction in cost can be realized with the system by installing only a single EASY system for each mission. A lead aircraft can then be used to ferry other aircraft around the radar.

A still greater cost reduction can be achieved by not installing any EASY systems at all, since, as mentioned earlier, the system is ineffective against conventional radars, of which there are many. It is hoped that discussion of the EASY system has nevertheless made clear some of the salient characteristics of MTI radar. ■ ■

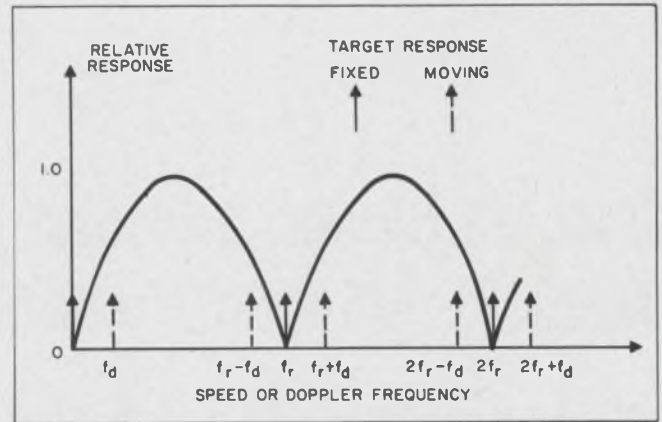

2. Response from a target will differ depending on whether the target is fixed or moving. In the case of a radar equipped with an MTI (Moving Target Indicator), periodic nulls occur at multiples of the radar's pulse repetition rate. It is these blind spots that make EASY possible.

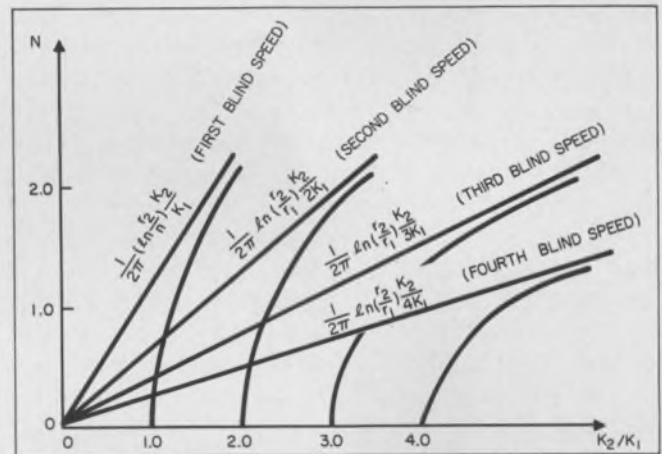

3. The number of logarithmic-spiral encirclements,  $N$ , required to take advantage of the radar's blind spots, vary as the ratio of vehicle speed to the radar's blind speed.

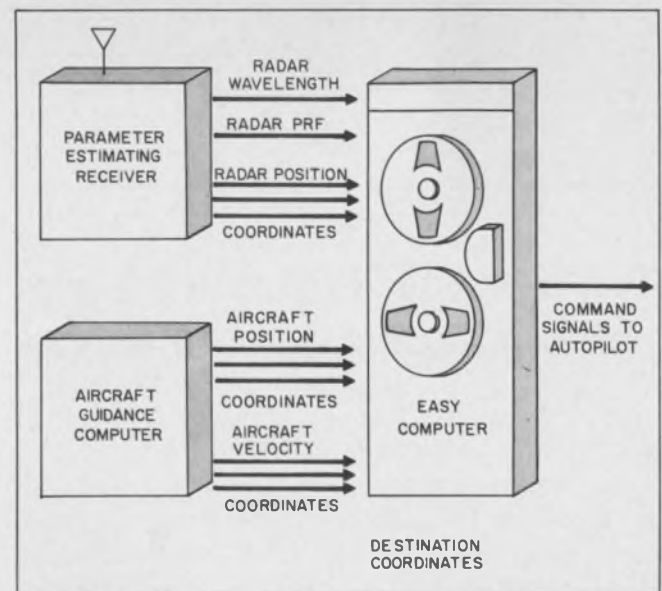

4. Instrumentation needed to incorporate EASY into an aircraft, or other vehicle, is relatively uncomplicated when considered on a functional basis. The actual hardware employed is not critical and may consist of anything that's handy.

## Two Si diodes and one Zener track temperature changes

Temperature compensation with an offset voltage can be achieved with a pair of silicon diodes and a Zener diode. The circuit introduces a temperature-dependent offset with either a positive or negative temperature coefficient and reduces the compensation to a simple two-point tracking. It is especially useful in cases when high stability is demanded of a production run of oscillators and when the normal tolerances of the temperature characteristics of the components preclude achieving the required degree of stability without hand-tailoring the compensation by repeated temperature runs.

To track a circuit over a temperature range, first adjust  $R2$  (see schematic) for equal voltages at points  $A$  and  $B$  at room temperature. Then raise or lower the temperature to one of the extremes desired and adjust  $R1$  for tracking.

Approximately equal but opposite incremental voltage changes with temperature will be obtained at points  $A$  and  $B$  by placing two forward-biased

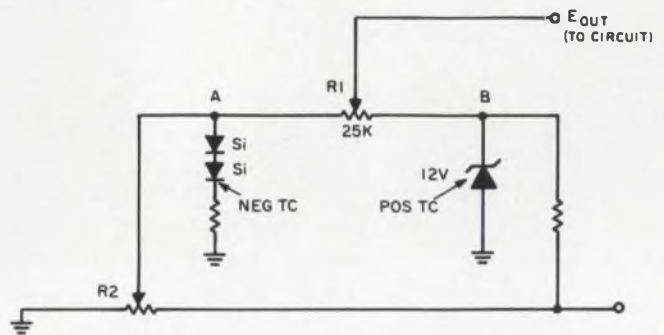

Temperature-dependent voltages are produced at points  $A$  and  $B$ . The operation is reduced to a simple two-point tracking method.

silicon diodes in one leg of the bridge and a back-biased 12-volt Zener diode in the other leg.

If the temperature-dependent voltage is always either positive or negative, the superfluous network may be replaced simply by a resistive divider.

For ease of adjustment in some applications, it is not necessary to place the two potentiometers  $R1$  and  $R2$  in the temperature chamber for calibration.

*Alex. W. Adler, President, Radio Research Co., Rockaway, N. J.*

VOTE FOR 110

**VOTE!** Circle the Reader-Service-Card number corresponding to what you think is the best Idea-for-Design in this issue.

**SEND US YOUR IDEAS FOR DESIGN.** Submit your IFD describing a new or important circuit or design technique, the clever use of a new component, or a cost-saving design tip to our Ideas-for-Design editor. If your idea is published, you will receive \$20 and become eligible for an additional \$30 (awarded for the best-of-issue Idea) and the grand prize of \$1000 for the Idea of the Year.

## Two-transistor exclusive-OR gate needs no external power supply

Here is a two-transistor exclusive-OR gate (modulo-2 adder) that does not require an external supply voltage.

When the inputs  $A$  and  $B$  (see Figure) are both at zero volts, the output  $C$  is obviously also zero volts. When  $A$  is +10 volts and  $B$  is zero volts, the base-to-emitter junction of  $Q1$  is forward-biased and the collector of  $Q1$  is at zero volts. There is no potential difference between the base and the emitter of  $Q2$ , and therefore the collector of  $Q2$  is at about +10 volts. Since the two diodes and the

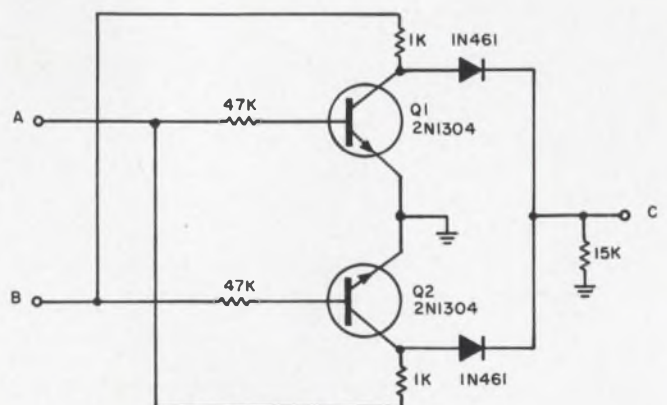

Simple two-transistor OR gate requires no external power source.

# CTC

trims size, cuts cost and eliminates temperature compensating circuits

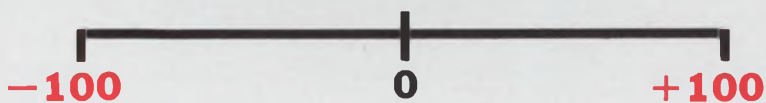

## New IRC metal film resistors with any specified TC between -100 and +100ppm

Controlled Temperature Characteristic—a new IRC line of high-stability precision metal film resistors—is made by a technology so refined that TC can be controlled to any desired point between -100 and +100ppm, ±5ppm.

In analog computers, CTC resistors offer fast rise times, precision and stability over a wide temperature range. They can simplify or completely eliminate temperature compensating devices in a wide range of delicate sensing instruments.



Inductance and capacitance are negligible. CTC resistors replace wire-wound types with space and cost savings, and are far more reliable . . . even at higher resistance values. Write for complete data and prices. IRC, Inc., 401 North Broad Street, Philadelphia, Pa. 19108.



### CAPSULE SPECIFICATIONS

SIZE	RN65
TC	Any TC between -100 and +100ppm, ±5ppm
TEMP. SPAN	Any 50°C increment between -55°C and 165°C
RESISTANCE	50Ω to 360KΩ
POWER	¼-W @ 125°C, ½-W @ 70°C
STD. TOLERANCE	0.1, 0.05, 0.025%

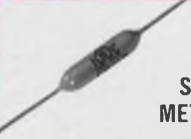
## INDUSTRY'S LARGEST SELECTION OF METAL FILM RESISTORS

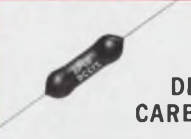
 <p><b>ASSURED RELIABILITY METAL FILM</b></p> <p>An industry first. 0.1, 0.01 or 0.001% levels. 1/20 to 2 watts. 20 ohms to 1 meg. ±25, 50 and 100ppm. 0.25, 0.5 and 1% tolerances.</p>	 <p><b>HIGH STABILITY METAL FILM</b></p> <p>Molded and coated types, including microminiature, 1/10 to 2 watts. 30 ohms to 10 meg. 8 TC's from ±25ppm. Tolerances from 0.05%.</p>	 <p><b>ECONOMICAL METAL FILM</b></p> <p>Molded and coated types for MIL-R-10509. TC guaranteed to within 100ppm. 1/10 to 2 watts, 10 ohms to 10 meg. 0.5 and 1% tolerances. •</p>	 <p><b>DEPOSITED CARBON FILM</b></p> <p>Molded types from ¼ to 2 watts, coated types from ½ to 2 watts. 10 ohms to 1 meg. 0.5, 1 and 2% tolerances. MIL-R-10509.</p>
--	--	---	---



ON READER-SERVICE CARD CIRCLE 46

## IDEAS FOR DESIGN

15-k $\Omega$  resistor form a simple OR gate, output  $C$  is at about +10 volts.

Because the circuit is symmetric, the same reasoning is used when  $A$  is zero volts and  $B$  is +10 volts: the output is about +10 volts.

When  $A$  and  $B$  are +10 volts, both transistors are driven into saturation. Thus, the collectors of  $Q1$  and  $Q2$  are at about zero volts; this makes  $C$  nearly zero volts.

Hence the truth table for the given circuit is:

A	B	C
0	0	0
0	+10	+10
+10	0	+10
+10	+10	0

and the network forms a two-input modulo-2 adder.

*L. S. Bobrow, Dept. of Electrical Engineering, Northwestern University, Evanston, Ill.*

NOTE FOR 111

## Economical IC test-set provides gate input/output characteristics

This test-set, used in conjunction with an oscilloscope, determines whether an IC gate is functional. Circuit characteristics, such as threshold voltages, stable-state voltages and loading capability, are all easily determined.

One of the important characteristics of a digital logic device is the minimum input voltage (threshold voltage) that is required to change the output voltage condition from a high-voltage state (logical 1) to a low-voltage state (logical 0) and vice versa. Since the device is not a perfect switch, the

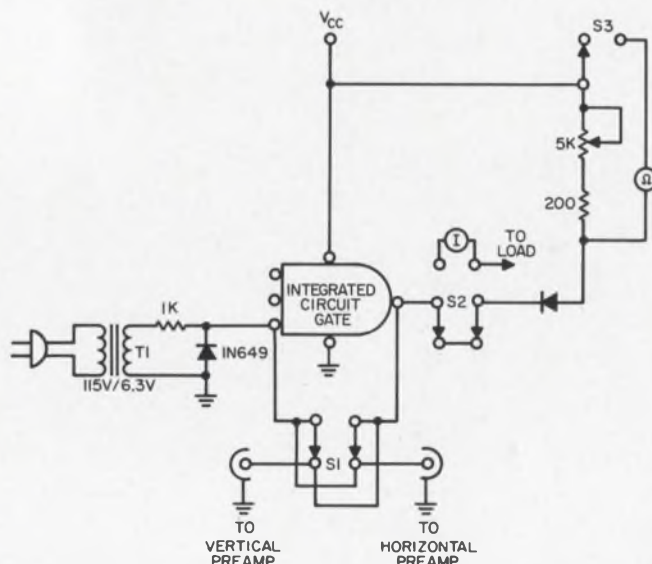

1. Characteristic tester uses 60-Hz sine-wave, clamped at ground during the negative cycle, as the input signal to the integrated circuit gate under test.

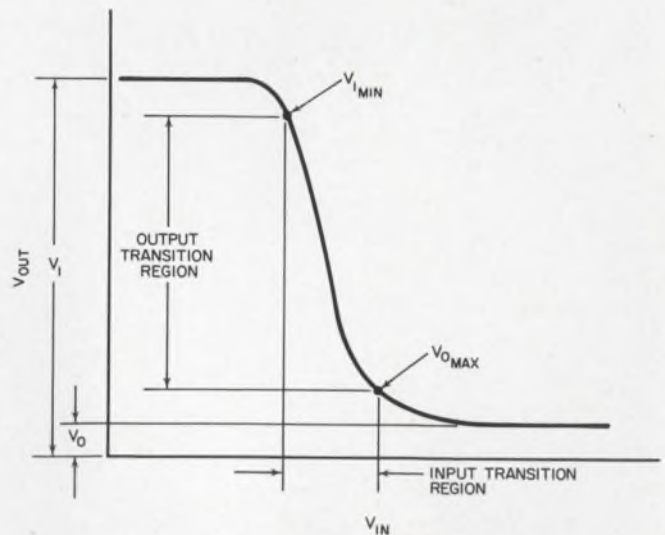

2. Input-output characteristic curve of NAND/NOR gate shows the two points,  $V_{1MIN}$  and  $V_{0MAX}$ , that define the threshold region.

threshold voltage is actually a threshold region, rather than a specific point. To define this region, one must determine the points at which the output will be considered in a stable 1 or 0 state. As shown in Fig. 1, this point, for the high-voltage, stable state, is the minimum voltage above which the output is considered in a stable state, and can be defined as  $V_{1MIN}$ .

For the low-voltage, stable state, this point is the maximum voltage below which the output would be considered in a stable state and is defined as  $V_{0MAX}$ . The area between these two parameters is the transition region and is an indeterminate state.

The test circuit (Fig. 2) displays this information. A 60-Hz sine-wave, applied to the input of the gate under test, causes the output to switch between cutoff and saturation and produces the characteristic trace on the oscilloscope. Knowing the oscilloscope zero-volt reference level and the supply voltage,  $V_0$  and  $V_1$  can be read directly from the scope face. Since  $V_0$  increases as the load (fan-out) increases, it is possible to relate the device operation to fan-out; switch  $S2$  is used to connect an external load to the device under test. To simplify the measurement of unknown loads, switch  $S3$  (momentary) connects an ohmmeter into the circuit.

*G. P. Carter, Product Marketing Engineer, Fairchild Semiconductor, Mountain View, Calif.*

NOTE FOR 112

## Low-impedance bias circuit improves amplifier linearity

A two-transistor circuit provides high-frequency linear amplifiers with the low-impedance base bias necessary to achieve good linearity.

High-frequency linear amplifiers, especially for

# Revolution in Resolution: 0.032% in a TRIMPOT® Potentiometer Package!

Seven inches of wirewound resistance element in a package just 5/16" square and one inch long—that's our new Model 3070! With resolution seven to ten times better than you normally get from wirewound units this small, Model 3070 TRIMPOT potentiometer gives you premium adjustability at no premium in space, weight, or temperature coefficient. Settings you make with this unit stay set, too; the exclusive rotor/wiper design, based on that of our precision potentiometers, is outstandingly stable under shock and vibration.

Model 3070 also offers slip-clutch action, the indestructible SILVERWELD® termination, and resistance wire with twice the normal cross-section area. Units are available immediately in a broad choice of terminal types and mounting styles, including two panel-mount versions.

Write today for free technical data.

Resolution:	0.032% to 0.15%
Standard resistances:	75 Ω to 50K
Power rating at 70°C:	1.5W
Max. operating temp.:	175°C
Temp. Coeff. (entire unit):	70ppm/°C
Humidity:	Meets MIL-STD-202B, Method 106 (Cycling)
Size:	5/16" x 5/16" x 1 1/16"

If it's TRIMPOT®, it's BOURNS

TRIMPOT is a registered trademark of Bourns, Inc.

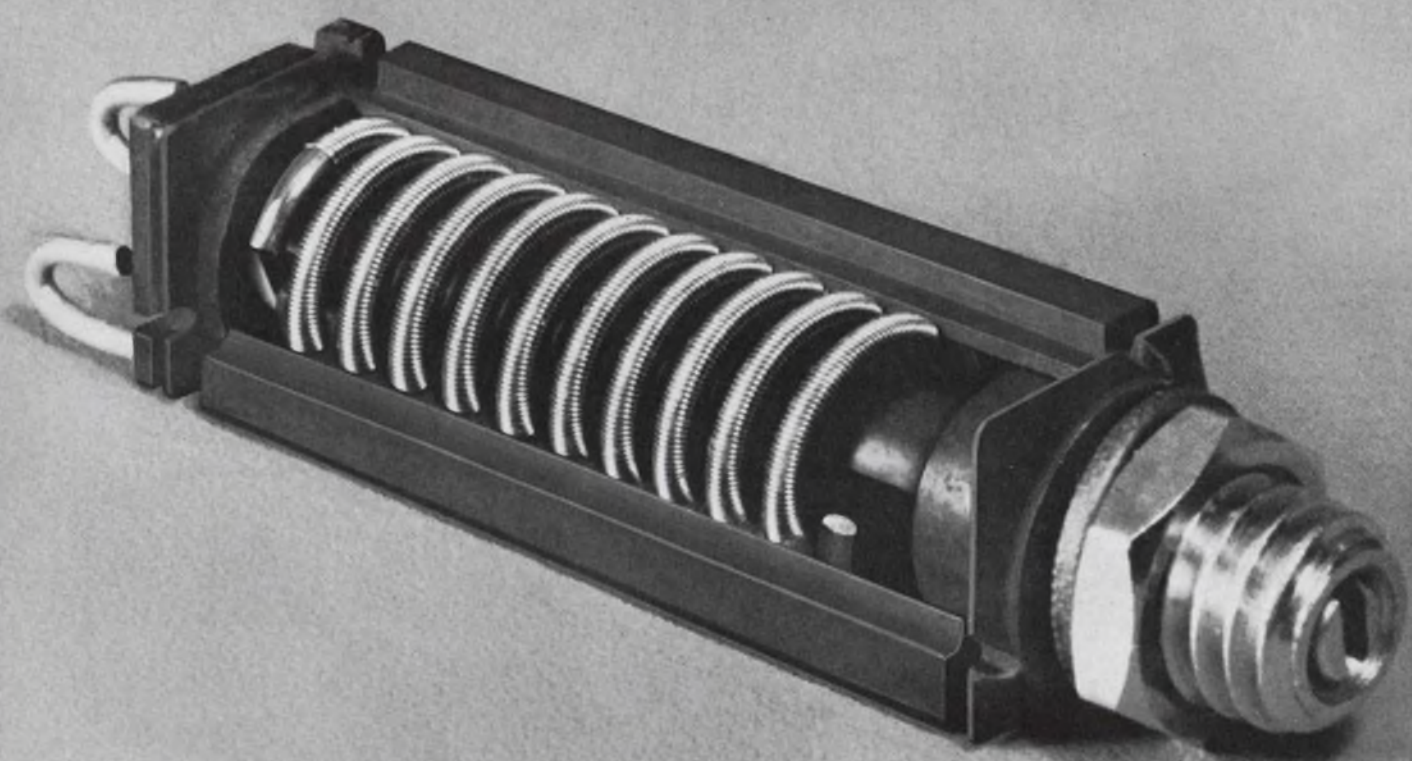
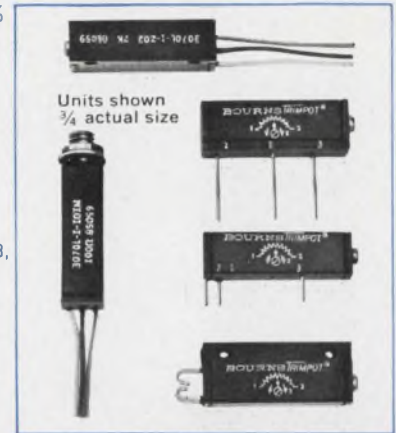



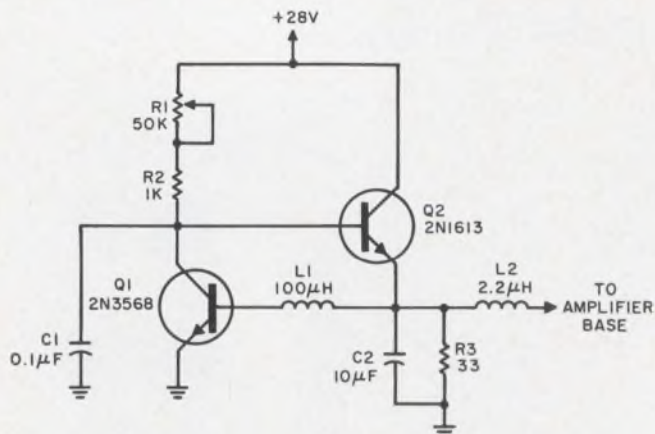

Bias supply voltage varies between 0.547 and 0.690 volt according to the setting of R1. The dc impedance is less than one-half ohm.

single-sideband applications, are often biased with diode and resistor networks. Their impedance, however, is generally so high and voltage-dependent that their linearity becomes degraded, particularly at low rf power, and some power gain is lost.

The dc impedance of this circuit (see schematic) is less than one-half ohm, and the bias voltage is adjustable between 0.547 and 0.690 volts. The emitter-to-base voltage of Q1 serves as the reference voltage, and is adjusted by varying R1. Transistor Q2 provides current to the base of the rf amplifier and negative feedback to the base of Q1. Capacitor C2 reduces the audio output impedance and L1 effectively prevents oscillation.

To provide thermal tracking between the emitter-base voltages of the linear amplifier and the bias reference, transistor Q1 should be mounted as close as possible to the linear amplifier transistor. A good thermal match will prevent large shifts in the quiescent current of the linear amplifier.

William Alexander, Applications Engineer, Fairchild Semiconductor, Mountain View, Calif.

VOTE FOR 113

## SCR and UJT form noise-immune mono

Standard long-delay transistor monostables require bulky and expensive capacitors, as well as careful noise suppression techniques. In the circuit shown, the unijunction timer lowers this capacity while a low-impedance SCR circuit reduces false triggering from noisy input lines, power supply lines and ground loops.

Circuit operation is as follows: Under quiescent conditions, SCR1 is ON and conducting  $I_{r1}$  current.  $V_{out}$  is about 1 volt. When a negative pulse occurs on the input lines, SCR1 turns off and  $V_{out}$  is 28 volts. This trigger pulse must be longer than

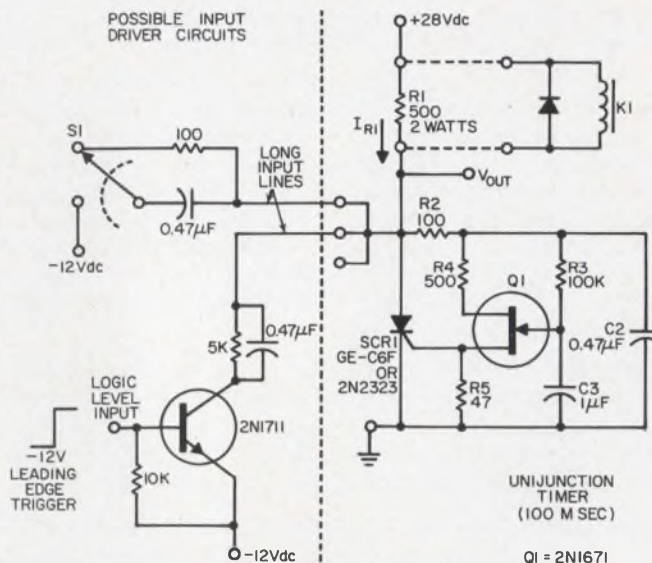

Noise immunity is the strong point of this SCR/UJT monostable. The circuit is simple and easily modified to provide varying delay times or to handle different values of currents and voltages.

the SCR turn-off time (about 40µs) and draw a current greater than  $I_{r1} - I_h$  ( $I_h$  = holding current of SCR1). Low power and/or short noise pulses will not cause false triggering. The unijunction timer circuit fires after a fixed delay of R3C3 seconds (100 ms in this instance), returning the circuit to the quiescent state. Time constant R2C2 is used to suppress noise near the end of this delay, when the unijunction is sensitive to noise. R2C2 can be deleted if desired.

Applications of this monostable include high-current control type circuits around keypunches, SCR circuits, motor controllers, etc., where a relay or solenoid may be substituted for R1, as indicated in the circuit. The circuit can be designed to accommodate shorter or longer delays and higher or lower currents and voltages.

David M. Weigand, Design Engineer, Brookhaven National Laboratory, Upton, N. Y.

VOTE FOR 114

## Square-wave generator uses gate turn-off SCR

A relatively simple square-wave generator utilizes a gate turn-off SCR (GTO) and two 4-layer diodes. The circuit (see Fig. a) was originally designed as a high-frequency chopper operating from a 117-volt line. However, it can be adapted for low-voltage applications by a suitable choice of components.

The ON operation of the circuit is shown in Fig. b, and the OFF operation in Fig. c.

In b, assume that Q (the gate turn-off SCR) is not conducting when an appropriate dc voltage is

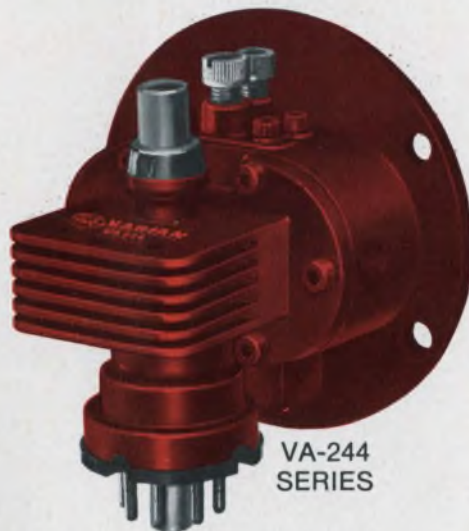

VA-244  
SERIES

## WARRANTY TRIPLED TO 15,000 HOURS

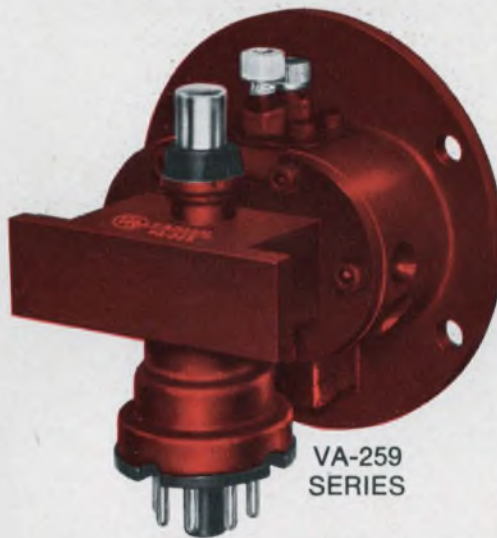

VA-259  
SERIES

### Two Varian klystrons in the 4.4 to 8.5 Gc range cut your warranty cost-per-operating-hour by a full *two-thirds*.

Originally warranted for 5,000 hours, the VA-244 and VA-259 klystrons have demonstrated a remarkably long life-expectancy. In the past two years, reports from users around the world, as well as results from our own laboratory Life Tests, indicate that the operating life of these tubes is far in excess of 15,000 hours. Therefore, we have tripled the warranty to

15,000 hours on both the VA-244 and VA-259 reflex klystrons.

For more complete information, write Palo Alto Tube Division, Executive Offices, 611 Hansen Way, Palo Alto, California. In Europe, write Varian A. G., Zug, Switzerland.



ON READER-SERVICE CARD CIRCLE 48

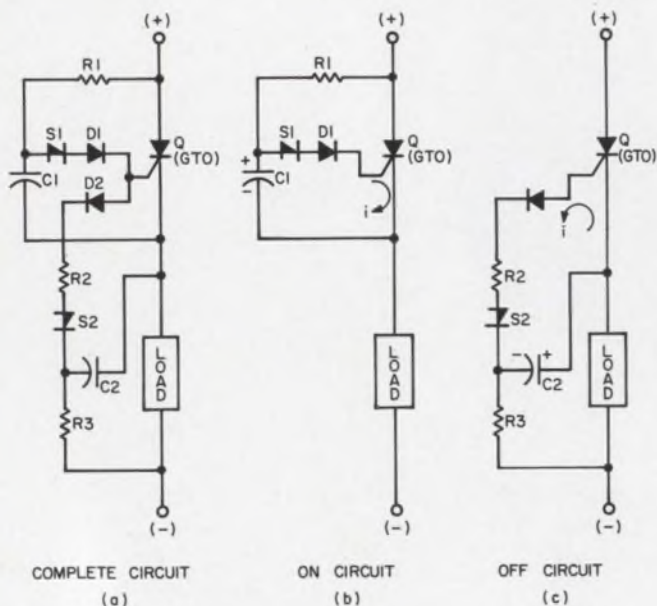

Square-wave generator circuit (a) is turned on and off by the action of Q, which is a gate turn-off SCR. The ON operation is shown in (b) and the OFF operation in (c).

applied to the marked terminals. Capacitor  $C_1$  is therefore charged by current through  $R_1$ . When  $C_1$  reaches the breakdown value of 4-layer diode  $S_1$ ,  $S_1$  conducts. This permits  $C_1$  to discharge through the gate of Q in a manner similar to conventional SCR circuitry, causing Q to conduct and supply power to the load.

In c, Q is conducting, so capacitor  $C_2$  is charged by current through  $R_3$ . When  $C_2$  reaches the breakdown value of 4-layer diode  $S_2$ ,  $S_2$  conducts. This causes  $C_2$  to discharge in the reverse direction through the gate of Q, causing Q to turn off and interrupt the power to the load.

In designing the circuit,  $R_3$  must be chosen so that the current it will permit to flow under a certain applied potential is less than the holding current of  $S_2$ , which sets the upper limit on the speed of turn-off time.  $R_2$  limits OFF gate current to a safe value with respect to the gate power capabilities of Q. The size of  $C_2$  is determined by the value of current through Q preceding turn-off. The time constant  $R_1C_1$  determines the turn-on time.

Alexander J. Prokop, Design Engineer, Skil Corp., Chicago, Ill.

VOTE FOR 115

## Four components stabilize common-base oscillator

A common-base oscillator can operate in the class-A mode with good amplitude stability. The secret is the addition of four components— $R_1$ ,  $R_2$ ,  $D_1$  and  $C_1$ , as shown in the circuit.

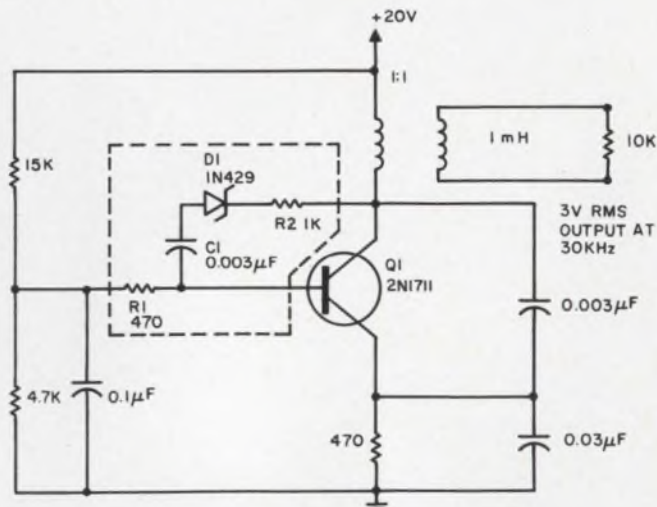

Common-base oscillator operates in class-A mode. The amplitude instability is less than 5%, because of the negative feedback through  $D_1$ ,  $R_2$ ,  $C_1$  and the gain-controlling effect of  $R_1$ .

The oscillations increase in amplitude until the zener diode,  $D_1$ , begins to conduct. This occurs when the peak-to-peak voltage across the zener exceeds 12 volts. Thus the negative feedback circuit between the base and collector of  $Q_1$  reduces the gain of  $Q_1$ , preventing the oscillation from increasing in amplitude.

$R_1$  and  $R_2$  determine the available negative feedback. If  $R_1$  is increased too much, the  $Q_1$  stage gain will be too low to start or sustain oscillations reliably. If  $R_2$  is decreased too much, the  $Q$  of the resonator will be reduced to the point where frequency stability and spectral purity may suffer. If very tight amplitude control is desired, an emitter-follower, inserted between the collector of  $Q_1$  and  $R_2$ , will prove useful.

With the circuit constants shown, oscillations occur at 30 kHz. Waveform distortion is under 1%, and amplitude instability is less than 5% for any combination of factors of temperature (0 to 65°C), supply voltage variation (18 to 22 V), and load (10 KΩ to infinity). Reliable starting is assured, because of the presence of a large positive feedback before the operating amplitude is reached.

Murray F. Feller, M. F. Feller Industries, Santa Maria, Calif.

VOTE FOR 116

## IFD Winner for Aug. 16, 1966

Andrew F. Cooper, Computer Engineer, Paragon Div. of Texaco, Long Island City, N. Y.

His Idea, "Universal waveform comparator uses UJT relaxation oscillators," has been voted the \$50 Most Valuable of Issue Award.

Cast Your Vote for the Best Idea in this Issue.

# RCA Announces the NEW 3N128 (MOS) FET for VHF applications

features: □ low feedback capacitance (0.2 pF max.) □ high power gain (18 dB typ. at 200 MHz) □ high forward transconductance (5,000  $\mu$ mho min.) □ low noise (4 dB typ. at 200 MHz) □ low cross-modulation distortion □ a hermetically sealed metal case

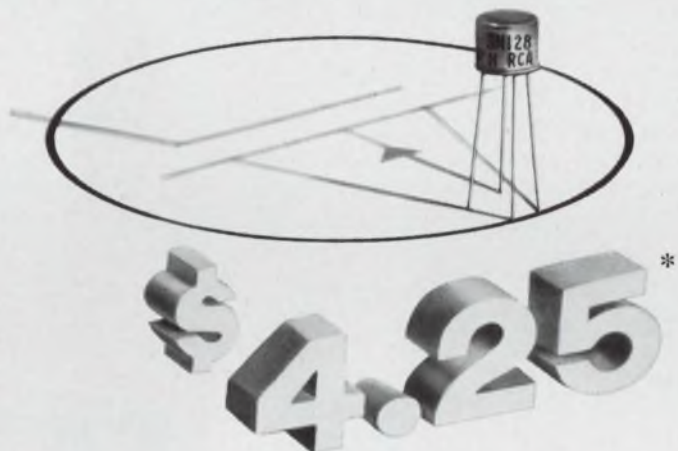

\*Price in quantities of 1,000 and up

RCA's 3N128 N-channel, depletion type, MOS field-effect transistor is now available in production quantities for communications and industrial applications. This new insulated gate MOS transistor exhibits (1) extremely low gate-leakage current (0.1 pA typ.) which permits stable operation over wide temperature ranges, (2) feedback capacitance substantially lower than that of conventional junction-gate devices, and (3) extremely high input resistance of  $10^{14}$  ohms typ.

The RCA 3N128 simplifies your designs because you can use conventional electron-tube type biasing techniques. In

addition, the drain current exhibits a negative temperature coefficient which makes thermal runaway virtually impossible. These attributes, combined with a large signal-handling capability and low cross-modulation distortion, make the 3N128 MOS a "must" for critical front-end designs.

Call your RCA Field Representative for complete technical information, price and delivery on the new 3N128 (MOS) FET. For Application Note AN-3193, or for a technical data sheet, write RCA Electronic Components and Devices, Commercial Engineering, Section EG-11-4, Harrison, N. J. 07029. SEE YOUR RCA DISTRIBUTOR FOR HIS PRICE AND DELIVERY

RCA Electronic Components and Devices



The Most Trusted Name in Electronics

# Bits and Pieces

*Wisdom and levity, well-developed fruits of frustration, will rarely be found, except in bits and pieces. . . .*

## Engineering waste

Grab the nearest engineering manager you know. Buy him a cup of coffee, and get his views on the shift from the technical to the managerial side of engineering.

Often, you'll get a picture of the engineering manager as a man who finds administrative tasks a waste of time and who wishes he could spend more time working with the technical details of a job. But he goes on with his administrative duties, and spends even less time with technical details.

Many people have discussed this problem, officially and unofficially, and the conclusion has often been—"waste of professional man-power." Here is an opposing viewpoint. Eldon Sweezy, executive director, Management Counsel, Bethesda, Md., speaking to the conferees attending the 1966 Joint Engineering Management Conference, said:

" . . . Let us dispose of one of the oldest wives' tales in technical management. From studies we have made . . . we can find no evidence that the selection of competent, intelligent, imaginative, rational people-conscious engineers to fill vital posts in the managerial structure is a significant source of "waste" of professional people. . . . Some [managers] viewed with nostalgia, as many of us do, the recently passed halcyon days of our earlier years, their days in the "lab," but as mature adults they recognized that these were not rational ends to their careers. The only conditions under which this type of assignment would be wasteful which we could identify were that the engineer was not qualified to perform executive ac-

tions or was not motivated though qualified. As in every walk of life, no man should be made a manager who is qualified but not motivated or who is motivated but not qualified."

## Engineering goals

To review and comment on the ASEE's (American Society for Engineering Education) "The Preliminary Report, Goals of Engineering Education," a panel was convened recently by the Engineers' Joint Council. The report of this panel, which has ". . . addressed itself to certain broad issues and problem areas of fundamental importance to the teaching and practice of engineering," includes the following three points:

- ". . . the emphasis on instruction must be placed more upon the development of the potential capacities and insights in the indi-

vidual and less upon the transfer of generally prescribed content in standardized courses."

- ". . . it is contrary to sound educational policy to standardize curricula, degrees, methods, or periods of instruction across institutions at the expense of flexibility, experimentation, and wholesome diversity among and within institutions."

- "To the extent that the licensing principle represents a restrictive influence on flexibility and innovation in engineering education, the principle itself and the laws on which it is based should be reviewed and modifications considered by the professional and technical societies concerned."

## Did you know . . .

. . . "Engineering . . . for the Human Environment" is the theme of the forthcoming National Engineering Conference. (continued on p. 99)

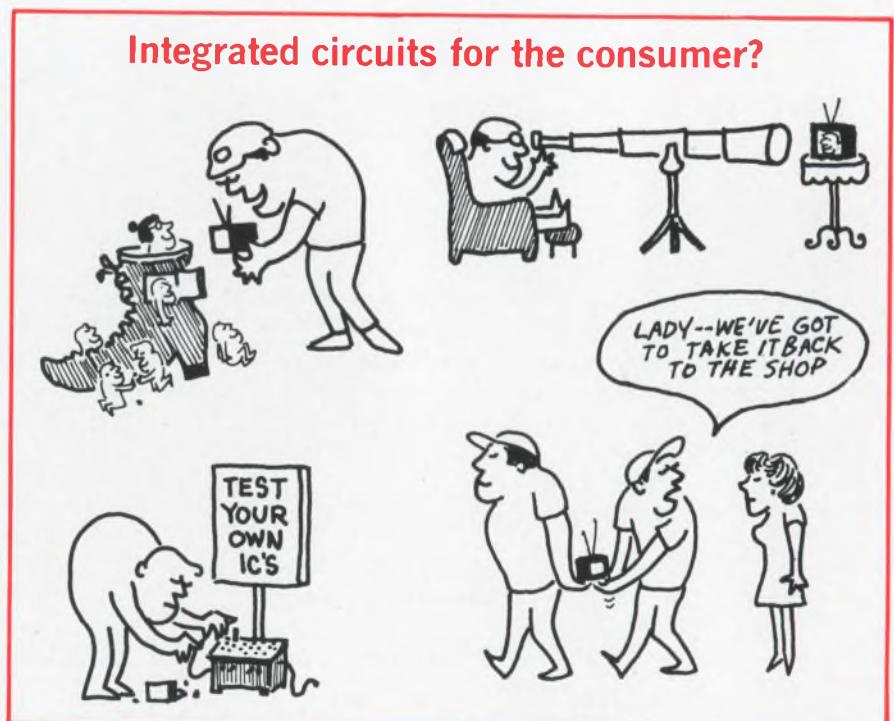

Have you got a contribution? We'll compensate. Be it a letter, commentary, puzzle, cartoon, or cartoon idea, send it along to: RC, Electronic Design, 850 Third Ave., New York, N. Y. 10022.

# CAREER INQUIRY - confidential

Respond to the career opportunities advertised in this issue. Fill out and send us this handy resume. **Electronic Design** will do the rest - neatly typed copies of this form will be mailed to the companies of your choice, indicated by the circled Career Inquiry Numbers at the bottom of this page.

26

Name		Home Phone	
Home Address (Street)		City	State
			ZIP Code
Age	U.S. Citizen <input type="checkbox"/> Yes <input type="checkbox"/> No	Security Clearance	

Prime Experience	Secondary Experience

Desired Salary	Availability Date
----------------	-------------------

**Employment History - present and previous employers**

Company	City, State	Dates	Title	Specialty
		to		
		to		
		to		

**Education - indicate major if degree is not self-explanatory**

Degree	College	City, State	Dates
			to
			to

**Additional Training - non-degree, industry, military, etc.**

---



---



---

**Professional Societies**

---

**Published Articles**

---

**Career Inquiry Numbers:**

900	901	902	903	904	905	906	907	908	909
910	911	912	913	914	915	916	917	918	919

**ELECTRONIC DESIGN**  
 850 Third Avenue  
 New York, New York 10022

# Reliability Engineers

Lockheed engineers are developing some of the most important vehicle systems in the country. There are major modifications underway on Polaris. And, the new fleet ballistic missile, Poseidon, is now in its early stages. Other systems include unique land vehicles and deep submersibles. Reliability engineers are needed in these areas and many more. We invite you to investigate the following:

**BSEE or BSME—Reliability design review:**

Experienced with small electrical components and semiconductors. Prepare procurement, test and design specifications.

**BSEE — Reliability analysis:**

Experienced in circuit design and analysis. Perform detailed reliability analyses of complex electronic parts and circuits and recommend improvements in design reliability.

**BSEE—Reliability test engineering:**

Prepare test procedures for electrical and electronic packages and coordinate procedures with test laboratories, conduct proofing of test procedures & equipment.

**BSME—Reliability and inspection:**

Perform mechanical and structural reliability analyses. Provide for inspection planning and review prints to determine inspection attributes. Experience in metallurgy and NDT helpful.

**Non-destructive testing:**

Background in electronics and applied physics plus knowledge of instrumentation related to the use of X-rays, sound waves, electrical fields and optics.

Write Mr. K. R. Kiddoo, Professional Placement Manager, Lockheed Missiles & Space Company, P.O. Box 504, Sunnyvale, California. An equal opportunity employer.

**LOCKHEED**

**MISSILES & SPACE COMPANY**

A GROUP DIVISION OF LOCKHEED AIRCRAFT CORPORATION

ON READER-SERVICE CARD CIRCLE 901  
Fold here, staple and Mail.

FIRST CLASS  
Permit No. 725  
New York, N.Y.

**BUSINESS REPLY MAIL**

No Postage Stamp Necessary if Mailed in the United States

POSTAGE WILL BE PAID BY

**ELECTRONIC DESIGN**

**READER SERVICE**

850 THIRD AVENUE

NEW YORK, NEW YORK 10022

# Bits and Pieces

CONTINUED

(continued from p. 96)

neers' Week. Sponsored by the National Society of Professional Engineers, it will be observed during the week of February 19-25, 1967. This theme will call attention to the increasing role that engineering plays in daily life—solutions to pollution, transportation and safety problems.

... "Dataport" is a recently announced device, developed by Carnegie Institute of Technology, that provides instant access to any time-sharing computer system over an ordinary telephone line. The unit is a portable keyboard that plugs into the ac line. From home, office or field location, you can now instantly communicate with the company computer.

... "The appliance and consumer electronics industry is doing more than any other segment of the economy to fight inflation," as stated by Armin Allen, vice-president of Philco-Ford. Whereas a housewife's average purchase costs 13.8% more now than in 1957-1959, Allen pointed out that a black and white TV set, selling at \$100 then, would sell for \$82.20 today.



You mean it's true? After seeing the cartoon in our October 11 issue (Bits and Pieces p. 110), someone came up with this photograph. However, the above gentleman stands, not on an integrated circuit as depicted in the cartoon, but in the core of the National Bureau of Standards' newly acquired nuclear reactor.

## Crossword Puzzle # 141

Edited by Rene' Colen

Submitted by James R. Kimsey

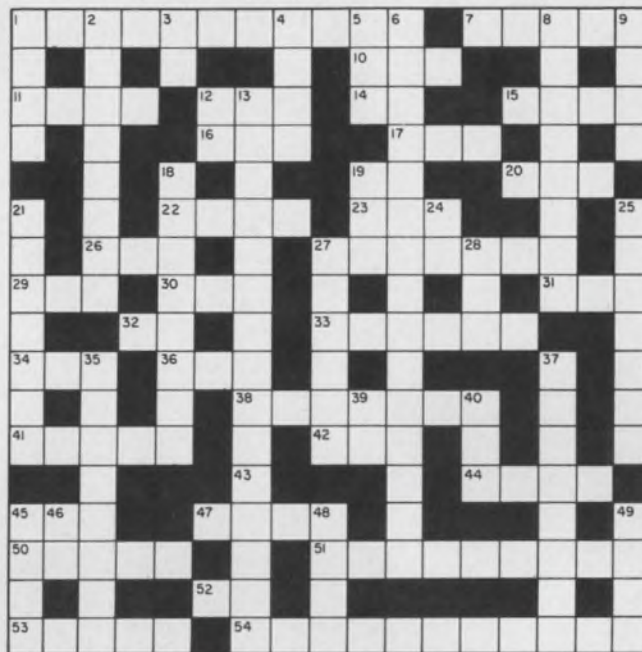

(solution on page 155)

### Across

1. Information recorder.
7. Line.
10. Not pos.
11.  $1/2$  bc sin A.
12. Hawaiian dish.
14. Not deb.
15. See 40 down.
16. Time zone: Abbr.
17. Million: Prefix.
19. Chem. element.
20. Fixed attenuator.
22. Leave out.
23. Binary digit.
26. Turntable drive.
27. Transmission line.
29. Employ.
30. Greek letter.
31. \_\_\_-of-transmission.
32. Greek letter.
33. Useful biography.
34. \_\_\_-top.
36. Knot.
38. Order.
41. House cable.
42. Second choice: Abbr.
44. Hole\_\_\_.
45. To soak.
47. Feedback\_\_\_.
50. Distribution line.
51. Line interference.
52. Current unit.

53. \_\_\_ modulation.

54. Transmission (shf).

### Down

1. Trace.
2. Magnetic component
3. Amplitude mod.
4. One of anything.
5. Unfin.
6. Equipment at end of a microwave system.
8. Changeable (memory).
9. Radar return.
12. IEEE abbreviation.
13. Antenna type.
18. Sophisticated calculator.
19. Also.
21. Frequency distortion.
24. Out of: Prefix.
25. Decrease signal.
27. Color quality.
28. Computer mfr.
35. Audio output circuit.
37. Not grounded.
39. Cap. unit.
40. Telegraph term.
45. \_\_\_ function.
46. \_\_\_ gate.
48. \_\_\_ position indicator.
49. Trial.





## What do they mean by "an engineer's company"?

Some very successful companies are "sales oriented"—others, equally successful, receive their primary impetus from accounting, legal or business-management directions. Probably because of the highly technical nature of its product, Motorola has always been a company wherein engineering has been the moving force. At any management conference at Motorola, you'll find men think like engineers, and talk like engineers, because so many in the management echelon *are* engineers.

At Motorola the engineer achieves full professional status—because he is working in an environment where the state of the art has progressed to the point where only an "engineering oriented" management can direct the flow of achievement.

In this dynamic atmosphere, of course, the challenges are great—but equally rewarding for truly qualified engineers. Would you like to talk to us?

**SYSTEMS ENGINEERS** advanced R & D in radio communications systems related to Two-way, portable, mobile and radio-telephone equipment.

**EQUIPMENT DESIGN** high performance solid state receivers, transmitters, and data processing equipment for radar, communications, command and control, tracking and telemetry.

**FAMILIARITY WITH STATE-OF-THE-ART** statistical communications theory, advanced signal processing techniques, solid state r. f. techniques, ultra-reliability, antenna systems, advanced structural and thermal designs.

**SECTION MANAGER** direct engineers and support personnel in state-of-the-art communications, including r. f. systems and input-output devices.

**CHIEF ENGINEER** technical management of R & D group in advanced technology related to solid state r. f. communications.

**CIRCUIT DESIGN ENGINEERS** advanced R & D in receivers, transmitters, RF, digital, Color TV and automotive electronics.

**DEVELOPMENT ENGINEERS** advanced communications products in consumer, industrial and military electronics.

*Excellent opportunities also available in Phoenix, Ariz.*

Mr. W. H. HAUSMANN, Engineering Personnel Mgr., Dept. B, 4545 Augusta Blvd., Chicago 51, Illinois

*An equal opportunity employer.*



**MOTOROLA Inc.**

ON CAREER-INQUIRY FORM CIRCLE 902

# Book Reviews

## Radio astronomy

*Radio Astronomy*, John D. Kraus (McGraw-Hill Book Co., New York). 481 pp. \$13.75.

This text is largely an outgrowth of lecture material presented by the author in courses on radio astronomy at Ohio State University. It brings together a selection of topics on astrophysics and radio-telescope receiver and antenna design. Particularly noteworthy is Chapter 8, the longest in the book, dealing with both galactic and extragalactic radio sources and our present knowledge of them as deduced from both radio and optical observations.

The book is aimed at the senior undergraduate and the junior graduate, and requires a knowledge of vector analysis and elementary electromagnetic and circuit theory. For those wishing to delve into a particular subject area more deeply, numerous references and extensive bibliographies are included.

## Electrical instruments

*Electrical Instruments in Hazardous Locations*, Ernest C. Magison (Plenum Press, New York), 225 pp. \$22.50.

This text gives the technical information needed to understand what is required for the safe, economical use of electrical instruments in hazardous locations. Much of the book is based on the work by the Instrument Society of America's Recommended Practice Committee, "Instruments for Hazardous Locations" (Publication no. 8D-RP12). Wherever possible specific sources or papers presented by committee members have been cited. Chapters deal with such topics as Article 500 of the National Electrical Code, explosions, electrical ignition of gases and vapors, principles of hazardous reduction and sealing. It is intended for use in courses on electrical safety and should be of value to electrical and safety engineers and instrumentation specialists of all sorts.

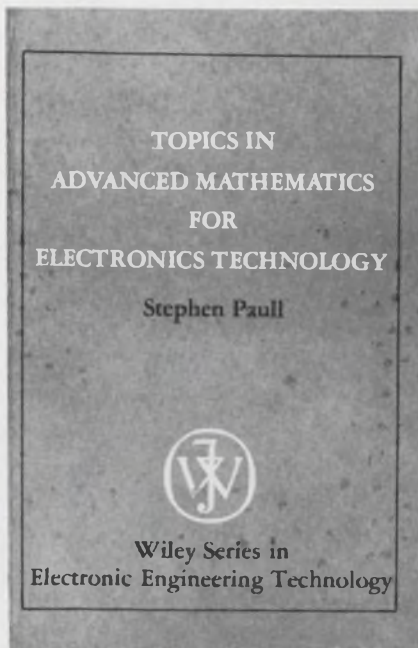

### Compact math reference strong on applications

*Topics in Advanced Mathematics For Electronics Technology*, Stephen Paull (John Wiley & Sons, Inc., New York), 420 pp. \$4.95.

An engineer's skill with mathematics often varies in direct (if not exponential) proportion to the amount of use that he has for it. Even with highly developed mathematical skill, he will frequently find the need to refresh himself in some areas of mathematics. At other times the need for familiarization with a new topic arises.

In either of these cases, reference to a standard text may be inconvenient because of time, availability, etc.

In one compact volume, Stephen Paull has presented a valuable reference covering those mathematical topics most useful to the practicing electronic engineer. In eight chapters, the author treats Infinite series, Fourier series, Fourier integrals, ordinary differential equations, Laplace transforms, Gamma and Bessel Functions, Vector analysis, determinants and matrix algebra.

A valuable feature of the book is the application examples in the text coupled with the practical problems provided for the reader's solution.



## LOOK WHAT'S HAPPENING AT PRD!

We're introducing a number of impressive new developments in the field of microwave and electronic test equipment... and are planning to set the pace in spearheading state-of-the-art programs in advanced measurements systems. Openings are available in our new engineering laboratories, if you would like to work on challenging assignments. Contact us today.

### ATTENTION: INSTRUMENT ENGINEERS

If you have background in High-Speed Circuitry, YIG Techniques, Microwave Test Equipment, System Test and Analysis Techniques, Digital Design and Fabrication, RF Circuitry, Advanced Systems (Avionic and Aerospace)... PRD NEEDS YOU. Send resume in confidence to PRD ELECTRONICS, INC., subsidiary of Harris-Intertype Corp., Dept. ED, 1200 Prospect Ave., Westbury, L. I., N. Y. 11590.



AN EQUAL OPPORTUNITY EMPLOYER

ON CAREER-INQUIRY FORM CIRCLE 903

This application information is especially useful for the engineer who meets a particular area of math for the first time.

Of special interest is the chapter covering matrix algebra, an area of mathematics that is increasing in importance as the use of digital computers for circuit analysis and design grows. In this chapter, as in others, the author has provided interesting and useful applications information.

Author Paull ends his book with appendices containing derivations of Fourier coefficients, derivations of differential equations for simple linear circuits, and a table of Laplace transform pairs.

Those engineers needing a handy reference, or wanting to investigate some unfamiliar aspect of mathematics, will find this little volume a very worthwhile addition to their libraries.

—Joseph J. Casazza

### Electron microscopy

*Introduction to Electron Microscopy*, Cecil E. Hall (McGraw-Hill Book Company, New York). 397 pp. \$17.50

This second edition offers a thorough background in the theories and practices of electron microscopy. Starting with the development of the theory of electron lenses and a description of their characteristics and functions, the book leads up to a final chapter describing the special techniques for preparing specimens for observation with the microscope. In the light of recent advances, revisions have been made in the discussion of high-resolution electron lenses evaluation and interpretation of the image, and techniques for preparing specimen materials. Many typical micrographs are provided to show how to evaluate and interpret normal and abnormal images quickly.

### Phaselock techniques

*Phaselock Techniques*, Floyd M. Gardner (John Wiley & Sons, New York), 182 pp. \$8.95.

Practicing communications engineers, who have to design, specify or use phaselock systems, will find this book an invaluable reference. The volume starts with the fundamental theory of the phaselocked loop with chapters on linearized transfer functions and behavior in noise. Tracking performance and acquisition problems are covered, followed by discussion of the operation of circuit components and optimization of loop parameters in the next two chapters. The remainder of the book is devoted to applications of phaselock techniques with emphasis on sensitive receivers and frequency discriminators. Also provided is a bibliography with over 150 entries and a list of design equations.

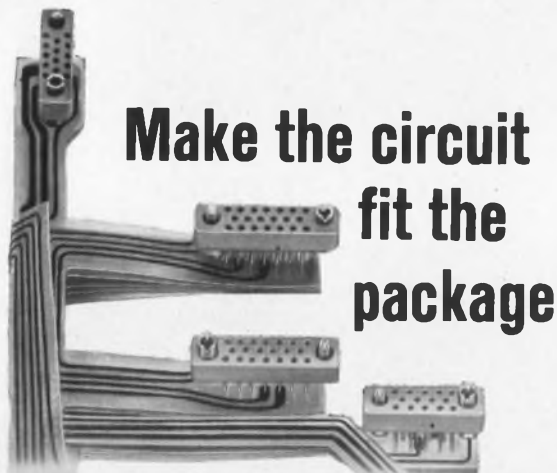

**Make the circuit  
fit the  
package**

FLEXPRINT® circuitry solves interconnection problems . . . it fits the package and lowers installed costs. It also offers repeatability, ease of assembly, reliability and reduction of rework. Got a circuit interconnection problem? Call us (area code 603) 627-3811. Free literature. Sanders Associates, Inc., FLEXPRINT Products Division, Grenier Field, Manchester, New Hampshire.

**SANDERS ASSOCIATES, INC.**  
FLEXPRINT PRODUCTS DIVISION  
*Creating New Directions in Electronics*



\*T.M., Sanders Associates, Inc.

ON READER-SERVICE CARD CIRCLE 50



To  
**ELECTRONIC  
ENGINEERS**  
with a sense  
of timing . . .

**BENDIX** (KANSAS CITY DIV.) **IS ON THE MOVE!**

This is the opportune moment to investigate your career potential at Bendix, Kansas City Division. As prime contractor for the AEC, we have enjoyed an enviable, orderly 16-year growth. Now we are entering a unique developmental phase, opening new fields of activity in microminiaturization, microwave and logic circuitry. This situation adds up to a ground-floor opportunity in a well-established corporation noted for advanced engineering. Cooperative, professional atmosphere, plus excellent living conditions. Let us hear from you promptly so we may detail more clearly the many advantages we can offer you.

Please mail résumé at once to:

Mr. T. E. Mason, Tech. Personnel Repr.  
THE BENDIX CORPORATION, Box 303-NE  
Kansas City, Missouri 64141

AN EQUAL OPPORTUNITY EMPLOYER



ON CAREER-INQUIRY FORM CIRCLE 904

ELECTRONIC DESIGN 26, November 22, 1966

# Solitron

announces

**V<sub>CEO</sub> (SUS)**

**325 v**

**300 v**

**250 v**

**225 v**

**200 v**



*in a 10 Amp. NPN Silicon  
Planar Power Transistor  
Plus  
50 mcs . . . . . 150 pfs*

Type Number	Pkg. Size	DESIGN LIMITS						PERFORMANCE SPECIFICATIONS					
		T <sub>J</sub>	θ	P <sub>T</sub>	BV <sub>CEO</sub>	V <sub>CEO</sub> (BUS)	BV <sub>EB0</sub>	h <sub>FE</sub>		V <sub>BE</sub> (sat)	V <sub>CE</sub> (sat)	I <sub>CEO</sub>	f <sub>T</sub>
		°C	°C/W	Watts	Volts	Volts	Volts	@I <sub>C</sub> = 5A V <sub>CE</sub> = 5V		Volts	Volts	μA	mc
		Max.	Max.	Max. @100°C Case	Min.	Min.	Min.	Min.	Max.	Max. @I <sub>C</sub> = 5A I <sub>B</sub> = 0.5A	Max. @I <sub>C</sub> = 5A I <sub>B</sub> = 0.5A	Max. V <sub>CE</sub> = 100V	Min.
MHT7201	TO-3	200	1.5	65	225	200	8	20	60	1.2	0.5	1.0	50
MHT7202	TO-3	200	1.5	65	250	225	8	20	60	1.2	0.5	1.0	50
MHT7203	TO-3	200	1.5	65	275	250	8	20	60	1.2	0.5	1.0	50
MHT7204	TO-3	200	1.5	65	325	300	8	20	60	1.2	0.5	1.0	50
MHT7205	TO-3	200	1.5	65	350	325	8	20	60	1.2	0.5	1.0	50

TRANSISTOR DIVISION

# Solitron DEVICES, INC.

1177 BLUE HERON BLVD. / RIVIERA BEACH, FLORIDA / (305) 848-4311 / TWX: (510) 952-6676

Leader in Germanium and Silicon Power Transistors, Cryogenic Thermometers, High Voltage Rectifiers, Hot Carrier Diodes, Temperature Compensated Zeners, Voltage Variable Capacitors, Random/White Noise Components, Microelectronic Circuits, and High-Pac Interconnection Systems.

ON READER-SERVICE CARD CIRCLE 51

For Capacitors with **GREATER RELIABILITY . . .**

Choose  
**EL-Menco**

*The Capacitors You  
Find Wherever  
There's Electronics!*

### EL-MENCO DUR-MICA CAPACITORS

**Only 1 Failure Per 43,000,000 Unit-Hours!**

- It has been computed that "debugged" DM30, 10,000 MMF units, when subjected to 257,000 hours of life at 85°C with 100% of the rated DC voltage applied, will yield only 1 FAILURE PER 43,000,000 UNIT-HOURS!
- DM15, DM16, DM19, DM20 . . . perfect for miniaturization and for new designs using printed wiring circuits. Also available in DM30, DM42 and DM43.
- New "hairpin" parallel leads insure easy application. Exceed all electrical requirements of military specification MIL-C-5A.

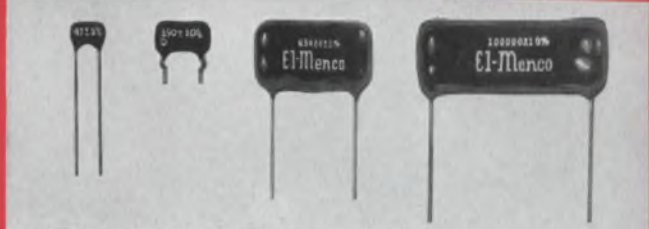

### EL-MENCO TRIMMERS & PADDERS

**Design Versatility!**

- Available in 350 VDC and 500 VDC as well as other test voltages.
- All bases are of low-loss steatite.
- Special lugs are obtainable for printed circuitry.
- Miniature units are available.
- Solder Lugs can be bent in any position without affecting the capacity setting due to the rigid construction.
- Various types of mounting brackets are available for all trimmers.
- Units can be constructed for special applications.



### EL-MENCO \*MYLAR-PAPER DIPPED CAPACITORS

**Only 1 Failure in 14,336,000 Unit-Hours!**

- Life tests at 105°C with rated voltage applied have yielded only 1 FAILURE PER 14,336,000 UNIT-HOURS for 1 MFD. Since the number of unit-hours for these capacitors is inversely proportional to the capacitance, 0.1 MFD Mylar-Paper Dipped capacitors will yield only 1 FAILURE PER 14,336,000 UNIT-HOURS!
- Working volts DC: 200, 400, 600, 1000 and 1600.
- Durez phenolic resin impregnated.
- Tolerances:  $\pm 10\%$  and  $\pm 20\%$  (closer tolerances available).
- Dielectric strength: 2 or  $2\frac{1}{2}$  times rated voltage, depending upon working voltage.
- Exceed all electrical requirements of E.I.A. specification RS-164 and military specifications MIL-C-91A and MIL-C-25A.

\*Registered Trademark of DuPont Co.

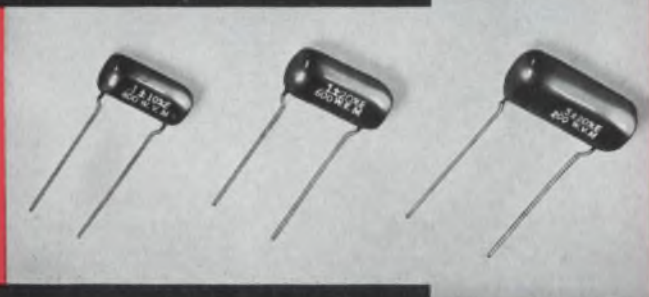

### EL-MENCO MOLDED MICA CAPACITORS

**Superior Performance!**

- Unmatched for excellent stability, dielectric strength, high insulation resistance, extremely high "Q" and correspondingly low power factor.
- Units can be subjected to a short "debugging" life test at elevated voltage and temperature for removal of early life failures and for improved reliability.

*Write for Free Samples and Booklets  
on Any of The Above Capacitors*

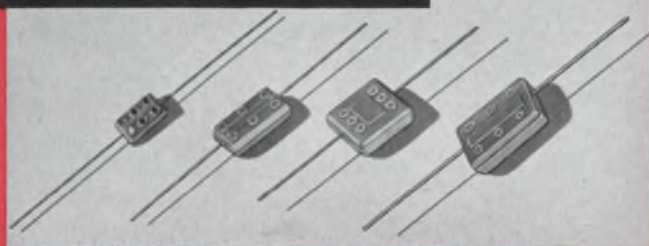

EL-MENCO OFFERS A COMPLETE LINE OF CAPACITORS . . . STANDS READY TO SERVE ALL YOUR CAPACITOR NEEDS

**THE ELECTRO MOTIVE MFG. CO., INC.**  
**WILLIMANTIC, CONNECTICUT**

*Dipped Mica • Molded Mica • Silvered Mica Films • Mica Trimmers & Padders  
Mylar-Paper Dipped • Paper Dipped • Mylar Dipped • Tubular Paper*

MANUFACTURERS OF

**EL-Menco**  
*Capacitors*

**ARCO ELECTRONICS, INC.**, Community Drive,  
Great Neck, L. I., New York  
*Exclusive Supplier to Jobbers and Distributors  
in the U. S. and Canada*

**West Coast Manufacturers Contact:**  
**COLLINS & HYDE CO.**, 1020 Corporation Way  
Palo Alto, California  
5380 Whittier Boulevard, Los Angeles, California

ON READER-SERVICE CARD CIRCLE 52

# Products

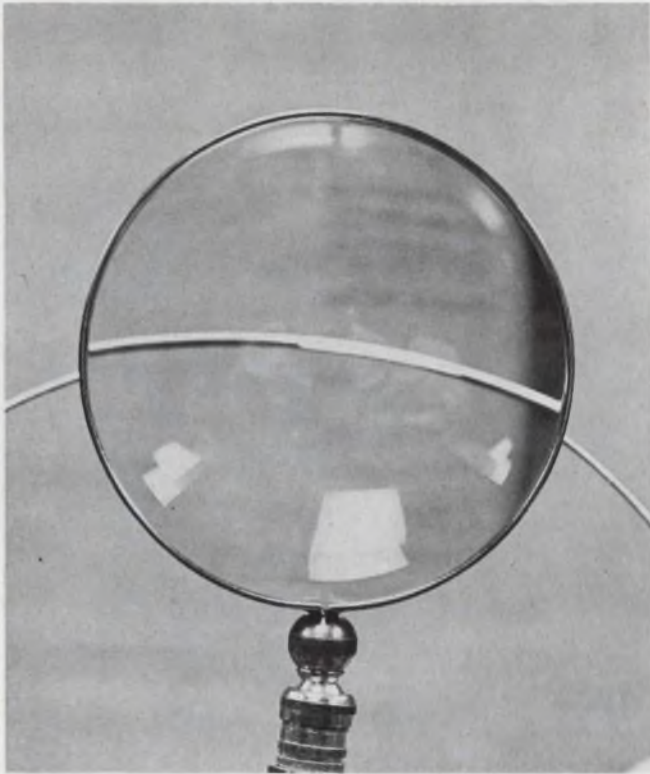

See the aluminum glittering where the copper is scraped. This wire saves copper. Page 132

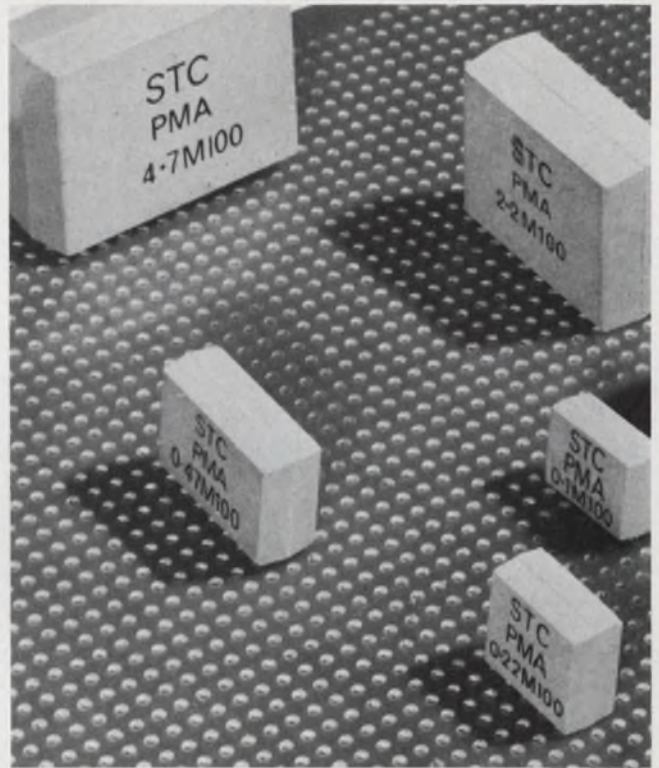

This switching matrix saves time in checking equipment. Program it in advance. Page 126

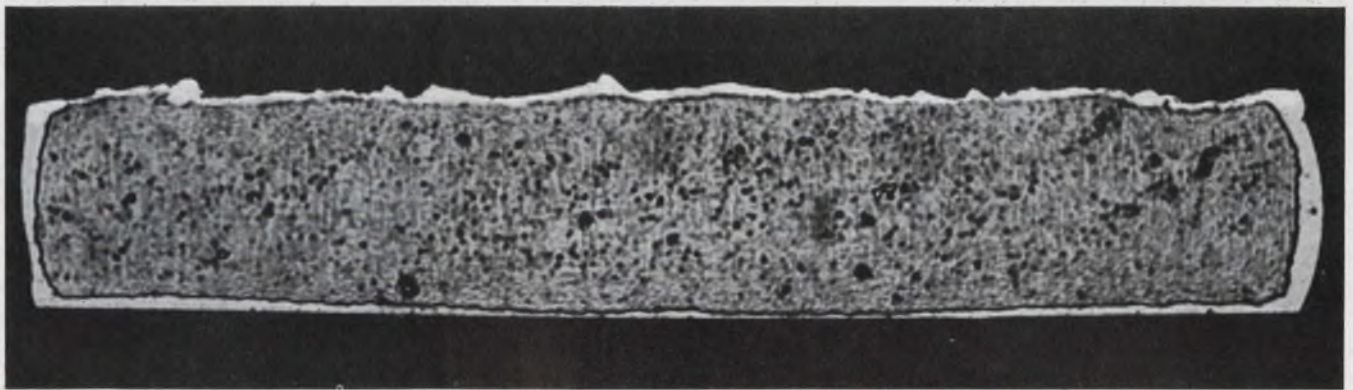

If your conductor needs some spring, this gold-plated, nickel-steel may be just what a

material conjurer would provide. Good stuff for relay and switch contacts? Page 133

## Also in this section:

A miniature sweep generator is all solid-state. Page 114

A yellowish liquid dissolves urethane potting compound. Page 133

A quiz can test your knowledge of op-amps in an hour. Page 153

# Integrated low-input, high-output drivers for FET analog switches.

Siliconix, Inc., 1140 W. Evelyn Ave., Sunnyvale, Calif. Phone: (408) 245-1000. P&A: \$25.30 to \$29.90 (100 lots); stock.

The first units of a family of integrated analog gate drivers are available. The major purpose behind their development is to provide a designer with a convenient buffer device that can receive low-level inputs and produce amplified, level-shifted outputs. These characteristics make them particularly useful in multiplexing analog signals, where FETs are used as gates and

the switching signals arrive from commonly employed low-level logic.

The most outstanding characteristics of the drivers can be summarized as follows:

- Inputs as low as 0.5 V.
- Level-shifted outputs up to 30 V.
- OFF power dissipation < 1 mW/driver.
- Choice of input circuit configurations.
- Flexibility in power vs speed trade-offs.

The driver family has been

designed by its developer, Siliconix, Inc., as the D011F-series of analog gate drivers. At this time six of the drivers of this family are available off the shelf.

For an article describing the design approach used in developing these drivers, see pp. 50-54.

The D011F and D019F are two-channel inverting circuits (See Fig. 1). That is, a positive-going input voltage will produce a negative-going output voltage, once the 0.5-volt minimum threshold is exceeded for the driver's input transistor base-emitter diode. This is indicated in Fig. 1b in the specially devised driver symbols by vertical arrows—up for positive, down for negative. Below this threshold, the maximum input current is 5  $\mu$ A. To produce a 30-volt output swing requires a maximum positive input swing of 0.8 volt and a 100- $\mu$ A input current. Consult the table for output current ranges and corresponding propagation time delays.

The D012F and D020F are two-channel noninverting circuits (i.e., a negative-going input voltage produces a negative-going output voltage). With these circuits, the switching threshold is controlled by  $V_L$ , which can be set anywhere from 3 to 25 volts above  $V_{EE}$ . When the input voltage is 0.5 volt below  $V_L$ , the input current spec is 20  $\mu$ A maximum, while a 1.5-mA maximum driving current will produce full output.

The D013 and D021F are two-channel inverting circuits that require 1 mA of input drive current to drop the output voltage to 1 volt above  $V_{EE}$ . A maximum positive input swing of 0.8 volt above ground is necessary to produce this.

All the drivers use FET current-limiting diodes for the collector load in each output state.

The prime purpose of these drivers is to amplify low-level logic signals and provide the high-level control voltage necessary to operate FET gates. However, the wide variety of integrated circuit logic blocks currently in use and the multifarious assortment of n- and p-channel junction and MOS-FETs available for switches or gates present an important dc level-shifting problem for the driver stage. Accommodating almost any dc level input is easiest with the D012F and

Table—Current ranges and time delays

Type number	Output stage $I_C$ range		Maximum propagation delays (driving 1 Mohm & 6 pf)	
	Minimum	Maximum	Turn-on	Turn-off
D011F, D012F, D013F	0.4 mA	1.8 mA	0.15 $\mu$ s	1.2 $\mu$ s
D019F, D020F, D021F	2.3	5.7	0.25	0.3

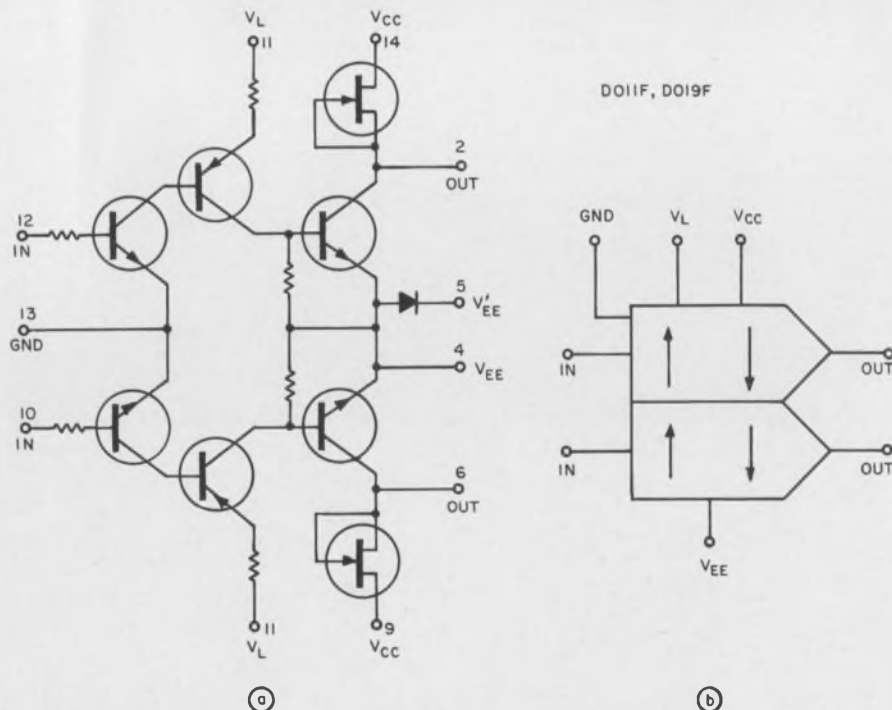

1. Typical analog gate driver circuit (a) employs output current "pull-up" FETs. New logic symbols (b) have been devised to represent the drivers. The arrows indicate input and output voltage polarities for the driver ON condition: up for positive, down for negative. Also see pp. 50-54.

# Worlds of Clifton Quality

## in our **NEW**, Competitively Priced DC Motors



Built to exacting Clifton and MIL-E-5272 standards, these DC motors are a completely new design. They offer many advantages such as: stainless steel, corrosion resistant housings and ball bearings, and brush springs which maintain constant pressure over brush life. Brush life itself is up to 1000 hours depending upon environmental conditions and application.

These motors feature a five bar commutator. Due to the inherent design, the rotor produces a magnetic detent under zero excitation which minimizes gear train drift. Units available in both 14 and 28 volt excitation. Special voltages, shafts and housings available upon request.

Clifton Precision Products, Division of Litton Industries, Clifton Heights, Pa., Colorado Springs, Colo.

The illustration of our Solar System shows the nine planets and their 31 satellites in scale with each other and the enormous sun. The procession starts with Mercury at the left and ends with Pluto on the far right.

**cppe**

**CLIFTON**  
PRECISION PRODUCTS  
DIVISION OF LITTON INDUSTRIES



ON READER-SERVICE CARD CIRCLE 53





## Is the Spectrol Model 140 really so great ?

### No, it just acts that way!

This precision pot is priced like a trimmer, and yet it outperforms many higher priced models.

Here's a half-inch, single-turn, precision potentiometer with rear terminals for optimum packaging density...a new type mechanical stop that provides exceptionally high stop strength...and a unique wiper design that assures positive contact under severe conditions of shock and vibration per MIL-R-12934. Also, here's a miniature pot with high "specability!" From our standard data sheet, you can choose from more than 100 mechanical and electrical options, in addition to resistance ratings from 50 ohms to 70K ohms.

On second thought maybe it really is so great! Why don't you find out for yourself? You'll find the standard Model 140 (with stops) stocked at your local distributor. Want more data? Send for the 140 data sheet and ask for our new Short Form Catalog, too. The Model 140 comes from a great family.



Spectrol Electronics Corporation  
17070 East Gale Avenue  
City of Industry, Calif. 91745

*Better Components for Better Systems*

ON READER-SERVICE CARD CIRCLE 54

D020F drivers. Here the threshold level is set by  $V_L$ . The other four types can provide some input threshold level adjustment by connecting a bias voltage to the common ground terminal.

The output dc levels are controlled by the polarity and magnitude of  $V_{CC}$  and  $V_{EE}$ . The sum of these two supply voltages cannot exceed 30 volts. Thus if  $V_{CC} = +15$  volts and  $V_{EE} = -15$  volts, the output will swing symmetrically with respect to ground. Another typical combination is when  $V_{CC} = +10$  volts and  $V_{EE} = -20$  volts; the output control voltage will then swing from around  $-20$  to  $+10$  volts. Since the magnitude of drive voltage needed to control a FET gate ranges from 5 to 15 volts, plus the peak-to-peak voltage being gated, the foregoing output levels are ideal. For example, given a  $\pm 5$ -volt range of analog signal, to be gated by a p-channel normally OFF MOS-FET that requires  $V_{ON} = -15$  volts to obtain an acceptable ON resistance level, the FET gate voltage must swing from  $-20$  volts to  $+5$  volts.

The user has two other options worth mentioning. First, with the drivers D011F, D019F, D013F, and D021F, it is practical to place diodes in series with the common ground lead, which will raise the threshold level and provide a significant improvement in noise immunity. Second, the  $V_{EE}$  supply may be connected through a series diode to avoid output loading in case the  $V_{EE}$  supply goes to zero. Although this connection decreases the available  $V_{EE}$  by 0.6 V, it ensures that the FET gate (connected to the output terminal) will never be current-loaded by a forward-biased substrate diode in the driver chip.

In addition to their prime function to operate as buffers between low level logic and FET gates, it is clear that they can be used for other purposes as well. To give just one example, consider a case where a low level logic output has to provide current drives exceeding its capacity. One of the new drivers can be selected to provide the needed assist.

All six of the series are mounted on TO-84 fourteen-lead flat packs.

CIRCLE NO. 230

evaluating  
semiconductors?

# use one of these Tektronix transistor curve tracers to meet your needs

The performance range of the Type 575 enables you to evaluate the dynamic characteristics of most semiconductor devices.

Several transistor characteristic curves may be displayed including the collector family of NPN or PNP devices in a common base or a common emitter configuration with forward or reverse biasing. The Type 575 features collector sweep supply ranges continuously variable from 0 to 20 V at 10 A, or 0-200 V at 1 A. A base or emitter step generator, operating at either 2 or 4 times the line frequency, provides 4 to 12 steps per family of characteristic curves in single or repetitive display modes. The step generator provides voltage increments from .01 V/step to 0.2 V/step or current increments from .001 mA/step to 200 mA/step.

Choose the Type 575 MOD 122C transistor curve tracer for evaluating higher voltage devices.

The Type 575 MOD 122C has the same features of the Type 575 plus the capability of diode breakdown test voltage variable from 0 to 1500 V at 1 mA and a much higher collector supply voltage of up to 400 V at 0.5 A.

For evaluating high current semiconductors, add the Type 175 High Current Adapter to either of these curve tracers.

The Type 175 features collector sweep supply ranges of 0-200 A at 0-20 V and 0-40 A at 0-100 V. The Type 175 step generator provides current ranges from 1 mA/step to 1000 mA/step and voltage steps from 0.5 to 10 V/step with driving resistance selectable from 11 values ranging from 0.5 ohms to 1 k ohm. Other resistance values may be added externally.

Type 575 Transistor Curve Tracer (including accessories) . . . . . \$1075

Type 575 Transistor Curve Tracer MOD 122C (including accessories) . . . . . \$1325

Type 175 High Current Adapter (including accessories) . . . . . \$1475

U. S. Sales Prices f.o.b. Beaverton, Oregon

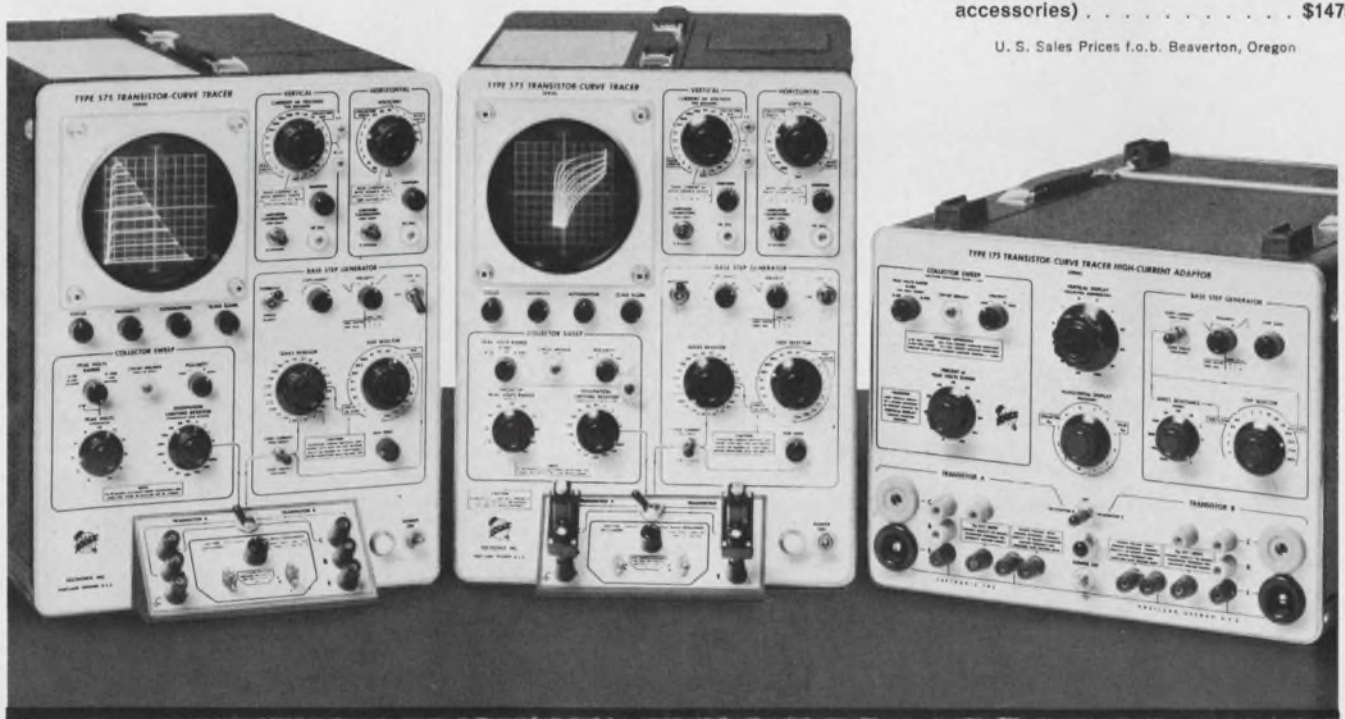

**Tektronix, Inc.**



For complete information, contact your nearby Tektronix field engineer or write: Tektronix, Inc., P.O. Box 500, Beaverton, Oregon 97005

ON READER-SERVICE CARD CIRCLE 55



## Integrating digital meter is 75 per cent integrated circuits

Fairchild Instrumentation, 475 Ellis St., Mountain View, Calif. Phone: (415) 962-2011. Price: \$1995.

High IC content and low price are features of the Model 7100A Integrating Digital Meter. The self-contained unit provides accurate measurement of dc voltages, voltage ratios and resistance.

Five-digit read-out is provided in the Model 7100A, with decimal point placement and polarity automatically selected. The unit gives direct read-out of voltages with full-scale ranges of 0.16, 1.6, 16, 160 and 1100 volts. Resistance ranges are 16 k $\Omega$ , 160 k $\Omega$ , 1.6 M $\Omega$  and 16 M $\Omega$  full-scale. Voltage ratios of 0.0001:1 to 1.6:1 can be measured in a single range of 1.6:1.

Separate floating and guarded input connectors are used in the Model 7100A for voltage and resistance measurements. An additional rear connector is provided for voltage input in ratio measurements.

### Ratio measurements

Unknown input:	$\pm 1$ mV to +15 V; input resistance >1000 M $\Omega$ .
Reference input:	+5 to +15 V; input resistance 3 k $\Omega$ .
Accuracy:	+10 V reference, 0.01% of reading $\pm 1$ digit; +5 to +15 V, 0.02% of reading $\pm 1$ digit.

Measurements. Optional remote programming and data output units can provide remote selection of range and mode, as well as BCD read-

### Dc voltage measurements

Ranging:	automatic or manual, switch selectable.
Accuracy:	$\pm 0.01\%$ of reading $\pm 1$ digit; for 160-mV range, $\pm 0.01\%$ of reading $\pm 2$ digits.
Input resistance:	1000 M $\Omega$ ; for 160- and 1100-V ranges, 10 M $\Omega$ .
Offset current:	20 pA maximum.
Max. input voltage:	1100 V.
Measurement time:	250 ms; 50 ms possible on four high ranges.

### Resistance measurements

Ranging:	automatic or manual, switch selectable.
Accuracy:	$\pm 0.02\%$ of reading $\pm 1$ digit.
Measurement current:	1 mA, 100 $\mu$ A, 10 $\mu$ A and 1 $\mu$ A on the 16-k $\Omega$ through 16-M $\Omega$ ranges, respectively.
Measurement time:	50 ms maximum.



out information and range/mode output.

Standard plug-in unit DM-01B provides manual selection of range and mode. With optional automatic ranging, it also selects automatic voltage and resistance modes. High-sensitivity ac-to-dc conversion is possible with an additional plug-in unit, DM-03.

Pertinent specifications of the Model 7100A are as shown:

P&A: \$1995. Fairchild Instrumentation, 475 Ellis Street, Mountain View, Calif. Phone: (415) 962-2011.

CIRCLE NO. 231



## Deviation calibrator accurate to 1%

Cushman Electronics, Inc., 166 San Lazaro Ave., Sunnyvale, Calif. Phone: (408) 739-6760.

A companion to the CE-2B communications monitor, the Model 107 FM deviation calibrator provides accuracies to 1%, guaranteed by the manufacturer. Operating on power supplied by the CE-2B, the Model 107 is said to establish the accuracy of the deviation meter ranges in a few minutes. The instrument is fully transistorized.

CIRCLE NO. 232



Technical  
Abstracts  
on  
Record / Reproduce  
Systems

ORATION, CONTROLS DIVISION | 717 NORTH CONEY AVENUE | AZUSA, CALIFORNIA | TELE: (213) 334-8211

**we wrote the book**

And a free copy is available for you. It's all about the development of magnetic tape recording systems. Write or phone:  
Leach Corporation, Controls Division, 1123 Wilshire Blvd., Dept. D11 Los Angeles, California 90017. Phone (213) 482-0794.

**LEACH**

RE-ENGINEERING  
SATELLITE  
ASW  
SURVEILLANCE  
APOLLO

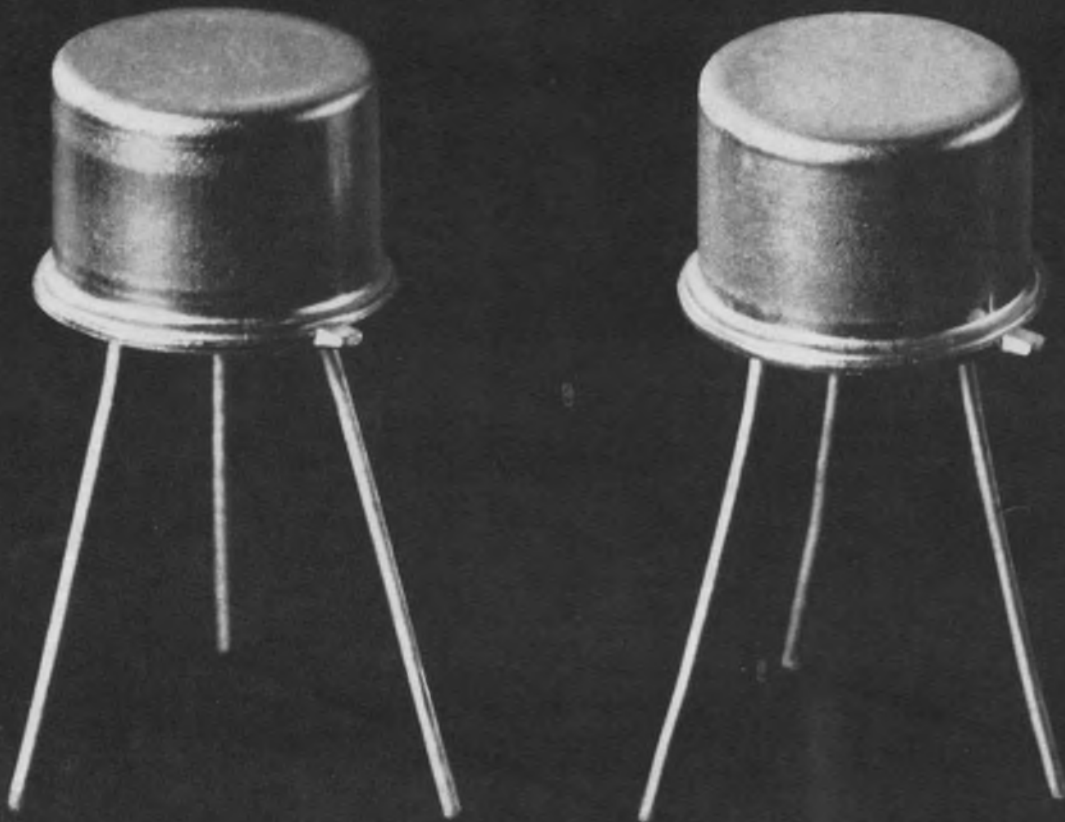

## Two for the space of

Fairchild dual transistors and differential amplifiers save space, give you greater design flexibility and provide uniform performance. You can get two discrete transistors into the space normally occupied by one. Pick virtually any of Fairchild's catalog PNP or NPN transistors for dual encapsulation. See table for several of Fairchild's PNP dual transistors and differential amplifiers. For differential amplifiers we select adjacent chips off the same wafer to give you the closest possible match of electrical characteristics. For price, delivery, and complete specifications, check with any Fairchild Distributor, or write for our new brochure.

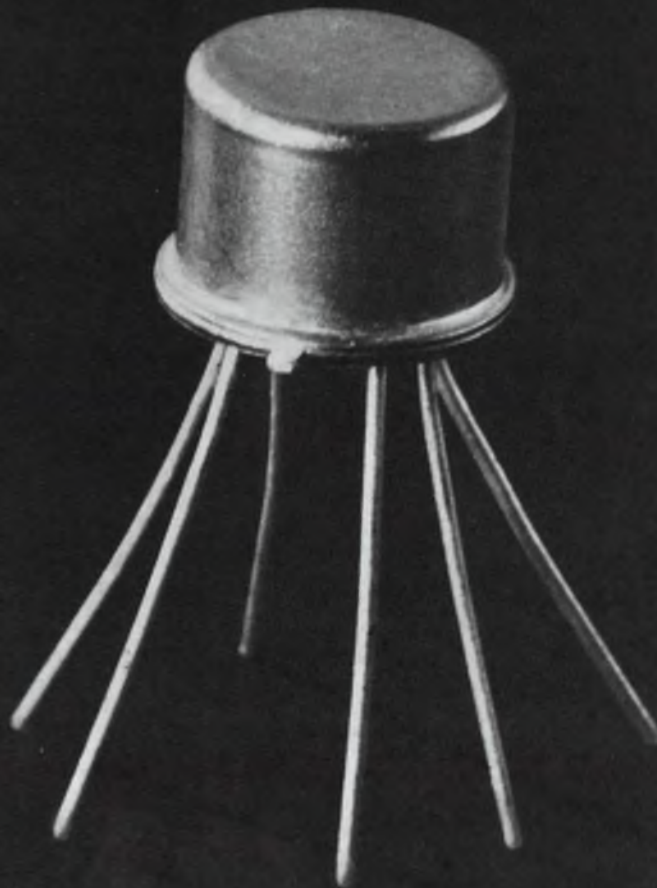

one.

**Selected PNP High-Gain, Low-Noise Dual Transistors and Differential Amplifiers:** (Write for full line PNP and NPN Brochure)

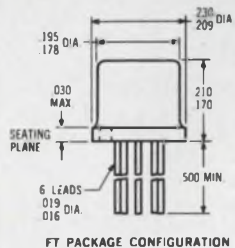

FT PACKAGE CONFIGURATION

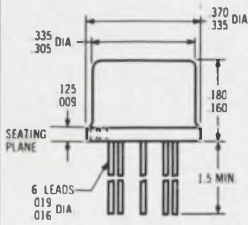

2N PACKAGE CONFIGURATION

Differential Amplifiers:	2N4020 FT4020	2N4021 FT4021	2N4022 FT4022	2N4023 FT4023	2N4024 FT4024	2N4025 FT4025
$V_{CE0}$	-45V	-60V	-60V	-45V	-60V	-60V
$h_{FE1}$ @ $I_C = 100\mu A$ to 1.0mA;	0.8 min.	0.8 min.	0.8 min.	0.9 min.	0.9 min.	0.9 min.
$h_{FE2}$ @ $V_{CE} = -5.0V$	1.0 max.	1.0 max.	1.0 max.	1.0 max.	1.0 max.	1.0 max.
$h_{FE}$ @ $V_{CE} = -5.0V$ ;						
$I_C = 1.0\mu A$	180 min.	60 min.	180 min.	180 min.	60 min.	180 min.
$I_C = 10\mu A$	250 min.	100 min.	250 min.	250 min.	100 min.	250 min.
$I_C = 100\mu A$	250 min.	100 min.	250 min.	250 min.	100 min.	250 min.
$I_C = 1.0mA$	250 min.	100 min.	250 min.	250 min.	100 min.	250 min.
NF @ $I_C = 20\mu A$ ; $V_{CE} = -5.0V$ ;						
$f = 100Hz$ ; BW = 15Hz; $R_s = 10k\Omega$	4.0db max.	10db max.	4.0db max.	4.0db max.	10db max.	4.0db max.
$ V_{BE1} - V_{BE2} $ @ $I_C = 100\mu A$	5.0mV max.	5.0mV max.	5.0mV max.	3.0mV max.	3.0mV max.	3.0mV max.
Dual Transistors:						
$h_{FE}$ @ $V_{CE} = -5.0V$ ;						
$I_C = 1.0\mu A$	60 min.	60 min.	180 min.			
$I_C = 10\mu A$	100 min.	100 min.	250 min.			
$I_C = 100\mu A$	100 min.	100 min.	250 min.			
$I_C = 1.0mA$	100 min.	100 min.	250 min.			
$V_{CE0}$	-80V	-60V	-45V			
NF @ $I_C = 20\mu A$ ; $V_{CE} = -5.0V$ ;						
$f = 100Hz$ ; BW = 15Hz; $R_s = 10k\Omega$	10db max.	10db max.	4.0db max.			



# IS MOVING AIR your problem?

With over 25 years of experience in this field and with proven production techniques you're sure of the right recommendation from a Ripley specialist.

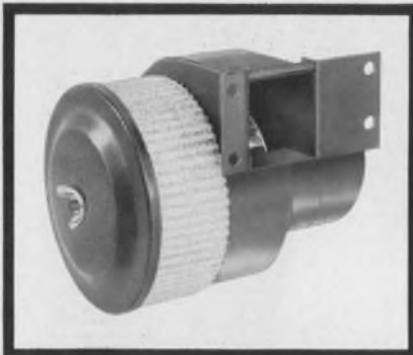

## CUSTOM ENGINEERED

to meet your exact  
application requirements.

We can design, develop and produce the precise air-moving unit to fit the product, the performance requirements and your budget.

...or STOCKED  
for immediate delivery!



Ripley offers a full line of air-moving units, axial fans, motor-blower assemblies, precision-bearing blowers.

For quick response, contact  
Sales Dept., Telephone (203) 346-6678

**RIPLY**  
COMPANY, INC.  
MIDDLETOWN, CONNECTICUT

ON READER-SERVICE CARD CIRCLE 58

### TEST EQUIPMENT

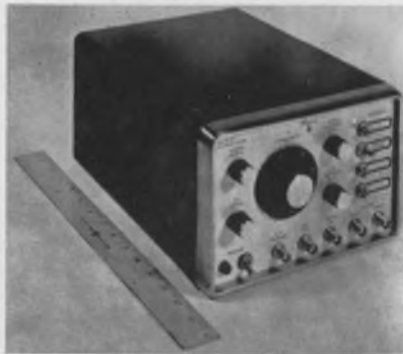

#### You select the range of small sweep generator

*Texscan Corp., 51 Koweba Lane,  
Indianapolis, Ind. Phone: (317)  
632-7351. P&A: \$575; 2 to 3 wks.*

A miniature, low-cost solid-state sweep generator offers either variable (0.1% to an octave) or fixed sweep widths and provisions for eight single-frequency or harmonic plug-in markers for accurate frequency identification. An external marker input is also available. Output is 0.5 V rms into a 50- $\Omega$  load and flatness is  $\pm 0.5$  dB at maximum sweep width. Sweep rate is 50/60 Hz.

CIRCLE NO. 233



#### Power supply tester checks 6 parameters

*Pacific Measurements, 940 Industrial Ave., Palo Alto, Calif. Phone: (415) 328-0300. Price: \$750.*

Power supply tests for transient response, loop stability, output impedance, ripple, and regulation line and load are provided by the model 1003 test assembly. The instrument has a regulated electronic load capable of pulse loading a power supply to 20 amp at 45 V. Oscilloscope readout is used to measure response, impedance, regulation and stability.

CIRCLE NO. 234

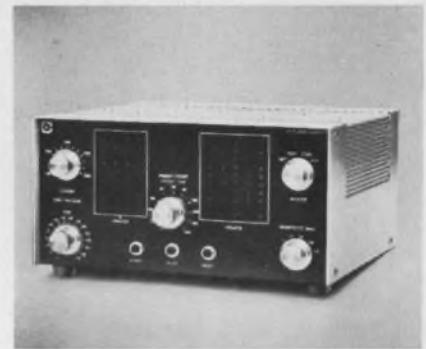

#### Scaler/timer for nuclear systems

*Nuclear-Chicago Corp., 359 E. Howard Ave., Des Plaines, Ill. Phone: (312) 827-4456.*

Combining scaling, timing and high-voltage detection in a single module, the Model 8775 is designed for nuclear-system use with most Geiger, gas-flow and scintillation radiation detectors. The scaler has a 1  $\mu$ sec pulse-pair resolution and a max accumulated count of 100,000. Timing range is 0-100 minutes in increments of 0.01 minute. Input sense is 1-250 mV variable and high voltage varies from 400-3100 V.

CIRCLE NO. 235



#### Digital scanner solves data interface problems

*LeCroy Research Systems Corp., Irvington-On-Hudson, N. Y. Phone: (914) 591-7668.*

The model 141A digital scanner is said to solve interface problems between primary data acquisition equipment and recorder-storage. Actually a buffer, the 141A permits the output of up to 18 LRS callers or A/D converters to be presented in sequence to a tape recorder, tape punch or computer. In scanning, the unit connects 6 volts, in turn, to each of 18 output lines.

CIRCLE NO. 236

# OUTSTANDING PERFORMANCE...AT REASONABLE COST HIGHEST ACROSS-THE-BOARD

PERFORMANCE AVAILABLE FROM A WIDEBAND DIFFERENTIAL DATA AMPLIFIER

New Hewlett-Packard 2470A Differential Data Amplifier...\$585

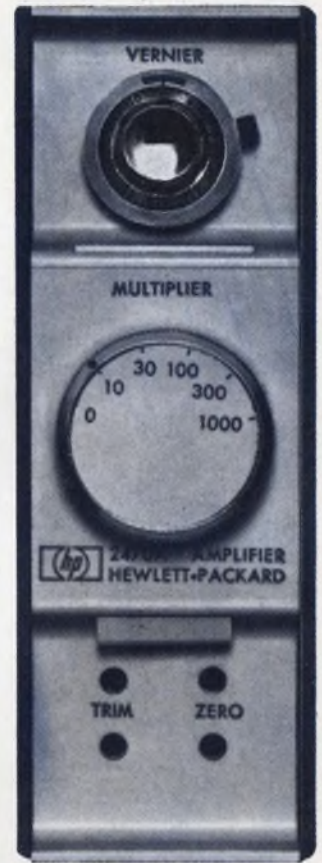
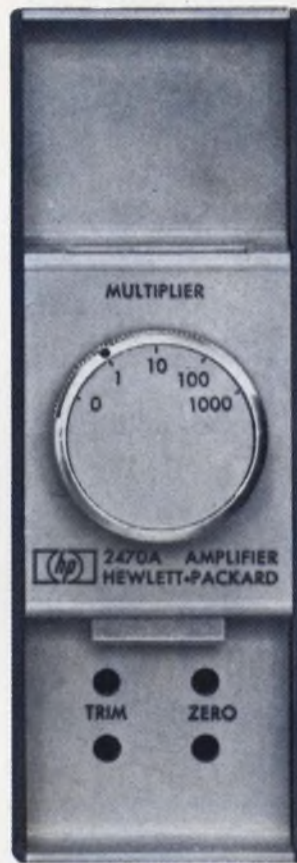
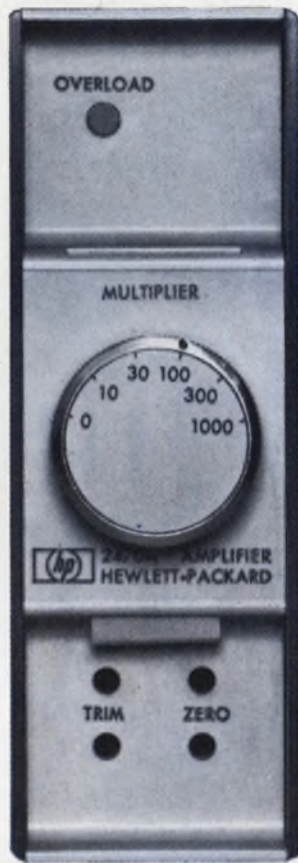
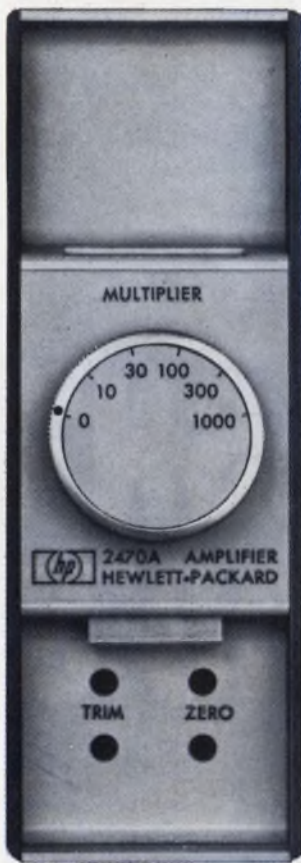

**Top electrical performance:** Compare, spec to spec—DC gain X10 to X1000 (optional precision vernier, X1 gain), output  $\pm 10$  v, 0-100 ma. Gain accuracy  $\pm 0.02\%$  range; constant 50 kHz bandwidth. Differential input for low drift, high cmr (120 db at 60 kHz on gains down to x30, 90 db at x1). Full output across full bandwidth ( $10^7$  v/sec RTO). High 1000-meg input impedance all gain settings, output impedance 0.1 ohm  $+10 \mu$ h. DC linearity of 0.002% on both polarities; dc gain stability of 0.005% per month achieved without chopper stabilization. Low drift and noise. Fast 100 microsecond settling, 100 microsecond overload recovery, excellent overload protection, optional overload indicator. Input and output isolated by internally driven guard shields; dual output available with fixed 2-pole filter.

**Built-in reliability:** The predicted MTBF of the 2470A is in excess of 20,000 hours. Silicon transistors are used throughout, and passive and active components are selected for dependability, as well as performance. Amplifier meets spec at 95% humidity at 40°C. Critical parameters (zero drift, full-scale accuracy, common mode rejection) are verified after 100 hours of "run-in" at elevated temperature.

**Packaging for value, compactness:** Amplifier and self-contained power supply are enclosed in a unique, rugged molded dielectric case. Combining case, bench stand, power and signal cables, plus many other accessories, are available.

**Use if for:** Amplifying signals from low-level resistive transducers, such as thermocouples, strain gages. High input and low output impedance make it ideal for amplification over long transmission lines; use it, with resistive or reactive loads, such as x-y, strip-chart or oscillographic recorders, digital voltmeters, null detectors and servo systems, telemetry systems... or use it as a high-performance bench amplifier.

Call your Hewlett-Packard field engineer for complete information or write the Dymec Division of Hewlett-Packard, 395 Page Mill Road, Palo Alto, California 94306, Tel. (415) 326-1755; Europe: 54 Route des Acacias, Geneva.

Price f.o.b. factory.  
Data subject to change without notice.

**HEWLETT  
PACKARD**  **DYMEC  
DIVISION**

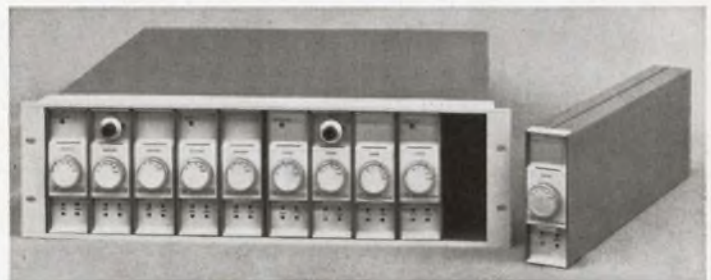

ON READER-SERVICE CARD CIRCLE 59

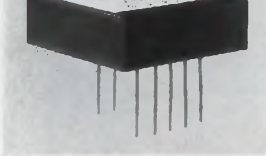

**Amperex announces the ATF-401...  
the operational amplifier made possible  
by our special production-line methods  
and thin film/LID circuit technology...**

**IF THIS  DOESN'T  
HYBRID LINEAR IC'S,**

**ATF-401 OP AMP QUICK REFERENCE DATA**

VOLTAGE GAIN (open loop, $R_L = 5k$ )	50,000 min
FREQUENCY FOR UNITY GAIN	2 MHz min
RATED OUTPUT	$\pm 11V$ @ $\pm 2.2$ mA min
INPUT NOISE ( $R_{in} = 1k$ )	5 $\mu V$ max
INPUT VOLTAGE OFFSET	10 mV max (externally adjustable to zero)
TEMPERATURE DRIFT	10 $\mu V/^{\circ}C$ max
INPUT CURRENT OFFSET	50 nA max TEMPERATURE DRIFT
	2 nA/ $^{\circ}C$ max
INPUT IMPEDANCE DIFFERENTIAL	200 kilohms min
COMMON MODE	10 megohms min
POWER REQUIREMENTS OPERATING (under load)	$\pm 15V$ , $\pm 7$ mA max
SHORT CIRCUIT CURRENT	$\pm 20$ mA max
DIMENSIONS	80 x 80 x .25 inches

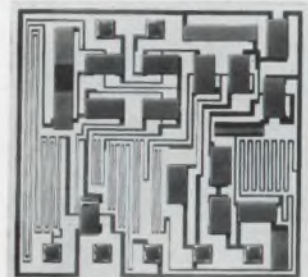

ATF-401 OP AMP BEFORE ENCAPSULATION

# MAKE THE CASE FOR NOTHING WILL!

**The ATF-401 is a thin film, linear, hybrid IC offering the best combination of price, size and performance of any monolithic, discrete or hybrid op amp now available**

Hybrid circuit technology, given its biggest boost in years by the introduction of Amperex LIDS last March, takes another leap forward with the introduction of the solid state ATF-401, the first commercially available linear hybrid integrated circuit employing LID technology.

Using LIDS and the advanced micro-circuit design and production technology developed at Amperex during the past several years, we are now able to produce large volume runs of all kinds of hybrid IC devices, both as off-the-shelf items and as custom production circuits to meet your special system requirements. Combining the advantage of discrete-component circuitry (performance) with the advantage of monolithic IC's (low cost), Amperex hybrids, made with Amperex LIDS offer high performance at low cost, plus the third big bonus—small size.

The ATF-401 at \$29.00 each, in hundred lots, outperforms many discrete op amps and without exception any monolithic op amp available. Further, since the ATF-401 is fully frequency-compensated it requires no external circuitry which would increase its effective size.

Take a look at these specifications:

- Open loop gain 50,000 (min)
- Full output to 10 KHz
- Gain bandwidth product of 2 MHz
- Temperature drift of only  $10\mu\text{V}/^\circ\text{C}$  and  $2\text{ nA}/^\circ\text{C}$
- Long term stability of  $25\mu\text{V}/\text{day}$
- Maximum noise contribution of  $5\mu\text{V}$  referred to input
- Common mode rejection ratio of 80 db (min)
- Complete short-circuit protection of all terminals
- All this in a small package less than 0.15 cubic inches

The ATF-401 is ideally suited for signal conditioning amplifiers, test equipment, control systems, AC and DC comparators, servo amplifiers and all instrumentation, computing and control applications where low-cost, small size, long life and low power consumption are of prime importance.

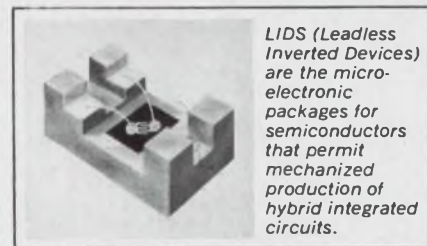

Write for additional data on the ATF-401 and for details on how Amperex can serve your custom hybrid IC requirements: Amperex Electronic Corporation, Semiconductor and Receiving Tube Div., Dept. 371, Slatersville, R. I. 02876.

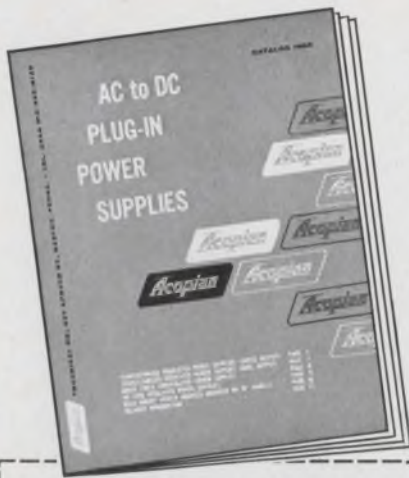

Please send me the latest Acopian catalog that lists

**62,000  
DIFFERENT  
POWER  
SUPPLIES**

available  
for shipment  
in 3 days.

Name \_\_\_\_\_

Title \_\_\_\_\_

Company \_\_\_\_\_

Address \_\_\_\_\_

City \_\_\_\_\_

State \_\_\_\_\_

ZIP \_\_\_\_\_

ACOPIAN CORP.  
EASTON, PENNSYLVANIA  
TEL: (215) 258-5441

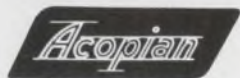

ON READER-SERVICE CARD CIRCLE 61

## MICROWAVES

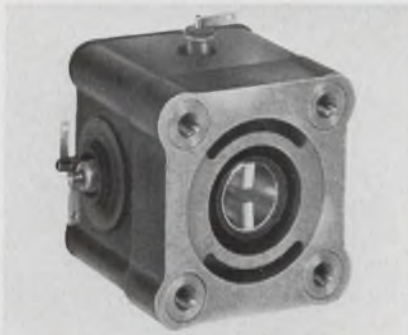

### Pulsed magnetron for radar detection

*Microwave Associates, Inc., South St., Burlington, Mass. Phone: (617) 272-3000.*

A new fixed-frequency pulsed beacon magnetron is designed for use in radar detection systems and missile and ground support equipment. The MA-252A magnetron is of ceramic and metal construction and provides 250-watts in the 818- to 916-GHz range. Pulse width is 0.5  $\mu$ sec and duty ratio is 0.005. Since this is a positive-pulse tube, it can be supplied for operation at other power/duty cycle combinations.

CIRCLE NO. 237

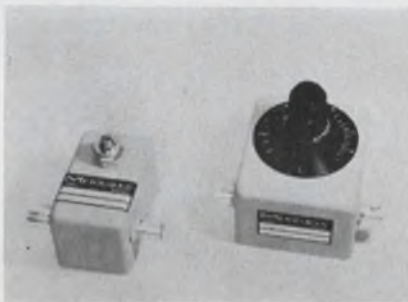

### Variable attenuators range over 30 MHz

*Merrimac Research & Development, Inc., 41 Fairfield Pl., W. Caldwell, N. J. Phone: (201) 371-1616. P&A: \$60 to \$80; stock to 30 days.*

Applied in areas such as audio, video and IF level-setting and control, the AR series of matched attenuators can be used up to 30 MHz without performance degradation. The series consists of two models, AR-1 which is uncalibrated and AR-2 which is calibrated accurate to 0.5 dB. Attenuation range is 0 to 20 dB, insertion loss is below 0.75 dB and typical vswr is 1.2.

CIRCLE NO. 238

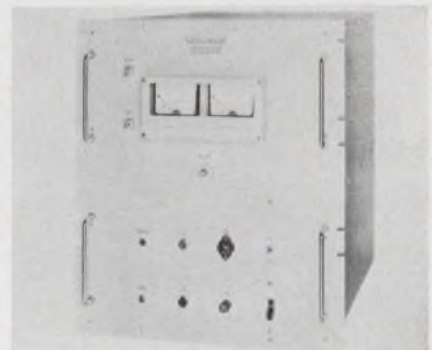

### 12 microwave amps cover vhf to X-band

*Alto Scientific Company, Inc., 4083 Transport St., Palo Alto, Calif. Phone: (415) 321-3434. Availability: 60-75 days.*

A line of 12 self-contained amplifiers covers vhf through X-band. Power out ranges from 100 W to 300 W cw depending on the frequency. Typical small-signal gain is 30 dB and typical noise is 35 dB. The 300-watt units are liquid cooled and lower ratings are forced-air cooled by integral blowers. All power supplies are electronically regulated.

CIRCLE NO. 239



### Mixer/preamplifiers for low-noise mixers

*Varian LEL Division, Akron St., Copiague, N. Y. Phone: (516) 264-2200. P&A: \$995; 1 month.*

Low-noise wideband orthogonal-mode waveguide mixers are used in the seven models of a new series of mixer-preamplifiers. The series covers the frequency range of 5.4 to 39 GHz. A typical unit of the series covers 8.2-12.4 GHz with a noise figure of 9-10 dB. Intermediate frequencies are 30, 60, or 70 GHz.

CIRCLE NO. 240

Report from

**BELL  
LABORATORIES**

# A 3-D Glimpse of the Hearing Process

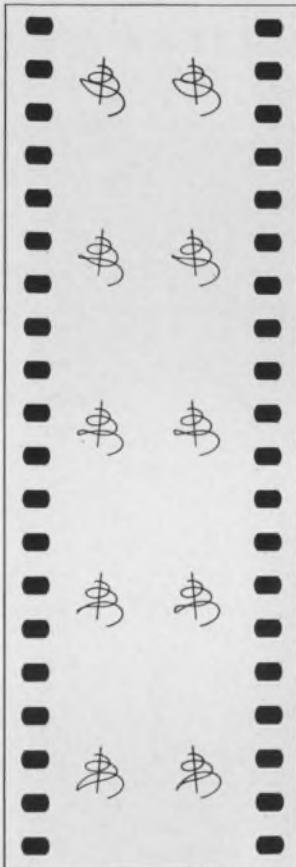

**THE MOVIE** shows the basilar membrane as a "stereo pair" of spiral lines. The sequential frames shown here represent the motion of the membrane responding to the sound "oo" in the word "too" as pronounced by R. C. Lummis, one of the scientists responsible for the film.

To view this illustration in 3-D, place a sheet of paper on edge between one stereo pair. Position your head so each eye sees only one image. The pictures should then seem to converge and appear three-dimensional.

For screen projection, polarized light and polarized eyeglasses are used to obtain a 3-D image.

**THE BASILAR MEMBRANE** is a lengthwise partition in the spiral, fluid-filled cochlea (figure). Sound, from the eardrum, by way of the hammer, anvil, and stirrup, produces vibrations in this membrane. The end nearest the stirrup resonates at the highest audible tones (approximately 20,000 Hz); the end near the apex of the spiral resonates at the lowest (approximately 20 Hz).

The cochlear nerve terminates near the membrane and, by sensing the vibration at each point, converts the mechanical motion into nerve impulses which the brain perceives as a sound.

Because of its filtering and analytical functions the basilar membrane is a center of interest in hearing research. Since it is embedded in the skull, direct study is extremely difficult.

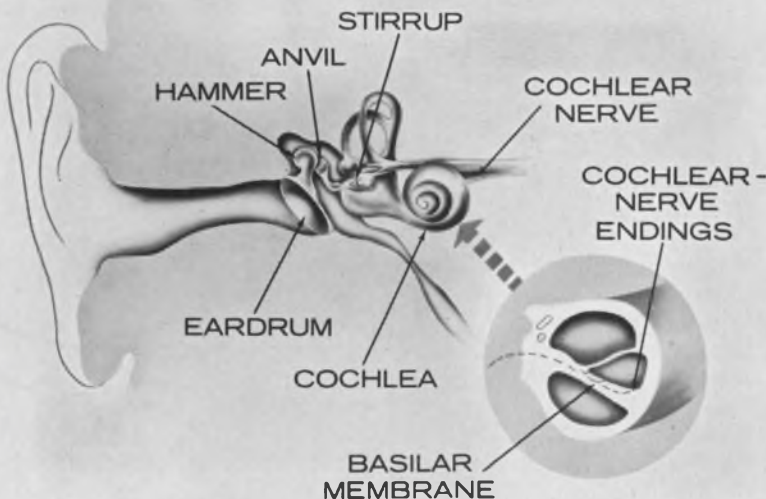

At Bell Telephone Laboratories, basic research in voice communications does not end with telephone equipment. For instance, three scientists here have made a stereoscopic motion picture showing how the ear's principal transducer—the basilar membrane—moves in response to sound.

A number of steps were involved: First, equations describing the membrane's response were converted to digital form, suitable for machine computation. Next, a program was devised so a computer could determine the precise motion of each point on the membrane as a function of any complex sound input. Finally, the resulting data were processed with another program which introduced the parallax effects inherent in binocular vision.

The output was a series of pairs of stereoscopic images. The computer drew these on the face of a cathode-ray tube where they were automatically photographed to form the frames of the movie.

In this film, the membrane's movements (actually microscopic) are greatly enlarged and slowed down for detailed examinations. Thus we have developed a promising tool for the study of hearing. For example, movies made in this way could help us evaluate theories of the basilar membrane's role in converting sound to nerve impulses. (Several complex mathematical relationships have been proposed; now we may see them in simulated action and measure their properties.)

The scientists who made this film are Robert C. Lummis, A. Michael Noll, and Man Mohan Sondhi. The membrane-response equations from which they began were originated by James L. Flanagan, also of Bell Laboratories. His work was based on anatomical measurements made by Nobel laureate Georg von Békésy of the University of Hawaii.



**Bell Telephone Laboratories**  
Research and Development Unit of the Bell System

# Meet any programable or fixed voltage need

Up to 150 volts • Up to 95 amps



## FEATURES and DATA

Full line of accessories and options to meet your system needs. Meet Mil. Environment Specs. RFI—MIL-I-16910: Vibration: MIL-T-4807A: Shock: MIL-E-4970A • Proc. 1 & 2: Humidity: MIL-STD-810 • Meth. 507: Temp. Shock: MIL-E-5272C • (ASG) Proc. 1: Altitude: MIL-E-4970A • (ASG) Proc. 1: Marking: MIL-STD-130: Quality: MIL-Q-9858: Fungus Proofing (optional) all models available with MIL-V-173 varnish for all nutrient components.

Convection cooled—no heat sinking or forced air required Wide input voltage and frequency range—105-132 VAC, (200-250 VAC, optional at no extra charge) 45-440 cps Regulation (line) 0.05% plus 4MV (load) 0.03% plus 3MV: Ripple and Noise—1 MV rms, 3MV p to p Overvoltage protection available for all models up to 70 VDC

High Performance Option—All models available with these specifications for \$25.00 extra: Line regulation—.01% + 1MV; Load regulation—.02% + 2MV: Ripple and Noise—½MV rms; 1½MV p to p: Temp. Coef.—.01% °C

## WIDE VOLTAGE RANGE PROGRAMABLE LM SERIES MODELS

PACKAGE A 3 1/8" x 3 1/4" x 6 1/2"	ADJ. VOLT. RANGE VDC	*MAX. AMPS AT AMBIENT OF:				Price**
		40°C	50°C	60°C	71°C	
LM 251	0-7	0.35	0.31	0.29	0.27	\$ 69
LM 201	0-7	0.85	0.75	0.70	0.55	79
LM 202	0-7	1.7	1.5	1.4	1.1	89
LM 252	0-7	2.0	1.8	1.4	1.1	99
LM 257	0-14	0.27	0.24	0.23	0.22	69
LM 203	0-14	0.45	0.40	0.38	0.28	79
LM 204	0-14	0.90	0.80	0.75	0.55	89
LM 258	0-14	1.2	1.1	1.0	0.80	99
LM 259	0-24	0.18	0.16	0.15	0.14	69
LM 260	0-24	0.35	0.30	0.25	0.20	79
LM 261	0-24	0.70	0.65	0.60	0.45	89
LM 262	0-24	0.80	0.75	0.70	0.60	99
LM 263	0-32	0.14	0.12	0.11	0.10	69
LM 205	0-32	0.25	0.23	0.20	0.15	79
LM 206	0-32	0.50	0.45	0.40	0.30	89
LM 264	0-32	0.66	0.60	0.50	0.32	99
LM 265	0-60	0.08	0.07	0.07	0.06	79
LM 207	0-60	0.13	0.12	0.11	0.08	89
LM 208	0-60	0.25	0.23	0.21	0.16	99
LM 266	0-60	0.35	0.31	0.28	0.25	109
LM 267	0-120	0.10	0.09	0.08	0.07	109
LM 268	0-120	0.13	0.12	0.10	0.09	119

PACKAGE B 3 1/8" x 4 1/8" x 6 1/2"	ADJ. VOLT. RANGE VDC	*MAX. AMPS AT AMBIENT OF:				Price**
		40°C	50°C	60°C	71°C	
LMB-0-7	0-7	2.8	2.6	2.3	1.5	\$109
LMB-0-14	0-14	1.6	1.5	1.3	1.2	109
LMB-0-32	0-32	0.80	0.70	0.60	0.5	109
LMB-0-60	0-60	0.45	0.40	0.35	0.3	109
LM-217	8.5-14	2.1	1.9	1.7	1.3	119
LM-218	13-23	1.5	1.3	1.2	1.0	119
LM-219	22-32	1.2	1.1	1.0	0.80	119
LM-220	30-60	0.70	0.65	0.60	0.45	129

PACKAGE C 3 1/8" x 4 1/8" x 9 1/8"	ADJ. VOLT. RANGE VDC	*MAX. AMPS AT AMBIENT OF:				Price**
		40°C	50°C	60°C	71°C	
LM-225	0-7	4.0	3.6	3.0	2.4	\$139
LMC-0-14	0-14	2.2	2.0	1.8	1.5	139
LMC-0-32	0-32	1.1	1.0	0.90	0.80	139
LMC-0-60	0-60	0.60	0.55	0.50	0.45	139
LM-226	8.5-14	3.3	3.0	2.5	2.0	139
LM-227	13-23	2.3	2.1	1.7	1.4	139
LM-228	22-32	2.0	1.8	1.5	1.2	139
LM-229	30-60	1.1	1.0	0.80	0.60	149

PACKAGE D 4 1/8" x 7 1/2" x 9 1/8"	ADJ. VOLT. RANGE VDC	*MAX. AMPS AT AMBIENT OF:				Price**
		40°C	50°C	60°C	71°C	
LM-234	0-7	8.3	7.3	6.5	5.5	\$199
LMD-0-14	0-14	4.9	4.2	3.4	2.7	199
LMD-0-32	0-32	2.5	2.1	1.7	1.3	180
LMD-0-60	0-60	1.3	1.1	0.95	0.75	239
LM-235	8.5-14	7.7	6.8	6.0	4.8	199
LM-236	13-23	5.8	5.1	4.5	3.6	209
LM-237	22-32	5.0	4.4	3.9	3.1	219
LM-238	30-60	2.6	2.3	2.0	1.6	239

PACKAGE E 4 1/8" x 7 1/2" x 11 1/8"	ADJ. VOLT. RANGE VDC	*MAX. AMPS AT AMBIENT OF:				Price**
		40°C	50°C	60°C	71°C	
LME-0-7	0-7	12.0	10.5	8.5	6.8	\$249
LME-0-14	0-14	7.4	6.4	5.2	4.1	249
LME-0-32	0-32	3.7	3.2	2.6	2.1	249
LME-0-60	0-60	2.1	1.7	1.4	1.1	249

PACKAGE F 3 1/2" x 19" x 16 1/2"	ADJ. VOLT. RANGE VDC	*MAX. AMPS AT AMBIENT OF:				Price**
		40°C	50°C	60°C	71°C	
LMF-0-7	0-7	25.0	21.0	17.0	14.0	\$425

PACKAGE G 5 1/4" x 19" x 16 1/2"	ADJ. VOLT. RANGE VDC	*MAX. AMPS AT AMBIENT OF:				Price**
		40°C	50°C	60°C	71°C	
LMG-0-7	0-7	35.0	29.0	24.0	20.0	\$575

## ACCESSORIES and OPTIONS



### System Rack Adapters

LRA-5 • 3 1/2" height by 2 7/16" depth. Price \$35.00

LRA-4 • 3 1/2" height by 14" depth. (For use with chassis slides) Price \$55.00

LRA-5 and LRA-4 mount the following combinations of LM models: up to 4 A package sizes • 3 B or 3 C package sizes • 2 A and 1 B or 1 C package sizes

LRA-3 • 5 1/4" height by 2 7/16" depth. Price \$35.00

LRA-6 • 5 1/4" height by 14" depth. (For use with chassis slides) Price \$60.00

LRA-3 and LRA-6 mount the following combinations of LM models: up to 4 A, B or C package sizes • 3 CC package sizes • 2 D or 2 E package sizes • 2 A, B or C and 1 CC or 1 D or 1 E package sizes • 1 CC and 1 D or 1 E package sizes • 1 D and 1 E package sizes

**Metered Panels** • 3 1/2" Metered panel MP-3 is used with rack adapters LRA-4, LRA-5 and packages A, B and C. Price \$40.00

5 1/4" Metered panel MP-5 is used with rack adapters LRA-6, LRA-3 and packages A, B, C, CC, D and E. Price \$40.00

To order these accessory metered panels, specify panel number which **MUST BE FOLLOWED BY** the MODEL NUMBER of the power supply with which it will be used.

F and G LM Packages are full rack power supplies available metered or non-metered. For metered models, add suffix M to the Model No. and \$30 to the non-metered price.

**Other Options** • Also available are Overvoltage Protectors, Fungus Proofing, and High Performance Options at moderate surcharges.

# with Lambda Modular Power Supply Systems

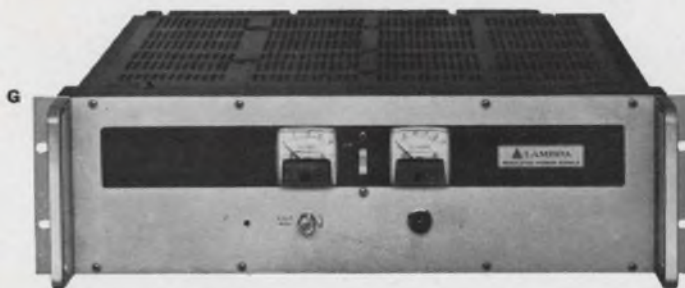
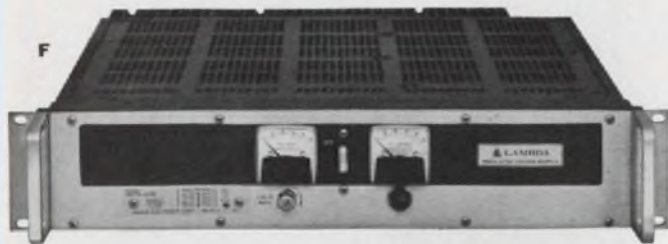

## FIXED VOLTAGE RANGE LM SERIES MODELS

PACKAGE B 3 1/8" x 14 1/8" x 16 1/2"	ADJ. VOLT. RANGE VDC	*MAX. AMPS AT AMBIENT OF:				Price**
		40°C	50°C	60°C	71°C	
LM B3	3 ±5%	3.8	3.3	2.6	1.6	\$119
LM B3P3	3.3 ±5%	3.8	3.3	2.6	1.6	119
LM B3P6	3.6 ±5%	3.8	3.3	2.6	1.6	119
LM B4	4 ±5%	3.8	3.3	2.6	1.6	119
LM B4P5	4.5 ±5%	3.7	3.2	2.5	1.5	119
LM B5	5 ±5%	3.7	3.2	2.5	1.5	119
LM B6	6 ±5%	3.2	2.9	2.4	1.4	119
LM B8	8 ±5%	3.2	2.9	2.4	1.4	119
LM B10	10 ±5%	2.7	2.5	2.2	1.4	119
LM B12	12 ±5%	2.5	2.3	2.1	1.3	119
LM B15	15 ±5%	2.2	2.0	1.8	1.3	119
LM B18	18 ±5%	2.0	1.8	1.7	1.3	119
LM B20	20 ±5%	1.8	1.6	1.5	1.2	119
LM B24	24 ±5%	1.4	1.3	1.2	1.1	119
LM B28	28 ±5%	1.3	1.2	1.1	1.0	119
LM B36	36 ±5%	1.1	1.0	0.90	0.85	129
LM B48	48 ±5%	0.9	0.85	0.80	0.75	129
LM B60	60 ±5%	0.7	0.65	0.60	0.54	129
LM B100	100 ±5%	0.37	0.34	0.30	0.28	139
LM B120	120 ±5%	0.30	0.28	0.25	0.23	139
LM B150	150 ±5%	0.25	0.23	0.20	0.19	149

PACKAGE C 3 1/8" x 14 1/8" x 19 1/2"	ADJ. VOLT. RANGE VDC	*MAX. AMPS		Price**
		40°C	60°C	
LM C3	3 ±5%	5.3	3.7	\$139
LM C4	4 ±5%	5.2	3.6	139
LM C4P5	4.5 ±5%	5.1	3.5	139
LM C5	5 ±5%	5.1	3.4	139
LM C6	6 ±5%	4.8	3.3	139
LM C12	12 ±5%	4.0	2.9	139
LM C15	15 ±5%	3.5	2.8	139
LM C20	20 ±5%	3.1	2.6	139
LM C24	24 ±5%	2.5	2.2	139
LM C28	28 ±5%	2.3	2.0	139
LM C48	48 ±5%	1.6	1.3	149
LM C150	150 ±5%	0.39	0.33	169

PACKAGE E 4 1/8" x 17 1/2" x 11 1/8"	ADJ. VOLT. RANGE VDC	*MAX. AMPS		Price**
		40°C	60°C	
LM E3	3 ±5%	22.0	16.5	\$269
LM E4	4 ±5%	21.0	16.5	269
LM E4P5	4.5 ±5%	20.0	16.4	269
LM E5	5 ±5%	20.0	16.4	269
LM E6	6 ±5%	19.0	15.6	269
LM E12	12 ±5%	15.0	12.3	269
LM E15	15 ±5%	14.0	11.5	269
LM E20	20 ±5%	12.0	9.8	269
LM E24	24 ±5%	11.0	9.0	269
LM E28	28 ±5%	10.0	8.0	269
LM E48	48 ±5%	6.0	4.9	299
LM E150	150 ±5%	1.4	1.2	299

NEW PACKAGE CC 4 1/8" x 14 1/8" x 19 1/2"	ADJ. VOLT. RANGE VDC	*MAX. AMPS		Price**
		40°C	60°C	
LM CC3	3 ±5%	11.0	8.2	\$179
LM CC4	4 ±5%	11.0	8.2	179
LM CC4P5	4.5 ±5%	10.5	8.0	179
LM CC5	5 ±5%	10.5	8.0	179
LM CC6	6 ±5%	9.0	7.7	179
LM CC12	12 ±5%	7.3	5.9	169
LM CC15	15 ±5%	6.0	5.1	169
LM CC20	20 ±5%	5.0	4.2	169
LM CC24	24 ±5%	4.0	3.4	169
LM CC28	28 ±5%	3.5	3.1	169
LM CC48	48 ±5%	2.5	2.2	189
LM CC150	150 ±5%	0.7	0.62	199

PACKAGE F 3 1/2" x 19" x 16 1/2"	ADJ. VOLT. RANGE VDC	*MAX. AMPS		Price**
		40°C	60°C	
LM FA3	3 ±5%	31.5	24.0	\$375
LM FA4	4 ±5%	31.5	24.0	375
LM FA4P5	4.5 ±5%	31.5	24.0	375
LM FA5	5 ±5%	31.5	23.7	375
LM FA6	6 ±5%	30.5	22.0	375
LM FA12	12 ±5%	22.0	16.2	375
LM FA15	15 ±5%	19.4	15.2	375
LM FA20	20 ±5%	16.0	12.6	350
LM FA24	24 ±5%	14.0	11.4	350
LM FA28	28 ±5%	13.5	10.4	350
LM FA48	48 ±5%	8.1	6.5	375
LM FA150	150 ±5%	2.4	1.8	410
LM F3	3 ±5%	48.0	34.0	425
LM F4	4 ±5%	48.0	34.0	425
LM F4P5	4.5 ±5%	48.0	34.0	425
LM F5	5 ±5%	48.0	33.0	425
LM F6	6 ±5%	47.0	32.0	425
LM F12	12 ±5%	33.0	22.0	425
LM F15	15 ±5%	28.0	19.0	425
LM F20	20 ±5%	23.0	17.0	395
LM F24	24 ±5%	20.0	14.0	380
LM F28	28 ±5%	19.0	13.0	380
LM F48	48 ±5%	10.0	7.5	425
LM F150	150 ±5%	3.1	2.1	460

PACKAGE D 4 1/8" x 17 1/2" x 19 1/2"	ADJ. VOLT. RANGE VDC	*MAX. AMPS		Price**
		40°C	60°C	
LM D3	3 ±5%	13.1	9.2	\$199
LM D4	4 ±5%	13.1	9.2	199
LM D4P5	4.5 ±5%	13.1	9.2	199
LM D5	5 ±5%	12.6	9.2	199
LM D6	6 ±5%	12.4	8.9	199
LM D12	12 ±5%	10.0	8.3	199
LM D15	15 ±5%	9.0	7.9	209
LM D20	20 ±5%	7.4	6.5	209
LM D24	24 ±5%	6.7	5.8	219
LM D28	28 ±5%	6.0	5.2	219
LM D48	48 ±5%	4.1	3.6	239
LM D150	150 ±5%	1.1	0.90	254

PACKAGE G 5 1/4" x 19" x 16 1/2"	ADJ. VOLT. RANGE VDC	*MAX. AMPS		Price**
		40°C	60°C	
LM G3	3 ±5%	95.0	62.0	\$575
LM G4	4 ±5%	85.0	62.0	575
LM G4P5	4.5 ±5%	85.0	62.0	575
LM G5	5 ±5%	80.0	62.0	575
LM G6	6 ±5%	80.0	62.0	525
LM G12	12 ±5%	56.0	37.0	525
LM G15	15 ±5%	45.0	36.0	525
LM G20	20 ±5%	35.0	28.0	525
LM G24	24 ±5%	32.0	21.0	480
LM G28	28 ±5%	28.0	21.0	480
LM G48	48 ±5%	17.0	12.0	575
LM G150	150 ±5%	5.5	4.5	675

### NOTE:

Space does not permit listing all LM Series fixed-voltage power supplies. In every package size there are models for each voltage range listed under the B package and all units are multi-current-rated for 40°C, 50°C, 60°C and 71°C. Call or write for data and prices.

\* Current rating is from zero to I max. at ambient. Current rating applies over entire output voltage range.

Current rating applies for input voltage 105-132 VAC 55-65 cps.

For operation at 45-55 cps derate current rating 10%.

For operation at 360-440 cps consult factory for ratings and specifications.

\*\* Prices F.O.B. Factory, Melville, N. Y. All specifications and prices subject to change without notice.



SEND FOR NEW CATALOG ON FIXED VOLTAGE  
AND WIDE RANGE MODULAR POWER SUPPLIES

**LAMBDA** ELECTRONICS CORP. A **Veeco** SUBSIDIARY  
615 BROAD HOLLOW ROAD · MELVILLE, L. I., NEW YORK · 616 MYRTLE 4-4200

rely on

**PERMACOR®**

where  
"custom" cores  
are almost  
"stock items"

At **PERMACOR**, custom powdered iron core production is a way of life. Our engineers are always ready to help you solve your design problems. And production problems are solved quickly, too. This is one reason why we are the largest maker of cores in the world. If you want stock cores, we can give you immediate delivery in quantity. "Custom" cores take slightly longer.

Write for the full story.



**PERMACOR®**

A Division of Radio Cores, Inc.  
9540 Tulley Ave.,  
Oak Lawn, Ill. 60454  
Phone: 312-422-3353

## SEMICONDUCTORS

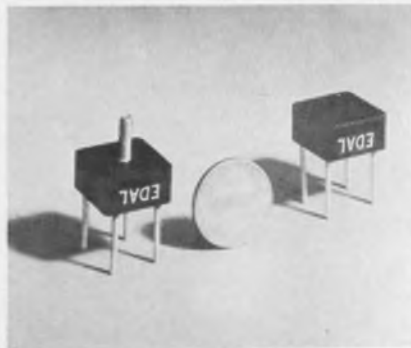

### Rectifier bridge saves wiring time

*Edal Industries Inc., 4 Short Beach Rd., East Haven, Conn. Phone: (203) 467-2591.*

By eliminating the need for assembling diode-bridge circuitry, the Series B191 single-phase bridge silicon rectifier is said to save assembly time and reduce inventory requirements. The 6-A module contains double-diffused controlled avalanche junctions in a cold case design. Voltage ratings range from 50 to 1200 V PIV.

CIRCLE NO. 226

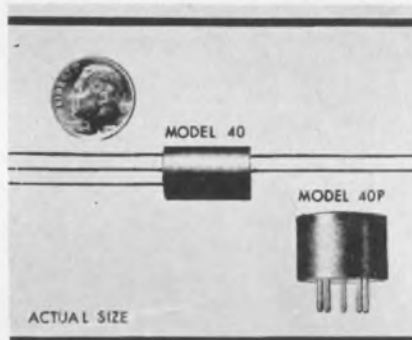

### Solid-state chopper ranges dc to 50 kHz

*Solid State Electronics Co., 15321 Rayen St., Sepulveda, Calif. Phone: (213) 364-2271.*

As choppers or demodulators, the model 40 and 40P have operating ranges of dc to 50 kHz. Linear chopping or demodulation can be accomplished with inputs from a fraction of a millivolt to 15 volts. Model 40 is identical to 40P except that 40 is tubular and is equipped with axial leads while 40P is a 7-pin plug-in module. All silicon transistors are used.

CIRCLE NO. 227

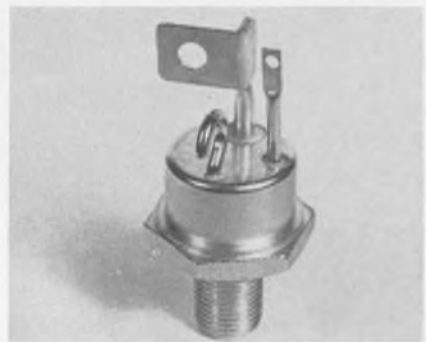

### NPN Si power device controls 100 amps

*Solitron Devices, Inc., 1177 Blue Heron Blvd., Riviera Beach, Fla. Phone: (305) 848-4311. Availability: stock.*

Meeting MIL-S-19500, 2N4866 and 2N4865 provide a 100-amp capability as high-current inverters for supplies and regulators. Combined with the 100-amp capability is a power rating of 350 watts. Sustaining voltage is 80 volts for the 2N4865 and 120 volts for the 2N4866. Cut-off for both is 10 MHz. The transistors have a  $h_{FE}$  of 10-40 at 70 amps and 5 at 90 amps.

CIRCLE NO. 228

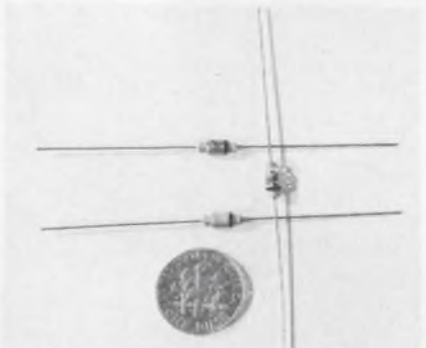

### Mil-type "Varicaps" priced for industry

*TRW Inc., 650 Sepulveda Blvd., El Segundo, Calif. Phone: (213) 322-2566. P&A: \$4.20; stock.*

Priced for industrial use, the JAN IN4801A through 15A Varicap voltage variable diode series conforms to MIL-S-19500/329B. The devices are packaged DO-14 and suggested for use in voltage controlled oscillators, delay lines and AFC circuitry. A variety of lead materials are offered.

CIRCLE NO. 229



## DC-500 MHz Mixers at realistic prices

RELCOM engineers have produced a new family . . . indeed, a new generation . . . of broadband mixers. Six models in three sizes for frequency mixing, phase detection, amplitude and pulse modulation.

Small size — .75x.5x.4" to 2x1x.6" Realistic prices — starting at \$50 for the miniature model M8. Only \$150 for the pocket-lighter size model M1. Heavy discounts on higher quantities. If you're looking for more than size and price in a rugged,

lightweight mixer, RELCOM offers other significant plus factors.

- PC mounting • Exceptional balance • Low level intermodulation products • Low noise figure
- Very low 1/f noise • Extremely wide dynamic range •  $\pm 0.3$  dB from 1 MHz thru 50 MHz
- Excellent RFI performance •  $-20$  to  $+65^\circ\text{C}$  operation • 1 year warranty

### SPECIFICATIONS

MODEL	IMP. (Ohms)	FREQ.* RANGE (MHz)	Type	BALANCE		CONV. EFF. & SSB NOISE FIGURE (dB)		CONN.	SIZE  (in.)	PRICE		
				L to R & I (dB)		1.0-50 MHz				1-4	5-9	10-29
				0.2-50 MHz	Remaining Freq. Range	1.0-50 MHz	Remaining Freq. Range					
M1	50	0.2-500	Double	40	20	6.5	8.5	BNC	2x1x.6	\$150	\$133	\$126
M2	50-75	0.2-500	Single	35	15	6.5	8.5	BNC	2x1x.6	110	98	92
M5	50	0.2-500	Double	35	20	6.5	9.5	Pins	1x.5x.4	100	98	92
M6	50-75	0.2-200	Double	35	20	6.5	7.5	Pins	1x.5x.4	90	80	76
M7	50-75	0.2-500	Single	35	15	6.5	8.5	Pins	.75x.5x.4	70	62	59
M8	50-75	0.2-200	Single	35	15	6.5	7.5	Pins	.75x.5x.4	50	44	42

\*R & L ports shown. I port: DC-500 MHz.

RELCOM's new family of mixers now available. Call collect to place orders.

# RELCOM

. . . for reliable rf signal processing components  
2164 E. Middlefield Road, Mountain View,  
California 94040 Telephone: (415) 961-6265

ON READER-SERVICE CARD CIRCLE 64



## **NEW LOW PRICES**

### **High Voltage Silicon Power Transistors**



**The new  
DTS 410  
(200v., 3.5a)  
\$1.95 each\***



**DTS 411  
(300v., 3.5a)  
Were \$5.75 ea.,  
now \$3.15 ea.\***



**DTS 413  
(400v., 2.0a)  
Were \$6.50 ea.,  
now \$3.95 ea.\***



**DTS 423  
(400v., 3.5a)  
Were \$7.16 ea.,  
now \$4.95 ea.\***

# We just lowered the cost of lowering the cost of high-energy circuits.

From now on, the cost-cutting advantages of Delco NPN high voltage silicon power transistors cost even less. Look over the new low prices on the opposite page.

You can use these transistors in applications ranging from large screen video deflection and line operated class A audio output to high voltage, high efficiency regulators, converters and (VLF) amplifiers.

By using Delco high voltage silicon power transistors, you can reduce the number and complexity of input, output and filtering components. Fewer components mean lower assembly cost, shorter assembly time. There's less chance for breakdown—lower maintenance costs. Circuitry can be more compact, lighter and easier to keep cool.

\*Prices shown are for quantities of 1,000 or more.

**FIELD SALES OFFICES**  
 UNION, NEW JERSEY\*\* Box 1018 Chestnut Station (201) 687-3770  
 DETROIT, MICHIGAN 57 Harper Avenue (313) 873-6560  
 SANTA MONICA, CALIF.\*\* 726 Santa Monica Blvd. (213) 393-1465  
 SYRACUSE, NEW YORK 1054 James Street (315) 472-2668  
 CHICAGO, ILLINOIS\*\* 5151 N. Harlem Avenue (312) 775-5411  
 General Sales Office: 700 E. Firmin, Kokomo, Ind. (317) 459-2175

\*\*Office includes field lab and resident engineer for applications assistance

These NPN silicon transistors are fabricated by our unique Delco 3-D process that provides high voltage protection, high frequency response and low saturation resistance. Each is packaged in a solid copper coldweld Delco TO3 case for low thermal resistance. Inside, they are ruggedly mounted to withstand mechanical and thermal shock due to special bonding of the emitter to base contacts.

Contact your nearest Delco sales office or distributor for complete data, application assistance or immediate delivery.

TYPE	V <sub>CEO</sub>	V <sub>CEO</sub> (sus)	I <sub>C</sub> Max	h <sub>FE</sub> Min V <sub>CE</sub> =5V @ I <sub>C</sub>	Power Diss Max
DTS 410	200V	200V (min)	3.5A	10 @ 2.5A	80W
DTS 411	300V	300V (min)	3.5A	10 @ 2.5A	100W
DTS 413	400V	325V (min)	2.0A	15 @ 1.0A	75W
DTS 423	400V	325V (min)	3.5A	10 @ 2.5A	100W

## DELCO RADIO

Division of General Motors, Kokomo, Indiana



ON READER-SERVICE CARD CIRCLE 65

# SCANBE

SPECIALISTS IN  
CIRCUIT CARD  
MOUNTING SYSTEMS

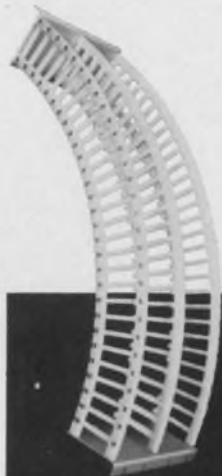

Scanbe offers the widest selection of hardware for electronic packaging emphasizing circuit card mounting. Products include card guides, card files, equipment drawers and complex system size configurations. Other Scanbe products include microcircuit mounting clips, card ejectors, drawer slides and card connectors. Available as kits, as standard items or many special items. Write for complete catalog.



**SCANBE MANUFACTURING CORP.**  
1181 MONTEREY PAGES RD., MONTEREY PARK CALIF.  
TELEPHONE: (213) 284-2300 TWX 266-6853

ON READER-SERVICE CARD CIRCLE 66

## COMPONENTS

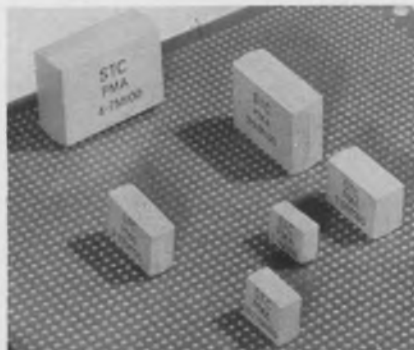

### Data switch gives up to 512 closures

3M Company, 300 S. Lewis Rd., Camarillo, Calif. Phone: (805) 482-1911.

A programmable switching matrix can save valuable set-up and execution time in a check-out operation. For comparatively sophisticated systems, the 3900 series data switch programs up to 512 contact closures. Programming is via address and BCD interconnect and command. For even more capacity, the matrix can be expanded in 4 x 16 increments.

CIRCLE NO. 241

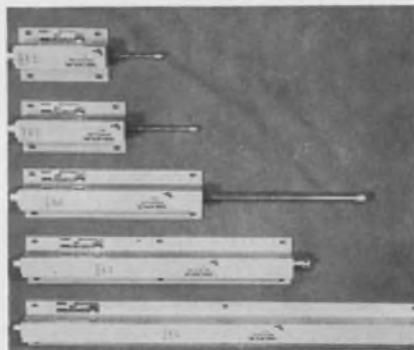

### Transducers have infinite resolution

Trans-Data Inc., 821 Wheeler Ave., Huntsville, Ala. Phone: (205) 539-2237.

A family of infinite resolution linear displacement transducers from Trans-Data feature low output impedance. These transducers have standard displacements from 1 to 16 inches spring loaded in or out, or without spring loading. Max output impedance is 10 ohms and sensitivity is 1-mV/in./volt. Calibration is internal and terminal linearity is 0.15%.

CIRCLE NO. 242



### Coupling unit aids in mechanical phasing

Designatronics Inc., 76 E. Second St., Mineola, N. Y. Phone: (516) 741-7070.

Close tolerance adjustments of the relative angular relationship between rotating components, after installation, is the function of the 9902 zero-adjustable coupling. The coupling is operated with an adjusting wrench that varies the angular phase of the coupling halves at the rate of 9°/turn. The unit is balanced to operate at high speeds without vibration and the requirements of MIL-E-5272 are met.

CIRCLE NO. 243



### Special-function pot based on new design

Ventura Scientific, P. O. Box 1202, Thousand Oaks, Calif.

Special-function potentiometer cost and lead time are said to be cut sharply by use of the model 4001 pot. The component can be fabricated to your specs quickly and at reduced costs since it uses resistor-bridged commutator segments rather than the usual continuous resistance element. From 57 to 60 resistors are used to perform a function within these pots.

CIRCLE NO. 244

ON READER-SERVICE CARD CIRCLE 67

Is there really a choice in differential voltmeters? You bet! You can buy Fluke solid state dc, ac/dc, or true rms differential voltmeters or you can buy our vacuum tube versions. After you take a look at the brief specs of each model, it's a sure thing you won't care about anyone else's differential voltmeter (if there are any).

DC DIFFERENTIAL VOLTMETERS						
MODEL	INPUT VOLTAGE	ACCURACY % OF INPUT	INPUT IMPEDANCE	MAX. METER RESOLUTION	PRICE	NOTES
801B	0-500 VDC	±0.05%	Infinite at null	50 uV	\$ 485.00	} +\$20 for rack models
825A	0-500 VDC	±0.02%		5 uV	\$ 590.00	
821A	0-500 VDC	±0.01%	Infinite at null	5 uV	\$ 795.00	} +\$130.00 for rechargeable battery pack
871A*	0-1100 VDC	±0.02%		10 uV	\$ 565.00	
881A*	0-1100 VDC	±0.005%	to ±11V 10 Meg	1 uV	\$ 825.00	}
885A*	0-1100 VDC	±0.0025%	above ± 14V	1 uV	\$ 965.00	
895A*	0-1100 VDC	±0.0025%	Infinite at null to ±1100V	1 uV	\$1,195.00	
AC/DC DIFFERENTIAL VOLTMETERS						
803B	0-500V AC or DC	±0.05% DC, ±0.2% AC	Infinite at null DC	50 uV	\$ 875.00	} +\$20 for rack models
803D	0-500V AC or DC	±0.02% DC, ±0.1% AC		5 uV	\$1,055.00	
823A	0-500V AC or DC	±0.01% DC, ±0.1% AC	1 Meg, 35-50 pf AC	5 uV	\$1,215.00	} +\$160.00 for rechargeable battery pack
873A*	0-1100V AC or DC	±0.02% DC, ±0.2% AC	Infinite at null to 10 Meg above 11 VDC	10 uV	\$ 875.00	
883A*	0-1100V AC or DC	±0.005% DC, ±0.1% AC		1 uV	\$1,215.00	}
887A*	0-1100V AC or DC	±0.0025% DC, ±0.05% AC	1 Meg, 40 pf AC	1 uV	\$1,375.00	
TRUE RMS DIFFERENTIAL VOLTMETER						
931A*	0-1100V AC	±0.05% AC	1 Meg, 8 pf with BNC Input	20 ppm of dial setting	\$ 895.00	+\$ 50.00 for permanent probe
			1 Meg, 5 pf with probe			+\$100.00 for rechargeable battery pack



FLUKE • Box 7428, Seattle, Washington 98133 • Phone: (206) 774-2211 • TWX: (910) 449-2850

All Fluke differential voltmeters from the least costly on up offer standard lab performance in portable instrumentation. They are "human engineered" for easy use. They give you direct digital readout, with automatic decimal point indicator. Fluke differential voltmeters feature highest possible off-null resistance. Solid state units are available as bench-top models adaptable for half-rack or full-rack mounting. All vacuum tube versions are available in cabinet or full-rack configurations. More accessories are available for greater flexibility. All but one of the solid state models are offered in both line and rechargeable battery operated versions. For full information, please call your Fluke sales engineer or write us.

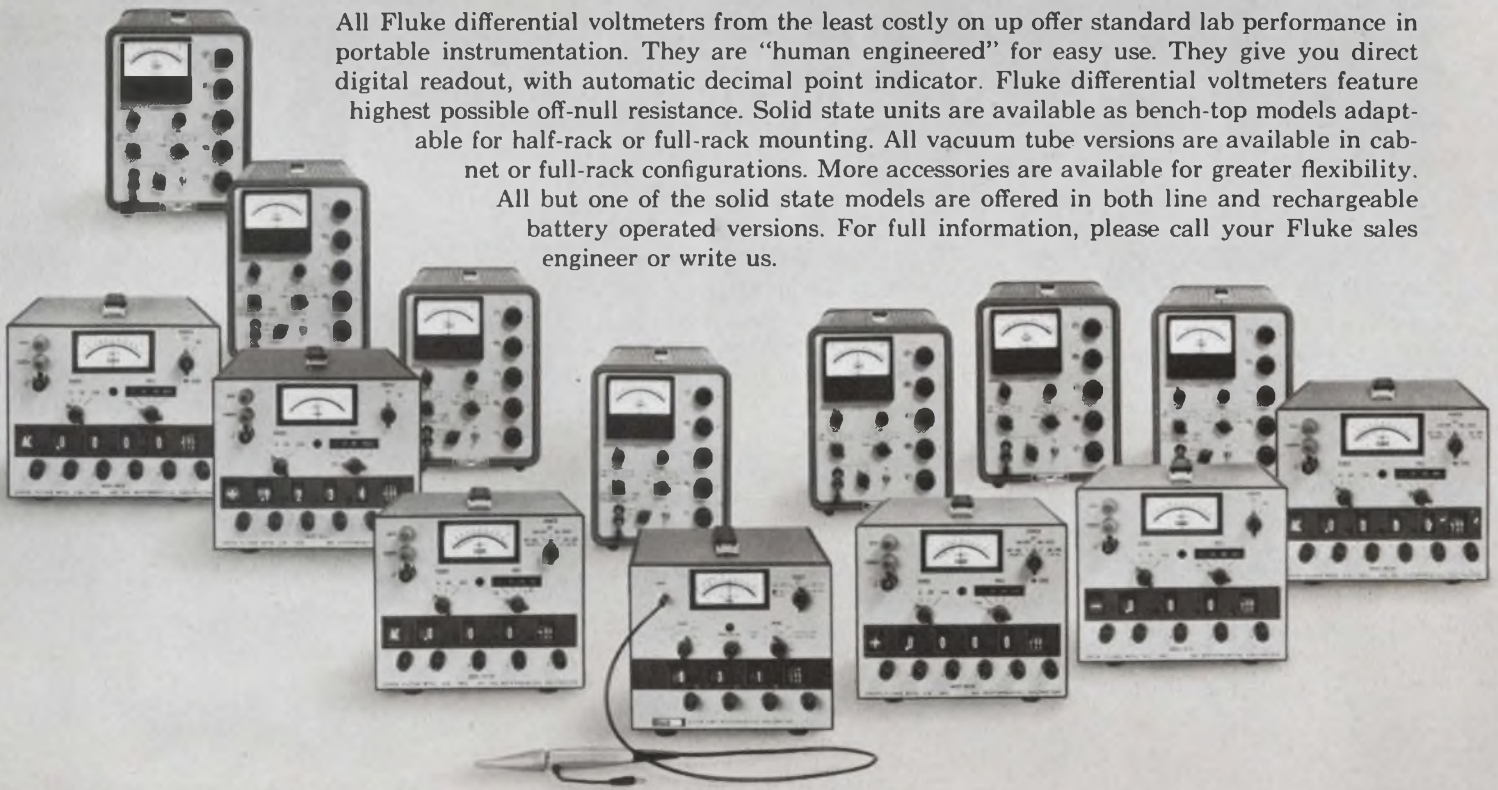



ACTUAL SIZE

## This new, sealed DIGISWITCH thumbwheel switch is designed for digital numerical machine and process controls

PHOTO COURTESY DATEG CORPORATION

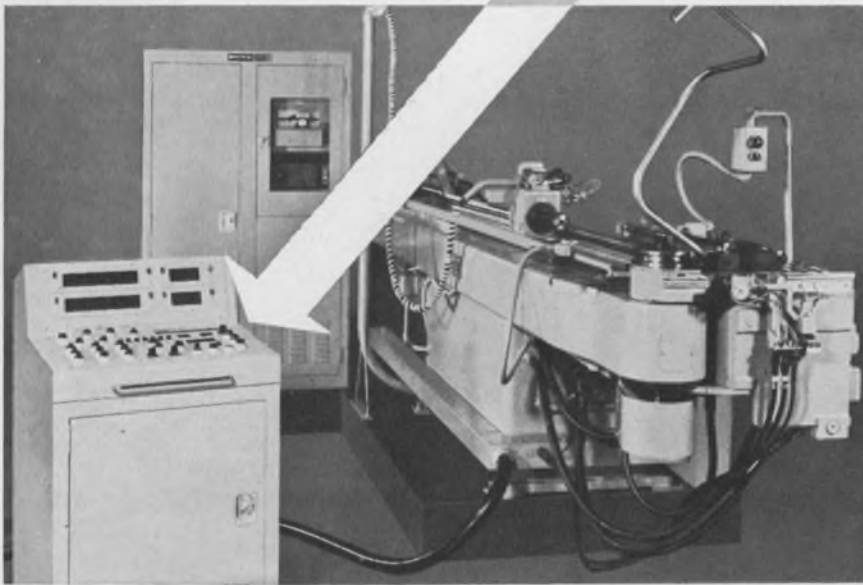

If your control equipment is subjected to fumes, oil, grease, humidity, coolants, chips, dust and the general hostile environment of today's high-speed production and processing machines—you need the new, all-sealed Series 9000 Digiswitch. More than 100 standard types of coded electrical outputs available. Output terminals can be soldered directly or mated with standard printed circuit board connectors. Components may be mounted directly to the PCB extension at the rear of the switch case.

Modules are .600 inch wide x 1.90 inch high with 2, 8, 10, 12, or 16 dial positions—for substantial savings in panel space. Special dial markings and dial stops are available on request.

Series 19000 is identical to Series 9000 except it is sealed against dust only. The O-ring seal around the drive shaft is eliminated and rear of switch case is not potted around the PCB. For complete data on Series 9000 and 19000, or a copy of Digitran's new catalog, please contact

## THE DIGITRAN COMPANY



A division of Endevco Corporation

855 SOUTH ARROYO PARKWAY, PASADENA, CALIFORNIA 91105 • PHONE 213/449-3110  
ON READER-SERVICE CARD CIRCLE 68

## COMPONENTS

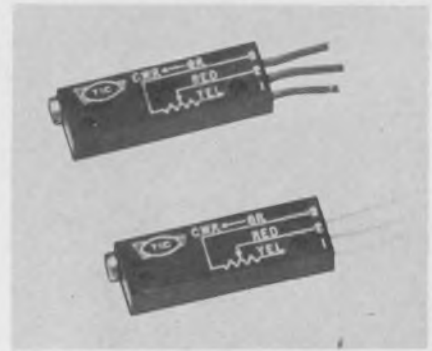

### Miniature trimmers have ceramic mandrels

*Technology Instrument Corp. of California, 850 Lawrence Dr., Newbury Park, Calif. Phone: (805) 498-2165.*

Ceramic mandrels and multiple, wire-welded terminals are the leading features of the TR-2 series RT-10 trimmers. Eleven standard resistances are offered in a range from 10 ohms to 20 kΩ. Meeting the requirements of MIL-R-27208A, the trimmers are housed in heat-resistant plastic and will serve at ambients from  $-65^{\circ}$  to  $+175^{\circ}$ C. Power handling is rated 1 W at  $70^{\circ}$ C.

CIRCLE NO. 245

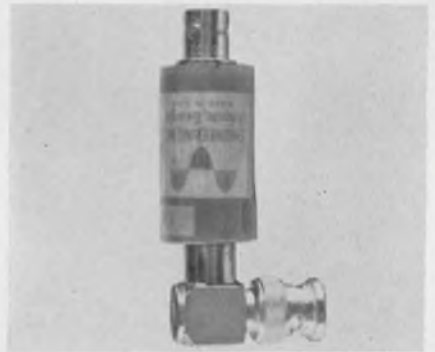

### Coax transformer steps-up, isolates

*RMS Engineering Inc., 486 Fourteenth St., N. W., Atlanta. Phone: (404) 873-5257. P&A: \$13.00; stock.*

At the end points of a frequency reference distribution system, the Model 5920 coaxial transformer gives needed isolation. It also allows the use of low-level distribution systems with instruments such as counters that require several volts for an external frequency reference. Toroidal design is used with turns ratios of 1:1, 1:3 or 1:5. Bandwidth is 100 KHz to 1 MHz.

CIRCLE NO. 246



## Linear accelerometers sensitive to 0.015 G/G

Bourns, Inc., 1200 Columbia Ave., Riverside, Calif. Phone: (714) 684-1700.

A transverse sensitivity of 0.015 G/G is typical for the Model 625 and 627 translational/potentiometric linear accelerometers. Both are designed with a translational spring-mass system that is said to minimize cross-axis error and hold it constant throughout the instrument range. Model 627 offers the additional feature of wiper lift-off to eliminate element wear during storage and transportation or when the unit is unenergized.

CIRCLE NO. 247

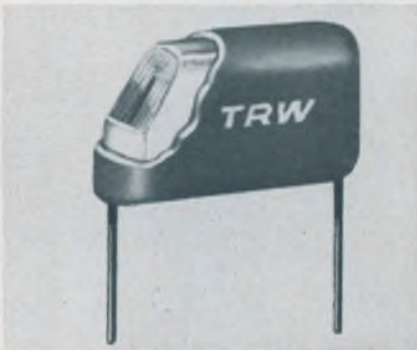

## Mylar capacitors metallized, epoxy dipped

TRW Inc., 1100 Glendon Ave., Los Angeles, Calif. Phone: (213) 477-6061. Availability: 3 weeks.

For printed circuit applications the XG01PE epoxy dipped metallized Mylar capacitors have flattened radial lead configurations. These components are said to be 50% smaller than film foil units of comparable value. Available values are 0.01 mfd to 10 mfd in 20%, 10% and 5% tolerances and ratings of 100 and 200 V.

CIRCLE NO. 248

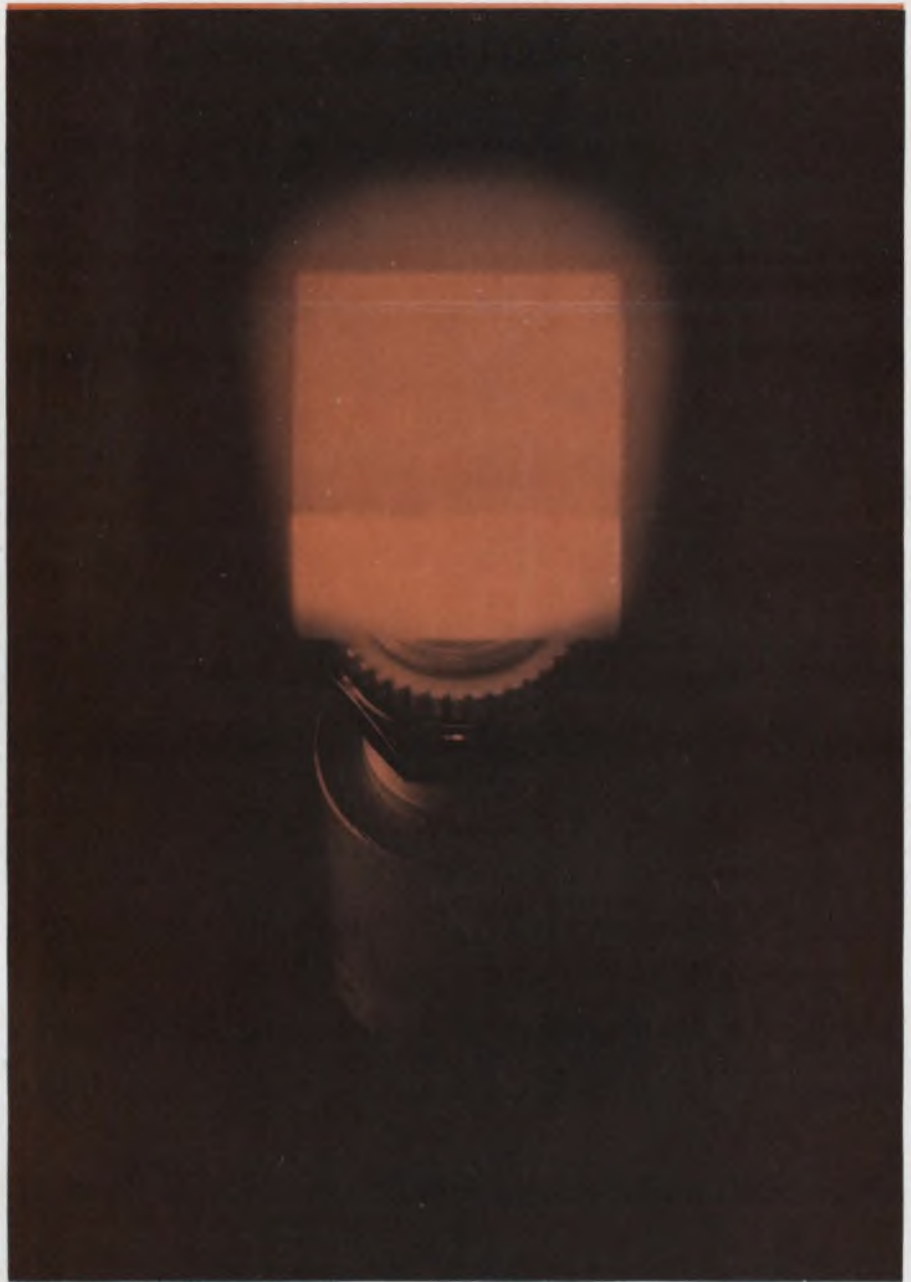

## new light on control panel design

Marco-Oak Presslite® switches give you instant light and color check of system status. They're the smallest illuminated pushbuttons available with contact ratings of 5 or 15 amps up to 120 vac...maximum body width or diameter is less than 3/4". Independent and isolated lamp circuits to indicate switch mode or remote system status mean less panel space, greater design latitude. Snap-action assures long contact life with a wide safety margin even beyond rated currents.

Presslite switches are available with a variety of options: SPDT or DPDT, alternate or momentary action, midget flange base, incandescent or neon lamps (with ballast resistors built into switch base). Ten basic cap styles (including Press-in caps in six sizes and shapes) give you a full color range. Matching indicators and recess panel mounting adaptors also available. Write today for the new S-66 Presslite catalog.

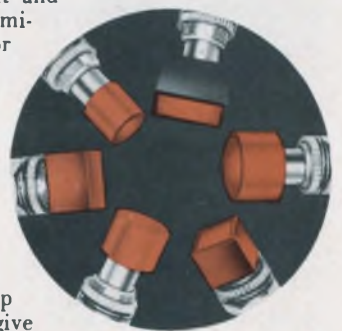

MARCO-OAK

A division of OAK ELECTRO/NETICS CORP  
207 S. Helena St., Anaheim, California 92805

ON READER-SERVICE CARD CIRCLE 69

**You  
can display  
anything  
with IEE  
series 10  
rear-projection  
readouts**



**numbers,  
letters,  
words, symbols,  
even colors!**

IEE readouts display anything that can be put on film, even colors! Single-plane presentation makes for visual crispness; bright, bold characters (up to 1" in height) for remarkable clarity. So if readability and versatility are what you're after, look into IEE Series 10 Readouts. Five other models available with maximum character heights from  $\frac{3}{8}$ " to  $3\frac{3}{8}$ ".

Send today for complete information on IEE rear-projection readouts and accessories!

**IEE INDUSTRIAL ELECTRONIC ENGINEERS, INC.**

7720 Lemona Avenue, Van Nuys, California  
Phone: (213) 787-0311 • TWX (910) 495-1707  
Representatives in Principal Cities © 1966 IEE

ON READER-SERVICE CARD CIRCLE 70

COMPONENTS

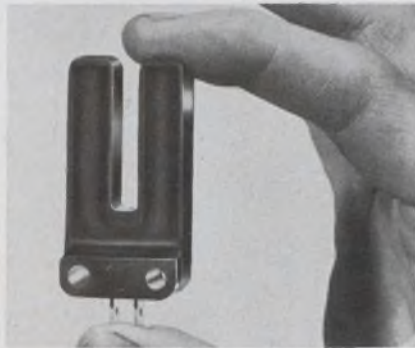

**Vane-switched reed  
for industrial control**

*Ampere Electronic Corp., Hicksville, N. Y. Phone: (516) 931-6200. P&A: \$4.50; stock.*

Designed to be used as a limit switch, position indicator or as a signal source for low counting speeds, an iron vane-switched reed measures 0.245 x 0.561 x 2.17-in. long. The unit consists of a magnet and a reed switch encapsulated in a U-shaped plastic housing. In conjunction with dc amplifiers or with thyristor trigger module, the switch can also be used for power switching.

CIRCLE NO. 249

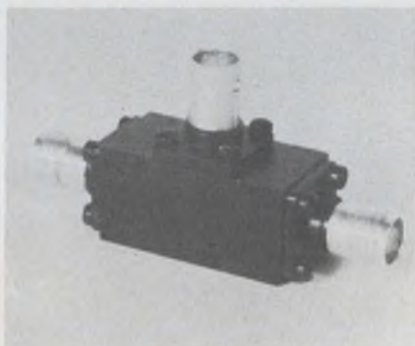

**50 dB diode switch with  
low insertion loss**

*Alpha Industries, Inc., 381 Elliot St., Newton Upper Falls, Mass. Phone: (617) 969-6480.*

Rock-bottom insertion loss, 0.3 dB at 50 dB isolation, is the primary specification of the MT-3002 diode switch. The component gives spst action over the 1200-1450 MHz range. Other specs include: max peak power rating of 1 kW, max cw power rating of 2 W, and a nominal switching speed of 25 nsec. Similar units are offered for uhf and L-band use.

CIRCLE NO. 250

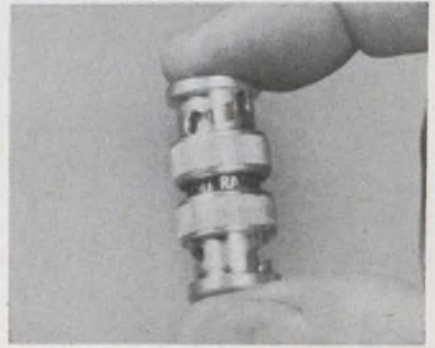

**Step-recovery diode  
ranges dc to 10 GHz**

*Somerset Radiation Laboratory, Inc., 2060 North 14th St., Arlington, Va. Phone: (703) 525-4255. P&A: \$130; 5 days.*

A single harmonic generator and pulser for the entire zero to 10 GHz range is seen in the B830 step recovery diode multiplier. Conversion efficiency is 200% divided by the operating harmonic number. For highest efficiency output at one frequency, an external cavity or tank can be used. For a comb of harmonics the B830 can be used with a low-Q output circuit.

CIRCLE NO. 251

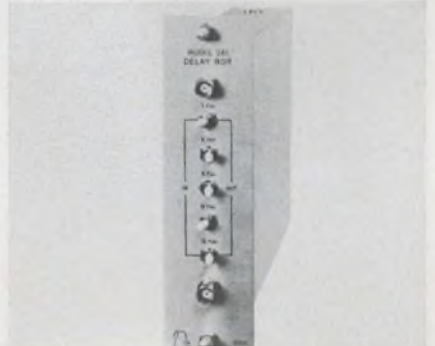

**Switchable delay  
incremented to 1 nsec**

*Nanosecond Systems, Inc., 176 Linwood Ave., Fairfield, Conn. Phone: (203) 255-1008.*

Following the binary system for application convenience, the 261N passive delay is switchable in 1-nsec increments. With a rated accuracy of +0.1 nsec the unit has a total max delay of 31 nsec. Input and output connections are made via BNC connectors and impedance is 50 ohms. Packing is either per AEC Report TID 20893 or 2 x 7-1/2 x 8-1/2-in. modules.

CIRCLE NO. 252

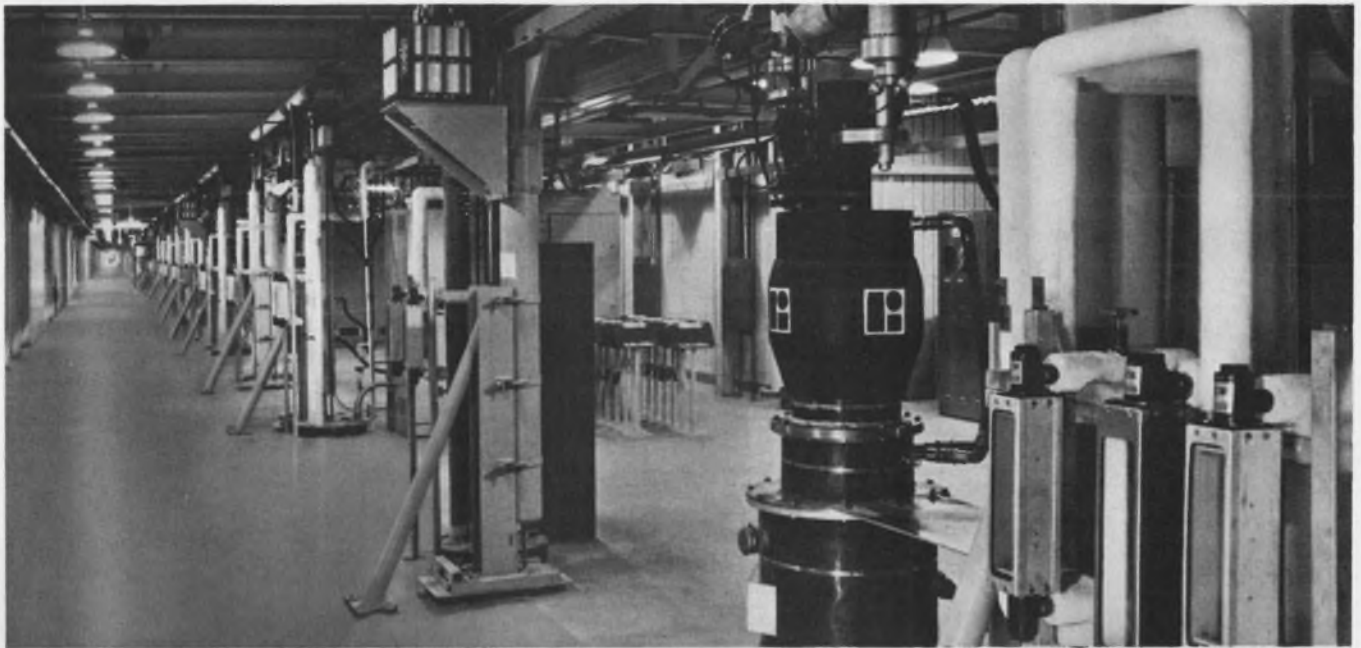

**In linear accelerator klystrons, the real problem is achieving long life at low operating cost.**



### **That's why we designed the new L-3980.**

Litton's new S-band pulsed amplifier klystron assures years of operation at 21Mw peak power on a .0009 duty cycle. And does it at a cost as low as \$.75 per hour.

Only Litton can offer klystrons with this kind of guaranteed low operating cost. That's because only Litton has the design and production experience to make it possible.

Put this ingenuity to work on your klystron applications.

Contact us with your requirements, or send for our L-3980 Data Package. Electron Tube Division, 960 Industrial Road, San Carlos, California 94070.

 **LITTON INDUSTRIES**  
ELECTRON TUBE DIVISION

ON READER-SERVICE CARD CIRCLE 71



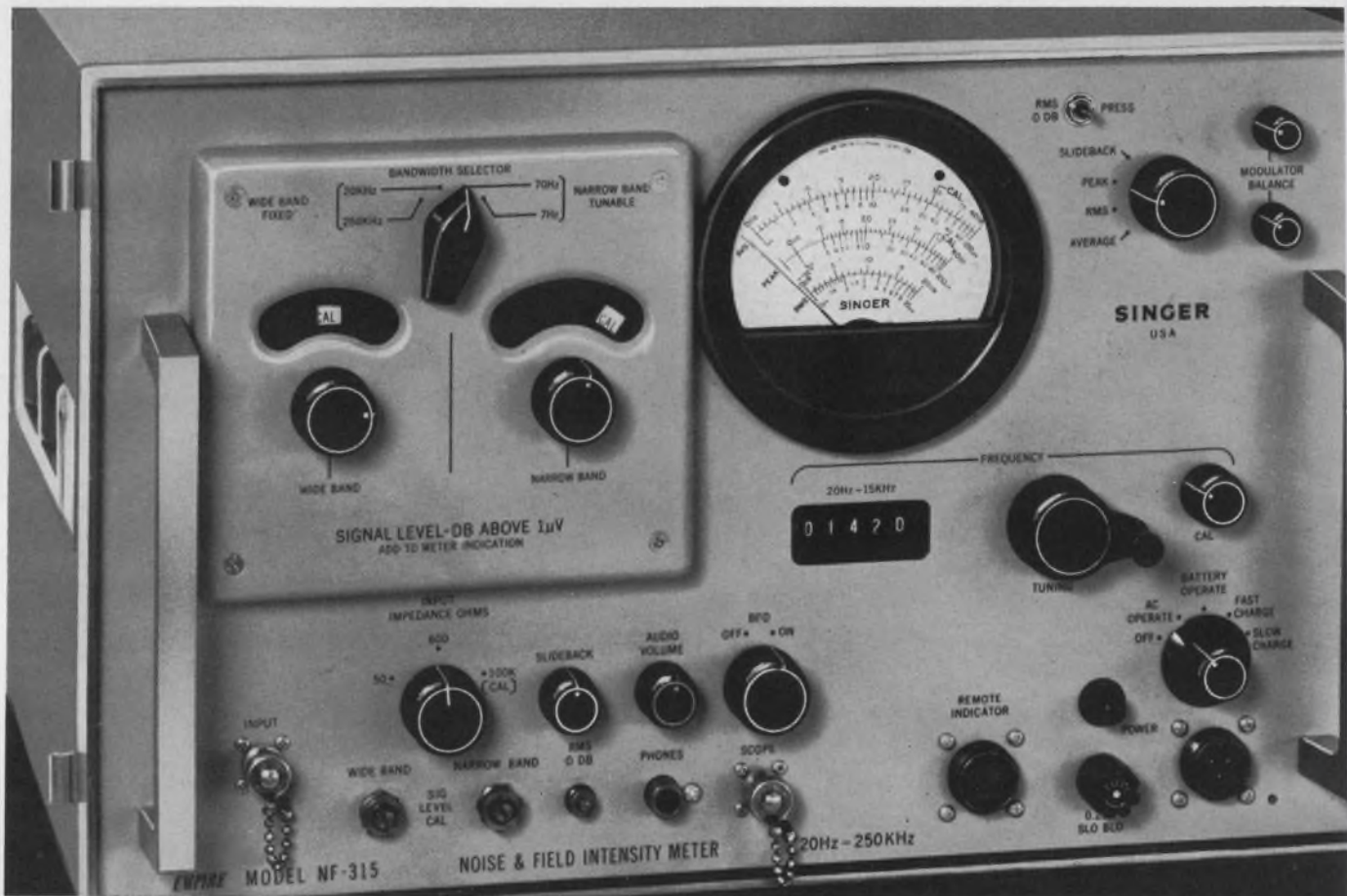

## MATERIALS



### Clad-metal wire saves copper

Texas Instruments, Inc., Attleboro, Mass. Phone: (617) 222-2800.

The scarcity of copper prompts the introduction of a line of clad metal wire made up of a skin of copper covering an aluminum body. This process, according to the manufacturer, enables wire suppliers to stretch their copper supply by as much as ten times and save up to 40% on material costs. The clad wire is equal to a solid copper conductor 24% smaller at low frequencies and virtually equal in high-frequency use.

CIRCLE NO. 253



### Epoxy adhesive cures at room temperature

Resin Formulators Co., Div. of E. V. Roberts & Assocs., 9601 W. Jefferson Blvd., Culver City, Calif. Phone: (213) 870-9561.

For general use, the two-part epoxy Resinbond 907 cures at room temperature to form a bond to 4000 psi. Features include a negligible shrinkage factor, -300 to 180°F temperature range and the ability to be drilled, sanded, machined or painted after cure. The resin is pale green in color when cured.

CIRCLE NO. 254

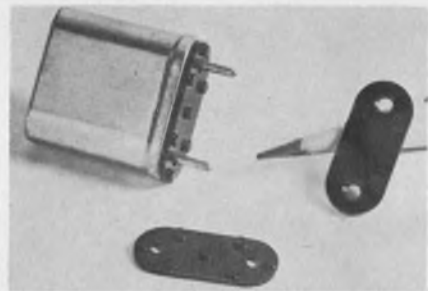

### Frequency crystals can be soldered to PC boards

Milton Ross Co., 511 Second St., Pike, Southampton, Pa. Phone: (215) 355-0200.

Frequency crystals can be soldered directly to a printed-circuit board with the #10274-DAP Transipad. This support allows for wash-away of solder flux after the can is attached to its board. Seven spacers allow air-flow under the crystal, preventing moisture accumulation. The pad is molded of black diallyl phthalate and measures 0.312 x 0.730 in. with 0.70-in. diameter holes on 0.486-in. centers.

CIRCLE NO. 255

# THE NEW STANDARD

## in 20-15000 Hz EMI measurements

### EMPIRE\* NF-315 Solid State Noise and Field Intensity Meter

Here in one light, compact package is everything you need to perform rapid EMI measurements with confidence: Solid-state dependability □ Internal frequency and amplitude calibrators for on-the-spot checking □ 0.005 microvolt sensitivity □ Greater than 70 db spurious response rejection □ Signal range of 180 db □ 8 hours of continuous portable operation with built-in rechargeable battery □ Highly-stabilized circuits to eliminate recalibrations when tuning to new frequencies. All-in-all, the sophisticated simplicity which adds up to engineering elegance.

The NF-315 is a precise, sensitive, easy to use instrument — backed by a company with an unparalleled dependability record. Military and civilian government agencies, major aerospace contractors insist on the NF-315. You should, too!

Write for brochure.



\*A Trademark of THE SINGER COMPANY

EMPIRE • GERTSCH • PANORAMIC • SENSITIVE RESEARCH

**SINGER**  
INSTRUMENTATION

THE SINGER COMPANY, METRICS DIVISION • 915 Pembroke St., Bridgeport, Conn. 06608, U. S. A. • PHONE (203) 366-3201

E-66-12 A

ON READER-SERVICE CARD CIRCLE 72

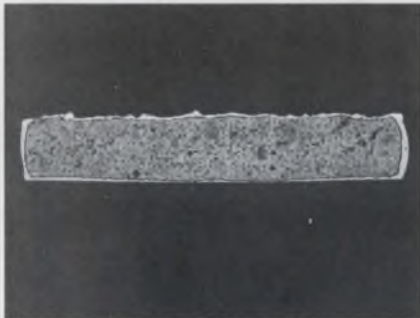

### Nickel-alloy ribbon plated with gold

Engelhard Industries, 113 Astor St., Newark, N. J. Phone: (201) 242-2700.

You can emboss gold-clad Iconel ribbon to finishes as rough as 90  $\mu$ m without rupturing the gold. The ribbon, with a 0.0003-in. plate, is offered to combine the characteristics of cold-worked Iconel with those of a gold-alloy sheath. Typical ribbon size is 0.0035-in. thick by 0.018-in. wide. Applications where spring-strength and conductivity are required are suggested.

CIRCLE NO. 256



### Potting compound conducts heat

Astrodyne Inc., 207 Cambridge St., Burlington, Mass. Phone: (617) 272-3850. Price: from \$4.25/small box.

For effective heat transfer from components to chassis or heat sink, Astrodyne offers Compound 166. The two-component system has a low thermal coefficient of expansion and a conductivity of 7.4 BTU/hr-ft<sup>2</sup>-°F/inch. It was specifically developed for potting transformers, resistors and rectifiers. Though generally supplied in individual boxes for single batches, bulk quantities are also available.

CIRCLE NO. 257

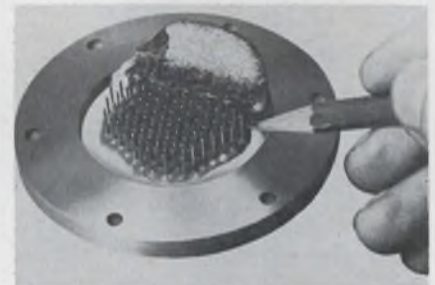

### Reactive solvent dissolves urethane

Dynaloy Inc., 408 Adams St., Newark, N. J. Phone: (201) 622-3228. Price: from \$6.95/gal.

Cured urethane resins can be removed from electronic components by a reactive solvent called Uresolve HF. The clear, yellow-brown liquid is said to completely dissolve the urethane potting without damaging other plastic components or metals. Uresolve is also offered as an aid in packaging. Its slow etching action on DAP and anhydride-cured epoxies aids the adhesion properties of epoxies and other encapsulants.

CIRCLE NO. 258

# D/A Converter with 8-Bit IC Register!

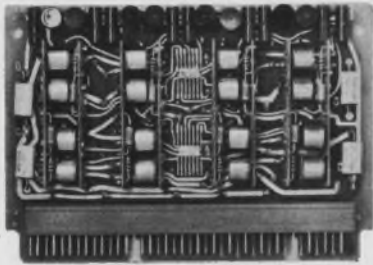

## MONILOGIC Type A51

Our new Type A51 Integrated Circuit D/A Converter is really self-contained. On a single standard 3.3" x 4.65" MONILOGIC card you get:

- a fully buffered 8-bit storage register driving an 8-bit D/A conversion network
- fully clocked jam-type inputs
- fully gated input transfer signals
- accommodation of parallel digital inputs as high as 300 kc
- 5 volt output full scale
- 0.1% accuracy full scale
- 9 easily accessible test points

Here's the logic of it all:

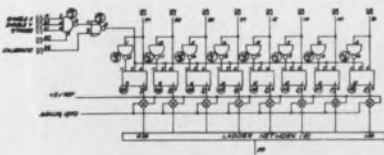

As an added incentive, consider this: you can use the outputs of two of our A51s to drive your recorders, servo systems, oscillators, etc., using only one of our Type A56 dual DC-amplifier cards as a complement. Result: greater operating efficiency at far lower cost. See for yourself.

PHONE 215-848-8100  
TWX 215-848-9398

**MONITOR**  
SYSTEMS INC.

FORT WASHINGTON, PENNSYLVANIA

A SUBSIDIARY OF *Spaco*

ON READER-SERVICE CARD CIRCLE 73

## SYSTEMS

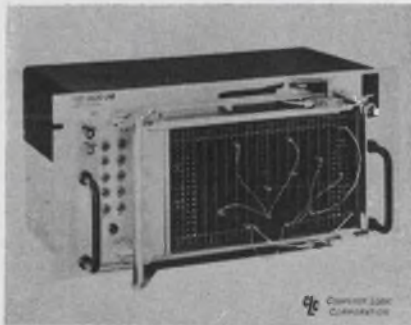

## Digital problem-solver called "universal"

Computer Logic Corp., 1528 20th St., Santa Monica, Calif. Phone: (213) 451-9754. Price: \$1240.

Applications such as generating and checking of word, code and format, interface problem-solving, proving system timing, even digital computation are cited for two "universal" logic instruments. Logic-Lab LL-350, for IC logic cards, and LL-150 for discrete cards are both fully assembled and tested. The basic frame includes the cover, patch-board, patchcords, terminals and connectors.

CIRCLE NO. 259

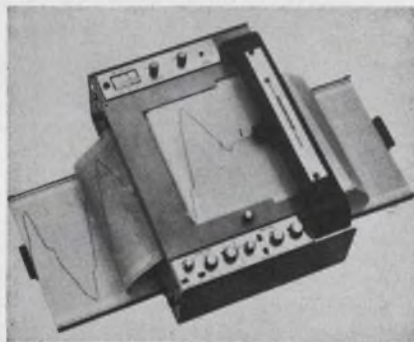

## Incremental plotter operates bidirectionally

Houston Omnigraphic Corp., 4950 Terminal Ave., Bellaire, Texas. Phone: (713) 667-7403. P&A: \$2850; 4 wks.

A record that you can read like a book, rather than a scroll, is provided by the model 6650 bidirectional incremental plotter. The recorder uses fan-fold paper that can be separated at perforated lines into standard-size pages. Recorder accuracy is 0.002-in. and the independently moveable pen and paper move at speeds to 18,000 increments per minutes.

CIRCLE NO. 260

## HAROWE INTEGRAL GEARED SERVO MOTORS



## Built together, Housed together, To work together

Harowe builds servo motors and precision gearheads (AGMA class II or better) in the same facility...then houses them in one-piece stainless steel cases.

One-piece case eliminates up to 14 coupling parts; guarantees accurate alignment; conducts heat better for cooler operation. And one-source responsibility gives you industry's shortest lead time on geared servo motors.

New catalog lists 61 standard ratios for sizes 8, 10, 11, 15, and 18 motors and motor-generators. (Any other ratio readily available.) Request your copy from—



Servo, Stepper &  
Synchronous Motors  
Motor Generators • Synchros  
Resolvers • Pancakes • Gearheads

## HAROWE SERVO CONTROLS, INC.

24 Westtown Road  
West Chester, Pa. 19380  
(215) 692-2700

ON READER-SERVICE CARD CIRCLE 74



## IC core memory rated 750 nsec

Honeywell, Computer Control Div.,  
Old Connecticut Path, Framingham,  
Mass. Phone: (617) 879-2600.

Especially designed for OEM applications, the ICM-47  $\mu$ -Store memory has a full-cycle time of 750 nsec. The basic design of the ICM-47 eliminates the adjustments and controls required by other memories, limits application of "Murphy's Law" and simplifies maintenance. For 4096 and 8192 word memories, max word length is 28-bits per module. In 16,384-word systems, lengths up to 14-bits are available.

CIRCLE NO. 261

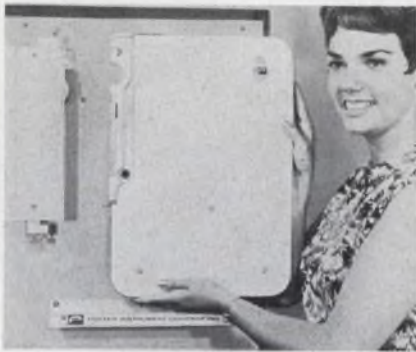

## Tape loop transport is cartridge loading

Potter Instrument Co. Inc., 151  
Sunnyside Blvd., Plainview, N. Y.  
Phone: (516) 681-3200.

Especially designed for correlation of data and real-time analysis in geophysics, aircraft and ship-board applications, the modular LT=1500 tape loop transport features interchangeable cartridge loading. The package operates from a 12-V battery drawing 300 W and provides six speeds through a single capstan drive system. Storage is rated 35 Mbits with transfer at 192,000 ch/s.

CIRCLE NO. 262

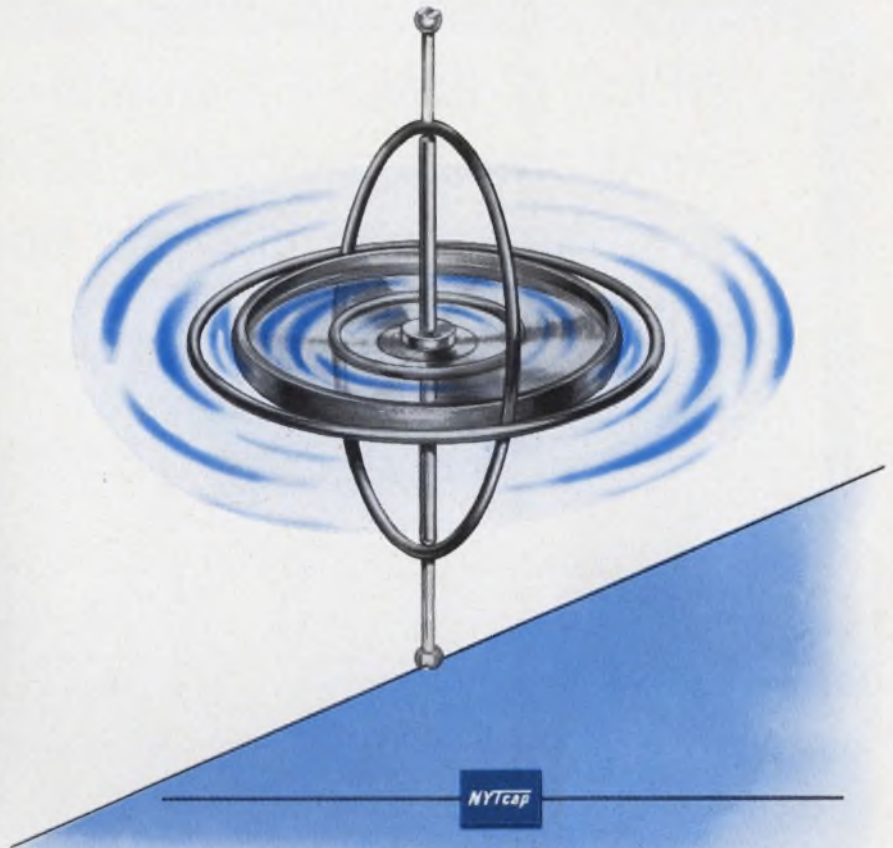

## Now! a Ceramic Capacitor that provides exceptional stability!

The new NYT-CAP concentrates within its miniaturized envelope the highly sophisticated capacitance stability and reliability needed for oscillators, filters, and other critical circuitry applications.

The new Nytcap is packaged in a molded epoxy case 0.350" x 0.250" x 0.1" (designed for high density applications), it has a capacitance range of 100pf to 1000 pf, with a tolerance of  $\pm 10\%$ , a rating of 200 volts D.C. and a temperature coefficient within  $\pm 1\%$  envelope over temperature range of  $-55^{\circ}\text{C}$  to  $+125^{\circ}\text{C}$ . Available as part of the Nytronics standard line of components, in volume quantity, for immediate off-the-shelf delivery.

Nytronics, as a pioneer in the concept of standardization is able to maintain large volume inventories of many other standardized high quality components: inductors, delay lines, and resistors, for immediate off-the-shelf delivery. Custom component capability is also available. Write today for complete engineering data.



...for Precision Electronic Components

550 Springfield Ave., Berkeley Heights, N.J. 07922 ■ (201) 464-9300 ■ TWX: 710-984-7977

ON READER-SERVICE CARD CIRCLE 75

# Which of these 4 miniature high-performance chopper-stabilized operational amplifiers is best for you?

All models occupy less than 3 cu in. All embody internal chopper-drive and overload-recovery circuits. They can be soldered directly onto p-c boards or plugged into your circuits with low-leakage sockets.

You get 1000-fold better current-drift performance than with differential op amps... picoamps instead of nanoamps. Voltage-drift is typically 100-fold better, too. Long-term drift is typically  $1\mu\text{V}$ .

Less well known is the chopper amplifier's immunity to serious offsets caused by temperature gradients. Differential op amps can develop  $200\mu\text{V}$  offsets for as little as  $0.1^\circ\text{C}$  thermal gradients across the input transistors.

Initial offsets as low as  $20\mu\text{V}$  &  $50\text{pA}$  also dispense with balance potentiometers in many applications.

Choice of 4 amplifiers gives you more freedom to match amplifier to specific application. **Model 203** makes an excellent long-term integrator or microvolt D-C amplifier. **Model 201** makes a precision  $\pm 100\text{mA}$  output current source. **Model 207** makes a  $\pm 100\text{V}$  precision computing amplifier. **Model 210** makes a fast-settling, low-cost amplifier.

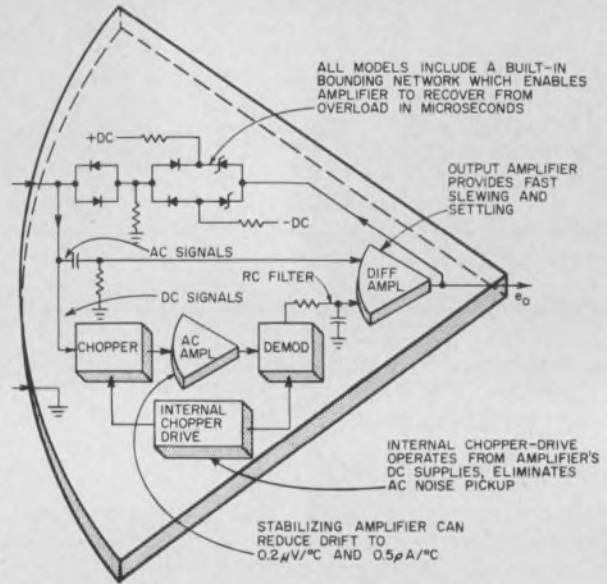

## PRODUCTION EQUIPMENT

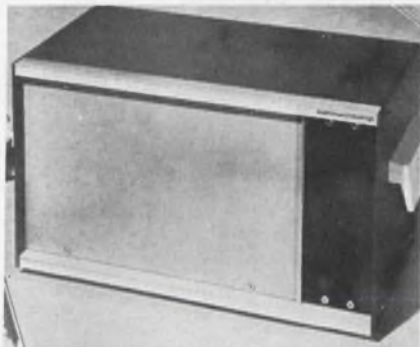

### Instrument housings allow 500 variations

*T. Foxall & Sons Ltd., Maylands Ave., Hemel Hempstead, Hertfordshire, England.*

A line of British instrument housings include 13 basic designs in a total of 57 sizes. Variations in trim and split panels bring the selection to 500. The housings use 1/8-in. aluminum alloy panels which are said to provide more stability than the usual thin-gage steel in these applications. A variety of finishes are offered.

CIRCLE NO. 263



### Solder "wavedipper" eliminates skimming

*Electrovert Inc., 86 Hartford Ave., Mt. Vernon, N. Y. Phone: (914) 664-6090. P&A \$750; stock.*

You don't have to interrupt dip-soldering to remove the oxide layer with the Wavedipper soldering unit. By pumping solder upwards through the reservoir from a circular nozzle, a 4-in. diameter raised solder surface is formed. Through this constant recirculation, the active area is always dross-free and held at constant temperature settable from  $400^\circ$  to  $600^\circ\text{C}$ .

CIRCLE NO. 264



### Nylon tool preforms leads

*Hunter Tools, 9851 Albutis Ave., Santa Fe Springs, Calif. Phone: (213) 692-7281. Price: \$1.16.*

Designed to form component leads before they are placed on printed circuit boards, tool #51FN is formed entirely of nylon. One end is shaped like a pencil point for forming radius leads and the other is like a slot screwdriver to smooth the leads after insertion and trimming. The nylon construction insures that neither leads nor board will be nicked or marred.

CIRCLE NO. 265



Price \$157, 5 $\mu$ V P-P noise  
Model 210 gives full  $\pm 10$ V,  $\pm 20$ mA output to 500kHz, has 1 $\mu$ V/ $^{\circ}$ C & 2pA/ $^{\circ}$ C max. drift, slews at 100V/ $\mu$ sec.

Output  $\pm 100$ V,  $\pm 10$ mA  
Model 207 features 10 $^{\circ}$  gain, 100/ $\mu$ sec slew rate, 0.5 $\mu$ sec recovery, 0.2 $\mu$ V/ $^{\circ}$ C and 0.5pA/ $^{\circ}$ C max. drift, \$270.

Output  $\pm 100$ mA,  $\pm 11$ V  
Model 201 has 500kHz full power response, 30V/ $\mu$ s slew rate, 10 $^{\circ}$  gain, 0.2 $\mu$ V/ $^{\circ}$ C & 0.5pA/ $^{\circ}$ C drift, \$270.

Drift 0.2 $\mu$ V/ $^{\circ}$ C, 0.5pA/ $^{\circ}$ C  
Model 203 has 10 $\mu$ V & 10pA P-P noise,  $\pm 11$ V, 20mA output, 10 $^{\circ}$  gain,  $\pm 50$ pA &  $\pm 20$  $\mu$ V max. offsets, \$215.

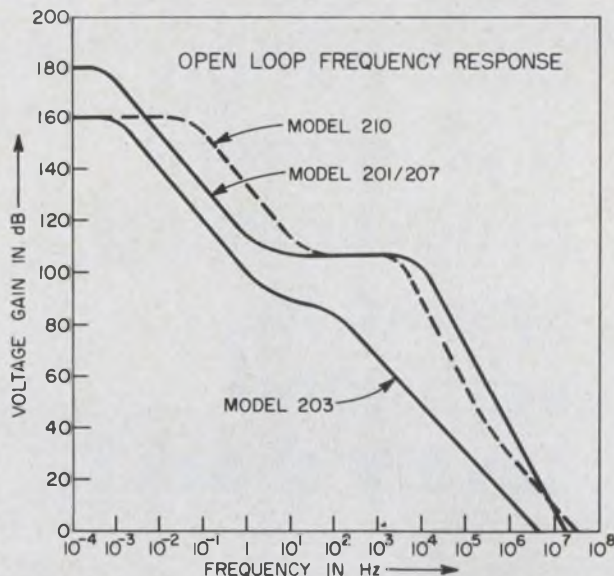

**Application Notes:** Write for 12-page technical article on chopper-stabilized op amps.  
**Evaluation Unit:** Contact Don Belanger, Applications Engineer, for an amplifier to check-out in your circuit. Don can also give application guidance on any of our 30 models.



**ANALOG DEVICES, INC.**  
221 FIFTH STREET  
CAMBRIDGE, MASS. 02142  
PHONE: 617/491-1650

ON READER-SERVICE CARD CIRCLE 76

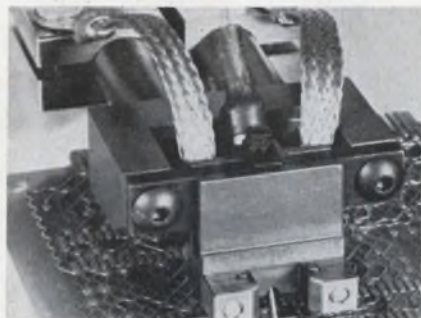

### Soldering head handles 7 leads

Development Assocs. Controls, 123 W. Padre St., Santa Barbara, Calif. Phone: (805) 963-3708. Price: \$295.

In a single operation, the 3007 soldering head attaches up to seven leads of a flat-pack module. A heated element, processed to prevent voltage differentials between leads, applies solder on pretinned leads to solder plated pads. A thermocouple control and self-aligning design are provided to prevent damage to the component or the board.

CIRCLE NO. 266

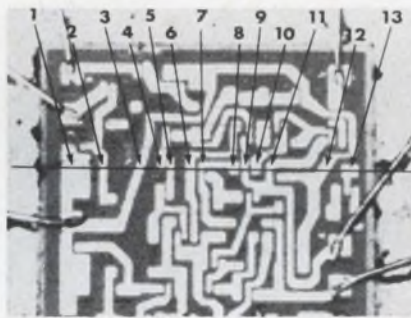

### Instrument measures chip's profile

Clevite Corp., 37th and Perkins, Cleveland, Ohio. Phone: (216) 361-3315.

An actual, undistorted surface profile of an IC chip is enlarged to 30 in. by an instrument called a Surfalyzer (which has nothing in particular to do with oceanography). By a combination of microphotography and the rectilinear output of a surface gage, profiles can be determined accurately without damage to the chip. Profile indications range down to 50 Å with repeatability.

CIRCLE NO. 267

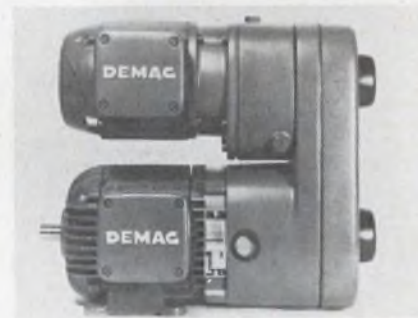

### Indexing drive can speed or creep

Demag Hoists & Cranes Corp., 4410 13th St., Wyandotte, Mich. Phone: (313) 386-7133.

This indexing drive permits a programmed selection of a fast speed followed by a creep cycle for accurate indexing. Outputs from 0.5 through 30 horsepower continuous or 50 horsepower intermittent are possible with speed ratios from 2:1 to 500:1. Variations available include reduction gearing, multipolarity and choice of pickaback or inline configurations.

CIRCLE NO. 268

who said you  
can't design  
a plugboard  
programming  
system to  
withstand  
severe shock?

## MAC Panel has done it!



**NEW SERIES 140**

MAC Panel's Series 140 Plugboard Programming Systems are available in a wide range of sizes . . . each designed and engineered to withstand the severest shock and vibration under operating conditions. Tested to 50G without self-generated contact noise. And life tested to 10,000 cycles with only random variation in contact voltage drop.

Not enough facts? Here are more: You can only insert plugboards one way. Receptacles are available for standard taper pins or series 53 pins. Contacts are spaced on  $\frac{1}{4}$ " x  $\frac{1}{4}$ " grid to allow more positions in a minimum of space.

How about plugwires? The new Series 140 Plugwires are interchangeable with most existing systems. Ball-D-Tent design prevents accidental dislodging, won't mar the surface.

Want more facts? Write today . . . outline your specific needs and let MAC engineers come up with the answers. They usually do.

**MAC**  
O.E.M. DIVISION

**MAC PANEL CO. High Point, N.C.**

ON READER-SERVICE CARD CIRCLE 77

## POWER EQUIPMENT



### Frequency changer uses rotary converter

*Kato Engineering Co., 1415 First Ave., Mankato, Minn. Phone: (507) 388-2941.*

A rotary converter provides the ac output in a new frequency changer. The input power is converted to dc which in turn drives a rotating converter which delivers 50 or 60 Hz output. Power capabilities are available in 225 W to 5 kW. Input can be any ac line frequency, the system of rectifiers and transformers is designed to use.

CIRCLE NO. 269

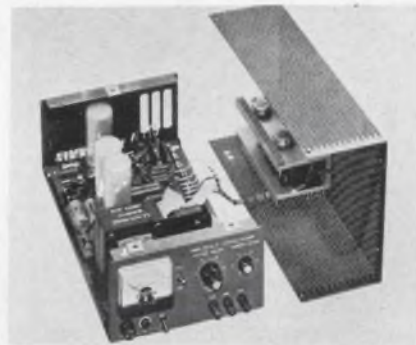

### Regulated supply packaged half-rack

*NJE Corp., 20 Boright Ave., Kenilworth, N. J. Phone: (201) 272-6000.*

Operation for either constant voltage or constant current is possible with the half-rack RB-36-2 supply. This supply incorporates full-range adjustability, 0-36 V, 0-2 A, and uses series transistor regulators driven by feedback amplifiers. Regulation is 0.01% and 1 mV for line and load respectively and current changes 1 mA/V in output, 0.5 mA operating constant-current.

CIRCLE NO. 270



## Honeywell's new 5 in 1 Instrumentation Package:

own this Model 1000 Differential Voltmeter, and you also own a Differential Ratiometer, a Decade Voltage Divider, a Precision Voltage Reference Source, and an Electronic Null Detector!

Here's the most versatile single instrument any lab can own — five essential measuring functions combined in one neat, fully portable package! Let's look at the new Honeywell Model 1000, function by function.

As a **Precision Differential Voltmeter**, the Model 1000 provides  $\pm 0.0025\%$  accurate measurements to your DC signals. And you get 7 digit resolution from 6 decades with 10% overrange (also eliminates time consuming dial manipulation). Potentiometric input impedance to 11V provides errorless measurements to standard cells or high source impedance signals. Polarity is reversible from the front panel.

As a **Differential Ratiometer**, the 1000 gives you precise DC ratio measurements with  $\pm 0.001\%$  accuracy. External reference signal level may range up to

$\pm 100$  VDC. All Voltmeter mode convenience features are applicable when the 1000 is used as a Ratiometer.

As a **Decade Voltage Divider**, the 1000's precision, 6 decade Kelvin-Varley divider network gives accurate voltage level divisions to  $\pm 0.001\%$ . AC power not required in this mode.

As a **Precision Voltage Reference Source**, calibrated voltage levels of 6 digit resolution are provided at the 1000's rear panel. Output levels are selected by front panel dials. Levels vary from 0 to 11 VDC, and may be used for calibration of potentiometric instrumentation. Accuracy:  $\pm 0.0025\%$ .

As an **Electronic Null Detector**, the 1000 offers high sensitivity for use with balance type instrumentation or other circuitry. Silicon field effect transistors eliminate electro-mechanical choppers and assure drift-free operation. Changes as minute as 10 nanovolts or an input current of  $10^{-15}$  amperes may be detected.

**Other features** of this versatile instrument include: complete cancellation of common mode, standoff voltages; high superimposed noise rejection; Zener reference supply with 2-3 ppm stability; 4 full-scale ranges of 1, 10, 100, and 1000 VDC; ratio ranges of 1:1, 10:1, and 100:1; recorder outputs on rear panel, and silicon solid-state circuitry throughout. Ask your Honeywell Representative for a demonstration of the Model 1000, or mail coupon for literature.

Honeywell, Test Instruments Div. 12-11  
Denver, Colorado 80217

Please send Model 1000 Literature to:

Name \_\_\_\_\_  
Company \_\_\_\_\_  
Address \_\_\_\_\_  
City \_\_\_\_\_ State \_\_\_\_\_ Zip \_\_\_\_\_

LABORATORY STANDARDS  
**Honeywell**

HONEYWELL IS WORLDWIDE • Sales and service offices in all principal cities of the world. Manufacturing in Brazil, Canada, France, Germany, Japan, Mexico, Netherlands, United Kingdom, United States.

ON READER-SERVICE CARD CIRCLE 78



# ALSiMAG<sup>®</sup>

## DICED CHIP CAPACITORS

Parts illustrated  
approximately actual size.



### Small and Reliable

New, unencapsulated chips, diced from thin sheets of ALSiMag dielectric, are now available using dielectric constants from 6 to 9000 with properties as outlined in ALSiMag Dielectric Ceramic Bulletin No. 644. Small .075" squares produce 5.0 pf NPO to .0015 mf Y5V. Smaller sizes available in limited quantities. Capacitance controlled from GMV to  $\pm 5\%$ . Electrodes are available using silver, gold, palladium-gold or platinum-gold.

If you will outline your requirements, we will design ALSiMag diced chip capacitors to meet your needs. ALSiMag Capacitor Bulletin 642 sent on request.

American Lava Corporation **3M**  
A SUBSIDIARY OF COMPANY  
Titania Division  
Chattanooga, Tennessee 37405  
Sixty-Fifth Year of Ceramic Leadership

ON READER-SERVICE CARD CIRCLE 79

### POWER EQUIPMENT

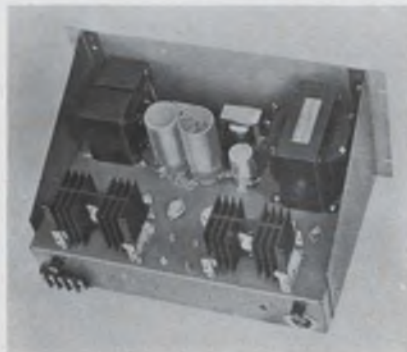

### Ac power converters designed for stability

Metric Engineering, 5221 E. Simpson Rd., Mechanicsburg, Pa. Phone: (717) 766-0741. P&A: \$595; 6-8 wks.

Designed to provide stable ac for speed control of synchronous motors, PC2100 converters handle from 25 to 2500 watts. Any frequency from 50 Hz to 15 kHz is available. Typical output voltage is 120 V rms,  $\pm 0.5\%$  no-load to full-load. Frequency stabilities range from  $\pm 0.01\%$  to 0.00001% or better. Ac line or battery units up to 128 Vdc can be specified.

CIRCLE NO. 271



### High voltage supply for lab and industry

Cober Electronics Inc., 7 Gleason Ave., Stamford, Conn. Phone: (203) 327-0003. Price: \$3,000.

Brute-force dc power supplies of the model BF20-300 pictured are offered as a low-cost source of high power for lab and industrial applications. Overvoltage and overcurrent protection is provided through meter relays. The BF20-300 has an output continuously variable from 0 to 20 kV dc with currents from 0 to 300 mA, positive or negative.

CIRCLE NO. 272



65 cfm  
in a  
3 1/2" Package!

## PAMOTOR

### Model 3000 Miniature Axial Fans

- 20,000+ operational hours at 45°C
- All metal construction
- Low-cost design
- Maximum air delivery at higher back pressures
- Unexcelled performance and reliability
- 50-60 cycles at 110 or 220 vac

**IN STOCK FOR  
IMMEDIATE DELIVERY!**

Write for technical data on the Model 3000 and other PAMOTOR axial fans to:

**PAMOTOR, INC.**  
312 SEVENTH STREET • SAN FRANCISCO, CALIF.

ON READER-SERVICE CARD CIRCLE 80

ELECTRONIC DESIGN 26, November 22, 1966



## White-noise source independent of line

*Aerospace Research, Inc., 130 Lincoln St., Boston (Brighton), Mass. Phone: (617) 254-7200.*

A servo-stabilized RF random noise generator is said to provide white noise output virtually independent of line voltage changes and change in ambient temperature. A resonant-line output-coupling circuit insures low vswr over the full 1 to 500 MHz range. The output is continually variable from 0-16 dB in two ranges. The meter is also calibrated in degrees K from 0-12,000° above KTB.

CIRCLE NO. 273



## Ac power source varies 45 Hz to 5 kHz

*Elgar Corp., 8046 Engineer Rd., San Diego, Calif. Phone: (714) 279-0800.*

At any frequency from 45 Hz to 5 kHz, the model 200 power source delivers 200 VA. Front panel plug-in oscillator modules are available to select fixed frequencies with accuracy from  $\pm 1\%$  to 0.0001%. Two- and three-phase output is obtained by stacking units. Line and load regulation as well as distortion are held to less than 1%.

CIRCLE NO. 274

ON READER-SERVICE CARD CIRCLE 81 >



Actual Size

## *Taber* TELEDYNE® Pressure Transducer offers exceptional performance over wide operating range

Without any sacrifice of accuracy, ruggedness, or reliability, Taber's newest TELEDYNE® electrical pressure transmitter offers exceptional repeatability, hysteresis, and stability at a new, low price. Ten standard pressure ranges available from 0-500 through 0-5000 psig.

Called the F-7, the new instrument operates on the gage diaphragm principle with four active 350-ohm foil strain gages in a Wheatstone bridge configuration. With no moving parts, friction is eliminated, resulting in negligible hysteresis and repeatability error.

The F-7 features high reliability over a wide operating temperature range in spite of its small size. The unit is field serviceable and may be used with any fluid compatible with 17-7 stainless steel. The pressure cavity may be opened without exposing any electrical connections so that complete cleaning and decontamination may be accomplished between tests.

If any or all of these features are important to pressure testing in your facility, look into Taber's new F-7 transducer right away. For complete information, write for Product Sheet P-66F7.

*Taber Instrument Corp., Section 161, 107 Goundry St., North Tonawanda, N. Y.*



## Methode's Solution to "Knotty" Harness Problems

Methode's unique Plycon harnesses can solve many of your design problems quickly, efficiently!

Available in both straight jumper and extensible styles, Plycon harnesses are ideal for use in drawers or racks or as jumpers between points on a chassis.

Plycon harnesses are a combination of two superior products: long-life Plyo-Duct multi-conductor wiring systems and Reli-Acon connectors.

Through an unusual Methode design, Plyo-Duct has memory characteristics, so that extensible harnesses will extend, then always retract to their original position.

Reliable male or female Reli-Acon connectors are available in a variety of standard sizes and number of contacts to meet your design requirements.

Both single and twin-layer harnesses with from 6 to 48 conductors, and any combination of connector style and number of contacts are available.

Write today for a new, fully-illustrated catalog with complete engineering data.



Connector Division

**Methode  
Electronics, Inc.**

7447 W. Wilson Ave. Chicago, Ill. 60656

312/867-9600

## POWER EQUIPMENT

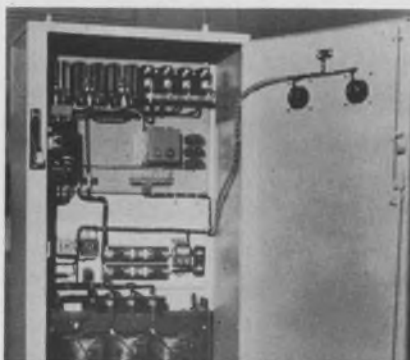

### Regulated dc supplies fill industrial needs

*Magnetics Inc., Butler, Pa. Phone: (412) 285-4711.*

Wherever dc power is required on large scale, these packaged units provide solid-state design and SCR control. At ratings of 2 to 80 kW at 125 Vdc or 250 Vdc, power control is effected by SCRs regulated by a magnetic amplifier. Voltage adjustment is 0 to 100% by means of a control potentiometer. Voltage control is  $\pm 1\%$  for 10% line variation and 2% rms ripple.

CIRCLE NO. 275

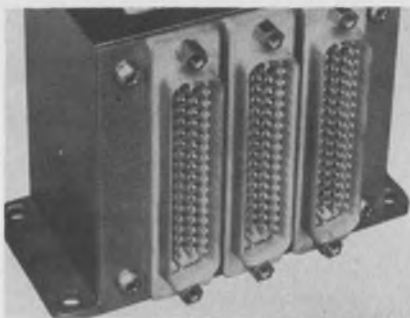

### Voltage reference accurate to $\pm 0.0025\%$

*General Resistance Inc., 430 Southern Blvd., Bronx, N. Y. Phone: (212) 292-1500. P&A: \$985; stock.*

Housed in an easily transportable case, the DAS-46L dialable voltage source features an accuracy of  $\pm 0.0025\%$  from 1  $\mu$  V to 10 V. The unit combines a "Dial-A-Volt" reference with a chopper-stabilized operational amplifier to provide totally isolated voltages. IR drops in interconnecting harnesses are automatically compensated. Output regulation is 5 ppm and stability is 10 ppm.

CIRCLE NO. 276

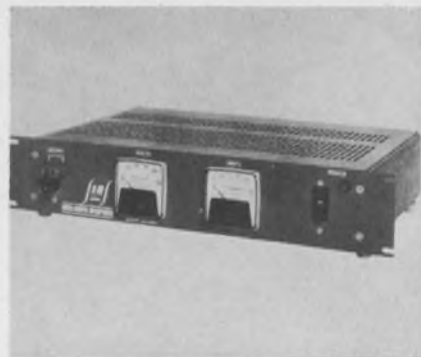

### Frequency converters rated to 750 VA

*Astro-Metrics Corp., 1123 Mission St., South Pasadena, Calif. Phone: (213) 799-1509. P&A: \$495; stock to 2 wks.*

For applications demanding high-level ac without high-level cost, a new line of converters includes ratings from 100 to 750 VA. Operation is at 60 to 400 Hz, single- or three-phase. All three-phase units maintain specs with load unbalance as high as 50%. The rack-mount units are fully solid-state.

CIRCLE NO. 278

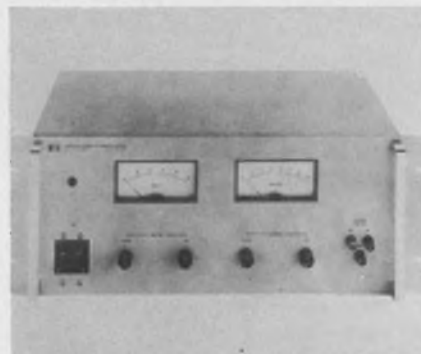

### Low-level rack supply is RFI shielded

*Hewlett-Packard, 100 Locust Ave., Berkeley Heights, N. J. Phone: (201) 464-1234. P&A: from \$350; 1-6 wks.*

A rack power-supply line consists of 10 transistor-regulated models with outputs from 0-10 to 0-60 V and power to 2 kW. All are RFI shielded in accordance with MIL-I-6181D. An optional over-voltage protection "crowbar" is available. Regulation is 0.01%, ripple is 1 mV at 2 kV and short recovery is below 50  $\mu$ s. Operation is constant/voltage/current.

CIRCLE NO. 277

# Most effective transient voltage arrester



## G-E Thyrector Diodes

■ Looking for the best way to arrest harmful voltage transients? G-E Thyrector Diodes provide maximum circuit protection . . . in the factory, office, or home. They clamp down instantly on surges from both inside and outside your circuit system.

**Quick Response** is your best guard against runaway voltage surges that often damage semiconductors and connected loads in the system. The G-E Thyrector Diode's response is instantaneous.

The Thyrector Diode permits you to limit transient voltage with simplified circuitry. One Thyrector Diode can often save you many times the cost of additional series silicon diodes used in typical high-voltage power supplies.

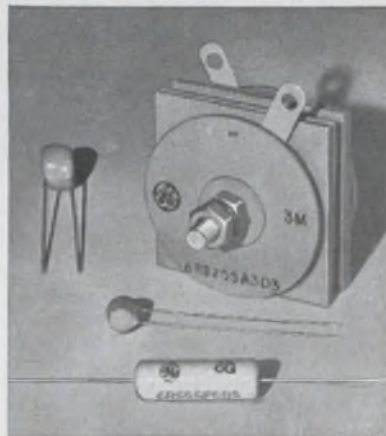

Available in a wide variety of configurations.

G-E Thyrector Diodes are available in sizes from  $\frac{3}{32}$ " diameter lead-mounted units to larger 2" x 2" plates. And, they are ideally suited for a variety of applications including light and heavy industrial and consumer . . . one more example of General Electric's total electronic capability.

If you want improved protection at low cost with G-E Thyrector Diodes contact your G-E engineer/salesman or authorized distributor. Or write to Section 220-36, General Electric Company, Schenectady, New York. In Canada: Canadian General Electric, 189 Dufferin St., Toronto, Ont. Export: Electronic Component Sales, IGE Export Division, 159 Madison Ave., New York, N.Y.

SEMICONDUCTOR PRODUCTS DEPARTMENT

**GENERAL  ELECTRIC**

ON READER-SERVICE CARD CIRCLE 83

**SAMPLE AND  
 HOLDHOLDHOLDHOLDHOLDHOLDHOLD  
 HOLDHOLDHOLDHOLDHOLDHOLDHOLD  
 HOLDHOLDHOLDHOLDHOLDHOLDHOLD  
 HOLDHOLDHOLDHOLDHOLDHOLDHOLD  
 HOLDHOLDHOLDHOLDHOLDHOLDHOLD  
 HOLDHOLDHOLDHOLDHOLDHOLDHOLD  
 HOLDHOLDHOLDHOLDHOLDHOLDHOLD  
 HOLDHOLDHOLDHOLDHOLDHOLDHOLD  
 HOLDHOLDHOLDHOLDHOLDHOLDHOLD  
 HOLDHOLDHOLDHOLDHOLDHOLDHOLD**



**ANALOG CONTROL SIGNALS**

PD & C's new Model 102 Analog Memory Device makes continuous, trouble-free operation of process control a practical, economical reality. When a disruption of incoming data occurs, Model 102 retains the last valid signal to within 1% for over an hour, permitting service to be maintained until the input can be restored. Eliminates costly downtime and maintenance interruptions.

*Find out more today.*



ON READER-SERVICE CARD CIRCLE 84

HEART of missile and radar modulators . . .



**PULSE FORMING  
 NETWORKS**

Always look to P.C. when there is no margin for anything but perfect performance. For minimum size plus maximum performance you can rely on P.C. As specialists, we have the training, the skills, and the facilities to produce outstanding examples of pulse forming networks for both standard and "specials" to meet your every requirement. Whatever your need or application, write today for our special bulletin on pulse forming networks; or, send your specifications including: Peak charging voltage, pulse duration, pulse rise time, characteristic impedance, rep. rate, max. ripple, temperature range, life, decay or fall time.

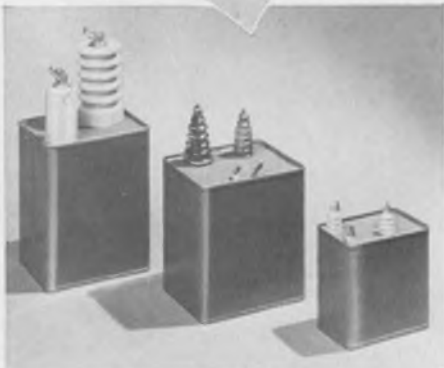

**Plastic Capacitors, INC.**

2620 N. Clyborn • Chicago, Ill. 60614  
 DI 8-3735

"Custom  Engineered at  
 Production Prices!"

ON READER-SERVICE CARD CIRCLE 85

**POWER EQUIPMENT**



**Fixed-level supplies  
 packaged 1/3rd rack**

*Lambda Electronics Corp., 515  
 Broad Hollow Rd., Melville, N. Y.  
 Phone (516) 694-4200. Price:  
 \$169.90 up.*

A total of 21 fixed-voltage supplies comprise the LM line of CC-packaged power supplies. These modular units are convection-cooled and have multiple current ratings based on 40°, 50°, 60°, and 71°C. Standard models are offered at 21 levels from 3 to 150 Vdc with a ±5% adjustment. On special order, voltages between the standard ratings are also available.

CIRCLE NO. 279



**Low-voltage supplies  
 safeguard ICs**

*Hewlett-Packard, 100 Locust Ave.,  
 Berkeley Heights, N. J. Phone:  
 (201) 464-1234. P&A: \$220; stock.*

Designed specifically for use with integrated circuits, a new series of low voltage power supplies pays particular attention to the danger of over-voltage. A "crowbar" protection circuit monitors the voltage and shorts the output within 10 us when an over-voltage condition arises. The first of the series of five, the 6384A provides 4 to 5.5 V at 0 to 8 A.

CIRCLE NO. 280



### Adjustable ac source meters to 1000 amps

Astro Lab, 9371-D Kramer Ave., Westminster, Calif. Phone: (714) 839-0741. P&A: \$225; stock to 60 days.

For bench testing, metered, adjustable ac up to 1000 A is provided by the Var-I-Amp source. Applications include high-current problems such as determining the fusing current of conductors, testing terminals and connectors and driving high-current soldering equipment. Output is accurate  $\pm 3\%$ , metered on 5 ranges, 0 to 1000 A.

CIRCLE NO. 281

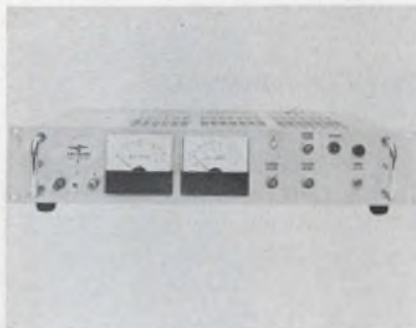

### System power units long on features

Trygon Electronics Inc., 111 Pleasant Ave., Roosevelt, N. Y. Phone: (516) 378-2800.

The story on L3R and L5R supplies from Trygon is the many standard features: All silicon design with matched differential amps and integrated reference amplifiers . . . 70 A in L5R, 5-1/4-in. rack-mount . . . 40 A in L3R, 3-1/2-in. rackmount . . . Full power to 60°C . . . Regulation to 0.005% . . . Stability to 0.01% . . . Ripple below 0.5 mV, 3 mV peak-to-peak . . . Automatic load-share paralleling . . . and others.

CIRCLE NO. 282



Standard Bud Imlok

Want to make something out of it?



Series 901 Bud Imlok

# BUD IMLOK

## EXTRUSIONS AND CONNECTORS

For truly creative packaging for electronic and electrical systems and devices, Bud Imlok permits you to develop enclosures whose shape and size are guided only by your requirements. The interlocking aluminum alloy components are quickly and easily combined by the use of simple hand tools to form housings of your design.

The use of the Bud Imlok system is recommended particularly for prototype, short run and research applications. Its versatility and economy for these uses is well known in many industries.

Whether you require a really attractive small rectangular case, a large elegant control console or a multiangular structure they can all be made with Bud Imlok. Elimination of tooling for special housings in single or small quantities brings both time saving and money saving to you.

Bud Imlok material is furnished in a number of ways . . . you select the best way for your fabrication plans. Bud offers a service where special housings can be fabricated completely from your blue prints or ours. Ask your local authorized Bud distributor to explain all the advantages of Imlok or write us for illustrated booklets.



Console fabricated from Standard Imlok



Display stand fabricated from Series 901 Imlok



## BUD RADIO, INC.

Willoughby, Ohio

BUD RADIO OF CANADA, LTD., 9 Milvan Dr., Weston, Ont.

ON READER-SERVICE CARD CIRCLE 86

# NEW. Low Frequency Ceramic Band Pass Filter.

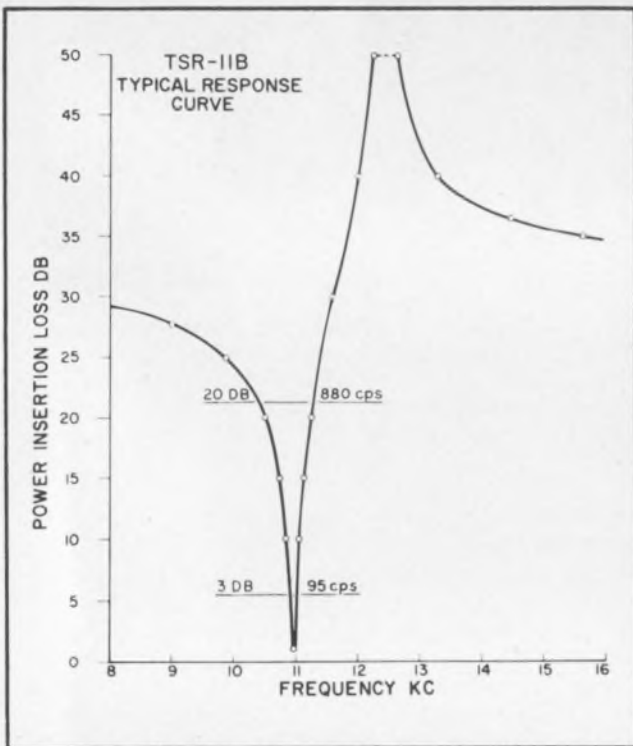

## Big performance in a quarter ounce package.

Looking for something better in a low frequency filter? Look no more. Clevite's new generation of fixed-tuned ceramic band pass filters combine narrow bandwidths and high performance with surprisingly small size and low weight.

Check the specs and see for yourself:

**Center Frequency** — from 9kc to 50kc

**Bandwidth (% fo)** — @ 3db-1%; @ 20db-13%

**Stability** — Within 0.2% for 5 years  
Within 0.2% from  $-40^{\circ}\text{C}$  to  $+85^{\circ}\text{C}$

**Dimensions**—HC-6/U case  $\frac{3}{8}$ " x  $\frac{3}{4}$ " x .34" (hermetically sealed)

**Shock** — 20g any axis 20-2000 cps per mil std. 202B.

As we said, look no more for a high performance, low frequency filter. This new one from Clevite is the perfect choice. Write for free Technical Bulletin 94023. Clevite Corporation, Piezoelectric Division, 232 Forbes Road, Bedford, Ohio 44014.

# CLEVITE

ON READER-SERVICE CARD CIRCLE 87

## POWER EQUIPMENT



### Strip-line oscillator delivers 150 watts

Terra Corporation, 505 Wyoming Blvd., N. E., Albuquerque, N. M.  
Phone: (505) 255-0157.

A power output of 150 watts, grid pulsed, is provided by the GLJ-1117 strip-line oscillator. For operation at 1.6 GHz, this oscillator features a 25-nsec pulse rise-time and pulse widths down to 100 nsec. The oscillator's size is 1.0 x 2.5 x 0.4-in. and total unit weight is below 2 ounces.

CIRCLE NO. 283



## R. F. INTERFERENCE PLAGUING YOU?



HOW ABOUT  
LITTELFUSE R.F.  
INTERFERENCE SHIELDED  
FUSE POSTS. MILITARY AND  
COMMERCIAL APPLICATIONS  
Write or phone for information

# LITTELFUSE

DES PLAINES, ILLINOIS

ON READER-SERVICE CARD CIRCLE 88  
ELECTRONIC DESIGN 26, November 22,

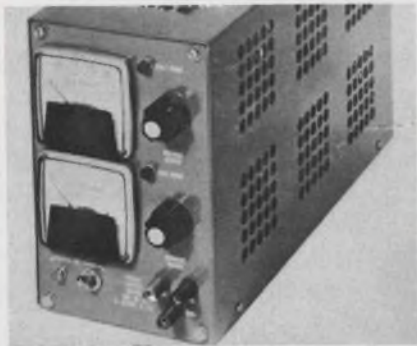

## Regulated dc supply operates triple-mode

NJE Corp., 20 Boright Ave., Kenilworth, N. J. Phone: (201) 272-6000.

Operation as either current- or voltage-regulated or both, is possible with the LabRak SVC-40-5. The unit, for lab or system use, is of all-silicon design. Voltage regulation for load and line changes is 0.01% or 1 mV respectively. Current regulation is 0.2 mA/V change and 1 mA in constant current mode.

CIRCLE NO. 284

# Telrex



"— with a MATERIAL DIFFERENCE!"

The Choice of the Discriminating Communication Engineer . . . the Man who Never Settles for Anything Less than THE-VERY-BEST!

## telrex "BEAMED-POWER" ANTENNAS and ANTENNA SYSTEMS

Provide optimum performance and reliability per element, per dollar. Antennas from 500 Kc to 1500 Mc. Free PL88 condensed data and pricing catalog. describes military and commercial antennas, systems, accessories, Towers, Masts, Rotators, "Baluns" and transmission line data.



Asbury Park 41, New Jersey, U.S.A.

ON READER-SERVICE CARD CIRCLE 89

ELECTRONIC DESIGN 26, November 22, 1966

IF THIS  
HIGH VALUE METAL  
FILM RESISTOR  
DOESN'T CHANGE YOUR  
*design ideas*

...try one of these



Part No.	Power	Ohms	Tol.	Temp. Coef.
PME 50	1/20 W	10Ω to 1M	±1% to .1%	T-0, T-2, T-9
PME 55	1/10 W	10Ω to 3M	±1% to .1%	T-0, T-2, T-9
PME 60	1/8 W	49Ω to 7.5M	±1% to .1%	T-0, T-2, T-9
PME 65	1/4 W	49Ω to 20M	±1% to .1%	T-0, T-2, T-9
PME 70	1/2 W	24Ω to 30M	±1% to .1%	T-0, T-2, T-9
PME 75	1 W	49Ω to 50M	±1% to .1%	T-0, T-2, T-9

The stability and accuracy of Pyrofilm's PME metal film resistors makes their use ideal in applications where before only wire wound resistors could be used. These resistors are virtually unaffected by environmental conditions and withstand constant exposure to high moisture conditions without change in specifications. PME resistors meet or surpass all requirements of MIL-R-10509F.

Send for fact-filled literature sheet!

**PYROFILM RESISTOR  
COMPANY, INC.**

3 SADDLE ROAD • CEDAR KNOLLS, NEW JERSEY • 201-539-7110

ON READER-SERVICE CARD CIRCLE 90



# NEW!

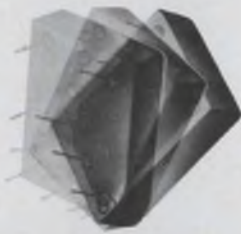

## Floating

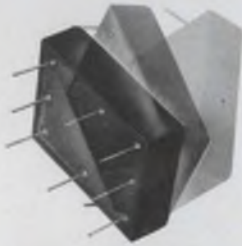

## Digital



## Driver

The DYNAMICS™ Floating Digital Driver (FDD), Model 601, is a unique, isolating digital circuit for transmission of dc logic levels, the equivalent of a nanosecond relay requiring very small reactive coupling between the driver and the switch closure.

#### Features:

- Nanosecond response
- dc operation-no dc connection
- Low reactive coupling
- Logic translation and inversion
- Small size— $1\frac{1}{2}'' \times 1\frac{1}{8}'' \times 0.4''$
- Low cost — \$39.\*

#### Applications:

- Isolation between input and output circuitry
- 120mA fan-out buffering
- Logic inversion and translation
- Digital system coupling
- Driving long transmission lines

\*Quantity-order price schedule available.

## DYNAMICS™

INSTRUMENTATION COMPANY

583 MONTEREY PASS ROAD  
MONTEREY PARK, CALIFORNIA  
(213) 283-7773

# Application Notes



221 FIFTH STREET CAMBRIDGE, MASS 02142 (617) 480-1000



## Op-amp probed

An application note defines offset as the input bias required to set an amplifier's output to zero when no input signal is applied.

It goes on to explain that offset is made up of separate voltage-offset and current-offset components, each of which must be allowed for in any practical application.

Having defined offset, the note proceeds to elaborate on the effects of changes in voltage-offset, which can be caused by variations in ambient temperature, supply-voltage change, or aging of amplifier components. Analog Devices.

CIRCLE NO. 285

## Frequencies compared

A 9-page application note describes how to make frequency comparisons with very high resolution in only a few minutes' time. Such measurements are valuable when adjusting a precision oscillator to match a known standard or in studies concerned with the effects of temperature and aging on precision oscillators. The application note (AN 77-2) discusses how a vector volt-meter is used to quickly compare precision frequency standards with a resolution of parts in  $10^{13}$ . Hewlett-Packard.

CIRCLE NO. 286

## S-parameter measurements

An important technique for measuring the characteristics of transistors in the 100- to 1000-MHz range is described in this 12-page application note. The technique involves "scattering" or s parameters; much easier to determine above 100 MHz than conventional h, y and z parameters. The note discusses the nature of s parameters and describes how they are derived from voltage and phase measurements. Several typical measurement examples are given. The note also shows how to re-convert the parameters to h, y or z. Several examples of high-frequency circuit design using the technique complete the discussion. Hewlett-Packard.

CIRCLE NO. 287

## Transient data analysis

"A New Technique for Transient Data Analysis and Signal-to-Noise Ratio Enhancement" describes a method of using conventional instruments for analyzing transient data with the accuracy and simplicity possible for periodic signals. A discussion of how the technique can be used for detecting transient and periodic signals in noise is included. The method involves converting data to be analyzed to a stable, periodic signal with high duty cycle. The 16-page note is complete with examples and illustrations. S. Himmelstein & Co.

CIRCLE NO. 288

## Tuning fork applications

An illustrated technical booklet, "Increasing Application of Tuning Forks in Control Systems," describes features and applications of tuning fork resonators and oscillators. The 12-page brochure details the advantages of the fork oscillator and its parameters, contrasting it to other frequency sources. Sections cover the use of regular and torsional tuning forks as modulators of light or energy beams. The discussion is complete with schematics and photographs. American Time Products, Bulova Watch Co., Inc.

CIRCLE NO. 289

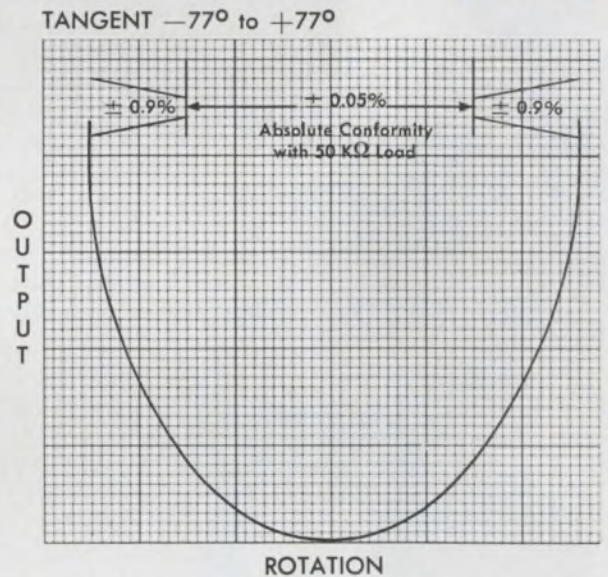
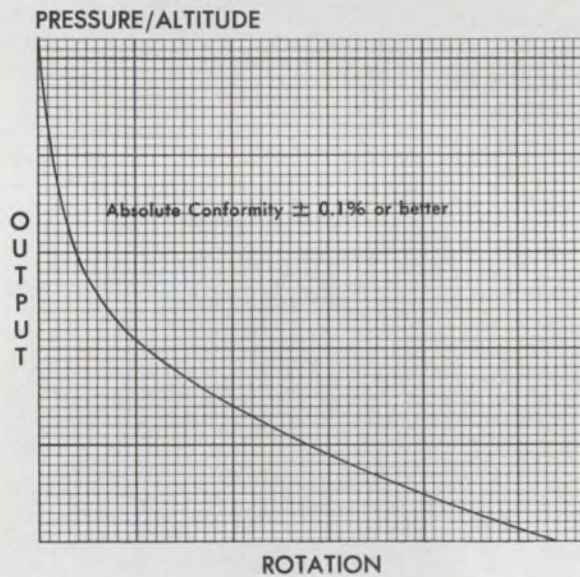
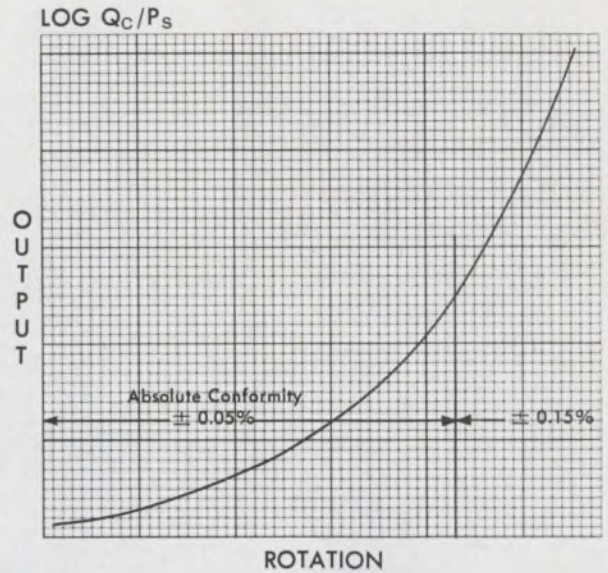
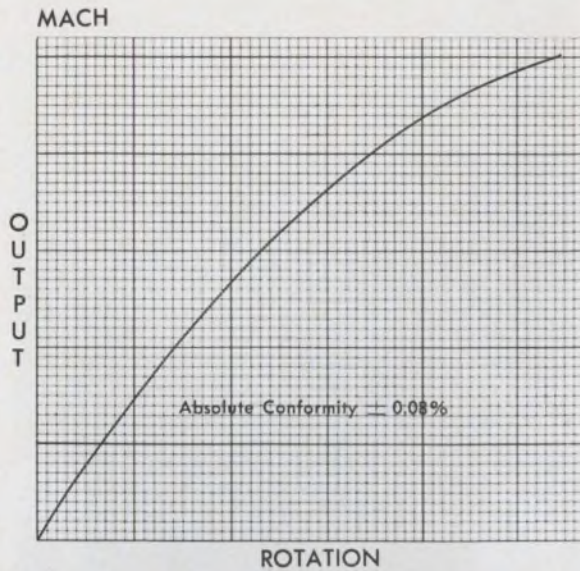

# OUR POTS CAN THROW A WICKED CURVE

If you require a precise non-linear voltage output, we have the answer. A Vernistat a.c. Potentiometer with a permanent wave. Take a look at some of the useful curves produced by Size 11 Series 4 Vernistats. Suppose you need a function generator or some other non-linear control. Remember there's a precise mechanism available for the job. It's called Vernistat. As for reliability—rotational life tests indicate that Vernistat a.c. Potentiometers are "run-in" where conventional units experience serious degradation.

All Vernistat a.c. Potentiometers feature:

- Reliability and long life
- High input and low output impedance
- Low quadrature output
- Small loading error
- Continuous rotation in a multiturn unit.

We'll be glad to assist with any problem of pot design. Call or write to Electronic Products Division, Perkin-Elmer Corporation, 768 Main Avenue, Norwalk, Connecticut 06852.

**PERKIN-ELMER**

ON READER-SERVICE CARD CIRCLE 92

# THE FIRST INEXPENSIVE SCR

FIRING CIRCUIT  
TO INDUSTRIAL  
STANDARDS

• MODEL R210 A331  
(for 120/240V 60 cycles)

COSTS ONLY

**\$29<sup>95</sup>**  
EACH

IN CARTONS  
OF TEN



The R210 Series are enclosed single phase, full wave magnetic amplifier firing circuits, with Marathon screw terminal blocks, for mixing "+" and "-" signals in 2 high gain quick response control windings. Also available card mounted.

## INTERESTED?

Write for Bulletin #R210 for full details



**FIRING  
CIRCUITS,  
INC.**

DIV. of MARATHON  
ELECTRIC MFG. CORP.

Muller Avenue • Norwalk, Conn. 06852  
(203) 846/1633

ON READER-SERVICE CARD CIRCLE 93

## New Literature



### Switch selection guide

This 72-page switch selection guide is border-indexed for handy reference to the more than 1000 switches covered. The index categories include switch information on limit, enclosed, explosion-proof, proximity, basic, small basic and mercury switches. A reference to lighted and unlighted pushbuttons, toggle, rotary, hermetically sealed and environment-proof switches included in the last section refers you to other available catalogs. Features included are mounting dimensions drawings, horsepower ratings, operating characteristics, contact arrangements, electrical ratings, actuator variations, replacement parts, environment data, pricing and a handy glossary of switch terms. Honeywell, Micro Switch Div.

CIRCLE NO. 290

### Zirconium copper

A 20-page technical data booklet on zirconium copper is now available. This metal is a heat-treatable copper alloy developed for applications requiring high conductivity and good strength at high temperature. It is an alloy that develops its strength primarily from cold working. Heat treatment precipitates the  $Cu_3Zr$  phase, increasing electrical conductivity, ductility and recrystallization temperatures, while retarding dislocation movements. The booklet contains 16 graphs and ten tables of the metal's properties. American Metal Climax Inc.

CIRCLE NO. 291



### Resistor line cataloged

The entire Dale line of wirewound and film resistors is covered in its Catalog A. Color coding of the book allows easy reference to sections on precision wirewounds, industrial wirewounds and precision film-types. Dale Electronics Inc.

CIRCLE NO. 292

### Microwave components

This catalog of microwave components takes the form of three standard-size data sheets in a file folder. The data sheets describe a line of low-noise solid-state front ends: preamps, mixer-preamps, and oscillators. Consolidated Airborne Systems, Inc., Microwave Products Group.

CIRCLE NO. 293

### NBS bulletins

The National Bureau of Standards, U.S. Department of Commerce, Washington, D. C., offers a group of publications to the engineering society. Below is a list of some that might be useful to electronic design engineers:

1. Silicon attenuators for laser measurements (15¢).
2. Modification simplifies volt box calibration (15¢).
3. Some techniques for measuring small mutual inductances. D. N. Hoeman (75¢).
4. Notes on the use of propagation-of-error formulas. H. H. Ku (75¢).

# THIS LITTLE THREAD HELPS OUR AIR-SPACED COAX DO BIG THINGS FOR IBM

Our coax can do the same for you! A spiral of flame-retardant polyethylene thread air-spaces the center conductor of Brand-Rex Turbo® 209A Coaxial Cable. The result: a tough, miniature coax, with excellent electricals for high-speed transmission, at moderate cost. □ We first developed the Turbo 209A for use in the IBM Computer /360, but you may find this space-saving performer

useful in a variety of data processing and communications applications. □ It is available as single cable, cemented ribbon cable (illustrated), or conventional round multiconductor cable. □ Substantially lower in price than standard 95 ohm High Temperature types, it also offers lower attenuation; higher velocity of propagation. A spiral drain wire under the shield simplifies termination.

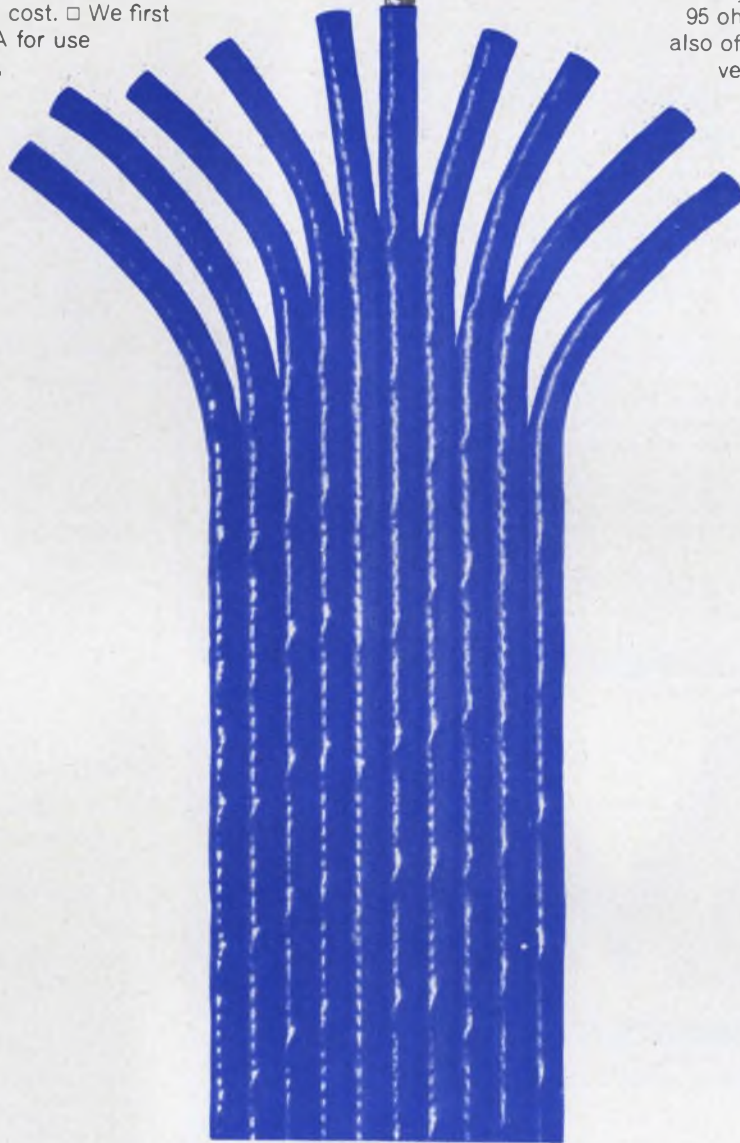

Check the specs. Sound good? Write for full information.

Brand-Rex Turbo 209A Coax U.L. Approvals: Style 1354 (single). Styles 2384, 2385, 2386, 2387, 2388 (cable).

Nominal voltage: 600 volts rms.

Nominal impedance: 95 ohms, +6 -4.

Nominal capacitance: 13.5 pf/ft.

Max. attenuation: 14 db/100 ft at 400 Mc.

Velocity of propagation: 80%.

Inner conductor: #29 AWG silver-coated Turballoy C.

Cable core: Air-spaced, flame-retardant polyethylene. 0.072, 0.078" O.D.

Drain wire: #29 AWG silver-coated Turballoy C spirally applied for flexibility and fatigue resistance.

Shield: #38 AWG tinned copper braid, providing 90% min coverage.

Jacket: High-density vinyl, 0.112" nom. O.D.; 0.122" max O.D. at drain wire points.

AMERICAN ENKA CORPORATION

BRAND-REX DIVISION

Willimantic, Connecticut 06226  
Phone: (203) 423-7771



ON READER-SERVICE CARD CIRCLE 94

# IF-to-Tape... CONVERTERS... Tape-to-IF

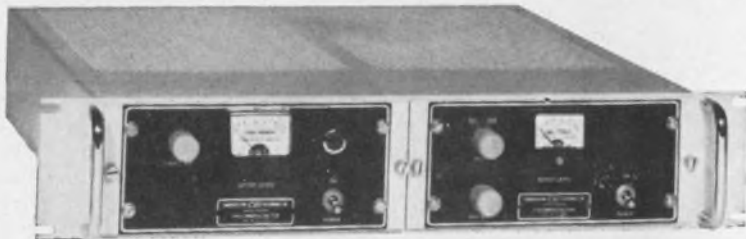

Type TF-201

Type FT-201A

## For Wideband Predetection Recording Uses

CEI developed these compact, solid-state converters to facilitate predetection recording of 21.4-mHz center frequencies. Type FT-201A (IF-to-tape) translates the 21.4-mHz IF output from a CEI or other receiver to a frequency that can be recorded on a wideband tape recorder. Data bandwidth is 100 kHz to 1.4 MHz with a 750-kHz output center frequency; other output center frequencies may be obtained by changing the crystal. Type TF-201 (tape-to-IF) translates tape recorder output signals up to 21.4 MHz, providing a data bandwidth of up to 1.3 MHz (when the input center frequency is 750 kHz). In both units, response over the data bandwidth varies less than 2 db.

These converters are available in half-rack configuration—as shown above—and in 19" full-rack versions. For further information and specifications, please contact:



### COMMUNICATION ELECTRONICS INCORPORATED

6006 Executive Boulevard, Rockville, Md. 20852 · Phone: (301) 933-2800 · TWX: 710-824-9603

ON READER-SERVICE CARD CIRCLE 95

## NEW LITERATURE

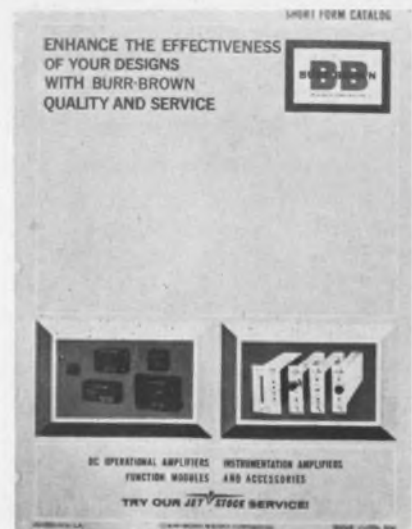

### Analog module catalog

Several broad lines of analog modules are described in a 12-page illustrated catalog. Units described include operational amplifiers, functional modules, instrumentation amplifiers, power supplies and accessories. Prices, mechanical and electrical specifications, definitions, and a list of customer services are provided. Burr-Brown Research Corp.

CIRCLE NO. 294

### Nuclear accessories

A 50-page catalog of nuclear accessories and detectors offers the user of radioisotopes a wide range of such equipment. Over 200 items include protective clothing, radioactive sources, handling tools, body phantoms and recording instruments among others. Detectors covered include the Molechem low-level counter, Harshaw integral and matched window lines, and Harshaw solid-state detectors. Hamner Electronics Co.

CIRCLE NO. 295

### Precision pot catalog

The revised catalog rp 962/D provides detailed specifications on the CIC line of rotary precision film potentiometers. This revised publication includes a new section on electromechanical assemblies and gears. Revised specifications are offered on the single and multi-turn units, their elements and on the electrical and mechanical configurations available. Computer Instruments Corp.

CIRCLE NO. 296

**CUT CONSTRUCTION DELAY**

with pre-punched  
**VECTORBORD,\*  
 PLUGBORDS and  
 Push-in TERMINALS**

Make circuits the fast, easy way . . . simply insert Vector push-in terminals (wide variety available) and component wires into pre-punched Vectorbord, or use punched copper clad for do-it-yourself etching; and, for production, we're geared to omit the holes not required and assemble terminals, eyelets, etc. to your specifications. Eleven patterns available with .025", .040", .062", .093" holes in XXXP phenolic, glass silicone, glass or paper epoxy and copper clad. Plugboards supplied in many sizes with etched pads, .040" dia. Edge-Pins or Elco Varicon\* contacts.

**Save time — Save work — Save money!**

® TRADE MARK

Send for complete literature  
**VECTOR ELECTRONIC CO., INC.**  
 1100 Flower St., Glendale, Calif. 91201 Area 213 Phone 245-8971

ON READER-SERVICE CARD CIRCLE 96



### Phenolic rods

This 4-page data folder contains actual samples of 3 basic types of turned and precision-ground phenolic rods for relay and other electronic applications. In addition, this useful, permanent file folder is furnished with complete data sheets listing full specifications, mechanical and physical properties, as well as prices on the entire line. Atlas Fibre Co.

CIRCLE NO. 297

### Short-form pot catalog

An 8-page condensed catalog covers over 50 Bourns adjustment potentiometers. The catalog contains the nomenclature, dimensions, specs and prices of wirewound, special, general purpose and non-wirewound units. Information on precision pots, power supplies, voltage sensors, relays, time delays micro-components and turns-counting dials is also included. Bourns Inc.

CIRCLE NO. 298

### Op-amp quiz

For teaching or brushing-up on basic analog techniques, two educational papers on operational amps are now available. Part One is called "An Introductory Laboratory Manual of Operational Amplifier Experiments." Part Two is called "Operational Amplifier Quiz" and is designed to give a one-hour test on one's knowledge of analog operational amplifier use. Nexus Research Lab., Inc.

CIRCLE NO. 299

# MINITAN®

## SOLID TANTALUM CAPACITORS

MINITAN® capacitors are designed specifically to provide the maximum capacitance in minimum size for microminiature circuit applications. Dependable operation from  $-55^{\circ}$  to  $+125^{\circ}$  Centigrade; weldable, solderable leads; variety of sizes and shapes for all applications.

### MODULAR:

Maximum packing density on printed circuit cards and micro circuits.

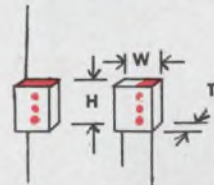

Case Size	AVAILABLE RATINGS	H	W	T
U	.001 MFD @ 20 VDC $T_0$	.125	.070	.040
	1.5 MFD @ 2 VDC			
F	.22 MFD @ 35 VDC $T_0$	.165	.120	.070
	10 MFD @ 2 VDC			
M	1.0 MFD @ 35 VDC $T_0$	.225	.185	.075
	22 MFD @ 2 VDC			
L	6.8 MFD @ 20 VDC $T_0$	.290	.220	.110
	47 MFD @ 3 VDC			
S	15 MFD @ 20 VDC $T_0$	.310	.230	.130
	82 MFD @ 2 VDC			
J	22 MFD @ 20 VDC $T_0$	.475	.375	.150
	220 MFD @ 3 VDC			

### CORDWOOD:

Big capacitance, small size — ideal for two or single board construction.

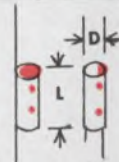

Case Size	AVAILABLE RATINGS	L	D
Y	.001 MFD @ 20 VDC $T_0$	.125	.070
	2.2 MFD @ 2 VDC		
P	.001 MFD @ 50 VDC $T_0$	.160	.070
	4.7 MFD @ 2 VDC		
B	.33 MFD @ 35 VDC $T_0$	.200	.080
	10 MFD @ 2 VDC		
A	.68 MFD @ 35 VDC $T_0$	.225	.100
	22 MFD @ 2 VDC		
G	3.3 MFD @ 20 VDC $T_0$	.250	.150
	47 MFD @ 3 VDC		

QUANTITIES UP TO 2,000 UNITS DELIVERED IN A MAXIMUM OF TWO WEEKS.

TECHNICAL BULLETIN AVAILABLE ON REQUEST.



COMPONENTS, INC.

CAPACITOR DIVISION

SMITH STREET / BIDDEFORD, MAINE - 04005 • PHONE 207-284-5956  
3540 OSBORN ROAD / PHOENIX, ARIZONA - 85019 • PHONE 602-272-1341

ON READER-SERVICE CARD CIRCLE 97

Subminiature  
**ILLUMINATED  
PUSH BUTTON  
SWITCHES**  
and matching  
**Indicator Lights**

Switch Form A or B  
with 3/4" sq. cap

Switch Form C  
with 1/2" rnd. cap

Matching Indicator  
with 3/4" rnd. cap

Matching Indicator  
with 1/2" sq. cap

For complete  
data, request  
current Catalog.

Illust. approx. 75% actual size

DIALCO Switches and Indicator Lights provide almost limitless applications—are flexible in arrangement—economical in price—and feature high reliability.

Switches are the silent, momentary type—requiring 24 oz. (approx.) operating force. Contact arrangements are: S.P.S.T., normally open or normally closed; S.P.D.T. two circuit (one normally open, one normally closed). Ratings: 3 amps, 125V A.C.; 3 amps, 30V D.C. (non-inductive). The switch is completely enclosed and independent of the lamp circuit. The light source is the T-1 3/4 incandescent lamp, available in voltages from 1.35 to 28V. Units are made for single hole (keyed) mounting in panels up to 3/16" thick and mount from back of panel in 1/2" clearance hole. Switch forms for dry circuits are also available.

Other features include: 1/2" or 3/4" interchangeable caps, round or square, rotatable or non-rotatable, in a choice of 7 color combinations.



FOREMOST MANUFACTURER OF PILOT LIGHTS  
**DIALIGHT** CORPORATION  
60 STEWART AVENUE, BROOKLYN, N.Y. 11237 212 HYACINTH 7-7600  
ON READER-SERVICE CARD CIRCLE 98

NEW LITERATURE

**Thin-metal tubing selector**

A 12-page selection guide describes more than 80 metal alloys available in thin-wall tubing and tubular fabrications. Selection tables include nominal chemical composition, melting range, density, coefficients of thermal expansion and electrical resistivity as well as tensile and yield strengths. Uni-form Tubes, Inc.

CIRCLE NO. 300

**Printed circuit drafting aids**

This cross-referenced printed circuit catalog illustrates a line of drafting aids, giving size, shape, price, delivery and notation. Aids such as transistor tri-pads and "tape-lift" shapes are included. By-Buk Co.

CIRCLE NO. 301

**Miniature coax connectors**

Miniature coaxial connectors for high-impedance systems are described in this catalog. Dimensional drawings for 21 connector varieties are shown. Cutaway drawings explain design features of the connectors. Cinch-Nuline Industries Inc.

CIRCLE NO. 302

**Real-time computer**

Sigma 2, a small, low-cost, real-time computer, is described in this 16-page brochure. The booklet describes the overall design concept, special design features, software and wired instructions, system interface units and peripheral equipment. Scientific Data Systems.

CIRCLE NO. 303

*your POSTMASTER suggests*  
**SHOP and MAIL EARLY**

**"MAIL PARCELS"**  
 > FOR OUT OF TOWN DELIVERY  
NO LATER THAN DECEMBER 5th  
 > FOR LOCAL DELIVERY  
NO LATER THAN DECEMBER 14th

**"GREETING CARDS"**  
 > FOR OUT OF TOWN DELIVERY  
BY DECEMBER 10th  
 > FOR LOCAL DELIVERY  
BY DECEMBER 15th

USE  
**ZIP CODE NUMBERS**  
IN ALL ADDRESSES

WRAP PACKAGES  
SECURELY

POSTMASTER



### Power supply catalog

Ac to dc, dc to ac, ac to ac and dc to dc supplies for industrial and military use are featured in this hard-cover catalog. The book lists full data, drawings, block diagrams, price and photos of MIL dc modules, industrial type modules, unregulated modules, variable supplies, inverters, frequency changers and high-voltage supplies. Electronic Research Associates Inc.

CIRCLE NO. 304

### Adjustment potentiometers

This catalog contains nomenclature, dimensions, specifications, price listings, and actual size photos of over 50 high performance wirewound, non-wirewound, special, and general purpose adjustment potentiometers. Bourns Inc.

CIRCLE NO. 305

### Answer to Puzzle on p. 99



# Did he have wave filters in mind?

## Чебышёв

Above is the original Russian spelling of Chebyshev, the name of a nineteenth century mathematician to whom modern network theory owes a debt of gratitude. His well known polynomials were published in "Oeuvres" Vol. 1, St. Petersburg, 1899, for use in studying the construction of steam engines. Obviously, he didn't have wave filters in mind.

When Chebyshev Polynomials are applied to modern filter synthesis they produce ladder networks with controlled pass band ripple, and roll-off which is more rapid than that produced by "classical" networks such as the image parameter "constant K".

The illustration below shows the improved sharpness at cutoff and increased roll-off rate for a one section Chebyshev Filter. Admittedly, this is a simplified example, but it provides an easily understandable comparison between "old" and "new" design methods.

When the use of more sophisticated tools such as elliptic functions and Bessel Polynomials are added to the Chebyshev Polynomials, Modern Network Synthesis becomes a powerful vehicle for the realization of today's computer and space oriented filtering problems.

ADC staff specialists are skilled in the art of Modern Network Synthesis. The classical, modern or computer approach to network design is used as each may fit a particular application. Facilities include those for design, prototype sampling, testing, and production.

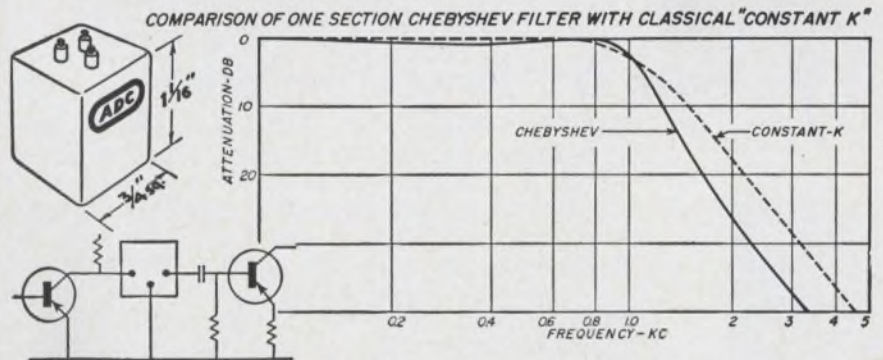

If modern network theory and its application interests you, we'll be glad to send you a copy of "General Approaches to Wave Filter Design"—no charge, no obligation.



### ADC PRODUCTS

A DIVISION OF MAGNETIC CONTROLS CO.  
6405 CAMBRIDGE STREET ■ MINNEAPOLIS, MINN. 55426

ON READER-SERVICE CARD CIRCLE 100



# Design Data from Manufacturers

Advertisements of booklets, brochures, catalogs and data sheets. To order use Reader-Service Card.

(Advertisement)

## 160 Page Power Supply Handbook



The Kepco Power Supply Handbook covers the subject of regulated DC Power Supplies in detail. Particular emphasis is placed on the programming concept and its myriad applications to complex systems control problems. A comprehensive chapter on Power Supply testing will be of value to the test engineer.

Profusely illustrated with innumerable circuit diagrams, block diagrams and photographs, the Kepco Power Supply Handbook is a valuable addition to any engineering library.

**Kepco, Inc.**

131-38 Sanford Avenue  
Flushing, N. Y. 11352

# 171

## Potentiometers, Switches & Turns-Counting Dials



A four-page, two-color short-form catalog from Duncan Electronics, Inc., gives complete specifications and prices on Duncan's precision multi- and single-turn potentiometers for both military and commercial applications. Also included are details on Duncan's Series 60 and 80 turns-counting dials designed for use with multi-turn potentiometers; non-linear potentiometer information for log, trig, empirical, or other forms of non-linear functions; and precision commutator switches for use either individually or in ganged assemblies with potentiometers and other switching devices.

**Duncan Electronics, Inc.**

2865 Fairview Road  
Costa Mesa, California 92626

# 172

## Multi-Purpose DC Power Supplies

### 0-40 Volts



CAL-POWER Series TVR Power Supplies are general purpose transistorized voltage-regulated power sources. They convert 105/125 volt single-phase AC input power into adjustable regulated DC output power up to 100 amperes. Fully solid state in construction, these power supplies are suitable for laboratory applications, system tests, component testing, production line use and applications where automatic or manual remote programming is desired. They may be used to furnish power to transistor circuits which are voltage sensitive, current-sensitive or both.

Send for Brochures TVR and TVR-040 for complete details and ordering information.

**Cal-Power Corporation**

140 Kansas Street  
El Segundo, California

# 173

## NEW LITERATURE

### Speed measurement

A 28-page booklet "Speed Measurement and Control," contains information on ac and dc tachometer systems. Included are instruments available, various methods of mounting and indicator devices. Weston Instruments. **CIRCLE NO. 306**

### Reprints Available

The following reprints are available free and in limited quantities. To obtain single copies, circle the number of the article you want on the Reader-Service Card.

*New FETs replace tubes* (No. 307)

*It's what's up front that counts* (No. 308)

*Simplified NAND Circuit synthesis.* (No. 309)

### Accuracy Policy

It is the policy of ELECTRONIC DESIGN:

To make reasonable efforts to insure accuracy of editorial matter.  
To publish promptly corrections brought to our attention.

To reserve the right to refuse any advertisement deemed misleading or fraudulent.

All editorial correspondence and manuscripts should be sent to:

Howard Bierman, Editor  
ELECTRONIC DESIGN  
850 Third Avenue  
New York, N. Y. 10022

### Subscription Policy

ELECTRONIC DESIGN is circulated free of charge to qualified design engineers in the U.S., Western European Continent and Britain. To establish your qualifications, send ELECTRONIC DESIGN the following information on your company's letterhead: Your name, engineering title, description of your design duties and a list of your company's major products. The letter must be signed by you personally.

Subscription rates for nonqualified subscribers—\$25 a year in the U.S., \$35 in all other countries. Single copy, \$1.50.

### Change of Address

A subscriber's change of address requires a restatement of his qualifications. To expedite the change, and to avoid missing any issues, send along a label from a back copy.

### Microfilm Copies

Microfilm copies of all 1961, 1962, 1963, 1964 and 1965 issues of ELECTRONIC DESIGN are available through University Microfilms, Inc., 313 N. First Street, Ann Arbor, Mich.

## Advertising Representatives

**New York 10022**  
 Robert W. Gascoigne  
 Thomas P. Barth  
 Samuel M. Deitch  
 Richard W. Nielson  
 850 Third Avenue  
 (212) PLaza 1-5530  
 TWX: 867-7866

**Philadelphia**  
 Fred L. Mowlds, Jr.  
 P. O. Box 206  
 Merion Station, Pa. 19066  
 (215) MO 4-1073

**Boston**  
 Richard Parker  
 7 Redstone Lane  
 Marblehead, Mass. 01945  
 (617) 742-0252

**Chicago 60611**  
 Thomas P. Kavooras  
 Berry Conner, Jr.  
 720 N. Michigan  
 (312) 337-0588

**Cleveland**  
 Robert W. Patrick  
 8410 Treetower Drive  
 Chagrin Falls, Ohio 44107  
 (216) 247-7670

**Los Angeles 90303**  
 Stanley I. Ehrenclou  
 Terrence D. Buckley  
 W. James Bischof  
 2930 W. Imperial Highway  
 Inglewood, Calif.  
 (213) 757-0183

**San Francisco**  
 Ashley P. Hartman  
 175 South San Antonio Rd.  
 Ste. 243  
 Los Altos, Calif. 94022  
 (415) 941-3084

**Southwestern 75206**  
 Tommy L. Wilson  
 6200 North Central Expressway  
 Dallas, Tex.  
 (214) EMerson 1-2311

**London W. 1**  
 Brayton C. Nichols  
 44 Conduit Street

**Tokyo**  
 Yoshihiro Takemura  
 International Planning  
 Service, Inc.  
 Room 231 Tokyu-Mita Bldg.  
 1, Shiba-Mita Koun-cho  
 Minato-ku, Tokyo



# IC PACKAGING PANELS

for high density packaging

**LOW COST  
 HIGH PERFORMANCE  
 FAST DELIVERY**

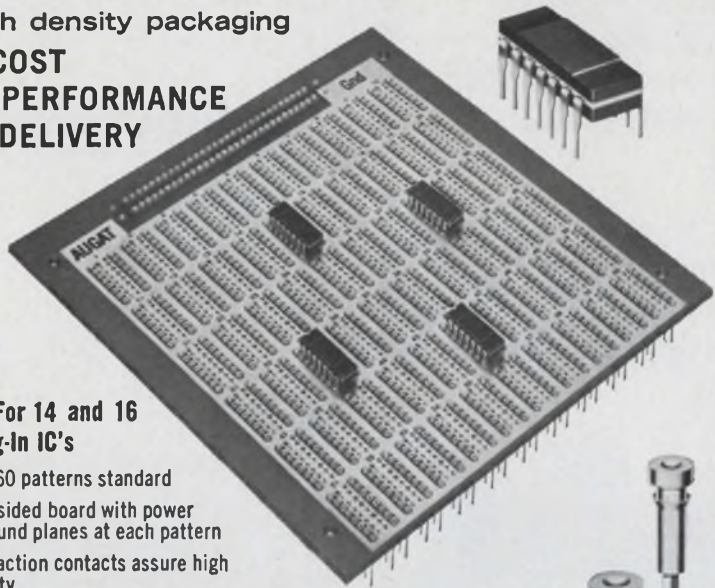

**PANELS For 14 and 16  
 Lead Plug-In IC's**

- 30 and 60 patterns standard
- Double-sided board with power and ground planes at each pattern
- Wiping-action contacts assure high reliability
- Wire-Wrap® or solder pot terminations
- Custom designs invited

®Trademark Gardner-Denver Co.

Request Catalog 364 describing our complete line of integrated circuit products for Testing, Breadboarding and Packaging.

**AUGAT** inc. 31 PERRY AVE., ATTLEBORO, MASS. 02703



ON READER-SERVICE CARD CIRCLE 106

# Photocell Decay Problems?

Typesetter  
 lost a zero.  
 This should be  
 .0006

Try Type 7H



Clairex Type 7H Photocells now offer decay times of .006 sec @ 100 ft-c. Couple this with 240 ohms @ 100 ft-c, CdS stability, and your problems are solved. Available in TO-18 and TO-5 cases. And 6 resistance ranges.

# CLAIREX

"The LIGHT Touch in Automation and Control"

1239 Broadway, New York, N.Y. 10001  
 212 MU 4-0940

ON READER-SERVICE CARD CIRCLE 107

**How do you  
evaluate audio  
oscillators?**

**How can you be sure  
of the right selection  
for your particular  
application?**

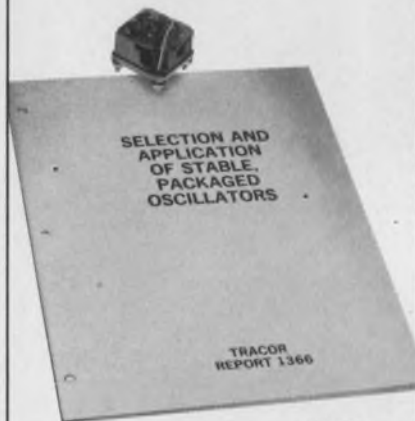

TFA-1066

**TRACOR® has an  
answer**

“Selection and Application of Stable, Packaged Oscillators” is a comprehensive two-part report. Section I outlines the availability of standard oscillators in the 0.5% to 0.0001% accuracy range. Section II offers guidelines for choosing a specific oscillator.

The report is free from TRACOR.

Whether or not you want a copy, may we help you evaluate oscillators in your next application?

TRACOR, Inc.  
General Sales Offices  
6500 Tracor Lane  
Austin, Texas 78721



REPRESENTATIVES IN PRINCIPAL CITIES

# Advertisers' Index

Advertiser	Page	Advertiser	Page
ADC Products, A Division of Magnetic Controls Co. ....	155	Lambda Electronics Corp. ....	112, 113
AMP, Incorporated ....	12	Leach Corporation ....	111
Acopian Corporation ....	118	Leeds & Northrup Company ....	40
Allen-Bradley Co. ....	32, A-B	Littelfuse ....	146
American Lava Corporation ....	140	Litton Industries, Electron Tube Division	131
Amperex Electronic Corporation ....	116, 117		
Analog Devices, Inc. ....	136, 137	Mac Panel Company ....	138
Augat, Inc. ....	157	Mallory & Co., Inc., P. R. ....	7
		Mallinckrodt Chemical Works, Electronic Chemicals ....	48
Bell Telephone Laboratories ....	119	Marco-Oak Industries/Division of Oak Electro/Metrics Corp. ....	129
Bendix Corporation, The, Semiconductor Division ....	62, 63	Methode Electronics, Inc. ....	142
Bourns, Inc. ....	91	Microdot, Inc. ....	24
Brand Rex, Div. of American Enka Corporation ....	151	Monitor Systems, Inc. ....	134
Bud Radio, Inc. ....	145	Motorola Semiconductor Products, Inc. ....	4, 5, 39
Burdny Corporation ....	23	Mullard Limited ....	31
Cal Power Corporation ....	156	National Semiconductor Corporation ....	31
Canoga Electronics Corporation ....	160	Nytronics, Inc. ....	135
Clairex Corporation ....	157		
Clevite Corporation, Piezoelectric Division ....	146	Ohmite Manufacturing Company ....	35
Clifton Precision Products, Division of Litton Industries ....	107		
Communications Electronics, Incorporated ....	152	Pacific Data & Controls ....	144
Components, Inc. ....	153	Pamotor, Inc. ....	140
Consolidated Electrodynamics, A Subsidiary of Bell & Howell ....	81	Perkin Elmer Corporation ....	149
Continental Device Corporation ....	68, 69	Phllco-Ford Corporation ....	61
Cutler-Hammer ....	45	Plastic Capacitors, Inc. ....	144
		Polaroid Corporation ....	2
		Pyrofilm Resistor Co., Inc. ....	147
Dale Electronics, Inc. ....	Cover III	RCA Electronic Components and Devices ....	85, Cover IV
Delco Radio, Division of General Motors ....	124, 125	RCL Electronics, Inc. ....	6
Dialight Corporation ....	154	Radiation, Incorporated ....	42, 43
Digitran Company, The ....	128	Radio Cores, Inc. ....	122
Duncan Electronics, Inc. ....	156	Raytheon Company, Sorensen Operation	16
Dynamics Instrumentation Company ....	148	Relcom ....	123
		Ripley Co., Inc. ....	114
Electro-Motive Mfg. Co. Inc., The ....	104	Sanders Associates, Inc. ....	102
Electronic Design ....	74, 75, 159	Scanbe Manufacturing Corp. ....	126
		Singer Company, The—Metrics Division ....	132, 133
Fairchild Semiconductor, A Division Fairchild Camera and Instrument Corporation ....	8, 9, 112, 113	Solitron Devices, Inc. ....	103
Firling Circuits, Inc. ....	150	Specific Products ....	44
Fluke Mfg. Co., Inc., John ....	127	Spectrol Electronics Corporation ....	108
		Sprague Electric Company ....	10, 20
		Systron-Donner Corporation ....	56, 57
General Electric Company, Electronic Components Division ....	80, 143	TRW Capacitors ....	46
General Electric Company, Sillicone Products Department ....	85	Taber Instrument Corporation Aerospace Electronics Division ....	141
General Instrument Corporation ....	15	Tektronix, Inc., Oscilloscopes ....	109
General Magnetics, Inc. ....	28, 29	Teledyne Telemetry Company ....	67
General Radio Company ....	1	Telrex Laboratories ....	147
		Thomas & Skinner, Inc. ....	79
		Tracor, Inc. ....	158
Harowe Servo Controls, Inc. ....	134	Varian Associates ....	93
Hathaway Instruments, Inc. ....	33	Vector Division of United Aircraft Corporation ....	27
Heinemann Electric Company ....	34	Vector Electronic Co. Inc. ....	152
Hewlett-Packard ....	Cover II		
Hewlett-Packard, Dymec Division ....	115	Westinghouse Molecular Electronics Division ....	55
Honeywell, Precision Meter Division ....	41		
Honeywell Test Instruments Division ....	139		
IRC, Inc. ....	89		
Industrial Electronic Engineers, Inc. ....	130		
Inland Motor Corporation ....	38		
Johanson Manufacturing Corporation ....	19		
Kepeco, Inc. ....	156		
Kester Solder Company ....	38, 37		

**Career Advertising:**

Bendix Corporation, The ....	102
Lockheed Missiles & Space Company ....	98
Motorola, Inc. ....	100
PRD Electronics, Inc. ....	101

# JAMES<sup>®</sup>

ELECTRONICS, INC.

## MADE A READERSHIP STUDY AMONG 586 CUSTOMERS AND PROSPECTS...HERE ARE THE RESULTS:

PUBLICATION	Rank	Read	% Read
ELECTRONIC DESIGN	<b>1</b>	75	54.0
ELECTRONIC INDUSTRIES	4 (tie)	35	25.2
ELECTRONICS	2	49	35.3
ELECTRICAL DESIGN NEWS	3	40	28.8
IEEE SPECTRUM	9	16	11.5
ELECTRONIC EQUIPMENT ENGINEERING	6	34	24.5
ELECTRO-TECHNOLOGY	4 (tie)	35	25.2
ELECTRO-MECHANICAL DESIGN	10	13	9.4
ELECTRONIC PRODUCTS	7	26	18.7
ELECTRONIC NEWS	8	17	12.2

### READERSHIP STUDY BOX SCORE

STUDY NUMBER	NUMBER OF STUDIES TO DATE	NUMBER WON BY ELECTRONIC DESIGN
52	52	48

James Electronics, Inc. has joined the ranks of those electronic marketers who have taken the guesswork out of media selection. James sent a questionnaire to 586 customers and prospects asking them to list the technical trade publications they read or scan. The chart, above, shows the results . . . *Electronic Design* is on top of the list!

Again, and again, and again, when manufacturers take the trouble to survey the readership of their own customers and prospects, *Electronic Design* turns up in first position. The box score shows that *Electronic Design* has won 48 out of 52 studies reported to date . . . a batting average of .923! When you buy *Electronic Design*, you buy readership!

## Electronic Design RANKS 1st in READERSHIP

a HAYDEN publication 850 Third Avenue, New York, N.Y. 10022 (212) PL 1-5530

## MICROCIRCUIT MODULES

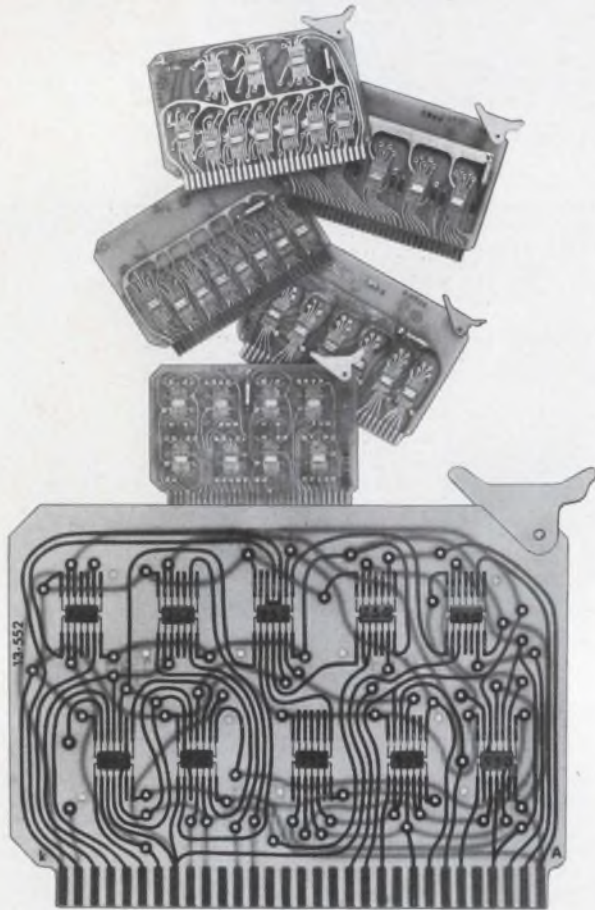

# HIGHEST DENSITY

...and simplified Gating Rules Reduce Costs

The ADC 13-Series features unique function grouping, simplified gating rules and a 62 pin connector which permits the highest density per board. This means more functions per board — fewer boards required — less wiring — less noise problems — less cost. The 13-Series offers the most economical logic implementation as well as field proven performance. ■ The ADC 13-Series further expands (more than 30 new modules) the most complete line of logic modules available. ■ The 100 kc - 10 Series, with germanium semi-conductors, is simple, economical and reliable. The 1 mc 11-Series using silicon semiconductors, is ideal for high performance applications and the 11G-Series meets all applicable MIL/NASA specifications. ADC offers free logic implementation service for competitive evaluation and application assistance.

■ Write for new short form catalog and obtain a free logic design handbook.



**CANOGA** ELECTRONICS CORPORATION  
ADC DIGITAL PRODUCTS DIVISION

20131 Sunburst St., Chatsworth, Calif. 91311, Tel. (213) 341-3010, Twx (910) 494-1214

## Designer's Datebook

DECEMBER						
S	M	T	W	T	F	S
				1	2	3
4	5	6	7	8	9	10
11	12	13	14	15	16	17
18	19	20	21	22	23	24
25	26	27	28	29	30	31

JANUARY						
S	M	T	W	T	F	S
1	2	3	4	5	6	7
8	9	10	11	12	13	14
15	16	17	18	19	20	21
22	23	24	25	26	27	28
29	30	31				

**Nov. 29-Dec. 2**

**AIAA Third Annual Meeting and Technical Display** (Boston) Sponsor: AIAA; Vincent J. Coates, Jr., Avco Everett Research Lab., 2385 Revere Beach Pkwy., Everett, Mass. 02149

**Nov. 27-Dec. 1**

**Energy Systems Exposition and Winter Annual Meeting** (New York) Sponsor: American Society of Mechanical Engineers; Marvin D. Frankel, Muller, Jordan & Herrick, Inc., 545 Fifth Ave., New York. 10017

**Dec. 7-9**

**15th Annual Wire and Cable Symposium** (Atlantic City, N. J.) Sponsor: Army Electronics Command; J. Spergel, Wire and Cable Symposium, U.S. Army Electronics Command, Fort Monmouth, N. J. 07703

**Dec. 7-9**

**International Scientific Radio Union (URSI)** (Palo Alto, Calif.) Sponsor: U.S. National Committee of the International Scientific Radio Union; Prof. R. A. Helliwell, Radioscience Lab., Stanford University, Stanford, Calif. 94305

**Dec. 26-31**

**133rd Meeting of the American Association for the Advancement of Sciences** (Washington, D. C.) Sponsor: AAAS; Mrs. Thelma C. Heatwole, 5110 W. Franklin St., Richmond, Va. 23226

**Jan. 4-7, 1967**

**Winter Meeting of the National Society of Professional Engineers** (San Juan, P. R.) Sponsor: NSPE; Kenneth E. Trombley, National Society of Professional Engineers, 2029 K. St., N.W., Washington, D. C. 20006



# Handle more heat with smaller resistors

Photo shows comparison of effective heat dissipation area of conventional 10 watt wirewound (top) with that of 10 watt Series G wirewound with beryllium oxide core.



## G SERIES ...more design freedom from an unmatched power-size ratio

Beryllium oxide cores in Dale's G Series wirewounds put almost the entire resistance element to work at maximum temperature — not just a tiny area. This creates a design bonus that includes: A power-size ratio 40% to 150% greater than conventional silicone-coated resistors *and* exceptional stability when derated to MIL-R-26D, MIL-R-26C or MIL-R-23379 levels.

G Series power-stability advantages are available in axial and radial lead styles and with non-inductive winding. For established reliability, check the AGS Series — proven failure rate .00051% per 1000 hours. G Series advantages can also be readily adapted to your special requirements. For complete G Series information call us now at 402-564-3131.

### CORE CONDUCTIVITY AT 275°C

BTU-Ft  
FP-Hr-F

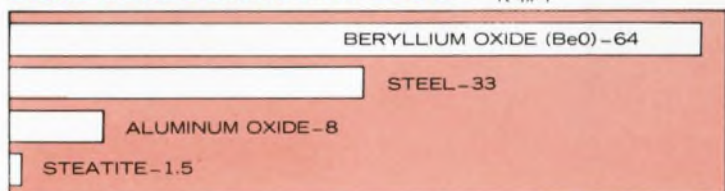

### SPECIFICATIONS

- **Ten sizes:** 1 through 15 watts
- **Meet requirements** of MIL-R-26D, MIL-R-26C and MIL-R-23379
- **Resistance Range:** .1 to 273K ohms, depending on tolerance and size
- **Tolerances:** .05%, .1%, .25%, .5%, 1%, 3%
- **Typical size:** G-1 (1 watt), .250" L. x .078" D.;  
G-15 (15 watts), 1.781" L. x .375" D.
- **Stability:** When G resistors are operated at the same ratings as conventional MIL-R-26D resistors of equivalent size, the G resistance shift will be 50% or less than that of the conventional resistor.

WRITE FOR CATALOG A



**DALE ELECTRONICS, INC.**

1328 28th Avenue, Columbus, Nebraska  
In Canada: Dale Electronics Canada, Ltd.





# RCA

## 2N4427...

### The First RCA "Overlay"

### Transistor

### For Under

### \$2.00\*

\*\$1.90 each in quantities of 1000 and up.

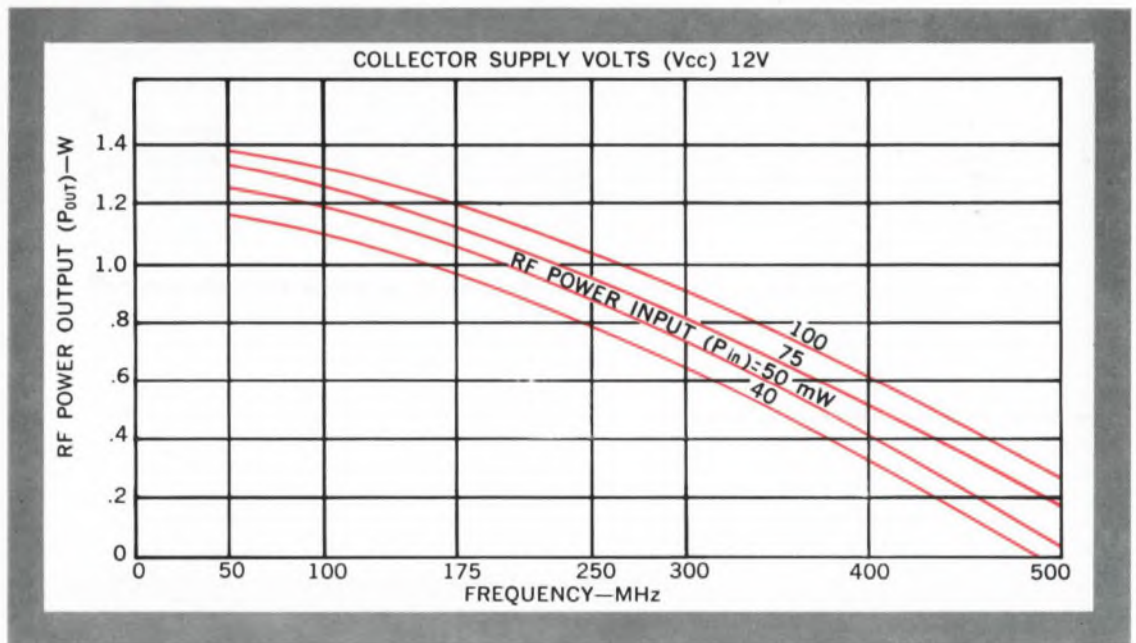

#### Available Now in Production Quantities

Price *plus* performance, that's what RCA's new 2N4427 delivers in a big way! Available at an unprecedented low price for RCA "overlay" transistors, the 2N4427 brings new economies to mobile, military and CATV designs, extending the industry-accepted benefits of RCA "overlay." And talk of circuit capability, no unit at this price can match the design features of the 2N4427. Here's proof:

- 1 W  $P_{out}$  with 10 dB gain (min) @ 175 MHz
- 0.4 W  $P_{out}$  with 5 dB gain (typ) @ 470 MHz

- 50% efficiency @ 175 MHz
- $V_{CC} = 12 V$

In pre-driver, driver, or final stages, each 2N4427 you use means more gain, improved power output, plus uncompromised reliability. Every unit undergoes 100% rf testing, assuring you of the same circuit safety offered by "overlay" types costing many times more.

Call your RCA representative today for additional information on the new 2N4427. For technical data sheet, write: RCA Commercial Engineering, Section IG-11-Y, Harrison, N.J. 07029.

SEE YOUR RCA DISTRIBUTOR FOR HIS PRICE AND DELIVERY

RCA ELECTRONIC COMPONENTS AND DEVICES



The Most Trusted Name in Electronics  
ON READER-SERVICE CARD CIRCLE 186