

# Electronic Design 18

VOL. 14, NO.

THE MAGAZINE OF ESSENTIAL NEWS, PRODUCTS AND TECHNOLOGY

AUGUST 2, 1966

**Electronics for the jungles.** Green Berets, America's guerilla warriors, give equipment its toughest field test. Failures can mean death, since 12-man

teams can't hold off VC hordes without air support. Vietnam veterans tell how gear is holding up, what they need for the future, in an exclusive interview (p. 36).



# IMPROVE MEASUREMENT ACCURACY

Clean pulse shapes assuring accurate, easy-to-interpret measurements is the important feature you get with any one of four hp Pulse Generators. Each pulser has a 50-ohm source impedance that minimizes error-producing reflections from distorting the waveform—even from badly mismatched loads.

You have a choice of four pulse rise times. Pulse rep rate, amplitude and width are variable to match your particular requirements. Triggering can be either internal

or external for accurate synchronization with other equipment. Trigger outputs are available for synchronizing other equipment.

Check the specifications given below to determine which model hp Pulse Generator best fits your signal requirements! Then call your nearest hp field engineer for a bench demonstration, or write for full information to Hewlett-Packard, Palo Alto, California 94304, Tel. (415) 326-7000. Europe: 54 Route des Acacias, Geneva.

*Work With The Cleanest Pulse Shapes! Pick One of Four hp Pulse Generators*

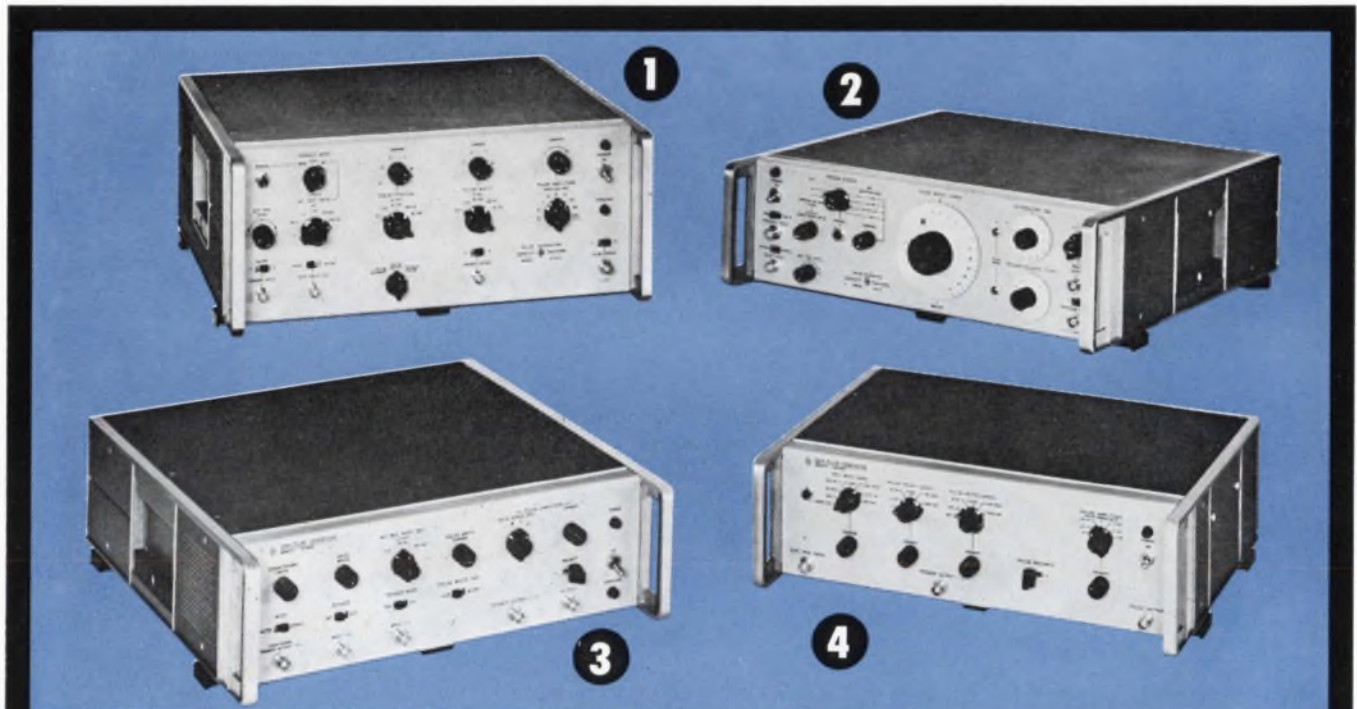

	<b>1 Model 214A</b> 15 nsec Rise Time, 100 v, 1 MHz	<b>2 Model 215A</b> 1 nsec Rise Time, 10 v, 1 MHz	<b>3 Model 216A</b> 2.5 nsec Rise Time, 10 v, 100 MHz	<b>4 Model 222A</b> 4 nsec Rise Time, 10 v, 10 MHz
<b>Source Impedance:</b>	50 ohms on all ranges except 100v	50 ohms $\pm$ 3%	50 ohms $\pm$ 3% approx. 10 pf shunt	50 ohms $\pm$ 3% approx. 15 pf shunt
<b>Pulse Shape:</b>				
Rise time:	<15 nsec	<1 nsec	<2.5 nsec	<4 nsec
Overshoot and ringing:	<5%	<5%	<4%	<4%
Corner rounding:		Occurs no sooner than 95% of pulse amplitude	Occurs no sooner than 95% of pulse amplitude	Occurs no sooner than 95% of pulse amplitude
Perturbations on flat top:	<5%	<2%	<3%	<3%
<b>Pulse Voltage:</b> (into 50)	+ or - 80 mv to 100 volts, vernier	+ or - 2.5 v to 10 volts, db steps	+ or - 0.4 v to 10 volts, vernier	+ or - 0.05 v to 10 volts, vernier
<b>Pulse Width:</b>	Continuously adjustable 50 nsec to 10 msec (5 ranges)	Continuously adjustable 0-100 nsec (4 ranges)	Continuously adjustable 5 to 100 nsec (2 ranges)	Continuously adjustable 30 nsec to 5 msec (6 ranges)
<b>Internal Pulse Rep Rate:</b>	Continuously variable from 10 Hz to 1 MHz in 5 ranges	Continuously variable from 100 Hz to 1 MHz in 3 ranges	Continuously variable from 1 MHz to 100 MHz in 3 ranges	Continuously variable from 10 Hz to 10 MHz in 6 ranges
<b>Price:</b>	\$875.00	\$1875.00	\$1775.00	\$690.00

Prices f.o.b. factory

**HEWLETT *hp* PACKARD**  
An extra measure of quality

ON READER-SERVICE CARD CIRCLE 242

# WIDE RANGE and FINE RESOLUTION In a \$190 Decade Capacitor



- 50 pF to 1.1115  $\mu$ F
- Double shielding . . . capacitance for 2- and 3-terminal connections differs by only 1 pF
- Low-loss polystyrene dielectric in all decades
- $\pm 1\%$  Accuracy
- Bright, in-line readout

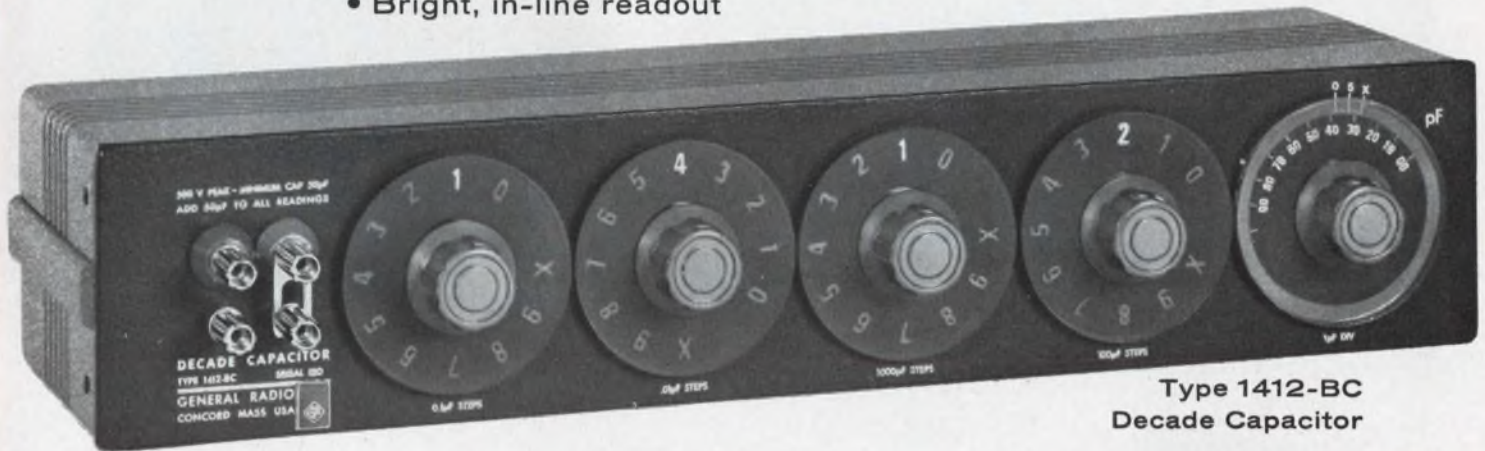

**Type 1412-BC  
Decade Capacitor**

This decade capacitor combines precision decade steps and a high-resolution variable capacitor for continuous adjustment to better than 1 pF between steps. The four decades make possible settings from 100 pF to 1.1111  $\mu$ F in 100-pF steps; nearly the entire range of commonly used capacitance is covered. The built-in 0-100 pF vernier extends the resolution still further for fine comparisons and allows precise calibration for demanding laboratory work. Small size (a mere 3 $\frac{1}{2}$ " high) and clean styling make this capacitor equally useful on a bench or in a rack. With all of its features, the Type 1412-BC is priced reasonably.

## Other Decade Capacitors available from General Radio

For 0.5% Accuracy . . .

**Type 1419-K**

**Decade Capacitor...\$385 in U.S.A.**

This three-decade unit covers the zero to 1.110- $\mu$ F range in 1000-pF steps; capacitance at zero setting is 41 pF when used as a two-terminal device, and 13 pF in three-terminal connections. Silvered-mica dielectric ensures extremely low dissipation factor (less than 0.0003) and temperature coefficient ( $\pm 35 \pm 10$  ppm/ $^{\circ}$ C). The 1419-K is ideal for the demanding 2- and 3-terminal capacitance requirements.

For the Highest Accuracy  
and Stability in a

**Decade Capacitor . . .**

**Type 1423-A**

**Precision Decade Capacitor**

**. . . \$750 in U.S.A.**

0.05% accuracy, 0.01%-per-year stability, and a 100-pF to 1.111- $\mu$ F range (in 100-pF steps). The Type 1423-A is especially valuable for precise comparison and substitution work, since its high accuracy and stability eliminate the need for repeated recalibration.

For

**High Values of Capacitance:**

Type 1424-A Standard Decade Capacitor,  
Polystyrene Dielectric

10  $\mu$ F in 1- $\mu$ F steps, 0.25% accuracy . . . . .  
\$345 in U.S.A.

Type 1424-M Decade Capacitor,  
Paper Dielectric

10  $\mu$ F in 1- $\mu$ F steps . . . 1.0% accuracy . . . . .  
\$210 in U.S.A.

Type 1425-A Standard Decade Capacitor,  
Polystyrene Dielectric

100  $\mu$ F in 10- $\mu$ F steps, 0.25% accuracy . . . . .  
\$1400 in U.S.A.

*Write for Complete Information*

BOSTON • NEW YORK • CHICAGO • PHILADELPHIA • WASHINGTON, D.C.  
SYRACUSE • DALLAS • SAN FRANCISCO • LOS ANGELES • ORLANDO  
CLEVELAND • TORONTO • MONTREAL

GENERAL RADIO COMPANY (Overseas), ZÜRICH, SWITZERLAND  
GENERAL RADIO COMPANY (U.K.) Ltd., BOURNE END, ENGLAND

# GENERAL RADIO

WEST CONCORD, MASSACHUSETTS

# ARE YOU OVERLOOKING THE DIGITAL-TO-ANALOG CONVERTER THAT CAN DO THE BEST JOB FOR YOU? FROM \$150 PER CHANNEL

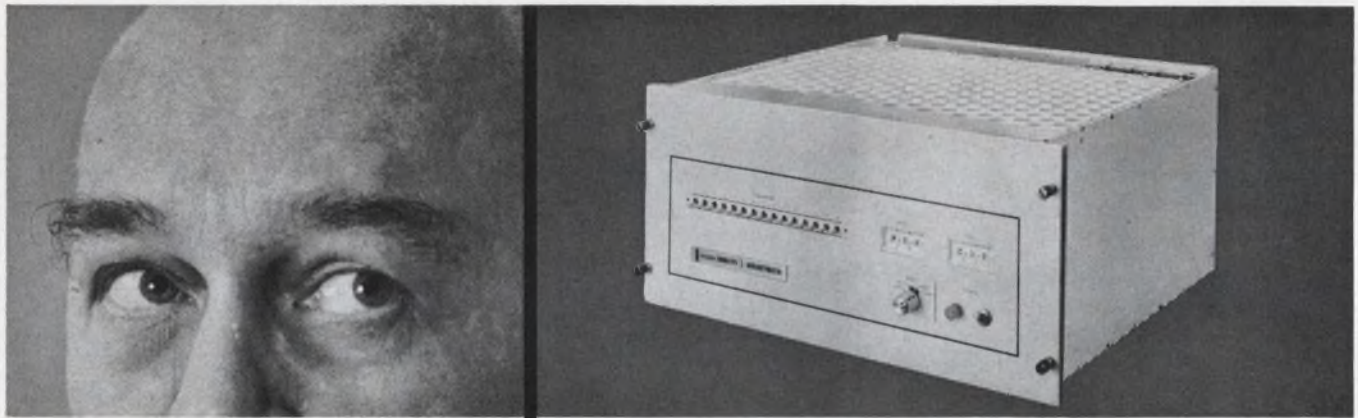

**Chances are it's a REDCOR.** REDCOR offers a family of integrated circuit D-A converters for every application and price range. Each model offers the design engineer a basic conversion system that can easily be expanded to 512 channels with over 5,500 off-the-shelf standard options. REDCOR D-A converters are designed for easy expansion eliminating equipment modification and system down time. Depending on model and option, REDCOR D-A converters can be expanded, in one-channel increments, from 1 to 512 channels. Every model is completely wired at the factory for its full complement of D-A's so that expansion is obtained by simply inserting additional D-A's.

## FEATURES

- TRANSFORMER COUPLED INPUTS provide optimum digital-to-analog ground isolation.
- PLUG-IN MODULAR CONSTRUCTION provides unique ease-of-maintenance.
- LOW OUTPUT IMPEDANCE with an amplifier per D-A converter module.
- HIGH ACCURACY — from  $\pm 0.1$  to  $\pm 0.01$  percent.
- HIGH CONVERSION RATE — up to 250,000 conversions per second.
- CHOICE OF BITS — 8 to 15-bits (including sign).
- FOUR SERIES TO CHOOSE FROM — Series 645 and 646 D-A converters and Series 673 and 675 D-A converters (data distributors).
- FULLY EXPANDABLE — depending on model, up to 128 channels per chassis (including control circuitry, interface power and reference power). Control circuitry of every model is capable of controlling 512 channels. Therefore, expansion up to 512 channels can be obtained by adding additional chassis.
- SMALL SIZE — 128 channel 15-bit D-A converter and data distributor system, 48-channel 8- to 12-bit D-A converter system or 16 channel 12- to 15-bit double-buffered input system in an 8.75 inch high chassis. (Standard 19-inch chassis for mounting to RETMA rails).
- DECAY RATE at 25°C is 0.00022%/ms.
- INTERNAL OR EXTERNAL reference and interface voltage sources.

**If you are looking for an exceptional digital-to-analog converter that will do the best job for you, get all the facts about REDCOR's series 645, 646, 673 & 675 D-A converters. They're worth looking into today.**

Engineers: If your field is analog/digital data systems or component design, a career opportunity awaits you at REDCOR. Write to Personnel Director.

*complete systems compatibility...*

**REDCOR**<sup>®</sup>  
CORPORATION

7800 DEERING AVENUE, P.O. BOX 1031/CANOGA PARK, CALIFORNIA 91304/PHONE (213) 348-5892/TWX 213-348-2573

Speed Inquiry to Advertiser via Collect Night Letter  
ON READER-SERVICE CARD CIRCLE 2

## NEWS

- 13 News Scope
  - 17 **Automated smog monitors on horizon**  
Massive anti-pollution programs foreshadow bigger use of electronics in monitoring systems.
  - 21 **Optics studied for faster space communications**  
Raytheon investigates laser methods for overcoming problems inherent in bulky RF systems.
  - 26 Gunn-effect oscillators have improved cw performance.
  - 33 CRT electron beam controls scanning laser.
  - 36 **Electronics needed for guerrilla warfare**  
An exclusive interview with members of the U.S. Special Forces—the Green Berets—on the equipment problems posed by the war in Vietnam and what they would like to see designed to overcome them.
  - 49 **Editorial:** The electronic designer plays a role in world leadership.
- 

## TECHNOLOGY

- 52 **Avoid power transistor failure!** Use these application-oriented guidelines to establish the device's safe operating area (Soar).
  - 60 **'Kick on' the tank circuit** to generate synchronous-keyed burst oscillation. Unlike other designs, this method is simple, stable, free of unwanted signals.
  - 64 **Complementary regulator design** boosts power supply versatility. Result is a low-drift, regulated, fast-turn-off, dual dc source needing no fuse protection.
  - 68 **Determine a one-shot's period** accurately. The graphical method described here produces exact results with minimum arithmetic.
  - 71 Ideas for Design
- 

## PRODUCTS

- 84 **Semiconductors:** Silicon transistor goes to 4 GHz as amp, 6 GHz as oscillator.
  - 88 Components 98 Systems
  - 94 Microelectronics 101 Microwaves
  - 97 Test Equipment
- 

## Departments

- 104 Design Aids 111 Advertisers' Index
- 106 New Literature 112 Designer's Datebook

Watch for "Design Directions," appearing for the first time in ED 20 on August 30. With the swift pace of today's technology goes the need to gain perspective on the developing areas of the design engineer's art. This regular new feature of the Technology section will supply the incisive discussion and in-focus look-ahead that are needed. Written by ED's engineer-editors and appearing every second issue, it will take up design subjects of broad significance to the industry. Keep an eye on it!

# New Tektronix Type 556

## DC-to-50 MHz, dual-beam, sweep-delay oscilloscope

The Type 556 and rack-mount Type R556 use any combination of Tektronix letter or 1-series plug-ins

The UPPER BEAM can display a signal from either *left* or *right* plug-in; with either Time Base A, Time Base B, or external signals; triggered from a composite vertical signal, plug-in single channel signal (with 1A1 or 1A2), external, or line.

The LOWER BEAM can display a signal from the *right* plug-in; with either Time Base B or external signals; triggered from a composite vertical signal, plug-in single channel signal (with 1A1 or 1A2), external, or line.

**Independent Vertical Systems** use Type 1A1 or 1A2 Plug-In Units for 50 MHz operation; also accept any other 1-series or letter-series plug-ins.

**Independent Sweep Systems** provide 24 calibrated steps from 0.1  $\mu\text{s}/\text{cm}$  to 5  $\text{s}/\text{cm}$ ; the X10 Magnifier extends the fastest sweep rates to 10  $\text{ns}/\text{cm}$ .

**Calibrated Sweep Delay** extends continuously from 0.1 microsecond to 50 seconds.

**Single-Sweep Operation** enables one-shot displays of normal or *delayed* sweeps.

**Independent Triggering Systems** provide stable displays to beyond 50 MHz. Either input signal can be used to trigger either or both time-bases.

**New Dual-Beam CRT** (with illuminated internal graticule) provides "zero-parallax" viewing of small spot size and uniform focus over the 8 cm by 10 cm display area. Each beam has 6 cm vertical scan, with overlap scan of 4 cm by 10 cm.

**EMI (RF) Suppression** — meets interference specifications of MIL-1-6181D over these frequency ranges: 150 kHz to 1 GHz — Radiated (with CRT mesh filter installed), and 150 kHz to 25 MHz — Conducted (power line).

Size is 15" x 17" x 24".

Weight is  $\approx$  80 pounds, without plug-ins.

Power Requirement is 100-130 V or 200-260 V, 50-60 Hz  $\approx$  850 watts.

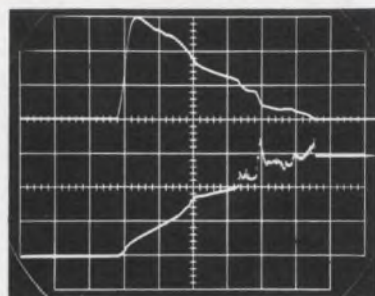
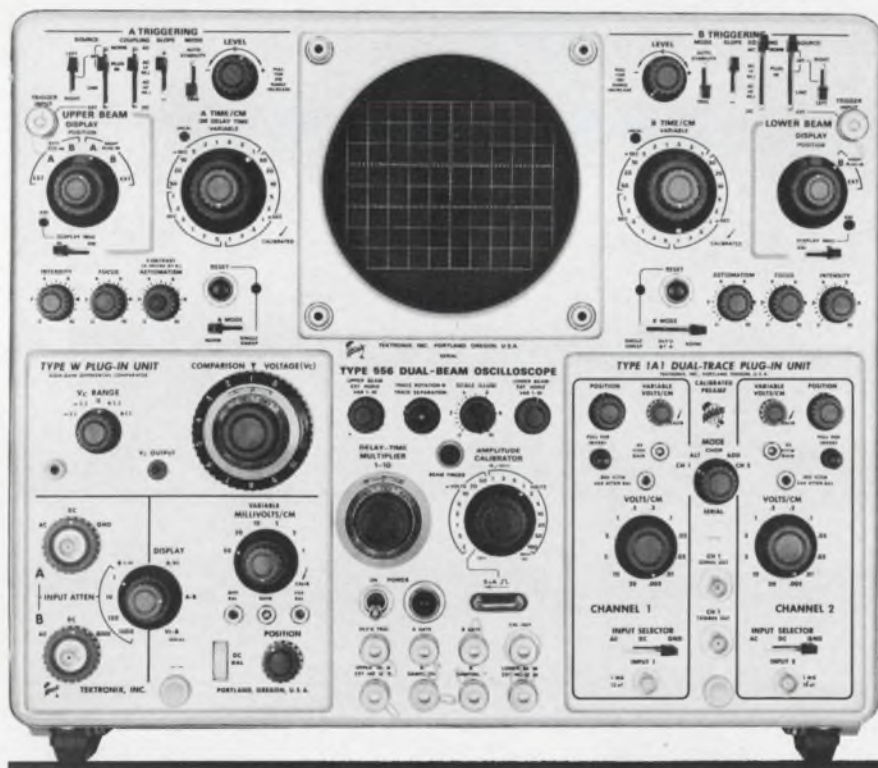

**Simultaneous Single-Shot Displays.** Current versus voltage display of a .75 ampere, fast-blow fuse during destructive overload. Both beams are driven by B Time-Base at 50  $\mu\text{s}/\text{cm}$  which is delayed by pre-triggered A Time-Base to provide base reference lines before and after the event. The upper beam shows the current waveform at 30 A/cm while the lower beam shows the corresponding voltage across the fuse at 100 V/cm.

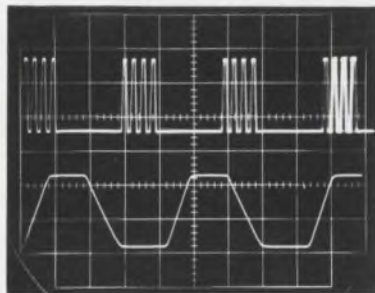

**Single-Input Dual-Beam Displays.** Upper beam shows bursts of 2.5 MHz pulses on Time Base A with time variation between bursts. This shows up as increasing time-jitter between the first and successive bursts. The lower beam shows B Sweep (0.1  $\mu\text{s}/\text{cm}$ ) delayed by A Sweep and triggered on the second pulse of the last burst to provide a jitter-free expanded display of the A Sweep intensified zone. The use of only one probe and one plug-in input simplifies signal connection and provides minimum loading on the source.

### Plug-ins illustrated

Type 1A1 Dual-Trace Unit . . . \$600  
(Dual-Trace—50 mV/cm at DC-to-28 MHz, 5 mV/cm at DC-to-28 MHz. Single-Trace—500  $\mu\text{V}/\text{cm}$  at 2 Hz-to-15 MHz. 5 Display Modes—Channel 1, Channel 2, Alternate, Chopped, Added Algebraically. Front-panel signal output.)

Type W Differential Comparator Unit . . . \$575  
(Conventional Preamplifier—50 mV/cm at DC-to-23 MHz to 1 mV/cm at DC-to-8 MHz. Decade Input Attenuator to X1000. Differential Input Preamplifier—CMRR of 20,000 to 1, DC-to-20 kHz. Max. Peak Input of  $\pm 15$  V, X1 Attenuation. Calibrated Differential Comparator—Vc Supply of 0 to  $\pm 11$  V. Accuracy of  $\pm 0.15\%$  of output  $\pm 0.05\%$  FS.)

Type 556 Dual-Beam Oscilloscope . . . \$3150  
Rack Mount Type R556 Oscilloscope . . . \$3250

U. S. Sales Prices, f.o.b. Beaverton, Oregon

## Tektronix, Inc.



For complete information, contact your nearby Tektronix field engineer or write:  
Tektronix, Inc., P.O. Box 500, Beaverton, Oregon 97005

SEE THE LATEST TEKTRONIX INSTRUMENTS AT WESCON — BOOTH 428-433

ON READER-SERVICE CARD CIRCLE 3

# AE's dry-reed switches are soggybobbinproof

On our PC Correeds\*, we soggy-proof the bobbins by molding them from fiberglass-reinforced nylon. This strong material is marvelously low in moisture absorption. It keeps its shape even when humidity stays at the saturation point.

That's good to know if you're designing AE Correeds into a piece of remote equipment that must work in a Louisiana bayou. Or anywhere that is exposed to moist atmospheres.

Enough about bobbins. Let's take a look at the "business end" of a PC Correed. We separated the leads from the terminals — to eliminate strain. We *welded* the terminals, for a better electrical

connection than possible with solder.

And for high-density packaging, we have designed low profiles, magnetic shielding and standard printed-circuit terminal spacing (multiples of 0.200").

You can get PC Correeds with 1, 2, 3 and 5 reedcapsules. In contact forms A, B, C and magnetic latching. Many of these modules are available directly from stock. Soggy-proof bobbin and all.

Could you use some helpful new design information? Ask your nearby AE representative for Circular 1070-B.

Or write to the Director, Electronic Control Equipment Sales, Automatic Electric Company, Northlake, Ill. 60164.

\*U.S. Patent applied for.



## **AUTOMATIC ELECTRIC**

SUBSIDIARY OF  
GENERAL TELEPHONE & ELECTRONICS **GT&E**

ON READER-SERVICE CARD CIRCLE 4

# Mention silicon Bendix throws book at you.

## A 25-watt plastic silicon transistor for under 40¢

It's loaded with silicon power transistors. Like our new 25-watt B-5000 that sells for under 40¢ in volume. Like our nuclear radiation devices. Like our silicon mesas, best-built and lowest priced in the business. And hundreds of other Bendix units available to meet your silicon needs exactly.

Take the new sensational low-cost B-5000 with 500,000 unit hours of successful life testing behind it. 25 watts at 2.5 amps, 10 volts and 100°C. It's a real breakthrough. No power compromise on normal heat sinks. Outstanding hermeticity. And you name the mounting that suits your production methods best—several

established mounting techniques are available.

Characteristic	Limits			Test Conditions				
	Min.	Max.	Unit	V <sub>CB</sub>	V <sub>CE</sub>	I <sub>C</sub>	I <sub>B</sub>	T <sub>J</sub>
				V	V	A	mA	°C
V <sub>CEO</sub>	35	—	V	—	—	0.2	—	—
I <sub>CEO</sub>	—	10	mA	—	25	—	—	—
I <sub>CBO</sub>	—	1.5	mA	14	—	—	—	150
V <sub>BE</sub>	—	1.2	V	—	14	0.5	—	—
h <sub>FE</sub>	30	250	—	—	14	0.5	—	—
h <sub>FE</sub>	20	—	—	—	14	1.0	—	—
V <sub>CE(s)</sub>	—	1.2	V	—	—	1.0	50	—

Or read all about our radiation-resistant 5- and 10-amp silicon transistors. With base transit times reduced to a

maximum of less than 0.5 nanoseconds at 1 amp collector current, they're great for use in advanced circuits hardened for nuclear radiation environments. Six packages to choose from, too.

RADIATION TYPES							
Max Radiation Level Exposure = 5 x 10 <sup>14</sup> NVT							
Symbol	Type	Pre Rad Limit			Post Rad Limit		
		Min	Typ	Max	Min	Typ	Max
V <sub>CEO</sub>	BR100	40	50	—	40	—	—
	BR101	75	—	—	75	—	—
h <sub>FE</sub>	BR100	40	100	200	15	25	—
	BR101	30	—	150	7	10	—
V <sub>CE(s)</sub>	BR100	—	0.5	1.0	—	1.5	2.0
	BR101	—	0.5	1.0	—	2.0	3.0

Or check the chapters on our regular 3-, 5-, and 10-amp units.

**Bendix Semiconductor Division**  
HOLMDEL, NEW JERSEY





# power and the

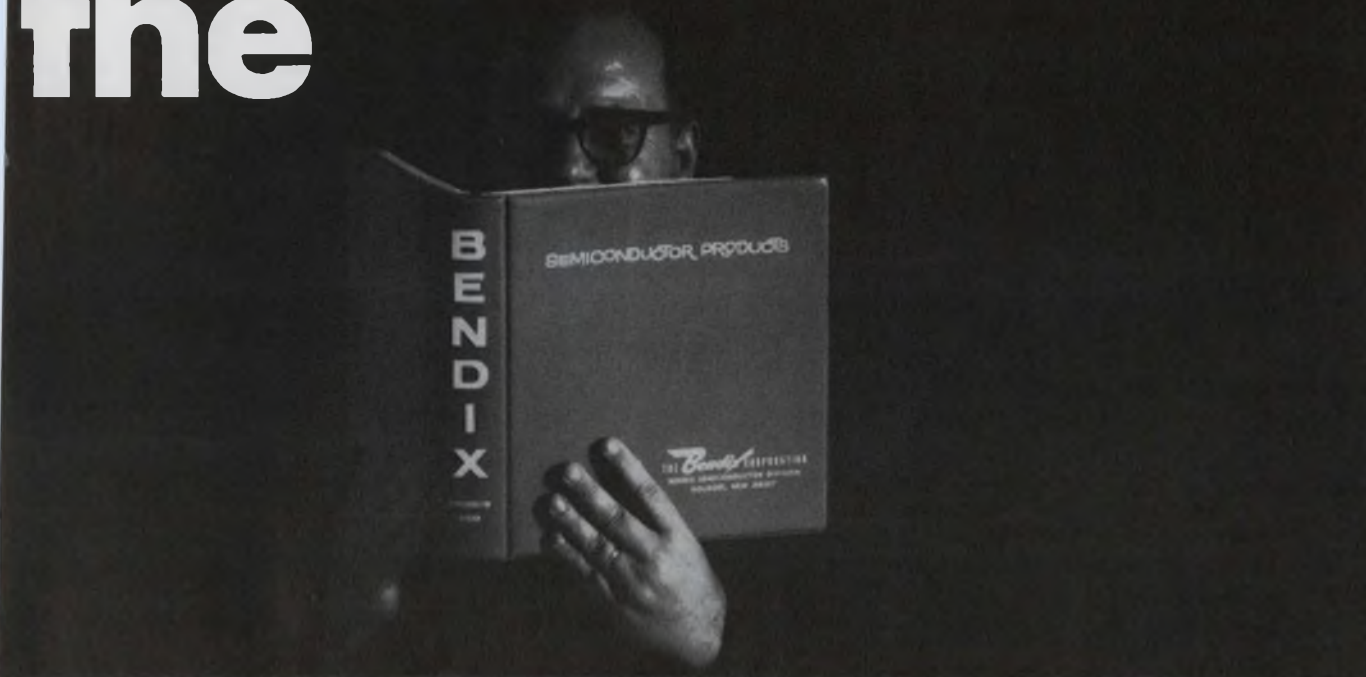

is just the beginning.

### 3 AMP TYPES

$V_{CE0} = 40 \text{ V to } 60 \text{ V}$      $V_{CB0} = 80 \text{ V to } 100 \text{ V}$   
 $P_c = 5 \text{ W to } 7.5 \text{ W}$   
 $V_{CE(s)} = 0.32 \text{ V Typ at } I_C = 1 \text{ A, } I_B = 100 \text{ mA}$   
 Switching Types:  $t_{on} < 35 \text{ ns}$  at  $I_C = 1.5 \text{ A, } I_B = 150 \text{ mA}$   
 $t_{off} < 75 \text{ ns}$   
 Amplifier Types:  $P_o > 4.5 \text{ W at } f = 50 \text{ MHz, } V_{CC} = 28 \text{ V,}$   
 $P_{in} = 0.5 \text{ W}$

### 5 AMP TYPES

$V_{CE0} = 40 \text{ V to } 80 \text{ V}$      $V_{CB0} = 50 \text{ V to } 90 \text{ V}$   
 $V_{CE(s)} = 0.4 \text{ V Typ at } I_C = 3 \text{ A, } I_B = 0.3 \text{ A}$      $P_c = 5 \text{ W}$   
 Switching Types:  $t_{on} < 40 \text{ ns}$  at  $I_C = 3 \text{ A, } I_B = 0.3 \text{ A}$   
 $t_{off} < 300 \text{ ns}$   
 Amplifier Types:  $P_c > 8 \text{ W at } f = 50 \text{ MHz, } V_{CC} = 30 \text{ V,}$   
 $P_{in} = 1 \text{ W}$

### 10 AMP TYPES

$V_{CE0} = 40 \text{ V to } 80 \text{ V}$      $V_{CB0} = 50 \text{ V to } 90 \text{ V}$   
 $V_{CE(s)} = 0.7 \text{ V Typ at } I_C = 5 \text{ A, } I_B = 0.5 \text{ A}$      $P_c = 25 \text{ W}$   
 Switching Types:  $t_{on} < 40 \text{ ns}$  at  $I_C = 3 \text{ A, } I_B = 0.3 \text{ A}$   
 $t_{off} < 300 \text{ ns}$   
 Amplifier Types:  $P_i > 25 \text{ W at } f = 50 \text{ MHz, } V_{CC} = 30 \text{ V,}$   
 $P_{in} = 5 \text{ W}$

Or review the pages on our silicon mesas. Our SOAR (Safe Operating Area) specified 2N3055 and its sister types are a natural for high power switching and amplifier applications. As well as our new B-170000 series.

### 2N3055

$V_{CB0} = 100 \text{ V}$      $V_{CE0} = 60 \text{ V}$   
 $I_C = 15 \text{ A}$      $P_{peak} = 900 \text{ W}$   
 $V_{CE(s)} = 0.4 \text{ V Typ at } I_C = 4 \text{ A, } I_B = 0.4 \text{ A}$   
 $t_r = 5 \mu\text{s Typ}$  at  $I_C = 7.5 \text{ A}$   
 $t_f = 1 \mu\text{s Typ}$

### B-170000 SERIES

$V_{CE0} = 40 \text{ V to } 100 \text{ V}$      $I_C = 6 \text{ A to } 15 \text{ A}$   
 $I_B = 3 \text{ A to } 7 \text{ A}$      $P_{peak} \text{ to } 1200 \text{ W}$   
**AMPLIFIER TYPES**  
 $f_{hfe} = 20 \text{ kc Typ at } I_C = 1 \text{ A, } V_{CE} = 10 \text{ V}$   
 $V_{BE} = 1.2 \text{ V max}$  at  $I_C = 500 \text{ mA, } V_{CE} = 4 \text{ V}$   
 $h_{FE} = 20 \text{ to } 120$   
**REGULATOR TYPES**  
 $V_{CE(s)} = 0.7 \text{ V Typ at } I_C = 5 \text{ A, } I_B = 0.5 \text{ A}$   
 $h_{FE} = 12 \text{ min at } I_C = 5 \text{ A, } V_{CE} = 4 \text{ V}$   
**SWITCHING TYPES**  
 $t_r = 6 \mu\text{s Typ}$   
 $t_s = 0.4 \mu\text{s Typ}$  at  $I_C = 5 \text{ A, } I_B = 0.5 \text{ A}$   
 $t_f = 1 \mu\text{s Typ}$

Or take the 300 different silicon power rectifiers in the rugged JEDEC DO-4 package.

TYPES MEETING MIL SPEC	AT 150°C	
	I <sub>o</sub> AMPS	PRV VOLTS
USN1N1124A,26A,28A	1	200-600
USAF1N1199-1206	12	50-600
JAN1N1202,R,04,R,06,R	12	200-600
JAN1N1614,R-16,R	5	240-720
JAN1N4458,R,59,R	5	960, 1200

It's this kind of reading material that's going to make Bendix a best seller. Why don't you throw your silicon power applications at us now? Or our nearest sales office.

See us at Wescon, Booth 1651, The Sports Arena.

Baltimore (Towson), Md.—(301) 828-6877; Chicago—(312) 637-6929; Dallas—(214) 357-1972; Detroit—(313) Jordan 6-1420; Holmdel, N. J.—(201) 946-9400; Los Angeles—(213) 776-4100; Miami Springs, Fla.—(305) 887-5521; Minneapolis—(612) 926-4633; Redwood City, Calif.—James S. Heaton Co., (415) 369-4671; Seattle—Ray Johnston Co., Inc., (206) LA 4-5170; Syracuse, N. Y.—(315) 474-7531; Waltham, Mass.—(617) 899-0770; Export—(212) 973-2121, Cable: "Bendixint," 605 Third Avenue, New York; Ottawa, Ont.—Computing Devices of Canada P.O. Box 508—(613) TALbot 8-2711.

ON READER-SERVICE CARD CIRCLE 5

# What brings a silicon chip like you to Taiwan, anyhow?

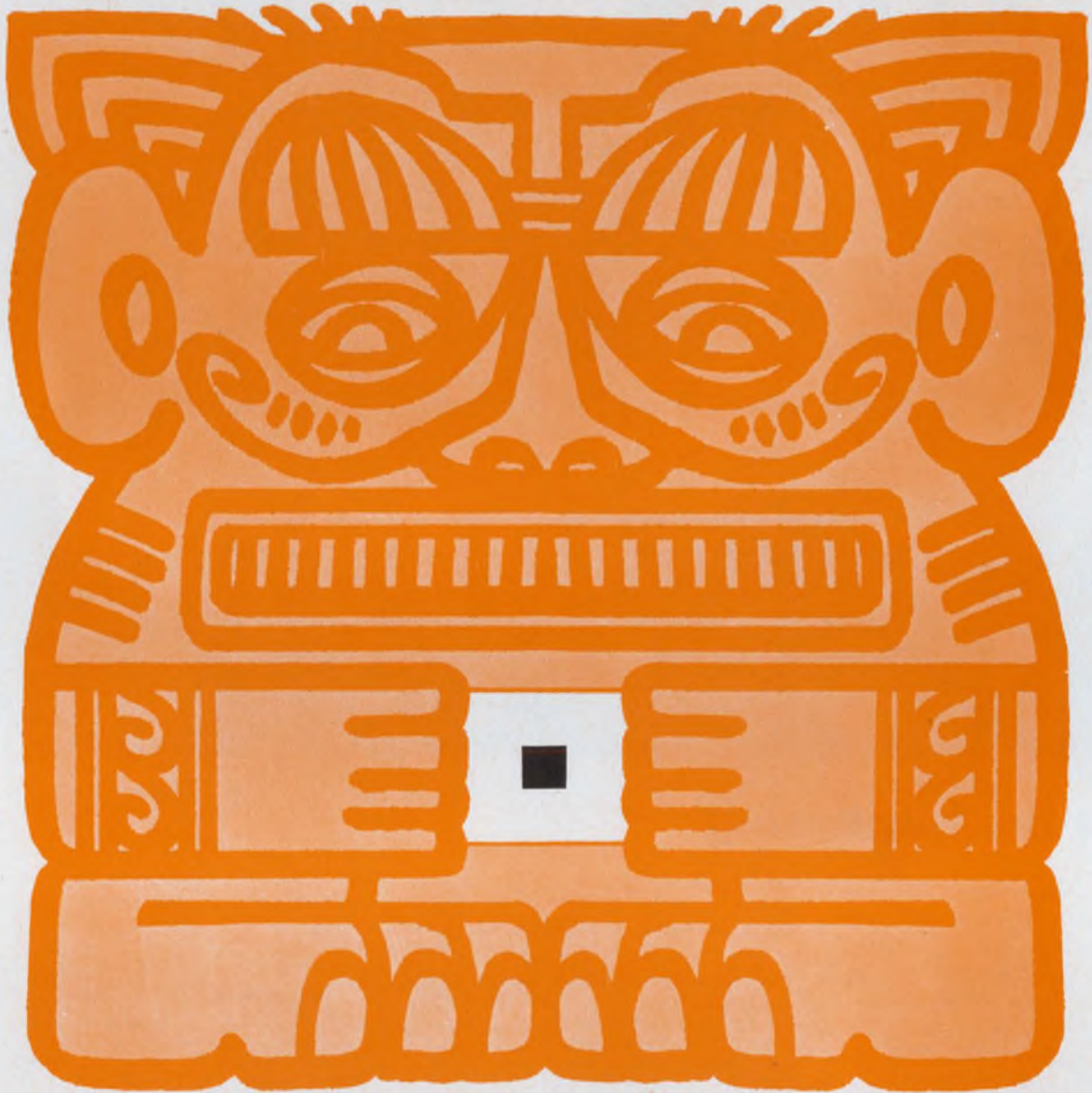

## Low-cost packaging, what else?

Our new Taiwan production facility packages a complete line of transistors and integrated circuits at the most competitive prices around. And available, *now*.

FOR EXAMPLE: IMMEDIATE DELIVERY ON PLANAR AND PLANAR EPITAXIAL SILICON TRANSISTORS.

**PNP:** General-purpose amplifier medium-speed switch.  
**NPN:** AM-FM receivers, 400 kc IF amplifier, 10.7 Mc IF amplifier, RF and video amplifier, low-noise high-gain amplifiers at low-level operation, UHF/VHF oscillator

RF amplifier, general-purpose amplifier medium-speed switch, high-speed switching saturated-logic circuits.

Call for the name of your nearest distributor. **Philco Microelectronics Division Sales Offices:** 2920 San Ysidro Way, Santa Clara, California (408-245-2966)/999 North Sepulveda, El Segundo, California (213-772-6226)/594 Marrett Road, Lexington, Mass (617-862-6000)/Benson Manor, Suite 114B, Washington Lane, Jenkintown, Pa. (215-885-0430)/314 South Missouri Avenue, Suite 212, Clearwater, Florida (813-446-0124)/815 Connecticut Avenue N. W., Washington, D. C. (202-965-0903)

**Microelectronics Division** | **PHILCO.**  
SANTA CLARA, CALIF. • LANSDALE, PA. • SPRING CITY, PA. | A SUBSIDIARY OF *Ford Motor Company*

ON READER-SERVICE CARD CIRCLE 6

# MOS FET RF AMP



The Fairchild FT57 is an N-channel depletion mode MOS field-effect transistor. It features low noise and low cross-modulation which give it superior performance characteristics in receiver RF amplifier and mixer stages. Two types are available: FT57 to meet military standards, and SE5301 for industrial and consumer applications. Both are high-reliability, Planar II devices. Both are now in stock. Ask for complete information.



**FT57 Specifications:**

- Low noise figure . . . . . 2.7dB (typ.), 4.5dB (max.)
- High power gain . . . . . 20dB (typ.), 15dB (min.)
- Low feedback capacitance . . . . . 0.6pF (typ.), 0.8pF (max.)
- All of the above specifications @ 100MHz
- High  $g_m(Y_{fi})$  . . . . . 9,000 $\mu$ mhos (typ.)  
6,000 $\mu$ mhos (min.)
- Reverse AGC capability

Planar is a patented Fairchild process.

# Sprague has what it takes to cope with any problem in electromagnetic interference or susceptibility control

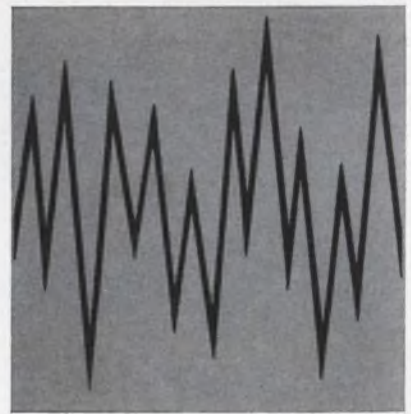

And we mean any problem . . . arising at any point in the development of any equipment or system!

Sprague's interference control facilities provide one of the most complete, fully integrated capabilities you can call on . . . embracing *every* aspect of interference and susceptibility control.

**Design Assistance:** Black boxes . . . subsystems . . . complete systems. Using advanced interference prediction techniques, Sprague engineers replace design by "hunch" with precise analysis of electrical schematics. Suppression and shielding can be designed into pre-prototype plans so accurately that little or no modification is required upon evaluation of the model. With today's more complex equipment and increasingly stringent EMI requirements, Sprague assistance in initial design can pay for itself in a dozen different ways by helping you be right the *first* time!

**Measurement, Evaluation:** Sprague can help you measure interference and susceptibility characteristics of your breadboard, prototype, or production equipment to the applicable interference specification. You know where you stand before investing in further development. We can also research such areas as shielding effectiveness, screen room integrity, transient susceptibility of digital equipment, and cable cross coupling.

**Component Design:** Sprague Filter Engineering Specialists can design, evaluate, and sample interference control devices to your particular requirements. These range from standard feed-thru capacitors and radio interference filters to the more sophisticated packages, such as frequency-controlling electric wave filters.

**Component Production:** Each of four Filter Development Centers maintains a well stocked model shop for the rapid fabrication of special

components in prototype quantities. Full scale production facilities are maintained in Visalia, Calif.; North Adams, Mass.; and Vandalia, Ohio.

**Compliance Testing:** Sprague can test your equipment or system and report on its compliance to the applicable specification: MIL-I-6181, MIL-I-26600, MIL-I-16910, MIL-E-6051 or to such other specialized interference documents as GM07-59-2617A, AFBSD Exhibit 62-87 (Minuteman WS133B), LSMC Specification ERS11897 (Polaris A3) or MIL-STD-449. If compliance is not indicated, a Sprague engineer will make concise recommendations and will, if you desire, give you every assistance in achieving that compliance.

**Regional Service:** Wherever you may be, this integrated EMI capability is readily available to you from strategically located Filter Development Centers in North Adams, Mass.; Annapolis Junction, Md.; Vandalia, Ohio; and Los Angeles, Calif. Each is fully equipped and staffed to evaluate, modify, or qualify your equipment.

**In-plant Service:** Sprague can put competent Interference Control Specialists at your service in your plant for consultation on, or supervision of, special projects.

*Whether your work involves military or industrial electronic equipment or systems, Sprague Filter Development Center personnel can help assure substantial savings in dollars and hours at many points during development. Get complete information from the development center nearest you or by writing for a comprehensive brochure (FD-101) to Technical Literature Service, Sprague Electric Company, 347 Marshall Street, North Adams, Mass. 01247*

## FILTER DIVISION PRODUCTS AND SERVICES

INTERFERENCE FILTERS AND CAPACITORS  
PRECISION TOROIDAL INDUCTORS  
FREQUENCY SPECTRUM SIGNATURES  
COMPONENT ENVIRONMENTAL TEST FACILITIES

ELECTRIC WAVE FILTERS  
TELEMETRY FILTERS  
EMI TEST FACILITIES  
EMI SYSTEMS ENGINEERING

**SPRAGUE**<sup>®</sup>  
THE MARK OF RELIABILITY

'Sprague' and '®' are registered trademarks of the Sprague Electric Co.

ON READER-SERVICE CARD CIRCLE 8

# News



**Green Berets** discuss their electronic equipment and its shortcomings. Page 36



**Scanlaser** uses electron beam of cathode-ray tube to control laser scanning. Page 33

## Also in this section:

**Anti-pollution programs** to make big use of electronics. Page 17

**Optics studied** for faster space communications. Page 21

**Gunn-effect 'sandwiches'** give higher cw power. Page 26

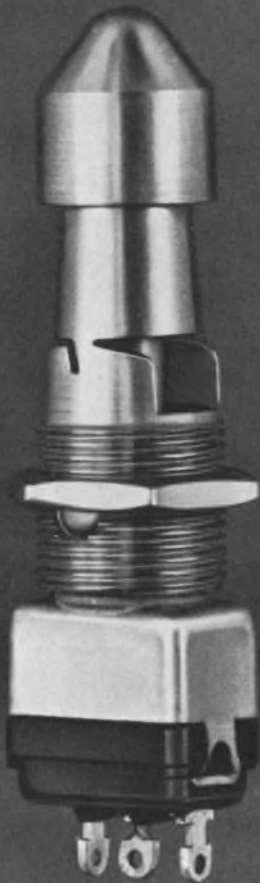

**NEW**

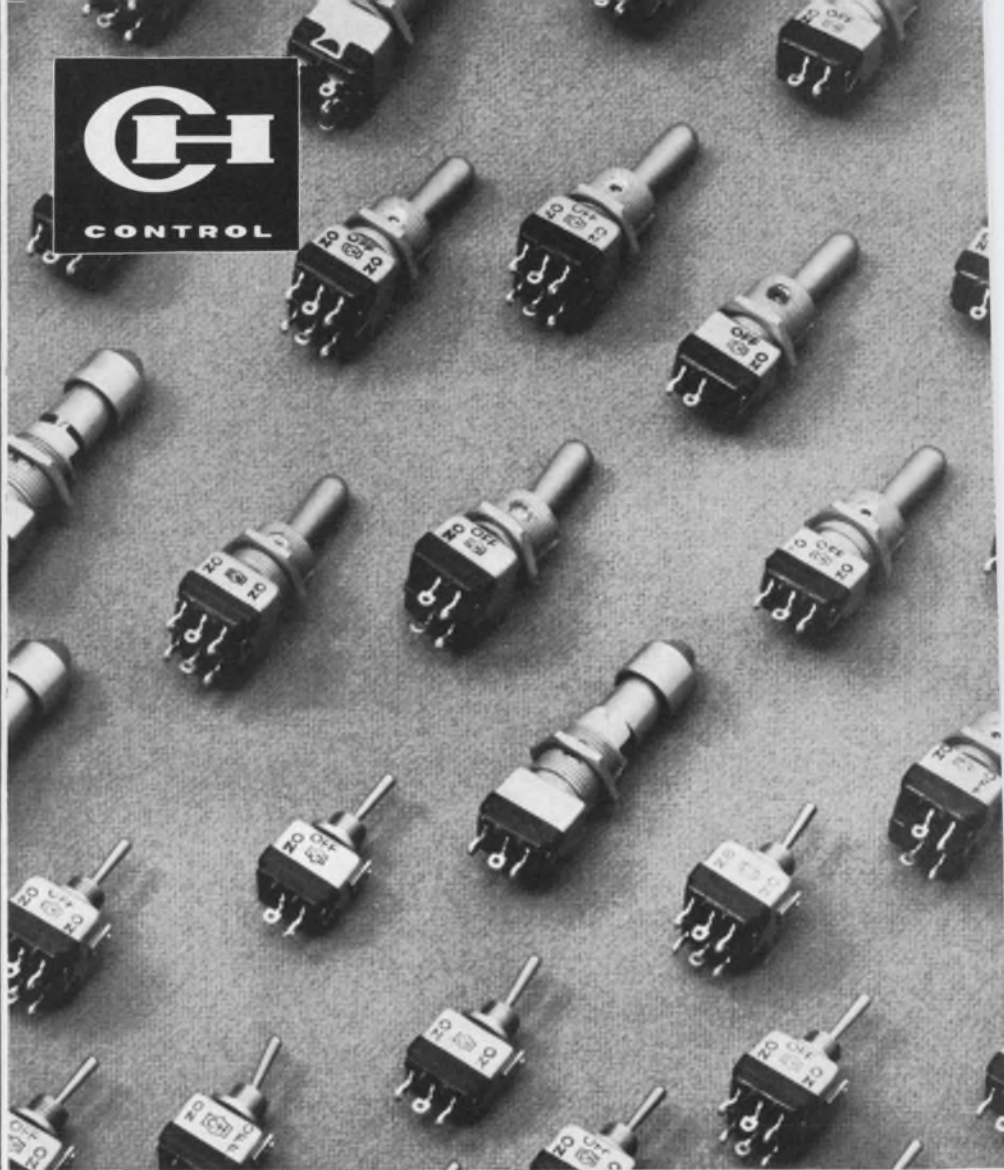

## A miniature switch with lever lock

*Exclusive Cutler-Hammer miniature switches make industry's broadest line even broader.*

New Cutler-Hammer "lever-lock" miniature switches keep accidents from happening . . . help you design-in greater safety.

They feature a variety of locking configurations with switch bases as small as a dime. And they offer shallow back-of-panel space and light weight—with top performance and reliability that's proven on critical applications.

All miniature switches are shock and vibration-resistant (20 G's up to 20,000 cps). All are Ac and Dc rated in a variety of circuit arrangements.

And all three types (lever locks, bat lever, and standard lever switches) feature these key advantages:

- Built to meet general requirements of MIL-S-8834 (Type I).
- Only miniature switch with lever seal.
- Both single and double-pole types.
- Positive detent action to enhance operator "feel."
- Dry-circuit (25 microamps @ 5 millivolts) reliability with gold-plated contacts opening and closing in wiping action; unusually low contact bounce.
- Positive make-break operation with toggle linked directly to moveable contact member.
- Maintained or momentary operation.
- Potted terminals prevent entry of contaminants.

Get all the details about new lever-lock switches and the complete miniature switch line from your nearby Cutler-Hammer Sales Office. Or write direct to Milwaukee, Wisconsin 53201.

WHAT'S NEW? ASK . . .

**CUTLER-HAMMER**

Cutler-Hammer Inc., Milwaukee, Wisconsin 53201

ON READER-SERVICE CARD CIRCLE 62

## Clues to Gemini's wake lost during undocking

Against a background of success for the Gemini 10 flight, scientists are disappointed that they did not obtain optimum ion-electron data on the space vehicle's wake.

One objective of the flight was to determine the composition and density of the wake and whether electricity builds up on the spacecraft.

Scientists attach considerable importance to an accurate measurement of space electricity. They believe that an electrical charge build-up on the earlier Gemini 8 may have caused the short circuit that created difficulty on that flight.

Both the Agena target rocket and the Gemini 10 capsule were launched with sensors aboard to measure negative and positive electrical particles in space. However, because of the exceptional fuel consumption during

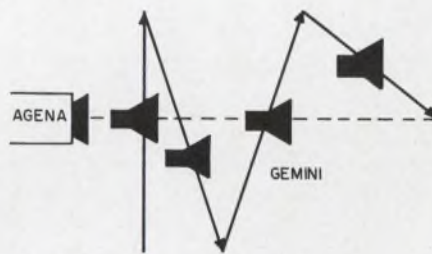

TOTAL TIME OF MANUEVERS= 10 MIN.

Diagram shows how Gemini 10 was to undock from Agena in zigzag fashion.

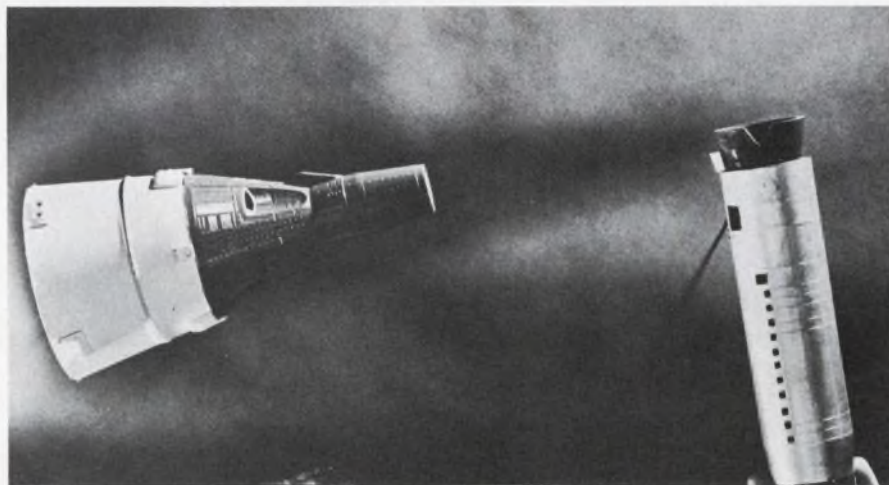

Experimental dance routine

Gemini 10's initial docking, the experiment maneuvers could not be carried out as planned.

Instead of zigzagging after undocking from the Agena, the Gemini kept to a straight path to conserve fuel. This prevented the obtaining of optimum data.

The sensors aboard the Agena functioned perfectly in accumulating data on the ambient ionospheric plasma. Although the space scientists believe the flight did establish new facts about the ionosphere, they will not be sure until the data radioed to earth have been interpreted—a process that could take several weeks.

Three sensor units were built into the docking cone of the Agena rocket to measure ion and electron density and the electron temperature of the Gemini wake. A build-up of electricity results as the craft flies through speeding ions and slower-moving electrons orbiting the earth at very high altitudes. These particles are believed to be pushed aside by the spacecraft and thus leave a "wake" of plasma.

As part of the experiment, it was intended that the capsule be maneuvered blunt-end forward, so that the resulting wake would sweep

backward through the sensors aboard the Agena.

In addition to learning more about the earth's ionosphere, NASA scientists are exploring the possibility of using the wakes as navigational aids in automatic rendezvousing and docking. Instrumentation will be devised to sense the characteristic plasma sheaths of various spacecraft.

NASA now is planning to expand the wake-measurement experiments during the Gemini 11 flight.

## Satellites may control nationwide road traffic

The traffic lights on the corner of the block may eventually be flashing red, amber or green on commands relayed from a few hundred miles out in space. Motor magnate Henry Ford 2nd told a businessmen's meeting in New Orleans that plans for such a control system will shortly be presented to the Government.

He said an earth-survey-satellite or aerial-reconnaissance system would be linked by computers to urban traffic control centers and ultimately to corner stoplights and even car radios. "As fantastic as it may seem, we believe such a system will be technically feasible and economically sound," he declared.

Ford said that the technical know-how for such a system had been accumulated from experience with the Manned Space Flight Control Center in Houston. The Philco Corporation, a Ford Motor Company subsidiary, designed and operated the center and a Philco communication system was in use in current Gemini space flights, he noted.

The application of space technology to traffic control, he said, would make available information that could be garnered no other way, and thus make a major contribution to road safety and efficiency. The system would reduce traffic jams and help investigators track down the real cause of highway accidents.

Ford also forecast that the system would have applications in water-shortage problems, air pollution control and large-scale city planning.

## NASA slows down to help Vietnam war effort

For the first time since the outbreak of the Vietnam "brush fire,"

NASA is starting to hurt. It has ordered a cutback in contractor projects that will free some 70,000 employees for war projects.

Dr. Robert C. Seamans, Jr., deputy administrator of NASA, disclosed at a press conference in Los Angeles, that the Apollo and Saturn projects will be especially hard hit. Some work, he indicated, is being "phased out."

About 430,000 employees in 20,000 companies are now engaged in space projects in the United States, according to Dr. Seamans. NASA plans for the work force to be slashed to 360,000 in the next year.

## No malfunction clouds Nimbus II's performance

Nimbus II, the world's largest weather satellite, had photographed everything from typhoons to local thunderstorms in its first two months in orbit. But for the engineers who designed the satellite, the performance was perfectly sunny.

NASA reported, as of July 15, that the 10-foot-tall space machine had traveled more than 20 million miles, taken more than 150,000 pictures and received more than 23,000 commands from ground controllers in continuous 24-hour-a-day operation—all without a single equipment failure.

One of the most significant engineering achievements, according to NASA, was the flawless operation of the Nimbus II control system, which kept the satellite pointing directly at the earth, plus or minus one degree. This operation required the consumption of less than 2 per cent of the control system's gas supply—freon gas that spurts, as needed, from small nozzles on top of the satellite to keep it aimed at the earth. Three electrically driven flywheels—one each for pitch, yaw and roll—were used extensively for control.

As it entered its third month in a near-polar orbit 700 miles up, Nimbus II began a new mission: extensive infrared photo coverage of hurricane breeding areas in the Atlantic. Two daytime cameras and

two infrared nighttime detectors are expected to provide the greatest hurricane surveillance to date from a single weather platform.

Meanwhile scientists at the Goddard Space Flight Center, Greenbelt, Md., are keenly interested in the more than 1000 hours of global radiation data that the satellite has collected on the earth's heat balance—how much radiation the earth absorbs each day and how much of it is reflected and radiated back into the atmosphere.

## Cosat outlines its own R&D program

Communications Satellite Corporation is planning its own R&D operations on a far larger scale than expected. Comsat president Joseph V. Charyk told stockholders earlier this year that the company wanted to start doing some of its own work and reduce its reliance on other firms for R&D.

The company has now revealed plans to build a laboratory costing between \$7 million and \$9 million in a Washington, D. C., suburb. It would employ some 100 persons. Comsat would use it to pursue the advance work on future communications satellites and related ground equipment.

## A clearer time beep to be heard in the land

Better reception of nationwide time signals is promised by the National Bureau of Standards by the end of the year.

Construction is under way at Fort Collins, Colo., on a new WWV broadcasting station and administration building. The projects are the last major ones affecting the move of WWV from Greenbelt, Md. Because of the central location of Fort Collins, time signals broadcast from there are expected to be received better in most of the country than those from Greenbelt.

The new transmitter building will be a T-shaped, cinder-block structure with a flat, steel-girder roof. Four of the eight transmitters will radiate 10 kW of power and the other four, 2.5 kW. Three of the 10-kW transmitters will operate continuously—at 5, 10 and 15 MHz—and one will be maintained as a standby for use at any of these fre-

quencies. Three of the 2.5-kW transmitters will operate at 2.5, 20 and 25 MHz, with the fourth a standby at these frequencies.

Six of the eight antennas that are going up are half-wave, center-fed, vertically polarized, modified sleeve types. Each will operate at one of the six official frequencies. Two monopole antennas that can be used at any of the WWV frequencies will be connected to the two standby transmitters.

The new station is scheduled to start broadcasting about Dec. 1.

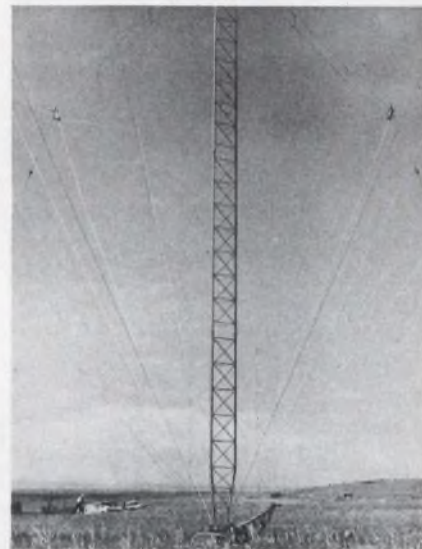

New site for WWV

## Passive satellite loses its thin skin

The U.S. Air Force has successfully launched into orbit around the earth an unusual open-wire-mesh satellite. What made this possible was a purple plastic developed by the Goodyear Aerospace Corp., Akron, Ohio.

The 30-ft structure was sent aloft atop an Atlas missile. Once in orbit, an explosive device split open and threw off the container it was in. The mesh-and-plastic skin was then inflated by a small bottle of pressurized helium. Within three hours the sun's ultraviolet rays disintegrated the plastic leaving just the open wire mesh.

Tests at the Air Force Avionics Laboratory indicate that such an open mesh structure reflects five times the energy of a solid conductor of similar size. Also, the open mesh configuration is far less susceptible to distortion due to the radiation pressure of the sun's light and to damage or drag caused by particles that it intercepts in orbit.



Spectrol pots that meet MIL-R-12934D...  
**SOUND OFF!**

Sir, Single-turn	Sir, Single-turn	Sir, Ten-Turn	Sir, Ten-turn	Sir, Single-turn	Sir, Single-turn	Sir, Single-turn	Sir, Ten-turn
<b>Model 121</b> (RR1100)	<b>Model 301</b> (RR2000)	<b>Model 501</b> (RR1000)	<b>Model 801</b> (RR2100)	<b>Model 191</b> (RR1500)	<b>Model 701</b> (RR0900)	<b>Model 401</b> (RR3000)	<b>Model 871</b> (RR1600)
Meets	Meets	Meets	Meets	Meets	Meets	Meets	Meets
<b>MIL-R-12934D!</b>	<b>MIL-R-12934D!</b>	<b>MIL-R-12934D!</b>	<b>MIL-R-12934D!</b>	<b>MIL-R-12934D!</b>	<b>MIL-R-12934D!</b>	<b>MIL-R-12934D!</b>	<b>MIL-R-12934D!</b>



Sir, all Spectrol MIL-R-12934D Models present and accounted for! And supporting the ranks of these standard MIL pots is our elite corps of "specials." Spectrol has won an illustrious reputation with quality-crafted "special" precision potentiometers. If you have a challenging design problem, put us to the test. And for your copy of our Short Form Catalog, technical data sheets on any of the above MIL-R-12934D pots, or a briefing on our custom capabilities — just sound off!

SPECTROL ELECTRONICS CORPORATION, 17070 EAST GALE AVE., CITY OF INDUSTRY, CALIF. 91745.

**spectrol**

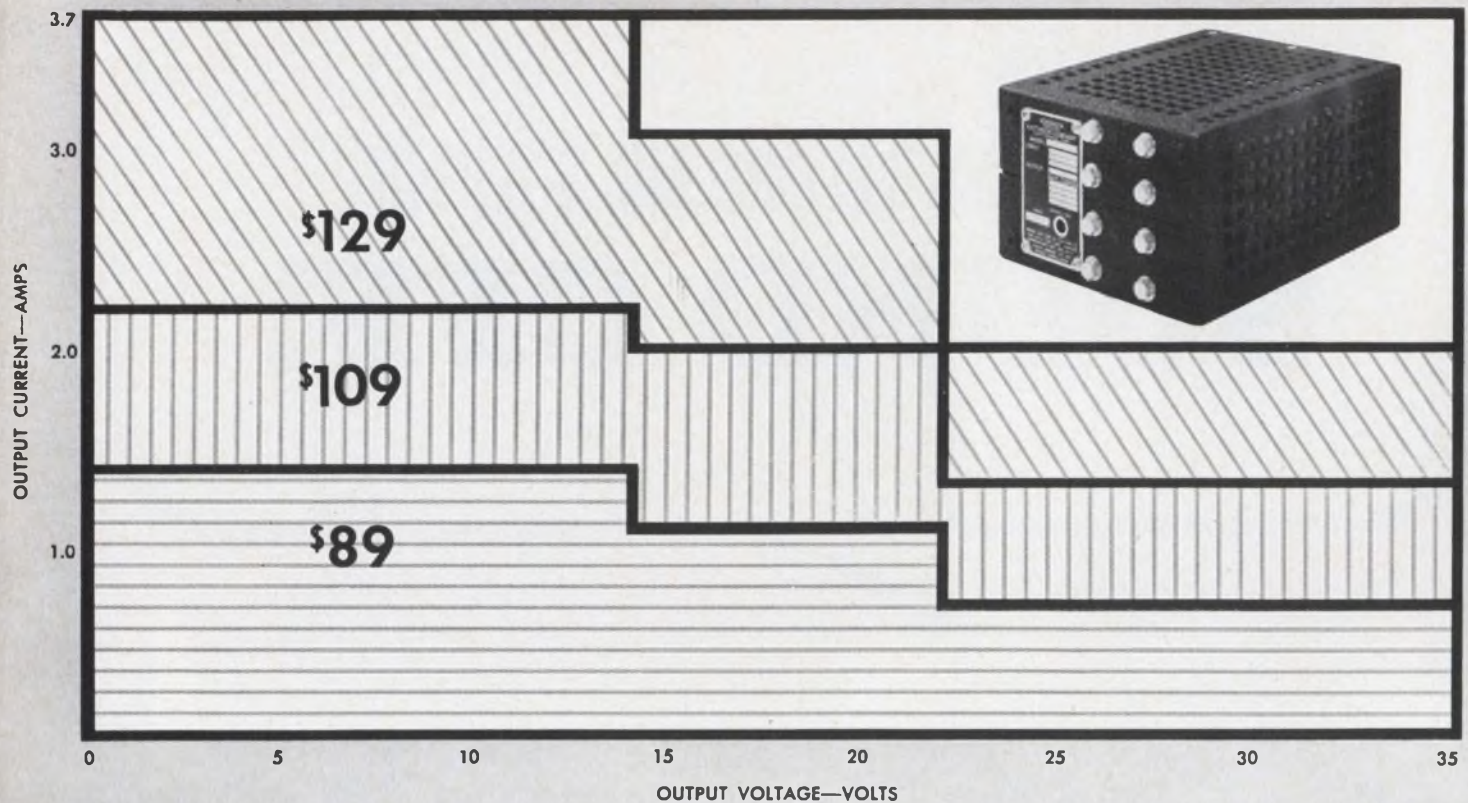

All-silicon QSA Series: 12 models; regulation  $\pm .005\%$ ; response time  $20 \mu s$ .

# New Sorensen Modular Power Supplies

The new Sorensen QSA Series offers the only modular power supply line in the 0 to 35 volt range that combines  $\pm .005\%$  regulation line and load,  $20 \mu s$  response time,  $71^\circ C$  operating temperatures,  $300 \mu V$  ripple—all at prices below other lines having lesser performance specifications. Sorensen's QSA Series modules are ideal for OEM, lab or system applications. They can be used as bench models (mounted in any position) or mounted in combinations of 3 or 4 in an optional 19" ( $3\frac{1}{2}$ " high) rack adapter. Other design features include: Load current vs. temperature,  $110\% @ 40^\circ C$ — $100\% @ 50^\circ C$ — $85\% @ 60^\circ C$ — $66\% @ 71^\circ C$  • Temperature coefficient  $0.01\%/^\circ C$  • Stability

$0.025\%/8$  hrs. • Models QSA10-1.4, QSA10-2.2 and QSA10-3.7 permit operation of up to 20 units in series; other units permit operation of 2 units in series; All models permit operation of 4 units in parallel • No turn-on/turn-off overshoots • Remote sensing • Remote programming • Ripple voltage peak to peak 3mV. All Sorensen power sources conform to proposed NEMA standards. For additional QSA Series details or for data on other standard/custom DC power supplies, AC line regulators or frequency changers, call your local Sorensen representative, or write: Raytheon Company, Sorensen Operation, Richards Avenue, Norwalk, Conn. Tel: 203-838-6571, TWX: 710-468-2940.

SPECIFICATIONS			
<b>MODELS (RANGES)</b>	QSA10-1.4 (0-10V, 1.4A) QSA12-1.4 (8-14V, 1.4A) QSA18-1.1 (14-22V, 1.1A) QSA28-.7 (22-35V, .7A)	QSA10-2.2 (0-10V, 2.2A) QSA12-2.2 (8-14V, 2.2A) QSA18-2.0 (14-22V, 2.0A) QSA28-1.3 (22-35V, 1.3A)	QSA10-3.7 (0-10V, 3.7A) QSA12-3.7 (8-14V, 3.7A) QSA18-3.0 (14-22V, 3.0A) QSA28-2.0 (22-35V, 2.0A)
<b>SIZES (IN.)</b>	7 x 3-5/16 x 3-7/8	7 x 3-5/16 x 5-1/8	10 x 3-5/16 x 5-1/8
<b>PRICES (U.S. List)</b>	\$89	\$109	\$129

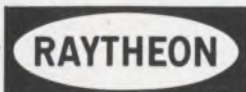

SEE US AT WESCON BOOTHS 145 & 146 HOLLYWOOD PARK.

# Automated smog monitors on horizon

## Massive anti-pollution programs foreshadow bigger use of electronics in monitoring systems.

Ralph Dobriner  
West Coast Editor

Electronics is expected to play an increasingly important role in various air-pollution monitoring programs being planned for some of the nation's largest cities.

Typical systems in use today comprise an amalgamation of chemical, electrochemical and electronic equipment, and it is therefore difficult to estimate precisely the potential market for electronic hardware alone. There is, however, growing federal and state spending on, and concern over, the air-pollution problem. And as some scientists talk about eventual establishment of a nationwide automated air-pollution monitoring network, the demand for specialized data-handling and -processing equipment is expected to rise rapidly.

### More Federal spending

Total Federal spending alone in

air-pollution programs will amount to about \$26 million in 1966. This represents an increase of more than 300% over five years ago. But this rate of spending may slow down in a few years while the huge amounts of data already acquired are digested.

According to one authority, every city in the U.S. with a population over 50,000 already has, or is considering the establishment of, an air-pollution control program which most likely will include purchase of air-monitoring instrumentation.

The Federal Government is heavily involved in air- (and water-) pollution monitoring and control and its role is expected to increase. For example, the U.S. Public Health Service samples the air for particulates every two weeks at over 200 stations in its National Air Sampling Network. At 50 similar stations the air is also sampled for pollution gases every two weeks.

Another program of the Federal

Government is the Continuous Air-Monitoring Program (CAMP), which takes measurements of the concentration of gaseous pollutants on round-the-clock basis at Chicago, Cincinnati, Denver, Detroit, Los Angeles, New Orleans, New York, Philadelphia and Washington, D.C.

The information gathered under these programs is co-ordinated with weather data obtained by meteorological instruments at these same sampling stations. Reports are then available for study by local air-quality control commissions.

### National network proposed

While these two programs are quite extensive and make a considerable contribution to the detection and control of air pollution, they apparently are not enough. They do not provide the degree of specific localized coverage that is required. For this reason, it is generally felt that local and state facilities are needed to supplement these efforts of the Federal government in order eventually to create a truly comprehensive nationwide air-pollution monitoring network. Such a net-

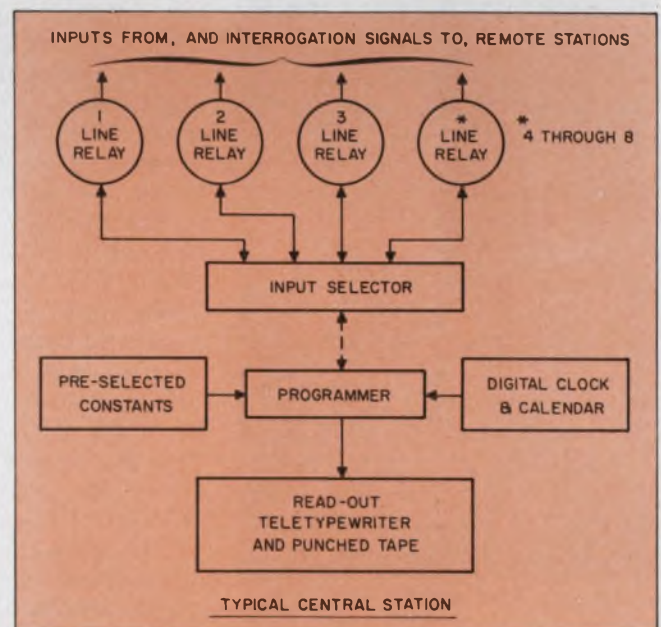
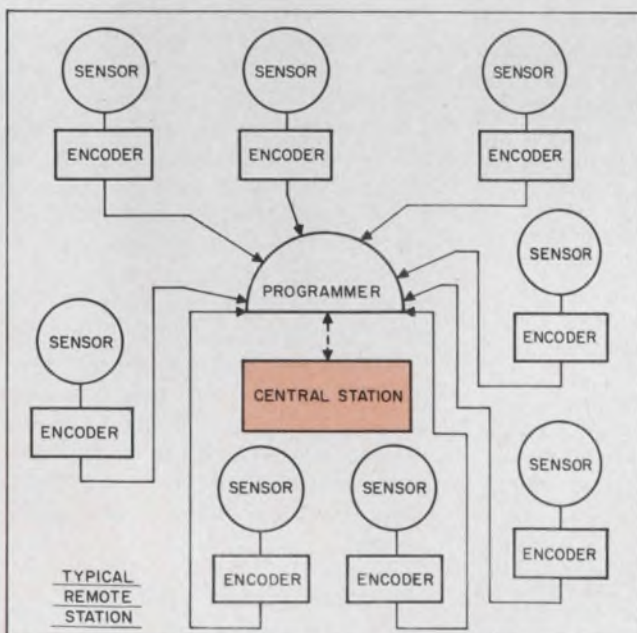

1. Typical air-quality monitoring system of the type recently installed in Chicago by Datex Corp. consists of eight remote data collection stations. Each station automatically measures air pollution content and meteorological data, digitizes the information and transmits it to a central computer station by means of telephone or teletype lines.

**(pollution, continued)**

work, it is anticipated, would rely heavily on modern communications links and data-processing systems.

In fact, it has been suggested that 90 permanent monitoring stations located in the nation's key pollution areas would be needed for such a network. The data accumulated at each would be telemetered back to the U.S. Public Health Service's Division of Air Pollution in Cincinnati, the Government's main processing center for pollution data.

Monitoring and analysis of air quality today is usually carried out in the laboratory with standard, commercially available chemical and electronic instruments; although automatic air-pollution recording equipment has been used for some time in Los Angeles. These instruments gather data on wind speed and direction, humidity, temperature, air opacity, and the presence of SO<sub>2</sub>, O<sub>3</sub>, NO<sub>2</sub> and other foreign substances in the air. The data are then recorded and manually evaluated to give an air-quality profile for a particular area.

But because of the need for rapid



2. Portable field weather station consists of ground electronics and 30-ft tower equipped with meteorological sensors. The station, available from Systron-Donner, contains a control and modulating unit, uhf radio equipment and batteries and is periodically interrogated by a central weather station 25 miles or more away.

and accurate data acquisition on a local as well as a regional basis, more sophisticated equipment employing electronic data-collection techniques and monitoring apparatus is now under development.

### Data may be telemetered

These air-quality monitoring systems would consist typically of remote, unattended stations to gather pollution and meteorological data. Each station would process the data and transmit them over commercial teletype lines, or, if more readily available, commercial telephone lines, to a central station. The central station would then automatically print out the information received so that it could be analyzed immediately and prepare a perforated tape of it. This tape could be fed directly into any commercially available computer or telemetered to distant data-collection and -processing centers.

One such air-monitoring system, developed by Datex Corporation, Monrovia, Calif., was installed last year in Chicago (Fig. 1).

The Datex system consists of eight remote stations set up in different parts of the city and provides for the establishment of 30 more later. Each station contains an anemometer to register wind direction and speed and an SO<sub>2</sub> sensor. Each station, however, is equipped with eight data channels, which means that five additional inputs could be added later. These could include air temperature, humidity, ozone content and so forth.

The readings of the sensors at the remote stations are converted to digital form by means of a shaft encoder. The system accepts inputs from any analytical instrument that uses a servo-balanced recorder or indicator on its output. In addition to digitizing the shaft rotation, the encoder is calibrated to correct for repeatable nonlinearities in the instrument's output.

The digital information is then transmitted over telephone lines to a central station. The central station is programmed to interrogate each of the eight remote stations every 5, 10, 15, 25 or 60 minutes, however preset. When it interrogates them, it receives an SO<sub>2</sub> reading, and wind-velocity and direction read-

ings averaged out over the preceding five minutes. This eliminates the reading of momentary gusts or wind changes. The incoming data are printed out on paper by a commercial teletype machine. At the same time, the same information is readied to be fed into a computer. The computer can store the information and recall it on demand to provide information on trends, or accumulated histories of any one station or any one variable, such as SO<sub>2</sub> content.

### Complete systems offered

Besides Datex, a few companies, including Beckman Instruments, Fullerton, Calif., and Instrument Development Co., Falls Church, Va., offer complete air-monitoring "packages" consisting of sensors (analyzers) and data-acquisition systems.

A number of firms, such as Precision Scientific Development Co., Chicago, Mine Safety Appliances Co., Pittsburgh and MAST Development Co., Davenport, Iowa, offer a variety of specialized chemical and electrochemical analyzers for laboratory applications. These include air-quality analyzers (used to measure nitrous oxides in the air), hydrocarbon analyzers, ozone monitors and nondispersive infrared analyzers to measure atmospheric carbon monoxide.

In addition to air-quality analyzers, Beckman Instruments offers stationary laboratories with data-handling systems as well as mobile monitoring laboratories housed in motorized vans. These vans contain a complete monitoring laboratory with the analyzers interconnected with a sampling system and appropriate strip-chart recorder. If desired, the entire system can be connected to an analog-to-digital system for punch- or magnetic-tape data collection. A number of these vans have been supplied to the U.S. Public Health Service and to Colorado, Akron, Ohio, and Los Angeles County.

### Electronic weather stations

An important adjunct to any air-pollution monitoring program is the rapid, periodic collection of weather data, such as wind speed and direction and temperature. A number of companies, including Packard-Bell

# BRAND NEW



NJE Power Supply Model SVC-40-10-M

## Constant $E_{dc}/I_{dc}$ Automatic Crossover — all silicon

- Output:**  
Voltage Range—0-40 Volts DC  
Current Range—0-10 AMPS
- Load Regulation:**  
Constant Voltage— $\pm 0.01\%$  or  $1Mv^*$   
Constant Current—0.5Ma Volt Change in Output
- Ripple:** Less than 1.0 Mv RMS
- Size:**  $3\frac{1}{2}$ " H x 19" W x  $16\frac{3}{8}$ " D
- $0^{\circ}$ — $71^{\circ}$  C Operating Ambient
  - Less than 20 Microsecond Recovery Time
  - Input—105-125 Vac, 55-65 cps
  - Mode Indicator Lamps
  - Voltage and Current Crossover Point Selectable and Pre-settable
  - Full Range Remote Programming (E and I)
  - Remote Sensing
  - Series or Parallel Operation
  - Electronic Overload Protection
  - Short Circuit Proof
  - Improved Solid State Circuitry
  - Units Supplied with dust cover
  - Unmetered Models Available—Deduct \$20 from Price and Delete Suffix—M
  - Immediate Delivery
  - 5 Year Warranty
- \*Whichever is greater

Model SVC-40-10-M is just one of a brand new line of power supplies that provides the utmost in reliability at competitive prices! Products of NJE engineering creativity, specialization and ingenious production methods, the SVC line can be used as voltage and/or current regulators in all (ranging from 0 to 125 volts and from 0 to 30 amps for complete versatility). Eight of these are 19" rack construction models.

Now, for the very first time, NJE is offering four Lab-Rak models in the SVC line! These laboratory bench units are all rack adaptable, if and when you wish to convert. Compact in size (8" x 5" x 14"), they range from 0 to 125 Volts and from 0 to 7.5 amps. For complete specs and prices on our entire line, circle Reader Service Number, or write direct.



Lab-Rak unit



**N.J.E. Corporation**  
Kenilworth, N. J. 07033 / (201) 272-6000  
Telefax: FFP • TWX: (201) 276-7630  
Electronic Development and Manufacture

**\$415**

SEE US AT WESCON BOOTH #136, HOLLYWOOD PARK

# ISOLAYER\* DIFFERENTIAL AMPLIFIERS WITH DIELECTRIC ISOLATION

## NEWS

(pollution, continued)

Electronics Corp., Newbury Park, Calif., Systron-Donner Corp., Concord, Calif., and Climet Instrument Co., Sunnyvale, Calif., have developed portable data acquisition systems designed to gather meteorological information from remote, unattended stations.

Packard-Bell recently announced Auto-Met, a weather data acquisition terminal which accepts input from weather sensors (both analog and digital), processes the information and transmits it by microwave or wire-link operation to a central air-pollution or weather monitoring station.

The terminal houses solid-state modules consisting of silicon semiconductor elements in cordwood and integrated flat-pack forms. The 4.4-cubic-foot unit houses all equipment necessary to acquire and assemble raw input data and present it to an output device.

A checking circuit associated with each signal-processing element provides a calibration check at the terminal output device for in-operation performance evaluation.

Systron-Donner's meteorological data acquisition system consists of a master station and from 1 to 10 portable remote field stations located 25 miles or more away. The preprogrammed master station interrogates the field stations at intervals adjustable from minutes to hours and converts these teletyped data into computer-compatible format correlated with the time of day.

The data are then sent to a teletype unit for manual interpretation or fed to a paper-tape punch or digital recorder for later computer processing.

Each remote station (Fig. 2) has a telescoping tower equipped with sensors for wind speed, direction and temperature, a control and modulating unit, uhf radio and a battery power supply. The master station is equipped with a command transmitter, receiver, control and timing units, data decoders with a numerical in-line display and teletype drive unit.

Power to operate the transistorized field stations is furnished by 12-volt batteries recharged from a 7-watt thermoelectric generator. ■ ■

 **V<sub>BE</sub> voltage differential down to 3 mV**  
**Tight beta matching · Low capacitance**

Low Silicium TD-5 Case	UD-2118	UD-2119	UD-2120	UD-2121
BV <sub>CEO</sub>	50V	50V	30V	30V
h <sub>FE</sub>	@ 10 μA	80	80	40
	@ 1 mA	150	150	100
V <sub>BE1</sub> - V <sub>BE2</sub>	3mV	5mV	3mV	5mV
Δ V <sub>BE1</sub> - V <sub>BE2</sub>	5 μV/°C	10 μV/°C	5 μV/°C	10 μV/°C
C <sub>ob</sub>	2pF	2pF	2pF	2pF

**Sprague Electric also makes a broad line of standard differential amplifiers, pairs, quads, and Darlington amplifiers**

\*trademark For complete information, write to Technical Literature Service,  
Sprague Electric Co., 347 Marshall St., North Adams, Mass. 01247

### SPRAGUE COMPONENTS

TRANSISTORS	PACKAGED COMPONENT ASSEMBLIES
CAPACITORS	FUNCTIONAL DIGITAL CIRCUITS
RESISTORS	MAGNETIC COMPONENTS
INTEGRATED CIRCUITS	PULSE TRANSFORMERS
THIN-FILM MICROCIRCUITS	CERAMIC-BASE PRINTED NETWORKS
INTERFERENCE FILTERS	PULSE-FORMING NETWORKS

85-0124



Sprague and ® are registered trademarks of the Sprague Electric Co.

ON READER-SERVICE CARD CIRCLE 10

# Optics studied for faster space communicating

## Raytheon researchers investigate three ways to replace bulky, high-power-drain RF systems.

Joseph J. Casazza  
Technical Editor

As man probes deeper into space, the transmissions of video data from millions of miles out is posing a serious question: Can radio-frequency systems do the job adequately?

Researchers aren't waiting for RF size and power snags to occur to find out. They're investigating the practicality of laser-based optical communications. Not only could more data be transmitted with less bulky optical equipment, but transmission would also be much more rapid. But a better laser will be needed than is now available.

Studies aimed at developing a

reliable optical transmitter were outlined by Meyer Kolker and Eli Brookner of the Raytheon Co. and Raymond Wilmotte, a consultant, in a paper at the National Telemetering Conference in Boston. They noted that bandwidth and transmission time were closely related (see accompanying table abstracted from the conference paper).

A look at the table shows the times required to transmit data at various rates. Consider, for example, a 9 in. x 9 in. photo that a geologist might require to analyze the terrain of Mars or Venus. This single 9 in. x 9 in. frame could contain as many as  $10^8$  bits of information. Based on the current capability of the Mariner 4 space probe

—transmission of data at the rate of 8 bps—it would take approximately 11,500 days to transmit  $10^{10}$  bits—more than 31 years. Increase this transmission speed to  $10^3$  bps, and the transmission time could be reduced to 115 days. Increase data rate to 10 megabits per second, and transmission time drops to seconds.

RF can, of course, handle such high data rates, but even at ehf (extremely high frequencies) this still calls for relatively large spacecraft and ground antennas, as well as greater spacecraft power requirements, both for flight and for electronic systems.

Here's where the laser-based system appears to offer its greatest advantages. The laser's short wavelength permits highly directional, narrow-beamwidth transmission using radiating elements (equivalent to RF antennas) that are much smaller than the RF antennas that

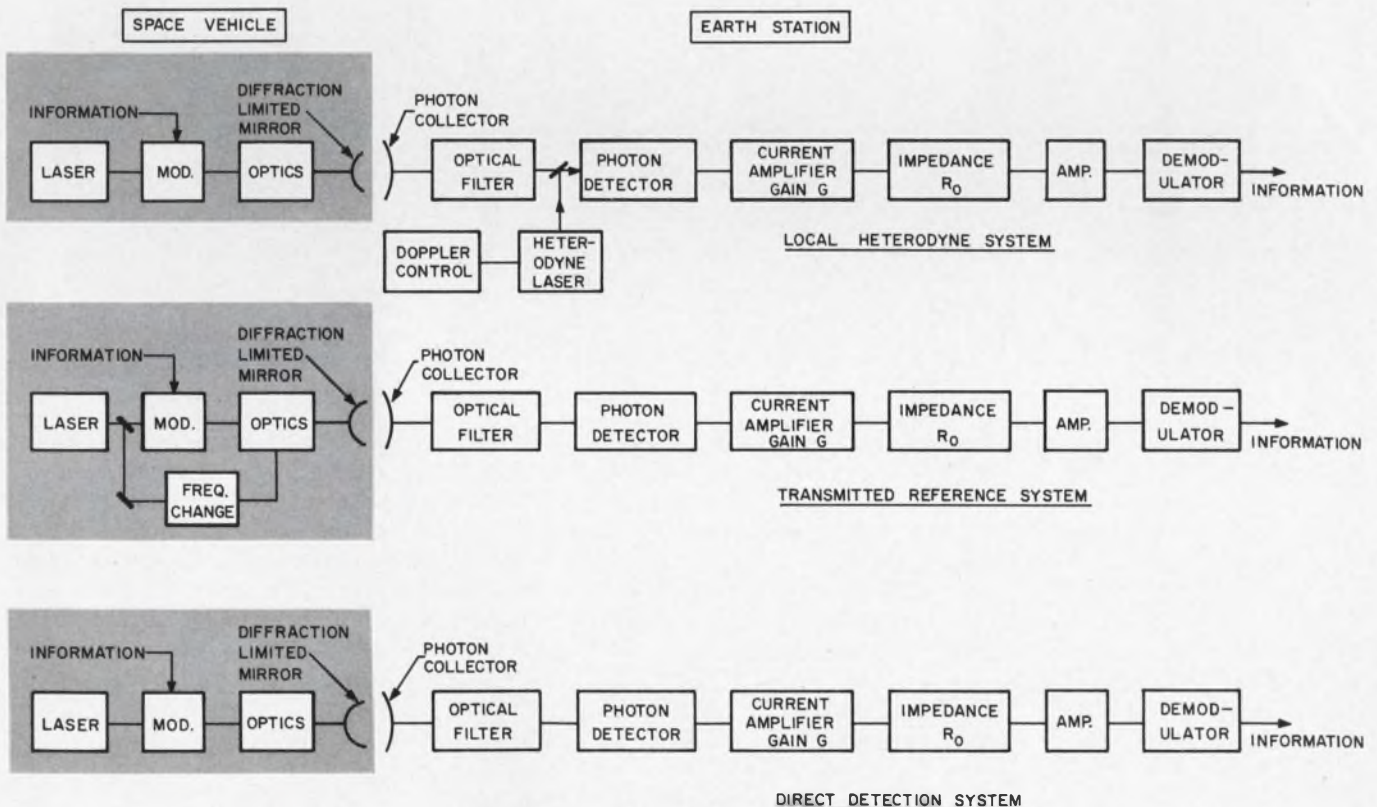

Researchers are investigating these systems to determine which is most suitable for deep-space video data communication. The direct detection system presently appears most promising.

(optics, continued)  
would be required to accomplish the same end.

### Three optical systems considered

Researchers at Raytheon have considered three types of optical communication system:

- Logical heterodyne system (LHS), which is analogous to a superheterodyne receiver. This system is said to provide the best signal-to-noise ratio of the three, but suffers from its need to maintain spatial coherence with the received signal over the entire face of the receiving "antenna." The high stability required of the receiving heterodyne laser is a second handicap. Doppler shift is also a problem.

- Transmitted reference system (TRS). This is a heterodyne system in which the reference is transmitted with the data signal from the spacecraft, thus avoiding the Doppler shift problem of the LHS. This system, like the LHS, also requires a

precisely machined receiving antenna.

- Direct detection system (DDS). Here is a straightforward, brute-force transmission and detection system with a single, modulated carrier providing video detection. This system can be thought of as analogous in operation to the TRF (tuned radio-frequency receiver) where detection is accomplished by rectification of the transmitted signal without any intervening heterodyning.

Of all three systems, Raytheon's researchers believe the DDS represents the most attractive choice at present.

### Multiple receiving sites proposed

The problem of keeping a light-transmitting satellite always in sight of Earth as the Earth rotates can be solved, say Raytheon's researchers, by locating a minimum of three receiving stations at different terrestrial sites. In addition to the problem of keeping the

satellite in sight, the receiving sites must be selected for their high probability of clear atmosphere in order to minimize attenuation of the transmitted light beam by bad weather. Using more than three sites will increase the probability of a clear transmission path.

### Laser development needed

The vital component of an optical space-communication system, the laser, still requires development, say the Raytheon researchers.

Of the three types of lasers—gas, solid-state and semiconductor—the researchers believe the semiconductor (currently gallium arsenide) to be the most promising for ultimate development for deep-space communications. This is due to the inherently high efficiency, small size, light weight and other favorable properties of the gallium arsenide device.

The gallium arsenide laser is not without drawbacks, however. It suffers from shifting of the lasing area's position. To make full use of the high-gain capability of the diffraction-limited transmitter optics, the lasing area's position must be extremely stable.

Still another problem presented by the GaAs laser is its requirement for continuous-wave power of the order of 10 watts. This power level requires operation at 4° K, a temperature difficult to reach in a spacecraft. ■ ■

### The Space Communication Problem

Early Voyager requirements (Total bits)	Transmission time			
	at 10 bps (Days)	at 100 bps (Days)	at 1000 bps (Days)	at 10 <sup>7</sup> bps (Seconds)
10 <sup>8*</sup>	115	11.5	1.15	10
10 <sup>10</sup>	11,500	1150	115	1000

\*Approximate requirements for one 9 in. x 9 in. photo with 15 shades of grey at 10 lines/mm

## System cost effectiveness is conference theme.

The integrated concept of system cost-effectiveness—rather than applications of techniques—was the theme of the 25th Annual Reliability and Maintainability Conference, held in New York, July 18-20.

The effectiveness of a system is usually determined by three considerations: its availability, dependability and capability, explained chairman Stanley A. Rosenthal, from Kollsman Instruments, Inc., Elmhurst, N. Y.

The system effectiveness approach to reliability and maintainability focuses on the trade-off between

these two factors, which is essential to achieve optimum operating conditions. The integrated concept of cost-effectiveness helps the designer to solve the trade-off problem economically, according to Rosenthal.

The organizers of the conference took care to present the material in terms of actual applications. The majority of the papers were hardware oriented. Also, a demonstration and exhibit held at Grumman Aircraft Co., Bethpage, N. Y., illustrated the maintainability design approach for aircraft, space vehicles and commercial vehicles.

The 600 engineers who attended the conference, was about two-thirds of the expected crowd. The airline strike, according to AIAA officials, prevented many from coming to New York.

### Proceedings available

For a bound volume of the proceedings, write to AIAA, Order Dept., 1290 Sixth Ave., New York, N. Y. 10019. The price of one copy is \$8 for members of AIAA, SAE, ASME, AICL, ASTM and EIA; for nonmembers, it is \$16.



## Pilot steers computer; computer steers jet

A grounded mock-up aircraft just doesn't handle like a real jet in flight, so NASA will loft a simulated cockpit into the air to give pilots the "true feel" of new high-speed aircraft.

To accomplish this task, Cornell University's Aeronautical Laboratory fills the passenger section of a little Lockheed Jetstar executive plane with a 750-lb computer. The evaluation pilot sits on the left and manipulates controls that are connected to the computer. It evaluates these manipulations, calculates the movements the simulated aircraft would have executed, and then adjusts the Jetstar's controls so that it approximates these maneuvers. A safety pilot sits in the righthand seat. His controls connect directly to the Jetstar's linkages, and he can instantly override both the computer and the evaluation pilot.

The analog computer, built by Electronic Associates, Inc., West Long Branch, N. J., can be programmed to simulate any aircraft, even aircraft that have yet to be built. But the computer limits the Jetstar to maneuvers that it can safely execute.

Besides its use as a training tool, the simulator can be used to test various types of new controls. These controls can be tested in the air while the computer makes the Jetstar simulate the motions of the aircraft for which the new controls are intended. This has the advantage of providing information about the pilot-control performance in a variety of real flight situations. ■ ■



Analog computer fills fuselage of Jetstar. Space normally holds eight executives.



basic measuring tools from  
**HEWLETT  
PACKARD**

### Field-proven 410C Electronic Voltmeter

Multiple functions—measure  $\pm 15$  mv to  $\pm 1500$  v,  $\pm 1.5$   $\mu$ a to  $\pm 150$  ma, full scale

Measure resistance 10 ohms-10 megohms, center scale

Use standard plug-in probe to measure ac, 50 mv-300 v, 20 Hz-700 MHz,  $\pm 2\%$  flatness from 100 Hz-100 MHz

Lab precision (ie,  $\pm 2\%$  of full scale for dc measurements)

High input impedance

Recorder output, compact, easily portable

#### Use it to:

Make accurate dc voltage measurements

Measure 1.5 nanoamps full scale

Measure resistance, ac voltages

Amplify signals (voltage gain 100 max.)

Make off-ground measurements (floating input)

Lab precision and extreme versatility are combined in the 410C Voltmeter to make it ideal for lab, production line or service department use. It offers 100-megohm input impedance on the dc voltmeter; no zero adjustment necessary on dc current, voltage and resistance ranges; no adjustment for infinite resistance. Fast overload recovery.

The 11036A AC Probe, \$60, is available to extend measurement of ac voltages to 3 GHz. Other accessories extend ac

voltage to 25 kv and dc to 30 kv. Individually calibrated taut-band meter for highest accuracy.

Ask your Hewlett-Packard field engineer for a demonstration of the 410C, \$425, or get full specifications by writing Hewlett-Packard, Palo Alto, California 94304, Tel. (415) 326-7000; Europe: 54 Route des Acacias, Geneva.

Data subject to change without notice.  
Prices f.o.b. factory.

See New hp Instruments  
Attend Measurement Seminars  
WESCON — Hollywood Park

**HEWLETT *hp* PACKARD**  
An extra measure of quality

1372



ON READER-SERVICE CARD CIRCLE 11

**MOTOROLA'S BROAD RF POWER CAPABILITY  
MAKES YOUR SELECTION EASIER...**

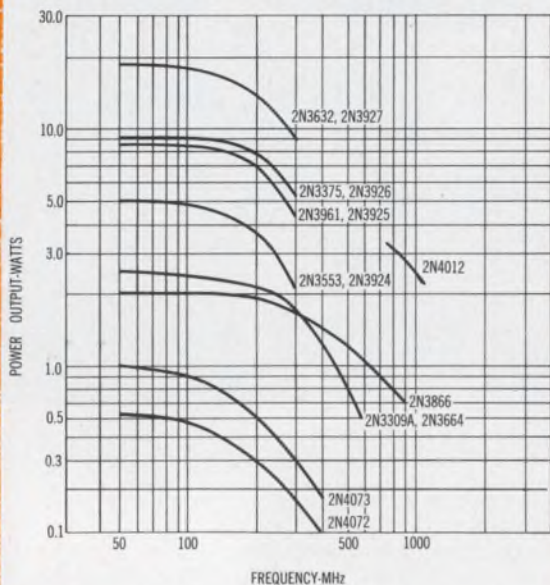

The power-frequency curves indicated here, cover only the EIA-registered device numbers available within Motorola's broad RF Power Transistor line. They are intended to help you narrow the range of possible choices for your specific application.

The power-output values shown are typical values achieved when operating within the maximum ratings for each device type with the unit performing at an efficiency level usable in most circuit applications.



**HIGH-POWER, HIGH-FREQUENCY DESIGN TECHNIQUES SHOWN IN APPLICATION NOTE 214**

A solution to the design errors caused by the use of small-signal design procedures for large-signal amplifiers is the thesis of this well-written technical report. The author employs large-signal transistor input-output admittance data in the network designs for a 160 MHz, 15-Watt Power Amplifier. You're sure to find Motorola Application Note 214 a valuable addition to your Semiconductor library. Write for it today, to Technical Information Center, Motorola Semiconductor Products Inc., P. O. Box 955, Phoenix, Arizona 85001.

# A REPORT ON HIGH-FREQUENCY HIGH-POWER OUTPUT CIRCUIT DESIGNS USING MOTOROLA RF POWER TRANSISTORS

***including types for high gain  
and efficiency combined with  
low input and output capacitance.***



Motorola provides *one* source for a broad range of RF Power Transistors for applications at a variety of power output and frequency requirements. Now, you can write *one* order, look to *one* source for applications and engineering help . . . indeed, rely on *one* highly reliable source for all of your RF communications needs.

The chart below is indicative of the range of possible applications using Motorola RF Power Transistors in the driver and output stages.

13.6-Volt Supply	2N3927	2N3926	2N3925	2N3924
28-Volt Supply	2N3632	2N3375	2N3961	2N3553
Stage(s) or Function(s)	Final	Driver/ Final	Driver/ Final	Driver/ Final
<b>APPLICATIONS:</b>				
Military Communications (225-400 MHz)	10 W	5 W	2 W	1 W
Mobile Commun. (156-175 MHz)	15 W	7 W	6 W	4 W
Portable Commun. (156-175 MHz)	15 W	7 W	6 W	4 W
Beacon (243 MHz)	12 W	6 W	4 W	2 W

## YOU CAN MATCH YOUR APPLICATION . . . TO A MOTOROLA POWER COMBINATION

### 10 Watts Power-out at 175 MHz For Military Communications

- Telemetry
- Beacons
- Radar
- Air to Air — Air to Ground

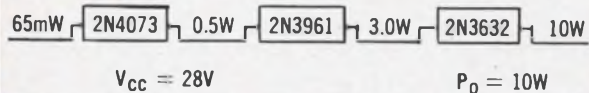

### For 13.6 Volt Mobile Communications 35 Watts Power-out at 175 MHz . . .

- Police Radio
- Sonobuoy
- Field Radio

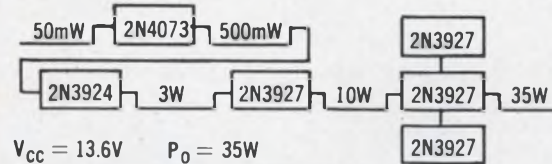

### 6 Watts Power-out at 175 MHz For Portable Communications

- Walkie-Talkie
- 2-Way Radio

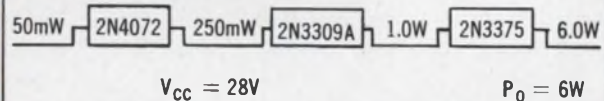

## NOW—DESIGN A 160 MHz, 15-WATT SOLID-STATE POWER AMPLIFIER . . .

If your application calls for high power gain with reliability, in a circuit that's simplicity itself, this design may be your answer . . . Here's a circuit that provides 30.5 db power gain with an efficiency of 62%, operating on a 28-volt power supply. Motorola RF Power types 2N4072, 2N3961 and 2N3632 make possible this unique, 3-stage amplifier design, with suitable connecting networks.

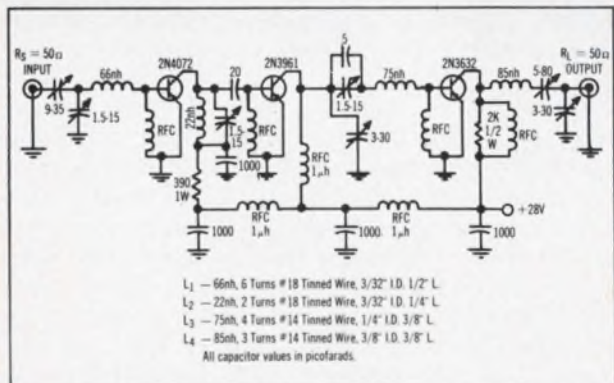

SEE HIGHLIGHTS OF **WESCON** AT BOOTH 1301-1304

# MOTOROLA Semiconductors

*— where the priceless ingredient is care!*

Speed Inquiry to Advertiser via Collect Night Letter  
ON READER-SERVICE CARD CIRCLE 12

# Gunn-effect 'sandwiches' give higher CW

Gunn-effect oscillators developed by Bell Telephone Laboratories are reported to generate continuous microwaves at higher frequency and power levels than have been previously reported. The gallium-arsenide devices are epitaxially grown as three-layer "sandwich" structures.

These solid-state devices, for use in microwave communications systems, generate fundamental oscillations in the 5-35 GHz frequency range. According to Bell spokesmen in Murray Hill, N. J., laboratory versions have achieved 65 mW of cw power at 5 GHz, 110 mW at 11 GHz, and 1 mW cw at 35 GHz.

The oscillations in Gunn-effect devices occur when they are subjected to a dc field exceeding about 3000 volts/cm.

When mounted in a tunable microwave cavity, the new devices can be tuned over an octave. A device designed to operate at 12 GHz, for example, can be tuned over the range of 8-16 GHz. Tuning is performed by adjustment of the cavity and, to a lesser extent, by the dc bias. The new oscillators have an

efficiency of 1 to 3 per cent.

The devices are made as sandwich structures of n-type gallium arsenide. The active region, made from intermediate-resistivity gallium arsenide, is sandwiched between two layers of low-resistivity gallium arsenide.

Device fabrication starts with a low-resistivity, gallium-arsenide substrate termed  $n^+$ . An  $n$  layer of gallium arsenide—the active region where microwave energy is produced—is then grown epitaxially onto the substrate. Finally another layer of low-resistivity gallium arsenide designated  $n^{++}$  is grown epitaxially onto the active region.

The low-resistivity  $n^+$  and  $n^{++}$  layers serve as ohmic contacts to the active region. A variety of metals and alloys can then be easily attached to these layers, according to the report.

Bell Laboratories spokesmen say that the sandwich construction of these devices eliminates the need to attach metal contacts directly onto the active regions. These procedures they say involve processes that are more complicated than

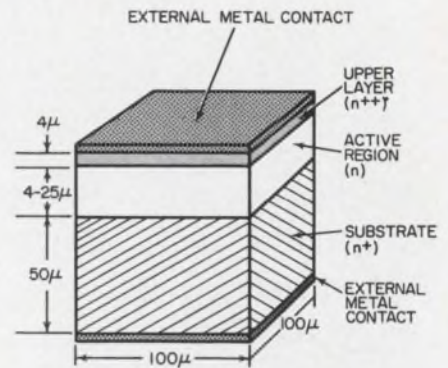

**Sandwich Gunn-effect oscillator devices** are grown epitaxially from gallium arsenide of varying resistivity to different thicknesses. Bell Laboratory scientists report improved cw power over a wide frequency range. Resistivity in the active  $n$  region is  $0.3 \Omega/\text{cm}$ ; in the  $n^+$  region,  $0.001 \Omega/\text{cm}$ ; and in the  $n^{++}$  region,  $0.0001 \Omega/\text{cm}$ .

the new method and harder to control.

In addition they report that this structure permits fabrication of Gunn-effect devices with the thin active regions necessary to permit them to operate at higher frequencies. This is based upon the finding that the thinner the active layer, the higher the frequency. ■ ■

## Electronic 'co-pilot' for drivers tested

Radio control for airplanes and ships is old hat, but what about the family car? A new experimental road-vehicle communications system demonstrated recently anticipates electronic guidance in everyman's vehicle.

The new system is called Driver Aid Information and Routing System (DAIR) by its inventors, the General Motors Research Laboratories, Warren, Mich. It is intended to remind drivers of speed and traffic signs, to permit them to call for help in emergency and to route the car automatically on trips.

Citizens Band radio channels and standard mobile CB transceivers, similar to those already in use in many automobiles in the United States, carry all the essential information.

Among the features of the DAIR system are these:

- Voice radio communications are

possible between cars and service stations.

- Coded emergency messages can be sent from cars to automatic recorders in service centers, with voice acknowledgement from the centers.

- A roadside-to-vehicle communication system transmits audio signs. These voice messages to the driver can include emergency traffic bulletins about the road ahead, as well as information on upcoming accommodations and service facilities.

- A visual sign minder, triggered by roadway signals from magnets or low-frequency transmitters, repeats highway sign information on a panel display inside the car.

- A route minder guides the driver to his destination without the use of maps. Equipment includes a programmed in-car-route selector and route direction indicator activated by coded roadway signals.

To demonstrate the system, two

1966 cars have been completely equipped with it and driven over an experimental highway system at the GM Technical Center. The course is complete with an information center for two-way radio communication, coded magnets buried in the pavement and low-frequency roadside repeater transmitters.

For the route minder, the driver uses a special card punched for his destination. The card fits a slot in the console. The routing equipment is activated by signals from magnets buried in the road at each major intersection. The equipment compares the signals with the punched instructions on the card. Panel lights tell the driver whether to turn left or right or to go straight through. With all major intersections in the country coded, GM spokesmen say, it would be possible to travel across the U.S. without maps. ■ ■

## CTS Cermet Trimmers

± 100 PPM/°C T.C. Available (Series 185)

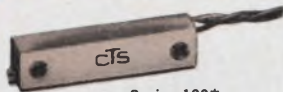

Series 180\*  
1-1/4" x .325 x .295  
Rectilinear



Series 170\*  
1/2" Square



Series 171\*  
1/2" Square

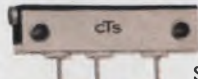

Series 180PC\*  
1-1/4" x .325 x .295  
Rectilinear

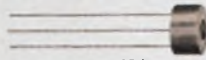

Series 385\*  
11/32" dia., single turn



Series 172\*  
1/2" Square



Series 660PC  
3/8" dia., single turn



Series 600LT\*  
2" dia., single turn  
locking bushing



Series 630  
1/2" dia., single turn



NEW Series 630 P  
1/2" dia.  
single turn



NEW Series B180  
1.30 X .378 X .385  
Rectilinear

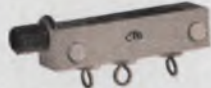

NEW Series B185  
1.30 X .378 X .385  
Rectilinear



NEW Series 185 PC  
1-1/4" x .345 x .290  
Rectilinear



NEW Series 185  
1-1/4" x .345 x .290  
Rectilinear

## CTS Wirewound Trimmers

Infinite Resolution Available. Stability .025% (Series IRW)



Series K350\*  
1/2" dia., single turn  
knob operated



Series 110\*  
3/4" dia., single turn

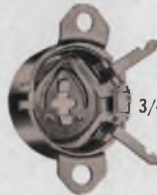

Series 112\*  
3/4" dia., single turn



Series P115\*  
3/4" dia., single turn



Series 115  
3/4" dia., single turn



Series 350\*  
1/2" dia., single turn



Series XPC110  
3/4" dia., single turn



Series 117\*  
3/4" dia., single turn



Exclusive Series IRW  
1-1/4" x .325 x .295  
Rectilinear spiral  
infinite resolution



Series 160  
1" x .320 x .180  
Rectilinear



NEW Series 116  
3/4" dia.  
single turn

## CTS Carbon Trimmers

for Lowest Prices



Series C140\*  
1-1/4" x .325 x .295  
Rectilinear



Series C140PC\*  
1-1/4" x .325 x .295  
Rectilinear



Series 220\*  
7/16" x 1/2" single turn



Series 330  
1/2" dia., single turn



Series U201\*  
19/32" dia., single turn  
knob operated









Series X201\*  
19/32" dia., single turn  
knob operated



NEW Series 330 P  
1/2" dia.  
single turn

# 7 New Trimmers added to CTS' Extensive Line

CTS TECHNOLOGICAL SUPERIORITY GIVES YOU:

-  Broadest Line of cermet trimmers.
-  Wide range of wirewound and carbon trimmers.
-  Prices from 10¢ to \$17.60 for industrial, military and entertainment applications.
-  Engineering versatility for challenging design requirements.
-  Precision controlled production from raw materials to finished product.
-  Unsurpassed mass production capability.

\*Immediately available from distributor stocks.

CTS will also design to your exact specifications. CTS is a major trimmer supplier.

Founded 1896

**CTS**  
CORPORATION  
Elkhart, Indiana

Request New Time-Saving Trimmer Selection Catalog. Contains complete technical data for every CTS trimmer.

Sales Offices and Representatives conveniently located throughout the world

### Principal Products

Variable Resistors  
Selector Switches  
Loudspeakers  
Trimming Potentiometers  
Microminiature Components  
& Circuit Packages  
Crystals, Filters,  
Oscillators & Ovens

### Subsidiaries:

CTS of Asheville, Inc., Skyland, N. C.  
CTS of Berne, Inc., Berne, Indiana  
CTS of Paducah, Inc., Paducah, Kentucky  
Chicago Telephone of California, Inc.,  
South Pasadena, California  
CTS of Canada, Ltd., Streetsville, Ontario  
CTS Microelectronics, Inc., Lafayette, Ind.  
CTS Research, Inc., Lafayette, Indiana  
CTS Knights, Inc., Sandwich, Illinois



ON READER-SERVICE CARD CIRCLE 13

**ONLY 3C OFFERS . . .**

# **NEW MODULES, HARDWARE, ACCESSORIES ADDED TO THE EXTENSIVE I/C $\mu$ -PAC DIGITAL LOGIC MODULE LINE**



New Model BT-332 TILT DRAWER BLOC houses 240  $\mu$ -PACS™ in only 5½" of rack panel height — pulls out, tilts down for PAC access, up to expose wire wrap terminals. Detents hold the BT-332 in any position from . . .



. . . horizontal to full vertical for convenient PAC replacement, testing, wiring, or system assembly. To further facilitate system fabrication, new mounting panels are available to adapt standard  $\mu$ -PAC hardware for 19" . . .

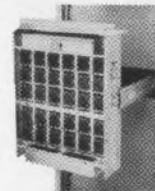

. . . rack installation. In addition, 3C offers custom system assembly and wiring capability for the special purpose system builder or volume manufacturer using  $\mu$ -PACS.

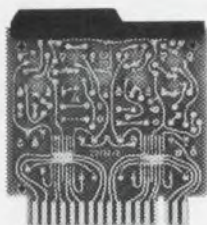

LD-331 HIGH-DRIVE LAMP DRIVER PAC contains 8 independent micro-electronic lamp-driver circuits with discrete output transistors. Each driver is capable of switching up to 300 ma at 35 volts from standard  $\mu$ -PAC signals.

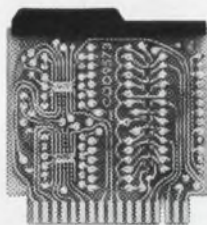

LD-335 NEGATIVE LOGIC LEVEL DRIVER PAC contains 8 two-input AND gates, followed by level shifters. Standard  $\mu$ -PAC signals (+6 V and 0 V) are converted to negative logic levels (0 V to -25 V at 60 ma per circuit).

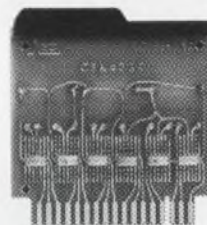

PN-335 NON-INVERTING POWER AMPLIFIER PAC contains 6 three-input AND gates. Each gate contains two inverting amplifiers in series which provide the non-inverted output. Electrically common outputs and built in short circuit protection are standard features.

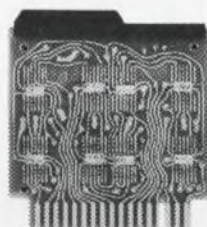

SR-335 SHIFT REGISTER PAC contains 8 prewired integrated circuit shift register stages. Up to 16 custom assembled stages can be supplied to meet customer design requirements.



TP-330 TEST POINT PAC provides convenient system trouble shooting capability without wire side probing for observation of waveform characteristics. Isolated test points for 34 PAC fingers are furnished.



AS-330 COPPER CLAD BLANK PAC kit provides a basic  $\mu$ -PAC card with 5.5 sq. in of copper plate on each side for custom etching of interconnections. PAC handle and fastener are included.

$\mu$ -PACS feature 5 mc operation, high packaging density, low cost per logic function, inherent reliability, low power consumption, and noise protection in excess of one volt utilizing NAND logic with DC coupled circuitry.

Write for complete catalog of  $\mu$ -PAC monolithic integrated circuit digital logic modules, power supplies, hardware, and system design and fabrication accessories.

## **Honeywell**



COMPUTER CONTROL DIVISION

OLD CONNECTICUT PATH, FRAMINGHAM, MASSACHUSETTS

Speed Inquiry to Advertiser via Collect Night Letter  
ON READER-SERVICE CARD CIRCLE 14



### Pollution war needs new technologies

It is not enough for Congress to pass laws against air and water pollution and to grant money and tax write-offs to places and industries that try to abate it. Congress must take the lead with legislation and far more generous appropriations to encourage R&D into ways of controlling it. Such is the gist of a landmark report just issued by the House Committee on Science and Astronautics. The report, drafted by a panel of leading experts, states that all present work on abatement is practically futile because the technology to do the job does not exist yet.

The report, approved by the Subcommittee on Science, Research and Development under chairman Emilio Q. Daddario (D-Conn), is full of promise for the electronic industry. Nine tightly packed pages spell out specific opportunities for industry R&D into pollution control. One is work on reducing the costs of electric cars, a prestigious boost for the development of battery-powered transport (see ED 13, pp. 17-22). Another area that it suggests industry should work on is an inexpensive means of removing SO<sub>2</sub> from stack gas.

The major stress, however, is on the need for industrial monitoring devices and for specifically developed instruments for use in pollution abatement research. The demand for both is growing, the report says, because of government pollution control regulations.

The report was prepared in advance of forthcoming hearings on industry's role in pollution control R&D. Its main thrust provides some clue to the probable legislative outcome of the hearings: that the technology is either inadequate or nonexistent in most areas of control, and that without further research even the best of present technology would still not meet the needs of the war to control it.

The panel and the subcommittee both re-echo a White House science advisory report that declares: "The nation can look to industry for the accomplishment of some of this research and development."

# Washington Report

S. DAVID PURSGLOVE,  
WASHINGTON EDITOR

### Inshore undersea warfare is new R&D area

Research has already begun into the Navy's newest clearly defined field of war: measures to protect coasts against hostile acts launched from beneath the surface of the sea. For the first time this year the Navy's proposed budget requested \$2 million for "inshore undersea warfare." The Pentagon had said nothing since March about the project, which is designed to deal with operations carried out by frogmen from submarine bases and to investigate the use of miniature submersibles for shallow-water surveillance, mining and sabotage.

The Navy is now watching closely a Coast Guard development that may become a major defense against inshore undersea operations. Under a Coast Guard contract, United Aircraft's Norden Division has evolved an infrared system to pinpoint human beings in water. The system can presumably spot them slightly under water and locate miniature submarines.

Helicopter-borne, it uses a nitrogen-cooled IR detector cell and an oscilloscope display. Norden has completed the feasibility model and the Coast Guard is now preparing to put it through trials.

### Electronics involved in cost-cutting

The electronic industry figured noticeably in Defense Secretary Robert McNamara's fourth annual report on the Defense Department's cost reduction program. During Fiscal 1966, McNamara reported, "efficiency improvements" saved a total of \$4.5 billion.

In one instance that McNamara cited, a review of recent experience had shown that a five per cent annual replacement factor projected for AN/GRC-50 tactical radio units could be reduced to two per cent. This was saving \$2,114,073 a year.

He said that the increasing use of competitive bidding instead of cost-plus-fixed-fee contracting was helping to reduce costs. McNamara noted an aircraft attitude indicator originally purchased for \$1425 on a noncompetitive

# Washington Report

CONTINUED

basis that was now being bought for \$987 after open bidding. The Pentagon confirms that the swing to competitive-bid contracts is continuing despite the existence of a shooting war where one might expect quick procurements to be made from single, proven sources even at higher prices.

The turn from single-year to multiyear procurement is also picking up speed—to the benefit of both the Pentagon and the industry, it is said. The Secretary reported that one unidentified radio receiver had cost the Defense Department \$1970 on a single-year basis but was now being purchased for \$1874 under a multiyear procurement plan.

McNamara reported an estimated saving of \$151 million for the fiscal year from the consolidation of the leased long lines of the Defense Communications Agency.

The goal of the cost reductions, set some time ago and due to be achieved by Fiscal 1969, is to save \$6.1 billion a year.

## TV confessions might satisfy courts

Attorney General Nicholas deB. Katzenbach apparently feels that the electronic industry may be able to resolve the difference between the police need to question suspects and obtain confessions and recent Supreme Court rulings. At the recent symposium on technology in crime control sponsored by the Justice Department and the White House Office of Science and Technology, Katzenbach suggested development of TV units that would permit pretrial questioning and confessions to be shown in full to the court by means of sight-and-sound recordings that could be indexed for automatic retrieval.

The full list of items wanted by the Justice Department and local police is now being put together. It includes machines that would automatically record, transcribe and duplicate courtroom proceedings; criminal history storage and automatic retrieval systems that would help judges to pass sentence sooner; night vision aids (such as cascaded image intensifiers) for policemen on the beat; cheap, portable, concealable closed-circuit TV units to replace on-the-spot human surveillance; central police control boards and automatic squad car position indicators, computers matched to optical scanners for high-speed search and comparison of fingerprints and mug shots; sensors to detect drugs or alcohol

without making physical contact with the suspect's body; and a myriad of teaching machines for police training.

Almost all these devices, as well as proposed systems for using them, are up for federal subsidy through the Justice Department's Office of Law Enforcement Assistance (OLEA). OLEA has granted over \$500,000 in research and demonstration money to cities and states since it started operating last fall. No money goes directly to electronic firms, but the companies have been told that, whenever they think they have a technical solution to a crime control problem, they should take it up with a city or police department. The department in turn can approach OLEA for financial support.

## 'Think factories' alter their sights

A change is coming over the structure of the nation's system of "think factories"—operations research-systems analysis firms that are often nonprofit and Pentagon-supported.

Aerospace Corporation has laid off 100 members of its technical staff following a drastic budget cut by Congress. System Development Corporation is diversifying into those civilian areas where aerospace technology can be applied following the termination of its special relationship with the Air Force. SDC now seeks to apply the systems concept to education, law enforcement and regional planning. And finally, RAND Corporation discloses that it, too, is considering diversifying into civilian fields similar to those being eyed by SDC. New management is taking control of RAND and is believed to be planning to end the organization's dependence on military contracts.

---

**Nod is given to traffic safety R&D** Almost lost amid the publicity surrounding the Senate passage of the automobile safety bill was another bill passed immediately afterwards. It provides \$465 million over three years to conduct traffic safety research, much of it involving electronics.

The bill is designed to encourage states and major metropolitan areas to adopt uniform standards and planning for traffic control, vehicle inspection, registration, driver education and licensing, and highway design. Money will also be provided for an R&D program covering highway safety systems, vehicle-highway-driver interrelations, accident investigation, communications, and emergency medical care. The program will be handled by the Commerce Department or, under proposed new legislation, the Department of Transportation.





For those who think big—about availability, that is. Babcock's 1/6-size Model BR10 with unique universal contacts gives you "nonstop" load performance dry circuit to 1 amp. in the same unit. Now, you can order *one* relay to meet all your high-density circuit-board requirements—at no cost premium. And you'll find that this subminiature unit has everything... MIL-R-5757 conformance, unitized construction, solder-sealed or welded versions, standard circuit-board grid pattern, and a wide choice of terminal and mounting styles. Get more information about

the BR10, and the complete Babcock line of relays, all with universal contacts. Write Babcock Relays, Division of Babcock Electronics Corp., 3501 Harbor Blvd., Costa Mesa, Calif.; (714) 540-1234.



**SPECIFICATIONS**

<b>SIZE:</b> .405" h. x .500" l. x .230" w.	<b>PULL-IN POWER:</b> Low as 80 mw.
<b>WEIGHT:</b> Approx. 0.15 oz.	<b>LIFE:</b> To 150,000 operations
<b>CONTACT ARRANGEMENT:</b> DPDT	<b>TEMP. RANGE:</b> -65° C + 125° C

**Babcock**  
**model BR10**  
**1/6-size relays**



**dry circuit**  
**to 1 amp**  
**universal**  
**contacts**

ON READER-SERVICE CARD CIRCLE 15

## New Step-Ahead Design Gives Big Scope Features In a Rugged, Lightweight Instrument

You get more total performance, more usability in the new hp 180A Oscilloscope—*more than any other scope on the market!* You get this greater measurement capability in a 30-pound package that goes anywhere—field, laboratory or production line. Designed from the user's viewpoint in, this new high-frequency scope is packed with new ideas and innovations to give you big picture CRT, plug-in versatility, step-ahead electrical performance, minimum weight and rugged design.

With hp's all-new CRT, you get a big picture 8 x 10 cm display in a compact 17-inch tube length to allow portability. Display area is 30% larger than on existing high-frequency scopes—and 100% larger than some portable scopes. This means that you make accurate measurements, easier!

The vertical amplifier drives the CRT vertical deflection plates directly, requiring only 3 v/cm. This allows extended bandwidth capabilities, and means the vertical amplifier is lightweight, requires low power. Solid-state amplifiers with FET input stages provide stable gain and low drift for accurate measurements. Vertical attenuation, which sets vertical deflection factor, is ahead of the amplifier. This prevents trace jumps as you change ranges; bandwidth is maintained on all ranges even when verniers are used.

For easy viewing of the leading edge of a fast pulse, a new lightweight 160 nsec, 140 MHz etched circuit delay line was developed. Wide bandwidth together with good impedance characteristics insure clean display of input signal.

A new type of horizontal amplifier has wide bandwidth with X10 magnification to provide linear 5 nsec/cm sweeps, giving you greater resolution of high frequency signals and fast pulses.

Circuitry in the new 180A is 100% solid state. Only premium quality components were used throughout. This means you have lower power requirements, lighter weight and increased reliability. This results in the utilization of convection cooling—no fans.

Circuit boards in the scope are arranged to provide easy access to all circuitry. Snap-off covers give quick access. The control panel has been "human-engineered"—control knobs and switches are "convenience-grouped" and plainly marked to make them easier to see, easier to operate. Control panel and nomenclature are selective dye anodized for permanence.

Ask your nearest hp field representative for a demonstration of the 180A Oscilloscope, and he will show how you can see *more, do more* with this new big picture, 30-pound scope! Or, write to Hewlett-Packard, Palo Alto, California 94304, Tel (415) 326-7000; Europe: 54 Route des Acacias, Geneva. Price: hp Model 180A Oscilloscope, \$825.00; hp Model 180AR (rack) Oscilloscope, \$900.00; hp Model 1820A Time Base, \$475.00; hp Model 1821A Time Base and Delay Generator, \$800.00; hp Model 1801A Dual Channel Vertical Amplifier, \$650.00, f.o.b. factory.

**HEWLETT**  **PACKARD**  
An extra measure of quality

**SEE MORE!** ▶

**DO MORE!** ▶

Tear out actual size photo of hp 180A Oscilloscope. Set it on your bench. See what the big picture display could mean to your work! ▶



## hp 180A Oscilloscope

is shown here ACTUAL SIZE:

# COMPARE DISPLAY!

See how the new 180A Big Picture Display can make it easier for you to get accurate measurements. Punch out this actual size CRT area on the perforations. Place the punched-out portion over the screen of your existing high-frequency scope. You will find the hp 180A Oscilloscope has 30% to 100% larger viewing area for easier-to-see, easier-to-read traces!

## COMPARE SPECIFICATIONS! (Condensed)

### 180A Oscilloscope

#### Horizontal Amplifier:

**External Input:** DC coupled, dc to 5 MHz; AC coupled, 5 Hz to 5 MHz; input RC, 1 megohm shunted by approximately 30 pF.

**Sweep Magnifier:** X1, X5, X10; magnified sweep accuracy  $\pm 5\%$ .

**Calibrator:** 1 kHz square wave, 250 mv and 10 v p-p,  $\pm 1\%$ .

**Cathode-ray Tube:** 8 x 10 cm parallax-free internal graticule marked in centimeter squares. Post-accelerator tube, 12 kv accelerating potential; aluminized P31 phosphor.

**Beam Finder:** Pressing Beam Finder control brings trace on CRT screen.

**Intensity Modulation:** Approx. +2 volts, dc to 15 MHz, will blank trace.

**Active Components:** All solid state, except CRT.

**Environment:** 180A scope with plug-ins operates within specs over the following ranges. Temperature:  $-28^{\circ}\text{C}$  to  $+65^{\circ}\text{C}$ . Humidity: To 95% relative humidity to  $40^{\circ}\text{C}$ . Altitude: To 15,000 ft. Vibration: Vibrated in three planes for 15 min. each with 0.010" excursion from 10 to 55 Hz.

**Power:** 115 or 230 volts,  $\pm 10\%$ , 50-1000 Hz, 95 watts, convection cooled.

**Dimensions:** Cabinet, overall dimensions with feet and handle: 8" x 11" x 22½" deep. Rack mount: 5¼" x 18" x 19½" deep behind front panel.

**Weight:** With plug-ins, net 30 pounds.

**Outputs:** Main and delayed gates, main and delayed sweeps.

**Accessories Furnished:** Two 10:1 voltage divider probes, mesh contrast filter.

**Price:** Without plug-ins, Model 180A, \$825.00; Model 180AR (rack), \$900.00.

### 1801A Dual Channel Vertical Amplifier

**Modes of Operation:** Chan. A alone; Chan. B alone; Chan. A and B displayed on alternate sweeps; Chan. A and B displayed by switching at 400 kHz rate, with blanking during switching; Chan. A plus Chan. B (algebraic addition).

**Deflection Factor (Sensitivity):** 0.005 v/cm to 20 v/cm; attenuator accuracy,  $\pm 3\%$ .

**Bandwidth and Rise Time:** DC coupled, dc to 50 MHz; AC coupled, 2 Hz to 50 MHz; rise time,  $< 7$  nsec.

**Input RC:** 1 megohm shunted by approx. 25 pF.

**Polarity Presentation:** + or - Up.

**Triggering:** Provides sufficient signal to the time base to trigger from dc to 50 MHz.

**Price:** Model 1801A, \$650.00.

### 1820A Time Base

**Sweep Range:** 24 ranges, 0.05  $\mu\text{sec/cm}$  to 2 sec/cm in a 1,2,5 sequence; accuracy,  $\pm 3\%$ ; to 5 nsec/cm with X10 magnifier. Also single sweep.

#### Triggering:

Internal: See vertical amplifier.

External: dc to 50 MHz from signals 0.5 v p-p, 90 MHz with 1 v p-p.

Automatic: Bright base line displayed in absence of input signal. Triggers from 40 Hz to  $> 50$  MHz.

Trigger point and slope: Controls allow selection of level and pos. or neg. slope; trigger level on external signal adjustable  $\pm 5$  v,  $\pm 50$  v in  $\div 10$  position.

Coupling: AC, DC, ACF.

**Variable Holdoff:** Permits variation of time between sweeps to allow triggering on asymmetrical pulse trains.

**Price:** Model 1820A, \$475.00.

### 1821A Time Base and Delay Generator

**Main Sweep:** 22 ranges, 0.1  $\mu\text{sec/cm}$  to 1 sec/cm in 1,2,5 sequence; accuracy,  $\pm 3\%$ ; to 10 nsec/cm with X10 magnifier. Also single sweep.

#### Triggering:

Internal: See vertical amplifier. External: dc to 50 MHz from signals 0.5 v p-p, 90 MHz with 1 v p-p.

Automatic: Bright base line displayed in absence of an input signal. Triggers from 40 Hz to  $> 50$  MHz.

Trigger point and slope: Controls allow selection of level and pos. and neg. slope; trigger level on external signal adjustable  $\pm 5$  v,  $\pm 50$  v in  $\div 10$  position. Coupling: AC, DC, ACF.

**Trace Intensification:** Used for setting up delayed or mixed sweep. Increases in brightness that part of main sweep to be expanded full screen in delayed sweep or made magnified part of display in mixed sweep.

**Delayed Sweep:** Delayed time base sweeps after time delay set by main sweep and delay controls. 18 ranges, 0.1  $\mu\text{sec/cm}$  to 50 msec/cm in 1,2,5 sequence; accuracy,  $\pm 3\%$ .

**Triggering:** Applied to intensified Main, Delayed, and Mixed Sweep modes. Automatic: Delayed sweep starts at end of delayed period. Internal, External, Slope, Level, and Coupling: same as Main Sweep.

**Delay Time:** (before start of delayed sweep); Continuously variable from 0.1  $\mu\text{sec}$  to 10 sec; accuracy,  $\pm 1\%$ ; linearity,  $\pm 0.2\%$ ; time jitter,  $< 0.005\%$  of maximum delay of each range.

**Trigger Output:** (at end of delay time): approx. 1.5 v pulse.

**Mixed Sweep:** Dual sweep display in which main sweep drives first portion of display and delayed sweep completes display at speeds up to 1000 times faster.

**Price:** Model 1821A, \$800.00.

# CRT electron beam controls scanning laser

A scanning laser controlled by the electron beam of a cathode ray tube has been successfully operated at the Research Div. of IBM.

Called a "scanlaser" by its developers, the device selects the beam direction from inside the laser cavity, taking advantage of the laser's sharp threshold of operation to achieve beam selection with a small amount of power. Nearly all the active volume of the laser contributes to each output beam. Another feature of the scanlaser is that it can be scanned by a digital or continuous signal.

According to Dr. E. S. Barrekte, the basic scanlaser technique, with refinements, should yield performance as good as conventional television in terms of resolution and scanning rate. This would offer attractive possibilities for wide-screen television.

In its present form, which demonstrates the feasibility of the scanning technique, the scanlaser consists of a mercury-vapor gas-discharge tube mounted in a carefully designed optical system. The lenses make it possible for the system to support a large number of different modes of oscillation (or beam directions), all with approximately equal gain. The mirror at one end of the laser cavity (Fig. 1)

is mounted inside a cathode ray tube, and has a coating of KDP ( $\text{KH}_2\text{PO}_4$ ).

Losses in the cavity are caused by phase retardation in a strained-quartz window in the cathode ray tube and by the polarizing effect of the Brewster-angle windows of the mercury-vapor tube.

## Operation uses phase retardation

To select a mode or group of modes, an electron beam is directed against a point on the dielectric mirror backing of the KDP crystal inside the cathode ray tube. The electron beam deposits a charge at this point, producing a potential difference across the KDP; this activates the crystal at that point and results in phase retardation. This phase retardation compensates for the retardation of the quartz window, reducing the losses for one or more modes of the laser and activating these modes.

When the electron beam is directed to another point on the mirror, a new set of modes is activated and the other is turned off as soon as the charge on the mirror decays to a level below threshold.

The present version of the scanlaser can generate a matrix of approximately 120 by 120 beam di-

rections, with the number of resolvable directions determined by the resolution of the electron gun. The ultimate limit is set by the optical properties of the cavity, and is about 2000 by 2000. A scanning angle of 60 degrees can be achieved with the present arrangement.

The scanning rate of the scanlaser is limited by the roughly 20-millisecond decay time of the KDP crystal. This slow decay time is suitable for such applications as the projection of television images, but is unsuitable for other possible applications, such as optically-read memory systems.

The charge decay time in the KDP crystal can be adjusted to a certain extent by varying its conductivity. The decay time might also be decreased by using a more energetic electron beam to discharge spots by secondary emission after they have been charged by the primary beam.

According to the developers, future work on the scanlaser principle will center on three areas: crystals with faster decay times, better-quality lenses for improved resolution, and larger-aperture laser cavities for wider scanning angles. In addition, laser gas mixtures suitable for color TV projection are being investigated. ■ ■

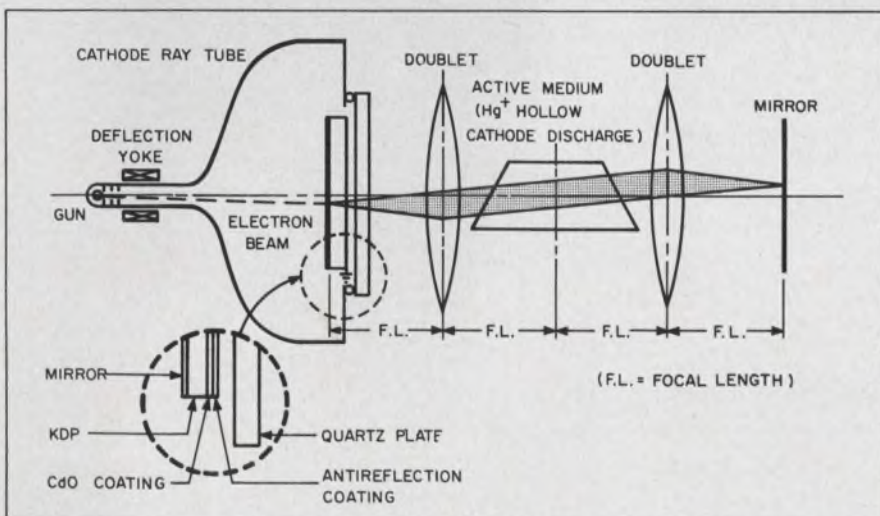

1. Beam direction in the scanlaser is selected by the CRT electron beam. The lenses enable the cavity to support many different modes with equal gain.



2. Scanlaser technique may prove feasible for wide-screen television.





# Treat yourself to a little extra design freedom from MICRO SWITCH

It's easy to satisfy your hunger for the right flavor in switches when you reach into the MICRO SWITCH line. For three reasons:

1. The world's largest selection, and local availability—meaning we can provide the practical answer to your design requirements right off-the-shelf.
2. The world's largest research and development facilities devoted exclusively to switch design—meaning the answer you need may be on file waiting for a problem like yours to come along.
3. The world's largest group of trained field engineers specializing in precision switching—meaning we can add a switch specialist to your design team for the asking.

These benefits can be helpful to you in finding the right combination of switch design, quality and cost.

Call a Branch Office or Authorized Distributor (see Yellow Pages, "Switches, Electric"). Or, write for the most complete switch selection guide ever published, Catalog 50.

## **MICRO SWITCH**

FREEPORT, ILLINOIS 61032

A DIVISION OF HONEYWELL

**HONEYWELL INTERNATIONAL** • Sales and service offices in all principal cities of the world. Manufacturing in United States, United Kingdom, Canada, Netherlands, Germany, France, Japan.

ON READER-SERVICE CARD CIRCLE 219

Speed Inquiry to Advertiser via Collect Night Letter

# Electronics needed for guerrilla warfare

**Green Berets spell out their Vietnam equipment problems and tell what they would like to see designed for the future.**

JOHN F. KENNEDY CENTER  
FOR SPECIAL WARFARE  
FORT BRAGG, N. C.

Robert Haavind, Managing Editor

*Electronics for guerrilla warfare? The idea sounds strange. In the past guerrilla fighters have usually been poor and ill-equipped. But, then, times have changed.*

\* \* \*

In a darkened jungle clearing somewhere in a troubled nation, 12 men gather up their blackened parachutes. The leader of the group—an "A" detachment of the United States Special Forces—begins to feel confident. His men were able to land in a tight cluster, because of their maneuverable chutes, and all are safe. They begin a hurried search for two supply bundles that were dropped by parachute just ahead of them. An hour passes fruitlessly. Then two, and three. Now voices are heard far off in the jungle. The Americans have been detected. Silently they fade into the jungle, without ever finding their supplies . . .

## The roll call for the interviews

The following Special Forces personnel made significant contributions to this interview story:

- Maj. Donald Keen, Signal Officer, JFK Center for Special Warfare.
- Maj. James Bailey, who was Group Signal Officer of the 5th Special Forces Group in Vietnam from July, 1964, to July, 1965, and thus was responsible for the equipment maintenance system now being used here.
- Lt. Ralph Ihli, communications instructor in the Special Warfare School and an ex-radio operator.
- Lt. Thomas Drinkard, Signal Section, JFK Center.
- Chief Warrant Officer Carl Sellers, who recently returned from Vietnam after making a three-month tour of most of the Special Forces camps there as head of a maintenance team.
- Sgt. 1st Class Aldege Martin, a radio operator who was in several 'A' team camps in Vietnam and was wounded at Soong Be.
- Sgt. 1st Class Buddy Chambers, communications instructor at JFK Center.
- Charles Swaringen, civilian engineer-adviser for electronics in the Combat Developments Special Warfare Agency, Fort Bragg.

*Disposable electronic homing devices on the supply bundles might have saved the mission.*

\* \* \*

Heavy fog, rolling down from the mountain above, cloaks a tiny Vietnamese hamlet. An American Special Forces detachment inside the hamlet nervously rechecks its defenses. Out in the chest-high grass surrounding the village a ring of mountain tribesmen stand sentry, listening for any tell-tale sound of attack. Sometime past midnight a black blob suddenly arcs into the center of the hamlet and explodes. In a moment a crowd of shouting, grenade-tossing Viet Cong are inside the village. They have managed to sneak by the sentries under cover of the tall grass and fog, and it appears that the village will be overrun. . .

*Sensitive metal detectors planted around the perimeter of the camp might have alerted the Americans and saved the village.*

\* \* \*

Hypothetical crises like these are of real concern to the men of America's Special Forces—or the Green Berets, as they are more popularly called. They have seen such seeming fiction spring into reality in Korea, Vietnam and other trouble spots in the world. They are looking to improve their capability, and electronics promises to provide them with many of the solutions.

A family of electronic equipment suitable for guerrilla action is already in the works. New radios and antennas, for example, are getting prime attention. Much of this work is classified. Much is taking too long to develop, the Green Berets say. They would welcome more and speedier electronic support. In particular they would like to see equipment designed specifically for the damp, rugged lands where guerrillas fight today—areas where even rodents can jeopardize a camp's safety by eating the insulation off wiring.

Since the Green Berets are apt to give military equipment its toughest field tests, equipment that is well designed for them should have wide application in other branches of the military.

To find out just what the electronic designer can do for these American guerrilla fighters, ELECTRONIC DESIGN visited their training camp in the forests of North Carolina. Taped interviews with some of the top electronic specialists here turned up many suggestions for improvements. Besides the homing devices and metal detectors, the following are eagerly sought:

- Blasting caps for mines actuated by RF.





**The Green Berets on patrol** carry a Hughes man-pack radio, the HC-162D (foreground) and a Hallicrafters hand-held HT-1 (rear). They prefer built-in antennas that can be used on the move. Here Maj. Donald Keen points out strategy to Lt. Thomas Drinkard during maneuvers near Fort Bragg.



**A hamlet communications system** is provided by this versatile Arvin Industries equipment. The use of the set (Model 63CRA11) as a public-address system, to allow a hamlet chief to address the villagers, is demonstrated here. A battery box is shown on top. As a radio, the set covers 535 to 1605 kHz. It also works with a tape recorder or phonograph. Note that all sockets are marked by sketches, so that natives can learn to operate the set.

(Green Berets, *continued*)

- Ambush detectors.
- New concepts in power generation.
- Better built-in cooling in equipment.
- Protection of delicate electronic equipment from power surges.

To design equipment that would fill these needs, engineers should first get out into the field, the Green Berets suggested. This was tried by some engineers from General Dynamics, who spent a couple of weeks on maneuvers with the Special Forces in this country. A light, "fish line" antenna, suitable for use on jungle trails, was one idea that emerged from the trip. Now another company engineer is arranging to go to Vietnam to observe equipment performance there. At present, reporting procedures for equipment failure are almost nonexistent. The valuable data that could help an engineer modify faulty equipment seldom get back to him.

### Homing devices for supply bundles

Lt. Ralph Ihli, an ex-radio operator and a signal instructor in the Special Warfare School, brought

up the idea of a homing device for finding supply bundles in a darkened drop zone. The objective would be to permit a 12-man team to evacuate a landing site within a half hour. At present it is not unusual for a Green Beret team to spend several hours looking for the bundles after a drop. The homing beacons would be simple, one-shot affairs. They would have to withstand the shock of a parachute landing, but otherwise they would not have to meet full military specifications. They could be packed in cases to protect them from dust and moisture until ready for use. Then, after the landing, they could be thrown away. The idea for this device was initiated by Maj. Donald Keen.

### Detectors for ambushes, perimeter defense

Because ambushes and sneak attacks are a chronic hazard, the Green Berets would like to see some new developments in detectors for ambushes and perimeter defense. The perimeter-defense type would be buried at points around a camp, while the ambush type would be portable. Here is how the ideas emerged in a discussion:

*Maj. Donald Keen:* "If anything is developed for perimeter defense it would have to be extremely



What does a Green Beret do about a damaged transmitter? Here Sgt. 1st Class Buddy Chambers demonstrates a cigar box transmitter made from a few parts salvaged from an inoperative T-784 transmitter used with the GRC-109 set. The floating neon bulb tells when the "designer" has achieved success. L1 is two sections of hand-wound coil (foreground). Mounting on a stick allows inductance

variation for tuning and proper antenna loading. The tube is a 2E26. The circuit should resonate at the desired frequency without multiplication in the final tank when it is tuned properly. Solder is heated and recaptured from the main set. This 6-watt transmitter has a range of more than 500 miles. Training focuses on being able to make do despite troubles.

simple. It would have to be something that we could plant out on the perimeter of the camp and that would bring back information to a central location in the camp. This would probably be something that could detect any metallic object."

*Sgt. Aldege Martin:* "Metallic detection would be best because you've got animals out there, and anything else could keep you out there all night long, going nuts."

*Question:* "How would you like to bring the information back to camp?"

*Maj. Keen:* "You might use audio or visual signals."

*Sgt. Martin:* "You could have a bank of lights. Then the sentries would have phones back to the central point. Now if a light lights, telling the man at the monitoring station that something has entered some area, he would pick up and call that post and say: 'You've got something moving out there in your area.'"

*Question:* "You don't have anything out there like that now?"

*Chief Warrant Officer Carl Sellers:* "Infrared. But this can't sort out the animals. Also, each detector uses a big pack of batteries. That means you have to have a big supply of batteries, and you need a battery charger."

*Sgt. Martin:* "Also, if you're going to have something out there, it can't be something that requires technical knowledge. It just has to be something that a man can look at and tell right away what it is, so that he can call the man on the post."

"Your Montagnards [mountain tribesmen] make good sentries. They can hear almost anything in the brush, but the trouble is you might have a 30-kilowatt generator running back in the camp, and with that thing put-putting, that's all they can hear. Then you have the grass and the fog to contend with. Outside your defenses you usually have grass growing like that. (*Indicates shoulder height*). You could have a whole battalion of Viet Cong sneaking up through there, and you wouldn't even know they were out there."

*Maj. Keen:* "When they come in like that they're bound to have something metallic with them. Like a knife even, or a grenade."

*Question:* "And if he doesn't have a weapon, you're not worried about him?"

*Mr. Sellers:* "Well, he might be infiltrating to try to get information."

*Sgt. Martin:* "But even so, these people wear coins and things around their necks, or a Buddha bag with a little metal Buddha."

### How Special Forces are organized

A breakdown of the Special Forces teams and military regions of Vietnam may help the reader to an easier understanding of the text.

Special Forces troops are split into three kinds of teams:

A team—Primary detachment of 12 guerrilla fighters who move into remote areas and organize paramilitary operations.

B team—Support unit for up to four A teams. The B unit secures supplies and handles administrative matters.

C team—A unit one level higher in the chain of command. It may control a combination of A and B teams.

Vietnam is divided into four Corps areas from North to South.

I Corps is the northernmost, and IV Corps the southernmost, delta area.

*Mr. Sellers:* "Even steel or gold teeth."

*Sgt. Martin:* "Let me say this. If they're going to attack a camp, they always send in a suicide squad in advance. All they carry is a sack of grenades. They're all doped up—they've probably smoked opium for two hours—and they'll just come charging in there right among their own mortars. After they've blitzed our mortars, the rest of them will come charging in behind. So a metal detector would definitely help in a case like this."

*Maj. Keen:* "Something that could be buried indefinitely in the area. There should be some method to sense if the system became inoperative, like a failure light to light up if the circuit is out or the line is cut. You'd check the system daily to see that it was working properly. But even with this kind of system, you wouldn't eliminate the human element. You'd still have your perimeter guards, but you wouldn't have to worry about a platoon of VC slipping by them."

"We do have another type of system called the GSS-9 that was developed for perimeter defense. It uses a small D-cell battery and has about a mile of wire wound up on a small spool. It sends back both audio and visual signals. You distribute it around the perimeter and then anything that breaks the field around the wire will give a signal—anything. If you have a few animals around, it will run you ragged. Metal detectors planted out there would be ideal—maybe the size of a shoebox. Size isn't so critical if you're going to bury the detectors, but they must be watertight."

The discussion then turned to what was now being used to detect ambushes. If an ambush were set up along a trail, how could the Green Berets tell it was there?

*Sgt. Martin:* "By the first round. . . . (*Laughter*) We did try to use dogs."

*Mr. Sellers:* "Dogs are the best bet, as far as I can see."

(Green Berets, *continued*)

*Sgt. Martin:* "We had dogs sent into our camp, but they couldn't hold up under the weather. They kept getting sick. And they couldn't eat our chow. We had to keep ordering dog food for them. . . . You might use a metal detector for detecting ambushes, too. It would have to give you at least 200 or 300 yards' warning, before you entered the killing zone."

### Electronic blasting caps sought

Another idea that the Green Berets would like to put into practice is electronically actuated blasting caps for mines.

*Lt. Ithi:* "You could set off a blasting cap with a radio signal by dialing a certain code or something. Then you could have charges scattered all over the trail or all around the base. By using a certain frequency, or a certain code combination—BLLLLAAAUUU. There goes the trail or a mortar position."

*Mr. Sellers:* "You couldn't use a regular battery for power. What you might do is to use these quick-activating, one-shot batteries—thermal batteries. You couldn't get an RF signal strong enough at any distance to detonate the cap without using a battery. And an ordinary battery would wear out too soon. The quick-activating type would sit there indefinitely. You can get these quick-activating batteries in all kinds of outputs, tremendous amperages. I think 200 amps is the biggest one I've seen."

*Lt. Ithi:* "The way it happens now is you set these charges out around your camp and lay wire to them. There's a possibility of a mortar round cutting the wires, or people—sabotage. So you'd like to have an alternative way to set these charges off where there's no physical connection. No wire."

*Mr. Sellers:* "You know these little remote-control aircraft? They've got motors that operate the

control surfaces by means of RF signals. We could get one of these electromechanical gadgets to pull the pin on one of these quick-activating batteries. That wouldn't be a very big strain."

### Need for better cooling

Vietnam is a hot country, and the heat causes a lot of equipment problems. The situation is worsened by the need to seal equipment from the dust that hangs in the air all through the dry season. Listen to Chief Warrant Officer Sellers, who toured the country as the leader of a three-man maintenance team:

*Mr. Sellers:* "At all the installations where they had a single sideband radio, the KWM-2A, or AN/FRC 93,\* usually you'd find a little fan, probably local-made, sitting and blowing across it to keep it cool. At the B and C detachment level, where they were always on the air, you always had the set cranked up, and you just can't do that without keeping it cooled off."

*Sgt. Martin:* "Usually the A teams keep the set in the kitchen, and they have at least one American awake 24 hours a day. As long as we weren't transmitting on the set constantly, cooling wasn't too critical. We'd be mostly listening, monitoring. But at the B and C team level you're constantly sending over them. You've got five or six teams out there and you've got to keep communicating with them. Those single-sideband transmitters are very accurate and you have to keep them cool. They should build a little fan right over the power amplifier section in that set."

*Maj. Keen:* "This single-sideband set they're talking about is a Collins ham rig bought right off the shelf. It has no military specifications or special characteristics whatsoever, but it does the job beautifully."

*Maj. James Bailey:* "This is a radio we had to import. It's a case where commercial electronics saved

\*Built by Collins Radio, Inc., Dallas.

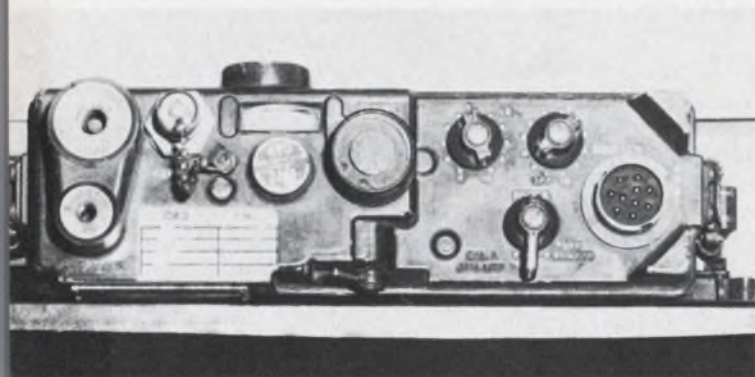

An old Army standby, the PRC-10, was pulled off the shelf for Vietnam duty. It is an FM voice set operating at 38 to 54.9 MHz. Weight is 26 pounds with batteries. Designed for jungle use, it puts out about a watt.

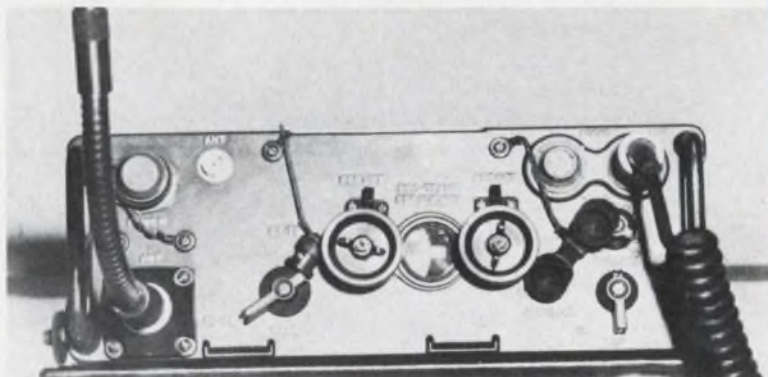

The PRC-25, a transistorized set, is replacing the PRC-10. It covers a wider range (30 to 75.95 MHz) at higher power (1.5 to 2 watts). Weight is 24.7 pounds. Its lower power drain means longer battery life.

our tail. Our problem was positive voice communications—24 hours a day—between our A, B and C detachments. We didn't have a radio in the Army that met all our requirements. So we purchased the KWM-2A, or AN/FRC 93, and it's now the backbone of our system. In the IV Corps, for example, the introduction of this set increased operational efficiency by 80%. What that really means is that you could get helicopters in, get medical cases evacuated and co-ordinate things that previously you couldn't get done at all. Performance of this set has been outstanding."

*Maj. Keen:* "Another radio that is a commercial type bought right off the shelf is our hand-held patrol radio, the HT-1."\*

*Mr. Sellers:* "This radio wasn't built to military specifications, either. It will leak if it gets wet, and dust can get in and gum up the works."

*Maj. Bailey:* "This radio is issued to CIDG (Civilian Indigenous Defense Group) troops on the basis of 20 per company. You can seal it with wax or with tape. When they take them on patrol, they should be sealed."

*Mr. Sellers:* "We tried this. Tape was the first thing, except that after you use it and reuse it, it loses its adhesive. So then we started to use a rubber preservative. It's for painting on power cables, rubber cables, to preserve them. It goes on like paint and dries like a layer of rubber or elastic. I got some of it from a marine up at Danang. It seals real well; in fact, too well. The darned thing just heats up and quits working. So then you take the sealing off, and after it cools it'll work fine again."

*Sgt. Martin:* "We had our worst trouble with the HT-1s."

*Mr. Sellers:* "They are miniaturized and they use printed circuits, all transistorized. They corrode a

lot, because of the moisture leaking in. Also, on some of the terminal ends they have a mixture of metals, solder and something else—these corrode, too."

ED asked if the field forces had trouble repairing the printed-circuit boards.

*Mr. Sellers:* "Yes, it takes an accomplished repairman to do this. A lot of them we just couldn't repair. We'd just smash them up and throw them away. One of the repair parts for the HT-1 is the entire guts. You just take out the bad one and put in a new one. You change crystals and align it."

*Sgt. Martin:* "We couldn't do the aligning if we changed crystals at the A camp. We couldn't do the frequency tuning. Same with the TR-20.\*

*Question:* "Do you have any radios that were designed specifically for use in Vietnam?"

*Maj. Bailey:* "Yes, there is. The AN/PRC-74 developed by Hughes Aircraft Co. It's a patrol radio, and it's an outstanding development. The kickoff was a 'lightweight jungle radio.' There are over 120 going into groups now in Vietnam. They are cw, a cw single-sideband set, 15 watts PEP, 2 to 12 MHz. It weighs 29-1/2 pounds with battery."

*Question:* "Does it use dry-cell batteries?"

*Charles Swaringen:* "It has a wet cell, a nicad battery. Then some people wanted to use a standard BA-30 battery with it. So we have a pack for it that can carry up to 70 BA-30s in it on patrol."

### Simplicity of design stressed

A point that came up again and again through the interviews was the need for simplicity in design. In some cases natives must be taught to use

\*Built by Radio Industries, Kansas City, Kan., now a division of Hallicrafters Corp.

\*The TR-20 is the base-camp radio used to communicate with the HT-1s out on patrol.



A popular ham radio, Collins KWM-2A was bought off the shelf and since has become the backbone of Special Forces communications in Vietnam. The Green Berets say they can talk to the U.S. almost as easily as to the next

hamlet on this ssb, 100-watt-output set. Frequency ranges are 3.4-to-5 MHz and 6.5-to-30 MHz. Biggest problem: the steel tape antenna may be fine for hams, but it snarls when hung in a jungle hamlet.



(Green Berets, continued)

equipment. (Note the Vietnamese labels printed on the HT-1 patrol radio in the photograph.) In other cases Vietnamese or Montagnards fiddle with equipment when they don't know how to use it. Here's what Maj. Keen had to say on this subject:

"We need equipment that's tinker-proof. Give those Montagnards any device with one knob on it, and they'll tinker with that knob. It's just infectious. It's best to have any variable features built into the set when possible. All he needs is an ON-OFF switch. You put a radio on frequency and give it to him working perfectly, and he won't be able to communicate with it because he'll fiddle with that knob until he gets it off frequency."

Another thing that radio operators would like to have is a patrol radio that would fit in the pocket. This would make their load lighter, and they might carry some other extra items instead, such as more food or ammunition. But that isn't the main reason. The biggest problem in Vietnam is that a man carrying a radio with a big antenna sticking up from his back is a prime target for a Viet Cong ambush or sniper. Visible antennas in Special Forces camps also present a problem, since they tip off an attacking force to the location of a critical target. This problem is being overcome by some wily radio operators, as the following discussion reveals. Radioman Martin, who was wounded during action at the A camp at Soong Be, cites some personal statistics:

*Sgt. Martin:* "I'll give you an example of how they pick out radio operators. In my team alone, while I was with them, we had five killed and 13 wounded. Out of the five killed, three were radio operators. And out of the wounded, it was five or six. The first thing they go for when they attack a camp is the commo bunker, too. When they hit our camp, they threw satchel charges right at where my commo bunker had been. But I'd just moved it."

*Lt. Ihli:* "In each Special Forces A camp you'll find a bunker with not only external antennas, but with buried antennas as well. You'll find dummy antennas all over the camp, too. So the VC don't really know where the radios are located."

*Mr. Sellers:* "Then another thing they do. . . . The A detachment has three or four PRC-10s [radios]. They put them in different spots around the camp, so that one hit can't take out all the radios. And at least one of those radios you don't tell anybody about, except the Americans in the camp."

*Sgt. Martin:* "I put in a lot of those buried antennas for my camps. You lay the antenna on the ground and move it back and forth to find the place where reception is best. Then you dig a trench about three feet deep right alongside it, and lay your ground wire coming right from the trench to your ground connection. You put about a foot of dirt over that and put in your antenna inside a plastic coating. Then you cover that over."

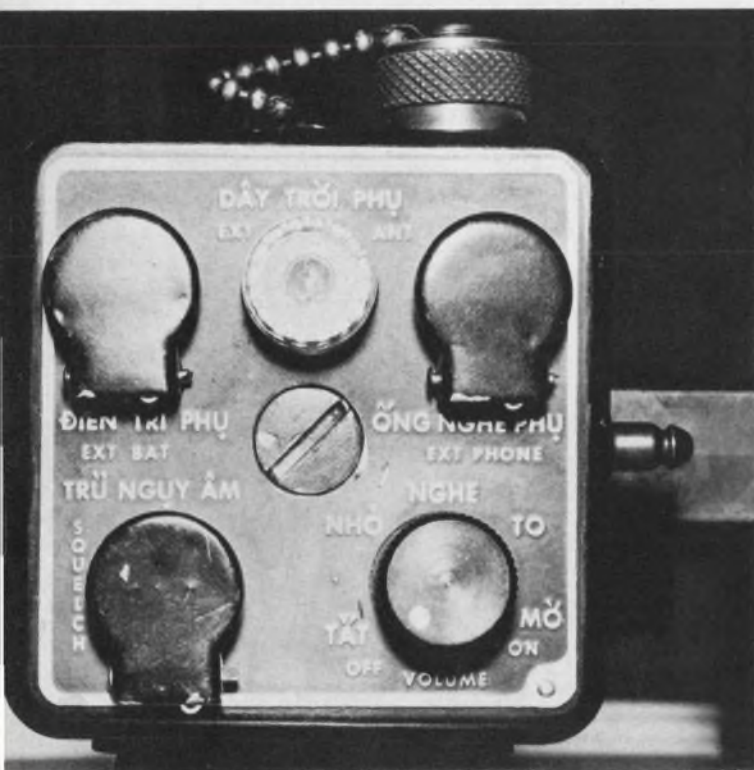

Montagnard patrol radio must be simple to operate and have instructions printed in the native tongue. This HT-1 set was a commercial unit adapted to military use. Sgt. Aldege Martin, who was wounded in Vietnam action, demonstrates operation of the set.



Tough training is a prerequisite for guerrilla fighters, and the Green Berets get plenty of it. For a quick descent from the tower, a trainee coils a rope about his waist and drops halfway down, before catching hold and scaling the rest of the way in three or four steps while carrying a full pack. (Lightweight electronic equipment is deeply appreciated

*Mr. Sellers:* "I saw one camp in I Corps where an operator took a piece of plywood about 4 by 6 and wrapped antenna wire around it in ever diminishing squares. He'd try it, cut off a little piece, try it again and then cut some more, until he got his best communications."

*Sgt. Martin:* "For a receiving antenna I used to use the tin roof on one hut. . . . [If] the VCs want to destroy the antenna, they're going to have to take that whole roof off!"

*Mr. Sellers:* "I heard about one guy near Saigon using a metal roof for a transmitting antenna."

*Sgt. Martin:* "I had my dummy antennas all around, but I was really using the roof for receiving. I never did try it for transmitting."

*Mr. Sellers:* "A guy can make do over there be-



during this exercise.) All Green Berets must be qualified for parachute jumping. Conventional chutes as well as a maneuverable one are shown. Each man is cross-trained in at least one other specialty. They all speak at least two languages—some several. Many are escapees from Communist countries.

cause his tail depends on it."

*Sgt. Martin:* "You make something work."

### Power surges, generator problems

The biggest difficulty in running electronic equipment is not in the equipment itself, these veterans said. It is rather the sources of their power—local power, motor-generator sets, hand-cranked generators and batteries—and they called for a fresh approach to this area of design. They would like to see silent, reliable, new power sources, such as fuel cells or thermionic converters [ED 16, July 5, 1966, p. 17], reach the field as soon as possible.

Present motor generators are far too noisy. The Montagnard sentries' keen sense of hearing is destroyed at night by the loud chugging of a motor generator set behind them. Local power is

(Green Berets, *continued*)

undependable. Blackouts sometimes occur, but even more serious are the frequent power surges. The voltage on the line is generally 80 volts, but it fluctuates considerably each day as the load on the generating station varies. If the load becomes very light, a situation like this results:

*Mr. Sellers:* "I was over at Banme Thuit at a B detachment, sitting in their headquarters. I hadn't been there more than an hour [when] all of a sudden the lights started getting brighter and brighter, and they all burned out—every one of them. And that was the reason, believe it or not, that they didn't want to use commercial power. Because it kept blowing out their light bulbs.

"So they wanted to use their Army generators to supply power for everything in their installation. I finally talked them out of it by getting a big switch installed that would throw in either the commercial power or the generators. But the generators were used most of the time for communications only after that.

"They had been having trouble with generators blowing out at that installation, but it wasn't because of problems in design. It's just that they were using those generators for more than they were supposed to be used for. Somebody at higher headquarters figured that it would take 10 kW maximum if all their communications equipment was running at the same time. So, to give them some leeway, they assigned them a 30-kW generator. But nobody had figured on the refrigerator, air conditioning, lights, fans—not everybody has all of this, but some of the detachments that have been there a long time are pretty well installed—and it's just too much of a load."

ED asked about the possibility of protecting equipment against such surges, with fuses or circuit breakers. Sgt. Martin pointed out that there are times when the supply of fuses can run pretty thin at a remote camp. He put the matter succinctly:

"What we're saying is that here you have a piece of equipment that's worth \$1200. And it's dead, because you don't have a 10-cent fuse. Some guys will put a piece of wire in there, but that way you'll probably blow the whole set."

Mr. Sellers suggested that circuit breakers would do the job better. These should be quick-acting types that would cut out the equipment when the voltage went too high, and then put it back on the line automatically when it returned to normal.

Voltage fluctuations caused particular difficulties with a 1.5-to-20-MHz transmitter for voice and cw traffic, the T-368. Both Sgt. Martin and Mr. Sellers had experience with losing the high-voltage rectifiers on these sets:

*Sgt. Martin:* "When voltage fluctuations knocked out a rectifier in the T-368, you couldn't put one in to fix it. You'd have to put in a pair of them."

*Mr. Sellers:* "That's right. They're high-voltage tubes, 3B28s. This is full-wave rectification, the two tubes are in parallel. So when one goes, it throws the full load on the other tube."

*Sgt. Martin:* "I had to replace mine every three or four weeks."

*Mr. Sellers:* "That's about the same as I found."

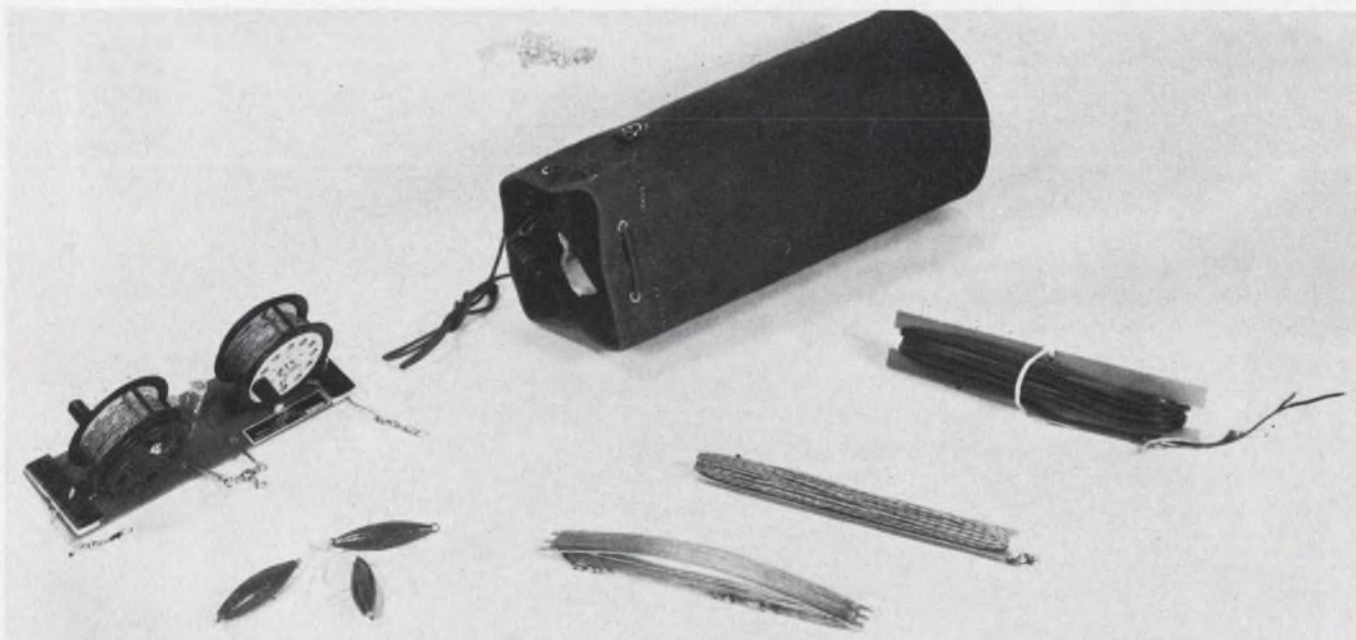

Angling is a favored pastime among the Green Berets, as it could mean the difference between snake-meat or fish for dinner at times. Here the angler's art is turned to an antenna set-up problem. With two reels and two plugs, casts can be made into nearby trees. A triple swivel (see

reel holder) allows a T-type antenna to be rigged up speedily. When the guerrillas aren't communicating, the reel of Teflon-coated wire, with a nylon leader, can be used to fish a handy stream. This antenna concept is being worked on by General Dynamics for the PRC-70 radio.



The voltage surges were particularly critical in the case of the AN/GRC-109, the primary detachment radio for many of the camps. This portable set transmits 10 to 15 watts over a 3-32-MHz range and receives over 3-24 MHz. At night a wet-cell can be charged from the set while it is being fed by commercial power. But to do this, a selector switch must be set to the proper voltage. Early in the evening, when everyone is using a lot of electricity, the voltage will be at about 80 volts, and the switch is set for this. Then, later on as lights go out, the voltage will quickly shoot to the 110- or 120-volt level, which has the undesirable effect of burning out a power supply and the rest of the set.

Sgt. Martin suggested that this trouble might be overcome by putting in a resistor network, so that if the voltage did go up, some of it would be dropped across resistors rather than ruin the equipment.

Another equipment problem has come up with 10-kW air-cooled generators, recently introduced in the Vietnam jungles. Since the generator is a vital target in case of an attack, it must be kept in a fortified bunker. The result is that during the day it won't cool properly because of poor air circulation. Sgt. Martin said the only time he ran the generator was at night. He explained some troubles he had with the muffler systems:

*Sgt. Martin:* "Also, the muffler systems on these generators could be improved, because at night you can hear that putt-putt all over the place. This was at Geo Vuc. A lot of nights when the fog rolled in, we'd just shut down the generator and use battery-powered communications. I was able to cut down quite a bit on the noise by taking an old deuce-and-a-half muffler [from a 2½-ton truck] and slapping it on the end of my 10-kW."

*Maj. Keen:* "As well as the noise, you've got a flame shooting out of the exhaust that you'd like to hide. The enemy can pinpoint that flame with mortars."

*Sgt. Martin:* "Another thing that would be very useful is a motor generator that would run on any kind of fuel. A lot of times you'd be running low on gas, and you'd drain all the trucks and jeeps just to fuel the generator. It's more important that you have communications than vehicles. But lots of times I'd have 60 gallons of kerosene sitting there, and all I could use it for were those little lanterns that we use over there."

The difficulties of resupplying make any common failure particularly disturbing. Besides light bulbs and fuses, other items that came up during discussions were two particular tubes that fail frequently and dry-cell batteries. One discussion began with a voltage-regulator problem:

*Lt. Ihli:* "The CN690 is a voltage regulator that we use with the hand-crank generator for the AN/GRC-109. I have to warn students in any

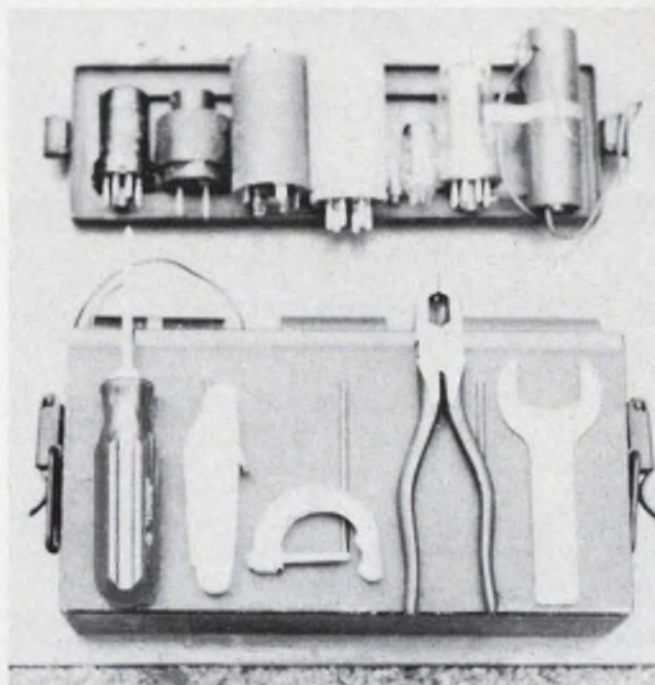

**A repair-parts kit for remote areas** doesn't exactly make a complete maintenance shop. But it weighs only two pounds, a distinct advantage on a 40-mile forced-march. Despite the paucity of spares, radio operators know they must keep on the air or risk the loss of their camps. Their record in Vietnam has been exemplary.

communications classes about the OB2 tube in there. If you get any moisture or condensation on the surface around that tube, it will arc over from the high-voltage pin to the casing. This can burn out some tubes, and if you're out in the field without spares, you're in trouble. Without the hand-crank generator, you can't use your 109." [Note: The cover illustrates the use of a 109 radio on field maneuvers with a hand-crank generator for power.]

*Question:* "What about a design change to straighten out this problem?"

*Lt. Ihli:* "If you had something like the 10-pin audio connector on the PRC-10, where you completely encase the whole thing, you'd probably clear up the trouble. You could put a lip on it. What a lot of operators are doing is to put the 7-foot power cord directly into the transmitter and skip the voltage regulator. Then they use the battery for the receiver."

*Sgt. Martin:* "You can put the CN690 voltage regulator into a plastic bag that the batteries come in to keep it dry. You tape it up for use."

*Lt. Ihli:* "I've seen people put them in plastic bags, and then the sun comes out, condensation forms inside the bag and that may be all the moisture you need."

*Mr. Sellers:* "Another tube that failed frequently was the 6AZ8 in the single-sideband set, the

KWM-2A ham radio. That tube is used in three different circuits in the radio. Nobody could figure out just why this tube was failing. We were having a lot of trouble getting enough spares."

*Sgt. Martin:* "Batteries were another problem. These BA279s for the PRC-10, we had some of those made in Japan and we'd have to go through two or three cases before we'd find a good one."

*Lt. Ihli:* "Even the U.S.-made batteries have caused us trouble with the PRC-10. This is an old Army set that was shelved after World War II and the Korean War. Some of my students have reported back to me that if they don't check out every battery before they leave on a patrol, they'll take a case of brand new batteries and they'll all be dead. The trouble is that a lot of these batteries have just been sitting on the shelf too long."

*Mr. Sellers:* "The heat has a lot to do with it, too. Batteries should be stored at low temperatures. It's a dilemma. You need loads of batteries all the time, but you can't store large quantities because you can't refrigerate that easily."

*Lt. Ihli:* "Now the batteries in the PRC-25, which is replacing the 10, are giving much better service. That's because the 25 is transistorized and requires less power."

#### **Antennas: big improvements possible**

Many of the antennas being used in Vietnam were not designed for conditions there. Several comments were made about individual antennas that caused trouble. Also, there was talk of a new antenna now being developed by General Dynamics for quick setup and removal, one of the most important requirements for a Special Forces patrol:

*Mr. Sellers:* "I'll tell you about one trouble with the PRC-64, the new patrol radio. It looks like a telephone box, and it's got an antenna that consists of two long wires about 50 feet long. That's the only antenna that comes with the set. It's got a banana plug on the end that fits into the radio. You cannot use this antenna while you're moving. To use it, you have to stop, set up the antenna, transmit, take it down and move. This is pretty impractical for a long-range patrol radio.

"This radio could use a whip antenna that is adapted to the connector that's already on the set."

*Sgt. Martin:* "Maybe you could have something to screw on to the set, or clamp on. I think the biggest trouble I found, though, was with the flexible steel tape antennas for the single sideband, the KWM-2A. It's a calibrated tape, marked off in meters."

*Mr. Sellers:* "You have to remember that this

radio was not designed for the military; it's strictly a civilian radio. So it comes in a big plastic gizmo with two reels, and it's got a plaque that says for frequency so-and-so, extend this tape out so many meters. So you pull the tape out until you read the proper number, lock it, stick it up, and you have an antenna pre-cut and ready to go. The only thing is it's tape, like a measuring tape. And after a few days up these in the trees, it gets all twisted up. So it's just no good for our purposes.

*Lt. Ihli:* "Plus the thing weighs about six or seven pounds. If you want to put it up with a doublet, you have to have a self-support. If you don't have a self-support, it's going to sag down like a half-rhombic, only inverted."

*Lt. Thomas Drinkard:* "A new antenna, the SC-885, being developed by General Dynamics uses a similar idea, but it's got a copper-coated steel wire instead of tape. Multiple strand. The whole thing, encased, weighs about two and a half pounds. It's marked to show the different lengths.

"In addition this antenna is designed so that it can be set up at night. It has plastic shrunk around the proper lengths, so that you can feel it in the dark. It's a Teflon-coated wire that winds on fishing-line holders."

*Mr. Sellers:* "Still, if this is for a portable radio, you should have a whip as an alternate antenna."

The discussion turned to a special antenna that had been built for the HT-1 patrol radio (the one with Vietnamese labels). This radio has an extensible antenna built in. But since it is purely line-of-sight in operation, patrols run into communications problems in heavily forested or mountainous regions. This antenna consists of a long piece of coaxial cable with another piece of coax, cut to frequency, mounted at the top of a T as a radiating element. It could be rolled up, to be carried on patrol, and then strung up on a pole or tree if the group moved out of range of the base camp with the built-in antenna.

Although the HT-1 puts out only about a watt, it has proved a life-saver more than once. Mr. Sellers told of an incident where this occurred:

*Mr. Sellers:* "This HT-1 uses 8 flashlight batteries and transmits vhf. It works back to the TR-20 radio back in the base camp. One time we were setting up a new camp with a group from Okinawa. We were supposed to go in on three helicopter lifts in one day, so that we'd have everything we needed to communicate, to fight, to move and to set up camp. The first lift got in with some people and a few supplies and then the weather closed in. We were out there for four days with nothing but HT-1s for communications among ourselves and one 109 with a hand-crank generator for transmitting back to the C detachment.

"We sent people out right away to secure the area and make sure the VC weren't getting ready

to wipe us out.

"But with those HT-1s we were able to patrol the area. The only VC we came across were seven or eight one night, just a little reconnoitering party, and I think we got all of them.

"But these HT-1s worked fine. We had a patrol out 12 clicks [kilometers], at its maximum range and they were up on the other side of a pretty high ridge—maybe a thousand feet. All they had was this little antenna built into the set. Back at the camp we had an antenna, three counter-poise and one radiating elements, mounted on a 20-foot pole. We had tremendous communications."

Burst communications is a development that lends itself particularly well to guerrilla operations, when the sender does not wish the local authorities to know that he is transmitting at all. If the transmission is picked up, it is so short that it cannot be tracked by radio direction finders.

The GRA-71 is a burst transmission device that is being used right now. An operator encodes a message onto a magnetic tape, using three keys—dash, dot and space. Then the tape is put onto a keyer that feeds the GRC-109. A button is pressed, and the message goes out at 300 words a minute. At the receiving end, a tape recorder is used to slow the speed and recover the message.

What would be the ideal radio for the Green Berets? Mr. Sellers recited his requirements for a short-range patrol radio:

"It should be sealed, lightweight and a size that will fit in your pocket. Very little training to operate. The fewer controls the better. Transistorized. Cheap enough so that if it conks out we can smash it and throw it away. Multichannel, and if it is multichannel, it should have a vhf frequency for aircraft communications as well as channels for ground-to-ground. A long-life battery. It shouldn't have a big antenna that you have to carry around on your back. It might use a lip mike and an ear plug, like the PRC-64 we have now.

"If this is what would be best for Vietnam, it would certainly hold true for other countries, too."

There is a new radio, the PRC-70, under development specifically for the Green Berets. But it is heavier than the ideal version that Mr. Sellers envisions. It will have the vhf capability, but it will weigh about 35 pounds. A general-purpose set, it will cover 2 to 30 MHz, either single sideband or cw, and 30 to 72 MHz, either fm or ssb. It will put out about 40 watts. Only feasibility models have been built so far by General Dynamics and Avco Corp.

This set will include a combination of thin-film, monolithic and discrete component circuits. The percentage of integrated circuits in the PRC-70 will depend on the availability of desired types at reasonable cost over the development cycle, according to Mr. Swaringen.

The present primary detachment radio, the GRC-109 (shown in the cover illustration) comes with a bagful of crystals for frequency changing. The planned PRC-70 will have a frequency syn-



The TR-20 is the base-camp radio used to communicate with the HT-1s carried by Montagnards on patrol. It puts out 20 watts at 30 to 40 MHz and weighs 20 pounds. Sgt. Chambers demonstrates operation.

thesizer, to eliminate crystal changing. In a guerrilla action, which is the main function of the Green Berets, the PRC-70 would be the only type of radio that a field force might carry. It would solve many of the problems that the forces now have in carrying spare parts for several different sets and in having to know how to keep all of them repaired.

A new version of the PRC-70, incorporating the best features of the first two prototypes, is expected to be completed in about two years.

Several times during the interviews, Special Forces veterans expressed impatience with the long development cycles required for new equipment. The need to meet full military specifications was questioned by some of them during the discussions—some requirements do not always seem germane to the functions of particular equipment.

When they can't get what they need through regular military development channels, the inventive Green Berets often come up with unorthodox solutions. Commercial ham sets for voice communications, for example, have in some cases proved excellent in the field. But an early problem arose: the need for suitable cases to carry the sets through the jungle. The Green Berets hit on a quick, practical solution: a three-piece set of civilian Samsonite luggage. With a little Styrofoam lining, the suitcases proved ideal. ■ ■

for the first time in a silicon power transistor...

**HIGH BREAKDOWN VOLTAGE** ( $BV_{CEO}^{(sus)} = 350 \text{ V}$ )

**HIGH GAIN BANDWIDTH** ( $f_T = 20 \text{ MHz}$ )

**LOW CAPACITANCE** ( $C_{cb} = 6 \text{ pF}$ )

**AND**

**20 WATTS DISSIPATION**



The RCA 2N4296 family is designed for high voltage, wide-band amplifiers and other military and critical industrial applications.

**Use it for:** high-voltage switches • relay drivers • switching and series regulators • waveform amplifiers • converters (low-voltage DC to high-voltage DC or AC) • high-voltage inverters • differential and operational amplifiers in analog computers • video amplifiers in camera chains, TV monitors, color-difference amplifiers.

Packaged in a TO-66 case, the RCA 2N4296, 2N4297, 2N4298 and 2N4299 are triple-diffused silicon NPN high-voltage power transistors, with exceptionally

high-frequency response and fast switching speeds. And they are priced *below* virtually every other transistor on the market with similar characteristics.

For delivery information, and for your copy of a technical bulletin which has all pertinent performance curves, applications data and electrical and mechanical specifications, call your local RCA Field Office; or write: RCA Electronic Components and Devices, Commercial Engineering, Section EG8-1, Harrison, N. J.

RCA 2N4296 SILICON POWER TRANSISTOR FAMILY CHARACTERISTICS					
	2N4296	2N4297	2N4298	2N4299	
Collector-to-Base Voltage, $BV_{CBO}$	350	350	500	500	max volts
Collector-to-Emitter Voltage, $BV_{CEO}^{(sus)}$	250	250	350	350	max volts
Emitter-to-Base Voltage, $BV_{EBO}$	4	4	4	4	max volts
Collector Current, $I_C$	1	1	1	1	max amps
Collector-to-Emitter Saturation Voltage $V_{CE}^{(sat)}$ $I_C = 50 \text{ mA}$ , $I_B = 5 \text{ mA}$	0.9	0.75	0.9	0.75	max volts
Base Current, $I_B$	0.25	0.25	0.25	0.25	max amps
DC Forward Current Transfer Ratio, $h_{FE}$ (at $V_{CE} = 10 \text{ V}$ , $I_C = 50 \text{ mA}$ )	50-150	75-300	25-75	50-150	
Transistor Dissipation $T_C$ up to 25°C $T_A$ up to 55°C	20 2.0	20 2.0	20 2.0	20 2.0	max watts max watts
	\$1.50*	\$1.75*	\$2.25*	\$2.50*	

Available Through Your RCA Distributor

SEE US AT WESCON BOOTHS 1240-1244; 1317-1321



The Most Trusted Name in Electronics

ON READER-SERVICE CARD CIRCLE 220

**Co-Publishers**

James S. Mulholland, Jr.  
Robert E. Ahrens Dorf

**Editorial Director**

Edward E. Grazda

**Editor**

Howard Bierman

**Managing Editor**

Robert C. Haavind

**Technical Editors**

Joseph J. Casazza  
Rene Colen  
Maria Dekany  
Mark B. Leeds

**News Editors**

Frank Egan  
Roger K. Field

**East Coast Editor**

Neil Sclater

**West Coast Editors**

Ralph Dobriner  
Peer Fossen

**Copy Editor**

Peter Beales

**New Products Editors**

David Surgan  
Genevieve Adee

**Washington Editor**

S. David Pursglove

**Editorial Production**

Dollie S. Viebig  
Anne T. Lombardi

**Art Director**

Clifford M. Gardiner

**Art Assistant**

William Kelly

**Technical Illustrators**

Lewis D. Hill  
Cheh Nam Low  
Douglas Luna  
Robert Ranta

**Production Manager**

Thomas V. Sedita

**Asst. Production Manager**

Helen De Polo

**Production Assistants**

Carl Merkin  
Bernard Wolinsky

**Circulation Manager**

Nancy L. Merritt

**Reader Service**

Diane Pellechi



## The electronic designer plays a role in world leadership

Since World War II the United States has been projected into a position of world leadership. Unlike other leading industrialized nations, the U.S. did not have to take time out to rebuild from the devastation of the war. In fact, with its industrial might, vast wealth and high standard of living, the U.S. has been called on to assist and defend a large part of Europe and Asia. Electronic designers are playing a vital supporting role, and their contributions are to become increasingly important.

We are still uncomfortable in our role as world leader. Our own colonial background only a few generations back gives us a natural antipathy to paternalism. If it were not for the threat of Communist expansion, we would probably be leaving things pretty much alone around the world.

But since we must exercise leadership, we have taken a few steps toward a new way of doing so. The Peace Corps is one example of this, the Alliance for Progress another. Our approach is to co-operate with underdeveloped nations in order to raise their standards of living. This is done not through exploitation, but by lending them our technical knowledge and skills, so that the peoples of these nations can do the job themselves. The Communist countries have, in some cases, used a similar approach. They have derived the fullest propaganda value from their project-oriented assistance programs in order to sway backward or exploited people. They often have been quite successful. At the same time, though, they have been backing guerrilla activity in many underdeveloped lands. And for many years the United States lacked the guerrilla capability to counter this challenge.

Now the situation is changing. We too have an emerging guerrilla force, discussed in the Green Beret article on page 36. These men are already operating in various spots around the world as well as in Vietnam. They are in touch with the common people of several nations, learning their views and winning them to our cause. Electronics is playing a key role in this undercover activity. Security cloaks much of what is going on, but the increasing need for specialized designs to carry out guerrilla missions is clear. There must be a flow of information from and to these men in the field. Yet their transmissions must not be detected and pinpointed by direction finders. Their lives will depend on good design.

Furthermore, distorted propaganda must be countered through communication to the people. Community radios are one answer that is already being used; loudspeakers allow messages to be broadcast to an entire village. Defense systems must also be developed to protect villages where our guerrillas operate.

These, and other aspects of our new world role, challenge the ingenuity of today's electronic designers. The future of our nation may depend on how well our engineers meet the need.

ROBERT HAAVIND

# THIS LITTLE THREAD HELPS OUR AIR-SPACED COAX DO BIG THINGS FOR IBM

Our coax can do the same for you! A spiral of flame-retardant polyethylene thread air-spaces the center conductor of Brand-Rex Turbo® 209A Coaxial Cable. The result: a tough, miniature coax, with excellent electricals for high-speed transmission, at moderate cost. □ We first developed the Turbo 209A for use in the IBM Computer/360, but you may find this space-saving performer

useful in a variety of data processing and communications applications. □ It is available as single cable, cemented ribbon cable (illustrated), or conventional round multiconductor cable. □ Substantially lower in price than standard 95 ohm High Temperature types, it also offers lower attenuation; higher velocity of propagation. A spiral drain wire under the shield simplifies termination.

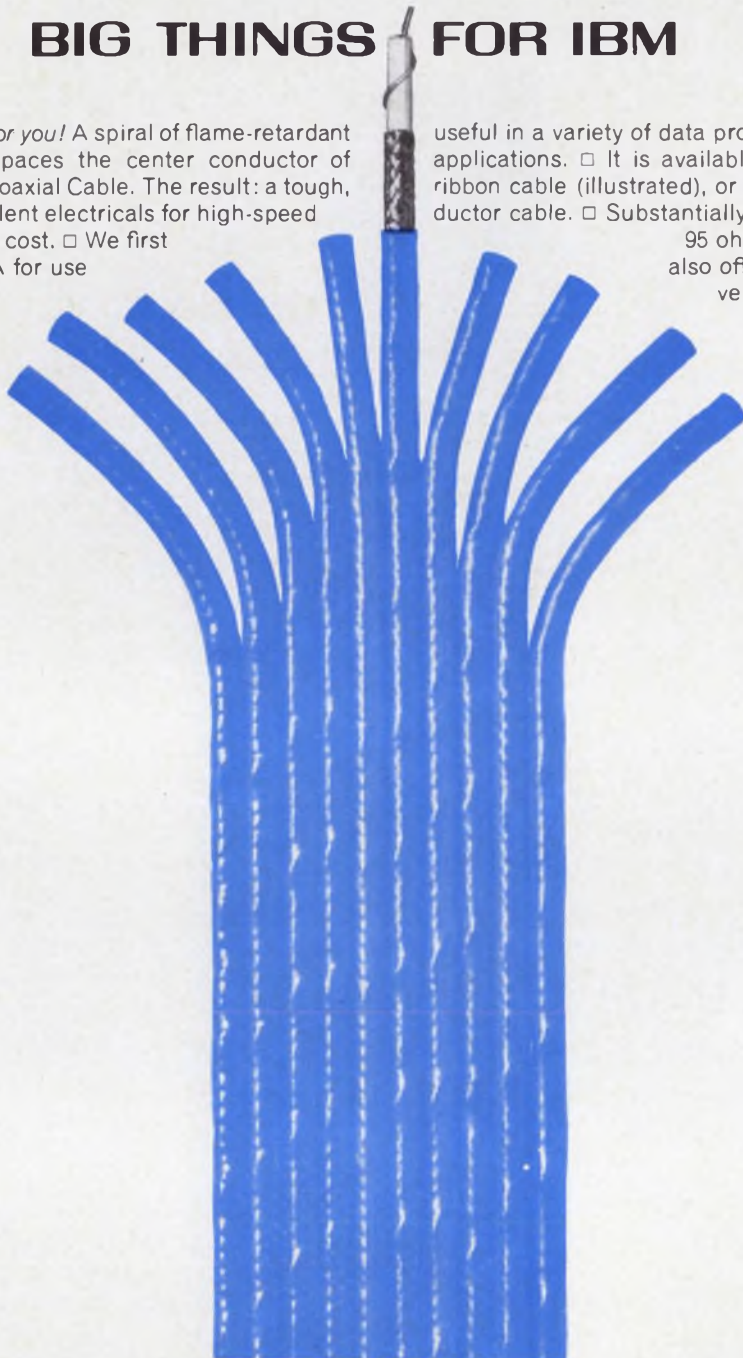

Check the specs. Sound good? Write for full information.

Brand-Rex Turbo 209A Coax U.L. Approvals. Style 1354 (single), Styles 2384, 2385, 2386, 2387, 2388 (cable).

Nominal voltage: 600 volts rms.

Nominal impedance: 95 ohms, +6 -4.

Nominal capacitance: 13.5 pf. ft.

Max. attenuation: 14 db/100 ft at 400 Mc.

Velocity of propagation: 80%.

Inner conductor: #29 AWG silver-coated Turballoy C.

Cable core: Air-spaced, flame-retardant polyethylene. 0.072, 0.078" O.D.

Drain wire: #29 AWG silver-coated Turballoy C spirally applied for flexibility and fatigue resistance.

Shield: #38 AWG tinned copper braid, providing 90% min coverage.

Jacket: High-density vinyl, 0.112" nom. O.D.; 0.122" max O.D. at drain wire points.

AMERICAN ENKA CORPORATION

BRAND-REX DIVISION

Willimantic, Connecticut 06226

Phone: (203) 423-7771



ON READER-SERVICE CARD CIRCLE 16

# Technology



Ensure your transistors won't burn out in control and power-switching circuits because of

inadequate safety margins. Simple guidelines set their safe operating area (Soar). Page 52

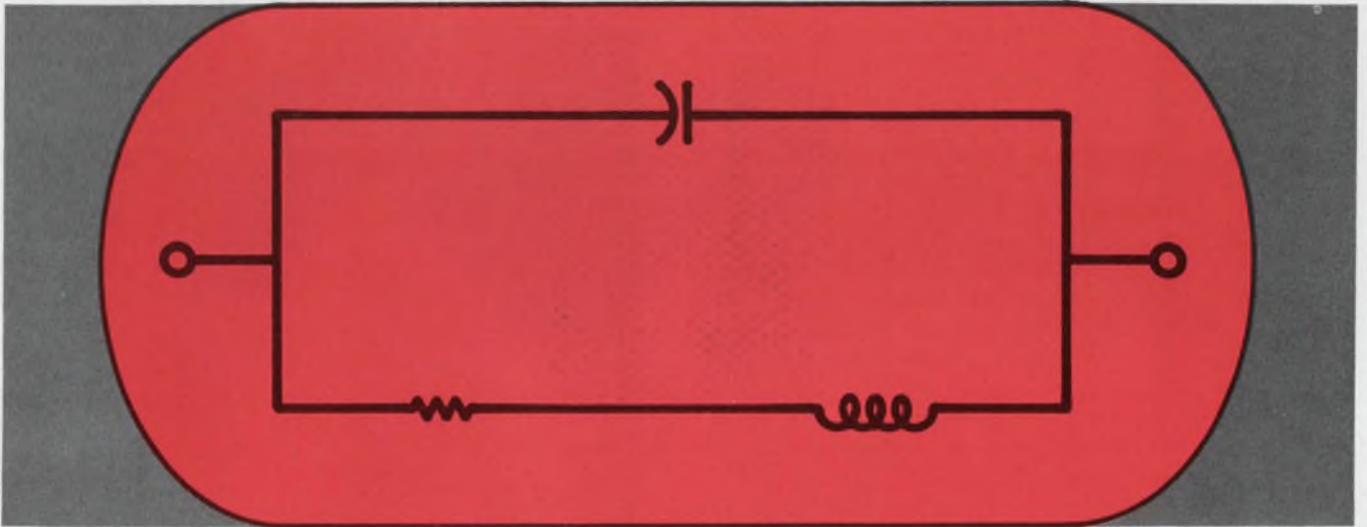

'Kick on' the tank circuit for synchronous-keyed burst oscillation instead of interrupting

current flow through the inductor. The method is stable and simple. Page 60

## Also in this section:

Complementary regulator design enhances versatility of power supply. Page 64

Graphical method accurately determines the period of a one-shot. Page 68

Ideas for Design. Pages 71 to 74

# Avoid power transistor failure! Use these application-oriented guidelines to establish the device's safe operating area (Soar).

## Part 1 of a two-part article

Failure of power-transistor switching and control circuits because of inadequately prescribed safety margins can be circumvented both easily and inexpensively.

The problem is generally traceable to improper interpretation of parameters on the specification sheets. And much of the difficulty stems from the lack of an easy-to-use, universal standard for the absolute maximum ratings appearing on these sheets. Each rating, although valid, applies to but one of the device's many parameters. A cumulative rating of vital characteristics, encompassing transistor application as a whole, has not yet been established. Yet, adherence to each individual rating is insufficient guarantee against device failure.

Safe operation of the transistor is usually the result of empirical and intuitive analyses which the engineer generally acquires only after long and costly experience. It is possible to eliminate this ordeal, however, by a method called Soar (Safe Operating Area) that guarantees safe transistor operation.

The method hinges on the functioning of the device in the application at hand. A different Soar is developed for each major application category, fitted to the particular design stresses peculiar to each. For example, the Soar used for dc operation differs from that pulse mode.

Soar is based on those parameters that best reflect the transistor's role in each application. Plotted on the device's  $I_C$  vs  $V_{CE}$  characteristic, Soar represents the combined effect of transistor limitations and the individual maximum absolute ratings.

The main areas of power transistor use are:

- Dc operation.
- Pulse operation.
- Resistive and clamped inductive switching networks.
  - Unclamped inductive switching circuits.
  - Shorted Class-B operation.

The first two categories are fairly broad, and will be examined first. The remaining applications

will be covered in Part 2 of this article appearing in the next issue of ELECTRONIC DESIGN.

## Power hyperbola sets dc operation

For dc operation of power transistors, the key specified parameters are:

$T_{J \min}$  - Junction temperature

$T_{J \max}$  - Junction temperature

$\theta_{JC}$  - Thermal resistance junction-to-case

$P_C$  - Total power dissipation

$I_{C \max}$  - Continuous collector current

$V_{CE \max}$  - Collector emitter voltage

This specification implies that both  $\theta_{JC}$  and  $P_{C \max}$  are constant for any  $V_{CE} \leq V_{CE \max}$  resulting in a power hyperbola (Fig. 1a). Dc operation itself is confined to the A area of the graph. The figure in-



**Open-and-shut case of power device mishap.** Author Balthasar examines power transistor that failed. Why? Because the prescription for safe operating area wasn't followed and second breakdown occurred.

**Peter P. Balthasar**, Manager of Applications Engineering, Bendix Semiconductor Div., Holmdel, N. J.



dicates that operation is accommodated at any point within the shaded area providing:

$$T_{J \min} \leq T_J = T_C + \theta_{JC} P_D \leq T_{J \max}. \quad (1)$$

The power dissipation capability of many transistors, especially those in the high-frequency ( $f_T > 1.0$  MHz) category, decreases with increasing collector voltage. In most cases this is due to either a second breakdown or a rise in  $\theta_{JC}$ . Therefore, the power hyperbola should be always based on the power at the highest allowable collector voltage. Otherwise, a special power derating curve must be established (Fig. 1b).

To demonstrate the use of these curves in practical circuits, a silicon npn transistor (Bendix type B170008) will be used. To simplify the presentation and the test procedure, straight-line approximations, rather than the actual oddly shaped (complex) curve, will be used. Note that the power hyperbola (Fig. 1a) requires only one test point, whereas the power derating curve (Fig. 1b) makes three test points necessary. However, the latter plot gives the user the benefit of higher power dissipation at low collector voltage.

When collector current  $I_C \leq I_{CE0}$  (collector current with base open), the power dissipation has to be drastically decreased. This is one reason why germanium high-power transistor units (where  $I_{CE0}$  may reach more than one ampere at  $T_J \approx 85^\circ\text{C}$ ) may frequently fail in dc series regulator applications. This precaution is especially relevant if the load current is divided by a parallel operation of devices resulting in small individual

collector currents at high collector voltage.

### Derating needed for temperature changes

As various case temperatures are encountered, the dc Soar based on Fig. 1 has to be derated. For the silicon npn unit in question the following conditions hold for its dc operation:

$$T_J = T_{CASE} + \theta_{JC} P_{DC} \leq 200^\circ\text{C}, \quad (2)$$

$$P_{DC} \leq P_{DC} = f(V_{CE}) \text{ (Area A)}, \quad (3)$$

$$I_C \leq I_{CE0}. \quad (4)$$

Figure 2 exhibits two simple test circuits used for measuring the voltage and current parameters appropriate to dc operation. Each is applicable to silicon npn devices in general. If the power dissipation is based on a case temperature of  $25^\circ\text{C}$ , it is difficult to maintain the heat sink at  $25^\circ\text{C}$ .

Most applications call for a case temperature of  $50^\circ\text{C}$  to  $80^\circ\text{C}$ , and a simple way of establishing the case temperature exists: Bring the transistor to the operating point and measure the rising, drifting case temperature with a thermocouple. At  $T_C = T_{J \max} - P_C \theta_{JC}$ , the circuit is switched off and the final case temperature is recorded. With the common collector circuit (Fig 2b), no adjustments have to be made when many transistors are measured at the same operating point.

The following dc applications, along with their pertinent Soars, may be designed by the above procedure (the crosshatched areas in Fig. 3 indicate the respective Soar): Series dc-regulators

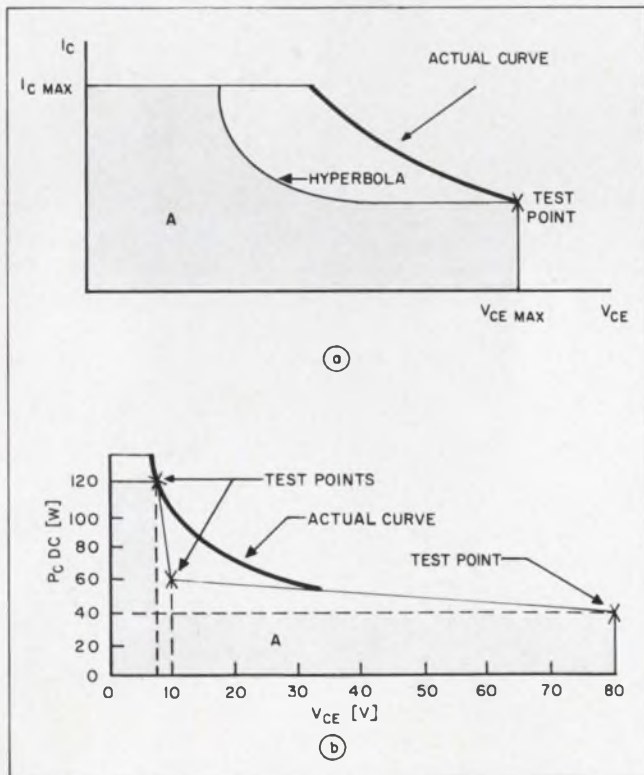

1. Safe operation of power transistor in dc mode is established by hyperbola relating  $I_C$  to  $V_{CE}$  (a). As  $V_{CE}$  increases, the device's dissipation capability diminishes, and a derating curve must be used (b).

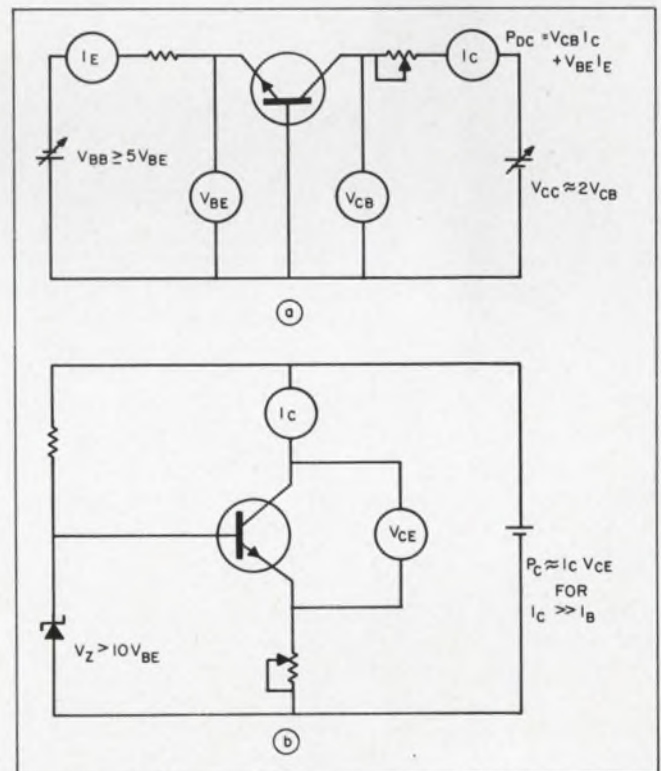

2. Test circuits are used to measure the key voltage and current parameters that govern dc power applications. Network (a) is for common-base modes and unit (b) for common-collector.

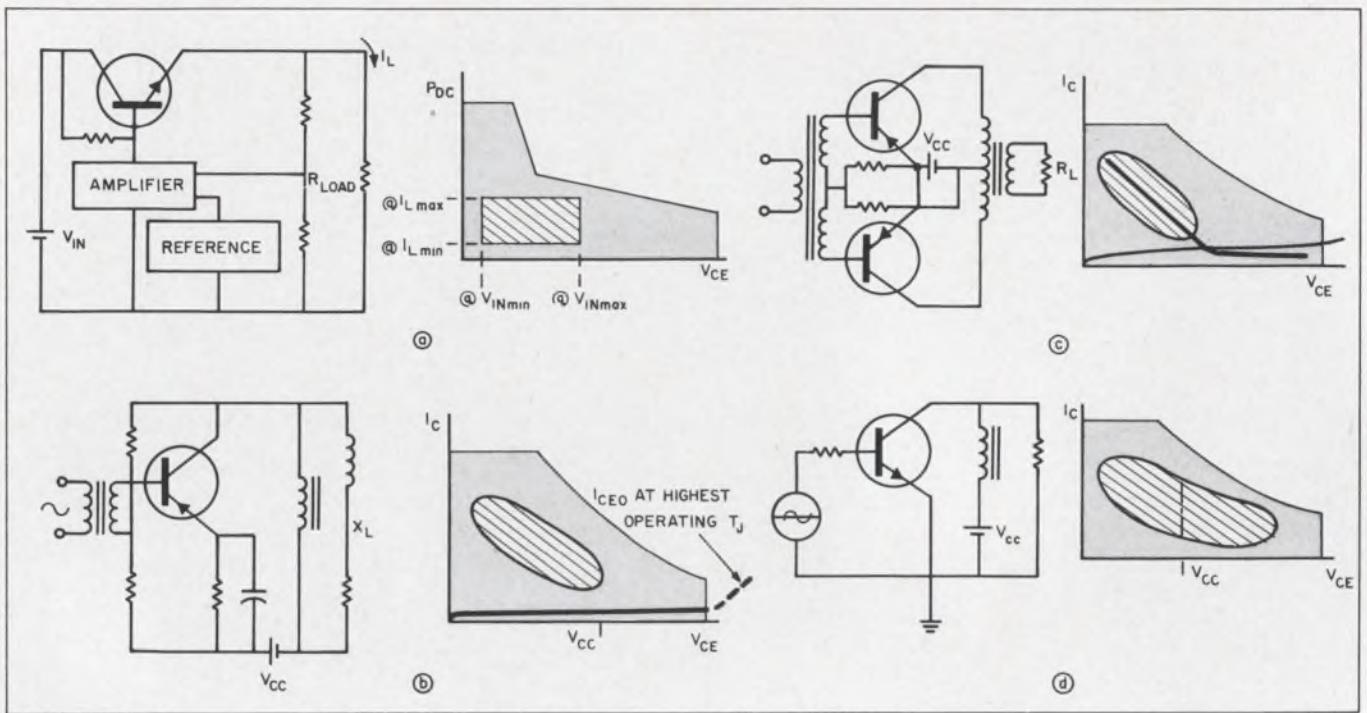

3. Safe operating area (Soar) for power transistor applications is designated by the crosshatched portions on the  $I_C-V_{CE}$  characteristic. Shown are a series dc regulator (a), a Class-A amplifier (b), a Class-B amplifier (c) and an

RF amplifier (d). Note that these are characterized by continuous dc operation. The Soar pattern takes into account junction temperature limits, thermal resistance and total power dissipation, as well as  $I_O$  and  $V_{CE}$  values.

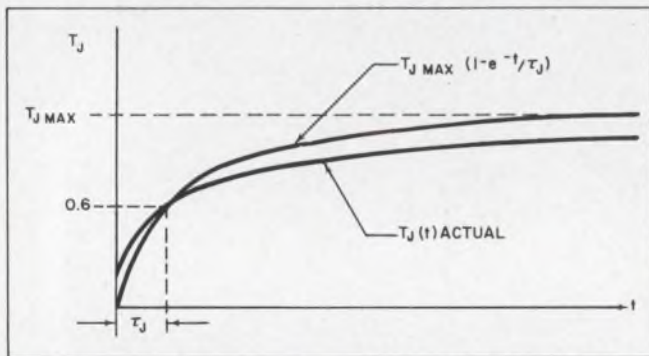

4. Pulse operation, in contrast to continuous dc, is more severe and requires a more complex analysis for determining the safe operating area of the device. Here a curve of an exponential series for the various time constants is used to establish the rise in junction temperature as a function of time.

(Fig. 3a), Class-A amplifiers (Fig. 3b), Class-B amplifiers (Fig. 3c) and RF amplifiers (Fig. 3d).

#### Pulse operation more arduous than dc

Unlike the case of continuous dc signals, most specifications do not give detailed information for pulses that have to be sustained at high-current, high-voltage levels. This is reflected by the JEDEC JS-6 registration format for power transistors, which does not require such information for a 2N-numbered device. The estimate of safe operation at power levels in excess of the maximum continuous power rating is very difficult, especially if the second-breakdown characteristic of the device is

not known.

It can be assumed, however, that for low-collector-voltage operation (about  $0.5 V_{CE0}$  for regular units and  $0.3 V_{CE0}$  for high-frequency devices), power points in excess of  $P_{C max}$  can be obtained up to the maximum collector current without second breakdown occurring. The junction temperature,  $T_J$ , should not exceed the maximum allowable  $T_J$  for the duration of the pulse,  $t_w$ . It is given by:

$$T_{J max} \leq T_{CASE} + I_C V_{CE} (1 - e^{-t_w/\tau_J}) \quad (5)$$

The time constant,  $\tau_J$ , of power transistors is typically 5 to 100 ms. This information, used in Eq. 5, gives a very rough estimate for accommodating a single pulse in excess of  $P_{C max}$ .

If repetitive pulses are applied, the problem is more complex. It should be pointed out that junction temperature rise as a function of time is not a simple  $e$ -function but rather a series of  $e$ -functions with various time constants (Fig. 4). The case temperature as well as the average junction temperature may rise under repetitive pulse applications. Therefore, an analysis based on a single time constant is erroneous. Also, to use more than one time constant for repetitive pulses is not practical. Fortunately, a simple, accurate means of establishing the Soar for forward-biased pulse operation exists.

#### Pulse widths set safety zones

Figure 5 presents safe operating areas B, C and D for various pulse widths. To use these graphical data, the following relationships are applied:

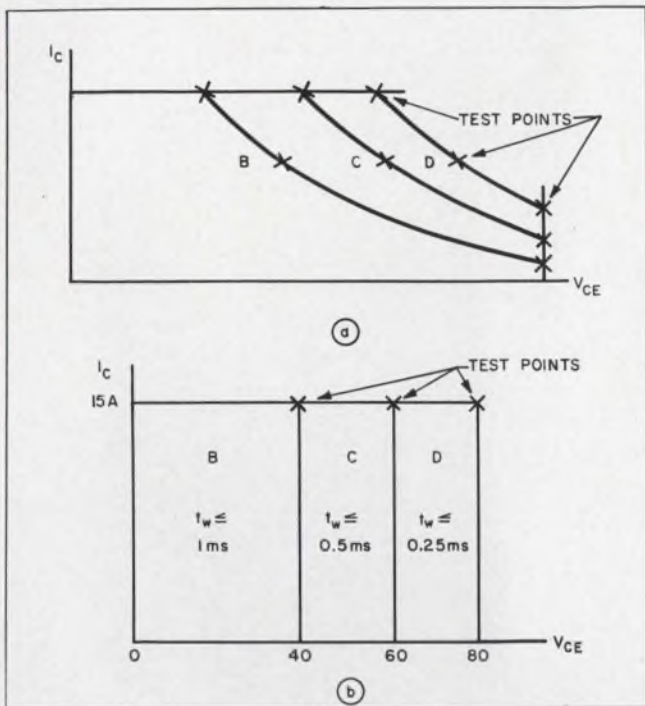

5. Safe operating area is a function of pulse width. The  $i_C$ - $V_{CE}$  curve is broken into three distinct regions (B, C and D), each bounded by a hyperbola (a). When a specific transistor type is involved (b), straight-line approximations may be used to save test procedure down time.

$$T_J = T_{CASE} + \theta_{JC} P_{C\text{ AVG}} \leq T_{J\text{ max}} = 200^\circ\text{C}, \quad (6)$$

$$P_{C\text{ AVG}} = \frac{1}{0.01s} \int_0^{0.01} s i_c v_{ce} dt, \quad (7a)$$

Note that  $P_{C\text{ AVG}}$  must be smaller than the allowed dc power dissipation for a dc collector voltage equal to the highest  $v_{ce}$  applied to the transistor. Also, operation in the active region should be limited to a maximum pulse width to  $t_w = 1\text{ ms}$  for Area B, a  $t_w = 0.5\text{ ms}$  for Area C and a  $t_w = 0.25\text{ ms}$  for Area D. Rise time  $t_r \leq 50\ \mu\text{s}$  and fall time  $t_f \leq 50\ \mu\text{s}$  for Areas B-D.

Should the repetitive pulses be very small when compared to  $\tau_J$  (for example,  $250\ \mu\text{s}$ ), when  $T_J$  can be calculated by using:

$$P_{C\text{ AVG}} = \frac{1}{0.1\tau_J} \int_0^{0.1\tau_J} i_c v_{ce} dt. \quad (7b)$$

which is the average power dissipation during a time interval equal to one-tenth of the junction time constant. For such small pulses,  $T_{J\text{ peak}}$  can be assumed to be equal to the average  $T_J$ .

Figure 6 displays two test circuits which can be used to establish Areas B, C and D. The testing can be done at various case temperatures and for a number of frequencies under the conditions specified in Eqs. 6 and 7.

A single pulse of longer duration than the indicated pulse widths in Fig. 5 may also be accommodated by a Soar design. Here, analysis has to be made through use of the given "Normalized Junction Temperature Response vs Time" curve (Fig. 7). When using such a plot, observe

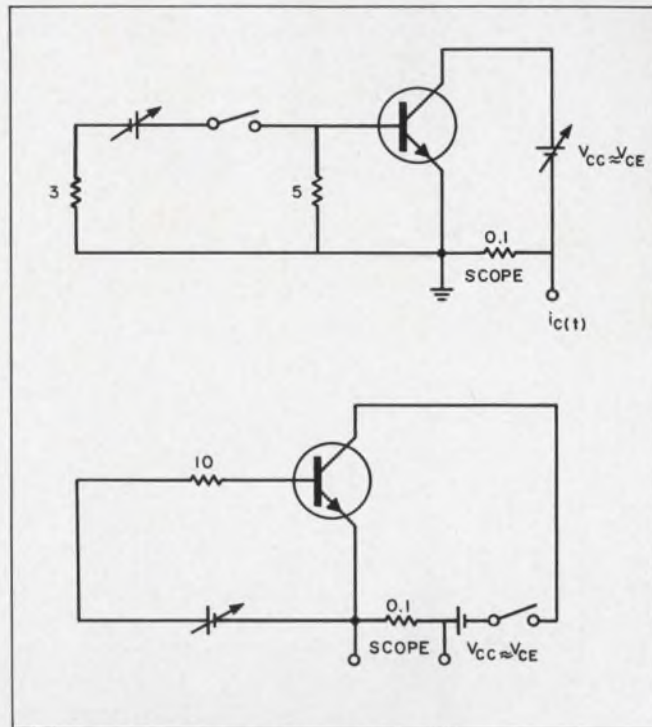

6. Test circuits for establishing Soar regions B, C and D (see Fig. 5) for the pulse operation of power devices are exhibited. Shown are the networks for pulsed base-drive (top) and pulsed collector-supply (bottom) modes.

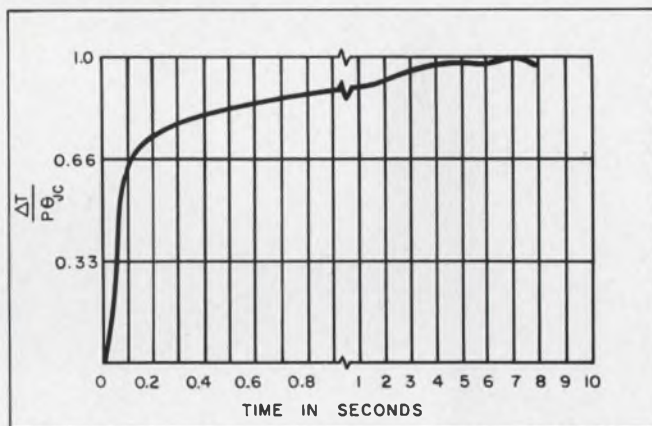

7. Normalized junction temperature response vs time plot is used to make safe-operating-area calculations for pulse widths in excess of 1.0 ms. Here  $\theta_{JC}$  refers to the thermal resistance, junction-to-case.

that  $\Delta T = T_J - T_c$ , where  $T_J$  is the junction temperature,  $T_c$  the case temperature,  $\theta_{JC}$  the thermal resistance (junction-to-case) and  $P$  is the step power input. Pulse operation under the Soar principles can then be fitted to switching regulators, series regulator transients, capacitive-load inverter turn-on circuits, incandescent lamp turn-on circuits, and motor start-up systems. These applications and their attendant pulse-handling Soars are shown in Fig. 8. ■ ■

Part 2 of this article will cover resistive and clamped-inductive switching circuits, unclamped inductive-switching networks and Class-B operating systems. For each application area, the Soar for popular power transistors will be developed.

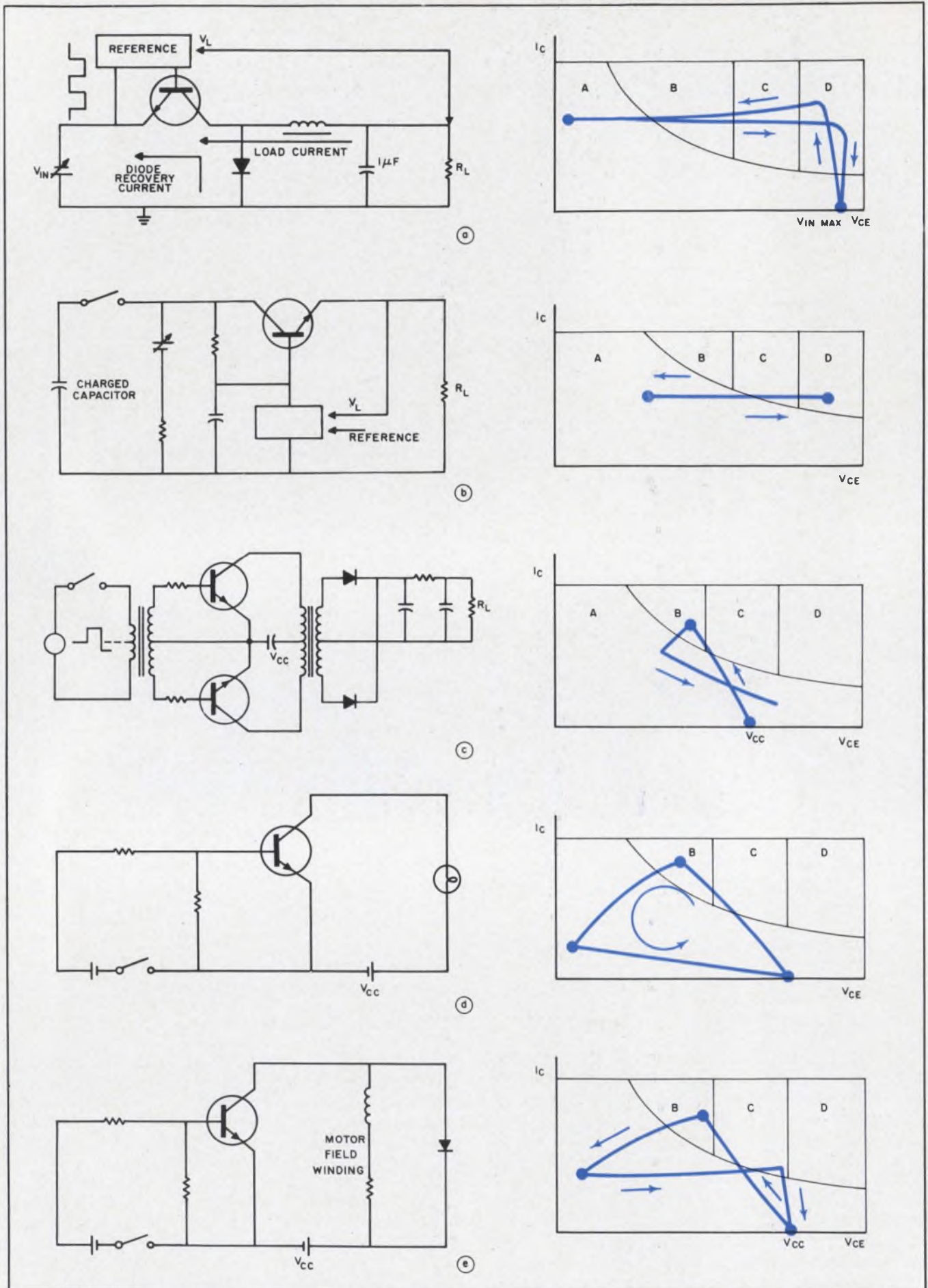

8. Each type of pulse application has its own Soar. Indicated by the heavy lines (in color) on the  $I_C-V_{CE}$  curve, it shows just how far to stress a transistor used in a switch-

ing regulator (a), a series regulator, transient case (b), a capacitive load, inverter turn-on (c), an incandescent load turn-on (d) and a motor start-up circuit (e).

# Challenge from Westinghouse:

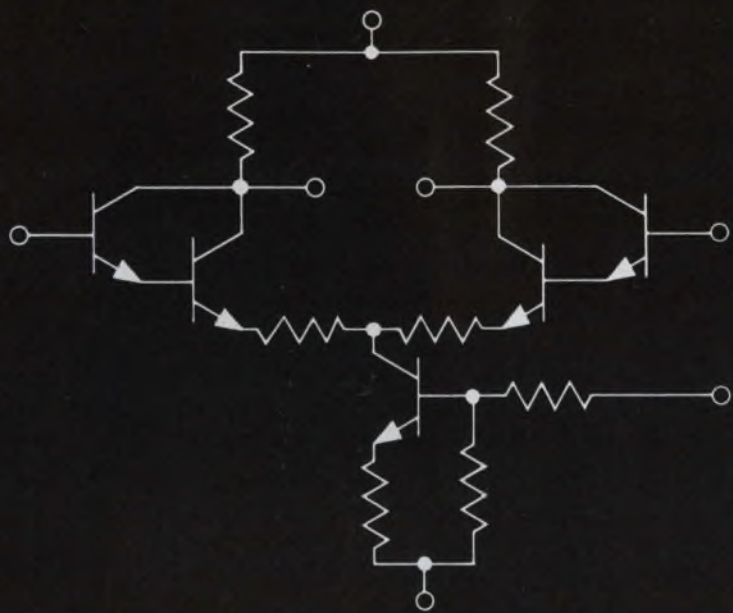

Input impedance	500 K $\Omega$
Output impedance	8 K $\Omega$
Output voltage swing	14 volts P/P
Differential gain	50 V/V
Frequency response	150 KHz
Common mode rejection ratio	80 db
Drift	10 $\mu$ V/°C
Supply voltage	+12 V, -9 V

## try to find another IC differential amplifier like this for \$7.50

### WC 115 T directly replaces IC's costing much more

This universal differential amplifier gives you two Darlington pairs in a differential connection with a constant-current source. Manufacturer's price in 50-499 quantities: \$7.50. For smaller orders: \$10.50.

How does Westinghouse do it? Having the most modern IC plant in the industry helps. But mostly, it's a product of Westinghouse research leadership in linear IC's.

This differential amplifier design gives you top performance in these parameters: input impedance, input current, source to load isolation, temperature stability, and DC drift. You can use it as either a differential or single-ended input and output amplifier. It gives both inverting and non-inverting operation. Frequency response exceeds 150 KHz.

For immediate delivery, call your Westinghouse electronic distributor\*. Or for complete specs, write Westinghouse Molecular Electronics Division, Box 7377, Elkridge, Maryland 21227.

\*Distributors determine resale prices

You can be sure if it's Westinghouse

J-09131

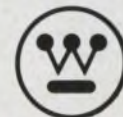

ON READER-SERVICE CARD CIRCLE 17

# Incomparable Performance at an Unbeatable Price

Time-saving features of the new Hewlett-Packard 427A Multi-Function Meter include: No need to change input connections to measure ac and dc volts—just change the function switch. Only one zero set for dc and resistance measurements . . . no need to re-zero when switching from dc to ohms measurements . . . seldom "zero" on the 1 v range and above. Instantaneous turn-on. Field-operate the compact hp 427A to typically 300 hours from one internal dry-cell battery (regulator included). AC-battery operation available at \$35 additional. All Hewlett-Packard voltmeter accessories, such as dividers, adapters and leads, available for flexible performance.

## ...the hp 427A Multi-Function Meter!

You can tell this is a measurement-packed Instrument just by looking at the front panel. To see the 427A run through its paces, call your Hewlett-Packard field engineer. For complete performance details, write Hewlett-Packard, Palo Alto, California 94304, Tel. (415) 326-7000; Europe: 54 Route des Acacias, Geneva.

Data subject to change without notice. Prices f.o.b. factory.



1481



See New hp Instruments  
Attend Measurement Seminars  
WESCON—Hollywood Park  
ON READER-SERVICE CARD CIRCLE 18

ON READER-SERVICE CARD CIRCLE 66 ▶



*Put the  
Blame  
on Mame, boys*

Donna Dinkler is a final inspector on one of our series 1220 relay production lines. The little picture below shows her doing her job. We only called her "Mame" up above because—well, we had trouble trying to rhyme Donna Dinkler.

Anyway, you'll look a long time before you find an inspector that's fussier than Donna. A 1220 doesn't measure up in every way and ZAP! Into the reject pile.

Now this kind of painstaking inspection doesn't speed up the production of 1220's one single bit. But it's the only way to assure that the 1220's you get are no less than perfect.

Multiply Donna by the other inspectors on the series 1220 lines and their fussiness and you see why we occasionally have sales running ahead of delivery. So many engineers have found these versatile, enclosed 10 amp. DPDT or

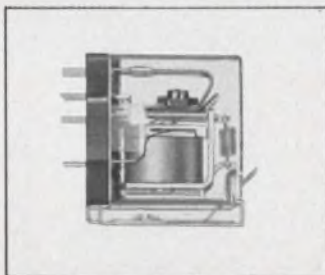

*3PDT relays to be so reliable and long lived that we're hard pressed at times to keep up with the demand. The 1220 is a U/L listed relay with terminals that can be used as solder lug, AMP Faston 110 series quick connect or socket plug-in that comes complete with mounting bracket.*

So, if you need 1220's in quantities up to 399, see your *Guardian distributor*. If you need larger quantities order direct from factory production. If you want more information, send for bulletin B2.



**GUARDIAN  
ELECTRIC**

1550 W. Carroll Avenue, Chicago, Ill. 60607  
Guardian Electric Manufacturing Company,

# 'Kick on' the tank circuit

to generate a synchronous-keyed burst oscillation. Unlike current-interruption designs, this method is simple, stable and free of unwanted signals.

Here's a twist to designing burst oscillators: instead of the conventional approach of interrupting the current through an inductor, use the opposite method. That is, provide an initial "kick" to the tuned circuit and obtain improved system performance with far fewer design problems.

The advantages of this technique are these:

- The synchronism between output burst and the zero-crossing of the control signal is automatically achieved.
- The unwanted zero-reference shift in the output (produced by feed-through of the keying signal in the current-interruption design)<sup>1</sup> does not occur.
- The output burst is much squarer, shows greater stability and does not require critical adjustment.
- The synchronized kick-on eliminates noise and other unwanted "grass" appearing between oscillator bursts.
- Circuit simplicity and economy are attendant: extra diodes, bias-shift networks and/or power supplies are not needed.

The kick-on method uses circuitry that is free of

complex multipliers, dividers, zero-crossing detectors, trigger circuits or gate switches.<sup>2</sup> The generated output burst starts in synchronism with the keying signal at a frequency established by the oscillator components only.

## Zero-crossing keys tone burst

The circuit (see schematic) produces a tone burst whenever the control signal is near zero volts. A saturated transistor stage ( $Q_1$ ) is held close to zero—at two volts. Whenever the control signal is high enough to saturate the keyer ( $Q_1$ ), the tuned circuit is heavily loaded, and the oscillator's input becomes shorted. This action quenches the oscillation and eliminates the noise—the "grass"—between bursts. The keyer drive required is 10 volts into 22 k $\Omega$  ( $R_5$ ), for the relatively low-gain, but economical, 2N696 used. Speed-up capacitor  $C_5$  is employed to compensate for the emitter-base capacity in  $Q_1$ .

When a burst is to be started, the input control signal is lowered, thereby unsaturating  $Q_1$ . The current that had been flowing through the keyer now goes to tuned circuit  $L_1-C_1-C_2$ . The current goes into  $C_1-C_2$  first, because an inductor's current cannot change instantaneously. This voltage

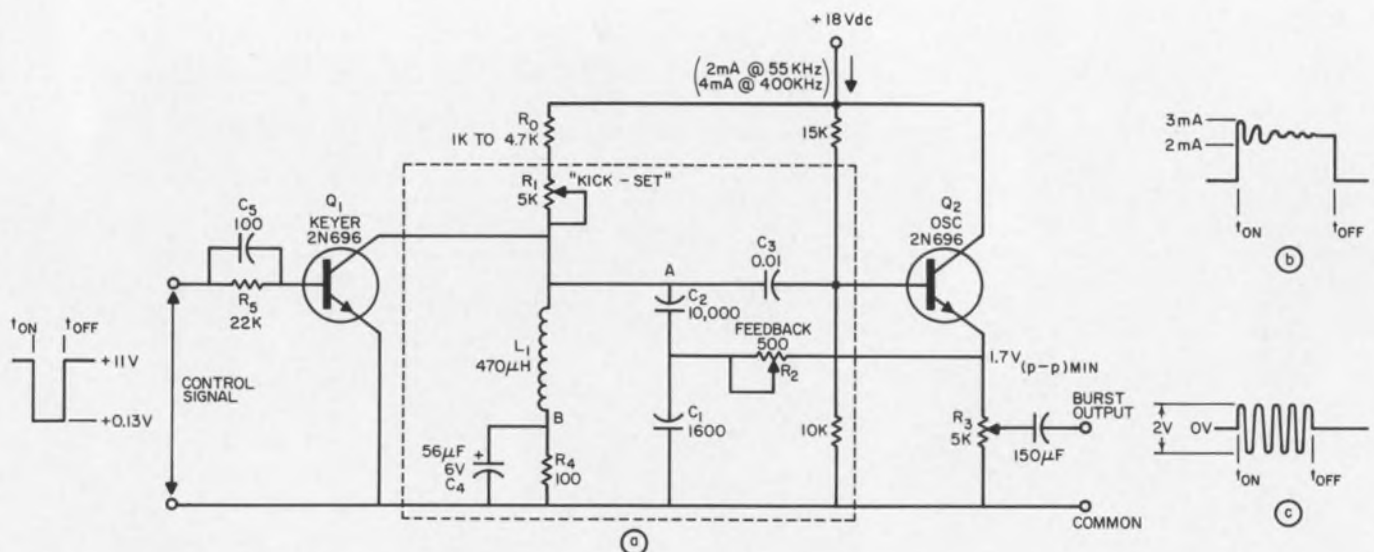

**Burst oscillator** is simple, stable and synchronous. Here (a) the tank circuit is "kicked on" to produce the oscillation, instead of interrupting the current flow through the inductor. Shifts in the reference level and noise appearing between bursts do not occur. If the feedback control  $R_2$

were opened and  $C_4$  removed, the waveform at point B (b) would be shorter and less square. Proper operation, taken across the output, at a 200-kHz burst frequency (c) is evident with  $R_2$  and  $C_4$  in. Note that the output is squarer and does not have a dc shift.



build-up is the initial kick energy supplied to the oscillator's tank circuit. It starts the first cycle of oscillation, always in the same direction, and without any build-up delay.

After the capacitor's voltage rises, the current can pass through the inductor, and then be considered as just a dc current through the inductor. Note that for good frequency stability, this bias current should neither approach saturation nor change the coil's permeability. The current also flows through the  $R_1$ - $C_1$  combination to produce a charge. This charge energy is a useful addition, for it ensures that when the keyer is again saturated the oscillations are immediately quenched.

If feedback were not provided to sustain the oscillation, the current through  $L_1$  would be a damped transient, as shown in (b). The output (c), similar but squarer, does not have a dc shift. This kick amplitude is set by the kick potentiometer,  $R_1$ . As  $R_2$  is decreased, the feedback acts to sustain the oscillations and set their amplitude.  $R_2$  is adjusted so normal oscillations of  $Q_2$  continue at the same amplitude as the kick amplitude.

#### Inductor is critical for quenching

Components  $R_1$  and  $C_1$  are not required at the lower frequencies (55 kHz), where the inductor has 40 ohms of resistance—but they are a comforting reassurance. At higher frequencies (350 kHz), for example, the inductor's resistance is small enough to prevent the keyer from carrying away enough current and impairing proper quenching. The resistance ( $R_1$ ) is bypassed so that it doesn't de- $Q$  the tuned circuit.

The tank circuit is already loaded by  $R_1$  and the kick potentiometer, causing some interaction between  $R_1$  and  $R_2$ . However, this loading does not complicate the alignment enough to justify the addition of an RF choke in series with  $R_1$ . Note, too, that a higher operating  $Q$  for the tuned circuit would not facilitate the build-up and quenching of oscillations.

The oscillator is a conventional Colpitts type with a feedback capability added to allow waveshape control (distortion and oscillation-amplitude). A  $C_2$ : $C_1$  ratio of six is a good empirical rule of thumb for this circuit. The output waveshape distortion is quite low (as viewed on a CRO).

If  $C_3$ , considered only as a dc blocking capacitor, is made large, it would feed some of the keying transient step into  $Q_2$ ; thus, it is kept just small enough to lower the oscillation. The output level control is used as a  $Q_2$  emitter-resistance to save parts. The small dc blocking capacitor is used to provide for independent resistive mixing. In one application, six of these burst oscillators were sequentially keyed by a ring counter and mixed across a 50  $\Omega$  resistor, to produce a multiburst signal. ■ ■

#### References:

1. Richard Cummings, "Build a Tone Burst Generator," *ELECTRONIC DESIGN*, XIV, No. 4 (Feb. 15, 1966), pp. 104-105.
2. "Ideas for Design #746", *ELECTRONIC DESIGN*, IX, No. 5 (March 1, 1961), p. 189.



## ARNOLD/TOROIDAL COIL WINDER

*sets up quickly... easy to operate...  
takes wide range of wire sizes*

#### SPECIFICATIONS:

- Min. finished hole size: .18 in.
- Max. finished toroid O.D.: 4.0 in.
- Winding speed: 1500 turns/min.
- Wire range: AWG 44 to AWG 26
- Dual, self-checking turns counting system
- Loading (wire length) counter
- Core range: 9/32" I.D. to 4" O.D. to 1 1/2" high

#### LABORATORY USE

- Change wire and core size in 45 sec.

#### PRODUCTION USE

- 1500 turns per minute
- Insert core and load in 20 sec.

**\$890.00** includes all rings, counters and accessories



*immediate delivery. literature on request*

#### ARNOLD MAGNETICS CORP.

6050 W. Jefferson Blvd., Los Angeles, Calif. 90016  
(213) 870-6284

ON READER-SERVICE CARD CIRCLE 19



## R. F. INTERFERENCE PLAGUING YOU?



HOW ABOUT  
LITTELFUSE R.F.  
INTERFERENCE SHIELDED  
FUSE POSTS. MILITARY AND  
COMMERCIAL APPLICATIONS  
Write or phone for information

### LITTELFUSE

DES PLAINES, ILLINOIS

ON READER-SERVICE CARD CIRCLE 20

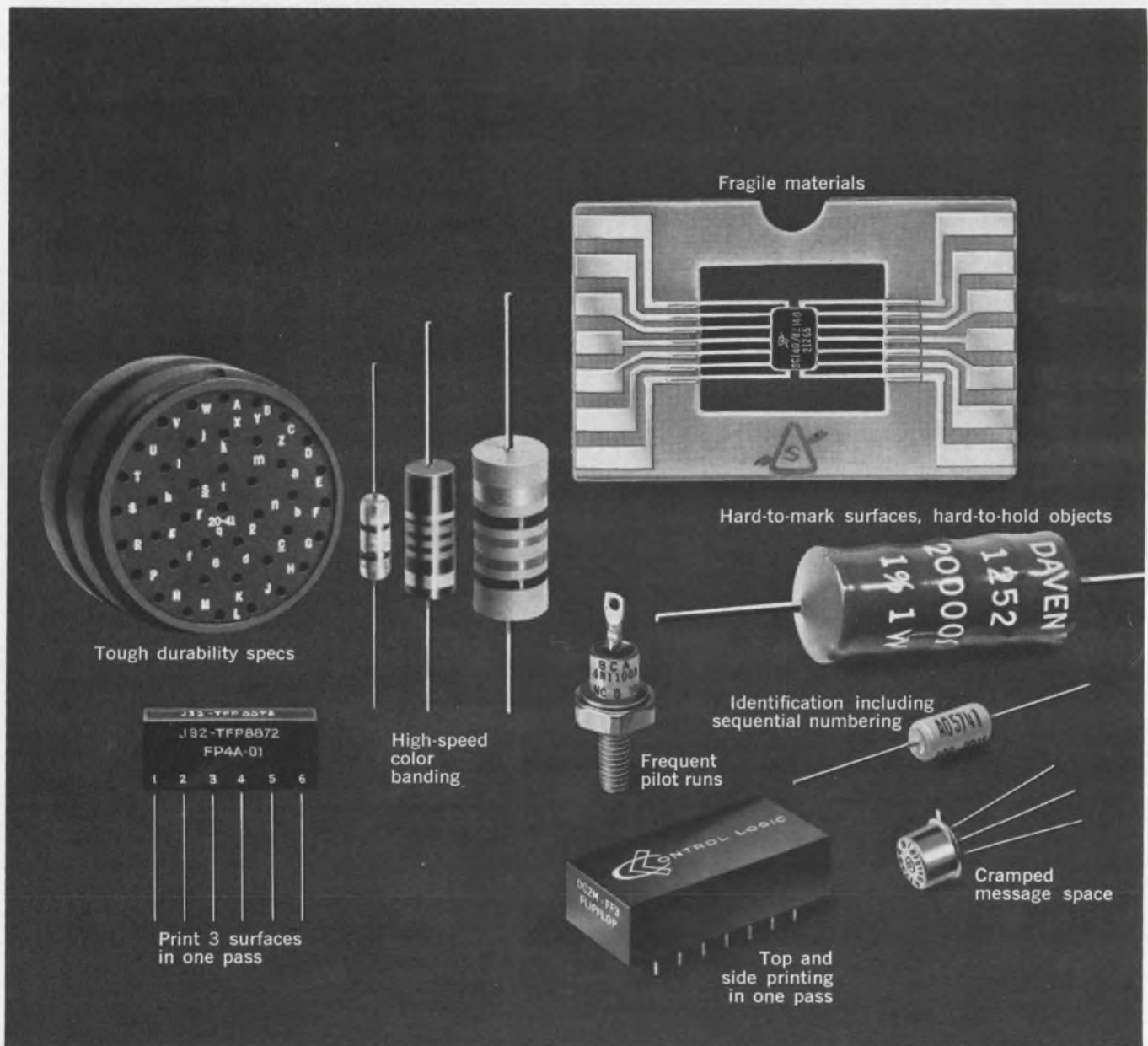

## What marking job can we help you do better?

These are only a few of hundreds of marking jobs you can do more efficiently and more economically with Markem machines. So why waste time improvising and experimenting?

Call in a Markem man and get acquainted with today's broadest line of marking equipment. New high-speed color banding machines — some capable of putting three tiny bands on a miniature diode. Machines that combine sequential numbering with identification. Type so small you can print 14 characters plus trademark in an 0.125" diameter area. Quick-change type for short or pilot runs. New techniques combining special ink with flash-curing to help you meet severe durability specs. A production-speed imprinter so gentle you can safely mark flat pack ceramic components. And many other machines, specialty inks and printing elements. Right now our research engineers and chemists are working on even better ways to mark components. We'd like to be working with you. Markem Machine Company, 319 Congress St., Keene, N.H.

# MARKEM<sup>®</sup>

HELPING YOUR PRODUCT SPEAK FOR ITSELF  
ON READER-SERVICE CARD CIRCLE 21

# Complementary FET Pairs

Available now... matched FETs for complementary symmetry applications! Example: The source follower.

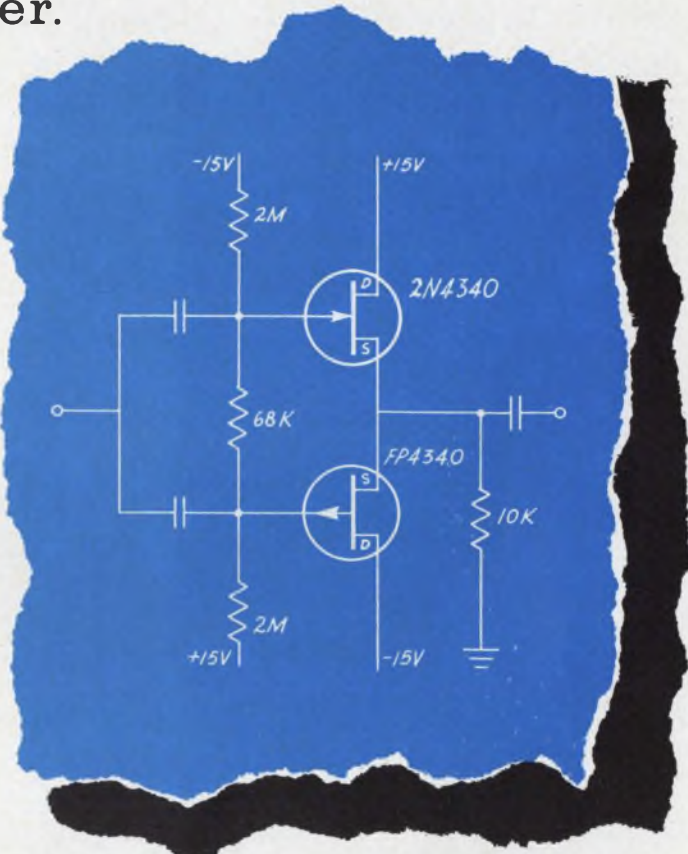
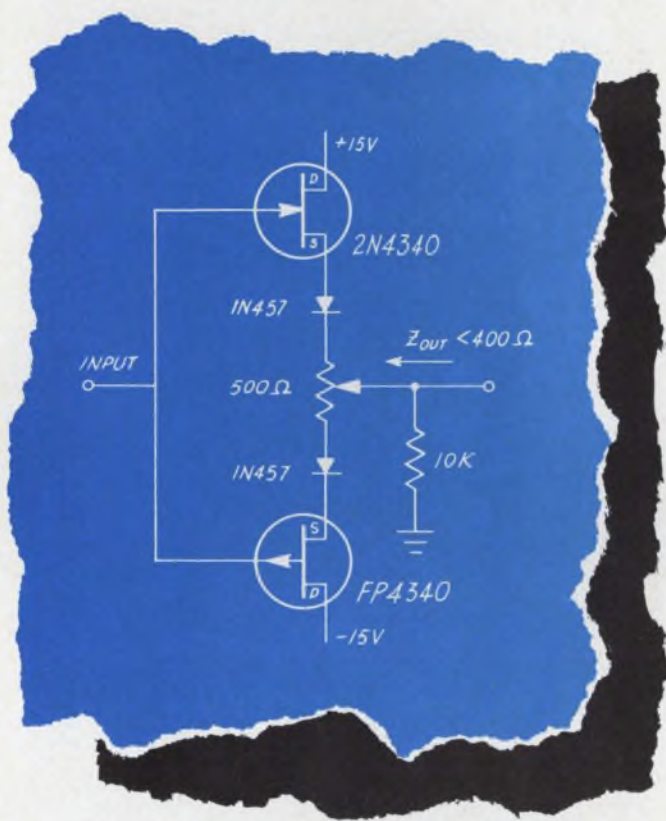

Siliconix assumes no responsibility for circuits shown, nor does it represent or warrant that they do not infringe any patents.

New from Siliconix... the 2N4339/FP4339 and 2N4340/FP4340 complementary FETs. Each pair has mirror image d-c characteristics matched to 5%. Used in a push-pull source follower, the result is both low distortion and low output impedance. Series diodes and a trimmer pot in the left circuit enable d-c coupling with zero offset voltage (i.e., zero d-c in corresponds to zero d-c out). The right circuit gives comparable performance with a-c coupling. How else to use them? Wherever you

need complementary transistors plus the advantages of the FET... high input impedance, square-law transfer characteristic, etc. etc. Circle the number for complete data on these new FETs. Better yet, give us a few applications challenges; we'll help you work them out.

 **Siliconix incorporated**  
1140 W. Evelyn Avenue • Sunnyvale, California 94086  
Phone 245-1000 • Area Code 408 • TWX 408-737-9948

## FRANCHISED DISTRIBUTORS

ALA., HUNTSVILLE, Tec-Sel, Inc., 837-4541 • ARIZ., PHOENIX, Barnhill Associates, 959-2115 • CALIF., HOLLYWOOD, Hollywood Radio and Electronics, 466-3181 • LOS ANGELES, Kierulff Electronics Inc., 685-5511 • MENLO PARK, Hollywood Radio and Electronics, 322-3431 • MOUNTAIN VIEW, Elmar Electronics Inc., 961-3611 • RIVERSIDE, Electronic Supply, Inc., 683-8110 • SAN DIEGO, Kierulff Electronics Inc., 278-2112 • COLO., DENVER, Barnhill Associates, 934-5505 • CONN., HAMDEN, Cramer Electronics, Inc., 288-7771 • FLA., WEST PALM BEACH, Perrott Associates, Inc., 585-8647 • WINTER PARK, Perrott Associates, Inc., 647-3038 • ILL., CHICAGO, Semiconductor Specialists, Inc., 622-8860 • MD., BALTIMORE, Wholesale Radio Parts Co., Inc., 685-2314 • MASS., NEWTON, Cramer Electronics, Inc., 969-7700 • MINN., MINNEAPOLIS, Semiconductor Specialists, Inc., 866-3435 • MO., ST. LOUIS, Semiconductor Specialists, Inc., 521-8866 • N. J., BERGENFIELD, Technical Electronics Distributors, Inc., 384-3643 • N. M., ALBUQUERQUE, Barnhill Associates, 265-7766 • N. Y., BUFFALO, Summit Distributors, Inc., 884-3450 • NEW YORK CITY, Milgray, 989-1600 • SYRACUSE, Eastern Semiconductor Sales, Inc., 455-6641 • OHIO, DAYTON, Alpine Industries, Inc., 278-5861 • OKLA., TULSA, Oil Capital Electronics Corp., 836-2541 • PA., PHILADELPHIA, Simco Electronics, Inc., 229-1880 • YORK, Wholesale Radio Parts Co., Inc., 755-2891 • TEX., DALLAS, Sterling Electronics, 351-9921 • HOUSTON, Lenert Company, 224-2663 • WASH., SEATTLE, Garretson Radio Supply, Inc., 682-8981 • WASH., D.C., HYATTSVILLE, MD., Milgray, 864-6330.

CANADA: MONTREAL; Prelo Electronics, Ltd., 389-8051 • OTTAWA; Wackid Radio, Ltd., 237-2190 • TORONTO; Electro Sonic Supply Co., Ltd., 924-9251

ON READER-SERVICE CARD CIRCLE 22

# Complementary regulator design boosts power supply versatility. Result is a low-drift, well-regulated, fast-turn-off, dual dc source that needs no fuse protection.

A high-speed-shut-off dc regulator may easily be converted into a more versatile, conventional dc power source. Moreover, the modified unit doesn't require fuses or special circuit breakers for protection against shorted loads.

The new system is put together with two simple series regulators connected in complementary fashion. This provides two, regulated, commonly referenced, interdependent dc outputs driven by the same ac supply.

The complementary, interconnected configuration provides both safety against shorts and a reset capability. Thus, if either or both of the regulated dc outputs were to become shorted, the circuit would shut itself off before any components were damaged. And once the short is removed, the circuit provides a power-on reset via the ac breaker on the unregulated input.

## Complementary connection is key to function

The circuit (Fig. 1) uses two standard series dc regulators connected in a complementary configuration.

Elias Thomas, Senior Designer, Development Laboratory, IBM Corp., Kingston, N. Y.

uration. The operation of each is dependent on the output of the other. A standard core oscillator is used to drive, through transformer coupling, a standard dc-to-dc converter. The operation of the over-all regulator circuit can be simply explained by examining an equivalent circuit which uses dc relays (Fig. 2).

The coil of circuit A ( $K_1$ ) is connected across the output of circuit B ( $E_{o2}$ ). The coil of circuit B ( $K_2$ ) is connected across the output of circuit A ( $E_{o1}$ ). In this way the output voltage of one circuit controls the output of the other. If the power-on switch ( $S_1$ ) is closed, the output voltage of circuit A is made available. This voltage activates coil  $K_2$ , closing its contacts and making the output voltage of circuit B available. In turn, this output activates coil  $K_1$ , closing its contacts, and keeping the output voltage of circuit A ON. This allows switch  $S_1$  to open. Circuit A is now holding circuit B ON, and circuit B is holding circuit A ON. A loss in output voltage (either  $E_{o1}$  or  $E_{o2}$ ) will deactivate the circuit.

For example, if a shorted load occurs in the output of circuit B, the output potential  $E_{o2}$  will essentially become zero. Coil  $K_1$  will be deactivated, opening its contacts and removing the output

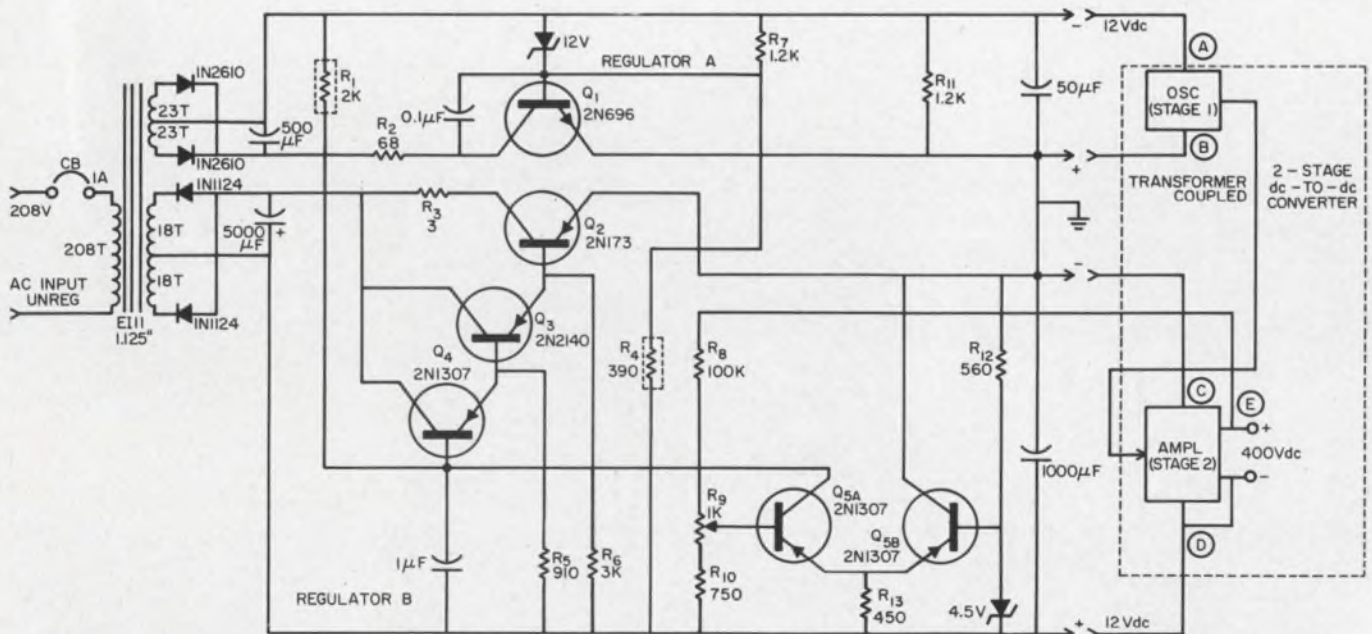

1. Fuseless high-speed shut-off dc regulator features two regulators in a complementary configuration. Resistors  $R_1$  and  $R_4$  provide feedback between the regulators—each

section protects the other when a load is shorted. A standard, two-stage dc-to-dc converter and an oscillator are connected to the two regulated dc outputs as loads.

voltage of circuit A. Coil  $K_2$  will now be deactivated, its contacts will open and remove the shorted load from the circuit. The circuit is now completely deconditioned. To turn the power back ON, remove the short and close switch  $S_1$ , as before.

Note that reference ground is the interconnecting point of circuits A and B. Therefore, the output of circuit A is negative and the output of circuit B is positive. Thus, coil  $K_1$  is activated by a positive potential and  $K_2$  by a negative potential.

Referring back to Fig. 1, we see that the relays  $K_1$  and  $K_2$  of Fig. 2 are replacing the transistors with their emitters connected together (reference ground). Since a positive voltage was required to activate relay  $K_1$ ,  $K_1$  represents a npn transistor which also requires a positive potential to be turned ON. Relay  $K_2$ , which required a negative potential to activate it, represents a pnp transistor which likewise requires a negative potential to be turned ON. Circuit A in Fig. 2 can now be Regulator A in Fig. 1, and Circuit B, regulator B. Relay  $K_1$  is the equivalent of transistor  $Q_1$ , and  $K_2$  is the equivalent of  $Q_2$ . Feedback is through resistors  $R_1$  and  $R_2$ .

### Versatile regulator also switches

This circuit operates both as a switch and as two dc regulators. Regulator A uses a zener diode in the base of  $Q_1$  to provide voltage regulation for light loads. In this case, it was designed to drive a small oscillator (stage 1 of the dc-to-dc converter, Fig. 3).

Regulator B (see Fig. 1) uses a differential amplifier with a zener-diode reference as an error detector for use with heavy loads. In this case, it was designed to operate an amplifier (stage 2 of the dc-to-dc converter, Fig. 3), which is driven by the oscillator. The test results obtained with a fuseless, high-speed shut-off dc regulator, using a 400-volt power supply, were:

- Drift in 8 hours (399.80 to 399.23 V) 0.57 V
- Steady-state, no-load-to-full-load variation 0.20 V
- Dynamic no-load-to-full-load variation 1.00 V
- Ripple variation 0.40 V
- Line variation (too small to measure) 0.00

$$\text{Total variation} = \frac{1.99 \text{ V}}{\text{Per cent of variation} = 0.497\%}$$

- Adjustability 270 to 600 V
- Turn-off time of regulator B 2.5 ms

The turn-off speed of the regulator circuit in case of a short circuit is limited by the speed (turn-off time) of the transistors used. The turn-off time is far faster than conventional fuses or circuit breakers. To provide additional protection against overloads, a sensing and switching circuit, which will detect minute overloads and then short the output, should be added.

This regulator is also flexible—it can accommodate design changes easily. For example, a reset switch may be installed in place of the

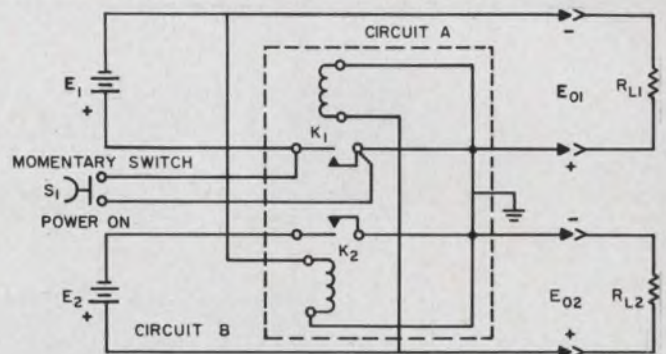

2. Equivalent circuit representation of regulator uses relays in place of the transistor elements. The interconnections here demonstrate the switching, regulating and feedback functions. Relay  $K_1$  represents  $Q_1$  and  $K_2$  is the  $Q_2$  element. Loads  $R_{L1}$  and  $R_{L2}$  depict the oscillator and dc-to-dc converter respectively (see Fig. 1).

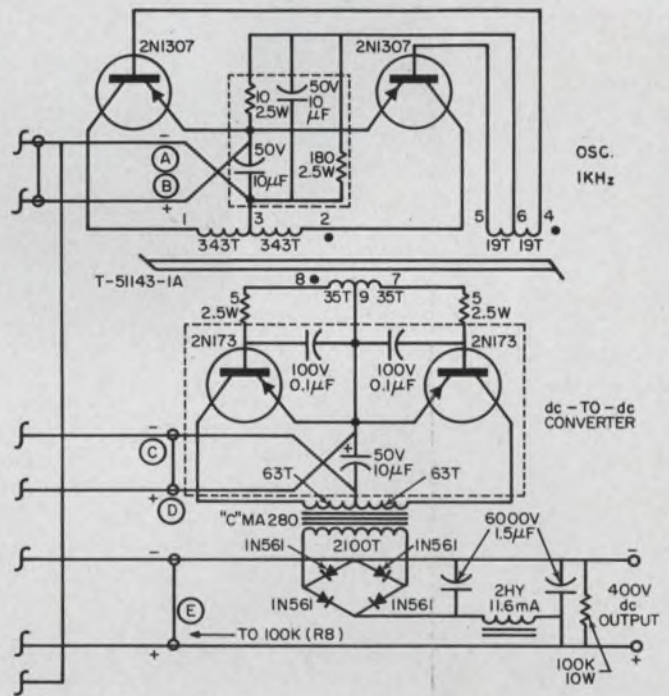

3. In this 2-stage, dc-to-dc converter (the load for the regulator of Fig. 1), a 1-kHz saturating-transformer oscillator (stage 1) drives a high-power amplifier (stage 2).

differentiating network ( $Q_3$  stages in Fig. 1). Only those circuits which require a positive action to reset power in case of a short are recommended here, in order to ensure safe operation of the power supply. Thus, in Regulator A,  $Q_1$  can be replaced with a SCR which can be used in place of the rectifier shown (1N2610), and the operation will be unchanged. Power systems can also be designed by using one regulator such as regulator A and a number of regulators similar to regulator B whose outputs are OR'd into regulator A, thereby providing a system overload protection.

Another application for this type of dc regulator is in the design of twin-dc, laboratory power supplies to provide high-speed protection for valuable circuits or components by shutting off both power supplies in case of an overload to either circuit. ■ ■

# New Ultronix D/A Converter Ladder Networks Are Faster...

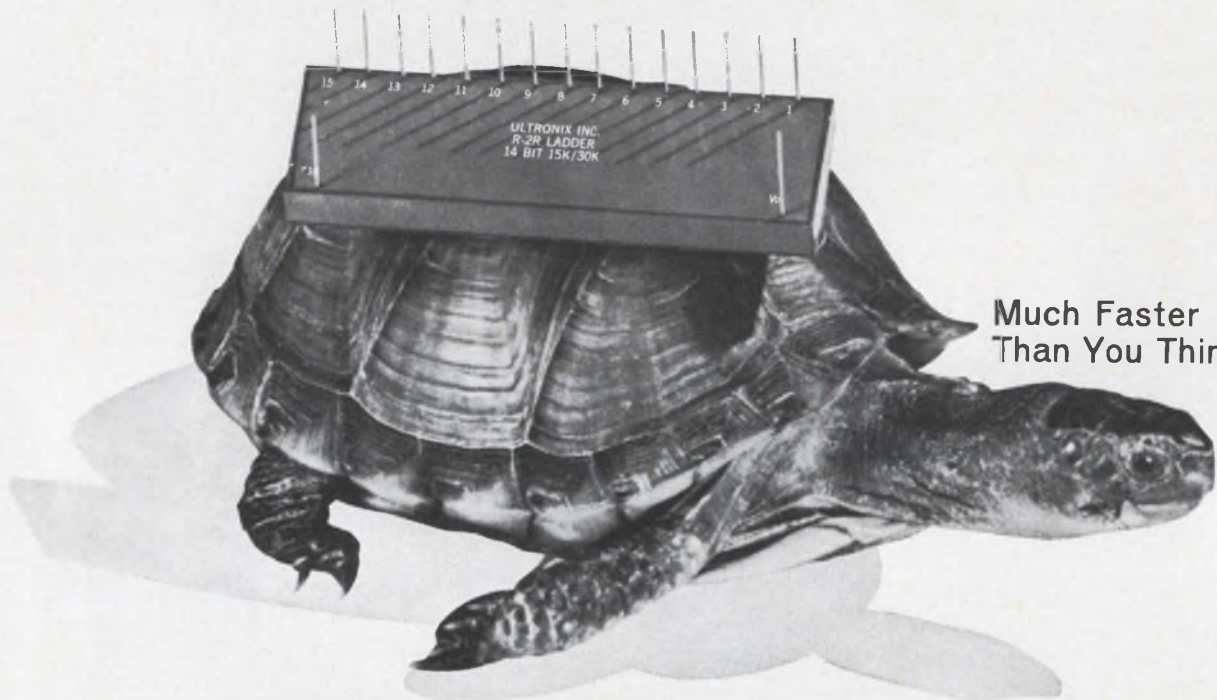

Much Faster  
Than You Think!

For most users, 0.1 to 2.0  $\mu$ sec settling time in Ultronix R-2R digital/analog ladder networks is more than adequate. For the vast majority of computer designers who can use these speeds, we add the unquestioned precision of wire-wound resistors! These benefits include ultra-stable voltage output, 4 to 14 bits,  $\pm 1/2$  least significant bit accuracy over wide temperature ranges, proven high reliability, low price and fast delivery. And, these benefits cannot be matched by metal film resistor networks!

- Compare Accuracy:** Straight binary conversion, 4 to 14 bits, giving recognition to 1 part in more than 30,000 ( $\pm .003\%$ ) over widely varying temperatures.
- Compare Stability:** Highly stable voltage output. Change in output voltage  $\pm 10$  ppm, one year operating, referenced to input voltage. Standard temperature stability  $\pm 2$  ppm/ $^{\circ}$ C ( $\pm 0.5$  ppm/ $^{\circ}$ C available).
- Compare Reliability:** Resistors used in these R-2R networks have accumulated over 450,000,000 part-hours at the field level, with no failures—giving a failure rate of .00022% per 1,000 hours (assuming one failure).
- Compare Size:** All packages—4 through 14 bits—have standardized height of 0.250" to make units compatible with standard packages for high density circuitry.

For complete information on the new Ultronix R-2R Ladder Networks, request Data Sheet N266 from Ultronix, Inc., 461 North 22nd St., Grand Junction, Colo. 81502.

# ULTRONIX

MANUFACTURERS OF THE ULTIMATE IN STABLE, WIRE-WOUND RESISTORS

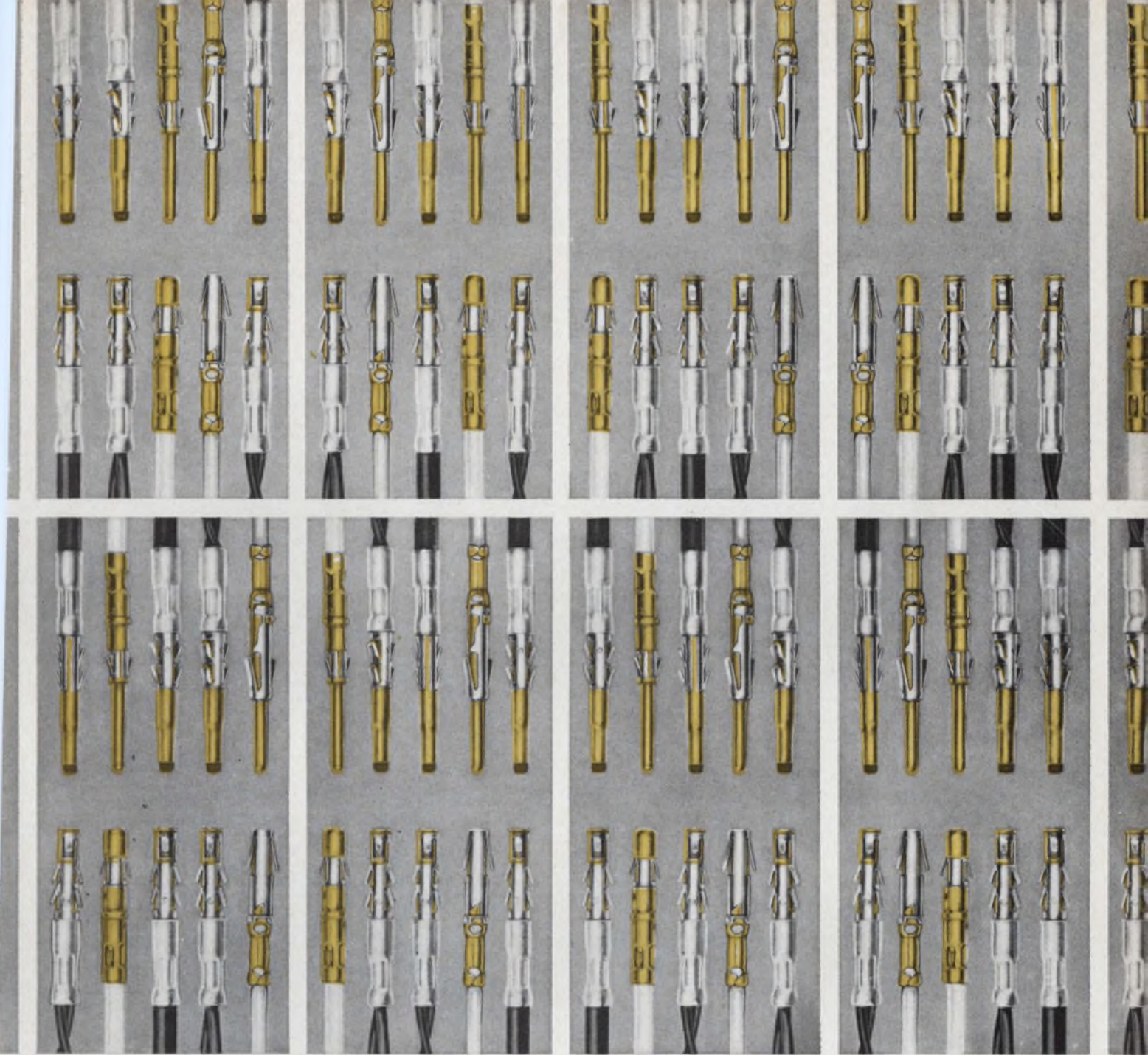

# Mix these signal, power and coax leads in any combination.

Burndy Trim Trio Connectors—available in many shapes—accept three contact styles, all crimp-removable, for signal and power leads #16 thru #24, twisted pair #24 and #26, and subminiature coaxial cables.

Changing conductors is fast and simple, whether for lower voltage drop or better shielding or mechanical reasons. This makes Trim Trio Connectors ideal for breadboard and prototype work as well as

production. For large production runs you can take advantage of the economies offered by the automatic Burndy Hyfematic™ with a crimp rate of up to 3000 contacts per hour.

Get more details on how you can take advantage of the Burndy Trim Trio System—THE ACCEPTED METHOD OF INTERMIXING CONTACTS.

 **BURNDY**  
Norwalk, Connecticut

INTERNATIONAL SALES HEADQUARTERS AND MANUFACTURING FACILITIES:

CANADA: Scarboro, Ontario / ENGLAND: St. Helens, Lancs. / BELGIUM: Mechelen / MEXICO: Naucalpan de Juarez / BRAZIL: Sao Paulo / JAPAN: Tokyo / Sales Offices in Other Major Cities

SEE MORE AT WESCON, BOOTH 1749-51

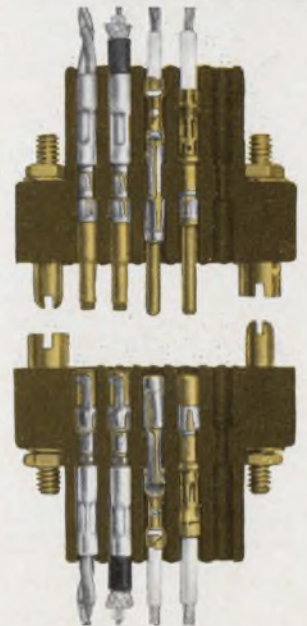

# Determine a one-shot's period accurately.

The graphical method described here produces accurate results with minimum arithmetic.

Conventional approximations do not always give the designer the degree of accuracy that he might require. The period of a transistorized one-shot, for instance, is generally approximated as  $0.694 RC$ . But a more precise value can be obtained from the equation:

$$T = -RC \ln \frac{V_{cc}}{V_{cc} + V_{EBQ_2}}, \quad (1)$$

where  $V_{cc}$  is the collector supply voltage and  $V_{EBQ_2}$  is the emitter base breakdown voltage of the normally-ON transistor.

A simple set of curves (Fig. 1) reduces the arithmetic involved in using Eq. 1.

A conventional one-shot is shown in Fig. 2a. An expression for the one-shot's period can be derived from the waveform (Fig. 2b) of voltage appearing at the base of  $Q_2$ .

As  $Q_1$  is turned ON (provided  $C$  is large enough not to discharge during the turn-on of  $Q_1$ ), the base-two voltage will decrease from  $V_{B_2}$  to either:

$$-|V_{EBQ_2}| \text{ if } V_{cc} > V_{EBQ_2}, \quad (2)$$

or

$$-|V_{cc} - V_{B_2}| \text{ if } V_{cc} < V_{EBQ_2}. \quad (3)$$

In a large number of applications the emitter-base breakdown voltage is from 6 to 8 volts (Table 1) and the collector supply voltage is from 10 to 24 volts. Thus, the condition given in Eq. 2 is of primary concern.

After the turn-on of  $Q_1$ , the capacitor discharges through  $R_1$  toward  $V_{cc}$ . But when  $V_{B_2}$  reaches the turn-on voltage of  $Q_2$ :

$$V_{B_2} = \frac{I_{c1}}{\alpha_1} R_e + V_{BE2}, \quad (4)$$

$Q_2$  is turned ON and regeneratively turns  $Q_1$  OFF (so long as negligible base-emitter voltage drops are assumed). The equation for the voltage at the base of  $Q_2$ , while  $Q_1$  is ON, is:

$$V_{B_2}(t) = -V_{EBQ_2} + (V_{cc} + V_{EBQ_2}) \left[ 1 - \exp\left(-\frac{t}{RC}\right) \right] \quad (5)$$

Setting  $V_{B_2}(t) = 0$  yields:

$$\exp\left(-\frac{T}{RC}\right) = \frac{V_{cc}}{V_{cc} + V_{EBQ_2}}. \quad (6)$$

Taking the natural log of both sides of Eq. 6 yields:

$$T = -RC \ln \frac{V_{cc}}{V_{cc} + V_{EBQ_2}} \quad \left| \quad V_{cc} > V_{EBQ_2}. \quad (7) \right.$$

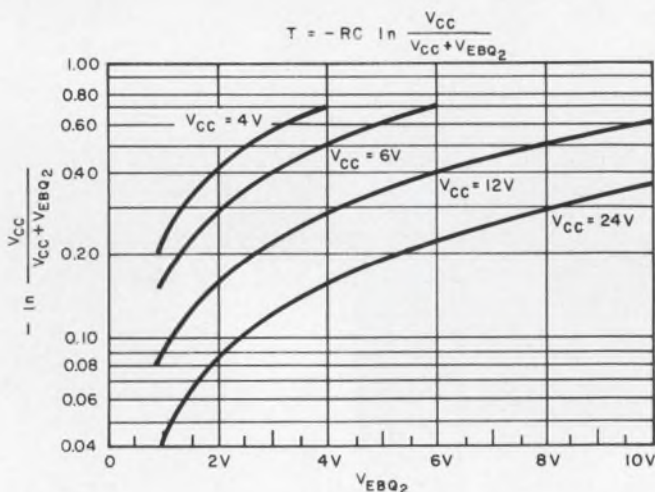

1. Graph simplifies accurate calculation of the period of a transistorized one-shot.

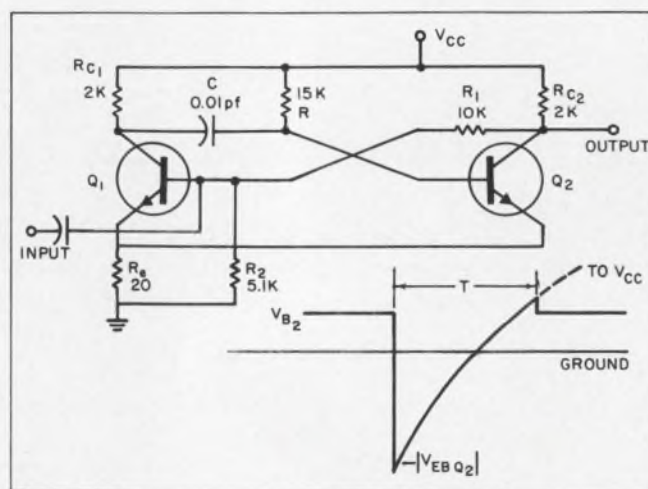

2. One-shot built with component values shown is used to measure the accuracy of the period-calculation method described in the test. The waveshape of the base voltage of  $Q_2$  is used to derive an expression for the period.

Richard S. Hughes, Senior Electronics Engineer, U.S. Naval Ordnance Test Site, China Lake, Calif.



Table 1. Emitter-base breakdown voltages (measured)

Transistor type	$V_{EB}$ (volts)
2N916	6.3
2N744	6.3
2N753	6.0
2N929	8.0
2N706A	6.3
2N657	10.0
2N918	5.6
2N697	6.3
2N2412	8.0
2N1613	8.6
2N1132	8.0

Table 2. Measured and calculated results compared

Transistor type	$V_{cc}$	Period (in $\mu$ sec)		
		Measured	Eq. 5	Eq. 6
2N916	6*	46	52	52
	12	60	63	104
	24	38	36	104
2N744	6*	46	52	52
	12	59	63	104
	24	38	36	104
2N753	6*	46	52	52
	12	59	61	104
	24	37	34	104
2N929	6*	49	52	52
	12	70	75	104
	24	48	49	104
2N706A	6*	43	52	52
	12	60	63	104
	24	39	36	104

\*R = 7.5 k $\Omega$  for all 6-volt  $V_{cc}$  values. The error for the 6-volt  $V_{cc}$  is due to the assumption that  $V_{cc} \gg V_{B2}$ .

If  $V_{cc} < V_{EBQ2}$ , and assuming  $(V_{cc} + V_{EBQ2}) = 2V_{cc}$ , we find that:

$$T = 0.694 RC \left| V_{cc} < V_{EBQ2} \right. \quad (8)$$

Figure 1 is a plot of  $\ln [V_{cc}/(V_{cc} + V_{EBQ2})]$  versus  $V_{EBQ2}$  for various values of  $V_{cc}$ . To calculate the period for a given one-shot, determine  $V_{cc}$  and  $V_{EBQ2}$  (Table 1), obtain the value for  $-\ln [V_{cc}/(V_{cc} + V_{EBQ2})]$  from Fig. 1, and multiply by  $RC$ . Table 2 illustrates the measured and predicted results obtained from a one-shot using component values shown in Fig. 2a. It will be seen that for supply voltage greater than  $V_{EBQ2}$ , the values obtained by using Eq. 7 are quite accurate.

It should be pointed out that for a given transistor family, the  $V_{EB}$  values from unit to unit are quite close (i.e., within  $\pm 5\%$ ).

If the emitter-base breakdown voltage cannot be tolerated, a diode may be placed in series with base of  $Q_2$  to prevent the emitter-base from breaking down. In this instance Eq. 8 should be used to determine the period. ■ ■

THE



MULTI-TRACK MIND...



Want to handle several PCM links simultaneously?  
Need to rapidly switch from format to format?  
DCS has the efficient answer—

Series 1100 PCM SYSTEMS



Look at these features:

- Multilink simultaneous processing, 2 to 16 links
- IBM compatible tapes
- Multilink time correlation
- Immediate format switching
- Pre-switching synchronization and data validity checking
- Memory not used for format synchronization

INTERESTED?

Write for your free copy of the new DCS Series 1100 PCM PROCESSING SYSTEMS brochure... or call the DCS office nearest you.

Dept. ED8-6, East Liberty Street, Danbury, Conn. 06813  
Telephone: 203-743-9241 • TWX 744-1990



DATA-CONTROL SYSTEMS INC.  
Instrumentation for Research

Sales Offices  
Silver Spring, Md., Huntsville, Winter Park, Long Beach, Santa Clara,  
Albuquerque  
Copenhagen London Rome Paris Munich Amsterdam

**T**hese cycle controlled tools give a precise, consistent crimp every time for terminals, lugs, splice fittings, RF fittings, connectors and special devices. They're light and have high-leverage action allowing low-closing hand pressure. Less operator fatigue means higher production . . . lower cost per crimp.

In-line die action and ratchet control provide the most uniform crimping. Tools are corrosion resistant. Available in standard and miniature models.

**CT Terminal Tools** crimp MS-25036 terminal lugs and MS-25181 thru-splices and other fittings. "Dial-for-Size" selector for quick crimp depth selection. Terminal locator properly positions fittings and wire for crimping. The CT-S standard-size tool crimps fittings 12-10 through 26-24. The miniature CT-M tool crimps fittings 16-14 through 26-24.

**CH Tools Crimp Co-axial and Shielded Fittings and Connectors**—Dies are interchangeable and positive bottoming. These tools will crimp BNC, TNC, and N series connectors, and many other fittings requiring hex crimps. Miniature models also available.

**CD Tools for Special Custom Applications** are furnished with blank dies or special dies as required.

Write today for complete information on these high performance crimping tools.



1075 Floral Avenue • Union, New Jersey  
(201) 289-8200 • Telex 1-25471  
a subsidiary of Elastic Stop Nut Corporation of America

# New Die-type tools Crimp easiest- fastest!

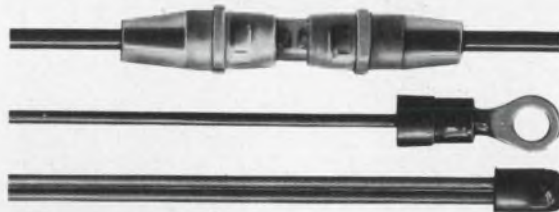

**"CT" Tools for Terminals, Splices and End Caps**

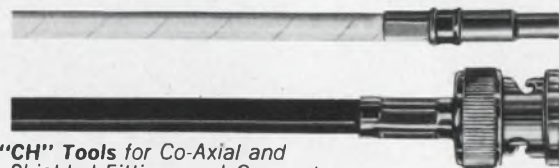

**"CH" Tools for Co-Axial and Shielded Fittings and Connectors**

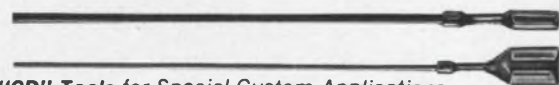

**"CD" Tools for Special Custom Applications**

SEE US AT BOOTHS 1359-60, SPORTS ARENA, WESCON  
ON READER-SERVICE CARD CIRCLE 25

ELECTRONIC DESIGN, August 2, 1966

# UJT, bipolars in compact, versatile generator

Only one UJT and four bipolar transistor stages are required to form a small-sized, multi-function signal generator. The circuit supplies pulse trains, triangular waves, sawtooths and square waves over a wide pulse-repetition-frequency (prf) range.

Specifically, the system (see 'a') generates:

- A narrow, negative-going pulse train.

- A triangular wave with a continuous symmetry-adjustment.
- A positive sawtooth.
- A square wave with a wide range of duty cycle adjustments (see 'b').

What makes this simplicity possible is a stage operated with equal collector and emitter load resistors. It converts an input ramp, which is properly centered between the stage's supply voltages, into a symmetrical triangle of which the amplitude is half that of the ramp.

With an npn stage (see 'c'), this bending is achieved in the following manner: The negative portion of the ramp is inverted and shows unity gain because of the equal collector and emitter

**VOTE!** Circle the Reader-Service-Card number corresponding to what you think is the best Idea-for-Design in this issue.

**SEND US YOUR IDEAS FOR DESIGN.** Submit your IFD describing a new or important circuit or design technique, the clever use of a new component, or a cost-saving design tip to our Ideas-for-Design editor. If your idea is published, you will receive \$20 and become eligible for an additional \$30 (awarded for the best-of-issue Idea) and the grand prize of \$1000 for the Idea of the Year.

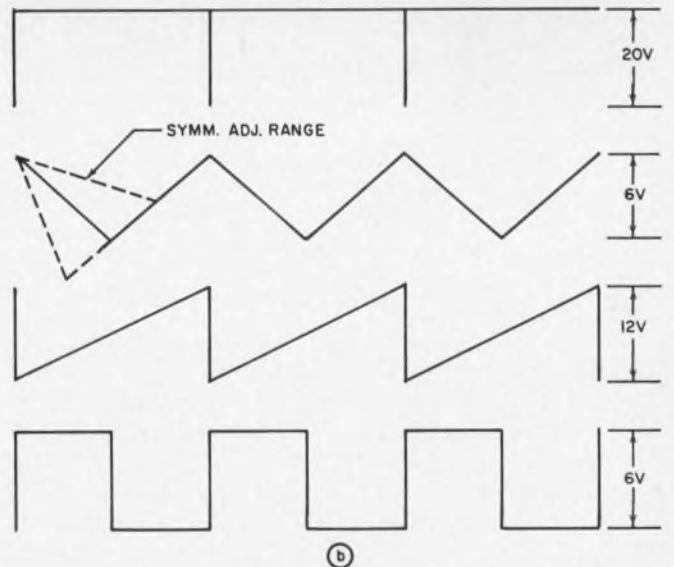
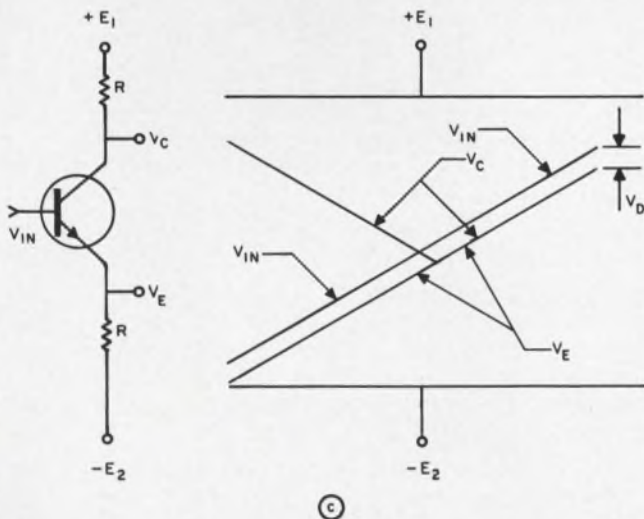
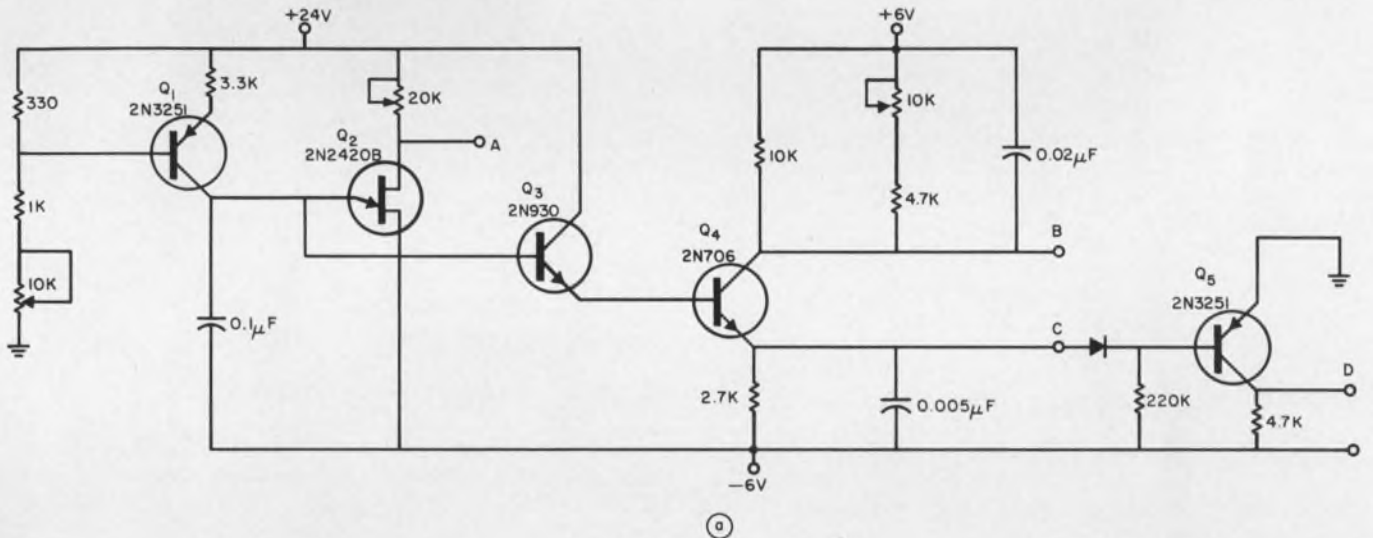

UJT and four bipolar stages are used in a compact multi-waveform generator (a). Circuit produces (b) pulse train, triangular wave, sawtooth and square wave. Npn stage

Q<sub>4</sub> (c) functioning as "signal bender" is mainly responsible for over-all simplicity and compactness. Stage Q<sub>5</sub> may be omitted if a square-wave is not desired.

resistors. The positive portion of the ramp keeps the transistor in saturation, with emitter and collector held essentially at the same potential. The collector-to-base junction is forward biased, and the collector stays one diode drop below the base. In the circuit  $Q_1$  serves as the bender.

The linear sawtooth is generated by unijunction transistor  $Q_2$ , operated from constant current source  $Q_1$ .  $R_1$  adjusts the current and therefore the prf. The sawtooth is applied to the base of  $Q_1$ , by high-beta, emitter-follower  $Q_3$ , which minimizes the loading of the charging circuit by  $Q_1$ .  $R_2$  is used to control the upper limit of the sawtooth without affecting the lower limit, thereby permitting the centering of the sawtooth for proper operation of  $Q_1$ .  $R_3$  adjusts the symmetry of the triangle. When it is equal to  $R_1$ 's emitter resistor, symmetry exists.

The capacitors in the collector and emitter circuits of  $Q_1$  remove the transient spike caused by the finite sawtooth retrace time of the UJT. Stage  $Q_5$  is overdriven by the sawtooth at the emitter of  $Q_1$ , to provide a constant amplitude square wave. Its duty cycle is controlled by  $R_2$ , which, by controlling the centering of the sawtooth, adjusts the point in the saw at which  $Q_5$  turns on.  $Q_5$  provides the square wave only. If that wave-shape is not required, the  $Q_5$  stage may be omitted.

*Bert Pearl, Project Engineer, Hallicrafters Co., Chicago, Ill.*

VOTE FOR 110

## Transient alarm indicator draws little stand-by current

The simple combination of a pair of complementary transistors and a Zener diode forms the heart of a transient alarm indicator. The circuit draws practically no stand-by current; also it locks up automatically.

In a piece of electronic equipment which was required to operate with an unregulated power source, it was desirable to know when the input voltage exceeded a certain limit. Also, since the operator would not always be present when the transient occurred, it was advantageous to have an indicator which would remain ON until reset. The complementary Q-Zener diode circuit (see schematic) filled this need.

The breakdown voltage of Zener diode  $CR1$  is chosen to be slightly greater than the input operating voltage labeled "+V". When an input transient which exceeds the diode breakdown voltage occurs, current is forced into the base of transistor  $Q1$ , causing it to be forward biased. This draws the collector of  $Q1$  to ground, thereby turning  $Q2$  ON. Consequently, current flowing through  $Q2$  causes additional forward bias to be applied to the base of  $Q1$ , ensuring its ON condition. When both transistors are turned ON in a

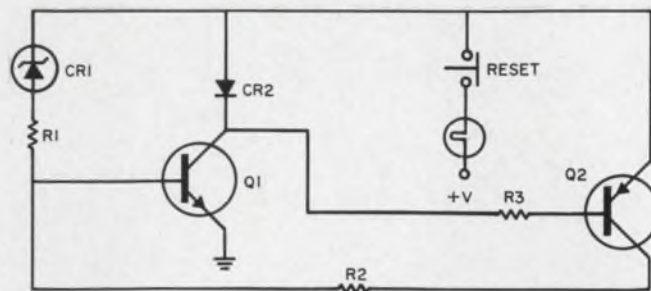

Transient alarm indicator formed by complementary transistor-Zener diode combination. Circuit draws little stand-by current.

locked-up condition, the light is turned on, and it will remain ON until the reset button is depressed.

Germanium transistors may be employed for  $Q1$  and  $Q2$ , but a silicon diode should be used for  $CR2$ . If  $Q1$  and  $Q2$  are silicon,  $CR2$  should be replaced by two silicon diodes in series to ensure proper circuit operation. The value of Zener diode  $CR1$  must be chosen within the voltage rating of the transistors used. Depending on the current requirements of the bulb and the  $h_{FE}$  of  $Q1$ , the  $R1$  and  $R2$  values should be chosen to provide ample forward-bias current. Note that the voltage across  $R2$  is very low when the circuit is locked up.

*Jack L. Shagena, Jr., and Aaron Mall, Design Engineers, Bendix Radio Div., Baltimore, Md.*

VOTE FOR 111

## Rubber sheets protect Yagi antenna elements

Steady winds often cause a metal-fatigue breakage of Yagi antenna elements because they are flexed continually as they vibrate in resonant modes. Flat rubber sheets, even garden hose, may easily be employed as energy absorbers to prevent this rupturing.

Such a simple solution to the problem is possible because the mechanical impedance of any rod-like element is high at the free end. This transverse-mode vibration impedance remains high, regardless of the number of nodes along the element. An energy-absorbant device capable of dissipating this mechanical energy would thus reduce the amplitude of the vibration and eliminate breakage.

The protective device can be made from a short section of lightweight garden hose, split lengthwise every 90 degrees, and held in place on the end of the antenna elements by a hose clamp. However, a more efficient and durable protection can be made from a sheet of flat rubber or pliable plastic material, 1/8 to 1/4 inch thick by 5 to 6 inches long (see photograph).

When just wide enough to wrap once round the element, the damping ability of the device will be properly matched to the size of the element. The material is cut lengthwise to make four tabs or energy absorbers. Although the energy absorbers

# In less time than it takes to read this page, you could learn to use this new Universal Impedance Bridge.

## Ready? One, two, three, go.

2. Adjust the range switch for an on-scale reading.



3. Obtain a null with the CRL dial. Now, read your measurement.

1. Select the function you want.

Nothing to it. No interacting controls to adjust and readjust. No multipliers. No non-linear dials. AUTO-BALANCE eliminates all that.

This new Hewlett-Packard Bridge is the first one that takes human beings into account as well as impedance. It's made for engineers who don't have time for a half-hour refresher course every time they want to use it.

You get direct digital readout of all C, R, and L values. Indicator lights show up-scale or down-scale unbalance. Decimal point and an equivalent circuit are automatically indicated. No problem with false or sliding nulls either: unique electronic AUTO-BALANCE takes care of that.

For a D or Q measurement, just switch from AUTO to low or high D or Q and turn the DQ control until you obtain another null. Simple. Particularly for low Q and high D cases.

So if you're the kind of engineer who's tired of complicated impedance bridges, Hewlett-Packard has your number: Model 4620A. \$550.

Ask your Hewlett-Packard field engineer for a demonstration. Or write us for complete specs: Palo Alto, California 94304. Tel. (415) 326-7000. Europe: 54 Route des Acacias, Geneva.

*Data subject to change without notice.  
Price f.o.b. factory.*

**HEWLETT**  **PACKARD**  
An extra measure of quality.

ON READER-SERVICE CARD CIRCLE 26

1844

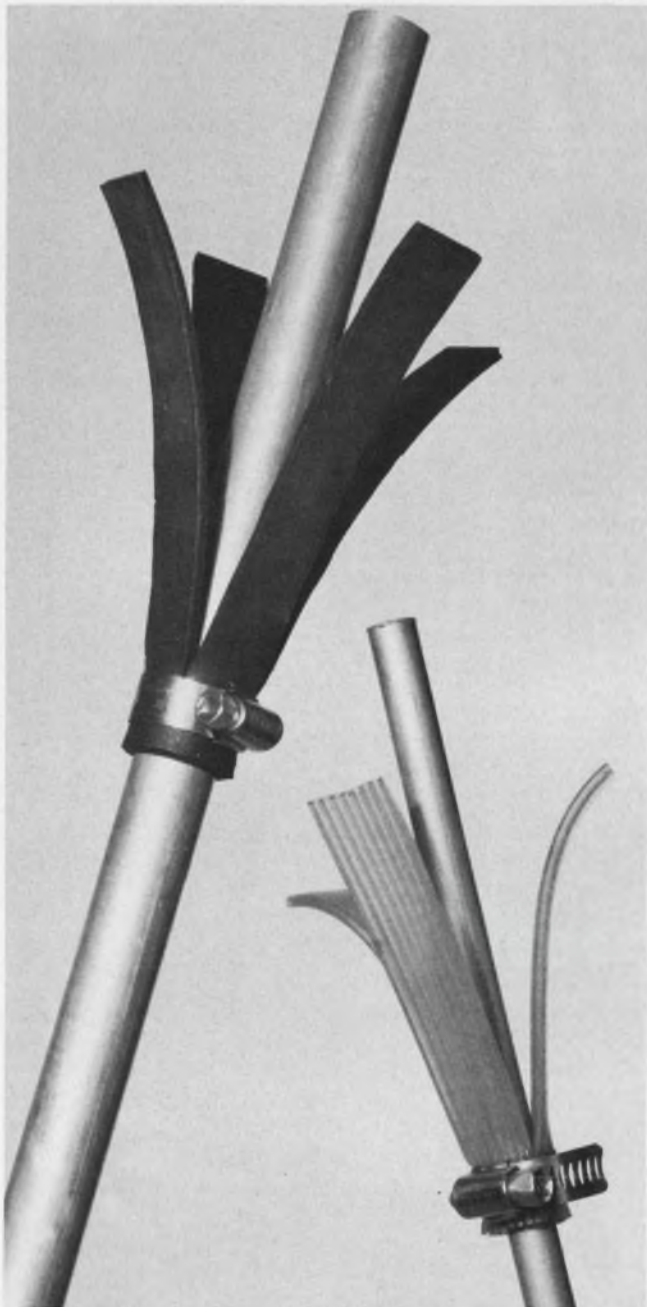

Flat rubber sheets protect antenna elements by absorbing and dissipating mechanical energy due to wind.

would be even more effective if clamped at the end of the element, they have to be fastened with their free ends positioned about 2 inches in from the end (as shown). This will prevent changes in the electrical length of the elements and the impedance of the antenna.

Vibration absorbers of the type shown have been used on eight Yagi and log periodic antennas for a period of three years. Element diameters ranged from 3/8 to 1 inch. Not a single breakage occurred.

*Robert A. Bureau, Chief Electronics Technician, Electrical Sciences Research Div., Washington State University, Pullman, Wash.*

VOTE FOR 112

## Differentiating network ensures astable starting

Transistorized astable multivibrators are often difficult to self-start, because in many instances both their transistors are turned on simultaneously and no regeneration occurs. Since a slight imbalance between transistor conduction currents is necessary to cause regeneration (and therefore sustained oscillation), an RC differentiating network is added to the base of one transistor to provide this imbalance.

When power is applied to the astable multivibrator (see schematic), a positive spike is gen-

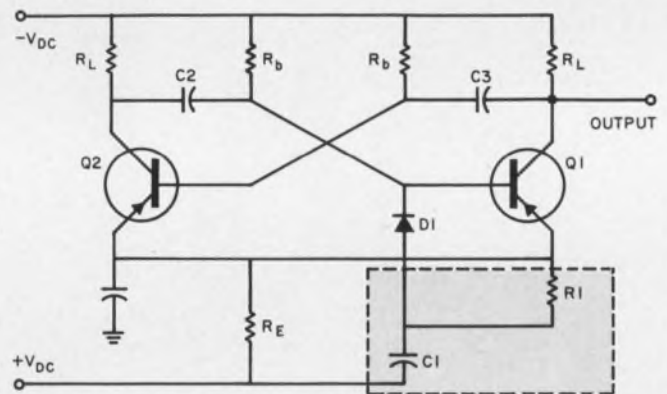

Differentiating network consisting of  $R1-C1$  provides astable multivibrator with a self-starting capability.

erated at the junction of  $R1$  and  $C1$ . This spike is applied to the base of  $Q1$  through diode  $D1$ . The positive-going spike ensures that  $Q1$  will turn off.

Hence, the multivibrator is in an unstable condition and will start to oscillate. The values of  $R1$  and  $C1$  are not critical but should be large enough for their time constant to exceed the turn-off time of  $Q1$ . The values of  $C1$  should be determined by the rise time of the positive dc voltage. There may be a slight loading effect because of  $R1$ , which may change the oscillator frequency, but this may be compensated for by suitable choice of coupling capacitors  $C2$  and  $C3$ .

*Fredric Ruben, Sr. Engineer, Courant Institute of Mathematical Sciences, New York University, New York.*

VOTE FOR 113

### IFD Winner for April 26, 1966

**R. T. (Ted) Hart**, Systems Project Engineer, Collins Radio Co., Dallas, Tex.

His idea, "Oscillator-multivibrator combo forms super-regenerative detector," has been voted the \$50 Most Valuable of Issue Award.

**Cast Your Vote for the Best Idea in this Issue.**

# Amperex



## now available

Three families of silicon planar epitaxial LID transistors are now available for immediate delivery in production quantities

### HIGH SPEED SWITCHES

LDS 200

LDS 201

functionally replace the following types:

2N706	2N744	2N914
2N708	2N834	2N2368
2N743	2N835	2N2369

### HIGH GAIN, LOW LEVEL AMPLIFIERS

LDA 400

LDA 401

functionally replace the following types:

2N929	2N2483
2N930	2N2484

### GENERAL PURPOSE AMPLIFIERS

LDA 402

LDA 403

functionally replace general-purpose amplifiers operating from 1 to 100 ma, such as:

2N696	2N2218
2N697	2N2219
2N1613	2N3390
2N3391	



#### NEW MICROELECTRONIC PACKAGE FOR SEMICONDUCTORS PERMITS MECHANIZED PRODUCTION OF HYBRID INTEGRATED CIRCUITS

When Amperex LIDS were introduced at the I.E.E.E. Show, designers of hybrid film circuits were unanimous in their recognition of the LID as the ideal semiconductor package for the new technology.

The Amperex LID (leadless inverted device) is an all-ceramic package, smaller (0.075" x 0.045" x 0.032") and less costly than any existing metal package. It permits the manufacturer to reduce costs by reducing the substrate size.

Because the LID has no external leads, wire-bonding machinery and the skilled labor to operate it are no longer needed, handling is simpler and production yields of integrated circuits will be higher.

In place of delicate wire leads, LIDS have four contact legs with metallized solderable surfaces. This construction permits the LIDS to be positioned on the substrate by automatic jigs, without the need for micro-optics for orientation.

Any number of LIDS can be mounted simultaneously for true mass production. LIDS are bonded to the substrate by low-temperature soldering, which, unlike the usual high temperature techniques does not alter the transistor characteristics.

Unlike chips, LIDS can be characterized and pre-selected for critical circuits; can be color-coded and identified for easy and efficient production.

To learn more about the immediately available LIDS listed above, and other transistors and diodes coming soon in the LID

package, write: Amperex Electronic Corporation, Semiconductor and Receiving Tube Division, Dept. 371, Slatersville, R. I. 02876.

LID (about 15 times magnification) showing chip placement before epoxy coating.



## Amperex®

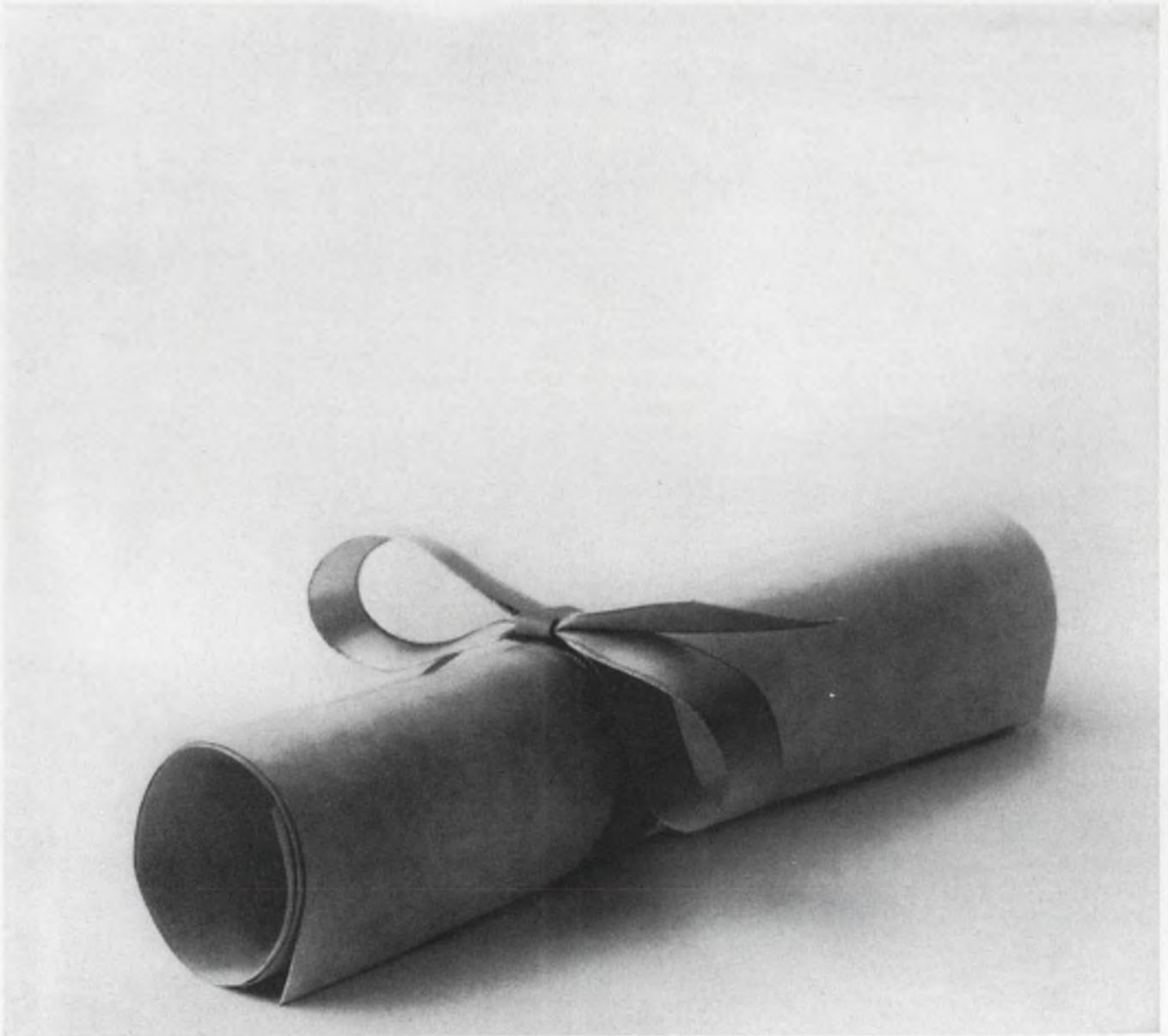

## It's only a beginning.

MIT says career engineers should spend 10% of their time keeping up with new technology. IBM agrees. Whatever degree you hold, you can't afford to stop learning.

If you worked at IBM's Office Products Division in Lexington, you could take graduate courses just across town at the University of Kentucky. Participate in the Accelerated Master's Degree Program there—using part of your actual work as thesis material. And if you qualified for the IBM Resident Graduate Program, you can do advanced

study almost anywhere.

These are only a few of the educational opportunities available through IBM Lexington. There are over 30 Voluntary Education Programs. Plus conferences with research and developmental managers from all other company divisions. And seminars with top scientists and engineers.

If you're looking for a location where you can keep growing while earning an excellent salary, better look into IBM Lexington—where engineers strike a balance between theory and

application, year in and year out.

Right now we have openings in development, product and manufacturing engineering; product testing; tool or manufacturing methods engineering; and mechanical design.

Write or call:

Mr. Thomas A. Viola  
Dept. 555V, IBM Corporation  
New Circle Road  
Lexington, Kentucky 40507  
Phone: 252-2250  
(Area Code 606)  
An Equal Opportunity  
Employer (M/F)

# IBM®

ON CAREER-INQUIRY FORM CIRCLE 901

ELECTRONIC DESIGN, August 2, 1966



# CAREER INQUIRY - confidential

18

Respond to the career opportunities advertised in this issue. Fill out and send us this handy resume. **Electronic Design** will do the rest - neat copies of this form will be mailed to the companies of your choice, indicated by the circled Career Inquiry Numbers at the bottom of this page.

<b>Name</b>		<b>Home Phone</b>	
<b>Home Address (Street)</b>		<b>City</b>	<b>State</b>
			<b>ZIP Code</b>
<b>Age</b>	<b>U.S. Citizen</b> <input type="checkbox"/> Yes <input type="checkbox"/> No	<b>Security Clearance</b>	

<b>Prime Experience</b>	<b>Secondary Experience</b>

<b>Desired Salary</b>	<b>Availability Date</b>
-----------------------	--------------------------

**Employment History - present and previous employers**

<b>Company</b>			
<b>City, State</b>			
<b>Dates</b>	to	to	to
<b>Title</b>			
<b>Specialty</b>			

**Education - indicate major if degree is not self-explanatory**

<b>Degree</b>			
<b>College</b>			
<b>City, State</b>			
<b>Dates</b>	to	to	to

**Additional Training - non-degree, industry, military, etc.**

---

---

**Professional Societies**

---

**Published Articles**

---

---

**Career Inquiry Numbers:**

900	901	902	903	904	905	906	907	908	909
910	911	912	913	914	915	916	917	918	919

**ELECTRONIC DESIGN**  
850 Third Avenue  
New York, New York 10022

**HAVE WE SET  
THE GOALS  
TOO HIGH  
IN  
CIRCUIT  
DESIGN?**

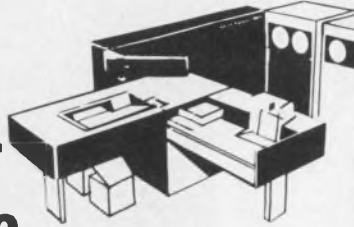

Not if you are aware of the exciting design breakthroughs already achieved by the Honeywell EDP Research and Engineering Division.

Our goals are set and we are looking for you to design and evaluate microminiature computer circuits to be fabricated by monolithic technology. Further responsibilities will include the evaluation of programs for the application of microminiaturization to scientific and commercial computer systems. If your goals are high and you have a minimum of two years' circuit design experience, please call or forward your resume to Mr. Edwin Barr, Employment Supervisor, Dept. ED 8, 200 Smith Street, Waltham, Mass.

(617) 891-8400

**Honeywell**

**ELECTRONIC DATA PROCESSING**

*An Equal Opportunity Employer*

ON CAREER-INQUIRY FORM CIRCLE 902

Fold here, staple and Mail.

FIRST CLASS  
Permit No. 725  
New York, N.Y.

**BUSINESS REPLY MAIL**

No Postage Stamp Necessary if Mailed in the United States

POSTAGE WILL BE PAID BY

**ELECTRONIC DESIGN**

**READER SERVICE  
850 THIRD AVENUE  
NEW YORK, NEW YORK 10022**



# ENGINEERS

## MARTIN

where advanced **ELECTRONICS** technologies go hand-in-hand with aerospace achievements!

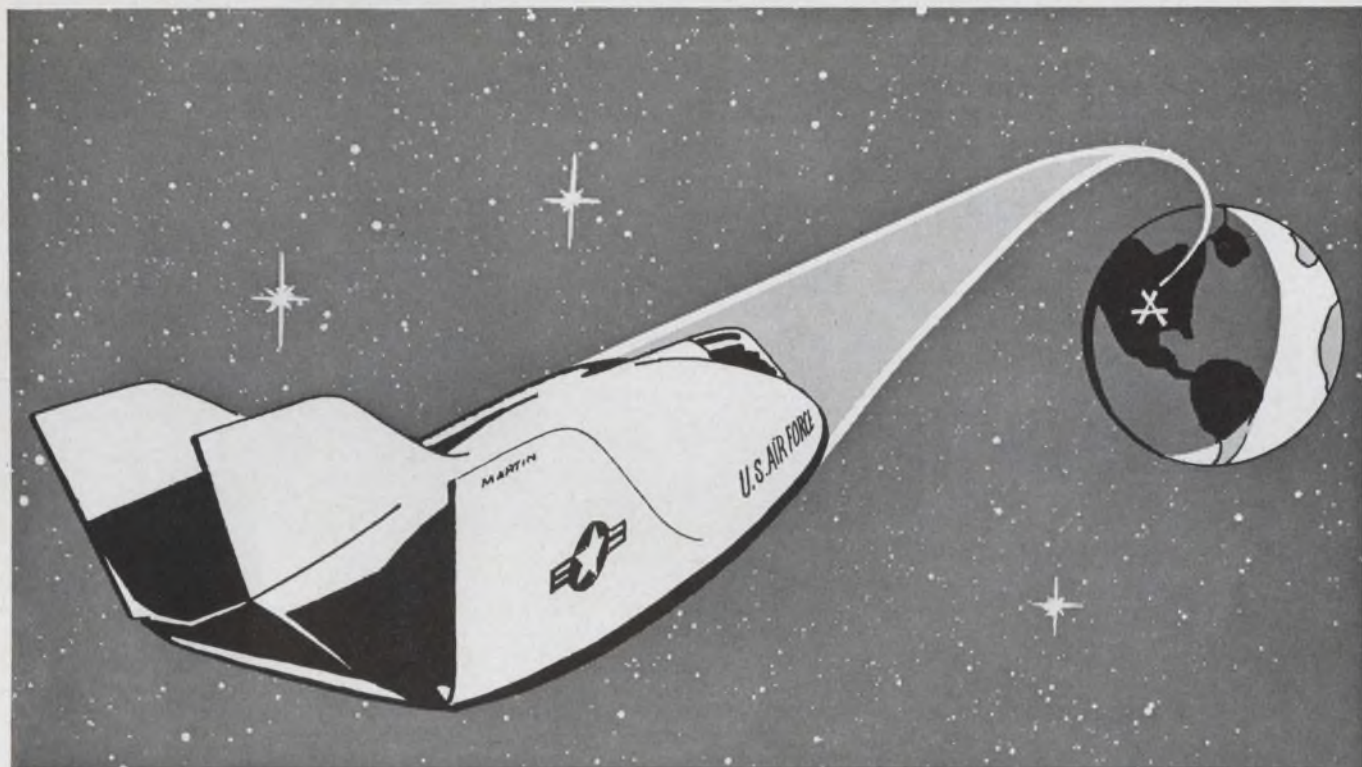

## PRIME Opportunities!

We have challenging assignments for Flight Controls Analysts and Systems Designers interested in moving ahead in the fields of reentry systems, including advanced versions of PRIME, PILOT, HL-10 and other advanced reentry spacecraft and high-performance aircraft.

Openings to work on advanced auto-pilots, on-board programmers and high-performance amplifiers involved in the various spacecraft reentry systems.

Other challenging electronics programs at Martin include advanced-concept ASW and RECON aircraft systems and equipments.

### CAREER POSITIONS IN THE FOLLOWING FIELDS:

- FLIGHT CONTROL SYSTEMS
- RECONNAISSANCE SYSTEMS
- ASW SYSTEMS
- COMMAND & CONTROL SYSTEMS
- CIRCUIT DESIGN (*Analog & Digital*)
- GUIDANCE SYSTEMS
- ELECTRONIC RESEARCH  
(*Supporting the above*)

FOR INTERVIEW WITH ONE  
OF OUR TECHNICAL MANAGERS  
CALL COLLECT OR WRITE  
Mr. J. W. Perry Professional Employment

## MARTIN COMPANY

A DIVISION OF MARTIN MARIETTA CORPORATION

BALTIMORE, MD. 21203 • Phone (301) MU. 7-3800, Ext. 8471

*An equal opportunity employer*

ON CAREER-INQUIRY FORM CIRCLE 903

# EE's & ME's

Share in the excitement at Delco Radio!  
Pick your opportunity from these openings in:

## PRODUCT DESIGN OR PROCESS ENGINEERING

Delco Radio Division of General Motors is on the move! Growing demand for Delco solid state products requires more expansion . . . new buildings (411,000 sq. ft. addition underway) . . . new equipment . . . new projects . . . and most importantly, new people.

The pace is dynamic. Challenging. Advancement opportunity is ripe—for those who choose to capitalize on it. Make your choice from the following openings—now!

### PRODUCT DESIGN

#### SUBMINIATURE MILITARY COMMUNICATIONS EQUIPMENT

EE or ME—for assignment to development group designing all-transistor portable transmitters and receivers, operating in 2-100 mc range. FM, AM, FSK, CW, SSB modulation.

#### HEATER, AIR CONDITIONER, AND VENTILATION CONTROL

ME's—with 3-5 years experience, for development, engineering production liaison, and re-designing of comfort control systems including vacuum valves and mechanical controls.

#### AUTOMOTIVE RADIO DESIGN AND DEVELOPMENT

EE—to work with Senior Engineer on advanced development of auto radios and other entertainment devices, including FM-AM, miniaturized circuitry and components.

ME—for design of small electronic mechanisms, including FM-AM, Signal Seeking and push-button tuners, and components modules. EE or ME—for packaging of auto radios and associated tuners, solenoids, etc. Required to make some engineering contacts with automobile manufacturers.

### PROCESS ENGINEERING

#### SEMICONDUCTOR PROCESS ENGINEERS

ME's or EE's—BS or MS, to develop and create new processes for manufacturing germanium and silicon semiconductor devices. Includes development of automatic and semiautomatic fabrication equipment, pilot line operation and general cost savings investigations pertinent to semiconductor manufacturing.

#### RELIABILITY ASSURANCE

ME—project engineer, for design and development work on test equipment for semiconductors and special products. Will handle tests and evaluations of transistorized systems and components, both power and small signal type. Must evaluate results and associated statistical data. Also includes failure analysis work with suppliers and production.

Interested? Don't waste time—call us collect! Area Code 317/459-2808. Ask for C. D. Longshore. Or, send your resume to Mr. Longshore, Salaried Employment, Dept. 204, Delco Radio Division, General Motors Corporation, Kokomo, Indiana.

*An equal opportunity employer*

**HEWLETT-PACKARD**  
*performance  
and value in  
electronic  
counters*



Model 5245L Electronic Counter with new 3-12.4 GHz Plug-in Heterodyne Converter

HEWLETT  
PACKARD

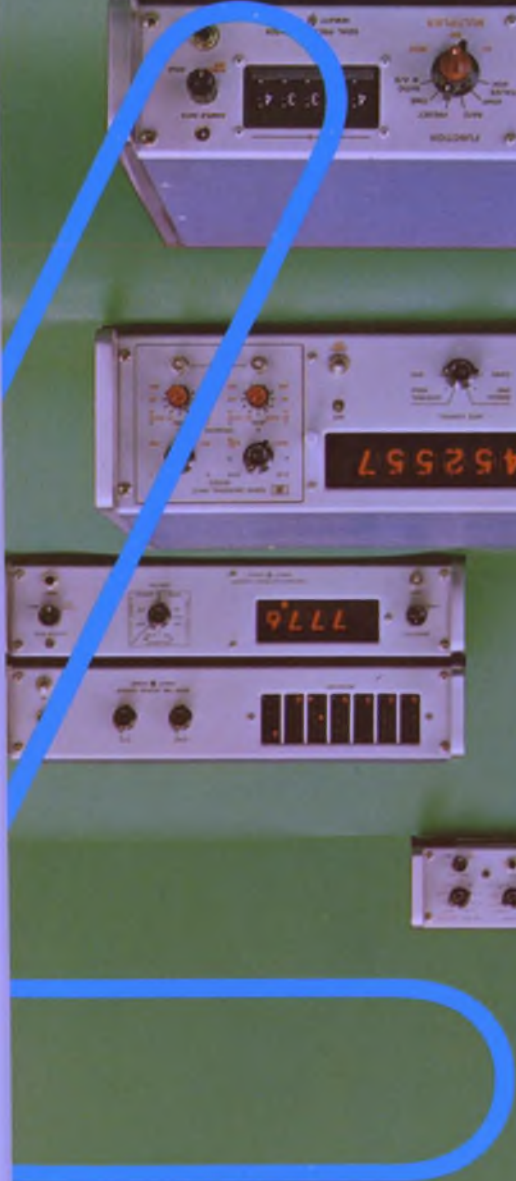

hp 5233L 2 MHz Counter with  
Time Interval Capability

hp 5275A Time Interval Counter

hp H22-5211B Low-cost Counter

hp 5280A Reversible Counter

hp 5214L Preset Counter

hp 5245L Counter with 5255A  
3-12.4 GHz Plug-in

From Hewlett-Packard, the world's most extensive line of electronic counters and accessory instrumentation... designed to make your measurements faster, easier, more accurate, and to make measurements that were heretofore impossible.

\*Measurement code used below: F=Frequency, P=Period, MP=Multiple Period, MPA=Multiple Period Average, TI=Time Interval, R=Ratio, MR=Multiple Ratio.

#### 50 MHz COUNTER WITH PLUG-INS TO 12.4 GHz

**Model 5245L Electronic Counter** measures F, P, MPA, R, MR, TI.\* Frequency measurement 0 Hz to 50 MHz directly; up to 100 MHz, 500 MHz, 3000 MHz and 12.4 GHz with plug-in converters. Sensitivity, 100 mv; time base, better than  $3/10^6$ /day; 8-digit in-line readout. 1 M $\Omega$  input, front panel trigger level control.

**HP 5245L Counter without plug-ins, \$2950**

**NEW! 1 Hz resolution at X-band in 4 seconds  
HP 5255A 12.4 GHz Heterodyne Converter, \$1650**

**HP 5251A 100 MHz Plug-in Converter, \$300**

**HP 5252A DC to 350 MHz Prescaler Plug-in, \$685**

**HP 5253B 500 MHz Plug-in Converter, \$500**

**HP 5254A 3000 MHz Plug-in Converter, \$825**

**HP 5261A Video Amplifier Plug-in, \$325**

**HP 5262A Time Interval Plug-in, \$300**

**HP 5264A Preset Unit Plug-in, \$650**

**HP 5265A DVM Plug-in, \$575**

#### OTHER HIGH-FREQUENCY COUNTERS

**Model 5244L 50 MHz Electronic Counter** measures F, P, MPA, R, MR.\* Time base  $\pm 2/10^7$ /month, gate times 1  $\mu$ sec-10 sec, 7-digit in-line readout. \$2225.

**Model 3734A 2.5 MHz Electronic Counter** measures F, P, MPA, R, MR, TI\* 2 Hz to 2.5 MHz. Time base,  $\pm 2/10^6$ /week; gate times, 0.01-1 sec (to 10 sec optional); 5-digit in-line readout. \$1075.

**Model 5233L 2 MHz Electronic Counter** measures F, P, MPA, R, MR, TI\* 0 Hz to 2 MHz. Time base,  $\pm 2/10^7$ /month; gate times, 10  $\mu$ sec-10 sec; 6-digit in-line readout. \$1750.

**Model 5232A 1.2 MHz Electronic Counter** measures F, P, MPA, R, MR\* 2 Hz to 1.2 MHz. Time base,  $\pm 2/10^7$ /month; gate times, 0.01-10 sec; 6-digit columnar readout. Model 5532A identical but with 6-digit in-line readout. HP 5232A, \$1300; HP 5532A, \$1450.

#### LOW-FREQUENCY COUNTERS

**Model 5211A 300 kHz Electronic Counter** measures F and R\* 2 Hz to 300 kHz with a 4-digit columnar readout. Uses power frequency line as time base; gate times of 0.1 and 1 second. Model 5211B identical except has gate times of 0.1-10 seconds. Model H22-5211B same as 5211B but with a 4-digit in-line readout. HP 5211A, \$600; HP 5211B, \$725; HP H22-5211B, \$825.

**Model 5212A 300 kHz Electronic Counter** measures F, P, MPA, R, MR\* 2 Hz to 300 kHz. Time base,  $\pm 2/10^6$ /week; gate times, 0.01 sec-10 sec; 5-digit columnar readout. Model 5512A identical but with 5-digit in-line readout. HP 5212A, \$925; HP 5512A, \$1050.

**Model 5223L 300 kHz Electronic Counter** measures F, P, MPA, R, MR, TI\* 0 Hz to 300 kHz. Time base,  $\pm 2/10^6$ /week; gate times, 10  $\mu$ sec-10 sec; 5-digit in-line readout. \$1325.

#### PRESET COUNTER

Measures normalized rates, ratio, normalized ratio and time for N events to occur. Direct reading in engineering units; N may be preset to any integer between 1 and 100,000; range is 2 Hz-300 kHz. HP 5214L, \$1475.

#### 10 nsec TIME INTERVAL COUNTER

Permits measuring of time interval with resolution to 10 nsec over the full 10 nsec to 0.1 sec range. Ideal for precise digital measurement of short-time events. 7-digit columnar readout. HP 5275A, \$2500.

#### REVERSIBLE PLUG-IN COUNTER

Totalizes, counts sum or difference of 2 inputs, totalizes 1 signal with direction of count as a function of polarity or quadrature phase of another signal; 2 MHz counting, 1 MHz subtracting, 250 nsec reversing. HP 5280A, \$1450; HP 5285A Plug-in for described operations, \$450.

#### NUCLEAR SCALER-TIMER

Accepts pulses from nuclear detectors to accumulate, display and record nuclear events. Three-mode pulse height analyzer, stability is 0.01%, 6-digit in-line display. HP 5201L, \$1950. Other models down to \$950.

#### AUTOMATIC FREQUENCY DIVIDER

Automatic direct readout of frequency, 0.3 to 12.4 GHz, on 5245L Counter. No ambiguity offset or arithmetic processing. HP 5260A, \$3250.

#### DIGITAL RECORDER

Prints 5-lines/sec; 11 digits (12 available) 2 msec input data transfer time, plug-ins for BCD or 10-line codes, HP 562A, \$1080-\$2100, depending upon options.

#### TRANSFER OSCILLATORS

Extend frequency range of 5245L Counter (with 5252A or 5253B Plug-in) and measure CW, pulsed and FM signals to 12.4 GHz and higher. HP 540B, \$1050; HP 2590B, \$1900.

#### DIGITAL-ANALOG CONVERTERS

Digital-Analog Converters make possible high resolution analog records from counters, scalars, DVM's; operate directly with HP and Dymec instrumentation. HP 580, \$525.

#### VLF COMPARATOR

A complete system for checking counter time bases and other oscillators against U.S. Frequency Standard broadcast by station WWVB (60 kHz). HP 117A, \$1300.



**EXCELLENCE**

*in electronic counters*

# HEWLETT PACKARD

*the standard of excellence*

*in reliability*

28835  
26572  
3498

HP counters are subjected to tests that are much more stringent than normally expected for commercially priced equipment. All instruments in development undergo extensive tests such as shock, vibration, high and low temperature, humidity, electromagnetic compatibility (RFI) and line voltage and frequency. Components undergo environmental tests in the HP Components Evaluation Laboratory. Quality audits are performed regularly to ensure that original performance and quality standards are being met. Finally, each solid-state

counter gets severe temperature testing before shipment.

One result of quality assurance at Hewlett-Packard is that, in long term reliability tests, twenty Model 5245L Counters survived a total of 18,077 test hours with only two disabling failures. That's an average of one failure per 4 years at 40 hours per week! Mean-time-between-failures (MTBF) exceeded military requirements comfortably. Another result: standard hp counters have passed military environmental tests and have been assigned MIL nomenclature (data upon request).



Here's a small part of hp's extensive in-house test facility where instruments are tested under extreme shock, vibration, temperature, humidity and electromagnetic conditions.



To force any marginal components to fail before shipment, all solid-state counters are operated at +65° C for at least 16 hours in heated cabinets.



Decade counting assemblies for all solid-state counters undergo a temperature of 80° C for 2 hours to force failure of any marginal components. Despite this torture, the failure rate of decades is less than 0.5%. The assemblies are also operated for 22 hours at room temperature.



In one of numerous tests, all Model 5245L crystal oscillator assemblies are operated and observed for two weeks to determine aging rates.

Since the introduction of the first hp counter more than 15 years ago, Hewlett-Packard has been the leader in virtually all areas of frequency generation and measurement. Hewlett-Packard's proficiency in cesium beam frequency standards, quartz oscillators, frequency synthesizers, signal generators and other electronic equipment has enabled Hewlett-Packard to excel in all areas of electronic counter design.

The Frequency and Time Division of Hewlett-Packard concentrates the full efforts of hundreds of engineers, technicians and manufacturing people on frequency and time measurements and standards.

For more information on Hewlett-Packard frequency and time measuring instrumentation, call your field engineer or write, Hewlett-Packard, Palo Alto, California 94304, Tel. (415) 326-7000; Europe: 54 Route des Acacias, Geneva.

*Data subject to change without notice. Prices f.o.b. Palo Alto, California; for prices in other countries, contact your hp field office.*

**HEWLETT**  **PACKARD**  
*An extra measure of quality*



# Products

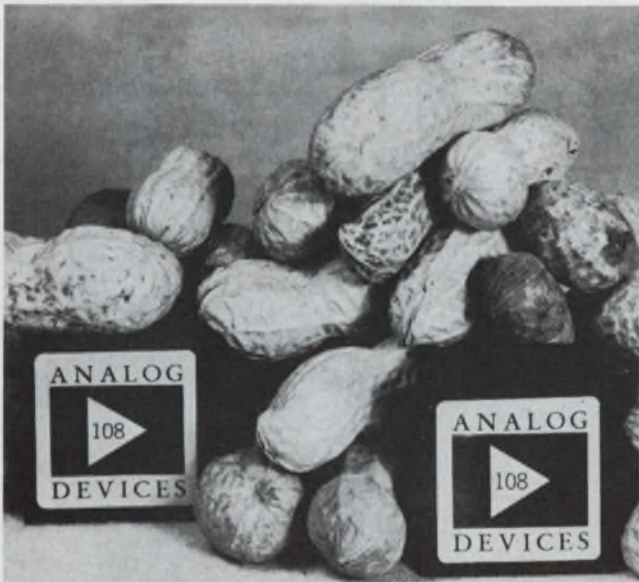

**Current drift is peanuts.** Op-amp also boasts low offset, high  $Z_{in}$  for low-level dc. Page 88

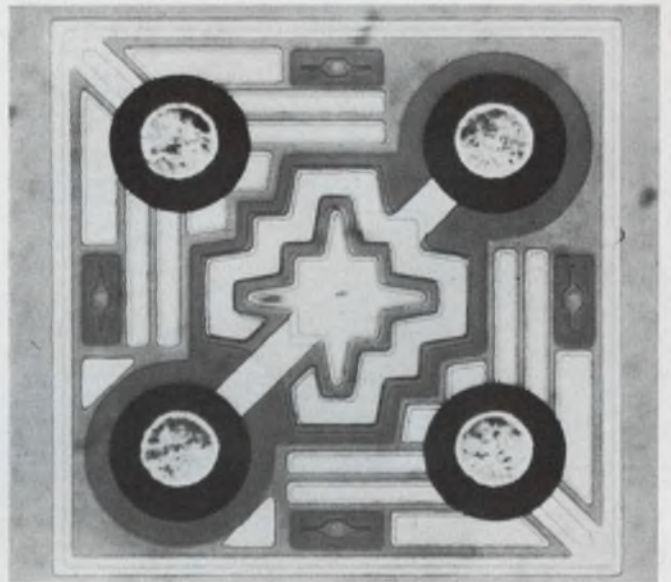

**Hybrid dc op-amp** has  $\pm 36$ -V output range,  $\pm 20$ -V input common-mode range. Page 94

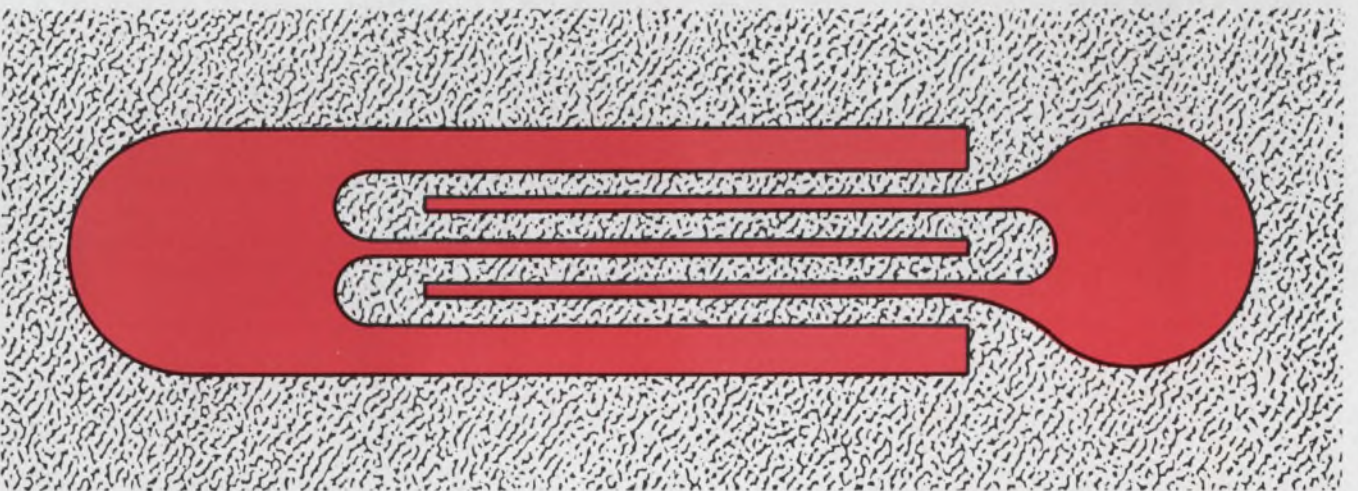

**Silicon microwave npn transistors** in strip-line package cover 0.06 to 4 GHz. They provide

solid-state retro-fits in paramp, tunnel diode and TWT applications. Page 84

## Also in this section:

**Semiconductor strain-gage transducer** goes to  $-320^{\circ}\text{F}$  with 0.01% accuracy. Page 92

**Teflon-laminated copper strips** provide flexible PC jumpers. Page 95

**Five-watt cw ionized argon laser.** Page 98



## 2N4080 PNP UHF Amplifier: $f_T = 1\text{KMc}$ minimum

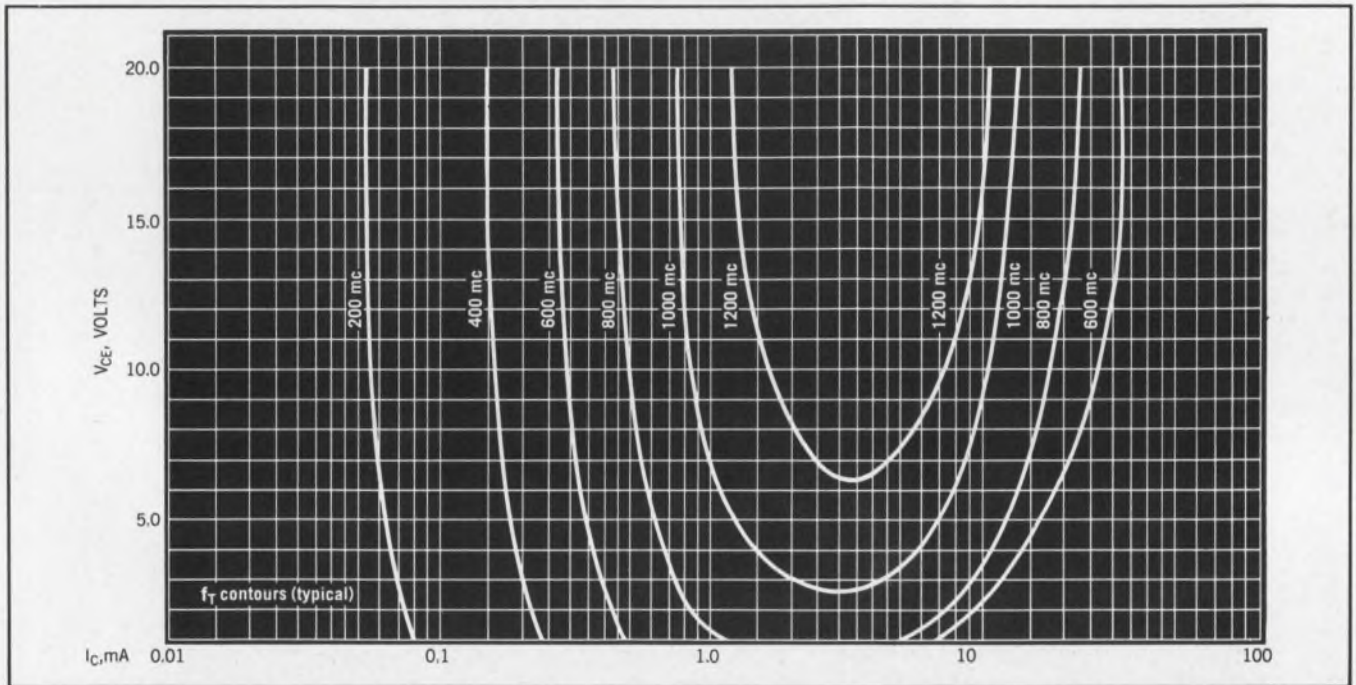

**High performance complement to the 2N918.** Now you can get PNP high frequency transistors for your VHF-UHF amplifiers, oscillators, and non-saturating switch requirements. Raytheon's 2N4080 is designed to deliver a minimum of 15db in 200 Mc class A amplifier circuits or switch in less than 10 nanoseconds turn-on time in non-saturated switching circuits. The 2N4080 is the high performance complement to the 2N 918 NPN amplifier.

**Other new additions to Raytheon's broad line of PNPs.** Now, from Raytheon, you can get 80-volt PNP transistors for general purpose applications. Type 2N3494 is an 80-volt transistor designed for ampli-

fier and switching applications up to  $\frac{1}{2}$  ampere levels.

**High Current Core Drivers.** Types 2N3244 or 2N3467 are suitable for fast switching applications at current levels up to one ampere. These devices are being widely used in military and space applications.

**Proven reliability of every type.** Raytheon manufactures all 2N4080s—and all PNPs—under its exclusive Mark XII reliability program which provides complete lot traceability to the silicon ingot. And all Raytheon PNPs are of PLANEX\* silicon planar design, utilizing Channelstopper™ construction to eliminate channeling problems.

\*PLANEX—Raytheon's designation for planar epitaxial

2N4080 TYPICAL DATA					
	Conditions	Minimum	Typical	Maximum	Unit
$BV_{CEO}$	$I_C = 3\text{mA}$	-15	-25		Volts
$C_{ob}$	$V_{CB} = -10\text{V}$		1.0	1.7	pf
$G_{pE}$	$V_{CC} = -5\text{V}$ $I_C = 1\text{mA}$ $f = 200\text{mc}$	15	18		db
$C_{ib}$	$V_{EB} = -0.5\text{V}$		1.3	2.0	pf
$N_F$	$V_{CE} = -5\text{V}$ $I_{CC} = 1.0\text{mA}$ $R_F = 5\Omega$ $f = 200\text{mc}$		4.5	6	db

Send reader service card for all PNP data sheets. Or write for information: Raytheon Company, Components Division, 141 Spring Street, Lexington, Massachusetts 02173.



# NEW TEC-LITE ELECTRONIC KEYBOARD SYSTEM...

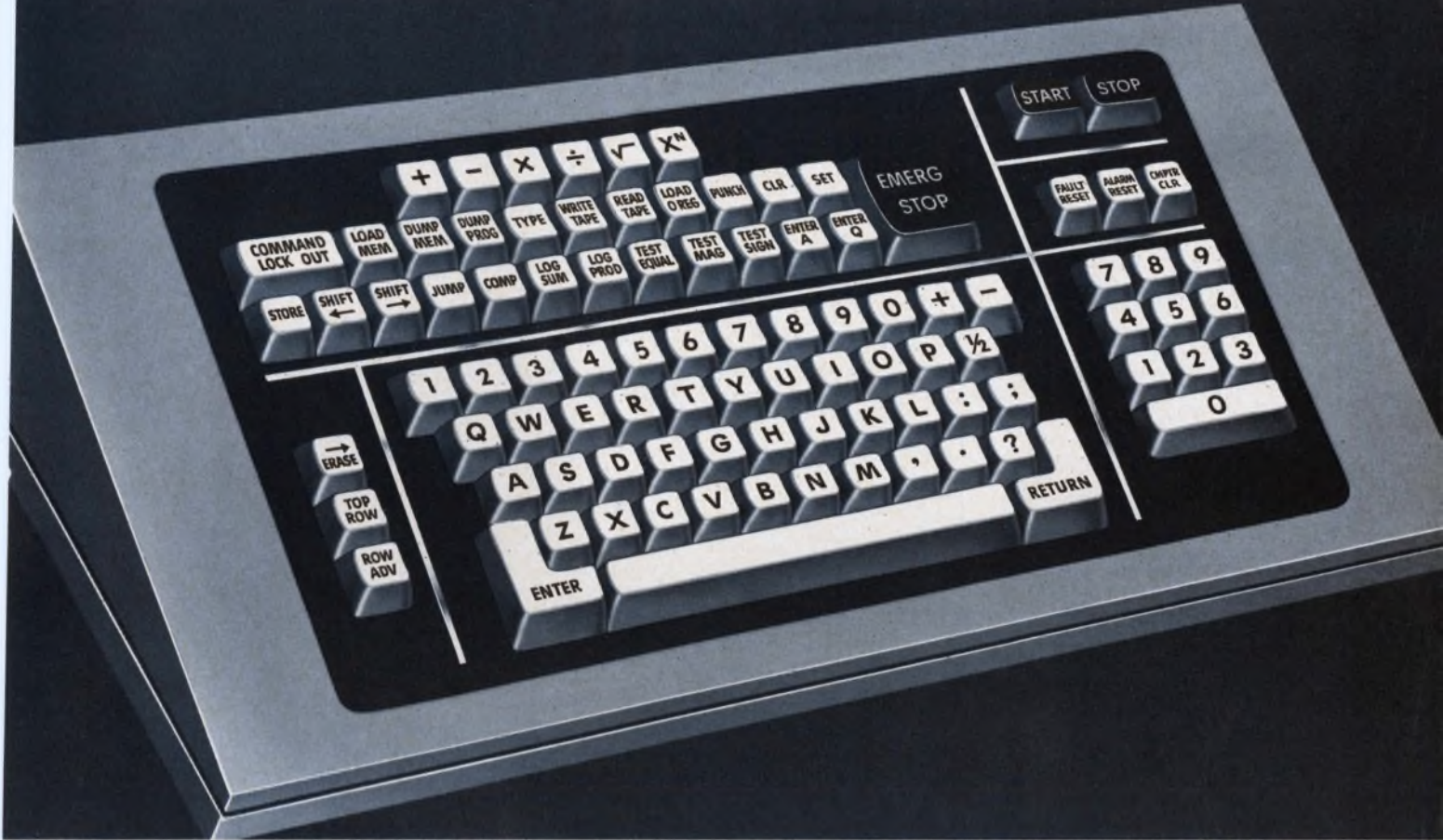

## NOW YOU CAN HAVE A COMPLETELY UNINHIBITED KEYBOARD SYSTEM... CUSTOM DESIGNED for FUNCTION AND STYLE

**Far cry from conventional keyboards!** Here's a completely new, completely flexible data entry and control device which can be incorporated into any computer or industrial control system.

The new TEC-LITE Electronic Keyboard System can generate any code up to eight levels or more and, in addition, provide command controls and indicators on the keyboard console itself. Key and control arrangement is determined by your requirements.

Compact, simple . . . fast. The new TEC-LITE Electronic Keyboard System features pulse or momentary key switches virtually identical in feel and action to electric typewriter keys. Pulse switches *make and break* on the downstroke. Typing speed can be as fast as the operator's normal typing ability. No mechanical linkage to cause jam-ups or noise.

When custom designed, the new TEC-LITE Electronic Keyboard System is built for your particular system, both electrically and mechanically. Its keys can be styled to complement your console design. From stock you can select standard typewriter or 10-key keyboards compatible with popular computer languages. Keyboards can be mounted in desk tops, rack mounted or be portable.



**Key to the TEC-LITE Electronic Keyboard System** is this snap action SPDT pulse or momentary switch which virtually duplicates the feel and travel of electric typewriter key action. Two key styles are standard . . . special styles, including most button designs offered on electric typewriters, are available. The molded plastic body mounts on .750 x .780 centers, minimum. Standard terminals provide for solder-mounting on printed circuit boards or solder-plated, quick-connect types, with other terminals also available. Switch life is 1,000,000 operations, minimum. Operating force is 2.5 ( $\pm .5$ ) ounces, with other pressures optional. Button travel is 5/32" and the switch will withstand a 50-pound downward force.

Write for complete information about the versatile TEC-LITE Electronic Keyboard System and individual Keyboard Switches.

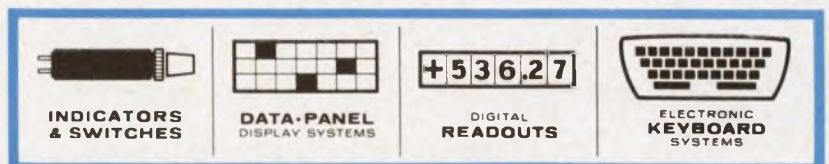

## Transistor Electronics Corporation

Box 6191 • Minneapolis, Minnesota 55424 • Phone (612) 941-1100

ON READER-SERVICE CARD CIRCLE 69

**How do you evaluate audio oscillators?**

**How can you be sure of the right selection for your particular application?**

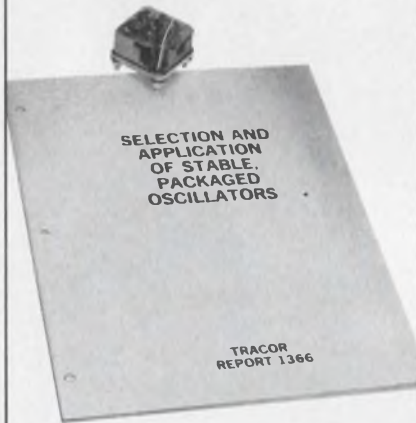

TFA-1066

**TRACOR® has an answer**

"Selection and Application of Stable, Packaged Oscillators" is a comprehensive two-part report. Section I outlines the availability of standard oscillators in the 0.5% to 0.0001% accuracy range. Section II offers guidelines for choosing a specific oscillator.

The report is free from TRACOR.

Whether or not you want a copy, may we help you evaluate oscillators in your next application?

TRACOR, Inc.  
General Sales Offices  
6500 Tracor Lane  
Austin, Texas 78721



REPRESENTATIVES IN PRINCIPAL CITIES

ON READER-SERVICE CARD CIRCLE 29

SEMICONDUCTORS

**Npn goes to 6 GHz, vies with paramp, tunnel diode and TWT**

Silicon transistors have taken a step upward in both frequency and power output capabilities. Improvements in photo-techniques enable the double-diffused, interdigital npn K5010 to span 0.06 to 4 GHz as an amplifier. Noise figure is 3 dB at 1 GHz. The K5010, with a maximum frequency of oscillation at 6 GHz, is designed for parametric amplifier, tunnel diode and traveling-wave-tube applications.

The continuing development of photolithographic techniques made fabrication of these uhf amplifiers possible. Problems which have been overcome are particle size in the photoresist, availability of suitable photoresist glass masks, the obtaining of developing solutions capable of reproducing fine lines and the development of metal etch techniques for contact area definition. Limitations on high-frequency performance still exist in the area of packaging techniques.

As a result of the improved photoresist techniques, base spreading resistance ( $r_{bb}'$ ) does not exceed 6  $\Omega$ . Collector-to-base feedback capacitance ( $C_{bc}'$ ) is  $250 \times 10^{-16}$  F and

the resistance-capacitance product is 3 picoseconds.

Noise figure is 1 dB at 60 MHz, 1.4 dB at 450 MHz and 3.0 dB at 1 GHz.  $V_{CBO}$  is 25 V max,  $V_{CEO}$  is 12 V max and  $V_{EBO}$  is 2.5 V max. Typically,  $h_{FE}$  is 100 at 3 mA and 1 V. Output capacitance is 0.8 pF. Typical small-signal gains are 13 dB at 1 GHz and 7 dB at 2 GHz. Power gain extends to 24 dB at 400 MHz. Power dissipation is 150 mW at 25°C ambient, derating at 1.72 mW/°C for 25°C case and 1.14 mW/°C for 25°C ambient. Operating junction temperature is 200°C max and storage temperature ranges from -55 to 200°C.

Base and emitter of the K5010 have 0.1-mil line widths. The device is mounted in a four-lead stripline package, with the fourth lead connected to the case for grounding and shielding purposes. All active elements are isolated from the case.

P&A: \$400 (1 to 9), \$320 (10 to 49), \$280 (50 to 99), \$200 (100 to 999); stock. KMC Semiconductor Corp., Parker Rd., RD. 2, Long Valley, N. J. Phone: (201) 876-3811.

Circle No. 252

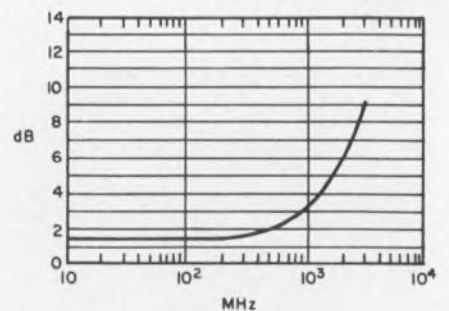
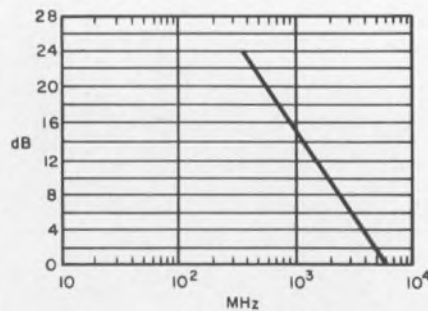

Power gain and common emitter noise figure as a function of frequency of 25°C.

**Silicon rectifiers**

Four new silicon rectifiers, 2000-V PIV through 5000-V PIV, feature recovery times of less than 300 ns. High voltage and current permit operation in high frequency applications such as inverters, ultrasonic generators and power supplies. The

rectifiers have been designed to meet all applicable requirements of MIL-S-19500, and are of avalanche construction so that no matching is required.

Slater Electric Inc., 45 Sea Cliff Ave., Glen Cove, N. Y. Phone: (516) 671-7000.

Circle No. 253

AC metrology will never be the same after the Fluke 931A, the first true rms differential voltmeter. Measure the precise rms value of virtually any waveform within 0.05% from 30 Hz to 50 KHz. Overall frequency response is 10 Hz to 1 MHz. Range is 0.01 to 1100 volts. Ten to one crest factor accounts for effects caused by voltage spikes and pulse trains. Comes with or without probe. Both line or combination line/rechargeable battery powered versions are offered. Base price is \$895.

The new Fluke Model 931A True RMS Differential Voltmeter yields accurate rms measurements of any waveform which previously could be made only by ac to dc comparison with a thermal transfer standard. Other features include high input impedance, in-line digital readout (lighted decimal), solid state design, and linear recorder output.

The null meter indicates percent deviation from the dialed voltage.

Ten percent overranging minimizes range changing.

Battery operation gives ideal isolation from ground loops.

Model 931A meets MIL-SPEC shock and vibration requirements.

For complete information, please call your Fluke Sales Engineer or write.



FLUKE • Box 7428, Seattle, Washington 98133 • Phone: (206) 776-1171 • TWX: (910) 449-2850

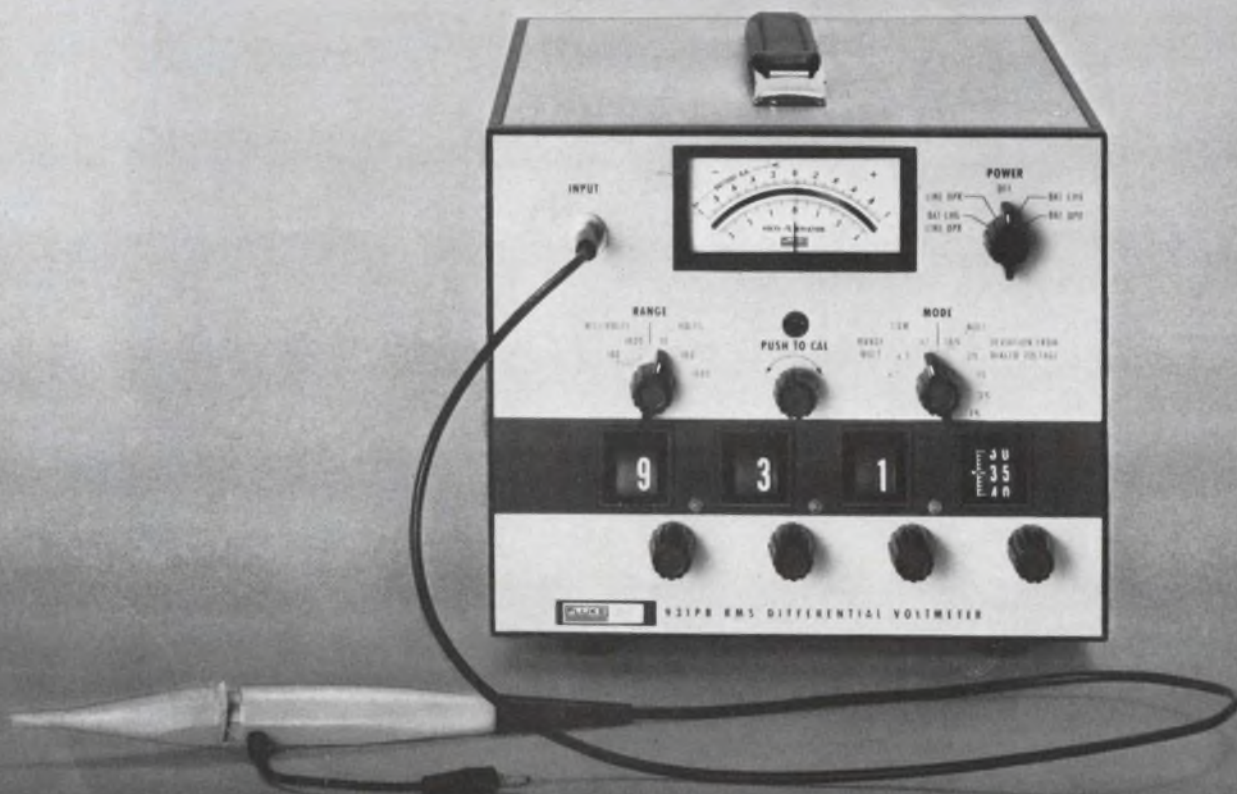



# Eliminate

your cable assembly problems. Let Times take over.



Here's what happens when Times takes on the job of getting your cable assembly problems off the ground: 1) Discussion of the problem. We'll find out quickly what can and cannot be done. 2) Quick delivery of a prototype and evaluation. 3) Specs written and 4) production started.

We have the staff and facilities to solve your problems—from design through manufacture. And the know-how to answer questions like:

How to achieve VSWR of 1.05 across C-Band. What is the phase temperature coefficient of RG-142B/U and RG-214/U. How to achieve 2% balance in a balanced transmission line. A computer cable with MTBF of 10<sup>6</sup> hours. A cable with a delay of 80 nanoseconds per foot. An adjustable HF delay line. A flexible cable with 30 db/100 ft. loss at 10 gigacycles.

For immediate assistance you are invited to call and discuss your problems with our Product Engineers, and to send for our helpful Assembly Design Check List.

Send for free catalog.  
Write or call our Product  
Engineering Department



**TIMES**  
**WIRE & CABLE**  
Wallingford, Conn.

A division of The International Silver Company

ON READER-SERVICE CARD CIRCLE 30

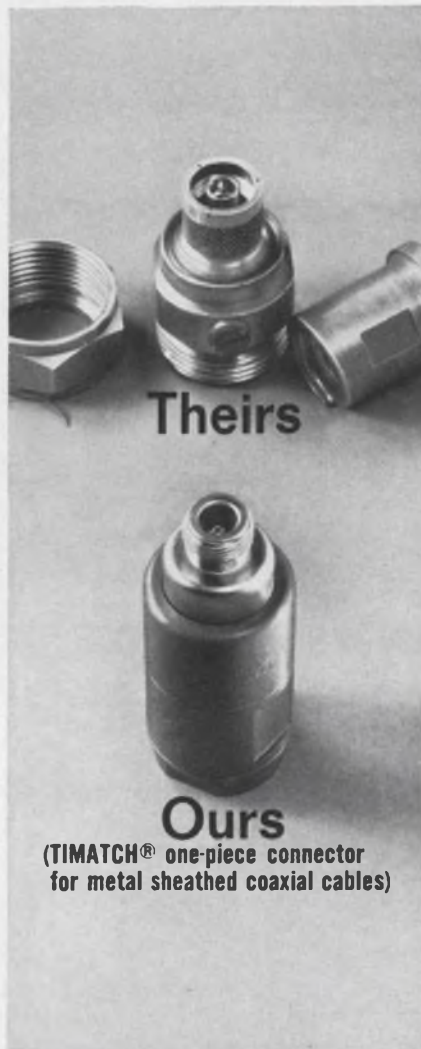

Theirs

Ours

(TIMATCH® one-piece connector  
for metal sheathed coaxial cables)

Who needs a kit when you have everything you need in Times one-piece Timatch Connector with its exclusive built-in CoilGrip® Cable Clamp?

To install, just slip the connector on the cable in a simple one-step operation. Absolutely no assembling required. You can use the Timatch Connector over and over again — it disconnects just as easily — without impairing either the RF or physical characteristics of connector or cable.

Timatch offers uniform mechanical and electrical characteristics and long-term reliability... *matching the life of the cable itself.* It's a major advance in the connector field that virtually makes all other connectors and kits obsolete. So why do it the hard way when Timatch makes it so easy?

Write for full data on Timatch connectors to TIMES WIRE & CABLE.

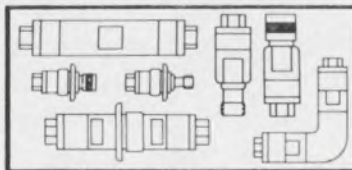

**TIMES**  
**WIRE & CABLE**  
DIVISION OF THE INTERNATIONAL SILVER CO  
Wallingford, Conn.

ON READER-SERVICE CARD CIRCLE 31

## SEMICONDUCTORS



### 240-A silicon rectifier

A 240-A silicon rectifier with a ceramic seal is designed for 1000- to 2400-V applications. Type 790 rectifier has compression-bonded encapsulation and can withstand a 4500-A one-cycle surge. The elimination of brazing and soldering makes the device thermal fatigue free. The ceramic seal effectively lengthens the path for any leakage current across the rectifier.

Westinghouse, Youngwood, Pa.  
Phone: (412) 925-7272.

Circle No. 254

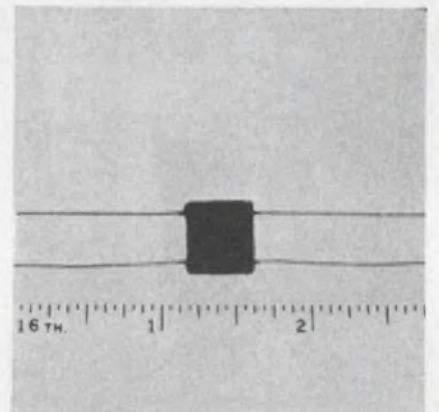

### GaAs Schottky quad

At 10  $\mu$ A this 4-diode bridge has a breakdown voltage of 6 V min. Leakage current at -3 V is 50 mA max. Total capacitance is 4 pF max and carrier lifetime is 150 ps max. All diodes in the quad are matched at three points to within 20 mV of the forward voltage levels specified. The capacitance of the diodes is matched to have a spread of 0.2 pF max.

P&A: \$36.90 (1 to 99); 10 days.  
International Semiconductor, Inc.,  
1 Charles St., Newburyport, Mass.  
Phone: (617) 465-9302.

Circle No. 255

ON READER-SERVICE CARD CIRCLE 225 ▶

Within this temperature range Indiana General TC-7 has the most linear temperature coefficient of inductance of any standard ferrite material available. It also has the highest "Q", lowest loss, and the greatest stability over a long period of time. TC-7 is the perfect material for use in filters, oscillators, and tuned circuits using fixed or adjustable in-

ductors and transformers at frequencies ranging from audio through the high frequency range (500 KC).

TC-7 is not just another laboratory ferrite. It is available in sample quantity orders and production runs in a wide range of cup core sizes including the International Series. TC-7 cup cores are also available with complete trimmer assem-

blies, bobbins, and bracket assemblies.

If you'd like sample cores to test yourself, or technical bulletins listing standard core sizes and assemblies, write Mr. Ken Talbot, Manager of Sales, Indiana General Corporation, Electronics Division/Ferrites, Keasbey, New Jersey.

**INDIANA GENERAL** 

**You can tempt it from  $-40^{\circ}\text{C}$  to  $+60^{\circ}\text{C}$  but our TC-7 ferrite won't stray from the straight and narrow**



# Let Bulova solve your servo problems!

You've got more important things to do.

Bulova makes servo products faster, better, and at less cost than anyone! It's our business.

Don't take your engineers off vital programs to home-brew! Developing your own electronic components to meet servo system requirements wastes time, money and key men, while chances are Bulova's group of engineering specialists have already tackled—and solved—a problem similar to yours.

Bulova offers a full line of solid-state electronic servo products—off-the-shelf or custom designed: servo amplifiers • resolver booster ampli-

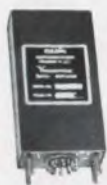

fiers • modulators • demodulators • quadrature rejection amplifiers • pre-amplifiers • isolation amplifiers • variable-gain amplifiers • two-speed switching amplifiers • DC torque amplifiers.

What's more, you get prototypes as fast as you need them, and production units to your schedule! Write for complete specifications. Address: Dept. ED-18

## BULOVA SERVO PRODUCTS

ELECTRONICS DIVISION  
OF BULOVA WATCH COMPANY, INC.

61-20 WOODSIDE AVENUE  
WOODSIDE, N.Y. 11377, (212) DE 5-6000

ON READER-SERVICE CARD CIRCLE 32

## COMPONENTS



### Low drift op-amp

Low level dc signals in integrators, ramp generators, logarithmic amplifiers, current-to-voltage converters and photocell amplifiers require low offset current and current drift. By sacrificing bandwidth in model 108, current drift is reduced to 0.3 nA/°C and input impedance raised to 500 MΩ. Actual offset current and drift at each input are ±2 nA max at 25°C, ±0.3 nA/°C and ±0.3 nA/% supply voltage coupling. Differential offset current drift is 0.1 nA/°C. Input impedance is 4 MΩ differential and 500 MΩ common mode. Open loop dc gain is 94 dB. Full output (±10 V, 2.5 mA) frequency is 2 kHz. Voltage drift is -20 μV/°C and supply voltage coupling is ±20 μV/%. Common mode rejection rating is 20,000:1, input noise is 4 μV and common mode rating is -10 V. Bandwidth is 500 kHz.

P&A: \$35; stock to 2 wks. Analog Devices, 221 Fifth St., Cambridge, Mass. Phone: (617) 491-1650.

Circle No. 256



### Metal film resistors

Available in values from 1 to 150 MΩ and 1/4 to 2 W, these metal film resistors have a temperature coefficient of 150 ppm/°C max over the entire range. Applied voltage effect is negligible. Load life is 0.5% max after 1000 hours. Shelf life is 0.25% max.

Welwyn International Inc., 811 Sharon Dr., Westlake, Ohio. Phone: (216) 871-7980.

Circle No. 257



### Mercury-wetted relay

For PC board applications, this mercury-wetted contact relay occupies 0.332-in.<sup>3</sup>. Either bridging or non-bridging contacts handle switching from low level to 100 VA, ac or dc, at billions of operations. Contact resistance is 20 mΩ max and operate time is 1.0 ms at maximum coil power. The relay can be driven by low power logic circuitry with a power gain of up to 5000 and can stand off a hi-pot voltage of 1000 Vac.

C. P. Clare & Co., 3101 Pratt Blvd., Chicago, Phone: (312) 262-7700.

Circle No. 258



### Zero speed switch

This zero speed switch performs an alarm-switching or equipment shutdown function used when the speed of a rotating shaft approaches zero. In conjunction with a magnetic pickup and sensed gear on the rotating shaft, the zero speed switch provides internal relay switching when the gear peripheral speed reaches 1 in./s. Power requirements for the AMS99 are 115 V rms, 50 to 400 Hz or 12 Vdc.

P&A: \$90; stock. Airpax Electronics Inc., P. O. Box 8488, Fort Lauderdale, Fla. Phone: (305) 587-1100.

Circle No. 259



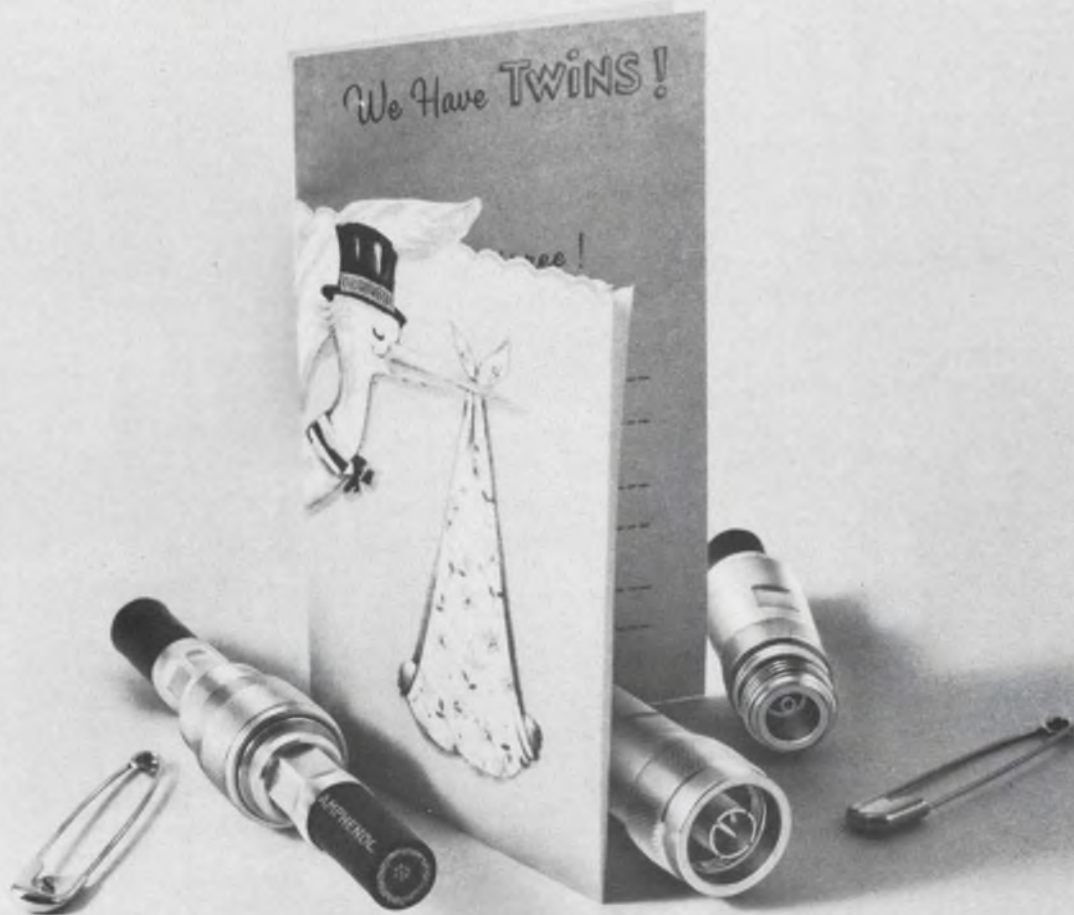

## Meet Amphenol MIL-Crimp\* and MIL-Clamp\* — new electrically identical "N" connectors

Now you can specify a crimp or field-serviceable connector and get the same superior electrical performance.

**INTERCHANGEABLE.** Amphenol MIL-Crimp (crimp version) and MIL-Clamp (field-serviceable version) have identical electrical characteristics and cable stripping dimensions. They can be used interchangeably in prototype, production or field applications. Now you can obtain well-known crimp assembly cost savings and if necessary, replace a MIL-Crimp with a MIL-Clamp connector without special tools.

**EASY TO ASSEMBLE.** No combing of the braid is required.

(MIL-Clamp is the first field-serviceable "N" connector to eliminate this step.) One tool performs all crimps on Amphenol MIL-Crimp "N" connectors.

**COMPLETE SELECTION.** Amphenol MIL-Crimp and MIL-Clamp come in the following configurations: plug, angle plug, jack, panel jack and bulkhead jack . . . panel and bulkhead receptacles, too. All competitively priced and sized to match a broad range of cable diameters.

**MIL-C-39012.** Tests conducted in Amphenol's laboratory indicate that these connectors comply fully with the performance requirements of MIL-C-39012, for

Class II type "N" connectors. Test data is available upon request.

Military specification	MIL-C-39012 Class II
VSWR	1.35 max from 0.5 to 10 GHz
Insertion loss	.05 db maximum at 10 GHz
RF leakage	at least 90 db down at 3 GHz
Dielectric with- standing voltage	2,500 volts rms at sea level

For complete technical data on MIL-Crimp and MIL-Clamp "N" connectors, call an Amphenol Sales Engineer. Or write Amphenol RF Division, 33 E. Franklin St., Danbury, Conn. 06810

\* Trademark



**AMPHENOL RF DIVISION**  
AMPHENOL CORPORATION

Specify Amphenol . . . the leading name in cable, connectors, assemblies, RF switches, potentiometers, motors, microelectronics

ON READER-SERVICE CARD CIRCLE 71

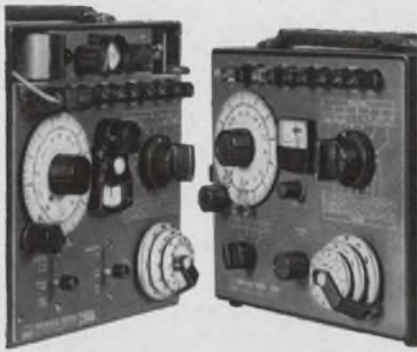

## The old master has met its match.

For more than twelve years, our 250 DA Universal Impedance Bridge ruled supreme in its field. No instrument could match its measurement performance.

Now along comes a serious challenger—our new 250 DE (at right). It has all of the reliability and accuracy of the classic model. As you can see, they look alike from the outside.

But inside, we've made many improvements. The new 250 DE is completely self reliant on its four flashlight batteries. It has a new solid-state detector with greatly improved sensitivities: better than 20 microvolts on DC, 10 microvolts on AC. For simplicity, there is a single meter null detector on the front panel. And for versatility, some useful front terminals have been added.

Why did we improve on the old master when it has delighted so many thousands with its performance in countless plants, laboratories and schools? Well, we figured eventually somebody would make a truly portable impedance bridge even better than the 250 DA. And we wanted it to be us. ESI, 13900 NW Science Park Drive, Portland, Ore. (97229).

### 250 DE Portable Universal Impedance Bridge Specifications

#### Range:

Resistance: 0 to 12 Megohms  
 Capacitance: 0 to 1200 Microfarads  
 Inductance: 0 to 1200 Henrys  
 Resistance: 0.1% + 1 dial division  
 Capacitance: 0.2% + 1 dial division  
 Inductance (Series and Parallel):  
 0.3% + 1 dial division  
 Sensitivity: Better than 20 microvolts DC, 10 microvolts AC  
 Frequency: 1 kc internal  
 (External terminals provided.)  
 Batteries: 4 D size flashlight batteries provide 6 months of normal service.  
 Weight: 12 lbs. Price: \$470.00

Note: The 250 DA features exactly the same accuracy specifications as the 250 DE. However, the 250 DA is AC line-operated. Price: \$495.

Electro Scientific Industries **esi**

See ESI at WESCON—Hollywood Park—  
 Booth numbers 401-402-403 and 404

## COMPONENTS

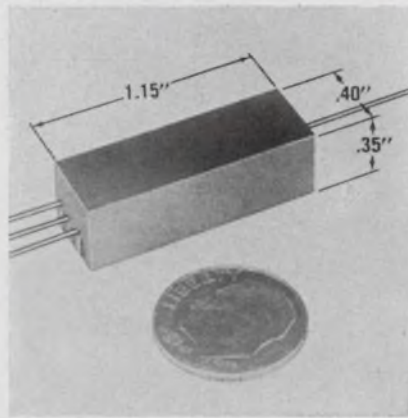

### Sp-NO reed relay

Capable of handling 0.125 A at 32 V for  $5 \times 10^6$  operations, this axial reed relay measures 1.15 x 0.4 x 0.35 in. Lead termination lengths (1/2-in. min) are staggered. Operating sensitivity is 150 mW. The unit is rated at 48 V at 30° C. With rhodium contacts the initial contact resistance is 60 to 100 mΩ. Operate time is 1 ms including bounce with release time of 0.5 ms. Reed sensitivity of 30 mW can be specified for pick up between 30 and 100 A turns with drop out from 45% to 55% of pick up.

Essex Wire Corp., 131 Godfrey St., Logansport, Ind. Phone: (219) 6121. *Circle No. 260*



### Differential amplifiers

Adjustable gain of 100 to 500 and zero offset of  $\pm 2.5$  V are offered in two differential amplifiers. Common mode rejection is 80 dB min  $\pm 5$  Vdc. Gain and zero stability is 0.025%/°F. Frequency response is dc to 10 kHz (flat  $\pm 1$  dB). Output voltage is 10 V p-p into 1 kΩ.

Price: \$440 (CB-50A), \$485 (CB-50AS). Nytron, Inc., 795 San Antonio Rd., Palo Alto, Cal. Phone: (415) 327-0490. *Circle No. 261*



### Directional coupler

For use from 30 kHz to 2 MHz, this directional coupler has a 0- to 5-W power range. Dc output, proportional to forward power, is 50  $\mu$ A into 5 kΩ. Impedance is 50 and 75 Ω, directivity is 30 dB min and accuracy is  $\pm 5\%$ . RF connector is N, UHF, C or BNC. Power ranges up to 1 kW are available with 50- to 200- $\mu$ A dc output.

Bayly Engineering Ltd., Hunt St., Ajax, Ontario. Phone: (705) 942-1020. *Circle No. 262*

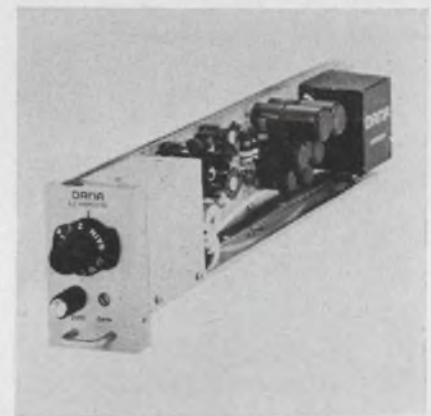

### Galvo driver

Front-panel gain settings from 0.1 to 25 enable this amplifier to use high-level and medium-level transducers in a single standardized data-gathering network. At 10-kHz, output impedance is 5 Ω max. Output is  $\pm 13$  V peak and 150 mA. The amplifier can withstand 20 V max across the input leads. Phase shift is 1° max from dc to 400 Hz. Linearity varies from 0.05% at dc to 0.2% at 3 kHz. Small-signal bandwidth at 3 dB is 50 kHz min. Overload recovery is 500  $\mu$ s and step-function settling time is 100  $\mu$ s.

Dana Laboratories, Irvine, Cal. Phone: (714) 833-1234. *Circle No. 263*

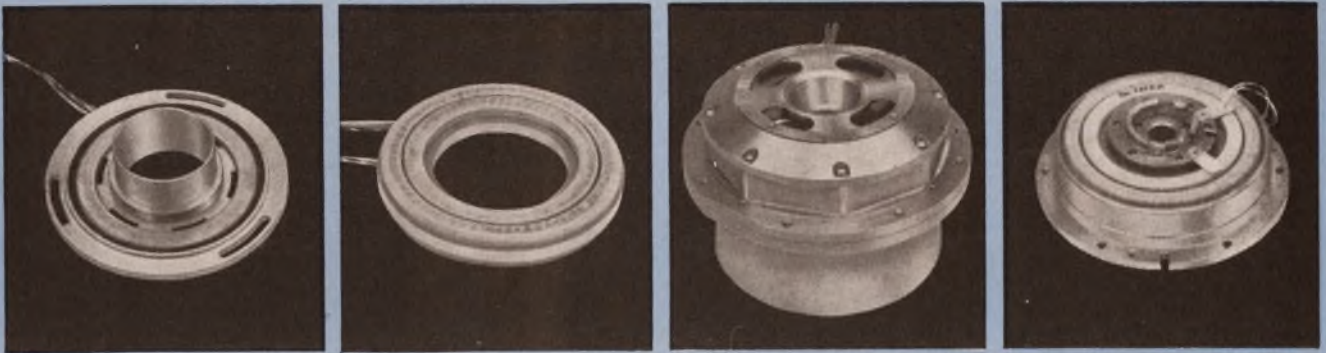

cppe

# Multispeed Gimbal Pickoff Synchros

Small quantities now available in 60 days

The table below shows a small sample of the multispeed pickoff units produced by CPPC for such high reliability programs as Apollo, SIDS, Titan, Pace.

The data listed below are representative of the input/output parameters that we have supplied to meet customer requirements. The accuracies reflect the maximum errors allowed. Clifton units usually are well below these specified maximums.

The outline dimensions given in the table are applicable to rotor-stator combinations; although, as the photographs on this page show, our multispeed units are usually supplied in housings.

If you have a requirement for a high accuracy, high

reliability multispeed component, contact CPPC Sales Engineering for additional information.

Clifton Precision Products, Division of Litton Industries, Clifton Heights, Pa., Colorado Springs, Colo. 215 622-1000, TWX 215 623-6068.

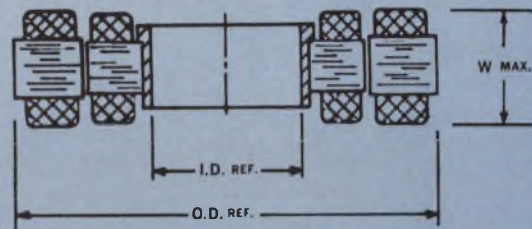

## CLIFTON Multispeed Gimbal Pickoff Synchros and Resolvers

Function	Input	Primary	Common Input Impedance	Output Imp., Prim Shorted		TR & Phase Shift		Accuracy		Dimensions		
				1x	Nx	1x	Nx	1x	Nx	I.D.	O.D.	W.
1x, 8x Resolver	26v 800-	Rotor	85 + j190	100 + j20	20 + j15	.220 - 9°	.220 - 24°	10'	1'	1.437	2.687	.500
1x, 15x Synchro	26v 400-	Rotor	105 + j165	150 + j25	160 + j130	.390 - 21°	.390 - 47°	10'	20"	1.500	3.400	.600
1x, 16x Resolver	28v 800-	Rotor	175 + j600	200 Max	100 Max	1.00 - 4°	.179 - 12°	2'	20"	1.687	3.687	.675
16x Resolver	28v 800-	Stator	40 + j350	-	450 + j800	-	1.00 - 6°	-	20"	1.687	3.687	.675
1x, 32x Resolver	15v 3200-	Rotor	100 + j300	100 Max	350 Max	.333 - 3°	.333 - 13°	10'	15"	2.187	3.750	.500
1x, 16x Resolver	28v 800-	Rotor	165 + j600	175 + j100	100 Max*	1.00 - 3.5°	.179 - 12°	4'	20"	2.187	4.000	.610
36x Resolver	28v 800-	Stator	120 + j200	-	230 + j200	-	.300 - 28°	-	8"	1.400	3.500	.850
1x, 64x Resolver	28v 4800~	Rotor	70 + j220	70 + j45	80 + j120	.400 - 2°	.270 - 15°	30'	7"	2.250	4.000	.700
64x Resolver	28v 800-	Rotor	260 + j200	-	350 + j260	-	.179 - 55°	-	5"	2.250	4.000	.700

cppe

**CLIFTON** PRECISION PRODUCTS  
DIVISION OF LITTON INDUSTRIES



Speed Inquiry to Advertiser via Collect Night Letter  
ON READER-SERVICE CARD CIRCLE 34

# Engineered for Non-Engineers\*

*\* (but don't let that fool you)*



*Compack controllers fit admirably into highly technical applications, despite their essential simplicity. Indeed, engineers appreciate them most.*

Compacts are self-contained controllers, ready for quick connection to any *unamplified* signal—AC, DC or temperature (thermocouple). They are easy to design into equipment, small in size and price.

Pyrometer models are available in popular temperature ranges between  $-450^{\circ}\text{F}$  and  $4000^{\circ}\text{F}$ , with choice of On/Off, Time Proportioning and SCR Driver output. They have electrical cold junction compensation—for better control and accuracy than bimetal. Cycle time, PR band and compensation for external resistance are all adjustable.

Non-temperature models begin with full scale ranges of 0-5 microamperes or 0-5 millivolts DC and go up to 0-50 amperes and 0-500 volts DC. Positive non-chatter operation at set point.

## Pyrometers and Others in Stock

These popular models of Compacks I and II may be ordered from stock.

### Pyrometer Models:

Compack I—On/Off (single or double set point) or Time Proportioning, Model 503-K ( $4\frac{1}{2}$ "") and Model 603-K ( $5\frac{1}{2}$ ""): 0 to 300, 500, 1000,  $2000^{\circ}\text{F}$ .  
Compack II—On/Off or Time Proportioning, Model 371-K (edge-reading). Same ranges as Compack I.

### Non-temperature Models:

Compack I—Model 503-K ( $4\frac{1}{2}$ ""), 0-10, 0-20, 0-50, 0-100 microamperes DC, 0-1 milliamperes DC and AC, 0-10 and 0-50 millivolts DC.  
Compack II—Model 371-K, same ranges as Compack I.

Ask for: Bulletin 48 B (non-temperature)  
Bulletin 49 (pyrometer models)

# api

## INSTRUMENTS CO.

CHESTERLAND OHIO - PHONE 216-423-3131

Wescon Booth No. 337-338.

ON READER-SERVICE CARD CIRCLE 35

## COMPONENTS



## Cryogenic transducer

Doped semiconductors permit high signal levels with  $0.01\%/^{\circ}\text{F}$  accuracy over a range of  $-320$  to  $250^{\circ}\text{F}$  with this strain-gage pressure transducer. The 150-mV signal level drives meters directly while the 0.15% combined nonlinearity and hysteresis meet high accuracy requirements. Incorporated in the 1.25-in diameter steel case are overload stops. Pressure ranges are 50 to 5000 psia full scale.

Schaevitz-Bytrex, Inc., 223 Crescent St., Waltham, Mass. Phone: (617) 899-5600.

Circle No. 264

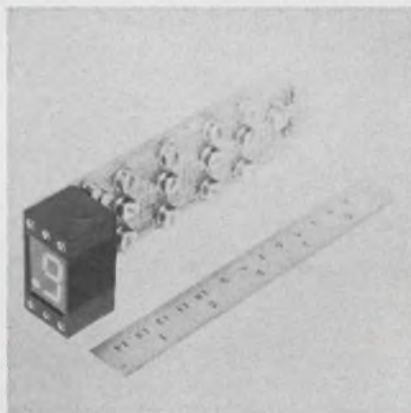

## Decade counter

With 10-line decimal or BCD output, this IC decade counter has a 3.3-V supply voltage at 120 mA for logic and 5 Vac, 60 to 400 Hz for lamps. The display has  $3/4$ -in. high numbers and decades mount on 1-in. centers. Counting speeds are dc to 3 MHz. The 3-oz unit measures  $1-11/16 \times 1 \times 5-3/4$  in.

P&A: \$66; 3 wks. United Computer Co., 930 W. 23 St., Tempe, Ariz. Phone: (602) 967-9122.

Circle No. 265

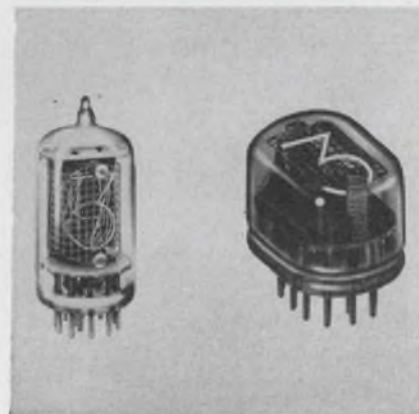

## Readout tubes

Two 10-digit readout tubes can be read at a distance of over 30 ft. The end-viewing BA-809 and the side-viewing BA-803 are both neon-glow numerical display tubes with close spacing and an integral decimal point. Operating life is 200,000 hours. The BA-803 is 2.065 in. high and the BA-809 is 1.12 in. high. Both have a character size of 0.61-in.

Baird-Atomic Inc., 33 University Rd., Cambridge, Mass. Phone: (617) 864-7420.

Circle No. 266

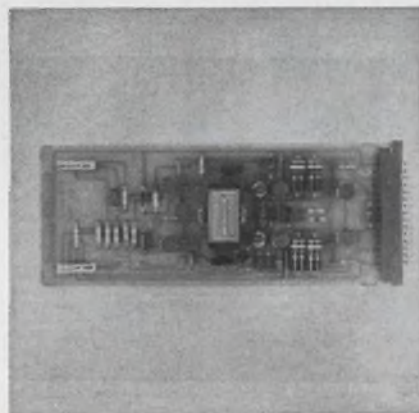

## Differential amplifier

Employing all silicon planar transistors, this dc differential amplifier has noise less than  $1 \mu\text{V}$  rms below 1 kHz and less than  $5 \mu\text{V}$  rms wide-band. Input impedance is  $1 \text{ M}\Omega$  and output impedance is less than  $1 \Omega$ . Drift is less than  $10 \mu\text{V}/^{\circ}\text{C}$  and output is  $\pm 100 \text{ mA}$  at 10 V. Adjustable gain is 50 to 500 or 200 to 2000. Common mode rejection ratio is 90 dB and frequency response is dc to 10 kHz.

P&A: \$175; stock to 2 wks. California Electronic Mfg. Co., P. O. Box 355, Alamo, Calif. Phone: (415) 932-3911.

Circle No. 267

# When the wrong relay can sink a good circuit design...

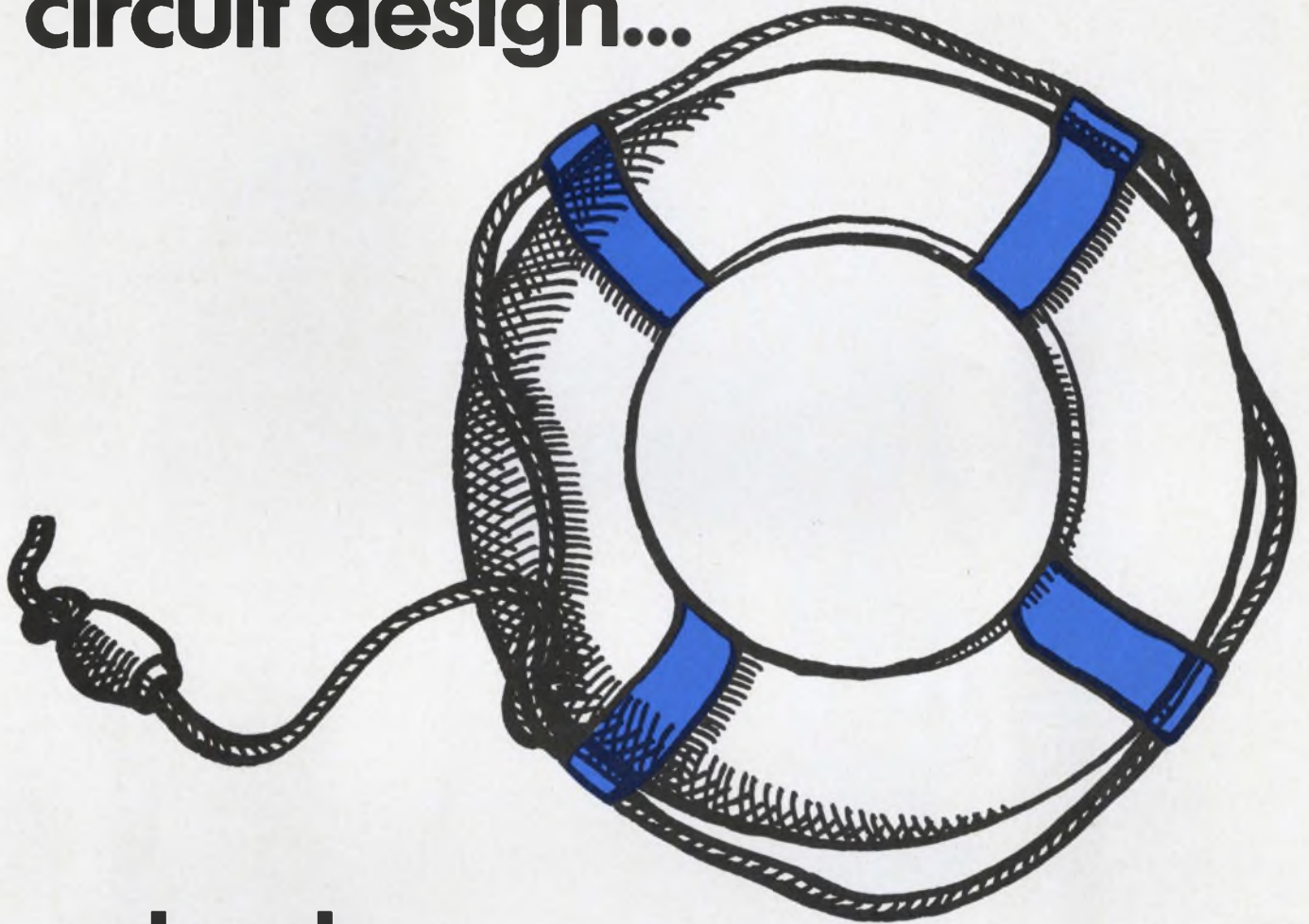

## nobody comes to the rescue like AE.

Why get scuttled by a relay that just seems OK? When you have your doubts, a call to your local AE representative can clear up the problem—quickly and effectively.

Your AE representative's training and experience have qualified him to help you pick the right relay for your application. If even more expert opinion is needed, he can call upon a staff engineer in our district office nearest you. This staff engineer has thousands of relay application experiences to help him help you.

Nobody else in the relay business can give you this kind of service. We can, because we're in the telephone

business too. We use a huge variety of relays and switches in our own equipment. So we're on intimate terms with relay capabilities—and peculiarities.

Take advantage of this AE know-how, next time you feel like hollering "Mayday." You'll find your AE representative in the Yellow Pages... under "Relays." Or drop a line to Director, Relay Control Equipment Sales, Automatic Electric, Northlake, Illinois 60164.

### **AUTOMATIC ELECTRIC**

SUBSIDIARY OF  
**GENERAL TELEPHONE & ELECTRONICS GTE**

ON READER-SERVICE CARD CIRCLE 36



### Hybrid dc op-amp has $\pm 36$ -V rating

Utilizing planar silicon transistors and nichrome resistors, this dc op-amp has an output voltage range of  $\pm 36$  V. Packaged in an 8-lead TO-5 package, the hybrid has a  $\pm 20$ -V input common-mode range.

Applications include use as a dc servo amplifier, voltage regulator, modulator-demodulator, filter amplifier, oscillator amplifier, computer amplifier and unity gain amplifier.

Input offset voltage is 0.2 V max, bias current is 2  $\mu$ A max, impedance is 100 k $\Omega$  and common mode voltage exceeds  $\pm 20$  V. Common mode rejection ratio is 80 dB. Dc open loop gain voltage gain is 600 and open loop bandwidth is 50 kHz. Output voltage exceeds  $\pm 20$  V into 40 k $\Omega$ . Unity gain bandwidth is 10 MHz. Output impedance is 5 k $\Omega$  max. Amplitude distortion is 2%.

The thin film device typically dissipates 400 mW internally.

P&A: \$28 (25 to 100); stock to 2 wks. Hughes Aircraft Co., 500 Superior Ave., Newport Beach, Calif. Phone: (714) 548-0671.

Circle No. 268

### DTL ICs

These DTL ICs have an operating range of  $-55$  to  $125^\circ$  C. Propagation delay for series 14200 gates is 25 ns and power dissipation is 7.5 mW/gate. Fan-out is 11 and dc noise margin is 1 V. The line is characterized for operation at 6 V. Single, dual, triple and quad gates and inverters with or without collector resistors are available.

Texas Instruments, 13500 N. Central Expwy. Dallas. Phone: (214) 235-3111.

Circle No. 269

## SUBMINIATURE TOGGLE SWITCHES

### SERIES 7100 / SPDT

subminiature toggle switches are among the smallest made in America! They feature rugged construction and long, dependable operation in manual switching operations involving computers, electronic testing, communications switchboards, etc.!

A COMPETITIVELY PRICED, MADE-IN-AMERICA PRODUCT!

**SERIES 7200 / DPDT** subminiature toggle switches also combine reliable performance (versatilely) with minimum weight and small size in the same wide range of exacting applications! Both Series 7100/7200 provide low contact resistance and a high capacity of 5 amperes at 115 VAC rating!

Write or call today for free descriptive literature!

**C&K**  
COMPONENTS, INC.

quality electro-mechanical products

103 Morse Street, Newton, Massachusetts 02158  
Telephone: 617 926-0800

C&K also manufactures a quality line of magnetic code converters, timers and logic elements.

ON READER-SERVICE CARD CIRCLE 37



## A-to-D converter

10 bit parallel binary output  
10 microseconds conversion time

Model ADC-10<sub>IC</sub> is a plug-in Analog-to-Digital Converter with a 10 volt input range and contains a Clock, Reference Supply, Resistor Network and Comparison Amplifier.

Also available

## D-to-A converter

10 bit strobed parallel binary input  
1 microsecond settling time  
(same size as A-to-D converter)

Model DAC-10<sub>IC</sub> is a Digital-to-Analog Converter and contains a Storage Register and high-speed Strobe System, Internal Reference Supply, Resistor Network and output Operational Amplifier.

Variations are available in input and output ranges, converting speeds, number of bits, and triggering modes.

Pastoriza also provides compatible Sample-and-Hold and Multiplexing Cards and Auxiliary Readout Equipment with self-contained power supplies to facilitate matching these units to OEM and system applications.

Write for A-to-D and D-to-A Converter literature.

 **PASTORIZA**  
ELECTRONICS, INC.

385 Elliot St., Newton Upper Falls, Mass. 02164  
(617) 332-2131

ON READER-SERVICE CARD CIRCLE 38  
ELECTRONIC DESIGN, August 2, 1966

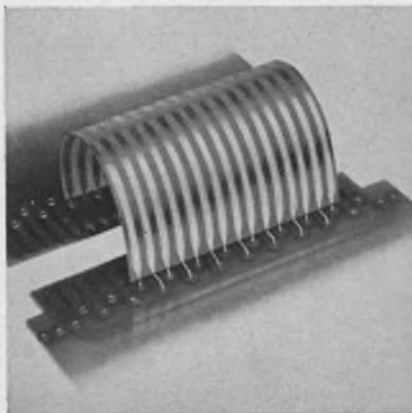

## PC board jumpers

High density flexible connections between circuit boards are provided by these jumpers. Laminated between two sheets of Teflon insulation, each conductor is one continuous piece of copper with a 0.0025 x 5-in. flat center section tapering to 0.02-in. diameter pins. Available in straight, right angle or staggered combinations, all pins terminate on 0.1-in. centers. Pins are pre-tinned to MIL-W-3861.

Price: under \$0.10 per conductor. Digital Sensors, Inc., 4127 N. Figueroa St., Los Angeles. Phone: (213) 223-2333.

Circle No. 270

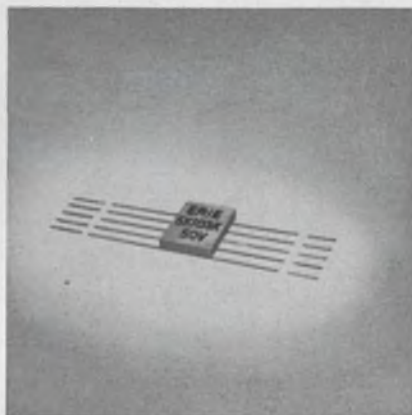

## 5-capacitor flat pack

These multiple-capacitor flat packs have five integrally fused 0.01- $\mu$ F ceramic capacitors in a 0.275-in. square x 0.1-in. pack. Each unit has its own leads permitting any combination of five capacitors for parallel or series connection. The unit is rated at 50 WVdc at 85°C. Insulation resistance is 10<sup>9</sup>  $\Omega$ .

Price: \$1.50 (1 to 49); \$0.98 (250 to 499). Erie Technological Products, Inc., Erie, Pa. Phone: (814) 456-8592.

Circle No. 271

## COMMUNICATIONS ENGINEERS

### RF ENGINEERING

ECI, a recognized leader in high performance RF communications equipment, has immediate and challenging opportunities for outstanding RF engineers.

The AN/ART-47 and AN/ARR-71, an airborne transmitter/receiver combination, typify the challenges being met at ECI. This equipment has 1 kW transmitter output, and it covers 3500 UHF channels with AM or FM duplex capability. Yet the transmitter/receiver combination occupies only 2.65 cubic feet.

Many other equally ambitious programs are in progress. They include communication equipment for satellite, airborne, shipboard and



AN/ART-47 and AN/ARR-71 transmitter/receiver combination.

ground transportable applications in voice or data link systems.

You can work on these exciting programs — and live in one of America's most desirable locations — if you are an unusually competent RF engineer. You'll need at least a BS degree, three years of appropriate experience and sound knowledge of solid-state design theory.

Find out about ECI opportunities in RF equipment design. Send your resume, in confidence, to Budd Cobb, ECI, Box 12248ED, St. Petersburg, Florida, or call him collect at (813) 347-1121. (An equal opportunity employer.)



ELECTRONIC COMMUNICATIONS, INC.  
St. Petersburg, Florida

ON READER-SERVICE CARD CIRCLE 39

# Any material that can help Western Electric cut down its phone bill must be something.

## Something called Plaskon Epoxy.

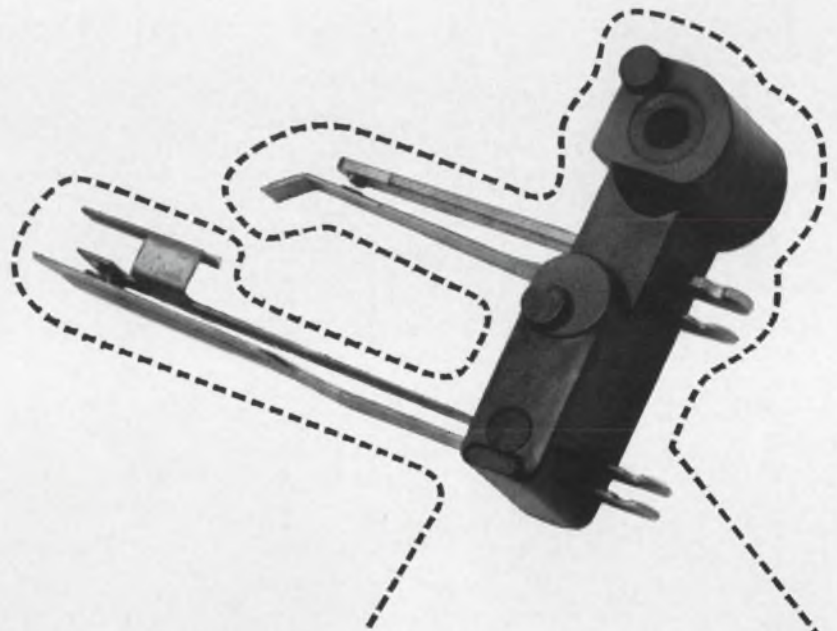

This phone dial relay switch used to be molded of soft-flow phenolic. Now it's made of a stronger, more versatile Plaskon® epoxy molding compound. Because of that, Western Electric was able to eliminate an expensive metal flange with no loss of strength. And at a substantial saving, considering the millions of parts that were made.

They were also able to use the existing molding equipment for the job.



Plaskon epoxies have excellent dimensional stability. They cure fast and shrinkage is often less than one percent. And because of great electrical insulation value, applications are numerous.

Allied Chemical has an extensive line of epoxy molding compounds, including DAP, phenolics and alkyls. Whatever your application requires, one of them should work best—and most economically. Call your Plastics Division representative for more information. Or, mail the coupon, and start saving right away.

Gentlemen:

I'd like to know more about the complete line of Plaskon epoxy molding compounds. Please send me your technical brochure.

ED-8

Name \_\_\_\_\_

Company \_\_\_\_\_

Address \_\_\_\_\_

City \_\_\_\_\_ State \_\_\_\_\_

**PLASTICS  
DIVISION**  
POST OFFICE BOX 365  
MORRISTOWN, N. J.



ON READER-SERVICE CARD CIRCLE 40

ELECTRONIC DESIGN, August 2, 1966



## TEST EQUIPMENT

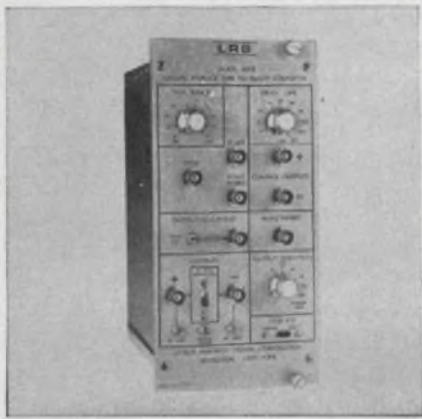

### 50-ns to 50- $\mu$ s time-to-pulse-height converter

Time interval measurements in high and low energy physics are made by this converter. Output pulse amplitude is proportional to the time interval between a "start" and a "stop" pulse. Decay time constant of the converted voltage is 1000 s min. The direct-coupled circuit has 0.1% output stability. Discriminators provide constant 50- $\Omega$  impedance  $\pm 100$  V. Stop rates are 30 MHz max without pile-up. Switch-selected analog output pulse durations range from 0.5 to 500  $\mu$ s. Inputs are protected to  $\pm 100$  V.

P&A: \$875; stock to 30 days. Le-Croy Research Systems Corp., 8 Station Road, Irvington-on-Hudson, N. Y. Phone: (914) 591-7668.

Circle No. 272

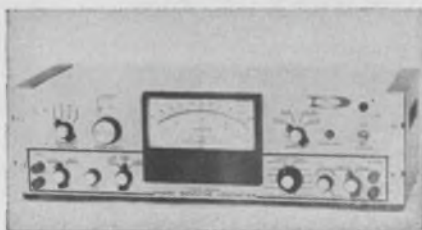

### Phase sensitive VTVM

Either a standard VTVM or a phase-sensitive VTVM, this unit has a full-scale sensitivity from 300  $\mu$ V to 300 V. The internal calibrated phase shifter covers 0 to 360°. Model 240SP incorporates isolation transformers in both signal and reference channels which may be switched in or out of the circuits. Internal filters reject the influence of noise and harmonics.

Dytronics Co. Inc., 5566 N. High St., Columbus, Ohio. Phone: (614) 885-3303.

Circle No. 273

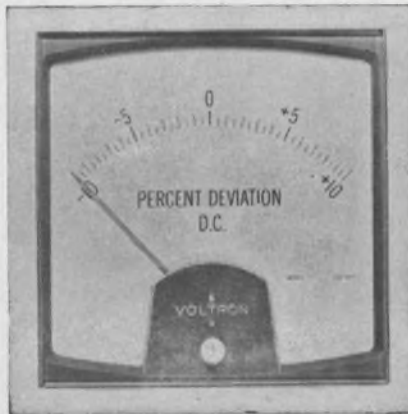

### Deviation meter

Readings of deviation from a desired voltage or current expressed in percent are made by this meter. Nominal value is programable from 0 to 1000 V by a 1000  $\Omega$ /V input resistor. Accuracy is 0.1, 0.25, or 0.5%. Meters for fixed voltages are supplied with built-in programing resistors.

Voltron Products Inc., 1020 S. Arroyo Pkwy., Pasadena, Cal. Phone: (213) 682-3377.

Circle No. 274



### Portable electrometer

A battery-powered electrometer offers 10<sup>11</sup>  $\Omega$  input resistance. Model 601 has 73 ranges for dc measurements: nine voltage ranges from 1 mV to 10 V, 28 current ranges from 10<sup>-14</sup> A to 0.3 A, 23 resistance ranges from 100  $\Omega$  to 10<sup>13</sup>  $\Omega$  and 13 coulomb ranges from 10<sup>-12</sup> coulomb to 10<sup>-6</sup> coulomb. Voltmeter accuracy is  $\pm 1\%$  of full scale, ammeter accuracy is  $\pm 4\%$  of full scale, ohmmeter accuracy is  $\pm 5\%$  of full scale and coulombmeter accuracy is  $\pm 5\%$  of full scale.

P&A: \$595; 60 days. Keithley Instruments Inc., 12415 Euclid Ave., Cleveland. Phone: (216) 795-2666.

Circle No. 275

## COMMUNICATIONS ENGINEERS

### MICROELECTRONICS

Unusual ground-floor opportunities in microcircuit design are available at ECI for engineers who have exceptional competence in this technology. An extensive capability in microelectronics has been built and continues to develop at ECI.

A UHF digital frequency synthesizer employing integrated circuits, one of the first in the industry, is an example of technical achievements recently attained at ECI. Continuing programs deal with application of microelectronic technology to multiplex, data link, and telemetry systems and with its greater exploitation in radio communications.

Immediate professional openings involve theory and application of thermodynamics, mechanics of materials and electronic component design in the development and application of microelectronic circuitry. If you have experience and career interest in these fields, plus a BS or MS in EE or physics, you can capitalize on ECI opportunities today.



1-inch microcircuit developed at ECI for UHF digital synthesizer.

For challenging assignments in microcircuit applications programs, for opportunity in an unusual professional atmosphere, and for pleasant living on Florida's "Sun Coast," Investigate ECI now.

Send your resume, in confidence, to Budd Cobb, ECI, Box 12248ED, St. Petersburg, Florida, or call him collect at (813) 347-1121. (An equal opportunity employer.)



ELECTRONIC COMMUNICATIONS, INC.  
St. Petersburg, Florida

ON READER-SERVICE CARD CIRCLE 14

# VOLTMETER WITH A MEMORY ...DC TO 20 MEGACYCLES

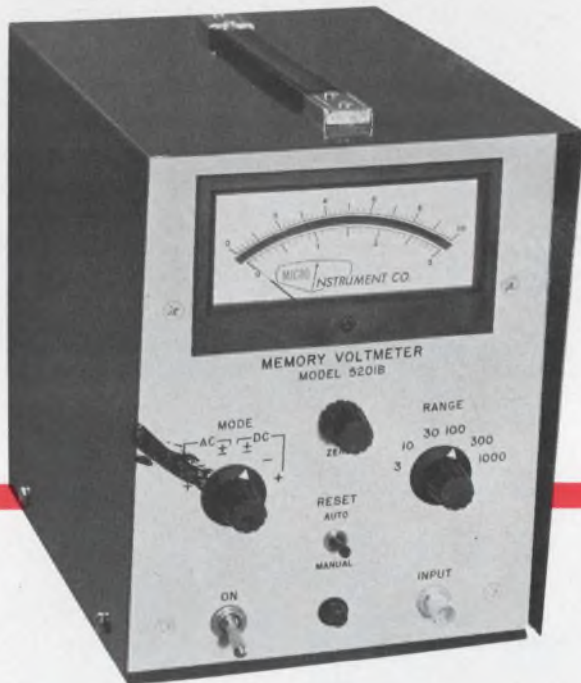

The Model 5201 memory voltmeter is a dc to 20 mc instrument which measures and stores indefinitely the maximum peak voltage applied, including continuous or one shot pulses as short as 50 nanoseconds. A memory reset-switch on the front panel allows the 5201 to monitor peak values of a varying waveform, either positive or negative going.

The solid-state 5201 is also available with a 4-digit in-line Nixie® tube readout. The voltage range may be extended to 30 kv with optional high voltage probes. For complete technical information, contact the Micro Instrument representative near you or write directly to us.

## Specifications

<b>VOLTAGE RANGE</b>	0-3, 10, 30, 100, 300, 1000 volts. Can be operated up to 1000 volts above ground.
<b>INPUT IMPEDANCE</b>	100 k-10 megohms (depending on range).
<b>PULSE WIDTH</b>	DC to 50 (typically 30) nanoseconds.
<b>OPERATING MODES</b>	+, -, ± (DC or AC coupled).
<b>READOUT</b>	5" mirror-backed 1% meter.
<b>PRICE</b>	\$695.00.



13100 CRENSHAW BLVD., GARDENA, CALIFORNIA 90249  
PHONES: (213) 323-2700 & 321-5704 / TWX (213) 327-1312

ON DEMONSTRATION AT WESCON—HOLLYWOOD PARK—BOOTH 133  
ON READER-SERVICE CARD CIRCLE 42

## SYSTEMS

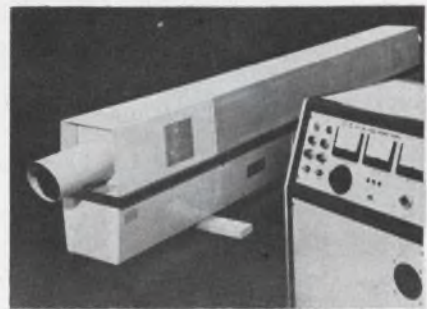

### 5-W cw argon laser

This cw ionized argon laser has a diffraction-limited output of 5 W and uniphase spherical TEM<sub>00</sub> operation. Output is over the 4545- to 5145-A range in the blue-green portion of the spectrum with principal lines at 5145 and 4880 Å. The water-cooled 350-lb laser measures 116 x 11 x 18 in. and the stabilized 600-lb dc power supply measures 26 x 48 x 34 in.

P&A: \$35,000; 90 days. Raytheon Co., 130 Second Ave., Waltham, Mass. Phone: (617) MU8-7148.

Circle No. 276

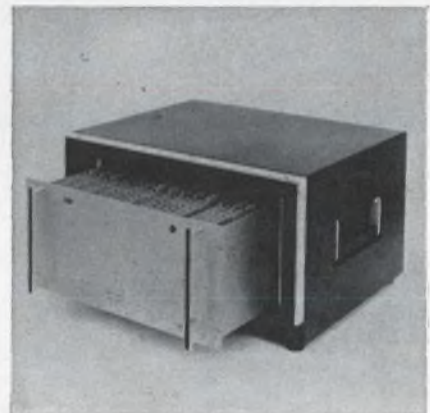

### Stroke writers

A series of high-speed stroke writers can produce symbols for CRT displays at speeds up to 4 μs/symbol. The 401 series has a 64-character repertoire expandable to 128 characters. All line components unique to a particular symbol are contained on the same circuit card. Adaptable to random-access writing systems or formatted systems, the 401 can operate from 50 ft max and can drive up to 50 non-parallel displays.

Tasker Instruments Corp., 7838 Orion Ave., Van Nuys, Calif. Phone: (213) 781-3150.

Circle No. 277

**PORTABLE TYPE  
32MHz FREQUEN-  
CY COUNTER  
-TR- 3666 GIVES  
INSTANT AND  
HIGH MEASURING  
ACCURACY**



■ Greater portability ■ Compact—12.0" wide × 6.0" high × 14.6" deep  
■ Lightweight—24.5 lbs ■ Durable  
■ Power—DC 12/24V and AC 115 V ■ Withstands use under rugged conditions ■ Low power consumption—34W ■ Built-in power line noise filter ■ Built-in WWV receiver—5/10MHz ■ High input sensitivity—50mV rms/min ■ High degree of measuring accuracy available instantly. No waiting for crystal oscillator oven temperature to build up.

**Specifications:**

□ Range: 10Hz to 32MHz □ Input Sensitivity: 50mV rms minimum, 140mV rms maximum □ Accuracy: ± 1 count ± time base accuracy  
□ Registrations: 6 digits in-line digital display tubes with display storage □ Time Base Accuracy:  $1 \times 10^{-7}$  or less adjustable after calibrated by WWV □ WWV Receiver: Sensitivity;  $3 \mu V$ , 5MHz and 10 MHz optional changeover  
□ Power Requirements: DC 24V ± 4V, approx. 24W; DC 12V ± 2V, approx. 36W; AC 100V ± 20V, approx. 34W □ Operating Temperature Range:  $-10^{\circ}C \sim +50^{\circ}C$   
□ Weight: Net 24.5 lbs □ Dimensions: 12" wide, 6" high, 14.6" deep

See for yourself by visiting Booth No. 158, WESCON/66, Hollywood Park, Los Angeles

For further details, write to:

**Takeda Riken Industry Co., Ltd.**

285, Asahi-cho, Nerima-ku, Tokyo, Japan  
Cables: TRITRONICS TOKYO Phones: 930-4111

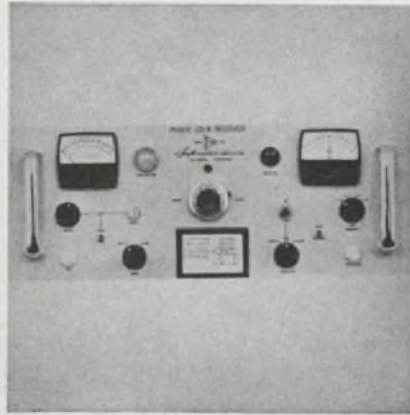

**Phase-lock receiver**

Modular construction of this phase-lock receiver allows changing received frequency, IF bandwidth, or demodulator characteristics. Multiple channel receivers may also be assembled. RF heads and phase-locked first local oscillators are available from 30 MHz to 16 GHz. IF bandwidths from 500 to 35 kHz and loop noise bandwidths from 5 Hz to 1 kHz are standard. Tetrode FETs provide logarithmic AGC over a 100-dB range. Automatic acquisition is standard, with switch selection of normal acquisition for use with extremely weak signals.

Smyth Research Associates, 3555 Aero Ct., San Diego, Calif. Phone: (714) 277-0543.

Circle No. 278

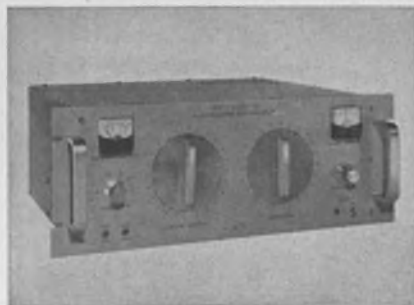

**FM discriminator**

A bandswitching discriminator features a phase-locked loop detector for FM multiplex systems. It has a 23-channel capability. The device uses silicon semiconductors. The discriminator, output amplifier and power supply regulators are constructed on plug-in PC cards. Selection of the subcarrier channel and output filter are made by two front-panel rotary switches.

Sonex Inc., 20 E. Herman St., Philadelphia. Phone: (215) 843 6400.

Circle No. 279

**COMMUNICATIONS ENGINEERS**

**SYSTEMS INTEGRATION**

If you're the kind of engineer who enjoys the challenge of complex system interface situations, ECI has the opportunity you are seeking.

At ECI, system integration touches many phases of communication: radio systems in all frequency ranges, multiplexing, telemetry, switching systems, etc. Programs involve satellite communication systems, airborne command posts on two continents and over the Pacific, communications for the Marine Tactical Data System and other air-ship-ground combinations of command and control systems.

Opportunities are immediate and attractive for professionals who are highly knowledgeable in aircraft, ground terminal and shipboard electronic communication systems and who



Communications Central for MTDS. System Integration by ECI.

are familiar with complex communication equipment installation and field test programs.

You will work for an aggressive, professionally oriented company and live in the pleasant atmosphere of Florida's Gulf Coast. Positions are available in St. Petersburg, Florida, with or without occasional field assignments.

For details send your resume, in confidence, to Budd Cobb, ECI, Box 12248ED, St. Petersburg, Florida, or call him collect at (813) 347-1121. (An equal opportunity employer.)



**ELECTRONIC COMMUNICATIONS, INC.**  
St. Petersburg, Florida

ON READER-SERVICE CARD CIRCLE 44

# AT WESCON: CATCH 22!

## ELECTRONIC DESIGN'S CONTRIBUTED SESSION

**Zero-in on semiconductor amplifier design.** Learn the why, where, how of solid-state devices in high-frequency applications by attending the Electronic Design - sponsored WESCON session.

Bipolars (such as this low-noise RF unit), FETs, MOSs and varactors, as they should properly be used in 0.5 MHz-5.0 GHz amplifiers, are the program targets. Also—design hints and trade offs.

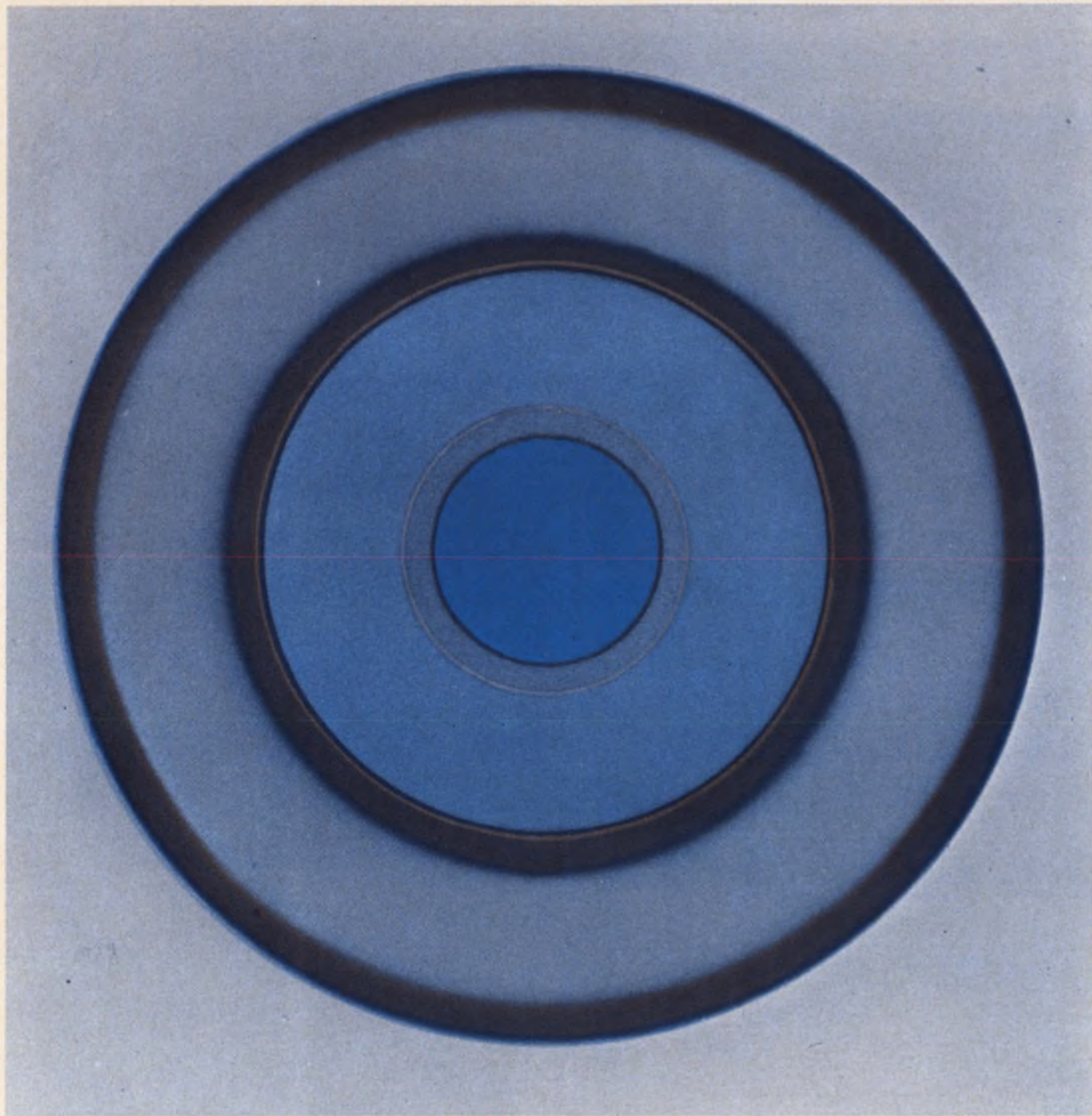

**PARTICIPANTS:** R.Q. Lane, **Fairchild Semiconductor**, "Small-signal design." Roy Hejhall, **Motorola Semiconductor**, "Large-signal design." J.B. Compton, **Siliconix**, "J-FET high-frequency amplifiers." Paul E. Kolk, **KMC Semiconductor**,

"MOS high-frequency amplifiers." George Johnson, **Texas Instruments**, "Low-noise amplifier design." R. Minton, **RCA**, "High-frequency amplifier design trade-offs. **CHAIRMAN:** Dr. John Moll, Dept. of Electrical Engineering, Stanford University.

**TIME:** Friday, Aug. 26, 9:30 A.M.

**PLACE:** Biltmore Music Room, Los Angeles, California

## MICROWAVES

### Communications switch

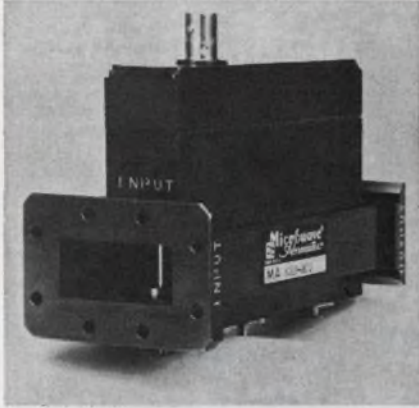

The MA-8319-1C3 switch is used for hot-standby operation in which two RF transmitters, tuned to the same frequency, are switched into a single transmit antenna. When one fails, operation is switched to the standby transmitter. The unit can switch up to 7 W cw in 500 ns. Bias power is 1/4 W and isolation is 90 dB. Insertion loss is 1 dB and vswr is 1.15 in the 6.5- to 7.2-GHz frequency range.

Microwave Associates, Burlington, Mass. Phone: (617) 272-3000.

Circle No. 280

### Stripline couplers

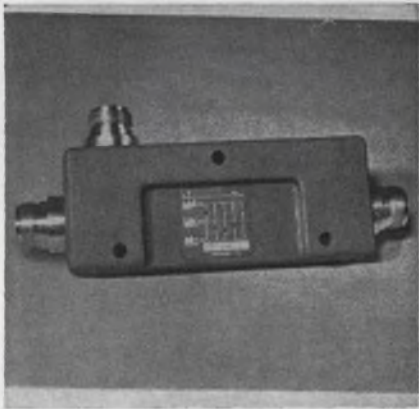

A 50% weight and size reduction is a feature of this series of 27 stripline directional couplers. The units have flat coupling of 10 to 20  $\pm 0.8$  dB, 20-dB directivity and a 1.2 vswr in both primary and secondary lines. Insertion loss is 0.2 dB max and calibration accuracy is  $\pm 0.2$  dB. Impedance is 50  $\Omega$  and ambient temperature range is  $-50$  to 250°F.

Elpac Inc., 3760 Campus Dr., Newport Beach, Calif. Phone: (714) 546-8640.

Circle No. 281

### 100-W C-band TWT

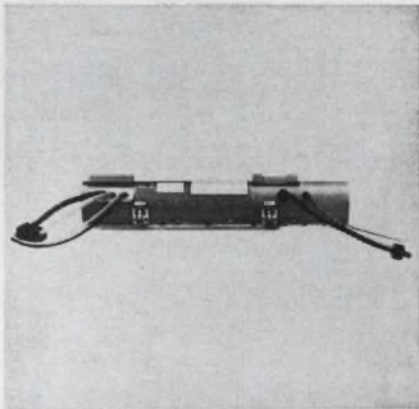

Pulse-position modulated and delivering 100 W in S through C band, the ppm-focused TWT operates from 2.5 to 5.2 GHz. Coaxially coupled, it operates with depressed collector in MIL-E-5400 Class II environments and performs with heat sink temperatures up to 100°C. The vacuum envelope is metal-ceramic and the focusing assembly is magnetically shielded.

Microwave Electronics, 3165 Porter Drive, Palo Alto, Calif. Phone: (415) 321-1770.

Circle No. 282

### Waveguide circulator



With a 7.05- to 10-GHz range, this 3-port waveguide circulator and flange offers a 20-dB min isolation, 0.3-dB insertion loss and 1.2 max vswr. Power ratings are 10 k-W peak and 20 W average. Custom models are available with 10% bandwidth or less for insertion losses down to 0.1 dB and vswr reduced to 1.05.

P&A: \$200; 30 days. Huggins Laboratories, 999 E. Arques Ave., Sunnyvale, Calif. Phone: (408) 736-9330.

Circle No. 283

## ELECTRONICS ENGINEERS

### SPACE ELECTRONICS

Exciting things are happening in space electronics at ECI. Present programs include flight control computers for Saturn IB and Saturn V; digital switch selectors; solid-state telemetry transmitters from VHF to X band; solid-state receivers and transmitters for ICBM launch sites, and an advanced microminiaturization program for the flight control computer.

ECI has immediate professional openings for development, senior and staff engineers on these and other space instrumentation programs. To qualify, you'll need experience in digital systems design, analog instrumentation or RF circuit design. And you'll need the kind of in-depth technical understanding that lets an engineer make genuine contributions to state-of-the-art programs.



ECI's flight control computer for Saturn IB.

You'll work in a unique, highly stimulating professional environment. And while you work at one of America's most respected and most stable communications companies, you and your family will enjoy living in St. Petersburg, Florida — one of America's truly desirable residential locations.

Get the details today. Send your resume, in confidence, to Budd Cobb, ECI, Box 12248ED, St. Petersburg, Florida, or call him at (813) 347-1121. (An equal opportunity employer.)



ELECTRONIC COMMUNICATIONS, INC.  
St. Petersburg, Florida

# EIMAC

## advanced traveling wave tube amplifiers drive military communications satellite system

Aerospace history was made on June 16, 1966, when the Space Systems Division, USAF, launched seven advanced military communications satellites from a single Titan III-C booster.

The satellites are in near-synchronous equatorial orbit at an altitude of more than 18,000 miles, and are reported to be functioning to specification.

EIMAC developed a new traveling wave tube amplifier for the satellites under USAF contract, for use in the three-phase launch feasibility demonstration of the system. Philco Corporation's Western Development Laboratories is prime contractor for the satellites.

The Philco WDL launch concept pioneers a unique satellite dispenser which provides great economy by substantially reducing the number of high-cost boosters required to establish the necessary communications capability. The simple and highly-reliable satellite design contains no moving parts, and is expected to operate in orbit for several years.

The hermetically-sealed EIMAC TWTA package includes a solid state power supply, and is optimized for operation in the X-band satellite-to-ground frequency band. In typical operation, the TWTA package has an overall efficiency of 26%, with saturated gain



EIMAC space-rated TWTA

of 39db. Weight of the unit, including base plate, is 3.35 pounds, and volume is less than 75 cubic inches. The unit is rated for 50,000 hours mean time operation before failure.

EIMAC has other space-rated satellite tube development programs underway. For additional information, contact Microwave Marketing.

**EIMAC**

Division of Varian

San Carlos, California 94070



*Artist's concept of military satellite system courtesy of Philco Corporation*

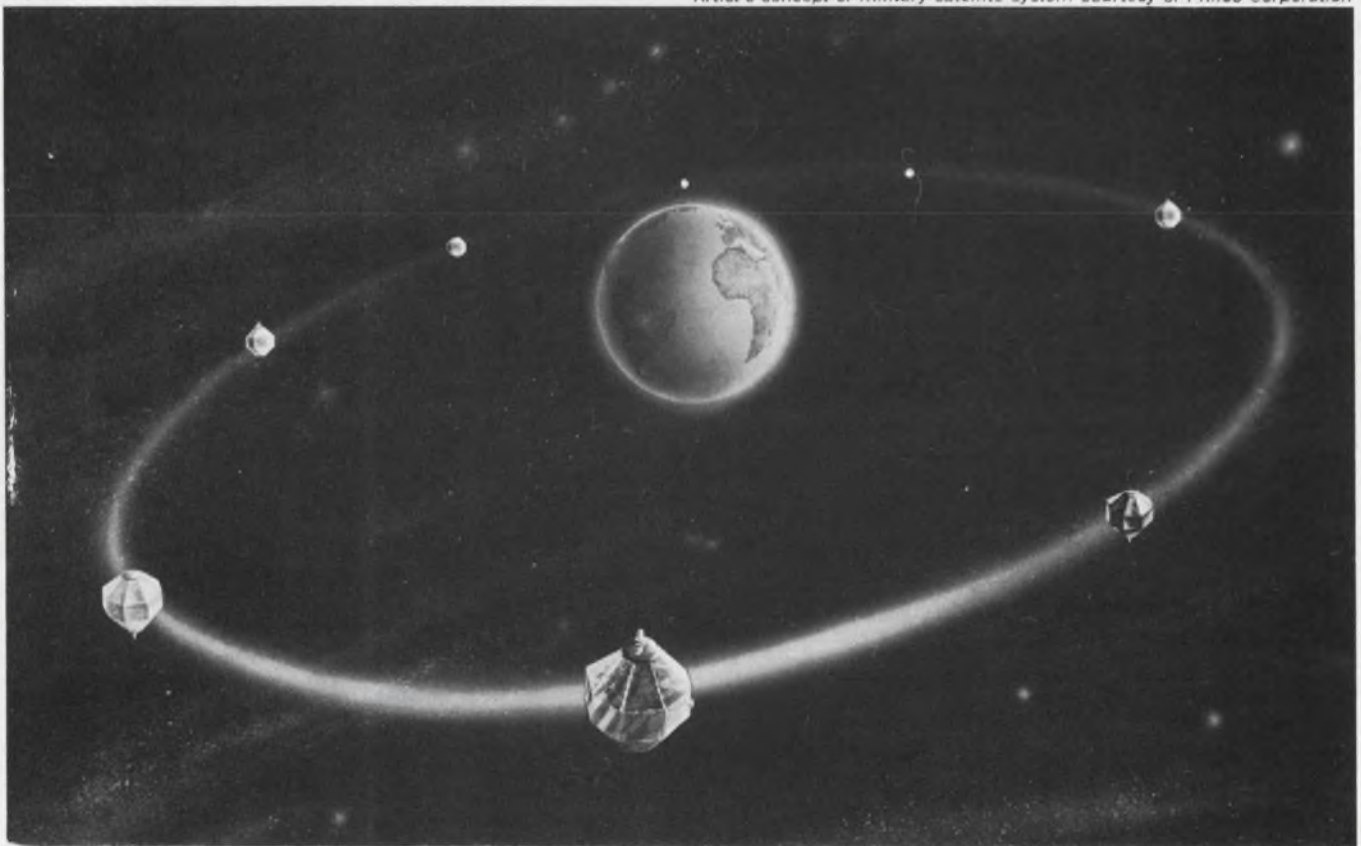

See this equipment at Varian booths #1349-1358 in the Sports Arena at Wescon/66

ON READER-SERVICE CARD CIRCLE 46

## MICROWAVES

### X-band isolator



For use from 9.1 to 9.5 GHz in an ambient temperature range of  $-55$  to  $80^{\circ}\text{C}$ , this X-band plug-in isolator has a vswr of 1.15 max. The J-7881 has an isolation of 40 to 50 dB and an insertion loss of 0.3 to 0.4 dB. A 4-port device with two internal terminations, the unit has a design compatible with strip-line assemblies. It is 1 X 0.75 X 0.625 in. and weighs 1 oz.

Melabs, 3300 Hillview Ave., Stanford Industrial Park, Palo Alto, Calif. Phone: (415) 326-9500.

Circle No. 284

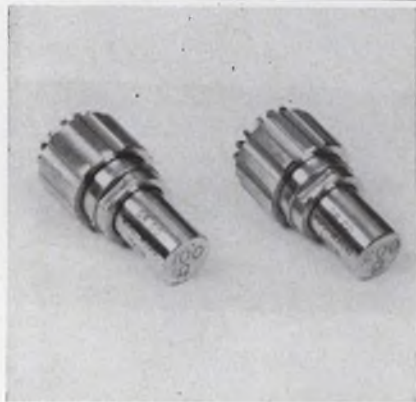

Two resistive terminations are the 100- $\Omega$  type 900-W100 and the 200- $\Omega$  type 900-W200. The 100- $\Omega$  termination has a resistance within  $\pm 1.5\%$  to 1 GHz and within  $\pm 5\%$  to 8.5 GHz. The 200- $\Omega$  unit holds its resistance within  $\pm 1.5\%$  to 1 GHz and within  $\pm 10\%$  to 8.5 GHz. The position of pure resistance is 4 cm from the reference plane of the connector.

Price: \$60. General Radio Co., West Concord, Mass. Phone (617) 369-4400.

Circle No. 285

### Coaxial terminations

### Coaxial tuner

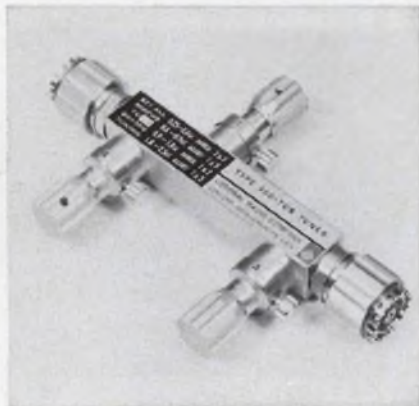

This matching tuner is a section of coax with three lockable screws to tune out small reflections in low-vswr measuring instruments. Frequency range is 0.25 to 2.5 GHz. The vswr matching range is 1.02 min at 0.4 GHz and 1.05 min from 1 to 2.5 GHz. Vswr resettability is better than 1.001 and connection is repeatable to within a vswr of 1.0005.

Price: \$195. General Radio Co., West Concord, Mass. Phone: (617) 369-4400.

Circle No. 286

### Micromin coax circulator



With a 50% reduction in size and weight, these coaxial circulators have customer-selected frequencies. An 8% bandwidth is offered from 1.6 to 1.9 GHz as well as 10% bandwidths from 1.9 to 12 GHz. All units have 20-dB isolation and 1.25 vswr. Insertion loss is 0.4 dB in the low frequency units and 0.3 dB above 1.9 GHz. Units from 5.4 to 12 GHz are 1/2 in. on each side and weigh 20 grams.

E&M Labs., 7419 Greenbush Ave., North Hollywood, Calif. Phone: (213) 875-1484.

Circle No. 287

ON READER-SERVICE CARD CIRCLE 72 ➤

Another Quality Product of  
**SIGMUND COHN CORP.**

**1% Silicon  
Aluminum  
Wire** [specially  
spooled]



Available in  
a complete  
range of sizes...

Made as small as  
.0007" diameter...

Precision spooled on  
our No. 3 (above) or  
No. 22 Spool; single  
or multiple layer...



Cased in dust-  
free, plastic  
container to  
safeguard  
wire during  
shipment.

SINCE 1901

**SIGMUND COHN CORP.**

121 S. Columbus Ave., Mt. Vernon, N.Y.



## Distinctively Styled



1½ in. AM-1 (actual size)

### high torque, self-shielded panel meters

Clean, modern styling... easy scale readability... sizes 1½ to 4¼". High torque mechanism gives 1% linearity, 2% accuracy and sensitivity to 20 ua. Magnetic system completely shields external field influences, permitting bezel-to-bezel mounting on any material without interaction or effect on calibration. Choice of colors or finishes, custom dials—ASA/MIL 4-stud mtg.

# AMMON

AMMON INSTRUMENTS, INC.  
345 Kelley Street, Manchester, N. H. 03105

ON READER-SERVICE CARD CIRCLE 47



**DIALCO**

**BIG, BOLD  
ANGULAR NUMERALS**

**LONG LIFE LAMPS and  
RUGGED CONSTRUCTION  
FOR  
UNMATCHED  
RELIABILITY**

WRITE FOR CURRENT CATALOG

*Foremost Manufacturer of Indicator Lights*

**DIALIGHT** CORPORATION

60 STEWART AVENUE, BROOKLYN, N.Y. 11237    212 HYACINTH 7-7600

ON READER-SERVICE CARD CIRCLE 48

## Design Aids



### Wire guide

This guide for selection of thermocouple and extension wire has actual samples of wire and insulation combinations. Calibration symbols for alloys and combinations, upper temperature limits, resistances, limits of error, insulation specification charts and insulation resistance are included. Pall Trinity Micro Corp.

Circle No. 288

### Rectifier rating nomograms

Two nomograms enable determination of maximum average forward current, distance from body of device to point of contact with lead and heatsink temperature of micromin semiconductor rectifiers. A straight line extending through any two scales to the third column will indicate the remaining variable. One nomogram covers ratings for standard silver lead devices and the second was prepared for rating devices with solid nickel leads. Hoffman Semiconductor.

Circle No. 289

### IC project book

An introduction to ICs, construction techniques and projects are included in this 96-page book. Projects such as computers, musical instruments and test equipment are described with illustrations, schematics, diagrams and building instructions.

Available for \$1 from Motorola Semiconductor Products Inc., Box 955, Phoenix, Ariz.





*You'd figure  
500 volts at  
60 cycles  
would darn near  
vaporize this  
M.A. Bobbin Core,  
right?*



**Wrong! Its got GVB\*.** Even at more than 1500 volts, tests show no breakdown on M.A. bobbin cores with GVB. In addition to guaranteeing the core's ability to withstand at least 500 volts between bare winding and bobbin, GVB finish also seals the bobbin to withstand a ten-inch mercury vacuum.

It seals against potting material, provides a resilient, non-slip base for winding, and its epoxy skin protects the core against wire cuts. Abraded wire problems are eliminated and no prior taping is required.

GVB has proven itself on thousands of cores . . . and now Magnetics has applied it to the bobbin core, the

miniature workhorse of computers, high frequency counters, timers, oscillators, inverters and magnetic amplifiers.

Made from ultra-thin permalloy 80 and Orthonol® (0.001" to 0.000125"), Magnetics' bobbin cores are available in tape widths from 0.023" to 0.250" or wider on request. Core diameters range down to less than 0.100" with flux capacities down to several maxwells.

For more information on GVB Bobbin Cores, write Magnetics Inc., Dept. ED-42, Butler, Pa. 16001.



\*Guaranteed voltage breakdown

# New Literature

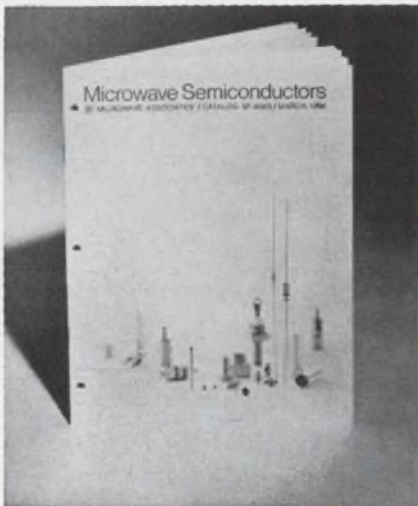

## Microwave semiconductors

This semiconductor catalog contains specs for mixer and detector diodes, power varactors, pin switching diodes, tuning varactors, harmonic generator circuit-characterized varactors, tunnel diodes and Schottky-barrier diodes. Photographs and outline drawings are included. Microwave Associates, Inc.

Circle No. 290

## Slip ring noise

Characteristics of slip ring noise and noise in sliding contacts are given with line drawings and photographs. The 12-page brochure describes a solution to the problem of noise characteristics by analysis techniques. Electro-Tec Corp.

Circle No. 291

## Alloy properties

A table giving the nominal composition, specific resistivity, temperature coefficient of resistance, linear coefficient of expansion, tensile strength and other characteristics of a series of alloys appears in this 4-page leaflet. Alloys containing nickel, chromium, copper, silicon, aluminum, iron and cobalt are included. The brochure contains applications suggestions. Wilbur B. Driver Co.

Circle No. 292

## Admittance calculations

The theoretical admittance calculation for a toroid-shaped sample in a parallel-plate capacitor system is presented in this 35-page bulletin. The calculation is a first and second order perturbation correction to the quasi-state formula. The FORTRAN listing of the machine program is included.

Available for \$0.30 from Clearinghouse, U.S. Dept. of Commerce, Springfield, Va.

## Inductor design

This bulletin describes the design of optimum inductors with ferrite cores. Listings of tight-tolerance pot cores, specifications on 30 mm, 36 mm and 42 mm cores and mechanical data covering printed circuit bobbins are given. Applications of pot cores in inductors for filters, delay lines, networks and tuned circuits are included. Ferroxcube Corporation of America.

Circle No. 293



## Bench instruments

Factors to be considered when selecting bench instruments for ac and dc measurement are discussed in this 8-page booklet. Topics include types of measurements, power line effects, intermodulation and shielding. Dynamics Instrumentation Co.

Circle No. 294

# DELCO RADIO SEMICONDUCTOR DISTRIBUTORS

## EAST

- Binghamton, N. Y. 13902**—Federal Electronics, Inc.  
P. O. Box 1208/(607)-748-8211
- Philadelphia, Penn. 19123**  
Almo Industrial Electronics, Inc.  
412 North 6th Street/(215)-922-5918
- Pittsburgh, Penn. 15206**—Radio Parts Company, Inc.  
6401 Penn Ave./ (412)-361-4600
- Newton, Mass. 02195**—Greene-Shaw Company  
341 Watertown Street/(617)-969-8900
- New York, New York 10036**—Harvey Radio Co., Inc.  
103 West 43rd St./ (212)-582-1500
- Clifton, N.J. 07015**—Eastern Radio Corporation  
312 Clifton Avenue/(201)-471-6600
- Woodbury, L. I., N. Y. 11797**  
Harvey Radio Company, Inc.  
60 Crossways Park West/(561)-921-8700
- Baltimore, Md. 21201**—Radio Electric Service Co.  
5 North Howard Street/(301)-539-3835

## SOUTH

- Birmingham, Ala. 35233**  
Forbes Distributing Company, Inc.  
2610 Third Avenue, South/(205)-251-4104
- Richmond, Va. 23220**—Meridian Electronics, Inc.  
1001 West Broad Street/(703)-353-6648

## MIDWEST

- Kalamazoo, Mich. 49006**—Electronic Supply Corp.  
P. O. Box 831/(616)-381-4623
- Indianapolis, Ind. 46225**  
Graham Electronics Supply, Inc.  
122 South Senate Avenue/(317)-634-8486
- Cleveland, Ohio 44101**  
The W. M. Pattison Supply Co.  
Industrial Electronics Division  
777 Rockwell Avenue/(216)-621-7320
- Chicago, Ill. 60630**—Merquip Electronics, Inc.  
4939 North Elston Avenue/(312)-282-5400
- Cincinnati, Ohio 45237**—United Radio, Inc.  
7713 Reinhold Drive/(513)-761-4030
- Kansas City, Mo. 64111**—Walters Radio Supply, Inc.  
3635 Main Street/(816)-531-7015
- St. Louis, Mo. 63144**  
Electronic Components for Industry Co.  
2605 South Hanley Road/(314)-647-5505
- Tulsa, Oklahoma 74119**—Radio, Inc.  
1000 South Main Street/(918)-587-9124
- Oklahoma City, Oklahoma 73102**—Radio, Inc.  
903 North Hudson/(405)-235-1551
- Minneapolis, Minnesota 55413**  
Northwest Electronics Corporation  
336 Hoover St., N. E./ (612)-331-6350

## WEST

- Dallas, Texas 75201**—Adleta Electronics Company  
1907 McKinney Ave./ (214)-742-8257
- Houston, Texas 77001**—Harrison Equipment Co., Inc.  
1422 San Jacinto Street/(713)-224-9131
- San Diego, Cal. 92101**—Milo of California, Inc.  
2060 India Street, Box 2710/(714)-232-8951
- Los Angeles, Cal. 90015**—Radio Products Sales, Inc.  
1501 South Hill Street/(213)-748-1271
- Los Angeles, Cal. 90022**—Kierulff Electronics, Inc.  
2585 Commerce Way/(213)-685-5511
- Mountain View, Cal. 94041**—Kierulff Electronics, Inc.  
2484 Middlefield Road/(415)-968-6292
- Denver, Colo. 80219**—L. B. Walker Radio Company  
300 Bryant Street/(303)-935-2409
- Seattle, Wash. 98121**—C & G Electronics Company  
2600 2nd Ave./ (206)-624-4354
- Phoenix, Ariz. 85005**—Midland Specialty Co., Inc.  
1930 North 22nd Ave./ (602)-258-4531
- Albuquerque, N. M. 87103**  
Midland Specialty Co., Inc.  
1712 Lomas Blvd., N. E./ (505)-247-2486
- Tucson, Ariz. 85719**—Midland Specialty Co., Inc.  
951 South Park Ave./ (602)-624-2315

# DELCO RADIO

DIVISION OF GENERAL MOTORS • KOKOMO, INDIANA

# Three new 400-volt silicon power transistors for military duty:



They're designed for high efficiency inverters, voltage and current regulators, control and switching circuits and high-power communications where extreme reliability is required.

DTS-423M is a NPN 3.5-amp 400-volt device in a TO-3 package, offering high sustaining voltage capability.

DTS-431M is a NPN 5-amp 400-volt device in a TO-3 package, offering higher gain and lower saturation resistance.

DTS-2N2580M is a NPN 10-amp 400-volt device in a TO-36 package for extra high power applications. Specifications on all three devices are based on full

mil-type environmental tests performed in an approved military qualification test lab.

Check with our nearest sales office or Delco Radio Distributor for full details.

TYPE	V <sub>CE0</sub>	V <sub>CBO</sub>	V <sub>CE0</sub> (sus)	I <sub>C</sub>	I <sub>B</sub>	h <sub>FE</sub> V <sub>CE</sub> =5V @ I <sub>C</sub>	R(sat) Max @ I <sub>C</sub>	Power Diss Max
DTS-423M	400V	400V	325V (min)	3.5A	2.0A	10 @ 2.5A	0.8 ohm @ 1.0A	100W
DTS-431M	400V	400V	325V (min)	5.0A	2.0A	10 @ 3.5A	0.28 ohm @ 2.5A	125W
DTS-2N2580M	400V	400V	325V (min)	10.0A	2.0A	4 @ 10.0A	0.14 ohm @ 5.0A	150W

**SEE YOU AT WESCON, BOOTHS 1503-4, SPORTS ARENA**

FIELD SALES OFFICES	UNION, NEW JERSEY*	DETROIT, MICHIGAN	SANTA MONICA, CALIFORNIA*
	Box 1018 Chestnut Station (201) 687-3770	57 Harper Avenue (313) 873-6560	726 Santa Monica Blvd. (213) 870-8807
	SYRACUSE, NEW YORK	CHICAGO, ILLINOIS*	General Sales Office:
	1054 James Street (315) 472-2668	5151 N. Harlem Avenue (312) 775-5411	700 E. Firmin, Kokomo, Ind. (317) 459-2175

\*Office includes field lab and resident engineer for applications assistance.

**DELCO RADIO**

Division of General Motors  
Kokomo, Indiana

ON READER-SERVICE CARD CIRCLE 49

# Service...Engineering...Experience

MAKE THE **BIG** DIFFERENCE  
BETWEEN A YOKE SPECIALIST  
AND A YOKE SUPPLIER



One of our newer types. 1" Vidicon Yoke for TV cameras.

Syntronic Yoke Specialists have more yoke knowledge and provide more engineering assistance than anyone else in the field.

The most extensive line of deflection yokes available is offered by Syntronic . . . in production quantities or custom designed to special requirements. See the BIG Difference for yourself the next time you specify a yoke.

*Syntronic* INSTRUMENTS, INC.  
100 Industrial Road, Addison, Illinois Phone 312, 543-6444

ON READER-SERVICE CARD CIRCLE 50

## For fast delivery of Specialty Motors

the new **Diehl**  
call ^

We don't know what *your* recollection of Diehl's delivery is. But with small motors in short supply we think you'll want to hear about delivery from the *new* Diehl. We are now supplying motors much faster than the industry average. Some of our current accounts tell us we move *three to four times faster* than other well known motor suppliers. Diehl has been building motors since 1888. But now we're building them faster! Try us again, East Coast or West, at the numbers below. THE SINGER COMPANY, Diehl Division, *East*: Finderne Plant, Somerville, N. J. 08876 (201) 725-2200; *West*: LA Plant, 2221 Barry Ave., Los Angeles, Cal. 90064 (213) 478-0896. Also, representatives in all major cities.

Speed Inquiry to Advertiser via Collect Night Letter  
ON READER-SERVICE CARD CIRCLE 51

## NEW LITERATURE

### Photoconductivity

Progress in the field of photoconductivity is reviewed in this 27-page publication. Optimization of parameters, development of images on surfaces and the effects of nuclear radiation on photoconductive properties of materials and on induced photoconductivity are covered. Clearinghouse, U.S. Dept of Commerce.

Circle No. 295

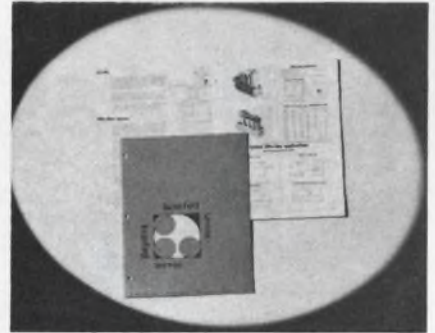

### Electromechanical servos

Miniature electromechanical servos for such applications as digital-to-analog conversion, reference positioning, program actuation, coordinate conversion, signal conversion and dc and ac integration are described in this catalog. Packs employing size 8 components are also described. General Precision Inc.

Circle No. 296

### Microwave components

An illustrated 20-page short form catalog covers the manufacturer's millimeter microwave component and antenna line. Ferrite components, circular waveguide components, flanges, waveguides, antennas, and power generation and detection equipment are described. A chart of standard rectangular waveguide and flanges is included. TRG Control Data Corp.

Circle No. 297

### Cw and pulsed magnetrons

A line of cw and pulsed magnetrons are featured in this 38-page illustrated brochure. Descriptions and photographs of magnetron capabilities and a series of technical bulletins describing the line are included. Microwave Associates, Inc.

Circle No. 298



### System instrumentation

Instrumentation designed for incorporation in modular systems, as well as for general purpose use, is described in this catalog. Specs are given for solid-state oscilloscopes with plug-ins, solid-state voltmeters and oscilloscope (data recording) camera systems. Benrus Technical Products Div.

*Circle No. 299*

### Subscription Policy

ELECTRONIC DESIGN is circulated free of charge to qualified design engineers in the U.S., Western European Continent and Britain. To establish your qualifications, send ELECTRONIC DESIGN the following information on your company's letterhead: Your name, engineering title, description of your design duties and a list of your company's major products. The letter must be signed by you personally.

Subscription rates for nonqualified subscribers—\$25 a year in the U.S., \$35 in all other countries. Single copy, \$1.50.

### Change of Address

A subscriber's change of address requires a restatement of his qualifications. To expedite the change, and to avoid missing any issues, send along a label from a back copy.

### Microfilm Copies

Microfilm copies of all 1961, 1962, 1963, 1964 and 1965 issues of ELECTRONIC DESIGN are available through University Microfilms, Inc., 313 N. First Street, Ann Arbor, Mich.

# THE EXTRA YOU GET WITH HUGHES QUARTZ CRYSTALS:

## EXPERTISE

How do you know you'll get the best when you buy a Hughes quartz crystal?

You don't—based on specifications alone. Most crystal specs are pretty much the same.

What really counts is the capability of the people who design, build and test your crystal. We call it **expertise**. We'd like to mention ours:

A staff of top frequency specialists, each with over 15 years of quartz crystal experience . . . some of the most efficient production and test equipment in the industry . . . a supporting research facility for advanced development work . . . plus the strength and solidarity of one of the largest electronics firms in the country.

Let Hughes expertise work for you. That way you can be sure you'll get the best! Just write or call: Hughes Electronic Devices, 500 Superior Avenue, Newport Beach, California.



**HUGHES**

HUGHES AIRCRAFT COMPANY  
ELECTRONIC DEVICES DEPARTMENT  
NEWPORT BEACH, CALIFORNIA

*Leader in Frequency Control Devices*

# Design Data from Manufacturers

Advertisements of booklets, brochures, catalogs and data sheets. To order use Reader-Service Card.

(Advertisement)

## Bus Bars For Noise Reduction



A 10 page Technical Bulletin is now available, describing a new concept in power or signal distribution. Basic mechanical and electrical design principles, along with descriptive pictures and diagrams, are included in this bulletin. These compact buses can replace bulky cable harnesses and repetitive wiring for computer or modular application. This method of construction satisfies the demanding requirements of low inductance and resistance of high speed, solid state systems, while controlling electrical noises.

### Eldre Components, Inc.

1239 University Avenue  
Rochester, New York 14607

# 171

## Terminal Board Engineers' Guide



"Broadest Line of Terminal Boards in the Industry" —the new Kulka Catalog 17A is designed for the Specifying Engineer and Purchasing Agent. It contains 56 pages of exhaustive data on every type of terminal board in current use, including "Kliptite," High Heat, Closed Back, High Barrier, Stud and Turret, Pressure Contact, Wire-Wrap, Screw Clamp, and Military Terminal Boards. Free copy on request.

### Kulka Electric Corporation

520 South Fulton Ave.  
Mount Vernon, N. Y. 10551

# 172

## Books For The Electronics Engineer



The 1966 Hayden Book Company, Inc., catalog contains such new titles as "Microelectronic Design," "100 Ideas for Design '66," "The Electron in Electronics," "Synthesis of RC Networks with Arbitrary Zeros," "Transistor and Diode Network Calculations," and "Matrix Algebra for Electronic Engineers." As well as the expanded list for design engineers, the catalog includes Hayden and John F. Rider Publisher training texts at all levels. Send for your free catalog today.

### Hayden Book Company, Inc.

116 West 14th Street  
New York, N. Y. 10011

# 173

# Advertisers' Index

## \*PARTICIPANTS IN NIGHT LETTER PROGRAM

API Instruments Co. ....	92
Allied Chemical, Plastics Division .....	96
Ammon Instruments, Inc. ....	104
*Amperex Electronic Corporation .....	75
Amphenol R F Division, Amphenol Corporation .....	89
Arnold Magnetics Corp. ....	61
Automatic Electric, A Subsidiary of General Telephone & Electronics .....	5, 93
Babcock Relays, A Div. of Babcock Electronics Corporation .....	31
Bendix Corporation, The, Semiconductor Division .....	6, 7
Brand Rex, Division, of American Enka Corporation .....	50
Buchanan Electrical Products Corporation .....	70
Bulova Electronics Division of Bulova Watch Company, Inc. ....	87
Burndy Corporation .....	68
C&K Components, Inc. ....	94
CTS Corporation .....	27
*Clifton Precision Products, Division of Litton Industries .....	91
Cohn Corp., Sigmund .....	103
Cutler-Hammer, Inc. ....	12
Data Control Systems, Inc. ....	69
Dale Electronics, Inc. ....	Cover III
Delco Radio, Division of General Motors .....	106, 107
Dialight Corporation .....	104
ESI/Electro Scientific Industries, Inc. ....	90
*Eimac, A Division of Varian Associates .....	102
Eldre Components, Inc. ....	110
Electronic Communications, Inc. 95, 97, 99, 101	
Electronic Design .....	100
Fairchild Semiconductor, A Division Fairchild Camera and Instrument Corporation ..	9
*Fluke Mfg. Co., Inc., John .....	85
General Radio Company .....	1
Guardian Electric Manufacturing Company .....	59
Hayden Book Co., Inc. ....	111
Hewlett-Packard .....	Cover II, 23, 32,
.....32A-B, 58, 73, 80A-B-C-D	
*Honeywell, Computer Control Division ..	28
Hughes Aircraft Company, Electronic Devices Division .....	109
Indiana General Corporation .....	87
Kulka Electric Corp. ....	110
Littelfuse .....	61
*Magnetics, Inc. ....	105
Mallory Controls Company .....	112
Markem Machine Company .....	62
Micro Instrument Company .....	98
*MicroSwitch, A Division of Honeywell 34, 35	
*Motorola Semiconductor Products, Inc. 24, 25	
NJE Corporation .....	19
Pastoriza Electronics, Inc. ....	95
Philco, Microelectronics Division .....	8
RCA Electronic Components and Devices .....	48, Cover IV
Raytheon Company, Components Division ..	82
*Redcor Corporation .....	2
Siliconix Incorporated .....	63
*Singer Company, The, Diehl Division .....	108
Sorensen Operation, Raytheon Company ..	16
*Spectral Electronics Corporation .....	15
Sprague Electric Company .....	10, 20
Syntronic Instruments, Inc. ....	108
Takeda Riken Industry Co. Ltd. ....	99
Tektronix, Inc., Oscilloscopes .....	4
Times Wire and Cable, Division of The International Silver Company .....	86
Tracor, Inc. ....	84
Transistor Electronics Corporation .....	83
Ultronix, Inc. ....	66
Westinghouse Molecular Electronics Division .....	57
<b>Regional Advertising</b>	
Arnold Engineering Company, The .....	80G
Brush Instrument Division of Clevite .....	80H
JFD Electronics Corporation .....	80E
Leach Corporation .....	80F
<b>Career Advertising</b>	
Delco Radio Division, General Motors ...	80
Honeywell .....	78
IBM Corporation .....	76
Martin Company .....	79

# Electronic Design HAYDEN BOOKS FOR DESIGN

## Advertising Representatives

### New York 10022

Robert W. Gascoigne  
Thomas P. Barth  
Samuel M. Deitch  
Richard W. Nielson  
850 Third Avenue  
(212) PLaza 1-5530  
TWX: 867-7866

### Philadelphia 19066

Fred L. Mowlds, Jr.  
P. O. Box 206  
Merion Station, Pa.  
(215) MO 4-1073

### Marblehead 01945

Richard Parker  
7 Redstone Lane  
(617) 742-0252

### Chicago 60611

Thomas P. Kavooras  
Berry Conner, Jr.  
720 N. Michigan  
(312) 337-0588

### Cleveland 44107

Robert W. Patrick  
8410 Treetower Drive  
Chagrin Falls, Ohio  
(216) 247-7670

### Los Angeles 90303

Stanley I. Ehrenclou  
Terrence D. Buckley  
W. James Bischof  
2930 W. Imperial Highway  
Inglewood, Calif.  
(213) 757-0183

### San Francisco

Ashley P. Hartman  
P. O. Box 1106  
Los Altos, Calif. 94022  
(415) 327-6536

### Southwestern 75206

Tommy L. Wilson  
6200 North Central Express-  
way  
Dallas, Tex.  
(214) EMerson 1-2311

### London W. 1

Brayton C. Nichols  
44 Conduit Street

### Tokyo

Yoshihiro Takemura  
International Planning  
Service, Inc.  
Room No. 512 Nikkoh  
Mita Building  
1, Nishidaimachi, Shiba-  
Takanawa  
Minato-ku, Tokyo

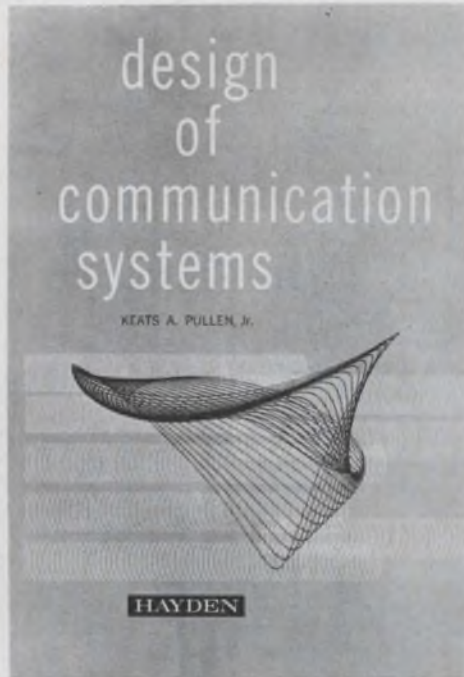

## Design Of Communication Systems

KEATS A. PULLEN, JR.

Here is an approach to the design of communication systems from a practical and useful point of view. Full consideration is given to design limitations of electronic communication systems and the variations resulting from the controlled change of parameters. The author has included a multitude of ideas for bridging the gap between all aspects of information theory and the routine decisions of systems design. Typical design problems discussed include: Range-Sum Instrumentation Systems; A Range Difference System; A Reflection Doppler System; A Radio Drone Control System; A Collision Warning Indicator for Aircraft.

CHAPTERS: Introduction. Design Considerations. Typical Design Problems. The Design of a Television System. Utilization Considerations. APPENDICES: Symbols and Definitions. Notes on the Minimum Useful Level for Electromagnetic Signals. The Transversal Filter. Phase Modulation of a Signal by Noise. Bibliography.

108 pages Illustrated Clothbound, \$4.25 Paperbound, \$2.75

Dept. ED-81, HAYDEN BOOK CO., INC. 116 W. 14 St., N.Y., N.Y. 10011

Please send me "Design of Communication Systems" for a 10-day Free Examination period. At the end of ten days I will remit payment plus postage or return the book. I would like the version checked below.

#5012, Clothbound, \$4.25

#5011, Paperbound, \$2.75

Name \_\_\_\_\_ Title \_\_\_\_\_

Company \_\_\_\_\_

Address \_\_\_\_\_

City \_\_\_\_\_ State \_\_\_\_\_ Zip \_\_\_\_\_

Check if payment enclosed. Publisher pays postage, with same return guarantee. (Foreign orders, except Canada, must include payment in \$ U.S.)



# MOL Resistors

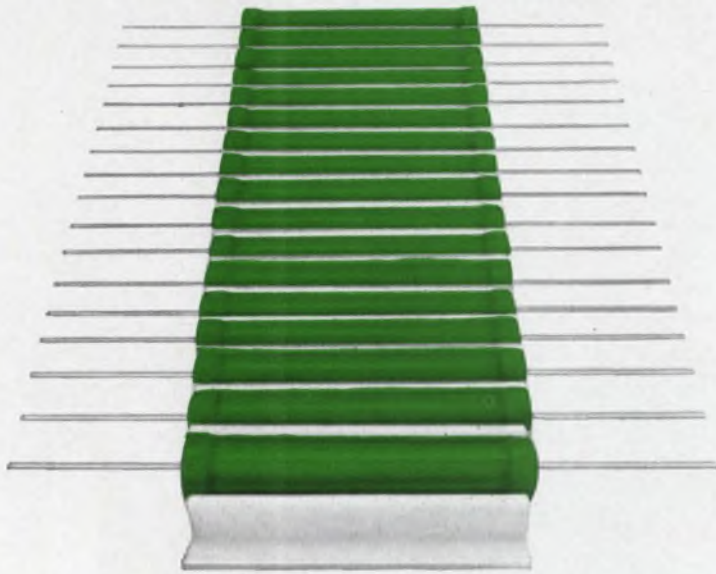

# PROMPT DELIVERY

...is one reason why all major TV manufacturers use Mallory MOL film resistors.

Other reasons? Temperature coefficient only 250 PPM/°C; proved flame resistance; high stability in humidity; less than 5% resistance change after 10,000-hour load-life test. Write for data and quotation. Mallory Controls Company, a division of P. R. Mallory & Co. Inc., Frankfort, Indiana 46041.

**50<sup>th</sup>**  
ANNIVERSARY

ON READER-SERVICE CARD CIRCLE 53

**MALLORY**

## Designer's Datebook

AUGUST						
S	M	T	W	T	F	S
7	8	9	10	11	12	13
14	15	16	17	18	19	20
21	22	23	24	25	26	27
28	29	30	31			

SEPTEMBER						
S	M	T	W	T	F	S
4	5	6	7	8	9	10
11	12	13	14	15	16	17
18	19	20	21	22	23	24
25	26	27	28	29	30	

### August 17-19

**Joint Automatic Control Conference** (Seattle, Wash.) Sponsor: AACC; Prof. Arthur Bryson, Dept. of A&A, MIT, Cambridge, Mass.

### August 23-26

**WESCON (Western Electronic Show & Convention)** (Los Angeles, Calif.) Sponsor: IEEE; Don Larson, WESCON, 3600 Wilshire Blvd., Los Angeles, Calif.

### August 29-31

**International Congress on Instrumentation in Aerospace Simulation Facilities** (Stanford University) Sponsor: IEEE, G-AES; R. K. Hallett, Jr., NASA, Ames Research Center, Moffett Field, Calif.

### August 29-31

**Annual Conference on Electronic Materials** (Boston, Mass.) Sponsor: AIME; Leonard R. Weisberg, the Metallurgical Society of AIME, 345 East 47th St., New York, N.Y.

### Sept. 15-16

**Computer Aided Solid-State Design Institute** (Santa Clara, Calif.) Sponsor: University of Santa Clara, Department of Electrical Engineering, Santa Clara, Calif.

### Sept. 20-22

**Eighth Annual Conference on Tube Techniques** (New York City) Sponsor: IEEE, G-ED; R. J. Bondley, General Electric Company, Schenectady, N. Y.

### Sept. 22-24

**IEEE Broadcast Symposium** (Cedar Rapids, Iowa) Sponsor: IEEE, G-B; Serge Bergen, 10828 Fairchester Drive, Fairfax, Va.

### Sept. 26-27

**Joint Engineering Management Conference** (Wash., D. C.) Sponsor: IEEE, G-EM et al; Homer Sarason, IBM, Armonk, N. Y.





MAKE US PROVE IT. Expanded production capabilities enable us to ship orders for 1,000 parts and up within 2 weeks. This includes all 57 catalog models: Military (RT-10, 11, 12) Commercial and General Purpose in rectilinear and square styles.

***For faster trimmer delivery phone 402-564-3131***

WRITE FOR CATALOG B

**DALE**

**DALE ELECTRONICS, INC.**

1328 28th Avenue, Columbus, Nebraska  
In Canada: Dale Electronics, Canada, Ltd.

Speed Inquiry to Advertiser via Collect Night Letter  
ON READER-SERVICE CARD CIRCLE 243

# Handle Every Power Stage in AM/FM Aircraft and Mobile Transmitters with Rugged RCA "overlay" Transistors

TYPE	FRE- QUENCY Mc/s	POWER OUTPUT WATTS (Min)	V <sub>CC</sub> VOLTS	GAIN dB (Min)	EFF. % (Min)	PKG.
40340	50	25	13.5	7	65	TO-60
40341		30	24	10	60	TO-60
40290	135	2*	12.5	6	70	TO-39
40291		2*		6	70	TO-60
40292		6*		5	70	TO-60
40280	175	1	13.5	9	60	TO-39
40281		4		6	70	TO-60
40282		12		5	80	TO-60
2N3553	175	2.5	28	10	50	TO-39
2N3632		7.5		6	70	TO-60
2N3375	400	3	28	5	40	TO-60
2N3733		10		4	45	TO-60

\*AM Carrier Power

For RF applications from 27 Mc/s To More than 400 Mc/s. "Overlay" is the RCA technology that brings high power and gain at high frequencies to the solid-state mobile and aircraft communications market. This high performance is available in a series of reliable and economical "overlay" transistors, offering the industry's widest choice of voltage, power and frequency performance for rf driver, pre-driver, and final amplifier stages.

Whatever RCA "overlay" type you select for your designs, you can be sure of efficient, rugged performance. Each "overlay" transistor undergoes Power-Rating Test (PRT) at maximum power levels for



one second. Both AM aircraft and FM mobile types are designed specifically to withstand load mismatch conditions. This capability means simpler design of the final stage and no need for protective circuits. In addition, types for AM aircraft display excellent modulation capability as well as high-voltage breakdown characteristics.

See your RCA representative for the full story on RCA "overlay" transistors for AM aircraft and FM mobile, as well as other types for citizens' band radio, military communications, and microwave applications. For technical data on specific types, write: RCA Commercial Engineering, Section IG8-1, Harrison, N. J.

Also Available From Your RCA Distributor

RCA Electronic Components and Devices



The Most Trusted Name in Electronics

See "THE OVERLAY TRANSISTOR—The Challenge and The Answer," a new 16-mm color film. Available through your local RCA representative.

ON READER-SERVICE CARD CIRCLE 244