

# Electronic Design 17

VOL. 14, NO.

THE MAGAZINE OF ESSENTIAL NEWS, PRODUCTS AND TECHNOLOGY

JULY 19, 1966

**Mix-and-match modules** create function generators. Start with the basic square-triangle module and power pack and build only as much generator as you need.

Three or four independent units for systems applications are no longer required. Specs are not sacrificed but costs are cut with this versatile system (page 104).

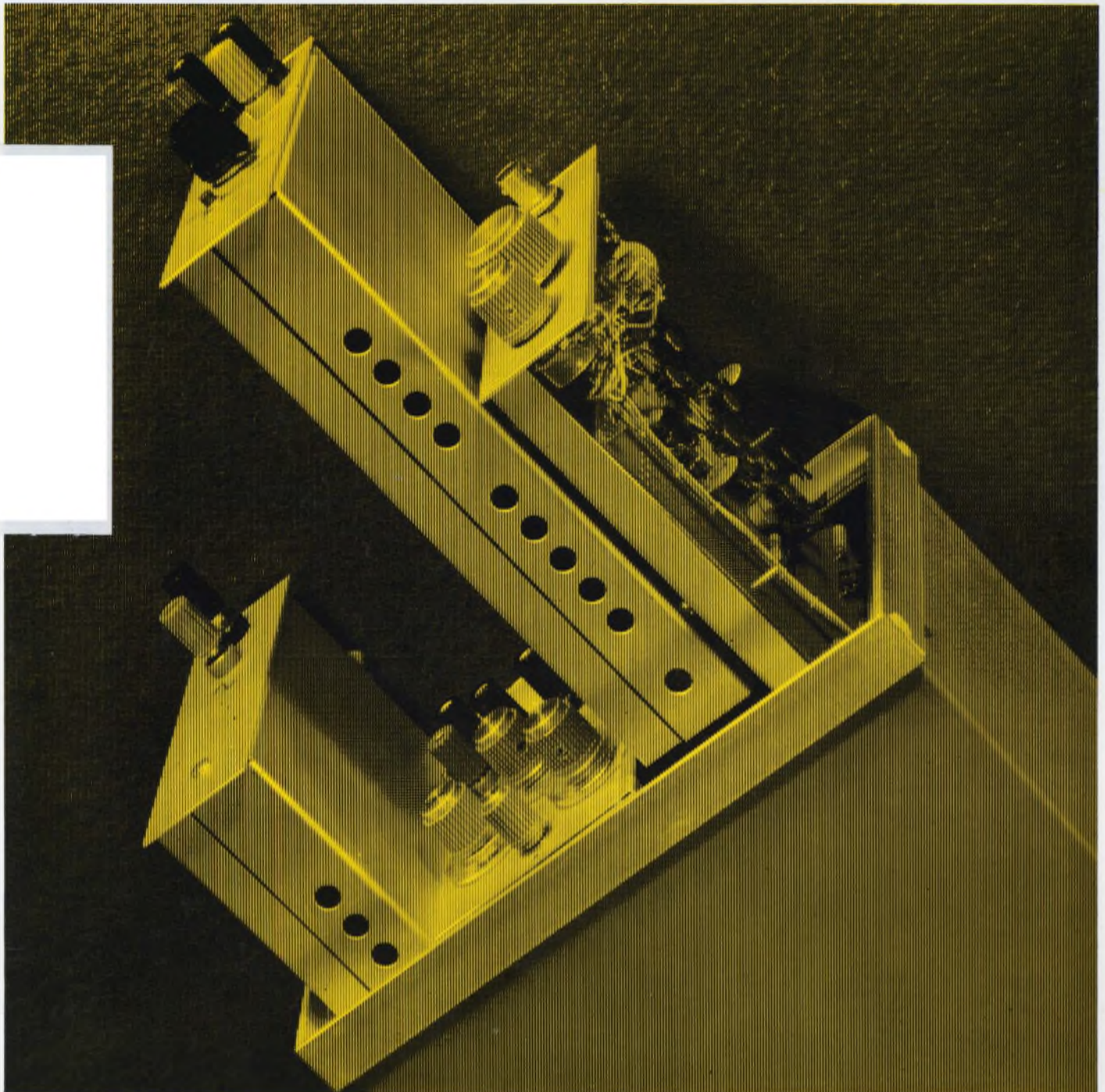



Gold-plated components  
conduct better,  
solder easier,  
reflect heat,  
and resist wear,  
corrosion,  
oxidation,  
galling.

Now let us give you the details.

The details are in our comprehensive reference guide—a voluminous encyclopedia of precious metal electroplating processes. Here you'll find charts, graphs, technical papers, magazine articles. A compendium of today's most advanced knowledge of gold-plating—the facts that have put gold into computers, communications equipment, jet aircraft, missiles, space probes. Write for your copy of "Gold Electroplating Processes."



Sel-Rex Corporation, Dept. A-7, 75 River Road, Nutley, N. J., 07110.

ON READER-SERVICE CARD CIRCLE 122

**A  
10 Hz  
to  
10 MHz  
AC Voltmeter  
with  
DC Output**



**With  
1 mV  
to  
300 V  
Linear/Log  
Ranges**



**for \$285**



**THAT'S WHAT HAPPENS WHEN THE HEWLETT-PACKARD 400 SERIES GOES SOLID-STATE!** Here's the world's first averaging ac voltmeter with a 0.5% of reading dc output... something you've never been able to get before. Offers a broad ac range, 10 Hz (cps) to 10 MHz (mc), 1 mV to 300 V, plus a log model, -72 to + 52 dBm.

Highest available input impedance, too, (10 M $\Omega$ ) with shunt capacity at a low value (8pf) unequalled by other instruments.

**WHAT'S EVEN BETTER:** Price... only \$285 for the 400E, only \$295 for the 400EL log model!

*If you have any of the following responsibilities, you should consider these points:*

**Design and production:** 1 mV-300 V range, adjustable meter setting

**Systems:** 0.5% of reading dc out (1 V) for ac/dc conversion

**Communications:** 10 Hz-10 MHz, dB scales, external battery operation

**Sciences:** ac amplifier output (150 mV), long-term stability

**Military:** More rugged than the reliability-proven tube versions

**University:** budget price

The brief specs here tell the story. Compare them with any others... and then call your Hewlett-Packard field engineer (you probably won't even need a demonstration). Or write for complete specs to Hewlett-Packard, Palo Alto, Calif. 94304, Tel. (415) 326-7000; Europe: 54 Route des Acacias, Geneva.

## SPECIFICATIONS

**Voltage range:** 1 mV to 300 V full scale, 12 ranges

**Frequency range:** 10 Hz to 10 MHz

hp 400E/EL							
Accuracy % of reading, 3 mV to 300 V ranges							
Frequency	10 Hz	20 Hz	40 Hz	2 MHz	4 MHz	10 MHz	
At full scale	$\pm 4$	$\pm 2$	$\pm 1$	$\pm 2$	$\pm 4$	$\pm 4$	
Accuracy % of reading, 1 mV range							
Frequency	10 Hz	20 Hz	40 Hz	500 kHz	1 MHz	4 MHz	6 MHz
At full scale	+4	$\pm 2$	$\pm 1$	$\pm 2$	$\pm 4$	+4	-10
		-10					
hp 400E/EL							
AC-to-DC Converter Output							
Accuracy % of reading, 3 mV to 300 V ranges							
Frequency	10 Hz	20 Hz	40 Hz	100 Hz	500 kHz	2 MHz	4 MHz
At full scale	$\pm 4$	$\pm 2$	$\pm 1$	$\pm 0.5^*$	$\pm 1$	$\pm 2$	$\pm 4$

\*For 15°C-40°C on 1 mV-1 V ranges only.

**Input impedance:** 10 megohms shunted by 21 pf on the 1 mV-1 V ranges, 10 megohms shunted by 8 pf on the 3 V-300 V ranges

**Amplifier ac output:** 150 mV rms for full-scale meter indication; output impedance 50 ohms, 10 Hz to 10 MHz (105 mV on the 1 mV range)

**AC-DC converter output:** 1 V dc output for full-scale meter deflection; output is linear for both 400E and 400EL

**External battery operation:** terminals provided on rear panel

**Price:** 400E, \$285 (replaces 400H-\$325)

400 EL, \$295 (replaces 400L-\$325)

Data subject to change without notice. Prices f.o.b. factory.

**HEWLETT**  **PACKARD**  
An extra measure of quality

ON READER-SERVICE CARD CIRCLE 2



## Our new Mother...all-silicon solid state

We're normally a hard-nosed, unsentimental bunch at CMC, dedicated to giving the other two major makers of electronic counters (Hewlett-Packard and Beckman) a run for their money. So you wouldn't think we'd have time for motherhood or advancing the counter art. **But**, we've scored on all three with our new 600-Series. (1) It's the first all-silicon solid state counter. (2) We're the first of the big three to use the advanced "Mother-Board" technique. So we've cut size, weight, and components while increasing reliability and ease-of-maintenance. (3) Operating temperatures from  $-30^{\circ}$  to  $+75^{\circ}\text{C}$  are available. (Other folks we know strain to claim  $-25^{\circ}$  to  $+65^{\circ}\text{C}$ ). Model 607 provides a frequency range of 0 to 5 Mc and period measurement of 0 to 1 Mc. Other models have readout from 2 cps to 2.5 Mc. That's eight times faster than any competitive counter at the price. All this, and a price that's competitive with ordinary germanium counters. **Something free!** We give a glorious Crusading Engineers' medal to engineers who have the courage to compare **everyone's** performance specs before buying a counter. Get yours by writing today for our new stimulating technical catalog. It's free, too. And your Mother will be so proud of your shiny medal.



12973 Bradley • San Fernando, California • Phone (213) 367-2161 • TWX 213-764-5993

COMPUTER MEASUREMENTS COMPANY IS A LEADING DESIGNER AND MANUFACTURER OF ELECTRONIC INSTRUMENTATION TO COUNT, MEASURE, AND CONTROL.

Speed Inquiry to Advertiser via Collect Night Letter  
ON READER-SERVICE CARD CIRCLE 3

---

## NEWS

- 13 News Scope
- 17 **Mount transistors in topsy-turvy holders**  
Small and simple, new inverted ceramic holders connect semiconductor chips to substrate.
- 18 **Advances sought for deep submersibles**  
Accurate navigation systems and improved power sources are needed for improved mission capability.
- 24 Supersensitive radars spot clear air turbulence.
- 26 Most powerful atom smasher to make debut.
- 29 Washington Report
- 33 'Resonistor' may tune ICs.
- 35 Sensitive SQUID measures minute magnetism.
- 38 Letters
- 41 Semiconductor Directory Reference Issue Errata
- 43 **Editorial:** The quest is on for the perfect micronym.

---

## TECHNOLOGY

- 46 **Tunnel diodes trigger thyristors** for a complementary, compatible design. Stability, accuracy, versatility and simplicity are the ancillary benefits.
- 56 **Log IF strips use cascaded ICs** in successive-detection-type amplifier to cut packaging time and costs.
- 61 **Perform binary division fast.** Here are some techniques for handling division that can improve computer operation.
- 68 **Neons control VOX circuits,** suppress transients in transceiver. Complete independence of VOX sensitivity and delay-time adjustment highlight the design.
- 72 **Consider double-loop regulation:** hybrid megamp-SCR circuit combines benefits of reactive and dissipative techniques in a five-pound unit.
- 78 **Measure potentiometer noise** correctly and you may find that your noise problem has disappeared—or at least eased.
- 83 Semiannual Index of Articles for January to June, 1966
- 88 Ideas for Design

---

## PRODUCTS

- 104 **Cover Feature:** Mix-and-match modules create function generators.
- 114 **Components:** Back-panel wiring harness supersedes connector blocks.
- 136 Materials
- 140 Production Equipment
- 144 Microelectronics
- 148 Power Equipment
- 150 Semiconductors
- 154 Microwaves
- 160 Systems

---

## Departments

- 96 Book Reviews
- 162 New Literature
- 170 Reprints
- 172 Application Notes
- 174 Advertisers' Index
- 176 Designer's Datebook

# Nobody but AE makes a Class E relay with all these terminals.

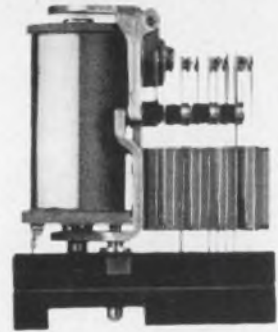

## Take your pick:

**1** *Solderless Wrap Terminals* eliminate the hazards of soldering. No splashes, heat or clippings. Faster, easier connections. And the technique is easy to learn.



**2** *Taper Tab Terminals* accept solderless, slip-on connections which are crimped to each wire lead. Easy to connect or disconnect. Simplify circuit changes and relay substitutions.



**3** *Solder Terminals*—the conventional way. For chassis and rack mounting where quick-connect methods aren't needed.



**4** *Printed Circuit Terminals* can be inserted directly into PC cards or boards. All terminals are soldered at one time by "flowing." This process can be automated.

You can get AE Class E relay with several types of plug-in sockets, too—that further in-

crease the number of mounting options.

But don't select the Class E relay because of wiring convenience alone. This is a miniaturized version of the premium-quality Class B—with most of its best features. Perfect contact reliability exceeding 200 million operations is common. That's why, even with ordinary solder terminals, the Class E is the most popular *quality* relay of its size!

For helpful information on the full line, ask for Circular 1942. Just write the Director, Relay Control Equipment Sales, Automatic Electric Company, Northlake, Illinois 60164.

**AUTOMATIC ELECTRIC**  
SUBSIDIARY OF  
GENERAL TELEPHONE & ELECTRONICS **GTE**

Schjel-Flex\*

... new twist  
in circuitry

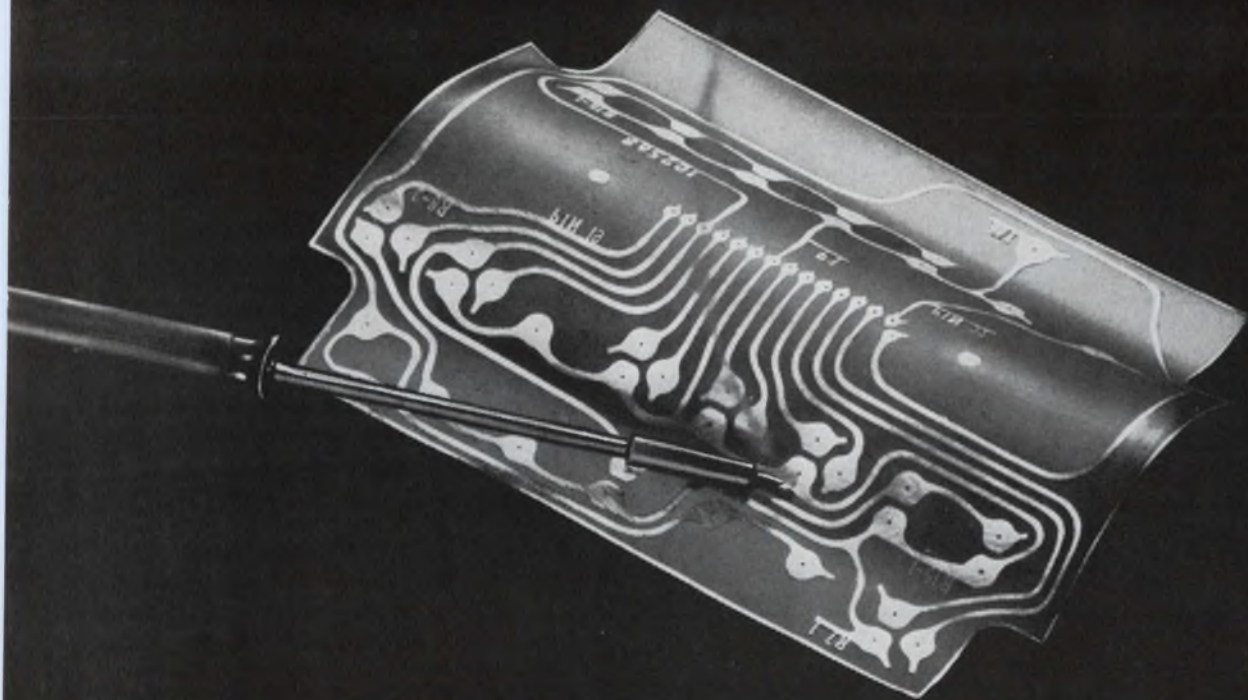

Schjel-Flex Kapton† circuit for Astronautics Corp. of America, Milwaukee, Wisconsin

## New Schjel-Flex\* Kapton circuit beats heat

Of course you wouldn't lay a hot soldering iron on a flexible printed circuit. But if someone *should*, this one wouldn't be a production reject. It takes the heat because the base is Kapton, laminated to copper with a proprietary Schjeldahl adhesive system that approximates the characteristics of the polyimide film.

We've made hundreds of thousands of Schjel-Flex circuits. Most often, we use our polyester laminate, GT-5500 Schjel-Clad.\* With polyester's excellent physical, electrical and chemical properties, the circuits are right for most applications. But sometimes extreme processes or service temperature requirements exceed polyester's limits. That's why we've developed the Kapton laminate. It retains poly-

ester properties at much greater temperature extremes.

For example, at room temperature, a Schjel-Flex Kapton circuit has tensile strength of about 25,000 psi. At 260°C, it's 14,000 to 15,000 psi. Typical cut-through temperature, using a weighted probe on heated film, is 435°C. Room temperature dielectric strength is 7,000 volts/mil; 4,000 volts/mil at 260°C. The Kapton base is non-flammable, infusible and unaffected by known organic solvents.

There are other high temperature circuits. But ours is the first to use an adhesive system — instead of fusion-bonding copper to Teflon† or a Teflon-Kapton combination. The adhesive doesn't permit conductor "swimming"

during processing. Tolerances of  $\pm 0.1\%$  can be achieved.

Schjel-Flex circuits offer the design freedom of materials you can bend, twist and flex. At the same time, they give you the precision and assembly ease of printed circuit boards. Yet with all their desirable qualities, our continuous roll production keeps unit costs low.

We'd like to help find a Schjel-Flex answer to your circuit problem — whether you want to make or buy. Our list of standard Schjel-Clad laminates will soon include the Kapton-base material (designated GT-7500). We're already making circuits of it. Don't let pronunciation stop you. Say "Shell-Doll."

\*Trademark, G. T. Schjeldahl Company

†Du Pont trademark



**Schjeldahl** / ELECTRICAL  
PRODUCTS  
DIVISION

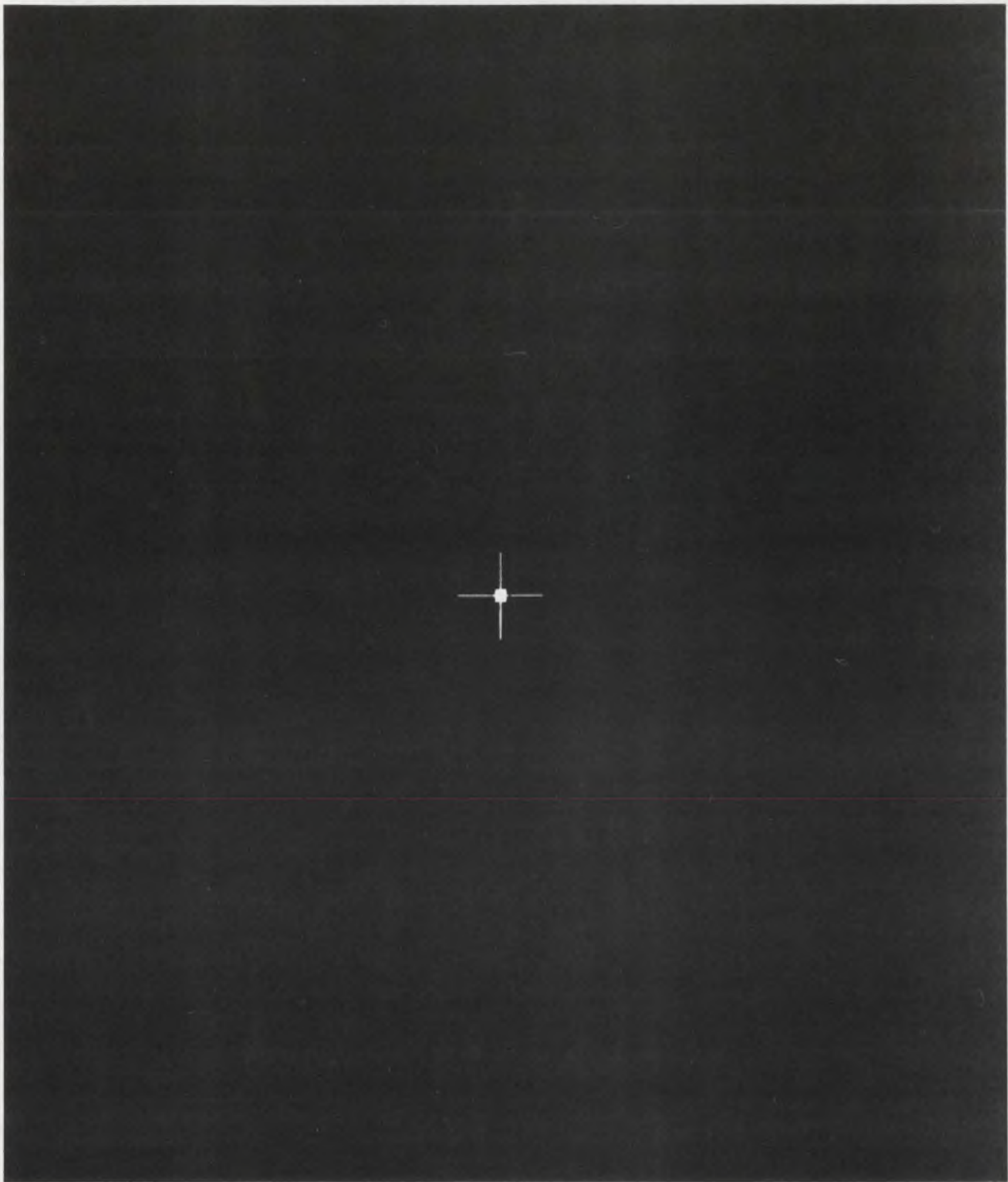

## Space capsule. (Actual size)

Meet Hermet. It takes up less space than any other hermetically sealed transistor capsule. Hermet is ceramic, hermetic, and measures only 80 x 80 x 50 mils. It passes all military environmental tests including hermeticity. It holds almost any of our standard transistors, except for power devices. It's readily available. You can get Hermet through Fairchild Distributors or from Fairchild. Use it wherever you need hermetic sealing and are cramped for space. Like in space.

**FAIRCHILD**  
SEMICONDUCTOR

FAIRCHILD SEMICONDUCTOR / A Division of Fairchild Camera and Instrument Corporation ■ 313 Fairchild Drive, Mountain View, California (415) 962-5011 ■ TWX: 910-379-6435

ON READER-SERVICE CARD CIRCLE 6



# Be a hero — design something with our new conductive-film pendulum pot —

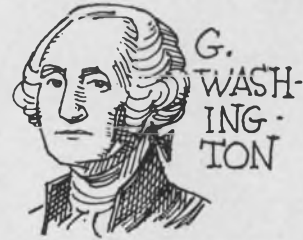

(and win your very own certificate of heroism).

Strong point of our new transducer is infinite resolution in both linear and nonlinear functions. Trigonometric, logarithmic, or any empirical functions can be generated to provide a smooth transition of a mathematical characteristic. This unique versatility makes it easy to win your certificate of heroism. Here are a few more specs to help you along.

The transducer consists of a pendulous high-density mass vertically suspended from an ultralow-torque bearing system. Hermetically sealed silicone fluids of varied viscosities mean you can use practically any damping ratio you like. What's more, your design element can be of deposited conductive material or of wire, wound in sizes down to .0003 inches.

Our ability to trim the resistive element down *after* manufacturing means, too, that your design can include a high order of accuracy conformity—up to .05%! And you needn't worry about striction because it's kept at a minimum with Litton's smooth track and light wiper pressure.

We've already thought of a few of the more obvious applications, but let's see what you can come up with. We'll send your certificate by return mail, and if yours is one of the 50 best ideas we'll publish it in our next IDEA BOOK.

**LITTON INDUSTRIES**   
POTENTIOMETER DIVISION

*If your present supplier can't solve your potentiometer problem, try us. For single-turn and multiturn, linear and functional, wirewound and conductive film, ganged or unitized with servo modules—Litton begins where others leave off.*

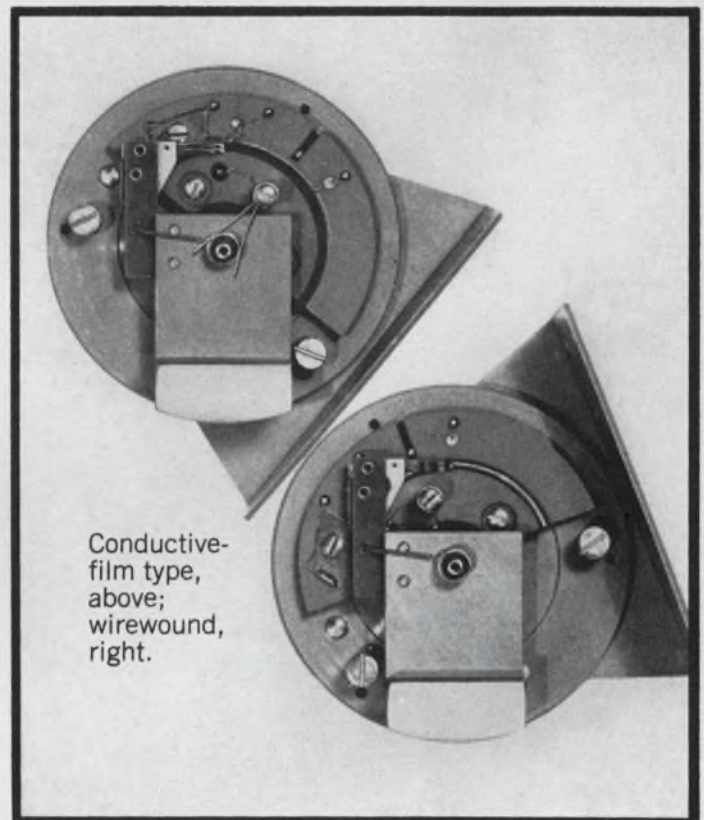

Litton Industries, Potentiometer Division  
226 East Third Street, Mt. Vernon, New York 10550

My idea for an application is attached. Send my hero certificate.

I have an idea, but need more data first. Send specs.

Name \_\_\_\_\_ Title \_\_\_\_\_

Company \_\_\_\_\_

Address \_\_\_\_\_

City \_\_\_\_\_ State \_\_\_\_\_ Zip \_\_\_\_\_



# half the picture

*When you look at electronic components  
are you seeing only half the picture?*

We're the last people to argue with component purchasers who put performance, price and delivery first — meeting these three basic requirements is what keeps us in business. But most engineers are also on the lookout for something more, and many of them find it at Mullard.

Take research and development for instance. Out of Mullard R&D have come outstanding devices such as the travelling wave tubes for the New York—San Francisco and Montreal—Vancouver microwave links. Production resources? Mullard

plants are among the most efficient anywhere, with a reputation for the production of tight-tolerance devices to proved standards of reliability. As for circuit know-how, Mullard has the best equipped applications laboratories in Britain. And when it comes to technical services, you will find that Mullard provides the kind of comprehensive performance specs, survey documents and application reports that are just that much more useful.

If you want to get the *whole* picture, why not ask us to help you with some of your component problems?

ON READER-SERVICE CARD CIRCLE 225

DIODES · TRANSISTORS · PHOTO-DEVICES AND RADIATION DETECTORS · RECTIFIER DIODES AND STACKS · THYRISTORS AND STACKS · INTEGRATED CIRCUITS · CATHODE RAY TUBES · RECEIVING TUBES · ELECTRON OPTICAL DEVICES · PHOTSENSITIVE DEVICES · COLD CATHODE DEVICES · POWER DEVICES · TRANSMITTING TUBES · MICROWAVE DEVICES · CAPACITORS · FERRITE MATERIALS AND ASSEMBLIES · COMPUTER COMPONENTS AND ASSEMBLIES · MAGNETIC MATERIALS · SPECIAL PURPOSE MAGNETS · VACUUM DEVICES · WOUND COMPONENTS.

# Mullard

*where the product is only part of the deal*

MULLARD LIMITED · TORRINGTON PLACE · LONDON WC1 · ENGLAND

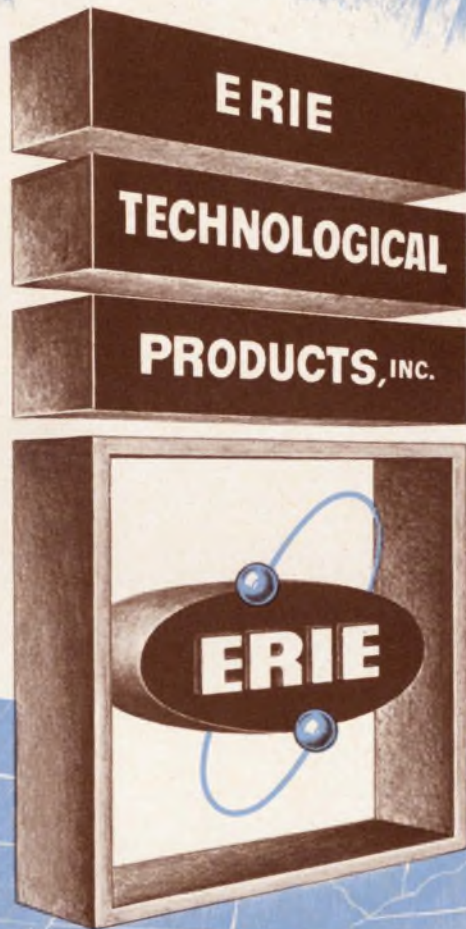

***A Growing Force in the World of Electronic Components***











SUBMINIATURE CAPACITORS • EMI FILTERS • SEMICONDUCTORS • THICK FILM INTEGRATED CIRCUITS •

ERIE, PENNSYLVANIA • OFFICES IN MOST PRINCIPAL CITIES •

ON READER-SERVICE CARD CIRCLE 8

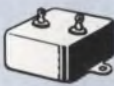
# All from Sprague!

## TWELVE OF OUR MOST POPULAR METALLIZED CAPACITOR TYPES

SPRAGUE TYPE	Case And Configuration	Dielectric	Temperature Range	Military Equivalent	Engineering Bulletin
 <b>680P</b>	hermetically-sealed metal-clad tubular	metallized Metfilm* 'A'	-55 C, +85 C	no specification	2650
 <b>431P</b>	film-wrapped axial-lead tubular	metallized Metfilm* 'E' (polyester film)	-55 C, +85 C	no specification	2445
 <b>155P, 156P</b>	molded phenolic axial-lead tubular	metallized paper	-40 C, +85 C	no specification	2030
 <b>218P</b>	hermetically-sealed metal-clad tubular	metallized Metfilm* 'E' (polyester film)	-55 C, +105 C	CH08, CH09 Characteristic R	2450A
 <b>260P</b>	hermetically-sealed metal-clad tubular	metallized Metfilm* 'K' (polycarbonate film)	-55 C, +105 C	no specification	2705
 <b>121P</b>	hermetically-sealed metal-clad tubular	metallized paper	-55 C, +125 C	no specification	2210C
 <b>118P</b>	hermetically-sealed metal-clad tubular	metallized Difilm® (polyester film and paper)	-55 C, +125 C	CH08, CH09 Characteristic N	2211D
 <b>143P</b>	hermetically-sealed metal-clad "bathtub" case	metallized paper	-55 C, +125 C	no specification	2220A
 <b>144P</b>	hermetically-sealed metal-clad "bathtub" case	metallized Difilm® (polyester film and paper)	-55 C, +125 C	CH53, CH54, CH55 Characteristic N	2221A
 <b>284P</b>	hermetically-sealed metal-clad rectangular case	metallized paper	-55 C, +105 C	no specification	2222
 <b>283P</b>	hermetically-sealed metal-clad rectangular case	metallized Difilm® (polyester film and paper)	-55 C, +125 C	CH72 Characteristic N	2223
 <b>282P</b> (energy storage)	drawn metal case, ceramic pillar terminals	metallized paper	0 C, +40 C	no specification	2148A

For additional information, write Technical Literature Service, Sprague Electric Company, 347 Marshall St., North Adams, Massachusetts 01247, indicating the engineering bulletins in which you are interested.

\*Trademark

### SPRAGUE COMPONENTS

CAPACITORS  
TRANSISTORS  
RESISTORS  
INTEGRATED CIRCUITS  
THIN-FILM MICROCIRCUITS

PULSE TRANSFORMERS  
INTERFERENCE FILTERS  
PULSE-FORMING NETWORKS  
TOROIDAL INDUCTORS  
ELECTRIC WAVE FILTERS

CERAMIC-BASE PRINTED NETWORKS  
PACKAGED COMPONENT ASSEMBLIES  
BOBBIN and TAPE WOUND MAGNETIC CORES  
SILICON RECTIFIER GATE CONTROLS  
FUNCTIONAL DIGITAL CIRCUITS

**SPRAGUE**<sup>®</sup>  
THE MARK OF RELIABILITY

"Sprague" and "®" are registered trademarks of the Sprague Electric Co.

# News

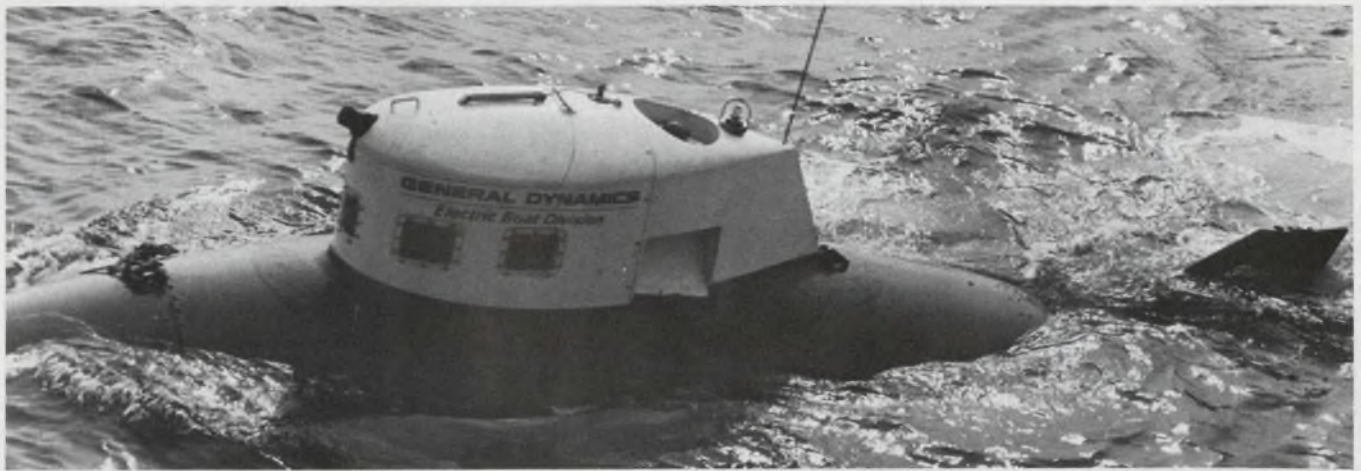

**Deep submersibles** are expected to play an important role in future exploitation of the

ocean. But improved power sources and navigation methods are needed. Page 18

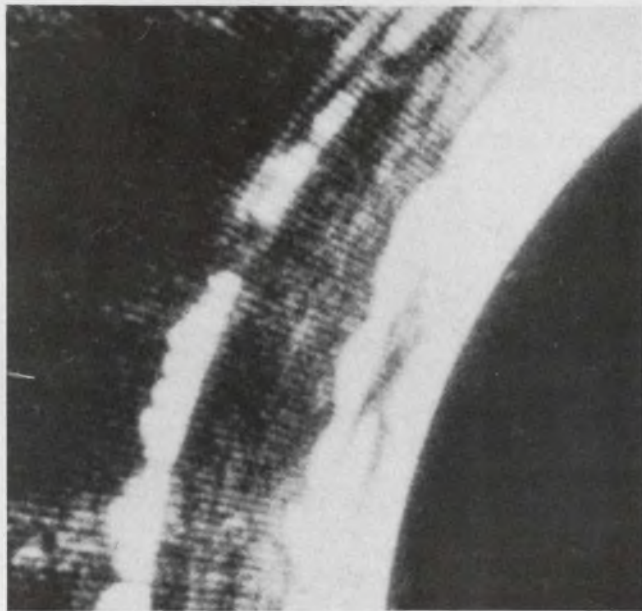

**Ultra-sensitive radars** effectively detect clear-air turbulence. Page 24

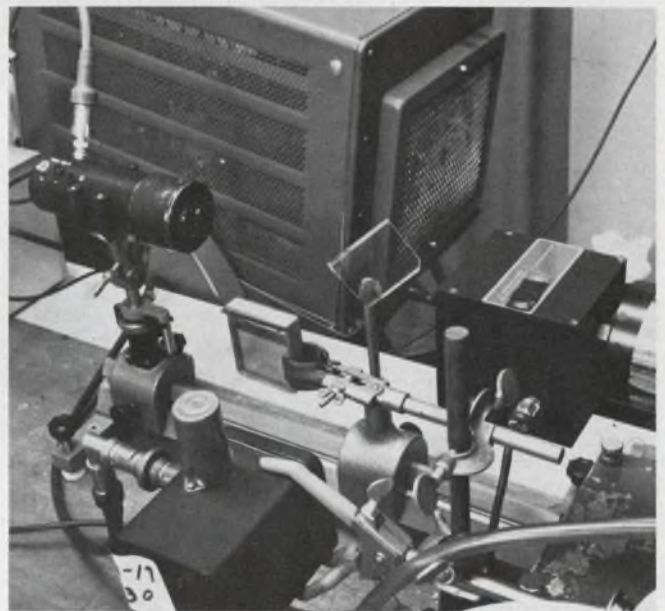

**Silicon attenuators** provide stable means for measuring laser power. Page 23

## Also in this section:

**Transistors fit onto hybrid substrates** in leadless ceramic packs . . . Page 17

**New undersea cable system** has 720 channels . . . Page 22

**Most powerful accelerator** to make debut . . . Page 26

**Resonistor** may provide new method for tuning integrated circuits . . . Page 33

## New Bridge Design For Safe, Accurate, Easy Measurement of 'Lytic Capacitors

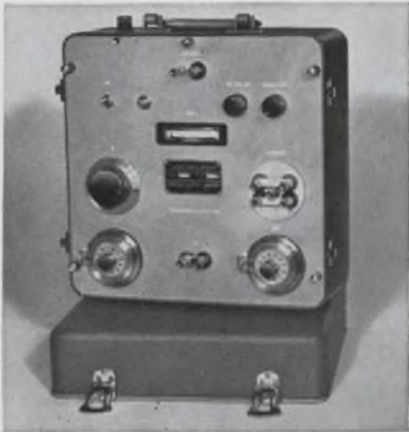

The Sprague Model 1W2A Capacitance Bridge introduces new, improved technical refinements as well as restyling for added attractiveness and ease of operation. Built by capacitor engineers for capacitor users, it incorporates the best features of bridges used for many years in Sprague laboratories and production facilities.

### Precision Measurements over Entire Range from 0 to 120,000 $\mu$ F

The internal generator of the 1W2A Bridge is a line-driven frequency converter, and detection is obtained from an internal tuned transistor amplifier-null detector, whose sensitivity increases as the balance point is approached. It has provision for 2-terminal, 3-terminal, and 4-terminal capacitance measurements, which are essential for accurate measurement...  $\pm 1\%$  of reading + 10  $\mu$ F... of medium, low, and high capacitance values, respectively.

### No Damage to Capacitors

The model 1W2A Capacitance Bridge will not cause degradation or failure in electrolytic or low-voltage ceramic capacitors during test, as is the case in many conventional bridges and test circuits. The 120 cycle A-C voltage, applied to capacitors under test from a built-in source, never exceeds 0.5 volt! It is usually unnecessary to apply d-c polarizing voltage to electrolytic capacitors because of this safe, low voltage.

### Complete Specifications Available

For complete technical data on this precision instrument, write for Engineering Bulletin 90,010A to Technical Literature Service, Sprague Electric Company, 347 Marshall Street, North Adams, Massachusetts.

488P-128-63

ON READER-SERVICE CARD CIRCLE 9

# Did You Know Sprague Makes 32 Types of Foil Tantalum Capacitors?

## 125 C TUBULAR TANTALEX® CAPACITORS



- Type 120D polarized plain-foil
- Type 121D non-polarized plain-foil
- Type 122D polarized etched-foil
- Type 123D non-polarized etched-foil

ASK FOR BULLETIN 3602C

ON READER-SERVICE CIRCLE 821

## 85 C TUBULAR TANTALEX® CAPACITORS



- Type 110D polarized plain-foil
- Type 111D non-polarized plain-foil
- Type 112D polarized etched-foil
- Type 113D non-polarized etched-foil

ASK FOR BULLETIN 3601C

ON READER-SERVICE CIRCLE 822

## RECTANGULAR TANTALEX® CAPACITORS



- Type 300D polarized plain-foil
- Type 301D non-polarized plain-foil
- Type 302D polarized etched-foil
- Type 303D non-polarized etched-foil

ASK FOR BULLETIN 3650

ON READER-SERVICE CIRCLE 823

## TUBULAR TANTALUM CAPACITORS TO MIL-C-3965C



- CL20, CL21 125 C polarized etched-foil
- CL22, CL23 125 C non-polarized etched-foil
- CL24, CL25 85 C polarized etched-foil
- CL26, CL27 85 C non-polarized etched-foil
- CL30, CL31 125 C polarized plain-foil
- CL32, CL33 125 C non-polarized plain-foil
- CL34, CL35 85 C polarized plain-foil
- CL36, CL37 85 C non-polarized plain-foil

ON READER-SERVICE CIRCLE 824

## RECTANGULAR TANTALUM CAPACITORS TO MIL-C-3965C



- CL51 polarized plain-foil
- CL52 non-polarized plain-foil
- CL53 polarized etched-foil
- CL54 non-polarized etched-foil

ON READER-SERVICE CIRCLE 825

For comprehensive engineering bulletins on the capacitor types in which you are interested, write to:

Technical Literature Service  
Sprague Electric Company  
347 Marshall Street  
North Adams, Mass. 01248

45C-5161

**SPRAGUE®**  
THE MARK OF RELIABILITY

Sprague and ® are registered trademarks of the Sprague Electric Co.

## Television programs rediffuse through England

Several English firms are taking the CATV (community antenna television) principle one step further. They manufacture centralized receiver circuitry that supplies several channels (both video and audio) to a compact remote unit that contains only deflection circuits, a picture tube and a speaker. The viewer can then select any channel by simply turning a switch on the set.

The National Community Television Association (NCTA) convention in Miami, Fla., discussed several such systems—all English. Although color television is not yet available to the public in England, at least one of these systems can be used to centralize color receivers.

Though rediffusion, as these systems are called, has only been used in large hotels so far, the city of Leicester, England, is examining the possibilities of offering it to local residents. The sets would be rented to the user and the signals would come from the central circuitry to the remote sets on either coaxial or multiconductor cables. Which kind of cable will depend on whether the Leicester City council decides to use

the vhf system (40-to-800-MHz signals traveling on two coaxial conductors) proposed by Multisignals, Ltd., or the hf system (2-to-10-MHz signals traveling on a pair of twisted, unshielded conductors for each channel) proposed by Rediffusion, Ltd., and British Relay Wireless and Television, Ltd.

There are many advantages to a community rediffusion system. The remote sets can be made cheaply. They require practically no maintenance. All fine tuning is done at the central control, a particularly important consideration for color reception. Interference due to electrical disturbance and aircraft is reduced to a minimum.

Most observers feel that the hf transmissions are more suitable for rediffusion than the vhf. The lower-frequency signals are attenuated less by the conductor and are more immune to interference. The sets, too, require less circuitry to receive the hf signals and convert them into audio and video.

A British official remarked that England was the logical place for rediffusion to gain a foothold be-

cause already 70% of all television sets in use are rented, not bought. The rediffusion system will offer the viewer a better-quality image at a lower rental than if he rented a regular unit and the services of a community antenna.

The United States has never been receptive to such proposals. But, according to R. P. Gabriel, chief engineer of Rediffusion, Ltd., "it is increasingly recognized that in the major cities of North America the ordinary means of television reception is becoming unsatisfactory, and every time a new skyscraper is built the pattern of ghosts and interference is altered in the locality. Furthermore, it is necessary for all the apartment blocks to have some kind of distribution system and it might make a lot of sense to connect them up and to have a single system serve the whole city."

### Surveyor chalks up A+ for endurance

The remarkable endurance of the Surveyor I spacecraft has both surprised and impressed project officials. After landing on the Ocean of Storms last June 2, it sent over 10,000 photographs back to Earth. It then "slept" through a two-week lunar night, during which the Moon's surface temperature dropped as low as  $-260^{\circ}\text{F}$ . And after a week of warming in the lunar morning, Surveyor successfully transmitted more pictures.

Shortly after this reawakening, it became evident that there was trouble in the spacecraft's battery, when the battery temperature rose to almost  $140^{\circ}\text{F}$ . But even this crisis passed, when all equipment except one receiver was turned off and the battery temperature dropped closer to normal.

When Surveyor I finally does succumb to what is tentatively diagnosed as a cracked battery, it will have provided significant information on equipment survival in the lunar environment.

### ICs make new inroads in consumer field

Breaking new ground in consumer electronics, the General Electric Co. earlier this month make public a tiny clock-radio that uses a single integrated circuit (IC).



Adjustments at central control . . .



Consumer market waking up to ICs.

The whole radio, except for speaker, battery, antenna, and tuning adjustments, is built right on a monolithic silicon chip. The chip is then encapsulated in an "economy," 14-lead, dual-in-line package. The consumer, besides getting a smaller clock-radio at lower cost, has the benefit of greatly improved reliability. GE has backed this by offering a three-year warranty on parts and labor. The warranty includes, to boot, the rechargeable nickel-cadmium battery that powers the set.

The radio is completely self-contained. When plugged into the combination clock-charger unit, it becomes a clock-radio complete with snooz-Alarm and extra speaker, while the radio's batteries are simultaneously recharged. Cost of the clock-radio, which will be available in October, is \$39.95.

George Farnsworth, marketing manager, GE Semiconductor Products Dept., pointed out that the "economy" ICs are presently only produced on an in-house basis.

He added, however, that by the spring of 1967 he expected a number of linear circuits to be available in this new package on an off-the-shelf basis. Farnsworth pointed out that the price could be as low as 80 cents in quantities of 100,000. First units to be offered will be the GE operational amplifiers now made in TO-5 cans.

## NASA looking into home-broadcast satellite

Television broadcasts relayed by Early Bird satellite are now commonplace to anyone who spends even a modest amount of time in front of

a TV set. But these relays must be received by special ground stations before being retransmitted commercially. A small first step toward the eventual elimination of this intermediary has recently been taken by NASA.

NASA is negotiating a contract with the Missile and Space Division of General Electric Co. and the Astro-Electronics Division of RCA for a study of the feasibility of a satellite capable of broadcasting directly to conventional home FM radios and/or short-wave radios. Each company will conduct a detailed mission study of two alternative spacecraft configurations: one for a satellite capable of transmitting in the hf (short-wave) band, and the other for a satellite transmitting in the commercial FM band.

According to NASA, the results of the two studies will be used to help direct its future research and development program.

## New NBS group to help standards-makers

The National Bureau of Standards has established a new office as a focal point for NBS assistance to engineering-standards-making bodies throughout the nation.

Called the Office of Engineering Standards Liaison and Analysis, the new Office will investigate new ways both to increase the effectiveness of NBS technical assistance in the development of engineering standards, and to match NBS technical resources to the needs of outside organizations. It will also, according to NBS, make a continuous effort to extend and improve communication between the bureau and other engineering-standards bodies.

## Two old satellites celebrate birthdays

Birthday greetings are in order for two satellites, both of which represent milestones in the U.S. space program.

The Tiros VII, launched with a mission goal of three months, has just passed its three-years-in-space mark with its cameras still fully operational and sending back pictures of the Earth's cloud cover. Even older is the Navy's experimental navigation satellite 4-A, which has clocked its fifth annivers-

ary in space still signaling to Navy tracking stations around the world.

The 4-A became the oldest operating satellite in May, 1964, when the signals of Vanguard I, launched on March 17, 1958, were heard by NASA stations for the last time. The drum-shaped 4-A has traveled more than 724,000,000 miles and was the forerunner of the now operational Navy navigation system. It was also the first satellite to carry a nuclear battery.

Despite their operational longevity, both the Tiros VII and the 4-A are relatively crude compared with their sophisticated successors being launched today. As a result, many of the newer satellites are being provided with disabling circuitry that will shut the satellite down when its mission goals have been achieved.

---

**Another Japanese manufacturer** has entered the U.S. electronic home entertainment products market. Toshiba, the giant international electrical and electronics firm, now offers a full line of "popular-price" items in the U.S., including both color and black-and-white television receivers, transistor radios, tape recorders and related products.

**A three-axis laser gyroscope** is to be developed by Honeywell's Aeronautical division for the Army Missile Command. Three helium-neon gas lasers will form the heart of the unit, to be developed under the 24-month, \$500,000 contract.

**RCA sales topped \$1 billion** for the first half of 1966—the top figure ever achieved at mid-year in the company's history. Color television, which accounted for a significant portion of the total sales, reached a milestone during the same period, when RCA produced more color sets than it did black-and-white units.

**Artificial hearts** of the type used by heart surgeon Michael DeBakey at Methodist Hospital in Houston will be produced by Statham Instruments, Inc. under a production-engineering contract with the National Heart Institute. Under this historic contract, 62 artificial hearts and 12 control consoles will be delivered.



# Challenge from Westinghouse:

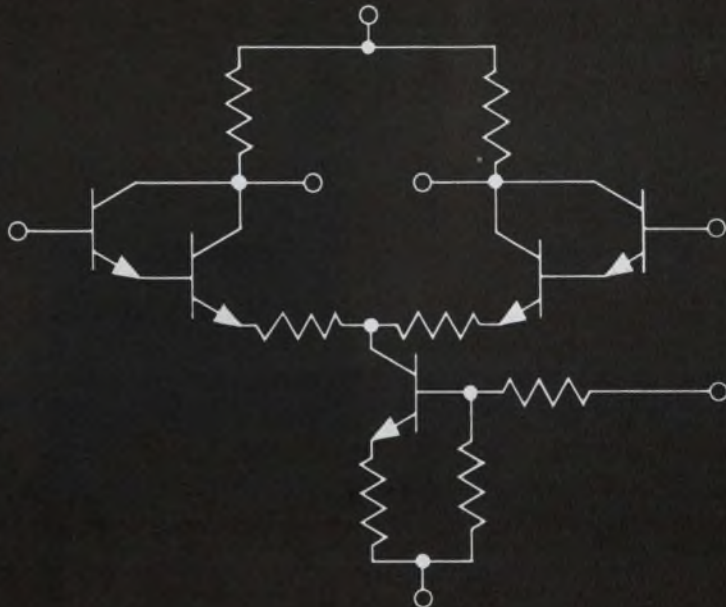

Input impedance	500 K $\Omega$
Output impedance	8 K $\Omega$
Output voltage swing	14 volts P/P
Differential gain	50 V/V
Frequency response	150 KHz
Common mode rejection ratio	80 db
Drift	10 $\mu$ V/ $^{\circ}$ C
Supply voltage	+12 V, -9 V

## try to find another IC differential amplifier like this for \$7.50

### WC 115 T directly replaces IC's costing much more

This universal differential amplifier gives you two Darlington pairs in a differential connection with a constant-current source. Manufacturer's price in 50-499 quantities: \$7.50. For smaller orders: \$10.50.

How does Westinghouse do it? Having the most modern IC plant in the industry helps. But mostly, it's a product of Westinghouse research leadership in linear IC's.

This differential amplifier design gives you top performance in these parameters: input impedance, input current, source to load isolation, temperature stability, and DC drift. You can use it as either a differential or single-ended input and output amplifier. It gives both inverting and non-inverting operation. Frequency response exceeds 150 KHz.

For immediate delivery, call your Westinghouse electronic distributor\*. Or for complete specs, write Westinghouse Molecular Electronics Division, Box 7377, Elkridge, Maryland 21227.

\*Distributors determine resale prices

You can be sure if it's Westinghouse

J-09131



ON READER-SERVICE CARD CIRCLE 10

# Now: A Fast Signal Averager

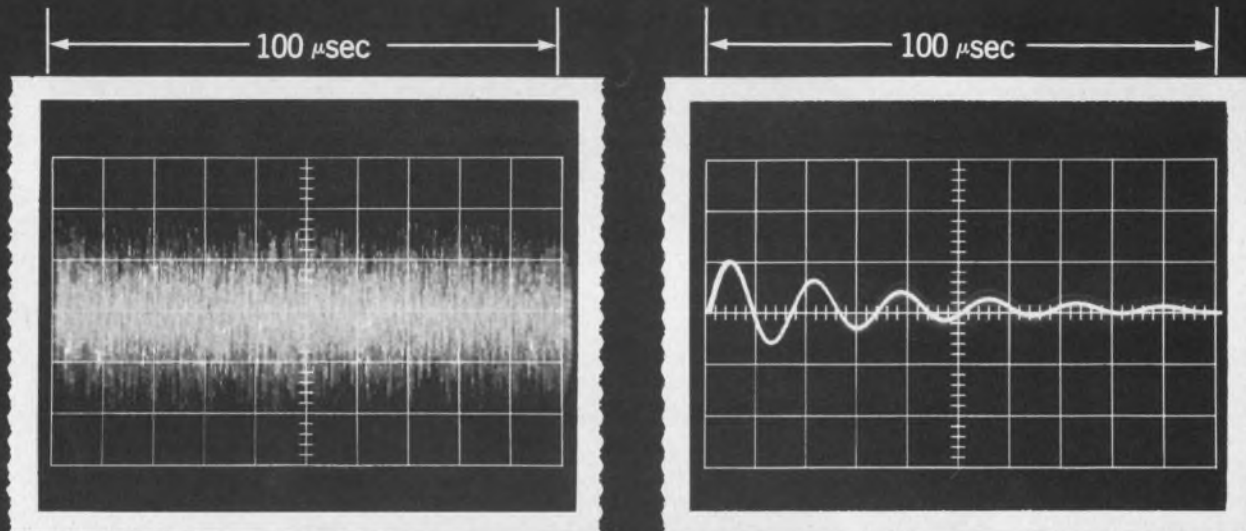

Photo #1—Input to Model TDH-9  
SENSITIVITY: 5 V/cm  
TIME: 10  $\mu$ sec/cm  
NOISE-TO-SIGNAL RATIO: 10:1

Photo #2—Output of Model TDH-9  
SENSITIVITY: 5 V/cm  
TIME: 10  $\mu$ sec/cm



## PAR Model TDH-9 Waveform Educator

Photo #1 is an actual oscillogram of a signal obscured by noise — a situation unfortunately prevalent in many research areas; such as, studies of bio-medical evoked potentials, seismology, spectroscopy, fluorescent lifetime studies, and vibration analysis. Photo #2 shows the dramatic improvement in signal-to-noise ratio when the noisy signal was processed

by the PAR Model TDH-9 Waveform Educator.

This new instrument employs a highly efficient waveform-averaging technique, and at the same time offers the fastest sweep rates obtainable in signal processing equipment of the signal-averaging type. Sweep durations as short as 100 microseconds, with dwell times per channel of 1 microsecond, are obtainable. The high resolution capability of the Model TDH-9 allows observation of waveforms or transients which have heretofore been unresolvable by averaging instruments employing a greater number of channels.

Although the Model TDH-9 Waveform Educator sells for only \$4,200,

we invite functional comparison with the higher-priced digital averagers. We believe you will be pleasantly surprised. For more information about the PAR Model TDH-9, ask for Bulletin No. T-126.

### *Have a noise problem?*

PAR's technical staff, unusually knowledgeable in signal processing problems and techniques as a result of its experience in the development and application of Lock-In Amplifiers, welcomes your specific inquiries. Please call or write.



ON READER-SERVICE CARD CIRCLE 11

# Mount transistors in topsy-turvy holders

## Small and simple, new inverted ceramic holders connect semiconductor chips to substrate

Roger Kenneth Field  
News Editor

Within a few weeks, Texas Instruments, Inc., will make available transistors mounted in an unusual, recently developed ceramic holder. The three-legged holder can be turned upside down and ultrasonically bonded to metal conductors on a substrate with passive thick- and thin-film components. It is to be called the "Flip Chip-Pak" (Fig. 1).

This innovation follows announcement by Amperex Electronics Corp. that it could supply transistors in a similar package that is called a Leadless Inverted Device (LID).

The new packages are considered a good compromise between selling semiconductor chips bare (unpacked and without leads) and selling them in standard, hermetically sealed cans with leads.

The Flip Chip-Paks measure 75 x 75 x 30 mils. The Amperex LID is smaller. The chip is set in a major channel in the ceramic and either ultrasonically bonded or thermocompressionally welded to it. Leads from the chip are attached to thick gold-plated pads on the holder legs. To protect chip and leads, the

channel can be filled with epoxy. In the past this tended to "creep" over the gold interfering with the electrical contact. Also, since many epoxy resins have a different thermal coefficient of expansion than the gold leads, large temperature changes severed the connection. But Amperex reports that these problems have been overcome.

The first of these inverted, leadless micropackages, called Flip Chip Versa Pak, was made by Ceramics for Industry, now Frenchtown/CFI, Inc. Sales Manager Charles Eliot says the package was designed to help the manufacturer of hybrid circuits attach active components directly to substrates containing passive components and metal-film interconnections. His firm has designed a 12-lead IC version and a holder for beam-lead diodes. Compared with unpackaged raw chips, the ceramic flip holders:

- Protect the chip from damage during handling in production.
- Can be ultrasonically bonded, rather than thermocompressionally welded, to the substrate. This eliminates heat deterioration of the chip.
- Allow chips to be tested easily before installation.
- Permit the chip's maker to at-

tach its leads, not the customer.

■ With their large metal surfaces, provide a fairly good heat sink for the chip.

Compared to chips mounted in standard cans, the flip holders:

- Take far less room on the hybrid substrate.
- Have no leads.
- Could ultimately cost less, particularly in high quantities.
- Allows the designer to put any combination of active and passive devices on a substrate, even to mix discrete components with integrated circuits (see Fig. 2).

Though it is not seriously contended that these packages will supersede metal cans with leads, they certainly offer a highly useful alternative to the purchase of raw chips. The holders give every indication of being very useful for high-production commercial products. The Delco Division of General Motors is examining flip ceramics for possible use in car radios. Collins Radio, Cedar Rapids, Iowa, has been trying the devices in digital frequency synthesizers. Sprague Electric Co., North Adams, Mass., is using a related device, called Cer-Chip, for in-house applications.

Other semiconductor makers are watching the marketplace for signs of flip-ceramic activity. ■ ■

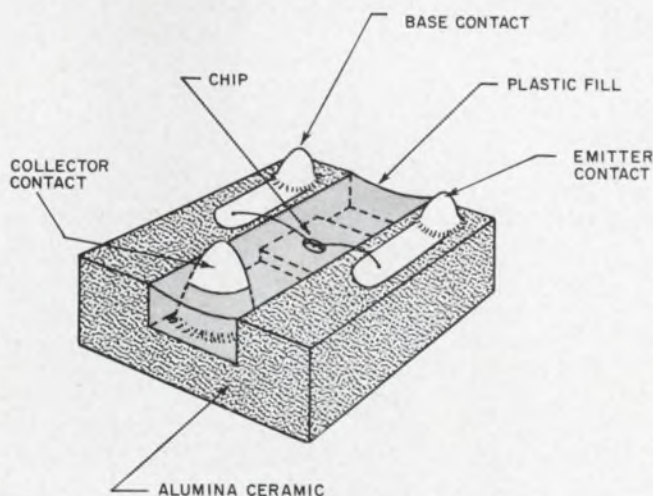

1. Flip Chip-Pak, by Texas Instruments Inc., has three legs. Its makers say the tripodal configuration assures good contact when the unit is bonded to a substrate.

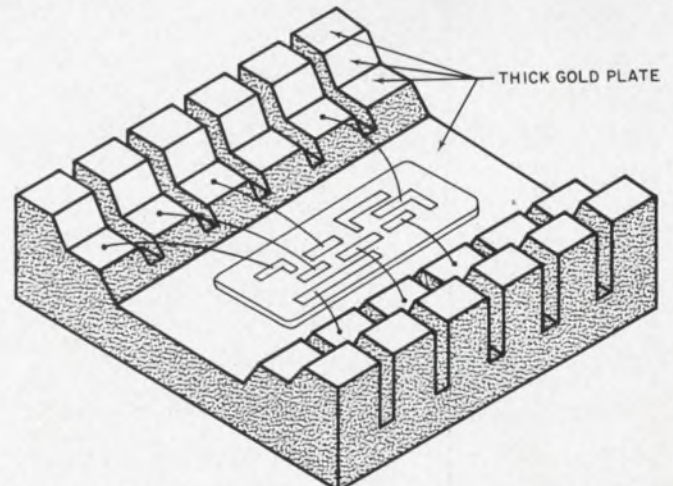

2. Integrated circuit Versa-Pak, made by Frenchtown/CFI, Frenchtown, N. J., allows the designer of hybrid circuits to include both discrete devices and ICs on one substrate.

# Deep-diving designers hunt two improvements

## Better power and navigation systems are musts before the world's oceans can be fully exploited

Frank Egan  
News Editor

WASHINGTON, D. C.

Designers and users of manned deep-diving vessels gathered here recently to analyze two crucial problems: how to improve power sources in order to prolong missions, and how to improve navigation methods.

Both problems, observers noted, were brought home forcefully in the undersea searches for the submarine "Thresher" and the H-bomb missing off Spain. Deep-diving methods would also have to be refined before such diverse industries as mining, petroleum, fishing and canning can exploit the oceans fully.

Representatives of these industries were among the more than 1000 persons who attended the Second Annual Conference on Exploiting the Ocean. At meetings on problems of the deep sea, results of power and navigation studies were revealed. They covered both the present state-of-the-art and the directions which new developments are taking.

The results of a power study by the Lockheed Missile and Space Co. were presented in a paper by J. C. Louzader and G. F. Turner. The power requirements for five

types of missions were considered (see Table 1). Batteries, fuel cells and radioisotope systems were all investigated from the following standpoints:

- Weight.
- Volume.
- Operational handling.
- Packaging and adaptability.
- Maintainability.
- Reliability.
- Cost.

According to the study, fuel cells offer the most reasonable advanced-system choice from the standpoint of weight, volume and packaging. However, because of their cost and availability, batteries will continue to play an important role. The present dominance of battery power sources can be seen in Table 2, which lists submersibles capable of operating at depths of 1000 feet and more.

### Batteries are least costly

The development costs for submersible battery systems, even for highly specialized applications, are expected to be considerably less than for either radioisotope or fuel-cell systems, the study indicated. In addition, say the authors, batteries have the advantage that they can be packaged compactly. And with pressure-balancing provisions, they can also be mounted

outside the submersible's pressure hull. This leads to a major saving in vehicle cost, since pressure hulls are expensive, and their cost increases rapidly with size.

A serious drawback with batteries, however, is the relatively long time it takes to recharge them. This can set a limit on their usefulness for certain missions, such as rescue operations.

Rechargeable lead-acid batteries are widely used, for they give highly reliable performance over several thousand recharge cycles. Recently, however, rechargeable silver-zinc batteries, with their high watt-hours/pound ratio, have been adopted to some extent for undersea use.

### Fuel cells cut weight

In the Lockheed study both hydrogen-oxygen and hydrazine-hydrogen peroxide fuel cells were considered applicable for deep-submersible use.

Weight and volume calculations for the two types of cells show them to offer the lowest power-source weight and volume for most missions considered. This can be seen from the figure (next page), which compares the specific weights of various power systems for a 10-hour mission.

From the standpoint of refueling or turn-around time, the two fuel cells differ considerably. The hydrogen-oxygen system, because of its cryogenic fuels, would re-

Table 1. Deep submersible missions and power requirements.

Mission	Power requirements	Maximum duration between power recharge
Ocean survey/bottom mapping	20 kW avg—40 kW max	12 hr
Salvage/recovery	30 kW avg—60 kW max	8 hr
Rescue of personnel	20 kW avg—40 kW max	2 hr*
Search	10 kW avg—40 kW max	12 hr
Bottom base support	20 kW avg—40 kW max	8 hr

\*Very short recharge time is required (about 10 min); otherwise the operational duration must be extended: 30 hours would be optimum.

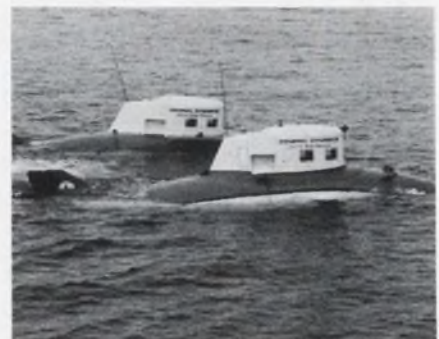

Both Star I and Star II, built by General Dynamics, completed their sea trials last month.

# ARNOLD IS



## **TAPE WOUND BOBBIN CORES**

**Standard Cores of 4-79 Mo-Permalloy and Deltamax  
on Ceramic or Stainless Steel Bobbins . . .**

engineered for use in sophisticated data processing systems, high frequency magnetic amplifiers, static inverters, timing circuits, shift registers, ring counters, pulse transformers and as static magnetic memory elements. All tapes are rolled on a beta-ray controlled Sendzimir mill in standard gages of 1,  $\frac{1}{2}$ ,  $\frac{1}{4}$  and  $\frac{1}{8}$  mil and slit to standard widths of 0.031, 0.0625, 0.125 and 0.250. Cores are wound on semi-automatic machines, then annealed at extremely high temperatures in specially designed dry hydrogen atmosphere furnaces to obtain the final magnetic properties. Arnold maintains complete control over all phases of fabrication. Melting, processing, rolling and slitting of raw materials (nickel iron) to winding annealing and final test are all "in-plant" functions.

Write for Catalog TC-108B.

 **ARNOLD**  
SPECIALISTS IN MAGNETIC MATERIALS

THE ARNOLD ENGINEERING COMPANY, Main Office: MARENGO, ILL.  
BRANCH OFFICES and REPRESENTATIVES in PRINCIPAL CITIES

Speed Inquiry to Advertiser via Collect Night Letter  
ON READER-SERVICE CARD CIRCLE 12

**New from Sprague!**

# TW-3000

TO-18 CASE

## MICROPOWER PNP SILICON HIGH-SPEED SWITCHING TRANSISTORS

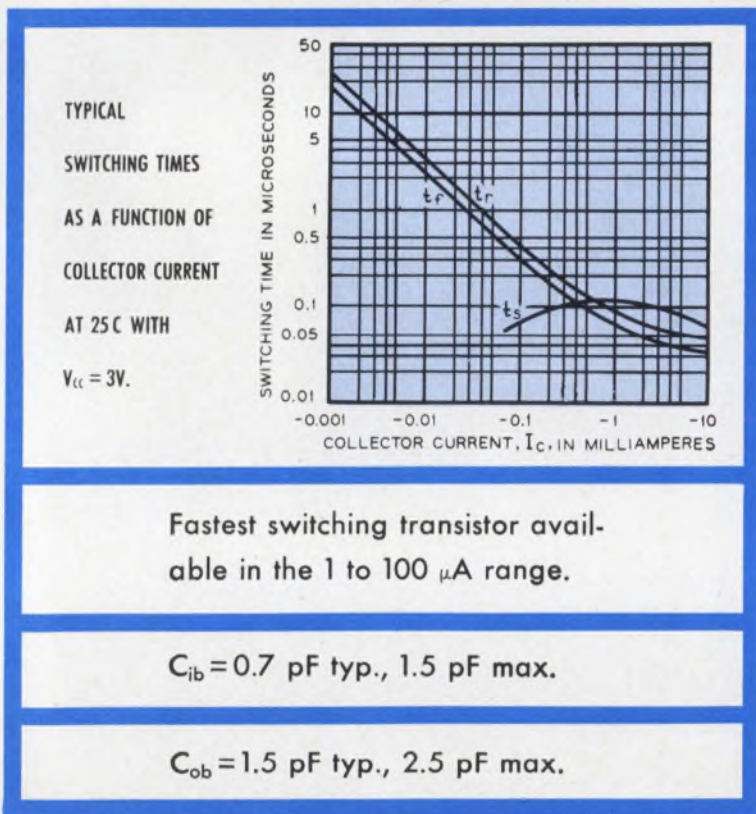

Fastest switching transistor available in the 1 to 100  $\mu$ A range.

$C_{ib} = 0.7$  pF typ., 1.5 pF max.

$C_{ob} = 1.5$  pF typ., 2.5 pF max.

Sprague Electric also makes more than 200 standard SEPT® (Silicon Epitaxial Planar Transistor) Types, including 2N2218A-2N2222A, 2N2904A-2N2907A, 2N2369A-2N3209.

For complete information, write to Technical Literature Service, Sprague Electric Co., 347 Marshall St., North Adams, Mass. 01247

### SPRAGUE COMPONENTS

- |                         |                               |
|-------------------------|-------------------------------|
| TRANSISTORS             | PACKAGED COMPONENT ASSEMBLIES |
| CAPACITORS              | FUNCTIONAL DIGITAL CIRCUITS   |
| RESISTORS               | MAGNETIC COMPONENTS           |
| INTEGRATED CIRCUITS     | PULSE TRANSFORMERS            |
| THIN-FILM MICROCIRCUITS | CERAMIC-BASE PRINTED NETWORKS |
| INTERFERENCE FILTERS    | PULSE-FORMING NETWORKS        |



Sprague and ® are registered trademarks of the Sprague Electric Co.

ON READER-SERVICE CARD CIRCLE 13

### NEWS

(submersibles, continued)

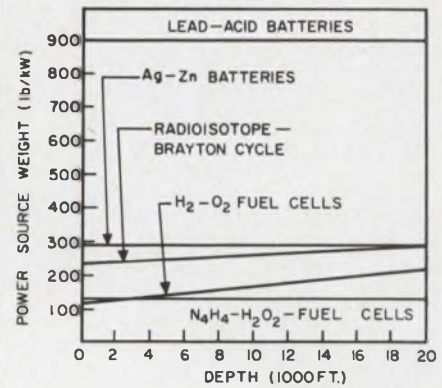

Fuel cells would offer lowest specific weight for 10-hour mission.

quire some five to eight hours for complete refueling, according to the Lockheed study. Refueling a hydrazine-hydrogen peroxide system, on the other hand, would be short, since it operates at ambient sea pressure with minimum complexity.

#### Radioisotope sources considered

Power sources consisting of a radioisotope heat source, coupled with a Brayton, Rankine or Sterling cycle heat engine, were also evaluated in the Lockheed study. They have the advantages of no exhaust products and long periods between refueling.

Because of its relatively low cost, cerium 144 was considered as the fuel, although polonium 210 or strontium 90 might also be used, but at much greater cost. In spite of certain advantages, the radioisotope system was the least attractive power source considered. Not only must all parts of the system be pressurized, but precautions must also be taken during refueling against radioactivity hazards. Furthermore, the heat source must be cooled continuously, whether in service, transit or storage.

Based on these investigations, Lockheed has provided for future incorporation of a fuel-cell system in its deep submersible, "Deep Quest," now under construction. This system would provide all or part of the primary power for missions of up to 24 hours.

#### Navigational improvements sought

The problem of navigation in deep submersibles was dealt with

**Table 2. Deep-submersible vehicles**

Name	Operator	Crew	Payload (lb)	Maximum operating depth (ft)	Status	Power source (batteries)
Aluminaut	Reynolds International, Inc.	3 + 3 observers	6000	15,000	Undergoing sea trials	silver-zinc
Alvin I	Woods Hole Oceanographic Institute	1 + 1 observer	—	6000	Operational	lead-acid
Cubmarine PLC4	Ocean Systems, Inc.	2 + 2 divers	1500	1500	Under construction	lead-acid
Deep Jeep	NOTS, China Lake	1 + 1 observer	—	2000	Operational	lead-acid
Deep Quest	Lockheed Missiles & Space Co.	2 + 2 observers	7000	6000	Under construction	lead-acid
Deep Star 2000	Westinghouse Electric Corp.	2 + 1 observer	100	2000	Under construction	lead-acid
Deep Star 4000	Westinghouse Electric Corp.	2 + 1 observer	100	4000	Undergoing test	lead-acid
Diving Saucer	Westinghouse Electric Corp.	1 + 1 observer	100	1000	Operational	lead-acid
Moray	NOTS, China Lake	1 + 1 observer	150	6000	Operational	silver-zinc
Star II	General Dynamics Electric Boat	2	250	2000	Under construction	lead-acid
Star III	General Dynamics Electric Boat	2	1000	2000	Under construction	lead-acid

in a paper by Kenneth V. Mackenzie, Chief Scientist of the Deep Submergence Program at the Navy Electronics Laboratory.

According to Mackenzie, dead reckoning was tried by the undersea vehicle "Trieste" in the search for the "Thresher," but was insufficiently exact. What was needed was navigational accuracy that would yield no more than 20 feet of accumulated error over eight hours of operation. An aircraft type of gyro gave headings to one degree, but measurements of the actual motion over the bottom were less accurate, because they were made relative to highly unpredictable prevailing currents.

Dead-reckoning navigation, Mackenzie says, requires some device to measure accurately actual motion over the bottom independent of the current. Some work has been done along these lines using a trailing wheel on the end of a trolley, attached to the underside of the submersible. Distance read-out is by means of an odometer.

#### Acoustic methods now best

Acoustic methods, according to

Mackenzie, offer the best hope for good navigation at present. These employ transponders that, when queried by a signal, produce acoustic responses which provide position data.

One method developed by the University of Washington Applied Physics Laboratory and called the 3-D acoustic tracking system, involves a surface vessel tracking the submersible. The surface ship queries and receives replies from a transponder mounted on the submersible. The difference in signal travel time from the transponder to three receiving hydrophones on the surface ship is used to compute the relative co-ordinates of the two vessels.

A variation of the 3-D system uses fixed transponders moored to the bottom and a submersible-mounted transponder. This allows the surface ship to determine the co-ordinates of the submersible relative to the moored transponders. The position information can then be relayed to the submersible by an underwater sound telephone system.

Another possible adaptation of

the 3-D system is to have the submersible query two or more moored transponders simultaneously and then compute its relative position by signal travel-time differences. This would require a small on-board computer.

#### Other methods under study

Other methods of navigation for deep submersibles are being studied. One promising method is inertial navigation. Although to date no system combining the required small size and high accuracy has been announced, a practical inertial system may be available in the near future.

Research is also under way on optical navigation by means of strobe-light flashes.

#### Conference data

The Second Annual Conference and Exhibit on Exploiting the Ocean was held June 27-29, 1966. It was sponsored by the Marine Technology Society. Copies of the conference proceedings may be obtained for \$6 each from the Marine Technology Society, Executive Building, 1030 15th Street N.W., Washington, D. C. 20005. ■ ■

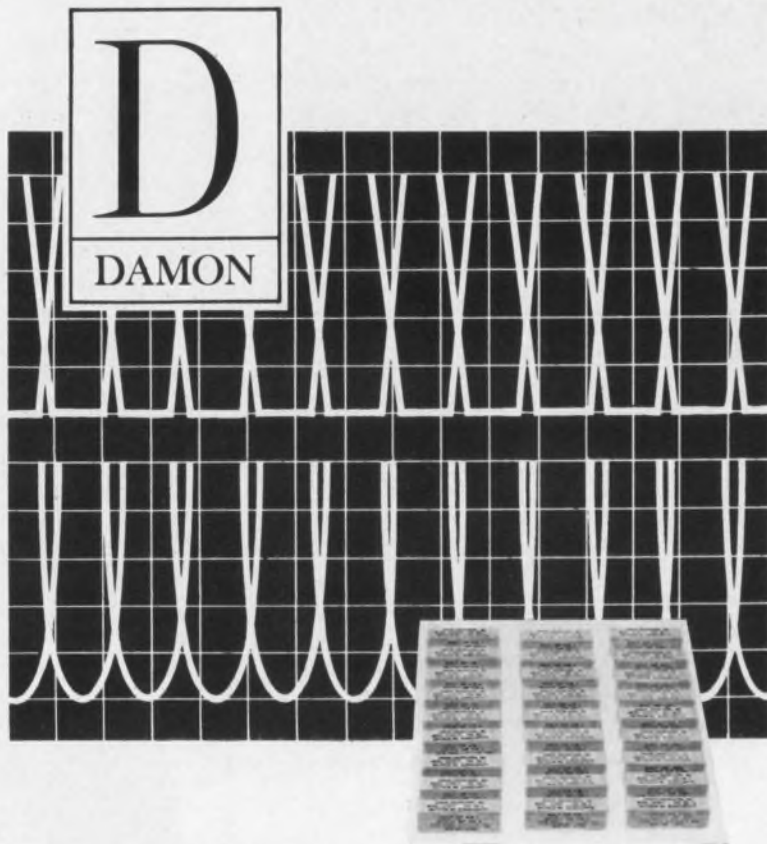

# Contiguous Comb Crystal Filters

## Multi-Channel Real-Time Signal Detection with Single Channel Driving Power

Contiguous Comb Crystal Filters (Damon's name for a unique new design) permit direct operation of large numbers of adjacent frequency channels from a single low power driver. As there are no padding or isolation losses, drive power requirements are no greater for multi-channel operation than for single channel. Miniaturized Contiguous Comb Crystal Filters with reduced active driving circuitry are now being used in airborne and ground-based Doppler radar systems where small size and high reliability are essential. A wide range of filters is available with Chebyshev, Butterworth or Gaussian characteristics for CW Doppler, FM Doppler, or Pulse Doppler Systems.

Write for Data on Contiguous Comb Crystal Filters

**DAMON ENGINEERING, INC.**

240 HIGHLAND AVENUE, NEEDHAM HEIGHTS 94, MASS.

(617) 449-0800

Speed Inquiry to Advertiser via Collect Night Letter  
ON READER-SERVICE CARD CIRCLE 14

### NEWS

## Silicon attenuators used with lasers

Attenuators made of elemental silicon have been used at the NBS Institute for Applied Technology to measure accurately the outputs of ruby and gallium arsenide lasers.

Unlike conventional glass attenuation filters, the pure silicon disks are relatively cheap and do not change their attenuation factor with use. The silicon attenuates the laser beam by means of a reradiation process, reducing the beam intensity sufficiently for the output pulse shape to be measured by calibrated photomultipliers.

The NBS work, performed by Dr. N. N. Winogradoff and H. K. Kessler, formed part of research into the major problems of characterizing and standardizing lasers—namely measuring the output energy.

The silicon absorbs the radiant energy, is excited and subsequently reradiates at a longer wavelength. The low efficiency of the wavelength-conversion process permits the intensity of the resulting radiation to be measured by direct radiometric techniques. The efficiency of conversion is nonlinear, and yields a response curve characteristic of silicon.

Further fundamental studies of properties of the radiative recombination processes are expected to result in accurate power and pulse-shape measurements using this technique. ■ ■



Silicon disk is placed over the aperture of a photodetector housing as an attenuator for laser measurements.



## New undersea cable uses transistors

The first undersea cable system to use transistor amplifiers instead of vacuum-tube amplifiers has been developed by Bell Telephone Laboratories. Increased reliability and broadened bandwidth are two advantages afforded by the use of transistors.

The new cable system, known as the SF system, provides for 720 two-way voice channels, compared with only 128 two-way circuits in the previous SD system. Transmission is divided into two major frequency bands of 2224 kHz each, one for each direction of transmission. One band extends from 564 kHz to 2788 kHz, while the other goes from 3660 kHz to 5884 kHz. The earlier SD system, by comparison, operates at a top frequency of 1052 kHz, with a bandwidth of 422 kHz each way.

The SF system can operate over distances as long as 4000 nautical miles and at depths down to four nautical miles. Amplifying repeaters are spaced at 10-mile intervals.

Each repeater contains one amplifier, a tone oscillator, high- and low-pass filters and diodes to protect components against accidental voltage surges. The high- and low-pass filters separate directions of transmission, permitting the single amplifier to serve both directions. The dc power required in each repeater is isolated from the transmission path by power-separation filters. Terminal dc voltage of the SF system is 3250 volts, compared with 5500 volts for the SD system. This lower voltage, too, was made possible by the use of transistors in the new repeaters. The system operates on 160 milliamperes of current.

Each transistorized repeater contains four pnp germanium diffused-mesa transistors specially developed by Bell Laboratories and manufactured by the Western Electric Co. The transistors have high, stable gain, high-frequency response, low noise over the cable bandwidth and low compression and distortion.

AT&T has asked the FCC for permission to lay the first SF cable 1250 nautical miles between Florida and St. Thomas in the Virgin Islands. ■ ■

*basic measuring tools from*

**HEWLETT  
PACKARD**



## *hp 333A, 334A Autonulling Distortion Analyzers*

automatic fundamental nulling for ease of operation  
harmonic distortion measurement 5 Hz-600 kHz  
0.1% full-scale distortion sensitivity  
input sensitivity 0.3 v rms for 100% set level reference  
maximum full-scale voltmeter sensitivity 300  $\mu$ v rms  
(residual noise < 25  $\mu$ v)

### *Use it to:*

- measure total broadband distortion
- measure noise and hum level
- measure envelope distortion of AM rf carriers
- measure voltage and amplifier gain
- amplify signals with high gain over a wide frequency range

The automatic fundamental nulling offered by the solid-state 333A and 334A Distortion Analyzers provides simple, fast measurements. Manually null to less than 10% of set level reference, flip a switch, and nulling is completed automatically. No tedious tuning on the more sensitive ranges. Greater than 80 db rejection with automatic nulling.

The switchable filter, which attenuates frequencies below 400 Hz on signals greater than 1 kHz, removes hum and provides pure distortion measurements. The two models differ only in that the

334A incorporates an amplitude modulation detector, 500 kHz to greater than 65 MHz, which measures distortion at carrier levels as low as 1 v. Prices: 333A, \$760; 334A, \$790.

Ask your Hewlett-Packard field engineer for a demonstration or for full specifications. Or write for information: Hewlett-Packard, Palo Alto, Calif. 94304, Tel. (415) 326-7000; Europe: 54 Route des Acacias, Geneva.

*Data subject to change without notice.  
Prices f.o.b. factory.*

**HEWLETT**  **PACKARD**  
*An extra measure of quality*

1227



334A

# Supersensitive radars spot perilous CAT

**Study of mysterious clear air turbulence may lead to forward-scatter warning network for aircraft.**

**Neil Sclater**  
East Coast Editor

Radars so sensitive that they have observed a bee leaving an aircraft 10 miles away are being used to investigate a mysterious phenomenon in aviation: a high-altitude layer of disturbed air known as clear air turbulence (CAT).

Potentially dangerous to aircraft because of its roughness, CAT has long remained invisible and eluded advance detection by aviation traffic controllers. But an international group of scientists, working at the Air Force-NASA radar facility on Wallops Island, Va., has succeeded in capturing images of the potentially dangerous rough air on radar scopes. The feat is comparable to observing ghosts six or seven miles aloft and the research holds promise that an effective network of ground-based radars could be developed to warn aircraft of the hazardous turbulence.

Identification of possible clear air turbulence was made by simultaneous use of radars operating at three different frequencies. Large, high-gain antennas, with sensitivities 30 dB greater than conventional antennas, enabled the radars to distinguish CAT from other atmospheric phenomena.

In their continuing project the scientists will send instrumented aircraft aloft to establish positive correlations between suspected

CAT and the turbulence shown on the scopes.

The importance attached to the study is indicated by the list of organizations co-operating in the joint effort. Scientists came from the Air Force Cambridge Research Laboratories, the Applied Physics Laboratory of Johns Hopkins University, the Mitre Corp., the Naval Research Laboratories and Britain's Radio and Space Research Station.

Project Director Dr. Kenneth Hardy of the Air Force says that clear air turbulence is most likely to occur in the winter in the vicinity of jet streams at 20,000 to 50,000 feet. Without advance warning and a chance to bypass the area of turbulence, high-speed aircraft may be subjected to perilous stresses, aviation officials fear. Investigators are looking into the possibility, for example, that CAT contributed to the crash of the XB-70 in the West last month.

The Wallops Island studies grew out of earlier work on the detection of the tropopause by the Air Force under Drs. Hardy and David Atlas and by Johns Hopkins University under Isadore Katz and Thomas Konrad. The tropopause—the boundary layer between the troposphere and the stratosphere—was suspected to be the zone where clear air turbulence formed.

The radars on Wallops Island

have such high resolving power, according to Dr. Hardy, that they have distinguished bees from moths at 10 miles. The equipment includes two 60-foot-diameter antennas operating at 71.5 and 10.71 cm and a 34-foot dish at 3.2 cm. By applying radar data to formulas relating reflectivity of the atmosphere, range and received power, the scientists obtained a profile to the tropopause and its associated turbulence.

After eliminating the effects of clouds and ground return, the scientists isolate probable clear air turbulence. The variations in refractive index make CAT visible at certain microwave frequencies, Dr. Hardy reports.

CAT shows no day-night variations, according to the scientist, and it is "typically more than 500 feet thick, 30 miles across and hundreds of miles long in the direction of the wind."

One important conclusion of the research is that ground-based radar that uses forward-scattering techniques may be the best method for monitoring CAT. In a scheme suggested by the scientists, transmitters and receivers 100 miles apart could detect the air turbulence with an increase in sensitivity of 20 to 30 dB over experimental back-scatter techniques. Such a system, set up along the principal airways, would give sufficient warning to pilots to alter their flight plans, and the networks might even be automated by tie-ins with computers, Dr. Hardy says. ■ ■

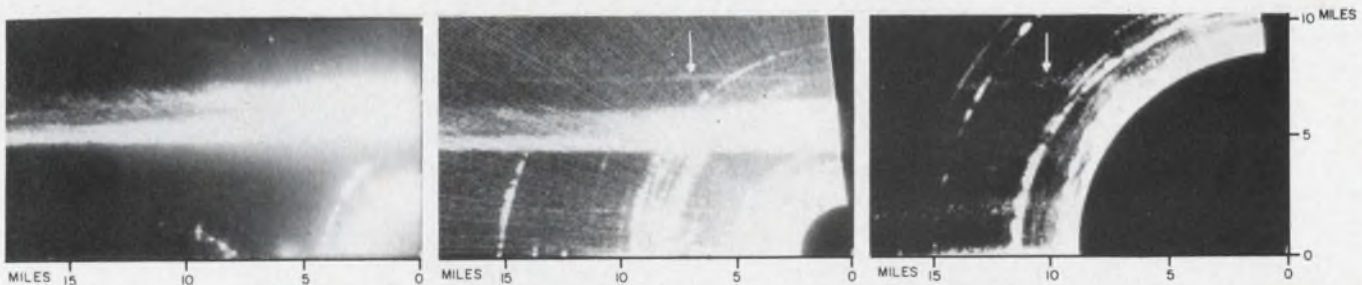

**Mysterious CAT** (clear air turbulence) suspect as it appears on radar. The left frame is at X-band, the middle at S-band and the right at uhf. All photos were taken at the same time and place. CAT appears only in the S-band and UHF views. Strong echoes four to seven miles up (S and X) are due to clouds.

**"We have learned through bitter experience that Allen-Bradley resistors are unmatched for reliability"**

*Philbrick Researches*

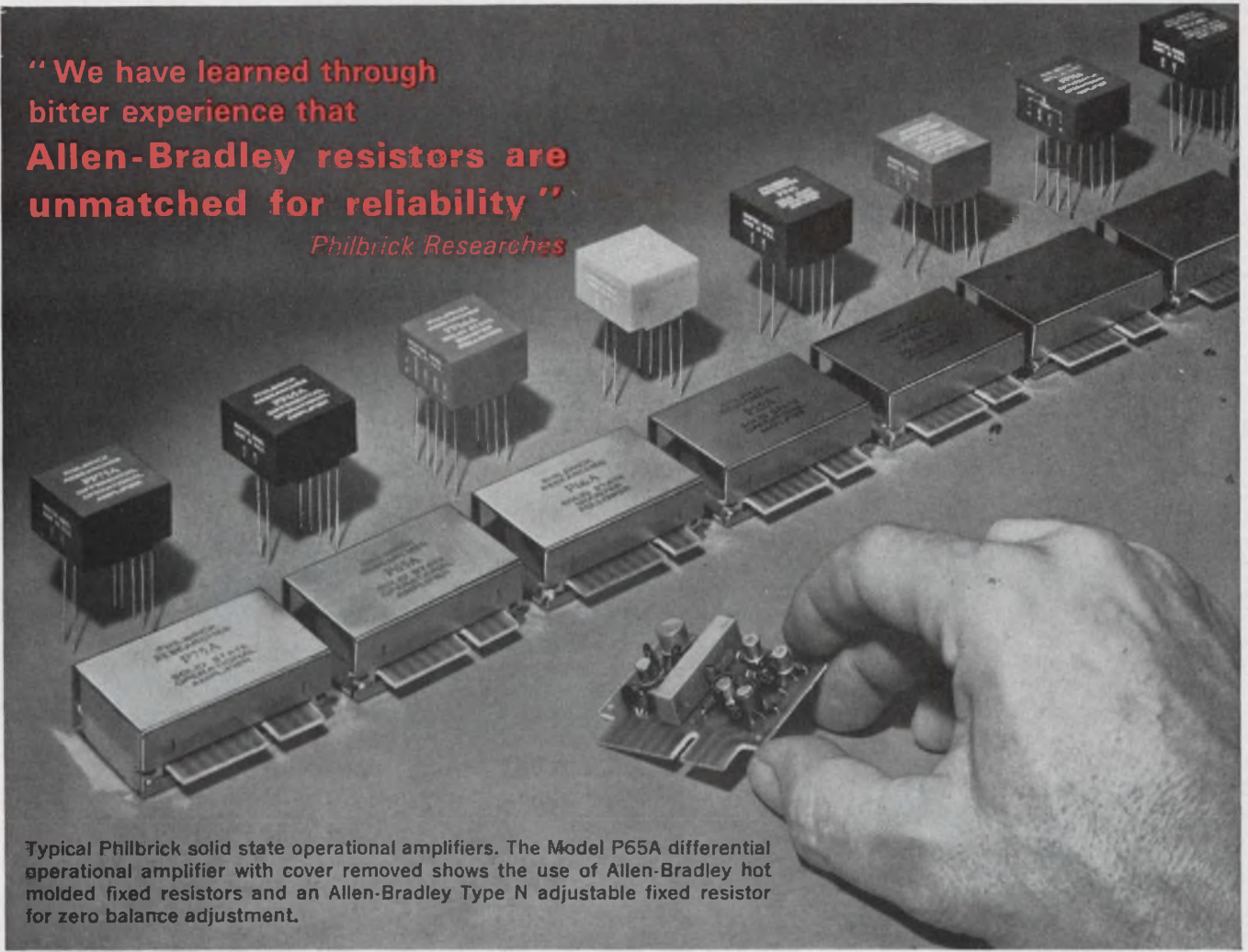

Typical Philbrick solid state operational amplifiers. The Model P65A differential operational amplifier with cover removed shows the use of Allen-Bradley hot molded fixed resistors and an Allen-Bradley Type N adjustable fixed resistor for zero balance adjustment.

TYPE BB 1/8 WATT		MIL TYPE RC 05
TYPE CB 1/4 WATT		MIL TYPE RC 07
TYPE EB 1/2 WATT		MIL TYPE RC 20
TYPE GB 1 WATT		MIL TYPE RC 32
TYPE HB 2 WATTS		MIL TYPE RC 42

**HOT MOLDED FIXED RESISTORS** are available in all standard EIA and MIL-R-11 resistance values and tolerances, plus values above and below standard limits. Shown actual size.

The need for a yearly production capacity of well over a billion units is a testimonial to the uniformity and reliability of all Allen-Bradley hot molded resistors.

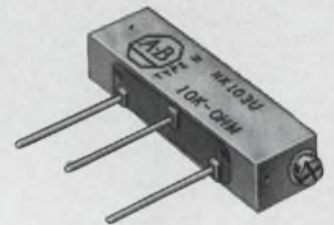

Type N hot molded adjustable fixed resistor rated 1/2 watt at 50°C ambient. Available with nominal resistance values from 100 ohms to 2.5 megohms with tolerances of ±10% and ±20%.

■ "Why have Allen-Bradley hot molded resistors been our first choice since the late 1940's? In a word: Reliability!" states Philbrick—the leading manufacturer of operational amplifiers. There's nothing accidental about this superiority of A-B resistors. A unique hot molding process using completely automatic machines, eliminates the "human element" and produces such uniformity from one resistor to the next—year in and year out—that long resistor performance can be accurately predicted. No instance of "catastrophic failures" has ever come to our attention.

Allen-Bradley Type N adjustable fixed resistors likewise use a solid hot molded resistance track. Adjustment is so smooth, it approaches infinite resolution—and settings remain fixed. Being noninductive, Type N controls can be used at high frequency, where wire-wound units would be completely unsatisfactory.

For more details on the full line of Allen-Bradley quality electronic components, please write for Publication 6024: Allen-Bradley Co., 1344 S. Second Street, Milwaukee, Wis. 53204. Export Office: 630 Third Ave., New York, N.Y., U.S.A. 10017.



**ALLEN-BRADLEY**  
QUALITY ELECTRONIC COMPONENTS

# Most powerful accelerator to make debut

Stanford University's 20-billion-electron-volt linear accelerator, the most powerful of its type ever built in the United States, is scheduled to become operational sometime this summer. The new accelerator will enable scientists to conduct hitherto impossible investigations of sub-atomic particles.

SLAC (Stanford Linear Accelerator Center), as the facility will be called, is being built by Stanford University under contract to the U. S. Atomic Energy Commission at a cost of \$114 million. When operational, it will function 24 hours a day, seven days a week with a staff of about 1000. Annual operating costs will be about \$20 million. ■ ■



**Aerial view of SLAC** shows the above-ground portion of the 2-mile-long linear accelerator. The buildings at the left will contain experiments to be bombarded by the 20-GeV (Bev) electrons, which will begin their 2-mile race from the distant end.

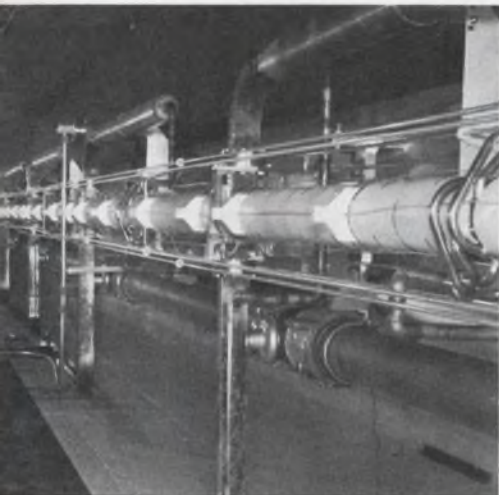

**SLAC comprises two main elements**, both extending over the 2-mile length. The accelerator housing (left) is an 11-foot-wide by 10-foot-high underground tunnel that contains the accelerator proper and related systems. The klystron gallery (right) is a 29-foot-wide by 13-foot-high above-ground installation containing the klystrons, modulators, vacuum pumps and other auxiliary equipment.



**Each of the 240 klystrons** that provide power for the accelerator can produce at least 21 MW peak power at 360 pulses per second. The power is supplied at a frequency of 2856 MHz. Barrel-shaped permanent magnets made by Arnold Engineering Co. are used for klystron focusing. Each barrel magnet is 27-1/2 inches high and weighs slightly over 1000 pounds. The cross-component of the magnetic field is less than 5 gauss average, which is only 1/2 of 1 per cent of the total main field. Interchangeability of the klystrons from any one barrel magnet to another is possible.

## A/D system has 100-kHz sampling rate

An analog-to-digital system with a 100-kHz sampling rate—said to be the highest speed yet achieved—will be delivered to the Air Force in August.

Called a Programed Data Acquisition Station (PDAS), the unit was developed by Stellarmetrics, Inc., Santa Barbara, Calif., and is designed as a general-purpose, on-line peripheral for a digital computer. The station allows real-time acquisition and processing of simultaneously applied analog, digital and PAM (pulse amplitude modulation) telemetry inputs.

In operation, incoming digital data from telemetry or other data acquisition systems are fed directly to the computer, while incoming analog data are first digitized and then presented to it. In the other direction, the computer controls the PDAS, instructing it what data are wanted for computation and at what rate.

The 100-kHz sampling rate—compared to a typical 25- to 40-kHz rate for current A/D systems—could be increased to 250 kHz with some redesign, according to Tom Norton, Stellarmetrics engineer.

He cited other "unusual" features of the PDAS:

- Ten channels of simultaneous sample and hold. For example, the computer may advise that it wants to compare 10 channels of data at an identical point in time. The system simultaneously samples the 10 channels, holding the information for sequential digitization and presentation to the computer at a 100-kHz rate.

- Data holding accuracy of  $\pm 0.02\%$  of full scale for 120  $\mu\text{s}$  (i.e., 10 channels at 100-kHz rate, including sample and settling times), with a decay rate of 0.001% of full scale per  $\mu\text{s}$  thereafter.

A manual control panel permits override of computer signals. It can be used to exercise PDAS functions for diagnostic, check-out, trouble-shooting or preprogramming purposes.

The PDAS can also recognize interrupt signals received from outside the system and pass these on to the computer. ■ ■

QUALITY ASSURED ACHIEVEMENT THROUGH RESEARCH

it is sure about time that someone put the proper technology and effort into a tunnel diode to insure unprecedented stability and uniformity. no longer is it necessary to depend upon the dubious impurity percentages encountered with the dot-alloy method of manufacturing - the "boulder on a pinnacle" concept is gone forever. here to replace the veritable antique is our FILMBLOC process\* of construction, which rarely allows the alloy region to exceed 0.00025. new concepts in reliability insure that ALL tunnel diodes will handily exceed 25,000 G shock and vibration. present materials of manufacture include germanium, gallium arsenide, gallium antimonide and silicon, but we would welcome the challenge of other materials if someone declares the need for them. WE ARE ABLE TO DUPLICATE ANY TUNNEL DIODE IN THE WORLD, REGARDLESS OF SPECIFICATIONS, and even sell it without a package. (that is if you can handle a chip measuring .010" x .006".) while you're using your imagination, perhaps you can dream up a use for our forthcoming 3-terminal tunnel diode\* essentially, it looks like this: 

SPECIFICATION SHEETS AVAILABLE FOR ALL BACK DIODES, DETECTORS, SWITCHES AND MICROWAVE COMMUNICATION DIODES. Watch for specifications of our: "SUPER" STEP RECOVERY DIODE & SILICION PIN DIODES WITH  $BV_R @ 1500V$   $R_S @ 1.0 \Omega$

\*patent applied for



Gemini semiconductors, inc.

482 RIDGEDALE AVENUE HANOVER N. J. 07936. TELEPHONE (201) 887-8181

ON READER-SERVICE CARD CIRCLE 17



■ **NEWEST SHAPE  
IN LOW-COST  
SIGNAL TRANSISTORS . . .**

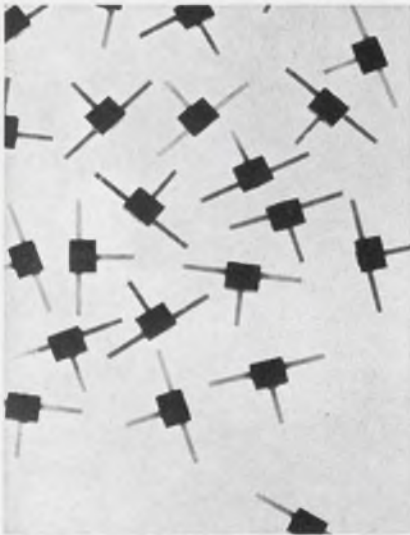

Actual size new G-E D24 Transistors

. . . is this new, compact silicone case and lead configuration. The case measures just 0.170 by 0.135 by 0.060 inch.

What an excellent device when you need low height or high density packaging! Already, seven distinct amplifier types of G-E D24 transistors are available for computers, electronic calculators, and many other industrial and consumer applications. And their electrical characteristics are the same as their "2N counterparts"—the 2N-3900 and 3900A, 2N3391 and 3391A, and 2N3392 through 3394 transistors.

Prices range from 25 to 35 cents in lots of 10,000 and up.

Thanks to transfer molded silicone encapsulation, each of these new amplifiers features excellent humidity resistance. Heat dissipation is over 300 milliwatts at 25°C. Each features low package capacitance and leakage current of 100 nanoamps maximum.

Try them out for flexibility. You can adapt them to thick and thin film microelectronics for hybrid circuits. And you can bend their leads so they'll fit conventional TO-5 hole patterns. *Circle Number 811* on the Reader's Service Card. (And if these transistors still aren't small enough for you, try the new G-E microtab transistors.)

**STICKY APPLICATION PROBLEM?  
PERHAPS ONE OF THESE NEW BULLETINS CAN HELP YOU**

**500-Watt AC Line Voltage and Power Regulator** (Application Note 201.12—Serge Zimmer). Easy to build at a relatively low components cost. Suitable for many applications in consumer, military and industrial equipments. **Circle Number 813.**

**Universal Motor Control with Built-in Self-Timer** (Application Note 201.13—Denis Grafham). Particularly suitable for blenders and larger pedestal type food mixers. Shuts off motor at the end of a predetermined time cycle. **Circle Number 814.**

**Automatic Liquid Level Control** (Application Note 201.14—Denis Grafham). Low cost, hybrid level control designed to maintain the liquid content of any well-grounded container

between two previously established limits. **Circle Number 815.**

**Fan Motor Speed Control or "High Intensity" Lamp Dimmer** (Application Note 201.16—Denis Grafham). Low cost variable voltage control that can either adjust the speed of a small, 120-v AC shaded pole fan motor or dim "high intensity", low voltage table-top lamps. **Circle Number 816.**

**High Voltage Power Supply for Low Current Applications** (Application Note 201.18—Andy Adem). Used in powering AC or DC for neon signs, electrostatic precipitators, copying machines, etc. **Circle Number 817.**

Any or all of these are yours for the asking. Just circle the Reader's Service Card indicated or contact General Electric direct.

■ **AND HOW ABOUT THIS  
NEW, ECONOMY LINE  
SWITCHING TRANSISTOR?**

It's the 2N4256—a new device you should consider for all your medium speed, low level switching applications. Why? Because it features high gain and low saturation voltages. This new, low-cost transistor has outstanding performance characteristics and very thorough specifications.

Among its more outstanding features are those listed at right.

These features can greatly aid to simplify certain design problems. You can have the transistor's  $V_{CE(SAT)}$  specified over a wide range of current and at a very high circuit  $\beta$ . And its stored charge capability simplifies your selection of trigger capacitors for flip-flops and one shots.



Max. $V_{CE(SAT)}$ for any $I_C$ between 0.1 and 10mA and a circuit $\beta$ of 50	0.2 volts
Minimum $h_{FE}$ at $I_C=2mA$	100
Maximum stored charge at $I_C=10mA$	600 pc
Maximum turn-on time at $I_C=10mA, \beta=30$	180 ns

**Circle Number 812** on the Reader's Service Card if you're interested in more details. This is one more example of General Electric's total electronic capability. Or ask your G-E engineer/salesman or distributor for more information or write to Section 220-38, General Electric Company, Schenectady, New York. In Canada: Canadian General Electric, 189 Dufferin St., Toronto, Ontario. Export: Electronic Components Sales, IGE Export Division, 159 Madison Avenue, New York, N.Y. 10016.

Playing back a tax return

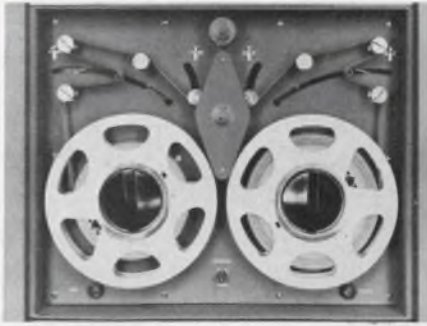

## IRS boosts ADP bookkeeping

Computer manufacturers and developers of automatic-data-processing software received heartening encouragement at a recent Computer and Tax Conference here. The conference was sponsored by the American and Federal Bar Associations and George Washington University's National Law Center under the auspices of the Internal Revenue Service.

The IRS interprets liberally the words "books" and "records" as they appear in laws and regulations. It now treats ADP-maintained or -produced data the same as manual, pen-and-ink bookkeeping systems. The tax men have now specifically invited a number of firms to submit their tax returns next year on magnetic tape.

An engineer at the conference commented on the significance of the new approach: "Some companies may be considering buying a computer to speed up billings, aid in the design of bridges, control chemical processes or improve a personnel department. But they know they would be using only part of the system's potential. If they know that they can also use that same system to keep their books and prepare their tax returns, then they'll likely be favorably persuaded." Many participants in the conference saw the IRS attitude as a boon to computer sales.

Though the IRS may seem optimistic, however, there are still some knotty problems to be solved. One speaker pointed out: "The whole nature of the audit trail has changed; now it's computer tapes, disks and print-outs instead of ledgers and vouchers. There has never been the widely publicized moan over any shortage of bookkeepers the way there is now deep concern over the shortage of programmers."

The most difficult adjustment for auditors, lawyers and the IRS will be to accustom themselves to not seeing actual figures but taking someone's word that they are there. Traditional records will be virtually eliminated and accountants will be performing "no pens, no paper" operations. Most participants agreed that somebody will have to set standards of acceptability for computer-produced audits.

# Washington Report

S. DAVID PURSGLOVE,  
WASHINGTON EDITOR

Another moot point is the ultimate responsibility for an error. Even lawyers do not know whose it is. In manual bookkeeping, the bookkeeper or the person who supplied him with the information is responsible for false or misleading entries. Most lawyers believe that the same holds true for ADP, but the defendant in an IRS suit may have had recourse to an outside programming firm or computer operator-time seller under certain circumstances. And in some cases, he may even have contacted the manufacturers.

Happily, the IRS has not simply shrugged off the problems. Its spokesmen made it clear that the IRS was aware of them and had instituted programs ranging from general surveys and literature searches to hardware research and engineering to solve them. They even pointed out some of the less evident potential problems, such as whether all businesses will have to use the same ADP system and whether advances in technology would be frozen out.

The IRS position is that, just as in manual bookkeeping, almost any system that works and accurately reflects business flow will be acceptable provided it is used consistently. The system must ultimately produce a print-out that is legible and suitable for audit.

The IRS itself had its own pat on the back for the industry in an official statement that it recognizes that "ADP systems are capable of recording business transactions with greater efficiency and accuracy than manual accounting systems."

## IRS funded for its own ADP system

The Internal Revenue Service already has wide insight into the use of ADP and has become one of the world's largest users. Now Congress has appropriated the money for it to become yet larger and to complete installation of its nationwide ADP system.

The big, master-file ADP system in Martinsburg, W.Va., is to be modified and expanded and several regional preliminary processing centers are to be operating fully before next January. The "Martinsburg Monster" is an IBM System/360, Model 62, which will be modified into a Model 65. A

# Washington Report

CONTINUED

second Model 65 is on order. The Martinsburg center uses IBM Hypertape and high-speed 7340 Hypertape drives. The instruments in the regional preliminary processing centers will be key punches and standard verification machines.

Five regions were considered operational by last January: Southeast, Mid-Atlantic, Central, Southwest and Western. Two states in those regions were not operational but will be by next January: California in the Western and Michigan in the Central. In addition, year's end will see the Midwest region, with headquarters at Kansas City, Mo., and the North Atlantic region, based at Lawrence, Mass., fully equipped and operating.

## Coal men call on electronics

The competition between coal and atomic power may be involving electronic firms more and more, an Interior Department spokesman believes.

The coal men will be offering increasingly valuable and challenging contracts to R&D firms. And the Department of the Interior's Office of Coal Research has already turned to them. It has contracts with universities and such companies as Gourdine Systems, Melpar and Foster Wheeler, and recently announced a \$1.8 million, 3-1/2-year contract with Avco Corp.'s Space Systems Research Division to develop a method of converting coal into a higher value gas or liquid product.

A leading coal-mining-equipment manufacturer, Bucyrus-Erie president E. P. Berg, recently told the National Coal Association: "Advanced techniques, proven concepts and new hardware from any technological field are considered almost immediately for any possible application to our mining techniques."

Berg's competitor, Joy Manufacturing president James A. Drain, stated that "interesting results" had been obtained from "push-button mining," which operates without a man at the working face and without roof support and is already in use in the high walls of opencast mines. The next step, he said, would bring R&D firms underground to evolve a below-the-surface model.

## Navy seeks new-generation simulators

The Navy has spelled out its ideas on new generations of computer-based training

simulators that it will seek from the electronics industry. At the top of the list are simulators for training crews of the future deep-submergence fleet.

The Navy's Bureau of Personnel wants equipment to simulate undersea rescue work, navigation at great depths, and the search, recovery and communications procedures being elaborated for the new fleet of small, deep-diving rescue, salvage and research vessels, which are being produced largely as a result of the "Thresher" tragedy.

Second in order of priority is greater realism in advanced submarine-control trainers. They must be able to simulate accurately and realistically such accidents as flooding, providing the crews with correct procedural and decision-making training. In this area, too, the Navy will look for improved simulation techniques for sonar classification training.

Finally, but still very high on the list, the Navy wants a line of hardware that will change the old adage to "A sailor has a computer in every port." Specifically, the bureau wants a generation of mobile, dockside computers. Then, whenever a ship ties up after sea duty, a simulator will be rolled out on the pier and plugged into the ship's Combat Information Center and other electronic gear and will simulate patrols, battles, or accidents.

## Police need more electronic help

The Man from Interpol recently spelled out in detail some of the hardware that working policemen would like to see developed. Arnold Sagalyn, director of the Treasury Department's Office of Law Enforcement and U.S. representative to the International Criminal Police Organization (Interpol), said that cars should be made not merely safer but also theft-proof.

Laws should be passed, he suggested, to make it an offense for drivers to leave their keys in their cars. But in addition, he said, "we look to science and technology for a technical solution which will lock the ignition and secure the car without regard to security habits of the driver." He proposed such gadgets as jump-proof ignition systems, audio and visual alarms that go off when an unauthorized person tries to drive a car, and spring locks that forcefully eject keys from the ignition.

Without turning homes into fortresses, he said, they could be protected at low cost if industry would develop new concepts of interior and exterior lighting and simple contact mats that would trigger alarms. Automatic elevators without operators that attract undesirables could be equipped with devices that would detect untoward activities and prevent their being stopped between floors.



# Now! All the Features of Larger Size Potentiometers—Except Larger Size!

- (1) Dimensions:  $\frac{1}{4}$ " x  $\frac{1}{4}$ " x 0.17"
- (2) Multi-turn adjustment
- (3) Damage-proof clutch action
- (4) Indestructible SILVERWELD<sup>®</sup> termination
- (5) Standard resistances from 10 $\Omega$  to 20K
- (6) 20 ppm wire

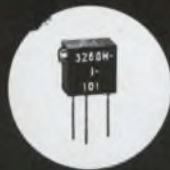

New TRIMPOT<sup>®</sup> Potentiometer Model 3260  
ACTUAL SIZE

Write today for complete technical data

If it's TRIMPOT<sup>®</sup>, it's BOURNS

TRIMPOT is a registered trademark of Bourns, Inc.

MANUFACTURER: TRIMPOT<sup>®</sup> & PRECISION POTENTIOMETERS, RELAYS; TRANSDUCERS FOR PRESSURE, POSITION, ACCELERATION. PLANTS: RIVERSIDE, CALIFORNIA; AMES, IOWA; TORONTO, CANADA



# Take a look at our family...



We've got lots of daughters and they're looking for dates. We can arrange a "wedding" to your specifications . . . quickly and with only a small dowry on your part. If you see a member of our family you'd like to know better . . . call one of our "kinfolk" in your neighborhood (see column at right) or get in touch with our "home" in Wheeling (Ill.).

\*Registered trademark—DuPont Co.  
\*\*Registered trademark—Precision Paper Tube Co.



## Precision Paper Tube Company

Divisions: Resinite • Buckeye Bobbin • Automation Devices  
1033 S. Noel Ave., Wheeling, Ill. Phones: Chicago: 631-1445 • Long Distance: 312-537-4250, TWX: 312-537-5202

ON READER-SERVICE CARD CIRCLE 18

our "kinfolk" are  
spread far and wide  
to serve you . . .

#### EASTERN STATES

(N.Y. City—South)  
H. Wm. Bauer,  
234 Terrace Ave.,  
Jersey City, N.J. 07307  
201-795-2480

#### E. MICHIGAN, OHIO, W. NEW YORK

John F. Kirby, Jr.,  
11120 Riveredge Dr.,  
Parma, Ohio 44080  
216-886-1221

#### NEW ENGLAND N.E. NEW YORK

Walter S. Peterson,  
Box 17, Station 1,  
E. Natick, Mass. 01760  
617-653-3855

#### S. ILLINOIS, MISSOURI

Tanler and Company  
7720 E. Big Bend Blvd.,  
St. Louis, Mo. 63119  
314-645-0590

#### KENTUCKY

Packaging Service Corp.,  
3001 W. Madison St.,  
Louisville, Ky.  
502-778-5565

#### MEXICO

Industrias Comerciales,  
S.A.,  
Medellin No. 184,  
Mexico 7, D.F.,  
14-65-58, 14-65-66

#### ENGLAND

Langley London Ltd.,  
Kelvin Way  
Crawley, Sussex  
Crawley 25955

#### CANADA

The Glendon Company Ltd.  
—Suite No. 4—603 Evans Ave.,  
Toronto 14, Ontario, Canada,  
416-255-5001  
—P.O. Box 101  
Ile Perrot Sud, Quebec  
514-453-6375

#### MOUNTAIN & WEST COAST

Electrical Specialty Co.  
with offices in: Denver,  
Phoenix, Los Angeles,  
San Francisco, Portland,  
Seattle.

No. ILL., WISC., IOWA,  
MINN., W. MICH., INDIANA

(AND BALANCE OF U.S.)

#### PRECISION PAPER TUBE CO.

1033 S. Noel Ave.,  
Wheeling, Illinois 60090  
Chicago: 631-1445, Long Dist.:  
312-537-4250, TWX: 312-537-5202

## 'Resonistor' may tune ICs

An experimental resonating device that may lead to a new way of tuning integrated circuits has been developed by IBM. Called a resonistor, the new device is essentially a cantilevered chip of silicon mounted, like a tiny diving board, on a substrate. It measures 0.0350 inch long, 0.090 inch wide and 0.008 inch thick, and contains two special diffused resistors.

When an input signal is applied to the resonistor, it causes the silicon chip to vibrate. The resonistor then delivers an output voltage with a specific, stable frequency. Not only is the resonistor compatible with integrated circuit technology from a fabrication and interconnection standpoint, but it is suited for relatively low operating frequencies—something difficult to achieve in monolithic integrated circuits.

In operation (Fig. 1), heat is

generated when an electrical input signal is applied to the diffused resistor located at the supported end of the cantilevered chip. Strains set up in the silicon by the heat cause the chip to vibrate at its resonant frequency. The unsupported end of the chip moves up and down approximately 50-millionths of an inch while vibrating.

The second diffused resistor is a piezoelectric type. As it senses the physical strain within the vibrating silicon chip, proportional changes in its electrical resistance take place. The frequency of the output voltage is therefore proportional to the chip's vibration. The resonant frequency of the resonistor can be controlled by weighting the unsupported end of the chip.

Several resonistors, designed to operate at different frequencies, have been built at IBM's Components Division. ■ ■

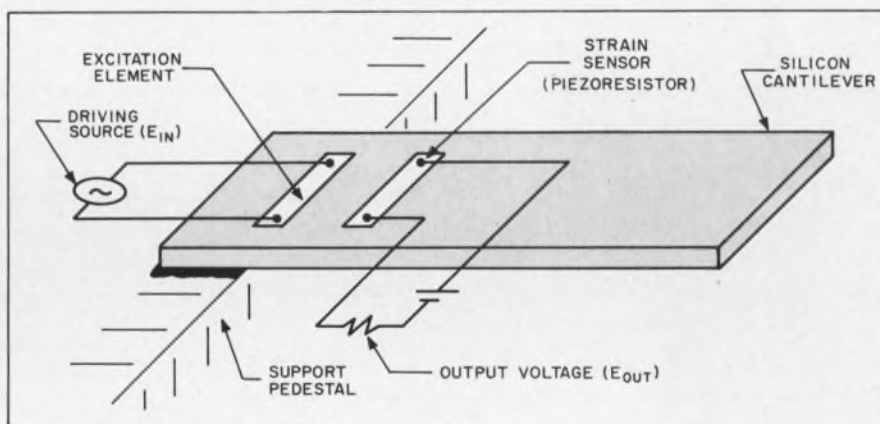

1. Heat makes silicon chip vibrate and produce an output voltage of a frequency proportional to its vibration.

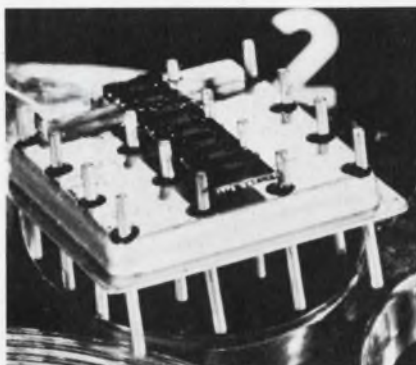

2. Resonistor is essentially a cantilevered chip of silicon mounted on a substrate.

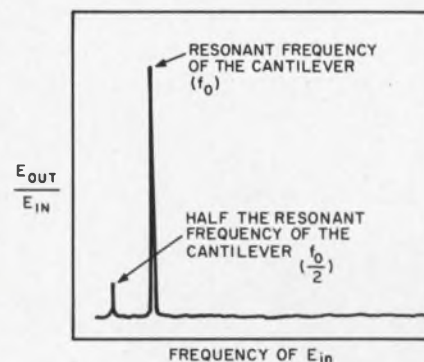

3. Frequency response of the resonistor is shown by this typical transfer characteristic.

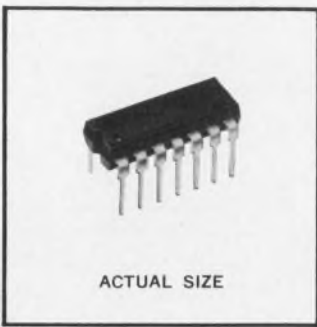

# Motorola's New MRTL Plastic Integrated Circuits Shatter IC Price Barriers

**As low as 56¢ per  
2-input gate function,  
and \$1.78 per J-K Flip-Flop  
function – (100-up)!**

These typical economies result from the multiple-circuit functions of these integrated circuits . . . For example, at a cost of \$2.25 each, the MC724P quad contains the functions of four 2-input gates, which lowers the cost to 56¢ per function. But, price is only *one* reason why you'll want to investigate this newest Motorola integrated circuit series.

The MC700P series is an expanded MRTL\* complement that offers a new level of system design flexibility with a multitude of circuit functions — including 10 entirely new multi-function devices not previously available in integrated RTL logic!

Multi-function capability in one small, low-cost package . . .

The MC700P series offers low-power milliwatt MRTL and medium-power MRTL in the 14-Pin dual in-line plastic package for such functions as:

Milliwatt MRTL	Price (100 up)
Quad 2-Input Gate (MC717P)	\$2.25
Dual 3-Input Gate (MC718P)	1.90
Dual 4-Input Gate (MC719P)	2.25
Triple 3-Input Gate (MC793P)	2.50
Dual Buffer (MC798P)	2.70
Medium-Power MRTL	
Dual 3-Input Gate (MC715P)	\$1.90
Quad 2-Input Gate (MC724P)	2.25
Dual 4-Input Gate (MC725P)	2.25
Triple 3-Input Gate (MC792P)	2.50
Hex Inverter (MC789P)	2.25
Dual Buffer (MC799P)	2.70
Dual Buffer (Non/inverting) (MC788P)	2.70
J-K Flip-Flop (MC723P)	2.70
Dual J-K Flip-Flop (MC790P)	3.55

One more point: You get the added assurance of rugged construction of the Motorola Unibloc\* package — the solid, single-piece, pressure-molded package that offers unusual physical strength for internal leads and connections, plus improved heat transfer characteristics. Write for complete data to: Motorola Semiconductor Products Inc., Dept. TIC, Box 955, Phoenix, Arizona 85001.

\*Trademark of Motorola Inc.



**MOTOROLA Semiconductors**  
*— where the priceless ingredient is care!*

Speed Inquiry to Advertiser via Collect Night Letter  
ON READER-SERVICE CARD CIRCLE 20

# Sensitive SQUID measures minute magnetism

**Magnetometer uses quantum interference and flux-nulling to gauge tiny magnetic variations.**

**Roger Kenneth Field**  
News Editor

A new device—called a SQUID magnetometer—can very accurately measure feeble magnetic fields with a sensitivity that is an order of magnitude greater than that of previous devices. Developed by Ford Motor Co. physicists, the SQUID (Superconducting Quantum Interference Device) is so sensitive that even tiny fluctuations in the earth's magnetic field are enough to drive it off its lowest scale.

This supersensitivity is achieved by a combination of a flux-nulling technique with the operation of two point contacts at the threshold between superconductivity and resistivity.

Sensitivity of the SQUID is at least  $10^{-8}$  gauss compared with  $10^{-7}$  gauss for the rubidium-vapor magnetometer. The new magnetometer can also measure flux densities in the range of zero to 50 microgauss; the rubidium-vapor device cannot do this.

This could be significant in certain areas of space, for instance, near Mars, where present magnetometers have yet to detect flux.

The SQUID magnetometer was designed at Ford's Scientific Laboratory in Dearborn, Michigan.

Ford's Western Development

Laboratories in Palo Alto, Calif., have used a version of the SQUID to check conventional magnetometers used aboard the Pioneer spacecraft.

## SQUID uses flux-nulling method

The SQUID's flux-nulling technique is not unlike everyday voltage-nulling methods. It neutralizes a flux with an equal and opposite flux.

The magnetometer's circuitry provides the field coil with a current and, hence, a magnetic field, which precisely counteracts the minutest changes in the magnetic field of the SQUID's sensitive aperture. Since this current is directly proportional to these tiny changes, an ammeter that measures this current is the register of the information that the SQUID garners.

## Step by step through the circuit

A cell provides direct current for the SQUID (see Fig. 1). Since the SQUID is supercooled by liquid helium, it should offer no resistance to this current, and voltage,  $V$ , across the "weak link" should equal zero. This "weak link" is a mechanical point of contact of extremely small contact area. It will offer no resistance to small currents, but a minimal increase in either flux or

current will convert the contact from superconductive to resistive; then a voltage will appear. The variable resistor in the bias loop is adjusted to bring the current just above the threshold. Thus a slight increase in flux through the sensitive aperture causes the "weak link" to go more resistive and a greater voltage appears across it. A 10-kHz oscillator drives a field coil in the proximity of the SQUID. The voltage thus induced passes through a transformer, is amplified by an ac amplifier and sent into a synchronous detector. The function of the detector is to

home in continuously on a 20-kHz output from the SQUID. It compares the signal with that of the 10-kHz oscillator. If the two signals are in phase, the detector directs the operational amplifier to increase the current through the field coil; if they are out of phase, it decreases

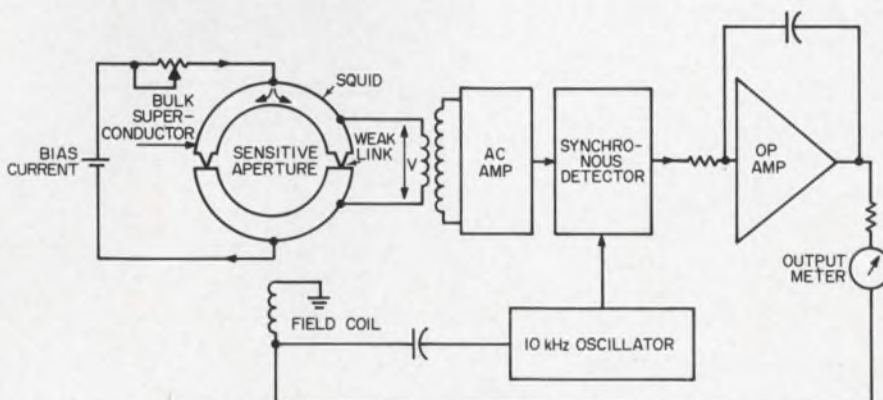

1. Block diagram of the SQUID magnetometer shows path of signal from SQUID to output meter. Voltage,  $V$ , appears when bias current and flux in the SQUID's aperture cause the "weak links" to go resistive.

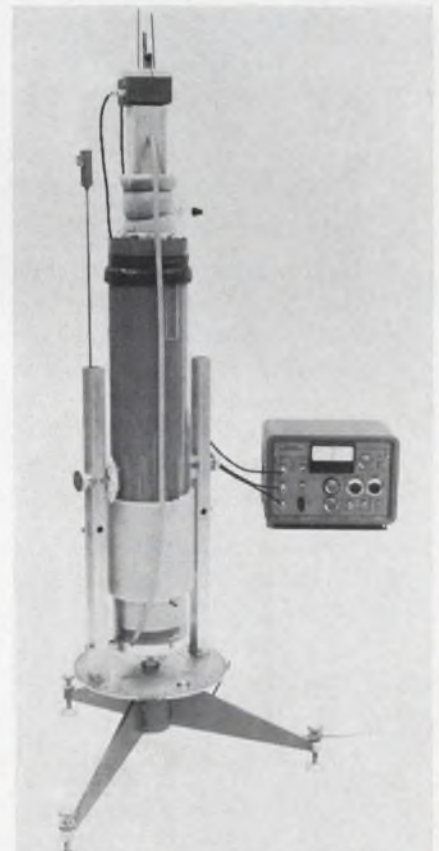

The probe is housed in its Dewar mount for measurements of the earth's magnetic field.

**KLIXON**  
PRECISION CONTROLS

## New TI cooling effect detector revolutionizes overheat protection of forced-air-cooled equipment!

KLIXON® 2ST Cooling Effect Detectors combine unprecedented sensitivity, reliability, simplicity and economy to prevent harmful overheating in computers, radar and microwave systems, copying machines, film projectors and other fan-cooled equipment. They completely eliminate the need for vane switches and thermostats.

Reliable solid-state sensing makes the difference! The sensor is a self-heated NTC (negative temperature coefficient) resistor. Mounted in the air stream and connected in series with a special rating of the KLIXON 4MC magnetic circuit breaker, it monitors the cooling capacity of the air stream. Loss of cooling effect as a result of clogged inlets, fan failure, air conditioner loss, or any combination of these causes a sharp drop in sensor resistance. The resultant increased current will trip the circuit breaker.

Unlike conventional thermistors, KLIXON 2ST Detectors sense over their entire surface, instead of only one point. This simplifies installation and mounting. Moreover, they can handle directly a current large enough to actuate a circuit breaker without intermediate amplification. They can be designed to operate at any voltage between 3 and 24 v-dc/60 cycle ac.

Bulletin PRET-16 gives you all the facts you need to evaluate these exclusive TI developments. Write for your copy today.



**METALS & CONTROLS INC.**  
5107 FOREST ST., ATTLEBORO, MASS.  
A CORPORATE DIVISION OF  
**TEXAS INSTRUMENTS**  
INCORPORATED

Speed Inquiry to Advertiser via Collect Night Letter  
ON READER-SERVICE CARD CIRCLE 21

NEWS

(SQUID, *continued*)

the field-coil current. This fluctuating current continually neutralizes the tiny but significant changes in the density of the magnetic field in the SQUID's aperture.

It is evident that this magnetometer measures relative changes in flux, not the absolute amount of flux. But it is the physics of the SQUID that explains why the phase of  $V$  reverses for flux densities higher than a certain value and remains unreversed for all lower densities.

### SQUID uses quantum interference

In any superconducting closed loop like the SQUID, circulating electron currents arrange themselves into a standing wave in the presence of magnetic flux. In an ordinary conductor the temperature (and therefore the average kinetic energy of its electrons) is too high to allow this to happen. The wave forms to neutralize a magnetic field in a superconductor just as electric charge redistributes itself along the surface of a metal to neutralize any electric field. Since the wave closes on itself, it must contain an integral number,  $n$ , of cycles.

The wave resists any increase in flux until the additional flux reaches a value corresponding to half a cycle. The wave then promotes the addition of flux up to the value of one full cycle. Thereafter it resists the addition of flux, and the cycle repeats itself. The alternating nature of the wave's resistance to flux is seen at the "weak link" as a periodic variation in voltage against a steady increase in flux (see Fig. 2). The period of this variation is  $h/2e$ , where  $h$  is the Planck constant and  $e$  the charge on an electron.

If the amount of flux in the aperture exactly equals  $\pm nh/2e$  (where

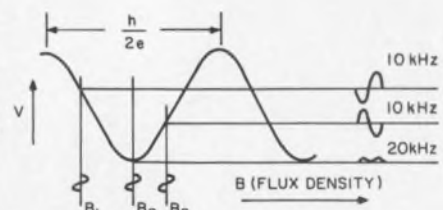

2. SQUID voltages take three forms depending on the level of ambient flux and the flux emanating from the field coil.

$n$  is any integer), then the small 10-kHz flux variations impressed on the aperture by the field coil result in a 20-kHz voltage across the "weak link" (see Fig. 2, signal  $B_0$ ). The synchronous detector orders no change in the field-coil current, as it responds only to 10-kHz signals. If the flux rises or falls slightly, the impressed signals from the oscillator behave like signals  $B_2$  or  $B_1$ , respectively. Either an ac voltage or its reciprocal prompt the operational amplifier to alter its dc output, and the level of flux returns to an integral number of energy units— $\pm nh/2e$ .

### SQUID has limitations

Obviously, an absolute magnetometer such as the rubidium-vapor unit can give relative measurements. A relative instrument like the SQUID, on the other hand, must be calibrated before it can be made to show absolute readings. Since the supercooled SQUID, as well as current in the probe, distorts a magnetic field, the calibration must take place in a field that has the same configuration as the field to be measured. To measure a uniform field, the SQUID can be calibrated with large Helmholtz coils which simulate such a field. But if a non-uniform field is to be measured, the nature of these non-uniformities must be known and must lend themselves to simulation in a calibration rig.

The SQUID must be cooled to cryogenic temperatures with liquid helium and liquid nitrogen. Though this limits the length of time it can be operated remotely, it does not preclude its use in space. Cryogenic fuel cells have been used in the Gemini Program, for example. And even on earth, a filling will last more than a day. One drawback of the SQUID is that it drifts.

### SQUIDS in the future

The Ford Scientific Laboratory is experimenting with thin-film versions of the SQUID. A thin film "weak link" should be completely free of drift.

The lab is also designing a digital read-out to register the number of flux cycles. An analog meter will show the fraction of the last cycle. This will provide a clearer and even more accurate reading than the present all-analog display. ■ ■



## black box '66

Handsome? You should see it in color! Black is only one of eight colors available at no extra cost. Use them singly or in two-tone combination. Here is instant distinction for your quality instruments.

Cases are made for 19" panels, 3½" to 28" high. All-aluminum/recessed handles/choice of panel patterns/color-matched front and rear panels/chassis slides and other accessories... from stock.

Matching consoles and racks offer you coordinated and outstanding style for equipments of virtually all sizes and arrangements. Ask for detailed catalog.

# Optima

enclosures

made by Scientific-Atlanta, Inc., Box 13654, Atlanta, Ga. 30324, Tel. 404-938-2930, TWX 810-766-4912.

# Letters

## Engineer qualifications need tightening

Sir:

Your report on the IEEE panel on the qualification for a professional engineer [ED 8, Apr. 12, 1966, p. 23] was of more than "academic interest." In the electronic industry, we have been neglected by the engineering schools and the professional registration system. Neither has been able to keep up with the industry. Until recently a BS in physics was the better preparation for electronic engineering. It has always been necessary for the electronic engineer to continue to pursue specific studies of immediate importance in his work. This is accomplished by graduate courses, self-teaching and by interacting with associates on the job or in professional societies like the IEEE. However, even the formal university graduate courses seldom fit into a master's program. The registration examination neglects electronics also. Only 10 years ago our "practical examination" was almost entirely power engineering. Now you report that ASEE advocates adding insult to injury.

In my opinion, the answer lies in improving the practical examination. This examination may be updated twice a year in order to measure the engineer's proficiency in the *current state* of the electronic art. An additional requirement might be added in the form of a paper or article equivalent to a master's thesis. This paper should be acceptable for publication in a recognized technical journal and concerned with design or research and development. It may be practical to use the master's degree as qualification for branches of engineering that do not change as rapidly as electronics. My personal concern is that we do not repeat the history of electronic engineering with biomedical engineering. We are just beginning to define this new area of engineering.

D. G. Kilpatrick

Project Engineer  
American Electronic Labs., Inc.  
Colmar, Pa.

## Black and white film gives color pictures?

Sir:

In reference to your article on photomicrography [ED 7, Mar. 29, 1966, p. 59 ff.], I should like to point out that Polaroid P/N 55 is a black and white film; yet the article said it was used for the color illustrations. Could you then advise me what film was in fact used and whether the exposure data are available?

D. Thomas Beach

Tektronix, Inc.  
Beaverton, Ore.

### Author's reply:

*Mr. Beach is entirely correct. The P/N 55 film was used only to obtain exposure information. The color shots were then made with Kodak Type-L negative color film.*

*As explained in the text, these consisted of multiple exposures: Chip exposure time was 1/10 second under 50× magnification using the internal light system of the microscope; the package exposure time*

*using the tenting technique was four seconds.*

Bernard W. White

Texas Instruments, Inc.  
Dallas, Tex.

## ED criticized for frivolity

Sir:

Reference is made to your cover feature on electric cars in ED 13, May 24, 1966. The photo on p. 17 shows Mr. Yardney about to plug the cord into the tree receptacle. The caption states that "it may be some while before a driver can recharge the batteries of his electric auto by plugging into any wayside tree."

While this may be a petty detail, ELECTRONIC DESIGN is a technical magazine, and as such it is my contention that phony setups and other Madison Avenue hocus pocus should not be used in the magazine.

Charles A. Klimko

Sr. Elect. Engr.  
Marietta, Ga.

## Editorgram comments: Keep them coming

Hundreds of Editorgrams are still pouring into us, bringing us your comments and criticisms. All of ELECTRONIC DESIGN's editors read your comments; every reader's suggestion is considered carefully.

Here is a sampling of some recent cards. Notice that we still do not identify the writers so that your comments can remain candid and uninhibited. Take out a minute yourself after you have finished reading this issue to let us know what you thought of it. Use the Editorgram inside the back cover. It's free.

First, here are some comments that have led to changes in our editorial practices:

"I dislike use of the following symbol:

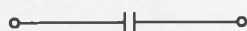

for a capacitor. It is the standard

symbol for a switch. This is the proper symbol:

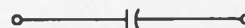

(Note: You'll find the correct symbol in use in this issue.)

\* \* \*

"The dark overlay on circuitry schematics does not reproduce on the 914 copier."

(Note: Dark overlays also make circuits hard to read. This problem has been corrected: Overlays will be light or absent altogether.)

\* \* \*

"Corrections should mention the subject of the article. I file by subject, after clipping. Hence, such a reference as 'Idea #115' is completely unusable by me."

(Note: Corrections, appearing at the end of the Letters column, now always refer to the subject.)





For those who think big—about availability, that is. Babcock's 1/6-size Model BR10 with unique universal contacts gives you "nonstop" load performance dry circuit to 1 amp. in the same unit. Now, you can order *one* relay to meet all your high-density circuit-board requirements—at no cost premium. And you'll find that this subminiature unit has everything... MIL-R-5757 conformance, unitized construction, solder-sealed or welded versions, standard circuit-board grid pattern, and a wide choice of terminal and mounting styles. Get more information about

the BR10, and the complete Babcock line of relays, all with universal contacts. Write Babcock Relays, Division of Babcock Electronics Corp., 3501 Harbor Blvd., Costa Mesa, Calif.; (714) 540-1234.



**SPECIFICATIONS**

<b>SIZE:</b> .405" h. x .500" l. x .230" w.	<b>PULL-IN POWER:</b> Low as 80 mw.
<b>WEIGHT:</b> Approx. 0.15 oz.	<b>LIFE:</b> To 150,000 operations
<b>CONTACT ARRANGEMENT:</b> DPDT	<b>TEMP. RANGE:</b> -65° C + 125° C

**Babcock**  
**model BR10**  
**1/6-size relays**



**dry circuit**  
**to 1 amp**  
**universal**  
**contacts**

ON READER-SERVICE CARD CIRCLE 23

# ALSiMAG<sup>®</sup>

## MULTI-CAP CAPACITORS

for high  
capacitance-to-volume  
ratio in micro-circuits and  
in equipment miniaturization

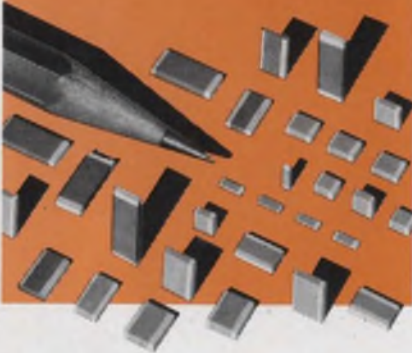

An exclusive manufacturing process insures a strong lamination of the high quality ALSiMAG thin strong ceramic dielectric and the electrode layers and virtually eliminates any tendency to delaminate. The edge termination is readily solderable for quick, reliable assembly.

These unencapsulated capacitors range from .152 x .052 x .055 inches to .375 x .155 x .065 inches with capacitance from 330 pf to .5 mfd, at voltages of 25-50, 100-200 D.C. Production quantities in this range are promptly available.

### NEW NPO CERAMIC

A K46 material with lower losses and better dielectric properties than conventional mica or glass capacitors.

### CUSTOM PROTOTYPES

The laminated thin ceramic-electrode principle can be applied in a great variety of electronic uses. Prototypes can be made to your specifications for your evaluation over a wide range of sizes and capabilities and at reasonable cost.

Write for Data Sheet CM

American Lava Corporation **3M**  
A SUBSIDIARY OF 3M COMPANY

Titania Division  
Chattanooga, Tennessee 37405  
Sixty-Fifth Year of Ceramic Leadership

ON READER-SERVICE CARD CIRCLE 24

## LETTERS

"Why not reprint the issues on microfilm cards? We have a problem filing back issues. These could be offered on a special subscription basis."

(Note: ED is available on microfilm. Copies of complete issues for the years 1961 through 1965, or selected articles, can be obtained from University Microfilms, Inc., 313 N. First St., Ann Arbor, Mich. 48103. Interested readers should correspond directly with University Microfilms for further information.)

### Some notes to manufacturers . . .

"Your advertising should always include price information. I read ED for two reasons: (1) because I need to know who is producing what; and (2) because you offer useful tips on most engineering problems."

\* \* \*

"Please ask manufacturers to give a number and a letter to all catalogs; for instance, 50B or 50C. This would help prevent duplicate catalog requests and would allow readers to check if they had the latest catalog."

\* \* \*

"Try to have every manufacturer state his prices. An open price in an ad helps me to an immediate decision on whether the product is of any use. This would save some manufacturers from sending out a lot of literature in vain."

### Linville article a hit . . .

Several articles have drawn high praise from readers, but the record-breaker so far is "Design high-frequency amplifiers graphically, relating stability, gain, bandwidth and sensitivity with easy-to-construct Linville-Smith charts" (Ed 8, Apr. 12, 1966, pp. 48-54). Many readers indicated that they had an immediate application for the method; several said it was the clearest explanation of the technique that they had yet seen.

Here are some more, specific article comments:

"'Committee meetings waste time' (ED 5, Mar. 1, 1966, pp. 66-68) describes our meetings to a T."

\* \* \*

"I like articles that include true component values, such as 'Device-hunting for motor speed control?' (Ed 11, May 10, 1966, pp. 38-45)."

\* \* \*

"I especially liked 'Swamp out distortion in wide-range agc systems' (ED 8, Apr. 12, 1966, pp. 72-74), because I have an immediate use for such a circuit."

\* \* \*

Another reader asked a couple of questions that others may also be curious about:

"What is the night letter program?"

(Those who have design problems may send a free telegram of up to 50 words asking for information to any participating manufacturer. Just call Western Union and send a collect night letter telegram. The manufacturers taking part in the program are marked with an asterisk in the Advertisers' Index in ED; their advertisements carry the line: "Speed Inquiry to Advertiser via Collect Night Letter.")

\* \* \*

Second question:

Where were pages 144A-D in ED 8, Apr. 12, 1966?"

(Certain advertisements appear only in those issues of ED that circulate in specified areas of the country. In the Advertisers' Index these are listed as "Regional Advertising.")

\* \* \*

One final Editorgram simply told us:

"I especially liked the Editorgram because closed loops are nicer!"

We look forward to hearing from more of you.

### Accuracy is our policy

Electronic Devices, Inc., points out that in the New Products section of ED 11, May 10, 1966, the item "SCRs" on p. 117 should refer throughout to silicon rectifiers, not to silicon-controlled rectifiers.

In "Microwave parley sees room for IC growth" in ED 15, June 21, 1966, the figure on p. 22 should be above the caption for Fig. 2 on p. 21, and vice versa.

# ED Semiconductor Directory Errata

Put your copy of Electronic Design's 1966 Semiconductor Directory (ED 12, May 17, 1966) in order by taking note of the omissions and incorrect listings pointed out below. Take advantage of the Reader-Service-Card system to obtain more detailed information directly from the semiconductor manufacturer involved.

**Crystalonics Inc.**'s analog-switching FETs were given the wrong figures for their  $I_{D(off)}$  parameters on pp. 104-105. These values should have been in nanoamps, not microamps as given. The correct parameters are:

Type No.	$I_{D(off)}$
C6690	1.0 nA
C6691	1.0 nA
C6692	1.0 nA
CM600	3.0 nA
CM601	3.0 nA
CM602	3.0 nA
CM603	3.0 nA

**Hoffman Electronics Corp.** is not at present a manufacturer of transistors or integrated circuits. Delete from the Manufacturers' List (p. 5) RSC numbers 254 and 256.

**ITT Semiconductors** produces nine DTL logic circuits that should have appeared in the Microelectronics Section of the directory (pp. 174-179). Add ITT to the "Who makes what in DTL" chart on page 179. The ITT circuits that should appear in the DTL lists are:

<b>Binary elements</b>	- MIC 950 (RS flip-flop), MIC 948 (RS/JK), MIC 945 (RS/JK).
<b>Drivers/ Buffers</b>	- MIC 932 (Dual 4-input).
<b>Gates (NAND/NOR)</b>	- MIC 930 (Dual 4-input), MIC 946 (Quad), MIC 962 (Triple).

**Gate Expanders** - MIC 933 (Dual 4-input).

**Multi-vibrators** - MIC 951 (2-input).

Additional data on these devices will be sent if you circle Reader Service Card number 600.

**Kemtron Electron Products, Inc.**, 14 Prince St., Newburyport, Mass. 01950 (617-462-4464), should be included in the List of Manufacturers (p. 6) and on the Diode Manufacturers' List (p. 165). Kemtron manufactures microwave, RF and general-purpose diodes.

**KMC Semiconductor Corp.** manufactures a number of bipolar and field-effect transistors that were omitted from the Directory listings. Here are the type numbers, according to their similarity to other devices, as listed in the cross-index key.

FET 1 (p. 104)	- K1501, K1502
FET 58 (p. 112)	- K1202.
HF 85 (p. 50)	- K3683C.
HF 91 (p. 50)	- 2N2857, 2N3572, K2523-K2526, K2857C.
HF 92 (p. 52)	- 2N3571, K3880C.
HF 93 (p. 52)	- 2N3570, K2101-K2127, K2601-K2604, K2607-K2616, K2601C-K2604C.
HF 94 (p. 52)	- K5001-K5003, K5010-K5012.
HF 106 (p. 53)	- K2501-K2503, K2507, K2509.

Circle Reader Service Card number 601 for data.

**M. S. Transistor Corp.**, 87-31 Britton Ave., Elmhurst, N.Y. 11373, (212) 478-3134, manufacturer of high-voltage, medium-power, silicon npn transistors (100-1000 volt units) was omitted from the listings. Circle RSC number 602 for data on their devices.

**Radio Corporation of America**

produces 13 linear integrated circuits that should be included on the chart on p. 196. These are:

**Audio Amp.** - CA3007

**Broadband**

**Amp.** - CA3011, CA3012.

**Gen. Purpose Amp.**

- CA3000.

**Operational Amp.** - CA3008, CA3010.

**RF/IF Amp.** - CA3002, CA3004, CA3005, CA3006, CA3013, CA3014.

**Video Amp.** - CA3001.

The following RCA digital integrated circuits should also be included:

In the DTL section (p. 174):

**Binary elements** - CD2203 (J-K flip-flop).

**Gates (NAND)** - CD2200 (Dual 4-input), CD2201 (Quad 2-input).

In the ECL section (p. 190):

**Gates (OR/NOR)** - CD2100, CD2150, CD2151 (Dual 4-input); CD2101 (Quad 2-input), CD2152 (8-input).

For additional information on these devices, circle Reader Service Card number 603.

RCA, not Motorola, is the original registrant of the 2N3866 high-frequency transistor (p. 50, HF 88). The credits for registrant and second-source were inadvertently interchanged.

**Westinghouse Electric Corp.**, Semiconductor Div., was incorrectly listed in the Diode Manufacturers' List (p. 168) as a manufacturer of zener and reference diodes. The dot listing should have been in the SCR and SCS columns. Westinghouse also manufactures diode bridges and high-voltage diode elements. Additional data on all these devices may be obtained by circling number 604.

**TRW**  
*Varicap*  
**DIODES  
STRETCH  
YOUR  
TUNING  
RANGE**

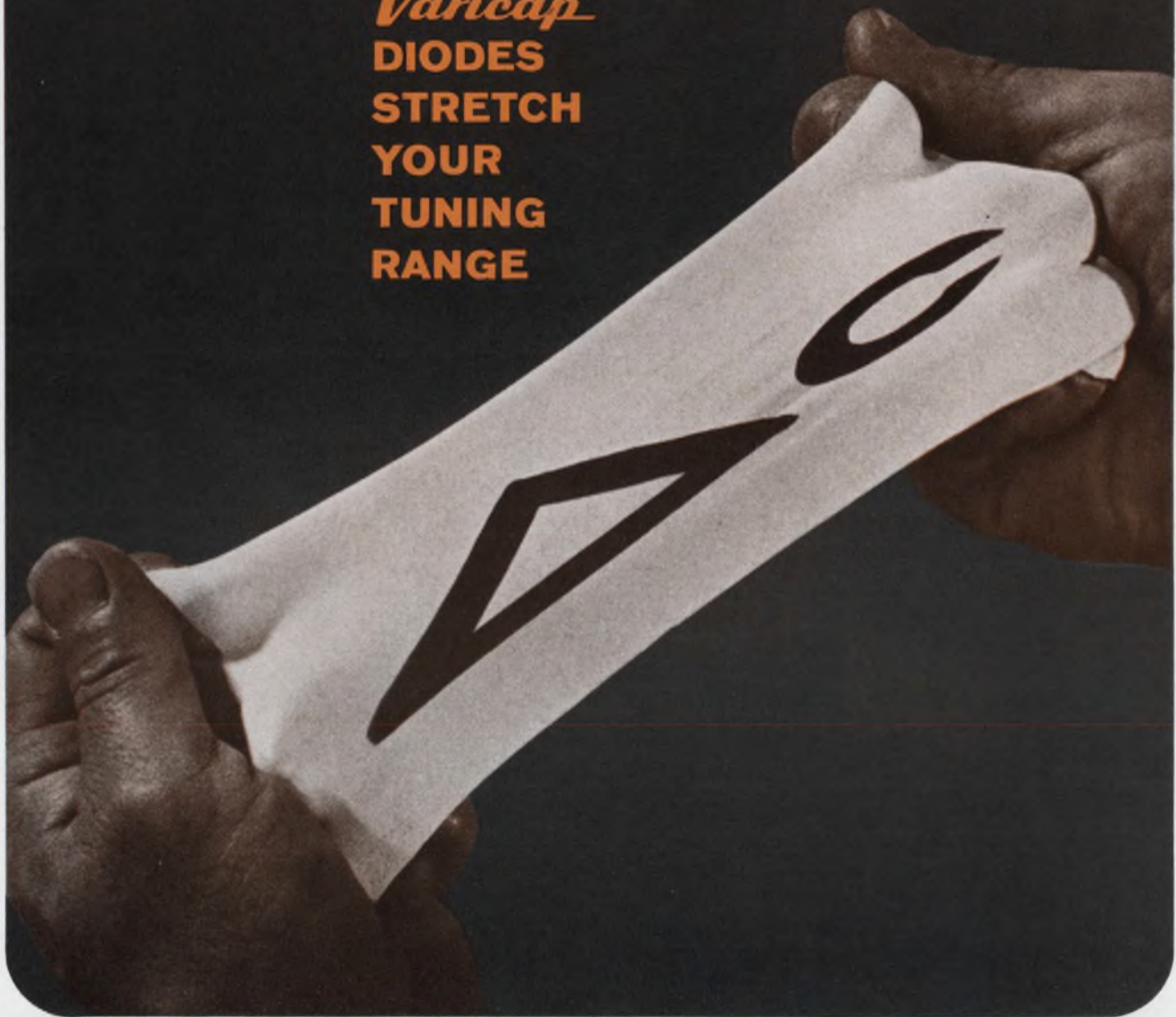

**...up to 20% greater  $\Delta c!$**

You have a lot of things working for you when you design your tuning system around TRW Varicap diodes. First of all, your circuit will provide controlled tuning range to spare—in many cases you can eliminate additional band switching.

Circuitry is simplified and fewer components are required. Varicap-controlled tuning systems assure the performance characteristics required in the most sensitive communications and monitoring networks.

TRW Varicap diodes are true abrupt junction devices, pro-

duced by proprietary processes. This construction gives the designer maximum capacitance change with voltage; optimum uniformity and tracking and superior performance under all operating conditions.

Varicap Bulletin No. 101 discusses wide-range theory in detail. Get a copy from your authorized distributor or write TRW Semiconductors Inc., 14520 Aviation Boulevard, Lawndale, California (213) 679-4561.

Varicap is the trademark of silicon voltage-variable capacitors manufactured by TRW Semiconductors Inc.

**TRW SEMICONDUCTORS**  
ON READER-SERVICE CARD CIRCLE 25

**Co-Publishers**  
James S. Mulholland, Jr.  
Robert E. Ahrensford

**Editorial Director**  
Edward E. Grazda

**Editor**  
Howard Bierman

**Managing Editor**  
Robert C. Haavind

**Technical Editors**  
Joseph J. Casazza  
Rene Colen  
Maria Dekany  
Mark B. Leeds

**News Editors**  
Frank Egan  
Roger K. Field

**East Coast Editor**  
Neil Sclater

**West Coast Editors**  
Ralph Dobriner  
Peer Fossen

**Copy Editor**  
Peter Beales

**New Products Editors**  
David Surgan  
Genevieve Adee

**Washington Editor**  
S. David Pursglove

**Editorial Production**  
Dollie S. Viebig  
Anne T. Lombardi

**Art Director**  
Clifford M. Gardiner

**Art Assistant**  
William Kelly

**Technical Illustrators**  
Lewis D. Hill  
Cheh Nam Low  
Douglas Luna  
Robert Ranta

**Production Manager**  
Thomas V. Sedita

**Asst. Production Manager**  
Helen De Polo

**Production Assistants**  
Carl Merkin  
Bernard Wolinsky

**Circulation Manager**  
Nancy L. Merritt

**Reader Service**  
Diane Pellechi

## EDITORIAL



## The quest is on for the perfect micronym

On one candy bar we recently consumed, we noticed that the confectioner had written his name hundreds of times all over the wrapper. It made us shed a tear for our semiconductor friends who can't even fit one name on their products.

Most manufacturers of tiny devices and circuits have long abandoned any attempt to print their names on these diminutive wonders. Texas Instruments, Incorporated, for example, finds it easier to produce a map of the largest state in the U.S. (save Alaska, naturally) on its transistors than to imprint its long moniker.

The problem sears the professional pride of manufacturers. And it is bound to get worse as microminiaturization advances to picominiaturization. Innovations in packaging are sorely needed. But thus far the matter has been treated more with humorous conjecture than serious consideration.

One suggestion has been that the miniature component companies follow the footsteps of pharmaceutical houses of the 19th Century.

Early in the internal medicine game, pill makers, realizing that the alphabet had no place in a patient's stomach, devised a simple code. They put the remedy for yellow jaundice in a green pill. They saw to it that the gangrene antidote was transported to the patient's spleen in a lovely yellow tablet. Orange pills countered violet pills, and indigo neutralized beige.

Contemplate the impact of this thinking on the electronics industry. All 2N-6034's could be one color; all 2N-4028's another. The plaids and tweeds might be reserved for the large-scale integrated circuits. Companies, no longer needing names, could identify themselves with hues, and all new equipment would be designed by interior decorators.

Don't laugh. Some manufacturers have already gone to distinctive colors for some of their smaller units. But to what method will the industry turn when device dimensions dwindle yet another order of magnitude?

With each "fleck" containing thousands of circuits and millions of devices, a few circuits easily could be reserved to identify the unit. Plugged into an oscilloscope, the grit-sized picomodule would proudly write its company's name across the tube face in a bold, green script.

Or perhaps the information would be borne in an audible form. When inserted into a small scan-feedback negative decay push-pull input-output loop sensor, a soft, female voice would purr: "I am a semiphased widget. I will deliver 69 sinusoidal ergs at a temperature of  $10^{10}$ °C. I will turn any signal around, flip it on to its reciprocal and spit it through the output leads. I cost \$100 in quantities of two handfuls and I have been made by Formile Semiconductors on the beach of Alo Palto."

Too bizarre? Well, then let's see the package designers come up with better ideas.

ROGER KENNETH FIELD

# Specify Union Carbide Duals

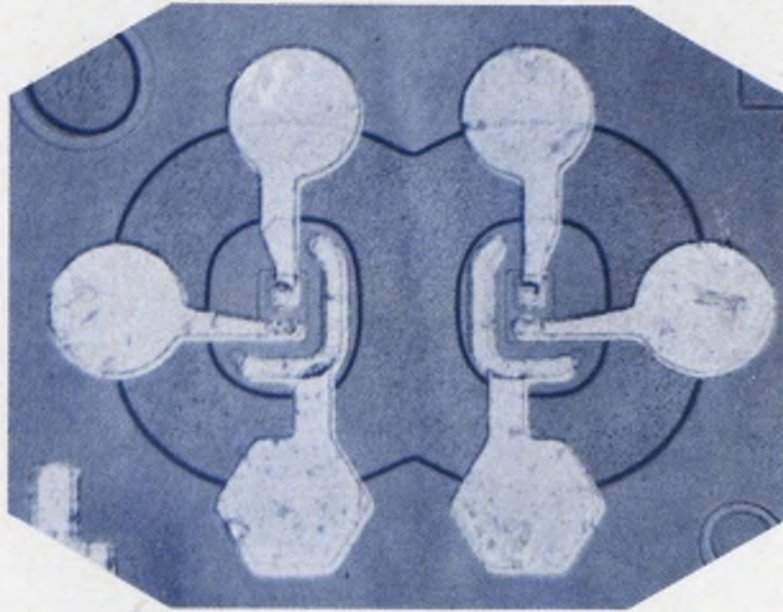

## Better Specs – Lower Cost

CHECK THESE SPECS & PRICES . . . AGAINST THESE!

	UCE's			ANYBODY'S	
	2N4043 2N4045	2N4099 2N4100	2N4042 2N4044	2N2920 2N2979	2N2060
$h_{FE}$	80	150	200	150	20
$h_{FE} (-55^\circ C)$	30	50	80	40	—
$C_{OB}$	0.8 pf	0.8 pf	0.8 pf	6.0 pf	15 pf
Noise	2.0 db	2.0 db	2.0 db	4.0 db	8.0 db
$V_{CE(SUST)}$	45	55	60	60	60
$V_{BE1} - V_{BE2}$	5.0 mV	5.0 mV	3.0 mV	5.0 mV	5.0 mV
$H_{FE}$ Ratio	0.8	0.85	0.9	0.9	0.9
$\Delta(V_{BE1} - V_{BE2})$	10 $\mu V / ^\circ C$	5.0 $\mu V / ^\circ C$	3.0 $\mu V / ^\circ C$	10 $\mu V / ^\circ C$	10 $\mu V / ^\circ C$
$\Delta(I_{B1} - I_{B2})$	1.0 nA / $^\circ C$	0.5 nA / $^\circ C$	0.3 nA / $^\circ C$		
1-99 Price	\$9.50	\$15.25	\$19.90	\$32.25	\$27.00

Also these UCE duals are suggested replacements for 2N2453A; 2N2639; 2N2640, 41, 42, 43, 44; 2N3680; 2N2903, 03A; 2N2913-19; 2N2972, 73, 74, 75, 76, 77, 78, 79.

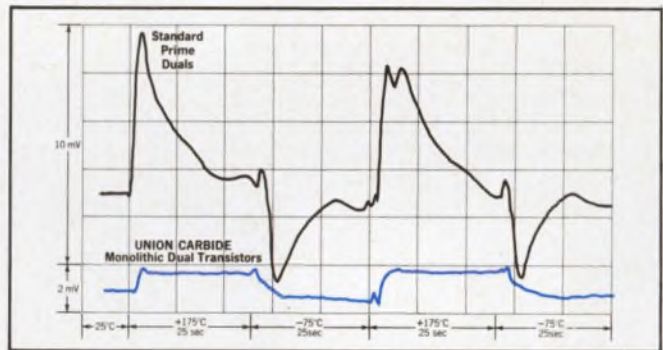

Comparative thermal transient response of standard prime duals and UCE Monolithic Dual Transistors.

Union Carbide Electronics duals are available off the shelf from distributors. Contact one of the UCE regional sales offices listed below for more information.

CALIFORNIA: Mountain View (415) 961-3300; Los Angeles (714) 871-5073; ILLINOIS: Park Ridge (312) 825-7181; MASSACHUSETTS: Needham (617) 444-5400; NEW YORK: Great Neck, L.I. (516) 466-8244; TEXAS, Dallas (214) 239-0221.

Also, distributors and representatives in key areas of U.S. and Canada. In ENGLAND: Union Carbide Ltd., London; FRANCE: Mesure et Controle Electroniques, Paris; Tranchant Electronique, Seine; GERMANY: Neumuller and Co., GMBH, Munich.



**UNION CARBIDE CORPORATION** 365 Middlefield Road, Mountain View, California 94041 TWX: 415-969-9166; Telephone: (415) 961-3300

**DISTRIBUTORS** ALABAMA, Hall-Mark Electronics (205) 536-9627 / ARIZONA, Avnet Electronics (602) 272-6821 / CALIFORNIA—NORTHERN, Avnet Electronics (415) 961-7700 CALIFORNIA—SOUTHERN, Avnet Electronics (714) 279-1550 / Kierulff Electronics (714) 278-2112 / K-Tronics (213) 685-5888 / Western Electronic Components (714) 540-1322 COLORADO, Newark-Denver Electronics (303) 757-3351 / FLORIDA, Hall-Mark Electronics (305) 855-4020 / ILLINOIS, Avnet Electronics (312) 678-8160 / MARYLAND Radio Electric Service Co. (301) 539-3835 / MASSACHUSETTS, Avnet Electronics (617) 272-3060 / KANSAS, Precision Electronic Devices, Inc. (913) 236-4343 / NEW JERSEY, Eastern Radio (201) 471-6600 / NEW YORK, Summit Electronics (716) 884-3450 / OKLAHOMA, Hall-Mark Electronics (918) 835-8458 / PENNSYLVANIA, Buyer's Electronic Distributors, Inc. (215) 744-3242 / TEXAS, Hall-Mark Electronics (214) 276-8531 / Sterling Electronics (713) 225-1321 / WASHINGTON, Garretson Radio Supply, Inc. (206) 682-4380.

Speed Inquiry to Advertiser via Collect Night Letter  
ON READER-SERVICE CARD CIRCLE 26

# Technology

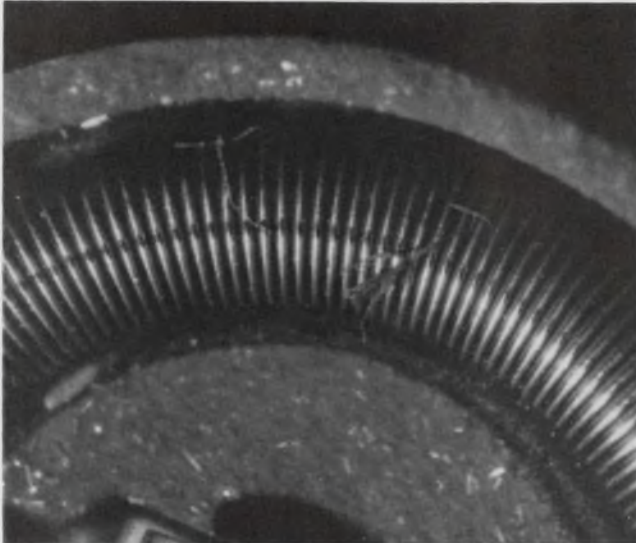

**A wisp of lint** can produce pot noise; exact measurement may help cure it. Page 78

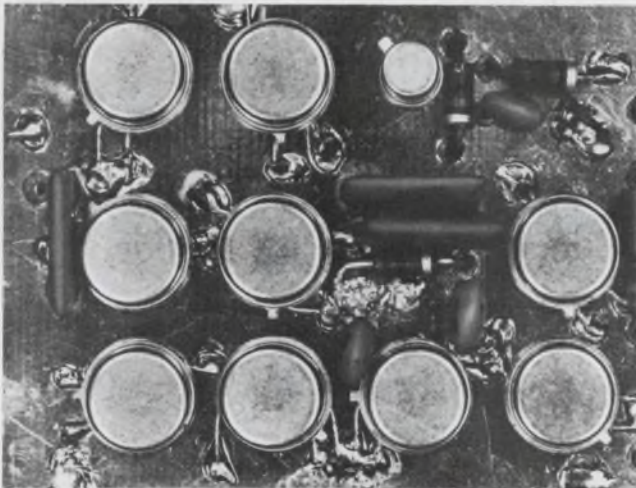

**Printed circuit board** holds all IC devices used to fabricate logarithmic IF amplifier. Page 56

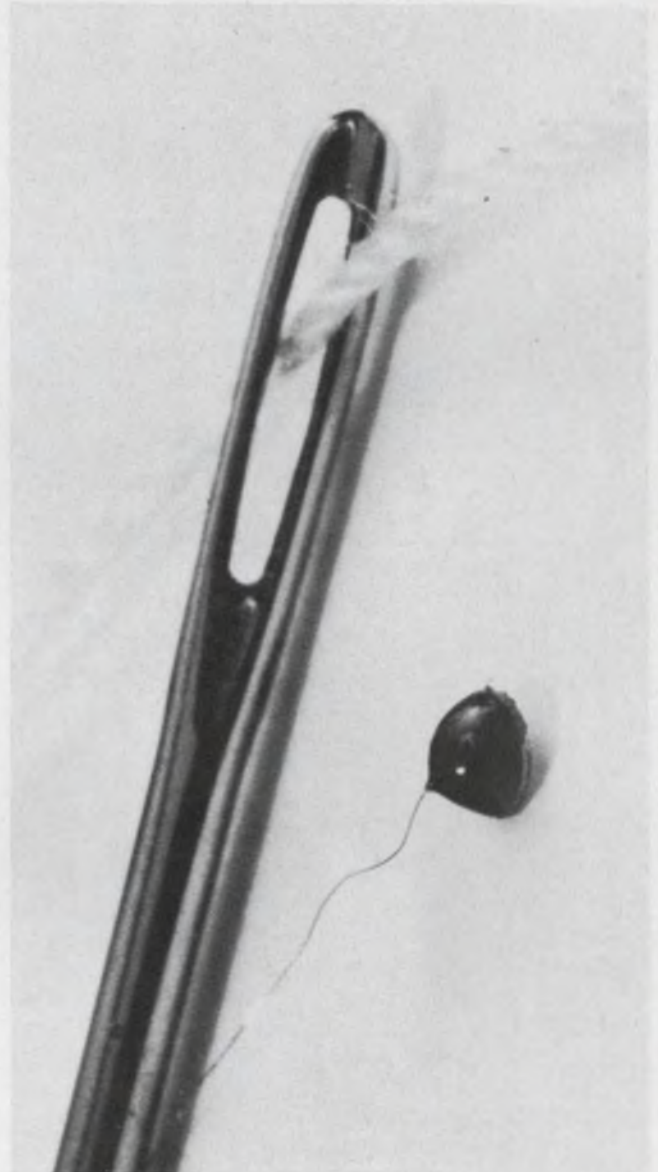

**Keep your eye on tunnel diodes.** These minute devices excel at thyristor triggering. Page 46

## Also in this section:

**Different binary-division techniques** affect computers' speed, cost and accuracy. Page 61

**Neons are used to control VOX circuits** and suppress transients in the transceiver. Page 68

**Double-loop regulation** combines the benefits of reactive and dissipative techniques. Page 72

**Semiannual index of articles** for January to June, 1966. Page 83

# Tunnel diodes trigger thyristors in a complementary, compatible design. Stability, accuracy, versatility and simplicity are the ancillary benefits.

Searching for a trigger device for your thyristor power control system? Don't overlook the silicon tunnel diode—it's especially well-suited for the more sensitive types (low-power SCRs).

These diodes are fast-switching, relatively insensitive to temperature variations, require little power and are accurate sensors of current levels. Their output, typically 0.8 V at a few milliamperes, is suitable for directly driving a number of these low-current thyristors.

Their advantages in this application are:

- They have complementary and compatible properties.
- Their firing function is stable and accurate.
- They provide improved SCR performance with inductive loads.
- They have a built-in low-voltage sensing property.
- They generate a high-speed trigger waveform.
- The trigger circuit is particularly simple.

## Diode characteristics meet drive needs

The important parameters of a silicon tunnel diode current-sensor are illustrated in Fig. 1. The tunnel diode, whatever the value of series load resistance  $R_s$ , switches to its high-voltage state when the current through it is essentially equal to  $I_p$ . Note that output voltage,  $V_o$ , of the tunnel diode is dependent on  $R_s$  and on the load in parallel with the diode. Figure 1b shows how to make voltage-current plots of the current available to the load across the tunnel diode for various values of  $R_s$ . After the curves (Fig. 1c) are determined, the voltage-current characteristic of the load will give the minimum value of  $R_s$  (called  $R_{s\ limit}$ ) that will enable the tunnel diode to drive this load.

The reason why a silicon tunnel diode, which exhibits the characteristic of a silicon diode in the high-voltage state, can easily drive the input of a controlled rectifier (also a silicon diode device), lies in the construction of the tunnel diode itself. The

device operates at current densities ( $I$ ) which are several orders of magnitude higher than the current densities of regular diodes. Thus, its forward voltage ( $V_f$ ) is somewhat higher than that of normal rectifiers. This enables it to be used directly for SCR triggering.

The thyristor-gate characteristic is that of a diode when the SCR is not in the conducting state. When the SCR is turned ON, the gate region is saturated and behaves like a positive voltage generator of about 0.7 V in magnitude, in series with an internal resistance. The current at which the SCR fires, dependent on the anode voltage, is  $I_{gt}$ . The corresponding firing voltage is  $V_{gt}$ . Both parameters are very sensitive to temperature (Fig. 2).

The low- and high-conductance limits are specified in conjunction with three basic areas—no firing, possible firing and certain firing—and the boundaries of each area vary with temperature.

## Meeting the compatibility criterion

The maximum loading effect that the SCR gate has on the tunnel diode is represented by point A of Fig. 2. With sensitive SCR units, the coordinates of point A are typically 20 to 200  $\mu$ A and 0.5 to 0.8 volts. For the SCR to fire, point A in Fig. 1c must be within the available output curves of the tunnel diode. For example, it can be seen (Fig. 1c) that curves corresponding to  $R_s = \infty$  and  $R_s = R_{s1}$  fulfill the above condition; for  $R_s = R_{s2}$ , the SCR may not trigger.

A simplified method for establishing the tunnel diode-SCR compatibility is as follows. The SCR firing characteristic can be divided into three voltage bands (Fig. 3). Below  $V_{go}$  (usually 0.2 V), no SCR fires; above  $V_{gt}$ , all SCRs fire. The tunnel diode also has three voltage bands: below  $V_p$  (70 mV approximately), all tunnel diodes are in the low-voltage state. In the high-voltage state firing is assured since the diode output is  $V_E$ , which is usually greater than  $V_{gt}$  for most sensitive SCRs. In the low-voltage state  $V_p$  is always much smaller than  $V_{go}$ , which ensures a very effective clamping of the gate and thus a reliable no-firing condition.

If the characteristics of the tunnel diode and of

Jacques A. Tazartes, Engineering Manager, Diodes and Assemblies, TRW Semiconductor, Inc., Lawndale, Calif. [This article was generated during the author's tenure as an employee of Hoffman Electronics, El Monte, Calif.]



the SCR gate are known, a composite curve can be generated for different values of  $V_o$  (Fig. 4a). Then, a plot can be constructed of  $I_o$  vs input current  $I$ , as shown in Fig. 4b. This plot may also be developed by analytical means.

The SCR gate, when the device is in the blocking state, is similar to an ideal diode in series with an internal resistance  $R_D$ . Note that  $R_D$  includes the ohmic drops in the bulk of the semiconductor material. The equation of an ideal diode in the forward direction is:

$$I_D = -I_{OD} (1 - \epsilon^{\frac{qV}{kT}}). \quad (1)$$

In the forward direction,  $\epsilon^{\frac{qV}{kT}}$  is much great-

er than unity for voltages in excess of several tens of millivolts. Thus:

$$I_D = I_{OD} \epsilon^{\frac{qV}{kT}}, \quad (2)$$

$$V = \frac{kT}{q} \ln \left( \frac{I_D}{I_{OD}} \right). \quad (3)$$

If the resistor  $R_D$  is now introduced:

$$V = R_D I_D + \frac{kT}{q} \ln \left( \frac{I_D}{I_{OD}} \right). \quad (4)$$

The silicon tunnel diode has a remarkably consistent characteristic when currents are normalized to the peak current. Therefore, to find the

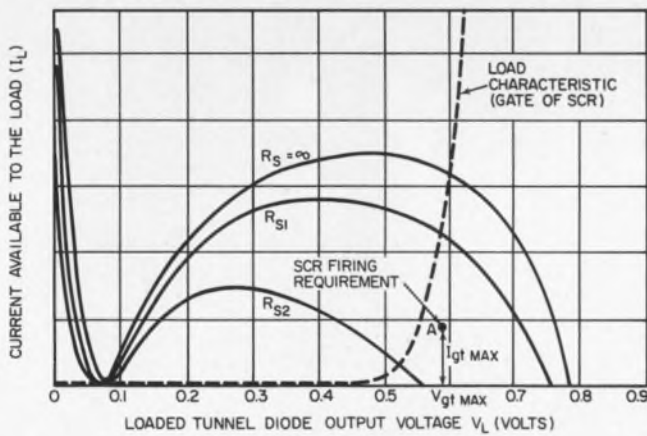
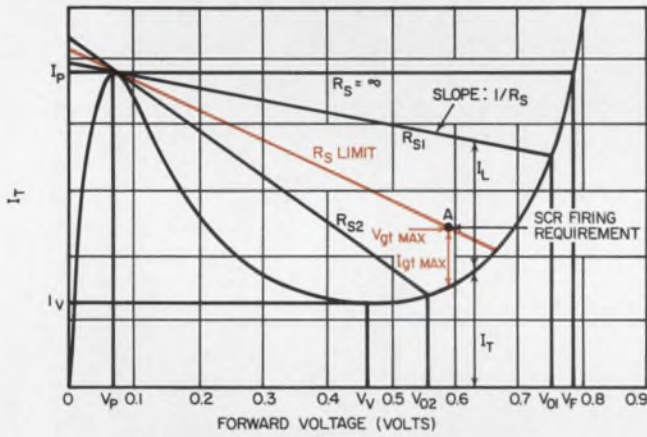
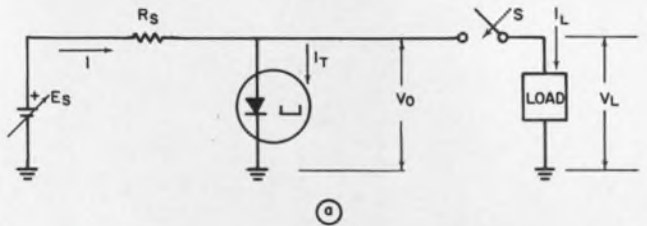

1. Tunnel diode sensors are fast switching, simple circuits capable of driving low voltage loads (a). Peak current  $I_p$  is the key sensing parameter. Forward current  $I_f$  as a function of forward voltage is plotted for various values of  $R_s$  (b). The firing requirements of a low-current SCR show how that kind of load may be driven by the diode. A graph of the load current available vs the loaded diode output voltage (c) shows that the  $R_s$  value must pass through or above point A.

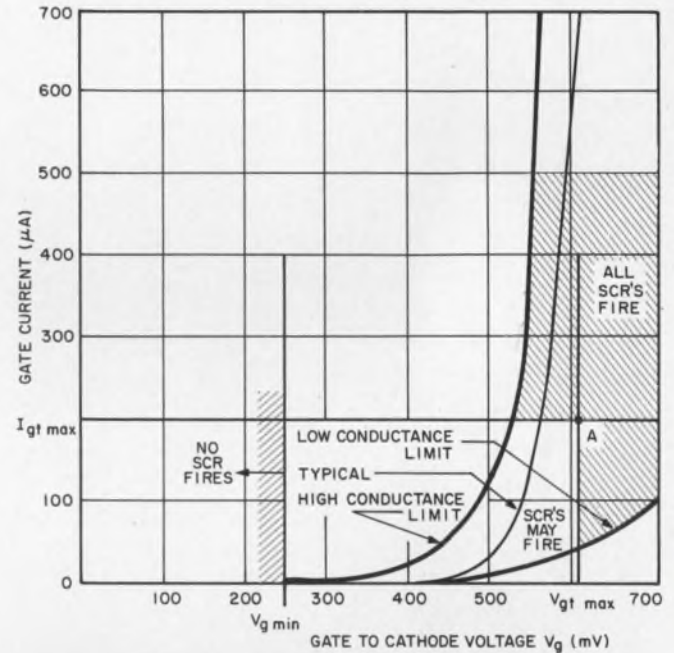

2. SCR gate characteristics are temperature-sensitive. The shaded area at the right is used to compare the tunnel diode output and SCR gate input.

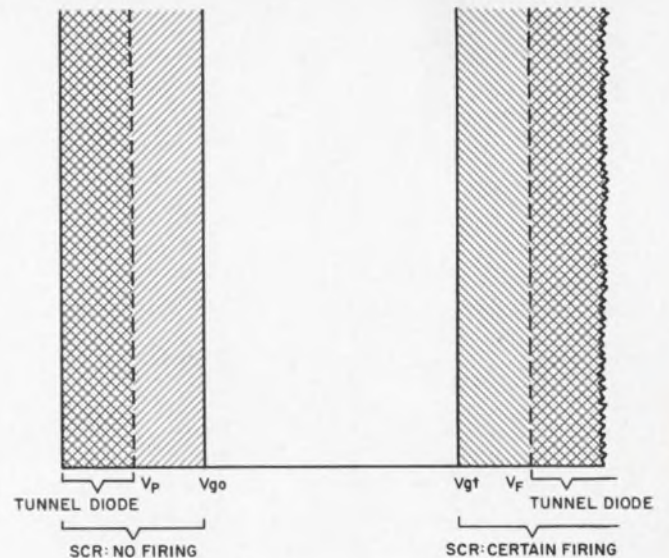

3. Voltage band characteristics of tunnel diode depict the needs of SCR firing and how they are met.

tunnel-diode equation, a one-milliampere-peak-current device is considered in the region of voltages greater than  $V_V$ . The quantity  $(V_T - V_V)$  ( $I_T - I_V$ ) is plotted first (Fig. 5). Note that a straight line with a slope of two is obtained for the lower values of  $I_T - I_V$ . Thus, in the low-current region, the tunnel-diode characteristic is a parabola expressed by:

$$I_T - I_V = m(V_T - V_V)^2, \quad (5)$$

where  $m$  is a constant determined by  $I_p$ . But as  $I_T$  approaches  $I_p$ , another current component appears. Its algebraic form is determined by the facts that the forward characteristic is that of a normal diode and the valley current is an "excess current." The tunnel-diode equation should then asymptotically tend toward that of a diode, as given by:

$$I_T - I_V = m(V_T - V_V)^2 + I_{OT} \epsilon^{\frac{qV_T}{kT}} \quad (6)$$

The series resistance of the tunnel diode is ignored, as it is too small to affect Eq. 6. For exam-

ple, a one-milliampere-peak-current tunnel diode has a series resistance of less than  $2 \Omega$ —this makes an additional drop of 2 mV, which is negligible here.

### Matching the tunnel and gate currents

Since the tunnel diode and the SCR gate are in parallel, voltage  $V$  is common to both. Thus, combining Eqs. 4 and 6 produces:

$$I_T - I_V = m \left[ \frac{kT}{q} \ln \left( \frac{I_D}{I_{OD}} \right) + R_D I_D - V_V \right]^2 + I_{OT} \epsilon^{\frac{qV}{kT}} \left[ \left( \frac{kT}{q} \right)^{1/2} \left( \frac{I_D}{I_{OD}} \right)^{1/2} + R_D I_D \right]. \quad (7)$$

Rewriting the second term in Eq. 7 as the product of two exponentials yields:

$$I_T - I_V = m \left[ \frac{kT}{q} \ln \left( \frac{I_D}{I_{OD}} \right) + R_D I_D - V_V \right]^2 + \left( \frac{I_{OT}}{I_{OD}} \right) I_D \epsilon^{\frac{qR_D I_D}{kT}}. \quad (8)$$

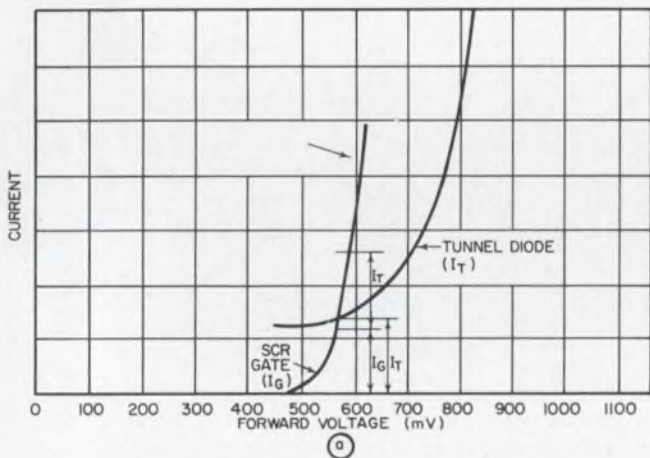

4. Composite of SCR-tunnel diode combination (a) is used to establish the gate current-transfer current character-

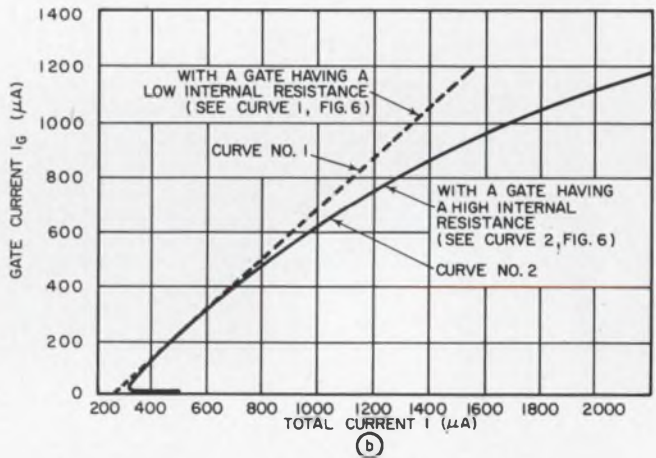

istics (b). Here  $I = I_T + I_G$ , where  $I_T$  is the tunnel diode current and  $I_G$  the SCR gate current.

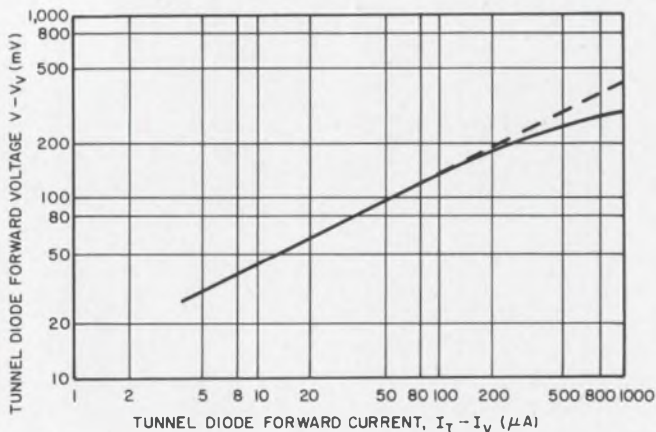

5. Forward characteristic of tunnel diode shows  $(V - V_V)$  vs  $(I_T - I_V)$  relationship. The evident linearity over most of this log plot indicates a parabolic relationship (this is a 1 mA peak-current device).

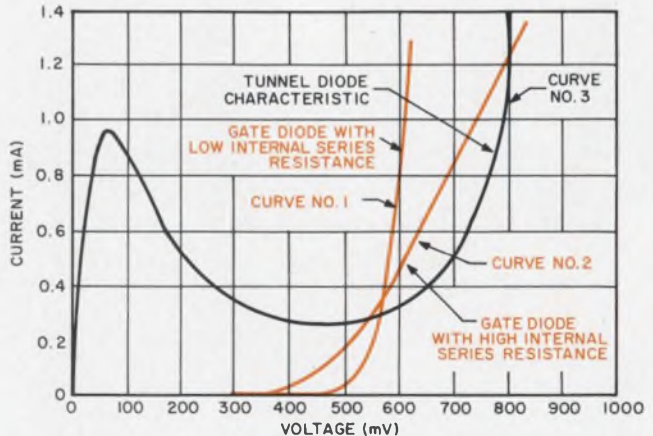

6. SCR gate diode is a factor in the tunnel diode-SCR gate parallel circuit. As can be seen, the composite  $V-I$  characteristics for a low  $R_s$  type differ markedly from those of the high  $R_s$  unit.

The total current ( $I$ ) is now:

$$I = I_T + I_D = I_D + I_V + m \left[ \frac{kT}{q} \ln \left( \frac{I_D}{I_{OD}} \right) + R_D I_D - V_V \right]^2 + \left( \frac{I_{OT}}{I_{OD}} \right) I_D \epsilon^{\frac{q R_D I_D}{kT}} \quad (9)$$

Reference to Fig. 4b, curve 1, and using Fig. 6, curve 1, show that, in the case of an ideal gate diode,  $R_D$  is equal to zero. Then, Eq. 9 becomes:

$$I = I_D + I_V + m \left[ \frac{kT}{q} \ln \left( \frac{I_D}{I_{OD}} \right) - V_V \right]^2 + \frac{I_{OT} I_D}{I_{OD}} \quad (10)$$

To determine the form of  $I$  as a function of  $I_D$ , the derivative of  $I$  with respect to  $I_D$  is calculated:

$$\frac{dI}{dI_D} = 1 + \frac{I_{OT}}{I_{OD}} + \frac{2mkT}{qI_D} \left[ \frac{kT}{q} \ln \left( \frac{I_D}{I_{OD}} \right) - V_V \right] \quad (11)$$

Values of coefficients  $m$  and  $I_{OT}$  are calculated by fitting the numerical data in Fig. 5 into Eq. 6 and the value of coefficient  $I_{OD}$  is calculated by using the data in Fig. 2 in Eq. 2.

To illustrate all this, with a 1-mA tunnel diode the typical parameters would be:

- $m = 5.7 \times 10^{-3} = 5.92 I_T$  (A/V<sup>2</sup>).
- $I_{OT} = 1.49 \times 10^{-18} = 1.55 \times 10^{-15} I_T$  (A).
- $I_{OD} = 4.63 \times 10^{-14}$  (A).

The value of Eq. 11 is then:

$$\frac{dI}{dI_D} = 1 + 3.2 \times 10^{-5} + \frac{2.96 \times 10^{-4}}{I_D} \left[ 26 \times 10^{-3} \ln \left( \frac{I_D}{4.63 \times 10^{-14}} \right) - 0.440 \right] \quad (12)$$

Equation 12 shows that as  $I_D$  increases, its third term approaches zero. For  $I_D$  values above 100  $\mu$ A  $dI/dI_D$  is approximately unity. As a consequence, any increase in total current,  $\Delta I$ , results in an equal increase in gate current,  $\Delta I_D$ , as illustrated in Fig. 4a, curve 1.

For a gate diode with high series resistance we use Fig. 6, curve 2, and Fig. 4b, curve 2. We again derive  $dI/dI_D$ , but this time we use Eq. 9. Thus:

$$\frac{dI}{dI_D} = 1 + 2 \left[ \left( \frac{kT}{qI_D} \right) + R_D \right] m \left[ \frac{kT}{q} \ln \left( \frac{I_D}{I_{OD}} \right) + R_D I_D - V_V \right] + \frac{I_{OT}}{I_{OD}} \left( 1 + R_D I_D \frac{kT}{q} \right) \epsilon^{q R_D I_D / kT} \quad (13)$$

In Eq. 13, observe that the second term increases almost linearly with  $I_D$  for values of  $I_D$  much greater than  $kT/qR_D$ , and the third term increases much faster. Thus  $dI/dI_D$  will increase to infinity as  $I_D$  increases, which means that the

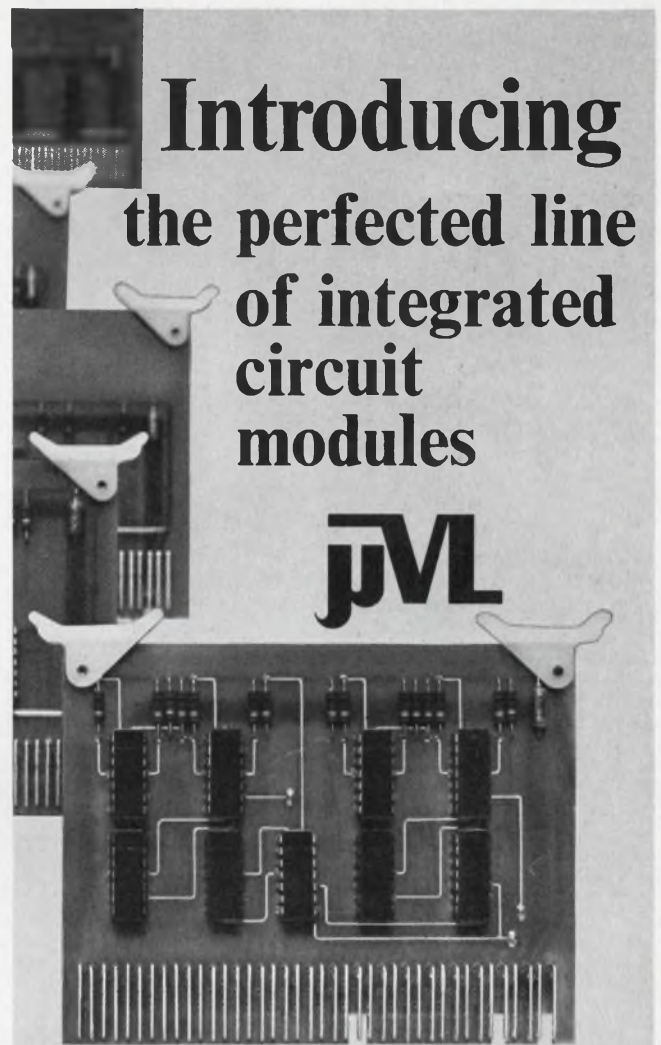

**Micro VersaLOGIC** is a complete new line of 5 M.C. general purpose integrated circuit modules incorporating many of the features of the proven VersaLOGIC line, such as NAND, NOR logic with wired OR capability at the collector.

Perfect for system use, and based on proven DTL circuits, Micro VersaLOGIC operates to 5v. logic levels, and has excellent noise rejection of over 1v. Micro VersaLOGIC modules are capable of driving high systems capacitances. The modules operate from 0°C. to plus 70°C. and require a single 5v. power supply.

Over twenty types of  $\mu$ VL modules are available, as well as interfacing and power driving modules. Mounting hardware, including card files and card drawers, is also available.

Plan Micro VersaLOGIC into your next system — we'll be happy to show you how easy and economical it is. In the meantime, write for our new Micro VersaLOGIC brochure.

**(dci) DECISION CONTROL, INC.**

1590 Monrovia Avenue, Newport Beach, Calif.  
Tel. (714) 646-9371 • TWX (714) 642-1364

ON READER-SERVICE CARD CIRCLE 27

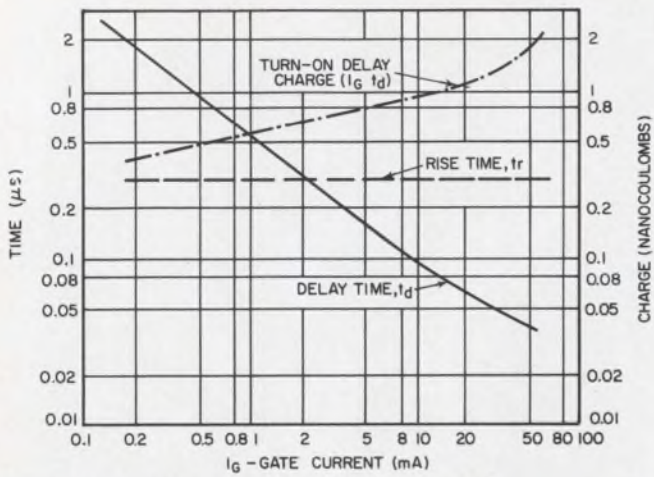

7. Transient behavior of the SCR is modified by the tunnel diode trigger. Delay time and rise time are both increased. Plot of  $t_d$ ,  $t_r$ , and turn-on delay charge ( $I_g t_d$ ) as functions of gate current must be altered accordingly (see Fig. 8).

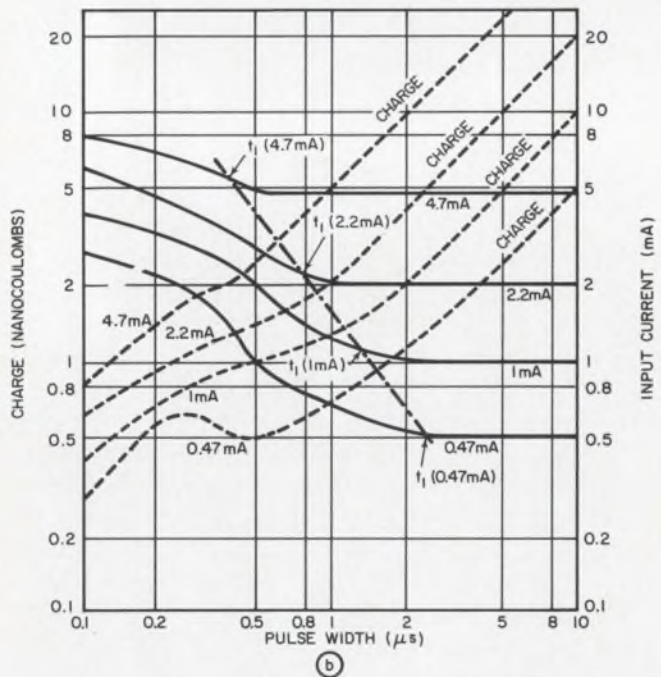
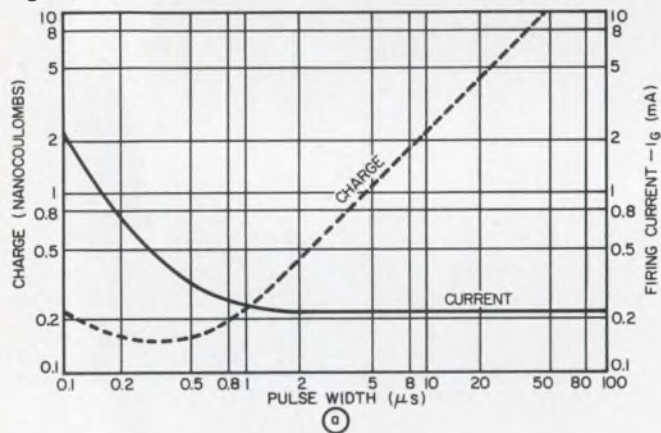

8. SCR trigger needs are set by the minimum pulse width vs firing current ( $I_g$ ) relationship (a). Alternatively, the charge ( $I_g \times t$ ) may be used. In either case, the effect of the tunnel diode  $I_p$  must be included (b). Here the straight-line segment ( $t_1$ ) represents the minimum pulse width (to fire) for the  $I_p$  values indicated.

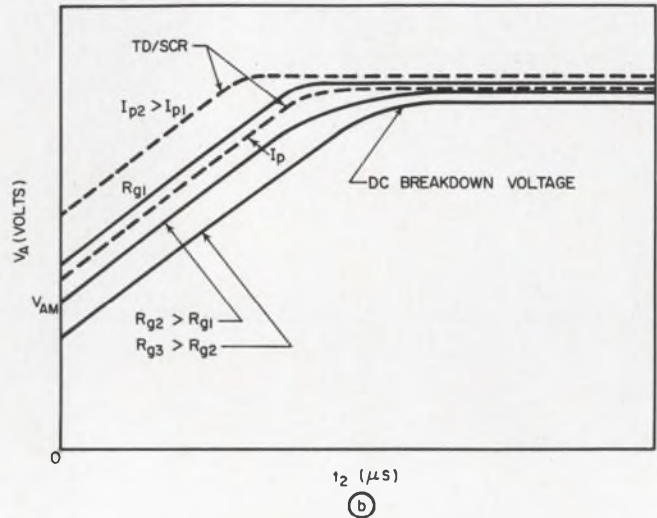
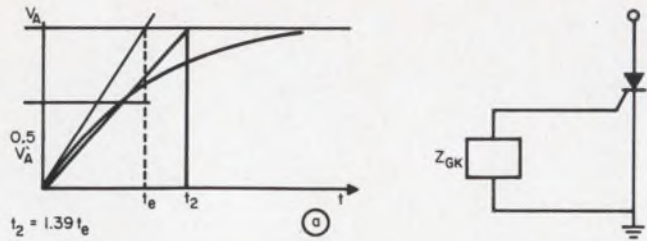

9. SCRs may be inadvertently triggered by too high a value of  $dv/dt$  (rate of anode voltage change). The inclusion of an impedance between gate and cathode helps to offset this (a). Also shown is how the rate of rise is measured, and the critical value  $t_2$ . A plot of  $V_A$  vs  $t_2$  (b) is then used to ensure that  $dv/dt$  breakdown does not occur.

tunnel diode will take most of the current away from the gate for  $I_D \ll kT/qR_D$ , as illustrated in the Fig. 4b, curve 2.

### Diode modifies turn-on delay time

It is important to examine how the tunnel-diode drive modifies the transient characteristic of the SCR. To fire an SCR, the gate current should supply enough charge to bring the gate and anode terminals to the proper potentials at the edge of conduction. The gate-to-cathode diode capacitance should be charged to its conduction potential. And, since delay time is measured at the point where the anode voltage drops 10% below its OFF value, the anode-to-gate capacitance should discharge approximately 10%. Since the SCR gate and anode electrodes are high impedances when in the OFF state, the charge to be supplied is essentially dependent on the initial gate and anode voltages, and not on the value of the gate current when the latter is well over  $I_{GT}$  (Fig. 7).

When a constant current is applied to the tunnel diode-SCR combination, the diode will switch to its high-voltage state and act as a generator to trigger the SCR. The dc value of the gate current can be calculated from Fig. 4b. The expected value of the delay time can then be obtained from Fig. 7. However, the actual measured value of the delay

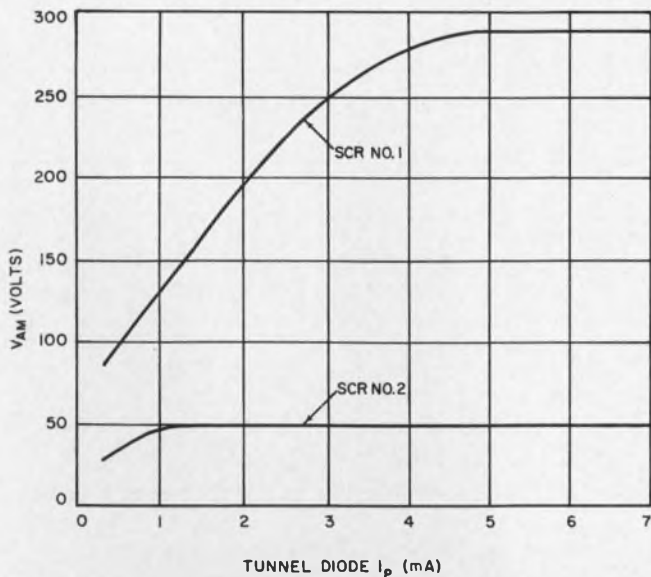

10. Plots of maximum applied anode voltage ( $V_{AM}$ ) vs tunnel diode  $I_p$  for two different SCRs demonstrate that  $V_{AM}$  lowers as  $I_p$  values decrease. This implies an increase in  $Z_{GK}$ , which is inadvisable for transient protection.

time proves to be larger. Thus, the average gate current supplied by the tunnel diode to the SCR gate is only a fraction of the current calculated from Fig. 4b. This is because, with submicrosecond pulses, the injected gate current flows only in the immediate vicinity of the gate and cathode electrodes, as it did not have enough time to spread. The voltage drop is consequently larger than that corresponding to the dc condition.

The anode current also produces an ohmic drop in the cathode region. This contributes to the increase in gate-voltage drop and acts as negative feedback. If the gate voltage becomes greater than the tunnel-diode output voltage when the SCR is completely ON, the tunnel-diode function will rapidly change from that of a voltage generator to that of a load, thereby increasing the SCR delay and rise times.

Experiments revealed that the effective gate current is usually 25 to 40 per cent of the gate current which would have flown under dc conditions. For pulses of the order of several microseconds, the ratio reaches 100%.

#### SCR rise time modified by diode

Turning to SCR rise times, the tunnel-diode trigger has some effect here. For low rise-time units (high-gain-bandwidth transistors in the thyristors), tunnel diodes with 0.47 to 2.2 mA peak currents do not cause any change. But for relatively slow SCR units (low-gain-bandwidth), the tunnel-diode loading of the gate increases the rise time. The effect is slight with the 0.47-mA diodes; but with 2.2-mA units, the SCR rise time is doubled.

Figure 8a shows the minimum gate current needed to fire a thyristor, versus the length of

time the firing current is maintained. In line with this, the charge introduced into the gate was also plotted in Fig. 7. The latter curve shows that the optimum firing pulse for the particular SCR under study has a duration of 0.2 to 0.5  $\mu$ s. The curves corresponding to the tunnel diode-SCR pair are shown in Fig. 8b. The curves demonstrate that for very long pulse durations the use of dc parameters will yield accurate designs. Under these conditions, when a current equal to  $I_p$  flows at the input, the tunnel diode switches to its high-voltage state. Its switching time is negligible in comparison with that of the thyristor's.

The tunnel diode applies a gate voltage and a gate current to the SCR which then turns on after a time,  $t_1$ , has elapsed. Obviously, no advantage accrues if the input-current pulse width is made much larger than  $t_1$ . Thus  $t_1$  represents the minimum pulse width at which the input sensitivity of the pair remains constant and equal to its dc value. A curve (a straight line in logarithmic coordinates) of  $t_1$  as a function of the tunnel-diode peak current appears in Fig. 8b. Its shape is predicted by Eq. 10. Also note that  $I_o/I_p$  is shown to be essentially constant.

#### Gate-cathode impedance critical to $dv/dt$

When an anode voltage is applied across the SCR in a very short time, the device may inadvertently turn ON. The critical rate-of-rise of anode voltage, known as the  $dv/dt$  effect, may be defined by using Fig. 9a. When anode voltage  $V_A$  is applied, the SCR will turn ON if time  $t_2$  is so small that it reaches a critical value. Critical  $t_2$ , plotted as a function of  $V_A$ , appears in Fig. 9b. Here,  $V_{AM}$  is the highest anode voltage which can be abruptly applied without causing the SCR to fire. Knowing the value of  $V_A$  enables us to find  $t_2$  from Fig. 9b. If  $t_2 \geq 1.39 t_e$  (Fig. 9a), the  $dv/dt$  effect will not be a problem.

For any thyristor, the values of  $V_{AM}$  are dependent on the impedance placed between gate and cathode,  $Z_{GK}$ — $V_{AM}$  decreases with increasing values of impedance. With tunnel-diode triggers, this increase of  $Z_{GK}$  corresponds to a decrease in  $I_p$  (Fig. 10).

A concept can be developed, based upon the total charge introduced into the gate, that will tie together the voltage and current relationships associated with SCR firing. The anode-to-gate capacitance here is  $C = C_o(V_o/V_A)^{1/3}$ . The total charge,  $Q$ , is then approximated by:

$$Q \approx \left(\frac{3}{2}\right) C_o V_o^{1/3} V_A^{2/3}, \quad (14)$$

where  $C_o$  is the anode-to-gate capacitance of the SCR (at  $V_o$ ),  $V_o$  the gate reference voltage and  $V_A$  the anode voltage. Equation 14 is used to generate a plot of the composite  $dv/dt$  characteristic (Fig. 11)— $\Delta Q$  vs  $t_2$ . Here,  $\Delta Q = Q - Q_M$ , where  $Q_M$  is the charge corresponding to  $V_{AM}$ . The linear

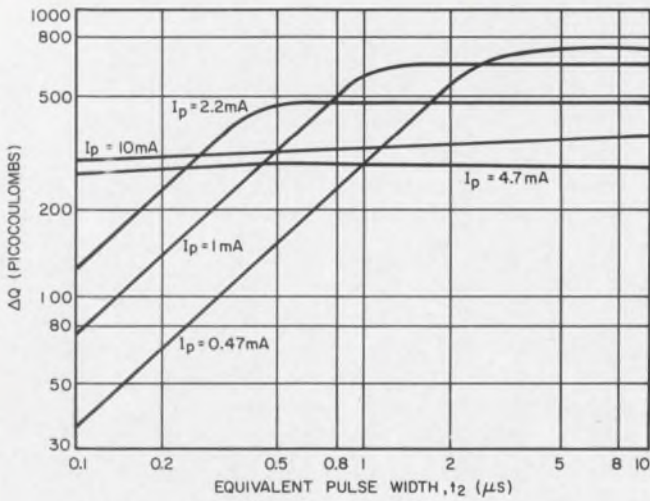

11. Composite  $dv/dt$  characteristic for a tunnel diode-SCR combination is a plot of minimum triggering charge ( $\Delta Q$ ) vs pulse width ( $t_2$ ). Note that the higher the  $I_p$ , the sooner the curves level off.

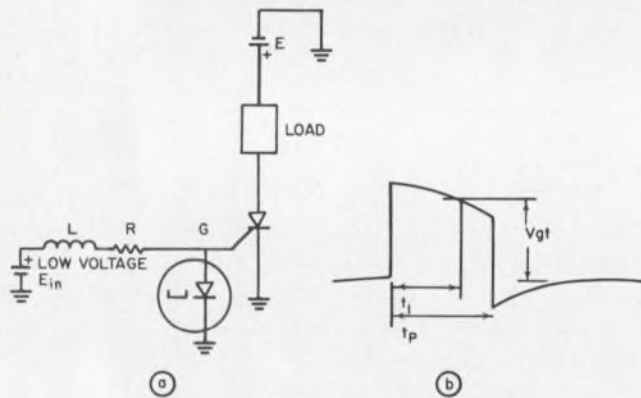

12. A low-voltage sensor is made with the tunnel diode-SCR combination (a). In essence, this circuit is a one-shot multivibrator, as indicated by the wave shape at the anode of the diode (b).

portion of the  $\Delta Q$  vs  $t_2$  curve can be explained as follows:

For the SCR to fire, the tunnel diode should be maintained in its high-voltage state. This requires that the current supplied to the tunnel diode be equal to  $0.7 I_p$  (approximately).

#### Tunnel diode helps SCR drive inductive loads

The holding current of an SCR is the minimum anode current which can maintain the SCR in the high-conductance state. It is dependent upon the amount of current drawn out of the gate. The lower the impedance from gate to cathode, the higher the holding current (see Table).

When the SCR is used with an inductive load, the device's anode current may have a substantial build-up time, as  $dI/dt = E/L$ , where  $E$  is the instantaneous supply voltage and  $L$  the load inductance.

Many of the thyristor-triggering systems use a capacitive discharge instead of a tunnel diode to

Table—SCR Holding correct vs  $Z_{rk}$

$Z_{rk}$	Holding current SCR <sub>1</sub> (mA)	Holding current SCR <sub>2</sub> (mA)
$R = \infty$	0.305	0.083
$R = 40 \text{ k}\Omega$	0.349	0.153
$R = 1 \text{ k}\Omega$	1.72	0.626
<b>Tunnel Diode</b> ( $I_p = 0.47 \text{ mA}$ )	1.39	0.748
<b>Tunnel Diode</b> ( $I_p = 2.2 \text{ mA}$ )	2.89	0.751

fire the SCR. With inductive loads, however, the discharge time may be too short to allow the SCR to latch on, and the device may then revert to its high-impedance state. With the tunnel-diode triggering system, the firing is dc-coupled to the gate. This will maintain the SCR in its low-impedance state, whatever the anode current or the nature of the load. This is an important advantage of the tunnel-diode trigger.

The tunnel-diode drive bestows still another benefit on SCR performance—it permits SCRs to be used as accurate low-voltage sensors.

When a very low voltage of the order of 100 millivolts is to be accurately sensed, conventional methods dictate the use of a low-drift dc amplifier or a chopper amplifier. Then, when enough amplitude is obtained, the actual sensing is performed.

By contrast, the tunnel diode-SCR pair (Fig. 12) presents a unique advantage here because:

- The SCR needs only one pulse with enough energy to trigger it.
- The tunnel diode is a very low-voltage, negative-resistance element, well adapted to make a one-shot multivibrator (voltage sensor).

In the one-shot multivibrator circuit of Fig. 12, when  $E_{in}$  reaches the firing value, the tunnel diode generates one pulse to fire the SCR. The conditions for such operation are that: (1)  $t_i$  be large enough to fire the SCR—this requires that  $t_p$  be several microseconds; and (2)  $R$  be smaller than the negative resistance of the tunnel diode. Experimental results show that the triggering of such a circuit is repeatable to within 0.5%, and that it is quite insensitive to temperature. ■ ■

#### Bibliography:

- McKintosh, I. M. "The Electrical Characteristics of Silicon pnpn Triodes," *Proc. of the IRE*, June, 1958.
- SCR Manual. Third ed.; Auburn, N. Y.: General Electric Co., 1964.
- Somos, I. "Switching Characteristics of Silicon Power-controlled Rectifiers—Part 1: Turn-on Action," *Proc. of the IRE*, July, 1961.
- Tazartes, J. A. "Silicon Tunnel Diodes & Controlled Rectifiers for Power Control," *Span*, WESCON '63 issue (Los Angeles, Calif.: Hoffman Electronics).
- Tunnel Diode Manual. First ed.; Liverpool, N. Y.: General Electric Co., 1961.

# OUTSTANDING PERFORMANCE... AT REASONABLE COST HIGHEST ACROSS-THE-BOARD PERFORMANCE AVAILABLE FROM A WIDEBAND DIFFERENTIAL DATA AMPLIFIER

New Hewlett-Packard 2470A Differential Data Amplifier... \$585

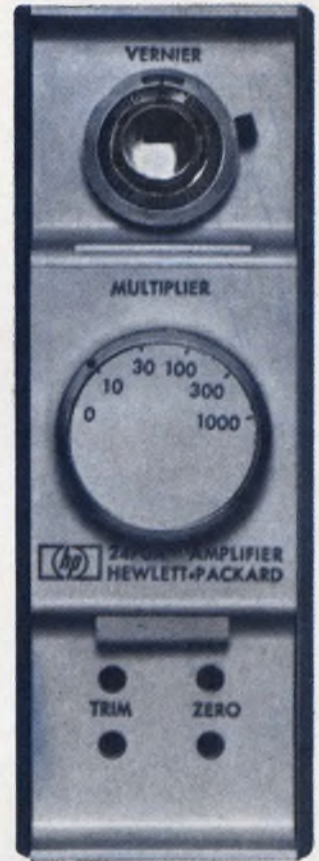
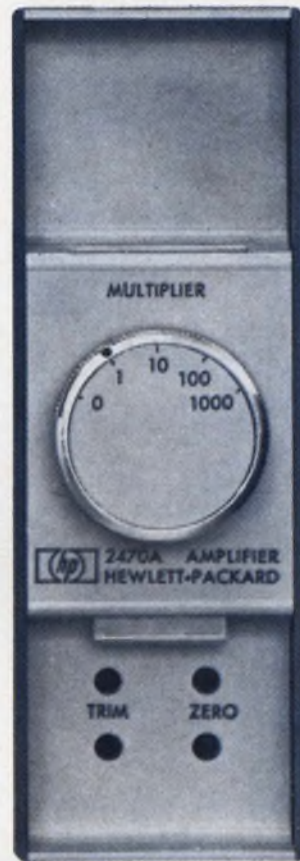
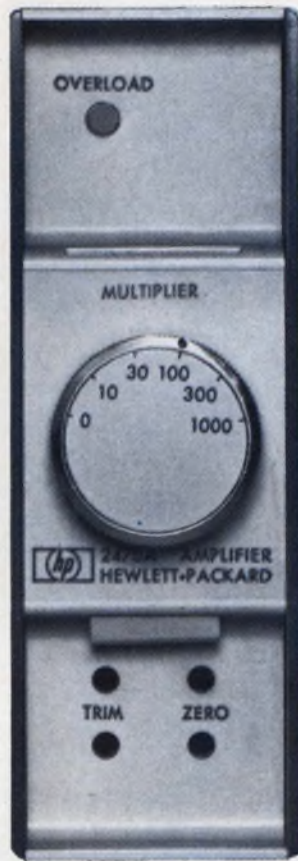
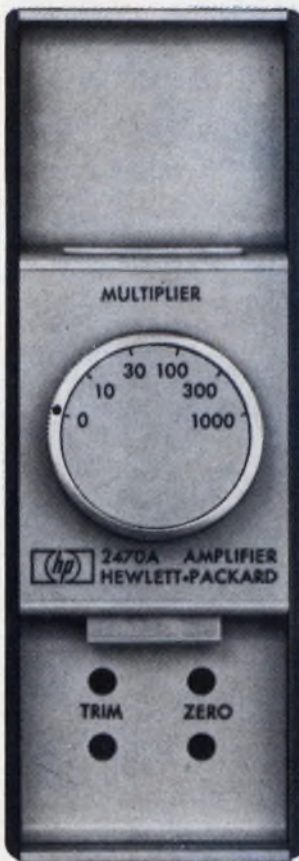

**Top electrical performance:** Compare, spec to spec—DC gain X10 to X1000 (optional precision vernier, X1 gain), output  $\pm 10$  v, 0-100 ma. Gain accuracy  $\pm 0.02\%$  range; constant 50 kHz bandwidth. Differential input for low drift, high cmr (120 db at 60 kHz on gains down to x30, 90 db at x1). Full output across full bandwidth (10' v/sec RTO). High 1000-meg input impedance all gain settings, output impedance 0.1 ohm  $\pm 10$   $\mu$ h. DC linearity of 0.002% on both polarities; dc gain stability of 0.005% per month achieved without chopper stabilization. Low drift and noise. Fast 100 microsecond settling, 100 microsecond overload recovery, excellent overload protection, optional overload indicator. Input and output isolated by internally driven guard shields; dual output available with fixed 2-pole filter.

**Built-in reliability:** The predicted MTBF of the 2470A is in excess of 20,000 hours. Silicon transistors are used throughout, and passive and active components are selected for dependability, as well as performance. Amplifier meets spec at 95% humidity at 40°C. Critical parameters (zero drift, full-scale accuracy, common mode rejection) are verified after 100 hours of "run-in" at elevated temperature.

**Packaging for value, compactness:** Amplifier and self-contained power supply are enclosed in a unique, rugged molded dielectric case. Combining case, bench stand, power and signal cables, plus many other accessories, are available.

**Use if for:** Amplifying signals from low-level resistive transducers, such as thermocouples, strain gages. High input and low output impedance make it ideal for amplification over long transmission lines; use it, with resistive or reactive loads, such as x-y, strip-chart or oscillographic recorders, digital voltmeters, null detectors and servo systems, telemetry systems... or use it as a high-performance bench amplifier.

Call your Hewlett-Packard field engineer for complete information or write the Dymec Division of Hewlett-Packard, 395 Page Mill Road, Palo Alto, California 94306, Tel. (415) 326-1755; Europe: 54 Route des Acacias, Geneva.

*Price f.o.b. factory.  
Data subject to change without notice.*

**HEWLETT  
PACKARD**  **DYMEC  
DIVISION**

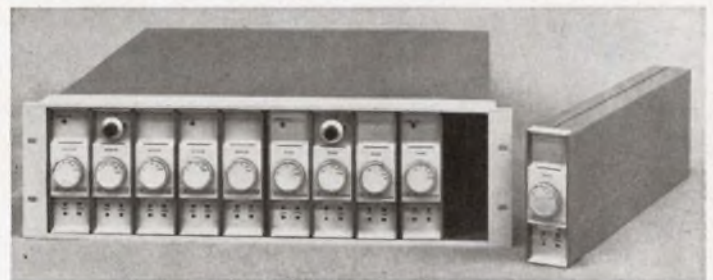

ON READER-SERVICE CARD CIRCLE 28

1306



# Six more semiconductor

## 1 New microwave transistors replace TWTs, tunnel diode amplifiers and parametric amplifiers

Low-noise, high gain TIXM103-104 germanium planar transistors offer cost, size, weight, performance, and reliability advantages over other amplifiers in the 1 to 4 GHz frequency range.

The table at left, for example, compares performance of TIXM103s with top-of-the-line TWTs. Three TIXM103s in a strip-line circuit will replace a TWT. Notice that noise figure and gain compare favorably, while power consumption, size, weight, reliability and cost are far superior to TWT performance.

When compared with tunnel diode amplifiers, the TIXM103-104 offers long-term noise and gain stability. Dynamic range is typically 20 dB better, while the elimination of circulators lowers cost, reduces size and weight, and improves reliability.

A *TI-Line*<sup>TM</sup> package, designed for stripline circuitry, is used. 50 Ω input and output impedances facilitate matching. Circle 140 for data sheet.

COMPARE TIXM103 Vs TYPICAL TRAVELING WAVE TUBE AMPLIFIERS					
CHARACTERISTIC	TIXM103	1-2 GHz TWT		2-4 GHz TWT	
		LO NOISE TWT	HI GAIN TWT	LO NOISE TWT	HI GAIN TWT
1.5 GHz NF	3.8 dB	4.5 dB	20 dB	-----	-----
1.5 GHz Gain	8.5 dB	25 dB	40 dB	-----	-----
3 GHz NF	5.5 dB	-----	-----	5 - 6 dB	25 dB
3 GHz Gain	6.5 dB	-----	-----	25 dB	40 dB
Unsaturated Output Power	*0 - 6 dBm	0 - 6 dBm	0 - 6 dBm	0 - 6 dBm	0 - 6 dBm
Power Consumption	< 25 mW	1 - 10 Watts	1 - 10 Watts	1 - 10 Watts	1 - 10 Watts
Size	0.25" X 0.10"	5" X 14"	5" X 14"	1½" X 12"	1½" X 12"
Weight	0.3 gram	1 - 10 lb.	1 - 10 lb.	1 - 5 lb.	1 - 5 lb.
Warm-up Time	NONE	1 hour	5 minutes	1 hour	5 minutes
Magnetic Field	NO	YES	YES	YES	YES
Solid State Reliability	YES	NO	NO	NO	NO

\*Circuit Dependent

1 Comparison shows performance, size, weight, power consumption, and reliability advantages of TIXM103 over typical traveling wave tube amplifiers for two frequency ranges.

## 2 900 MHz $f_T$ , minus-70 dB 3rd order IM from new TI silicon transistor

The TIXS39 RF-VHF-UHF NPN epitaxial planar silicon transistor is ideal for such applications as the AMECO CATV all-band trunk line amplifier. Notice, from the curves at the left, that both gain and intermodulation is far better with TIXS39s than with the best competitive units tested.

Other suggested applications include sonoboy transmitters and multicoupler amplifiers.

High  $f_T$  (900 MHz typ) and low intermodulation distortion (see curves) are combined with such other operating features as 13 dB power gain at 200 MHz, 4 dB noise figure at 200 MHz, and 5 W power dissipation at 25°C case temperature. Circle 141 for data sheet.

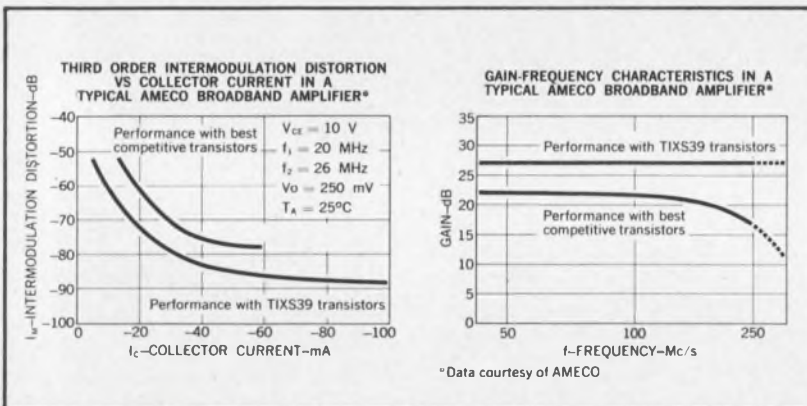

2 Data supplied by AMECO show how TIXS39 transistors reduced intermodulation and improved gain-frequency characteristics of ATM-70 CATV all-band trunkline amplifier.

## 3 New germanium FET features 12,000 to 14,000 $\mu\text{mhos}$ , 1.8 dB noise figure and useful amplification to 500 MHz

The TIXM301 is industry's first high frequency epitaxial planar P-channel germanium field-effect transistor. The inherently high mobility of germanium gives this device a higher figure-of-merit and higher transconductance than presently available FETs.

The TIXM301 is ideal for VHF amplifiers. Typically, transconductance remains above 12,000  $\mu\text{mhos}$  to beyond 300 MHz and typical noise figure is 1.8 dB at 100 MHz. Circle 142 for data sheet.

*TI cannot assume any responsibility for any circuits shown or represent that they are free from patent infringement.*



# advances from TI

## 4 17 ohms "on" resistance of new TI FET chopper permits high-accuracy analog switching

Low "on" resistance ( $17 \Omega$  typ,  $25 \Omega$  max) and low drain-gate leakage current (less than  $0.1 \text{ nA}$  typ) make the TIXS41 exceptionally well-suited for use as a series-type or shunt-type switching element. This new N-channel epitaxial-planar silicon field-effect transistor is ideal for such applications as commutators, relay-contact replacements, and high-accuracy analog-digital converters.

Two applications of the TIXS41 are shown at the right: a series connection, as in the analog gate, and a shunt connection, as in the shunt chopper. In both instances, the excellent measured performance results from low leakage and "on" resistance.

Circle 143 for data sheet.

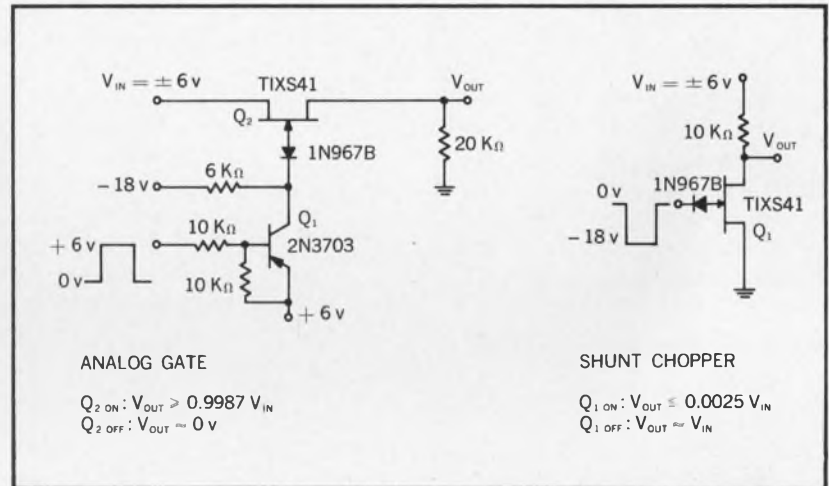

4 Two circuit applications demonstrate performance advantages of TIXS41 silicon FET.

## 5 New TI Schottky-barrier UHF mixer diode features 6.5 dB typical noise figure, at 900 MHz

This planar silicon diode offers a noise figure approximately 5 dB lower than popular point-contact diodes used in UHF TV tuners, resulting in greatly improved picture fidelity. Low noise and low conversion loss permit use in fringe areas where other tuners will not work. Designated TIV305, the new device is also well-suited for use in video detectors, microwave mixers and high-speed switching applications.

Low total capacitance ( $C_T = 0.75 \text{ pF}$  typ) reduces possibility of violating FCC radiation rules.

For switching applications, the TIV305 offers a fast recovery time of 50 picoseconds typical.

Rugged Schottky-barrier construction eliminates fragile point contacts. The TIV305 withstands 20,000 G constant acceleration and 1000 G drop shock.

Circle 144 for data sheet.

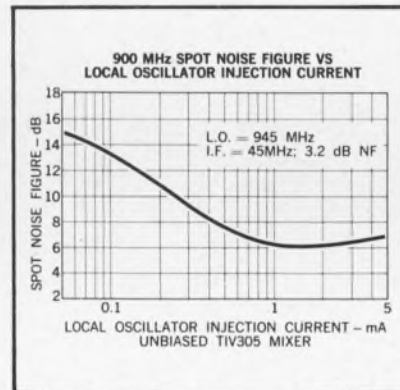

5 TIV305 diode delivers lower noise figure than conventional point contact diodes.

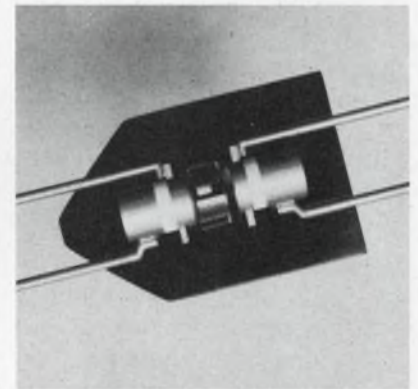

6 TIXL101 optoelectronic isolator combines two proven TI units in single package.

## 6 New optoelectronic coupling device isolates 5000 volts

The TIXL101 optoelectronic isolator combines an LS600 planar silicon light sensor and a TIXL01 gallium arsenide light source in the single opaque epoxy package shown at the right. As a replacement for electro-mechanical relays, the new device offers faster switching times (typically  $1.5 \mu\text{sec}$  reverse, and  $15 \mu\text{sec}$  forward). It also offers great mechanical ruggedness, small size and reasonable cost.

Input current rating is 50 mA, and output is  $250 \mu\text{A}$  min — sufficient to drive simple amplifier circuits.

Circle 145 for data sheet.



**TEXAS INSTRUMENTS**  
**INCORPORATED**  
 13500 N. CENTRAL EXPRESSWAY  
 P. O. BOX 5012 • DALLAS 22, TEXAS

# Log IF strips use cascaded ICs in successive-detection-type amplifier to cut down on packaging time and costs.

Logarithmic IF amplifiers, often considered a difficult design problem, can now be developed in almost routine fashion. The simplifying ingredient is a monolithic integrated circuit (IC) specially designed for this application.

An integrated circuit has been developed that includes amplifier, limiter and detector—all in a single package. Now in production, this unit is intended for use in a successive-detection type of log amplifier. The system, shown in Fig. 1, was chosen because the output signal is supplied by having all the stages work in parallel. This provides lower power consumption per stage than would be required if all the stages had to handle the full output signal.

## Decoupling capacitor on IC chip

The integrated circuit, shown in Fig. 2, includes an emitter-coupled-pair amplifier limiter with an emitter follower completing the amplifier section. The gain and frequency response are controlled by series voltage feedback and a second emitter-coupled pair serves as a low-level detector with a current output. At 60 MHz, the maximum rectified output current is 1.05 mA (see Fig. 3). The unit operates from a single 6-volt supply, has supply-line decoupling and can be directly coupled to the following stages. Decoupling of the input bias network in the first stage of a chain (done to obtain an optimum noise figure) is simply accomplished by use of the separate bias connecting pin that is available. Two grounds are provided to avoid the problems of common-ground coupling.

The complete amplifier is built on a 50-mil-square chip, as shown in Fig. 2b. The large areas represent the junction-type decoupling capacitors<sup>1</sup>. The circuit is suitable for use at center frequencies between 10 and 100 MHz and can be cascaded to provide dynamic ranges of greater than 100 dB. Though the accompanying table provides some of the typical performance data, more complete design information is available in the amplifier data sheets.

## Broadband amplifier had 90-dB range

The units may be cascaded, as shown in Fig. 4a, to obtain IF strips with over-all bandwidths in excess of 100 MHz. The maximum useful number of stages in such chains is 6, since additional

stages would become noise-limited. The attainable dynamic range with this circuit is around 70 dB; the lower limit is set by noise and the upper limit by the voltage level that will cause the first stage to limit.

The upper end of the range may be extended, however, since the units will tolerate input levels as high as 2 V rms. The technique is to feed an attenuated fraction of the input voltage (1/4 or 1/16) to a separate stage or pair of stages, as in Fig. 5. The upper limit is thus raised to around 1.5 V rms and the dynamic range increased to around 90 dB. Fig. 6 shows the transfer characteristic of an eight-stage IF strip connected in this manner.

The supply line may be decoupled by a single low-inductance capacitor, a disc ceramic type, with a value chosen from the following:

Number of stages in chain	≥6	5	4	3
Capacitor value (nF)	30	10	3	1

## Narrow-band amplifier uses interstage filters

For applications in which the noise associated with bandwidths in excess of 100 MHz is unacceptable, one or more filters may be inserted in the amplifier chain. The filter network must be compatible with the amplifier's low output impedance and high input impedance. Also, unless inserted

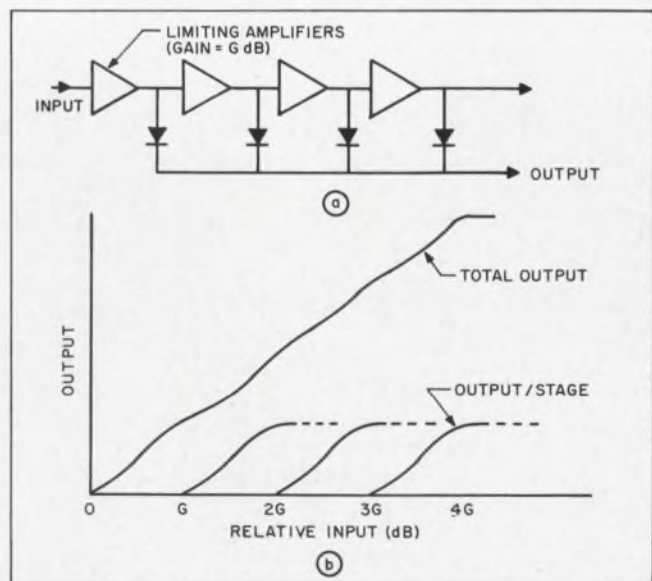

1. Successive-detection technique leads to lower power dissipation per stage. The logarithmic-amplifier (a) output is equal to the sum of the paralleled outputs of each stage (b).

M. J. Gay, Asst. Group Leader, The Allen Clark Research Centre, The Plessey Co., Ltd., Caswell, Towcester, Northants., England.

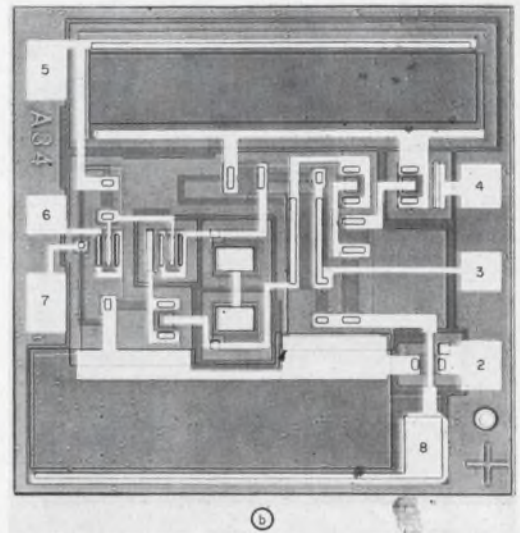
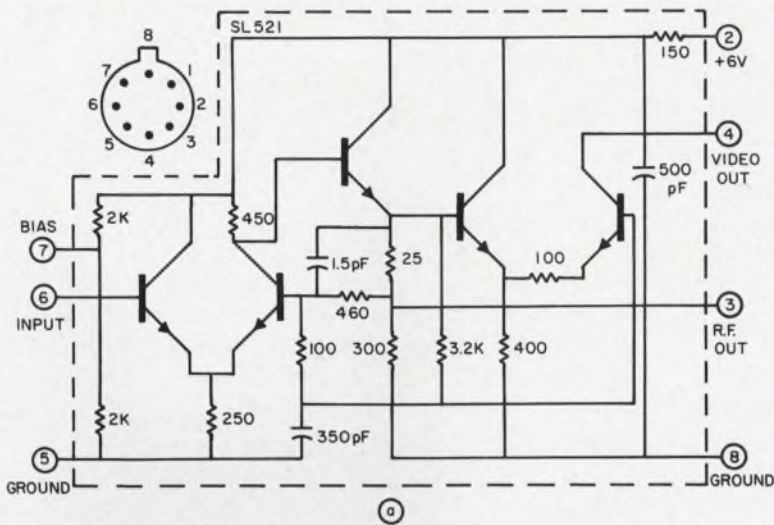

2. Integrated amplifier circuit uses just five transistors to amplify (12 dB, type), limit, and detect the input signal (a). The entire chip is mounted in a TO-5-type can with

the pin configuration shown. The large, junction-type capacitors can be seen at the top and bottom of this photograph (b) of the 50-mil-square chip.

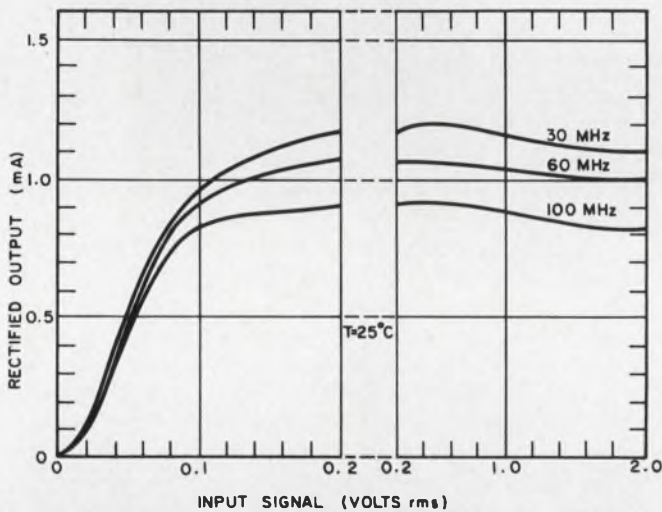

3. Rectified output current of the amplifier at 60 MHz reaches a maximum of 1.05 mA at a 0.5-volt input. At 100 MHz there is some reduction in the output level.

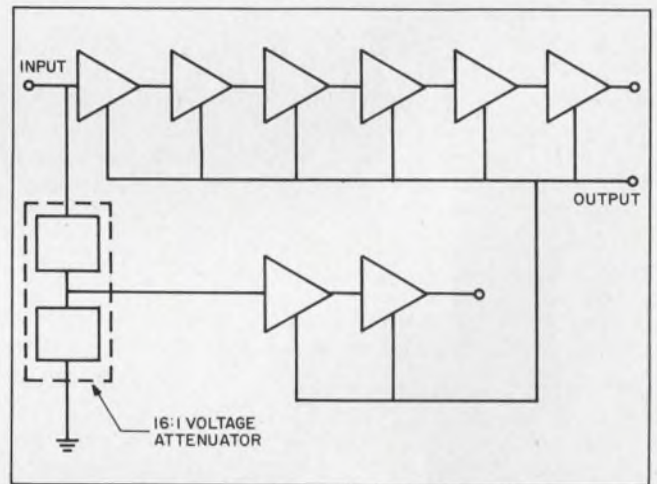

5. Attenuator and two-stage amplifier increases the dynamic range of the six-stage broad-band amplifier from 70 dB to 90 dB.

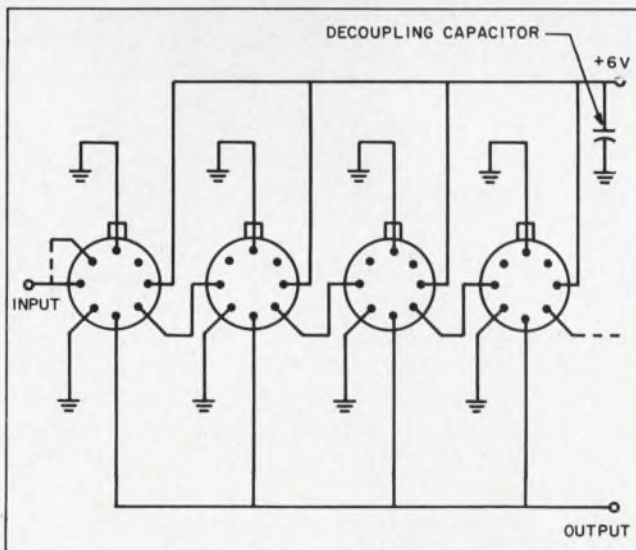

4. Wiring diagram of the cascaded stages illustrates the simplicity with which a broad-band amplifier can be assembled. The component count is greatly reduced.

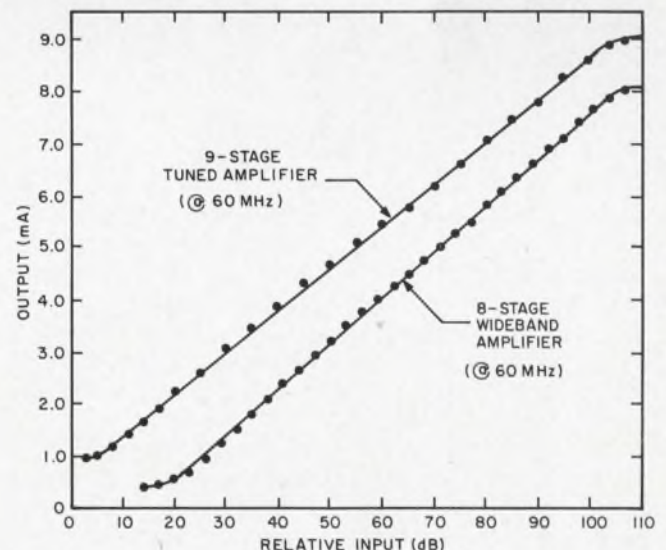

6. Transfer characteristics of a tuned and a broad-band amplifier (actual measurements) illustrate the large dynamic ranges that can be achieved.

between each pair of stages, these filters must provide a unity voltage transfer at resonance to avoid distorting the logarithmic law. Suitable networks are shown in Fig. 7. Unity voltage transfer at resonance is obtained if the susceptance of  $C_1$  at resonance equals the total effective shunt conductance across the tuned circuit. The effects of the amplifier input and output impedances are normally very small but can be readily calculated with the information given on the data sheets.

The filter bandwidth can be calculated from the relationship:

$$Q = \frac{\text{Total capacitive susceptance}}{\text{Total shunt conductance}},$$

$$\approx \frac{C_1 + C_2 + C_{in}}{C_1},$$

where  $C_{in}$  is the amplifier input capacitance. The signal delay introduced by a filter of bandwidth  $B$  at a center frequency  $f_o$  is given by:

$$\tau_d = \frac{1}{4B} = \frac{Q}{4f_o}.$$

The insertion of filters will often reduce the value of the supply-line decoupling capacitor that is required. For example, a 60-MHz tuned IF strip will normally require only a 1-nF decoupling capacitor.

#### Delay lines are not needed

The rectified current outputs from a chain of SL521s can be added in a simple parallel connection (as in Fig. 4a). The total output current is then either fed to a video amplifier or passed through a resistive load to the positive supply line. To avoid ringing due to stray capacitances, the video amplifier must have a capacitive input impedance. Whatever the load, a certain voltage swing will be required, and this will set the limit on the attainable rise time of the output pulse.

On the assumption that all currents arrive simultaneously at the output point, the rate of rise of voltage across the total load capacitance  $C_L$  is given by:

$$\frac{dV}{dt} = \frac{\text{Total current}}{C_L}.$$

Since each stage has an output stray capacitance of approximately 5 pF and provides an output current that rises to 2.8 mA during the conduction periods, the maximum value of voltage rate of rise, for any number of stages, is approximately 0.5 V/ns. With this rating it is possible to have the output pulse reach the full output level within one cycle of the RF signal.

To obtain this performance, however, it would normally be necessary to feed the output currents into a delay line to match the delay through the amplifiers and the interstage filters used. The advantage of the IC amplifier is that most, if not all, of the interstage filters are eliminated, and thus the total propagation delay down the am-

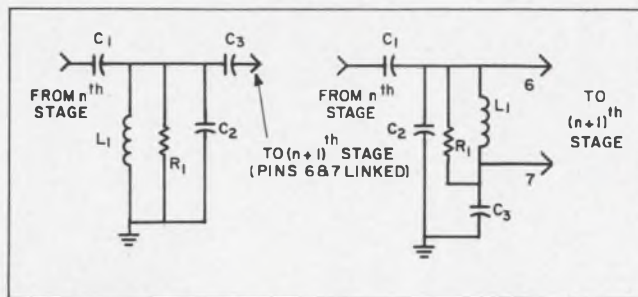

7. Interstage filters are used for narrow-band applications.  $R_1$  acts as a damping resistor and  $C_3$  is a dc blocking capacitor (about 1 nF).

Table. Typical performance data (SL521)

Voltage gain	12 dB
Lower cutoff frequency	5 MHz
Upper cutoff frequency	170 MHz
Noise figure (@ 60 MHz)	4 dB (450Ω source)
Power supply requirement	15 mA @ 6 V
Operating temperature range	-55 to +125°C

plifier chain is small enough for delay lines to be rarely necessary.

Another problem that has to be taken into account concerns the parasitic feedback path in the output line. Precautions must be taken if more than four stages are used in an untuned cascade, or more than five stages are used in a cascade tuned to 30 MHz or higher. The simplest precaution is the addition of an output smoothing capacitor. This will often be satisfactory in tuned systems in which fast rise time is not required; for example, a seven-stage amplifier tuned to 60 MHz requires a 500-pF smoothing capacitor for a stability factor of 5 and will give an output rise time (to 90% of full output) of 150 ns. If the fast response characteristics are to be preserved, a simple method of reducing the parasitic feedback is to use a transistor buffer stage in the output line, as in Fig. 8.

The total current output of the amplifier, approximately 1 mA/stage (averaged), must be fed to a suitable video amplifier or returned to a positive supply line via a resistor. To prevent the output transistors from going into saturation, the voltage level at the rectified output terminals of each amplifier must not drop below 1.8 volts at any time. Consequently, if the outputs are returned to the 6-volt line, the maximum output voltage swing is 4.2 volts. Larger swings can be obtained by returning the outputs to a higher-voltage line (12 volts maximum).

#### Design example operates at 60 MHz

The amplifier circuit shown in Fig. 8 was built to demonstrate the capabilities of these integrated circuits. It operates at 60 MHz with a 10-MHz

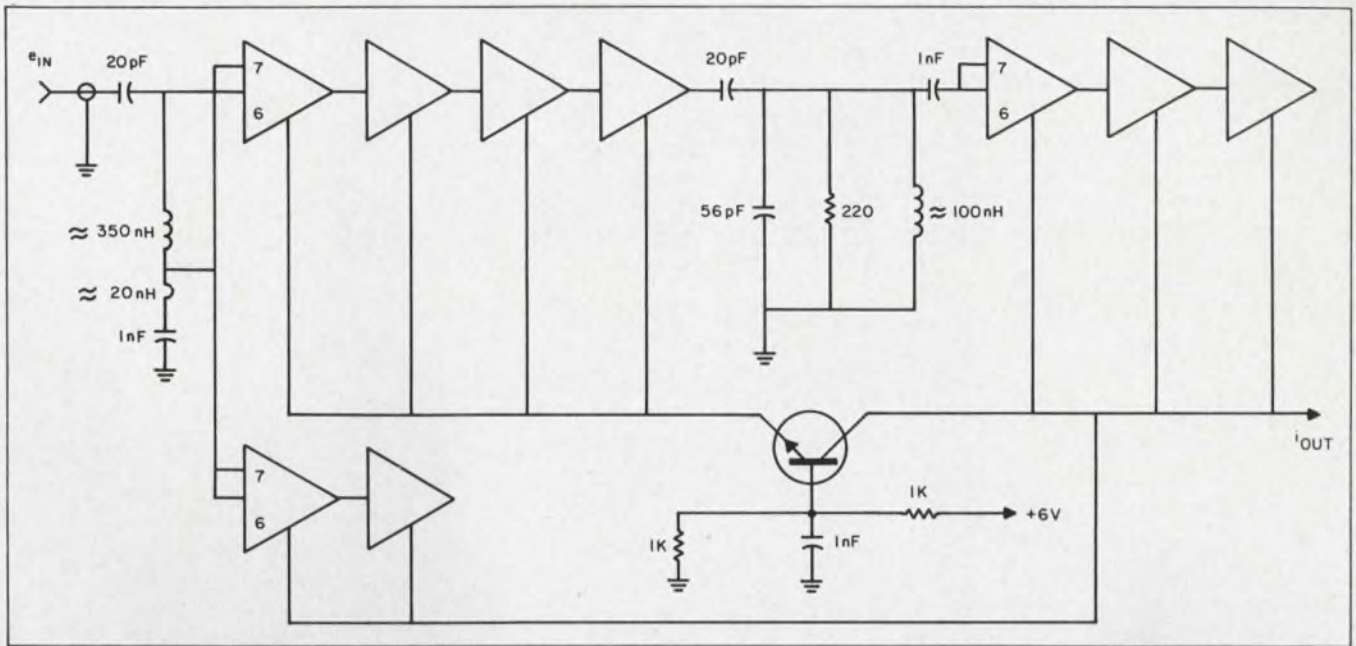

8. Narrow-band log amplifier operates at 60 MHz with a 10-MHz bandwidth. A transistor buffer amplifier is in-

serted in the output line to reduce the spurious feedback, while maintaining a fast response characteristic.

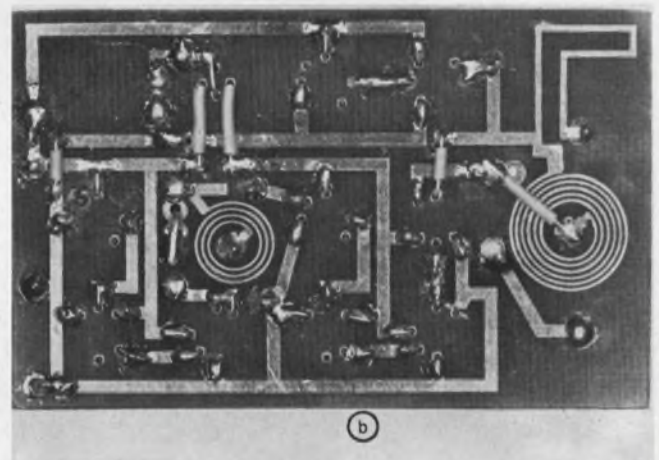
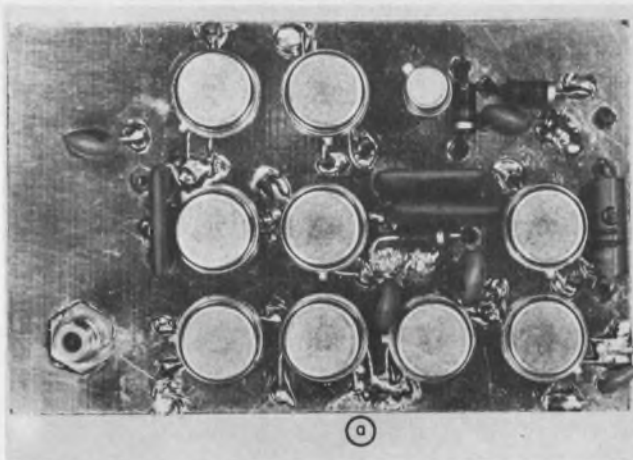

9. Double-sided printed circuit board (about 2.8-by-1.6 inches) is used to hold and interconnect all the com-

ponents used in the 60-MHz amplifier. Note the use of printed inductors (spirals) in the filters.

bandwidth that is defined by the input and inter-stage filters. The main chain provides a dynamic range at 80 dB, which is raised to 104 dB by the addition of the second untuned two-stage chain. A transistor buffer stage was used in the output summing line to reduce spurious feedback without seriously degrading the output rise time. The unit was built on a double-sided printed-circuit board measuring about 2.8-by-1.6 in., and it used printed inductors (Fig. 8). The noise figure of the complete amplifier was 4 dB with a 50- $\Omega$  source, and the transfer characteristic, shown in Fig. 6, was accurate to  $\pm 0.5$  dB over a 100-dB range.

With respect to noise figure, this amplifier compares unfavorably with the best conventional circuits on the market. This is a serious problem, but it appears to be surmountable. Studies indicate that noise figures of better than 2 dB at 60 MHz can be obtained, and future work will be

aimed at achieving this.

Since each stage can be directly coupled, it becomes practical to build cascades of amplifier stages on single silicon chips. Though the yields on such multistage chips will be lower, the resulting increase in costs should be more than offset by savings in testing and encapsulating the units and by an anticipated increase in reliability. A four-stage chip is now under development. The ultimate aim is to go into production on one-, two- and four-stage chips. ■ ■

#### Acknowledgement:

The author is indebted to the British Ministry of Defence (Naval) and the directors of the Plessey Co., Ltd., for permission to publish this article.

#### Reference:

1. J. S. Brothers and M. J. Gay, "Monolithic Integrated Circuit Capacitors," *Proc. of the IEEE*, LIII, No. 6 (June, 1965), 644.

# INKLESS

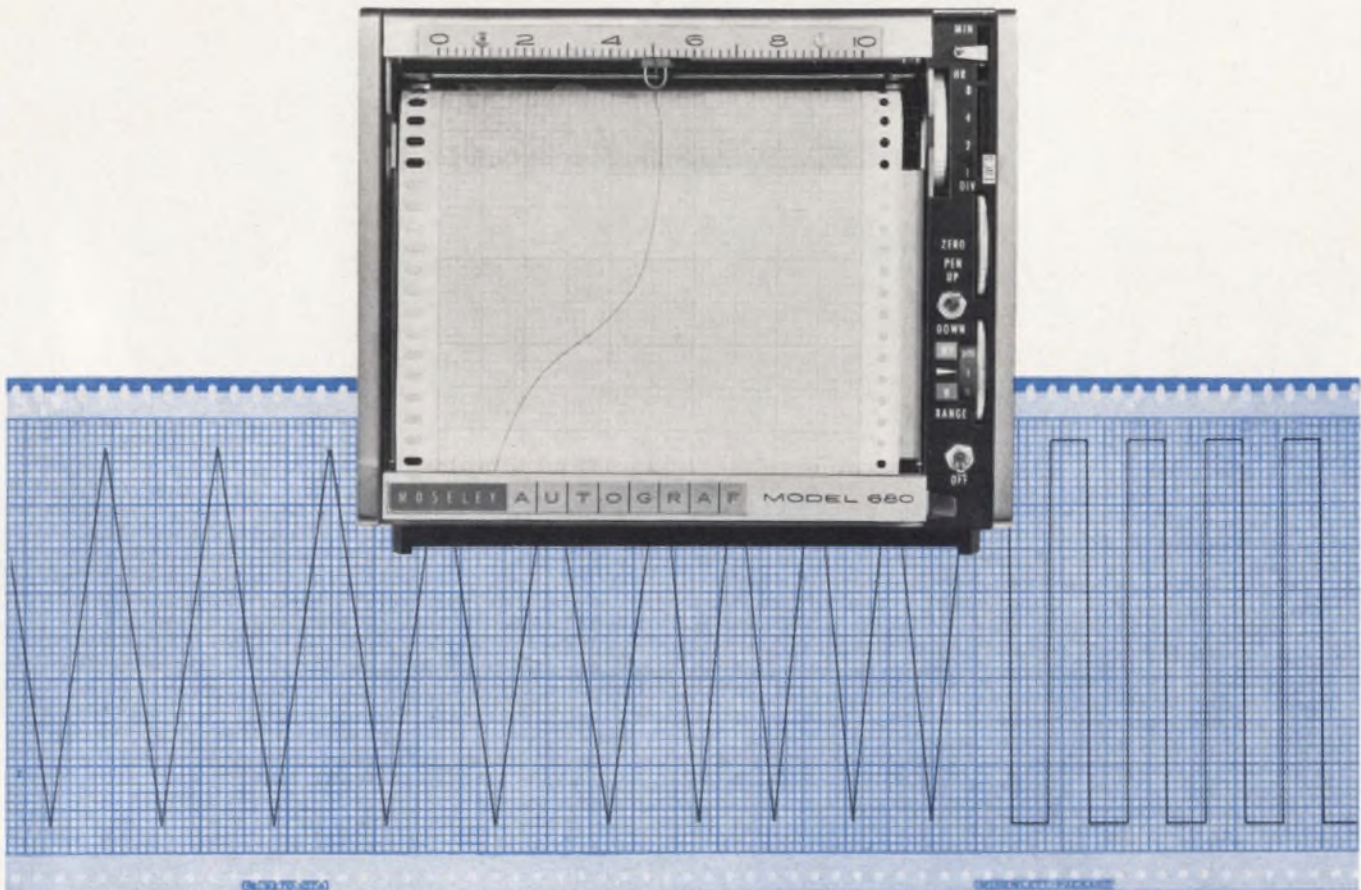

## NEW STRIP-CHART WRITING TECHNIQUE:

**Ends pen clogging, ink drying**  
**Gives clear, clean traces**  
**Provides new economy**

New Hewlett-Packard electrosensitive paper, available as a standard option on Moseley 680 and 7100 Series Strip-Chart Recorders, ends the problems associated with pen-and-ink writing techniques... at an economical price and without the disadvantages inherent in other available electric writing methods.

The Hewlett-Packard electrosensitive paper is a special electro-chemical coated chart paper. The coating is current sensitive, changing to a dark brown trace with application of voltage from the recorder stylus. The new technique eliminates the familiar arc method of electric writing on carbon-backed paper.

With Hewlett-Packard electric writing, you can use your strip-chart recorders for long-term, unattended monitoring, with increased performance at slow writing speeds, as well as at high writing speed. It is non-

pressure sensitive, so that you can't damage or obscure your recordings.

Here's another advance in recording capability from Hewlett-Packard. Call your Hewlett-Packard field engineer for information on converting your strip-chart recorder to maintenance-free electric writing. Or write for information: Hewlett-Packard, Palo Alto, California 94304, Tel. (415) 326-7000; Europe: 54 Route des Acacias, Geneva.

*Data subject to change without notice.*

**HEWLETT  
PACKARD**  **MOSELEY  
DIVISION**

1189

# Perform binary division fast.

Here are some techniques for handling binary division that can improve computer operation.

## Part 2 of a two-part article\*

Like a student involved in the "new math," a computer can do high-speed division in several ways. Which algorithm the engineer uses depends on such needs as speed, cost and accuracy.

In order of increasing speed, the leading methods for computer division are these:

- *Restoring division.* This technique, the slowest, is basically the same as manual binary division and relies on repeated subtraction. Some improvement results from "skipping zeroes" to simplify quotient-bit selection.

- *Nonrestoring division.* With this method, the digital computer combines both binary addition and subtraction. Further improvement is possible here by "skipping zeroes" and also by "skipping ones."

- *Use of divisor multiples.* With the use of multiples of the divisor, the computer can be made to produce two or more quotient bits simultaneously.

- *Division by repeated multiplication.* Here is an algorithm especially suited to the use of integrated circuitry. Most useful for precise floating-point arithmetic, this method is essentially an approximation technique that uses a converging series. A large multiply unit is required.

The repeated-multiplication method is the most costly and is used mainly in scientific applications. But each of the other methods finds widespread use in less demanding applications.

### What is restoring division?

The basic approach to binary division, also called restoring division, may be performed by repeated subtraction as shown in the following example.

		100111	quotient
divisor	1011	110110010	(a) dividend
		-1011	(b)
partial dividend		xx10100	(c)
		-1011	(d)
		10011	
		-1011	
		10000	
		-1011	
		101	

\* Part I of this article (ED 16, July 5, 1966, pp. 52-57) discussed algorithms for high-speed addition and multiplication in digital computers.

Martin S. Schmookler, Project Engineer, IBM, Poughkeepsie, N. Y.

The similarity to longhand decimal division is apparent. Binary division, however, possesses an inherent simplicity not present in decimal division; i.e., in binary division, after each trial subtraction of divisor from partial dividend there are only two choices (0 or 1) for the quotient bit. If the divisor can be subtracted from the partial dividend, the quotient bit is 1; if not, then the quotient bit is 0. Contrast this with the ten possible choices (0 through 9) in the decimal case.

A computer can exploit this simplicity of quotient-bit choice by comparing the divisor with the partial dividend. When the divisor is smaller than, or equal to, the partial dividend, subtraction takes place and the difference becomes the new partial dividend. When the divisor is greater than the partial dividend, the partial dividend is shifted without being modified and a 0 is placed in the quotient. That is, a trial subtraction has taken place, but the result is not used; in other words, the previous dividend is restored. This method is therefore called restoring division. (Ordinary decimal division which we do by hand is restoring.) Allowing one cycle time for each trial subtraction, this method requires one cycle for each quotient bit developed.

Note that while the leftmost bit of the dividend in the above example is assumed to line up with the leftmost bit of the divisor [(a) and (b) in the example] when attempting subtraction, the leftmost 1 in the partial dividend could extend one position farther to the left [(c) and (d) in the example]. This additional bit position (underlined) will be considered to be the high-order bit position of the partial dividend in the following discussion.

In each of the following methods of accelerated division, it is assumed that the divisor is normalized. This means that the divisor has been shifted left until a 1 appears at the high-order position, e.g., 1XXXX. This is similar to decimal division. In decimal division, we usually guess what quotient digit to try by looking at the leftmost significant digit. If there are any zeros to the left, we ignore them. Analogously, in binary division, a trial quotient bit is selected according to some rule which must consider the most significant bits of the divisor.

If the leftmost bits are all 0's they are not significant. The hardware is designed to look at the leftmost bits. Shifting an unnormalized number left can place its most significant 1 in the leftmost position.

Since normalized fractions usually appear in floating-point arithmetic, these improved algo-

**Table 1. Multiples used when dividend is true**

Normalized divisor (hi-order bits)	*High order 3 bits of dividend							
	000	001	010	011	100	101	110	111
10	0	1	2	3	3	3	—	—
11	0	1	2	2	3	3	3	3

The following list indicates the corresponding quotient bits for each iteration, which depends on the multiple chosen and whether the remainder is positive or negative.

Multiple subtracted	Remainder	Quotient bits
0	true	00
1	compl.	00
1	true	01
2	compl.	01
2	true	10
3	compl.	10
3	true	11

\*The entries are divisor multiples which must be subtracted.

**Table 2. Multiples used when dividend is complemented**

Normalized divisor (hi-order bits)	**High order 3 bits of dividend							
	111	110	101	100	011	010	001	000
10	1	1	2	3	3	3	—	—
11	1	1	2	2	3	3	3	3

The following list indicates the corresponding quotient bits for each iteration, which depends on the multiple chosen and whether the remainder is positive or negative.

Multiple added	Remainder	Quotient bits
1	true	11
1	compl.	10
2	true	10
2	compl.	01
3	true	01
3	compl.	00

\*\*The entries are divisor multiples which must be added.

rithms are often restricted to floating-point division, where it is necessary to retain as many significant bits as possible to achieve maximum precision. For instance, in decimal floating point,  $0.473256 \times 10^{-1}$  is in normalized form, and is more precise than  $0.004732 \times 10^{-2}$ . However, these algorithms may be applied to unnormalized quantities in fixed-point division also by shifting both the divisor and dividend an equal number of positions until a high-order 1 appears in the divisor.

If the divisor is normalized and the partial dividend has two or more high-order 0's [see x's in (c) in the example], then the divisor must be greater than the partial dividend, and no trial subtraction is needed. Shifting can take place without modifying the partial dividend, and the quotient bits must be 0. One obvious means, then, of speeding up restoring division when the divisor is normalized, is to skip across 0's in the partial dividend by shifting. In the example, two shifts occurred because of the two leading 0's in (c). Then, a trial subtraction showed one more shift was needed. If the partial dividend has  $n$  high-order 0's, we would shift across  $n$  0's and enter  $n-1$  0's in the quotient. Although the average division would be improved, a worst case (e.g., all 1's in the partial dividend) would still require one cycle for each quotient bit.

**Nonrestoring division improves on the basic method**

A nonrestoring division algorithm is one which always uses the difference between divisor and partial dividend regardless of the sign of the difference. Thus, the new partial dividend may be either positive or negative. Assume initially that the divisor is subtracted from the dividend. If the result is positive, then the quotient bit is 1. If the result is negative, the quotient bit is 0. In either case, the difference is the new partial dividend.

When the partial dividend is negative, the procedure is slightly altered. The divisor must now be added to the partial dividend to obtain their difference. As before, the quotient bit is 1 for a positive result, and 0 for a negative result.

The two methods of division may be compared using the same example as before:

<i>Restoring Division</i>	<i>Nonrestoring Division</i>
$  \begin{array}{r}  100111 \\  1011 \overline{) 110110010} \\  \underline{-1011} \phantom{0} \\  10100 \phantom{0} \\  \underline{-1011} \phantom{0} \\  10011 \phantom{0} \\  \underline{-1011} \phantom{0} \\  10000 \phantom{0} \\  \underline{-1011} \phantom{0} \\  101  \end{array}  $	$  \begin{array}{r}  100111 \\  1011 \overline{) 110110010} \\  \underline{-1011} \phantom{0} \\  001010010 \\  \underline{-1011} \phantom{0} \\  -01011110 \text{ (e)} \\  \underline{+1011} \phantom{0} \\  -0000110 \text{ (f)} \\  \underline{+1011} \phantom{0} \\  +100110 \\  \underline{-1011} \phantom{0} \\  +10000 \\  \underline{-1011} \phantom{0} \\  +101  \end{array}  $



Since a computer normally performs subtraction by complementing the divisor and adding this complement to the dividend or partial dividend, the remainder produced when the divisor is greater than the dividend will be in 2's complement form as in (e) and (f) above, i.e., all 1's changed to 0's and all 0's changed to 1's with a 1 added to the result. As an example, consider the binary number 11010. To change this to 2's complement form, we first change 1's to 0's and 0's to 1's: The result is 00101. Adding a 1 we get:

$$\begin{array}{r} 00101 \\ + 00001 \\ \hline 00110 \end{array}$$

Therefore 00110 is the 2's complement form of 11010.

When the divisor is less than the dividend, the remainder will be in true (i.e., noncomplemented) form.

With negative partial dividends in this complemented form (see two lines marked "neg." in following example), we can simply add these to the divisor and save the complementing step. The partial dividend would then actually appear after each cycle as shown in the following example. (Compare the partial dividends marked "neg." with (e) and (f) in the preceding nonrestoring-division example.)

$$\begin{array}{r} \phantom{1011} \overline{) 110110010} \\ \phantom{1011} \underline{- 1011} \\ \phantom{1011} 00101 \\ \phantom{1011} \underline{- 1011} \\ \text{neg.} \phantom{1011} 10100 \\ \phantom{1011} \underline{+ 1011} \\ \text{neg.} \phantom{1011} 11110 \\ \phantom{1011} \underline{+ 1011} \\ \phantom{1011} 10011 \\ \phantom{1011} \underline{- 1011} \\ \phantom{1011} 10000 \\ \phantom{1011} \underline{- 1011} \\ \phantom{1011} 0101 \end{array}$$

Again, if the partial dividend is true (i.e., not complemented) and has  $n$  leading 0's, we know that subtraction of the divisor would leave a negative result (in 2's complement form). We can therefore skip across  $n$  0's and enter  $n$  0's in the quotient. Similarly, if the partial dividend is negative, and has  $n$  leading 1's in complement form, then addition of the divisor would surely leave a positive result. We may therefore skip across  $n$  1's and enter  $n-1$  1's in the quotient. Note that a quantity whose magnitude is small has leading 0's in true form, but leading 1's in complement form.

#### Use divisor multiples to increase speed

Division may also be accelerated by a method which produces two quotient bits each cycle. This method requires that the computer be capable of adding or subtracting multiples of the divisor, rather than just the divisor itself. This concept can be illustrated by considering a simple decimal

division: 2 into 145. In this case a step-by-step division would take three operations (i.e. one operation per quotient digit). However if we used divisor multiples we would recognize immediately that the seventy-second multiple of 2 (i.e. 144) would give us the first two quotient digits, 72.

To use divisor multiples in binary the three-times multiple of the divisor is developed and placed in a register. The two-times multiple of the divisor is the divisor itself, shifted left one position on entering the adder. Other divisor multiples can be formed with combinations of these. These multiples may now be used as follows:

The computer examines the leading digits of the divisor multiples and partial dividend to determine which multiples will guarantee a remainder whose magnitude is less than the divisor.

For a positive dividend, subtracting the smaller multiple produces a positive remainder, while subtracting the larger multiple produces a negative remainder. The quotient digit corresponds to the smaller divisor multiple. If the examined leading digits of one of the multiples are identical to the corresponding digits of the dividend, then that multiple must be chosen, and the quotient is determined after the sign of the remainder is known. The quotient digit corresponds to the divisor multiple if the remainder is positive, and is one less if the remainder is negative. The ability to proceed two bits at a time in these cases is made possible by use of nonrestoring division. Tables 1 and 2 show the action taken for each combination of leading bits of the partial dividend, and an example is shown below. Note that the remainder is shifted two positions left each cycle to form the new partial dividend. The leading bits of the partial dividend then extend two positions to the left of the divisor.

$$\begin{array}{r} \phantom{1011} \overline{) 0.110110010} \\ \phantom{1011} \underline{- 100001} \\ \phantom{1011} 101000 \\ \phantom{1011} \underline{+ 10110} \\ \phantom{1011} 111010 \\ \phantom{1011} \underline{+ 1011} \\ \phantom{1011} 000101 \end{array}$$

1st quotient digit  
↓  
1.00111

For illustration, the same example previously used is shown above using divisor multiples. Since the divisor is 1011, entries from Table 1 will always be chosen corresponding to the high order bits of the divisor 10. Initially, the dividend must be regarded as having a 0 in the most significant position, so the first multiple is chosen from Table 1 corresponding to a dividend of 011 (i.e. the  $-3x$  multiple). Since the result of the first subtraction is negative, the first quotient digit is two (i.e. 10). The lower part of Table 1 shows the quotient bits obtained for each multiple.

Upon shifting the partial dividend left two positions, the high order 1's are dropped. Since it is in complement form, these 1's correspond to 0's

for positive numbers. The next multiple then must be chosen from Table 2 corresponding to a partial dividend of 101, etc; etc.

The principles just described can be extended and combined to provide further improvement in division. For example, the method of skipping across 1's and 0's can be combined with the use of divisor multiples. Carry-save adders (as described in ED 16, July 5, 1966, pp. 52-57) can be used to provide a variety of divisor multiples. Figure 1 shows a configuration which permits all divisor multiples up to the ten-times multiple to be added to, or subtracted from, the partial dividend.

### Division by repeated multiplication

A method which recently has been favored for machines having an extremely fast multiply unit is one based on a converging series. The method is inexact and no remainder is produced. A normalized divisor is also required. For these reasons, its use is generally restricted to floating-point or fractional arithmetic.

Assume we want to calculate the quotient,  $Q$ , of two fractions:

$$Q = \frac{N}{D}, \text{ where } 1/2 \leq D < 1.$$

By means of wired-in decoder circuits called a "table lookup," an approximate reciprocal,  $R > 1$ , of the denominator (i.e.,  $R = 1/D$ ) is found by examination of several higher-order bits. The number of bits examined usually varies from two through seven, depending on the degree of accuracy required. For example, assume  $D = 3/4 = 0.750$ . Then  $R = 1/D = 0.750 = 1.33$ . Expressed in binary, 0.750 is equal to .110. Had we looked only at the first-bit position, we would have taken  $D$  as equal to 0.5, which would have yielded  $R = 2$  with an obvious loss in accuracy. Next, both numerator (dividend) and denominator (divisor) are multiplied by the reciprocal  $R$ . If  $R = 1/D$  exactly, then  $DR = 1$ . But because of the approximation, it will normally be slightly greater or less than 1.

$$Q = \frac{NR}{DR} = \frac{NR}{1 \pm x}, \text{ where } x \ll 1.$$

We can obtain  $NR$  by multiplication. If  $x$  is very small,  $NR$  is a good approximation to  $Q$ . We can improve this approximation by multiplying  $NR$  by  $1 \mp x$ , since:

$$\frac{NR}{1 \pm x} \frac{(1 \mp x)}{(1 \mp x)} = \frac{NR(1 \mp x)}{1 - x^2},$$

If  $x$  is very small,  $x^2$  approaches zero. For instance, if  $x < 2^{-6}$ , then  $x^2 < 2^{-12}$ . We can improve the approximation even more by multiplying by  $(1 + x^2)$ , since:

$$\frac{NR(1 \mp x)(1 + x^2)}{1 - x^2(1 + x^2)} = \frac{NR(1 \mp x)(1 + x^2)}{1 - x^4}$$

where  $x^4 < 2^{-24}$  for the same  $x$ . Improving it one more time, we get:

$$Q = \frac{NR(1 \mp x)(1 + x^2)(1 + x^4)}{1 - x^8}$$

But since  $x^8 < 2^{-48}$ , we can let  $Q$  equal the

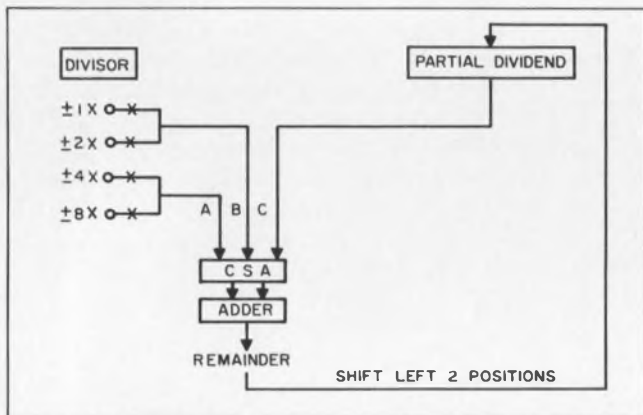

1. Carry-save adders can be used to provide a variety of divisor multiples. In this configuration, all divisor multiples up to ten-times can be added to, or subtracted from, the partial dividend.

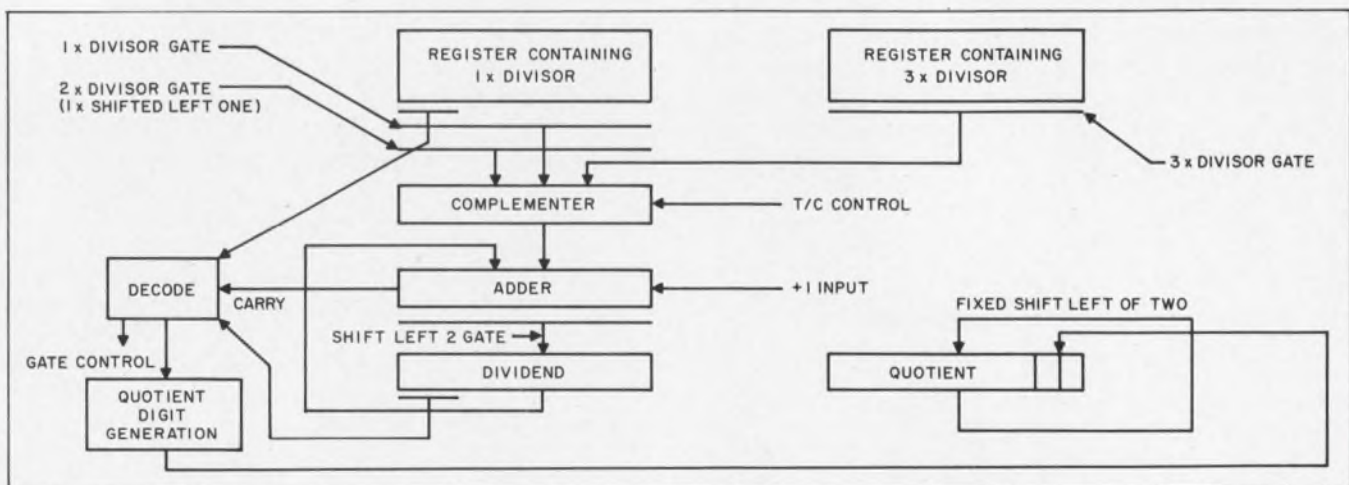

2. Division by repeated multiplication can be accomplished with the arithmetic unit shown above.

numerator only, which is accurate to 48 bits (that is, it has an error less than  $2^{-48}$ ). This completes calculations of the quotient  $Q$ .

We obtained  $1 \pm x$  by multiplication of  $DR$ , where  $R$  is obtained by wired-in circuits from the high-order bits of  $D$ . From  $1 \pm x$ , the factors  $(1 \mp x)$ ,  $(1 + x^2)$ , and  $(1 + x^4)$  can be obtained as follows:

Starting with  $1 + x$ , we complement it. This is approximately equivalent to subtracting it from 2. That is:

$$\text{complement of } 1 \pm x = 2 - (1 \pm x) = 1 \mp x,$$

which is the first factor. Complementing it only requires changing 1's to 0's and 0's to 1's, and is therefore considerably faster than subtracting from 2. Now that we have  $(1 \pm x)$  and  $(1 \mp x)$ , multiplying them gives  $(1 - x^2)$ . Complementing again, we get  $2 - (1 - x^2) = (1 + x^2)$ , which is the second factor.

Then  $(1 - x^2)(1 + x^2)$  gives  $(1 - x^4)$ . This may be complemented and the process taken as far as is required.

The actual number of multiplications performed will depend on the degree of accuracy required in the quotient. For example, if the precision required of the quotient is 48 bits or less, and  $x$  is smaller than  $2^{-6}$ , then  $x^8$  is smaller than  $2^{-48}$  which indicates that multiplication by  $(1 + x^8)$  would produce more lower-order bits than are required. Therefore  $(1 + x^4)$  is the last factor needed. A total of seven multiplications are needed to obtain the quotient. The sequence of steps to be followed is:

- 1) Obtain  $Q_1 = NR$ . (1st multiplication)
- 2) Obtain  $1 \pm x = DR$ . (2nd multiplication)
- 3) Complement  $(1 \pm x)$  to obtain  $(1 \mp x)$ .
- 4) Obtain  $Q_2 = Q_1(1 \mp x)$ . (3rd multiplication)
- 5) Multiply  $(1 \mp x)$  by its complement to obtain  $(1 - x^2)$ . (4th multiplication)
- 6) Complement  $(1 - x^2)$  to obtain  $(1 + x^2)$ .
- 7) Obtain  $Q_3 = Q_2(1 + x^2)$ . (5th multiplication)
- 8) Multiply  $(1 + x^2)$  by its complement to obtain  $(1 - x^4)$ . (6th multiplication)
- 9) Complement  $(1 - x^4)$  to obtain  $(1 + x^4)$ .
- 10) Obtain  $Q_4 = Q_3(1 + x^4)$ .

$Q_4$  is the final quotient. Figure 2 shows how a computer's arithmetic unit could be organized to implement this algorithm.

Several of the multiplications need not involve the full 48 bits. For instance,  $x^4$  is less than  $2^{-24}$ . Therefore, the high-order 24 bits of the fractional part of  $(1 + x^4)$  must all be 0, and may therefore be skipped when  $(1 + x^4)$  is used as a multiplier in the last step. The precision required in the other multiplications is 24 bits or less permitting early termination. Taking full advantage of these techniques, the time required for division is three to four times as long as multiplication for 48 or less bits of precision.

This method can be further improved if two multiply units are available. The first two multiplications can be performed concurrently; similarly the third and fourth and also the fifth and sixth multiplications. An execution time only twice as long as multiplication could be achieved. ■ ■



# High Q with Assured Reliability!



## The Johanson 3955 Series Variable Air Capacitors are backed by these special **RELIABILITY ASSURANCE PROVISIONS**

1. Parts examined and assembled in accordance with special Johanson high reliability inspection and assembly procedures.
2. All sub-assemblies inspected under magnification to assure highest quality components prior to final assembly.
3. Final assemblies subjected to 100% burn-in and screening tests.
4. Samples taken from each lot and subjected to life tests.
5. Test data supplied on request.

### SPECIFICATIONS

Capacity Range: 0.8 - 10 pf  
Working Voltage: 250 VDC  
 $Q > 2000$  @ 100 MC  
Temperature Coefficient:  $0 \pm 20.0$  ppm/°C

Write Today for Full Data



**MANUFACTURING  
CORPORATION**

400 Rockaway Valley Road.  
Boonton, N. J. 07005 (201) 334-2676

ELECTRONIC ACCURACY THROUGH MECHANICAL PRECISION

ON READER-SERVICE CARD CIRCLE 30



**The 777 comes complete  
with four cavities.**

**There are 19 modules  
you can plug into  
any one of them.**

**In any combination.**

**We have a booklet  
that takes 16 pages  
just to describe the scope,  
the modules, and the  
wave forms they produce.**

**Get one.**

**FAIRCHILD**  
INSTRUMENTATION

FAIRCHILD INSTRUMENTATION / A Division of Fairchild Camera and Instrument Corporation • 475 Ellis Street, Mountain View, California, (415) 962-2011 • TWX: 910-379-6944

ON READER-SERVICE CARD CIRCLE 31

## Neons control VOX circuits, suppress transients in transceiver. Complete independence of VOX sensitivity and delay-time adjustment highlight the design.

The use of neon lamps in EICO's 753 transceiver has made possible a design of outstanding simplicity that combines low cost with complete independence of sensitivity and delay-time adjustment.

The function of VOX (voice-operated) circuits in transceivers is relatively simple—to switch automatically from “receive” to “transmit” on receipt of a signal from the microphone. A number of conflicting operational considerations, however, has led to circuits that are elaborate for what is basically a voice-operated relay. The need for a simplified approach induced EICO to make an early decision to use neon lamps.

### VOX design considerations

A prime consideration is that the VOX circuit must provide a controlled delay to prevent the relay from returning the transceiver to the “receive” condition between words or during short pauses in the operator's speech. This delay must be adjustable to allow each operator to set it to his own preferences. At the same time, the VOX must switch from “receive” to “transmit” as rapidly as possible, so that the first portion of the spoken message is not lost.

Secondly, since many station operators employ a speaker instead of headphones, there exists the possibility that the speaker output will be picked up by the microphone and cause the transceiver to switch to the “transmit” mode. This tendency is overcome by introduction of an ANTI-VOX feature to reduce the VOX circuit's sensitivity to signals received from the speaker. The level of ANTI-VOX control should be adjustable, just like the basic sensitivity of the VOX circuit itself.

Although there are many designs for such control circuits, few, if any, provide complete independence of the sensitivity, ANTI-VOX, and delay-time adjustments; the alteration of one parameter usually requires a change of the others. Use of neon lamps, however, solves these problems.

### One neon for VOX switching

In the circuit shown in Fig. 1, the speech am-

plifier in the transmitter employs two stages. The output of the first stage is applied to the input of the VOX amplifier tube,  $V_{2A}$ , through the VOX sensitivity control,  $R_1$ . Since the transmitter speech gain control is in the following stage, the operation of the VOX will be independent of the level at which the transmitter is driven. Assume for the moment that the “cold” end of  $R_1$  is grounded, and that points A and B are connected together. Under these conditions the grid of  $V_{2A}$  is at zero potential, the tube conducts heavily, and neon bulb  $PL_1$  is extinguished.

When  $PL_1$  is extinguished, a negative bias of 25 volts is applied to the grid of  $V_{2B}$ , causing the tube to be cut off, and leaving the relay in its normal, or “receive,” position. On receipt of a negative pulse from the speech amplifier,  $V_{2A}$  will momentarily cut off, and  $PL_1$  will ignite. The transmission of a positive voltage through  $PL_1$  to the grid of  $V_{2B}$  will cause this tube to conduct heavily, thus closing the relay, and changing the equipment function to “transmit”.

Diodes  $CR_1$  and  $CR_2$  detect the signal in the speaker and produce a dc voltage across  $R_2$ , which is proportional to this signal. Thus, anti-VOX control  $R_2$  may be adjusted so that the positive voltage developed by the detector is applied to the grid of  $V_{1A}$  in any desired amount. This voltage tends to keep  $V_{2A}$  conducting, and reduces the VOX sensitivity during those times when a signal is present in the speaker.

To provide extreme VOX sensitivity, a threshold control,  $R_{13}$ , is included. This control places a small negative voltage on the grid of  $V_{2A}$ , and is adjusted so that  $PL_1$  is just on the verge of igniting when no input is applied.

To analyze the delay mechanism, assume  $PL_1$  has just extinguished. The grid of  $V_{2B}$  begins to decay from zero volts to  $-25$  volts with a time constant which is determined by  $R_8$  and  $C_7$ . If  $C_7$  were returned to ground instead of to point C, this indeed would be the case. If  $R_9$  is temporarily ignored,  $C_7$  is effectively connected to the variable arm on potentiometer  $R_{10}$ . When the arm is at the ground end of  $R_{10}$ , the decay time constant in the grid circuit of  $V_{2B}$  is simply  $(R_8)(C_7)$ . On the other hand, when the arm of  $R_{10}$  is moved up to the plate, the decay time constant will be increased, by Miller effect.  $(R_9)(C_7)(A)$ , where  $A$  represents the gain of  $V_{2B}$ . Thus, by varying the

T. Bially, Chief Engineer, Eico Electronic Instrument Co., Inc., Flushing, N. Y.

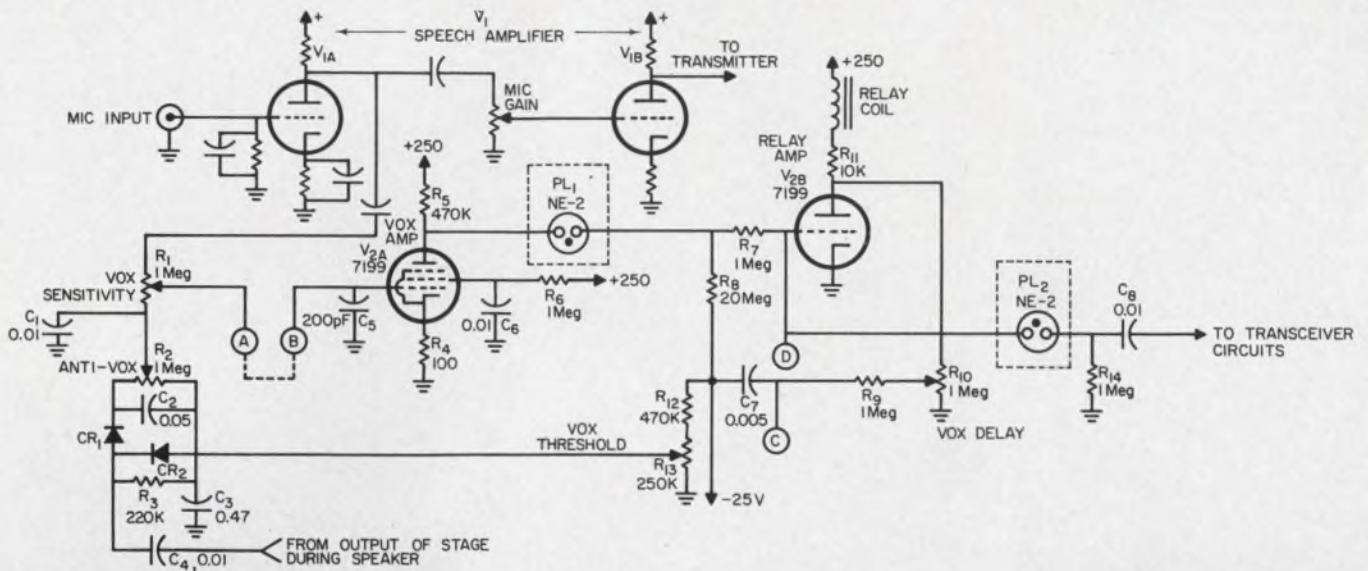

Neon bulb  $PL_1$  controls relay amplifier  $V_{2B}$ . In "receive" function (no signal through microphone or speech amplifier  $V_{1A}$ ),  $V_{2A}$  conducts, neon  $PL_1$  is extinguished, and relay amplifier  $V_{2B}$  is cut off by  $-25$  V applied to its grid; the relay remains in its open or "receive" position. Dur-

ing "transmit," the microphone signal is amplified by  $V_{1A}$  and  $V_{1B}$ . The negative peaks from  $V_{1B}$  cause  $V_{2B}$  to cut off, igniting  $PL_1$ , and thus applying a positive voltage to  $V_{2B}$  that causes the relay contacts to close. Up to 3 seconds delay is provided by  $R_{10}$ .

arm position of  $R_{10}$ , the VOX delay may be adjusted over the unusually wide range of 0.2 to 3 seconds. Since no dc components are controlled by this setting, the VOX delay control in no way affects other parts of the circuit.

If it is desired to control the operation of the transceiver manually, point C is grounded and the push-to-talk switch is connected between point D and ground. Point C is grounded to make the transceiver switch back to "receive" in the shortest possible time (regardless of the setting of the delay control) when the push-to-talk switch is released.

### Another neon for transient immunity

In changing the function of the transceiver, several high-voltage points are switched by the relay. The transients thus produced may, in some cases, be picked up by the microphone amplifier circuits and be transmitted to the VOX circuit. The circuit might then return to "transmit" immediately after switching to "receive".

To prevent this action, capacitor  $C_3$  is connected to a point in the transceiver circuit that drops to ground from a potential of  $+250$  volts as soon as the transceiver is switched to "receiver." A 250-volt negative impulse is thus developed across resistor  $R_{14}$ , and is transmitted by neon  $PL_2$  to the grid of  $V_{2B}$ . This pulse tends to keep  $V_{2B}$  cut off for a short period of time following the change-over, and makes the relay immune to transients received by the VOX circuit during this time. These transients will have disappeared before  $PL_2$  extinguishes, so that the circuit remains stable in the "receive" position.

An additional function of the VOX is to provide automatic change-over from "receive" to "trans-

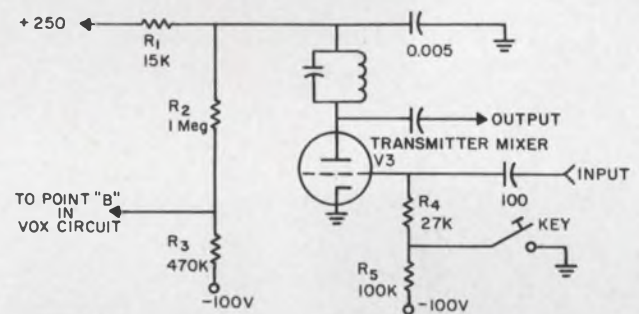

Automatic switching during cw operation is accomplished by connection of junction  $R_2$  and  $R_3$  to the grid of the VOX amplifier tube ( $V_{2A}$  in Fig. 1). When the key is up, transmitter mixer  $V_3$  is cut off by  $-100$  V, and a positive voltage will appear at junction  $R_2$  and  $R_3$ ; relay tube  $V_{2B}$  (Fig. 1) will be cut off, placing the contacts in "receive" position. When the key is depressed,  $V_3$  conducts, its plate voltage drops and junction  $R_2$  and  $R_3$  becomes negative; relay tube  $V_{2B}$  conducts, placing the contacts in "transmit" position.

mit" when the transceiver is used in a Morse Code or cw mode. In this case, the closure of the telegraph key provides the VOX triggering signal. Fig. 2, the keyed stage in the transmitter obtains its plate voltage through resistor  $R_1$ . When the key is up, the stage is cut off, and the voltage at the plate end of  $R_1$  is the same as that of the supply. When the key is closed, this voltage will drop appreciably. The voltage at the junction of  $R_2$  and  $R_3$  will be positive when the key is up, and negative when the key is down. For cw operation, points A and B in the VOX circuit of Fig. 1 are disconnected, and point B is connected to the junction of  $R_2$  and  $R_3$  in Fig. 2. This voltage then controls the operation of the VOX, and the telegraph key simply replaces the microphone in its effect upon the circuit. ■ ■



## **Reliable electrical connections**

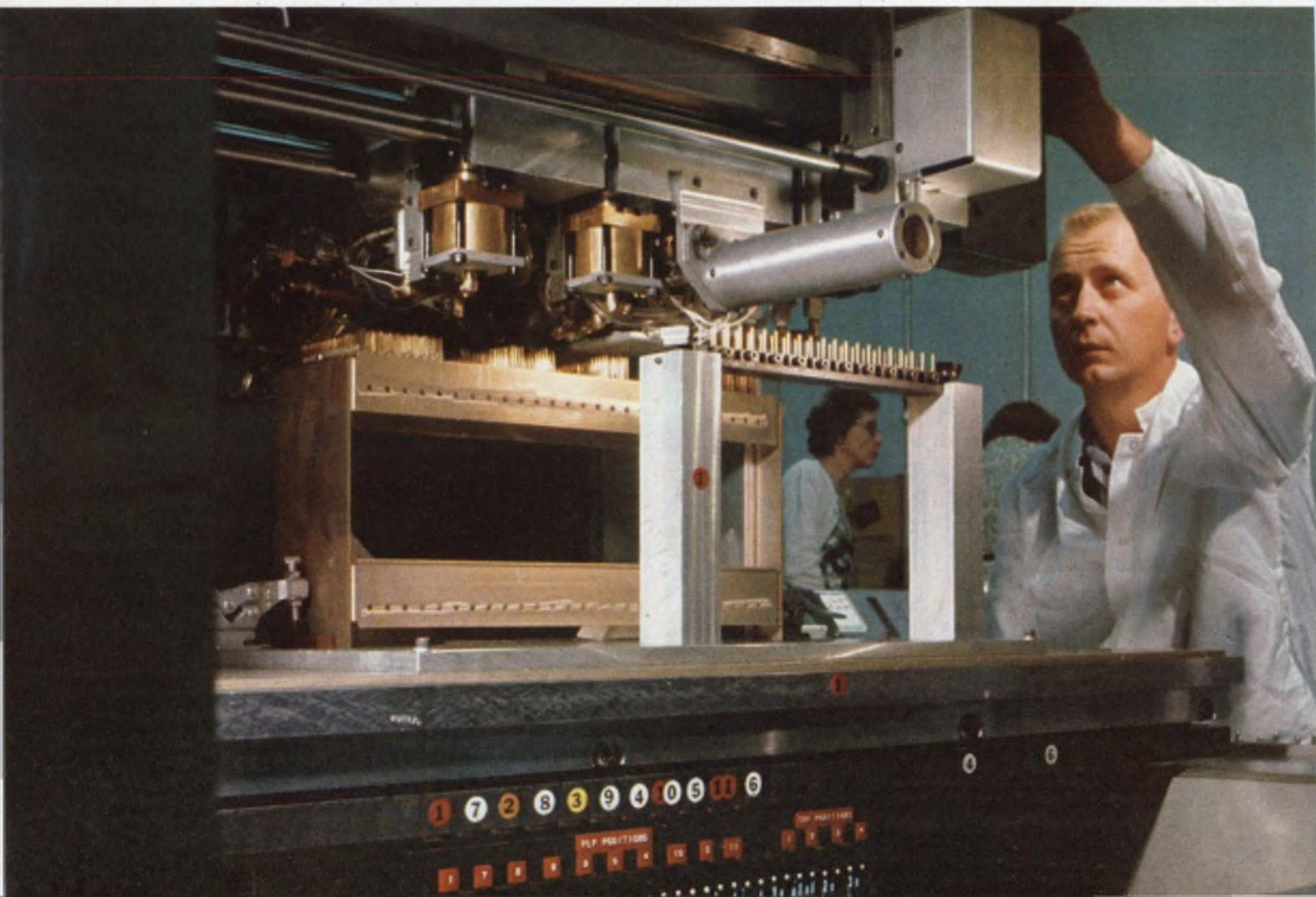



Your choice of power for hand "Wire-Wrap" tools . . . electricity, compressed air, or rechargeable battery. We also make manual tools for field servicing. Bulletins 14-1, 14-3 and 14-7.

Solderless electrical connections are wrapped to stay . . . wrapping time is less than one second each . . . Using Gardner-Denver "Wire-Wrap"<sup>®</sup> tools. You save hours of handwork. You save inspection and rework time as well, because "Wire-Wrap" tools make reliable connections, even in inexperienced hands. Widely used for wiring television, instruments, communications equipment, computer panels and missile guidance systems.

## in less than one second each

Modular panels are quickly and securely wired on Gardner-Denver automatic "Wire-Wrap" machines, which are programmed with punched cards for maximum flexibility. Bulletin 14-121.

Reliable! More than 40 billion solderless wrapped connections have been made with "Wire-Wrap" equipment without a single reported electrical failure.



Film is scraped from wire and terminal at contact points. High pressure metal-to-metal contact invites solid state diffusion, maintaining low connection resistance.



Solderless wrapped connections remain gastight even when exposed to severe changes of temperature and humidity . . . so they're not affected by atmospheric corrosion.



Initial pressure may go as high as 100,000 psi. Pressure drops as wire relaxes, but stabilizes at a value greater than 29,000 psi.

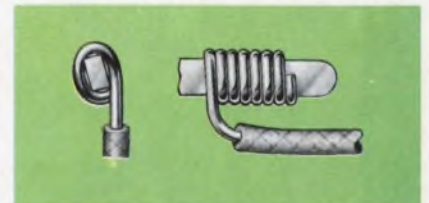

Flexible lead-off absorbs vibration and handling shocks . . . permits wrapped connection to stay tight and mechanically stable.



SEE WHAT AIR IS DOING NOW...SEE

**GARDNER - DENVER**

Gardner-Denver Company, Quincy, Illinois

ON READER-SERVICE CARD CIRCLE 213

# Consider double-loop regulation: hybrid magamp-SCR circuit combines benefits of reactive and dissipative techniques in a five-pound unit.

A hybrid regulator scheme for general-purpose power supplies combines in a five-pound, 80-watt unit the high efficiency of a reactive regulator and the precision and fast response of a dissipative regulator.

This is accomplished by use of a magnetic amplifier as the control element and feedback path. Further advantage is gained from use of SCRs in the coarse-regulator stage, necessary for low-voltage, high-current applications. Here the magamp acts as the SCR trigger—much simpler and offering higher gain than transistor trigger circuits.

The Table lists the performance of a power supply of this type with self-resetting short-circuit protection.

Typically, dissipative regulators employ transistors as series-gating elements that act as variable "self-adjusting" resistors to compensate for line and load changes. Reactive regulators, on the other hand, employ switching devices that deliver gated bursts of constant average power to the load, independent of line changes. SCRs, magnetic amplifiers or series-switching transistors are among the control elements used in this mode.

The dissipative approach features precise regulation, low ripple, low output impedance and fast transient response. This type of circuit is a good choice for narrow input-voltage swing or low-load-current applications. However, if the dissipative regulator is used in applications involving wide input-voltage regulation or wide output adjustments and/or high load currents, the penalty is high gate dissipation with resulting low efficiency. As a direct consequence of these considerations, the regulator package size is now dictated by thermal considerations rather than by component accommodation.

The reactive regulator is a good choice for higher load-current applications where considerable power must be absorbed to compensate for a wide range of input and/or load variations and where close control of the output and fast transient response is not essential.

An efficiency and volume comparison of double-loop versus dissipative regulators with the same specs, (Fig. 2) shows that the latter would have to be nearly twice the volume of the former and would have an efficiency of only 54%. The graph shows further that double-loop regulator efficiencies are very flat, from 85% for low-power outputs to approximately 80% for higher outputs. The corresponding efficiencies for dissipative regulators run from 63% to 40%.

## How the circuit operates

In general terms, the double-loop regulator consists of a reactive coarse preregulator in cas-

Double-loop regulator supply characteristics

	single-phase	three-phase
Input voltage	90-127 Vac (square)	135 Vac (sine)
Frequency	2000 Hz	400 Hz
Output voltage	65 V	100 V
Output current	40 mA- 1.2 A	1.0 A
Output power	80 W	100 W
Regulation (max)	±1%	±1%
Ripple (max)	25 mV p-p	5 mV p-p
Output impedance (max)	0.25 Ω (0.5 kHz)- 1.0 Ω (5-50 kHz)	
Line transient response (10% step change)	3 mV max amplitude; 4 ms max recovery time	
Load transient response (25% step, 25-75% load)	3 mV max amplitude; 4 ms max recovery time	
Size	6.5x6.5 x1.75 in.	7x7x2 in.
Weight	5 lb	6 lb
Temperature range	-32 to +65°C	-40 to +60°C

Anthony A. Annunziato, Sperry Gyroscope Co., Great Neck, N. Y.

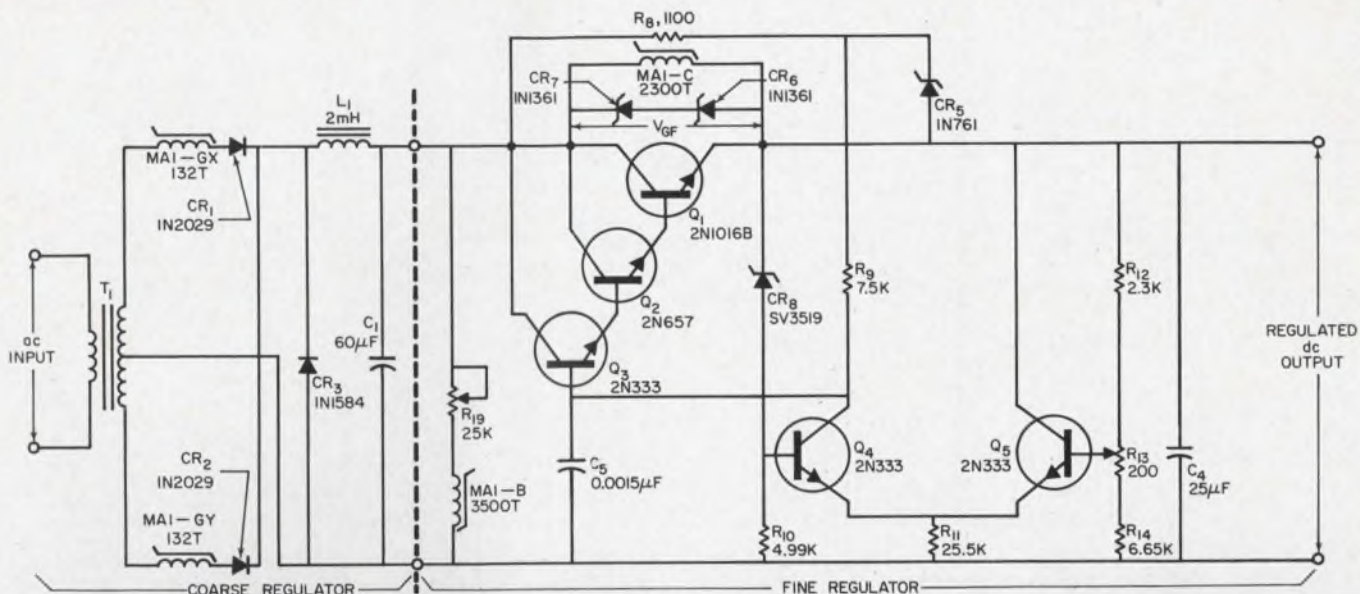

1. Magnetic-amplifier feedback loop in five-pound power supply allows 80% efficiency at 80 watts. Control winding (MA<sub>1</sub>-C) of magamp in fine regulator gate senses  $V_{GF}$

cade with a dissipative fine regulator. The magamp provides the feedback or control path. Refer to Fig. 1 for the basic circuitry of a regulator of this type employing a full-wave, center-tap magamp as the coarse regulating element.

MA<sub>1</sub>-GX and MA<sub>1</sub>-GY are the gate windings of the magamp, which uses 1DU laminations, 6 mil Orthonol, and is wound as indicated in Fig. 1. CR<sub>3</sub> is a free-wheeling diode that provides a discharge path for the current in filter choke L<sub>1</sub> during the exciting interval of the magamp. The L<sub>1</sub>-C<sub>1</sub> filter serves to smooth out the voltage pulsations caused by the magamp operation.

MA<sub>1</sub>-C and MA<sub>1</sub>-B are the control and bias windings of the coarse-regulator magamp. Q<sub>1</sub> is the gate transistor of the fine regulator. CR<sub>8</sub>, R<sub>10</sub>, R<sub>12</sub>, R<sub>13</sub>, and R<sub>14</sub> form the output error-sensing network with R<sub>13</sub> serving as the output adjustment. C<sub>4</sub> aids in reducing the remaining ripple and provides for low output impedance in those frequency ranges where the gate transistor gain falls off. CR<sub>5</sub> provides a positive voltage for the base drive of gate transistors Q<sub>3</sub>, Q<sub>2</sub> and Q<sub>1</sub>. R<sub>19</sub>,

fluctuations and adjusts the magamp firing angle to raise or lower coarse-regulator output. The fine regulator then provides the required precise regulation.

a one-time adjustment, sets the level of the magamp's bias winding.

The regulators, both coarse and fine, act like any degenerative feedback device, sensing the output and controlling the gating element to cancel, or act in opposition to, any fluctuation resulting from line or load changes. If the line voltage rises above, or falls below, nominal while the load remains unchanged, the fine-regulator gate,  $V_{GF}$ , instantaneously absorbs more or less voltage, respectively, to maintain a constant output voltage.

This change in gate voltage (from nominal of about five volts in this case) is sensed by the magamp control winding MA<sub>1</sub>-C. This causes the magamp to adjust its firing angle for a lower or higher (for line-voltage rise or fall, respectively) average coarse output voltage. Thus, the output voltage of the coarse regulator is automatically adjusted to maintain the minimum voltage required at the collector of the fine regulator pass-transistor. The coarse regulator essentially attends to the "long-term" regulation needs of the fine regulator.

The fine regulator, in turn, takes care of the instantaneous tasks of the power supply, thereby providing precise regulation, fast transient response and low output impedance. A similar regulating action takes place if the load is changed, while the line voltage is held constant.

### SCRs improve output capability

A further advantage of the double-loop regulator is that the size of its coarse-regulator portion need not increase in proportion to power output. Figure 3 illustrates how the output capability (e.g., low-voltage, high-current) of the coarse regulator may be extended by replacing the magamp with SCRs as coarse-gating elements. At the expense of only a minor increase in circuit com-

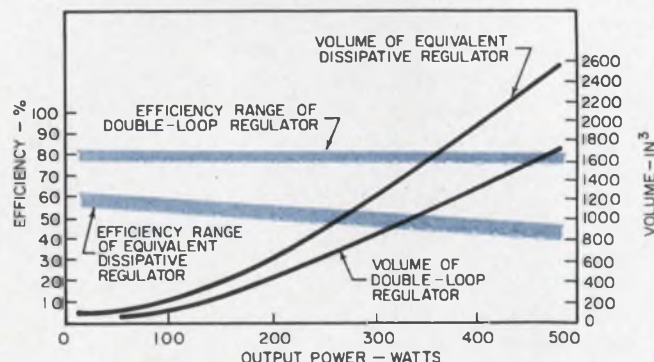

2. Efficiency-volume comparison of double-loop regulator with dissipative type reveals a figure of merit of 1/3 to 1 watt/in.<sup>3</sup>, and 1/5 to 1/2 watt/in.<sup>3</sup> respectively.

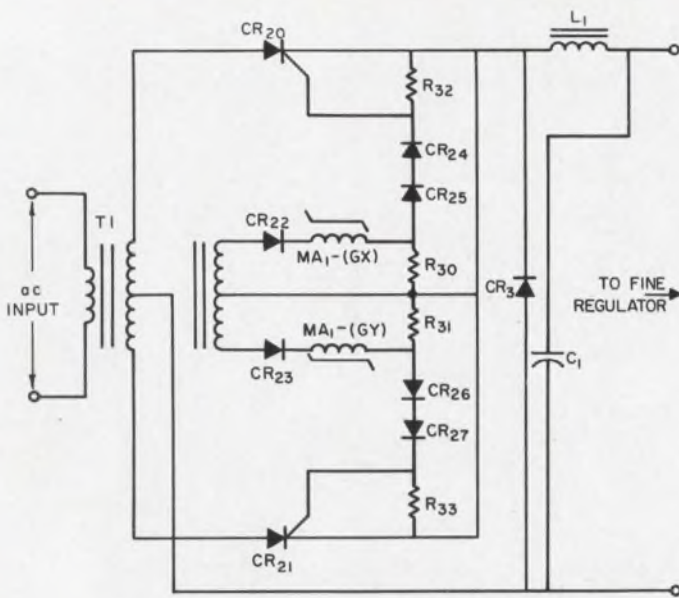

3. Magamp triggers SCR coarse-control in this hybrid variation. Smaller size, faster response, and increased gain are among the resultant benefits.

plexity, the magamp is now used merely as a low-level trigger for the SCRs. The speed and gain are thereby improved significantly and the magamp's postsaturation inductive drop is not a problem. (Care should be taken, however, in stabilizing the loop.) The magamp can also be smaller; as a result, the volume of the coarse-regulator portion, instead of being determined mainly by the size of the magamp and only to some extent by that of the LC-filter combination, now depends mainly on the size requirements of the filter alone.

Because of the inherently low long-term power dissipation of the fine regulator's gate, the fine-regulator output capability may easily be extended by merely adding gate transistors in parallel. Except for higher base-drive requirements, the fine-regulator circuitry is not affected by the addition of parallel gates.

#### Add self-reset short-circuit protection

Because of its ability to gate from full-ON to full-OFF in a lossless manner, the double-loop regulator lends itself particularly well to self-resetting short-circuit protection. In Fig. 4, rectifiers  $CR_9$  and  $CR_{10}$  act as auxiliary power supplies for the protective circuit.  $R_{17}$  and  $C_9$  serve as an RC filter. An additional magamp winding,  $MA_1-SC$ , is the short-circuit control winding of the coarse-regulator magamp.  $Q_6$  acts as a normally open switch, closed during short-circuit conditions.  $R_2$  and zener  $CR_4$  function as short-circuit sensing elements. The  $L_2-R_4$  parallel combination serves to prevent  $C_1$  from dumping current through the fine-regulator gate until the magamp responds to the short-circuit cut-off signal.

Under normal operating conditions, the voltage developed across  $R_2$  by the load current is insufficient to break down zener  $CR_4$ , thereby

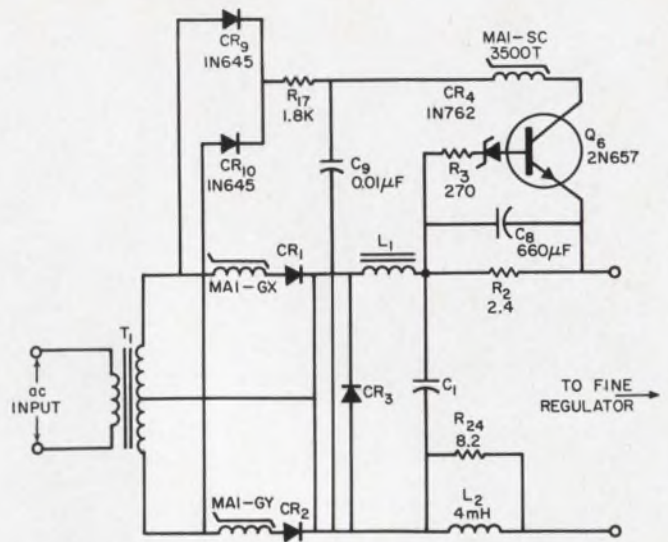

4. Self-resetting short-circuit protection is easily added to double-loop regulator.  $Q_6$  saturates when  $R_2$  and  $CR_4$  sense a short circuit, causing current to flow in  $MA_1-SC$  in a direction to drive magamp to cut off. Circuit resets upon removal of short circuit.

holding  $Q_6$  in cut-off and preventing current flow in the magamp winding,  $MA_1-SC$ . Upon application of a short circuit to the output terminals, the following sequence of events takes place: The build-up of short-circuit current causes a voltage drop to build up across  $R_2$ . When this drop exceeds the zener  $CR_4$  breakdown voltage, it conducts, driving  $Q_6$  into saturation. This causes current to flow in the magamp short-circuit winding  $MA_1-SC$  in a direction to drive the magamp to cut off, thereby effecting a reduction in the coarse-regulator output voltage.

The circuit will then settle at some equilibrium point at which the magnitude of the short-circuit current will be no more than required to cause the magamp to supply a reduced magnitude of  $V_{COARSE}$ , just sufficient to drive this short-circuit current through the various short-circuit impedances. Upon removal of the short, the protective circuit resets and the regulator reverts to its normal operating mode.

For the sake of comparison it is interesting to note that additional gate capacity and heat dissipation capability would be required if this short-circuit protection was to be accomplished with an ordinary dissipative regulator. Furthermore, the ability of the magamp to accept isolated inputs makes the double-servo-loop regulator suitable for a variety of auxiliary control functions.

The double-loop technique is not limited exclusively to regulators with single-phase inputs. For three-phase inputs, the circuit is essentially the same as that shown in Fig. 1, except that the magamp is replaced by a three-phase, full-wave bridge magamp having its three control windings series-connected across the fine-regulator gate. Operating characteristics of the three-phase unit are also shown in the Table.

The double-servo-loop regulator technique can also be applied to current regulators. ■ ■

# Introducing: The Fabri-Tek **FAST** Line concept

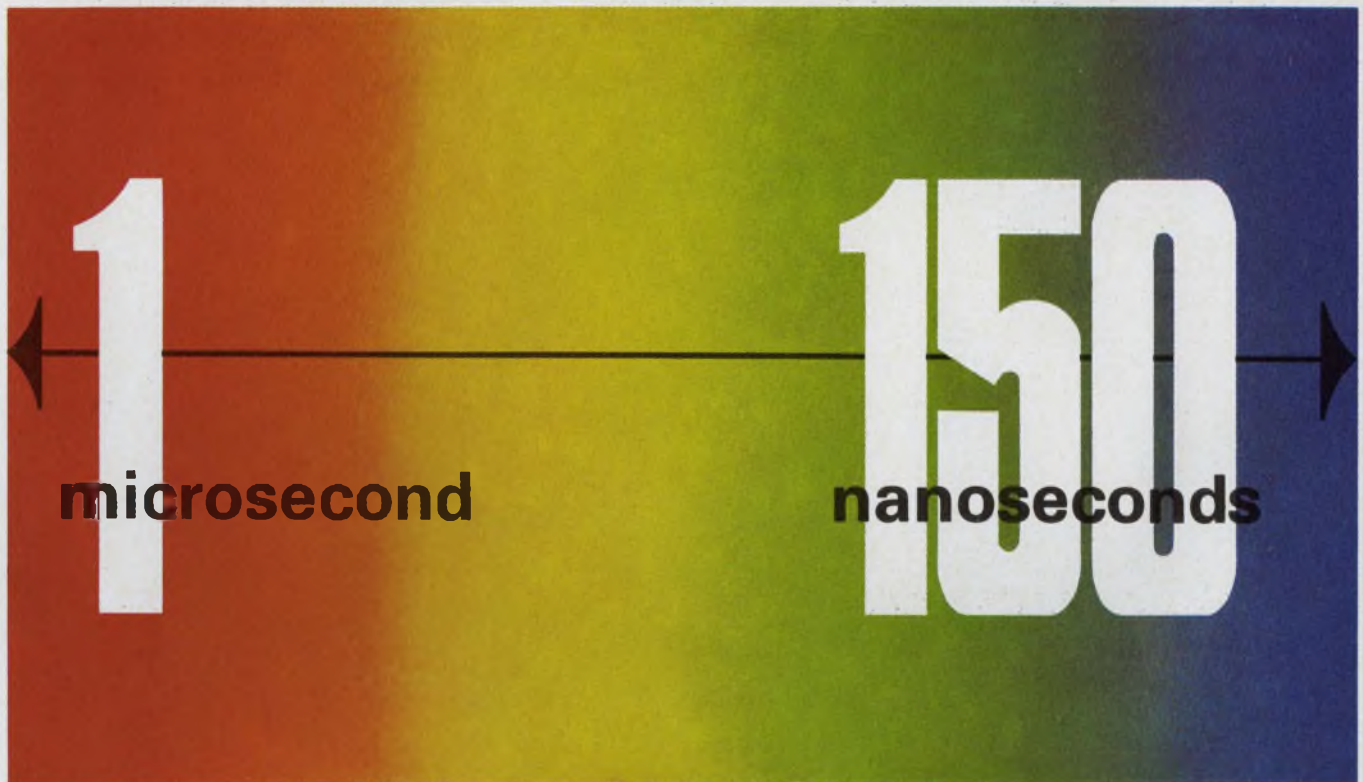

—a unique solution to  
COMPUTER MEMORY  
requirements in the  
sub-microsecond  
speed range!

The Fabri-Tek FAST Line concept represents a significant departure from the discrete memory speeds of equipment currently available. FAST Line provides a free selection of any memory speed between 1 usec and 150 nsec without specific incremental restrictions.

Now, you can select an optimized memory stack or system from the FAST Line spectrum which matches exactly the logical organization and internal circuit speeds of your computer design.

Here's what the Fabri-Tek FAST Line concept means to you:

1. Exact match of speed and capacity to your next computer design.
2. Value-engineered memories. You pay for only the speed required.
3. Speed-cost evaluation resulting in lowest ultimate cost to you.
4. Standardized designs and organizational techniques for reduced manufacturing costs and improved reliability.
5. All organizational modes available to match your needs (3D, 2½D and linear select).
6. . . . and a serious commitment in depth of our entire company to helping you fill your computer memory requirements.

The FAST Line memory includes core memories from 1 usec to the 375 nsec range and film memories from 500 to 150 nsec. If your present or future computer design calls for memory stack or system speeds in this spectrum, the FAST Line concept is worth your time to check out. Call: 612-935-8811, TWX: 910-576-2913 or Write: Fabri-Tek Incorporated, 5901 South County Road 18, Minneapolis, Minnesota 55436.



***The Leader in Memory Technology***

ON READER-SERVICE CARD CIRCLE 32

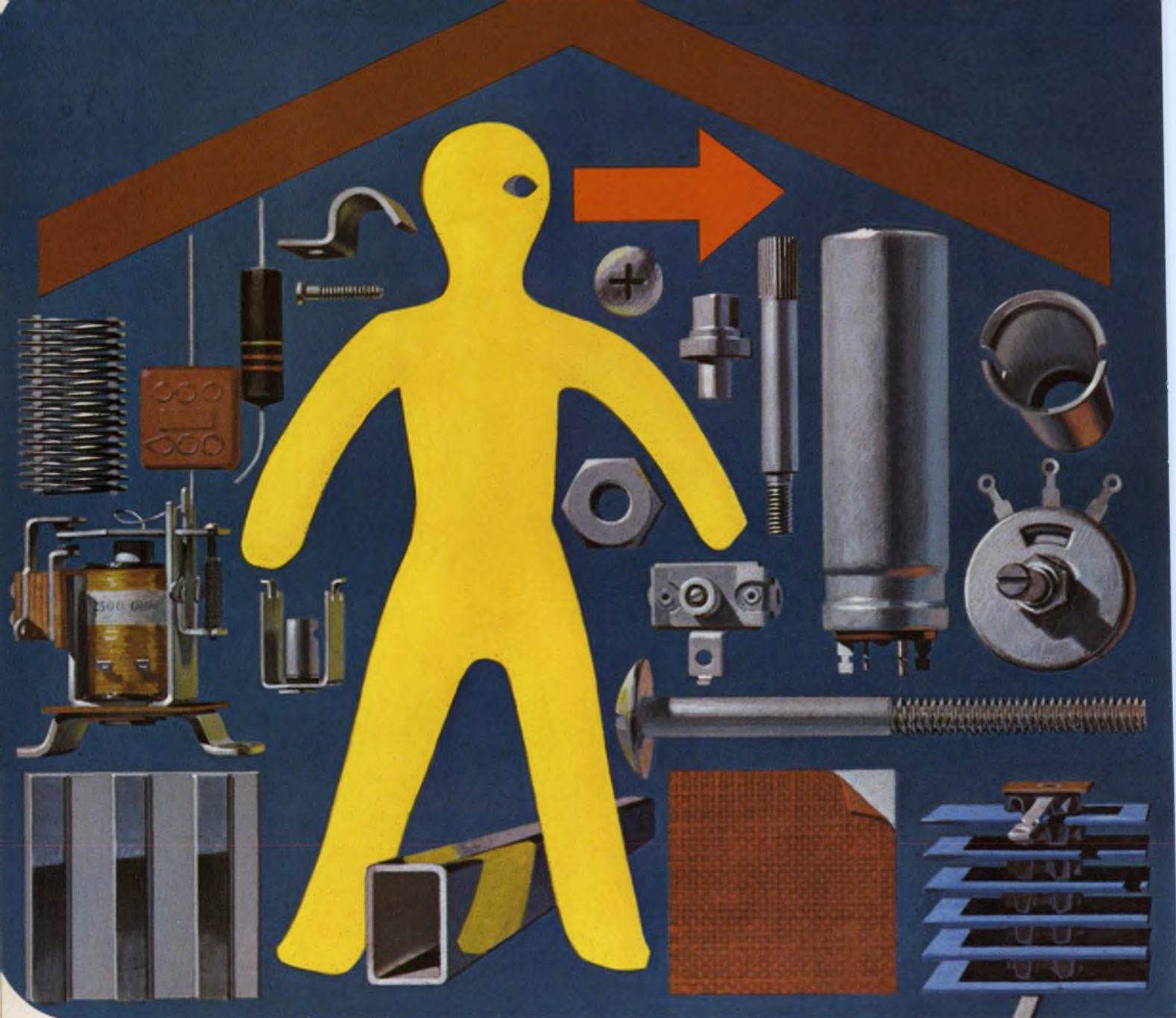

**Alcoa Aluminum  
makes your choice  
easier when you  
must meet all  
5 product-  
personality  
requirements.**



### **Environment**

Alcoa® Aluminum is durable. In the lab or in the field, lightweight, corrosion-resistant Alcoa Aluminum will stand up against everyday wear and tear. Pound for pound, it's stronger than steel. And Alcoa has the alloys that can meet your most exacting requirements.



### **Application**

Alcoa Aluminum is versatile. It's nonmagnetic, nonsparking, dampens vibration and, since it is an excellent conductor of both heat and electricity, it's suitable for a wide variety of enclosed applications.

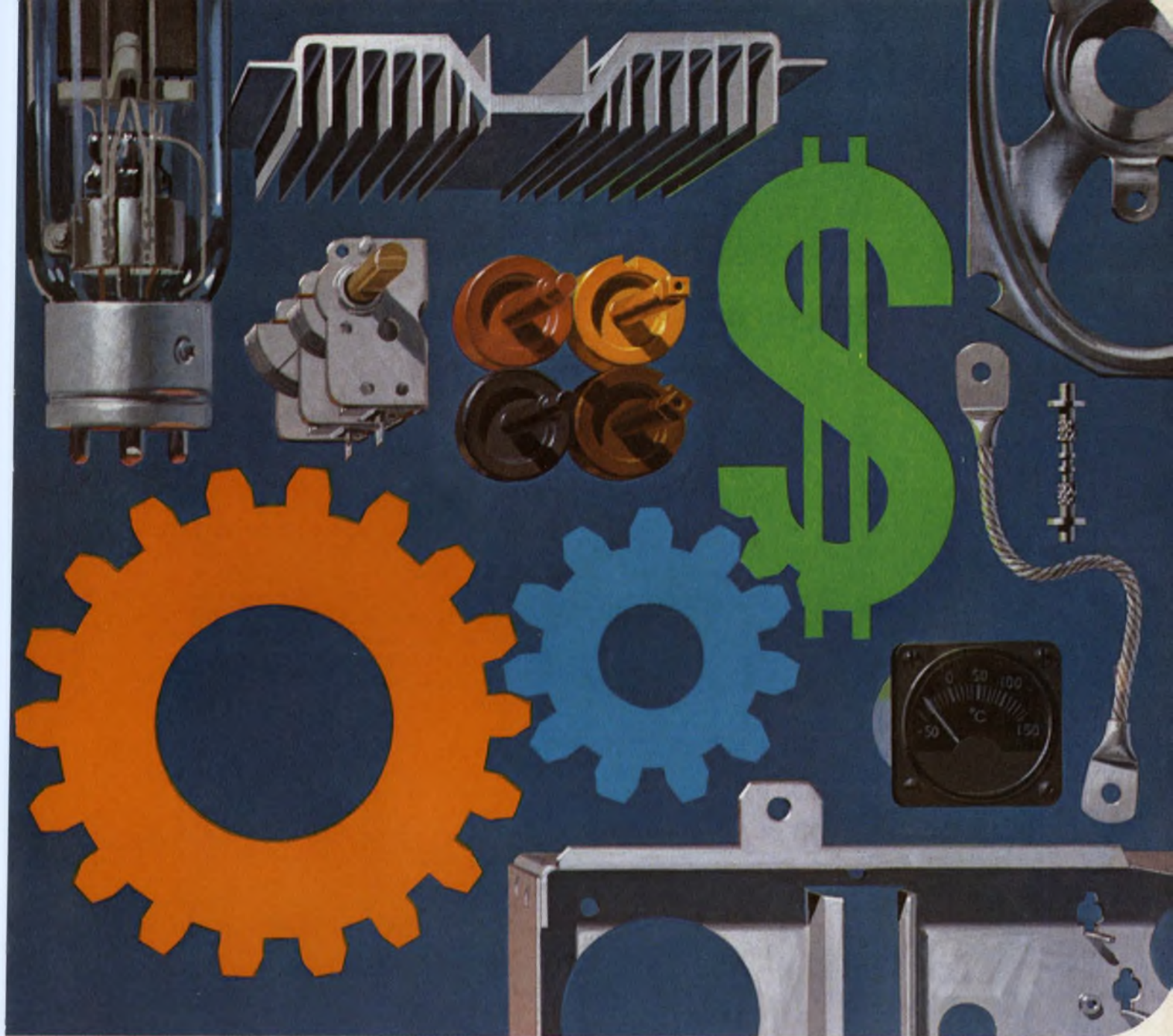

## Aesthetics

Alcoa Aluminum is easy to finish. Either alone or in combination with many other materials, natural aluminum has a pleasing appearance that can be enriched by embossing the surface or by the addition of color—in a broad spectrum.

## Production

Alcoa Aluminum is easy to fabricate. It can be cast, forged, extruded, machined or drawn . . . formed or fastened by practically any method, often at cost savings.

## Customer Satisfaction

Alcoa Aluminum is oriented to your customer's needs. A wide variety of shapes and sizes, alloys and finishes, properly applied, assure the best performance of your product.

For complete information on how to put aluminum's five-point

personality into your product, contact your nearest Alcoa sales office. Or write: Aluminum Company of America, 1780-G Alcoa Building, Pittsburgh, Pa. 15219.



# Measure potentiometer noise correctly

and you may find that your noise problem has disappeared—or at least eased.

Just as gardeners have to "live with" some weeds, so must you, as an engineer, put up with a certain degree of noise in potentiometers. But if you are overly concerned with that degree, perhaps you are not taking into account all the necessary factors when measuring noise.

Better materials and manufacturing techniques have improved inherent noise figures to the point where they may no longer be significant in your design. With correct noise measurement, you may find that what you thought was a problem no longer exists, or that you have overdesigned.

In any analysis of the problem, it may help to consider first the sources of noise in precision and adjustment potentiometers, some of which are shown in the accompanying photographs.

It is interesting to observe that most potentiometers that are discarded are rejected because of noise at incoming inspection. Few rejects actually occur during use. One reason is that many users specify noise levels well above available minimums. These minimums have been accepted by many other users as standard. Cognizant of this problem, most manufacturers strive to reduce the noise level of all potentiometer types below the generally established standard for precision types. The result actually is some degree of overdesign.

Under definitions of the Military and the Precision Potentiometers Manufacturers Association, the two most common ingredients of noise are its apparent random nature and the fact that it is a distortion of the desired voltage.

## Where does noise originate?

Two types of noise usually occur from several sources in a wirewound potentiometer: mechanical and residual.

Mechanical noise is produced under dynamic conditions when excessive resistance is introduced between wiper and element. It can vary from a few ohms to an open circuit. Causes can be excessive vibration, acceleration, cycling rate, shock, etc. To prepare for it, the unit should have a properly designed wiper to minimize bounce on lift-off. Wiper pressures must be controlled and minimum relaxation of the spring contact allowed during use. Coarse windings are undesirable; but with present day equipment are usually not a problem. Lubricants must not be too viscous lest

they impede the wiper-to-element contact. Resolution noise is a sawtooth voltage variation introduced when the wiper contact moves across discrete turns of a resistance wire, and it is inversely proportional to the resolution figure of the potentiometer.

Residual-noise effects can show up as sharp random voltage peaks generated between the moving contact surface and winding. The principal cause is foreign material—dirty windings, oxide films, wear products, etc., which introduce extra resistance between the contact surface and turns of resistance wire. Contact-resistance fluctuations arising from such contamination are characteristically large, usually stationary with respect to time, and independent of slider velocities. This noise effect may properly be called "passive." It is precluded by careful design, clean manufacturing conditions and wise use of long-wearing, stable wire and contact materials, as well as by periodic cleaning after use.

Sources of "active" residual noise are not so easily analyzed. Fortunately these disturbances in wirewound potentiometers rarely exceed a small fraction of a millivolt. Active noise is a self-generated voltage, found under three principal sets of conditions: galvanic or chemical action at the point of contact between slider and wire; thermo-junction effects, which depend on frictional or external heat, and triboelectrical phenomena, which are small voltages generated by abrasion of the contact upon the wire. Here again, noise is minimized by use of compatible materials, proved welding techniques and optimum contact pressures.

## The correct way to measure

Let's examine now both the correct way to measure noise and some pitfalls that can affect those measurements. The total noise figure is most commonly expressed as an equivalent resistance. Some users define noise by voltage. In either case, evaluations of noise are generally made with a constant current of one milliamperere. The noise figure is, in brief, a quantitative measurement of the total noise, and it is defined as the total residual noise peak voltage divided by the source current, with the source current and shaft velocity usually specified.

The most common specifications used for noise measurements are MIL-R-12934C, MIL-R-27208A, MIL-R-22097B. These military docu-



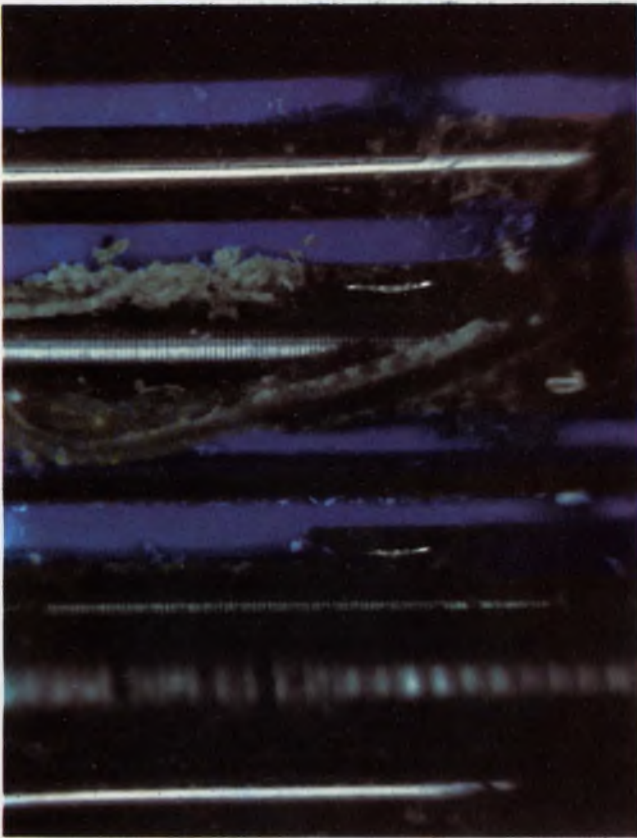

The effects of a chemically active cleaning solvent can be seen inside an adjustment potentiometer. Organic materials reacted with the solvent and caused the debris and noise.

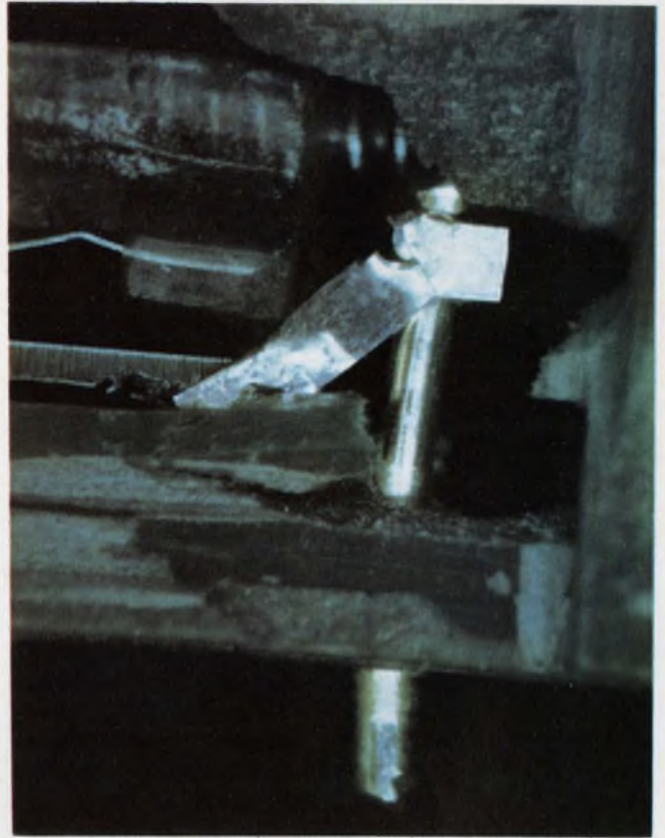

Intermittent noise was created when a terminal on a potentiometer element was structurally damaged by an attempted forced installation.



Ordinary lint on a wirewound potentiometer was sufficient to produce noise spikes, illustrating that even the smallest particle can cause trouble.



The entry of chemical agents caused a small section of the element to deteriorate. The resultant chemical action caused noisy performance.

ments specify the test circuit, frequency response, input impedance and test current for both precision and adjustment potentiometers.

In an effective noise-measurement circuit, a source of constant current is placed across one end of the potentiometer and the wiper (see Fig. 1). The wiper and the other end of the potentiometer are then connected to a voltage-measuring circuit with a high input impedance (audio amplifier, scope, etc.). When the constant-current source is applied, a voltage drop occurs across any resistance that may exist between the wiper and the resistance element. This voltage output is equivalent to noise resistance.

To standardize these equivalent noise-resistance measurements, the source current has been arbitrarily set at one milliamperere flowing from the contact to the winding. For calibration, it is necessary to insert rapidly the calibrating resistance (50  $\Omega$ , 100  $\Omega$ , 500  $\Omega$ , etc.) in series with the wiper, as shown in Fig. 1.

When an oscilloscope is used for detection, the signal should be fed to the vertical amplifier input. When the circuit is functioning properly, there will be a single line across the face of the scope. With an open circuit, an ac signal will be imposed on the screen. The calibration will appear as a definite deflection, which will be equivalent to the calibration resistance.

If an audio amplifier is used for detection, the method is the same as that for the scope—that is, the calibrating resistance must be inserted rapidly in series with the wiper of the potentiometer. The output from the speaker should be barely audible with proper calibration resistance, and it will not be audible at all if the calibration resistance is about 10% below the required value.

#### Consider these points, too

In the measurement of noise, several other factors should be taken into consideration, depending on the type of potentiometer being evaluated. These factors are:

- Product type.
- Contact-resistance variation.
- Application.
- Wiper position.
- System bandwidth.
- Input impedance of test circuit.

**Product type**—A distinction must be made between adjustment potentiometers and precision potentiometers. The latter are typically rotary types, although applications do exist for linear-motion types. The user is concerned primarily with noise under dynamic conditions. Therefore noise performance after use is of considerable importance. Such things as cycling rate and noise appearance and disappearance must be checked.

With the adjustment potentiometer, on the other hand, the user faces a different problem. Stability under static conditions becomes the prevailing concern. Once an adjustment is made, the user would like to be assured that there will

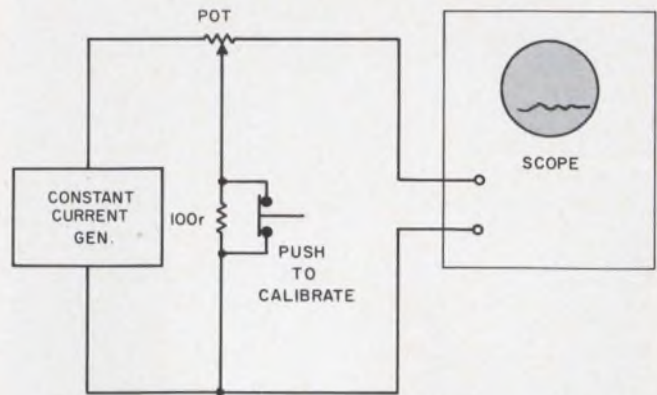

1. The total noise figure is determined with this setup. With constant current applied on wiper and one end, any noise will appear as a voltage at the other end.

not be any change in the selected setting. Contamination or oxidation will cause a change.

**Contact-resistance variation**—The designer should determine whether the potentiometer is made of a wirewound or non-wirewound element. In a wirewound type, this resistance variation doesn't occur, because of the uniformity of the resistance winding.

In non-wirewound units, however, contact-resistance variation is of utmost importance. There are several theories, but perhaps the most easily understood is the one that assumes a mean current path through a composition resistance element.

If resistance is to be measured through the wiper, an additional resistance is introduced into the circuit. This resistance exists between the mean current path through the element and the contact point on the surface of the element. An additional variable is the resistance introduced at the surface of the element between the surface and the wiper-contact material. Since the resistance path in a non-wirewound element does not follow a straight course and is not always at a fixed distance below the surface of the element, different levels of contact resistance will be noted at different points on the element. Under dynamic conditions, such as when the adjustment screw is being turned, these changes in static contact-resistance level appear as contact-resistance variation. If these variations are large or rapid, erratic linearity can result.

However, all problems with contact resistance and contact-resistance variation are of little consequence if the non-wirewound potentiometer is used as a pure potentiometer—that is, with no wiper current being drawn. If no wiper current exists, no voltage drop occurs across the resistance between the resistance path and the wiper; therefore, contact resistance is not present.

Unfortunately, few applications use potentiometers as pure potentiometers. Oftentimes wiper current is drawn, and in many other cases the unit is used as a variable resistor. In both instances contact-resistance variation becomes a factor.

Fortunately the contact-resistance variation does not usually change over a period of life but

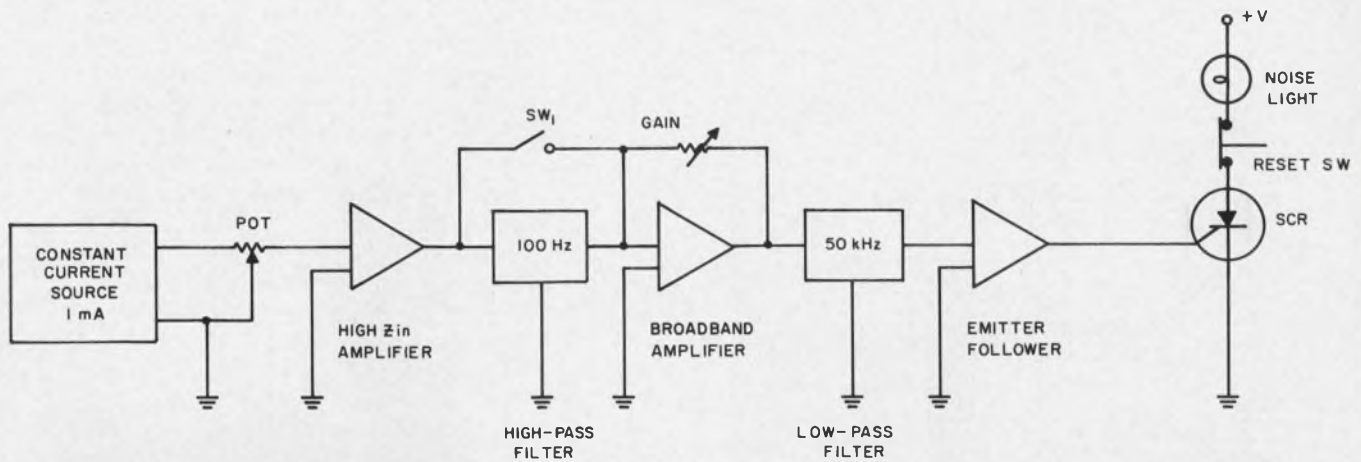

2. SCR go-no-go potentiometer tester rejects units with noise above a level selected by gain control. High-pass

filter is switched out to ignore high-frequency noise. Desired noise cutoff level is selected by gain pot.

Table. Major sources of noise

Types	Origin	Expression (noise figure)
Loading noise	Load current flowing through fluctuating contact resistance.	Ohms (peak-to-peak variations in contact resistance).
Shorting noise	Winding current flowing through fluctuating contact resistance.	Equivalent ohms peak-to-peak (calculated from an observed winding current and noise voltage).
Resolution noise (due to winding current)	Stepped nature to wirewound resistance element.	Percent (reciprocal of number of turns of resistance wire).
(due to load current)	Same.	Ohms (resistance per turn of resistance wire).
Generated noise	Tribo effect.	Millivolts or microvolts.
High velocity noise	Brush leaving winding above critical velocity.	In terms of pulse width and artificial velocity.
Active residual noise	Self-generated voltages such as tribo effect, thermo-electric effect, or electro-chemical effects.	Millivolts or microvolts.
Passive residual noise	Occurs when excitation current flows in winding. Principal cause is fluctuating contact resistance between moving slide and resistance element.	In ohms.
Contact resistance variation	Variations in resistance due to non-homogenous nature of resistive path. (non-wirewounds)	Percentage of total resistance.

remains fairly constant.

The requirements and specifications for measuring contact-resistance variation are given in MIL-R-22097B, Par. 4.6.4. The circuit requirements described there are very similar to those for measuring total noise.

At present, contact-resistance variation specifications exist only for non-wirewound adjustment potentiometers. The typical specification is 2% or 3% of the total resistance value. Under evaluation is a non-wirewound precision potentiometer specification for contact-resistance

variation measurement.

Several new methods of determining the relationship of output, accuracy and the contact resistance factor are also under consideration. Output smoothness and window-resolution tests have been recommended as more indicative of actual circuit noise for these units. In an output-smoothness test, changes to the output slope, noise and discontinuity will appear as spikes on a filtered output. The range of noise may be evaluated by the use of suitably designed electronic filters and specified wiper load in conjunction with a

Designed  
for  
Advanced  
Data Systems ...



The  Series 400  
TELCOM Receiver

Look at these features ...

- All solid state design
- Superior performance
- Completely modular, plug-in construction
- RF heads for VHF and S-Band telemetry, sweep tuned and wide band heads for surveillance applications
- Plug-in pre-detection recording converter, spectrum display, electrically switchable IF Filters

Interested? Get the detailed specifications. Write for your free copy of the DCS Series 400 TELCOM Receiver brochure.

Would you like an appointment to see a TELCOM Receiver for yourself? Just call the DCS office below nearest you ...

Dept. ED7-6, East Liberty Street, Danbury, Conn. 06813  
Telephone: 203-743-9241 • TWX 744-1990



**DATA-CONTROL SYSTEMS INC.**  
*Instrumentation for Research*

Sales Offices  
Silver Spring, Md., Huntsville, Winter Park, Long Beach, Santa Clara,  
Albuquerque  
Copenhagen London Rome Paris Munich Amsterdam

strip-chart recorder. In the window method, the slope of the output characteristic is analyzed by observing the voltage difference at the beginning and the end of a very small shaft movement.

**Application intended**—For wirewound potentiometers the most common total noise level is 100  $\Omega$ . If commercial applications or products are under consideration, the noise level is typically relaxed to values such as 200 or 500  $\Omega$ . For adjustment potentiometers, 500  $\Omega$  is considered a typical specification, and for precision potentiometers 200  $\Omega$  is more common.

**Wiper position**—It is sometimes important to determine the wiper position at the time of calibration. If the total potentiometer resistance is included in the calibration, a difference in the final accurate measurement can result. For example, if the resistance is one megohm and the input impedance 10 M $\Omega$ , 10:1, or 10%, error is introduced into the final measurement. To insure proper detection of noise the system should be calibrated with the wiper at the point of maximum noise. The important idea is to realize that a basic calibration error does exist and take it into account.

**System bandwidth**—The frequency response for wirewound potentiometers is dc to 50 kHz and 100 Hz to 50 kHz for non-wirewound units. The oscilloscope is useful in diagnosing noise causes and in determining the total noise level, but high-frequency noise may not be detected. A better method in this case would be a go-no-go arrangement. Here, a thyatron or SCR is triggered to detect a specified level of noise, regardless of frequency (see Fig. 2.). This approach is also used in testing of large quantities of units.

**Input impedance** of test circuit—The input impedance of the measuring equipment should be at least 10 times the total resistance of the potentiometer under test. The obvious reason for this condition is to prevent loading the noise signal, which would result in errors of measurement.

To give a true picture of noise performance over the frequency range, the input impedance must also be maintained constant throughout the frequency band. Therefore careful design or selection of test equipment is necessary. The wiring and interconnections must not influence the input impedance and subsequently change the frequency response characteristics. This problem is especially critical with high-resistance potentiometers.

**Cycle rate**—The established cycling rate for adjustment potentiometers is typically between one cycle every five seconds and one cycle every two minutes. For precision potentiometers, the rate is  $4 \pm 1$  rpm. These rates fulfill most application requirements.

In properly designed potentiometers noise should not increase appreciably with cycling rates until a critical speed is attained in wiper bounce or until the inertia of cycling reversal causes the wiper to leave the element. With the increase of noise frequency at faster cycling rates, a potentiometer may appear to perform better, because higher-frequency noise is not as easy to see. ■ ■

# ELECTRONIC DESIGN

## semiannual index of articles

January-June, 1966

### Careers and Management

Committee meetings waste time  
.....C&M p. 66 ED 5

EE societies: Are they doing enough?  
.....SR p. U86 ED 6

How does your company rate?  
.....C&M p. 68 ED 2

Tackle those tough decisions  
.....C&M p. 76 ED 10

Try designing your career  
.....C&M p. 70 ED 3

Work hard to get less done!  
.....C&M p. 70 ED 13

### Circuits and Mathematical Analysis

Alarm circuit replaces large nonpolar tantalum capacitor IFD p. 86 ED 2

Amplifier has 85% efficiency ....  
.....ART p. 38 ED 5

Avalanche circuit produces ultra fast light pulses .....IFD p. 102 ED 15

Bipolar current source simplifies triangle generator .....  
.....IFD p. 130 ED 1

Blueprint for rapid design of high-voltage vhf stages IFD p. 134 ED 1

Bootstrap action yields high  $Z_{in}$  wide-

band amplifier ...IFD p. 93 ED 10

Carpet plotting is easy.....  
.....ART p. 226 ED 6

Cascade circuit arrangement generates sequential pulses.....  
.....IFD p. 82 ED 2

Cell and LC network form frequency selective photo relay.....  
.....IFD p. 84 ED 13

Circuit converts generator into monopulser unit .....IFD p. 92 ED 10

Circuit provides constant gain and variable dc offset ..IFD p. 80 ED 5

Circuit uses few components for sine-wave frequency doubling .....  
.....IFD p. 86 ED 7

Combine reverse age and diodes .....  
.....DD p. 72 ED 10

Complementary monostable circuit has low-standby current drain ....  
.....IFD p. 88 ED 4

Current-mode detector is inexpensive and precise .....IFD p. 89 ED 4

Dc-coupled flip-flop acts as Schmitt trigger .....IFD p. 244 ED 6

Design high-frequency amplifiers graphically .....ART p. 48 ED 8

Difference amplifier forms short-cir-

cuit detector .....IFD p. 84 ED 3

Diode-resistor network simplifies linear triangle wave generator .....  
.....IFD p. 84 ED 7

Diodes ensure start of astable multivibrator .....IFD p. 60 ED 14

Dual 2-input gate forms free-running clock .....IFD p. 90 ED 4

Fast, free-running pulses generated by tunnel diode ...IFD p. 88 ED 2

FET audio signal mixer exhibits linearity, isolation ...IFD p. 242 ED 6

FET-bipolar oscillator features notch network .....IFD p. 102 ED 15

FET circuit measures low-level, sub-audio signals .....IFD p. 82 ED 7

FET for ac amplifiers .....  
.....NASA p. 79 ED 13

FET impedance converter used in sample-and-hold circuits .....  
.....IFD p. 86 ED 7

FET replaces vacuum tube in 1.0-MHz Miller oscillator ...IFD p. 81 ED 5

FET to replace bulky transformer .....  
.....NASA p. 116 ED 15

Flip-flop reset circuit requires no diodes .....IFD p. 66 ED 11

Four-layer diodes form 'first one

### Subject listing

Careers and Management

Circuits and Mathematical Analysis

Communications

Components

Computers, Data Processing and Auxiliary Devices

Consumer Electronics

Controls, Automatic

Editorials

Measurements, Instruments and Test Equipment

Medical Electronics

Microelectronics

Microwaves

Missiles and Space

Packaging

Power Sources

Production Processes and Cooling

Reliability

Research and Development

Semiconductors and Solid-State Devices

Telemetry

### Department keys

AN	Application Note
ART	Article
C & M	Careers and Management
DD	Design Decision
EDIT	Editorial
ENG DATA	Engineering Data
IFD	Ideas for Design
NASA	NASA Tech Brief
PF	Product Feature
SR	Special Report

there' circuit .....IFD p. 80 ED 5  
 Gain insight into FET amplifiers  
 .....ART p. 40 ED 14  
 High-speed limiter is efficient .....  
 .....NASA p. 94 ED 7  
 Independent astable multi uses adjust-  
 able current sources.....  
 .....IFD p. 100 ED 4  
 Inexpensive null detector is sensitive  
 and accurate .....IFD p. 86 ED 8  
 Logic-circuit multi yields precise  
 pulse-delay periods IFD p. 98 ED 4  
 Low-frequency astable circuit uses  
 three inexpensive relays.....  
 .....IFD p. 66 ED 11  
 Modified monostable flip-flop has im-  
 proved duty cycle ..IFD p. 81 ED 3  
 MOS-FET circuit stores input voltage  
 peaks as dc .....IFD p. 76 ED 3  
 NAND gates form tri-stable flip-flop  
 .....IFD p. 64 ED 11  
 Need a pedestal-free gate? .....  
 .....ART p. 58 ED 8  
 Neon lamp arrangement forms 60-Hz  
 divider .....IFD p. 76 ED 3  
 New time-voltage integrator has in-  
 finite recall .... PF p. U132 ED 6  
 Nonlinear design yields linearity  
 .....DD p. 76 ED 15  
 Nuvistor and bipolars form low-noise  
 preamplifier ....IFD p. 108 ED 15  
 OR gates and RC timing control UJT  
 pulse rate .....IFD p. 84 ED 8  
 Oscillator-multivibrator combo forms  
 super-regenerative detector .....  
 .....IFD p. 87 ED 10  
 Peak-following amplifier provides two  
 outputs .....IFD p. 102 ED 4  
 Predict common-emitter performance  
 .....ART p. 52 ED 10  
 Push-button monopulse unit shows  
 clean, ring-free output.....  
 .....IFD p. 88 ED 8  
 Remote-control time delay needs no  
 turn-off signal ...IFD p. 108 ED 15  
 Sample-hold amplifier recalls analog  
 input for hours .....PF p. 98 ED 5  
 Sawtooth frequency range extended  
 by extra transistor IFD p. 83 ED 7  
 SCR plus zener extend one-shot's time  
 delay .....IFD p. 242 ED 6  
 SCR-UJT circuit gives economical  
 time delay .....IFD p. 90 ED 8  
 SCS and UJT form count generator  
 .....IFD p. 82 ED 13  
 Simple oscillator for high power .....  
 .....NASA p. 70 ED 5

Simple transition detector has unipolar  
 outputs .....IFD p. 88 ED 10  
 Simplify dc amplifier design .....  
 .....AN p. 64 ED 3  
 Slide-rule procedure directly yields  
 equivalent resistances .....  
 .....IFD p. 98 ED 4  
 Small-signal amplifier performance  
 .....ART p. 111 ED 1  
 Swamp out distortion in wide-range  
 age systems .....DD p. 72 ED 8  
 Switch-bridge provides versatile load  
 control .....IFD p. 90 ED 10  
 System conditions cells selectively ...  
 .....NEWS p. 24 ED 15  
 Take the fog out of field-effect design  
 .....ART p. 38 ED 13  
 TD improves monostable circuit ....  
 .....NASA p. 72 ED 5  
 Three-stage pulse limiter has short  
 recovery time ...IFD p. 86 ED 13  
 Time-shared readout uses standard  
 logic blocks .....IFD p. 82 ED 7  
 Transistor bridge circuit monitors two  
 voltage sources ..IFD p. 78 ED 3  
 Transmission-gate circuit processes  
 video signals ....IFD p. 128 ED 1  
 Treat the flip-flop logically .....  
 .....ART p. 48 ED 2  
 Tristable multivibrator forms 3-phase  
 generator .....IFD p. 84 ED 2  
 Tunnel diode and transistor form linear  
 monopolar gate .IFD p. 86 ED 8  
 Tunnel-diode generator calibrates fre-  
 quency counter ...IFD p. 63 ED 14  
 UJT, flip-flop form stable, 20-second  
 one-shot .....IFD p. 86 ED 3  
 UJT pulse generator makes bistable  
 multi more versatile IFD p. 246 ED 6  
 Vacuum photo-diode constitutes simple,  
 accurate current source  
 .....IFD p. 60 ED 14  
 Variable pulse limiter uses few compo-  
 nents .....IFD p. 94 ED 10  
 Variable-speed photochopper gener-  
 ates teletype signals IFD p. 246 ED 6  
 Voltage comparator is also sensor  
 .....NASA p. 241 ED 6  
 Voltage, current transients suppressed  
 by relay .....IFD p. 88 ED 13  
 Widen multivibrator ranges .....  
 .....ART p. 66 ED 10

## Communications

Dual MOS-FET simplifies FM multi-  
 plex decoder .....IFD p. 78 ED 5  
 Estimate the solar noise.....  
 .....ART p. 56 ED 7  
 Find the received signal level  
 .....ART p. 84 ED 4  
 New system transmits documents by  
 telephone .....NEWS p. 32 ED 13  
 Pick a delay equalizer.....  
 .....ART p. 62 ED 13  
 Receiving unwanted signals? .....  
 .....ART p. 50 ED 4  
 Replace expensive coils with pulse  
 transformers in phase-lock detectors  
 .....ART p. 82 ED 15  
 Showdown near on airborne phone  
 system .....NEWS p. 17 ED 3  
 Telephone system uses time-sharing  
 .....NEWS p. 22 ED 14  
 Two-stage network provides 60-dB  
 age .....IFD p. 84 ED 7

## Components

Chopper-stabilized amp has superior  
 price/specs ratio ..PF p. 84 ED 5  
 Cryogenic dc transformer .....  
 .....NEWS p. 24 ED 4

Differential op-amp has Schmitt trig-  
 ger applications ...PF p. 124 ED 4  
 Guide to crystal selection.....  
 .....ART p. 48 ED 11  
 New panel-meter mounts with nothing  
 behind the panel but terminals  
 .....PF p. 108 ED 7  
 Paris electronics show dominated by  
 ICs .....NEWS p. 17 ED 5  
 Silent stepping relay? .....  
 .....ART p. 60 ED 11  
 Solar cells charge operational am-  
 plifier .....PF p. 88 ED 11  
 Stepless control with a \$1 Triac  
 .....PF p. 116 ED 8  
 Testing coaxial cables.....  
 .....ART p. 62 ED 4  
 Try capacitance transducers .....  
 .....ART p. 188 ED 6  
 Varactor bridge op-amp provides pico-  
 level performance PF p. 140 ED 15  
 Will a switch fail? ART p. 58 ED 10

## Computers, Data Processing and Auxiliary Devices

A/D converter goes adaptive .....  
 .....ART p. 78 ED 4  
 Analog desk-top computer designed  
 for economy .....PF p. 106 ED 2  
 Cascade circuit arrangement gener-  
 ates sequential pulses.....  
 .....IFD p. 82 ED 2  
 Circuit protects memory against pow-  
 er interruptions ..IFD p. 84 ED 13  
 Complement of exclusive-OR .....  
 .....ART p. 48 ED 3  
 Computers aid circuit design  
 .....SR p. 96 ED 1  
 Computers control Sky Bus  
 .....NEWS p. 40 ED 6  
 Computer speaks with "optical voice"  
 .....NEWS p. 47 ED 15  
 Computer wires chip with discretion  
 .....NEWS p. 32 ED 6  
 Data system has automatic error de-  
 tection.....NEWS p. 32 ED 6  
 Dial a computer for design informa-  
 tion at NAA ...NEWS p. 26 ED 2  
 Fast, free-running pulses generated  
 by tunnel diode ...IFD p. 88 ED 2  
 Forty-eight column high-speed al-  
 phanumeric printer PF p. 122 ED 3  
 Miniature 14-bit A/D converter gives  
 2 microseconds per bit .....  
 .....PF p. 110 ED 4  
 Modified monostable flip-flop has im-  
 proved duty cycle ..IFD p. 81 ED 3  
 Neurons generate parity.....  
 .....ART p. 70 ED 15  
 One-bit comparator uses FETs  
 .....ART p. 58 ED 13  
 Simplify NAND-circuit synthesis  
 .....ART p. 203 ED 6  
 Tristable multivibrator forms 3-phase  
 generator .....IFD p. 84 ED 2  
 UJT, flip-flop form stable, 20-second  
 one-shot .....IFD p. 86 ED 3  
 Unique laboratory customizes comput-  
 er systems ...NEWS p. 26 ED 11

## Consumer Electronics

Bat-like detectors to direct traffic  
 .....NEWS p. 32 ED 15  
 CdS photocells smooth electronic-or-  
 gan transients ...IFD p. 84 ED 13  
 Coin operates SCR-type electronic dis-  
 penser .....IFD p. 90 ED 2  
 Computer speaks with "optical voice"  
 .....NEWS p. 47 ED 15  
 Deflection amplifier shows high

## Department keys

AN	Application Note
ART	Article
C & M	Careers and Management
DD	Design Decision
EDIT	Editorial
ENG DATA	Engineering Data
IFD	Ideas for Design
NASA	NASA Tech Brief
PF	Product Feature
SR	Special Report

efficiency, linearity IFD p. 88 ED 10  
 Electric cars .....SR p. 17 ED 13  
 Electronic eavesdropping devices ...  
 .....SR p. 34 ED 15  
 Electronic pop-op art pops on the scene  
 .....NEWS p. 42 ED 1  
 Electronics at the Boat Show  
 .....NEWS, p. 34 ED 4  
 Electronic typesetting combines com-  
 puter and TV techniques .....  
 .....NEWS p. 24 ED 15  
 Focus '66: \$18 billion for electronics  
 .....NEWS p. 17 ED 1  
 New FETs replace tubes .....  
 .....ART p. 196 ED 6  
 Phono cartridge uses strain gauge ..  
 .....NEWS p. 26 ED 11  
 3-D television is still a long way off  
 .....NEWS p. 28 ED 11  
 Transmission-gate circuit processes  
 video signals .....IFD p. 128 ED 1

### Controls, Automatic

Alarm circuit replaces large nonpolar  
 tantalum capacitor IFD p. 86 ED 2  
 Coin operates SCR-type electronic dis-  
 penser .....IFD p. 90 ED 2  
 Cure force-transducer inaccuracies  
 .....DD p. 98 ED 15  
 Device-hunting for motor speed con-  
 trol? .....ART p. 38 ED 11  
 Difference amplifier forms short-cir-  
 cuit detector .....IFD p. 84 ED 3  
 Differentiator noise is no problem  
 .....ART p. 92 ED 15  
 Full speed ahead for high-speed trains  
 .....NEWS p. 22 ED 6  
 Heat detector uses fiber optics ....  
 .....DD p. 66 ED 2  
 Keep sampled-data systems accurate  
 .....ART p. 54 ED 13  
 Neon lamp arrangement forms 60-Hz  
 divider .....IFD p. 76 ED 3  
 SCRs control truck motors .....  
 .....NEWS p. 26 ED 1  
 Shunt-motor speed control .....  
 .....ART p. 56 ED 2  
 Simplify dc amplifier design .....  
 .....AN p. 64 ED 3  
 Speed control-system response .....  
 .....ART p. 68 ED 8

### Editorials

Craftsmanship is the mark of the  
 professional engineer.....  
 .....EDIT p. 41 ED 10  
 Dispersal—one answer to civil defense  
 .....EDIT p. 47 ED 4  
 Engineers are too often silent on ma-  
 jor social issues ..EDIT p. 43 ED 8  
 Here are some winners ... And here  
 are some losers ..EDIT p. 29 ED 7  
 Is electronics doing enough for puz-  
 zled astronomers.....  
 .....EDIT p. 35 ED 5  
 It's the engineer's job to bring order  
 out of chaos ....EDIT p. 63 ED 6  
 Making the proper first impression  
 .....EDIT p. 35 ED 11  
 Need better calibrations? Then, speak  
 out! .....EDIT p. 35 ED 13  
 The year to do yourself a favor  
 .....EDIT p. 39 ED 2  
 Training for tomorrow's jobs must be-  
 gin today .....EDIT p. 67 ED 15  
 "True democracy" will be based on  
 electronic voting" EDIT p. 63 ED 1  
 We're indebted to you.....  
 .....EDIT p. 41 ED 3  
 What's happening in computer-aided

design? .....EDIT p. 31 ED 14

### Measurements, Instruments and Test Equipment

Build a tone-burst generator .....  
 .....DD p. 104 ED 4  
 Buying a spectrum analyzer? .....  
 .....ART p. 218 ED 6  
 Crystal and recovery diode used in RF  
 calibration .....IFD p. 104 ED 15  
 Curve-tracer test jig matches diodes  
 quickly .....IFD p. 252 ED 6  
 Difference amplifier forms short-cir-  
 cuit detector .....IFD p. 84 ED 3  
 Equipment for blind engineers  
 .....NEWS p. 52 ED 6  
 Heat-aging detects transistor failure  
 .....NEWS p. 20 ED 15  
 Industry standards picture confused  
 .....NEWS p. 17 ED 11  
 Iron mightier than pen for polaroid  
 data marking .....IFD p. 78 ED 3  
 Low-power precision calibrator gives  
 rms, peak and dc .PF p. 101 ED 7  
 Memory tester uses 5-MHz IC logic  
 .....PF p. 98 ED 10  
 Null-detector digital voltmeter adjusts  
 itself .....PF p. 92 ED 5  
 Phase-shift oscillator measures induct-  
 ance precisely ....IFD p. 106 ED 15  
 Photomicrography is a powerful tool  
 .....ART p. 59 ED 7  
 Preprogramed transistor classification  
 system .....PF p. 112 ED 13  
 Show off your display system  
 .....ART p. 46 ED 5  
 Small-capacitor measurements .....  
 .....ART p. 52 ED 3  
 Testing coaxial cables .....  
 .....ART p. 62 ED 4  
 Transistor bridge circuit monitors two  
 voltage sources ...IFD p. 78 ED 3  
 True rms differential voltmeter gives  
 0.05% accuracy, digital read-out  
 .....PF p. 98 ED 7  
 Twenty-five-MHz oscilloscope with  
 zero dc drift .....PF p. 90 ED 3  
 Two-channel function generator gives  
 sines and cosines .PF p. U168 ED 6  
 Use magnetic deflection to iron out  
 problems in display systems  
 .....ART p. 210 ED 6  
 Variable resistor for precision uses  
 .....PF p. 104 ED 8  
 Voltage and phase-angle measure-  
 ments, 1 MHz-1 GHz .....  
 .....PF p. 120 ED 4  
 Volt/ratiometer features accuracy  
 and stability .....PF p. 78 ED 11  
 Wideband true rms/dc converter covers  
 20 Hz-100 kHz ...PF p. U142 ED 6

### Medical Electronics

Avoid over-integration .....

.....ART p. 56 ED 3  
 Chips falling the right way  
 .....SR p. 85 ED 1  
 Crowbar circuit protects expensive IC  
 components .....IFD p. 89 ED 10  
 D/A converter uses thin-films .....  
 .....ART p. 48 ED 14  
 Design a transformerless chopper  
 .....ART p. 54 ED 11  
 Dual MOSs handle microvolt sampling  
 .....PF p. 146 ED 1  
 Flat-pack carrier speeds production  
 .....PF p. 114 ED 3  
 Half-a-meg resistance on a chip  
 .....PF p. 96 ED 5  
 IC breadboard allows bench assembly  
 with the drop of a dot .....  
 .....PF p. 66 ED 14  
 ICs for bounceless push-button  
 switching .....IFD p. 62 ED 14  
 It's what's up front that counts  
 .....ART p. 40 ED 7  
 Lack of inductors blocks microwave  
 ICs .....NEWS p. 21 ED 15  
 Logic family features very low power  
 dissipation .....PF p. 104 ED 7  
 LSI highlighted at solid-state confer-  
 ence .....NEWS p. 17 ED 6  
 Microwave ICs are on the horizon  
 .....NEWS p. 34 ED 1  
 More and more on a chip  
 .....NEWS p. 4 ED 7  
 MOS arrays diffuse into commercial  
 market .....NEWS p. 22 ED 2  
 Need a small power inverter? ....  
 .....ART p. 62 ED 10  
 Output circuit increases noise immuni-  
 ty of ICs .....IFD p. 66 ED 11  
 Paris electronics show dominated by  
 ICs .....NEWS p. 17 ED 5  
 Photomicrography is a powerful tool  
 .....ART p. 59 ED 7  
 Planning to use MOS arrays? .....  
 .....ART p. 42 ED 2  
 Put a computer on a chip? .....  
 .....SR p. 90 ED 1  
 Saw cuts IC wafers without touching  
 .....NEWS p. 26 ED 11  
 Thick or thin films: panel debates pros  
 and cons .....NEWS p. 24 ED 13  
 Try IC gate-ring counters! .....  
 .....ART p. 56 ED 4  
 Use an IC counter next time!  
 .....ART p. 62 ED 8  
 Why use IC gate ring counters? ..  
 .....ART p. 52 ED 5  
 Wire modules fast with sticks and  
 stacks .....NEWS p. 21 ED 8

### Microwaves

ABC of dummy loads.....  
 .....ART p. 60 ED 5  
 Antenna-beam offset improves radar  
 resolution .....IFD p. 92 ED 10  
 Coupling-irises arrangement solves  
 microwave filter need IFD p. 84 ED 8  
 Cut radar hardware needs and costs  
 .....DD p. 76 ED 8  
 Design efficient multipliers .....  
 .....ART p. 44 ED 3  
 Diamond dies are cut by ruby laser  
 .....NEWS p. 21 ED 2  
 Fewer dramatics, more uses for lasers  
 .....NEWS p. 21 ED 11  
 Germanium planar transistor outdoes  
 TWTs .....PF p. 88 ED 5  
 Good diode phase-shifter .....  
 .....ART p. 46 ED 13  
 Gunn-effect devices invade millimeter  
 bands .....NEWS p. 28 ED 8  
 Lack of inductors blocks microwave  
 ICs .....NEWS p. 21 ED 15

Microwave ICs are on the horizon  
 .....NEWS p. 34 ED 1  
 Microwave parley sees room for IC  
 growth .....NEWS p. 21 ED 15  
 Microwave power race subsiding  
 .....NEWS p. 23 ED 10  
 Microwaves study rocket plumes  
 .....NEWS p. 24 ED 14  
 Millimeter wave switch operates in 2.5  
 ms .....PF p. 96 ED 2  
 Modular microwave source covers 0.25  
 to 40 GHz .....PF p. 106 ED 10  
 Pace of Gunn-effect research quickens  
 .....NEWS p. 17 ED 2  
 Parametric amplifier .....  
 .....NEWS p. 28 ED 4  
 Simple optical radar fires like a spark  
 plug .....NEWS p. 26 ED 13  
 Solid-state invades microwaves  
 .....SR p. 67 ED 1  
 Switch high power with diodes  
 .....ART p. 118 ED 1  
 Transmission losses .....  
 .....ENG DATA p. 124 ED 1  
 Use ferrite phase-shifters .....  
 .....ART p. 34 ED 14

### Missiles and Space

ACME flaw spotter to check big radio  
 dishes .....NEWS p. 35 ED 6  
 ESSA: technical and meteorological  
 success .....NEWS p. 17 ED 10  
 First the Moon, then Mars .....  
 .....SR p. 72 ED 1  
 Jet engines power satellite ground  
 station .....NEWS p. 28 ED 11  
 Navy elevates deep-submergence pro-  
 gram .....NEWS p. 21 ED 3  
 Plotting the ocean's profile .....  
 .....SR p. 80 ED 1  
 Radio controlled parachutes .....  
 .....NEWS p. 46 ED 6  
 Reaching for the Moon . . . and be-  
 yond .....SR p. 30 ED 7  
 Solutions sought for deep-space link  
 problems .....NEWS p. 21 ED 5  
 Spacecraft designers plan for un-  
 manned exploration of Mars .....  
 .....NEWS p. 26 ED 15  
 Undersea atom power: wave of the fu-  
 ture .....NEWS p. 20 ED 7

### Packaging

Molded spacer protects transistors  
 .....NASA p. 100 ED 8  
 Mount improves transducer accuracy  
 .....NASA p. 58 ED 14  
 Package electronic modules with  
 shrinkable tubing .IFD p. 68 ED 11  
 Simple splash-proof guard protects  
 printed circuits .IFD p. 94 ED 4  
 Sleeve for RF cables bridges shielding  
 gap .....NASA p. 74 ED 11

### Power sources

Are you up on power supplies? . . .  
 .....NEWS p. 26 ED 8  
 Current transformer protects regulator  
 against overloads .IFD p. 104 ED 15  
 Do you know when to consider a cus-  
 tom power supply? ART p. 20 ED 9  
 Heat-pipes to convert thermal energy  
 into electricity .NEWS p. 18 ED 15  
 Lithium batteries promise high yields  
 .....NEWS p. 28 ED 3  
 Low-voltage supply replaces small  
 batteries .....IFD p. 64 ED 11  
 New trends are emerging in power  
 supply design .ART p. 24 ED 9  
 Programable power supply regulates  
 1  $\mu$ A .....PF p. U158 ED 6  
 Seventy watthours per pound from

regenerative fuel cell .....  
 .....NASA p. 73 ED 11  
 Thermocouple power source guaran-  
 tees safe control device .....  
 .....IFD p. 88 ED 7  
 Use a systematic approach to buying  
 a power supply .ART p. 14 ED 9

### Production Processes and Cooling

ACME flaw spotter to check big radio  
 dishes .....NEWS p. 35 ED 6  
 Computer wires chip with discretion  
 .....NEWS p. 32 ED 6  
 Laser holography may bring major  
 wafer-making breakthrough .....  
 .....NEWS p. 17 ED 15

### Reliability

Guarantee circuit performance! . . .  
 .....ART p. 70 ED 4  
 National role for reliability  
 .....NEWS p. 22 ED 4

### Research and Development

Ceramic laser tube .NEWS p. 38 ED 1  
 Cheap tools for budding physicists  
 .....NEWS p. 26 ED 5  
 Electro-optical reader automatically  
 sorts P.O. letters .NEWS p. 30 ED 1  
 Flame amplifies sonic energy .....  
 .....NEWS p. 50 ED 1  
 Giant pulse lasers emit high-intensity  
 beams .....NEWS p. 20 ED 8  
 Infrared aimed laser radar prototyped  
 for Army .....NEWS p. 50 ED 1  
 Plastic fiber optics NEWS p. 23 ED 15  
 Plotting the ocean's profile .....  
 .....SR p. 80 ED 1  
 Sensor detects eyeball movements  
 .....NASA p. 77 ED 5  
 Spacecraft designers look ahead to  
 Mars .....NEWS p. 26 ED 15  
 Speech compressor adapted to "speed-  
 hearing" for the blind .....  
 .....NEWS p. 27 ED 2  
 Superconductive atom smasher at SRI  
 .....NEWS p. 38 ED 1

### Semiconductors and Solid-State Devices

Amplifier has 85% efficiency .....  
 .....ART p. 38 ED 5  
 Batch diodes apply beam-lead method  
 .....NEWS p. 26 ED 3  
 Chips falling the right way  
 .....SR p. 85 ED 1  
 Choosing ICs needn't be a chore  
 .....ART p. 170 ED 12  
 Combine reverse agc with diodes  
 .....DD p. 72 ED 10  
 Design efficient multipliers .....  
 .....ART p. 44 ED 3  
 Device-hunting for motor speed con-  
 trol? .....ART p. 38 ED 11  
 Electroacoustic amplifiers about to  
 leave laboratory? NEWS p. 17 ED 8  
 FET operating at uhf? .....  
 .....ART p. 48 ED 7  
 For the how, why and where of FET  
 usage, consult parameters .....  
 .....ART p. 94 ED 12  
 Forward with backward diodes  
 .....ART p. 44 ED 10  
 Germanium FET goes plastic, bears  
 \$1 price tag .....PF p. 120 ED 15  
 Germanium planar transistor outdoes  
 TWTs .....PF p. 88 ED 5  
 Guarantee circuit performance! . . .  
 .....ART p. 70 ED 4  
 Gunn-effect devices invade millimeter

### Department keys

AN	Application Note
ART	Article
C & M	Careers and Management
DD	Design Decision
EDIT	Editorial
ENG DATA	Engineering Data
IFD	Ideas for Design
NASA	NASA Tech Brief
PF	Product Feature
SR	Special Report

bands .....NEWS p. 28 ED 8  
 Hot-carrier diode opens new vistas  
 .....ART p. 178 ED 6  
 In choosing diodes, don't settle for  
 second-best .ART p. 156 ED 12  
 Inexpensive transistor functions as  
 low-TC reference diode .....  
 .....IFD p. 100 ED 4  
 Junction-switching FET has 30-ohm  
 on-resistance .....PF p. 144 ED 1  
 Large-signal FET amplifiers? .....  
 .....ART p. 102 ED 1  
 Low-cost 5-watt laser diode.....  
 .....PF p. 94 ED 13  
 LSI highlighted at solid-state confer-  
 ence .....NEWS p. 17 ED 6  
 New FETs replace tubes.....  
 .....ART p. 196 ED 6  
 New process boosts gallium arsenide  
 devices .....NEWS p. 21 ED 14  
 Novelty abounds at solid-state confer-  
 ence .....NEWS p. 17 ED 4  
 Parameters key applications, govern  
 transistor selection.....  
 .....ART p. 10 ED 12  
 Photodiode and transistor read cards  
 and tape .....PF p. 114 ED 2  
 Plastic UJT in planar form has low  
 leakage .....PF p. U110 ED 6  
 Power FETs headed for wide expan-  
 sion .....NEWS p. 17 ED 7  
 Predict common-emitter performance  
 .....ART p. 52 ED 10  
 SCRs control ac truck motors  
 .....NEWS p. 26 ED 1  
 Selecting thyristors to fill a control  
 need .....ART p. 144 ED 12  
 Shunt-motor speed control .....  
 .....ART p. 56 ED 2  
 Simplify dc amplifier design .....  
 .....AN p. 64 ED 3  
 Simplify low-frequency FET designs  
 .....ART p. 86 ED 15  
 Stepless control with a \$1 Triac  
 .....PF p. 116 ED 8  
 Treat the flip-flop logically  
 .....ART p. 48 ED 2  
 Two-hundred MW at 2 GHz from this  
 microwave oscillator.....  
 .....PF p. 114 ED 4  
 Use the UJT that does the job best  
 .....ART p. 114 ED 12

### Telemetry

Analog-to-frequency converter has  
 improved linearity, range .....  
 .....IFD p. 248 ED 6  
 Test system uses telemetry data  
 .....DD p. 80 ED 8



# AUTOMATIC OPERATION

for your Tektronix Type 561A or 564 oscilloscope — with Type 3A5/3B5 plug-ins

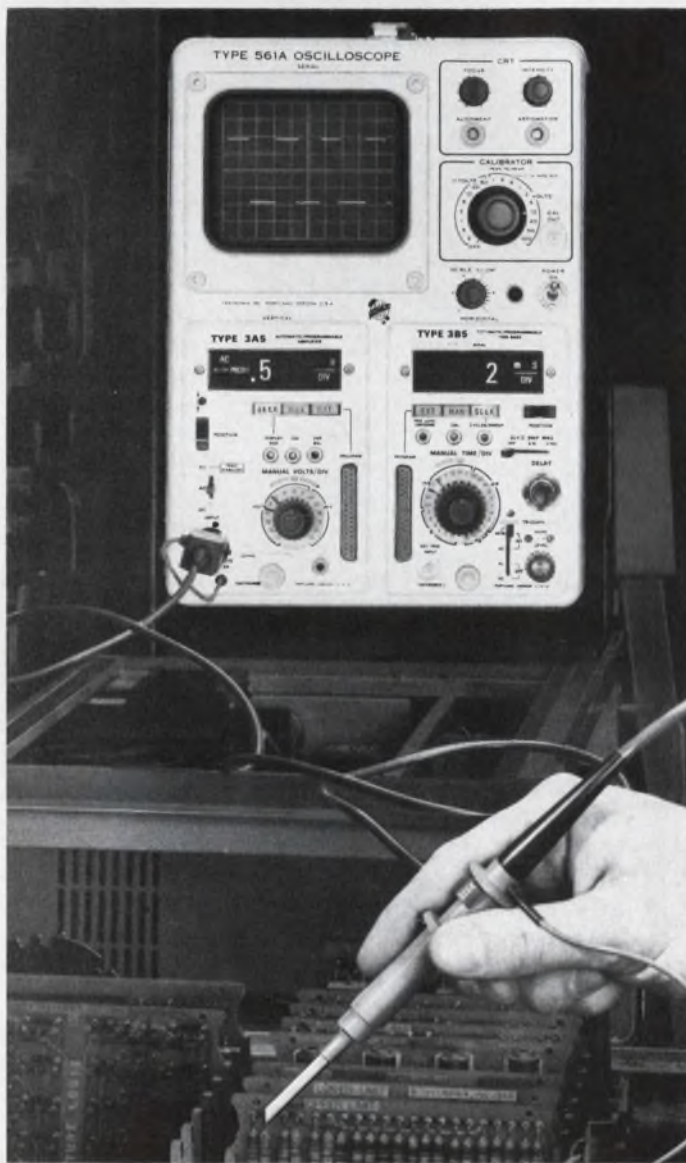

Now, with two Tektronix automatic/programmable plug-ins—a Type 3A5, with included P6030 Probe, and a Type 3B5—you can make DC-to-15 MHz measurements with new ease, and in any of these modes of operation:

## AUTOMATIC SEEKING

In this mode, upon SEEK command from the probe or the plug-ins, the oscilloscope automatically presents an optimum display. The SEEK command to the plug-in units automatically controls the triggering settings and the time and amplitude settings, eliminating the need for continuous front-panel adjustments. Indicators on the plug-ins light automatically to show the time and amplitude settings. Measurements can then be made quickly and accurately from the CRT display. In AUTOMATIC SEEKING mode, the deflection factor is 10 mV/div to 50 V/div and sweep range is 5 s/div to 0.1  $\mu$ s/div.

### when plug-ins receive SEEK command

**Type 3A5** automatically establishes the optimum deflection factor. Indicators light to show readout with input coupling, such as .5 V/DIV, DC (coupled) WITH PROBE. (Coupling can also be DC or AC Trace Stabilized.)

**Type 3B5** automatically establishes optimum trigger settings and automatically selects time per division setting. Indicators light to show readout, such as .2  $\mu$ s/DIV, and to show NOT TRIG'D condition. (IF X10 or X100 Magnifier operative, readout is automatically corrected and indicates SWP MAG'D condition.)

## REMOTE PROGRAMMING

overrides the SEEK command and Manual Operation. In this mode, both plug-ins can be programmed using the Type 263 Programmer, which accepts up to 6 plug-in type program cards. Each program card, after initial set-up, establishes the plug-in control functions required for a particular test or measurement . . . with actual measurements made conveniently from the CRT display, as usual. Automatic/Programmable Plug-Ins provide selection of eleven different programmable functions. Any number of programmers can be cascaded for applications requiring pushbutton control of more than six measurement set-ups. In REMOTE PROGRAMMING mode, the deflection factor is 10 mV/div to 50 V/div and sweep range is 5 s/div to 10 ns/div.

## MANUAL OPERATION

In this mode, both plug-ins are controlled conventionally. Indicators on the plug-ins show the time and amplitude settings. In MANUAL OPERATION mode, deflection factor is 1 mV/div to 50 V/div (5 MHz bandwidth at 1, 2 or 5 mV/div and 15 MHz at 10 mV/div to 50V/div) and sweep range is 5 s/div to 10 ns/div.

Type 3A5 Automatic/Programmable Amplifier Unit . . . . .	\$760
Type 3B5 Automatic/Programmable Time-Base Unit . . . . .	\$890
Type 263 Programmer (complete with 6 program cards) . . . . .	\$325

Oscilloscopes which accept both Automatic/Programmable Plug-Ins:	
Type 561A Oscilloscope . . . . .	\$500
Type RM561A Oscilloscope . . . . .	\$550
Type 564 Storage Oscilloscope . . . . .	\$875
Type RM564 Storage Oscilloscope . . . . .	\$960

U.S. Sales Prices f.o.b. Beaverton, Oregon

**Tektronix, Inc.**



For complete information, contact your nearby Tektronix field engineer or write:  
Tektronix, Inc., P.O. Box 500, Beaverton, Oregon 97005

ON READER-SERVICE CARD CIRCLE 35

# Infinite heat control uses Triac and contacts

The power in a resistive heater load may be controlled by ON-OFF switching at a relatively slow rate. Since the Triac device is immune to the wear, arcing and pitting of ordinary contacts, it is very well suited for this type of control. The use of mechanical contacts to control the gate of the Triac further increases over-all system simplicity and economy.

These control contacts are very small and have extremely long life because of the Triac's high sensitivity. The circuits (see schematics) are arranged so that current through the control contacts drops virtually to zero when the Triac turns ON. If the contacts are closed at the beginning of a half cycle of the supply voltage, current will build up through the contacts, following the sine wave, until the Triac turns ON. The maximum current that can occur under this condition is 50 mA and the maximum time needed to reach this level from the start of each half cycle is 75  $\mu$ s.

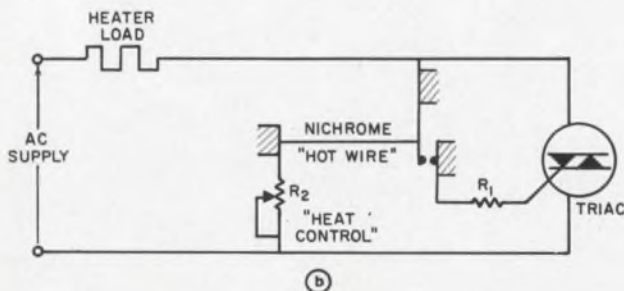
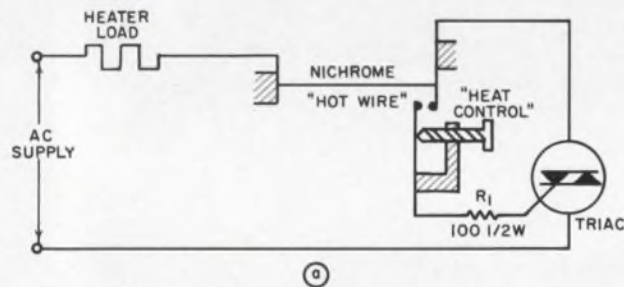

Infinite heat control is provided by a semiconductor (Triac)–mechanical (wire contact) combination. Shown are the series type (a) for controlling average load (heater) power and the shunt type (b) for phase-control functions.

**VOTE!** Circle the Reader-Service-Card number corresponding to what you think is the best Idea-for-Design in this issue.

**SEND US YOUR IDEAS FOR DESIGN.** Submit your IFD describing a new or important circuit or design technique, the clever use of a new component, or a cost-saving design tip to our Ideas-for-Design editor. If your idea is published, you will receive \$20 and become eligible for an additional \$30 (awarded for the best-of-issue Idea) and the grand prize of \$1000 for the Idea of the Year.

These values are based on a 120-volt ac supply and a 100- $\Omega$  current-limiting resistor in the gate.

If the contacts close some time during the cycle, the peak current will be higher than this value (50 mA) and its duration will be less than 20  $\mu$ s, depending on the magnitude of the current. Since the Triac is triggered by a specific amount of charge, the time will be inversely proportional to current in this range. Because the contacts cannot interrupt a current higher than 50 mA and since the line voltage under this condition is invariably low, arcing cannot exist between these contacts.

Figure 1a shows an infinite heat control of the series type. Load current flows through a taut nichrome wire, causing it to expand and open contacts controlling the gate of the Triac. This stops load current and allows the wire to cool, contract, and reclose the contacts. As long as the contacts are closed, the Triac will conduct. When the contacts open, the Triac turns OFF at the next successive current zero. The control of average power applied to the load is mechanically accomplished by adjustment of the fixed contact relative to the movable contact. The thermal characteristics of the hot wire and the relative setting of the two contacts determine the time required to open and close the contacts during the ON and OFF portions of the cycle.

With a shunt-type infinite heat control (Fig. 1b), operation is by voltage appearing across the Triac in the OFF state, rather than by current through the load. Thus, the circuit is not sensitive to the size of the connected load. However, the operation of this control is similar to the series type in that it involves the expansion and contraction of a wire to operate a pair of contacts.

Regulation of load power is accomplished by a variable resistor,  $R_2$ , which controls the rate at which the hot-wire element can be heated during the time the Triac is nonconducting. If  $R_2$  is made very small, or zero, the hot wire will heat very rapidly at the beginning of each half cycle, causing the Triac to turn ON early in each half cycle. If  $R_2$  is made very large, a considerable length of time will be required to heat the wire sufficiently to close the contacts in the gate circuit.

With the shunt-type control, it is desirable to have the power dissipation in  $R_2$  rather low. This requires that the hot-wire element be small and responsive to a relatively low current. The result can be very fast response characteristics, which produce the equivalent of a phase-control func-

tion, particularly at the lower resistance settings of  $R_2$ .

Since both these circuits depend on the temperature of a hot wire, they will also respond to any cooling effects upon this wire, such as the flow of air across it. Air flow across the wire in the series-type unit (Fig. 1a) will increase power applied to the load. Conversely, air flow across the wire in the shunt-type control of Fig. 1b will decrease power to the load. This effect can be quite useful in certain applications, such as a forced-air heating element. There, the use of the series-type control can provide a large reduction in heater power in the event of failure of the fan to deliver the proper amount of air. The shunt-type operation may regulate the flow of air if it is made to control a series motor instead of a heater load.

These hybrid types of controls which use mechanical contacts to actuate semiconductor power switches provide simple, effective, and economical solutions to many control problems.

*E. K. Howell, Applications Engineer, General Electric Co., Auburn, N. Y.*

VOTE FOR 110

## BCD counter uses ICs to minimize component count

Binary-coded-decimal counting with a resultant 8-4-2-1 signal output can be performed using DTL integrated circuits. Just two flip-flop IC packages, one resistor and one capacitor are needed in this minimum-component subsystem.

The circuit (see schematic) uses two dual flip-flops. Flip-flops 1, 2 and 3 act like straight binary counters. Flip-flop 4 is effectively reset for the first 8 counts by the input from flip-flop (FF) 1. On count 8, FF 4 is set by the pulse from FF 3, through  $C_1$ . The pulse at the preset input overrides the reset pulse at the clock input. When FF 4 is set, its  $\bar{Q}$  output inhibits FF 2 from changing state. On count 10, the output from FF 1 resets FF 4 again; FF 2 is enabled, and the circuit is ready for a new count.

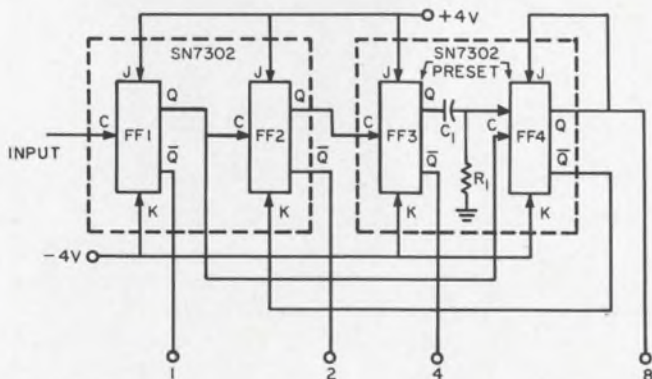

**BCD counter** uses just two ICs and two discrete components to produce an 8-4-2-1 coded output. The RC network provides a set pulse to the last flip-flop, overriding the reset pulse present at the clock input.

The 8-4-2-1 outputs are obtained from  $\bar{Q}$  of FF 1, 2 and 3, and  $Q$  of FF 4. With  $C_1 = 100$  pF and  $R_1 = 1$  k $\Omega$ , the pulse at FF 4 is less than 1 microsecond, but sufficient to set the flip-flop.

*Hans H. Nord, Consultant, Little Falls, N. J.*

VOTE FOR 111

## Curve tracer adapter unit shows FET 'zero-tc point'

A simple resistance chain and switches forming a circuit to be used with a Transistor Curve Tracer\* will produce smooth-line tracings of a FET's drain current vs gate-to-source voltage. The super-imposed photograph of these characteristics at different temperatures enables the user to determine the exact bias point at which the zero temperature coefficient of the FET (junction-type) occurs.

The circuit (Fig. 1) uses the external input to the vertical amplifier of the 575 for a vertical deflection that indicates drain current. The external input is made through pins J and H of the type-175 adapter socket on the rear of the curve tracer. The current-viewing resistors in the source leg of the FET give the required 0.1 V/div input to the vertical amplifier and produce the current calibration indicated parenthetically.

Gate drive and horizontal deflection are obtained by use of the collector sweep voltage of the 575; positive for p-channel devices and negative for n-channel units. If the scope ground is placed at the source lead of the FET, the horizontal deflection drive becomes the gate-to-source voltage.

\*Tektronix 575 unit

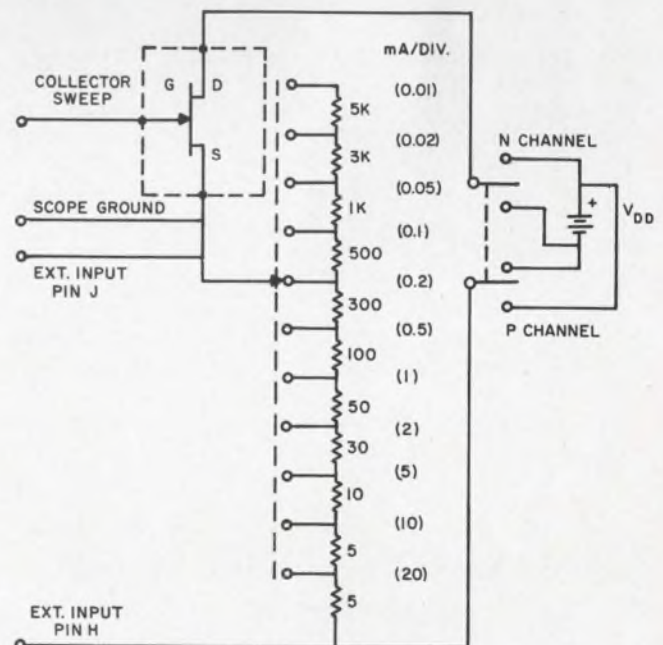

**1. Curve-Tracer adapter circuit** consisting of resistors and switches enables  $I_D$  vs  $V_{GS}$  characteristic of junction-FETs to be easily displayed.

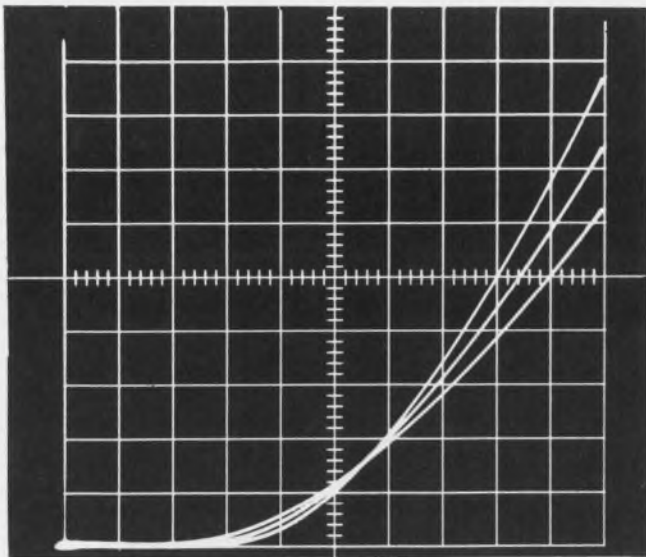

(a)

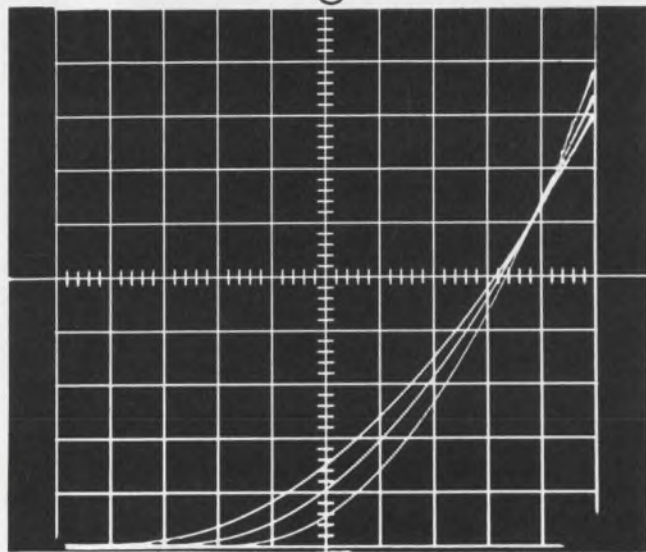

(b)

2. Cross-over of FET  $I_D$  vs  $V_{GS}$  curves indicates zero-temperature-coefficient point of junction-FETs. N-channel device is shown in (a); p-channel unit in (b). Vertical scale in both traces is 0.1 mA/div; horizontal in (a) is 0.2 V/div, in (b) 0.1 V/div.

The drain supply,  $V_{DD}$ , should be adjusted to a value above the FET's pinch-off voltage. The supply should also be well isolated from ground to prevent phase interference on the scope trace. The zero temperature coefficient point is indicated by the crossover of the superimposed  $I_D$  vs  $V_{GS}$  curves (Fig. 2).

Ross B. Yingst, Design Engineer, Sandia Corp., Albuquerque, N. M.

Vote for 112

## Thermoelectric module senses its own temperature

Monitoring the temperature of a cold chamber normally requires a thermistor or thermocouple in a bridge circuit. But if thermoelectric cooling is

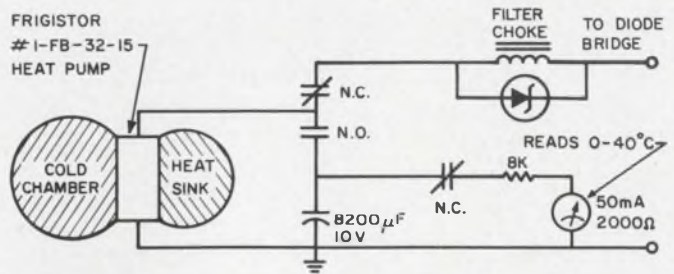

Thermoelectric heat pump senses its own temperature. Module current interruptions generate a voltage proportional to the temperature differential.

used, the thermoelectric heat pump can serve as its own sensor to economical advantage.

The voltage across a thermoelectric module varies fairly linearly with current and temperature differentials. If the current is interrupted, the module will generate a voltage proportional to temperature differential.

In a cold-chamber application, the module is connected between a cold chamber and a heat sink at ambient temperature. In steady-state these act as a cold sink and a heat sink, respectively, preventing a sudden change in temperature differential if the current is interrupted. The initial open-circuit output depends only on temperature.

In the illustrated circuit the relay disconnects the module from the current supply and connects it across a large capacitor,  $C_1$ . Then  $C_1$  charges up to  $V_{thermal}$  in a few milliseconds because of the module's small internal resistance. When the relay opens,  $C_1$  slowly discharges through the high impedance voltmeter, which reads  $V_{thermal}$ .

For the Frigistor I-FB-32-15,  $V_{thermal}$  is approximately 12 mV/°C. After subtracting a constant number of degrees for thermal drops between the module and the sinks, the temperature difference between the cold chamber and the ambient is readily obtained. Because the module generates such a high voltage compared with normal thermocouple voltages, a simple meter can measure  $V_{thermal}$ . Note that the relay should only be actuated for a few seconds, to increase over-all system accuracy.

S. E. Summer, Consultant, Bellrose, N. Y.

Vote for 113

## Frequency doubler yields rectangular pulse outputs

Four transistors are all that are needed to form a frequency doubler. The circuit yields two rectangular pulse outputs for each input sine wave and operates from audio to beyond 200 kHz.

Its operation (see schematic) is straightforward.  $Q_1$  functions as a noninverting follower and responds to the positive sine-wave input. The signal is coupled to the emitter of  $Q_2$  which serves as a grounded-base amplifier (noninverting) and the amplified pulse appears at the common 2.2-k $\Omega$

for the first time in a silicon power transistor...

**HIGH BREAKDOWN VOLTAGE** ( $BV_{CEO}^{(sus)} = 350 \text{ V}$ )  
**HIGH GAIN BANDWIDTH** ( $f_T = 20 \text{ MHz}$ )  
**LOW CAPACITANCE** ( $C_{cb} = 6 \text{ pF}$ )  
**AND**  
**20 WATTS DISSIPATION**



The RCA 2N4296 family is designed for high voltage, wide-band amplifiers and other military and critical industrial applications.

**Use it for:** high-voltage switches • relay drivers • switching and series regulators • waveform amplifiers • converters (low-voltage DC to high-voltage DC or AC) • high-voltage inverters • differential and operational amplifiers in analog computers • video amplifiers in camera chains, TV monitors, color-difference amplifiers.

Packaged in a TO-66 case, the RCA 2N4296, 2N4297, 2N4298 and 2N4299 are triple-diffused silicon NPN high-voltage power transistors, with exceptionally

high-frequency response and fast switching speeds. And they are priced *below* virtually every other transistor on the market with similar characteristics.

For delivery information, and for your copy of a technical bulletin which has all pertinent performance curves, applications data and electrical and mechanical specifications, call your local RCA Field Office; or write: RCA Electronic Components and Devices, Commercial Engineering, Section EG7-3, Harrison, N. J.

	2N4296	2N4297	2N4298	2N4299	
Collector-to-Base Voltage, $BV_{CBO}$	350	350	500	500	max volts
Collector-to-Emitter Voltage, $BV_{CEO}^{(sus)}$	250	250	350	350	max volts
Emitter-to-Base Voltage, $BV_{EB0}$	4	4	4	4	max volts
Collector Current, $I_C$	1	1	1	1	max amps
Collector-to-Emitter Saturation Voltage $V_{CE}^{(sat)}$ $I_C = 50 \text{ mA}, I_B = 5 \text{ mA}$	0.9	0.75	0.9	0.75	max volts
Base Current, $I_B$	0.25	0.25	0.25	0.25	max amps
DC Forward Current Transfer Ratio, $h_{FE}$ (at $V_{CE} = 10 \text{ V}, I_C = 50 \text{ mA}$ )	50-150	75-300	25-75	50-150	
Transistor Dissipation $T_C$ up to 25°C $T_A$ up to 55°C	20 2.0	20 2.0	20 2.0	20 2.0	max watts max watts
	\$1.50*	\$1.75*	\$2.25*	\$2.50*	

Available Through Your RCA Distributor

\*Prices indicated are for quantities of 1,000 and up.



The Most Trusted Name in Electronics

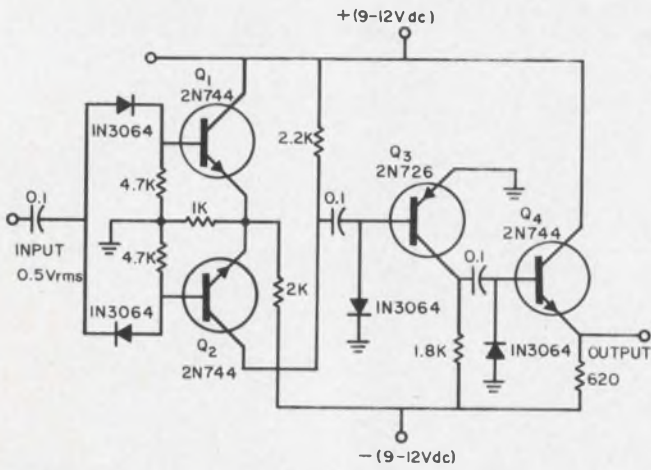

**Frequency doubler** uses only four transistors. Two rectangular pulse outputs are produced for each input sine wave.

collector load. During the negative sine-wave input,  $Q_2$  functions as a grounded-emitter amplifier (i.e., it inverts) and again the amplified pulse appears at the common 2.2-k $\Omega$  collector load. Transistors  $Q_3$  and  $Q_4$  function as a limiter amplifier and follower, respectively.

Output pulses are clipped and of uniform height. The follower output is sufficiently stiff to work into a 50- $\Omega$  resistive load. Note that the output may be direct-coupled. In the absence of an input signal the dc output rests at approximately -1.2 V. If this bias is objectionable, the output may be capacitively coupled to its working load.

Robert S. Selleck, Consultant, Educ Assoc., Los Angeles, Calif.

VOTE FOR 114

## Transformer in delay circuit compensates for attenuation

A phase-shift and group-delay adjusting network uses a step-up autotransformer coil to obtain a 74-ns adjustment range and to compensate signal losses up to 10 dB.

The autotransformer is strictly bifilar-wound and can be tuned by its parallel capacitor,  $C_2$ , to the center frequency of the line bandpass. If a sine-wave signal is fed into the input, the phase of the voltages at the two transformer tops is  $0^\circ$  (at A) and  $180^\circ$  (at B) with respect to the input (Fig. 1).

Let us consider now the phase of the voltage appearing at the junction P, between  $L_1$  and  $C_1$ , for an infinite value of  $R_3$ . Since  $L_1$  and  $C_1$  resonate at the mid-band frequency of the input, ideally the phase of the voltage at point P lags by  $90^\circ$  behind the voltage phase at A, because  $R_1$  is negligible in comparison with  $\omega L_1$ . In reality,  $R_1$  must be large enough for the Q of the series resonating circuit,  $R_1$  and  $\omega L_1$ , to be relatively low. A low Q is needed to preserve the fixed phase relation between the voltages at points A and P over the whole-pass-band of the delay line.

The adjustable phase-shift effect of the entire

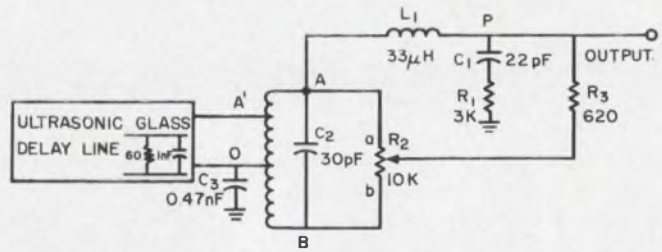

1. Step-up transformer coil in time-delay trimmer compensates for losses up to 10 dB and provides impedance matching between a conventional delay line and the circuit following it.

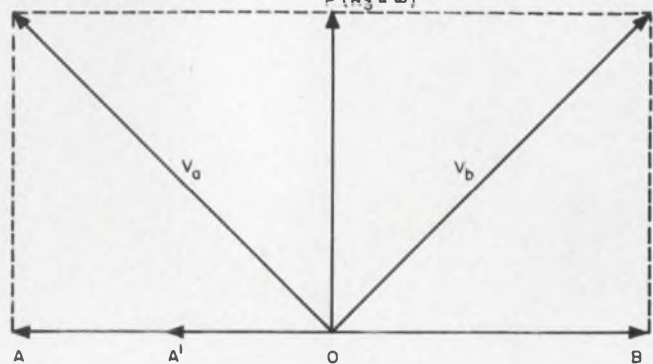

2. Vector relationship of voltages appearing at points A, B, A' and P, shown in Fig. 1, does not take into account the mutual effects of the various branches.

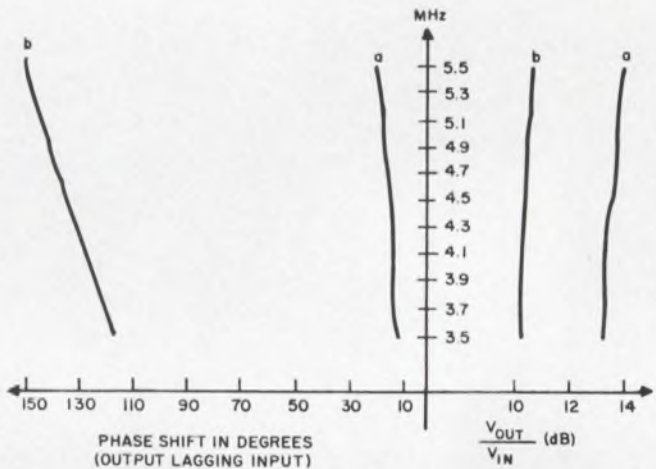

3. Phase delay vs frequency curves are almost straight lines for the two end positions of the potentiometer,  $R_2$  (left curves). The amplitude of the output (right curves) remains fairly constant through the band, maintaining a voltage gain of 10 dB.

circuit is due to the addition of the two voltages, one of which depends on the position of the slider of  $R_2$ .

The voltage at the slider of potentiometer  $R_2$  can be varied continuously from a full-amplitude in-phase to a full-amplitude phase-opposition with respect to the input voltage.

The vector relationships of the voltages at the points indicated in Fig. 1 are plotted in the vector diagram of Fig. 2.  $V_a$  and  $V_b$  represent the output voltages of the circuit, if  $R_3$  has the indicated value, when the slider of  $R_2$  is at a and b, respectively. This diagram can only be taken as a rough explanation of the principle of operation. The mutual loading of the various arms of the circuit influences the actual vector relationship. Resistor

## Hydro-Aire reports



**a 30% reduction in installed costs**



**with FLEXPRI<sup>®</sup>NT Circuitry**

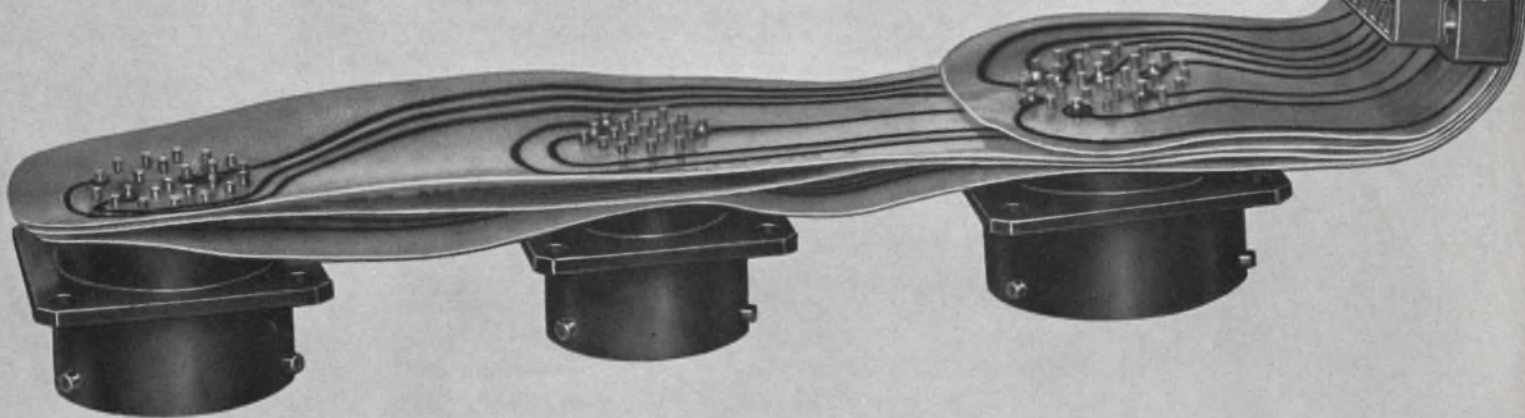

Hydro-Aire engineers turned to FLEXPRI<sup>®</sup>NT Circuitry instead of conventional wire for two reasons — reliability — economy.

Normally it takes at least 80 separate wires to interconnect three MS connectors and 5 printed circuit card connectors that go into a Hytrol aircraft anti-skid brake system. Now Sanders FLEXPRI<sup>®</sup>NT Circuitry replaces all this bulky hook-up harness, saves space and lowers the installed wiring cost of every unit by 30%.

Because FLEXPRI<sup>®</sup>NT Circuitry comes made to order, it assembles faster, eliminates rework time and increases reliability. There are no wires to cut, strip, tin, solder, color code or lace.

Whether your needs demand a simple circuit or sophisticated system incorporating many different components, Sanders can produce a FLEXPRI<sup>®</sup>NT Circuit that will make the whole package more economical. We've got the experience . . . we've produced more flexible printed circuits than anyone else in the business.

For detailed information on Sanders FLEXPRI<sup>®</sup>NT Circuitry, FLEXMAX flexible multilayer circuitry and INTRAMAX<sup>®</sup> multilayer hardboard, call your local Sanders representative or write Sanders Associates, Inc., FLEXPRI<sup>®</sup>NT Products Division, Nashua, New Hampshire 03060. Phone: 603-883-3321.

\*T. M., Sanders Associates, Inc.

**SANDERS ASSOCIATES, INC.**  
FLEXPRI<sup>®</sup>NT PRODUCTS DIVISION



*Creating New Directions in Electronics*

## IDEAS FOR DESIGN

$R_3$  somewhat limits the mutual loading effect.

The input-output characteristics, referring to a mid-band frequency of 4.43 MHz and a bandwidth of about 2 MHz, are shown in Fig. 3. The phase-delay vs frequency curve (left) for the two end positions,  $a$  and  $b$ , of the slider of  $R_2$  is almost a straight line with a positive slope, within the frequency range of interest. The amplitude vs frequency curve (right) has a nearly constant amplitude, with only a slight decline at the higher frequencies. The voltage gain is always higher than 10 dB.

The phase and amplitude characteristics do not distort the signal. The group-delay time,  $\Delta\phi/\Delta\omega$ , is constant over the whole frequency band, and increases from 11 to 37 ns as the slider of  $R_2$  is moved from  $a$  to  $b$ .

The phase-delay time,  $\phi/\omega$ , may be varied continuously from about 9 to 83 ns.

Piero Zamperoni, *Electronic Engineer, Telefunken, A. G., Ulm, W. Germany.* VOTE FOR 116

## Buffered binary affords accuracy and stability

When an emitter-coupled binary has an input buffer stage, it exhibits the operational characteristics of a Schmitt trigger or similar level-detection device. The buffering feature offers the greater over-all binary accuracy and additional capabilities usually found in more complex circuits.

The hysteresis of the subject binary (see schematic) when silicon transistors are employed is typically 15 mV compared with several hundred millivolts for standard circuits. Its temperature stability is excellent.

Since the loading of the first stage collector is minimized by buffer unit  $Q_3$ , the normally-distorted inverted waveform at the  $Q_1$  collector is as suitable for use as the noninverted output at the  $Q_2$  collector. Where the collector-emitter saturation voltage of most switching transistors is somewhat less than the base-emitter drop at saturation,  $Q_2$  here is slightly back-biased when-

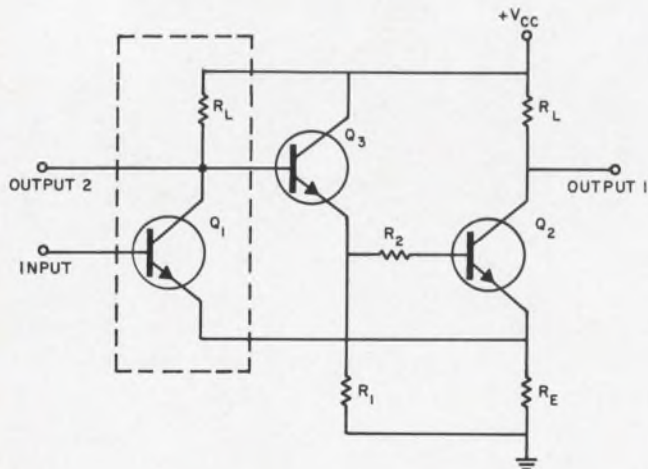

Buffered emitter-coupled binary offers low hysteresis, circuit simplicity and thermal stability as a level detector.

ever  $Q_1$  is saturated. The amount of back-bias, however, is limited to 200 or 300 mV over a wide range of reference voltages at the emitters ( $Q_1$ ,  $Q_2$ ) and the hysteresis remains at a low value.

Another significant feature of the circuit is the ease with which it may be designed. Once  $R_L$  and  $R_E$  have been selected from standard considerations of desired reference voltage, driving impedance level, etc., the designer may calculate  $R_1$  and  $R_2$  straightforwardly. Component  $R_3$  is chosen to provide a minimum current to keep  $Q_3$  in the active region when  $Q_1$  is saturated.  $R_2$  is such that  $Q_2$  will be in saturation when  $Q_1$  is cut off.

Rhoderick H. Zimmerman, *Sr. Engineer, Litton Industries, Data Systems Div., Van Nuys, Calif.*

VOTE FOR 115

## Diode tester offers no risk to components

Test apparatus for assembled circuits (such as the conventional ohmmeter) usually involve currents of 50 mA or more flowing through the test device. Here is a lamp-transistor arrangement that limits test currents to 2.0 mA, a much safer value for most diode measurements. It is also a small enough current not to harm the base-emitter function of a sensitive transistor.

With a test diode (see schematic), half-cycle pulses of base current are supplied to the 2N1308,

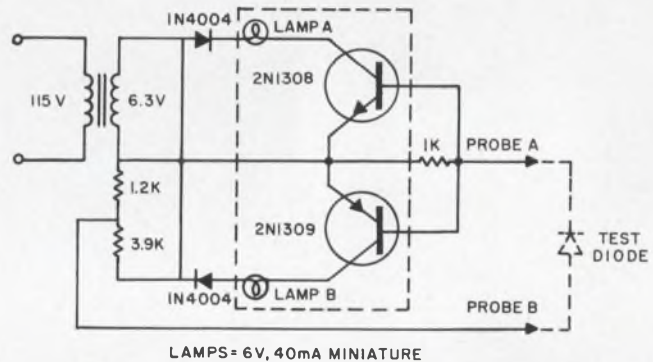

Lamp and complementary transistors are used in this nondestructive diode tester. Test current is  $\leq 2.0$  mA.

causing lamp A to light. The opposite orientation of the diode would cause lamp B to light. A short-circuit condition would light both lamps.

The tester is more convenient to use if the lamps are physically located within their associated probes. The probes may then be used interchangeably, since a lighted probe indicates a cathode whichever probe is used.

J. L. Divilbiss, *Sr. Research Engineer, Dept. of Computer Science, Univ. of Ill., Urbana, Ill.*

VOTE FOR 117

## IFD Winner for April 12, 1966

Phil M. Salomon, *Consultant, Impro Corp., Pasadena, Calif.*

His idea, "Inexpensive null detector is sensitive and accurate," has been voted the \$50 Most Valuable of Issue Award.

Cast Your Vote for the Best Idea in this Issue.



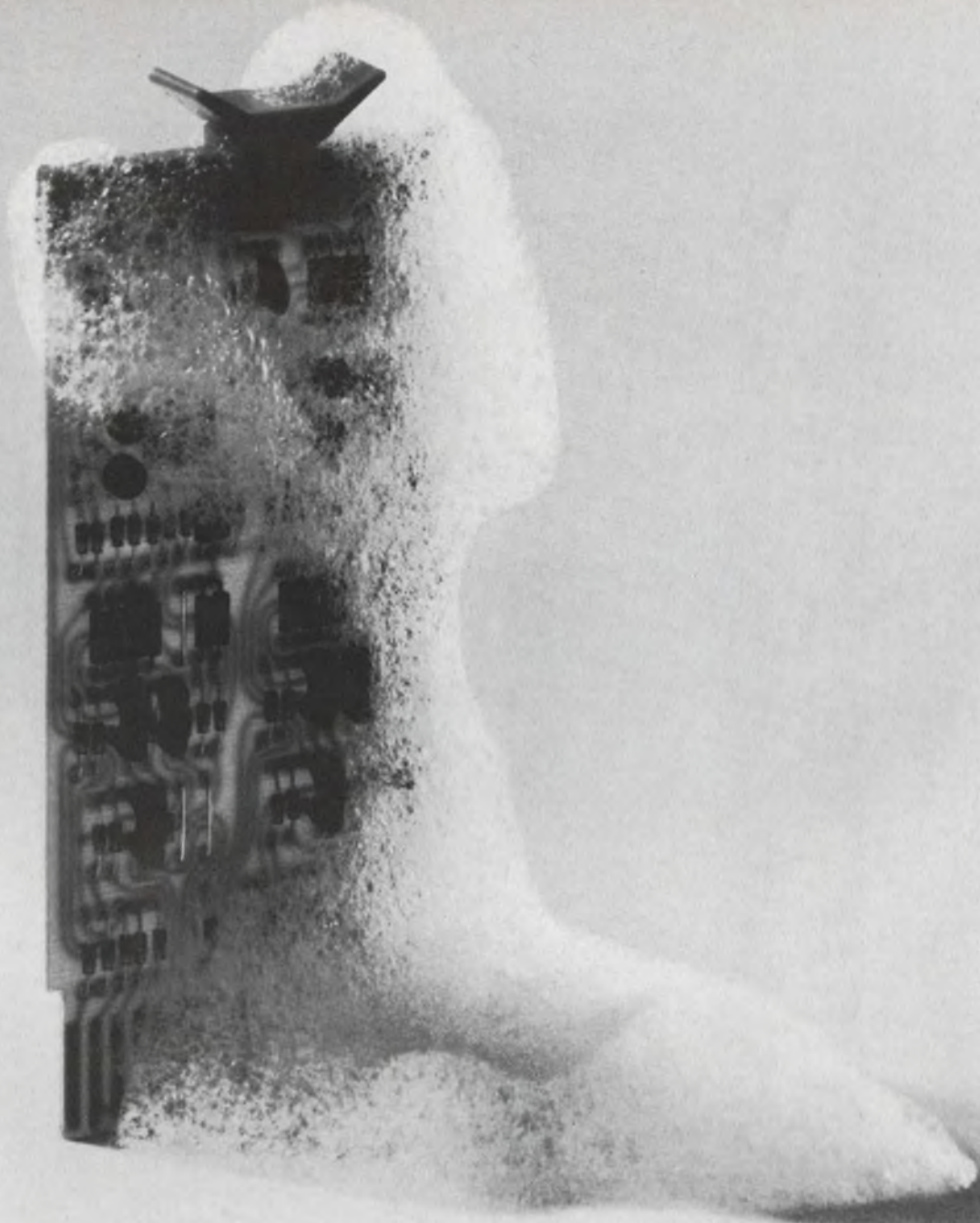

## **Rub-a-dub-dub**

If you're going to guarantee every digital Flip Chip™ module for ten years, you worry about reliability.

This particular module was routinely run through 120 standard tests, component by component, spec by spec. (The tests took 25 seconds on one of our PDP general purpose computers, a machine mostly made of modules just like this.)

Then, we duplicated the laboratory environment. We dropped the module from a table, blew smoke at it,

spilled coffee over the components. We left the module on a radiator overnight.

All components still okay.

Somehow the module got left in a shirt pocket and subjected to a further unplanned test — wash, rinse, wash, rinse, spin dry.

Know what happened? The coffee stains washed off.

Write for a catalog.

**digital**  
MODULES • COMPUTERS

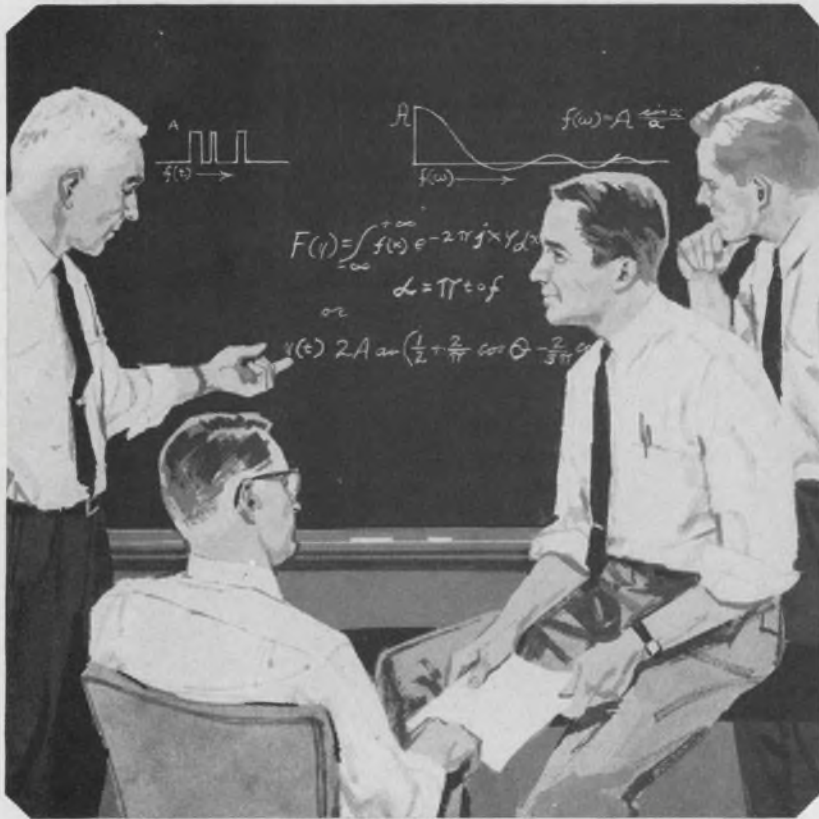

## Above all...the creative IDEA

From the very beginning, Motorola has been an "engineer's company"—an organization where every consideration was secondary to the newest technological development. As a result, Motorola has attracted the type of engineer and scientist who is noted, not for his ability to conform—but to create.

In this intellectually rarified atmosphere, the challenges to an engineer are great—but, of course, the rewards are commensurate.

Motorola does *not* need "engineers" per se, but there is always an urgent need for really *good* engineers and scientists—men who are inspired by this dynamic environment rather than afraid of it—men who shun monotony and search for diversified projects. If you are such a man, we would like very much to talk with you.

**SYSTEMS ENGINEERS** advanced R & D in radio communications systems related to Two-way, portable, mobile and radio-telephone equipment.

**EQUIPMENT DESIGN** high performance solid state receivers, transmitters, and data processing equipment for radar, communications, command and control, tracking and telemetry.

**FAMILIARITY WITH STATE-OF-THE-ART** statistical communications theory, advanced signal processing techniques, solid state r.f. techniques, ultra-reliability, antenna systems, advanced structural and thermal designs.

**SECTION MANAGER** direct engineers and support personnel in state-of-the-art communications, including r.f. systems and input-output devices.

**CHIEF ENGINEER** technical management of R & D group in advanced technology related to solid state r.f. communications.

**CIRCUIT DESIGN ENGINEERS** advanced R & D in receivers, transmitters, RF, digital, Color TV and automotive electronics.

**DEVELOPMENT ENGINEERS** advanced communications products in consumer, industrial and military electronics.

Excellent opportunities also available in Phoenix, Ariz.

Mr. W. H. HAUSMANN, Engineering Personnel Mgr., Dept. B 4545 Augusta Blvd., Chicago 51, Illinois

An equal opportunity employer.



**MOTOROLA inc.**

ON CAREER-INQUIRY FORM CIRCLE 901

## Book Reviews

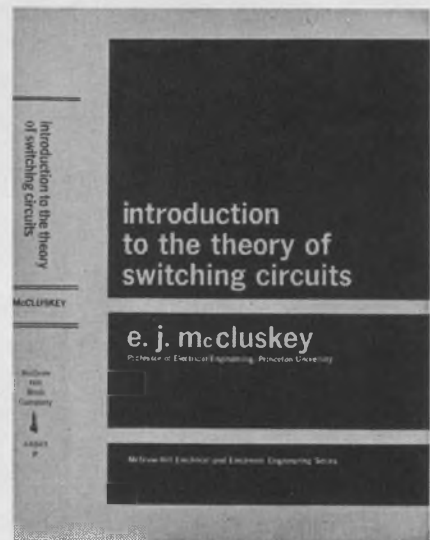

### Switching circuits

The words "introduction to" in the title of a book often give the author free reign in the pursuit of his subject. Depending on his bent, he may present an exhaustive exposition of the major principles, or he may instead provide cursory treatment of every topic remotely related to the subject. Professor McCluskey has done an excellent job of avoiding both extremes. He has selected from the vast body of switching circuit theory those topics which, because of their fundamental nature, should be of lasting importance to anyone engaged in switching circuit design. The selected topics are covered in comfortable depth, without delving into the highly detailed subject matter of more advanced texts.

In addition to covering number systems, switching algebra and function simplification, the author devotes a considerable amount of attention to the analysis and synthesis of sequential circuits, covering each separately.

An especially noteworthy contribution of the text is its inclusion of a separate chapter on the transient behavior of switching circuits. Although introductory works tend to overlook or minimize the effects of spurious delays and their effects on switching networks, Professor McCluskey has insured that readers of his book will be aware

(continued on p. 100)

# CAREER INQUIRY - confidential

17

Respond to the career opportunities advertised in this issue. Fill out and send us this handy resume. **Electronic Design** will do the rest - neat copies of this form will be mailed to the companies of your choice, indicated by the circled Career Inquiry Numbers at the bottom of this page.

<b>Name</b>		<b>Home Phone</b>	
<b>Home Address (Street)</b>		<b>City</b>	<b>State</b>
			<b>ZIP Code</b>
<b>Age</b>	<b>U.S. Citizen</b> <input type="checkbox"/> Yes <input type="checkbox"/> No	<b>Security Clearance</b>	
<b>Prime Experience</b>		<b>Secondary Experience</b>	
<b>Desired Salary</b>		<b>Availability Date</b>	
<b>Employment History - present and previous employers</b>			
<b>Company</b>			
<b>City, State</b>			
<b>Dates</b>	to	to	to
<b>Title</b>			
<b>Specialty</b>			
<b>Education - indicate major if degree is not self-explanatory</b>			
<b>Degree</b>			
<b>College</b>			
<b>City, State</b>			
<b>Dates</b>	to	to	to
<b>Additional Training - non-degree, industry, military, etc.</b>			
<b>Professional Societies</b>			
<b>Published Articles</b>			

**Career Inquiry Numbers:**

900 901 902 903 904 905 906 907 908 909  
910 911 912 913 914 915 916 917 918 919

**ELECTRONIC DESIGN**  
850 Third Avenue  
New York, New York 10022



# *EE's & ME's*

Share in the excitement at Delco Radio!  
Pick your opportunity from these openings in:

## PRODUCT DESIGN OR PROCESS ENGINEERING

Delco Radio Division of General Motors is on the move! Growing demand for Delco solid state products requires more expansion . . . new buildings (411,000 sq. ft. addition underway) . . . new equipment . . . new projects . . . and most importantly, new people.

The pace is dynamic. Challenging. Advancement opportunity is ripe—for those who choose to capitalize on it. Make your choice from the following openings—now!

### PRODUCT DESIGN

#### SUBMINIATURE MILITARY COMMUNICATIONS EQUIPMENT

EE or ME—for assignment to development group designing all-transistor portable transmitters and receivers, operating in 2-100 mc range. FM, AM, FSK, CW, SSB modulation.

#### HEATER, AIR CONDITIONER, AND VENTILATION CONTROL

ME's—with 3-5 years experience, for development, engineering production liaison, and re-designing of comfort control systems including vacuum valves and mechanical controls.

#### AUTOMOTIVE RADIO DESIGN AND DEVELOPMENT

EE—to work with Senior Engineer on advanced development of auto radios and other entertainment devices, including FM-AM, miniaturized circuitry and components.

ME—for design of small electronic mechanisms, including FM-AM, Signal Seeking and push-button tuners, and components modules. EE or ME—for packaging of auto radios and associated tuners, solenoids, etc. Required to make some engineering contacts with automobile manufacturers.

### PROCESS ENGINEERING

#### SEMICONDUCTOR PROCESS ENGINEERS

ME's or EE's—BS or MS, to develop and create new processes for manufacturing germanium and silicon semiconductor devices. Includes development of automatic and semiautomatic fabrication equipment, pilot line operation and general cost savings investigations pertinent to semiconductor manufacturing.

#### RELIABILITY ASSURANCE

ME—project engineer, for design and development work on test equipment for semiconductors and special products. Will handle tests and evaluations of transistorized systems and components, both power and small signal type. Must evaluate results and associated statistical data. Also includes failure analysis work with suppliers and production.

Interested? Don't waste time—call us collect! Area Code 317/459-2808. Ask for C. D. Longshore. Or, send your resume to Mr. Longshore, Salaried Employment, Dept. 204, Delco Radio Division, General Motors Corporation, Kokomo, Indiana.

*An equal opportunity employer*

## BOOK REVIEWS

(continued from p. 96)

that there is more to the theory than just building a circuit to implement some Boolean equation.

*Introduction to the Theory of Switching Circuits.* E. J. McCluskey (McGraw-Hill Book Co.: New York). 318 pp., \$12.50.

### Computer design

This discussion of the addition of redundancy to computers to increase reliability is primarily theoretical in approach, with problems included at chapter endings and in appendices. Limit theorems for vote-taking, multiple-relay and generalized quadding types of error-correction circuits are covered. A conceptual foundation is provided for the theory of correcting errors in the same circuits that perform logic, and a systematic theory for structuring the interconnections in redundant logic is given.

*Failure-tolerant Computer Design.* William H. Pierce (Academic Press, Inc.: New York). 242 pp., \$8.50.

### Semiconductor surfaces

Theories, techniques and experimental data on the electrical behavior of semiconductor surfaces are found in an illustrated volume containing several reference lists. Emphasis is on electrical aspects, but lattice structure and chemical reactivity of the surface are also described. Experimental methods relating to field effect, optical and magnetic measurements and noise are critically reviewed.

*Semiconductor Surfaces.* A. Many, Y. Goldstein and N. B. Grover (John Wiley & Sons, Inc.: New York). 496 pp., \$17.50.

### Electronics dictionary

Definitions of electronics terms and fundamental facts are listed. Supplementary material includes an appendix of circuit symbols, abbreviations, color codes, conversion tables and value bases.

*Dictionary of Electronics.* Harley Carter (Hart Publishing Company, Inc.: New York). 410 pp., \$6.95 (cloth edition) and \$2.65 (paperback).

### Optical tooling

This text explains and illustrates the applications and mechanics of optical tooling in industrial use. The potentialities of the field of optical measurement, alignment and collimation are described and the advantages of optical tooling are pointed out.

Included in the book is a glossary of terms which apply specifically to this field.

*Optical Tooling in Industry.* John D. McGrae (Hayden Book Company, Inc.: New York). 122 pp., \$7.

### Matrix algebra

A basic course in matrix algebra is divided into two sections. Part I covers the essentials of matrix methods and their applications and requires background in basic algebra only.

Part II treats the development of matrix algebra up to the eigenvalue problem and an introduction of functional concepts relevant to matrices.

*Matrix Algebra for Electronic Engineers.* Paul Hlawiczka (Hayden Book Company, Inc.: New York). 216 pp., \$8.75.

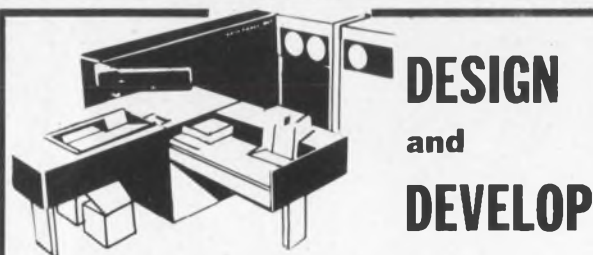

## DESIGN and DEVELOP

### POWER SUPPLIES

At the Research and Engineering Division of Honeywell EDP we have developed many new techniques in computer design and capabilities. An integral function of these advances are the design and development of power supplies utilizing passive regulating, switching type regulating or C.V.T. techniques. Another activity would be the design of electronic power control, sensing and interlocking circuits for computer systems.

If you are currently a power supply designer familiar with magnetic circuit as well as electronic circuit design OR if you have three to four years' electronic circuit design and a hankering to design power circuits,

call or write Mr. Edwin Barr, Employment Supervisor, Dept. E D -7 200 Smith Street, Waltham, Massachusetts.

(617) 891-8400

# Honeywell

ELECTRONIC DATA PROCESSING

An Equal Opportunity Employer

ON CAREER-INQUIRY FORM CIRCLE 904



To  
**ELECTRONIC  
ENGINEERS**  
with a sense  
of timing...

## BENDIX (KANSAS CITY DIV.) IS ON THE *MOVE!*

This is the opportune moment to investigate your career potential at Bendix, Kansas City Division. As prime contractor for the AEC, we have enjoyed an enviable, orderly 16-year growth. Now we are entering a unique developmental phase, opening new fields of activity in microminiaturization, microwave and logic circuitry. This situation adds up to a ground-floor opportunity in a well-established corporation noted for advanced engineering. Cooperative, professional atmosphere, plus excellent living conditions. Let us hear from you promptly so we may detail more clearly the many advantages we can offer you.

Please mail résumé at once to:

Mr. E. C. McGurren, Tech. Personnel Repr.  
THE BENDIX CORPORATION, Box 303-HE  
Kansas City, Missouri 64141

AN EQUAL OPPORTUNITY EMPLOYER



ON CAREER-INQUIRY FORM CIRCLE 905

ELECTRONIC DESIGN, July 19, 1966

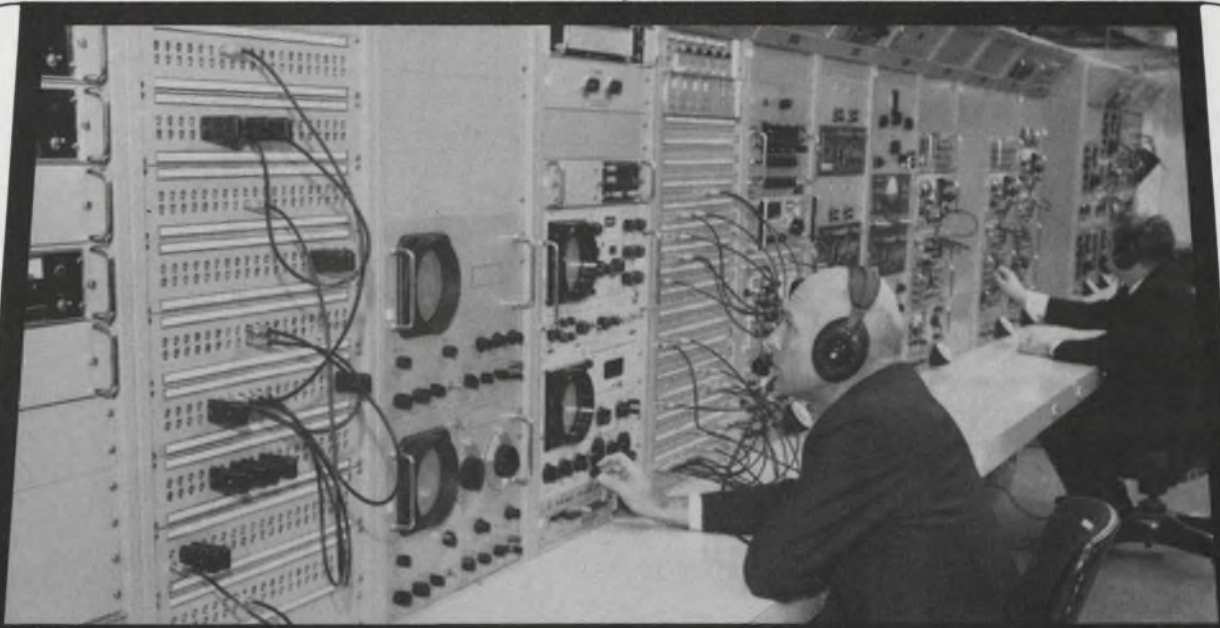

Top—For quick reaction in airborne and ground based electronic systems, LTV ElectroSystems' Greenville Division is the experienced leader. Range instrumentation and tracking, ground-based satellite tracking stations, command and control systems — all are in production or in use.

Right—Designer and builder of the world's most powerful transmitting equipment, Continental Electronics, an LTV ElectroSystems subsidiary, was the prime contractor for the NATO VLF installation at Anthorn, England. Continental is the Free World's most experienced organization specializing in super-power electronics.

Left—Powerful, compact units such as the ESC-1000 Long Range Ground/Air/Ground Secure Digital Communications System demonstrate only one phase of LTV ElectroSystems' Garland Division's experience and capability in systems design. The ESC-1000 system will communicate up to 6000 miles in conventional applications and up to 12,000 miles in conjunction with a satellite.



## complete spectrum of opportunity for creative challenge

At LTV ElectroSystems, Inc., talented electronic systems oriented engineers know the excitement of creativity, the satisfaction of personal and professional advancement and contribution in an expanding organization, the flexibility and creative freedom of small product groups. Still they enjoy big company growth and opportunity.

LTV ElectroSystems is an organization delivering highly complex new electronic systems to meet defense and space

demands of today and the future. Major fields of capability include: space/air/ground electromagnetic reconnaissance and surveillance systems; command and control systems; high-power radar and radio; nuclear detection and surveillance equipment; information processing and display systems; super power equipment; VLF transmitters; commercial radio transmitters; guidance systems; antennas; electronic warfare systems; satellite tracking systems . . . and more.

These vital programs offer exceptional career positions to engineers in the following disciplines: **RF SYSTEMS ANALYSIS / RF CIRCUIT DESIGN / DIGITAL CIRCUITS DESIGN / DIGITAL SYSTEMS ANALYSIS / WEAPONS SYSTEMS ANALYSIS / GUIDANCE SYSTEMS / RADAR SYSTEMS / ANTENNA SYSTEMS DESIGN / ELECTRO-MECHANICAL PACKAGING / AIR-CRAFT ELECTRICAL INSTALLATION DESIGN / AIRCRAFT STRUCTURES DESIGN / MECHANICAL SYSTEMS / ELECTRO-OPTICS / STRESS ANALYSIS / SCIENTIFIC PROGRAMMING . . . plus others.**

For complete information about a career with LTV ElectroSystems, Inc., write: Professional Placement, Dept. 176A, P. O. Box 6118, Dallas, Texas 75222. LTV is an equal opportunity employer.

**LTV**  
**ELECTROSYSTEMS, INC.**

A SUBSIDIARY OF LING-TEMCO-VOUGHT, INC  
GREENVILLE AND DALLAS, TEXAS

ON CAREER-INQUIRY FORM CIRCLE 906

**you can't make a commercial stack work  
in a military memory system.**

**that's why we make both.**

When you build a military stack you're dealing with severe environment reliability problems, low weight and volume, wide operating margins and high speed. That's why we have a complete engineering group at Electronic Memories devoted exclusively to the design of stacks and systems for military environments. Now all this may not be particularly exotic — but it's not easy — and let's face it, these qualities have to be designed in from the ground up — not adapted from commercial stacks.

We've cut our teeth on military memory systems for fire control systems, ASW, ECM, navigation and display systems and we've successfully met applicable portions of the following Mil specs: Mil-E-16400, Mil-E-4158, Mil-E-5400 and Mil-Q-9858.

In effect, no one else has Electronic Memories' experience or track record. But don't believe us — we'll send you the names of our customers and you can ask them. They know commercial stacks won't do. If they did, we'd sell them. We make them too.

## **EM electronic memories**

Memory systems, stacks and cores for commercial,  
military and space applications

12621 Chadron Avenue, Hawthorne, California  
(213) 772-5201

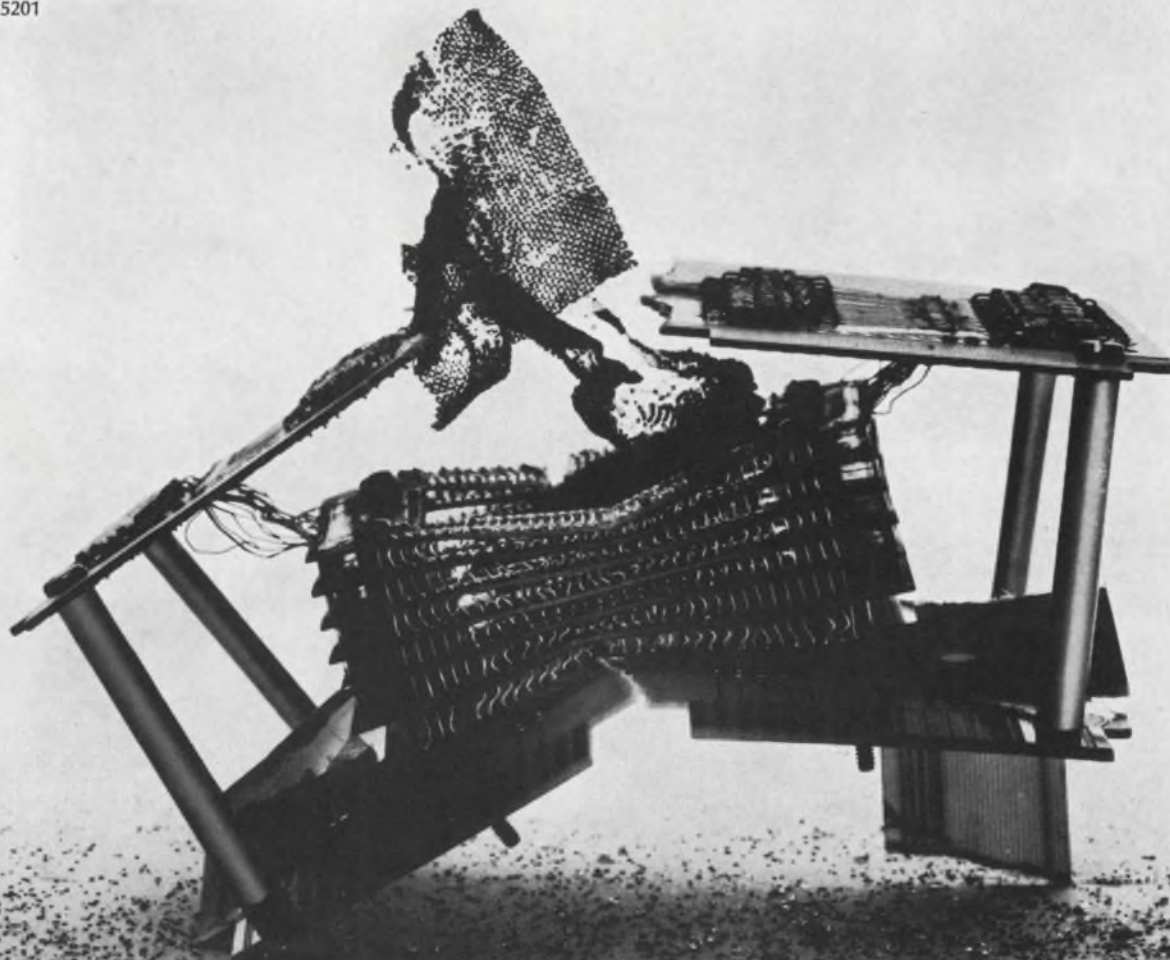



# Products

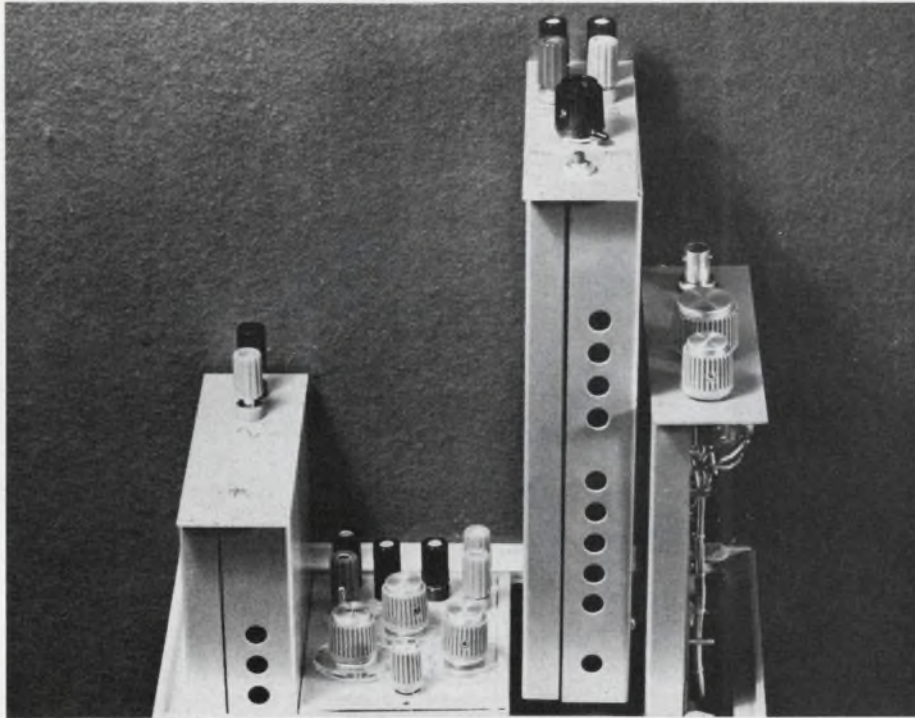

**Function generator modules** afford versatility but cost less. With this system, all signals are go! Page 104

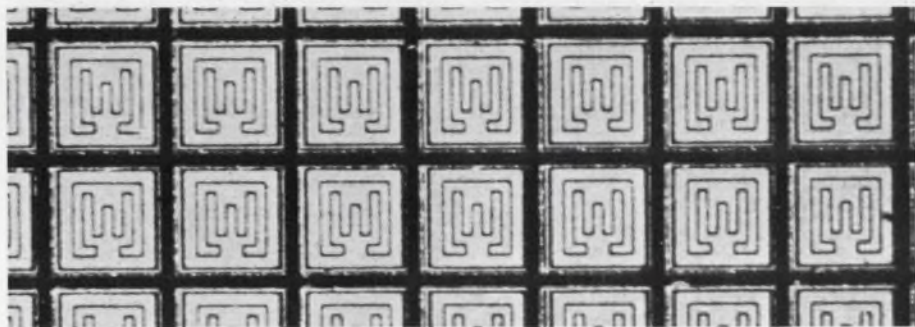

**Semiconductor dicer** uses abrasive slurry on 0.015-in.<sup>2</sup> silicon, ferrite or ceramic wafers for 95% yield. Page 140

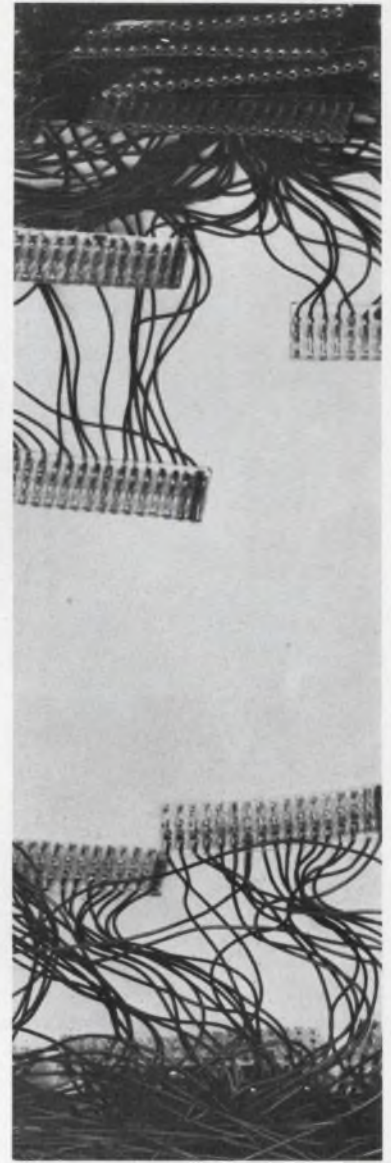

**Wire harness** ousts connector blocks. Page 114

## Also in this section:

**Dc op-amp** neutralizes summing-node capacitance to cut ac error. Page 116

**Carbon-14 battery** is ultra-stable current standard. Page 120

**Component spacers** dissolve in water after use. Page 134

**PC board** translates decimal code to energize 7-bar display. Page 144

## Multi-function modular series eliminates purchase of several units for function generator applications

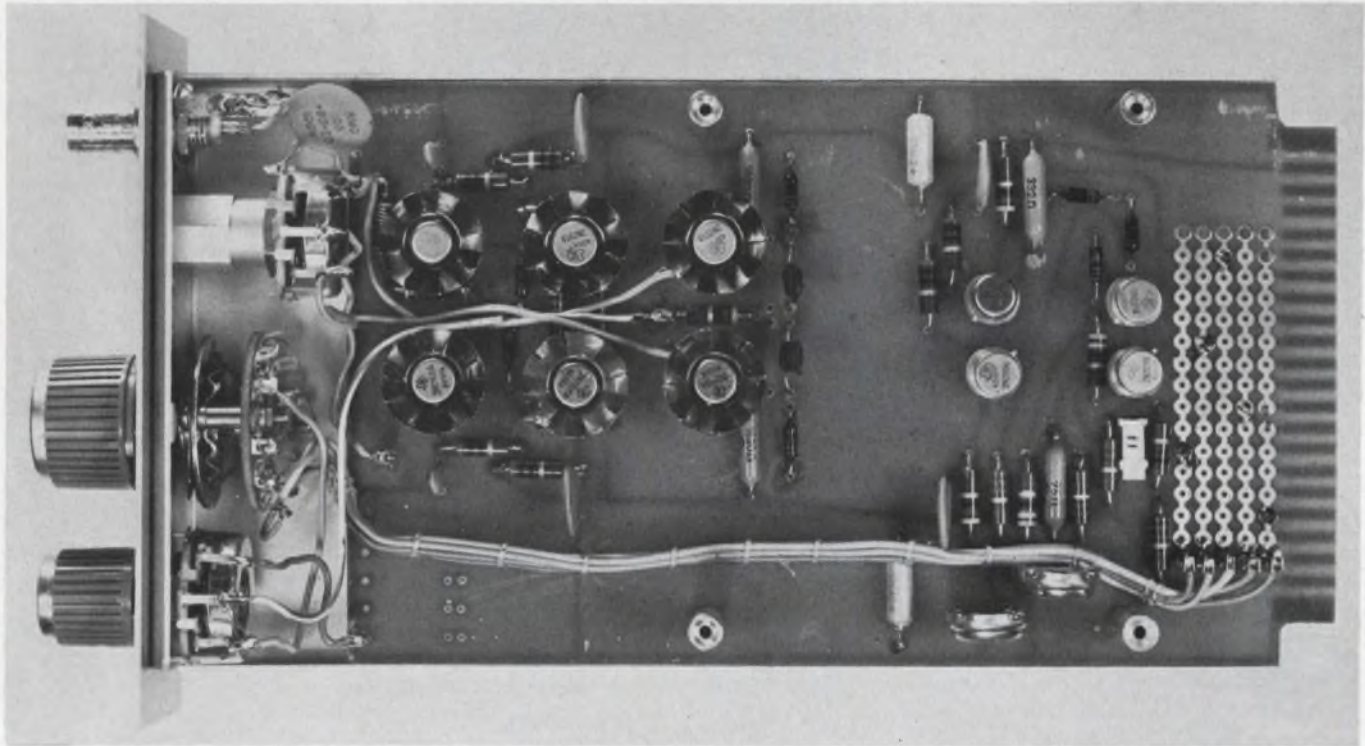

Different function generator applications normally each require individual fixed-package purchases. In contrast, this modular series offers the designer at-the-bench flexibility. With 15 initial modules already available and five others currently in the engineering stage, you can specify and buy no more or no less generator than you need. Off-the-shelf plug-ins add features or functions as needed.

In many systems applications three or four individual signal sources are required. This involves the purchase of three or four complete generators. With system 1000 the same thing can be accomplished with one modular unit. All that is necessary is a single power-pack and a series of waveform modules—sines, cosines, diode-shaper units or whatever the job calls for. Cost will be cut by two-thirds.

A typical workhorse generator application requires only a pulse or square wave. Sophisticated rise time is not the objective; yet where today can a unit that does not have a relatively fast rise time be found? Normally the buyer would have to outlay \$700. But system 1000 provides an "unsophisticated" pulse or square-wave generator for under \$300.

Checking computer cores normally takes a variable-power multiple-driving source to check

several cores simultaneously. But one of the new high-current output modules, coupled with a series of waveform modules, will handle the job inexpensively.

Tentative specifications of system 1000 modules are as follows:

- **Power supplies:** Types 1001, 1002, 1003 and 1004 may be used independently or in conjunction with any of the modules. Type 1004 Ni/Cd battery pack will power 5 modules for 6 hours. Output is  $\pm 15$  V at 500 mA (1001), 250 mA (1004), 1.5 A (1003) or 1 A (1002). Regulation is 0.05% (1001) and 0.1% (1002 and 1003). The supplies are rated at 50 W (1001 and 1002) and 75 W (1003) full load. Price: \$100, \$125, \$150, \$65 respectively.

- **Square-triangle generator:** Types 1101 and 1102 may be termed "basic" to any system. Decade-multiplier controls, digital frequency dials and a  $\pm 2\%$  vernier give 1% accuracy over the  $10^9$  frequency range. Voltage-controlled frequency (VCF) over a two-decade range is featured in the 1102. The applied VCF voltage will always sweep the generator at a lower frequency than the calibrated dial position. VCF range is 100:1, corresponding to 5 V, and linearity is 1%. Amplitude is an adjustable 10-V and source impedance



## New JFD Air Variable Capacitors offer higher frequencies with negligible loss of Q

### Plus

- Ultra Stability
- Highest Q
- Small Size
- Rugged Construction

Now JFD air variable capacitors offer circuit designers the advantages of extremely high "Q" and greater capacitance values in a rugged miniature size unit. Offered in both a printed circuit (VAM 010W) and a panel mounting model (VAM 010), the new units operate at far higher frequencies with negligible loss of "Q" in comparison to other types.

Internal air meshing shells are silver plated to provide good surface conductivity and to prevent corrosive effects. Three internal contact springs assure positive electrical contact of rotor at all times. Leads on printed circuit model are tinned for ease in soldering.

The high density insulator between stator and rotor has excellent electrical properties and contributes to overall structural strength. Rubber gasketed threaded end caps effectively seal the units against dirt entrance or atmospheric contamination after tuning.

WRITE FOR JFD BULLETIN VAM-65

JFD 120-A



Components Division  
 JFD ELECTRONICS CORPORATION, 15th Ave. at 62nd St., Brooklyn, N. Y. 11219  
 Tel: 212 DE 1-1000  
 JFD NORTHEASTERN, Ruth Drive, P. O. Box 228, Marlboro, Mass. 07152  
 JFD NEW YORK-NORTHERN, Damiano Pl., P. O. Box 96, New Hartford, N. Y. 13503  
 JFD MID-ATLANTIC, P. O. Box 5055, Philadelphia, Pa. 19111  
 JFD MID-ATLANTIC-MARYLAND, P. O. Box 7676, Baltimore, Md. 21207  
 JFD MIDWESTERN, 6330 W. Hermione St., Chicago, Ill. 60646  
 JFD MIDWESTERN-OHIO, P. O. Box 8086, Cincinnati, Ohio 45208  
 JFD WESTERN, 9 Morlan Place, Arcadia, California 91006  
 JFD ISRAEL LTD., Industrial Area B, Bldg. 23, Azor, Israel  
 JFD ELECTRONICS, EUROPE S A, 7 Rue de Rocroy, Paris, 10, France

Precision Pisto. Trimmer Capacitors ■ Metalized Inductors ■ LC Tuners ■ Ceramic Fixed and Variable Capacitors ■ Fixed and Variable Distributed and Lumped Constant Delay Lines

Speed Inquiry to Advertiser via Collect Night Letter  
 ON READER-SERVICE CARD CIRCLE 36

is 50  $\Omega$ . Frequency range is 0.001 Hz to 1 MHz in 900 discrete steps. Square-wave rise and fall times are 40 ns, with symmetry exceeding 99%. Triangle deviation from linearity is 0.3% max to 100 kHz (1101) and 1% max to 1 MHz (1102). Both modules will "free-run" with proper supply voltage, and the addition of a gate-trigger module will control operating modes. Trigger output is 100 ns at 5 V and 50  $\Omega$ . Price: \$155, \$190, respectively.

▪ **Sine shaper:** Type 1301 (see photo below) shapes the 10-V triangle from a system 1000 module; however, its 14 diode transfer points will shape any comparable input. The 10- $\Omega$  input impedance allows several of these modules to be driven by one modular generator. The 10-V p-p sinusoidal output can also drive several other modules without degradation. Dc reference level is center 0, adjustable  $\pm 100$  mV. Sinusoidal distortion is  $\pm 0.5\%$  max to 10 kHz, 1% max to 100 kHz and 2% max to 1 MHz. Price: \$65.

▪ **Ramp generator:** Type 1103 generates a ramp or sawtooth and a 50-ns rise-time gate over a  $10^3$  frequency range (1000 s to 10  $\mu$ s in 800 discrete steps). Two-significant-figure and decade-multi-

plier digital dials and a  $\pm 2\%$  vernier give 1% over-all accuracy. In conjunction with the VCF square-triangle module, the ramp generator forms a sweep-voltage source. Amplitude is an adjustable 10 V, and source impedance is 50  $\Omega$ . Deviation from linearity is 0.5% max. Fall time is less than 0.1% of period (ramp) or 50 ns (gate). Price: \$165.

▪ **Delay logic module:** Type 1011 provides the logic to control delay time between two or more modules for double pulse generation, delay triggering and notch or delay burst generation. Delays range from 0.1 s to 100 ns with a 50-ns rise time and 1% accuracy. Delay trigger output is 5 V into 50  $\Omega$ , with a 3-V input needed to start the delay. Module delayed and delay source are switch-selected. Price: \$145.

▪ **Gate/trigger module:** One or more Type 1010 gate/trigger modules can control any one or more generator modules. The units furnish gating and triggering pulses (10 V/100 ns) either manually or upon receipt of an external signal. Since the module has its own high-speed flip-flop and is dc-coupled, the slowest waveform will produce a sharp triggering pulse. Input (manual) is 5 V (gate or trigger on) or 2 V (gate or trigger off). Price: \$50.

▪ **Output amplifiers:** The 20- $\Omega$  input impedance of Type 1201, 1202, 1203 (see photo p. 104), 1204, and 1205 output amplifier modules allows one modular generator to drive several amplifiers. A maximum choice of 11 output waveforms is offered to the customer. Outputs are a variable 10 V into 50  $\Omega$  (1201 and 1202), 5 V into 5  $\Omega$  (1205) and 30 V into 600  $\Omega$  (1203 and 1204). Rise and fall times are 10, 12, 100, 100 and 10 ns respectively. The dc reference level is center 0 (1201, 1202, 1204 and 1205) or a variable +4 to -4 V offset (1203). The balanced push-pull output of type 1204 has amplitude symmetry within 0.5% with respect to ground. The high-current type 1205 (1 A) requires the 1003 power supply. Price: \$95, \$145, \$95, \$135, \$175, respectively.

In the engineering stage are cosine/phase shift, phase lock control, tone burst control, diode shaper and programmable modules. All modules are of PC board construction with 22-pin ribbon connectors. Packaging is 5-1/4 in. high for rack mounting. The smallest width bench box is 9 in., which holds 5 modules 1-5/8-in. high.

The manufacturer will provide "specials" to order and expects to supply its representatives with replacement modules. Thus the concept of the modular instrument will allow the rep to serve in a factory-supply role.

Availability: August. Exact Electronics Inc., 455 S.E. Second Ave., Hillsboro, Ore. Phone: (503) 648-6661.

Circle No. 250

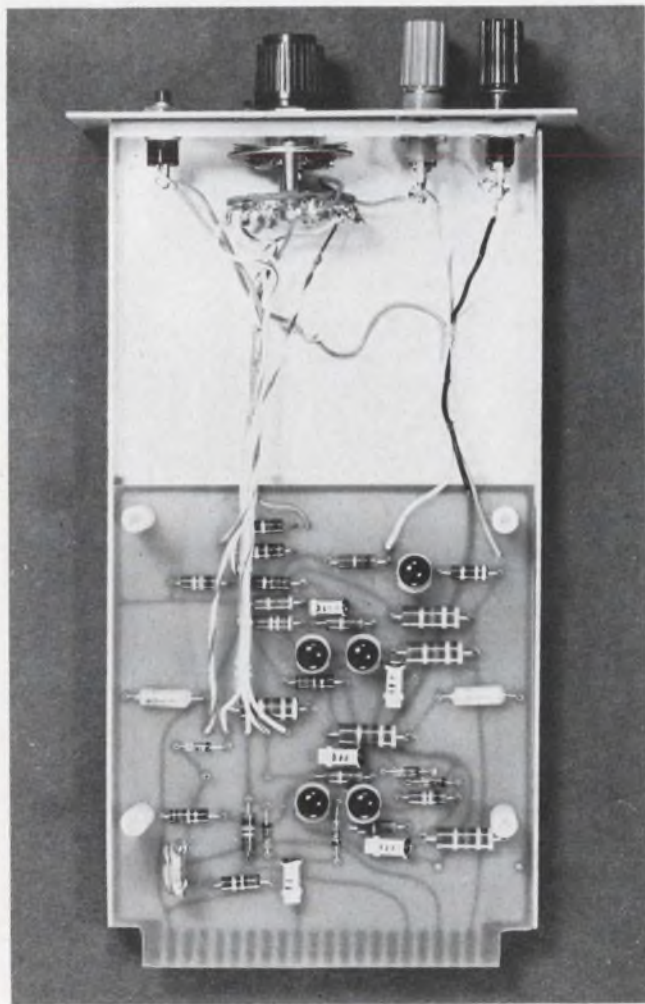

# Semiconductor Report



NEW PRODUCTS, DESIGNS AND APPLICATIONS FROM MOTOROLA

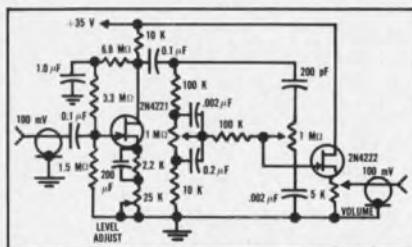

FIGURE 1 — TONE CONTROL FOR THE HIGH FIDELITY AUDIO AMPLIFIERS

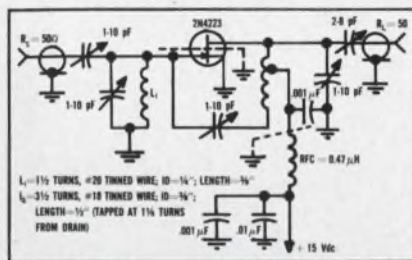

FIGURE 2 — 200 MHz RF AMPLIFIER TEST CIRCUIT

## FOR LOW-NOISE, HIGH-GAIN RF DESIGNS

For application in low-noise RF amplifiers, as shown in the 200 MHz Amplifier Test Circuit (above), Motorola's FET series types 2N4223-24 offer a low 200 MHz noise figure of 5 db (max), a minimum gain of 10 db at 200 MHz (measured "in circuit"), and low cross-modulation and intermodulation distortion. As a result, you can design RF Amplifier circuits with good gain and the assurance of minimum distortion and device noise, plus the expected solid-state advantages of small size and reliability.

ON READER-SERVICE CARD CIRCLE 147

## FET's OFFER ANSWER TO RF/AUDIO AMPLIFIER DESIGN PROBLEMS

If you've had trouble finding the right answer for solid-state design of audio and RF amplifier circuits, two new series of Motorola Field Effect Transistors could be the solution.

For example, in Tone Control for high fidelity audio amplifiers, (see circuit above) the high input impedance of Motorola's new audio amplifier FET's (types 2N4220-22) allows for "vacuum-tube" design principles in the selection of tone control elements — thus permitting the use of high resistance values and small, low-cost, reliable capacitors. In addition, low "1/F noise" provides a definite advantage over "bipolar" transistors. The noise figure of the 2N4220-22 types is just 2 db (typ.) at 100 cycles, while their very high input impedance is indicated by the 0.1 nanoamp  $I_{gss}$  value at 15 volts (greater than  $10^{10}$  ohms) and the  $C_{iss}$  value of less than 6 pF.

ON READER-SERVICE CARD CIRCLE 146



**MOTOROLA Semiconductors**  
— where the priceless ingredient is care!



## WHAT & WHY OF FET's EXPLAINED IN NEW APPLICATION NOTE

Motorola Application Note -211 — "Field Effect Transistors in Theory and Practice" — has been prepared to help circuit designers to better understand how FET's operate and how they are specified. This report is designed to provide an insight into the physics of the device which will permit its use with maximum effectiveness. You're sure to find it a valuable addition to your semiconductor library. Write for it today, to Technical Information Center, Motorola Semiconductor Products Inc., P. O. Box, 955, Phoenix, Arizona 85001.

ON READER-SERVICE CARD CIRCLE 148

### Electrical Characteristics 2N4220-22 & 2N4223-24

CHARACTERISTICS	SYMBOL	MIN	MAX	UNIT	
Forward Transfer Admittance ( $V_{DS} = 15$ Vdc, $V_{GS} = 0$ , $f = 1$ kHz)	2N4220	[Yfs]	1000	$\mu$ mhos	
	2N4221	2000	5000		
	2N4222	2500	6000		
	2N4223	3000	7000		
	2N4224	2000	7500		
Zero-Gate-Voltage Drain Current ( $V_{DS} = 15$ Vdc, $V_{GS} = 0$ )	2N4220	$I_{DSS}$	0.5	3.0	mA dc
	2N4221	2.0	6.0		
	2N4222	5.0	15		
	2N4223	3.0	18		
	2N4224	2.0	20		
Input Capacitance ( $V_{DS} = 15$ Vdc, $V_{GS} = 0$ , $f = 1$ MHz)	2N4220-22	$C_{iss}$	—	6.0	pF
	2N4223-24	—	6.0		
Noise Figure ( $V_{DS} = 15$ Vdc, $V_{GS} = 0$ , $R_s = 1$ kohm, $f = 200$ MHz)	2N4223	NF	—	5.0	dB
Small-Signal Power Gain ( $V_{DS} = 15$ Vdc, $V_{GS} = 0$ , $f = 200$ MHz)	2N4223	$G_{ps}$	10	—	dB

# Shake,



## rattle and roll...

When they made the 1912 Simplex, the art of vibration control was virtually unexplored—if you go by the theory of what you don't know can't hurt you, fine! Today's engineers are a little different (thank heavens) they design every shock and vibration problem possible out of a product. A good example is Rolls-Royce, they just installed 16 of our all-metal Met-L-Flex mounts. They will now become a production standard.

Rolls-Royce chose Met-L-Flex because it's the only mount that completely resists all elements—extreme high or low temperatures, oils, chemicals, fuels, etc. You see Met-L-Flex mounts are all-metal—they incorporate a resilient cushioning material of fabricated, knitted stainless steel wire. It isolates your product from vibration and shock and we're the only ones that make it!

We also have a complete line of elastomeric mounts to meet vibration and shock problems—so whether you're mounting engine and exhaust systems, electronic gear, industrial equipment, or computer systems, we have the mount to solve the problem.



Met-L-Flex unit isolator for Airborne, Vehicular and Industrial applications.



High Frequency engineered mounting systems for missile applications.

## VibraShock

ROBINSON TECHNICAL PRODUCTS, INC.  
3310 Vanowen Street, Burbank, California 91504  
Teterboro, New Jersey  
(213) 849-7181 TWX 910-498-2217  
ON READER-SERVICE CARD CIRCLE 37

### TEST EQUIPMENT High speed scaler



A scaler and timer/scaler are of 6-decade capacity with built-in printer output. Both incorporate a direct-coupled internal discriminator. Input signals to the scaler range from  $\pm 0.1$  to  $\pm 11$  V. The timer/scaler accepts from dc to 10 MHz with a pulse-pair resolution of 66 ns. Scaling rate of the timer-scaler is 2 MHz min. Minimum gate signal is 100 ns.

P&A: \$835 (model 430), \$780 (model 431A); 90-120 days. Ortec Corp., P.O. Box C, Oak Ridge, Tenn. Phone: (615) 483-8451.

Circle No. 251

### Digital indicator



Transducer-measured forces are read by the digital indicator. The manual null-balance instrument has a 4-position bridge resistance selector switch with a 6-position mV/V range selector switch. Model 350 has a  $\pm 0.1\%$  accuracy full scale and a system accuracy of  $\pm 0.25\%$ . Repeatability is  $\pm 0.05\%$  min full scale and resolution is 0.025%.

Baldwin-Lima-Hamilton Corp., Waltham, Mass. Phone: (617) 894-6700.

Circle No. 252

### Frequency changers



Produced in 8 sizes from 0.1 to 15.0 kVA, frequency changers have input frequencies of 47 to 73 Hz, 350 to 450 Hz and output frequencies of 50 to 60 Hz and 350 to 450 Hz. Output frequencies are continuously variable and/or fixed with 0.1% standard stability. The units have an efficiency of better than 80% and meet MIL-1-26600. The sinewave output has 5% max third harmonic distortion.

Avtel Corp., 1130 E. Cypress St., Covina, Cal. Phone: (213) 331-0661.

Circle No. 253

### Selective voltmeter

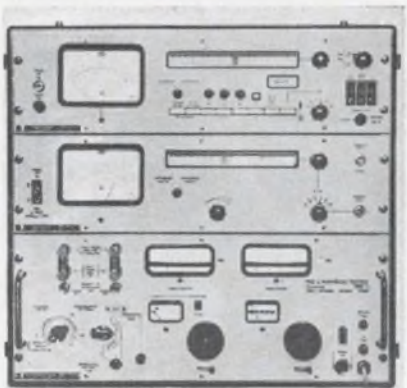

A 10-kHz to 36-MHz selective and wideband voltmeter combines a generator and frequency selective receiver with a frequency locking oscillator for common tuning. The PSM-5 can be tuned over a 36-MHz range or internally swept about a center frequency from  $\pm 17.5$  Hz to  $\pm 17.5$  MHz. Reading sensitivity is  $-120$  dBm max. Frequency stability is  $2 \times 10^{-6} \pm 100$  Hz.

Tel-Com Instruments, Inc., 17715 Chatsworth St., Granada Hills, Calif. Phone: (213) 360-2278.

Circle No. 254



**then add  
this complete,  
low cost  
data system!**

*(only \$4,300, including DVM!)*

**Start with the EI-620  
DVM with *autoject* ...**

Whether your signal levels are single ended or floating above ground, fool proof operation is provided by the 620's isolated-guarded differential input (140 db of CMR). Ground loops, offset or error due to noise are eliminated. The 620's constant high input impedance of greater than 1000 megohms eliminates errors due to source of loading. Fluctuating DC signals are accurately measured with the 620's integrating logic, the value being integrated over the sampling time base of 100 msec.

The exclusive autoject circuitry provides greater than 60 db of normal mode rejection to superimposed noise of any frequency above 30 Hz, without the delay required by filters. (See graph.) *All this at ±.01% accuracy!*

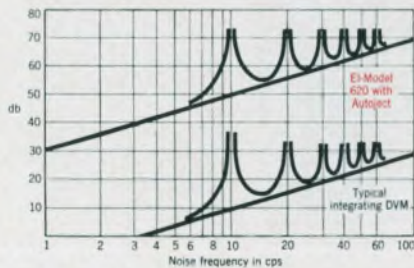

**620 features** — • ±.01% accuracy • 4 full digits plus 5th for 20% overrange • Automatic ranging and polarity • 4 readings per second • DC and Ratio • Differential inputs • Isolated electrical outputs • Remote control • Completely solid state circuitry including logic • From \$995.00

\* **620 Data System** — Now, a low cost portable measuring and recording system utilizing as its heart, the EI-620 DVM with *autoject*. Plug in your EI-620 and the system is complete.

Whether your application is for in house or field use, the 620 system provides a portable package everyone can use, anywhere!

**System features** — • 40 points of guarded scanning • High-Low limit channel selection • Automatic or manual channel selection • Single or continuous cycle operation • Printed record on

4 inch wide paper tape • Printed record includes channel ID, polarity, 5 digits of measured value and range • New, bold printed numerals • Automatic or single print operation • From \$4300.00 (including DVM)

**Additional systems extensions**—are also available to provide additional signal conditioning and printout capability. Write for systems brochure No. S25.512.

**Your choice of system or portable DVM use.** When systems operation is not required, the EI-620 is unplugged and used with its portable case, carrying handle, and bench stand. All features and specifications are identical in both.

Contact your Honeywell Sales Office or write: Honeywell, Test Instruments Division, San Diego Operation, 8611 Balboa Ave., San Diego, Calif. 92112.



**DATA HANDLING SYSTEMS**

**Honeywell**

**DI DIGITAL VOLTMETERS**

HONEYWELL IS WORLDWIDE • Sales and service offices in all principal cities of the world. Manufacturing in Brazil, Canada, France, Germany, Japan, Mexico, Netherlands, United Kingdom, United States.

ON READER-SERVICE CARD CIRCLE 38

# SEQUENTIAL SWITCHING— Compact, Efficient, Low Cost with **CLARE STEPPING SWITCHES**

*Counting • Totalizing • Sequence Control • Monitoring*

■ Where circuit requirements call for selecting, interrupting, or changing connections in response to momentary impulses of current, CLARE's full line of rotary stepping switches provides exactly the device you need.

Compact and ruggedly built, CLARE Stepping Switches have many new, improved features which contribute to longer service life, greater capacity and unusual freedom from maintenance. Contacts are bifurcated for maximum operating reliability. They may be gold plated for low-level switching, with consistently low contact resistance. Your choice of terminals: taper tabs, solder, or plug-in. Special units available to meet airborne shock and vibration requirements.

## ONLY CLARE GIVES YOU ALL THIS:

### 1 Special Purpose Shorting Switches...for Test and Encoding Circuits



#### **"All but one"**

Ideal for the classic "multi-conductor cable" test for leaks, shorts, continuity, etc. Shorts all circuits except one together, making possible sequential testing of each circuit individually.

#### **"Progressive"**

Useful for location of trouble sources in test circuits. Provides incremental increases and decreases in power as required by some control systems.

#### **"Alternate"**

An excellent device for process control functions, generating a wide variety of coded control outputs. Useful in transmitting special coding in sequential repetition. Readily adaptable to binary coded decimal encoding.

### 2 High Voltage Sequential Control Capacity

CLARE will provide special stepping switches to stand off voltages up to 2500 volts. Number of switch levels available depends upon voltage.

### 3 Special Enclosures for Adverse Environments



CLARE Stepping Switches may be enclosed in removable covers, or hermetically-sealed (with either nitrogen or fluid) to minimize undesirable effects of tampering, shock, or vibration, as well as salt air, humidity, fungus, corrosive atmosphere, sand and dust.



Type 26: Up to 624 contact points

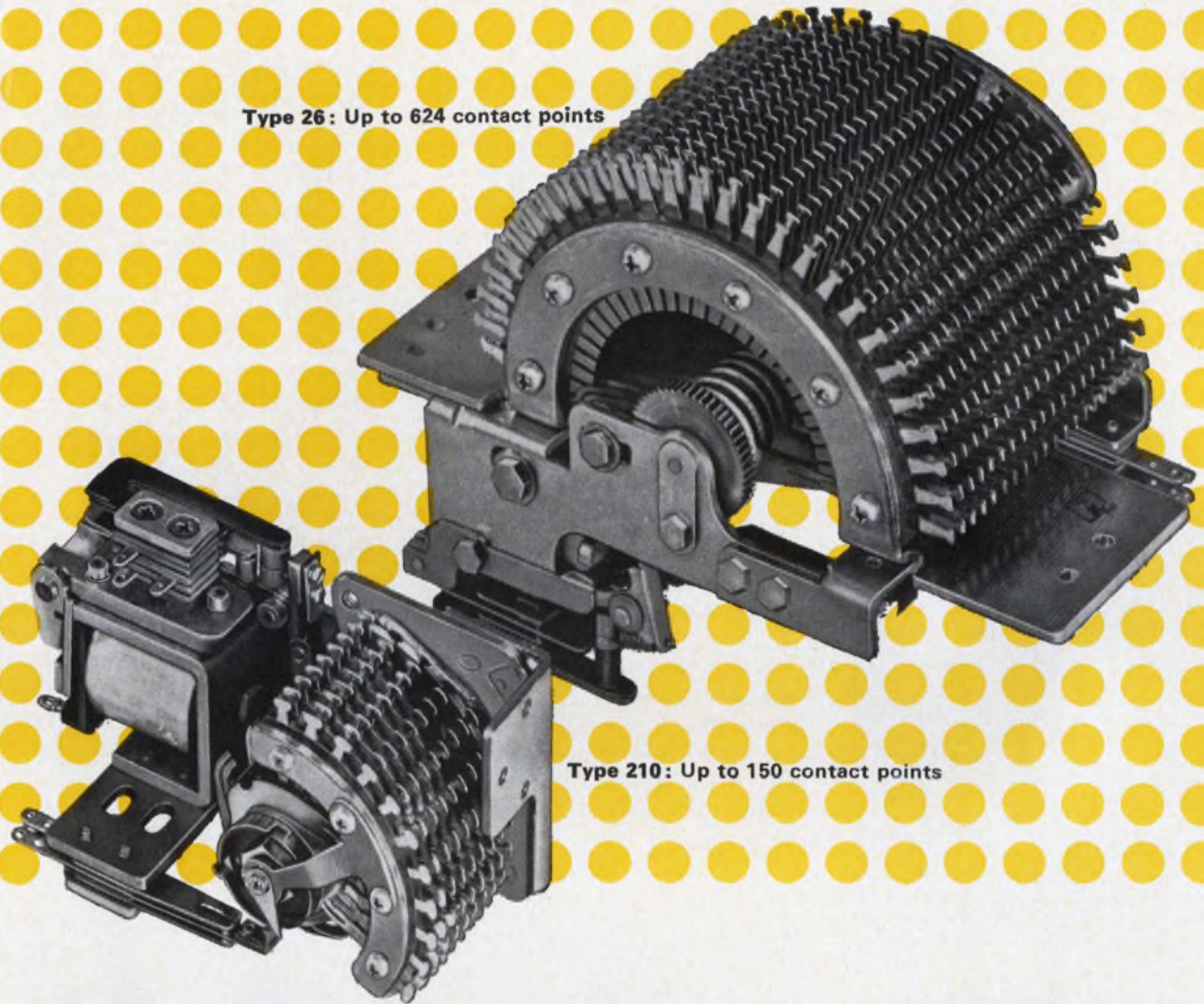

Type 210: Up to 150 contact points

#### 4 Custom-Designed Functional Sequence Control Units...

CLARE engineering can provide functional assemblies incorporating such features as variable time delay pulse generators. Combining stepping switches with solid state (for time delay and pulse generation) and relays (for switch-over between stepper levels), these assemblies expand the capabilities of Clare Stepping Switches.

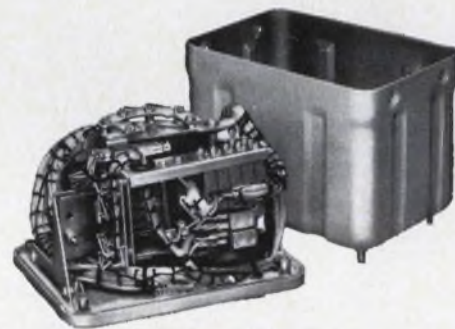

Typical Clare-designed sequential switching unit: 104 point sequence scanner. Solid State pulse generator, driving 10-level, 52-point stepping switch, provides predetermined time interval of 160 ms to 10 seconds at each position.

#### 5 Easy Installation with New Plug-in Connector for Type 211 Stepping Switches



Faster, easier assembly and replacement. Connector contacts, crimped to lead wires, snap into connector frame. Plated contact areas (tin or gold over nickel) for contact reliability.

For information  
write:  
C. P. CLARE & CO.  
Group 07A6,  
3101 Pratt Boulevard,  
Chicago, Illinois  
60645



Speed Inquiry to Advertiser via Collect Night Letter  
ON READER-SERVICE CARD CIRCLE 39

## NEW MAGNETIC RELAY plugs into your PC board!

NO Springs, NO Wiring,  
NO Sockets, NO Soldering,  
NO Mechanical Linkage

# Printact®

Standard Series G  
Latching Series LS/LD

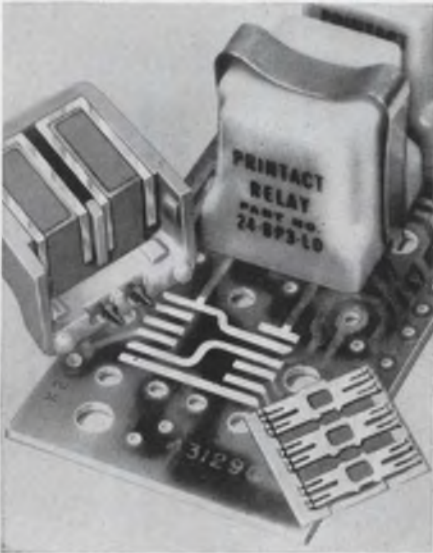

(actual size)

### Plated Conductors on Your PC Board are the Fixed Contacts

Save SPACE, MONEY and MANHOURS with these new small, lightweight, highly reliable Standard and Latching PRINTACT Relays.

Available with Bifurcated Palladium or Gold Alloy contacts for more than 10 million cycle 2 or 3 pole switching. Handles up to 3 amp. res. loads. Coils for 6, 12, 24 and 48 vdc at 500 mw. Operating temperature  $-30^{\circ}\text{C}$  to  $+95^{\circ}\text{C}$ . Operate time 7 ms. The little gem is an 0.8 oz.  $\frac{7}{8}$ " cube.

Quality features include: double-break contacts; balanced armature, enclosed housing, plug-in application; encapsulated coil; self-wiping contacts and inherent snap-action—and the cost is lower than you think!

## Executone

MAIL COUPON TODAY

PRINTACT RELAY DIVISION  
47-37 Austell Place  
Long Island City, N.Y. 11101

- Send Printact data and prices.  
 Have your local rep. call.

Name \_\_\_\_\_ Title \_\_\_\_\_

Firm \_\_\_\_\_ Tel. # \_\_\_\_\_

Address \_\_\_\_\_

City \_\_\_\_\_

ON READER-SERVICE CARD CIRCLE 40

## TEST EQUIPMENT



### Field vibration meter

Available in ac or dc, model 1-157 vibration meter indicates p-p displacement and average velocity. The input signal is averaged and displayed on a meter to peak or average values based upon equivalent sinusoidal input. Frequency range is 5 to 2000 Hz (displacement), 5 to 20,000 Hz (velocity) and frequency response is  $\pm 2\%$ .

P&A: \$1195 (ac), \$1135 (dc); 90 days. Consolidated Electrodynamics Corp., 360 Sierra Madre Villa, Pasadena, Calif. Phone: (213) 796-9381.

Circle No. 255

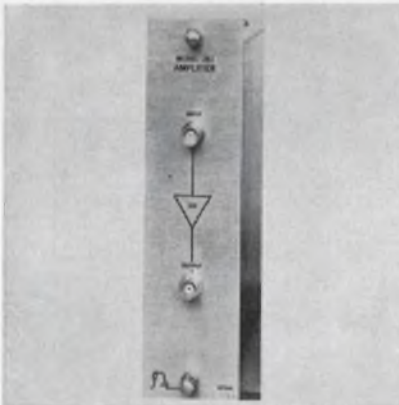

### High-gain pulse amplifier

Completely shielded and decoupled to operate at input levels of 300 mV max, this 2-transistor multiple feedback amplifier has a 20-dB  $\pm 3\%$  gain. Model 281 has a 50- $\Omega$  input and output impedance. Rise time is 2 ns max and pulse distortion is 15 mV p-p max with a 300 mV output. Undistorted output is 600 mV max and droop time constant is  $1/2 \mu\text{s}$ . Noise referred to input is 50  $\mu\text{V}$ .

Nanosecond Systems, Inc., 176 Linwood Avenue, Fairfield, Conn. Phone: (203) 255-1008.

Circle No. 256



### Milliwatt test set

Fitted with BNC connectors, this mW test set measures 1 to  $-1$  dB referred to 1 mW on 75- $\Omega$  unbalanced circuits at frequencies up to 30 MHz. It measures heater voltages of 5.6 to 7 V. A wired-in thermocouple is used with heater impedance of 75  $\Omega$ . The standardizing circuit can send 1 mW dc into external 75- $\Omega$  circuits for calibrating other apparatus. The device operates from three integral 1.5-V dry cells.

ITT Corp., 320 Park Ave., New York. Phone: (212) 752-6000.

Circle No. 257

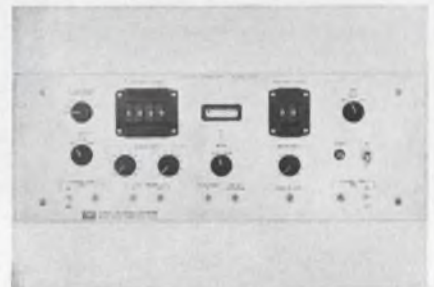

### Spectrum stabilizer

Two independent sections of this digital spectrum stabilizer correct for gain and baseline drift effects. The gain section corrects for changes in steps of one part in 64,000 to one part in 1000. Stabilization is unaffected by variations in input counting rate up to 50 kHz. Gain and/or zero stabilization may be based on a prominent peak in the input spectrum or an externally generated reference signal. The gain stabilization channel can be incremented from 0 to 9999 and the zero peak channel is switch-selectable from 0 to 99.

Technical Measurement Corp., 441 Washington Ave., North Haven, Conn. Phone: (203) 239-2501.

Circle No. 258



## After 130,000,000 diodes



# 1-amp glass rectifiers come easy

The basic technology required for making silicon glass rectifiers has long since been proved out in ITT's diode operation. More than 130,000,000 diodes last year paved the way for 1966 1-amp glass rectifier capability that's already operating at better than a 1.2 million annual rate.

If you're using old-fashioned top-hats because delivery is slow on DO-29 glass rectifiers, make the switch now.

ITT offers immediate shipment of 200 to 1000 V, 1-amp glass rectifiers from factory stock or from ITT distributors' shelves. See how fast silicon glass rectifier delivery can be — call your ITT factory representative or any of ITT's semiconductor distributors throughout the United States today. ITT Semiconductors, a division of International Telephone and Telegraph Corporation, 3301 Electronics Way, West Palm Beach, Florida.

**ITT**  
SEMICONDUCTORS

FACTORIES IN PALO ALTO, CALIFORNIA; LAWRENCE, MASSACHUSETTS; WEST PALM BEACH, FLORIDA; HARLOW AND FOOTSCRAY, ENGLAND; FREIBURG AND NURENBERG, GERMANY.

ON READER-SERVICE CARD CIRCLE 41

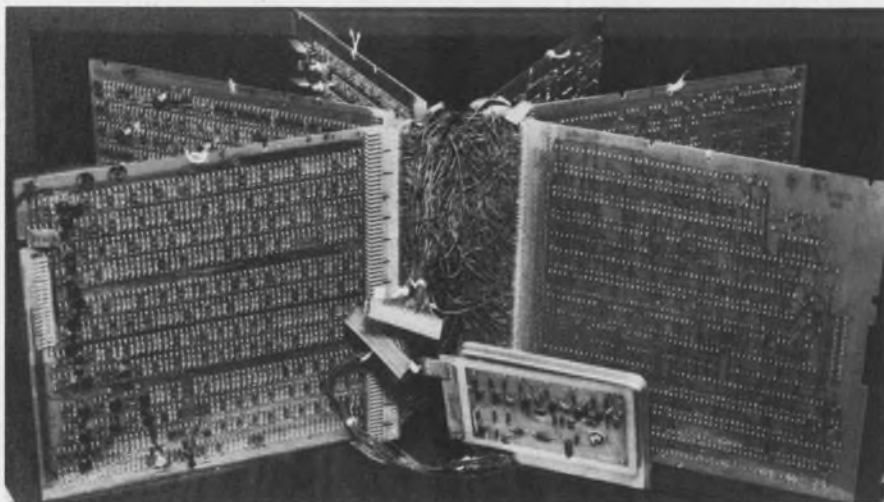

## Back-panel wiring harness ousts connector blocks

A back-panel interconnection system completely supplants more expensive connector blocks. The wiring harness is an independent unit that is plugged on to the array of PC boards. The male pins are supplied on strips wound on reels. Wiring logic and gauge are customer-specified.

The connecting hardware is the combination of 0.025-in.<sup>2</sup> male pins staked in rows on the edge of the PC boards and a female connector crimped to the harness wires. These wires are insulated and ganged together by sandwiching them between layers of PVC. The layers are sealed by an RF dielectric heat-sealer to form the female connector.

The harness itself is produced on a tape-programmed machine, which eliminates bugs associated with hand-wiring. Two wires can be crimped into one terminal allowing

the jumpering or commoning of any number of pins in the array. The male pins are automatically staked on a machine supplied by the manufacturer located in the customer's plant. The machine stakes 4000 terminals/hour.

Two heights of male pins are available. Using one type of pin permits a minimum spacing of 0.125-in. centers. By alternating the two heights, a density of 0.0625-in. center-to-center can be achieved. In a typical harness of over 800 wires on 0.0625-in. centers, the harness projection beyond the board is limited to 1.25 in. with slight compression. Eliminating custom wiring and debugging each back panel saves production line time and money. The cost of fabricating a connector-block array is completely eliminated.

The resistance of the mated connection is 5 m $\Omega$  max at 2 A after 100 cycles of the connection. A minimum tensile strength of three pounds for #28 AWG and 4.5 pounds for #26 AWG is maintained between the wire and the terminals.

P&A: \$4 to \$7/M; stock to 2 wks (male pins). \$0.05 to \$0.10/connection; 3 to 4 months (initial order), 3 to 4 wks (subsequent orders); (harness). Berg Electronics Inc., New Cumberland, Pa. Phone: (717) 938-6711.

Circle No. 259

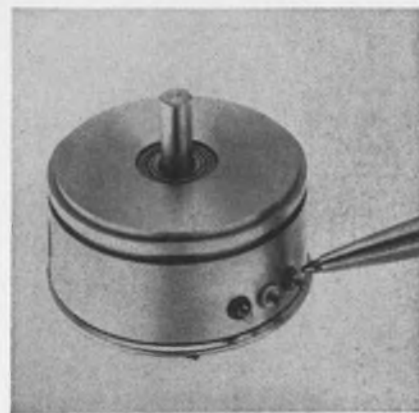
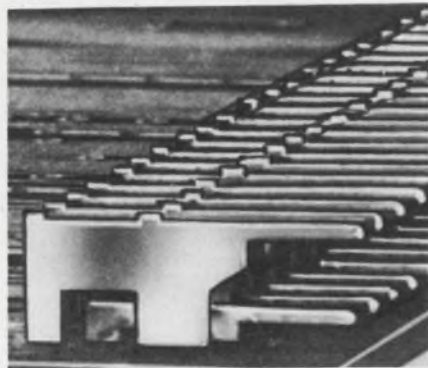

## Gangable plastic pot

Servo-mounted, 2-in. diameter pots offer  $\pm 0.5\%$  linearity, a 4-W power rating at 85°C and resistance tolerance of  $\pm 3\%$ . Model 2580 withstands temperatures of 150°C. Resistances are available from 20 to 125,000  $\Omega$ . The rotor, insulator ring and element mount are of diallyl phthalate. The resistance element is epoxyed to the diallyl mount. The pots are gangable up to 8 units and available with up to 9 additional taps.

P&A: \$25 (1 to 9); stock to 6 wks. Amphenol, 120 S. Main St., Janesville, Wis. Phone: (608) 754-2211.

Circle No. 260

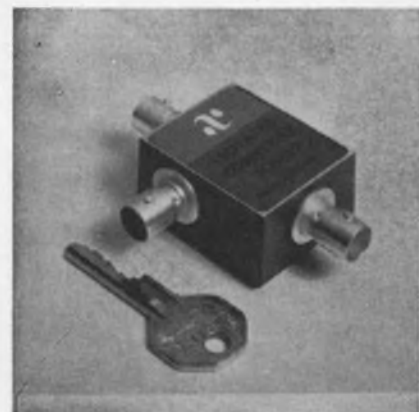

## Isolated converter

An isolated converter provides high isolation and minimum conversion loss from dc to 400 MHz with a noise figure of 7.5 dB. RF range is 500 kHz to 400 MHz. Conversion loss is 7 dB. The unit weighs 4 oz and has BNC connectors.

P&A: \$268; stock. Adams-Russell Co. Inc., 280 Bear Hill Rd., Waltham, Mass. Phone: (617) 899-3145.

Circle No. 261

**SERIES 930 DTL**

**Evaluate ITT**

**ITT**  
SEMICONDUCTORS

ITT SEMICONDUCTORS IS A DIVISION OF THE INTERNATIONAL TELEPHONE AND TELEGRAPH CORPORATION  
FACTORIES IN WEST PALM BEACH, FLORIDA; PALO ALTO, CALIFORNIA; LAWRENCE, MASSACHUSETTS; HARLOW AND FOOTSCRAY, ENGLAND; FREIBURG AND NURENBERG, GERMANY

ON READER-SERVICE CARD CIRCLE 42

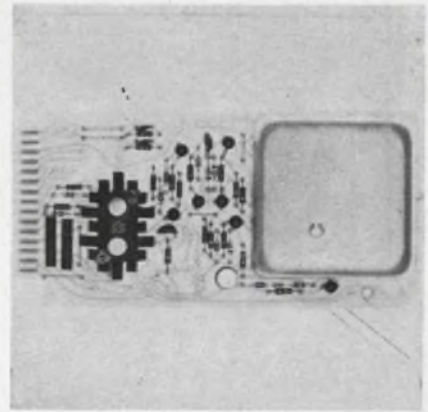

### Dc op-amp cuts ac error

A 100-Vdc operational amplifier reduces ac error by neutralizing summing-node capacitance. In systems requiring physical separation of the gain-determining network from the amplifier, the summing node is loaded by cable capacitance which impairs ac system performance. A "guard driver" reduces the effective magnitude of such capacitance by a factor of 10. The open-loop single-ended amplifier has an output capability of 30 mA at 110 V. Input impedance is  $10^{11} \Omega$  shunted by 3 pF. Gain is  $10^6$  at dc. Small-signal gain rolls off at 6 dB/octave to unity at 5 MHz. Output slewing limit is 20 V/ $\mu$ s. Input offsets are 1  $\mu$ V/ $^{\circ}$ C and 2 pA.

P&A: \$180; stock to 40 days. Newport Labs., P. O. Box 2087, Newport Beach, Calif. Phone: (714) 646-9295.

Circle No. 262

### Micromin mW preamp

Employing silicon semiconductors and FETs, these preamplifiers may be cascaded to obtain a gain of 40 to 70 dB. All units have a per cycle noise figure of -168 dB at 1 KHz. Frequency response is 3 Hz to 100 kHz  $\pm 3$  dB. Input impedance is 1 M $\Omega$  and output impedance is 30  $\Omega$ . The broadband minimum detectable signal is 1.25- $\mu$ V for 100 kHz bandwidth. Power consumption is 12 mV, output signal is 2.5 V rms min and dynamic range is 70 dB.

Applied Cybernetics Systems, 880 Bonifant St., Silver Spring, Md. Phone: (301) 588-4873.

Circle No. 263

You can see the difference  
in the twinkling of an eye

The big difference is beam control. This General Electric TL 1 $\frac{3}{4}$  lens-end lamp puts 750 footcandles on a  $\frac{1}{8}$ " spot. From  $\frac{3}{8}$ " away, this type puts no light at all outside an area  $\frac{5}{8}$ " by  $\frac{3}{8}$ ".

For the electronic eyes of reader-sorters, computers, scanners — anywhere errant light can mean error — G-E TL 1 $\frac{3}{4}$  lamps keep a tight squeeze on light.

Choose from seven with five different beam patterns. Available with midget flange, midget groove or wire terminal. All with low color temperature (2225K $\pm$ 175) and average life of 10,000 hours or more.

For detailed specifications on all G-E TL 1 $\frac{3}{4}$  lens-end lamps, write: General Electric Company, Miniature Lamp Department, M 6-2, Nela Park, Cleveland, Ohio 44112.

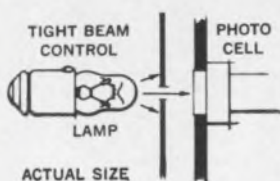

*Progress Is Our Most Important Product*

**GENERAL ELECTRIC**

ON READER-SERVICE CARD CIRCLE 43

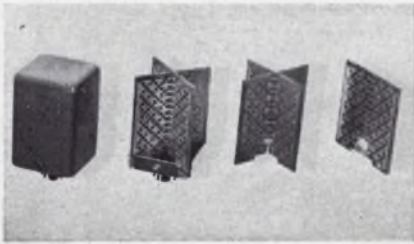

## PC plug-in cans

Two epoxy-glass, single-sided printed circuit boards (2-1/2 x 2-1/4 x 1/16-in.) with 312 soldering pads each mount in 3 x 2 x 2 in. cans. Prototype circuits may be quickly built by mounting transistors or other components, wiring and soldering.

Plug-In Instruments Inc., 1416 Lebanon Rd., Nashville, Tenn. Phone: (615) 244-1330.

Circle No. 264

## 100-Meg decade box

Two resistance decade boxes have a 100-Ω to 111.111-MΩ range with positive in-line read-out. Models RDS 67A and 67B have accuracies of 0.01% and 0.025%. Resistance settings are accurate to 0.01%. Stability is 25 ppm/year and switch life is 10<sup>6</sup> operations. Temperature coefficient is 5 ppm/°C.

P&A: \$575 (67B), \$695 (67A); stock to 30 days. General Resistance Inc., 430 Southern Blvd., Bronx, N. Y. Phone: (212) 292-1500.

Circle No. 265

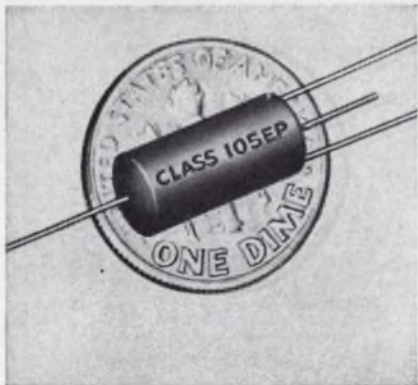

## Micromin reed relay

Including epoxy resin encapsulation, this spst-NO reed relay is 7/16-in. long by 1/4-in. diameter. Operate time is 0.25 ms and release time is 0.5 ms. Contacts are rated 0.1 VA max at 10 mA max or 12 V max, non-inductive.

Magnecraft Electric Co., 5575 N. Lynch, Chicago. Phone: (312) 282-5500.

Circle No. 266



Mark II Series 300 and Series 350

## SIZE DOWN. PERFORMANCE UP!

**Our new one-inch 6PDT and 4PDT relays give you established dry-circuit reliability**

Electro-Tec's wedge-action contact mechanism\* has been proving itself in conventional 6PDT operations for 9 years. It's established an outstanding dry-circuit confidence level of 90% based on a failure rate of .001% per 10,000 operations. Now we've put wedge-action to work in two 1" x 1" miniature relays, the Series 300 (6PDT) and Series 350 (4PDT). The Series 300 will replace three half-size crystal-can relays in approximately the same space while giving you the advantage of a proven reliability factor. Wedge-action, precious metal contacts combine long contact wipe area with high contact force. Results? Low, low contact resistance, stable over operating life. Extreme shock, vibration, and acceleration immunity. Performance exceeds all MIL-R-5757/1 and /7 requirements. Competitively priced, with in-house testing to your high-rel specifications.

\*U.S. Patent No. 2,866,046 and others pending.

### CHARACTERISTIC PERFORMANCE DATA

Contact Rating: Low-level to 2 amps  
Operate and Release Time: 10 ms max. @ 26.5 VDC and 25°C  
Contact Bounce: 1 ms max. even at low-level loads  
Shock: 100G—11 ±1 ms Vibration: 30G up to 3000 cps



# Electro-Tec Corp.

SLIP RINGS • RELAYS • SWITCHES • OPTICS

P. O. Box 667 • Ormond Beach, Florida  
(904) 677 1771 • TWX 810-857-0305

Manufacturing facilities: Ormond Beach, Fla. • Blacksburg, Va.

ON READER-SERVICE CARD CIRCLE 44

# Think of a number between 1 and 6,000.

That's how many lines per minute the MC 4000 can print.



Monroe Datalog®'s MC 4000 ultra high speed optical printer records 6000 lines per minute, or any speed less that your application requires. Truly synchronous or asynchronous. Completely silent. Absolutely reliable—only two moving parts. Available in numeric or alphanumeric models—both 32 columns wide. Any 4 or 6 line code with any logic level.

Features: character serial input, bit parallel. 6 microseconds per character data transfer time. Exceptional compactness— $10\frac{1}{2}$ " x  $10\frac{3}{4}$ " x  $21\frac{1}{2}$ ". All

solid state. Cathode ray tube with fiber optics.

Permanent copy option available.

And a full year's warranty. Price: \$5650 for numeric model; \$5850 for alphanumeric model.

For information, contact Monroe Datalog Division of Litton Industries, 343 Sansome St., San Francisco 94104. (415) 397-2813.

ON READER-SERVICE CARD CIRCLE 45

**MONROE DATALOG**   
DIVISION OF LITTON INDUSTRIES



# Militarized versions of MC 4000 also available.

The Monroe DATALOG MC 4000 is available in any configuration or to any military specifications that your application requires.

For further information, call the Monroe DATALOG Division of Litton Industries, 343 Sansome St., San Francisco 94104. (415) 397-2813.

**MONROE DATALOG**   
DIVISION OF LITTON INDUSTRIES  
ON READER-SERVICE CARD CIRCLE 46  
ELECTRONIC DESIGN, July 19, 1966

## COMPONENTS

### Logic sensing module



A solid-state sensing module performs AND, OR, NOT, NOR, NAND and memory logic functions. The module has plug-in PC board design. Up to 4 isolated  $\mu$ A control signals may be algebraically mixed to yield an on/off mA output capable of driving a small dc relay, indicating lamp or power thyristor.

Norbatrol Electronics Corp., 356 Collins Ave., Pittsburgh. Phone: (412) 362-2020.

Circle No. 267

### Crystal oscillator



Frequency tolerances of  $\pm 0.001\%$  can be met over the 5- to 100-MHz range of this crystal oscillator. Available supply voltages of 5 to 28 Vdc suggest uses as an IC frequency source. Output voltages of 3 V p-p square wave with 20-ns rise time and 2 V rms sine wave with 10% distortion into a 1-k $\Omega$  load are typical.

Price: \$71.50 to \$169.75. Accu-tronics Inc., 12 S. Island Ave., Batavia, Ill. Phone: (312) 879-1000.

Circle No. 268

### Dc to dc plug-in

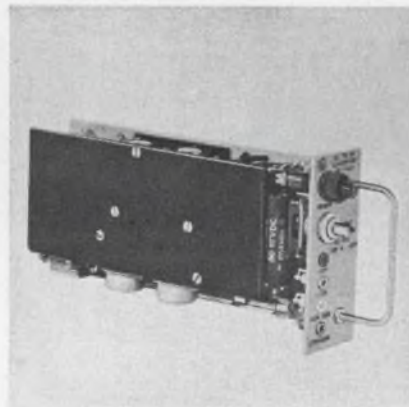

A plug-in dc to dc converter reduces the output voltage of a 130 Vdc power supply to lower regulated voltage levels. It eliminates large voltage-dropping resistors and provides transformer isolation from the battery. Regulating circuits function over an input range of 104 to 140 Vdc. Maximum total output is 6 W.

Radio Frequency Labs. Inc., Boonton, N. J. Phone: (201) 334-3100.

Circle No. 269

### Strain gage transmitter

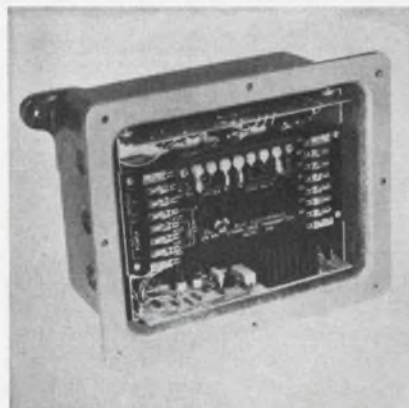

A transistorized strain gage transmitter for transducer force-measuring systems connects a strain gage transducer output directly to all three of the standard control current signals. The unit has linearity of  $\pm 0.20\%$ , repeatability of  $\pm 0.05\%$  and sensitivity of 0.05% over an operating range of  $-20$  to  $140^\circ$ F.

Baldwin-Lima-Hamilton Corp., 42 Fourth Ave., Waltham, Mass. Phone: (617) 894-6700.

Circle No. 270

# ELIMINATE COSTLY DATA REDUCTION!

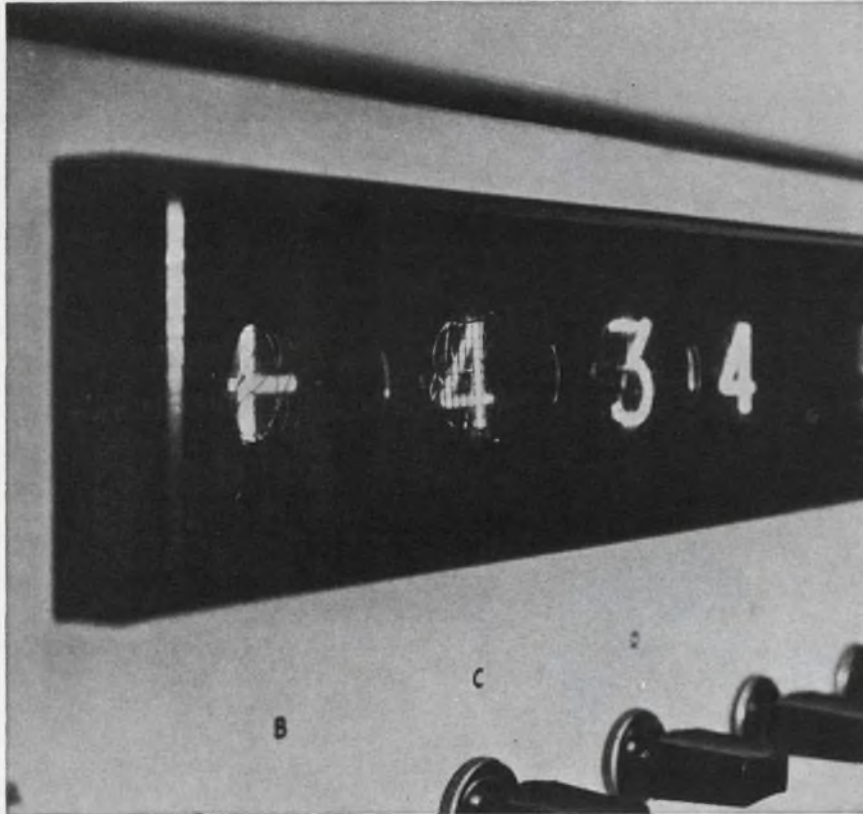

## READ TEMPERATURE DIRECTLY.....

### WITH REC'S NEW MODEL 414 LINEAR BRIDGE

Now you can read temperature directly and accurately to 0.03 per cent, in a range of  $-100^{\circ}$  to  $+500^{\circ}\text{F}$ ! Simply combine REC's Model 414 Bridge with platinum resistance temperature sensor\* and any digital voltmeter.

REC's Model 414 linear bridge provides 1 millivolt per  $^{\circ}\text{C}$  or  $^{\circ}\text{F}$  suitable for direct presentation on digital voltmeters, printers, etc. Or use it as an input for recorders, computers and control systems. No further signal conditioning is required. Ideal for differential measurements (2 units required).

The cost? Approximately \$155.00 complete for bridge and integral power supply. Write today for full details.

\*REC also manufactures a complete line of Surface and Immersion Temperature Sensors, Air Data Sensors, Pressure Calibration equipment, Mass Flow and Pressure Sensors and related accessory equipment.

*we invite inquiries regarding  
your particular requirements...*



4900 WEST 78th STREET • MINNEAPOLIS, MINNESOTA 55435  
ON READER-SERVICE CARD CIRCLE 47

## COMPONENTS



### Carbon-14 battery is stable current standard

"Perma-Nuclear" batteries produce a  $5 \times 10^{-13}$ -A current by collecting beta particles from the decay of Carbon-14. Since the half-life of Carbon-14 is 5,570 years, current decreases less than 0.1%/year. The battery produces the same current whether connected to a short or to up to  $10^{15} \Omega$ . The source is permanently shielded and license-exempt.

General Radioisotope Processing Corp., 3000 San Ramon Valley Rd., San Ramon, Calif. Phone: (415) 837-5424.

Circle No. 271

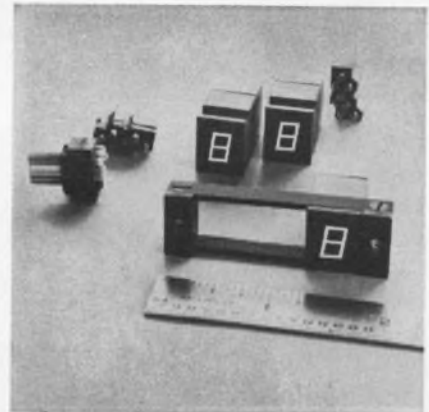

### Single-digit read-outs

Single-digit read-outs are each capable of representing 21 standard alphanumeric characters in a 7-segmented bar configuration. They use miniature 0.7-A incandescent lamps and silvered light pipe segments to achieve a brilliance of 500 foot-lamberts. The units meet MIL-E-5400.

Tung-Sol Electric Inc., One Summer Ave., Newark, N. J. Phone: (201) 484-8500.

Circle No. 272

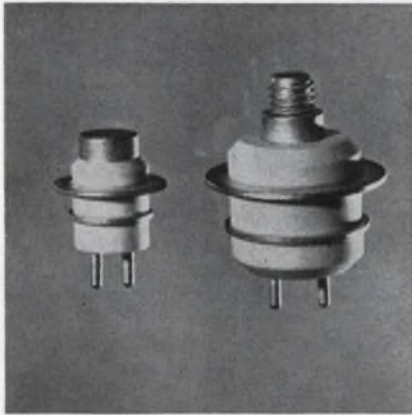

### Ceramic planar triodes

Two ceramic planar triodes are designed for the telemetry frequencies of 2.2 to 2.3 GHz. The Y-1266 weighs 2-oz and is designed for applications requiring power outputs up to 3 W. It has a power gain of 9 to 12 dB. Plate voltage is 200 V and current is 30 mA. The Y-1223 has a high-dissipation anode designed to increase plate dissipation to achieve a 10-W output at 2.3 GHz. Power gain is 7 to 9 dB.

General Electric Co., 1 River Rd., Schenectady, N. Y. Phone: (518) 374-2211.

Circle No. 273

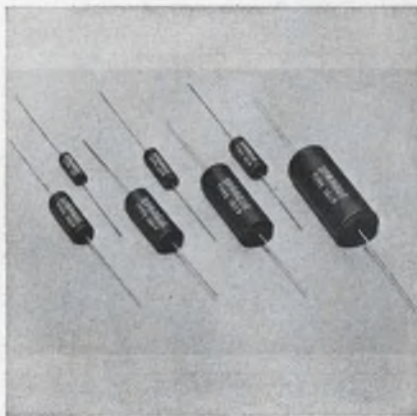

### Dual-dielectric capacitor

Dual-dielectric capacitors using paper and polyester-film are rated at 1600 Vdc in capacitance values of 0.001 to 0.1  $\mu$ F. Type 160P capacitors are fully molded while type 161P capacitors utilize premolded cases. Both use a synthetic hydrocarbon solid impregnant which is polymerized in situ. The capacitors have standard working voltages of 200, 400, 600, 1000 and 1600 Vdc with operating temperatures of 85°C max.

Sprague Electric, 347 Marshall St., North Adams, Mass.

Circle No. 274

# BIG POWER SMALL PACKAGE CERMET STABILITY UNDER \$2.00 each

(in production quan.)

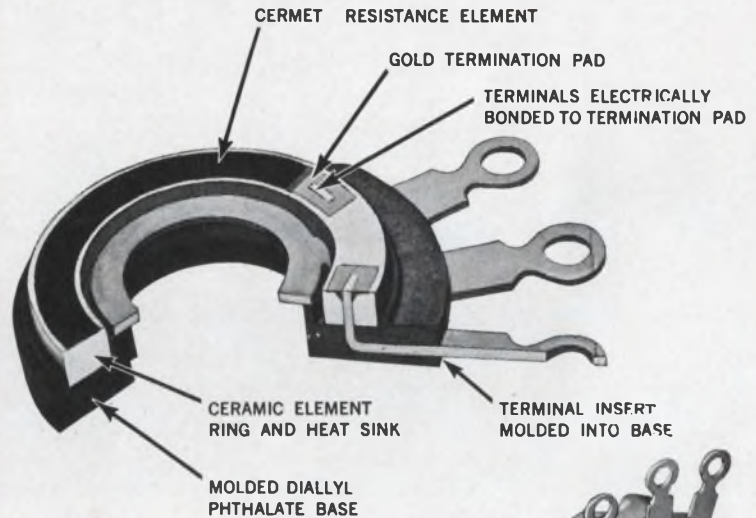

Series 550 has long life—  
no catastrophic failures



## New 2-watt, 3/4" diameter CERMET Variable Resistor

Applications: computers, instruments, medical electronics, communications equipment, electronic machine controls, electronic processing equipment, aerospace electronics, microwave transmission, etc.

#### Outstanding features:

- Closed construction*—Cover entirely protects against dust and dirt. Exceeds MIL-R-23285 (Navy) metal film, Cermet; also far exceeds MIL-R-94B.
- Extreme stability* under severe environmental conditions.
- Resistance range*—50 ohms through 1 Megohm.
- Infinite resolution.*
- Low noise and long life.*
- Excellent high frequency characteristics.*



Founded 1896

Request data sheet 3550.

**CTS OF BERNE, INC.**  
**BERNE, INDIANA**

a subsidiary of

**CTS Corporation, Elkhart, Indiana**

ON READER-SERVICE CARD CIRCLE 48

# OFF-THE-SHELF MAGNETIC SHIELDS



About 80% of all magnetic shield designs now in use originated here.

Maybe it's because our designs work. Maybe our designs work because we've had the most experience. All are good reasons to contact us.

Netic and Co-Netic magnetic shields are the recognized standard all over the world for military, laboratory, industrial and commercial applications. They are insensitive to ordinary shock, do not require periodic annealing, and have minimal retentivity. A few typical applications are illustrated. Our design department is yours.



Magnetically Shielded Room



CRT Shield Complex



Sectionalized P.M. Shield



Nesting Cans

## MAGNETIC SHIELD DIVISION

Perfection Mica Company

1322 N. ELSTON AVENUE, CHICAGO, ILLINOIS 60622

ORIGINATORS OF PERMANENTLY EFFECTIVE NETIC CO-NETIC MAGNETIC SHIELDING

ON READER-SERVICE CARD CIRCLE 49

# NEW Cold-Weld Crystals withstand 20g vibration at 10-2,000 Hz



Actual Size

### TYPICAL SPECIFICATIONS

Frequency Range... 300 to 700 KHz Shock..... 100g  
Holder..... HC-6 type Vibration.... 20g at 10-2,000 Hz

After 5,000-hour life test at 65°C,

$$\frac{\Delta F}{F} \text{ less than } 2 \times 10^{-8} \text{ per day.}$$

Reeves-Hoffman's high reliability cold-welded crystals meet all requirements for space programs such as Apollo and Ranger. Cold welding solves problems of damping and corrosion, permits minaturization, provides typical specifications as shown above. We invite your inquiry for complete information.



400 WEST NORTH STREET, CARLISLE, PENNSYLVANIA 17013

ON READER-SERVICE CARD CIRCLE 50

### COMPONENTS



### Phase-locked oscillator

Automatic phase control combined with automatic frequency control gives this oscillator the crystal stability of the APC circuit with the wide capture range of AFC. A stabilization indicator lamp is incorporated. Frequency range is 1850 to 2050 MHz and output power is 25 mW. Long-term stability is 1 ppm and short-term stability is 0.3 ppm min. An integral proportional controlled crystal oven requires 28 Vdc, 15 W. The oscillator requires 10 W max.

Litton Industries, 200 E. Hanover Ave., Morris Plains, N. J. Phone: (201) 539-5500.

Circle No. 275

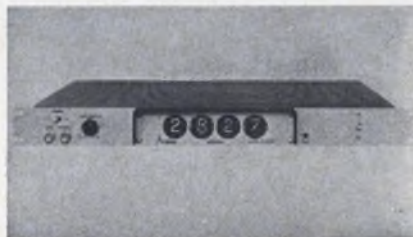

### "Slim" totalizer

The 1-3/4-in. high front panel of this 3- to 6-decade totalizer contains the reset push-button, power on-off controls and input terminal. Input is square wave or positive pulse with amplitude 6 V p-p. Rise time is 1 μs max and duration is 4 μs min. Frequency range is dc to 200 kHz. Options include digital printer output, 6-digit mechanical totalizer, pre-amp for 10 mV sensitivity and +12 Vdc level gating and pre-amp to provide 10 mV sensitivity and 2-line pulse gating.

P&A: \$445; stock to 4 wks. Ana-dex Instruments Inc., 7833 Haskell Ave., Van Nuys, Calif. Phone: (213) 782-9527.

Circle No. 276

# Now! Transistor chips for hybrid circuits!

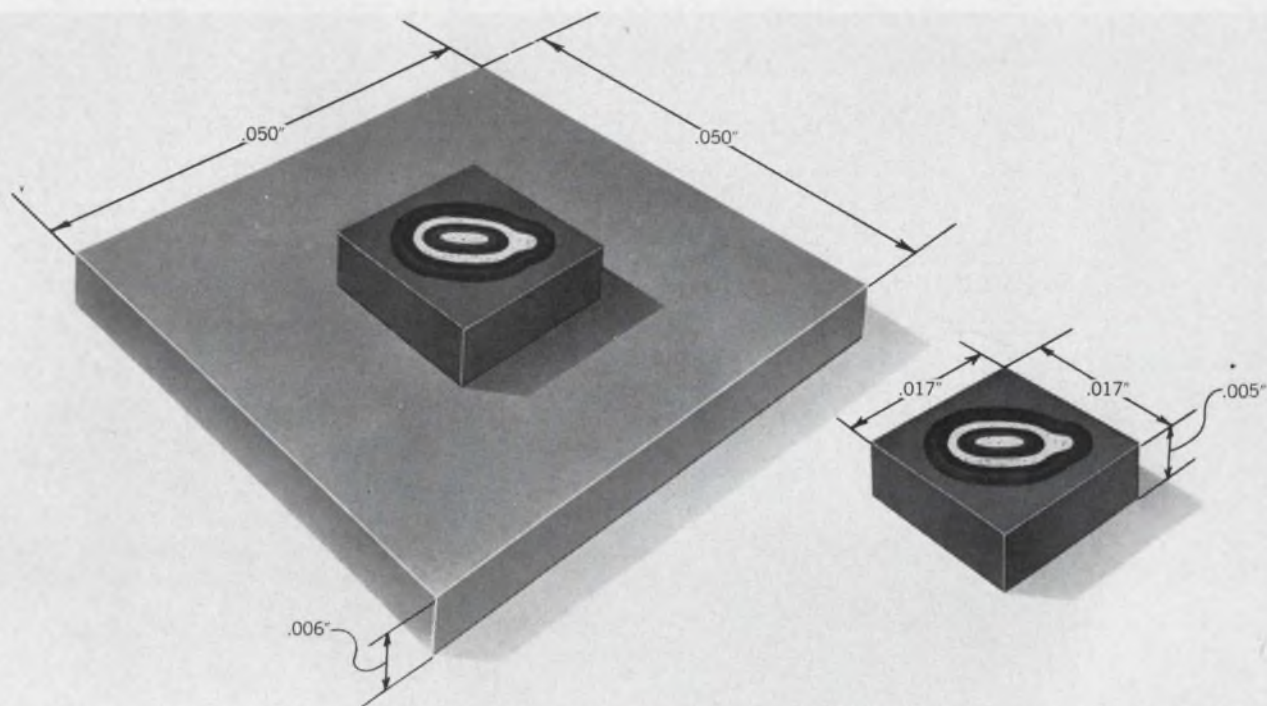

These are standard PNP and NPN silicon PLANEX\* chip transistors, supplied in gold-backed form or as chips pre-attached to gold-plated Kovar Tabs. They are available for your hybrid circuits now.

These chips are 100% tested to all low level DC parameters. Sample lots are tested for all

AC and DC data sheet parameters to assure full specification compliance.

For specifications, price and delivery information, call your nearest Raytheon regional sales office. Or write: *Raytheon Company, Components Division, 141 Spring Street, Lexington, Mass. 02173.*

TYPES	DESCRIPTION	ABSOLUTE MAXIMUM RATINGS			
		V <sub>CB0</sub>	V <sub>CEO</sub>	V <sub>EB0</sub>	I <sub>C</sub>
TA4980 (2N918)	NPN chip transistor for low-level high-frequency amplifiers. Dice size .017x.017"	30V	15V	3V	100mA
TA4981 (2N2369A)	NPN chip transistor for high-speed saturated switching. Dice size .017x.017"	40V	15V	45V	200mA
TA4982 (2N3011)	NPN chip transistor for high-speed saturated switching. Dice size .017x.017"	30V	12V	5V	200mA
TA4972 (2N2904A)	PNP chip transistors for general purpose usage. Dice size .020 x .027"	60V	60V	5V	1000mA
TA4973 (2N2905A)	PNP chip transistors for general purpose usage. Dice size .020 x .027"	60V	60V	5V	1000mA
TA4984 (2N2218A)	NPN chip transistors for general purpose usage. Dice size .020 x .027"	75V	40V	6V	1000mA
TA4985 (2N2219A)	NPN chip transistors for general purpose usage. Dice size .020 x .027"	75V	40V	6V	1000mA
TA4974 (2N1890)	NPN chip transistors for general purpose usage. Dice size .036 x .036"	120V	80V	7V	1000mA
TA4975 (2N1893)	NPN chip transistors for general purpose usage. Dice size .036 x .036"	100V	60V	7V	1000mA
TA4976 (2N3250)	PNP chip transistors for low-level and preamplifier usage. Dice size .017 x .017"	50V	40V	5V	100mA
TA4977 (2N3251)	PNP chip transistors for low-level and preamplifier usage. Dice size .017 x .017"	50V	40V	5V	100mA
TA4991 (2N2483)	NPN chip transistors for high-gain preamplifier usage. Dice size .019 x .019"	60V	60V	6V	100mA
TA4992 (2N2484)	NPN chip transistors for high-gain preamplifier usage. Dice size .019 x .019"	60V	60V	6V	100mA
TA4978 (2N3244)	PNP chip transistors for high current saturated switching. Dice size .036x.036"	40V	40V	5V	1000mA
TA4983 (2N3252)	NPN chip transistor for high current saturated switching. Dice size .036x.036"	60V	30V	5V	1000mA

\*PLANEX—Raytheon's designation for Planar Epitaxial

**RAYTHEON**

Raytheon Components Division—A single source for Transistors/Diodes/Integrated Circuits/Industrial Tubes/Control Knobs/Panel Hardware/Raysistors/Circuit Modules/Display Devices

ON READER-SERVICE CARD CIRCLE 51

**Need a portable recorder  
to read and write  
IBM computer  
compatible tapes  
at 200,  
556,  
800  
bits**

**per  
inch?**



Maybe the Parsons DR 1200 is what you've been looking for. This new digital recorder is compact, weighs only 45 pounds, operates with only 100 watts of power and reads and writes IBM computer compatible tapes with tape speeds up to 120 inches per second. Recording format is 7 or 9 track data on IBM reels. Overall dimensions: 19 in. x 14 in. x 7.5 in.

Its rugged construction, precision performance and fail-safe features make the DR 1200 an ideal instrument for field or fixed installations in virtually any kind of environment. Best of all, it is priced considerably lower than you would expect to pay for a comparable unit. It is now in production and deliveries can be made within six weeks.

Dial 213-681-0461 (or drop us a line) and tell us what you need. Chances are the DR 1200 can be adapted to meet your optional requirements at a price you are ready to pay. For the white glove treatment, contact Jim Vallely, Sales Manager, at



## COMPONENTS



### Thermocouple reference

A self-powered thermocouple and reference temperature compensator simulates any hot or cold reference temperature. It features a replaceable energy cell. Units are supplied with mounting straps and mating connectors. Maximum error is  $\pm 1/2^\circ\text{F}$  and continuous duty life is 10,000 hours. The unit is manufactured to NASA specs with all solid-state passive elements in any of the common thermocouple materials.

General Resistance Inc., 430 Southern Blvd., Bronx, N. Y. Phone: (212) 292-1500.

Circle No. 277

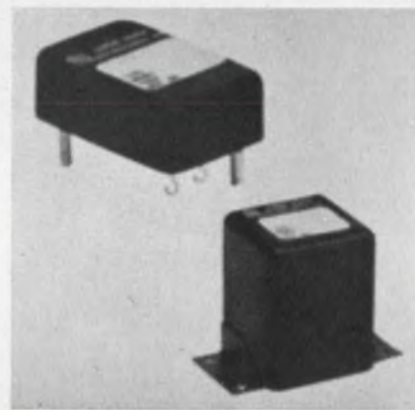

### Pulse generators

Temperature stability without the use of an oven is provided by a MIL-E-5272 crystal-controlled pulse generator. Frequency range is 2 to 499 kHz for model PG-111 and 500 kHz to 20 MHz for model PG-112. Frequency stability is  $\pm 0.005\%$  for the PG-111 and  $\pm 0.01\%$  for the PG-112 at a load of  $600\ \Omega$ . Standard output is  $\pm 10\ \text{V} \pm 10\%$ . At a  $600\text{-}\Omega$  load, rise time is 300 ns and fall time is 200 ns.

Solid State Electronic Corp., 15321 Rayen St., Sepulveda, Calif. Phone: (213) 894-2271.

Circle No. 278



## THE RALPH M. PARSONS ELECTRONICS COMPANY

151 S. DE LACEY AVE., PASADENA, CALIF.  
A subsidiary of The Ralph M. Parsons Company

LOS ANGELES  
NEW YORK  
WASHINGTON

OFFICES IN OTHER  
PRINCIPAL CITIES  
THROUGHOUT  
THE WORLD

ON READER-SERVICE CARD CIRCLE 52

# what's so great about Hoffman's controlled avalanche rectifier? it's what we've got up our sleeve.

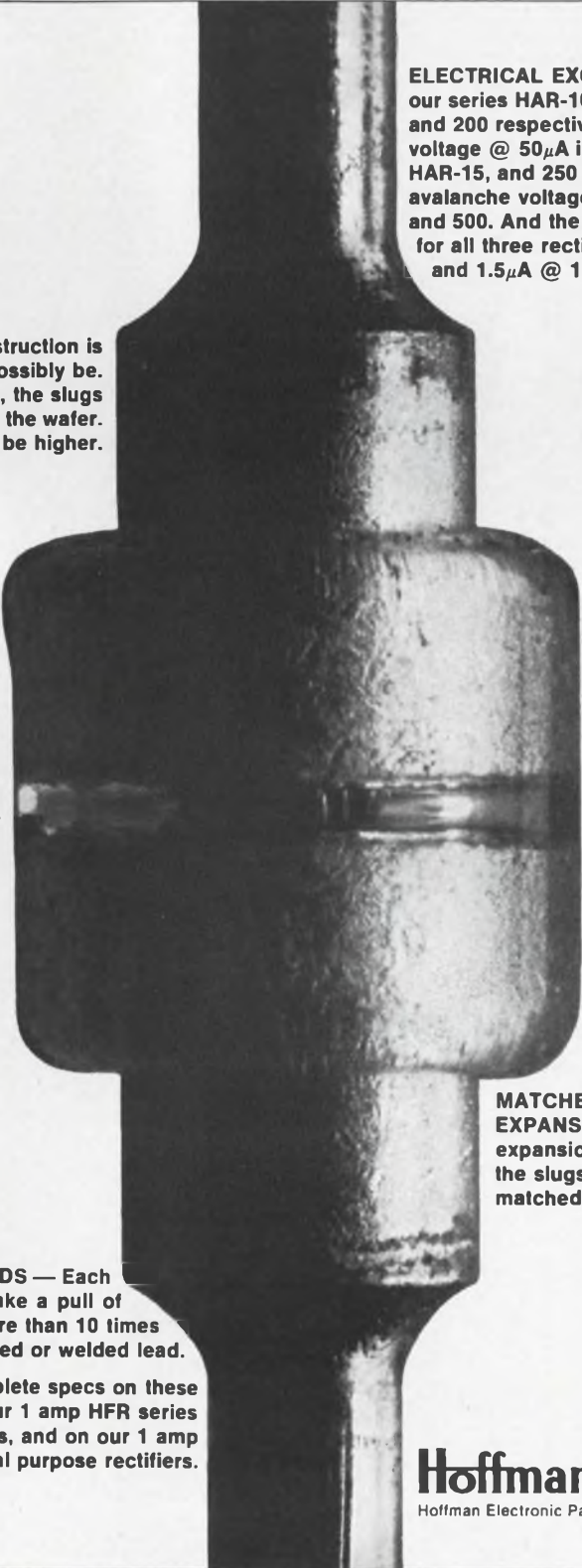

**ELECTRICAL EXCELLENCE** — PRV's for our series HAR-10, 15, and 20 are 100, 150, and 200 respectively. Minimum avalanche voltage @  $50\mu\text{A}$  is 125 for HAR-10, 175 for HAR-15, and 250 for HAR-20. Maximum avalanche voltage @  $500\mu\text{A}$  is 250, 350, and 500. And the maximum reverse current for all three rectifiers is  $0.1\mu\text{A}$  @  $25^\circ\text{C}$ , and  $1.5\mu\text{A}$  @  $100^\circ\text{C}$ .

**BUTTED SLUGS** — Construction is as simple as it could possibly be. In a body only 0.160" long, the slugs butt right up against the wafer. Reliability couldn't be higher.

**PASSIVATED WAFER** — Our passivating technique forms an impenetrable shield wrapped around the silicon wafer creating a lifetime barrier against electrical enemies.

**COMPRESSION GLASS SEAL** — No fusion of the metal-glass interface takes place. All contaminants are sealed out. No trapped impurities are sealed in. And the sleeve doesn't touch the wafer anywhere.

**MATCHED COEFFICIENTS OF EXPANSION** — The contraction and expansion properties of the glass, the slugs, and the wafer are matched to less than 5%.

**BRAZED LEADS** — Each terminating wire can take a pull of 12 lbs. This is more than 10 times the strength of a soldered or welded lead.

Ask us for complete specs on these devices; also on our 1 amp HFR series fast recovery rectifiers, and on our 1 amp HGR series general purpose rectifiers.

**Hoffman Semiconductor**

Hoffman Electronic Park, El Monte, California 91734 • 686-0123

ON READER-SERVICE CARD CIRCLE 53

## READ, PLOT, OR SCALE CURVES WITHOUT CALCULATION

The Gerber Variable Scale is based on a precision extensible spring, calibrated in hundredths. It allows you to read curve amplitudes directly, read frequencies directly, multiply by scale factors, plot with correction factors or other constants included, interpolate, normalize, etc. It eliminates routine calculations. Accurate to 0.05% in full scale of ten inches. ■ Partially shown below (actual size) plotting curve from original. ■ Send for literature: THE GERBER SCIENTIFIC INSTRUMENT CO., P.O. Box 305, Hartford 1, Connecticut.

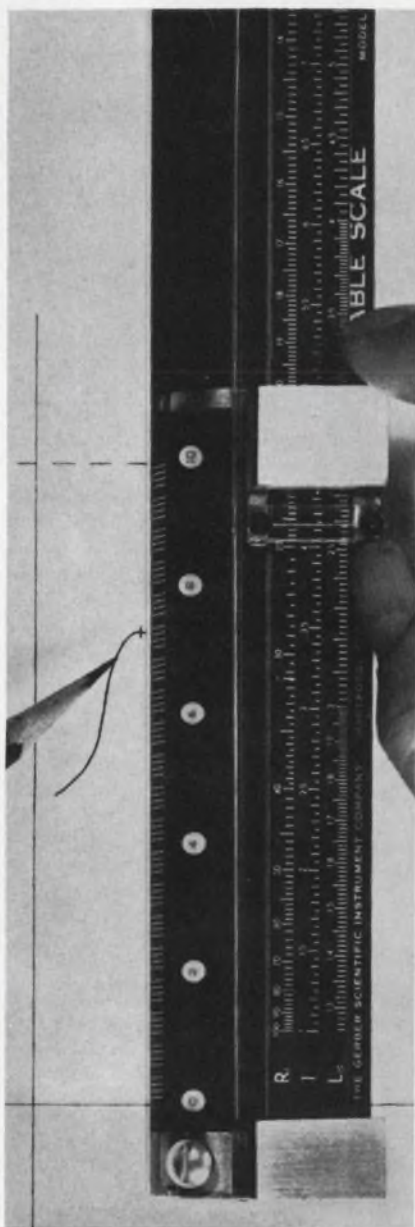

ON READER-SERVICE CARD CIRCLE 54

## COMPONENTS

### Ultra-stable resistors

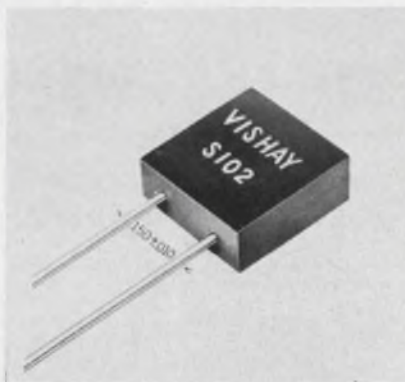

Guaranteed max shelf life drift of 25 ppm/year is offered in a line of 10- $\Omega$  to 30- $\Omega$  resistors. Absolute tolerance is 0.01% and temperature coefficient is  $\pm 1$  ppm/ $^{\circ}$ C from 0 to 60 $^{\circ}$ C. Noise and inductance are non-measurable. Standard resistance values in the S-102 case range from 10  $\Omega$  to 30 k $\Omega$  with values to 120 k available in other cases.

P&A: \$1.55 to \$3; stock to 4 wks. Vishay Resistor Products, 63 Lincoln Highway, Malvern, Pa. Phone: (215) 644-1300. *Circle No. 279*

### Operational amplifier



Offset current of typically 5 nA (10 nA max), voltage drift of typically 5  $\mu$ V/ $^{\circ}$ C (15  $\mu$ V/ $^{\circ}$ C max) and an output of  $\pm 10$  V at 20 mA are features of this all-silicon operational amplifier. The D-22 will drive loads up to 10  $\mu$ F without stability loss. Minimum gain is 100 dB, current drift is 0.5 nA/ $^{\circ}$ C and noise is 8  $\mu$ V max.

P&A: \$75 (10 to 24); stock. Data Device Corp., 240 Old Country Rd., Hicksville, N. Y. Phone: (516) 433-5330.

*Circle No. 280*

### Low torque circular pot



A low torque circular potentiometer may be used as a sensing element in instrumentation systems, or as a pickoff device for oceanographic current direction sensors and magnetic compass devices. The standard model CP39 has a 10 M $\Omega$  resistance element with continuous mechanical rotation and 355 $^{\circ}$  minimum electrical travel. Starting and running torque is 1 gm-cm max. Independent linearity is  $\pm 0.5\%$ .

Humphrey Inc., 2805 Canon St., San Diego, Calif. Phone: (714) 223-1654.

*Circle No. 281*

### Strain gage transducer



A semiconductor strain gage transducer measures pressure of 0-100 through 0-5000 psia. The unit operates from a constant 30-Vdc max and provides a 15-mV/V min output. Combined accuracy is  $\pm 0.25\%$ . Natural frequency is 35 kHz min in the 100 psi range. Response is 0.5 ms max to achieve 63% rise time. Model 1029 has an MTBF of  $5 \times 10^6$  hours.

Micro-Systems Inc., 255 N. Halstead St., Pasadena, Calif. Phone: (213) 355-7111.

*Circle No. 282*



## SITUATION WANTED



Young trimming potentiometer seeks small ( $\frac{3}{8}$ " opening in electronics firm. Accurate, dependable worker. Good background. Will accept low pay for chance to prove ability and help company grow.

# Hire Helipot's $\frac{3}{8}$ " cermet trimmer for the jobs too tough for wirewounds

Got a big job for a small, square trimmer? Sign up the new Helitrim® Model 63P trimming potentiometer. Smallest of its class in size and price, the tough little 63P offers essentially infinite resolution, with ruggedness and reliability twice as high as you'd expect.

No wonder. Beneath its sealed  $\frac{3}{8}$ " x  $\frac{3}{8}$ " x  $\frac{3}{16}$ " molded plastic housing, the 63P has a heart of cermet. No other resistance element can match its combination of high power rating, essentially infinite resolution, freedom from sudden failure, resistance stability, and wide 10 ohm to 2 megohm resistance range. Wirewounds or carbon won't even come close.

References? This new trimmer just graduated from Helipot. It's been thoroughly checked out and tested again and again.

It meets or exceeds requirements of MIL-R-22097B. We'll vouch for it... and so will you, once you've tried it. Send now for full details, or ask a Helipot sales rep to introduce you.

### RESUME

#### GENERAL

Ambient temp. .... -65 to +150°C  
Power rating, watts....0.5 at 85°C, derating to 0 at 150°C  
Adjustment turns, nominal.....20

#### ELECTRICAL

Standard res. range, ohms.....10 to 2 meg.  
Resistance tolerance .....±20%  
Resolution ..... essentially infinite

#### MECHANICAL

Stop.....clutch action, both ends  
Starting torque, max.....5.0 oz.-in.  
Weight, approx. ....1 gm.

**Beckman**

INSTRUMENTS, INC.

HELIPOT DIVISION

FULLERTON, CALIFORNIA • 92634

INTERNATIONAL SUBSIDIARIES: GENEVA; MUNICH; GLENROTHES, SCOTLAND; TOKYO; PARIS; CAPE TOWN; LONDON; MEXICO CITY

Speed Inquiry to Advertiser via Collect Night Letter  
ON READER-SERVICE CARD CIRCLE 55

IF THIS  
HIGH VALUE METAL  
FILM RESISTOR  
DOESN'T CHANGE YOUR  
*design ideas*

...try one of these



Part No.	Power	Ohms	Tol.	Temp. Coef.
PME 50	1/20 W	10Ω to 1M	±1% to .1%	T-0, T-2, T-9
PME 55	1/10 W	10Ω to 3M	±1% to .1%	T-0, T-2, T-9
PME 60	1/8 W	49Ω to 7.5M	±1% to .1%	T-0, T-2, T-9
PME 65	1/4 W	49Ω to 20M	±1% to .1%	T-0, T-2, T-9
PME 70	1/2 W	24Ω to 30M	±1% to .1%	T-0, T-2, T-9
PME 75	1 W	49Ω to 50M	±1% to .1%	T-0, T-2, T-9

The stability and accuracy of Pyrofilm's PME metal film resistors makes their use ideal in applications where before only wire wound resistors could be used. These resistors are virtually unaffected by environmental conditions and withstand constant exposure to high moisture conditions without change in specifications. PME resistors meet or surpass all requirements of MIL-R-10509F.

Send for fact-filled literature sheet!

## PYROFILM RESISTOR COMPANY, INC.

3 SADDLE ROAD • CEDAR KNOLLS, NEW JERSEY • 201-539-7110

ON READER-SERVICE CARD CIRCLE 56

## COMPONENTS

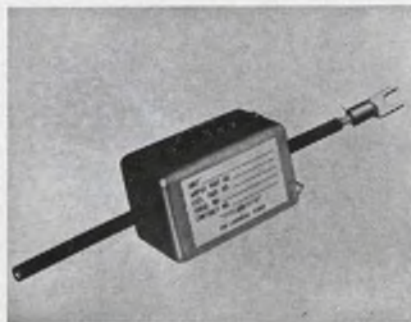

### Dc transducers

Dc transducers enable dc measurement with the instrumental isolation standard in measuring ac. Standard units have full-scale input sensitivities as low as 1 mA. In operation, the dc cable passes through a hole in the transducer with no connection or break in insulation. This input signal, in standard ranges from 0 to 1 mA to 0 to 3 A, is converted by the transducer into an output of 0 to 200  $\mu$ A which is directly proportional to the input signal current.

Airpax Electronics Inc., P. O. Box 8488, Ft. Lauderdale, Fla. Phone: (305) 587-1100.

Circle No. 283

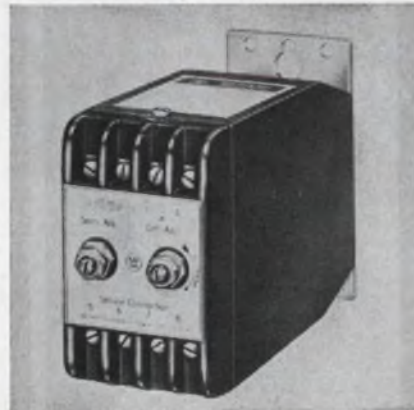

### Solid-state relay

With a sensing accuracy of 0.1%, this all solid-state relay has an output rating of 2 A continuous. The relay can be used with any sensor that changes resistance or makes and breaks a contact. It can be mounted on standard 300-V relay mounting strips. Four sensor terminals permit a connection providing a NO or NC contact with any sensor. They also permit sensors of inverse characteristics to perform the same control function.

Westinghouse, Beaver, Pa. Phone: (412) 775-2000.

Circle No. 284

*You'd figure  
500 volts at  
60 cycles  
would darn near  
vaporize this  
M.A. Bobbin Core,  
right?*



**Wrong! Its got GVB\***. Even at more than 1500 volts, tests show no breakdown on M.A. bobbin cores with GVB. In addition to guaranteeing the core's ability to withstand at least 500 volts between bare winding and bobbin, GVB finish also seals the bobbin to withstand a ten-inch mercury vacuum.

It seals against potting material, provides a resilient, non-slip base for winding, and its epoxy skin protects the core against wire cuts. Abraded wire problems are eliminated and no prior taping is required.

GVB has proven itself on thousands of cores . . . and now Magnetics has applied it to the bobbin core, the

miniature workhorse of computers, high frequency counters, timers, oscillators, inverters and magnetic amplifiers.

Made from ultra-thin permalloy 80 and Orthonol® (0.001" to 0.000125"), Magnetics' bobbin cores are available in tape widths from 0.023" to 0.250" or wider on request. Core diameters range down to less than 0.100" with flux capacities down to several maxwells.

For more information on GVB Bobbin Cores, write Magnetics Inc., Dept. ED-42, Butler, Pa. 16001.



\*Guaranteed voltage breakdown

ON READER-SERVICE CARD CIRCLE 240

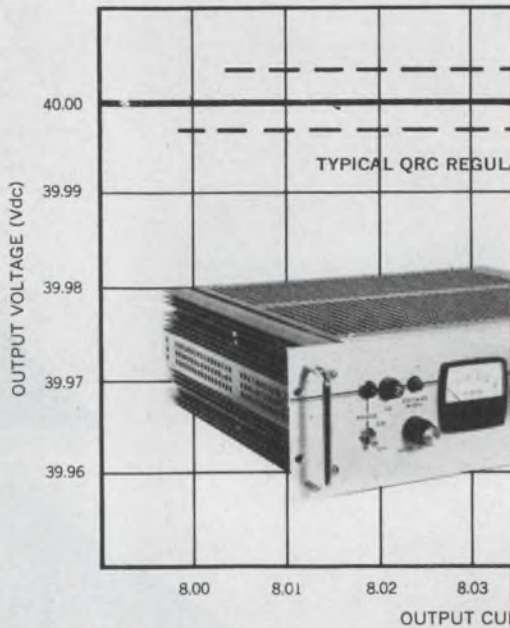

Automatic crossover between constant

# Sorense Power Supplies offer $\pm .005\%$

The Sorense QRC series—wide range, transistorized power supplies—provide constant voltage/constant current regulation so sharp the units operate without ever leaving the specified regulation band. Voltage regulation is  $\pm .005\%$  for line and load combined. The QRC's are provided with front panel dial set adjustment of voltage and current limits, as well as voltage/current mode indicator lights. Other design features include: Low ripple . . . 1 mV rms • No turn-on/turn-off overshoots • Remote sensing and

#### ELECTRICAL & MECHANICAL

MODEL NUMBER	OUTPUT VOLTAGE RANGE (Vdc)	CURRENT OUTPUT RANGE (Adc)	VOLTAGE REGULATION (LINE & LOAD COMBINED)	RIPPLE VOLT (rms)
QRC20-08A	0-20	0-8	$\pm .005\%$ or $\pm 1$ mv	1 m
QRC20-15A	0-20	0-15	$\pm .005\%$ or $\pm 1$ mv	1 m
QRC20-30A	0-20	0-30	$\pm .005\%$ or $\pm 1$ mv	1 m
QRC40-4A	0-40	0-4	$\pm .005\%$ or $\pm 1$ mv	1 m
QRC40-8A	0-40	0-8	$\pm .005\%$ or $\pm 1$ mv	1 m
QRC40-15A	0-40	0-15	$\pm .005\%$ or $\pm 1$ mv	1 m
QRC40-30A	0-40	0-30	$\pm .005\%$ or $\pm 1$ mv	1 m

†Half rack

RAYTHEON

FOR FOREIGN SALES AND PRICES consult nearest facility. CONTINENTAL EUROPE: Sorense 25 A Rue du Chablais, 74 Annemasse; GERMANY: Sorense G.m.b.H, 6 Frankfurt am Main; FRANCE: Sorense S.A., 10 rue de Valenciennes, 75013 Paris; ENGLAND: Sorense Electronics, 100, Elizabeth Way, Harlow Essex, England. ALL OTHER FOREIGN SALES: Raytheon

# 4 BONUS FEATURES

resistors offer more than any other w

## 1. MORE POWER in MIL SPEC SI

### G SERIES\*

DALE TYPE	MIL-R-26C TYPE	MIL-R-23379 TYPE	POWER RATING (WATTS)		RESISTANCE RANGE (OHMS)		
			Dale	Mil.	.05%, .1%, .25%	.5%, 1%, 3%	
G-1	—	—	1.0	—	10 to 950	1 to 3.4K	
G-3	RW-70	RWP-18	2.25	1	1 to 2.7K	.1 to 10.4K	
G-5C	RW-69	RWP-20	5	3	1 to 8.6K	.1 to 32.3K	
G-15	RW-68	RWP-23	15	10	.5 to 73.4K	.1 to 273K	

Major Environmental Specifications: LOAD LIFE: 1% Max.  $\Delta R$  in 1000 hours at full power, 3, 5, or 10 times momentary overload per applicable Mil. Spec. OPERATING TEMPERATURE: -55°C to +125°C

\*G Series models are typical: 10 resistors in complete line.

## 2. THE SAME POWER in LESS SP

### 1 Watt Silicone Coated Resistor

Conventional MIL-R-26C and MIL-R-23379

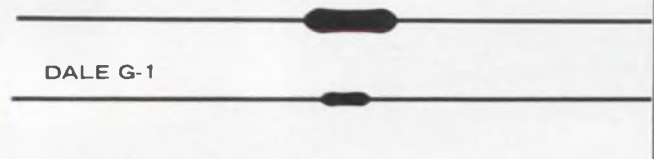

## 3. EXCEPTIONAL STABILITY at CO

Two RW-69, MIL-R-26C resistors (Dale G-5C and conventional silicone-coated wirewound) operated at Mil power levels.

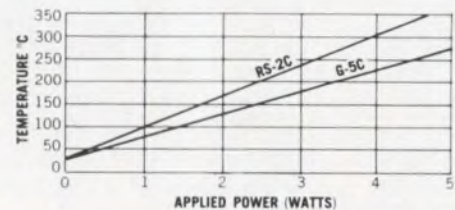

## 4. IMPROVED THERMAL EFFICIEN

The chart at right shows the outstanding heat dissipation advantages of the beryllium oxide cores used in Dale G and HG resistors have over conventional core materials. To complement this advantage, Dale uses a special high temperature silicone coating on the G Series and a new extruded aluminum housing for the HG Series.

FOR COMPLETE INFORMATION  
WRITE FOR CATALOG A



DALE ELECTRONICS

1328 28th Ave

Also Sold by Dale Electro

COMPONENTS



**Vacuum relay**

This vacuum relay is capable of switching up to 50 kVac at 60 Hz and carrying up to 15 A. The spdt model H-25 has an operating time of 20 ms max. Standard coil resistance is 120  $\Omega$ , and coil voltage is 26.5 Vdc. The unit will withstand vibration to 5 G from 55 to 500 Hz and shock to 15 G for 11 ms.

Availability: 20 to 30 days. High Vacuum Electronics Inc., 538 Mission St., South Pasadena, Calif. Phone: (213) 682-3661.

Circle No. 301

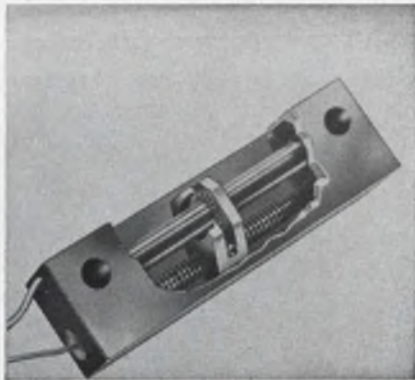

**35-turn trimming pot**

A ring of multiple contacts around the resistance element of this 1-W trimming pot provides uniform contact pressure. During adjustment the spring ring makes many sequential contacts on each turn of resistance wire. Resolution is 0.2% min and wiper contact noise is less than 20  $\Omega$  at vibration levels of 20 G. Resistance ranges are available from 10  $\Omega$  to 100 M $\Omega$  with a 50-ppm/ $^{\circ}$ C temperature coefficient.

Price: \$1.96 to \$6.65. Newport Instrument Corp., 893 W. 16th St., Newport Beach, Calif. Phone: (714) 646-1994.

Circle No. 302



FOR COMPLETE  
DESIGN FREEDOM IN CONTROL PANELS  
SPECIFY

**SWITCHCRAFT SWITCHES**

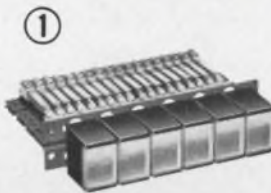

**PUSHBUTTON ACTION**  
*ILLUMINATED LITTEL "MULTI-SWITCH."* Virtually unlimited lighting effects and switching functions in one ultra-compact unit . . . enables you to design a cybernetically correct, error-reducing panel for your special applications. Single color or split-face lighting. Up to 6PDT in only .6 sq. in. panel space! 1 to 18 stations per row . . . can be ganged and coupled.

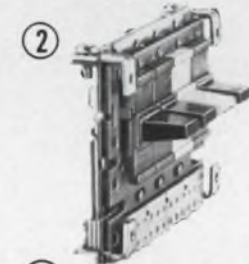

**SLIDE ACTION**  
*"MULTI-SLIDE" SWITCHES.* New! A slide switch offering all 3 types of actuation: interlock, all-lock, non-lock. Speeds operator reaction while minimizing errors through slide-switch variety and visibility! 1 to 18 stations.

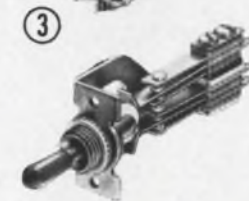

**LEVER ACTION**  
Switchcraft offers the largest selection of illuminated and non-illuminated lever-type switches in the industry. Wide variety of sizes from miniaturized "Feather Lever" (featuring changeable push-on color knobs) to the industry standard "Telever"™ telephone-type switches with field changeable functions. Specialized types to solve such problems as capacitance build up, need for switches with 1/2 lock and 1/2 non-lock functions, extra length bushings, etc.

\*T.M.

WRITE FOR COMPLETE LEVER, SLIDE AND PUSHBUTTON SWITCH CATALOGS or see your Switchcraft Authorized Industrial Distributor for immediate delivery at factory prices.

**SWITCHCRAFT**  
INC.

5529 North Elston Avenue  
Chicago, Illinois 60630



SEE IT AT BOOTH 1645 AT WESCON  
ON READER-SERVICE CARD CIRCLE 57

# HAROWE INTEGRAL GEARED SERVO MOTORS



## Built together, Housed together, To work together

Harowe builds servo motors and precision gearheads (AGMA class II or better) in the same facility... then houses them in one-piece stainless steel cases.

One-piece case eliminates up to 14 coupling parts; guarantees accurate alignment; conducts heat better for cooler operation. And one-source responsibility gives you industry's shortest lead time on geared servo motors.

New catalog lists 61 standard ratios for sizes 8, 10, 11, 15, and 18 motors and motor-generators. (Any other ratio readily available.) Request your copy from—



Servo, Stepper &  
Synchronous Motors  
Motor Generators • Synchros  
Resolvers • Pancakes • Gearheads

## HAROWE SERVO CONTROLS, INC.

20 Westtown Road  
West Chester, Pa. 19380  
(215) 692-2700

ON READER-SERVICE CARD CIRCLE 58

## COMPONENTS

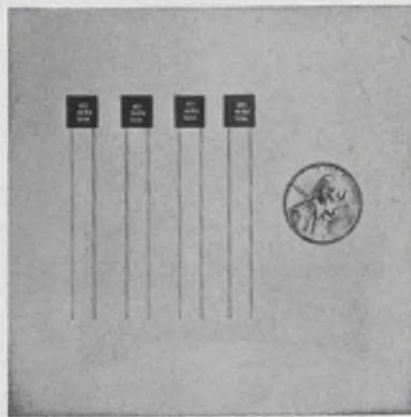

### Ceramic capacitors

These MIL-C-11015C molded miniature ceramic capacitors have PC by-pass and coupling applications. Leads are available in tinned copper and gold-flashed du-met, weldable or solderable. Capacitance range is 1200 to 10,000 and 12,000 to 100,000 pF at 200 and 100 Vdc. Operating temperature ranges from  $-55$  to  $125^{\circ}\text{C}$ .

P&A: \$1.08 to \$2.84; stock. American Components Inc., 8th Ave. at Harry St., Conshohocken, Pa. Phone: (215) 828-6240.

Circle No. 303

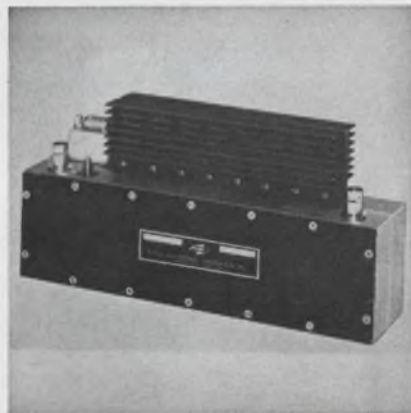

### 1/2-W amplifier

Covering a frequency range of 100 to 200 MHz, model BH604 has a 1/2-W output. Power output capability is 27 dBm at 1 dB compression with third order intermodulation products down 30 dB at 1/2 W. Input and output impedance is  $50\ \Omega$  with vswr of 2 max. Noise figure is 10 dB max and gain is 30 dB.

Price: \$450. RHG Electronics Laboratory Inc., 94 Milbar Blvd., Farmingdale, N. Y. Phone: (516) 694-3100.

Circle No. 304

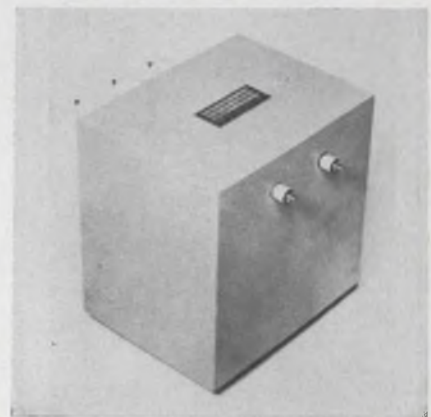

### 10-kV rms transformer

Phase and amplitude measurements for power amplifiers, transformers, transmission systems and electro-acoustical transducers may be made to 10 kV rms. With a 1000:1 turns ratio, this high voltage attenuation transformer converts standard lab instruments for these measurements. Frequency range is 20 Hz to 30 kHz.

Dranetz Engineering Labs. Inc., 1233 North Ave., Plainfield, N. J. Phone: (201) 755-7080.

Circle No. 305

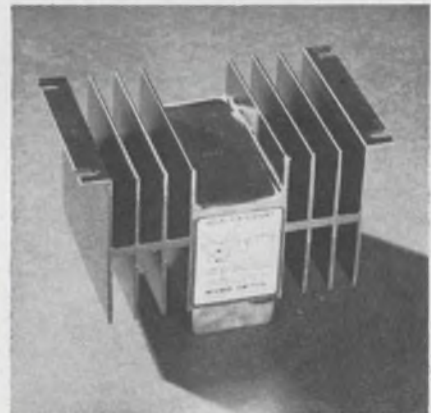

### 5-A relay

An epoxy-potted SCR, triggered by external switch actuation is the heart of this 5-A relay. Response time is 1 ms min. Maximum inrush current is 11 A and max supply frequency is 500 Hz. Controlling contacts need 100 mA min at 120 Vac. Leakage current is 3 mA at standby conditions. Operating temperature range is  $-40$  to  $+190^{\circ}\text{F}$ .

Price: \$33.30. Honeywell, Micro Switch Div., 11 W. Spring St., Freeport, Ill. Phone: (815) 232-1122.

Circle No. 306

Want a new slant on how much capacitor performance you can get in a low cost molded plastic case?

Test our MTA molded electrolytic!

**Here's how it stacks up for performance:**

**Life at High Temperature**—zero failures in one million piece-hours at 85°C. Only one failure in 2½ million piece-hours at 65°C.

**Stability at Low Temperature**—equal to or better than most metal-case miniatures down to -30°C.

**Maximum Values**—800 mfd, 3 VDC, to 85 mfd, 50 VDC.

*For sample order, call Jim Shaffer, collect, at 317-636-5353, Extension 403.*

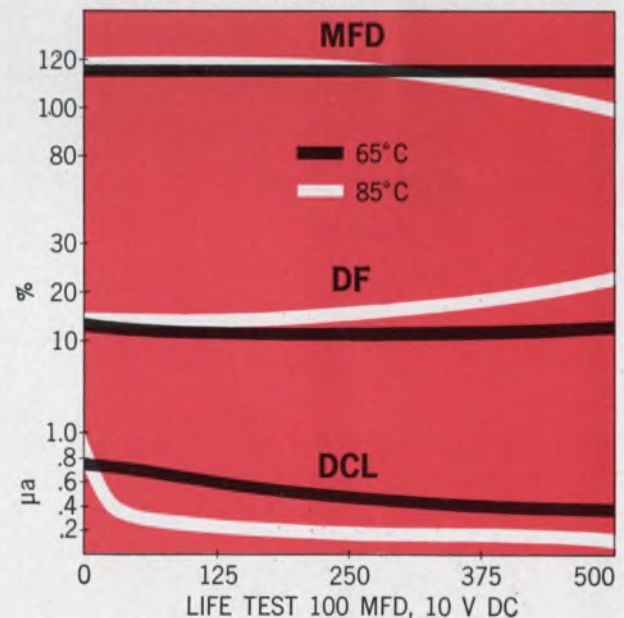
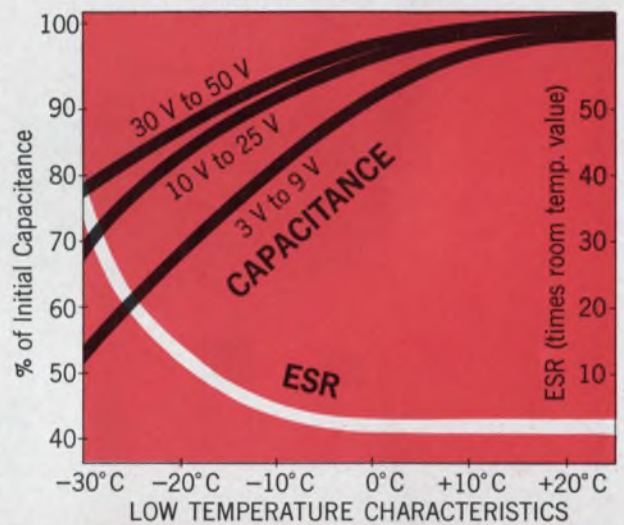

Available from stock at factory prices in quantities to 2499 from franchised Mallory distributors



**MALLORY CAPACITOR COMPANY**

a division of P. R. MALLORY & CO. INC.  
3029 E. Washington St., Indianapolis, Indiana 46208

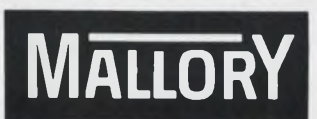

ON READER-SERVICE CARD CIRCLE 59

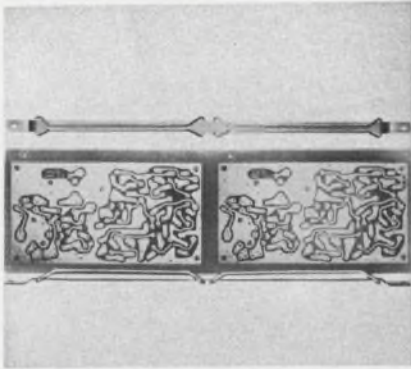

### PC board guides

All-steel PC board guides are available in variable lengths. They can be applied for horizontal or vertical mounting with an effective grip of 2 or 3 in./wire. Series 90 is available with 1, 2 or 3 wires. The finish is cadmium plate.

Taurus Corp., Academy Hill, Lambertville, N. J. Phone: (609) 397-2390.

Circle No. 307

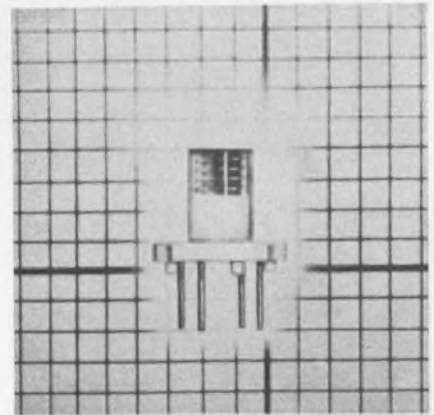

### Flangeless PC coil forms

For use with pi-wound coils, two new coil forms have a molded diallyl phthalate base and polypropylene liner. Both have flangeless construction. Engineered for vertical mounting on 0.2-in. centers in PC applications, the coil forms can be used wherever an RF coil is required. Type 3618 measures 0.325-in. above board while the 3619 measures 0.480-in. Both have a 0.375-in.<sup>2</sup> base with solid brass pins.

P&A: \$0.88 to \$1 (1 to 9); stock. Cambridge Thermionic Co., 445 Concord Ave., Cambridge, Mass. Phone: (617) 876-2800.

Circle No. 308

# Announcing

## MIL-C-39104

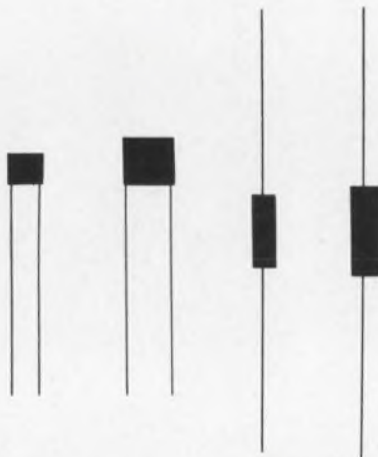

POTTER P/N

CHR05

CHR06

CHR12

CHR19

MIL. EQUIV.

CKR05

CKR06

CKR12

CKR19

**DELIVERY: FROM STOCK TO 6 WEEKS**

*(Other styles, configurations and characteristics available from 0.5 PFD to 20 MFD.)*

**THE POTTER COMPANY**

**Chem Electro-Research Div.**

**11144 Penrose Street**

**Sun Valley, Calif. 91351**

**Tel: 213-875-1090 TWX 910-498-2248**



### Micromin low pass filter

A diameter of 11/32 in. with a height of 5/8 in. suit this 0.2-oz filter for printed-circuit applications. Source and load are 10 kΩ. Response from dc to 22 kHz is within 3 dB. At 36 kHz response measures 20 dB min, at 44 kHz it is 30 dB and above 48 kHz the response is 35 dB min.

United Transformer Corp., 150 Varick St., New York. Phone: (212) 255-3500.

Circle No. 309

ON READER-SERVICE CARD CIRCLE 60





**Declare Your Independence.** The revolutionary Deutch Terminal Junction is here to lead you to freedom from the restrictions of the terminal strip. Your wires no longer must follow the dictates of the old system which leaves them frayed and defenseless against the hazards of environment. • **To bring you more perfect junctions,** Deutch has combined the protection of silicone seals and the freedom of rear release contacts so that you may terminate, bus, and feed-through in tranquility. • **Secure the blessings of modular design, high density and light weight;** promote the general welfare of all your wires from AWG 22 through AWG 4. • Each TJ module accommodates

eight leads in a package slimmer than a Yankee's budget and with enough combinations to challenge his ingenuity.

• TJ contacts are crimped with standard tooling, and are inserted and removed from the Terminal Junction, individually, without grievances. Preserve your basic rights of design, get rid of the posts that bind. Phone, wire or write your Deutchman for the complete declaration about TJ's in Data File T-1.

# DEUTSCH

ELECTRONIC COMPONENTS DIVISION • Municipal Airport • Banning, California

**ADVANCED SPECIFICATION REAR RELEASE ELECTRICAL CONNECTORS**

ON READER-SERVICE CARD CIRCLE 61

# These choppers work in any position

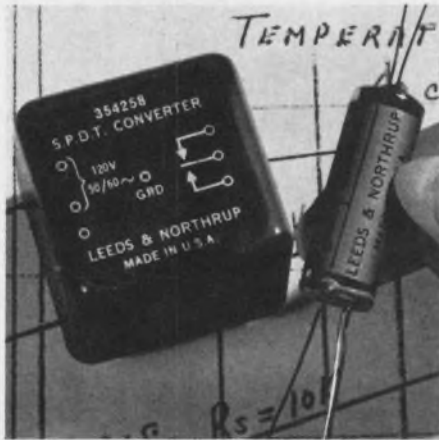

If you're looking for exceptional reliability, look at the life ratings of these two photo-choppers from L&N—25,000 to 50,000 hours.

They're designed to operate with good efficiency into a wide range of circuit impedances, especially at high impedances. Efficiency goes beyond 95% when load is in the megohm range. And they're not as sensitive to shock and vibration as mechanical choppers.

For SPST application, we provide a tubular chopper with CdSe cell. For SPDT application, the chopper is in a flat package, plug-in configuration with two lamps and two CdS cells. A unique electrostatic shield is used between lamp and cell, reducing interaction and giving better noise characteristics.

Features include low d-c voltage offset—less than 1  $\mu$ V and low microvolt noise levels.

Applications? The SPST chopper can be used to stabilize high-gain amplifiers, cutting drift to negligible levels. The SPDT design can profitably replace an electromechanical chopper in a low-level, d-c servo amplifier circuit. Both have excellent capability for handling low-level signals.

They're so good, we use them in our latest Speedomax recorders and other L&N instruments.

They're the newest in our family of choppers, which includes mechanical, photo-conductive and — soon — solid-state types.

To learn more about these choppers and how to order, write or call Components Division, Leeds & Northrup, North Wales, Pa. 19454. (212) 699-5353.



**LEEDS & NORTHRUP**  
Philadelphia 44 • Pioneers in Precision

ON READER-SERVICE CARD CIRCLE 62

## COMPONENTS

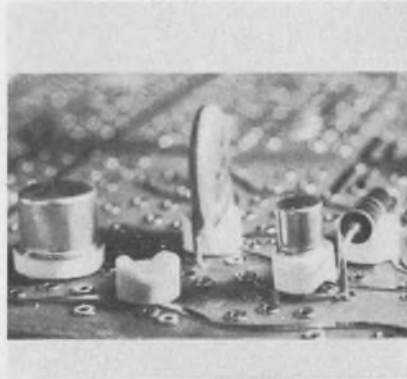

### Component spacers dissolve after use

TO-5, -18, -65, -19, -20 and -21 component mounting pads space semiconductors 0.075-in. above board. After mounting and soldering, running water of 125°F completely dissolves the pad in 1 minute. "Dissopads" withstand the high temperature met in pre-heating and wave-soldering and leave no residue when washed away. The pads are non-conductive and non-corrosive.

P&A: \$9/M to \$12.50/M; stock. Bivar Co. Inc., 725 Loma Verde Ave., Palo Alto, Calif. Phone: (415) 327-1202. *Circle No. 310*



### DC torque motors

Brushless wide-angle dc torque motors with a 400-ms response can replace servo motors and gear trains. The standard series covers the torque range of 6.5 to 750 oz-in. max and response of 0.0004 to 0.02 s. Torque is approximately sinusoidal. A typical model size 27 has an OD of 2.6093, is rated at 71 W at peak torque, and comes in two-pole (180°), four-pole (90°), and six-pole (60°) designs.

Sperry Rand Corp., Durham, N. C. Phone: (919) 682-8161.

*Circle No. 311*

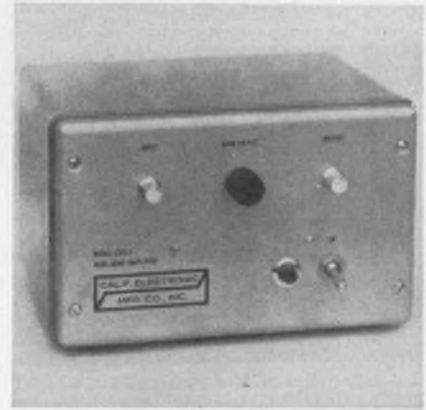

### Wideband amplifier

By using feedback, model 1202-3 achieves fast response and gain stability of 0.05/°C min with the gain adjustable from 10 to 100. The frequency response is 5 Hz to 10 MHz at 20 dB and 10 Hz to 1 MHz at 40 dB. Output voltage is 6 V p-p across 1000  $\Omega$ . Pulse rise time is 60 ns at 20 dB. Input impedance is 100 k $\Omega$  min shunted by 25 pF. Noise is 15  $\mu$ V rms max referred to the input with the input shorted.

P&A: \$135; 3 wks. California Electronic Mfg. Co. Inc., P.O. Box 555, Alamo, Calif. Phone: (415) 932-3911.

*Circle No. 312*

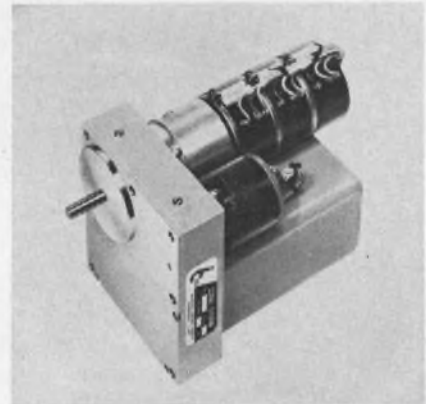

### Potentiometer servos

MIL-E-6400 pot repeaters are unitized servo assemblies which convert an input command voltage into a shaft rotation. They incorporate servo motor, gear train, feedback pot, servo amplifier and power supply. The line includes 48 standard models, with customer options on 60- or 400-Hz line power, dc, 60- or 400-Hz command voltage and single, 3- or 10-turn feedback pot.

P&A: about \$920, 6 wks. Industrial Control Co., Central Ave. at Pinelawn, Farmingdale, N. Y. Phone: (516) 694-3000.

*Circle No. 313*

# new

## solutions to tough meter applications



# Simpson

INSTRUMENTS THAT STAY ACCURATE

### NEW *contactless* meter relays (4½")

Utter reliability . . . utter simplicity. Completely fail-safe circuitry insures 100% reliability. No limitation on pointer travel due to mechanical contacts. Model 3324XA meter relays are CONTACTLESS. An infinite life lamp and solid state photo-conductors do the sensing. Solid state switching circuit and relay (10 amp, DPDT, 115VAC) are contained internally on single and double control point units. Set point accuracy rate  $\pm 1\%$  of full scale. Available through distributors in ranges shown. For specials in 3½" and 4x6" models and other ranges contact factory.

RANGE	Approx. Ohms	Single Control Cat. No.	Control Price	Double Control Cat. No.	Control Price
DC Microammeters					
0-50	3000	16451	\$99.00	16470	\$136.35
0-100	1300	16452	96.15	16471	133.65
0-200	570	16453	96.15	16472	133.50
0-500	220	16454	96.15	16473	133.50
DC Milliammeter					
0-1	80	16455	95.10	16474	132.45
DC Millivoltmeter					
0-50	10	16460	95.40	16480	137.25

### NEW miniature edgewise meters (1½")

Takes only *half the space* of a 2½" Edgewise meter with little sacrifice in scale length. Movement is *self-shielded*. DC accuracy is  $\pm 2\%$  (F.S.); AC (rectifier type),  $\pm 3\%$  (F.S.) at 25°, 60 cycle sine wave. Dustproof case. Meter comes complete with bezel and mounting hardware. 20 Ranges are STOCKED (see sampling below). Contact your ELECTRONIC DISTRIBUTOR about Model 1521.

RANGE	Approx. Ohms	Cat. No.	Price
DC Voltmeters			
0-150	1000 o/v	10358	\$15.45
DC Milliammeters			
0-100	1.35	6817	15.90
DC Millivoltmeters			
0-50	10	7013	16.20
DC Microammeters			
0-25	3150	4552	23.40
AC Voltmeters			
0-150	1000 o/v	10415	20.10

For Complete Details, Request Bulletin 2073 and Meter Relay Reprint Article.

**SIMPSON ELECTRIC COMPANY**

5202 W. Kinzie Street, Chicago, Ill. 60644 • Phone: 312-379-1121

Export Dept.: 400 W. Madison Street, Chicago, Ill. 60606 • Cable, Amergaco

In Canada: Bach-Simpson Ltd., London, Ontario

In India: Ruttonsha-Simpson Private Ltd., International House, Bombay-Agra Road, Vikhroli, Bombay





### PC board spray coating

Meeting the fungus and moisture resistance requirements of MIL-V-173B, this aerosol coating is colorless, odorless, non-toxic and non-hygroscopic. By forming tough fillets at the junction of components, the coating adds to the mechanical strength. The coating dries in 15 minutes and cures completely in 3 hours. Coated parts have an insulation resistance 10 times that of uncoated parts. Dielectric strength is 850 V/mil and dc resistivity is  $5 \times 10^{14} \Omega/\text{cm}$ .

Price: \$1.95/can. Product Techniques Inc., 12049 Regentview Rd., Downey, Calif. Phone: (213) 923-9271.

Circle No. 314

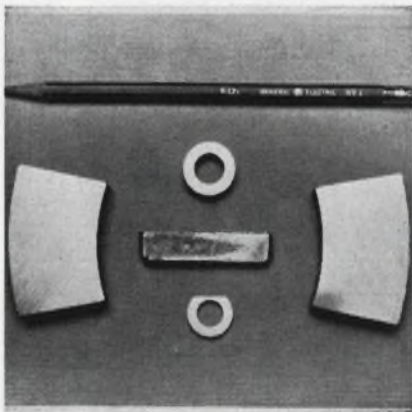

### Alnico 8

Alnico 8 permanent magnet has a useful recoil energy product of  $2.1 \times 10^6$  gauss-Oersteds. The cast material offers a nominal coercive force of 1850 Oe. Both coercive force and operating flux density remain stable over a wide temperature range.

General Electric Co., P.O. Box 72, Edmore, Mich. Phone: (517) 427-5151.

Circle No. 315

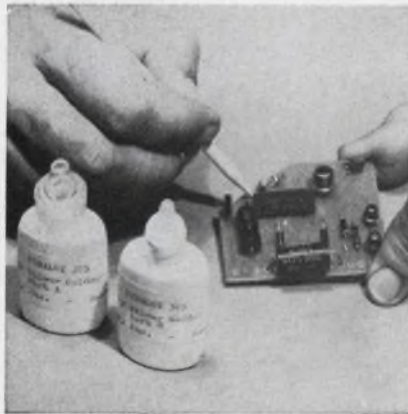

### Epoxy/silver solder

Two solders combine the adhesive properties of epoxies with the electrical conductivity ( $0.01 \Omega\text{-cm max}$ ) of silver. Type 320 features fast set and type 325 offers an effective working time of 3 to 4 hours. Both solders have a 1:1 mix ratio and cure to form a tough bond. Tensile shear strength at  $25^\circ\text{C}$  is 1200 to 2500 psi. Both set at room temperature.

Price: \$10/2-oz kit. Dynaloy Inc., 408 Adams St., Newark, N. J. Phone: (201) 622-3228.

Circle No. 316



### Epoxy coating

A clear epoxy coating material, "Eccocoat C-26," can be used continuously at  $500^\circ\text{F}$  and for short periods at  $600^\circ\text{F max}$ . The material is supplied as a two-part system containing a solvent. After mixing, the coating is applied by brush, dip or spray. Pot life at room temperature is 24 to 48 hours. Multiple coats may be applied. An elevated temperature cure is required with a post-cure at  $350^\circ\text{F}$ .

Price: \$2 to \$3/lb. Emerson & Cuming Inc., Canton, Mass. Phone: (617) 828-3300.

Circle No. 317



### Fluorocarbon bonding

Under normal circumstances, there is no adequate adhesion of any material to such fluorocarbons as "Teflon-TFE" and "-FEP," "Fluon," "Kel-F," "Halon" or "Kynar." This etchant kit is offered as a do-it-yourself method of bonding most materials to fluorocarbons. The etchant is a stabilized dispersion of metallic sodium which modifies the surface of the polymers so that the adhesive, which is contained in the kit, can be used.

Price: \$7.50. Seezak Products Inc., 5057 W. Washington Blvd., Los Angeles. Phone: (213) 939-3129.

Circle No. 318



### Epoxy evaluation kit

Cured epoxy resins range from a hard, brittle material to a rubber-like compound. Adhesion between a cured epoxy and a given material may range from poor to superior. To select the desired epoxy-curing agent/filler combination, an epoxy kit has 4 different types of epoxy resin, 6 curing agents, 5 fillers, together with instructions, properties tables and mixing and curing data.

Price: \$37.50. Ring Chemical Co., 1112 Rosine St., Houston, Tex. Phone: (713) 526-2091.

Circle No. 319

# Get a record you can *clearly* read— even at 5 KC

... from the one system  
supplied complete with your  
choice of amplifier

Now you can have all the Sanborn advantages of a DC—5KC optical oscillograph supplied as a *complete, integrated package ready to record*—plus clearer, higher resolution recordings made possible by improvements in optical system design and chart papers. Put one to 8 traces on the 8" ultraviolet-sensitive chart of a standard 4508B system— with p-p amplitudes up to 4" at DC—5kHz, to 8" at DC—3kHz. Or record up to 25 channels of high frequency information with a 4524B system. Save valuable time by recording all frequencies up to 5 kc with a *single* set of galvanometers driven by amplifiers incorporating frequency boost and compensating circuits, thus eliminating an "inventory" of different galvanometers and the time required to install and align a new set for each recording requirement. Make signal connections quickly and conveniently to front-panel or rear input connectors, and have complete operational control with amplifier front panel basic controls for each signal. Change system sensitivity from 2.5 mv/inch to 625 mv/inch by easily changing 8-channel amplifier modules (choice of three). Load paper in daylight . . . select any of 9 chart speeds by pushbutton or control them remotely . . . see fully developed traces a few seconds after recording . . . use system in mobile console, rack mount or portable cases.

Ask your local Sanborn Division/Hewlett-Packard sales office for technical data and expert application assistance. Offices in 47 U.S. and Canadian cities, and major areas overseas. Hewlett-Packard Company, Sanborn Division, Waltham, Massachusetts 02154.

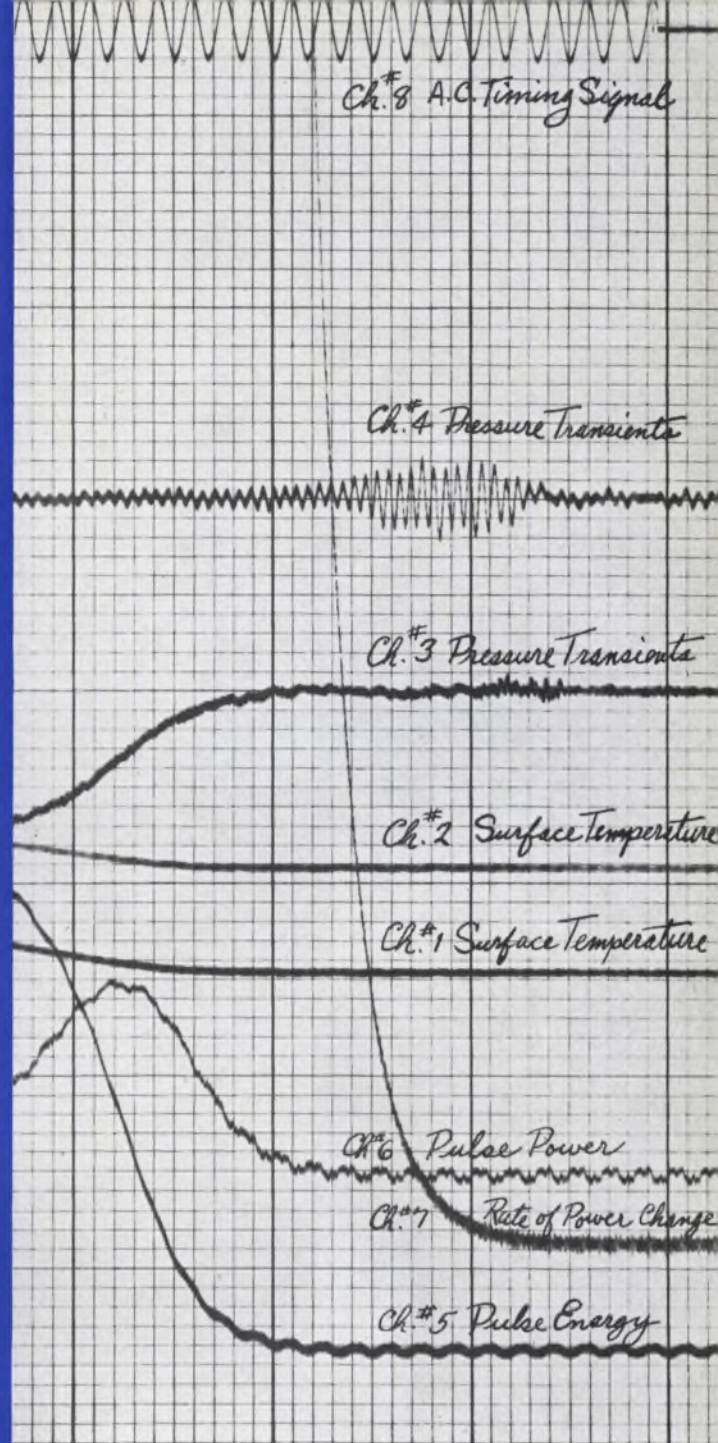

## Specifications — 4500 Series Optical Oscillographs

Sensitivity	625 mv/1", 50 mv/1", or 2.5 mv/1", depending on amplifier chosen.
Frequency Response	DC to 5 KC (—3db) at 4" p-p
Common Mode Performance	Rejec. ratio at least 140 db at DC, max. c.m. voltage $\pm 500$ v (with Medium Gain Amplifier)
Linearity	1½% of full scale (8 inches)
Gain Stability	Better than 1%, 0° to 50°C, 103 to 127 (line) volts
Noise	0.02" p-p, max.
Chart Speeds	Nine, 0.25 to 100"/sec.
Prices	Complete 8-channel system in cabinet, with galvanometer driver amplifiers, \$7400; with medium gain amplifiers, \$8980 (F.O.B. Waltham, Mass.)

HEWLETT  
PACKARD  SANBORN  
DIVISION

# AMPERITE

## Thermostatic DELAY RELAYS

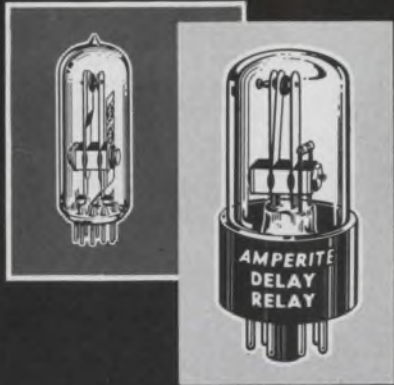

**Only a glass seal**  
offers true hermetic sealing  
... assuring maximum stability and life!

**Delays: 2 to 180 seconds** . . . Actuated by a heater, they operate on A.C., D.C., or Pulsating Current . . . Being hermetically sealed, they are not affected by altitude, moisture, or climate changes . . . SPST only—normally open or normally closed . . . Compensated for ambient temperature changes from -55° to +80° C. . . Heaters consume approximately 2 W. and may be operated continuously . . . The units are rugged, explosion-proof, long-lived, and—inexpensive!

TYPES: Standard Radio Octal, and 9-Pin Miniature.  
List Price, \$4.00

**PROBLEM? Send for Bulletin No. TR-81**

# AMPERITE

## BALLAST REGULATORS

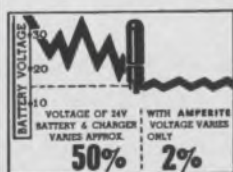

Hermetically sealed, they are not affected by changes in altitude, ambient temperature (-50° to +70° C.), or humidity . . . Rugged, light, compact, most inexpensive . . . List Price, \$3.00.

Write for 4-page Technical Bulletin No. AB-51

# AMPERITE

600 PALISADE AVE., UNION CITY, N.J.

Telephone: 201 Union 4-9503

In Canada: Atlas Radio Corp., Ltd.,  
50 Wingham Ave., Toronto 10

## MATERIALS

### High purity crystals

Randomly and specifically oriented single crystals of tungsten to 3/8-in. diameter and tantalum to 1/2-in. diameter, in lengths up to 3-in., are offered. Electron beam refining techniques yield purities of up to 99.999% including gases. Purities have been confirmed by mass spectrographic analysis.

P&A: \$100/in. (tungsten), \$200/in. (tantalum); stock to 2 wks. Materials Research Corp., Orangeburg, N. Y. Phone: (914) 359-4200.

Circle No. 320

### Thermocouple alloys

Two thermocouple alloys have improved emf stability and oxidation resistance. Tophel II (91% nickel, 9% chromium) is used for positive thermoelements and Nial II (95% nickel, 5% silicon) for negative thermoelements. The materials eliminate positive leg failure in a protective atmosphere caused by drifting from the original emf. Lack of oxidation resistance of the negative leg is also eliminated.

Wilbur B. Driver Co., 1875 McCarter Hwy., Newark, N. J. Phone: (201) 482-5550.

Circle No. 321

### Pt thermocouple wire

This thermocouple grade platinum is used with conventional platinum rhodium wires to form R & S thermocouples conforming to NBS emf values. Because of its grain structure, "Thermoplatinum FG" retains high ductility and tensile strength after long exposures to temperatures over 1200°C.

Electric Thermometers Inc., 615 Schuyler Ave., Kearney, N. J. Phone: (201) 998-8005.

Circle No. 322

### Niobates/tantalates

Niobates and tantalates of lithium, potassium and sodium are supplied in powder form. They are used as transducer elements, ferroelectric and laser elements. Aggregate impurities are less than 150 ppm. All impurities are below the detection limits of emission spectroscopy.

CIBA Corp., Summit, N. J. Phone: (201) 273-3500.

Circle No. 323

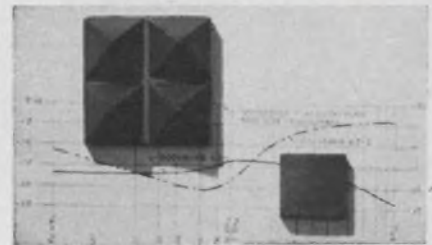

### Ceramic absorbers

Broadband absorbing materials for 50 MHz to 15 GHz use are composed of a sintered ceramic of dielectric and magnetic materials unaffected by high vacuum. They are resistant to high energy radiation and have excellent thermal conductivity. NZ-1 tiles are 4 in.<sup>2</sup> with 4 pyramids with 1-in. over-all thickness. NZ-2 tiles are 1 × 1 × 1/4 in. They are available with a threaded metal projection from the back surface.

Price: \$100/sq ft, \$60/sq ft Emerson & Cuming Inc., Canton, Mass. Phone: (617) 828-3300.

Circle No. 324

### Solder powder

Solder powder with an extremely low metal-to-oxide ratio meets Federal Spec QQ-S-571d and ASTM standards. "Vaculoy" solder powders absorb IR heat. Fluxed remelting of this material indicates there is no appreciable amount of oxide, permitting rapid heat transfer. Soldering requires less active fluxes and metallic salts do not form readily. Powders are available in any alloy with a melting range of 200 to 625°F.

Alpha Metals Inc., 56 Water St., Jersey City, N. J. Phone: (201) 434-6778.

Circle No. 325

### Eutectic solder

This solder, a high-purity 63% tin/37% lead eutectic, has a melt and solidus point at 360°F. The solder softens and hardens at a much faster rate than non-eutectics, thus limiting oxide build-up within the solder joint. Uses are in wave solder machines.

Semi-Alloys Inc., 20 N. MacQuesten Pkwy., Mt. Vernon, N. Y. Phone: (914) 664-2800.

Circle No. 326

# Lambda adds new WIDE VOLTAGE RANGE PROGRAMABLE power supplies to all-silicon LM series

**Up to 60 volts.  
Up to 35 amps.  
7 power packages.  
Prices starting  
at \$69.00.**

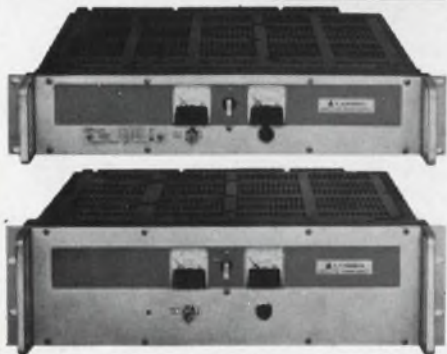

**Package A** 3 1/16" x 3 1/4" x 6 1/4"



Accessory Metered Panels: \$40.00

Model	ADJ. VOLT. RANGE VDC	I MAX. AMPS <sup>1</sup>				Price
		40°C	50°C	60°C	71°C	
LM 251	0-7	0.35	0.31	0.29	0.27	\$ 69
LM 201	0-7	0.85	0.75	0.70	0.55	79
LM 202	0-7	1.7	1.5	1.4	1.1	89
LM 252	0-7	2.0	1.8	1.4	1.1	99
LM 257	0-14	0.27	0.24	0.23	0.22	69
LM 203	0-14	0.45	0.40	0.38	0.28	79
LM 204	0-14	0.90	0.80	0.75	0.55	89
LM 258	0-14	1.2	1.1	1.0	0.80	99
LM 259	0-24	0.18	0.16	0.15	0.14	69
LM 260	0-24	0.35	0.30	0.25	0.20	79
LM 261	0-24	0.70	0.65	0.60	0.45	89
LM 262	0-24	0.80	0.75	0.70	0.60	99
LM 263	0-32	0.14	0.12	0.11	0.10	69
LM 205	0-32	0.25	0.23	0.20	0.15	79
LM 206	0-32	0.50	0.45	0.40	0.30	89
LM 264	0-32	0.66	0.60	0.50	0.32	99
LM 265	0-60	0.08	0.07	0.07	0.06	79
LM 207	0-60	0.13	0.12	0.11	0.08	89
LM 208	0-60	0.25	0.23	0.21	0.16	99
LM 266	0-60	0.35	0.31	0.28	0.25	109

**Package E** 4 1/16" x 7 1/2" x 11 1/2"

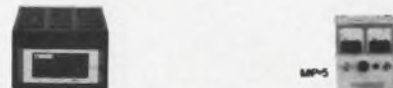

Accessory Metered Panels: \$40.00

Model	ADJ. VOLT. RANGE VDC	I MAX. AMPS <sup>1</sup>				Price
		40°C	50°C	60°C	71°C	
LME-0-7	0-7	12.0	10.5	8.5	6.8	\$249
LME-0-14	0-14	7.4	6.4	5.2	4.1	249
LME-0-32	0-32	3.7	3.2	2.6	2.1	249
LME-0-60	0-60	2.1	1.7	1.4	1.1	249

**Package F** 3 1/4" x 19" x 16 1/2"



For metered models, add suffix (M) to model number and \$30.00 to the price below.

Model	ADJ. VOLT. RANGE VDC	I MAX. AMPS <sup>1</sup>				Price
		40°C	50°C	60°C	71°C	
LMF-0-7	0-7	25.0	21.0	17.0	14.0	\$425

**Package B** 3 1/16" x 4 1/16" x 6 1/4"



Accessory Metered Panels: \$40.00

Model	ADJ. VOLT. RANGE VDC	I MAX. AMPS <sup>1</sup>				Price
		40°C	50°C	60°C	71°C	
LMB-0-7	0-7	2.8	2.6	2.3	1.5	\$109
LMB-0-14	0-14	1.6	1.5	1.3	1.2	109
LMB-0-32	0-32	0.80	0.70	0.60	0.5	109
LMB-0-60	0-60	0.45	0.40	0.35	0.3	109
LM-217	8.5-14	2.1	1.9	1.7	1.3	119
LM-218	13-23	1.5	1.3	1.2	1.0	119
LM-219	22-32	1.2	1.1	1.0	0.80	119
LM-220	30-60	0.70	0.65	0.60	0.45	129

**Package C** 5 1/4" x 19" x 16 1/2"



For metered models, add suffix (M) to model number and \$30.00 to the price below.

Model	ADJ. VOLT. RANGE VDC	I MAX. AMPS <sup>1</sup>				Price
		40°C	50°C	60°C	71°C	
LMC-0-7	0-7	35.0	29.0	24.0	20.0	\$575

<sup>1</sup> Current rating is from zero to I max. Current rating applies over entire output voltage range. Current rating applies for input voltage 105-132 VAC 55-65 cps. \* For operation at 45-55 cps derate current rating 10%. \* For operation at 360-440 cps consult factory for ratings and specifications. \* <sup>2</sup> Prices F.O.B. Factory, Melville, N. Y. All specifications and prices subject to change without notice.

**Features and Data** Meet Mil. Environment Specs. RFI—MIL-I-16910; Vibration: MIL-T-4807A; Shock: MIL-E-4970A • Proc. 1 & 2; Humidity: MIL-STD-810 • Meth. 507; / Temp. Shock: MIL-E-5272C • (ASG) Proc. 1; Altitude: MIL-E-4970A • (ASG) Proc. 1; Marking: MIL-STD-130; Quality: MIL-Q-9858.

Convection cooled—no heat sinking or forced air required

Wide input voltage and frequency range—105-132 VAC, (200-250 VAC, optional at no extra charge) 45-440 cps

Regulation (line) 0.05% plus 4MV (load) 0.03% plus 3MV; Ripple and Noise—1 MV rms, 3MV p to p

Temp. Coef.—0.03%/°C

**RACK ADAPTERS**

LRA-3

LRA-3—5 1/4" height by 2 7/16" depth. Price \$35.00

LRA-4—3 1/2" height by 14" depth. (For use with chassis slides) Price \$55.00

LRA-6—5 1/4" height by 14" depth. (For use with chassis slides) Price \$60.00



LRA-5—3 1/2" height by 2 7/16" depth. Price \$35.00

**Package C** 3 1/16" x 4 1/16" x 9 1/4"



Accessory Metered Panels: \$40.00

Model	ADJ. VOLT. RANGE VDC	I MAX. AMPS <sup>1</sup>				Price
		40°C	50°C	60°C	71°C	
LM 225	0-7	4.0	3.6	3.0	2.4	\$139
LMC-0-14	0-14	2.2	2.0	1.8	1.5	139
LMC-0-32	0-32	1.1	1.0	0.90	0.80	139
LMC-0-60	0-60	0.60	0.55	0.50	0.45	139
LM-226	8.5-14	3.3	3.0	2.5	2.0	139
LM-227	13-23	2.3	2.1	1.7	1.4	139
LM-228	22-32	2.0	1.8	1.5	1.2	139
LM-229	30-60	1.1	1.0	0.80	0.60	149

**Package D** 4 1/16" x 7 1/2" x 9 1/4"

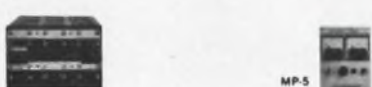

Accessory Metered Panels: \$40.00

Model	ADJ. VOLT. RANGE VDC	I MAX. AMPS <sup>1</sup>				Price
		40°C	50°C	60°C	71°C	
LM-234	0-7	8.3	7.3	6.5	5.5	\$199
LMD-0-14	0-14	4.9	4.2	3.4	2.7	199
LMD-0-32	0-32	2.5	2.1	1.7	1.3	180
LMD-0-60	0-60	1.3	1.1	0.95	0.75	239
LM-235	8.5-14	7.7	6.8	6.0	4.8	199
LM-236	13-23	5.8	5.1	4.5	3.6	209
LM-237	22-32	5.0	4.4	3.9	3.1	219
LM-238	30-60	2.6	2.3	2.0	1.6	239

**SEND FOR NEW CATALOG ON FIXED VOLTAGE AND WIDE RANGE MODULAR POWER SUPPLIES**



**LAMBDA ELECTRONICS CORP.** A  SUBSIDIARY  
815 BROAD HOLLOW ROAD • MELVILLE, L. I., NEW YORK • 516 MYRTLE 4-4200

# special problem? see the specialists!

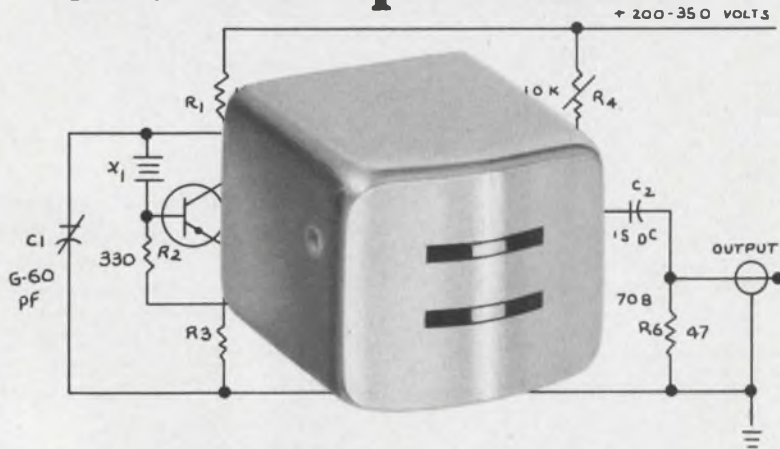

Michigan Magnetics, the world's largest manufacturer of precision tape heads, produces a complete line—meets every conceivable audio need. High volume production with one hundred percent on-the-line inspections insure uniform high quality at low unit cost. Interested? Then send us your specifications.

Send for new  
full-line catalog



**MICHIGAN MAGNETICS, INC.**

VERMONTVILLE, MICHIGAN  
A Subsidiary of VSI Corporation

ON READER-SERVICE CARD CIRCLE 64

## NEW THERMOCOUPLE REFERENCES WITH 25 CHANNELS ONLY \$259.00!

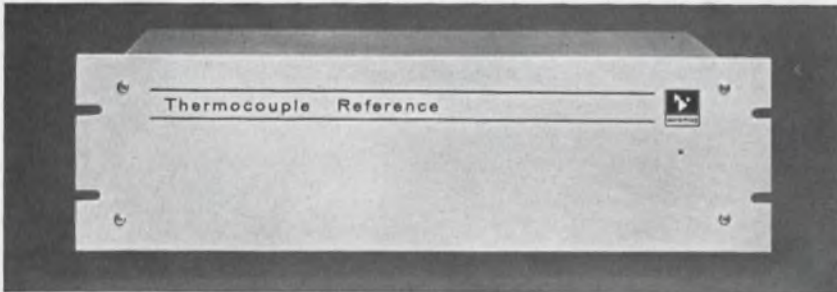

Now — ACROMAG Series 330 Thermocouple References with 25 channels of 0°C ice-point compensation for only \$259.00, including ALL 25 thermocouples! Uniformity 0.05°C, one-second warmup, easy to use. Ideal for scanned TC systems, DDC, and laboratory use. Series 340 References (150°F oven-type) with 25 channels for \$289.00! Both Series stocked in ISA Types, J, K, T, R & S. Others to order.

Request Technical Data 32 . . . . .

**ACROMAG**  
INCORPORATED

15360 Telegraph Road • Detroit, Michigan 48239  
Phone (313) 538-4242 • Teletype (313) 583-4536

Makers of Precision Instrumentation and Controls



ON READER-SERVICE CARD CIRCLE 65

## PRODUCTION



### Flatpack assembler

A flatpack leadframe and die attach machine consists of a movable stage on which dies, a heated holding fixture and a die transfer arm are placed. The movable stage is positioned so that the die is located in the microscope cross-hairs. The preglazed ceramic part is placed in the heated fixture and the leadframe placed on top. The "operate" switch causes the transfer arm to pick up the die and deposit it. The machine can be adapted for eutectic bonding. Typical production rates are 6 to 10 assemblies/minute.

P&A: \$3500; 6 to 8 wks. D. P. Veen Co., 1737 Kimberly Dr., Sunnysvale, Calif. Phone: (408) 739-7318.

Circle No. 327

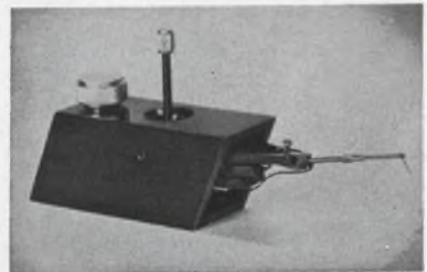

### Probe positioner

The "Micropositioner" is for in-line or analytical testing of semiconductor microcircuits, thin-film circuits and other microelectronic devices. It covers 360° in scanning and probing diameters up to 0.3-in. A spring-loaded positioning handle contacts points with an 8-micron diameter. Probe pressure on contact has a continuously adjustable range of 2 to 20G.

P&A: \$198; stock. Alessi Associates, 8710 Pershing Dr., Playa Del Rey, Calif. Phone: (213) 823-2255.

Circle No. 328



## You can save a lot of troublesome circuit engineering with the AE Series OCS Relay. We've "packaged" most of the programming!

AE's Series OCS Relay is low in cost and no bigger than a pack of king-size cigarettes. But it can save you a lot of engineering time.

This little relay can do the work of a whole battery of solid-state devices. And it won't lose its memory in a power failure or a circuit interruption.

*"Packaged" programming.* The AE Series OCS will follow or initiate a prescribed series of events or cycles at 30 steps per second impulse-controlled—or 65 per second self-interrupted. You can set up any programming sequence on one to eight cams, with as many as 36 on-and-off steps per cam. And each cam, tailored to your specifications, will actuate as many as six contact springs.

Can AE help take the "snags" out of your job? Our engineers are ready to work with you, to find the most practical and economical solution to any circuit-transfer problem.

There's a lot of helpful application information in the 160-page book, "How to Use Rotary Stepping Switches." Just ask your AE representative. Or write Director, Relay Control Equipment Sales, Automatic Electric, Northlake, Illinois 60164.

# **AUTOMATIC ELECTRIC**

SUBSIDIARY OF

**GENERAL TELEPHONE & ELECTRONICS GTE**

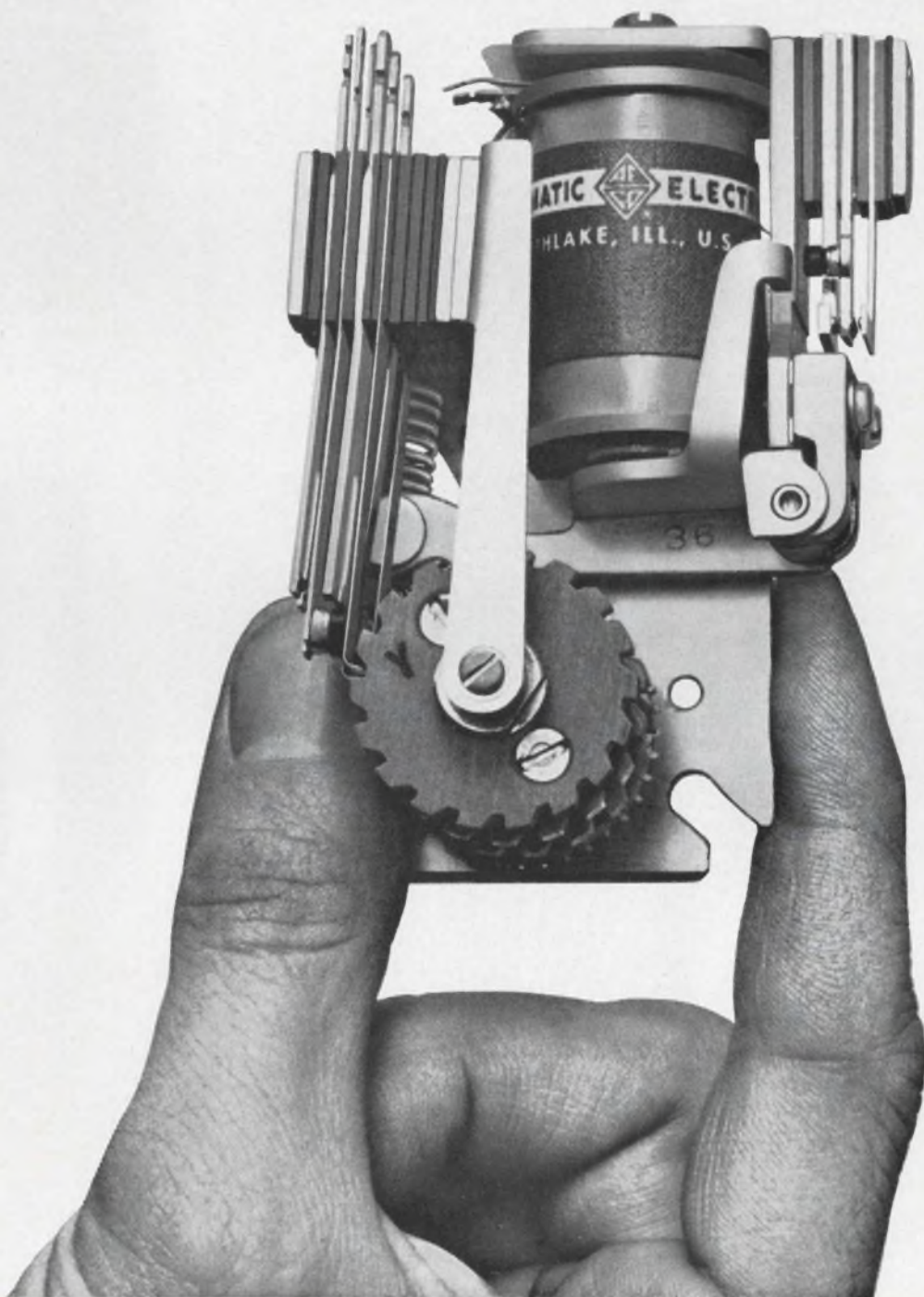

ON READER-SERVICE CARD CIRCLE 66

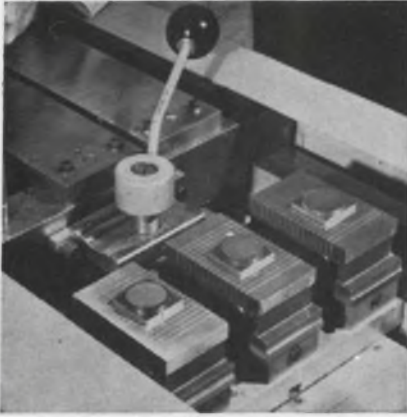

### Semiconductor dicer cuts 0.015 in.<sup>2</sup> wafers

Ganged steel blades and an abrasive slurry are used in the model 311 dicer to cut semiconductor materials such as silicon, ferrites and ceramics. Spaced straight steel blades reciprocate over the work. Dice as small as 0.015-in.<sup>2</sup> may be cut. The machine has a capacity for up to six 1-1/4-in. diameter wafers and cuts at rates to 0.001-in./minute. Reduced chipping and cracking are claimed to raise yields to 95%. Wafers with metallic or oxide layers can be successfully diced. Grooves can be cut to any thickness down to 0.0025-in.

P&A: \$12,000; 12 wks. Norton Co., Worcester, Mass. Phone: (617) 853-1000.

Circle No. 329

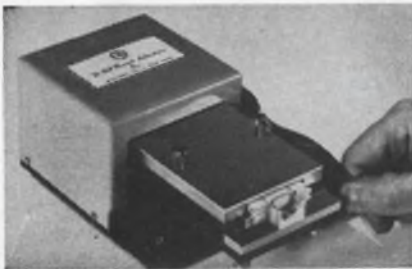

### IC lead former

This hand-operated device is designed to produce bends in multiple-lead components. The model 100B "Leadbender" handles up to 600 components/hour including flat packs, reed relays, diodes and miniature electrolytic capacitors. Components 1-in. long, with any number of leads and any center-to-center spacing can be accommodated. Dies are interchangeable.

D. Vel Research Labs. Inc., 555 Bedford Rd., Bedford Hills, N. Y. Phone: (914) 666-3455.

Circle No. 330

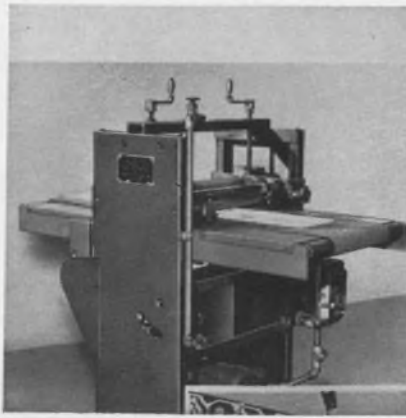

### PC roller coater

Coatings can be applied to printed-circuit blanks, with or without filling small holes or depressions. The roller coater has a 4-in.-diameter chrome-plated roller, with a 2-3/4-in. spring-loaded doctor roll, both mounted in self-aligning ball bearings. Series 5 coaters can be furnished with rolls from 14 to 50 in. wide, single or double coating with variable speed drives. The machine can be adjusted to accept material up to 4-in. thick.

Union Tool Corp., Warsaw, Ind. Phone: (219) 267-3211.

Circle No. 331

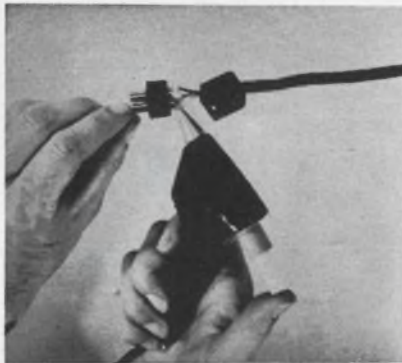

### Electric glue gun

Polyethylene-based glue for insulation and waterproofing is heated to 400°F in 3 minutes in a thermostatically controlled aluminum chamber. When glue cartridges are forced through the chamber, the glue is liquified and emitted from the 1/16-in. diameter nozzle. Approximately 90% of the moderately flexible bond strength is reached through cooling within 60 s, and the remainder in 24 hours. High temperature limitation of the glue is 130 to 150°F.

P&A: \$7.95; stock. United Shoe Machinery Corp., 784 Memorial Dr., Cambridge, Mass. Phone: (617) 542-9100.

Circle No. 332



### PC board probe

A portable constant-pressure probe is designed for measurements of coating thicknesses on pad areas, tracer lines or contact fingers of PC boards. Use of lights, mirrors and weights for alignment is eliminated. A locating ring with a translucent guide is placed on the circuit board surrounding the general area of measurement. The translucent disc is removed and replaced by the probe.

Twin City Testing Corp., 533 Niagara St., Tonawanda, N. Y. Phone: (716) 693-6303.

Circle No. 333



### 4-point crystal probe

Four-point probes for measurement of thin semiconductor slices or raw crystals have adjustable probe point pressures of 70 to 180 grams. Point spacing ranges from 0.025 to 0.0625 in. Coil springs coupled to an adjustment screw make each probe adaptable to the measurement of thin slices or raw crystals as opposed to fixed or pre-set pressures. Units are equipped with 12-in. color-coded leads.

P&A: from \$45; stock to 5 days. Alessi Associates, 8710 Pershing Dr., Playa Del Rey, Calif. Phone: (213) 823-2255.

Circle No. 334

# new

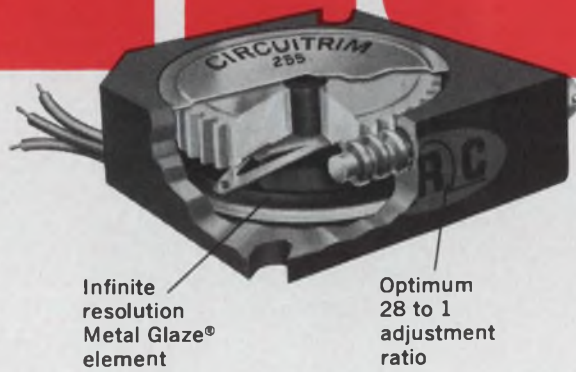

Infinite resolution Metal Glaze® element

Optimum 28 to 1 adjustment ratio

**TYPE 255**

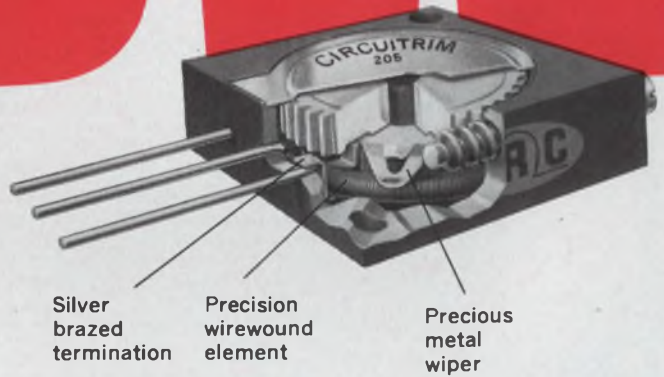

Silver brazed termination

Precision wirewound element

Precious metal wiper

**TYPE 205**

IRC's new 1/2" trimmers offer

## MIL performance at industrial prices

Value engineered for precision and economy, these new CIRCUITRIM trimmers offer upgraded circuit performance for industrial applications and considerable cost savings for military equipment.

**METAL GLAZE TYPE 255** is built to specifications of MIL-R-22097, RJ22 style. It offers essentially infinite resolution, higher resistance values and excellent high frequency characteristics.

**WIREWOUND TYPE 205** is built to specifications of MIL-R-27208, RT22 style. Designed to "set and forget," it offers wirewound stability and indestructible silver brazed terminations.

Increased reliability results from simplified design and IRC's years of experience in building high-quality trimmers. High-temperature thermosetting plastic housings are moisture sealed, and resist effects of automatic soldering and cleaning. Choice of terminations. Write for data and prices. IRC, Inc., 401 N. Broad St., Philadelphia, Pa. 19108

**ONLY IRC OFFERS ALL 4 POPULAR STYLES**  
Wirewound or infinite resolution elements



### CAPSULE SPECIFICATIONS

	TYPE 255	TYPE 205
POWER:	3/4 watt @ 70°C	1 watt @ 70°C
TEMPERATURE:	-55°C to 150°C	-55°C to 150°C
RESISTANCE:	100 ohms to 1 meg.	10 ohms to 50 K
TOLERANCE:	±10% std., ±5% and ±20% available	±5%



Speed Inquiry to Advertiser via Collect Night Letter  
ON READER-SERVICE CARD CIRCLE 67

**BERYLLIUM OXIDE  
TRANSISTOR HEAT  
SINKS**

Made of high purity (99.99%) sintered BeO, these sinks provide a satisfactory solution to the design engineer where electronic applications require both dielectric insulation and high heat transfer.

CATALOG SERIES — BOS



**NYLON  
TRANSISTOR PADS**

Precision molded from Zytel 101 (MIL-P-20693), these pads provide an economical insulator and thermal barrier with high dielectric strength. Resist continuous exposure to 135° C.

CATALOG SERIES — TPN



Many other heat sink, transistor pad and specialty items not shown are available. Write for additional information.

**MICA INSULATORS**

Delbert Blinn mica insulators are precision stamped from quality controlled stock and will withstand temperatures to 1000 F. with negligible dehydration. Standard thickness is .002 ± .001. Other designs, shapes, thicknesses or tolerances are available on special order.

CATALOG SERIES — MI

**HEAT SINK  
DISSIPATORS**

Efficiency, light weight and economy are incorporated in a complete line of professionally engineered heat sinks available in a variety of sizes and shapes. Material: Aluminum 6063-T5 alloy, mill finish. Lengths to 5 ft. available. (Serrations—U.S. Pat. No. 3163207). Can be cut, drilled, anodized or painted to your specifications.

CATALOG SERIES — AHS



When custom designs or modifications of standard electronic hardware parts are needed, our years of experience in the molding, extruding, stamping and fabrication of metal and plastic parts enables us to supply you with parts unsurpassable in quality.

We can help you successfully meet competition in today's highly competitive market.

**THE DELBERT BLINN CO.**

P. O. BOX 2007 • POMONA, CALIFORNIA • PHONE (714) 623-1257 (213) 628-8794

ON READER-SERVICE CARD CIRCLE 68

**MICROELECTRONICS**

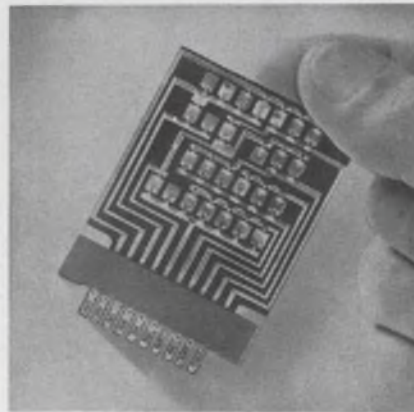

**PC board energizes segmented displays**

Decimal code is translated by this PC board to energize various segment combinations of 7-bar segmented display read-outs. The "Decimal to Visual Translator" can be used with all 7-bar segmented displays now available. It is rated at 6 Vdc and 0.5 A max input. Measuring 1-7/8- x 2-3/8-in., the translator consists of silicon planar semiconductors wave-soldered to a PC board. Operating temperature range is -20 to 100°C.

P&A: \$12.50; stock. Shelly Associates, 111 Eucalyptus Dr., El Segundo, Calif. Phone: (213) 322-2374. *Circle No. 335*

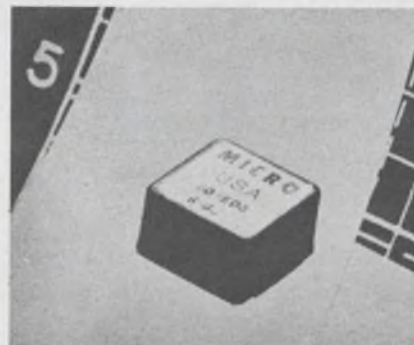

**One-shot pulse circuit**

An encapsulated pulse circuit for PC board mounting gives a single pulse whose duration is inversely proportional to the output voltage. Pulse duration varies from 0.1 to 2.5 μs. The circuits are suitable for any unitary-bit inputs. They are available for inputs ranging from 6 to 35 Vdc and impedances from 47 to 2200 Ω. Output pulses can be either polarity.

Honeywell, Micro Switch Div., 11 W. Spring St., Freeport, Ill. Phone: (815) 232-2730.

*Circle No. 336*

**RS-111-1B VHF-UHF Receiving System**



**(30-1000 MHz, no "plug-ins" required)**

Sales continue to climb for this CEI solid state receiving system, attesting to both its performance and its feature-packed design concept.

No plug-in modules are required. The RS-111-1B spans 30-1000 MHz in four bands—all built in. A sensitive, high-resolution signal monitor is also built in. This complete frequency coverage and visual display are combined in a compact unit just 5 1/4" high.

AM, FM and CW reception are provided, with audio and video outputs available simultaneously from a 2-MHz IF strip and a selectable 20-kHz/75-kHz/300-kHz IF strip. For full details and specifications of the RS-111-1B, please write:



**COMMUNICATION ELECTRONICS INCORPORATED**

6006 Executive Boulevard, Rockville, Md. 20852 • Phone: (301) 933-2800 • TWX: 710-824-9603

ON READER-SERVICE CARD CIRCLE 69

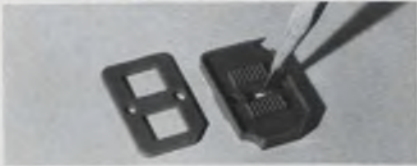

### IC carrier

Flat packs are held for testing and shipping without any stress being applied to the leads by this IC carrier. The "Auto-Pak" is a 2-piece device which positions the flat pack within a boss molded into the base. A snap-in cover locks the flat pack in place. The leads are neither twisted around supports nor clamped. The polysulfone carriers have an operating range of  $-100$  to  $+150^{\circ}\text{C}$ . They are produced in four designs to accept a variety of EIA-registered flat packs.

Westinghouse, Molecular Electronics Div., Elkridge, Md. Phone: (301) 796-3666.

Circle No. 341

### J-K flip-flop

A new J-K flip-flop provides the OR function on both J and K sides. The SF-60 operates at clock speeds up to 20 MHz and triggers on clock edges as long as 200 ns. Data inputs are 1.0 gate load and clock is 2.0 gate loads. The circuit is available in a hard glass flat-pack or a dual in-line plug-in. Both are hermetically sealed.

Sylvania Electric Products Inc., Electronic Components Group, Seneca Falls, N. Y. Phone: (315) 568-5881.

Circle No. 342

### TTL ICs

A family of TTL monolithic integrated circuits in TO-5 or flat packs dissipates 1.3 mW/node. Propagation delay is 50 ns/node, noise immunity is 800 mV and 2.5 V with interface circuits, fan-out is 9 and single power supply is 4 V. Initially, eight elements are offered: Five/three-input NAND/NOR gate, dual-three input gate, RST flip-flop, dual-shift register, gated buffer, flip-flop driving buffer, and input and output interface circuits.

P&A: \$23.10 to \$28.50 (1 to 24); stock. Amelco Semiconductor, 1300 Terra Bella Ave., Mountain View, Calif. Phone: (415) 968-9241.

Circle No. 343

## The First 3/4" Lighted Pushbutton Switch With 6 Pole Double Throw Capacity and Plug-In Convenience



### USECO introduces ORCON\*

**New Breakthrough in Switch Design.** ORCON is the first lighted pushbutton switch that matches the needs of today's technology in design versatility, operational flexibility and ease of maintenance. Here's why:

- 25% Smaller — only 3/4" Diameter.
- Multicircuit capacity — 2 pole double throw through 6 pole double throw — other variations available.
- Plug-in convenience — optional connector simplifies installation and maintenance.
- Isolated self-aligning contacts — for increased reliability.
- Independent light circuit — accepts incandescent or neon without lens modification.
- Operating action versatility — choice of four actions.
- "Customized" to your exact requirements from standard options.

Developed by USECO engineers for Computer and Data processing equipment, Tape Recorders, Telemetering Devices, Control Panels, Broadcasting Consoles and Business Machines, ORCON's advanced features are adaptable to an expanding variety of new applications, and are available for immediate delivery. Please contact us with your specific needs.



For complete information send for the illustrated technical brochure today. USECO DIVISION, 13536 Saticoy Street, Van Nuys, California. Phone (213) 786-9381.

\*USECO TRADEMARK, PATENT PENDING



DIVISION OF LITTON INDUSTRIES



ON READER-SERVICE CARD CIRCLE 70

# Need Cables

of SPECIAL CONSTRUCTION

500 Feet to ONE MILLION Feet

Columbia has the facilities to manufacture cables up to one inch in diameter with almost any number of conductors of various gauges, solid and stranded, bare or tinned copper. Wire and cable can be made from single conductors to pairs, triplets, quads, etc. Shielding where required can be braided, spiral wrapped, aluminum mylar or the new conductive vinyls and polyethylenes. Outer coverings are available in a broad temperature range. Also included are extremely flexible and weatherproof compounds. Steel support wires with tensile strengths of from 900 lbs. to 5,000 lbs. can also be furnished as part of the cable.

For a prompt quotation on your special cable write us giving full information regarding your requirements.

Send for our Catalog No. 111 describing "America's Most Complete Wire Line".



**Columbia**  
**WIRE & SUPPLY CO.**

2850 Irving Park Road • Chicago 18, Ill.

ON READER-SERVICE CARD CIRCLE 71

## MICROELECTRONICS

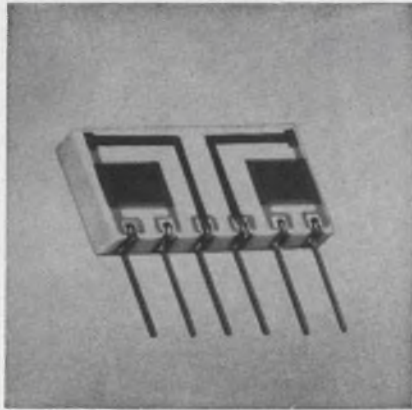

### Cermet resistor networks

Cermet resistor networks in standard 2-, 4-, 6- and 8-lead configurations can be adjusted to 0.25% tolerance after firing and retain better than a 1% load life when subjected to rated power and 70°C ambient. The passive networks feature a constant positive temperature co-efficient of  $200 \pm 50$  ppm/°C. Resistance range is from 10  $\Omega$  to 500 k $\Omega$  and dissipation is 0.16 W/in.<sup>2</sup>. The devices maintain temperature coefficient tracking from resistor path to path within 25 ppm/°C linearly over a -55 to 150°C range. They are available in tolerances from 0.25 to 5% with a conformal coating over the ceramic substrate or in a transfer-molded epoxy package.

Electra Mfg. Co., 800 N. 21st St., Independence, Kans. Phone: (316) 331-3400.

Circle No. 337

### High-gain op-amp

With an open loop gain of 50,000 and a 750-k $\Omega$  input impedance at 25°C, the WM 174Q IC op-amp has a unity gain bandwidth of 10 MHz. Input offset current is 100 nA and output current is 20 mA. Output impedance is 75  $\Omega$  and output swing is  $\pm 12$  V. The unit has 83-dB common mode rejection and common mode voltage range of  $\pm 4$  V. Zero voltage offset is obtainable by connecting a 5-k $\Omega$  pot between 2 leads. Packaging is in a 14-lead TO-86 flat pack.

P&A: \$39.50 (1 to 49), \$29 (50 to 499); stock. Westinghouse, Molecular Electronics Div., Box 7377, Elkridge, Md. Phone: (301) 796-3666.

Circle No. 338

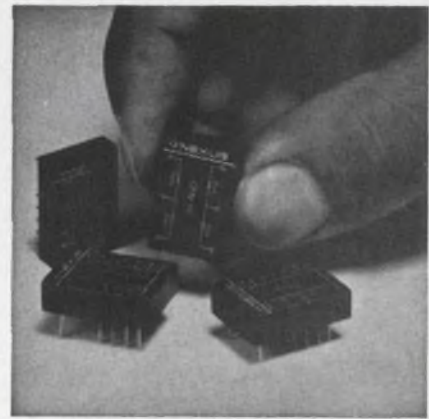

### Cermet resistor network

Encapsulated cermet resistance networks are available in configurations including binary and BCD-related resistance ratios for use in D/A interface converters. Standard resistance tolerances are 1 and 0.5% and special order tolerances are 0.25% and 0.1%. Thermal tracking ratio between units on common substrate is  $\pm 20$  ppm/°C and power dissipation per substrate is 0.5 W.

Price: about \$10. Nexus Research Lab. Inc., 480 Neponset St., Canton, Mass. Phone: (617) 828-9000.

Circle No. 339

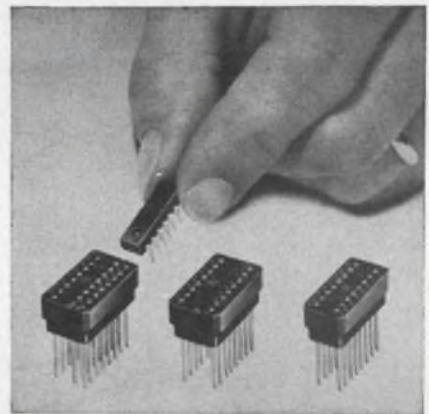

### Plug-in connector

The "Universal Pin Pack Connector" allows interconnection of all popular in-line or plug-in flat-pack types of ICs with flat or round leads. The device permits plug-in and operation of up to 16-position devices for testing, prototype design and packaging. The connector is available with 0.025-in.<sup>2</sup> wire wrap terminals or solder tails. Models are available for 14- or 16-lead devices.

Texas Instruments Inc., 34 Forest St., Attleboro, Mass. Phone: (617) 222-2800.

Circle No. 340

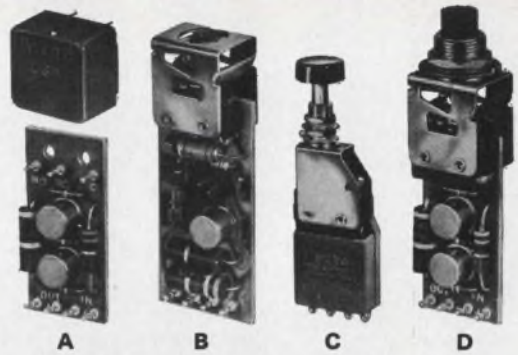

A: Circuit packages for printed circuit or conventional mounting. B, C and D: typical switch-circuit assemblies for panel mounting.

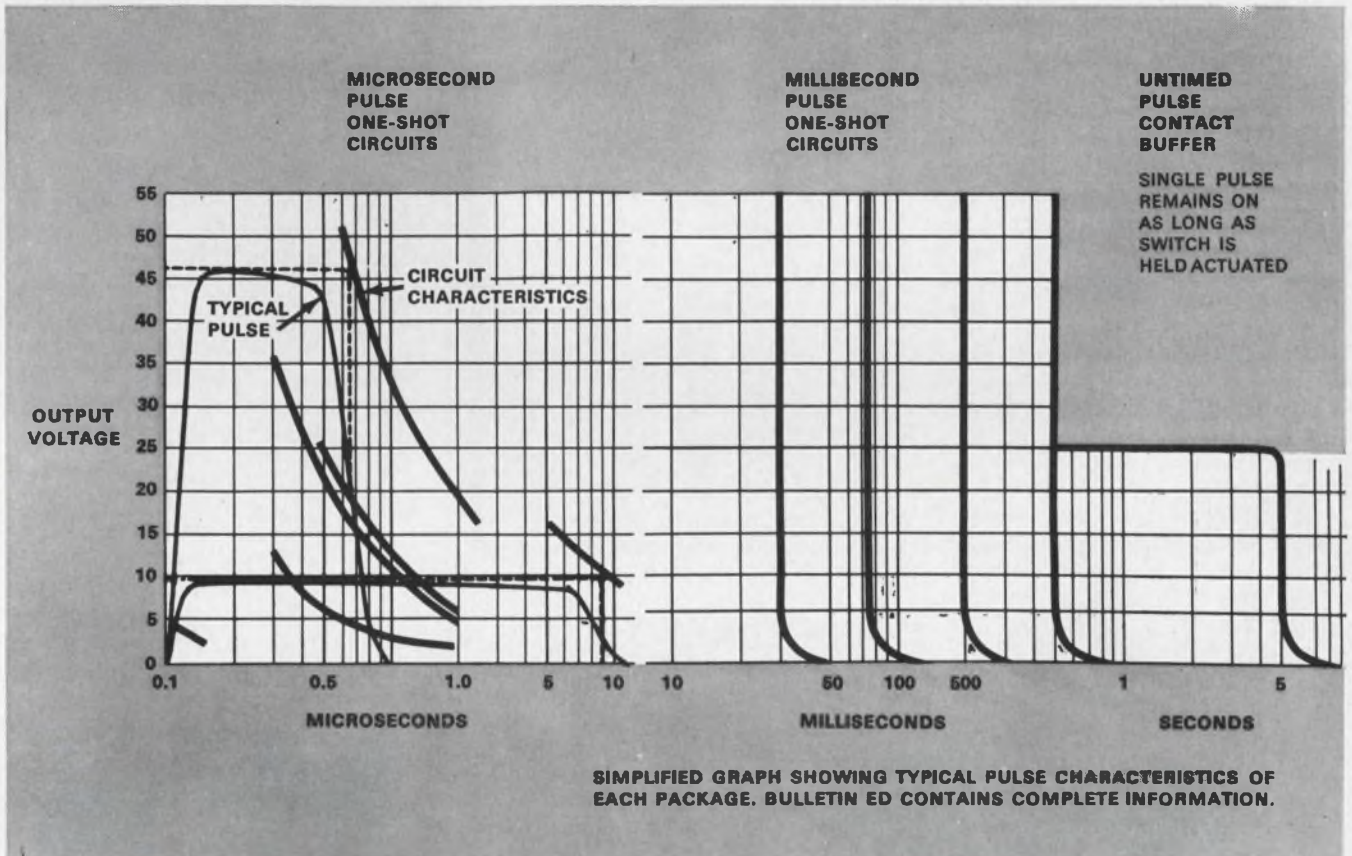

SIMPLIFIED GRAPH SHOWING TYPICAL PULSE CHARACTERISTICS OF EACH PACKAGE. BULLETIN ED CONTAINS COMPLETE INFORMATION.

## Need a pulse input, but don't have the engineering time?

A full line of electronic pulse circuit packages is now available from MICRO SWITCH.

These compact packages provide a single output pulse for each actuation of the controlling switch. They provide versatility in packaging and mounting—save engineering time, assembly costs and space.

Microsecond, millisecond and untimed pulse circuits are available pre-assembled to a variety of push-button switches, or as separate packages.

Send for this new design guide and application manual. Keep it handy for quick reference. Save time and money the next time you need an electronic pulse circuit.

Or call a Branch Office or Authorized Distributor (Yellow Pages, "Switches, Electric")



BULLETIN ED

## MICRO SWITCH

FREEPORT, ILLINOIS 61032

A DIVISION OF HONEYWELL

HONEYWELL INTERNATIONAL—Sales and service offices in all principal cities of the world. Manufacturing in United States, United Kingdom, Canada, Netherlands, Germany, France, Japan.

Speed Inquiry to Advertiser via Collect Night Letter  
ON READER-SERVICE CARD CIRCLE 72

# PACKAGING PANELS

CUSTOM DESIGNED • FAST DELIVERY • MINIMUM COST



## DUAL-IN-LINE WIRE-WRAP® SOCKET/PANEL for high density packaging

This packaging application with Wire-Wrap terminals is typical of how Augat custom designs to fit any component requirement. Because we work in a wide range of applications every day, our designing ability is uninhibited. Due to complete in-house facilities, our delivery is fast and at lowest possible cost.

Wide selection of Socket/Terminals with brass sleeves and beryllium copper, gold plated contacts available. May be purchased separately.

Write for data sheet 266.

**AUGAT**

INC. 31 PERRY AVE., ATTLEBORO, MASS. 02703 ©Trademark Gardner-Denver Co.

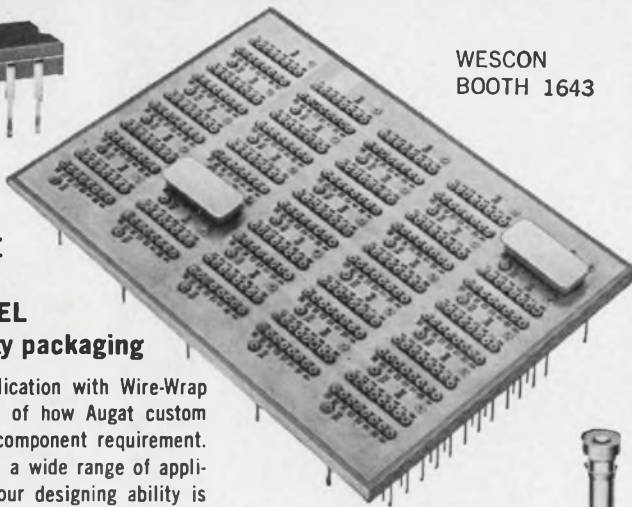

WESCON  
BOOTH 1643

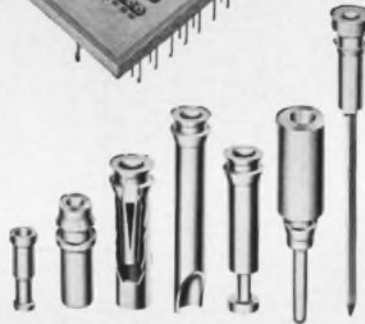

ON READER-SERVICE CARD CIRCLE 73

## Quick Adjusting . . COMPONENT LEADS BENDING BLOCK

**CUTS COMPONENT  
LOSSES TO A  
MINIMUM  
AND ELIMINATES  
PLIER DAMAGE**



MODEL 700  
with gauge plate

Quickly adjustable to any component body length from 0" to 1 3/4". Leads can be bent within .070 of end of component and up to 3" centers. Handles any diameter lead up to .045".

Dimensions: 1" x 3 3/4" x 5 3/8"  
Weight: 10 oz.

A hand tool for bending leads on resistors, diodes, capacitors, etc., to accurately register with their holes in printed circuit panels.

Only \$19.80 each  
IMMEDIATE DELIVERY

MANUFACTURED BY

**BY-BUK COMPANY**

4326 West Pico Boulevard • Los Angeles, California 90019  
Phone: 937-3511 • Long Distance Area Code 213

Speed Inquiry to Advertiser via Collect Night Letter  
ON READER-SERVICE CARD CIRCLE 75

## POWER EQUIPMENT

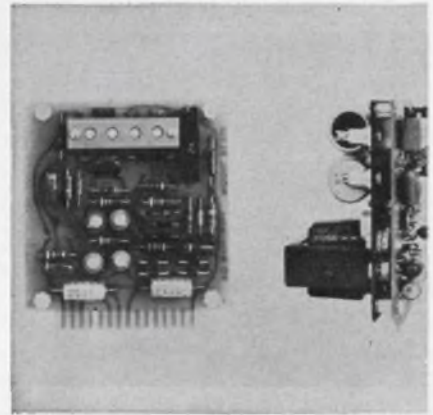

## 6-Vdc IC supply

With remote programming and sensing capability and convection cooling, models 505 and 507 are designed to power ICs. Both supplies operate from a 45- to 440-Hz, 105- to 130-Vac input, over a -20 to 70°C range. Ripple is 0.005% max and output is adjustable from 3 to 6 Vdc. The model 505 has 0.02% regulation with line or load and an 8-A output. Model 507 has 0.015% regulation with line or load and a 5-A output.

P&A: \$190 (507), \$199 (505); stock to 2 wks. RO Associates, 917 Terminal Way, San Carlos, Calif. Phone: (415) 591-9443.

Circle No. 366

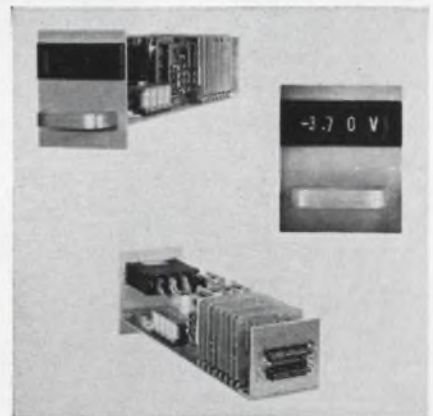

## Programmable power

Digitally programmed supplies are programmed by BCD logic levels (0 and +12 V) and can deliver either voltage or current on command. Programming time with a resistive load is 1 ms max with no overshoot. Ranges are 0 to 0.999, 9.99 V and 0 to 9.99, 99.9, 999  $\mu$ A, 9.99 and 99.9 mA. Accuracy is  $\pm 0.1\%$   $\pm 1$  digit.

Optimized Devices Inc., Pleasantville, N. Y. Phone: (914) 768-6100.

Circle No. 367



**courting  
capacitor  
disaster?**



## **ONLY Hi-Q CERALAM® CAPACITORS OFFER YOU PROVEN HIGH PERFORMANCE & ESTABLISHED HIGH RELIABILITY**



With so much current talk about jamming more and more performance into smaller and smaller packages, we think it's about time attention was called to this kind of "brinkmanship." These claims are okay—usually—as far as they go. But how often do you see them underscored with a promise of tops in reliability? Not often? Never! (Unless the reference is to a CERALAM capacitor.) It's simply a fact that you can't jam a conventional capacitor construction into a smaller package without sacrificing reliability. And you can't put one of these "wonder" capacitors into your equipment without risking its reliability.

There's just one way to cram more performance into a smaller package and still provide the kind of reliability that's demanded in a probe going millions of miles into space. That's with CERALAM construction... a lamination so dense it becomes a rugged monolithic block. Hi-Q developed the technique, *and proved it in performance* so we could guarantee reliability. That's something you can't buy anywhere else. So don't mess around, call us and be sure.



**AEROVOX**  
CORPORATION  
OLEAN, NEW YORK  
MYRTLE BEACH, SOUTH CAROLINA

SELECTED COMMERCIAL and MILITARY HI-Q PRODUCTS ARE AVAILABLE OFF-THE-SHELF FROM AUTHORIZED AEROVOX DISTRIBUTORS  
ON READER-SERVICE CARD CIRCLE 74

# CUT BREADBOARDING TIME . . . . 4 WAYS

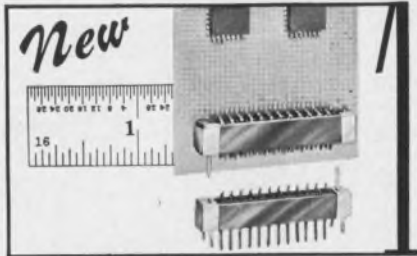

New **MICRO PLUGBORDS** with subminiature connectors. The .042" or .025" dia. holes on .1" or .05" centers allow greater packaging density than possible before with pre-punched boards. Available also without connectors and in copper clad epoxy glass.

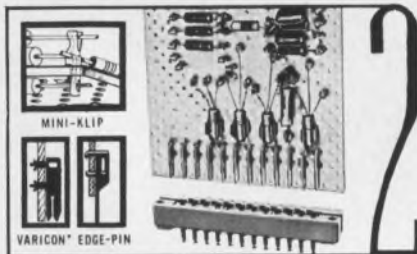

Pre-punched **PLUGBORDS** with Varicon\* or Vector Edge-Pin contacts ready for your components. Insert Mini-Klip Push-In terminals where needed. JEDEC hole spacing matches transistor leads. \*Elco Trademark.



**ETCHED CIRCUIT KITS 27X and 27XA** provide all materials for making quick, inexpensive etched circuits. New 27XA has time-saving **Vectoresist**, the "rub-on" transfer resist sheet with lines, circles, ellipses, pads and standard .156" contacts, plus **Vector-board** and unpunched copper clad cards and ready-to-use etch bags.

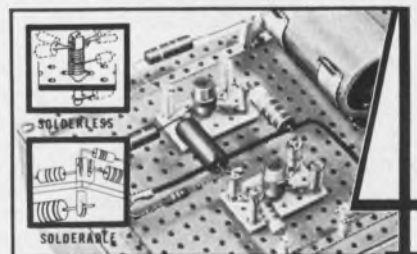

Large and small **BREADBOARD KITS** with complete hardware systems for faster breadboarding in Lab. or school experiments. Complete with solderless Springclip, solderable push-in terminals, transistor and tube sockets. New **Hi Frequency** breadboard kit now available.

May we send you literature and prices?

**VECTOR ELECTRONIC CO. INC.**  
1100 Flower St., Glendale, Calif. 91201  
Phone (213) 245-8971 • TWX (213) 240-2162

ON READER-SERVICE CARD CIRCLE 76

## SEMICONDUCTORS

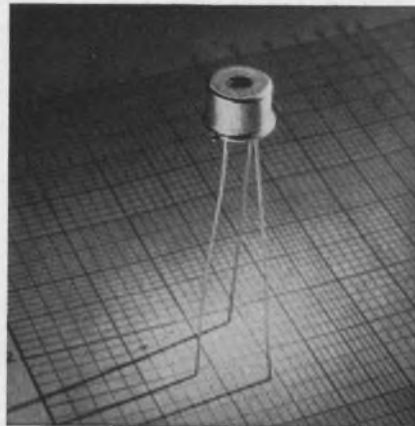

### 100-MHz photodiode

Diffused guard-ring construction gives this silicon photodiode a spectral range of 0.35 to 1.13 microns and a high response in the "blue" region. Sensitivity is  $0.5 \mu\text{A}/\mu\text{W}$  at 0.9 microns (70% quantum efficiency). Leakage currents at 90-V bias are less than  $0.1 \mu\text{A}$ . The photodiode has a rise time of 4 ns and will operate up to 100 MHz. Linearity of response has been demonstrated over a seven-decade range of incident power levels.

EG&G Inc., 160 Brookline Ave., Boston, Mass. Phone: (617) 267-9700.

Circle No. 344

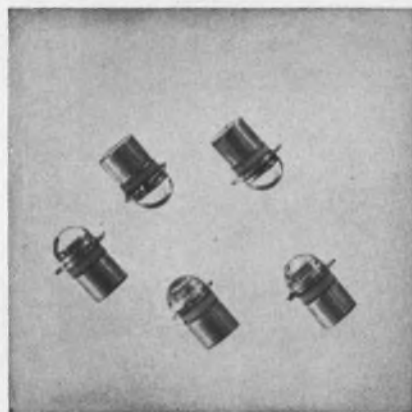

### Pin photodiode

The silicon planar pin photodiode has a dark current of 150 pA max. Speed of response is 1 ns max and frequency response extends from dc to 1 GHz. Laser pulses of less than 0.1 ns can be detected. Quantum detection response is constant over six decades of light intensity. The 4205 is packaged in kovar-ceramic with a glass lens.

P&A: \$19.15, (10 to 99); stock. hp associates, 620 Page Mill Rd., Palo Alto, Calif. Phone: (415) 321-8510.

Circle No. 345

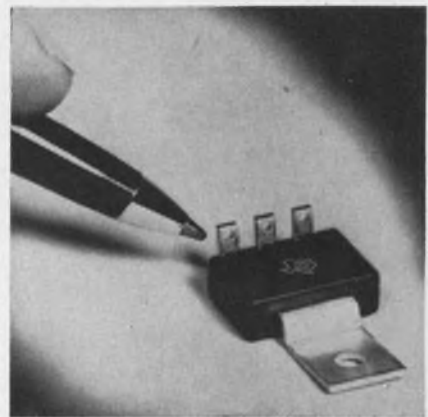

### Potted power transistor

A 2-A epitaxial planar silicon power transistor is characterized for Class B operation up to 20 W rms/channel. Dc beta brackets provide pairs matched within 20% ( $I_C = 1.5 \text{ A}$ ).  $H_{FE}$  is typically 50 at 50 mA and 1.5 A and 66 at 300 mA.  $V_{CE(SAT)}$  is 0.3 V at 1.5 A. Power capability is 10 W at 70 V and 75°C case temperature.

Price: \$0.55. Texas Instruments, 13500 N. Central Expwy., Dallas. Phone: (214) 235-3111.

Circle No. 346

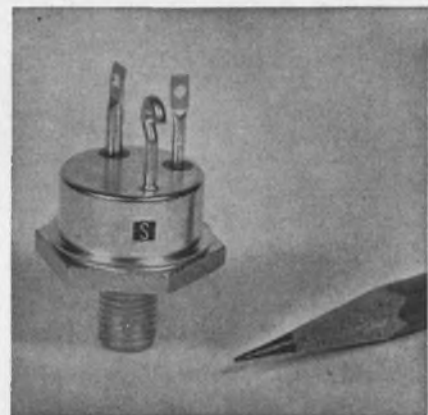

### Npn power transistors

High voltage silicon npn planar power transistors in a TO-63 can are capable of collector-to-emitter sustaining voltages of 300 V max. Beta is 50 at 5 A and ranges from 15 to 45 at 10 A. The gain curve is virtually flat from 10 mA to 2 A.  $V_{CE(SAT)}$  is typically 0.6 V at 10 A with  $f_t$  of 40 MHz. Switching times are in the  $\mu\text{s}$  range. The devices dissipate 100 W at 100°C case temperature.

Soliton Devices Inc., 1177 Blue Heron Blvd., Riviera Beach, Fla. Phone: (305) 848-4311.

Circle No. 347

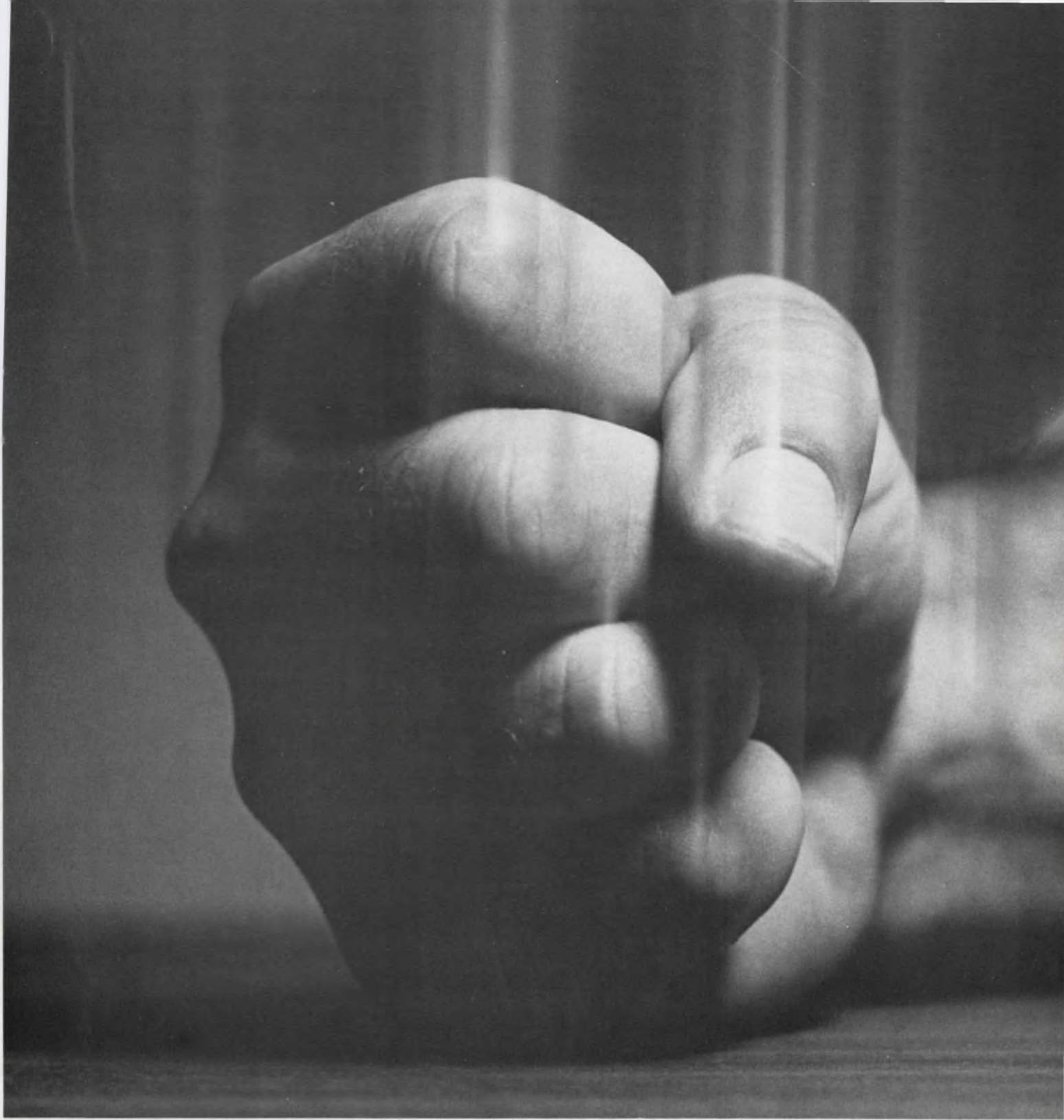

**If you felt like this the last time your subminiature relay order was rescheduled, next time call Leach**

We've got over 7,000 subminiature relays in stock at key locations throughout the country. Ready for immediate delivery. Relays like our SERIES E., a half-size unit rated for top performance in dry circuit to 2 amp switching.

Designed for printed circuit and high environmental applications, this subminiature relay offers you space and weight economies of better than 50% over full size crystal can types. Available in voltages from 6 to 26.5 VDC, the SERIES E has an operate and release time

of less than 4 milliseconds maximum, including bounce. It will withstand 100g shock, 30g vibration and operating temperatures from -65 to +125° C. Life is 1,000,000 cycles, dry circuit. Need one tomorrow? A dozen, a hundred? Then call us today. You'll have them right on time.

Leach Corporation, Relay Division, 5915 Avalon Blvd., Los Angeles, California; 90003  
Phone (Area code 213) 232-8221  
Export: LEACH INTERNATIONAL S. A.



**LEACH**



If you thought  
our "Compact" was  
great @ \$17.50...

look what we have  
for \$9.\*



It's our new TCD filter. And for the money, it's the finest filter around. Bandwidth @ 6 db is 8 kc (minimum); at 60 db—20 kc (maximum). Transformer input provides a DC path and an input impedance of 40 K ohms, suitable for transistor and vacuum tube circuits. We designed it specifically for CB, mobile, aircraft and marine radios... put it in a package that's less than .6 cu. in. The following specs are for our standard model (but say the word and we'll custom design to your special requirements):

#TCD-4-8D20A	B/W @ 27°C		Impedance	
Insertion Loss: 5db max. Temp. Stability: less than 800 cps variation -20 to +60°C.	Center Freq. @ 6db 455 ± 1kc 8kc min	max. @ 60db 20 kc max.	In 40 K ohms	Out 1.5 K ohms

\*For orders of 100 to 499. Complete TCD Prices: 1-24 — \$15 ea; 25-99 — \$12 ea.; 100-499 — \$9 ea.; 500-1999 — \$7.50 ea.; 2000-4999 — \$6.50 ea. (Prices subject to change without notice.)

Send order or request for free Technical Brochure to: Piezoelectric Division, Clevite Corporation, 232 Forbes Road, Bedford, Ohio 44014.

See it at WESCON  
Booth 420

**CLEVITE**

ON READER-SERVICE CARD CIRCLE 78

## SEMICONDUCTORS

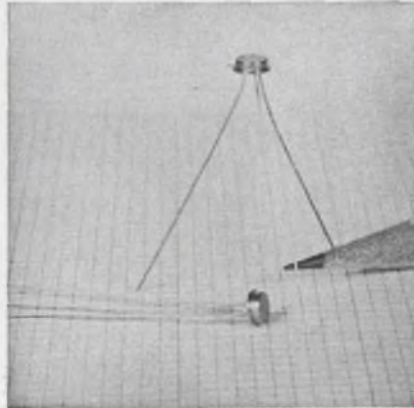

### 2-A npn transistor

Available in a TO-46 can, this npn dissipates 4 W at 100°C case temperature. The MHT 5051 through MHT 5056 are characterized at  $I_C = 0.5$  A with  $V_{CE(SAT)}$  of 0.35 V max. The two gain ( $h_{fe}$ ) families, 30 to 90 and 50 to 150, are available with unity gain voltages of 150, 175 or 200 V collector to emitter.

Availability: stock. Solitron Devices Inc., 1177 Blue Heron Blvd., Riviera Beach, Fla. Phone: (305) 848-4311.

Circle No. 348

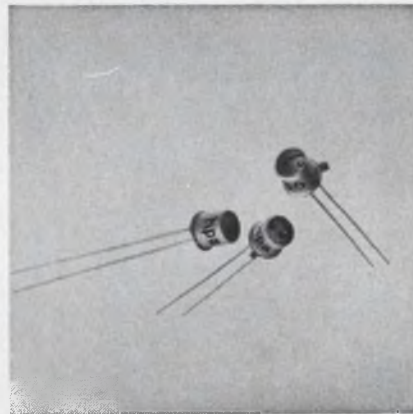

### GaAs light source

This high-intensity IR source, when forward biased, emits 0.2 mW at a wavelength of 9000 Å. Type 4106 GaAs electroluminescent diode is packaged on a TO-46 header with a plane glass window with the anode connected to the case. Minimum power output is 0.15 mW when the diode is forward biased with 100 mA at 1.25 V.

P&A: \$21.25 (1 to 99); stock. hp associates, 620 Page Mill Rd., Palo Alto, Calif. Phone: (415) 321-8510.

Circle No. 349

# these terminals are engineered to give

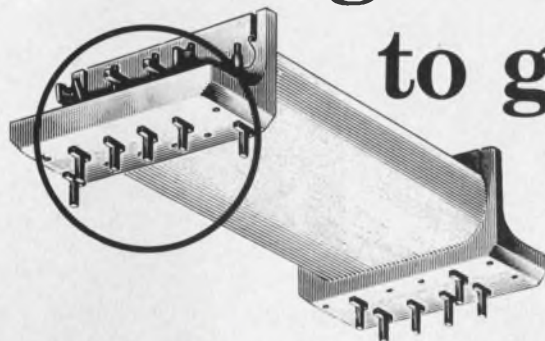

## P&B dry reed relays extra stability

Now you can have the assurance of P&B quality in a complete new line of dry reed relays.

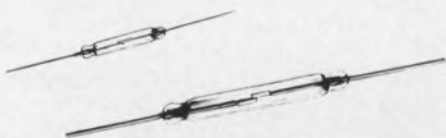

JR standard size reed relays are available in assemblies of 1 to 5 switches. In the JRM miniature series up to 6 reeds are available in one assembly. Both sizes come in a standard range of coil voltages and various combinations of Form A and Form C contact arrangements.

### **BOBBIN FLANGE SUPPORTS TERMINALS FOR STRESS PROTECTION**

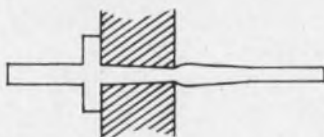

P&Breed relays employ an unusually sturdy terminal configuration. Extensions of the molded coil bobbin

support the cross-shaped terminal pins. Stresses that otherwise would be transmitted to the reed extensions are confined, instead, to the bobbin thus protecting the glass-to-metal seal of the capsule.

### **METAL HOUSING PROVIDES MAGNETIC SHIELDING, INCREASES SENSITIVITY**

Metal housings for the various assemblies provide magnetic shielding, eliminate stray magnetic fields and protect the relays from mechanical damage. JRM miniature relays are

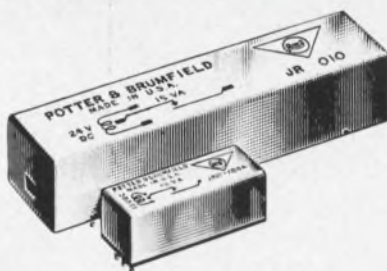

potted in a high melting point compound to insure mechanical stability. Speeds of less than 1 millisecond are attainable.

### **MAY REPLACE EXPENSIVE SOLID STATE DEVICES**

In many applications JR and JRM reed relays may be used in place of more expensive solid state devices over which they have one basic advantage . . . they are not subject to inadvertent switching by ambient or line transients.

### **IDEAL FOR LOW POWER LONG LIFE LOGIC SWITCHING**

JR and JRM are especially suited for applications where fast operating time, low power and long life are required. Their high sensitivity and compact size recommend them for data processing, computer equipment, logic circuitry, for voltage or current sensing and various other types of sophisticated control circuits.

Send for data sheets giving complete specifications. Contact your local P&B representative or the factory direct for complete information.

**P&B Dry Reed Relays are now  
available from authorized  
Electronic Parts Distributors**



**POTTER & BRUMFIELD**

Division of American Machine & Foundry Co., Princeton, Ind.  
Export: AMF International, 261 Madison Ave., New York, N.Y.

Speed Inquiry to Advertiser via Collect Night Letter  
ON READER-SERVICE CARD CIRCLE 79

# Aladdin<sup>®</sup> electronics

## ADJUSTABLE INDUCTORS



If your problem is one of packaging inductive components, then the answer can probably be found in one of the Aladdin Electronics configurations shown above. As specialists in inductive components for frequency generation or selectivity, we can confidently recommend our products for your exacting applications. The units shown above may be used as fixed and adjustable inductors, fixed and adjustable transformers (either tuned or untuned), and as filter elements. They have been designed to help you solve both the problem of making your equipment more compact and also the problem of improving performance through the use of more stable inductive components.

For help concerning component selection for FREQUENCY SELECTIVE NETWORKS or for free literature on Aladdin inductive components write to:

Dept. 3-G

# Aladdin<sup>®</sup> electronics

where the magic of magnetism is a science<sup>®</sup>

Nashville, Tennessee 37210  
615-242-3411 TWX: NV252

Speed Inquiry to Advertiser  
via Collect Night Letter

<sup>®</sup>T.M.

ON READER-SERVICE CARD CIRCLE 80

## MICROWAVES

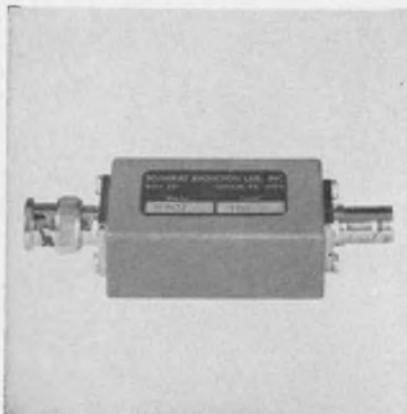

### Frequency multiplier

The usable frequency range of signal generators and frequency synthesizers is extended with a minimum conversion loss by this frequency multiplier. Input power of 400 mW max from 50 MHz to 4 GHz produces harmonic energy of 100 MHz to 12 GHz at efficiencies of 200% max divided by harmonic number. The N807 can generate a comb of harmonics from a crystal-controlled 100-MHz source. A 100-ps step recovery diode is the harmonic generating device.

P&A: \$110; 10 days. Somerset Radiation Lab. Inc., P.O. Box 201, Edison, Pa. Phone: (215) 348-8883.

Circle No. 350



### Forward wave amplifier

A 100-kw peak power L-band forward wave amplifier weighs 35 lbs. The QKS-1319 has a 15% bandwidth and features constant voltage operation without a heater. Average power is 3 kw and peak anode current is 20 A. Pulse width is 300  $\mu$ s. Gain is 15 dB over the 1.2- to 1.4-GHz band.

Raytheon Co., Waltham, Mass.  
Phone: (617) 899-8400.

Circle No. 351



### Varactor multipliers

Stripline varactor multipliers have a 3 to 15% bandwidth over the 0.3- to 6-GHz range. Conversion loss is 2.8 dB at 5%, 3.5 dB at 10% and 7 dB at 15% bandwidth. With a clean input signal within the multiplication band, spurious signals are -27 to -30 dB. The multiplier is internally biased and fixed tuned, so that installation consists of inserting the RF input and obtaining 2f at the output.

Elpac Inc., 3760 Campus Dr., Newport Beach, Calif. Phone: (714) 546-8640.

Circle No. 352



### Wide-range receiver

With appropriate local oscillator and mixer, this receiver measures attenuation over a 10-MHz to 40 GHz range. Single-step attenuation measurements of 100 dB and relative power measurements at a level of -120 dBm can be made. The parallel IF substitution receiver can be used for signal generator attenuation calibration, vswr measurements or as a detector in RF and microwave systems.

P&A: \$2800; stock. PRD Electronics Inc., 1200 Prospect Ave., Westbury, N. Y. Phone: (516) 334-7810.

Circle No. 353

# SELECTED FOR THE MINUTEMAN PROJECT

*More than 6 million El-Menco Dipped Mica Capacitors have been used in the Minuteman ground support and control equipment.*

**After 64,000,000 ACTUAL TEST unit-hours at 85°C with 225% of the rated DC voltage applied, no failures of any type occurred.**

The accumulated  $64 \times 10^6$  test unit-hours without any failures can be used to calculate many different failure rates depending upon the confidence level desired. However, we shall explore the meaning of the results at a 90% confidence level.

Assuming no acceleration factor for either temperature or voltage, we have verified a failure rate of less than 0.004% per 1000 hours. (Actually, there is a temperature effect and it has been found that, with the DC voltage stress remaining constant, the life decreases approximately 50% for every 10°C rise in temperature. There is also a voltage effect such that, with the temperature stress remaining constant, the life is inversely proportional to the 8th power of the applied DC voltage.)

Assuming no temperature acceleration factor and assuming the voltage acceleration exponent is such as to yield an acceleration factor as low as 100, we have nevertheless verified a failure rate of less than 0.00004% per 1000 hours.

Assuming no temperature acceleration factor and assuming the voltage acceleration factor is on the order of 250 (test results are available to confirm this) we have accumulated sufficient unit-hours to verify a failure rate of less than 0.000015% per 1000 hours!

*All above failure rates are calculated at a 90% confidence level!*

Write for a complete reliability study on your company letterhead.

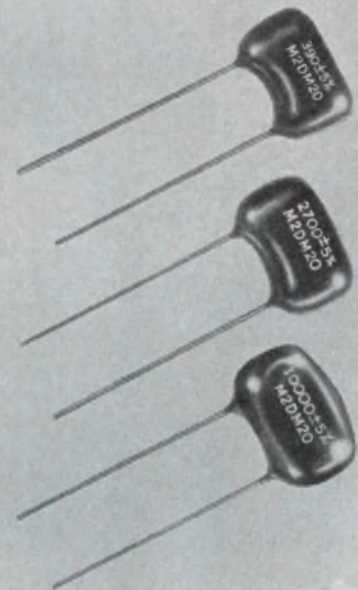

**DIPPED MICA  
CAPACITORS  
TYPE M2DM**

**THE ELECTRO MOTIVE MFG. CO., INC.**

MANUFACTURERS OF

**El-Menco**  
*Capacitors*

**WILLIMANTIC, CONNECTICUT**

*Dipped Mica • Molded Mica • Silvered Mica Films • Mica Trimmers & Padders  
Mylar-Paper Dipped • Paper Dipped • Mylar Dipped • Tubular Paper*

ARCO ELECTRONICS, INC., Community Drive,  
Great Neck, L. I., New York  
*Exclusive Supplier to Jobbers and Distributors  
in the U. S. and Canada*

*West Coast Manufacturers Contact:*  
**COLLINS & HYDE CO.**, 1020 Corporation Way  
Palo Alto, California  
5380 Whittier Boulevard, Los Angeles, California

ON READER-SERVICE CARD CIRCLE 81

# KILLS SNIVETS INSTANTLY

**H**ow would you like an anti-snivet tube for your color TV horizontal deflection circuits? That's right—an anti-snivet tube would eliminate the need for snivet-suppression circuitry with its extra components and extra costs.

The new Amperex 6KG6 output pentode is your tube! It was specifically developed to eliminate Barkhausen oscillations and achieves its snivet-free performance through the use of a Cavitrap anode and other unique design characteristics. The 6KG6 can be operated with grounded suppressor at B+ supply voltages from 240 to 400 volts and still remain snivet-free.

Life-expectancy and reliability of the 6KG6 is far above that of ordinary output pentodes in similar service due to its lower bulb temperature at maximum operating conditions; it operates about 50°C. cooler than comparable tubes in similar service. But in spite of its low operating temperature, the 6KG6 packs plenty of reserve power and added safety factors. It has a max. 7,000 V peak plate voltage, 34 watts max. plate dissipation and 1.4 amps peak anode current.

The 6KG6 is but one of the growing family of new Amperex tubes for color TV that make possible lower costs, higher quality and more reliable performance. Other new tubes in this family include the 6EC4 damper diode, a matching companion to the 6KG6 for horizontal deflection circuits, the 3BH2 high voltage rectifier diode and the ED500 shunt stabilizer.

For data and applications information, write to the company *still doing new things with receiving tubes*: Amperex Electronic Corporation, Semiconductor and Receiving Tube Division, Dept. 371, Slatersville, Rhode Island, 02876.

## Amperex®

Speed Inquiry to Advertiser via Collect Night Letter  
ON READER-SERVICE CARD CIRCLE 220





## MICROWAVES



### 2.69-GHz antennas

Directive parabolic receiving antennas cover the 2.5 to 2.69-GHz range and are available in 1, 2, 4 and 6-ft. diameters. Reflectors are aluminum and meet all EIA wind-load specs. Adjustment is provided through 360° of horizontal rotation and 0 to ±7° of vertical tilt. Installed from the rear of the reflector, the slot-dipole feed is radome protected.

Jerrold Electronics Corp., 15th & Lehigh, Philadelphia. Phone: (215) 226-3456.

Circle No. 354

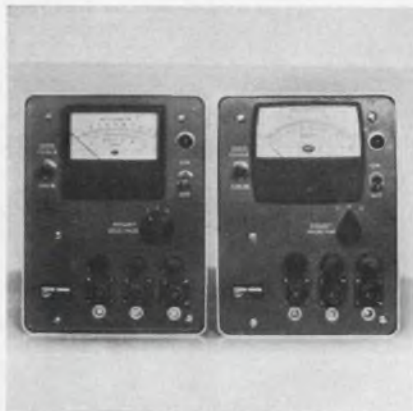

### Power meters

RF power is measured at 3 locations with a switch-selected choice of mounts. Full scale is 10 mW of RF (model A610) and 30 mW (A630). Mounts in 3 waveguide sizes cover the 7- to 12.4-GHz band. Max error is 5% up to 1000 ft from the meter. The meters are rated at 117 V ±10%, 50 to 1000 Hz.

P&A: \$265; 30 days. MSI Electronics Inc., 116-06 Myrtle Ave., Richmond Hill, N. Y. Phone: (212) 441-6420.

Circle No. 355



## WE'VE GOT A BABY FIREFLY THAT REALLY PERFORMS!



NO FOOLING! ONE OF OUR competitors is telling about a lamp that is as big as a firefly — claims it flies, too! Says it's dependable and if you want a smaller lamp than theirs you'll have to consider *baby fireflies*. How droll!

### LOOK NO FARTHER!

We've got baby fireflies *and* the mother too! Our babies are every bit as *dependable* as the parent — real performers. Hudson's T-3/4 lamps actually have the same electrical ratings as *our* famous, but bigger, T-1 lamps. They're just as bright and also have design lives exceeding 100,000 plus hours.

Where you have the space, Hudson's T-1 lamp will do a great job. *If* your space is limited, the Hudson T-3/4 lamp will do the job equally well. Regardless of which size you need, why not get them from Hudson the next time?



We make no claim that our fireflies fly. Unless, of course, they get an assist from an airplane. And many of them do.

Write for new catalog.

**Hudson LAMP COMPANY**  
Miniature Lamp Specialists



518 ELM STREET, KEARNY, NEW JERSEY 07032

ON READER-SERVICE CARD CIRCLE 82

who said you  
can't design  
a plugboard  
programming  
system to  
withstand  
severe shock?

**MAC Panel  
has done it!**



**NEW SERIES 140**

MAC Panel's Series 140 Plugboard Programming Systems are available in a wide range of sizes . . . each designed and engineered to withstand the severest shock and vibration under operating conditions. Tested to 50G without self-generated contact noise. And life tested to 10,000 cycles with only random variation in contact voltage drop.

Not enough facts? Here are more: You can only insert plugboards one way. Receptacles are available for standard taper pins or series 53 pins. Contacts are spaced on  $\frac{1}{4}$ " x  $\frac{1}{4}$ " grid to allow more positions in a minimum of space.

How about plugwires? The new Series 140 Plugwires are interchangeable with most existing systems. Ball-D-Tent design prevents accidental dislodging, won't mar the surface.

Want more facts? Write today . . . outline your specific needs and let MAC engineers come up with the answers. They usually do.

**MAC**

O.E.M. DIVISION

**MAC PANEL CO. High Point, N.C.**

ON READER-SERVICE CARD CIRCLE 84

MICROWAVES

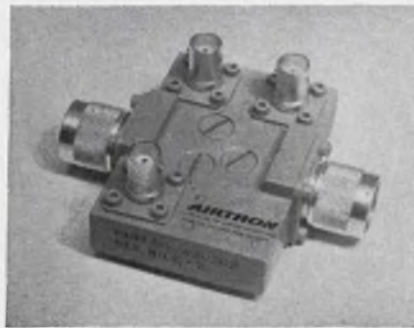

**Diode switch**

Model 420263 C-band diode switch has a power capability of 200 W peak and 100 W cw. Switching time is 1  $\mu$ s max and pulsewidth is 50  $\mu$ s. Insertion loss is 0.6 dB max, isolation is 40 dB min and vswr is 1.25 max. The switch exceeds MIL-E-5400. The 2-in.<sup>3</sup> unit weighs 4 oz.

Litton Industries, 200 E. Hanover Ave., Morris Plains, N. J. Phone: (201) 539-5500.

Circle No. 356

**Tunnel diode amplifiers**

Designed as IF amplifiers in radiometry applications, these tunnel diode amplifiers provide a 50-dB min gain with a 500-MHz min bandwidth from 4.4 to 6.8 GHz. Noise figure is 5.5 dB. Units operate from 12 to 28 Vdc at 50 mA.

P&A: \$4000; 45 days. International Microwave Corp., River Rd., Cos Cob, Conn. Phone: (203) 661-6277.

Circle No. 357



**Grid pulsed oscillator**

A high-power S-band grid pulsed strip transmission line oscillator provides 2 kW at 2 GHz. Tuning range is 10 MHz. Test pulse width is 0.5 ms and rep rate is 1 kHz. Rise time of RF pulses is 25 ns. Similar models are available in L- and S-bands.

Terra Corp., Albuquerque, N. M. Phone: (505) 255-0157.

Circle No. 358

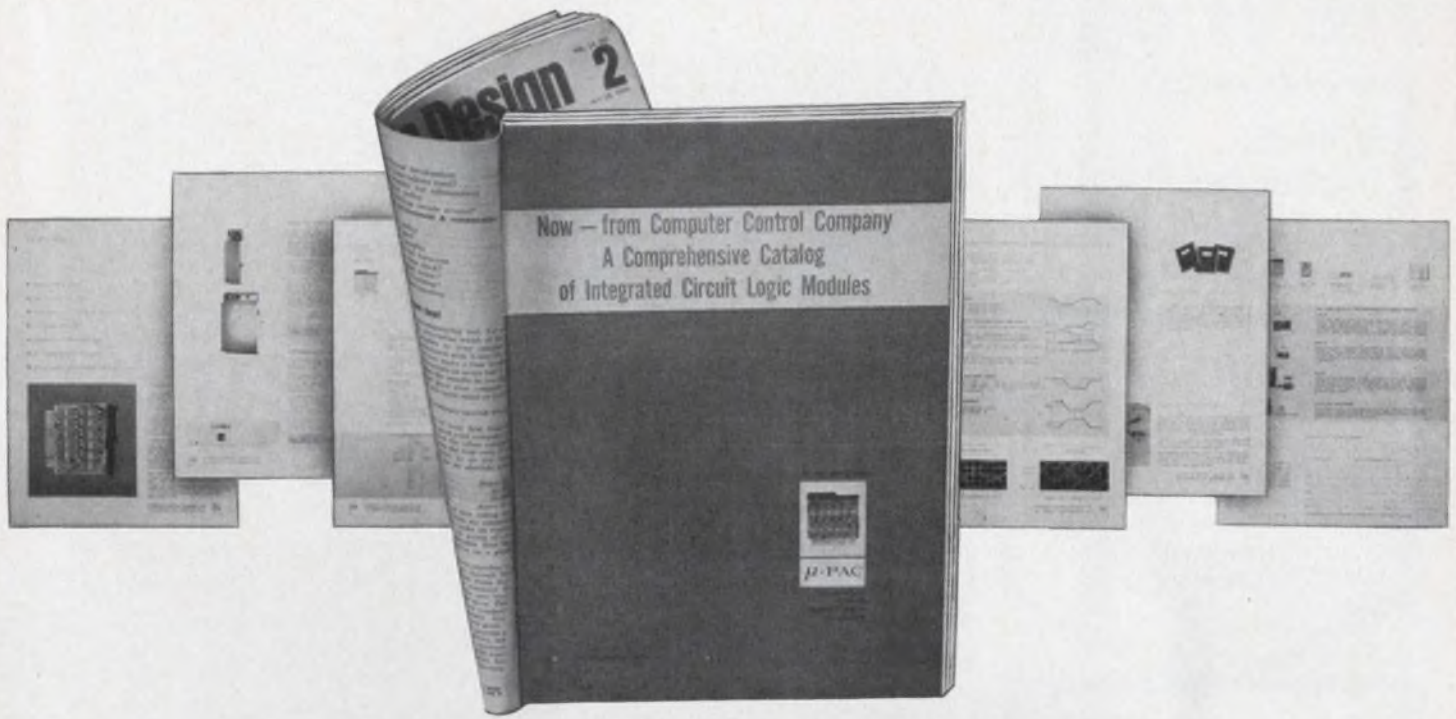

## “orders zoomed 250%”



William F. Taylor  
Director of Advertising  
Honeywell, Computer Control Division

Computer Control Division of Honeywell  
builds amazing sales with unique  
catalog insert program



**William F. Taylor, Director of Advertising, Honeywell, Computer Control Division, reports that Electronic Design has helped achieve record sales goals for his company. Mr. Taylor writes:**

“Our 44-page catalog insert in the January 18 issue of *Electronic Design* is judged a complete success . . . every objective was met.

“Although we could have communicated our digital logic module product story to customers and potentials in an “ad” of less magnitude, we would not have achieved a particularly strong impression per reader. Since the easy-to-detach catalog insert contained complete specifications on 128 logic modules, potential customers were able to make detailed product comparisons. Result-

ing inquiries, therefore, were of a qualified nature and dealt primarily with delivery time and in some cases quantity pricing — product suitability was already a fait accompli and the cost per sale was automatically reduced.

“Because of the recognized correlation between advertising and sales, (I consider communication, not sales, to be the primary function of industrial advertising), it is interesting to note that our order entries zoomed 250% since the insert appeared.”

**No wonder the Computer Control Division of Honeywell gets these remarkable results . . . Electronic Design is the best read publication in this industry. If you have a case history of interest to our management readers, please let us know. We'll pass it along in this series.**

# Electronic Design

SERVES BY COMMUNICATING

# new

op amp  
measures  
 $10^{-13}$  amps  
handles  
 $10^{10}$  ohm  
sources

301  
ANALOG  
DEVICES

Model 301's varactor input circuit virtually eliminates  $1/f$  noise, provides 100-fold better offset-current drift than FET amplifiers. Encapsulated, 3 cu-inch unit costs \$198, works from  $-25^{\circ}\text{C}$  to  $+85^{\circ}\text{C}$ , is P-C mounting.

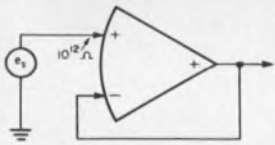

Electrometer's  $10^{12}$  ohms  $Z_{CM}$ , 0.06 pa/ $^{\circ}\text{C}$  drift at  $25^{\circ}\text{C}$ , develops low offsets from high impedance sources. Unit has only  $1\ \mu\text{V}$  p-p noise, 30  $\mu\text{V}$  max drift, plus  $10^8$  CMRR.

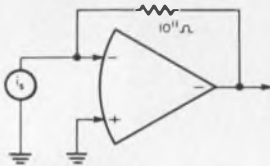

Current amplifier's 1 pa offset at  $25^{\circ}\text{C}$ , 0.01 pa p-p noise,  $10^{10}$  ohms differential impedance, and 30 pa offset change from  $-25^{\circ}\text{C}$  to  $+75^{\circ}\text{C}$ , permits  $10^{-12}$  amp resolution, builds 9-decade log amplifiers.

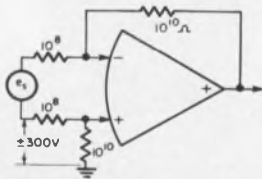

Differential amplifier's  $\pm 300$  Volts CM and  $10^{10}$  ohms  $Z_{DIFF}$ , permits use of  $10^8$  ohm input resistors, resolves millivolt signals on  $\pm 300$  volt inputs.

ANALOG



DEVICES

221 FIFTH STREET  
CAMBRIDGE,  
MASS. 02142  
617/491-1650

ON READER-SERVICE CARD CIRCLE 86

## SYSTEMS



### Frequency standard consumes 7 watts

A new frequency standard and time code generator offers frequency stabilities to 1 part in  $10^9$  per day and uses 7 W. The system can also provide 115-V 60-Hz frequency-regulated power at levels of 10, 100, or 100 VA.

Time code and calibration programs required by short and long-period seismographs, and the Vela Uniform code for magnetic tape recording are generated. Modifications yield IRIG and NASA time programs. Readout is BCD or decimal in-line. Other outputs are frequency-regulated square wave trains at 100 kHz, 10 kHz, 100 Hz, 50 Hz and 1 Hz.

P&A: \$4250 to 6500; stock to 90 days. Teledyne Industries Inc., 3401 Shiloh Rd., Garland, Tex. Phone: (214) 278-8102. *Circle No. 359*

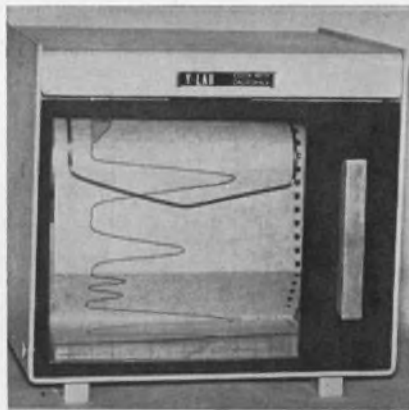

### Graphic recorder

The low cost graphic recorder has a flip-fold chart width of 4 in. Accuracy is better than 1% at 1 V span setting. The recorder will follow 1 Hz full scale and 5 Hz at 1/2-in. deflection. Chart speeds are available from 1 in./hour to 4 in./minute.

Price: \$150. Yeiser Laboratories, 881 W. 18th St., Costa Mesa, Calif. Phone: (714) 548-2458.

*Circle No. 360*

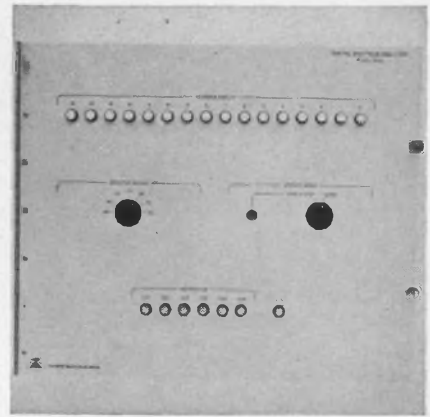

### Digital spectral analyzer

With correlation and spectral analysis techniques, model 2632 performs on-line analysis and off-line data reduction. Power spectral density of digitized analog data of 2.5-kHz max bandwidth, performed with 10-Hz resolution, can be determined on-line and displayed in 1.5 s max. The resolution bandwidth of the spectral analysis may be changed by program.

Astrodata Inc., 240 E. Palais Rd., Anaheim, Calif. Phone: (714) 772-1000.

*Circle No. 361*



### PCM signal conditioner

A PCM telemetry signal conditioner and bit synchronizer features both computer and manual control. Model 2720 provides a synchronized PCM output from a PCM telemetry input. It reconstitutes noisy PCM signals over a 60:1 dynamic input range at rates up to 1 Mbit. Bit-rate tracking ranges of 1, 3 and 10% are selectable. A digital restorer establishes the median of the PCM signal at ground potential.

Electro-Mechanical Research Inc., Box 3041, Sarasota, Fla. Phone: (813) 958-0811.

*Circle No. 362*



### Signal averaging system

To average on-line signals containing frequency components up to 200 kHz this system has a 1024-address computer of average transients, and a sweep expander. Effective dwell time is reduced to 1  $\mu$ s/data point by sampling the input waveform at different points during successive analysis sweeps. Each input waveform sample is digitized with 1% accuracy.

Technical Measurement Corp., 441 Washington Ave., North Haven, Conn. Phone: (203) 239-2501.

Circle No. 363

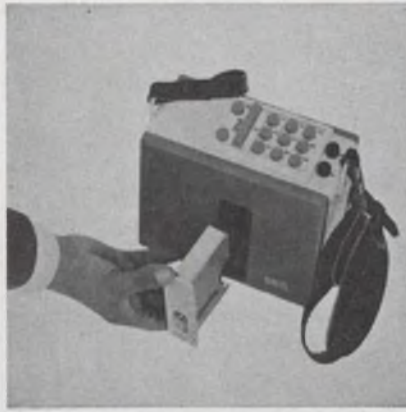

### Tape recorder keyboard

Data are entered manually on a 12-key numeric keyboard on this digital magnetic tape recorder. Keyboard includes a "space" and "error" key. When two or more keys are depressed simultaneously, the R41 activates an error light. The unit records 20,000 characters max on a re-usable cartridge of 1/2-in. 5-track tape. Three cartridges can be recorded before recharging.

Price: \$1900. Hersey-Sparling Meter Co., 210 W. 131 St., Los Angeles. Phone: (213) 321-6283.

Circle No. 364

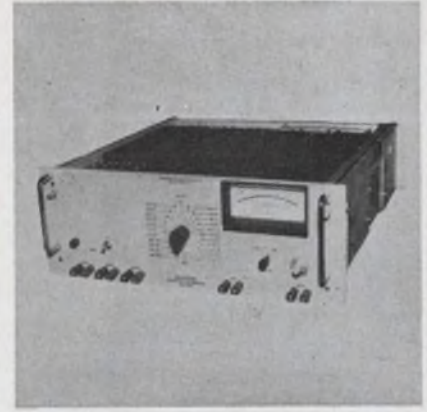

### 60-dB discriminator

Employing solid-state circuitry, this bandswitching discriminator has 23 channels and constant amplitude or zero overshoot low-pass filters.

The unit has 0.1% linearity and a 60-dB dynamic range without adjustment. Output is adjustable from  $\pm 1$  to  $\pm 10$  V and 0 to  $\pm 100$  mA.

Price: about \$7000. Airpax Electronics Inc., P. O. Box 8488, Fort Lauderdale, Fla. Phone: (305) 587-1100.

Circle No. 365

## Need a frequency? Make Allen your source.

### Allen Components

Prompt Delivery • Low Cost • High Quality —

used by leading electronic manufacturers, laboratories, designers, government agencies



### Allen Frequency Sources Types C and P (plug-in type)

Low-priced compact audio oscillators designed for applications that have moderate requirements for stability in respect to temperature and frequency drift.



### Allen Toroids

Over 150 sizes available from stock include Permalloy, Ferrite and Powdered Iron types. Inductance ranges from 50 henries to 6 millihenries.

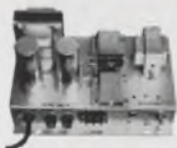

### Allen 20-Watt and 50-Watt Transistorized Amplifiers

Utilize latest developments in solid-state technology. They demonstrate characteristics normally associated with such circuitry (compact design, low heat dissipation). High sensitivity, conservatively rated.

Write for our free catalog!

# Allen

Components Division

Allen Organ Co., Dept. ED766,  
Macungie, Pa. 18062. Phone 215-965-9801

Please send me your components catalog

I am interested in:  Oscillators  
 Toroidal coils  Amplifiers

Name \_\_\_\_\_

Firm \_\_\_\_\_

Street \_\_\_\_\_

City \_\_\_\_\_

State \_\_\_\_\_ Zip Code \_\_\_\_\_

© A. O. Co.

ON READER-SERVICE CARD CIRCLE 87

# New Literature

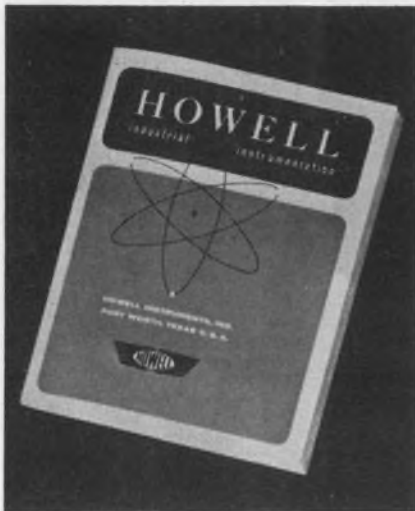

## Instruments catalog

A 48-page brochure on industrial instrumentation is offered. Units with direct digital readout for measurement, recording and control of temperature, speed or rate, pressure or load, flow and voltage are covered. Howell Instruments Inc.

Circle No. 368

## Hall devices

A short-form illustrated catalog covers the manufacturer's line of Hall-effect instrumentation and components. F. W. Bell Inc.

Circle No. 369

## Trimmer capacitors

Catalog C-66 of precision piston trimming and tuning capacitors presents over 500 models. The 24-page brochure contains dimensioned outline drawings, tabular listings of electrical and physical characteristics and an illustrated description of the adjustment mechanisms for each series. It includes information on tuning tools and kits and test fixtures. JFD Electronics Corp.

Circle No. 370

## Planar power transistors

Planar power transistors and SCRs are cataloged and described and power packages are illustrated in this 8-page brochure. A complete discussion of planar power advantages is included. Fairchild Semiconductor.

Circle No. 371

## Copper-clad laminates

Glass-base, epoxy resin, copper-clad laminates for printed circuits are described in this illustrated data sheet. A table lists the properties of four grades, including two that are flame retardant. Thickness tolerances and NEMA and MIL specs are also given. Taylor Corp.

Circle No. 372

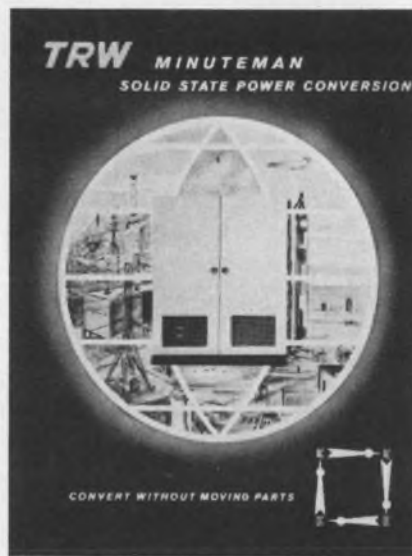

## Power converters

An 8-page color brochure illustrates a line of solid-state power converters. Product categories include dc to dc converters, dc to ac static inverters, ac to ac frequency changers and ac to dc converters. TRW, Equipment Operations.

Circle No. 373

## Switch selector

A pocket-sized "Switch Selector Guide" contains switch sizes and ratings, along with illustrations of the most widely used precision snap action switches. Cherry Electrical Products Corp.

Circle No. 374

## Conversion factors

A reference table for engineers in wall chart form is offered. Included are many common conversions as well as those difficult to locate in reference manuals. Precision Equipment Co.

Circle No. 375

## Sample/hold amplifier

This bulletin describes a sample-and-hold amplifier with built-in floating power supply used to prevent loss of information in data transmission links and control systems. It shows how to replace a slide-wire and recorder system with the all-electronic holding circuit, including bumpless switchover to manual control. Pacific Data & Controls.

Circle No. 376

## Test equipment

Equipment for the scientific and laboratory field is described and pictured in the 224-page catalog. Specifications and prices on ovens, water, oil and refrigerated baths, furnaces and temperature/humidity-environmental chambers are given. Subjects related to temperature and temperature control are covered with the aid of temperature, measurement and relative humidity conversion tables. Blue M Electric Co.

Circle No. 377



## Solderless terminals

Noninsulated and pre-insulated solderless terminals are fully described in a new 28-page illustrated catalog. Specifications for flanged and square spade, ring and quick-connect types are given. Aerovox Corp.

Circle No. 378

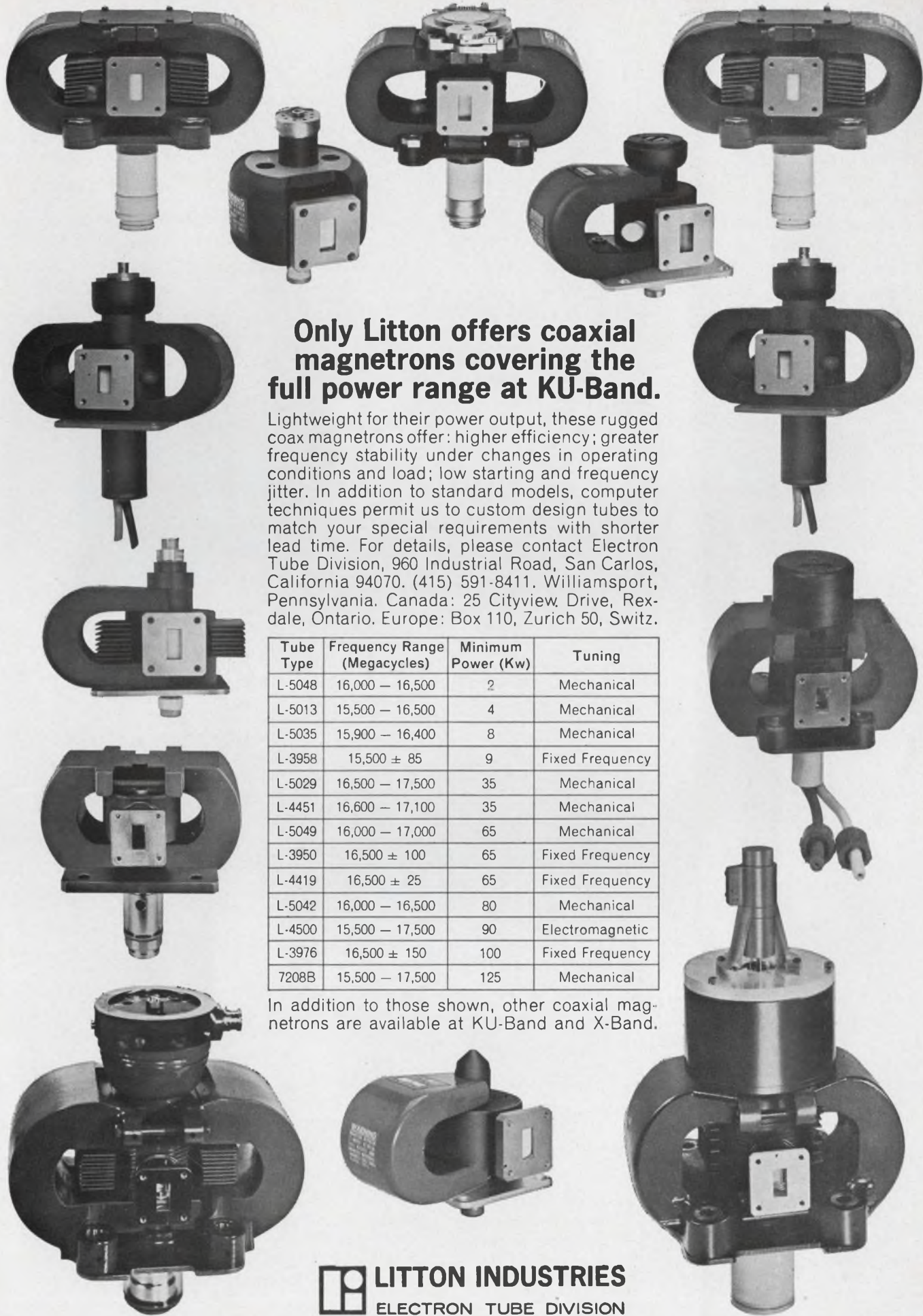

## Only Litton offers coaxial magnetrons covering the full power range at KU-Band.

Lightweight for their power output, these rugged coax magnetrons offer: higher efficiency; greater frequency stability under changes in operating conditions and load; low starting and frequency jitter. In addition to standard models, computer techniques permit us to custom design tubes to match your special requirements with shorter lead time. For details, please contact Electron Tube Division, 960 Industrial Road, San Carlos, California 94070. (415) 591-8411. Williamsport, Pennsylvania. Canada: 25 Cityview Drive, Rexdale, Ontario. Europe: Box 110, Zurich 50, Switz.

Tube Type	Frequency Range (Megacycles)	Minimum Power (Kw)	Tuning
L-5048	16,000 — 16,500	2	Mechanical
L-5013	15,500 — 16,500	4	Mechanical
L-5035	15,900 — 16,400	8	Mechanical
L-3958	15,500 ± 85	9	Fixed Frequency
L-5029	16,500 — 17,500	35	Mechanical
L-4451	16,600 — 17,100	35	Mechanical
L-5049	16,000 — 17,000	65	Mechanical
L-3950	16,500 ± 100	65	Fixed Frequency
L-4419	16,500 ± 25	65	Fixed Frequency
L-5042	16,000 — 16,500	80	Mechanical
L-4500	15,500 — 17,500	90	Electromagnetic
L-3976	16,500 ± 150	100	Fixed Frequency
7208B	15,500 — 17,500	125	Mechanical

In addition to those shown, other coax magnetrons are available at KU-Band and X-Band.



**LITTON INDUSTRIES**

**ELECTRON TUBE DIVISION**

Speed Inquiry to Advertiser via Collect Night Letter  
ON READER-SERVICE CARD CIRCLE 104

**Need a small 1, 5 or 10 mc crystal oscillator for use in synthesizers, timing systems, counters, communication systems, time-code generators, tape systems, or some other small black box?**

**Think *TRACOR*®**



Shown half actual size

TFA 766

Volume 19.1 in.<sup>3</sup>  
That's about the size of it.

For further information:  
TRACOR, Inc.  
General Sales Office  
6500 Tracor Lane  
Austin, Texas 78721  
Phone: 512-926-2800



**SULZER  
DIVISION**

REPRESENTATIVES IN PRINCIPAL CITIES

We are looking for EE's, ME's and Physicists for design consultation or systems development in ASW and undersea problems—experience in penetrations aids—design studies, tests, analysis and reports on electronic and mechanical systems. Your reply strictly confidential.

ON READER-SERVICE CARD CIRCLE 88

NEW LITERATURE

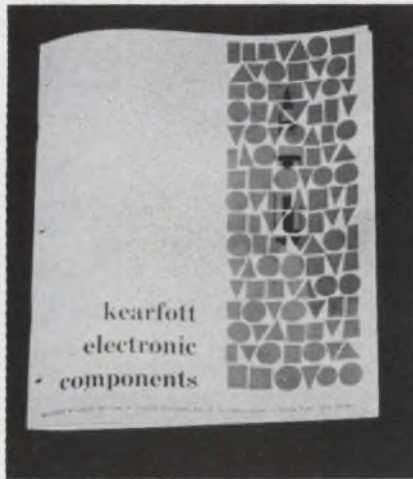

**Components catalog**

This 40-page catalog describes more than 96 different components. Drawings, curves, schematics, photographs and descriptions are included. Transistorized servo amplifiers, choppers, dc supplies, isolation amplifiers, signal sensors, mag amps, driver and logic packages are among the devices covered. Application data and hook-up information is included. General Precision Inc.

Circle No. 379

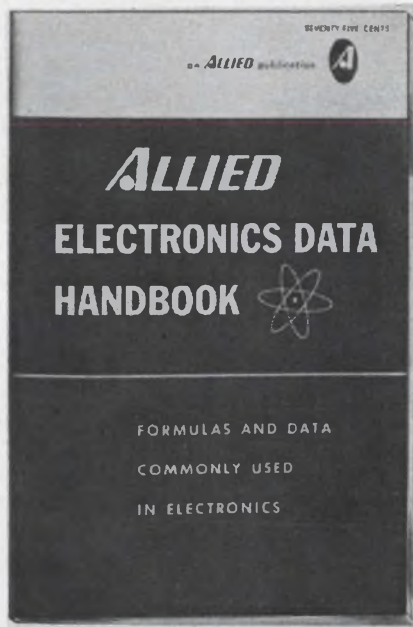

**Electronic data handbook**

This reference book includes math constants and symbols, algebraic formulas and mathematical tables. The 112-page handbook also contains basic radio and electronic formulas and engineering and servicing data.

Available for \$0.75 from Allied Radio Corp., 100 N. Western, Chicago.

**Switch catalog**

Precision switches including sub-miniature, miniature, general purpose, metal enclosed, appliance and open blade models are fully described in this 120-page catalog. Schematics and tabular data are included. Robertshaw Controls Co.

Circle No. 380



**Power supplies**

In addition to complete specs for voltage and current regulated supplies, this 52-page catalog contains a glossary of terms. Specifications are accompanied by explanations of regulated supply capabilities. Kepco, Inc.

Circle No. 381

**Linear programing**

Applications of linear programing for computers are given in this 16-page illustrated brochure. Specific experiences with linear programing within several industries are cited and available programing packages are described in detail. General Electric, Information Systems.

Circle No. 382

**Digital logic plug-ins**

A 40-page catalog describes a line of digital plug-in modules. The brochure contains circuit diagrams of the modules and detailed engineering data. Included are flip-flops, gates, clock and timing modules, system interface modules, drivers and A/D modules. Decision Control Inc.

Circle No. 383



GLOBE

# Globe A. C. Centrifugals COOL with slingshot force

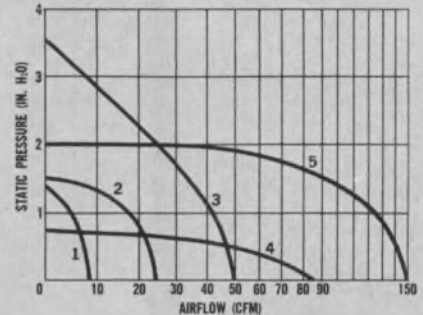
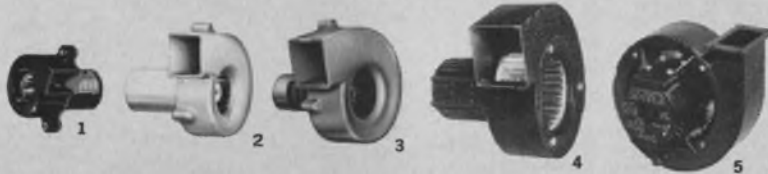

For economical cooling and pressurization, obtain a Globe proposal the next time you need standard or special centrifugal blowers. Globe makes single and double styles, for military or commercial applications. We also make a.c. and d.c. vaneaxial, tubeaxial, and multistage blowers and fans. Request Bulletin CB.

Globe Industries, Inc., 2275 Stanley Ave., Dayton, Ohio, 45404, U.S.A., Tel.: 513 222-3741.

### PERFORMANCE

- 1" wheel. 115 v.a.c., 400 cps. Overall length 2.48". Weight 4 oz. Part Number 19A565.
- 1½" wheel. 115 v.a.c., 400 cps. Overall length 3.30". Weight 16¼ oz. Part Number 19A690.
- 2" wheel. 115 v.a.c., 400 cps. Overall length 3.77". Weight 18¾ oz. Part Number 19A694.
- 3" wheel. 115 or 208 v.a.c., 50 or 60 cps. Overall length 6" max. Weight 3½ lb. Part No. 19A1540.
- 5" wheel. 115 v.a.c., 50 or 60 cps. Overall length 5½". Weight 7.5 lb. Part No. 19A1670.

ON READER-SERVICE CARD CIRCLE 89

The Choice of the Discriminating Communication Engineer . . . the Man who Never Settles for Anything Less than THE-VERY-BEST!

## telrex "BEAMED-POWER" ANTENNAS and ANTENNA SYSTEMS

Provide optimum performance and reliability per element, per dollar. Antennas from 500 Kc to 1500 Mc. Free PL88 condensed data and pricing catalog, describes military and commercial antennas, systems, accessories, Towers, Masts, Rotators, "Baluns" and transmission line data.

Communication and TV Antennas

ANTENNAS SINCE 1921 **telrex** LABORATORIES

Asbury Park 41, New Jersey, U.S.A.

ON READER-SERVICE CARD CIRCLE 91

ELECTRONIC DESIGN, July 19, 1966

# New DC Scope! ... the Heathkit® 10-14

- Sets New Standard for Performance & Value . . . \$299.00 Kit . . . \$399.00 Assembled
- DC to 8 mc Bandwidth—0.04 usec. rise time • Calibrated Vertical Attenuator — .05 v/cm to 600 v. (max.) Input • Triggered Sweep — 18 calibrated rates • Delay-Line Vertical Amplifiers for Fast Rise Signal Analysis • Electronically Regulated Power Supplies — Forced Air Cooling • Built for Continuous-Duty Industrial & Lab Use



- A 5" DC scope with calibrated time base & 5X sweep magnifier. For 115/230 volt, 50-60 cycle operation.
- Kit 10-14, 45 lbs. . . . \$299.00
- Assembled 10W-14, 45 lbs. . . . . \$399.00

**HEATHKIT**

**FREE CATALOG!**

Heath Company, Dept. 60-7  
Benton Harbor, Michigan 49022

Please send FREE Heathkit Catalog & Information describing the New Heathkit 10-14 Oscilloscope

Enclosed is \$ \_\_\_\_\_, plus shipping. Please send model \_\_\_\_\_

Name \_\_\_\_\_

Address \_\_\_\_\_

City \_\_\_\_\_ State \_\_\_\_\_ Zip \_\_\_\_\_

Prices & specifications subject to change without notice. TE-141

ON READER-SERVICE CARD CIRCLE 90

**How do you evaluate audio oscillators?**

**How can you be sure of the right selection for your particular application?**

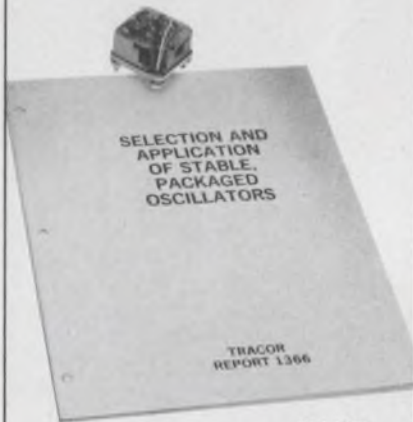

TFA-1066

**TRACOR® has an answer**

"Selection and Application of Stable, Packaged Oscillators" is a comprehensive two-part report. Section I outlines the availability of standard oscillators in the 0.5% to 0.0001% accuracy range. Section II offers guidelines for choosing a specific oscillator.

The report is free from TRACOR. Whether or not you want a copy, may we help you evaluate oscillators in your next application?

TRACOR, Inc.  
General Sales Offices  
6500 Tracor Lane  
Austin, Texas 78721



REPRESENTATIVES IN PRINCIPAL CITIES

**NEW LITERATURE**

**PC materials**

A selection guide for designers of flexible printed circuits is offered. Copper-clad materials, flexible insulating materials and coatings are included. Tables of electrical and mechanical data on unclad adhesive-coated insulating materials and copper-clad flexible laminates aid in selection. Westinghouse Electric Corp.

Circle No. 384



**Telemetry modules**

A 40-page catalog describes a line of FM-FM telemetering modules. Included are VCOs, dc amplifiers, dc signal isolators, frequency-to-dc converters, tone oscillators, pressure transducers and laboratory telemetering systems. Solid State Electronics Corp.

Circle No. 385

**Turbulence amplifiers**

Theory and applications of turbulence amplifiers are described in this 6-page catalog of fluidic components for logic and control systems. Aspects of fluidics and specifications of the units with tables, charts and graphs are given. Howie Corp.

Circle No. 386

**Power supplies**

A listing of the MTBF among the specs for each line of power supplies is given in this 20-page catalog. A nomograph on determining heat sinking requirements, drawings of the power supplies, rack mount adapters and heat sinks are included. Prices and options are listed for each supply. Stanley Schwartz Co.

Circle No. 387



**Solder alloys**

This illustrated technical catalog describes solder alloys, wire sizes and flux core percentages. A line of liquid fluxes for applications from PC boards to sheet metal are also given. Gardiner Solder Co.

Circle No. 388



**Crystal cross reference**

A 32-page crystal cross reference booklet lists numbers for every known CB transceiver by manufacturer. Cross reference is also made by listing CB models under the available crystal numbers. Six pages are devoted to a classification of crystal frequencies by channel number for all 23 CB channels. Classifications are made for both transmit and receive functions. Shepherd Industries. Circle No. 389

# New total protection... against all hostile environments

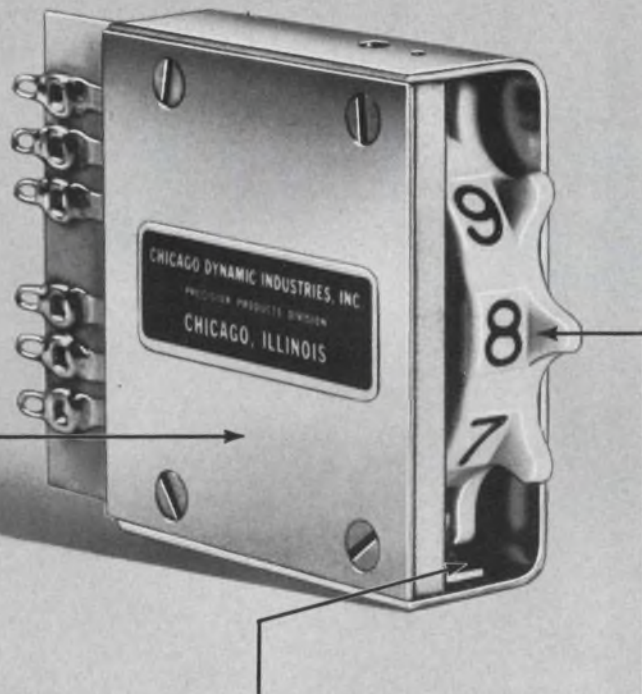

Completely sealed switching area for positive switching and long, trouble-free life

Wheel totally panel sealed against all hostile environments

Machine-engraved numerals or legends white paint filled for maximum readability & life

**Most switch manufacturers seal just the switching area. But Only CDI Seals BOTH The Switching Area AND THE PANEL. Pat. Pending.**

Exclusive CDI total switch sealing benefits you by protecting all other components in your system against dust, dirt, salt spray and other foreign elements which reduce performance. Switching area and panel are independently sealed for full protection and reliability.

Clean room assembled. Decimal or coded models. For R.F.I. applications. Series PS tab type Thumbwheel Switch mounts on  $\frac{5}{8}$ " centers and retrofits Series TTS. Switch life exceeds 100,000 operations. Send for data sheet.

**NO SCREWS VISIBLE. NEW ALUMINUM BEZEL** permits rear mounting of miniature and standard type switches with no screws visible. Accommodates to 20 switch modules. Miniature model fits CDI Series TTD and TTB standard type switches. Available in colors to match any instrument panel. Send for data sheet.



## CHICAGO DYNAMIC INDUSTRIES, INC.

PRECISION PRODUCTS DIVISION 1725 Diversey Blvd., Chicago, Illinois 60614 Phone: (312) 935-4600

ON READER-SERVICE CARD CIRCLE 93



## Cramped for space?

### Use Couch 1/7-size Relays

Space/weight problem? The new Couch 2X 1/7-size crystal can relay gives you tremendous savings in space and weight. 0.1" grid — plus many outstanding specs — *all in micro-miniature*. Thoroughly field-proven in electronics and space applications.

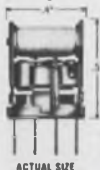

	2X (DPDT)	1X (SPDT)
Size	0.2" x 0.4" x 0.5"	same
Contacts	0.5 amp @ 30 VDC	same
Coil Operating Power	100 mw 150 mw	70 mw 100 mw
Coil Resistance	60 to 4000 ohms	125 to 4000 ohms
Temperature	-65°C to 125°C	same
Vibration	20 G	same
Shock	75 G	same

Broad choice of terminals, coil resistances, mounting styles. Write for detailed data sheets.

**RUGGED ROTARY RELAYS**  *Dynamically and Statically Balanced*

## COUCH ORDNANCE INC.

3 Arlington St., North Quincy, Mass. 02171, Area Code 617.  
 CYPRESS 8-4147 - A subsidiary of S. H. COUCH COMPANY, INC.

ON READER-SERVICE CARD CIRCLE 94

## NEW LITERATURE

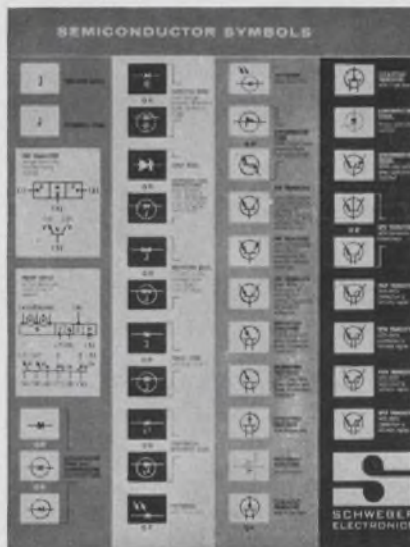

### Logic symbols

A fold-out chart contains graphic symbols used in logic diagrams, with explanations. Integrated circuits and semiconductor symbols are also included. Schweber Electronics.

Circle No. 390

### Capacitor specs

A line of capacitors for oscillatory and nonoscillatory duty is featured in the 8-page illustrated application and specification guide. The effect of duty requirements on energy storage life is detailed along with ratings and dimensions of standard castor oil impregnated capacitors. General Electric.

Circle No. 391

### Proximity switches

A 75-page illustrated proximity switch manual gives a detailed description of all-metals sensitive and ferromagnetic sensitive systems. The theory of operation, installation, maintenance and trouble shooting is described. Charts, graphs, wiring diagrams and dimensional data are included. Micro Switch.

Circle No. 392

### Pulsating battery

Applications of a battery that gives pulsating current are given in this report. It describes research of Army engineers on this dc battery that delivers a current in oscillations characterized by amplitude, wave form and frequency.

Available for \$1 from Clearinghouse, U.S. Dept. of Commerce, Springfield, Va.

## Thermocouple connectors

A 12-page comprehensive catalog of connectors and connector systems for thermocouples is offered. Illustrations and technical information from single plugs and jacks to mass panels accommodating virtually unlimited thermocouple circuits are included. Marlin Mfg. Corp.

Circle No. 393

## RF preamplifier

A short form catalog covers a complete line of standard, solid-state, low noise preamplifiers. Power requirements, mounting provisions and RF connectors are listed for every model. A nomograph which predicts intermodulation values on a relative and absolute level with specified input signal conditions forms the latter section of the catalog. Avantek, Inc.

Circle No. 394

## Test equipment

Complete technical data, photos, prices and delivery information for high-voltage test equipment are contained in an 8-page catalog. Included are 1 to 300 kV ac and dc power packs, power supplies and test sets for dielectric strength, breakdown, leakage, corona and continuity tests. Peschel Instruments Inc.

Circle No. 395



## Microwave diodes

This 24-page catalog contains complete specifications for mixer and detector diodes, power varactors, switching diodes, tuning varactors, harmonic generator circuit characterized varactors, tunnel diodes and Schottky-barrier diodes. Photographs and outline drawings are included. Microwave Associates Inc.

Circle No. 396



## Hold the winning hand.

Triad deals out two new integrated circuit cards for breadboarding with TO-5's and flat packs—the 13540 and 13541. They give the engineer new flexibility in pre-design testing of discrete components.

Both cards are two-sided, 1/16" G-10 glass epoxy, gold plated, with flat pack mounting tabs on one side and TO-5 pads on the other. You can mount six TO-5's or six flat packs or a mixture of both. The only difference between the 13540 and 13541 is the connector pattern. Both are in stock now!

We're also offering the CE-5 card extractor to go with them, an unbeatable combination for development and prototype breadboarding of integrated circuitry.

Stock Triad, and come up winners every time. One way to make sure you have all the Triad transformers your customers need is to keep a copy of our catalog handy...over 1700 items immediately available, more added each month. Get it from your distributor or write us direct. Triad Distributor Division, 305 North Briant Street, Huntington, Indiana.



**Triad Distributor Division**

LITTON INDUSTRIES



ON READER-SERVICE CARD CIRCLE 95

**IS AIR MOVEMENT YOUR PROBLEM?**

**WANT GUARANTEED  
TROUBLE-FREE PERFORMANCE?**



Over 5 million successful installations! That's the record of the Howard Unit Bearing Motor, available only in HOWARD CYCLOHM Fans and Blowers. A complete line engineered to provide greater output at less cost, and guaranteed for 5 years to require no maintenance or re-lubrication. For rating tables, prices and full information, ask for the Howard Fan and Blower bulletins.



**HOWARD INDUSTRIES**

DIVISION OF MSL INDUSTRIES, INC.

1760 STATE STREET, RACINE, WIS. 53404

ON READER-SERVICE CARD CIRCLE 96

ELECTRONIC DESIGN, July 19, 1966



**LOOK WHAT'S HATCHED AT  
LITTELFUSE**

**The world's smallest fuse—Picofuse.  
1/8 thru 5 amps...1/6 gram...125 v.**

**LITTELFUSE**

DES PLAINES, ILLINOIS

ON READER-SERVICE CARD CIRCLE 97

**Resistor design**

Resistor design and manufacture are explained in this 8-page brochure. Physical aspects such as new construction and packaging techniques are described with listings of basic styles and specs. Vishay Inter-technology Inc.

Circle No. 397

**IC package guide**

This brochure gives 13 worst-case guidelines for comparison between IC packaging techniques based on the time required to replace the component.

Available for \$2 from Electronic Industries Assoc., 2001 Eye St., N. W., Washington, D. C.

**Reprints Available**

The following reprints are available free and in limited quantities. To obtain single copies, circle the number of the article you want on the Reader-Service Card.

*High Volume—Low Cost: Designers' Challenge* (No. 740)

*Improve Device Reliability with Physics of Failure Techniques* (No. 741)

*Guidelines for Selecting Laser Materials* (No. 742)

**Subscription Policy**

ELECTRONIC DESIGN is circulated free of charge to qualified design engineers in the U.S., Western European Continent and Britain. To establish your qualifications, send ELECTRONIC DESIGN the following information on your company's letterhead: Your name, engineering title, description of your design duties and a list of your company's major products. The letter must be signed by you personally.

Subscription rates for nonqualified subscribers—\$25 a year in the U.S., \$35 in all other countries. Single copy, \$1.50.

**Change of Address**

A subscriber's change of address requires a restatement of his qualifications. To expedite the change, and to avoid missing any issues, send along a label from a back copy.

**Microfilm Copies**

Microfilm copies of all 1961, 1962, 1963, 1964 and 1965 issues of ELECTRONIC DESIGN are available through University Microfilms, Inc., 313 N. First Street, Ann Arbor, Mich.

# Design Data from

## Complete Line of Non-Linear Resistors



This 110-page engineering guide covers the most complete line of heat-, light-, and voltage-sensitive resistors available today. Prepared by the Components Division of Amperex, the book describes physical principles, measurement techniques and the electrical and mechanical properties of the non-linear resistors in the Amperex line. These fall into four broad categories: negative temperature-coefficient thermistors, positive temperature-coefficient thermistors, voltage-dependent resistors, and light-dependent resistors. Applications data, including circuits and selection criteria, are given for each type.

**Amperex Electronic Corporation**

Components Division  
Hicksville, Long Island, N. Y. 11802

**171**

## Piezotron® Quartz Accelerometer



Four-page illustrated Bulletin 321466 on Model 818 quartz accelerometer describes Piezotron principle which eliminates need for costly amplifiers and permits use of just one single-wire shielded cable for both power and signal. Bulletin also describes how base strain sensitivity, ground loop, cable noise and insulation resistance problems are prevented. Diagrams of the basic circuit and a typical system show operation. Performance data is graphically displayed. Complete specs and ordering information are included.

**Kistler Instrument Corporation**

8969 Sheridan Drive  
Clarence, N. Y. 14031

**173**

## Integrated Circuit Logic Modules



General specifications bulletin and price list for over 20 in-stock integrated circuit logic cards. Electrical and mechanical specifications given for product line plus description of each model. Line offers comprehensive selection of modules, including flip-flops, counters, AND and NAND gates, buffer amplifiers, lamp and relay drivers, decoders, one-shot and free-running multivibrators, crystal oscillators, and Schmitt triggers. Card mounting hardware, power supplies, and other accessory parts are available. Special cards designed, built to customer specifications.

**Wyle Laboratories, Products Division**

133 Center Street  
El Segundo, California 90245

**175**

## Miniature Film Resistors

CADDOCK ADVANCED STATE OF THE ART  
MICROMINIATURE FILM RESISTORS



A new catalog describing miniature film resistors produced with proprietary Micronox\* films is now available. Design data for three basic types is included:

- 1—Miniature Megohm resistors, one-fifth conventional size in 1 to 20 megohm range.
- 2—Miniature Precision Film resistors, 10 ohms to 5 megohms, 1/2 conventional size.
- 3—Miniature Power Film Resistors operating to  $-275^{\circ}\text{C}$ .

\*MICRONOX—Trade Mark.

### CADDOCK ELECTRONICS

6151 Columbus Ave.  
Riverside, California 91769

# 172

## Bus Bars For Noise Reduction



A 10 page Technical Bulletin is now available, describing a new concept in power or signal distribution. Basic mechanical and electrical design principles, along with descriptive pictures and diagrams, are included in this bulletin. These compact buses can replace bulky cable harnesses and repetitive wiring for computer or modular application. This method of construction satisfies the demanding requirements of low inductance and resistance of high speed, solid state systems, while controlling electrical noises.

### Eldre Components, Inc.

1239 University Avenue  
Rochester, New York 14607

# 174

## Catalog Of G. E. Semiconductors



Schweber catalog  
of General Electric  
semiconductors

The Schweber Catalog of General Electric Semiconductors lists the major specifications of a broad product range from signal to power devices, in silicon, germanium, and selenium. Special products to meet individual needs include tunnel diodes, light emitting diodes, light activated SCR's, rectifier stacks, strain sensors, uni-junction transistors, stabistors, reference amplifiers. Fifty-five pages of General Electric product innovation.

### Schweber Electronics

Westbury, N. Y. 11591  
(516) ED 4-7474

# 176

## Advertising Representatives

### New York 10022

Robert W. Gascoigne  
Thomas P. Barth  
Samuel M. Deitch  
Richard W. Nielson  
850 Third Avenue  
(212) PLaza 1-5530  
TWX: 867-7866

### Philadelphia 19066

Fred L. Mowlds, Jr.  
P. O. Box 206  
Merion Station, Pa.  
(215) MO 4-1073

### Marblehead 01945

Richard Parker  
7 Redstone Lane  
(617) 742-0252

### Chicago 60611

Thomas P. Kavooras  
Berry Conner, Jr.  
720 N. Michigan  
(312) 337-0588

### Cleveland 44107

Robert W. Patrick  
8410 Treetower Drive  
Chagrin Falls, Ohio  
(216) 247-7670

### Los Angeles 90303

Stanley I. Ehrenclou  
Terrence D. Buckley  
W. James Bischof  
2930 W. Imperial Highway  
Inglewood, Calif.  
(213) 757-0183

### San Francisco

Ashley P. Hartman  
P. O. Box 1106  
Los Altos, Calif. 94022  
(415) 327-6536

### Southwestern 75206

Tommy L. Wilson  
6200 North Central Express-  
way  
Dallas, Tex.  
(214) EMerson 1-2311

### London W. 1

Brayton C. Nichols  
44 Conduit Street

### Tokyo

Yoshihiro Takemura  
International Planning  
Service, Inc.  
Room No. 512 Nikkoh  
Mita Building  
1, Nishidaimachi, Shiba-  
Takanawa  
Minato-ku, Tokyo



# printed circuit

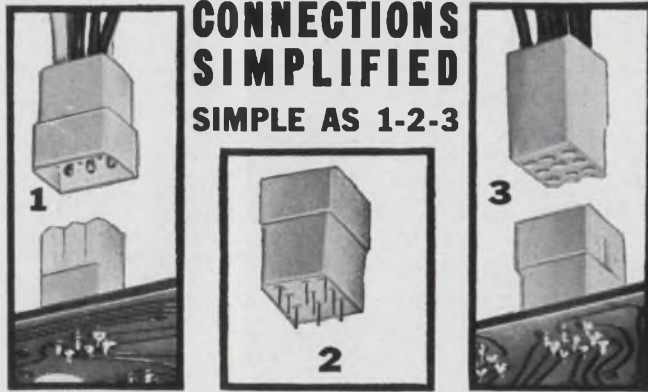

**CONNECTIONS  
SIMPLIFIED  
SIMPLE AS 1-2-3**

## LOW COST Nylon Plug & Receptacles

- 1** Plug connector with protected male crimped terminals. Receptacle soldered to circuit board.
- 2** Plug or receptacle with snap-in pin terminals for dip soldering to printed circuit board.
- 3** Receptacle with encased crimped snap-in female terminals. Male plug with snap-in terminals dip soldered to board.

- Positive polarity ● Extremely low resistance
- High contact pressure without injury to printed circuit ● Other units for up to 60 circuits available.



**MOLEX PRODUCTS CO.**

5235 Katrine Ave. (312) 969-4550  
Downers Grove, Ill. 60515  
TWX 910-695-3533

ON READER-SERVICE CARD CIRCLE 98

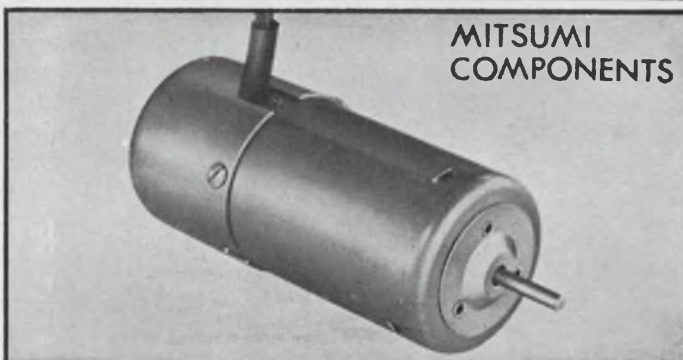

**MITSUMI  
COMPONENTS**

### NEW MICRO-MOTOR

The most excellent characteristics of Mitsumi micro-motor is in its extremely high efficiency. Formerly it has been considered impossible to attain an efficiency of more than 50% for micro-motors with a diameter of 20mm or less. We have, however, succeeded in breaking through this common concept through the adoption of a new system in the magnetic circuit. We serves many types of micro-motors to our customers with automated and quality-controlled mass production.

#### Main Products

Polyvaricon · IFT · Oscillator coil · Antenna coil · Composite coil · Special coil · Micro motor · Synchronous motor · Variable resistor · Trimming potentiometer · FM tuner TV tuner · Various sockets · CdS photo-conductive cell.



**MITSUMI ELECTRIC CO., LTD.**

New York office: 11 Broadway, New York, N.Y. 10004, U.S.A. Phone: HA-5-3085, 3086  
Main office: 1056, Koadachi, Komae-machi, Kitatama-gun, Tokyo, Japan. Phone: Tokyo 415-6211/23

ON READER-SERVICE CARD CIRCLE 99

## Application Notes



### RF shielding

A 4-page pamphlet describes how to build a high-performance RF shielded room using the manufacturer's metal-clad panels and joint-sealing components. The pamphlet discusses design considerations, installation techniques and gives a quick method for calculating material requirements. Emerson & Cuming Inc. *Circle No. 398*

### Bridge measurement

Methods for making resistance bridge measurements in rotating systems are covered in a 2-page application note. A multichannel rotary transformer is used to transfer signals between rotating and stationary members. The note includes a discussion of dc and ac bridge excitation systems, general methods of employing the transformer in lieu of slip rings, a typical schematic and a step-by-step procedure describing the selection of optimum transformer windings. S. Himmelstein & Co. *Circle No. 399*

### Safe operating area

This application note is a handy discussion of the concept of SOAR (Safe Operation AREA) and its ramifications. It covers definition, circuit applications, inductive spikes, safe operating area for switching, base current, driving circuit output resistance, switching time, average power dissipation and junction temperature. A reference table for germanium alloy and power transistor safe operating area and a section on safe operating area for dc operation are also included. Milgray Electronics Inc. *Circle No. 500*

*Circle No. 500*



# Timely, Thorough, To-The-Point

Three new books to keep you abreast of modern electronic theory and practice

## MATRIX ALGEBRA FOR ELECTRONIC ENGINEERS

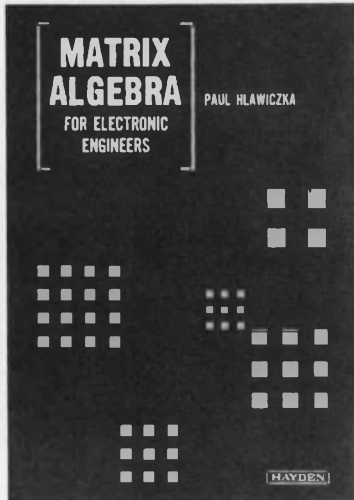

**PAUL HLAWICZKA.** A working knowledge of matrix algebra has become a useful and often indispensable tool for solving many problems in electronics. This introductory book gives a general orientation and shows the solution of numerous simple problems. Part I covers the essentials of matrix methods and their applications to various networks – requiring only a basic algebra background. Part II treats more complex methods, applying them to the differential equations of linear networks. 224 pages, illustrated, clothbound, \$8.75.

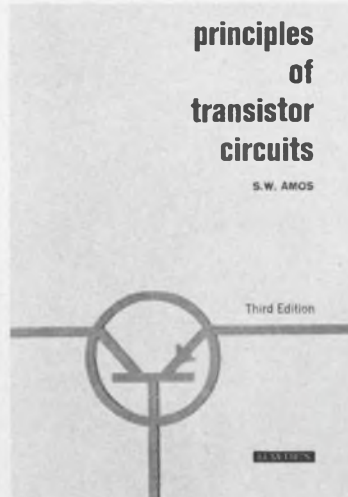

## PRINCIPLES OF TRANSISTOR CIRCUITS

**3rd Ed. S. W. AMOS.** Keeping up with the rapid advance in transistor technology, this updated revision contains fifty per cent more information than the second edition. Includes new material on dc stabilization of amplifiers by direct-coupled feedback, phase shift and Weinbridge oscillators, blocking oscillators and transistor sawtooth generators. New appendices of transistor parameters and transistor manufacture add to the completeness of this definitive work. 293 pages, illustrated, clothbound, \$7.95.

## THE ELECTRON IN ELECTRONICS

**M. G. SCROGGIE.** An engineer's introduction to the modern physical concepts such as wave mechanics, quantum theory and relativity. These give an entirely new view of the electron, the structure of atoms, and the radiation of energy – all insights of particular importance to the understanding of solid state electronics. This descriptive treatment is expressed in terms and symbols used by the practicing engineer rather than the mathematical physicist. 275 pages, illus., clothbound \$9.95.

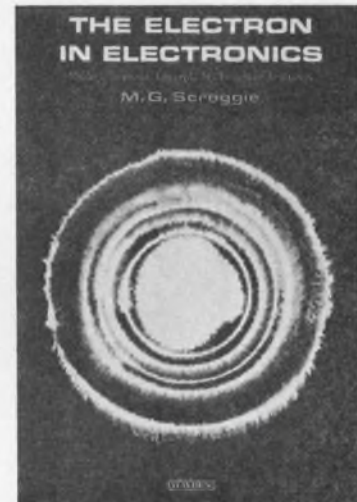

### 10-DAY FREE EXAMINATION – SEND NO MONEY!

Hayden Book Co., Inc., Dept. ED-72, 116 W. 14th St., N. Y., N. Y. 10011

Gentlemen:

Send me the book(s) checked below. At the end of ten days, I will remit payment (plus a few cents postage) or return the books with no further obligation.

- Matrix Algebra for Electronic Engineers, \$8.75       Principles of Transistor Circuits (3rd Ed.), \$7.95  
 The Electron in Electronics, \$9.95

Name \_\_\_\_\_ Title \_\_\_\_\_

Company \_\_\_\_\_

Address \_\_\_\_\_

City \_\_\_\_\_ State \_\_\_\_\_ Zip \_\_\_\_\_

Check here if payment is enclosed. Publisher will pay postage with same return guarantee.



From  
McGraw-Hill

### 1. AMPLIFIER HANDBOOK. Edited by R. F. SHEA.

Just out. This all-inclusive handbook fully describes and explains all types of amplifiers covering the entire frequency and power spectrums. The book is divided into three parts: Amplifier Fundamentals; Amplifying Devices; and Amplifier Circuits. The approach is practical. Applications are stressed. Valuable data has been consolidated from many scattered sources. 1,280 pp., \$37.50.

### 2. SOLID - STATE COMMUNICATIONS. By the Engineering Staff, Texas Instruments, Inc.

From RF to VHF, this book brings you an up-to-the-minute examination of a wide range of the most significant new communications components now applicable in industry, the military, and consumer products. The book is of inestimable value to all concerned with contemporary electronics design. 365 pp., \$12.50.

### 3. PULSE, DIGITAL, AND SWITCHING WAVEFORMS. By Jacob Millman and Herbert Taub.

This comprehensive book provides a wealth of fully detailed information for all who work in electronics. New developments—such as transistors and other semiconductor devices—are carefully explained and illustrated. 958 pp., \$18.00.

### 4. WAVE AND DIFFUSION ANALOGIES. By Richard K. Moore.

This detailed treatment of the relations between electric transmission waves and others shows how to solve a wide range of problems by use of analogies. 139 pp., \$4.95.

#### —10 DAYS FREE EXAMINATION—

McGraw-Hill Book Co  
Dept. 23-ED-76, 330 West 42 Street  
New York, N. Y. 10036

Send me the book(s) encircled below for 10 days on approval. In 10 days I will remit for book(s) I keep plus a few cents for delivery costs, and return unwanted book(s) postpaid.

1 2 3 4

Name (print) .....

Address .....

City ..... State ..... Zip .....

For prices and terms outside U.S.  
write McGraw-Hill Book Int'l., N.Y.C.

23-ED 76

# Advertisers' Index

## \*PARTICIPANTS IN NIGHT LETTER PROGRAM

Advertiser	Page	Advertiser	Page
Acromag, Inc. ....	140	*JFD Electronics Corporation .....	105
Aerovox Corporation Hi Q Division .....	149	Johanson Manufacturing Corp. ....	65
*Agastat Timing Instruments, Elastic Stop Nut Corporation of America .....	176	Kistler Instrument Corporation .....	170
Aladdin Electronics, A Division of Aladdin Industries, Inc. ....	154	Lambda Electronics Corp .....	139
Allen-Bradley Co. ....	25	*Leach Corporation .....	151
Allen Organ Company, Inc. ....	161	Leeds & Northrup, Components Division .....	134
Aluminum Company of America .....	76, 77	Littelfuse .....	169
American Airlines .....	175	Litton Industries, Electron Tube Division .....	163
American Lava Corporation .....	40	Litton Industries, Triad Distributor Division .....	169
*Amperex Electronic Corporation .....	156, 170	Litton Industries, Potentiometer Division .....	7
Amperite .....	138	McGraw-Hill Book Co. ....	174
Analog Devices, Inc. ....	160	Mac Panel Company .....	158
*Arnold Engineering Company, The .....	19	Mallory Capacitor Company .....	131
Augat, Inc. ....	148	*Metals & Controls, Inc. ....	36
Automatic Electric, A Subsidiary of General Telephone & Electronics .....	4, 141	Michigan Magnetics, Inc. ....	140
Babcock Relays, A Division of Babcock Electronics Corp. ....	39	*MicroSwitch, A Division of Honeywell .....	147
*Beckman Instruments, Inc., Helipot Division .....	127	Mitsumi Electric Co., Inc. ....	172
*Bourns, Inc. ....	31	Molex Products Co. ....	172
By-Buk Company .....	148	Monroe/Data Log, Division of Litton Industries .....	118, 119
CTS of Berne, Inc. ....	121	*Motorola Semiconductor Products, Inc. ....	34, 107
Caddock Electronics .....	171	Mullard Limited .....	8
Chicago Dynamics Industries, Inc. ....	167	Parsons Electronics Company, The Ralph .....	124
*Clare & Co., C. P. ....	110, 111	Perfection Mica Company .....	122
Clevite Corporation, Piezoelectric Division .....	152	Potter Company, The .....	132
Columbia Wire & Supply Co. ....	146	*Potter & Brumfield Division of American Machine & Foundry Company .....	153
Communication Electronics, Incorporated .....	144	Precision Paper Tube Company .....	32, 33
*Computer Measurements Company .....	2	Princeton Applied Research Corp. ....	16
Couch Ordnance, Inc. ....	168	Pyrofilm Resistor Co., Inc. ....	128
*Damon Engineering, Inc. ....	22	RCA Electronic Components and Devices .....	91, Cover IV
Data Control Systems, Inc. ....	82	Raytheon Company, Components Division .....	123
Decision Control, Inc. ....	49	Reeves Hoffman Division of DCA .....	122
Delbert Blinn Co., The .....	144	Robinson Technical Products Inc. ....	108
Deutsch Electronic Components Division .....	133	Rosemount Engineering Company .....	120
Digital Equipment Corporation .....	95	Sanders Associates, Inc. ....	93
Eldre Components, Inc. ....	171	Schjeldahl Company, G. T. ....	5
Electro-Motive Mfg. Co. ....	155	Schweber Electronics .....	171
Electro Tec Corp. ....	117	Scientific Atlanta, Inc. ....	37
Electronic Design .....	159	Sel-Rex Corporation .....	Cover IV
Electronic Memories .....	102	Simpson Electric Company .....	135
Erie Technological Products, Inc. ....	9	Sprague Electric Company .....	10, 12, 20
Executone, Inc. ....	112	Switchcraft, Inc. ....	129
Fabri-Tek, Incorporated .....	75	TRW Semiconductors .....	42
Fairchild Instrumentation, A Division of Fairchild Camera and Instrument Corporation .....	66, 67	Tektronix, Inc., Oscilloscopes .....	87
Fairchild Semiconductor, A Division Fairchild Camera and Instrument Corporation .....	6	Telrex Laboratories .....	165
Gardner-Denver Company .....	70, 71	*Texas Instruments Incorporated, Metals & Controls Inc., a corporate division .....	36
Gemini Semiconductors, Inc. ....	27	Texas Instruments Incorporated, Semiconductors-Components Division .....	54, 55
General Electric Company, Electronic Components Division .....	28	Tracor, Inc. ....	164, 166
General Electric Company Miniature Lamp Dept .....	116	*Union Carbide Corporation .....	44
Gerber Scientific Instrument Co., The .....	126	Uesco Division of Litton Industries .....	145
Globe Industries, Inc. ....	165	Vector Electronic Co. Inc. ....	150
Gudebrod Bros Silk Co., Inc. ....	Cover III	Westinghouse Molecular Electronics Division .....	15
Harowe Servo Controls, Inc. ....	130	Wyle Laboratories .....	170
Hayden Book Company, Inc. ....	173	Regional Advertising	
Heath Company .....	165	Burndy Corporation .....	128C
Hewlett-Packard .....	1, 23	*Dale Electronics, Inc. ....	128D
Hewlett-Packard, Dymec Division .....	53	*Magnetics, Inc. ....	128A
Hewlett-Packard, Moseley Division .....	60	Sorensen Operation, Raytheon Company .....	128B
Hewlett-Packard, Sanborn Division .....	137	Career Advertising	
Huffman Semiconductor Division .....	125	Bendix Corporation, The .....	100
Honeywell Test Instrument Division .....	109	Delco Radio Division, General Motors .....	99
Howard Industries, Inc. ....	169	Honeywell, Electronic Data Processing .....	100
Hudson Lamp Company .....	157	LTV ElectroSystems, Inc. ....	101
*IRC, Inc. ....	143	Lockheed Missiles & Space Company .....	98
ITT Semiconductors .....	113, 115	Motorola, Inc. ....	96

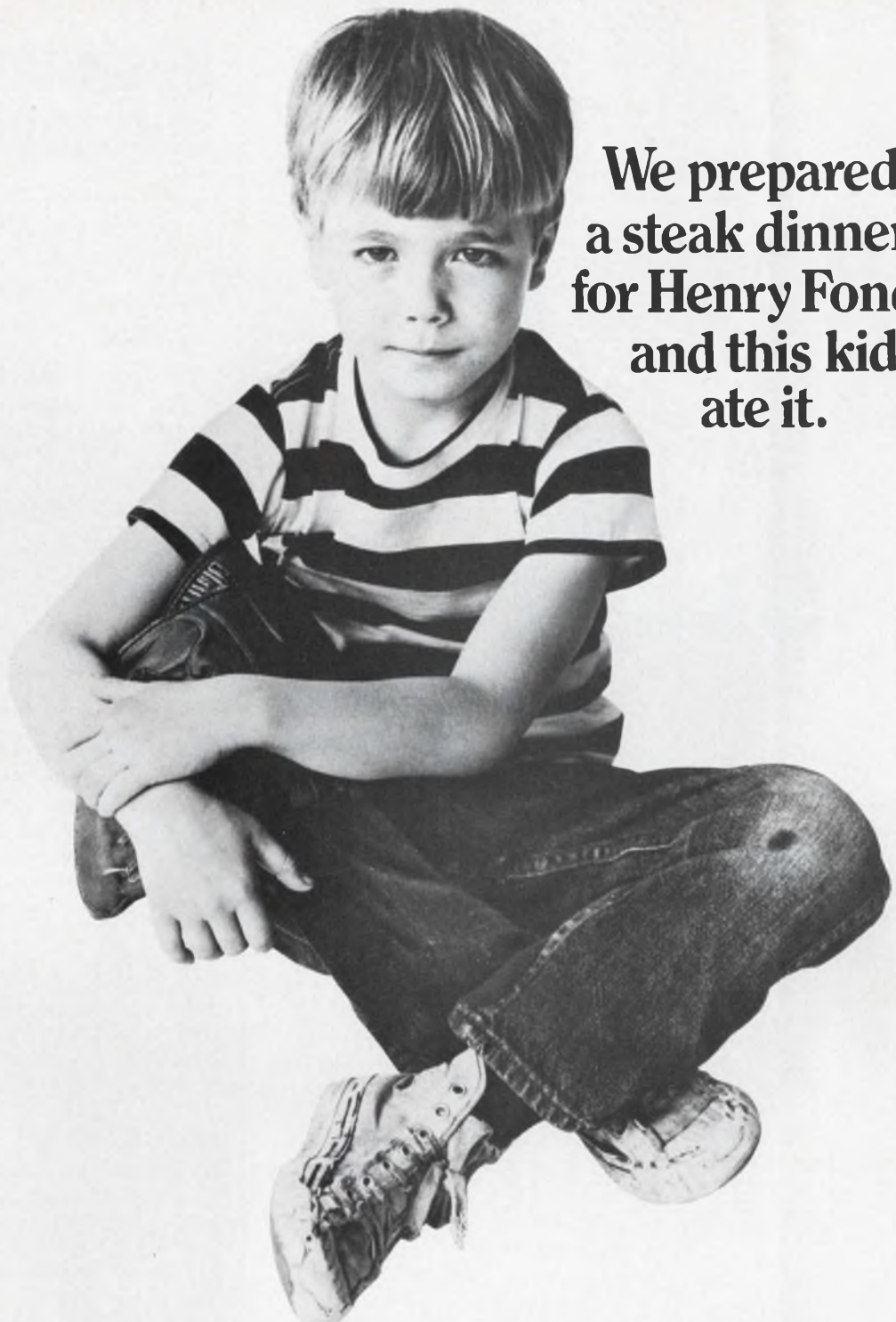

**We prepared  
a steak dinner  
for Henry Fonda  
and this kid  
ate it.**

We weren't thinking of the kid when we set up the menu.

(We loved having him aboard. We just weren't thinking of him to start with.)

We were thinking of people like Fonda.

A Henry Fonda buys up to 50 tickets a year.

And setting up an airline to get customers like this takes a "tight ship."

Sidewalk check-in service. Quick baggage delivery. Fan-jets. (Seasoned fliers want the shortest take-offs they can get.)

And steaks that are *steaks*. Serve these people a piece of gristle and you lose more business than we like to think about.

Anyhow, the kid turned up for a flight to his grandmother's and stuffed himself. (A travel agent put him on the airline we built for

Henry Fonda. He got the service Fonda gets.)

This is one of those little discoveries that a lot of vacationists have made lately.

But in case you didn't know there *was* an airline like this, we thought we'd run some ads.

**American built an airline  
for professional travellers.**

# American Airlines

# TWO WAY DELAY

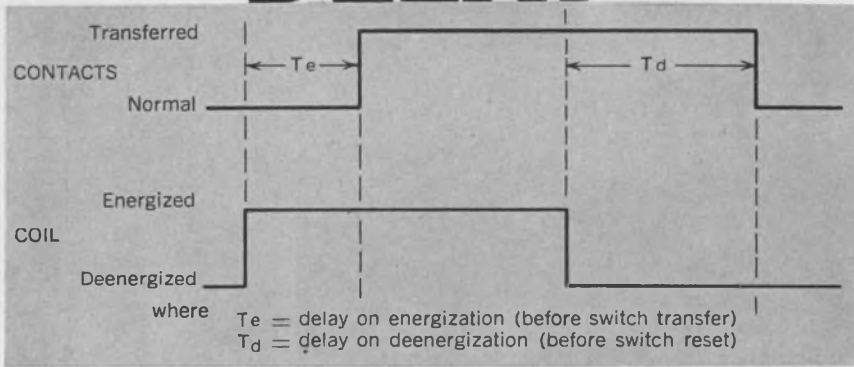

You get "on-delay" and "off-delay" operation in sequence in the same unit with the new AGASTAT® Double Head time/delay/relay. Each delay can be independently set on the unit's time-calibrated dials, in any of eight ranges covering a total span from .01 second to a full thirty minutes. Thus, the unit can take the place of two conventional timers, with substantial savings in panel space and installation time.

This new model of the 2400 Series is supplied for operation on all standard ac and dc voltages. Pneumatic timing offers high repeat accuracy, not affected by normal voltage and temperature fluctuations. DPDT switches handle loads up to 20 amps.

Want more complete data? Write the leader in time/delay instrumentation since 1931. Department A33

**AGASTAT** TIMING INSTRUMENTS  
 ELASTIC STOP NUT CORPORATION OF AMERICA  
 ELIZABETH DIVISION • ELIZABETH, NEW JERSEY

IN CANADA: ESNA LIMITED, 271 PROGRESS AVENUE, SCARBOROUGH, ONTARIO  
 Speed Inquiry to Advertiser via Collect Night Letter

ON READER-SERVICE CARD CIRCLE 101

## Designer's Datebook

JULY						
S	M	T	W	T	F	S
					1	2
3	4	5	6	7	8	9
10	11	12	13	14	15	16
17	18	19	20	21	22	23
24	25	26	27	28	29	30
31						

AUGUST						
S	M	T	W	T	F	S
	1	2	3	4	5	6
7	8	9	10	11	12	13
14	15	16	17	18	19	20
21	22	23	24	25	26	27
28	29	30	31			

### July 18-20

**Fifth Annual Reliability and Maintainability Conference** (New York) Sponsor: AIAA, SAE, ASME, EIA, ASTM, AIChE & ASTME; Stanley A. Rosenthal, Kollsman Instruments Corp., Syosset, N. Y.

### July 18-20

**Microelectronics Symposium** (St. Louis, Mo.) Sponsor: IEEE; Dr. John W. Buttrey, McDonnell Aircraft Corp., P. O. Box 516, St. Louis, Mo.

### July 22-26

**Photo-optical Instrumentation Engineers Annual Symposium and Exhibit** (St. Louis, Mo.) Sponsor: SPIE; J. Friedman, SPIE, P.O. Box 288, Redondo Beach, Calif., 90277.

### August 17-19

**Joint Automatic Control Conference** (Seattle, Wash.) Sponsor: AACC; Prof. Arthur Bryson, Dept. of A&A, MIT, Cambridge, Mass.

### August 23-26

**WESCON (Western Electronic Show & Convention)** (Los Angeles, Calif.) Sponsor: IEEE; Don Larson, WESCON, 3600 Wilshire Blvd., Los Angeles, Calif.

### August 29-31

**International Congress on Instrumentation in Aerospace Simulation Facilities** (Stanford University) Sponsor: IEEE, G-AES; R. K. Hallett, Jr., NASA, Ames Research Center, Moffett Field, Calif.

### August 29-31

**Annual Conference on Electronic Materials** (Boston, Mass.) Sponsor: AIME; Leonard R. Weisberg, the Metallurgical Society of AIME, 345 East 47th St., New York, N.Y. 10017.

WANT TO SAVE MONEY BY  
 USING **GUDEBROD**  
 LACING TAPE? . . .



**YOU DO IT HERE!**

Harness tying may be a relatively minor operation. But it also can be a major cost drain. Lacing tape is one of the smallest costs in the harnessing operation but with Gudebrod Tape you can save dollars in making harnesses. Knots tie easier, workers say they almost tie themselves, knots stay tied, the harness workers can go right on with the harnessing without having to go back for re-tightening. Workers like to use Gudebrod Tape. You cut harnessing time—you have fewer rejects. All of this works for you in saving money on cable harnesses—that's why it pays to specify Gudebrod Lacing Tape, the original flat braided tape. Prove these statements in your own harnessing department—give Gudebrod Tape a comparative test.



**GUDEBROD  
 CABLE LACER**

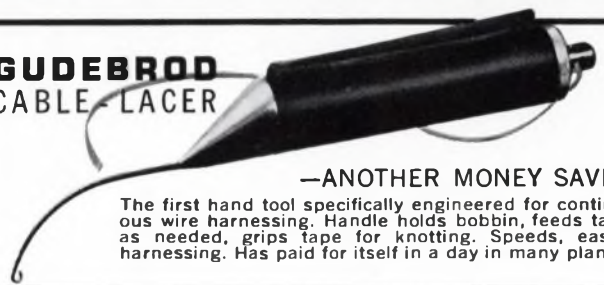

—ANOTHER MONEY SAVER

The first hand tool specifically engineered for continuous wire harnessing. Handle holds bobbin, feeds tape as needed, grips tape for knotting. Speeds, eases harnessing. Has paid for itself in a day in many plants.

**CABLE LACING INFORMATION:**

When you need help on knots, on spacing, on the type of tape to use—Gudebrod is your one best source for information. We have over 200 different lacing tapes in stock, for temperatures up to 1500° F. or down to -100° F., burn proof

tapes, tapes that do not outgas in vacuum, color coded tapes, cut lengths, tapes of nylon, Dacron\*, Teflon\*, spun glass, silica fiber. Ask for a copy of our Product Data Book.

\*Du Pont Registered Trade Mark

Area Code 215, WA 2-1122



**GUDEBROD BROS. SILK CO., INC.**

FOUNDED IN 1870

*Electronics Division*

12 SOUTH 12th STREET, PHILADELPHIA, PENNSYLVANIA 19107

See us at WESCON Show, Booth 707, Hollywood Park

ON READER-SERVICE CARD CIRCLE 123

# The world's smallest scan-conversion tube designed for multi-sensor display capability

## RCA-C22007 PERMITS DESIGN OF ULTRA-COMPACT SYSTEMS FOR TV AND RADAR READOUT ON A SINGLE MONITORING DEVICE

RCA-C22007 is the smallest Scan-Converter ever built for multi-sensor displays. Designed especially for use in combination with a TV monitor for ultra-compact, airborne detection and surveillance systems, this tube can revolutionize your design thinking regarding radar and TV input capability for readout on a single monitoring device.

Type C22007 is the ideal answer for multi-sensor display where critical space requirements make larger scan-converter systems impractical. This 10" tube uses a magnetic-focus, magnetic-deflection type reading gun and an electrostatic-focus writing gun.

**RESOLUTION:** Intended primarily for use in systems employing TV monitors utilizing 500-1000 scanning lines.

**SIZE:** 10" long. (Longer variants are also available, such as RCA-C22001, 16" long, for applications requiring higher resolution.)

**STORAGE TIME:** Adjustable over a wide range to provide signal persistence times of from 0.5 to 20 seconds.

RCA-C22007 and other RCA Scan-Converter Tubes may be customized for size, resolution, and other characteristics to provide optimum performance for a specific system. Your RCA Representative has complete information on prices and delivery. For technical data, write: Manager, Marketing, Display Tubes, RCA, Lancaster, Pa.

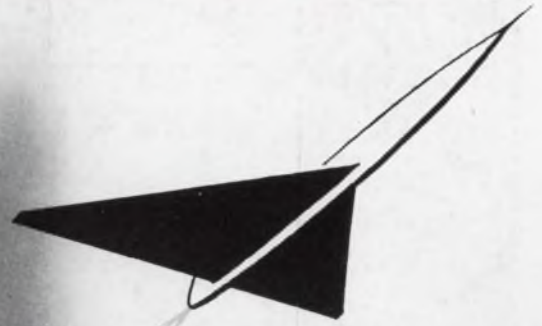

RCA Electronic Components and Devices, Harrison, N.J.



**The Most Trusted Name in Electronics**

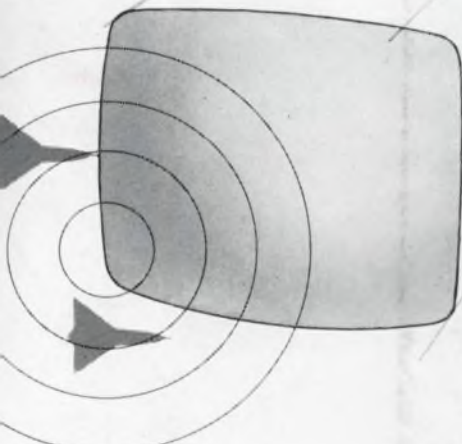

RCA-C22007  
Actual Size