

**True rms digital readout** at 0.05% accuracy is attained by a new differential voltmeter. It uses a d'Arsonval ranging meter and covers 30 Hz-50 kHz.

A balanced thermocouple pair, with calibration system, and a magnetic-type dc amplifier give a capability for a 10:1 crest factor (see page 98).

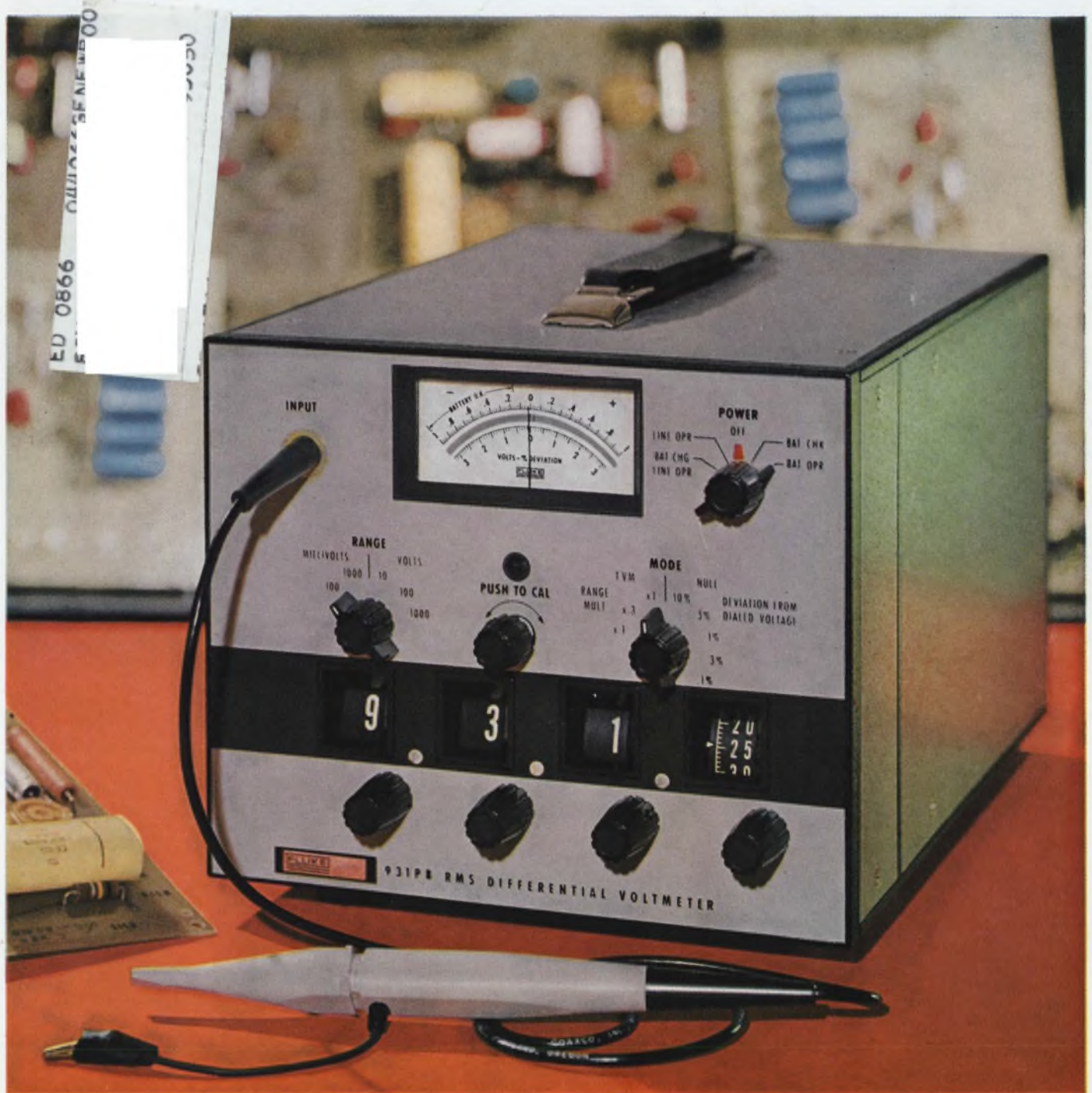

# To make it solder right, you need the right kind of gold for the job.



Good soldering techniques work better when best-for-the-job gold deposits are present. Sel-Rex can supply the right gold plating process for each specific application. For example: the deposit structures of several Type I and Type II patented Sel-Rex formulations aid the capillary flow of solder materials. And one unique Sel-Rex gold deposit offers exceptional hardness along with excellent solderability.

Detailed knowledge of gold plate characteristics—electrical, chemical, mechanical—stems from long term research. Sel-Rex leads not only in research, but also in the diversity of gold processes available to match the formulation to the job.

Write for your free copy of a paper on our soldering study and details on Sel-Rex processes. Sel-Rex Corporation, Department A-3, 75 River Road, Nutley, New Jersey, 07110.



# automate your DVM

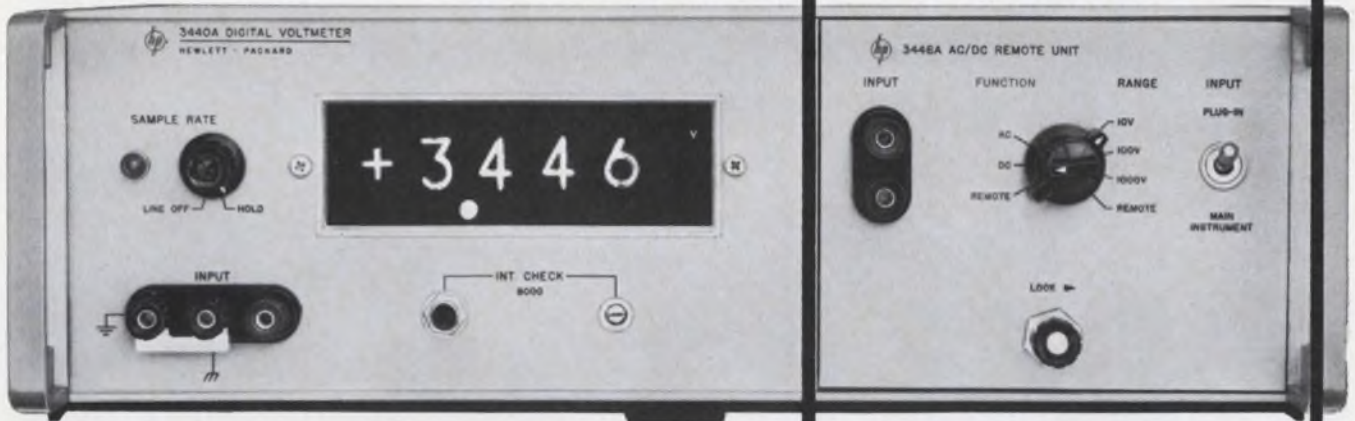

## with remote function, range plug-in

The new 3446A AC/DC Remote Plug-in unit lets you automate your Hewlett-Packard 3439A or 3440A Plug-in Digital Voltmeter by permitting remote programming of function (ac or dc measurements) and/or range (10, 100, 1000 v full scale). An ideal instrumentation package for automatic test stations, programmable routine measurements required at a distance from the DVM.

The DVM's themselves are compact instruments with a selection of plug-ins to provide the choice of manual, automatic and remote ranging, extra-high sensitivity, ac/dc voltage/current/resistance measurements; dc accuracy better than  $\pm 0.05\%$  of reading  $\pm 1$  digit; 4-digit readout; 30 db ac rejection at 60 Hz; capability of floating input pair up to 500 v above chassis ground. The 3440A (\$1160) is systems oriented. The 3439A (\$950) is a bench model. Both use the same plug-ins.

The specifications tell the performance story of the DVM's and this new plug-in. Ask your Hewlett-Packard field engineer for a demonstration of the voltmeter most useful for your application, or write for full specifications to Hewlett-Packard, Palo Alto, California 94304, Tel. (415) 326-7000; Europe: 54 Route des Acacias, Geneva.

*Data subject to change without notice. Prices f.o.b. factory.*

### SPECIFICATIONS, 3446A

<b>Voltage range (ac and dc):</b>	4-digit full-scale readings of 9.999, 99.99 and 999.9 v; 5% overrange capability, indicator.
<b>Voltage accuracy (ac):</b>	50 Hz-20 kHz, $\pm 0.1\%$ of reading $\pm 2$ counts. 20 kHz-50 kHz, $\pm 0.1\%$ of full scale $\pm 2$ counts. 50 kHz-100 kHz, $< \pm 0.3\%$ of full scale $\pm 2$ counts, from 20°C to 30°C, including $\pm 10\%$ line variations. Temperature coefficient = $\pm 0.005\%/^{\circ}\text{C}$ from 0-20°C and 30-50°C.
<b>Voltage accuracy (dc):</b>	$\pm 0.05\%$ of reading $\pm 1$ digit, including 10% line variation, +15°C to +40°C ( $\pm 0.1\%$ $\pm 1$ digit 0°C to +50°C).
<b>Range selection (ac):</b>	Manual, remote; auto reading $< 2$ sec; max. remote ranging time 40 msec.
<b>Range selection (dc):</b>	Manual, remote; auto reading $< 1$ sec; max. remote ranging time 40 msec.
<b>Function selection (ac or dc):</b>	front panel or remote.
<b>Input impedance:</b>	10 megs shunted by $< 35$ pf, all ac ranges; 10.2 megs, dc.
<b>Price:</b>	\$575

HEWLETT  PACKARD

*An extra measure of quality*

1187



## This is where the eagle sits

Look who stepped out of the Great Seal to wear a CMC Crusading Engineers' medal. Think he looks proud? You should see us! **He's on the first and only solid-state counter fully militarized to meet Mil Specs.**

If you want the safety of a counter providing full Mil Specs reliability at a price surprisingly close to a commercial counter, then check these specs: 0 to 100 Mc frequency range; oscillator stability of 1 part in 10<sup>9</sup>; meets or exceeds MIL-E-16400, including appropriate temperature, humidity, vibration, shock, and RFI

specs; built-in time interval measurement. Three militarized plug-ins available: 500 Mc heterodyne converter, 3 Gc heterodyne, and a 15 Gc transfer oscillator.

It may take some time, but you can probably expect copies of this counter from our creative competition at high-powered H-P and big, bad B. But they'll be copying the instrument



originated and designed by CMC. State-of-the-art development of a fully militarized solid-state counter isn't the first or last technological coup for CMC. Add to it the first all solid-state counter, first all-silicon solid-state counter, first 10-line-per-second low-cost printer, first dual plug-in counter, and numerous others.

Write today for a complete spec sheet on our new Model 880 so you can compare when and if the others arrive on the market. And remember, we won't give you the bird, we'll give you a medal.

12973 Bradley • San Fernando, California • Phone (213) 367-2161 • TWX 213-764-5993

COMPUTER MEASUREMENTS COMPANY IS A LEADING DESIGNER AND MANUFACTURER OF ELECTRONIC INSTRUMENTATION TO COUNT, MEASURE, AND CONTROL.

Speed Inquiry to Advertiser via Collect Night Letter  
ON READER-SERVICE CARD CIRCLE 3

---

## NEWS

- 4 **More and more on a chip**  
Large-scale integration blossoms as additional manufacturers announce their capabilities at IEEE Show.
- 13 News Report
- 17 **Power FETs headed for wide expansion**  
The interest and ingenuity of component manufacturers may possibly make FETs the solid-state power panacea.
- 20 **Undersea atom power: Wave of the future**  
Marine explorers look to U.S. space programs for nuclear batteries that will last for years.
- 25 Washington Report
- 29 **Editorial:** Here are some winners . . . And here are some losers.
- 30 **Reaching for the Moon . . . and beyond**  
An exclusive interview with Engineer-Astronaut Roger B. Chaffee, the "rookie" assigned to join Grissom and White for the first manned Apollo flight.

---

## TECHNOLOGY

- 40 **It's what's up front that counts** when good noise performance is needed in IC amplifiers. An analysis of direct-coupled cascades proves the point.
- 48 **A FET operating at uhf?** That's right. And here's how to design a high-gain, low-noise, stable 500-MHz amplifier with field-effects.
- 56 **Estimate the solar noise** of optical communication systems graphically. The results show noise depends on wavelength, receiver aperture and look angle.
- 59 **Photomicrography is a powerful tool** for detecting flaws in integrated circuits. Here are tips to help you take good, detailed pictures.
- 65 ELECTRONIC DESIGN announces winners of "Top Ten" Contest
- 82 Ideas for Design
- 94 NASA Tech Briefs

---

## PRODUCTS

- 98 **Cover Feature:** True rms differential voltmeter gives 0.05% accuracy, digital readout, and portability.
- 101 **Test Equipment:** Ac and dc calibration voltages at 100  $\mu$ V to 1110 V, NBS certificate too, with this 421A.
- 104 **Microelectronics:** Low power dissipation for this 8-element TTL logic family—no extra charge for flatpacks.
- 106 Systems
- 108 **Components:** New panel-meter mounts with nothing behind the panel but terminals.
- 119 Semiconductors

---

## Departments

- |     |                   |     |                     |
|-----|-------------------|-----|---------------------|
| 120 | New Literature    | 126 | Advertisers Index   |
| 124 | Design Aids       | 128 | Designer's Datebook |
| 124 | Application Notes |     |                     |

# More and more circuits per chip

**Large scale integration (LSI) blossoms as integrated circuit manufacturers announce new products. Both unipolar and bipolar arrays shown at the IEEE show.**

**Rene Colen**  
Microelectronics Editor

The concept of a "computer on a chip" seemed to move closer to reality last week as three integrated circuit (IC) manufacturers, Sylvania Electric Products, Inc., Fairchild Semiconductor and Texas Instruments Inc., announced the development of large scale integrated circuits.

What is large scale integration (LSI)? In the fast-moving semiconductor industry, few manufacturers have the time or inclination to agree on standards of any kind, let alone on component call-outs. Each manufacturer applies his own names to the devices he makes. Generally LSI refers to the placing of about 50 or more circuits on one chip. The first step toward LSI involves the placing of complete complex logic functions on a single IC chip. These complex functions could be a decade

counter, a 64-bit shift register or a complete scratch-pad memory, for example.

Existing IC devices, except for the products of two companies, contain only a few logic elements which must then be interconnected with other similar units to obtain a complete logic function. The two exceptions are General Micro-electronics Inc. and General Instrument Corp., who have produced and marketed complete logic functions in individual packages for some time. However, these products use only MOS unipolar (FET) transistors as the active devices.

## Complex functions introduced

Sylvania's product line, introduced by Alvin B. Phillips, general manager, Integrated Circuits, will use only bipolar transistors, and thus operate much faster than existing IC arrays. In developing

this line, a definite design philosophy (and there are different ones) had to be established.

Dr. Richard C. Sirrine, manager, Integrated Circuit Development, pointed out that Sylvania's approach was to select those logic arrangements that have a general and repetitive usage in a wide variety of computers. Having analyzed user demand, a family of functional devices was developed which was compatible and could be mated to each other. The overall aim was to achieve circuit economy and reliability by minimizing the amount of external wiring.

Called "Monolithic Digital Functional Arrays," this product line presently includes a fast adder, a four-bit binary register, and a decade frequency counter. Planned future additions are shift registers, encoders and decoders, and memory arrays. All of these subsystems use a transistor-transistor logic (TTL) that is compatible with the Sylvania Universal High-Level Logic (SUHL) line of integrated circuits.

The difference in design philosophy used by the major manufacturers in developing complex-function circuits was clearly emphasized by Fairchild's introduction of its Micromatrix program. Dr. Gordon E. Moore, director of research and development, announced that feasibility samples of silicon monolithic IC arrays have been delivered for evaluation. These devices are all made from the same set of diffusion masks; the different logic functions are achieved by using custom-made sets of metalization masks to produce the circuit interconnections.

The major advantage of such a system is the capability to develop highly specialized circuitry to fulfill a customer's particular requirements. Other advantages include the production of large numbers of the exact same circuit. This leads to better process control, with its associated higher yields, lower costs and better reliability figures, Dr. Moore pointed out. Another important facet of this program is its inherent capability for computer programming of the metalization pat-

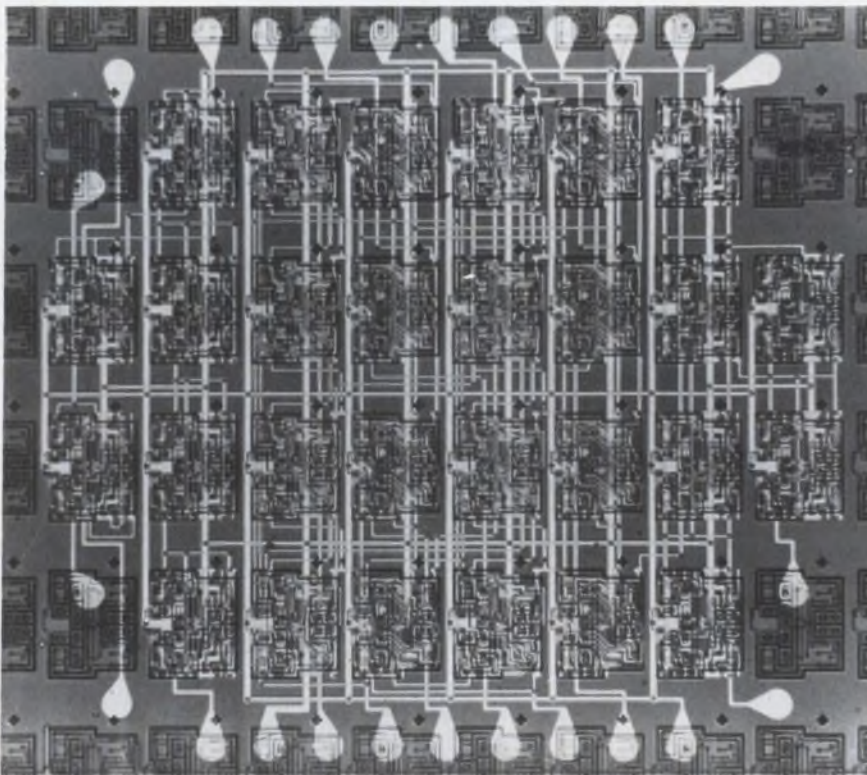

Integrated bipolar transistor array is part of Fairchild's "Micromatrix" program.

tern, thus bringing about additional savings in time and cost.

The program is broken down into three parallel phases. One deals with the generation of an "Interface Language," published as a design manual, which will be used by the customer to specify his circuit needs. The second phase involves the generation of the mechanical artwork for the circuit layouts and interconnection patterns. The third phase is the development of testing methods for the devices. Because smaller geometries and more complex functions are involved, the testing problem becomes greatly aggravated. New methods of testing will have to be developed. At present, two customers have signed exploratory contracts. Expected date of delivery is in 1966.

One other manufacturer, Texas Instruments Inc., also announced a line of complex-function circuits at the IEEE Show. Originally developed for a custom application, these circuits have been modified to perform in a wide variety of computer applications. The series presently consists of a full adder, a decade counter, an eight-bit shift register, and a memory array. All of the units use TTL circuitry to achieve high-speed operation and are fully compatible with Series-54

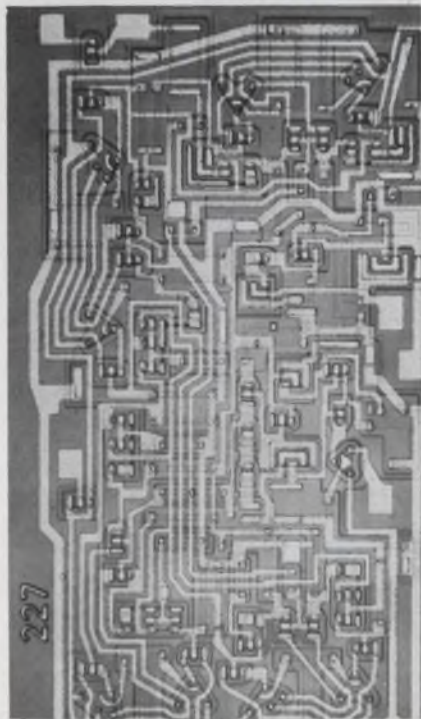

**Decade frequency divider, SM 50,** has as many as forty logic gates on one chip. This bipolar unit is manufactured by Sylvania.

multi-function ICs.

Also demonstrated were two of Texas Instruments developmental products: an MOS binary-to-decimal decoder and a gallium-phosphide monolithic light-emitting array. The light emitting array is arranged in a three-by-five matrix and driven by the MOS decoder to produce a decimal numeric number. Though this particular display emits green light, the device can be made to emit either red or yellow light by varying the doping techniques. Still in development, it will be some time before this unit becomes commercially available.

Though both Fairchild and Texas Instruments have demonstrated capabilities in processing MOS arrays, the consensus of opinion is that these devices have only a limited application. The major drawback seems to be the operating speed that the units can attain.

General Micro-electronics, which has been marketing MOS arrays for well over a year, feels that the inherent speed limitations do not have to be a handicap. Mike Dix, MOS product manager, points out that the customer is only interested in performing a complete logic function within a certain time span; the speed of the individual devices on the chip should be of little concern. By using proper logic and circuit design, the speed problem can be somewhat avoided. In keeping with this thought, the company emphasized a custom approach in its discussions at the IEEE Show, and did not exhibit any new additions to its existing line of complex function integrated circuits.

William A. Berg, product marketing manager, Signetics Corp., stated that his firm was in full production of an eight-bit shift register. However, the unit was developed solely for the use of a customer, and will not be available as a standard item until some future date.

Another complex-function device introduced at the IEEE Show is a 16-bit memory made by Transitron Electronic Corp. This unit (TMC-3162) employs high-level transistor-transistor logic, and is for scratch-pad memory applications. It has a typical operating speed of 20 ns.

#### Circuit details

Sylvania's decade frequency di-

vider (SM 50) provides a square-wave output at 1/10th the input frequency. Operating with either analog or digital inputs, this divider works over the frequency range from 5 Hz to 30 MHz. The device is claimed to have a seven-to-one size advantage over a counter using multiple IC packages. Placed on a 47-by-82 mil chip are four flip-flops and two gates. An equivalent design would have required four to five separate logic packages.

There are other advantages to increasing the complexity of circuit functions per chip besides reduction in cost and the increase in reliability. Closer spacing between gates reduces propagation delay times and permits an increase in the operating speed of the function. Also, the closer spacing leads to very low values of line capacity. This allows the use of higher resistance values and appreciably reduces the power dissipation in the package.

The Sylvania four-bit shift register (SM60, SM70) can store and transfer about 250 million binary bits per second. This array of 25 logic gates can process the four input signals within 15 ns. The chip size is 45-by-105 mil.

All of the Sylvania circuits are now in pilot production and are scheduled for full production during the coming summer. Unit prices range from \$17 to \$47 in 100 lot quantities.

The SN5490, Texas Instruments' decade counter offers some flexibility by having pin connections which provide either a divide-by-five divide-by-two or divide-by-ten function. The maximum count frequency is 12 MHz and the power dissipation is 150 mW. In 100-lot units the price of this circuit is \$31.20.

The binary full adder the SN54-80, made by Texas Instruments has complementary inputs and outputs, as well as an inverted carry output. The addition takes about 70 nanoseconds. Power dissipation is 105 mW. To perform the same function by using presently available ICs requires about five multi-function packages. The SN5480 sells for \$19.40 in 100-lot quantities. Both this unit and the SN5490 are available for half the price of the SN7480 and the SN7490. The SN74 series devices have a limited temperature range of 0° to +70°C.



here are the resistors  
you've been looking for  
*to use in your miniaturized circuits*





ALLEN-BRADLEY Type BB  $\frac{1}{8}$ -watt and  
Type CB  $\frac{1}{4}$ -watt hot molded resistors  
shown approximately 4 times actual size

Here are two resistors that are ideally suited for your miniaturized circuits—the Allen-Bradley Type BB  $\frac{1}{8}$ -watt and the Type CB  $\frac{1}{4}$ -watt units. While extremely small, both have integrally molded insulated bodies and are full-fledged members of the Allen-Bradley hot molded resistor family.

This is made possible by employing the same exclusive hot molding process as used for the higher ratings of A-B resistors. The use of special automatic machines removes the element of human error, assuring complete uniformity of physical and electrical properties from one resistor to the next—from one billion to the next. And catastrophic failures are absolutely unheard of with Allen-Bradley hot molded resistors.

Be sure you have full specifications on both of these A-B hot molded resistors on hand. Please send for Technical Bulletin 5050 on the Type CB and Technical

Bulletin B5005 on the Type BB: Allen-Bradley Co., 222 W. Greenfield Ave., Milwaukee, Wis. 53204. In Canada: Allen-Bradley Canada Ltd. Export Office: 630 Third Avenue, New York, New York, U.S.A. 10017.

TYPE BB 1/8 WATT		MIL TYPE RC 05
TYPE CB 1/4 WATT		MIL TYPE RC 07
TYPE EB 1/2 WATT		MIL TYPE RC 20
TYPE GB 1 WATT		MIL TYPE RC 32
TYPE HB 2 WATTS		MIL TYPE RC 42

HOT MOLDED FIXED RESISTORS are available in all standard EIA and MIL-R-11 resistance values and tolerances, plus values above and below standard limits. Shown actual size.

1065-11AB



**ALLEN - BRADLEY**

QUALITY ELECTRONIC COMPONENTS

ON READER-SERVICE CARD CIRCLE 4



Helipot's side-adjust  
Helitrim<sup>®</sup> cermet  
trimmer—world's  
smallest—costs as little  
as \$1.50 in quantity.



Helipot's side-adjust  
Helitrim<sup>®</sup> cermet  
trimmer—world's  
smallest—costs as little  
as \$1.50 in quantity.



Helipot's side-adjust  
Helitrim<sup>®</sup> cermet  
trimmer—world's  
smallest—costs as little  
as \$1.50 in quantity.



Helipot's side-adjust  
Helitrim<sup>®</sup> cermet  
trimmer—world's  
smallest—costs as little  
as \$1.50 in quantity.



The Model 62PA side-adjust is a new easy-access cermet trimmer with these quality features: virtually infinite resolution; excellent high frequency characteristics; and standard resistance from 10 ohms to 1 megohm. Its rugged cermet resistance element gives you long, trouble-free life and freedom from sudden failure. Inside its plastic case is a sealed metal housing identical to the popular 1/4" top-adjust Model 62P.

Focus in on delivery advantages, too... immediate stock availability. Call your Helipot sales rep for full specs.

**Beckman**

INSTRUMENTS, INC.  
HELIPOT DIVISION  
FULLERTON, CALIFORNIA • 92634

INTERNATIONAL SUBSIDIARIES: GENEVA; MUNICH; GLENROTHES, SCOTLAND; TOKYO; PARIS; CAPETOWN; LONDON

Speed Inquiry to Advertiser via Collect Night Letter

ON READER-SERVICE CARD CIRCLE 5

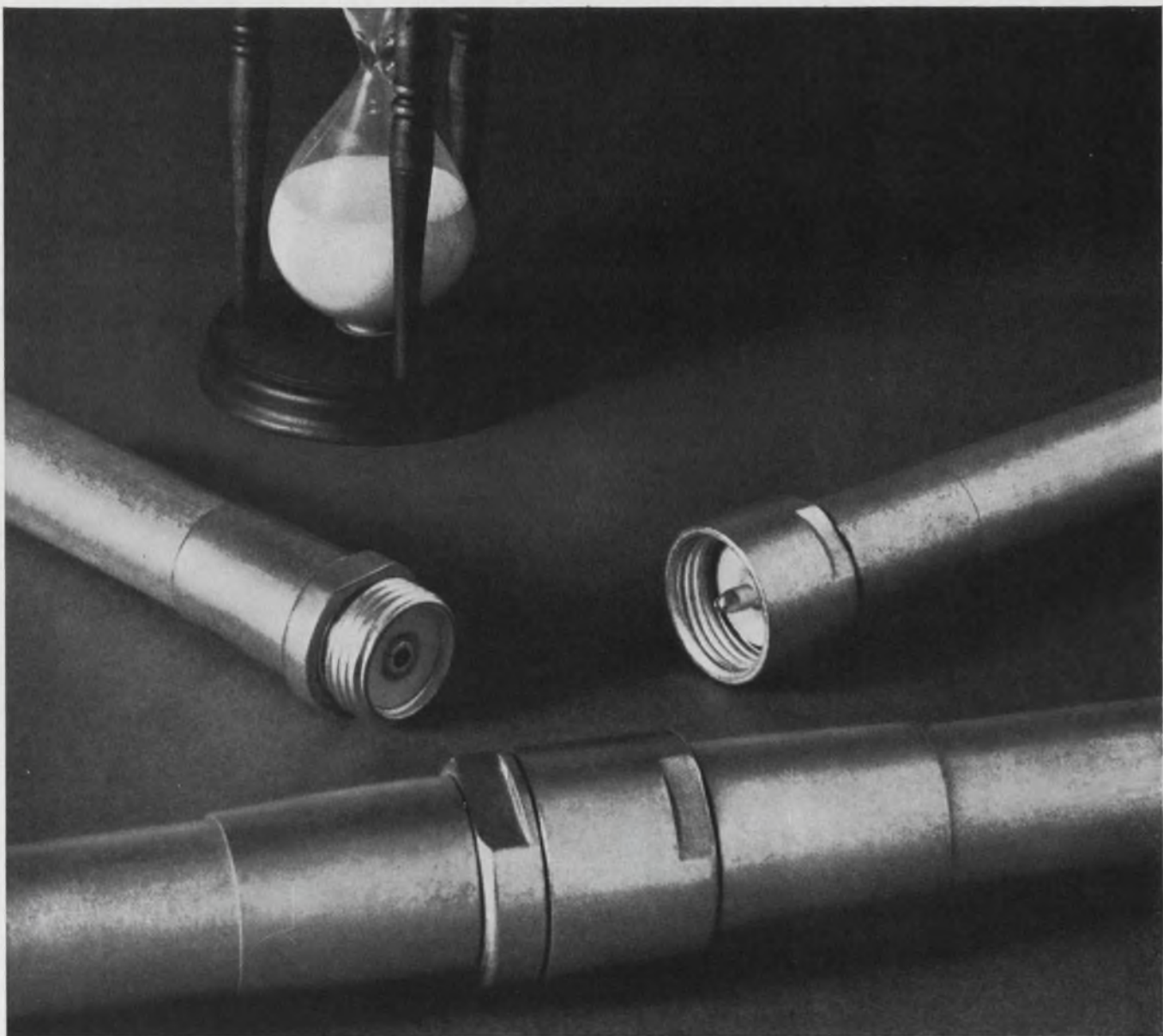

## Three minute coax connector for semi-rigid cable

Believe it or not, these trim COAXICLAMP\* connectors for 50-ohm semi-rigid coax can be installed in three minutes! Permanent splices take slightly longer: five minutes.

A few more surprises—they're about 50% smaller and lighter than other semi-rigid coax connectors; they have a VSWR of less than 1.15 from 0 to 10GHz. They convert quickly to mate with standard N, BNC, TNC, and other coax connectors. Best of all, no amount of bending, twisting, and pulling, short of that required to permanently deform the cable, has any effect on the appearance or performance of these COAXICLAMP connectors. They can withstand temperatures up to 500°F and internal pressure up to 50 psi without discernable leakage or degradation.

Check this list of COAXICLAMP connector features:

- Constant 50-ohm impedance connectors and splices
- Unaffected by 100 hours in salt spray
- Fast assembly with matched tooling: 3 minutes for connectors; 5 minutes for splices
- Available for air dielectric or foam filled semi-rigid coaxial cable in sizes from 1/4" to 1/2"
- Converts quickly to type N, BNC, or TNC connector
- Retains coaxial symmetry for optimum electrical performance

If you'd like more information about this amazing COAXICLAMP connector, write or call today.

\*Trademark of AMP Incorporated



AMP products and engineering assistance available through subsidiary companies in: Australia • Canada • England • France • Holland • Italy • Japan • Mexico • Spain • West Germany

Speed Inquiry to Advertiser via Collect Night Letter  
ON READER-SERVICE CARD CIRCLE 6



## FOR FREQUENCY MEASUREMENTS TO 15 GHz WITH COUNTER ACCURACY

The improved Hewlett-Packard 2590B Microwave Frequency Converter, used with the hp 5245L Counter (with the 5253B or 5252A Plug-in) measures cw frequencies 0.5 Hz to 15 GHz with the accuracy of the counter time base... even on drifting signals. A 12.4-18 GHz range is optional. The 5252A Counter Plug-in with a modification to the counter itself permits direct readout of the frequency.

The 2590B phase-locks an internal transfer oscillator to the signal frequency. When used with the 5245L, accuracy is 5 parts in  $10^9$  short term, 3 parts in  $10^7$ /day. Using an external quartz frequency standard for the counter reference provides even higher accuracy.

The 2590B provides pushbutton mode and range selection, front-panel indication of lock, agc to accommodate variations in signal level. The transfer oscillator can be externally modulated for dynamic measurements of signal generator modula-

tion linearity. Direct access to the transfer oscillator and harmonic mixer allow the 2590B to be used as a variable microwave frequency reference, for applications such as wave-meter calibration and frequency marker generation. Yet another way the 2590B can be used is as a 30 MHz receiver with AM and FM demodulating capability.

Here's an instrument that lets you make measurements never before possible... and improves on measurement capabilities previously available. Model 2590B, \$1900. Complete specifications, indicating the versatility of this microwave converter, are available with a call to your Hewlett-Packard field engineer or by writing Hewlett-Packard's Dymec Division, 395 Page Mill Road, Palo Alto, Calif. 94306, Tel. (415) 326-1755, TWX 910-373-1296. Europe: 54 Route des Acacias, Geneva.

*Data subject to change without notice. Price f.o.b. factory.*

### *Here are some of the advantages offered by the 2590B*

- Wide phase-lock range for easy monitoring of drifting signals
- Automatic search oscillator for easy synchronization to the signal
- Continuous observation of jitter, FM and AM on drifting signal, with low-frequency scope
- Accurate FM measurements at deviation rates to 1 MHz, using internal precision FM discriminator
- Measurement of the carrier frequency of pulses as short as 0.5  $\mu$ sec
- Sensitivity better than -30 dbm at 0.5 GHz, -10 dbm at 14 GHz

**HEWLETT  
PACKARD**  **DYMEC  
DIVISION**

ON READER-SERVICE CARD CIRCLE 7

# New from Sprague!

**1966**  
SPRAGUE  
METFILM 'A'  
CAPACITORS



**1963**  
ULTRA-THIN  
METALLIZED  
POLYESTER FILM  
CAPACITORS

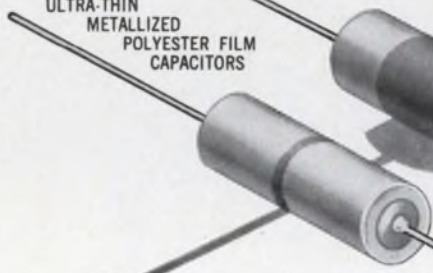

**1956**  
METALLIZED  
POLYESTER FILM  
CAPACITORS

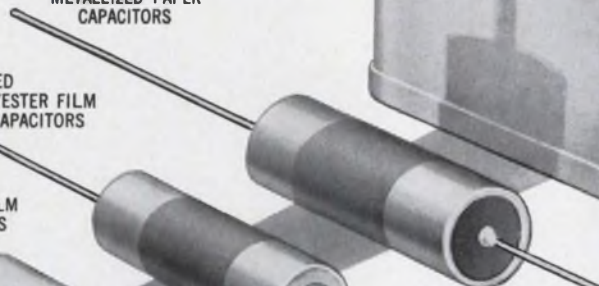

**1947**  
METALLIZED PAPER  
CAPACITORS

**1944**  
OIL-IMPREGNATED  
PAPER  
CAPACITORS

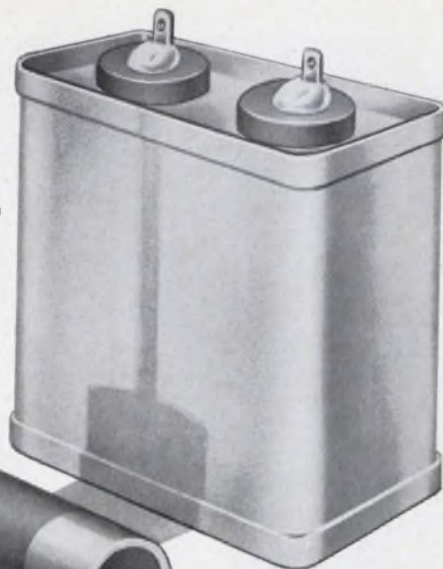

## METFILM\* 'A' CAPACITORS ... dramatically smaller in size, yet more reliable than military-grade capacitors of the past!

Just a few years ago, the only 10  $\mu$ F capacitor considered dependable enough for military applications was Type CP70 (to JAN-C-25), and was a block-busting 3 $\frac{3}{4}$ " wide x 1 $\frac{3}{4}$ " thick x 4" high. Today, you can get a military-quality 10  $\mu$ F tubular capacitor measuring only  $\frac{1}{2}$ " in diameter x 2 $\frac{1}{4}$ " long. And it's more reliable than any capacitor of the past!

Sprague Type 680P Metfilm 'A' Metallized Capacitors meet all environmental requirements of MIL-C-18312, yet they occupy only one-third the volume of conventional metallized film capacitors of equivalent capacitance and voltage rating. Employing a new thin organic film dielectric system, Type 680P capacitors use a dual film totalling only 0.00008" thick, as compared to conventional polyester-film capacitors with a single film measuring 0.00015".

\*Trademark

Another distinct advantage of the Metfilm 'A' dielectric system is minimum degradation of electrical properties during life.

Hermetically sealed in corrosion-resistant metal cases, capacitor sections are effectively of non-inductive construction, resulting in capacitors with performance characteristics superior to those of comparably-sized capacitors.

Type 680P Metfilm 'A' Capacitors are available with capacitance values to 10  $\mu$ F in both 50 and 100 volt ratings.



For complete technical data, write for Engineering Bulletin 2650 to Technical Literature Service, Sprague Electric Company, 347 Marshall St., North Adams, Mass. 01247.

### SPRAGUE COMPONENTS

CAPACITORS  
TRANSISTORS  
RESISTORS  
INTEGRATED CIRCUITS  
THIN-FILM MICROCIRCUITS

PULSE TRANSFORMERS  
INTERFERENCE FILTERS  
PULSE-FORMING NETWORKS  
TOROIDAL INDUCTORS  
ELECTRIC WAVE FILTERS

CERAMIC-BASE PRINTED NETWORKS  
PACKAGED COMPONENT ASSEMBLIES  
BOBBIN and TAPE WOUND MAGNETIC CORES  
SILICON RECTIFIER GATE CONTROLS  
FUNCTIONAL DIGITAL CIRCUITS



'Sprague' and  are registered trademarks of the Sprague Electric Co.

# ED News

Advances in power FETs are in the wind PAGE 17

Nuclear power sources ideal for undersea use PAGE 20

To the Moon and back—as seen by an astronaut PAGE 30

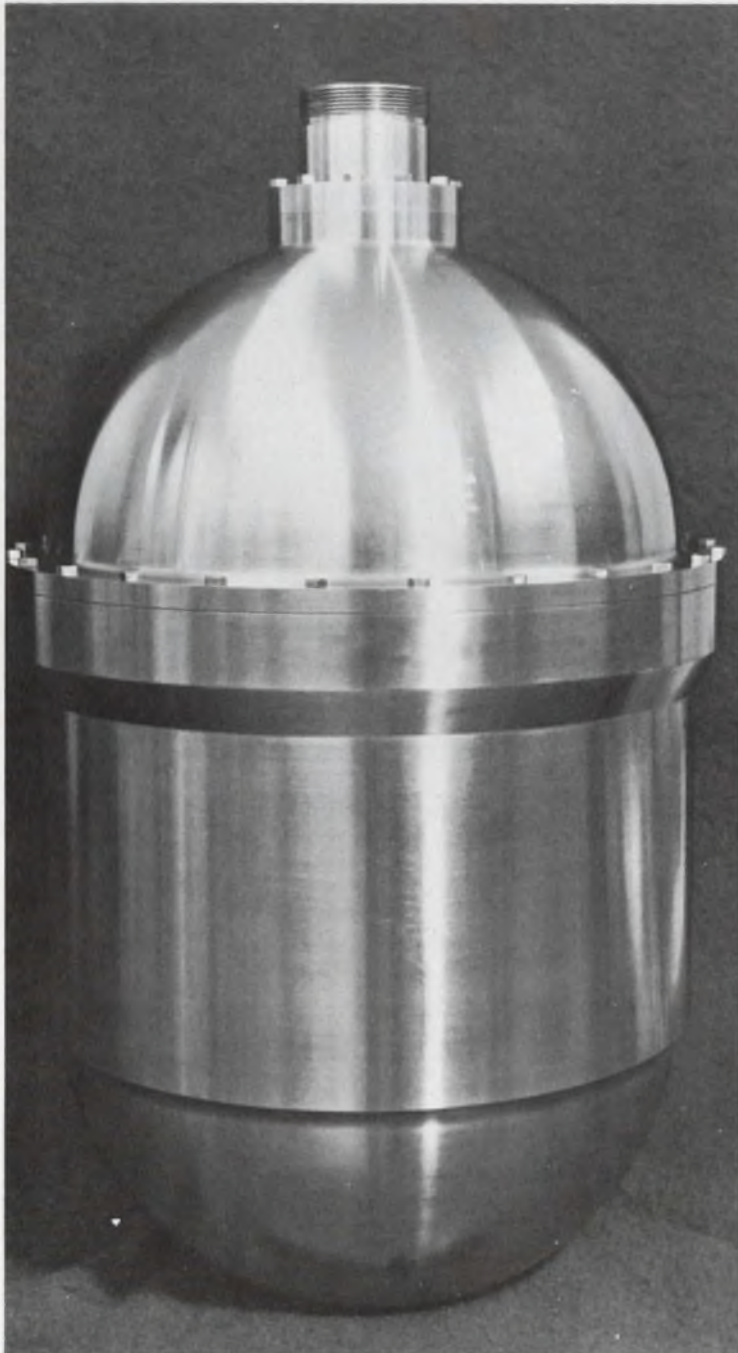

Undersea power sources are a SNAP... 20

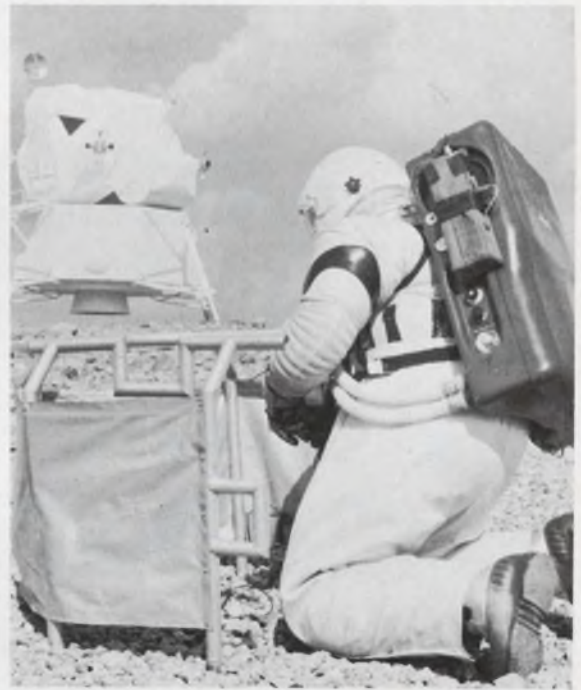

Destination, Moon... 30

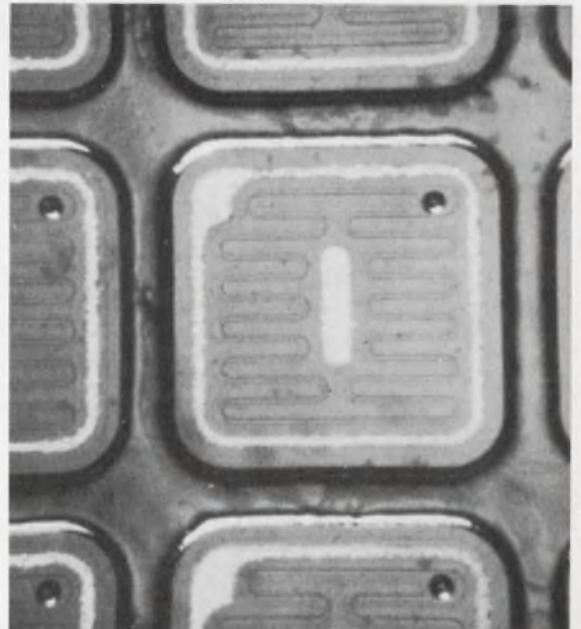

Put power in your FETs... 17

**New from Sprague!**

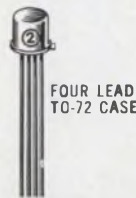

# LOW COST DUET<sup>★</sup> 3N123

## DUAL-EMITTER CHOPPER TRANSISTORS



### CHECK THESE FEATURES!

$BV_{EEO} > 25$  VOLTS

$|V_o| < 250$   $\mu$ V

$|\Delta V_o / T_A| < 2.3$   $\mu$ V per  $^{\circ}$ C

$f_T > 6$  mc

**HIGH VOLTAGE! RELIABLE PLANAR CONSTRUCTION!**

Sprague offers more dual-emitter transistor types than any other source!

TYPE No.	$BV_{EEO}$ (volts)	$V_o$ ( $\mu$ V)	TYPE No.	$BV_{EEO}$ (volts)	$V_o$ ( $\mu$ V)	TYPE No.	$BV_{EEO}$ (volts)	$V_o$ ( $\mu$ V)	TYPE No.	$BV_{EEO}$ (volts)	$V_o$ ( $\mu$ V)	TYPE No.	$BV_{EEO}$ (volts)	$V_o$ ( $\mu$ V)
3N90	30	50	3N95	50	200	3N104	20	50	3N109	50	150	3N116	12	200
3N91	30	100	3N100	10	50	3N105	15	250	3N110	30	30	3N117	20	50
3N92	30	200	3N101	30	50	3N106	30	250	3N111	30	150	3N118	20	100
3N93	50	50	3N102	40	50	3N107	50	250	3N114	12	50	3N119	20	200
3N94	50	100	3N103	50	50	3N108	50	30	3N115	12	100	3N123	25	250

★Trademark

For complete information, write to Technical Literature Service,  
Sprague Electric Co., 347 Marshall St., North Adams, Mass. 01248

### SPRAGUE COMPONENTS

TRANSISTORS  
CAPACITORS  
RESISTORS  
INTEGRATED CIRCUITS  
THIN-FILM MICROCIRCUITS  
455-5153R1

PULSE TRANSFORMERS  
INTERFERENCE FILTERS  
PULSE-FORMING NETWORKS  
TOROIDAL INDUCTORS  
ELECTRIC WAVE FILTERS

CERAMIC-BASE PRINTED NETWORKS  
PACKAGED COMPONENT ASSEMBLIES  
BOBBIN and TAPE WOUND MAGNETIC CORES  
SILICON RECTIFIER GATE CONTROLS  
FUNCTIONAL DIGITAL CIRCUITS



\*Sprague' and '®' are registered trademarks of the Sprague Electric Co.



## Gemini-8 poses questions

The short-circuit in the yaw thruster that cut short the flight of Gemini-8 has raised some questions concerning future U.S. manned space flights. The most immediate is whether the launching of Gemini-9, scheduled for May, will be affected. No decision on this is expected from NASA until the Gemini-8 problem has been completely evaluated.

A more far-reaching question is this: What steps should the U.S. take in the event of a completely disabled space vehicle in the future. Malfunctions like that in Gemini-8 can never be totally eliminated, and there is a limit to the number of back-up systems that can be carried aboard a spacecraft.

Some observers feel that the answer lies in setting up a rescue squad that could be launched on short notice to assist a crippled space vehicle. This, of course, would require a high-degree of perfection in docking techniques—which are just beginning to be perfected thanks to Gemini-8 itself. The New York Times has suggested that the U.S. and the Soviet Union explore the possibility of setting up an international space rescue squad, but other observers point out that the Russians have yet to demonstrate mastery of docking maneuvers in space.

## NASA advisory panel organized

A Science Advisory Committee has been formed to advise NASA on the conduct of future space projects. Announcing the new group, NASA Administrator James E. Webb said, "The new committee is being formed because, in the next generation of space projects, NASA will need new policies and procedures and possible new organizational arrangements to enable scientists to participate."

The committee will study all NASA projects, including both manned and unmanned flight programs. It will then advise NASA on the following:

- How to organize the projects to enable the most competent scientists and engineers to take part.

# News Report

- What steps should be taken, both inside and outside of NASA, to ensure that the right personnel manage these projects.
- What system should be used to select the scientific investigations that are to be conducted.
- Whether some NASA field centers should be oriented to support the projects.

The Advisory Committee, which is temporary and is to be disbanded after completing its work, will concern itself only with approved programs. It will not recommend new programs, since this is the function of NASA's Space Science Board. The committee is headed by Dr. Norman F. Ramsey of Harvard University.

## Comsat proposes air-traffic control

Airline traffic control using communication satellite links may soon be a reality. The Communications Satellite Corporation (Comsat) has submitted a proposal to the Federal Aviation Agency for what may be the first step toward such a worldwide system.

The proposal, still being evaluated, calls for the launching of a 210-pound satellite over the North Atlantic by August, 1967. The satellite would provide reliable vhf communications between aircraft and traffic-control stations. At present hf radio is used for this purpose, and it is highly unreliable in bad weather and during sunspot activity.

Despite the fact that the Comsat proposal will undoubtedly face some technical, political and economic hurdles, many major U.S. airlines have already indicated strong interest in it. At least two, Pan American and Trans World, have already done some minor experimenting with satellite communications.

## Color TV planned for Britain

British television viewers will begin seeing some of their favorite programs in color toward the end of next year. Compared with the present "color boom" in the U.S., initial color programming by the British Broadcasting Company will be fairly modest. Plans call for four hours of color a day at first, gradually increasing to ten.

# News Report

CONTINUED

According to Anthony Wedgwood Benn, the British Postmaster General, BBC will almost certainly adopt the Phase Alternation Line (PAL) color system developed in West Germany. Reportedly the preference for PAL over the French SECAM (Sequential and Memory) system is due partly to the fact that the British hope to export color sets to the Continent, where PAL seems to be gaining most acceptance.

## New home for U.S. standards

The nation's two key measurement standards have been moved to a new home at the National Bureau of Standards research center in Gaithersburg, Md. Both standards—a platinum-iridium meter bar and a kilogram weight—had been kept at the NBS facility in Washington, D.C., for over 60 years.

So valuable are they that during their long stay in Washington the two standards were taken out of their vault less than once a year, usually to check the value of some lesser standards or to be checked against the world standards kept in Paris.

The kilogram and meter bar are the basis for virtually the entire system of measurement used in the United States. The kilogram is the national standard of mass, and any related measurements are made in terms defined by this one weight. The meter bar was the national standard for length measurements for 70 years. In 1960 it was replaced by a new and more accurate standard based on a wavelength of light from a krypton-86 lamp. However, the bar is still a valued measuring tool.

## Editorial board set for U.S.-Soviet venture

Seven American scientists have agreed to serve on an editorial board that will prepare and publish a joint U.S.-Soviet work on space biology and medicine.

The agreement to collaborate on this venture was signed last year by the Soviet Academy of Sciences and NASA. The editorial board will supervise collection of pertinent material in the two countries, determine the title and content of each chapter and volume, and select compilers and authors to do the writing.

Co-chairmen of the editorial board will be two scientists—one U.S., and one Soviet.

Melvin Calvin, professor of chemistry, Laboratory of Chemical Biodynamics, University of California, has accepted the position for the U.S. The completed work is expected to be published in both English and Russian some time during 1967-1968.

## Engineers on medical team

In an unusual setup, engineers and medical men will work side-by-side to restore patients to more normal lives after strokes, heart attacks or crippling accidents.

The team plan is being put into practice at the Moss Rehabilitation Hospital in Philadelphia, where a special Biomedical Engineering Services Section has been set up. Martin Kaplan, executive director of the hospital, says: "Engineering skills have a particularly important role to play in rehabilitation. The engineer can be very helpful in designing devices and appliances for specific patients, so that they can function better and do more things despite their handicaps."

The new arrangement is expected to benefit patients significantly, even after they leave the hospital—especially through suggested modifications to the patient's home. For example, the engineer may recommend a stair elevator, a walk-up ramp, or other easy-to-operate devices for the bedroom or kitchen that will enable the disabled person to live at home rather than in an institution.

---

An agreement between the Sprague Electric Co. and the Signetics Corp. has been concluded for the exchange of technology on integrated microcircuits. Research and development data will be exchanged, as well as other information that will lead to the fully compatible manufacture of integrated microcircuits. The aim is to allow each company, if it wishes, to serve as a "second source" to the other.

Cash awards totaling \$275,000 were given to 29 employees of IBM at the company's annual awards dinner. The largest award, \$30,000, went to John A. Perri and Jacob Riseman, engineers, for developing a method of sealing semiconductor devices with a very thin layer of oxide and then a thin layer of glass.

A five-day seminar covering the economics and basic technology of integrated circuits will be held in the Washington, D.C., area May 2-6. For details, write Integrated Circuit Engineering Corporation, P. O. Box 4388, Philadelphia, Pennsylvania.





**We think big when it comes to  
dipped mica capacitors.**

**Now we make the smallest.**

Producing our exclusive micro-miniatures is quite a trick. In fact, both the products and the processes are patented.

Our Types CD6, 7, 8 and 9 range from 3 to 11,000 pf. and are frequently interchangeable with considerably larger sizes. This means volume efficiency with CDE micro-miniatures is *4 to 12 times greater* than the standard CM04, 05 and 06 classes of capacitors!

What's more, this new "small" line is just *part . . .* of the most complete line of mica capacitors in the industry. A line that includes many Mil-Spec types. And our Sprint service program means you can get any of these capacitors in volume—in a hurry!

For more information, contact your Authorized Industrial Distributor, or your local CDE field engineering office.

**CDE** CORNELL-  
DUBILIER

# 1 PPM

## Potentiometric Measuring System

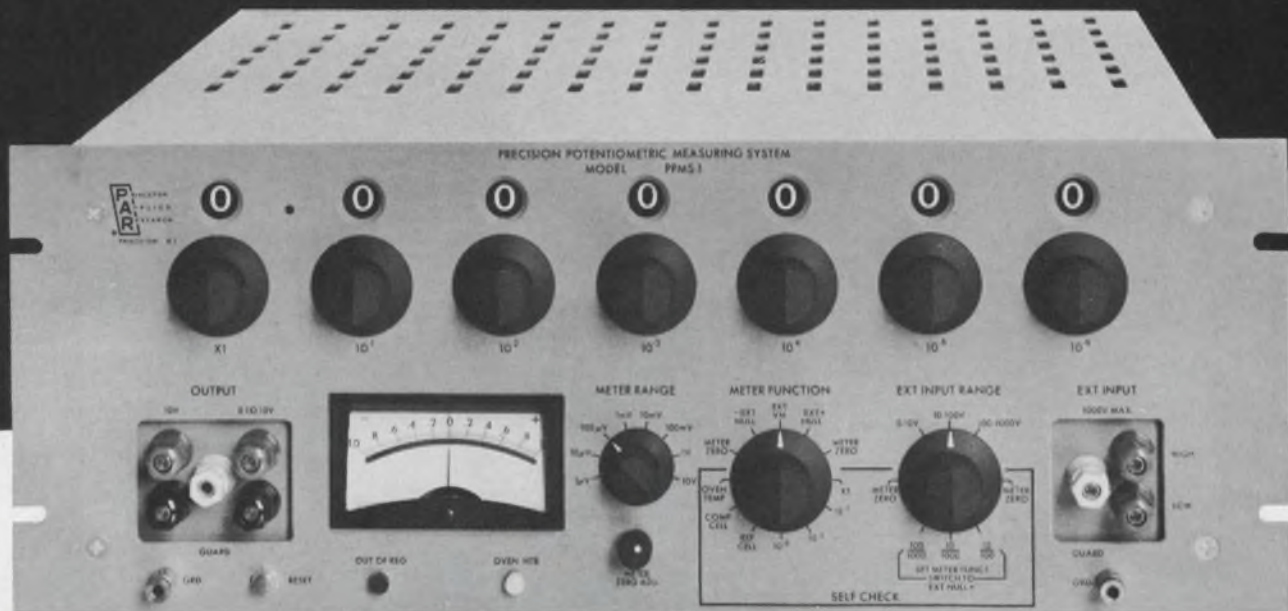

The PAR Model PPMS-1 is a self-contained system consisting of the basic components required for making one part per million measurements of external resistance ratios or external DC voltages extending to 1000 volts. The system, with accuracy traceable to N.B.S., consists basically of a 10 volt DC source whose saturated standard cell reference is housed in a proportional temperature controlled oven (maintained within 0.001°C), a self-calibrating 7 decade Kelvin-Varley divider and a null indicator having a basic full scale sensitivity of  $\pm 1$  microvolt.

An output signal fully isolated from, but proportional

to the deflection of the null meter is provided to drive strip-chart recorders and thereby function as a self-contained monitor of the stability of other voltage supplies. In addition, this unit can serve as the controlling element in ultra-stable variable voltage or current supplies with the addition of power amplifiers which are available as accessory items.

A unique method of self-calibrating the four most significant decades of the Kelvin-Varley divider without additional equipment as well as means of verifying oven temperature and standard cell voltage are provided. Price \$4950.

*Write for bulletin No. 121 or ask for information about PAR's complete line of precision reference sources.*



# Power FETs headed for wide expansion

## Five manufacturers have firm plans to produce field-effect transistors as alternatives to present bipolar power devices

Roger Kenneth Field  
News Editor

Interest in power FETs is growing so rapidly that at least five manufacturers will enter the market with new devices this year. In addition three big producers of semiconductors are investigating the manufacture of the devices, but they decline to disclose their progress at this time.

Power FETs, which are inherently free from secondary breakdown and thermal runaway, are field-effect transistors that can handle several watts when operating as amplifiers.

Crystalonics possibly the only

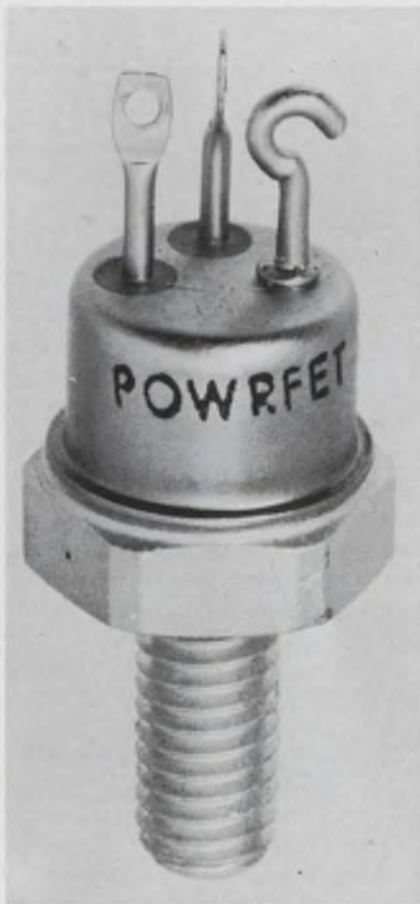

Crystalonics' power FET in its package. The stud conducts heat away from the chip.

manufacturer of power FETs, at present, is marketing one, CP603. But this unit can sustain a source-to-drain voltage of only 30 volts. This low value of  $V_{sd}$  makes it difficult for a designer to actually use the 9 watts that the unit can develop.

Dickson Electronics in Scottsdale, Ariz., introduced a chopper at the IEEE Show, and it intends to repackage the device in a heat sink, so that it can be used as a 5-watt power FET. According to Robert Jones, general manager of special devices, his company will offer the same device as a low "R-on" switch (chopper) in a TO5 or TO18 package and as a power FET (linear amplifier) in either a TO3 or a 7/16-inch stud package. Jones says that a 20-watt power FET is fairly easy to make with present technology, but, again, to use this power, the drain-to-source breakdown voltage must be more than 30 volts. Dickson's power FET can handle 50 volts.

A spokesman at one of the big semiconductor manufacturers that prefers not to publish their power FET plans does not feel that you can make a good unit by putting a FET switch in a heat sink. "You must have a breakdown voltage of at least 100 volts and to accomplish that while maintaining a low input capacitance you really must improve the technology." He feels that there must be a market for a 100-volt, 100-mA device that can be controlled with no drive current.

Unhappy with the 30-volt breakdown potential, Joel Cohen, director of engineering at Crystalonics, says the company is shooting for a prototype that will withstand 200 volts. He hopes that this new device will deliver 25 entirely useful watts, with an input capacitance of 60 pF. Crystalonics is planning to offer delivery on this device by August.

Cohen sees the power FET as a

natural for radio-frequency work, since increases in its dimensions don't lower its frequency range, and overlays and a large number of emitters aren't needed to achieve high speed. The first obvious application of the power FET might well be in the output stages of transmitters. But this optimism is not shared universally in the industry.

### Power MOSFETS come too

Douglas Schliebus, senior engineer at Fairchild, says that his concern's research has convinced him that at any stage of development the bipolars will consistently top FETs in radio-frequency work. Still, Fairchild's actions indicate a duck's calmness above the water but a lot of paddling below. The company is working on a 10-watt MOSFET with source-to-drain breakdown at 50 volts. This has been achieved without great sacrifices to the input capacitance, which has been held to less than 20 pF. And Fairchild isn't the only component manufacturer to investigate power MOSFETs.

The Sprague Electric Co. has developed a MOSFET at its North Adams, N. H., laboratory that will handle 20 watts in a stud package. The unit can withstand 40 volts and has a transconductance of around 100,000  $\mu\text{mho}$ . While this sounds like the perfect unit, the trade-off was made at the gate, and the input capacitance of this p-channel enhancement unit is 1000 pF.

Another MOSFET manufacturer, KMC Semiconductors of Long Valley, N. J., just received some masks to run off a series of prototypes. Paul Kolk, vice president of engineering, reports that his company's n-channel depletion units can handle 35 volts and deliver two watts. The input capacitance is 25 pF, and the MOSFET is laid out in a comb structure. Kolk believes that this power FET will be ideal for linear power amplifiers in transmitters that operate in the 2-80 GHz range. Most of the 12 prototypes that he tested, he said, have a transconductance of around 20,000  $\mu\text{mhos}$ . This compares favorably with junction

## NEWS

(power FET, *continued*)

power FETs and bipolar power transistors.

### How does a potential user feel?

Daniel Von Recklinghausen, H.H. Scott's chief engineer, sums up the attitude of potential users of power FETs this way:

"Certainly the bipolar power transistors are far from perfection.



An inside view of the Crystallonics power FET. Each device can handle nine watts.

Secondary breakdown can suddenly fuse the emitter and the collector, causing a complete short. Any current increase can start a snowballing thermal runaway. The temperature increases, causing an increase in the leakage current and the gain, and these, in turn, push the temperature still higher, until the bipolar burns out. We have to take precautions to prevent failure, and these precautions include adding resistance to the emitter circuit, using very low driving impedance and employing diodes and thermistors in the circuit. FETs are above all this. They can be viewed as just voltage-controlled resistors, and like all resistors, an increase in temperature brings an increase in channel resistance. Hence, runaway in power FETs is impossible. But there are drawbacks.

"In a push-pull amplifier we adjust bias for minimum distortion. In FETs the current at this optimum bias would be about 25% of the zero-bias current. Bipolars idle between 1/2% and 2% of their maximum current. For two power

transistors of about equal power-handling capabilities, the FETs dissipate in excess of an order of magnitude more current than their bipolar counterparts. This is considerable heat and wasted power. This could be offset somewhat if the FETs were extremely easy to drive. To insure this, the input capacitance should be held to less than 100 ohms.

"But I still think that the power FETs most reprehensible disadvantage is their high standby power dissipation, compared to their output power in a push-pull circuit. I feel that the power FET designers can approach this problem by investigating very special geometries along with alternative doping techniques."

Along these lines, two Frenchmen, S. Teszner and R. Gicquel have been experimenting for over a year with a FET containing embedded grids arranged in a comb structure. Teszner is with the Centre National d'Etudes des Telecommunications, and Gicquel is with the Societe Europeene des Semiconducteurs in Paris. ■ ■

## New computer family announced

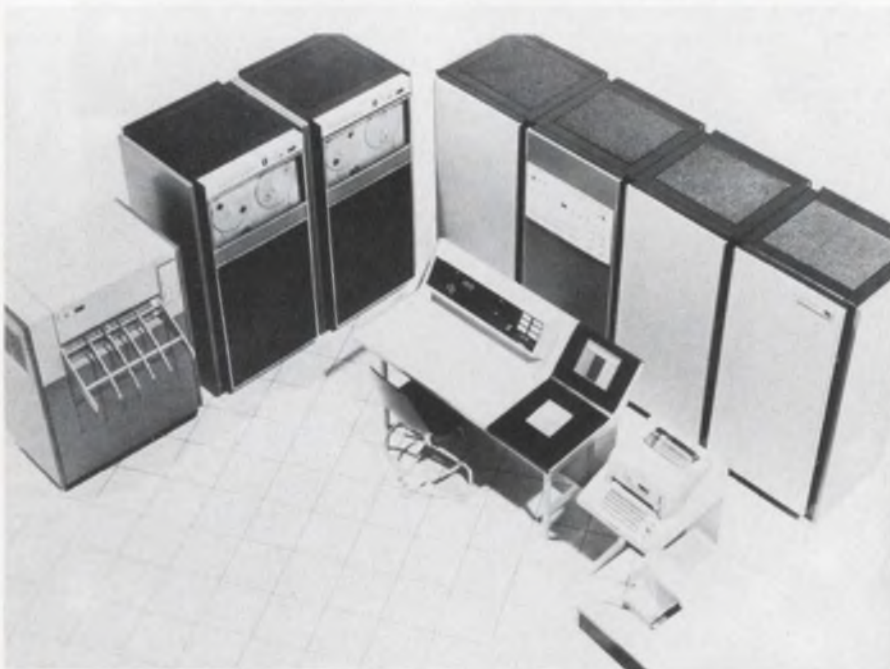

**Sigma 7 computer** provides real time, multi-programming, multiprocessing, and time sharing. Equipment shown includes (left to right): line printer, magnetic tape systems, central processor unit, operator's console, Teletype, and card reader and punch.

Simultaneous computer service for over 200 users is offered by the new Sigma 7, first of a new family of computers announced by Scientific Data Systems (SDS). The Sigma 7 has been designed to handle business, scientific and real time computing tasks simultaneously.

Features of the new family of computers include an input/output rate of 160-million bits per second; compatibility with IBM 360 computers in word structure, floating point arithmetic and input/output equipment; a modularized core memory with 4096 to 131,072 word (8 bits plus parity) capacity; and automatic error detection and correction while a program is in operation.

Monolithic integrated circuits are used for 90 percent of the active circuitry in the Sigma 7.

Typical Sigma configurations range in price from \$200,000 to \$1-million. Delivery of Sigma hardware is scheduled for the fourth quarter, 1966.



## SPECIFY ARNOLD

Non-columnar Alnico 8 with a guaranteed minimum coercive force of 1650 oersteds and a guaranteed minimum energy product of  $5.00 \times 10^6$  is just the beginning. Our regular production test results show consistently higher values. (see chart)

Representative values taken from test records of particular magnets made in production:		
Coercive Force Oersteds	Residual Induction Gauss	Energy Product BH Max. $\times 10^6$
1810	8050	5.76
1840	8150	6.02
1730	7900	5.38
1850	8200	6.20
1780	7950	5.52

Microwave equipment, DC motors, meter movements, AC-DC generators, transducers and even super power klystrons need Arnold Alnico 8.

The most modern Alnico 8 facilities, are at your command. Specify Arnold, we'll do the rest.



**ARNOLD**  
SPECIALISTS IN MAGNETIC MATERIALS

THE ARNOLD ENGINEERING COMPANY, Main Office: MARENGO, ILL.  
BRANCH OFFICES and REPRESENTATIVES in PRINCIPAL CITIES

Speed Inquiry to Advertiser via Collect Night Letter  
ON READER-SERVICE CARD CIRCLE 11

# Undersea atom power: Wave of the future

Marine explorers look to U.S. space programs for nuclear 'batteries' that will last years. Milliwatt units already undergoing tests.

Ralph Dobriner  
West Coast Editor

Nuclear "batteries" are beginning to find increasing favor as the coming prime power source in deep-sea exploration and research programs.

Such units are already being used in tests in the Atlantic, the Gulf of

Mexico and elsewhere, both at and below the surface of the sea. Their potential as a power source at great depths is obvious.

As one scientist at the recent Offshore Exploration Conference in Long Beach, Calif, observed:

"Nuclear systems operating unattended and at any depth could oper-

ate automatic valves, power remote instrument packages, operate long-lived location beacons, or provide process heat for underwater operations all independent of the surface."

At present conventional power units left unattended under the sea for more than two years must be serviced and replaced regularly. One Navy test has shown that they quit performing efficiently after six months.

## SNAP units most promising

Probably the most promising of the future compact power sources for underwater application is the Atomic Energy Commission's family of SNAP (Systems for Nuclear Auxiliary Power) units. Such systems have been around for over six years and have been widely publicized; however, they are being developed mainly for U. S. space programs, and relatively little money has been spent to adapt them for marine applications.

According to Richard Johnson of Atomics International, Canoga Park, Calif., SNAP systems already satisfy most of the design requirements for underwater use, since they were designed to withstand the extreme environments of space and the shock that occurs during launching.

"By relaxing the low weight requirement and the requirement dictated by the space vacuum and zero-gravity operation, the systems can be simplified for marine use, with an attendant decrease in cost," Johnson says.

## Four nuclear systems developed

Four types of SNAP power systems have been developed for the space program, and all are considered adaptable to the underwater environment. They are:

- Combined radioisotope and thermoelectric.
- Conduction-cooled reactor and thermoelectric.
- Liquid-cooled reactor and thermoelectric.

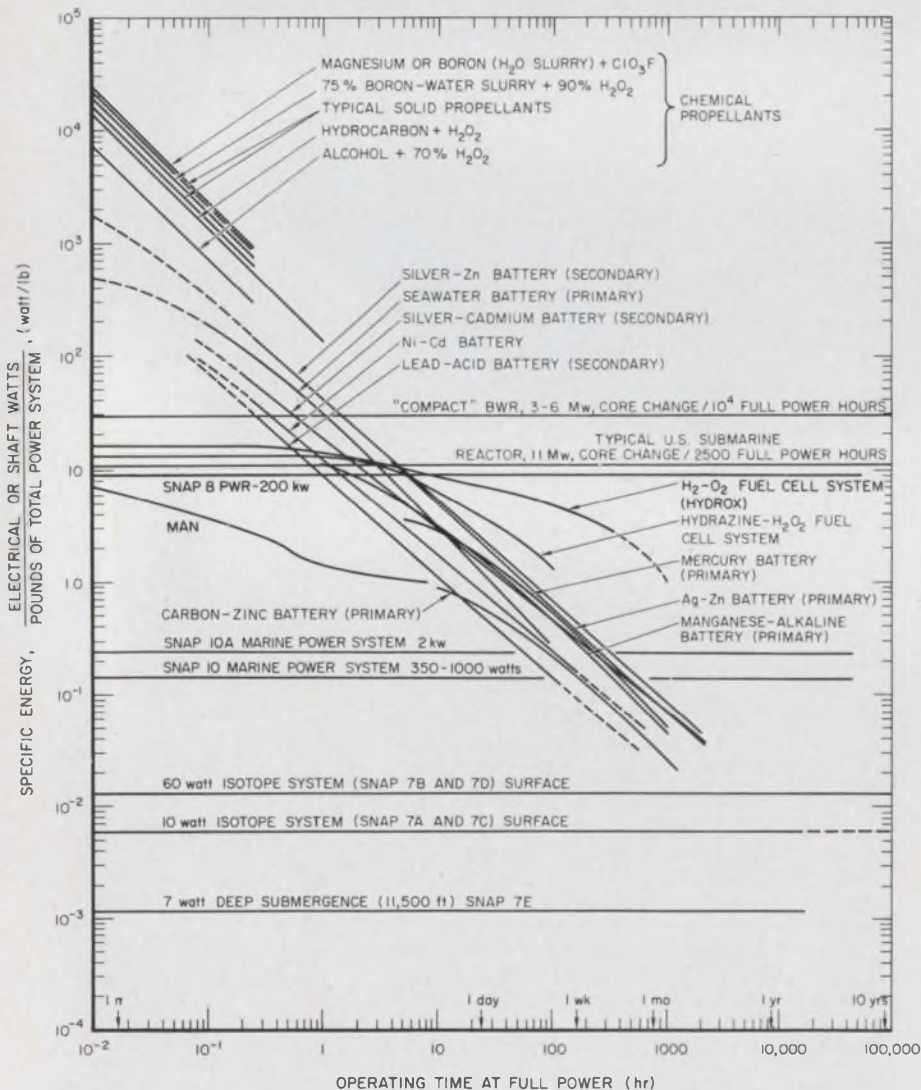

A comparison of the specific energy of various underwater power systems shows that nuclear types are especially suited for deep-sea missions of long duration. (Figure courtesy of Paul D. Cohn and Joseph R. Wetch, Atomics International, from the soon-to-be-published "Handbook of Ocean and Underwater Engineering.")

■ Pressurized-water reactor and Rankine cycle.

The first of these uses a radioactive isotope such as strontium-90 or plutonium-238 as a heat source and thermoelectric elements for power conversion.

The other systems all use a nuclear reactor for the heat source, with the thermal energy derived from the fissioning of uranium. In the conduction-cooled reactor system heat is conducted directly from the reactor, through thermoelectric elements for power conversion, and then dissipated in the sea water. In the liquid-cooled reactor system the heat is transported by a fluid to the hot junction of the thermoelectric elements. In the pressurized-water reactor system, which delivers the highest power of all the systems, the reactor is cooled by a pressurized water loop, and power conversion is obtained in a secondary loop that employs a standard Rankine steam cycle.

The reactor-systems are generally heavily shielded, are quite large, and deliver power in the kilowatt and even megawatt range. These would generally be used to supply large amounts of power for complex undersea operations or aboard submarines.

The isotope-thermoelectric systems are the simplest of the nuclear power sources, consisting only of a mass of radioactive material whose heat is conducted through thermoelectric elements to generate electricity. No starting or control is necessary.

A spokesman for Atomics International says that the smaller isotope systems, such as the SNAP-7, 15 and 21 series, will probably "really begin to catch on" for marine applications within three years. The SNAP-7 units have been undergoing tests for some time and are beginning to prove successful, he said.

The isotope systems are most attractive in the power range of a few watts to about 400 watts and can be designed for lifetimes in excess of five years.

#### Batteries limit long-term tests

The specific energy (watts per pound) of all types of underwater power systems is compared in the drawing.

Practically all self-contained un-

# Did You Know Sprague Makes 32 Types of Foil Tantalum Capacitors?

## 125 C TUBULAR TANTALEX® CAPACITORS



Type 120D polarized plain-foil  
Type 121D non-polarized plain-foil  
Type 122D polarized etched-foil  
Type 123D non-polarized etched-foil

ASK FOR BULLETIN 3602C

ON READER-SERVICE CIRCLE 821

## 85 C TUBULAR TANTALEX® CAPACITORS



Type 110D polarized plain-foil  
Type 111D non-polarized plain-foil  
Type 112D polarized etched-foil  
Type 113D non-polarized etched-foil

ASK FOR BULLETIN 3601C

ON READER-SERVICE CIRCLE 822

## RECTANGULAR TANTALEX® CAPACITORS



Type 300D polarized plain-foil  
Type 301D non-polarized plain-foil  
Type 302D polarized etched-foil  
Type 303D non-polarized etched-foil

ASK FOR BULLETIN 3650

ON READER-SERVICE CIRCLE 823

## TUBULAR TANTALUM CAPACITORS TO MIL-C-3965C



CL20, CL21 125 C polarized etched-foil  
CL22, CL23 125 C non-polarized etched-foil  
CL24, CL25 85 C polarized etched-foil  
CL26, CL27 85 C non-polarized etched-foil  
CL30, CL31 125 C polarized plain-foil  
CL32, CL33 125 C non-polarized plain-foil  
CL34, CL35 85 C polarized plain-foil  
CL36, CL37 85 C non-polarized plain-foil

ON READER-SERVICE CIRCLE 824

## RECTANGULAR TANTALUM CAPACITORS TO MIL-C-3965C



CL51 polarized plain-foil  
CL52 non-polarized plain-foil  
CL53 polarized etched-foil  
CL54 non-polarized etched-foil

ON READER-SERVICE CIRCLE 825

For comprehensive engineering bulletins on the capacitor types in which you are interested, write to:

Technical Literature Service  
Sprague Electric Company  
347 Marshall Street  
North Adams, Mass. 01248

49C-5551

**SPRAGUE®**  
THE MARK OF RELIABILITY

\*Sprague and ® are registered trademarks of the Sprague Electric Co.

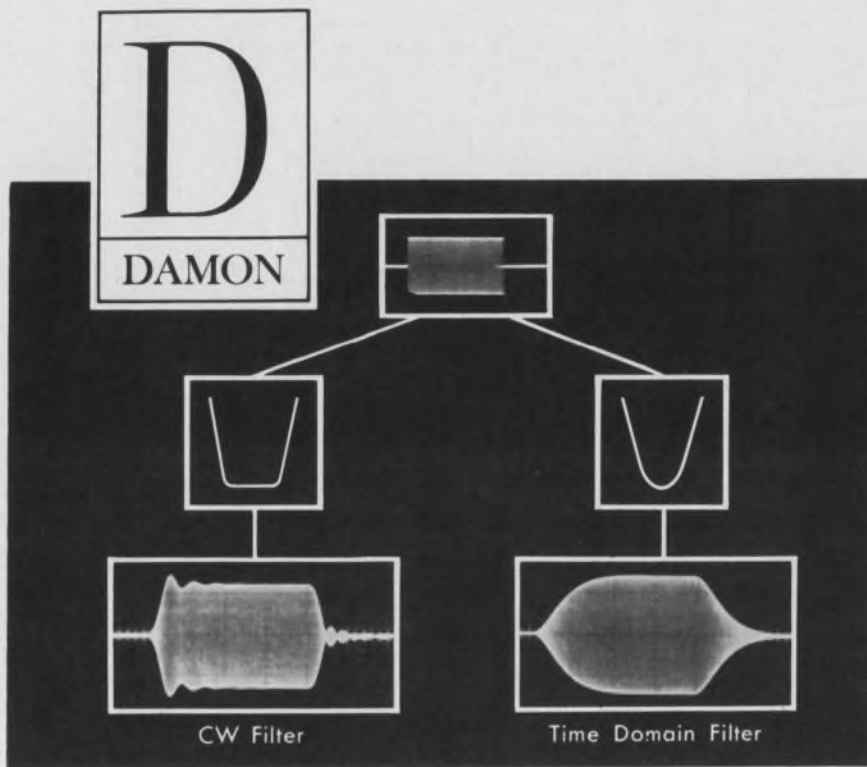

# Time Domain Crystal Filters

## Modern Network Synthesis Assures Specified Pulse Behavior

Damon applies advanced insertion loss design techniques to realize Time Domain Crystal Filters with prescribed transient behavior. Overshoot and ringing can now be eliminated in pulse systems. Damon has supplied filters with Gaussian, Bessel and Thomson polynomial characteristics. Completely eliminated are the pitfalls inherent in attempting to obtain desired pulse behavior from "equivalent" steady state design. Damon Time Domain Filters are aligned and tested under pulse conditions simulating actual equipment operation. Applications include Pulse Doppler Radar, FM-CW Radar, Spectrum Analysis, Pulse Interference Rejection, and Pulse Data Communications Systems such as PCM, FSK.

Write for Data on Time Domain Crystal Filters.

### DAMON ENGINEERING, INC.

240 HIGHLAND AVENUE, NEEDHAM HEIGHTS 94, MASS.

(617) 449-0800

Speed Inquiry to Advertiser via Collect Night Letter

ON READER-SERVICE CARD CIRCLE 12

## NEWS

(power sources, continued)

derwater electronic instruments in use today are powered by conventional batteries or fossil fuels. However, as Ronald Jones, scientist at the U.S. Naval Civil Engineering Laboratory, Port Hueneme, Calif., observed, batteries are the biggest stumbling block to long-term data collection.

He cited a current program at his laboratory in which test units are placed on the ocean floor at depths to 6700 feet. These units, which contain various materials, are exposed to the deep-ocean environment for as long as a year and are then retrieved.

The scientist noted that self-contained, battery-powered current and temperature recorders, as well as pingers (used to determine the position of the test units), stopped performing satisfactorily after six months. He attributed these failures in almost all cases to battery leakage or power loss.

The naval laboratory is now looking to SNAP radioisotope thermoelectric systems to provide steady, reliable low-level power (about 100 mW) for up to five years. Such units, Jones speculates, will use strontium-90, weigh from 150 to 180 pounds, including shielding, and cost about \$1000.

### Milliwatt SNAP units studied

The Atomic Energy Commission has contracted for several studies to determine the requirements for milliwatt power sources of from 150 mW to 1 watt. Following these studies, it is expected that within a year some representative nuclear "batteries" will be built and delivered for testing.

There is general agreement that if a high degree of reliability can be achieved with such nuclear power sources, they will prove economical in the long run.

Jones estimated that service and repair operations at sea can cost up to \$3000 a day just for ship rental. Thus if a 100-mW nuclear battery with a minimum reliable life of five years can be built for \$1000, or even for as high as \$5000, a long-term saving will result.

### Some units already on station

A number of the isotope sys-





**SNAP-21 radioisotope-thermoelectric generator** will be used for oceanographic research projects and underwater navigational aids. Under development by the 3M Co. for the Atomic Energy Commission, the 500-pound unit is fueled by strontium-90 and is designed to deliver 10 watts for a minimum of five years.

tems—especially the Martin Co.'s SNAP-7 series—are already in use or are in the operational testing stage in a number of marine applications.

For example, SNAP-7D supplies power for a weather station floating in the Gulf of Mexico. It produces 60 watts, has a design life of 10 years and weighs 4600 pounds, with most of the weight going into the shield. SNAP-7E, a 6.5-watt device, is even heavier (6000 pounds). It powers an acoustic beacon on the floor of the Atlantic. Another unit SNAP-7F, is used to operate a navigation warning device on an offshore oil rig. It produces 60 watts, has a design life of 10 years and weighs 4600 pounds.

Since this series uses strontium-90 fuel, all units are heavily shielded—which is one of the factors that has impeded wider use of the systems.

SNAP-21, presently under construction by the 3M Co., St. Paul, Minn., will be used for a variety of oceanographic research projects and underwater navigational aids.

Although fueled by strontium-90, the unit will reportedly produce 10 watts and weigh only about 500 pounds, because of more efficient shielding material.

The British have been operating two demonstration model strontium-90 fueled devices for navigation marker lights for a year. Each has an output of about 20 mW and a design life of 20 years. ■ ■

March 29, 1966



*basic measuring tools from*  
**HEWLETT  
PACKARD**

## *Field-proven hp 241A Pushbutton Oscillator*

Accurate, stable test signals for lab or production  
4500 discrete frequency selections, 10 Hz (cps) to 1 MHz (mc),  
vernier overlap  
3-digit pushbutton frequency resolution  
Frequency response flat  $\pm 2\%$  over entire range  
Frequency accuracy within  $\pm 1\%$   
Output  $-30$  dbm to  $+10$  dbm, 600 ohm output impedance  
Low hum and noise

### *Use it for:*

Production line and repetitive testing  
Calibrating ac-to-dc converters  
Response testing, narrow or wide band  
Low-distortion source in presence of shock, vibration, hf radiation  
Special versions for transmission line testing

In addition to the 241A, portable, solid-state oscillator, Hewlett-Packard offers the H30-241A (30 v, \$675) and H48-241A (48 v, \$650) battery-operated versions for transmission line testing, 100 Hz to 10 kHz. These versions offer balanced output, 600 and 900 ohm output terminals. The 241A itself is a true standard of the industry as a simple, fast, convenient source of test signals. \$490.

Call your Hewlett-Packard field engineer for a demonstration or write for full specifications of the model of your choice: Hewlett-Packard, Palo Alto, California 94304, Tel. (415) 326-7000; Europe: 54 Route des Acacias, Geneva.

*Data subject to change without notice.  
Prices f.o.b. factory.*

**HEWLETT *hp* PACKARD**  
*An extra measure of quality*



ON READER-SERVICE CARD CIRCLE 13

906

23



### ■ AT LAST— AN ALL-PURPOSE LINE OF LOW-CURRENT RECTIFIERS

Call off the search if you've been trying to track down a truly all-purpose 1.5-amp rectifier. Here's a new glass-encapsulated, general purpose device you can use almost anywhere. We call it the A14, and it's rated up to 800 volts PRV.

Try it out in your TV and radio power supplies, power logic circuits, free-wheeling rectifiers, battery chargers or communication equipments. You'll find they're great, too, for arc suppression and general purpose power supplies.

Every rectifier in the all-new line is transient-voltage protected . . . will dissipate voltage transients to 1000 watts in the reverse direction without

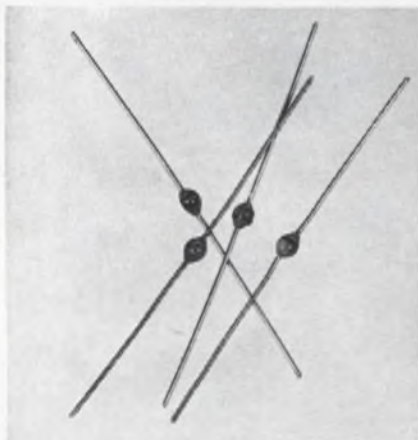

ACTUAL SIZE G-E 1.5-amp rectifiers

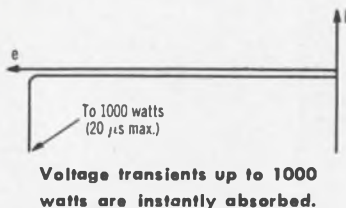

damage. Each device is hermetically sealed to keep harmful moisture out. Each features dual heatsink design for maximum heat dissipation under both surge and continuous duty. And all are available at competitive prices.

Want more details? Circle Number 811 on the magazine Reader's Service Card.

### Trigger Happy?

We are, if variety and breadth are what you're seeking in negative-resistance trigger device lines. G.E. offers no fewer than four major lines to choose from: unijunction transistors, characterized by their very stable trigger points; silicon unidirectional switches, character-

ized by fixed stable breakover voltage (6 to 10-volt range); silicon bilateral switches, bilateral versions of the SUS; and G-E DIACs, the ideal devices for low-cost TRIAC triggering on 120/240-volt a-c lines. Circle Number 813 to learn more about any or all of them.



Unijunction Transistor (UJT)



Silicon Unidirectional Switch (SUS)



Silicon Bilateral Switch (SBS)



DIAC

### ■ BREADBOARDING THE EASY WAY

Why re-invent a power control circuit that may already have been designed, built and stocked for you? Try these G-E standard TRIAC assemblies first:

- S100A1-4 Basic Variable Voltage Circuits
- S100B1-4 Extended Range Variable Voltage Circuits
- S100C1-4 Extended Range Variable Voltage Circuits (RFI Suppressed)
- S100D1-4 Combination Variable Voltage Circuits and Static Switches (RFI Suppressed)
- S100E1-4 Blower Motor Speed Controls with Set Low Speed (RFI Suppressed)
- S100F1-4 Basic Variable Voltage Controls (RFI Suppressed)
- S100G1-4 Static Switches

Each standard assembly is two inches wide, one inch high and three inches long complete with electrically isolated heatsink. Each is available both direct from G.E. and from your authorized G-E distributor. Try 'em. Or ask for more facts by circling Number 812. Ask about our specialty assemblies, too.

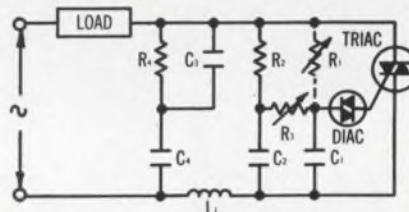

S100C1-4 Extended Range Variable Voltage Assembly with RFI Suppression

More information on all G-E semiconductor products can be obtained by calling your G-E engineer/salesman or distributor. Or write to Section 220-30, General Electric Company, Schenectady, N. Y. In Canada: Canadian General Electric, 189 Dufferin St., Toronto, Ont. Export: Electronic Component Sales, IGE Export Division, 159 Madison Ave., New York, N. Y.



## New prestige for Navy electronics

The Navy's new reorganization along Army and Air Force lines has given electronics a major boost in prestige. Most of the traditional bureaus—all that deal with weapons and hardware—have been abolished. A set of "systems commands" has been set up that reports to the Chief of Naval Operations through a "Naval Material Command." Formerly the almost autonomous bureaus reported to the Secretary of the Navy, bypassing the Chief of Naval Operations.

The new set-up is similar to the Air Force organization with its Systems Command. Gone are the Bureau of Weapons, Bureau of Ships, Bureau of Docks and Bureau of Supplies and Accounts. Replacing them in the new Material Command are an Air Systems Command and a Ship Systems Command, which, it now appears, will have slightly more stature than the four other new commands. The others are Electronic Systems Command, Ordnance Systems Command, Supply Systems Command and a Facilities Engineering Command. The Bureau of Personnel and the Bureau of Medicine remain unchanged.

Electronics activities have been split out of the former BuWeps and BuShips and, for the first time, have been set up in a major activity of their own. The new Electronic Systems Command will be headed by Rear Adm. Joseph E. Rice, present commander of the Naval Shore Electronics Center, Washington, D.C., and former industrial manager of the Washington Naval District. He will be in charge of 1000 persons in Washington and 3000 in the field.

The Electronics System Command will have full responsibility for all ground electronics. It will provide, under the systems management of the Ship Systems Command, shipboard communications, IFF (identification, friend or foe), electronic countermeasures, navigation aids, and air-traffic-control equipment, except for the antenna systems. It will support the Air Systems Command in navigation aids, air traffic control and meteorology. It will be responsible for satellite communications and the material support of the SPASUR tracking net; shore-based strategic data systems, such as

# Washington Report

S. DAVID PURSGLOVE,  
WASHINGTON EDITOR

those at operations control centers; data-link systems between ships and planes (but not on-board internal data links); and radiac equipment, except for installed shipboard monitoring systems. The command will also be responsible for general-purpose electronic test equipment and components, techniques and services common to all elements of the Navy.

## Pentagon reveals electronics plans

The Pentagon's electronic-equipment and R&D fund request for fiscal 1967, delayed this year until after special Vietnam supplemental appropriation requests were out of the way, contains plans for the following: accelerated development of missile-penetration aids; an increased effort on over-the-horizon radar; purchases of new Army vehicle radios and a start on the "area communications" concept, and what appears to be a major spurt in anti-submarine warfare electronics. At the same time the Pentagon plans to continue to get rid of a number of old radar installations—"reduce excess radar coverage" is the phrase used by Defense Secretary Robert S. McNamara—and is still holding up a decision on whether to procure and deploy Nike-X.

Although hinted before, it is now fairly clear that point defense systems, as represented by Nike-X, never will be installed. Instead the Pentagon seems ready to begin installation of area defense systems that would be combinations of Nike-X, Zeus and other elements still to be developed. McNamara told Congress that the timing of the deployment of some "light" antiballistic missile defenses would be paced by the progress that the Chinese make on development of nuclear warheads and their delivery systems. Observers, viewing this against the recently publicized timetable of Chinese progress, believe this means that some light anti-ICBM defenses will be under construction in the Pacific and on the West Coast by 1970.

## 'Spanish Civil War' in Vietnam?

One of Washington's leading "hawks" inadvertently confirmed a point that the Capital's doves have tried to make: that Vietnam has become a munitions and tactics proving

# Washington Report

CONTINUED

ground for U.S. and Allied forces, much the way that Spain was in the nineteen-thirties for the Axis and other military establishments. One of the Pentagon's most powerful supporters and a leader of the "hawks," Georgia's Senator Richard B. Russell, chairman of the Senate Armed Services Committee, made the point in a moment of exasperation with Gen. Earle G. Wheeler, chairman of the Joint Chiefs of Staff. Behind closed doors at hearings on the Vietnam supplemental appropriations bill, Senator Russell queried General Wheeler:

"What are we doing in research and development with all of these weapons systems that have fallen so far below expectations, such as [censored]. We have produced four or five weapons systems on which we have been relying very heavily for our very existence as a free country, and yet when we get them in combat where they are really tested, which is about the only benefit we are going to get out of this war—the actual worth of these weapons—and a defect develops, what do we do about it?"

The Pentagon would not allow the Armed Services Committee chairman to identify the weapons publicly. General Wheeler's reply was that Army R&D personnel and representatives of weapons contractors study the performance of weapons in Vietnam and "send back reports through military channels to the military commanders and to the appropriate research and development people in the office of the Secretary of Defense or in the services."

## Army seeks jam-proof IR systems

Can infrared surveillance and mapping be jammed from the ground? The Army is afraid so, but it wants to find out for sure. It is seeking an IR counter-counter-measure system. The Electronics Command at Fort Monmouth, N. J., has begun work on a project that will move laboratory tests to the field, where IR reconnaissance equipment will be evaluated against electromagnetic jamming under battle conditions. The Army is sure that the field studies will confirm what the laboratory has found: the equipment is vulnerable. The contractor selected will have to come up with ways to reduce the vulnerability.

At the same time the Edgewood Arsenal is planning a new IR project. The Army hopes to convert its mainstay chemical and biological-agent detection system, LOPAIR (long path infrared), to passive operation. Such a move would likely reduce the size and weight of equipment, and certainly its complexity,

according to officers. It is understood that an additional reason for the project is that the passive system would not be detected in operation, would not confirm an enemy's suspicions of the presence of U.S. troops and would not reveal our preparations against chemical, biological and radiological (CBR) agents.

Although the Army's long-range plans have called for reliance on LOPAIR and improved LOPAIR-type equipment to detect CBR agents, the Edgewood Arsenal has recently started to look at solid-state devices. At least one project is known to be underway to determine the possible role for solid-state detectors in spotting extremely small concentrations of airborne chemical agents.

## N.B.S. likes new industry computer aid

How do you look up information in a table? There's an art to it—if the information is to be used to program a computer, says the National Bureau of Standards. Union Carbide's Nuclear Division at Oak Ridge, Tenn., looked into problems that had been slowing computer programmers, decided that they were legion and turned the small project into a major endeavor. The result was a 21-page booklet that fell into the hands of a Bureau of Standards official.

The booklet suggests step-by-step guides to the sequential, the merge, the binary, the formula, and the computed position look-up. An N.B.S. evaluator praised the booklet as "a useful and succinct compilation for the practicing programmer," provided the programmer understands basic computer concepts. The booklet, "Table Look-up Techniques For Computer Programming," can be ordered by stock number (K-DP-515) from the Commerce Department Clearinghouse, Springfield, Va. 22151. The price is \$1 (50 cents in microfilm).

## EIA planning new series of reports

The Electronic Industries Association is considering several new areas for statistical reporting. Among the fields that may be the subjects of recurring reports are radar systems, marine communications and navigation equipment, nuclear-electronic systems, laser systems, power supplies, and radio astronomy equipment. EIA is also examining the availability of information and the need for special reports in several areas.

Under consideration are market studies in the use of telemetering transmitters in the trucking industry and an analysis of Federal foreign-aid funds available for electronics expenditures. The new studies and reports are being considered as part of the association's Industrial Electronics Division's new five-year plan, being developed under General Electric's Wayne Rash, division chairman.



# PULSE INSTRUMENTS



Type 1217-C

Type 1398-A

Type 1397-A

Type 1395-A

## High Performance at Minimum Cost

Type 1217-C Unit Pulse Generator is a new model whose applications are many and varied, ranging all the way from testing high-speed computing circuits to physiological pulse simulation.

Pulse Repetition Frequency: controllable internally from 2.5 c/s to 1.2 Mc/s or externally from dc to 2.4 Mc/s.

Rise and Fall Times: 12 ns.

Pulse Duration: adjustable from 100 ns to 1.1 s.

Output: positive and negative 40-mA current pulses available simultaneously; adjustable to 40 V, peak. Positive and negative sync pulses and a delayed synchronizing pulse are also provided. Single pulses obtainable with the accessory Type 1217-P2 Single-Pulse Trigger (\$25).

Price: \$275 in U.S.A.

This generator requires an external power supply, such as GR's Type 1203 Unit Power Supply, \$65 in U.S.A.

## Fast Rise and Fall Times

Type 1398-A Pulse Generator is basically a Type 1217-C Unit Pulse Generator (see above) with a self-contained power supply, higher output, and improved output-pulse characteristics. Rise and fall times are less than 5 ns, and the output consists of positive and negative 60-mA current pulses, providing 60 V across the 1-k $\Omega$  internal load impedance.

Price: \$535 in U.S.A.

## Linear Amplifier with 1.2-Ampere Output

Type 1397-A Pulse Amplifier output pulses have typical rise and fall times of 50 ns when used with Types 1217-C or 1398-A Pulse Generators. Can also be used as a pulse shaper with rise and fall times continuously adjustable from 0.1 to 100  $\mu$ s.

Price: \$495 in U.S.A.

## Produce Any Pulse You May Want

With the Type 1395-A Modular Pulse Generator, you can order only the pulse-generating capability you require. Five different modules are available, and as many as seven modules can be inserted in the main frame. Modules can be arranged in 38,400 different combinations.

Buy a main frame and as many modules as you need to custom-build your own pulse generator.

**PRF Unit:** provides internally generated repetition rates from 2.5 c/s to 1.2 Mc/s, from dc to 2 Mc/s when driven externally. Can use 7 per frame. Price: \$160 in U.S.A.

**Pulse/Delay Unit:** delays input pulses from 100 ns to 1 s and adjusts amplitude, polarity, and duration. Can use 7 per frame. Price: \$190 in U.S.A.

**Pulse Shaper:** adjusts rise and fall times from 100 ns to 10 ms, either individually or simultaneously. Limit of 3 per frame. Price: \$375 in U.S.A.

**Power Amplifier:** delivers 20-V pulses of either polarity into a 50-ohm load. Limit of one per frame. Price: \$270 in U.S.A.

**Word Generator:** produces binary words up to 16 bits long; as many as seven modules can be cascaded to provide 112-bit capability. Can use 7 per frame. Price: \$400 in U.S.A.

**Main Frame:** contains power supply and other circuits that are common to all modules. Price: \$575 in U.S.A. (without modules).

Write for Complete Information

## GENERAL RADIO COMPANY

WEST CONCORD, MASSACHUSETTS

BOSTON • NEW YORK • CHICAGO • PHILADELPHIA • WASHINGTON, D.C. • SYRACUSE • DALLAS • SAN FRANCISCO • LOS ANGELES • ORLANDO • CLEVELAND — TORONTO • MONTREAL  
GENERAL RADIO COMPANY (Overseas), ZURICH GENERAL RADIO COMPANY (U.K.) Ltd., BOURNE END, ENGLAND

# TRW IGFET

## 24 DB gain / 120 DB dynamic range at 100 Mc

The TRW 2N4038/PT200 Insulated Gate Field Effect Transistor has many unique characteristics that will intrigue and inspire the resourceful designer.

- **N CHANNEL:** Enhancement or Depletion Types.
- **HIGH G<sub>m</sub>** ( $\approx 2000 \mu$  mho): RF/IF Amplifiers, AC/DC Amplifiers.
- **LOW NOISE** (3 DB): RF/IF Amplifiers, Mixers, AC/DC Amplifiers.
- **LOW FEEDBACK** ( $C_{gd} = 0.2$  pf): Choppers, Multiplexers, RF Amplifiers.

- **TRUE SQUARE LAW DEVICE:** Product Detectors, AGC Amplifiers.
- **HIGH INPUT R** ( $10^{15} \Omega$ ): Logic Circuits, Instrumentation.

If you have an unusual circuit design problem, TRW IGFET technology may solve your problem. Get your IGFET at local distributors or write TRW Transistor Plant, 14520 Aviation Boulevard, Lawndale, California 90260.

TRW designs and manufactures high performance transistors for the communications industry and specialized types for military and industrial applications.

**TRW** SEMICONDUCTORS

ON READER-SERVICE CARD CIRCLE 14

**Co-Publishers**

James S. Mulholland, Jr.  
Robert E. Ahrendorf

**Editorial Director**

Edward E. Grazda

**Editor**

Howard Bierman

**Managing Editor**

Robert C. Haavind

**Technical Editors**

Joseph J. Casazza  
Rene Colen  
Maria Dekany  
Richard Harnar  
Mark B. Leeds  
Neil Sclater

**News Editors**

Frank Egan  
Roger K. Field  
Alfred Rosenblatt

**West Coast Editors**

Ralph Dobriner  
Peer Fossen

**New Products Editors**

Patrick Cook  
David Surgan

**Washington Editor**

S. David Pursglove

**Editorial Production**

Dollie S. Viebig  
Anne T. Lombardi

**Art Director**

Clifford M. Gardiner

**Art Assistant**

William Kelly

**Technical Illustrators**

Lewis D. Hill  
Leonard P. Levenson  
Cheh Nam Low

**Production Manager**

Thomas V. Sedita

**Asst. Production Manager**

Helen De Polo

**Production Assistants**

Carl Merkin  
Bernard Wolinsky

**Circulation Manager**

Nancy L. Merritt

**Reader Service**

Diane Pellechi

## E|D EDITORIAL

**Here are some winners . . .**

At least 3322 of you will remember our "Top Ten" contest, featured in our January 4 issue—because that many entries arrived within 30 days after issue mailing. The contest invited you to pick what you considered to be the ten advertisements that all readers would be most likely to recall. The winners are announced in this issue (p 65). The "Top Ten" advertisements are displayed on pp 66 to 79. Look them over again. Why did most readers remember them? Advertising experts might say the copy was brightly worded, the art work was eye-catching, the color helped. And they might be right—up to a point. But what do design engineers look for in an advertisement?

We suspect they look beyond the flashy layout. Clever phrasing, humor, sex appeal—all the traditional "come hither" of Madison Avenue—might sell engineers a sports car, or shaving cream, or a new toothpaste. If the product is bad—well, it's not that earth-shaking really, is it? You can always switch to Brand X next time, with no great harm done.

But precision engineering equipment is different. Mistakes can be costly. Defects may wreck a whole product line. So while the advertising layout may attract the engineer's attention, he also is turning over in his mind some hard questions about the product's efficiency and reliability.

In this respect, ELECTRONIC DESIGN has, since its inception, followed one strict rule: We never knowingly accept false advertising. We reserve the right to refuse any advertisement deemed misleading or fraudulent.

We welcome comments from our readers, in enforcing this policy.

**. . . And here are some losers**

Don't envy the college graduate who is pursuing an advanced degree—not if his interest was advanced physics. Federal budget cuts in the last two years, coupled with sharp increases in equipment costs, have seriously hampered research programs in advanced physics, according to a recently published survey by the National Academy of Sciences.

Only 7 percent of the funds requested by new physicists have been awarded this past fiscal year, with most of the backing going to space-oriented projects. Although Federal support for physics research has increased by 6 to 7 percent, inflationary costs have more than offset these grants. For this reason, the survey proposes an annual 21 per cent increase through 1969, followed by a 16 percent rise thereafter.

The survey reports the U.S. is presently a leader in three of six fields of physics—elementary particle physics, solid-state physics and the study of atomic and molecular structure. However, weaknesses exist in astrophysics, plasma physics and nuclear physics. Particularly unfortunate, the survey says, is a "precarious situation" in solid-state physics; here, research gains in understanding the atomic structure of materials could lead to the ultimate in strength, heat resistance and other desirable properties in materials.

Recent gains in basic research by Japanese, European and Soviet physicists clearly indicate an increase in spending by these nations. To maintain its leadership, the U.S. must back its physicists and scientists, the survey concludes. There just doesn't seem to be any good reason for the nation and its physicists to be losers.

HOWARD BIERMAN

## AN EXCLUSIVE INTERVIEW

## Reaching for the Moon . . . and beyond

**Engineer-astronaut at U.S. space center outlines, in an informal chat, some of the electronics problems that the nation's Apollo program is facing.**

**Robert Haavind**  
Managing Editor

Roger B. Chaffee is an unusual engineer. Like almost any engineer, he has an undergraduate degree—in aeronautical engineering from Purdue University. Like some others, he has started work on a master's degree—in reliability engineering at the Air Force Institute of Technology, Wright-Patterson Air Force Base. Like fewer still, he is a rated pilot, who once tested jet planes. And, at 31 years old, he is in rare company. He is an astronaut.

Chaffee is busily involved in the Apollo lunar-spacecraft program. From a modest office at the United States Manned Spacecraft Center in Houston, Tex.—an office not much different from other engineers' offices in electronics plants around the country—he is liaison man for Apollo communications systems. He also has responsibilities for the attitude and translation-control-systems for the spacecraft. Correspondence, memos, instructions and other printed dispatches flow IN and OUT. The phone rings, and near-impossible technical re-

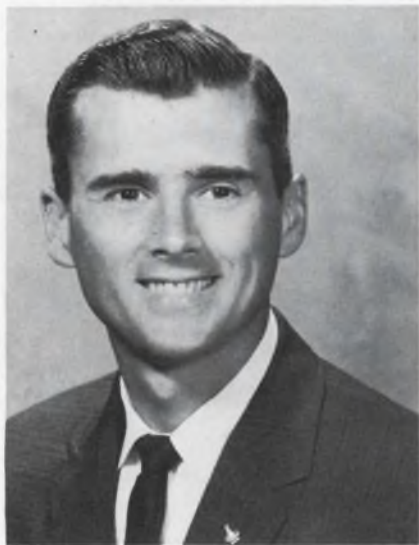

**Astronaut Roger B. Chaffee**

quests, to be filled on near-impossible schedules, reach Chaffee's ear. Like engineers everywhere, he carefully explains that doing the near-impossible sometimes takes a little time, but he promises to do all he can to get the job done as rapidly as possible.

The astronaut works in civilian clothes, though he is a Navy lieutenant. He is married and has a son, 4, and a daughter, 7. He travels a good deal to check on equipment. At other times, as part of his training, he takes part in field surveys that broaden his education. He is learning about geology, for example, so he will be able to identify rock formations on the moon.

Chaffee consented readily when ELECTRONIC DESIGN asked to interview him in his office. In an hour-and-a-half conversation, he told how the astronauts feel about some of the electronic systems that will one day guide them to the moon and provide their only link to the earth. Not given to bluster, Chaffee said his knowledge of electronics was scanty, but, as later answers reveal, it wasn't as superficial as he was inclined to make it sound. He pointed out that astronauts are concerned with the outputs of systems and the functions of black boxes, rather than with the workings of the hardware inside. This led naturally to exploration of the first subject of the interview—on-board repair and redundancy.

### Redundancy and repair

**Q.** How is redundancy being used in Apollo?

**A.** In Block II (the latest communications and data subsystem designed for the lunar mission) everything that we have is redundant. We have redundant components in all our systems—stabilization, control, communications—but it's switchable redundancy.

We don't change any components. We just switch from the primary system to a back-up.

**Q.** You don't have automatic switching?

**A.** In some of the components we do, yes. Like the premodulation processor. Block II has two power supplies. These are automatically switched in case sensors detect a failure. Some of the switching is manual, some of it is automatic. Let's take an example. In our PCM telemetry box we have three sections. There are two of each of these sections. Everything starts running in system A. There's an error detection system in each section, and it detects any errors in the output—within its test group ability—from that section. If an error occurs, the system automatically switches to box B. Then you can't get back into box A except by actually turning the equipment off. If it's a transient-type failure, you completely shut off power and then start it up again. This would be like starting a new system, and if the failure, the error, was no longer there, everything would start in system A. The ground knows which parts of A and B are in operation.

**Q.** Can you tell that on the spacecraft?

**A.** No, there's no reason to. I guess the only situation where this might be necessary is: Suppose we had a failure in one of our A boxes. And then, later in the mission, B in that section failed also. If B failed completely, and A was only a partial failure, we might want to try to get back into A. Maybe it was a transient that caused A to switch to B. So we interrupt power and start up again and see whether we stay locked up. The ground knows which boxes we're using and they can tell us whether the system is still in A or it has switched back to B.

Things such as our S-band transponders, our vhf equipment, our S-band power amplifiers—where



there are two aboard—are all switchably redundant. The pilot can switch them.

**Q.** Would you rather do in-flight maintenance? Would you feel more secure if you knew that if something went wrong, you could at least try to fix it?

**A.** Not in the electronics. As you know, these systems are pretty complex. You're talking about welded joints that are made under magnifying glasses, with precision-heat-controlled ovens. And there are quite a few integrated circuits. I don't think we could bring enough test equipment and tools along to make repairs, really.

**Q.** What about just pulling out a block and putting in a new one?

**A.** If we have to carry two blocks, I'd rather have a switch so that I could switch from one to the other. It doesn't cost me any more. I've got to store it some place, anyway. The only addition in weight is the cabling and the hardware associated with the switch. The best way is to build the extra blocks into the spacecraft at the start.

Actually, it might end up lighter that way. Once you bolt your components to the cold plates, you don't have to have removable fasteners. In Block I we had a rather exotic system of wedges that you drove in on a screw to hold components to the cold plate. You had to release the wedges to take the box out, turn it around—swap ends—or put a new box in. You needed a special tool to put back the wedges. It was a pretty time-consuming job; sometimes it took an hour to change one box. There's another problem. If for some reason your cabin isn't pressurized and you are in a spacesuit, you find that working is quite difficult, especially inside the spacecraft. Then changing the boxes would have been at least an hour's job.

**Q.** When do you think full double redundancy is needed?

**A.** It depends on what the component is, and what the circuit is, and what reliability goal has been placed on it. To take an example, consider the premodulation processor. It processes all signals—audio, telemetry and up-data. Generally



**Lunar Topographical Simulation Area** provides an eerie setting for tests of the portable life-support backpack and a "lunar walker." The backpack system weighs about 60 pounds on earth, 10 on the moon. The walker helps the astronaut move over the rough terrain in his bulky suit.



**Geology training** takes Astronauts Chaffee (left) and Eugene Cernan to Grendavil in southwestern Iceland to study land faults.



**Chaffee studies map** during another field trip to Medicine Lake, Calif., to collect and study geology specimens.

(Astronaut . . . , *continued*)

we have signals feeding different amplifiers, and the outputs modulate a sub-carrier, and it's the reverse coming back. Now we only have one—even though it's the heart of the system—yet we have a tremendous amount of internal circuit redundancy, such as series-parallel resistors. The only part of that system that is completely redundant is the power supply. Complete redundancy is also used for other critical things, such as the fuel valves to the main engines.

### Systems design and displays

**Q.** What general advice would you give to designers working on systems for spacecraft?

**A.** I couldn't tell design engineers how to build their systems, because I don't have that much knowledge of it. But one thing that I have noticed is that designers tend to get so engrossed in each particular little black box that they aren't sufficiently aware of the over-all picture. At some point in time you may have a highly efficient transmitter, for example, but you know you can build a better one. Well, the best thing to do is to quit playing with it. It's only the world's second best, but you know it will do the job. There often isn't time to build the world's

best. Also, as systems get more complex, reliability begins to go down, weight begins to increase, and it gets difficult to keep the equipment working properly.

Here's the trouble: Instead of starting from the system's viewpoint that the equipment must be reliable and get the job done, designers will build a fancy L-band or X-band transmitter and then try to fit the job to it. We've seen a lot of over-design.

We prefer systems using proven designs; as simple as feasible. That's one reason why there's not much microelectronics in Apollo. Oh, there's a little, in the computer and the stabilization and control system. At the time the system design was done for Apollo the most reliable equipment then available was welded modules of cordwood construction. Those are used primarily in Apollo systems. Of course our systems would be a lot lighter if we'd gone to integrated circuits. But at the time the reliability of microcircuits hadn't been proven, and no one really knew how fast they would improve. Weight is important, of course, and undoubtedly the next generation of manned spacecraft will use much more microelectronics.

**Q.** What about displays? Do present types seem adequate?

**A.** Generally, yes. Most of the displays that we have are the results of our work here. They were built to our specifications. The designs were worked out with the help of the astronauts, as well as human factors specialists, and they seem to be working out quite well. They seem to have sufficient light output so that they're visible at some distance.

Present research efforts are aimed at finding out how accurately we can build the displays to actually represent the parameter being measured. In some cases the errors add up to give quite inaccurate readings. This can cause trouble in things like rendezvous. One thing we're short on right now is a really accurate radar altimeter. We have one now but the accuracy isn't quite as good as we would like to have it for the lunar landing. The radar has to radiate and receive back through a rocket plume and a lot of flying debris and dust. What

we're bound up in right now is the accuracy within the lower hundred feet or so. We can do it with the present radar, but this is one case where we would really like to improve it.

**Q.** Do you have a good chance of being within the group that makes the first trip to the moon?

**A.** Your guess is as good as mine. We don't like to speculate on things like that so far in advance.

**Q.** Do you want to be?

**A.** Oh, certainly! There are 31 of us here that want to make the first trip. We obviously can't all be, but there's no question we'd all like the chance.

### Mars and beyond

**Q.** What type of electronic equipment do you foresee will be needed for manned exploration of Mars and other planets?

**A.** Basically, it's going to be the same type, as far as functions go, as we have now. We're going to need ranging systems between spacecraft that will be accurate to a couple hundred yards. We're going to need electronic guidance and all of the common test systems.

I think one of the things that will become more necessary as we go to the planets will be better strap-down inertial systems. In Apollo we have a stable platform, a gimballed platform, that we use as an inertial reference. But for a back-up system, we have a strap-down inertial system that uses three rate gyros. We integrate the outputs of the gyros and compute total attitude. We then compare this with the gimballed system output to correct any error. We'd like to use a strap-down system as a primary reference, but you can't make one that's as accurate as a stable platform system because of problems in the loop made up of the gyro and its associated electronics. With the present state-of-the-art the drift of such a system is just too great. However, one advantage of the strap-down system is that it uses a lot less power.

Some of the other systems under development might be useful. Air-mounted gyros, for example, or some of the more exotic types. People are even playing with the angular momentum of molecules and using magnetic fields to estab-

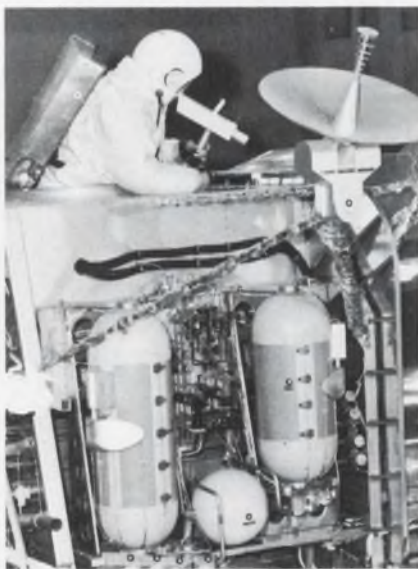

Wearing a lunar thermal suit, Astronaut Charles Conrad emerges from the upper docking tunnel of a LEM mock-up.

lish a stable reference [nuclear gyros].

Inertial reference systems using some of these devices might prove to be lighter, more reliable, more accurate and to use less power than conventional inertial reference systems using a stable platform. I think that strap-down gyro system accuracies are going to be competitive with conventional stable platforms within the next 5 to 10 years.

One thing that we're really going to have to work at is integrated-circuit equipment. We're going to need it in order to provide the redundancy necessary for long flights. Right now we're talking about an 8-day trip to the moon. Well, compare this to a 600-day round trip to Mars—you'll need a lot more reliability. It turns out that for things like trips to Mars you'll even need such things as redundant antennas. Of course, you wouldn't think that an antenna could fail. But they'll have to be steerable, and with a steerable antenna you have quite a few things that can fail. Reliability figures will also be critical for computers and communications equipment. All of these things present a challenge to the electronics industry. How can systems be designed to survive a mission of this length and complexity?

We're even going to get more sophisticated electronic support control of our environment support system.

Now a lot of things are basically operated manually. Ultimately there'll be more electronic control. This sort of controlled environment system isn't quite within the state-of-the-art at present.

**Q.** Buckminster Fuller, the inventor of the geodesic dome, believes that the most important contribution of the space program in the evolution of mankind is the development of completely self-contained environments. Thus, man would not need the earth to support him. Can you visualize such systems, where man would go to the stars while generations pass?

**A.** I wouldn't say anything's impossible. I remember when I was a boy, 5 to 10 years old, Buck Rogers was pretty far out then. But essentially we're doing those things now. Regenerative life systems are definitely possible, we know that already. In fact, several have been in operation in which food is converted to waste products and the wastes back to food. Also oxygen-carbon dioxide-oxygen cycles.

Of course, the other problems are tremendous. You wouldn't want to build a system for just one man, you'd want to make it suitable for families; so considerable weight would be involved. We'd need bigger boosters to allow us to get such heavy systems into space. Of course, our propulsion power is increasing and the system can be assembled in orbit. I think it will

be possible within 5 or 10 years to have systems like this ready for test in some of our larger orbiting laboratories. We'll need data like this in order to move further out into space.

### The voyage to the moon

**Q.** Have you heard about the Pilgrim concept? A book was written about the idea that the Russians or the Americans could send a man to the moon and then keep shooting food at him, and oxygen and other supplies. Then he would just wait there until a system was built that could bring him back.

[Laughter]

**A.** I've heard of it. There was a piece in the paper about it. But I don't think either the Americans or the Russians are going to try it. This just isn't the way to go about it. By the time you have a system developed that could land a manned spacecraft safely on the moon, you've got most of your problems licked. All you need to add is a booster to get the man back. If you don't have the complete system for him to live in and get back in, you've got to have at least two successes in a row. One to leave him there, and at least one other, unmanned, to make an automatic landing, pick him up and bring him back. With other successful landings needed to bring him supplies, this would be an expensive operation.



Sweating out a stroll over a simulated lunar landscape, John Slight, test engineer, wears an Apollo pressure suit, a thermal over-garment, and a life-support backpack. A Jacob's staff here aids in walking. He is approaching a full-scale mock-up of the LEM used in simulation studies.

(Astronaut . . . , *continued*)

**Q.** When the manned landing on the moon is made, wouldn't it be reassuring to have a back-up system so that they could send someone else up to try to get the astronauts back?

**A.** We're not working on the theory of a rescue mission. We've been working from the beginning on the theory that the original system will be sufficiently reliable so that we can make it back.

It would be extremely expensive to have a back-up system. You'd have to have two separate Saturns, with two separate crews, ready for launch almost simultaneously, in order to have the second system react in time to do any good. You'd

have to design different systems, because you couldn't use the same system for the rescue; you'd have to have room for two extra astronauts, so that you could get them back.

**Q.** What about navigation on the trip? There have been reports that the astronauts couldn't see the stars through the windows of the Gemini vehicle in daylight. Yet the designers of the Apollo equipment are certain that the telescope optics will allow the stars to be seen under daylight conditions.

**A.** Actually I don't know what the light illumination figures are for the Gemini windows or the Apollo telescope. But I daresay the telescope isn't much better in daylight than the Gemini windows. We will be doing on-board navigation, even though the spacecraft will always be

tracked by radar. We will be trying to take star sights in daylight—on the night side there's no problem—and it is true that the astronauts haven't been able to see the stars through the Gemini windows.

**Q.** Well, on the moon it would be mostly daylight, wouldn't it?

**A.** Yes, but if we get some pretty low sun angles, we should be able to see them there. If we look away from the sun or the reflection from the lunar surface, they will probably be visible.

**Q.** Is there a back-up system for navigation?

**A.** You do have navigation information and range transmitted during the flight, all the way to the moon, for your reference. Your navigation around the moon is what's really critical. First, it puts

## U.S. Space Center: the Laughs, the Tensions

### "PALM READING."

A crudely drawn hand gives emphasis to this sign on a laboratory door at the Manned Spacecraft Center in Houston. The sign itself reveals something significant about the center, which operates usually in earnest, Government-regulations fashion.

That is that humor is still alive there, despite the deadly serious business of getting a man to the moon by 1970—or before the Russians do, at any rate.

Though the center might wish for an omniscient palmist to give it some hint, however small, of how events will turn out around 1970, there is a general feeling of confidence everywhere. People are busy; equipment is being built, checked, changed, re-changed. New developments are emerging. The atmosphere might be described as one of "intense calm."

There is obvious mutual respect among team members. At the same time there is a cautiousness toward outsiders. And, as in any intense effort in which the stakes are high, the submerged frustrations, the minor frictions between team members, sometimes break into the open.

The astronauts are the "glamour boys" of the program, of course. And they have a lot to say on equipment. When equip-

ment doesn't work to their satisfaction, the designers and technicians may find themselves rolling up hours of nervous overtime. At such times more than circuiting may sizzle, more than wiring may be frayed. Hearing of a comment by an astronaut on a possible problem in the operation of an Apollo system, an engineer mutters: "That sounds just like an astronaut!"

The astronauts are not always happy with the designer's tendency to redesign and redesign again. In one lab a young engineer built a microcircuit version of one of the boxes used in Apollo. It was lighter, smaller, and used less power than its equivalent welded-module counterpart. He put it together in his garage in about 10 hours.

Yet the device probably won't be used in Apollo. The problems of integrating it into the rest of the equipment, redistributing weight, changing wiring diagrams, might foul up schedules.

It turned out that the manager had encouraged the young designer to build and test the new equipment. If any weight problems developed or new requirements came along, he wanted to be ready to move without wasting valuable weeks.

The team members know where they are going. Their engineering is careful. For the

most part they are using well-known, proved designs. In a few areas, where they know reliability will not suffer, they have gone to the latest developments. But so far integrated circuits (as Chaffee explains in the interview) have been used sparingly.

Still, there has been no fear of pioneering, when necessary. The spacecraft-simulation system used is probably the most advanced in the country. Massive simulation problems are run by a group of engineers, under James Lawrence. They have tied together a virtual image-projection system with a scene-generation computer, built by General Electric; four Electronic Associates 231R analog computers; a Raytheon system including a general-purpose digital control computer, a Trice 440 DDA, and a total of 48 D-A and A-D converters; a hybrid computing set-up including a Comcor 6500 analog computer, a DDP-24 digital computer, an Applied Dynamics 256 analog computer and an Astrodata linkage system.

What the space team seems to fear most is that some high-placed "meddler" will suddenly demand a shift in the program that will set it back irretrievably. Barring such an unfortunate incident, it's not hard to believe that the team will reach its goal by its 1970 deadline.

you into the proper orbit, and then you want to find your orbital parameters—although you're not really looking for that directly. You take a few fixes, and your computer does the rest. You need to establish your orbit, so that you can land in the proper place.

On the ground you can do the same thing. They will be continuously tracking, and they will be able to establish the orbital parameters, so that you can land in the right spot.

**Q.** There's a tricky part of the mission where you have to rendezvous with the lunar orbiting vehicle. The proper time to launch will be critical. Do you think that will work out well?

**A.** Yes, I think so. Of course, you have to launch at a certain time to meet the Command Module, within a certain "window," but the window is fairly lenient. You have about 20 minutes. I don't think there'll be any trouble with the rendezvous itself. I think that the recent Gemini 6 and 7 flight—or "Gemini '76," as we've been calling it around here—was a good demonstration that the rendezvous can be accomplished. The pilots involved in the flight were backing up the computer with manual calculations, just to see if it could be

done, using instructions from the ground. And it didn't appear that they were having any problems. In fact, it appeared that it was somewhat easier than we had anticipated from ground tests.

**Q.** Does it get confusing trying to keep track of all the things that are going on in the space vehicle? What about something like a tape recorder that tells you when to watch out for something, or when to adjust something, or calls your attention to some condition?

**A.** That's really two questions. First, does it get confusing; and second, do we need a prompting device.

I don't think it's confusing, at least according to the experience of the men who have flown in Gemini. The panels and controls aren't any more confusing than those in a modern jet aircraft. Now, of course, none of us have any flight experience in Apollo, and this represents, probably, another order of magnitude of complexity in a spacecraft—more systems. I would say that people are going to specialize; for example, one of the guys will be a top-notch specialist on one system. He'll have a broad knowledge of the other equipment, but he'll know a lot more about his own equipment.



**Model of a small region of the lunar surface with astronaut and LEM (Lunar Excursion Module), along with Surveyor unmanned exploration vehicle. The lunar model was constructed from a photo sent from Ranger VII.**

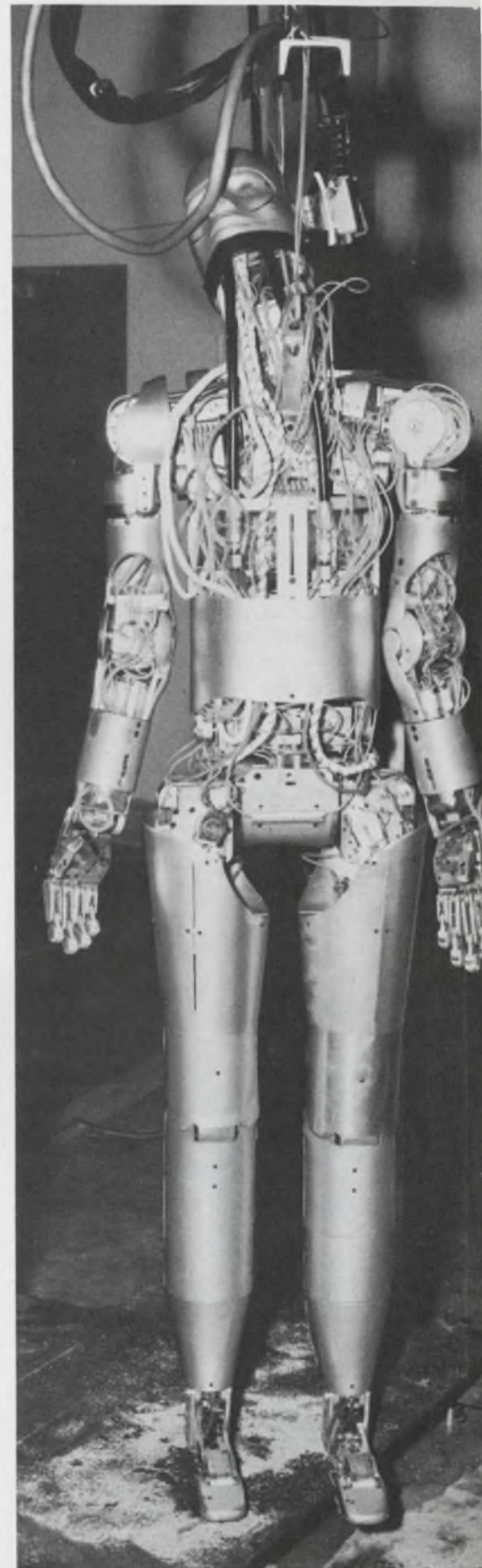

**Robot astronaut was used to evaluate suit mobility. It simulates a combination of 35 human motions. Torque sensors on the limbs measure the force needed to bend joints.**

(Astronaut . . . , continued)

As for the prompter, we have a caution and warning system in the spacecraft, and this gives us an output from our sensors the same way that the various displays do. Sometimes the warning devices are redundant, or sometimes they're the only indication that we have of a particular condition. All the critical parameters in the spacecraft—and by critical I mean the real serious type—are monitored by this caution and warning logic system. If one of these parameters is out-of-limits, the master alarm light comes on on the master display and control console. This light comes on no matter what parameter is out of limits.

Then you look up at a big display board [points up to a sketch of the Apollo interior lay-out on the wall behind his desk] right in here, where there's a matrix of lights, there must be forty of them, just like we use in modern aircraft today. Each one has a different label. No matter what parameter is out, its particular light will turn on. For example, you've got lights for the inertial measuring unit, inverter No. 1

(maybe temperature's high), fuel-cell No. 1 off the line (maybe due to an over-voltage).

Well, now, each one of these lights has a number of conditions it monitors. The fuel-cell No. 1 light, for example, will go on when any one of 11 parameters goes out of limits. If the light goes on when nobody's looking at it—say you were down underneath in the lower equipment bay, doing something—it also sounds a warbling audio tone in your headset. It tells you one of the lights is on, so you go up and look at the console. Then you would proceed to trouble-shoot the system and find the specific problem that turned on the light.

Now take the fuel-cell No. 1 light. There are 11 parameters that can trip it, so all it tells you is that something's wrong—not really what. Then you go to your standard instrumentation—such things as monitors; dc amps out of voltage, hydrogen and oxygen flow rates, anything that's indicative of a leak; pH sensors that would be indicative of an electrolyte leak that could get into your drinking water; pressures or temperatures too high or too low—the things that tell you whether to cut the system off or what to do. You could have gauges for all of them, or you

could use the same set of gauges for similar systems. In the case of the fuel-cells, you have the same set of gauges and you select either fuel-cell 1, 2 or 3. Then you go to your standard isolation procedures to correct the trouble.

So, in a way, we do have a tape-recorded voice saying what's wrong, but maybe in a little broader sense than to specifically say, "You're drawing too many amps on a fuel cell."

These lights are also coded to help interpret the seriousness of the trouble. Some of the lights are yellow, they are the caution lights, and the more serious, or warning lights, are red.

**Q.** When the landing on the moon is made, will both astronauts be out of the LEM at the same time? How will they talk to each other?

**A.** It will be possible for two to be out at once. Of course, the LEM carries two men, and you can operate it either way—two men out or one man out. The back-pack, that is the personal life support system to give the extra-vehicular mobility you need, has in it two transmitters and two receivers in addition to the oxygen system, the cooling system and everything else. So the two astronauts can talk to each other, or they can talk through the spacecraft to the earth. The LEM has a relay capability. Whatever it receives by vhf, it can put on the unified S-band system down to earth. And whatever it receives on S-band from the earth, goes out by vhf to the astronaut, or astronauts, all the time. There will be a tremendous amount of flexibility.

**Q.** How much do the back-packs weigh?

**A.** In the neighborhood of 60 pounds.

**Q.** Which will be about a sixth of that on the moon?

**A.** Yes, about 10 pounds.

**Q.** So it would be heavy here, but up there it won't be much to lug around.

**A.** No, it shouldn't be. Of course, there are a lot of other things. Thermal and micrometeorite garments for protection. I don't think weight will be any problem. It can become a bit bulky up there, though. ■ ■



**Tense moments in the blockhouse** will be common on the ground, as the Apollo mission progresses from stage to stage. While astronauts roam about the moon, they will talk by vhf to the LEM. This will be converted to an S-band transmission to the ground. The reverse will also occur, so the ground controllers can chat with the men on the moon.



**Astronaut scans the landing site, as LEM approaches the lunar surface in this artist's conception. Crew commander and a systems engineer will make the landing.**



**A lonely trek over the lunar wastelands will follow the soft landing on the moon. The system will allow one or both astronauts to explore the surface.**

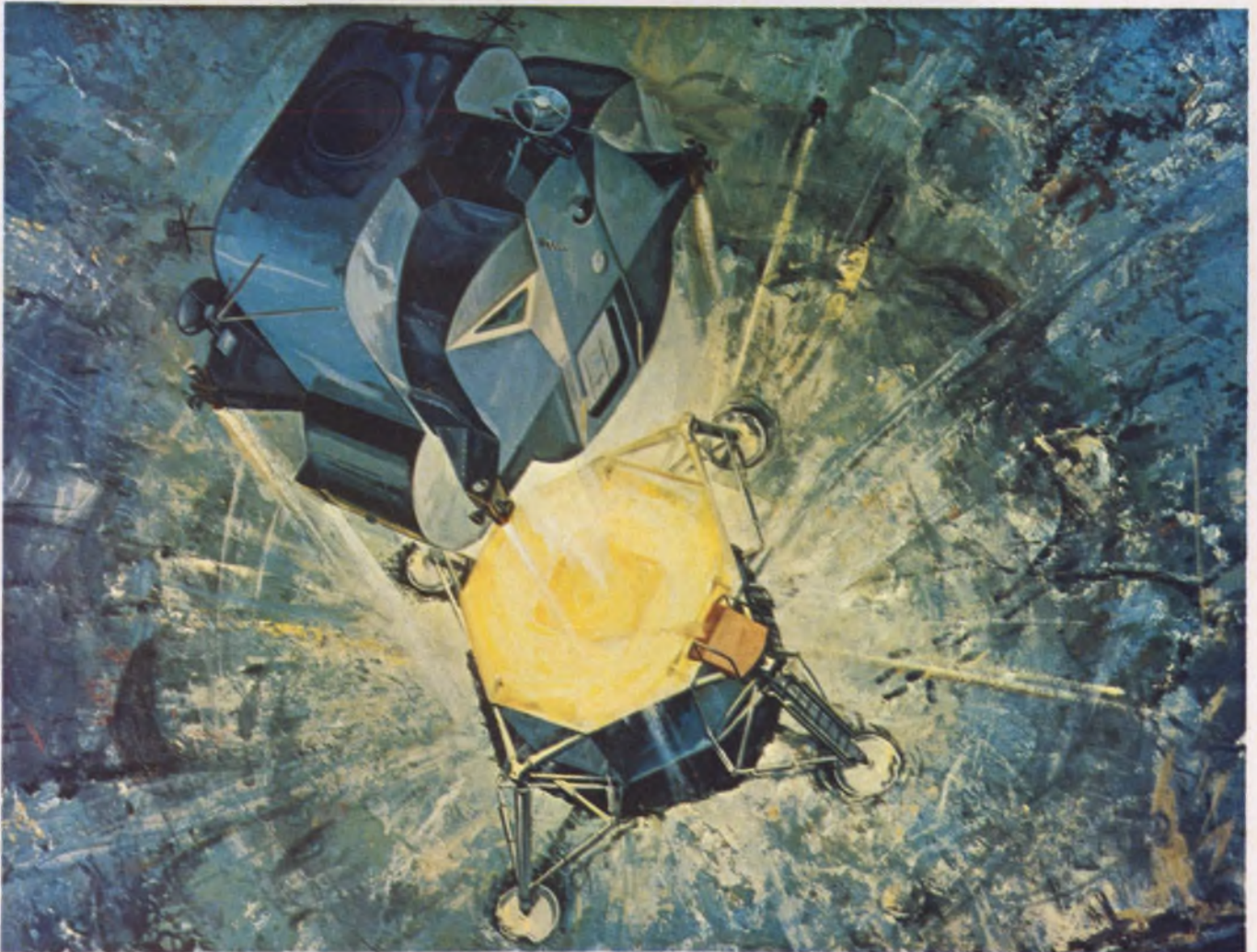

**A critical point in the mission is the launching of the LEM from the lunar surface. As Chaffee explains, a fairly tolerant "window" of about 20 minutes is allowed for the**

**take-off. The rendezvous—as "Gemini '76" showed—shouldn't be a problem. The LEM then links up with the Command Module, in a lunar orbit, for the trip home.**

## DUAL FET's

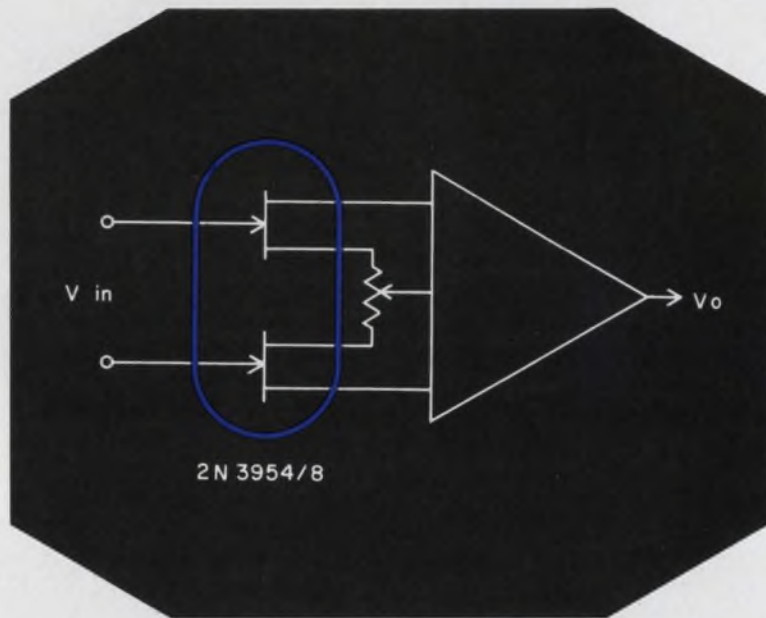

**CHECK THE SPECS!**

### SPECIFICATIONS

	2N3954	2N3955	2N3956	2N3957	2N3958	Units
Breakdown Voltage (min.)	50	50	50	50	50	V
Leakage Current (max.)	100	100	100	100	100	pA
Saturation Current (min./max.)	0.5/5.0	0.5/5.0	0.5/5.0	0.5/5.0	0.5/5.0	mA
Transconductance (min./max.)	1000/3000	1000/3000	1000/3000	1000/3000	1000/3000	$\mu$ mhos
Pinch-off Voltage (min./max.)	1.0/4.5	1.0/4.5	1.0/4.5	1.0/4.5	1.0/4.5	V
$\Delta V_{GS1} \cdot V_{GS2}$ (max.)	10	25	50	75	100	$\mu$ V/°C

Why wait for Dual FET's! Place your order with your UNION CARBIDE ELECTRONICS Distributor today.



**ELECTRONICS**

**UNION CARBIDE CORPORATION** 365 Middlefield Road, Mountain View, California 94041 TWX: 415-969-9166; Telephone: (415) 961-3300  
 Speed Inquiry to Advertiser via Collect Night Letter  
 ON READER-SERVICE CARD CIRCLE 15



# ED Technology

Noise figure shows merit of IC cascade amplifiers PAGE 40

Junction FETs rate high for uhf applications PAGE 48

Estimate solar noise in optical communication systems PAGE 56

Photomicrography aids the circuit designer PAGE 59

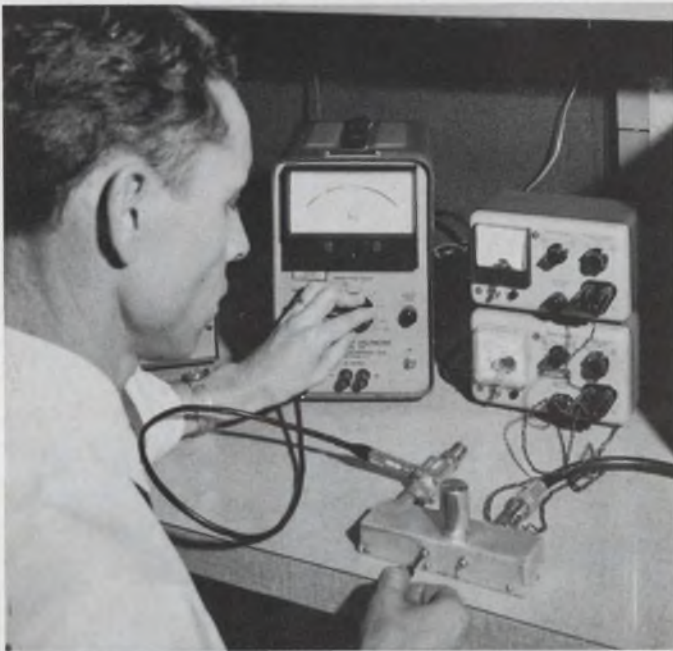

Turn to the FET for uhf... 48

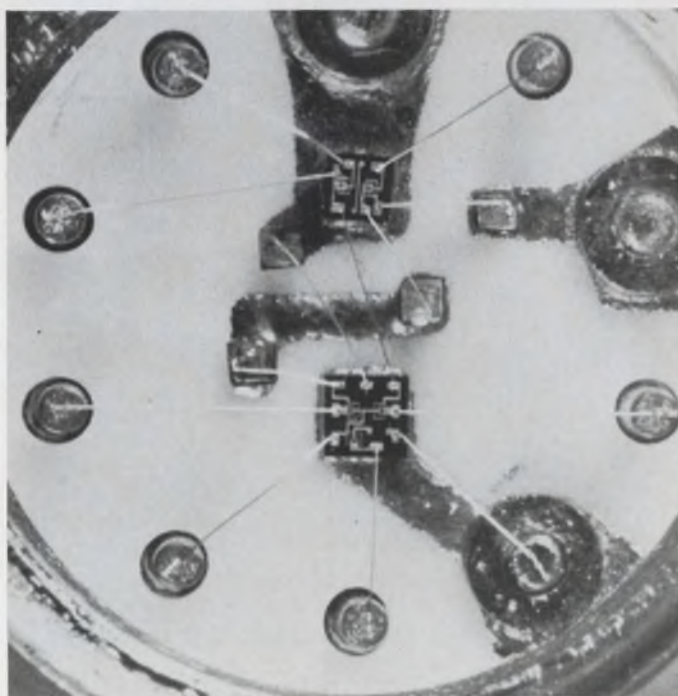

Getting the low down on IC noise... 40

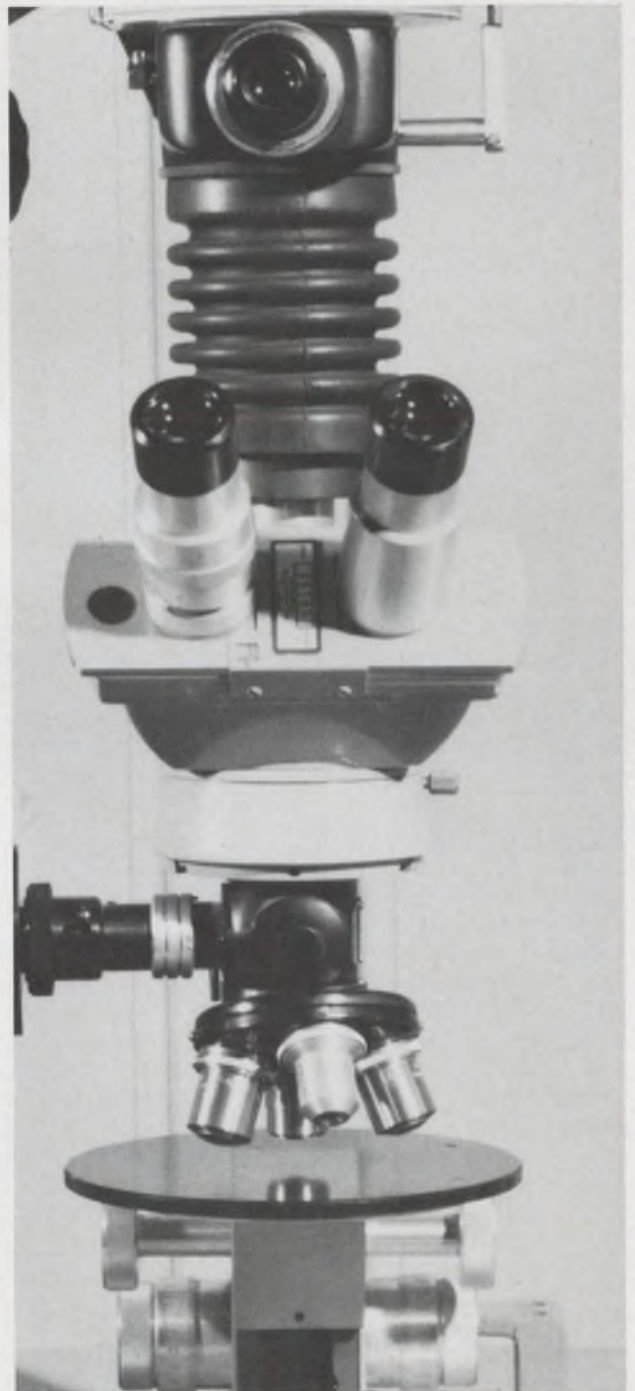

Get the picture (the little one!)... 59

# It's what's up front that counts when good noise performance is needed in integrated amplifiers. An analysis of direct-coupled cascades proves the point.

Suppose you are faced with an application calling for the use of a direct-coupled, multi-stage integrated amplifier. Noise figure is crucial, but you don't know which of the various configurations (common-emitter, base, collector or combinations thereof) will yield the best results.

Here is a detailed examination that develops the governing design relationships. It points the way to optimum performance for any cascade configuration.

Analysis of all basic circuit arrangements shows how to choose both the first and second stages in an amplifier to achieve optimum performance. It is found, for example, that the second stage in a direct-coupled cascade may have any orientation; this will not affect overall noise performance.

Moreover the analysis demonstrates that the popular and conventional use of optimum transformer-coupling between the stages isn't worth the cost or effort involved. This is because the technique doesn't buy any significant improvement in the noise figure of the cascade.

The examination also reveals just what you can get in the way of noise figure and power gain from the several possible cascade combinations. The results are applicable to frequency levels up to a few hundred megahertz, and enable the designer to select the circuit arrangement that best suits his needs.

## Finding the right cascade combination

Vacuum-tube theory has long held that the combination of the grounded-cathode and grounded-grid cascade has superior noise properties to all other two-stage amplifiers. In transistor theory the noise performance of single-stage amplifiers is well known.<sup>1,2</sup> But very little information has been published about the best performance obtainable from two-stage transistor amplifiers. Let's evaluate, therefore, the noise performance of all possible two-stage combinations of transistor amplifiers. Note that the noise contributions from the stages beyond the second are normally very small. These will be neglected in our analysis (which remains valid for amplifiers with any number of stages).

Three basic transistor orientations for either stage in the cascade are possible: common-emitter (CE), common-base (CB) and common-collector (CC). Thus nine possible two-stage combinations may be employed. In addition alternate versions must be considered for each of the nine combinations. For example, one circuit may or may not permit the use of a transformer-coupling network between the two stages. Ordinarily (in conventional design) one would use transformer coupling to optimize the second-stage noise figure.\* For applications involving integrated circuits, the use of such an interstage is ruled out, because the

\*It is easily shown that the optimum ratio of the transformer is always that which reflects the optimum noise source to the second stage. The transformer thus functions only to minimize second-stage noise figure.

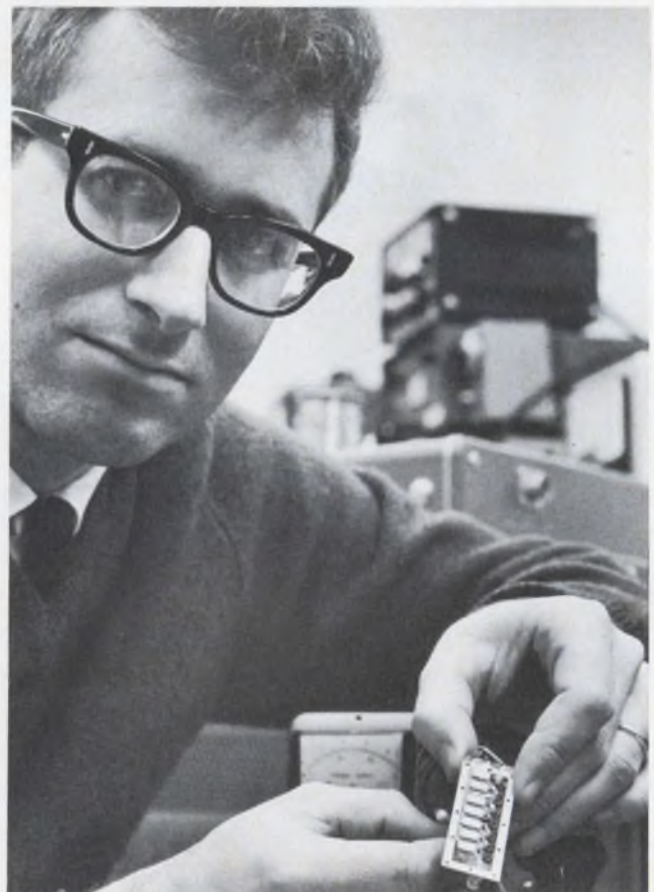

**Brooks no interference . . .**

Author Solomon displays his low-noise IF strip.

James E. Solomon, Manager of Linear I/C Research and Development, Motorola Semiconductor Products, Inc., Phoenix, Ariz.

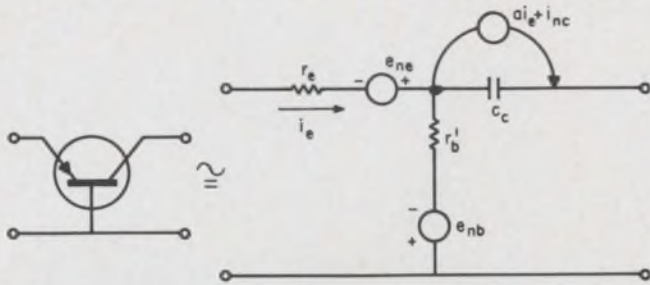

1. Analysis of noise behavior in hybrid integrated transistor amplifiers makes use of the conventional noise model. Shown is a simplified version of the van der Ziel model in a common-base connection.

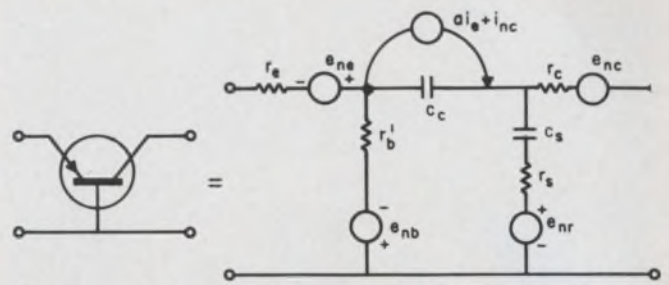

2. The noise model for monolithic transistors is more complicated than its hybrid counterpart. Important strays, like the collector saturation resistance ( $r_c$ ) and depletion capacity ( $C_s$ ) are included here.

transformer element cannot be integrated. Therefore we confine our attention to determining the best two-stage combination of directly connected transistors.

Two analyses will be made. The first will apply to hybrid integrated circuits and will employ well known transistor noise models. This analysis tells conclusively which is the best transistor cascade. The second analysis will include the effects of lossy strays encountered in monolithic integrated-circuit amplifiers.

### A model of noise behavior

For noise calculations the hybrid transistor may be considered identical with its discrete counterpart. Consequently conventional transistor noise models may be used for the analysis. A simplified version of the van der Ziel model has been shown to give good agreement with practice.<sup>3,4</sup> This model is the starting point for the derivations and calculations, and it involves a grounded-base orientation (Fig. 1).

The noise sources shown in the circuit are all uncorrelated and have mean-square values given by:

$$\overline{e_{ne}^2} = 2kTB r_e \quad (1)$$

$$\overline{e_{nb}^2} = 4kTB r_b' \quad (2)$$

$$\overline{i_{nc}^2} = \left( \frac{2kTB}{\beta_o r_e} \right) \frac{(1 + \beta_o \omega^2 / \omega_\alpha^2)}{(1 + \omega^2 / \omega_\alpha^2)} \quad (3)$$

In the derivation of Eq. 3 it has been assumed that  $\alpha_o = \alpha_{dc}$ , where  $\alpha_o$  and  $\alpha_{dc}$  are the low-frequency and dc values of  $\alpha$ , respectively. Van der Ziel has shown that this assumption is incorrect for silicon transistors; he has produced a corrected expression for uncorrelated collector noise ( $i_{nc}$ ).<sup>5</sup> However, for our purposes this correction is usually small enough that it can be neglected, without any appreciable sacrifice in accuracy.

A number of other important approximations are necessary. These have been made in the model, as follows:

- The effect of space charge layer widening is ignored, so the results are valid only for  $\omega >$

$1/r_c C_c$ , where  $r_c$  is the resistive part of the collector leg impedance.

- The frequency dependence of the emitter-leg impedance is neglected.
- Both the  $1/f$  noise figure and the leakage currents are neglected.

### Strays must not be left out

For application to transistors used in monolithic circuits, the model must be further modified to include two important strays. The first of these is a high collector-saturation-resistance ( $r_{cs}$ ) resulting from the top collector connection through high resistivity collector bulk.

A second stray, depletion capacity  $C_s$ , exists between the collector and the p-type substrate. This is because the collector is isolated from the substrate by a reverse-biased junction. The substrate is normally tied to a small-signal ground; thus  $C_s$  appears from the collector terminal to ground. Bulk resistance in series with  $C_s$  is also important for most calculations; so it is included here. The resulting noise model for the monolithic transistor incorporating these parameters (Fig. 2) is shown in a grounded-base orientation.

Referring to the model, we see that the collector saturation resistance and substrate bulk resistance both exhibit thermal noise, given by:

$$\overline{e_{nc}^2} = 4kTB r_{cs} \quad (4a)$$

$$\overline{e_{nr}^2} = 4kTB r_s \quad (4b)$$

Let us now determine the noise figures for the various configurations. In general, either of two methods can be used to calculate the noise figure of a cascade. One involves the calculation of total output noise current directly from the noise equivalent-circuit of the two tandem stages. Alternatively, the second method employs the well-known Friis cascading formula:

$$F = F_1 + \frac{F_2 - 1}{G_1} \quad (5)$$

The over-all noise figure that is determined will, of course, be the same regardless of the method used. The use of Eq. 5 is advantageous here, since it involves a minimum number of calculations to obtain the nine possible combinations. Care must

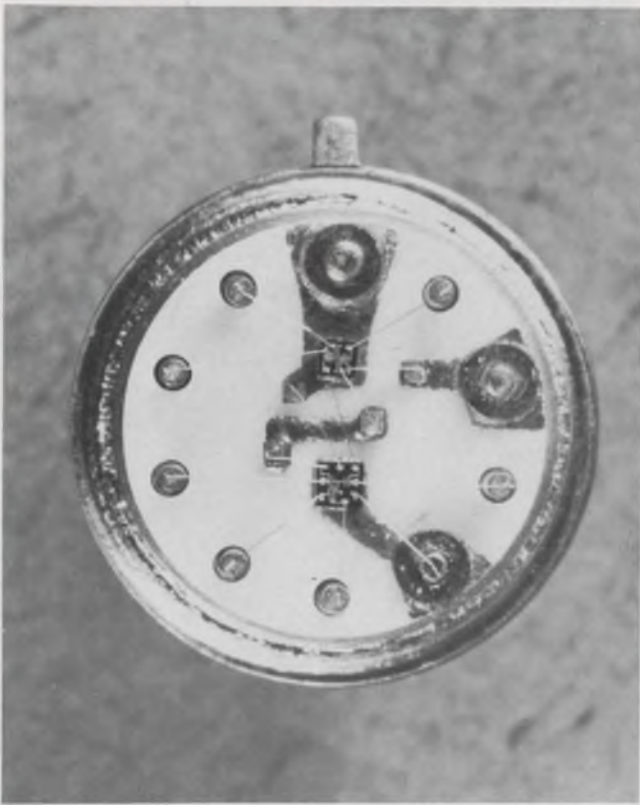

### Chips a la mode . . .

This integrated differential amplifier features output connections in both the common-emitter and common-collector modes. The common-emitter has slightly better noise performance than the collector configuration.

be taken that  $F_2$  is evaluated for a source impedance that is equal to the output impedance of the first stage, because we are considering only direct-coupled transistors. In the following calculations standard definitions for noise figure and available power gain are used,<sup>6</sup> and noise contributions from the load are not included.

### Figuring hybrid single-stage noise

If the small effect of collector depletion-layer capacitance is neglected,<sup>7</sup> the noise figures of the CE, CB, and CC transistors are, respectively:

$$F^{CE} = F^{CB} = 1 + \frac{r_b' + r_e/2}{R_s} + \frac{|r_e + r_b' + Z_s|^2}{2\beta_o r_e R_s} \left(1 + \frac{\beta_o \omega^2}{\omega_a^2}\right) \quad (6)$$

$$F^{CC} = 1 + \frac{r_b' + r_e/2}{R_s} + \frac{|r_b' + Z_s|^2}{2\beta_o r_e R_s} \left(1 + \frac{\beta_o \omega^2}{\omega_a^2}\right) \quad (7)$$

By employing the T-equivalent circuit of Fig. 1 (neglecting the noise sources), we can compute the available power gain and output impedance for each of the transistor orientations. The results, including the effects of  $C_c$ , are:

$$G_{av}^{CE} = \frac{R_s}{\text{Re}Z_{oE}} \frac{\left|r_e - \frac{\alpha}{SC_c}\right|^2}{|r_e + r_b' + Z_s|^2} \quad (8)$$

$$G_{av}^{CB} = \frac{R_s}{\text{Re}Z_{oB}} \frac{\left|r_b' + \frac{\alpha}{SC_c}\right|^2}{|r_e + r_b' + Z_s|^2} \quad (9)$$

$$G_{av}^{CC} = \frac{R_s}{\text{Re}Z_{oC}} \frac{1}{|1 + SC_c (r_b' + Z_s)|^2} \quad (10)$$

$$Z_{oE} = \frac{1}{SC_c} + \frac{\left(r_e - \frac{\alpha}{SC_c}\right) (r_b' + Z_s)}{r_e + r_b' + Z_s} \quad (11)$$

$$Z_{oB} = \frac{1}{SC_c} + \frac{r_b' \left(Z_s + r_e + \frac{\alpha}{SC_c}\right)}{r_e + r_b' + Z_s} \quad (12)$$

$$Z_{oC} = r_e + \frac{(1 - \alpha) (r_b' + Z_s)}{1 + SC_c (r_b' + Z_s)} \quad (13)$$

In the derivation of Eqs. 6-13, the following approximations were assumed to be valid:

$$\omega < \omega_a \quad (14)$$

$$r_e, r_b' < \frac{\alpha}{\omega C_c} \quad (15)$$

$$(1 - \alpha) \cong \frac{1}{\beta_o} + j \frac{\omega}{\omega_T} \quad (16)$$

$$\omega^2 C_c^2 |r_e + r_b' + Z_s|^2 < 1 \quad (17)$$

$$\omega C_c (r_b' + Z_s) < 1 \quad (18)$$

### Capacitance quietly drops out

Except for Eqs. 17 and 18, these approximations are easily satisfied. Approximations (17) and (18) may be marginal for calculations involving a common-base input stage where the second stage source impedance is not small. But as we shall see, cascades with a common-base input have the poorest noise figure, so the elimination of (17) and (18), which would worsen common-base noise figures only slightly, does not alter our results.

Equations 6 through 13 can now be combined, according to Eq. 5, to give all nine possible two stage combinations—that is, CE-CE, CE-CB, CE-CC, CB-CE, CB-CB, CB-CC, CC-CE, CC-CB and CC-CC. For simplicity each of these cascades is denoted by the last letter of each stage followed by a T. For example, CET is the same as CC-CE, and ECT is the same as CE-CC. Using the approximations cited (Eqs. 14-18), we can reduce the nine noise-figure equations to three sets of identical equations:

$$F^{EET} = F^{EBT} = F^{ETC} = F^E \quad (19)$$

$$F^{BET} = F^{BBT} = F^{BCT} = F^B \quad (20)$$

$$F^{CET} = F^{CBT} = F^{CCT} = F^C \quad (21)$$

In these relationships,

$$F^E = 1 + \frac{r_b' + r_e/2}{R_s} + \frac{|r_e + r_b' + Z_s|^2}{2\beta_o r_e R_s} \left(1 + \frac{\beta_o \omega^2}{\omega_a^2}\right) \left(1 + \frac{\omega^2}{\omega_T^2}\right), \quad (22)$$

$$F^B =$$

$$C = r_b'/r_e \quad (37)$$

Our goal is to determine which noise figure (as given by Eqs. 29-31) is best. Comparing the equations term by term, we see immediately that

$$F_o^E < F_o^B \text{ and } F_o^C < F_o^B.$$

Thus the problem reduces to finding which is smaller,  $F_o^E < F_o^C$ . For convenience, a term  $\phi$  is defined as:

$$\phi = F_o^C - F_o^E. \quad (38)$$

such that, if  $F_o^E$  is the smaller,  $\phi > 0$ , while if  $F_o^C$  is smaller,  $\phi < 0$ . Substitution of Eqs. 29 and 31 into Eq. 38 shows us that  $\phi$  becomes:

$$\phi = \sqrt{B} [\sqrt{A} (\sqrt{2} - 1) - \sqrt{B}] \quad (39)$$

From Eq. 39 it is seen that  $\phi$  is *positive* if  $B < A (\sqrt{2} - 1)^2$ . Combining this with Eq. 35 and rearranging terms, we see that  $\phi$  is positive if

$$\omega < \omega_a \left[ \frac{\left(1 + \frac{2r_b'}{r_e}\right) (\sqrt{2} - 1)^2}{1 - \frac{r_b'^2}{r_e^2} (\sqrt{2} - 1)^2} - \frac{1}{\beta_o} \right]^{1/2} \quad (40)$$

A worst-case test of this inequality occurs for  $r_b'/r_e = 0$ . In this case the inequality is closely given by  $\omega < 0.41 \omega_a$ .

#### Common-emitter best for openers

We conclude that over the frequency range in which the transistor is a useful low-noise amplifier,  $\phi$  is positive and  $F_o^E < F_o^C$ . In general, then,  $F_o^E < F_o^C < F_o^B$ —that is, two-stage cascades in which the first stage is a common-emitter transistor have the lowest noise figure; cascades with a common-collector first stage are second best, and cascades with a common-base first stage are worst.

Note that the choice of second-stage orientation (CE, CB or CC) is completely arbitrary in all cases. The engineer is free to choose whichever second stage provides the best power gain and/or stability. It would appear that the common-emitter, common-base cascade is the best compromise for high stability and power gain. The direct-coupled, common-emitter, common-emitter amplifier has higher power gain, but it may require neutralization to insure stable performance at high frequencies.

For comparative purposes the calculated minimum noise figures and optimum source resistances for the various direct-coupled cascades (employing integrated small-geometry transistors) are shown in Figs. 3 and 4 respectively. Note that Fig. 3 demonstrates that the noise figure of the cascade with a common-emitter first stage is always lower than with either of the other cascades. It is also apparent that at high frequencies the cascade with a common-collector first stage is only slightly worse than the common-emitter circuit; therefore the designer may use either cascade and hardly experience any difference in performance.

For the sake of comprehensiveness it would be

$$1 + \frac{r_b' + r_c/2}{R_s} + \frac{2|r_e + r_b' + Z_s|^2}{2\beta_o r_e R_s} \left(1 + \frac{\beta_o \omega^2}{\omega_a^2}\right), \quad (23)$$

$$F^C = 1 + \frac{2(r_b' + r_c/2)}{R_s} + \quad (24)$$

$$\left[ \frac{|r_b' + Z_s|^2 + |r_e + r_b' + (1 - \alpha)Z_s|^2}{2\beta_o r_e R_s} \right] \left(1 + \frac{\beta_o \omega^2}{\omega_a^2}\right)$$

and the source impedance is:

$$Z_s = R_s + jX_s. \quad (25)$$

#### Source impedance is a governing parameter

Inspection of Eqs. 22 and 23 indicates that the optimum source reactance for minimum  $F^E$  and  $F^B$  is:

$$X_{so}^E = X_{so}^B = 0 \quad (26)$$

If we set the derivative of  $F^C$  with respect to  $X_s$  equal to zero, the optimum source reactance  $X_{so}^C$  for minimum  $F^C$  is:

$$X_{so}^C = \frac{\frac{\omega}{\omega_t} (2r_e + r_b')}{\left(1 + \frac{\omega^2}{\omega_t^2} + \frac{1}{\beta_o^2}\right)} \quad (27)$$

Note that for  $\omega < \omega_t$ ,  $X_{so}^C$  is small; consequently little error is introduced if  $X_{so}^C$  is assumed to be zero. Thus,

$$\text{for } \omega < \omega_t, X_{so}^C \approx 0 \quad (28)$$

At this point it is a straightforward matter to minimize each of the cascade noise figures with respect to source resistance  $R_s$ . Neglecting a few small terms, we find that the minimum noise figures ( $F_o$ ) and the optimum source resistances ( $R_{so}$ ) for  $\omega < \omega_t$  are:

$$F_o^E = 1 + (AB)^{\frac{1}{2}} + (1 + C)B \quad (29)$$

$$F_o^B = 1 + (2AB)^{\frac{1}{2}} + 2(1 + C)B \quad (30)$$

$$F_o^C = 1 + (2AB)^{\frac{1}{2}} + CB \quad (31)$$

$$R_{so}^E = r_e (A/B)^{\frac{1}{2}} \quad (32)$$

$$R_{so}^B = \frac{r_e}{\sqrt{2}} (A/B)^{\frac{1}{2}} \quad (33)$$

$$R_{so}^C = \sqrt{2} r_e (A/B)^{\frac{1}{2}} \quad (34)$$

In Eqs. 29-34 the A, B and C parameters are defined as follows:

$$A = 1 + \frac{2r_b'}{r_e} + \frac{r_b'^2}{r_e^2 \beta_o} + \frac{r_b'^2}{r_e^2} \frac{\omega^2}{\omega_a^2} \quad (35)$$

$$B = \frac{1}{\beta_o} + \frac{\omega^2}{\omega_a^2} \quad (36)$$

and

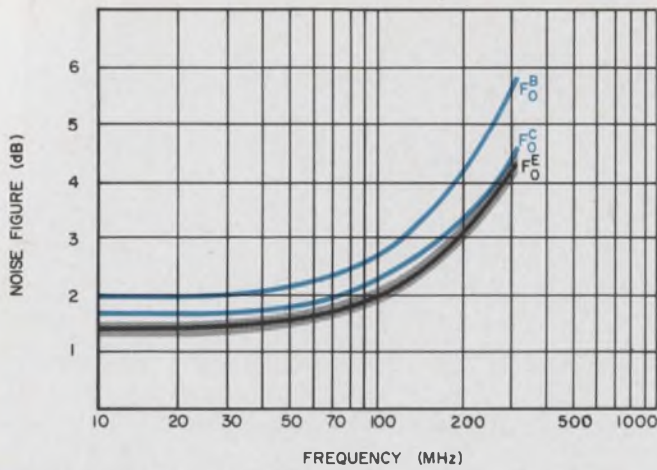

3. Optimum cascade noise figure is shown as a function of frequency for the three types of direct-coupled cascades. Note the superiority of common-emitter ( $F_o^E$ ) over common-collector ( $F_o^C$ ) and common-base ( $F_o^B$ ). These data were calculated with the use of a small-geometry integrated transistor operating at an  $I_E$  1.0-mA.



Stage ready for strip

This fully integrated 60-MHz IF stage is part of an IF strip that includes a video detector. The gain is 90 dB with a 6.0-MHz bandwidth, a noise figure of 4.5 dB and an agc range of 70 dB.

useful to compare the noise figures obtained here with those resulting from optimum transformer-coupled cascades. Ideally (neglecting transformer losses) the transformer-coupled stages have noise figures that are equal to or lower than those of the direct-coupled stages. An estimate of the improvement available from transformers can be obtained by contrasting the best direct-coupled cascade noise figure  $F^E$  (Eq. 22) with the first-stage noise figure of that cascade,  $F^{CE}$  (Eq. 6).

For  $\omega < \omega_1$ , the equations are seen to be identical, indicating that the second-stage contribution is negligible. Since transformer coupling serves only to minimize the second-stage noise figure, no improvement is available over the

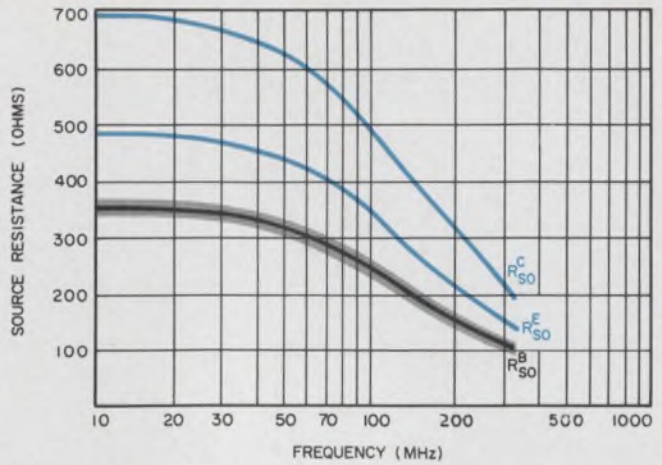

4. Optimum cascade source resistance vs frequency are shown for common-base ( $R_{so}^B$ ), common-emitter ( $R_{so}^E$ ) and common-collector ( $R_{so}^C$ ) configurations. Note that the CB input cascade may be the best choice if the source resistance is small. If optimum noise performance is paramount, the CE or CC inputs are preferable.

direct-coupled cascade. Some improvement can be obtained in  $F_o^C$ , but at best this would be only slightly better than in  $F_o^E$  (because  $F^{CC}$  in Eq. 7 is only slightly better than  $F^{CE}$ ). We conclude that no significant improvement over  $F_o^E$  can be obtained by employing a transformer interstage.

#### Hybrid quieter than monolithic

Using the same techniques as employed for the hybrid calculations, we can obtain the noise figure of the monolithic transistor from the equivalent circuit model (Fig. 2). The results for CE, CB and CC orientations (designated CEM, CBM and CCM) are given below for frequencies such that  $r_b', r_s, r_{cs} < 1/\omega C_e, 1/\omega C_s$  and  $\omega C_c Z_s < 1.0$ . The results are:

$$F^{CEM} = 1 + \frac{r_b' + r_e/2}{R_s} + \frac{|r_e + r_b' + Z_s|^2}{2\beta_o r_e R_s} \left(1 + \frac{\beta_o \omega^2}{\omega_a^2}\right) + \frac{r_s}{R_s} |r_e \omega C_s|^2 + \frac{r_{cs}}{R_s} |sC_c(r_b' + r_e + Z_s) + r_e sC_s|^2 \quad (41)$$

$$F^{CBM} = 1 + \frac{r_b' + r_e/2}{R_s} + \frac{|r_e + r_b' + Z_s|^2}{2\beta_o r_e R_s} \left(1 + \frac{\beta_o \omega^2}{\omega_a^2}\right) + \frac{r_s}{R_s} |\omega C_s(Z_s + r_e)|^2 + \frac{r_{cs}}{R_s} |sC_c(r_b' + r_e + Z_s) + sC_s(r_e + Z_s)|^2 \quad (42)$$

$$F^{CCM} = 1 + \frac{r_b + r_e/2}{R_s} + \frac{|r_b' + r_{cs} + Z_s|^2}{2\beta_o r_e R_s} \left(1 + \frac{\beta_o \omega^2}{\omega_a^2}\right) + \frac{r_{cs}}{R_s} |\omega C_c Z_s|^2 \quad (43)$$

If the noise sources are neglected, the available power gains and output impedances may also be computed from Fig. 2. The results are:

$$G_{av}^{CEM} \cong \frac{\left| r_e - \frac{\alpha}{sC_c} \right|^2 R_s}{|r_e + r_b' + Z_s|^2 \operatorname{Re} Z_{OEM}} \quad (44)$$

$$G_{av}^{CBM} \cong \frac{\left| r_b' + \frac{\alpha}{sC_c} \right|^2}{|r_e + r_b' + Z_s|^2} \frac{1}{\left| 1 + \frac{C_s}{C_c} \right|^2} \frac{R_s}{\operatorname{Re} Z_{OBM}} \quad (45)$$

$$G_{av}^{CCM} \cong \frac{1}{|1 + sC_c(Z_s + r_b' + r_e)|^2} \frac{R_s}{\operatorname{Re} Z_{OCM}} \quad (46)$$

$$Z_{OEM} \cong r_{cs} + \frac{(1 - \alpha)}{sC_c} \quad (47)$$

$$Z_{OBM} \cong \frac{1}{1 + \frac{C_s}{C_c}} \left[ r_{cs} + \frac{r_b'}{R_s \omega_c C_c} + \frac{1}{sC_c} \right] \quad (48)$$

$$Z_{OCM} \cong r_e + (r_b' + Z_s) [(1 - \alpha) + sC_c r_{cs}] \quad (49)$$

#### Real part determines power gain

Some real terms that might appear negligible in Eqs. 47-49 were not dropped, because the available power gains are strongly dependent upon the real part of the output impedances.

The cascade noise figures for monolithic pairs have also been calculated. In the interests of brevity and scope, they are not included here. However, the results for the monolithics are nearly identical with those from the hybrid case. As before, a common-emitter first stage offers superior noise performance; common-base inputs are the least desirable. We further find that the noise contributions of the monolithic strays ( $r_s$  and  $r_{cs}$ ) are small for frequencies below 100 MHz.\* Engineers using properly designed monolithic amplifiers may thus expect to see little degradation in noise performance when compared to hybrid usage. ■ ■

\*Typical values for these strays in a 2N918-type monolithic transistor are:  $C_{cs} = 2.5$  pf,  $R_{cs} = 65 \Omega$  and  $r_s = 50 \Omega$ .

#### References:

1. A. van der Ziel, "Shot Noise in Junction Diodes and Transistors," Proc. IRE, Vol. 43, November, 1955, pp 1639-1696.
2. E. G. Nelson, "Behavior of Noise Figure in Junction Transistors," Proc. IRE, Vol. 45, June, 1957, p 957.
3. See reference 1, supra
4. See reference 2, supra.
5. A. van der Ziel, "Shot Noise in Transistors," Proc. IRE, Vol. 48, January, 1960, pp 114-115.
6. H. A. Haus, et. al., "Representation of Noise in Linear Two-Ports," Proc. IRE, Vol. 48, January, 1960, pp 69-74.
7. See reference 2, supra.

March 29, 1966

When  
you're in  
the dark...

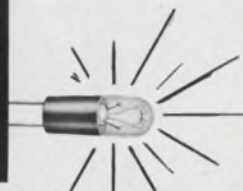

light up  
with Hudson  
lamps

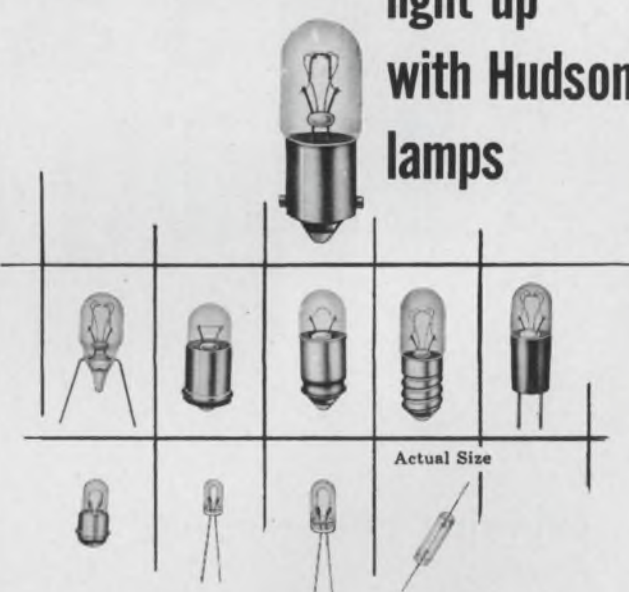

Actual Size

**Lives to over 100,000 hours  
Install 'em and Forget 'em!**

PROBLEMS OF SMALL SPACE ARE SOLVED in read-out devices, edge-lighted panels, illuminated switches, instruments, indicators and similar devices with miniature, sub-miniature and micro-miniature Hudson lamps immediately available from stock. Where standard lamps won't serve, special ones can be developed, such as the Tu-Pin and Axial Lead styles pioneered by Hudson to fill specific needs and now "shelf-items". You can depend on Hudson lamps to equal or better any others in standard or special applications.

Write for new catalog.

Hudson LAMP COMPANY

Miniature Lamp Specialists

524 ELM STREET, KEARNY, NEW JERSEY 07032

ON READER-SERVICE CARD CIRCLE 32

# An industry first from IRC...PAR

# metal film resistors meet 3 assured reliability levels

## published prices for PAR

(Program for Assured Reliability)

**.1%, .01% or .001% levels**

Up to now, assured registered reliability could only be obtained through negotiations for screening or additional lot testing.

Now IRC eliminates the need for negotiation and offers a truly low-cost approach to established reliability. For the first time in the industry, users of standard evaporated metal film resistors can specify one of three assured failure rate levels at established published prices.

### **PUBLISHED SPECIFICATION**

IRC has published a specification covering three established reliability levels for its standard evaporated metal film resistors—.1%, .01% and .001%. These failure rates are per 1000 hours, full rated load at 125°C, to 60% confidence.

This Program for Assured Reliability marries the high stability performance requirements of MIL-R-10509 and the stringent reliability levels of

MIL-R-55182. It also defines the requirements to prove failure rate levels as well as necessary control procedures to assure continuing compliance.

### **LOWEST PUBLISHED PRICES**

IRC is the first to publish a price schedule for a pre-determined level of resistor reliability. And, only IRC can offer such assured reliability at these low prices.

FAILURE RATE LEVEL	IRC TYPE	T.C. (/°C)	COST (250 LOT)
.1%	CCA	± 100ppm	.21
.01%	CCA	± 50ppm	.57
.001%	CCA	± 25ppm	3.32

Above prices are excerpted from IRC's published price schedule.



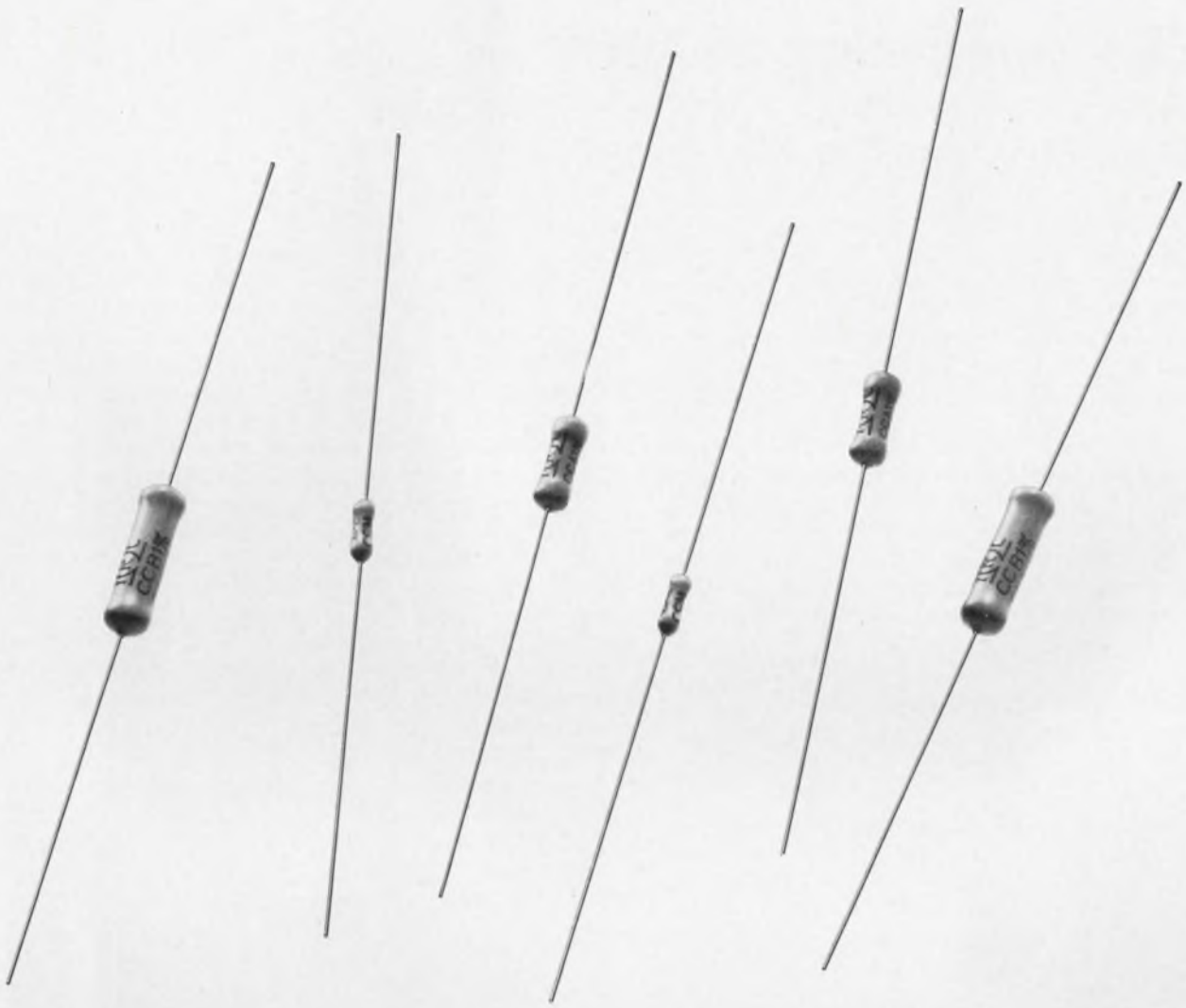

**ESTABLISHED RELIABILITY  
IN A STANDARD PRODUCT LINE**

All evaporated metal film resistors covered by IRC's Program for Assured Reliability meet MIL-R-10509, characteristics C and E, with the added benefits of assured reliability at the lowest cost. These types are immediately available.



Fill out the coupon for your copy of IRC's Program for Assured Reliability and price schedule. The specification defines performance characteristics, failure rate determination, testing methods and conditions.

TYPE		MIL-R-10509 CHAR.	WATTAGE @125°C	TOLERANCE	TEMP. COEFFICIENT	RESISTANCE RANGE*
IRC	MIL					
MMC	RN50	Meets all MIL-R-10509 environmental requirements	1/20	± 1% ± 0.5%	± 25ppm ± 50ppm ± 100ppm	20 to 100K
CCM	RN55	E C D	1/10	± 1% ± 0.5% ± 0.25%	± 25ppm ± 50ppm ± 100ppm	20 to 301K
CCA	RN60	E C D	1/8	± 1% ± 0.5% ± 0.25%	± 25ppm ± 50ppm ± 100ppm	20 to 499K
CCB	RN65	E C D	1/4	± 1% ± 0.5% ± 0.25%	± 25ppm ± 50ppm ± 100ppm	20 to 1 meg

\*Summarized. Standard values fully described in PAR Specification.

IRC, Inc., 401 N. Broad St., Philadelphia, Pa. 19108  
Attn: Dept. 201

Send me a copy of IRC's Program for Assured Reliability and price schedule.

NAME \_\_\_\_\_ TITLE \_\_\_\_\_

COMPANY \_\_\_\_\_

ADDRESS \_\_\_\_\_

CITY \_\_\_\_\_ STATE \_\_\_\_\_ ZIP CODE \_\_\_\_\_



Speed Inquiry to Advertiser via Collect Night Letter  
ON READER-SERVICE CARD CIRCLE 16

# A FET operating at uhf? That's right.

And here's how to design a high-gain, low-noise, stable 500-MHz amplifier with field effects.

Contrary to popular belief, the field-effect transistor does make a useful small-signal amplifying device well into the uhf range. At frequencies as high as 500 MHz it can simultaneously provide 11 dB of gain with a 5-MHz bandwidth, show a noise figure of 4.5 dB and exhibit good circuit stability.

This can be accomplished with FETs in a common-gate, linear-amplifier onfiguration. The more widely recognized common-source mode has a role here, too, but it involves greater complexity and higher cost. These higher-frequency abilities of the FET are somewhat esoteric and this has misled engineers into avoiding them for amplification at hundreds of megahertz.

## A model for high-frequency behavior

Let us see then what the engineer who would use FETs in uhf circuit design must take into consideration:

- Interpretation and use of measured terminal FET parameters.
- Basic amplifier criteria (gain, noise figure, bandwidth and stability).
- Uhf characteristics (coupling, source and load impedance, matching, neutralization and cross-modulation).

Analysis will point to the preferability of the common-gate mode over the common-source in most cases. In the few instances when the designer must choose between the two, he can optimize his selection by consulting a table that compares their uhf attributes. Are you still skeptical? The design procedure for a 500-MHz FET amplifier should prove the case fully. Its actual performance, when compared with predictive (theoretical) data, will demonstrate the value of FETs here.

The terminal-parameter data are the bases for distinguishing between the amplifying capabilities of the common-gate and common-source orientations. The small-signal admittance parameters of both are shown as functions of frequency for a single 2N3823 device in Fig. 1. The parameters represent the actual measured data for both configurations, as opposed to calculating the values for one mode from parameters measured in the other orientation.\*

\*The 2N3823 transistor is a four-terminal device, the fourth lead being tied to the metal case. In parameter measurements, the fourth lead is tied to the common active terminal for each configuration. Consequently the common-source and common-gate parameters are not, in general, related through third-order matrix transformations.

George Pierson, Member of Technical Staff, Semiconductor R&D Laboratory, Texas Instruments, Inc., Dallas, Tex.

Calculated small-signal amplifier performance characteristics for this FET appear in Fig. 2a. The basic schematic configurations for both modes appear in simplified form in Fig. 2b. These characteristics are obtained from the measured admittance parameters and are defined by the expressions given in Table 1. Unilateralized gain ( $U$ ) is indicative of the maximum gain realizable in a neutralized tuned amplifier. Maximum stable gain ( $G_{MS}$ ), maximum available gain ( $G_{MA}$ ) and device stability factor ( $k$ ) are applicable to unneutralized tuned amplifiers.<sup>1</sup>

At frequencies below 300 MHz, the values for these characteristics are subject to relatively large uncertainties, due primarily to the difficulty of measuring accurately the small reverse-transfer admittances of this device. Consequently the curves (Fig. 2) represent only approximate values over the frequency range of 100 to 300 MHz.



Reaping the benefETs: Author Pierson checks the performance of his FET 500-MHz linear amplifier. For uhf operation, the common-gate mode exhibits good gain and bandwidth, low noise and excellent stability.

Table 1. UHF Amplifier performance parameters\*

Definition-Symbol	Relationship
Unilateralized gain-U	$\frac{ y_r - y_r ^2}{4[(\text{Re}[y_r]) (\text{Re}[y_r]) - (\text{Re}[y_r]) (\text{Re}[y_r])]}$
Device stability factor-k	$\frac{2\text{Re}(y_r) \text{Re}(y_r) - \text{Re}(y_r y_r)}{ y_r y_r }$
Maximum stable gain- $G_{MS}$	$ y_r / y_r $
Maximum available gain- $G_{MA}$	$G_{MS}[k - \sqrt{k^2 - 1}]$ (for $k \geq 1$ )

\* (Refer to Fig. 2)

## Impedance eases configuration contrast

Examination of the data in Figs. 1 and 2 reveals two primary differences between the common-source and common-gate characteristics. First, in the common-source configuration the input impedance is higher (input admittance is lower) than with the common-gate connection, and particularly so at the lower frequencies. This difference favors the common-source connection if high input impedance is desired.

However, if the device is to be driven from a low-impedance source, matching problems are minimized if it is operated common-gate. Moreover, cross-modulation performance is upgraded (for a given degree of mismatch) with the common-gate. This stems from the fact that an impedance step-up is, of course, also a voltage step-

up, and cross-modulation performance is inversely proportional to the magnitude of the undesired signal appearing at the device input terminals.

Quantitatively the cross-modulation characteristic of a device is commonly expressed in terms of undesired signal voltage,  $V_{in(u)}$ , when:

- The undesired signal is modulated  $100m_u$  per cent (usually 30%).
- The desired signal has been modulated  $100m_d$  per cent (usually 1%) by the undesired signal.
- The desired signal voltage is less than about one millivolt at the device input terminals. Note that  $m$  here refers to a modulation index.

Alternatively Terman<sup>2</sup> has defined a cross-modulation factor as  $CMF = m_d/m_u$ . For comparative purposes, the  $CMF$  for pentode vacuum-tube circuits in which the load resistance is small compared with the dynamic plate resistance is

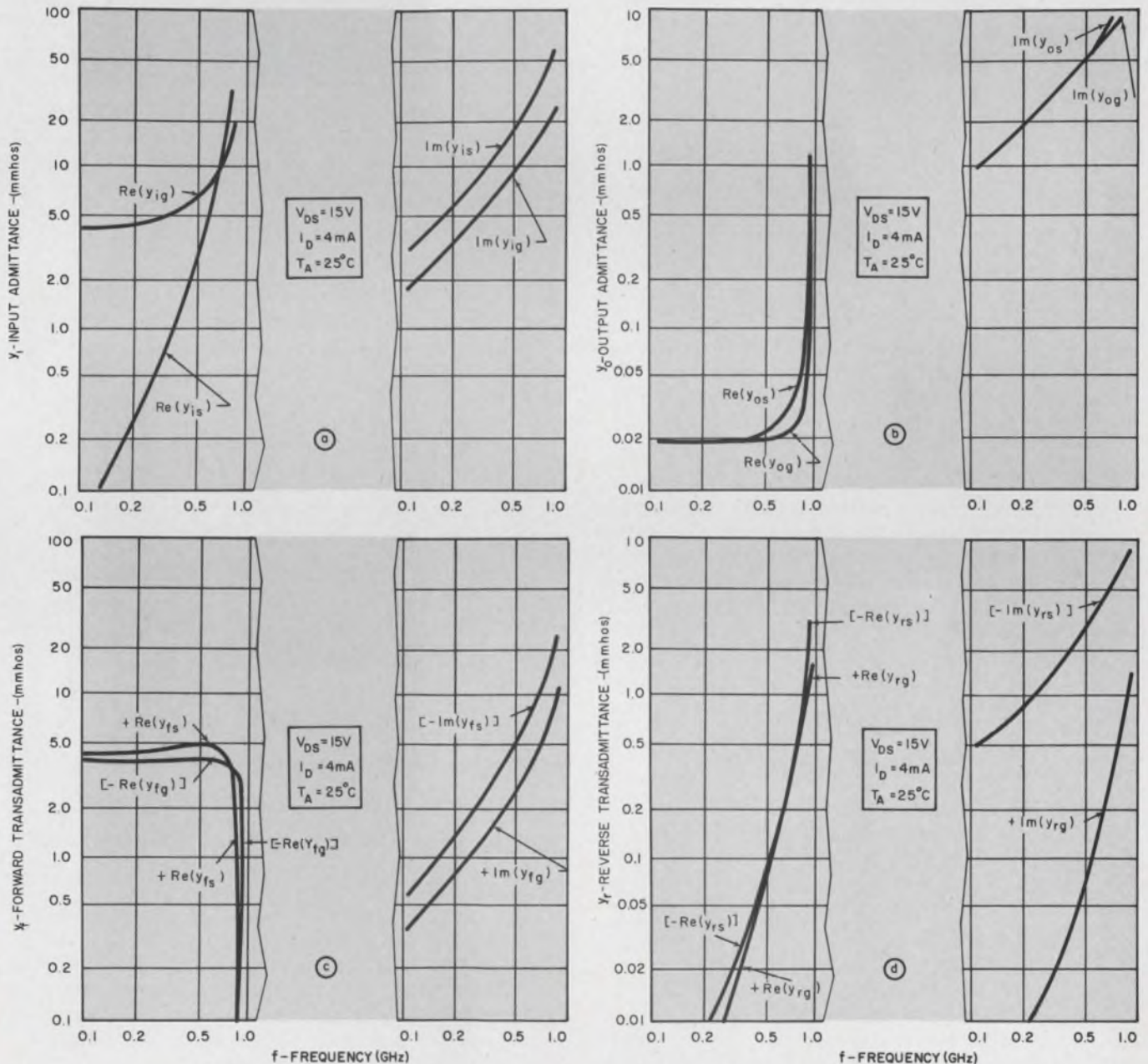

1. Frequency is a determinant of the small-signal admittance parameters of the FET. The real and imaginary parts of the input admittance (a), output admittance (b), for-

ward transmittance (c) and reverse transmittance (d) are used to distinguish between the common-gate and common-source operating modes.

**Table 2. Preferred FET configurations at UHF**

Paramount criterion	Preferred configuration
1. High input impedance	Common-source
2. Low input impedance	Common-gate
3. Minimum cross-modulation	Common-gate
4. Maximum circuit stability	Common-gate
5. Maximum gain—neutralized	Common-source
6. Maximum gain—unneutralized	Common-gate
7. Minimum noise figure	Common-source
8. Best compromise involving gain, noise figure, cross-modulation, and stability	Common-gate

**Table 3. Common gate parameters\***

$k = 1.35$	
$y_{ig} = 6.0 + j9.0 \text{ mmho}$	$y_{rg} = 0.10 + j0.08 \text{ mmho}$
$y_{tg} = -4.4 + j2.8 \text{ mmho}$	$y_{og} = 0.02 + j5.5 \text{ mmho}$

\* (for 2N3823 at 500 MHz)

$$(CMF)_{\text{pentode}} = \frac{[V_{in(u)}]^2}{2g_m} \left( \frac{\partial^2 g_m}{\partial V_G^2} \right); (R_1 \ll r_p), \quad (1)$$

where  $V_{in(u)}$  is the peak amplitude of undesired signal,  $g_m$  the dynamic transconductance,  $r_p$  the dynamic plate resistance,  $R_1$  the dynamic load resistance and  $V_G$  the dc grid-cathode voltage.

### Better cross-modulation with FETs

Direct applicability of the pentode  $CMF$  figure to FETs has not been verified at uhf frequencies. In fact, the requirement that the load resistance be small compared with the device's output impedance is not likely to be satisfied with the FET. However, the FET  $CMF$  would in all likelihood be proportional to both the undesired signal level  $V_{in(u)}$  and the rate of change of curvature of the static transfer ( $I_D - V_{GS}$ ) characteristic. Thus,

$$(CMF)_{\text{FET}} \propto [V_{in(u)}] \frac{\partial^2 g_{mo}}{\partial V_{GS}^2}, \quad (2)$$

where  $g_{mo}$  is the low-frequency forward transadmittance and  $V_{GS}$  is the dc gate-source voltage.

For a device having an ideal-square-law transfer characteristic, this rate of change of curvature is zero. For example, using the FET transfer characteristic given by

$$I_D = I_{DSS} \left[ 1 - \left( \frac{V_{GS}}{V_p} \right) \right]^n, \quad (3)$$

we can analyze this behavior. In Eq. 3,  $I_D$  is the dc drain current,  $I_{DSS}$  the dc drain current for  $V_{GS} = 0$ , and  $V_p$  is the pinch-off voltage (gate-source voltage at which the channel is completely depleted and  $I_D$  goes to zero). Thus,

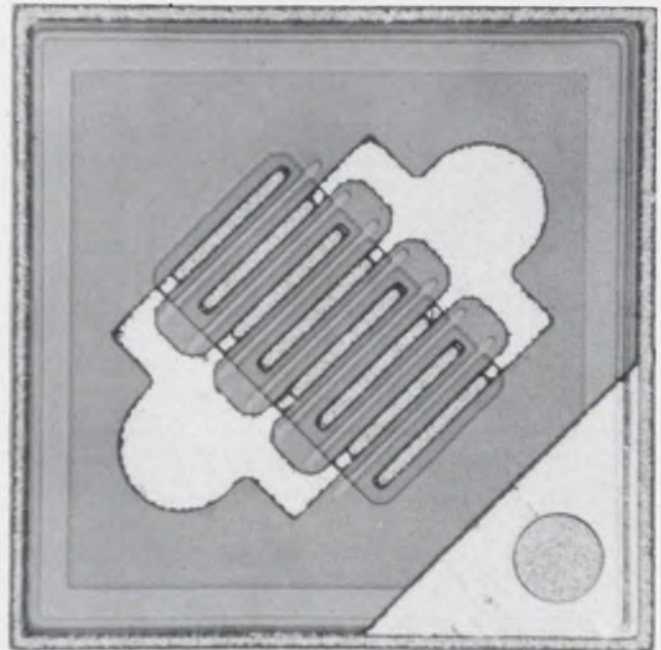

**Breaks frequency barrier:** This field-effect transistor can be relied on for effective amplification at uhf. In a 500-MHz linear amplifier, this 2N3823 device is operated in the common-gate mode for good gain and bandwidth, low noise and stability.

$$g_{mo} = \frac{\partial I_D}{\partial V_{GS}} = -\frac{I_{DSS}}{V_p} \left[ 1 - \left( \frac{V_{GS}}{V_p} \right) \right]^{n-1} [(n)] \quad (4a)$$

$$\frac{\partial g_{mo}}{\partial V_{GS}} = \frac{\partial^2 I_D}{\partial V_{GS}^2} = \frac{I_{DSS}}{V_p^2} \left[ 1 - \left( \frac{V_{GS}}{V_p} \right) \right]^{n-2} [(n)(n-1)] \quad (4b)$$

$$\frac{\partial^2 g_{mo}}{\partial V_{GS}^2} = \frac{\partial^3 I_D}{\partial V_{GS}^3} = \frac{-I_{DSS}}{V_p^3} \left[ 1 - \left( \frac{V_{GS}}{V_p} \right) \right]^{n-3} [(n)(n-1)(n-2)] \quad (4c)$$

Rewriting Eq. 4c we obtain

$$\frac{\partial^2 g_{mo}}{\partial V_{GS}^2} = \frac{g_{mo}}{(V_p - V_{GS})^2} [(n-1)(n-2)] \quad (5)$$

Therefore, with an ideal-square-law device (that is,  $n=2$ ), the rate of change of curvature, and hence the  $CMF$ , would be zero. Practical FET devices, as might be expected, do not exhibit a perfect square-law transfer characteristic. Nevertheless it is more nearly square-law (that is,  $n$  is closer to 2) than the bipolar transistor's transfer characteristic. Hence the FET's claim to superior cross-modulation performance is valid. This is true provided that  $V_{in(u)}$  is not increased through impedance matching to the point of nullifying the lower  $CMF$  brought about by the characteristic.

### Gate opens way to stability

Stability is also a criterion for choosing between

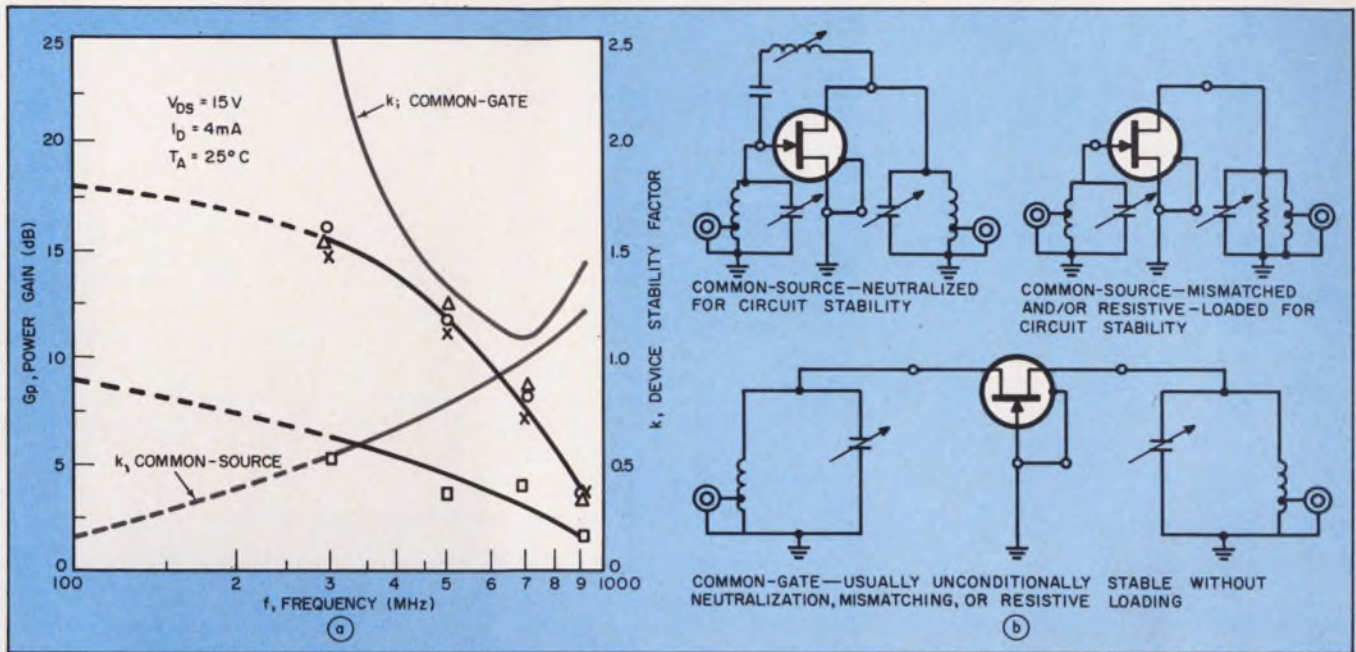

2. Gain and stability are indices of FET performance as a uhf amplifier (a). In the plot (see Table 1), circles (o) and crosses (x) refer to the unilateralized gain (U) of the common-source and common-gate configurations, respectively. Triangles ( $\Delta$ ) and squares ( $\square$ ) denote, re-

the two configurations. In the common-gate connection the device is inherently more stable than in common-source. In fact, the 2N3823 FET is unconditionally stable ( $k \geq 1$ ) in the common-gate configuration over the full frequency range shown in Fig. 2. In addition common-gate maximum available gain (unneutralized),  $G_{MA}$ , is approximately equal to unilateralized gain (U) for frequencies greater than 300 MHz. In the common-source connection, however, the unit is potentially unstable ( $k < 1$ , as shown in Fig. 2) below approximately 700 MHz. Moreover unneutralized gain ( $G_{MS}$  or  $G_{MA}$ ) here is considerably less than unilateralized gain over most of this frequency range. Consequently neutralization is virtually mandatory for common-source amplifier applications.

Referring to Fig. 2, we see that the device is unconditionally stable at 500 MHz in the common-gate configuration and that gains of 12 dB can be realized in an unneutralized circuit ( $k \approx 1.35$  and  $G_{MA} \approx 12$  dB). Note that the predicted gain in a neutralized circuit, for either configuration at 500 MHz, is also about 12 dB ( $U \approx 12$  dB). However, the maximum stable unneutralized gain for common-source operation is only about 4 dB ( $k \approx 0.77$  and  $G_{MS} \approx 4$  dB). In view of the factors discussed thus far, the choice of configuration points to the unneutralized common-gate connection (see Table 2). Proceeding along this line, we can start the design of a 500-MHz amplifier by obtaining the common-gate parameters from the data in Figs. 1 and 2 (see Table 3).

Since in this case neutralization is not required, the next consideration goes directly to the input and output matching networks. It is assumed that the amplifier will operate between a generator

respectively, the common-gate and common-source measures of maximum available gain ( $G_{MA}$ ). Using this data and the stability plot ( $k$  vs frequency for the basic circuits (b), we observe that the common-gate orientation is preferable at uhf (see Table 2).

and load each having internal admittances of 20 mmhos. Single-tuned networks will be used.

#### Compromise necessary for good match

The three primary considerations governing the design of the matching networks are gain, bandwidth and noise performance. From a gain standpoint, it is desirable to match conjugately at both the input and output of the transistor. However, conjugate matching does not, in general, provide the desired bandwidth and noise performance. Consequently some sort of compromise, depending on the intended application, is usually made.

In the case of the single-stage, narrow-band, common-gate amplifier under consideration here, the compromise primarily involves gain and bandwidth. The compromise involving noise figure and gain is usually not too severe, for two reasons. First, the noise figure for FETs is relatively insensitive to effective generator conductance. Secondly, even though noise figure is fairly sensitive to effective generator susceptance, the source admittance for optimum noise figure is usually (for common-gate operation) reasonably close to that which maximizes power gain.

Concerning noise figure and bandwidth, virtually no compromise is required, since the device input  $Q$  is so low that the bandwidth is essentially determined by the drain circuit  $Q$ . This circuit has very little effect on spot noise figure. The gain and bandwidth trade-offs can be determined analytically in the form of data shown in Fig. 3.

Of particular interest is the power-gain-bandwidth product, which is seen to be constant only for large values of mismatch ratio. For example, Fig. 3 shows that with a mismatch ratio of 2.0, the

gain is down only about 11% ( $\approx 0.5$  dB), whereas the bandwidth is up 50% relative to the values obtained at the power-match condition ( $m = 1$ ). These changes correspond to an increase of about 33% in the product of power-gain and bandwidth (again compared with the power-match value). Thus the circuit designer can select the mismatch ratio that gives the best gain-bandwidth compromise for a particular application. Here it will be assumed that maximum gain is of prime importance; thus the output circuit will be designed for  $m = 1.0$ . Note that if noise were our most important consideration, we would base our design upon data similar to those presented in Fig. 3, with noise replacing the gain factor. In that case the driving-source admittance for optimum noise figure with the 2N3823 (for 500-MHz, common-gate operation at a drain current of 4.0 mA) is given approximately by:

$$[Y_{G(opt)}]_{NF} = 15 - j 13 \text{ mmho.} \quad (6)$$

On the other hand, for optimum gain, the required driving-source and load admittances are calculated from:<sup>3</sup>

$$[Y_{G(opt)}]_{G_P} = \frac{|y_{fg}y_{rg}| \sqrt{k^2 - 1}}{2 \operatorname{Re}(y_{og})}$$

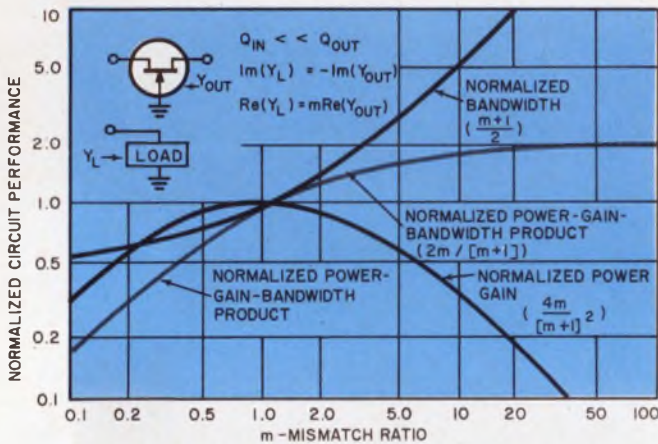

3. Trade-offs between gain, bandwidth and noise are necessary in designing FET uhf stages. A normalized plot of bandwidth and power gain, as functions of conductance mismatch ratio ( $m$ ), is used to give the best design compromise when noise considerations are secondary. These data refer to one single-tuned circuit in which the performance has been normalized to values corresponding to a power-match condition of  $m = 1.0$ .

Table 4. Comparison of performance\*

Characteristics	Observed†		Predicted
	Spread	Typical	
Insertion gain (dB)	8-12.5	11.0	12
Half-power bandwidth (MHz)	4-7	5.0	5.0
Spot noise figure (dB)	3.5-6	4.5	—

†For a sample of 60 devices measured in circuit described, using  $V_{DS} = 15$  V and  $I_D = 4$  mA.

(Refer to Fig. 4)

$$+ j \left[ \frac{\operatorname{Im}(y_{fg}y_{rg})}{2 \operatorname{Re}(y_{og})} - \operatorname{Im}(y_{ig}) \right] \quad (7)$$

$$[Y_{L(opt)}]_{G_P} = \frac{|y_{fg}y_{rg}| \sqrt{k^2 - 1}}{2 \operatorname{Re}(y_{ig})} + j \left[ \frac{\operatorname{Im}(y_{fg}y_{rg})}{2 \operatorname{Re}(y_{ig})} \operatorname{Im}(y_{og}) \right] \quad (8)$$

Using the parameters listed in Table 3 gives  $[Y_{G(opt)}]_{G_P} = 15.1 - j 10.8$  and  $[Y_{L(opt)}]_{G_P} = 0.15 - j 5.5$  mmhos. Since the driving-source admittance for maximum gain and minimum noise figure each have (approximately) the same real part, the input matching network may be designed so that either admittance value can be presented to the transistor. This is achieved by varying the input tuning.

### Solve for Q to obtain bandwidth

At this point the bandwidth resulting from the use of the above terminating admittances can be estimated. To do this, we must first calculate the input and output (loaded) Qs. Thus

$$Q_{in} = \frac{-\operatorname{Im}[Y_{G(opt)}]}{2 \operatorname{Re}[Y_{G(opt)}]} = 0.4 \quad (9)$$

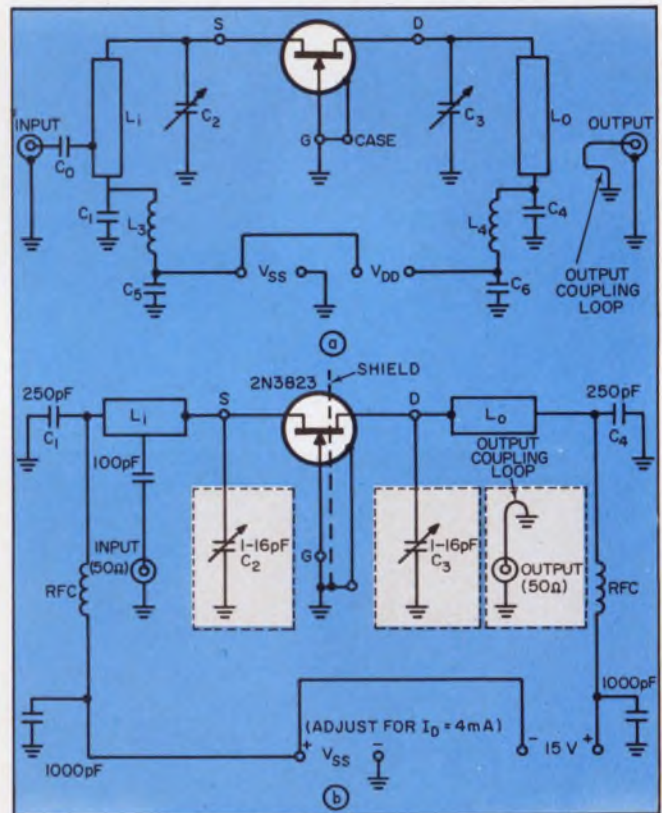

4. For optimum FET performance at uhf, the common-gate configuration (a) offers the best compromise involving gain, noise figure, cross-modulation and circuit stability. The complete circuit (b) exhibits 11 dB of gain at a bandwidth of 5 MHz, and a spot noise figure of 4.5 dB. In this 500-MHz linear amplifier,  $C_2$  and  $C_3$  are used to compensate for device and stray capacitance variations. An inductive coupling loop is used at the output to achieve proper transformation between load and line.

$$\text{and } Q_{out} = \frac{-Im [Y_{L(opt)}]}{2 Re [Y_{L(opt)}]} = 55.0 \quad (10)$$

These figures tell us that the bandwidth will be determined almost exclusively by the output  $Q$ . Since single-tuned networks are being used, the upper limit on bandwidth is given by

$$BW \leq \frac{f}{Q_{out}} = 9 \text{ MHz.} \quad (11)$$

However, since the output susceptance corresponds to a capacitance of only 1.8 pF, unavoidable stray capacitance in the completed circuit will lower the realizable bandwidth (note that  $-Im [Y_{L(opt)}] / 2\pi f = 1.8 \text{ pF}$ . If we assume a stray capacitance value of 2.0 pF, the expected bandwidth drops (from 9 MHz) to roughly 5 MHz.

The calculated loaded- $Q$ 's tell us that the output network must have an exceptionally good unloaded  $Q$ , if circuit losses are not to be excessive. At 500 MHz, high- $Q$  networks can best be realized in the form of tuned distributed lines. Therefore shorted quarter-wave lines, having the advantage of minimum physical length, will be used.

The first step in designing these lines is the establishment of a characteristic admittance,  $Y_o$ . The use of 0.25-inch diameter rod, in an air dielectric, with its centerline positioned 0.25-inch above the ground plane (chassis) gives a convenient value of 12.5 mmhos. This was calculated from

$$\frac{1}{Y_o} = \frac{60}{\sqrt{\epsilon_r}} \left[ \cosh^{-1} \left( \frac{2h}{d} \right) \right], \quad (12)$$

where  $d$  is the rod diameter,  $h$  the centerline height above ground plane, and  $\epsilon_r$  the relative dielectric constant. In this case  $\epsilon_r$  is taken as unity, since air is the dielectric.

Having determined  $Y_o$ , we then calculate the physical lengths of the lines. The input admittance of a shorted line is given by the relationship

$$Y_{in} = -j Y_o \cot \left( \frac{2\pi l}{\lambda} \right), \quad (13)$$

where  $l$  is the physical line length and  $\lambda$  is the wavelength. This line admittance is equated to the imaginary parts of the desired driving-source and load admittances (less the susceptance of the circuit stray capacitances), and the resulting equation is then solved for the line length. Thus, in general terms, the required line-length,  $l$ , is:

$$l = \frac{\lambda}{2\pi} \cot^{-1} \left\{ \frac{-[Im(Y_{opt}) - 2\pi f C_x]}{Y_o} \right\}, \quad (14a)$$

where  $C_x$  is the appropriate stray capacitance.

Assuming a stray capacitance value of 2.0 pF, we determine output line length  $l_o$  as equal to

$$\frac{60}{2\pi} \cot^{-1} \left\{ \frac{-[-5.5 - 6.3]}{12.5} \right\} \text{ cm} = 3.1 \text{ in.} \quad (14b)$$

Note that a free-space wavelength of 60 cm at 500 MHz has been used in Eq. 14b because air is the dielectric. A similar calculation for input line

length,  $l_i$ , gives  $l_i = 2.4$  inches.

### Transformation is a coupling requirement

The final stage of the design involves the coupling between the lines and the generator and load. For our purposes, both generator and load are assumed to have a characteristic admittance ( $Y_c$ ) of 20 mmhos.

At the input only a small transformation is required; thus the generator input can be tapped into the line. To determine the tap position ( $l_i$ ), measured from the shorted end of the line, we can use an approximating linear relationship:  $l_i \approx l_i Re [Y_{g(opt)}] / Y_c$  suffices. Solving, we obtain a value of 1.8 inches.

At the output, a rather large transformation is required. This can best be accomplished with an inductive coupling loop positioned near the shorted end (current-node point) of the line. Optimum spacing between the loop and line is determined experimentally by adjusting the spacing for maximum gain. A simplified circuit schematic of the amplifier is shown in Fig. 4a. The tuned lines are represented by  $l_i$  (input line) and  $l_o$  (output line).  $C_2$  and  $C_3$  (which should be of minimum possible value, so that bandwidth will not be reduced) are trimmer capacitors that compensate for small variations in both device and stray circuit capacitance. Moreover  $C_2$  may be tuned to provide either minimum noise figure or optimum gain in this particular case. Output coupling is provided by, approximately, a 3/4-turn loop. Both input and output bias voltages are inserted at the low-potential ends of the tuned lines through the networks  $L_3 - C_5$  and  $L_1 - C_6$ .

The complete 500-MHz FET amplifier is shown in Fig. 4b. The amplifier was constructed under the usual practices appropriate to uhf circuitry. In particular, since the output impedance level is rather high (approximately 20 k $\Omega$  here), it was extremely important to minimize spurious coupling between input and output. Consequently input and output lines were placed in separate, completely enclosed compartments. In addition the transistor metal case was grounded through a low-inductance clamp, as well as through the case lead.

The measured performance characteristics of several 2N3823 devices operating in this circuit are presented in Table 4. The actual values compare nicely with the predicted values, based on the single device represented in Figs. 1 and 2. In obtaining the measured values, input tuning capacitor  $C_2$  was adjusted for minimum-noise figure (as opposed to adjusting for maximum gain) for a single device. It was then left fixed for the subsequent measurements on the other samples. The output coupling loop was similarly adjusted, with maximum gain as the criterion. Output tuning capacitor  $C_3$  was adjusted for maximum gain for each device. With  $C_2$  adjusted for maximum gain, a 1.0-dB increase in both gain and noise figure was evident. The noise-figure values shown include the small contribution of a second stage with a noise figure of approximately 5 dB. ■ ■



# Semicondu

## “ANNULAR TRANSIST PLANAR TYPE DEV

### FOUR PATENTS ISSUED ON ANNULAR DEVICES

PHOENIX, ARIZONA — A series of four patents covering generic developments in the design and manufacture of semiconductor devices has been issued to Motorola's Semiconductor Products Division. The patents, according to Dr. C. Lester Hogan, vice president and general manager of the Division, cover annular semiconductor devices which, he says, represent the only practical method for making passivated, high-voltage PNP transistors and related products.

According to Hogan, Motorola's invention of annular semiconductors overcomes some of the basic functional limitations of passivated semiconductor devices. Prior to this invention, he said, it was impossible to manufacture these widely used device types to operate above approximately 30 volts without seriously degrading their performance and reliability capabilities. With annular construction, however, Motorola is already marketing transistors capable of operating at several hundred volts while maintaining, in all other respects, the highest level of performance currently achievable



Jack C. Haenichen (right), inventor of the annular transistor, receives congratulations and formal copies of the U.S. patents on annular semiconductor devices from Foorman Mueller, patent attorney for Motorola Inc.

## ANNULAR SEMICONDUCTORS TO GIVE MOTOROLA SILICON TRANSISTOR LEAD

PHOENIX, ARIZONA — Motorola Semiconductor Products Inc., a company which, until 1961 had not produced and marketed any silicon transistors, now claims to have out-distanced all of its competitors in the silicon transistor field. The company now says it manufactures silicon transistors for more different applications than any other single



Dr. Hogan general manager of Motorola's Semiconductor Products Division, was the

semiconductor manufacturer.

The major reason for this advance, according to Dr. C. Lester Hogan, vice president and general manager of Motorola's Semiconductor Products Division, was the

invention of the annular structure.

The annular invention, he pointed out, made it possible for Motorola to introduce a steady stream of improved devices, in both the NPN and PNP transistor areas. It led to new breakthroughs in the high-voltage area, making such devices ideal for the production of line-operated equipment for which high-



# Motor News



## TRANSISTORS ARE REPLACING MESAS" - MOTOROLA

### DEMAND FOR HIGHER VOLTAGE SPURS USE

PHOENIX, ARIZONA — Motorola's patented silicon annular transistors, which now offer much higher voltage ratings than previously available, are replacing many planar devices in newer state-of-the-art designs, according to Dr. C. Lester Hogan, vice president and general manager of Motorola's Semiconductor Products Division in Phoenix, Arizona.

Motorola's development was successful in solving the channeling problem which limits the voltage rating achievable with PNP planar transistors to some relatively low value and annular devices have proved equally successful in providing similar advantages for silicon NPN types as well.

According to Dr. Hogan, Motorola has almost universally applied the annular device structure to its silicon transistors and the tell-tale "ring" that is characteristic of those devices is seen with increasing frequency in silicon devices.

"This is not surprising," he said, "because the Motorola-invented annular structure represents the only known method for conquering the high-voltage limitation of planar transistors while providing the advantages of low-leakage protection."

For example, the company presently manufactures both PNP and NPN annular transistors with voltage ratings as high as 300 volts! And, Motorola says even higher voltages are in the offing. An important aspect of these transistors is that the high-voltage rating has been achieved without any sacrifice in gain and collector saturation resistance — normal trade-offs for high voltage with other device structures. The 300-volt transistors (types 2N3742 and 2N3743) are designed for either amplifier or switching applications and feature the multifinger geometry of Motorola's Star transistor line. They are packaged in a solid-header TO-5 package.

The annular device structure is also applicable to silicon semiconductor devices.

### ANNULAR DEVICES A "GIANT STEP"

"Ever since the invention of the transistor," according to Jack C. Haenichen, inventor of the Annular structure for semiconductor devices, "we have been searching for a way to manufacture devices whose characteristics were not limited by process considerations. Thus, we have seen the many variations of the

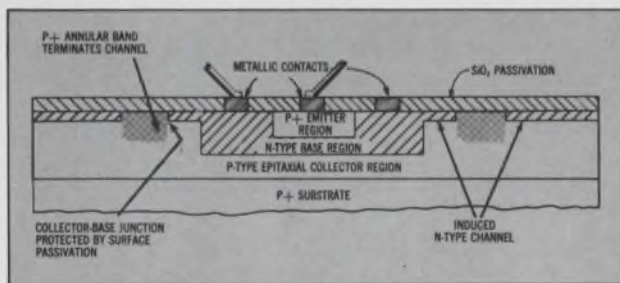

PNP Annular Transistor Structure

g r o w n - junction transistor give way to the improved characteristics of alloy and diffused-base micro-alloy devices, which yielded higher-frequency response but were limited to low-breakdown voltages. These, in turn, were superseded by the mesa structure with its high-speed, high-voltage capabilities which, for

while promised to be the ultimate structure. Although the silicon transistor with a passivating film was advertised as the answer to the shortcomings of the mesa transistor, it too fell short of the "ideal device". The passivating film gave rise to a phenomenon called "channeling," which limited such transistors to low-voltage applications.

Channeling is a random effect that tends to invert the conductivity type of the col-

lector region underneath the  $SiO_2$  film and, therefore, produces a channel that extends the base region from underneath the film to the unprotected edges of the transistor. When this occurs, the apparent leakage current rises to a point where the transistor becomes useless.

Even in low-voltage structures, the tendency towards channeling is present and its random nature can affect transistor stability even before junction deterioration is



Haenichen

lectors, which yielded higher-frequency response but were limited to low-breakdown voltages. These, in turn, were superseded by the mesa structure with its high-speed, high-voltage capabilities which, for

# Estimate the solar noise of optical communication systems graphically. The results show noise depends on wavelength and look angle.

Solar noise, originating from the sun's irradiance, may mask the signal that an optical communication system receives. But the magnitude of solar background noise can be quickly estimated with the following graphical technique.

The solar spectral irradiance at the surface of the earth is a function of wavelength<sup>1</sup> (Fig. 1), since the sun may be likened to a black body radiating at about 6000°K. It is important to note that the solar irradiance also depends on atmospheric conditions and the angle of the sun. The curve in Fig. 1 indicates the maximum radiation under normal atmospheric conditions—that is, when the sun is at its zenith. At any other angle the radiation decreases. (Normal atmospheric conditions are defined as barometric pressure of 760 mm, a depth of precipitable water of 20 mm, a dust density of 300 particles/cm<sup>3</sup> and an ozone content of 2.8 mm.)

The amount of solar energy reflected from a particular target, or from the surface around the target, and collected by an optical system can be computed with the geometry in Fig. 2. The symbols used are as follows:

$R$  = receiver, with aperture  $d_R$  (cm).

$l$  = path length, from receiver to reflecting surface (cm).

$A_s$  = area (cm<sup>2</sup>) subtended on surface by receiver's look-angle,  $\theta$ , (radians).

$P_{s(\lambda)}$  = solar irradiance at surface (watts/cm<sup>2</sup> -  $\mu$ ).

$\rho$  = reflectivity of surface.

The reflected power at the receiver aperture is equal to:

$$P_{R(\lambda)} = A_R A_s \rho P_{s(\lambda)} / 2\pi l^2.$$

This is the radiation reflected from the surface, and it radiates into  $2\pi$  steradians.

But  $A_s = \pi D_s^2 / 4$ , where  $D_s$  = diameter of  $A_s$ . To a reasonable approximation:  $D_s = l\theta$ .

Then  $A_s = \pi l^2 \theta^2 / 4$ ,

and  $P_{R(\lambda)} = A_R \theta^2 \rho P_{s(\lambda)} / 8$ .

Finally, since  $A_R = \pi d_R^2 / 4$ , the reflected power is:

$$P_{R(\lambda)} = \pi d_R^2 \theta^2 \rho P_{s(\lambda)} / 32$$

Note that, with the units as indicated,  $P_{R(\lambda)}$  is given in watts per micron.

These calculations are performed often enough to warrant construction of a graph of  $P_{R(\lambda)}$  versus the other parameters in the expression for  $P_{R(\lambda)}$ . Fig. 3 is a graph of  $P_{R(\lambda)}$  versus the receiver aperture-diameter  $d_R$  for various values of the look-angle,  $\theta$ .  $P_{s(\lambda)}$  is the solar irradiance at 9000 Å, a useful point in the spectrum when employing any of the numerous gallium arsenide (GaAs) light-emitting diodes, as well as injection lasers.

The average value of  $P_{s(\lambda)}$  in the visible spectral interval, between 4500 and 7000 Å, is shown in Fig. 4. This graph is useful for systems like the 6328-Å He-Ne gas laser and the 6943-Å pulsed ruby laser. In each graph the reflectivity  $\rho$  is taken as unity.

As an example of the use of these graphs, consider an active optical communication system using a GaAs light-emitting diode and a Si photodiode detector. An optical filter with a 500-Å band-

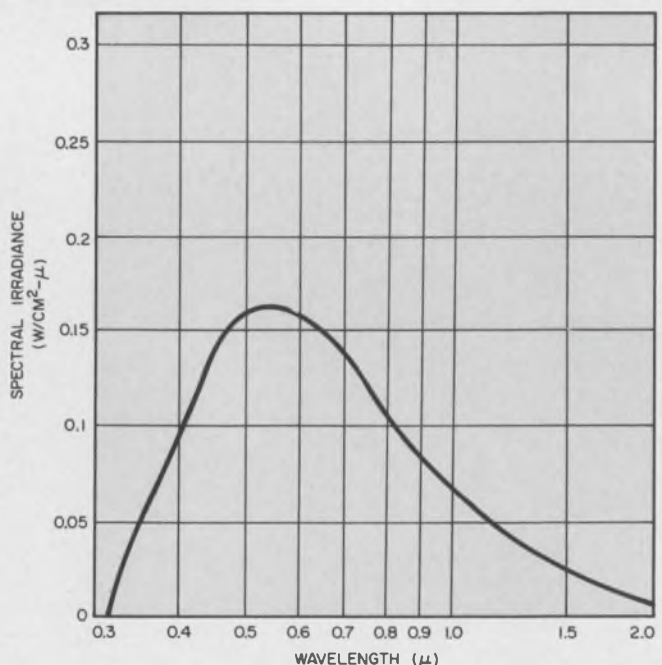

1. Spectral irradiance from sun reaches its maximum level of 0.16 watts/cm<sup>2</sup>/micron at about 5000 Å. This wavelength is found from Wien's law:  $\lambda_{\text{max}} = 2900/T^\circ \text{K}$ , where  $T = 6000^\circ \text{K}$ . The curve indicates values when the sun is at its zenith, under normal atmospheric conditions.

Norman Koch, Member of Technical Staff, The Bissett-Berman Corp., Santa Monica, Calif.

width will define the limits within which solar background radiation will be received. In addition, assume:

$$d_R = 8 \text{ cm}$$

$$\theta = 2.9^\circ, (5 \times 10^{-2} \text{ radians})$$

$$P_{s(\lambda)} = 8 \times 10^{-2} \text{ w/cm}^2 - \mu$$

$$\rho = 1 \text{ (worst case, 100\%)}$$

Referring to Fig. 3, enter the graph along the horizontal scale at  $d_R = 8 \text{ cm}$ . A line is drawn vertically until it intersects the  $5 \times 10^{-2}$  radian curve. A horizontal line is then drawn to the vertical axis, where it intersects the scale at a value of  $P_{R(\lambda)} = 1.2 \times 10^{-3}$  watts/micron. This number is multiplied by the optical bandwidth ( $0.05\mu$ ) to give a value of  $P_R = 6 \times 10^{-5}$  watts. This is the solar background noise level, which will be a limiting factor in determining the system's performance (assuming the system is not limited by the detector's noise).

Any value taken from Figs. 3 or 4 is based on an assumed 100% reflectivity. This value is obviously excessively conservative in many cases. Some typical values of reflectivity are given as follows:<sup>2</sup>

Fresh snow	80-85%
Old snow	40%
Grass	33%
Rock	12-15%
Dry earth	14%
Wet earth	8-9%

If a particular system analysis indicates a lower value of reflectivity, this value may be applied to change linearly the value of  $P_R$ . ■ ■

**References:**

1. P. Moon, Proposed Standard Solar-Radiation Curves for Engineering Use, *J Franklin Inst.*, 1940, 230, p 583-617.
2. Handbook of Meteorology, p 296, Berry, Bollay and Beers.

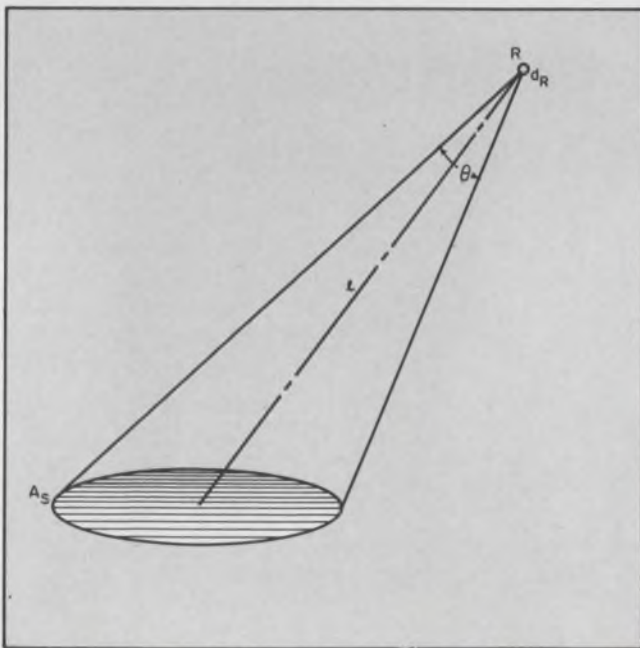

2. Geometry finds solar energy that is reflected by a target and picked up by a detector. A receiver R, with aperture  $d_R$ , looks at an area  $A_s$  on the reflecting surface and records all energy intercepted by  $d_R$  and radiated by this surface.

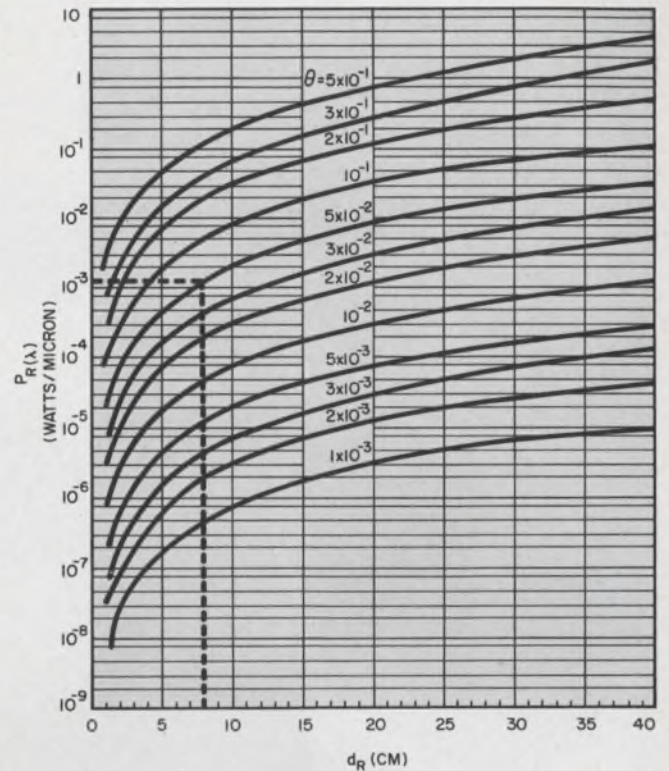

3. The reflected solar background radiation picked up by the detector depends on its aperture,  $d_R$ . This noise power,  $P_{R(\lambda)}$ , also increases with larger look angle,  $\theta$ . Here the solar irradiance is  $8 \times 10^{-2}$  watts/cm<sup>2</sup>/micron at a wavelength of  $0.92 \mu$ . These curves are useful for GaAs diodes and for injection lasers.

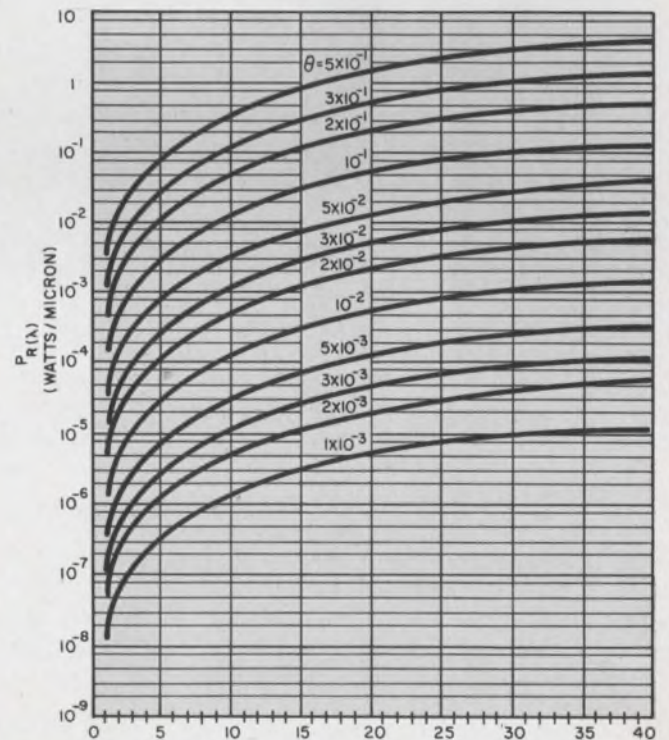

4. Incident solar power versus the receiver's aperture for systems operating in the range of 4500 and 7000 Å. The solar irradiance on the surface is taken as  $1.6 \times 10^{-1}$  watts/cm<sup>2</sup>/micron. These curves should be used for most He-Ne lasers and the 6943-Å ruby laser.

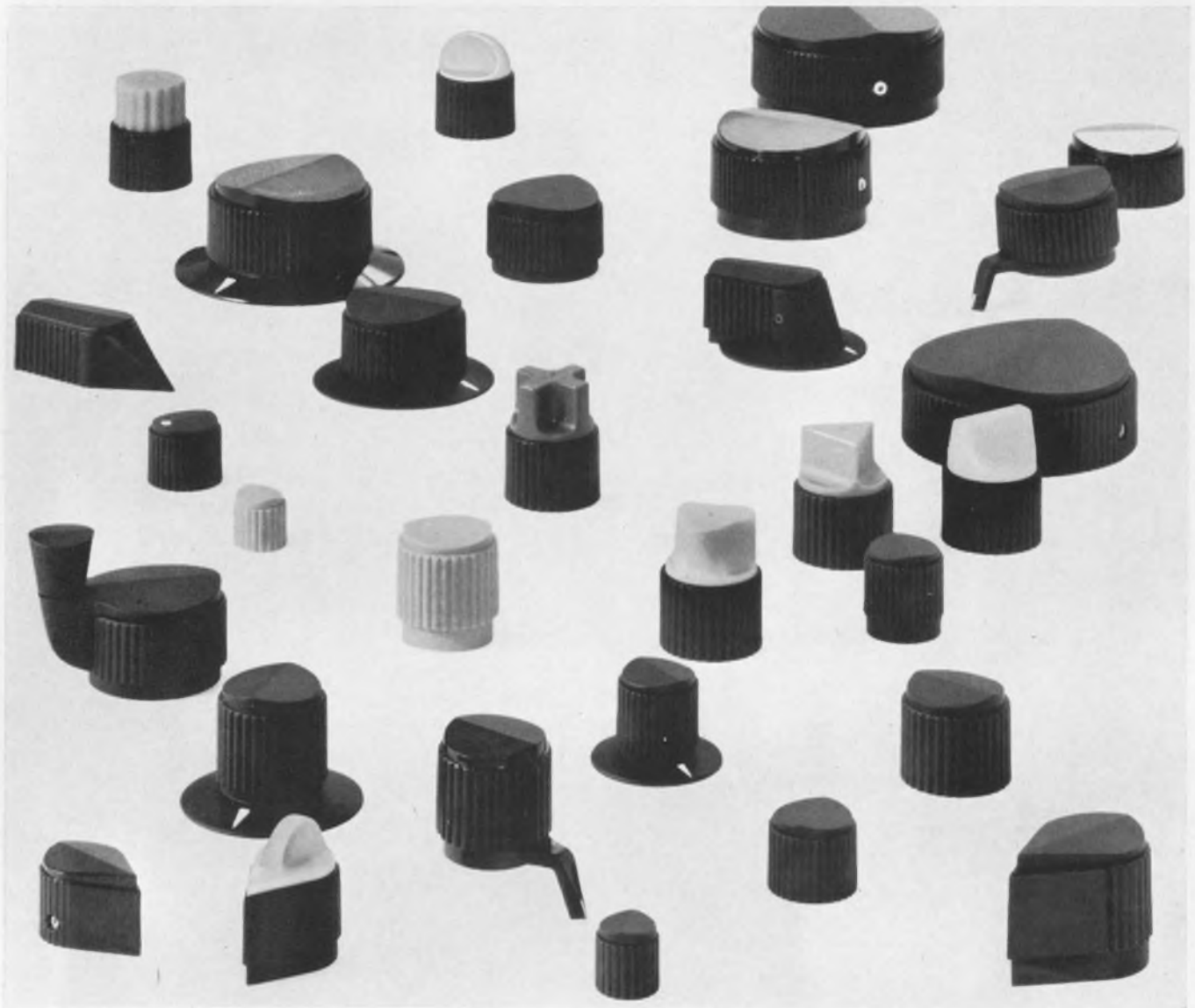

## Raytheon MS91528C Control Knobs... choose from over 300 standard types

With Raytheon's broad line of Standard Series control knobs, you can design control panels to meet every requirement. You can choose from more than 300 standard types and have modifications made when needed! *We've made over 2,000 special modifications!*

Every Raytheon knob is functionally designed. All styles have an integrated design to give uniformity to your panel. And each knob fully meets MS91528C requirements to withstand flame, torque, vibration, temperature and humidity extremes, salt spray, and ultraviolet radiation.

For more than a decade, Raytheon has been the leading manufacturer of MS91528 military control knobs. Today Raytheon continues to keep abreast of defense requirements *and often anticipates them*. So, be sure to get approved control knobs made by the leading qualified source: Raytheon.

For small order or prototype requirements, call your local Raytheon industrial distributor. For data sheets and a catalog, call your Raytheon regional office or send the reader service card.



Raytheon Company, Components Division,  
Industrial Components Operation,  
Lexington, Massachusetts 02173

# Photomicrography is a powerful tool

for detecting flaws in integrated circuits. Here are tips to help you take good, detailed pictures.

High-resolution color photos of semiconductor devices can furnish valuable clues to circuit failure. With good photos, the engineer can spot flaws in the circuit and its connecting bonds.

But good photomicrography is no accident. It takes knowledge and the right equipment to bring out sharp details of lead connections and circuit topology, despite surface non-uniformity and reflections from the silicon-dioxide layers.

Several photographic approaches may be used. Let's consider some, naming appropriate equipment that may be employed, but bearing in mind that any equivalent apparatus is suitable.

One requirement for a good photograph of an

integrated circuit (or any semiconductor device) is almost obvious, but important: The object must be clean. The device usually has lint, wax or other foreign matter on its surface that mars the photo. But cleaning by physical contact isn't wise, because of possible damage to the leads that connect the device to the header pins. A Paasche air brush can be used to spray alcohol on the surface of the device to remove the unwanted particles.

Table 1. Film characteristics.

Film type	ASA rating	Exposure
P/N 55 Polaroid	50	1/5 sec.
Tungsten positive color film	32*	1/2 sec.
Type L negative color film	75*	1/10+1/25 sec.

\*Check Recommendation sheet of manufacturer

**Bernard W. White** and **W. A. Little**, Texas Instruments Inc., Dallas, Tex.

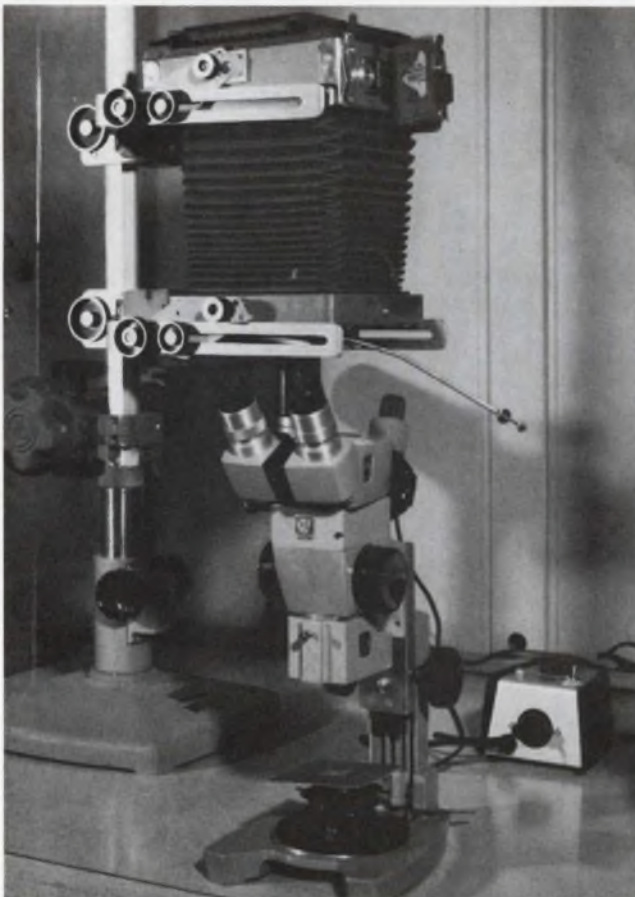

1. Microscope and camera setup for taking photomicrographs. The camera is a 4-by-5-inch B&J View camera with a 12.5X Bausch and Lomb eyepiece.

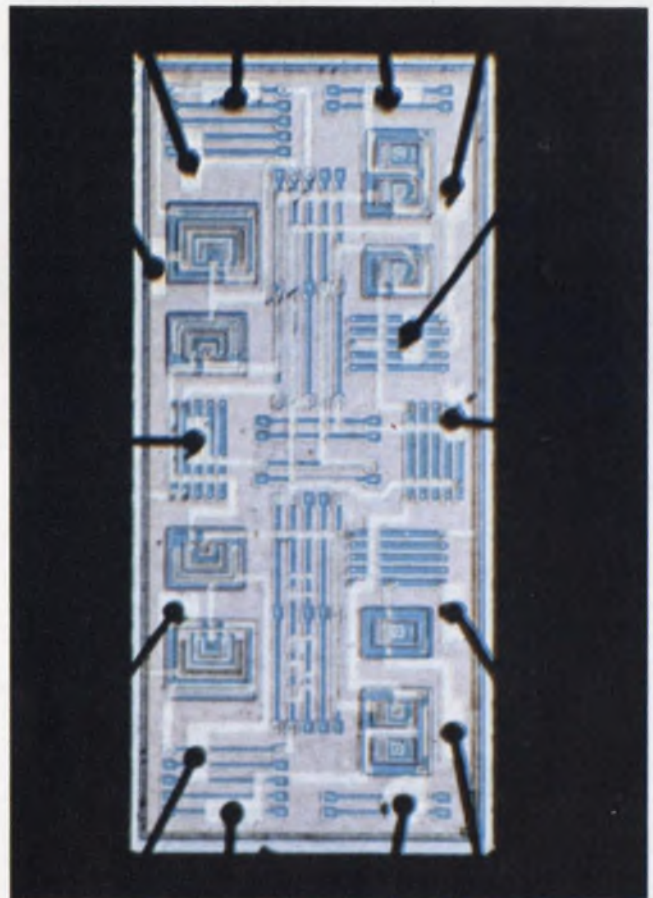

2. Integrated-circuit photomicrograph with vertical illuminator as the light source. Notice clear wafer detail and the lack of package detail.

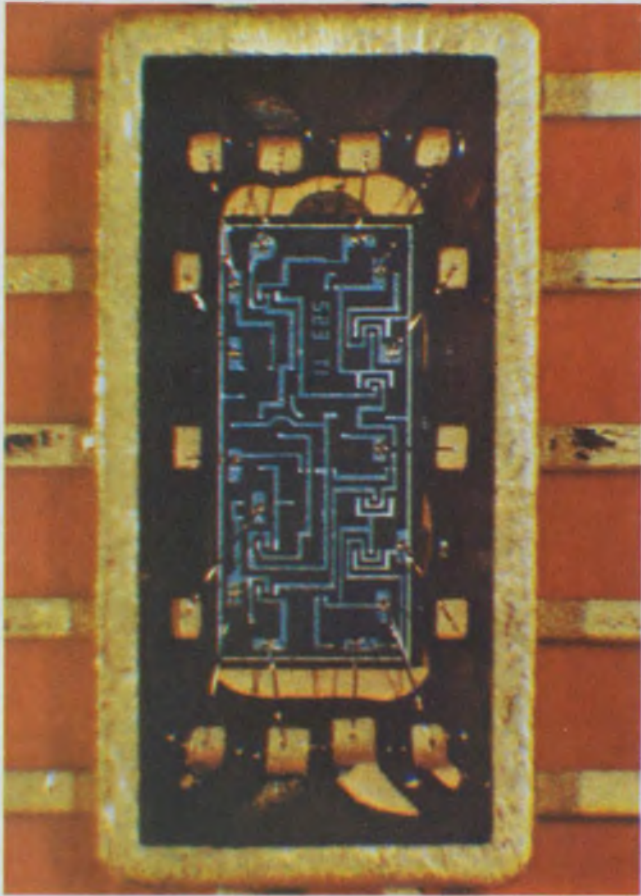

3. External light sources bring out package details, but wafer details are lost.

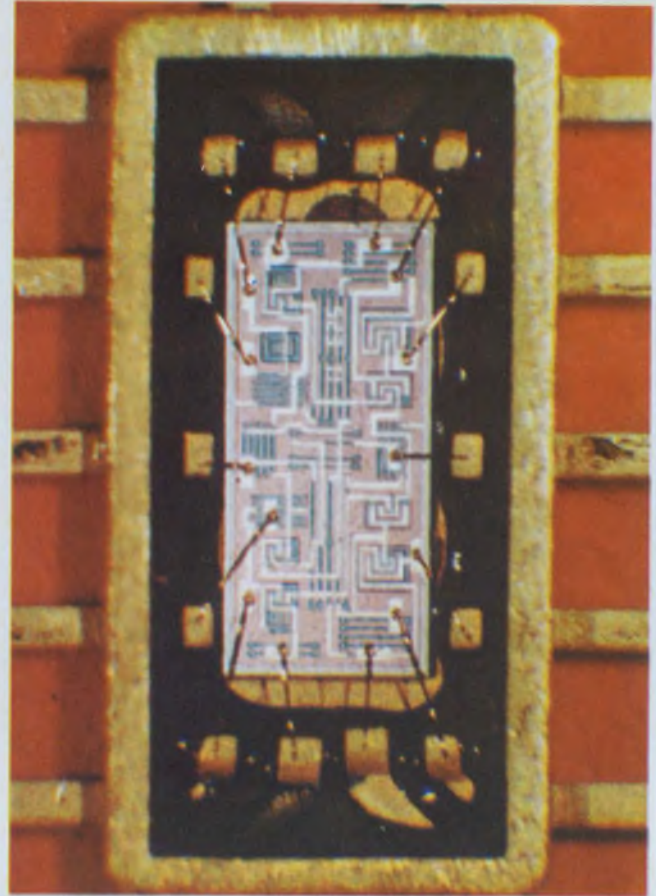

4. Double exposure, with techniques used for Figs. 2 and 3, results in both wafer and package detail.

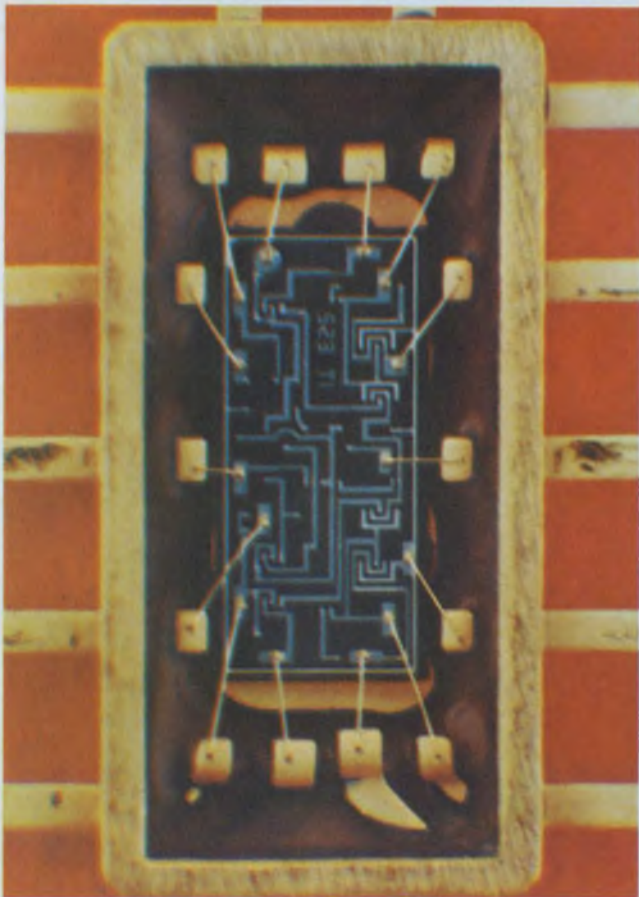

5. "Tenting" technique clearly brings out all of the package details, but circuit detail remains hidden.

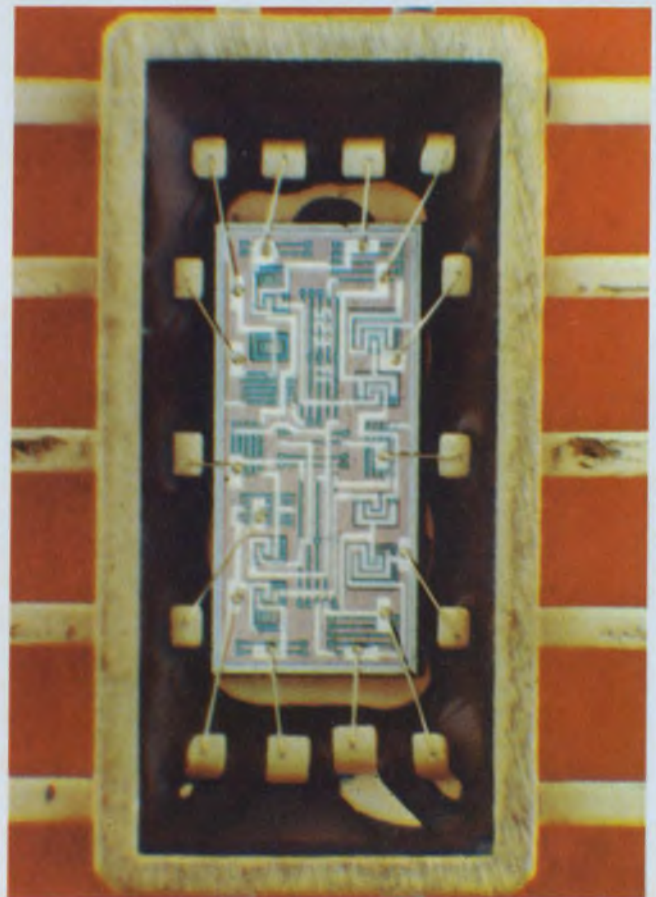

6. Double exposure, combining the results of Figs. 2 and 5, presents an excellent picture of the devices.

For low-power ( $\approx 5x$  to  $50x$ ) photomicrography, an American Optical Cycloptic microscope with a vertical illuminator can be used. A Cyclo-spot microscope illuminator with a model 350 transformer is a good light source. It provides light that has a color temperature very close to  $3200^\circ\text{K}$ , permitting the use of tungsten color film. Add a model 649 A/O photographic tube adapter to the microscope. As a camera lens, place a 12.5X Bausch and Lomb apochromatic compensating eyepiece in the tube. This lens is color-corrected and has a very flat field.

A good camera to use with this microscope is a 4-by-5-inch B&J View Camera. The lens board is fitted with an Ilex No. 4 Universal Shutter, and the adapter tube screws directly into this shutter. With this system, the focus on the semiconductor device depends on its distance from the objective lens. The camera bellows is used only for size control. With the camera backs and film holders available, all kinds of film can be used to produce photomicrographs and negatives for black-and-white or color prints and transparencies.

One other piece of equipment is required. To obtain uniform illumination of the polished silicon surface, it is necessary to tilt the semiconductor device slightly. A manipulator makes it possible to align the device with the microscope and the camera back. When a vertical illuminator is used, this presents a slight problem with depth of field and sharp over-all focus. With care, this problem can be minimized and its effects neglected. The manipulator consists of a vacuum chuck that can be rotated  $360^\circ$  around its vertical axis and tilted  $30^\circ$  from the vertical in either the x or y direction.

To illustrate the use of this equipment, let's consider the techniques used in making a series of photographs with different lighting methods. In our first equipment setup (Fig. 1) let's use vertical illumination only. The problem here is to expose correctly for both the package and the semiconductor wafer. The reflectivity of the

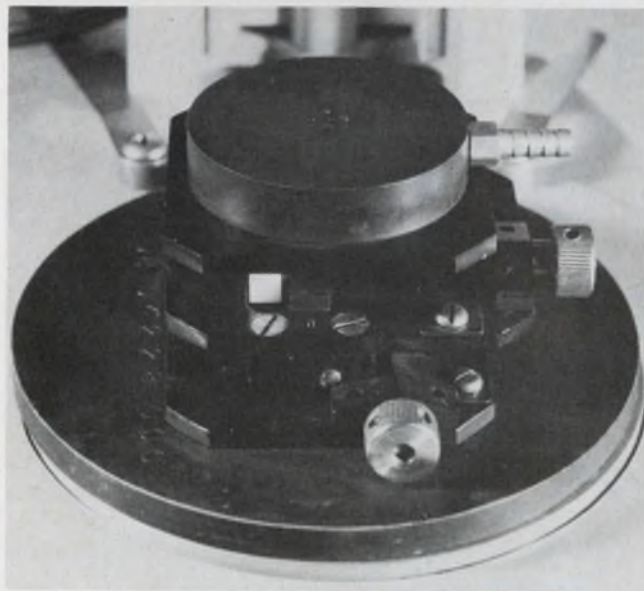

**Manipulator** simplifies the job of positioning.

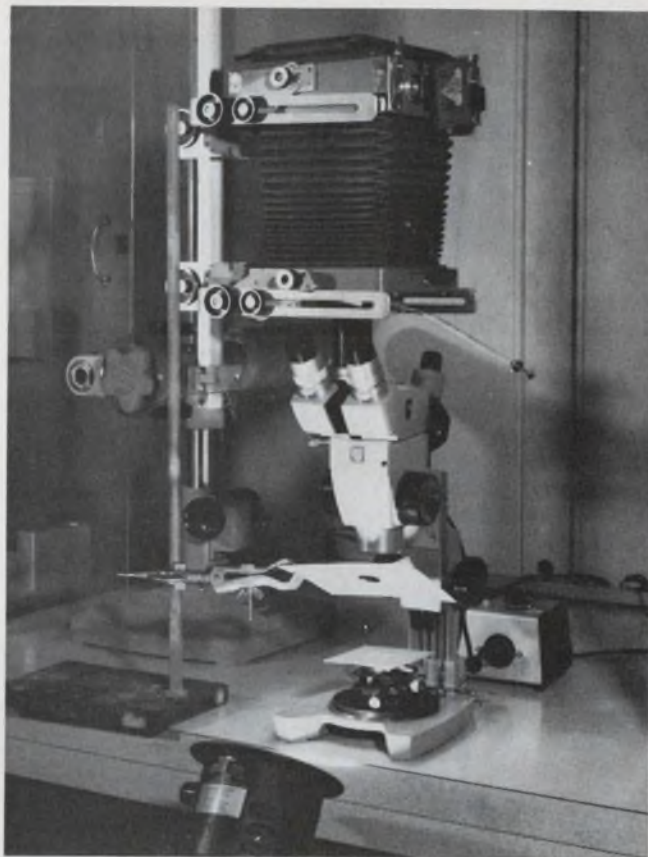

**7. Reflected light** from quartz iodide lamp is used as source of illumination to photograph non-planar surfaces.

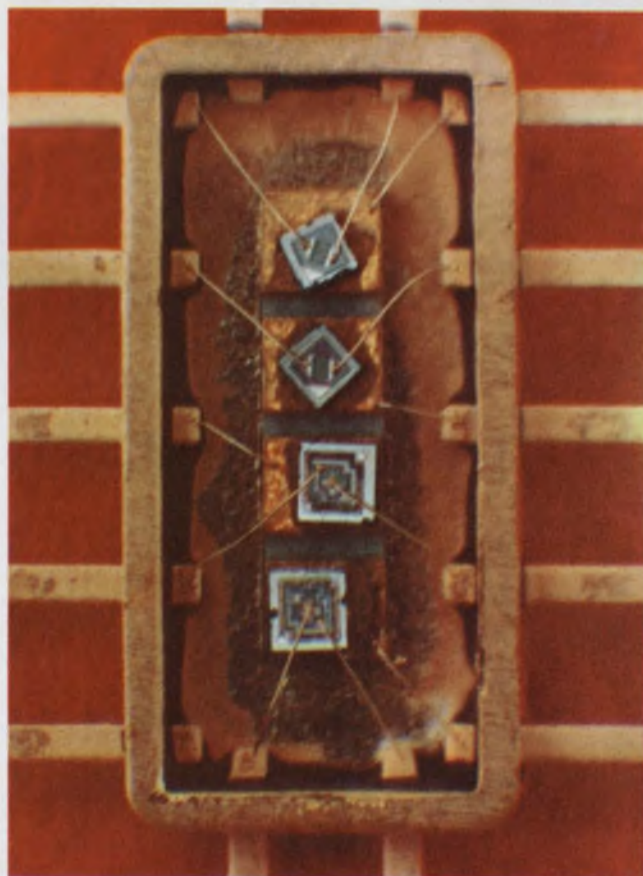

**8. Multi-chip device** requires a different lighting technique, using reflected light, to bring out details on the many planes being photographed.

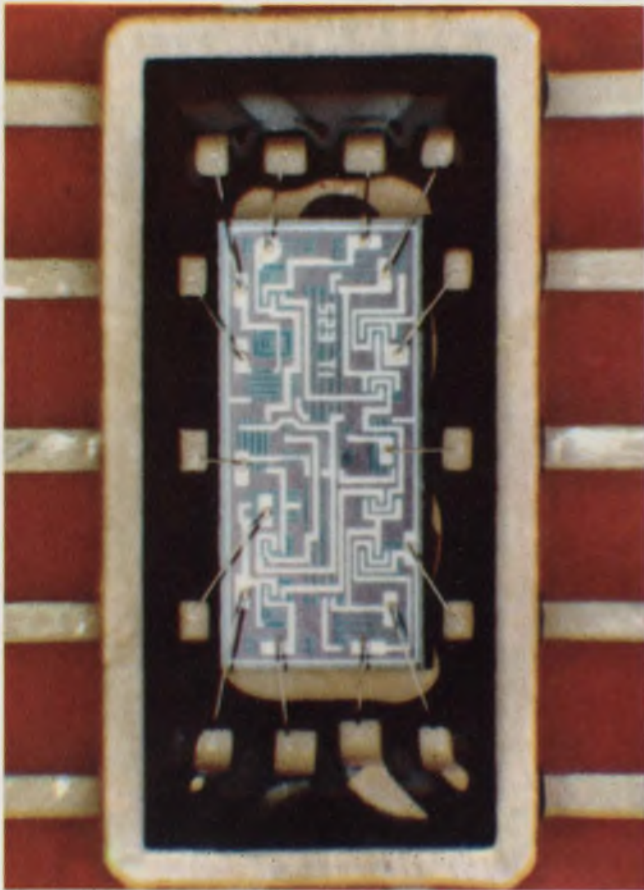

9. A single exposure may be taken to bring out a reasonable amount of detail on both the chip and the package. This picture was taken by using reflected light from a piece of cardboard, as described in the text. This type of picture is adequate if a double-exposure becomes impractical.

mirror surface of the silicon and the surface of the package are too different for a single exposure. Correct exposure for one results in over-exposure or under-exposure for the other. However, the exposure can be made for the integrated-circuit wafer alone (as shown in Fig. 2). The exposure data are given in Table 1.

An exposure for Type 55 Polaroid film is obtained by making several tests. Other exposures are figured on the basis of the ASA ratings. However, for longer exposures in the case of slower color film, the ASA ratings are too high, and the exposure must be increased. For example, tungsten positive color film has a rating of 32, but for the exposures used here, a rating of 25 gives best results. Some experience is necessary in determining the right exposures under given conditions. Also, it is recommended that the transformer be operated at its highest setting for good color balance. Lower settings result in a change in the color temperature of the light, and the color rendition is not true.

To obtain package detail, two external microscope illuminators can be placed on either side of the setup and aimed at the wafer. The vertical illuminator is turned off. Fig. 3 shows the results obtained with an exposure of four seconds on Type 55 Polaroid film. This gives very little detail on the silicon wafer, since it has a mirror surface. This type of lighting brings out all the flaws (peaks and valleys) in the leads and package material. In some experimental work, it is desirable to emphasize these imperfections.

By combining the methods used in obtaining Figs. 2 and 3, we obtain the results in Fig. 4. Use

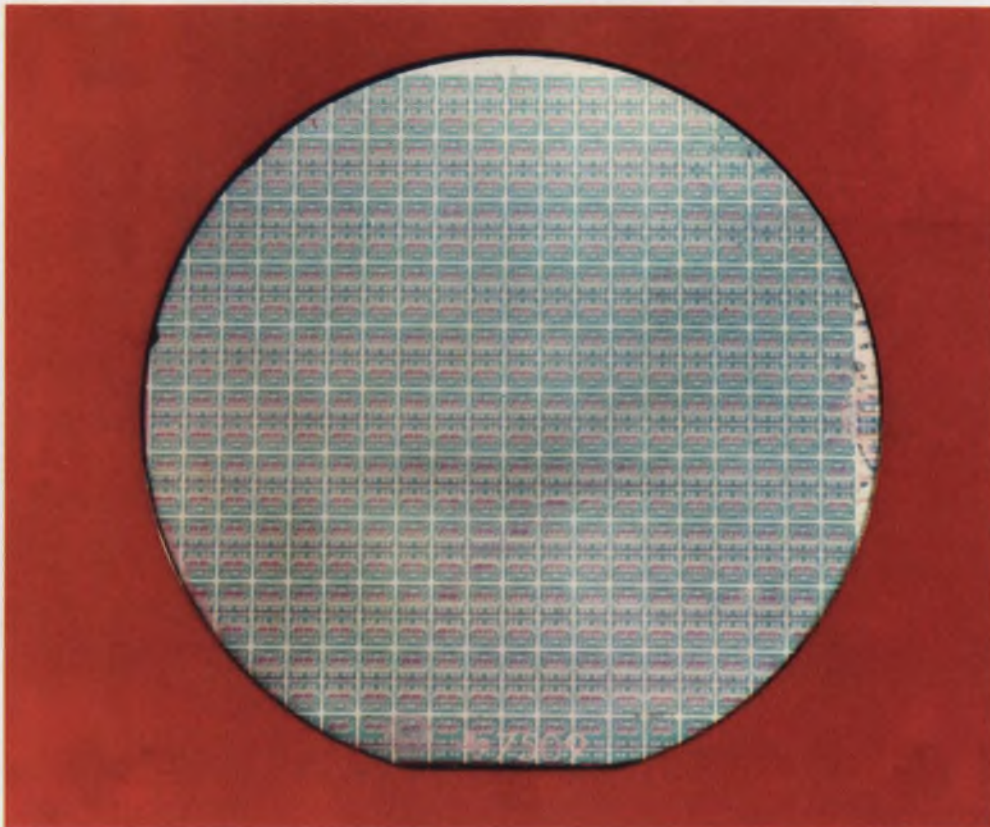

10. Silicon wafer photograph made with reflected light. For this picture, the B&J View Camera was fitted with a six-inch Golden Dagor lens.



the same exposure times as before—that is, one exposure using the vertical illuminator, and a second using the external lighting source. The double exposure results in fair detail on both the package and silicon wafer. On the silicon wafer, it is possible to see the resistors, diodes, transistors, etc., as the variations in the oxide are brought out. Also, some detail in the package can be seen. However, there is some loss of definition in leads from the silicon wafer to the package pins.

Another type of lighting can be used to bring out the detail in the package. Known as “tenting,” it is created by wrapping a piece of white paper around the object to be photographed and placing high-intensity lights about it. Two, 650-watt quartz iodide lamps can be used, to maintain the color balance and obtain the desired intensity of light. The high intensity keeps the exposure as short as possible and gives excellent results.

A photograph made with this setup, with a four-second exposure on Type 55 Polaroid film, is shown in Fig. 5. The result is excellent detail in the package and the leads connecting the circuit to the package pins. Again, a second exposure is made (as for Fig. 2) to bring out the detail on the silicon wafer. The result of this double exposure is shown in Fig. 6. Both the package and the silicon wafer are uniformly lighted and have excellent detail. This type of lighting gives good, even illumination of surfaces that are highly polished, such as glass, metal and ceramic.

Occasionally the surface of the silicon wafer is not flat, and this makes it harder to achieve even illumination. In other cases, a ceramic block or header may have several silicon wafers mounted

with the surfaces at slightly different angles. The lighting arrangement shown in Fig. 7 makes a good photograph possible. A piece of white cardboard with a hole in the center is used to reflect light on the semiconductor device. Fig. 8 shows the result. The exposure was for four seconds with Polaroid P/N 55 film. Good detail is obtained of the package, leads and metal contacts on the silicon wafer. If vertical illumination is not available, this method will produce acceptable results (Fig. 9) for the single integrated circuit shown in Fig. 6. However, there is a loss of detail on the wafer: The junctions and circuit components are not as clearly defined as before.

At times a reproduction of a whole slice is desired. The cardboard reflector with a hole in it can be used for illumination. With a B&J View Camera with a six-inch Golden Dagor lens, Fig. 10 was produced. The magnification in this case is at most two or three power.

In all of our illustrations we have been talking about power photomicrography, where the working distance between the specimen and objective lens is large enough to permit use of these techniques. For magnification in the 1000-to-2000-power range, different equipment is needed—like the American Optical Metalstar metallurgical microscope, equipped with a photographic adapter and various camera back. Cut film, roll film and Polaroid film can then be used. The camera lens is an apochromatic compensating eyepiece lens, which provides a good flat field. Fig. 11 is an example of a transistor photographed with this equipment. The magnification is about 1000 times. ■ ■

11. Microwave power transistor (1000X) photograph is achieved by using metallurgical microscope equipped with a photographic adapter.

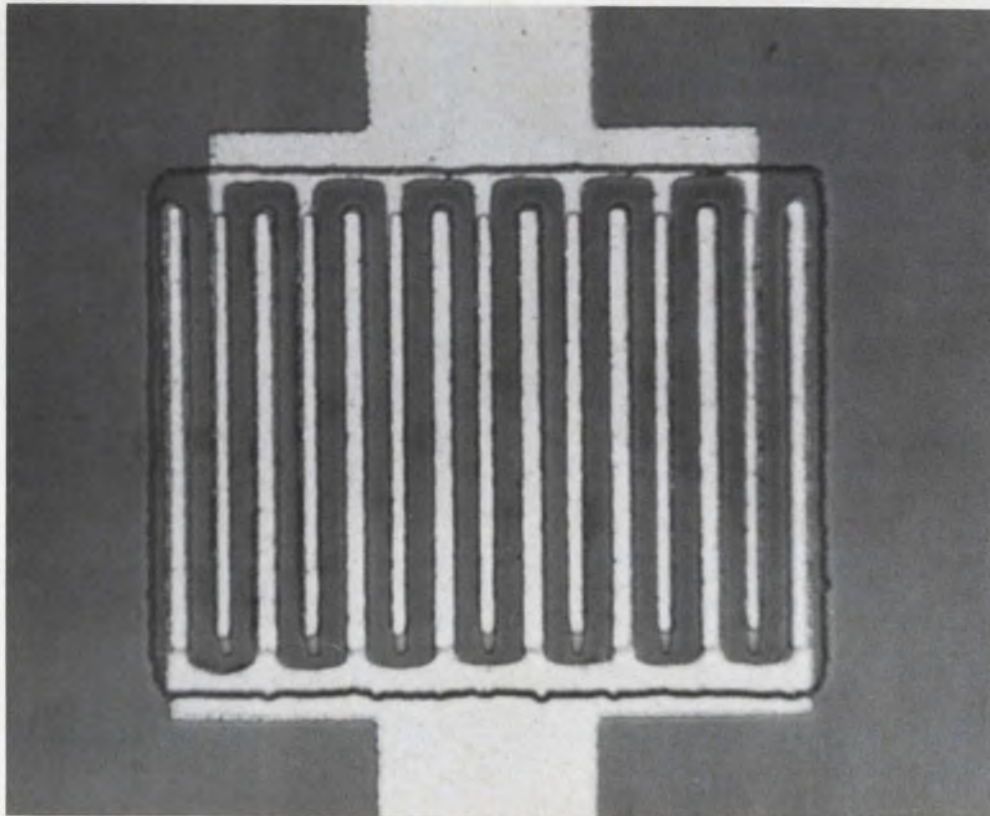

# INTEGRATED LOGIC MODULES

*Lowest Prices in the Industry\**

- 30 FAN-OUT, ALL SOURCES
- UP TO 4V NOISE REJECTION
- DC TO 5 MC
- 0 TO 70°C

**After 9 Months  
Our Baby Is Ready**



NEW logic and circuit techniques, thoroughly tested for 9 months, have resulted in a minimum fan-out of 30 from all sources, 25% lower prices, and REALISTIC noise immunity from 0.9V to 4V. Delivery from stock. Send for complete and ACCURATE data.

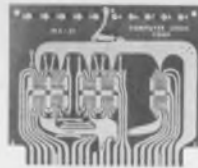
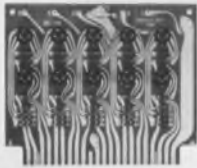

Phone: 213 451-9754



**COMPUTER LOGIC CORP.**

1528 20th Street • Santa Monica, California

\* \$11.20 per JK Flip-Flop Unit Load Concept

A COMPLETE FAMILY OF COMPATIBLE TRUE BLUE LOGIC MODULES

ON READER-SERVICE CARD CIRCLE 19

## NEW ALTERNATE ACTION SWITCH WITH INTEGRAL INDICATOR

MOUNTS ON  
19/32" CENTERS



New push-on, push-off switch is offered with a replaceable, isolated neon or incandescent indicator (ABL Series), or as a switch only (ABS Series). Housed in a 9/16" diameter x 1 7/8" long body, both series provide a two-circuit double break switch for controlling two separate circuits. When the button-lens is depressed, one circuit is closed and the other opened. Mechanical memory holds this status until the switch is actuated again. An SPDT switch is also offered. Rated for dry circuits, and loads to 1 amp. at 120 VAC, non inductive. Life, 1,000,000 operations. Series "53" taper pin receptacle, turret lug or wire-wrap terminals are gold plated. Both Series mount from the rear in 3/8" holes on 19/32" centers. Price: ABL, \$5.65 each without lamp in 100-499 quantities.

**TEC LITE INDICATING DEVICES**

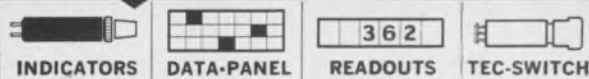

**Transistor Electronics Corporation**

Box 6191 Minneapolis, Minnesota 55424 Phone (612) 941-1100

ON READER-SERVICE CARD CIRCLE 20



give...so more will live

**HEART FUND**



Mix  
& match.

## From breadboard to prototype to production.

Sub-miniature coax, standard machined or formed strip contacts can be intermixed instantly in the same connector block.

You can begin wiring your breadboard or prototype with standard wire. If noise develops, just switch signal leads to sub-miniature coax without changing the connector block.

Here's a twist. You can also convert standard leads to twisted pair. In case we forgot to mention it, the sub-minia-

ture coax contacts take twisted pairs as well as coax cable.

And the formed contact is a big money saver in initial and installed costs. Throw in the automatic Burndy Hyfematic™ and crimp up to 3000 contacts per hour. Blocks available for 14 to 152 positions.

Now put it all together. Contact intermixing, economy, universality. Get in touch with Burndy for all the details. Hurry.



**BURNDY**

Norwalk  Connecticut

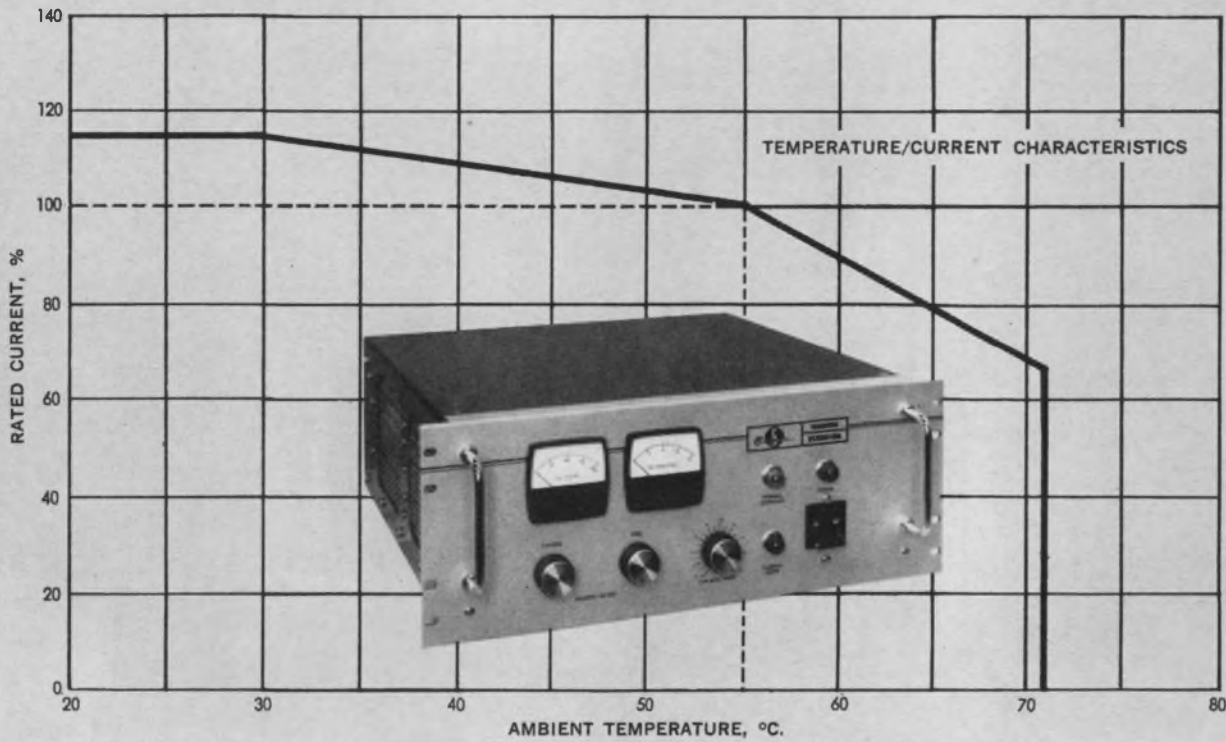

Sorensen DCR Series now with temperature capability to 71°C.

# All-Silicon Power Supplies to 20 kW.

Sorensen's wide range DCR Series has been up-dated and improved. What's new about the DCR's? They are now 100% silicon; ambient temperature capability is now to 71°C. • Four 3-phase models have been added extending power capability to 20 kW; 24 models are now available with ranges up to 300 volts. • Multiple mode programming—voltage/current/resistance. • Voltage regulation, line and load combined, is  $\pm 0.075\%$  for most models • Constant current range 0 to rated current. • DCR's meet MIL-I-26600 and MIL-I-6181

specifications and conform to proposed NEMA standards. • Front panel indicator for voltage/current crossover. These features of the improved DCR (model numbers will have an "A" suffix) are offered at no increase in price.

For DCR details, or for data on other standard/custom power supplies, voltage regulators or frequency changers, call your local Sorensen representative, or write: Sorensen, A Unit of Raytheon Company, South Norwalk, Connecticut 06856.

MODEL SELECTION CHART

Voltage	Amps.	Model	Price	Amps.	Model	Price	Amps.	Model	Price	Amps.	Model	Price
0-20	125	DCR 20-125A	\$1055	250	DCR 20-250A	\$1495	—	—	—	—	—	—
0-40	10	DCR 40-10A	325	20	DCR 40-20A	525	35	DCR 40-35A	\$ 710	60	DCR 40-60A	\$925
0-40	125	DCR 40-125A	1350	250	DCR 40-125A	1995	500	DCR 40-500A	2950	—	—	—
0-60	13	DCR 60-13A	525	25	DCR 60-25A	710	40	DCR 60-40A	900	—	—	—
0-80	5	DCR 80-5A	325	10	DCR 80-10A	525	18	DCR 80-18A	710	30	DCR 80-30A	875
0-150	2.5	DCR 150-2.5A	325	5	DCR 150-5A	525	10	DCR 150-10A	710	15	DCR 150-15A	825
0-300	1.25	DCR 300-1.25A	325	2.5	DCR 300-2.5A	525	5	DCR 300-5A	710	8	DCR 300-8A	825



A UNIT OF RAYTHEON COMPANY

ON READER-SERVICE CARD CIRCLE 92

# New Dale commercial wirewounds...**priced right!**











*Dale expands with new silicone coated resistors to replace & outperform vitreous enamel*

- **Expanded Commercial Line** provides direct replacements for the full range of vitreous enamel styles and sizes. You pay no more—less in many cases
- **Proven Reliability:** Over 1,800,000 unit test hours prove maximum HL failure rate to be .05% per 1,000 hours (full power, 25°C; failure defined as 3% Δ R, 60% confidence level)
- **Superior Stability:** Multi-layer silicone coating provides lower T.C. (±30 ppm). Standard tolerance ±5%. Precision tolerances available.

Write for ■ **New Commercial Resistor Brochure** ■ **Complete Resistor Catalog A**

## BUY NEW MODELS...NEW SIZES...FROM THIS COMPLETE COMMERCIAL WIREWOUND LINE!

TYPE	APPLICATION	APPLICABLE MIL SPEC AND TYPES	WATTAGE RATING	RESISTANCE RANGE	CORE SIZES	TOLERANCE
<b>CW</b> Axial Lead 	Axial leads. For applications requiring high performance at low cost	MIL-R-26 RW-57, 58, 59	4.25-13 watts	.1 ohm to 273K ohms	Body Dia. .188 to .375" Body Length .500 to 1.781" Leads 1.5 to 2"	±5%
<b>HL</b> Tubular 	Silicone-coated general purpose wirewound resistor. A direct replacement in both cost and performance for vitreous enamel types.	MIL-R-26C RW-29, 30, 31, 32, 33, 35, 36, 37, 38, 47	5-225 watts	.1 ohm to 1.3 Megohms	O.D. ¼ to 1 ½" Length 1-10 ½"	±5% (10% below 1 ohm)
<b>NHL</b> Non-Inductive 	High frequency circuits and applications requiring low inductive effect and minimum distributed capacity	None	5-225 watts	1 ohm to 90K ohms	O.D. ¼ to 1 ½" Length 1-10 ½"	±5%
<b>HL</b> Flat 	High power-to-size ratio. Self-stacking hardware for vertical or horizontal mounting.	MIL-R-26C RW-20 thru RW-24	24-95 watts	.1 ohm to 150K ohms	Length 1 ¼ to 6"	±5% (10% below 1 ohm)
<b>HLM</b> Miniature Flat 	For limited space, high power-to-size requirements particularly in high vibration areas.	None	10-20 watts	.1 ohm to 51K ohms	Length ¾ to 2-1/16"	±5% (10% below 1 ohm)
<b>HLA</b> Adjustable 	For resistance or voltage adjustment	MIL-R-19365C RX-29, 32, 33, 35, 36, 37, 38, 47	12-225 watts	1 ohm to 100K ohms	O.D. 5/16 to 1 ½" Length 1 ½ to 10 ½"	±5% (10% below 1 ohm)
<b>HLT</b> Tapped 	For voltage divider networks	None	11-225 watts	.1 ohm to 1.1 Megohms	O.D. 5/16 to 1 ½" Length 1 ½ to 10 ½"	±10% each section (±10% total)
<b>HLW</b> Tubular 	General application where terminal wires are required for direct electrical connection	None	5-20 watts	.1 ohm to 80K ohms	O.D. ¼ to 7/16" Length 1 to 2"	±5% (10% below 1 ohm)



**DALE ELECTRONICS, INC.**  
1328 28th Avenue, Columbus, Nebraska



ON READER-SERVICE CARD CIRCLE 93

# ALLOYS CUSTOM BLENDED TO YOUR SPECS

through powder metallurgy

Need a nickel alloy that will perform exactly as you want? No tramp elements, low carbon and gas content, exact performance reproducibility, uniform etching properties, excellent surface and mechanical characteristics?

Here at Magnetics Inc. we call such metals Blendalloy®. With more than 10 years' experience in powder metallurgy, we are now prepared to formulate and produce custom blended alloys to your specs—and to guarantee performance under the conditions you name.

*Example:* Blendalloy 52. We developed this 52% nickel controlled expansion alloy for dry reed switches and mercury wetted relays. Blendalloy 52 is made to match with precision the expansion characteristics of Corning 0120 glass. When used with other types of glass, Blendalloy 52 is modified to match any change in expansion characteristics. Dilatometry and polarimetry tests on both laboratory and production runs assure this match for both standard and modified alloys.

Magnetics Inc. produces Blendalloy metals in bar, rod, strip and wire, in lots from one pound to 50 tons or more. For information, write for our Blendalloy 52 technical data sheet. For general information, ask for our new metals capabilities brochure: *Metals From Magnetics*, Magnetics Inc., Dept. M-98, Butler, Pa. 16001

**METALS  
FROM  
MAGNETICS**

Guaranteed Performance  
Reproducibility through  
Powder Metallurgy  
Techniques

**MAGNETICS inc.**

ON READER-SERVICE CARD CIRCLE 94

# ELECTRONIC DESIGN announces winners of 'Top Ten' contest

It's showdown time—payoff week—for more than a hundred readers of the 3322 who entered this year's "Top Ten" contest in ELECTRONIC DESIGN. The lucky ones merely picked the ten advertisements in the January 4 issue that they thought would be best remembered by readers, as determined by "recall-seen" scores in E|D's regular Reader Recall survey.

The "Top Ten" advertisements are reprinted on the accompanying pages. They led a field of 149 contestants. In order of highest Reader Recall scores, the winners are as follows:

1. Allen-Bradley Co.
2. Oak Manufacturing Co.
3. John Weston Photo Mechanical Co.
4. Westinghouse Electric Corp., Molecular Electronics Div.
5. Wavetek
6. Stackpole Electro-Mechanical Products Div.
7. Hewlett-Packard
8. Motorola Semiconductor Products, Inc.
9. Gardner-Denver Co.
10. Tektronix, Inc.

With so many winning advertisements in any issue of E|D, it wasn't easy to narrow the selection to ten, many readers have reported. But some readers are more clairvoyant than others—or is it just luck? Here are the top prizes and the readers who won:

A trip to Paris for two, via Air France, goes to:

**John P. Thomas**, Engineer, General Electric, Richland, Wash.

A 23-inch Hoffman color television set is on its way to:

**Gerald Buchko**, Engineer, RCA, Lancaster, Pa.

Bulova Accutron watches will soon be worn by:

**Stanley A. Klein**, Engineer, Martin Co., Baltimore, Md.

**Edmund T. Maciag**, Project Engineer, Clevite, Bedford, Ohio.

**Paul M. Danzer**, Senior Engineer, Lockheed Electronics, Plainfield, N. J.

**W. C. Irwin**, Quality Control Representative, ARO, Inc., AEDC, Arnold AFS, Tenn.

**Bruce Davidson**, Engineer, Royal Typewriter, Hartford, Conn.

**W. Basinger**, Research Specialist, Lockheed Missiles and Space, Sunnyvale, Calif.

**James L. Cummings**, Product Engineer, B. F. Goodrich Co., Akron, Ohio.

Copies of the latest "400 Ideas for Design" book, published by John F. Rider, are on their way to 100 runner-ups.

Finally to see how closely an advertising pro could pick winning ads, the "Top Ten" contest had a separate competition for them at industrial companies and advertising agencies.

A trip to Paris for two, via Air France, has been won by:

**R. E. Lagrand**, Raytheon Co. (formerly with Space Craft, Inc., Huntsville, Ala.).

A 23-inch Hoffman color television set will soon be viewed by:

**Daniel J. Stemper**, Holt Instrument Labs, Oconto, Wis.

A Bulova Accutron watch is going to:

**Carl Martin**, Marketing Staff, Leach Corp., San Marino, Calif.

\* "Allen-Bradley hot molded resistors have always proved **absolutely reliable and superior to any others . . . foreign or domestic**"

*H. H. Scott, Inc.*  
Maynard, Mass.



In the Scott 344 transistor FM stereo tuner/amplifier, Allen-Bradley hot molded resistors provide excellent gain stability, low noise, at top operating voltages.

\* "Based on our use of more than 30,000,000 Allen-Bradley hot molded resistors over the past 18 years, under a continuous re-evaluation program for all component parts."

The known reputation of Scott hi-fi equipment is based on their unquestioned engineering excellence and their rigid quality standards. And Allen-Bradley hot molded resistors have played an important role in this achievement.

The consistently high quality of Allen-Bradley resistors—year after year, and million after million—is the result of an *exclusive* hot molding process developed and used only by Allen-Bradley. It produces such uniformity that the long term performance of Allen-Bradley resistors can be accurately predicted . . . and catastrophic failures *never* occur.

You can be certain of this same "built-in" resistor reliability and superlative performance *only* when standardizing on Allen-Bradley hot molded resistors. For more

complete specifications, please send for Technical Bulletin 5050: Allen-Bradley Co., 222 West Greenfield Avenue, Milwaukee, Wisconsin 53204. Export Office: 630 Third Avenue, New York, New York, U.S.A. 10017.



**HOT MOLDED FIXED RESISTORS** are available in all standard EIA and MIL-R-11 resistance values and tolerances, plus values above and below standard limits. Shown actual size.



**ALLEN-BRADLEY**  
QUALITY ELECTRONIC COMPONENTS



This Wilcox Model 914 ATC transponder uses Allen-Bradley Type CB ¼-watt and Type EB ½-watt fixed resistors, Type G variable resistors, and Type R adjustable fixed resistors. The Model 914 transponder is for aircraft operating under ground control radar.

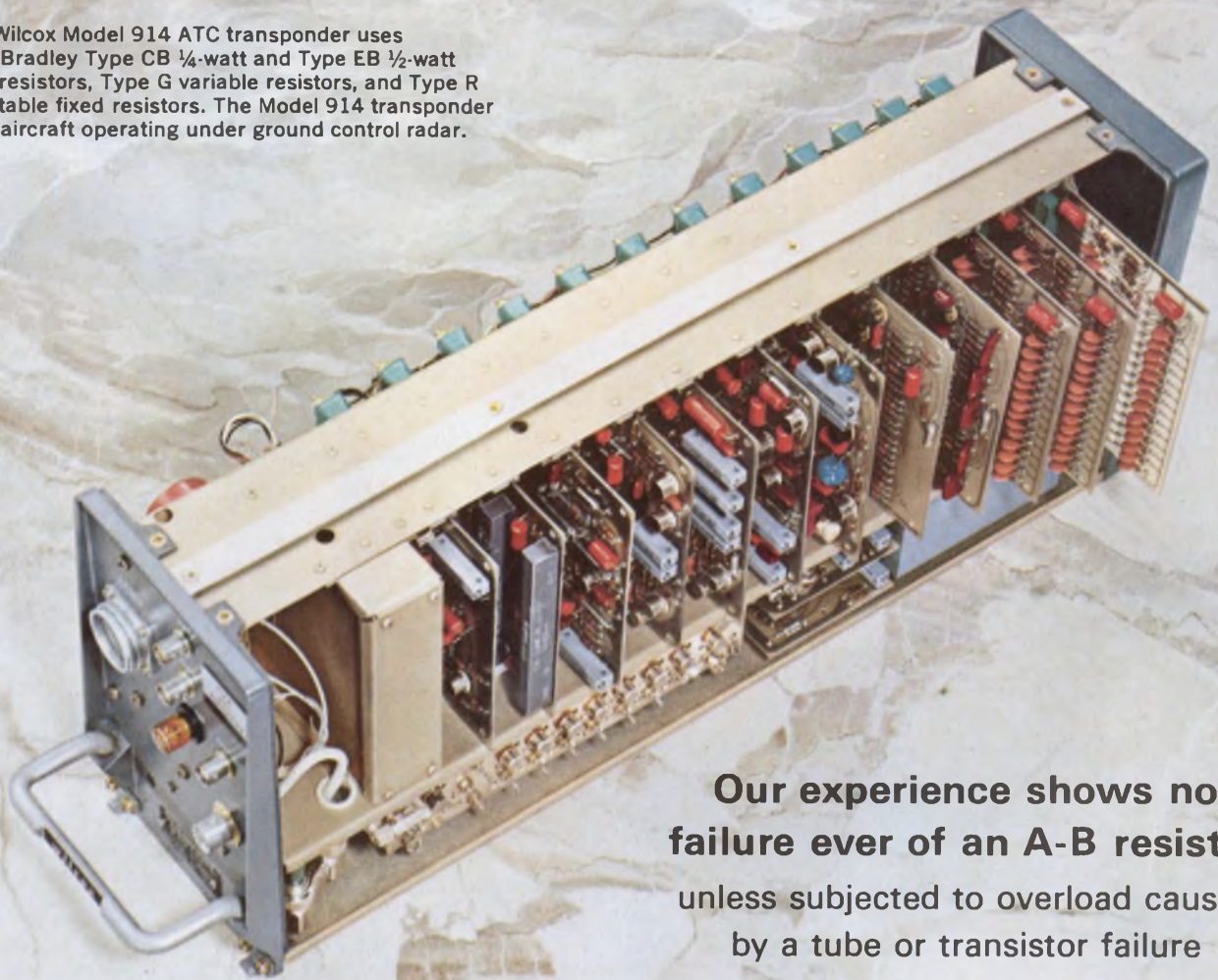

**Our experience shows no failure ever of an A-B resistor unless subjected to overload caused by a tube or transistor failure**

*Wilcox Electric Co., Inc.*

Prompt shipment of **HOT MOLDED FIXED RESISTORS** in all standard EIA and MIL-R-11 resistance values and tolerances. Values above and below standard limits can be furnished. Resistors are shown actual size.

TYPE BB 1/8 WATT		MIL TYPE RC 05
TYPE CB 1/4 WATT		MIL TYPE RC 07
TYPE EB 1/2 WATT		MIL TYPE RC 20
TYPE GB 1 WATT		MIL TYPE RC 32
TYPE HB 2 WATTS		MIL TYPE RC 42

**Type R Hot Molded Adjustable Fixed Resistors** are rated ¼ watt at 70°C. Supplied in resistance values from 100 ohms to 2.5 megohms.

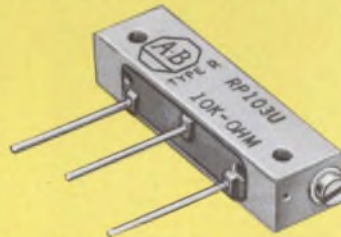

**Type G Hot Molded Variable Resistors** are rated ½ watt at 70°C. Resistance values from 100 ohms to 5.0 megohms.



“No failure ever” is an impressive record, especially since Allen-Bradley fixed and variable resistors have been used in Wilcox transponders for around ten years.

The reason for this consistently high performance is the unique hot molding process developed and used only by Allen-Bradley. In fixed resistors, it produces such complete uniformity that long term A-B resistor performance can be accurately predicted. Catastrophic failures don't occur with Allen-Bradley hot molded resistors.

Use of the hot molded resistance element in the Allen-Bradley Type G variable resistors assures very smooth operation—there are never any abrupt changes in resistance during adjustment. The Type G controls have

a very low initial noise factor, becoming lower with use.

Type R adjustable fixed resistors also have a solid molded resistance track. Adjustment of resistance is so smooth, it approaches infinite resolution. Settings will remain fixed under severe vibration or shock. The Type R molded enclosure is dustproof and watertight—it can be potted after adjustment.

For more complete details on the full line of A-B quality electronic components, please write for Publication 6024: Allen-Bradley Co., 222 W. Greenfield Ave., Milwaukee, Wisconsin 53204.

Export Office: 630 Third Ave., N.Y., N.Y., U.S.A. 10017.

ON READER-SERVICE CARD CIRCLE 214



**ALLEN-BRADLEY**  
QUALITY ELECTRONIC COMPONENTS

# spectrum analysis

with your  oscilloscope

*provides phase lock  
and 100 MHz dispersion*

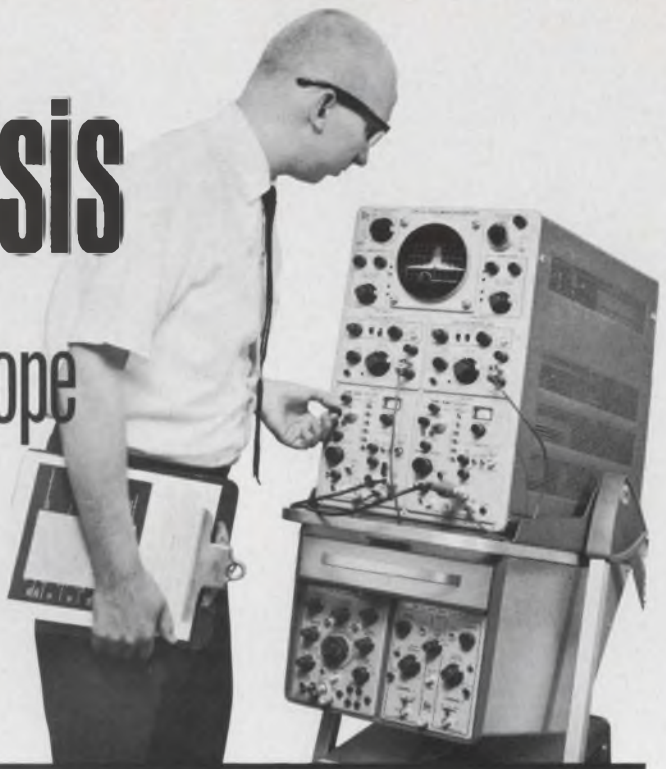

**phase lock** — Permits stable displays at 1 kHz/cm dispersion by locking the frequency of the RF local oscillator to the internal 1-MHz crystal-controlled reference, or to an external standard frequency.

**calibrated dispersion** — Screen width calibrated from 1 kHz/cm to 10 MHz/cm in 1-2-5 sequence permits direct readings of displayed frequencies. For ease of operation, resolution is coupled to dispersion and varies from 1 kHz to 100 kHz. Can be uncoupled for optimized displays.

**display flatness** —  $\pm 1$  dB over 100 MHz dispersion.

**recorder output** — A front-panel connector provides a dc-coupled analog output of the spectral display for chart recorders or other uses.

TYPE 1L20 <b>10 MHz · 4.2 GHz</b>	TYPE 1L30 <b>925 MHz · 10.5 GHz</b>
--------------------------------------	--

other characteristics	Type 1L20	Type 1L30
Frequency Range	10 MHz—4.2 GHz	925 MHz—10.5 GHz
Minimum Sensitivity	110—90 (-dBm)	105—75 (-dBm)
Incidental FM	With Phase Lock, less than 300 Hz on fundamental.	
Dial Accuracy	$\pm(2 \text{ MHz} \pm 1\% \text{ of rf input frequency})$	
IF Attenuation	51 dB $\pm 0.1$ dB/dB in 1-dB steps	
IF Gain	50 dB, variable	
Display	Log, linear, square law, video	
Price	\$1995.00	\$1995.00

Type 3L10 for Tektronix 560-Series Oscilloscopes provides 1 MHz to 36 MHz spectrum analysis capability.

U.S. Sales Prices, f.o.b. Beaverton, Oregon

For more information or a demonstration, call your Tektronix field engineer.

**Tektronix, Inc.**

**ENVIRONMENTAL PROOF**  
is what we call it . . .



**Stackpole Rotary Switches**  
**Specially Designed to Guard Against**  
**EXPOSURE—CONTACT CONTAMINATION—PRODUCTION DAMAGE**

**COMPETITIVELY PRICED** — This completely enclosed, rugged switch costs no more than the open clip type.

**SAMPLES IN 3 DAYS**—to your exact specifications. Send your drawing and prove it to yourself.

**ORDERS IN 2 TO 3 WEEKS**—On-time delivery of uniform, high quality production quantities to meet your schedule.

**SEND YOUR DRAWING FOR A QUOTATION AND SAMPLE.** Take advantage of Stackpole quality, price and service. For additional information and technical data write: Electro-Mechanical Products Division, Stackpole Carbon Company, St. Marys, Pennsylvania 15857. Phone: 814-834-1521. TWX: 510-693-4511.



**STACKPOLE**

ELECTRO-MECHANICAL  
PRODUCTS DIVISION



## **Reliable electrical connections**

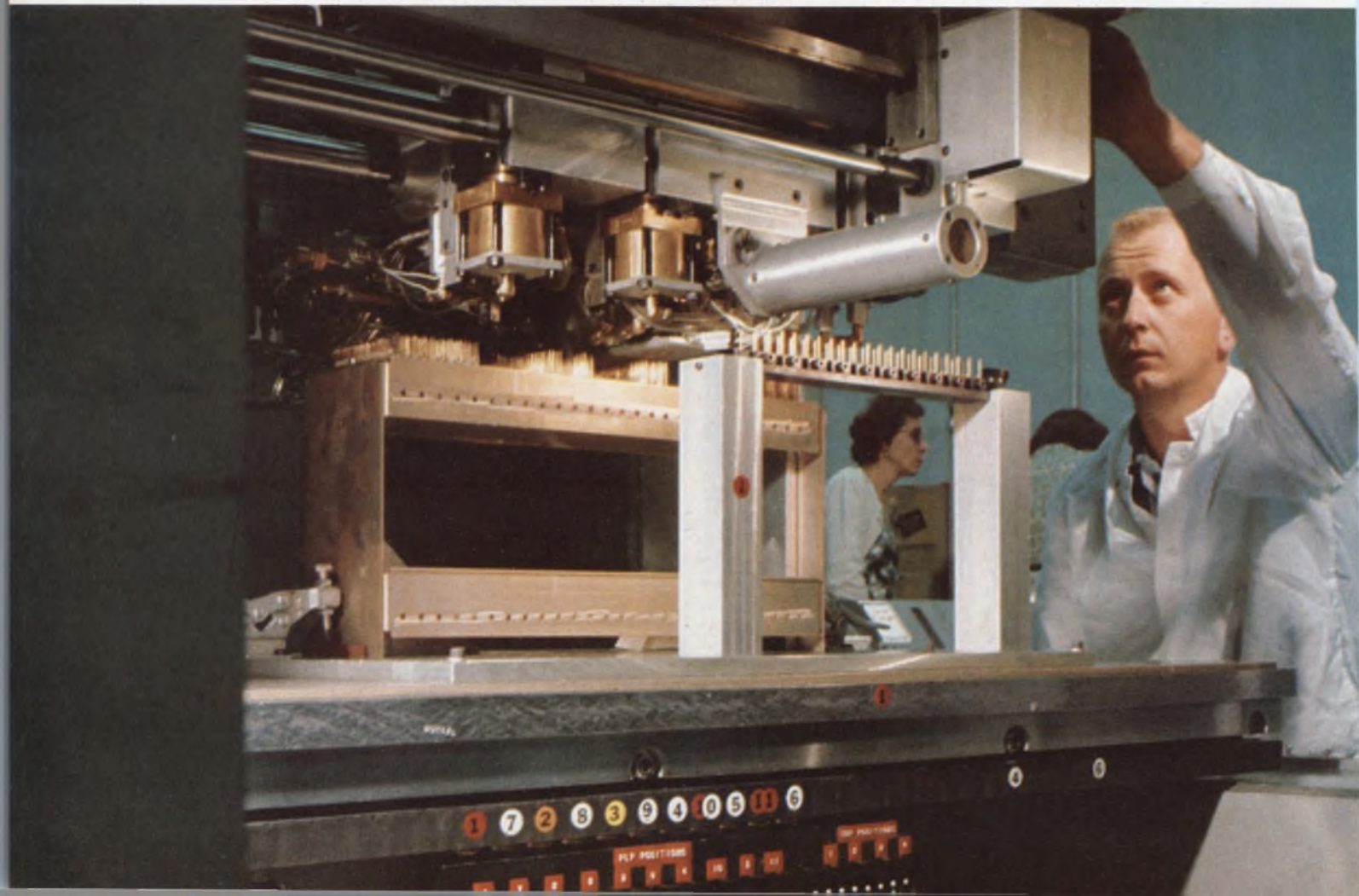

Your choice of power for hand "Wire-Wrap" tools . . . electricity, compressed air, or rechargeable battery. We also make manual tools for field servicing. Bulletins 14-1, 14-3 and 14-7.

Solderless electrical connections are wrapped to stay . . . wrapping time is less than one second each . . . Using Gardner-Denver "Wire-Wrap"<sup>®</sup> tools. You save hours of handwork. You save inspection and rework time as well, because "Wire-Wrap" tools make reliable connections, even in inexperienced hands. Widely used for wiring television, instruments, communications equipment, computer panels and missile guidance systems.

## in less than one second each

Modular panels are quickly and securely wired on Gardner-Denver automatic "Wire-Wrap" machines, which are programmed with punched cards for maximum flexibility. Bulletin 14-121.

Reliable! More than 40 billion solderless wrapped connections have been made with "Wire-Wrap" equipment without a single reported electrical failure.



Film is scraped from wire and terminal at contact points. High pressure metal-to-metal contact invites solid state diffusion, maintaining low connection resistance.



Solderless wrapped connections remain gastight even when exposed to severe changes of temperature and humidity . . . so they're not affected by atmospheric corrosion.

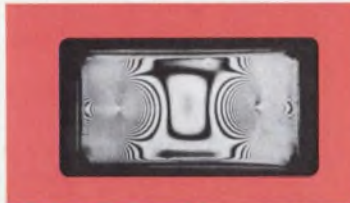

Initial pressure may go as high as 100,000 psi. Pressure drops as wire relaxes, but stabilizes at a value greater than 29,000 psi.

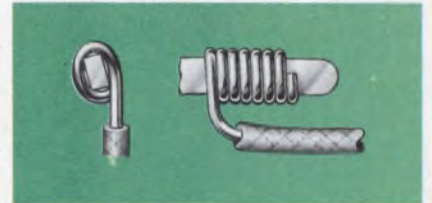

Flexible lead-off absorbs vibration and handling shocks . . . permits wrapped connection to stay tight and mechanically stable.



SEE WHAT AIR IS DOING NOW...SEE

**GARDNER - DENVER**

Gardner-Denver Company, Quincy, Illinois

ON READER-SERVICE CARD CIRCLE 23



## It's a steal.

We're not trying to bug you. Just proving a couple of points about advertising.

First, we'll get your attention if we use the right props. (Actually there's a bona fide reason for picturing the VW.)

Second, we'll sell more Series 150 programmable function generators if we keep harping about their virtues.

By programmable, we mean that you have digital control of frequency, function and amplitude. For local or remote programming.

Frequency is 0.01 cycles to 1 mc in 8

ranges. With 3 decades of resolution, fully rotatable.

Function gives you triggered or continuous sine, square and triangle waveforms digitally programmed.

Amplitude goes from 10 millivolts to 10 volts in 3 ranges. With 3 decades of resolution, all programmable.

Altogether there are more than 50 million discrete outputs.

About prices. The Model 150, remote only, goes for \$995. The Model 155, local and remote, is \$1195.

Either one is cheaper than a VW.

ON READER-SERVICE CARD CIRCLE 24

Which brings us to the reason for the one in the picture. Our marketing manager brought it back from Germany last month. With only 4,000 easy European miles.

So if you already have one of our function generators, maybe you can use a good used VW.

### WAVETEK

8159 Engineer Rd., San Diego, Calif., Tel. 279-2200  
3000 Bern 9, Seidenweg 17, Switzerland

ELECTRONIC DESIGN

# ALL US KIDS LOOK ALIKE!



## ...EXCEPT TO OUR MOTHERS

Mothers see all the little differences that outsiders miss.

All printed circuit manufacturers also look alike... except to specifying engineers.

Engineers who have specified printed circuits from

JOHN WESTON PHOTO MECHANICAL have seen differences, too!

There are a lot of printed circuit manufacturers to choose from, and they all provide just about the same services and products. WESTON is one of the many. But, the discerning engineer who is "mothering" a circuit packaging project usually isn't satisfied with the standard run of PC boards. He wants quick and accurate service with no excuses. He looks for superb etching, center-on drilling, he wants physical dimensions kept to his specified tolerances, and he's looking for quality at the right price. He has learned to expect these things as a matter of course from WESTON.

Here is a magnified cross-section of a WESTON multilayer plated-through hole. Notice the uniform molecular copper plating has the same sectional area as the circuits it connects. WESTON specializes in the latest state-of-the-art multilayer techniques.



FREE! Send for your booklet, *How to SUCCEED IN MULTILAYER CIRCUIT PACKAGING WITHOUT REALLY TRYING*, by JOHN WESTON. Write: JOHN WESTON PHOTO MECHANICAL COMPANY, 5200 W. 74th Street, Minneapolis, Minnesota 55424, or call: 612-941-3660.



 **JOHN WESTON**

PHOTO MECHANICAL COMPANY

5200 W. 74th St., Minneapolis, Minn. 55424

Phone 941-3660 (Area 612)

ON READER-SERVICE CARD CIRCLE 25



## SNICK!\*

More than 15 times actual size, this picture shows how precisely and firmly the rotor blade is grasped by double-wiping contacts—pioneered by Oak. Our research and development people are a restless group . . . never satisfied,

always trying to make something better. This constant updating of technology has been the driving force behind Oak's growth. The recently-developed items described here are just a few of the many reasons why you should buy from Oak . . . 35 years the leader in switches!



New Unidex universal index has velvet-feel consistent torque for full switch life. It provides closer limits of precision and uniformity, lasts for thou-

sands more operations than other indexes. Many Oak rotary switches are now available with Unidex.



Now, engineering studies have created the Moduline™ system—over two million switch variations shipped in only seven days. This complements our distributor switch line and custom OEM switch line. Oak has 150% more switches that meet MIL-S-3786 than any other manufacturer.





Oak offers you variety in choice of pushbutton switches—lighted or unlighted, single units or multiple banks . . . various latching arrangements (or non-latching) . . . optional blocking mechanism.



New Oak rocker actuated thumbwheel switches provide readout from either right or left, recessed characters for continued legibility, up to 20 active switching positions per section and a

choice of four contact materials. Write for details and availability.

Molded diallyl phthalate stators are a new feature on Acorn switches from Oak. They allow more clips per section (22 instead of 18) and recessing of clips provides secure clip mounting, minimizes electrical leakage . . . all at no extra cost. These stators will be avail-

able soon on other Oak switches.

Whatever you need in a single, multi-gang or spring-return lever switch, Oak has it. Different types available are 2-5 positions, 20° and 30° throw, index or spring-return types.

For detailed information on these new items or any other Oak products, check postcard and mail . . . today.

\*a snug click



## OAK MANUFACTURING CO.

CRYSTAL LAKE, ILLINOIS 60614 · A DIVISION OF OAK ELECTRO/NETICS CORP.  
telephone: 815-459-5000 TWX: 815-459-5628 CABLE ADDRESS: OAKMANCO

ON READER-SERVICE CARD CIRCLE 216

# Cut communication system cost— use this universal Westinghouse IC amplifier in many stages

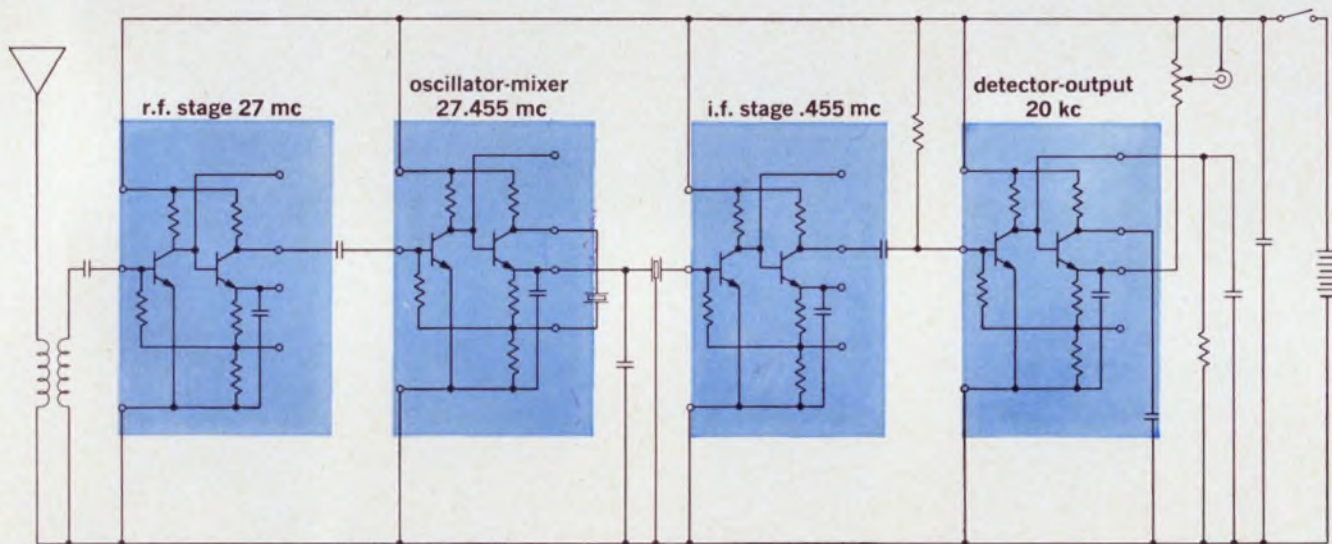

The Westinghouse WM1146Q wide-band integrated amplifier is a true "linear building block." You can design many communications and radar systems so that most amplifier functions are well served by this one wide-band unit. You'll eliminate many special-purpose amplifiers... simplify ordering and inventory... save by buying in larger quantities. The WM1146Q costs no more than special-purpose limited-frequency devices.

The WM1146 is: 1) a wide-band RF amplifier which may be cascaded for very high gains; 2) an oscillator-mixer when used with external crystal; 3) a 0.455, 10.7, 30, or 60 mc IF amplifier with AGC capabilities when used with frequency selective elements; 4) a detector and output stage.

Features of the WM1146Q include: usable range DC to 100 mc • gain 16 db @ 60 mc • 6 VDC to 12 VDC operation • low power dissipation (9 ma with 6 V power supply) • only one power supply needed • every unit subjected to +150°C storage bake, three cycles of thermal shock, 30,000 G centrifuge, gross and helium hermeticity tests.

Get technical data now, and cut your system costs. Write Westinghouse Electric Corporation, Molecular Electronics Division, Box 7377, Elkridge, Maryland 21227.



J09124

You can be sure if it's Westinghouse

ON READER-SERVICE CARD CIRCLE 26

**A  
10 Hz  
to  
10 MHz  
AC Voltmeter  
with  
DC Output**



**With  
1 mV  
to  
300 V  
Linear/Log  
Ranges**



**for \$285**



THAT'S WHAT HAPPENS WHEN THE HEWLETT-PACKARD 400 SERIES GOES SOLID-STATE! Here's the world's first averaging ac voltmeter with a 0.5% of reading dc output... something you've never been able to get before. Offers a broad ac range, 10 Hz (cps) to 10 MHz (mc), 1 mV to 300 V, plus a log model, -72 to + 52 dBm.

Highest available input impedance, too, (10 MΩ) with shunt capacity at a low value (8pf) unequalled by other instruments.

**WHAT'S EVEN BETTER:** Price... only \$285 for the 400E, only \$295 for the 400EL log model!

*If you have any of the following responsibilities, you should consider these points:*

**Design and production:** 1 mV-300 V range, adjustable meter setting

**Systems:** 0.5% of reading dc out (1 V) for ac/dc conversion

**Communications:** 10 Hz-10 MHz, dB scales, external battery operation

**Sciences:** ac amplifier output (150 mV), long-term stability

**Military:** More rugged than the reliability-proven tube versions

**University:** budget price

The brief specs here tell the story. Compare them with any others... and then call your Hewlett-Packard field engineer (you probably won't even need a demonstration). Or write for complete specs to Hewlett-Packard, Palo Alto, Calif. 94304, Tel. (415) 326-7000; Europe: 54 Route des Acacias, Geneva.

## SPECIFICATIONS

**Voltage range:** 1 mV to 300 V full scale, 12 ranges

**Frequency range:** 10 Hz to 10 MHz

hp 400E/EL								
Accuracy % of reading, 3 mV to 300 V ranges								
Frequency	10 Hz	20 Hz	40 Hz	2 MHz 4 MHz 10 MHz				
At full scale	±4	±2	±1	±2	±4			
Accuracy % of reading, 1 mV range								
Frequency	10 Hz	20 Hz	40 Hz	500 kHz	1 MHz	4 MHz	6 MHz	
At full scale	+4	±2	±1	±2	±4	+4		
	-10						-10	
hp 400E/EL								
AC-to-DC Converter Output								
Accuracy % of reading, 3 mV to 300 V ranges								
Frequency	10 Hz	20 Hz	40 Hz	100 Hz	500 kHz	2 MHz	4 MHz	10 MHz
At full scale	±4	±2	±1	±0.5*	±1	±2	±4	

\*For 15°C-40°C on 1 mV-1 V ranges only.

**Input impedance:** 10 megohms shunted by 21 pf on the 1 mV-1 V ranges, 10 megohms shunted by 8 pf on the 3 V-300 V ranges

**Amplifier ac output:** 150 mV rms for full-scale meter indication; output impedance 50 ohms, 10 Hz to 10 MHz (105 mV on the 1 mV range)

**AC-DC converter output:** 1 V dc output for full-scale meter deflection; output is linear for both 400E and 400EL

**External battery operation:** terminals provided on rear panel

**Price:** 400E, \$285 (replaces 400H-\$325)  
400 EL, \$295 (replaces 400L-\$325)

*Data subject to change without notice. Prices f.o.b. factory.*

**HEWLETT  PACKARD**  
An extra measure of quality

ON READER-SERVICE CARD CIRCLE 27

## MILITARY RTL MC900G SERIES

*... for the most critical  
design jobs!*

Designed for low-power military applications in which wide environmental extremes may be encountered in normal application, the series is specified for  $-55^{\circ}\text{C}$  to  $+125^{\circ}\text{C}$  operation.

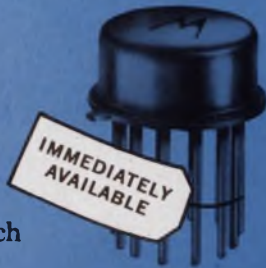

## INDUSTRIAL RTL MC800G SERIES

*... for broad applications  
of all types!*

Specially intended for reliable operation in industrial logic applications, this series operates over a temperature range from 0 to  $+100^{\circ}\text{C}$ . Priced for economical use in areas where wider temperature of operation is not required.



### Both Offer These Key Performance Features . . .

- 12 nsec Propagation Delay
- Fan-out Capability Up to 5
- 15 mW/Node Dissipation
- For System Clock Rates to 8 mc

### ... and this wide range of circuit functions:

Buffer . . . . .	MC900G/ MC800G
Counter Adapter . . . . .	MC901G/ MC801G
Flip-Flop . . . . .	MC902G/ MC802G
3-Input Gate . . . . .	MC903G/ MC803G
Half-Adder . . . . .	MC904G/ MC804G
Half-Shift Register . . . . .	MC905G/ MC805G
Half-Shift Register (W/O Inv.) . . . . .	MC906G/ MC806G
4-Input Gate . . . . .	MC907G/ MC807G
Dual 2-Input Gate . . . . .	MC914G/ MC814G
Dual 3-Input Gate . . . . .	MC915G/ MC815G
J-K Flip-Flop . . . . .	MC916G/ MC816G
J-K Flip-Flop . . . . .	MC926G/ MC826G
Quad Inverter . . . . .	MC927G/ MC827G

...THERE'S A  
MOTOROLA  
RTL  
INTEGRATED  
CIRCUIT  
TO FIT YOUR  
EXACT  
PERFORMANCE  
AND COST  
REQUIREMENT!

*... you can choose from  
4 different RTL complements  
for your design.*

## LOW-COST COMMERCIAL RTL MC700G SERIES



... combining RTL & mWRTL  
circuits for  
utmost versatility!

Designed and priced for a wide variety of commercial applications (as low as \$2.55 for a 3-input gate circuit in quantities of 100 or more), this low-cost series offers a combination of mWRTL and RTL circuits including some 22 circuit functions from which to choose. They open the door to new economical integrated circuit applications in such areas as instrumentation, industrial controls, test equipment, and many commercial computer designs.

### COMPARE THESE LOW, LOW PRICES!

		100-Up
Buffer	MC700G	\$2.55
Counter Adapter	MC701G	3.80
Flip-Flop	MC702G	3.20
3-Input Gate	MC703G	2.55
Half-Adder	MC704G	2.65
Half-Shift Register	MC705G	4.35
Half-Shift Register (W/O Inv.)	MC706G	3.65
4-Input Gate	MC707G	2.65
Adder	MC708G	3.75
Buffer	MC709G	2.55
Dual 2-Input Gate	MC710G	2.65
4-Input Gate	MC711G	2.65
Half-Adder	MC712G	3.65
Type D Flip-Flop	MC713G	6.35
Dual 2-Input Gate	MC714G	2.65
Dual 3-Input Gate	MC715G	3.20
Dual 3-Input Gate	MC718G	3.20
J-K Flip-Flop	MC720G	6.35
Expander	MC721G	2.65
J-K Flip-Flop	MC723G	6.35
J-K Flip-Flop	MC726G	6.35
Quad Inverter	MC727G	4.60

## LOW-POWER MILLIWATT RTL MC908G SERIES



... where minimum operating  
power level is required!

- 2.5 mW/Node Power Dissipation
- 40 nsec Propagation Delay
- Full Military Temperature Range —  
-55°C to +125°C

The low-operating power requirements of this Motorola RTL circuit series (only 2.5 mW/node) makes this logic complement especially attractive to military and space users. To meet the requirements of this market, the series is designed for operation throughout the full military operating temperature range from -55°C to +125°C.

Adder	MC908G
Buffer	MC909G
Dual 2-Input Gate	MC910G
4-Input Gate	MC911G
Half Adder	MC912G
Type D Flip-Flop	MC913G
Dual 3-Input Gate	MC918G
J-K Flip-Flop	MC920G
Gate Expander	MC921G

See your local Motorola semiconductor distributor for the Motorola RTL integrated circuit type which fits your immediate need. For production quantity requirements, call your nearest Motorola district office — or write Motorola Semiconductor Products Inc., Box 955, Phoenix, Arizona 85001.



**MOTOROLA**  
Semiconductor Products Inc.

## Wait Till Next Year!

Look easy? Sorry you didn't try? Well, there's always next year.

ELECTRONIC DESIGN will run the same "Top Ten" advertising contest in its first issue of January. You'll receive ample advance notice.

Meanwhile . . . maybe you ought to keep this year's "Top Ten" in your files for review?



## Another steal.

We decided that function generators didn't have to sell for \$550 or more.



The new 110 is more than just a function generator. It's a precision source of sine, square and triangle waveforms.

It operates at servo, audio and video frequencies with six (6) simultaneous outputs.

Actually, the 110 is a complete laboratory of signal sources all by itself.

Like most Wavetek function generators, the 110 is portable. Just 7 lbs. light. Goes anywhere you

\$50 and get the Model 110R. It has ni-cad batteries with a built-in recharger. And our new voltage-controlled generator (VCG), the Model 111, goes for only \$545.

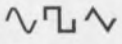
- 0.005 Hz to 1 MHz 
- 30v p-p into 600Ω
- 10v p-p into 50Ω
- 6 simultaneous outputs
- Clean HF waveforms
- 0.5% sine distortion
- Flat frequency response
- Calibrated outputs
- 5 nSec. rise and fall time
- All silicon
- 0°C to 55°C operation

So we designed the most versatile function generator yet, the Model 110, to sell for just \$395.

You're probably thinking we skimped on quality or cut something out in order to do this.

We didn't.

In fact, we've improved the quality. And we've added versatility that our earlier instruments didn't have.

We've been working toward this goal since we designed the first portable, broad-frequency-range function generator more than three years ago.

need it.

And it's rugged. Wavetek portables installed in trucks, ships and airplanes have taken all kinds of rough treatment and continued to function according to specs.

The standard ac-powered version sells for \$395. If you want added portability, spend another

At any of these prices, you'll be getting more signals per dollar than with any oscillator or function generator on the market today.

Talk about a steal!



**WAVETEK**  
8159 Engineer Rd., San Diego, Calif., Tel. 279-2200  
3000 Bern 9, Seidenweg 17, Switzerland

ON READER-SERVICE CARD CIRCLE 29

# FET circuit measures low-level, sub-audio signals

A FET is the heart of a circuit used for measuring low-level, low-frequency signals. It forms a matching network that is easily coupled to an oscilloscope for display purposes.

Often the engineer must measure small-signal amplitudes of very low, sub-audio signals (less than one cycle per second). Almost all ac meters roll off somewhere between 1 and 5 cycles. The majority of oscilloscopes similarly roll off at about the same frequencies with ac preamps.

To make a reasonably accurate measurement (about 2%) of these signals, you can use a matching circuit that is ac-coupled into the dc amplifier of an oscilloscope (Fig. 1a). Since the input impedance of the scope is about 1 MΩ, a low-frequency roll-off of 0.0016 cycles can be obtained by using a 100 μF coupling capacitor.

A good matching circuit for making these measurements will present a very high impedance

to the circuit under test. The signals to be measured usually originate in high-impedance circuits and require a unity gain match to maintain fidelity. In addition the matching network must have a low output-impedance to avoid loading by the 1MΩ input impedance of the scope. A circuit that satisfies these requirements is shown in Fig. 1b.

The circuit's input impedance is determined primarily by the resistor  $R_1$ , connected from the FET gate to ground. Note that the impedance of the FET at low frequencies is easily  $10^{10}$  ohms with a typical junction device. Transistor  $Q_2$  is a current source that is used to establish the operating point of  $Q_1$ . The unloaded gain of the circuit is approximately unity, according to the equation for the gain of a source-follower. This is given by

$$A_v = \frac{g_m R_L}{1 + g_m R_L}, \quad (1)$$

where  $R_L$  is the collector impedance of  $Q_2$ .

This impedance is much larger than 1.0 MΩ so that  $g_m R_L \gg 1.0$ . Even with the scope impedance loading the circuit, the gain is maintained at unity. The output impedance of the circuit is less than 1k, thus satisfying the third matching network requirement.

*Joseph J. Panico, Section Head, GCA Technology Division of GCA Corp., Bedford, Mass.*

VOTE FOR 110

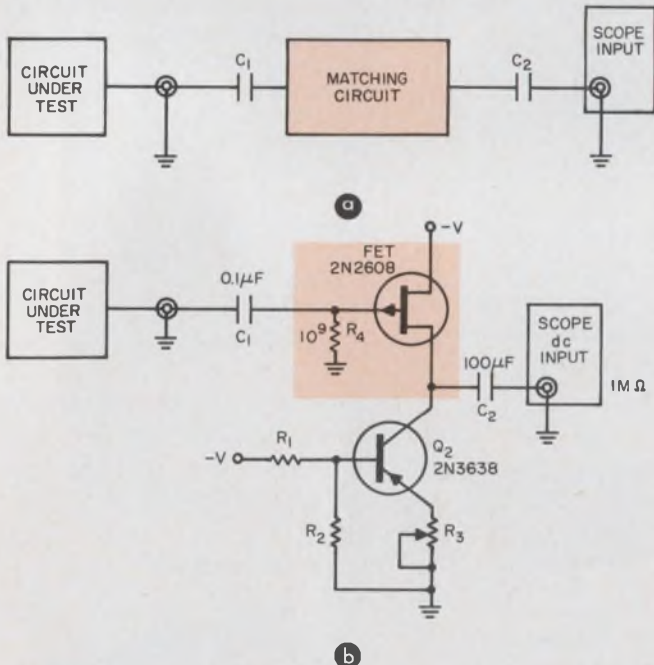

1. Matching circuit for measuring low-level low-frequency signals (a) must possess unity gain, high  $Z_{in}$  and low  $Z_{out}$ . FET stage (b) satisfies these requirements and permits sub-audio signals to be displayed on scope.

## Time-shared readout uses standard logic blocks

Any number of digital-readout sources can be displayed on one set of Nixie tubes with a time-sharing technique that uses standard logic blocks. The method saves components and simplifies input-switching needs.

For a  $10^7$  readout, all of the corresponding numeric cathodes of the seven alpha-numeric display tubes are connected in parallel (see illustration). The anodes are connected to a seven-bit ring counter, which turns each anode on for 140 μs, stepping one anode at a time through the ring and repeating this indefinitely. The cathodes are returned to ground through a circuit that can inhibit any unneeded element, as determined by the digit stored in a four-bit memory register. The arrangement makes it possible to display seven decades of data, by serially reading the individual

IDEAS FOR DESIGN: Submit your Idea for Design describing a new or important circuit or design technique, the clever use of a new component, or a cost-saving design tip to our Ideas for Design editor. If your idea is published, you will receive \$20 and become eligible for an additional \$30 (awarded for the Best of Issue Idea) and the grand prize of \$1000 for the Idea of the Year.



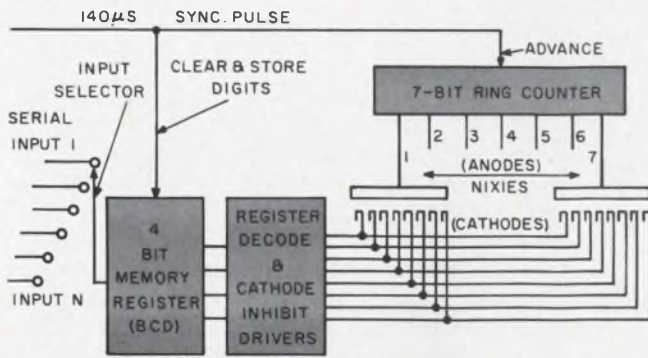

Standard logic blocks are used in a time-sharing design for digital readout. This technique requires few components and simplifies input-switching requirements.

digits into the memory register and synchronizing the anode scaler-advance to correspond to the digit being read.

In one application the device was used to read one selected output at a time from 100 remote counters, each having a memory capacity of  $10^7$ . An input consisted of a repeated train of 28 serial BCD bits (7 digits x 4 bits/digit). A synchronization pulse from a pulse generator caused the memory register to store and clear the digits in phase with the advance of the anode scaler.

The resulting display repetition rate of approximately 1000 Hz completely eliminated visible flicker, while the intensity appeared comparable to normal operation. The device provided substantial component savings over full-time, parallel systems, while achieving great input-switching simplification.

James Gray, Associate Electronics Engineer, Argonne National Laboratory, Argonne, Ill.

NOTE FOR 111

## Sawtooth frequency range extended by extra transistor

The operating frequency range of a sawtooth generator may be extended by the use of an extra transistor. The unit functions as a shunt across the charging capacitor section to make the turn-off independent of the current source circuitry.

The circuit shown in Fig. 1a is conventionally used to produce a sawtooth voltage waveform across capacitor  $C_1$ .  $Q_3$  is a current source, and the capacitor voltage swing is between  $-8$  volts and  $-20$  volts. The frequency of oscillation may be varied by changing the current produced by  $Q_3$ . When operated in such a fashion, the frequency range is limited because the current produced by  $Q_2$  must never exceed the minimum holding current of the hook connection formed by  $Q_1$  and  $Q_2$ . For the component values shown,  $500 \text{ Hz} \leq f \leq 5 \text{ KHz}$ .

The circuit in Fig. 1b overcomes this difficulty. Note that  $Q_1$  and  $Q_2$  are connected essentially as before. Here, however, when the capacitor voltage rises to  $-8\text{V}$ , transistor  $Q_2$  begins to conduct and turn on  $Q_1$ . The base voltages of  $Q_2$  and  $Q_4$  now

move toward  $-20$  volts, as does the capacitor voltage. This is due to the current flowing through resistors  $R_5$  and  $R_6$ . The voltage divider formed by  $R_3$  and  $R_2$  ensures that the base voltage of  $Q_1$  is more negative than that of  $Q_2$ .

Therefore the capacitor voltage will tend to move to the more negative voltage at the base of  $Q_1$ . As it does, it will fall to a value more negative than the voltage at the base of  $Q_2$ , causing  $Q_2$  to turn off. This in turn shuts off  $Q_1$ , permitting the base voltage of  $Q_1$  to increase in a positive fashion. Thus  $Q_1$  is also turned off, and the capacitor voltage begins to increase again. When the capacitor voltage reaches  $-8\text{V}$ , the cycle repeats.

Resistor  $R_1$  is used to ensure that the hook connection will not spontaneously turn on due to collector leakage current flow (during the time when the circuit should be in the OFF condition.)  $R_4$  is used to bias the emitter of  $Q_3$  slightly negative with respect to the emitter of  $Q_2$  during the OFF condition. This ensures that  $Q_2$ , and therefore the hook connection, will turn on before

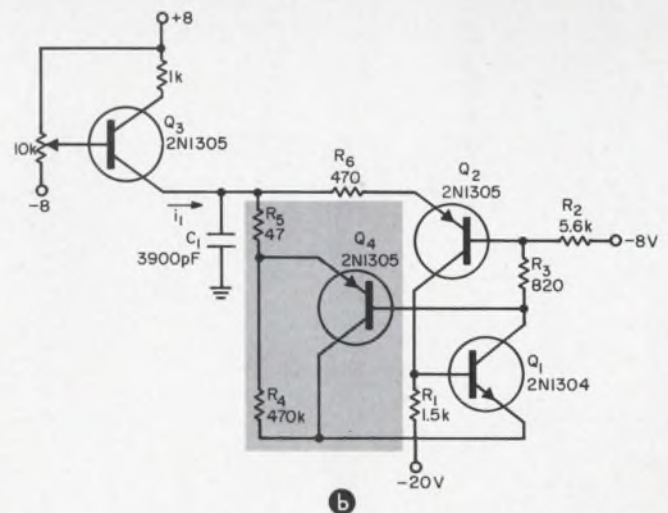
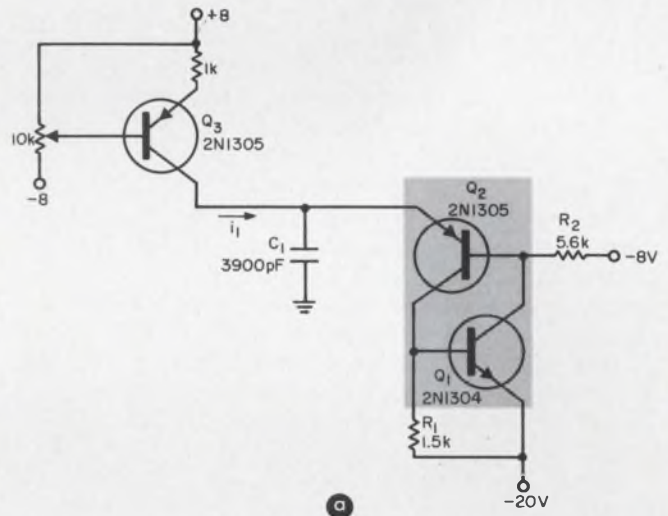

Conventional sawtooth generator circuit (a) uses the hook connection formed by  $Q_1 - Q_2$ . When an extra transistor is placed across the memory capacitor (b), the frequency of operation is extended. This is because turn-off is now independent of the charging current magnitude.

$Q_1$  begins to conduct. The result is a positive turn-on action.

Note that as  $Q_2$  begins to turn off,  $Q_1$  is still conducting, because  $Q_1$  has not yet turned off. Also, due to the presence of  $R_3$  the base voltage of  $Q_1$  almost independently of the magnitude of the base voltage of  $Q_4$ . These facts guarantee that the turn-off procedure of the hook connection will occur almost independently of the magnitude of the charging current produced by  $Q_3$ . Thus  $i_1$ , and therefore the frequency of oscillation, may be varied over a greater range than that afforded by the conventional circuit. Here,  $500 \text{ Hz} \leq f < 150\text{-KHz}$ .

Joseph P. Chidester, Research and Development Engineer, Bendix Corp., Baltimore.

VOTE FOR 112

## Two-stage network provides 60-dB agc

Only two transistor stages are needed for a super agc circuit, capable of a 60-dB control swing. Distortion and power requirements are low, and a remote cutoff characteristic exists.

The operation of the circuit (see illustration) is quite simple: Assume that a signal has just appeared at the input and has caused a positive signal to appear on the input of the long-TC (time-constant) circuit.  $Q_1$  conducts and causes a current to flow through  $D_1$ , lowering its dynamic impedance and providing a low impedance path between the amplified signal at the collector of  $Q_2$  and its base.

When  $D_1$  conducts heavily, the feedback is nearly 100%, and npn stage gain approaches unity. Moreover the input impedance of this stage has become very low, thereby causing a large

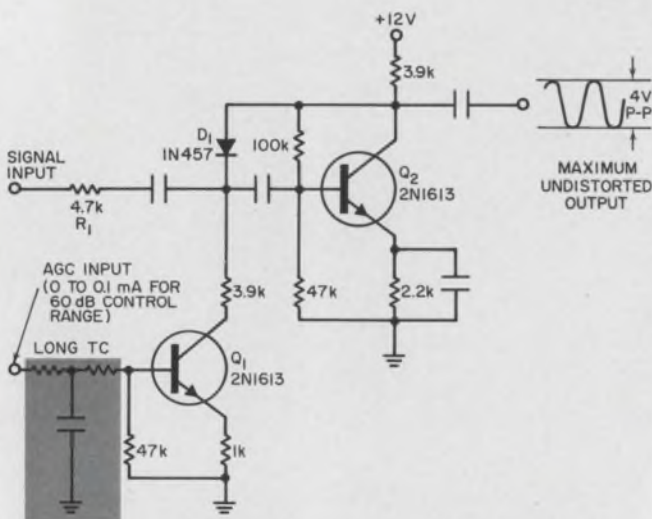

Two-stage transistor network provides a 60-dB agc.  $Q_1$  and long time-constant network serve to regulate the feedback operation on  $D_1$ .

input voltage drop across  $R_1$ . Moderate values of  $Q_1$  collector current accordingly reduce the feedback through  $D_1$ , and the voltage drop across  $R_1$ , permitting appreciable stage gain. When the  $Q_1$  collector current is reduced to nearly zero, the feedback through  $D_1$  is negligible, and the  $Q_2$  stage gain and input characteristic is that of a standard common-emitter amplifier.

With the component values shown, a 60-dB control range is provided. Higher-gain transistors, more appropriate diodes and a higher-voltage power supply will significantly increase this range.

Murray F. Feller, Design Engineer, Santa Maria, Calif.

VOTE FOR 113

## Diode-resistor network simplifies linear triangle wave generator

A design technique that uses two diodes and four resistors as additions to the standard integrating capacitor allows a square wave to be linearly integrated and the average level of the resulting triangular output to be adjusted arbitrarily. This method overcomes nonlinearities and shifts in the output.

In general application terms, a triangular wave synchronized to an external square wave is of use in the simulation of antenna scan and the testing of amplifier linearity.

A variety of complicated techniques can generate triangular waves to meet these applications. Most use transistors to charge capacitors with a constant current. The main disadvantage of this method is that the integrating capacitor sees an impedance directly proportional to the load, even when emitter-followers are used. Nonlinearity is then evident at low frequencies.

A dc operational amplifier used as an integrator has the advantage of linearity that is independent of output loading. However, the feedback capacitor around the operational amplifier is not sufficient to integrate a square wave properly. This is because any asymmetry in the input will shift the triangular wave output until the amplifier saturates, and the circuit accumulates more area on one side because of the asymmetry.

These problems are solved by the addition of a simple diode-resistor network (see illustration). If the input is a positive square wave,  $R_1$  and  $R_2$  are chosen to supply equal amounts of current in either direction through the capacitor, as the input swings from positive to ground. The current through the capacitor is

$$I = \frac{E_1 E_{off}}{R_1 R_2} \quad (1)$$

The capacitor may then be determined by

$$C = \frac{IT}{2\Delta E} \quad (2)$$

(continued on p 86)

Now Vector can supply you with a full range of microelectronic subcarrier oscillators for your FM telemetry systems: The Low Level MMO-30, for inputs from 0 to 20mV or  $\pm 10\text{mV}$ , has complete input to output isolation and a truly differential floating input, measures 0.271 cubic inch and weighs 15.0 grams. The High Level MMO-11, for inputs from 0 to 5V or  $\pm 2.5\text{V}$ , measures 0.108 cubic inch and weighs only 3.8 grams.

You can order both from Vector today.

The world's smallest microelectronic voltage controlled subcarrier oscillators are part of Vector's full line of FM, Digital, and RF telemetry equipment. For more information, write or call Vector, (215) 355-2700.

**Vector** DIVISION OF UNITED AIRCRAFT CORPORATION  
SOUTHAMPTON, PENNSYLVANIA

U  
A  
C



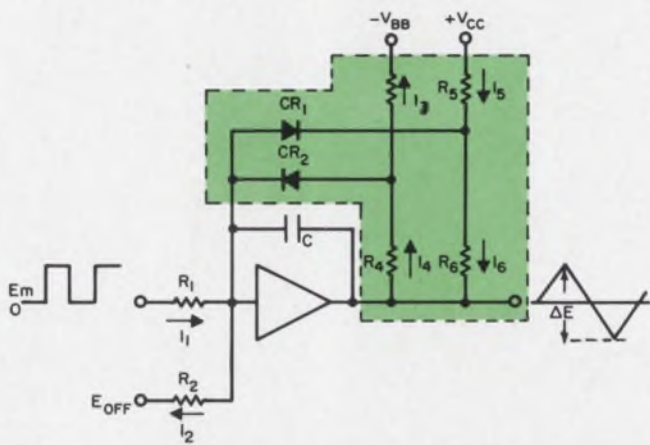

**Addition of resistor-diode network to operational amplifier feedback capacitor permits square-wave inputs to be linearly integrated. Average level of triangular output may then be adjusted arbitrarily.**

where  $\Delta E$  is the total output swing. The average dc output level is established by  $CR_1$ ,  $CR_2$ ,  $R_3$ ,  $R_4$ ,  $R_5$  and  $R_6$ . When  $I_1$  is equal to  $I_3$ ,  $CR_2$  conducts, clamping the output in the positive direction to  $E_0 = I_4 R_3$ . When  $I_5$  is equal to  $I_6$ ,  $CR_1$  clamps the output in the negative direction to  $E_0 = I_6 R_6$ . With the output swing initially settled, the resistor values may then be determined for the output to be linearly triangular between chosen limits.

Larry Diamond and Gilbert Marosi, Senior Engineers, General Precision Link Div., Palo Alto, Calif.

VOTE FOR 114

## Circuit uses few components for sinewave frequency doubling

A frequency-doubler circuit for use with sine-wave inputs can be built with a minimum of components. It employs a simple resistive feedback technique to produce the doubling capability.

As shown in Fig. 1a, the two transistors for the minimum component frequency-doubler are the 2N706. The first stage is the doubler, and the second stage is an amplifier. The circuit operates with a nonlinear characteristic. Feedback resistors  $R_f$  and  $R_e$  are used to double the input frequency.

Note that a coupling capacitor between the stages is not used. The  $0.01 \mu\text{F}$  capacitor depicted filters out the higher harmonics to obtain a distortion-free sinewave output. The circuit has an input impedance of  $5.5 \text{ k}\Omega$  and an output impedance of  $350 \Omega$ . Its gain is 26 dB.

Referring to Fig. 1b, we see the oscillographs of the key waveforms, taken at the marked terminals in Fig. 1a. These wave-forms display the circuit's performance both with and without the  $0.01 \mu\text{F}$

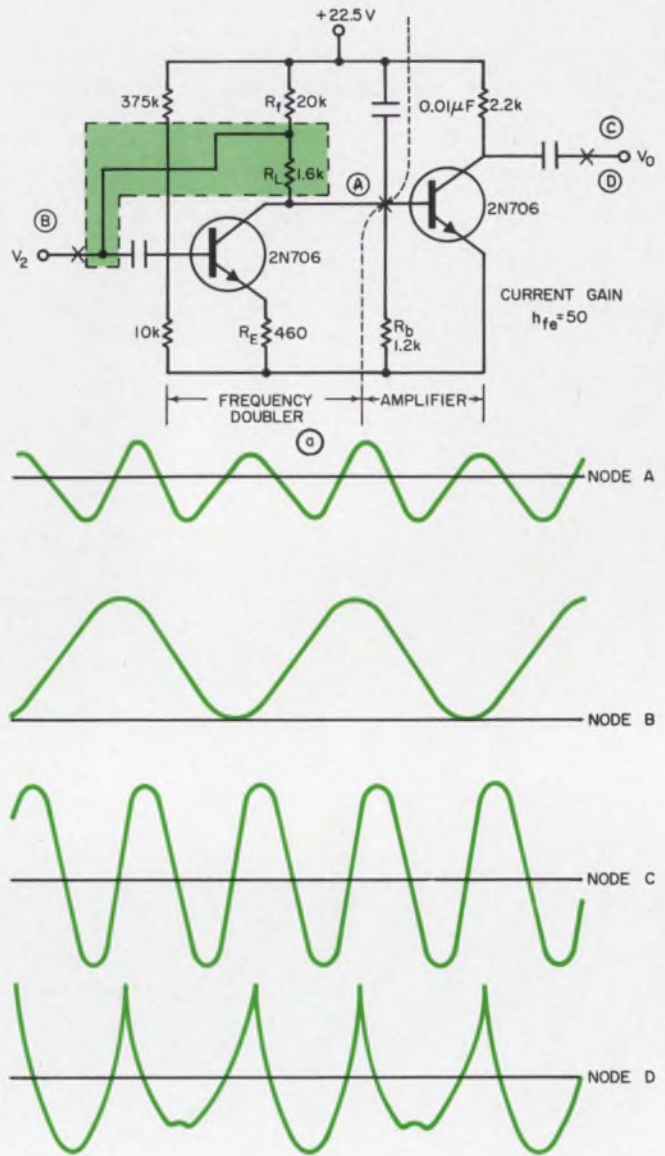

(b)

**Sinewave frequency-doubler circuit (a) uses few components. Note the absence of a coupling capacitor between the two stages. Waveform diagram (b) shows voltage at base of output stage (Node A), input (Node B) and output (Node C) when  $0.01 \mu\text{F}$  filter capacitor is in. Output when the filter capacitor is removed (Node D) shows poorer wave-shaping.**

filter capacitor. For operation outside the audio-frequency range,  $R_L$ ,  $R_f$ ,  $R_e$  and  $R_b$  are adjusted accordingly.

Thac Mac, Research and Development Engineer, Allen Bradley Co., Milwaukee, Wis.

VOTE FOR 115

## FET impedance converter used in sample-and-hold circuits

A sample-and-hold circuit required an extremely high-input impedance amplifier to provide an effective time constant of at least 5 minutes for the holding capacitor. A very simple FET feed-  
(continued on p 88)

# FREE

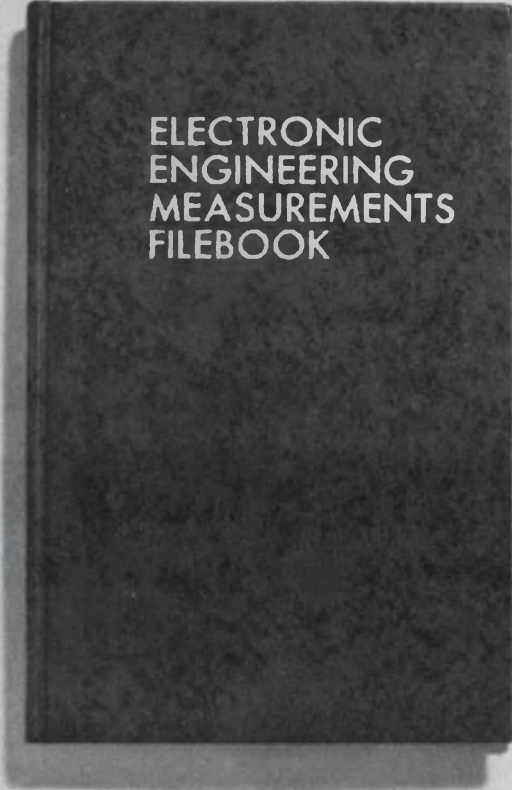

## ELECTRONIC ENGINEERING MEASUREMENTS FILEBOOK

This \$9.95 volume, the *Electronic Engineering Measurements Filebook*, is free with a \$250 or larger order of semiconductors and/or integrated circuits made by Fairchild, Motorola and Westinghouse. Written by top electronic engineering specialists, it is a single source of measurement principles and practices for 44 specific parameters deemed most important in electronic circuit design. Includes test setups, waveforms, mathematical analysis, etc. 192 pages, hardbound and profusely illustrated. • This offer is good until May 31, 1966.

Westbury, New York / Waltham, Mass. / Silver Spring, Md. / Cleveland, Ohio / Huntsville, Ala.  
516/334-7474 / 617/891-8484 / 301/585-7023 / 216/333-7020 / 205/539-2756



**SCHWEBER  
ELECTRONICS**

ON READER-SERVICE CARD CIRCLE 30

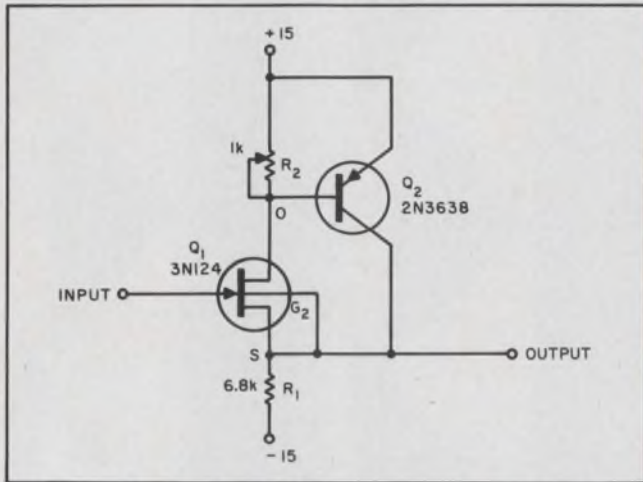

**Simple FET impedance converter shows** unity gain. It provides long time constants for sample-and-hold circuits.

back impedance converter was developed to meet this need.

The FET (see diagram) is biased for  $V_{GS} = 0$ , since the gate-to-source voltage is the amplifier offset potential. The offset voltage itself may be set to zero by adjusting  $R_2$ . The FET may be used at the zero-bias point for both temperature stability and high incremental transconductance. The input impedance is approximately 1000 M $\Omega$  at dc and falls to 100 k $\Omega$  at 500 KHz. The output impedance is less than 50 ohms.

With no output load, signal levels of  $\pm 10$  volts can be easily handled. If the value of  $R_1$  is reduced to 1.0 k $\Omega$  (which raises the power-supply drain), then loads as small as 10 k $\Omega$  may be driven at  $\pm 10$  volts. The response in both cases is flat beyond 600 kHz.

Normally FETs are not used in dc-coupled circuits, because of the temperature dependence of  $I_{DSS}$  and other parameters. This limitation is overcome here by the feedback circuit, which makes the temperature drift of the offset voltage reasonably small in comparison with the signal levels that are handled. The change in  $V_{BE}$  of  $Q_2$  with temperature partially compensates for changes in  $I_{DSS}$  of  $Q_1$ . The typical offset voltage drift was within  $\pm 10$  mV over a temperature change of about 40°C. The sensitivity of the offset voltage to power-supply variations was measured at 5 mV per volt.

*Thomas H. Baker, Chief Engineer, Beaver Research Corporation, Cambridge, Mass.*

VOTE FOR 116

## Thermocouple power source guarantees safe control device

Any isolated-contact, electrical-control device can be guaranteed intrinsically safe for operation in explosion-prone areas by the use of lower

power circuitry that is incapable of causing an ignition spark. One circuit that accomplishes this uses the Seebeck effect (thermocouple) as a power source.

The circuit (see schematic) is simple. Its components merely consist of a 115-volt, 6-watt pilot lamp, a short piece of Constantan wire and a 10-mV contactless meter relay. The circuit operates when a remote-control device (placed in the hazardous area) closes the thermocouple (T/C) circuit. The T/C instantly generates a low-level millivolt signal and drives the signal coil of the meter relay (placed in a non-hazardous area) to operate the meter's internal relay.

The thermocouple is made by butt-soldering 20 Ga. copper and Constantan wire together and cementing the butt joint onto the surface of the pilot-lamp glass bulb. This lamp serves as the T/C hot junction, as well as a power-on indicator. The meter relay terminals function as the T/C cold junction. The difference in temperature between the hot junction (approximately 300°F) and the

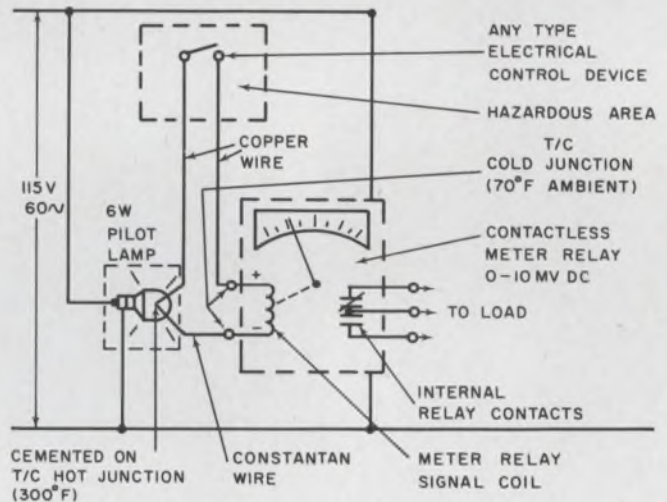

**Thermocouple power source makes** for an intrinsically safe control device in explosion-prone environments. Pilot lamp functions as hot junction and indicator.

cold junction (ambient, 70°F) will generate a 4-to-5-mV signal. The T/C loop resistance should be held under 10 ohms.

A fail-safe version may be designed with the use of a normally closed control device and a low contact on the meter relay.

*M. K. Kessie, Design Specialist, Atomics International, Canoga Park, Calif.*

VOTE FOR 117

IFD Winner for Dec. 20, 1965

*John S. Poole, Systems Engineer, U.S. Naval Research Laboratory, Washington, D.C.*

His idea, "SCR pulse-follower circuit alternates latching relay," has been voted the \$50.00 Most Valuable of Issue Award.

**Cast Your Vote for the Best Idea in this Issue.**

# Soliton

announces  
*Germanium PNP  
 Power Transistors with  
 150 Amps to 200 Amps  
 maximum collector  
 current and  
 $V_{CE(SAT)} \approx 70 \text{ mv max}$   
 @ rated  $I_c$*



(ACTUAL SIZE)

MHT 2110  
 MHT 2111  
 MHT 2112

(ACTUAL SIZE)



MHT 2150  
 MHT 2151  
 MHT 2152

Type Number	Pkg. Size	DESIGN LIMITS						PERFORMANCE SPECIFICATIONS				
		$T_j$	$\theta$	$I_c$	$V_{CBO}$	$V_{CEO}$	$V_{EBO}$	$h_{FE}$	$V_{BE(sat)}$	$V_{CE(sat)}$	$f_T$	
		$^{\circ}C$	$^{\circ}C/W$	Amp.	Volts	Volts	Volts		Volts	Volts		
		Max.	Max.	Max.	Min.	Min.	Min.	@ RATED $I_c$ $V_{CE} = -1V$	@ RATED $I_c$ $I_c/I_B = 20$	@ RATED $I_c$ $I_c/I_B = 20$	kc	
							Min.	Max.	Max.	Typ.		
MHT2110	MT-41	100	0.75	150	10	5	5	40	-0.7	-0.07	450	
MHT2111	MT-41	100	0.75	175	10	5	5	40	-0.7	-0.07	450	
MHT2112	MT-41	100	0.75	200	10	5	5	40	-0.7	-0.07	450	
MHT2150	SAME WITHOUT STUD MOUNT	100	0.75	150	10	5	5	40	-0.7	-0.07	450	
MHT2151		100	0.75	175	10	5	5	40	-0.7	-0.07	450	
MHT2152		100	0.75	200	10	5	5	40	-0.7	-0.07	450	

## Soliton TRANSISTOR DIVISION DEVICES, INC.

1177 BLUE HERON BLVD. / RIVIERA BEACH, FLORIDA / (305) 848-4311 / TWX: (510) 952-6676

Leader in Germanium and Silicon Power Transistors, Cryogenic Thermometers, High Voltage Rectifiers, Temperature Compensated Zeners, Voltage Variable Capacitors, Random/White Noise Components and Microelectronic Components.

ON READER-SERVICE CARD CIRCLE 31

## **ELECTRONIC ENGINEERS**

### Outstanding Non-Defense Digital Systems Opportunities

The continued, planned expansion of our Digital Systems activities has created career opportunities in the Development of small, high-speed digital computers and peripheral equipment for industrial systems.

The men we seek will possess a degree or equivalent, and will have 2-5 years' experience. This experience can be with digital computers (design, development or manufacturing) or will have created the capability for analog and digital circuit design with the ability to integrate peripherals into an industrial control system.

FISCHER & PORTER is the fastest growing manufacturer of control instrumentation for the automation of process industries (chemical, petroleum, petrochemical, pulp and paper, metal, food processing, water and sewage treatment, etc.).

Our dedication to growth has created the ideal environment for individual professional achievement, personal satisfaction, and financial reward. To explore the career opportunities for you at FISCHER & PORTER, call or write:

**KIP BRADLEY**

## **FISCHER & PORTER CO.**

E. County Line Road,  
Warminster, Pa.  
215—OS 5-6000

*An Equal Opportunity Employer / Male And Female*

ON CAREER-INQUIRY FORM CIRCLE 901

## **ELECTRONIC ENGINEERS**

and

## **PHYSICISTS**

Investigate this immediate requirement at . . .

## **VON KARMAN CENTER**

of

## **AEROJET**

(25 miles east of Los Angeles)

**Specialists in Applied**

## **INFORMATION THEORY**

and

## **STOCHASTIC PROCESSES**

Advanced work in adaptive passive pattern recognition systems has created immediate openings for Physicists, Mathematicians and Engineers with backgrounds and interest in Information Theory, Circuit Theory and Stochastic Processes. Stimulating work combines advanced theory and concepts of electro-optical signal processing, linear and non-linear filtering/spatial and spectral discrimination, pattern detection and correlation.

*For your personal interview, direct your resume to:*

**Mr. R. S. Lawrence**

**P. O. Box 303 sp, Azusa, California**

A subsidiary of the  
General Tire & Rubber Co.

*An equal opportunity employer*



ON CAREER-INQUIRY FORM CIRCLE 902

# Looking for a New Job?

- Fill out one application . . .
- Check off the companies that interest you . . .
- We do the rest

Contacting the job market takes only ten minutes with ELECTRONIC DESIGN's Career Inquiry Service. To put Career Inquiry Service to work for you, fill in the attached resume. Study the employment opportunity ads in this section. Then circle the numbers at the bottom of the form that correspond to the numbers of the ads that interest you.

ELECTRONIC DESIGN will be your secretary, type neat duplicates of your application and send them to any number of companies you select—the same day the resume is received.

Career Inquiry Service is a fast, efficient way to present your job qualifications to companies recruiting engineering personnel—as confidentially and discreetly as you would in person. This service is the first of its kind in the electronic field, and one that engineers have used effectively since its inception in 1959.

We take the following precautions to ensure that your application receives complete, confidential protection:

- All forms are delivered unopened to one reliable specialist at ELECTRONIC DESIGN.
- Your form is kept confidential and is processed only by this specialist.
- The "circle number" portion of the form is detached before the application is sent to an employer, so that no company will know how many numbers you circled.
- All original applications are placed in confidential files at ELECTRONIC DESIGN and after a reasonable lapse of time they are destroyed.



# CAREER INQUIRY SERVICE

After completing, staple, fold and mail career form to ELECTRONIC DESIGN, 850 Third Avenue, New York, N. Y. Our Reader Service Department will forward copies to the companies you select below.

(Please print with a soft pencil or type.)

Name \_\_\_\_\_ Telephone \_\_\_\_\_

Home Address \_\_\_\_\_ City \_\_\_\_\_ Zone \_\_\_\_\_ State \_\_\_\_\_

Date of Birth \_\_\_\_\_ Place of Birth \_\_\_\_\_ Citizenship \_\_\_\_\_

Position Desired \_\_\_\_\_

### Educational History

College	Dates	Degree	Major	Honors

Recent Special Training \_\_\_\_\_

### Employment History

Company	City and State	Dates	Title	Engineering Specialty

Outstanding Engineering and Administrative Experience \_\_\_\_\_

Professional Societies \_\_\_\_\_

Published Articles \_\_\_\_\_

Minimum Salary Requirements (Optional) \_\_\_\_\_

Use section below instead of Reader Service Card. Do not write personal data below this line. This section will be detached before processing.

Circle Career Inquiry numbers of companies that interest you

- 900 901 902 903 904 905 906 907 908 909 910 911 912 913 914 915 916 917 918 919 920 921 922 923 924
- 925 926 927 928 929 930 931 932 933 934 935 936 937 938 939 940 941 942 943 944 945 946 947 948 949

Fold here, staple and Mail.

FIRST CLASS  
Permit No. 725  
New York, N. Y.

**BUSINESS REPLY MAIL**

No Postage Stamp Necessary if Mailed in the United States

POSTAGE WILL BE PAID BY

**ELECTRONIC DESIGN**

**READER SERVICE**  
850 THIRD AVENUE  
NEW YORK, NEW YORK 10022

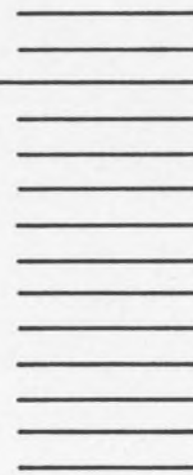

# LATCH on to the EXCITEMENT in MICROELECTRONICS and SILICON DEVICE DEVELOPMENT at DELCO RADIO

Enthusiasm is running high at General Motor's Delco Radio Division.

Exciting developments in microelectronics and silicon devices have spawned a rapidly expanding research effort. New buildings . . . new equipment . . . and most importantly, new people!

The dynamic pace of accomplishment at Delco is pushing the state of the art clear out of sight. The opportunity is here for those who choose to capitalize on it.

## Microelectronics

Circuit oriented EE's—0 to 5 years experience. Here's a chance to get in on the excitement in microelectronics. Research programs in both linear and digital circuitry embrace monolithic . . . thick film . . . thin film . . . and hybrid microcircuits.

## Silicon Device Development

Lots of room here for the BS, MS, PhD in Physics, Chemistry, Physical Chemistry, or related fields. Development programs are underway in these areas:

Low power and very high power monolithic and hybrid circuits.

Silicon Transistors—from very high

frequency 10 milliamperes through 25 ampere, 1000 volts.

Thyristors—from 50 milliamperes through 500 ampere, 2000 volts.

Zener Diodes.

Silicon Rectifiers—from milliamperes through 250 ampere, 3000 volts.

Continuing R&D efforts already have led to Delco's leadership in high power, high voltage silicon transistors. Delco rectifiers—rated at 250 amps, 2000 volts—are going into alternators designed to handle the full power generated by the latest Diesel-electric locomotives.

Full-size, fully-transistorized TV sets now are in production, thanks to a Delco high powered transistor in the horizontal and vertical deflection circuits.

A tremendous momentum is building at Delco. The time is ripe—now—to join this outstanding research group.

If you'd like more information immediately, pick up the phone and call us collect, Area Code 317/459-2808. Ask for C. D. Longshore. Or, send your resume to Mr. Longshore, Salaried Employment, Dept. 101, Delco Radio Division, General Motors, Kokomo, Indiana.

*An equal opportunity employer*

# NASA Tech Briefs

## High-speed limiter is efficient

**Problem:** Design a circuit that will operate efficiently at high speeds to limit the current from a square-wave ac power supply to a predetermined value.

**Solution:** A transistorized current limiter in which the transistors operate as switches, resetting after each half cycle of the square wave and thus minimizing power losses.

During normal operation, when limiting is necessary only for momentary loads, such as square-wave switching transients, the diode bridge directs the input through filter  $L_1$  and transistor  $Q_1$ .

Filter  $L_1$  acts to limit current transients in the square-wave input much as a series inductor does in a dc line. Transistor  $Q_1$  operates as a switch, and is normally saturated by current transformer  $T_1$  through filter  $L_2$ .  $T_1$  also provides the collector voltage for transistor  $Q_3$  by charging capacitor  $C_1$  with transient voltage spikes.

Transformers  $T_2$  and  $T_3$  are square-loop current transformers normally saturated in opposite directions by the bias current from transistor  $Q_4$ . During a particular half cycle, one of the transformers will be driven out of saturation. If the current is sufficiently high, it will overcome the bias current of  $Q_3$ .

Transistor  $Q_3$  drives  $Q_2$  into saturation which, in turn cuts off  $Q_1$  and directs the square-wave input through current-limiting resistors  $R_1$  and  $R_2$ . At the end of the half cycle, the reversal of the square-wave input causes  $Q_2$  to turn off, allowing  $Q_1$  to saturate again. The high impedance of resistors  $R_1$  and  $R_2$  is shunted out and the line current is allowed to increase until it reaches the predetermined peak whereupon the limiting process repeats. In this way, the current is limited on an instantaneous basis to a predetermined value without producing high losses when the load is normal.

The  $-10$ -volt reference of transistor  $Q_1$  is obtained from a winding on output transformer  $T_4$  so that the bias current, applied to  $T_2$  and  $T_3$ , is a function of the output transformer's voltage. An extremely heavy load on the power transformer will cause current limitation even if the instantaneous current is below the normal limiting value.

An important feature of this design is that the transistors do not have to dissipate high power.

*For further information, contact: Technology Utilization Officer, Jet Propulsion Laboratory, 4800 Oak Grove Drive, Pasadena, California, 91103 (B65-10233).*

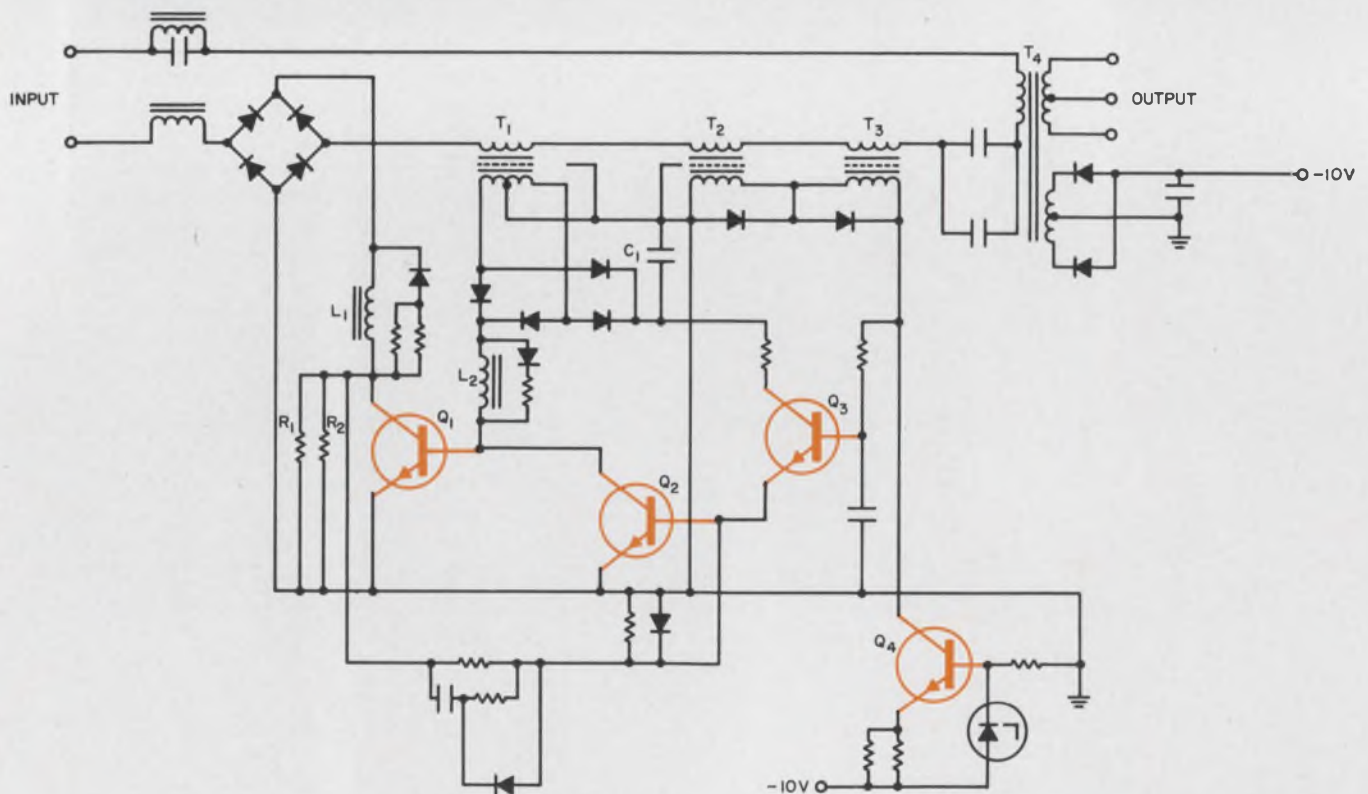

Report from

**BELL  
LABORATORIES**

R. C. Miller (left) and J. A. Giordmaine check the alignment of the crystal in which variable-frequency, laser-type light is generated.

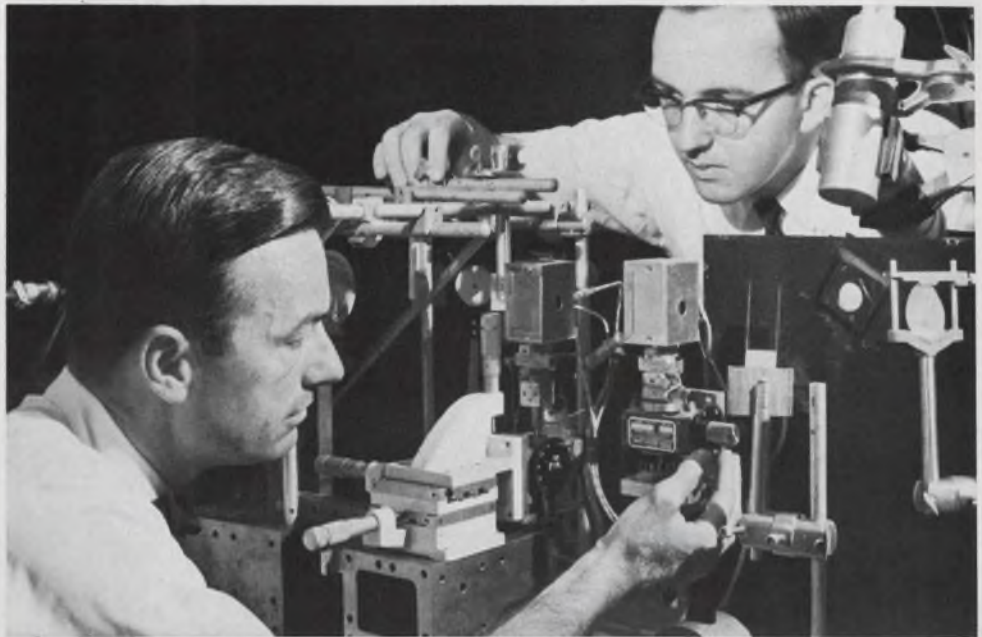

## A Tunable Source of "Laser" Light

A narrow beam of light, as generated by a laser, appears to offer many desirable qualities as a possible medium of communication. Individual lasers, however, operate at separate, discrete frequencies. For communications, tunable sources of light comparable to the variable-frequency oscillators used in radio work are useful.

Recently, Bell Telephone Labora-

tories scientists J. A. Giordmaine and R. C. Miller demonstrated an experimental tunable source of this type. Operating on parametric oscillation principles at optical frequencies (see illustration below), the device uses a crystal of lithium metaniobate, which is "pumped" by a laser beam. The device emits two beams, each of which is tuned by changing the temperature

of the crystal. With the present model an 11° C temperature change produces a 6 percent change in output wavelength of each of the beams.

Tunable, coherent sources represent a versatile scientific tool of importance for optical spectroscopy. In other applications, they could function as local oscillators in optical-frequency superheterodyne receivers.

**Operating features of tunable source based on parametric oscillation at optical frequencies: "pump" light from laser enters lithium metaniobate crystal at left, and, as a consequence of parametric oscillation, two additional beams are produced in the crystal. End surfaces of crystal, to which dielectric coatings have been applied, are partially reflecting. From right end emerge the two beams, plus the pump light, which is blocked by the filter.**

The principles governing parametric oscillation include the conservation of the energy and momentum of the interacting photons. As a consequence of energy conservation, the sum of the two output frequencies equals that of the pump. These output frequencies vary with temperature since the crystal's temperature-dependent index of refraction controls photon momentum in the beams.

In current work, the second harmonic of a pulsed calcium tungstate/neodymium-doped laser provides the required 7 kilowatts of pump power. Pump frequency of  $5.7 \times 10^5$  gigacycles (5290A wavelength) produces output frequencies ranging from about  $2.6 \times 10^5$  gigacycles (11,500A) to  $3.1 \times 10^5$  gigacycles (9700A), depending on temperature.

Lithium metaniobate, whose unique optical properties are essential to this effect, was first investigated in detail at Bell Laboratories where, also, large optical-quality crystals for this experiment were grown.

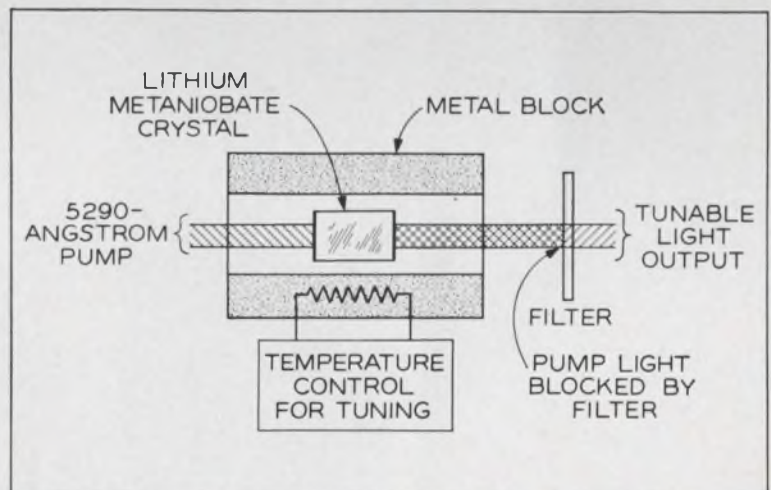

**Bell Telephone Laboratories**

Research and Development Unit of the Bell System

A whole litter of them, in fact. In the form of technical bulletins covering the most complete line of ferrite materials and shapes in the world. Included are core sizes and shapes not available as standard from any other manufacturer and ferrite materials made only by Indiana General.

Take flyback transformers, for example. In color-TV our 05 ferrite is the leading core material because of its high-voltage per-

formance. Where ferrites for filters are concerned, our TC-7 combines extremely high "Q" and low loss with the most linear temperature coefficient of inductance found anywhere.

In all, we list 11 ferrite materials in 315 standard shapes and sizes including: cup cores; toroids; transformer C cores; rods and strips; E, I, U, and C cores; the international series of cup cores, and cross cores.

Whether you are designing circuits or purchasing components, you can have our Ferramic® Materials Bulletins Nos. 100 thru 105 on your desk. Write Mr. K. S. Talbot, Manager of Sales, Indiana General Corporation, Electronics Division/Ferrites, Keasbey, New Jersey.

**INDIANA GENERAL** 

COPYRIGHT 1966, INDIANA GENERAL CORPORATION.

**We're ready to let the cat out on our 315 standard ferrite core shapes and 11 different materials.**



# ED Products

5 Hz-100 kHz true rms readings, 10:1 crest factor PAGE 98

Precision calibration with rms accuracy, ac or dc PAGE 101

8-element TTL logic family has low power dissipation PAGE 104

Panel meter keeps the works in front PAGE 108

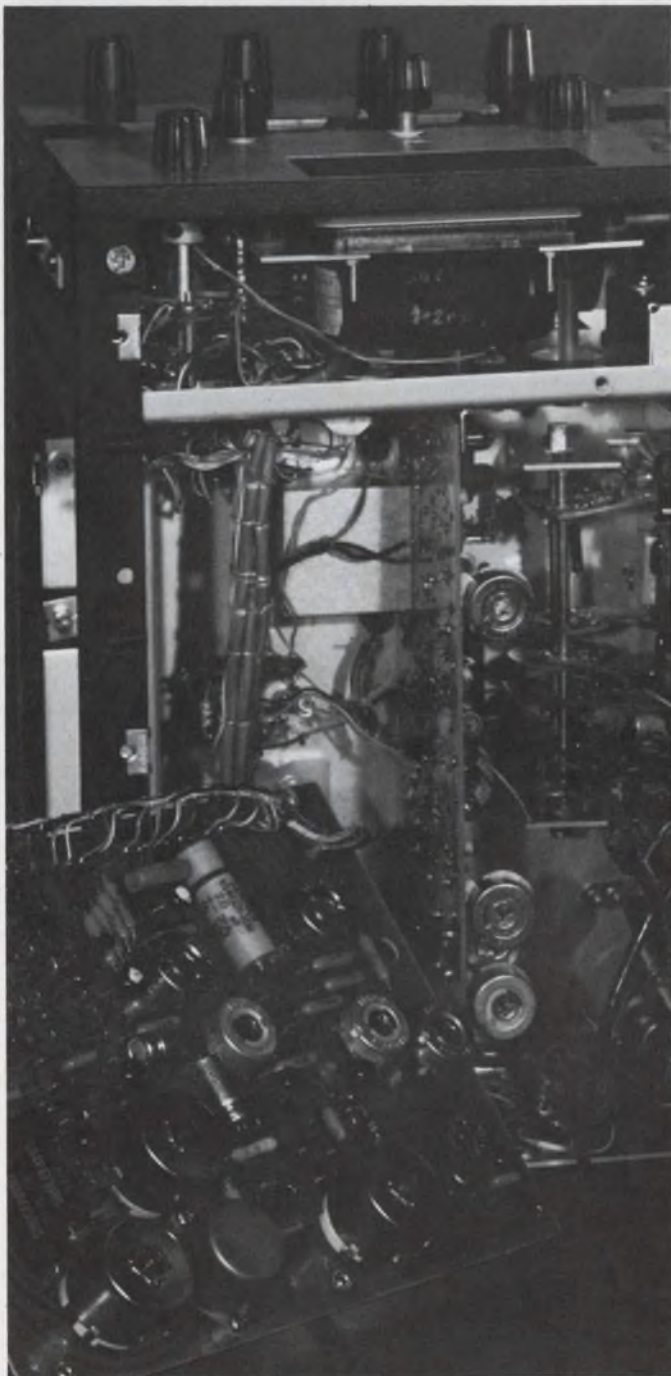

True rms readings from 5 Hz to 100 MHz . . . 98

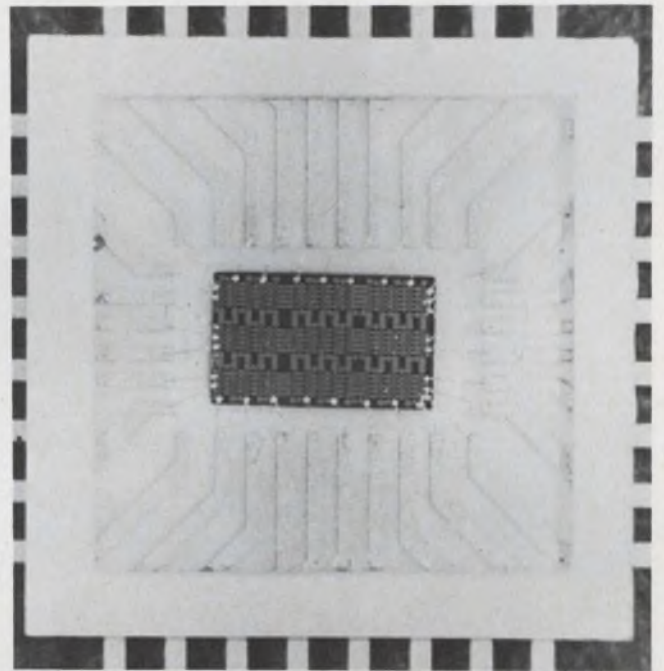

Passivated silicon diode array for computers . . . 104

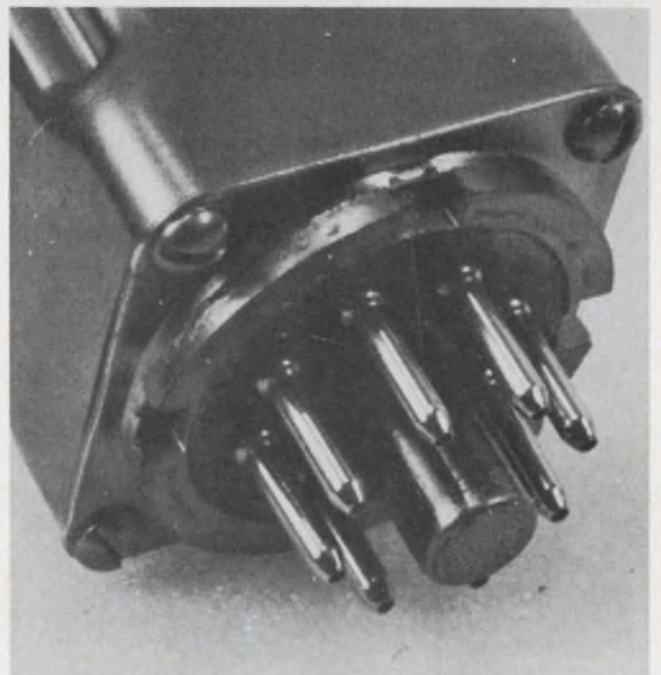

Tuning-fork accuracy from this reed-relay . . . 108

# True rms readings from 30 Hz to 50 kHz within 0.05% with this differential voltmeter



Measurement of ac in the lab, production-line, or field entails consideration of waveforms with no control over harmonic content. Since small harmonic content is beyond the detection capability of an oscilloscope, it is necessary to use a measuring device which responds to the true rms level. With this meter, model 931A, it is possible to measure and calibrate ac voltages such as square, triangle, and sawtooth waves without calculation.

Standards lab devices have low input impedance, require auxiliary equipment, and burden the operator with complexities. This portable meter provides high input impedance, digital readout, high resolution, a voltage excursion indication, battery operation, and low capacitance probe, not to mention a dc recorder output.

A front-panel null-meter indicates percent difference between the measured voltage and the value set on the front-panel voltage dials. Adjusting the dials to produce a null gives an in-line five digit readout with an automatically lighted decimal point. When not at null, a percentage-of-dial-reading value is given, enabling voltage-change monitoring. End-scale ranges of the null-meter extend from  $\pm 10\%$  of dialed value down to 0.1% of dialed value where meter resolution is 0.002% per scale division.

A TVM (Transistor Volt-Meter) mode is pro-

vided for conventional voltmeter operation of the deflecting scale. In this mode the ranges are 0.1 V, 1 V, 10 V, 100 V, and 1000 V, as in the null mode, plus range multipliers of 0.3 and 0.1 for increased accuracy with readings of less than 0.3 full-scale deflection.

In operation, the voltage is read conventionally by the TVM to get an approximation. The voltage

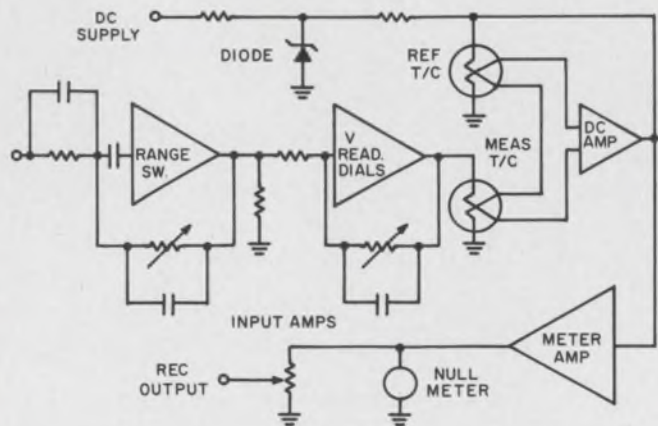

True rms voltage is read by differential thermocouples and a dc null-detector. The input signal is adjustably amplified to null-match a known dc by the range-switch and the voltage readout dial amplifiers.





## New JFD Air Variable Capacitors offer higher frequencies with negligible loss of Q

### Plus

- Ultra Stability
- Highest Q
- Small Size
- Rugged Construction

Now JFD air variable capacitors offer circuit designers the advantages of extremely high "Q" and greater capacitance values in a rugged miniature size unit. Offered in both a printed circuit (VAM 010W) and a panel mounting model (VAM 010), the new units operate at far higher frequencies with negligible loss of "Q" in comparison to other types.

Internal air meshing shells are silver plated to provide good surface conductivity and to prevent corrosive effects. Three internal contact springs assure positive electrical contact of rotor at all times. Leads on printed circuit model are tinned for ease in soldering.

The high density insulator between stator and rotor has excellent electrical properties and contributes to overall structural strength. Rubber gasketed threaded end caps effectively seal the units against dirt entrance or atmospheric contamination after tuning.

**WRITE FOR JFD BULLETIN VAM-65**

JFD 120-A



Components Division  
 JFD ELECTRONICS CORPORATION, 15th Ave. at 62nd St., Brooklyn, N. Y. 11219  
 Tel: 212 DE 1-1000  
 JFD NORTHEASTERN, Ruth Drive, P. O. Box 228, Marlboro, Mass. 07152  
 JFD NEW YORK-NORTHERN, Damiano Pl., P. O. Box 96, New Hartford, N. Y. 13503  
 JFD MID-ATLANTIC, P. O. Box 5055, Philadelphia, Pa. 19111  
 JFD MID-ATLANTIC-MARYLAND, P. O. Box 7676, Baltimore, Md. 21207  
 JFD MIDWESTERN, 6330 W. Hermione St., Chicago, Ill. 60646  
 JFD MIDWESTERN-OHIO, P. O. Box 8086, Cincinnati, Ohio 45208  
 JFD WESTERN, 9 Morlan Place, Arcadia, California 91006  
 JFD ISRAEL LTD., Industrial Area B, Bldg. 23, Azor, Israel  
 JFD ELECTRONICS, EUROPE S A, 7 Rue de Rocroy, Paris, 10, France

Precision Piston Trimmer Capacitors ■ Metalized Inductors ■ LC Tuners ■ Ceramic Fixed and Variable Capacitors ■ Fixed and Variable Distributed and Lumped Constant Delay Lines

Speed Inquiry to Advertiser via Collect Night Letter  
 ON READER-SERVICE CARD CIRCLE 33

## Dc amplifier

The 931 voltmeter's high crest factor is due to a unique application of the magnetic amplifier principle. Very low level dc from the thermocouple network (drawing 1), is impressed on a toroidal core. Present in the core is the static resultant of equal and opposed sinewaves (waveform A). The input dc offsets the reference center of the sinewaves, aiding the positive going wave (waveform B). This drives the core at time *K*, producing a current until time *L* when the opposing sinewave returns the core to balance. The negative-going current is now affected by the positive dc level, producing a time (*M* to *N*) when a negative pulse is registered. The pulses have an equivalent ac frequency, (waveform C) which is detected, amplified, and fed to the nullmeter.

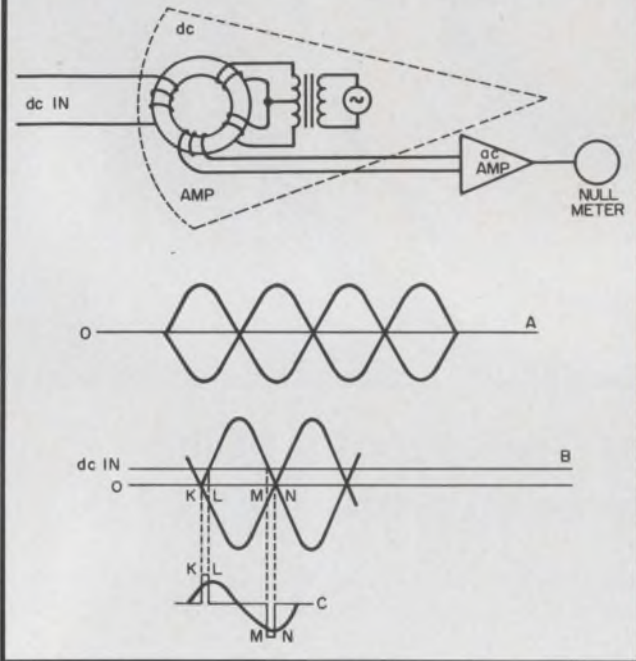

dials are then set up to that value, observing decimal placement, and the instrument is switched to the null mode. The null meter now indicates percent of deviation between the true rms and the dialed value. Further adjustment of the dials and advancing the null sensitivity for maximum, produces an accurate null. At frequencies between 30 Hz and 50 kHz, measurements can be made to within 0.05%. From 5 Hz to 100 MHz, lower accuracy is specified.

When in TVM mode, the 931A can also be used as an rms-to-dc converter, as the dc recorder output is proportional to the rms input. In this mode, the thermocouples are caused to track by the dc amplifier that drives the reference-thermocouple heater. The thermocouple outputs are series connected, in opposite polarity, to the dc amplifier in such a manner that when the measuring TC is heated more than the reference TC, the amplifier output increases. Conversely, when the reference TC is heated more than the measuring TC, the output is reduced. The amplifier thereby controls the reference TC temperature in a manner that causes the summed output of the thermocouple pair to be reduced toward zero.

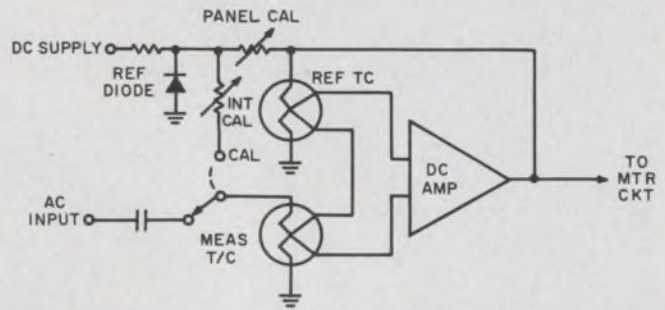

In calibrating, the reference thermocouple dc is null-matched to the measuring-couple ac, previously set against a known standard ac input.

This indicates equal heating of the two TCs, one heated by the input ac—the other by dc. Thus the dc input to the reference couple is equal to the effective, or rms, input to the measuring TC.

In the null mode, the detector circuitry operates similarly, except that the reference-couple heater is maintained by a zener-regulated dc source. The null detector indicates "zero" when an ac level equal to the known dc reference is placed on the measuring couple. This is done by altering the range-switch and voltage-readout dials in the direction and magnitude indicated by the null indicator.

Periodic recalibration is accomplished by feeding a known ac to the measuring TC and adjusting the panel CAL-control for meter null. Next, the panel CAL knob is depressed, placing the dc supply onto the measuring TC. The dc level in the reference TC is adjusted for a null, thus setting the dc equivalent to the known ac. This gives the dc reference voltage. Calibration thereafter is accomplished by biasing the reference TC to match the measuring TC with the CAL knob in and dc fed to the measuring couple. Complete recalibration will be necessary only after several months.

Input impedance at the binding posts is 1 Meg, shunted by 8 pF. The probe gives 1 Meg input Z, shunted by less than 5 pF.

Heretofore a considerable problem with rms reading devices has been in the low crest factors. The necessity of using a signal sufficiently high to be distinguished from noise obviated the possibility of detecting high-amplitude voltage spikes. This meter overcomes this with a unique application of the mag-amp- or saturable reactor-principle. The circuit is described in the accompanying box—here let it suffice to say that the unsaturated reactor enables very minute dc input changes to be detected.

No hysteresis problem is encountered, for the toroidal coil never reaches saturation—only the approaches to saturation are measured. The 931 A's crest factor is minimally 10:1 or 1800 V peak in the differential mode. In the direct (TVM) mode, this figure is 10:1 at end scale, increasing to 30:1 at 1/3 scale, or 1800 V peak.

P&A: \$895-basic, \$100-battery, \$50-probe. 6 weeks. John Fluke Manufacturing Co., P.O. Box 7428, Seattle, Wash. Phone: (206) 776-1171.

Circle No. 251

# Low power precision calibrator gives rms, peak, and dc

A source of ac or dc voltage that can be precisely set for any value up to 111 Vdc or 1110 Vac is designated model 421A. The selected voltage is indicated digitally to four significant figures on each of six decade ranges.

The portable power supply can function as a calibration standard for voltmeters, oscilloscopes, recorders, or other ac or dc voltage-sensing devices. It may also be used as an accurate, stable source for gain or loss measurements, or as a biasing source for bridges or strain gage devices. It replaces the manufacturer's 421, adding high voltage provision, error computing capability, and lower ac source impedance.

A binding post or uhf coaxial output is provided for all voltages up to 111 V and a specially protected receptacle is provided for voltages from 100 to 1110 V. Up to 111 V, the output may be positive or negative dc, or it may be 400 or 1000 Hz, rms or peak-to-peak. The high voltage output provides any value from 100 to 1110 volts at 400 Hz, rms or peak-to-peak.

Ac and dc are obtained from a stabilized, low-distortion oscillator whose amplitude is maintained by an rms sensing baretter bridge in a temperature-controlled oven. This constant input to the attenuator is divided by ratio transformers, amplified, and fed to a decading output transformer. The design of the circuitry allows selection of voltages between 100  $\mu$ V and 1000 V to at least four digit resolution. Dc is obtained from regulated ac with dividers for each range.

An optional error computer mounts on a rack model (-S2) of the unit, and comes permanently mounted on another (-S3) rack model. When connected, it provides for a change in output up to  $\pm 5\%$  as read directly on the 2421 error computer dial. The instrument under calibration is fed its nominal voltage by the 421A. The 2421 dial is then adjusted until the instrument under calibration reads its nominal value, then the per cent of error can be read from the 2421 directly. Tracking error of an instrument can also be measured directly.



Line voltage effect on the unit is  $\pm 0.05\%$  max at 115/230 V  $\pm 10\%$ . Ambient temperature effect at 25°C  $\pm 10^\circ$ C is within  $\pm 0.005\%/^\circ$ C; and short-term stability is  $\pm 0.01\%$ .

Waveform distortion is 0.15% max, and frequency is accurate within  $\pm 2\%$  of nominal. Ripple on dc is 0.1% of full-range max, and noise is within  $\pm 0.05\%$  of full-range, max.

P&A: \$650, 2421 extra; stock. Ballantine Labs, 102 Fanny, Boonton, N.J. Phone: (201) 334-1432.

Circle No. 252

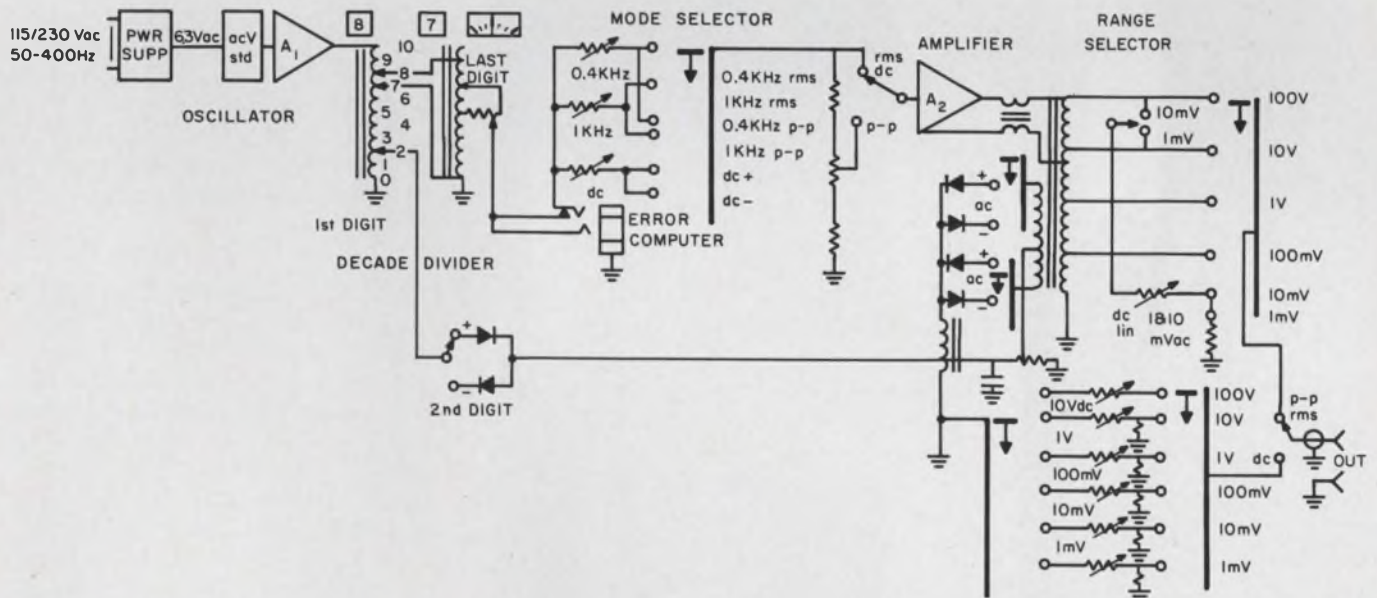

Both the ac and dc outputs are obtained from a highly stabilized, low distortion oscillator. An rms sensing baretter bridge in a temperature-controlled space maintains constant amplitude. A constant input to the attenuator system is maintained over disparate conditions, and is fed to the decade transformer. Voltages from 100  $\mu$ V to 1000

V may be selected with four-digit minimum resolution. External controls include the power switch; the mode selector and range selectors with six positions each; output voltage indicators and three knobs for selecting the first, second, and last two digits with ten percent overrange on the second digit. Outputs are described in the text.

## TEST EQUIPMENT

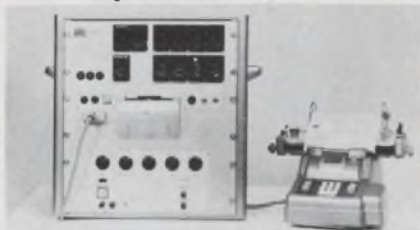

### Complex ratio bridge displays and prints

This new bridge takes continuous measurements of the complex ratio between two ac voltages. In-phase and quadrature signs and values are digitally presented. The compensation/comparison technique affords accurate determination of phase coordinates without loading the test object, regardless of minor supply voltage variations.

A compensation voltage from two stepping-switch controlled transformers ( $90^\circ$  out of phase) is matched to the test signal.

An optional automatic printout features a numerical comparator and punched memory card for up to 35 test points. Added automation is available in a 30 ms stepping time test-point sequencing unit.

P&A: \$8,000, \$10,500 with print-out, sequencing unit to customer's order; 6 to 9 weeks. Arenco Machine Co. Inc., 500 Hollister Rd., Teterboro, N. J. Phone: (201) 288-4444.

Circle No. 253

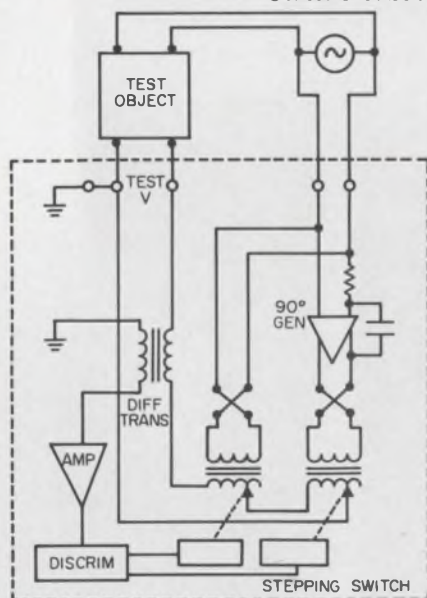

Decade transformers are fed by signals with  $90^\circ$  phase difference. The discriminator compares them with the test V. The stepping switches adjust for match; they then correspond to the complex ratio.

### Cable tester



Continuity and shorts in cables, chassis wiring, connectors, or PC boards may be checked with this 17-lb portable cable tester. The model 50 tests up to 50 circuits for continuity up to  $1 \Omega$  adjustable, and for shorts to 200 Meg. adjustable, with a capability for branched circuits. All tests are performed automatically at 4/second. The unit stops and identifies faults.

P&A: \$595; stock to 90 days. VJ Electronics, P.O. Box 1355, Ontario, Calif., Phone: (714) 986-5095.

Circle No. 254

### Calibration standard



This true rms ac/dc V/I calibration standard provides automatic overload protection without signal degradation. The console operates to 25 kHz and covers a range of 0.2 mV to 1110 V and  $0.2 \mu\text{A}$  to 11.1 A. Digital readout is in percent error or actual value, 6 digits in 1 mV steps and 5 digits in  $100 \mu\text{A}$  steps. Accuracy is  $\pm 0.035\%$  on voltage,  $\pm 0.05\%$  on current.

Singer Co., Metrics Div., 915 Pembroke St., Bridgeport, Conn. Phone: (203) 366-3201.

Circle No. 255

### RFI meter



This RFI and field intensity analyzer covers a 150 kHz to 32 MHz range. Accuracy is  $\pm 2\%$  for frequency and  $\pm 2$  dB for voltage. Sensitivity is  $0.2 \mu\text{V}$  across a  $50 \Omega$  load and input vswr less than 1.25. 50-dB image rejection, 60-dB IF rejection and 100-dB shielding effectiveness are offered. The unit is powered by a 40-hour integral battery pack.

Price: \$3250. Stoddart Electro Systems, 2045 W. Rosecrans Ave., Gardena, Calif. Phone: (213) 770-0270.

Circle No. 256

### Eddy current tester



This 20 Hz to 20 kHz magnetic reaction analyzer permits non-contact testing of variations in metallic electromagnetic properties. The unit uses a constant amplitude magnetizing field and field detectors with frequency independent flux response. A Hall element in the probe enables use of phase and amplitude information over the full frequency range.

P&A: \$1700; stock. F. W. Bell, Inc., 1356 Norton Ave., Columbus, Ohio. Phone: (614) 759-0193.

Circle No. 257



### Dual function DVM

Both dc and ac are simultaneously measured and displayed on the model 5600 DVM. A 4-digit in-line Nixie display provides 1, 10, 100 and 1,000 Vdc ranges with automatic polarity reversal. A separate 3-digit display provides ranges from 10 mVac to 1000 Vac full scale in 6-decade steps. Accuracy of 0.1% is offered for p-p or rms measurements.

Price: \$1195. Micro Instrument Co., 13100 Crenshaw Blvd., Gardena, Calif. Phone: (213) 323-2700.

Circle No. 258



### Open/short locator

This wire and cable open and short locator tests for wire breaks and voltage failure, high resistance or copper cross shorts. A bridge circuit and null detector, front panel connecting terminals and remote operation testing leads are featured. Specifications include 115 V in, 0 to 10 kVdc at 60 mA for shorts and 0 to 1 kVdc at 20 mA for opens.

P&A: \$900; 2 weeks. Hipotronics, Inc., P. O. 1, Brewster, N. Y. Phone: (914) 225-4075.

Circle No. 259

## Ballantine Sensitive R-A-P VTVM

(true-Rms) (Av.) (Peak)

### Model 321

Price: \$560

Measures True-RMS, Average, or Peak Voltage

Same Accuracy and Resolution over entire Five-Inch Log Scales

Accuracy of 2% of Indication is far better over the lower half of the scale than for a linear scale instrument rated at 1% F.S.D.



THREE INSTRUMENTS  
IN ONE

## Measures Wide Range of Voltages, Frequencies, and Waveforms

Ballantine's Model 321 is an electronic voltmeter designed for accurate measurements of the true-rms, average, or peak values of a wide range of voltages and waveforms. It is *not* limited to measurement of pure sine waves to obtain the specified accuracy, but will measure sine, distorted sine, complex, pulse, or random signals whose frequency components lie within the designated frequency range.

The instrument's five-inch voltage scales make it possible for you to specify uniform resolution and accuracy in % of indication over the entire scale length. This feature is not possible with a linear scale meter.

#### PARTIAL SPECIFICATIONS

##### VOLTAGE RANGE

RMS ..... 100  $\mu$ V — 330 V  
Average & Peak ..... 300  $\mu$ V — 330 V  
As null detector ..... to 10  $\mu$ V

##### WAVEFORMS

Sine, distorted sine, complex, pulse, random

Power Requirements: 115/230 V, 50 — 420 Hz, 90 W

##### FREQUENCY RANGE

RMS ..... .5 Hz — 4 MHz  
3 db bandwidth ..... 2 Hz — 7 MHz

##### ACCURACY, ABOVE 300 $\mu$ V, MID-BAND

RMS & Average ..... 2% of indication  
Peak ..... 3% f.s.

Amplifier: 90 db  
Mean Square Output (dc): 1 V

Available in portable or rack versions

Write for brochure giving many more details

Member Scientific Apparatus Makers Association

— Since 1932 —



**BALLANTINE LABORATORIES INC.**

Boonton, New Jersey

CHECK WITH BALLANTINE FIRST FOR DC AND AC ELECTRONIC VOLTMETERS/AMMETERS/OHM METERS, REGARDLESS OF YOUR REQUIREMENTS. WE HAVE A LARGE LINE, WITH ADDITIONS EACH YEAR. ALSO AC/DC LINEAR CONVERTERS, AC/DC CALIBRATORS, WIDE BAND AMPLIFIERS, DIRECT-READING CAPACITANCE METERS, AND A LINE OF LABORATORY VOLTAGE STANDARDS FOR 0 TO 1,000 MHZ.

Free Night Letter for Descriptive Inquiry  
Speed Inquiry to Advertiser via Collect Night Letter

ON READER-SERVICE CARD CIRCLE 34

## Logic family features very low power dissipation

A new logic family, TTL, has been developed for airborne computer applications where size and weight of the over-all computer is critical. The family consists of two binaries (a master-slave flip-flop, and a three-element flip-flop), two gated buffers, a five-three gate, a dual-three gate and a line driver and line receiver intended for long connecting lines.

The very low power dissipation, typically 1.3 mW per node at 25°C, actually decreases thereafter as temperature rises. Propagation delay times remain respectable with typical values in the range of 50 nanoseconds. Noise immunity is typically 800 mV and can be boosted to 2.5 V by the use of the line-driver and receiver.

The fanout for the TTL gates is minimally nine. The gated buffers have fanouts of 50 min and 33 min in the low and high states respectively. All functions use only one

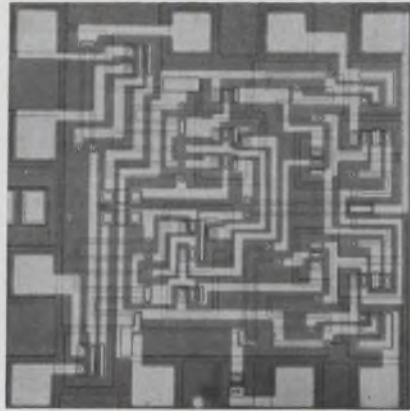

power-source, 4 Vdc. The family is available either in the TO-5 can, or at no extra charge, in flatpacks.

P&A: \$23.10-\$28.50 per unit, \$16.20-\$20.00 in hundred unit lots; stocks. Amelco Semiconductor Div. Teledyne, 1300 Terra Bella Ave., Mountain View, Calif. Phone: (415) 968-9241. TWX: (415) 969-9112.

Circle No. 260

## Flatpack diode matrix replaces discrete devices

This monolithic diode matrix contains 225 passivated silicon diodes in a square configuration. The diodes are fabricated using dielectrically isolated moats. The diode ma-

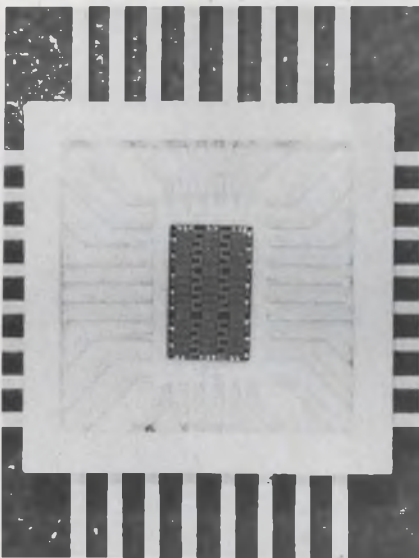

trix is packaged in a specially designed 32-lead flatpack offering connections and characteristics to the customer's needs. This is made possible by the use of a new manufacturing process.

The microelectronic units are suited for coding, decoding, addressing, steering, and any other use involving multiple diodes. They can be employed in lieu of discrete semiconductor components without increasing system costs, says the manufacturer.

The matrix device is designated the RM-50. It specifies performance characteristics which include 100 milliamperes forward current and four nanoamperes reverse leakage current at 25 volts. Normally applicable reverse recovery times are specified in the ten nanosecond range. Reverse breakdown voltage is typically in excess of 60 volts.

Radiation Inc., P. O. Box 37, Melbourne, Fla., Phone: (305) 723-1511.

Circle No. 261

## DELCO RADIO SEMICONDUCTOR DISTRIBUTORS

### EAST

**Binghamton, N. Y. 13902**—Federal Electronics, Inc.  
P. O. Box 1208/(607)-748-8211

**Philadelphia, Penn. 19123**  
Almo Industrial Electronics, Inc.  
412 North 6th Street/(215)-922-5918

**Pittsburgh, Penn. 15206**—Radio Parts Company, Inc.  
6401 Penn Ave./ (412)-361-4600

**Newton, Mass. 02195**—Greene-Shaw Company  
341 Watertown Street/(617)-969-8900

**New York, New York 10036**—Harvey Radio Co., Inc.  
103 West 43rd St./ (212)-582-1500

**Clifton, N. J. 07015**—Eastern Radio Corporation  
312 Clifton Avenue/(201)-471-6600

**Woodbury, L. I., N. Y. 11797**  
Harvey Radio Company, Inc.  
60 Crossways Park West/(561)-921-8700

**Baltimore, Md. 21201**—Radio Electric Service Co.  
5 North Howard Street/(301)-539-3835

### SOUTH

**Birmingham, Ala. 35233**  
Forbes Distributing Company, Inc.  
2610 Third Avenue, South/(205)-251-4104

**West Palm Beach, Fla. 33402**—Goddard, Inc.  
1309 North Dixie/(305)-833-5701

**Richmond, Va. 23220**—Meridian Electronics, Inc.  
1001 West Broad Street/(703)-353-6648

### MIDWEST

**Kalamazoo, Mich. 49006**—Electronic Supply Corp.  
P. O. Box 831/(616)-381-4623

**Indianapolis, Ind. 46225**  
Graham Electronics Supply, Inc.  
122 South Senate Avenue/(317)-634-8486

**Cleveland, Ohio 44101**  
The W. M. Pattison Supply Co.  
Industrial Electronics Division  
777 Rockwell Avenue/(216)-621-7320

**Chicago, Ill. 60630**—Merquip Electronics, Inc.  
4939 North Elston Avenue/(312)-282-5400

**Cincinnati, Ohio 45237**—United Radio, Inc.  
7713 Reinhold Drive/(513)-761-4030

**Kansas City, Mo. 64111**—Walters Radio Supply, Inc.  
3635 Main Street/(816)-531-7015

**St. Louis, Mo. 63144**  
Electronic Components for Industry Co.  
2605 South Hanley Road/(314)-647-5505

**Tulsa, Oklahoma 74119**—Radio, Inc.  
1000 South Main Street/(918)-587-9124

**Oklahoma City, Oklahoma 73102**—Radio, Inc.  
903 North Hudson/(405)-235-1551

**Minneapolis, Minnesota 55413**  
Northwest Electronics Corporation  
336 Hoover St., N. E./ (612)-331-6350

### WEST

**Dallas, Texas 75201**—Adleta Electronics Company  
1907 McKinney Ave./ (214)-742-8257

**Houston, Texas 77001**—Harrison Equipment Co., Inc.  
1422 San Jacinto Street/(713)-224-9131

**San Diego, Cal. 92101**—Milo of California, Inc.  
2060 India Street, Box 2710/(714)-232-8951

**Los Angeles, Cal. 90015**—Radio Products Sales, Inc.  
1501 South Hill Street/(213)-748-1271

**Los Angeles, Cal. 90022**—Kierulff Electronics, Inc.  
2585 Commerce Way/(213)-685-5511

**Mountain View, Cal. 94041**—Kierulff Electronics, Inc.  
2484 Middlefield Road/(415)-968-6292

**Denver, Colo. 80219**—L. B. Walker Radio Company  
300 Bryant Street/(303)-935-2409

**Seattle, Wash. 98121**—C & G Electronics Company  
2600 2nd Ave./ (206)-624-4354

**Phoenix, Ariz. 85005**—Midland Specialty Co., Inc.  
1930 North 22nd Ave./ (602)-258-4531

**Albuquerque, N. M. 87103**  
Midland Specialty Co., Inc.  
1712 Lomas Blvd., N. E./ (505)-247-2486

**Tucson, Ariz. 85719**—Midland Specialty Co., Inc.  
951 South Park Ave./ (602)-624-2315

## DELCO RADIO

DIVISION OF GENERAL MOTORS • KOKOMO, INDIANA

Delco Radio's new 400V silicon power transistors will change your thinking about high voltage circuitry. You can reduce current, operate directly from rectified line voltage, and use fewer components. Our standard TO-3 package stays cool (junction to heat sink  $1.0^{\circ}\text{C}$  per watt). And price is low—less than 3c a volt even in sample quantities—for wide ranging applications. Vertical and horizontal wide-screen TV out-

# The heat's off high energy circuits

puts, high voltage, high efficiency regulators and converters. Your Delco Radio Semiconductor distributor keeps them on ice. Call him today for data sheets, prices and delivery.

RATINGS	DTS 413	DTS 423
<b>VOLTAGE</b>		
V <sub>CEO</sub>	400 V	400 V
V <sub>CEO</sub> (Sus)	325 V (Min)	325 V (Min)
V <sub>CE</sub> (Sat)	0.8 (Max) 0.3 (Typ)	0.8 (Max) 0.3 (Typ)
<b>CURRENT</b>		
I <sub>c</sub> (Cont)	2.0 A (Max)	3.5 A (Max)
I <sub>c</sub> (Peak)	5.0 A (Max)	10.0 A (Max)
I <sub>b</sub> (Cont)	1.0 A (Max)	2.0 A (Max)
POWER	75 W (Max)	100 W (Max)
<b>FREQUENCY RESPONSE</b>		
f <sub>t</sub>	6 MC (Typ)	5 MC (Typ)

#### FIELD SALES OFFICES

UNION, NEW JERSEY\*  
Box 1018 Chestnut Station  
(201) 687-3770

SYRACUSE, NEW YORK  
1054 James Street  
(315) 472-2668

DETROIT, MICHIGAN  
57 Harper Avenue  
(313) 873-6560

CHICAGO, ILLINOIS\*  
5151 N. Harlem Avenue  
(312) 775-5411

SANTA MONICA, CALIF.\*  
726 Santa Monica Blvd.  
(213) 870-8807

General Sales Office:  
700 E. Firmin, Kokomo, Ind.  
(317) 457-8461—Ext. 2175

\*Office includes field lab and resident engineer for application assistance.

## DELCO RADIO

Division of General Motors • Kokomo, Indiana



ON READER-SERVICE CARD CIRCLE 35

# INTEGRATED CIRCUIT



## TIME CODE GENERATOR EECO 911

All silicon semiconductors  
Integrated-circuit logic  
5 simultaneous time codes  
Change code by inserting new circuit card  
Automatic time presetting  
with thumbwheel switches  
5 1/4 inch panel height  
Battery backup



1 pps pulse for triggering horizontal sweep on scope  
Thumbwheel switches preset generator to desired start time  
Pushbutton sets accumulator to time selected by thumbwheel switches  
Pushbutton advances time in one-second increments for coarse corrections  
Switch starts and stops seconds accumulation  
Normally-off switch advances or retards time at selected rate for fine corrections  
Selects desired advance or retard rate

**EECO 911**  
... from \$4,000



**Electronic Engineering Company**

of California  
1601 East Chestnut Avenue (Box 58)  
Santa Ana, California 92702  
Phone: Kimberly 7-5501 (714) • TWX: 714-531-5711

ON READER-SERVICE CARD CIRCLE 36

## SYSTEMS



### Diode laser pulser

The model T-2 pulser features 12 ns rise time, 25 ns pulse length, dc to 20 kHz rep rate and 1 to 160 A pulses. An integral current sampling resistor, providing an output of 1 V per ampere of pulse current, allows continuous monitoring of current amplitude and wave shape. The model Q-1 internal universal trigger is available as option.

P&A: \$850, \$950 with Q-1; 25 days. Seed Electronics Corp., 258 East St., Lexington, Mass. Phone: (617) 862-8090.

Circle No. 262

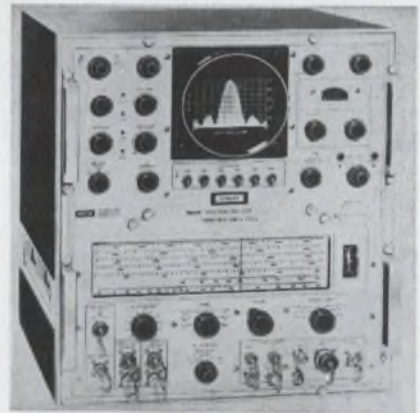

### Spectrum analyzer

This analyzer has a tuning range of 10 MHz to 73 GHz and provides 1 kHz usable resolution from 10 MHz to 10.3 GHz without local oscillator phase locking. Standard features include crystal-controlled RF markers, 160 MHz IF terminals, adjustable smoothing filter, linear and 40 dB log and power scales calibrated on CRT graticule.

Price: \$6,400. Singer Co., Metrics Div., 915 Pembroke St., Bridgeport, Conn. Phone: (203) 366-3201.

Circle No. 263



## Tracking filter

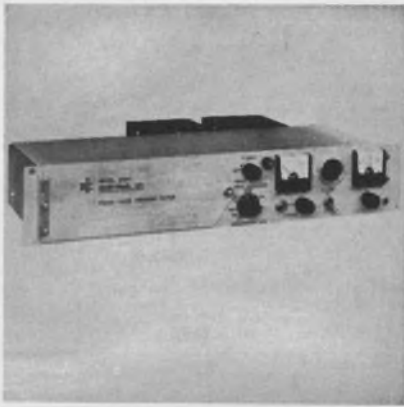

The model 220R phase lock tracking filter accepts timing channel outputs and tracks them over  $\pm 10\%$  of the selectable 100 kHz, 200 kHz or 1 MHz nominal input frequency. Bandwidth is controlled to 7 kHz. The VCO provides a continuous output despite input dropout. The unit requires 105 to 125 V, 50 to 400 Hz, 25 W and uses solid-state plug-in circuit cards.

P&A: \$3980; 30 days. Electrac, Inc., 1614 Orangethorpe, Anaheim, Calif. Phone: (714) 879-6021.

*Circle No. 264*

## Field regulator

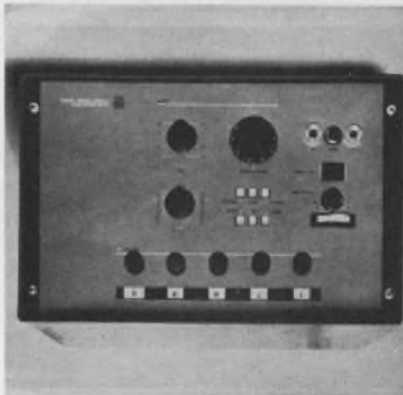

A field sensing probe on the pole cap face and temperature control make for long-term stability on this magnetic field regulator. At  $\pm 5^\circ\text{C}$  variations, magnetic stability to 1 part in  $10^5$  of set field per day is available. The unit offers single ramp and repetitive triangular wave-form sweeps and 0.1 gauss incrementally set digital field control dials.

Varian Associates, 611 Hansen Way, Palo Alto, Calif. Phone: (415) 326-4000.

*Circle No. 265*

## Converter amplifier

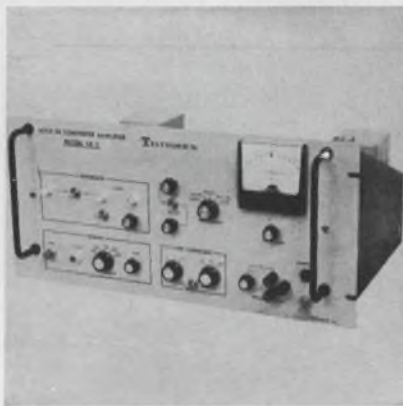

The model CK-3 lock-in converter amplifier is a narrow band processor for noise-obscured low level signals. Optional 1 Meg input Z,  $3 \mu\text{V}$  sensitivity and 2 W reference drive are offered. A self test feature allows pre-alignment of in-phase and quadrature components. Front panel phase shifters cover the 20 Hz to 15 kHz range.

P&A: \$995; 45 days. Teletronics, Inc., 24 Main St., Nashua, N. H. Phone: (603) 882-6264.

*Circle No. 266*

## Storage unit

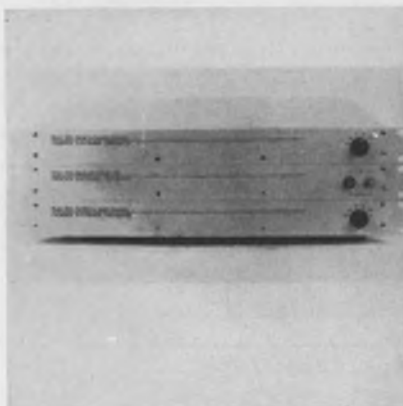

With the use of a magnetostrictive delay line of expandable 2400 character capacity, this solid-state unit serves as an interface between teleprinter circuits with speed differentials.

Input and output are standard 5 level codes. The unit is packaged as serial/parallel and parallel/serial converters and as storage unit.

P&A: \$2,400; 90 days. Frederick Electronics Corp., Box 502, Frederick, Md. Phone: (301) 662-5901.

*Circle No. 267*

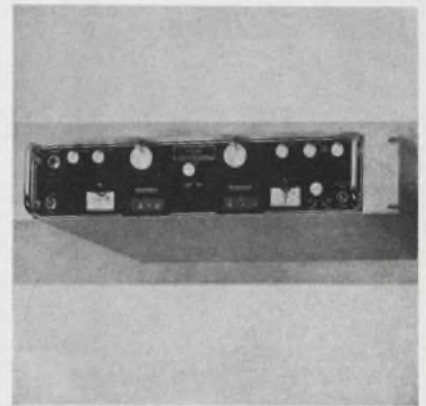

## Vhf receivers

The 4-model series 900 receives AM, FM, and CW and tunes in 30 to 90 MHz and 60 to 300 MHz bands with automatic gain control for FM, manual for CW and a choice for AM. Front panel selectable bandwidths of 20 kHz and 300 kHz are featured. A BFO operates in both, and is automatically activated for CW operation.

P&A: \$1925 to \$2175; 30 days. Communication Electronics, Inc., 6006 Executive Blvd., Rockville, Md. Phone: (301) 933-2800.

*Circle No. 268*

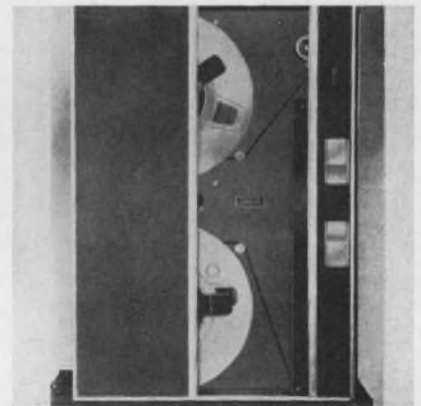

## Digital recorder

This 45-lb portable digital tape recorder reads and writes IBM computer compatible tapes at 200, 556, and 800 bits per in.

Tape speeds may range to 120 ips. Recording format is 7 or 9 track data on IBM reels. This 100 W model DR 1200 features highly flexible design to meet requirements for fixed or field applications.

Ralph M. Parsons Electronics Co., 151 S. DeLacey St., Pasadena, Calif. Phone: (213) 795-7061.

*Circle No. 269*

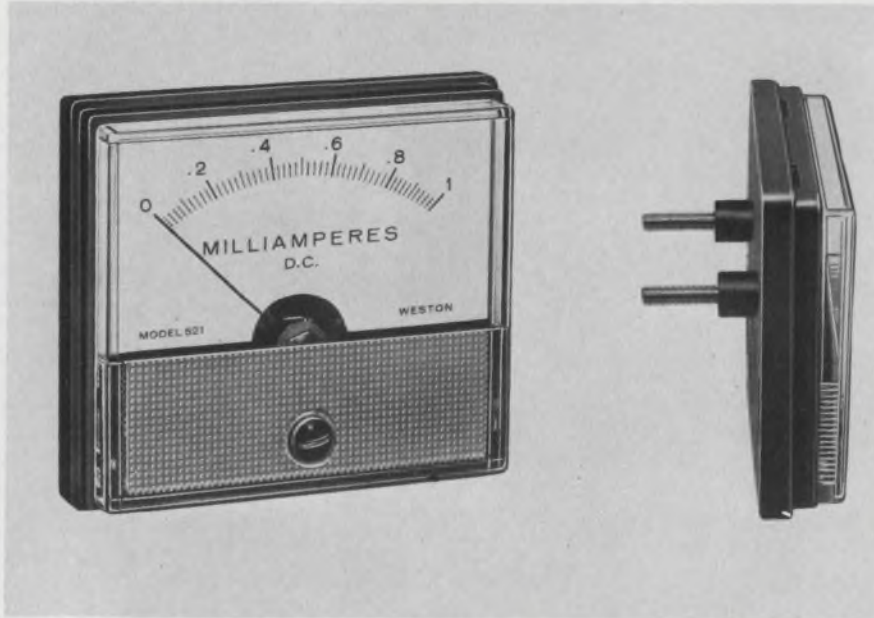

## Front panel meters present slim profile

Miniature meters are now adopting a new slim line profile. Bulky meter movements have been eliminated from the new flatback meter family. Combined cover and case dimensions are less than 3/4-in. thick. The new meters lend themselves to applications where space is at a premium. Drilling two 3/8-inch screw holes is all that is needed to mount the meters on equipment panels. The mounting screws, which double as terminal posts, are passed through the holes and the meter is fastened with insulators and nuts.

Meter movements used in the new instrument line are recently announced Weston moving coils.

Movements have maximum sensitivity of 100  $\mu$ A/dc with full scale readings up to 10 A.

Dc voltmeters are available in the new configuration with ranges from 50 mV to 500 V and ac meters are available in 150 V to 300 V models. The ac rectifier-type meter has a sensitivity of 1000 ohms/volt. The family conforms to ASA standard C-39.1. Outline measurements of depth are 0.067-in., width 2.50-in. and height 1.46-in. Larger versions with 3.12-in. faces are available.

P&A: \$8.50 in 100 quantity; May 1st. Weston Instruments, 614 Frelinghuysen, Newark, N. J. Phone: (201) 243-4700.

Circle No. 270

## Contactless decoder

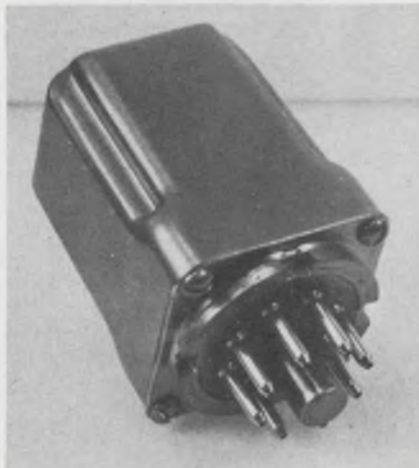

This decoder employs a resonant reed without contacts in a bridge followed by an amplifier and trigger. The bridge is unbalanced when a proper frequency causes the reeds to vibrate, altering impedance. A signal is then allowed through.

A tuning-fork type dual-reed oscillator is used. Frequency is 300 to 1000 Hz, and input sensitivity is one milliwatt. Voltage is 12 Vdc. An octal plug base is used.

P&A: \$40 each, \$25 each in 1000 lots, 2 wks. Perry Laboratories, 83 Perry St., Buffalo, N. Y. Phone: (716) 853-0282.

Circle No. 271

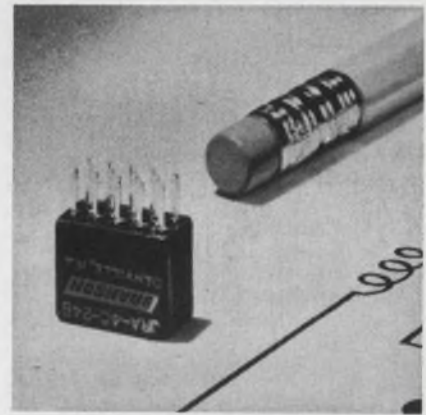

## 4pdt relay

The new type JR 4pdt relay occupies a 1/6 crystal can size package of 0.04 in.<sup>3</sup>, and provides a contact rating of 0.5 A, 28 Vdc resistive load. Dielectric strength at sea level is 500 Vrms.

The tiny unit is virtually unaffected by vibration and G levels exceeding MIL-specs. Light weight and high reliability suit the JR to deep space applications.

Branson Corp., Vanderhoof Ave., Denville, N. J. Phone: (201) 625-0600.

Circle No. 276



## Coax switch

This 1-3/4 in.<sup>3</sup>, 5-oz, spdt or transfer coax switch was developed for the APOLLO program. The type S is available with RF connectors up to TNC. The RF design utilizes flat strip-line techniques with increased area wiping contact action. It provides low cross-talk and is applicable at high G vibration levels. At 5 GHz vswr is 1.25:1, insertion loss 0.3 dB.

Transco Products, Inc., 4241 Glencoe Ave., Venice, Calif. Phone: (213) 391-7291.

Circle No. 277



## Dc amplifiers

These transistorized chopper-stabilized amplifiers are designed for 0 to 1 mA chart recorders. Five units offer combinations of input R, offset, and sensitivity.

They can be calibrated for 20°C ranges with any low mV transducer. The compensated cold-junction eliminates temperature effects. The 12 Vdc model operates for 72 hours on 10D flashlight cells.

Price: From \$160. Rustrak Instrument Co., 130 Silver, Manchester, N. H. Phone: (603) 623-3596.

*Circle No. 278*



## Electron-beam centering

The B3072 model provides front panel remote control display centering and beam aligning. The need for complicated spot-centering circuits used with deflection yokes is eliminated.

The short 1/2-in. length enables a compact fit behind the yoke and focus coil on all CRTs. Full 1-33/64-in. ID facilitates an easy fit on 1-1/2-in. neck CRTs.

P&A: \$35; 4 wks. Syntronic Instruments, 100 Industrial Rd., Addison, Ill. Phone: (312) 543-6444.

*Circle No. 279*



ACTUAL SIZE

# Is the Spectrol Model 140 really so great ?

## No, it just acts that way!

This precision pot is priced like a trimmer, and yet it outperforms many higher priced models.

Here's a half-inch, single-turn, precision potentiometer with rear terminals for optimum packaging density...a new type mechanical stop that provides exceptionally high stop strength...and a unique wiper design that assures positive contact under severe conditions of shock and vibration per MIL-R-12934. Also, here's a miniature pot with high "specability!" From our standard data sheet, you can choose from more than 100 mechanical and electrical options, in addition to resistance ratings from 50 ohms to 70K ohms.

On second thought maybe it really is so great! Why don't you find out for yourself? You'll find the standard Model 140 (with stops) stocked at your local distributor. Want more data? Send for the 140 data sheet and ask for our new Short Form Catalog, too. The Model 140 comes from a great family.

**spectrol**

Spectrol Electronics Corporation  
17070 East Gale Avenue  
City of Industry, Calif. 91745

Speed Inquiry to Advertiser via Collect Night Letter  
ON READER-SERVICE CARD CIRCLE 38

*If it's your job  
to evaluate and specify  
electronic test instruments...*

***YOUR JOB  
JUST GOT EASIER***

*Figure it on features or price...  
Monsanto's new line adds up to "buy"*

ELECTRONICS 

## PULSE GENERATOR

- Extremely clean waveforms • Independent width and delay on double pulse mode • Both pulses referenced to the same trigger in double pulse operation • Provides sweep delay for oscilloscopes not so equipped • Three trigger output signals, all available in both single and double pulse operation.

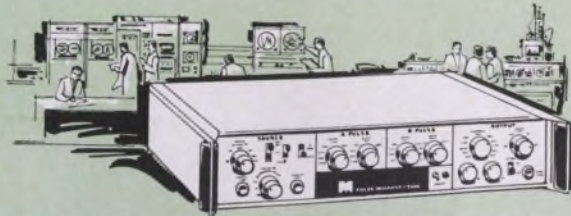

All-silicon, solid-state instrument provides both single and double pulse operation. A great number of the active circuits are integrated for reliability and performance in a compact package only 3½ inches high. **\$1,100.00**

## 20 MHz COUNTER/TIMER

- Stored Display • Modular Construction • Front panel only 3½ inches high • Weight only 16 pounds • Versatile instrument measures frequency, frequency ratio, period, and time interval.

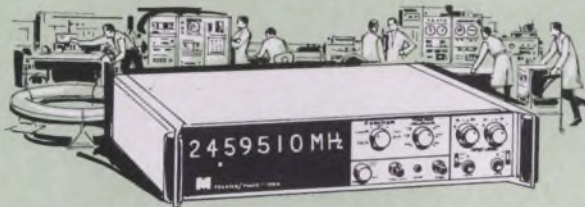

Reliability, accuracy and compactness because Monsanto designs this counter-timer with 90% integrated circuits. Seven of its sixteen printed circuit boards are interchangeable for easy maintenance. **\$1,975.00**

## 5 MHz COUNTER/TIMER

- Time base range from 1μ second to 100 seconds in decade steps • Resolution for frequency measurement of 0.01 Hz. • Compact, light package—only 3½ inches high and 16 pounds.

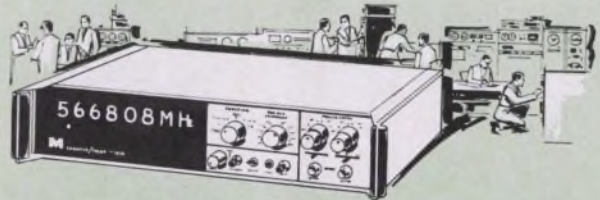

Integrated circuits in 90% of the active circuits build big performance into a small package. Plus speed, accuracy, reliability, and easy maintenance. Six of the 13 printed circuit boards are interchangeable. **\$1,575.00**

## DIGITAL VOLTMETER

- Fully floated and guarded • Input impedance—10 megohms (all ranges) • Accuracy .01% on all ranges • 4 digits + 100% over-range digit • Common mode rejection: DC > 140 DB ; AC > 120 DB at 60 Hz.

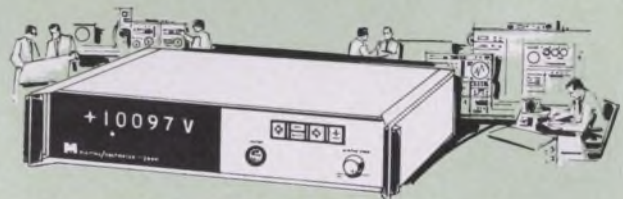

Auto-ranging digital voltmeter with integrated circuits that hold size down to 3½ inches high and only 20 pounds. Automatic operation—ranging, decimal point and polarity—built in at the basic price. **\$1,975.00**

Let us fill you in with details.  
Just return the coupon.

**Monsanto Electronics Department  
St. Louis, Missouri 63166**

Details, please, on the

- |  |   |
|--|---|
| <input type="checkbox"/> Pulse Generator     | <input type="checkbox"/> 20 MHz Counter/Timer |
| <input type="checkbox"/> 5 MHz Counter/Timer | <input type="checkbox"/> Digital Voltmeter    |

Name/Title \_\_\_\_\_

Company \_\_\_\_\_

Address \_\_\_\_\_

City \_\_\_\_\_

State \_\_\_\_\_ Zip \_\_\_\_\_

# INEXPENSIVE WAY TO MICROMINIATURIZE YOUR CIRCUITRY

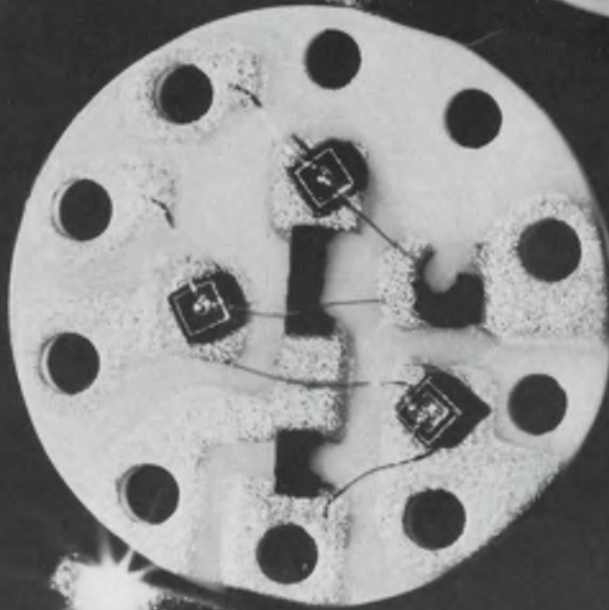

## NSC's CHIC

CERMET    HYBRID    INTEGRATED    CIRCUITS

Design your circuit, breadboard it with discrete components, thoroughly test it for system compatibility and environmental performance—then let NSC microminaturize your exact design with CHIC.

You'll keep set-up costs low, turnaround time to a minimum. The CHIC approach specifically lends itself to designs that require the newest, discrete, active devices and passive networks. These consist of high value, tight tolerance, low temperature coefficient resistors and mos capacitors. Married in the CHIC hybrid form they meet the high component density and reliability requirements of the electronics industry.

In the table at the right are some typical device types available in NSC customized CHIC circuits.

### TYPICAL NSC DEVICE TYPES

Small Signal NPN	2N3246
Small Signal PNP	2N3548
Medium Power NPN	2N2219
Medium Power PNP	2N2905
Medium Power Switching NPN	2N3981
Medium Power Switching PNP	2N2905
High Speed Switches NPN	2N2369
High Speed Switches PNP	2N3829
UHF Small Signal NPN	NS9728
VHF Small Signal NPN	2N918
Inch NPN	3N70
Inch PNP	3N95
Single Ended Choppers NPN	2N2432
Single Ended Choppers PNP	2N2945
Differential Amplifiers NPN	2N2920
Differential Amplifiers PNP	NS7200

### RESISTORS

Resistances	10 Ohms to 3 Meg Ohms
Resistivities	10 $\Omega$ /square—100 K $\Omega$ /square
Untrimmed Tolerance	10%
Trimmed Tolerance	To 1%
Temperature Coefficient	Typically 200 ppm/°C from 0 to +125°C
Voltage Coefficient	.02% per volt
Power Dissipation	Up to 25 W/in. <sup>2</sup>

### CAPACITORS

Capacitance	10 pf to .1 $\mu$ f
Working Volt	50 VDC Max.
Temperature Coefficient	300 ppm/°C from 0 to +125°C

### PACKAGES

TO 5 • Flat Pack • Epoxy



NATIONAL SEMICONDUCTOR CORPORATION  
DANBURY, CONN



## Hybrids now available for off-the-shelf delivery

### NSC's STANDARD LINE OF CHIC CERMET HYBRID INTEGRATED CIRCUITS DEVICES

#### AUDIO AMPLIFIER—NSC 7558

A versatile audio amplifier — efficient operation from 1 mW to over 50 mW output. Bias taps allow user to set gain and power drain to best match circuit application. Gain, once set, is extremely stable with respect to frequency, ambient temperature and power supply variations.

#### VIDEO AMPLIFIER—NS 7512

A two-stage, wide band video amplifier, with extremely constant gain characteristics. The gain is constant ( $\pm 2$  db) from D.C. to 30mc.

#### OPERATIONAL AMPLIFIER—NS 7560

Provides low input offset currents, low drift, wide output voltage swing and high output current capacity suitable for use in a wide variety of digital and analog applications.

#### $\mu$ CHOPPERS—NS 8000

50KC to 1.5MC Operating Frequency Range. A complete, transformer isolated integrated chopper which contains a miniature toroidal transformer and an INCH. Ideally suited for low level electronic commutating and demodulating applications because of extremely low offset voltage, low leakage currents, low saturated dynamic impedance and high-speed switching characteristics.

#### CHOPPERS—NS 8003

0 CPS to 50KC Operating Frequency Range when used with suitable drive circuitry. Also a complete, transformer isolated, integrated chopper that includes a diode and resistor to provide the rectification necessary for low frequency operation. Ideally suited for low level commutating, demodulating, and chopper applications.



NATIONAL SEMICONDUCTOR CORPORATION  
DANBURY, CONN.

ON READER-SERVICE CARD CIRCLE 219

March 29, 1966

## COMPONENTS

### Microminiature readout

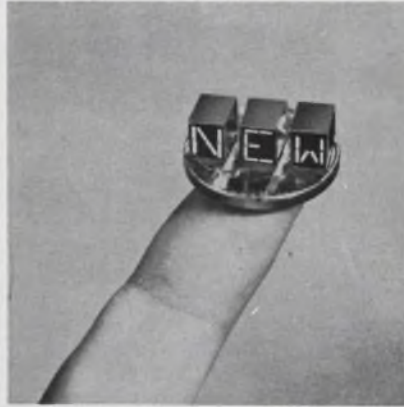

This 3V, 16-segment incandescent light bar arrangement is capable of making numeric, alphabetic, and symbol displays. A 0.25-in.<sup>3</sup> module, the unit allows for plug-in rows, and is used with modular digital units. Hermetic units of any alpha-numeric combinations, and symbol displays. A 0.25-in.<sup>3</sup> be offered as mates. The unit features a 50,000 hour life.

Price: \$75. Pinlites, Inc., 1275 Bloomfield Ave., Fairfield, N. J. Phone: (201) 226-7724.

Circle No. 272

### Fuel ignitor

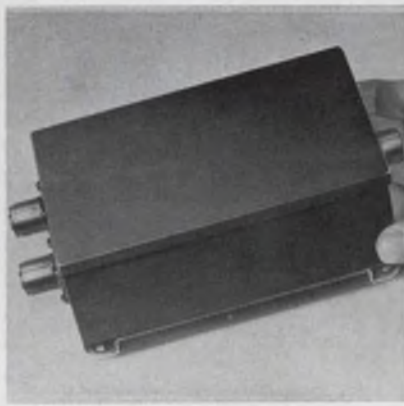

This solid-state, battery powered device features widely varied output spark energy and duration for many gaseous ignition applications. The 0.5 A basic circuit consists of an oscillator, transformer coil and SCR. The rectifier provides static switching of primary current to the coil to produce voltages from 10 V to 20 kV. The device is operable over a  $-65^{\circ}\text{F}$  to  $200^{\circ}\text{F}$  range, with a 20  $\mu\text{s}$  rise time.

Prestolite Co., 511 Hamilton, Toledo, Ohio. Phone: (419) 370-0104.

Circle No. 273

### Miniature drivers

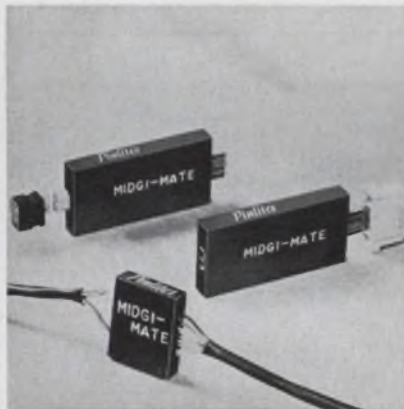

These 1/4-in. wide, epoxy-encapsulated drivers furnish a clear digital display. Pulses are counted or held with a 2 MHz latching counter. 8-4-2-1 BCD display is continuous or latched. A 10-line decimal may be displayed with low-level input or miniature diode matrix. Mounting varies from plug-in or remote cable with pigtailed, to permanent panel.

Price: \$50-130, 1-9. Pinlites, Inc., 1275 Bloomfield Ave., Fairfield, N. J. Phone: (201) 226-7724.

Circle No. 274

### Variable capacitors



A new line of high voltage, high current variable capacitors features minimum size for given voltage and capacitance ranges.

A gas dielectric, low loss ceramic envelopes and precision machined parts result in greater ruggedness, longer life and lower tuning torque. Design allows a variety of peak voltages and capacitance ranges for all configurations.

Energy Laboratories, Inc., 1 School St., Yonkers, N. Y. Phone: (914) 423-2217.

Circle No. 275

## Miniature display



Model E-1 is a recessed protected in-plane display. Six front inserts permit mounting on front panels; side inserts permit printed circuit mounting.

Available in voltages from 1.5 to 28 V, the 7/8- x 7/8- x 1-11/16-in. high unit plugs into standard 9-pin tube sockets. Display colors are red, gray, amber, blue, green and clear.

P&A: \$16.50; 2 weeks. United Computer, 930 W. 23, Tempe, Ariz. Phone: (602) 967-9122.

Circle No. 280

## Oscillator



The model GOC-5 charge amplifier/voltage-controlled oscillator is designed to signal condition hydrophone, accelerometer and other piezoelectric transducer derived data. Analog voltage or FM wave outputs enable transmission or recording. Up to 7 channels with responses from 0.2 to 10 kHz can be transmitted on a single coax.

P&A: \$500 to 800 per channel; 30 to 60 days. Data-Control Systems, Inc., E. Liberty, Danbury, Conn. Phone: (203) 743-9241.

Circle No. 281

## Potentiometers

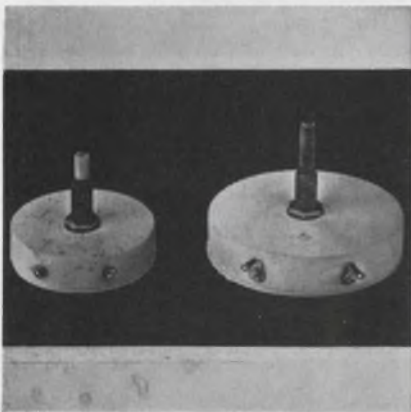

Two series of high-voltage potentiometers are offered, of resistance values said to be heretofore non-stocked. The RX-17-5 series unit is for operation to 5 kV, the RX-17-10 for 10 kV. Wattage rating is, respectively, 3 and 5 W. Min R is 10 and 20 Meg, while 5000 Meg is max R for both.

P&A: \$7.20 to \$7.80 (100-999). The Victoreen Instrument Co., 10101 Woodland, Cleveland. Phone: (216) 795-8200.

Circle No. 282

## Relay

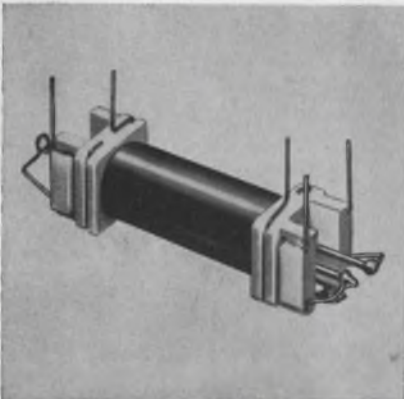

The Dormite Sr. relay is said to feature high reliability. Form A and Form C configurations are available with nominal coil voltages from 6 to 24 Vdc. Capacities range from 3 to 100 W, and dry circuit capacity to 3 A.

The reed switch is protected and free from strain inside the coil bobbin. It can be inspected before and after assembly, and can be easily replaced.

Dormeyer Industries, 3418 N. Milwaukee Ave., Chicago. Phone: (312) 283-4000.

Circle No. 283

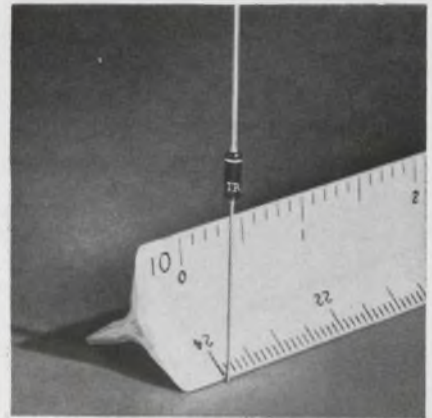

## High stability zeners

A dc voltage reference series of zener diodes is rated at 0.9 V with temperature coefficients covering the range of 0.01%/°C to 0.0005%/°C. Designated the 1N935 series, units are three groups with operating temperatures of 0° to 75°C, -55° to +100°C, and -55° to +150°C respectively. Storage temperature is -65° to +175°C.

P&A: \$1.65 to \$27; 2 to 4 weeks. International Rectifier, 233 Kansas, El Segundo, Calif. Phone: (213) 678-6281.

Circle No. 284



## Charge amplifier

The 3-1/2-in.<sup>3</sup> charge amplifier, model 5600, detects transducer charge in coulombs, not voltage. Flat frequency curve and residual noise of 30 mV p-p are achieved from 5 Hz to 10 kHz, while gain is adjustable from 5 to 50 mV out/pC in. Output bias of 2.5 V with 10X overdrive and zero recovery time is possible with the unit's direct-coupled output driver.

Columbia Research Laboratories, MacDade Blvd., Woodlyn, Pa. Phone: (215) 532-9464.

Circle No. 285





## Electrometer op-amp

A true electrometer amplifier for currents from  $10^{-14}$  offers  $10^{14}$  ohms input resistance and  $5 \times 10^{-14}$  amps offset current. Electrometer tube inputs are used with the solid-state device for their better stability, lower noise, and lower high-voltage-transient sensitivity.

Power for the 300 can be unregulated dc, +16-25 V, or -16-25 V. The unit will withstand 400 V overloads, and can't be damaged by static induced voltages with open input. This, and compensating networks to prevent oscillations in allied circuitry, give the unit a high degree of operating flexibility. It has exceedingly high current sensitivity and can operate as a linear or logarithmic amplifier, or other current modifier for signals from  $10^{-14}$  to  $10^{-2}$  A.

The high input impedance allows linear current amplifier operation with high value resistors (as high as  $10^{13}$  ohms) in the feedback loop.

The low noise level ( $5 \times 10^{-15}$  amps current noise) and open loop dc gain of 20,000 contribute to the stability of operation.

Current drift is  $10^{-15}$  amperes per 24 hour period, and output is  $\pm 11$  V, 11 mA.

Specific applications include logarithmic amplification, useful in nuclear monitoring systems and mass spectrometer current amplification. As an impedance matching amplifier, the 300's high input impedance allows high source resistances with minimum circuit loading when used with a floating power supply for 10 mV to 10 V signals.

The 300 is priced at \$200 in unit quantity with numerous optional accessories (resistors and switches). Kiethley Instruments, 12415 Euclid Ave., Cleveland. Phone: (216) 795-2666.

Circle No. 286

from stock . . .  
**Optima** cases, consoles and racks  
 enhance your instruments.  
 Obviously.



See the full line at  
 IEEE/New York/March '66,  
 booth 4L15,  
 or request detailed catalog.

**Optima**®

made by Scientific-Atlanta, Inc., Box 13654, Atlanta, Ga. 30324

# Two new 40 mw and 20 mw high-speed, billion-operation CLARE Relays

■ These CLARE Type HGSL and HGSM Mercury-Wetted Contact Relays meet the requirements of modern electronic systems.

■ Their complete freedom from contact bounce, isolation between coil and contacts and high speed qualify them as excellent input buffers to solid state circuitry. As output buffers they can be driven by low power logic circuitry with an input to output power gain of up to 5000. Contacts can handle up to 100 va, ac or dc, over billions of operations without derating.

■ As scanner contacts in checkout systems they can stand off a hi-pot voltage of 1000 vac and, at the same time, offer a contact resistance variation of less than 2 milliohms over life for critical resistance measuring circuits. Their lack of contact bounce, high speed and low noise generation commend them for tape transport read-write head switching. In their compact, space-saving packages these relays meet a wide range of design requirements for both printed circuit boards and wired assemblies.

## type HGSM

Module  
for printed  
circuit boards



Relays shown actual size

## type HGSL

Plug-in  
for wired  
Assemblies



### Sensitive

40 mw Single-Side  
Stable  
20 mw Bi-Stable

### High Speed

Nominal operate  
time: 1.0 ms

### Long Life

Billion operations  
minimum at rated  
load

### Contact Advantages

Low and consistent  
contact resistance  
over complete life.

No bounce.

Both form C and form  
D contacts available.

# OPERATE AND RELEASE TIMES

20 MW BI-STABLE DOUBLE WOUND COIL

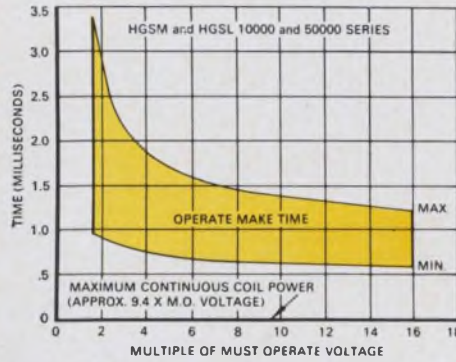

40 MW SINGLE-SIDE STABLE SINGLE WOUND COIL

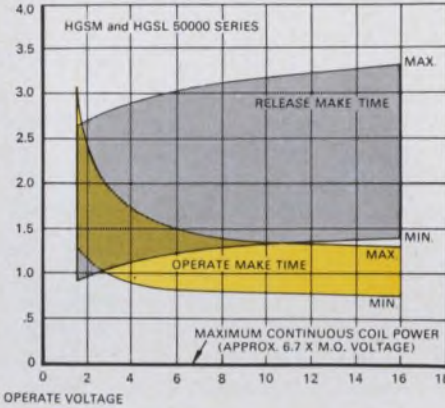
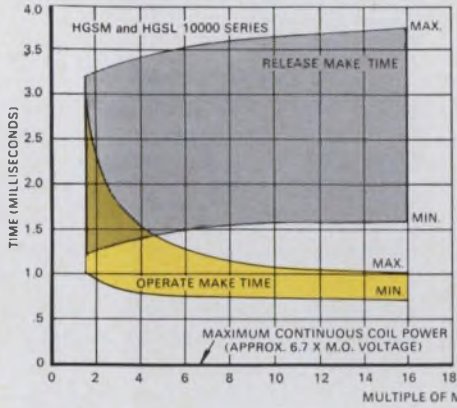

ELECTRICAL CHARACTERISTICS	FOR WIRED ASSEMBLIES		FOR PRINTED CIRCUIT BOARDS	
	HGSL		HGSM	
	Series 10000	Series 50000	Series 10000	Series 50000
Contact Arrangement	1 Form D	1 Form C	1 Form D	1 Form C
Sensitivity	40 mw. Single-Side Stable 20 mw. Bi-Stable			
Contact Rating Low Level	0-100 Microamperes 0-300 Millivolts			
Power (with Contact Protection)	2 amperes max. 500 volts max. 100 volt amperes max.			
Contact Circuit Resistance	35 milliohms max.		20 milliohms max.	
	Variation less than $\pm 2$ milliohms from initial value through $20 \times 10^9$ operations (Independent of Current or Voltage)			
Nominal Operating Voltage	Up to 90 vdc			
Nominal Operate Time at Maximum Coil Power	1.0 ms			

Send for Data Sheet 852 giving complete information on these new miniature, high-speed, sensitive relays. Address C. P. Clare & Co., Group 03A8, 3101 Pratt Boulevard, Chicago, Illinois 60645.



relays and related control components

For complete information contact your nearest CLARE Sales Engineer

CALL— NEEDHAM (Mass.): (617) 444-4200 • GREAT NECK, L.I. (N.Y.): (516) 466-2100 • SYRACUSE: (315) 422-0347 • PHILADELPHIA: (215) 386-3385 • BALTIMORE: (202) 393-1337 • ORLANDO: (305) 424-9508 • CHICAGO: (312) 262-7700 • MINNEAPOLIS: (612) 920-3125 • CLEVELAND: (216) 221-9030 • XENIA (Ohio): (513) 426-5485 • CINCINNATI: (513) 891-3827 • MISSION (Kansas): (913) 722-2441 • DALLAS: (214) 741-4411 • HOUSTON: (713) 528-3811 • SEATTLE: (206) 725-9700 • SAN FRANCISCO: (415) 982-7932 • VAN NUYS (Calif.): (213) 787-2510 • TORONTO, CANADA: C. P. Clare Canada Ltd. • TOKYO, JAPAN: Westrex Co., Orient IN EUROPE: C. P. Clare International N. V., TONGEREN, BELGIUM

Speed Inquiry to Advertiser via Collect Night Letter  
ON READER-SERVICE CARD CIRCLE 40

## COMPONENTS

### RFI-free switch

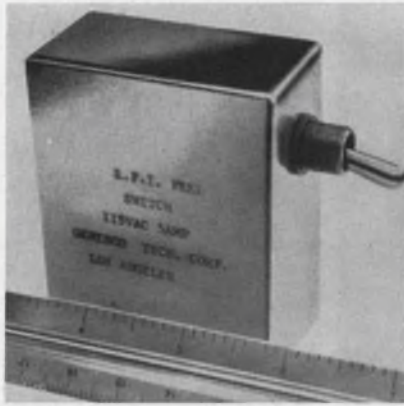

This power circuit switch can be opened and closed without excessive conducted interference transients. The device senses the point where line Vac is zero and passes current to the load at or after that point. The switches operate on 110 or 125 Vac, 5 or 10 A and 60 or 400 Hz power. They are suitable for panel mounting and exceed MIL-I-26600.

Genisco Technology Corp., Genis-tron Div., 6320 W. Arizona Circle, Los Angeles. Phone: (213) 776-1411.

Circle No. 287

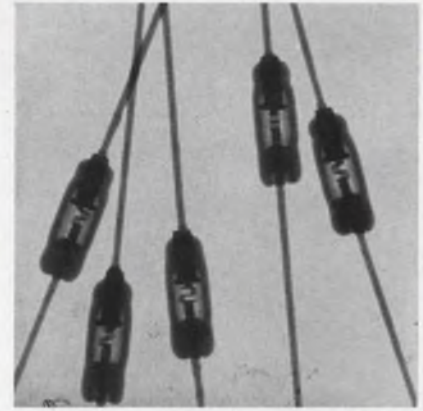

### HV rectifier

This planar-passivated HV radiation-tolerant rectifier guarantees forward voltage and conductance after fast neutron radiation. The FRR-300 provides up to 1 V at 100 mA after exposure to  $5 \times 10^{14}$  nvt (neutron velocity x time), and up to 1.1 V after  $10^{15}$  nvt. It is available in single units, series arrays, matched pairs, quads or bridges.

Price: \$5. Fairchild Semiconductor, 313 Fairchild Dr., Mountain View, Calif. Phone: (415) 962-2530.

Circle No. 291

### Digital panel meter

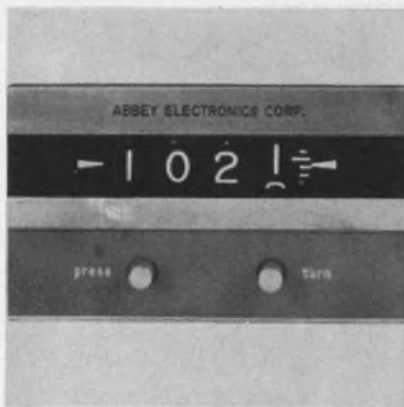

Model DM-25 digital panel meter offers a simply installed digital readout for any equipment.

The illustrated bezel measures 1-7/8 x 3-1/8-in. A push-button switch and variable control extend through the bezel for occasional re-zeroing of the meter. A remotely operated hold-control is included, and BCD contact closure and zero-center scales are optional.

P&A: \$260; stock. Abbey Electronics, 2-6 St., New Hyde Park, N. Y. Phone: (516) 248-8060.

Circle No. 288

### Selector switch

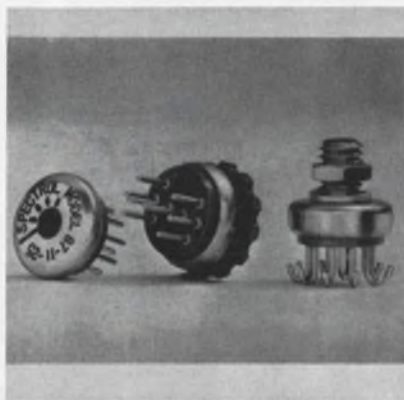

This series of miniature rotary selector switches consists of 1, 2 or 3-pole models with stop capability. They are designed with a cam-operated wiper to reduce arcing and noise, a self-cleaning feature for contacts and a MIL-202B silicon/rubber cover. The units are compatible with other components and PC pins for plug-in on standard PC boards.

Price: \$4.25. Spectrol Corp., 17070 E. Gale Ave., City of Industry, Calif. Phone: (213) 964-6565.

Circle No. 289

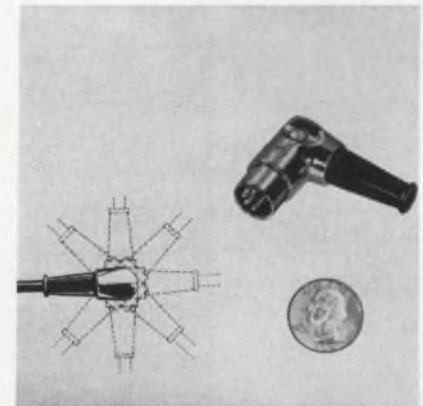

### Right-angle plug

A right-angle, 8-position plug eliminates cable-entry and routing problems in compact equipment.

It is adjustable so that cable can be routed through the integral rubber strain relief in any of 8 directions, or every  $45^\circ$  in a plane parallel to the mounting plane. Mechanical alignment is guaranteed by a keyrib. Cable entry is 7/32-in. maximum size.

Switchcraft, Inc., 5555 North Elston Ave., Chicago, Ill. Phone: (312) 774-4020.

Circle No. 292

### Synchro/simulator

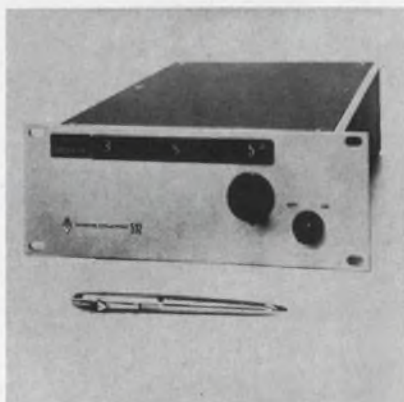

A synchro/simulator gives 2-second accuracy at all angles. The model 532 generates electrical data of angular shaft position three-wire synchros.

Simplified  $360^\circ$  angular readout has in-line digital display with optional resolution to  $0.0001^\circ$ . Operating frequency is 400-1,000 Hz, or to 10 kHz with reduced accuracy. Inputs are for 26 and 115 V operation.

North Atlantic Industries, 200 Terminal, Plainview, N. Y. Phone: (516) 681-8600.

Circle No. 290

**Low-noise photodiode**

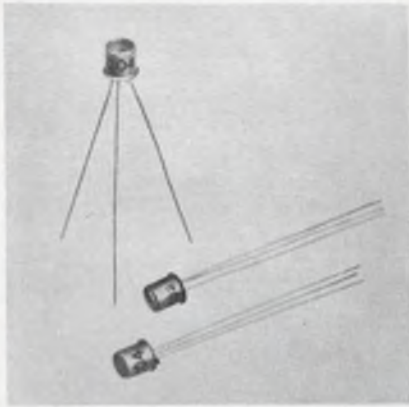

An ultra low-noise silicon photodiode is hpa-4204. Noise equivalent power due to leakage current is less than  $1.2 \times 10^{-14}$  watts/root cycle.

Maximum dark current is 100 pA at  $-10$  V reverse bias at  $25^\circ\text{C}$ . Series resistance is 50 ohms max, diode to case capacitance is 2 pF typical, and junction capacitance at  $-10$  V reverse bias is 2 pF typical. Speed of response is 1 ns or less with  $-10$  V bias and 50 ohms load.

P&A: \$90; stock. hp associates, 620 Page Mill Rd., Palo Alto, Calif. Phone: (415) 321-8510. TWX: (415) 492-9443.

Circle No. 293

**Dc chopper**

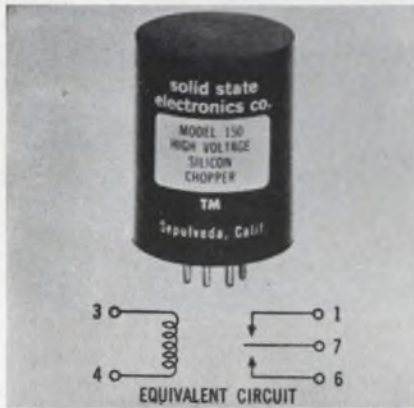

This encapsulated plug-in is designed to connect and disconnect a load from sinusoidal or square wave drives. As an ac to dc demodulator, the chopper can linearly switch or chop from  $1 \mu\text{V}$  to  $\pm 150$  V, while handling to  $5 \mu\text{A}$ . With a built-in transformer-coupled isolator, the unit can be driven from a 400 Hz line or a drive common to the chopped dc voltage.

Solid State Electronics Co., 15321 Rayen St., Sepulveda, Calif. Phone: (213) 894-2271.

Circle No. 294

**Silicon rectifiers**

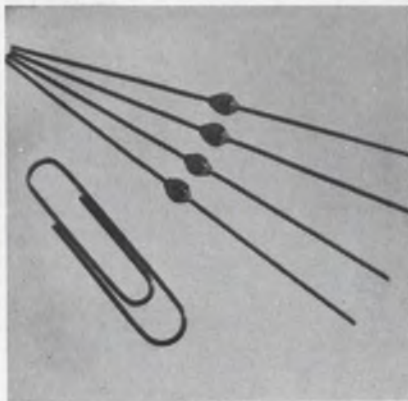

This line of SCRs offers increased stability and line transient protection. The rectifiers withstand short-time reverse-polarity transient power to 1 kW and peak forward surge current to 100 A. The double heatsink design eliminates S springs, which can loosen.

Price: \$.22 to \$.58 in 10,000 lots. Semiconductor Production, General Electric Co., BG 7, Electronics Park, Syracuse, N. Y. Phone: (315) 456-0123.

Circle No. 295

**Diode switch**

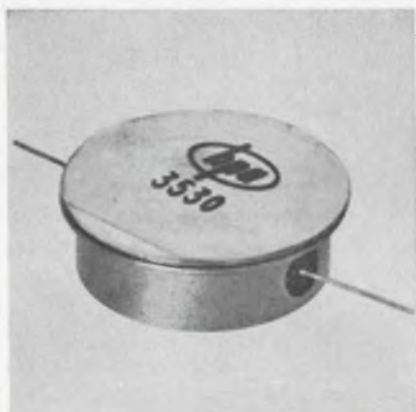

A microwave spst PIN diode switch for integration into stripline circuits is designated hpa-3530.

Frequency range is dc-14 GHz and beyond, insertion loss specs range from 0.5 dB max to 1.5 dB max at 12.4 GHz and above. Minimum isolation is 25 dB at 500 MHz, 45 dB at 12.4 GHz and above. Max vswr is 2.0:1 (switch "on"). Operating and storage temperature limits are  $-65^\circ$  to  $+150^\circ\text{C}$ .

P&A: \$175; 2-4 weeks. hp associates, 620 Page Mill Rd., Palo Alto, Calif. Phone: (415) 321-8510.

Circle No. 296

**No amplifier needed with Vernistat<sup>®</sup> a.c. pots**

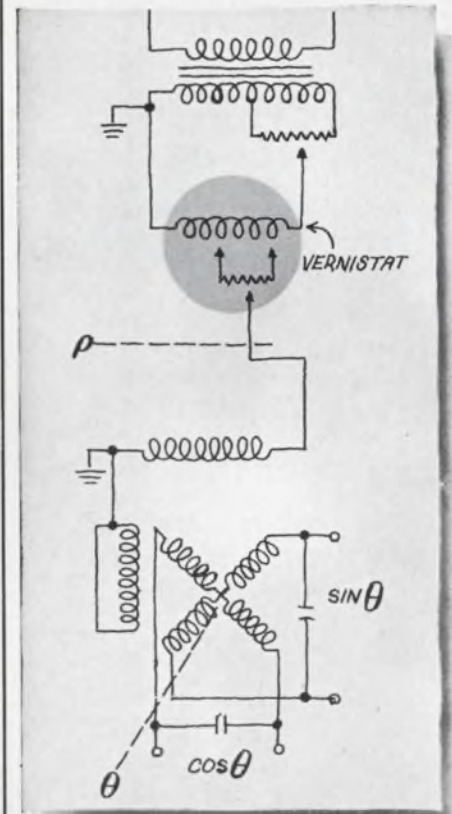

You don't need a buffer amplifier to drive a servomechanism—if you use a Vernistat a-c potentiometer. It has an output impedance low enough to drive a resolver or other low input impedance device directly. Use an a-c potentiometer to simplify circuits, improve reliability, gain greater accuracy and reduce circuit costs. For full information and data sheets, write to Electronic Products Division, Perkin-Elmer Corporation, 810 Main Avenue, Norwalk, Connecticut.



**PERKIN ELMER**

# New Literature



## Electronics catalog

From adapters to zeners, with 55,000 otherwise alphabetized components are contained in the 450-page 1966 "Buyers Guide for Electronics." Thumbnail indexed, the catalog also contains pricing data and order forms. Cramer/Esco.

Circle No. 297

## Wire and cable

Six new catalogs on wire and cable are available. They include: apparatus and motor lead wires (cat. ML), control cables (cat. C), power cables (cat. P), switchboard wires (cat. SW), computer systems cables (cat. CS), and a series of tables (cat. T) of wire and cable technical data. Rockbestos Wire & Cable Co.

Circle No. 298

## Glass capacitors

The illustrated 4-page reference file CE-1.03 describes medium power transmitting glass-dielectric capacitors. They are used for power amplifiers, low power transmitters, and in many devices in grid, plate, coupling, tank and bypass functions.

A page of characteristics, eight charts, a table of standard values and a listing of U.S. and foreign sales offices are contained. Corning Glass Works, Electronic Product Div.

Circle No. 299

## Semiconductor catalog

Semiconductors and integrated circuitry, including logic and linear circuits, are offered in this 26-page catalog. Specifications are given for transistors, diodes and ICs. Motorola.

Circle No. 300

## Relays

Some 400 relay types, with illustrations and diagrams are covered in a 16-page catalog. For reference purposes, a grouping into 6 categories aids in locating basic data. Sigma Instruments.

Circle No. 301

## Epoxies and resins

The revised and updated "Isochemrez 400" data sheet shows several new non-dermatitic epoxies plus a wide range of hardeners and fillers. Also redesigned and enlarged is a resin selector chart tabulating 23 properties of each material. Isochem Resins.

Circle No. 302



## Solid-state modules

Choppers, signal isolators, dc amplifiers, oscillators, A/D converters and relays are among the products listed in a 140-page catalog. Solid-State Electronics.

Circle No. 303

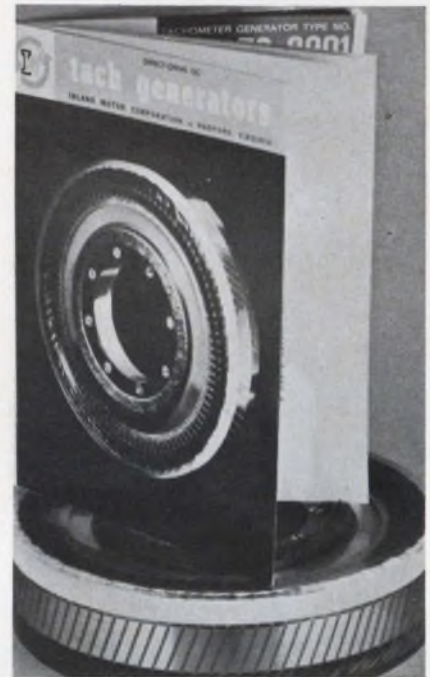

## Dc tach gen

This 32-page catalog describes fundamentals, characteristics and installation of dc direct drive tachometer generators. Selection factors such as size, winding constants and mounting considerations are discussed. Inland/Kollmorgen.

Circle No. 304

## Pulse generator

Technical bulletin 110A gives information on a fast-rise-time pulse generator with up to 40 MHz pulse rep rate. Waveform photographs and specification listings are included in the two-color brochure. Datapulse.

Circle No. 305

## Semiconductor products

A series of application notes for semiconductors with form numbers in the SMA series is offered. It provides general technical information and specific circuit configurations for applications concerning a family of semiconductors. RCA.

Circle No. 306

# STEP UP

TO WIDER RANGES  
GREATER ACCURACY



## Model 630-NA

VOLT-OHM-MILLIAMMETER

PRICE \$85.00

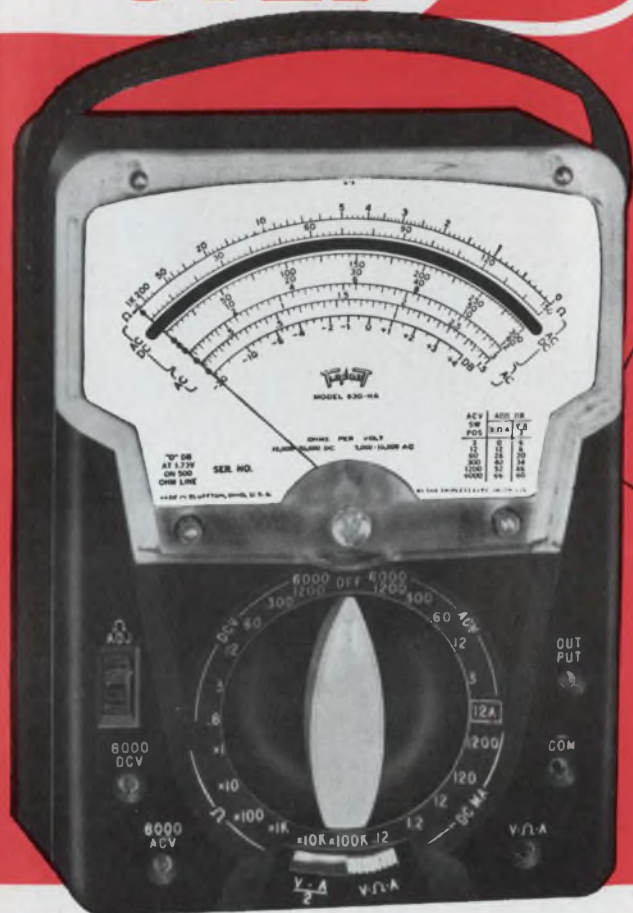

EXCLUSIVE PATENTED  
Bar-Ring Shielded Movements

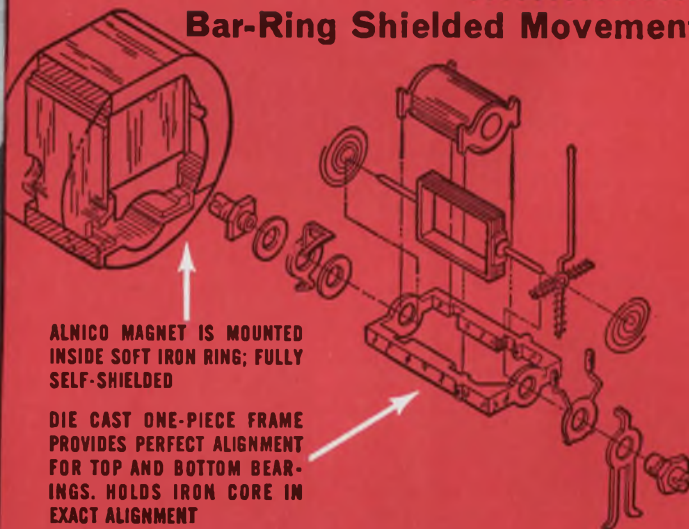

ALNICO MAGNET IS MOUNTED  
INSIDE SOFT IRON RING; FULLY  
SELF-SHIELDED

DIE CAST ONE-PIECE FRAME  
PROVIDES PERFECT ALIGNMENT  
FOR TOP AND BOTTOM BEAR-  
INGS. HOLDS IRON CORE IN  
EXACT ALIGNMENT

**Uses Unlimited:**

FIELD ENGINEERS ■ APPLICATION  
ENGINEERS ■ ELECTRICAL, RADIO,  
TV, AND APPLIANCE SERVICEMEN  
■ ELECTRICAL CONTRACTORS ■  
FACTORY MAINTENANCE MEN ■  
INDUSTRIAL ELECTRONIC MAIN-  
TENANCE TECHNICIANS ■  
HOME OWNERS, HOBBYISTS

## FACTS MAKE FEATURES:

- 1** 70 RANGES—nearly double those of conventional testers. Un-breakable window. Mirror Scale.
- 2** HIGHEST ACCURACY—1½% DC to 1200 volts, 3% AC to 1200 volts; mirror scale and knife-edge pointer to eliminate parallax.
- 3** FREQUENCY COMPENSATED—Flat from 20 CPS to 100,000 CPS; varies from ¼ to 1¼ DB at 500,000 CPS. Temperature compensated. Meter protection against overloads.

THE TRIPLET ELECTRICAL INSTRUMENT COMPANY, BLUFFTON, OHIO



THE WORLD'S MOST COMPLETE LINE OF V-O-M'S. AVAILABLE FROM YOUR TRIPLET DISTRIBUTOR'S STOCK

### Coil forms

A new 32-page diagrammed catalog describes ceramic, resinite and Velvetork coil forms. These forms are available with cores permitting operation over a 50 kHz to 300-MHz range. Specifications, dimensions and prices are listed for forms in 20 basic configurations with diameters from 0.162 to 0.500 in. J. W. Miller Co.

Circle No. 307

### Varistors

This new brochure lists complete varistor characteristics and specifications. Applications noted include transient suppression, use as an alternate to the RC network, constant arc suppression on relays and switches, voltage regulation and control. Characteristic curves of E vs I, dimensional drawings of standard configurations and pricing are given. Carborundum Co.

Circle No. 308



### Drafting symbols

A catalog, samples and price list are available on a line of flat-pack and plug-in micrologic symbols for draftsmen. Bishop Industries, Inc.

Circle No. 309

### Variable capacitors

This four-page folder includes nine separate data sheets describing a line of ceramic variable capacitors. Special features, technical data and outline drawings are provided in the package. Energy Laboratories, Inc.

Circle No. 310



### Antennas

The 104-page catalog 24 offers detailed product information on uhf, vhf and microwave antennas. Flexible coax, "Heliac", RF switching devices and waveguides are covered for integrated systems. Andrew Corp.

Circle No. 311

### Filters

A wide range of tubular and bathtub style RFI filters for military and commercial uses is the subject of a 6-page brochure. Design meets or exceeds MIL-F-15733D and applicable UL specifications. Relevant electrical and physical characteristics are completely described. Gudeman Co.

Circle No. 312

### Power modules

The 2-page technical catalog 136 covers a line of wide-range programmable 0 to 60 Vdc power modules. Model types from 200 mA to 8 A, circuit design, performance data and prices are provided. Electronic Research Associates, Inc.

Circle No. 313

### Filters

This catalog, series 258, covers 13 new varieties of communications and data filters. Maximum suppression of extraneous frequencies and low bandpass loss are considered. Power filters, per MIL-220A, are also covered together with drawings, data and applications. Hopkins Engineering.

Circle No. 314

### Computing Resolvers

"A Primer for Computing Resolvers" is offered as a reprint. This 16-page, fully diagrammed monograph describes in detail such definitive resolver properties as function and axis errors, transformation ratio, null and electrical zero. Applications, operation and theory are fully explained. Manufacturer's and MIL-spec terminology are analyzed in depth. Theta Instrument Corp.

Circle No. 315



### Coax connectors

This series 2900 catalog of miniature RF coax connectors covers plugs, jacks, receptacles and adapters. Standard and crimp configurations, and complete cable assembly instructions are coupled with specifications and technical descriptions in this reference catalog. General RF Fittings, Inc.

Circle No. 316

### Modulators

Microwave ferrite amplitude modulators, covering the 2.5 to 35.5 GHz range are discussed in catalog 700. Listed characteristics show minimum attenuations from 10 to 25 dB at 0.1 to 70 kHz modulation frequencies with very low insertion loss.

Application information is featured. AM sans FM distortion, signal simulation, load isolation, switching and AGC are topics covered. Huggins Laboratories.

Circle No. 317



## Fractional hp motors

Data on precision permanent magnet motors make up this eight-piece package. These tiny motors are primarily used for tuners, tape recorder and chart drives, actuators, and positioning devices.

Typical performance data are plotted in 47 graphs, each of which shows speed, current, hp and efficiency/torque for the 3 frame sizes. Illustrations include photos and dimensioned drawings. Indiana General Corp.

Circle No. 318

## Switching module

A 2-page data sheet F-5604 sec. 5 provides specifications for the Microscanner relay-PC board module. It achieves high speed, low to medium level signal switching for data multiplexing, analog switching and process control with transducer inputs. The data sheet includes driving and switching systems, environmental specifications and schematics. James Electronics, Inc.

Circle No. 319

## Switch catalog

The 28-page catalog 1-A offers detailed information on a broad line of precision snap action switches. An illustrated index chart provides a handy reference for switch selection. Potter & Brumfield.

Circle No. 320

## Correlation computing

On-line computation of auto- and cross-correlation functions is the subject of the new 24-page application bulletin No. 4. Starting with a mathematical definition of the function, the bulletin details the use of digital computing techniques and applications of correlation computation. An extensive bibliography is included. Technical Measurement Corp.

Circle No. 330



## Relays

Illustrations, drawings and dimensions highlight a 64-page descriptive manual. Operating and electrical characteristics and mounting information for over 40 different types of relays, timers and sockets are provided. Allied Control.

Circle No. 321



## Control components

This 32-page brochure provides a reference guide for control components used in extreme environments.

Outline drawings, prices, ratings and related data are included for ac and dc contactors and relays, thermal overload and reset relays, panel mount pushbutton and selector switches and power resistors. General Electric.

Circle No. 322

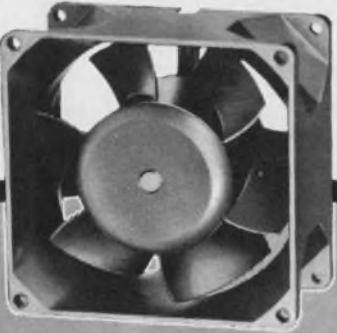

**New**  
**3 1/2"**

**INDUCTION  
Model 3000  
PAMOTOR  
Miniature  
Axial Fans**

- 20,000+ operational hours at 45°C
- All metal construction
- Low-cost design
- Maximum air delivery at higher back pressures
- Unexcelled performance and reliability
- 50-60 cycles at 110 or 220 vac
- In stock for immediate delivery

Write for technical data on the Model 3000 and other PAMOTOR axial fans to:

**PAMOTOR, INC.**  
312 SEVENTH STREET • SAN FRANCISCO, CALIF.

ON READER-SERVICE CARD CIRCLE 42

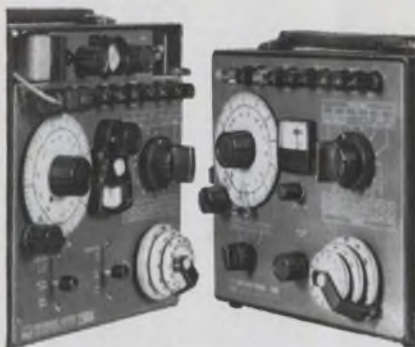

## The old master has met its match.

For more than twelve years, our 250 DA Universal Impedance Bridge ruled supreme in its field. No instrument could match its measurement performance.

Now along comes a serious challenger—our new 250 DE (at right). It has all of the reliability and accuracy of the classic model. As you can see, they look alike from the outside.

But inside, we've made many improvements. The new 250 DE is completely self reliant on its four flashlight batteries. It has a new solid-state detector with greatly improved sensitivities: better than 20 microvolts on DC, 10 microvolts on AC. For simplicity, there is a single meter null detector on the front panel. And for versatility, some useful front terminals have been added.

Why did we improve on the old master when it has delighted so many thousands with its performance in countless plants, laboratories and schools? Well, we figured eventually somebody would make a truly portable impedance bridge even better than the 250 DA. And we wanted it to be us. ESI, 13900 NW Science Park Drive, Portland, Ore. (97229).

### 250 DE Portable Universal Impedance Bridge Specifications

Range:  
 Resistance: 0 to 12 Megohms  
 Capacitance: 0 to 1200 Microfarads  
 Inductance: 0 to 1200 Henrys  
 Resistance: 0.1% + 1 dial division  
 Capacitance: 0.2% + 1 dial division  
 Inductance (Series and Parallel):  
 0.3% + 1 dial division  
 Sensitivity: Better than 20 microvolts  
 DC, 10 microvolts AC  
 Frequency: 1 kc internal  
 (External terminals provided.)  
 Batteries: 4 D size flashlight batteries  
 provide 6 months of normal service.  
 Weight: 12 lbs. Price: \$470.00

Note: The 250 DA features exactly the same accuracy specifications as the 250 DE. However, the 250 DA is AC line-operated. Price: \$495.

Electro Scientific Industries **esi**<sup>®</sup>  
 ON READER-SERVICE CARD CIRCLE 43

## Design Aids

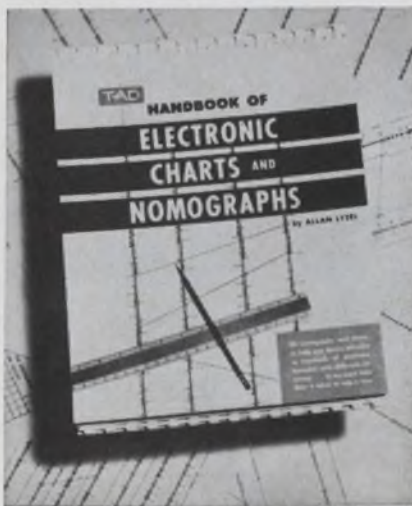

### Nomograph handbook

The "Handbook of Electronic Charts and Nomographs," by Allan Lytel, is the first broad collection assembled for electronics usage. Contents range from simple arithmetic to the computation of "Phase Angle Resistance, Capacitance and Inductance in Parallel." In most cases, slide rule accuracy is equaled or surpassed, and shortcuts not common to slide rule computation are provided. An explanatory text and sample solution are provided to aid in the use of each of the 58 charts and nomographs.

A hinged vinyl plastic overlay sheet serves as an erasable work surface.

Available for \$4.95 from Tad, Inc., 639 Mass. Ave., Cambridge, Mass.

Circle No. 323

### DC power slide rule

A complete line of all silicon modular dc power supplies and their specifications is presented in handy form on this circular slide rule.

Voltage ratings range to 200 V and current ratings to 75 A. In addition to the all-silicon line, specifications are given for vacuum tube modules, programable modules, unregulated modules and overvoltage load protectors. Dressen-Barnes Electronics Corp.

Circle No. 324

## Application Notes

### SCR applications

A series of engineering notes on SCR applications is numbered Vol. 4, No. 4, 5, 6, and 7. Respectively, they are: a paper on transformer-fed triggering of SCRs, a 4-page article on designing the unijunction transistor trigger circuit for SCR applications, 4 pages on the uses of pulse-transformers with SCR circuits, and a paper on a solid-state ac time delay. All four papers are profusely illustrated with schematics, nomograms, trigger design curves, diagrams, and tabular material. Aladdin Electronics.

Circle No. 325

### Ratio transformers

A series of 7 engineering bulletins cover theory and applications of the "Gertsch" ratio transformers.

Theoretical analysis, low impedance voltmeter calibration, accuracy calculations, use of the precision ac voltage divider in bridge circuits, measuring small phase angles, the rotary ratio transformer and use of the rotary voltage divider for calibration of precision potentiometers are discussed. The Singer Co., Metrics Div.

Circle No. 326

### Thermocouple data

High temperature thermocouple data is given in Con-O-Chart 2. A new system of specification is expounded and used. Continental Sensing.

Circle No. 327

### Lvdt applications

Linear variable differential transformers are discussed in a new application note. Mechanical displacement, velocity, acceleration, pressure, weight and force can be converted into electrical output for fine measurement and gaging. Circuitry and dimensions are diagrammed with specification tables of the manufacturer's line. Pickering.

Circle No. 328

## Negator data book

A collection of ingenious applications for the spring-steel devices manufactured by this company is assembled in this 16-page note. Illustrations leave no doubt as to the device being described. Ametek—Hunter Spring Div.

Circle No. 329

## Reprints Available

The following reprints are available free and in limited quantities. To obtain single copies, circle the number of the article you want on the Reader-Service Card.

*A Design Approach to Transistorized Voltage Controlled Crystal Oscillators* (No. 740)

*Achieving High Performance in vhf/uhf Tuned Amplifiers* (No. 741)

*Harmonic Generators: Is the Step Recovery Diode Best* (No. 742)

*Inside the Company Library* (No. 743)

*Simple IC Tester Handles Prototype Quantities* (No. 744)

*Which Device for High Power Switching-Parts I and II* (No. 745)  
*High volume-Low Cost: Designers' Challenge* (No. 746)

*Improve Device Reliability with Physics of Failure Technique* (No. 747)

*Guidelines for Selecting Laser Materials* (No. 748)

## Subscription Policy

ELECTRONIC DESIGN is circulated free of charge to qualified design engineers in the U.S., Western free Europe and England. To establish your qualifications, send ELECTRONIC DESIGN the following information on your company's letterhead: Your name, engineering title, description of your design duties and a list of your company's major products. The letter must be signed by you personally.

Subscription rates for nonqualified subscribers—\$25.00 per year in U.S.A., \$35.00 in all other countries. Single copy, \$1.50.

## Change of Address

An address change for a subscriber requires a restatement of his qualifications. To expedite the change, and to avoid missing any issues, send along a label from a back copy.

Microfilm copies of all 1961, 1962, 1963 and 1964 issues of ELECTRONIC DESIGN are available through University Microfilms, Inc., 313 N. First Street, Ann Arbor, Mich.

# If you design (or use) transistorized audio amplifiers ...check these new Triad Driver & Power Transformers

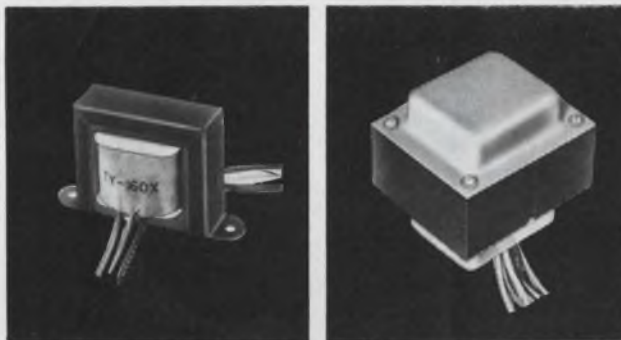

Developed specifically for Delco Radio, Triad's new driver and power transformers help make maximum use of a minimum number of high-performance circuit components in 50- and 100-watt transistorized audio power amplifiers.

They're readily available now from your local Triad distributor... to speed your prototype work, to save shopping around for custom-made units, and to cut costs of special sampling.

The TY-160X driver, ideal for both 50- and 100-watt amplifiers, is a split-primary design with silicon steel core. It is constructed with a 1-mil air gap between the E and I member for optimum signal linearity. Ratings are 50 mA DC primary current and primary inductance of 4 h at 10 mA DC.

An economical unit for 100-watt amplifier use, the Triad R-82B power transformer also has a laminated silicon steel core. A companion power transformer is also available for 50-watt design use.

See your distributor today... or send for more information on these and other Triad transformers designed to meet your specifications. Write: Triad Distributor Division, 305 N. Briant Street, Huntington, Indiana.



**Triad Distributor Division**

LITTON INDUSTRIES



ON READER-SERVICE CARD CIRCLE 44

# PERFORATED SCREENS FOR CENTRIFUGES

Stainless steel etched screens for extracting juices and crystals are resistant to acids, easy to clean, long lived — may be used wherever centrifuge requires small regular holes. Openings may be as small as .005 inches, on centers to your specification. \*\*\* Also available, back up plates for filter particle determination. Send us your problem in etched or formed metal — we produce to tolerances of  $\pm .000039$  inches.

**BUCKBEE MEARS CO.**

245 E. 6th ST., SAINT PAUL, MINN.

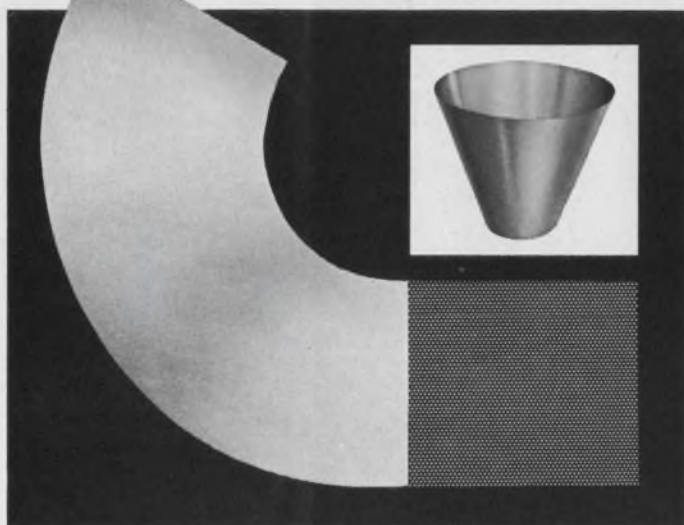

ON READER-SERVICE CARD CIRCLE 45

**LOOK WHAT'S HATCHED AT  
LITTELFUSE**

**The world's smallest fuse—Picofuse.**  
**1/8 thru 5 amps...1/6 grain...125 v.**

**LITTELFUSE**

DES PLAINES, ILLINOIS

ON READER-SERVICE CARD CIRCLE 46

# Advertisers' Index

## \*PARTICIPANTS IN NIGHT LETTER PROGRAM

*AMP, Incorporated	8
Allen-Bradley Co.	6, 66, 67
Analog Devices, Inc.	128
*Arnold Engineering Company, The	19
*Ballantine Laboratories, Inc.	103
*Beckman Instruments, Inc., Helipot Division	7
Bell Telephone Laboratories	95
Buckbee Mears Co.	126
*Clare & Co., C. P.	116, 117
*Clevite, Brush Instruments Division	Cover III
Computer Logic Corporation	64
*Computer Measurements Company	2
Cornell-Dubilier Electronics	15
*Damon Engineering, Inc.	22
Delco Radio, Division of General Motors	104, 105
ESI/Electro Scientific Industries	124
Electronic Engineering Co. of California	106
Gardner-Denver Company	70, 71
General Electric Company, Electronic Components Sales	24
General Radio Company	27
Globe Industries, Inc.	127
Hewlett-Packard	1, 23, 77
Hewlett-Packard, Dymec Division	9
Hudson Lamp Company	45
*IRC, Inc.	46, 47
Indiana General Corporation	96
International Diode Corp.	127
*JFD Electronics Corporation	99
Littelfuse	126
Monsanto Electronics Department	110, 111
*Motorola Semiconductor Products, Inc.	54, 55, 78, 79
National Semiconductor Corporation	112, 113
Oak Manufacturing Co.	74, 75
Pamotor, Inc.	123
Perkin Elmer	119
Princeton Applied Research Corp.	16
RCA Electronic Components and Devices	Cover IV
Raytheon Company, Components Division	58
Schweber Electronics	87
Scientific Atlanta, Inc.	115
Sel-Rex Corporation	Cover II
Solitron Devices, Inc.	89
*Spectrol Electronics Corporation	109
Sprague Electric Company	10, 12, 21
Stackpole Carbon Company	69
TWR Semiconductors	28
Tektronix, Inc. Oscilloscopes	68
Transistor Electronics Corp.	64
Triad Distributor Division, Litton Industries	125
Triplett Electrical Instrument Company	121
*Union Carbide Corporation	38
Vector Division of United Aircraft	85
Wavetek	72, 81
Westinghouse Electric Corporation	76
Weston Photo Mechanical Company, John	73
<b>Regional Advertising</b>	
Burndy Corporation	64A
*Dale Electronics, Inc.	64C
*Magnetics, Inc.	64D
Sorensen, A Unit of Raytheon Company	64B
<b>Career Advertising</b>	
Aerojet General	90
Delco Radio	93
Fischer & Porter	90

## Advertising Representatives

New York 10022  
 Robert W. Gascoigne  
 Thomas P. Barth  
 George W. Fleck  
 John F. Gilbert, Jr.  
 Rick Brough  
 850 Third Avenue  
 (212) PLaza 1-5530  
 TWX: 867-7866

Philadelphia 19066  
 Fred L. Mowlds, Jr.  
 P. O. Box 206  
 Merion Station, Pa.  
 (215) MO 4-1073

Marblehead 01945  
 Richard Parker  
 7 Redstone Lane  
 (617) 742-0252

Chicago 60611  
 Thomas P. Kavooras  
 Berry Conner, Jr.  
 720 N. Michigan  
 (312) 337-0588

Cleveland 44107  
 Robert W. Patrick  
 8410 Treetower Drive  
 Chagrin Falls, Ohio  
 (216) 247-7670

Los Angeles 90005  
 Stanley I. Ehrenclou  
 Terrence D. Buckley  
 W. James Bischof  
 2930 W. Imperial Highway  
 Inglewood, Calif. 90303  
 (213) 757-0183

San Francisco 94306  
 Ashley P. Hartman  
 541 Del Medio  
 Suite #301  
 Mountain View, Calif.  
 (415) 327-6536

Southwestern 75235  
 Tommy L. Wilson  
 6200 North Central Express-  
 way  
 Dallas, Tex. 75206  
 (214) EMerson 1-2311

London W. 1  
 Brayton C. Nichols  
 44 Conduit Street

Tokyo  
 Yoshihiro Takemura  
 International Planning  
 Service, Inc.  
 Room No. 512 Nikkoh  
 Mita Building  
 1, Nishidaimachi, Shiba-  
 Takanawa  
 Minato-ku, Tokyo



## Performance Proves:

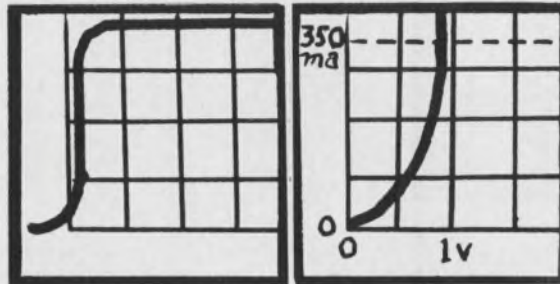

### Fastest Switching Diode With High Forward Current

Test waveforms show that International Diode Corp.'s ID3-050T alloy junction diode has a reverse recovery time (left) in the picosecond range, with a 200-to-400 milliamperere forward conductance (right). IDC can provide more than 100 types to solve your design problems, including Q6-100, Q5-100, ID3-050, 1N3146. Price as low as 45 cents in quantities; delivery mostly from stock. Write or phone for details.

### INTERNATIONAL DIODE CORP.

90 Forrest Street, Jersey City, N. J. 07304  
 201 - 432-7151

ON READER-SERVICE CARD CIRCLE 47

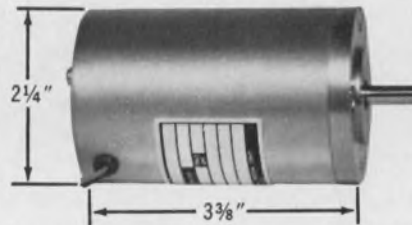

## 1/10 HP D.C. MOTOR

a new permanent magnet motor

New Globe permanent magnet GRP d.c. motor drastically cuts space requirements for a powerful reliable MIL spec unit. While the PM type offers utmost efficiency, we can also furnish wound field designs in this frame for series, split series, shunt, split shunt, or universal operation. SPECS: 0.1 hp in the 4,000 to 10,000 rpm range, 2 1/4" dia., weight 40 ounces. We'll supply special gearing for any speed-torque combination. Voltages to 115 v.d.c. Governors, brakes, radio noise filters available. Request Bulletin GRP. Check our stock list for 24-hour prototypes. Globe Industries, Inc., Dayton, Ohio 45404.



ON READER-SERVICE CARD CIRCLE 48

# Designer's Datebook

APRIL						
S	M	T	W	T	F	S
3	4	5	6	7	1	2
10	11	12	13	14	15	16
17	18	19	20	21	22	23
24	25	26	27	28	29	30

MAY						
S	M	T	W	T	F	S
1	2	3	4	5	6	7
8	9	10	11	12	13	14
15	16	17	18	19	20	21
22	23	24	25	26	27	28
29	30	31				

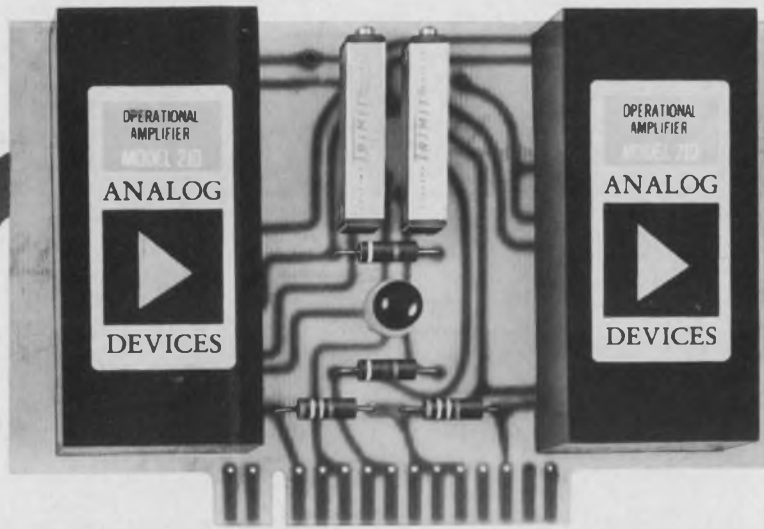

**Drift of only  $1 \mu\text{V}/^\circ\text{C}$  and  $2 \text{ pa}/^\circ\text{C}$   
at a price you can afford**

**\$157**

## Chopper Stabilized Operational Amplifier

For little more than the cost of a differential op amp you can reach right down into microvolt signals with orders-of-magnitude better stability and accuracy. Model 210 mounts right onto your P-C card, provides 100 volt/ $\mu\text{sec}$  slewing-rate, only  $3 \mu\text{V}$  peak-to-peak noise

### SPECIFICATIONS (Model 210)

DC Gain	Max Drift	Noise DC-2cps	Bandwidth	Slewing Rate	Max Offset	Output Rating	OEM Price
160 db	$1 \mu\text{V}/^\circ\text{C}$ $2 \text{ pa}/^\circ\text{C}$	$3 \mu\text{V}$ peak-peak	20 Mc	100 V/ $\mu\text{Sec}$	$50 \mu\text{V}$ 50 pa	$\pm 10 \text{ V}$ @ 20 ma	\$128 (100 lot)

Isn't that a spec-and-a-half for only \$157? Well there's more yet. This new 3 cubic-inch op amp has built-in chopper-drive, plus an internal 0.2  $\mu\text{sec}$  fast overload recovery network. Output is shortproof too.

No more AC chopper-excitation voltages, no more plug-and-socket interconnections, no long wires to suck up noise on their way to the summing junction, no problem of finding P-C card "floor-space" for an external overload recovery circuit. In many applications, the 50  $\mu\text{V}$  & 50 pa offsets even let you

eliminate the external balance potentiometer.

This is an excellent amplifier for such applications as precision integrators, low-level DC amplifiers, fast A-D and D-A converters, accurate pulse amplifiers, and many precision circuits in high-speed analog computers.

**DRIFT  $0.2 \mu\text{V}/^\circ\text{C}$**  — If you need even more exotic performance, our Model 203 has  $0.2 \mu\text{V}/^\circ\text{C}$  &  $0.5 \text{ pa}/^\circ\text{C}$  drift in the same miniature P-C mounting package. (Price \$215)

**APPLICATION MANUAL**—Write for free manual giving valuable op amp theory and application aids. We'll also send you data on our 16 other op amp models.

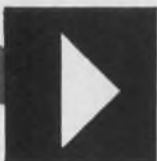

**ANALOG DEVICES, INC.**

221 Fifth Street, Cambridge, Mass.  
Phone 617/491-1650

ON READER-SERVICE CARD CIRCLE 49

### April 12-15

**International Quantum Electronics Conference** (Phoenix) Sponsors: AIP/IEEE; Dr. J. P. Gordon, Bell Telephone Laboratories, Murray Hill, N. J.

### April 17-20

**International Conference on Electron and Ion Beam Technology** (New York) Sponsors: AIME and Electrochemical Society; Metallurgical Society of AIME, 345 East 47th St., New York, N. Y.

### April 18-20

**Symposium on Process Automation** (Newport Beach, Calif.) Sponsors: Beckman Instruments, Consolidated Electrodynamics, Control Data, SDS Data Systems; Dr. William Biles, Shell Development Co., Houston, Tex.

### April 20-22

**1966 InterMag** (International Conference on Magnetism) (Stuttgart, Germany) Sponsor: IEEE G-Mag; Dr. E. W. Pugh, IBM Corp., 1000 Westchester Ave., White Plains, N. Y.

### April 25-28

**Audio Engineering Society Convention** (Los Angeles) Sponsor: Audio Engineering Society; John C. Baumann, Ampex Corp., 8467 Beverly Boulevard, Los Angeles, Calif.

### April 26-28

**Spring Joint Computer Conference** (Boston) Sponsors: AFIPS, IEEE, ACM; Dr. Harlan Anderson, Digital Equip. Corp., Maynard, Mass.

### May 2-4

**Aerospace Instrumentation Symposium** (Philadelphia) Sponsor: Instrument Society of America; William Redstreake, Moore Products Co., Sumneytown Pike, Spring House, Pa.

For research labs and rolling mills and everything in between...

# The Incomparable Brush Mark 200.

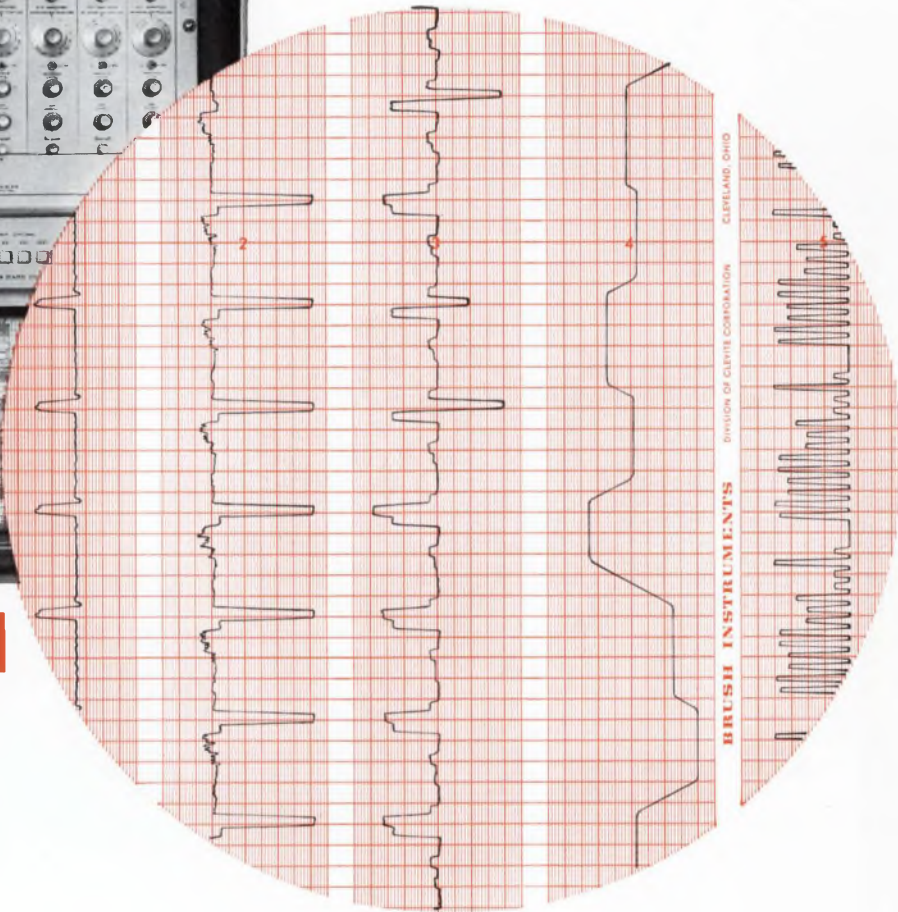
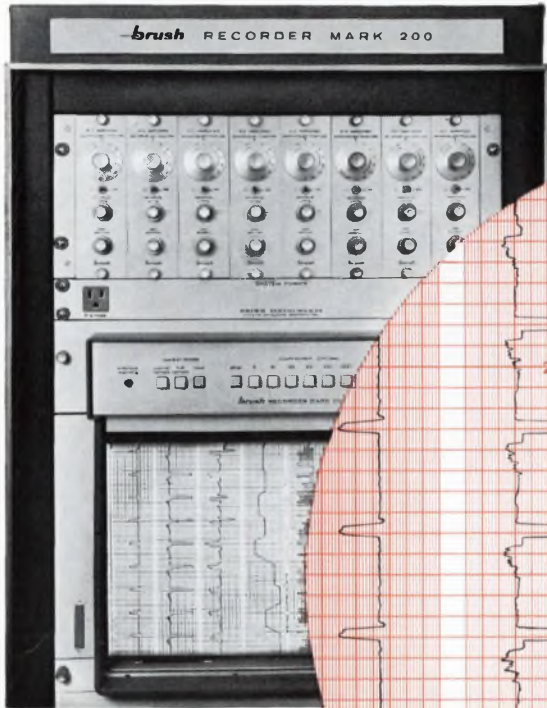

**The record  
speaks  
for itself!**

Look again.

Only one direct writing recording system in the world will give you such incredibly crisp traces: the Brush Mark 200. No wonder people call it "the finest ever built!"

That's what we had in mind when we designed it.

That's why Mark 200 Systems have a patented Hydrostatic Inking System that puts the trace *into* the paper . . . not just on it. And a unique, reliable pen position feed-

back system that delivers *total* system accuracy of better than 1/2%! Plus a totally new pen linkage that assures *true* rectilinear writing.

But that's not all. Thanks to modular sub-systems, we can match a Mark 200 to your specific requirements *without* special engineering time and costs. Choice of three different penmotors . . . thirty-two pre-amplifiers . . . vertical or horizontal oscillographs. Any combination you want for any recording job

that comes along.

But words alone don't do the Mark 200 justice.

The only way to *really* appreciate a Mark 200 is to see one perform. And with well over 20,000 channels now operating across the country, a demonstration under actual field conditions is easy. Ask your Brush representative. Or write for our free booklet. Brush Instruments Division, Clevite Corporation, 37th and Perkins, Cleveland, Ohio 44114.

**brush** **CLEVITE** INSTRUMENTS DIVISION

Speed Inquiry to Advertiser via Collect Night Letter  
ON READER-SERVICE CARD CIRCLE 122

# Handle Every Power Stage in AM/FM Aircraft and Mobile Transmitters with Rugged RCA "overlay" Transistors

TYPE	FRE- QUENCY Mc/s	POWER OUTPUT WATTS (Min)	V <sub>CC</sub> VOLTS	GAIN dB (Min)	EFF. % (Min)	PKG.
40340	50	25	13.5	7	65	TO-60
40341		30	24	10	60	TO-60
40290	135	2*	12.5	6	70	TO-39
40291		2*		6	70	TO-60
40292		6*		5	70	TO-60
40280	175	1	13.5	9	60	TO-39
40281		4		6	70	TO-60
40282		12		5	80	TO-60
2N3553	175	2.5	28	10	50	TO-39
2N3632		7.5		6	70	TO-60
2N3375	400	3	28	5	40	TO-60
2N3733		10		4	45	TO-60

\*AM Carrier Power

For RF applications from 27 Mc/s To More than 400 Mc/s. "Overlay" is the RCA technology that brings high power and gain at high frequencies to the solid-state mobile and aircraft communications market. This high performance is available in a series of reliable and economical "overlay" transistors, offering the industry's widest choice of voltage, power and frequency performance for rf driver, pre-driver, and final amplifier stages.

Whatever RCA "overlay" type you select for your designs, you can be sure of efficient, rugged performance. Each "overlay" transistor undergoes Power-Rating Test (PRT) at maximum power levels for



one second. Both AM aircraft and FM mobile types are designed specifically to withstand load mismatch conditions. This capability means simpler design of the final stage and no need for protective circuits. In addition, types for AM aircraft display excellent modulation capability as well as high-voltage breakdown characteristics.

See your RCA representative for the full story on RCA "overlay" transistors for AM aircraft and FM mobile, as well as other types for citizens' band radio, military communications, and microwave applications. For technical data on specific types, write: RCA Commercial Engineering, Section I-G-3-5, Harrison, N. J.

Also Available From Your RCA Distributor

RCA Electronic Components and Devices



The Most Trusted Name in Electronics

See "THE OVERLAY TRANSISTOR—The Challenge and The Answer," a new 16-mm color film. Available through your local RCA representative.

ON READER-SERVICE CARD CIRCLE 123